

EDSVS9332S
13440809

Global Drive

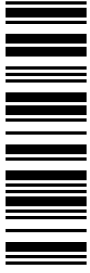

System Manual

9300 *0.37 ... 75 kW*



EVS9321xS ... EVS9332xS

Servo inverters

Lenze

1	Preface	1-1
	1.1 How to use this System Manual	1.1-1
	1.1.1 Information provided by the System Manual	1.1-1
	1.1.2 Products to which the System Manual applies	1.1-3
	1.1.3 Document history	1.1-4
	1.2 Legal regulations	1.2-1
	1.3 Conventions used	1.3-1
	1.4 Notes used	1.4-1
2	Safety instructions	2-1
	2.1 General safety information	2.1-1
	2.2 Thermal motor monitoring	2.2-1
	2.2.1 Forced ventilated or naturally ventilated motors	2.2-2
	2.2.2 Self-ventilated motors	2.2-3
	2.3 Residual hazards	2.3-1
	2.4 Safety instructions for the installation according to UL	2.4-3
3	Technical data	3-1
	3.1 General data and operating conditions	3.1-1
	3.2 Open and closed loop control	3.2-1
	3.3 Rated data	3.3-1
	3.3.1 Operation at 400 V	3.3-1
	3.3.2 Operation at 480 V	3.3-2
	3.3.3 Overcurrent operation	3.3-4
	3.4 Current characteristics	3.4-1

4	Installation of the standard device	4-1
4.1	Standard devices in the power range 0.37 ... 11 kW	4.1-1
4.1.1	Important notes	4.1-1
4.1.2	Mounting with fixing rails (standard)	4.1-2
4.1.3	Thermally separated mounting (push-through technique) .	4.1-3
4.1.4	Mounting in "cold plate" technique	4.1-4
4.2	Standard devices in the power range 15 ... 30 kW	4.2-1
4.2.1	Important notes	4.2-1
4.2.2	Mounting with fixing brackets (standard)	4.2-2
4.2.3	Thermally separated mounting (push-through technique) .	4.2-3
4.2.4	Mounting in "cold plate" technique	4.2-4
4.3	Standard devices with a power of 45 kW	4.3-1
4.3.1	Important notes	4.3-1
4.3.2	Mounting with fixing brackets (standard)	4.3-2
4.3.3	Thermally separated mounting (push-through technique) .	4.3-3
4.3.4	Modification of the fan module for push-through technique	4.3-4
4.4	Standard devices in the power range 55 ... 75 kW	4.4-1
4.4.1	Important notes	4.4-1
4.4.2	Mounting with fixing brackets (standard)	4.4-2
4.4.3	Thermally separated mounting (push-through technique) .	4.4-3

5	Wiring of the standard device	5-1
5.1	Important notes	5.1-1
5.1.1	Protection of persons	5.1-1
5.1.2	Device protection	5.1-3
5.1.3	Motor protection	5.1-3
5.2	Notes on project planning	5.2-1
5.2.1	Supply forms / electrical supply conditions	5.2-1
5.2.2	Operation on public supply systems (compliance with EN 61000-3-2) .. 5.2-1	
5.2.3	Controllers in the IT system	5.2-2
5.2.4	Operation at earth-leakage circuit breaker (e.l.c.b.)	5.2-3
5.2.5	Interaction with compensation equipment	5.2-3
5.2.6	Discharge current for mobile systems	5.2-4
5.2.7	Optimisation of the controller and mains load	5.2-5
5.2.8	Reduction of noise emissions	5.2-6
5.2.9	Mains choke/mains filter assignment	5.2-7
5.2.10	Motor cable	5.2-8
5.3	Basics for wiring according to EMC	5.3-1
5.3.1	Shielding	5.3-1
5.3.2	Mains connection, DC supply	5.3-1
5.3.3	Motor cable	5.3-1
5.3.4	Control cables	5.3-3
5.3.5	Installation in the control cabinet	5.3-4
5.3.6	Wiring outside of the control cabinet	5.3-5
5.3.7	Detecting and eliminating EMC interferences	5.3-6
5.4	Standard devices in the power range 0.37 ... 11 kW	5.4-1
5.4.1	Wiring according to EMC (CE-typical drive system)	5.4-1
5.4.2	Important notes	5.4-3
5.4.3	Mains connection, DC supply	5.4-4
5.4.4	Mains connection: Fuses and cable cross-sections	5.4-6
5.4.5	Mains choke/mains filter assignment	5.4-7
5.4.6	Motor connection	5.4-8
5.5	Standard devices in the power range 15 ... 30 kW	5.5-1
5.5.1	Wiring according to EMC (CE-typical drive system)	5.5-1
5.5.2	Important notes	5.5-3
5.5.3	Mains connection, DC supply	5.5-3
5.5.4	Mains connection: Fuses and cable cross-sections	5.5-5
5.5.5	Mains choke/mains filter assignment	5.5-6
5.5.6	Motor connection	5.5-7

5.6	Standard devices with a power of 45 kW	5.6-1
5.6.1	Wiring according to EMC (CE-typical drive system)	5.6-1
5.6.2	Important notes	5.6-3
5.6.3	Mains connection, DC supply	5.6-3
5.6.4	Mains connection: Fuses and cable cross-sections	5.6-5
5.6.5	Mains choke/mains filter assignment	5.6-6
5.6.6	Motor connection	5.6-7
5.7	Standard devices in the power range 55 ... 75 kW	5.7-1
5.7.1	Wiring according to EMC (CE-typical drive system)	5.7-1
5.7.2	Important notes	5.7-3
5.7.3	Mains connection, DC supply	5.7-3
5.7.4	Mains connection: Fuses and cable cross-sections	5.7-5
5.7.5	Mains choke/mains filter assignment	5.7-6
5.7.6	Motor connection	5.7-7
5.8	Control terminals	5.8-1
5.8.1	Important notes	5.8-1
5.8.2	Connection terminal of the control card	5.8-3
5.8.3	Device variant without "Safe torque off" function	5.8-4
5.8.4	Device variant with "Safe torque off" function	5.8-5
5.8.5	State bus	5.8-8
5.8.6	Terminal assignment	5.8-9
5.8.7	Technical data	5.8-10
5.9	Wiring of the system bus (CAN)	5.9-1
5.10	Wiring of the feedback system	5.10-1
5.10.1	Important notes	5.10-1
5.10.2	Resolver at X7	5.10-2
5.10.3	Incremental encoder with TTL level at X8	5.10-3
5.10.4	SinCos encoder at X8	5.10-4
5.11	Wiring of digital frequency input / digital frequency output	5.11-1
5.12	Communication modules	5.12-1

6	Commissioning	6-1
6.1	Important notes	6.1-1
6.2	Before switching on	6.2-1
6.3	Switch-on sequence	6.3-1
6.4	Controller inhibit	6.4-1
6.5	Basic settings	6.5-1
6.5.1	Changing the basic configuration	6.5-1
6.5.2	Adapting the controller to the mains	6.5-2
6.5.3	Entry of motor data	6.5-3
6.5.4	Motor selection list	6.5-6
6.5.5	Motor temperature monitoring with PTC or thermal contact	6.5-14
6.5.6	Motor temperature monitoring with KTY	6.5-15
6.6	Setting the speed feedback	6.6-1
6.6.1	Resolver at X7	6.6-1
6.6.2	Incremental encoder with TTL level at X8	6.6-1
6.6.3	SinCos encoder at X8	6.6-2
6.7	Current controller adjustment	6.7-1
6.8	Adjusting the rotor position	6.8-1
6.9	Changing the assignment of the control terminals X5 and X6	6.9-1
6.9.1	Free configuration of digital input signals	6.9-1
6.9.2	Free configuration of digital outputs	6.9-2
6.9.3	Free configuration of analog input signals	6.9-3
6.9.4	Free configuration of analog outputs	6.9-4
7	Parameter setting	7-1
7.1	Important notes	7.1-1
7.2	Parameter setting with the XT EMZ9371BC keypad	7.2-1
7.2.1	General data and operating conditions	7.2-1
7.2.2	Installation and commissioning	7.2-2
7.2.3	Display elements and function keys	7.2-3
7.2.4	Changing and saving parameters	7.2-5
7.2.5	Loading a parameter set	7.2-7
7.2.6	Transferring parameters to other standard devices	7.2-8
7.2.7	Activating password protection	7.2-10
7.2.8	Diagnostics	7.2-11
7.2.9	Menu structure	7.2-12

8	Configuration	8-1
8.1	Important notes	8.1-1
8.2	Monitoring	8.2-1
8.2.1	Fault responses	8.2-1
8.2.2	Setting of responses	8.2-2
8.2.3	Monitoring times for process data input objects	8.2-3
8.2.4	Maximum speed	8.2-4
8.2.5	Motor	8.2-4
8.2.6	Controller current load (I x t monitoring)	8.2-5
8.2.7	Motor temperature	8.2-6
8.2.8	Current load of motor (I2 x t monitoring: OC6, OC8)	8.2-7
8.2.9	Heatsink temperature	8.2-10
8.2.10	DC-bus voltage	8.2-11
8.2.11	External error (EEr)	8.2-11
8.3	Overview of monitoring functions	8.31
8.4	Code table	8.4-1
8.5	Selection lists	8.5-1
8.5.1	Selection list 1: Analog output signals	8.5-1
8.5.2	Selection list 2: Digital output signals	8.5-3
8.5.3	Selection list 3: Angle signals	8.5-7
8.5.4	Selection list 4: Speed signals	8.5-7
8.5.5	Selection list 5: Function blocks	8.5-8
8.5.6	Selection list 10: Error messages	8.5-10
8.6	Table of attributes	8.6-1
9	Troubleshooting and fault elimination	9-1
9.1	Display of operating data, diagnostics	9.1-1
9.2	Troubleshooting	9.2-1
9.2.1	Status display via controller LEDs	9.2-1
9.2.2	Fault analysis with the history buffer	9.2-1
9.2.3	Fault analysis via LECOM status words (C0150/C0155)	9.2-3
9.3	System error messages	9.3-1
9.3.1	General error messages	9.3-1
9.3.2	Resetting system error messages	9.3-6
10	DC-bus operation	10-1
10.1	Function	10.1-1
10.2	Conditions for trouble-free DC-bus operation	10.2-1
10.3	Fuses and cable cross-sections	10.3-1
10.4	Distributed supply (several supply points)	10.4-1
10.5	Central supply (one supply point)	10.5-1

11	Safety engineering	11-1
	11.1 Important notes	11.1-1
	11.2 Operating mode	11.2-1
	11.3 Safety relay KSR	11.3-1
	11.4 Wiring	11.4-1
	11.5 Functional test	11.5-1
	11.5.1 Important notes	11.5-1
	11.5.2 Manual safety function check	11.5-2
	11.5.3 Monitoring the safety function with a PLC	11.5-3
12	Accessories (overview)	12-1
	12.1 General accessories	12.1-1
	12.2 Type-specific accessories	12.2-1
13	Appendix	13-1
	13.1 Glossary	13.1-1
	13.1.1 Terminology and abbreviations used	13.1-1
	13.2 Index	13.2-1

1 Preface

Contents

1.1	How to use this System Manual	1.1-1
1.1.1	Information provided by the System Manual	1.1-1
1.1.2	Products to which the System Manual applies	1.1-3
1.1.3	Document history	1.1-4
1.2	Legal regulations	1.2-1
1.3	Conventions used	1.3-1
1.4	Notes used	1.4-1

1.1 How to use this System Manual

1.1.1 Information provided by the System Manual

Target group This System Manual addresses to all persons who dimension, install, commission, and set 9300 servo inverters.

Together with the System Manual (supplement), document number EDSVS9332S-EXT, and the catalogue, it provides the basis for project planning for the mechanical engineer and the plant constructor.

Contents The System Manual provides the basis for the description of the 9300 servo inverter. Together with the System Manual (supplement), document number EDSVS9332S-EXT, a complete System Manual is available:

- ▶ The features and functions are described in detail.
- ▶ The parameterisation for typical applications is pointed up by the use of examples.
- ▶ In case of doubt always the mounting instructions supplied with the 9300 servo inverter are valid.

Contents of System Manual	Contents of System Manual (supplement)
1 Preface	1 Preface
2 Safety	-
3 Technical data	-
4 Mounting the standard device	-
5 Wiring the standard device	-
6 Commissioning	-
7 Parameter setting	-
8 Configuration	2 Configuration
8.1 Monitoring	2.1 Configuration with Global Drive Control
8.2 Monitoring functions	2.2 Basic configurations
8.3 Code table	2.3 Modes of operation
8.4 Selection lists	
8.5 Table of attributes	
-	3 Function library
-	4 Application examples
9 Troubleshooting and fault elimination	-
10 DC-bus operation	-
11 Safety engineering	-
12 Accessories	-
13 Appendix	5 Appendix

How to find information

Use the System Manual as the basis. It contains references to the corresponding chapters in the System Manual Supplement:

- ▶ Each chapter is a complete unit and comprehensively informs about a subject.
- ▶ The Table of Contents and Index help you to find all information about a certain topic.
- ▶ Descriptions and data of other Lenze products (Drive PLC, Lenze geared motors, Lenze motors, ...) can be found in the corresponding catalogs, Operating Instructions and manuals. The required documentation can be ordered at your Lenze sales partner or downloaded as PDF file from the Internet.



Tip!

Information and auxiliary devices related to the Lenze products can be found in the download area at

<http://www.Lenze.com>

1.1.2 Products to which the System Manual applies

This documentation is valid for 9300 servo inverters as of nameplate data:

	①	②	③	Nameplate
	EVS	93xx	- x x	Vxx 6x 8x
Product range				
EVS =	servo controller			
Type no. / rated power				
	400V	480 V		
9321 =	0.37 kW	0.37 kW		
9322 =	0.75 kW	0.75 kW		
9323 =	1.5 kW	1.5 kW		
9324 =	3.0 kW	3.0 kW		
9325 =	5.5 kW	5.5 kW		
9326 =	11 kW	11 kW		
9327 =	15 kW	18.5 kW		
3928 =	22 kW	30 kW		
9329 =	30 kW	37 kW		
9330 =	45 kW	45 kW		
9331 =	55 kW	55 kW		
9332 =	75 kW	90 kW		
Design				
E =	built-in unit			
C =	built-in unit in "cold plate" technology			
Version				
S =	servo inverter			
Variant				
-	standard			
V003 =	in "cold plate" technology			
V004 =	with "safe torque off" function			
V100 =	for IT mains			
V104 =	with "safe torque off" function and for IT mains			
Hardware version (as of 6x)				
Software version (as of 8.0)				

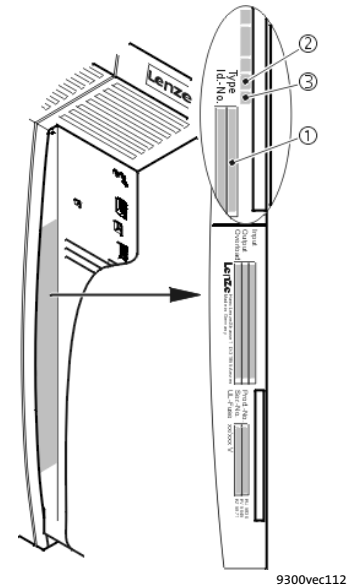

1 Preface and general information

1.1 How to use this System Manual

1.1.3 Document history

1.1.3 Document history

What is new / what has changed?

Material number	Version			Description
13440809	6.0	09/2013	TD06	Error corrections
13375723	5.3	08/2012	TD23	Error corrections
13375723	5.2	03/2012	TD23	Error corrections
13375723	5.1	04/2011	TD23	Chapter "DC-bus operation" updated due to changes of DC fuses Error corrections
13270788	4.1	07/2010	TD23	New edition due to reorganisation of the company
13270788	4.0	05/2010	TD23	Extended by functions for software version 8.0 Complete editorial revision and error correction Division of the System Manual into 2 parts (EDSVS9332S and EDSVS9332S-EXT)
00481343	3.0	02/2004	TD23	Extended by functions for software version 6.2 Error correction
00465483	2.0	09/2003	TD23	Chapter "Technical data" supplemented by information on circuit breakers for the types 9321 and 9322 Error correction

1.2 Legal regulations

Identification	Lenze controllers are unambiguously identified by the contents of the nameplate.
Manufacturer	Lenze Automation GmbH, Hans-Lenze-Str. 1, D-31855 Aenzen, Germany
CE conformity	In conformity with EC "Low Voltage" Directive
Application as directed	<p>9300 servo controllers and accessories</p> <ul style="list-style-type: none">▶ may only be operated under the conditions specified in this System Manual.▶ are components<ul style="list-style-type: none">– for open and closed loop control of variable speed drives with PM synchronous motors, asynchronous standard motors or asynchronous servo motors.– for installation in a machine.– for assembly with other components to form a machine.▶ comply with the protection requirements of the EC "Low Voltage" Directive.▶ are not machines for the purpose of the EC "Machinery" Directive.▶ are not to be used as domestic appliances, but only for industrial purposes. <p>Drive systems with 9300 servo controllers</p> <ul style="list-style-type: none">▶ comply with the EC "Electromagnetic Compatibility" Directive if they are installed according to the guidelines of CE-typical drive systems.▶ can be used<ul style="list-style-type: none">– for operation on public and non-public mains supplies.– for operation in industrial premises and residential and commercial areas.▶ The user is responsible for the compliance of the machine application with the EC Directives. <p>Any other use shall be deemed inappropriate!</p>

Liability

The information, data and notes given in this System Manual met the state of the art at the time of printing. Claims on modifications referring to controllers and components which have already been supplied cannot be derived from the information, illustrations and descriptions contained in this manual.

The procedural notes and circuit details given in this System Manual are suggestions and their transferability to the respective application has to be checked. Lenze does not take any responsibility for the suitability of the given procedures and circuit suggestions.

The specifications given in this System Manual describe the product features without guaranteeing them.

Lenze does not accept any liability for damage and malfunctioning caused by:

- ▶ Disregarding the System Manual
- ▶ Unauthorised modifications to the controller
- ▶ Operating faults
- ▶ Improper working on and with the controller

Warranty







See terms of sales and delivery of Lenze Automation GmbH.

Warranty claims must be made to Lenze immediately after detecting the deficiency or fault.

The warranty is void in all cases where liability claims cannot be made.

1.3 Conventions used

This documentation uses the following conventions to distinguish between different types of information:

Type of information	Identification	Examples/notes
Spelling of numbers		
Decimal separator	language-dependent	In each case, the signs typical for the target language are used as decimal separators. For example: 1234.56 or 1234,56
Warnings		
UL warnings		Are only given in English.
UR warnings		
Text		
Program name	» «	PC software For example: »Engineer«, »Global Drive Control« (GDC)
Icons		
Page reference		Reference to another page with additional information For instance:  16 = see page 16
Documentation reference		Reference to another documentation with additional information For example:  EDKxxx = see documentation EDKxxx

1.4 Notes used

The following pictographs and signal words are used in this documentation to indicate dangers and important information:

Safety instructions

Structure of safety instructions:

**Danger!**

(characterises the type and severity of danger)

Note

(describes the danger and gives information about how to prevent dangerous situations)

Pictograph and signal word	Meaning
Danger!	Danger of personal injury through dangerous electrical voltage. Reference to an imminent danger that may result in death or serious personal injury if the corresponding measures are not taken.
Danger!	Danger of personal injury through a general source of danger. Reference to an imminent danger that may result in death or serious personal injury if the corresponding measures are not taken.
Stop!	Danger of property damage. Reference to a possible danger that may result in property damage if the corresponding measures are not taken.

Application notes

Pictograph and signal word	Meaning
Note!	Important note to ensure troublefree operation
Tip!	Useful tip for simple handling
	Reference to another documentation

Special safety instructions and application notes for UL and UR

Pictograph and signal word	Meaning
Warnings!	Safety or application note for the operation of a UL-approved device in UL-approved systems. Possibly the drive system is not operated in compliance with UL if the corresponding measures are not taken.
Warnings!	Safety or application note for the operation of a UR-approved device in UL-approved systems. Possibly the drive system is not operated in compliance with UL if the corresponding measures are not taken.

2 Safety instructions

Contents

2.1	General safety information	2.1-1
2.2	Thermal motor monitoring	2.2-1
2.2.1	Forced ventilated or naturally ventilated motors	2.2-2
2.2.2	Self-ventilated motors	2.2-3
2.3	Residual hazards	2.3-1
2.4	Safety instructions for the installation according to UL	2.4-3

2.1 General safety information

Scope The following general safety instructions apply to all Lenze drive and automation components.

The product-specific safety and application notes given in this documentation must be observed!

Note for UL-approved systems: UL warnings are notes which only apply to UL systems. The documentation contains specific notes with regard to UL.

For your own safety



Danger!

Disregarding the following basic safety measures may lead to severe personal injury and damage to material assets!

- ▶ Lenze drive and automation components ...
 - ... must only be used for the intended purpose.
 - ... must never be operated if damaged.
 - ... must never be subjected to technical modifications.
 - ... must never be operated unless completely assembled.
 - ... must never be operated without the covers/guards.
 - ... can - depending on their degree of protection - have live, movable or rotating parts during or after operation. Surfaces can be hot.
- ▶ All specifications of the corresponding enclosed documentation must be observed.

This is vital for a safe and trouble-free operation and for achieving the specified product features.

The procedural notes and circuit details provided in this document are proposals which the user must check for suitability for his application. The manufacturer does not accept any liability for the suitability of the specified procedures and circuit proposals.
- ▶ Only qualified skilled personnel are permitted to work with or on Lenze drive and automation components.

According to IEC 60364 or CENELEC HD 384, these are persons ...

 - ... who are familiar with the installation, assembly, commissioning and operation of the product,
 - ... possess the appropriate qualifications for their work,
 - ... and are acquainted with and can apply all the accident prevent regulations, directives and laws applicable at the place of use.
- ▶ Transport and storage in a dry, low-vibration environment without aggressive atmosphere; preferably in the packaging provided by the manufacturer.
 - Protect against dust and shocks.
 - Comply with climatic conditions according to the technical data.

Transport, storage

Mechanical installation

- ▶ Install the product according to the regulations of the corresponding documentation. In particular observe the section "Operating conditions" in the chapter "Technical data".
- ▶ Provide for a careful handling and avoid mechanical overload. During handling neither bend components, nor change the insulation distances.
- ▶ The product contains electrostatic sensitive devices which can easily be damaged by short circuit or static discharge (ESD). Thus, electronic components and contacts must not be touched unless ESD measures are taken beforehand.

Electrical installation

- ▶ Carry out the electrical installation according to the relevant regulations (e. g. cable cross-sections, fusing, connection to the PE conductor). Additional notes are included in the documentation.
- ▶ When working on live products, observe the applicable national regulations for the prevention of accidents (e.g. BGV 3).
- ▶ The documentation contains information about EMC-compliant installation (shielding, earthing, arrangement of filters and laying cables). The system or machine manufacturer is responsible for compliance with the limit values required by EMC legislation.
Warning: The controllers are products which can be used in category C2 drive systems as per EN 61800-3. These products may cause radio interference in residential areas. If this happens, the operator may need to take appropriate action.
- ▶ For compliance with the limit values for radio interference emission at the site of installation, the components - if specified in the technical data - have to be mounted in housings (e. g. control cabinets). The housings have to enable an EMC-compliant installation. In particular observe that for example control cabinet doors preferably have a circumferential metallic connection to the housing. Reduce openings or cutouts through the housing to a minimum.
- ▶ Only plug in or remove pluggable terminals in the deenergised state!

Commissioning

- ▶ If required, you have to equip the system with additional monitoring and protective devices in accordance with the respective valid safety regulations (e. g. law on technical equipment, regulations for the prevention of accidents).
- ▶ Before commissioning remove transport locking devices and keep them for later transports.

Operation

- ▶ Keep all protective covers and doors closed during operation.

Safety functions

- ▶ Without a higher-level safety system, the described product must neither be used for the protection of machines nor persons.
- ▶ Certain controller versions support safety functions (e.g. "Safe torque off", formerly "Safe standstill").
The notes on the safety functions provided in the documentation of the versions must be observed.

Maintenance and servicing

- ▶ The components are maintenance-free if the required operating conditions are observed.
- ▶ If the cooling air is polluted, the cooling surfaces may be contaminated or the air vents may be blocked. Under these operating conditions, the cooling surfaces and air vents must be cleaned at regular intervals. Never use sharp objects for this purpose!
- ▶ Only replace defective fuses in the deenergised state to the type specified.
- ▶ After the system has been disconnected from the supply voltage, live components and power connections must not be touched immediately because capacitors may be charged. Please observe the corresponding notes on the device.

Disposal

- ▶ Recycle metals and plastic materials. Ensure professional disposal of assembled PCBs.

2.2 Thermal motor monitoring

From software version 8.0 onwards, the 9300 controllers are provided with an $I^2 \times t$ function for sensorless thermal monitoring of the connected motor.



Note!

- ▶ $I^2 \times t$ monitoring is based on a mathematical model which calculates a thermal motor load from the detected motor currents.
- ▶ The calculated motor load is saved when the mains is switched.
- ▶ The function is UL-certified, i.e. no additional protective measures are required for the motor in UL-approved systems.
- ▶ However, $I^2 \times t$ monitoring is **no** full motor protection as other influences on the motor load could not be detected as for instance changed cooling conditions (e.g. interrupted or too warm cooling air flow).

The $I^2 \times t$ load of the motor is displayed in C0066.

The thermal loading capacity of the motor is expressed by the thermal motor time constant (τ , C0128). Find the value in the rated motor data or contact the manufacturer of the motor.

The $I^2 \times t$ monitoring has been designed such that it will be activated after 179 s in the event of a motor with a thermal motor time constant of 5 minutes (Lenze setting C0128), a motor current of $1.5 \times I_N$ and a trigger threshold of 100 %.

Two adjustable trigger thresholds provide for different responses.

- ▶ Adjustable response OC8 (TRIP, warning, off).
 - The trigger threshold is set in C0127.
 - The response is set in C0606.
 - The response OC8, for instance, can be used for an advance warning.
- ▶ Fixed response OC6-TRIP.
 - The trigger threshold is set in C0120.

Behaviour of the $I^2 \times t$ monitoring	Condition
The $I^2 \times t$ monitoring is deactivated. C0066 is set = 0 % and MCTRL-LOAD-I2XT is set = 0.00 %.	When C0120 = 0 % and C0127 = 0 %, set controller inhibit.
$I^2 \times t$ monitoring is stopped. The current value in C0066 and at the MCTRL-LOAD-I2XT output is frozen.	When C0120 = 0 % and C0127 = 0 %, set controller enable.
$I^2 \times t$ monitoring is deactivated. The motor load is displayed in C0066.	Set C0606 = 3 (off) and C0127 > 0 %.



Note!

An error message OC6 or OC8 can only be reset if the $I^2 \times t$ load falls below the set trigger threshold by 5 %.

2 Safety instructions

2.2 Thermal motor monitoring

2.2.1 Forced ventilated or naturally ventilated motors

2.2.1 Forced ventilated or naturally ventilated motors

Parameter setting

The following codes can be set for $I^2 \times t$ monitoring:

Code	Meaning	Value range	Lenze setting
C0066	Display of the $I^2 \times t$ load of the motor	0 ... 250 %	-
C0120	Threshold: Triggering of error "OC6"	0 ... 120 %	0 %
C0127	Threshold: Triggering of error "OC8"	0 ... 120 %	0 %
C0128	Thermal motor time constant	0.1 ... 50.0 min	5.0 min
C0606	Response to error "OC8"	TRIP, warning, off	Warning

Calculate release time and $I^2 \times t$ load

Formula for release time	Information
$t = -(\tau) \times \ln \left[1 - \frac{z + 1}{\left(\frac{I_{Mot}}{I_N} \right)^2 \times 100} \right]$	I_{Mot} Actual motor current (C0054)
	I_r Rated motor current (C0088)
	τ Thermal motor time constant (C0128)
	z Threshold value in C0120 (OC6) or C0127 (OC8)

Formulae for $I^2 \times t$ load	Information
$L(t) = \left(\frac{I_{Mot}}{I_N} \right)^2 \times 100\% \times \left(1 - e^{-\frac{t}{\tau}} \right)$	$L(t)$ Chronological sequence of the $I^2 \times t$ load of the motor (Display: C0066)
	I_{Mot} Actual motor current (C0054)
	I_r Rated motor current (C0088)
	τ Thermal motor time constant (C0128)

If the controller is inhibited, the $I^2 \times t$ load is reduced:

$L(t) = L_{start} \times \sqrt{e^{-\frac{t}{\tau}}}$	L_{start} $I^2 \times t$ load before controller inhibit If an error is triggered, the value corresponds to the threshold value set in C0120 (OC6) or C0127 (OC8).
--	--

Read release time in the diagram

Diagram for detecting the release times for a motor with a thermal motor time constant of 5 minutes (Lenze setting C0128):

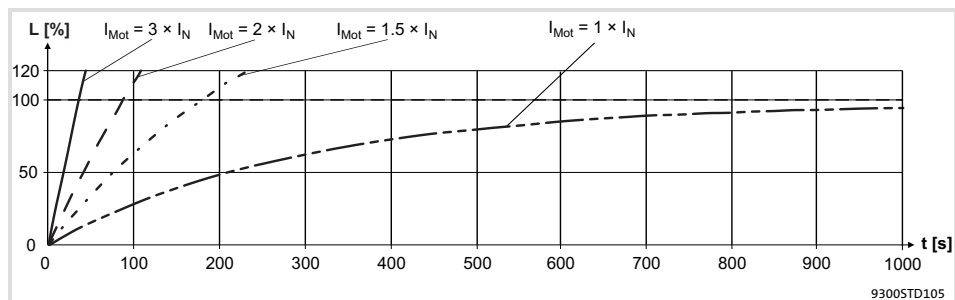

Fig. 2.2-1 $I^2 \times t$ -monitoring: Release times for different motor currents and trigger thresholds

I_{Mot}	Actual motor current (C0054)
I_r	Rated motor current (C0088)
L	$I^2 \times t$ load of the motor (display: C0066)
T	Time

2.2.2 Self-ventilated motors

Due to the construction, self-ventilated standard motors are exposed to an increased heat generation in the lower speed range compared to forced ventilated motors.



Warnings!

For complying with the UL 508C standard, you have to set the speed-dependent evaluation of the permissible torque via code **C0129/x**.

Parameter setting

The following codes can be set for $I^2 \times t$ monitoring:

Code	Meaning	Value range	Lenze setting
C0066	Display of the $I^2 \times t$ load of the motor	0 ... 250 %	-
C0120	Threshold: Triggering of error "OC6"	0 ... 120 %	0 %
C0127	Threshold: Triggering of error "OC8"	0 ... 120 %	0 %
C0128	Thermal motor time constant	0.1 ... 50.0 min	5.0 min
C0606	Response to error "OC8"	TRIP, warning, off	Warning
C0129/1	S1 torque characteristic I_1/I_{rated}	10 ... 200 %	100 %
C0129/2	S1 torque characteristics n_2/n_{rated}	10 ... 200 %	40 %

Effect of code C0129/x

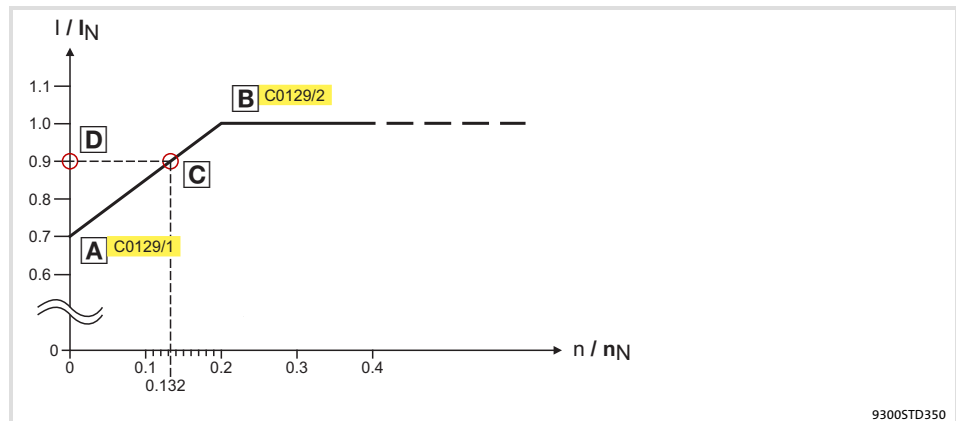

Fig. 2.2-2 Working point in the range of characteristic lowering

The lowered speed / torque characteristic (Fig. 2.2-2) reduces the permissible thermal load of self-ventilated standard motors. The characteristic is a line the definition of which requires two points:

- ▶ Point **A**: Definition with **C0129/1**
 This value also enables an increase of the maximally permissible load.
- ▶ Point **B**: Definition with **C0129/2**
 With increasing speeds, the maximally permissible load remains unchanged ($I_{Mot} = I_{rated}$).

In Fig. 2.2-2, the motor speed and the corresponding permissible motor torque (**D**) can be read for each working point (**C**) on the characteristic (**A**) ... (**B**). **D** can also be calculated using the values in **C0129/1** and **C0129/2** (evaluation coefficient "y", 2.2-4).

Calculate release time and I²x t load

Calculate the release time and the I² x t load of the motor considering the values in **C0129/1** and **C0129/2**(evaluation coefficient "y").

Formulae for release time	Information
$T = - (\tau) \times \ln \left[1 - \frac{z + 1}{\left(\frac{I_{Mot}}{y \times I_N} \right)^2 \times 100} \right]$	T Release time of the I ² x t monitoring
	τ Thermal motor time constant (C0128)
$y = \frac{100\% - C0129/1}{C0129/2} \times \frac{n}{n_N} + C0129/1$	ln Function: Natural logarithm
	I _{Mot} Actual motor current (C0054)
	I _r Rated motor current (C0088)
	z Threshold value in C0120 (OC6) <u>or</u> C0127 (OC8)
	y Evaluation coefficient
	n _{rated} Rated speed (C0087)

Formulae for I ² x t load	Information
$L(t) = \left(\frac{I_{Mot}}{y \times I_N} \right)^2 \times 100\% \times \left(1 - e^{-\frac{t}{\tau}} \right)$	L(t) Chronological sequence of the I ² x t load of the motor (Display: C0066)
	y Evaluation coefficient
	I _{Mot} Actual motor current (C0054)
	I _r Rated motor current (C0088)
	τ Thermal motor time constant (C0128)

If the controller is inhibited, the I² x t load is reduced:

$L(t) = L_{start} \times \sqrt{e^{-\frac{t}{\tau}}}$	L _{start} I ² x t load before controller inhibit If an error is triggered, the value corresponds to the threshold value set in C0120 (OC6) <u>or</u> C0127 (OC8).
--	--

2.3 Residual hazards

Protection of persons

- ▶ According to their enclosure, Lenze controllers (frequency inverters, servo inverters, DC speed controllers) and their components can carry a voltage, or parts of the controllers can move or rotate during operation. Surfaces can be hot.
 - If the required cover is removed, the controllers are used inappropriately or installed or operated incorrectly, severe damage to persons or material assets can occur.
 - For more detailed information please see the documentation.
- ▶ There is a high amount of energy within the controller. Therefore always wear personal protective equipment (body protection, headgear, eye protection, ear protection, hand guard) when working on the controller when it is live.
- ▶ Before working on the controller, check if no voltage is applied to the power terminals.
 - the power terminals U, V, W, +UG and -UG still carry dangerous voltage for at least 3 minutes after power-off.
 - the power terminals L1, L2, L3; U, V, W, +UG and -UG carry dangerous voltage when the motor is stopped.
- ▶ Before power-off during DC-bus operation, all controllers must be inhibited and disconnected from the mains.
- ▶ The discharge current to PE potential is > 3.5 mA. In accordance with EN 61800-5-1
 - a fixed installation is required.
 - the design of the PE conductor has to be double or, in the case of a single design, must have a cable cross-section of at least 10 mm^2 .
- ▶ The controller can only be safely disconnected from the mains via a contactor on the input side.
- ▶ During parameter set transfer the control terminals of the controller can have undefined states.
 - Therefore the connectors X5 and X6 must be disconnected from the controller before the transfer takes place. This ensures that the controller is inhibited and all control terminals have the defined state "LOW".

- ▶ Controllers can cause a DC current in the PE conductor. If a residual current device (RCD) or a fault current monitoring unit (RCM) is used for protection in the case of direct or indirect contact, only one RCD/RCM of the following type can be used on the current supply side:
 - Type B for the connection to a three-phase system
 - Type A or type B for the connection to a single phase system
 Alternatively another protective measure can be used, like for instance isolation from the environment by means of double or reinforced insulation, or isolation from the supply system by using a transformer.

Device protection

- ▶ Frequent mains switching (e.g. inching mode via mains contactor) can overload and destroy the input current limitation of the drive controller:
 - At least 3 minutes must pass between switching off and restarting the devices EVS9321-xS and EVS9322-xS.
 - At least 3 minutes must pass between two starting procedures of the devices EVS9323-xS ... EVS9332-xS.
 - Use the "safe torque off" safety function (STO) if safety-related mains disconnections occur frequently. The drive variants Vxx4 are equipped with this function.

Motor protection

- ▶ For some controller settings, the connected motor may overheat (e.g. when operating the DC injection brake or a self-ventilated motor at low speed for longer periods).
 - Using an overcurrent relay or a temperature monitoring device provides a large degree of protection against overload.
 - We recommend to use PTC thermistors or thermal contacts for motor temperature monitoring. (Lenze three-phase AC motors are equipped with thermal contacts (NC contacts) as standard)
 - PTC thermistors or thermal contacts can be connected to the controller.
- ▶ Drives can attain dangerous overspeeds (e.g. setting of high output frequencies with motors and machines not qualified for this purpose).

2.4 Safety instructions for the installation according to UL



Warnings!

- ▶ Motor Overload Protection
 - For information on the protection level of the internal overload protection for a motor load, see the corresponding manuals or software helps.
 - If the integral solid state motor overload protection is not used, external or remote overload protection must be provided.
- ▶ Branch Circuit Protection
 - The integral solid state protection does not provide branch circuit protection.
 - Branch circuit protection has to be provided externally in accordance with corresponding instructions, the National Electrical Code and any additional codes.
- ▶ Please observe the specifications for fuses and screw-tightening torques in these instructions.
- ▶ EVS9321 ... EVS9326:
 - Suitable for use on a circuit capable of delivering not more than 5000 rms symmetrical amperes, 480 V maximum, when protected by fuses.
 - Suitable for use on a circuit capable of delivering not more than 50000 rms symmetrical amperes, 480 V maximum, when protected by CC, J, T or R class fuses.
 - Maximum surrounding air temperature: 0 ... +55 °C
 - > +40 °C: reduce the rated output current by 2.5 %/°C
 - Use 75 °C copper wire only.
- ▶ EVS9327 ... EVS9329:
 - Suitable for use on a circuit capable of delivering not more than 5000 rms symmetrical amperes, 480 V maximum, when protected by fuses.
 - Suitable for use on a circuit capable of delivering not more than 50000 rms symmetrical amperes, 480 V maximum, when protected by J, T or R class fuses.
 - Maximum surrounding air temperature: 0 ... +50 °C
 - > +40 °C: reduce the rated output current by 2.5 %/°C
 - Use 60/75 °C or 75 °C copper wire only.

- ▶ EVS9330 ... EVS9332:
 - Suitable for use on a circuit capable of delivering not more than 10000 rms symmetrical amperes, 480 V maximum, when protected by fuses.
 - Suitable for use on a circuit capable of delivering not more than 50000 rms symmetrical amperes, 480 V maximum, when protected by J, T or R class fuses.
 - Maximum surrounding air temperature: 0 ... +50 °C
 - > +40 °C: reduce the rated output current by 2.5 %/°C
 - Use 60/75 °C or 75 °C copper wire only.

3 Technical data

Contents

3.1	General data and operating conditions	3.1-1
3.2	Open and closed loop control	3.2-1
3.3	Rated data	3.3-1
3.3.1	Operation at 400 V	3.3-1
3.3.2	Operation at 480 V	3.3-2
3.3.3	Overcurrent operation	3.3-4
3.4	Current characteristics	3.4-1

3.1 General data and operating conditions

General data

Conformity and approval		
Conformity		
CE	2006/95/EC	Low-Voltage Directive
	2004/108/EG	EMC Directive
Approval		
UL	cULus	Power Conversion Equipment (File No. E132659)

Protection of persons and equipment		
Type of protection	EN 60529	IP20 IP41 in case of thermally separated installation (push-through technique) between the control cabinet (inside) and the environment.
	NEMA 250	Protection against accidental contact in accordance with type 1
Earth leakage current	IEC/EN 61800-5-1	> 3.5 mA Observe regulations and safety instructions!
Insulation of control circuits	EN 61800-5-1	Safe mains isolation by double (reinforced) insulation for terminals X1 and X5. Basic insulation (single isolating distance) for terminals X3, X4, X6, X7, X8, X9, X10 and X11.
Insulation resistance	IEC/EN 61800-5-1	< 2000 m site altitude: overvoltage category III
		> 2000 m site altitude: overvoltage category II
Protective measures		Against short circuit, earth fault (earth-fault protected during mains connection, limited earth-fault protection during operation), overvoltage, motor overtemperature (input for PTC or thermal contact)

EMC		
Noise emission	IEC/EN 61800-3	Cable-guided, up to 10 m motor cable length with mains filter A: category C2.
		Radiation, with mains filter A and installation in control cabinet: category C2
Interference immunity	IEC/EN 61800-3	Category C3

Operating conditions

Ambient conditions			
Climatic			
Storage	IEC/EN 60721-3-1	1K3 (-25 ... +55 °C)	< 6 months
		1K3 (-25 ... +40 °C)	> 6 months > 2 years: anodise DC bus capacitors
Transport	IEC/EN 60721-3-2	2K3 (-25 ... +70 °C)	
Operation			
EVS9321 ... EVS9326	IEC/EN 60721-3-3	3K3 (0 ... +55 °C)	> +40 °C: reduce the rated output current by 2.5 %/°C.
EVS9327 ... EVS9332		3K3 (0 ... +50 °C)	> +40 °C: reduce the rated output current by 2.5 %/°C.
Pollution	EN 61800-5-1	Degree of pollution 2	

Ambient conditions										
Site altitude		< 4000 m amsl > 1000 m amsl: reduce the rated output current by 5 %/ 1000 m								
Mechanical										
Vibration resistance	EN 50178 EN 61800-5-1 Germanischer Lloyd, general conditions	Tested according to "General Vibration Stress Characteristic 1"								
Electrical										
AC-mains connection										
Max. mains voltage range		320 V - 0 % ... 528 V + 0 %								
Mains frequency		45 Hz - 0 % ... 65 Hz + 0 %								
Power system TT, TN		Operation permitted without restrictions with earthed neutral.								
Power system IT		Operation only permitted with the device variants V024 or V100. Operation permitted without restrictions with insulated neutral. Observe instructions on specific measures!								
Operation on public supply systems	EN 61000-3-2	<table border="1"> <thead> <tr> <th colspan="2">Limitation of harmonic currents</th> </tr> <tr> <th>Total output at the mains</th> <th>Compliance with the requirements ¹⁾</th> </tr> </thead> <tbody> <tr> <td>< 1 kW</td> <td>With mains choke.</td> </tr> <tr> <td>> 1 kW</td> <td>Without additional measures.</td> </tr> </tbody> </table> <p>¹⁾ The additional measures mentioned have the effect that solely the controllers meet the requirements of EN 61000-3-2. The machine/system manufacturer is responsible for the compliance with the requirements for the machine/system!</p>	Limitation of harmonic currents		Total output at the mains	Compliance with the requirements ¹⁾	< 1 kW	With mains choke.	> 1 kW	Without additional measures.
Limitation of harmonic currents										
Total output at the mains	Compliance with the requirements ¹⁾									
< 1 kW	With mains choke.									
> 1 kW	Without additional measures.									
DC-mains connection										
Max. mains voltage range		450 V - 0 % ... 740 V + 0 %								
Operating conditions		DC voltage must be symmetrical to PE. The controller will be destroyed when +U _G or -U _G are earthed.								
Motor connection										
Length of the motor cable		< 50 m No additional output filters are required at a rated mains voltage and a switching frequency of 8 kHz. If EMC requirements have to be met, the permissible cable length may be affected.								
Mounting conditions										
Mounting place		In the control cabinet								
Mounting position		Vertical								
Free spaces Dimensions Weights		 4-1								

3.2 Open and closed loop control

Open and closed loopcontrol		
Switching frequency	8 kHz or 16 kHz	
Digital setpoint selection		
Accuracy	± 0.005 Hz (= ± 100 ppm)	
Analog setpoint selection		
Linearity	± 0.15 % Signal level: 5 V or 10 V	
Temperature sensitivity	± 0.1 % 0 ... 50 °C	
Offset	± 0.1 %	
Analog inputs	<ul style="list-style-type: none"> ● 2 inputs (bipolar) 	
Analog outputs	<ul style="list-style-type: none"> ● 2 outputs (bipolar) 	
Digital inputs	<ul style="list-style-type: none"> ● 5 inputs (freely assignable) ● 1 input for controller inhibit ● 4 outputs (freely assignable) ● 1 resolver input; design: 9-pole Sub-D socket ● 1 incremental encoder input (500 kHz, TTL level); design: 9-pole Sub-D socket (pin) ● 1 digital frequency input (500 kHz, TTL level); design: 9-pole Sub-D socket (pin); can be optionally used as incremental encoder input (500 kHz, TTL level) ● 1 digital frequency output (500 kHz, TTL level); design: 9-pole Sub-D socket 	
Digital outputs		
Cycle times		
Digital inputs		1 ms
Digital outputs		1 ms
Analog inputs		1 ms
Analog outputs	1 ms (smoothing time: $\tau = 2$ ms)	

3.3 Rated data



Note!

The controllers EVS9324, EVS9326 and EVS9328 ... EVS9332 may only be operated with the prescribed mains chokes and mains filters.

3.3.1 Operation at 400 V

Basis of the data			
		Voltage	Frequency
AC mains connection	$[V_{rated}]$	3/PE AC 320 V - 0 % ... 440 V + 0 %	45 Hz - 0 % ... 65 Hz + 0 %
DC-mains connection (alternatively)	$[U_{DC}]$	DC 450 V - 0 % ... 620 V + 0 %	–
Output voltage			
With mains choke		3 ~ 0 approx. 94 % V_{rated}	–
Without mains choke		3 ~ 0 ... U_N	–

9300	Mains current ¹⁾		Typical motor power		Output power		Power loss
	With mains choke	Without mains choke	ASM (4-pole)		8 kHz ²⁾	+ U_G , - U_G ³⁾	
Type	I_r [A]	I_r [A]	P_r [kW]	P_r [hp]	S_{r8} [kVA]	P_{DC} [kW]	P_V [W]
EVS9321-xS	1.5	2.1	0.37	0.5	1.0	2.0	100
EVS9322-xS	2.5	3.5	0.75	1.0	1.7	0.75	110
EVS9323-xS	3.9	5.5	1.5	2.0	2.7	2.2	140
EVS9324-xS	7.0	–	3.0	4.0	4.8	0.75	200
EVS9325-xS	12.0	16.8	5.5	7.5	9.0	0	260
EVS9326-xS	20.5	–	11.0	15.0	16.3	0	390
EVS9327-xS	27.0	43.5	15.0	20.0	22.2	10	430
EVS9328-xS	44.0	–	22.0	30.0	32.6	4	640
EVS9329-xS	53.0	–	30.0	40.0	40.9	0	810
EVS9330-xS	78.0	–	45.0	60.0	61.6	5	1100
EVS9331-xS	100	–	55.0	75.0	76.2	0	1470
EVS9332-xS	135	–	75.0	100	100.5	0	1960

Bold print = Lenze setting

¹⁾ Mains currents at 8 kHz switching frequency

²⁾ Switching frequency of the inverter

³⁾ Power which can additionally be drawn from the DC bus at operation with power-adapted motor

3 Technical data

3.3 Rated data

3.3.2 Operation at 480 V

9300	Output currents					
	Rated current	8 kHz ¹⁾		Standstill current	16 kHz ¹⁾	
		Maximum current ²⁾	Standstill current		Rated current	Maximum current ²⁾
Type	I_{r8} [A]	I_{M8} [A]	I_{08} [A]	I_{r16} [A]	I_{M16} [A]	I_{016} [A]
EVS9321-xS	1.5	2.25	2.3	1.1	1.65	1.7
EVS9322-xS	2.5	3.75	3.8	1.8	2.7	2.7
EVS9323-xS	3.9	5.85	5.9	2.9	4.35	4.4
EVS9324-xS	7.0	10.5	10.5	5.2	7.8	7.8
EVS9325-xS	13.0	19.5	19.5	9.7	14.6	14.6
EVS9326-xS	23.5	35.3	23.5	15.3	23.0	15.3
EVS9327-xS	32.0	48.0	32.0	20.8	31.2	20.8
EVS9328-xS	47.0	70.5	47.0	30.6	45.9	30.6
EVS9329-xS	59.0	88.5	52.0	38.0	57.0	33.0
EVS9330-xS	89.0	133.5	80.0	58.0	87.0	45.0
EVS9331-xS	110	165	110	70.0	105	70.0
EVS9332-xS	145	21.5	126	90.0	135	72.0

Bold print = Lenze setting

¹⁾ Switching frequency of the inverter

²⁾ The currents apply to a periodic load change cycle with max. 1 minute overcurrent duration and 2 minutes base load duration at max. 75 % I_r

3.3.2 Operation at 480 V

Basis of the data		
	Voltage	Frequency
Supply		
3/PE 480 V AC $[U_r]$	320 V - 0 % ... 528 V + 0 %	45 Hz - 0 % ... 65 Hz + 0 %
DC 678 V (alternatively) $[U_{DC}]$	460 V - 0 % ... 740 V + 0 %	–
Output voltage		
With mains choke	3 ~ 0 ... approx. 94 % U_r	–
Without mains choke	3 ~ 0 ... U_r	–

9300	Mains current ¹⁾		Typical motor power		Output power		Power loss
	With mains choke	Without mains choke	ASM (4-pole)		8 kHz ²⁾	+U _G , -U _G ³⁾	P _V [W]
	I _r [A]	I _r [A]	P _r [kW]	P _r [hp]	U, V, W S _{r8} [kVA]		
EVS9321-xS	1.5	2.1	0.37	0.5	1.2	2.0	100
EVS9322-xS	2.5	3.5	0.75	1.0	2.1	0.75	110
EVS9323-xS	3.9	5.5	1.5	2.0	3.2	2.2	140
EVS9324-xS	7.0	–	3.0	4.0	5.8	0.75	200
EVS9325-xS	12.0	16.8	5.5	7.5	10.8	0	260
EVS9326-xS	20.5	–	11.0	15.0	18.5	0	390
EVS9327-xS	27.0	43.5	18.5	25.0	25.0	12	430
EVS9328-xS	44.0	–	30.0	40.0	37.0	4.8	640
EVS9329-xS	53.0	–	37.0	50.0	46.6	0	810
EVS9330-xS	78.0	–	45.0	60.0	69.8	6	1100
EVS9331-xS	100	–	55.0	75.0	87.3	0	1470
EVS9332-xS	135	–	90.0	125	104	6	1960

Bold print = Lenze setting

¹⁾ Mains currents at 8 kHz switching frequency

²⁾ Switching frequency of the inverter

³⁾ Power which can additionally be drawn from the DC bus at operation with power-adapted motor

9300	Output currents						
	Rated current	8 kHz ¹⁾			16 kHz ¹⁾		
		I _{r8} [A]	Maximum current ²⁾	Standstill current	Rated current	Maximum current ²⁾	Standstill current
Type	I _{r8} [A]	I _{M8} [A]	I ₀₈ [A]	I _{r16} [A]	I _{M16} [A]	I ₀₁₆ [A]	
EVS9321-xS	1.5	2.25	2.3	1.1	1.65	1.7	
EVS9322-xS	2.5	3.75	3.8	1.8	2.7	2.7	
EVS9323-xS	3.9	5.85	5.9	2.9	4.35	4.4	
EVS9324-xS	7.0	10.5	10.5	5.2	7.8	7.8	
EVS9325-xS	13.0	19.5	19.5	9.7	14.6	14.6	
EVS9326-xS	22.3	33.5	22.3	14.5	21.8	14.5	
EVS9327-xS	30.4	45.6	30.4	19.2	28.8	19.2	
EVS9328-xS	44.7	67.1	44.7	28.2	42.3	28.2	
EVS9329-xS	56.0	84.0	49.0	35.0	52.5	25.0	
EVS9330-xS	84.0	126	72.0	55.0	82.5	36.0	
EVS9331-xS	105	157.5	105	65.0	97.5	58.0	
EVS9332-xS	125	187.5	111	80.0	120	58.0	

Bold print = Lenze setting

¹⁾ Switching frequency of the inverter

²⁾ The currents apply to a periodic load change cycle with max. 1 minute overcurrent duration and 2 minutes base load duration at max. 75 % I_r

3.3.3 Overcurrent operation

Under the operating conditions described here, the EVS9321-xS ... EVS9324-xS controllers can supply a rated output current which is up to twice as high.



Note!

If you enter values $> 1.5 \times$ rated output current under C0022, the controller switches to overcurrent operation.

- ▶ Switching between overcurrent operation and standard operation is only possible if the controller is inhibited (X5/28 = LOW).
- ▶ The continuous current is automatically reduced to 70 % of the rated output current.

3.3.3.1 Operation at 400 V

Basis of the data			
		Voltage	Frequency
AC mains connection	$[V_{rated}]$	3/PE AC 320 V - 0 % ... 440 V + 0 %	45 Hz - 0 % ... 65 Hz + 0 %
DC-mains connection (alternatively)	$[U_{DC}]$	DC 450 V - 0 % ... 620 V + 0 %	–
Output voltage			
With mains choke		3 ~ 0 approx. 94 % V_{rated}	–
Without mains choke		3 ~ 0 ... U_N	–

9300	Mains current ¹⁾		Typical motor power		Output power		Power loss
	With mains choke	Without mains choke	ASM (4-pole)		8 kHz ²⁾	+ U_G , - U_G ³⁾	
Type	I_r [A]	I_r [A]	P_r [kW]	P_r [hp]	U, V, W S_{r8} [kVA]	P_{DC} [kW]	P_V [W]
EVS9321-xS	1.5	2.1	0.37	0.5	1.0	2.0	100
EVS9322-xS	2.5	3.5	0.75	1.0	1.7	0.75	110
EVS9323-xS	3.9	5.5	1.5	2.0	2.7	2.2	140
EVS9324-xS	7.0	–	3.0	4.0	4.8	0.75	200

Bold print = Lenze setting

¹⁾ Mains currents at 8 kHz switching frequency

²⁾ Switching frequency of the inverter

³⁾ Power which can additionally be drawn from the DC bus at operation with power-adapted motor

9300	Output currents							
	Rated current	8 kHz ¹⁾			16 kHz ¹⁾			
Type		Continuous thermal current ³⁾	Maximum current ²⁾	Standstill current	Rated current	Continuous thermal current ³⁾	Maximum current ²⁾	Standstill current
	I_{r8} [A]	I_{M8} [A]	I_{08} [A]	I_{r16} [A]	I_{r16} [A]	I_{M16} [A]	I_{016} [A]	
EVS9321-xS	1.5	1.05	3.0	3.0	1.1	0.77	2.2	2.2
EVS9322-xS	2.5	1.75	5.0	5.0	1.8	1.26	3.6	3.6
EVS9323-xS	3.9	2.73	7.8	7.8	2.9	2.03	5.8	5.8
EVS9324-xS	7.0	4.9	14.0	14.0	5.2	3.64	10.4	10.4

- ¹⁾ Switching frequency of the inverter
²⁾ The currents apply to a periodic load change cycle with max. 10 seconds overcurrent duration and 50 seconds base load duration at max. 44 % of the rated current
³⁾ 70 % of the rated current

3.3.3.2 Operation at 480 V

Basis of the data			
		Voltage	Frequency
Supply			
3/PE 480 V AC	$[U_r]$	320 V - 0 % ... 528 V + 0 %	45 Hz - 0 % ... 65 Hz + 0 %
DC 678 V (alternatively)	$[U_{DC}]$	460 V - 0 % ... 740 V + 0 %	–
Output voltage			
With mains choke		3 ~ 0 ... approx. 94 % U_r	–
Without mains choke		3 ~ 0 ... U_r	–

9300	Mains current ¹⁾		Typical motor power		Output power		Power loss
	With mains choke	Without mains choke	ASM (4-pole)		8 kHz ²⁾	$+U_G, -U_G$ ³⁾	
Type	I_r [A]	I_r [A]	P_r [kW]	P_r [hp]	S_{r8} [kVA]	P_{DC} [kW]	P_V [W]
EVS9321-xS	1.5	2.1	0.37	0.5	1.2	2.0	100
EVS9322-xS	2.5	3.5	0.75	1.0	2.1	0.75	110
EVS9323-xS	3.9	5.5	1.5	2.0	3.2	2.2	140
EVS9324-xS	7.0	–	3.0	4.0	5.8	0.75	200

- Bold print = Lenze setting
¹⁾ Mains currents at 8 kHz switching frequency
²⁾ Switching frequency of the inverter
³⁾ Power which can additionally be drawn from the DC bus at operation with power-adapted motor

9300	Output currents							
	Rated current	8 kHz ¹⁾			16 kHz ¹⁾			
Type		Continuous thermal current ³⁾	Maximum current ²⁾	Standstill current	Rated current	Continuous thermal current ³⁾	Maximum current ²⁾	Standstill current
	I_{r8} [A]	I_{M8} [A]	I_{08} [A]	I_{r16} [A]	I_{r16} [A]	I_{M16} [A]	I_{016} [A]	
EVS9321-xS	1.5	1.05	3.0	3.0	1.1	0.77	2.2	2.2
EVS9322-xS	2.5	1.75	5.0	5.0	1.8	1.26	3.6	3.6
EVS9323-xS	3.9	2.73	7.8	7.8	2.9	2.03	5.8	5.8
EVS9324-xS	7.0	4.9	14.0	14.0	5.2	3.64	10.4	10.4

- ¹⁾ Switching frequency of the inverter
²⁾ The currents apply to a periodic load change cycle with max. 10 seconds overcurrent duration and 50 seconds base load duration at max. 44 % of the rated current
³⁾ 70 % of the rated current

3.4 Current characteristics

The maximum output current of the EVS9326 ... EVS9332 devices is limited under certain operating conditions:

- ▶ At output frequencies $f_{out} < |5 \text{ Hz}|$ and heatsink temperatures $\vartheta_K > 40^\circ \text{C}$.
- ▶ The current limitation depends on the switching frequency.

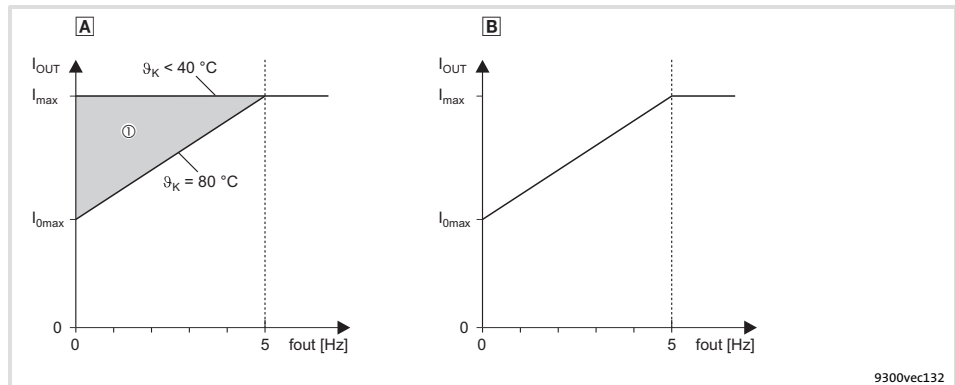

Fig. 3.4-1 Current derating characteristics

- A** Operation at switching frequency $f_{chop} = 8 \text{ kHz}$ (C0018 = 1)
 The current limitation follows the characteristic curve
 At output frequencies $f_{out} < |5 \text{ Hz}|$ and heatsink temperatures $\vartheta_K = 40 \dots 80^\circ \text{C}$, the current limit is steplessly adjusted in the ① range
- B** Operation at switching frequency $f_{chop} = 16 \text{ kHz}$ (C0018 = 2)
 The current limitation follows the characteristic curve and is independent of the heatsink temperature

At automatic change-over of the switching frequency (C0018 = 0), the controller operates at $f_{chop} = 16 \text{ kHz}$. The current limitation follows the characteristic curve **B**.

If an increased torque is required (e.g. acceleration processes), the controller automatically switches over to $f_{chop} = 8 \text{ kHz}$. The current limitation follows the characteristic curve **A**.

9300	$I_{0max} [\text{A}]$ ¹⁾		$I_{0max} [\text{A}]$ ²⁾	
	$f_{chop} = 8 \text{ kHz}$		$f_{chop} = 16 \text{ kHz}$	
	U_{mains}		U_{mains}	
	400 V	480 V	400 V	480 V
EVS9326-xS	23.5	22.3	15.3	14.5
EVS9327-xS	32.0	30.4	20.8	19.2
EVS9328-xS	47.0	44.7	30.6	28.2
EVS9329-xS	52.0	49.0	33.0	25.0
EVS9330-xS	80.0	72.0	45.0	36.0
EVS9331-xS	110	105	70.0	58.0
EVS9332-xS	126	111	72.0	58.0

- 1) Maximum available output current at an output frequency $f_{out} = |0 \text{ Hz}|$ and heatsink temperature $\vartheta_K = 80^\circ \text{C}$
- 2) Maximum available output current at an output frequency $f_{out} = |0 \text{ Hz}|$

4 Installation of the standard device

Contents

4.1	Standard devices in the power range 0.37 ... 11 kW	4.1-1
4.1.1	Important notes	4.1-1
4.1.2	Mounting with fixing rails (standard)	4.1-2
4.1.3	Thermally separated mounting (push-through technique) .	4.1-3
4.1.4	Mounting in "cold plate" technique	4.1-4
4.2	Standard devices in the power range 15 ... 30 kW	4.2-1
4.2.1	Important notes	4.2-1
4.2.2	Mounting with fixing brackets (standard)	4.2-2
4.2.3	Thermally separated mounting (push-through technique) .	4.2-3
4.2.4	Mounting in "cold plate" technique	4.2-4
4.3	Standard devices with a power of 45 kW	4.3-1
4.3.1	Important notes	4.3-1
4.3.2	Mounting with fixing brackets (standard)	4.3-2
4.3.3	Thermally separated mounting (push-through technique) .	4.3-3
4.3.4	Modification of the fan module for push-through technique	4.3-4
4.4	Standard devices in the power range 55 ... 75 kW	4.4-1
4.4.1	Important notes	4.4-1
4.4.2	Mounting with fixing brackets (standard)	4.4-2
4.4.3	Thermally separated mounting (push-through technique) .	4.4-3

4.1 Standard devices in the power range 0.37 ... 11 kW

4.1.1 Important notes

Mass of the devices

9300	Standard device	"Cold plate" device
Type	EVS93xx-ES [kg]	EVS93xx-CS [kg]
EVS9321-xS	4.0	3.1
EVS9322-xS	4.0	3.1
EVS9323-xS	5.5	3.9
EVS9324-xS	5.5	3.9
EVS9325-xS	7.4	5.2
EVS9326-xS	7.4	5.2

4 Installing of the standard device

4.1 Standard devices in the power range 0.37 ... 11 kW

4.1.2 Mounting with fixing rails (standard)

4.1.2 Mounting with fixing rails (standard)

Mounting material required from the scope of supply:

Description	Use	Quantity	
		EVS9321-ES ... EVS9324-ES	EVS9325-ES EVS9326-ES
Fixing rails	Drive controller fixing	2	4

Dimensions

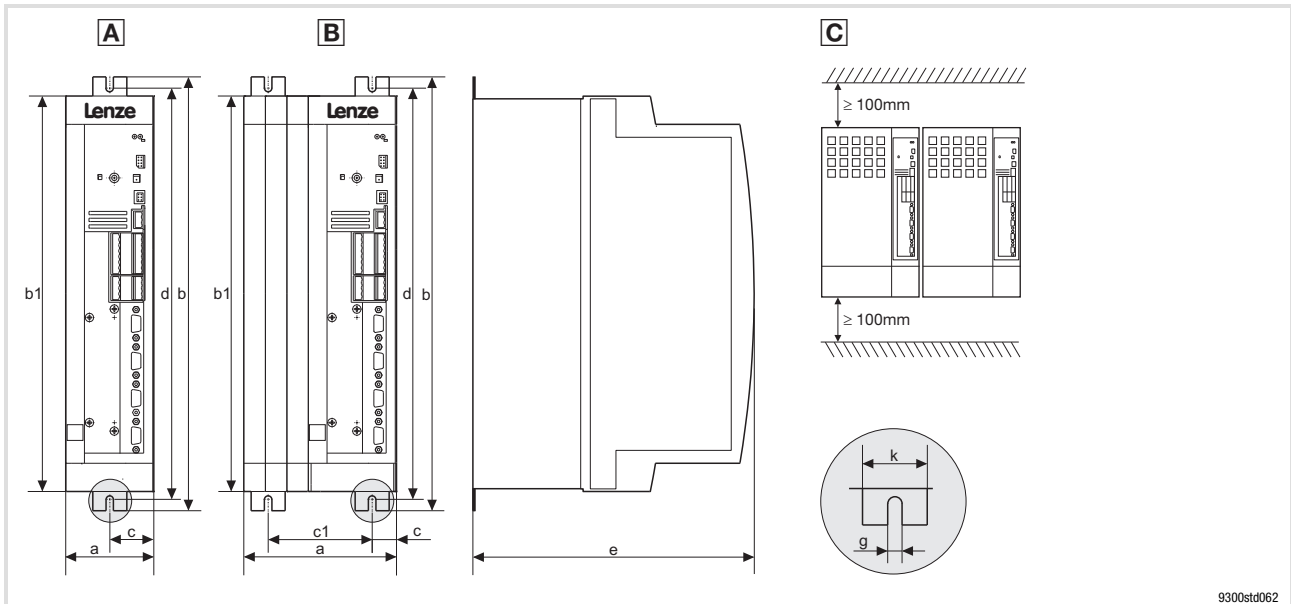

Fig. 4.1-1 Standard mounting with fixing rails 0.37 ... 11 kW

ⓐ Drive controllers can be mounted side by side without spacing

9300		Dimensions [mm]									
Type		a	b	b1	c	c1	d	d1	e ¹⁾	g	k
EVS9321-ES EVS9322-ES	ⓐ	78	384	350	39	-	365	-	250	6.5	30
EVS9323-ES EVS9324-ES	ⓐ	97	384	350	48.5	-	365	-	250	6.5	30
EVS9325-ES EVS9326-ES	ⓑ	135	384	350	21.5	92	365	-	250	6.5	30

¹⁾ For a fieldbus module plugged onto X1, consider mounting space for connecting cables

Mounting

► Attach the fixing rails to the housing of the drive controller.

4.1.3 Thermally separated mounting (push-through technique)

For mounting in push-through technique you have to use the controller type EVS93xx-ES. Additionally you will require the mounting set for push-through technique:

Type	Mounting set
EVS9321-ES, EVS9322-ES	EJ0036
EVS9323-ES, EVS9324-ES	EJ0037
EVS9325-ES, EVS9326-ES	EJ0038

Dimensions

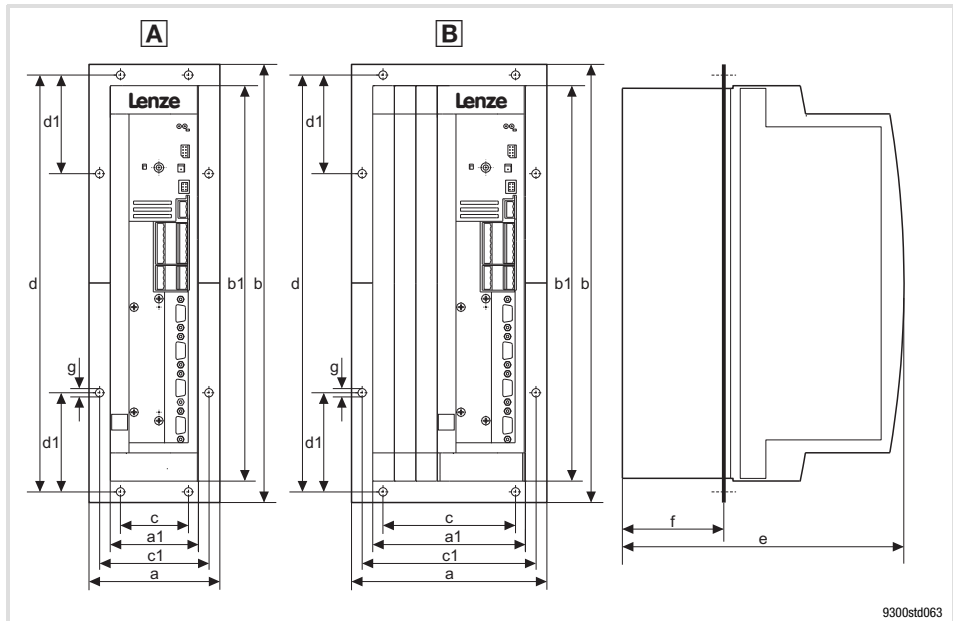

Fig. 4.1-2 Dimensions for thermally separated mounting 0.37 ... 11 kW

9300		Dimensions [mm]										
Type		a	a1	b	b1	c	c1	d	d1	e ¹⁾	f	g
EVS9321-ES EVS9322-ES	A	112.5	78	385.5	350	60	95.5	365.5	105.5	250	92	6.5
EVS9323-ES EVS9324-ES	A	131.5	97	385.5	350	79	114.5	365.5	105.5	250	92	6.5
EVS9325-ES EVS9326-ES	B	169.5	135	385.5	350	117	152.5	365.5	105.5	250	92	6.5

¹⁾ For a fieldbus module plugged onto X1, consider mounting space for connecting cables

Mounting cutout in control cabinet

9300		Dimensions [mm]	
Type		Width	Height
EVS9321-ES EVS9322-ES	A	82	350
EVS9323-ES EVS9324-ES	A	101	350
EVS9325-ES EVS9326-ES	B	139	350

4 Installing of the standard device

4.1 Standard devices in the power range 0.37 ... 11 kW

4.1.4 Mounting in "cold plate" technique

4.1.4 Mounting in "cold plate" technique

The drive controllers can be mounted in "cold plate" technique, e.g. on collective coolers. For this purpose, the drive controllers of type EVS93xx-CSx must be used.

Mounting material required from the scope of supply:

Description	Use	Quantity		
		EVS9321-CS EVS9322-CS	EVS9323-CS EVS9324-CS	EVS9325-CS EVS9326-CS
Fixing bracket	Controller fixing	2	2	2
Sheet metal screw 3.5 × 13 mm (DIN 7981)	Mounting the fixing bracket to the controller	6	6	6

Requirements for collective coolers

The following points are important for safe and reliable operation of the controller:

- ▶ Good thermal connection to the cooler
 - The contact surface between the collective cooler and the controller must be at least as large as the cooling plate of the controller.
 - Plane contact surface, max. deviation 0.05 mm.
 - When attaching the collective cooler to the controller, make sure to use all specified screw connections.
- ▶ Observe the thermal resistance R_{th} given in the table. The values are valid for controller operation under rated conditions.

9300	Cooling path	
	Power to be dissipated P_v [W]	Heatsink - environment R_{th} [K/W]
Type		
EVS9321-CS	24	1.45
EVS9322-CS	42	0.85
EVS9323-CS	61	0.57
EVS9324-CS	105	0.33
EVS9325-CS	180	0.19
EVS9326-CS	360	0.10

Ambient conditions

- ▶ The rated data and the derating factors at increased temperature also apply to the ambient temperature of the drive controllers.
- ▶ Temperature at the cooling plate of the drive controller: max. 75 °C.

Dimensions

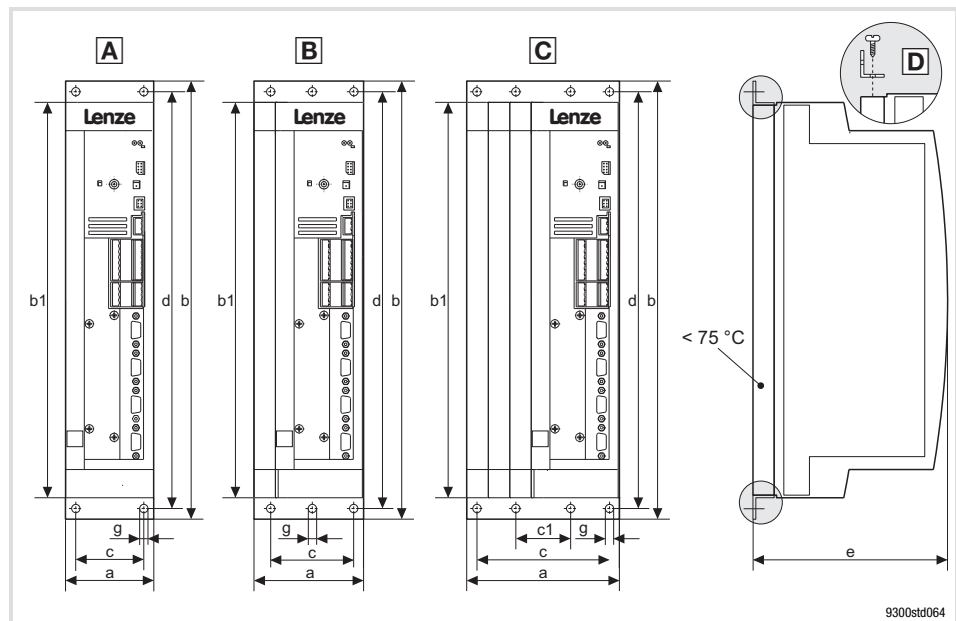

Fig. 4.1-3 Dimensions for mounting in "cold plate" technique 0.37 ... 11 kW

9300		Dimensions [mm]							
Type		a	b	b1	c	c1	d	e ¹⁾	g
EVS9321-CS	A	78	381	350	48	-	367	168	6.5
EVS9322-CS									
EVS9323-CS	B	97	381	350	67	-	367	168	6.5
EVS9324-CS									
EVS9325-CS	C	135	381	350	105	38	367	168	6.5
EVS9326-CS									

¹⁾ For a fieldbus module plugged onto X1, consider mounting space for connecting cables

Mounting

Apply heat conducting paste before screwing together the cooler and cooling plate of the drive controller so that the heat transfer resistance is as low as possible.

1. Fasten the fixing bracket with sheet metal screws 3.5 × 13 mm at the top and bottom of the drive controller D.
2. Clean the contact surface of cooler and cooling plate with spirit.
3. Apply a thin coat of heat conducting paste with a filling knife or brush.
 - The heat conducting paste in the accessory kit is sufficient for an area of approx. 1000 cm².
4. Mount the drive controller on the cooler.

4.2 Standard devices in the power range 15 ... 30 kW

4.2.1 Important notes

The accessory kit is located inside the controller.

Remove the cover of the drive controller

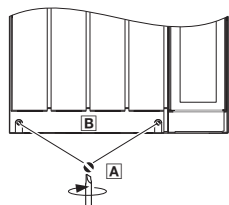

9300vec113

1. Remove the screws **A**
2. Lift cover **B** up and detach it

Mass of the devices

9300	Standard device	"Cold plate" device
Type	EVS93xx-ES [kg]	EVS93xx-CS [kg]
EVS9327-xS	13.5	9.5
EVS9328-xS	15.0	9.5
EVS9329-xS	15.0	–

4 Installing of the standard device

4.2 Standard devices in the power range 15 ... 30 kW

4.2.2 Mounting with fixing brackets (standard)

4.2.2 Mounting with fixing brackets (standard)

Mounting material required from the scope of supply:

Description	Use	Quantity
Fixing bracket	Drive controller fixing	4
Raised countersunk head screw M5 × 10 mm (DIN 966)	Mounting of fixing bracket to the drive controller	4

Dimensions

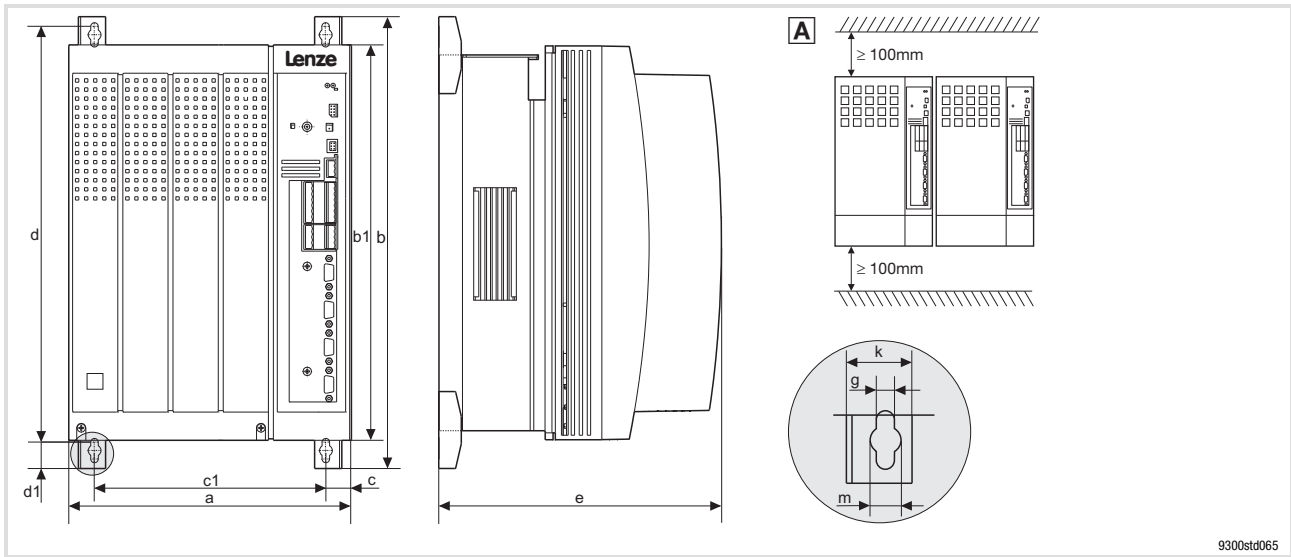

Fig. 4.2-1 Standard mounting with fixing brackets 15 ... 30 kW

A Drive controllers can be mounted side by side without spacing

9300	Dimensions [mm]										
Type	a	b	b1	c	c1	d	d1	e ¹⁾	g	k	m
EVS9327-ES											
EVS9328-ES	250	402	350	22	206	370	24	250	6.5	24	11
EVS9329-ES											

¹⁾ For a fieldbus module plugged onto X1, consider mounting space for connecting cables

Mounting

- ▶ Attach the fixing brackets to the heatsink plate of the drive controller.

4.2.3 Thermally separated mounting (push-through technique)

For mounting in push-through technique, the drive controller of type EVS93xx-ESx must be used. In addition, the mounting set EJ0011 for the push-through technique is required.

Dimensions

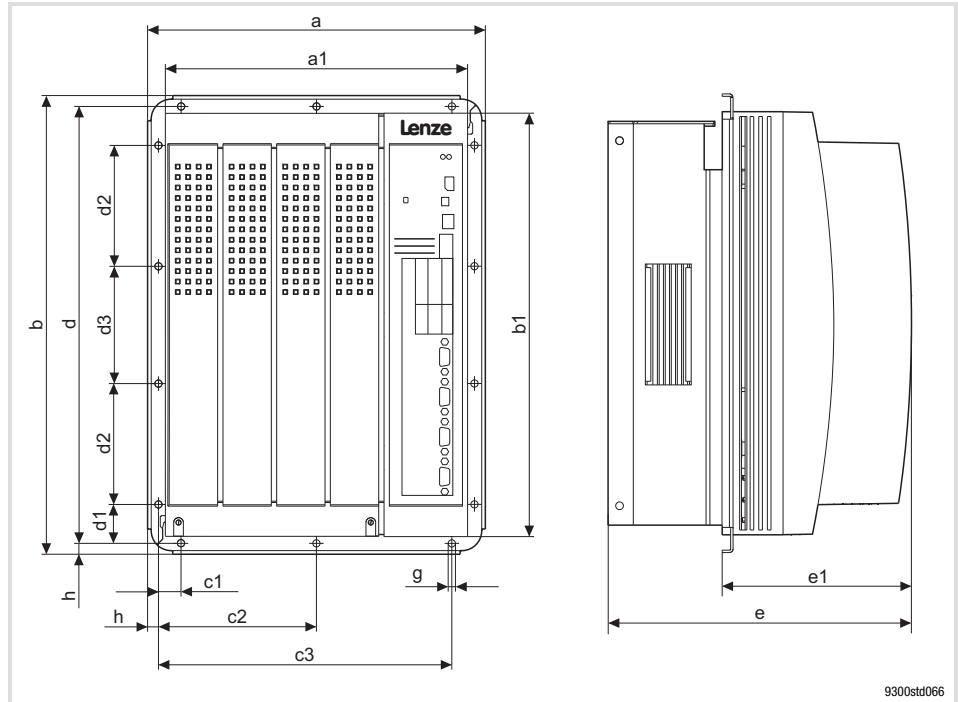

Fig. 4.2-2 Dimensions for thermally separated mounting 15 ... 30 kW

9300	Dimensions [mm]														
Type	a	a1	b	b1	c1	c2	c3	d	d1	d2	d3	e ¹⁾	e1	g	h
EVS9327-ES															
EVS9328-ES	279.5	250	379.5	350	19	131	243	361.5	32	100	97	250	159.5	6	9
EVS9329-ES															

¹⁾ For a fieldbus module plugged onto X1, consider mounting space for connecting cables

Mounting cutout in control cabinet

9300	Dimensions [mm]	
Type	Width	Height
EVS9327-ES		
EVS9328-ES	236	336
EVS9329-ES		

4 Installing of the standard device
 4.2 Standard devices in the power range 15 ... 30 kW
 4.2.4 Mounting in "cold plate" technique

4.2.4 Mounting in "cold plate" technique

The drive controllers can be mounted in "cold plate" technique, e.g. on collective coolers. For this purpose, the drive controllers of type EVS93xx-CSx must be used.

Requirements for collective coolers

The following points are important for safe and reliable operation of the controller:

- ▶ Good thermal connection to the cooler
 - The contact surface between the collective cooler and the controller must be at least as large as the cooling plate of the controller.
 - Plane contact surface, max. deviation 0.05 mm.
 - When attaching the collective cooler to the controller, make sure to use all specified screw connections.
- ▶ Observe the thermal resistance R_{th} given in the table. The values are valid for controller operation under rated conditions.

9300	Cooling path	
	Power to be dissipated	Heatsink - environment
Type	P_v [W]	R_{th} [K/W]
EVS9327-CS	410	0.085
EVS9328-CS	610	0.057

Ambient conditions

- ▶ The rated data and the derating factors at increased temperature also apply to the ambient temperature of the drive controllers.
- ▶ Temperature at the cooling plate of the drive controller: max. 75 °C.

Dimensions

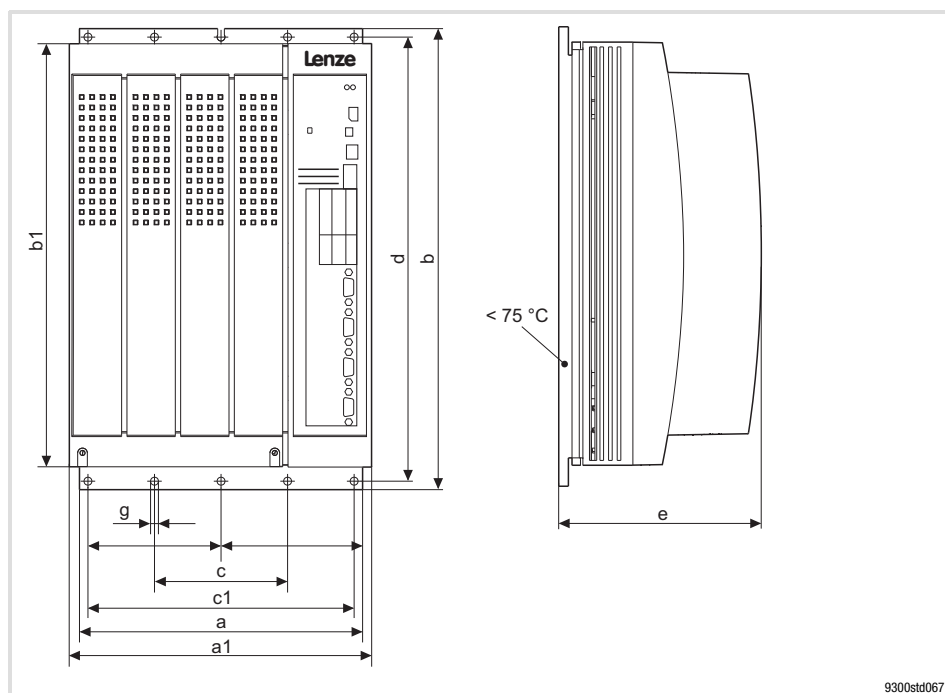

Fig. 4.2-3 Dimensions for mounting in "cold plate" technique 15 ... 22 kW

9300	Dimensions [mm]								
	a	a1	b	b1	c	c1	d	e ¹⁾	g
EVS9327-CS	234	250	381	350	110	220	367	171	6.5
EVS9328-CS									

¹⁾ For a fieldbus module plugged onto X1, consider mounting space for connecting cables

Mounting

Apply heat conducting paste before screwing together the cooler and cooling plate of the drive controller so that the heat transfer resistance is as low as possible.

1. Clean the contact surface of cooler and cooling plate with spirit.
2. Apply a thin coat of heat conducting paste with a filling knife or brush.
 - The heat conducting paste in the accessory kit is sufficient for an area of approx. 1000 cm².
3. Mount the drive controller on the cooler.

4.3 Standard devices with a power of 45 kW

4.3.1 Important notes

The accessory kit is located inside the controller.

Remove the cover of the drive controller

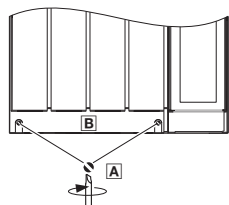

9300vec113

1. Remove the screws **A**
2. Lift cover **B** up and detach it

Mass of the devices

9300	Standard device	"Cold plate" device
Type	EVS93xx-ES [kg]	EVS93xx-CS [kg]
EVS9330-xS	38.0	–

4 Installing of the standard device

4.3 Standard devices with a power of 45 kW

4.3.2 Mounting with fixing brackets (standard)

4.3.2 Mounting with fixing brackets (standard)

Mounting material required from the scope of supply:

Description	Use	Quantity
Fixing bracket	Drive controller fixing	4
Hexagon head cap screw M8 × 16 mm (DIN 933)	Mounting of fixing bracket to the drive controller	4
Washer \varnothing 8.4 mm (DIN 125)	For hexagon head cap screw	4
Spring washer \varnothing 8 mm (DIN 127)	For hexagon head cap screw	4

Dimensions

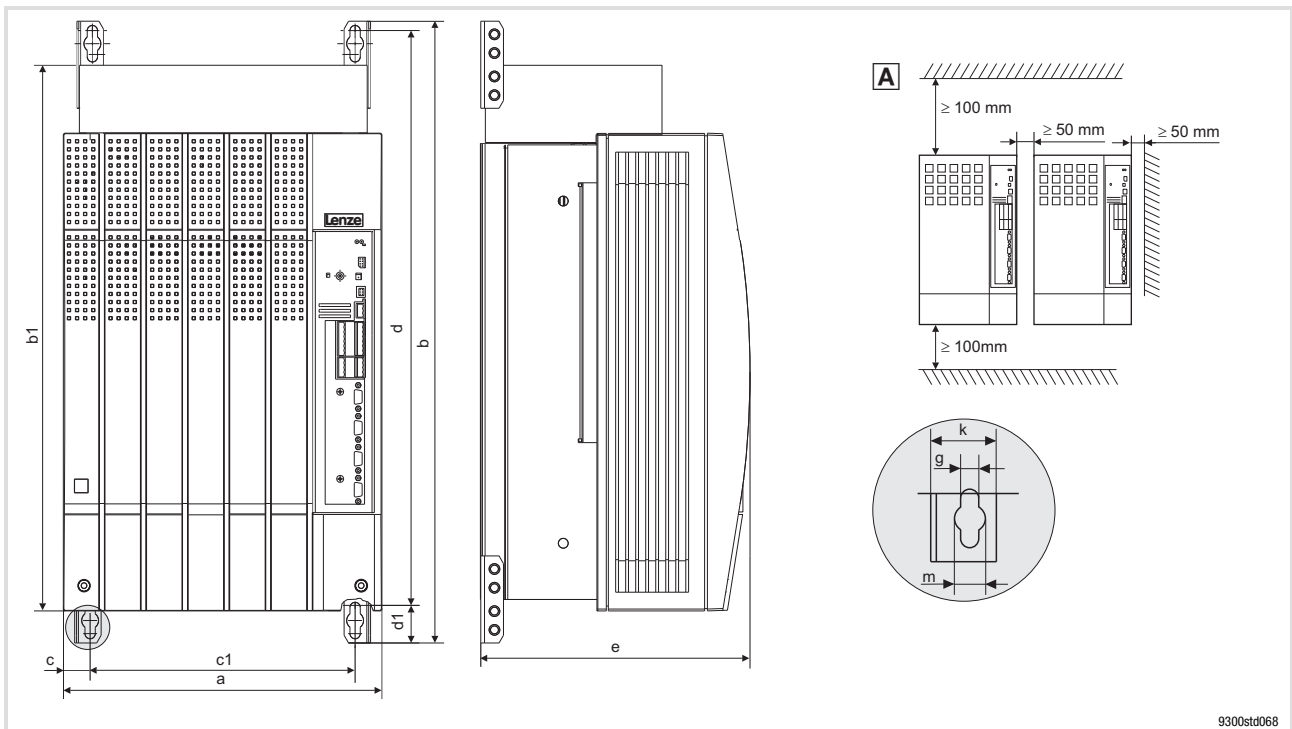

Fig. 4.3-1 Standard mounting with fixing brackets 45 kW

A Arrange drive controllers in a row with spacing to be able to remove eye bolts

9300	Dimensions [mm]										
Type	a	b	b1	c	c1	d	d1	e ¹⁾	g	k	m
EVS9330-ES	340	580	591	28.5	283	615	38	285	11	28	18

¹⁾ For a fieldbus module plugged onto X1, consider mounting space for connecting cables

Mounting

► Attach the fixing brackets to the heatsink plate of the drive controller.

4.3.3 Thermally separated mounting (push-through technique)

For mounting in push-through technique, the drive controller of type EVS93xx-ESx must be used. In addition, the mounting set EJ0010 for the push-through technique is required.

Dimensions

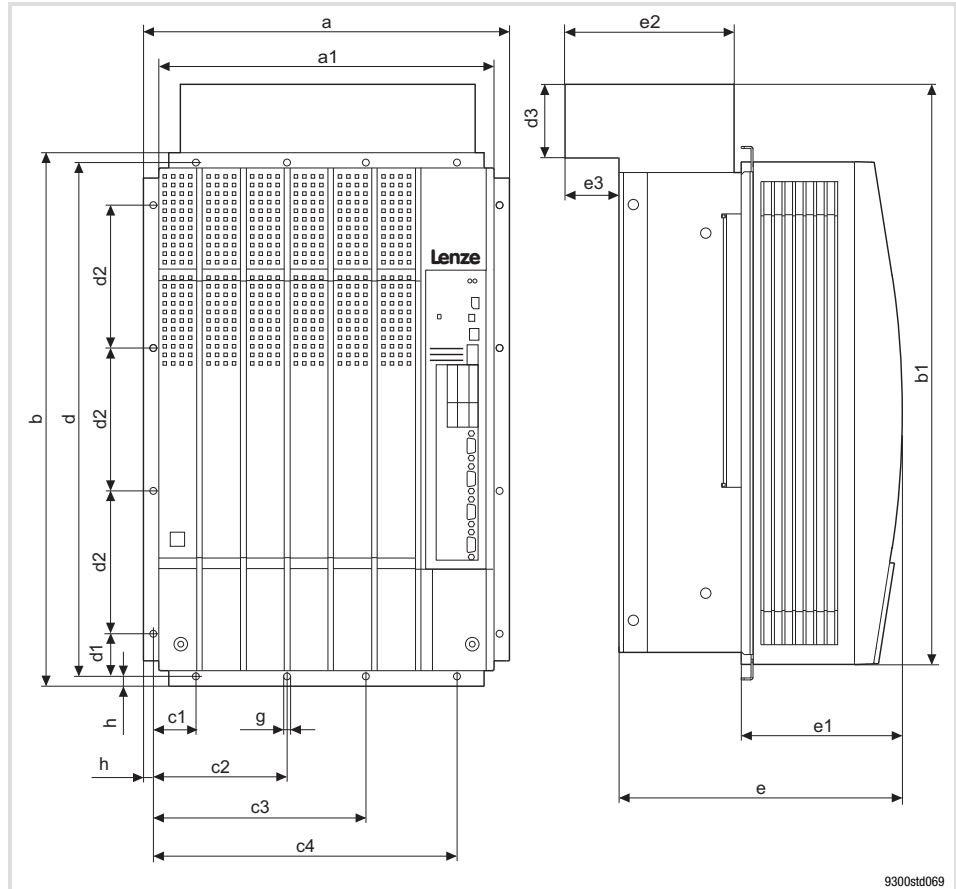

Fig. 4.3-2 Dimensions for thermally separated mounting 45 kW

9300 Type	Dimensions [mm]																	
	a	a1	b	b1	c1	c2	c3	c4	d	d1	d2	d3	e ¹⁾	e1	e2	e3	g	h
EVS9330-ES	373	340	543	591	45	137.5	217.5	310	525	45	145	81	285	163.5	185	66	7	9

¹⁾ For a fieldbus module plugged onto X1, consider mounting space for connecting cables

Mounting cutout in control cabinet

9300 Type	Dimensions [mm]	
	Width	Height
EVS9330-ES	320	515

4 Installing of the standard device

4.3 Standard devices with a power of 45 kW

4.3.4 Modification of the fan module for push-through technique

4.3.4 Modification of the fan module for push-through technique

For thermally separated mounting the fan module has to be rotated by 180° so that the controller fits into the mounting cutout.

Removing the fan module

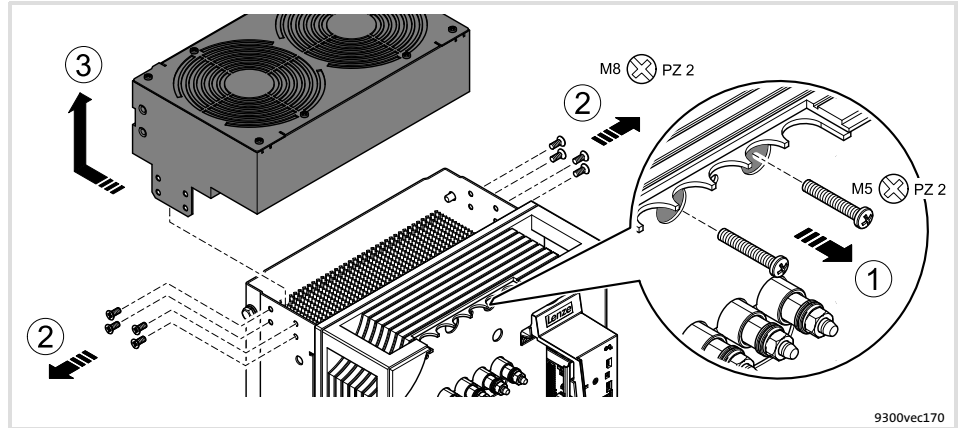

Fig. 4.3-3 Removing the fan module from the controller

1. Remove both screws.

The screws connect the fans to the supply voltage.

2. Remove the 4 screws for fixing the fan module on each side.

3. Pull back the fan module and carefully remove it to the top.

Make sure that the threaded sleeves do not touch the housing edge. They may break off.

Modifying the threaded sleeves on the fan module

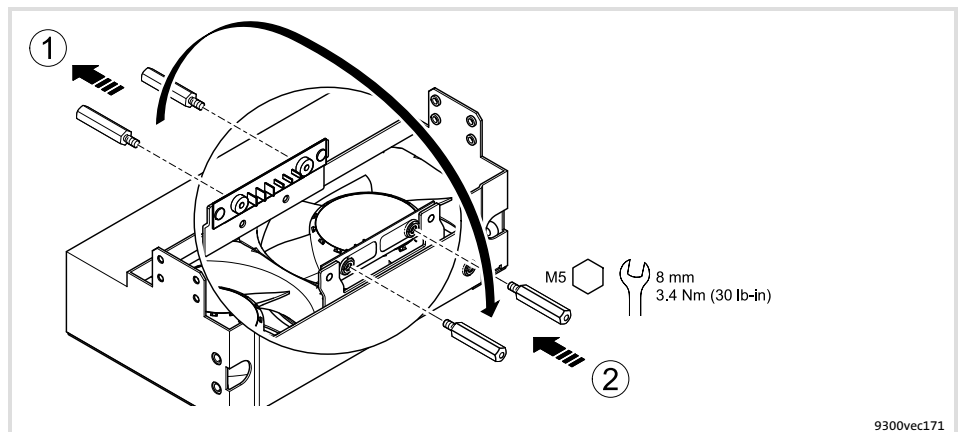

Fig. 4.3-4 Modifying the threaded sleeves for the voltage supply of the fans

1. Remove the threaded sleeves.

2. Screw-in the threaded sleeves on the opposite side and fasten them.

Plugging the fan connecting cable to another terminal on the fan module

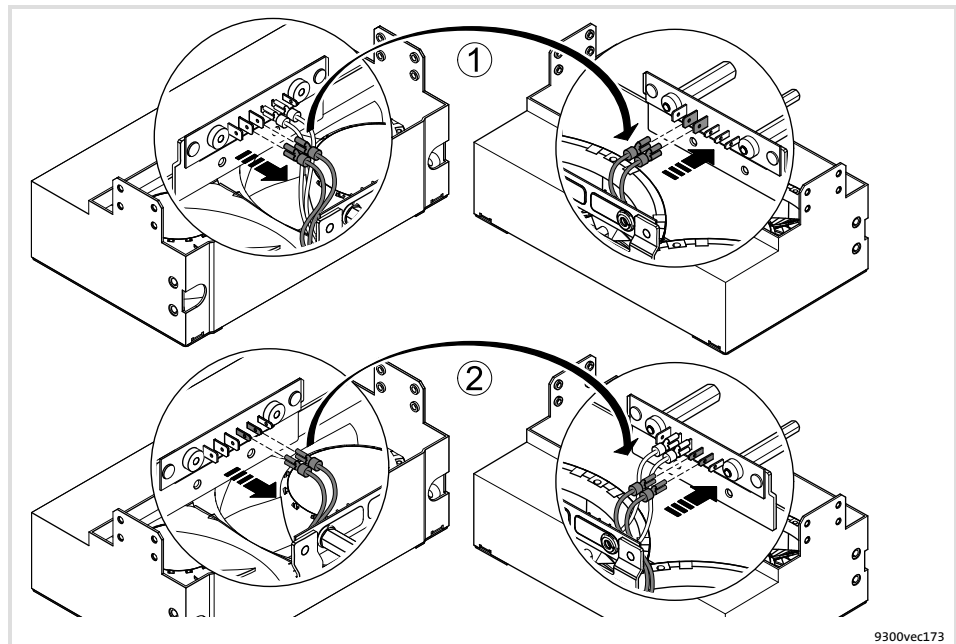

Fig. 4.3-5 Plugging the fan connecting cable for the voltage supply to another terminal

1. Remove the cable lugs of the two red connecting cables and plug them in again on the diagonally arranged side.
2. Remove the cable lugs of the two blue connecting cables and plug them in again on the diagonally arranged side.

Mounting the fan module in a manner rotated by 180°

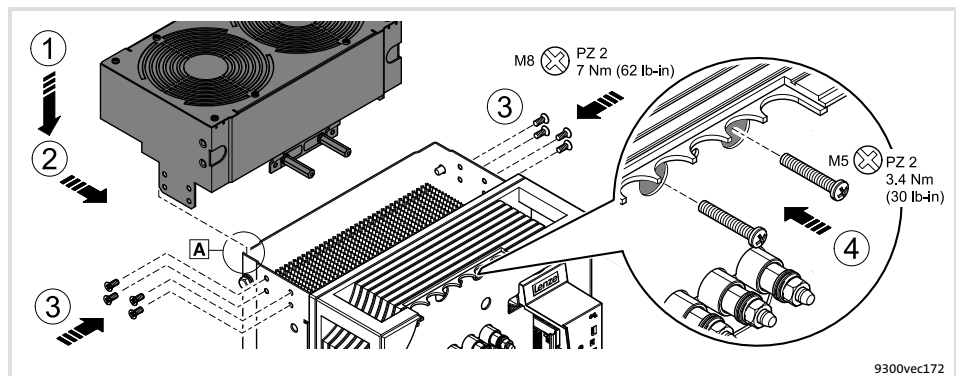

Fig. 4.3-6 Mounting the fan module on the controller

1. Place the fan module onto the controller. Insert the lugs at the back into the base plate **A**.
Make sure that the threaded sleeves do not touch the housing edge. They may break off.
2. Push the fan module to the front.
3. Screw-in and fasten the 4 screws for fixing the fan module on each side.
4. Screw-in and fasten the two screws for the supply voltage.

4.4 Standard devices in the power range 55 ... 75 kW

4.4.1 Important notes

The accessory kit is located inside the controller.

Remove the cover of the drive controller

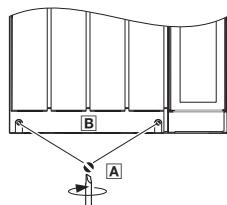

9300vec113

1. Remove the screws **A**
2. Lift cover **B** up and detach it

Mass of the devices

9300	Standard device	"Cold plate" device
Type	EVS93xx-ES [kg]	EVS93xx-CS [kg]
EVS9331-xS	59.0	–
EVS9332-xS	59.0	–

4 Installing of the standard device

4.4 Standard devices in the power range 55 ... 75 kW

4.4.2 Mounting with fixing brackets (standard)

4.4.2 Mounting with fixing brackets (standard)

Mounting material required from the scope of supply:

Description	Use	Quantity
Fixing bracket	Drive controller fixing	4
Hexagon head cap screw M8 × 16 mm (DIN 933)	For fixing bracket	8
Washer Ø 8.4 mm (DIN 125)	For hexagon head cap screw	8
Spring washer Ø 8 mm (DIN 127)	For hexagon head cap screw	8

Dimensions

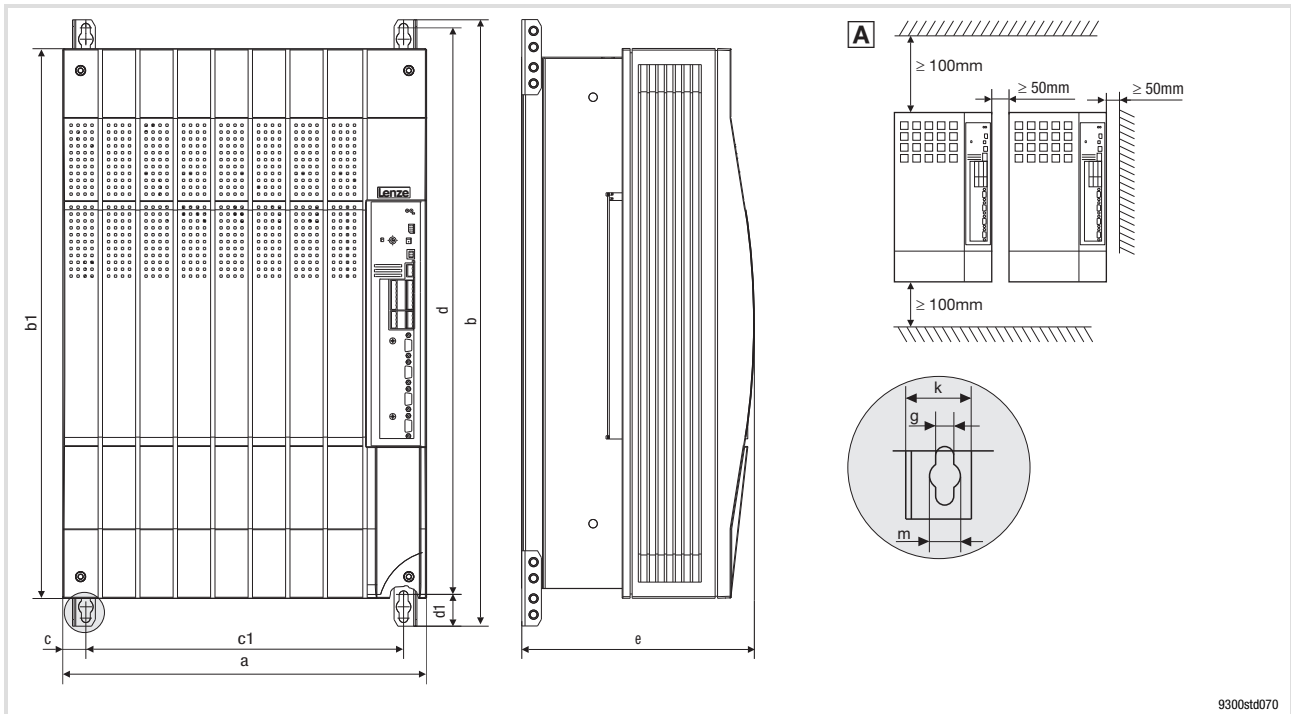

Fig. 4.4-1 Standard mounting with fixing brackets 55 ... 75 kW

- Ⓐ Arrange drive controllers in a row with spacing to be able to remove eye bolts

9300	Dimensions [mm]										
Type	a	b	b1	c	c1	d	d1	e ¹⁾	g	k	m
EVS9331-ES	450	750	680	28.5	393	702	38	285	11	28	18
EVS9332-ES											

¹⁾ For a fieldbus module plugged onto X1, consider mounting space for connecting cables

Mounting

- ▶ Attach the fixing brackets to the heatsink plate of the drive controller.

4.4.3 Thermally separated mounting (push-through technique)

For mounting in push-through technique, the drive controller of type EVS93xx-ESx must be used. In addition, the mounting set EJ0009 for the push-through technique is required.

Dimensions

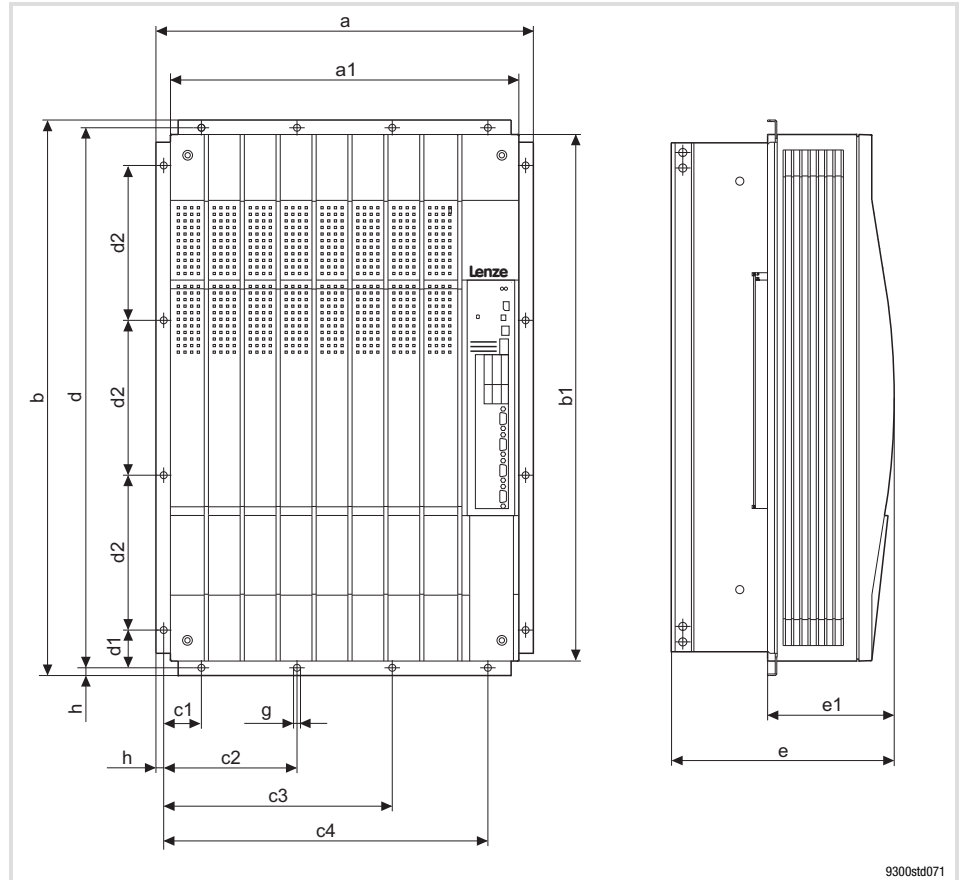

Fig. 4.4-2 Dimensions for thermally separated mounting 55 ... 75 kW

9300	Dimensions [mm]														
Typ	a	a1	b	b1	c1	c2	c3	c4	d	d1	d2	e ¹⁾	e1	g	h
EVS9331-ES	488	450	718	680	49	172.5	295.5	419	698	49	200	285	164	9	10
EVS9332-ES															

¹⁾ For a fieldbus module plugged onto X1, consider mounting space for connecting cables

Mounting cutout in control cabinet

9300	Dimensions [mm]	
Type	a1	b1
EVS9331-ES	428.5	660
EVS9332-ES		

5 Wiring of the standard device

Contents

5.1	Important notes	5.1-1
	5.1.1 Protection of persons	5.1-1
	5.1.2 Device protection	5.1-3
	5.1.3 Motor protection	5.1-3
5.2	Notes on project planning	5.2-1
	5.2.1 Supply forms / electrical supply conditions	5.2-1
	5.2.2 Operation on public supply systems (EN 61000-3-2)	5.2-1
	5.2.3 Controllers in the IT system	5.2-2
	5.2.4 Operation at earth-leakage circuit breaker (e.l.c.b.)	5.2-3
	5.2.5 Interaction with compensation equipment	5.2-3
	5.2.6 Discharge current for mobile systems	5.2-4
	5.2.7 Optimisation of the controller and mains load	5.2-5
	5.2.8 Reduction of noise emissions	5.2-6
	5.2.9 Mains choke/mains filter assignment	5.2-7
	5.2.10 Motor cable	5.2-8
5.3	Basics for wiring according to EMC	5.3-1
	5.3.1 Shielding	5.3-1
	5.3.2 Mains connection, DC supply	5.3-1
	5.3.3 Motor cable	5.3-1
	5.3.4 Control cables	5.3-3
	5.3.5 Installation in the control cabinet	5.3-4
	5.3.6 Wiring outside of the control cabinet	5.3-5
	5.3.7 Detecting and eliminating EMC interferences	5.3-6
5.4	Standard devices in the power range 0.37 ... 11 kW	5.4-1
	5.4.1 Wiring according to EMC (CE-typical drive system)	5.4-1
	5.4.2 Important notes	5.4-3
	5.4.3 Mains connection, DC supply	5.4-4
	5.4.4 Mains connection: Fuses and cable cross-sections	5.4-6
	5.4.5 Mains choke/mains filter assignment	5.4-7
	5.4.6 Motor connection	5.4-8
5.5	Standard devices in the power range 15 ... 30 kW	5.5-1
	5.5.1 Wiring according to EMC (CE-typical drive system)	5.5-1
	5.5.2 Important notes	5.5-3
	5.5.3 Mains connection, DC supply	5.5-3
	5.5.4 Mains connection: Fuses and cable cross-sections	5.5-5
	5.5.5 Mains choke/mains filter assignment	5.5-6
	5.5.6 Motor connection	5.5-7

5.6	Standard devices with a power of 45 kW	5.6-1
5.6.1	Wiring according to EMC (CE-typical drive system)	5.6-1
5.6.2	Important notes	5.6-3
5.6.3	Mains connection, DC supply	5.6-3
5.6.4	Mains connection: Fuses and cable cross-sections	5.6-5
5.6.5	Mains choke/mains filter assignment	5.6-6
5.6.6	Motor connection	5.6-7
5.7	Standard devices in the power range 55 ... 75 kW	5.7-1
5.7.1	Wiring according to EMC (CE-typical drive system)	5.7-1
5.7.2	Important notes	5.7-3
5.7.3	Mains connection, DC supply	5.7-3
5.7.4	Mains connection: Fuses and cable cross-sections	5.7-5
5.7.5	Mains choke/mains filter assignment	5.7-6
5.7.6	Motor connection	5.7-7
5.8	Control terminals	5.8-1
5.8.1	Important notes	5.8-1
5.8.2	Connection terminal of the control card	5.8-3
5.8.3	Device variant without "Safe torque off" function	5.8-4
5.8.4	Device variant with "Safe torque off" function	5.8-5
5.8.5	State bus	5.8-8
5.8.6	Terminal assignment	5.8-9
5.8.7	Technical data	5.8-10
5.9	Wiring of the system bus (CAN)	5.9-1
5.10	Wiring of the feedback system	5.10-1
5.10.1	Important notes	5.10-1
5.10.2	Resolver at X7	5.10-2
5.10.3	Incremental encoder with TTL level at X8	5.10-3
5.10.4	SinCos encoder at X8	5.10-4
5.11	Wiring of digital frequency input / digital frequency output	5.11-1
5.12	Communication modules	5.12-1

5.1 Important notes



Stop!

The drive controller contains electrostatically sensitive components.

The personnel must be free of electrostatic charge when carrying out assembly and service operations.

5.1.1 Protection of persons



Danger!

Before working on the controller, check that all power terminals are deenergised:

- ▶ The power terminals U, V, W, +U_G and -U_G remain live for at least 3 minutes after disconnection from the mains.
- ▶ The power terminals L1, L2, L3, U, V, W, +U_G and -U_G remain live when the motor is stopped.

Pluggable terminal strips

Connect or disconnect all pluggable terminals only in the deenergised state!

5 Wiring of the standard device

5.1 Important notes

5.1.1 Protection of persons

Electrical isolation

The terminals X1 and X5 have double (reinforced) insulation according to EN50178. The protection against accidental contact is ensured without additional measured being taken.



Danger!

- ▶ The terminals X3, X4, X6, X7, X8, X9, X10, X11 have basic insulation (single isolating distance).
- ▶ In the event of a defective isolating distance, protection against accidental contact can only be guaranteed by taking external measures such as double insulation.
- ▶ If an external DC 24 V voltage source is used, the insulation degree of the controller depends on the insulation degree of the voltage source.

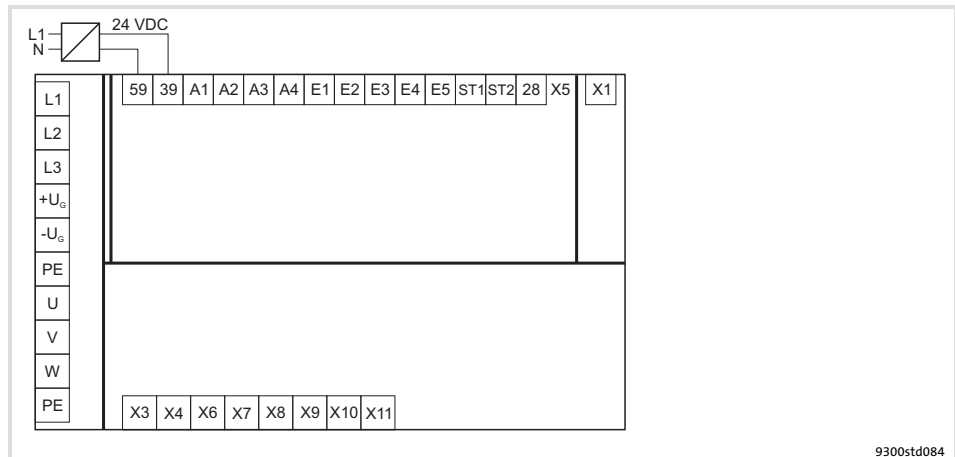

Fig. 5.1-1 Electrical isolation between power terminals, control terminals and housing

≡ Double (reinforced) insulation
— Basic insulation

Replacing defective fuses

Only replace defective fuses in the deenergised state to the type specified.

Disconnecting the controller from the mains

Only carry out the safety-related disconnection of the controller from the mains via a contactor on the input side or a manually operated toggle switch.

5.1.2 Device protection

- ▶ In the event of condensation, only connect the controller to the mains voltage after the humidity has evaporated.
- ▶ The controller is protected by external fuses.
- ▶ Drive controllers EVS9324-xS, EVS9326-xS and EVS9328-xS ... EVS9332-xS must only be operated with assigned mains choke / mains filter.
- ▶ Length of the screws for connecting the shield sheet for the control cables: **12 mm**.
- ▶ Provide unused control inputs and outputs with terminal strips. Cover unused Sub-D sockets with protective covers included in the scope of supply.
- ▶ Switching on the motor side of the controller is only permissible for safety shutdown (emergency-off).
- ▶ Frequent mains switching (e.g. inching mode via mains contactor) can overload and destroy the input current limitation of the drive controller:
 - At least 3 minutes must pass between switching off and restarting the devices EVS9321-xS and EVS9322-xS.
 - At least 3 minutes must pass between two starting procedures of the devices EVS9323-xS ... EVS9332-xS.
 - Use the "safe torque off" safety function (STO) if safety-related mains disconnections occur frequently. The drive variants Vxx4 are equipped with this function.

5.1.3 Motor protection

- ▶ Extensive protection against overload:
 - By overcurrent relays or temperature monitoring.
 - We recommend the use of PTC thermistors or thermostats to monitor the motor temperature.
 - PTC thermistors or thermostats can be connected to the controller.
 - For monitoring the motor, we recommend the use of the I²xt monitoring.
- ▶ Only use motors with an insulation suitable for the inverter operation:
 - Insulation resistance: min. $\hat{u} = 1.5 \text{ kV}$, min. $du/dt = 5 \text{ kV}/\mu\text{s}$
 - When using motors with an unknown insulation resistance, please contact your motor supplier.

5.2 Notes on project planning

5.2.1 Supply forms / electrical supply conditions

Observe the restrictions for the different supply forms!

Supply system	Operation of controller	Notes
Supply system: TT, TN (with earthed neutral)	Permitted without restrictions.	<ul style="list-style-type: none"> Observe the rated data of the controller RMS mains current: see chapter "Technical data".
Supply system: IT (with isolated neutral)	Possible if the controller is protected in the event of an earth fault in the supply system <ul style="list-style-type: none"> by means of suitable devices which detect the earth fault and immediately separate the controller from the supply system. 	<ul style="list-style-type: none"> Safe operation in the event of an earth fault at the inverter output cannot be guaranteed. The variants V024 / V104 and V100 enable operation of the controller on IT systems.
DC supply via +U _G /-U _G	Permitted if the DC voltage is symmetrical to PE.	Earthing of the +U _G or -U _G conductor will destroy the controller.

5.2.2 Operation on public supply systems (compliance with EN 61000-3-2)

European standard EN 61000-3-2 defines limit values for the limitation of harmonic currents in the supply system. Non-linear consumers (e.g. frequency inverters) generate harmonic currents which "pollute" the supplying mains and may therefore interfere with other consumers. The standard aims at assuring the quality of public supply systems and reducing the mains load.



Note!

The standard only applies to public systems. Mains which are provided with a transformer substation of their own as in industrial plants are not public and not included in the application range of the standard.

If a device or machine consists of several components, the limit values of the standard apply to the entire unit.

Measures for compliance with the standard

With the measures described, the controllers comply with the limit values according to EN 61000-3-2.

Operation on public supply systems	EN 61000-3-2	Limitation of harmonic currents
	Total power on the mains	Compliance with the requirements ¹⁾
	< 1 kW	With mains choke
	> 1 kW	No measures required

¹⁾ The additional measures mentioned have the effect that solely the controllers meet the requirements of EN 61000-3-2. The machine/system manufacturer is responsible for the compliance with the requirements for the machine/system!

5 Wiring of the standard device

5.2 Notes on project planning

5.2.3 Controllers in the IT system

5.2.3 Controllers in the IT system

Controllers in the V024, V104 or V100 variants are suitable for operation on insulated supply systems (IT systems). The controllers also have an insulated design. This avoids the activation of the insulation monitoring, even if several controllers are installed.

The electric strength of the controllers is increased so that damage to the controller are avoided if insulation or earth faults in the supply system occur. The operational reliability of the system remains intact.



Stop!

Only operate the controllers with the mains chokes assigned.

Operation with mains filters or RFI filters by Lenze is not permitted, as these modules contain components that are interconnected against PE. By this the protective design of the IT system would be cancelled out. The components are destroyed in the case of an earth fault.

Protect the IT system against earth fault at the controller.

Due to physical conditions, an earth fault on the motor side at the controller can interfere with or damage other devices on the same IT system. Therefore appropriate measures have to be implemented, by means of which the earth fault is detected and which disconnect the controller from the mains.

Permissible supply forms and electrical supply conditions

Mains	Operation of the controllers	Notes
With isolated star point (IT systems)	Possible, if the controller is protected in the event of an earth fault in the supplying mains. <ul style="list-style-type: none">• Possible, if appropriate earth fault detections are available and• the controller is immediately disconnected from the mains.	Safe operation in the event of an earth fault at the inverter output cannot be guaranteed.

DC-bus operation of several drives

Central supply with 9340 regenerative power supply module is not possible.

Installation of the CE-typical drive system

For the installation of drives on IT systems, the same conditions apply as for the installation on systems with an earthed neutral point.

According to the binding EMC product standard EN61800-3, no limit values are defined for IT systems for noise emission in the high-frequency range.

5.2.4 Operation at earth-leakage circuit breaker (e.l.c.b.)



Danger!

The controllers are internally fitted with a mains rectifier. In case of a short circuit to frame a pulsating DC residual current can prevent the AC sensitive or pulse current sensitive earth-leakage circuit breakers from being activated, thus cancelling the protective function for the entire equipment being operated on this earth-leakage circuit breaker.

- ▶ For the protection of persons and farm animals (DIN VDE 0100), we recommend
 - pulse current sensitive earth-leakage circuit breakers for plants including controllers with a single-phase mains connection (L1/N).
 - universal-current sensitive earth-leakage circuit breakers for plants including controllers with a three-phase mains connection (L1/L2/L3).
- ▶ Only install the earth-leakage circuit breaker between supplying mains and drive controller.
- ▶ Earth-leakage circuit breakers may trigger a false alarm due to
 - capacitive compensation currents flowing in the cable shields during operation (particularly with long, shielded motor cables),
 - simultaneous connection of several inverters to the mains
 - the use of additional interference filters.

5.2.5 Interaction with compensation equipment

- ▶ Controllers only consume very little reactive power of the fundamental wave from the AC supply mains. Therefore, a compensation is not required.
- ▶ If the controllers are connected to a supply system with compensation equipment, this equipment must comprise chokes.
 - For this, contact the supplier of the compensation equipment.

5.2.6 Discharge current for mobile systems

Frequency inverters with internal or external RFI filters usually have a discharge current to PE potential that is higher than 3.5 mA AC or 10 mA DC. Therefore, fixed installation as protection is required (see EN 61800-5-1). This must be indicated in the operational documents.

If a fixed installation is not possible for a mobile consumer although the discharge current to PE potential is higher than 3.5 mA AC or 10 mA DC, an additional two-winding transformer (isolating transformer) can be included in the current supply as a suitable countermeasure. Here, the PE conductor is connected to the PEs of the drive (filter, inverter, motor, shieldings) and also to one of the poles of the secondary winding of the isolating transformer.

Devices with a three-phase supply must have a corresponding isolating transformer with a secondary star connection, the star point being connected to the PE conductor.

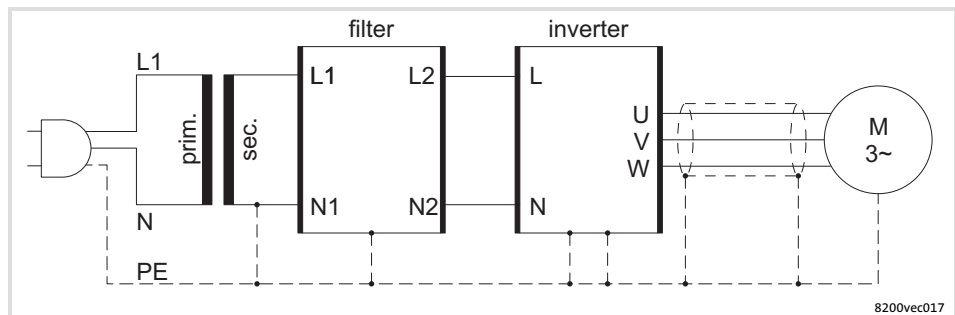

Fig. 5.2-1 Installation of a two-winding transformer (isolating transformer)

5.2.7 Optimisation of the controller and mains load

A mains choke is an inductance which can be included in the mains cable of the frequency inverter. As a result, the load of the supplying mains and the controller is optimised:

- ▶ **Reduced system perturbation:** The curved shape of the mains current approaches a sinusoidal shape.
- ▶ **Reduced mains current:** The effective mains current is reduced, i.e. the mains, cable, and fuse loads are reduced.
- ▶ **Increased service life of the controller:** The electrolytic capacitors in the DC bus have a considerably increased service life due to the reduced AC current load.

There are no restrictions for the combinations of mains chokes and RFI filters and/or motor filters. Alternatively, a mains filter can be used (combination of mains choke and RFI filter in a common housing).



Note!

- ▶ Some controllers must generally be operated with a mains choke or a mains filter.
- ▶ If a mains choke or a mains filter is used, the maximum possible output voltage does not reach the value of the mains voltage (typical voltage drop at the rated point 4 ... 6 %).

5.2.8 Reduction of noise emissions

Due to internal switching operations, every controller causes noise emissions which may interfere with the functions of other consumers. Depending on the site of the frequency inverter, European standard EN 61800-3 defines limit values for these noise emissions:

Limit class C2: Limit class C2 is often required for industrial mains which are isolated from the mains of residential areas.

Limit class C1: If the controller is operated in a residential area, it may interfere with other devices such as radio and television receivers. Here, interference suppression measures according to limit class C1 are often required.

Limit class C1 is much more strict than limit class C2. Limit class C1 includes limit class C2.

For compliance with limit class C1 / C2, corresponding measures for the limitation of noise emissions are required, e.g. the use of RFI filters.

There are no restrictions for the combinations of RFI filters and mains chokes and/or motor filters. Alternatively, a mains filter can be used (combination of mains choke and RFI filter in a common housing).

The selection of the frequency inverter and the corresponding filters, if applicable, always depends on the application in question and is determined by e.g. the switching frequency of the controller, the motor cable length, or the protective circuit (e.g. earth-leakage circuit breakers).



Note!

- ▶ Some controllers must generally be operated with a mains choke or a mains filter.
- ▶ If a mains choke or a mains filter is used, the maximum possible output voltage does not reach the value of the mains voltage (typical voltage drop at the rated point 4 ... 6 %).

The graphics below illustrates the maximum possible motor cable length based on the type of filter and the resulting interference voltage category according to EN 61800-3. Depending on the used motor cable, the used controller, and its switching frequency, the mentioned maximum motor cable lengths may vary.

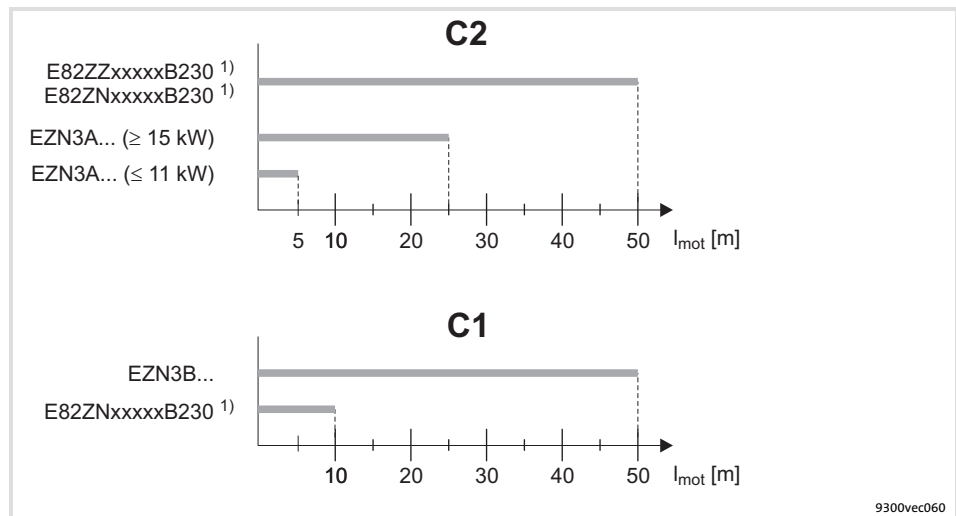

Fig. 5.2-2 Maximum motor cable lengths l_{mot} based on the type of filter for compliance with limit class C2 / C1

1) Use low-capacitance cables

5.2.9 Mains choke/mains filter assignment

9300	Mains choke	Interference voltage category according to EN 61800-3 and motor cable length			
		Component C2		Component C1	
Type			max. [m]		max. [m]
EVS9321-xS	EZN3A2400H002	EZN3A2400H002	5	EZN3B2400H002	50
EVS9322-xS	EZN3A1500H003	EZN3A1500H003	5	EZN3B1500H003	50
EVS9323-xS	EZN3A0900H004	EZN3A0900H004	5	EZN3B0900H004	50
EVS9324-xS	EZN3A0500H007	EZN3A0500H007	5	EZN3B0500H007	50
EVS9325-xS	EZN3A0300H013	EZN3A0300H013	5	EZN3B0300H013	50
EVS9326-xS	ELN3-0150H024-001	EZN3A0150H024	5	EZN3B0150H024	50
EVS9327-xS	ELN3-0088H035-001	EZN3A0110H030	25	E82ZN22334B230	10
				E82ZZ15334B230 ¹⁾	10
		E82ZN22334B230	50	EZN3B0110H030U ²⁾	50
		E82ZZ15334B230 ¹⁾	50		
EVS9328-xS	ELN3-0075H045	EZN3A0080H042	25	E82ZN22334B230	10
		E82ZN22334B230	50	EZN3B0080H042	50
EVS9329-xS	ELN3-0055H055	EZN3A0055H060	25	E82ZN30334B230	10
		E82ZN30334B230	50	EZN3B0055H060	50
EVS9330-xS	ELN3-0038H085	EZN3A0030H110	25	EZN3B0030H110	50
		EZN3A0030H110N001 ³⁾	25		
		E82ZN55334B230	50		
EVS9331-xS	ELN3-0027H105	EZN3A0022H150	25	E82ZN75334B230	10
		E82ZN75334B230	50	EZN3B0022H150	50
EVS9332-xS	ELN3-0022H130	EZN3A0022H150	25	E82ZN75334B230	10
		E82ZN75334B230	50	EZN3B0022H150	50

- 1) RFI filter
- 2) Footprint filter
- 3) For controllers with thermal separation

5 Wiring of the standard device

5.2 Notes on project planning

5.2.10 Motor cable

5.2.10 Motor cable

Specification

- ▶ The used motor cables must
 - meet the requirements on site (e.g. EN 60204-1, UL),
 - comply with the following voltage data: EN 0.6/1 kV, UL 600 V.
- ▶ For shielded motor cables, only use cables with braid made of tinned or nickel-plated copper. Shields made of steel braid are not suitable.
 - The overlap rate of the braid must be at least 70 % with an overlap angle of 90°.
- ▶ Use low-capacitance motor cables:

Power class	Capacitance per unit length	
	Core/core	Core/shield
3 ... 11 kW	from 2.5 mm ² ≤100 pF/m	≤ 150 pF/m
15 ... 30 kW	≤ 140 pF/m	≤ 230 pF/m
45 ... 55 kW	≤ 190 pF/m	≤ 320 pF/m
75 ... 90 kW	≤ 250 pF/m	≤ 410 pF/m

Cable length

9300	Maximum permissible motor cable length			
	U _r = 400 V		U _r = 480 V	
	f _{chop} = 8 kHz	f _{chop} = 16 kHz	f _{chop} = 8 kHz	f _{chop} = 16 kHz
Type				
EVS9321-xS, EVS9322-xS	50 m	45 m	50 m	25 m
EVS9323-xS ... EVS9332-xS	50 m	50 m	50 m	50 m



Note!

- ▶ The motor cable must be as short as possible for having a positive effect on the drive behaviour.
- ▶ If EMC requirements must be met, the permissible cable length may be affected.
- ▶ EVS9321-xS and EVS9322-xS: At a mains voltage of 480 V and a switching frequency f_{chop} = 16 kHz, the maximum permissible cable length is reduced if the motor cable has more than a single core:
 - The following holds true for two parallel single cores:
l_{max} = 17 m
 - The following holds true for three parallel single cores:
l_{max} = 9 m

Cable cross-section

**Note!**

The cable cross-sections have been assigned to the permissible current loading of the motor cables under the following conditions:

- ▶ Compliance with IEC/EN 60204-1 for fixed cable installation
- ▶ Compliance with IEC 60354-2-52, table A.52-5 when using the cable in a trailing cable
- ▶ Laying system C
- ▶ Ambient temperature 45 °C
- ▶ Continuous motor operation at a
 - standstill current I_0 for servo motors or a
 - rated current I_R for three-phase asynchronous motors

The user is responsible for selecting a motor cable which complies with the requirements of the current conditions if different situations arise. Different situations may arise due to:

- ▶ Laws, standards, national and regional regulations
- ▶ Type of application
- ▶ Motor utilisation
- ▶ Ambient and operating conditions
- ▶ Laying system and bundling of cables
- ▶ Cable type

Motor cable		Cable cross-section	
permanently installed	for trailing cable	[mm ²]	[AWG]
I_M [A]	I_M [A]		
10.0	11.8	1.0	18
13.8	17.3	1.5	16
19.1	23.7	2.5	14
25.5	30.9	4.0	12
32.8	41.0	6.0	10
45.5	55.5	10	8
60.1	75.5	16	6
76.4	92.8	25	4
94.6	115	35	2
114	140	50	1
146	179	70	00
177	217	95	000
205	252	120	0000

**Note!**

Information on the design of the motor cable is provided in the "System cables and system connectors" manual.

5.3 Basics for wiring according to EMC

5.3.1 Shielding

The quality of shielding is determined by a good shield connection:

- ▶ Connect the shield with a large surface.
- ▶ Connect the shield directly to the intended shield sheet of the device.
- ▶ In addition, connect the shield to the conductive and earthed mounting plate with a large contact surface by using a conductive clamp.
- ▶ Unshielded cable ends must be as short as possible.

5.3.2 Mains connection, DC supply

- ▶ Controllers, mains chokes, or mains filters may only be connected to the mains via unshielded single cores or unshielded cables.
- ▶ When a mains filter or RFI filter is used, shield the cable between mains filter or RFI filter and controller if its length exceeds 300 mm. Unshielded cores must be twisted.
- ▶ In DC-bus operation or DC supply, use shielded cables.
- ▶ The cable cross-section must be dimensioned for the assigned fusing (observe national and regional regulations).

5.3.3 Motor cable

- ▶ Only use shielded motor cables with braids made of tinned or nickel-plated copper. Shields made of steel braids are not suitable.
 - The overlap rate of the braid must be at least 70 % with an overlap angle of 90 °.
- ▶ The cables used must correspond to the requirements at the location (e.g. EN 60204-1).
- ▶ Shield the cable for motor temperature monitoring (PTC or thermal contact) and install it separately from the motor cable.
 - In Lenze system cables, the cable for brake control is integrated into the motor cable. If this cable is not required for brake control, it can also be used to connect the motor temperature monitoring up to a length of 50 m.
- ▶ Connect the shield with a large surface and fix it with metal cable binders or a conductive clamp.
- ▶ Connect the shield directly to the corresponding device shield sheet.
 - If required, additionally connect the shield to the conductive and earthed mounting plate in the control cabinet.
- ▶ The motor cable is optimally installed if
 - it is separated from mains cables and control cables,
 - it only crosses mains cables and control cables at right angles,

- it is not interrupted.
- ▶ If the motor cable must be opened all the same (e.g. due to chokes, contactors, or terminals):
 - The unshielded cable ends may not be longer than 100 mm (depending on the cable cross-section).
 - Install chokes, contactors, terminals etc. spatially separated from other components (with a min. distance of 100 mm).
 - Install the shield of the motor cable directly before and behind the point of separation to the mounting plate with a large surface.
- ▶ Connect the shield with a large surface to PE in the terminal box of the motor at the motor housing.
 - Metal EMC cable glands at the motor terminal box ensure a large surface connection of the shield with the motor housing.

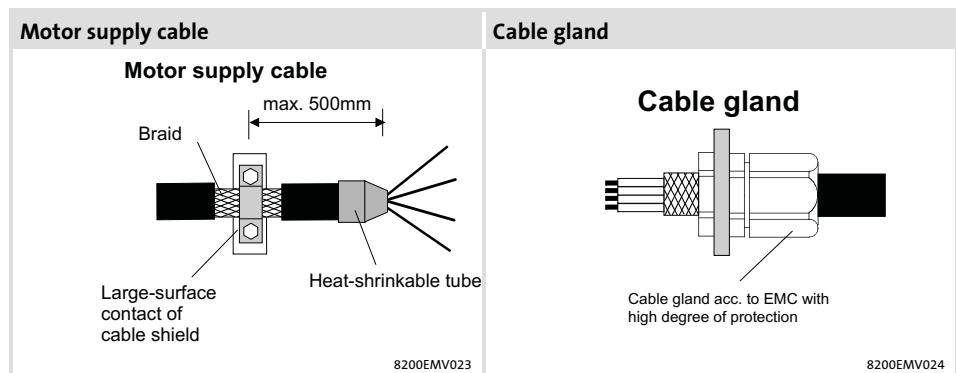

Fig. 5.3-1 Shielding of the motor cable

5.3.4 Control cables

- ▶ Control cables must be shielded to minimise interference injections.
- ▶ For lengths of 200 mm and more, use only shielded cables for analog and digital inputs and outputs. Under 200 mm, unshielded but twisted cables may be used.
- ▶ Connect the shield correctly:
 - The shield connections of the control cables must be at a distance of at least 50 mm from the shield connections of the motor cables and DC cables.
 - Connect the shield of digital input and output cables at both ends.
 - Connect the shield of analog input and output cables at one end (at the drive controller).
- ▶ To achieve an optimum shielding effect (in case of very long cables, with high interference) one shield end of analog input and output cables can be connected to PE potential via a capacitor (e.g. 10 nF/250 V) (see sketch).

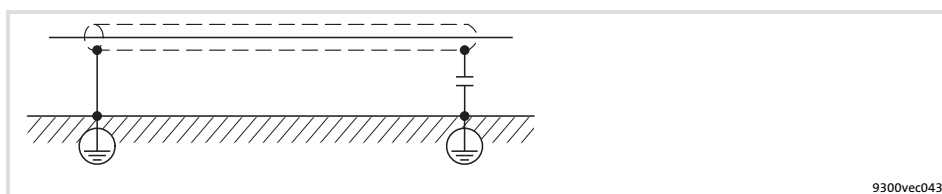

Fig. 5.3-2 Shielding of long, analog control cables

5 Wiring of the standard device

5.3 Basics for wiring according to EMC

5.3.5 Installation in the control cabinet

5.3.5 Installation in the control cabinet

- Mounting plate requirements**
- ▶ Only use mounting plates with conductive surfaces (zinc-coated or V2A-steel).
 - ▶ Painted mounting plates are not suitable even if the paint is removed from the contact surfaces.
 - ▶ If several mounting plates are used, ensure a large-surface connection between the mounting plates (e.g. by using earthing strips).
- Mounting of the components**
- ▶ Connect controllers, filters, and chokes to the earthed mounting plate with a surface as large as possible.
- Optimum cable routing**
- ▶ The motor cable is optimally installed if
 - it is separated from mains cables and control cables,
 - it crosses mains cables and control cables at right angles.
 - ▶ Always install cables close to the mounting plate (reference potential), as freely suspended cables act like aerials.
 - ▶ Lead the cables to the terminals in a straight line (avoid tangles of cables).
 - ▶ Use separated cable channels for motor cables and control cables. Do not mix up different cable types in one cable channel.
 - ▶ Minimise coupling capacities and coupling inductances by avoiding unnecessary cable lengths and reserve loops.
 - ▶ Short-circuit unused cores to the reference potential.
 - ▶ Install the positive and negative wires for DC 24 V close to each other over the entire length to avoid loops.
- Earth connections**
- ▶ Connect all components (drive controllers, chokes, filters) to a central earthing point (PE rail).
 - ▶ Set up a star-shape earthing system.
 - ▶ Comply with the corresponding minimum cable cross-sections.

5.3.6 Wiring outside of the control cabinet

Notes for cable routing outside the control cabinet:

- ▶ The longer the cables the greater the space between the cables must be.
- ▶ If cables for different signal types are routed in parallel, the interferences can be minimized by means of a metal barrier or separated cable ducts.

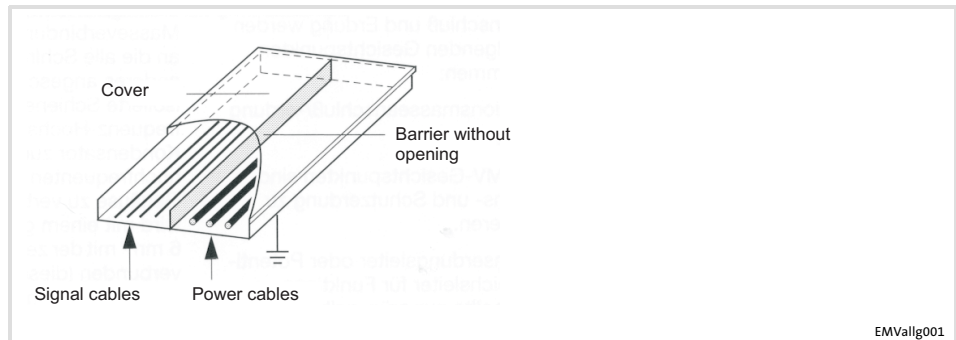

Fig. 5.3-3 Cable routing in the cable duct with barrier

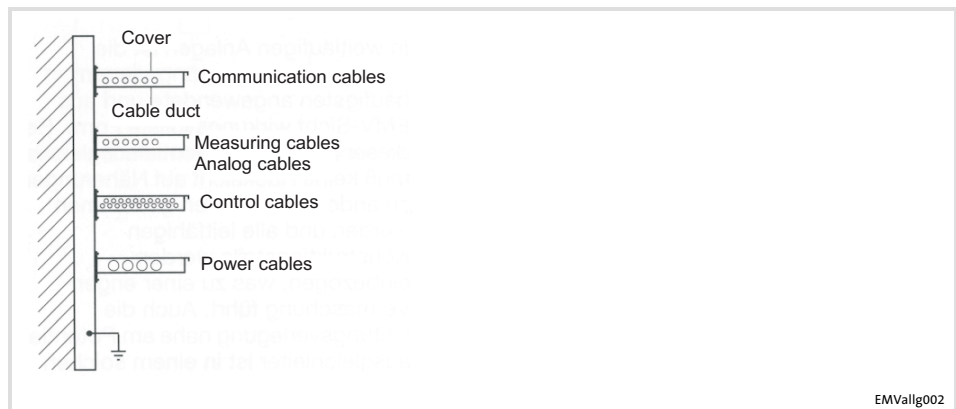

Fig. 5.3-4 Cable routing in separated cable ducts

5.3.7 Detecting and eliminating EMC interferences

Fault	Cause	Remedy
Interferences of analog setpoints of your own or other devices and measuring systems	Unshielded motor cable	Use shielded motor cable
	Shield contact is not extensive enough	Carry out optimal shielding as specified
	Shield of the motor cable is interrupted by terminal strips, switched, etc.	<ul style="list-style-type: none"> • Separate components from other component part with a minimum distance of 100 mm • Use motor choke/motor filter
	Install additional unshielded cables inside the motor cable (e.g. for motor temperature monitoring)	Install and shield additional cables separately
	Too long and unshielded cable ends of the motor cable	Shorten unshielded cable ends to maximally 40 mm
Conducted interference level is exceeded on the supply side	Terminal strips for the motor cable are directly located next to the mains terminals	Spatially separate the terminal strips for the motor cable from main terminals and other control terminals with a minimum distance of 100 mm
	Mounting plate varnished	Optimise PE connection: <ul style="list-style-type: none"> • Remove varnish • Use zinc-coated mounting plate
	HF short circuit	Check cable routing

5.4 Standard devices in the power range 0.37 ... 11 kW**5.4.1 Wiring according to EMC (CE-typical drive system)**

The drives comply with the EC Directive on "Electromagnetic Compatibility" if they are installed in accordance with the specifications for the CE-typical drive system. The user is responsible for the compliance of the machine application with the EC Directive.

**Note!**

Observe the notes given in the chapter "Basics for wiring according to EMC"!

5

Wiring of the standard device

5.4

Standard devices in the power range 0.37 ... 11 kW

5.4.1

Wiring according to EMC (CE-typical drive system)

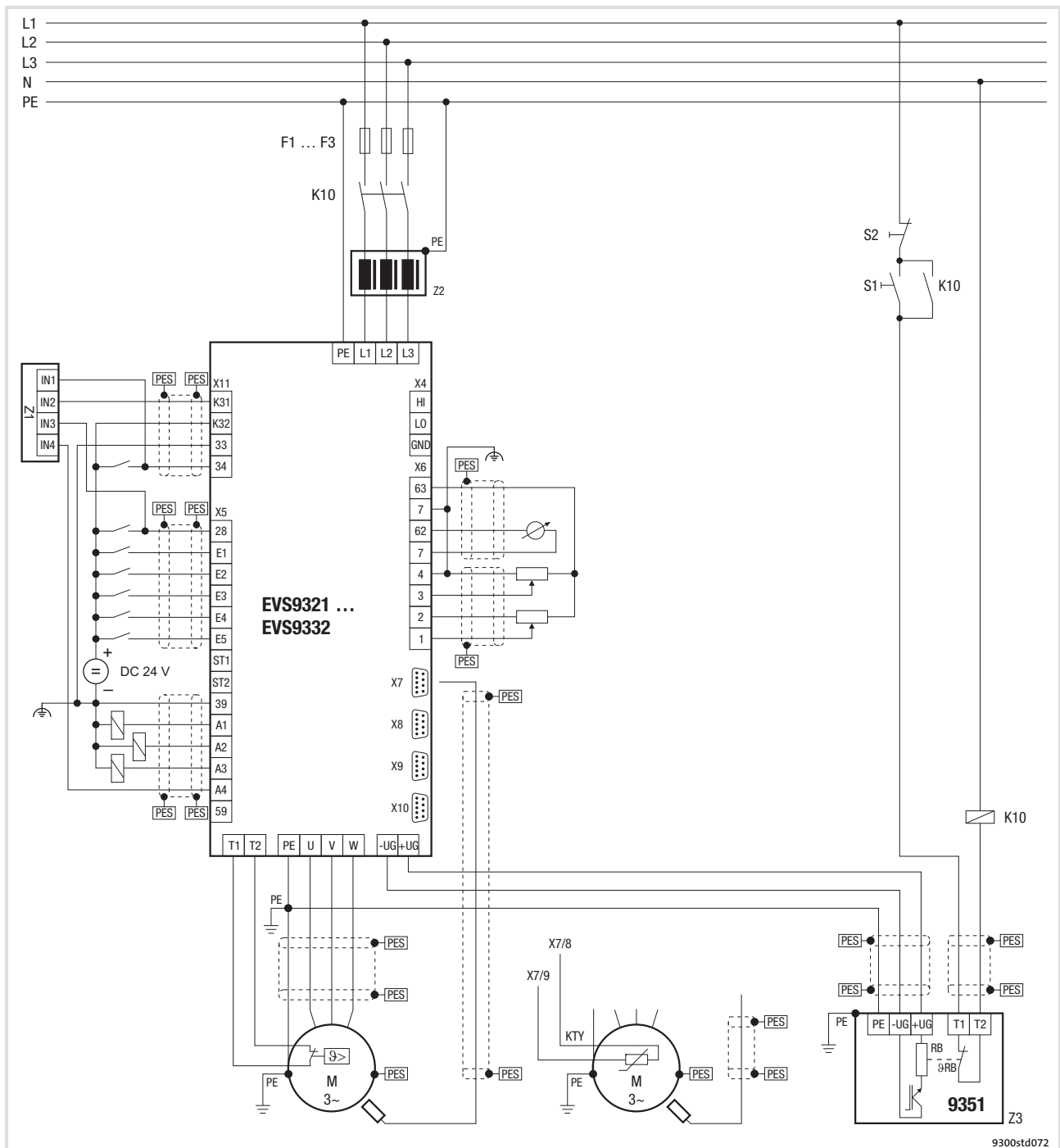

9300std072

Fig. 5.4-1 Example for wiring in accordance with EMC regulations

F1 ... F3	Fuses
K10	Mains contactor
Z1	Programmable logic controller (PLC)
Z2	Mains choke or mains filter
Z3	EMB9351-E brake module
S1	Mains contactor on
S2	Mains contactor off
+UG, -UG	DC-bus connection
PES	HF shield termination through large-surface connection to PE

5.4.2 Important notes

To gain access to the power connections, remove the covers:

- ▶ Release the cover for the mains connection with slight pressure on the front and pull it off to the top.
- ▶ Release the cover for the motor connection with slight pressure on the front and pull it off to the bottom.

Installation material required from the scope of supply:

Description	Use	Quantity
Shield connection support	Support of the shield sheets for the supply cable and motor cable	2
Hexagon nut M5	Fastening of shield connection supports	4
Spring washer \varnothing 5 mm (DIN 127)		2
Serrated lock washer \varnothing 5.3 mm (DIN 125)		2
Shield sheet	Shield connections for supply cables, motor cable	2
Screw and washer assembly M4 \times 10 mm (DIN 6900)	Fastening of shield sheets	4

5.4.3

Mains connection, DC supply

**Note!**

- ▶ If a mains filter or RFI filter is used and the cable length between mains/RFI filter and drive controller exceeds 300 mm, install a shielded cable.
- ▶ For DC-bus operation or DC supply, we recommend using shielded DC cables.

Shield sheet installation

**Stop!**

- ▶ To avoid damaging the PE stud, always install the shield sheet and the PE connection in the order displayed. The required parts are included in the accessory kit.
- ▶ Do not use lugs as strain relief.

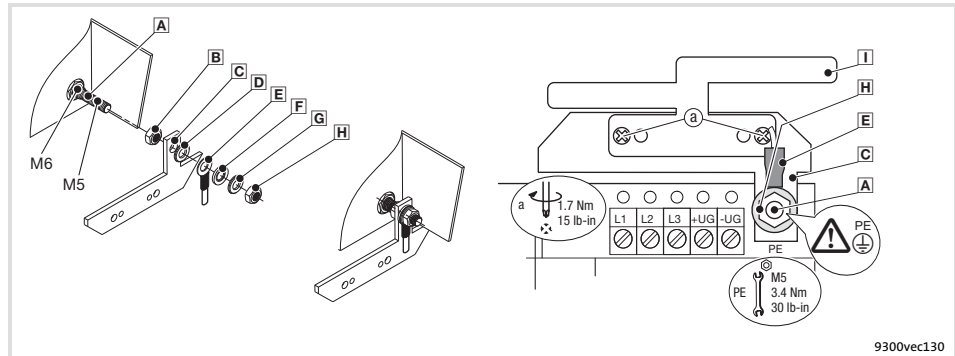

Fig. 5.4-2 Installation of shield sheet for drive controllers 0.37 ... 11 kW

- A PE stud
- B Screw on M5 nut and tighten hand-tight
- C Slide on fixing bracket for shield sheet
- D Slide on serrated lock washer
- E Slide on PE cable with ring cable lug
- F Slide on washer
- G Slide on spring washer
- H Screw on M5 nut and tighten it
- I Screw shield sheet on fixing bracket with two M4 screws (a)

Mains connection, DC supply

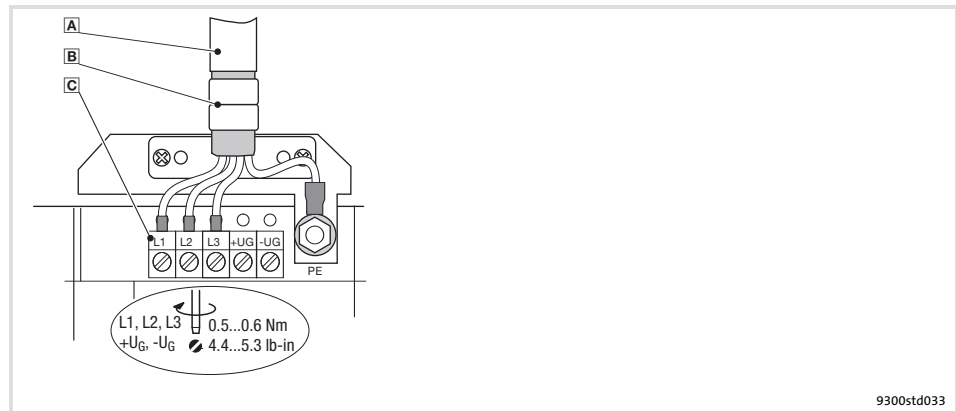

Fig. 5.4-3 Mains connection, DC supply for drive controllers 0.37 ... 11 kW

A Mains cable

B Shield sheet

Securely clamp mains cable with the lugs

C Mains and DC bus connection

L1, L2, L3: Connection of mains cable

+UG, -UG: Connection of DC-bus components or connection of the controller in the DC-bus system (see system manual)

Cable cross-sections up to 4 mm²: Use wire end ferrules for flexible cables

Cable cross-sections > 4 mm²: Use pin-end connectors

5 Wiring of the standard device

5.4 Standard devices in the power range 0.37 ... 11 kW

5.4.4 Mains connection: Fuses and cable cross-sections

5.4.4 Mains connection: Fuses and cable cross-sections

Installation in accordance with EN 60204-1

Supply conditions	
Range	Description
Fuses	<ul style="list-style-type: none"> Utilisation category: only gG/gL or gRL
Cables	Laying systems B2 and C: Use of PVC-insulated copper cables, conductor temperature < 70 °C, ambient temperature < 40 °C, no bundling of the cables or cores, three loaded cores. The data are recommendations. Other dimensionings/laying systems are possible (e.g. in accordance with VDE 0298-4).
RCCB	<ul style="list-style-type: none"> Controllers can cause a DC current in the PE conductor. If a residual current device (RCD) or a fault current monitoring unit (RCM) is used for protection in the case of direct or indirect contact, only one RCD/RCM of the following type can be used on the current supply side: <ul style="list-style-type: none"> Type B (universal-current sensitive) for connection to a three-phase system Type A (pulse-current sensitive) or type B (universal-current sensitive) for connection to a 1-phase system Alternatively another protective measure can be used, like for instance isolation from the environment by means of double or reinforced insulation, or isolation from the supply system by using a transformer. Earth-leakage circuit breakers must only be installed between mains supply and controller.

Observe all national and regional regulations!

9300	Rated fuse current		Cable cross-section		FI ¹⁾
	Fuse	Circuit-breaker	Laying system L1, L2, L3, PE		
			B2	C	
Type	[A]	[A]	[mm ²]	[mm ²]	[mA]
Operation without mains choke/mains filter					
EVS9321-xS	6	C6, B6 ²⁾	1	1	300
EVS9322-xS	6	C6, B6 ²⁾	1	1	
EVS9323-xS	10	B10	1.5	1	
EVS9325-xS	25	B20	4	2.5	
Operation with mains choke/mains filter					
EVS9321-xS	6	C6, B6 ²⁾	1	1	300
EVS9322-xS	6	C6, B6 ²⁾	1	1	
EVS9323-xS	10	B10	1.5	1	
EVS9324-xS	10	B10	1.5	1	
EVS9325-xS	20	B16	2.5	2.5	
EVS9326-xS	32	B25	–	4	

¹⁾ Universal current-sensitive earth-leakage circuit breaker

²⁾ For short-time mains interruptions, use circuit breakers with tripping characteristic "C"

Installation to UL

Supply conditions	
Range	Description
Fuses	<ul style="list-style-type: none"> Only in accordance with UL 248 System short-circuit current up to 5000 A_{rms} : All classes are permissible System short-circuit current up to 50000 A_{rms} : Only classes "CC", "J", "T" or "R" permissible
Cables	<ul style="list-style-type: none"> Only in accordance with UL The cable cross-sections specified in the following apply under the following conditions: <ul style="list-style-type: none"> Conductor temperature < 60 °C Ambient temperature < 40 °C

Observe all national and regional regulations!

9300	Rated fuse current	Cable cross-section
Type	Fuse [A]	L1, L2, L3, PE [AWG]

Operation without mains choke/mains filter

EVS9321-xS	6	18
EVS9322-xS	6	18
EVS9323-xS	10	16
EVS9325-xS	25	10

Operation with mains choke/mains filter

EVS9321-xS	6	18
EVS9322-xS	6	18
EVS9323-xS	10	16
EVS9324-xS	10	16
EVS9325-xS	25	10
EVS9326-xS	25	10

Max. connection cross-section of the terminal strip: AWG 12, with pin-end connector AWG 10

5.4.5 Mains choke/mains filter assignment

9300	Mains choke	Interference voltage category according to EN 61800-3 and motor cable length			
		Component C2		Component C1	
Type			max. [m]		max. [m]
EVS9321-xS	EZN3A2400H002	EZN3A2400H002	5	EZN3B2400H002	50
EVS9322-xS	EZN3A1500H003	EZN3A1500H003	5	EZN3B1500H003	50
EVS9323-xS	EZN3A0900H004	EZN3A0900H004	5	EZN3B0900H004	50
EVS9324-xS	EZN3A0500H007	EZN3A0500H007	5	EZN3B0500H007	50
EVS9325-xS	EZN3A0300H013	EZN3A0300H013	5	EZN3B0300H013	50
EVS9326-xS	ELN3-0150H024-001	EZN3A0150H024	5	EZN3B0150H024	50

5

Wiring of the standard device

5.4

Standard devices in the power range 0.37 ... 11 kW

5.4.6

Motor connection

5.4.6

Motor connection



Note!

- ▶ Fusing the motor cable is not required.
- ▶ The drive controller features 2 connections for motor temperature monitoring:
 - Terminals T1, T2 for connecting a PTC thermistor or thermal contact (NC contact).
 - Pins X8/5 and X8/8 of the incremental encoder input (X8) for connecting a KTY thermal sensor.

Shield sheet installation



Stop!

- ▶ To avoid damaging the PE stud, always install the shield sheet and the PE connection in the order displayed. The required parts are included in the accessory kit.
- ▶ Do not use lugs as strain relief.

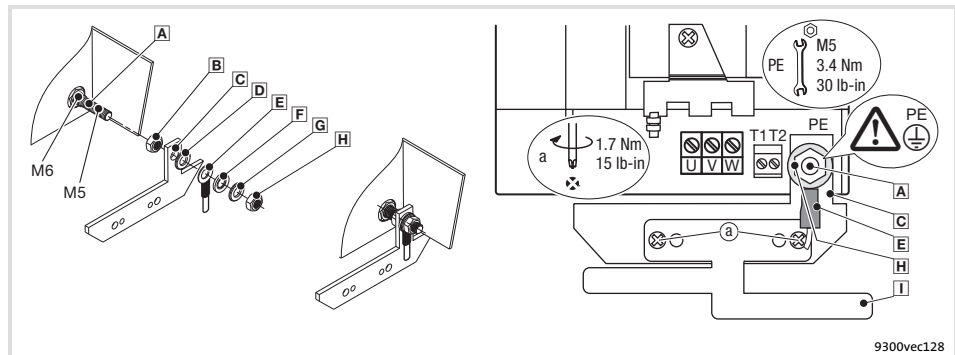

Fig. 5.4-4 Installation of shield sheet for drive controllers 0.37 ... 11 kW

- A PE stud
- B Screw on M5 nut and tighten hand-tight
- C Slide on fixing bracket for shield sheet
- D Slide on serrated lock washer
- E Slide on PE cable with ring cable lug
- F Slide on washer
- G Slide on spring washer
- H Screw on M5 nut and tighten it
- I Screw shield sheet on fixing bracket with two M4 screws (a)

Motor with PTC thermistor or thermal contact (NC contact)

Wire T1, T2 only if the motor is equipped with a PTC thermistor or thermal contact (NC contact).

- ▶ An "open" cable acts like an antenna and can cause faults on the drive controller.



Danger!

- ▶ All control terminals only have basic insulation (single isolating distance) after connecting a PTC thermistor or a thermal contact.
- ▶ Protection against accidental contact in case of a defective isolating distance is only guaranteed through external measures, e.g. double insulation.

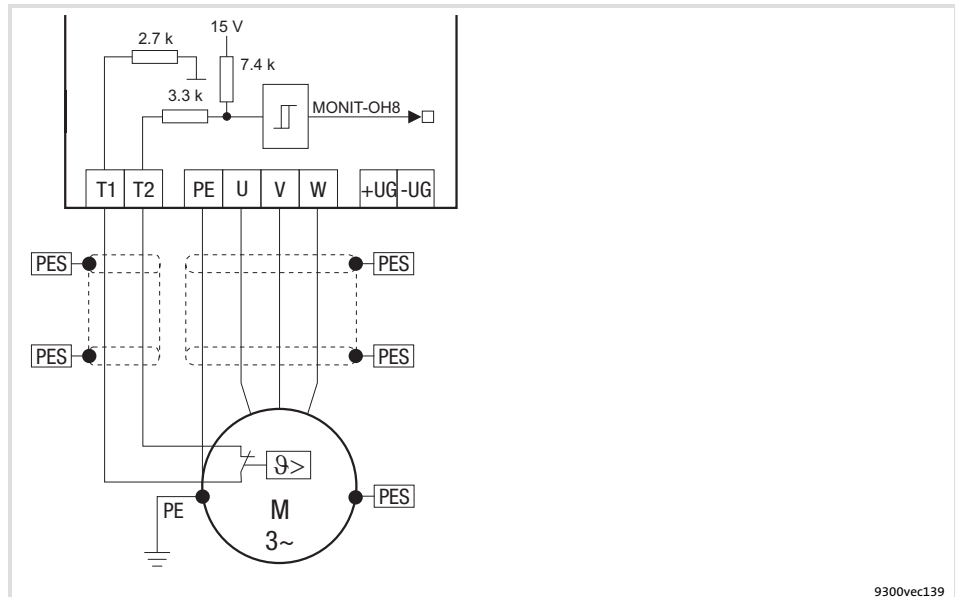

Fig. 5.4-5 Circuit diagram of motor connection with PTC thermistor or thermal contact (NC contact) at T1, T2

Characteristics of the connection for motor temperature monitoring:

Terminals T1, T2	
Connection	<ul style="list-style-type: none"> ● PTC thermistor <ul style="list-style-type: none"> – PTC thermistor with defined tripping temperature (acc. to DIN 44081 and DIN 44082) ● Thermal contact (NC contact) <ul style="list-style-type: none"> – Thermostat as NC contact
Tripping point	<ul style="list-style-type: none"> ● Fixed (depending on the PTC/thermal contact) ● PTC: $R_{\theta} > 1600 \Omega$ ● Configurable as warning or error (TRIP)
Notes	<ul style="list-style-type: none"> ● Monitoring is not active in the Lenze setting. ● If you do not use a Lenze motor, we recommend the use of a PTC thermistor up to 150°C.

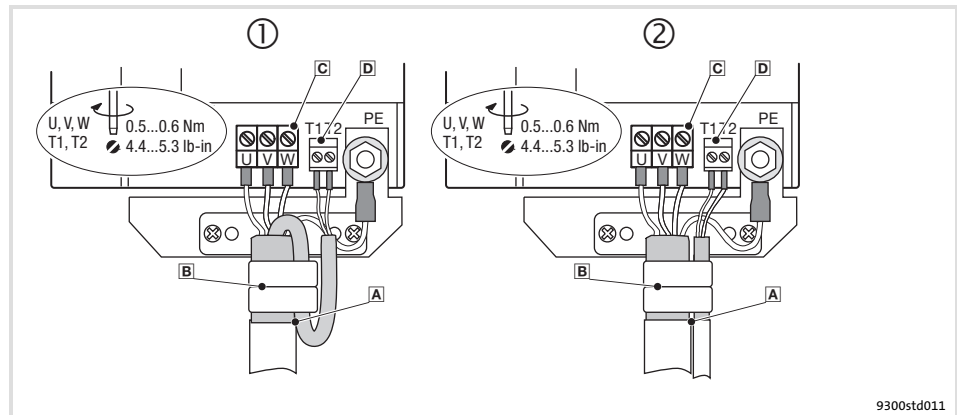

Fig. 5.4-6 Motor connection with PTC thermistor or thermal contact (NC contact)

- ① **A** Motor connection with Lenze system cable with integrated control cable for the motor temperature monitoring
- B** Shield sheet
Clamp entire shield **and** shield of the control cable for the motor temperature monitoring with the straps. If required, fix by means of cable tie.
- ② **A** Motor cable connection and separate control cable for the motor temperature monitoring
- B** Shield sheet
Clamp shield of the motor cable **and** shield of the cable for the motor temperature monitoring with the straps. If required, fix by means of cable tie.
- C** U, V, W
Motor cable connection
Check the correct polarity. Observe maximum length of the motor cable. Use wire end ferrules for flexible cables.
Max. connectable cable cross-section: 4 mm², with pin-end connector > 4 mm²
- D** T1, T2 for motor temperature monitoring
Cable connection for PTC thermistors or thermal contacts (NC contacts)

Motor with KTY thermal sensor



Note!

- ▶ We recommend to use Lenze system cables for wiring.
- ▶ For self-made cables only use cables with shielded cores twisted in pairs.

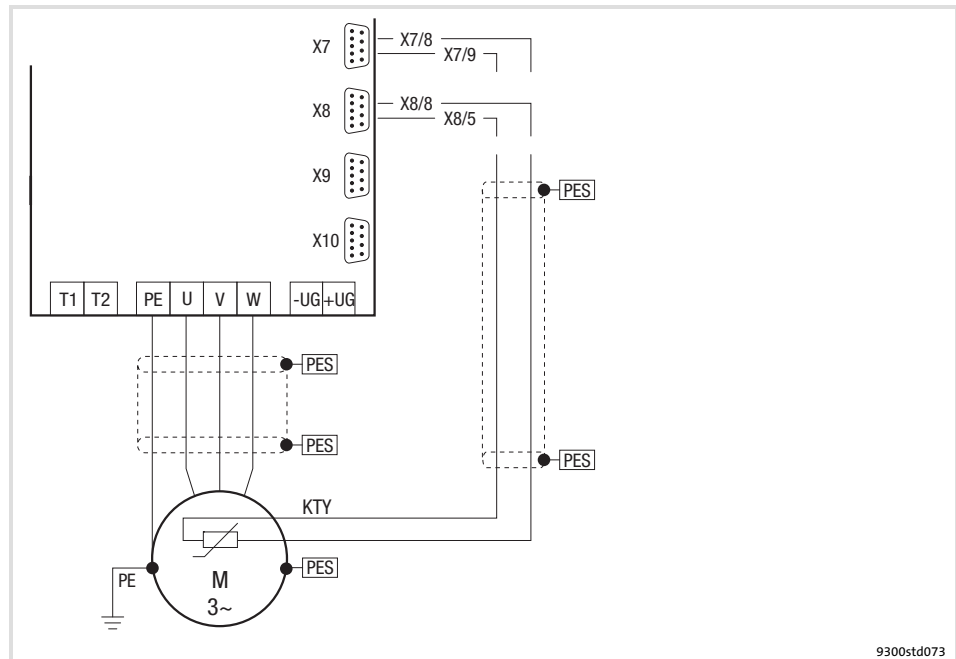

Fig. 5.4-7 Circuit diagram for the motor connection with KTY temperature sensor at X7 or X8

Features of the connection for motor temperature monitoring:

**Pins X7/8, X7/9 of resolver input (X7), or
 pins X8/8, X8/5 of incremental encoder input (X8)**

Connection	Linear KTY temperature sensor
Tripping point	<ul style="list-style-type: none"> ● Warning: adjustable ● Error (TRIP): fixed at 150 °C
Notes	<ul style="list-style-type: none"> ● Monitoring is not active in the Lenze setting. ● The KTY temperature sensor is monitored with regard to interruption and short circuit.

5

Wiring of the standard device

5.4

Standard devices in the power range 0.37 ... 11 kW

5.4.6

Motor connection

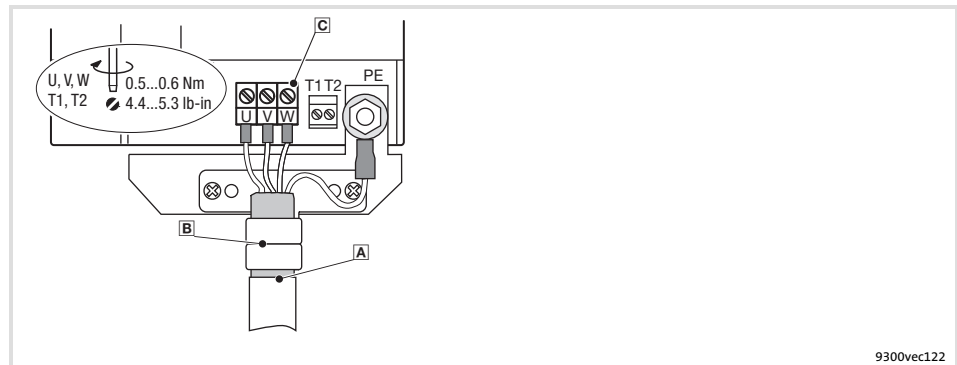

Fig. 5.4-8 Motor connection with KTY thermal sensor

A Motor cable

B Shield sheet

Clamp the motor cable shield with the straps. If required, fix by means of cable tie.

C U, V, W

Motor cable connection

Check the correct polarity. Observe maximum length of the motor cable. Use wire end ferrules for flexible cables.

Max. connectable cable cross-section: 4 mm², with pin-end connector > 4 mm²

Wiring of the standard device	5
Standard devices in the power range 15 ... 30 kW	5.5
Wiring according to EMC (CE-typical drive system)	5.5.1

5.5 Standard devices in the power range 15 ... 30 kW

5.5.1 Wiring according to EMC (CE-typical drive system)

The drives comply with the EC Directive on "Electromagnetic Compatibility" if they are installed in accordance with the specifications for the CE-typical drive system. The user is responsible for the compliance of the machine application with the EC Directive.



Note!

Observe the notes given in the chapter "Basics for wiring according to EMC"!

5

Wiring of the standard device

5.5

Standard devices in the power range 15 ... 30 kW

5.5.1

Wiring according to EMC (CE-typical drive system)

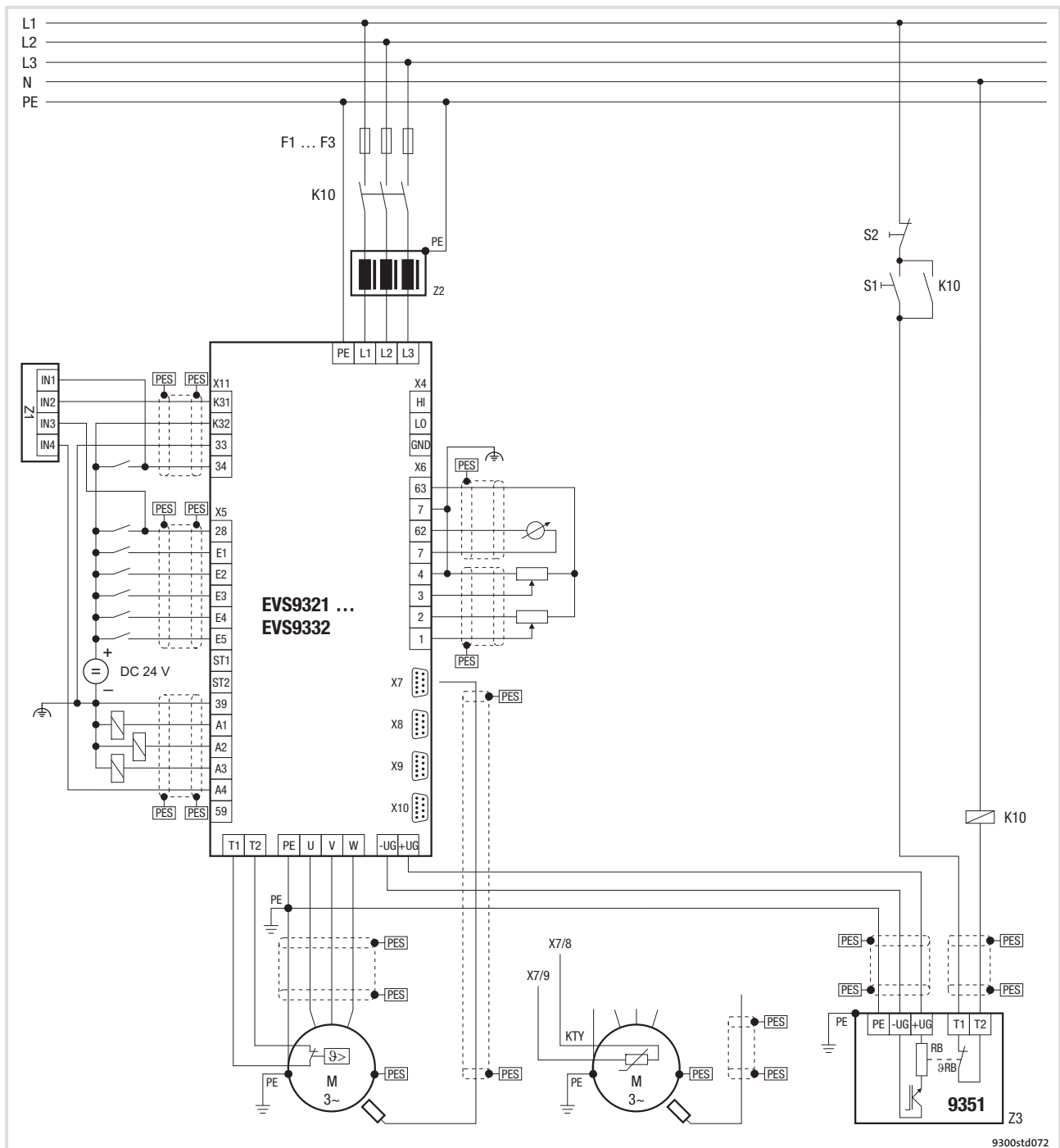

9300std072

Fig. 5.5-1 Example for wiring in accordance with EMC regulations

- | | |
|-----------|--|
| F1 ... F3 | Fuses |
| K10 | Mains contactor |
| Z1 | Programmable logic controller (PLC) |
| Z2 | Mains choke or mains filter |
| Z3 | EMB9351-E brake module |
| S1 | Mains contactor on |
| S2 | Mains contactor off |
| +UG, -UG | DC-bus connection |
| PES | HF shield termination through large-surface connection to PE |

5.5.2 Important notes

To gain access to the power connections, remove the cover:

Remove the cover of the drive controller

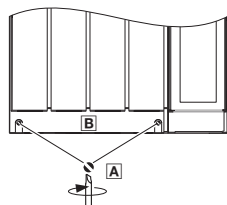

9300vec113

1. Remove the screws **A**
2. Lift cover **B** up and detach it

Installation material required from the scope of supply:

Description	Use	Quantity
Hexagon nut M6 (DIN 934)	Connection of supply cables (mains, +U _G , -U _G) and motor cable to the stud bolts	10
Washer Ø 6 mm (DIN 125)	For hexagon nut M6	10
Spring washer Ø 6 mm (DIN 127)	For hexagon nut M6	10
Grommet	Motor cable	1
Shield connection support	Support of the shield sheet for motor cable	1
Self-tapping screw Ø 4 × 14 mm	Fastening of shield connection support	2
Shield sheet	Shield connection for motor cable	1

5.5.3 Mains connection, DC supply



Note!

- ▶ If a mains filter or RFI filter is used and the cable length between mains/RFI filter and drive controller exceeds 300 mm, install a shielded cable.
- ▶ For DC-bus operation or DC supply, we recommend using shielded DC cables.

5

Wiring of the standard device

5.5

Standard devices in the power range 15 ... 30 kW

5.5.3

Mains connection, DC supply

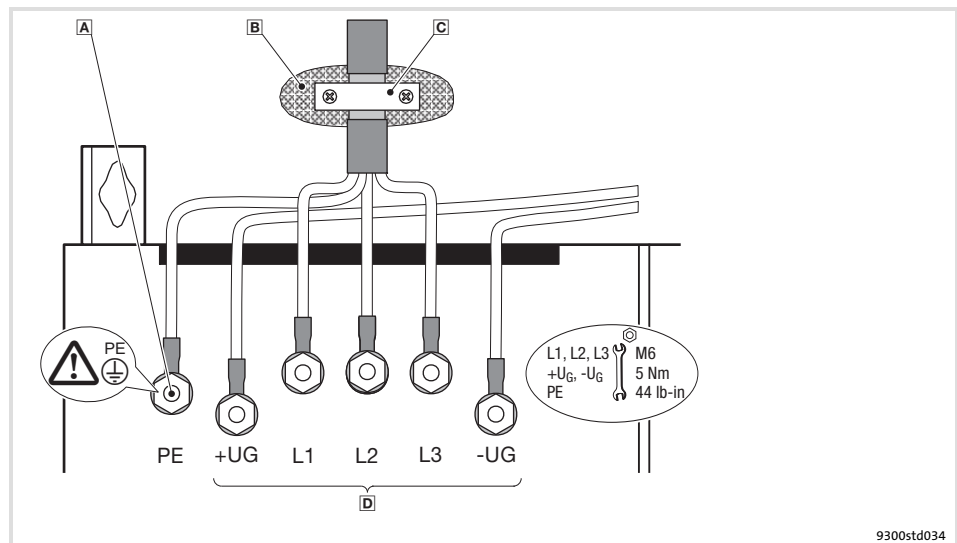

Fig. 5.5-2 Mains connection, DC supply for drive controllers 15 ... 30 kW

- A** PE stud
Connect PE cable with ring cable lug
- B** Conductive surface
- C** Shield clamp
Place shield with large surface on control cabinet mounting plate and fasten with shield clamp (shield clamp is not part of the scope of supply)
To improve the shield connection, also place the shield on the PE stud
- D** Mains and DC bus connection
L1, L2, L3: Connection of mains cable with ring cable lugs
+UG, -UG: Connection of DC-bus components or connection of the controller in the DC-bus system (see system manual)

5.5.4 Mains connection: Fuses and cable cross-sections

Installation in accordance with EN 60204-1

Supply conditions	
Range	Description
Fuses	<ul style="list-style-type: none"> Utilisation category: only gG/gL or gRL
Cables	Laying systems B2 and C: Use of PVC-insulated copper cables, conductor temperature < 70 °C, ambient temperature < 40 °C, no bundling of the cables or cores, three loaded cores. The data are recommendations. Other dimensionings/laying systems are possible (e.g. in accordance with VDE 0298-4).
RCCB	<ul style="list-style-type: none"> Controllers can cause a DC current in the PE conductor. If a residual current device (RCD) or a fault current monitoring unit (RCM) is used for protection in the case of direct or indirect contact, only one RCD/RCM of the following type can be used on the current supply side: <ul style="list-style-type: none"> Type B (universal-current sensitive) for connection to a three-phase system Type A (pulse-current sensitive) or type B (universal-current sensitive) for connection to a 1-phase system Alternatively another protective measure can be used, like for instance isolation from the environment by means of double or reinforced insulation, or isolation from the supply system by using a transformer. Earth-leakage circuit breakers must only be installed between mains supply and controller.

Observe all national and regional regulations!

9300	Rated fuse current		Cable cross-section		FI ¹⁾
	Fuse	Circuit-breaker	Laying system L1, L2, L3, PE		
	[A]	[A]	B2 [mm ²]	C [mm ²]	
Type	[A]	[A]	[mm ²]	[mm ²]	[mA]
Operation without mains choke/mains filter					
EVS9327-xS	63	–	16	16	300
Operation with mains choke/mains filter					
EVS9327-xS	40	–	10	10	300
EVS9328-xS	63	–	25	16	
EVS9329-xS	80	–	–	25	

¹⁾ Universal current-sensitive earth-leakage circuit breaker

5 Wiring of the standard device

5.5 Standard devices in the power range 15 ... 30 kW

5.5.5 Mains choke/mains filter assignment

Installation to UL

Supply conditions		
Range	Description	
Fuses	<ul style="list-style-type: none"> Only according to UL 248 Mains short-circuit current up to 5000 A_{rms}: All classes permissible Mains short-circuit current up to 50000 A_{rms}: Only classes "J", "T" or "R" permissible 	
Cables	<ul style="list-style-type: none"> Only in accordance with UL The cable cross-sections specified in the following apply under the following conditions: <ul style="list-style-type: none"> Conductor temperature < 60 °C Ambient temperature < 40 °C 	
Observe all national and regional regulations!		
9300	Rated fuse current	Cable cross-section
Type	Fuse [A]	L1, L2, L3, PE [AWG]
Operation with mains choke/mains filter		
EVS9327-xS	35	8
EVS9328-xS	60	4
EVS9329-xS	80	4

5.5.5 Mains choke/mains filter assignment

9300	Mains choke	Interference voltage category according to EN 61800-3 and motor cable length			
		Component C2		Component C1	
Type		Component	max. [m]	Component	max. [m]
EVS9327-xS	ELN3-0088H035-001	EZN3A0110H030	25	E82ZN22334B230	10
				E82ZZ15334B230 ¹⁾	10
		E82ZN22334B230	50	EZN3B0110H030U ²⁾	50
		E82ZZ15334B230 ¹⁾	50		
EVS9328-xS	ELN3-0075H045	EZN3A0080H042	25	E82ZN22334B230	10
		E82ZN22334B230	50	EZN3B0080H042	50
EVS9329-xS	ELN3-0055H055	EZN3A0055H060	25	E82ZN30334B230	10
		E82ZN30334B230	50	EZN3B0055H060	50

- 1) RFI filter
2) Footprint filter

5.5.6 Motor connection



Note!

- ▶ Fusing the motor cable is not required.
- ▶ The drive controller features 2 connections for motor temperature monitoring:
 - Terminals T1, T2 for connecting a PTC thermistor or thermal contact (NC contact).
 - Pins X8/5 and X8/8 of the incremental encoder input (X8) for connecting a KTY thermal sensor.

Shield sheet installation



Stop!

Do not use lugs as strain relief.

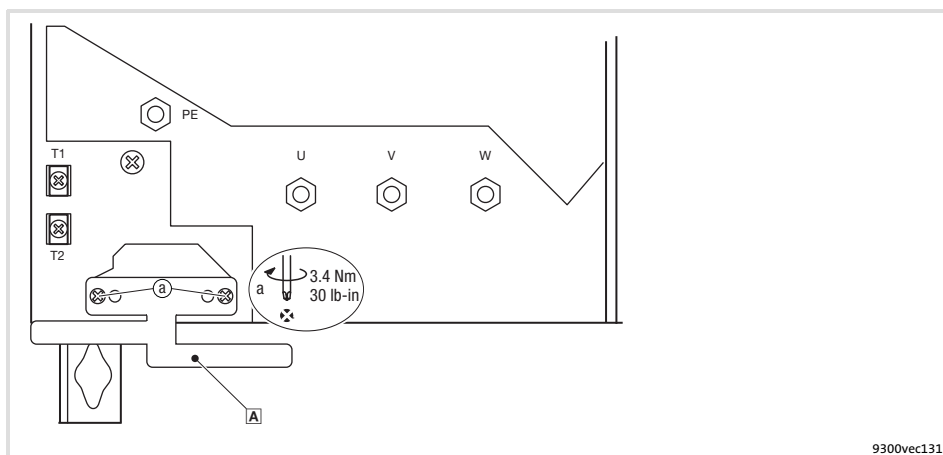

Fig. 5.5-3 Installation of shield sheet for drive controllers 15 ... 30 kW

A Fasten the shield sheet with two self-tapping screws $\varnothing 4 \times 14$ mm (a)

Motor with PTC thermistor or thermal contact (NC contact)

Wire T1, T2 only if the motor is equipped with a PTC thermistor or thermal contact (NC contact).

- ▶ An "open" cable acts like an antenna and can cause faults on the drive controller.



Danger!

- ▶ All control terminals only have basic insulation (single isolating distance) after connecting a PTC thermistor or a thermal contact.
- ▶ Protection against accidental contact in case of a defective isolating distance is only guaranteed through external measures, e.g. double insulation.

5

Wiring of the standard device

5.5

Standard devices in the power range 15 ... 30 kW

5.5.6

Motor connection

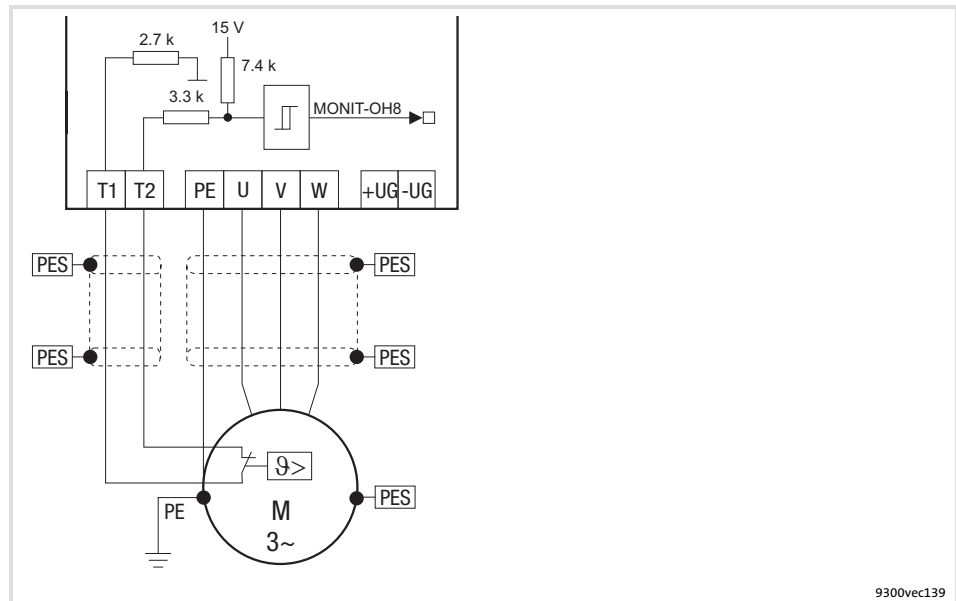

Fig. 5.5-4 Circuit diagram of motor connection with PTC thermistor or thermal contact (NC contact) at T1, T2

Characteristics of the connection for motor temperature monitoring:

Terminals T1, T2	
Connection	<ul style="list-style-type: none"> • PTC thermistor <ul style="list-style-type: none"> – PTC thermistor with defined tripping temperature (acc. to DIN 44081 and DIN 44082) • Thermal contact (NC contact) <ul style="list-style-type: none"> – Thermostat as NC contact
Tripping point	<ul style="list-style-type: none"> • Fixed (depending on the PTC/thermal contact) • PTC: $R_{\theta} > 1600 \Omega$ • Configurable as warning or error (TRIP)
Notes	<ul style="list-style-type: none"> • Monitoring is not active in the Lenze setting. • If you do not use a Lenze motor, we recommend the use of a PTC thermistor up to 150°C.

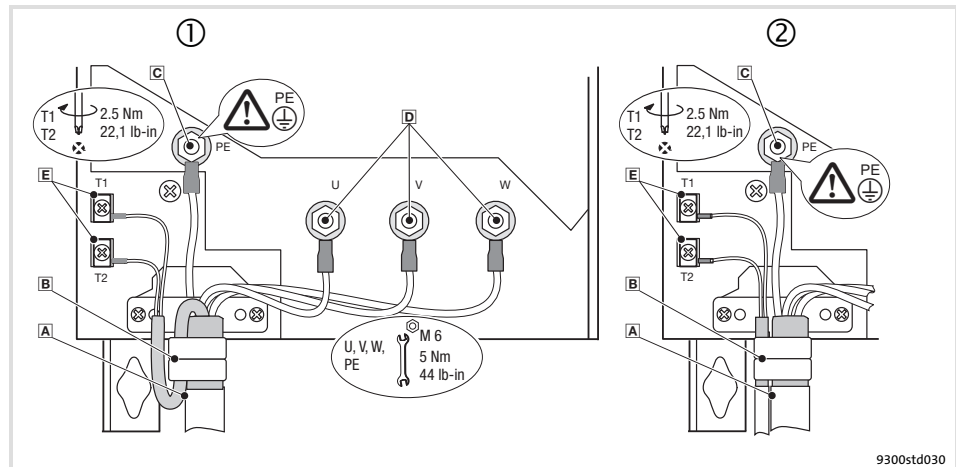

Fig. 5.5-5 Motor connection with PTC thermistor or thermal contact (NC contact)

- ① **A** Motor connection with Lenze system cable with integrated control cable for the motor temperature monitoring
- B** Shield sheet
Clamp entire shield **and** shield of the control cable for the motor temperature monitoring with the straps. If required, fix by means of cable tie.
- ② **A** Motor cable connection and separate control cable for the motor temperature monitoring
- B** Shield sheet
Clamp shield of the motor cable **and** shield of the cable for the motor temperature monitoring with the straps. If required, fix by means of cable tie.
- C** PE stud
PE cable connection with ring cable lug
- D** U, V, W
Motor cable connection
Check the correct polarity. Observe maximum length of the motor cable.
Max. connectable cable cross-section: 50 mm² with ring cable lug
- E** T1, T2 for motor temperature monitoring
Cable connection for PTC thermistors or thermal contacts (NC contacts)

Motor with KTY thermal sensor



Note!

- ▶ We recommend to use Lenze system cables for wiring.
- ▶ For self-made cables only use cables with shielded cores twisted in pairs.

5

Wiring of the standard device

5.5

Standard devices in the power range 15 ... 30 kW

5.5.6

Motor connection

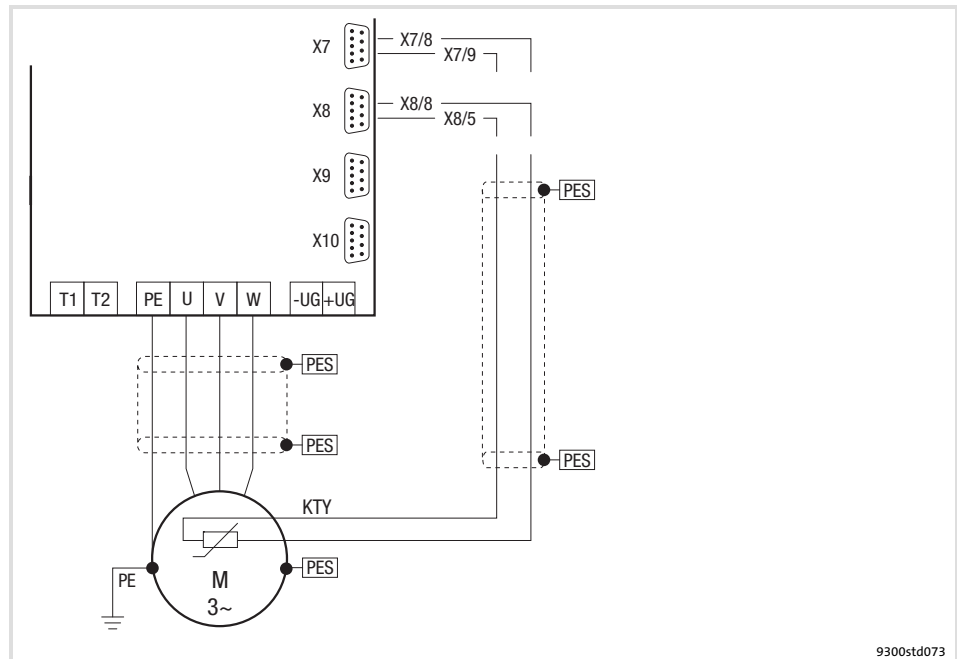

Fig. 5.5-6 Circuit diagram for the motor connection with KTY temperature sensor at X7 or X8

Features of the connection for motor temperature monitoring:

**Pins X7/8, X7/9 of resolver input (X7), or
pins X8/8, X8/5 of incremental encoder input (X8)**

Connection	Linear KTY temperature sensor
Tripping point	<ul style="list-style-type: none"> Warning: adjustable Error (TRIP): fixed at 150 °C
Notes	<ul style="list-style-type: none"> Monitoring is not active in the Lenze setting. The KTY temperature sensor is monitored with regard to interruption and short circuit.

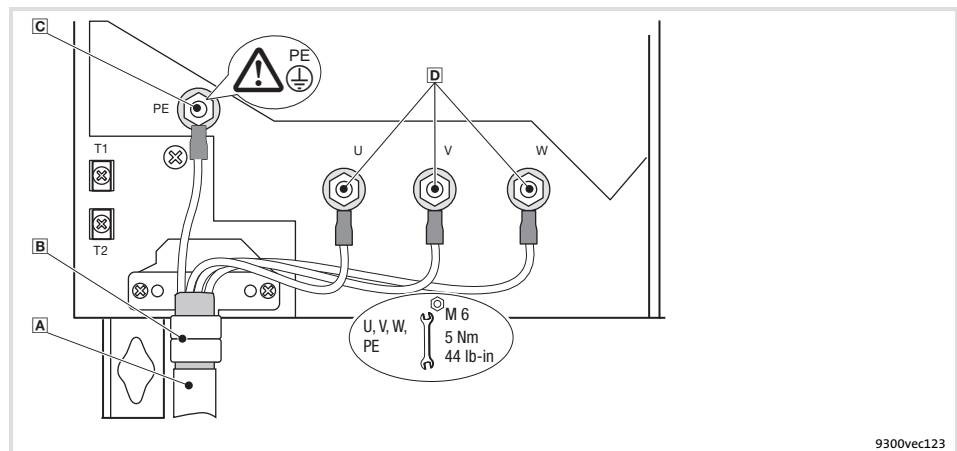

Fig. 5.5-7 Motor connection with KTY thermal sensor

- A** Motor cable
- B** Shield connection
Clamp the motor cable shield with the straps. If required, fix by means of cable tie.
- C** PE stud
PE cable connection with ring cable lug
- D** U, V, W
Motor cable connection
Check the correct polarity. Observe maximum length of the motor cable.
Max. connectable cable cross-section: 50 mm² with ring cable lug

Wiring of the standard device	5
Standard devices with a power of 45 kW	5.6
Wiring according to EMC (CE-typical drive system)	5.6.1

5.6 Standard devices with a power of 45 kW

5.6.1 Wiring according to EMC (CE-typical drive system)

The drives comply with the EC Directive on "Electromagnetic Compatibility" if they are installed in accordance with the specifications for the CE-typical drive system. The user is responsible for the compliance of the machine application with the EC Directive.



Note!

Observe the notes given in the chapter "Basics for wiring according to EMC"!

5

Wiring of the standard device

5.6

Standard devices with a power of 45 kW

5.6.1

Wiring according to EMC (CE-typical drive system)

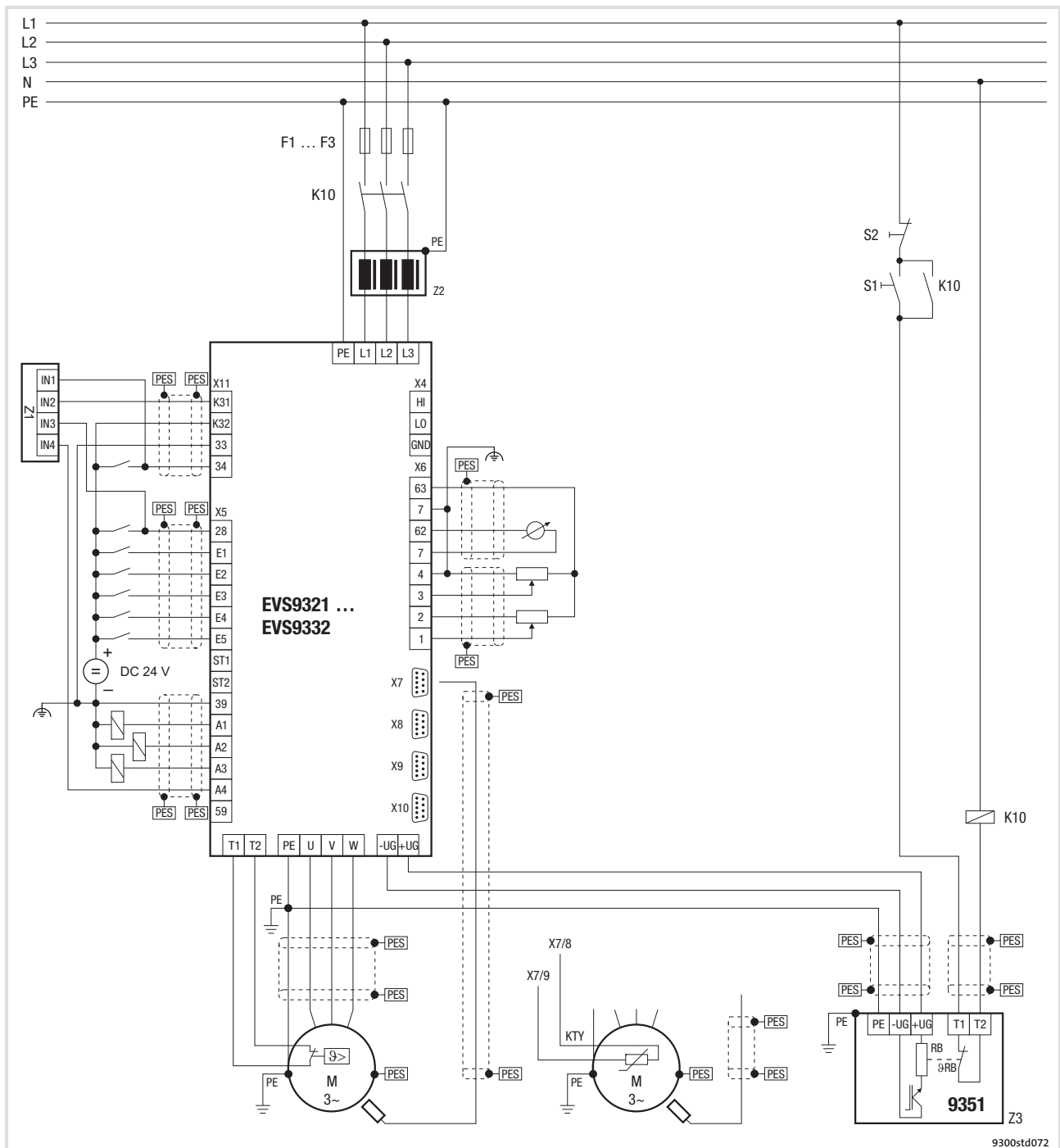

9300std072

Fig. 5.6-1 Example for wiring in accordance with EMC regulations

- | | |
|-----------|--|
| F1 ... F3 | Fuses |
| K10 | Mains contactor |
| Z1 | Programmable logic controller (PLC) |
| Z2 | Mains choke or mains filter |
| Z3 | EMB9351-E brake module |
| S1 | Mains contactor on |
| S2 | Mains contactor off |
| +UG, -UG | DC-bus connection |
| PES | HF shield termination through large-surface connection to PE |

5.6.2 Important notes

To gain access to the power connections, remove the cover:

Remove the cover of the drive controller

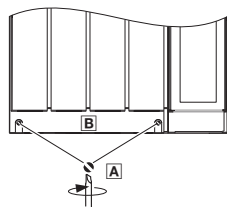

9300vec113

1. Remove the screws **A**
2. Lift cover **B** up and detach it

Installation material required from the scope of supply:

Description	Use	Quantity
Cable ties 3.5 × 150 mm	Strain relief/shield connection for motor cable	4

5.6.3 Mains connection, DC supply



Note!

- ▶ If a mains filter or RFI filter is used and the cable length between mains/RFI filter and drive controller exceeds 300 mm, install a shielded cable.
- ▶ For DC-bus operation or DC supply, we recommend using shielded DC cables.

5

Wiring of the standard device

5.6

Standard devices with a power of 45 kW

5.6.3

Mains connection, DC supply

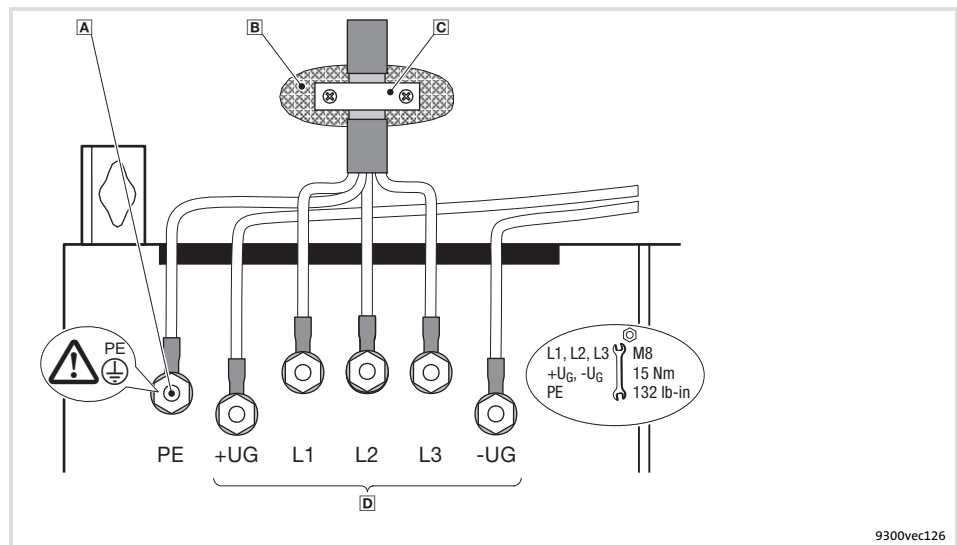

Fig. 5.6-2 Mains connection, DC supply for 45 kW controller

- A** PE stud
Connect PE cable with ring cable lug
- B** Conductive surface
- C** Shield clamp
Place shield with large surface on control cabinet mounting plate and fasten with shield clamp (shield clamp is not part of the scope of supply)
To improve the shield connection, also place the shield on the PE stud
- D** Mains and DC bus connection
L1, L2, L3: Connection of mains cable with ring cable lugs
+UG, -UG: Connection of DC-bus components or connection of the controller in the DC-bus system (see system manual)

5.6.4 Mains connection: Fuses and cable cross-sections

Installation in accordance with EN 60204-1

Supply conditions	
Range	Description
Fuses	<ul style="list-style-type: none"> Utilisation category: only gG/gL or gRL
Cables	Laying systems B2 and C: Use of PVC-insulated copper cables, conductor temperature < 70 °C, ambient temperature < 40 °C, no bundling of the cables or cores, three loaded cores. The data are recommendations. Other dimensionings/laying systems are possible (e.g. in accordance with VDE 0298-4).
RCCB	<ul style="list-style-type: none"> Controllers can cause a DC current in the PE conductor. If a residual current device (RCD) or a fault current monitoring unit (RCM) is used for protection in the case of direct or indirect contact, only one RCD/RCM of the following type can be used on the current supply side: <ul style="list-style-type: none"> Type B (universal-current sensitive) for connection to a three-phase system Type A (pulse-current sensitive) or type B (universal-current sensitive) for connection to a 1-phase system Alternatively another protective measure can be used, like for instance isolation from the environment by means of double or reinforced insulation, or isolation from the supply system by using a transformer. Earth-leakage circuit breakers must only be installed between mains supply and controller.

Observe all national and regional regulations!

9300	Rated fuse current		Cable cross-section		FI ¹⁾
	Fuse	Circuit-breaker	Laying system L1, L2, L3, PE		
	[A]	[A]	B2 [mm ²]	C [mm ²]	
Type					
Operation with mains choke/mains filter					
EVS9330-xS	100	–	–	35	300

¹⁾ Universal current-sensitive earth-leakage circuit breaker

5 Wiring of the standard device

5.6 Standard devices with a power of 45 kW

5.6.5 Mains choke/mains filter assignment

Installation to UL

Supply conditions		
Range	Description	
Fuses	<ul style="list-style-type: none"> Only according to UL 248 Mains short-circuit current up to 10000 A_{rms}: All classes permissible Mains short-circuit current up to 50000 A_{rms}: Only classes "J", "T" or "R" permissible 	
Cables	<ul style="list-style-type: none"> Only in accordance with UL The cable cross-sections specified in the following apply under the following conditions: <ul style="list-style-type: none"> Conductor temperature < 60 °C Ambient temperature < 40 °C 	
Observe all national and regional regulations!		
9300	Rated fuse current	Cable cross-section
Type	Fuse [A]	L1, L2, L3, PE [AWG]
Operation with mains choke/mains filter		
EVS9330-xS	100	1

5.6.5 Mains choke/mains filter assignment

9300	Mains choke	Interference voltage category according to EN 61800-3 and motor cable length			
Type		Component		Component	
		C2	max. [m]	C1	max. [m]
EVS9330-xS	ELN3-0038H085	EZN3A0030H110	25	EZN3B0030H110	50
		EZN3A0030H110N001 ³⁾	25		
		E82ZN55334B230	50		

³⁾ For controllers with thermal separation

5.6.6 Motor connection



Note!

- ▶ Fusing the motor cable is not required.
- ▶ The drive controller features 2 connections for motor temperature monitoring:
 - Terminals T1, T2 for connecting a PTC thermistor or thermal contact (NC contact).
 - Pins X8/5 and X8/8 of the incremental encoder input (X8) for connecting a KTY thermal sensor.

Motor with PTC thermistor or thermal contact (NC contact)

Wire T1, T2 only if the motor is equipped with a PTC thermistor or thermal contact (NC contact).

- ▶ An "open" cable acts like an antenna and can cause faults on the drive controller.



Danger!

- ▶ All control terminals only have basic insulation (single isolating distance) after connecting a PTC thermistor or a thermal contact.
- ▶ Protection against accidental contact in case of a defective isolating distance is only guaranteed through external measures, e.g. double insulation.

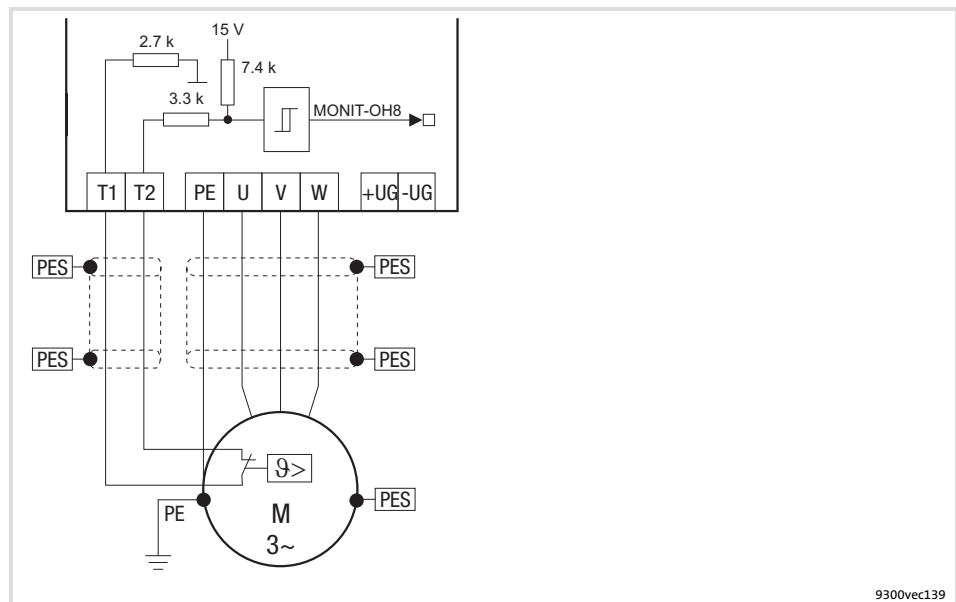

Fig. 5.6-3 Circuit diagram of motor connection with PTC thermistor or thermal contact (NC contact) at T1, T2

Characteristics of the connection for motor temperature monitoring:

Terminals T1, T2	
Connection	<ul style="list-style-type: none"> • PTC thermistor <ul style="list-style-type: none"> – PTC thermistor with defined tripping temperature (acc. to DIN 44081 and DIN 44082) • Thermal contact (NC contact) <ul style="list-style-type: none"> – Thermostat as NC contact
Tripping point	<ul style="list-style-type: none"> • Fixed (depending on the PTC/thermal contact) • PTC: $R_9 > 1600 \Omega$ • Configurable as warning or error (TRIP)
Notes	<ul style="list-style-type: none"> • Monitoring is not active in the Lenze setting. • If you do not use a Lenze motor, we recommend the use of a PTC thermistor up to 150°C.

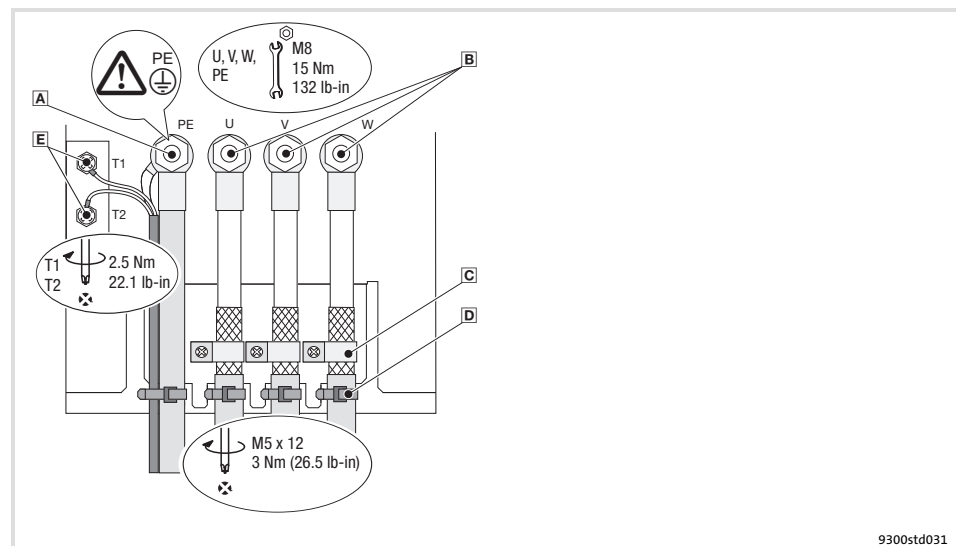

Fig. 5.6-4 Motor connection with PTC thermistor or thermal contact (NC contact)

- A** PE stud
PE cable connection with ring cable lug
- B** U, V, W
Motor cable connection
Check the correct polarity. Observe maximum length of the motor cable.
Max. connectable cable cross-section: 120 mm² with ring cable lug
- C** Shield clamps
Place shields of motor cable with large surface on the shield sheet and fasten with shield clamps and M5 × 12 mm screws
- D** Cable ties
Strain relief of motor cable
- E** T1, T2 for motor temperature monitoring
Cable connection for PTC thermistors or thermal contacts (NC contacts)
Place shield with large surface on PE stud

Motor with KTY thermal sensor



Note!

- ▶ We recommend to use Lenze system cables for wiring.
- ▶ For self-made cables only use cables with shielded cores twisted in pairs.

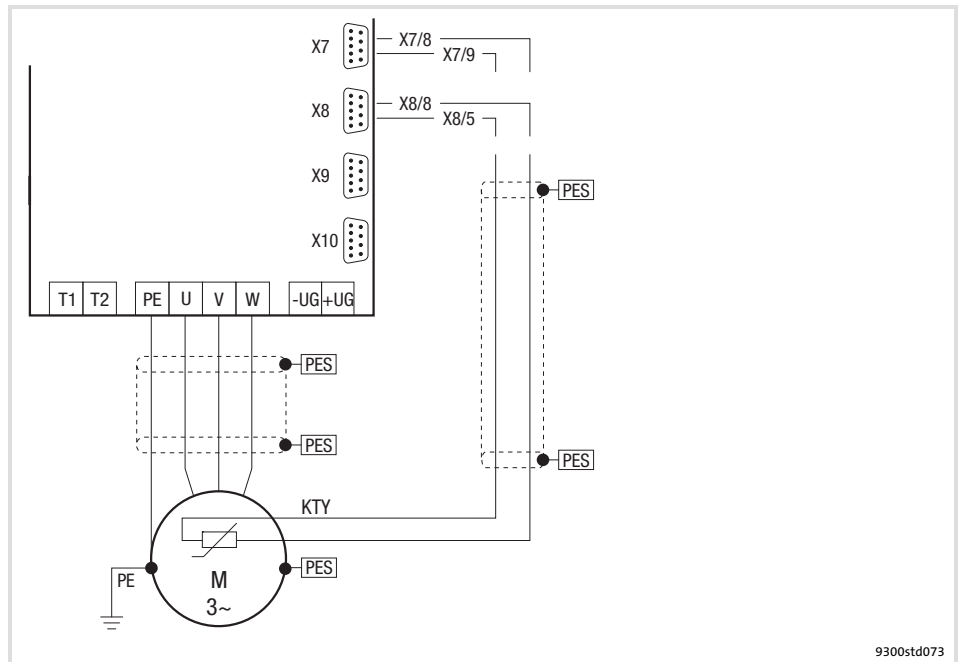

Fig. 5.6-5 Circuit diagram for the motor connection with KTY temperature sensor at X7 or X8

Features of the connection for motor temperature monitoring:

**Pins X7/8, X7/9 of resolver input (X7), or
 pins X8/8, X8/5 of incremental encoder input (X8)**

Connection	Linear KTY temperature sensor
Tripping point	<ul style="list-style-type: none"> ● Warning: adjustable ● Error (TRIP): fixed at 150 °C
Notes	<ul style="list-style-type: none"> ● Monitoring is not active in the Lenze setting. ● The KTY temperature sensor is monitored with regard to interruption and short circuit.

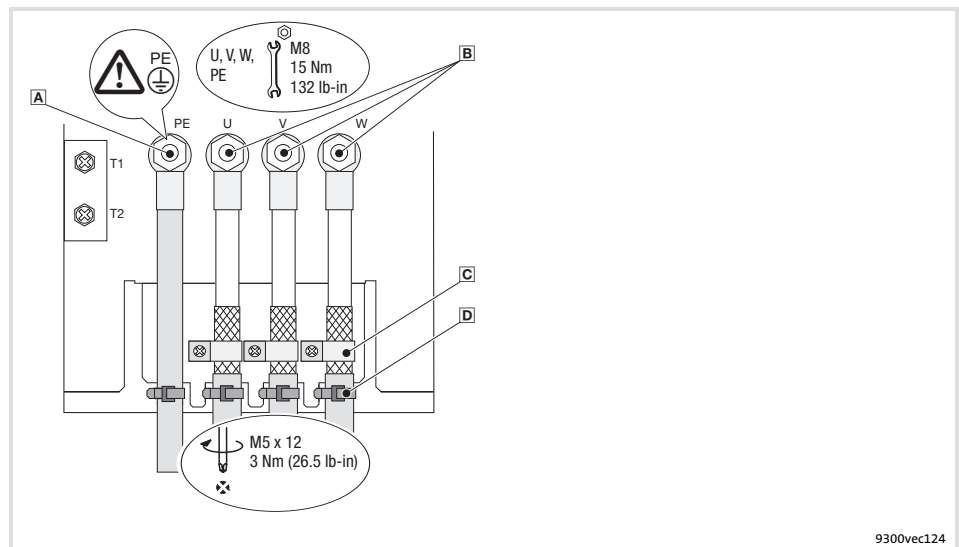

Fig. 5.6-6 Motor connection with KTY thermal sensor

- A** PE stud
PE cable connection with ring cable lug
- B** U, V, W
Motor cable connection
Check the correct polarity. Observe maximum length of the motor cable.
Max. connectable cable cross-section: 120 mm² with ring cable lug
- C** Shield clamps
Place shields of motor cable with large surface on the shield sheet and fasten with shield clamps and M5 × 12 mm screws
- D** Cable ties
Strain relief of motor cable

Wiring of the standard device	5
Standard devices in the power range 55 ... 75 kW	5.7
Wiring according to EMC (CE-typical drive system)	5.7.1

5.7 Standard devices in the power range 55 ... 75 kW

5.7.1 Wiring according to EMC (CE-typical drive system)

The drives comply with the EC Directive on "Electromagnetic Compatibility" if they are installed in accordance with the specifications for the CE-typical drive system. The user is responsible for the compliance of the machine application with the EC Directive.



Note!

Observe the notes given in the chapter "Basics for wiring according to EMC"!

5

Wiring of the standard device

5.7

Standard devices in the power range 55 ... 75 kW

5.7.1

Wiring according to EMC (CE-typical drive system)

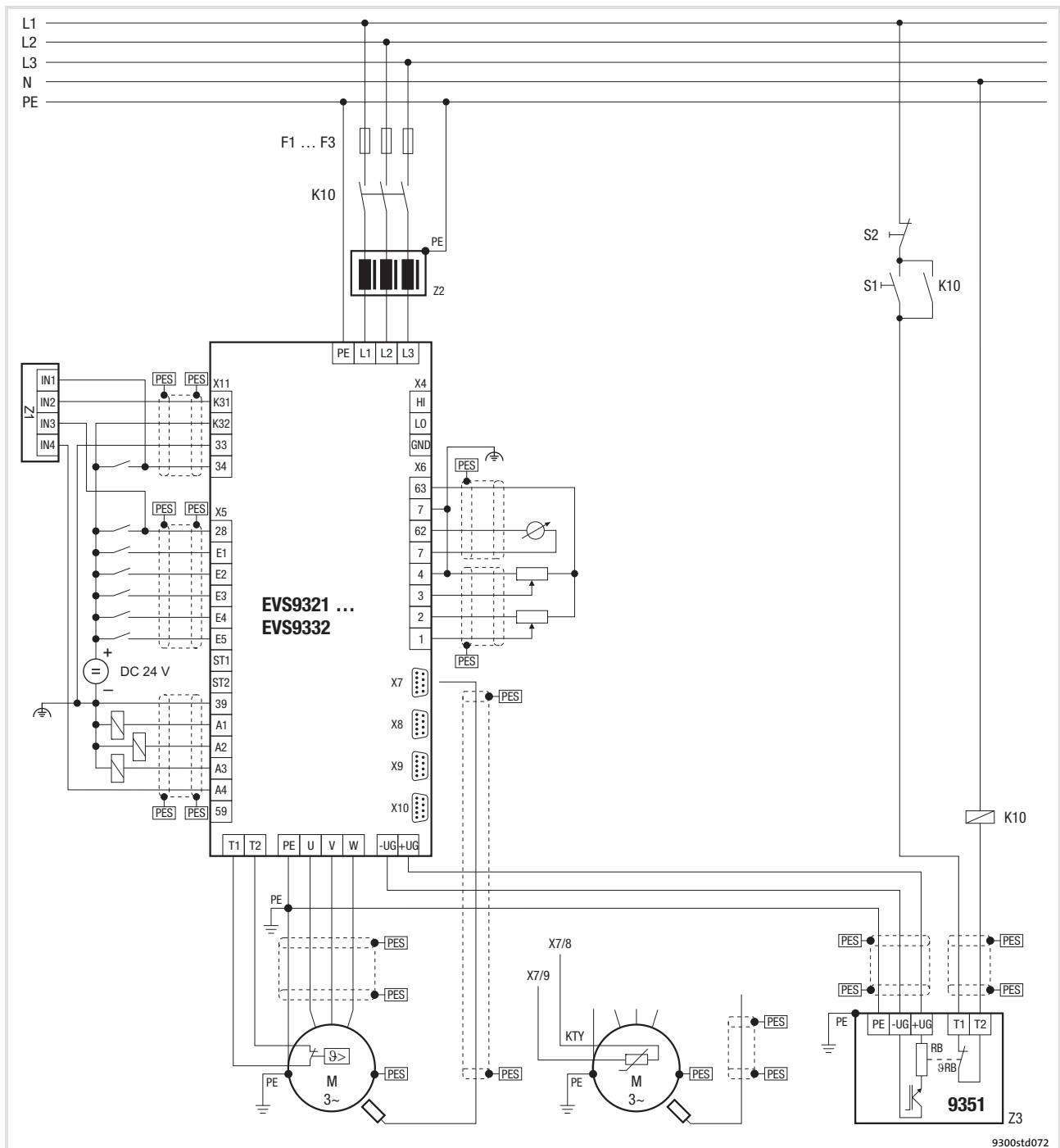

Fig. 5.7-1 Example for wiring in accordance with EMC regulations

- | | |
|-----------------------------------|--|
| F1 ... F3 | Fuses |
| K10 | Mains contactor |
| Z1 | Programmable logic controller (PLC) |
| Z2 | Mains choke or mains filter |
| Z3 | EMB9351-E brake module |
| S1 | Mains contactor on |
| S2 | Mains contactor off |
| +U _G , -U _G | DC-bus connection |
| PES | HF shield termination through large-surface connection to PE |

5.7.2 Important notes

To gain access to the power connections, remove the cover:

Remove the cover of the drive controller

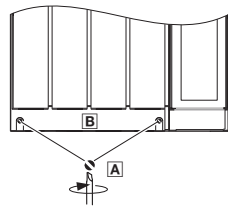

1. Remove the screws **A**
2. Lift cover **B** up and detach it

Installation material required from the scope of supply:

Description	Use	Quantity
Cable ties 3.5 × 150 mm	Strain relief/shield connection for motor cable	4

5.7.3 Mains connection, DC supply



Note!

- ▶ If a mains filter or RFI filter is used and the cable length between mains/RFI filter and drive controller exceeds 300 mm, install a shielded cable.
- ▶ For DC-bus operation or DC supply, we recommend using shielded DC cables.

5

Wiring of the standard device

5.7

Standard devices in the power range 55 ... 75 kW

5.7.3

Mains connection, DC supply

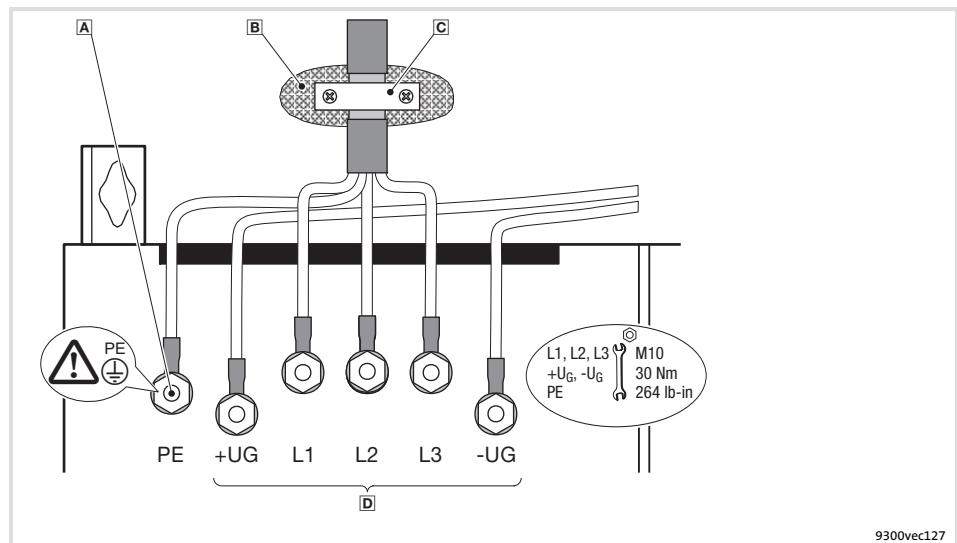

Fig. 5.7-2 Mains connection, DC supply for 55 ... 75 kW drive controller

- A** PE stud
Connect PE cable with ring cable lug
- B** Conductive surface
- C** Shield clamp
Place shield with large surface on control cabinet mounting plate and fasten with shield clamp (shield clamp is not part of the scope of supply)
To improve the shield connection, also place the shield on the PE stud
- D** Mains and DC bus connection
L1, L2, L3: Connection of mains cable with ring cable lugs
+UG, -UG: Connection of DC-bus components or connection of the controller in the DC-bus system (see system manual)

5.7.4 Mains connection: Fuses and cable cross-sections

Installation in accordance with EN 60204-1

Supply conditions	
Range	Description
Fuses	<ul style="list-style-type: none"> Utilisation category: only gG/gL or gRL
Cables	Laying systems B2 and C: Use of PVC-insulated copper cables, conductor temperature < 70 °C, ambient temperature < 40 °C, no bundling of the cables or cores, three loaded cores. The data are recommendations. Other dimensionings/laying systems are possible (e.g. in accordance with VDE 0298-4).
RCCB	<ul style="list-style-type: none"> Controllers can cause a DC current in the PE conductor. If a residual current device (RCD) or a fault current monitoring unit (RCM) is used for protection in the case of direct or indirect contact, only one RCD/RCM of the following type can be used on the current supply side: <ul style="list-style-type: none"> Type B (universal-current sensitive) for connection to a three-phase system Type A (pulse-current sensitive) or type B (universal-current sensitive) for connection to a 1-phase system Alternatively another protective measure can be used, like for instance isolation from the environment by means of double or reinforced insulation, or isolation from the supply system by using a transformer. Earth-leakage circuit breakers must only be installed between mains supply and controller.

Observe all national and regional regulations!

9300	Rated fuse current		Cable cross-section		FI ¹⁾
	Fuse	Circuit-breaker	Laying system L1, L2, L3, PE		
	[A]	[A]	B2 [mm ²]	C [mm ²]	
Type	[A]	[A]	[mm ²]	[mm ²]	[mA]
Operation with mains choke/mains filter					
EVS9331-xS	125	–	–	35	300
EVS9332-xS	160	–	–	70	

¹⁾ Universal current-sensitive earth-leakage circuit breaker

5 Wiring of the standard device

5.7 Standard devices in the power range 55 ... 75 kW

5.7.5 Mains choke/mains filter assignment

Installation to UL

Supply conditions		
Range	Description	
Fuses	<ul style="list-style-type: none"> Only according to UL 248 Mains short-circuit current up to 10000 A_{rms}: All classes permissible Mains short-circuit current up to 50000 A_{rms}: Only classes "J", "T" or "R" permissible 	
Cables	<ul style="list-style-type: none"> Only in accordance with UL The cable cross-sections specified in the following apply under the following conditions: <ul style="list-style-type: none"> Conductor temperature < 60 °C Ambient temperature < 40 °C 	
Observe all national and regional regulations!		
9300	Rated fuse current	Cable cross-section
Type	Fuse [A]	L1, L2, L3, PE [AWG]
Operation with mains choke/mains filter		
EVS9331-xS	125	1/0
EVS9332-xS	175	2/0

5.7.5 Mains choke/mains filter assignment

9300	Mains choke	Interference voltage category according to EN 61800-3 and motor cable length			
		Component		Component	
		C2	max. [m]	C1	max. [m]
EVS9331-xS	ELN3-0027H105	EZN3A0022H150	25	E82ZN75334B230	10
		E82ZN75334B230	50	EZN3B0022H150	50
EVS9332-xS	ELN3-0022H130	EZN3A0022H150	25	E82ZN75334B230	10
		E82ZN75334B230	50	EZN3B0022H150	50

5.7.6 Motor connection



Note!

- ▶ Fusing the motor cable is not required.
- ▶ The drive controller features 2 connections for motor temperature monitoring:
 - Terminals T1, T2 for connecting a PTC thermistor or thermal contact (NC contact).
 - Pins X8/5 and X8/8 of the incremental encoder input (X8) for connecting a KTY thermal sensor.

Motor with PTC thermistor or thermal contact (NC contact)

Wire T1, T2 only if the motor is equipped with a PTC thermistor or thermal contact (NC contact).

- ▶ An "open" cable acts like an antenna and can cause faults on the drive controller.



Danger!

- ▶ All control terminals only have basic insulation (single isolating distance) after connecting a PTC thermistor or a thermal contact.
- ▶ Protection against accidental contact in case of a defective isolating distance is only guaranteed through external measures, e.g. double insulation.

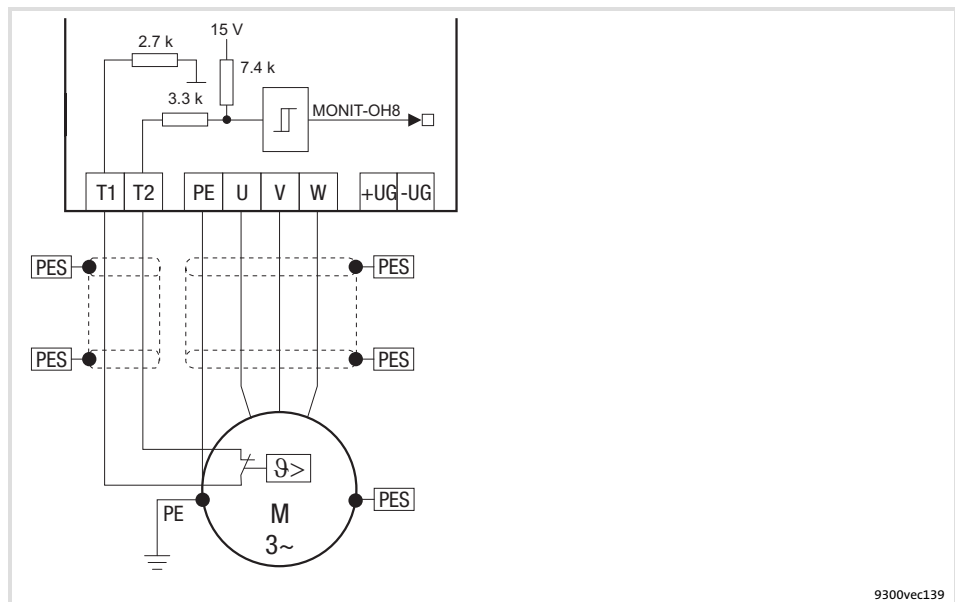

Fig. 5.7-3 Circuit diagram of motor connection with PTC thermistor or thermal contact (NC contact) at T1, T2

Characteristics of the connection for motor temperature monitoring:

Terminals T1, T2	
Connection	<ul style="list-style-type: none"> • PTC thermistor <ul style="list-style-type: none"> – PTC thermistor with defined tripping temperature (acc. to DIN 44081 and DIN 44082) • Thermal contact (NC contact) <ul style="list-style-type: none"> – Thermostat as NC contact
Tripping point	<ul style="list-style-type: none"> • Fixed (depending on the PTC/thermal contact) • PTC: $R_9 > 1600 \Omega$ • Configurable as warning or error (TRIP)
Notes	<ul style="list-style-type: none"> • Monitoring is not active in the Lenze setting. • If you do not use a Lenze motor, we recommend the use of a PTC thermistor up to 150°C.

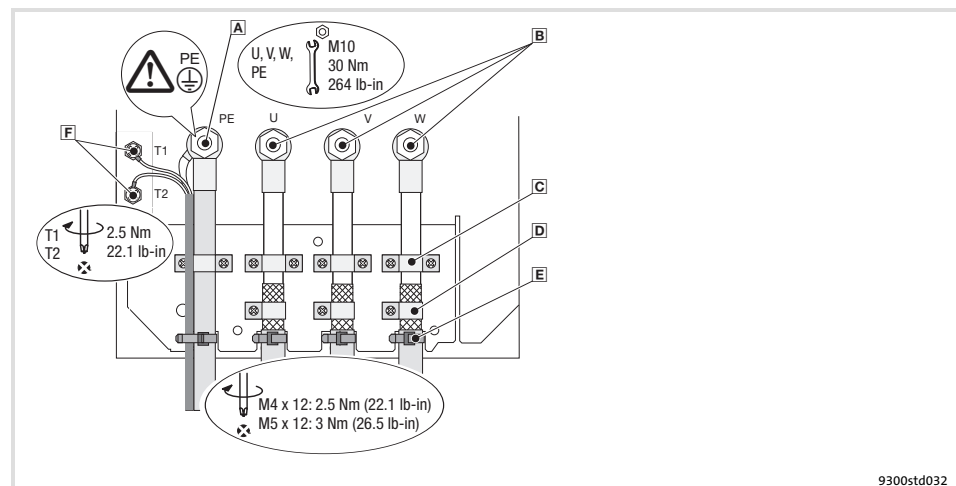

Fig. 5.7-4 Motor connection with PTC thermistor or thermal contact (NC contact)

- A** PE stud
PE cable connection with ring cable lug
- B** U, V, W
Motor cable connection
Check the correct polarity. Observe maximum length of the motor cable.
Max. connectable cable cross-section: 240 mm² with ring cable lug
- C** Cable clamps for strain relief of motor cable
Fasten cable clamps with M4 × 12 mm screws
- D** Shield clamps
Place shields of motor cable with large surface on the shield sheet and fasten with shield clamps and M5 × 12 mm screws
- E** Cable ties for additional strain relief of motor cable
- F** T1, T2 for motor temperature monitoring
Cable connection for PTC thermistors or thermal contacts (NC contacts)
Place shield with large surface on PE stud

Motor with KTY thermal sensor



Note!

- ▶ We recommend to use Lenze system cables for wiring.
- ▶ For self-made cables only use cables with shielded cores twisted in pairs.

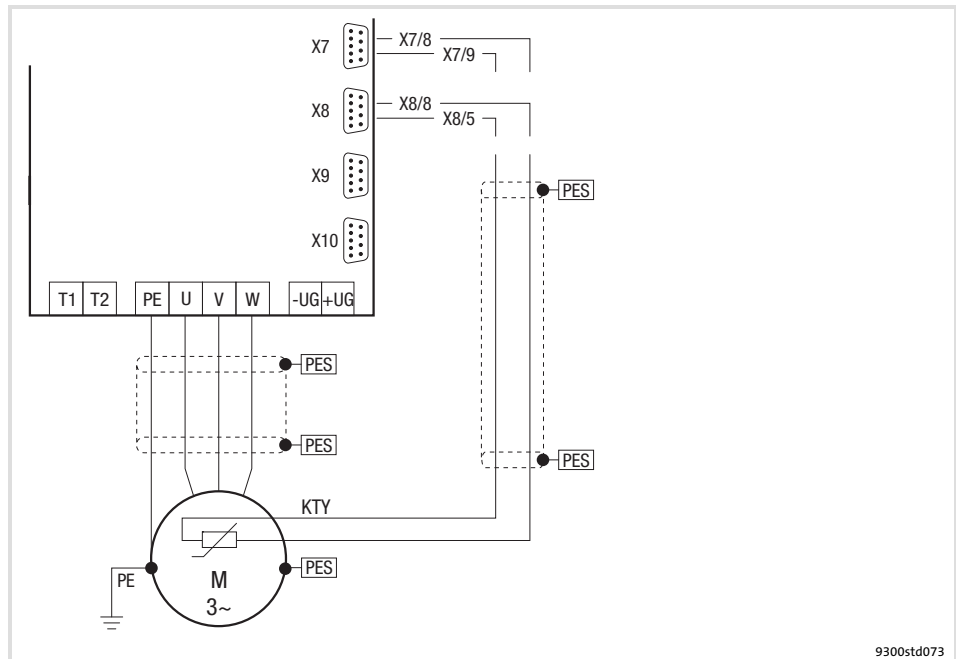

Fig. 5.7-5 Circuit diagram for the motor connection with KTY temperature sensor at X7 or X8

Features of the connection for motor temperature monitoring:

Pins X7/8, X7/9 of resolver input (X7), or pins X8/8, X8/5 of incremental encoder input (X8)

Connection	Linear KTY temperature sensor
Tripping point	<ul style="list-style-type: none"> ● Warning: adjustable ● Error (TRIP): fixed at 150 °C
Notes	<ul style="list-style-type: none"> ● Monitoring is not active in the Lenze setting. ● The KTY temperature sensor is monitored with regard to interruption and short circuit.

5

Wiring of the standard device

5.7

Standard devices in the power range 55 ... 75 kW

5.7.6

Motor connection

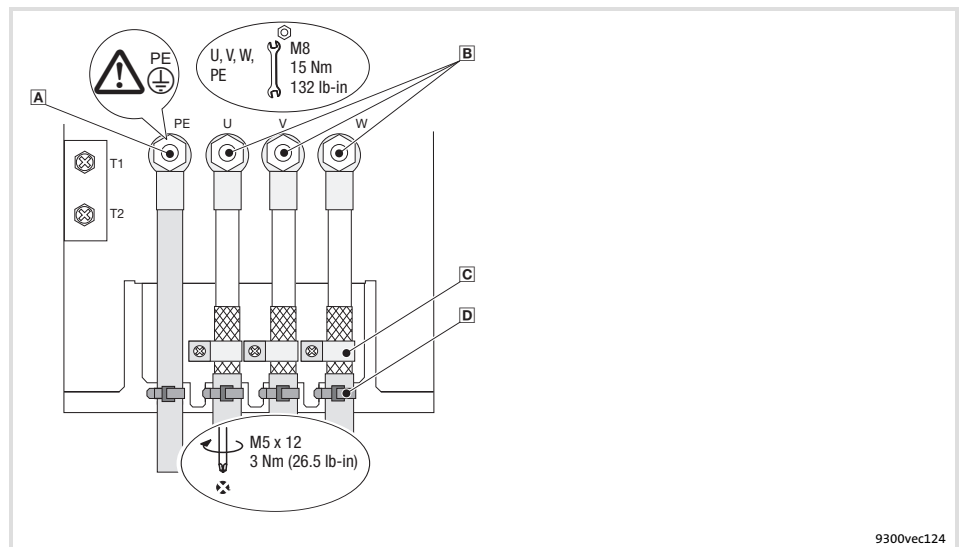

Fig. 5.7-6 Motor connection with KTY thermal sensor

- A** PE stud
PE cable connection with ring cable lug
- B** U, V, W
Motor cable connection
Check the correct polarity. Observe maximum length of the motor cable.
Max. connectable cable cross-section: 240 mm² with ring cable lug
- C** Shield clamps
Place shields of motor cable with large surface on the shield sheet and fasten with shield clamps and M5 × 12 mm screws
- D** Cable ties
Strain relief of motor cable

5.8 Control terminals

5.8.1 Important notes



Stop!

The control card will be damaged if

- ▶ the voltage between X5/39 and PE or X6/7 and PE is greater than 50 V,
- ▶ the voltage between voltage source and X6/7 exceeds 10 V (common mode) in case of supply via external voltage source.

Limit the voltage before switching on the drive controller:

- ▶ Connect X5/39, X6/2, X6/4 and X6/7 directly to PE or
 - ▶ use voltage-limiting components.
- ▶ For trouble-free operation, the control cables must be shielded:
- Connect the shield of digital input and output cables at both ends.
 - Connect the shield of analog input and output cables at one end (at the drive controller).
 - For lengths of 200 mm and more, use only shielded cables for analog and digital inputs and outputs. Under 200 mm, unshielded but twisted cables may be used.

Installation material required from the scope of supply:

Description	Use	Quantity
Shield sheet	Shield connection for control cables	1
Screw M4 × 10 mm (DIN 7985)	Shield sheet fastening	1
Terminal strip, 4-pole (only for variants V004 and V024)	Connection of safety relay K _{SR} at X11	1
Terminal strip, 7-pole	Connection of digital inputs and outputs at X5	2
Terminal strip, 4-pole	Connection of analog inputs and outputs at X6	2

5 Wiring of the standard device

5.8 Control terminals

5.8.1 Important notes

How to connect the shield

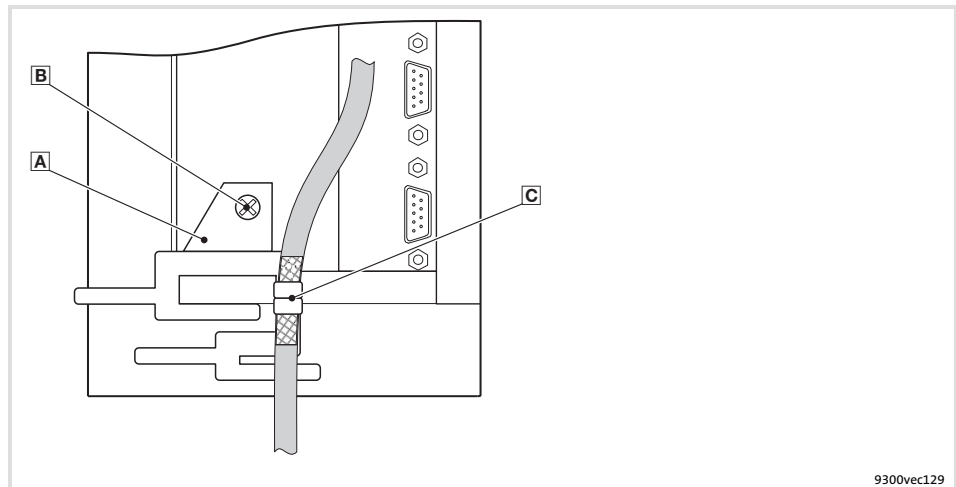

Fig. 5.8-1 Connection of cable shield to shield sheet





- A Shield sheet
- B Fasten shield sheet with M4 × 10 mm screw at the bottom of the control card
- C Securely clamp cable shield with lugs

Terminal data



Stop!

- ▶ Connect or disconnect the terminal strips only if the controller is disconnected from the mains!
- ▶ Wire the terminal strips before connecting them!
- ▶ Unused terminal strips must also be plugged on to protect the contacts.

Cable type	Wire end ferrule	Maximum cable cross-section	Tightening torque	Stripping length
 Rigid	–	2.5 mm ² (AWG 14)	0.5 ... 0.6 Nm (4.4 ... 5.3 lb-in)	5 mm
 Flexible	Without wire end ferrule	2.5 mm ² (AWG 14)		
 Flexible	Wire end ferrule without plastic sleeve	2.5 mm ² (AWG 14)		
 Flexible	Wire end ferrule with plastic sleeve	2.5 mm ² (AWG 14)		

5.8.2 Connection terminal of the control card

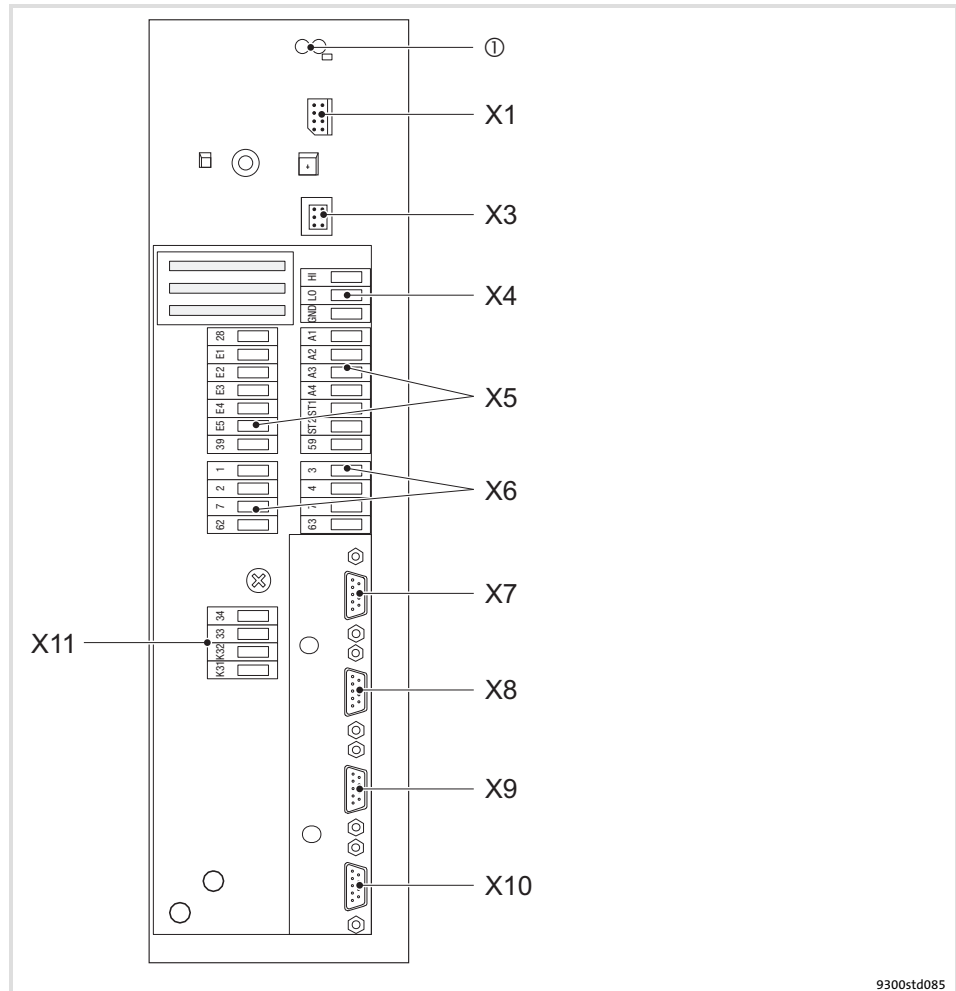

Fig. 5.8-2 Connection terminal of the control card

- ① 2 light-emitting diodes (red, green) for status display
- X1 Automation interface (AIF)
Slot for communication modules (e.g. keypad XT)
- X3 Jumper for the preselection of the signal type for the input signal at X6/1, X6/2
- X4 System bus (CAN) connection, terminal strip
- X5 Connection of digital inputs and outputs, terminal strips
- X6 Connection of analog inputs and outputs, terminal strips
- X7 Resolver connection
Plug-in connector: Socket, 9-pole, Sub-D
- X8 Incremental encoder connection
Plug-in connector: Pin, 9-pole, Sub-D
- X9 Connection of digital frequency input signal
Plug-in connector: Pin, 9-pole, Sub-D
- X10 Connection of digital frequency output signal
Plug-in connector: Socket, 9-pole, Sub-D
- X11 Connection of safety relay K_{SR} , terminal strip

5 Wiring of the standard device

5.8 Control terminals

5.8.3 Device variant without "Safe torque off" function

5.8.3 Device variant without "Safe torque off" function

Internal voltage supply

- ▶ For the supply of the digital inputs (X5/E1 ... X5/E5) you have to set a freely assignable digital output (e. g. X5/A1) permanently to HIGH level.
- ▶ For the supply of the analog inputs (X6/1, X6/2 and X6/3, X6/4) you have to set a freely assignable analog output (e. g. X6/63) permanently to HIGH level.

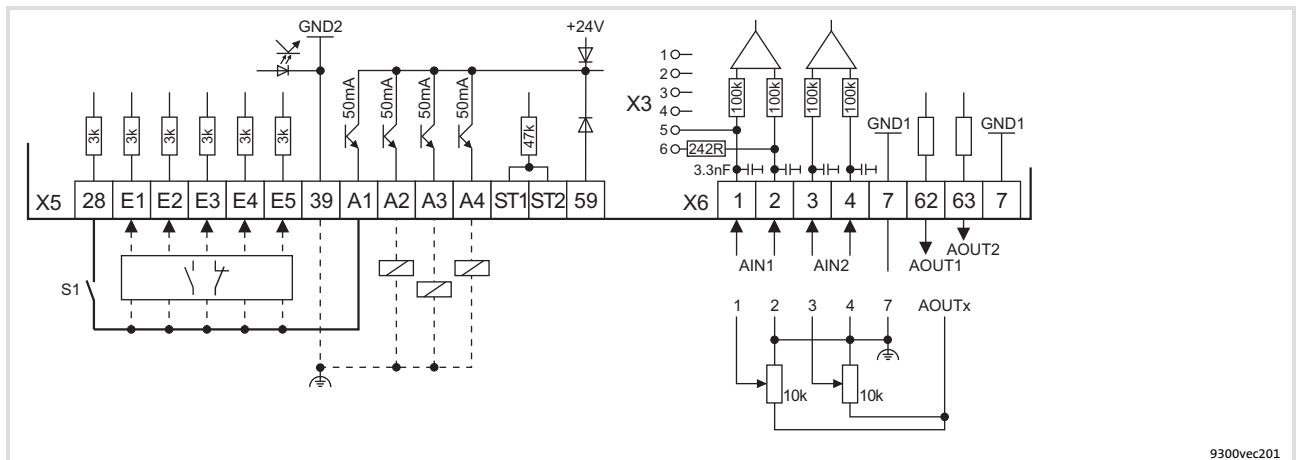

Fig. 5.8-3 Wiring of digital and analog inputs/outputs for internal voltage source

- S1 Controller enable
- NO contact or NC contact
- Load
- Minimum wiring required for operation
- Terminal assignment in the Lenze setting: 5.8-9

Supply via external voltage source

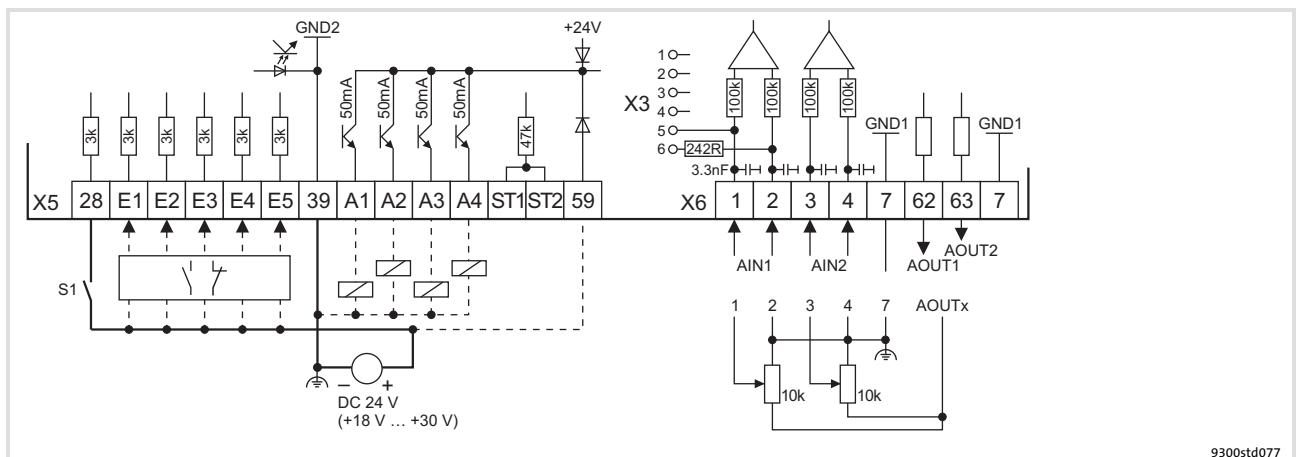

Fig. 5.8-4 Wiring of digital and analog inputs/outputs for external voltage source

- S1 Controller enable
- NO contact or NC contact
- Load
- Minimum wiring required for operation
- Terminal assignment in the Lenze setting: 5.8-9

5.8.4 Device variant with "Safe torque off" function

Safety instructions for the installation of the "Safe torque off" function

- ▶ The installation and commissioning of the "Safe torque off" function must be carried out by skilled personnel only.
- ▶ All safety-relevant cables (e.g. control cable for the safety relay, feedback contact) outside the control cabinet must be protected, for instance by a cable duct. Short circuits between the single cables must be ruled out!
- ▶ Wiring of the safety relay K_{SR} with insulated wire end ferrules or rigid cables is absolutely vital.
- ▶ The electrical reference point for the coil of the safety relay K_{SR} must be connected with the protective conductor system (DIN EN 60204-1 paragraph 9.4.3). Only this measure guarantees that the operation is protected against earth faults.



Tip!

A complete description can be found in the chapter "Safe torque off".

5 Wiring of the standard device

5.8 Control terminals

5.8.4 Device variant with "Safe torque off" function

Internal voltage supply

- ▶ If a freely assignable digital output (e. g. X5/A1) is fixedly applied to HIGH level, it serves as an internal voltage source. An output can be loaded with a maximum of 50 mA.
 - Via a digital output you can supply the relay K_{SR} and two digital inputs (X5/28, and for instance X5/E1) with voltage.
 - For the maximum connection (relay K_{SR} and X5/E1 ... X5/E5) you have to connect two digital outputs in parallel and fixedly apply them to HIGH level.
- ▶ For the supply of the analog inputs (X6/1, X6/2 and X6/3, X6/4) you have to set a freely assignable analog output (e. g. X6/63) permanently to HIGH level.

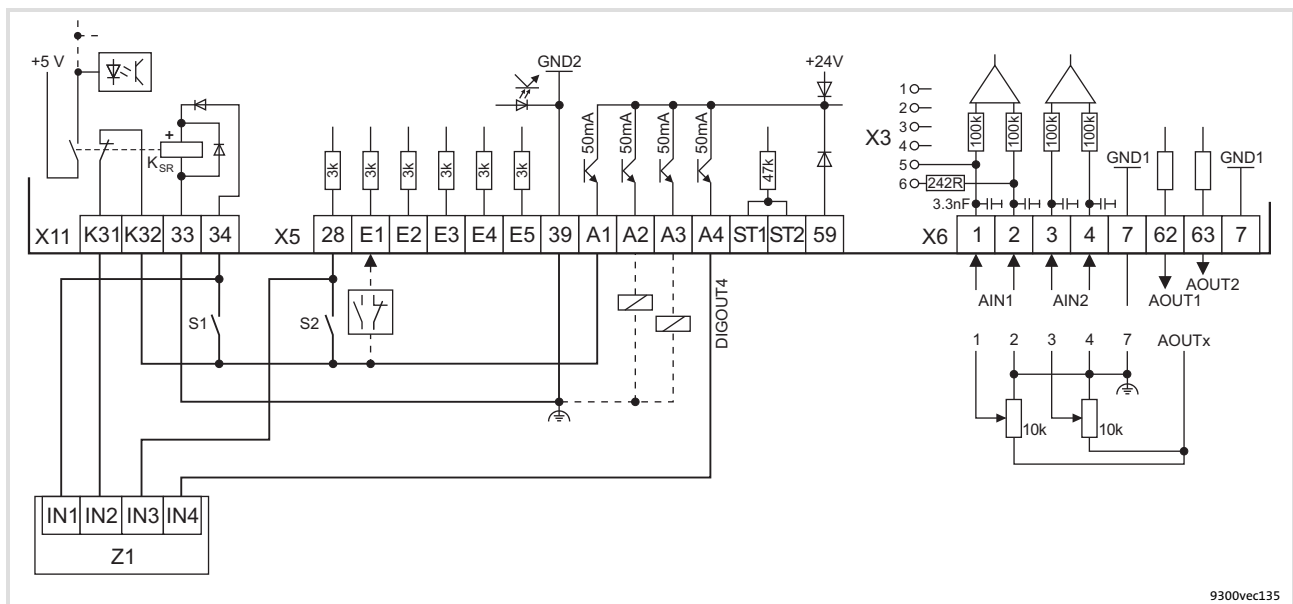

Fig. 5.8-5 Wiring of digital and analog inputs/outputs with active "Safe torque off" function and internal voltage source

- S1 Deactivate pulse inhibit (1st disconnecting path)
 - S2 Enable controller (2nd disconnecting path)
 - Z1 Programmable logic controller (PLC)
- The PLC monitors the "Safe torque off" function
- X5/A4 Feedback via a digital output (e. g. DIGOUT4)
- NO contact or NC contact
- Load
- Minimum wiring required for operation
- Terminal assignment in the Lenze setting: 5.8-9



Note!

If you load a basic configuration C0005 = xx1x (e.g. 1010 for speed control with control via terminals), the following terminals are switched to a fixed signal level:

- ▶ Terminal X5/A1 to FIXED1 (corresponds to DC 24 V).
- ▶ Terminal X6/63 to FIXED100% (corresponds to 10 V).

Supply via external voltage source

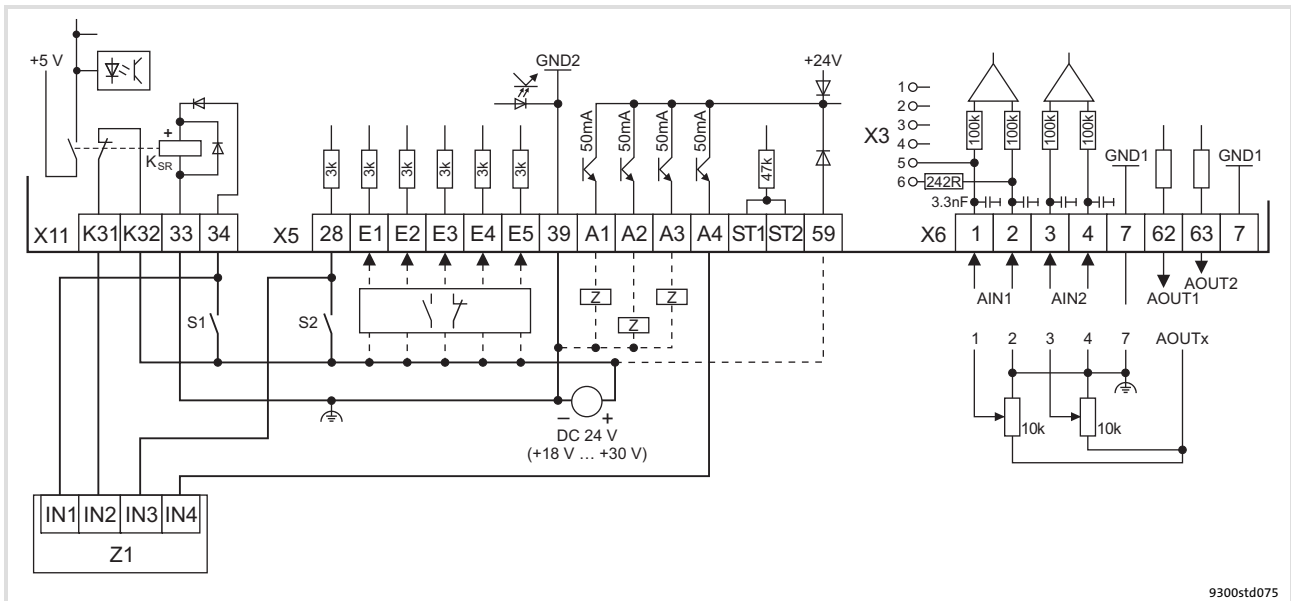

Fig. 5.8-6 Wiring of digital and analog inputs/outputs with active "Safe torque off" function and external voltage source

- S1 Deactivate pulse inhibit (1st disconnecting path)
- S2 Enable controller (2nd disconnecting path)
- Z1 Programmable logic controller (PLC)
The PLC monitors the "Safe torque off" function
- X5/A4 Feedback via a digital output (e. g. DIGOUT4)
- NO contact or NC contact
- Load
- Minimum wiring required for operation
- Terminal assignment in the Lenze setting: 5.8-9



Note!

Supplying the digital inputs via an external voltage source enables a **backup operation in the case of mains failure**. After switching off the mains voltage, all actual values are continued to be detected and processed.

- ▶ Connect the positive pole of the external voltage source with X5/59 to establish the backup operation in the event of mains failure.
- ▶ The external voltage source must be able to supply a current ≥ 1 A.
- ▶ The starting current of the external voltage source is not limited by the controller. Lenze recommends the use of voltage sources with current limitation or with an internal impedance of $Z > 1 \Omega$.

5 Wiring of the standard device

5.8 Control terminals

5.8.5 State bus

5.8.5 State bus



Stop!

Destruction of the control card!

External voltage at X5/ST1, X5/ST2 destroys the control card.

Protective measure:

Do not connect an external voltage to X5/ST1, X5/ST2.

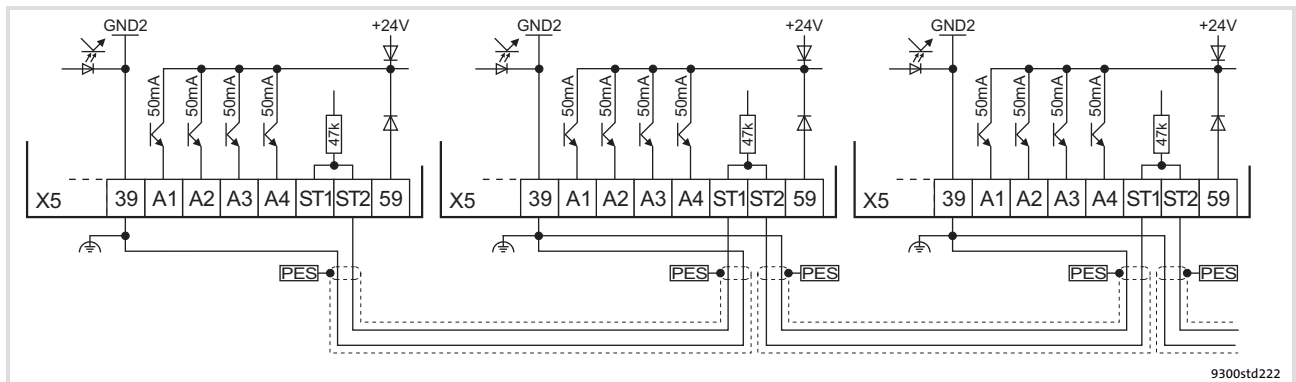

Fig. 5.8-7 Example for wiring a drive system to the STATE BUS

PES

HF shield termination by large-surface connection to PE

9300std222

5.8.6 Terminal assignment

Analog input configuration

Terminal	Jumper strip X3	Jumper setting	Possible levels
X6/1, X6/2		1-2 ¹⁾	-10 V ... +10 V ¹⁾
		3-4	-10 V ... +10 V
		5-6	-20 mA ... +20 mA

¹⁾ Lenze setting (delivery state)

Non-configurable control terminals

Terminal	Description	Function	Level / state
X11/K32 X11/K31	Safety relay K _{SR} 1st disconnecting path	Pulse inhibit feedback	Open contact: pulse inhibit is inactive (operation) Closed contact: pulse inhibit is active
X11/33		– coil of safety relay K _{SR}	Coil is not carrying any current: pulse inhibit is active
X11/34		+ coil of safety relay K _{SR}	Coil is carrying current: pulse inhibit is inactive (operation)
X5/28	Controller inhibit (DCTRL-CINH) 2nd disconnecting path	Controller enable/inhibit	LOW: Controller inhibited HIGH: Controller enabled
X5/ST1 X5/ST2		STATE-BUS	

Configurable control terminals (Lenze setting)

Terminal	Description	Function	Level
X5/E1	Digital inputs	Deactivate quick stop/ CW rotation	HIGH
X5/E2		Deactivate quick stop/ CCW rotation	HIGH
X5/E3		Activate fixed frequency 1	HIGH
X5/E4		Set error message (TRIP set)	LOW
X5/E5		Reset error message (TRIP reset)	LOW-HIGH edge
X5/A1	Digital outputs	Error message available	LOW
X5/A2		Switching threshold Q _{MIN} : actual speed < setpoint speed in C0017	LOW
X5/A3		Ready for operation (DCTRL-RDY)	HIGH
X5/A4		Maximum current reached (DCTRL-IMAX)	HIGH
X6/1, X6/2	Analog inputs	Main speed setpoint	-10 V ... +10 V
X6/3, X6/4		Additional speed setpoint	-10 V ... +10 V
X6/62	Analog outputs	Actual speed value	-10 V ... +10 V
X6/63		Torque setpoint	-10 V ... +10 V

5 Wiring of the standard device

5.8 Control terminals

5.8.7 Technical data

5.8.7 Technical data

Safety relay K_{SR}

Terminal	Description	Field	Values
X11/K32 X11/K31 X11/33 X11/34	Safety relay K _{SR} 1st disconnecting path	Coil voltage at +20 °C	DC 24 V (20 ... 30 V)
		Coil resistance at +20 °C	823 Ω ±10 %
		Rated coil power	Approx. 700 mW
		Max. switching voltage	AC 250 V, DC 250 V (0.45 A)
		Max. AC switching capacity	1500 VA
		Max. switching current (ohmic load)	AC 6 A (250 V), DC 6 A (50 V)
		Recommended minimum load	> 50 mW
		Max. switching rate	6 switchings per minute
		Mechanical service life	10 ⁷ switching cycles
		Electrical service life	
		at 250 V AC (ohmic load)	10 ⁵ switching cycles at 6 A 10 ⁶ switching cycles at 1 A 10 ⁷ switching cycles at 0.25 A
		at 24 V DC (ohmic load)	6 × 10 ³ switching cycles at 6 A 10 ⁶ switching cycles at 3 A 1.5 × 10 ⁶ switching cycles at 1 A 10 ⁷ switching cycles at 0.1 A

Digital inputs, digital outputs

Terminal	Description	Field	Values
X5/28	Controller inhibit (DCTRL-CINH) 2nd disconnecting path	PLC level, HTL	LOW: 0 ... +3 V HIGH: +12 ... +30 V
X5/E1 X5/E2 X5/E3 X5/E4 X5/E5	Digital inputs	PLC level, HTL	LOW: 0 ... +3 V HIGH: +12 ... +30 V
		Input current per input	8 mA for +24 V
		Cycle time	1 ms
X5/A1 X5/A2 X5/A3 X5/A4	Digital outputs	PLC level, HTL	LOW: 0 ... +3 V HIGH: +12 ... +30 V
		Load capacity per output	Maximally 50 mA
		Load resistance	For +24 V at least 480 Ω
		Cycle time	1 ms
X5/39	GND2	Reference potential for digital signals Isolated to X6/7 (GND1)	
X5/59	Connection of external voltage source for backup operation of the drive controller in the case of mains failure	Input voltage	DC 24 V (+18 ... +30 V)
		Current consumption	Maximally 1 A for 24 V
X5/ST1 X5/ST2	STATE-BUS	Maximum number of nodes	20
		Maximum length of the bus cable	5 m

Analog inputs, analog outputs

Terminal	Description	Field	Values
X6/1 X6/2	Analog input 1	Voltage range	
		Level	-10 V ... +10 V
		Resolution	5 mV (11 Bit + sign)
		Current range	
		Level	-20 mA ... +20 mA
		Resolution	20 μ A (10 Bit + sign)
X6/3 X6/4	Analog input 2	Voltage range	
		Level	-10 V ... +10 V
		Resolution	5 mV (11 Bit + sign)
X6/62	Analog output 1	Level	-10 V ... +10 V
		Load capacity	Maximum 2 mA
		Resolution	20 mV (9 bits + sign)
		Cycle time	1 ms (smoothing time $\tau = 2$ ms)
X6/63	Analog output 2	Level	-10 V ... +10 V
		Load capacity	Maximum 2 mA
		Resolution	20 mV (9 bits + sign)
		Cycle time	1 ms (smoothing time $\tau = 2$ ms)
X6/7	GND1	Reference potential for analog signals Isolated to X5/39 (GND2)	

5.9 Wiring of the system bus (CAN)

Wiring

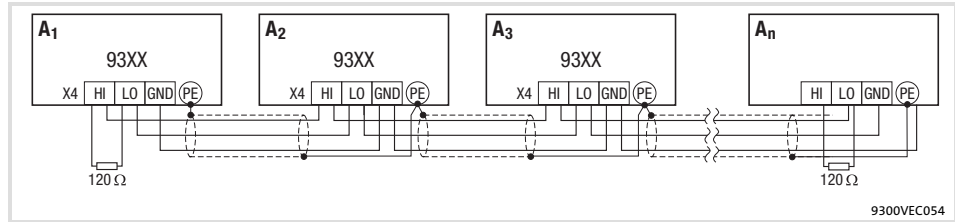

Fig. 5.9-1 System bus (CAN) wiring

- A₁ Bus device 1 (controller)
- A₂ Bus device 2 (controller)
- A₃ Bus device 3 (controller)
- A_n Bus device n (e. g. PLC), n = max. 63
- X4/GND CAN-GND: System bus reference potential
- X4/LO CAN-LOW: System bus LOW (data line)
- X4/HI CAN-HIGH: System bus HIGH (data line)



Stop!

Connect a 120 Ω terminating resistor to the first and last bus device.

We recommend the use of CAN cables in accordance with ISO 11898-2:

CAN cable in accordance with ISO 11898-2	
Cable type	Paired with shielding
Impedance	120 Ω (95 ... 140 Ω)
Cable resistance/cross-section	
Cable length ≤ 300 m	≤ 70 mΩ/m / 0.25 ... 0.34 mm ² (AWG22)
Cable length 301 ... 1000 m	≤ 40 mΩ/m / 0.5 mm ² (AWG20)
Signal propagation delay	≤ 5 ns/m

5.10 Wiring of the feedback system

5.10.1 Important notes

The feedback signal can either be supplied via input X7 or via input X8.

- ▶ At X7 a resolver can be connected.
- ▶ At X8 an encoder can be connected.
 - Incremental encoder TTL
 - SinCos encoder
 - SinCos encoder with serial communication (single-turn or multi-turn)

The resolver or encoder signal for slave drives can be output at the digital frequency output X10.



Note!

- ▶ We recommend to use Lenze system cables for wiring.
- ▶ For self-made cables only use cables with shielded cores twisted in pairs.

Installation material required from the scope of supply:

Description	Use	Quantity
Protective cover	Protection for unused Sub-D connections	4

5 Wiring of the standard device

5.10 Wiring of the feedback system

5.10.2 Resolver at X7

5.10.2 Resolver at X7

Technical data

Field	Values
Connection at drive controller	Connector: Socket, 9-pole, Sub-D
Resolver type recommended	Receiver
Number of pole pairs of the resolver	1
Transmission ratio	0.3
Evaluation method	Voltage impression in the sine and cosine winding
Max. output voltage	± 10 V
Max. current consumption	50 mA per winding
Max. impedance [Z]	500 Ω per winding
Output frequency	4 kHz
Monitoring	Monitoring for open circuit of the resolver and the resolver cable (configurable)

Wiring

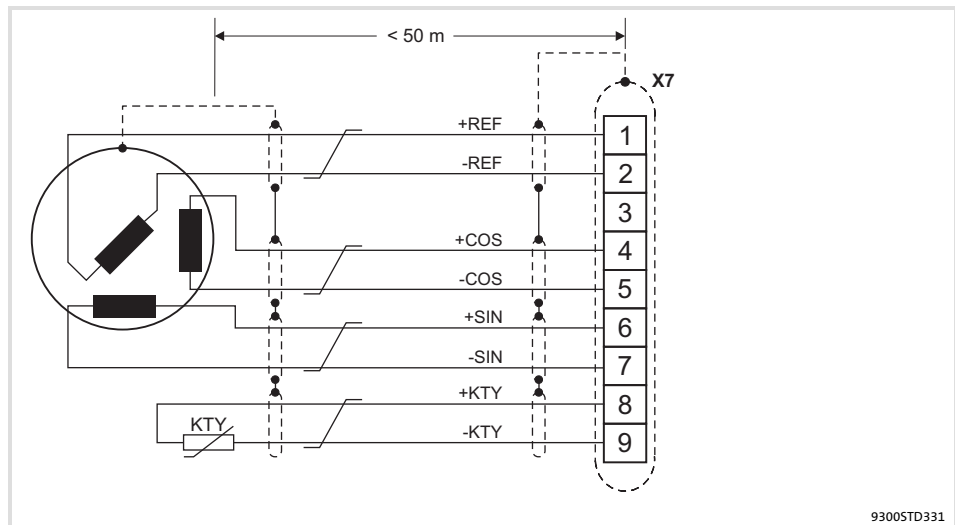



Fig. 5.10-1 Resolver connection

↗ Cores twisted in pairs

X7 - Resolver									
Connector: Socket, 9-pole, Sub-D									
Pin	1	2	3	4	5	6	7	8	9
Signal	+REF	-REF	GND	+COS	-COS	+SIN	-SIN	+KTY	-KTY
	0.5 mm ² (AWG 20)		-	0.14 mm ² (AWG 26)					

5.10.3 Incremental encoder with TTL level at X8

Technical data	Values
Connection at drive controller	Connector: Pin, 9-pole, Sub-D
Connectable incremental encoder	Incremental encoder with TTL level <ul style="list-style-type: none"> Encoder with two 5 V complementary signals electrically offset by 90° Connection of zero track is possible (optional)
Input frequency	0 ... 500 kHz
Current consumption	6 mA per channel
Internal voltage source (X8/4, X8/5)	5 V DC / max. 200 mA

Wiring

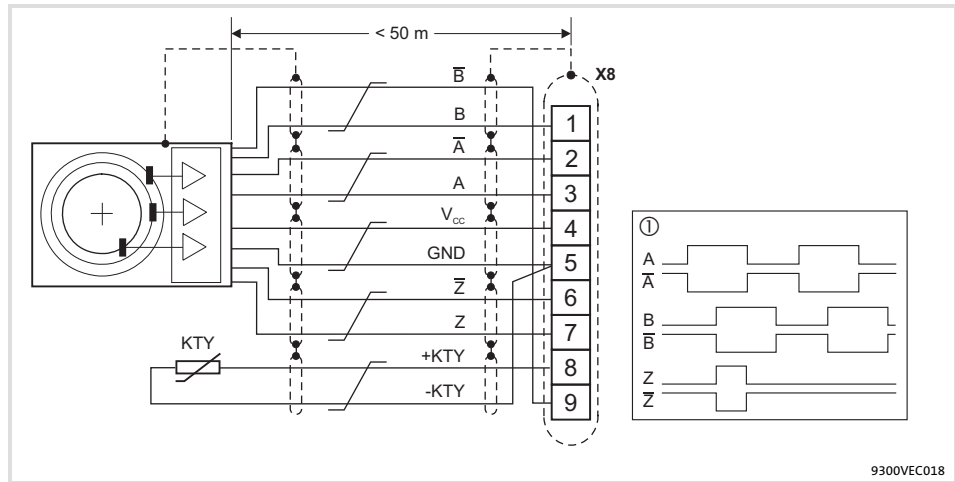

Fig. 5.10-2 Connection of incremental encoder with TTL level (RS-422)

- ① Signals for CW rotation
- ∕ Cores twisted in pairs

X8 - Incremental encoder with TTL level									
Connector: Pin, 9-pole, Sub-D									
Pin	1	2	3	4	5	6	7	8	9
Signal	B	\bar{A}	A	V_{CC}	GND (-KTY)	\bar{Z}	Z	+KTY	\bar{B}
	0.14 mm ² (AWG 26)			1 mm ² (AWG 18)		0.14 mm ² (AWG 26)			

5 Wiring of the standard device

5.10 Wiring of the feedback system

5.10.4 SinCos encoder at X8

5.10.4 SinCos encoder at X8

Technical data

Field	Values
Connection at drive controller	Connector: Pin, 9-pole, Sub-D
Connectable SinCos encoders	<ul style="list-style-type: none"> • SinCos encoders with a rated voltage from 5 V... 8 V. • SinCos encoder of the company Stegmann with Hiperface® interface, Stegmann type SCS/SCM (prolongs the initialisation time of the controller to approx. 2 seconds)
Sine and cosine track voltage	$1 V_{SS} \pm 0.2 V$
Voltage RefSIN and RefCOS	+2.5 V
Internal resistance R_i	221 Ω
Internal voltage source (X8/4, X8/5)	5 V DC / max. 200 mA

Wiring

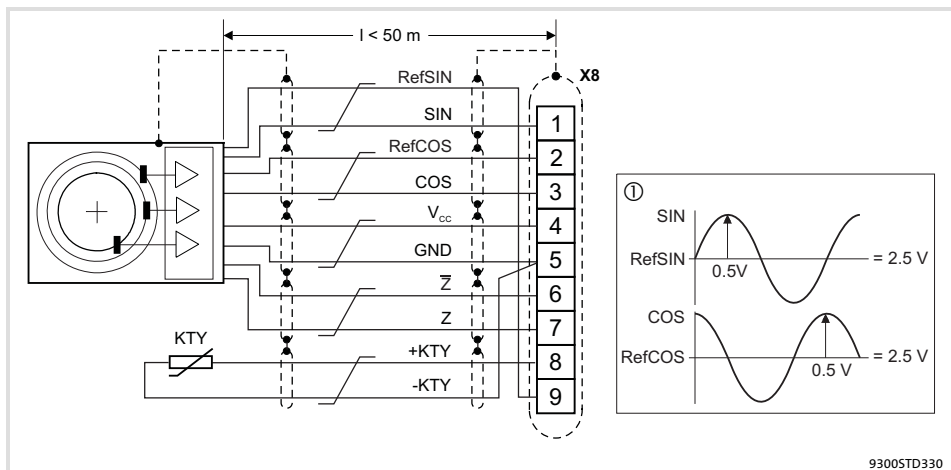



Fig. 5.10-3 SinCos encoder connection

- ① Signals for CW rotation
- / Cores twisted in pairs

X8 - SinCos encoder

Connector: Pin, 9-pole, Sub-D

Pin	1	2	3	4	5	6	7	8	9
Signal	SIN	RefCOS	COS	V_{CC}	GND (-KTY)	\bar{Z} or -RS485	Z or +RS485	+KTY	RefSIN
	0.14 mm ² (AWG 26)			1 mm ² (AWG 18)		0.14 mm ² (AWG 26)			



Note!

- For encoders with tracks SIN, \bar{SIN} , COS, \bar{COS} :
 - Assign RefSIN with \bar{SIN} .
 - Assign RefCOS with \bar{COS} .

5.11 Wiring of digital frequency input / digital frequency output

Installation material required from the scope of supply:

Description	Use	Quantity
Protective cover	Protection for unused Sub-D connections	4

Technical data

Field	Digital frequency output X10
Connection at drive controller	Connector: Socket, 9-pole, Sub-D
Pin assignment	Dependent on the selected basic configuration
Output frequency	0 ... 500 kHz
Signal	Two-track with inverse 5 V signals (RS422) and zero track
Load capacity	Max. 20 mA per channel (up to 3 slave drives can be connected)
Special features	The "Enable" output signal at X10/8 switches to LOW if the drive controller is not ready for operation (e.g. disconnected from mains). This can trip SD3 monitoring on the slave drive.
Internal voltage source (X10/4, X10/5)	DC 5 V / max. 50 mA Total current at X9/4, X9/5 and X10/4, X10/5: max. 200 mA
Field	Digital frequency input X9
Connection at drive controller	Connector: Pin, 9-pole, Sub-D
Input frequency	0 ... 500 kHz (TTL level)
Signal	Two-track with inverse 5 V signals (RS422) and zero track
Signal evaluation	Via code C0427
Current consumption	Max. 5 mA
Special features	With activated SD3 monitoring, TRIP or warning is tripped if the "Lamp Control" input signal at X9/8 switches to LOW. Due to this the drive controller can respond if the master drive is not ready for operation.

Wiring



Note!

- ▶ We recommend to use Lenze system cables for wiring.
- ▶ For self-made cables only use cables with shielded cores twisted in pairs.

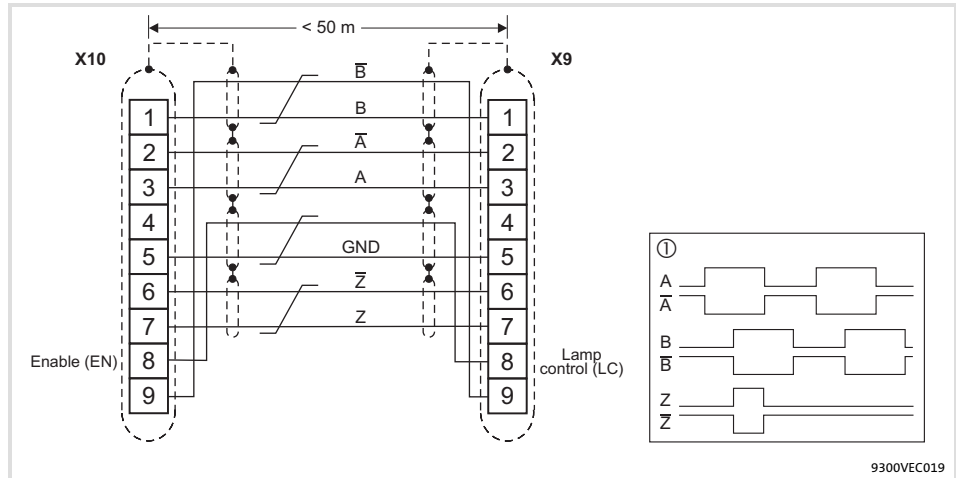



Fig. 5.11-1 Connection of digital frequency input (X9) / digital frequency output (X10)

X9 Slave drive
X10 Master drive

① Signals for CW rotation
⌘ Cores twisted in pairs

X9 - Digital frequency input
Connector: Pin, 9-pole, Sub-D

Pin	1	2	3	4	5	6	7	8	9
Signal	B	\bar{A}	A	+5 V	GND	\bar{Z}	Z	LC	\bar{B}
	0.14 mm ² (AWG 26)		0.5 mm ² (AWG 20)		0.14 mm ² (AWG 26)		0.5 mm ² (AWG 20)		0.14 mm ² (AWG 26)

X10 - Digital frequency output
Connector: Socket, 9-pole, Sub-D

Pin	1	2	3	4	5	6	7	8	9
Signal	B	\bar{A}	A	+5 V	GND	\bar{Z}	Z	EN	\bar{B}
	0.14 mm ² (AWG 26)		0.5 mm ² (AWG 20)		0.14 mm ² (AWG 26)		0.5 mm ² (AWG 20)		0.14 mm ² (AWG 26)

Adjustment

Evaluation of the input signals at X9

Code	Function	
C0427 = 0	CW rotation	Track A leads track B by 90° (positive value at DFIN-OUT)
	CCW rotation	Track A lags track B by 90° (negative value at DFIN-OUT)
C0427 = 1	CW rotation	Track A transmits the speed Track B = LOW (positive value at DFIN-OUT)
	CCW rotation	Track A transmits the speed Track B = HIGH (negative value at DFIN-OUT)
C0427 = 2	CW rotation	Track A transmits the speed and direction of rotation (positive value at DFIN-OUT) Track B = LOW
	CCW rotation	Track B transmits the speed and direction of rotation (negative value at DFIN-OUT) Track A = LOW

5.12 Communication modules



Communication manuals for the communication modules

Here you will find detailed information on how to wire and use the communication modules.

Possible communication modules

Communication module	Type/order number
Keypad XT	EMZ9371BC
LECOM-A/B (RS232/485)	EMF2102IBV001
LECOM-B (RS485)	EMF2102IBV002
LECOM-LI (optical fibre)	EMF2102IBV003
LON	EMF21411B
INTERBUS	EMF21131B
INTERBUS Loop	EMF21121B
PROFIBUS-DP	EMF21331B
DeviceNet/CANopen	EMF21751B

Handling

Plug the communication module onto the AIF interface (X1) or pull it off from the interface. The communication module can also be connected/disconnected during operation.

6 Commissioning

Contents

6.1	Important notes	6.1-1
6.2	Before switching on	6.2-1
6.3	Switch-on sequence	6.3-1
6.4	Controller inhibit	6.4-1
6.5	Basic settings	6.5-1
6.5.1	Changing the basic configuration	6.5-1
6.5.2	Adapting the controller to the mains	6.5-2
6.5.3	Entry of motor data	6.5-3
6.5.4	Motor selection list	6.5-6
6.5.5	Motor temperature monitoring with PTC or thermal contact	6.5-12
6.5.6	Motor temperature monitoring with KTY	6.5-13
6.6	Setting the speed feedback	6.6-1
6.6.1	Resolver at X7	6.6-1
6.6.2	Incremental encoder with TTL level at X8	6.6-1
6.6.3	SinCos encoder at X8	6.6-2
6.7	Current controller adjustment	6.7-1
6.8	Adjusting the rotor position	6.8-1
6.9	Changing the assignment of the control terminals X5 and X6	6.9-1
6.9.1	Free configuration of digital input signals	6.9-1
6.9.2	Free configuration of digital outputs	6.9-2
6.9.3	Free configuration of analog input signals	6.9-3
6.9.4	Free configuration of analog outputs	6.9-4

6.1 Important notes

Active loads



Stop!

For applications with active loads (e.g. hoists), you must set C0172 = 0 (OV reduce: threshold for activation of brake torque reduction before OV message) so that an overvoltage message (OV) can be generated.

- ▶ As long as the overvoltage message (OV) is active, pulse inhibit is set and the drive operates in zero-torque mode.
- ▶ The controller inhibit is also evaluated by the “holding brake (BRK)” function block.

»Global Drive Control« (GDC)

Use a PC with the »Global Drive Control« (GDC) PC software for commissioning. The full functionality of the servo cam profiler can only be obtained through GDC.

- ▶ Possible communication paths between GDC and controller including adapters and connection cables required:

Controller Interface	Connection	PC	
		PC adapter	Interface
Integrated system bus or CANopen communication module EMF2175IB	System bus cable (supplied with the system bus adapters)	System bus adapter EMF2173IB	Parallel (printer interface)
		System bus adapter EMF2177IB	USB
Communication module LECOM-A/B EMF2102IBCV001	Serial cable EWL0020 EWL0021	A standard RS232 / RS485 converter and an RS485 connection cable are required for LECOM-B.	Serial (RS232)
Communication module LECOM-LI EMF2102IBCV003	Optical fibre EWZ0006 EWZ0007	Optical fibre adapter EMF2125IB EMF2126IB	

6.2 Before switching on



Stop!

Special commissioning procedure after long-term storage

If controllers are stored for more than two years, the insulation resistance of the electrolyte may have changed.

Possible consequences:

- ▶ During initial switch-on, the DC-bus capacitors and hence the controller are damaged.

Protective measures:

- ▶ Form the DC-bus capacitors prior to commissioning. Instructions can be found on the Internet (www.Lenze.com).



Note!

- ▶ Keep to the switch-on sequence described.
- ▶ The chapter "Troubleshooting and fault elimination" helps you to eliminate faults during commissioning.

To avoid injury to persons or damage to material assets ...









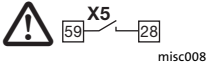

... before the mains supply is connected, check:

- ▶ The wiring for completeness, short circuit and earth fault.
- ▶ The "EMERGENCY STOP" function of the entire system.
- ▶ The in-phase connection of the motor.
- ▶ The correct connection of the resolver or incremental encoder to prevent the motor from rotating in the wrong direction.

... check the setting of the most important drive parameters before enabling the controller:

- ▶ Is the U/f rated frequency adapted to the motor circuit configuration?
- ▶ Are the drive parameters relevant for your application set correctly?
- ▶ Is the configuration of the analog and digital inputs and outputs adapted to the wiring?

6.3 Switch-on sequence

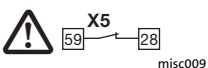
Switch-on sequence		Note
1.	Ensure that controller inhibit is active after mains connection.	 misc008 Terminal X5/28 = LOW
2.	Ensure that no external error is pending.	Terminal X5/E4 = HIGH
3.	Switch on controller.	
A	The control card is operated via an external voltage supply: Switch on the external DC 24 V supply voltage.	 misc002
B	The control card is operated via an internal voltage supply: Switch on the mains. The controller provides the DC 24 V supply.	
4.	After approx. 2 s the controller has initialised.	
5.	Switch on the PC and start GDC.	GDC starts in the online mode if the PC and the controller are connected. Information on the connection establishment can be found in the "Global Drive Control (GDC) - Getting started" manual.
6.	Enter the machine parameters in GDC.	
A	Select the basic configuration. Lenze setting: C0005 = 1000 (basic configuration "speed control").	 6.5-2
B	Adapt the controller to the mains.	 6.5-2
C	Enter motor data.	 6.5-3
D	Set temperature monitoring of the motor.	Motor with PTC or thermal contact:  6.5-14 Motor with KTY:  6.5-15
E	Select feedback system.	 6.6-1
7.	If required, carry out a current controller adjustment.	 6.7-1
8.	If required, carry out a rotor position adjustment.	 6.8-1
9.	Configure the function of the control terminals to adapt them to your application.	If an internal voltage supply is used, assign X5/x with "FIXED1" and X6/x with "FIXED100%".  6.9-1
10.	Save the settings with mains failure protection in one of the 4 parameter sets (C0003). With C0003 = 1 the settings are saved in parameter set 1.	After connecting the DC 24 V supply or after mains connection, parameter set 1 is activated automatically. (See chapter "Parameterisation")
11.	Switch on the mains if previously only the external DC 24 V supply voltage was switched on.	
12.	Enable controller.	 misc009 Terminal X5/28 = HIGH (see chapter "Commissioning" → "Controller inhibit")
13.	Define setpoint.	Analog setpoint selection: -10 ... +10 V via potentiometer at X6/1 and X6/2
	Fixed speed: Activate JOG 1 with X5/E3 = HIGH	JOG 1 is parameterised in C0039/1.

Switch-on sequence		Note
14.	The drive is now running.	CW rotation: X5/E1 = HIGH and X5/E2 = LOW CCW rotation: X5/E1 = LOW and X5/E2 = HIGH

**Note!**

In the "Diagnostics" menu, the most important drive parameters can be monitored.

6.4 Controller inhibit

Description

If the controller inhibit is active, the power outputs are inhibited.

- ▶ The drive coasts in zero-torque mode.
- ▶ Status display of keypad: Pulse inhibit **IMP**
- ▶ Status display at the controller: The green LED is blinking.



Danger!

Do not use the "controller inhibit" function (DCTRL1-CINH) for emergency-off. The controller inhibit only inhibits the power outputs and does **not** disconnect the controller from the mains! The drive could start again any time.

Activation

Via terminal X5/28:

- ▶ A LOW level at the terminal inhibits the controller (cannot be inverted)
- ▶ A HIGH level re-enables the controller

Via the keys of the keypad (if C0469 = 1):

- ▶ **STOP** inhibits the controller
- ▶ **RUN** re-enables the controller

Via code C0040:

- ▶ C0040 = 0 inhibits the controller
- ▶ C0040 = 1 re-enables the controller



Note!

- ▶ The sources for controller inhibit are ANDed, i.e. the drive only restarts if the controller inhibit signals of all signal sources have been eliminated.
- ▶ The restart starts with zero speed. If centrifugal masses are still rotating, this can lead to an overcurrent.

6.5 Basic settings

6.5.1 Changing the basic configuration

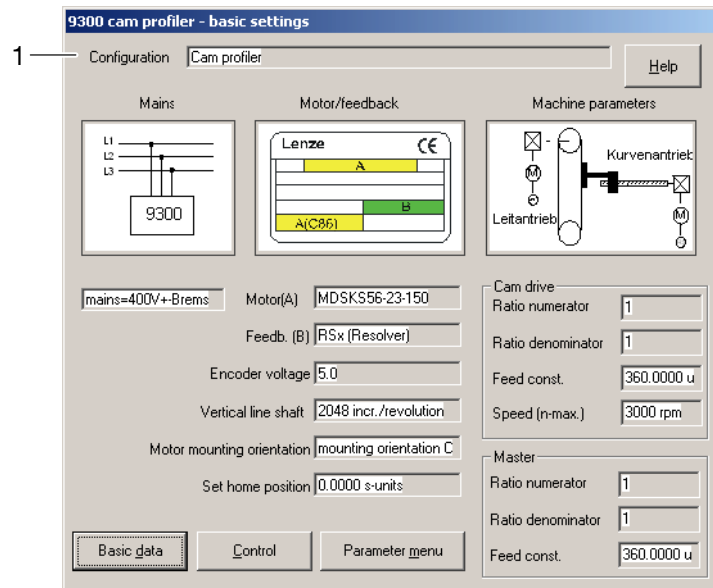

9300kur006

Fig. 6.5-1 "Basic settings" dialog box

Procedure

1. Open the "Basic settings" dialog box.
2. Click on field (1) and select a basic configuration suitable for your application, e.g. "10000" (Cam profiler)

6.5.2 Adapting the controller to the mains

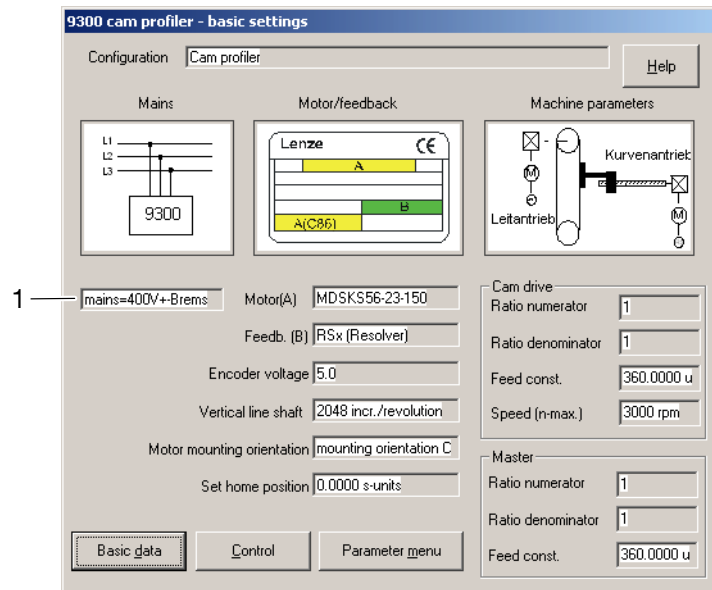

9300kur006

Fig. 6.5-2 "Basic settings" dialog box

Procedure

1. Open the "Basic settings" dialog box.
2. Click on field (1) and select the mains voltage and the supplementary component (if used).

6.5.3 Entry of motor data

For Lenze motors:

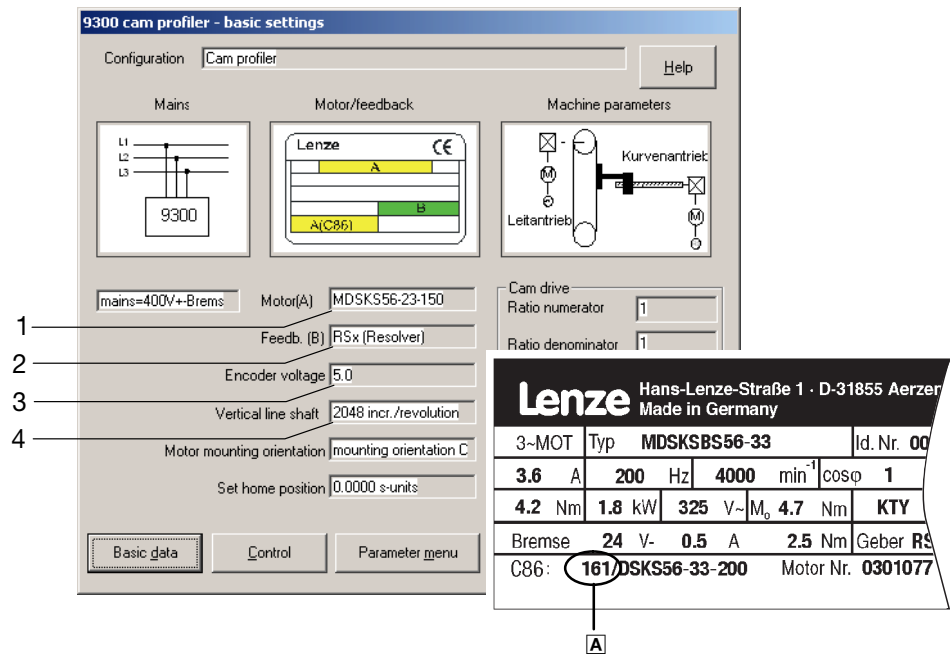

Fig. 6.5-3 "Basic settings" dialog box

- Procedure**
1. Open the "Basic settings" dialog box.
 2. Click into the field (1) and select the motor connected.
 Just select the number **A** specified on the nameplate of the motor from the open field.
Note!
 A list of the motors available can be found in the chapter "Motor selection list". 6.5-6
 3. Click into the field (2) and select the feedback system used.
 4. Click into the field (3) and, if required, set the voltage supply for the encoder at X8.
Important!
 For C0025 = 309, 310, 311, 409, 410 or 411 you have to adapt the voltage to 8 V.
 5. Click into the field (4) and adapt the constant of the digital frequency input to the output signal of the encoder connected.

Enter the 8-digit resolver designation of the nameplate to achieve the highest accuracy.

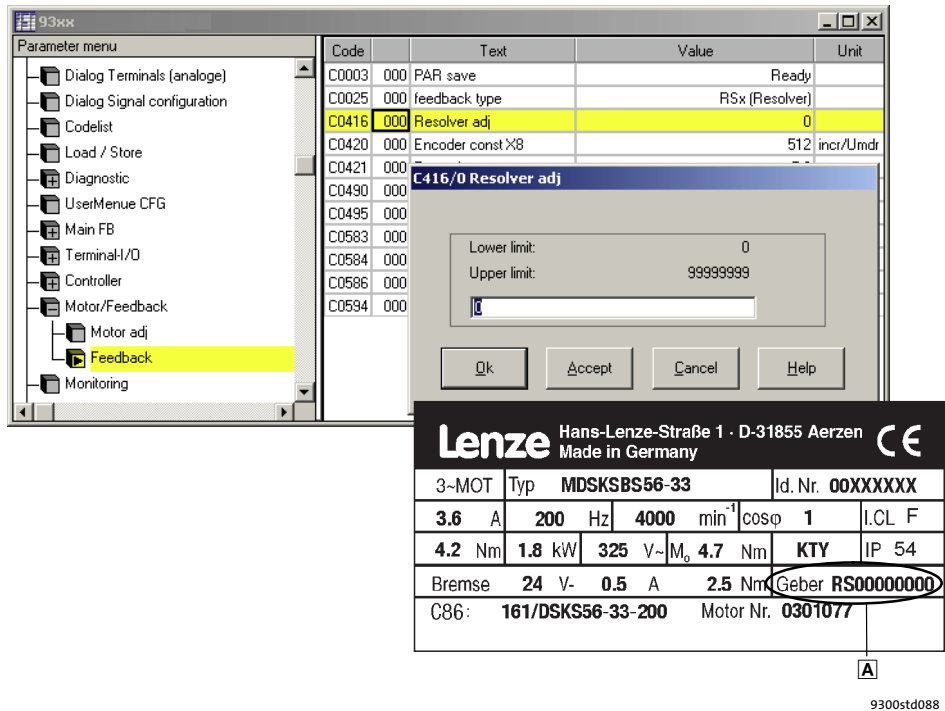
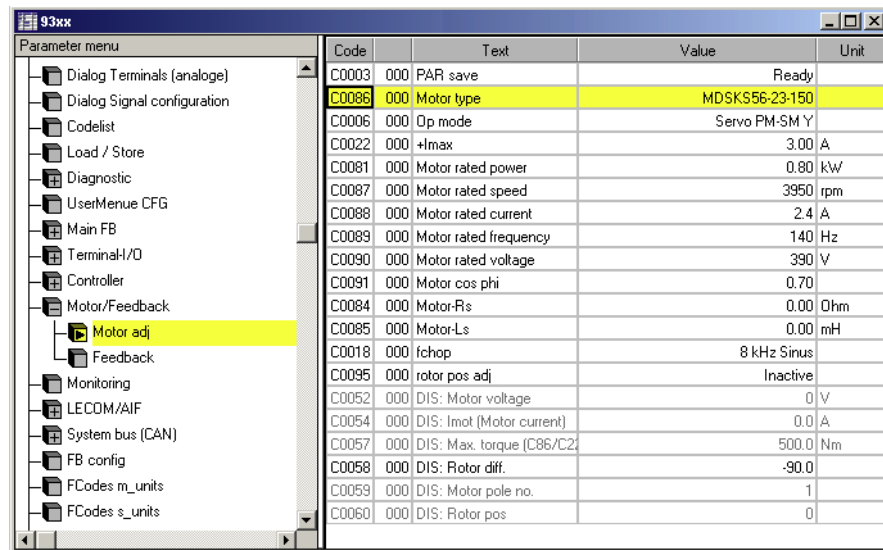

Fig. 6.5-4 "Feedback" menu of the parameter menu

Procedure

1. Open the "Parameter menu → Motor/Feedback → Feedback" menu.
2. Click on C0416.
3. Enter the 8-digit designation **A** of the motor nameplate in the dialog box.
4. Confirm with "OK".
5. Save the setting with C0003 = 1.

For non-Lenze motors or
 Lenze motors not listed under
 C0086



9300std089

Fig. 6.5-5 "Motor adj" menu of the parameter menu

Procedure

1. Open the "Parameter menu → Motor/Feedback → Motor adj" menu.
2. Click on C0086 and select the motor whose data corresponds best with the connected motor.

Note!

The available motors are listed in chapter "Motor selection list". 6.5-6

3. Click on C0006 and select the motor control operating mode.
4. Enter the data of the connected motor in the following codes. The data can be found on the nameplate or the data sheet of the motor.

C0022	Maximum current I_{max} of the motor
C0081	Rated motor power
C0084	Stator resistance of the motor (The setting is only required if the demands on the control characteristics are very high)
C0085	Leakage inductance of the motor (The setting is only required if the demands on the control characteristics are very high)
C0087	Rated motor speed
C0088	Rated motor current
C0089	Rated motor frequency
C0090	Rated motor voltage
C0091	Cos φ .

5. Save the setting with C0003 = 1.

6 Commissioning

6.5 Basic settings

6.5.4 Motor selection list

6.5.4 Motor selection list

Servo motors

The following table lists all servo motor which can be selected under C0086. In the "Servo motor reference list" you can find the servo motors for which the motor data must be entered manually. (📖 6.5-8)

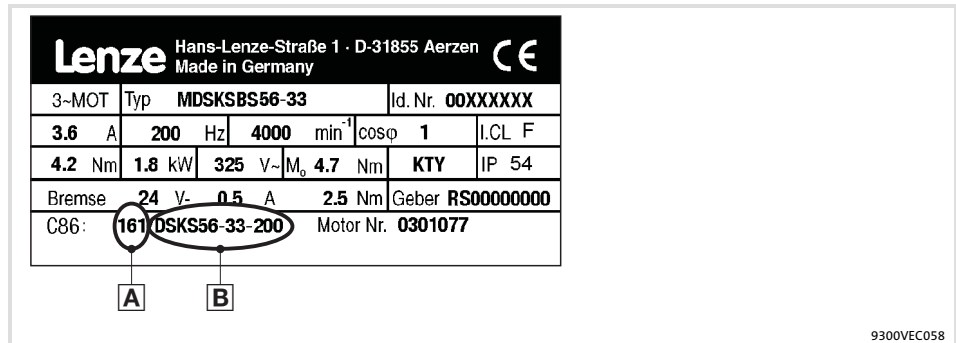

Fig. 6.5-6 Nameplate of a Lenze motor

A	B	Lenze type	C0081 P _r [kW]	C0087 n _r [rpm]	C0088 I _r [A]	C0089 f _r [Hz]	C0090 U _r [V]	Motor type	Temperature sensor
10	MDSKA56-140	MDSKAXX056-22	0.80	3950	2.4	140	390	Asynchronous servo motor	KTY
11	MDFKA71-120	MDFKAXX071-22	2.20	3410	6.0	120			
12	MDSKA71-140	MDSKAXX071-22	1.70	4050	4.4	140			
13	MDFKA80-60	MDFKAXX080-22	2.10	1635	4.8	60			
14	MDSKA80-70	MDSKAXX080-22	1.40	2000	3.3	70			
15	MDFKA80-120	MDFKAXX080-22	3.90	3455	9.1	120			
16	MDSKA80-140	MDSKAXX080-22	2.30	4100	5.8	140			
17	MDFKA90-60	MDFKAXX090-22	3.80	1680	8.5	60			
18	MDSKA90-80	MDSKAXX090-22	2.60	2300	5.5	80			
19	MDFKA90-120	MDFKAXX090-22	6.90	3480	15.8	120			
20	MDSKA90-140	MDSKAXX090-22	4.10	4110	10.2	140	350		
21	MDFKA100-60	MDFKAXX100-22	6.40	1700	13.9	60	390		
22	MDSKA100-80	MDSKAXX100-22	4.00	2340	8.2	80			
23	MDFKA100-120	MDFKAXX100-22	13.20	3510	28.7	120	330		
24	MDSKA100-140	MDSKAXX100-22	5.20	4150	14.0	140			
25	MDFKA112-60	MDFKAXX112-22	11.00	1710	22.5	60			
26	MDSKA112-85	MDSKAXX112-22	6.40	2490	13.5	85	390		
27	MDFKA112-120	MDFKAXX112-22	20.30	3520	42.5	120			
28	MDSKA112-140	MDSKAXX112-22	7.40	4160	19.8	140	320		
30	DFQA100-50	MDFQAXX100-22	10.60	1420	26.5	50	360		
31	DFQA100-100	MDFQAXX100-22	20.30	2930	46.9	100			
32	DFQA112-28	MDFQAXX112-22	11.50	760	27.2	28			
33	DFQA112-58	MDFQAXX112-22	22.70	1670	49.1	58			
34	DFQA132-20	MDFQAXX132-32	17.00	555	45.2	20			
35	DFQA132-42	MDFQAXX132-32	35.40	1200	88.8	42			
40	DFQA112-50	MDFQAXX112-22	20.10	1425	43.7	50			
41	DFQA112-100	MDFQAXX112-22	38.40	2935	81.9	100			
42	DFQA132-36	MDFQAXX132-32	31.10	1035	77.4	36			
43	DFQA132-76	MDFQAXX132-32	60.10	2235	144.8	76		340	

A	B	Lenze type	C0081 P _r [kW]	C0087 n _r [rpm]	C0088 I _r [A]	C0089 f _r [Hz]	C0090 U _r [V]	Motor type	Temperature sensor	
50	DSVA56-140	DSVAXX056-22	0.80	3950	2.4	140	390	Asynchronous servo motor	Thermal contact	
51	DFVA71-120	DFVAXX071-22	2.20	3410	6.0	120				
52	DSVA71-140	DSVAXX071-22	1.70	4050	4.4	140				
53	DFVA80-60	DFVAXX080-22	2.10	1635	4.8	60				
54	DSVA80-70	DSVAXX080-22	1.40	2000	3.3	70				
55	DFVA80-120	DFVAXX080-22	3.90	3455	9.1	120				
56	DSVA80-140	DSVAXX080-22	2.30	4100	5.8	140				
57	DFVA90-60	DFVAXX090-22	3.80	1680	8.5	60				
58	DSVA90-80	DSVAXX090-22	2.60	2300	5.5	80				
59	DFVA90-120	DFVAXX090-22	6.90	3480	15.8	120				
60	DSVA90-140	DSVAXX090-22	4.10	4110	10.2	140				350
61	DFVA100-60	DFVAXX100-22	6.40	1700	13.9	60				390
62	DSVA100-80	DSVAXX100-22	4.00	2340	8.2	80				
63	DFVA100-120	DFVAXX100-22	13.20	3510	28.7	120				
64	DSVA100-140	DSVAXX100-22	5.20	4150	14.0	140	330			
65	DFVA112-60	DFVAXX112-22	11.00	1710	22.5	60	390			
66	DSVA112-85	DSVAXX112-22	6.40	2490	13.5	85				
67	DFVA112-120	DFVAXX112-22	20.30	3520	42.5	120				
68	DSVA112-140	DSVAXX112-22	7.40	4160	19.8	140		320		
108	DSKS36-13-200	MDSKSXX036-13	0.25	4000	0.9	200	245	Synchronous servo motor	KTY	
109	DSKS36-23-200	MDSKSXX036-23	0.54	4000	1.1	200	345			
110	MDSKS56-23-150	MDSKSXX056-23	0.60	3000	1.25	150	350			
111	MDSKS56-33-150	MDSKSXX056-33	0.91	3000	2.0	150	340			
112	MDSKS71-13-150	MDSKSXX071-13	1.57	3000	3.1	150	360			
113	MDFKS71-13-150	MDFKSXX071-13	2.29	3000	4.35	150	385			
114	MDSKS71-23-150	MDSKSXX071-23	2.33	3000	4.85	150	360			
115	MDFKS71-23-150	MDFKSXX071-23	3.14	3000	6.25	150	375			
116	MDSKS71-33-150	MDSKSXX071-33	3.11	3000	6.7	150	330			
117	MDFKS71-33-150	MDFKSXX071-33	4.24	3000	9.1	150	345			
160	DSKS56-23-190	MDSKSXX056-23	1.1	3800	2.3	190	330			
161	DSKS56-33-200	MDSKSXX056-33	1.8	4000	3.6	200	325			
162	DSKS71-03-170	MDSKSXX071-03	2.0	3400	4.2	170	330			
163	DFKS71-03-165	MDFKSXX071-03	2.6	3300	5.6	165	330			
164	DSKS71-13-185	MDSKSXX071-13	3.2	3700	7.0	185	325			
165	DFKS71-13-180	MDFKSXX071-13	4.1	3600	9.2	180	325			
166	DSKS71-33-180	MDSKSXX071-33	4.6	3600	10.0	180	325			
167	DFKS71-33-175	MDFKSXX071-33	5.9	3500	13.1	175	325			

6 Commissioning

6.5 Basic settings

6.5.4 Motor selection list

Servo motor reference list

The motors listed in the “Motor nameplate data” table column are not included in Global Drive Control (GDC) and in the controller software.

1. Enter the corresponding value of column “C86” in C0086.
2. Compare the motor data codes with the table values.
 - If necessary, adapt the values in the controller to the table values.
3. Optimise the dynamic performance of your machine via codes C0070 and C0071 if necessary.

Motor nameplate data		Motor data													
C86	Field	C0086	C0022	C0081	C0084	C0085	C0087	C0088	C0089	C0090	C0091	C0070	C0071	C0075	C0076
	Type		I_{max} [A]	P_r [kW]	R_s [Ω]	L_σ [mH]	n_r [rpm]	I_r [A]	f_r [Hz]	U_r [V]	$\cos \varphi$	V_{pn}	T_{nn}	V_{pi}	T_{ni}
1000	MDSKA-71-22	54	3.75	0.88	8.4	34.98	1950	2.50	70	390	0.82	2	100	1.5	1.5
1001	MDFQA-112-12	33	42.60	12.90	0.45	4.3	1660	28.40	58	360	0.85	20	21	2	1
1002	MDFQA-112-12	41	70.50	21.80	0.45	4.3	2930	47.00	100	360	0.83	14	21	1.3	1
1003	MDSKA-56-22	50	6.75	1.57	2.25	6.5	6000	4.50	202	280	0.72	3	50	1.3	1.5
1004	MDSKS071-33-39	112	5.10	0.95	7.2	34.5	780	3.40	39	325	1.00	3	20	2.5	1.5
1005	MDSKS071-33-41	112	2.25	0.45	16.3	68	820	1.50	41	330	1.00	2	20	2.5	1.5
1076	MDSKS071-33-90	112	5.85	1.60	3.67	17.7	1800	3.90	90	310	1.00	10	20	0.7	1.7
1077	MDSKA-71-22	51	2.18	0.33	35.7	131.8	725	1.45	30	360	0.78	10	70	1.5	2
1103	SDSGA056-22	50	1.20	0.24	29.3	123	2790	0.80	100	390	0.71	14	150	0.35	1.8
1104	SDSGA056-22	40	2.55	0.24	29.3	123	2790	1.70	100	230	0.71	14	150	0.35	1.8
1105	SDSGA063-22	50	1.80	0.40	29.3	123	2800	1.20	100	390	0.70	14	150	0.35	1.8
1106	SDSGA063-22	40	3.15	0.40	29.3	123	2800	2.10	100	230	0.70	14	150	0.35	1.8
1107	SDSGA063-32	50	2.55	0.60	29.3	123	2800	1.70	100	390	0.70	14	150	0.35	1.8
1108	SDSGA063-32	40	4.50	0.6	29.3	123	2800	3	100	230	0.70	14	150	0.35	1.8
1109	MDSKS056-23-280	114	8.00	1.10	6.72	8.34	5600	2.30	280	320	1.00	10	20	1.3	1.5
1110	MDSKS056-23-310	114	9.00	1.10	5.42	6.78	6200	2.30	310	320	1.00	10	20	1.3	1.5
1111	MDSKS056-33-300	114	10.00	1.75	3.31	4.62	6000	3.60	300	320	1.00	10	20	1.3	1.5
1112	MDSKS056-33-265	114	8.00	1.72	4.1	5.73	5300	3.60	265	320	1.00	10	20	1.3	1.5
1113	MDSKS071-13-265	114	23.00	3.20	0.54	2.56	5300	7.00	265	320	1.00	10	20	1.3	1.5
1116	MDSKS071-33-270	114	25.00	5.70	0.38	1.91	5400	12.50	270	320	1.00	10	20	1.3	1.5

Three-phase asynchronous motors

The following table lists all asynchronous motors which can be selected under C0086.

In the "Asynchronous motor reference list" you can find the asynchronous motors for which the motor data must be entered manually. (6.5-11)

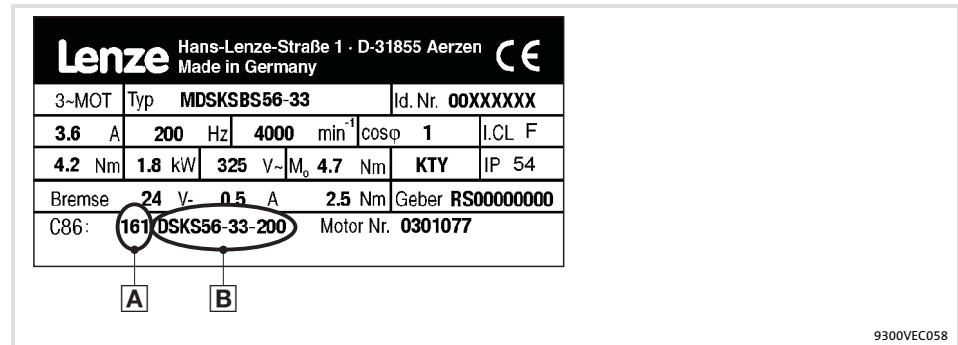

Fig. 6.5-7 Nameplate of a Lenze motor

A	B	Lenze type	C0081 P _r [kW]	C0087 n _r [rpm]	C0088 I _r [A]	C0089 f _r [Hz]	C0090 U _r [V]	Motor type	Temperature sensor
210	DXRAXX071-12-50	DXRAXX071-12	0.25	1410	0.9	50	400	Asynchronous inverter motor (star connection)	Thermal contact
211	DXRAXX071-22-50	DXRAXX071-22	0.37	1398	1.2				
212	DXRAXX080-12-50	DXRAXX080-12	0.55	1400	1.7				
213	DXRAXX080-22-50	DXRAXX080-22	0.75	1410	2.3				
214	DXRAXX090-12-50	DXRAXX090-12	1.10	1420	2.7				
215	DXRAXX090-32-50	DXRAXX090-32	1.50	1415	3.6				
216	DXRAXX100-22-50	DXRAXX100-22	2.20	1425	4.8				
217	DXRAXX100-32-50	DXRAXX100-32	3.00	1415	6.6				
218	DXRAXX112-12-50	DXRAXX112-12	4.00	1435	8.3				
219	DXRAXX132-12-50	DXRAXX132-12	5.50	1450	11.0				
220	DXRAXX132-22-50	DXRAXX132-22	7.50	1450	14.6				
221	DXRAXX160-12-50	DXRAXX160-12	11.00	1460	21.0				
222	DXRAXX160-22-50	DXRAXX160-22	15.00	1460	27.8				
223	DXRAXX180-12-50	DXRAXX180-12	18.50	1470	32.8				
224	DXRAXX180-22-50	DXRAXX180-22	22.00	1456	38.8				
225	30kW-ASM-50	–	30.00	1470	52.0	50	400	Asynchronous inverter motor (star connection)	–
226	37kW-ASM-50	–	37.00	1470	66.0				
227	45kW-ASM-50	–	45.00	1480	82.0				
228	55kW-ASM-50	–	55.00	1480	93.0				
229	75kW-ASM-50	–	75.00	1480	132.0	87	400	Asynchronous inverter motor (delta connection)	Thermal contact
250	DXRAXX071-12-87	DXRAXX071-12	0.43	2525	1.5				
251	DXRAXX071-22-87	DXRAXX071-22	0.64	2515	2.0				
252	DXRAXX080-12-87	DXRAXX080-12	0.95	2515	2.9				
253	DXRAXX080-22-87	DXRAXX080-22	1.3	2525	4.0				
254	DXRAXX090-12-87	DXRAXX090-12	2.0	2535	4.7				
255	DXRAXX090-32-87	DXRAXX090-32	2.7	2530	6.2				
256	DXRAXX100-22-87	DXRAXX100-22	3.9	2535	8.3				
257	DXRAXX100-32-87	DXRAXX100-32	5.35	2530	11.4				
258	DXRAXX112-12-87	DXRAXX112-12	7.10	2545	14.3				
259	DXRAXX132-12-87	DXRAXX132-12	9.7	2555	19.1				
260	DXRAXX132-22-87	DXRAXX132-22	13.2	2555	25.4				
261	DXRAXX160-12-87	DXRAXX160-12	19.3	2565	36.5				
262	DXRAXX160-22-87	DXRAXX160-22	26.4	2565	48.4				
263	DXRAXX180-12-87	DXRAXX180-12	32.4	2575	57.8				
264	DXRAXX180-22-87	DXRAXX180-22	38.7	2560	67.4				

6 Commissioning
6.5 Basic settings
6.5.4 Motor selection list

A	B	Lenze type	C0081 P _r [kW]	C0087 n _r [rpm]	C0088 I _r [A]	C0089 f _r [Hz]	C0090 U _r [V]	Motor type	Temperature sensor
265	30kW-ASM-87	–	52.00	2546	90.0	87	400	Asynchronous inverter motor (delta connection)	–
266	37kW-ASM-87	–	64.00	2546	114.0				
267	45kW-ASM-87	–	78.00	2563	142.0				
268	55kW-ASM-87	–	95.00	2563	161.0				
269	75kW-ASM-87	–	130.00	2563	228.0				

Asynchronous motor reference list

The motors listed in the “Motor nameplate data” table column are not included in Global Drive Control (GDC) and in the controller software.

1. Enter the corresponding value of column “C86” in C0086.
2. Compare the motor data codes with the table values.
– If necessary, adapt the values in the controller to the table values.
3. Optimise the dynamic performance of your machine via codes C0070 and C0071 if necessary.

Motor nameplate data		Motor data													
C86	Field	C0086	C0022	C0081	C0084	C0085	C0087	C0088	C0089	C0090	C0091	C0070	C0071	C0075	C0076
	Type														
410	MDXMAXM-071-12	210	1.23	0.25	35.80	116.80	1400	0.82	50	400	0.70	6	300	1.5	10
411	MDXMAXM-071-32	211	1.80	0.37	27.00	112.70	1400	1.20	50	400	0.71	6	300	1.5	10
412	MDXMAXM-080-12	212	2.40	0.55	16.30	78.60	1400	1.60	50	400	0.72	6	300	1.5	10
413	MDXMAXM-080-32	213	3.00	0.75	11.20	59.30	1380	2.00	50	400	0.76	6	300	1.5	10
414	MDXMAXM-090-12	214	3.90	1.10	9.14	41.80	1410	2.60	50	400	0.80	6	300	1.5	10
415	MDXMAXM-090-32	215	5.25	1.50	5.10	27.70	1420	3.50	50	400	0.80	6	300	1.5	10
416	MDXMAXM-100-12	216	8.40	2.20	2.96	18.20	1400	5.60	50	400	0.78	6	300	1.5	10
417	MDXMAXM-100-32	217	10.95	3.00	2.20	13.40	1400	7.30	50	400	0.81	6	300	1.5	10
418	MDXMAXM-112-22	218	12.75	4.00	1.50	10.80	1430	8.50	50	400	0.85	6	300	1.5	10
440	MDXMAXM-071-12	250	2.10	0.43	35.8	116.80	2510	1.40	87	400	0.70	6	300	1.5	10
441	MDXMAXM-071-32	251	3.15	0.64	27.0	112.70	2510	2.10	87	400	0.71	6	300	1.5	10
442	MDXMAXM-080-12	252	4.20	0.95	16.3	78.60	2510	2.80	87	400	0.72	6	300	1.5	10
443	MDXMAXM-080-32	253	5.25	1.30	11.2	59.30	2490	3.50	87	400	0.76	6	300	1.5	10
444	MDXMAXM-090-12	254	6.75	2.00	9.14	41.80	2520	4.50	87	400	0.80	6	300	1.5	10
445	MDXMAXM-090-32	255	9.15	2.70	5.1	27.70	2530	6.10	87	400	0.78	6	300	1.5	10
446	MDXMAXM-100-12	256	14.55	3.90	2.96	18.20	2510	9.70	87	400	0.81	6	300	1.5	10
447	MDXMAXM-100-32	257	19.05	5.40	2.2	13.40	2510	12.70	87	400	0.85	6	300	1.5	10
448	MDXMAXM-112-22	258	22.20	7.10	1.5	10.80	2540	14.80	87	400	0.78	6	300	1.5	10
449	MDXMAXM-112-32	259	18.75	5.50	2.45	21.40	1440	12.50	50	400	0.78	6	300	1.5	10
450	MDXMAXM-132-22	259	25.20	7.50	1.42	15.00	1460	16.80	50	400	0.77	6	300	1.5	10
451	MDXMAXM-132-32	259	29.25	9.20	1.34	14.00	1450	19.50	50	400	0.85	6	300	1.5	10
1006	MDXMAxx-071-12	210	1.28	0.25	39.90	157.20	1355	0.85	50	400	0.70	6	300	3.6	2
1007	MDXMAxx-071-12	250	2.25	0.47	39.90	157.20	2475	1.50	87	400	0.66	6	300	2	2
1008	MDXMAxx-071-32	211	1.73	0.37	25.03	122.60	1345	1.15	50	400	0.74	6	300	3.4	2
1009	MDXMAxx-071-32	251	3.00	0.67	25.03	122.60	2470	2.00	87	400	0.70	6	300	2.5	2
1010	MDXMAxx-080-12	212	2.40	0.55	20.69	89.00	1370	1.60	50	400	0.78	6	300	3.2	2
1011	MDXMAxx-080-12	252	3.90	1.00	20.69	89.00	2480	2.60	87	400	0.73	6	300	1.6	2
1012	MDXMAxx-080-32	213	2.85	0.75	11.69	65.20	1390	1.90	50	400	0.80	6	300	3.5	2
1013	MDXMAxx-080-32	253	4.95	1.35	11.69	65.20	2510	3.30	87	400	0.77	6	300	1.9	3
1014	MDXMAxx-090-12	214	3.90	1.10	10.01	40.20	1405	2.60	50	400	0.80	6	300	2.5	2
1015	MDXMAxx-090-12	254	6.75	2.00	10.01	40.20	2520	4.50	87	400	0.77	6	300	2	2
1016	MDXMAxx-090-32	215	5.25	1.50	5.85	28.80	1410	3.50	50	400	0.78	6	300	2	2
1017	MDXMAxx-090-32	255	9.15	2.70	5.85	28.80	2525	6.10	87	400	0.76	6	300	1	2
1018	MDXMAxx-100-12	216	7.20	2.20	2.90	20.00	1425	4.80	50	400	0.80	6	300	1	1.5
1019	MDXMAxx-100-12	256	12.45	3.90	2.90	20.00	2535	8.30	87	400	0.76	6	300	0.8	1.5
1020	MDXMAxx-100-32	217	9.75	3.00	2.10	17.00	1415	6.50	50	400	0.81	6	300	2.5	1.5
1021	MDXMAxx-100-32	257	17.10	5.40	2.10	17.00	2530	11.40	87	400	0.78	6	300	1.4	1.8
1022	MDXMAxx-112-22	218	12.45	4.00	1.50	11.00	1435	8.30	50	400	0.82	6	300	2	2
1023	MDXMAxx-112-22	258	21.45	7.10	1.50	11.00	2545	14.30	87	400	0.83	6	300	1	2
1024	MDXMAxx-132-12	219	16.50	5.50	0.86	13.00	1450	11.00	50	400	0.84	6	300	1.5	2
1025	MDXMAxx-132-12	259	28.65	9.70	0.86	13.00	2555	19.10	87	400	0.83	6	300	1.3	2
1026	MDXMAxx-132-22	220	21.90	7.50	0.80	11.00	1450	14.60	50	400	0.85	6	300	1.5	2
1027	MDXMAxx-132-22	260	38.10	13.20	0.80	11.00	2555	25.40	87	400	0.84	6	300	0.95	1.8

6 Commissioning

6.5 Basic settings

6.5.4 Motor selection list

Motor nameplate data		Motor data													
C86	Field	C0086	C0022	C0081	C0084	C0085	C0087	C0088	C0089	C0090	C0091	C0070	C0071	C0075	C0076
	Type		I _{max} [A]	P _r [kW]	R _s [Ω]	Lσ [mH]	n _r [rpm]	I _r [A]	f _r [Hz]	U _r [V]	cos φ	V _{pn}	T _{nn}	V _{pi}	T _{ni}
1028	MDXMAxx-160-22	221	31.50	11.00	0.50	7.00	1460	21.00	50	400	0.85	6	300	1.9	2.2
1029	MDXMAxx-160-22	261	54.75	19.30	0.50	7.00	2565	36.50	87	400	0.85	6	300	1	2
1030	MDXMAxx-160-32	222	41.70	15.00	0.40	5.50	1460	27.80	50	400	0.87	6	300	1.7	2.5
1031	MDXMAxx-160-32	262	72.60	26.40	0.40	5.50	2565	48.40	87	400	0.86	6	300	1	1.8
1032	MDXMAxx-180-12	223	49.20	18.50	0.40	4.00	1470	32.80	50	400	0.90	6	300	1.4	1.7
1033	MDXMAxx-180-12	263	86.70	32.40	0.40	4.00	2575	57.80	87	400	0.89	6	300	1	1.7
1034	MDXMAxx-180-22	224	58.20	22.00	0.20	3.80	1456	38.80	50	400	0.90	6	300	1	1.5
1035	MDXMAxx-180-22	264	101.1	38.70	0.20	3.80	2560	67.40	87	400	0.89	6	300	1	1.5
1036	MDXMAXM-63-12	210	0.68	0.12	87.58	610.53	1390	0.45	50	400	0.65	6	300	1.5	10
1037	MDXMAXM-63-12	250	1.17	0.21	87.58	610.53	2500	0.78	87	400	0.65	6	300	1.5	10
1038	MDXMAXM-63-32	210	0.98	0.18	56.90	342.11	1400	0.65	50	400	0.65	6	300	1.5	10
1039	MDXMAXM-63-32	250	1.70	0.31	56.90	342.11	2510	1.13	87	400	0.65	6	300	1.5	10
1040	MDXMAXM-112-32	219	18.75	5.50	0.86	7.20	1440	12.50	50	400	0.78	6	300	1.5	10
1041	MDXMAXM-112-32	259	32.55	9.60	0.86	7.20	2550	21.70	87	400	0.78	6	300	1.5	10
1042	MDXMAXM-132-22	220	25.20	7.50	0.54	4.80	1460	16.80	50	400	0.77	6	300	1.5	10
1043	MDXMAXM-132-22	260	43.80	13.10	0.54	4.80	2570	29.20	87	400	0.77	6	300	1.5	10
1044	MDXMAXM-132-32	221	29.25	9.20	0.46	4.70	1450	19.50	50	400	0.85	6	300	1.5	10
1045	MDXMAXM-132-32	261	50.70	16.00	0.46	4.70	2560	33.80	87	400	0.85	6	300	1.5	10
1046	MDXMAXM-160-22	260	31.50	11.00	1.27	18.97	1466	21.00	50	400	0.86	6	300	1.5	10
1047	MDXMAXM-160-32	260	42.30	15.00	0.87	14.28	1466	28.20	50	400	0.87	6	300	1.5	10
1048	MDXMAXM-180-22	260	54.60	18.50	0.40	4.00	1440	36.40	50	400	0.87	6	300	1.5	10
1049	MDXMAXM-180-32	260	66.15	22.00	0.20	3.80	1465	44.10	50	400	0.85	6	300	1.5	10
1050	MDXMAXM-200-32	260	90.00	30.00	0.17	3.50	1455	60.00	50	400	0.85	6	300	1.5	10
1051	MDXMAXM-225-12	260	108.0	37.00	0.15	2.00	1460	72.00	50	400	0.86	6	300	1.5	10
1052	MDXMAXM-225-22	260	128.25	45.00	0.15	2.00	1475	85.50	50	400	0.84	6	300	1.5	10
1053	MDXMAXM-063-11	210	1.43	0.18	51.00	273.7	2760	0.95	50	400	0.80	6	300	1.5	10
1054	MDXMAXM-063-31	210	1.65	0.25	33.00	93.4	2760	1.10	50	400	0.83	6	300	1.5	10
1055	MDXMAXM-071-11	211	1.50	0.37	22.50	90.2	2840	1.00	50	400	0.78	6	300	1.5	10
1056	MDXMAXM-071-31	212	2.25	0.55	16.90	62.9	2840	1.50	50	400	0.82	6	300	1.5	10
1057	MDXMAXM-080-11	213	2.85	0.75	11.36	47.4	2850	1.90	50	400	0.80	6	300	1.5	10
1058	MDXMAXM-080-31	214	4.20	1.10	6.86	33.4	2810	2.80	50	400	0.82	6	300	1.5	10
1059	MDXMAXM-090-11	215	4.80	1.50	5.10	22.2	2840	3.20	50	400	0.85	6	300	1.5	10
1060	MDXMAXM-090-31	216	7.20	2.20	3.20	14.5	2840	4.80	50	400	0.86	6	300	1.5	10
1061	MDXMAXM-100-31	217	9.30	3.00	1.81	10.7	2850	6.20	50	400	0.88	6	300	1.5	10
1062	MDXMAXM-100-41	218	12.75	4.00	1.45	8.6	2830	8.50	50	400	0.85	6	300	1.5	10
1063	MDXMAXM-112-31	250	18.30	5.50	3.10	17	2890	12.20	50	400	0.83	6	300	1.5	10
1064	MDXMAXM-112-41	250	23.25	7.50	1.96	12	2900	15.50	50	400	0.87	6	300	1.5	10
1065	MDXMAXM-132-21	250	28.05	9.00	1.41	11.292	2925	18.70	50	400	0.89	6	300	1.5	10
1066	MDXMAXM-071-13	210	1.13	0.18	58.93	342	870	0.75	50	400	0.71	6	300	1.5	10
1067	MDXMAXM-071-13	250	1.95	0.31	58.93	342	1610	1.30	87	400	0.71	6	300	1.5	10
1068	MDXMAXM-071-33	210	1.50	0.25	37.90	116.8	920	1.00	50	400	0.63	6	300	1.5	10
1069	MDXMAXM-071-33	250	2.55	0.43	37.90	116.8	1660	1.70	87	400	0.63	6	300	1.5	10
1070	MDXMAXM-080-13	211	2.10	0.37	28.00	112.7	900	1.40	50	400	0.67	6	300	1.5	10
1071	MDXMAXM-080-13	251	3.60	0.64	28.00	112.7	1640	2.40	87	400	0.67	6	300	1.5	10
1072	MDXMAXM-080-33	212	2.85	0.55	16.60	78.6	900	1.90	50	400	0.68	6	300	1.5	10
1073	MDXMAXM-080-33	252	4.95	0.95	16.60	78.6	1640	3.30	87	400	0.68	6	300	1.5	10
1078	MDFMAxx-250-22	224	147.75	55.00	0.04	1.92	1475	98.50	50	400	0.86	6	300	1	2
1079	MDFMAxx-250-22	264	255.90	95.00	0.04	1.92	2585	170.60	87	400	0.86	6	300	1	2
1080	MDEBAXM-063-12	210	0.68	0.12	87.58	610.53	1390	0.45	50	400	0.65	6	300	1.5	10
1081	MDEBAXM-063-12	250	1.17	0.21	87.58	610.53	2500	0.78	87	400	0.65	6	300	1.5	10
1082	MDEBAXM-063-32	210	0.98	0.18	56.90	342.11	1400	0.65	50	400	0.65	6	300	1.5	10
1083	MDEBAXM-063-32	250	1.70	0.31	56.90	342.11	2510	1.13	87	400	0.65	6	300	1.5	10
1084	MDEBAXM-071-12	210	1.35	0.25	39.90	157.20	1390	0.90	50	400	0.64	6	300	3.6	2

Motor nameplate data		Motor data													
C86	Field	C0086	C0022	C0081	C0084	C0085	C0087	C0088	C0089	C0090	C0091	C0070	C0071	C0075	C0076
	Type		I _{max} [A]	P _r [kW]	R _s [Ω]	Lσ [mH]	n _r [rpm]	I _r [A]	f _r [Hz]	U _r [V]	cos φ	V _{pn}	T _{nn}	V _{pi}	T _{ni}
1085	MDEBAXM-071-12	250	2.34	0.43	39.90	157.20	2500	1.56	87	400	0.64	6	300	2	2
1086	MDEBAXM-071-32	211	1.95	0.37	25.03	122.60	1380	1.30	50	400	0.64	6	300	3.4	2
1087	MDEBAXM-071-32	251	3.38	0.64	25.03	122.60	2490	2.25	87	400	0.64	6	300	2.5	2
1088	MDEBAXM-080-12	212	2.40	0.55	20.69	89.00	1400	1.60	50	400	0.68	6	300	3.2	2
1089	MDEBAXM-080-12	252	4.16	0.95	20.69	89.00	2510	2.77	87	400	0.68	6	300	1.6	2
1090	MDEBAXM-080-32	213	3.00	0.75	11.69	65.20	1400	2.00	50	400	0.72	6	300	3.5	2
1091	MDEBAXM-080-32	253	5.20	1.30	11.69	65.20	2510	3.46	87	400	0.72	6	300	1.9	3
1092	MDEBAXM-090-12	214	4.05	1.10	6.40	37.00	1420	2.70	50	400	0.77	6	300	2.5	2
1093	MDEBAXM-090-12	254	7.05	2.00	6.40	37.00	2535	4.70	87	400	0.77	6	300	2	2
1094	MDEBAXM-090-32	215	5.40	1.50	4.80	26.00	1415	3.60	50	400	0.77	6	300	2	2
1095	MDEBAXM-090-32	255	9.30	2.70	4.80	26.00	2530	6.20	87	400	0.77	6	300	1	2
1096	MDEBAXM-100-12	216	7.20	2.20	2.90	20.00	1425	4.80	50	400	0.80	6	300	1	1.5
1097	MDEBAXM-100-12	256	12.45	3.90	2.90	20.00	2535	8.30	87	400	0.80	6	300	0.8	1.5
1098	MDEBAXM-100-32	217	9.90	3.00	2.10	17.00	1415	6.60	50	400	0.81	6	300	2.5	1.5
1099	MDEBAXM-100-32	257	17.10	5.35	2.10	17.00	2530	11.40	87	400	0.81	6	300	1.4	1.8
1100	MDEBAXM-112-22	218	12.45	4.00	1.50	11.00	1435	8.30	50	400	0.82	6	300	2	2
1101	MDEBAXM-112-22	258	21.45	7.10	1.50	11.00	2545	14.30	87	400	0.82	6	300	1	2
1102	MDEBAXM-112-32	219	17.85	5.50	2.71	21.40	1425	11.90	50	400	0.84	6	300	1.5	10
1114	MDFMAxx-200-32	224	83.25	30.00			1465	55.50	50	400	0.85	6	300	1	2
1115	MDFMAxx-200-32	264	145.50	52.00			2575	97.00	87	400	0.85	6	300	1	2

6.5.5 Motor temperature monitoring with PTC or thermal contact

Description

PTC resistors according to DIN 44081 and DIN 44082 can be connected via the terminal inputs T1 and T2. The motor temperature is measured and integrated into the drive monitoring.

A thermal contact (NC contact) can also be connected to T1 and T2. Lenze three-phase AC motors provide thermal contacts as default.

When using motors equipped with PTC resistors or thermostats, we recommend to always activate the PTC input. This prevents the motor from being destroyed by overheating.



Stop!

- ▶ The motor temperature monitoring may only be connected to T1, T2 if the cable is terminated with a PTC or thermal contact (NC contact) on the motor side.
 - An "open" cable acts like an antenna and can cause faults on the drive controller.
 - Input signals at T1, T2 are processed with a delay of 2 s.
- ▶ The drive controller can only evaluate one PTC resistor! Do not connect several PTC resistors in series or in parallel:
 - The motor temperature would be measured incorrectly.
 - The motors could be destroyed by overheating.
- ▶ If you operate several motors on a drive controller, use thermal contacts (NC contacts) for motor temperature monitoring and connect these in series.
- ▶ To achieve full motor protection, an additional temperature monitoring with separate evaluation must be installed.

Activation



Note!

- ▶ In the Lenze setting the motor temperature monitoring is switched off!
- ▶ If you work with several parameter sets, the monitoring must be activated separately in each parameter set!

1. Connect the monitoring circuit of the motor to T1 and T2.
 - With $1.6 \text{ k}\Omega < R < 4 \text{ k}\Omega$, the monitoring responds.
2. Set the controller reaction:
 - C0585 = 3: Temperature monitoring of the motor is switched off.
 - C0585 = 0: TRIP error message (display of keypad: OH8 **Trip**)
 - C0585 = 2: Warning signal (display of keypad: OH8 **Warn**)

Function test

Connect the PTC input with a fixed resistor:

- ▶ $R > 4 \text{ k}\Omega$: The fault message OH8 must be activated.
- ▶ $R < 1 \text{ k}\Omega$: Fault message must not be activated.

6.5.6 Motor temperature monitoring with KTY

Description

- ▶ There are two possibilities to connect a KTY resistor:
 - At the incremental encoder connection X8 (pins X8/5 and X8/8)
 - At the resolver connection X7 (pins X7/8 and X7/9)
- ▶ The motor temperature is measured and integrated into the drive monitoring.
- ▶ The KTY resistor is monitored for open and short circuit.
- ▶ When using motors equipped with KTY resistors, we recommend always to activate the KTY input. This prevents the motor from being destroyed by overheating.



Stop!

- ▶ The controller can only evaluate one KTY resistor! Do not use several KTY resistors connected in series or in parallel:
 - This would result in an incorrect measurement of the motor temperature.
 - The motors could be destroyed by overheating.
- ▶ If several motors are operated on a controller, use thermal contacts (NC contacts) for monitoring the motor temperature and connect these contacts in series.
- ▶ To ensure full motor protection, an additional temperature monitoring with separate evaluation has to be installed.

Activation

**Stop!****Overheating of the motor!**

In the Lenze setting, temperature monitoring of the motor is deactivated (C0583 = 3). The motor temperature in C0063 shows 0 °C even if C0584 = 2 is set.

Possible consequences:

- ▶ The motor can be damaged by a too high motor temperature.

Protective measures:

- ▶ Activate the monitoring of the motor temperature via X7 or X8 with C0583 = 2 or C0584 = 2.
- ▶ Set C0594 = 2 or 3. Then the connection is additionally monitored with regard to short circuit and interruption.
- ▶ If you work with several parameter sets, you have to activate the monitoring separately in each parameter set.

1. Connect monitoring circuit of the motor to X7/8, X7/9 or X8/5, X8/8.
2. Set response of the controller for short circuit or interruption on the connection (monitoring of the motor temperature has to be activated):
 - C0594 = 3: monitoring is switched off.
 - C0594 = 0: TRIP error message (keypad display: Sd6 **Trip**)
 - C0594 = 2: warning signal (keypad display: Sd6 **Warn**)

Adjustment

Monitoring with a fixed operating temperature (150 °C)

1. Set response of the controller:
 - C0583 = 3: temperature monitoring of the motor switched off.
 - C0583 = 0: TRIP error message (keypad display: OH3 **Trip**)
 - C0583 = 2: warning signal (keypad display: OH3 **Warn**)

Monitoring with a variable operating temperature (45...150 °C)

1. Set the operating temperature in C0121.
2. Set response of the controller:
 - C0584 = 3: temperature monitoring of the motor switched off.
 - C0584 = 2: warning signal (keypad display: OH7 **Warn**)

Adjustment of KTY operating range

The temperature and resistance range can be adapted to the KTY used.

- ▶ C1190 = 0: Fixed operating range for KTY in Lenze motors (Lenze setting)
- ▶ C1190 = 1: Adjustable operating range

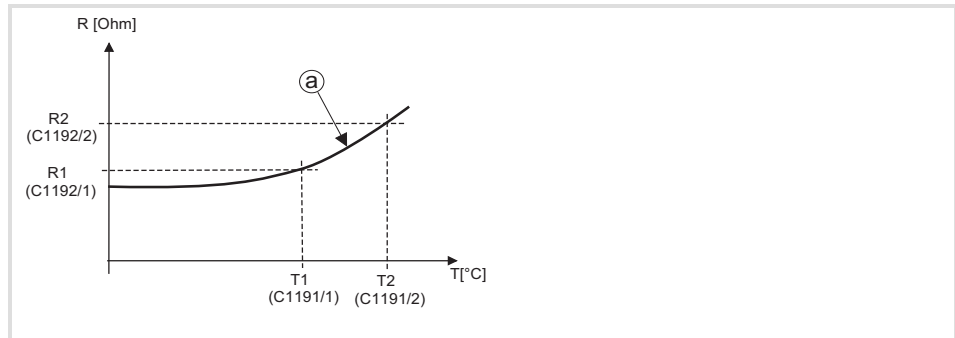

Fig. 6.5-8 Setting of the operating range for the KTY (C1190 = 1)

The operating range is specified by means of limit values and is in the almost linear section of the graph (a). The operating values are determined by interpolation.

C1191/1	Setting of the lower and upper temperature value (T1, T2)
C1191/2	corresponding to the KTY used.
C1192/1	Setting of the lower and upper resistance value corresponding to
C1192/2	the KTY used.

6.6 Setting the speed feedback

Description

The feedback signal can either be supplied via input X7 or via input X8.

- ▶ At X7 a resolver can be connected.
- ▶ At X8 an encoder can be connected.
 - Incremental encoder TTL
 - SinCos encoder
 - SinCos encoder with serial communication (single-turn or multi-turn)

The resolver or encoder signal for slave drives can be output at the digital frequency output X10.



Note!

- ▶ Use a SinCos encoder with serial communication (multi-turn) if homing of the drive is not possible. Please specify the motor/encoder combination in your order.
- ▶ You can only use 2 of the 3 interfaces X8, X9, X10 simultaneously. Due to this it may be possible that the incremental encoder input cannot be activated or the digital frequency input / digital frequency output does not work.
 - This dependency does not apply if the digital frequency output X10 is set to reproduction of the input signals at X8 or X9 (C0540 = 4 or 5).
 - To deactivate the digital frequency input, it may be necessary to delete the internal signal link from function block DFIN to the following function block. Remove the function block DFIN from the processing table.

6.6.1 Resolver at X7

Resolvers can be operated at X7. For the wiring diagram and the pin assignment of X7, please refer to chapter "Wiring of the standard device" → "Wiring of the feedback system".

Activation

- ▶ C0025 = 10 (Lenze setting)
- ▶ Monitoring (SD2) of the resolver and the resolver cable for open circuit:
 - C0586 = 0 (TRIP, Lenze setting)
 - C0586 = 2 (warning)
 - C0586 = 3 (off)

6.6.2 Incremental encoder with TTL level at X8

Incremental encoders with TTL level can be operated at X8. For the wiring diagram and the pin assignment of X8, please refer to chapter "Wiring of the standard device" → "Wiring of the feedback system".

Activation

- ▶ C0025 = 110, 111, 112 or 113. The number of increments (512, 1024, 2048 or 4096) is set automatically.

Adjustment

The incremental encoder is supplied with voltage by the drive controller.

**Stop!**

If the supply voltage is too high, it may destroy the incremental encoder.

Under C0421 you can adjust the supply voltage V_{CC} (5 V) of the incremental encoder in order to compensate for the voltage drop along the incremental encoder cable (if required).

Calculation of the voltage drop

$$\Delta U \approx l [m] \cdot \frac{R [\Omega]}{[m]} \cdot I_{inc} [A]$$

l	Length of the incremental encoder cable
R	Resistance of the incremental encoder cable
I_{inc}	Current consumption of the incremental encoder

6.6.3

SinCos encoder at X8

SinCos encoders can be operated at X8. For the wiring diagram and the pin assignment of X8, please refer to chapter "Wiring of the standard device" → "Wiring of the feedback system".

Activation

**Stop!****Uncontrolled acceleration of the motor!**

- ▶ If the SinCos encoder fails, the motor may accelerate in an uncontrolled manner.

Protective measures:

- ▶ Activate the monitoring for the SinCos encoder with $C0580 = 0$.

- ▶ SinCos encoder with 5 V supply voltage:
C0025 = 210, 211, 212, or 213. The number of increments (512, 1024, 2048 or 4096) is set automatically.
- ▶ Single-turn SinCos encoder with 8 V supply voltage:
C0025 = 309, 310, or 311. The number of increments (128, 512 or 1024) is set automatically.
- ▶ Multi-turn SinCos encoder with 8 V supply voltage:
C0025 = 409, 410, or 411. The number of increments (128, 512 or 1024) is set automatically.
- ▶ Monitoring (SD8) of the SinCos encoder:
C0580 = 0 (TRIP, Lenze setting)
C0580 = 3 (off)

Adjustment

The SinCos encoder is supplied with voltage by the controller.



Stop!

If the supply voltage is too high, the SinCos encoder may be damaged.

Under C0421 you can adjust the supply voltage V_{CC} (5 ... 8 V) of the SinCos encoder in order to compensate for the voltage drop along the cable (if required).

Calculation of the voltage drop

$$\Delta U \approx l \text{ [m]} \cdot \frac{R \text{ [\Omega]}}{l \text{ [m]}} \cdot I_{\text{SINCOS}} \text{ [A]}$$

l	Length of the SinCos encoder cable
R	Resistance of the SinCos encoder cable
I_{SINCOS}	Current consumption of the SinCos encoder

6.7 Current controller adjustment

When is a current controller adjustment required?

- ▶ The motor data of the motor used is not contained in GDC (e.g. motors from other manufacturers).
- ▶ The application makes high demands on the dynamic performance of the drive controller (e.g. dynamic positioning, cross cutter).
- ▶ The motor/drive controller combination does conform to the standard power-based assignment. The basic current controller settings only match for a power-based assignment of the drive controller.

Preparations

Measure	Setting	Explanation
Reduce maximum current	Reduce the value in C0022	With the motor at standstill, the motor current of the motor phase U is measured (field frequency 0). This increases the motor current in the motor phase to 141% and the motor temperature rises significantly.
Generate maximum torque setpoint	Connect MCTRL-M-ADD with FIXED100%	For speed control or position control (MCTRL-N/M-SWT = 0)
	<ul style="list-style-type: none"> ● Connect MCTRL-M-ADD with FIXED100% ● Connect MCTRL-N-SET with FIXED100% 	For torque control (MCTRL-N/M-SWT = 1)
Deactivate integral action component of current controller	Set C0076 = 2000 ms	The integral action component of the current controller is deactivated by setting the reset time T_n (C0076) to the longest time. The gain (C0075) remains unchanged (Lenze setting still valid).
Deactivate quick stop	Set X5/E1 = HIGH or X5/E2 = HIGH	By preselecting a direction of rotation the quick stop is deactivated.
Change the operation of the motor control	Set C0006 = 3	Even if an asynchronous motor is connected, set the motor control to 'synchronous motor'.
Set the rotor position setpoint	Set C0058 = -90°	Set the rotor displacement angle to -90°.
Set the actual value display of the rotor position to 0° under C0060	<ol style="list-style-type: none"> 1. Select a TTL encoder under C0025 2. Save settings with C0003 = 1 3. If required, disconnect the encoder cable at X8 4. Switch off the mains supply and the external 24V supply (if required) and then on again. 	After mains connection C0060 = 0° is displayed.
Connect the storage oscilloscope	Put the clamp-on ammeter around the motor phase U and connect it to the oscilloscope	Oscilloscope settings: <ul style="list-style-type: none"> ● Time base: 400 μs/DIV ● Auto-triggering

Adjustment



Stop!

Thermal destruction of the motor!

► If the controller is enabled for too long and the motor current is too high, the motor may be destroyed by overtemperature.

Protective measures:

► Reduce motor current under C0022 and enable the controller only for some seconds.

1. Inhibit the controller (X5/28 = LOW)
2. Deactivate quick stop (X5/E1 =HIGH or X5/E2 =HIGH)
3. Enable the controller for some seconds and then inhibit it again.
4. Record the current flowing in motor phase U with the controller being enabled.
5. Set the gain V_p (C0075) in such a way that the current rises rapidly.
6. Reduce the reset time T_n (C0076) so much that the transient response shows almost no overshoot and an optimum rise is achieved.
7. After each change of C0075 and C0076, the time course of the motor current must be recorded and checked again.

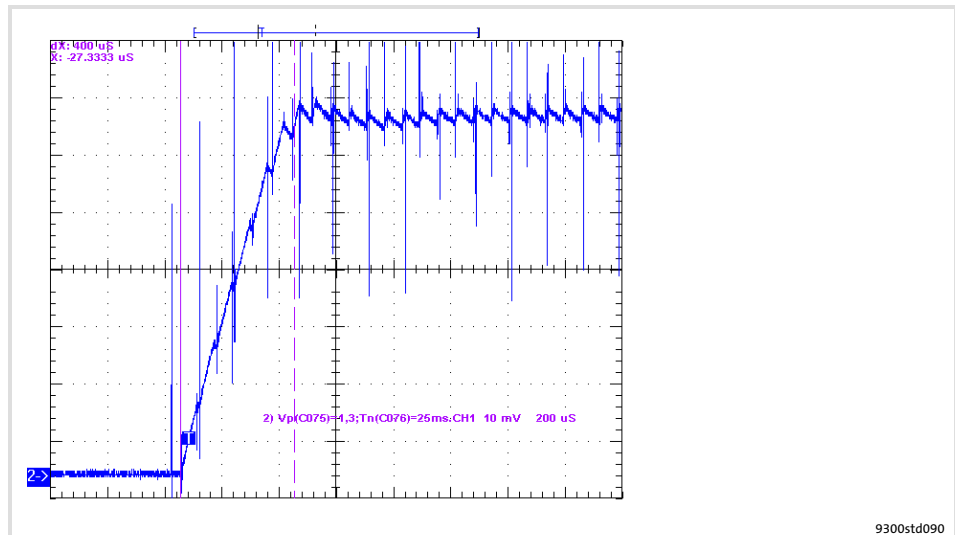

Fig. 6.7-1 Current characteristic for optimum controller adjustment
Time base 200 μ s/DIV

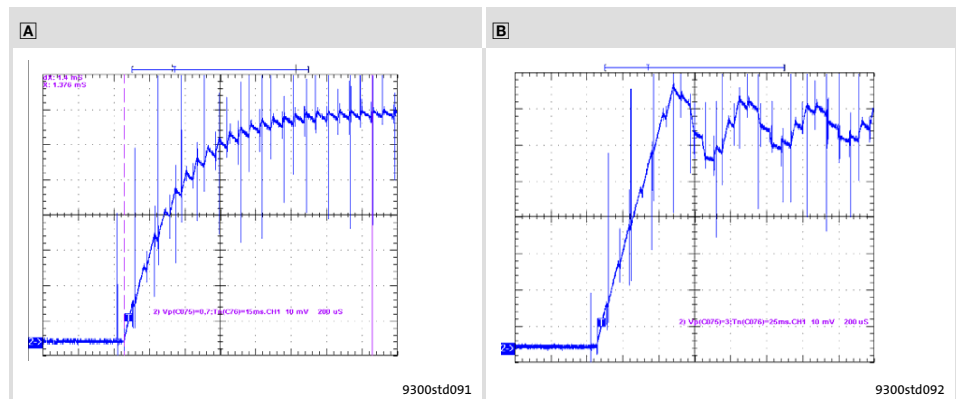

Fig. 6.7-2 Current characteristic for non-optimum controller adjustment

- A** Current rise of motor current too slow
Reset time T_n (C0076) too long and/or gain V_p (C0075) too small
Measured at time base 200 μs/DIV
- B** High-frequency oscillations of motor current, motor noises may occur
Reset time T_n (C0076) too short and/or gain V_p (C0075) too large
Measured at time base 200 μs/DIV

8. Check the transient response over a longer period of time (e.g. with time base 4000 μs/DIV). The motor current must reach the final steady-state value within the shortest possible time.

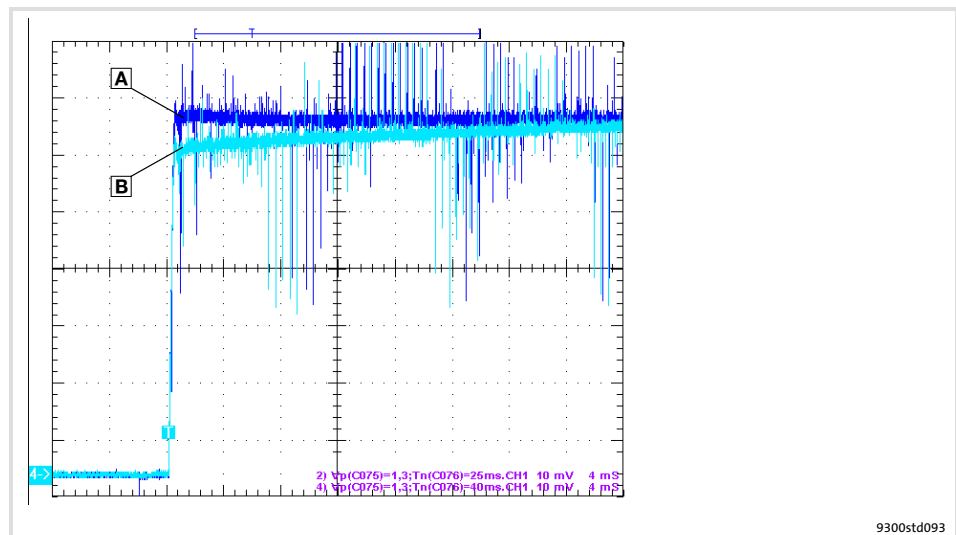

Fig. 6.7-3 Transient response of motor current over longer period of time

- A** Optimum transient response
- B** Final steady-state value is reached too slowly
Measured at time base 4000 μs/DIV

9. When the current controller adjustment is completed, reset the temporary settings:

- Set the initial values again in C0006, C0022 and C0025. If necessary, reconnect the encoder cable to X8.
- Connect the inputs MCTRL-M-ADD and MCTRL-N-SET with the initial signals.

6.8 Adjusting the rotor position

When is a rotor position adjustment required?

- ▶ A synchronous non-Lenze motor is used. The motor used is not included in GDC.
- ▶ Another encoder was mounted to the motor later on.
- ▶ A defective encoder was replaced.



Note!

Only use single-pole resolvers or SinCos encoders (single-turn or multi-turn).

Preparatory work

- ▶ Inhibit the controller.
- ▶ Unload the motor mechanically.
 - Disconnect the motor from the gearbox/machine.
 - If necessary, remove toothed lock washers, gears, etc. from the motor shaft.
 - If necessary, support the holding torques provided by mounted motor brakes by means of locking devices.
- ▶ Deactivate the "safe torque off" function so that the motor can be energised for the motor pole angle adjustment.
- ▶ Release the holding brake (if available).
- ▶ Adjust the current controller (see chapter "Current controller adjustment").
- ▶ Check resolver polarity.
- ▶ Set C0006 = 3.
 - For carrying out a rotor position adjustment, a synchronous motor must be selected.

Resolver polarity check

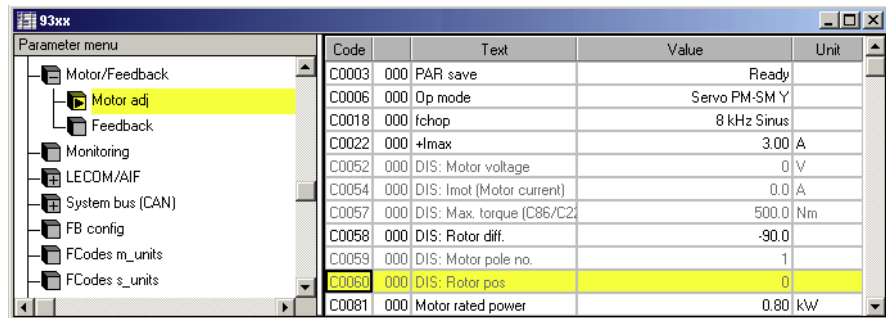

Code	Text	Value	Unit
C0003	000 PAR save	Ready	
C0006	000 Op mode	Servo PM-SM Y	
C0018	000 fchop	8 kHz Sinus	
C0022	000 +Imax	3.00	A
C0052	000 DIS: Motor voltage	0	V
C0054	000 DIS: Imot (Motor current)	0.0	A
C0057	000 DIS: Max. torque (C86/C2)	500.0	Nm
C0058	000 DIS: Rotor diff.	-90.0	
C0059	000 DIS: Motor pole no.	1	
C0060	000 DIS: Rotor pos	0	
C0081	000 Motor rated power	0.80	kW

9300std200

Fig. 6.8-1 "Motor adj" menu of the parameter menu

Procedure

1. Inhibit the controller (X5/28 = LOW).
2. Disconnect the motor from the gearbox/machine.
3. Open the "Parameter menu → Motor/Feedback → Motor adj" menu.
4. Turn the rotor to the right (when looking at the front end of the motor shaft). The value in C0060 must increase.
 - In C0060 the angle of rotation is displayed as a numerical value between 0 and 2047.

Note!
The actual value is only displayed if the selection cursor is placed on the code and [F6] is pressed.
5. If the value decreases, swap the signals at X7/6 and X7/7 (+SIN and -SIN).

Rotor position adjustment

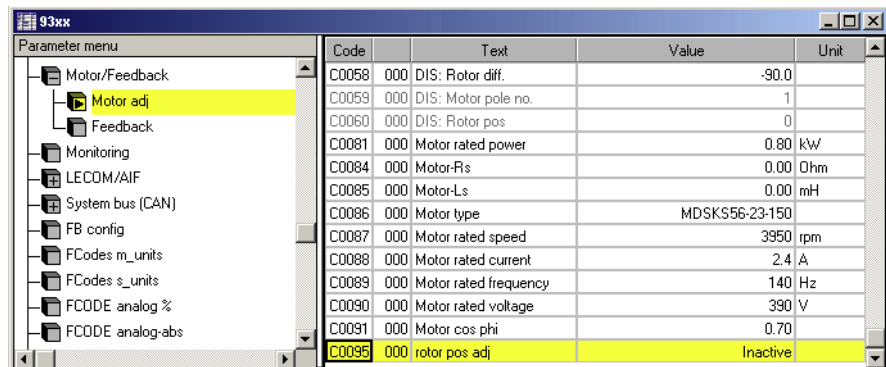

Code	Text	Value	Unit
C0058	000 DIS: Rotor diff.	-90.0	
C0059	000 DIS: Motor pole no.	1	
C0060	000 DIS: Rotor pos	0	
C0081	000 Motor rated power	0.80	kW
C0084	000 Motor-Rs	0.00	Ohm
C0085	000 Motor-Ls	0.00	mH
C0086	000 Motor type	MDSKS56-23-150	
C0087	000 Motor rated speed	3950	rpm
C0088	000 Motor rated current	2.4	A
C0089	000 Motor rated frequency	140	Hz
C0090	000 Motor rated voltage	390	V
C0091	000 Motor cos phi	0.70	
C0095	000 rotor pos adj	Inactive	

9300std203

Fig. 6.8-2 "Motor adj" menu of the parameter menu

Procedure

1. Inhibit controller (X5/28 = LOW).
2. Open the "Parameter menu → Motor/feedback system → Motor setting" menu.
3. Select C0006 = 3.
 - A synchronous motor with feedback must be selected for pole position adjustment.
4. Click C0095 and activate the adjustment process by selecting C0095 = 1.
5. Enable controller (X5/28 = HIGH).
6. The position adjustment program of the controller is started.
 - The rotor rotates a full revolution in several steps.
 - Then C0095 is automatically set to 0.
7. C0058 displays the current rotor displacement angle.

Note!

 - The current value will not be displayed until the bar cursor is on the code and [F6] is pressed.
 - For sin/cos encoders, C0058 always displays a value of 0 because the value is saved to the encoder.

Procedure

8. Inhibit controller (X5/28 = LOW).
9. Reset C0006 to default setting if necessary.
10. Click C0003 and save the setting by selecting C0003 = 1.
11. Disconnect the mains and reconnect the motor to the machine.



Danger!

Uncontrolled movements of the drive after an "Sd7" error in conjunction with absolute value encoders or in the case of a "PL-TRIP" error.

If the rotor position adjustment was completed with an "Sd7" or "PL-TRIP" error (see 9.3-1) it was not possible to assign the rotor position to the feedback system. In this case the drive may carry out uncontrolled movements after the controller has been enabled.

Possible consequences:

- ▶ Death or severe injuries.
- ▶ Destruction or damage to the machine.

Protective measures:

- ▶ Repeat rotor position adjustment (start with step 1).
- ▶ Check the wiring and the interference immunity of the encoder at X8.

6.9 Changing the assignment of the control terminals X5 and X6



Danger!

If you select a configuration in C0005, the signal assignment of the inputs and outputs will be overwritten with the corresponding basic assignment!

- ▶ Adapt the signal assignment to your wiring!

6.9.1 Free configuration of digital input signals

Description

- ▶ Internal digital signals can be freely linked with external digital signal sources. This serves to establish a freely configurable control of the drive controller.
 - Digital inputs X5/E1 ... X5/E5
- ▶ A signal source can be linked with several targets. Ensure reasonable linkages for not activating functions that are mutually exclusive (e. g. linking a digital input with quick stop and DC injection braking at the same time).

Linking signals

The internal digital signal can be linked with an external signal source by entering the selection figure of the external signal into the configuration code of the internal digital signal.

Example

- ▶ $C0787/2 = 53 \Rightarrow$ signal source for JOG2 is terminal X5/E3

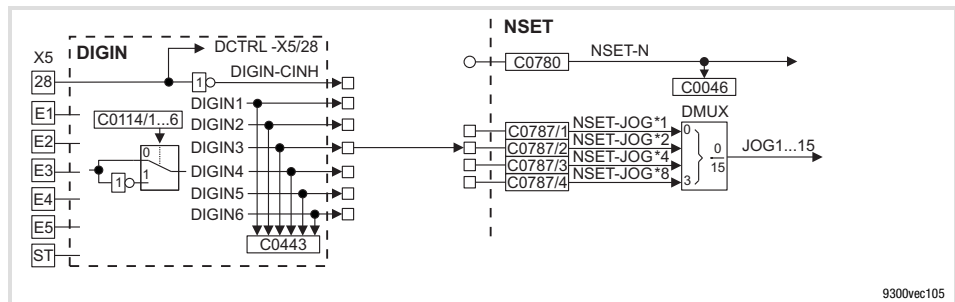

Fig. 6.9-1 Connecting digital signal JOG2 with terminal X5/E3



Tip!

- ▶ A list with all selection figures is included in the chapter "Configuration" → "Selection lists".
- ▶ For signal linkage we recommend the function block editor in GDC (ESP-GDC2).

Signal level	<ul style="list-style-type: none"> ▶ Terminals (X5/E1 ... X5/E5): <ul style="list-style-type: none"> – HIGH = +12 V ... +30 V – LOW = 0 V ... +3 V ▶ Response times: 1 ms
Inverting the signal level	<p>In C0114 you can define the active signal level (HIGH level active or LOW level active) for the terminals X5/E1 ... X5/E5.</p> <p>Example</p> <ul style="list-style-type: none"> ▶ C0114/3 =1 ⇒ LOW level at X5/E3 activates JOG2

6.9.2 Free configuration of digital outputs

Description	<ul style="list-style-type: none"> ▶ The digital outputs X5/A1 ... X5/A4 can be freely linked with internal digital signals. ▶ One signal source can be linked with several targets.
Linking signals	<p>The digital outputs can be linked with internal digital signals by entering the selection figure of the internal signal into corresponding subcode of C0117.</p> <p>Example</p> <ul style="list-style-type: none"> ▶ C0117/2 = 505 ⇒ signal source for X5/A2 is the status message "direction of rotation" (DCTRL-CW/CCW)
Signal level	<ul style="list-style-type: none"> ▶ Terminals (X5/A1 ... X5/A4): <ul style="list-style-type: none"> – HIGH = +12 V ... +30 V – LOW = 0 V ... +3 V ▶ Response times: 1 ms
Inverting the signal level	<p>In C0118 you can define the active signal level (HIGH level active or LOW level active) for the terminals X5/A1 ... X5/A4.</p> <p>Example</p> <ul style="list-style-type: none"> ▶ C0118/2 =1 ⇒ With LOW level at X5/A2 the motor rotates in CW direction (with in-phase motor connection)

6.9.3 Free configuration of analog input signals

- Description**
- ▶ Internal analog signals can be freely linked with external analog signal sources:
 - Analog inputs X3/1, X3/2 and X3/3, X3/4
 - ▶ One signal source can be linked with several targets.

Linking signals The internal analog signals can be linked with an external signal source by entering the selection figure of the external signal into the configuration code of the internal analog signal.

Example

- ▶ C0780 = 50 ⇒ signal source for the main setpoint (NSET-N) is terminal X6/1, X6/2

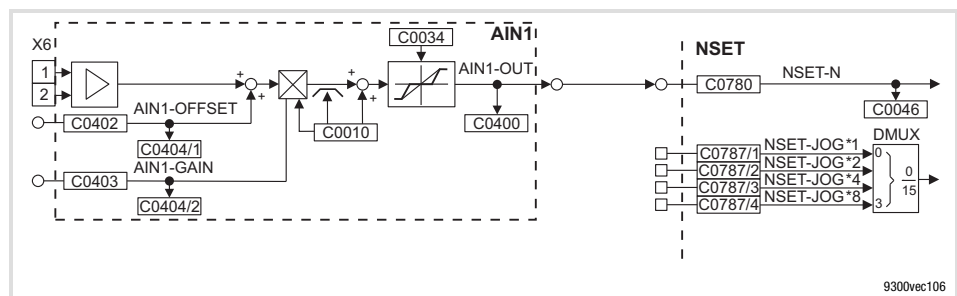

Fig. 6.9-2 Linking analog signal NSET-N with terminal X6/1, X6/2



Tip!

- ▶ A list with all selection figures is included in the chapter "Configuration" → "Selection lists".
- ▶ For signal linkage we recommend the function block editor in GDC (ESP-GDC2).

Adjustment

Gain and offset

Set gain (C0027) and offset (C0026) to adapt the input signal to the application.

Input range of X6/1, X6/2

Input range	C0034	Position of jumper at X3
-10 V ... +10 V	C0034 = 0	
+4 mA ... +20 mA	C0034 = 1	
-20 mA ... +20 mA	C0034 = 2	



Note!

Different settings in C0034 and of X3 result in a wrong input signal.

6.9.4 Free configuration of analog outputs**Description**

- ▶ The analog outputs (X6/62, X6/63) can be freely linked with internal analog process or monitoring signals. The controller outputs a voltage proportional to the internal signal at the analog outputs.
- ▶ One signal source can be linked with several targets.

Linking signals

Analog outputs can be linked with internal analog signals by entering the selection figure of the internal signal into the code of C0431 (AOUT1, X6/62) or C0436 (AOUT2, X6/63).

Example

- ▶ C0436 = 5006 ⇒ signal source for X6/63 is the actual motor voltage

**Tip!**

- ▶ A list with all selection figures is included in the chapter "Configuration" → "Selection lists".
- ▶ For signal linkage we recommend the function block editor in GDC (ESP-GDC2).

Adjustment

Set gain (C0108) and offset (C0109) to adapt the output signal to the application.

With an internal signal of 100 % and a gain of 1, a voltage of 10 V is output at the terminal.

7 Parameter setting

Contents

7.1	Important notes	7.1-1
7.2	Parameter setting with the XT EMZ9371BC keypad	7.2-1
7.2.1	General data and operating conditions	7.2-1
7.2.2	Installation and commissioning	7.2-2
7.2.3	Display elements and function keys	7.2-2
7.2.4	Changing and saving parameters	7.2-4
7.2.5	Loading a parameter set	7.2-6
7.2.6	Transferring parameters to other standard devices	7.2-7
7.2.7	Activating password protection	7.2-9
7.2.8	Diagnostics	7.2-10
7.2.9	Menu structure	7.2-11

7.1 Important notes

Adapting the controller functions to the application

The controller functions can be adapted to your applications by means of parameterisation. You can either parameterise via keypad, PC or via the parameter channel of a bus system.

The function library contains a detailed description of the functions, the signal flow diagrams contain all configurable signals.

Parameters and codes

The parameters for the functions are stored in numbered codes:

- ▶ Codes are marked in the text with a "C" (e.g. C0002).
- ▶ The code table provides a quick overview of all codes. The codes are sorted according to their numbers and can be used as reference.
(📖 8.4-1)

Parameter setting via keypad

A quick parameter setting is provided by the keypad XT. Moreover, it serves as status display, error diagnosis and transfer of parameters to other drive controllers.

	Keypad XT EMZ9371BC
Can be used with	8200 vector, 8200 motec, starttec, Drive PLC, 9300 vector, 9300 servo
Operator buttons	8
Plain text display	yes
Menu structure	yes
Configurable menu ("user menu")	yes
Predefined basic configurations	yes
Non-volatile memory for parameter transfer	yes
Password protection	yes
Diagnosis terminal	Keypad XT in handheld design, IP 20 (E82ZBBXC)
Installation in control cabinet	no
Type of protection	IP 20
Detailed description	(📖 7.2-1)

Parameter setting via PC

You need the parameter setting / operating software »Global Drive Control« (GDC) or »Global Drive Control easy« (GDC easy) and an interface for communication:

- ▶ Interface for system bus (CAN) (preset in GDC):
 - PC system bus adapter
- ▶ Serial interface for LECOM:
 - Communication module LECOM-A/B (RS232/RS485)
EMF2102IB-V001

The parameter setting /operating software of the Global Drive Control family are easy-to-understand and tools for the operation, parameter setting and diagnostics or Lenze drive controllers.

	GDC easy ESP-GDC2-E	GDC ESP-GDC2
Supply	Free download from the internet at www.lenze.com	Program package must be charged for
Operation in interactive mode	yes	yes
Comprehensive help functions	yes	yes
Menu "Short setup"	yes	yes
Monitor windows for displaying operating parameters and for diagnostic purposes	yes	yes
Saving and printing of parameter settings as code list	yes	yes
Loading of parameter files from the controller to the PC	yes	yes
Storing of parameter files from the PC in the controller	yes	yes
Function block editor	no	yes
Technology functions for 9300 Servo	no	yes
Oscilloscope function for 9300 Servo and 9300 vector	no	yes
Detailed description	Online help of the program	Online help of the program

Parameter setting via bus system

Detailed information can be found in the documentation of the corresponding bus system.

7.2 Parameter setting with the XT EMZ9371BC keypad

7.2.1 General data and operating conditions

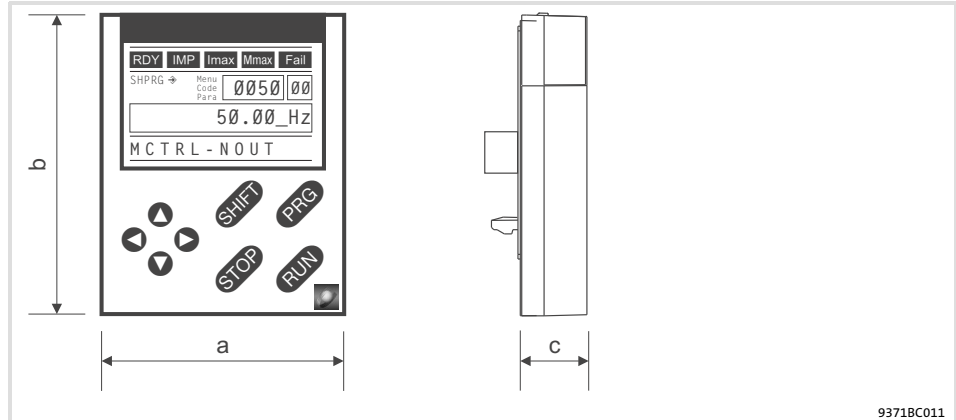

Feature		Values
Dimensions		
Width	a	60 mm
Height	b	73.5 mm
Depth	c	15 mm
Environmental conditions		
Climate		
Storage	IEC/EN 60721-3-1	1K3 (-25 ... +60 °C)
Transport	IEC/EN 60721-3-2	2K3 (-25 ... +70 °C)
Operation	IEC/EN 60721-3-3	3K3 (-10 ... +60 °C)
Enclosure		IP 20

7.2.2 Installation and commissioning

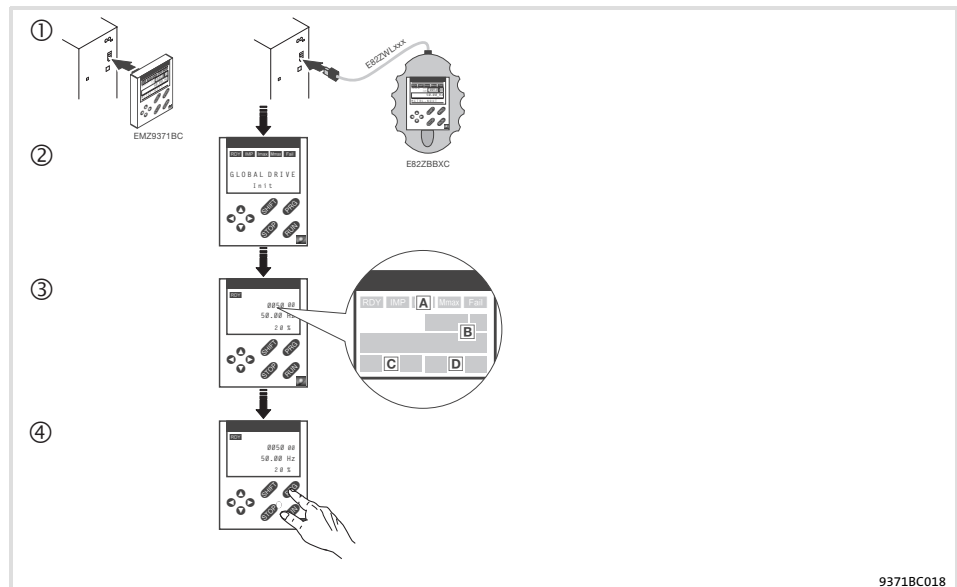

Fig. 7.2-1 Installation and commissioning of XT EMZ9371BC keypad or E82ZBBXC diagnosis terminal

- ① Connect keypad to the AIF interface on the front of the standard device. The keypad can be connected/disconnected during operation.
- ② As soon as the keypad is supplied with voltage, it carries out a short self-test.
- ③ The operation level indicates when the keypad is ready for operation:
 - Ⓐ Current state of the standard device
 - Ⓑ Memory location 1 of the user menu (C0517): Code number, subcode number, and current value
 - Ⓒ Active fault message or additional status message
 - Ⓓ Actual value in % of the status display defined in C0004
- ④ **PRG** must be pressed to leave the operation level

7.2.3 Display elements and function keys

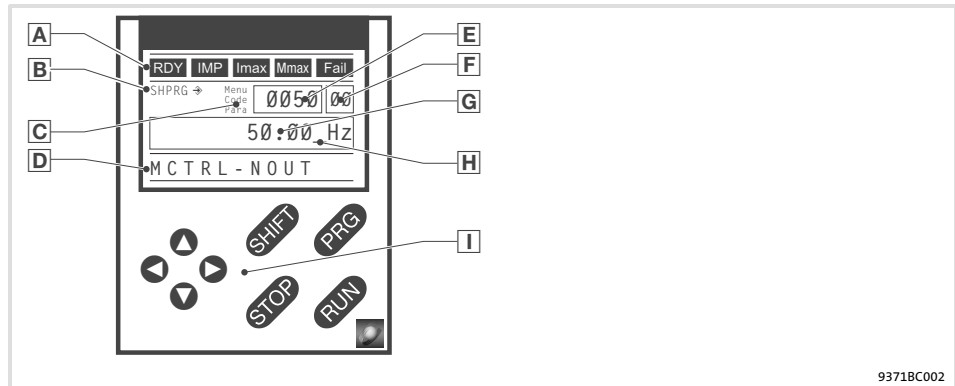

Fig. 7.2-2 Display elements and function keys of the XT EMZ9371BC keypad

Displays

A) Status displays of standard device		
Display	Meaning	Explanation
RDY	Ready for operation	
IMP	Pulse inhibit is active	Power outputs are inhibited
Imax	The set current limit is exceeded in motor or generator mode	
Mmax	Speed controller 1 in the limitation	Drive is torque-controlled (Only active for operation with standard devices of the 9300 series)
Fail	Active fault	

B) Acceptance of the parameters		
Display	Meaning	Explanation
↔	Parameter is accepted immediately	Standard device operates immediately with the new parameter value
SHPRG ↔	Parameter must be acknowledged with SHIFT PRG	Standard device operates with the new parameter value after being acknowledged
SHPRG	Parameter must be acknowledged in case of controller inhibit SHIFT PRG	Standard device operates with the new parameter value after the controller is enabled again
None	Display parameter	Change is not possible

C) Active level		
Display	Meaning	Explanation
Menu	Menu level is active	Select main menu and submenus
Code	Code level is active	Select codes and subcodes
Para	Parameter level is active	Change parameters in the codes or subcodes
None	Operating level is active	Display operating parameters

D) Short text		
Display	Meaning	Explanation
alphanumeric	Contents of the menus, meaning of the codes and parameters	
	In the operating level display of C0004 in % and the active fault	

E	Number		
	Active level	Meaning	Explanation
	Menu level	Menu number	Display is only active for operation with standard devices of the 8200 vector or 8200 motec series
	Code level	Four-digit code number	
F	Number		
	Active level	Meaning	Explanation
	Menu level	Submenu number	Display is only active for operation with standard devices of the 8200 vector or 8200 motec series
	Code level	Two-digit subcode number	
G	Parameter value		
		Parameter value with unit	
H	Cursor		
		In the parameter level, the digit above the cursor can be directly changed	
I	Function keys		
		For description see the following table	

Function keys



Note!

Shortcuts with **SHIFT** :
Press and hold **SHIFT**, then press the second key in addition.

Key	Function			
	Menu level	Code level	Parameter level	Operating level
PRG		Change to the parameter level	Change to the operating level	Change to the code level
SHIFT PRG	Go to the "Short setup" menu and load predefined configurations ¹⁾		Accept parameters when SHPRG ⇌ or SHPRG is displayed	
▲ ▼	Change between menu items	Change of code number	Change of digit via cursor	
SHIFT ▲ ▼	Quick change between menu items	Quick change of code number	Quick change of digit via cursor	
▶ ◀	Change between main menu, submenu and code level		Cursor to the right Cursor to the left	
RUN	Deactivate the function of the key STOP , the LED in the key goes off			
STOP	Inhibit the controller, the LED in the key is lit.			
	Reset fault (TRIP-Reset):	<ol style="list-style-type: none"> 1. Remove the cause of malfunction 2. Press STOP 3. Press RUN 		

¹⁾ Only active for operation with standard devices of the 8200 vector or 8200 motec series

7.2.4 Changing and saving parameters



Note!

Your settings have an effect on the current parameters in the main memory. You must save your settings in a parameter set so that they are not lost when the mains are connected.

If you only need one parameter set, save your settings as parameter set 1, since parameter set 1 is loaded automatically after mains connection.

Step		Key sequence	Action
1.	Select the menu	⬆ ⬇ ⬆ ⬇	Use the arrow keys to select the desired menu
2.	Change to the code level	⬇	Display of the first code in the menu
3.	Select code or subcode	⬆ ⬇	Display of the current parameter value
4.	Change to the parameter level	PRG	
5.	When SHPRG is displayed, inhibit the controller	STOP ¹⁾	The drive coasts
6.	Change parameter		
	A	⬆ ⬇	Move cursor below the digit to be changed
	B	⬆ ⬇	Change of digit
		SHIFT ⬆ SHIFT ⬇	Quick change of digit
7.	Accept the changed parameter		
	Display of SHPRG or SHPRG ⇨	SHIFT PRG	Confirm change to accept the parameter Display "OK"
	Display ⇨	-	The parameter has been accepted immediately
8.	Enable the controller, if required	RUN ¹⁾	The drive runs again
9.	Change to the code level		
	A	PRG	Display of the operating level
	B	PRG	Display of the code with changed parameter
10.	Change further parameters		Restart the "loop" with step 1. or 3.
11.	Save changed parameters		
	A	⬆ ⬇ ⬆ ⬇	Select the code C0003 "PAR SAVE" in the menu "Load/Store"
	B	PRG	Change to the parameter level Display "0" and "READY"
	C	⬇	Save as parameter set 1: ⇨ Set "1" "Save PS1" Save as parameter set 2: ⇨ Set "2" "Save PS2" Save as parameter set 3: ⇨ Set "3" "Save PS3" Save as parameter set 4: ⇨ Set "4" "Save PS4"
	D	SHIFT PRG	When "OK" is displayed, the settings are permanently saved in the selected parameter set.

7



Parameter setting

7.2

Parameter setting with the XT EMZ9371BC keypad

7.2.4

Changing and saving parameters

Step	Key sequence	Action
12. Change to the code level	A 	Display of the operating level
	B 	Display of C0003 "PAR SAVE"
13. Set parameters for another parameter set		Restart the "loop" with step 1. or 3.

- ¹⁾ The function of the  key can be programmed:
C0469 = 1: Controller inhibit
C0469 = 2: Quick stop (Lenze setting)

7.2.5 Loading a parameter set

The keypad serves to load a saved parameter set into the main memory when the controller is inhibited. After the controller is enabled, it operates with the new parameters.



Danger!

- ▶ When a new parameter set is loaded, the controller is reinitialised and acts as if it had been connected to the mains:
 - System configurations and terminal assignments can be changed. Make sure that your wiring and drive configuration comply with the settings of the parameter set.
- ▶ Only use terminal X5/28 as source for the controller inhibit! Otherwise the drive may start in an uncontrolled way when switching over to another parameter set.



Note!

- ▶ After switching on the supply voltage, the controller always loads parameter set 1 into the main memory.
- ▶ It is also possible to load other parameter sets into the main memory via the digital inputs or bus commands.

Step	Key sequence	Action
1. Inhibit controller		Terminal X5/28 = LOW
2. Load the saved parameter set into the main memory	A	Select the code C0002 "PAR LOAD" in the menu "Load/Store"
	B	Change to the parameter level The active parameter set is displayed, e. g. display "0" and "Load Default" If you want to restore the delivery status, proceed with D
	C	Load parameter set 1: ⇒ Set "1" "Load PS1" Load parameter set 2: ⇒ Set "2" "Load PS2" Load parameter set 3: ⇒ Set "3" "Load PS3" Load parameter set 4: ⇒ Set "4" "Load PS4"
	D	"RDY" goes off. The parameter set is loaded completely into the main memory if "RDY" is displayed again.
3. Change to the code level	A	Display of the operating level
	B	Display of C0002 "PAR LOAD"
4. Enable controller		Terminal X5/28 = HIGH The drive is running with the settings of the loaded parameter set

7.2.6

Transferring parameters to other standard devices

Parameter settings can be easily copied from one standard device to another by using the keypad.

For this purpose use the "Load/Store" menu

**Danger!**

During the parameter transfer from the keypad to the standard device the control terminals can adopt undefined states!

Therefore the plugs X5 and X6 must be disconnected from the standard device before the transfer takes place. This ensures that the controller is inhibited and all control terminals have the defined state "LOW".

Copying parameter sets from the standard device into the keypad

**Note!**

After copying the parameter sets into the XT keypad (C0003 = 11), always the parameter set that was loaded last via C0002 is activated.

Like this the current parameters also remain active after copying:

- ▶ Save the current parameters in the parameter set before copying and load this parameter set in the controller via C0002.

Step	Key sequence	Action
1. Connect the keypad to standard device 1		
2. Inhibit controller		Terminal X5/28 = LOW The drive coasts.
3. Select C0003 in the "Load/Store" menu	◀ ▶ ◀ ▶	Select code C0003 "PAR SAVE" in the "Load/Store" menu using the arrow keys.
4. Change to the parameter level	PRG	Display "0" and "READY"
5. Copy all parameter set into the keypad		The settings saved in the keypad are overwritten.
	▲	Set "11" "Save extern"
6. Start copying	SHIFT PRG	The "RDY" status display goes off. As parameter value "BUSY" is displayed. If "BUSY" goes off after approx. one minute, all parameter sets were copied into the keypad. The "RDY" status display is lit.
7. Change to the code level	A PRG	Display of the operating level
	B PRG	Display C0003 and "PAR SAVE"
8. Enable controller		Terminal X5/28 = HIGH
9. Remove keypad from standard device 1		

Copying parameter sets from keypad into the standard device

Step	Key sequence	Action
1.	Connect the keypad to standard device 2	
2.	Inhibit controller	Terminal X5/28 = LOW The "IMP" status display is lit. The drive coasts
3.	Pull the plugs X5 and X6	All control terminals have the defined "LOW" status.
4.	Select C0002 in the "Load/Store" menu	◀ ▶ ◂ ◃
5.	Change to the parameter level	PRG
6.	Select the correct copy function	The settings saved in the standard device are overwritten.
	<ul style="list-style-type: none"> Copy all parameter sets available into the EEPROM of the standard device and save them permanently. 	<ul style="list-style-type: none"> The parameter set that was active before copying is overwritten. The parameters are not yet active after copying. Select parameter set and load it in the main memory. 7.2-7
		◀
	Set "20" "ext -> EEPROM"	
6.	<ul style="list-style-type: none"> Copy individual parameter sets into the main memory of the standard device. 	
		◀
	Copy parameter set 1 into the main memory: Set ⇔ "11" "Load ext PS1"	
	Copy parameter set 2 into the main memory: Set ⇔ "12" "Load ext PS2"	
		Copy parameter set 3 into the main memory: Set ⇔ "13" "Load ext PS3"
		Copy parameter set 4 into the main memory: Set ⇔ "14" "Load ext PS4"
7.	Start copying	SHIFT PRG
8.	Change to the code level	
	A	PRG
	B	PRG
9.	<ul style="list-style-type: none"> If the function "Copy all parameter sets into the EEPROM" (C0002 = 20) is selected, they might have to be loaded in the main memory manually. If the function "Copy individual parameter sets into the main memory" (C0002 = 1x) is selected, they might have to be saved permanently in the EEPROM manually. 	◀ ▶ ◂ ◃
10.	Plug in plugs X5 and X6	
11.	Enable controller	Terminal X5/28 = HIGH The drive is running with the new settings.

7.2.7

Activating password protection

**Note!**

- ▶ If the password protection is activated (C0094 = 1 ... 9999), you only have free access to the user menu.
- ▶ To access the other menus, you must enter the password. By this, the password protection is annulled until you enter a new password.
- ▶ Please observe that the password-protected parameters can be overwritten as well when transferring the parameter sets to other standard devices. The password is not transferred.
- ▶ Do not forget your password! If you have forgotten your password, it can only be reset via a PC or a bus system!

Activate password protection

Step	Key sequence	Action
1. Select the "USER menu"	▲ ▼ ▶ ◀	Change to the user menu using the arrow keys
2. Change to the code level	▶	Display of code C0051 "MCTRL-NACT"
3. Select C0094	▲	Display of code C0094 "Password"
4. Change to the parameter level	PRG	Display "0" = no password protection
5. Set password		
	A ▲	Select password (1 ... 9999)
	B SHIFT PRG	Confirm password
6. Change to the code level		
	A PRG	Display of the operating level
	B PRG	Display of C0094 and "Password"
7. Change to the "USER menu"	◀ ◀ ▼	

The password protection is active now.

You can only quit the user menu if you re-enter the password and confirm it with SHIFT PRG.

Remove password protection

Step	Key sequence	Action
1. Change to the code level in the user menu	▶	
2. Select C0094	▲	Display of code C0094 "Password"
3. Change to the parameter level	PRG	Display "9999" = password protection is active
4. Enter password		
	A ▼	Set valid password
	B SHIFT PRG	Confirm The password protection is deactivated by entering the password once again.
5. Change to the code level		
	A PRG	Display of the operating level
	B PRG	Display of C0094 and "Password"

The password protection is deactivated now. All menus can be freely accessed again.

7.2.8 Diagnostics

In the "Diagnostic" menu the two submenus "Actual info" and "History" contain all codes for

- ▶ monitoring the drive
- ▶ fault/error diagnosis

In the operating level, more status messages are displayed. If several status messages are active, the message with the highest priority is displayed.

Priority	Display	Meaning
1	GLOBAL DRIVE INIT	Initialisation or communication error between keypad and controller
2	XXX - TRIP	Active TRIP (contents of C0168/1)
3	XXX - MESSAGE	Active message (contents of C0168/1)
4	Special device states:	
		Switch-on inhibit
5	Source for controller inhibit (the value of C0004 is displayed simultaneously):	
	STP1	9300 servo: Terminal X5/28 ECSxS/P/M/A: Terminal X6/SI1
	STP3	Operating module or LECOM A/B/LI
	STP4	INTERBUS or PROFIBUS-DP
	STP5	9300 servo, System bus (CAN) ECSxA/E: ECSxS/P/M: MotionBus (CAN)
	STP6	C0040
6	Source for quick stop (QSP):	
	QSP-term-Ext	The MCTRL-QSP input of the MCTRL function block is on HIGH signal.
	QSP-C0135	Operating module or LECOM A/B/LI
	QSP-AIF	INTERBUS or PROFIBUS-DP
	QSP-CAN	9300 servo, System bus (CAN) ECSxA: ECSxS/P/M: MotionBus (CAN)
7	XXX - WARNING	Active warning (contents of C0168/1)
8	xxxx	Value below C0004

7.2.9

Menu structure

For simple, user-friendly operation, the codes are clearly arranged in function-related menus:

Main menu	Submenus	Description
Display	Display	
User-Menu		Codes defined in C0517
Code list		All available codes
	ALL	All available codes listed in ascending order (C0001 ... C7999)
	PS 1	Codes in parameter set 1 (C0001 ... C1999)
	PS 2	Codes in parameter set 2 (C2001 ... C3999)
	PS 3	Codes in parameter set 3 (C4001 ... C5999)
	PS 4	Codes in parameter set 4 (C6001 ... C7999)
Load/Store		Parameter set management Parameter set transfer, restore delivery status
Diagnostic		Diagnostic
	Actual info	Display codes to monitor the drive
	History	Fault analysis with history buffer
Short setup		Quick configuration of predefined applications Configuration of the user menu The predefined applications depend on the type of the standard device (frequency inverter, servo inverter, position controller, ...)
Main FB		Configuration of the main function blocks
	NSET	Setpoint processing
	NSET-JOG	Fixed setpoints
	NSET-RAMP1	Ramp function generator
	MCTRL	Motor control
	DFSET	Digital frequency processing
	DCTRL	Internal control
Terminal I/O		Connection of inputs and outputs with internal signals
	AIN1 X6.1/2	Analog input 1
	AIN2 X6.3/4	Analog input 2
	AOUT1 X6.62	Analog output 1
	AOUT2 X6.63	Analog output 2
	DIGIN	Digital inputs
	DIGOUT	Digital outputs
	DFIN	Digital frequency input
	DFOUT	Digital frequency output
	State bus	State bus (not with 9300 frequency inverter)
Controller		Configuration of internal control parameters
	Speed	Speed controller
	Current	Current controller or torque controller
	Phase	Phase controller (not with 9300 frequency inverter)
Motor/Feedb.		Input of motor data, configuration of speed feedback
	Motor adj	Motor data
	Feedback	Configuration of feedback systems
Monitoring		Configuration of monitoring functions

Main menu	Submenus	Description
Display	Display	
LECOM/AIF		Configuration of operation with communication modules
	LECOM A/B	Serial interface
	AIF interface	Process data
	Status word	Display of status words
System bus		Configuration of system bus (CAN)
	Management	CAN communication parameters
	CAN-IN1	CAN object 1
	CAN-OUT1	
	CAN-IN2	CAN object 2
	CAN-OUT2	
	CAN-IN3	CAN object 3
	CAN-OUT3	
	Status word	Display of status words
	FDO	Free digital outputs
	Diagnostic	CAN diagnostic
FB config		Configuration of function blocks
Func blocks		Parameterisation of function blocks The submenus contain all available function blocks
FCODE		Configuration of free codes
Identify		Identification
	Drive	Software version of standard device
	Op Keypad	Software version of keypad

8 Configuration

Contents

8.1	Important notes	8.1-1
8.2	Monitoring	8.2-1
8.2.1	Fault responses	8.2-1
8.2.2	Setting of responses	8.2-2
8.2.3	Monitoring times for process data input objects	8.2-3
8.2.4	Maximum speed	8.2-4
8.2.5	Motor	8.2-4
8.2.6	Controller current load (I x t monitoring)	8.2-5
8.2.7	Motor temperature	8.2-6
8.2.8	Current load of motor (I2 x t monitoring: OC6, OC8)	8.2-7
8.2.9	Heatsink temperature	8.2-10
8.2.10	DC-bus voltage	8.2-11
8.2.11	External error (EEr)	8.2-11
8.3	Overview of monitoring functions	8.31
8.4	Code table	8.4-1
8.5	Selection lists	8.5-1
8.5.1	Selection list 1: Analog output signals	8.5-1
8.5.2	Selection list 2: Digital output signals	8.5-3
8.5.3	Selection list 3: Angle signals	8.5-7
8.5.4	Selection list 4: Speed signals	8.5-7
8.5.5	Selection list 5: Function blocks	8.5-8
8.5.6	Selection list 10: Error messages	8.5-10
8.6	Table of attributes	8.6-1

8.1 Important notes

The chapter "Configuration" consists of two parts.

System Manual

Contents of the chapter "Configuration" in the System Manual:

- ▶ Monitoring
- ▶ Monitoring functions
- ▶ Code table
- ▶ Selection lists
- ▶ Table of attributes

System Manual (Extension)

Contents of the chapter "Configuration" in the System Manual (Extension):

- ▶ Configuring with Global Drive Control (GDC)
- ▶ Basic configurations
- ▶ Operating modes

8.2 Monitoring



Different monitoring functions (📖 8.31) protect the drive system from impermissible operating conditions.

If a monitoring function responds,

- ▶ the set fault response is triggered to protect the drive and
- ▶ the fault message is entered position 1 in the fault history buffer (C0168/x, in case of ECSxP: C4168/x) (📖 9.2-1).

8.2.1 Fault responses

Depending on the failure, one or more of the following responses are possible:

Response	Effects on the drive and controller	Danger warnings
TRIP (highest priority)	<ul style="list-style-type: none"> • Switches the power outputs U, V, W to a high resistance until TRIP is reset • The drive coasts (no control!). • After TRIP reset, the drive accelerates to its setpoint on the ramps set. 	
Message	<p>Switches the power outputs U, V, W to a high resistance as long as the message is active.</p> <ul style="list-style-type: none"> • Short-time message ≤ 0.5 s The drive coasts (no control) as long as the message is active. If the message is no longer available, the drive accelerates to its setpoint with maximum torque. • Longer message > 0.5 s The drive coasts (due to internal controller inhibit) as long as the message is active. If required, restart the drive. 	<div style="text-align: center;">  Danger! </div> <p>The drive restarts automatically if the message is no longer available.</p>
Warning	<ul style="list-style-type: none"> • Only display of the failure. • The drive operates in a controlled manner. 	<div style="text-align: center;">  Stop! </div>
Off	<ul style="list-style-type: none"> • No response on failures! Monitoring is deactivated. 	<p>As these responses have no effect on the drive behaviour, the drive can be destroyed.</p>

8.2.2 Setting of responses

- Open the **Diagnostics** dialog box in the parameter menu.

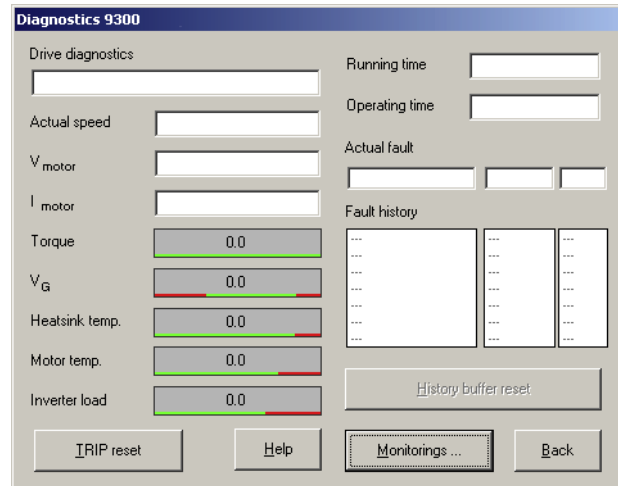

9300std230

Fig. 8.2-1 "Diagnostics" dialog box

- Click on the "Monitorings" button.

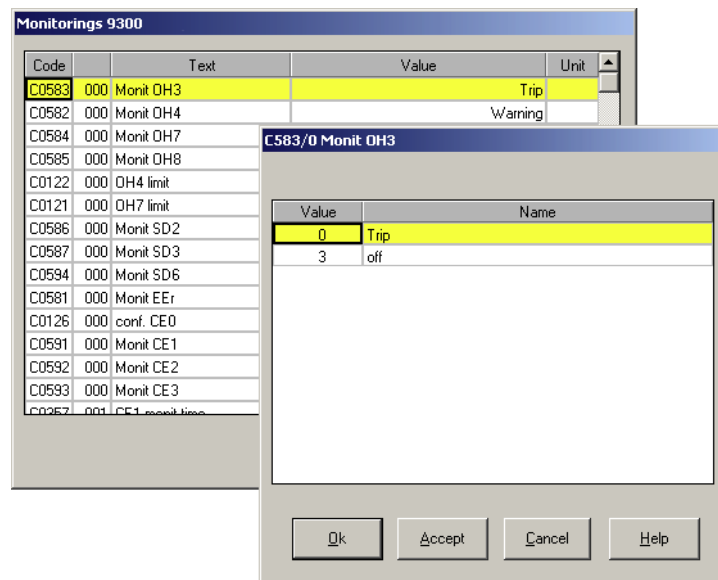

9300std233

Fig. 8.2-2 "Monitorings" dialog box

1. Click on a monitoring option. The configuration dialog box opens.
2. Select the desired response and confirm with "OK".

8.2.3 Monitoring times for process data input objects

Each process data input object can monitor whether a telegram has been received within a time set. As soon as a telegram arrives, the corresponding monitoring time (C0357) is restarted ("retriggerable monoflop" function).

The following assignments are valid:

Setting the response to the monitoring:

- ▶ C0591 for CAN1_IN ("CE1")
- ▶ C0592 for CAN2_IN ("CE2")
- ▶ C0593 for CAN3_IN ("CE3")

The following can be set:

- ▶ 0 = error (TRIP) - controller sets controller inhibit (CINH)
- ▶ 2 = warning
- ▶ 3 = monitoring is switched off

You can also use the signals as binary output signals, e. g. for the assignment of the output terminal.

Bus off

If the controller disconnects from the CAN bus due to faulty telegrams, the "BusOffState" (CE4) signal is set.

"BusOffState" can trigger an error (TRIP) or warning (like CE1, CE2, CE3). You can also switch the signal off. The response is set via C0595. You can also assign the terminal output.

Reset node

Changes with regard to the baud rates, the CAN node addresses, or the addresses of process data objects are only valid after a reset node.

The reset node can be effected by:

- ▶ A reconnection of the low-voltage supply
- ▶ Reset node via the bus system
- ▶ Reset node via C0358

8.2.4 Maximum speed



Stop!

Destruction of the drive!

- ▶ If the fault is triggered, the drive is without torque.
- ▶ In the event of an actual speed value encoder failure it is not guaranteed that the monitoring responds.

Protective measures:

- ▶ Use a mechanical brake if necessary.
- ▶ Special, system-specific measures are to be taken.

The NMAX fault is triggered if the system speed (MCTRL-NACT)

- ▶ exceeds the value set under C0596 or
- ▶ exceeds the maximum speed n_{\max} (C0011) by twice the max. speed value.

A fault initiates TRIP NMAX. Other responses cannot be set.

8.2.5 Motor

Overcurrent in the motor cable (OC1)

Fault OC1 is triggered if the motor current exceeds the 2.25-fold rated controller current.

If a fault occurs, TRIP OC1 is triggered. Other responses cannot be set.

Earth fault in the motor cable (OC2)

The OC2 fault is triggered if

- ▶ the motor has a short circuit to the frame,
- ▶ one of the phases has a short circuit to the shield,
- ▶ one of the phases has a short circuit to PE,
- ▶ the capacitive charging current of the motor cable is too high.

A fault initiates TRIP OC2. Other responses cannot be set.

Failure of a motor phase (LP1)

If a current-carrying motor phase fails, a motor winding is broken or the current limit value set in C0599 is too high, the LP1 fault is triggered.

The monitoring is not appropriate for field frequencies > 480 Hz and when synchronous servo motors are used. Deactivate the monitoring at these conditions.

The response to exceeding the thresholds can be set under C0597.



Note!

The monitoring can only be activated if the function block MLP1 is entered in the processing table (C0465).

8.2.6 Controller current load (I x t monitoring)

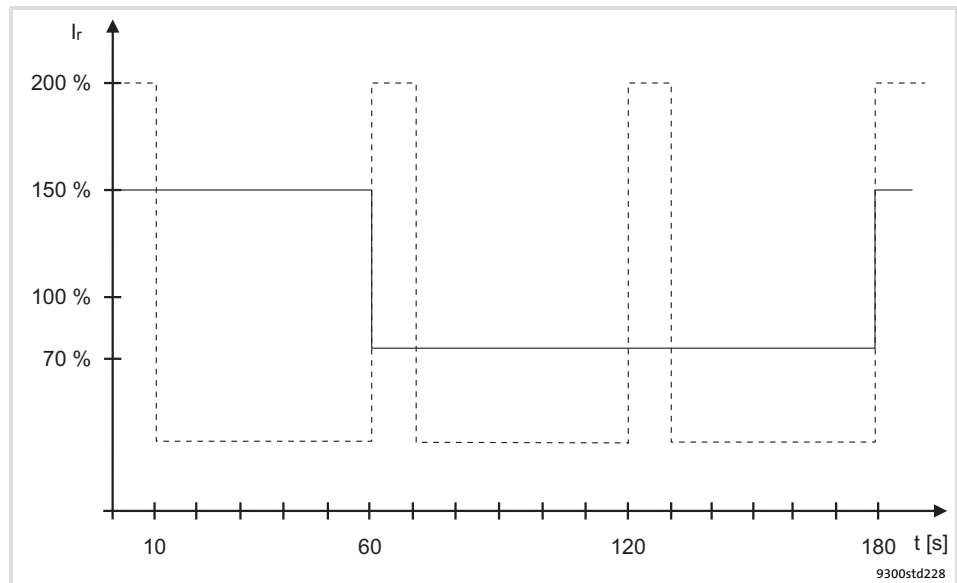

Fig. 8.2-3 I x t diagram

I_r	Device output current
—	100 % continuous thermal current at $C0022 \leq 1.5 I_r$
- - - - -	70 % continuous thermal current at $C0022 > 1.5 I_r$

The I x t monitoring monitors the current load of the controller. The current load is calculated from the mean value of the motor current over the acquisition period of 180 s.

The monitoring is set in such a way that the following operation modes are possible:

- ▶ Continuously with device output current = I_r .
- ▶ ≤ 60 s with device output current $\leq 1.5 \times I_r$.

A fault initiates TRIP OC5. Other responses cannot be set.

8.2.7 Motor temperature

KTY at X7 or X8

The motor temperature is monitored by means of a KTY. Connect the thermal sensor to the resolver cable at X7 or the encoder cable at X8.

- ▶ Warning threshold (OH7) can be set via C0121
 - The switch-on point is 5 °C below the threshold set.
- ▶ Fixed warning threshold (OH3) = 150 °C
 - The switch-on point is 135 °C.

The response for the case when the thresholds are exceeded can be defined in:

- ▶ C0584 (adjustable threshold)
- ▶ C0583 (fixed threshold)



Stop!

With the setting C0583 = 3, monitoring is deactivated. The motor temperature in C0063 shows 0 °C, even if C0584 = 2 (warning) is set.

Monitoring of the KTY at X7 or X8

The SD6 fault is triggered if there is a short or open circuit between X7/8 and X7/9 or X8/5 and X8/8.

The response can be set under C0594.

PTC thermistor or thermal contact (NC contact) at T1, T2

The motor temperature is monitored with a PTC thermistor or thermal contact. Wire the temperature sensor to T1, T2.

- ▶ Fixed warning threshold (OH8)
 - The switch-off threshold and the hysteresis depend on the temperature sensor (DIN 44081).

The response to exceeding the threshold can be set under C0585.



Stop!

Motor could be destroyed!

- ▶ If the responses "Warning" or "Off" are set, the motor could be destroyed by overload.

Protective measure:

- ▶ Set the response "TRIP".

8.2.8 Current load of motor (I² x t monitoring: OC6, OC8)

From software version 8.0 onwards, the 9300 controllers are provided with an I²x t function for sensorless thermal monitoring of the connected motor.



Note!

- ▶ I² x t monitoring is based on a mathematical model which calculates a thermal motor load from the detected motor currents.
- ▶ The calculated motor load is saved when the mains is switched.
- ▶ The function is UL-certified, i.e. no additional protective measures are required for the motor in UL-approved systems.
- ▶ However, I² x t monitoring is **no** full motor protection as other influences on the motor load could not be detected as for instance changed cooling conditions (e.g. interrupted or too warm cooling air flow).

The I² x t load of the motor is displayed in C0066.

The thermal loading capacity of the motor is expressed by the thermal motor time constant (τ , C0128). Find the value in the rated motor data or contact the manufacturer of the motor.

The I² x t monitoring has been designed such that it will be activated after 179 s in the event of a motor with a thermal motor time constant of 5 minutes (Lenze setting C0128), a motor current of 1.5 x I_N and a trigger threshold of 100 %.

Two adjustable trigger thresholds provide for different responses.

- ▶ Adjustable response OC8 (TRIP, warning, off).
 - The trigger threshold is set in C0127.
 - The response is set in C0606.
 - The response OC8, for instance, can be used for an advance warning.
- ▶ Fixed response OC6-TRIP.
 - The trigger threshold is set in C0120.

Behaviour of the I ² x t monitoring	Condition
The I ² x t monitoring is deactivated. C0066 is set = 0 % and MCTRL-LOAD-I2XT is set = 0.00 %.	When C0120 = 0 % and C0127 = 0 %, set controller inhibit.
I ² x t monitoring is stopped. The current value in C0066 and at the MCTRL-LOAD-I2XT output is frozen.	When C0120 = 0 % and C0127 = 0 %, set controller enable.
I ² x t monitoring is deactivated. The motor load is displayed in C0066.	Set C0606 = 3 (off) and C0127 > 0 %.



Note!

An error message OC6 or OC8 can only be reset if the I² x t load falls below the set trigger threshold by 5 %.

8 Configuration

8.2 Monitoring

8.2.8 Current load of motor (I² x t monitoring: OC6, OC8)

8.2.8.1 Forced ventilated or naturally ventilated motors

Parameter setting

The following codes can be set for I² x t monitoring:

Code	Meaning	Value range	Lenze setting
C0066	Display of the I ² x t load of the motor	0 ... 250 %	-
C0120	Threshold: Triggering of error "OC6"	0 ... 120 %	0 %
C0127	Threshold: Triggering of error "OC8"	0 ... 120 %	0 %
C0128	Thermal motor time constant	0.1 ... 50.0 min	5.0 min
C0606	Response to error "OC8"	TRIP, warning, off	Warning

Calculate release time and I²x t load

Formula for release time	Information
$t = -(\tau) \times \ln \left[1 - \frac{z + 1}{\left(\frac{I_{Mot}}{I_N}\right)^2 \times 100} \right]$	I _{Mot} Actual motor current (C0054)
	I _r Rated motor current (C0088)
	τ Thermal motor time constant (C0128)
	z Threshold value in C0120 (OC6) or C0127 (OC8)

Formulae for I ² x t load	Information
$L(t) = \left(\frac{I_{Mot}}{I_N}\right)^2 \times 100\% \times \left(1 - e^{-\frac{t}{\tau}}\right)$	L(t) Chronological sequence of the I ² x t load of the motor (Display: C0066)
	I _{Mot} Actual motor current (C0054)
	I _r Rated motor current (C0088)
	τ Thermal motor time constant (C0128)

If the controller is inhibited, the I² x t load is reduced:

$L(t) = L_{Start} \times \sqrt{e^{-\frac{t}{\tau}}}$	L _{Start} I ² x t load before controller inhibit If an error is triggered, the value corresponds to the threshold value set in C0120 (OC6) or C0127 (OC8).
--	---

Read release time in the diagram

Diagram for detecting the release times for a motor with a thermal motor time constant of 5 minutes (Lenze setting C0128):

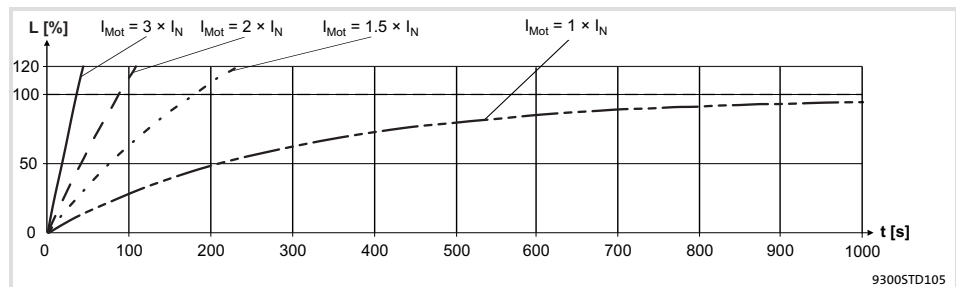

Fig. 8.2-4 I² x t-monitoring: Release times for different motor currents and trigger thresholds

- I_{Mot} Actual motor current (C0054)
- I_r Rated motor current (C0088)
- L I² x t load of the motor (display: C0066)
- T Time

8.2.8.2 Self-ventilated motors

Due to the construction, self-ventilated standard motors are exposed to an increased heat generation in the lower speed range compared to forced ventilated motors.



Warnings!

For complying with the UL 508C standard, you have to set the speed-dependent evaluation of the permissible torque via code **C0129/x**.

Parameter setting

The following codes can be set for $I^2 \times t$ monitoring:

Code	Meaning	Value range	Lenze setting
C0066	Display of the $I^2 \times t$ load of the motor	0 ... 250 %	-
C0120	Threshold: Triggering of error "OC6"	0 ... 120 %	0 %
C0127	Threshold: Triggering of error "OC8"	0 ... 120 %	0 %
C0128	Thermal motor time constant	0.1 ... 50.0 min	5.0 min
C0606	Response to error "OC8"	TRIP, warning, off	Warning
C0129/1	S1 torque characteristic I_1/I_{rated}	10 ... 200 %	100 %
C0129/2	S1 torque characteristics n_2/n_{rated}	10 ... 200 %	40 %

Effect of code C0129/x

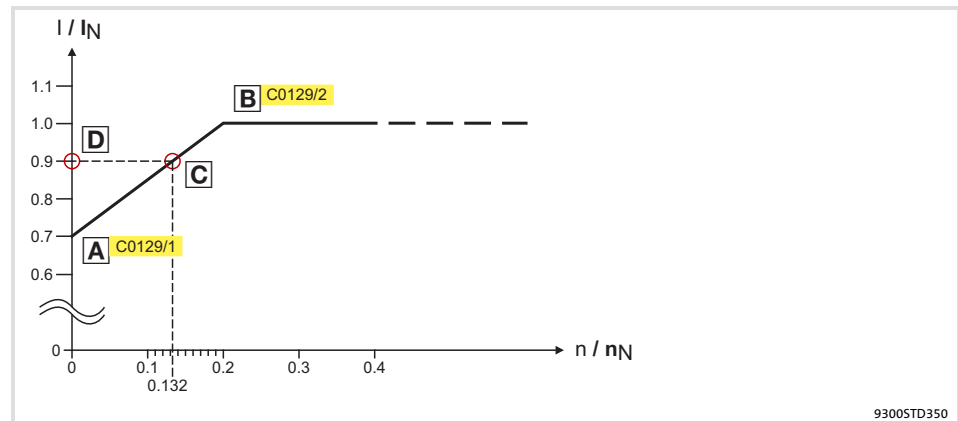

Fig. 8.2-5 Working point in the range of characteristic lowering

The lowered speed / torque characteristic (Fig. 8.2-5) reduces the permissible thermal load of self-ventilated standard motors. The characteristic is a line the definition of which requires two points:

- ▶ Point **A**: Definition with **C0129/1**
This value also enables an increase of the maximally permissible load.
- ▶ Point **B**: Definition with **C0129/2**
With increasing speeds, the maximally permissible load remains unchanged ($I_{Mot} = I_{rated}$).

In Fig. 8.2-5, the motor speed and the corresponding permissible motor torque (**D**) can be read for each working point (**C**) on the characteristic (**A**) ... **B**). **D** can also be calculated using the values in **C0129/1** and **C0129/2** (evaluation coefficient "y", 8.2-10).

Calculate release time and I²x t load

Calculate the release time and the I² x t load of the motor considering the values in **C0129/1** and **C0129/2**(evaluation coefficient "y").

Formulae for release time	Information
$T = - (\tau) \times \ln \left[1 - \frac{z + 1}{\left(\frac{I_{Mot}}{y \times I_N} \right)^2 \times 100} \right]$	T Release time of the I ² x t monitoring
	τ Thermal motor time constant (C0128)
$y = \frac{100\% - C0129/1}{C0129/2} \times \frac{n}{n_N} + C0129/1$	ln Function: Natural logarithm
	I _{Mot} Actual motor current (C0054)
	I _r Rated motor current (C0088)
	z Threshold value in C0120 (OC6) <u>or</u> C0127 (OC8)
	y Evaluation coefficient
	n _{rated} Rated speed (C0087)

Formulae for I ² x t load	Information
$L(t) = \left(\frac{I_{Mot}}{y \times I_N} \right)^2 \times 100\% \times \left(1 - e^{-\frac{t}{\tau}} \right)$	L(t) Chronological sequence of the I ² x t load of the motor (Display: C0066)
	y Evaluation coefficient
	I _{Mot} Actual motor current (C0054)
	I _r Rated motor current (C0088)
	τ Thermal motor time constant (C0128)

If the controller is inhibited, the I² x t load is reduced:

$L(t) = L_{start} \times \sqrt{e^{-\frac{t}{\tau}}}$	L _{start} I ² x t load before controller inhibit If an error is triggered, the value corresponds to the threshold value set in C0120 (OC6) <u>or</u> C0127 (OC8).
--	--

8.2.9 Heatsink temperature

Via a temperature threshold, the heatsink temperature of the controller can be monitored:

- ▶ Adjustable threshold (OH4) under C0122
 - The reset point is 5° C below the adjusted threshold.
- ▶ Fixed threshold (OH) = 85° C
 - The reset point is at 80° C.

The response for exceeding the adjustable threshold can be set under C0582.

8.2.10 DC-bus voltage

In C0173 the mains voltage and the DC-bus voltage are set. The switching thresholds for overvoltage and undervoltage are based on these settings.

Selection	Mains voltage	Braking unit	Message LU (undervoltage)		Message OU (overvoltage)	
			Set	Reset	Set	Reset
C0173	[V AC]		[V DC]	[V DC]	[V DC]	[V DC]
0	< 400	Yes / no	285	430	770	755
1	400	Yes / no	285	430	770	755
2	400 ... 460	Yes / no	328	473	770	755
3	480	No	342	487	770	755
4	480	Yes	342	487	800	785

C0173 = 1: Lenze setting

Overvoltage

If the DC-bus voltage exceeds the upper switch-off threshold set in C0173, the OU message is triggered.

Undervoltage

If the DC-bus voltage falls below the lower switch-off threshold set in C0173, the LU message is triggered.

- ▶ An undervoltage message > 3 seconds is interpreted as an operating state (e.g. mains switched off) and entered in the history buffer. The entry is, however, deleted as soon as the cause has been eliminated (e.g. mains switched on again).

This operating state can occur if the control module is already supplied externally via terminals X5/39 and X5/59, but the mains voltage is not yet switched on.

- ▶ An undervoltage message < 3 seconds is interpreted as a fault (e.g. mains fault), entered in the history buffer and saved.

8.2.11 External error (EEr)

A HIGH signal at DCTRL-TRIP-SET triggers the EEr fault.

You can, for example, connect the digital input DCTRL-TRIP-SET with an input terminal (X5/Ex). In this way an external encoder can trigger the EEr fault.

The response can be set under C0581.

8.3 Overview of monitoring functions

The responses of monitoring functions can be partly parameterised via codes – in GDC in the parameter menu under **Monitoring** –.

Monitoring			Possible responses				
Error message	Description	Source	CoDe	TRIP	Message	Warning	Off
0071	CCr	System fault	Internal	●			
x091	EEr	External monitoring (activated via DCTRL)	FWM	●	✓	✓	✓
Voltage supply							
1020	OU	Overvoltage in the DC bus (C0173)	MCTRL		●		
1030	LU	Undervoltage in the DC bus (C0173)	MCTRL		●		
0107	H07	Internal fault (power section)	Internal	●			
Communication							
x061	CE0	Communication error on the automation interface (AIF)	AIF	C0126	✓		●
x062	CE1	Communication error at process data input object CAN1_IN (monitoring time can be set with C0357/1)	CAN1_IN	C0591	✓		●
x063	CE2	Communication error at process data input object CAN2_IN (monitoring time can be set with C0357/2)	CAN2_IN	C0592	✓		●
x064	CE3	Communication error at process data input object CAN3_IN (monitoring time can be set with C0357/3)	CAN3_IN	C0593	✓		●
x065	CE4	BUS-OFF state of the system bus (CAN) (too many faulty telegrams)	CAN	C0595	✓		●
x166	P16	Incorrect transmission of the sync telegram (CAN system bus)	Internal	C1290	✓		●
Temperatures / sensors							
0050	OH	Heatsink temperature > 85° C	MCTRL		●		
x053	OH3	Motor temperature > 150° C	MCTRL	C0583	✓		●
x054	OH4	Heatsink temperature > C0122	MCTRL	C0582		●	✓
x057	OH7	Motor temperature > C0121	MCTRL	C0584		●	✓
x058	OH8	Motor temperature across inputs T1 and T2 is too high. Please note: In the case of "Warning" (C0585 = 2) or "Off" (C0585 = 3), the drive can be destroyed if the fault is not eliminated in time!	MCTRL	C0585	✓		●
x086	Sd6	Thermal sensor error at motor (X7 or X8)	MCTRL	C0594	✓		●
x110	H10	Thermal sensor error at heatsink	FWM	C0588	●		1)
x111	H11	Thermal sensor error in the device interior	FWM	C0588	●		1)
Motor / feedback system							
0011	OC1	Motor cable overcurrent	MCTRL		●		
0012	OC2	Motor cable earth fault	MCTRL		●		

Monitoring				Possible responses				
				● Lenze setting ✓ Setting possible				
Error message		Description	Source	CoDe	TRIP	Message	Warning	Off
0015	OC5	I x t overload	MCTRL		●			
0016	OC6	I ² x t overload	MCTRL		●			
0018	OC8	I ² x t overload advance warning	MCTRL	C0606	✓		●	✓
x032	LP1	Motor phase failure (current limit can be set in C0599) Please note: Can only be used for asynchronous motors. The function block MLP1 has to be entered in C0465.	MCTRL	C0597	✓		✓	●
x082	Sd2	Resolver error at X7 Please note: If "Warning" (C0586 = 2) is displayed, the drive can be destroyed if the fault is not eliminated in time!	MCTRL	C0586	●		✓	✓
x083	Sd3	Interruption of the digital frequency coupling. The input signal "Lamp Control" at X9/8 is LOW Please note: In the case of "Warning" (C0587 = 2), the drive can be destroyed if the fault is not eliminated in time!	MCTRL	C0587	●		✓	✓
x085	Sd5	At analog input X6/1, X6/2, the input current is < 2 mA Monitoring only possible if C0034 = 1	MCTRL	C0598	✓		✓	●
x087	Sd7	Absolute value encoder error at X8	MCTRL		●			
x088	Sd8	SinCos encoder error at X8 (filter setting in C0575)	MCTRL	C0580	✓			●
Speed								
x190	nErr	Speed control error (speed window can be set in C0576)	MCTRL	C0579	✓			●
0200	NMAX	Maximum speed (C0596) has been exceeded.	MCTRL		●			
Time-out / overflow								
0105	H05	Intern fault (memory)	Internal		●			
x153	P03	Following error (digital frequency > C0255)	Internal	C0589	✓		●	✓
x163	P13	Overflow of the angle controller	Internal	C0590	●		✓	✓
x169	P19	Input signal at X9 is limited	Internal	C1292	✓		●	✓
Parameter setting								
0072	PR1	Checksum error in parameter set 1	Internal		●			
0074	PEr	Program error	Internal		●			
0075	PR0	Error in the parameter sets	Internal		●			
0079	PI	Fault during the parameter initialisation	Internal		●			
x089	PL	Error during rotor position adjustment	Internal		●			

Representation of the error number:

x 0 = TRIP, 1 = message, 2 = warning

E. g. "2091": An external monitoring has triggered EEr warning

1) Setting only permitted by Lenze service

8.4 Code table

How to read the code table

Column	Abbreviation	Meaning
Code	Cxxxx	Code Cxxxx
	1	Subcode 1 of Cxxxx
	2	Subcode 2 of Cxxxx
		Changed parameter of code or subcode is accepted after pressing
		Changed parameter of code or subcode is accepted after pressing when the controller is inhibited
Designation		Designation of the code
Lenze		Lenze setting (value at delivery or after restoring the delivery status with C0002)
	→	The column "IMPORTANT" contains additional information
		The code only displays a value. It cannot be configured.
Selection	1 {%} 99	Min. value {unit} max. value
IMPORTANT	-	Short, important explanation









Code		Possible settings		IMPORTANT	
No.	Designation	Lenze	Selection		
C0002 	PAR LOAD	0		Load parameter set	
			0	Default setting	Restore delivery status
			1	Load parameter set 1	Load and activate parameter set saved in the controller ● Parameter set 1 is loaded automatically after every mains connection.
			2	Load parameter set 2	
			3	Load parameter set 3	
			4	Load parameter set 4	
			11	Load parameter set 1externally	Load parameter set from the keypad in the controllerand activate it
12	Load parameter set 2 externally				
13	Load parameter set 3 externally				
14	Load parameter set 4externally				
20		Load all parameter sets from the keypad in the EEPROM of the controller. ● The current parameter set in the RAM of the controller is overwritten. Save the parameter set.			
C0003	PAR SAVE	0		Save parameter set	
			0	Executed	Saving completed
			1	Save parameter set 1	Save the parameters loaded in the controller in the parameter set selected
			2	Save parameter set 2	
			3	Save parameter set 3	
			4	Save parameter set 4	
11	Save all parameter sets into keypad	Copying parameter sets from the standard device into the keypad XT			
C0004	OP DISPLAY	56	0 {1} 1999	Status display Keypad shows selected code in the operating level if no other status messages from C0183 are active	

Code		Possible settings			IMPORTANT	
No.	Designation	Lenze	Selection			
C0005 	SIGNAL CFG	1000			Signal configuration (predefined basic configurations)	
			0	COMMON		Modified basic configuration
			1	86xx -1-		Compatible to 86xx frequency inverter
			2	86xx -2-		
			11	86xx -11-		
20	922x -20-		Compatible to 922xx frequency inverter			
21	922x -21-					
C0005 	SIGNAL CFG	1000	100	empty		All internal links are deleted
			1000	Speed control		The first digit indicates the predefined basic function, e. g.: <ul style="list-style-type: none"> ● 1xxx: Speed control ● 4xxx: Torque control with speed limitation
			4000	Torque control with speed limitation		The second digit indicates additional functions x0xx: No additional function x1xx: Brake control x9xx: In the case of quick stop, the complete drive system is brought to zero speed in a phase-controlled manner
			5000	Master for digital frequency coupling		The third digit indicates the predefined voltage source for the control terminals: <ul style="list-style-type: none"> ● xx0x: External supply voltage ● xx1x: Internal supply voltage
			6000	Slave to digital frequency bus		The fourth digit indicates the predefined device control: <ul style="list-style-type: none"> ● xxx0: Terminal control ● xxx1: RS232, RS485 or optical fibre ● xxx3: INTERBUS or PROFIBUS-DP ● xxx5: System bus (CAN)
			7000	Slave to digital frequency cascade		
C0006 	OP MODE	→			Motor control operation	
			1	SSC norm Y sensorless star standard motor		→ Depending on C0086 <ul style="list-style-type: none"> ● Change of C0086 resets value to the assigned default setting ● Change of C0006 sets C0086 = 0!
			2	Servo async. Y asynchronous motor, star		
			3	Servo PM-SM Y PM synchronous motor, star		
			11	SSC standard motor sensorless standard motor, delta		
			22	Servo asyn asynchronous motor, delta		
C0009	LECOM ADDRESS	1	1	{1}	99	LECOM device address Bus device number when operated via interface <ul style="list-style-type: none"> ● 10, 20, ..., 90 reserved for broadcast to device groups for RS232, RS485, fibre optics.
C0011	NMAX	3000	500	{1 rpm}	16000	Max speed N_{max} Reference value for the absolute and relative setpoint selection for the acceleration and deceleration times. <ul style="list-style-type: none"> ● Parameter setting via interface: – Greater changes in one step should only be made when the controller is inhibited.

Code		Possible settings				IMPORTANT		
No.	Designation	Lenze	Selection					
C0012	TIR (ACC)	0.000	0.000	{0.001 s}	999.900	NSET Acceleration time T_{ir} for the main setpoint of NSET (related to the speed variation 0 ... n_{max})		
C0013	TIF (DEC)	0.000	0.000	{0.001 s}	999.900	NSET Deceleration time T_{if} for the main setpoint of NSET (related to the speed variation n_{max} ... 0)		
C0017	FCODE (QMIN)	50	-16000	{1 rpm}	16000	FCODE (Q_{min}) Switching threshold $n_{act.} < n_x$ $n_{act} < C0017$ activates the comparator output CMP1-OUT		
C0018	FCHOP	1				Chopper frequency f_{chop}		
			0	16/8 kHz			Noise optimised operation with automatic changeover to 8 kHz	
			1	8 kHz sine			Noise optimised operation	
			2	16 kHz sine				
C0019	THRESH NACT=0	0	0	{1 rpm}	16000	Threshold $n_{act} = 0$ Threshold is recognised at $n_{act} = 0$		
C0021	SLIPCOMP	0.00	0.00	{0.01 %}	20.00	Slip compensation <ul style="list-style-type: none"> Only active with sensorless control below the value of C0291 		
C0022	IMAX CURRENT	→	0	{0.01 A}	1.50 I _N	I_{max} limit current → Depending on C0086 <ul style="list-style-type: none"> Change of C0086 resets value to the assigned factory setting (1.5×I_{motor}) 		
C0025 	FEEDBACK TYPE	10				Feedback Input of the encoder specified on the nameplate of the Lenze motor: C0025 automatically changes C0420, C0490, C0495		
			0	COMMON			C0420, C0490 or C0495 was changed subsequently	
			1	Without feedback			Control without feedback system (sensorless control, SSC)	
			10	RSx (Resolver)			The resolver is designated with RSxxxxxxx. If a resolver is selected, the rotor displacement angle in C0058 is set to -90°.	
			110	IT-512-5V			Incremental encoder with TTL level	
			111	IT-1024-5V				
			112	IT-2048-5V				
			113	IT-4096-5V				
			210	IS-512-5V				Sin/cos encoder
			211	IS-1024-5V				
			212	IS-2048-5V				
			213	IS-4096-5V				
			309	AS-128-8V SKS			Single-turn SinCos encoder with RS485 interface Co. Stegmann (absolute value encoder)	
			310	AS-512-8V SCS				
			311	AS-1024-8V SRS				
			409	AM-128-8V SKM				Multi-turn SinCos encoder with RS485 interface Co. Stegmann (absolute value encoder)
			410	AM-512-8V SCM				
411	AM-1024-8V SRM							
				If an absolute value encoder is selected, an SD7 trip is triggered.				

Code		Possible settings				IMPORTANT
No.	Designation	Lenze	Selection			
C0026			-199.99	{0.01 %}	199.99	FCODE (AIN offset) Freely configurable code for relative analog signals ● Used for: – Offset for terminal X6/1,2 – Offset for terminal X6/3,4
1	FCODE (OFFSET)	0.00				
2	FCODE (OFFSET)	0.00				
C0027			-199.99	{0.01 %}	199.99	FCODE (AIN gain) Freely configurable code for relative analog signals ● Used for: – Gain X6/1,2 – Gain X6/3,4
1	FCODE (GAIN)	100.0 0				
2	FCODE (GAIN)	100.0 0				
C0030	DFOUT CONST	3	0 1 2 3 4 5 6	256 inc/revolution 512 inc/revolution 1024 inc/revolution 2048 inc/revolution 4096 inc/revolution 8192 inc/revolution 16384 inc/revolution		DFOUT constant Constant for the digital frequency output in increments per revolution
C0032	FCODE GEARBOX	1	-32767	{1}	32767	FCODE (gearbox factor numerator) Freely configurable code
C0033	GEARBOX DENOM	1	1	{1}	32767	Gearbox factor denominator
C0034	MST CURRENT	0	0 1 2	-10 V ... +10 V +4 mA ... +20 mA -20 mA ... +20 mA		AIN input signal Selection of the input signal for X6/1, X6/2
C0037	SET-VALUE RPM	0	-16000	{1 rpm}	16000	Setpoint selection (rpm)
C0039			-199.99	{0.01 %}	199.99	NSET JOG setpoints Fixed speeds (JOG setpoints) can be selected for NSET using digital inputs.
1	JOG SET-VALUE	100.0 0				
2	JOG SET-VALUE	75.00				
3	JOG SET-VALUE	50.00				
4	JOG SET-VALUE	25.00				
5	JOG SET-VALUE	0.00				
...				
14	JOG SET-VALUE	0.00				
15	JOG SET-VALUE	0.00				
C0040	CTRL ENABLE	1	0 1	Controller inhibited Controller enabled		
C0042	QSP	<input type="checkbox"/>	1 2	QSP: Not active QSP: Active		Quick stop
C0043	TRIP RESET	0	0 1	TRIP RESET Active fault		Reset fault Reset of an active trip: ● Set C0043 = 0
C0045	ACT JOG	<input type="checkbox"/>	0 1 2 ... 15	Nset is active JOG 1 JOG 2 ... JOG 15		NSET JOG selection
C0046	NSET-N	<input type="checkbox"/>	-199.99	{0.01 %}	199.99	NSET Main setpoint
C0049	NSET-NADD	<input type="checkbox"/>	-199.99	{0.01 %}	199.99	NSET Additional setpoint
C0050	MCTRL-NSET2	<input type="checkbox"/>	-100.00	{0.01 %}	100.00	MCTRL n _{set} at speed controller input

Code		Possible settings				IMPORTANT
No.	Designation	Lenze	Selection			
C0051	MCTRL-NACT	<input type="text" value="Disp"/>	-30000	{1 rpm}	30000	Actual speed
C0052	MCTRL-UMOT	<input type="text" value="Disp"/>	0	{1 V}	800	Motor voltage
C0053	UG-VOLTAGE	<input type="text" value="Disp"/>	0	{1 V}	900	DC-bus voltage
C0054	IMOT	<input type="text" value="Disp"/>	0.0	{0.1 A}	300.0	Current motor current I_{mot} MCTRLfunction block <ul style="list-style-type: none"> Read only MCTRL-IACT = 100 % = C0022
C0056	MCTRL-MSET2	<input type="text" value="Disp"/>	-100.00	{0.01 %}	100.00	MCTRL-MSET2 (Mset) Torque setpoint (n-controller output)
C0057	MAX TORQUE	<input type="text" value="Disp"/>	0	{1 Nm}	500	Maximum torque Maximum possible torque of the drive configuration <ul style="list-style-type: none"> Depending on C0022, C0086
C0058	ROTOR DIFF	-90.0	-180.0	{0.1 °}	179.9	Rotor displacement angle of motor (offset angle) Zero phase of the rotor for synchronous motors (C0095). If a resolver is selected in C0025 or C0490, C0058 is set to -90°. <ul style="list-style-type: none"> Lenze motor with resolver: C0058 = -90° Lenze motor with absolute value encoder: C0058 = 0°
C0059	MOT POLE NO.	<input type="text" value="Disp"/>	1	{1}	50	Number of motor pole pairs
C0060	ROTOR POS	<input type="text" value="Disp"/>	0	{1}	2048	Motor rotor position <ul style="list-style-type: none"> 1 revolution = 2048 inc
C0061	HEATSINK TEMP	<input type="text" value="Disp"/>	0	{1 °C}	100	Heatsink temperature
C0063	MOT TEMP	<input type="text" value="Disp"/>	0	{1 °C}	200	Motor temperature
C0064	UTILIZATION	<input type="text" value="Disp"/>	0	{1 %}	150	Device utilisation $I \times t$ of the last 180 s <ul style="list-style-type: none"> C0064 >100 % releases trip OC5 Trip reset is only possible if C0064 < 95 %
C0066	MOTOR LOAD	<input type="text" value="Disp"/>	0	{1 %}	250	$I^2 \times t$ utilisation of the motor
C0067	ACT TRIP	<input type="text" value="Disp"/>	All fault messages	→ Selection list 10		Trip error message Current fault message
C0070	VP SPEED CTRL	→	0.0	{0.5}	255.0	V_{pn} speed controller → Depending on C0086 <ul style="list-style-type: none"> Change of C0086 resets value to the assigned Lenze setting
C0071	TN SPEED CTRL	→	1.0	{0.5 ms}	600.0	T_{nn} speed controller At >512 ms the function is deactivated → Depending on C0086 <ul style="list-style-type: none"> Change of C0086 resets value to the assigned Lenze setting
C0072	TD SPEED CTRL	0.0	0.0	{0.1 ms}	32.0	T_{dn} speed controller
C0075	VP CURR CTRL	0.35	0.00	{0.01}	15.99	V_{pi} current controller <ul style="list-style-type: none"> Depending on C0086 Change of C0086 resets value to the assigned Lenze setting
C0076	TN CURR CTRL	1.8	0.5	{0.1 ms}	2000.0	T_{ni} current controller At 2000 ms the function is deactivated <ul style="list-style-type: none"> Depending on C0086 Change of C0086 resets value to the assigned Lenze setting
C0077	VP FIELD CTRL	0.25	0.00	{0.01}	15.99	V_{pF} field controller
C0078	TN FIELD CTRL	15.0	1.0	{0.5 ms}	8000.0	T_{nF} field controller At 8000 ms the function is deactivated

Code		Possible settings				IMPORTANT
No.	Designation	Lenze	Selection			
C0081 	MOT POWER	→	0.01	{0.01 kW}	150.00	Rated motor power acc. to nameplate → Depending on C0086 ● Change of C0086 resets value to the assigned Lenze setting ● Change of C0081 sets C0086 = 0
C0084 	MOT RS	→	0.00	{0.01 Ω}	150.00	Motor stator resistance → Depending on C0086 ● Change of C0086 resets value to the assigned Lenze setting
C0085 	MOT LS	→	0.00	{0.01 mH}	655.35	Motor leakage inductance → Depending on C0086 ● Change of C0086 resets value to the assigned Lenze setting
C0086 	MOT TYPE	→	See motor selection list			Motor type selection → Depending on the controller used ● Change of C0086 resets C0006, C0022, C0070, C0071, C0075, C0076, C0081, C0084, C0085, C0087, C0088, C0089, C0090, C0091 to the assigned Lenze setting
			Controller	Lenze setting	Motor type assigned	Lenze motor type
			EVS9321	110	MDSKS56-23-150	MDSKSXX056-23, f _r : 150 Hz
			EVS9322	111	MDSKS56-33-150	MDSKSXX056-33, f _r : 150Hz
			EVS9323	112	MDSKS71-13-150	MDSKSXX071-13, f _r : 150 Hz
			EVS9324	116	MDSKS71-33-150	MDSKSXX071-33, f _r : 150Hz
			EVS9325	15	MDFKA80-120	MDFKAXX080-22, f _r : 120Hz
			EVS9326	19	MDFKA90-120	MDFKAXX090-22, f _r : 120Hz
			EVS9327	23	MDFKA100-120	MDFKAXX100-22, f _r : 120Hz
			EVS9328	27	MDFKA112-120	MDFKAXX112-22, f _r : 120Hz
			EVS9329	225	30kW-ASM-50	–
			EVS9330	227	45kW-ASM-50	–
			EVS9331	228	55kW-ASM-50	–
			EVS9332	229	75kW-ASM-50	–
C0087 	MOT SPEED	→	300	{1 rpm}	16000	Rated motor speed → Depending on C0086 ● Change of C0086 resets value to the assigned Lenze setting
C0088 	MOT CURRENT	→	0.2	{0.1 A}	500.0	Rated motor current → Depending on C0086 ● Change of C0086 resets value to the assigned Lenze setting
C0089 	MOT FREQUENCY	→	10	{1 Hz}	1000	Rated motor frequency
C0090 	MOT VOLTAGE	→	50	{1 V}	500	Rated motor voltage → Depending on C0086 ● Change of C0086 resets value to the assigned Lenze setting
C0091 	MOT COS PHI	→	0.50	{0.01}	1.00	Motor cos φ → Depending on C0086 ● Change of C0086 resets value to the assigned Lenze setting
C0093	DRIVE IDENT		0 1 93xx	Defective power section No power section 93xx		Controller identification 93xx: type of servo inverter

Code		Possible settings			IMPORTANT	
No.	Designation	Lenze	Selection			
C0094	PASSWORD	0	0	{1}	9999	Password <ul style="list-style-type: none"> Parameter access protection for the keypad. When the password is activated, only codes of the user menu can be accessed. For further possible selections see C0096
C0095	ROTOR POS ADJ	0	0	Inactive		Rotor position adjustment of a synchronous motor <ul style="list-style-type: none"> C0058 displays the zero angle of the rotor C0095 = 1 starts position adjustment
C0096			0	No access protection		Extended password protection for bus systems with activated password (C0094). <ul style="list-style-type: none"> All codes in the user menu can be accessed.
			1	Read protection		
			2	Write protection		
	1 AIF PROTECT.	0		Read/write protection		AIF access protection
	2 CAN PROTECT.	0				CAN access protection
C0099	S/W VERSION	<input type="text" value="Disp"/>	x.xx			Software version
C0101			0.000	{0.001 s}	999.900	NSET Additional acceleration for the main setpoint (based on speed variation 0...n _{max} .)
	1 NSET-TIR (ACCELERATION)	0.000				
	2 NSET TIR	0.000				
				
	15 NSET-TIR	0.000				
C0103			0.000	{0.001 s}	999.900	NSET Additional deceleration times for the main setpoint (based on speed variation 0...n _{max} .)
	1 NSET-TIF	0.000				
	2 NSET-TIF	0.000				
				
	15 NSET-TIF	0.000				
C0105	QSP TIF	0.000	0.000	{0.001 s}	999.900	QSP deceleration time Deceleration time for quick stop (QSP) (based on speed variation 0...n _{max} .)
C0108		100.0 0	-199.99	{0.01 %}	199.99	FCODE (AOUT gain)
	1 FCODE (GAIN AOUT)					
	2 FCODE (GAIN AOUT)					
C0109			-199.99	{0.01 %}	199.99	FCODE (offset AOUT)
	1 FCODE (OFFSET AOUT)	0.00				
	2 FCODE (OFFSET AOUT)	0.00				
C0114			0	HIGH active		DIGINterminal polarity
			1	LOW active		
	1 DIGIN1 POL	0				X5/E1
	2 DIGIN2 POL	0				X5/E2
	3 DIGIN3 POL	0				X5/E3
	4 DIGIN4 POL	1				X5/E4
	5 DIGIN5 POL	0				X5/E5

Code		Possible settings				IMPORTANT	
No.	Designation	Lenze	Selection				
C0141	FCODE (SETVAL)	0.0	-199.9	{0.1 %}	199.9	Main setpoint	
C0142	START OPTIONS	1				Start option	
			0	Start lock		<ul style="list-style-type: none"> Automatic start inhibited after <ul style="list-style-type: none"> Mains connection Reset of a message (t > 0.5 s) TRIP RESET Start after HIGH-LOW-HIGH level change at X5/28 	
			1	Auto start		Automatic start if X5/28 = HIGH	
C0150	STATUS WORD	<input type="checkbox"/> Disp	0	{1}	65535	Status word when linked to automation interfaces <ul style="list-style-type: none"> Binary interpretation indicates the bit states 	
C0151	FDO (DW)	<input type="checkbox"/> Disp				Hexadecimal display of the free digital output signals configured in C0116 <ul style="list-style-type: none"> Binary interpretation indicates the bit states 	
C0155	STATUS WORD 2	<input type="checkbox"/> Disp	Bit00	Fail	Bit08	R/L	Status word 2 Extended decimal status word <ul style="list-style-type: none"> Binary interpretation indicates the bit states
			Bit01	Mmax	Bit09	–	
			Bit02	Imax	Bit10	–	
			Bit03	IMP	Bit11	–	
			Bit04	RDY	Bit12	–	
			Bit05	RSP	Bit13	–	
			Bit06	Trip	Bit14	–	
			Bit07	Init	Bit15	–	
C0156 STOP			→ Selection list 2			Configuration of the free bits of the status word	
	1	STAT.B0	2000	DCTRL-PAR*1-O			
	2	STAT.B2	5002	MCTRL-IMAX			
	3	STAT.B3	5003	MCTRL-MMAX			
	4	STAT.B4	5050	NSET-RFG I=O			
	5	STAT.B5	10650	CMP1-OUT			
	6	STAT.B14	505	DCTRL-CW/CCW			
	7	STAT.B15	500	DCTRL-RDY			
C0157		<input type="checkbox"/> Disp				Display of the freely definable bits of the status word	
	1	(C0156/1)					
					
	7	(C0156/7)					
C0161	ACT TRIP	<input type="checkbox"/> Disp	All fault messages			Trip error message Current fault message (as in C0168/1)	
C0167	RESET FAILMEM	0	0	No reset		Reseterror message C0167 = 1 deletes the history buffer	
			1	Reset			
C0168		<input type="checkbox"/> Disp	All fault messages			List of faults occurred	
	1	FAIL NO. ACT				Currently active fault	
	2	FAIL NO. OLD1				Last fault	
	
	8	FAIL NO. OLD7				Last but six fault	

Code		Possible settings			IMPORTANT	
No.	Designation	Lenze	Selection			
C0169		<input type="checkbox"/> Disp	corresponding mains switch-on time		List of the times when the faults occurred under C0168 (based on C0179)	
1	FAILTIME ACT				Currently active fault	
2	FAILTIME OLD1				Last fault	
...	
8	FAILTIME OLD7				Last but six fault	
C0170		<input type="checkbox"/> Disp	corresponding mains switch-on time		List of how often the faults have occurred consecutively under C0168 History buffer	
1	COUNTER ACT				Currently active fault	
2	COUNTER OLD1				Last fault	
...	
8	COUNTER OLD7				Last but six fault	
C0172	OV REDUCE	0	0	{10 V}	100	OV reduce Threshold for activating the brake torque reduction before OU message
C0173	UG LIMIT	1				DC-bus voltage thresholds Check during commissioning and adapt if necessary! All drive components in the interconnection must have the same thresholds!
			0	Mains<400V +-brake LU=285V, OU=770V-755V		Operation on mains <400 V with or without braking unit
			1	Mains=400V +-brake LU=285V, OU=770V-755V		Operation on 400 V mains with or without braking unit
			2	Mains=460V +-brake LU=328V, OU=770V-755V		Operation on 460 V mains with or without braking unit
			3	Mains=480V -brake LU=342V, OU=770V-755V		Operation on 480 V mains without braking unit
			4	Mains=480V +-brake LU=342V, OU=800V-785V		Operation on 480 V mains with braking unit
C0178	OP TIMER	<input type="checkbox"/> Disp	0	{1 s}	4294967295	Elapsed-time meter ● Time when the controller was enabled
C0179	MAINS TIMER	<input type="checkbox"/> Disp	0	{1 s}	4294967295	Power-on time meter ● Time during which the mains was switched on
C0182	TI S-SHAPED	20.00	0.01	{0.01 s}	50.00	NSET T _i time of the S-shaped ramp function generator (determines the shape of the S curve) ● Low values ⇒ small S rounding ● High values ⇒ large S rounding

Code		Possible settings		IMPORTANT	
No.	Designation	Lenze	Selection		
C0183	DIAGNOSTICS	Disp		Drive diagnostics <ul style="list-style-type: none"> Indicates fault or status information If several items of fault or status information are to be shown, the information with the smallest number is displayed 	
			0	OK	No fault
			101	Initialisation	Initialisation phase
			102	TRIP/fault	TRIP active
			103	Emergency stop	Emergency stop was carried out
			104	IMP message	Message active
			105	Power OFF	Function is not supported
			111	BSP C135 operation inhibit	Operation inhibited
			112	BSP AIF operation inhibit	
			113	BSP CAN operation inhibit	
			121	CINH terminal 28 controller inhibit	Controller inhibited via X5/28
			122	CINH internal 1 controller inhibit	DCTRL-CINH1
			123	CINH internal 2 controller inhibit	DCTRL-CINH2
			124	CINH C135/STOP controller inhibit	STOP key at the keypad
			125	CINH AIF controller inhibit	Controller inhibited via AIF
			126	CINH CAN controller inhibit	Controller inhibited via system bus
			141	Switch-on inhibit	Restart protection active
			142	IMP inhibit Pulse inhibit	High-resistance power outputs
			151	QSP terminal ext. quick stop	Quick stop via MCTRL-QSP
			152	QSP-C135 quick stop	Quick stop via STOP key on the keypad
			153	QSP-AIF quick stop	Quick stop via AIF
154	QSP-CAN quick stop	Quick stop via system bus			
250	Warning C168	Warning active			
C0190	NSET ARIT	0	0 OUT = C46 1 C46 + C49 2 C46 - C49 3 C46 * C49 4 C46 / C49 5 C46/(100 - C49)	NSET Arithmetic block in NSET function block. Connects main setpoint C0046 and additional setpoint C0040.	
C0195	BRK1 T ACT	99.9	0.0 {0.1 s} 99.9	BRK1 Brake closing time. Engagement time of the mechanical holding brake. <ul style="list-style-type: none"> After the time under C0195 has elapsed, the "mechanical brake closed" status is reached. 	
C0196	BRK T RELEASE	0.0	0.0 {0.1 s} 60.0	BRK1 Brake opening time. Disengagement time of the mechanical holding brake (see technical data of the brake). <ul style="list-style-type: none"> After time has elapsed under C0195, the status "mechanical brake opened" is reached. 	
C0200	S/W ID	Disp		Software manufacturer's product code Software identification	
C0201	S/W DATE	Disp		Software generation Creation date	
C0203	COMM. NO.	Disp	x / xxxx / xxxxx	Commission number	
C0204	SERIAL-NO.	Disp	0 {1} 65535	Serial number	

Code		Possible settings				IMPORTANT
No.	Designation	Lenze	Selection			
C0206	PROD. DATE	<input type="text" value="Disp"/>				Production date
C0207	DL INFO 1	<input type="text" value="Disp"/>				Download-Info 1
C0208	DL INFO 2	<input type="text" value="Disp"/>				Download info 2
C0209	DL INFO 3	<input type="text" value="Disp"/>				Download info 3
C0220	NSET TIR ADD	0.000	0.000	{0.001 s}	999.900	NSET Acceleration time T_{ir} of the additional setpoint for NSET (based on speed variation 0... n_{max} .)
C0221	NSET TIF ADD	0.000	0.000	{0.001 s}	999.900	NSET Deceleration time T_{if} of the additional setpoint for NSET (based on speed variation 0... n_{max} .)
C0222	PCTRL VP	1.0	0.1	{0.1}	500.0	PCTRL V_p gain
C0223	PCTRL TN	400	20	{1 ms}	99999	PCTRL T_n I component 99999 ms: Switched off
C0224	PCTRL KD	0.0	0.0	{0.1}	5.0	PCTRL K_d differential component
C0241	CMP RFG-I = O	1.00	0.00	{0.01 %}	100.00	NSET Threshold ramp function generator for main setpoint Input = output, (100 % = n_{max})
C0244	BRK M SET	0	-100	{1 %}	100	BRK1 Holding torque of the DC injection brake 100 % = value of C0057
C0250	FCODE 1BIT	0	0 1	Lower limit Upper limit		FCODE 1 bit digital
C0252	ANGLE OFFSET	0	-245760000	{1 inc}	245760000	DFSET Angular offset, fixed angular offset for digital frequency configurations ● 1 rev. = 65536 inc
C0253	ANGLE N-TRIM	→	-32767	{1 inc}	32767	DFSET Speed-dependent phase trimming → Depending on C0005, C0025, C0490 ● Change of C0005, C0025, or C0490 resets C0253 to the Lenze setting assigned ● 1 rev. = 65536 inc ● C0253 is reached at 15000 rpm
C0254	VP ANGLE CTRL	0.400 0	0.0000	{0.0001}	3.9999	MCTRL V_p angle controller
C0255	THRESHOLD P03	32768 0	10	{1 inc}	1800000000	Following error limit P03 ● 1 rev. = 65536 inc ● Following error > C0255 triggers fault "P03"
C0260	MPOT1 HIGH	100.0 0	-199.99	{0.01 %}	199.99	MPOT1 Upper limit (condition: C0260 > C0261)
C0261	MPOT1 LOW	-100.0	-199.99	{0.01 %}	199.99	MPOT1 Lower limit (condition: C0261 < C0260)
C0262	MPOT1 TIR	10.0	0.1	{0.1 s}	6000.0	MPOT1 Acceleration time (relating to change 0...100 %)
C0263	MPOT1 TIF	10.0	0.1	{0.1 s}	6000.0	MPOT1 Deceleration time (based on change 0...100 %)



Code		Possible settings				IMPORTANT
No.	Designation	Lenze	Selection			
C0264	MPOT1 ON/OFF	0	0	No change		MPOT1 Executable functions if motor potentiometer is deactivated via input MPOT1-INACTIVE.
			1	Deceleration with T_{if} to 0%		
			2	Deceleration with T_{if} to C0261		
			3	Skip with $T_{if} = 0$ to 0%		
			4	Skip with $T_{if} = 0$ to C0261		
			5	Acceleration with T_{ir} to C0260		
C0265	MPOT1 INIT	0	0	Value during mains failure		MPOT1 Initialisation Value which is accepted during mains switching and activated motor pot.
			1	Lower limit value from C0261		
			2	0 %		
C0267				→ Selection list 2		MPOT1 Configuration of digital input signals
	1 UP	1000	FIXED0			
	2 DOWN	1000	FIXED0			
C0268	MPOT1-INACT	1000	FIXED0	→ Selection list 2		MPOT1 Configuraton of digital input signal
C0269		<input type="checkbox"/> Disp				
	1 (C0267/1)					
	2 (C0267/2)					
	3 (C0268)					
C0291	SSC OVERRIDE	0	0	{1 rpm}	16000	SSC cutout frequency Cutout frequency for the transition from sensorless control to controlled operation
C0292	SSC IM SET	0.00	0.00	{0.01 A}	500.00	SSC Im setpoint Motor current setpoint. For sensorless control, set 1.0 ... 1.1-fold rated motor current.
C0293	SSC DYNAMIC	0.00	0.00	{0.01 %}	199.00	SSC dynamic constant
C0294	VP FRQ CTRL	→	0.0	{0.1}	99.9	Vp frequency controller Proportional gain of frequency controller → Depending on C0086
C0295	Tn FRQ CTRL	→	2	{1 ms}	20000	Tn frequency controller Adjustment time frequency controller → Depending on C0086
C0296	DYNAMIC CONST	100	0	{0.1}	32767	Dynamic constant
C0325	VP2 ADAPT	1.0	0.1	{0.1}	500.0	PCTRL Adaption Vp2 Process controller adaptation gain (V_{p2})
C0326	VP3 ADAPT	1.0	0.1	{0.1}	500.0	PCTRL adaptation Vp3 Process controller adaptation gain (V_{p3})
C0327	SET2 ADAPT	100.0 0	0.00	{0.01 %}	100.00	PCTRL adaptation nset2 Set speed threshold of the process controller adaptation (condition: C0327 > C0328)
C0328	SET1 ADAPT	0.00	0.00	{0.01 %}	100.00	PCTRL adaptation nset1 Set speed threshold of the process controller adaptation (condition: C0328 < C0327)
C0329	ADAPT ON/OFF	0	0	No process controller adaptation		PCTRL Adaptation on/off Activate process controller adaptation
			1	External via input		
			2	Adaptation via setpoint		
			3	Adaptation via control difference		
C0332	PCTRL TIR	0.000	0.000	{0.001 s}	999.900	PCTRL Acceleration time T_{ir} (relating to setpoint change 0...100 %)
C0333	PCTRL TIF	0.000	0.000	{0.001 s}	999.900	PCTRL Deceleration time T_{if} (based on setpoint change 0...100 %)



Code		Possible settings				IMPORTANT
No.	Designation	Lenze	Selection			
C0336	ACT VP	<input type="checkbox"/> Disp	0.0	{0.1}	500.0	PCTRL Current V_p
C0337	BI/UNIPOLAR	0	0	Bipolar		PCTRL Bipolar/unipolar range
			1	Unipolar		
C0338	ARIT1 FUNCT	1	0	OUT = IN1		ARIT1 Function selection
			1	OUT = IN1 + IN2		
			2	OUT = IN1 - IN2		
			3	OUT = IN1 × IN2		
			4	OUT = IN1 / IN2		
			5	OUT = IN1/(100% - IN2)		
C0339					→ Selection list 1	ARIT1 Configuration - analog input signals
	1 ARIT1-IN1	1000	FIXED0%			
	2 ARIT1-IN2	1000	FIXED0%			
C0340		<input type="checkbox"/> Disp				ARIT1 Display of analog input signals
	1 (C0339/1)					
	2 (C0339/2)					
C0350	CAN ADDRESS	1	1	{1}	63	CAN System bus node address • Change becomes effective after "reset node" command
C0351	CAN BAUD RATE	0	0	500 kbps		CAN System bus baud rate • Change becomes effective after "reset node" command
			1	250 kbps		
			2	125 kbps		
			3	50 kbps		
			4	1000 kbits/s		
C0352	CAN MST	0	0	Slave		CAN Configuration of system bus nodes • Change becomes effective after "reset node" command
			1	Master		
C0353			0	C0350		CAN CAN-IN / CAN-OUT selection of the system bus address
			1	C0354		
	1 IN/OUT1 ADR	0				CAN-IN1, CAN-OUT1
	2 IN/OUT2 ADR	0				CAN-IN2, CAN-OUT2
	3 IN/OUT3 ADR	0				CAN-IN3, CAN-OUT3
C0354			1	{1}	513	CAN CAN-IN / CAN-OUT node address 2 • Individual addressing of the system bus process data objects
	1 IN1 ADR2	1				CAN-IN1
	2 OUT2 ADR2	129				CAN-OUT1
	3 IN2 ADR2	257				CAN-IN2
	4 OUT2 ADR2	258				CAN-OUT2
	5 IN3 ADR2	385				CAN-IN3
	6 OUT3 ADR2	386				CAN-OUT3
C0355		<input type="checkbox"/> Disp	0	{1}	2047	CAN System bus identifiers
	1 IN1 ID					
	2 OUT1 ID					
	3 IN2 ID					
	4 OUT2 ID					
	5 IN3 ID					
	6 OUT3 ID					

Code		Possible settings			IMPORTANT	
No.	Designation	Lenze	Selection			
C0356			0	{1 ms}	65000	CAN System bus time settings
1	CAN BOOT UP	3000				Required for CAN interconnection without master
2	OUT2 CYCLE	0				0 = event-controlled process data transfer
3	OUT3 CYCLE	0				>0 = cyclic process data transfer
4	CAN DELAY	20				When the "Operational" NMT status is reached (after "Pre-operational" or "Stopped"), the "CANdelay" delay time is started. After the delay time has elapsed, the PDO's CAN-OUT2 and CAN-OUT3 are transmitted for the first time.
C0357			0	{1 ms}	65000	CAN System bus monitoring times <ul style="list-style-type: none"> After a fault message, the CAN objects remain in receive position
1	CE1 MONIT TIME	3000				CAN-IN1
2	CE2 MONIT TIME	3000				CAN-IN2
3	CE3 MONIT TIME	3000				CAN-IN3
C0358	RESET NODE	0	0	No function		CAN Establish nodal reset pointfor system bus
			1	CAN reset		
C0359	CAN STATE	<input type="checkbox"/> Disp	0	Operational		CAN System bus status
			1	Pre-Operational		
			2	Warning		
			3	Bus off		
C0360		<input type="checkbox"/> Disp	0		65535	CAN Telegram counter (number of telegrams) Count values > 65535: Restart with 0
1	MESSAGE OUT					All telegrams sent
2	MESSAGE IN					All telegrams received
3	MESSAGE OUT1					Telegrams sent on CAN-OUT1
4	MESSAGE OUT2					Telegrams sent on CAN-OUT2
5	MESSAGE OUT3					Telegrams sent on CAN-OUT3
6	MESSAGE OUT1					Telegrams sent via parameter channel 1
7	MESSAGE OUT2					Telegrams sent on parameter channel 2
8	MESSAGE IN1					Telegrams received from CAN-IN1
9	MESSAGE IN2					Telegrams received from CAN-IN2
10	MESSAGE IN3					Telegrams received from CAN-IN3
11	MESSAGE IN1					Telegrams received from parameter channel 1
12	MESSAGE IN2					Telegrams received via parameter channel 2

Code		Possible settings				IMPORTANT
No.	Designation	Lenze	Selection			
C0361		<input type="checkbox"/> Disp	0.00	{1.00 %}	100.00	CAN Bus load of system bus To ensure a perfect operation, the total bus load (all connected devices) should be less than 80%
1	LOAD OUT					All telegrams sent
2	LOAD IN					All telegrams received
3	LOAD OUT1					Telegrams sent on CAN-OUT1
4	LOAD OUT2					Telegrams sent on CAN-OUT2
5	LOAD OUT3					Telegrams sent on CAN-OUT3
6	LOAD OUT1					Telegrams sent via parameter channel 1
7	LOAD OUT2					Telegrams sent on parameter channel 2
8	LOAD IN1					Telegrams received from CAN-IN1
9	LOAD IN2					Telegrams received from CAN-IN2
10	LOAD IN3					Telegrams received from CAN-IN3
11	LOAD IN1					Telegrams received from parameter channel 1
12	LOAD IN2					Telegrams received via parameter channel 2
C0362	SYNC CYCLE	1.000	-32.000	{0.100 ms}	32.000	CAN Time between two sync telegrams on the system bus
C0363	SYNC CORR	1	1 0.8 µs 2 1.6 µs 3 2.4 µs 4 3.2 µs 5 4.0 µs			CAN Correction value for C0362
C0364	CAN ACTIVE	1000	FIXED0		→ Selection list 2	CAN Configuraton of digital input signal ● Switches system bus from "Pre-operational" to "Operational" via external signal
C0365	(C0364)	<input type="checkbox"/> Disp				CAN System bus status
C0366	SYNC RESPONSE	1	0 No sync response 1 Sync response			CAN Response to sync telegram by master
C0367	SYNC RX ID	128	1	{1}	256	CAN Receive identifier (Rx) ● Sync identifier for grouping for accepting the data in CAN-IN1
C0368	SYNC TX ID	128	1	{1}	256	CAN Transmit identifier (Tx) ● Identifier for the generation of a sync telegram
C0369	SYNC TX TIME	0	0	{1}	65000	CAN Sync transmission time (Tx) ● Transmission interval of the object set under C0368
C0400	AIN1-OUT	<input type="checkbox"/> Disp	-199.99	{0.01 %}	199.99	AIN1 Display of the output signal
C0402	OFFSET	19502	FCODE-26/1		→ Selection list 1	AIN1 Offset configuration
C0403	GAIN	19504	FCODE-27/1		→ Selection list 1	AIN1 Gain configuration







Code		Possible settings			IMPORTANT	
No.	Designation	Lenze	Selection			
C0404		<input type="checkbox"/> Disp	-199.99	199.99	AIN1 Display of analog input signals	
1	(C0402)					
2	(C0403)					
C0405	OUT	<input type="checkbox"/> Disp	-199.99	199.99	AIN2 Display of the output signal	
C0407	AIN2-OFFSET	19503	FCODE-26/2	→ Selection list 1	AIN2 Offset configuration	
C0408	AIN2-GAIN	19505	FCODE-27/2	→ Selection list 1	AIN2 Gain configuration	
C0409		<input type="checkbox"/> Disp	-199.99	{0.01 %}	199.99	AIN2 Display of analog input signals
1	(C0407)					
2	(C0408)					
C0416	RESOLVER ADJ	0	0	{1}	99999999	Correction of resolver fault For Lenze motors read out resolver errors from nameplate
C0420	ENCODER CONST	512	1	{1 inc/rev}	8192	<ul style="list-style-type: none"> Encoder constant for encoder input X8 in increments per revolution If an absolute value encoder is selected in C0025, an SD7 trip is triggered when the encoder constant is changed.
C0421	ENC VOLTAGE	5.00	5.00	{0.1 V}	8.00	Encoder voltage Set size of voltage for encoder <ul style="list-style-type: none"> PLEASE NOTE: incorrect entry can destroy encoder
C0425	DFIN CONST	3	0	256 inc/rev 1 512 inc/rev 2 1024 inc/rev 3 2048 inc/rev 4 4096 inc/rev 5 8192 inc/rev 6 16384 inc/rev		DFIN Number of Increments of the digital frequency input
C0426	DFIN-OUT	<input type="checkbox"/> Disp	-32767	{1 rpm}	32767	Output signal of DFIN
C0427	DFIN FUNCTION	0	0	2 phases 1 A pulse / B direction of rotation (right) 2 Pulse A or B		DFIN Selection of the digital frequency signal
C0429	TP5 DELAY	0	-32767	{1 inc}	32767	DFSET, DFRFG Dead time compensation for the touch probe function
C0431	IN	5001	MCTRL-NACT	→ Selection list 1		AOUT1 Configuration of analog input signal
C0432	OFFSET	19512	FCODE-109/1	→ Selection list 1		AOUT1 Offset configuration
C0433	GAIN	19510	FCODE-108/1	→ Selection list 1		AOUT1 Gain configuration
C0434		<input type="checkbox"/> Disp	-199.99	{0.01 %}	199.99	AOUT1 Display of analog input signals
1	(C0431)					
2	(C0432)					
3	(C0433)					
C0436	IN	5002	MCTRL-MSET2	→ Selection list 1		AOUT2 Configuration of analog input signal
C0437	OFFSET	19513	FCODE-109/2	→ Selection list 1		AOUT2 Offset configuration
C0438	GAIN	19511	FCODE-108/2	→ Selection list 1		AOUT2 Gain configuration

Code		Possible settings				IMPORTANT
No.	Designation	Lenze	Selection			
C0439		<input type="checkbox"/> Disp	-199.99	{0.01 %}	199.99	AOUT2 Display of analog input signals
1	(C0436)					
2	(C0437)					
3	(C0438)					
C0440	STATE-BUS	1000			→ Selection list 2	Configuration of state bus X5/ST
 C0441	(C0440)	<input type="checkbox"/> Disp				
C0443	DIGIN-OUT	<input type="checkbox"/> Disp	0	{1}	255	Signals at X5/E1 to X5/E5, decimal value ● Binary interpretation indicates terminal signals
C0444	(C0118)	<input type="checkbox"/> Disp	0		1	
C0450	NX	1000	FIXED0%		→ Selection list 1	BRK1 Configuration of analog input signal
 C0451	SET	1000	FIXED0		→ Selection list 2	BRK1 Configuraton of digital input signal
 C0452	SIGN	1000	FIXED0%		→ Selection list 1	BRK1 Configuration of analog input signal
C0458		<input type="checkbox"/> Disp	-199.99	{0.01 %}	199.99	BRK1 Display of analog input signals
1	(C0450)					
2	(C0452)					
C0459	(C0451)	<input type="checkbox"/> Disp				BRK1 Display of digital input signal
C0464	CUSTOMER I/F	<input type="checkbox"/> Disp	0 1	original changed		Customer interface Status of selected basic configuration ● Reassignment of terminals in a basic configuration from C0005 does not change C0005 and sets C0464 = 1. ● Adding or removing of function blocks or changing the signal flow among the function blocks in a basic configuration of C0005 sets C0005 = 0 and C0464= 1

Code		Possible settings		IMPORTANT	
No.	Designation	Lenze	Selection		
C0465 	FB LIST	→	→ Selection list 5	FB processing list Includes the program for signal processing (sequence in which the function blocks are processed) → Depending on C0005. Change of C0005 loads assigned processing list → Valid for C0005 = 1000 <ul style="list-style-type: none"> After changing the signal flow the processing list must be adapted. Otherwise the device may work with wrong signals! The function blocks DIGIN, DIGOUT, AIF-IN, CAN-IN, and MCTRL are always processed and do not have to be entered in the list. 	
1		200			
2		0			
3		50			
4		0			
5		0			
6		55			
7		0			
8		0			
9		10250			
10		0			
11		0			
12		0			
13		5650			
14		0			
15		0			
16		5050			
...		0			
19		5700			
...		0			
22		10650			
...		0			
25		70			
..		0			
28		75			
...		0			
31		250			
...		0			
41		25000			
42		20000			
...		0			
49		0			
50		0			
C0466	CPU T REMAIN			Remaining process time For processing function blocks	
C0469 	KEY STOPFUNCTION	2	0 switched off 1 set controller inhibit 2 set quick stop	set function of the STOP key on the keypad	
C0470			0 {1}	255	Freely configurable code for digital signals <ul style="list-style-type: none"> Data words C0470 and C0471 are in parallel and identical
0	FCODE 8BIT DIGITAL	0			
1	FCODE BIT 0-7	0			
2	FCODE BIT8-15	0			
3	FCODE BIT16-23	0			
4	FCODE BIT24-31	0			

Code		Possible settings			IMPORTANT
No.	Designation	Lenze	Selection		
C0471	FCODE 32 BIT	0	0 {1} 4294967296		FCODE 32 bits digital Freely configurable code for digital signals <ul style="list-style-type: none"> Data words C0470 and C0471 are in parallel and identical
C0472	FCODE ANALOG		-199.99 {0.01 %} 199.99		Freely configurable code for relative analog signals
1		0.00			
2		0.00			
3		100.0 0			
6		100.0 0			
...		...			
19		0.00			
20		0.00			
C0473	FCODE ABS		-32767 {1} 32767		FCODE Freely configurable code for absolute analog signals
1		1			
2		1			
3		0			
...		...			
9		0			
10		0			
C0474	FCODE PH		-2147483648 {1} 2147483647		FCODE Freely configurable code for angle singals 1 rev. = 65536 inc
1		0			
...		...			
5		0			
C0475	FCODE DF		-16000 {1 rpm} 16000		FCODE Freely configurable code for angular difference singals 1 rev. = 65536 inc
1		0			
2		0			
C0490	FEEDBACK POS	0			Position feedback system Feedback system for the position controller
		0	Resolver at X7		The feedback system can be combined with the settings C0495 = 0, 1, 2, 3, 4.
		1	Encoder TTL at X8		The selection also sets C0495 to the same value.
		2	Sin/cos encoder at X8		
		3	Hiperface absolute value encoder singleturn at X8		
		4	Hiperface absolute value encoder multiturn at X8		
C0495	FEEDBACK N	0			Speed feedback system Feedback system for the speed controller
		0	Resolver at X7		The feedback system can be combined with the settings C0495 = 0, 1, 2, 3, 4. <ul style="list-style-type: none"> The rotor displacement angle in C0058 is set to -90°.
		1	Encoder TTL at X8		The selection also sets C0490 to the same value.
		2	Encoder sin at X8		
		3	Absolute ST at X8		
		4	Absolute MT at X8		

Code		Possible settings			IMPORTANT	
No.	Designation	Lenze	Selection			
C0497	NACT-FILTER	2.0	0.0	{0.1 ms}	50.0	N_{act} filter time constant Time constant for actual speed C0497 = 0 ms: Switched off
C0517			0.00	{0.01}	1999.00	User menu Up to 32 entries <ul style="list-style-type: none"> • Under the subcodes the numbers of the desired code are entered. • The input is effected in the format xxx.yy <ul style="list-style-type: none"> – xxx: Code number – yy: Subcode number • It is not checked whether the code entered exists.
1	USER MENU	51.00	C0051/0 MCTRL-NACT			
2	USER MENU	54.00	C0054/0 Imot			
3	USER MENU	56.00	C0056/0 MCTRL-MSET2			
4	USER MENU	46.00	C0046/0 N			
5	USER MENU	49.00	C0049/0 NADD			
6	USER MENU	183.0 0	C0183/0 Diagnostics			
7	USER MENU	168.0 1	C0168/1 Fail no. act			
8	USER MENU	86.00	C0086/0 Mot type			
9	USER MENU	22.00	C0022/0 lmax current			
10	USER MENU	5.00	C005/0 signal cfg			
11	USER MENU	11.00	C0011/0 Nmax			
12	USER MENU	12.00	C0012/0 T _{ir}			
13	USER MENU	13.00	C0013/0 T _{if}			
14	USER MENU	105.0 0	C0105/0 QSP T _{if}			
15	USER MENU	39.01	C0039/1 JOG setpoint			
16	USER MENU	70.00	C0070/0 V _p speed CTRL			
17	USER MENU	71.00	C0071/0 T _n speed CTRL			
18	USER MENU	0	not assigned			
...	...	0	not assigned			
31	USER MENU	94.00	C0094/0 Password			
32	USER MENU	3.00	C0003/0 Par save			
C0520	IN	1000	FIXEDPHI-0	→ Selection list 4	DFSET Input signal configuration	
C0521	VP-DIV	1000	FIXED0%	→ Selection list 1	DFSET Configuration of gain factor - numerator	
C0522	RAT-DIV	1000	FIXED0%	→ Selection list 1	DFSET Configuration of gearbox factor - numerator	
C0523	A-TRIM	1000	FIXED0%	→ Selection list 1	DFSET Configuration of phase trimming	
C0524	N-TRIM	1000	FIXED0%	→ Selection list 1	DFSET Speed trimming of DFSET	
C0525	0-PULSE	1000	FIXED0	→ Selection list 2	DFSET Configuration of one-time zero pulse activation	
C0526	RESET	1000	FIXED0	→ Selection list 2	DFSET Reset integrators	
C0527	SET	1000	FIXED0	→ Selection list 2	DFSET Configuration - set integrators	

Code		Possible settings			IMPORTANT	
No.	Designation	Lenze	Selection			
C0528			-2·10 ⁹	{1}	2·10 ⁹	DFSET Angular difference between 2 zero pulses Offset results from C0523 × C0529 + C0522 Number of increments between two set pulses at X5/E5. Code is available from software version 6.2. Number of increments between two actual pulses at X5/E4. Code is available from software version 6.2.
1	0-PULSE A					
2	OFFSET					
3	PULSE DIST SET					
4	PULSE DIST ACT					
C0529	MULTIP OFFSET	1	-20000	{1}	20000	Offset multiplier
C0530	DF EVALUATION	0	0	With gearbox factor		DFSET Evaluation of the digital frequency
			1	Without gearbox factor		
C0531	ACT 0 DIV	1	1	{1}	16384	DFSET actual zero pulse scaler
C0532	0-PULSE/TP	1	1	0-pulse		DFSET zero pulse/touch probe Selection of zero pulse, touch probe, or zero pulse and touch probe
			2	Touch probe		
			3	0 pulse and touch probe		
C0533	VP DENOM	1	1	{1}	32767	DFSET Vp denominator Gain factor denominator
C0534	SYNC MODE	0	0	Inactive		DFSET Mode for synchronising the zero pulse and/or touch probe
			1	Continuous		
			2	Continuously switchable		
			10	Once, fast way		
			11	Once, + direction		
			12	Once, - direction		
			13	Once, 2 × zero pulse		
C0535	SET 0 DIV	1	1	{1}	16384	DFSET Setpoint zero pulse divider
C0536			-32767	{1}	32767	DFSET Display of analog input signals
1	(C0521)					
2	(C0522)					
3	(C0523)					
C0537	(C0524)		-199.99	{0.01 %}	199.99	DFSET Display of analog input signal
C0538						DFSET Display of digital input signals
1	(C0525)					
2	(C0526)					
3	(C0527)					
C0539	(C0520)		-32767	{1 rpm}	32767	DFSET Input signal display
C0540	FUNCTION	2	0	Analog input		DFOUT Function of the encoder outputs
			1	Phase difference input		
			2	Resolver simulation + zero pulse		
			3	Resolver simulation without zero pulse		
			4	X10 = X9		
			5	X10 = X8		
C0541	AN-IN	5001	MCTRL-NACT		→ Selection list 1	DFOUT Configuration of analog input
						
C0542	DF-IN	1000	FIXEDPHI-0		→ Selection list 4	DFOUT Configuration of the dig. frequency input
						
C0544	SYN-RDY	1000	FIXED0		→ Selection list 2	DFOUT Synchronisation signal for the zero pulse
						
C0545	PH OFFSET	0	0	{1 inc}	65535	DFOUT Angular offset









Code		Possible settings				IMPORTANT
No.	Designation	Lenze	Selection			
C0546	PULSE MIN SET	1000	1	{1 inc}	2147483647	DFSET Masking (suppressing) interference pulses at X5/E5 (set pulse of touch probe signal). The size of the masking window between two set pulses is set.
C0547	(C0541)	<input type="text" value="Disp"/>	-199.99	{0.01 %}	199.99	DFOUT Display of analog input signal
C0548	(C0544)	<input type="text" value="Disp"/>	0		1	DFOUT Display of digital input signal
C0549	(C0542)	<input type="text" value="Disp"/>	-32767	{1 rpm}	32767	DFOUT Input signal display
C0551	PULSE MIN ACT	1000	1	{1 inc}	2147483647	DFSET Masking (suppressing) interference pulses at X5/E4 (actual pulse of touch probe signal). The size of the masking window between two actual pulses is set. Code is available from software version 6.2.
C0560	FIX SET-VALUE		-199.99	{0.01 %}	199.99	Fixed setpoints
	1	100				
	2	75				
	3	50				
	4	25				
	5	0				
				
	15	0				
C0561	AIN	1000	FIXED0%		→ Selection list 1	FIXSET1 Configuration of analog input signal
C0562					→ Selection list 2	FIXSET1 Configuration of digital input signals
	1 IN1	1000	FIXED0			
	2 IN2	1000	FIXED0			
	3 IN3	1000	FIXED0			
	4 IN4	1000	FIXED0			
C0563	(C0561)	<input type="text" value="Disp"/>	-199.99	{0.01 %}	199.99	FIXSET1 Display of analog input signal
C0564		<input type="text" value="Disp"/>				FIXSET1 Display of digital input signals
	1 (C0562/1)					
	...					
	4 (C0562/4)					
C0570	IN	1000	FIXED0%		→ Selection list 1	S&H1 Configuration of analog input signal
C0571	LOAD	1000	FIXED0		→ Selection list 2	S&H1 LOAD Configuraton of digital input signal
C0572	(C0570)	<input type="text" value="Disp"/>	-199.99	{0.01 %}	199.99	S&H1 Display of analog input signal
C0573	(C0571)	<input type="text" value="Disp"/>				S&H1 LOAD Display of digital input signal
C0575	SD8 FILTER	1	0	{1 ms}	200	SD8 monitoring Tripping delay of error message SD8
C0576		100.0 0	0.00	{0.01 %}	100.00	nErr monitoringspeed window Setting of the system deviation between actual speed value and speed setpoint
C0577	VP FLD WEAK	3.00	0.00	{0.01}	15.99	Field weakening controller V _{pgain}

Code		Possible settings				IMPORTANT	
No.	Designation	Lenze	Selection				
C0578	TN FLD WEAK	50.0	2.0	{0.5 ms}		8192.0	Field weakening controller Reset time Tn C0578 = 8000 ms: Switched off
C0579	MONIT NERR	3	0 1 2 3	Trip Message Warning Off			NEER monitoring Configuration of "system deviation between actual speed value and speed setpoint" monitoring
C0580	MONIT SD8	3	0 3	Trip Off			SD8 monitoring Configuration of "Encoder error at X8" monitoring
C0581	MONIT EER	0	0 1 2 3	Trip Message Warning Off			EER monitoring Configuration of "external fault" monitoring
C0582	MONIT OH4	2	2 3	Warning Off			OH4 monitoring Configuration of heatsink temperature monitoring
C0583	MONIT OH3	→	0 2 3	Trip Warning Off			OH3 monitoring Configuration of "fixed motor temperature" monitoring → Depending on C0086
C0584	MONIT OH7	→	2 3	Warning Off			OH7 monitoring Configuration of "adjustable motor temperature" monitoring → Depending on C0086 Temperature monitoring via resolver input
C0585	MONIT OH8	3	0 2 3	Trip Warning Off			OH8 monitoring Configuration of "adjustable motor temperature" monitoring Temperature monitoring via PTC input
C0586	MONIT SD2	0	0 2 3	Trip Warning Off			SD2 monitoring Configuration of resolver monitoring
C0587	MONIT SD3	3	0 2 3	Trip Warning Off			SD3 monitoring Configuration of "encoder at X9" monitoring
C0588	MONIT H10/H11	0	0 2 3	Trip Warning Off			H10 / H11 monitoring Setting C0588 = 2 or C0588 = 3 only allowed for Lenze service
C0589	MONIT P03	2	0 2 3	Trip Warning Off			P03 monitoring Configuration of following error monitoring ● The following error is monitored by the DFSET function block. The monitoring is only active if DFSET is used.
C0590	MONIT P13	0	0 2 3	Trip Warning Off			P13 monitoring Configuration of angle error monitoring ● The following error is monitored by the DFSET function block. The monitoring is only active if DFSET is used.
C0591	MONIT CE1	3	0 2 3	Trip Warning Off			CE1 monitoring Configuration of "CAN-IN1 fault" monitoring
C0592	MONIT CE2	3	0 2 3	Trip Warning Off			CE2 monitoring Configuration of "CAN-IN2 error" monitoring
C0593	MONIT CE3	3	0 2 3	Trip Warning Off			CE3 monitoring Configuration of "CAN-IN3 error" monitoring

Code		Possible settings			IMPORTANT	
No.	Designation	Lenze	Selection			
C0594	MONIT SD6	→	0 2 3	Trip Warning Off	SD6 monitoring Configuration of "motor temperature sensor" monitoring → Depending on C0086	
C0595	MONIT CE4	3	0 2 3	Trip Warning Off	CE4 monitoring Configuration of "CAN bus off" monitoring	
C0596	NMAX LIMIT	5500		{1 rpm}	16000	System speed monitoring
C0597	MONIT LP1	3	0 2 3	Trip Warning Off	LP1 monitoring Configuration of motor phase failure monitoring	
C0598	MONIT SD5	3	0 2 3	Trip Warning Off	SD5 monitoring Configuration monitoring master current at $X5/1.2 < 2\text{mA}$	
C0599	LIMIT LP 1	5.0	1.0	{0.1 %}	10.0	LP1 monitoring Current limit value for motor phase monitoring
C0600	FUNCTION	1	0 1 2 3 4 5	OUT = IN1 OUT = IN1 + IN2 OUT = IN1 - IN2 OUT = IN1 × IN2 OUT = IN1 / IN2 OUT = IN1/(100% - IN2)	ARIT2 Function selection	
C0601	IN				→ Selection list 1	ARIT2 Configuration - analog input signals
	1	1000	FIXED0%			ARIT2-IN1
	2	1000	FIXED0%			ARIT2-IN2
C0602		<input type="checkbox"/> Disp	-199.99	{0.01 %}	199.99	ARIT2 Display of analog input signals
	1 (C0601/1)					
	2 (C0601/2)					
C0606	MONIT OC8	2	0 2 3	Trip Warning Off		Configuration of the I² × t advance warning The threshold is set in C0127.
C0610	IN				→ × Selection list 1	ADD Configuration - analog input signals
	1	1000	FIXED0%			ADD1-IN1
	2	1000	FIXED0%			ADD1-IN2
	3	1000	FIXED0%			ADD1-IN3
C0611		<input type="checkbox"/> Disp	-199.99	{0.01 %}	199.99	ADD Display of analog input signals
	1 (C0610/1)					
	2 (C0610/2)					
	3 (C0610/3)					
C0620	DB1 GAIN	1.00	-10.00	{0.01}	10.00	DB1 gain Gain of dead band component DB1
C0621	DB1 VALUE	1.00	0.00	{0.01 %}	100.00	DB1 dead band Dead band of DB1
C0622	DB1-IN	1000	FIXED0%			→ Selection list 1 DB1 Configuration of analog input signal
C0623	(C0622)	<input type="checkbox"/> Disp	-199.99	{0.01 %}	199.99	DB1 Display of analog input signal
C0630	MAX LIMIT	100.0 0	-199.99	{0.01 %}	199.99	LIM upper limit Upper limit of limiter LIM1
C0631	MIN LIMIT	-100.0	-199.99	{0.01 %}	199.99	LIM lower limit Lower limit of limiter LIM1

















Code		Possible settings				IMPORTANT
No.	Designation	Lenze	Selection			
C0632 	LIM-IN	1000	FIXED0% → Selection list 1			LIM1 Configuration of analog input signal
C0633	(C0632)		-199.99	{0.01 %}	199.99	LIM1 Display of analog input signal
C0640	DELAY T	20.00	0.01	{0.01 s}	50.00	PT1-1 Setting of the time constant
C0641 	PT1-1-IN	1000	FIXED0% → Selection list 1			PT1-1 Configuration of analog input signal
C0642	(C0641)		-199.99	{0.01 %}	199.99	PT1-1 Display of analog input signal
C0650	DT1-1 GAIN	1.000	-320.00	{0.01}	320.00	DT1-1 Gain
C0651	DELAY T	1.000	0.005	{0.001 s}	5.000	DT1-1 Time constant
C0652 	IN	1000	FIXED0% → Selection list 1			DT1-1 Configuration of analog input signal
C0653	SENSIBILITY	1	1 15-bit 2 14-bit 3 13-bit 4 12-bit 5 11-bit 6 10-bit 7 9-bit			DT1-1 Sensitivity
C0654	(C0652)		-199.99	{0.01 %}	199.99	
C0655	NUMERATOR	1	-32767	{1}	32767	CONV5 Numerator
C0656	DENOMINATOR	1	1	{1}	32767	CONV5 Denominator
C0657 	IN	1000	FIXED0% → Selection list 1			CONV5 Configuration of analog input signal
C0658	(C0657)		-199.99	{0.01 %}	199.99	CONV5 Display of analog input signal
C0661 	IN	1000	FIXED0% → Selection list 1			ABS1 Configuration of analog input signal Input for absolute value generators
C0662	(C0661)		-199.99	{0.01 %}	199.99	ABS1 Display of analog input signal
C0671	RFG1 TIR	0.000	0.000	{0.01 s}	999.900	RFG1 Acceleration time T_{ir}
C0672	RFG1 TIF	0.000	0.000	{0.01 s}	999.900	RFG1 Deceleration time T_{if}
C0673 	IN	1000	FIXED0% → Selection list 1			RFG1 Configuration of analog input signal
C0674 	SET	1000	FIXED0% → Selection list 1			RFG1 Configuration of analog input signal
C0675 	LOAD	1000	FIXED0 → Selection list 2			RFG1 Configuraton of digital input signal
C0676			-199.99	{0.01 %}	199.99	RFG1 Display of analog input signals
	1 (C0673)					
	2 (C0674)					
C0677	(C0675)					RFG1 Display of digital input signal

Code		Possible settings				IMPORTANT
No.	Designation	Lenze	Selection			
C0680	FUNCTION	6	1	IN1 = IN 2		CMP1 Selection of the function on how the inputs IN1 and IN2 are to be compared
			2	IN 1 > IN2		
			3	IN 1 < IN2		
			4	IN1 = IN2		
			5	IN1 > IN2		
			6	IN1 < IN2		
C0681	HYSTERESIS	1.00	0.00	{0.01 %}	100.00	CMP1 Hysteresis
C0682	WINDOW	1.00	0.00	{0.01 %}	100.00	CMP1 Window
C0683					→ Selection list 1	CMP1 Configuration - analog input signals
1	CMP1-IN1	5001	MCTRL-NACT			
2	CMP1-IN2	19500	FCODE-17			
C0684		<input type="checkbox"/> Disp	-199.99	{0.01 %}	199.99	CMP1 Display of analog input signals
1	(C0683/1)					
2	(C0683/1)					
C0685	FUNCTION	1	1	IN1 = IN2		CMP2 Selection of the function on how the inputs IN1 and IN2 are to be compared
			2	IN 1 > IN2		
			3	IN 1 < IN2		
			4	IN1 = IN2		
			5	IN1 > IN2		
			6	IN1 < IN2		
C0686	HYSTERESIS	1.00	0.00	{0.01 %}	100.00	CMP2 Hysteresis
C0687	WINDOW	1.00	0.00	{0.01 %}	100.00	CMP2 Window
C0688					→ Selection list 1	CMP2 Configuration - analog input signals
1	CMP2-IN1	1000	FIXED0%			
2	CMP2-IN2	1000	FIXED0%			
C0689		<input type="checkbox"/> Disp	-199.99	{0.01 %}	199.99	CMP2 Display of analog input signals
1	(C0688/1)					
2	(C0688/2)					
C0690	FUNCTION	1	1	IN1 = IN 2		CMP3 Selection of the function on how the inputs IN1 and IN2 are to be compared
			2	IN 1 > IN2		
			3	IN 1 < IN2		
			4	IN1 = IN2		
			5	IN1 > IN2		
			6	IN1 < IN2		
C0691	HYSTERESIS	1.00	0.00	{0.01 %}	100.00	CMP3 Hysteresis
C0692	WINDOW	1.00	0.00	{0.01 %}	100.00	CMP3 Window
C0693					→ Selection list 1	CMP3 Configuration - analog input signals
1	CMP3-IN1	1000	FIXED0%			
2	CMP3-IN2	1000	FIXED0%			
C0694		<input type="checkbox"/> Disp	-199.99	{0.01 %}	199.99	CMP3 Display of analog input signals
1	(C0693/1)					
2	(C0693/2)					
C0695	FUNCTION	2	1	IN 1 < IN2		PHCMP1 Selection of the function on how the inputs IN1 and IN2 are to be compared
			2	IN1 < IN2		











Code		Possible settings			IMPORTANT
No.	Designation	Lenze	Selection		
C0697 				→ Selection list 3	PHCMP1 Input signal configuration
1	IN	1000	FIXED0INC		
2	IN	1000	FIXED0INC		
C0698			-2147483647	{1} 2147483647	PHCMP1 Display of input signals
1	(C0697/1)				
2	(C0697/2)				
C0700 	IN	19523	FCODE-472/3 → Selection list 1		ANEG1 Configuration of analog input signal
C0701	(C0700)		-199.99	{0.01 %} 199.99	
C0703 	IN	1000	FIXED0% → Selection list 1		ANEG2 Configuration of analog input signal
C0704	(C0703)		-199.99	{0.01 %} 199.99	
C0710	FUNCTION	0	0 Rising edge 1 Falling edge 2 Both edges		TRANS1 Signal evaluation In the case of a corresponding signal edge at IN, OUT switches to HIGH
C0711	PULSE T	0.001	0.001	{0.001 s} 60.000	
C0713 	IN	1000	FIXED0 → Selection list 2		TRANS1-IN Configuraton of digital input signal
C0714	(C0713)				
C0715	FUNCTION	0	0 Rising edge 1 Falling edge 2 Both edges		TRANS2 Signal evaluation In the case of a corresponding signal edge at IN, OUT switches to HIGH
C0716	PULSE T	0.001	0.001	{0.001 s} 60.000	
C0718 	IN	1000	FIXED0 → Selection list 2		TRANS2 Configuraton of digital input signal
C0719	(C0718)				
C0720	FUNCTION	2	0 On delay 1 Off delay 2 On/off delay		DIGDEL1 Function selection
C0721	DELAY T	1.000	0.001	{0.001 s} 60.000	
C0723 	IN	1000	FIXED0 → Selection list 2		DIGDEL1 Configuraton of digital input signal
C0724	(C0723)				
C0725	FUNCTION	2	0 On delay 1 Off delay 2 On/off delay		DIGDEL2 Function selection
C0726	DELAY T	1.000	0.001	{0.001 s} 60.000	
C0728 	IN	1000	FIXED0 → Selection list 2		DIGDEL2 Configuraton of digital input signal
C0729	(C0728)				
C0730	OSZ MODUS	0	0 Start measurement 1 Stop measurement		OSZ Start / stop of the measured value recording





Code		Possible settings			IMPORTANT		
No.	Designation	Lenze	Selection				
C0731	OSZ STATUS	0	0	Measurement completed	OSZ Current operating status		
			1	Measurement active			
			2	Trigger detected			
			3	Abort			
			4	Abort after trigger			
			5	Read memory			
C0732				→ Selection list 1	OSZ Configuration - analog input signals		
STOP							
1	CHANNEL1	1000	FIXED0%				
2	CHANNEL2	1000	FIXED0%				
3	CHANNEL3	1000	FIXED0%				
4	CHANNEL4	1000	FIXED0%				
C0733				→ Selection list 2	OSZ Trigger input		
1	TRIG INP	1000	FIXED0				
C0734	TRIG-SOURCE	1	0	Digital trigger input	OSZ Selection of trigger source		
			1	Measuring channel 1			
			2	Measuring channel 2			
			3	Measuring channel 3			
			4	Measuring channel 4			
C0735	TRIGGER-LEVEL	0	-32767	{1}	32767	OSZ Set trigger level for channels 1 ... 4	
C0736	TRIGGER-SLOPE	0	0	LOW-HIGH edge	OSZ Selection of the trigger edge		
			1	HIGH-LOW edge			
C0737	TRIGGER DELAY	0.0	-100.0	{0.1 %}	999.9	OSZ Setting of pretriggering and posttriggering	
C0738	PROBE PERIOD	3	3	1 ms	OSZ Selection of the sampling period		
			4	2 ms			
			5	5 ms			
			6	10 ms			
			7	20 ms			
			8	50 ms			
			9	100 ms			
			10	200 ms			
			11	500 ms			
			12	1 s			
			13	2 s			
			14	5 s			
			15	10 s			
			16	20 s			
			17	50 s			
			18	1 min			
			19	2 min			
			20	5 min			
			21	10 min			
C0739	NUMBER OF CHANNELS	4	1	{1}		4	OSZ Number of channels to be measured
C0740	DATA READ	0					OSZ
	1	0	0	{1}	65535	Define the starting point for reading the data memory. This enables a selective access to a memory block	
	2	0	0	Inhibit "Read data"	Inhibit "Read memory"		
			1	Enable "Read data"			

















Code		Possible settings				IMPORTANT
No.	Designation	Lenze	Selection			
C0741						OSZ
1	VERSION OSZ	<input type="checkbox"/> Disp				Version
2	LENGTH MEMORY					Memory size
3	DATA WIDTH					Data width
4	NO. CHANNELS					Number of channels
C0742	LENGTH OF DB	<input type="checkbox"/> Disp				OSZ Show data block length
C0743	READ DB	<input type="checkbox"/> Disp				OSZ Reading an 8 byte data block
C0744	MEM: DEPTH	2048	0	512 measured values		OSZ Adapt memory depth to the measuring task
			1	1024 measured values		
			2	1536 measured values		
			3	2048 measured values		
			4	3072 measured values		
			5	4096 measured values		
			6	8192 measured values		
C0749		<input type="checkbox"/> Disp				OSZ Information on the storage of the measured values
1	BRK:OFF INDEX					
2	TRIGGER INDEX					
3	END INDEX					
C0750	VP DENOM	16	1	Vp = 1		DFRFG1 Denominator of the position controller gain
			2	Vp = 1/2		
			4	Vp = 1/4		
			8	Vp = 1/8		
			16	Vp = 1/16		
			34	Vp = 1/32		
			64	Vp = 1/64		
			128	Vp = 1/128		
			256	Vp = 1/256		
			512	Vp = 1/512		
			1024	Vp = 1/1024		
			2048	Vp = 1/2048		
			4096	Vp = 1/4096		
			8192	Vp = 1/8192		
			16384	Vp = 1/16384		
C0751	DFRFG1 TIR	1.000	0.001	{0.001 s}	999.900	DFRFG1 T _{ir} (acceleration time)
C0752	MAX SPEED	3000	1	{1 rpm}	16000	DFRFG1 Maximum speed (here: maximum compensation speed)
C0753	DFRFG1 QSP	0.000	0.000	{0.001 s}	999.900	DFRFG1 Deceleration time T _{if} for activation of the deceleration ramp
C0754	PH ERROR	2·10 ⁹	10	{1 inc}	2·10 ⁹	DFRFG1 Following error
C0755	SYN WINDOW	100	0	{1 inc}	65535	DFRFG1 Synchronisation window
C0756	OFFSET	0	-1·10 ⁹	{1 inc}	1·10 ⁹	DFRFG1 Offset
C0757	FUNCTION	0	0	TP start inactive		DFRFG1 Function
			1	TP start active		
C0758	IN	1000	FIXEDPHI-0		→ Selection list 4	DFRFG1 Input signal configuration
 C0759	QSP	1000	FIXED0		→ Selection list 2	DFRFG1 Configuraton of digital input signal









Code		Possible settings			IMPORTANT
No.	Designation	Lenze	Selection		
C0760 	STOP	1000	FIXED0	→ Selection list 2	DFRFG1-STOP Configuraton of digital input signal "Ramp function generator stop"
C0761 	RESET	1000	FIXED0	→ Selection list 2	DFRFG1 Configuraton of digital input signal Reset integrators
C0764					DFRFG1 Display of digital input signals
	1 (C0759)				
	2 (C0760)				
	3 (C0761)				
C0765	(C0758)		-32767	{1 rpm} 32767	DFRFG1 Input signal display
C0766	SPEED DIR	1	1 both directions (cw/ccw) 2 positive direction only (cw) 3 negative direction only (ccw)		DFRFG1 Define direction of rotation
C0770 	D	1000	FIXED0	→ Selection list 2	FLIP1 Data input Configuraton of digital input signal
C0771 	CLK	1000	FIXED0	→ Selection list 2	FLIP1 Configuration of clock input signal
C0772 	CLR	1000	FIXED0	→ Selection list 2	FLIP1 Configuration of reset input signal
C0773					FLIP1 Display of digital input signals
	1 (C0770)				
	2 (C0771)				
	3 (C0772)				
C0775 	D	1000	FIXED0	→ Selection list 2	FLIP2 Data input Configuraton of digital input signal
C0776 	CLK	1000	FIXED0	→ Selection list 2	FLIP2 Configuration of clock input signal
C0777 	CLR	1000	FIXED0	→ Selection list 2	FLIP2 Configuration of reset input signal
C0778					FLIP1 Display of digital input signals
	1 (C0775)				
	2 (C0776)				
	3 (C0777)				
C0780 	N	50	AIN1-OUT	→ Selection list 1	NSET Configuration of input signal for main setpoint
C0781 	N-INV	10251	R/L/Q-R/L	→ Selection list 2	NSET Configuration of input signal for main setpoint inversion
C0782 	NADD	5650	ASW1-OUT	→ Selection list 1	NSET Configuration of input signal for additional setpoint
C0783 	NADD-INV	1000	FIXED0	→ Selection list 2	NSET Configuration of inversion of additional setpoint
C0784 	CINH-VAL	5001	MCTRL-NACT	→ Selection list 1	NSET Configuration of output signal with inhibited controller

Code		Possible settings			IMPORTANT	
No.	Designation	Lenze	Selection			
C0785 	SET	5000	MCTRL-NSET2	→ Selection list 1	NSET Configuration of input signal for ramp function generator	
C0786 	LOAD	5001	MCTRL-QSP-OUT	→ Selection list 2	NSET Load configuration of digital input signal for ramp function generator	
C0787 				→ Selection list 2	NSET Configuration of JOG selection and JOG activation Binary interpretation	
	1 JOG*1	53	DIGIN3			
	2 JOG*2	1000	FIXED0			
	3 JOG*4	1000	FIXED0			
	4 JOG*8	1000	FIXED0			
C0788 				→ Selection list 2	NSET Configuration of Ti selection and Ti activation • Binary interpretation • T _{ir} and T _{if} are identical	
	1 TI*1	1000	FIXED0			
	2 TI*2	1000	FIXED0			
	3 TI*4	1000	FIXED0			
	4 TI*8	1000	FIXED0			
C0789 	RFG-0	1000	FIXED0	→ Selection list 2	NSET Configuration of digital input signal (ramp function generator 0)	
C0790 	RFG-STOP	1000	FIXED0	→ Selection list 2	NSET Configuration of digital input signal (ramp function generator stop)	
C0798			-199.99	{0.01 %}	199.99	NSET Display of analog input signals
	1 CINH-VAL					
	2 SET					
C0799						NSET Display of digital input signals
	1 (781)					
	2 (783)					
	3 (786)					
	4 (787/1)					
	5 (787/2)					
	6 (787/3)					
	7 (787/4)					
	8 (788/1)					
	9 (788/2)					
	10 (788/3)					
	11 (788/4)					
	12 (789)					
	13 (790)					
C0800 	SET	1000	FIXED0%	→ Selection list 1	PCTRL1 Configuration - setpoint input signal	
C0801 	ACT	1000	FIXED0%	→ Selection list 1	PCTRL1 Configuration of actual value input signal	
C0802 	INFLU	1000	FIXED0%	→ Selection list 1	PCTRL1 Configuration of evaluation input signal	
C0803 	ADAPT	1000	FIXED0%	→ Selection list 1	PCTRL1 Configuration - adaptation input signal	
C0804 	INACT	1000	FIXED0	→ Selection list 2	PCTRL1 Configuration - inactivation input signal	















Code		Possible settings			IMPORTANT
No.	Designation	Lenze	Selection		
C0805 	I-OFF	1000	FIXED0	→ Selection list 2	PCTRL1 Configuration of digital input signal (switch-off I component)
C0808			-199.99 {0.01 %}	199.99	PCTRL1 Display of analog input signals
	1 (C0800)				
	2 (C0801)				
	3 (C0802)				
	4 (C0803)				
C0809					PCTRL1 Display of digital input signals
	1 (C0804)				
	2 (C0805)				
C0810 				→ Selection list 1	ASW1 Configuration - analog input signals
	1 IN	55	AIN2-OUT		
	2 IN	1000	FIXED0%		
C0811 	SET	1000	FIXED0	→ Selection list 2	ASW1 Configuraton of digital input signal
C0812			-199.99 {0.01 %}	199.99	ASW1 Display of analog input signals
	1 (C0810/1)				
	2 (C0810/2)				
C0813	(C0811)				ASW1 Display of digital input signal
C0815 				→ Selection list 1	ASW2 Configuration - analog input signals
	1 IN	1000	FIXED0%		
	2 IN	1000	FIXED0%		
C0816 	SET	1000	FIXED0	→ Selection list 2	ASW2 Configuraton of digital input signal
C0817			-199.99 {0.01%}	199.99	ASW2 Display of analog input signals
	1 (C0815/1)				
	2 (C0815/2)				
C0818	(C0816)				ASW2 Display of digital input signal
C0820 				→ Selection list 2	AND1 Configuration of digital input signals
	1 IN	1000	FIXED0		
	2 IN	1000	FIXED0		
	3 IN	1000	FIXED0		
C0821					AND1 Display of digital input signals
	1 (C0820/1)				
	2 (C0820/2)				
	3 (C0820/3)				
C0822 		1000		→ Selection list 2	AND2 Configuration of digital inputs
	1 IN	1000	FIXED0		
	2 IN	1000	FIXED0		
	3 IN	1000	FIXED0		

Code		Possible settings		IMPORTANT
No.	Designation	Lenze	Selection	
C0823		<input type="checkbox"/> Disp		AND2 Display of digital input signals
1	(C0822/1)			
2	(C0822/2)			
3	(C0822/3)			
C0824			→ Selection list 2	AND3 Configuration of digital input signals
				
1	IN	1000	FIXED0	
2	IN	1000	FIXED0	
C0825		<input type="checkbox"/> Disp		AND3 Display of digital input signals
1	(C0824/1)			
2	(C0824/2)			
3	(C0824/3)			
C0826			→ Selection list 2	AND4 Configuration of digital input signals
				
1	IN	1000	FIXED0	
2	IN	1000	FIXED0	
C0827		<input type="checkbox"/> Disp		AND4 Display of digital input signals
1	(C0826/1)			
2	(C0826/2)			
3	(C0826/3)			
C0828			→ Selection list 2	AND5 Configuration of digital inputs
				
1	IN	1000	FIXED0	
2	IN	1000	FIXED0	
C0829		<input type="checkbox"/> Disp		AND5 Display of digital input signals
1	(C0828/1)			
2	(C0828/2)			
3	(C0828/3)			
C0830			→ Selection list 2	OR1 Configuration of digital input signals
				
1	IN	1000	FIXED0	
2	IN	1000	FIXED0	
C0831		<input type="checkbox"/> Disp		OR1 Display of digital input signals
1	(C0830/1)			
2	(C0830/2)			
3	(C0830/3)			
C0832			→ Selection list 2	OR2 Configuration of digital input signals
				
1	IN	1000	FIXED0	
2	IN	1000	FIXED0	
C0833		<input type="checkbox"/> Disp		OR2 Display of digital input signals
1	(C0832/1)			
2	(C0832/2)			
3	(C0832/3)			









Code		Possible settings		IMPORTANT
No.	Designation	Lenze	Selection	
C0834 				→ Selection list 2 OR3 Configuration of digital input signals
1	IN	1000	FIXED0	
2	IN	1000	FIXED0	
3	IN	1000	FIXED0	
C0835				OR3 Display of digital input signals
1	(C0834/1)			
2	(C0834/2)			
3	(C0834/3)			
C0836 				→ Selection list 2 OR4 Configuration of digital input signals
1	IN	1000	FIXED0	
2	IN	1000	FIXED0	
3	IN	1000	FIXED0	
C0837				OR4 Display of digital input signals
1	(C0836/1)			
2	(C0836/2)			
3	(C0836/3)			
C0838 				→ Selection list 2 OR5 Configuration of digital input signals
1	IN	1000	FIXED0	OR5-IN1
2	IN	1000	FIXED0	OR5-IN2
3	IN	1000	FIXED0	OR5-IN3
C0839				OR5 Display of digital input signals
1	(C0838/1)			
2	(C0838/2)			
3	(C0838/3)			
C0840 	IN	1000	FIXED0	→ Selection list 2 NOT1 Configuraton of digital input signal
C0841	(C0840)			NOT1 Display of digital input signal
C0842 	IN	1000	FIXED0	→ Selection list 2 NOT2 Configuraton of digital input signal
C0843	(C0842)			NOT2 Display of digital input signal
C0844 	IN	1000	FIXED0	→ Selection list 2 NOT3 Configuraton of digital input signal
C0845	(C0844)			NOT3 Display of digital input signal
C0846 	IN	1000	FIXED0	→ Selection list 2 NOT4 Configuraton of digital input signal
C0847	(C0846)			NOT4 Display of digital input signal
C0848 	IN	1000	FIXED0	→ Selection list 2 NOT5 Configuraton of digital input signal
C0849	(C0848)			NOT5 Display of digital input signal

Code		Possible settings			IMPORTANT	
No.	Designation	Lenze	Selection			
C0850 				→ Selection list 1	AIF-OUT Configuration process output words for automation interface AIF (X1)	
1	OUT.W1	1000	FIXED0%			
2	OUT.W2	1000	FIXED0%			
3	OUT.W3	1000	FIXED0%			
C0851 	OUT.D1	1000	FIXED0INC → Selection list 3		AIF-OUT Configuration of 32-bit angle information	
C0852	TYPE OUT.W2	0	0	Analog signal	AIF-OUT	
			1	Digital 0-15	Configuration of process output word 2 for automation interface AIF (X1)	
			2	D1: LOW angle		
			3	D2: HIGH angle		
C0853	TYPE OUT.W3	0	0	Analog signal	AIF-OUT	
			1	Digital 16-31	Configuration - process output word 3 for automation interface AIF (X1)	
			2	High phase		
C0854	TYPE OUT.W1	0	0	Analog signal	AIF-OUT	
			3	D2: LOW phase	Configuration process output word 1 for automation interface AIF (X1)	
C0855					AIF	
1	IN (0-15)		Bit 00	{1}	Bit15	Process input words hexadecimal for automation interface X1
2	IN (16-31)		16 bit	{1}	Bit 31	
C0856			-199.99	{0.01 %}	199.99	AIF-IN
1	IN.W1					Decimal process input words Display: 100.00 % = 16384
2	IN.W2					
3	IN.W3					
C0857	IN.D1		-2147483648	{1}	2147483647	AIF-IN 32-bit phase information
C0858			-199.99	{0.01 %}	199.99	AIF-OUT
1	OUT.W1					Process output words Display: 100 % = 16384
2	OUT.W2					
3	OUT.W3					
C0859	OUT.D1		-2147483648	{1}	2147483647	AIF-OUT 32-bit phase information
C0860 				→ Selection list 1	AIF	
1	OUT1.W1	5001				
2	OUT1.W2	1000	FIXED0%			
3	OUT1.W3	1000	FIXED0%			
4	OUT2.W1	1000	FIXED0%			
5	OUT2.W2	1000	FIXED0%			
6	OUT2.W3	1000	FIXED0%			
7	OUT2.W4	1000	FIXED0%			
8	OUT3.W1	1000	FIXED0%			
9	OUT3.W2	1000	FIXED0%			
10	OUT3.W3	1000	FIXED0%			
11	OUT3.W4	1000	FIXED0%			
C0861 				→ Selection list 3	AIF	
1	OUT1.D1	1000	FIXED0INC			
2	OUT2.D1	1000	FIXED0INC			
3	OUT3.D1	1000	FIXED0INC			

Code		Possible settings			IMPORTANT	
No.	Designation	Lenze	Selection			
C0863		<input type="checkbox"/> Disp	0		1 AIF	
	1 IN1 (0-15)					
	2 IN1 (16-31)					
	3 IN2 (0-15)					
	4 IN2 (16-31)					
	5 IN3 (0-15)					
	6 IN3 (16-31)					
C0864			0	Analog signal	CAN Configuration of process output words for system bus (CAN)	
	1 TYPEOUT1.W2	0	1	Digital 0-15		
	2 TYPEOUT2.W1	0	2	LOW angle		
	3 TYPEOUT3.W1	0				
C0865			0	Analog signal	CAN Configuration of process output words for system bus (CAN)	
	1 TYPEOUT1.W3	0	1	Digital 16-31		
	2 TYPEOUT2.W2	0	2	High phase		
	3 TYPEOUT3.W2	0				
C0866		<input type="checkbox"/> Disp	-32768.00	{0.01%}	32767.00	CAN
	1 IN1.W1					
	2 IN1.W2					
	3 IN1.W3					
	4 IN2.W1					
	5 IN2.W2					
	6 IN2.W3					
	7 IN2.W4					
	8 IN3.W1					
	9 IN3.W2					
	10 IN3.W3					
	11 IN3.W4					
C0867		<input type="checkbox"/> Disp				CAN
	1 IN1.D1					
	2 IN2.D1					
	3 IN3.D1					
C0868		<input type="checkbox"/> Disp	-199.99	{0.01%}	199.99	CAN
	1 OUT1.W1					
	2 OUT1.W2					
	3 OUT1.W3					
	4 OUT2.W1					
	5 OUT2.W2					
	6 OUT2.W3					
	7 OUT2.W4					
	8 OUT3.W1					
	9 OUT3.W2					
	10 OUT3.W3					
	11 OUT3.W4					
C0869		<input type="checkbox"/> Disp	-2147483648	{1}	2147483647	CAN
	1 OUT1.D1					
	2 OUT2.D1					
	3 OUT3.D1					

Code		Possible settings		IMPORTANT
No.	Designation	Lenze	Selection	
C0870 				→ Selection list 2 DCTRL Configuration of digital input signals (inhibit controller)
1	CINH1	1000	FIXED0	
2	CINH2	1000	FIXED0	
C0871 	TRIP-SET	54	DIGIN4	→ Selection list 2 DCTRL Configuraton of digital input signal
C0876 	TRIP-RES	55	DIGIN5	→ Selection list 2 DCTRL Configuraton of digital input signal
C0878				DCTRL Display of digital input signals
1	(C0870/1)			
2	(C0870/2)			
3	(C0871)			
4	(C0876)			
C0879			0 No reset 1 Reset	DCTRL Reset control words
1	RESET C135	0		
2	RESET AIF	0		
3	RESET CAN	0		
C0880				→ Selection list 2 DCTRL Configuration of digital input signals
1	PAR*1	1000	FIXED0	
2	PAR*2	1000	FIXED0	
C0881	PAR-LOAD	1000	FIXED0	→ Selection list 2 DCTRL Configuraton of digital input signal
C0884				DCTRL Display of digital input signals
1	PAR*1			
2	PAR*2			
3	PAR-LOAD			
C0885 	R	51	DIGIN1	→ Selection list 2 R/L/Q Configuraton of digital input signal(CW rotation)
C0886 	L	52	DIGIN2	→ Selection list 2 R/L/Q Configuraton of digital input signal(CCW rotation)
C0889				R/L/Q Display of digital input signals
1	(C0885)			
2	(C0886)			
C0890 	N-SET	5050	NSET-NOUT	→ Selection list 1 MCTRL Configuration of input signal for speed setpoint
C0891 	M-ADD	1000	FIXED0%	→ Selection list 1 MCTRL Configuration of input signal for torque setpoint
C0892 	LO-M-LIM	5700	ANEG1-OUT	→ Selection list 1 MCTRL Configuration of input signal for lower torque limit
C0893 	HI-M-LIM	19523	FCODE-472/3	→ Selection list 1 MCTRL Configuration of input signal for upper torque limit
C0894 	PHI-SET	1000	FIXED0INC	→ Selection list 3 MCTRL Configuration of input signal for rotor position setpoint
C0895 	PHI-LIM	1006	FIXED100%	→ Selection list 1 MCTRL Configuration of input signal for angle controller limit

Code		Possible settings			IMPORTANT	
No.	Designation	Lenze	Selection			
C0896 	N2-LIM	1000	FIXED0%	→ Selection list 1	MCTRL Configuration of input signal for 2. speed limitation value	
C0897 	PHI-ON	1000	FIXED0	→ Selection list 2	MCTRL Configuration of switch-on signal for angle controller	
C0898 	FLD-WEAK	1006	FIXED100%	→ Selection list 1	MCTRL Configuration of input signal for field weakening	
C0899 	N/M-SWT	1000	FIXED0	→ Selection list 2	MCTRL Configuration of input signal for change-over between n and M control	
C0900 	QSP	10250	R/L/Q-QSP	→ Selection list 2	MCTRL Configuration of control signal for activation	
C0901 	I-SET	1000	FIXED0%	→ Selection list 1	MCTRL Configuration of input signal for loading the I component for the speed controller	
C0902 	I-LOAD	1000	FIXED0	→ Selection list 2	MCTRL Configuration of tripping signal for loading the I component for the speed controller	
C0903 	P-ADAPT	1006	FIXED0%	→ Selection list 1	MCTRL Configuration of input signal for adaptation of the angle controller	
C0906			-199.99	{0.01 %}	199.99	MCTRL Display of analog input signals
	1 (C0890)					
	2 (C0891)					
	3 (C0892)					
	4 (C0893)					
	5 (C0895)					
	6 (C0896)					
	7 (C0898)					
	8 (C0901)					
	9 (C0903)					
C0907						MCTRL Display of digital input signals
	1 (C0897)					
	2 (C0899)					
	3 (C0900)					
	4 (C0902)					
C0908	(C0894)		-2147483647	{1 inc}	2147483647	Set phase signal ● 1 rev. = 65536 inc
C0909	SPEED LIMIT	1	1 +/- 175 % 2 0 ... +175 % 3 -175 ... 0 %			Limitation of direction of rotation for the speed setpoint
C0920 	REF-ON	1000	FIXED0	→ Selection list 2	REF Configuraton of digital input signal Activation of homing function	
C0921 	REF-MARK	1000	FIXED0	→ Selection list 2	REF Configuraton of digital input signal Digital reference switch	
C0922 	REF-PHI-IN	1000	FIXED0INC	→ Selection list 3	REF Configuration of angle input signal	
C0923 	REF-N-IN	1000	FIXED0%	→ Selection list 1	REF Configuration of speed input signal	

Code		Possible settings			IMPORTANT	
No.	Designation	Lenze	Selection			
C0924 	REF-POS-LOAD	1000	FIXED0	→ Selection list 2	REF Configuraton of digital input signal Control "set position"	
C0925 	REF-ACTPOS-IN	1000	FIXED0INC	→ Selection list 3	REF Configuration of input signal for "Set position"	
C0926			-2147483647	{1 inc}	2147483647	REF Display of input signals
1	REF-ACTPOS-IN					Actual position
2	REF-PHI-IN					Target position
3	REF-ACTPOS					
4	REF-TARGET					
C0927						REF Display of digital input signals
1	REF-ON					
2	REF-MARK					
3	REF-POS-LOAD					
C0928	REF-PHI-IN		-2147483647	{1 inc}	2147483647	REF Angle signal (following error) ● 1 rev. = 65536 inc
C0929	REF-N-IN		-199.99	{0.01 %}	199.99	REF Display of analog input signal
C0930 	REF-GEARBOX MOT	1	1	{1}	65535	REF Encoder/gearbox factor - numerator (on the motor side)
C0931 	REF-GEARBOX ENC	1	1	{1}	65535	REF Encoder/gearbox factor - denominator (on the encoder side)
C0932	REF MODE	0				REF Homing function mode
			0	Mode 0		Positive direction, reference switch, zero pulse
			1	Mode 1		Negative direction, reference switch, zero pulse
			6	Mode 6		Positive direction, reference switch, touch probe
			7	Mode 7		Negative direction, reference switch, touch probe
			8	Mode 8		Positive direction, touch probe
			9	Mode 9		Negative direction, touch probe
			20	Mode 20		Direct homing
			21	Mode 21		Direct homing, save actual value
C0933	REF TRANS	0	0	Rising edge		REF Reference signal edge
			1	Falling edge		
C0934	REF OFFSET	0	-2140000000	{1 inc}	2140000000	REF Home position offset
C0935	REF SPEED	2.000 0	0.0001	{0.0001 %}	100.0000	REF Homing speed Homing speed The value set is the percentage value of N _{max}
C0936	REF TI	1.00	0.01	{0.01 s}	990.00	REF Homing acceleration/deceleration time T _{ir} and T _{if} are identical
C0940	NUMERATOR	1	-32767	{1}	32767	CONV1 Numerator

Code		Possible settings				IMPORTANT
No.	Designation	Lenze	Selection			
C0941	DENOMINATOR	1	1	{1}	32767	CONV1 Denominator
C0942	CONV1-IN	1000	FIXED0%		→ Selection list 1	CONV1 Configuration of analog input
C0943	(C0942)	<input type="checkbox"/> Disp	-199.99	{0.01 %}	199.99	CONV1 Display of analog input signal
C0945	NUMERATOR	1	-32767	{1}	32767	CONV2 Numerator
C0946	DENOMINATOR	1	1	{1}	32767	CONV2 Denominator
C0947	IN	1000	FIXED0%		→ Selection list 1	CONV2 Configuration of analog input
C0948	(C0947)	<input type="checkbox"/> Disp	-199.99	{0.01 %}	199.99	CONV2 Display of analog input signal
C0950	NUMERATOR	1	-32767	{1}	32767	CONV3 Numerator
C0951	DENOMINATOR	1	1	{1}	32767	CONV3 Denominator
C0952	IN	1000	FIXEDPHI-0		→ Selection list 4	CONV3 Configuration of analog input
C0953	(C0952)	<input type="checkbox"/> Disp	-32767	{1 rpm}	32767	CONV3 Display of analog input signal
C0955	NUMERATOR	1	-32767	{1}	32767	CONV4 Numerator
C0956	DENOMINATOR	1	1	{1}	32767	CONV4 Denominator
C0957	IN	1000	FIXEDPHI-0		→ Selection list 4	CONV4 Configuration of analog input
C0958	(C0957)	<input type="checkbox"/> Disp	-32767	{1 rpm}	32767	CONV4 Display of analog input signal
C0960	FUNCTION	1	1 2 3	Characteristic 1 Characteristic 2 Characteristic 3		CURVE Selection of the characteristic function
C0961	Y0	0.00	0.00	{0.01 %}	199.99	CURVE Configuration of grid point
C0962	Y1	50.00	0.00	{0.01 %}	199.99	CURVE Configuration of grid point
C0963	Y2	75.00	0.00	{0.01 %}	199.99	CURVE Configuration of grid point
C0964	Y100	100.0 0	0.00	{0.01 %}	199.99	CURVE Configuration of grid point
C0965	X1	50.00	0.01	{0.01 %}	99.00	CURVE Configuration of grid point
C0966	X2	75.00	0.01	{0.01 %}	99.00	CURVE Configuration of grid point
C0967	IN	1000	FIXED0%		→ Selection list 1	CURVE Configuration of analog input
C0968	(C0967)	<input type="checkbox"/> Disp	-199.99	{0.01 %}	199.99	CURVE Display of analog input signal
C0970	N-SET	1000	FIXED0%		→ Selection list 1	MFAIL Configuration of speed input signal (setpoint path)
C0971	FAULT	1000	FIXED0		→ Selection list 2	MFAIL Configuration of digital input signal (activation of the mains failure control)

Code		Possible settings				IMPORTANT
No.	Designation	Lenze	Selection			
C0972 	RESET	1000	FIXED0		→ Selection list 2	MFAIL Configuration of digital input signal (reset of the mains failure control)
C0973 	ADAPT	1000	FIXED0%		→ Selection list 1	MFAIL Configuration of input signal for adaptation of the voltage controllerP gain
C0974 	CONST	1000	FIXED0%		→ Selection list 1	MFAIL Configuration of input signal for adaptation of the voltage controllerP gain
C0975 	THRESHLD	1000	FIXED0%		→ Selection list 1	MFAIL Configuration of input signal for restart protection for when speed threshold is under-run
C0976 	NACT	1000	FIXED0%		→ Selection list 1	MFAIL Configuration of input signal for comparison value for threshold function • Start for V ₂ controller
C0977 	SET	1000	FIXED0%		→ Selection list 1	MFAIL Configuration of input signal for speed starting value
C0978 	DC-SET	1000	FIXED0%		→ Selection list 1	MFAIL Configuration of input signal for DC-bus voltage setpoint
C0980	MFAIL VP	0.500	0.001	{0.001}	31.000	MFAIL Setting of gain V _p
C0981	MFAIL TN	100	20	{1 ms}	2000	MFAIL Setting of reset time T _n
C0982	MFAIL TIR	2.000	0.001	{0.001 s}	16.000	MFAIL Setting of acceleration time T _{ir}
C0983	RETRIGGER T	1.000	0.001	{0.001 s}	60.000	MFAIL Retrigger time
C0988			-199.99	{0.01 %}	199.99	MFAIL Display of analog input signals
	1 (C0970)					
	2 (C0973)					
	3 (C0974)					
	4 (C0975)					
	5 (C0976)					
	6 (C0977)					
	7 (C0978)					
C0989						MFAIL Display of digital input signals
	1 (C0971)					
	2 (C0972)					
C0990 	IN	1000	FIXEDPHI-0		→ Selection list 4	PHINT1 Input signal configuration
C0991 	RESET	1000	FIXED0		→ Selection list 2	PHINT1 Configuration - reset signal
C0992	(C0990)		-32767	{1}	32767	PHINT1 Input signal display
C0993	(C0991)					PHINT1 Display of digital input signal
C0995	DIVISION	0	-31	{1}	31	PHDIV Divisor in the power-of-two-format (2 ^{C0995})
C0996 	IN	1000	FIXED0INC		→ Selection list 3	PHDIV Input signal configuration

















Code		Possible settings				IMPORTANT
No.	Designation	Lenze	Selection			
C0997	(C0996)	<input type="checkbox"/> Disp	-2147483647	{1}	2147483647	PHDIV Input signal display
C1000	DIVISION	1	0	{1}	31	CONVPHA1 Divisor in the power-of-two-format (2 ^{C0995})
C1001	IN	1000	FIXED0INC		→ Selection list 3	Configuration input of CONVPHA1
C1002	(C1001)	<input type="checkbox"/> Disp	-2147483647	{1}	2147483647	CONVPHA1 Input signal display
C1010	ARITPH1 FUNCT	1	0 1 2 3 14 21 22	OUT = IN1 OUT = IN1 + IN2 OUT = IN1 - IN2 OUT = IN1 × IN2 OUT = IN1 / IN2 OUT = IN1 + IN2 (no limit) OUT = IN1 - IN2 (no limit)		ARITPH1 Arithmetic function selection
C1011					→ Selection list 3	ARITPH1 Input signal configuration
	1 IN	1000	FIXED0INC			
	2 IN	1000	FIXED0INC			
C1012		<input type="checkbox"/> Disp	-2147483647	{1}	2147483647	ARITPH1 Display of input signals
	1 (C1011/1)					
	2 (C1011/2)					
C1030	IN	1000	FIXEDPHI-0		→ Selection list 4	PHINT2 Input signal configuration
C1031	RESET	1000	FIXED0		→ Selection list 2	PHINT2 Reset input
C1032	(C1030)	<input type="checkbox"/> Disp	-32767	{1}	32767	PHINT2 Display of input signals
C1033	(C1031)	<input type="checkbox"/> Disp				PHINT2 Display of digital input signal
C1040	ACCELERATION	100.0 0	0.001	{0.001}	5000.000	SRFG1 Setting of acceleration
C1041	JERK	0.200	0.001	{0.001 s}	999.999	SRFG1 Setting of jerk
C1042	IN	1000	FIXED0%		→ Selection list 1	SRFG1 Input signal configuration
C1043	SET	1000	FIXED0%		→ Selection list 1	SRFG1 Input signal configuration
C1044	LOAD	1000	FIXED0		→ Selection list 2	SRFG1 Input signal configuration
C1045		<input type="checkbox"/> Disp	-199.99	{0.01 %}	199.99	SRFG1 Display of analog input signal
	1 (C1042)					
	2 (C1043)					
C1046	(C1044)	<input type="checkbox"/> Disp				SRFG1 Display of digital input signal
C1090	OUTPUT SIGNAL	<input type="checkbox"/> Disp	-2147483648	{1}	2147483647	FEVAN1 Signal output
C1091	CODE	141	2	{1}	2000	FEVAN1 Selection of the target code
C1092	SUBCODE	0	0	{1}	255	FEVAN1 Selection of the target subcode
C1093	NUMERATOR	1.000 0	0.0001	{0.0001}	100000.0000	FEVAN1 Numerator

Code		Possible settings				IMPORTANT
No.	Designation	Lenze	Selection			
C1094	DENOMINATOR	0.000 1	0.0001	{0.0001}	100000.0000	FEVAN1 Denominator
C1095	OFFSET	0	0	{1}	1000000000	FEVAN1 Offset setting
C1096	IN	1000	FIXED0%		→ Selection list 1	FEVAN1 Configuration of analog input signal
C1097	FEVAN1-LOAD	1000	FIXED0		→ Selection list 2	FEVAN1 Configuraton of digital input signal
C1098	(C1096)	<input type="checkbox"/> Disp	-32768	{1}	32767	FEVAN1 Display of analog input signal
C1099	(C1097)	<input type="checkbox"/> Disp				FEVAN1 Display of digital input signal
C1100	FUNCTION	1				FCNT1 Function selection
			1	Return		If counter content ≥ FCNT1-CMP-Val , FCNT1-EQUAL is set to HIGH for 1 ms
			2	Hold if >=		If counter content ≥ FCNT1-CMP-Val , the counter stops
			3	Hold if =		If counter content = FCNT1-CMP-Val , the counter stops
C1101					→ Selection list 1	FCNT1 Configuration - analog input signals
	1 LD-VAL	1000	FIXED0%			
	2 CMP-VAL	1000	FIXED0%			
C1102					→ Selection list 2	FCNT1 Configuration of digital input signals
	1 CLKUP	1000	FIXED0			
	2 CLKDWN	1000	FIXED0			
	3 LOAD	1000	FIXED0			
C1103		<input type="checkbox"/> Disp	-32768	{1}	32768	FCNT1 Display of analog input signals
	1 (C1101/1)					
	2 (C1101/2)					
C1104		<input type="checkbox"/> Disp				FCNT1 Display of digital input signals
	1 (C1102/1)					
	2 (C1102/2)					
	3 (C1102/3)					
C1120	SYNC MODE	2	0 Sync switched off 1 CAN sync activated 2 Terminal sync activated			SYNC1 Function
C1121		2	0	{1 ms}	13	SYNC1 The interpolation is restarted with every sync signal.
	1 SYNC CYCLE	2				SYNC1 Definition of the cycle time of the sync signals (in the slave); only for system bus
	2 INTERPOL. CYCL	2				SYNC1 Definition of the interpolation time between the sync signals (in the slave), only for terminal
C1122	SYNC TIME	0.460	0.000	{0.001 ms}	10.000	SYNC1 Phase shift between CAN sync and internal control program cycle ● For system bus only ● Depends on baud rate and bus load

Code		Possible settings				IMPORTANT
No.	Designation	Lenze	Selection			
C1123			-0.450	{0.001 ms}	0.450	SYNC1
1	PHASESHIFT	0.000				Phase shift between terminal synch and internal program cycle, for terminal sync only.
2	SYNC WINDOW	0.200				Synchronisation window for the synchronisation edge of the terminal sync (LOW-HIGH edge). Only for terminal sync. If the sync signal transmitted is within the window, SYNCx-STAT switches to HIGH
C1124	IN1	1000	FIXED0%		→ Selection list 1	SYNC1 Configuration of analog input signal
C1125	IN2	1000	FIXED0INC		→ Selection list 3	SYNC1 Input signal configuration
C1126	IN3	1000	FIXED0%		→ Selection list 1	SYNC1 Configuration of analog input signal
C1127	(C1124)	<input type="checkbox"/> Disp	-2147483647	{1}	2147483647	SYNC1 Display of analog input signal
C1128	(C1125)	<input type="checkbox"/> Disp	-2147483647	{1}	2147483647	SYNC1 Input signal display
C1129	(C1126)	<input type="checkbox"/> Disp	-2147483647	{1}	2147483647	SYNC1 Display of analog input signal
C1140	FUNCTION	0	0 1 2	Rising edge Falling edge Both edges		TRANS3 Selection of the edge evaluation
C1141	PULSE T	0.001	0.001	{0.001 s}	60.000	TRANS3 Setting of the pulse period
C1143	IN	1000	FIXED0		→ Selection list 2	TRANS3 Display of digital input signal
C1144	(C1143)	<input type="checkbox"/> Disp				TRANS3 Configuraton of digital input signal
C1145	FUNCTION	0	0 1 2	Rising edge Falling edge Both edges		TRANS4 Selection of the edge evaluation
C1146	PULSE T	0.001	0.001	{0.001 s}	60.000	TRANS4 Setting of the pulse period
C1148	IN	1000	FIXED0		→ Selection list 2	TRANS4 Configuraton of digital input signal
C1149	(C1148)	<input type="checkbox"/> Disp				TRANS4 Display of digital input signal
C1150	FUNCTION	0	0 1 2	Load permanent Load edge Compare & subtract		PHINT3 Function selection
C1151	CMP. VALUE	2·10 ⁹	0	{1}	2000000000	PHINT3 Setting of a comparison value
C1153	IN	1000	FIXEDPHI-0		→ Selection list 4	PHINT3 Configuration - speed input signal
C1154	LOAD	1000	FIXED0		→ Selection list 2	PHINT3 Configuraton of digital input signal
C1155	SET	1000	FIXED0INC		→ Selection list 3	PHINT3 Configuration - phase input signal
C1157	(C1153)	<input type="checkbox"/> Disp	-32767	{1}	32767	PHINT3 Input signal display
C1158	(C1154)	<input type="checkbox"/> Disp				PHINT3 Display of digital input signal
C1159	(C1155)	<input type="checkbox"/> Disp	-2147483647	{1}	2147483647	PHINT3 Input signal display

Code		Possible settings			IMPORTANT	
No.	Designation	Lenze	Selection			
C1160 STOP				→ Selection list 1	ASW3 Configuration - analog input signals	
1	IN1	1000	FIXED0%			
2	IN2	1000	FIXED0%			
C1161 STOP	SET	1000	FIXED0	→ Selection list 2	ASW3 Configuraton of digital input signal	
C1162		<input type="checkbox"/> Disp	-199.99	{0.01 %}	199.99	ASW3 Display of analog input signals
1	(C1160/1)					
2	(C1160/2)					
C1163	(C1161)	<input type="checkbox"/> Disp				ASW3 Display of digital input signal
C1165 STOP				→ Selection list 1	ASW4 Configuration - analog input signals	
1	IN1	1000	FIXED0%			
2	IN2	1000	FIXED0%			
C1166 STOP	SET	1000	FIXED0	→ Selection list 2	ASW4 Configuraton of digital input signal	
C1167		<input type="checkbox"/> Disp	-199.99	{0.01 %}	199.99	ASW3 Display of analog input signals
1	(C1165/1)					
2	(C1165/2)					
C1168	(C1166)	<input type="checkbox"/> Disp				ASW4 Display of digital input signal
C1170	NUMERATOR	1	-32767		32767	CONV6 Numerator
C1171	DENOMINATOR	1	1	{1}	32767	CONV6 Denominator
C1172 STOP	IN	1000	FIXED0%	→ Selection list 1		CONV6 Configuration of analog input signal
C1173	(C1172)	<input type="checkbox"/> Disp	-199.99	{0.01 %}	199.99	CONV6 Display of analog input signal
C1175 STOP				→ Selection list 2		AND6 Configuration of digital input signals
1	IN1	1000	FIXED0			
2	IN2	1000	FIXED0			
3	IN3	1000	FIXED0			
C1176		<input type="checkbox"/> Disp				AND6 Display of digital input signals
1	(C1175/1)					
2	(C1175/2)					
3	(C1175/3)					
C1178 STOP				→ Selection list 2		AND7 Configuration of digital input signals
1	IN1	1000	FIXED0			AND7-IN1
2	IN2	1000	FIXED0			AND7-IN2
3	IN3	1000	FIXED0			AND7-IN3
C1179		<input type="checkbox"/> Disp				AND7 Display of digital input signals
1	AND7-IN1					
2	AND7-IN1					
3	AND7-IN1					

Code		Possible settings		IMPORTANT					
No.	Designation	Lenze	Selection						
C1190		0		Temperature characteristic for PTC thermistors Selection of the characteristic for PTC thermistors at X7 or X8 for detecting the motor temperature					
		0	Standard	Characteristic for PTC thermistors in Lenze motors					
		1	Characteristic	Characteristic for application-specific PTC thermistors					
C1191		0	{1 °C}	Temperature range for PTC thermistors Define temperature points on the characteristic for PTC thermistors					
		1	100	Lower temperature T1					
		2	150	Upper temperature T2					
C1192		0	{1 Ω}	Resistance range for PTC thermistors Define resistance points on the characteristic for PTC thermistors					
		1	1670	Resistance R1 at T1					
		2	2225	Resistance R2 at T2					
C1195	OUT.D2	1000	FIXED0INC → Selection list 3	AIF-OUT Configuration of angle input signal					
C1196	(C1195)	<input type="checkbox"/> Disp	-2147483647 {1} 2147483647	AIF-OUT Input signal display					
C1197	IN.D2	<input type="checkbox"/> Disp		AIF-IN Input signal display					
C1200				→ Selection list 3 PHADD1 Configuration - phase input signals					
					1	IN1	1000	FIXED0INC	
					2	IN2	1000	FIXED0INC	
					3	IN3	1000	FIXED0INC	
C1201		<input type="checkbox"/> Disp		-2147483647 {1} 2147483647	PHADD1 Display of input signals				
						1	IN1		
						2	IN2		
						3	IN3		
C1205				→ Selection list 3	PHCMP2 Input signal configuration				
						1	IN1	1000	FIXED0INC
						2	IN2	1000	FIXED0INC
C1206		<input type="checkbox"/> Disp		-2147483647 {1} 2147483647	PHCMP2 Display of input signals				
						1	IN1		
						2	IN2		
C1207	FUNCTION	2	1 IN1 < IN2 2 IN1 < IN2	PHCMP2 Selection of the comparison operation					
C1210				→ Selection list 2	STORE1 Configuration of digital input signals				
						1	STORE1-RESET	1000	FIXED0
						2	STORE1-ENTP	1000	FIXED0
						3	STORE1-ENWI N	1000	FIXED0
						4	STORE1-LOAD0	1000	FIXED0
						5	STORE1-LOAD1	1000	FIXED0

Code		Possible settings			IMPORTANT
No.	Designation	Lenze	Selection		
C1211 				→ Selection list 4	STORE1 Input signal configuration
1	STORE1-IN	1000	FIXEDPHI-0		
2	STORE1-MASKI	1000	FIXEDPHI-0		
C1212 	MASKV	1000	FIXED0INC → Selection list 3		STORE1 Input signal configuration
C1215					STORE1 Display of digital input signals
1	(C1210/1)				
...	...				
5	(C1210/5)				
C1216			-32767	{1 rpm} 32767	STORE1 Display of input signals
1	(C1211/1)				
2	(C1211/2)				
C1217	(C1212)		-2147483647	2147483647	STORE1 Input signal display
C1220 				→ Selection list 2	STORE2 Configuration of digital input signals
1	STORE2-RESET	1000	FIXED0		
2	STORE2-ENTP	1000	FIXED0		
C1223					STORE2 Display of digital input signals
1	(C1220/1)				
2	(C1220/2)				
C1230 				→ Selection list 2	PHDIFF1 Configuration of digital input signals
1	PHDIFF1-EN	1000	FIXED0		
2	PHDIFF1-RES	1000	FIXED0		
C1231 	IN	1000	FIXEDPHI-0 → Selection list 4		PHDIFF1 Input signal configuration
C1232 				→ Selection list 3	PHDIFF1 Input signal configuration
1	PHDIFF1-SET	1000	FIXED0INC		
2	PHDIFF1-ADD	1000	FIXED0INC		
C1235					PHDIFF1 Display of digital input signals
1	(C1230/1)				
2	(C1230/2)				
C1236	(C1231)		-32767	{1 rpm} 32767	
C1237			-2147483647	2147483647	PHDIFF1 Display of input signals
1	(C1232/1)				
2	(C1232/2)				
C1240 				→ Selection list 1	CONVPHPH1 Input signal configuration
1	CONVPHPH1-NUM	1000	FIXED0%		
2	CONVPHPH1-DEN	1000	FIXED0%		
C1241 	CONVPHPH1-ACT	1000	FIXED0 → Selection list 2		CONVPHPH1 Input signal configuration
C1242 	CONVPHPH1-IN	1000	FIXED0INC → Selection list 3		CONVPHPH1 Input signal configuration

Code		Possible settings				IMPORTANT
No.	Designation	Lenze	Selection			
C1245		<input type="checkbox"/> Disp	-199.99	{0.01 %}	1999.99	CONVPHPH1 Display of analog input signals
1	(C1240/1)					
2	(C1240/2)					
C1246	(C1241)	<input type="checkbox"/> Disp				CONVPHPH1 Display of digital input signal
C1247	(C1242)	<input type="checkbox"/> Disp	-2147483647		2147483647	CONVPHPH1 Input signal display
C1250	IN	1000	FIXEDPHI-0		→ Selection list 4	CONVPP1 Input signal configuration
C1251		1000			→ Selection list 3	CONVPP1 Input signal configuration
1	CONVPP1-NU M		FIXED0INC			
2	CONVPP1-DEN		FIXED0INC			
C1253	(C1250)	<input type="checkbox"/> Disp	-32767	{1 rpm}	32767	CONVPP1 Input signal display
C1254		<input type="checkbox"/> Disp	-2147483647	{1}	2147483647	CONVPP1 Display of input signals
1	CONVPP1-NU M					
2	CONVPP1-DEN					
C1255	N-TRIM2	1000	FIXEDPHI-0		→ Selection list 4	DFSET Input signal configuration
C1258	(C1255)	<input type="checkbox"/> Disp	-32767	{1 rpm}	32767	
C1260	OFFSET	0	-16383	{1}	16383	GEARCOMP Offset
C1261	NUM	1	-32767	{1}	32767	GEARCOMP Numerator
C1262	DENUM	1	1	{1}	32767	GEARCOMP Denominator
C1265	TORQUE	1000	FIXED0%		→ Selection list 1	GEARCOMP Configuration of input signal correction
C1266	PHI-IN	1000	FIXED0INC		→ Selection list 3	GEARCOMP Input signal configuration
C1268	(C1265)	<input type="checkbox"/> Disp	-199.99	{0.01 %}	199.99	GEARCOMP Display of analog input signal
C1269	(C1266)	<input type="checkbox"/> Disp	-2147483647	{1}	2147483647	GEARCOMP Input signal display
C1270					→ Selection list 3	PHCMP3 Input signal configuration
1	PHCMP3-IN1	1000	FIXED0INC			
2	PHCMP3-IN2	1000	FIXED0INC			
C1271		<input type="checkbox"/> Disp	-2147483647	{1}	2147483647	PHCMP3 Display of input signals
1	(C1270/1)					
2	(C1270/2)					
C1272	FUNCTION	2	1 IN1 < IN2 2 IN1 < IN2			PHCMP3 Selection of the comparison operation
C1290	MONIT P16	3	0 Trip 2 Warning 3 Off			P16 monitoring Configuration of monitoring in the case of a sync error
C1292	MONIT P19	2	0 Trip 2 Warning 3 Off			P19 monitoring Configuration of monitoring a limitation of the input value at DFIN

Code		Possible settings				IMPORTANT
No.	Designation	Lenze	Selection			
C1500	OUTPUT SIGNAL	<input type="text" value="Disp"/>	-2147483648	{1}	2147483647	FEVAN2 Signal output
C1501	CODE	141	2	{1}	2000	FEVAN2 Target code of FEVAN2
C1502	SUBCODE	0	0	{1}	255	FEVAN2 Target subcode FEVAN2
C1503	NUMERATOR	1.000 0	0.0001	{0.0001}	100000.0000	FEVAN2 Numerator
C1504	DENOMINATOR	0.000 1	0.0001	{0.0001}	100000.0000	FEVAN2 Denominator
C1505	OFFSET	0	0		1000000000	FEVAN2 Offset
C1506 <input type="text" value="STOP"/>	FEVAN2-IN	1000	FIXED0%		→ Selection list 1	FEVAN2 Configuration of analog input signal
C1507 <input type="text" value="STOP"/>	LOAD	1000	FIXED0		→ Selection list 2	FEVAN2 Configuraton of digital input signal
C1508	(C1506)	<input type="text" value="Disp"/>	-32768	{1}	32767	FEVAN2 Display of analog input signal
C1509	(C1507)	<input type="text" value="Disp"/>				FEVAN2 Display of digital input signal
C1799		1250	20	{1}	1250	DFOUT f_{max} (kHz) 1250 corresponds to 500 kHz
C1810		<input type="text" value="Disp"/>				SW-EKZ LECOM
C1811		<input type="text" value="Disp"/>				SW generation

8.5 Selection lists

8.5.1 Selection list 1: Analog output signals

Parameter	Analog output signal (O)
000050	AIN1-OUT
000055	AIN2-OUT
000100	DFSET-NOUT
001000	FIXED0%
001006	FIXED100%
001007	FIXED-100%
005000	MCTRL-NSET2
005001	MCTRL-NACT
005002	MCTRL-MSET2
005003	MCTRL-MACT
005004	MCTRL-IACT
005005	MCTRL-DCVOLT
005009	MCTRL-PHI-ACT
005050	NSET-NOUT
005051	NSET-RFG-I
005100	MPOT1-OUT
005150	PCTRL1-OUT
005200	REF-N-SET
005500	ARIT1-OUT
005505	ARIT2-OUT
005550	ADD1-OUT
005600	RFG1-OUT
005610	SRFG1-OUT
005611	SRFG1-DIFF
005650	ASW1-OUT
005655	ASW2-OUT
005660	ASW3-OUT
005665	ASW4-OUT
005700	ANEG1-OUT
005705	ANEG2-OUT
005750	FIXSET1-OUT
005800	LIM1-OUT
005850	ABS1-OUT
005900	PT1-1-OUT
005950	DT1-1-OUT
006100	MFAIL-NOUT
006150	DB1-OUT
006200	CONV1-OUT
006205	CONV2-OUT
006210	CONV3-OUT
006215	CONV4-OUT
006230	CONVPHA1-OUT
006300	S&H1-OUT

Parameter	Analog output signal (O)
006350	CURVE1-OUT
006400	FCNT1-OUT
006600	SYNC1-OUT3
010000	BRK-M-SET
015028	UTILIZATION
015030	MCTRL-LOAD-I ² XT
019500	FCODE-17
019502	FCODE-26/1
019503	FCODE-26/2
019504	FCODE-27/1
019505	FCODE-27/2
019506	FCODE-32
019507	FCODE-37
019510	FCODE-108/1
019511	FCODE-108/2
019512	FCODE-109/1
019513	FCODE-109/2
019515	FCODE-141
019521	FCODE-472/1
019522	FCODE-472/2
019523	FCODE-472/3
019524	FCODE-472/4
019525	FCODE-472/5
019526	FCODE-472/6
019527	FCODE-472/7
019528	FCODE-472/8
019529	FCODE-472/9
019530	FCODE-472/10
019531	FCODE-472/11
019532	FCODE-472/12
019533	FCODE-472/13
019534	FCODE-472/14
019535	FCODE-472/15
019536	FCODE-472/16
019537	FCODE-472/17
019538	FCODE-472/18
019539	FCODE-472/19
019540	FCODE-472/20
019551	FCODE-473/1
019552	FCODE-473/2
019553	FCODE-473/3
019554	FCODE-473/4
019555	FCODE-473/5

8

Configuration

8.5

Selection lists

8.5.1

Selection list 1: Analog output signals

Parameter	Analog output signal (O)
019556	FCODE-473/6
019557	FCODE-473/7
019558	FCODE-473/8
019559	FCODE-473/9
019560	FCODE-473/10
020101	CAN-IN1.W1
020102	CAN-IN1.W2
020103	CAN-IN1.W3
020201	CAN-IN2.W1
020202	CAN-IN2.W2
020203	CAN-IN2.W3
020204	CAN-IN2.W4
020301	CAN-IN3.W1
020302	CAN-IN3.W2
020303	CAN-IN3.W3
020304	CAN-IN3.W4
025101	AIF-IN.W1
025102	AIF-IN.W2
025103	AIF-IN.W3

8.5.2 Selection list 2: Digital output signals

Parameter	Digital output signal (□)
000051	DIGIN1
000052	DIGIN2
000053	DIGIN3
000054	DIGIN4
000055	DIGIN5
000060	STATE-BUS-O
000065	DIGIN-CINH
000100	DFSET-ACK
000500	DCTRL-RDY
000501	DCTRL-CINH
000502	DCTRL-INIT
000503	DCTRL-IMP
000504	DCTRL-NACT=0
000505	DCTRL-CW/CCW
001000	FIXED0
001001	FIXED1
002000	DCTRL-PAR*1-O
002001	DCTRL-PAR*2-O
002002	DCTRL-PARBUSY
005001	MCTRL-QSP-OUT
005002	MCTRL-IMAX
005003	MCTRL-MMAX
005050	NSET-RFG-I=0
005200	REF-OK
005201	REF-BUSY
006000	DFRFG1-FAIL
006001	DFRFG1-SYNC
006100	MFAIL-STATUS
006101	MFAIL-I-RESET
006400	FCNT1-EQUAL
006600	SYNC1-STAT
010000	BRK1-OUT
010001	BRK1-CINH
010002	BRK1-QSP
010003	BRK1-M-STORE
010250	R/L/Q-QSP
010251	R/L/Q-R/L
010500	AND1-OUT
010505	AND2-OUT
010510	AND3-OUT
010515	AND4-OUT
010520	AND5-OUT
010525	AND6-OUT
010530	AND7-OUT

Parameter	Digital output signal (□)
010550	OR1-OUT
010555	OR2-OUT
010560	OR3-OUT
010565	OR4-OUT
010570	OR5-OUT
010600	NOT1-OUT
010605	NOT2-OUT
010610	NOT3-OUT
010615	NOT4-OUT
010620	NOT5-OUT
010650	CMP1-OUT
010655	CMP2-OUT
010660	CMP3-OUT
010680	PHCMP1-OUT
010685	PHCMP2-OUT
010690	PHCMP3-OUT
010700	DIGDEL1-OUT
010705	DIGDEL2-OUT
010750	TRANS1-OUT
010755	TRANS2-OUT
010760	TRANS3-OUT
010765	TRANS4-OUT
010900	FLIP1-OUT
010905	FLIP2-OUT
012000	PHINT1-FAIL
012005	PHINT2-FAIL
012010	PHINT3-STAT
013000	FEVAN1-BUSY
013001	FEVAN1-FAIL
013005	FEVAN2-BUSY
013006	FEVAN2-FAIL
014050	STORE1-TP-INH
014055	STORE2-TP-INH
015000	DCTRL-TRIP
015001	DCTRL-MESS
015002	DCTRL-WARN
015003	DCTRL-FAIL
015010	MONIT-LU
015011	MONIT-OU
015012	MONIT-EEr
015013	MONIT-OC1
015014	MONIT-OC2
015015	MONIT-LP1
015016	MONIT-OH

8

Configuration

8.5

Selection lists

8.5.2

Selection list 2: Digital output signals

Parameter	Digital output signal (□)
015017	MONIT-OH3
015018	MONIT-OH4
015019	MONIT-OH7
015020	MONIT-OH8
015021	MONIT-Sd2
015022	MONIT-Sd3
015023	MONIT-P03
015024	MONIT-P13
015026	MONIT-CE0
015027	MONIT-NMAX
015028	MONIT-OC5
015029	MONIT-SD5
015030	MONIT-SD6
015031	MONIT-SD7
015032	MONIT-H07
015033	MONIT-H10
015034	MONIT-H11
015040	MONIT-CE1
015041	MONIT-CE2
015042	MONIT-CE3
015043	MONIT-CE4
015044	MONIT-PL
015045	MONIT-P19
015047	MONIT-OC6
015048	MONIT-OC8
015320	MONIT-SD8
015321	MONIT-nErr
019500	FCODE-250
019521	FCODE-471.B0
019522	FCODE-471.B1
019523	FCODE-471.B2
019524	FCODE-471.B3
019525	FCODE-471.B4
019526	FCODE-471.B5
019527	FCODE-471.B6
019528	FCODE-471.B7
019529	FCODE-471.B8
019530	FCODE-471.B9
019531	FCODE-471.B10
019532	FCODE-471.B11
019533	FCODE-471.B12
019534	FCODE-471.B13
019535	FCODE-471.B14
019536	FCODE-471.B15
019537	FCODE-471.B16
019538	FCODE-471.B17
019539	FCODE-471.B18
019540	FCODE-471.B19

Parameter	Digital output signal (□)
019541	FCODE-471.B20
019542	FCODE-471.B21
019543	FCODE-471.B22
019544	FCODE-471.B23
019545	FCODE-471.B24
019546	FCODE-471.B25
019547	FCODE-471.B26
019548	FCODE-471.B27
019549	FCODE-471.B28
019550	FCODE-471.B29
019551	FCODE-471.B30
019552	FCODE-471.B31
019751	FCODE-135.B0
019752	FCODE-135.B1
019753	FCODE-135.B2
019755	FCODE-135.B4
019756	FCODE-135.B5
019757	FCODE-135.B6
019758	FCODE-135.B7
019763	FCODE-135.B12
019764	FCODE-135.B13
019765	FCODE-135.B14
019766	FCODE-135.B15
020001	CAN-CTRL.B0
020002	CAN-CTRL.B1
020003	CAN-CTRL.B2
020005	CAN-CTRL.B4
020006	CAN-CTRL.B5
020007	CAN-CTRL.B6
020008	CAN-CTRL.B7
020013	CAN-CTRL.B12
020014	CAN-CTRL.B13
020015	CAN-CTRL.B14
020016	CAN-CTRL.B15
020101	CAN-IN1.B0
020102	CAN-IN1.B1
020103	CAN-IN1.B2
020104	CAN-IN1.B3
020105	CAN-IN1.B4
020106	CAN-IN1.B5
020107	CAN-IN1.B6
020108	CAN-IN1.B7
020109	CAN-IN1.B8
020110	CAN-IN1.B9
020111	CAN-IN1.B10
020112	CAN-IN1.B11
020113	CAN-IN1.B12
020114	CAN-IN1.B13

Parameter	Digital output signal (□)
020115	CAN-IN1.B14
020116	CAN-IN1.B15
020117	CAN-IN1.B16
020118	CAN-IN1.B17
020119	CAN-IN1.B18
020120	CAN-IN1.B19
020121	CAN-IN1.B20
020122	CAN-IN1.B21
020123	CAN-IN1.B22
020124	CAN-IN1.B23
020125	CAN-IN1.B24
020126	CAN-IN1.B25
020127	CAN-IN1.B26
020128	CAN-IN1.B27
020129	CAN-IN1.B28
020130	CAN-IN1.B29
020131	CAN-IN1.B30
020132	CAN-IN1.B31
020201	CAN-IN2.B0
020202	CAN-IN2.B1
020203	CAN-IN2.B2
020204	CAN-IN2.B3
020205	CAN-IN2.B4
020206	CAN-IN2.B5
020207	CAN-IN2.B6
020208	CAN-IN2.B7
020209	CAN-IN2.B8
020210	CAN-IN2.B9
020211	CAN-IN2.B10
020212	CAN-IN2.B11
020213	CAN-IN2.B12
020214	CAN-IN2.B13
020215	CAN-IN2.B14
020216	CAN-IN2.B15
020217	CAN-IN2.B16
020218	CAN-IN2.B17
020219	CAN-IN2.B18
020220	CAN-IN2.B19
020221	CAN-IN2.B20
020222	CAN-IN2.B21
020223	CAN-IN2.B22
020224	CAN-IN2.B23
020225	CAN-IN2.B24
020226	CAN-IN2.B25
020227	CAN-IN2.B26
020228	CAN-IN2.B27
020229	CAN-IN2.B28
020230	CAN-IN2.B29

Parameter	Digital output signal (□)
020231	CAN-IN2.B30
020232	CAN-IN2.B31
020301	CAN-IN3.B0
020302	CAN-IN3.B1
020303	CAN-IN3.B2
020304	CAN-IN3.B3
020305	CAN-IN3.B4
020306	CAN-IN3.B5
020307	CAN-IN3.B6
020308	CAN-IN3.B7
020309	CAN-IN3.B8
020310	CAN-IN3.B9
020311	CAN-IN3.B10
020312	CAN-IN3.B11
020313	CAN-IN3.B12
020314	CAN-IN3.B13
020315	CAN-IN3.B14
020316	CAN-IN3.B15
020317	CAN-IN3.B16
020318	CAN-IN3.B17
020319	CAN-IN3.B18
020320	CAN-IN3.B19
020321	CAN-IN3.B20
020322	CAN-IN3.B21
020323	CAN-IN3.B22
020324	CAN-IN3.B23
020325	CAN-IN3.B24
020326	CAN-IN3.B25
020327	CAN-IN3.B26
020328	CAN-IN3.B27
020329	CAN-IN3.B28
020330	CAN-IN3.B29
020331	CAN-IN3.B30
020332	CAN-IN3.B31
025001	AIF-CTRL.B0
025002	AIF-CTRL.B1
025003	AIF-CTRL.B2
025005	AIF-CTRL.B4
025006	AIF-CTRL.B5
025007	AIF-CTRL.B6
025008	AIF-CTRL.B7
025013	AIF-CTRL.B12
025014	AIF-CTRL.B13
025015	AIF-CTRL.B14
025016	AIF-CTRL.B15
025101	AIF-IN.B0
025102	AIF-IN.B1
025103	AIF-IN.B2

8

Configuration

8.5

Selection lists

8.5.2

Selection list 2: Digital output signals

Parameter	Digital output signal (□)
025104	AIF-IN.B3
025105	AIF-IN.B4
025106	AIF-IN.B5
025107	AIF-IN.B6
025108	AIF-IN.B7
025109	AIF-IN.B8
025110	AIF-IN.B9
025111	AIF-IN.B10
025112	AIF-IN.B11
025113	AIF-IN.B12
025114	AIF-IN.B13
025115	AIF-IN.B14
025116	AIF-IN.B15
025117	AIF-IN.B16
025118	AIF-IN.B17
025119	AIF-IN.B18
025120	AIF-IN.B19
025121	AIF-IN.B20
025122	AIF-IN.B21
025123	AIF-IN.B22
025124	AIF-IN.B23
025125	AIF-IN.B24
025126	AIF-IN.B25
025127	AIF-IN.B26
025128	AIF-IN.B27
025129	AIF-IN.B28
025130	AIF-IN.B29
025131	AIF-IN.B30
025132	AIF-IN.B31

8.5.3 Selection list 3: Angle signals

Parameter	Angle signal (▲)
000100	DFSET-PSET
000101	DFSET-PSET2
001000	FIXED0INC
005000	MCTRL-PHI-ANG
005200	REF-PSET
005520	ARITPH1-OUT
005580	PHADD1-OUT
005581	PHADD1-OUT2
006235	CONVPHPH1-OUT
006600	SYNC1-OUT2
012000	PHINT1-OUT
012005	PHINT2-OUT
012010	PHINT3-OUT
012050	PHDIV1-OUT
014000	PHDIFF1-OUT
014050	STORE1-PHACT

Parameter	Angle signal (▲)
014051	STORE1-PH1
014052	STORE1-PH2
014053	STORE1-PHDIFF
014055	STORE2-PHACT
014056	STORE2-PH1
014057	STORE1-PH2
014100	GEARCOMP-OUT
019521	FCODE-474/1
019522	FCODE-474/2
019523	FCODE-474/3
019524	FCODE-474/4
019525	FCODE-474/5
020103	CAN-IN1.D1
020201	CAN-IN2.D1
020301	CAN-IN3.D1
025103	AIF-IN.D1
025104	AIF-IN.D2

8.5.4 Selection list 4: Speed signals

Parameter	Speed signal (Δ)
000050	DFIN-OUT
000100	DFSET-POUT
000250	DFOUT-OUT
001000	FIXEDPHI-0
005000	MCTRL-PHI-ACT
006000	DFRFG-OUT
006220	CONV5-OUT
006225	CONV6-OUT
006230	CONVPHA1-OUT2
006240	CONVPP1-OUT
006600	SYNC1-OUT1
019521	FCODE-475/1
019522	FCODE-475/2

8.5.5 Selection list 5: Function blocks

Parameter	Function block
000000	empty
000050	AIN1
000055	AIN2
000070	AOUT1
000075	AOUT2
000100	DFSET
000200	DFIN
000250	DFOUT
005050	NSET
005100	MPOT1
005150	PCTRL1
005200	REF
005500	ARIT1
005505	ARIT2
005520	ARITPH1
005550	ADD1
005580	PHADD1
005600	RFG1
005610	SRFG1
005650	ASW1
005655	ASW2
005660	ASW3
005665	ASW4
005700	ANEG1
005705	ANEG2
005750	FIXSET1
005800	LIM1
005850	ABS1
005900	PT1-1
005950	DT1-1
006000	DFRFG1
006100	MFAIL
006150	DB1

Parameter	Function block
006200	CONV1
006205	CONV2
006210	CONV3
006215	CONV4
006220	CONV5
006225	CONV6
006230	CONVPHA1
006235	CONVPHPH1
006240	CONVPP1
006300	S&H1
006350	CURVE1
006420	FCNT1
006600	SYNC1
010000	BRK1
010250	R/L/Q
010500	AND1
010505	AND2
010510	AND3
010515	AND4
010520	AND5
010525	AND6
010530	AND7
010550	OR1
010555	OR2
010560	OR3
010565	OR4
010570	OR5
010600	NOT1
010605	NOT2
010610	NOT3
010615	NOT4
010620	NOT5
010650	CMP1

Parameter	Function block
010655	CMP2
010660	CMP3
010680	PHCMP1
010685	PHCMP2
010690	PHCMP3
010700	DIGDEL1
010705	DIGDEL2
010750	TRANS1
010755	TRANS2
010760	TRANS3
010765	TRANS4
010900	FLIP1
010905	FLIP2
012000	PHINT1
012005	PHINT2
012010	PHINT3
012050	PHDIV1
013000	FEVAN1
013005	FEVAN2
013100	OSZ
014000	PHDIFF1
014050	STORE1
014055	STORE2
014100	GEARCOMP
015100	MLP1
020000	CAN-OUT
025000	AIF-OUT

8

Configuration

8.5

Selection lists

8.5.6

Selection list 10: Error messages

8.5.6 Selection list 10: Error messages

Parameter	Error message
00000	No fail
00011	OC1-TRIP
00012	OC2-TRIP
00015	OC5-TRIP
00016	OC6-TRIP
00018	OC8-TRIP
00022	LUQ-TRIP
00032	LP1-TRIP
00050	OH-TRIP
00053	OH3-TRIP
00057	OH7-TRIP
00058	OH8-TRIP
00061	CE0-TRIP
00062	CE1-TRIP
00063	CE2-TRIP
00064	CE3-TRIP
00065	CE4-TRIP
00070	U15-TRIP
00071	CCr-TRIP
00072	Pr1-TRIP
00073	Pr2-TRIP
00074	PEr-TRIP
00075	Pr0-TRIP
00077	Pr3-TRIP
00078	Pr4-TRIP
00079	PI-TRIP
00082	Sd2-TRIP
00083	Sd3-TRIP
00085	Sd5-TRIP
00086	Sd6-TRIP
00087	Sd7-TRIP
00088	Sd8-TRIP
00089	PL-TRIP
00091	EEr-TRIP
00105	H05-TRIP
00107	H07-TRIP
00110	H10-TRIP
00111	H11-TRIP
00153	P03-TRIP
00163	P13-TRIP
00166	P16-TRIP
00169	P19-TRIP
00190	nErr-TRIP
00200	NMAX-TRIP
01020	OU message

Parameter	Error message
01030	LU message
01091	EEr message
01190	nEEr message
02018	OC8 warning
02032	LP1 warning
02053	OH3 warning
02054	OH4 warning
02057	OH7 warning
02058	OH8 warning
02061	CEO warning
02062	CE1 warning
02063	CE2 warning
02064	CE3 warning
02065	CE4 warning
02082	Sd2 warning
02083	Sd3 warning
02085	Sd5 warning
02086	Sd6 warning
02091	EER warning
02153	P03 warning
02163	P13 warning
02166	P16 warning
02169	P19 warning
02190	nEEr warning

8.6 Table of attributes

The attribute table describes the properties of the codes used. It enables you to create your own communication programs for the controller.

How to read the table of attributes

Column		Abbreviation	Meaning	
Code		Cxxxx	Name of the Lenze code	
Index	dec	24575 - Lenze code number	Index under which the parameter is addressed	Is only required for control via INTERBUS, PROFIBUS DP or system bus (CAN)
	hex	5FFFh - Lenze code number	The subindex of array variables corresponds to the Lenze subcode number	
Data	DS	E	Data structure	Single variable (only one parameter element)
		A		Array variable (several parameter elements)
	DA	xx	Number of array elements (subcodes)	
	DT	B8	Data type	1 byte bit-coded
		B16		2 bytes bit-coded
		B32		4 bytes bit-coded
		FIX32		32-bit value with sign; decimal with four decimal places
		I32		4 bytes with sign
		U32		4 bytes without sign
	Format	VS	LECOM format (see also Operating Instructions of the bus module)	ASCII string
		VD		ASCII decimal format
		VH		ASCII hexadecimal format
		VO		Octet string format for data blocks
	DL		Data length in byte	The column "Important" contains further information
Access	LCM-R/W	Ra	Access authorisation for LECOM	Reading is always permitted
		Wa		Writing is always permitted
		W		Writing is restricted
	Condition	CINH	Condition for writing	Writing permitted only when controller is inhibited

Code	Index		Data					Access	
	dec	hex	DS	DA	DT	Format	DL	LCM-R/W	Condition
C0002	24573	5FFD	E	1	FIX32	VD	4	Ra/W	CINH
C0003	24572	5FFC	E	1	FIX32	VD	4	Ra/Wa	
C0004	24571	5FFB	E	1	FIX32	VD	4	Ra/Wa	
C0005	24570	5FFA	E	1	FIX32	VD	4	Ra/W	CINH
C0006	24569	5FF9	E	1	FIX32	VD	4	Ra/W	CINH
C0009	24566	5FF6	E	1	FIX32	VD	4	Ra/Wa	
C0011	24564	5FF4	E	1	FIX32	VD	4	Ra/Wa	
C0012	24563	5FF3	E	1	FIX32	VD	4	Ra/Wa	
C0013	24562	5FF2	E	1	FIX32	VD	4	Ra/Wa	
C0017	24558	5FEE	E	1	FIX32	VD	4	Ra/Wa	
C0018	24557	5FED	E	1	FIX32	VD	4	Ra/Wa	
C0019	24556	5FEC	E	1	FIX32	VD	4	Ra/Wa	
C0021	24554	5FEA	E	1	FIX32	VD	4	Ra/Wa	
C0022	24553	5FE9	E	1	FIX32	VD	4	Ra/Wa	
C0025	24550	5FE6	E	1	FIX32	VD	4	Ra/W	CINH
C0026	24549	5FE5	A	2	FIX32	VD	4	Ra/Wa	
C0027	24548	5FE4	A	2	FIX32	VD	4	Ra/Wa	
C0030	24545	5FE1	E	1	FIX32	VD	4	Ra/Wa	
C0032	24543	5FDF	E	1	FIX32	VD	4	Ra/Wa	
C0033	24542	5FDE	E	1	FIX32	VD	4	Ra/Wa	
C0034	24541	5FDD	E	1	FIX32	VD	4	Ra/Wa	
C0037	24538	5FDA	E	1	FIX32	VD	4	Ra/Wa	
C0039	24536	5FD8	A	15	FIX32	VD	4	Ra/Wa	
C0040	24535	5FD7	E	1	FIX32	VD	4	Ra/Wa	
C0042	24533	5FD5	E	1	FIX32	VD	4	Ra	
C0043	24532	5FD4	E	1	FIX32	VD	4	Ra/Wa	
C0045	24530	5FD2	E	1	FIX32	VD	4	Ra	
C0046	24529	5FD1	E	1	FIX32	VD	4	Ra	
C0049	24526	5FCE	E	1	FIX32	VD	4	Ra	
C0050	24525	5FCD	E	1	FIX32	VD	4	Ra	
C0051	24524	5FCC	E	1	FIX32	VD	4	Ra	
C0052	24523	5FCB	E	1	FIX32	VD	4	Ra	
C0053	24522	5FCA	E	1	FIX32	VD	4	Ra	
C0054	24521	5FC9	E	1	FIX32	VD	4	Ra	
C0056	24519	5FC7	E	1	FIX32	VD	4	Ra	
C0057	24518	5FC6	E	1	FIX32	VD	4	Ra	
C0058	24517	5FC5	E	1	FIX32	VD	4	Ra/Wa	
C0059	24516	5FC4	E	1	FIX32	VD	4	Ra	
C0060	24515	5FC3	E	1	FIX32	VD	4	Ra	
C0061	24514	5FC2	E	1	FIX32	VD	4	Ra	
C0063	24512	5FC0	E	1	FIX32	VD	4	Ra	
C0064	24511	5FBF	E	1	FIX32	VD	4	Ra	
C0066	24509	5FBD	E	1	FIX32	VD	4	Ra	
C0067	24508	5FBC	E	1	FIX32	VD	4	Ra	
C0070	24505	5FB9	E	1	FIX32	VD	4	Ra/Wa	
C0071	24504	5FB8	E	1	FIX32	VD	4	Ra/Wa	

Code	Index		Data					Access	
	dec	hex	DS	DA	DT	Format	DL	LCM-R/W	Condition
C0072	24503	5FB7	E	1	FIX32	VD	4	Ra/Wa	
C0075	24500	5FB4	E	1	FIX32	VD	4	Ra/Wa	
C0076	24499	5FB3	E	1	FIX32	VD	4	Ra/Wa	
C0077	24498	5FB2	E	1	FIX32	VD	4	Ra/Wa	
C0078	24497	5FB1	E	1	FIX32	VD	4	Ra/Wa	
C0081	24494	5FAE	E	1	FIX32	VD	4	Ra/W	CINH
C0084	24491	5FAB	E	1	FIX32	VD	4	Ra/W	CINH
C0085	24490	5FAA	E	1	FIX32	VD	4	Ra/W	CINH
C0086	24489	5FA9	E	1	FIX32	VD	4	Ra/W	CINH
C0087	24488	5FA8	E	1	FIX32	VD	4	Ra/W	CINH
C0088	24487	5FA7	E	1	FIX32	VD	4	Ra/W	CINH
C0089	24486	5FA6	E	1	FIX32	VD	4	Ra/W	CINH
C0090	24485	5FA5	E	1	FIX32	VD	4	Ra/W	CINH
C0091	24484	5FA4	E	1	FIX32	VD	4	Ra/W	CINH
C0093	24482	5FA2	E	1	FIX32	VD	4	Ra	
C0094	24481	5FA1	E	1	FIX32	VD	4	Ra/Wa	
C0095	24480	5FA0	E	1	FIX32	VD	4	Ra/W	CINH
C0096	24479	5F9F	A	2	FIX32	VD	4	Ra/Wa	
C0099	24476	5F9C	E	1	FIX32	VD	4	Ra	
C0101	24474	5F9A	A	15	FIX32	VD	4	Ra/Wa	
C0103	24472	5F98	A	15	FIX32	VD	4	Ra/Wa	
C0105	24470	5F96	E	1	FIX32	VD	4	Ra/Wa	
C0108	24467	5F93	A	2	FIX32	VD	4	Ra/Wa	
C0109	24466	5F92	A	2	FIX32	VD	4	Ra/Wa	
C0114	24461	5F8D	A	5	FIX32	VD	4	Ra/Wa	
C0116	24459	5F8B	A	32	FIX32	VD	4	Ra/W	CINH
C0117	24458	5F8A	A	4	FIX32	VD	4	Ra/W	CINH
C0118	24457	5F89	A	4	FIX32	VD	4	Ra/Wa	
C0120	24455	5F87	E	1	FIX32	VD	4	Ra/Wa	
C0121	24454	5F86	E	1	FIX32	VD	4	Ra/Wa	
C0122	24453	5F85	E	1	FIX32	VD	4	Ra/Wa	
C0125	24450	5F82	E	1	FIX32	VD	4	Ra/Wa	
C0126	24449	5F81	E	1	FIX32	VD	4	Ra/Wa	
C0127	24448	5F80	E	1	FIX32	VD	4	Ra/Wa	
C0128	24447	5F7F	E	1	FIX32	VD	4	Ra/Wa	
C0130	24445	5F7D	E	1	FIX32	VD	4	Ra	
C0134	24441	5F79	E	1	FIX32	VD	4	Ra/Wa	
C0135	24440	5F78	E	1	B16	VH	2		
C0136	24439	5F77	A	3	B16	VH	2	Ra	
C0141	24434	5F72	E	1	FIX32	VD	4	Ra/Wa	
C0142	24433	5F71	E	1	FIX32	VD	4	Ra/Wa	
C0150	24425	5F69	E	1	B16	VH	2	Ra	
C0151	24424	5F68	E	1	B32	VH	4	Ra	
C0155	24420	5F64	E	1	B16	VH	2	Ra	
C0156	24419	5F63	A	7	FIX32	VD	4	Ra/W	CINH
C0157	24418	5F62	A	7	FIX32	VD	4	Ra	
C0161	24414	5F5E	E	1	FIX32	VD	4	Ra	

8

Configuration

8.6

Table of attributes

Code	Index		Data					Access	
	dec	hex	DS	DA	DT	Format	DL	LCM-R/W	Condition
C0167	24408	5F58	E	1	FIX32	VD	4	Ra/Wa	
C0168	24407	5F57	A	8	FIX32	VD	4	Ra	
C0169	24406	5F56	A	8	U32	VH	4	Ra	
C0170	24405	5F55	A	8	FIX32	VD	4	Ra	
C0172	24403	5F53	E	1	FIX32	VD	4	Ra/Wa	
C0173	24402	5F52	E	1	FIX32	VD	4	Ra/Wa	
C0178	24397	5F4D	E	1	U32	VH	4	Ra	
C0179	24396	5F4C	E	1	U32	VH	4	Ra	
C0182	24393	5F49	E	1	FIX32	VD	4	Ra/Wa	
C0183	24392	5F48	E	1	FIX32	VD	4	Ra	
C0190	24385	5F41	E	1	FIX32	VD	4	Ra/Wa	
C0195	24380	5F3C	E	1	FIX32	VD	4	Ra/Wa	
C0196	24379	5F3B	E	1	FIX32	VD	4	Ra/Wa	
C0200	24375	5F37	E	1	VS	VS	14	Ra	
C0201	24374	5F36	E	1	VS	VS	20	Ra	
C0202	24373	5F35	E	1	FIX32	VD	4	Ra	
C0203	24372	5F34	E	1	VS	VS	12	Ra	
C0204	24371	5F33	E	1	FIX32	VD	4	Ra	
C0206	24369	5F31	E	1	VS	VS	13	Ra	
C0207	24368	5F30	E	1	VS	VS	14	Ra	
C0208	24367	5F2F	E	1	VS	VS	14	Ra	
C0209	24366	5F2E	E	1	VS	VS	14	Ra	
C0220	24355	5F23	E	1	FIX32	VD	4	Ra/Wa	
C0221	24354	5F22	E	1	FIX32	VD	4	Ra/Wa	
C0222	24353	5F21	E	1	FIX32	VD	4	Ra/Wa	
C0223	24352	5F20	E	1	FIX32	VD	4	Ra/Wa	
C0224	24351	5F1F	E	1	FIX32	VD	4	Ra/Wa	
C0241	24334	5F0E	E	1	FIX32	VD	4	Ra/Wa	
C0244	24331	5F0B	E	1	FIX32	VD	4	Ra/Wa	
C0250	24325	5F05	E	1	FIX32	VD	4	Ra/Wa	
C0252	24323	5F03	E	1	I32	VH	4	Ra/Wa	
C0253	24322	5F02	E	1	FIX32	VD	4	Ra/Wa	
C0254	24321	5F01	E	1	FIX32	VD	4	Ra/Wa	
C0255	24320	5F00	E	1	U32	VH	4	Ra/Wa	
C0260	24315	5EFB	E	1	FIX32	VD	4	Ra/Wa	
C0261	24314	5EFA	E	1	FIX32	VD	4	Ra/Wa	
C0262	24313	5EF9	E	1	FIX32	VD	4	Ra/Wa	
C0263	24312	5EF8	E	1	FIX32	VD	4	Ra/Wa	
C0264	24311	5EF7	E	1	FIX32	VD	4	Ra/Wa	
C0265	24310	5EF6	E	1	FIX32	VD	4	Ra/Wa	
C0267	24308	5EF4	A	2	FIX32	VD	4	Ra/W	CINH
C0268	24307	5EF3	E	1	FIX32	VD	4	Ra/W	CINH
C0269	24306	5EF2	A	3	FIX32	VD	4	Ra	
C0291	24284	5EDC	E	1	FIX32	VD	4	Ra/Wa	
C0292	24283	5EDB	E	1	FIX32	VD	4	Ra/Wa	
C0293	24282	5EDA	E	1	FIX32	VD	4	Ra/Wa	
C0294	24281	5ED9	E	1	FIX32	VD	4	Ra/Wa	

Code	Index		Data					Access	
	dec	hex	DS	DA	DT	Format	DL	LCM-R/W	Condition
C0295	24280	5ED8	E	1	FIX32	VD	4	Ra/Wa	
C0296	24279	5ED7	E	1	FIX32	VD	4	Ra/Wa	
C0325	24250	5EBA	E	1	FIX32	VD	4	Ra/Wa	
C0326	24249	5EB9	E	1	FIX32	VD	4	Ra/Wa	
C0327	24248	5EB8	E	1	FIX32	VD	4	Ra/Wa	
C0328	24247	5EB7	E	1	FIX32	VD	4	Ra/Wa	
C0329	24246	5EB6	E	1	FIX32	VD	4	Ra/Wa	
C0332	24243	5EB3	E	1	FIX32	VD	4	Ra/Wa	
C0333	24242	5EB2	E	1	FIX32	VD	4	Ra/Wa	
C0336	24239	5EAF	E	1	FIX32	VD	4	Ra	
C0337	24238	5EAE	E	1	FIX32	VD	4	Ra/Wa	
C0338	24237	5EAD	E	1	FIX32	VD	4	Ra/Wa	
C0339	24236	5EAC	A	2	FIX32	VD	4	Ra/W	CINH
C0340	24235	5EAB	A	2	FIX32	VD	4	Ra	
C0350	24225	5EA1	E	1	FIX32	VD	4	Ra/Wa	
C0351	24224	5EA0	E	1	FIX32	VD	4	Ra/Wa	
C0352	24223	5E9F	E	1	FIX32	VD	4	Ra/Wa	
C0353	24222	5E9E	A	3	FIX32	VD	4	Ra/Wa	
C0354	24221	5E9D	A	6	FIX32	VD	4	Ra/Wa	
C0355	24220	5E9C	A	6	FIX32	VD	4	Ra	
C0356	24219	5E9B	A	4	FIX32	VD	4	Ra/Wa	
C0357	24218	5E9A	A	3	FIX32	VD	4	Ra/Wa	
C0358	24217	5E99	E	1	FIX32	VD	4	Ra/Wa	
C0359	24216	5E98	E	1	FIX32	VD	4	Ra	
C0360	24215	5E97	A	12	FIX32	VD	4	Ra	
C0361	24214	5E96	A	12	FIX32	VD	4	Ra	
C0362	24213	5E95	E	1	FIX32	VD	4	Ra	
C0363	24212	5E94	E	1	FIX32	VD	4	Ra/Wa	
C0364	24211	5E93	E	1	FIX32	VD	4	Ra/W	CINH
C0365	24210	5E92	E	1	FIX32	VD	4	Ra	
C0366	24209	5E91	E	1	FIX32	VD	4	Ra/Wa	
C0367	24208	5E90	E	1	FIX32	VD	4	Ra/Wa	
C0368	24207	5E8F	E	1	FIX32	VD	4	Ra/Wa	
C0369	24206	5E8E	E	1	FIX32	VD	4	Ra/Wa	
C0400	24175	5E6F	E	1	FIX32	VD	4	Ra	
C0402	24173	5E6D	E	1	FIX32	VD	4	Ra/W	CINH
C0403	24172	5E6C	E	1	FIX32	VD	4	Ra/W	CINH
C0404	24171	5E6B	A	2	FIX32	VD	4	Ra	
C0405	24170	5E6A	E	1	FIX32	VD	4	Ra	
C0407	24168	5E68	E	1	FIX32	VD	4	Ra/W	CINH
C0408	24167	5E67	E	1	FIX32	VD	4	Ra/W	CINH
C0409	24166	5E66	A	2	FIX32	VD	4	Ra	
C0416	24159	5E5F	E	1	U32	VH	4	Ra/W	CINH
C0420	24155	5E5B	E	1	FIX32	VD	4	Ra/W	CINH
C0421	24154	5E5A	E	1	FIX32	VD	4	Ra/W	CINH
C0425	24150	5E56	E	1	FIX32	VD	4	Ra/Wa	
C0426	24149	5E55	E	1	FIX32	VD	4	Ra	

Code	Index		Data					Access	
	dec	hex	DS	DA	DT	Format	DL	LCM-R/W	Condition
C0427	24148	5E54	E	1	FIX32	VD	4	Ra/Wa	
C0429	24146	5E52	E	1	FIX32	VD	4	Ra/Wa	
C0431	24144	5E50	E	1	FIX32	VD	4	Ra/W	CINH
C0432	24143	5E4F	E	1	FIX32	VD	4	Ra/W	CINH
C0433	24142	5E4E	E	1	FIX32	VD	4	Ra/W	CINH
C0434	24141	5E4D	A	3	FIX32	VD	4	Ra	
C0436	24139	5E4B	E	1	FIX32	VD	4	Ra/W	CINH
C0437	24138	5E4A	E	1	FIX32	VD	4	Ra/W	CINH
C0438	24137	5E49	E	1	FIX32	VD	4	Ra/W	CINH
C0439	24136	5E48	A	3	FIX32	VD	4	Ra	
C0440	24135	5E47	E	1	FIX32	VD	4	Ra/W	CINH
C0441	24134	5E46	E	1	FIX32	VD	4	Ra	
C0443	24132	5E44	E	1	B8	VH	1	Ra	
C0444	24131	5E43	A	4	FIX32	VD	4	Ra	
C0450	24125	5E3D	E	1	FIX32	VD	4	Ra/W	CINH
C0451	24124	5E3C	E	1	FIX32	VD	4	Ra/W	CINH
C0452	24123	5E3B	E	1	FIX32	VD	4	Ra/W	CINH
C0458	24117	5E35	A	2	FIX32	VD	4	Ra	
C0459	24116	5E34	E	1	FIX32	VD	4	Ra	
C0464	24111	5E2F	E	1	FIX32	VD	4	Ra	
C0465	24110	5E2E	A	50	FIX32	VD	4	Ra/W	CINH
C0466	24109	5E2D	E	1	FIX32	VD	4	Ra	
C0469	24106	5E2A	E	1	FIX32	VD	4	Ra/W	CINH
C0470	24105	5E29	A	4	B8	VH	1	Ra/Wa	
C0471	24104	5E28	E	1	B32	VH	4	Ra/Wa	
C0472	24103	5E27	A	20	FIX32	VD	4	Ra/Wa	
C0473	24102	5E26	A	10	FIX32	VD	4	Ra/Wa	
C0474	24101	5E25	A	5	I32	VH	4	Ra/Wa	
C0475	24100	5E24	A	2	FIX32	VD	4	Ra/Wa	
C0490	24085	5E15	E	1	FIX32	VD	4	Ra/W	CINH
C0495	24080	5E10	E	1	FIX32	VD	4	Ra/W	CINH
C0497	24078	5E0E	E	1	FIX32	VD	4	Ra/Wa	
C0517	24058	5DFA	A	32	FIX32	VD	4	Ra/Wa	
C0520	24055	5DF7	E	1	FIX32	VD	4	Ra/W	CINH
C0521	24054	5DF6	E	1	FIX32	VD	4	Ra/W	CINH
C0522	24053	5DF5	E	1	FIX32	VD	4	Ra/W	CINH
C0523	24052	5DF4	E	1	FIX32	VD	4	Ra/W	CINH
C0524	24051	5DF3	E	1	FIX32	VD	4	Ra/W	CINH
C0525	24050	5DF2	E	1	FIX32	VD	4	Ra/W	CINH
C0526	24049	5DF1	E	1	FIX32	VD	4	Ra/W	CINH
C0527	24048	5DF0	E	1	FIX32	VD	4	Ra/W	CINH
C0528	24047	5DEF	A	4	I32	VH	4	Ra	
C0529	24046	5DEE	E	1	FIX32	VD	4	Ra/Wa	
C0530	24045	5DED	E	1	FIX32	VD	4	Ra/Wa	
C0531	24044	5DEC	E	1	FIX32	VD	4	Ra/Wa	
C0532	24043	5DEB	E	1	FIX32	VD	4	Ra/Wa	
C0533	24042	5DEA	E	1	FIX32	VD	4	Ra/Wa	

Code	Index		Data					Access	
	dec	hex	DS	DA	DT	Format	DL	LCM-R/W	Condition
C0534	24041	5DE9	E	1	FIX32	VD	4	Ra/Wa	
C0535	24040	5DE8	E	1	FIX32	VD	4	Ra/Wa	
C0536	24039	5DE7	A	3	FIX32	VD	4	Ra	
C0537	24038	5DE6	E	1	FIX32	VD	4	Ra	
C0538	24037	5DE5	A	3	FIX32	VD	4	Ra	
C0539	24036	5DE4	E	1	FIX32	VD	4	Ra	
C0540	24035	5DE3	E	1	FIX32	VD	4	Ra/Wa	
C0541	24034	5DE2	E	1	FIX32	VD	4	Ra/W	CINH
C0542	24033	5DE1	E	1	FIX32	VD	4	Ra/W	CINH
C0544	24031	5DDF	E	1	FIX32	VD	4	Ra/W	CINH
C0545	24030	5DDE	E	1	FIX32	VD	4	Ra/Wa	
C0546	24029	5DDD	E	1	U32	VH	4	Ra/Wa	
C0547	24028	5DDC	E	1	FIX32	VD	4	Ra	
C0548	24027	5DDB	E	1	FIX32	VD	4	Ra	
C0549	24026	5DDA	E	1	FIX32	VD	4	Ra	
C0551	24024	5DD8	E	1	U32	VH	4	Ra/Wa	
C0560	24015	5DCF	A	15	FIX32	VD	4	Ra/Wa	
C0561	24014	5DCE	E	1	FIX32	VD	4	Ra/W	CINH
C0562	24013	5DCD	A	4	FIX32	VD	4	Ra/W	CINH
C0563	24012	5DCC	E	1	FIX32	VD	4	Ra	
C0564	24011	5DCB	A	4	FIX32	VD	4	Ra	
C0570	24005	5DC5	E	1	FIX32	VD	4	Ra/W	CINH
C0571	24004	5DC4	E	1	FIX32	VD	4	Ra/W	CINH
C0572	24003	5DC3	E	1	FIX32	VD	4	Ra	
C0573	24002	5DC2	E	1	FIX32	VD	4	Ra	
C0575	24000	5DC0	E	1	FIX32	VD	4	Ra/Wa	
C0577	23998	5DBE	E	1	FIX32	VD	4	Ra/Wa	
C0578	23997	5DBD	E	1	FIX32	VD	4	Ra/Wa	
C0581	23994	5DBA	E	1	FIX32	VD	4	Ra/Wa	
C0582	23993	5DB9	E	1	FIX32	VD	4	Ra/Wa	
C0583	23992	5DB8	E	1	FIX32	VD	4	Ra/Wa	
C0584	23991	5DB7	E	1	FIX32	VD	4	Ra/Wa	
C0585	23990	5DB6	E	1	FIX32	VD	4	Ra/Wa	
C0586	23989	5DB5	E	1	FIX32	VD	4	Ra/Wa	
C0587	23988	5DB4	E	1	FIX32	VD	4	Ra/Wa	
C0588	23987	5DB3	E	1	FIX32	VD	4	Ra/Wa	
C0589	23986	5DB2	E	1	FIX32	VD	4	Ra/Wa	
C0590	23985	5DB1	E	1	FIX32	VD	4	Ra/Wa	
C0591	23984	5DB0	E	1	FIX32	VD	4	Ra/Wa	
C0592	23983	5DAF	E	1	FIX32	VD	4	Ra/Wa	
C0593	23982	5DAE	E	1	FIX32	VD	4	Ra/Wa	
C0594	23981	5DAD	E	1	FIX32	VD	4	Ra/Wa	
C0595	23980	5DAC	E	1	FIX32	VD	4	Ra/Wa	
C0596	23979	5DAB	E	1	FIX32	VD	4	Ra/Wa	
C0597	23978	5DAA	E	1	FIX32	VD	4	Ra/Wa	
C0598	23977	5DA9	E	1	FIX32	VD	4	Ra/Wa	
C0599	23976	5DA8	E	1	FIX32	VD	4	Ra/Wa	

Code	Index		Data					Access	
	dec	hex	DS	DA	DT	Format	DL	LCM-R/W	Condition
C0600	23975	5DA7	E	1	FIX32	VD	4	Ra/Wa	
C0601	23974	5DA6	A	2	FIX32	VD	4	Ra/W	CINH
C0602	23973	5DA5	A	2	FIX32	VD	4	Ra	
C0606	23969	5DA1	E	1	FIX32	VD	4	Ra/Wa	
C0610	23965	5D9D	A	3	FIX32	VD	4	Ra/W	CINH
C0611	23964	5D9C	A	3	FIX32	VD	4	Ra	
C0620	23955	5D93	E	1	FIX32	VD	4	Ra/Wa	
C0621	23954	5D92	E	1	FIX32	VD	4	Ra/Wa	
C0622	23953	5D91	E	1	FIX32	VD	4	Ra/W	CINH
C0623	23952	5D90	E	1	FIX32	VD	4	Ra	
C0630	23945	5D89	E	1	FIX32	VD	4	Ra/Wa	
C0631	23944	5D88	E	1	FIX32	VD	4	Ra/Wa	
C0632	23943	5D87	E	1	FIX32	VD	4	Ra/W	CINH
C0633	23942	5D86	E	1	FIX32	VD	4	Ra	
C0640	23935	5D7F	E	1	FIX32	VD	4	Ra/Wa	
C0641	23934	5D7E	E	1	FIX32	VD	4	Ra/W	CINH
C0642	23933	5D7D	E	1	FIX32	VD	4	Ra	
C0650	23925	5D75	E	1	FIX32	VD	4	Ra/Wa	
C0651	23924	5D74	E	1	FIX32	VD	4	Ra/Wa	
C0652	23923	5D73	E	1	FIX32	VD	4	Ra/W	CINH
C0653	23922	5D72	E	1	FIX32	VD	4	Ra/Wa	
C0654	23921	5D71	E	1	FIX32	VD	4	Ra	
C0655	23920	5D70	E	1	FIX32	VD	4	Ra/Wa	
C0656	23919	5D6F	E	1	FIX32	VD	4	Ra/Wa	
C0657	23918	5D6E	E	1	FIX32	VD	4	Ra/W	CINH
C0658	23917	5D6D	E	1	FIX32	VD	4	Ra	
C0661	23914	5D6A	E	1	FIX32	VD	4	Ra/W	CINH
C0662	23913	5D69	E	1	FIX32	VD	4	Ra	
C0671	23904	5D60	E	1	FIX32	VD	4	Ra/Wa	
C0672	23903	5D5F	E	1	FIX32	VD	4	Ra/Wa	
C0673	23902	5D5E	E	1	FIX32	VD	4	Ra/W	CINH
C0674	23901	5D5D	E	1	FIX32	VD	4	Ra/W	CINH
C0675	23900	5D5C	E	1	FIX32	VD	4	Ra/W	CINH
C0676	23899	5D5B	A	2	FIX32	VD	4	Ra	
C0677	23898	5D5A	E	1	FIX32	VD	4	Ra	
C0680	23895	5D57	E	1	FIX32	VD	4	Ra/Wa	
C0681	23894	5D56	E	1	FIX32	VD	4	Ra/Wa	
C0682	23893	5D55	E	1	FIX32	VD	4	Ra/Wa	
C0683	23892	5D54	A	2	FIX32	VD	4	Ra/W	CINH
C0684	23891	5D53	A	2	FIX32	VD	4	Ra	
C0685	23890	5D52	E	1	FIX32	VD	4	Ra/Wa	
C0686	23889	5D51	E	1	FIX32	VD	4	Ra/Wa	
C0687	23888	5D50	E	1	FIX32	VD	4	Ra/Wa	
C0688	23887	5D4F	A	2	FIX32	VD	4	Ra/W	CINH
C0689	23886	5D4E	A	2	FIX32	VD	4	Ra	
C0690	23885	5D4D	E	1	FIX32	VD	4	Ra/Wa	
C0691	23884	5D4C	E	1	FIX32	VD	4	Ra/Wa	

Code	Index		Data					Access	
	dec	hex	DS	DA	DT	Format	DL	LCM-R/W	Condition
C0692	23883	5D4B	E	1	FIX32	VD	4	Ra/Wa	
C0693	23882	5D4A	A	2	FIX32	VD	4	Ra/W	CINH
C0694	23881	5D49	A	2	FIX32	VD	4	Ra	
C0695	23880	5D48	E	1	FIX32	VD	4	Ra/Wa	
C0697	23878	5D46	A	2	FIX32	VD	4	Ra/W	CINH
C0698	23877	5D45	A	2	I32	VH	4	Ra	
C0700	23875	5D43	E	1	FIX32	VD	4	Ra/W	CINH
C0701	23874	5D42	E	1	FIX32	VD	4	Ra	
C0703	23872	5D40	E	1	FIX32	VD	4	Ra/W	CINH
C0704	23871	5D3F	E	1	FIX32	VD	4	Ra	
C0710	23865	5D39	E	1	FIX32	VD	4	Ra/Wa	
C0711	23864	5D38	E	1	FIX32	VD	4	Ra/Wa	
C0713	23862	5D36	E	1	FIX32	VD	4	Ra/W	CINH
C0714	23861	5D35	E	1	FIX32	VD	4	Ra	
C0715	23860	5D34	E	1	FIX32	VD	4	Ra/Wa	
C0716	23859	5D33	E	1	FIX32	VD	4	Ra/Wa	
C0718	23857	5D31	E	1	FIX32	VD	4	Ra/W	CINH
C0719	23856	5D30	E	1	FIX32	VD	4	Ra	
C0720	23855	5D2F	E	1	FIX32	VD	4	Ra/Wa	
C0721	23854	5D2E	E	1	FIX32	VD	4	Ra/Wa	
C0723	23852	5D2C	E	1	FIX32	VD	4	Ra/W	CINH
C0724	23851	5D2B	E	1	FIX32	VD	4	Ra	
C0725	23850	5D2A	E	1	FIX32	VD	4	Ra/Wa	
C0726	23849	5D29	E	1	FIX32	VD	4	Ra/Wa	
C0728	23847	5D27	E	1	FIX32	VD	4	Ra/W	CINH
C0729	23846	5D26	E	1	FIX32	VD	4	Ra	
C0750	23825	5D11	E	1	FIX32	VD	4	Ra/Wa	
C0751	23824	5D10	E	1	FIX32	VD	4	Ra/Wa	
C0752	23823	5D0F	E	1	FIX32	VD	4	Ra/Wa	
C0753	23822	5D0E	E	1	FIX32	VD	4	Ra/Wa	
C0754	23821	5D0D	E	1	U32	VH	4	Ra/Wa	
C0755	23820	5D0C	E	1	FIX32	VD	4	Ra/Wa	
C0756	23819	5D0B	E	1	I32	VH	4	Ra/Wa	
C0757	23818	5D0A	E	1	FIX32	VD	4	Ra/Wa	
C0758	23817	5D09	E	1	FIX32	VD	4	Ra/W	CINH
C0759	23816	5D08	E	1	FIX32	VD	4	Ra/W	CINH
C0760	23815	5D07	E	1	FIX32	VD	4	Ra/W	CINH
C0761	23814	5D06	E	1	FIX32	VD	4	Ra/W	CINH
C0764	23811	5D03	A	3	FIX32	VD	4	Ra	
C0765	23810	5D02	E	1	FIX32	VD	4	Ra	
C0766	23809	5D01	E	1	FIX32	VD	4	Ra/Wa	
C0770	23805	5CFD	E	1	FIX32	VD	4	Ra/W	CINH
C0771	23804	5CFC	E	1	FIX32	VD	4	Ra/W	CINH
C0772	23803	5CFB	E	1	FIX32	VD	4	Ra/W	CINH
C0773	23802	5CFA	A	3	FIX32	VD	4	Ra	
C0775	23800	5CF8	E	1	FIX32	VD	4	Ra/W	CINH
C0776	23799	5CF7	E	1	FIX32	VD	4	Ra/W	CINH

Code	Index		Data					Access	
	dec	hex	DS	DA	DT	Format	DL	LCM-R/W	Condition
C0777	23798	5CF6	E	1	FIX32	VD	4	Ra/W	CINH
C0778	23797	5CF5	A	3	FIX32	VD	4	Ra	
C0780	23795	5CF3	E	1	FIX32	VD	4	Ra/W	CINH
C0781	23794	5CF2	E	1	FIX32	VD	4	Ra/W	CINH
C0782	23793	5CF1	E	1	FIX32	VD	4	Ra/W	CINH
C0783	23792	5CF0	E	1	FIX32	VD	4	Ra/W	CINH
C0784	23791	5CEF	E	1	FIX32	VD	4	Ra/W	CINH
C0785	23790	5CEE	E	1	FIX32	VD	4	Ra/W	CINH
C0786	23789	5CED	E	1	FIX32	VD	4	Ra/W	CINH
C0787	23788	5CEC	A	4	FIX32	VD	4	Ra/W	CINH
C0788	23787	5CEB	A	4	FIX32	VD	4	Ra/W	CINH
C0789	23786	5CEA	E	1	FIX32	VD	4	Ra/W	CINH
C0790	23785	5CE9	E	1	FIX32	VD	4	Ra/W	CINH
C0798	23777	5CE1	A	2	FIX32	VD	4	Ra	
C0799	23776	5CE0	A	13	FIX32	VD	4	Ra	
C0800	23775	5CDF	E	1	FIX32	VD	4	Ra/W	CINH
C0801	23774	5CDE	E	1	FIX32	VD	4	Ra/W	CINH
C0802	23773	5CDD	E	1	FIX32	VD	4	Ra/W	CINH
C0803	23772	5CDC	E	1	FIX32	VD	4	Ra/W	CINH
C0804	23771	5CDB	E	1	FIX32	VD	4	Ra/W	CINH
C0805	23770	5CDA	E	1	FIX32	VD	4	Ra/W	CINH
C0808	23767	5CD7	A	4	FIX32	VD	4	Ra	
C0809	23766	5CD6	A	2	FIX32	VD	4	Ra	
C0810	23765	5CD5	A	2	FIX32	VD	4	Ra/W	CINH
C0811	23764	5CD4	E	1	FIX32	VD	4	Ra/W	CINH
C0812	23763	5CD3	A	2	FIX32	VD	4	Ra	
C0813	23762	5CD2	E	1	FIX32	VD	4	Ra	
C0815	23760	5CD0	A	2	FIX32	VD	4	Ra/W	CINH
C0816	23759	5CCF	E	1	FIX32	VD	4	Ra/W	CINH
C0817	23758	5CCE	A	2	FIX32	VD	4	Ra	
C0818	23757	5CCD	E	1	FIX32	VD	4	Ra	
C0820	23755	5CCB	A	3	FIX32	VD	4	Ra/W	CINH
C0821	23754	5CCA	A	3	FIX32	VD	4	Ra	
C0822	23753	5CC9	A	3	FIX32	VD	4	Ra/W	CINH
C0823	23752	5CC8	A	3	FIX32	VD	4	Ra	
C0824	23751	5CC7	A	3	FIX32	VD	4	Ra/W	CINH
C0825	23750	5CC6	A	3	FIX32	VD	4	Ra	
C0826	23749	5CC5	A	3	FIX32	VD	4	Ra/W	CINH
C0827	23748	5CC4	A	3	FIX32	VD	4	Ra	
C0828	23747	5CC3	A	3	FIX32	VD	4	Ra/W	CINH
C0829	23746	5CC2	A	3	FIX32	VD	4	Ra	
C0830	23745	5CC1	A	3	FIX32	VD	4	Ra/W	CINH
C0831	23744	5CC0	A	3	FIX32	VD	4	Ra	
C0832	23743	5CBF	A	3	FIX32	VD	4	Ra/W	CINH
C0833	23742	5CBE	A	3	FIX32	VD	4	Ra	
C0834	23741	5CBD	A	3	FIX32	VD	4	Ra/W	CINH
C0835	23740	5CBC	A	3	FIX32	VD	4	Ra	

Code	Index		Data					Access	
	dec	hex	DS	DA	DT	Format	DL	LCM-R/W	Condition
C0836	23739	5CBB	A	3	FIX32	VD	4	Ra/W	CINH
C0837	23738	5CBA	A	3	FIX32	VD	4	Ra	
C0838	23737	5CB9	A	3	FIX32	VD	4	Ra/W	CINH
C0839	23736	5CB8	A	3	FIX32	VD	4	Ra	
C0840	23735	5CB7	E	1	FIX32	VD	4	Ra/W	CINH
C0841	23734	5CB6	E	1	FIX32	VD	4	Ra	
C0842	23733	5CB5	E	1	FIX32	VD	4	Ra/W	CINH
C0843	23732	5CB4	E	1	FIX32	VD	4	Ra	
C0844	23731	5CB3	E	1	FIX32	VD	4	Ra/W	CINH
C0845	23730	5CB2	E	1	FIX32	VD	4	Ra	
C0846	23729	5CB1	E	1	FIX32	VD	4	Ra/W	CINH
C0847	23728	5CB0	E	1	FIX32	VD	4	Ra	
C0848	23727	5CAF	E	1	FIX32	VD	4	Ra/W	CINH
C0849	23726	5CAE	E	1	FIX32	VD	4	Ra	
C0850	23725	5CAD	A	3	FIX32	VD	4	Ra/W	CINH
C0851	23724	5CAC	E	1	FIX32	VD	4	Ra/W	CINH
C0852	23723	5CAB	E	1	FIX32	VD	4	Ra/Wa	
C0853	23722	5CAA	E	1	FIX32	VD	4	Ra/Wa	
C0854	23721	5CA9	E	1	FIX32	VD	4	Ra/Wa	
C0855	23720	5CA8	A	2	B16	VH	2	Ra	
C0856	23719	5CA7	A	3	I32	VH	4	Ra	
C0857	23718	5CA6	E	1	I32	VH	4	Ra	
C0858	23717	5CA5	A	3	I32	VH	4	Ra	
C0859	23716	5CA4	E	1	I32	VH	4	Ra	
C0860	23715	5CA3	A	11	FIX32	VD	4	Ra/W	CINH
C0861	23714	5CA2	A	3	FIX32	VD	4	Ra/W	CINH
C0863	23712	5CA0	A	6	B16	VH	2	Ra	
C0864	23711	5C9F	A	3	FIX32	VD	4	Ra/Wa	
C0865	23710	5C9E	A	3	FIX32	VD	4	Ra/Wa	
C0866	23709	5C9D	A	11	FIX32	VD	4	Ra	
C0867	23708	5C9C	A	3	I32	VH	4	Ra	
C0868	23707	5C9B	A	11	FIX32	VD	4	Ra	
C0869	23706	5C9A	A	3	I32	VH	4	Ra	
C0870	23705	5C99	A	2	FIX32	VD	4	Ra/W	CINH
C0871	23704	5C98	E	1	FIX32	VD	4	Ra/W	CINH
C0876	23699	5C93	E	1	FIX32	VD	4	Ra/W	CINH
C0878	23697	5C91	A	4	FIX32	VD	4	Ra	
C0879	23696	5C90	A	3	FIX32	VD	4	Ra/Wa	
C0880	23695	5C8F	A	2	FIX32	VD	4	Ra/W	CINH
C0881	23694	5C8E	E	1	FIX32	VD	4	Ra/W	CINH
C0884	23691	5C8B	A	3	FIX32	VD	4	Ra	
C0885	23690	5C8A	E	1	FIX32	VD	4	Ra/W	CINH
C0886	23689	5C89	E	1	FIX32	VD	4	Ra/W	CINH
C0889	23686	5C86	A	2	FIX32	VD	4	Ra	
C0890	23685	5C85	E	1	FIX32	VD	4	Ra/W	CINH
C0891	23684	5C84	E	1	FIX32	VD	4	Ra/W	CINH
C0892	23683	5C83	E	1	FIX32	VD	4	Ra/W	CINH

Code	Index		Data					Access	
	dec	hex	DS	DA	DT	Format	DL	LCM-R/W	Condition
C0893	23682	5C82	E	1	FIX32	VD	4	Ra/W	CINH
C0894	23681	5C81	E	1	FIX32	VD	4	Ra/W	CINH
C0895	23680	5C80	E	1	FIX32	VD	4	Ra/W	CINH
C0896	23679	5C7F	E	1	FIX32	VD	4	Ra/W	CINH
C0897	23678	5C7E	E	1	FIX32	VD	4	Ra/W	CINH
C0898	23677	5C7D	E	1	FIX32	VD	4	Ra/W	CINH
C0899	23676	5C7C	E	1	FIX32	VD	4	Ra/W	CINH
C0900	23675	5C7B	E	1	FIX32	VD	4	Ra/W	CINH
C0901	23674	5C7A	E	1	FIX32	VD	4	Ra/W	CINH
C0902	23673	5C79	E	1	FIX32	VD	4	Ra/W	CINH
C0903	23672	5C78	E	1	FIX32	VD	4	Ra/W	CINH
C0906	23669	5C75	A	9	FIX32	VD	4	Ra	
C0907	23668	5C74	A	4	FIX32	VD	4	Ra	
C0908	23667	5C73	E	1	I32	VH	4	Ra	
C0909	23666	5C72	E	1	FIX32	VD	4	Ra/Wa	
C0920	23655	5C67	E	1	FIX32	VD	4	Ra/W	CINH
C0921	23654	5C66	E	1	FIX32	VD	4	Ra/W	CINH
C0922	23653	5C65	E	1	FIX32	VD	4	Ra/W	CINH
C0923	23652	5C64	E	1	FIX32	VD	4	Ra/W	CINH
C0924	23651	5C63	E	1	FIX32	VD	4	Ra/W	CINH
C0925	23650	5C62	E	1	FIX32	VD	4	Ra/W	CINH
C0926	23649	5C61	A	4	I32	VH	4	Ra	
C0927	23648	5C60	A	3	FIX32	VD	4	Ra	
C0928	23647	5C5F	E	1	I32	VH	4	Ra	
C0929	23646	5C5E	E	1	FIX32	VD	4	Ra	
C0930	23645	5C5D	E	1	FIX32	VD	4	Ra/W	CINH
C0931	23644	5C5C	E	1	FIX32	VD	4	Ra/W	CINH
C0932	23643	5C5B	E	1	FIX32	VD	4	Ra/Wa	
C0933	23642	5C5A	E	1	FIX32	VD	4	Ra/Wa	
C0934	23641	5C59	E	1	I32	VH	4	Ra/Wa	
C0935	23640	5C58	E	1	FIX32	VD	4	Ra/Wa	
C0936	23639	5C57	E	1	FIX32	VD	4	Ra/Wa	
C0940	23635	5C53	E	1	FIX32	VD	4	Ra/Wa	
C0941	23634	5C52	E	1	FIX32	VD	4	Ra/Wa	
C0942	23633	5C51	E	1	FIX32	VD	4	Ra/W	CINH
C0943	23632	5C50	E	1	FIX32	VD	4	Ra	
C0945	23630	5C4E	E	1	FIX32	VD	4	Ra/Wa	
C0946	23629	5C4D	E	1	FIX32	VD	4	Ra/Wa	
C0947	23628	5C4C	E	1	FIX32	VD	4	Ra/W	CINH
C0948	23627	5C4B	E	1	FIX32	VD	4	Ra	
C0950	23625	5C49	E	1	FIX32	VD	4	Ra/Wa	
C0951	23624	5C48	E	1	FIX32	VD	4	Ra/Wa	
C0952	23623	5C47	E	1	FIX32	VD	4	Ra/W	CINH
C0953	23622	5C46	E	1	FIX32	VD	4	Ra	
C0955	23620	5C44	E	1	FIX32	VD	4	Ra/Wa	
C0956	23619	5C43	E	1	FIX32	VD	4	Ra/Wa	
C0957	23618	5C42	E	1	FIX32	VD	4	Ra/W	CINH

Code	Index		Data					Access	
	dec	hex	DS	DA	DT	Format	DL	LCM-R/W	Condition
C0958	23617	5C41	E	1	FIX32	VD	4	Ra	
C0960	23615	5C3F	E	1	FIX32	VD	4	Ra/Wa	
C0961	23614	5C3E	E	1	FIX32	VD	4	Ra/Wa	
C0962	23613	5C3D	E	1	FIX32	VD	4	Ra/Wa	
C0963	23612	5C3C	E	1	FIX32	VD	4	Ra/Wa	
C0964	23611	5C3B	E	1	FIX32	VD	4	Ra/Wa	
C0965	23610	5C3A	E	1	FIX32	VD	4	Ra/Wa	
C0966	23609	5C39	E	1	FIX32	VD	4	Ra/Wa	
C0967	23608	5C38	E	1	FIX32	VD	4	Ra/W	CINH
C0968	23607	5C37	E	1	FIX32	VD	4	Ra	
C0970	23605	5C35	E	1	FIX32	VD	4	Ra/W	CINH
C0971	23604	5C34	E	1	FIX32	VD	4	Ra/W	CINH
C0972	23603	5C33	E	1	FIX32	VD	4	Ra/W	CINH
C0973	23602	5C32	E	1	FIX32	VD	4	Ra/W	CINH
C0974	23601	5C31	E	1	FIX32	VD	4	Ra/W	CINH
C0975	23600	5C30	E	1	FIX32	VD	4	Ra/W	CINH
C0976	23599	5C2F	E	1	FIX32	VD	4	Ra/W	CINH
C0977	23598	5C2E	E	1	FIX32	VD	4	Ra/W	CINH
C0978	23597	5C2D	E	1	FIX32	VD	4	Ra/W	CINH
C0980	23595	5C2B	E	1	FIX32	VD	4	Ra/Wa	
C0981	23594	5C2A	E	1	FIX32	VD	4	Ra/Wa	
C0982	23593	5C29	E	1	FIX32	VD	4	Ra/Wa	
C0983	23592	5C28	E	1	FIX32	VD	4	Ra/Wa	
C0988	23587	5C23	A	7	FIX32	VD	4	Ra	
C0989	23586	5C22	A	2	FIX32	VD	4	Ra	
C0990	23585	5C21	E	1	FIX32	VD	4	Ra/W	CINH
C0991	23584	5C20	E	1	FIX32	VD	4	Ra/W	CINH
C0992	23583	5C1F	E	1	FIX32	VD	4	Ra	
C0993	23582	5C1E	E	1	FIX32	VD	4	Ra	
C0995	23580	5C1C	E	1	FIX32	VD	4	Ra/Wa	
C0996	23579	5C1B	E	1	FIX32	VD	4	Ra/W	CINH
C0997	23578	5C1A	E	1	I32	VH	4	Ra	
C1000	23575	5C17	E	1	FIX32	VD	4	Ra/Wa	
C1001	23574	5C16	E	1	FIX32	VD	4	Ra/W	CINH
C1002	23573	5C15	E	1	I32	VH	4	Ra	
C1010	23565	5C0D	E	1	FIX32	VD	4	Ra/Wa	
C1011	23564	5C0C	A	2	FIX32	VD	4	Ra/W	CINH
C1012	23563	5C0B	A	2	I32	VH	4	Ra	
C1030	23545	5BF9	E	1	FIX32	VD	4	Ra/W	CINH
C1031	23544	5BF8	E	1	FIX32	VD	4	Ra/W	CINH
C1032	23543	5BF7	E	1	FIX32	VD	4	Ra	
C1033	23542	5BF6	E	1	FIX32	VD	4	Ra	
C1040	23535	5BEF	E	1	FIX32	VD	4	Ra/Wa	
C1041	23534	5BEE	E	1	FIX32	VD	4	Ra/Wa	
C1042	23533	5BED	E	1	FIX32	VD	4	Ra/W	CINH
C1043	23532	5BEC	E	1	FIX32	VD	4	Ra/W	CINH
C1044	23531	5BEB	E	1	FIX32	VD	4	Ra/W	CINH

Code	Index		Data					Access	
	dec	hex	DS	DA	DT	Format	DL	LCM-R/W	Condition
C1045	23530	5BEA	A	2	FIX32	VD	4	Ra	
C1046	23529	5BE9	E	1	FIX32	VD	4	Ra	
C1090	23485	5BBD	E	1	I32	VH	4	Ra	
C1091	23484	5BBC	E	1	FIX32	VD	4	Ra/Wa	
C1092	23483	5BBB	E	1	FIX32	VD	4	Ra/Wa	
C1093	23482	5BBA	E	1	FIX32	VD	4	Ra/Wa	
C1094	23481	5BB9	E	1	FIX32	VD	4	Ra/Wa	
C1095	23480	5BB8	E	1	I32	VH	4	Ra/Wa	
C1096	23479	5BB7	E	1	FIX32	VD	4	Ra/W	CINH
C1097	23478	5BB6	E	1	FIX32	VD	4	Ra/W	CINH
C1098	23477	5BB5	E	1	FIX32	VD	4	Ra	
C1099	23476	5BB4	E	1	FIX32	VD	4	Ra	
C1100	23475	5BB3	E	1	FIX32	VD	4	Ra/Wa	
C1101	23474	5BB2	A	2	FIX32	VD	4	Ra/W	CINH
C1102	23473	5BB1	A	3	FIX32	VD	4	Ra/W	CINH
C1103	23472	5BB0	A	2	FIX32	VD	4	Ra	
C1104	23471	5BAF	A	3	FIX32	VD	4	Ra	
C1120	23455	5B9F	E	1	FIX32	VD	4	Ra/Wa	
C1121	23454	5B9E	A	2	FIX32	VD	4	Ra/Wa	
C1122	23453	5B9D	E	1	FIX32	VD	4	Ra/Wa	
C1123	23452	5B9C	A	2	FIX32	VD	4	Ra/Wa	
C1124	23451	5B9B	E	1	FIX32	VD	4	Ra/W	CINH
C1125	23450	5B9A	E	1	FIX32	VD	4	Ra/W	CINH
C1126	23449	5B99	E	1	FIX32	VD	4	Ra/W	CINH
C1127	23448	5B98	E	1	I32	VH	4	Ra	
C1128	23447	5B97	E	1	I32	VH	4	Ra	
C1129	23446	5B96	E	1	I32	VH	4	Ra	
C1140	23435	5B8B	E	1	FIX32	VD	4	Ra/Wa	
C1141	23434	5B8A	E	1	FIX32	VD	4	Ra/Wa	
C1143	23432	5B88	E	1	FIX32	VD	4	Ra/W	CINH
C1144	23431	5B87	E	1	FIX32	VD	4	Ra	
C1145	23430	5B86	E	1	FIX32	VD	4	Ra/Wa	
C1146	23429	5B85	E	1	FIX32	VD	4	Ra/Wa	
C1148	23427	5B83	E	1	FIX32	VD	4	Ra/W	CINH
C1149	23426	5B82	E	1	FIX32	VD	4	Ra	
C1150	23425	5B81	E	1	FIX32	VD	4	Ra/Wa	
C1151	23424	5B80	E	1	I32	VH	4	Ra/Wa	
C1153	23422	5B7E	E	1	FIX32	VD	4	Ra/W	CINH
C1154	23421	5B7D	E	1	FIX32	VD	4	Ra/W	CINH
C1155	23420	5B7C	E	1	FIX32	VD	4	Ra/W	CINH
C1157	23418	5B7A	E	1	FIX32	VD	4	Ra	
C1158	23417	5B79	E	1	FIX32	VD	4	Ra	
C1159	23416	5B78	E	1	I32	VH	4	Ra	
C1160	23415	5B77	A	2	FIX32	VD	4	Ra/W	CINH
C1161	23414	5B76	E	1	FIX32	VD	4	Ra/W	CINH
C1162	23413	5B75	A	2	FIX32	VD	4	Ra	
C1163	23412	5B74	E	1	FIX32	VD	4	Ra	

Code	Index		Data					Access	
	dec	hex	DS	DA	DT	Format	DL	LCM-R/W	Condition
C1165	23410	5B72	A	2	FIX32	VD	4	Ra/W	CINH
C1166	23409	5B71	E	1	FIX32	VD	4	Ra/W	CINH
C1167	23408	5B70	A	2	FIX32	VD	4	Ra	
C1168	23407	5B6F	E	1	FIX32	VD	4	Ra	
C1170	23405	5B6D	E	1	FIX32	VD	4	Ra/Wa	
C1171	23404	5B6C	E	1	FIX32	VD	4	Ra/Wa	
C1172	23403	5B6B	E	1	FIX32	VD	4	Ra/W	CINH
C1173	23402	5B6A	E	1	FIX32	VD	4	Ra	
C1175	23400	5B68	A	3	FIX32	VD	4	Ra/W	CINH
C1176	23399	5B67	A	3	FIX32	VD	4	Ra	
C1178	23397	5B65	A	3	FIX32	VD	4	Ra/W	CINH
C1179	23396	5B64	A	3	FIX32	VD	4	Ra	
C1190	23385	5B59	E	1	FIX32	VD	4	Ra/Wa	
C1191	23384	5B58	A	2	FIX32	VD	4	Ra/Wa	
C1192	23383	5B57	A	2	FIX32	VD	4	Ra/Wa	
C1195	23380	5B54	E	1	FIX32	VD	4	Ra/W	CINH
C1196	23379	5B53	E	1	I32	VH	4	Ra	
C1197	23378	5B52	E	1	I32	VH	4	Ra	
C1200	23375	5B4F	A	3	FIX32	VD	4	Ra/W	CINH
C1201	23374	5B4E	A	3	I32	VH	4	Ra	
C1205	23370	5B4A	A	2	FIX32	VD	4	Ra/W	CINH
C1206	23369	5B49	A	2	I32	VH	4	Ra	
C1207	23368	5B48	E	1	FIX32	VD	4	Ra/Wa	
C1210	23365	5B45	A	5	FIX32	VD	4	Ra/W	CINH
C1211	23364	5B44	A	2	FIX32	VD	4	Ra/W	CINH
C1212	23363	5B43	E	1	FIX32	VD	4	Ra/W	CINH
C1215	23360	5B40	A	5	FIX32	VD	4	Ra	
C1216	23359	5B3F	A	2	FIX32	VD	4	Ra	
C1217	23358	5B3E	E	1	I32	VH	4	Ra	
C1220	23355	5B3B	A	2	FIX32	VD	4	Ra/W	CINH
C1223	23352	5B38	A	2	FIX32	VD	4	Ra	
C1230	23345	5B31	A	2	FIX32	VD	4	Ra/W	CINH
C1231	23344	5B30	E	1	FIX32	VD	4	Ra/W	CINH
C1232	23343	5B2F	A	2	FIX32	VD	4	Ra/W	CINH
C1235	23340	5B2C	A	2	FIX32	VD	4	Ra	
C1236	23339	5B2B	E	1	FIX32	VD	4	Ra	
C1237	23338	5B2A	A	2	I32	VH	4	Ra	
C1240	23335	5B27	A	2	FIX32	VD	4	Ra/W	CINH
C1241	23334	5B26	E	1	FIX32	VD	4	Ra/W	CINH
C1242	23333	5B25	E	1	FIX32	VD	4	Ra/W	CINH
C1245	23330	5B22	A	2	FIX32	VD	4	Ra	
C1246	23329	5B21	E	1	FIX32	VD	4	Ra	
C1247	23328	5B20	E	1	I32	VH	4	Ra	
C1250	23325	5B1D	E	1	FIX32	VD	4	Ra/W	CINH
C1251	23324	5B1C	A	2	FIX32	VD	4	Ra/W	CINH
C1253	23322	5B1A	E	1	FIX32	VD	4	Ra	
C1254	23321	5B19	A	2	I32	VH	4	Ra	

Code	Index		Data					Access	
	dec	hex	DS	DA	DT	Format	DL	LCM-R/W	Condition
C1255	23320	5B18	E	1	FIX32	VD	4	Ra/W	CINH
C1258	23317	5B15	E	1	FIX32	VD	4	Ra	
C1260	23315	5B13	E	1	FIX32	VD	4	Ra/W	CINH
C1261	23314	5B12	E	1	FIX32	VD	4	Ra/W	CINH
C1262	23313	5B11	E	1	FIX32	VD	4	Ra/W	CINH
C1265	23310	5B0E	E	1	FIX32	VD	4	Ra/W	CINH
C1266	23309	5B0D	E	1	FIX32	VD	4	Ra/W	CINH
C1268	23307	5B0B	E	1	FIX32	VD	4	Ra	
C1269	23306	5B0A	E	1	I32	VH	4	Ra	
C1270	23305	5B09	A	2	FIX32	VD	4	Ra/W	CINH
C1271	23304	5B08	A	2	I32	VH	4	Ra	
C1272	23303	5B07	E	1	FIX32	VD	4	Ra/Wa	
C1290	23285	5AF5	E	1	FIX32	VD	4	Ra/Wa	
C1292	23283	5AF3	E	1	FIX32	VD	4	Ra/Wa	
C1500	23075	5A23	E	1	I32	VH	4	Ra	
C1501	23074	5A22	E	1	FIX32	VD	4	Ra/Wa	
C1502	23073	5A21	E	1	FIX32	VD	4	Ra/Wa	
C1503	23072	5A20	E	1	FIX32	VD	4	Ra/Wa	
C1504	23071	5A1F	E	1	FIX32	VD	4	Ra/Wa	
C1505	23070	5A1E	E	1	I32	VH	4	Ra/Wa	
C1506	23069	5A1D	E	1	FIX32	VD	4	Ra/W	CINH
C1507	23068	5A1C	E	1	FIX32	VD	4	Ra/W	CINH
C1508	23067	5A1B	E	1	FIX32	VD	4	Ra	
C1509	23066	5A1A	E	1	FIX32	VD	4	Ra	
C1799	22776	58F8	E	1	FIX32	VD	4	Ra/Wa	

9 Troubleshooting and fault elimination

Contents

9.1	Display of operating data, diagnostics	9.1-1
9.2	Troubleshooting	9.2-1
9.2.1	Status display via controller LEDs	9.2-1
9.2.2	Fault analysis with the history buffer	9.2-1
9.2.3	Fault analysis via LECOM status words (C0150/C0155)	9.2-3
9.3	System error messages	9.3-1
9.3.1	General error messages	9.3-1
9.3.2	Resetting system error messages	9.3-6

9.1 Display of operating data, diagnostics

The dialog box displays important operating parameters and supports you in diagnosing the drive controller.

- Open the **Diagnostics** dialog box in the parameter menu.

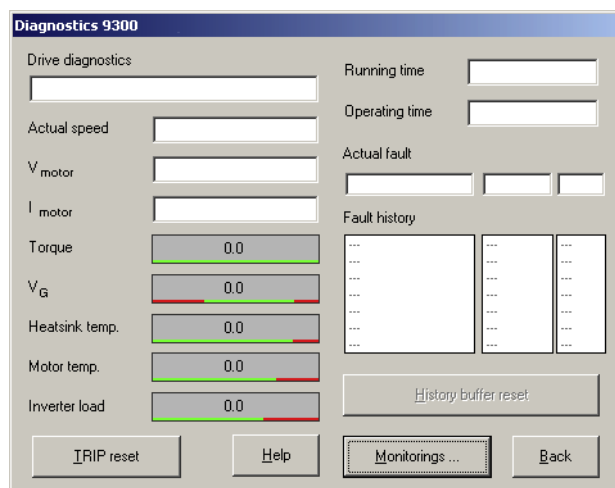

9300std230

Fig. 9.1-1 "Diagnostics" dialog box

- You can recognise immediately that a fault has occurred from the display elements or status information.
- An error can be analysed with
 - the history buffer in Global Drive Control (GDC) (📖 9.2-1) or
 - the XT keypad
 - and with the "General error messages" table in the "System error messages" chapter.
- The "General error messages" table provides tips on how to eliminate an error.

9.2 Troubleshooting

Detecting breakdowns A breakdown can be detected quickly via the LEDs at the controller or via the status information at the keypad.

Analysing errors Analyse the error using the history buffer. The list of fault messages gives you advice how to remove the fault. (📖 9.3-1)

9.2.1 Status display via controller LEDs

During operation the operating status of the controller is shown by 2 LEDs.

LED	Operating status	
Red ①	Green ②	
Off	On	Controller enabled
On	On	Mains switched on and automatic start inhibited
Off	Blinking slowly	Controller inhibited
Blinking quickly	Off	Undervoltage or overvoltage
Blinking slowly	Off	Fault active

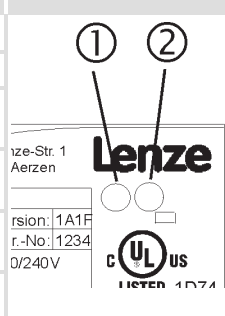

9.2.2 Fault analysis with the history buffer

The history buffer can be used to trace faults. The fault messages are stored in the 8 memory locations in the order of their occurrence.

► Open the **Diagnostics** dialog box in the parameter menu.

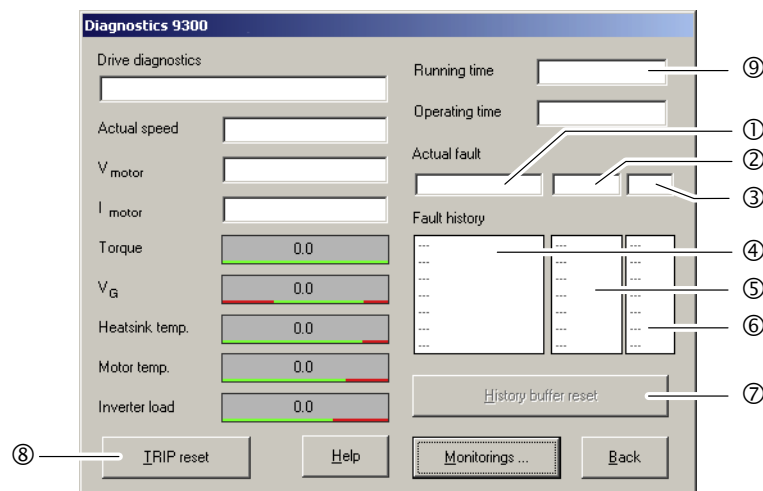

9300std230

Fig. 9.2-1 "Diagnostics" dialog box

Field	History buffer location	Entry	Note
① ② ③	1	Active fault	If the fault is no longer pending or has been acknowledged:
	2	Last fault	• The content of memory units 1 – 7 is

Field			History buffer location	Entry	Note
④	⑤	⑥	3	Next to last fault	<ul style="list-style-type: none"> • The content of memory units 1 ... 7 is shifted "upwards" by one memory unit. • The content of memory unit 8 is removed from the history buffer and can no longer be retrieved. • Memory unit 1 is deleted (= no active fault).
			4	Third to last fault	
			5	Fourth to last fault	
			6	Fifth to last fault	
			7	Sixth to last fault	
			8	Seventh to last fault	

Explanations

①, ④

Fault indication and fault response (C0168)

- The entry is effected as LECOM error number.
- If several faults with a different response occur at the same time:
 - Only the fault the response of which has the highest priority is entered (1. TRIP, 2. message, 3. warning).
- If faults with the same response occur (e. g. 2 messages) at the same time:
 - Only the fault that was triggered first is entered.
 - The OH7 and OH3 warnings are exceptions. If an OH7 warning is pending and the OH3 motor temperature threshold is reached, the OH7 warning is overwritten by the OH3 warning. If the motor temperature decreases again, the OH7 warning reappears.

②, ⑤

Time of the fault (C0169)

- Reference time is the content of the power-on time meter ⑨.
- If a fault is immediately followed by another fault for several times, only the time of the last occurrence is stored.

③, ⑥

Frequency of occurrence of the fault (C0170)

- The time of the last occurrence is stored.

⑦

Click on **Fault memory reset** to clear the history buffer.
The history buffer can only be cleared if no fault is active.

⑧

Click on **TRIP reset** to reset the fault.

9.2.3 Fault analysis via LECOM status words (C0150/C0155)

The LECOM status words (C0150/C0155) are coded as follows:

Code		Possible settings		IMPORTANT
No.	Designation	Lenze/ {Appl.}	Selection	
C0150	Status word	0		Device status word for networking via automation interface (AIF) Read only
			0	{1}
			Bit 0 Not assigned Bit 1 Pulse inhibit (IMP) Bit2 Not assigned Bit3 Not assigned Bit4 Not assigned Bit5 Not assigned Bit 6 n = 0 Bit 7 Controller inhibit (CINH) Bit 8 Device status bit 1 Bit 9 Device status bit 2 Bit10 Device status bit 3 Bit11 Device status bit 4 Bit12 Warning Bit13 Message Bit14 Not assigned Bit15 Not assigned	
C0155	Status word 2	0		Status word 2 (advanced status word) Display only
			0	{1}
			Bit 0 Active fault Bit 1 M_{max} reached Bit 2 I_{max} reached Bit 3 Pulse inhibit(IMP) Bit 4 Ready for operation (RDY) Bit 5 Controller inhibit (CINH) Bit 6 TRIP active Bit 7 Initialisation Bit 8 Motor direction of rotation (Cw/CCw) Bit 9 Not assigned Bit 10 Not assigned Bit 11 Not assigned Bit 12 Not assigned Bit 13 Not assigned Bit 14 Not assigned Bit 15 Not assigned	

9.3 System error messages

9.3.1 General error messages



Note!

In the case of a query via system bus (CAN), the fault messages are represented as numbers (see first column of the table).

Fault message		Description	Cause	Remedy
No.	Display			
---	---	No fault	-	-
0011	OC1	Short circuit of motor cable	Short circuit	<ul style="list-style-type: none"> Search for cause of short circuit. Check motor cable.
			Excessive capacitive charging current in the motor cable.	Use motor cable which is shorter or of lower capacitance.
0012	OC2	Motor cable earth fault	One of the motor phases has earth contact.	<ul style="list-style-type: none"> Search for cause of short circuit. Check motor cable.
0015	OC5	I x t overload	<ul style="list-style-type: none"> Frequent and too long acceleration with overcurrent Continuous overload with $I_{motor} > 1.05 \times I_{rx}$. 	Check drive dimensioning.
0016	OC6	I ² x t overload	<ul style="list-style-type: none"> Frequent and too long acceleration processes with motor overcurrent. Permanent motor overload with $I_{motor} > I_{r motor}$ 	Check drive dimensioning.
x018	OC8	I ² x t overload advance warning	<ul style="list-style-type: none"> Frequent and too long acceleration processes with motor overcurrent. Permanent motor overload with $I_{motor} > I_{r motor}$ 	Check drive dimensioning.
1020	OU	Overvoltage in DC bus	Braking energy is too high. (DC-bus voltage is higher than set in C0173.)	<ul style="list-style-type: none"> Use braking unit or regenerative module. Check dimensioning of the brake resistance.
1030	LU	Undervoltage in the DC bus	DC bus voltage is lower than specified in C0173.	<ul style="list-style-type: none"> Check mains voltage Check supply cable
x032	LP1	Motor phase failure	A current-carrying motor phase has failed.	<ul style="list-style-type: none"> Check motor. Check motor cable. Switch off monitoring (C0597 = 3).
			The current limit value is set too low.	Set higher current limit value via C0599.
0050	OH	Heatsink temperature > +90 °C	Ambient temperature $T_u > +40$ °C or $> +50$ °C	<ul style="list-style-type: none"> Allow module to cool and ensure better ventilation. Check ambient temperature in the control cabinet.
			Heatsink is very dirty.	Clean heatsink.
			Wrong mounting position	Change mounting position.

9

Troubleshooting and fault elimination

9.3

System error messages

9.3.1

General error messages

Fault message		Description	Cause	Remedy
No.	Display			
x053	OH3	Motor temperature > +150 °C threshold (temperature detection via resolver or incremental value encoder)	Motor is thermally overloaded due to: <ul style="list-style-type: none"> ● Impermissible continuous current ● Frequent or too long acceleration processes 	<ul style="list-style-type: none"> ● Check drive dimensioning. ● Switch off monitoring (C0583 = 3).
			No PTC/temperature contact connected.	Correct wiring.
x054	OH4	Heatsink temperature > C0122	Ambient temperature $T_u > +40$ °C or $> +50$ °C	<ul style="list-style-type: none"> ● Allow module to cool and ensure better ventilation. ● Check ambient temperature in the control cabinet. ● Switch off monitoring (C0582 = 3).
			Heatsink is very dirty.	Clean heatsink
			Wrong mounting position	Change mounting position.
			The value specified under C0122 is set too low.	Enter a higher value under C0122.
x057	OH7	Motor temperature > C0121 (temperature detection via resolver or incremental value encoder)	Motor is thermally overloaded due to: <ul style="list-style-type: none"> ● Impermissible continuous current ● Frequent or too long acceleration processes 	<ul style="list-style-type: none"> ● Check drive dimensioning. ● Switch off monitoring (C0584 = 3).
			No PTC/temperature contact connected.	Correct wiring.
			The value specified under C0121 is set too low.	Enter a higher value in C0121.
x058	OH8	Motor temperature via inputs T1 and T2 is too high.	Motor is thermally overloaded due to: <ul style="list-style-type: none"> ● Impermissible continuous current ● Frequent or too long acceleration processes 	<ul style="list-style-type: none"> ● Check drive dimensioning. ● Switch off monitoring (C0585 = 3).
			Terminals T1 and T2 are not connected	Connect PTC/temperature contact.
x061	CE0	Automation interface (AIF) communication error	Faulty transfer of control commands via AIF.	<ul style="list-style-type: none"> ● Plug in the communication module/keypad XT firmly, screw down, if necessary. ● Switch off monitoring (C0126 = 3).
x062	CE1	Communication error on the process data input object CAN1_IN	CAN1_IN object receives faulty data or communication is interrupted.	<ul style="list-style-type: none"> ● Check wiring at X4. ● Check sender. ● Increase monitoring time under C0357/1, if necessary. ● Switch off monitoring (C0591 = 3).
x063	CE2	Communication error on the process data input object CAN2_IN	CAN2_IN object receives faulty data or communication is interrupted.	<ul style="list-style-type: none"> ● Check wiring at X4. ● Check sender. ● Increase monitoring time under C0357/2, if necessary. ● Switch off monitoring (C0592 = 3).
x064	CE3	Communication error on the process data input object CAN3_IN	CAN3_IN object receives faulty data or communication is interrupted.	<ul style="list-style-type: none"> ● Check wiring at X4. ● Check sender. ● Increase monitoring time under C0357/3, if necessary. ● Switch off monitoring (C0593 = 3).

Fault message		Description	Cause	Remedy
No.	Display			
x065	CE4	BUS-OFF state of system bus (CAN)	The controller has received too many faulty telegrams via the system bus (CAN) and has disconnected from the bus.	<ul style="list-style-type: none"> • Check wiring at X4: Is the bus correctly terminated? • Check shield connection of the cables. • Check PE connection. • Check bus load, reduce the baud rate if necessary. (Observe the cable length!) • Switch off the monitoring (C0595 = 3).
0071	CCr	System failure	Strong interference injection on the control cables	Screen control cables
			Ground or earth loops in the wiring	<ul style="list-style-type: none"> • Check wiring • Check PE connection <p>After troubleshooting: Deenergise the device completely (disconnect 24 V supply, discharge DC bus)!</p>
0072	PR1	Checksum error in parameter set 1 CAUTION: The Lenze setting is loaded automatically!	<ul style="list-style-type: none"> • Fault when loading a parameter set. • Interruption while transmitting the parameter set via keypad. 	<ul style="list-style-type: none"> • Set the required parameters and store them under C0003 = 1. • As to PLC devices, check the use of pointers.
			The stored parameters are incompatible with the loaded software version.	Store the parameter set under C0003 = 1 first to allow for a faults reset.
0074	PEr	Program error	Error in the program flow	Send the parameter set (on floppy disk/CD-ROM) with a detailed description of the problem to Lenze. After troubleshooting: Deenergise the device completely (disconnect 24 V supply, discharge DC bus)!
0075	PR0	Error in parameter set.	The operating system software has been updated.	Storage of the Lenze setting C0003 = 1. After troubleshooting: Deenergise the device completely (disconnect 24 V supply, discharge DC bus)!
0079	PI	Fault during parameter initialisation	<ul style="list-style-type: none"> • An error has been detected during the parameter set transfer between two devices. • The parameter set does not match the controller, e.g. if data has been transferred from a higher-power controller to a lower-power controller. 	<ul style="list-style-type: none"> • Correct parameter set. • Send parameter set (on floppy disk/CD-ROM) and a detailed description of the problem to Lenze.
x082	Sd2	Resolver error at X7	Resolver cable interrupted.	<ul style="list-style-type: none"> • Check cable for open circuit. • Check resolver. • Switch off the monitoring (C0586 = 3).
x083	Sd3	Encoder error at X9	Cable interrupted.	Check cable for open circuit.
			Pin X9/8 not connected.	Apply 5 V to pin X9/8 or switch off monitoring (C0587 = 3).
x085	Sd5	Encoder error at X6/1 and X6/2 (C0034 = 1)	Current signal at X6/1 X6/2 < 2mA.	<ul style="list-style-type: none"> • Check cable for open circuit. • Check current signal encoder. • Switch off monitoring (C0598 = 3).
x086	Sd6	Motor temperature sensor error (X7 or X8)	Encoder for detecting the motor temperature at X7 or X8 indicates undefined values.	<ul style="list-style-type: none"> • Check cable for firm connection. • Switch off the monitoring (C0594 = 3).

9

Troubleshooting and fault elimination

9.3

System error messages

9.3.1

General error messages

Fault message		Description	Cause	Remedy
No.	Display			
x087	Sd7	Selection of the feedback in C0025 as absolute value encoder or alteration of the encoder constant in C0420 for setting $C0025 \geq 309$	The absolute value encoder must be initialised.	Save parameter set, then completely deenergise the device, and afterwards switch it on again.
		Initialisation error of absolute value encoder at X8	<ul style="list-style-type: none"> Defect of the encoder electronics Absolute value encoder at X8 does not send data. <p>Tip: The encoder must not rotate during mains switching.</p>	<ul style="list-style-type: none"> Make sure that the cable at X8 is tightened properly, and check it with regard to open circuit. Check absolute value encoder with regard to correct function. Set voltage supply via C0421 to 8.0 V. No Stegmann encoder connected. Replace defective encoder.
		Communication error of absolute value encoder at X8 during rotor position adjustment	A rotor position adjustment via $C0095 = 1$ could not be completed successfully.	Repeat rotor position adjustment.  6.8-1 Note: After an Sd7 fault it is absolutely required to carry out another rotor position adjustment. Otherwise the drive may carry out uncontrolled movements after controller enable. The drive must not be commissioned without a successfully executed rotor position adjustment!
				After fault elimination: Completely deenergise device (switch off 24 V supply, discharge DC bus)!
x088	Sd8	SinCos encoder at X8 sends inconsistent data.	The tracks in the SinCos encoder are damaged.	Replace SinCos encoder.
			Interference level on the encoder cable is too high.	<ul style="list-style-type: none"> Check correct shield connection of encoder cable. Where required, decelerate the actuation of the fault message via the filter time constant. Setting: <ul style="list-style-type: none"> for ECSxS/P/M/A in C0559. for 9300 servo cam in C0575.
		SinCos encoder at X8 does not send any data.	Open circuit.	Check cable for wire breakage.
			Incorrect encoder connected.	Connect SinCos encoder of the Stegmann company.
			SinCos encoder is defective.	Replace SinCos encoder.
Supply voltage set incorrectly.	Set voltage supply in C0421.			
				After fault correction: completely deenergise the device (switch off 24 V supply, discharge DC bus)!

Fault message		Description	Cause	Remedy
No.	Display			
x089	PL	Error during rotor position adjustment (the error is saved with mains failure protection)	<ul style="list-style-type: none"> The rotor position adjustment was cancelled. During rotor position adjustment with an absolute value encoder the error Sd7 or SD8 occurred. 	Repeat rotor position adjustment. ☐ 6.8-1 Note: After an Sd7 fault it is absolutely required to carry out another rotor position adjustment. Otherwise the drive may carry out uncontrolled movements after controller enable. The drive must not be commissioned without a successfully executed rotor position adjustment!
x091	EEr	External monitoring has been triggered via DCTRL .	A digital signal assigned to the TRIP-SET function has been activated.	<ul style="list-style-type: none"> Check external encoder. Switch off the monitoring (C0581 = 3).
0105	H05	Internal fault (memory)		Contact Lenze.
0107	H07	Internal fault (power stage)	During initialisation of the controller, an incorrect power stage was detected.	Contact Lenze.
x110	H10	Heatsink temperature sensor error	Sensor for detecting the heatsink temperature indicates undefined values.	<ul style="list-style-type: none"> Contact Lenze. Switch off the monitoring (C0588 = 3).
x111	H11	Temperature sensor error: Temperature inside the controller	Sensor for detecting the internal temperature indicates undefined values.	<ul style="list-style-type: none"> Contact Lenze. Switch off the monitoring (C0588 = 3).
x153	P03	Following error	The angle difference between set and actual position is larger than the following error limit set under C0255.	<ul style="list-style-type: none"> Increase following error limit under C0255. Switch off the monitoring (C0589 = 3).
			Drive cannot follow the digital frequency (I_{max} limit).	Check drive dimensioning.
x163	P13	Angle overrun.	<ul style="list-style-type: none"> Phase controller limit reached Drive cannot follow the digital frequency (I_{max} limit). 	<ul style="list-style-type: none"> Enable drive Check drive dimensioning.
x166	P16	Faulty transfer of system bus (CAN) sync telegram.	The sync telegram from the master (PLC) is out of sync cycle.	<ul style="list-style-type: none"> Set the "sync cycle" to the transmission cycle of the master (PLC) under C1121. Note: <ul style="list-style-type: none"> C0362 displays the time interval between 2 sync telegrams. C0362 = 0: communication interrupted.
			The sync telegram of the master (PLC) is not received.	<ul style="list-style-type: none"> Check communication channel. Check baud rate, controller address. Note: <ul style="list-style-type: none"> C0362 displays the time interval between 2 sync telegrams. C0362 = 0: communication interrupted.
			The controller is enabled too fast.	Delay the controller enable. The time delay required depends on the time interval between the sync telegrams.

9 Troubleshooting and fault elimination

9.3 System error messages

9.3.2 Resetting system error messages



Fault message		Description	Cause	Remedy
No.	Display			
x169	P19	The input values at X9 are limited.	The function block DFIN limits the input values. This causes the loss of increments.	<ul style="list-style-type: none"> Reduce the frequency on the digital frequency connection. Check the settings for the slave (C0425) and for the master (C0030). These settings must be identical.
x190	nErr	Speed control error (Speed out of tolerance margin (C0576))	<ul style="list-style-type: none"> Active load (e.g. for hoists) is too high. Mechanical blockades on the load side 	Check drive dimensioning.
x200	NMAX	Maximum system speed (C0596) has been exceeded.	<ul style="list-style-type: none"> Active load (e.g. for hoists) is too high. Drive is not speed-controlled, torque is excessively limited. 	<ul style="list-style-type: none"> Check drive dimensioning. Increase torque limit, if necessary. Switch off monitoring (C0607 = 3).

Representation of the error number:

x 0 = TRIP, 1 = message, 2 = warning

E. g. "2091": An external monitoring function has triggered EEr warning

9.3.2 Resetting system error messages

Response	Measures for resetting the fault message
TRIP	<p> Note! If a TRIP source is still active, the pending TRIP cannot be reset.</p> <p>Resetting the TRIP can be effected by:</p> <ul style="list-style-type: none"> Pressing the keypad XT EMZ9371 BC ⇒ STOP. Then press RUN to re-enable the controller. Setting code C0043 = 0. Control word C0135, bit 11 Control word AIF Control word of system bus (CAN) <p>After resetting the TRIP, the drive remains at standstill.</p>
Message	<p> Danger! After elimination of the fault, the fault message is cancelled automatically and the drive restarts automatically.</p>
Warning	After elimination of the fault, the fault message is cancelled automatically.

10 DC-bus operation

Contents

10.1	Function	10.1-1
10.2	Conditions for trouble-free DC-bus operation	10.2-1
10.3	Fuses and cable cross-sections	10.3-1
10.4	Distributed supply (several supply points)	10.4-1
10.5	Central supply (one supply point)	10.5-1

10.1 **Function**

- ▶ DC-bus connections of drive systems enable the exchange of energy between connected controllers.
- ▶ If one or more controllers operate in generator mode (braking operation), the energy will be fed into the shared DC-voltage bus. The energy will then be available to the controllers which operate in motor mode.
- ▶ The use of braking units and supply units can be reduced.
- ▶ The energy consumption from the three-phase AC mains can be reduced.
- ▶ The number of mains supplies and the related expenses (e.g. wiring) can be perfectly adapted to your application.

10.2 Conditions for trouble-free DC-bus operation

- ▶ Distributed supply (parallel mains supply):
 - Always use the prescribed mains choke when connecting a controller to the mains.
 - Controllers of the EVx9321 ... EVx9333, 8200 and 8200 vector series must not be connected to the mains if they are operated in a DC-bus connection with EVx9335 ... EVx9338 and EVx9381 ... EVx9383 controllers.
- ▶ Only controllers with identical mains voltage/DC bus voltage ranges can be operated in a DC-bus connection:
 - Set the mains voltage/DC-bus voltage under C0173.
- ▶ 9340 regenerative power supply modules and 9360 DC input modules cannot be used together in the DC-bus connection.
- ▶ Read the documentation for the other controllers connected to the DC bus with regard to "DC-bus operation".

10.3 Fuses and cable cross-sections



Note!

- ▶ All fuses specified here only have the purpose of disconnection after a short circuit. For cable protection specific fuses must be used.
- ▶ In the following tables the rated currents of the Lenze fuses are listed. If other fuses are used, other fuse currents and cable cross-sections may result.
- ▶ We recommend using fuse holders with a signalling contact. Like this, the entire drive system can be switched off (inhibited) when a fuse fails.
- ▶ Always fuse DC cables using 2 poles (+U_G, -U_G).

Installation in accordance with EN 60204-1

Supply conditions

Range	Description
Mains	DC 460 ... 740 V
Fuses	<ul style="list-style-type: none"> ● Only semiconductor fuses. ● If you are using fuses other than those indicated, other fuse currents and cable cross-sections may result.
Cables	<ul style="list-style-type: none"> ● DC cables (+U_G, -U_G) must always have two-pole insulation. ● Laying systems B2 and C: Use of PVC-insulated copper cables, conductor temperature < 70 °C, ambient temperature < 40 °C, no bundling of cables or cores, three loaded cores. The information is a recommendation. Other designs/laying systems are possible (e.g. according to VDE 0298-4).

Observe all national and regional regulations!

Inverter		DC fuse 14 × 51 (EFSGR0xx0AYHx)	DC fuse 22 × 58 (EFSGR0xx0AYIx)	Installation in accordance with EN 60204-1	
Type	Mains	Rated current of fuse [A]	Rated current of fuse [A]	+U _G , -U _G Laying system	
				B2 [mm ²]	C [mm ²]
EVS9321	3/PE 400 V	12	12	1.5	1.5
EVS9322		12	12	1.5	1.5
EVS9323		12	12	1.5	1.5
EVS9324		20	20	1.5	1.5
EVS9325		40	40	4.0	4.0
EVS9326		50	50	6.0 ¹⁾	4.0

¹⁾ Pin-end connector required, since a maximum cable cross-section of 4 mm² can be connected to the inverter.

Inverter		DC fuse NH1 (EFSGRxxx0ANVx)	DC fuse 22 × 58 (EFSGR0xx0AYIx)	Installation in accordance with EN 60204-1	
Type	Mains	Rated current of fuse [A]	Rated current of fuse [A]	+U _G , -U _G Laying system	
				B2 [mm ²]	C [mm ²]
EVS9327	3/PE 400 V	100	100	-	25
EVS9328		100	100	-	25
EVS9329		200	-	-	25
EVS9330		200	-	-	50
EVS9331		200	-	-	50

Inverter		DC fuse NH2 (EFSGRxxx0ANWx)	DC fuse 22 × 58 (EFSGR0xx0AYIx)	Installation in accordance with EN 60204-1	
Type	Mains	Rated current of fuse [A]	Rated current of fuse [A]	+U _G , -U _G Laying system	
				B2 [mm ²]	C [mm ²]
EVS9332	3/PE 400 V	250	-	-	95

10.4 Distributed supply (several supply points)

Basic circuit diagram

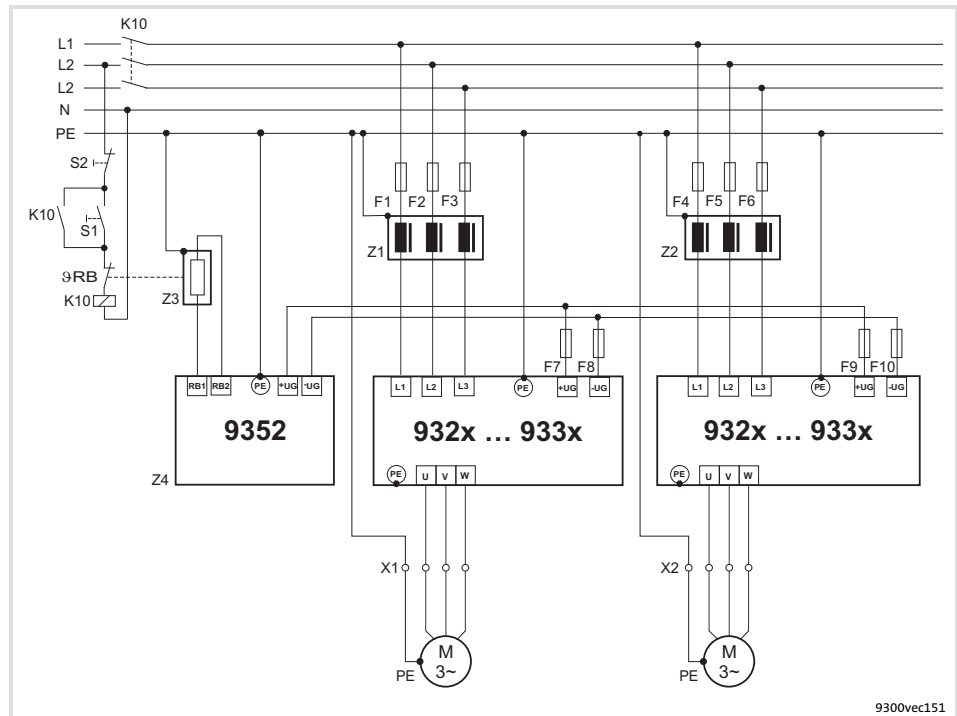

Fig. 10.4-1 Basic circuit diagram of a distributed supply with brake chopper

F1 ... F10	Fusing
K10	Mains contactor
Z1, Z2	Mains choke / mains filter
Z3	Brake resistor
Z4	Brake chopper
S1	Mains supply on
S2	Mains supply off

- Dimension the components according to the requirements of the DC-bus operation.



Stop!

Set the DC-bus voltage thresholds of the controller (C0173) and the brake chopper (see documentation of the brake chopper) to the same values.

10.5 Central supply (one supply point)

Basic circuit diagram

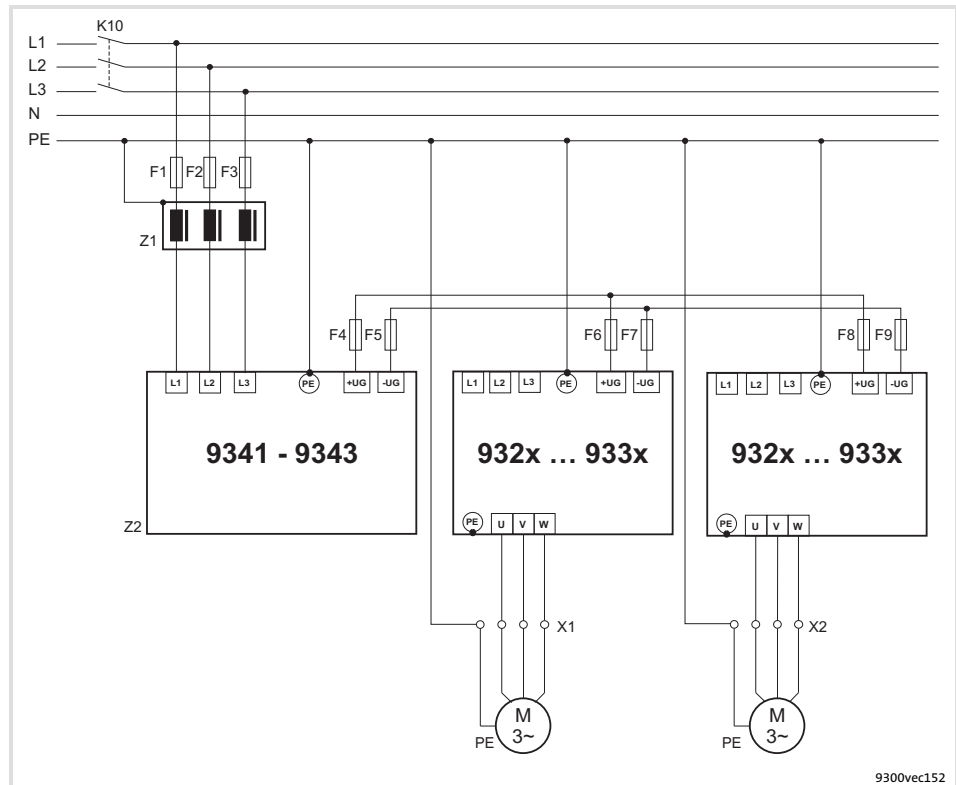

Fig. 10.5-1 Basic circuit diagram of a central supply with regenerative power supply module

F1 ... F9	Fusing
K10	Mains contactor
Z1	Mains choke / mains filter
Z2	Regenerative power supply module

- Dimension the components according to the requirements of the DC-bus operation.



Note!

- If the supply power of the regenerative power supply module is not sufficient, the system can be additionally supplied via the mains connection of further controllers.
- Before connecting the supply module and the controllers read the Operating Instructions of the regenerative power supply module.

11 Safety engineering

Contents

11.1	Important notes	11.1-1
11.2	Operating mode	11.2-1
11.3	Safety relay KSR	11.3-1
11.4	Wiring	11.4-1
11.5	Functional test	11.5-1
11.5.1	Important notes	11.5-1
11.5.2	Manual safety function check	11.5-2
11.5.3	Monitoring the safety function with a PLC	11.5-3

11.1 Important notes

The controllers support the safety functions "Safe torque off" (former designation "Safe standstill"), "Protection against unexpected start-up", in accordance with the requirements of control category 3 of ISO 13849-1 (former EN 954-1). Depending on the external interconnection, a standard up to "category 3" in accordance with ISO 13849-1 is achieved.



Note!

In order to comply with control category 3 in accordance with ISO 13849-1 (former EN 954-1), the two methods "Pulse inhibit via safety relay K_{SR} " **and** "Controller inhibit", which are independent of each other, have to be used.

- ▶ Only qualified personnel may install and commission the "Safe torque off" function.
- ▶ All control components (switches, relays, PLC, ...) and the control cabinet must comply with the requirements of EN ISO 13849-1 and EN ISO 13849-2. This includes among other things:
 - Control cabinet, switches, relays in enclosure IP54!
 - All other requirements can be found in EN ISO 13849-1 and EN ISO 13849-2!
- ▶ Wiring with insulated wire end ferrules or rigid cables is absolutely required.
- ▶ All safety-relevant cables (e.g. control cable for the safety relay, feedback contact) outside the control cabinet must be protected, e.g. by a cable duct. It must be ensured that short circuits between the individual cables cannot occur!
- ▶ With the "Safe torque off" function no emergency stop can be effected without additional measures:
 - There is neither an electrical isolation between motor and controller nor a service or repair switch!
 - An "Emergency stop" requires the electrical isolation of the conductor to the motor, e.g. by means of a central mains contactor with emergency stop wiring.
- ▶ If in the case of the "Safe torque off" a force effect is to be expected from outside, (e.g. sagging of hanging loads), additional measures are required (e.g. mechanical brakes).
- ▶ After the installation the operator has to check the function of the "Safe torque off" circuit.
 - The functional test must be repeated at regular intervals.
 - Basically, the inspection intervals depend on the application, the related risk analysis, and the overall system. The inspection intervals must not be longer than 1 year.

11.2 Operating mode

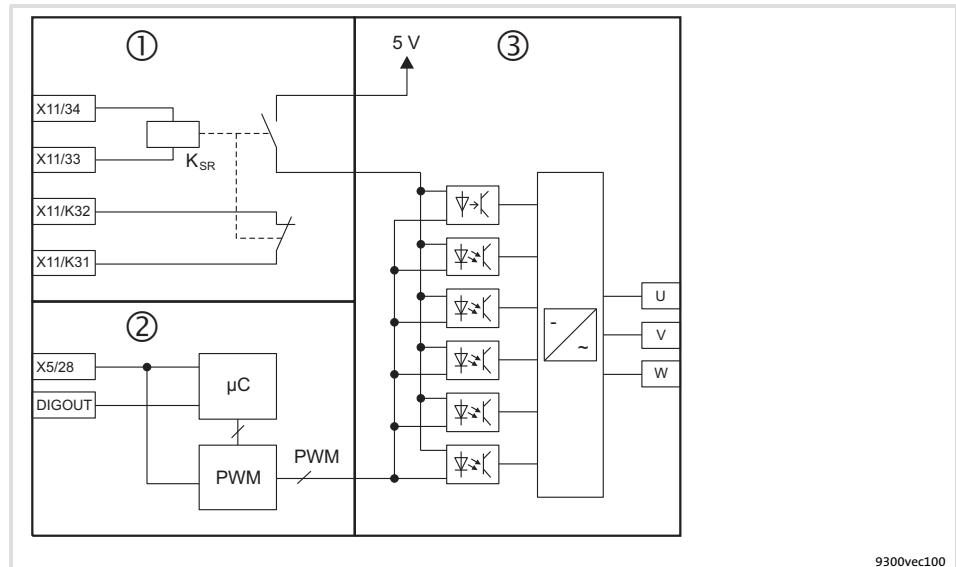

Fig. 11.2-1 Internal connection of the "Safe torque off" function with 3 electrically isolated circuits

- Area ①: Pulse inhibit via safety relay K_{SR}; forcibly guided feedback for monitoring the safety relay
- Area ②: Controller inhibit (X5/28), optional feedback via a digital output (DIGOUT)
- Area ③: Power output stage

Activating "Safe torque off"

The "Safe torque off" status is activated via two different disconnecting paths which are independent of each other:

1. disconnecting path: Pulse inhibit via safety relay K_{SR} (terminal X11/33, X11/34)

- ▶ In the case of LOW level at terminals X11/33, X11/34, the safety relay K_{SR} is deactivated. The driver supply of the power section drivers is interrupted. The inverter no longer receives pulses.
- ▶ The disconnection of the safety relay K_{SR} has to be monitored externally, so that a failure of this disconnecting path can be detected. X11/K31, X11/K32 is a forcibly guided break contact, i. e. if the safety relay K_{SR} has been deactivated ("Safe torque off" activated), the contact is closed.

2. disconnecting path: Controller inhibit by input signal at terminal X5/28

- ▶ The input signal at X5/28 is fed to the microcontroller system and the PWM unit. In the case of LOW level at terminal X5/28, the output of pulses to the inverter is inhibited in the microcontroller system.
- ▶ The disconnecting path "Controller inhibit" can be evaluated optionally via a digital output. Further information can be gathered from the chapter "Functional test" (11.5-1).

"Safe torque off" is activated if **both disconnecting paths are on LOW level**.

Deactivating "Safe torque off"

An AND operation of the disconnecting paths prevents the drive from restarting if only one disconnecting path is enabled.

"Safe torque off" is deactivated if **both disconnecting paths are on HIGH level.**

11.3 Safety relay K_{SR}

Technical data

Terminal	Description	Field	Values
X11/K32 X11/K31 X11/33 X11/34	Safety relay K _{SR} 1st disconnecting path	Coil voltage at +20 °C	DC 24 V (20 ... 30 V)
		Coil resistance at +20 °C	823 Ω ±10 %
		Rated coil power	Approx. 700 mW
		Max. switching voltage	AC 250 V, DC 250 V (0.45 A)
		Max. AC switching capacity	1500 VA
		Max. switching current (ohmic load)	AC 6 A (250 V), DC 6 A (50 V)
		Recommended minimum load	> 50 mW
		Max. switching rate	6 switchings per minute
		Mechanical service life	10 ⁷ switching cycles
		Electrical service life	
		at 250 V AC (ohmic load)	10 ⁵ switching cycles at 6 A 10 ⁶ switching cycles at 1 A 10 ⁷ switching cycles at 0.25 A
		at 24 V DC (ohmic load)	6 × 10 ³ switching cycles at 6 A 10 ⁶ switching cycles at 3 A 1.5 × 10 ⁶ switching cycles at 1 A 10 ⁷ switching cycles at 0.1 A

11.4 Wiring

Wiring



Danger!

Faulty operation in case of earth faults possible

The correct functioning of the safety function is not ensured if an earth fault occurs.

Possible consequences:

- ▶ A failure of the safety function can lead to death, severe injuries or damage to material.

Protective measures:

The electrical reference point for the coil of the safety relay K_{SR} must be connected to the PE conductor system (EN 60204-1, paragraph 9.4.3)!

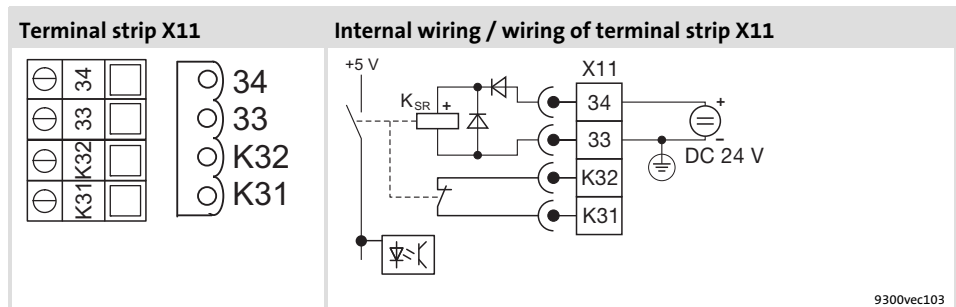

Fig. 11.4-1 Safety relay K_{SR}

Terminal	Function	Level / state	Electrical data
X11/K32 X11/K31	Safety relay K_{SR} 1st disconnecting path	Feedback - pulse inhibit	See technical data of the safety relay K_{SR}
X11/33	- coil of safety relay K_{SR}	Open contact: Pulse inhibit is inactive (operation) Closed contact: Pulse inhibit is active	
X11/34	+ coil of safety relay K_{SR}	Coil is not carrying any current: pulse inhibit is active Coil is carrying current: pulse inhibit is inactive (operation)	
X5/28	Controller inhibit (DCTRL-CINH) 2nd disconnecting path	Controller enable/inhibit	LOW: 0 ... +3 V HIGH: +12 ... +30 V Input current at +24 V: 8 mA Reading and processing the input signals - 1/ms (mean value)

Terminal data

Wiring of the terminals X11/34, X11/33, X11/K32, X11/K31, X5/28:

Leitungstyp	Wire end ferrule	Cable cross-section	Tightening torque	Stripping length
Rigid	-	2,5 mm ² (AWG 14)	0,5 ... 0,6 Nm (4.4 ... 5.3 lb-in)	5 mm
Flexible	With plastic sleeve	2,5 mm ² (AWG 14)		

11.5 **Functional test**

11.5.1 **Important notes**



Danger!

Unexpected start-up of the machine possible

The "Safe torque off" safety function provides protection against an unexpected start-up of the drive and therefore is an important item within the safety concept for a machine. It has to be ensured that this function works correctly.

Possible consequences:

- ▶ Death, severe injury, or damage to material assets, when the safety function fails.

Protective measures:

After the installation and at regular intervals, the operator has to check the function of the "Safe torque off" circuit.

- ▶ When doing this, check both disconnecting paths separately with regard to their disconnection capability.
- ▶ The functional test can be carried out manually or automatically via the PLC.
- ▶ Basically the inspection interval depends on the application and the corresponding risk analysis, as well as on the system as a whole. It should not exceed 1 year.
- ▶ If the functional test shows impermissible states,
 - the drive or the machine has to be shut down immediately.
 - commissioning is not permitted until the safety function operates correctly.

11.5.2 Manual safety function check

For the functional test, check both disconnecting paths **separately**.

1. disconnecting path: Pulse inhibit via safety relay K_{SR}

How to proceed during the test:

1. Alternately apply LOW and HIGH level to input X11/34 and check the states given in the table below.

	Specification	Correct status
Individual test	Input relay activation (X11/34)	Output feedback (X11/K31)
Pulse inhibit	LOW	HIGH
Pulse enable	HIGH	LOW

The individual tests are passed if the correct states given in the table result.

2. disconnecting path: Controller inhibit

Requirement for the test:

- ▶ "Quickstop" (QSP) function deactivated
- ▶ "Automatic DC injection brake" deactivated ($C0019 = 0$)
- ▶ Pulses enabled by the safety relay K_{SR} ($X11/34 = HIGH$)

How to proceed during the test:

1. Set controller inhibit ($X5/28 = LOW$).
2. Define a setpoint $n_{set} > 0$.
3. Check that the motor is not rotating.

The individual test is passed if the motor does not rotate.

Functional test not passed

If an individual test results in an impermissible status, the functional test is not passed.

- ▶ The drive or machine has to be shut down immediately.
- ▶ Commissioning is not permitted until the safety function operates correctly.

11.5.3 Monitoring the safety function with a PLC

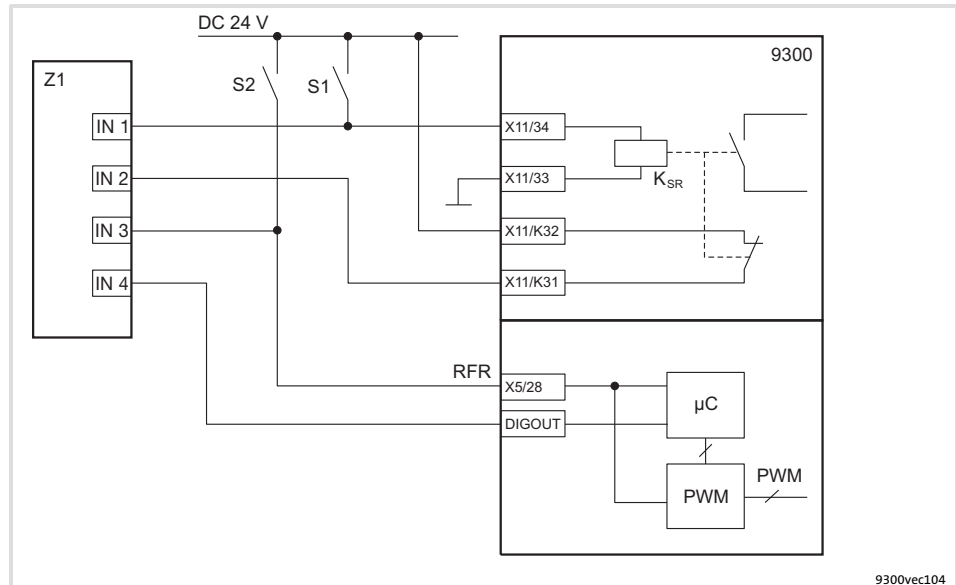

Fig. 11.5-1 Circuit diagram for monitoring the safety function with a PLC

- S1, S2 Separate disconnection options of the two disconnecting paths
- K_{SR} Safety relay
- X11/34 Safety relay control
- X11/33 Safety relay control (GND)
- X11/K32 Forcibly guided feedback contact (24 V)
- X11/K31 Forcibly guided feedback contact
- DIGOUT Digital output for evaluating the motor current
- X5/28 Controller inhibit
- Z1 Programmable logic controller (PLC)
- IN 1 - 4 Digital inputs

Requirements

The following conditions must be met:

- ▶ The PLC must be programmed such that the complete system is set to a safe state immediately when the function check leads to an impermissible state.
- ▶ The parameter setting of a digital output must be such that you can conclude to the output current I_{motor} of the drive (see parameterisation example).

11 Safety engineering

11.5 Functional test

11.5.3 Monitoring the safety function with a PLC

Example: Parameterising a digital output

In the following we will show you a possibility of parameterising a digital output, so that a conclusion with regard to the motor current is provided.

Sequence	Parameter	Note
1.	Configure function block CMP3 (comparator)	
	• Connect CMP3-IN1 to MCTRL-IACT	C0693/1 = 5004
	• Connect CMP3-IN2 to FCODE-472/1	C0693/2 = 19521
	• Configure the function IN1 < IN2	C0690 = 3
2.	Configure output signal of CMP3 • Connect DIGOUT4 to CMP3-OUT	C0117/4 = 10660
3.	Enter function block CMP3 in the processing table	
	• Select a free space in the processing table In the Lenze setting, for instance space 2 of the processing table is free	C0465/2 = 10660
4.	Set the current threshold • Set the current threshold for I_{rated_FI} to 2 %	$I_{Motor} = 0 \rightarrow DIGOUT4 = HIGH$ $I_{Motor} \neq 0 \rightarrow DIGOUT4 = LOW$

Functional test within the inspection interval

For the functional test, check both disconnecting paths **separately**.

1. disconnecting path: Pulse inhibit via safety relay K_{SR}

The individual tests are passed if the correct states given in the table result.

Individual test	Specification		Correct status
	Input relay activation (X11/34)		Output feedback (X11/K31)
Pulse inhibit	LOW		HIGH
Pulse enable	HIGH		LOW

2. disconnecting path: Controller inhibit

Requirement for the test:

- ▶ "Quickstop" (QSP) function deactivated
- ▶ "Automatic DC injection brake" deactivated (C0019 = 0)
- ▶ Pulses enabled by the safety relay K_{SR} (X11/34 = HIGH)

The individual tests are passed if the correct states given in the table result.

Individual test	Specification		Correct status
	X5/28	Setpoint	Output DIGOUT
Controller inhibit	LOW	n _{set} > 0	HIGH
Controller enable	HIGH		LOW

Functional test not passed

If an individual test results in an impermissible status, the functional test is not passed.

- ▶ The drive or machine has to be shut down immediately.
- ▶ Commissioning is not permitted until the safety function operates correctly.

12 Accessories (overview)

Contents

12.1	General accessories	12.1-1
12.2	Type-specific accessories	12.2-1

12.1 General accessories

Accessories	Designation	Order number	
Communication modules	LECOM-LI (optical fibre)	EMF2102IBC003	
	LECOM-B (RS485)	EMF2102IBC002	
	LECOM-A/B (RS232/485)	EMF2102IBC001	
	LON	EMF2141IB	
	INTERBUS	EMF2113IB	
	INTERBUS-Loop	EMF2112IB	
	PROFIBUS-DP	EMF2133IB	
	DeviceNet/CANopen	EMF2175IB	
	Operating module keypad XT	EMZ9371BC	
	Diagnosis terminal (keypad XT in handheld design, IP20) ¹⁾	E82ZBBXC	
Other	Connecting cable	2.5 m	E82ZWL025
		5 m	E82ZWL050
		10 m	E82ZWL100
	Parameterisation/operating software »Global Drive Control« (GDC)		ESP-GDC2
	PC system bus adapter (Voltage supply via DIN connection)		EMF2173IB
	PC system bus adapter (Voltage supply via PS2 connection)		EMF2173IB-V002
	PC system bus adapter (Voltage supply via PS2 connection, electrical isolation)		EMF2173IB-V003
	PC system bus adapter USB		EMF2177IB
	CAN repeater		EMF2176IB
	PC system cable RS232	5 m	EWL0020
		10 m	EWL0021
	Optical fibre adapter (standard output power)		EMF2125IB
	Optical fibre adapter (increased output power)		EMF2126IB
	Power supply unit for optical fibre adapter		EJ0013
	Optical fibre, single-core, black PE sheath (basic protection), sold by the meter		EWZ0007
	Optical fibre, single-core, red PUR sheath (reinforced protection), sold by the meter		EWZ0006
	Setpoint potentiometer		ERPD0010k0001W
	Rotary knob for setpoint potentiometer		ERZ0001
	Scale for setpoint potentiometer		ERZ0002
	Digital display		EPD203
	Encoder cable	2.5 m	EWLE002GX-T
		5.0 m	EWLE005GX-T
		10.0 m	EWLE010GX-T
		15.0 m	EWLE015GX-T
		20.0 m	EWLE020GX-T
		25.0 m	EWLE025GX-T
		30.0 m	EWLE030GX-T
		35.0 m	EWLE035GX-T
		40.0 m	EWLE040GX-T
		45.0 m	EWLE045GX-T
50.0 m		EWLE050GX-T	

Accessories	Designation	Order number
	Connecting cable for digital frequency coupling 2.5 m	EWLD002GGBS93

¹⁾ Additional connecting cable required



Tip!

Information and auxiliary devices related to the Lenze products can be found in the download area at

<http://www.Lenze.com>

12.2 Type-specific accessories

9300	EVS9321	EVS9322	EVS9323	EVS9324
Accessories	Order No.			
Mains choke	EZN3A2400H002	EZN3A1500H003	EZN3A0900H004	EZN3A0500H007
Mains filter				
Category C2 EN 61800-3	EZN3A2400H002	EZN3A1500H003	EZN3A0900H004	EZN3A0500H007
Category C1 EN 61800-3	EZN3B2400H002	EZN3B1500H003	EZN3B0900H004	EZN3B0500H007
Brake chopper	EMB9352-E	EMB9352-E	EMB9352-E	EMB9352-E
Brake resistor	ERBD180R300W	ERBD180R300W	ERBD082R600W	ERBD068R800W
Shield mounting kit				
Control cable	EZZ0015	EZZ0015	EZZ0015	EZZ0015
Motor cable	EZZ0016	EZZ0016	EZZ0016	EZZ0016
Mounting kit for push-through technique	EJ0036	EJ0036	EJ0037	EJ0037

9300	EVS9325	EVS9326	EVS9327	EVS9328
Accessories	Order No.			
Mains choke	EZN3A0300H013	ELN3-0150H024-001	ELN3-0088H035-001	ELN3-0075H045
Mains filter				
Category C2 EN 61800-3	EZN3A0300H013	EZN3A0150H024	EZN3A0110H030 E82ZN22334B230 E82ZZ15334B230 ¹⁾	EZN3A0080H042 E82ZN22334B230
Category C1 EN 61800-3	EZN3B0300H013	EZN3B0150H024	E82ZN22334B230 E82ZZ15334B230 ¹⁾ EZN3B0110H030U ²⁾	E82ZN22334B230 EZN3B0080H042
Brake chopper	EMB9352-E	EMB9352-E	EMB9352-E	EMB9352-E
Brake resistor	ERBD047R01k2	ERBD047R01k2	ERBD033R02k0	ERBD022R03k0
Shield mounting kit				
Control cable	EZZ0015	EZZ0015	EZZ0015	EZZ0015
Motor cable	EZZ0016	EZZ0016	EZZ0017	EZZ0017
Mounting kit for push-through technique	EJ0038	EJ0038	EJ0011	EJ0011

12 Accessories (overview)

12.2 Type-specific accessories

9300	EVS9329	EVS9330	EVS9331	EVS9332
Accessories	Order No.			
Mains choke	ELN3-0055H055	ELN3-0038H085	ELN3-0027H105	ELN3-0022H130
Mains filter				
Category C2 EN 61800-3	E82ZN30334B230 EZN3A0055H060	E82ZN55334B230 EZN3A0030H110 EZN3A0030H110N001 ³⁾	E82ZN75334B230 EZN3A0022H150	E82ZN75334B230 EZN3A0022H150
Category C1 EN 61800-3	E82ZN30334B230 EZN3B0055H060	EZN3B0030H110	E82ZN75334B230 EZN3B0022H150	E82ZN75334B230 EZN3B0022H150
Brake chopper	EMB9352-E	2 × EMB9352-E	2 × EMB9352-E	3 × EMB9352-E
Brake resistor	ERBD018R03k0	2 × ERBD022R03k0	2 × ERBD022R03k0	3 × ERBD022R03k0
Shield mounting kit				
Control cable	EZZ0015	EZZ0015	EZZ0015	EZZ0015
Motor cable	EZZ0017	–	–	–
Mounting kit for push-through technique	EJ0011	EJ0010	EJ0010	EJ0009

13 Appendix

Contents

13.1	Glossary	13.1-1
	13.1.1 Terminology and abbreviations used	13.1-1
13.2	Index	13.2-1

13.1 **Glossary**

13.1.1 **Terminology and abbreviations used**

	Cross-reference to a chapter with the corresponding page number
AC	AC current or AC voltage
AIF	Automation interface AIF interface, interface for communication modules
CE	Communauté Européene
Controller	Any frequency inverter, servo inverter, or DC speed controller
Cxxxx/y	Subcode y of code Cxxxx (e. g. C0404/2 = subcode 2 of code C0404)
DC	DC current or DC voltage
DIN	Deutsches Institut für Normung(German Institute for Standardization)
Drive	Lenze controller in combination with a geared motor, a three-phase AC motor, and other Lenze drive components
EMC	Electromagnetic compatibility
EN	European standard
f_r [Hz]	Rated motor frequency
I_a [A]	Current output current
IEC	International Electrotechnical Commission
I_{mains} [A]	Mains current
I_{max} [A]	Maximum output current
IP	International Protection Code
IPC	Industrial PC
I_{PE} [mA]	Discharge current
I_r [A]	Rated output current
L [mH]	Inductance
M_r [Nm]	Rated motor torque
NEMA	National Electrical Manufacturers Association
P_{DC} [kW]	Power that can be additionally taken from the DC bus if a power-adapted motor is used for operation
PLC	Programmable control system
P_{loss} [W]	Power loss of inverter

P_r [kW]	Rated motor power
R [Ω]	Resistance
S_N [kVA]	Controller output power
U_{DC} [V]	DC supply voltage
UL	Underwriters Laboratories
U_M [V]	Output voltage
U_{mains} [V]	Mains voltage
VDE	Verband deutscher Elektrotechniker (Association of German Electrical Engineers)
Xk/y	Terminal y on terminal strip Xk (e. g. X5/28 = terminal 28 on terminal strip X5)

13.2 Index

A

Acceleration time, 8.4-3, 8.4-12

Accessories, 12-1

- General, 12.1-1
- Type-specific, 12.2-1

Activating the incremental encoder, 6.6-1

Actual motor current, 8.4-5

Actual motor voltage, 8.4-5

Actual speed, 8.4-5

Additional setpoint, 8.4-4

Ambient conditions

- Climatic, 3.1-1
- electrical, 3.1-2
- Mechanical, 3.1-2

Analog inputs

- Configuration, 5.8-9
- Signals, 6.9-3
- Terminal assignment, 5.8-9

Analog outputs

- Configuration, 6.9-4
- Signals, 6.9-4
- Terminal assignment, 5.8-9

Application as directed, 1.2-1

B

Basic function, 8.4-2

Bus off, 8.2-3

C

Cable

- For control connections, 5.3-3
- for the motor connection, 5.2-8, 5.3-1

Cable cross-section, Motor cable, 5.2-9

Cable cross-sections, 10.3-1

- mains connection, 5.4-6, 5.5-5, 5.6-5, 5.7-5

CAN bus identifiers, 8.4-14

CE conformity, 1.2-1

CE-typical drive system, 5.4-1, 5.5-1, 5.6-1, 5.7-1

Central supply. *Siehe DC-bus connection*

Changing parameters

- EMZ9371BC keypad, 7.2-8, 7.2-9
- Keypad EMZ9371BC, 7.2-5, 7.2-7, 7.2-10

Code, 7.1-1

Code table, 8.4-1

Commissioning, 6-1

- Before switching on, 6.2-1
- Entry of motor data, 6.5-3
- Switch on, 6.3-1

Communication modules, 5.12-1

Compensation equipment, Interaction with, 5.2-3

Configuration, 8-1

- Analog input signals, 6.9-3
- Analog output signals, 6.9-4
- Analog outputs, 6.9-4
- Code table, 8.4-1
- Controller inhibit (DCTRL1-CINH), 6.4-1
- Digital input signals, 6.9-1
- Digital output signals, 6.9-2
- Digital outputs, 6.9-2
- Display functions, 9.1-1
- Monitoring
 - Current load of controller (Ixt monitoring), 8.2-5
 - DC-bus voltage, 8.2-11
 - Heatsink temperature, 8.2-10
 - Monitoring times for process data input objects, 8.2-3
- monitoring, 8.2-1
 - bus off, 8.2-3
 - current load of the motor (I2 x t monitoring), 2.2-1, 8.2-7
 - motor temperature, 8.2-6
 - reset node, 8.2-3
- Monitoring functions, Motor temperature, 2.2-1
- monitoring functions
 - overview, 8.31
 - responses, 8.2-1
- Relay output, 6.9-2
- Table of attributes, 8.6-1
- Thermal motor monitoring, 2.2-1

Conformity, 1.2-1

Control cable, 5.3-3

Control connections, Analog inputs, configuration, 5.8-9

Control terminals, 5.8-1

- Changing the assignment of X5, 6.9-1
- Changing the assignment of X6, 6.9-1

Controller

- Adaptation to mains, 6.5-2
- Application as directed, 1.2-1
- Identification, 1.2-1

Controller inhibit

- Drive behaviour, 6.4-1
- Terminal assignment, 5.8-9

Current characteristics, current derating, 3.4-1

Current controller adjustment, 6.7-1

Current derating, 3.4-1
Current load of controller, Ixt monitoring, 8.2-5
Current load of the motor, I2 x t monitoring, 2.2-1, 8.2-7

D

DC supply, 5.3-1, 5.4-4, 5.5-3, 5.6-3, 5.7-3
DC-bus connection
- Central supply, 10.5-1
- Distributed supply, 10.4-1
DC-bus operation, 10-1
- Conditions, 10.2-1
- Several drives, 10-1
DC-bus voltage, 8.2-11, 8.4-5
- Monitoring, 8.2-11
- Overvoltage, 8.2-11
- Undervoltage, 8.2-11
Deceleration time, 8.4-3, 8.4-12
Definition of notes used, 1.4-1
Definitions, Terms, 13.1-1
Device control, 8.4-2
Device protection, 2.3-2
Diagnostics, 7.2-11, 9.1-1
Digital frequency input, connection to X9, 5.11-1
Digital frequency output, connection to X10, 5.11-1
Digital input signals, 6.9-1
Digital inputs, Terminal assignment, 5.8-9
Digital inputs/outputs, Terminal assignment, 11.4-1
Digital output signals, 6.9-2
Digital outputs
- Configuration, 6.9-2
- Terminal assignment, 5.8-9
Dimensions, 3.1-2, 4.1-3, 4.1-5, 4.2-3, 4.2-5, 4.3-3, 4.4-3
Discharge current, Mobile systems, 5.2-4
Display, operating status, 9.2-1
Display functions, 9.1-1
Disposal, 2.1-3
Distributed supply, 10.4-1
Drive behaviour
- Controller inhibit, 6.4-1
- Influence of the motor cable length, 5.2-8

E

E.I.c.b., 5.2-3
- operation at, 5.2-3
Earth fault in motor cable (OC2), 8.2-4
Earth-leakage circuit breaker, 5.2-3
- operation at, 5.2-3
Electrical installation, system bus (CAN), 5.9-1
EMC, what to do in case of interferences, 5.3-6
Emergency-off, Controller inhibit, 6.4-1
EMZ9371BC keypad, changing parameters, 7.2-8, 7.2-9
EN 61000-3-2, 3.1-2, 5.2-1
- operation on public supply systems, 5.2-1
Entry of motor data, 6.5-3
Error analysis
- Via history buffer, 9.2-1
- via LECOM status word, 9.2-3
Error messages, 9.3-1
- causes and remedies, 9.3-1
- configuration, 8.31
- General, 9.3-1
- Resetting, 9.3-6
Exceeding of the maximum speed (NMAX), 8.2-4
Explanations, Code table, 8.4-1
External error (EEr), 8.2-11

F

Failure of a motor phase, 8.2-4
Fault analysis
- Via history buffer, 9.2-1
- via LECOM status word, 9.2-3
Fault messages, causes and remedies, 9.3-1
Fault responses, 8.2-1
Feedback system, wiring, 5.10-1
field controller, 8.4-5
Free spaces, 3.1-2
Function keys, keypad XT EMZ9371BC, 7.2-4
Functional test, safety function, 11.5-2, 11.5-5
Fuses, 10.3-1
- mains connection, 5.4-6, 5.5-5, 5.6-5, 5.7-5

G

General accessories, 12.1-1

General data, 3.1-1, 7.2-1

H

Harmonic currents

- Limitation according to EN 61000-3-2, 5.2-1
- limitation in accordance with EN 61000-3-2, 3.1-2

Heatsink temperature, monitoring, 8.2-10

History buffer, 9.2-1

I

Identification, Controller, 1.2-1

I_{max} limit, 8.4-3

Incremental encoder

- At X8, 5.10-3, 6.6-1
- With TTL level, 5.10-3, 6.6-1

Input signals

- Analog, Configuration, 6.9-3
- Digital, Configuration, 6.9-1

Inputs

- Digital, Response times, 6.9-1
- KTY, 6.5-15
- PTC, 6.5-14

Installation

- Mechanical
 - Cold plate technique, 4.1-4, 4.2-4
 - Standard mounting 45 kW, 4.3-2
 - Standard mounting 55 ... 75 kW, 4.4-2
 - Thermally separated mounting (push-through technique) 45 kW, 4.3-3
 - Thermally separated mounting (push-through technique) 55 ...75 kW, 4.4-3
- mechanical, thermally separated (push-through technique) 15 ... 30 kW, 4.2-3

Interaction with compensation equipment, 5.2-3

Interferences, eliminating EMC interferences, 5.3-6

IT system, 5.2-2

J

JOG setpoint, 8.4-4

K

Keypad EMZ9371BC, Changing parameters, 7.2-5, 7.2-7, 7.2-10

Keypad XT EMZ9371BC

- function keys, 7.2-4
- status display, 7.2-3

KSR safety relay, Terminal assignment, 5.8-9

KTY motor monitoring, 6.5-15

L

Leakage inductance, 8.4-6

LECOM, status word (C0150/C0155), 9.2-3

LED display, 9.2-1

Legal regulations, 1.2-1

Liability, 1.2-2

Light-emitting diodes, 9.2-1

Limit class C1/C2, 5.2-6

M

Mains, controller adaptation, 6.5-2

Mains choke, Assignment to standard device, 5.2-7, 5.4-7, 5.5-6, 5.6-6, 5.7-6

Mains connection, 5.3-1, 5.4-4, 5.5-3, 5.6-3, 5.7-3

- AC mains, 3.1-2
- DC mains, 3.1-2

Mains filter, Assignment to standard device, 5.2-7, 5.4-7, 5.5-6, 5.6-6, 5.7-6

Manufacturer, 1.2-1

Max. mains voltage range, 3.1-2

Maximum speed, 8.4-2

Mechanical installation

- Cold plate technique, 4.1-4, 4.2-4
- Standard mounting 45 kW, 4.3-2
- Standard mounting 55 ... 75 kW, 4.4-2
- thermally separated (push-through technique) 15 ... 30 kW, 4.2-3
- Thermally separated mounting (push-through technique) 45 kW, 4.3-3
- Thermally separated mounting (push-through technique) 55 ...75 kW, 4.4-3

Menu structure, XT EMZ9371BC keypad, 7.2-12**Message, 8.2-1****Mobile systems, 5.2-4****Monitoring, 8.2-1**

- bus off, 8.2-3
- configuring, 8.31
- Current load of controller, Ixt monitoring, 8.2-5
- current load of the motor, I2 x t monitoring, 2.2-1, 8.2-7
- DC-bus voltage, 8.2-11
- Earth fault in motor cable (OC2), 8.2-4
- Exceeding of the maximum speed (NMAX), 8.2-4
- External error (EEr), 8.2-11
- Failure of a motor phase (LP1), 8.2-4
- Heatsink temperature, 8.2-10
- Monitoring times for process data input objects, 8.2-3
- motor cable overcurrent (OC1), 8.2-4
- motor temperature, 8.2-6
- possible responses, 8.31
- reset node, 8.2-3
- responses, 8.2-1
 - message, 8.2-1
 - TRIP, 8.2-1
 - warning, 8.2-1

Monitoring functions

- Motor temperature, 2.2-1
- Overview, 8.31
- responses, 8.2-1

Monitoring times for process data input objects, 8.2-3**Motor, thermal monitoring, with PTC thermistor, 6.5-14, 6.5-15****motor, Thermal monitoring, Sensorless, 2.2-1****Motor cable, 5.2-8, 5.3-1**

- Cable cross-section, 5.2-9
- for trailing cable, 5.2-9
- Influence of the length, 5.2-8
- length, 3.1-2
- max. length, 5.2-7
- permanently installed, 5.2-9
- permissible length, 5.2-8
- Specification, 5.2-8

Motor cable overcurrent (OC1), 8.2-4**Motor connection, 3.1-2****Motor monitoring, 2.2-1****motor pot, 8.4-12****Motor protection, 2.3-2****Motor stator resistance, 8.4-6****Motor temperature, monitoring, 8.2-6****Motor type selection, 8.4-6****Mounting conditions**

- Dimensions, 3.1-2
- Free spaces, 3.1-2
- Mounting place, 3.1-2
- Mounting position, 3.1-2
- Weights, 3.1-2

Mounting place, 3.1-2**Mounting position, 3.1-2****N****Nameplate, 1.1-3****Network of several drives, Function, 10.1-1****Noise optimised operation, 8.4-3****Notes, definition, 1.4-1****O****Operating conditions, 3.1-1, 7.2-1**

- Ambient conditions
 - Climatic, 3.1-1
 - Mechanical, 3.1-2
- ambient conditions, electrical, 3.1-2
- Mounting conditions
 - Dimensions, 3.1-2
 - Free space, 3.1-2
 - Mounting place, 3.1-2
 - Mounting position, 3.1-2
 - Weight, 3.1-2

Operating mode of the motor control, 8.4-2**Operating status, display, 9.2-1****Operation, at earth-leakage circuit breaker, 5.2-3****Operation on public supply systems, EN 61000-3-2, 5.2-1****Optimisation of the controller and mains load, 5.2-5****Output signals**

- Analog, Configuration, 6.9-4
- Digital, Configuration, 6.9-2

Outputs

- Analog, 6.9-4
- Digital, 6.9-2

Overview, Accessories, 12-1

Overvoltage threshold, DC-bus voltage, 8.2-11

P

Parameter setting, 7-1

- code, 7.1-1

- with bus system, 7.1-2

- With XT EMZ9371BC keypad, 7.2-1

Pollution, 3.1-1

Power system, 3.1-2

Process controller adaptation, 8.4-13

Process input words, 8.4-36

Process output words, 8.4-36

Protection against unexpected start-up, 11.1-1

- operating mode, 11.2-1

- safety relay, 11.3-1

Protection of persons, 2.3-1

- with earth-leakage circuit breaker, 5.2-3

PTC motor monitoring, 6.5-14

Q

QSP deceleration time, 8.4-7

R

Rated motor power, 8.4-6

Rated motor voltage, 8.4-6

Reaction times of digital inputs, 6.9-1

Reduce noise emissions, 5.2-6

Relay output, Configuration, 6.9-2

Residual hazards, 2.3-1

Resolver, Connecting, 5.10-2, 6.6-1

Resolver polarity check, 6.8-2

Responses, 8.2-1

- message, 8.2-1

- TRIP, 8.2-1

- warning, 8.2-1

Rotor position adjustment, 6.8-1, 6.8-2

S

Safe standstill, 11.1-1

Safe torque off, 11.1-1

- device variant with, 5.8-5

- device variant without, 5.8-4

- functional test, 11.5-2, 11.5-5

- operating mode, 11.2-1

- safety relay, 11.3-1

Safety, safety engineering, 11-1

Safety engineering, 11-1

Safety function

- functional test, 11.5-2, 11.5-5

- Safe torque off, 11.1-1

Safety instructions, 2-1

- definition, 1.4-1

- layout, 1.4-1

Safety relay, 11.3-1

- Connector X11

Terminal assignment, 11.4-1

Wiring, 11.4-1

Safety relay KSR, Terminal assignment, 11.4-1

Selection of the feedback system, 8.4-3

Setting the feedback system, 6.6-1

Setting the speed feedback, 6.6-1

Site altitude, 3.1-2

Status display, keypad XT EMZ9371BC, 7.2-3

Status word, 8.4-9

- LECOM (C0150/C0155), 9.2-3

Supply conditions, 5.4-6, 5.4-7, 5.5-5, 5.5-6, 5.6-5, 5.6-6, 5.7-5, 5.7-6, 10.3-1

Supply forms, IT system, 5.2-2

Supply forms / electrical supply conditions, 5.2-1

Switch on, 6.3-1

Switch-on, check before switching on, 6.2-1

System bus (CAN), wiring, 5.9-1

System error messages, 9.3-1

- configuration, 8.31

- General, 9.3-1

- Resetting, 9.3-6

T

Table of attributes, 8.6-1

Technical data, 3-1

- Current characteristics, device protection through current derating, 3.4-1
- General data, 3.1-1
- Operating conditions, 3.1-1

Terminal assignment

- Analog inputs, 5.8-9
- Analog outputs, 5.8-9
- Controller inhibit, 5.8-9
- Digital inputs, 5.8-9
- Digital inputs/outputs, 11.4-1
- Digital outputs, 5.8-9
- KSR safety relay, 5.8-9
- Safety relay KSR, 11.4-1

Terminal data, 5.8-2, 11.4-1**Terms**

- controller, 13.1-1
- Definitions, 13.1-1
- drive, 13.1-1

Thermal monitoring, motor

- Sensorless, 2.2-1
- with PTC thermistor, 6.5-14, 6.5-15

Tni current controller, 8.4-5**Tnn speed controller, 8.4-5****TRIP, 8.2-1****Troubleshooting, 9.2-1****Troubleshooting and fault elimination, 9-1**

- Monitoring, 8.2-1
 - Current load of controller (lxt monitoring), 8.2-5
 - DC-bus voltage, 8.2-11
 - Heatsink temperature, 8.2-10
 - Monitoring times for process data input objects, 8.2-3
- monitoring
 - bus off, 8.2-3
 - current load of the motor (l2 x t monitoring), 2.2-1, 8.2-7
 - motor temperature, 8.2-6
 - reset node, 8.2-3
 - responses, 8.2-1

Type-specific accessories, 12.2-1**U****Undervoltage threshold, DC-bus voltage, 8.2-11****V****Vpi current controller, 8.4-5****Vpn speed controller, 8.4-5****W****Warning, 8.2-1****Warranty, 1.2-2****Weights, 3.1-2****Wiring**

- digital frequency input to X9, 5.11-1
- digital frequency output to X10, 5.11-1
- in the control cabinet, 5.3-4
- Mobile systems, 5.2-4
- outside of the control cabinet, 5.3-5
- system bus (CAN), 5.9-1

Wiring according to EMC, 5.4-1, 5.5-1, 5.6-1, 5.7-1**X****XT EMZ9371BC keypad, Menu structure, 7.2-12**



© 09/2013

Lenze Automation GmbH
Hans-Lenze-Str. 1
D-31855 Aerzen
Germany



+49 (0)51 54 / 82-0



+49 (0)51 54 / 82 - 28 00



Lenze@Lenze.de



www.Lenze.com

Service

Lenze Service GmbH
Breslauer Straße 3
D-32699 Extertal
Germany



00 80 00 / 24 4 68 77 (24 h helpline)



+49 (0)51 54 / 82-11 12



Service@Lenze.de



EDSV59332S ■ 13440809 ■ EN ■ 6.0-07/2013 ■ TD06

10 9 8 7 6 5 4 3 2 1