



MC1000 Series

Operation Manual



Lenze

CONTENTS

1	GENERAL	1
1.1	PRODUCTS COVERED IN THIS MANUAL	1
1.2	PRODUCT CHANGES	1
1.3	WARRANTY	1
1.4	RECEIVING	1
1.5	CUSTOMER MODIFICATION	1
1.6	SAFETY INFORMATION	1
2	MC1000 SPECIFICATIONS	4
3	MC1000 MODEL DESIGNATION CODE	5
4	MC1000 DIMENSIONS	6
4.1	TYPE 1 DIMENSIONS: MODELS RATED UP TO 30 HP	6
4.2	TYPE 1 DIMENSIONS: MODELS RATED ABOVE 30 HP	8
4.3	TYPE 4, 4X & 12 DIMENSIONS: MODELS RATED UP TO 30HP	9
4.4	TYPE 12 DIMENSIONS: MODELS RATED ABOVE 30 HP	11
5	MC1000 RATINGS	12
6	THEORY	16
6.1	DESCRIPTION OF AC MOTOR OPERATION	16
6.2	DRIVE FUNCTION DESCRIPTION	18
7	INSTALLATION	19
7.1	INSTALLATION AFTER A LONG PERIOD OF STORAGE	20
7.2	EXPLOSION PROOF APPLICATIONS	20
8	INPUT AC REQUIREMENTS	21
8.1	INPUT AC POWER REQUIREMENTS	21
8.2	INPUT FUSING AND DISCONNECT REQUIREMENTS	21
9	VOLTAGE SELECTION	22
10	POWER WIRING	23
10.1	WIRING FOR SINGLE PHASE OR THREE PHASE INPUT	23
10.2	MAXIMUM TIGHTENING TORQUE	24
11	MC1000 POWER WIRING DIAGRAM	26
12	INITIAL POWER UP	27
13	KEYPAD CONTROL	28
13.1	KEYPAD FUNCTIONS (IN LOCAL MODE)	28
13.2	MC1000 DISPLAY	29
14	CONTROL WIRING	33
14.1	GENERAL	33
14.2	START/STOP AND SPEED CONTROL	33
15	MC1000 CONTROL WIRING DIAGRAMS	38
15.1	MC1000 TERMINAL STRIP	38
15.2	TWO-WIRE START/STOP CONTROL	39
15.3	THREE-WIRE START/STOP CONTROL	40
15.4	SPEED POT AND PRESET SPEED CONTROL	41
16	PROGRAMMING THE MC1000 DRIVE	42
16.1	PROGRAMMING THE PARAMETERS	42
16.2	PARAMETER ACCESS USING SPEED DIAL	44
17	PARAMETER MENU	45
18	DESCRIPTION OF PARAMETERS	48
19	MC1000 PID SET POINT CONTROL	74
19.1	FEEDBACK DEVICES	74
19.2	THE SYSTEM - DIRECT AND REVERSE ACTING	75
19.3	PID CONTROL - DIRECT AND REVERSE ACTING	75
19.4	SET POINT REFERENCE SOURCES	76
19.5	TUNING THE PID CONTROL	76
19.6	MC1000 DISPLAY IN PID MODE	77
20	TROUBLESHOOTING	78
21	USER SETTING RECORD	80
	APPENDIX	82
A	SINGLE PHASE DATA SELECTED MODELS	82
A-1	WIRING	82
A-2	DERATING	82

1 GENERAL

1.1 PRODUCTS COVERED IN THIS MANUAL

This manual covers the Lenze AC Tech MC1000 Variable Frequency Drive.

1.2 PRODUCT CHANGES

Lenze AC Tech Corporation reserves the right to discontinue or make modifications to the design of its products and manuals without prior notice, and holds no obligation to make modifications to products sold previously. Lenze AC Tech Corporation also holds no liability for losses of any kind which may result from this action. Instruction manuals with the most up-to-date information are available for download from the Lenze website (www.lenze.com).

1.3 WARRANTY

Lenze AC Tech Corporation warrants the MC Series AC motor control to be free of defects in material and workmanship for a period of two years from the date of shipment from Lenze Americas' factory. An MC Series control, or any component contained therein, which under normal use, becomes defective within the stated warranty time period, shall be returned to Lenze AC Tech Corporation, freight prepaid, for examination (contact Lenze AC Tech Corporation for authorization prior to returning any product). Lenze AC Tech Corporation reserves the right to make the final determination as to the validity of a warranty claim, and sole obligation is to repair or replace only components which have been rendered defective due to faulty material or workmanship. No warranty claim will be accepted for components which have been damaged due to mishandling, improper installation, unauthorized repair and/or alteration of the product, operation in excess of design specifications or other misuse, or improper maintenance. Lenze AC Tech Corporation makes no warranty that its products are compatible with any other equipment, or to any specific application, to which they may be applied and shall not be held liable for any other consequential damage or injury arising from the use of its products.

This warranty is in lieu of all other warranties, expressed or implied. No other person, firm or corporation is authorized to assume, for Lenze AC Tech Corporation, any other liability in connection with the demonstration or sale of its products.

1.4 RECEIVING

Inspect all cartons for damage which may have occurred during shipping. Carefully unpack equipment and inspect thoroughly for damage or shortage. Report any damage to carrier and/or shortages to supplier. All major components and connections should be examined for damage and tightness, with special attention given to PC boards, plugs, knobs and switches.

1.5 CUSTOMER MODIFICATION

Lenze AC Tech Corporation, its sales representatives and distributors, welcome the opportunity to assist our customers in applying our products. Many customizing options are available to aid in this function. Lenze AC Tech Corporation cannot assume responsibility for any modifications not authorized by its engineering department.

1.6 SAFETY INFORMATION

Some parts of Lenze AC Tech controllers can be electrically live and some surfaces can be hot. Non-authorized removal of the required cover, inappropriate use, and incorrect installation or operation creates the risk of severe injury to personnel and/or damage to equipment. All operations concerning transport, installation, and commissioning as well as maintenance must be carried out by qualified, skilled personnel who are familiar with the installation, assembly, commissioning, and operation of variable frequency drives and the application for which it is being used.

1.6.1 EXPLOSION PROOF APPLICATIONS

Explosion proof motors that are not rated for inverter use lose their certification when used for variable speed. Due to the many areas of liability that may be encountered when dealing with these applications, the following statement of policy applies:

Lenze AC Tech Corporation inverter products are sold with no warranty of fitness for a particular purpose or warranty of suitability for use with explosion proof motors. Lenze AC Tech Corporation accepts no responsibility for any direct, incidental or consequential loss, cost or damage that may arise through the use of AC inverter products in these applications. The purchaser expressly agrees to assume all risk of any loss, cost or damage that may arise from such application.

1.6.2 EN 61800-5-1 COMPLIANCE



WARNING!

This product can cause a d.c. current in the protective earthing (PE) conductor. Where a residual current-operated (RCD) or monitoring (RCM) device is used for protection in case of direct or indirect contact, only an RCD or RCM Type B is allowed on the supply side of this product.



WARNING!

Leakage Current may exceed 3.5mA AC. The minimum size of the protective earth (PE) conductor shall comply with local safety regulations for high leakage current equipment.



DANGER! Hazard of Electric Shock

Capacitors retain charge for approximately 180 seconds after power is removed. Allow at least 3 minutes for discharge of residual charge before touching the drive.



NOTE

Control terminals provide basic isolation (insulation per EN 61800-5-1, for up to 300V to ground). Protection against contact can only be ensured by additional measures (e.g. supplemental insulation).



WARNING!

In a domestic environment this product may cause radio interference in which case supplementary mitigation measures may be required.

1.6.3 PICTOGRAPHS USED IN THESE INSTRUCTIONS

The safety information provided in this Installation and Operating manual includes a visual icon, a bold signal word and a description.



Signal Word! (characterizes the severity of the danger)

Text (describes the danger and informs on how to proceed)

Icon	Signal Word	Meaning	Consequences if ignored
	DANGER!	Hazardous electrical voltage	Death or severe injuries.
	WARNING!	Potential, very hazardous situations for persons near machinery.	Risk of severe injury to personnel and/or damage to equipment.
	STOP!	Potential damage to material and equipment.	Damage to the controller/drive or its environment.
	NOTE	Designates a general, useful note.	None. If observed, then using the controller is made easier.

Note for UL approved system with integrated controllers
UL warnings are notes which apply to UL systems. The documentation contains special information about UL.



• Integral solid state protection does not provide branch circuit protection. Branch circuit protection must be provided in accordance with the National Electrical Code and any additional local codes. The use of fuses or circuit breakers is the only approved means for branch circuit protection.

• When protected by CC and T Class Fuses, rated for 150% of the input current, suitable for use on a circuit capable of delivering not more than 200,000 rms symmetrical amperes, at the maximum voltage rating marked on the drive.

• Additionally suitable for use when protected by a circuit breaker rated for 150% of the input current, and having an interrupting rating not less than 200,000 rms symmetrical amperes, at the maximum voltage rating marked on the drive. (Excludes 240V models requiring >40A protection and 480V/590V models requiring >32A protection. Additionally excludes M1103S models when supplied using 240VAC.)

• Use minimum 75°C copper wire only, except for control circuits.

• For control circuits, use wiring suitable for NEC Class 1 circuits only.

• Torque Requirements are listed in section 10, POWER WIRING, and section 14, CONTROL WIRING.

• Suitable for installation in a compartment handling conditioned air.



DANGER!

Risk of Electric Shock! Capacitors retain charge for approximately 180 seconds after power is removed. Disconnect incoming power and wait at least 3 minutes before touching the drive.



DANGER!

Risque de choc électrique! Les condensateurs restent sous charge pendant environ 180 secondes après une coupure de courant. Couper l'alimentation et patienter pendant au moins 3 minutes avant de toucher l'entraînement.



WARNING!

The opening of branch-circuit protective device may be an indication that a fault has been interrupted. To reduce the risk of fire or electric shock, current carrying parts and other components of the controller should be examined and replaced if damaged.



AVERTISSEMENT!

Le déclenchement du dispositif de protection du circuit de dérivation peut être dû à une coupure qui résulte d'un courant de défaut. Pour limiter le risque d'incendie ou de choc électrique, examiner les pièces porteuses de courant et les autres éléments du contrôleur et les remplacer s'ils sont endommagés.

2 MC1000 SPECIFICATIONS

Storage Temperature	-20° to 70° C
Ambient Operating Temperature (With 2, 5, 6, and 8 kHz carrier, derate for higher carriers)	Chassis (w/o cover) -10° to 55°C Type 1 (IP 31) -10° to 50°C ¹ Type 4 (IP 65) -10° to 40°C Type 12 (IP 54) -10° to 40°C ¹ (with 2.5%/°C current derating above max. temp, up to 55°C)
Ambient Humidity	Less than 95% (non-condensing)
Altitude	3300 feet (1000 m) above sea level without derating
Input Line Voltages	240/120 Vac, 240/200 Vac, 480/400 Vac, and 590/480 Vac
Input Voltage Tolerance	+10%, -15%
Input Frequency Tolerance	48 to 62 Hz
Output Wave Form	Sine Coded PWM
Output Frequency	0-120 Hz, Consult factory for operation above 120Hz
Carrier Frequency	2.5 kHz to 14 kHz
Frequency Stability	+0.00006% / °C
Service Factor	1.00
Efficiency	> 97% throughout speed range
Power Factor (displacement)	> 0.96
Overload Current Capacity	150% of output rating for 60 seconds 180% of output rating for 30 seconds
Speed Reference Follower	0-10 VDC, 4-20 mA
Control Voltage	15 VDC
Analog Outputs	0 - 10 VDC, or 2 - 10 VDC Proportional to speed and load
Digital Outputs	Form C relay: 2 A at 28 VDC or 120 Vac Open-collector outputs: 40 mA at 30 VDC

¹Model M14300 has an ambient operating temperature of -10° to 35°C

3 MC1000 MODEL DESIGNATION CODE

The model number of an MC1000 Series drive gives a full description of the basic drive unit (see example below).

EXAMPLE: M1450BP

(MC1000, 480 Vac, 5 HP, Type 1 Enclosure, with a Remote Keypad Assembly)

	M1	4	50		B		P
Series:							
M1 = M1000 Series Variable Speed AC Motor Drive							
Input Voltage:							
1 = 240/120 Vac (For 110, 115, 120, 230 and 240 Vac; 50 or 60 Hz)							
2 = 240/200 Vac (For 208, 230, and 240 Vac; 50 or 60 Hz)							
4 = 480/400 Vac (For 380, 415, 440, 460 and 480 Vac; 50 or 60 Hz)							
5 = 590/480 Vac (For 440, 460, 480, 575 and 600 Vac; 50 or 60 Hz)							
Rating:							
03 = ¼ HP (0.18 kW) 75 = 7½ HP (5.5 kW) 500 = 50 HP (37.5 kW)							
05 = ½ HP (0.37 kW) 100 = 10 HP (7.5 kW) 600 = 60 HP (45 kW)							
10 = 1 HP (0.75 kW) 150 = 15 HP (11 kW) 750 = 75 HP (55 kW)							
15 = 1½ HP (1.1 kW) 200 = 20 HP (15 kW) 1000 = 100 HP (75 kW)							
20 = 2 HP (1.5 kW) 250 = 25 HP (18.5 kW) 1250 = 125 HP (90 kW)							
30 = 3 HP (2.2 kW) 300 = 30 HP (22 kW) 1500 = 150 HP (110 kW)							
50 / 51 = 5 HP (3.7 kW) 400 = 40 HP (30kW)							
Input Phase:							
S = Single phase input only.							
<i>No character indicates three phase input only</i>							
Enclosure Type:							
B = NEMA 1 - General Purpose, vented							
C = NEMA 4 - Water-tight and Dust-tight							
D = NEMA 12 - Oil-tight and Dust-tight							
E = NEMA 4X - Water-tight, Dust-tight, and Corrosion Resistant (Stainless Steel)							
Standard Options:							
H = Additional Form C Relay circuit board							
J = Dynamic Braking circuit board							
K = Dynamic Braking & Additional Form C Relay board (not available on all HP sizes - consult factory)							
<i>No character when this type of option is not specified</i>							
Interface Options:							
P = Remote keypad assembly							
<i>No character when this type of option is not specified</i>							

4 MC1000 DIMENSIONS

4.1 TYPE 1 DIMENSIONS: MODELS RATED UP TO 30 HP AT 240/200 Vac AND 60 HP AT 590/480/400 Vac

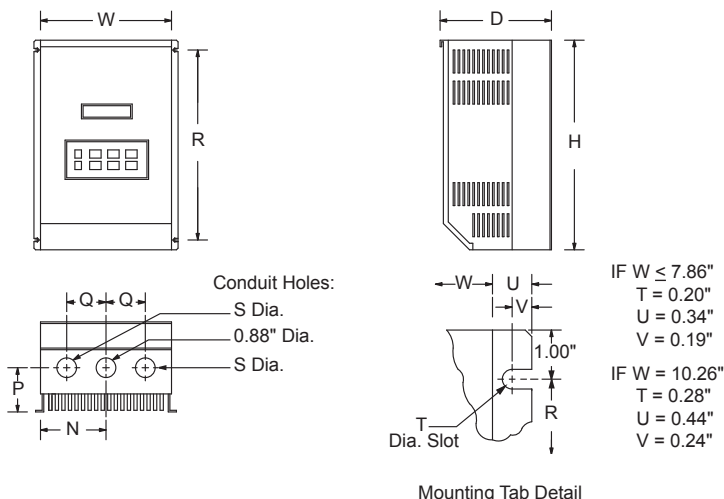

HP (kW)	INPUT VOLTAGE	MODEL	H	W	D	N	P	Q	R	S
0.25 (0.18)	240 / 120	M1103SB	7.50	4.70	3.33	2.35	1.60	1.37	5.50	0.88
0.5 (0.37)	240 / 120	M1105SB	7.50	6.12	3.63	3.77	1.80	1.37	5.50	0.88
	240	M1205SB	7.50	4.70	3.63	2.35	1.90	1.37	5.50	0.88
	240/200	M1205B	7.50	4.70	3.63	2.35	1.90	1.37	5.50	0.88
1 (0.75)	240 / 120	M1110SB	7.50	6.12	4.22	3.77	2.40	1.37	5.50	0.88
	240	M1210SB	7.50	4.70	4.33	2.35	2.60	1.37	5.50	0.88
	240 / 200	M1210B	7.50	4.70	4.33	2.35	2.60	1.37	5.50	0.88
	480 / 400	M1410B	7.50	4.70	3.63	2.35	1.90	1.37	5.50	0.88
	590	M1510B	7.50	4.70	3.63	2.35	1.90	1.37	5.50	0.88
1.5 (1.1)	240/120	M1115SB	7.50	6.12	4.22	3.77	2.40	1.37	5.50	0.88
	240	M1215SB	7.50	6.12	4.22	3.77	2.40	1.37	5.50	0.88
	240/200	M1215B	7.50	4.70	4.33	2.35	2.60	1.37	5.50	0.88
2 (1.5)	240	M1220SB	7.50	6.12	5.12	3.77	3.30	1.37	5.50	0.88
	240 / 200	M1220B	7.50	6.12	5.12	3.77	3.30	1.37	5.50	0.88
	480/400	M1420B	7.50	6.12	4.22	3.77	2.40	1.37	5.50	0.88
	590	M1520B	7.50	6.12	4.22	3.77	2.40	1.37	5.50	0.88

TYPE 1 DIMENSIONS (continued)

HP (kW)	INPUT VOLTAGE	MODEL	H	W	D	N	P	Q	R	S
3 (2.2)	240	M1230SB	7.50	6.12	5.12	3.77	3.30	1.37	5.50	0.88
	240 / 200	M1230B	7.50	6.12	5.12	3.77	3.30	1.37	5.50	0.88
	480 / 400	M1430B	7.50	6.12	5.12	3.77	3.30	1.37	5.50	0.88
	590	M1530B	7.50	6.12	5.12	3.77	3.30	1.37	5.50	0.88
5 (3.7)	240 / 200	M1250B	7.88	7.86	5.94	5.13	3.95	1.50	5.88	1.13
	480 / 400	M1450B	7.50	6.12	5.12	3.77	3.30	1.37	5.50	0.88
	590	M1551B	7.88	7.86	5.94	5.13	3.95	1.50	5.88	1.13
7.5 (5.5)	240 / 200	M1275B	9.38	7.86	6.84	3.93	4.19	2.00	5.88	1.13
	480 / 400	M1475B	9.38	7.86	6.25	5.13	3.95	1.50	7.38	1.13
	590	M1575B	9.38	7.86	6.25	5.13	3.95	1.50	7.38	1.13
10 (7.5)	240 / 200	M12100B	11.25	7.86	6.84	3.93	4.19	2.00	7.75	1.38
	480 / 400	M14100B	9.38	7.86	6.84	3.93	4.19	2.00	5.88	1.13
	590	M15100B	9.38	7.86	7.40	3.93	4.19	2.00	5.88	1.13
15 (11)	240/200	M12150B	12.75	7.86	6.84	3.93	4.19	2.00	9.25	1.38
	480/400	M14150B	11.25	7.86	6.84	3.93	4.19	2.00	7.75	1.38
	590	M15150B	12.75	7.86	6.84	3.93	4.19	2.00	9.75	1.38
20 (15)	240 / 200	M12200B	12.75	10.26	7.74	5.13	5.00	2.50	9.25	1.38
	480/400	M14200B	12.75	7.86	6.84	3.93	4.19	2.00	9.25	1.38
	590	M15200B	12.75	7.86	7.40	3.93	4.19	2.00	9.25	1.38
25 (18.5)	240 / 200	M12250B	15.75	10.26	8.35	5.13	5.00	2.50	12.25	1.38
	480/400	M14250B	12.75	10.26	7.74	5.13	5.00	2.50	9.25	1.38
	590	M15250B	12.75	10.26	7.74	5.13	5.00	2.50	9.25	1.38
30 (22)	240 / 200	M12300B	15.75	10.26	8.35	5.13	5.00	2.50	12.25	1.38
	480/400	M14300B	12.75	10.26	7.74	5.13	5.00	2.50	9.25	1.38
	590	M15300B	12.75	10.26	8.25	5.13	5.00	2.50	9.25	1.38
40 (30)	480/400	M14400B	15.75	10.26	8.35	5.13	5.00	2.50	12.25	1.38
	590	M15400B	15.75	10.26	8.35	5.13	5.00	2.50	12.25	1.38
50 (37.5)	480/400	M14500B	19.75	10.26	8.55	5.13	5.75	2.50	16.25	1.75
	590	M15500B	19.75	10.26	8.55	5.13	5.75	2.50	16.25	1.75
60 (45)	480/400	M14600B	19.75	10.26	8.55	5.13	5.75	2.50	16.25	1.75
	590	M15600B	19.75	10.26	8.55	5.13	5.75	2.50	16.25	1.75

4.2 TYPE 1 DIMENSIONS: MODELS RATED ABOVE 30 HP
 AT 240/200 Vac AND 60 HP AT 590/480/400 Vac

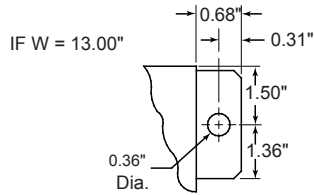
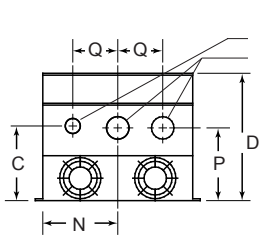
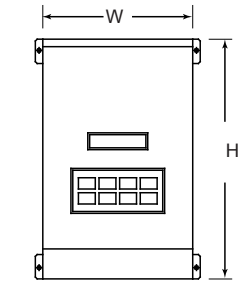

Mounting Tab Detail

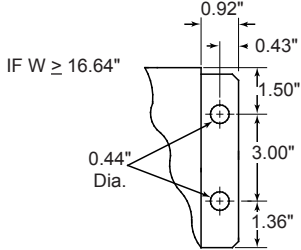

HP/kW	INPUT VOLTAGE	MODEL	H	W	D	N	C	P	Q	S
40/30	240 / 200	M12400B	25.00	13.00	10.50	5.56	6.50	6.50	2.62	1.38
60/45	240 / 200	M12600B	47.00	16.64	11.85			See below		
75/55	480 / 400	M14750B	29.00	16.64	11.85	7.14	6.88	6.88	3.12	1.75
100/75	480 / 400	M141000B	29.00	24.42	11.85	11.12	7.25	6.50	4.50	2.50
125/90	480 / 400	M141250B	29.00	24.42	11.85	11.12	7.25	6.50	4.50	2.50
150/110	480 / 400	M141500B	29.00	36.66	11.85			See below		

CONDUIT HOLES FOR M12600B

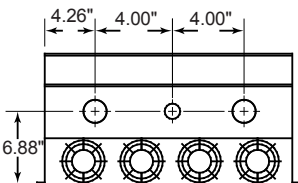

Conduit Holes: Large holes = 1.75"
 Small hole = 1.13"

CONDUIT HOLES FOR M141500B

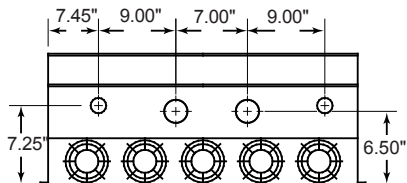

Conduit Holes: Large holes = 3.00"
 Small holes = 1.13"

4.3 TYPE 4, 4X & 12 DIMENSIONS: MODELS RATED UP TO 30HP
 AT 240/200 Vac AND 60 HP AT 590/480/400 Vac

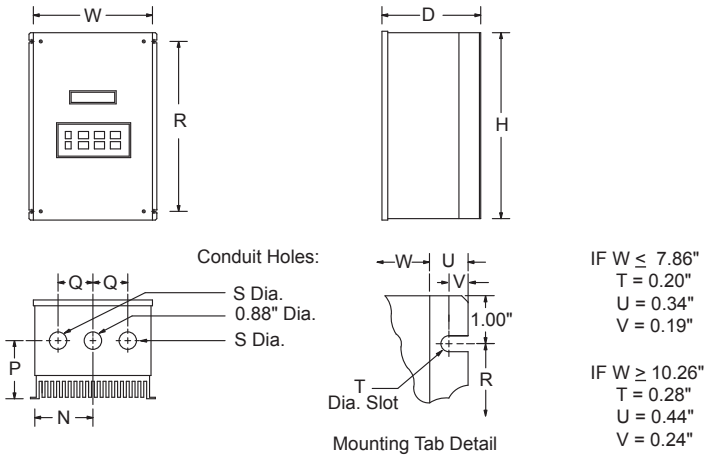

HP (kW)	INPUT VOLTAGE	MODEL	H	W	D	N	P	Q	R	S
0.25 (0.18)	240 / 120	M1103S	7.88	6.12	3.63	3.06	2.00	1.37	5.88	0.88
	240 / 120	M1105S	7.88	7.86	3.75	4.80	2.10	1.37	5.88	0.88
0.5 (0.37)	240	M1205S	7.88	6.12	4.35	3.06	2.70	1.37	5.88	0.88
	240/200	M1205	7.88	6.12	4.35	3.06	2.70	1.37	5.88	0.88
1.5 (1.1)	240/120	M1115S	7.88	7.86	4.90	4.80	3.25	1.37	5.88	0.88
	240	M1215S	7.88	7.86	4.90	4.80	3.25	1.37	5.88	0.88
	240/200	M1215	7.88	6.12	5.25	3.06	3.60	1.37	5.88	0.88
2 (1.5)	240	M1220S	7.88	7.86	4.90	4.80	3.25	1.37	5.88	0.88
	240 / 200	M1220	7.88	7.86	4.90	4.80	3.25	1.37	5.88	0.88
	480/400	M1420	7.88	7.86	4.90	4.80	3.25	1.37	5.88	0.88
3 (2.2)	590	M1520	7.88	7.86	4.90	4.80	3.25	1.37	5.88	0.88
	240	M1230S	7.88	7.86	5.90	4.80	4.25	1.37	5.88	0.88
	240 / 200	M1230	7.88	7.86	5.90	4.80	4.25	1.37	5.88	0.88
3 (2.2)	480 / 400	M1430	7.88	7.86	4.90	4.80	3.25	1.37	5.88	0.88
	590	M1530	7.88	7.86	4.90	4.80	3.25	1.37	5.88	0.88

DIMENSIONS - TYPE 4, 4X, AND 12 ENCLOSED (continued)

HP (kW)	INPUT VOLTAGE	MODEL	H	W	D	N	P	Q	R	S
5 (3.7)	240 / 200	M1250	9.75	10.26	7.20	5.13	5.25	2.00	7.75	1.13
	480 / 400	M1450	7.88	7.86	5.90	4.80	4.25	1.37	5.88	0.88
	590	M1550	7.88	7.86	5.90	4.80	4.25	1.37	5.88	0.88
7.5 (5.5)	240 / 200	M1275	11.75	10.26	8.35	5.13	5.75	2.00	9.75	1.13
	480 / 400	M1475	9.75	10.26	7.20	5.13	5.25	2.00	7.75	1.13
	590	M1575	9.75	10.26	7.20	5.13	5.25	2.00	7.75	1.13
10 (7.5)	240 / 200	M12100	13.75	10.26	8.35	5.13	5.75	2.00	11.75	1.38
	480 / 400	M14100	11.75	10.26	8.35	5.13	5.75	2.00	9.75	1.13
	590	M15100	11.75	10.26	8.35	5.13	5.75	2.00	9.75	1.13
15 (11)	240/200	M12150	15.75	10.26	8.35	5.13	5.75	2.00	13.75	1.38
	480/400	M14150	13.75	10.26	8.35	5.13	5.75	2.00	11.75	1.38
	590	M15150	13.75	10.26	8.35	5.13	5.75	2.00	11.75	1.38
20 (15)	240 / 200	M12200D*	15.75	10.26	8.35	5.13	5.75	2.00	11.75	1.38
	480/400	M14200	15.75	10.26	8.35	5.13	5.75	2.00	13.75	1.38
	590	M15200	15.75	10.26	8.35	5.13	5.75	2.00	13.75	1.38
25 (18.5)	240 / 200	M12250D*	20.25	10.26	8.35	5.13	5.75	2.00	16.25	1.38
	480/400	M14250D*	15.75	10.26	8.35	5.13	5.75	2.00	11.75	1.38
	590	M15250D*	15.75	10.26	8.35	5.13	5.75	2.00	11.75	1.38
30 (22)	240 / 200	M12300D*	20.25	10.26	8.35	5.13	5.75	2.00	16.25	1.38
	480/400	M14300D*	15.75	10.26	8.35	5.13	5.75	2.00	11.75	1.38
	590	M15300D*	15.75	10.26	8.35	5.13	5.75	2.00	11.75	1.38
40 (30)	480/400	M14400D*	20.25	10.26	8.35	5.13	5.75	2.00	16.25	1.38
	590	M15400D*	20.25	10.26	8.35	5.13	5.75	2.00	16.25	1.38
50 (37.5)	480/400	M14500D*	21.00	13.72	8.35	5.13	6.10	2.00	16.25	1.38
	590	M15500D*	21.00	13.72	8.35	5.13	6.10	2.00	16.25	1.38
60 (45)	480/400	M14600D*	21.00	13.72	8.35	5.13	6.10	2.00	16.25	1.38
	590	M15600D*	21.00	13.72	8.35	5.13	6.10	2.00	16.25	1.38

Models available in NEMA 12 only.

4.4 TYPE 12 DIMENSIONS: MODELS RATED ABOVE 30 HP
 AT 240/200 Vac AND 60 HP AT 590/480/400 Vac

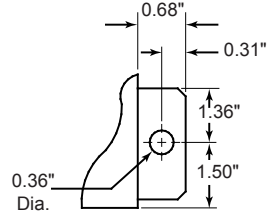
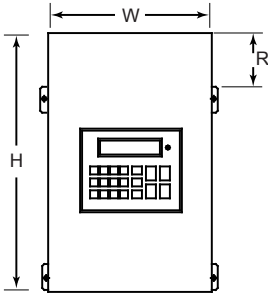

IF W = 14.00"
 Mounting Tab Detail

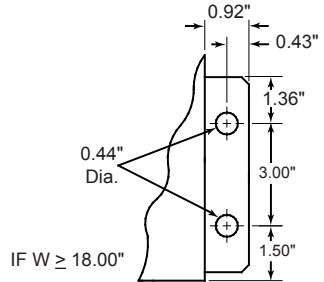
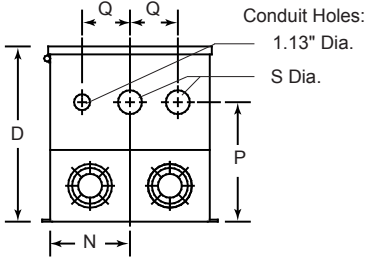

IF W ≥ 18.00"

HP/kW	INPUT VOLTAGE	MODEL	H	W	D	N	P	Q	R	S
75/55	480 / 400	M14750D	37.00	18.00	13.30	7.50	8.00	3.13	7.14	1.75
100/75	480 / 400	M141000D	39.00	26.00	13.30	11.50	9.00	4.50	9.14	2.50
125/90	480 / 400	M141250D	39.00	26.00	13.30	11.50	9.00	4.50	9.14	2.50

5 MC1000 RATINGS

The following tables indicate the input and output ratings of the MC1000 Series.

NOTE: The output current ratings are based on operation at carrier frequencies of 8 kHz and below. At full ambient temperature, operation at carrier frequencies above 8 kHz require derating the drive by multiplying the output current rating by the following factors: 0.94 at 10 kHz, 0.89 at 12 kHz, and 0.83 at 14 kHz. Refer to Parameter 23 - CARRIER in Section 18 - DESCRIPTION OF PARAMETERS.



NOTE

Refer to Appendix A for derated single phase ratings on selected models.

M1100 SERIES RATINGS							
MODEL			INPUT (120/240 Vac, 50 - 60 Hz)			OUTPUT (0 - 230 Vac)	
MODEL NUMBER ¹	FOR MOTORS RATED		INPUT PHASE	NOMINAL CURRENT ² (AMPS)	POWER (KVA)	NOMINAL CURRENT (AMPS)	POWER (KVA)
	HP	KW					
M1103S	0.25	0.18	1	6.0 / 3.0	0.72	1.4 / 1.4	0.56
M1105S	0.5	0.37	1	9.2 / 4.6	1.1	2.2 / 2.2	0.88
M1110S	1	0.75	1	16.2 / 8.1	1.9	4.0 / 4.0	1.6
M1115S	1.5	1.1	1	21 / 10.4	2.5	5.2 / 5.2	2.1

¹ Refer to Section 3 for model number breakdown.

² Refer to Section 8 for recommended fuse type.

M1200 SERIES RATINGS							
MODEL			INPUT (200/240 Vac, 50 - 60 Hz)			OUTPUT (0 - 200/230 Vac)	
MODEL NUMBER ¹	FOR MOTORS RATED		INPUT PHASE	NOMINAL CURRENT ² (AMPS)	POWER (KVA)	NOMINAL CURRENT (AMPS)	POWER (KVA)
	HP	KW					
M1205S	0.5	0.37	1	5.8 / 5.0	1.2	2.5 / 2.2	0.9
M1205	0.5	0.37	3	3.1 / 2.7	1.1	2.5 / 2.2	0.9
M1210S	1	0.75	1	10.4 / 9.0	2.2	4.6 / 4.0	1.6
M1210	1	0.75	3	5.5 / 4.8	2.0	4.6 / 4.0	1.6
M1215S	1.5	1.1	1	13.3 / 11.6	2.8	6.0 / 5.2	2.1
M1215	1.5	1.1	3	7.1 / 6.2	2.6	6.0 / 5.2	2.1
M1220S	2	1.5	1	17.1 / 14.9	3.6	7.8 / 6.8	2.7
M1220	2	1.5	3	9.3 / 8.1	3.4	7.8 / 6.8	2.7
M1230S	3	2.2	1	24 / 21	5.0	11.0 / 9.6	3.8
M1230	3	2.2	3	13.0 / 11.3	4.7	11.0 / 9.6	3.8
M1250	5	3.7	3	20 / 17.7	7.4	17.5 / 15.2	6.1
M1275	7.5	5.5	3	30 / 26	10.6	25 / 22	8.8
M12100	10	7.5	3	37 / 32	13.2	32 / 28	11.2
M12150	15	11	3	55 / 48	19.8	48 / 42	16.7
M12200	20	15	3	70 / 61	25.3	62 / 54	21.5
M12250	25	18.5	3	89 / 77	32.0	78 / 68	27.1
M12300	30	22	3	104 / 90	37.6	92 / 80	31.9
M12400 ³	40	30	3	119 / 99	41.0	120 / 104	41.4
M12600 ³	60	45	3	174 / 145	60.5	177 / 154	61.3

¹ Refer to Section 3 for model number breakdown.

² Refer to Section 8 for recommended fuse type.

³ For branch circuit protection, the 40HP and 60HP 230V models must only be installed with the appropriately rated UL Listed fuses.

M1400 SERIES RATINGS							
MODEL			INPUT (400/480 Vac, 50 - 60 Hz)			OUTPUT (0 - 400/460 Vac)	
MODEL NUMBER ¹	FOR MOTORS RATED		INPUT PHASE	NOMINAL CURRENT ² (AMPS)	POWER (KVA)	NOMINAL CURRENT (AMPS)	POWER (KVA)
	HP	kW					
M1410	1	0.75	3	2.8 / 2.4	2.0	2.3 / 2.0	1.6
M1420	2	1.5	3	4.7 / 4.1	3.4	3.9 / 3.4	2.7
M1430	3	2.2	3	6.6 / 5.7	4.7	5.5 / 4.8	3.8
M1450	5	3.7	3	10.2 / 8.9	7.3	8.7 / 7.6	6.1
M1475	7.5	5.5	3	14.7 / 12.8	10.6	12.6 / 11.0	8.8
M14100	10	7.5	3	18.3 / 15.9	13.2	16.0 / 14.0	11.2
M14150	15	11	3	28 / 24	19.8	24 / 21	16.7
M14200	20	15	3	36 / 31	25.3	31 / 27	21.5
M14250	25	18.5	3	44 / 38	31.9	39 / 34	27.1
M14300	30	22	3	52 / 45	37.6	46 / 40	31.9
M14400	40	30	3	68 / 59	49.0	60 / 52	41.4
M14500	50	37.5	3	85 / 74	61.5	75 / 65	51.8
M14600	60	45	3	100 / 87	72.3	88 / 77	61.3
M14750	75	55	3	109 / 91	75.5	110 / 96	76.5
M141000	100	75	3	139 / 116	96.4	143 / 124	98.8
M141250	125	90	3	175 / 146	121.4	179 / 156	124.3
M141500	150	110	3	202 / 168	139.7	207 / 180	143.4

¹Refer to Section 3 for model number breakdown.

²Refer to Section 8 for recommended fuse type.

M1500 SERIES RATINGS							
MODEL			INPUT (480/590 Vac, 50 - 60 Hz)			OUTPUT (0 - 460/575 Vac)	
MODEL NUMBER ¹	FOR MOTORS RATED		INPUT PHASE	NOMINAL CURRENT ² (AMPS)	POWER (KVA)	NOMINAL CURRENT (AMPS)	POWER (KVA)
	HP	KW					
M1510	1	0.75	3	1.9 / 1.9	1.9	1.6 / 1.6	1.6
M1520	2	1.5	3	3.3 / 3.3	3.4	2.7 / 2.7	2.7
M1530	3	2.2	3	4.6 / 4.6	4.7	3.9 / 3.9	3.9
M1550/51	5	3.7	3	7.1 / 7.1	7.3	6.1 / 6.1	6.1
M1575	7.5	5.5	3	10.5 / 10.5	10.7	9.0 / 9.0	8.8
M15100	10	7.5	3	12.5 / 12.5	12.8	11.0 / 11.0	11.0
M15150	15	11	3	19.3 / 19.3	19.7	17.0 / 17.0	16.9
M15200	20	15	3	25 / 25	25.4	22 / 22	21.5
M15250	25	18.5	3	31 / 31	31.2	27 / 27	26.9
M15300	30	22	3	36 / 36	37.1	32 / 32	31.9
M15400	40	30	3	47 / 47	47.5	41 / 41	40.8
M15500	50	37.5	3	59 / 59	60.3	52 / 52	51.8
M15600	60	45	3	71 / 71	72.5	62 / 62	61.7

¹Refer to Section 3 for model number breakdown.

²Refer to Section 8 for recommended fuse type.

6 THEORY

6.1 DESCRIPTION OF AC MOTOR OPERATION

Three phase AC motors are comprised of two major components, the stator and the rotor. The stator is a set of three electrical windings held stationary in the motor housing. The rotor is a metal cylinder, fixed to the motor drive shaft, which rotates within the stator. The arrangement of the stator coils and the presence of three phase AC voltage give rise to a rotating magnetic field which drives the rotor. The speed at which the magnetic field rotates is known as the synchronous speed of the motor. Synchronous speed is a function of the frequency at which the voltage is alternating and the number of poles in the stator windings.

The following equation gives the relation between synchronous speed, frequency, and the number of poles:

$$S_s = 120 f/p$$

Where: S_s = Synchronous speed (rpm), f = frequency (Hz),

p = number of poles

In three phase induction motors the actual shaft speed differs from the synchronous speed as load is applied. This difference is known as “slip”. Slip is commonly expressed as a percentage of synchronous speed. A typical value is three percent at full load.

The strength of the magnetic field in the gap between the rotor and stator is proportional to the amplitude of the voltage at a given frequency. The output torque capability of the motor is, therefore, a function of the applied voltage amplitude at a given frequency. When operated below base (rated) speed, AC motors run in the range of “constant torque”. Constant torque output is obtained by maintaining a constant ratio between voltage amplitude (Volts) and frequency (Hertz). For 60 Hz motors rated at 230, 460, and 575 Vac, common values for this V/Hz ratio are 3.83, 7.66, and 9.58 respectively. Operating with these V/Hz ratios generally yields optimum torque capability. Operating at lower ratio values results in lower torque and power capability. Operating at higher ratio values will cause the motor to overheat. Most standard motors are capable of providing full torque output from 3 to 60 Hz. However, at lower speeds, where motor cooling fans become less effective, supplemental cooling may be needed to operate at full torque output continuously.

If the frequency applied to the motor is increased while the voltage remains constant, torque capability will decrease as speed increases. This will cause the horsepower capability of the motor to remain approximately constant. Motors run in this mode when operated above base speed, where drive output voltage is limited by the input line voltage. This operating range is known as the “constant horsepower” range. The typical maximum range for constant horsepower is about 2.3 to 1 (60 to 140 Hz). The diagram below depicts the characteristics of a typical AC induction motor with a 60 Hz base speed.



WARNING!

Consult motor manufacturer before operating motor and/or driven equipment above base speed.

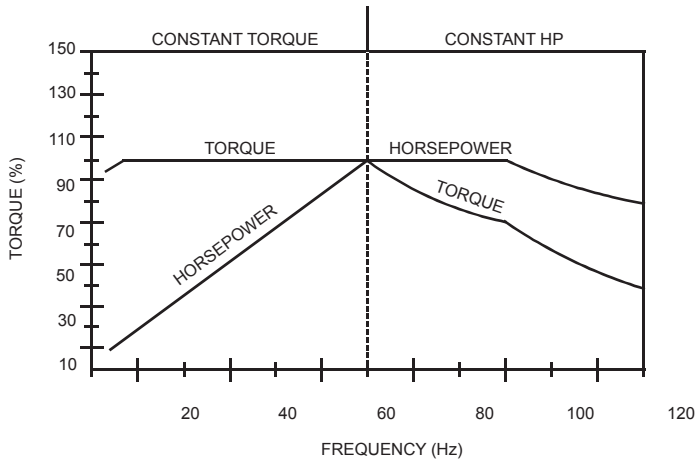

6.1.1 VARIABLE TORQUE VS. CONSTANT TORQUE

Variable frequency drives, and the loads they are applied to, can generally be divided into two groups: constant torque and variable torque. Constant torque loads include: vibrating conveyors, punch presses, rock crushers, machine tools, and just about every other application that is not considered variable torque. Variable torque loads include centrifugal pumps and fans, which make up the majority of HVAC applications.

Variable torque loads are governed by the affinity laws, which define the relationships between speed, flow, torque and horsepower. The diagram below illustrates these relationships:

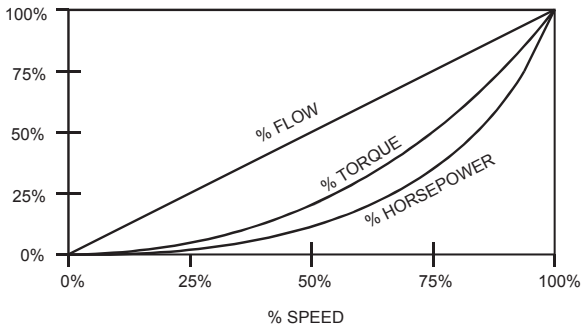

“Variable torque” refers to the fact that the torque required varies with the square of the speed. Also, the horsepower required varies with the cube of the speed, resulting in a large reduction in horsepower for even a small reduction in speed. It is easily seen that substantial energy savings can be achieved by reducing the speed of a fan or pump. For example, reducing the speed to 50% results in a 50 HP motor having to produce only 12.5% of rated horsepower, or 6.25 HP.

Variable torque drives usually have a low overload capacity (110% - 120% for 60 seconds), because variable torque applications rarely experience overload conditions. To optimize efficiency and energy savings, variable torque drives are usually programmed to follow a variable V/Hz ratio.

The term “constant torque” is not entirely accurate in terms of the actual torque required for an application. Many constant torque applications have reciprocating loads, such as vibrating conveyors and punch presses, where the rotational motion of the motor is being converted to a linear motion. In such cases, the torque required can vary greatly at different points in the cycle. For constant torque loads, this fluctuation in torque is not a direct function of speed, as it is with a variable torque load. As a result, constant torque drives typically have a high overload rating (150% for 60 seconds) in order to handle the higher peak torque demands. To achieve maximum torque, constant torque drives follow a constant V/Hz ratio.

Both MC Series product lines (MC1000 and MC3000) have full overload capacity (150% for 60 seconds, 180% for 30 seconds), so that either one can be used for either type of application. The V/Hz ratio can also be changed to optimize performance for either type of application.

6.2 DRIVE FUNCTION DESCRIPTION

The MC Series is a 16 bit microprocessor based, keypad programmable, variable speed AC motor drive. There are four major sections: an input diode bridge and filter, a power board, a control board, and an output intelligent power module.

6.2.1 DRIVE OPERATION

Incoming AC line voltage is converted to a pulsating DC voltage by the input diode bridge. The DC voltage is supplied to the bus filter capacitors through a charge circuit which limits inrush current to the capacitors during power-up. The pulsating DC voltage is filtered by the bus capacitors which reduces the ripple level. The filtered DC voltage enters the inverter section of the drive, composed of six output intelligent insulated gate bi-polar transistors (IGBTs) which make up the three output legs of the drive. Each leg has one intelligent IGBT connected to the positive bus voltage and one connected to the negative bus voltage. Alternately switching on each leg, the intelligent IGBT produces an alternating voltage on each of the corresponding motor windings. By switching each output intelligent IGBT at a very high frequency (known as the carrier frequency) for varying time intervals, the inverter is able to produce a smooth, three phase, sinusoidal output current wave which optimizes motor performance.

6.2.2 CIRCUIT DESCRIPTION

The control section consists of a control board with a 16 bit microprocessor, keypad and display. Drive programming is accomplished via the keypad or the serial communications port. During operation the drive can be controlled via the keypad, by control devices wired to the control terminal strip, or by the serial communications port. The Power Board contains the control and protection circuits which govern the six output IGBTs. The Power Board also contains a charging circuit for the bus filter capacitors, a motor current feedback circuit, a voltage feedback circuit, and a fault signal circuit. The drive has several built in protection circuits. These include phase-to-phase and phase-to-ground short circuit protection, high and low line voltage protection, protection against excessive ambient temperature, and protection against continuous excessive output current. Activation of any of these circuits will cause the drive to shut down in a fault condition.

6.2.3 MC1000 INPUTS AND OUTPUTS

The drive has two analog inputs (0-10 VDC and 4-20 mA) that can be used for speed reference, PID set point reference, or PID feedback. A speed potentiometer (10,000 Ohm) can be used with the 0-10 VDC input.

There are also two analog outputs: one is proportional to speed (frequency), and the other is proportional to load.

The drive has three programmable outputs for status indication: one Form C relay and two open-collector outputs.

NOTE: Models rated above 30 Hp at 200/240 Vac and 60 Hp at 400/480 Vac have a second Form C relay.

Refer to Sections 14 - CONTROL WIRING and 15 - CONTROL WIRING DIAGRAMS for more information.

7 INSTALLATION



WARNING!

Drives must not be installed where subjected to adverse environmental conditions! Drives must not be installed where subjected to: combustible, oily, or hazardous vapors or dust; excessive moisture or dirt; strong vibration; excessive ambient temperatures. Consult Lenze AC Tech for more information on the suitability of a drive to a particular environment

The drive should be mounted on a smooth vertical surface capable of safely supporting the unit without vibrating. The LCD display has an optimum field of view, this should be considered when determining the mounting position.

Chassis models must be installed in an electrical enclosure that will provide complete mechanical protection and maintain uniform internal temperature within the drive's ambient operating temperature rating. All drive models **MUST** be mounted in a vertical position for proper heatsink cooling.

Maintain a minimum spacing around the drive as follows:

SPACING REQUIREMENTS		
HP	SPACING	
	INCHES	mm
0.25 - 5	2	50
7.5 - 25	4	100
30 - 60	6	150
75 - 150	8	200

All drive models **MUST** be mounted in a vertical position for proper heatsink cooling. Fans or blowers should be used to insure proper cooling in tight quarters. **Do not mount drives above other drives or heat producing equipment** that would impede the cooling of the drive. Note the ambient operating temperature ratings for each drive model.

If it is necessary to drill or cut the drive enclosure or panel, extreme care must be taken to avoid damaging drive components or contaminating the drive with metal fragments (which cause shorting of electrical circuits). Cover drive components with a clean cloth to keep out metal chips and other debris. Use a vacuum cleaner to clean drive components after drilling, even if chips do not appear to be present. Do not attempt to use positive air pressure to blow chips out of drive, as this tends to lodge debris under electronic components. Contaminating the drive with metal chips can cause drive failure and will void the warranty. The MC1000 Series is UL approved for solid state motor overload protection. Therefore, a separate thermal overload relay is not required for single motor applications. In applications where one drive is operating more than one motor, a separate thermal overload relay is required for each motor per NEC.

7.1 INSTALLATION AFTER A LONG PERIOD OF STORAGE



WARNING!

Severe damage to the drive can result if it is operated after a long period of storage or inactivity without reforming the DC bus capacitors!

If input power has not been applied to the drive for a period of time exceeding three years (due to storage, etc), the electrolytic DC bus capacitors within the drive can change internally, resulting in excessive leakage current. This can result in premature failure of the capacitors if the drive is operated after such a long period of inactivity or storage.

In order to reform the capacitors and prepare the drive for operation after a long period of inactivity, apply input power to the drive for 8 hours prior to actually operating the drive/motor system.

7.2 EXPLOSION PROOF APPLICATIONS

Explosion proof motors that are not rated for inverter use lose their certification when used for variable speed. Due to the many areas of liability that may be encountered when dealing with these applications, the following statement of policy applies:

“Lenze AC Tech Corporation inverter products are sold with no warranty of fitness for a particular purpose or warranty of suitability for use with explosion proof motors. Lenze AC Tech Corporation accepts no responsibility for any direct, incidental or consequential loss, cost, or damage that may arise through the use of its AC inverter products in these applications. The purchaser expressly agrees to assume all risk of any loss, cost, or damage that may arise from such application.”

8 INPUT AC REQUIREMENTS



WARNING!

Hazard of electrical shock! Disconnect incoming power and wait three minutes before servicing the drive. Capacitors retain charge after power is removed.

8.1 INPUT AC POWER REQUIREMENTS

8.1.1 VOLTAGE

The input voltage must match the drive's nameplate voltage rating. Voltage fluctuation must not vary by greater than 10% over voltage or 15% under voltage.

NOTE: Drives with dual rated input voltage must be programmed for the proper supply voltage. Refer to Parameter 0 - LINE VOLTS in Section 18 - DESCRIPTION OF PARAMETERS.

The UL file for this drive shows that it is suitable for use on a circuit capable of delivering not more than 200,000 RMS symmetrical amperes, at the drive's rated voltage. The CSA file identifies a short-circuit withstand rating of 5,000 RMS symmetrical amperes at the drives rated voltage.

Three phase voltage imbalance must be less than 2.0% phase to phase. Excessive phase to phase imbalance can cause severe damage to the drive's power components.

Motor voltage should match line voltage in normal applications. The drive's maximum output voltage will equal the input voltage. Use extreme caution when using a motor with a voltage rating which is different from the input line voltage.

8.1.2 SUPPLY TRANSFORMER KVA RATINGS

If the kVA rating of the AC supply transformer is greater than ten times the input kVA rating of the drive, a drive isolation transformer, or a 2 - 3% input line reactor (also known as a choke) must be added.

8.2 INPUT FUSING AND DISCONNECT REQUIREMENTS

A circuit breaker or a disconnect switch with fuses must be provided in accordance with the National Electric Code (NEC) and all local codes.

The MC1000 drive is capable of withstanding up to 150% current overload for 60 seconds. Except as noted below, select a fuse or circuit breaker rated at 1.5 times the input current rating of the drive (the minimum size should be 10 amps, regardless of input current rating). Refer to Section 5 - MC1000 RATINGS. Minimum voltage rating of the protection device should be 250 Vac for 240/120 Vac and 240/200 Vac rated drives, and 600 Vac for 480/400 Vac and 590/480 Vac drives.

Use UL Class CC or Class T current-limiting type fuses with low I²T values, rated at 200,000 AIC. Recommended fuses are Bussman type KTK-R, JJN, and JJS, or equivalent.



WARNING!

Per UL requirements, use a FUSE (not a circuit breaker) for 240VAC drives requiring >40A protection and for 480VAC & 600VAC drives requiring >32A protection.

Additionally, use fuses only for M1103S models when supplied using 240VAC. Circuit breaker is acceptable only for 120VAC operation.

9 VOLTAGE SELECTION

M1100 Series drives are rated for 240/120 Vac, 50-60 Hz input. The drive will function with input voltage of 120 Vac (+ 10%, -15%) at 48 to 62 Hz when wired for 120 Vac input, or with input voltage of 240 Vac (+ 10%, - 15%), at 48 to 62 Hz, when wired for 240 Vac input.

M1200 Series drives are rated for 240/200 Vac, 50-60 Hz input. The drive will function with input voltages of 200 to 240 Vac (+ 10%, - 15%), at 48 to 62 Hz.

M1400 Series drives are rated for 480/400 Vac, 50-60 Hz input. The drive will function with input voltages of 400 to 480 Vac (+ 10%, - 15%), at 48 to 62 Hz.

M1500 Series drives are rated for 590/480 Vac, 50-60 Hz input. The drive will function with input voltages of 480 to 590 Vac (+ 10%, - 15%), at 48 to 62 Hz.

To select the proper input voltage on 240/200 VAC 40-60 Hp models, 400/480 VAC 75-150 Hp and 480/590 VAC 75-150 Hp models the PL2 plug must be in the correct position. PL2 is located either at the lower right corner, or upper right corner of the power board, depending on horsepower. The PL2 plug is used to select the correct input voltage. Plug PL2 into the top and middle pins to select 240, 480, or 590 VAC or the middle and bottom pins to select 200, 400, or 480.



NOTE:

In addition to the voltage plug selection, Parameter 0 – LINE VOLTS must also be programmed for the proper voltage. Refer to Section 18 - DESCRIPTION OF PARAMETERS.

Voltage Selection Plug (PL2)

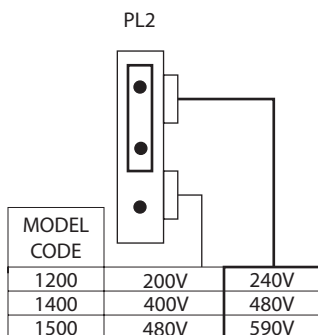

240 / 480 / 590 Vac INPUT

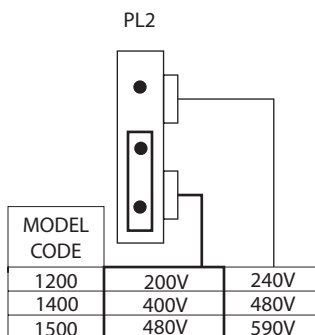

200 / 400 / 480 Vac INPUT

10 POWER WIRING



WARNING!

Hazard of electrical shock! Wait three minutes after disconnecting incoming power before servicing drive. Capacitors retain charge after power is removed.

Note drive input and output current ratings and check applicable electrical codes for required wire type and size, grounding requirements, over current protection, and incoming power disconnect, before wiring the drive. Size conservatively to minimize voltage drop.

Input fusing and a power disconnect switch or contactor **MUST** be wired in series with terminals L1, L2, and L3 (L1 and L2 if input is single phase). If one has not been supplied by Lenze AC Tech Corporation, a disconnect means must be wired during installation. This disconnect must be used to power down the drive when servicing, or when the drive is not to be operated for a long period of time, but should not be used to start and stop the motor.

Repetitive cycling of a disconnect or input contactor (more than once every two minutes) may cause damage to the drive.

10.1 WIRING FOR SINGLE PHASE OR THREE PHASE INPUT

If the drive is name plated for 240/120 Vac single phase input, wire the input to terminals L1 and N and jumper terminals L1 to L2 for 120 Vac input voltage, or wire to terminals L1 and L2 (do not wire to N) for 240 Vac input voltage. Refer to Section 11 - MC1000 POWER WIRING DIAGRAM.

If the drive is name plated for three phase input only, wire the input to terminals L1, L2, and L3.



NOTE: Refer to Appendix A for alternate single wiring configuration on selected models.

All three power output wires, from terminals T1, T2, and T3 to the motor, must be kept tightly bundled and run in a separate conduit away from all other power and control wiring.

Do not install contactors or disconnect switches between the drive and motor. Operating such devices while the drive is running can potentially cause damage to the drive's power components. If such a device is required, it should only be operated when the drive is in a STOP state. If there is potential for the device to be opened while the drive is running, the drive must be programmed for COAST TO STOP (see Parameter 26 - STOP), and an auxiliary contact on the device must be interlocked with the drive's run circuit. This will give the drive a stop command at the same time the device opens, and will not allow the drive to start again until the device is closed.

10.2 MAXIMUM TIGHTENING TORQUE

HP (kW)	MODEL NUMBER	INPUT TERMINALS		MOTOR TERMINALS	
		Lb-in	Nm	Lb-in	Nm
0.25 (0.18)	M1103S	7	0.79	7	0.79
0.5 (0.37)	M1105S	9	1	7	0.79
	M1205S	20	2.2	7	0.79
	M1205	7	0.79	7	0.79
1 (0.75)	M1110S	9	1	7	0.79
	M1210S	20	2.2	7	0.79
	M1210	7	0.79	7	0.79
	M1410	10	1.1	10	1.1
	M1510	10	1.1	10	1.1
1.5 (1.1)	M1115S	9	1	7	0.79
	M1215S	20	2.2	7	0.79
	M1215	7	0.79	7	0.79
2 (1.5)	M1220S	20	2.2	7	0.79
	M1220	7	0.79	7	0.79
	M1420	10	1.1	10	1.1
	M1520	10	1.1	10	1.1
3 (2.2)	M1230S	20	2.2	7	0.79
	M1230	7	0.79	7	0.79
	M1430	10	1.1	10	1.1
	M1530	10	1.1	10	1.1
5 (3.7)	M1250	7	0.79	7	0.79
	M1450	10	1.1	10	1.1
	M1550/51	10	1.1	10	1.1
7.5 (5.5)	M1275	16	2	16	2
	M1475	10	1.1	10	1.1
	M1575	10	1.1	10	1.1
10 (7.5)	M12100	16	2	16	2
	M14100	10	1.1	10	1.1
	M15100	10	1.1	10	1.1

10.2 MAXIMUM TIGHTENING TORQUE

HP (kW)	MODEL NUMBER	INPUT TERMINALS		MOTOR TERMINALS	
		Lb-in	Nm	Lb-in	Nm
15 (11)	M12150	23	2.5	23	2.5
	M14150	16	2	16	2
	M15150	16	2	16	2
20 (15)	M12200	23	2.5	23	2.5
	M14200	16	2	16	2
	M15200	16	2	16	2
25 (18.5)	M12250	31	3.5	31	3.5
	M14250	16	2	16	2
	M15250	16	2	16	2
30 (22)	M12300	31	3.5	31	3.5
	M14300	16	2	16	2
	M15300	16	2	16	2
40 (30)	M12400	50	5.6	50	5.6
	M14400	23	2.5	23	2.5
	M15400	23	2.5	23	2.5
50 (37.5)	M14500	31	3.5	31	3.5
	M15500	31	3.5	31	3.5
60 (45)	M12600	375	42.3	375	42.3
	M14600	31	3.5	31	3.5
	M15600	31	3.5	31	3.5
75 (55)	M14750	50	5.6	50	5.6
100 (75)	M141000	375	42.3	375	42.3
125 (90)	M141250	375	42.3	375	42.3
150 (110)	M141500	375	42.3	375	42.3

11 MC1000 POWER WIRING DIAGRAM

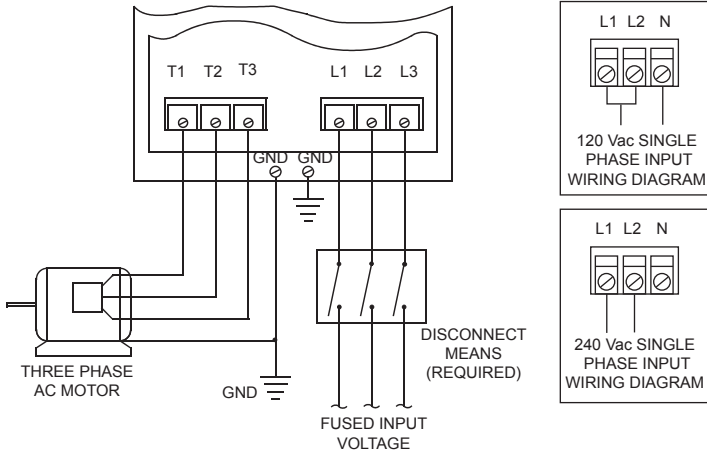

WARNING!

Do not connect incoming AC power to output terminals T1, T2, or T3! Severe damage to the drive will result.

INSTALL, WIRE, AND GROUND IN ACCORDANCE WITH ALL APPLICABLE CODES.

NOTES:

1. Wire the motor for the proper voltage per the output rating of the drive. Motor wires **MUST** be run in a separate steel conduit away from control wiring and incoming AC power wiring.
2. Do not install contactors between the drive and the motor. Damage to the drive may result. Refer to Section 10.1.
3. Remove any existing, and do not install, power factor correction capacitors between the drive and the motor. Failure to do so will result in drive damage.
4. Use only UL and CSA listed and approved wire.
5. Minimum wire voltage ratings: 300 V for 120, 200 and 240 Vac systems, and 600 V for 400, 480, and 590 Vac systems.
6. Wire gauge must be based on a minimum of 125% of the rated input/output current of the drive, and a minimum 75°C insulation rating. Use copper wire only.
7. Wire and ground in accordance with NEC or CEC, and all applicable local codes.
8. Refer to Appendix A for alternate single phase wiring configuration on selected models.

12 INITIAL POWER UP



WARNING!

Hazard of electrical shock! Wait three minutes after disconnecting incoming power before servicing drive. Capacitors retain charge after power is removed.

Before attempting to operate the drive, motor, and driven equipment be sure all procedures pertaining to installation and wiring have been properly followed.



WARNING!

Severe damage to the drive can result if it is operated after a long period of storage or inactivity without reforming the DC bus capacitors!

If input power has not been applied to the drive for a period of time exceeding three years (due to storage, etc), the electrolytic DC bus capacitors within the drive can change internally, resulting in excessive leakage current. This can result in premature failure of the capacitors if the drive is operated after such a long period of inactivity or storage.

In order to reform the capacitors and prepare the drive for operation after a long period of inactivity, apply input power to the drive for 8 hours prior to actually operating the drive/motor system.

Disconnect the driven load from the motor. Verify that the drive input terminals (L1, L2, and L3) are wired to the proper input voltage per the nameplate rating of the drive.



WARNING!

DO NOT connect incoming AC power to output terminals T1, T2, and T3! Do not cycle input power to the drive more than once every two minutes. Damage to the drive will result.

Energize the incoming power line. The LCD display should light and flash "TESTING" and then show the voltage and horsepower rating of the drive. The display should then show "STOP > 20.00 HZ" which indicates that the drive is in a STOP condition, and the speed set point is 20.00 Hz:

STOP > 20.00 HZ

If the display does not appear, remove the incoming power, wait three minutes for the bus capacitors to discharge, and verify correct installation and wiring. If the wiring is correct, re-apply incoming power and note the display for drive status. If the display still does not appear contact the factory for assistance.



NOTE

If the drive's display is blank after power up, and it is a model equipped with heatsink fans, check to make sure the fans are operating (they should be spinning anytime power is applied to the drive). If they are not spinning, the drive's display will be blank and the drive cannot be operated. If the fans are clogged or jammed, disconnect power from the drive and remove any obstructions from the fans. Re-apply power to the drive and check the fans. If they are spinning, the drive's display should appear and the drive should operate properly. If there are no obstructions, the fan itself may be defective. Please contact the factory for assistance.

If the drive powers up correctly, follow the procedure given below to check the motor rotation:

1. Use the ▼ key to decrease the speed set point to the minimum value allowed (0.50 Hz if Parameter 10 - MIN FRQ has not been changed).
2. Press the START key. The drive should indicate RUN, but if the speed set point is .50 Hz, the motor may not rotate. Press the ▲ key to increase the speed set point until the motor starts to rotate.
3. If the motor is rotating in the wrong direction, press the STOP key and remove power from the drive. Wait three minutes for the bus capacitors to discharge, and swap any two of the motor wires connected to T1, T2, and T3.



NOTE

The drive is phase insensitive with respect to incoming line voltage. Therefore, to change the motor rotation, the phases must be swapped at the drive output terminals or at the motor.

13 KEYPAD CONTROL

The drive can be operated in a number of different ways: keypad (LOCAL), control devices wired to the terminal strip (REMOTE), serial communications (SERIAL), or a combination of each. The drive should first be operated from the keypad during initial start-up. Refer to Sections 14 - CONTROL WIRING, and 18 - DESCRIPTION OF PARAMETERS for information on remote operation.

13.1 KEYPAD FUNCTIONS (IN LOCAL MODE)

START/STOP	To start the drive, press the START key. To stop the drive, press the STOP key. NOTE: The STOP key is active in both LOCAL and REMOTE modes.
SPEED SET POINT	To increase the speed set point, press the ▲ key. To decrease the speed set point, press the ▼ key. NOTE: The ▲ and ▼ keys will only function if another speed reference source is not selected.
FORWARD/REVERSE	To change rotation direction, press the FWD/REV key to select the desired direction, and then press the ENTER key within three seconds to confirm the change. NOTE: Parameter 27 - ROTATION must be set to FWD & REV for this key to be active.
AUTO/MANUAL	To toggle between AUTOMATIC (terminal strip) and MANUAL (keypad) speed control, press the AUTO/MAN key to select the desired mode, and then press the ENTER key within three seconds to confirm the change. NOTE: Parameter 28 - AUTO/MAN must be set to BOTH for this key to be active. Refer to Section 14 - CONTROL WIRING for information on automatic speed references.
FAULT RESET	Use the STOP key to reset a fault. If the fault condition has passed, pressing the STOP key will reset the fault and return the drive to a STOP condition. NOTE: If an OUTPUT fault occurs, there will be a 30 second delay before the fault can be cleared using the STOP key.

13.2 MC1000 DISPLAY

The following describes the possible display configurations for the MC1000 Series drive.

13.2.1 MC1000 DISPLAY IN STOP MODE

When the drive is in the STOP mode, there are three possible displays. The first is the SPEED display, which looks like this:

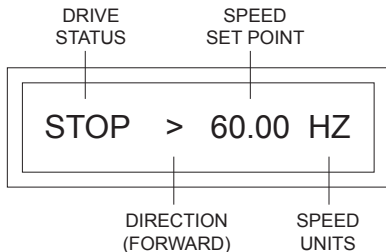

NOTE: Refer to Parameter 31 - UNITS for the SPEED UNITS display options.

Pressing the ENTER key will change the display from the SPEED indication to the % LOAD indication:

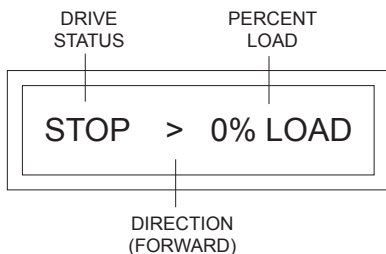

Pressing the ENTER key again will change the display from the % LOAD indication to the VAC (motor voltage) indication:

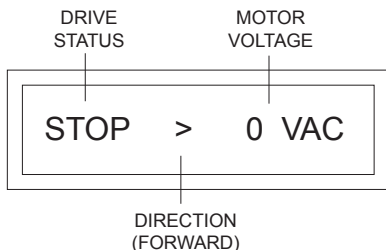

Pressing ENTER again will change the display back to the SPEED indication.

The following table shows the possible DRIVE STATUS indications that can appear on the drive display:

DRIVE STATUS TABLE	
DISPLAY	DESCRIPTION
STOP	Drive to STOP mode - No output to motor.
RUN	Drive is in RUN mode and is within ± 0.3 Hz of the speed set point.
FAULT	Drive has shut down due to a FAULT condition. If the fault condition has passed, pressing the STOP key will clear the fault and return the drive to the STOP mode.
LOCK	Drive is in FAULT LOCKOUT after five unsuccessful restart attempts.
BRAKE	DC BRAKE is energized.
LIMIT	Drive is in CURRENT LIMIT due to an overloaded motor, or ACCEL is set too fast.
F DEC	Drive is in DECEL FREEZE because DECEL is set too fast.

13.2.2 MC1000 DISPLAY IN RUN MODE

When the drive is in the RUN mode, the default display will look like this:

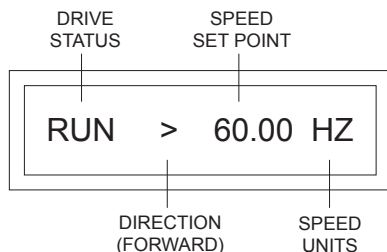

As in the STOP mode, the ENTER key can be used to toggle the display from SPEED to % LOAD to VAC (motor voltage):

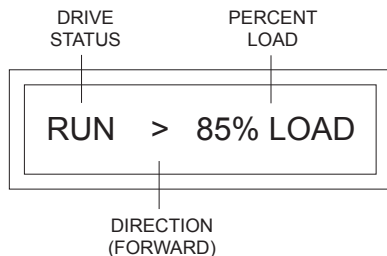

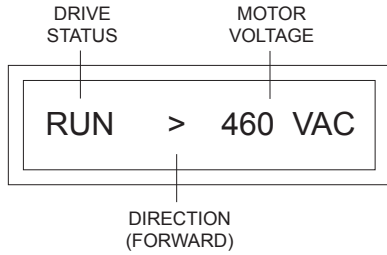

NOTE: During acceleration and deceleration to the SPEED SET POINT, the DRIVE STATUS will show the actual drive speed. When the SPEED SET POINT is reached, the DRIVE STATUS will change to RUN (or STOP if the drive is decelerating to a STOP).

13.2.3 MC1000 DISPLAY IN FAULT MODE

When the drive trips into a fault, the display will automatically change to the FAULT display, which indicates the FAULT MESSAGE:

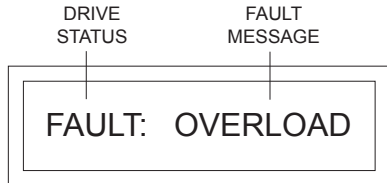

In FAULT mode, the ENTER key will toggle the display between four screens: FAULT, SPEED, % LOAD and VAC. The DRIVE STATUS for these displays will be FAULT. An example is shown below of the drive in the FAULT mode displaying SPEED.

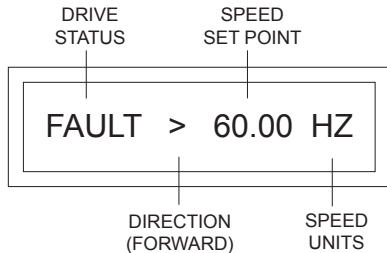

NOTE: To clear a FAULT, press the STOP key, issue a remote STOP command at TB-1, or use TB-13D (refer to Parameter 50 - TB13D).

13.2.4 MC1000 DISPLAY IN AUXILIARY MODE

If the ENTER key is held down, the display will enter the auxiliary mode, which indicates the control source (LOCAL, REMOTE, or SERIAL), AUTO or MANUAL mode, and the speed reference source. When the ENTER key is released, the display will return to the previous screen. An example of the auxiliary mode display is shown below:

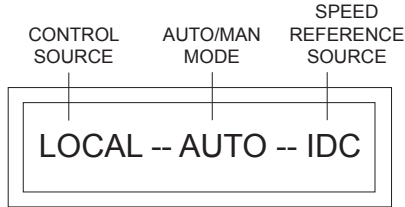

The table below shows the possible SPEED REFERENCE SOURCE indications for the auxiliary mode display:

SPEED REFERENCE SOURCE TABLE	
DISPLAY	DESCRIPTION
KEY	KEYPAD - Change speed using the ▲ and ▼ keys.
VDC	0 - 10 VDC analog input at TB-5A.
IDC	4 - 20 mA analog input at TB-5B.
SP#1	PRESET SPEED #1
SP#2	PRESET SPEED #2
SP#3	PRESET SPEED #3
SP#4	PRESET SPEED #4
JOG	JOG SPEED - In JOG mode, JOG SPEED = PRESET SPEED #2.
MOP	MOTOR OPERATED POT - Change speed using contact closures at TB-13A (DEC FREQ) and TB-13B (INC FREQ).

14 CONTROL WIRING

14.1 GENERAL

14.1.1 KEYPAD CONTROL

The drive can be controlled by the keypad or by control devices wired to the terminal strip. The drive will run from the keypad "out of the box", requiring no connections to the terminal strip. Refer to Section 13 - KEYPAD CONTROL.

14.1.2 CONTROL WIRING VS. POWER WIRING

External control wiring MUST be run in a separate conduit away from all other input and output power wiring. If control wiring is not kept separate from power wiring, electrical noise may be generated on the control wiring that will cause erratic drive behavior. Use twisted wires or shielded cable grounded at the drive chassis ONLY. Recommended control wire is Belden 8760 (2-wire) or 8770 (3-wire), or equivalent.

Torque the control terminals to 2 lb-in (0.2 Nm). Be careful not to overtorque the control terminals, as this will cause damage to the terminal strip. This is not covered under warranty and can only be repaired by replacing the control board.

14.1.3 TB-2: CIRCUIT COMMON

The TB-2 terminals are used as circuit common for the start/stop, forward/reverse, input select, local/remote, analog input, and analog output functions. There are three TB-2 terminals available on the terminal strip, and they are all internally connected to each other on the main control board. If necessary TB-2 may be connected to chassis ground.

NOTE: TB-2 MUST be connected to chassis ground when using serial communications.

14.1.4 SURGE SUPPRESSION ON RELAYS

Current and voltage surges and spikes in the coils of contactors, relays, solenoids, etc, near or connected to the drive, can cause erratic drive operation. Therefore, a snubber circuit should be used on coils associated with the drive. For AC coils, snubbers should consist of a resistor and a capacitor in series across the coil. For DC coils, a free-wheeling or fly back diode should be placed across the coil. Snubbers are typically available from the manufacturer of the device.

14.2 START/STOP AND SPEED CONTROL

14.2.1 REMOTE MODE SELECTION

The REMOTE mode can be selected by one of two methods:

1. Program Parameter 30 - CONTROL to REMOTE, or:
2. Program CONTROL to BOTH, set the TB-13A or TB-13C function (see Parameter 47 or 49) to LOCAL SELECT, and DO NOT make a contact closure between TB-13A or TB-13C and TB-2 (making the contact closure will select LOCAL mode).



WARNING!

If CONTROL is set to LOCAL, TB-1 is disabled and **CANNOT** be used as a STOP switch! Incorrect use of TB-1 may result in damage to equipment and/or injury to personnel! Refer to Parameter 30 - CONTROL.



WARNING!

STOP (TB-1) and EXTERNAL FAULT (TB-13D) circuitry may be disabled if parameters are reset to factory defaults! The drive must be reprogrammed after a RESET in order to insure proper operation (see Parameter 65 - PROGRAM).

FAILURE TO DO SO MAY RESULT IN DAMAGE TO EQUIPMENT AND/OR INJURY TO PERSONNEL!

14.2.2 TWO-WIRE START/STOP CONTROL

A two-wire start/stop circuit can be accomplished by one of three methods on the MC Series drive. Follow the appropriate procedure listed below:

FORWARD ROTATION ONLY

1. Select REMOTE mode (see above).
2. Connect a jumper between TB-12A and TB-2 to provide a permanent START command to the drive.
3. Wire a normally open maintained contact between TB-1 and TB-2. Closing this contact will RUN the drive and opening this contact will STOP the drive.

FORWARD and REVERSE ROTATION

1. Select REMOTE mode (see above).
2. Program Parameter 27 - ROTATION to FWD & REV to allow rotation in both directions.
3. Program Parameter 49 - TB13C to START REVERSE. This will force TB-12A to act as START FORWARD.
4. Select the desired rotation by closing the appropriate terminal (TB-12A for forward, or TB-13C for reverse) to TB-2. This can be done with a toggle switch or equivalent circuit.
5. Wire a normally open maintained contact between TB-1 and TB-2. Close this contact to RUN the drive, and open this contact to STOP the drive.

14.2.3 ALTERNATE TWO-WIRE START/STOP CONTROL METHOD



WARNING!

This method requires TB-13C to be set for RUN REVERSE, which will disable TB-1 as a STOP switch! Incorrect use of TB-1 may result in damage to equipment and/or injury to personnel! Refer to Parameter 49 - TB13C.

FORWARD ROTATION ONLY

1. Select REMOTE mode (see above).
2. Program Parameter 27 - ROTATION to FWD & REV.
3. Program Parameter 49 - TB13C to RUN REVERSE. This will force TB-12A to act as RUN FORWARD.
4. Wire a normally open maintained contact between TB-12A and TB-2. Close this contact to RUN the drive in FORWARD, and open this contact to STOP the drive.

FORWARD and REVERSE ROTATION with TWO RUN CONTACTS

1. Follow 1-4 above and also wire a normally open maintained contact between TB-13C and TB-2. Close this contact to RUN the drive in REVERSE, and open this contact to STOP the drive.

FORWARD and REVERSE ROTATION with ONE RUN CONTACT

1. Follow 1-3 above and wire a normally open maintained contact between TB-2 and the common of a single-pole, double-throw toggle switch. Wire the poles of the toggle switch to TB-12A and TB-13C. Select the desired rotation with the toggle switch. Close the maintained contact to RUN, and open to STOP.

14.2.4 THREE-WIRE START/STOP CONTROL

A three-wire start/stop circuit can be accomplished by one of two methods on the MC Series drive. Follow the appropriate procedure listed below:

FORWARD ROTATION ONLY

1. Select REMOTE mode (see above).
2. Wire a normally closed momentary STOP contact between TB-1 and TB-2. Momentarily open this contact to STOP the drive.
3. Wire a normally open momentary START contact between TB-12A and TB-2. Momentarily close this contact to START the drive.

FORWARD and REVERSE ROTATION with TWO START CONTACTS

1. Select REMOTE mode (see above).
2. Program Parameter 27 - ROTATION to FWD & REV.
3. Program Parameter 49 - TB13C to START REVERSE.
4. Wire a normally closed momentary STOP contact between TB-1 and TB-2. Momentarily open this contact to STOP the drive.
5. Wire a normally open momentary START FORWARD contact between TB-12A and TB-2. Momentarily close this contact to START the drive in FORWARD.
6. Wire a normally open momentary START REVERSE contact between TB-13C and TB-2. Momentarily close this contact to START the drive in REVERSE.

NOTE: If the drive is operating in one direction, and is given the START command for the opposite direction, the drive will decelerate to 0 Hz and then accelerate back to the speed set point in the opposite direction.

FORWARD and REVERSE ROTATION with ONE START CONTACT

1. Follow 1-4 above and wire a normally open momentary contact between TB-2 and the common of a single-pole, double-throw toggle switch. Wire the poles of the toggle switch to TB-12A and TB-13C. Refer to the wiring diagram in Section 15.3.

14.2.5 SPEED REFERENCE SIGNALS

The drive allows for three analog speed reference inputs: a speed potentiometer (10,000 Ohm), 0-10 VDC, or 4-20 mA.

SPEED POT	Connect the wiper to terminal TB-5A, and connect the high and low end leads to terminals TB-6 and TB-2, respectively.
0-10 VDC	Wire the positive to terminal TB-5A and the negative to terminal TB-2. TB-5A input impedance is 200 kilohms.
4-20 mA	Wire the positive to terminal TB-5B and the negative to terminal TB-2. TB-5B input impedance is 100 ohms.

14.2.6 SPEED REFERENCE SELECTION

AUTO/MAN vs. LOCAL/REMOTE

In the MC Series drive, AUTO/MAN refers to speed control, and LOCAL/REMOTE refers to START/STOP control. AUTOMATIC or MANUAL speed control selection is affected by whether the drive is in LOCAL or REMOTE mode.

In LOCAL mode (keypad start/stop control), AUTOMATIC and MANUAL speed control is selected using Parameter 28 - AUTO/MAN. When AUTO/MAN is set to BOTH, the AUTO/MAN button on the keypad is active and is used to toggle between MANUAL (keypad or speed pot) and AUTOMATIC (0-10 VDC, 4-20 mA, or preset speeds) speed control. When set to MANUAL, speed control is governed by Parameter 29 - MANUAL, which selects either KEYPAD or 0-10 VDC (speed pot). When set to AUTOMATIC, one of the TB-13 input selects must be set to the desired speed reference, and that terminal must be closed to TB-2. The drive will then respond to the automatic speed reference. If one of the TB-13 input selects is set for a speed reference, and the contact closure is not made to TB-2, speed control will remain in AUTO mode, but the drive will respond to the keypad or speed pot, depending on Parameter 29 - MANUAL. Therefore, if the Form C relay or open-collector outputs are set to indicate AUTO/MAN mode, they will still indicate AUTO mode. In REMOTE mode (terminal strip start/stop control), speed control is only selected using the TB-13 input selects. For AUTOMATIC speed control, one of the TB-13 input selects must be set to the desired speed reference, and that terminal must be closed to TB-2. The drive will then respond to the automatic speed reference. If none of the TB-13 input selects are closed to TB-2, speed control will default to MANUAL mode, and the drive will respond to the keypad or speed pot, depending on Parameter 29 - MANUAL. This will cause the Form C relay or open-collector outputs to indicate MANUAL mode if set to indicate AUTO/MAN mode.

0 - 10 VDC and 4 - 20 mA INPUT SIGNALS

TB-13A, TB-13B, and TB-13C can all be programmed to select 0-10 VDC or 4-20 mA input.

PRESET SPEEDS

TB-13A can be programmed to select SPEED #1, TB-13B to select SPEED #2, and TB-13C to select SPEED #3. Closing any two of these terminals to TB-2 will select SPEED #4. Refer to Parameters 1-4: SPEED #1 - #4 in Section 18 - DESCRIPTION OF PARAMETERS.

JOG

The JOG function only works when the drive is in REMOTE mode, and only when the drive is in a STOP condition. TB-13B can be programmed to select either JOG FORWARD or JOG REVERSE. The jog speed is set by PRESET SPEED #2. Close TB-13B to TB-2 to JOG, and open the contact to STOP.



WARNING!

When operating in JOG mode, the STOP key **WILL NOT** stop the drive. To stop the drive, the contact between TB-13B and TB-2 must be opened.

MOP - MOTOR OPERATED POT

TB-13A and TB-13B are used for this function, which sets the speed of the drive using contacts wired to the terminal strip. Program TB-13A to select DEC FREQ, and program TB-13B to select INC FREQ. Closing TB-13A to TB-2 will activate the DEC FREQ function, and will cause the speed set point to decrease until the contact is opened. DEC FREQ will operate when the drive is in RUN mode or STOP mode. Closing TB-13B to TB-2 will activate the INC FREQ function, and will cause the speed set point to increase until the contact is opened. INC FREQ will only operate when the drive is in RUN mode.

NOTE: If TB-13A, TB-13B, and TB-13C are all programmed to select speed references, and two or three of the terminals are closed to TB-2, the higher terminal has priority and will override the others. For example, if TB-13A is programmed to select 0-10VDC, and TB-13C is programmed to select PRESET SPEED #3, closing both terminals to TB-2 will cause the drive to respond to PRESET SPEED #3, because TB-13C overrides TB-13A.

14.2.7 ANALOG OUTPUT SIGNALS

There are two terminals that can supply analog output signals proportional to output frequency or load. Terminal TB-10A can provide a 0-10 VDC or a 2-10 VDC signal proportional to output frequency, and TB-10B can provide the same signals proportional to load. The 2-10 VDC signals can be converted to a 4-20 mA signal using a resistor in series with the signal such that the total load resistance is 500 Ohms. Refer to Parameters: 42 - TB10A OUT, 43 - @TB10A, 44 - TB10B OUT, and 45 - @TB10B in Section 18 - DESCRIPTION OF PARAMETERS.

NOTE: These analog output signals cannot be used with "loop-powered" devices that derive power from a 4-20 mA signal.

14.2.8 DRIVE STATUS OUTPUT CONTACTS

The control board has one Form C relay at terminals TB-16, TB-17, and TB-18. Contacts are rated 2 amps at 28 VDC or 120 Vac.

NOTE: Models rated above 30 Hp at 200/240 Vac and 60 Hp at 400/480 Vac have a second Form C relay at terminals TB-19, TB-20, and TB-21.

There are also two open-collector outputs at terminals TB-14 and TB-15. The open-collector circuit is a current-sinking type rated at 30 VDC and 40 mA maximum. An external power supply (30 VDC max) must be used to power the open-collector outputs. The drive does not have a dedicated power supply for the open-collector outputs.

The Form C relay and the open collector outputs can be programmed to indicate any of the following: RUN, FAULT, /FAULT (INVERSE FAULT), LOCK (FAULT LOCKOUT), AT SPEED, ABOVE #3, I LIMIT (CURRENT LIMIT), or AUTO/MAN. See Parameters: 52 - TB14 OUT, 53 - TB15 OUT, and 54 - RELAY. Refer to Section 6.2.5 for a complete description of each of these status indications.

15 MC1000 CONTROL WIRING DIAGRAMS

15.1 MC1000 TERMINAL STRIP

Shown below is the terminal strip on the main control board, along with a brief description of the function of each terminal. Wiring shown above the terminal strip indicates internal wiring on the main control board.

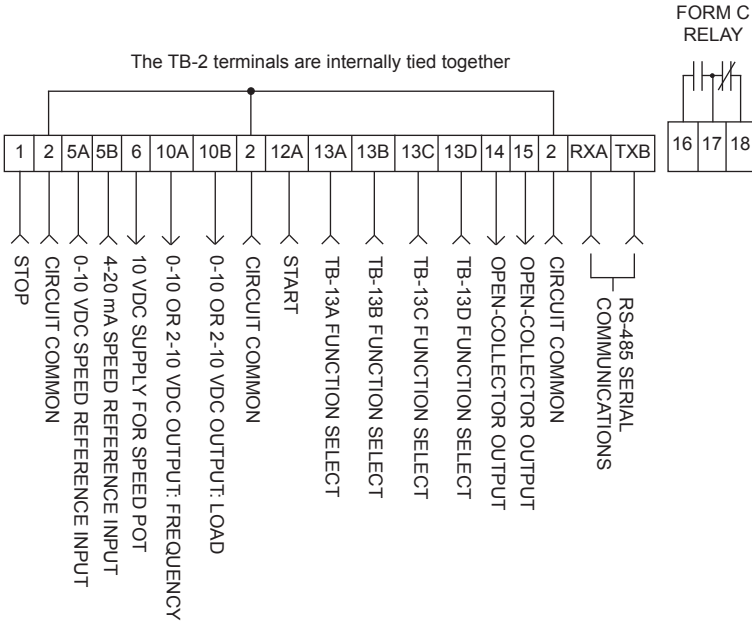

NOTE

The function of terminals TB-10A, TB-10B, TB-13A, TB-13B, TB-13C, TB-13D, TB-14, TB-15, TB-16, and TB-18 are dependent on the programming of certain parameters. In most cases, the name of the parameter matches the number of the terminal, allowing quick and easy programming of the terminals to suit the application. The exception is TB-16 and TB-18, which are governed by Parameter 54 - RELAY.

A complete description of operating the drive in the REMOTE mode can be found in Section 14.2. The following diagrams provide a quick reference to wire the drive for the most common configurations.

15.3 THREE-WIRE START/STOP CONTROL

Shown below is the wiring diagram for a typical three-wire start/stop control scheme, using momentary contacts (such as push buttons) for START and STOP commands. Also shown is the wiring for a 0-10 VDC or 4-20 mA speed reference signal.

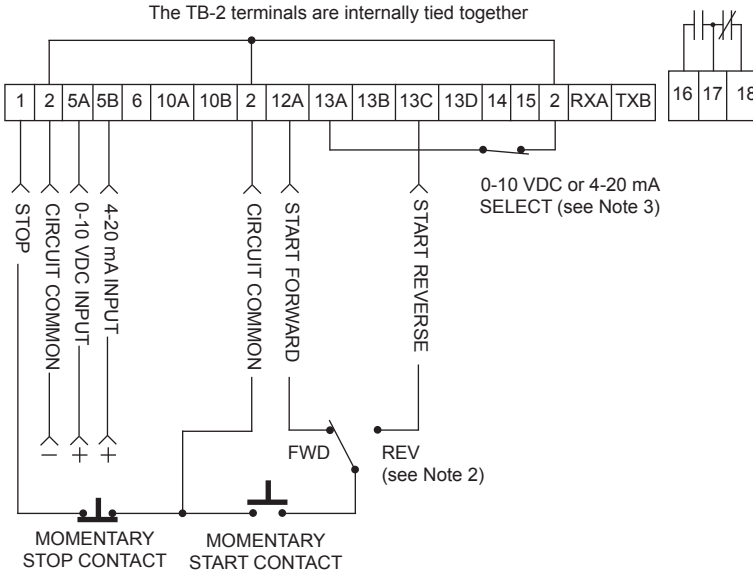

NOTE

1. Momentarily close TB-12A to TB-2 to START, and momentarily open TB-1 to TB-2 to STOP.
2. If REVERSE direction is required, ROTATION must be set to FWD&REV, and TB-13C must be set to START REVERSE (refer to Parameters: 27 - ROTATION, and 49 - TB13C).

If REVERSE is not required, wire the Start button directly to TB-12A and eliminate the FWD/REV switch.

3. Program TB-13A, 13B, or 13C to select the appropriate speed reference signal that will control the drive speed (refer to Parameters 47, 48, and 49). When that TB-13 terminal is closed to TB-2, the drive will respond to the selected speed reference signal. In the diagram above, TB-13A is programmed to select either a 0-10 VDC or 4-20 mA signal.
4. If the contact closure is not made between TB-13A and TB-2 to select a speed reference, the drive will default to MANUAL speed control, which is determined by Parameter 29 - MANUAL.

15.4 SPEED POT AND PRESET SPEED CONTROL

Shown below is the wiring diagram for a control scheme that utilizes a speed pot and PRESET SPEEDS for speed control, and either a two-wire or three-wire START/STOP circuit:

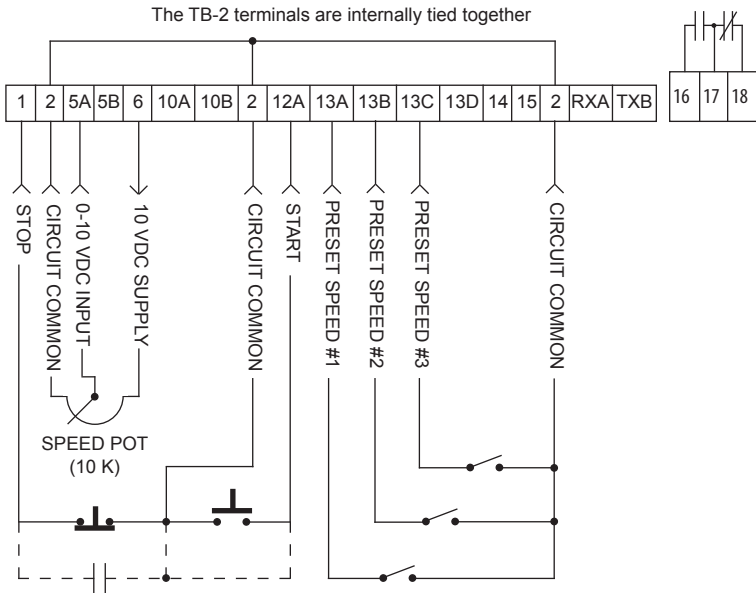

NOTE

1. Program the PRESET SPEEDS (Parameters 1-4) to the desired values.
2. Program TB-13A to select SPEED #1, TB-13B to select SPEED #2, and TB-13C to select SPEED #3 (refer to Parameters 47, 48, and 49).
3. To select a preset speed, close the appropriate terminal to TB-2. To select SPEED #4, close any two of the preset speed terminals to TB-2.
4. Speed pot control can be selected by one of two methods. If none of the preset speeds are selected (all TB-13 terminals are open), the drive will default to speed pot control if Parameter 29 - MANUAL is set to 0-10 VDC. The speed pot can also be selected if one of the TB-13 terminals is programmed to select 0-10 VDC and that terminal is closed to TB-2.
5. If REVERSE rotation is required, TB-13C cannot be used to select SPEED #3. TB-13C must be programmed to select RUN REVERSE or START REVERSE, leaving only TB-13A and TB-13B to select preset speeds.

16 PROGRAMMING THE MC1000 DRIVE

16.1 PROGRAMMING THE PARAMETERS

The MC1000 keypad serves two purposes: operating the drive when in the LOCAL mode, and programming the parameters for particular applications. The keypad is shown below, along with the display that should appear when the drive is first powered up:

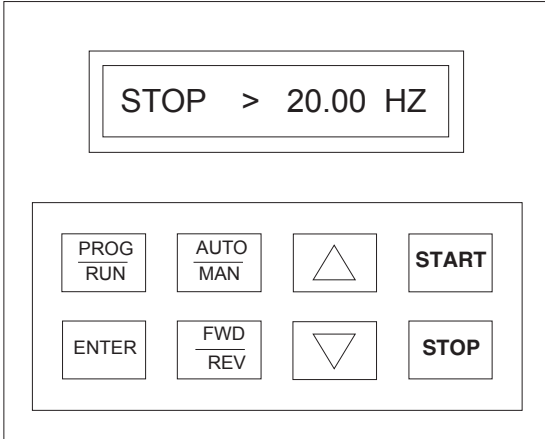

To program the drive, the PROGRAM mode must be entered by pressing the PROG/RUN button. If the password protection is disabled, pressing the PROG/RUN button will result in direct entry into the PROGRAM mode. If the password protection is enabled, the PASSWORD prompt will appear when an attempt is made to enter the PROGRAM mode. The PASSWORD prompt appears as follows:

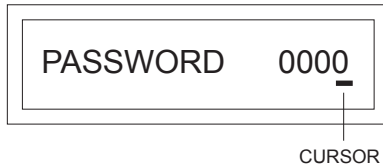

To enter the password, use the UP and DOWN arrow keys to scroll to the password value, and then press the ENTER key.



NOTE:

The factory default password is 0019.

Once the correct password is entered, the PROGRAM mode will be entered and the first parameter will be displayed, which is Parameter 0 - LINE VOLTS. This is shown below:

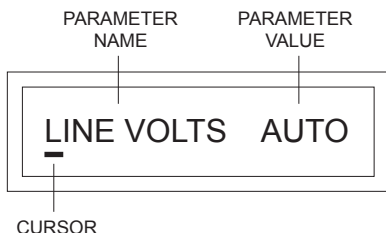

To scroll through the parameters, use the UP and DOWN arrow buttons on the keypad. When the desired parameter is found, press the ENTER key to shift the cursor from the parameter name to the parameter value. In this example, the cursor shifts from LINE VOLTS to AUTO:

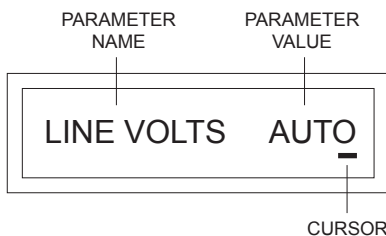

The parameter value can then be changed using the UP and DOWN arrow buttons. If the parameter has a numerical value, the UP arrow will increase the value and the DOWN arrow will decrease the value. If the parameter has specific choices that can be selected, the UP and DOWN arrow keys will scroll through the list of possible settings. When the desired value or option is selected, press the ENTER key to store the new setting. If the new setting is not ENTERED, it will not take effect and the old setting will still be valid.

If the PROG/RUN key is pushed while the cursor is highlighting the parameter value, the value will change back to the original setting (if it had been changed, but not ENTERED), and the cursor will shift back to the parameter name. Pressing PROG/RUN again will exit the PROGRAM mode. If the PROGRAM mode is entered again within two minutes, the last parameter that was viewed, or changed, will come up on the display. After two minutes has elapsed, the password will have to be entered again when attempting to access the PROGRAM mode.

16.2 PARAMETER ACCESS USING SPEED DIAL

SPEED DIAL is used to access parameters quickly using the parameter number. Once accessed, the parameter can be programmed as described in Section 16.1. SPEED DIAL is accessed by pressing the AUTO/MAN key while in the PROGRAM mode. This will activate the SPEED DIAL display as shown below:



Once in SPEED DIAL, the UP and DOWN arrow keys will allow the operator to scroll through the parameter numbers. The display will continue to show SPEED DIAL while scrolling through the parameter numbers, as shown below:

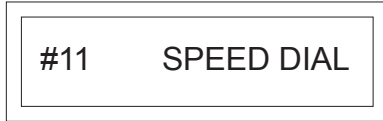

When the desired parameter is reached, the SPEED DIAL display will be replaced by the parameter name:

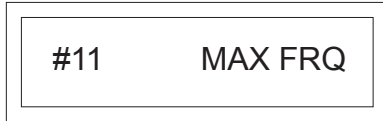

Once the desired parameter is displayed on the screen, press the ENTER key to display the parameter name and present setting. The parameter setting can now be changed by the method described in Section 16.1. Press the AUTO/MAN key to return to SPEED DIAL.

17 PARAMETER MENU

PARAMETER MENU			
PARAM. NUMBER	PARAMETER NAME	RANGE OF ADJUSTMENT	FACTORY DEFAULT
0	LINE VOLTS	HIGH, LOW, AUTO	AUTO
1	SPEED #1	MIN FRQ - MAX FRQ	20.00 Hz
2	SPEED #2	MIN FRQ - MAX FRQ	20.00 Hz
3	SPEED #3	MIN FRQ - MAX FRQ	20.00 Hz
4	SPEED #4	MIN FRQ - MAX FRQ	20.00 Hz
5	SKIP #1	0.00 Hz - MAX FRQ	0.00 Hz
6	SKIP #2	0.00 Hz - MAX FRQ	0.00 Hz
7	BAND WID	0.00 - 10.00 Hz	1.00 Hz
8	ACCEL	(NOTE 1)	30.0 SEC
9	DECEL	(NOTE 1)	30.0 SEC
10	MIN FRQ	0.00 - MAX FRQ	0.50 Hz
11	MAX FRQ	MIN FREQ - 120.0 Hz (NOTE 2)	60.00 Hz
12	DC BRAKE	(NOTE 1)	0.0 VDC
13	DC TIME	0.0 - 999.9 SEC	0.0 SEC
14	DYN BRAKE	OFF, ON	OFF
16	CURRENT	25 - 180 % (NOTE 3)	180 %
17	MOTOR OL	25 - 100 %	100 %
18	BASE	20.00 - 360.0 Hz (NOTE 2)	60.00 Hz
19	FX BOOST	0.0 - 30.0 %	(NOTE 1)
20	AC BOOST	0.0 - 20.0 %	0.00 %
21	SLIP CMP	0.0 - 5.0 %	0.00 %
22	TORQUE	CONSTANT, VARIABLE, CT / NOCMP	CONSTANT
23	CARRIER	2.5, 6, 8, 10, 12, 14 kHz	2.5 kHz
25	START	NORMAL, POWER UP, AUTO RE-, RE-BRAKE	NORMAL
26	STOP	COAST, RAMP, RAMP 2	COAST
27	ROTATION	FORWARD, REVERSE, FWD&REV, FWD@LOC	FORWARD

NOTE 1: REFER TO SECTION 18 - DESCRIPTION OF PARAMETERS

NOTE 2: CONSULT FACTORY FOR OPERATION ABOVE 120Hz.

NOTE 3: IF LINE VOLTS IS SET TO "LOW" (OR SET TO "AUTO" AND THE INPUT VOLTAGE IS LOW), THE RANGE IS 25 - 150%.

PARAMETER MENU			
PARAM. NUMBER	PARAMETER NAME	RANGE OF ADJUSTMENT	FACTORY DEFAULT
28	AUTO/MAN	AUTO, MANUAL, BOTH	BOTH
29	MANUAL	KEYPAD, 0-10 VDC	KEYPAD
30	CONTROL	LOCAL, REMOTE, BOTH	LOCAL
31	UNITS	sp: HERTZ, RPM, % HZ, /SEC, /MIN, /HR, GPH, NONE pid: %, PSI, FPM, CFM, GPM, IN, FT, /SEC, /MIN, /HR, F, C, MPM, GPH	sp: HERTZ
32	HZ MULT	0.10 - 650.0	1.00
33	SPEED DP	XXXXX, XXX.X, XX.XX, X.XXX, .XXXX	XXXXX
34	LOAD MLT	95 - 139 %	100 %
35	CONTRAST	LOW, MED, HIGH	MED
36	SLEEP TH	0.00 - 360.0 Hz	0.00 Hz
37	SLEEP DL	0.0 - 300.0 SEC	30.0 SEC
38	SLEEP BW	FB @ MIN - FB @ MAX	0 %
39	TB5 MIN	0.00 - 360.0 Hz (NOTE 2)	0.00 Hz
40	TB5 MAX	0.00 - 360.0 Hz (NOTE 2)	60.00 Hz
41	AIN FLTR	0.01 - 10.0 SEC	0.02 SEC
42	TB10A OUT	NONE, 0-10V, 2-10V	NONE
43	@TB10A	0.00 - 360.0 Hz (NOTE 2)	60.00 Hz
44	TB10B OUT	NONE, 0-10V, 2-10V	NONE
45	@TB10B	10-200%	125 %
47	TB13A	NONE, 0-10VDC, 4-20MA, SPEED#1, LOC SEL, DEC FREQ	NONE
48	TB13B	NONE, 0-10VDC, 4-20MA, SPEED#2, INC FREQ, JOG FWD, JOG REV	NONE
49	TB13C	NONE, 0-10VDC, 4-20MA, SPEED#3, LOC SEL, RUN REV, STRT REV	NONE

NOTE 2: CONSULT FACTORY FOR OPERATION ABOVE 120Hz.

PARAMETER MENU			
PARAM. NUMBER	PARAMETER NAME	RANGE OF ADJUSTMENT	FACTORY DEFAULT
50	TB13D	EXT FAULT EXT/FAULT, EXT CLEAR	EXT FAULT
52 53 54	TB14 OUT TB15 OUT RELAY	NONE, RUN, FAULT, /FAULT, LOCK, @ SPEED, ABOVE #3, I LIMIT, AUT/MAN, FLWR PR, MIN/MAX ALARM, INV MIN/MAX A, MIN ALARM, INV MIN ALARM, MAX ALARM, INV MAX ALARM, REVERSE, SLEEP, SPD = OHZ	NONE
55	TB5B LOSS	FAULT, SP#4, NONE	FAULT
57	SERIAL	DISABLED, W/TIMER, W/O TIMR	DISABLE
58	ADDRESS	1 - 247	30
61	PASSWORD	0000 - 9999	0019
63	SOFTWARE	(VIEW - ONLY)	(N/A)
64	MONITOR	OFF, ON	ON
65	PROGRAM	MAINTAIN, RESET 60, RESET 50, (NOTE 4)	RESET 60
66	HISTORY	MAINTAIN, CLEAR	MAINTAIN
70	PID MODE	OFF, NORMAL, REVERSE	OFF
74	PID FB	TB-5A, TB-5B	TB-5A
75	FB @ MIN	-32768 to 32767	0.0 %
76	FB @ MAX	-32768 to 32767	100.00 %
77	P GAIN	0.0 - 999.9 %	5.0 %
78	I GAIN	0.0 - 10.0 SEC	0.0 SEC
79	D GAIN	0.0 - 10.0 SEC	0.0 SEC
80	PID ACC	0.0 - 100.0 SEC	30.0 SEC
81	MIN ALRM	FB @ MIN - FB @ MAX	0.0 %
82	MAX ALRM	FB @ MIN - FB @ MAX	0.0 %
98	LANGUAGE		ENGLISH
99	FAULT HISTORY	(VIEW - ONLY)	(N/A)

NOTE 4: "RST HIGH" WILL APPEAR IF HIGH FREQUENCY OPTION HAS BEEN ENABLED.

18 DESCRIPTION OF PARAMETERS

0 LINE VOLTS (LINE VOLTAGE)

This parameter calibrates the drive for the correct input voltage, and can be set to AUTO, HIGH, or LOW.

When set to AUTO, the drive measures the DC bus voltage when power is applied and automatically calibrates itself according to the measured value (DC bus voltage is equal to input voltage multiplied by 1.4).

This parameter can also be set “manually”, using the HIGH or LOW settings. For actual line voltages of 230/240 Vac (on 240/200 Vac models), 460/480 Vac (on 480/400 Vac models), or 575/590 Vac (on 590/480 Vac models), set this parameter to HIGH. Also use the HIGH setting for 240/120 Vac single-phase input models. Refer to the table below.

For actual line voltages of 200/208 Vac (on 240/200 Vac models), 380/415 Vac (on 480/400 Vac models), or 460/480 Vac (on 590 Vac models), set this parameter to LOW. Refer to the table below.

INPUT LINE VOLTAGE SELECTION				
MODEL	RATED INPUT VOLTAGE	INPUT PHASE	ACTUAL INPUT VOLTAGE	PARAM. SETTING
M1100S	240 / 120 Vac	1	220 - 240 Vac	HIGH
	240 / 120 Vac	1	110 - 120 Vac	
M1200(S)	240 Vac	1	220 - 240 Vac	HIGH
	240 / 200 Vac	3	220 - 240 Vac	LOW
	240 / 200 Vac	3	200 - 208 Vac	LOW
M1400	480 / 400 Vac	3	460 - 480 Vac	HIGH
	480 / 400 Vac	3	380 - 415 Vac	LOW
M1500	590 / 480 Vac	3	575 - 600 Vac	HIGH
	590 / 480 Vac	3	460 - 480 Vac	LOW

1-4 SPEED #1- #4 (PRESET SPEEDS #1, #2, #3, AND #4)

PRESET SPEEDS are only active when the drive is in AUTO mode, and are activated via contact closures between terminal TB-2 and terminals TB-13A, TB-13B, and TB-13C. These terminals must be programmed as preset speed selects using Parameters 47 - 49: TB13A, TB13B, and TB13C.

The preset speeds can only be set to values that are within the operating range defined by the minimum and maximum frequency (see Parameters: 10 - MIN FREQ, and 11 - MAX FREQ).

The following table shows how each preset speed is selected using the TB-13 terminals. The terms OPEN and CLOSED refer to the state of the TB-13 terminal relative to TB-2.

PRESET ACTIVATION			
PRESET #	TB - 13A	TB - 13B	TB - 13C
1	CLOSED	OPEN	OPEN
2	OPEN	CLOSED	OPEN
3	OPEN	OPEN	CLOSED
4	CLOSED	CLOSED	OPEN
	CLOSED	OPEN	CLOSED
	OPEN	CLOSED	CLOSED

NOTE: SPEED #4 is selected if any two of the three TB-13 terminals are closed to TB-2.

5,6 **SKIP #1 & #2** (SKIP SPEED #1 & #2)

7 **BAND WID** (SKIP BANDWIDTH)

These parameters are used to prevent the drive from operating continuously at critical speeds, or frequencies, that cause excessive mechanical vibration of the driven equipment. The SKIP SPEEDS (Parameters 5 and 6) and the SKIP BANDWIDTH (Parameter 7) are used to define up to two speed avoidance ranges. The SKIP SPEED settings define the starting point of the speed range that is to be avoided, and the SKIP BANDWIDTH setting defines how far the speed range extends beyond SKIP SPEED. Setting the SKIP SPEEDS to .00 Hz disables this function.

Example: The critical frequency is 21 Hz, and a bandwidth of 2 Hz is desired. Therefore, set SKIP #1 to 20 Hz and set SKIP BANDWIDTH to 2 Hz. This results in a speed range from 20 Hz to 22 Hz that the drive will not operate within continuously. If the drive were operating at 25 Hz and then commanded to operate at a speed within the range of avoidance, the drive would decelerate to 22 Hz and remain at that frequency until commanded to 20 Hz or below. The drive would then decelerate through the range of avoidance to the new frequency. Likewise, if the drive were operating at 18 Hz, and then commanded to operate at a speed within the range of avoidance, the drive would accelerate to 20 Hz and remain at that frequency until commanded to a speed of 22 Hz or above. The drive would then accelerate through the range of avoidance to the new frequency.

8 **ACCEL** (ACCELERATION TIME)

ACCEL sets the acceleration rate for all speed reference sources (keypad, speed pot, 4-20 mA, 0-10 VDC, jog, and the preset speeds). The ACCEL setting is the time to accelerate from 0 Hz to the BASE FREQUENCY (Parameter 18). The range of adjustment for ACCEL depends on horsepower. Refer to the following table:

ACCELERATION LIMITS		
120 - 240 Vac Models	400 - 590 Vac Models	RANGE OF ADJUSTMENT
0.25 - 20 HP	1 - 20 HP	0.1 - 3600 SEC
25 - 30 HP	25 - 60 HP	0.3 - 3600 SEC
40 - 60 HP	75 - 150 HP	1.0 - 3600 SEC

Example: If ACCEL is set to 30 seconds, and the BASE FREQUENCY is set to 60 Hz, the drive will ramp from 0 Hz to 60 Hz in 30 seconds. This is a linear function, therefore the drive would ramp up to 30 Hz in 15 seconds, etc.

NOTE: The ability to accelerate a given load at a particular rate will be limited by the output power capability of the drive/motor combination. The acceleration of high-inertia and high-friction loads may be affected by the current limiting characteristics of the drive. Refer to Parameters: 16 - CURRENT, 19 - FX BOOST, and 20 - AC BOOST for more information.

9 **DECEL** (DECELERATION TIME)

DECEL sets the deceleration rate for all speed reference sources. The DECEL setting indicates the time to decelerate from BASE FREQUENCY to 0 Hz. As with Parameter 8 - ACCEL, this is a linear function. If the drive is set to COAST to stop, this parameter will have no effect when a STOP command is given. The range of adjustment for DECEL depends on horsepower, voltage, and whether Dynamic Braking (DB) is being used. Refer to the table below:

DECELERATION LIMITS				
HORSEPOWER / VOLTAGE RATING			RANGE OF ADJUSTMENT	
120 - 240 Vac Models (NOTE 1)	480/400 Vac Models	590 / 480 Vac Models	WITHOUT DB (NOTE 2)	WITH DB
0.25 - 7.5 HP	1 - 7.5 HP	----	0.3 - 3600 SEC	0.1 - 3600 SEC
10 - 15 HP	10 - 20 HP	1 - 7.5 HP	0.5 - 3600 SEC	0.1 - 3600 SEC
20 - 30 HP	25 - 60 HP	10 - 20 HP	1.0 - 3600 SEC	0.2 - 3600 SEC
40 HP	----	----	1.0 - 3600 SEC	0.3 - 3600 SEC
----	----	25 - 60 HP	2.0 - 3600 SEC	0.2 - 3600 SEC
60 HP	75 HP	----	3.0 - 3600 SEC	0.8 - 3600 SEC
----	100 - 150 HP	----	7.0 - 3600 SEC	1.8 - 3600 SEC

NOTE 1: 120/240 Vac units have the same limits as 240/200 Vac units.

NOTE 2: The parameter value can be set below the minimum value shown, but the value shown is the operational limit of the drive. For example, if DECEL is set for 0.1 seconds on a 10 HP, 480 Vac drive without dynamic braking, the actual deceleration time would be 0.5 seconds.

If an attempt is made to decelerate a high-inertia load too quickly, the motor will regenerate voltage back into the drive. This will cause the DC bus voltage to rise, which can result in a HI VOLTS fault. In order to prevent faulting, the drive will enter DECEL FREEZE, which halts the deceleration until the DC bus voltage returns to a normal level. The drive will then begin to decelerate again, and if necessary, will enter DECEL FREEZE repeatedly to avoid faulting. If a very short deceleration time is programmed, DECEL FREEZE may not be able to compensate fast enough, resulting in a HI VOLTS fault.

In applications where very short deceleration times are required on high-inertia loads, dynamic braking may be required. Consult the factory for more information on the Dynamic Braking option.

10 **MIN FRQ** (MINIMUM FREQUENCY)

This parameter defines the lower limit of the drive's speed range. MIN FRQ is used in conjunction with MAX FRQ (Parameter 11 below) to define the operating range of the drive.

If MIN FRQ is set to a value above 0.0 Hz, the drive will ramp up from 0.0 Hz when given a start command. Once running, however, the drive will not operate below the MIN FRQ setting unless the rotation is changed, or a stop command is issued and the drive is programmed to ramp to a stop.

If the MINIMUM FREQUENCY is set to 0.0 Hz, the drive may be operated in ZERO SPEED mode (drive is in RUN state, but there is no output to the motor). ZERO SPEED operation can be used in applications requiring the ability to start and stop the drive using only the selected speed reference. The drive will start when the speed reference is raised above 0 VDC or 4 mA, and it will stop when the reference is lowered to 0 VDC or 4 mA. Note that the drive must be initially started using one of the normal start commands (keypad or terminal strip).

11 **MAX FRQ** (MAXIMUM FREQUENCY)

This parameter defines the upper limit of the drive's speed range. MAX FRQ is used in conjunction with MIN FRQ (Parameter 10 above) to define the operating range of the drive.



WARNING!

Consult motor manufacturer before operating motor above rated frequency. Overspeeding the motor and/or driven equipment can cause damage to equipment and injury to personnel!

NOTE: CONSULT FACTORY FOR OPERATION ABOVE 120Hz.

12 DC BRAKE (DC BRAKE VOLTAGE)

DC braking creates a braking torque by injecting DC voltage into the motor. This parameter sets the magnitude of that DC voltage. The point at which the drive applies DC braking to the motor depends on which STOP mode is programmed (either COAST or RAMP, see Parameter 26 - STOP).

If the drive is set to COAST, DC braking is activated when the stop command is given. In this case, DC braking helps decelerate the motor. This is useful in applications where a quick deceleration is desired on a load that would normally take a long time to coast to a stop.

If the drive is set to RAMP, DC braking is activated when the output frequency reaches 0 Hz. In this case, the drive decelerates the load to a near stop and then DC braking is used to stop and hold the motor. This is useful in applications where the load needs to be stopped in a certain position. Similar applications with high-inertia loads utilize both dynamic braking and DC braking. The dynamic braking allows the high-inertia load to be decelerated quickly, while the DC braking stops the load in the desired position.

Due to heat generated in the motor, DC braking should only be used in applications where the load is stopped infrequently. In high duty-cycle applications, dynamic braking is recommended because the heat is dissipated through external resistor banks, rather than in the motor. When used, DC BRAKE should be set to the lowest voltage that provides satisfactory operation in order to minimize motor heating. The maximum voltage available depends on the voltage rating of the drive. Refer to the table below:

MAXIMUM DC BRAKE VOLTAGE			
MODEL M1100 240 / 200 Vac	MODEL M1200 240 / 200 Vac	MODEL M1400 480 / 400 Vac	MODEL M1500 590 / 480 Vac
24 VOLTS	24 VOLTS	48 VOLTS	59 VOLTS

13 DC TIME (DC BRAKE TIME)

This parameter determines the length of time that the DC braking voltage is applied to the motor. DC TIME should be set to the lowest value that provides satisfactory operation in order to minimize motor heating.

NOTE: If this parameter is set to 999.9 seconds (the maximum value), the DC braking will be continuous. If it is set to .0 seconds, it is disabled.

14 DYN BRAK (DYNAMIC BRAKE)

This parameter enables the dynamic braking circuit. Set this parameter to ON only if the optional dynamic braking circuit board and resistors are installed.

Dynamic braking is used in applications where high-inertia loads need to be decelerated quickly. When this is attempted, the motor regenerates voltage back into the drive, causing the DC bus voltage to rise, eventually resulting in a HI VOLTS fault. With the dynamic braking option, the DC bus voltage is monitored, and when it reaches a certain level, a transistor is switched on that connects an external resistor bank across the DC bus. This allows the regenerated energy from the motor to be dissipated through the resistors as heat, which keeps the DC bus voltage below the trip level.

16 CURRENT (CURRENT LIMIT)

This parameter sets the maximum allowable output current of the drive, which also determines the torque capability of the motor. For most applications, CURRENT is left at the maximum setting, which is 150% or 180% (of the drive's output current rating), depending on whether the input voltage to the drive is low or high (refer to Parameter 0 - LINE VOLTS).

The drive will enter current limit when the current draw of the motor exceeds the current limit setting. To respond to this condition, the drive will enter "frequency foldback", which commands the drive to decelerate in order to reduce the output current and regain synchronization with the motor. When the over current condition passes, the drive will return to normal operation and reaccelerate to the speed set point. However, if "frequency foldback" cannot correct the condition and the drive remains in current limit for too long, it will trip into an OVERLOAD fault. If the drive enters current limit while accelerating, the time required to reach the speed set point will be longer than the time programmed into ACCEL (Parameter 8).

Regardless of the CURRENT setting, the drive is capable of delivering a maximum of 150% current for one minute, and 180% current for approximately 30 seconds, before tripping into an OVERLOAD fault. Refer to Parameter 17 – **MOTOR OL**.

17 MOTOR OL (MOTOR OVERLOAD)

The MC1000 Series is UL approved for solid state motor overload protection. Therefore, a separate thermal overload relay is not required for single motor applications. The MOTOR OVERLOAD circuit is used to protect the motor from overheating due to excessive current draw. The trip time for the MOTOR OVERLOAD setting is based on what is known as an "inverse I²t" function. This function allows the drive to deliver 150% of the rated output current for one minute, and even higher current levels for shorter periods of time. Once the overload circuit "times out", the drive will trip into an OVERLOAD fault.

The MOTOR OVERLOAD should be set to a value which is equal to the ratio (in percentage) of the motor full load current rating to the drive output current rating. This will result in an overload capacity of 150% of the MOTOR current rating for one minute. If this parameter is set to 100%, the motor will be allowed to draw 150% of the DRIVE output current rating for one minute. This distinction is important in cases where the motor full load current rating is significantly less than the drive output current rating, such as applications where the drive is oversized to meet torque requirements.

Example 1: A 5 Hp, 480 Vac drive is operating a 3 HP motor with a full load current rating of 4.8 amps. Divide the motor current rating by the drive output current rating: $4.8 / 7.6 = 63\%$. Entering this value will allow continuous operation at 4.8 amps, and will also allow the motor to draw 7.2 amps (150% of 4.8 amps) for one minute. If the setting is left at 100%, the motor could draw 11.4 amps (150% of 7.6 amps) for one minute before tripping the drive.

The MC Series drive has two options for thermal overload protection. One depends on the speed of the drive, and the other does not. The diagram below illustrates the difference between "speed compensated" and "non-compensated" thermal overload protection.

The "speed-compensated" thermal overload circuit offers additional protection from high load conditions at low speeds, where motor cooling is often less effective (e.g., motors with shaft-mounted fans). As seen on the diagram below, the drive reduces the allowable continuous output current when operating at frequencies less than 30 Hz.

Example 2: A 480 Vac, 20 HP drive is operating a motor at 10 Hz. From the diagram, a drive operating at 10 Hz can deliver about 75% of its output current rating continuously. A 480 Vac, 20 HP drive's output current rating is 27 Amps. Therefore, the drive would be able to operate continuously at 20 Amps. The drive would also be able to deliver 150% of that value (30 Amps) for one minute before tripping into an OVERLOAD fault.

The "speed compensated" thermal overload is the factory default and should be used in applications where the motor does not normally experience high loads at low speeds for extended periods of time.

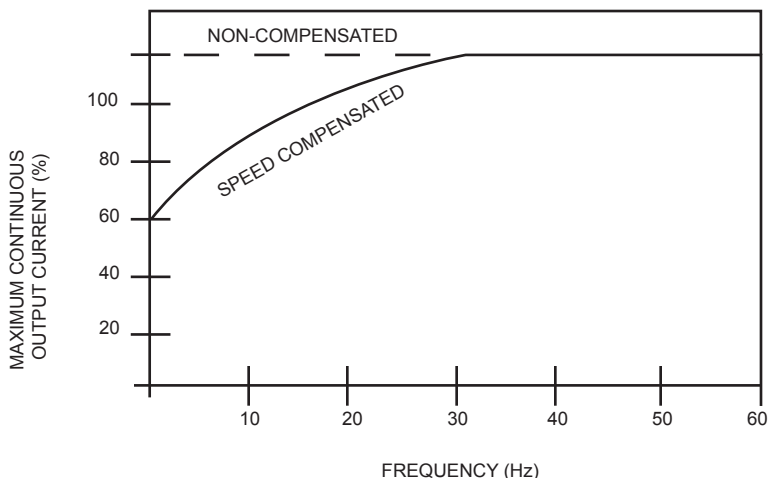

NOTE 1: The above diagram is based on a MOTOR OL setting of 100%. For lower MOTOR OL settings, reduce the % CURRENT values by the same percentage. For example, if MOTOR OL is set to 75%, reduce the % CURRENT values by 25%. Therefore, the curve shifts down, but the shape of the curve remains the same.

The "non-compensated" thermal overload circuit allows 100% current continuously, and 150% current for one minute, at all speeds. In the example above, the motor operating at 10 Hz without "speed-compensated" protection would be allowed to operate continuously at 27 Amps, and could draw 40.5 Amps for one minute before tripping. Without sufficient motor cooling, this can result in motor failure due to overheating.

The "non-compensated" circuit is selected by setting Parameter 22 - TORQUE to CT/NOCMP. The "non-compensated" setting should only be used in applications where the motor is properly cooled at all speeds, or the motor manufacturer has approved the motor for full-load operation at low speeds.

NOTE 2: The operation of the motor thermal overload circuit is affected by the setting of Parameter 34 - LOAD MLT.

18 BASE (BASE FREQUENCY)

The BASE FREQUENCY determines the V/Hz ratio by setting the frequency at which the drive will output full voltage to the motor. For most applications the base frequency should be set to match the motor's rated frequency.

For example, if the drive is rated for 460 Vac output, and the BASE FREQUENCY is set to 60 Hz, the drive will maintain a constant ratio of 7.66 V/Hz (except when AC BOOST or FX BOOST are active, refer to Parameters 19 and 20) from 0 Hz to 60 Hz. This range is the region of constant torque. If the motor speed is increased past 60 Hz, the output voltage remains constant while the frequency increases, resulting in a reduced V/Hz ratio. This range, from 60 Hz to about 90 Hz, is the region of constant horsepower. Above 90 Hz, horsepower begins to decrease as frequency increases. Refer to Section 6.1 - DESCRIPTION OF AC MOTOR OPERATION.

19 FX BOOST (FIXED BOOST)

This parameter is used in applications which require high starting torque. FX BOOST increases the output voltage at lower output frequencies (below 30 Hz for 60 Hz base frequency), in order to boost the torque capability of the motor. Refer to the diagram below. The factory default for FX BOOST depends on the horsepower rating. Refer to the table below:

FX BOOST FACTORY DEFAULT SETTINGS				
HP	FACTORY DEFAULT (ALL VOLTAGES)	HP	FACTORY DEFAULT (240 / 200 VAC)	FACTORY DEFAULT (400+ VAC)
0.25 - 1 HP	5.30 %	40 HP	2.30 %	1.20 %
1.5 - 2 HP	4.40 %	50 HP	---	0.80 %
3 HP	3.60 %	60 HP	2.10 %	0.80 %
5 HP	3.00 %	75 HP	---	2.00 %
7.5 HP	2.70 %	100 HP	---	1.90 %
10 HP	2.40 %	125 HP	---	1.90 %
15 HP	2.20 %	150 HP	---	1.80 %
20 HP	2.00 %			
25 HP	1.80 %			
30 HP	1.60 %			

20 AC BOOST (ACCELERATION BOOST)

AC BOOST is similar to FX BOOST, but is only active when the drive is accelerating. During acceleration, the output voltage is increased according to the setting of AC BOOST, which increases motor torque. Refer to the diagram below. AC BOOST, like FX BOOST, is used in applications with high-inertia loads.

The diagram below illustrates how FX BOOST and AC BOOST alter the V/Hz ratio to increase motor torque.

FX BOOST sets the boost at 0 Hz (approximately 15% in the example above), and as the output frequency approaches 30 Hz, the boost decreases to zero.

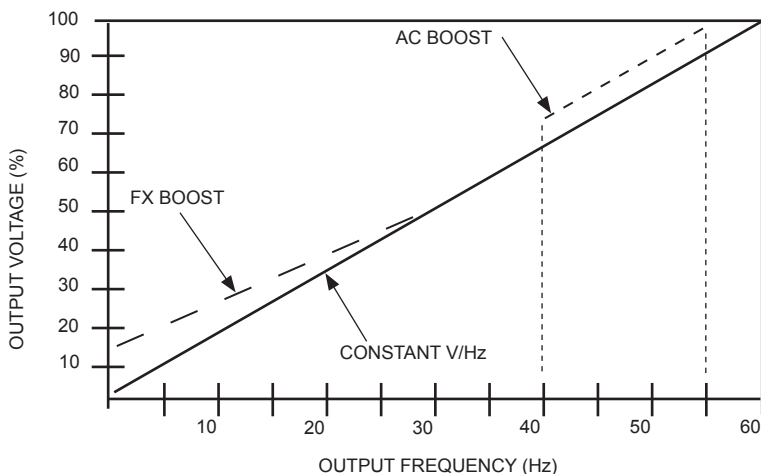

AC BOOST only functions during acceleration. In the diagram above, the drive is operating at 35 Hz and is then commanded to 50 Hz. The output voltage is increased by the AC BOOST setting (approximately 15% in the example above) during acceleration to the new speed set point. Once the new set point is reached, the output voltage returns to normal.

21 SLIP CMP (SLIP COMPENSATION)

SLIP COMPENSATION is used to compensate for changes in motor speed ("slip") which occur due to changes in load. In a standard AC induction motor, as the load on the motor increases, the motor current increases and the motor shaft speed decreases. By increasing the output frequency in response to the increased motor current, SLIP COMPENSATION is able to counteract the reduction in motor speed due to increased load. This parameter is useful in applications where precise speed regulation is needed, even under changing load conditions. The use of SLIP COMPENSATION can result in speed regulation of less than 1% of base speed in most applications. SLIP COMPENSATION is often set to 3%, which is the standard slip rating of most AC induction motors.

22 TORQUE (TORQUE CURVE SELECTION)

This parameter is used to select whether the output of the drive follows a constant or variable V/Hz curve. The following selections are available:

CONSTANT	Use for constant torque applications to optimize torque.
VARIABLE	Use for variable torque applications to optimize energy savings.
CT / NOCMP	Use for constant torque applications that require full overload capacity at low speeds (see Parameter 17 - MOTOR OL).

23 CARRIER (CARRIER FREQUENCY)

This parameter sets the carrier, or switching, frequency of the output IGBT's. Higher switching rates result in less audible noise from the motor, but the efficiency of the drive decreases as the carrier frequency increases. Therefore, this parameter should be set to the lowest value which yields acceptable sound levels. Available settings are: 2.5 kHz, 6 kHz, 8 kHz, 10 kHz, 12 kHz and 14 kHz.

NOTE 1: The 2.5 kHz carrier frequency setting is a variable carrier. The carrier frequency remains fixed at 1.5 kHz up to 25 Hz output frequency. Above 25 Hz, the carrier is a fixed multiple of 60 times the drive's output frequency. For example, if the output frequency of the drive was set to 45 Hz, the carrier frequency would be 2.7 kHz (45 Hz x 60 = 2700 Hz).

NOTE 2: The ability to operate a drive in the quiet (high carrier frequency) mode is dependent on the drive horsepower rating, driven load, drive enclosure, and the ambient temperature. At full ambient temperature, operation above 8 kHz requires derating the drive by multiplying the output current rating by the following factors: 0.94 at 10 kHz, 0.89 at 12 kHz, and 0.83 at 14 kHz.

NOTE 3: If the drive is equipped with the High Output Frequency option, and MAX FRQ is set above 120 Hz, CARRIER will automatically change to 14 kHz, and the CARRIER parameter will disappear from the parameter menu. Operation at 14 kHz carrier frequency requires derating as shown in NOTE 2 above.

25 **START** (START MODE)



WARNING!

Automatic start of equipment may result in damage to equipment and/or injury to personnel! Automatic start should only be used on equipment that is inaccessible to personnel.

This parameter selects the starting method for the drive, and can be set for one of the following:

NORMAL	The drive will start when the appropriate contact closure is made on the terminal strip (in REMOTE mode), or by pressing the keypad START key (in LOCAL mode). To start the drive in NORMAL mode, a start command must be issued at least two seconds AFTER input power is applied.
POWER UP	The drive will automatically start upon application of input power. The drive MUST be wired for a two-wire start/stop circuit (refer to Section 14 - CONTROL WIRING). The start command MUST be present when power is applied for this function to operate.
AUTO RE-	The drive will automatically restart after a protective fault or upon application of input power. As with the POWER-UP option, a start command must be present for this function to operate.
RE-BRAKE	After a fault, the drive will apply DC braking equal to the DC BRAKE setting for 15 seconds and then restart. This is done to ensure the motor is stopped during the restart attempt, as the drive will not start into a spinning motor.

NOTE 1: POWER UP, AUTO RE-, and RE-BRAKE settings are only active when the drive is in REMOTE mode (see Parameter 30 - CONTROL).

NOTE 2: After a fault, the drive will attempt to restart five times, and if unsuccessful, will shut down on a FAULT LOCKOUT. Every 15 minutes that passes will decrement the restart counter by one. Therefore, 75 minutes after a successful restart, the restart counter is fully reset, and the drive can once again attempt five restarts.

NOTE 3: The drive WILL NOT restart after the following faults: CONTROL and PWR SAG. Also, if an OUTPUT fault occurs below 1.5 Hz, only one restart will be attempted, after a four minute delay. If unsuccessful, it will then trip into FAULT LOCKOUT, which will require a manual reset. This is done to protect the drive in case of a shorted motor.

26 **STOP** (STOP MODE)

This parameter selects whether the motor will COAST to a stop, or RAMP to a stop, when the drive is given a stop command.

COAST	When a stop command is given, the drive shuts off the output to the motor, allowing it to coast to a stop. The time required for the motor to stop is governed by the inertia of the load.
RAMP	When a stop command is given, the drive will decelerate the motor to a stop over a period of time according to Parameter 9 - DECEL. Once the output frequency reaches 0.0 Hz, there will be a 200 ms delay before the drive can be started again.
RAMP 2	Same as RAMP, but without the 200 ms start delay. This allows faster start/stop cycles for applications that require it.

**WARNING!**

If TB-13C is programmed for RUN REVERSE, TB-1 is disabled and **CANNOT** be used as a STOP switch! This is true in LOCAL and REMOTE mode. Incorrect use of TB-1 may result in damage to equipment and/or injury to personnel! Refer to Parameter 49 - TB13C for more information.

This parameter is used to limit the motor rotation direction to forward or reverse, or to allow rotation in both directions. The parameter can be set to one of the following:

FORWARD	Rotation is allowed in the forward direction only. This selection disables the FWD/REV button on the keypad and TB-13C (REVERSE).
REVERSE	Rotation is allowed in the reverse direction only. This selection disables the FWD/REV button on the keypad and TB-12A (FORWARD). TB-13C must be programmed for either RUN REV or STRT REV for this function to operate in the REMOTE mode.
FWD&REV	Rotation is allowed in both directions. The FWD/REV button is enabled. Rotation can be changed from the keypad (LOCAL mode), or the terminal strip (REMOTE mode). In the REMOTE mode, TB-13C must be programmed for either RUN REV or STRT REV for this function to operate.
FWD@LOC	In LOCAL mode, rotation is allowed in the forward direction only. In REMOTE mode, rotation is allowed in both directions.

NOTE: If the rotation is changed while the drive is running, the drive will decelerate to 0 Hz, and then accelerate back up to the speed set point in the opposite direction.

28 **AUTO / MAN** (AUTO / MANUAL SPEED CONTROL)

This parameter is used to select the method of speed control when the drive is in the LOCAL mode. The choices are explained below:

MANUAL	The drive will accept a speed reference from the keypad (UP and DOWN ARROW keys) or a speed potentiometer (wired to TB-2, 5A, and 6). Parameter 29 - MANUAL below selects either keypad or speed potentiometer. The AUTO/MAN button on the keypad is disabled.
AUTO	The drive will accept a 0-10 VDC input signal on TB-5A and TB-2, a 4-20 mA input signal on TB-5B and TB-2, or one of the four PRESET SPEEDS. The programming of TB-13A, TB-13B and TB-13C determines which AUTO reference is selected. The AUTO/MAN button on the keypad is disabled.
BOTH	The AUTO/MAN key on the keypad is enabled and can be used to toggle between MANUAL and AUTO control ONLY if the drive is in LOCAL mode.

NOTE: If the drive is in the AUTO mode, and a speed reference is not selected using TB-13A, TB-13B, or TB-13C, the speed reference source will default to the setting of Parameter 29 - MANUAL (KEYPAD or 0-10 VDC).

29 **MANUAL** (MANUAL)

This parameter selects the speed reference source when the drive is set for MANUAL speed control (see Parameter 28 - AUTO/MAN above). The speed reference options are KEYPAD (UP and DOWN ARROW keys), or 0 - 10 VDC (from a speed pot wired to TB-2, 5A, and 6; or some other 0-10 VDC source).

30 CONTROL (START/STOP CONTROL)



WARNING!

If CONTROL is set to LOCAL, TB-1 is disabled and **CANNOT** be used as a STOP switch! Incorrect use of TB-1 may result in damage to equipment and/or injury to personnel!



WARNING!

STOP (TB-1) and EXTERNAL FAULT (TB-13D) circuitry may be disabled if parameters are reset to factory defaults! The drive must be reprogrammed after a RESET in order to insure proper operation (see Parameter 65 - PROGRAM).

FAILURE TO DO SO MAY RESULT IN DAMAGE TO EQUIPMENT AND/OR INJURY TO PERSONNEL!

This parameter is used to select the source of the start/stop command and direction control. The following settings are available:

- | | |
|--------|---|
| LOCAL | START/STOP and FORWARD/REVERSE commands from the keypad only. |
| REMOTE | START/STOP and FORWARD/REVERSE commands from the terminal strip only. |
| BOTH | LOCAL operation if TB-13A or TB-13C is programmed for LOCAL SELECT and a contact closure is made from TB-13A or TB-13C to TB-2. If the contact closure is not made, the drive will be in REMOTE mode. |

31 UNITS (SPEED/PID UNITS)

UNITS sets the units of the output speed or PID display on the keypad. The following choices are available:

Speed mode: HERTZ, RPM, %HZ, /SEC, /MIN, /HR, GPH, NONE

PID mode: %, PSI, FPM, CFM, GPM, IN, FT, /SEC, /MIN, /HR, F, C, MPM, GPH

NOTE: If one of the "pid" units is selected, but the drive is in Manual (open-loop) speed control mode or PID MODE is DISABLED, the displayed speed units will default to HERTZ. If one of the "speed" units is selected, but PID MODE is ENABLED and the drive is in Auto mode, the displayed PID units will default to %.

32 HZ MULT (HERTZ MULTIPLIER)

The HZ MULTIPLIER is used to scale the output speed indication on the display. If UNITS is set for HERTZ or % HZ, this parameter has no effect. Multiplying the output frequency by the HZ MULTIPLIER will yield the desired speed value on the display.

Example: The desired speed units is RPM with a standard 60 Hz, 1800 RPM motor. Set UNITS to RPM and set HZ MULT to 30.00. This will result in a speed display of 1110 RPM for an output frequency of 37 Hz (37 Hz X 30 = 1110 RPM). Also, if there was a 100:1 gear reducer in the system, Parameter 33 - SPEED DP below could be set to XX.XX to represent the output of the gear reducer (11.10 RPM in the example).

33 **SPEED DP** (SPEED DECIMAL POINT)

This parameter is used to move the decimal point location in the speed display. This parameter will not have any effect if UNITS is set to HERTZ or % HZ. The possible settings are: XXXXX, XXX.X, XX.XX, X.XXX, and .XXXX. Refer to Parameter 32 - HZ MULT above for an example on the use of SPEED DP.

34 **LOAD MLT** (LOAD MULTIPLIER)

This parameter is used to scale the % LOAD display. If the drive output current rating is higher than the motor full load current rating, the drive will not display 100% load when the motor is at full load. Setting this parameter to the ratio (in %) of the drive output current rating to the motor full load current rating will scale the load display to show motor load instead of drive load. This will result in a display of 100% when the motor is at full load.

The motor overload circuitry is also affected by this parameter. When the display reads 150% load, the drive will trip on OVERLOAD in one minute, regardless of the actual motor current. If this parameter is used to scale the display to show actual motor load, then Parameter 17 - MOTOR OL should be left at 100%. Likewise, if MOTOR OL has been set according to the motor full load rating, this parameter should be left at 100%. Changing both parameters will result in an OVERLOAD fault sooner than expected.

The output signal at TB-10B is also affected by this parameter. When set to the ratio of current ratings as explained above, the output signal will be proportional to motor load instead of drive load.

35 **CONTRAST** (LCD DISPLAY CONTRAST)

This parameter is used to adjust the contrast of the drive display and can be set to LOW, MED, or HIGH in order to obtain the most visible display. If the drive is mounted lower than eye level, a HIGH setting may make the display more visible. Likewise, if the drive is mounted higher than eye level, a LOW setting may make the display more visible.

36 **SLEEP TH** (SLEEP THRESHOLD)

The MC1000 Series drive has a Sleep Mode function that allows the drive to cease operation when system demand falls below a preset level. This is to prevent the motor from operating at low speeds for long periods of time. It is commonly used along with the PID Set point Control feature, but can also be used in standard speed control mode.

When the commanded speed falls below the SLEEP THRESHOLD setting for the defined SLEEP DELAY time (see Parameter 37 below), the drive will "go to sleep" and the motor will go to zero speed. The drive will remain "sleeping" until it is commanded to operate at a speed that is 2 Hz above the SLEEP THRESHOLD, at which point it will "wake up" and ramp the motor up to the commanded speed.

NOTE 1: While the drive is in Sleep Mode, the Status portion of the display will read SLEEP.

NOTE 2: If the drive's commanded speed goes below the SLEEP THRESHOLD, the SLEEP DELAY timer will start to count down. If the commanded speed equals or exceeds the SLEEP THRESHOLD before the SLEEP DELAY times out, the SLEEP DELAY timer will be reset.

NOTE 3: If the drive is in a Stop state, and the commanded speed is below the SLEEP THRESHOLD, the drive will immediately go to sleep upon a Start command, bypassing the SLEEP DELAY.

37 SLEEP DL (SLEEP DELAY)

This parameter sets the amount of time the drive must operate below the SLEEP THRESHOLD (see Parameter 36 above) before the drive "goes to sleep" and brings the motor to zero speed.

Example: SLEEP THRESHOLD is set to 15 Hz and SLEEP DELAY is set to 60 seconds. If the drive operates below 15 Hz for 60 seconds, the drive will "go to sleep" and the motor will stop. The drive's display will indicate SLEEP, and the drive will remain "sleeping" until the drive commanded to a speed equal to greater than 17 Hz. At this point, the drive will "wake up" and ramp the motor up to the commanded speed.

38 SLEEP BW (SLEEP BANDWIDTH)

This parameter allows the PID feedback signal to determine when drive should "wake up" when operating in Sleep Mode. In process systems that utilize Integral Gain (see Parameter 78), the drive may cycle in and out of Sleep Mode more often than desired, due to the Integral function of the PID algorithm.

When SLEEP BANDWIDTH is used, the feedback signal must decrease or increase (depending on whether the system is normal or reverse-acting) by the programmed amount before the drive will "wake up". This parameter is set in PID units.

Example: In a normal-acting system, the PID set point is 50 PSI, SLEEP THRESHOLD is set to 20 Hz, and SLEEP BANDWIDTH is set to 5 PSI. The drive will enter Sleep Mode when the commanded speed drops below 20 Hz for the time defined in SLEEP DELAY. The drive will wake up when the feedback signal drops below 45 PSI (50 PSI set point minus 5 PSI bandwidth = 45 PSI), even if the commanded speed is still below 20 Hz.

NOTE: If SLEEP BANDWIDTH is set to 0, this function is disabled, and the drive will wake up when the commanded speed exceeds the SLEEP THRESHOLD plus 2 Hz, as described in Parameters 36 and 37.

39 TB5 MIN (TERMINAL TB-5 INPUT)

TB5 MIN selects the output frequency of the drive that will correspond to the minimum analog speed reference input (0 VDC or 4 mA). This parameter is used in conjunction with Parameter 40 - TB5 MAX to define a speed range that corresponds to the analog speed reference input (0 - 10 VDC or 4 - 20 mA).

40 TB5 MAX (TERMINAL TB-5 INPUT)

TB5 MAX selects the output frequency of the drive that will correspond to the maximum analog speed reference input (10 VDC or 20 mA). This parameter is used in conjunction with Parameter 39 - TB5 MIN to define a speed range that corresponds to the analog speed reference input (0 - 10 VDC or 4 - 20 mA).

Example 1: The drive is required to operate from 0 to 60 Hz in response to a 0-5 VDC speed reference signal (rather than the "normal" 0-10 VDC). Because TB5 MAX is based on a 0-10 VDC (or 4-20 mA) signal, the drive will operate at half of the TB5 MAX value if it is given a 5 VDC signal. Therefore, setting TB5 MAX to 120 Hz will cause the drive to run at 60 Hz when it is given a 5 VDC speed reference signal.

NOTE: The drive can be programmed for inverse operation so that as the speed reference increases, the drive speed will decrease, and as the speed reference decreases, the drive speed will increase. This is accomplished by setting TB5 MIN to the desired maximum output frequency, and TB5 MAX to the desired minimum output frequency.

Example 2: The drive is being controlled by a pressure transducer that provides a 4-20 mA signal proportional to duct pressure. The minimum frequency desired is 20 Hz, and the maximum is 60 Hz. Set TB5 MIN for 60 Hz, and TB5 MAX for 20 Hz. As the duct pressure rises, the output signal from the transducer will increase, causing the speed of the drive to decrease. This results in a decrease in duct pressure and a decreasing transducer signal. The drive responds to the decreasing signal by increasing speed, which again raises the duct pressure. In this way, the average duct pressure can be maintained at a certain level. If the acceleration and deceleration rates are set too fast however, the drive will react quickly to signal changes which will cause the drive speed to “hunt” up and down excessively.

41 AIN FLTR (ANALOG INPUT FILTER)

This parameter adjusts the filter on the analog input terminals (TB-5A and TB-5B) to reduce the effect of any electrical noise that may be present on the analog input signals. This filter works in both PID mode and standard speed control mode. It should be set to the lowest value that yields acceptable performance, as setting it too high may cause the drive to react too slowly to signal changes.

42 TB10A OUT (TERMINAL TB-10A OUTPUT)

The analog output signal at TB-10A is proportional to the output frequency of the drive. This parameter selects whether that signal is 0-10 VDC or 2-10 VDC. The 2-10 VDC signal can be converted to a 4-20 mA signal by connecting a resistor in series with the signal such that the total load resistance is 500 Ohms. If set to NONE, the function is disabled.

NOTE: This output cannot be used with “loop-powered” devices that derive power from a 4-20 mA signal.

43 @ TB10A (TERMINAL TB-10A SCALING)

This parameter scales the analog output signal at TB-10A. This setting is the output frequency that is indicated when the TB-10A output measures 10VDC.

Example: The drive is part of a control system that requires a 0-5 VDC signal (rather than 0-10 VDC) that is proportional to 0-60 Hz output frequency. The output signal is linear, so setting this parameter to 120 Hz would yield 10 VDC at 120 Hz, and 5 VDC at 60 Hz.

44 TB10B OUT (TERMINAL TB-10B OUTPUT)

The analog output signal at TB-10B is proportional to the drive load. This parameter selects whether that signal is 0-10 VDC or 2-10 VDC. The 2-10 VDC signal can be converted to a 4-20 mA signal by connecting a resistor in series with the signal such that the total load resistance is 500 Ohms.

NOTE: This output cannot be used with “loop-powered” devices that derive power from a 4-20 mA signal.

45 @ TB10B (TERMINAL TB-10B SCALING)

This parameter scales the analog output signal at TB-10B. This setting is the load (in %) that is indicated when the TB-10B output measures 10 VDC.

Example: The drive is part of a control system that requires a 0-10 VDC signal to indicate 0-150% drive load. If this parameter were set to 150%, the drive would output 10 VDC at 150% load (and about 6.7 VDC at 100% load).

NOTE: The output signal at TB-10B is affected by the setting of Parameter 34 - LOAD MLT.

47 **TB13A** (TB-13A INPUT FUNCTION)

This parameter is used to select the function of terminal TB-13A. Closing TB-13A to TB-2 activates the TB-13A input function.

The following functions can be selected:

NONE	Disables the TB-13A function.
0-10VDC	Selects 0-10 VDC as the AUTO speed reference input. The 0-10 VDC signal is wired to TB-5A and TB-2.
4-20 MA	Selects 4-20 mA as the AUTO speed reference input. The 4-20 mA signal is wired to TB-5B and TB-2.
SPEED#1	Selects PRESET SPEED #1 as the AUTO speed reference.
LOC SEL	Selects LOCAL mode when Parameter 30 - CONTROL is set to BOTH. Drive is in REMOTE mode if contact closure is not made.
DEC FREQ	Decrease frequency set point. Used with the MOP (motor operated pot) function. Refer to Section 14.2.6 - SPEED REFERENCE SELECTION.

48 **TB13B** (TB-13B INPUT FUNCTION)



WARNING!

When operating in JOG mode, the STOP key WILL NOT stop the drive. To stop the drive, the contact between TB-13B and TB-2 must be opened.

This parameter is used to select the function of terminal TB-13B. Closing TB-13B to TB-2 activates the TB-13B function. The following functions can be selected:

NONE	Disables the TB-13B function.
0-10VDC	Selects 0-10 VDC as the AUTO speed reference input. The 0-10 VDC signal is wired to TB-5A and TB-2.
4-20 MA	Selects 4-20 mA as the AUTO speed reference input. The 4-20 mA signal is wired to TB-5B and TB-2.
SPEED#2	Selects PRESET SPEED #2 as the AUTO speed reference.
INC FREQ	Increase frequency set point. Used with the MOP (motor operated pot) function. Refer to Section 14.2.6 - SPEED REFERENCE SELECTION.
JOG FWD	Jog in the forward direction. Active only when drive is STOPPED. The jog speed is set by Parameter 2 -SPEED#2.
JOG REV	Jog in the reverse direction. Active only when drive is STOPPED. The jog speed is set by Parameter 2 - SPEED#2.

49 **TB13C** (TB-13C INPUT FUNCTION)



WARNING!

If TB-13C is programmed for RUN REVERSE, TB-1 is disabled and **CANNOT** be used as a STOP switch! This is true in LOCAL and REMOTE mode. Incorrect use of TB-1 may result in damage to equipment and/or injury to personnel!

This parameter is used to select the function of terminal TB-13C. Closing TB-13C to TB-2 activates the TB-13C input function. The following functions can be selected:

NONE	Disables the TB-13C function.
0-10VDC	Selects 0-10 VDC as the AUTO speed reference input. The 0-10 VDC signal is wired to TB-5A and TB-2.
4-20 MA	Selects 4-20 mA as the AUTO speed reference input. The 4-20 mA signal is wired to TB-5B and TB-2.
SPEED#3	Selects PRESET SPEED #3 as the AUTO speed reference.
LOC SEL	LOCAL SELECT - Selects LOCAL mode when Parameter 30 - CONTROL is set to BOTH. Drive is in REMOTE mode if contact closure is not made.
RUN REV	RUN REVERSE - Run in reverse direction. Requires a maintained contact closure - close to RUN in reverse direction, open to STOP. This will cause TB-12A to function as RUN FORWARD, also requiring a maintained contact to RUN in forward.
STRT REV	START REVERSE - Start in reverse direction. Requires a momentary contact closure to RUN in reverse direction. A momentary STOP contact must be wired between TB-1 and TB-2. Setting this parameter to START REVERSE causes TB-12A to function as START FORWARD, also requiring a momentary contact closure to RUN in forward.
50	TB13D (TB-13D FUNCTION)



WARNING!

STOP (TB-1) and EXTERNAL FAULT (TB-13D) circuitry may be disabled if parameters are reset to factory defaults! The drive must be reprogrammed after a RESET in order to insure proper operation (see Parameter 65 - PROGRAM).

FAILURE TO DO SO MAY RESULT IN DAMAGE TO EQUIPMENT AND/OR INJURY TO PERSONNEL!

This parameter selects the function for TB-13D.

EXT FAULT	Sets TB-13D as a normally open EXTERNAL FAULT contact. Close TB-13D to TB-2 to trip the drive into an EXTERNAL FAULT.
EXT / FAULT	Sets TB-13D as a normally closed EXTERNAL FAULT contact. Open TB-13D to TB-2 to trip the drive into an EXTERNAL FAULT.
EXT CLEAR	Sets TB-13D as a normally open FAULT RESET. Close TB-13D to TB-2 to clear a fault.

NOTE: When set to CLEAR, TB-13D becomes the only terminal that can be used to clear a fault (TB-1 will not work). However, the keypad STOP key can still be used to clear faults.

52 **TB14 OUT** (TB-14 OPEN COLLECTOR OUTPUT)

This parameter sets the open-collector output indication for terminal TB-14. The following conditions can be selected:

NONE	This setting disables the output.
RUN	The relay energizes when the drive is given a START command, and remains energized until: a STOP command is given and the output frequency has decelerated to 0.5 Hz, the drive has “tripped”, or the input voltage is removed. Note that this relay indicates only that the drive is in the RUN mode. It does not necessarily indicate that the motor is turning.
FAULT	The relay energizes when input voltage is applied to the drive and remains energized until the drive “trips” into a fault condition, or input voltage is removed.
/ FAULT	INVERSE FAULT - The relay energizes when the drive “trips” into a fault condition, and remains energized until the fault condition is cleared.
LOCK	FAULT LOCKOUT - This relay is used when the drive is programmed to automatically restart after a fault. The relay energizes when input voltage is applied to the drive and remains energized until the drive has faulted and unsuccessfully attempted five restarts, or input voltage is removed.
@ SPEED	AT SPEED - The relay energizes when the drive reaches the speed set point. To avoid a “chattering” relay (energizing and de-energizing), due to small fluctuations in speed, the relay will remain energized as long as the actual speed is within ± 0.50 Hz of the speed set point.
ABOVE #3	ABOVE SPEED #3 - The relay energizes when the output frequency exceeds the SPEED #3 value, and de-energizes when the output frequency returns to a value lower than the SPEED #3 value. Refer to Parameter 3 - SPEED #3 in Section 18 - DESCRIPTION OF PARAMETERS.
I LIMIT	CURRENT LIMIT - The relay energizes when the drive is operating in current limit. Once the current limit relay is energized, it remains energized for a minimum of 500ms, regardless of whether the drive is still in current limit. At the end of the 500ms interval, the relay will de-energize if the drive is no longer in current limit. Refer to Parameter 16 - CURRENT in Section 18 - DESCRIPTION OF PARAMETERS.
AUT/MAN	AUTO/MANUAL MODE - The relay energizes when the drive is in the AUTOMATIC mode, and de-energizes in the MANUAL mode. Refer to Section 14.2.5 - SPEED REFERENCE SELECTION.
FLWR PR	FOLLOWER PRESENT - The relay energizes when the analog input reference signal at TB-5B is greater than 2 mA, and de-energizes if the signal falls below 2 mA.
REVERSE	The relay energizes when Reverse direction is selected, and de-energizes when Forward direction is selected.

MIN/MAX ALARM	The relay energizes when the feedback signal (in PID mode) or the speed reference signal (in open-loop speed mode) is within the limits set by MIN ALARM and MAX ALARM (Parameters 81 and 82), and de-energizes when the signal falls below the MIN ALARM setting or exceeds the MAX ALARM setting.
INV MIN/MAX A	INVERSE MIN/MAX ALARM - The relay de-energizes when the feedback signal (in PID mode) or the speed reference signal (in open-loop speed mode) is within the limits set by MIN ALARM and MAX ALARM (Parameters 81 and 82), and energizes when the signal falls below the MIN ALARM setting or exceeds the MAX ALARM setting.
MIN ALARM	The relay de-energizes when the feedback signal (in PID mode) or the speed reference signal (in open-loop speed mode) equals or exceeds the MIN ALARM setting (Parameter 81), and energizes when the signal falls below the MIN ALARM setting.
INV MIN ALARM	INVERSE MIN ALARM - The relay energizes when the feedback signal (in PID mode) or the speed reference signal (in open-loop speed mode) equals or exceeds the MIN ALARM setting (Parameter 81), and de-energizes when the signal falls below the MIN ALARM setting.
MAX ALARM	The relay de-energizes when the feedback signal (in PID mode) or the speed reference signal (in open-loop speed mode) is less than or equal to the MAX ALARM setting (Parameter 82), and energizes when the signal exceeds the MAX ALARM setting.
INV MAX ALARM	INVERSE MAX ALARM - The relay energizes when the feedback signal (in PID mode) or the speed reference signal (in open-loop speed mode) is less than or equal to the MAX ALARM setting (Parameter 82), and de-energizes when the signal exceeds the MAX ALARM setting.
SLEEP	The relay energizes when the drive is in SLEEP MODE. Refer to Parameters 36 - 38.
SPD = 0HZ	The relay energizes when there is no output to the motor, for any reason, such as: drive is in STOP mode, drive is in RUN mode but the speed command is 0 Hz, drive is in SLEEP mode, drive has tripped into a fault, etc.

The open-collector output circuit is a current-sinking type rated at 30 VDC and 40 mA maximum. An external power supply (30 VDC max.) must be used to power the open-collector outputs. The drive does not have a dedicated power supply for the open-collector outputs.

53 **TB15 OUT** (TB-15 OPEN COLLECTOR OUTPUT)

This parameter sets the open-collector output indication for terminal TB-15. It has the same functionality as Parameter 52 - TB14 OUT above.

54 **RELAY** (RELAY FUNCTION)

The control board has one set of FORM C relay contacts at TB-16, 17, and 18 that can be programmed for the same indications as the open-collector outputs described in parameter 52.

The FORM C contacts at TB-16, 17, and 18 are rated 2 amps at 28 VDC or 120 Vac. Control wiring diagrams show relays in the rest state (coils NOT energized).

NOTE: Models rated above 30 Hp at 200/240 Vac and 60 Hp at 400/480 Vac have a second Form C relay at terminals TB-19, TB-20, and TB-21. This relay is controlled by Parameter 52 - TB14 OUT.

55 **TB5B LOSS** (LOSS OF FOLLOWER ACTION)

This parameter selects the action taken by the drive if the follower signal is lost at TB-5B. This function is only active if the follower signal is 4-20 mA. The signal is considered lost if it falls below 2 mA.

- | | |
|-------|--|
| FAULT | The drive will trip into a FOLLOWER fault condition. |
| SP #4 | The drive will go to SPEED #4 (Parameter 4). |
| NONE | The drive will go to the programmed minimum speed. |

57 **SERIAL** (SERIAL COMMUNICATIONS)

This parameter is used to activate serial communications. When using this feature, the drive can communicate with a personal computer (PC), programmable logic controller (PLC), or other external device that utilizes RS-485 serial communications for control. The serial interface may be used to read present parameter settings (uploading to the control device), write new parameter settings (downloading from the control device), monitor present drive activity, and control drive activity. The following settings are available:

- | | |
|------------|--|
| DISABLE | Serial communication function is disabled. |
| W / TIMER | Enables serial communications with a watchdog timer. If there is no serial activity (read or write) for more than 10 seconds, serial control will turn off and the drive will stop. |
| W / O TIMR | Enables serial communications without a watchdog timer. However, after 10 seconds of no serial activity, serial control can be turned off by issuing a STOP command from any source (keypad, terminal strip) other than the serial link. |

NOTE 1: The keypad STOP button is always active, regardless of what method (LOCAL, REMOTE, or SERIAL) is being used to control the drive. The remote STOP input (TB-1) may also be active, depending on how the drive is programmed.

NOTE 2: If a RESET command (Parameter 65 - PROGRAM) is issued through the serial link, this parameter will not default back to DISABLE. However, explicitly setting this parameter to DISABLE through the serial link will cut off communication with the drive.

If developing an application for serial communications, refer to the RS-232/RS-485 Modbus® Communications Protocol Specification.

58 **ADDRESS** (SERIAL ADDRESS)

This parameter is used with the serial communications feature, and is intended for use in a multiple drive network (RS-485). The serial link will support drives with addresses from 1 up to 247.

61 **PASSWORD** (PASSWORD NUMBER)

This feature limits access to the programmable parameters for added security. The correct password must be entered in order to change the parameters.

Pressing the PROG/RUN button on the keypad will activate the PASSWORD prompt. If the correct password is entered, the PROGRAM MODE is entered and parameters can be changed.

If the wrong password is entered, the drive will flash ERROR: INCORRECT and then return to the PASSWORD prompt to allow another attempt at entering the correct password.

If the ENTER key is pressed while PASSWORD reads 0000, the MONITOR MODE will be entered (if Parameter 64 - MONITOR, is set to ON), which will allow the parameters to be viewed (except for PASSWORD), but not changed.

NOTE 1: The factory default value is 0019.

NOTE 2: If PASSWORD is set to 0000, the function is disabled. Pressing the PROG/RUN key will result in direct entry into the PROGRAM mode without having to enter a password.

63 **SOFTWARE** (SOFTWARE VERSION)

This parameter displays the software code and revision number of the control board software. This information is useful when contacting the factory for programming or troubleshooting assistance. This is a "view-only" parameter, and cannot be changed.

64 **MONITOR** (MONITOR MODE)

This parameter is used to enable (ON) or disable (OFF) the MONITOR MODE function. The functionality is explained below:

- | | |
|-----|--|
| ON | Pressing the PROG/RUN key will call up the PASSWORD prompt. If the ENTER key is pressed while the password value reads 0000, the MONITOR MODE is entered and parameters can be viewed (except for PASSWORD), but not changed. |
| OFF | Pressing the PROG/RUN key will call up the PASSWORD prompt. If the ENTER key is pressed while the password value reads 0000 (or any other incorrect value), it will be treated as an incorrect password and the display will flash ERROR: INCORRECT, and then return to the PASSWORD prompt to allow another attempt at entering the correct password. |

65 **PROGRAM** (PROGRAM FACTORY DEFAULTS)



WARNING!

STOP (TB-1) and EXTERNAL FAULT (TB-13D) circuitry may be disabled if parameters are reset to factory defaults! The drive must be reprogrammed after a RESET in order to insure proper operation.

FAILURE TO DO SO MAY RESULT IN DAMAGE TO EQUIPMENT AND/OR INJURY TO PERSONNEL!

This parameter is used to reset the programmable parameters back to the factory default settings. This parameter has four possible settings:

MAINTAIN	Maintain parameter settings as they are.
RESET 60	Resets parameters to factory defaults for 60 Hz base frequency.
RESET 50	Resets parameters to factory defaults for 50 Hz base frequency.
RST HIGH	Consult factory. This option will only appear if the drive has the High Frequency Output option enabled.

When a factory reset is performed, the following terminals are affected:

TB-1 will be disabled as a STOP input because Parameter 30 - CONTROL will default to LOCAL.

TB-13A, 13B, and 13C will be disabled because Parameters 47, 48, and 49 will default to NONE. If TB-13C was set to RUN REVERSE, TB-12A will default to a momentary START contact.

TB-13D will default to a normally open EXTERNAL FAULT contact because Parameter 50 - TB13D will be reset to EXT FAULT.

NOTE: This parameter will display RESET 60, RESET 50 or RST HIGH until a change is made to one or more of the parameter settings. Once a parameter is changed, the display will change to MAINTAIN.

66 **HISTORY** (CLEAR FAULT HISTORY)

This parameter is used to clear the previous faults in the FAULT HISTORY. When set to CLEAR and the ENTER key is pushed, the display will change to MAINTAIN, and the FAULT HISTORY will display NO FAULT for each of the eight fault histories.

70 **PID MODE** (PID MODE SELECT)

This parameter activates the PID function, and selects whether the PID control will be direct or reverse acting. Refer to Section 19 - MC1000 PID SET POINT CONTROL. The following options are available:

OFF	Disables the PID function to allow "standard" drive operation.
NORMAL	Enables the PID function for direct acting systems. An increase in the feedback variable will cause a decrease in motor speed.
REVERSE	Enables the PID function for reverse acting systems. An increase in the feedback variable will cause an increase in motor speed.

NOTE: The REVERSE selection is not used to compensate for reverse acting feedback devices. If a reverse acting feedback device is used, program Parameters 75 and 76 - FB @ MIN and FB @ MAX as described in Section 19.1 - FEEDBACK DEVICES.

When PID is enabled, and the drive is in REMOTE and AUTO mode, the drive will operate in a CLOSED LOOP fashion, responding to the feedback signal in order to maintain the process set point. In this case, the set point reference can be a 0-10 VDC or 4-20 mA signal, or the keypad. The SPEED REFERENCE SOURCE indication in the CONTROL display will indicate VDC (0-10 VDC), IDC (4-20 mA), or AKB (keypad), depending on the set point reference.

When PID is enabled, and the drive is in LOCAL and AUTO mode, the drive will also operate in a CLOSED LOOP fashion. However, in this case, the only set point reference available is the keypad, and the SPEED REFERENCE SOURCE indication in the CONTROL display will indicate AKB.

When PID is enabled, and the drive is in MANUAL and LOCAL or REMOTE mode, the drive will operate in an OPEN LOOP fashion, responding directly to speed commands from the keypad only. The SPEED REFERENCE SOURCE indication in the CONTROL display will indicate MKB.

When PID is disabled, the drive will operate in an OPEN LOOP mode, responding directly to speed commands from either the keypad (MANUAL mode) or an analog input signal or preset speed (AUTO mode).

74 **PID FB** (PID FEEDBACK SOURCE)

This parameter selects the terminal to be used for the feedback signal, and can be set to TB-5A or TB-5B. TB-5A is used for 0-10 VDC signals, and TB-5B is used for 4-20 mA signals.

NOTE: The MC1000 has only one analog input of each type, so the same type of signal cannot be used for feedback and set point reference. For example, a 4-20 mA signal from a transducer could not be used as a feedback signal if the set point is being controlled by a 4-20 mA signal from a PLC.

75 **FB @ MIN** (MINIMUM FEEDBACK VALUE)

This parameter should be set to the value of the process variable that corresponds to the minimum transducer feedback signal (0 VDC or 4 mA).

76 **FB @ MAX** (MAXIMUM FEEDBACK VALUE)

This parameter should be set to the value of the process variable that corresponds to the maximum transducer feedback signal (10 VDC or 20 mA).

NOTE: If a reverse acting feedback device is being used, FB @ MIN should be set to the maximum process variable value, and FB @ MAX should be set to the minimum process variable value.

77 **P GAIN** (PROPORTIONAL GAIN)

This parameter setting represents the speed command output (in % of maximum speed) that results from each 1% of error (1% of the feedback range; FB @ MAX minus FB @ MIN).

Example: If P GAIN is programmed for 5%, and the error (difference between set point and feedback) is 10%, the speed command output of the Proportional term is 50% ($10 \times 5 = 50$) of maximum speed.

78 **I GAIN** (INTEGRAL GAIN)

This parameter setting represents the ramp rate of the speed command output (in % of maximum speed per second) that results from each 1% of error.

Example: If I GAIN is programmed for 0.5 seconds, and the error is 5%, the rate of rise of the speed command output of the Integral term is 2.5% ($0.5 \times 5 = 2.5$) of maximum speed per second.

79 **D GAIN** (DIFFERENTIAL GAIN)

This parameter setting represents the speed command output (in % of maximum speed) that results from each 1% per second change in the error.

Example: If D GAIN is programmed for 5 seconds, and the error is increasing at 2% per second, the speed command output of the Differential term is 10% ($5 \times 2 = 10$) of maximum speed.

NOTE: Differential gain is used as a “shock-absorber” to dampen overshoots in fast-acting systems. However, it can be very sensitive to “noise” on the feedback signal and to digitizing errors, so it must be used with caution.

80 PID ACC (PID ACCEL/DECEL)

This parameter sets the acceleration and deceleration rate of the set point reference into the PID unit. When the set point changes, this function will “filter” the input to the PID unit by ramping the set point reference from the previous value to the new value. This will help prevent overshoots that can occur when the PID control attempts to respond to step changes in set point, resulting in smoother operation. If PID ACC is set to 0.0 seconds, it is effectively disabled.

81 MIN ALARM (PID MINIMUM ALARM)

This parameter setting represents the value that the feedback signal (in PID mode) or speed reference signal (in open-loop speed mode) must fall below to activate the MIN ALARM output (see Parameters 52, 53, and 54).

82 MAX ALARM (PID MAXIMUM ALARM)

This parameter setting represents the value that the feedback signal (in PID mode) or speed reference signal (in open-loop speed mode) must exceed to activate the MAX ALARM output (see Parameters 52, 53, and 54).

NOTE 1: The MIN/MAX ALARM function can be used to start and stop the drive based on the level of the speed reference signal or PID feedback signal. This is done by wiring a 2-wire start/stop circuit through the drive's Form C relay or open-collector output, and setting the Form C relay or open-collector output for MIN/MAX (see Parameters 52, 53, and 54). When the signal drops below the MIN ALARM setting, the relay or open-collector output will de-energize, which opens the start contact and stops the drive. When the signal is equal to or greater than the MIN ALARM setting, the relay or open-collector output will energize, which closes the start contact and starts the drive. The drive must be in REMOTE mode to use the MIN/MAX function to start and stop the drive.

NOTE 2: When using the MIN and MAX ALARM functions in open-loop speed mode (PID is disabled), parameter 74 - PID FB must still be set to match the speed reference signal being used.

98 LANGUAGE (LANGUAGE SELECTION)

The MC Series drive can support other languages with the addition of an optional LANGUAGE EEPROM chip installed in socket U11 on the control board of the drive. If the EEPROM is not present, the default language will be ENGLISH. Also, this parameter is not affected when the parameters are reset using Parameter 65 - PROGRAM. Therefore, if a language other than ENGLISH is selected, it will remain in effect after a RESET.

99 FAULT HISTORY

The FAULT HISTORY stores the previous eight fault conditions that caused the drive to trip. The information stored here is view-only, it cannot be altered. The FAULT HISTORY can be used to determine if there is a pattern, or trend, to the faults, which may indicate a problem in the system. Refer to Section 20 - TROUBLESHOOTING for more information on faults.

The FAULT HISTORY indicates the number of the fault (number 1 is the most recent fault), the fault message, and the status of the drive at the time of the fault. An example is shown below:

FAULT NUMBER	FAULT MESSAGE	DRIVE STATUS
3	OVERLOAD	RUN

In the example above, the third fault log is being viewed, which is an OVERLOAD fault that occurred while the drive was in a RUN state

19 MC1000 PID SET POINT CONTROL

PID Set point Control allows the MC1000 to maintain a process set point, such as PSI or CFM, without using an external controller. When PID is activated, the MC1000 will operate in a closed-loop fashion, automatically adjusting the motor speed to maintain the set point.

PID set point control requires feedback from the process in order to compare the process variable “value” to the set point. The difference between the process variable “value” and the set point is called the error. The MC1000 will increase or decrease the motor speed in an attempt to minimize the error. By constantly adjusting the motor speed, the PID control will drive the process toward the set point. Refer to the PID block diagram below:

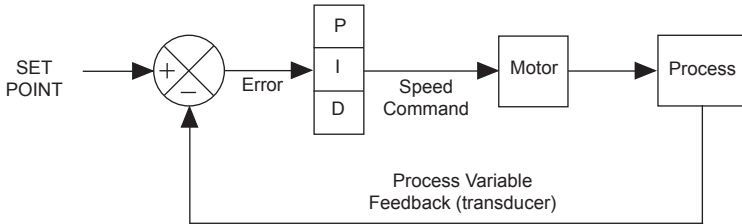

19.1 FEEDBACK DEVICES

A transducer or transmitter is required to monitor the process variable and provide feedback to the PID unit in order to compare the process variable feedback to the set point. A transducer outputs a signal corresponding to a fixed range of the process variable. A transmitter provides offset and gain adjustments to allow the output signal to be adjusted to correspond to different ranges of the process variable. Typical output signals for transducers and transmitters are: 0-5 VDC, 0-10 VDC, or 4-20 mA. The feedback device must be externally powered, as the drive does not have a power supply for such devices. Program Parameter 74 - PID FB (PID FEEDBACK SOURCE) for the appropriate terminal (TB-5A or TB-5B), and connect the feedback device as described below:

POT The positive signal wire (wiper) is connected to TB-5A, and the “high” lead is connected to TB-6.

0-5, 0-10 VDC Connect the positive signal wire to TB-5A.

4-20 mA Connect the positive signal wire to TB-5B.

The common, or negative signal wire, is connected to TB-2 (circuit common).

Feedback devices can be direct or reverse acting. A direct acting device outputs a signal that increases as the process variable increases. A reverse acting device outputs a signal that decreases as the process variable increases. The programming of Parameters 75 - FB @ MIN and 76 - FB @ MAX depend on the type of feedback device being used.

When using a direct acting transducer, Parameter 75 - FB @ MIN should be set to the value of the process variable feedback corresponding to the minimum feedback signal (0 VDC or 4 mA), and Parameter 76 - FB @ MAX should be set to the value of the process variable feedback corresponding to the maximum feedback signal (5 or 10 VDC, or 20 mA).

Example 1: A 0-100 psi transducer outputs a 4 mA signal at 0 psi and 20 mA at 100 psi. Program Parameter 75 to 0.0 PSI, and Parameter 76 to 100.0 PSI (This assumes that Parameter 31 - UNITS is set to pid PSI, and Parameter 33 - UNITS DP is set to XXX.X).

For a reverse acting transducer, set Parameter 75 - FB @ MIN to the maximum process variable feedback value, and set Parameter 76 - FB @ MAX to the minimum process variable feedback value. In other words, Parameter 75 is set higher than Parameter 76. See the example below:

Example 2: A 0-100 psi transducer outputs a 20 mA signal at 0 psi and 4 mA at 100 psi. Program Parameter 75 to 100.0 PSI, and Parameter 76 to 0.0 PSI (This assumes that Parameter 31 - UNITS is set to pid PSI, and Parameter 33 - UNITS DP is set to XXX.X).

19.2 THE SYSTEM - DIRECT AND REVERSE ACTING

The entire system can also be direct or reverse acting. In a direct acting system, an increase in motor speed causes an increase in the process variable. This is equivalent to requiring an increase in motor speed in response to a decreasing process variable feedback.

In a reverse acting system, an increase in motor speed causes a decrease in the process variable. This is equivalent to requiring an increase in motor speed in response to an increasing process variable feedback. Examples of direct and reverse acting systems are described in the next section.

19.3 PID CONTROL - DIRECT AND REVERSE ACTING

The PID Set point Control software can be direct or reverse acting, and must be set to match the system. This is accomplished with Parameter 70 - PID MODE. When set to NORMAL (for direct acting systems), the PID unit will command an increase in motor speed if the process variable feedback decreases, and a decrease in motor speed if the process variable feedback increases. When set to REVERSE (for reverse acting systems), the opposite is true.

NOTE: The REVERSE setting for Parameter 70 - PID MODE is not used to compensate for reverse acting feedback devices. If a reverse acting feedback device is used, program Parameters 75 and 76 as described above.

An example of a direct acting system is one that maintains duct pressure. Duct pressure is the process variable that is monitored by the feedback device. As duct pressure rises, motor speed needs to be decreased to maintain the pressure. A direct acting PID control will command a decrease in motor speed in response to an increasing process variable feedback.

An example of a reverse acting system is one that maintains water temperature in a cooling tower. Water temperature is the process variable that is monitored by the feedback device. As the water temperature rises, motor speed needs to be increased to lower the temperature of the water. A reverse acting PID control will command an increase in motor speed in response to an increasing process variable feedback.

19.4 SET POINT REFERENCE SOURCES

The set point reference input can be one of the following:

1. Keypad
2. 4-20 mA signal at TB-5B
3. 0-10 VDC signal at TB-5A
4. Potentiometer signal at TB-5A

In order to use TB-5A or TB-5B for a set point input, one of the terminals must be programmed for the appropriate signal. Closing the TB-13 terminal to TB-2 will then select that signal as the set point reference. If the contact closure is not made to TB-2, the set point reference source will default to the keypad. See Parameters 47 - TB13A, 48 - TB13B, and 49 - TB13C.

Remote set point reference inputs at TB-5A and TB-5B can only be used if that terminal is NOT being used for the process feedback signal from a transducer. The MC1000 has only one analog input of each type, so the same type of signal cannot be used for transducer feedback and set point reference. For example, a 4-20 mA signal from a transducer could not be used as a feedback signal if the set point is being controlled by a 4-20 mA signal from a PLC.

19.5 TUNING THE PID CONTROL

Once the PID control is set up correctly, it needs to be tuned in order to maintain the process set point. First, set the Integral and Differential Gains to zero, and increase the Proportional Gain (Parameter 77) until the system becomes unstable, then lower the gain until the system stabilizes again. Set the Proportional Gain about 15% less than that value that stabilizes the system. If only Proportional Gain is used, and the system is operating in a steady-state condition (set point is fixed and process variable has settled to a fixed value), there will always be a certain amount of error in the system. This is called the steady-state error.

Integral Gain (Parameter 78) is used to force the steady-state error to zero by increasing the output speed command with respect to time. Over time, the error will be forced to zero because the Integral term will continue to change the speed command, even after the Proportional term reaches steady state and no longer affects the speed command. The Integral Gain affects the rate of rise of the output speed command from the Integral term. Small amounts of Integral Gain can cause large changes in PID performance, so care must be taken when adjusting Integral Gain. Too much Integral Gain will result in overshoots, especially if large step changes in error occur.

Typically, Proportional and Integral Gain are all that is needed to fine-tune the system. However, it may be necessary to use Differential Gain (Parameter 79) to further stabilize the system, especially when quick responses are required. The Differential term responds to the rate of change of the error, not the actual error itself. Differential Gain acts like a "shock-absorber" to dampen overshoots that can occur when the PID tries to react quickly to changes in error or set point. This allows fast PID response, with reduced risk of becoming unstable due to overshoots. The Differential term is very sensitive to electrical noise on the feedback signal and to digitizing errors, so it must be used with caution.

The other parameter setting that affects the response of the PID control is Parameter 80 - PID ACC. This sets the acceleration (and deceleration) rate of the set point reference into the PID unit. When the set point changes, this function will "filter" the input to the PID unit by ramping the set point reference from the previous value to the new value. This will help prevent overshoots that can occur when the PID control attempts to respond to step changes in set point, resulting in smoother operation. If PID ACC is set to 0.0 seconds, it is effectively disabled.

19.6 MC1000 DISPLAY IN PID MODE

When the drive is in PID mode, the DRIVE STATUS portion of the display will indicate actual output frequency (in Hertz) instead of RUN, and the right side of the display will indicate PID SET POINT, % LOAD, or PID FEEDBACK. The ENTER key is used to toggle between the different displays. Examples of the possible displays are shown below:

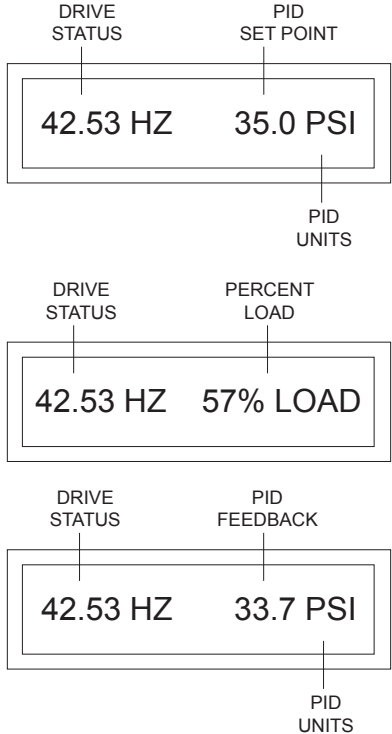

In the examples above, the drive is running at 42.53 Hz to maintain the PID SET POINT of 35.0 psi. Pressing the ENTER key displays % LOAD, which is 57%. Pressing ENTER again displays the PID FEEDBACK from the process, which is 33.7 psi.

When the PID SET POINT and PID FEEDBACK displays are entered, the display will flash SET POINT or FEEDBACK before displaying the value to indicate which display is being viewed.

20 TROUBLESHOOTING

The table below lists the fault conditions that will cause the drive to shut down, as well as some possible causes. Please contact the factory for more information on troubleshooting faults.



NOTE

The drive will not automatically restart after a PWR SAG or a CONTROL fault. Also, if an OUTPUT fault occurs below 1.5 Hz, the drive will only attempt one restart, after a four minute delay. If unsuccessful, it will then trip into FAULT LOCKOUT, which will require a manual reset. This is done to protect the drive in case of a shorted motor.



NOTE

In the event of an OVERLOAD fault there is a 3-minute delay before resetting is possible. This is a requirement of UL508C. This delay is intended to allow time for the motor to cool. If power is removed when in an OVERLOAD fault state, when the power is restored the OVERLOAD fault will still be present and the delay will still be active even if power was removed for longer than 3 minutes.

FAULT MESSAGES		
FAULT	DESCRIPTION	POSSIBLE CAUSES
OUTPUT	Output transistor fault: Output current exceeded 200% of drive rating.	Phase to ground short. Phase to phase short. FX or AC BOOST set too high. Bad transistor module (IPM).
LO VOLTS	Low DC Bus Voltage fault: DC bus voltage below 60% of normal.	Low line voltage.
HI VOLTS	High DC Bus Voltage fault: DC bus voltage above 120% of normal.	High line voltage. Overhauling load. DECEL rate is set too fast.
HI TEMP	Temperature fault: Internal drive temperature too high.	Ambient temperature too high. Fan failure (if equipped).
OVERLOAD	Current Overload fault: Output current rating exceeded for too long.	Drive undersized for the application. Problem with motor and/or driven equipment.
PWR TRAN	Power Transient fault: Low line voltage.	AC line dipped or sagged.

FAULT MESSAGES		
FAULT	DESCRIPTION	POSSIBLE CAUSES
PWR SAG	Power Sag fault: Control board voltage is below tolerance. A new control board has been installed that is different from the previous version.	Erratic AC line. Perform a factory reset using Parameter 65-PROGRAM. This will update the software and allow the fault to be reset
LANGUAGE	Language fault: Selected language not present	Defective language EEPROM. Language EEPROM (U11) removed after programming.
EXTERNAL	External fault: TB-13D is open or closed to TB-2, depending on the setting of Parameter 50 - TB13D.	Check setting of Parameter 50-TB 13D Check devices wired between TB13D and TB-2.
DB ERROR	Dynamic Brake fault: DB circuit has sensed a resistor overload.	The DB duty cycle is too high, causing the resistors to overheat.
CONTROL	Control Board fault: New software has been installed that is different from the previous version.	Perform a factory reset using Parameter 65-PROGRAM. This will update the software and allow the fault to be reset.
INTERNAL INTERN (#)	Internal fault: The micro-processor has sensed a problem.	Electrical noise on control wiring. Defective microprocessor.
FOLLOWER	Loss of Follower fault: 4-20 mA signal at TB-5B is below 2 mA.	Parameter 55 - TB5B LOSS is set to FAULT.
Blank display or repeatedly flashes TESTING (drive will not run)	The power supply has shut down. This can be the result of clogged or failed heatsink fans.	Check heatsink fans (if equipped). Clear any obstructions. If they are not clogged, contact the Lenze AC Tech Service Department.

21 USER SETTING RECORD

PARAMETER MENU: USER SETTING RECORD			
PARAM. NUMBER	PARAMETER NAME	FACTORY DEFAULT	USER SETTING
0	LINE VOLTS	AUTO	
1	SPEED #1	20.00 Hz	
2	SPEED #2	20.00 Hz	
3	SPEED #3	20.00 Hz	
4	SPEED #4	20.00 Hz	
5	SKIP #1	0.00 Hz	
6	SKIP #2	0.00 Hz	
7	BAND WID	1.00 Hz	
8	ACCEL	30.0 SEC	
9	DECEL	30.0 SEC	
10	MIN FRQ	.50 Hz	
11	MAX FRQ	60.00 Hz	
12	DC BRAKE	0.0 VDC	
13	DC TIME	0.0 SEC	
14	DYN BRAKE	OFF	
16	CURRENT	180 %	
17	MOTOR OL	100%	
18	BASE	60.00 Hz	
19	FX BOOST	(NOTE 1)	
20	AC BOOST	0.00%	
21	SLIP CMP	0%	
22	TORQUE	CONSTANT	
23	CARRIER	2.5 kHz	
25	START	NORMAL	
26	STOP	COAST	
27	ROTATION	FORWARD	
28	AUTO/MAN	BOTH	
29	MANUAL	KEYPAD	
30	CONTROL	LOCAL	
31	UNITS	sp: HERTZ	
32	HZ MULT	1.00	
33	SPEED DP	XXXXX	
34	LOAD MLT	100%	
35	CONTRAST	MED	
36	SLEEP TH	0.00 Hz	

NOTE 1: Refer to Section 18 - Description of Parameters.

PARAMETER MENU: USER SETTING RECORD			
PARAM. NUMBER	PARAMETER NAME	FACTORY DEFAULT	USER SETTING
37	SLEEP DL	30.0 SEC	
38	SLEEP BW	0%	
39	TB5 MIN	0.00 Hz	
40	TB5 MAX	60.00 Hz	
41	AIN FLTR	0.02 SEC	
42	TB10A OUT	NONE	
43	@TB10A	60.00 Hz	
44	TB10B OUT	NONE	
45	@TB10B	125%	
47	TB13A	NONE	
48	TB13B	NONE	
49	TB13C	NONE	
50	TB13D	EXT FAULT	
52	TB14 OUT	NONE	
53	TB15 OUT	NONE	
54	RELAY	NONE	
55	TB5B LOSS	FAULT	
57	SERIAL	DISABLE	
58	ADDRESS	30	
61	PASSWORD	0019	
63	SOFTWARE	(N/A)	
64	MONITOR	ON	
65	PROGRAM	RESET 60	
66	HISTORY	MAINTAIN	
70	PID MODE	OFF	
74	PID FB	TB-5A	
75	FB @ MIN	0.00 %	
76	FB @ MAX	100.00 %	
77	P GAIN	5.00 %	
78	I GAIN	0.0 SEC	
79	D GAIN	0.0 SEC	
80	PID ACC	30.0 SEC	
81	MIN ALRM	0.0 %	
82	MAX ALRM	0.0 %	
98	LANGUAGE	ENGLISH	
99	FAULT HISTORY	(N/A)	

APPENDIX

A SINGLE PHASE DATA SELECTED MODELS

Wiring & Derating of Selected Models Using Single Phase Input Power

A-1 WIRING

Alternative wiring for single phase input on selected models.

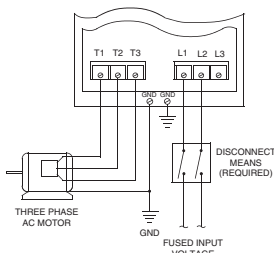

Refer to Table A1 for single phase derating of select models
 Refer to section 8.2 for sizing fuses and disconnecting means.
 Refer to sections 10 and 11 for wire sizing and type.

A-2 DERATING

Table A1: Select MC1000 Series Models
 Alternate Ratings using single-phase input power

Model	Input			Output		
	phase	voltage (V)	current (A)	phase	voltage (V)	current (A)
M12150	1	200/240	54.7/47.6	3	0 - 230	21
M12200	1	200/240	70.1/61.0	3	0 - 230	27
M12250	1	200/240	88/77	3	0 - 230	34
M12300	1	200/240	103/90	3	0 - 230	40





Model	Input			Output		
	phase	voltage (V)	current (A)	phase	voltage (V)	current (A)
M1410	1	400/480	2.7/2.4	3	0 - 460	1
M1420	1	400/480	4.7/4.1	3	0 - 460	1.7
M1430	1	400/480	6.5/5.7	3	0 - 460	2.4
M1450	1	400/480	10.2/8.9	3	0 - 460	3.8
M1475	1	400/480	14.7/12.8	3	0 - 460	5.5
M14100	1	400/480	18.3/15.9	3	0 - 460	7
M14150	1	400/480	27.4/23.8	3	0 - 460	10.5
M14200	1	400/480	35.1/30.5	3	0 - 460	13.5
M14250	1	400/480	44.2/38.4	3	0 - 460	17
M14300	1	400/480	52.0/45.0	3	0 - 460	20
M14400	1	400/480	68/59	3	0 - 460	26
M14500	1	400/480	85/74	3	0 - 460	32.5
M14600	1	400/480	100/87	3	0 - 460	38.5

Model	Input			Output		
	phase	voltage (V)	current (A)	phase	voltage (V)	current (A)
M1510	1	480/590	1.9	3	0 - 460	0.8
M1520	1	480/590	3.3	3	0 - 575	1.3
M1530	1	480/590	4.6	3	0 - 575	1.9
M1550	1	480/590	7.1	3	0 - 575	3
M1551	1	480/590	7.1	3	0 - 575	3
M1575	1	480/590	10.5	3	0 - 575	4.5
M15100	1	480/590	12.5	3	0 - 575	5.5
M15150	1	480/590	19.3	3	0 - 575	8.5
M15200	1	480/590	24.9	3	0 - 575	11
M15250	1	480/590	30.9	3	0 - 575	13.5
M15300	1	480/590	36.2	3	0 - 575	16
M15301	1	480/590	36.2	3	0 - 575	16
M15400	1	480/590	46.5	3	0 - 575	20.5
M15500	1	480/590	58.9	3	0 - 575	26
M15600	1	480/590	71	3	0 - 575	31



Lenze 13466148 EDBM101 v25



Lenze Americas Corporation
630 Douglas Street
Uxbridge, MA 01569
USA

 800-217-9100
 508-278-7873
 marketing@lenzeamericas.com
 www.Lenze.com

Service
Lenze AC Tech Corporation
630 Douglas Street
Uxbridge, MA 01569
USA

 508-278-9100
 508-278-6620
 repair@lenzeamericas.com