

# i550 cabinet frequency inverter





## Contents

<b>1</b>	<b>About this document</b>	<b>17</b>
1.1	Document description	18
1.2	Further documents	19
1.3	Notations and conventions	20
<b>2</b>	<b>Safety instructions</b>	<b>21</b>
2.1	Basic safety instructions	21
2.2	Application as directed	22
2.3	Handling	23
2.4	Residual hazards	24
<b>3</b>	<b>Product information</b>	<b>25</b>
3.1	Identification of the products	25
3.2	License information	26
<b>4</b>	<b>Commissioning</b>	<b>27</b>
4.1	Important notes	28
4.2	Initial switch-on and functional test	29
4.3	Operating interfaces	31
4.3.1	Keypad	31
4.3.2	Engineering tool »EASY Starter«	32
4.3.2.1	Generate a connection between inverter and »EASY Starter«	33
4.3.3	SMART Keypad App	36
4.4	General information on parameter setting	37
4.4.1	Addressing of the parameters	37
4.4.2	Structure of the parameter descriptions	38
4.4.3	Parameter overview lists	38
4.4.4	Favorites	39
4.4.4.1	Accessing the "Favorites" with the keypad	39
4.4.4.2	Favorites parameter list (default setting)	40
4.4.4.3	Configuring the "Favorites"	41
4.5	Saving the parameter settings	45
4.5.1	Save parameter settings with keypad	45
4.5.2	Save parameter settings with »EASY Starter«	45
4.5.3	Saving the settings	45
<b>5</b>	<b>Basic setting</b>	<b>46</b>
5.1	Device name	46
5.2	Mains voltage	47
5.3	Dual rating	49
5.4	Frequency limits	50
5.5	Start behavior	51
5.6	Stop behavior	54
5.7	Function assignment of the inputs and outputs (default setting)	56
5.8	Motor data	57
5.8.1	Select motor from motor catalog	58
5.8.2	Manual setting of the motor data	59
5.8.3	Motor mounting direction	60
5.9	Motor control mode	61

# Contents

<b>6</b>	<b>Start, stop and rotating direction commands</b>	<b>62</b>
6.1	Control selection	62
6.1.1	Flexible I/O configuration	64
6.1.2	Keypad control	65
6.1.3	Keypad full control	66
6.2	Flexible I/O configuration of the start, stop and rotating direction commands	67
6.2.1	Trigger list	73
6.2.2	Example: Start/stop (1 signal) and reversal	76
6.2.3	Example: Start forward/start reverse/stop (edge-controlled)	77
6.2.4	Example: Run forward/Run reverse/stop (status-controlled)	79
6.2.5	Example: Quick stop	81
6.2.6	Example: Enable inverter	82
6.2.7	Example: Jog forward/Jog reverse	83
6.3	Control/restrict direction of rotation of the motor	85
6.4	Changing the control source during operation	86
6.4.1	Example: Change-over from terminal control to keypad control	89
6.4.2	Example: Change-over from terminal control to network control	91
<b>7</b>	<b>Configuring the frequency control</b>	<b>92</b>
7.1	Basic setting	92
7.1.1	Standard setpoint source	93
7.1.2	Ramp times	95
7.2	Configure setpoint sources	97
7.2.1	Keypad	97
7.2.2	Setpoint presets	98
7.2.3	Motor potentiometer (MOP)	100
7.2.4	Sequencer	102
7.2.4.1	Segment configuration	104
7.2.4.2	Sequence configuration	115
7.2.4.3	Sequencer basic settings	119
7.2.4.4	Sequencer control functions	122
7.2.4.5	Sequencer diagnostics	126
7.3	Configuring the process controller	128
7.3.1	Basic setting	129
7.3.2	Process controller sleep mode	136
7.3.3	Process controller rinse function	138
7.3.4	Process controller function selection	138
7.3.5	Process controller diagnostics	140
7.4	Changing the setpoint source during operation	142
7.4.1	Example: Change-over from keypad setpoint to AI1/AI2 setpoint	146
7.4.2	Example: Change-over from AI1 setpoint to keypad setpoint	148
7.4.3	Example: Change-over from keypad setpoint to preset 1 ... 7	150
7.4.4	Example: Change-over from AI1 setpoint to MOP setpoint	153
7.5	Change over to ramp 2 during operation	155
7.6	"Switch-off positioning" stop mode	158
7.7	Setpoint diagnostics	160

<b>8</b>	<b>Configuring the torque control</b>	<b>161</b>
8.1	Basic setting	162
8.1.1	Standard setpoint source	163
8.1.2	Torque limits	165
8.1.3	Speed limitation	167
8.1.4	Ramp time	169
8.2	Configure setpoint sources	170
8.2.1	Keypad	170
8.2.2	Setpoint presets	171
8.2.3	Motor potentiometer (MOP)	171
8.3	Process input data (CiA 402 objects)	172
8.4	Process output data (CiA 402 objects)	173
8.5	Setpoint diagnostics	174
<b>9</b>	<b>Configuring the feedback system</b>	<b>175</b>
9.1	HTL encoder	176
9.2	Encoder monitoring	179
9.3	Synchronous motor: Pole position identification (PPI)	183
9.3.1	Monitoring the pole position identification	183
9.3.2	Pole position identification (PPI) without movement	184

# Contents

<b>10</b>	<b>Configuring the motor control</b>	<b>185</b>
10.1	Servo control for asynchronous motor (SC-ASM)	187
10.1.1	Required commissioning steps	187
10.2	Sensorless control for synchronous motor (SL-PSM)	188
10.2.1	Required commissioning steps	189
10.2.2	Stalling protection	189
10.2.3	Expert settings	190
10.3	Sensorless vector control (SLVC)	191
10.3.1	Required commissioning steps	191
10.3.2	Expert settings	192
10.4	V/f characteristic control for asynchronous motor (VFC open loop)	193
10.4.1	Required commissioning steps	193
10.4.2	Basic setting	194
10.4.3	Define V/f characteristic shape	195
10.4.3.1	Linear V/f characteristic	196
10.4.3.2	Square-law V/f characteristic	197
10.4.3.3	Multipoint V/f characteristic	198
10.4.3.4	Energy-saving V/f characteristic (VFC-Eco)	199
10.4.3.5	User-definable V/f characteristic	200
10.4.4	Set voltage boost	202
10.4.5	Set slip compensation	203
10.4.6	Set oscillation damping	205
10.4.7	Optimising the stalling behaviour	206
10.4.8	Torque limitation setting	208
10.4.9	Flying restart circuit	209
10.4.10	Additive voltage impression	211
10.5	V/f characteristic control for asynchronous motor (VFC closed loop)	213
10.5.1	Required commissioning steps	214
10.6	Sensorless control for synchronous motor (SLSM-PSM)	215
10.6.1	Required commissioning steps	217
10.6.2	Expert settings	218
10.7	Parameterisable motor functions	219
10.7.1	Skip frequencies	219
10.7.2	DC braking	221
10.7.2.1	Example: Automatic DC braking when starting the motor	222
10.7.2.2	Example: Automatic DC braking when stopping the motor	223
10.7.2.3	Activating DC braking manually	225
10.7.2.4	Migration of Lenze Inverter Drives 8200/8400	227
10.7.3	Holding brake control	228
10.7.3.1	Basic setting	229
10.7.3.2	"Automatic" brake mode (automatic operation)	230
10.7.3.3	Brake holding load	231
10.7.3.4	Brake closing threshold	233
10.7.3.5	Manual release of the holding brake	235
10.7.4	Load loss detection	237

10.8	Options for optimizing the control loops.....	238
10.8.1	Automatic motor identification (energized).....	241
10.8.2	Automatic motor calibration (non-energized).....	243
10.8.3	Tuning of the motor and the speed controller.....	244
10.8.4	Inverter characteristic.....	245
10.8.5	Motor equivalent circuit diagram data.....	246
10.8.6	Motor control settings.....	247
10.8.6.1	Speed controller .....	248
10.8.6.2	Current controller.....	249
10.8.6.3	Current controller (field-oriented control).....	250
10.8.6.4	ASM field controller.....	250
10.8.6.5	ASM field weakening controller .....	251
10.8.6.6	ASM field weakening controller (extended) .....	251
10.8.6.7	PSM operation outside the voltage range .....	251
10.8.6.8	I <sub>max</sub> controller .....	252
10.8.6.9	Flying restart controller.....	253
10.8.6.10	SLVC controller.....	253
10.8.6.11	Slip controller .....	254
10.8.6.12	General optimizations.....	255
10.9	Motor protection.....	256
10.9.1	Motor overload monitoring (i <sup>2</sup> xt).....	257
10.9.2	Motor temperature monitoring.....	261
10.9.3	Overcurrent monitoring.....	262
10.9.4	Motor phase failure detection .....	263
10.9.5	Motor speed monitoring .....	264
10.9.6	Motor torque monitoring .....	265
10.9.7	Maximum overload current of the inverter.....	267
10.9.8	Heavy load monitoring .....	269
10.10	Monitoring settings.....	271

# Contents

<b>11 I/O extensions and control connections</b> .....	<b>272</b>
11.1 Configure digital inputs.....	272
11.1.1 Configure digital inputs DI3/DI4 for detecting a pulse train.....	276
11.1.1.1 Example 1: Input range 10 ... 85 kHz = setting range 0 ... 50 Hz.....	281
11.1.1.2 Example 2: Input range 10 ... 85 kHz = setting range -50 ... 50 Hz.....	281
11.1.1.3 Example 3: Pulse train as frequency setpoint source.....	282
11.2 Configure analog inputs.....	284
11.2.1 Analog input 1.....	284
11.2.1.1 Example: Input range 0 ... 10 V = setting range 0 ... 50 Hz.....	287
11.2.1.2 Example: Input range 0 ... 10 V = setting range -40 ... +40 Hz.....	287
11.2.1.3 Example: Input range -10 ... +10 V = setting range -40 ... +40 Hz.....	288
11.2.1.4 Example: Error detection.....	288
11.2.2 Analog input 2.....	289
11.3 Configure digital outputs.....	292
11.3.1 Relay output.....	292
11.3.2 Digital output 1.....	297
11.3.2.1 Configure the digital output 1 as pulse train output.....	299
11.3.3 Digital output 2.....	303
11.4 Configure analog outputs.....	305
11.4.1 Analog output 1.....	305
11.4.1.1 Example: Output voltage 0 ... 10 V = output frequency 0 ... 100 Hz.....	307
11.4.1.2 Example: Output voltage 2 ... 10 V = output frequency 30 ... 60 Hz.....	307
11.4.1.3 Example: mirrored output range.....	308
11.4.2 Analog output 2.....	309



<b>12</b>	<b>Configuring the network</b>	<b>310</b>
12.1	Control the inverter via network	311
12.1.1	Activate network control	311
12.1.2	Predefined control and status words	312
12.1.3	Define your own control word format	314
12.1.4	Define your own status word format	322
12.2	Define setpoint via network	327
12.2.1	Option 1: Define network as standard setpoint source	328
12.2.2	Option 2: Change over to the network setpoint during operation	329
12.2.3	Mappable parameters for exchanging setpoints and actual values	330
12.3	Further mappable parameters	332
12.3.1	Process input data	333
12.3.1.1	Feedback of PID variable via network	333
12.3.1.2	Control digital outputs via network	333
12.3.1.3	Control analog outputs via network	333
12.3.1.4	Additive voltage impression via network	334
12.3.2	Process output data	335
12.3.2.1	Drive status	335
12.3.2.2	Output messages of the "sequencer" function via network	336
12.4	Parameter access monitoring (PAM)	337
12.5	Process data handling in the event of error	339
12.6	Suppress certain alarm / emergency messages to the master	340
12.7	CiA 402 device profile	341
12.7.1	Supported operating modes	341
12.7.2	Basic setting	342
12.7.3	Process input data	343
12.7.4	Process output data	343
12.7.5	Commands for device state control	344
12.7.5.1	Switch-off	346
12.7.5.2	Switch on	347
12.7.5.3	Enable operation	348
12.7.5.4	Activate quick stop	349
12.7.5.5	Disable operation	350
12.7.5.6	Pulse inhibit	351
12.7.5.7	Reset fault	352
12.7.6	Device states	353
12.7.6.1	Not ready to switch on	354
12.7.6.2	Switch-on inhibited	355
12.7.6.3	Ready to switch on	356
12.7.6.4	Switched on	357
12.7.6.5	Operation enabled	358
12.7.6.6	Quick stop active	359
12.7.6.7	Fault reaction active	360
12.7.6.8	Trouble	361
12.7.6.9	STO (Safe Torque Off)	362
12.8	AC drive	363
12.8.1	AC drive control word	363
12.8.2	AC drive status word	364
12.9	Lenze LECOM profile	365

# Contents

12.10	CANopen	366
12.10.1	Commissioning	367
12.10.2	Basic setting and options	371
12.10.2.1	Activating the bus terminating resistor	371
12.10.2.2	Node address setting	371
12.10.2.3	Baud rate setting	372
12.10.2.4	Configuring the device as mini master	373
12.10.3	Process data transfer	374
12.10.3.1	Data mapping	379
12.10.4	Parameter data transfer	382
12.10.5	Monitoring	384
12.10.5.1	Emergency telegram	384
12.10.5.2	Heartbeat protocol	384
12.10.5.3	Error responses	385
12.10.6	Diagnostics	387
12.10.6.1	Status LEDs	387
12.10.6.2	Information on the network	387
12.10.6.3	Device identification	390
12.11	Modbus RTU	391
12.11.1	Commissioning	392
12.11.2	Basic setting and options	394
12.11.2.1	Node address setting	394
12.11.2.2	Baud rate setting	394
12.11.2.3	Data format setting	395
12.11.2.4	Minimum response time setting	395
12.11.3	Data transfer	396
12.11.3.1	Function codes	397
12.11.3.2	Data mapping	399
12.11.4	Monitoring	400
12.11.5	Diagnostics	401
12.11.5.1	Status LEDs	401
12.11.5.2	Information on the network	401
12.12	IO-Link	405
12.12.1	Commissioning	407
12.12.2	Basic setting and options	408
12.12.3	Process data transfer	410
12.12.3.1	Data mapping	411
12.12.4	Acyclic data transfer	414
12.12.5	Data Storage	415
12.12.6	Monitoring	417
12.12.7	Diagnostics	418
12.12.7.1	Status LEDs	418
12.12.7.2	Information on protocol identification	418
12.12.7.3	Device identification	419
12.12.7.4	IODD and Engineering	419
12.12.7.5	IO-Link event IDs	420

12.13	PROFIBUS.....	423
12.13.1	Commissioning.....	425
12.13.2	Basic setting and options.....	427
12.13.2.1	Station address setting.....	427
12.13.2.2	Baud rate setting.....	427
12.13.2.3	Suppress diagnostic messages to the master.....	428
12.13.3	Process data transfer.....	429
12.13.3.1	Standard mapping.....	430
12.13.4	Parameter data transfer.....	432
12.13.4.1	Read parameter data acyclically.....	434
12.13.4.2	Write parameter data acyclically.....	437
12.13.4.3	Event IDs.....	440
12.13.5	Monitoring.....	441
12.13.6	Diagnostics.....	442
12.13.6.1	Status LEDs.....	442
12.13.6.2	Information on the network.....	442
12.14	EtherCAT.....	445
12.14.1	Commissioning.....	446
12.14.2	Basic setting and options.....	451
12.14.3	Process data transfer.....	452
12.14.3.1	Standard mapping.....	452
12.14.3.2	Dynamic (free) configuration.....	453
12.14.3.3	Expert settings.....	455
12.14.4	Parameter data transfer.....	457
12.14.5	Parameter download.....	458
12.14.6	Monitoring.....	459
12.14.7	Diagnostics.....	463
12.14.7.1	Status LEDs.....	463
12.14.7.2	Information on the network.....	463
12.14.7.3	Device identification.....	464
12.14.8	EoE communication.....	466
12.14.9	Automatic firmware download with Lenze Controller.....	468

# Contents

12.15	EtherNet/IP.....	470
12.15.1	AC drive profile.....	470
12.15.2	Supported CIP objects.....	471
12.15.2.1	0x01-Identity Object.....	471
12.15.2.2	0x04-Assembly Object.....	472
12.15.2.3	0x28-Motor Data Object.....	478
12.15.2.4	0x29-Control Supervisor Object.....	478
12.15.2.5	0x2A-AC Drive Object.....	479
12.15.2.6	0x47-Device Level Ring (DLR) Object.....	480
12.15.2.7	0x48-Quality of Service (QoS) Object.....	480
12.15.2.8	0x67-Lenze Class Object 103.....	480
12.15.2.9	0x68-Lenze Class Object 104.....	480
12.15.2.10	0x6E-Lenze Class Object 110.....	481
12.15.2.11	0xF5-TCP/IP Interface Object.....	481
12.15.2.12	0xF6-Ethernet Link Object.....	482
12.15.3	AC motor type.....	482
12.15.4	Commissioning.....	483
12.15.4.1	Restarting or stopping the communication.....	486
12.15.5	Basic setting and options.....	486
12.15.6	Process data transfer.....	489
12.15.7	Parameter data transfer.....	500
12.15.8	Monitoring.....	504
12.15.8.1	EtherNet/IP communication monitoring.....	504
12.15.8.2	Other monitoring.....	504
12.15.9	Diagnostics.....	506
12.15.9.1	Status LEDs.....	506
12.15.9.2	Information on the network.....	506
12.16	Modbus TCP.....	509
12.16.1	Commissioning.....	510
12.16.2	Basic setting and options.....	513
12.16.2.1	IP settings.....	513
12.16.2.2	Baud rate setting.....	515
12.16.3	Data transfer.....	516
12.16.3.1	Function codes.....	517
12.16.3.2	Data mapping.....	523
12.16.4	Monitoring.....	525
12.16.5	Diagnostics.....	527
12.16.5.1	Status LEDs.....	527
12.16.5.2	Information on the network.....	528

12.17	POWERLINK.....	530
12.17.1	Commissioning.....	531
12.17.2	Basic setting and options.....	532
12.17.3	Process data transfer.....	534
12.17.4	Parameter data transfer.....	535
12.17.5	Monitoring.....	536
12.17.6	Diagnostics.....	537
12.17.6.1	Status LEDs.....	537
12.17.6.2	Information on the network.....	538
12.17.6.3	Information on the Ethernet interface.....	540
12.17.6.4	Declaration of all nodes and their properties.....	541
12.17.6.5	Display of the multiplexed cycles of all nodes.....	541
12.17.6.6	Device identification.....	542
12.17.6.7	Error history buffer.....	542
12.18	PROFINET.....	543
12.18.1	Commissioning.....	545
12.18.1.1	Restarting or stopping the communication.....	547
12.18.1.2	Device description file.....	547
12.18.2	Basic setting and options.....	548
12.18.2.1	Station name and IP configuration.....	548
12.18.2.2	Suppress diagnostic messages to the IO controller.....	549
12.18.3	Process data transfer.....	550
12.18.4	Parameter data transfer.....	554
12.18.5	Monitoring.....	555
12.18.6	Diagnostics.....	556
12.18.6.1	Status LEDs.....	556
12.18.6.2	Information on the network.....	556
12.18.7	PROFIenergy.....	558
12.18.7.1	Supported measured values.....	558
12.19	Internal mapping of the process data.....	559
<b>13</b>	<b>Device functions.....</b>	<b>561</b>
13.1	Optical device identification.....	561
13.2	Reset parameters to default.....	562
13.2.1	Configure reset behaviour.....	563
13.3	Saving/loading the parameter settings.....	564
13.4	Access protection.....	567
13.4.1	Write access protection.....	567
13.4.1.1	Write access protection in the »EASY Starter«.....	569
13.4.1.2	Write access protection in the keypad.....	572
13.5	Switching frequency changeover.....	576
13.6	Device overload monitoring (ixt).....	577
13.7	Heatsink temperature monitoring.....	578
13.8	Automatic restart after a fault.....	579
13.9	User-defined error triggering.....	580
13.10	Update device firmware.....	581
13.10.1	Firmware download with »EASY Starter (firmware loader)«.....	582
13.11	Behaviour of the inverter in case of incompatible data in the memory module.....	583

# Contents

<b>14 Additional functions</b> .....	<b>586</b>
14.1 Brake energy management .....	586
14.1.1 Use of a brake resistor .....	589
14.1.2 Stopping the deceleration ramp function generator .....	591
14.1.3 Inverter motor brake .....	592
14.2 Parameter change-over.....	593
14.2.1 Example: Selective control of several motors with one inverter .....	594
14.2.2 Parameter set configuration .....	595
14.2.3 Device commands for parameter change-over.....	596
14.2.4 Functions for parameter change-over.....	598
14.2.4.1 Example: Activation via command (only when disabled).....	600
14.2.4.2 Example: Activation via command (immediately).....	601
14.2.4.3 Example: Activation if the selection is changed (only if the inverter is disabled)....	602
14.2.4.4 Example: Activation if the selection is changed (immediately) .....	603
14.3 Trigger action if a frequency threshold is exceeded.....	604
14.4 Position counter.....	606
14.5 Mains failure control.....	609
14.5.1 Activating the mains failure control .....	611
14.5.2 Restart protection.....	612
14.5.3 Fast mains recovery .....	612
14.5.4 Commissioning the mains failure control .....	613
14.6 Operation with UPS.....	614
14.7 Cascade function for pumps and fans.....	617
<b>15 Functional safety</b> .....	<b>622</b>
15.1 General information and basics.....	622
15.1.1 Acceptance.....	623
15.1.2 Periodic inspections.....	623
15.1.3 Device exchange.....	623
15.2 Safe interfaces .....	624
15.2.1 Safe inputs.....	625
15.3 Safety functions .....	626
15.3.1 Safe torque off (STO) .....	627
15.3.1.1 Basic Safety - STO.....	628
15.4 Safety-related data.....	631
15.4.1 Safety-related characteristics Basic Safety - STO.....	631

<b>16 Using accessories</b>	<b>632</b>
16.1 Keypad	632
16.1.1 Keypad basic settings	633
16.1.1.1 Select language	633
16.1.1.2 Change setpoint increment	633
16.1.1.3 Configure status display - Custom units	633
16.1.1.4 Configure R/F and CTRL keys	635
16.1.2 Keypad operating mode	637
16.1.2.1 Keypad status display	637
16.1.2.2 Function of keypad keys in operating mode	638
16.1.2.3 Error reset with keypad	639
16.1.3 Keypad parameterisation mode	640
16.1.3.1 Parameter groups	640
16.1.3.2 Function of the keypad keys in the parameterisation mode	641
16.1.3.3 Save parameter settings with keypad	642
16.1.3.4 Display of status words on keypad	643
16.1.3.5 Keypad parameter list	644
16.2 WLAN module	667
16.2.1 WLAN LED status displays	667
16.2.2 WLAN basic settings	668
16.2.2.1 Resetting WLAN settings to default setting	670
16.2.3 WLAN access point mode	671
16.2.3.1 Establish a WLAN connection between smartphone and inverter	672
16.2.3.2 Using the smartphone as "Smart Keypad"	673
16.2.3.3 Establish a WLAN connection between Engineering PC and inverter	674
16.2.4 WLAN client mode	677
16.2.5 WLAN diagnostics	678
<b>17 Diagnostics and fault elimination</b>	<b>680</b>
17.1 Status LEDs	681
17.2 Logbook	682
17.3 Error history buffer	683
17.3.1 Read out error history buffer	686
17.4 Diagnostic parameters	687
17.4.1 Inverter diagnostics	688
17.4.2 Network diagnostics	693
17.4.3 I/O diagnostics	694
17.4.3.1 Digital inputs and outputs	694
17.4.3.2 Analog inputs and outputs	695
17.4.4 Service life diagnostics	696
17.4.5 Device identification	697
17.5 Event handling	699
17.5.1 Severity	700
17.5.1.1 Timeout for error response	701
17.5.2 Configuring the severity	702
17.5.3 Error reset	702
17.6 Events, causes and remedies	705
17.6.1 Event ID overview	705
17.6.2 Causes and remedies	708
<b>18 Technical data</b>	<b>729</b>

# Contents

<b>19 Environmental notes and recycling</b> .....	<b>730</b>
<b>20 Appendix</b> .....	<b>731</b>
20.1 Parameter attribute list.....	731
20.2 Glossary.....	778





# 1 About this document

## **WARNING!**

Read this documentation carefully before starting any work.

► Please observe the safety instructions!

---

# About this document

Document description



## 1.1 Document description

This documentation is valid up to firmware version:

Firmware version	Date	Internal data ID
06.05.00.00	2023-12-08	V0016



## 1.2 Further documents

For certain tasks, information is available in further documents.

Document	Contents/topics
Mounting sheet	General safety instructions and important UL/CSA instructions, connection diagram and technical data. • The mounting sheet is included in the delivery of the product.
Operating instructions	Basic information on installing and commissioning the product.
Original operating instructions / project planning document	Basic information for project planning and for ordering the product. The document also contains information on mechanical and electrical installation, product extensions and accessories.
"Functional safety" configuration document	Basic information on configuring "functional safety" of the product.
Quick Reference Card	Brief information on the operation and device properties of the product

### More information

For certain tasks, information is available in other media.

Medium	Contents/topics
Engineering Tools	For commissioning
AKB articles	Additional technical information for users in the Application Knowledge Base
CAD data	Download in different formats from the EASY Product Finder
EPLAN macros	Project planning, documentation and management of projects for EPLAN P8.
Device descriptions	Standardized files for network configuration







Information and tools with regard to the Lenze products can be found on the Internet:

[www.lenze.com](http://www.lenze.com) → Downloads



### 1.3 Notations and conventions

Conventions are used in this document to distinguish between different types of information.

Numeric notation		
Decimal separator	Point	Generally shown as a decimal point. Example: 1 234.56
Warnings		
UL Warnings	UL	Are used in English and French.
UR warnings	UR	
Text		
Engineering Tools	" "	Software Example: "EASY Starter", "PLC Designer"
Icons		
Page reference		Reference to another page with additional information. Example:  16 = see page 16
Documentation reference		Reference to other documentation with additional information. Example:  EDKxxx = see documentation EDKxxx

#### Layout of the safety instructions

#### DANGER!

Indicates an extremely hazardous situation. Failure to comply with this instruction will result in severe irreparable injury and even death.

#### WARNING!

Indicates an extremely hazardous situation. Failure to comply with this instruction may result in severe irreparable injury and even death.

#### CAUTION!

Indicates a hazardous situation. Failure to comply with this instruction may result in slight to medium injury.

#### NOTICE

Indicates a material hazard. Failure to comply with this instruction may result in material damage.



## 2 Safety instructions

### 2.1 Basic safety instructions

Disregarding the following basic safety instructions and safety information may lead to severe personal injury and damage to property!

- Only use the product as directed.
- Never commission the product in the event of visible damage.
- Never modify the product technically.
- Never commission the product before assembly has been completed.
- Never operate the product without the required covers.
- Connect/disconnect all pluggable connections only in deenergized condition!
- Only remove the product from the installation in the deenergized state.
- The product can – depending on their degree of protection – have live, movable or rotating parts during or after operation. Surfaces can be hot.
- Observe the specifications of the corresponding documentation. This is the condition for safe and trouble-free operation and the achievement of the specified product features.
- The procedural notes and circuit details given in the associated documentation are suggestions and their transferability to the respective application has to be checked. The manufacturer of the product does not take responsibility for the suitability of the process and circuit proposals.
- All work with and on the product may only be carried out by qualified personnel. IEC 60364 and CENELEC HD 384 define the qualifications of these persons:
  - They are familiar with installing, mounting, commissioning, and operating the product.
  - They have the corresponding qualifications for their work.
  - They know and can apply all regulations for the prevention of accidents, directives, and laws applicable at the place of use.

Please observe the specific safety information in the other sections!



## 2.2 Application as directed

- The product is a professional equipment intended for use by trades, specific professions or industry and not for sale to the general public. IEC 60050 [IEV 161-05-05]
- To prevent personal injury and damage to property, higher-level safety and protection systems must be used!
- All transport locks must be removed.
- The product may only be operated under the specified operating conditions and in the specified mounting positions.
- The product is exclusively suitable for installation in control cabinets and, depending on the protection class and design, for wall and motor mounting.
- The product must only be actuated with motors that are suitable for the operation with inverters.
- The product must not be operated in private areas, in potentially explosive atmospheres and in areas with harmful gases, oils, acids and radiation.



## 2.3 Handling

The user is not allowed to change inverters that come with integrated functional safety.

- The safety module must not be removed.
- The user must not carry out any repairs on the safety module.
- The safety module is not a spare part.
- If the safety module is defective, the inverter has to be replaced.



## 2.4 Residual hazards

Even if notes given are taken into consideration and protective measures are implemented, the occurrence of residual risks cannot be fully prevented.

The user must take the residual hazards mentioned into consideration in the risk assessment for his/her machine/system.

If the above is disregarded, this can lead to severe injuries to persons and damage to property!

### Product

Observe the warning labels on the product!



#### **Dangerous electrical voltage:**

Before working on the product, make sure there is no voltage applied to the power terminals! After mains disconnection, the power terminals will still carry the hazardous electrical voltage for the time given next to the symbol!



#### **Electrostatic sensitive devices:**

Before working on the product, the staff must ensure to be free of electrostatic charge!



#### **High leakage current:**

Carry out fixed installation and PE connection in compliance with:  
EN 61800-5-1 / EN 60204-1



#### **Hot surface:**

Use personal protective equipment or wait until the device has cooled down!

### Degree of protection - protection of persons and device protection

- Information applies to the mounted and ready-for-use state.
- Information does not apply to the wire range of the terminals.
  - Terminals that are not wired have low protection against physical contact.
  - Terminals for large cable cross-sections have lower classes of protection, e. g. from 15 kW IP10 only.

### Device protection

- The maximum test voltage for insulation tests between a control potential of 24 V and PE must not exceed 110 V DC (EN 61800-5-1).

### Motor protection

With some settings of the inverter, the connected motor can be overheated.

- E. g. by longer operation of self-ventilated motors at low speed.
- E. g. by longer operation of DC-injection braking.

### Protection of the machine/system

Drives can reach dangerous overspeeds.

- E. g. by setting high output frequencies in connection with motors and machines not suitable for this purpose.
- The inverters do not provide protection against such operating conditions. For this purpose, use additional components.

### Motor

If there is a short circuit of two power transistors, a residual movement of up to  $180^\circ/\text{number of pole pairs}$  can occur at the motor! (e. g. 4-pole motor: residual movement max.  $180^\circ/2 = 90^\circ$ ).





### 3 Product information

#### 3.1 Identification of the products

##### Order code structure

		I	5	5	A	E	□□□	□	1	□	□	□	□	□□□□
Product type	Inverter	I												
Product family	i500		5											
Product	i550			5										
Product generation	Generation 1				A									
	Generation 2				B									
Mounting type	Control cabinet mounting					E								
Rated power (Examples)	0.25 kW						125							
	0.55 kW						155							
	2.2 kW						222							
	3.0 kW						230							
	15 kW						315							
	30 kW						330							
Mains voltage and connection type	1/N/PE AC 120 V							A						
	1/N/PE AC 230/240 V							B						
	3/PE AC 230/240 V							C						
	1/N/PE AC 230/240 V							D						
	3/PE AC 230/240 V													
	3/PE AC 400 V							F						
Motor connections	Single axis								1					
	Without functional safety									0				
Integrated functional safety	Basic Safety - STO										A			
												V		
Degree of protection	IP20, coated												0	
Interference suppression	Without interference suppression													1
	Integrated RFI filter													
Application	Default parameter setting: Region EU (50-Hz networks)													0
	Default parameter setting: Region US (60-Hz networks)													1
Design types	Standard I/O without network													000S
	Application I/O without network													001S
	Standard I/O with CANopen													002S
	Standard I/O with Modbus RTU													003S
	Standard I/O with PROFIBUS													004S
	Standard I/O with POWERLINK													012S
	Standard I/O with EtherCAT													00KS
	Standard I/O with PROFINET													0xLS
	Standard I/O with EtherNet/IP													0xMS
	Standard I/O with Modbus TCP													0xWS
	Standard I/O with IO-Link													016S

##### Example:

Order code	Meaning
I55AE311F1AV1000KS	Inverter i550 cabinet, 11 kW, 3-phase, 400 V/480 V STO safety function, IP20, varnished, integrated RFI filter; 50 Hz variant Standard I/O with EtherCAT network



## 3.2 License information

### PROFINET

---



The PROFINET firmware is optional.

The PROFINET firmware uses the following open source software packages under a modified GPL license: eCos Operating System. These components are used at the operating system level of the firmware. The protocol stack does not use source code under a GPL license.

View license: <https://ecos.sourceware.org/license-overview.html>

---



## 4 Commissioning

The purpose of commissioning is to adapt the inverter as part of a machine with a variable-speed drive system to its drive task.



## 4.1 Important notes

### DANGER!

Incorrect wiring can cause unexpected states during the commissioning phase.

Possible consequences: death, severe injuries or damage to property

Ensure the following before switching on the mains voltage:

- ▶ Wiring must be complete and correct.
  - ▶ Wiring must be free of short circuits and earth faults.
  - ▶ The motor circuit configuration (star/delta) must be adapted to the inverter output voltage.
  - ▶ The motor must be connected in-phase (direction of rotation).
  - ▶ The "emergency switching off" function of the overall system must operate correctly.
- 

### DANGER!

Incorrect settings during commissioning may cause unexpected and dangerous motor and system movements.

Possible consequences: death, severe injuries or damage to property

- ▶ Clear hazardous area.
  - ▶ Observe safety instructions and safety clearances.
-



## 4.2 Initial switch-on and functional test

### Drive behaviour by default

By default, the V/f characteristic control with a linear characteristic is preset as motor control for asynchronous motors. The V/f characteristic control is a motor control for conventional frequency inverter applications. It is based on a simple and robust control mode for the operation of asynchronous motors with a linear or square-law load torque characteristic (e.g. fan). Because of the minimal parameterisation effort, such applications can be commissioned easily and quickly.

**The default settings of the parameters ensure that the inverter is ready for operation immediately and the motor works adequately without further parameterisation if an inverter and an asynchronous motor\* Hz asynchronous machine with matching performances are assigned to each other.**

\* Depending on the device/mains frequency either 50-Hz asynchronous motor or 60-Hz asynchronous motor.

### Functional test

Target: the motor connected to the inverter should rotate as quickly as possible.

Requirements:

- The connected motor matches the inverter in terms of power.
- The parameter settings correspond to the state upon delivery.

#### 1. Preparation

1. Wire the power connections. See the operating instructions for more details.
2. Wire digital inputs X3/DI1 (start/stop), X3/DI3 (reversal) and X3/DI4 (frequency preset 20 Hz).
3. Do not connect terminal X3/AI1 (analog setpoint selection) or connect it to GND.

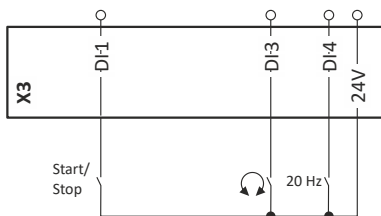

#### 2. Switch on mains and check readiness for operation

1. Switch on mains voltage.
2. Observe LED status displays "RDY" and "ERR" on the front of the inverter:
  - a) If the blue "RDY" LED is blinking and the red "ERR" LED does not light up, the inverter is ready for operation. The controller is inhibited. You can now start the drive.
  - b) If the red "ERR" LED is lit permanently, a fault is pending. Eliminate the fault before you carry on with the functional test.



### Carry out functional test

#### 1. Start drive

1. Start inverter: X3/DI1 = HIGH.
  - a) If the inverter is equipped with an integrated safety system: X1/SIA = HIGH and X1/SIB = HIGH.
2. Activate frequency preset 1 (20 Hz) as speed setpoint: X3/DI4 = HIGH.  
The drive rotates with 20 Hz.
3. Optional: Activate reversal
  - a) X3/DI3 = HIGH.  
The drive rotates at 20 Hz in the opposite direction.
  - b) Deactivate reversal again: X3/DI3 = LOW.  
Speed characteristic (example)

#### 2. Stop drive

1. Deactivate frequency preset 1 again: X3/DI4 = LOW.
2. Stop inverter again: X3/DI1 = LOW.

The functional test has been completed.

### Related topics

- ▶ [Function assignment of the inputs and outputs \(default setting\)](#) 56
- ▶ [Status LEDs](#) 681
- ▶ [Events, causes and remedies](#) 705



## 4.3 Operating interfaces

Depending on the inverter, there are one or several options for accessing the device parameters that are available for customising the drive task.

Simple access to the device parameters is provided by the Lenze Engineering Tool »EASY Starter«. Other operating interfaces include the keypad or the Smart Keypad App.

If the inverter is equipped with the "PROFINET" network option, the connectors X2x6 or X2x7 can also be utilised.

### 4.3.1 Keypad

The keypad is an easy means for the local operation, parameterisation, and diagnostics of the inverter.



- The keypad is simply connected to the diagnostic module interface on the front of the inverter.
- The keypad can also be connected and removed during operation.

Function of keypad keys in operating mode			
Key	Actuation	Condition	Action
	Briefly	Local keypad control active. Display "LOC"	Run motor.
		Remote control active Display "REM" Display "KSTOP"	Deactivate keypad triggered stop. The motor remains at standstill. Display changes from "KSTOP" to "STOP".
	Briefly	No Jog operation	Stop motor. Display "KSTOP"
	Briefly	Operating mode	Change to parameterisation mode. ▶ <a href="#">Keypad parameterisation mode</a> <a href="#">640</a>
	Longer than 3 s	None (anytime possible)	Save parameter settings in the user memory of the memory module.
	Briefly	During operation	Scroll through information in the above status line.
	Briefly	Manual setpoint selection via keypad active. Display "MAN"	Change frequency setpoint.
	Briefly	Operating mode	Activate full keypad control Display "ON?" → Confirm with Control and setpoint selection can now only be carried out via keypad. Renewed clicking: Exit full keypad control. Display "OFF?" → Confirm with ▶ <a href="#">Keypad full control</a> <a href="#">66</a>
	Briefly	Local keypad control active. Display "LOC"	Reversal of rotation direction. Display "REV?" → Confirm with ▶ <a href="#">Configure R/F and CTRL keys</a> <a href="#">635</a>

Detailed information on the keypad can be found in the Chapter "Using accessories".

▶ [Keypad](#) [632](#)



### 4.3.2 Engineering tool »EASY Starter«

The »EASY Starter« is a PC software that is especially designed for the commissioning and diagnostics of the inverter.

- »EASY Starter« [Download](#)

Screenshot:

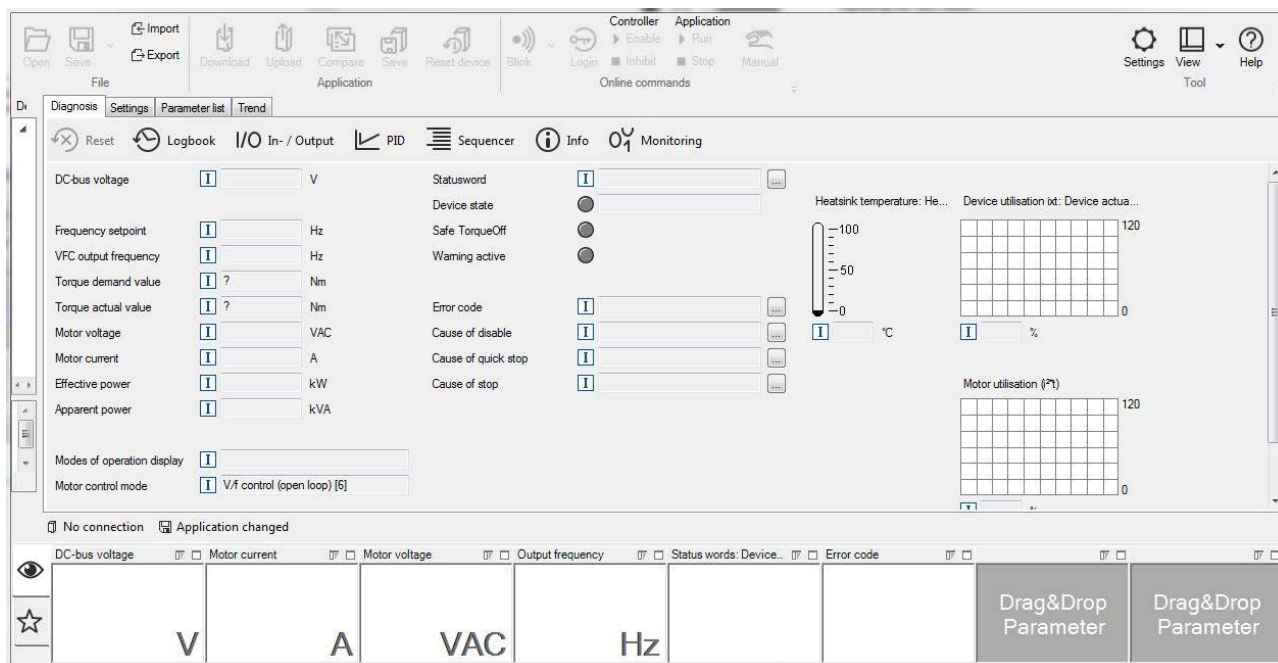





### 4.3.2.1 Generate a connection between inverter and »EASY Starter«

For commissioning the inverter with the »EASY Starter«, a communication link with the inverter is required. This can be established in a wired or wireless manner via WLAN.

#### Preconditions

- A USB module and a USB 2.0 cable (A plug on Micro-B plug) are required for wired communication.



- A WLAN module is required for wireless communication with the inverter. In addition the PC on which the »EASY Starter« is installed must be wireless-enabled.



# Commissioning

Operating interfaces

Engineering tool »EASY Starter«

Generate a connection between inverter and »EASY Starter«



## Details

The following instructions describe how to establish a connection via the USB module.



---

The USB interface must only be used temporarily for the diagnostics and parameterization of the inverter. It is recommended to always keep the inverter and the diagnostic device on the same earth potential or separate the diagnostic device from the mains.

---

- Parameterising without motor operation does not require a mains voltage. If you connect the inverter directly to the PC without a hub, the USB interface of the PC is sufficient for the voltage supply.
- Instructions for the establishing a connection via the WLAN module can be found in the chapter "Using accessories: [WLAN module](#)". [667](#)

How to establish a communication to the inverter via USB:

Preconditions for commissioning:

- The functional test described in the mounting and switch-on instructions has been completed successfully (without any errors or faults).
- The inverter is ready for operation. The mains voltage is switched on.

Accessories required for commissioning:

- The USB module
- The USB 2.0 cable (A-plug on micro B-plug)



# Commissioning

Operating interfaces

Engineering tool »EASY Starter«

Generate a connection between inverter and »EASY Starter«

- The PC with installed »EASY Starter« software
1. Plug the USB module onto the diagnostic module interface on the front of the inverter.
  2. Use a USB cable to connect the inverter to the PC on which »EASY Starter« is installed:
    - a) Plug the micro B plug of the USB cable into the socket of the USB module.
    - b) Plug the other end into a free USB type A-socket of the PC.
  3. Start »EASY Starter«.  
The "Add devices" dialog is shown.
  4. Select the "USB - USB with module i5MADU0000000S" connection:

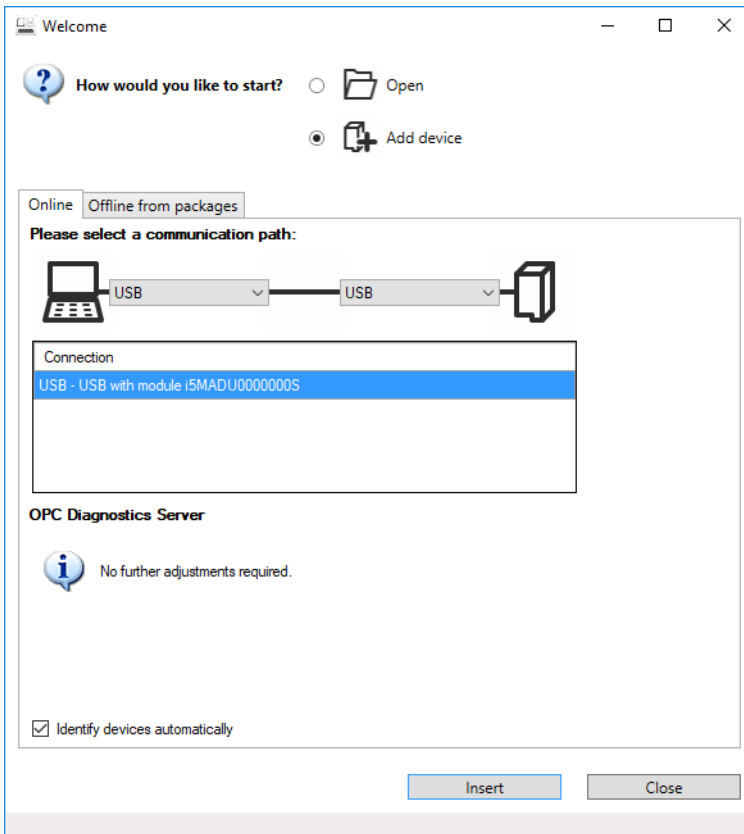

5. Click the **Insert** button.  
»EASY Starter« searches for connected devices via the communication path selected. When the connection has been established successfully, the inverter is displayed in the device list of »EASY Starter«. The inverter parameters can now be accessed via the tabs of »EASY Starter«.



## 4.3.3 SMART Keypad App

The Lenze »SMART Keypad App« for Android or iOS allows you to diagnose and parameterize an inverter. A WLAN module on the inverter is required for communication.

- Ideal for the parameterization of simple applications such as a conveyor belt.
- Ideal for the diagnostics of the inverter.

The app can be found in the Google Play Store or in the Apple App Store.

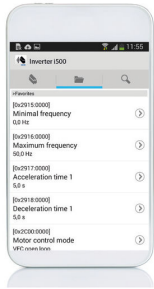

Android



iOS



## 4.4 General information on parameter setting

Being a component of a machine which includes a speed-variable system, the inverter needs to be adapted to its drive task. The inverter is adjusted by changing parameters.

The parameters can be accessed via the operating interfaces on the inverter. ▶ [Operating interfaces](#) 31

If the inverter is equipped with a network option, access from a higher-level controller via the network is also possible.



---

Certain device commands or settings which might cause a critical state of the drive behavior can only be carried out when the device is disabled.

---

### 4.4.1 Addressing of the parameters

Each parameter features a 16-bit index as its address. Under this address, the parameter is stored in the object directory of the device.

- Parameters that belong together functionally are combined in a data set. These parameters are additionally provided with an 8-bit subindex.
- The colon is used as a separator between the index and subindex Example: "0x2540:001"
- There are parameter settings that can be changed, and (diagnostic) parameters that can only be read.



---

The following conventions are used in this documentation for specifying the parameter address:

- The index is specified as a hexadecimal value.
  - The subindex is specified as a decimal value.
- 

#### Parameterisation using the keypad

- All parameters which can also be accessed by means of the keypad have a "Display code", with the first digit of the display code specifying the group in which the parameter can be found on the keypad.
- In the documentation, the display code is specified in brackets behind the address. Example: "0x2915 (P210.00)".



## 4.4.2 Structure of the parameter descriptions

- The parameter descriptions in this documentation are structured in table form.
- The representation distinguishes parameters with a setting range, text, selection list, and bit-coded display.
- The default setting of parameters with a write access feature is shown in **bold**.
- The display code as well as the short keypad designation of the parameter, which is limited to 16 characters, are shown in brackets.

### Example: parameters with a setting range

Address	Name / setting range / [default setting]	Information
Index:Subindex (display code)	Parameter designation (abbreviated keypad designation) Minimum value ... <b>[default setting]</b> ... maximum value • Optional information with regard to the parameter.	Explanations and notes with regard to the parameter.

### Example: parameters with a selection list

Address	Name / setting range / [default setting]	Information
Index:Subindex (display code)	Parameter designation (abbreviated keypad designation) • Optional information with regard to the parameter.	Explanations and notes with regard to the parameter. <b>Note:</b> The corresponding selection number (here 0, 1, or 2) must be set. Other values are not permissible.
	<b>0</b> Designation of selection 0	Optionally: explanations and notes with regard to the corresponding selection.
	1 Designation of selection 1	
	2 Designation of selection 2	The default selection is shown in <b>bold</b> .

### Example: parameters with a bit-coded display

Address	Name / setting range / [default setting]	Information
Index:Subindex (display code)	Parameter designation (abbreviated keypad designation) • Optional information with regard to the parameter.	Explanations and notes with regard to the parameter.
	Bit 0 Designation of bit 0	Optionally: explanations and notes with regard to the corresponding bit.
	Bit 1 Designation of bit 1	
	Bit 2 Designation of bit 2	
	... ...	
	Bit 15 Designation of bit 15	

## 4.4.3 Parameter overview lists

- [Keypad parameter list](#): for the parameterisation using the keypad, contains a list of all parameters which can also be accessed by means of the keypad. [644](#)
- [Parameter attribute list](#): contains a list of all inverter parameters. This list in particular includes some information that is relevant for the reading and writing of parameters via the network. [731](#)











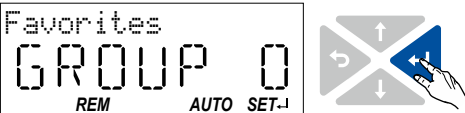

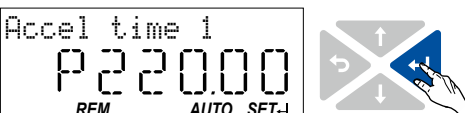

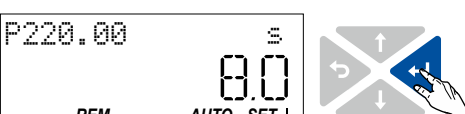

#### 4.4.4 Favorites

In order to gain quick access using »EASY Starter« or the keypad, frequently used parameters of the inverter can be defined as "Favorites".

- The *Favorites* tab in »EASY Starter« is used to quickly access the favorites.
- On the keypad, the "Favorites" can be found in group 0.

##### 4.4.4.1 Accessing the "Favorites" with the keypad

- 
- 
- 
- 
- 
- 

1. Use the  key in the operating mode to navigate to the parameterisation mode one level below.  
You are now in the group level. All parameters of the inverter are divided into different groups according to their function.  
Group 0 contains the "Favorites".  
Note: By using the  key you can navigate one level upwards again anytime.
2. Use the  key to navigate to one level below.  
You are now in the parameter level of the group selected.
3. Use the  and  navigation keys to select the desired parameter.
4. Use the  key to navigate to one level below.  
You are now in the editing mode.
5. Set the desired value using the  and  navigation keys.
6. Use the  key to accept the changed setting.  
The editing mode is exited.  
Note: By using the  key you can exit the editing mode without accepting the new setting (abort).

# Commissioning

General information on parameter setting  
 Favorites  
 Favorites parameter list (default setting)



## 4.4.4.2 Favorites parameter list (default setting)

In the default setting, parameters for resolving typical applications are defined as "Favorites".

No.	Display code	Name	Default setting	Setting range	Information
1	P100.00	Inv. outp. freq.	x.x Hz	- (Read only)	0x2DDD
2	P103.00	Actual current	x.x %	- (Read only)	0x6078
3	P106.00	Motor voltage	x VAC	- (Read only)	0x2D89
4	P150.00	Error code	-	- (Read only)	0x603F
5	P200.00	Control select.	<b>Flexible I/O [0]</b>	Selection list	0x2824
6	P201.01	Freq. setp. src.	<b>Analog input 1 [2]</b>	Selection list	0x2860:001
7	P203.01	Start method	<b>Normal [0]</b>	Selection list	0x2838:001
8	P203.03	Stop method	<b>Standard ramp [1]</b>	Selection list	0x2838:003
9	P208.01	Mains voltage	<b>230 Veff [0]</b>	Selection list	0x2540:001
10	P210.00	Min. frequency	<b>0.0 Hz</b>	0.0 ... 599.0 Hz	0x2915
11	P211.00	Max. frequency	<b>50.0 Hz*   60.0 Hz**</b>	0.0 ... 599.0 Hz	0x2916
12	P220.00	Accelerat.time 1	<b>5.0 s</b>	0.0 ... 3600.0 s	0x2917
13	P221.00	Decelerat.time 1	<b>5.0 s</b>	0.0 ... 3600.0 s	0x2918
14	P300.00	Motor ctrl mode	<b>VFC open loop [6]</b>	Selection list	0x2C00
15	P302.00	V/f charac.shape	<b>Linear [0]</b>	Selection list	0x2B00
16	P303.01	Base voltage	type-dependent	0 ... 5000 V	0x2B01:001
17	P303.02	Base frequency	type-dependent	0 ... 1500 Hz	0x2B01:002
18	P304.00	Limit. rotation	<b>Both rot. direct [1]</b>	Selection list	0x283A
19	P305.00	Switching freq.	type-dependent	1 ... 33	0x2939
20	P306.01	Duty selection	<b>Heavy Duty [0]</b>	Selection list	0x2D43:001
21	P308.01	Max.load.for 60s	<b>150 %</b>	30 ... 200 %	0x2D4B:001
22	P316.01	Fixed V/f boost	type-dependent	0.0 ... 20.0 %	0x2B12:001
23	P323.00	Rated mot.curr.	type-dependent	0.001 ... 500.000 A	0x6075
24	P324.00	Max. current	<b>200.0 %</b>	0.0 ... 3000.0 %	0x6073
25	P400.01	Enable inverter	<b>TRUE [1]</b>	Trigger list <a href="#">73</a>	0x2631:001
26	P400.02	Run	<b>Digital input 1 [11]</b>	Trigger list <a href="#">73</a>	0x2631:002
27	P400.03	Quick stop	<b>Not connected [0]</b>	Trigger list <a href="#">73</a>	0x2631:003
28	P400.04	Reset fault	<b>Digital input 2 [12]</b>	Trigger list <a href="#">73</a>	0x2631:004
29	P400.05	DC braking	<b>Not connected [0]</b>	Trigger list <a href="#">73</a>	0x2631:005
30	P400.06	Start forward	<b>Not connected [0]</b>	Trigger list <a href="#">73</a>	0x2631:006
31	P400.07	Start reverse	<b>Not connected [0]</b>	Trigger list <a href="#">73</a>	0x2631:007
32	P400.08	Run forward	<b>Not connected [0]</b>	Trigger list <a href="#">73</a>	0x2631:008
33	P400.09	Run reverse	<b>Not connected [0]</b>	Trigger list <a href="#">73</a>	0x2631:009
34	P400.13	Reverse rot.dir.	<b>Digital input 3 [13]</b>	Trigger list <a href="#">73</a>	0x2631:013
35	P400.18	Setp: Preset b0	<b>Digital input 4 [14]</b>	Trigger list <a href="#">73</a>	0x2631:018
36	P400.19	Setp: Preset b1	<b>Digital input 5 [15]</b>	Trigger list <a href="#">73</a>	0x2631:019
37	P400.20	Setp: Preset b2	<b>Not connected [0]</b>	Trigger list <a href="#">73</a>	0x2631:020
38	P420.01	Relay function	<b>Rdy for operat. [51]</b>	Selection list	0x2634:001
39	P420.02	DO1 function	<b>Release brake [115]</b>	Selection list	0x2634:002
40	P430.01	AI1 input range	<b>0 ... 10 VDC [0]</b>	Selection list	0x2636:001
41	P430.02	AI1 freq @ min	<b>0.0 Hz</b>	-1000.0 ... 1000.0 Hz	0x2636:002
42	P430.03	AI1 freq @ max	<b>50.0 Hz*   60.0 Hz**</b>	-1000.0 ... 1000.0 Hz	0x2636:003
43	P440.01	AO1 outp. range	<b>0 ... 10 VDC [1]</b>	Selection list	0x2639:001
44	P440.02	AO1 function	<b>Outp. frequency [1]</b>	Selection list	0x2639:002
45	P440.03	AO1 min. signal	<b>0</b>	-2147483648 ... 2147483647	0x2639:003
46	P440.04	AO1 max. signal	<b>1000</b>	-2147483648 ... 2147483647	0x2639:004
47	P450.01	Freq. preset 1	<b>20.0 Hz</b>	0.0 ... 599.0 Hz	0x2911:001
48	P450.02	Freq. preset 2	<b>40.0 Hz</b>	0.0 ... 599.0 Hz	0x2911:002
49	P450.03	Freq. preset 3	<b>50.0 Hz*   60.0 Hz**</b>	0.0 ... 599.0 Hz	0x2911:003
50	P450.04	Freq. preset 4	<b>0.0 Hz</b>	0.0 ... 599.0 Hz	0x2911:004

\* Device for 50-Hz mains \*\* Device for 60-Hz mains





### 4.4.4.3 Configuring the "Favorites"

The "Favorites" can be configured by the user.

#### Details

A maximum number of 50 parameters can be defined as "Favorites".

The easiest way to process the selection of the favorites is via the parameterisation dialog in the »EASY Starter«:

1. Change to the "Parameter list" tab.
2. Select group 0 - Favorites.
3. Click the button.
4. Process favorites:

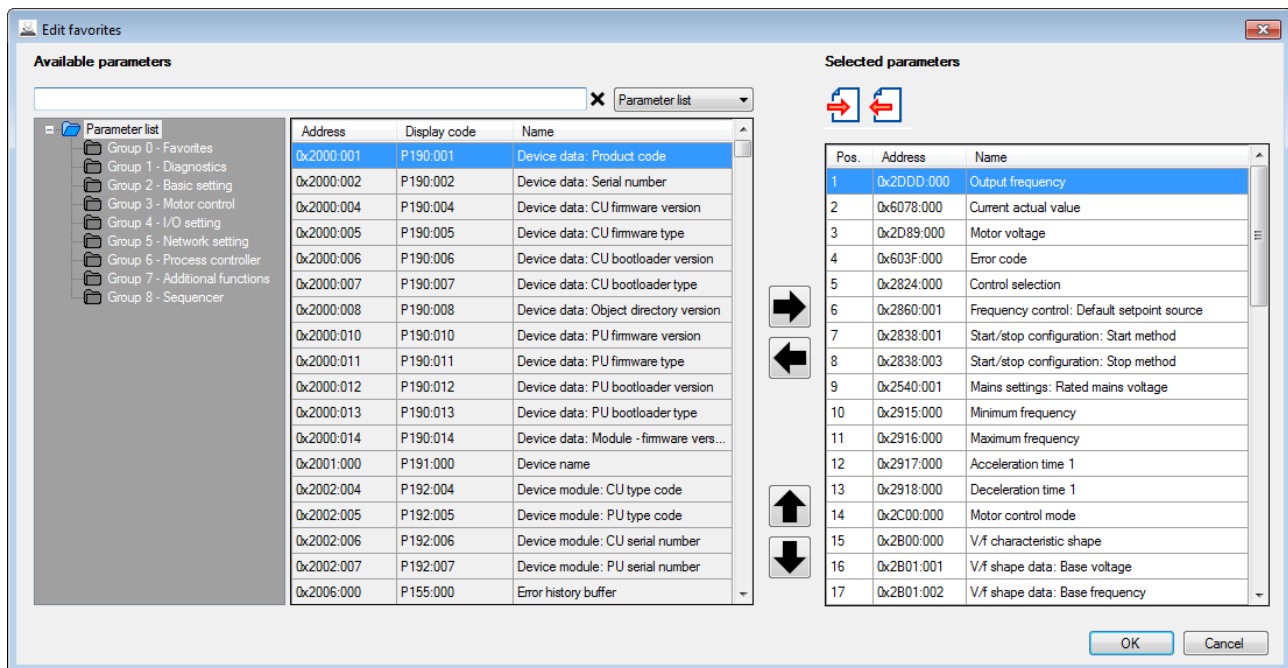

The default favorites can be modified using the keypad or via the network with the following parameters:

#### Parameter

Address	Name / setting range / [default setting]	Information
0x261C:001 (P740.01)	Favorites settings: Parameter 1 (Favorites sett.: Parameter 1) 0x00000000 ... [0x2DDD0000] ... 0xFFFFFFFF00	Definition of the "Favorites" parameters.
0x261C:002 (P740.02)	Favorites settings: Parameter 2 (Favorites sett.: Parameter 2) 0x00000000 ... [0x60780000] ... 0xFFFFFFFF00	<ul style="list-style-type: none"> <li>• Format: 0xiiii00 (iiii = hexadecimal index, ss = hexadecimal subindex)</li> <li>• The lowest byte is always 0x00.</li> </ul>
0x261C:003 (P740.03)	Favorites settings: Parameter 3 (Favorites sett.: Parameter 3) 0x00000000 ... [0x2D890000] ... 0xFFFFFFFF00	<ul style="list-style-type: none"> <li>• The keypad can be used to select the desired parameter from a list.</li> </ul>
0x261C:004 (P740.04)	Favorites settings: Parameter 4 (Favorites sett.: Parameter 4) 0x00000000 ... [0x603F0000] ... 0xFFFFFFFF00	
0x261C:005 (P740.05)	Favorites settings: Parameter 5 (Favorites sett.: Parameter 5) 0x00000000 ... [0x28240000] ... 0xFFFFFFFF00	
0x261C:006 (P740.06)	Favorites settings: Parameter 6 (Favorites sett.: Parameter 6) 0x00000000 ... [0x2860100] ... 0xFFFFFFFF00	
0x261C:007 (P740.07)	Favorites settings: Parameter 7 (Favorites sett.: Parameter 7) 0x00000000 ... [0x28380100] ... 0xFFFFFFFF00	

# Commissioning

General information on parameter setting

Favorites

Configuring the "Favorites"



Address	Name / setting range / [default setting]	Information
0x261C:008 (P740.08)	Favorites settings: Parameter 8 (Favorites sett.: Parameter 8) 0x00000000 ... [0x28380300] ... 0xFFFFFFFF00	
0x261C:009 (P740.09)	Favorites settings: Parameter 9 (Favorites sett.: Parameter 9) 0x00000000 ... [0x25400100] ... 0xFFFFFFFF00	
0x261C:010 (P740.10)	Favorites settings: Parameter 10 (Favorites sett.: Parameter 10) 0x00000000 ... [0x29150000] ... 0xFFFFFFFF00	
0x261C:011 (P740.11)	Favorites settings: Parameter 11 (Favorites sett.: Parameter 11) 0x00000000 ... [0x29160000] ... 0xFFFFFFFF00	
0x261C:012 (P740.12)	Favorites settings: Parameter 12 (Favorites sett.: Parameter 12) 0x00000000 ... [0x29170000] ... 0xFFFFFFFF00	
0x261C:013 (P740.13)	Favorites settings: Parameter 13 (Favorites sett.: Parameter 13) 0x00000000 ... [0x29180000] ... 0xFFFFFFFF00	
0x261C:014 (P740.14)	Favorites settings: Parameter 14 (Favorites sett.: Parameter 14) 0x00000000 ... [0x2C000000] ... 0xFFFFFFFF00	
0x261C:015 (P740.15)	Favorites settings: Parameter 15 (Favorites sett.: Parameter 15) 0x00000000 ... [0x2B000000] ... 0xFFFFFFFF00	
0x261C:016 (P740.16)	Favorites settings: Parameter 16 (Favorites sett.: Parameter 16) 0x00000000 ... [0x2B010100] ... 0xFFFFFFFF00	
0x261C:017 (P740.17)	Favorites settings: Parameter 17 (Favorites sett.: Parameter 17) 0x00000000 ... [0x2B010200] ... 0xFFFFFFFF00	
0x261C:018 (P740.18)	Favorites settings: Parameter 18 (Favorites sett.: Parameter 18) 0x00000000 ... [0x283A0000] ... 0xFFFFFFFF00	
0x261C:019 (P740.19)	Favorites settings: Parameter 19 (Favorites sett.: Parameter 19) 0x00000000 ... [0x29390000] ... 0xFFFFFFFF00	
0x261C:020 (P740.20)	Favorites settings: Parameter 20 (Favorites sett.: Parameter 20) 0x00000000 ... [0x2D430100] ... 0xFFFFFFFF00	
0x261C:021 (P740.21)	Favorites settings: Parameter 21 (Favorites sett.: Parameter 21) 0x00000000 ... [0x2D4B0100] ... 0xFFFFFFFF00	
0x261C:022 (P740.22)	Favorites settings: Parameter 22 (Favorites sett.: Parameter 22) 0x00000000 ... [0x2B120100] ... 0xFFFFFFFF00	
0x261C:023 (P740.23)	Favorites settings: Parameter 23 (Favorites sett.: Parameter 23) 0x00000000 ... [0x60750000] ... 0xFFFFFFFF00	
0x261C:024 (P740.24)	Favorites settings: Parameter 24 (Favorites sett.: Parameter 24) 0x00000000 ... [0x60730000] ... 0xFFFFFFFF00	
0x261C:025 (P740.25)	Favorites settings: Parameter 25 (Favorites sett.: Parameter 25) 0x00000000 ... [0x26310100] ... 0xFFFFFFFF00	
0x261C:026 (P740.26)	Favorites settings: Parameter 26 (Favorites sett.: Parameter 26) 0x00000000 ... [0x26310200] ... 0xFFFFFFFF00	
0x261C:027 (P740.27)	Favorites settings: Parameter 27 (Favorites sett.: Parameter 27) 0x00000000 ... [0x26310300] ... 0xFFFFFFFF00	
0x261C:028 (P740.28)	Favorites settings: Parameter 28 (Favorites sett.: Parameter 28) 0x00000000 ... [0x26310400] ... 0xFFFFFFFF00	



# Commissioning

General information on parameter setting  
Favorites  
Configuring the "Favorites"

Address	Name / setting range / [default setting]	Information
0x261C:029 (P740.29)	Favorites settings: Parameter 29 (Favorites sett.: Parameter 29) 0x00000000 ... [0x26310500] ... 0xFFFFFFFF00	
0x261C:030 (P740.30)	Favorites settings: Parameter 30 (Favorites sett.: Parameter 30) 0x00000000 ... [0x26310600] ... 0xFFFFFFFF00	
0x261C:031 (P740.31)	Favorites settings: Parameter 31 (Favorites sett.: Parameter 31) 0x00000000 ... [0x26310700] ... 0xFFFFFFFF00	
0x261C:032 (P740.32)	Favorites settings: Parameter 32 (Favorites sett.: Parameter 32) 0x00000000 ... [0x26310800] ... 0xFFFFFFFF00	
0x261C:033 (P740.33)	Favorites settings: Parameter 33 (Favorites sett.: Parameter 33) 0x00000000 ... [0x26310900] ... 0xFFFFFFFF00	
0x261C:034 (P740.34)	Favorites settings: Parameter 34 (Favorites sett.: Parameter 34) 0x00000000 ... [0x26310D00] ... 0xFFFFFFFF00	
0x261C:035 (P740.35)	Favorites settings: Parameter 35 (Favorites sett.: Parameter 35) 0x00000000 ... [0x26311200] ... 0xFFFFFFFF00	
0x261C:036 (P740.36)	Favorites settings: Parameter 36 (Favorites sett.: Parameter 36) 0x00000000 ... [0x26311300] ... 0xFFFFFFFF00	
0x261C:037 (P740.37)	Favorites settings: Parameter 37 (Favorites sett.: Parameter 37) 0x00000000 ... [0x26311400] ... 0xFFFFFFFF00	
0x261C:038 (P740.38)	Favorites settings: Parameter 38 (Favorites sett.: Parameter 38) 0x00000000 ... [0x26340100] ... 0xFFFFFFFF00	
0x261C:039 (P740.39)	Favorites settings: Parameter 39 (Favorites sett.: Parameter 39) 0x00000000 ... [0x26340200] ... 0xFFFFFFFF00	
0x261C:040 (P740.40)	Favorites settings: Parameter 40 (Favorites sett.: Parameter 40) 0x00000000 ... [0x26360100] ... 0xFFFFFFFF00	
0x261C:041 (P740.41)	Favorites settings: Parameter 41 (Favorites sett.: Parameter 41) 0x00000000 ... [0x26360200] ... 0xFFFFFFFF00	
0x261C:042 (P740.42)	Favorites settings: Parameter 42 (Favorites sett.: Parameter 42) 0x00000000 ... [0x26360300] ... 0xFFFFFFFF00	
0x261C:043 (P740.43)	Favorites settings: Parameter 43 (Favorites sett.: Parameter 43) 0x00000000 ... [0x26390100] ... 0xFFFFFFFF00	
0x261C:044 (P740.44)	Favorites settings: Parameter 44 (Favorites sett.: Parameter 44) 0x00000000 ... [0x26390200] ... 0xFFFFFFFF00	
0x261C:045 (P740.45)	Favorites settings: Parameter 45 (Favorites sett.: Parameter 45) 0x00000000 ... [0x26390300] ... 0xFFFFFFFF00	
0x261C:046 (P740.46)	Favorites settings: Parameter 46 (Favorites sett.: Parameter 46) 0x00000000 ... [0x26390400] ... 0xFFFFFFFF00	
0x261C:047 (P740.47)	Favorites settings: Parameter 47 (Favorites sett.: Parameter 47) 0x00000000 ... [0x29110100] ... 0xFFFFFFFF00	
0x261C:048 (P740.48)	Favorites settings: Parameter 48 (Favorites sett.: Parameter 48) 0x00000000 ... [0x29110200] ... 0xFFFFFFFF00	
0x261C:049 (P740.49)	Favorites settings: Parameter 49 (Favorites sett.: Parameter 49) 0x00000000 ... [0x29110300] ... 0xFFFFFFFF00	

# Commissioning

General information on parameter setting

Favorites

Configuring the "Favorites"



Address	Name / setting range / [default setting]	Information
0x261C:050 (P740.50)	Favorites settings: Parameter 50 (Favorites sett.: Parameter 50) 0x00000000 ... [0x29110400] ... 0xFFFFFFFF00	



## 4.5 Saving the parameter settings

### 4.5.1 Save parameter settings with keypad

If one parameter setting has been changed with the keypad but has not been saved in the memory module with mains failure protection, the SET display is blinking.

In order to save parameter settings in the user memory of the memory module, press and hold the enter key for longer than 3 s.



### 4.5.2 Save parameter settings with »EASY Starter«

If a parameter setting has been changed with the »EASY Starter« but not yet saved in the memory medium with mains failure protection, the status line of the »EASY Starter« displays the note "The parameter set was changed".

There are 3 options to save the parameter settings in the user memory of the storage medium

- Click the button in the toolbar of the »EASY Starter« .
- Press the function key **F6**.
- Execute the device command "Save user data": [0x2022:003 \(P700.03\)](#) = "On / start [1]".

### 4.5.3 Saving the settings

#### Parameter

Address	Name / setting range / [default setting]	Information
0x2829 (P732.00)	Automatic storage in the memory module (Auto-Save EPM)	1 = Activate automatic saving of parameters in the memory module. Saving is undertaken to a parameter stored on the memory module with each write cycle. An excessively high number of write cycles reduces the service life of the memory module. <ul style="list-style-type: none"> <li>• With the setting 0, the "Save user data" <a href="#">0x2022:003 (P700.03)</a> device command must be explicitly executed, or the enter key must be pressed and held for longer than 3 s to save the current parameter settings in the memory module of the inverter with mains failure protection.</li> </ul> <b>Warning</b> The "Automatic saving" function must not be used together with cyclical writing of parameters via PDO.
	0 Inhibit 1 Enable	



## 5 Basic setting

### 5.1 Device name

#### Parameter

Address	Name / setting range / [default setting]	Information
0x2001 (P191.00)	Device name (Device name) ["My Device"]	Any device name can be set in this object for the purpose of device identification.



## 5.2 Mains voltage

The rated mains voltage set for the inverter has an impact on the operating range of the inverter.

### Details

By default, the rated mains voltage in [0x2540:001 \(P208.01\)](#) is set according to the product code of the inverter.



Check the setting of the rated mains voltage in [0x2540:001 \(P208.01\)](#). Ensure that it matches the mains voltage applied!

Region	Inverter	Product code <a href="#">0x2000:001 (P190.01)</a>	Rated mains voltage	
			Default setting	Possible settings
EU	i500, 230 V, 1-phase	i55xxxxxBxxxx0xxxx	230 Veff [0]	230 Veff [0]
US	i500, 230 V, 1-phase	i55xxxxxBxxxx1xxxx	230 Veff [0]	230 Veff [0]
EU	i500, 230 V, 1/3-phase	i55xxxxxDxxxx0xxxx	230 Veff [0]	230 Veff [0]
US	i500, 230 V, 1/3-phase	i55xxxxxDxxxx1xxxx	230 Veff [0]	230 Veff [0]
EU	i500, 400 V, 3-phase	i55xxxxxFxxxx0xxxx	400 Veff [1]	400 Veff [1], 480 Veff [2]
US	i500, 480 V, 3-phase	i55xxxxxFxxxx1xxxx	480 Veff [2]	400 Veff [1], 480 Veff [2]
EU	i500, 120 V, 1-phase	i55xxxxxAxxxx0xxxx	120 Veff [3]	120 Veff [3]
US	i500, 120 V, 1-phase	i55xxxxxAxxxx1xxxx	120 Veff [3]	120 Veff [3]

Notes regarding the table:

- The inverter types 400/480 V can be used with different mains voltages. For establishing the internal limit values, the rated mains voltage can be set in [0x2540:001 \(P208.01\)](#).
- The inverter types 120 V are designed for a 1-phase 120-V mains voltage and 3-phase 230-V three-phase AC motors. These inverters have an internal DC bus similar to the 230-V inverters. The voltage thresholds correspond to the ones of the 230-V inverters.
- If the inverter is reset to the factory settings, the rated mains voltage is also reset to the default setting (see table).

The following results from the rated mains voltage set:

- the error threshold for monitoring the DC-bus voltage and
- the voltage threshold for braking operation ("brake chopper threshold").

### Monitoring of the DC-bus voltage

- The warning thresholds for monitoring are adjustable.
- The error thresholds and reset thresholds for monitoring result from the rated mains voltage set:

Rated mains voltage	Undervoltage thresholds			Overvoltage thresholds		
	Warning threshold	Error threshold	Reset threshold	Warning threshold	Error threshold	Reset threshold
Setting in <a href="#">0x2540:001 (P208.01)</a>	Setting in <a href="#">0x2540:002 (P208.02)</a>	Display in <a href="#">0x2540:003 (P208.03)</a>	Display in <a href="#">0x2540:004 (P208.04)</a>	Setting in <a href="#">0x2540:005 (P208.05)</a>	Display in <a href="#">0x2540:006 (P208.06)</a>	Display in <a href="#">0x2540:007 (P208.07)</a>

- If the DC-bus voltage of the inverter falls below the undervoltage error threshold, the "Trouble" response is triggered.
  - Without external 24-V supply: the motor behaves according to [0x2838:002 \(P203.02\)](#).
  - With external 24-V supply: at undervoltage, the motor behaves according to "Trouble" response.
- If the DC-bus voltage of the inverter exceeds the overvoltage error threshold, the "Fault" response is triggered.



The motor does not restart automatically after the overvoltage monitoring function has been activated.

# Basic setting

## Mains voltage



### Parameter

Address	Name / setting range / [default setting]	Information
0x2540:001 (P208.01)	Mains settings: Rated mains voltage (Mains settings: Mains voltage) <ul style="list-style-type: none"> <li>Setting can only be changed if the inverter is disabled.</li> </ul>	Selection of the mains voltage for actuating the inverter.
	<b>0</b> 230 Veff	
	1 400 Veff	
	2 480 Veff	
	3 120 Veff	
	5 480 Veff (600 V devices)	
	6 600 Veff	
	10 230 Veff/reduced LU level	
0x2540:002 (P208.02)	Mains settings: Undervoltage warning threshold (Mains settings: LU warn. thresh.) 0 ... [0]* ... 1000 V * Default setting dependent on the model.	Monitoring for undervoltage (LU) in the DC bus: Setting of the warning threshold. <ul style="list-style-type: none"> <li>If the DC voltage in the DC bus falls below the threshold set, the inverter outputs a warning.</li> <li>The warning is reset with a hysteresis of 10 V.</li> </ul>
0x2540:003 (P208.03)	Mains settings: Undervoltage error threshold (Mains settings: LU error thresh.) <ul style="list-style-type: none"> <li>Read only: x V</li> </ul>	Monitoring for undervoltage (LU) in the DC bus: Display of the fixed threshold. <ul style="list-style-type: none"> <li>If the DC voltage in the DC bus falls below the threshold displayed, the error"" response is triggered.</li> </ul>
0x2540:004 (P208.04)	Mains settings: Undervoltage reset threshold (Mains settings: LU reset thresh.) <ul style="list-style-type: none"> <li>Read only: x V</li> </ul>	Display of the fixed reset threshold for monitoring DC bus undervoltage.
0x2540:005 (P208.05)	Mains settings: Overvoltage warning threshold (Mains settings: OU warn. thresh.) 0 ... [0]* ... 1000 V * Default setting dependent on the model.	Monitoring for overvoltage (OU) in the DC bus: Setting of the warning threshold. <ul style="list-style-type: none"> <li>If the DC bus voltage exceeds the threshold set, the inverter outputs a warning.</li> <li>The warning is reset with a hysteresis of 10 V.</li> </ul>
0x2540:006 (P208.06)	Mains settings: Overvoltage error threshold (Mains settings: OU error thresh.) <ul style="list-style-type: none"> <li>Read only: x V</li> </ul>	Monitoring for overvoltage (OU) in the DC bus: Display of the fixed threshold. <ul style="list-style-type: none"> <li>If the DC-bus voltage exceeds the threshold displayed, the "Fault" response is triggered.</li> </ul>
0x2540:007 (P208.07)	Mains settings: Overvoltage reset threshold (Mains settings: OU reset thresh.) <ul style="list-style-type: none"> <li>Read only: x V</li> </ul>	Display of the fixed reset threshold for monitoring DC bus overvoltage.





## 5.3 Dual rating

The inverter has two different load characteristics: "Light Duty" and "Heavy Duty". The load characteristic "Light Duty" enables a higher output current with restrictions regarding overload capacity, ambient temperature and switching frequency. As a result, the motor can be driven by a less powerful inverter. The selected load characteristic depends on the application.

### NOTICE

Load characteristic "Light Duty"

In order to avoid irreversible damage to the inverter/motor:

- ▶ Based on the configuration document, check whether the inverter can be operated with the load characteristic "Light Duty".
- ▶ Comply with all data in the configuration document for this load characteristic and the corresponding mains voltage range. Among other things, this includes information on the type of installation and required fuses, cable cross-sections, mains chokes and filters.
- ▶ Set the parameters only in accordance with the following specifications .

### Details

The following table compares the two load characteristics:

	Duty selection 0x2D43:001 (P306.01)	
	"Heavy Duty [0]"	"Light Duty [1]"
Characteristics	High dynamic requirements	Low dynamic requirements
Typical applications	Main tool drives, travelling drives, hoist drives, winders, forming drives, and conveyors.	Centrifugal pumps, fans, general horizontal materials handling technology, line drives and centrifugal pumps.
Overload capacity	3 s/200 %, 60 s/150 % For details see configuration document	Reduced overload For details see configuration document



If the inverter is reset to the default setting, the load characteristic is set to "Heavy Duty [0]".

### Parameter

Address	Name / setting range / [default setting]	Information
0x2D43:001 (P306.01)	Inverter load characteristic: Duty selection (Inv. load char.: Duty selection) • Setting can only be changed if the inverter is disabled.	Selection of the load characteristic. Further required settings: • Set the data of the motor used. • Set application-specific parameters such as current limits.
	0 Heavy Duty	Load characteristic for high dynamic requirements.
	1 Light Duty	Load characteristic for low dynamic requirements. • The device overload monitoring (i*t) is adapted. <b>⚠ CAUTION!</b> Observe the information in the configuration document for this load characteristic.

### Related topics

- ▶ [Motor data](#) 57
- ▶ [Maximum overload current of the inverter](#) 267



## 5.4 Frequency limits

The frequency range can be limited by setting a minimum and maximum frequency.

### Parameter

Address	Name / setting range / [default setting]	Information
0x2915 (P210.00)	Minimum frequency (Min. frequency) 0.0 ... [0.0] ... 599.0 Hz	Lower limit value for all frequency setpoints.
0x2916 (P211.00)	Maximum frequency (Max. frequency) Device for 50-Hz mains: 0.0 ... [50.0] ... 599.0 Hz Device for 60-Hz mains: 0.0 ... [60.0] ... 599.0 Hz	Upper limit value for all frequency setpoints.



## 5.5 Start behavior

The start can be optionally made with DC braking or flying restart circuit. Moreover, an automatic start can be activated after switch-on.

### Details

The start method can be selected in [0x2838:001 \(P203.01\)](#). The following diagram demonstrates the different start methods:

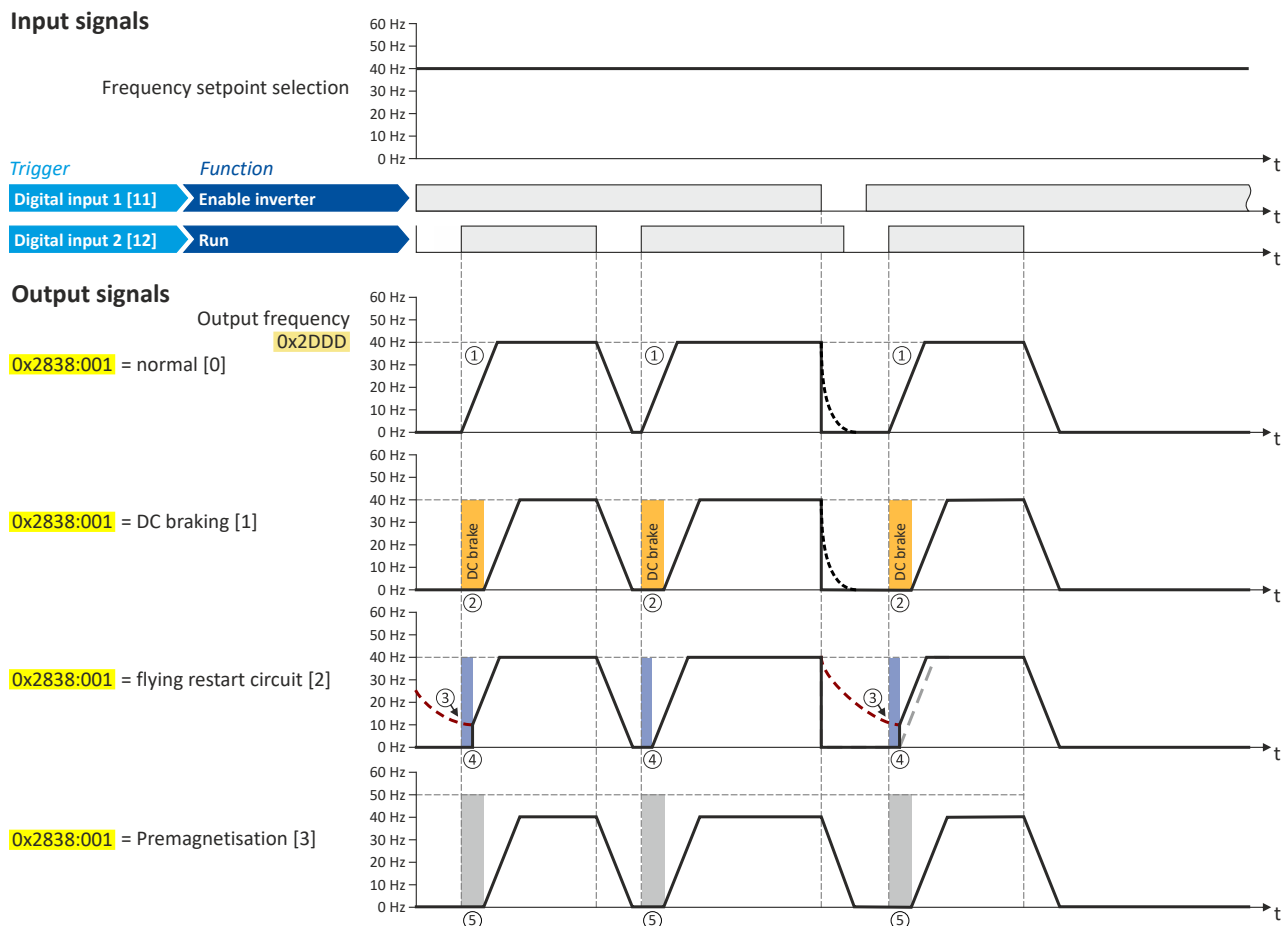

- ① Start method = "Normal [0]": After the start command, the motor is accelerated to the setpoint with the set acceleration time.
- ② Start method = "DC braking [1]": After the start command, the "DC braking" function is active. Only after the hold time set in [0x2B84:002 \(P704.02\)](#) has elapsed is the motor accelerated to the setpoint with the set acceleration time.  
▶ [DC braking](#) □ 221
- ③ For demonstrating the flying restart circuit: At the time of the start command, the motor is not at a standstill (for instance due to loads with high inertia such as fans or flywheels).
- ④ Start method = "Flying restart circuit [2]": After the start command, the flying restart circuit is active. The flying restart circuit serves to restart a coasting motor on the fly during operation without speed feedback. The synchronicity between inverter and motor is coordinated so that the transition to the rotating motor is effected without jerk at the time of connection.  
▶ [Flying restart circuit](#) □ 209
- ⑤ Start method = "Pre-magnetisation [3]": normal start and premagnetisation - this setting corresponds to the setting [0] normal, but adds the premagnetisation of the motor before the motor rotation begins. The premagnetisation property is generally relevant when operating in V/f motor control modes.

Some asynchronous motors which have a lower stator resistance can experience high amperages when accelerating from a stopped/deactivated state. The premagnetisation property can reduce the motor current during the acceleration and is able to generate a more even acceleration curve with this motor. A property of the start method is a slight delay before the motor acceleration begins.



### Automatic start after switching on the mains voltage

The automatic start can be activated in [0x2838:002 \(P203.02\)](#).

Preconditions for the automatic start:

- The flexible I/O configuration is selected: [0x2824 \(P200.00\)](#) = "Flexible I/O configuration [0]"
- For the start command, a digital input has been configured. (In case of keypad or activated network control, an automatic start is not possible.)

The following diagram demonstrates the function:

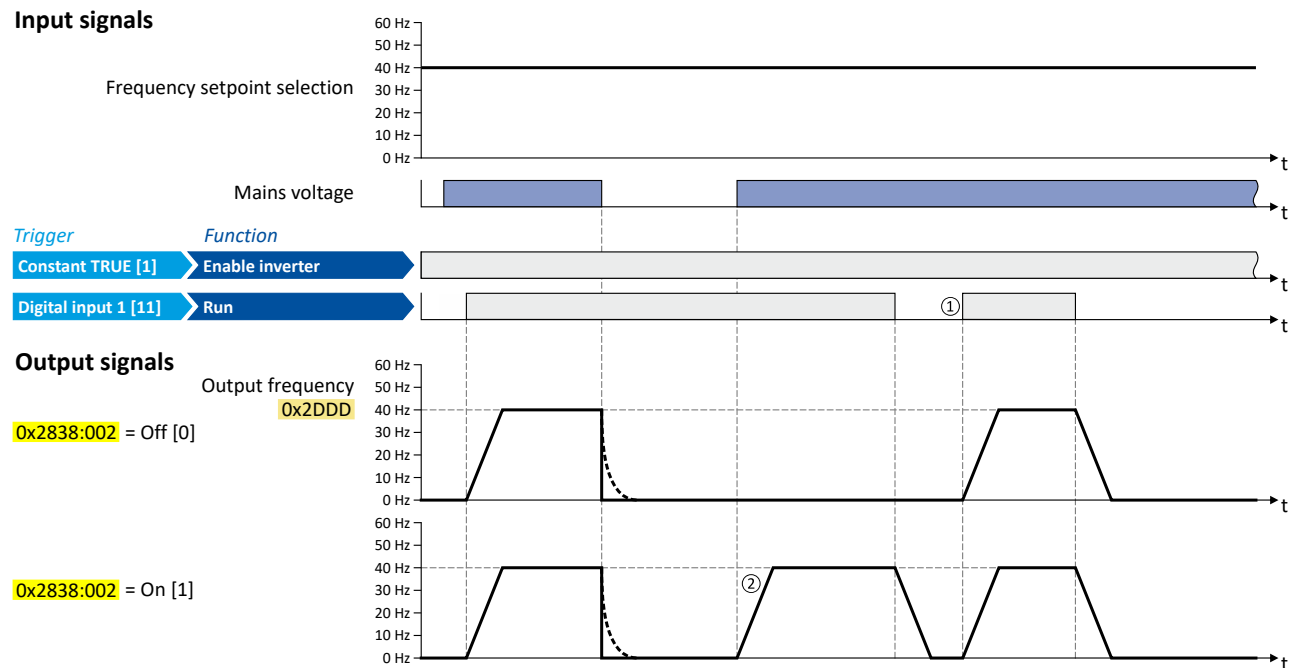

- ① Start at power-up = "Off [0]": After switching on the mains voltage, a renewed start command is required to start the motor.
- ② Start at power-up = "On [1]": After switching on the mains voltage, the motor starts automatically if a start command is present.



### Parameter

Address	Name / setting range / [default setting]	Information
0x2838:001 (P203.01)	Start/stop configuration: Start method (Start/stop cfg: Start method) <ul style="list-style-type: none"> <li>Setting can only be changed if the inverter is disabled.</li> </ul>	Response after starting command.
	<b>0 Normal</b>	After start command, the standard ramps are active. <ul style="list-style-type: none"> <li>Acceleration time 1 can be set in <a href="#">0x2917 (P220.00)</a>.</li> <li>Deceleration time 1 can be set in <a href="#">0x2918 (P221.00)</a>.</li> </ul>
	1 DC braking	After start command, the "DC braking" function is active for the time set in <a href="#">0x2B84:002 (P704.02)</a> . <a href="#">▶ DC braking ☐ 221</a> <b>⚠ CAUTION!</b> Deactivate automatic DC braking, if a holding brake is used.
	2 Flying restart circuit	After the start command, the flying restart circuit is active. The flying restart function makes it possible to restart a coasting motor during operation without speed feedback. The course between the inverter and motor is coordinated so that the transition to the rotating motor is effected without jerk at the time of connection. <a href="#">▶ Flying restart circuit ☐ 209</a>
	3 Pre-magnetisation (from version 05.03)	This setting corresponds to the setting [0] Normal, but adds the premagnetisation of the motor before the rotation/acceleration begins. The premagnetisation can reduce the motor current during the acceleration and generate a more even acceleration curve (by avoiding overcurrent situations). The premagnetisation function is relevant when operating in V/f motor control modes. The premagnetisation causes a slight delay before the motor acceleration begins (typically 50-200 ms, depending on motor characteristic).
0x2838:002 (P203.02)	Start/stop configuration: Start at power-up (Start/stop cfg: Start at powerup)	Start behavior after switching on the mains voltage.
	<b>0 Off</b>	No automatic start after switching on mains voltage. In addition to the inverter enable, a renewed start command is always required to start the motor.
	1 On	Automatic start of the motor after switching on the mains voltage if the inverter is enabled and a start command exists.

### Related topics

▶ [Start, stop and rotating direction commands ☐ 62](#)



## 5.6 Stop behavior

In the default setting, the motor is brought to a standstill after a stop command with standard ramp. Alternatively, coasting, ramping down with quick stop ramp or a switch-off positioning can be selected.

### Details

The stop method can be selected in `0x2838:003 (P203.03)`. The following diagram demonstrates the different stop methods:

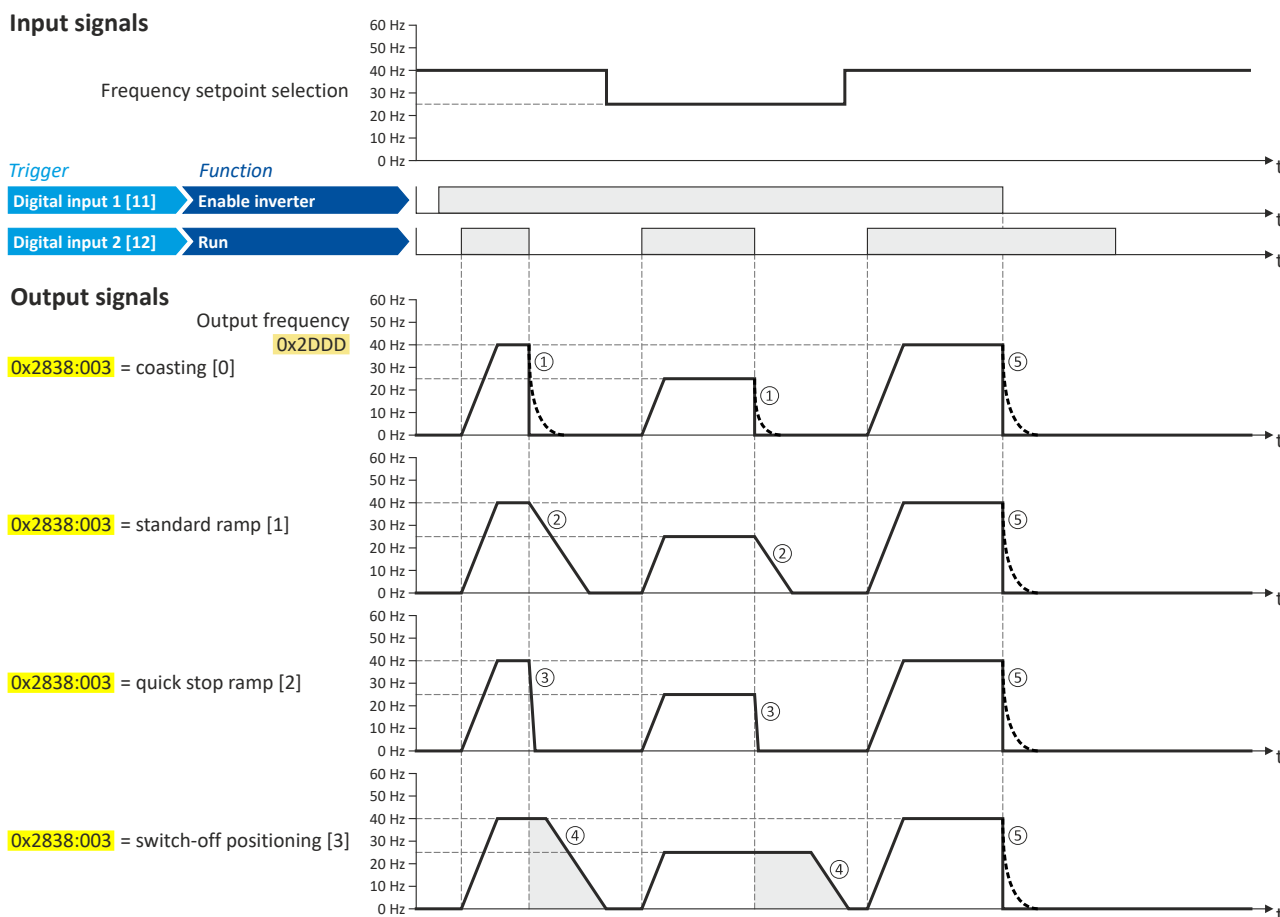

- ① Stop method = "Coasting [0]": The motor coasts down.
- ② Stop method = "Standard ramp [1]": The motor is brought to standstill with a deceleration time 1 (here: 10 s).
- ③ Stop method = "Quick stop ramp [2]": The motor is brought to a standstill with the deceleration time for quick stop (here: 1 s).
- ④ Stop method = "Switch-off positioning [3]": this method is similar to the stop method "Standard ramp". Depending on the current output frequency, however, the inverter delays the beginning of the down-ramping so that the number of motor revolutions until a standstill is reached and thus the stopping position is always relatively constant.
- ⑤ If "Enable inverter" is set to FALSE, the inverter is disabled. The motor has no torque and coasts to standstill depending on the mass inertia of the machine (irrespective of the set stop method).



### Parameter

Address	Name / setting range / [default setting]	Information
0x2838:003 (P203.03)	Start/stop configuration: Stop method (Start/stop config: Stop method)	Response after stop command.
	0 Coasting	The motor has no torque (coasts down to standstill).
	1 <b>Standard ramp</b>	The motor is brought to a standstill with deceleration time 1 (or deceleration time 2, if activated). <ul style="list-style-type: none"> <li>Deceleration time 1 can be set in <a href="#">0x2918 (P221.00)</a>.</li> <li>Deceleration time 2 can be set in <a href="#">0x291A (P223.00)</a>.</li> </ul> <a href="#">▶ Ramp times</a> <a href="#">□ 95</a>
	2 Quick stop ramp	The motor is brought to a standstill with the deceleration time set for the "Quick stop" function. <ul style="list-style-type: none"> <li>Deceleration time for quick stop can be set in <a href="#">0x291C (P225.00)</a>.</li> <li>The "quick stop" function can also be activated manually, for instance via a digital input. <a href="#">▶ Flexible I/O configuration of the start, stop and rotating direction commands</a> <a href="#">□ 67</a></li> </ul>
3 Switch-off positioning (from version 05.01)	Is similar to the stop method "Standard ramp [1]". Depending on the current output frequency, however, the inverter delays the beginning of the down-ramping so that the number of motor revolutions until a standstill and thus the stopping position is always relatively constant. <ul style="list-style-type: none"> <li><a href="#">▶ "Switch-off positioning" stop mode</a> <a href="#">□ 158</a></li> </ul>	



## 5.7 Function assignment of the inputs and outputs (default setting)

By default, the inverter can be controlled via the I/O terminals as follows:

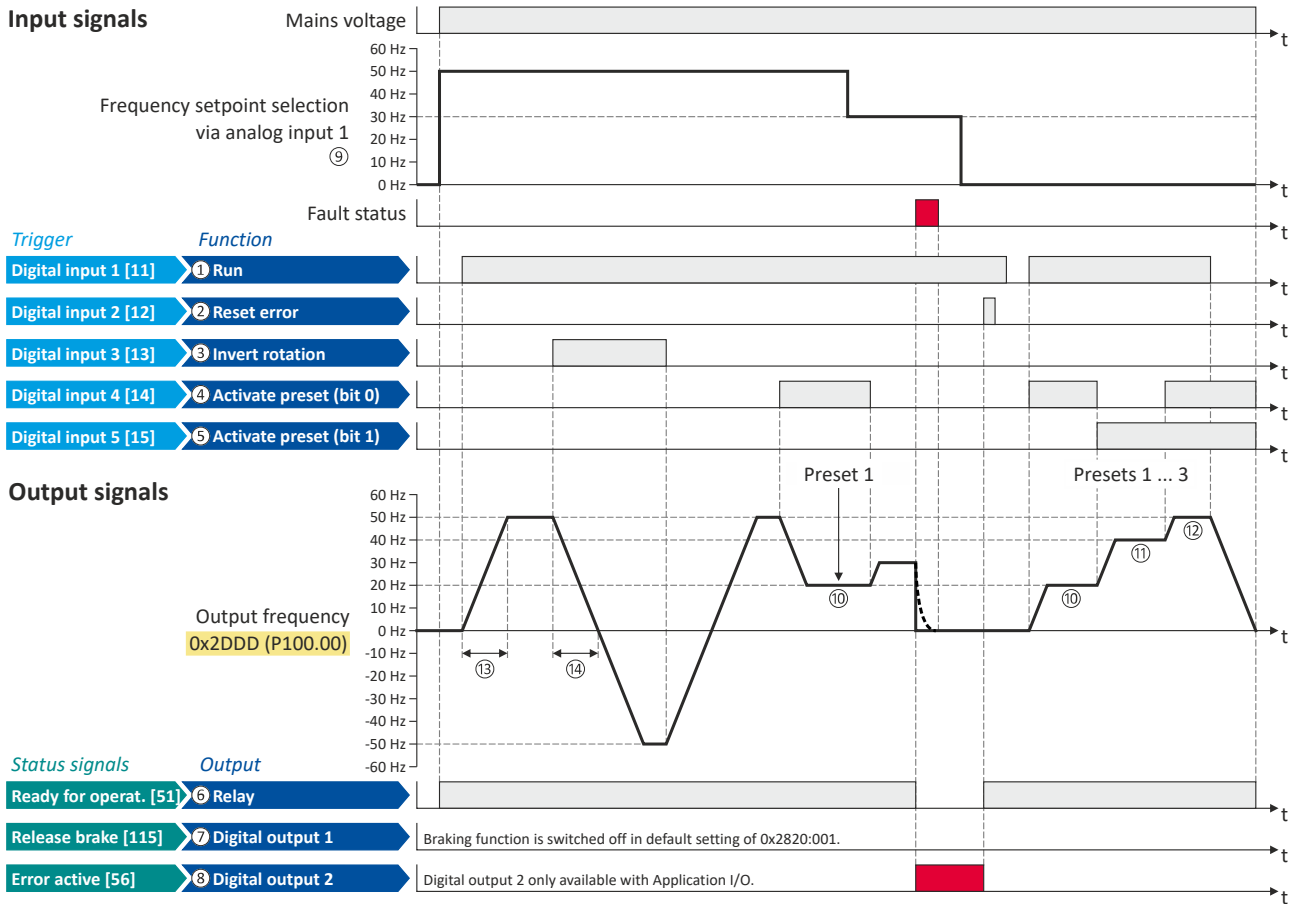

Parameter	Designation	Default setting
<b>Control functions</b>		
①	0x2631:002 (P400.02)	Run
②	0x2631:004 (P400.04)	Reset fault
③	0x2631:013 (P400.13)	Reverse rotational direction
④	0x2631:018 (P400.18)	Activate preset (bit 0)
⑤	0x2631:019 (P400.19)	Activate preset (bit 1)
<b>Configuration of digital outputs</b>		
⑥	0x2634:001 (P420.01)	Relay
⑦	0x2634:002 (P420.02)	Digital output 1
⑧	0x2634:003 (P420.03)	Digital output 2 (only for application I/O)
<b>Settings for the frequency setpoint</b>		
④	0x2860:001 (P201.01)	Frequency control: Default setpoint source
⑩	0x2911:001 (P450.01)	Frequency setpoint presets: Preset 1
⑪	0x2911:002 (P450.02)	Frequency setpoint presets: Preset 2
⑫	0x2911:003 (P450.03)	Frequency setpoint presets: Preset 3
⑬	0x2917 (P220.00)	Acceleration time 1
⑭	0x2918 (P221.00)	Deceleration time 1

All functional possible settings for controlling the inverter are described in the "Start, stop and rotating direction commands" chapter. [62](#)





## 5.8 Motor data

The term "motor data" comprises all parameters only depending on the motor and only characterising the electrical behaviour of the motor. Motor data are independent of the application in which the inverter and the motor are used.

### Preconditions

The equivalent circuit data ("Settings" tab, path: "Basic setting\motor", parameterisation dialog "Derived motor properties and equivalent circuit") apply to a motor in star connection. In case of a motor in delta connection, the delta values must be converted into equivalent star values.

### Possible settings

If a Lenze motor is connected to the inverter, you can select the motor in the engineering tool from the "motor catalogue".

- For details see chapter "[Select motor from motor catalog](#)". [📖 58](#)

Otherwise the motor data must be set manually (for details see chapter "[Manual setting of the motor data](#)"). [📖 59](#)

# Basic setting

Motor data

Select motor from motor catalog



## 5.8.1 Select motor from motor catalog

The following describes how to parameterise your drive system by selecting a Lenze motor from the motor catalogue. Several processes are started invisibly in the background to load/ calculate the settings for the relevant parameters.

### Preconditions

- Access to a Lenze engineering tool (e. g. »EASY Starter«).
- Parameters can be set online or offline (with or without connected motor).

### Required steps

1. Open the Lenze engineering tool that provides for the functionality of a "Motor catalog".
2. Click the **Select motor...** button. In case of the »EASY Starter«, you find the **Select motor...** button on the "settings". tab.
3. Select the motor used in the "Select motor" dialog:

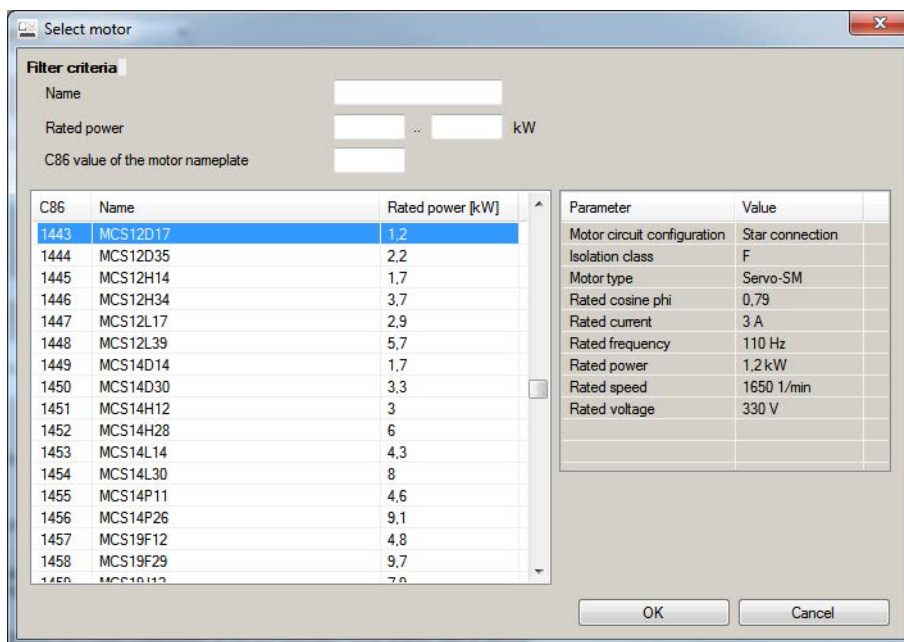

By entering filter criteria, you can restrict the selection.

Name (e. g. "MCS..."), rated power and C86 value can be found on the motor nameplate.

4. Press the **Please select** button to select the thermal sensor.

This is not required for all motors. For older motors, such as MDSKA056-22 (C86=10), a thermal sensor **CANNOT** be selected.



Observe the notes on the ? button.

5. Click the **OK** button to start the optimisation.



### Parameterisation sequence

As soon as the parameterisation has been started, the following steps are initiated by the engineering tool:

1. The motor rating data and the motor equivalent circuit diagram data are loaded from the motor catalogue.
2. The motor controller settings and the speed controller settings are automatically calculated based on the previously loaded data.

Notes:

- The data involved in this parameterisation are provided by the motor catalog alone. Further user data is not required.
- The inverter characteristic is not changed by this optimisation.

### Parameter

Address	Name / setting range / [default setting]	Information
0x2C01:010	Motor parameters: Motor name	The name (e.g. "1") can be freely selected by the user. If the motor in the engineering tool has been selected from the "motor catalog", the respective motor name is automatically entered here (example: "MDSKA080-22, 70").

## 5.8.2 Manual setting of the motor data

Manually set the motor data in accordance with the manufacturer's information / motor data sheet in the following parameters, provided that a third party motor is connected to the inverter.

### Parameter

Address	Name / setting range / [default setting]	Information
0x2910:001 (P335.01)	Inertia settings: Motor moment of inertia (Moment of inert.: Motor inertia) 0.00 ... [3.70]* ... 20000000.00 kg cm <sup>2</sup> * Default setting dependent on the model.	Setting of the moment of inertia of the motor, relating to the motor.
0x2C01:001	Motor parameters: Number of pole pairs • Read only	Display of the number of pole pairs calculated from the rated speed and rated frequency.
0x2C01:002	Motor parameters: Stator resistance 0.0000 ... [10.1565]* ... 125.0000 Ω * Default setting dependent on the model.	General motor data. Carry out settings as specified by manufacturer data/motor data sheet.
0x2C01:003	Motor parameters: Stator leakage inductance 0.000 ... [23.566]* ... 500.000 mH * Default setting dependent on the model.	Note! When you enter the motor nameplate data, take into account the phase connection implemented for the motor (star or delta connection). Only enter the data applying to the connection type selected.
0x2C01:004 (P320.04)	Motor parameters: Rated speed (Motor parameters: Rated speed) Device for 50-Hz mains: 50 ... [1450] ... 50000 rpm Device for 60-Hz mains: 50 ... [1750] ... 50000 rpm	General motor data. Carry out settings as specified by motor nameplate data.
0x2C01:005 (P320.05)	Motor parameters: Rated frequency (Motor parameters: Rated frequency) Device for 50-Hz mains: 1.0 ... [50.0] ... 1000.0 Hz Device for 60-Hz mains: 1.0 ... [60.0] ... 1000.0 Hz	Note! When you enter the motor nameplate data, take into account the phase connection implemented for the motor (star or delta connection). Only enter the data applying to the connection type selected.
0x2C01:006 (P320.06)	Motor parameters: Rated power (Motor parameters: Rated power) 0.00 ... [0.25]* ... 655.35 kW * Default setting dependent on the model.	
0x2C01:007 (P320.07)	Motor parameters: Rated voltage (Motor parameters: Rated voltage) 0 ... [230]* ... 65535 V * Default setting dependent on the model.	
0x2C01:008 (P320.08)	Motor parameters: Cosine phi (Motor parameters: Cosine phi) 0.00 ... [0.80] ... 1.00	

# Basic setting

Motor data  
Motor mounting direction



Address	Name / setting range / [default setting]	Information
0x2C02:003 (P351.03)	Motor parameter (ASM): Magnetising current (ASM motor par.: Magn. current) 0.00 ... [0.96]* ... 500.00 A * Default setting dependent on the model.	Equivalent circuit data required for the motor model of the asynchronous machine.
0x2C03:001 (P352.01)	Motor parameter (PSM): Back EMF constant (PSM motor par.: BEMF constant) 0.0 ... [41.8] ... 100000.0 V/1000rpm • From version 02.00	Voltage induced by the motor (rotor voltage / 1000 rpm). For permanently excited synchronous motors, the e.m.f. constant describes the r.m.s. value of the line-to-line voltage (phase voltage) induced in idle state by the motor (reference: 1000 rpm, 20 °C). Measured: Line to Line (L - L)
0x6075 (P323.00)	Rated motor current (Rated mot.curr.) 0.001 ... [1.700]* ... 500.000 A * Default setting dependent on the model. • Setting can only be changed if the inverter is disabled.	The rated motor current that needs to be set here serves as a reference value for different parameters that involve a setting for/display of a current value in percent.  Example: • Rated motor current = 1.7 A • Max. current 0x6073 (P324.00) = 200 % Rated motor current = 3.4 A
0x6076 (P325.00)	Rated motor torque (Rated mot torque) 0.001 ... [1.650]* ... 4294967.295 Nm * Default setting dependent on the model. • Setting can only be changed if the inverter is disabled.	The rated motor torque to be set here serves as a reference value for different parameters with a setting/display of a torque value in percent.  Example: • Rated motor torque = 1.65 Nm • Max. torque 0x6072 (P326.00) = 250 % Rated motor torque = 4.125 Nm
0x6080 (P322.00)	Max. motor speed (Max. motor speed) 0 ... [6075] ... 480000 rpm	Limitation of the max. motor speed. Depending on the parameter setting of 0x2D44:001 (P350.01) (Overspeed monitoring: threshold), the speed limitation (0x6080 / Max. motor speed) may become active before speed monitoring.

## 5.8.3 Motor mounting direction

### Parameter

Address	Name / setting range / [default setting]	Information
0x2811:003	Motor mounting direction • Setting can only be changed if the inverter is disabled. • From version 06.04	Setting a motor attachment rotated by 180°.
	0 Not inverted	
	1 Inverted	



## 5.9 Motor control mode

The inverter supports different modes for closed-loop/open-loop motor control.

### Parameter

Address	Name / setting range / [default setting]	Information
0x2C00 (P300.00)	Motor control mode (Motor ctrl mode) <ul style="list-style-type: none"> <li>Setting can only be changed if the inverter is disabled.</li> </ul>	Selection of the motor control mode.
2	Servo control (SC ASM) (from version 02.00)	This control mode is used for servo control of an asynchronous motor. A motor encoder must be connected to the inverter. This motor encoder is used as a feedback system for the motor control. <a href="#">▶ Servo control for asynchronous motor (SC-ASM) 187</a>
3	Sensorless control (SL PSM) (from version 02.00)	This control type is used for the sensorless control of a synchronous motor. <a href="#">▶ Sensorless control for synchronous motor (SL-PSM) 188</a>
4	Sensorless vector control (SLVC)	This control type is used for sensorless vector control of an asynchronous motor. <a href="#">▶ Sensorless vector control (SLVC) 191</a>
6	<b>V/f characteristic control (VFC open loop)</b>	This control mode is used for the speed control of an asynchronous motor via a V/f characteristic and is the simplest control mode. <a href="#">▶ V/f characteristic control for asynchronous motor (VFC open loop) 193</a>
7	V/f characteristic control (VFC closed loop) (from version 04.00)	The control mode is used for speed control of an asynchronous motor via a V/f characteristic with speed feedback. A motor encoder must be connected to the inverter. This motor encoder is used as a feedback system for the motor control. <a href="#">▶ V/f characteristic control for asynchronous motor (VFC closed loop) 213</a>
8	Sensorless control for synchronous motors (SLSM-PSM) (from version 05.05)	This control type is used for the sensorless control of a synchronous motor. <b>Note!</b> This control mode is not available in the version with network IO-Link! Compared to the sensorless "SL-PSM" control, the "SLSM-PSM" control offers the following advantages: <ul style="list-style-type: none"> <li>Lower power consumption and more torque through HF injection in the lower speed range</li> <li>Easier commissioning due to support for automatic identification of the motor</li> </ul> <a href="#">▶ Sensorless control for synchronous motor (SLSM-PSM) 215</a>

The detailed description of each motor control type can be found in the chapter "[Configuring the motor control](#)". [185](#)



## 6 Start, stop and rotating direction commands

### 6.1 Control selection

The selected "control source" serves to provide the inverter with its start, stop, and reversal commands.

Possible control sources:

- Digital inputs
- Keypad
- Network

The following signal flow shows the internal control logics:

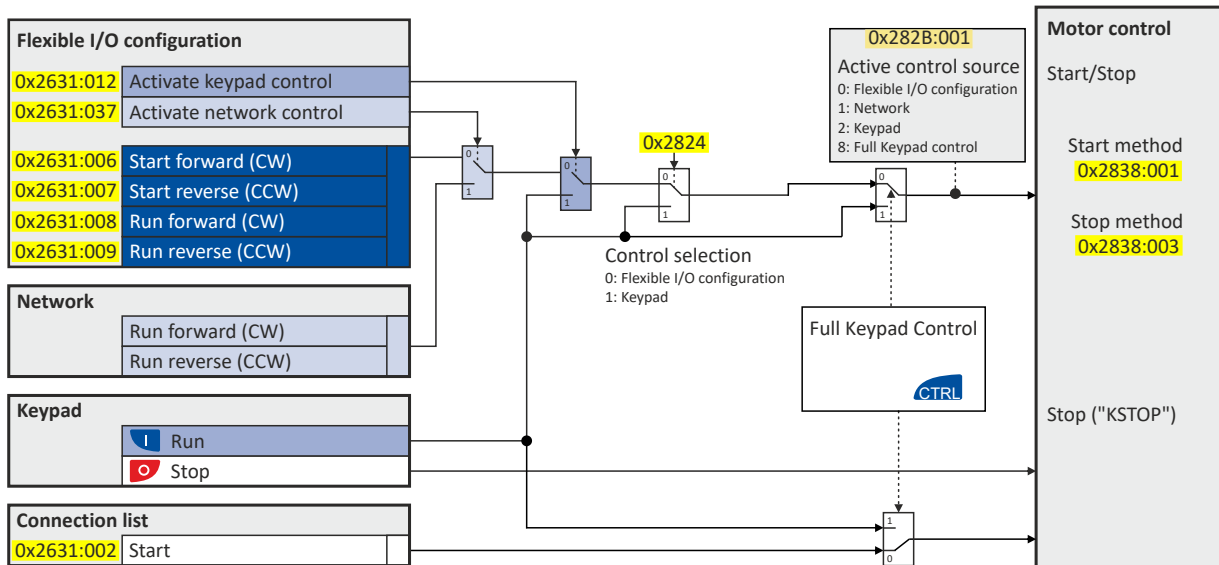

#### NOTICE

Stop commands are always active from any connected source, regardless of which control source is selected!

If, for example, the network control is activated and a keypad is plugged in for diagnostic purposes, the motor is also stopped when the  keypad key is pressed.

► **Exception:** A stop command has no effect in jog operation.

#### Details

- The default setting "Flexible I/O configuration [0]" in 0x2824 (P200.00) enables a flexible control of the inverter via digital inputs, network and keypad. The control of the inverter via the digital inputs is preconfigured. For details see the subchapter "Flexible I/O configuration". [64](#)
- For details of the network control of the inverter, see the chapter "Control the inverter via network". [311](#)
- If the keypad is to be used as the control source for the application, set "Keypad [1]" in 0x2824 (P200.00). For details, see subchapter "Keypad control". [65](#)
- The control source that is currently active is displayed in 0x282B:001 (P125.01).



In order to control the inverter from the network, the network share [0x2631:037 \(P400.37\)](#) must be configured.

In case of an activated network control, the following functions are still active:

- [0x2631:001 \(P400.01\)](#): Enable inverter
- [0x2631:002 \(P400.02\)](#): Run
- [0x2631:003 \(P400.03\)](#): Activate quick stop
- [0x2631:004 \(P400.04\)](#): Reset error
- [0x2631:005 \(P400.05\)](#): DC braking
- [0x2631:010 \(P400.10\)](#): Jog forward (CW)
- [0x2631:011 \(P400.11\)](#): Jog reverse (CCW)\*
- [0x2631:012 \(P400.12\)](#): Activate keypad control\*
- [0x2631:037 \(P400.37\)](#): Activate network control\*
- [0x2631:043 \(P400.43\)](#): Activate fault 1
- [0x2631:044 \(P400.44\)](#): Activate fault 2
- [0x2631:054 \(P400.54\)](#): Reset position counter



(\*Not active in case of network operation in CiA402 mode ).

In case of an activated network control, the following functions are also still active if they are not configured in the NetWordIN1 bit functionality:

- [0x2631:048 \(P400.48\)](#): Activate PID influence ramp
- [0x2631:041 \(P400.41\)](#): Select parameter set (bit 0)
- [0x2631:042 \(P400.42\)](#): Select parameter set (bit 1)

All other functions configurable via [0x2631:xx \(P400.xx\)](#) are deactivated in case of network control.

## Parameter

Address	Name / setting range / [default setting]	Information
0x2824 (P200.00)	Control selection (Control select.)	Selection of the type of inverter control.
	<b>0</b> Flexible I/O configuration	This selection enables a flexible assignment of the start, stop, and rotating direction commands with digital signal sources. <ul style="list-style-type: none"> <li>• Digital signal sources can be digital inputs, network and keypad.</li> <li>• The I/O configuration is made via the parameters <a href="#">0x2631:xx (P400.xx)</a>.</li> </ul>
	<b>1</b> Keypad	This selection enables the motor to be started exclusively via the start key of the keypad. Other signal sources for starting the motor are ignored. <div style="display: flex; align-items: center; gap: 10px;"> <span> Start motor</span> <span> Stop motor</span> </div> <p>Note!</p> <ul style="list-style-type: none"> <li>• The functions "Enable inverter" <a href="#">0x2631:001 (P400.01)</a> and "Run" <a href="#">0x2631:002 (P400.02)</a> must be set to TRUE to start the motor.</li> <li>• If jog operation is active, the motor cannot be stopped via the  keypad key.</li> </ul>



## 6.1.1 Flexible I/O configuration

Use parameters 0x2631:xx (P400.xx) to individually adapt the inverter control to the respective application. This is basically effected by assigning digital control sources ("triggers") to functions of the inverter.

### NOTICE

A digital signal source can be assigned to several functions.

Possible consequences: Unforeseeable behaviour of the drive in case of incorrect assignment

► Carry out assignment of a digital signal source to several functions with greater care.

### Details

- The flexible I/O configuration is active if the selection "Flexible I/O configuration [0]" (default) is set in 0x2824 (P200.00).
- Each subcode of 0x2631 (P400) is permanently assigned to a specific function. Functions are for example "Enable inverter", "Activate quick stop" or "Start forward (CW)".
- For a function, exactly one (digital) trigger can be set:



- Possible triggers to be selected are for example the digital input and internal status signals of the inverter.
- A list of all available triggers can be found in the "Trigger list". [📖 73](#)
- The corresponding function is executed if the trigger condition is fulfilled.

### Example: changing the function assignment of a digital input

Task for this example:

1. The preset assignment of the digital input 3 for the function "Reverse rotational direction" is to be cancelled.
2. Instead, the digital input 3 is to be assigned to the "Activate DC braking" function.

For this purpose, the following two settings are required:

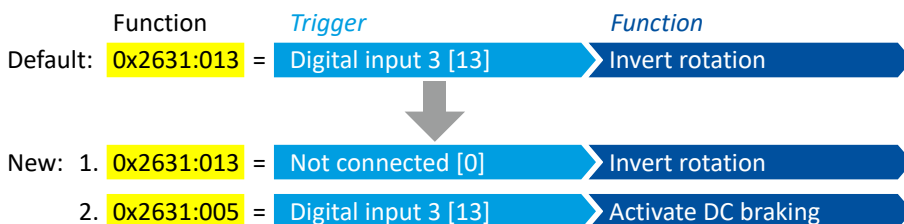

### Related topics

- Flexible I/O configuration of the start, stop and rotating direction commands [📖 67](#)





## 6.1.2 Keypad control

The "Keypad" control selection enables the motor to be started exclusively via the start key of the keypad. Other signal sources for starting the motor are ignored.

### Details

If the keypad is to be used as the sole control source for the application, set [0x2824 \(P200.00\)](#) to "Keypad [1]".

If the local keypad control is active, "LOC" is displayed in the lower status row of the keypad. The keys on the keypad then have the following function:

Function of keypad keys in operating mode			
Key	Actuation	Condition	Action
	Briefly	Local keypad control active. Display "LOC"	Run motor.
	Briefly	No Jog operation	Stop motor. Display "KSTOP"
	Briefly	Operating mode	Change to parameterization mode. ▶ <a href="#">Keypad parameterisation mode</a> 640
	Longer than 3 s	None (anytime possible)	Save parameter settings in the user memory of the memory module.
	Briefly	During operation	Scroll through information in the above status line.
	Briefly	Operating mode	Activate full keypad control. Display "ON?" → Confirm with Control and setpoint selection can now only be carried out via keypad. Renewed clicking: Exit full keypad control. Display "OFF?" → Confirm with ▶ <a href="#">Keypad full control</a> 66
	Briefly	Local keypad control active. Display "LOC"	Reversal of rotation direction. Display "REV?" → Confirm with ▶ <a href="#">Configure R/F and CTRL keys</a> 635

- In case of keypad control, the following functions continue to be active:
  - [0x2631:001 \(P400.01\)](#): Enable inverter
  - [0x2631:003 \(P400.03\)](#): Activate quick stop
  - [0x2631:004 \(P400.04\)](#): Reset fault
  - [0x2631:005 \(P400.05\)](#): Activate DC braking
  - [0x2631:010 \(P400.10\)](#): Jog forward (CW)
  - [0x2631:011 \(P400.11\)](#): Jog reverse (CCW)
  - All other functions of [0x2631:012 \(P400.12\)](#) - [0x2631:055 \(P400.55\)](#)

### Related topics

▶ [Keypad](#) 632



## 6.1.3 Keypad full control

The "Keypad Full Control" control mode can be activated with the keypad key "CTRL". Both the control and the setpoint selection are then made via the keypad. This special control mode can be, for instance, used during the commissioning phase if external control and setpoint sources are not ready to use yet.



### ⚠ CAUTION!

If the "Keypad Full Control" control mode is active, the "Run" [0x2631:002 \(P400.02\)](#) function is internally set to TRUE.

In this case, the motor cannot be stopped via this function.

► For stopping the motor, use the  keypad key, deactivate the "Enable inverter" or activate the "quick stop" function.

#### Details

- After the "CTRL" key has been pressed, the activation of the control mode must be confirmed with the  key. (The  key serves to cancel the action.)
- When the control mode is changed over, the motor is first stopped and the "Forward" direction of rotation is set. Then, the motor can be started and stopped via the keypad.

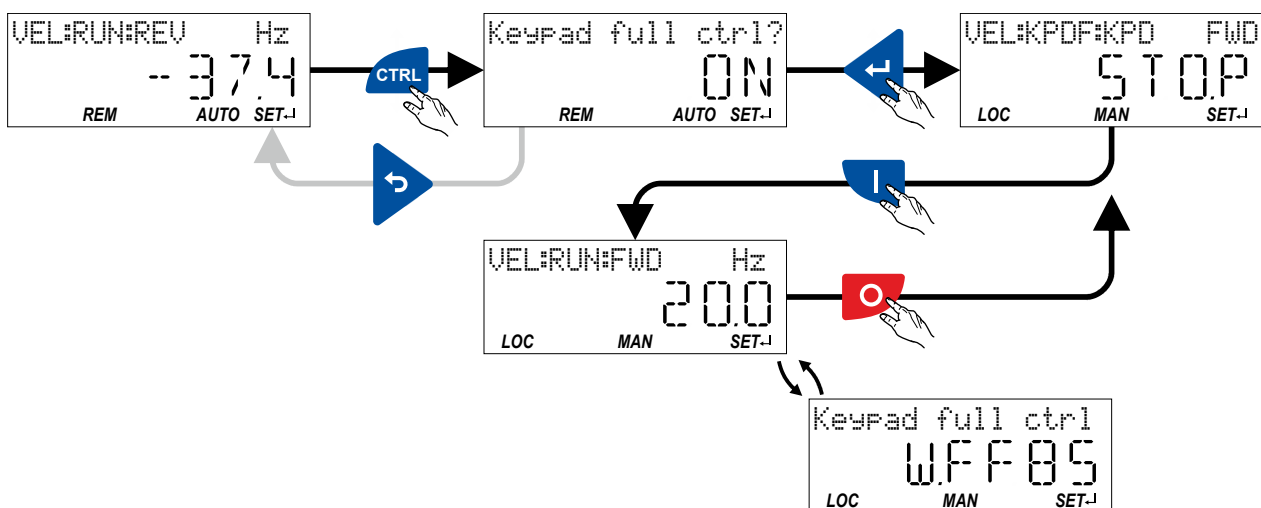

If the "Keypad Full Control" control mode is active,

- the keypad shows the warning "Keypad full ctrl" alternately with the status display.
- the set standard setpoint sources are ignored.
- a changeover to other setpoint sources is not possible.
- a changeover to network control is not possible.

In case of keypad control, the following functions continue to be active:

- [0x2631:001 \(P400.01\)](#): Enable inverter
- [0x2631:003 \(P400.03\)](#): Activate quick stop
- [0x2631:004 \(P400.04\)](#): Reset fault
- [0x2631:005 \(P400.05\)](#): Activate DC braking
- [0x2631:010 \(P400.10\)](#): Jog forward (CW)
- [0x2631:011 \(P400.11\)](#): Jog reverse (CCW)
- All other functions of [0x2631:012 \(P400.12\)](#) - [0x2631:055 \(P400.55\)](#)

The control mode can be terminated again if the "CTRL" keypad key is pressed again.

#### Related topics

- [Configure R/F and CTRL keys](#)  635





## 6.2 Flexible I/O configuration of the start, stop and rotating direction commands

Configuration of the triggers for the basic functions for controlling the motor.

### Details

The following table contains a short overview of the basic functions. For more details see the following parameter descriptions.

Function	Info
Enable inverter <a href="#">0x2631:001 (P400.01)</a>	<p>Enable/disable operation.</p> <ul style="list-style-type: none"> <li>The function must be set to TRUE to start the motor. Either via a digital input or the default setting "Constant TRUE [1]".</li> <li>If the function is set to FALSE, the inverter is disabled. The motor has no torque (coasts).</li> </ul> <p>▶ <a href="#">Example: Enable inverter</a> <a href="#"></a> 82</p>
Run <a href="#">0x2631:002 (P400.02)</a>	<p>Function 1: Start / stop motor (default setting)</p> <ul style="list-style-type: none"> <li>Function 1 is active if no further start commands (start forward/start reverse) have been connected to triggers, no keypad control is active and no network control is active.</li> </ul> <p>TRUE: Let motor rotate forward (CW). FALSE: Stop the motor.</p> <p>▶ <a href="#">Example: Start/stop (1 signal) and reversal</a> <a href="#"></a> 76</p> <hr/> <p>Function 2: Start enable/stop motor</p> <ul style="list-style-type: none"> <li>Function 2 is active if further start commands have been connected to triggers, the keypad control is active or the network control is active.</li> </ul> <p>TRUE: Start commands of the active control source are enabled. FALSE: Stop the motor.</p> <p>▶ <a href="#">Example: Start forward/start reverse/stop (edge-controlled)</a> <a href="#"></a> 77 ▶ <a href="#">Example: Run forward/Run reverse/stop (status-controlled)</a> <a href="#"></a> 79</p>
Activate quick stop <a href="#">0x2631:003 (P400.03)</a>	<p>Bring the motor to a standstill in best time.</p> <p>▶ <a href="#">Example: Quick stop</a> <a href="#"></a> 81</p>
Start forward (CW) <a href="#">0x2631:006 (P400.06)</a>	<p>Start the motor edge-controlled.</p> <ul style="list-style-type: none"> <li>In order to be able to start the motor, the "Run" function must be set to TRUE.</li> <li>The motor is stopped by resetting the "Run" function to FALSE.</li> <li>The functions are deactivated in case of keypad or network control.</li> </ul> <p>▶ <a href="#">Example: Start forward/start reverse/stop (edge-controlled)</a> <a href="#"></a> 77</p>
Start reverse (CCW) <a href="#">0x2631:007 (P400.07)</a>	
Run forward (CW) <a href="#">0x2631:008 (P400.08)</a>	<p>Let the motor rotate in a status-controlled way.</p> <ul style="list-style-type: none"> <li>In order to be able to start the motor, the "Run" function must be set to TRUE.</li> <li>The functions are deactivated in the case of keypad or network control.</li> </ul> <p>▶ <a href="#">Example: Run forward/Run reverse/stop (status-controlled)</a> <a href="#"></a> 79</p>
Run reverse (CCW) <a href="#">0x2631:009 (P400.09)</a>	
Jog forward (CW) <a href="#">0x2631:010 (P400.10)</a>	<p>Jog operation: Let the motor rotate in a status-controlled way with setpoint preset.</p> <p> CAUTION!</p> <p>The jog operation has a higher priority than the "Run" function, all other start commands and the keypad key .</p> <ul style="list-style-type: none"> <li>If the jog operation is active, the motor cannot be stopped with the previously mentioned functions!</li> <li>However, jog operation can be interrupted by the "Quick stop" function.</li> <li>Jog operation can always be activated, even in case of keypad or network control.</li> </ul> <p>▶ <a href="#">Example: Jog forward/Jog reverse</a> <a href="#"></a> 83</p>
Jog reverse (CCW) <a href="#">0x2631:011 (P400.11)</a>	
Reverse rotational direction <a href="#">0x2631:013 (P400.13)</a>	<p>Invert the frequency setpoint.</p> <ul style="list-style-type: none"> <li>The function can be used in combination with all start commands.</li> <li>The function is deactivated in the case of network control.</li> </ul> <p>▶ <a href="#">Example: Start/stop (1 signal) and reversal</a> <a href="#"></a> 76</p>

# Start, stop and rotating direction commands

Flexible I/O configuration of the start, stop and rotating direction commands



## Assignment guidelines

The error message "Trigger/functions connected incorrectly" (error code [25216 | 0x6280](#)) is output if one of the following assignment guidelines is not observed:

- If the "flexible I/O configuration" is active as control source, the "Enable inverter" or "Run" function must be connected to a digital input in order that the motor can be stopped again any time!
- With keypad or network control, the two functions "Enable inverter" and "Run" can also be set to "Constant TRUE [1]" to start the motor.
- The use of the "Start forward (CW)" and "Start reverse (CCW)" functions excludes the use of the "Run forward (CW)" and "Run reverse (CCW)" functions, and vice versa.

## Parameter

Address	Name / setting range / [default setting]	Information
0x2631:001 (P400.01)	Function list: Enable inverter (Function list: Enable inverter) <ul style="list-style-type: none"> <li>• Setting can only be changed if the inverter is disabled.</li> <li>• Further possible settings: <a href="#">▶ Trigger list ☐ 73</a></li> </ul>	Assignment of a trigger for the "Enable inverter" function. Trigger = TRUE: The inverter is enabled (unless there is another cause for inverter disable). Trigger = FALSE: The inverter is disabled.  Notes: <ul style="list-style-type: none"> <li>• This function must be set to TRUE to start the motor. The signal TRUE is activated either via an assigned digital input or the default setting "Constant TRUE [1]".</li> <li>• Changing to the inhibited state causes an immediate stop of the motor, regardless of the stop method set in <a href="#">0x2838:003 (P203.03)</a>. The motor has no torque and coasts down.</li> <li>• The cause(s) for the inhibited state are shown in <a href="#">0x282A:001 (P126.01)</a>.  <a href="#">▶ Example: Enable inverter ☐ 82</a></li> </ul>
	<b>1 Constant TRUE</b>	Trigger is constantly TRUE.



# Start, stop and rotating direction commands

Flexible I/O configuration of the start, stop and rotating direction commands

Address	Name / setting range / [default setting]	Information
0x2631:002 (P400.02)	Function list: Run (Function list: Run) <ul style="list-style-type: none"> <li>Setting can only be changed if the inverter is disabled.</li> <li>Further possible settings: <a href="#">▶ Trigger list □ 73</a></li> </ul>	Assignment of a trigger to the "Run" function.  <b>Function 1: Start / stop motor (default setting)</b> Function 1 is active if no further start commands (start forward/start reverse) have been connected to triggers, no keypad control is active and no network control is active. Trigger = TRUE: Let motor rotate forward (CW). Trigger = FALSE: Stop motor.  Notes to function 1: <ul style="list-style-type: none"> <li>If "Enable inverter" <a href="#">0x2631:001 (P400.01)</a> = "Constant TRUE [1]", only a digital input is permissible as trigger for this function in order that the motor can be stopped again any time.                Exception: If the "Safe torque off (STO)" safety function is available, both functions "Enable inverter" and "Run" can be set to "Constant TRUE [1]". The inverter is then controlled via the STO signal unless no other start commands (start-forward/start-backward) have been connected to triggers.</li> <li>The stop method can be selected in <a href="#">0x2838:003 (P203.03)</a>.</li> <li>The function also serves to realise an automatic start after switch-on.                ▶ <a href="#">Start behavior □ 51</a>                ▶ <a href="#">Example: Start/stop (1 signal) and reversal □ 76</a></li> </ul> <b>Function 2: Start enable/stop motor</b> Function 2 is active if further start commands have been connected to triggers, keypad control is active or network control is active. Trigger = TRUE: Start commands of the active control source are enabled. Trigger = FALSE: Stop motor.  Notes to function 2: <ul style="list-style-type: none"> <li>If no separate start enable is required for the application, the trigger "Constant TRUE [1]" must be set.</li> <li>The stop method can be selected in <a href="#">0x2838:003 (P203.03)</a>.                ▶ <a href="#">Example: Start forward/start reverse/stop (edge-controlled) □ 77</a>                ▶ <a href="#">Example: Run forward/Run reverse/stop (status-controlled) □ 79</a></li> </ul>
	<b>11</b> Digital input 1	State of X3/DI1, taking an inversion set in <a href="#">0x2632:001 (P411.01)</a> into consideration.
0x2631:003 (P400.03)	Function list: Activate quick stop (Function list: Quick stop) <ul style="list-style-type: none"> <li>Setting can only be changed if the inverter is disabled.</li> <li>Further possible settings: <a href="#">▶ Trigger list □ 73</a></li> </ul>	Assignment of a trigger for the "Activate quick stop" function. Trigger = TRUE: Activate quick stop. Trigger = FALSE: Deactivate quick stop.  Notes: <ul style="list-style-type: none"> <li>The "Quick stop" function brings the motor to a standstill within the deceleration time set in <a href="#">0x291C (P225.00)</a>.                ▶ <a href="#">Example: Quick stop □ 81</a></li> </ul>
	<b>0</b> Not connected	No trigger assigned (trigger is constantly FALSE).
0x2631:006 (P400.06)	Function list: Start forward (CW) (Function list: Start forward) <ul style="list-style-type: none"> <li>Setting can only be changed if the inverter is disabled.</li> <li>Further possible settings: <a href="#">▶ Trigger list □ 73</a></li> </ul>	Assignment of a trigger for the "Start forward (CW)" function. Trigger = FALSE↗TRUE (edge): Let motor rotate forward. Trigger = TRUE↘FALSE (edge): No action.  Notes: <ul style="list-style-type: none"> <li>In order to start the motor, "Enable inverter" <a href="#">0x2631:001 (P400.01)</a> and "Run" <a href="#">0x2631:002 (P400.02)</a> must be set to TRUE.</li> <li>After the start, the motor runs until "Run" is set to FALSE, another stop command is given or the inverter is disabled.</li> <li>In the case of a bipolar setpoint selection (e.g. ±10 V), the function is executed independent of the direction of rotation. The rotating direction is determined by the sign of the setpoint.                ▶ <a href="#">Example: Start forward/start reverse/stop (edge-controlled) □ 77</a></li> </ul>
	<b>0</b> Not connected	No trigger assigned (trigger is constantly FALSE).

# Start, stop and rotating direction commands

Flexible I/O configuration of the start, stop and rotating direction commands





Address	Name / setting range / [default setting]	Information
0x2631:007 (P400.07)	Function list: Start reverse (CCW) (Function list: Start reverse) <ul style="list-style-type: none"> <li>Setting can only be changed if the inverter is disabled.</li> <li>Further possible settings: <a href="#">▶ Trigger list □ 73</a></li> </ul>	Assignment of a trigger for the "Start reverse (CCW)" function Trigger = FALSE ↗ TRUE (edge): Let motor rotate backward. Trigger = TRUE ↘ FALSE (edge): No action.  Notes: <ul style="list-style-type: none"> <li>In order to start the motor, "Enable inverter" <a href="#">0x2631:001 (P400.01)</a> and "Run" <a href="#">0x2631:002 (P400.02)</a> must be set to TRUE.</li> <li>After the start, the motor runs until "Run" is set to FALSE, another stop command is given or the inverter is disabled.</li> <li>In the case of a bipolar setpoint selection (e.g. ±10 V), the function is executed independent of the direction of rotation. The rotating direction is determined by the sign of the setpoint.</li> </ul> <a href="#">▶ Example: Start forward/start reverse/stop (edge-controlled) □ 77</a>
	<b>0</b> Not connected	No trigger assigned (trigger is constantly FALSE).
0x2631:008 (P400.08)	Function list: Run forward (CW) (Function list: Run forward) <ul style="list-style-type: none"> <li>Setting can only be changed if the inverter is disabled.</li> <li>Further possible settings: <a href="#">▶ Trigger list □ 73</a></li> </ul>	Assignment of a trigger for the "Run forward (CW)" function. Trigger = TRUE: Let motor rotate forward. Trigger = FALSE: Stop motor.  Notes: <ul style="list-style-type: none"> <li>In order to start the motor, "Enable inverter" <a href="#">0x2631:001 (P400.01)</a> and "Run" <a href="#">0x2631:002 (P400.02)</a> must be set to TRUE.</li> <li>The inverter always responds to the run command detected last. A start enable must exist.</li> <li>The stop method can be selected in <a href="#">0x2838:003 (P203.03)</a>.</li> <li>In the case of a bipolar setpoint selection (e.g. ±10 V), the function is executed independent of the direction of rotation. The rotating direction is determined by the sign of the setpoint.</li> <li>The "Run forward (CW)" function also serves to realise an automatic start after switch-on. <a href="#">▶ Start behavior □ 51</a></li> </ul> <a href="#">▶ Example: Run forward/Run reverse/stop (status-controlled) □ 79</a>
	<b>0</b> Not connected	No trigger assigned (trigger is constantly FALSE).
0x2631:009 (P400.09)	Function list: Run reverse (CCW) (Function list: Run reverse) <ul style="list-style-type: none"> <li>Setting can only be changed if the inverter is disabled.</li> <li>Further possible settings: <a href="#">▶ Trigger list □ 73</a></li> </ul>	Assignment of a trigger for the "Run reverse (CCW)" function. Trigger = TRUE: Let motor rotate backward. Trigger = FALSE: Stop motor.  Notes: <ul style="list-style-type: none"> <li>In order to start the motor, "Enable inverter" <a href="#">0x2631:001 (P400.01)</a> and "Run" <a href="#">0x2631:002 (P400.02)</a> must be set to TRUE.</li> <li>The inverter always responds to the run command detected last. A start enable must exist.</li> <li>The stop method can be selected in <a href="#">0x2838:003 (P203.03)</a>.</li> <li>In the case of a bipolar setpoint selection (e.g. ±10 V), the function is executed independent of the direction of rotation. The rotating direction is determined by the sign of the setpoint.</li> <li>The "Run reverse (CCW)" function also serves to realise an automatic start after switch-on. <a href="#">▶ Start behavior □ 51</a></li> </ul> <a href="#">▶ Example: Run forward/Run reverse/stop (status-controlled) □ 79</a>
	<b>0</b> Not connected	No trigger assigned (trigger is constantly FALSE).



# Start, stop and rotating direction commands

Flexible I/O configuration of the start, stop and rotating direction commands

Address	Name / setting range / [default setting]	Information
0x2631:010 (P400.10)	Function list: Jog forward (CW) (Function list: Jog forward) <ul style="list-style-type: none"> <li>Setting can only be changed if the inverter is disabled.</li> </ul>	Assignment of a trigger for the "Jog forward (CW)" function. Trigger = TRUE: Let motor rotate forward with preset 5. Trigger = FALSE: Stop motor.  <b>⚠ CAUTION!</b> The jog operation has a higher priority than the "Run" function, all other start commands and the keypad key  . <ul style="list-style-type: none"> <li>If jog operation is active, the motor cannot be stopped with the previously mentioned functions!</li> <li>However, jog operation can be interrupted by the "Quick stop" function.</li> </ul> Notes: <ul style="list-style-type: none"> <li>The preset 5 can be set in <a href="#">0x2911:005 (P450.05)</a>.</li> <li>The stop method can be selected in <a href="#">0x2838:003 (P203.03)</a>.</li> <li>If "Jog forward (CW)" and "Jog reverse (CCW)" are activated at the same time, the motor is stopped using the set stop method and jog operation must be triggered again.</li> <li>Jog operation cannot be started automatically. The "Start at power-up" option in <a href="#">0x2838:002 (P203.02)</a> does not apply to jog operation.</li> </ul> ▶ <a href="#">Example: Jog forward/Jog reverse </a> 83
	<b>0 Not connected</b>	No trigger assigned (trigger is constantly FALSE).
11	Digital input 1	State of X3/DI1, taking an inversion set in <a href="#">0x2632:001 (P411.01)</a> into consideration.
12	Digital input 2	State of X3/DI2, taking an inversion set in <a href="#">0x2632:002 (P411.02)</a> into consideration.
13	Digital input 3	State of X3/DI3, taking an inversion set in <a href="#">0x2632:003 (P411.03)</a> into consideration.
14	Digital input 4	State of X3/DI4, taking an inversion set in <a href="#">0x2632:004 (P411.04)</a> into consideration.
15	Digital input 5	State of X3/DI5, taking an inversion set in <a href="#">0x2632:005 (P411.05)</a> into consideration.
16	Digital input 6	State of X3/DI6, taking an inversion set in <a href="#">0x2632:006 (P411.06)</a> into consideration. Digital input 6 is only available in the Control Unit (CU) with application I/O.
17	Digital input 7	State of X3/DI7, taking an inversion set in <a href="#">0x2632:007 (P411.07)</a> into consideration. Digital input 7 is only available in the Control Unit (CU) with application I/O.
50	Running	TRUE if inverter and start are enabled and output frequency > 0 Hz. Otherwise FALSE. Exception, quick stop mode: TRUE if inverter and start are enabled and output frequency > 0.2 Hz. Otherwise FALSE.
51	Ready for operation	TRUE if inverter is ready for operation (no error active, no STO active and DC-bus voltage ok). Otherwise FALSE.
53	Stop active	TRUE if inverter is enabled and motor is not started and output frequency = 0.
54	Quick stop active	TRUE if quick stop is active. Otherwise FALSE.
58	Device warning active	TRUE if warning is active. Otherwise FALSE. <ul style="list-style-type: none"> <li>A warning has no impact on the operating status of the inverter.</li> <li>A warning is reset automatically if the cause has been eliminated.</li> </ul>
59	Device trouble active	TRUE if a fault is active. Otherwise FALSE. <ul style="list-style-type: none"> <li>In the event of a fault, the motor is brought to a standstill with the quick stop ramp. The inverter is then disabled.</li> <li>Exception: In case of a serious fault, the inverter is disabled immediately. The motor has no torque (coasts).</li> <li>The error state will be left automatically if the error condition is not active anymore.</li> <li>The restart behaviour after trouble can be configured. ▶ <a href="#">Automatic restart after a fault </a> 579</li> </ul>

# Start, stop and rotating direction commands

Flexible I/O configuration of the start, stop and rotating direction commands



Address	Name / setting range / [default setting]	Information
60	Heatsink temperature warning active	TRUE if current heatsink temperature > warning threshold for temperature monitoring. Otherwise FALSE. <ul style="list-style-type: none"> <li>• Display of the current heatsink temperature in <a href="#">0x2D84:001 (P117.01)</a>.</li> <li>• Setting of the warning threshold in <a href="#">0x2D84:002</a>.</li> </ul>
68	Stop command active	TRUE if delay to standstill active. Otherwise FALSE.
69	Rotational direction reversed	TRUE if output frequency is negative. Otherwise FALSE.
70	Frequency threshold exceeded	TRUE if current output frequency > frequency threshold. Otherwise FALSE. <ul style="list-style-type: none"> <li>• Display of the current output frequency in <a href="#">0x2DDD (P100.00)</a>.</li> <li>• Setting Frequency threshold in <a href="#">0x4005 (P412.00)</a>.</li> </ul> <p>▶ <a href="#">Trigger action if a frequency threshold is exceeded</a> <a href="#">□ 604</a></p>
71	Actual speed = 0	TRUE if actual output frequency = 0 Hz (± 0.3 Hz), irrespective of the operating mode. Otherwise FALSE. <ul style="list-style-type: none"> <li>• Display of the current output frequency in <a href="#">0x2DDD (P100.00)</a>.</li> </ul>
78	Current limit reached	TRUE if current motor current ≥ maximum current. Otherwise FALSE. <ul style="list-style-type: none"> <li>• Display of the present motor current in <a href="#">0x2D88 (P104.00)</a>.</li> <li>• Setting for the maximum current in <a href="#">0x6073 (P324.00)</a>.</li> </ul>
79	Torque limit reached (from version 02.00)	TRUE if torque limit has been reached or exceeded. Otherwise FALSE. <ul style="list-style-type: none"> <li>• Setting "Actual positive torque limit" in <a href="#">0x2949:003 (P337.03)</a>.</li> <li>• Setting "Actual negative torque limit" in <a href="#">0x2949:004 (P337.04)</a>.</li> </ul> <p>▶ <a href="#">Motor torque monitoring</a> <a href="#">□ 265</a></p>
81	Error of analog input 1 active	TRUE if the monitoring of the input signal at the analog input 1 has responded. Otherwise FALSE.  This trigger is set as a function of the following settings: <ul style="list-style-type: none"> <li>• Monitoring threshold <a href="#">0x2636:008 (P430.08)</a></li> <li>• Monitoring condition <a href="#">0x2636:009 (P430.09)</a></li> </ul> The setting of the Error response in <a href="#">0x2636:010 (P430.10)</a> has no effect on this trigger. <p>▶ <a href="#">Analog input 1</a> <a href="#">□ 284</a></p>
82	Error of analog input 2 active	TRUE if the monitoring of the input signal at the analog input 2 has responded. Otherwise FALSE.  This trigger is set as a function of the following settings: <ul style="list-style-type: none"> <li>• Monitoring threshold <a href="#">0x2637:008 (P431.08)</a></li> <li>• Monitoring condition <a href="#">0x2637:009 (P431.09)</a></li> </ul> The setting of the Error response in <a href="#">0x2637:010 (P431.10)</a> has no effect on this trigger. <p>▶ <a href="#">Analog input 2</a> <a href="#">□ 289</a></p>
83	Load loss detected	TRUE if actual motor current < threshold for load loss detection after delay time of the load loss detection has elapsed. Otherwise FALSE. <ul style="list-style-type: none"> <li>• Display of the actual current in <a href="#">0x6078 (P103.00)</a>.</li> <li>• Setting Threshold in <a href="#">0x4006:001 (P710.01)</a>.</li> <li>• Setting Delay time in <a href="#">0x4006:002 (P710.02)</a>.</li> </ul> <p>▶ <a href="#">Load loss detection</a> <a href="#">□ 237</a></p>
84	Heavy load monitoring	TRUE if the actual apparent current of the motor exceeds the threshold for longer than the delay time. FALSE if the actual apparent current of the motor falls below the threshold value minus 5 % (hysteresis). <p>▶ <a href="#">Heavy load monitoring</a> <a href="#">□ 269</a></p>
102	Sequence suspended (from version 03.00)	Status signal of the "sequencer" function: TRUE if the sequence is currently suspended. <p>▶ <a href="#">Sequencer</a> <a href="#">□ 102</a></p>
103	Sequence done (from version 03.00)	Status signal of the "sequencer" function: TRUE if the sequence is completed (final segment has been passed through). <p>▶ <a href="#">Sequencer</a> <a href="#">□ 102</a></p>
104	Local control active	TRUE if local keypad control ("LOC") active. Otherwise FALSE.
105	Remote control active	TRUE if remote control ("REM") via terminals, network, etc. active. Otherwise FALSE.





# Start, stop and rotating direction commands

Flexible I/O configuration of the start, stop and rotating direction commands

Trigger list

Address	Name / setting range / [default setting]	Information
	106 Manual setpoint selection active	TRUE if manual setpoint selection ("MAN") via keypad active. Otherwise FALSE. • Selection of the trigger for the "Activate keypad setpoint" function in <a href="#">0x2631:016 (P400.16)</a> .
	107 Automatic setpoint selection active	TRUE if automatic setpoint selection ("AUTO") via terminals, network, etc. active. Otherwise FALSE.
	201 Internal value (from version 05.00)	Internal values of the manufacturer.
	202 Internal value (from version 05.00)	
	203 Internal value (from version 05.00)	
	204 Internal value (from version 05.00)	
	205 Internal value (from version 05.00)	
	206 Internal value (from version 05.00)	
0x2631:011 (P400.11)	Function list: Jog reverse (CCW) (Function list: Jog reverse) • Setting can only be changed if the inverter is disabled. • For further possible settings, see parameter <a href="#">0x2631:010 (P400.10)</a> . <a href="#">□ 71</a>	Assignment of a trigger for the "Jog reverse (CCW)" function. Trigger = TRUE: Let motor rotate backward with preset 6. Trigger = FALSE: Stop motor.  <b>⚠ CAUTION!</b> The jog operation has a higher priority than the "Run" function, all other start commands and the keypad key  . • If jog operation is active, the motor cannot be stopped with the previously mentioned functions! • However, jog operation can be interrupted by the "Quick stop" function.  Notes: • The preset 6 can be set in <a href="#">0x2911:006 (P450.06)</a> . • The stop method can be selected in <a href="#">0x2838:003 (P203.03)</a> . • If "Jog forward (CW)" and "Jog reverse (CCW)" are activated at the same time, the motor is stopped using the set stop method and jog operation must be triggered again. • Jog operation cannot be started automatically. The "Start at power-up" option in <a href="#">0x2838:002 (P203.02)</a> does not apply to jog operation. <a href="#">▶ Example: Jog forward/Jog reverse □ 83</a>
	<b>0</b> Not connected	No trigger assigned (trigger is constantly FALSE).
0x2631:013 (P400.13)	Function list: Reverse rotational direction (Function list: Reverse rot.dir.) • Setting can only be changed if the inverter is disabled. • Further possible settings: <a href="#">▶ Trigger list □ 73</a>	Assignment of a trigger for the "Reverse rotational direction" function. Trigger = TRUE: the setpoint specified is inverted (i. e. the sign is inverted). Trigger = FALSE: no action / deactivate function again. <a href="#">▶ Example: Start/stop (1 signal) and reversal □ 76</a>
	<b>13</b> Digital input 3	State of X3/DI3, taking an inversion set in <a href="#">0x2632:003 (P411.03)</a> into consideration.

## 6.2.1 Trigger list

The trigger list lists all selection options (triggers) for the functions which can be configured using the parameters 0x2631:xx (P400.xx).

Selection	Information
0 Not connected	No trigger assigned (trigger is constantly FALSE).
1 Constant TRUE	Trigger is constantly TRUE.
11 Digital input 1	State of X3/DI1, taking an inversion set in <a href="#">0x2632:001 (P411.01)</a> into consideration.
12 Digital input 2	State of X3/DI2, taking an inversion set in <a href="#">0x2632:002 (P411.02)</a> into consideration.
13 Digital input 3	State of X3/DI3, taking an inversion set in <a href="#">0x2632:003 (P411.03)</a> into consideration.
14 Digital input 4	State of X3/DI4, taking an inversion set in <a href="#">0x2632:004 (P411.04)</a> into consideration.
15 Digital input 5	State of X3/DI5, taking an inversion set in <a href="#">0x2632:005 (P411.05)</a> into consideration.

# Start, stop and rotating direction commands

Flexible I/O configuration of the start, stop and rotating direction commands  
Trigger list



Selection	Information
16 Digital input 6	State of X3/DI6, taking an inversion set in <a href="#">0x2632:006 (P411.06)</a> into consideration. Digital input 6 is only available in the Control Unit (CU) with application I/O.
17 Digital input 7	State of X3/DI7, taking an inversion set in <a href="#">0x2632:007 (P411.07)</a> into consideration. Digital input 7 is only available in the Control Unit (CU) with application I/O.
50 Running	TRUE if inverter and start are enabled and output frequency > 0 Hz. Otherwise FALSE. Exception, quick stop mode: TRUE if inverter and start are enabled and output frequency > 0.2 Hz. Otherwise FALSE.
51 Ready for operation	TRUE if inverter is ready for operation (no error active, no STO active and DC-bus voltage ok). Otherwise FALSE.
53 Stop active	TRUE if inverter is enabled and motor is not started and output frequency = 0.
54 Quick stop active	TRUE if quick stop is active. Otherwise FALSE.
58 Device warning active	TRUE if warning is active. Otherwise FALSE. <ul style="list-style-type: none"> <li>• A warning has no impact on the operating status of the inverter.</li> <li>• A warning is reset automatically if the cause has been eliminated.</li> </ul>
59 Device trouble active	TRUE if a fault is active. Otherwise FALSE. <ul style="list-style-type: none"> <li>• In the event of a fault, the motor is brought to a standstill with the quick stop ramp. The inverter is then disabled.</li> <li>• Exception: In case of a serious fault, the inverter is disabled immediately. The motor has no torque (coasts).</li> <li>• The error state will be left automatically if the error condition is not active anymore.</li> <li>• The restart behaviour after trouble can be configured. <a href="#">▶ Automatic restart after a fault □ 579</a></li> </ul>
60 Heatsink temperature warning active	TRUE if current heatsink temperature > warning threshold for temperature monitoring. Otherwise FALSE. <ul style="list-style-type: none"> <li>• Display of the current heatsink temperature in <a href="#">0x2D84:001 (P117.01)</a>.</li> <li>• Setting of the warning threshold in <a href="#">0x2D84:002</a>.</li> </ul>
68 Stop command active	TRUE if delay to standstill active. Otherwise FALSE.
69 Rotational direction reversed	TRUE if output frequency is negative. Otherwise FALSE.
70 Frequency threshold exceeded	TRUE if current output frequency > frequency threshold. Otherwise FALSE. <ul style="list-style-type: none"> <li>• Display of the current output frequency in <a href="#">0x2DDD (P100.00)</a>.</li> <li>• Setting Frequency threshold in <a href="#">0x4005 (P412.00)</a>.</li> </ul> <a href="#">▶ Trigger action if a frequency threshold is exceeded □ 604</a>
71 Actual speed = 0	TRUE if actual output frequency = 0 Hz (± 0.3 Hz), irrespective of the operating mode. Otherwise FALSE. <ul style="list-style-type: none"> <li>• Display of the current output frequency in <a href="#">0x2DDD (P100.00)</a>.</li> </ul>
78 Current limit reached	TRUE if current motor current ≥ maximum current. Otherwise FALSE. <ul style="list-style-type: none"> <li>• Display of the present motor current in <a href="#">0x2D88 (P104.00)</a>.</li> <li>• Setting for the maximum current in <a href="#">0x6073 (P324.00)</a>.</li> </ul>
79 Torque limit reached (from version 02.00)	TRUE if torque limit has been reached or exceeded. Otherwise FALSE. <ul style="list-style-type: none"> <li>• Setting "Actual positive torque limit" in <a href="#">0x2949:003 (P337.03)</a>.</li> <li>• Setting "Actual negative torque limit" in <a href="#">0x2949:004 (P337.04)</a>.</li> </ul> <a href="#">▶ Motor torque monitoring □ 265</a>
81 Error of analog input 1 active	TRUE if the monitoring of the input signal at the analog input 1 has responded. Otherwise FALSE.  This trigger is set as a function of the following settings: <ul style="list-style-type: none"> <li>• Monitoring threshold <a href="#">0x2636:008 (P430.08)</a></li> <li>• Monitoring condition <a href="#">0x2636:009 (P430.09)</a></li> </ul> The setting of the Error response in <a href="#">0x2636:010 (P430.10)</a> has no effect on this trigger.  <a href="#">▶ Analog input 1 □ 284</a>



# Start, stop and rotating direction commands

Flexible I/O configuration of the start, stop and rotating direction commands  
Trigger list

Selection		Information
82	Error of analog input 2 active	TRUE if the monitoring of the input signal at the analog input 2 has responded. Otherwise FALSE.  This trigger is set as a function of the following settings: <ul style="list-style-type: none"> <li>Monitoring threshold <a href="#">0x2637:008 (P431.08)</a></li> <li>Monitoring condition <a href="#">0x2637:009 (P431.09)</a></li> </ul> The setting of the Error response in <a href="#">0x2637:010 (P431.10)</a> has no effect on this trigger. <a href="#">▶ Analog input 2 □ 289</a>
83	Load loss detected	TRUE if actual motor current < threshold for load loss detection after delay time of the load loss detection has elapsed. Otherwise FALSE. <ul style="list-style-type: none"> <li>Display of the actual current in <a href="#">0x6078 (P103.00)</a>.</li> <li>Setting Threshold in <a href="#">0x4006:001 (P710.01)</a>.</li> <li>Setting Delay time in <a href="#">0x4006:002 (P710.02)</a>.</li> </ul> <a href="#">▶ Load loss detection □ 237</a>
84	Heavy load monitoring	TRUE if the actual apparent current of the motor exceeds the threshold for longer than the delay time. FALSE if the actual apparent current of the motor falls below the threshold value minus 5 % (hysteresis). <a href="#">▶ Heavy load monitoring □ 269</a>
102	Sequence suspended (from version 03.00)	Status signal of the "sequencer" function: TRUE if the sequence is currently suspended. <a href="#">▶ Sequencer □ 102</a>
103	Sequence done (from version 03.00)	Status signal of the "sequencer" function: TRUE if the sequence is completed (final segment has been passed through). <a href="#">▶ Sequencer □ 102</a>
104	Local control active	TRUE if local keypad control ("LOC") active. Otherwise FALSE.
105	Remote control active	TRUE if remote control ("REM") via terminals, network, etc. active. Otherwise FALSE.
106	Manual setpoint selection active	TRUE if manual setpoint selection ("MAN") via keypad active. Otherwise FALSE. <ul style="list-style-type: none"> <li>Selection of the trigger for the "Activate keypad setpoint" function in <a href="#">0x2631:016 (P400.16)</a>.</li> </ul>
107	Automatic setpoint selection active	TRUE if automatic setpoint selection ("AUTO") via terminals, network, etc. active. Otherwise FALSE.
201	Internal value (from version 05.00)	Internal values of the manufacturer.
202	Internal value (from version 05.00)	
203	Internal value (from version 05.00)	
204	Internal value (from version 05.00)	
205	Internal value (from version 05.00)	
206	Internal value (from version 05.00)	

# Start, stop and rotating direction commands

Flexible I/O configuration of the start, stop and rotating direction commands  
 Example: Start/stop (1 signal) and reversal



## 6.2.2 Example: Start/stop (1 signal) and reversal

This example shows a simple control option via two switches which should be sufficient for many applications:

- The switch S1 starts the motor in forward rotating direction. The switch S1 in the initial position stops the motor again.
- The switch S2 switches the direction of rotation.

Connection plan	Function	
	Potentiometer R1	Frequency setpoint selection
	Switch S1	Run
	Switch S2	Reverse rotational direction

The example uses the preset I/O configuration of the inverter:

Parameter	Designation	Setting for this example (corresponds to default setting)
0x2631:001 (P400.01)	Enable inverter	Constant TRUE [1]
0x2631:002 (P400.02)	Run	Digital input 1 [11]
0x2631:013 (P400.13)	Reverse rotational direction	Digital input 3 [13]

### Input signals

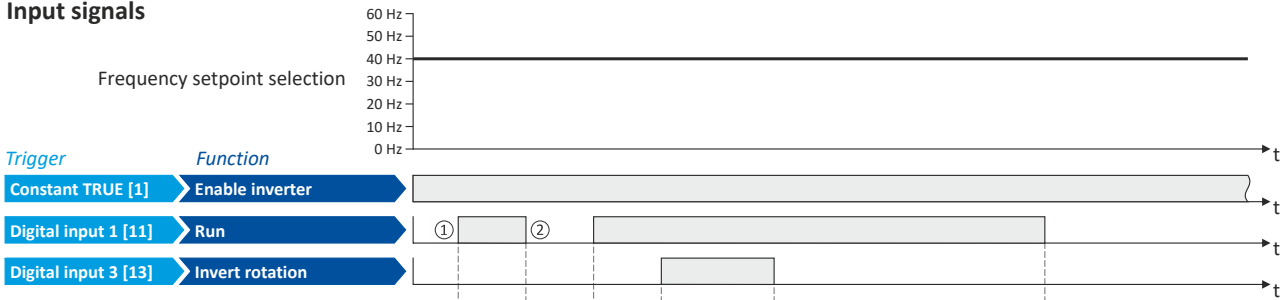

### Output signals

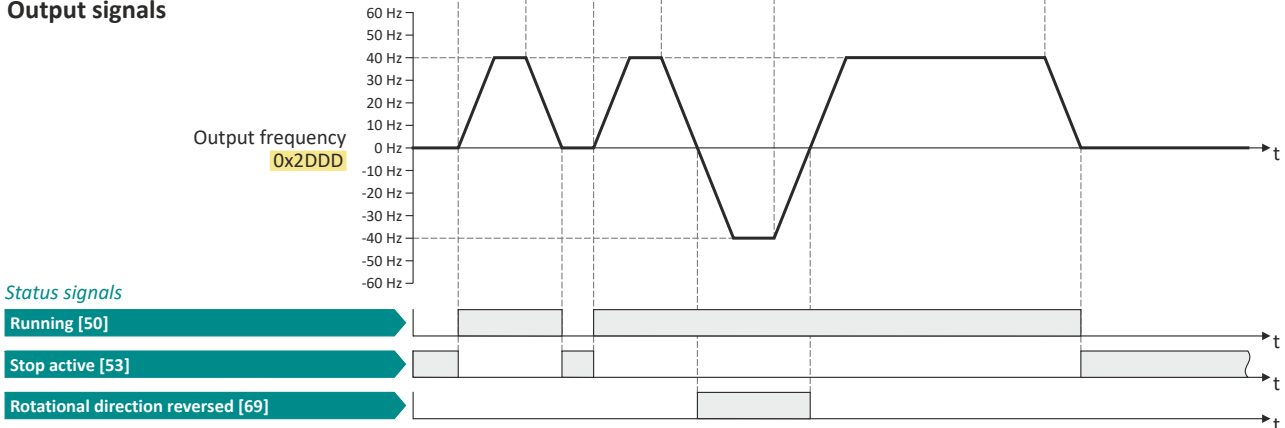

The status signals can be assigned to digital outputs. [▶ Configure digital outputs](#) 292

- ① If the inverter is enabled and no error is active, the motor can be started with the "Run" function in forward rotating direction.
- ② If "Run" is set to FALSE, the motor is stopped with the stop method set in 0x2838:003 (P203.03). In the example: Stop with standard ramp.



## 6.2.3 Example: Start forward/start reverse/stop (edge-controlled)



The "Run" function automatically becomes a "start enable" if the functions "Start forward (CW)"/"Start reverse (CCW)" are connected to triggers.

This example shows an edge-controlled start/stop via three buttons:

- In the non-operating state of button S1 (normally-closed contact), there is already a start enable.
- Button S2 starts the motor in forward rotating direction.
- Button S3 starts the motor in the reverse rotating direction.
- Button S1 (normally-closed contact) stops the motor by (momentary) cancellation of the start enable. The inverter then waits for the next start command via button S2/S3.

Connection diagram	Function	
	Potentiometer R1	Frequency setpoint selection
	Button S1	Stop
	Button S2	Start forward (CW)
	Button S3	Start reverse (CCW)

Parameter	Name	Setting for this example
0x2631:001 (P400.01)	Enable inverter	Constant TRUE [1]
0x2631:002 (P400.02)	Run	Digital input 1 [11]
0x2631:004 (P400.04)	Reset fault	Not connected [0]
0x2631:006 (P400.06)	Start forward (CW)	Digital input 2 [12]
0x2631:007 (P400.07)	Start reverse (CCW)	Digital input 3 [13]
0x2631:013 (P400.13)	Reverse rotational direction	Not connected [0]

# Start, stop and rotating direction commands

Flexible I/O configuration of the start, stop and rotating direction commands  
 Example: Start forward/start reverse/stop (edge-controlled)

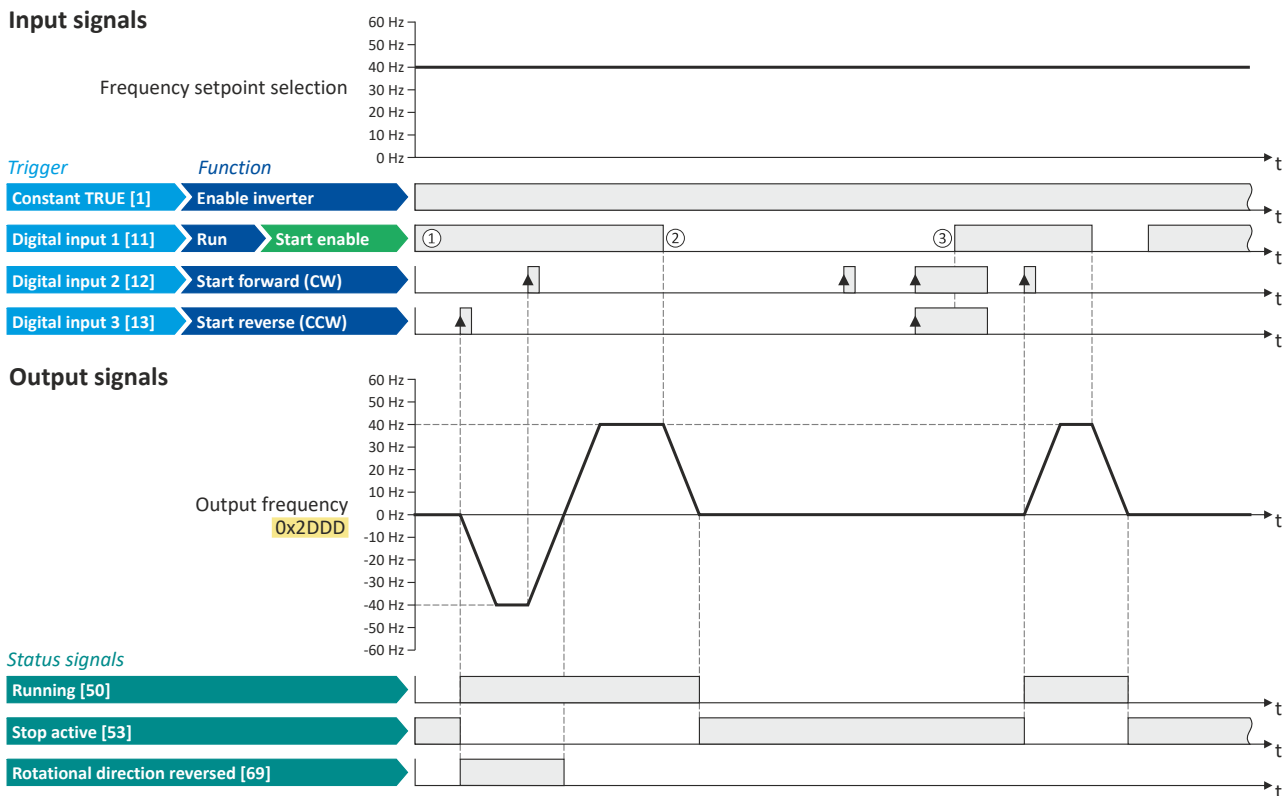

The status signals can be assigned to digital outputs. [▶ Configure digital outputs](#) 292

- ① The "Run" function serves as start enable for the functions "Start forward (CW)" and "Start reverse (CCW)". Without start enable, the motor cannot be started.
- ② If the start enable is cancelled, the motor is stopped with the stop method set in [0x2838:003 \(P203.03\)](#). In the example: Stop with standard ramp.
- ③ If, at start enable, "Start forward (CW)" and "Start reverse (CCW)" are already set to TRUE, the motor remains stopped and the inverter waits for the next valid start edge.



# Start, stop and rotating direction commands

Flexible I/O configuration of the start, stop and rotating direction commands  
 Example: Run forward/Run reverse/stop (status-controlled)

## 6.2.4 Example: Run forward/Run reverse/stop (status-controlled)



The "Run" function automatically becomes a "start enable" if the functions "Run forward (CW)"/"Run reverse (CCW)" are connected to triggers.

This example shows a status-controlled start/stop via three switches:

- Switch S1 enables the start. Without start enable, the motor cannot be started.
- Switch S2 starts the motor in forward direction of rotation.
- Switch S3 starts the motor in backward direction of rotation.
- The motor is stopped by cancelling the run commands (switches S2 and S3 open) or by cancelling the start enable (switch S1 open).

Connection diagram	Function	
	Potentiometer R1	Frequency setpoint selection
	Switch S1	Start enable
	Switch S2	Run forward (CW)
	Switch S3	Run reverse (CCW)

Parameter	Name	Setting for this example
0x2631:001 (P400.01)	Enable inverter	Constant TRUE [1]
0x2631:002 (P400.02)	Run	Digital input 1 [11]
0x2631:004 (P400.04)	Reset fault	Not connected [0]
0x2631:008 (P400.08)	Run forward (CW)	Digital input 2 [12]
0x2631:009 (P400.09)	Run reverse (CCW)	Digital input 3 [13]
0x2631:013 (P400.13)	Reverse rotational direction	Not connected [0]

# Start, stop and rotating direction commands

Flexible I/O configuration of the start, stop and rotating direction commands  
 Example: Run forward/Run reverse/stop (status-controlled)

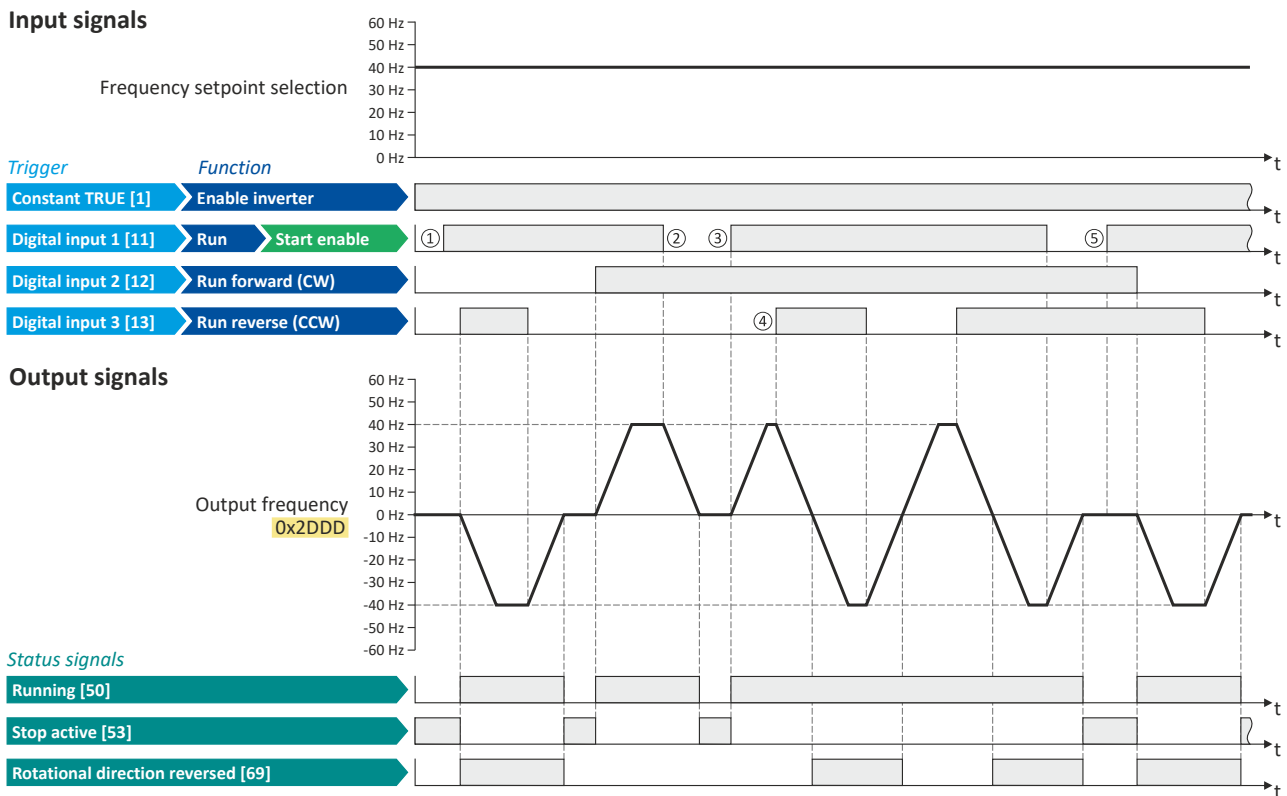

The status signals can be assigned to digital outputs. [▶ Configure digital outputs](#) 292

- ① The "Run" function serves as start enable for the functions "Run forward (CW)" and "Run reverse (CCW)". Without start enable, the motor cannot be started.
- ② If the start enable is cancelled, the motor is stopped with the stop method set in [0x2838:003 \(P203.03\)](#). In the example: Stop with standard ramp. After a renewed start enable, the inverter waits for the next run command.
- ③ If, at start enable, either "Run forward (CW)" or "Run reverse (CCW)" is set to TRUE, the motor starts in the triggered direction.
- ④ The inverter always responds to the run command detected last (if start enable is available). In the example, the "Run reverse (CCW)" command replaces the still active "Run forward (CW)" command.
- ⑤ If, at start enable, both run commands are set to TRUE, the motor remains stopped until only one valid run command is available.





## 6.2.5 Example: Quick stop

This example illustrates the "quick stop" function. If a quick stop is activated, the motor is brought to a standstill within the deceleration time set in [0x291C \(P225.00\)](#).

- The switch S1 starts the motor in forward rotating direction. The switch S1 in the initial position stops the motor again.
- The switch S2 activates the "quick stop" function.



Cancelling the quick stop causes a restart of the motor if the "Run" function is still active (switch S1 closed)!

Connection plan	Function
	Potentiometer R1
	Frequency setpoint selection
	Switch S1
	Run
	Switch S2
	Activate quick stop

Parameter	Name	Setting for this example
0x2631:001 (P400.01)	Enable inverter	Constant TRUE [1]
0x2631:002 (P400.02)	Run	Digital input 1 [11]
0x2631:003 (P400.03)	Activate quick stop	Digital input 2 [12]
0x2631:004 (P400.04)	Reset fault	Not connected [0]
0x2917 (P220.00)	Acceleration time 1	3.0 s
0x2918 (P221.00)	Deceleration time 1	3.0 s
0x291C (P225.00)	Quick stop deceleration time	1.0 s

### Input signals

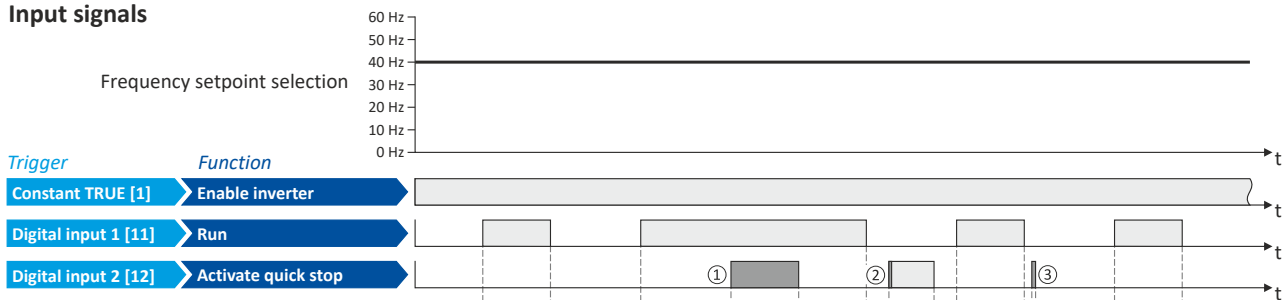

### Output signals

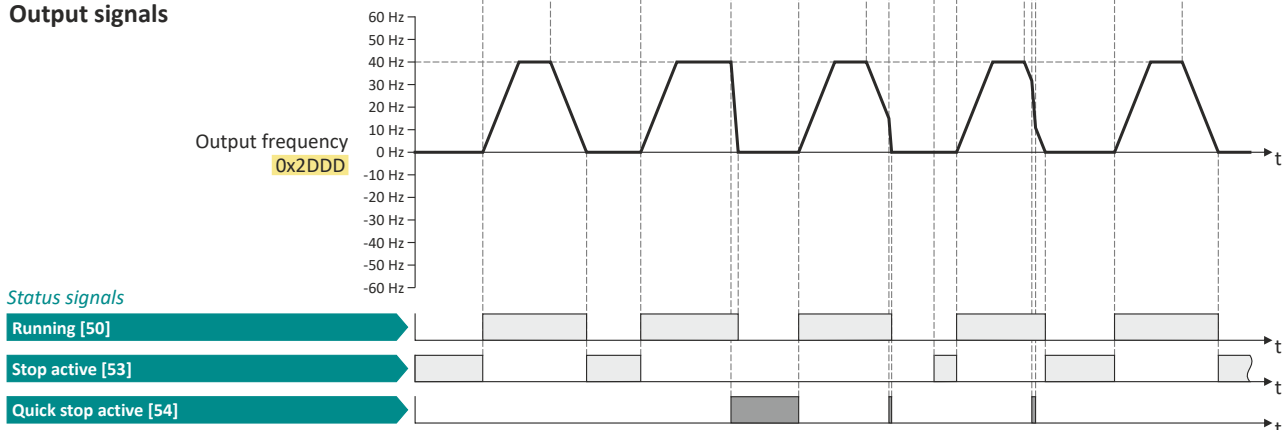

The status signals can be assigned to digital outputs. ▶ [Configure digital outputs](#) 292

- ① If a quick stop is activated, the motor is decelerated to the frequency setpoint 0 Hz within a short period of time. The "Quick stop active [54]" status is set as long as quick stop is activated. The "Stop active [53]" status is not set.
- ② An active stop command is interrupted by a quick stop.
- ③ If quick stop is cancelled again before standstill is reached, stopping is continued with the stop method set in [0x2838:003 \(P203.03\)](#). In the example: Stop with standard ramp.

# Start, stop and rotating direction commands

Flexible I/O configuration of the start, stop and rotating direction commands

Example: Enable inverter



## 6.2.6 Example: Enable inverter

This example shows how to use the "Enable inverter" function for a separate enable input.

- In sleep mode of switch S1 (normally-closed contact), "Enable inverter" is already available.
- Switch S2 starts the motor in forward rotating direction (if switch S1 is closed). Switch S2 in initial position stops the motor again.
- Switch S1 disables the inverter. The motor becomes torqueless (coasts).

Connection plan	Function
	Potentiometer R1: Frequency setpoint selection
	Switch S1: Disable inverter
	Switch S2: Run

Parameter	Name	Setting for this example
0x2631:001 (P400.01)	Enable inverter	Digital input 1 [11]
0x2631:002 (P400.02)	Run	Digital input 2 [12]
0x2631:004 (P400.04)	Reset fault	Not connected [0]

### Input signals

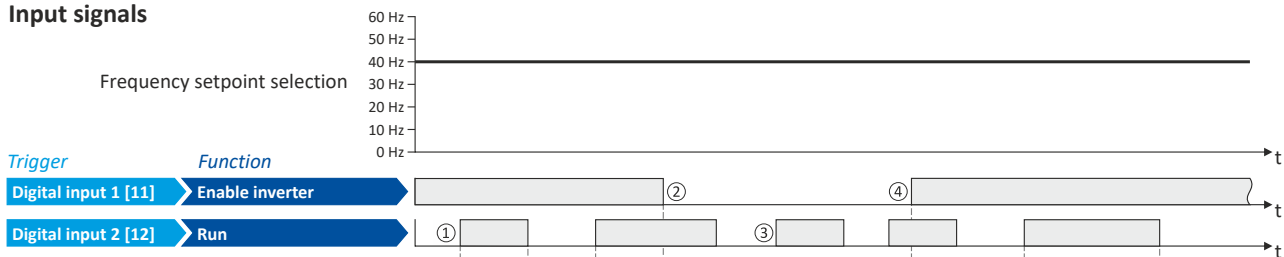

### Output signals

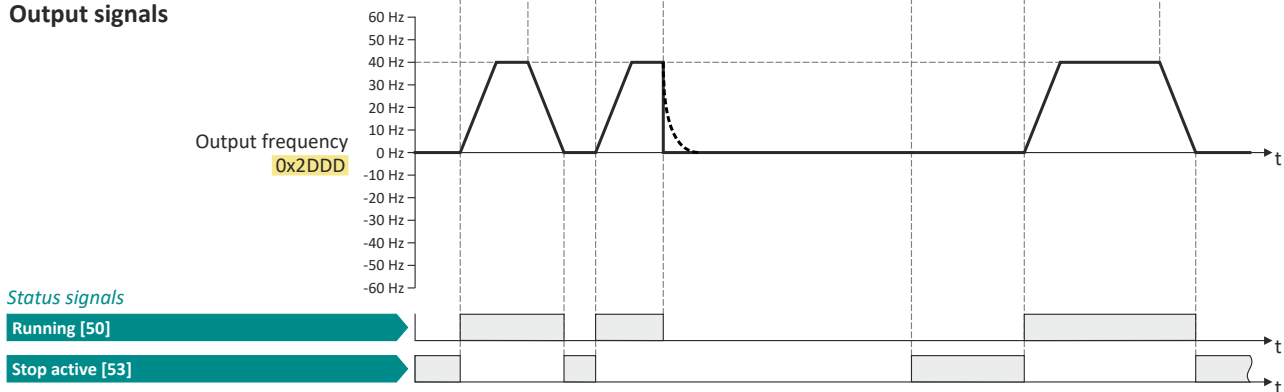

The status signals can be assigned to digital outputs. [▶ Configure digital outputs](#) 292

- ① If the inverter is enabled and no error is active, the motor can be started with the "Run" function in forward rotating direction.
- ② If "Enable inverter" is set to FALSE, the inverter is disabled. The motor becomes torqueless and coasts to standstill as a function of the mass inertia of the machine.
- ③ Without "Enable inverter", the motor cannot be started.
- ④ In the default setting, the motor does not start if the "Run" function is set to TRUE during "Enable inverter". "Start" has to be triggered again after "Enable inverter" to start the motor.  
[▶ Start behavior](#) 51



## 6.2.7 Example: Jog forward/Jog reverse

This example shows the functions "Jog forward (CW)" and "Jog reverse (CCW)" for Jog operation.

- Switch S1 starts the motor in the forward direction of rotation. Switch S1 in initial position stops the motor again.
- The button S2 starts the motor in the forward direction of rotation with frequency preset 5.
- The button S3 starts the motor in the backward direction of rotation with frequency preset 6.
- The motor rotates in jog operation as long as the respective button is pressed. If both buttons are pressed at the same time, the motor is stopped.

### ⚠ CAUTION!

The jog operation has a higher priority than the "Run" function, all other start commands and the keypad key .

If jog operation is active, the motor cannot be stopped with the previously mentioned functions!

- ▶ The jog operation is stopped by cancelling the functions "Jog forward (CW)"/"Jog reverse (CCW)".
- ▶ The jog operation can be interrupted with the "Activate quick stop" [0x2631:003 \(P400.03\)](#) function.

Connection diagram	Function	
	Potentiometer R1	Frequency setpoint selection
	Switch S1	Run
	Button S2	Jog forward (CW)
	Button S3	Jog reverse (CCW)

Parameter	Name	Setting for this example
<a href="#">0x2631:001 (P400.01)</a>	Enable inverter	Constant TRUE [1]
<a href="#">0x2631:002 (P400.02)</a>	Run	Digital input 1 [11]
<a href="#">0x2631:004 (P400.04)</a>	Reset fault	Not connected [0]
<a href="#">0x2631:010 (P400.10)</a>	Jog forward (CW)	Digital input 2 [12]
<a href="#">0x2631:011 (P400.11)</a>	Jog reverse (CCW)	Digital input 3 [13]
<a href="#">0x2631:013 (P400.13)</a>	Reverse rotational direction	Not connected [0]
<a href="#">0x2911:005 (P450.05)</a>	Frequency setpoint presets: Preset 5	15 Hz (is used for jog forward)
<a href="#">0x2911:006 (P450.06)</a>	Frequency setpoint presets: Preset 6	10 Hz (is used for jog reverse)

# Start, stop and rotating direction commands

Flexible I/O configuration of the start, stop and rotating direction commands  
 Example: Jog forward/Jog reverse

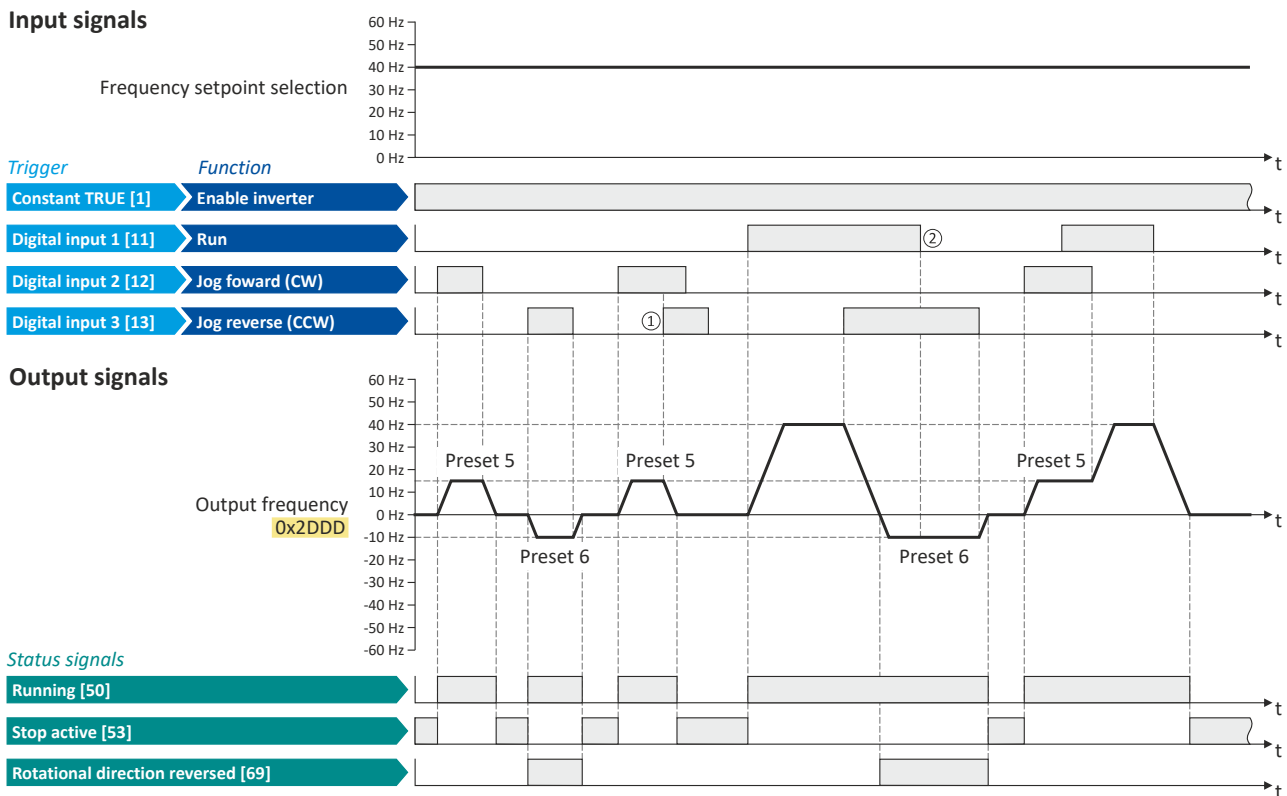

The status signals can be assigned to digital outputs. ▶ [Configure digital outputs](#) 292

- ① If "Jog forward (CW)" and "Jog reverse (CCW)" are activated at the same time, the motor is stopped with the stop method set in 0x2838:003 (P203.03) and the jog operation must be triggered again.
- ② The jog operation cannot be terminated with the "Run" function but only by cancelling the jog command.



## 6.3 Control/restrict direction of rotation of the motor

In the default setting, both directions of motor rotation are enabled. Optionally, the direction of rotation can be restricted so that only a clockwise rotation (CW) of the motor is possible.

### Preconditions

Wiring of the motor phases must be carried out correctly with regard to the direction of motor rotation.

In the documentation and the parameter selection texts, the following terms are used for the direction of rotation:

- Forward = clockwise direction of rotation (CW)
- Reverse = counter-clockwise direction of rotation (CCW)

### Details

The direction of rotation of the motor can be controlled in various ways:

- Via the function "Reverse rotational direction". Possible triggers for the function "Reverse rotational direction" are available for selection in [0x2631:013 \(P400.13\)](#), e.g. the digital inputs and internal status signals of the inverter.
- Via the network. The definition of the direction of rotation is possible via the mappable NetWordIN1 data word or one of the predefined process data words.
- By specifying a bipolar setpoint value via an analog input. Either via a bipolar input range (-10 ... +10 V) or the configuration of a bipolar setting range.

If a reversal of rotation is not required, the direction of rotation can be restricted in [0x283A \(P304.00\)](#) to "Only clockwise (CW) [0]".

### Parameter

Address	Name / setting range / [default setting]	Information
0x283A (P304.00)	Limitation of rotation (Limit. rotation)	Optional restriction of the rotating direction.
	0 Only clockwise (CW)	The motor can only be rotated clockwise (CW). The transfer of negative frequency and PID setpoints to the motor control is prevented. <ul style="list-style-type: none"><li>• This function takes effect after the "Reverse rotational direction" function (<a href="#">0x2631:013 (P400.13)</a>).</li><li>• Since this function only prevents negative setpoints, counter-clockwise rotation (CCW) is possible if the motor has been wired for this rotating direction.</li></ul>
	1 Both rotational directions	Both directions of motor rotation are enabled.

### Related topics

- ▶ [Example: Start/stop \(1 signal\) and reversal](#) 76



## 6.4 Changing the control source during operation

The term "control sources" in this connection refers to the digital signal sources from which the inverter receives its start, stop, and reversal commands.

Possible control sources:

- Digital inputs
- Keypad
- Network

### Details

First, select in [0x2824 \(P200.00\)](#) whether the start of the motor is to be configured flexibly (default setting) or exclusively via the keypad. ▶ [Control selection](#) [62](#)

If "Flexible I/O configuration" is set, a change-over from one control source to another can be effected during operation via the functions listed in the following table. The inverter not only supports such a change-over via its digital inputs, but also as a function of internal inverter states.

Activate keypad control <a href="#">0x2631:012 (P400.12)</a>	Activate network control <a href="#">0x2631:037 (P400.37)</a>	Active control source
FALSE / Not connected	FALSE / Not connected	Flexible I/O configuration (default setting) <ul style="list-style-type: none"> <li>• The motor is controlled via the digital inputs.</li> <li>• For preconfigured assignment of the digital inputs, see chapter "<a href="#">Function assignment of the inputs and outputs (default setting)</a>". <a href="#">66</a></li> <li>• For description of the basic functions for controlling the motor, see chapter "<a href="#">Flexible I/O configuration of the start, stop and rotating direction commands</a>". <a href="#">67</a></li> </ul>
FALSE / Not connected	TRUE	Network <ul style="list-style-type: none"> <li>• Starting the motor is only possible via the network control word.</li> <li>• Exception: jog operation; see chapter "<a href="#">Flexible I/O configuration of the start, stop and rotating direction commands</a>". <a href="#">67</a></li> <li>▶ <a href="#">Example: Change-over from terminal control to network control</a> <a href="#">91</a></li> </ul>
TRUE	Any	Keypad <ul style="list-style-type: none"> <li>• Starting the motor is only possible via the  keypad key.</li> <li>• Exception: jog operation; see chapter "<a href="#">Flexible I/O configuration of the start, stop and rotating direction commands</a>". <a href="#">67</a></li> <li>▶ <a href="#">Example: Change-over from terminal control to keypad control</a> <a href="#">89</a></li> </ul>

### Parameter

Address	Name / setting range / [default setting]	Information
0x2631:012 (P400.12)	Function list: Activate keypad control (Function list: Keypad control) • Further possible settings: ▶ <a href="#">Trigger list</a> <a href="#">73</a>	Assignment of a trigger for the "Activate keypad control" function. Trigger = TRUE: activate keypad as control source. Trigger = FALSE: no action / deactivate keypad as control source again.
	<b>0</b> Not connected	No trigger assigned (trigger is constantly FALSE).
0x2631:037 (P400.37)	Function list: Activate network control (Function list: Network control) • Further possible settings: ▶ <a href="#">Trigger list</a> <a href="#">73</a>	Assignment of a trigger for the "Activate network control" function. Trigger = TRUE: Activate network control. Trigger = FALSE: no action / deactivate network control again.
	<b>0</b> Not connected	No trigger assigned (trigger is constantly FALSE).
	114 Network control active (from version 02.00)	TRUE if the network control is requested via bit 5 of the AC drive control word <a href="#">0x400B:001 (P592.01)</a> . Otherwise FALSE.  Notes: • Set this selection if the network control is to be activated via bit 5 of the AC drive control word. • The AC drive control word can be used with any communication protocol. ▶ <a href="#">AC drive control word</a> <a href="#">363</a>



## Internal control logic

The following signal flow shows the internal control logic:

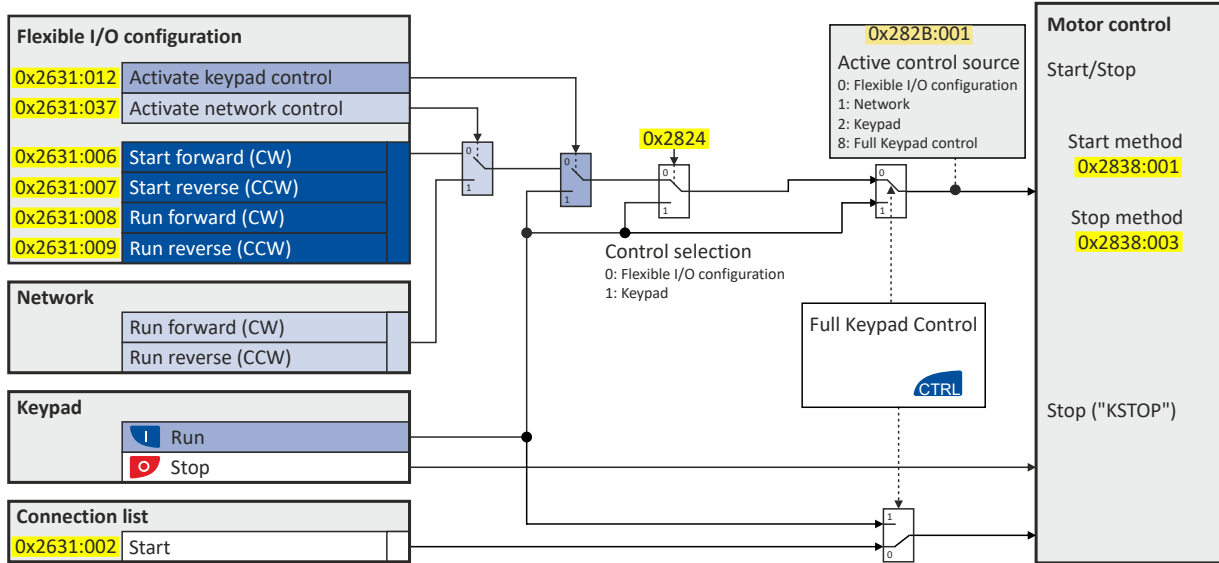

### Notes:

In case of an activated **keypad or network control**, the "Run" [0x2631:002 \(P400.02\)](#) function must be set to TRUE to start the motor in addition to the "Enable inverter", either via digital input or by the "Constant TRUE [1]" setting.

In case of an activated **network control**, the following functions are still active:

- [0x2631:001 \(P400.01\)](#): Enable inverter
- [0x2631:002 \(P400.02\)](#): Run
- [0x2631:003 \(P400.03\)](#): Activate quick stop
- [0x2631:004 \(P400.04\)](#): Reset error
- [0x2631:005 \(P400.05\)](#): DC braking
- [0x2631:010 \(P400.10\)](#): Jog forward (CW)
- [0x2631:011 \(P400.11\)](#): Jog reverse (CCW)\*
- [0x2631:012 \(P400.12\)](#): Activate keypad control\*
- [0x2631:037 \(P400.37\)](#): Activate network control\*
- [0x2631:043 \(P400.43\)](#): Activate fault 1
- [0x2631:044 \(P400.44\)](#): Activate fault 2
- [0x2631:054 \(P400.54\)](#): Reset position counter

(\*Not active in case of network operation in CiA402 mode 0x6060=2).

In case of an activated **network control**, the following functions are also still active if they are not configured in the NetWordIN1 bit functionality:

- [0x2631:048 \(P400.48\)](#): Activate PID influence ramp
- [0x2631:041 \(P400.41\)](#): Select parameter set (bit 0)
- [0x2631:042 \(P400.42\)](#): Select parameter set (bit 1)

All other functions configurable via [0x2631:xx \(P400.xx\)](#) are deactivated in case of network control.

In case of **keypad control**, the following functions continue to be active:

- [0x2631:001 \(P400.01\)](#): Enable inverter
- [0x2631:002 \(P400.02\)](#): Run
- [0x2631:003 \(P400.03\)](#): Activate quick stop
- [0x2631:004 \(P400.04\)](#): Reset error
- [0x2631:005 \(P400.05\)](#): DC braking
- [0x2631:010 \(P400.10\)](#): Jog forward (CW)

# Start, stop and rotating direction commands

Changing the control source during operation



- [0x2631:011 \(P400.11\)](#): Jog reverse (CCW)\*
- All other functions of [0x2631:012 \(P400.12\)](#) - [0x2631:055 \(P400.55\)](#)

The functions for setpoint changeover. ▶ [Changing the setpoint source during operation](#)  142

Diagnostic parameters:

- [0x282A:001 \(P126.01\)](#): Cause of disable
- [0x282A:002 \(P126.02\)](#): Cause of quick stop
- [0x282A:003 \(P126.03\)](#): Cause of stop
- [0x282B:001 \(P125.01\)](#): Active control source







# Start, stop and rotating direction commands

Changing the control source during operation

Example: Change-over from terminal control to keypad control

## 6.4.1 Example: Change-over from terminal control to keypad control

- The control is executed primarily via the I/O terminals: Switch S1 serves to start and stop the motor.
- Switch S2 serves to optionally change over to local keypad control. In case of activated keypad control, the motor can only be started via the keypad key . However, the condition is that switch S1 is closed.
- If switch S1 is opened again or the keypad key  is pressed, the motor is stopped (regardless of the active control source).
- For details of the keypad control of the inverter, see the chapter "[Keypad operating mode](#)".

 637

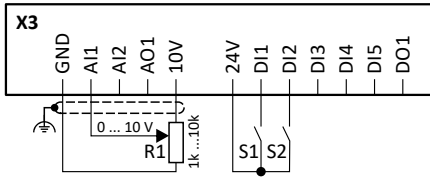
Connection diagram		Function	
		Potentiometer R1	Frequency setpoint selection
		Switch S1	Run
		Switch S2	Activate keypad control
Parameter	Name	Setting for this example	
0x2631:001 (P400.01)	Enable inverter	Constant TRUE [1]	
0x2631:002 (P400.02)	Run	Digital input 1 [11]	
0x2631:004 (P400.04)	Reset fault	Not connected [0]	
0x2631:012 (P400.12)	Activate keypad control	Digital input 2 [12]	
0x2824 (P200.00)	Control selection	Flexible I/O configuration [0]	

# Start, stop and rotating direction commands

Changing the control source during operation

Example: Change-over from terminal control to keypad control

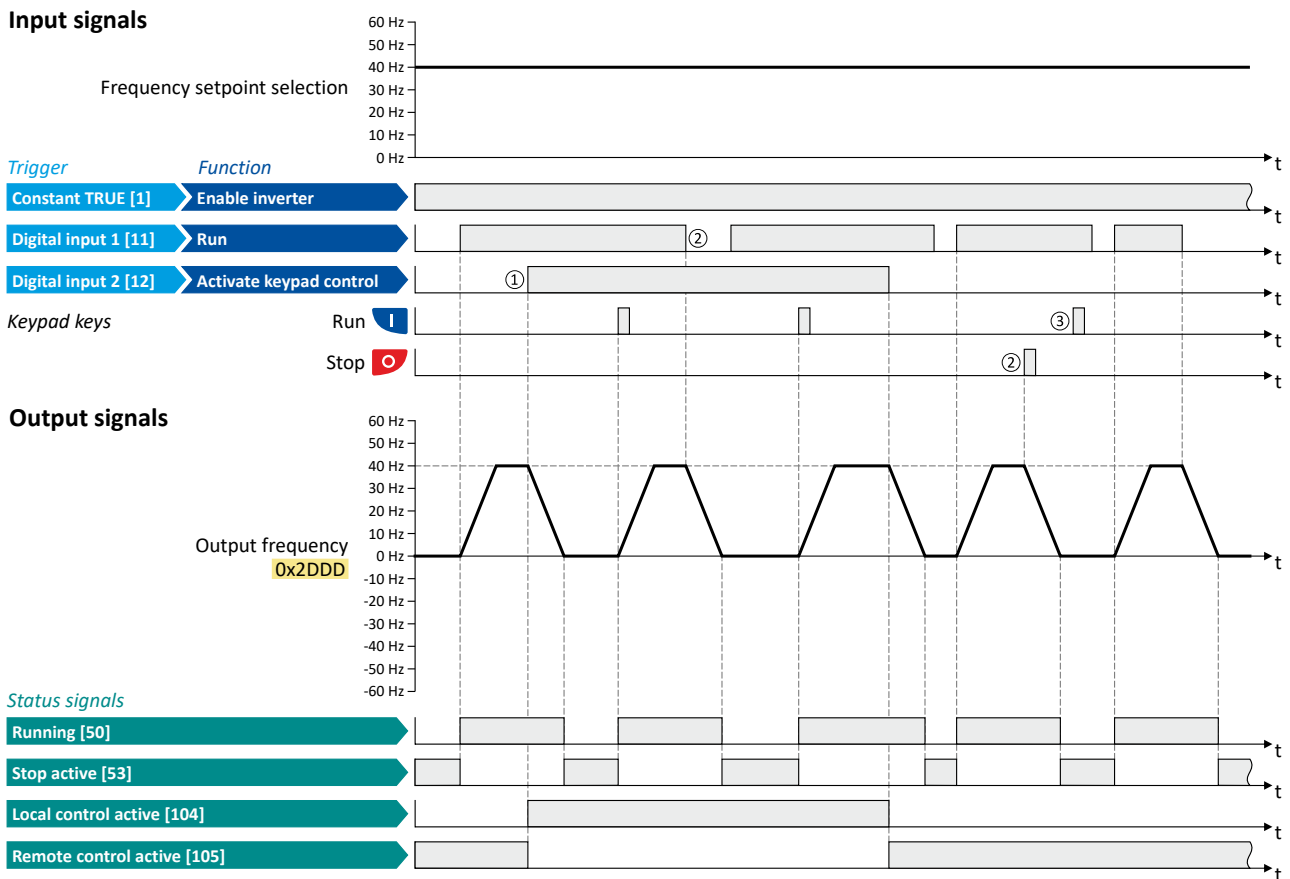

The status signals can be assigned to digital outputs. ▶ [Configure digital outputs](#) 292

- ① When changing over to another control source, the motor is first stopped with the stop method set in [0x2838:003 \(P203.03\)](#).
- ② The motor is also stopped when the "Run" function is cancelled or the keypad key is pressed (regardless of the active control source).
- ③ After stopping with the keypad key , the key on the keypad must be pressed to cancel the keypad stop ("KSTOP") again before a new start command from another control source.



# Start, stop and rotating direction commands

Changing the control source during operation

Example: Change-over from terminal control to network control

## 6.4.2 Example: Change-over from terminal control to network control

- The control is executed primarily via the I/O terminals. The switch S1 serves to start and stop the motor.
- Switch S2 serves to activate the network control. In case of activated network control, the motor can only be started via the network control word. However, the condition is that switch S1 is closed.
- If the switch S1 is opened again, the motor is stopped (irrespective of the active control source).

Connection plan	Function
	Potentiometer R1: Frequency setpoint selection
	Switch S1: Run
	Switch S2: Activate network control

Parameter	Name	Setting for this example
0x2631:001 (P400.01)	Enable inverter	Constant TRUE [1]
0x2631:002 (P400.02)	Run	Digital input 1 [11]
0x2631:004 (P400.04)	Reset fault	Not connected [0]
0x2631:037 (P400.37)	Activate network control	Digital input 2 [12]
0x2824 (P200.00)	Control selection	Flexible I/O configuration [0]

### Input signals

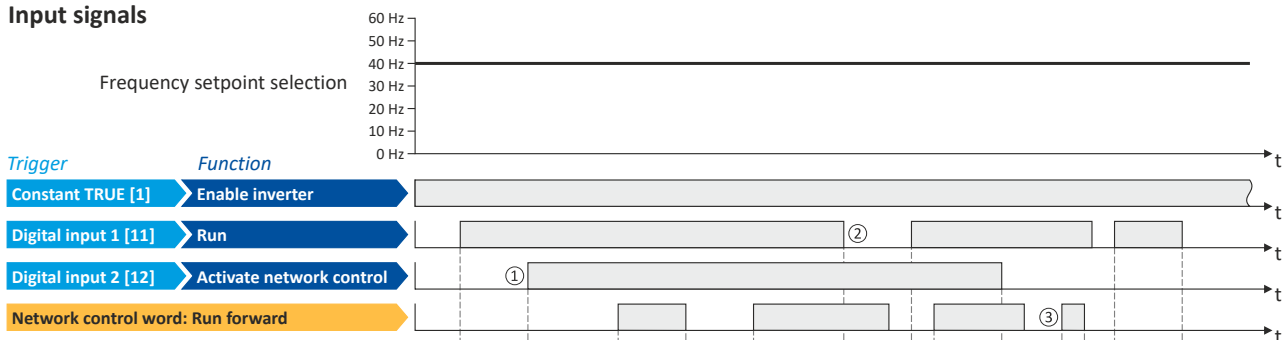

### Output signals

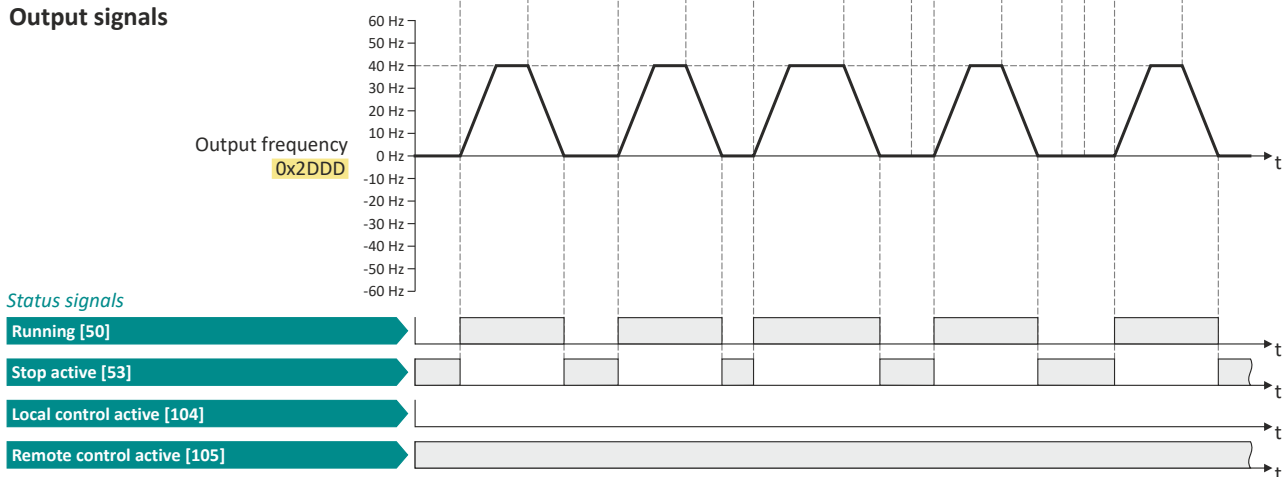

The status signals can be assigned to digital outputs. [▶ Configure digital outputs](#) 292

- ① When changing over to another control source, the motor is first stopped with the stop method set in 0x2838:003 (P203.03).
- ② The motor will also be stopped if the "Run" function is deactivated (irrespective of the active control source).
- ③ Commands via the network are ignored if the network control is not active.



## 7 Configuring the frequency control

### 7.1 Basic setting

In the following, the steps required for configuring the frequency control are described.

1. Set **0x6060 (P301.00)** to "MS: Velocity mode [-2]" operating mode (default setting).
2. Select the standard setpoint source for the frequency control in **0x2860:001 (P201.01)**.
3. Configure the selected standard setpoint source. ▶ [Configure setpoint sources](#) 97
4. Adjust the ramp times to the application. ▶ [Ramp times](#) 95
5. Optional: [Configuring the process controller](#) 128

The following signal flow shows the internal setpoint logics:

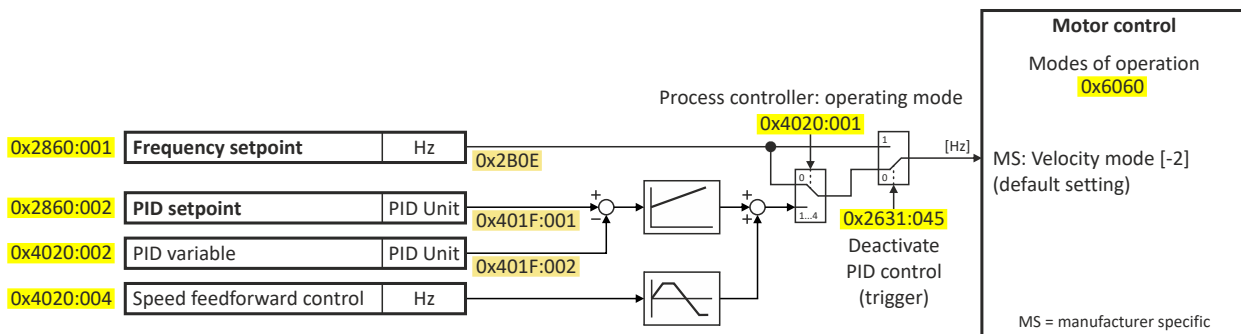

The frequency control is now active and the inverter responds to the frequency setpoint given by the selected setpoint source.



## 7.1.1 Standard setpoint source

The selected "setpoint source" serves to provide the inverter with its setpoint. The setpoint source can be selected individually for each operating mode.

Possible setpoint sources:

- Analog inputs
- Keypad
- Network
- Parameterisable setpoints (presets)
- Digital inputs (configured as HTL input for pulse train or HTL encoder)
- "Motor potentiometer" function
- "Sequencer" function

### Details

- For applications only requiring one setpoint, it is sufficient to define the standard setpoint source in [0x2860:001 \(P201.01\)](#).
- For applications requiring a change-over of the setpoint source during operation, the functions for setpoint change-over have to be configured accordingly. [▶ Changing the setpoint source during operation](#) [□ 142](#)

### Parameter

Address	Name / setting range / [default setting]	Information
0x2860:001 (P201.01)	Frequency control: Default setpoint source (Freq. setp. src.)	Selection of the standard setpoint source for operating mode "MS: Velocity mode". <ul style="list-style-type: none"> <li>• The selected standard setpoint source is always active in the operating mode <a href="#">0x6060 (P301.00)</a> = "MS: Velocity mode [-2]" when no setpoint change-over to another setpoint source via corresponding triggers/functions is active.</li> <li>▶ <a href="#">Changing the setpoint source during operation</a> <a href="#">□ 142</a></li> </ul>
	1 Keypad	The setpoint is specified locally by the keypad. <ul style="list-style-type: none"> <li>• Default setting: <a href="#">0x2601:001 (P202.01)</a></li> <li>• Use the <b>↑</b> and <b>↓</b> navigation keys to change the keypad setpoint (also during running operation).</li> </ul>
	2 <b>Analog input 1</b>	The setpoint is defined as analog signal via the analog input 1. ▶ <a href="#">Analog input 1</a> <a href="#">□ 284</a>
	3 Analog input 2	The setpoint is defined as analog signal via the analog input 2. ▶ <a href="#">Analog input 2</a> <a href="#">□ 289</a>
	4 HTL input (from version 04.00)	The digital inputs DI3 and DI4 can be configured as HTL input to use an HTL encoder as setpoint encoder or define the setpoint as a reference frequency ("pulse train"). ▶ <a href="#">HTL encoder</a> <a href="#">□ 176</a> ▶ <a href="#">Configure digital inputs DI3/DI4 for detecting a pulse train</a> <a href="#">□ 276</a>
	5 Network	The setpoint is defined as process data object via the network. ▶ <a href="#">Define setpoint via network</a> <a href="#">□ 327</a>

# Configuring the frequency control

Basic setting  
Standard setpoint source



Address	Name / setting range / [default setting]	Information
11	Frequency preset 1	For the setpoint selection, preset values can be parameterised and selected. <a href="#">▶ Setpoint presets □ 98</a>
12	Frequency preset 2	
13	Frequency preset 3	
14	Frequency preset 4	
15	Frequency preset 5	
16	Frequency preset 6	
17	Frequency preset 7	
18	Frequency preset 8	
19	Frequency preset 9	
20	Frequency preset 10	
21	Frequency preset 11	
22	Frequency preset 12	
23	Frequency preset 13	
24	Frequency preset 14	
25	Frequency preset 15	
31	Segment preset 1 (from version 03.00)	For the setpoint selection, the segment presets parameterised for the "sequencer" function can be selected as well. <a href="#">▶ Sequencer □ 102</a>
32	Segment preset 2 (from version 03.00)	
33	Segment preset 3 (from version 03.00)	
34	Segment preset 4 (from version 03.00)	
35	Segment preset 5 (from version 03.00)	
36	Segment preset 6 (from version 03.00)	
37	Segment preset 7 (from version 03.00)	
38	Segment preset 8 (from version 03.00)	
50	Motor potentiometer	The setpoint is generated by the "motor potentiometer" function. This function can be used as an alternative setpoint control which is controlled via two signals: "MOP setpoint up" and "MOP setpoint down". <a href="#">▶ Motor potentiometer (MOP) □ 100</a>
201	Internal value (from version 05.00)	Internal values of the manufacturer.
202	Internal value (from version 05.00)	
203	Internal value (from version 05.00)	
204	Internal value (from version 05.00)	
205	Internal value (from version 05.00)	
206	Internal value (from version 05.00)	



## 7.1.2 Ramp times

The frequency setpoint is internally guided via a ramp generator. The acceleration time and the deceleration time are independently adjustable.

### Details

- The acceleration time set in [0x2917 \(P220.00\)](#) refers to an acceleration from standstill to the maximum frequency set in [0x2916 \(P211.00\)](#). At a low setpoint selection, the real acceleration time decreases accordingly.
- The deceleration time set in [0x2918 \(P221.00\)](#) refers to the deceleration of the set maximum frequency to standstill. In case of a lower actual frequency, the actual deceleration time is reduced accordingly.

### Input signals

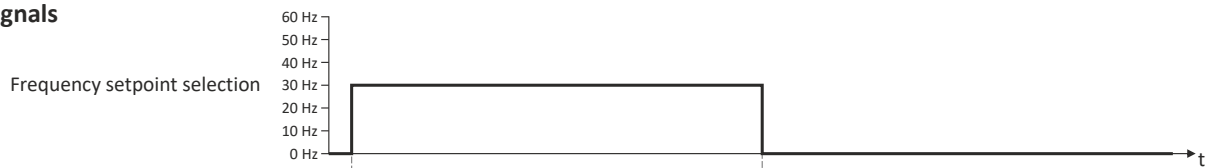

### Output signals

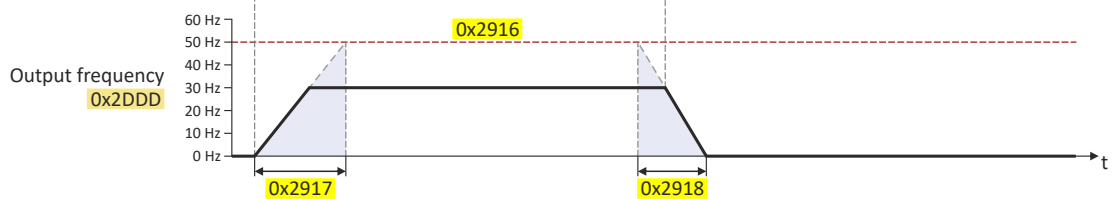

### Parameter

Address	Name / setting range / [default setting]	Information
0x2917 (P220.00)	Acceleration time 1 (Accelerat.time 1) 0.0 ... [5.0] ... 3600.0 s	Acceleration time 1 for the operating mode "MS: Velocity mode". <ul style="list-style-type: none"> <li>• The acceleration time set refers to the acceleration from standstill to the maximum frequency set. In the case of a lower setpoint selection, the actual acceleration time is reduced accordingly.</li> <li>• Setting is not effective in the operating mode <a href="#">0x6060 (P301.00)</a> = "CiA: Velocity mode (vl) [2]".</li> </ul>
0x2918 (P221.00)	Deceleration time 1 (Decelerat.time 1) 0.0 ... [5.0] ... 3600.0 s	Deceleration time 1 for the operating mode "MS: Velocity mode". <ul style="list-style-type: none"> <li>• The deceleration time set refers to the deceleration from the maximum frequency set to standstill. In the case of a lower actual frequency, the actual deceleration time is reduced accordingly.</li> <li>• Setting is not effective in the operating mode <a href="#">0x6060 (P301.00)</a> = "CiA: Velocity mode (vl) [2]".</li> </ul>
0x291C (P225.00)	Quick stop deceleration time (QSP dec. time) 0.0 ... [1.0] ... 3600.0 s	Quick stop deceleration time for the operating mode "MS: Velocity mode". <ul style="list-style-type: none"> <li>• If the "Quick stop" function is activated, the motor is brought to a standstill within the deceleration time set here.</li> <li>• The deceleration time set refers to the deceleration from the maximum frequency set to standstill. In the case of a lower actual frequency, the actual deceleration time is reduced accordingly.</li> <li>• Setting is not effective in the operating mode <a href="#">0x6060 (P301.00)</a> = "CiA: Velocity mode (vl) [2]".</li> </ul> <p>▶ Example: <a href="#">Quick stop</a> <a href="#">81</a></p>
0x291E:001 (P226.01)	S-Ramp characteristic: Smoothing factor (S-ramp char.: Smoothing factor) 0.0 ... [0.0] ... 100.0 %	Factor for S-rounding of the acceleration/deceleration ramps. <ul style="list-style-type: none"> <li>• With the setting "0.0", the S-rounding is deactivated and acceleration/ deceleration with linear ramps is carried out.</li> <li>• The smoothing factor increases the ramp time as follows: 50 % --&gt; 1.5 x configured ramp time 100 % --&gt; 2 x configured ramp time</li> </ul>

# Configuring the frequency control

Basic setting  
Ramp times



## Example for operating mode

Parameter	Name	Setting for this example
0x2631:001 (P400.01)	Enable inverter	Constant TRUE [1]
0x2631:002 (P400.02)	Run	Digital input 1 [11]
0x2915 (P210.00)	Minimum frequency	15 Hz
0x2916 (P211.00)	Maximum frequency	40 Hz
0x2917 (P220.00)	Acceleration time 1	4 s
0x2918 (P221.00)	Deceleration time 1	3 s

### Input signals

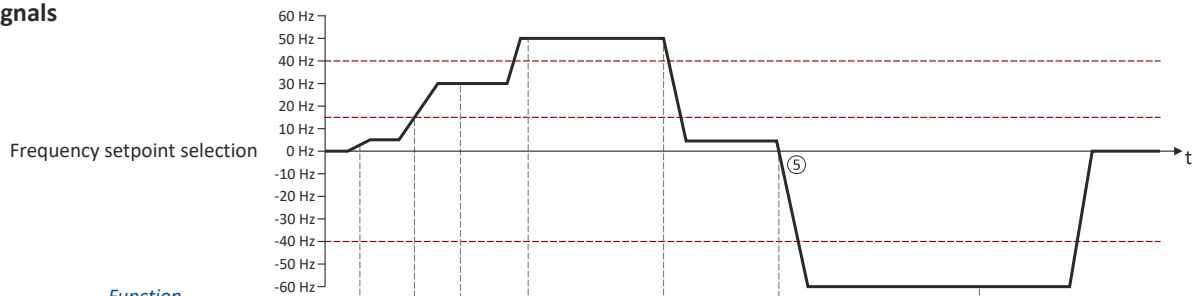

### Trigger

### Function

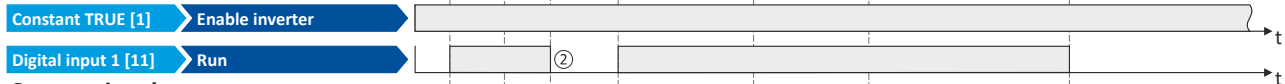

### Output signals

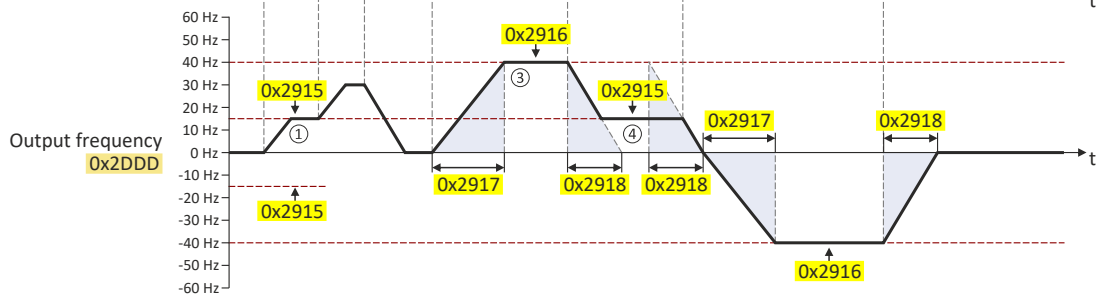

- ① After start command, the motor is accelerated to the minimum frequency. This is also the case if the setpoint selection is = 0 Hz. If the setpoint exceeds the minimum frequency, the ramp generator follows the setpoint.
- ② If the start command is deactivated again, the motor is stopped with the stop method set in 0x2838:003 (P203.03) (here: Standard ramp).
- ③ The motor is accelerated to the set maximum frequency.
- ④ If the setpoint falls below the minimum frequency, it is decelerated up to the minimum frequency.
- ⑤ In case of a sign reversal of the setpoint, a change of direction of rotation takes place, the minimum and maximum frequency, however, continue to apply.





## 7.2 Configure setpoint sources

The following setpoint sources are described in this chapter:

- [Keypad](#) 97
- [Setpoint presets](#) 98
- [Motor potentiometer \(MOP\)](#) 100
- [Sequencer](#) 102

Other setpoint source descriptions can be found here:

- [Analog input 1](#) 284
- [Analog input 2](#) 289
- HTL input (HTL encoder): [HTL encoder](#) 176
- HTL input (pulse train): [Configure digital inputs DI3/DI4 for detecting a pulse train](#) 276
- Network: [Define setpoint via network](#) 327

### 7.2.1 Keypad

For the manual setpoint selection via keypad, the following default settings are used:

#### Parameter

Address	Name / setting range / [default setting]	Information
0x2601:001 (P202.01)	Keypad setpoints: Frequency setpoint (Keypad setpoints: KP freq.setpoint) 0.0 ... [20.0] ... 599.0 Hz	Default setting of the keypad setpoint for the operating mode <a href="#">0x6060</a> ( <a href="#">P301.00</a> ) = "MS: Velocity mode [-2]".
0x2601:002 (P202.02)	Keypad setpoints: Process controller setpoint (Keypad setpoints: KP PID setpoint) -300.00 ... [0.00] ... 300.00 PID unit	Default setting of the keypad setpoint for the reference value of the PID control.

The increment for keypad setpoints can be adapted in [0x2862](#) ([P701.00](#)) by pressing a keypad arrow key once.

A switch-over to the keypad during operation is also possible as an alternative to the standard setpoint source setting.

- ▶ [Example: Change-over from AI1 setpoint to keypad setpoint](#) 148

#### Related topics

- ▶ [Keypad](#) 632

# Configuring the frequency control

Configure setpoint sources  
Setpoint presets



## 7.2.2 Setpoint presets

15 different frequency setpoints (presets) can be parameterised for the frequency control. 8 process controller setpoints (presets) can also be parameterised for the optional PID control.

### Parameter

Address	Name / setting range / [default setting]	Information
0x2911:001 (P450.01)	Frequency setpoint presets: Preset 1 (Freq. presets: Freq. preset 1) 0.0 ... [20.0] ... 599.0 Hz	Parameterisable frequency setpoints (presets) for operating mode "MS: Velocity mode".
0x2911:002 (P450.02)	Frequency setpoint presets: Preset 2 (Freq. presets: Freq. preset 2) 0.0 ... [40.0] ... 599.0 Hz	
0x2911:003 (P450.03)	Frequency setpoint presets: Preset 3 (Freq. presets: Freq. preset 3) Device for 50-Hz mains: 0.0 ... [50.0] ... 599.0 Hz Device for 60-Hz mains: 0.0 ... [60.0] ... 599.0 Hz	
0x2911:004 (P450.04)	Frequency setpoint presets: Preset 4 (Freq. presets: Freq. preset 4) 0.0 ... [0.0] ... 599.0 Hz	
0x2911:005 (P450.05)	Frequency setpoint presets: Preset 5 (Freq. presets: Freq. preset 5) 0.0 ... [0.0] ... 599.0 Hz	
0x2911:006 (P450.06)	Frequency setpoint presets: Preset 6 (Freq. presets: Freq. preset 6) 0.0 ... [0.0] ... 599.0 Hz	
0x2911:007 (P450.07)	Frequency setpoint presets: Preset 7 (Freq. presets: Freq. preset 7) 0.0 ... [0.0] ... 599.0 Hz	
0x2911:008 (P450.08)	Frequency setpoint presets: Preset 8 (Freq. presets: Freq. preset 8) 0.0 ... [0.0] ... 599.0 Hz	
0x2911:009 (P450.09)	Frequency setpoint presets: Preset 9 (Freq. presets: Freq. preset 9) 0.0 ... [0.0] ... 599.0 Hz	
0x2911:010 (P450.10)	Frequency setpoint presets: Preset 10 (Freq. presets: Freq. preset 10) 0.0 ... [0.0] ... 599.0 Hz	
0x2911:011 (P450.11)	Frequency setpoint presets: Preset 11 (Freq. presets: Freq. preset 11) 0.0 ... [0.0] ... 599.0 Hz	
0x2911:012 (P450.12)	Frequency setpoint presets: Preset 12 (Freq. presets: Freq. preset 12) 0.0 ... [0.0] ... 599.0 Hz	
0x2911:013 (P450.13)	Frequency setpoint presets: Preset 13 (Freq. presets: Freq. preset 13) 0.0 ... [0.0] ... 599.0 Hz	
0x2911:014 (P450.14)	Frequency setpoint presets: Preset 14 (Freq. presets: Freq. preset 14) 0.0 ... [0.0] ... 599.0 Hz	
0x2911:015 (P450.15)	Frequency setpoint presets: Preset 15 (Freq. presets: Freq. preset 15) 0.0 ... [0.0] ... 599.0 Hz	



# Configuring the frequency control

Configure setpoint sources  
Setpoint presets

Address	Name / setting range / [default setting]	Information
0x4022:001 (P451.01)	PID setpoint presets: Preset 1 (PID presets: PID preset 1) -300.00 ... [0.00] ... 300.00 PID unit	Parameterisable process controller setpoints (presets) for PID control.
0x4022:002 (P451.02)	PID setpoint presets: Preset 2 (PID presets: PID preset 2) -300.00 ... [0.00] ... 300.00 PID unit	
0x4022:003 (P451.03)	PID setpoint presets: Preset 3 (PID presets: PID preset 3) -300.00 ... [0.00] ... 300.00 PID unit	
0x4022:004 (P451.04)	PID setpoint presets: Preset 4 (PID presets: PID preset 4) -300.00 ... [0.00] ... 300.00 PID unit	
0x4022:005 (P451.05)	PID setpoint presets: Preset 5 (PID presets: PID preset 5) -300.00 ... [0.00] ... 300.00 PID unit	
0x4022:006 (P451.06)	PID setpoint presets: Preset 6 (PID presets: PID preset 6) -300.00 ... [0.00] ... 300.00 PID unit	
0x4022:007 (P451.07)	PID setpoint presets: Preset 7 (PID presets: PID preset 7) -300.00 ... [0.00] ... 300.00 PID unit	
0x4022:008 (P451.08)	PID setpoint presets: Preset 8 (PID presets: PID preset 8) -300.00 ... [0.00] ... 300.00 PID unit	

A switch-over to a preset during operation is also possible as an alternative to the standard setpoint source setting.

▶ [Example: Change-over from keypad setpoint to preset 1 ... 7](#) 150

# Configuring the frequency control

Configure setpoint sources  
Motor potentiometer (MOP)



## 7.2.3 Motor potentiometer (MOP)

The "Motor potentiometer" function can be used as an alternative setpoint control that is controlled via two functions: "MOP setpoint up" and "MOP setpoint down".

### Details

If the motor potentiometer is active as the setpoint source, the setpoint generated by this function ("MOP value") can be changed according to following the truth table via the triggers assigned to the two functions "MOP setpoint up" and "MOP setpoint down":

MOP setpoint up 0x2631:023 (P400.23)	MOP setpoint down 0x2631:024 (P400.24)	Response of the function
FALSE	FALSE	The last MOP value is maintained.
TRUE	FALSE	The MOP value is increased to a maximum of the upper limit value for the respective operating mode with the acceleration time 2. (The motor follows the setpoint change with acceleration time 1.)
FALSE	TRUE	The MOP value is increased to a maximum of the lower limit value for the respective operating mode with the deceleration time 2. (The motor follows the setpoint change with deceleration time 1.)
TRUE	TRUE	The last MOP value is maintained.

The start behavior can be selected in [0x4003 \(P413.00\)](#). In the default setting, the last MOP value is used as the initial value. The last MOP value remains available after switching the mains voltage off and on again. As an alternative, an adjustable initial value or the minimum value can be used for starting.

### Parameter

Address	Name / setting range / [default setting]	Information
0x2631:023 (P400.23)	Function list: MOP setpoint up (Function list: MOP up) • Further possible settings: <a href="#">▶ Trigger list 73</a>	Assignment of a trigger for the "MOP setpoint up" function. Trigger = TRUE: setpoint generated by the "Motor potentiometer" function ("MOP value") is maximally increased to the upper range limit with acceleration time 2. Trigger = FALSE: last MOP value is maintained.  Notes: • If the "MOP setpoint up" and "MOP setpoint down" functions are active at the same time, the last MOP value is maintained. • Acceleration time 2 can be set in <a href="#">0x2919 (P222.00)</a> .
	<b>0</b> Not connected	No trigger assigned (trigger is constantly FALSE).
0x2631:024 (P400.24)	Function list: MOP setpoint down (Function list: MOP down) • Further possible settings: <a href="#">▶ Trigger list 73</a>	Assignment of a trigger for the "MOP setpoint down" function. Trigger = TRUE: setpoint generated by the "Motor potentiometer" function ("MOP value") is maximally decreased to the lower range limit with deceleration time 2. Trigger = FALSE: last MOP value is maintained.  Notes: • If the "MOP setpoint up" and "MOP setpoint down" functions are active at the same time, the last MOP value is maintained. • Deceleration time 2 can be set in <a href="#">0x291A (P223.00)</a> .
	<b>0</b> Not connected	No trigger assigned (trigger is constantly FALSE).



# Configuring the frequency control

Configure setpoint sources  
Motor potentiometer (MOP)

Address	Name / setting range / [default setting]	Information
0x4003 (P413.00)	MOP starting mode (MOP startmode)	Selection of the initial value which is used after activation of the function.
	0 Last value	The last MOP value is used as initial value. It is still provided after the mains voltage has been switched off and on again. Note: The last MOP value is saved in the internal EEPROM of the inverter. If the memory module is transferred to a compatible device, the last MOP value will therefore not be accepted.
	1 Starting value	The starting value of the corresponding operating mode is used as initial value: <ul style="list-style-type: none"> <li>• 0x4004:001 (P414.01) for the operating mode "MS: Velocity mode"</li> <li>• 0x4004:002 (P414.02) for PID control</li> <li>• 0x4004:003 (P414.03) for the operating mode "MS: Torque mode"</li> </ul>
	2 Minimum value	The minimum value of the corresponding operating mode is used as initial value: <ul style="list-style-type: none"> <li>• 0x2915 (P210.00) for the operating mode "MS: Velocity mode"</li> <li>• 0x404E:001 (P605.01) for PID control</li> </ul>
0x4004:001 (P414.01)	MOP starting values: Frequency (MOP start value: Frequency) 0.0 ... [0.0] ... 599.0 Hz	Starting value for operating mode "MS: Velocity mode". <ul style="list-style-type: none"> <li>• This value is used as initial value if "Starting value [1]" is set in 0x4003 (P413.00).</li> </ul>
0x4004:002 (P414.02)	MOP starting values: PID value (MOP start value: PID value) -300.00 ... [0.00] ... 300.00 PID unit	Starting value for reference value of the PID control. <ul style="list-style-type: none"> <li>• This value is used as initial value if "Starting value [1]" is set in 0x4003 (P413.00).</li> </ul>
0x4004:003 (P414.03)	MOP starting values: Torque (MOP start value: Torque) 0.0 ... [0.0] ... 1000.0 %	Starting value for operating mode "MS: Torque mode". <ul style="list-style-type: none"> <li>• This value is used as initial value if "Starting value [1]" is set in 0x4003 (P413.00).</li> <li>• 100 % = motor rated torque (0x6076 (P325.00)).</li> </ul>
0x4009:001	MOP values saved: Frequency <ul style="list-style-type: none"> <li>• Read only: x.x Hz</li> </ul>	Display of the last MOP value saved internally for the operating mode "MS: Velocity mode". <ul style="list-style-type: none"> <li>• This value is used as initial value if "Last value [0]" is set in 0x4003 (P413.00).</li> </ul>
0x4009:002	MOP values saved: PID value <ul style="list-style-type: none"> <li>• Read only: x.xx PID unit</li> </ul>	Display of the last MOP value saved internally for the reference value of the PID control. <ul style="list-style-type: none"> <li>• This value is used as initial value if "Last value [0]" is set in 0x4003 (P413.00).</li> </ul>
0x4009:003	MOP values saved: Torque <ul style="list-style-type: none"> <li>• Read only: x.x %</li> </ul>	Display of the last MOP value saved internally for the operating mode "MS: Torque mode". <ul style="list-style-type: none"> <li>• This value is used as initial value if "Last value [0]" is set in 0x4003 (P413.00).</li> <li>• 100 % = motor rated torque (0x6076 (P325.00)).</li> </ul>

A switch-over to the motor potentiometer during operation is also possible as an alternative to the standard setpoint source setting.

▶ Example: Change-over from AI1 setpoint to MOP setpoint [153](#)

# Configuring the frequency control

Configure setpoint sources  
Sequencer



## 7.2.4 Sequencer

The "sequencer" function serves to transfer a programmed sequence of setpoints to the motor control. The switch-over to the next setpoint can be made time-controlled or even-controlled. Optionally, the "sequencer" function can also trigger the digital and analog outputs.



The sequencer only generates setpoints. However, the sequencer does not control the motor operation (does not output any start and stop commands). Versions with IO-Link do not offer this function.

### Basics: Sequences, steps and segments

- Overall, sequences with the numbers 1 to 8 can be configured.
- Each sequence consists of 16 configurable steps.
- Each step of a sequence can call a "segment".
  - A segment contains, among other things preset setpoints (speed setpoint, PID control value, torque setpoint), a combined acceleration/deceleration for the speed setpoint and optionally a configuration for the digital and analog outputs.
  - 8 different segments and one end segment can be configured.
- Alternatively to calling a single segment, a complete sequence (with a higher number) can also be called from one step. This serves to implement nested sequences or summarize several sequences to one sequence.

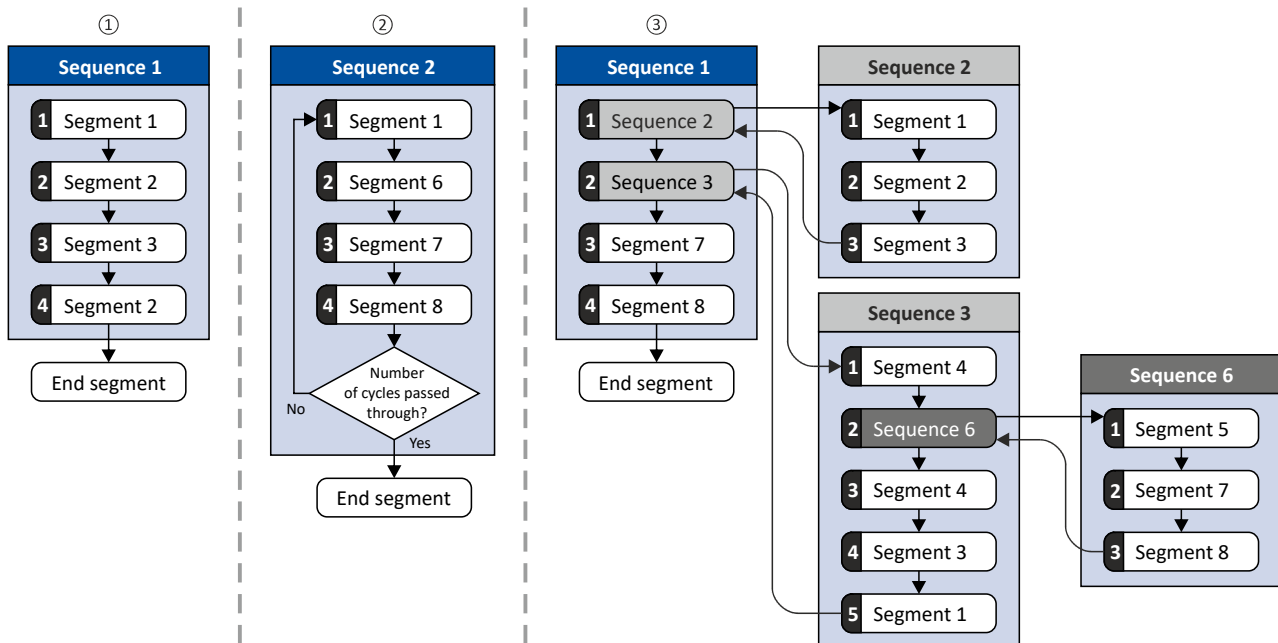

- Simple sequence with four steps.
- Simple sequence with four steps that are passed through several times (number of cycles > 1). For each sequence, the number of cycles can be set individually.
- Nested sequence, in which other (sub) sequences are called by one (main) sequence.



## Commissioning

For commissioning the sequencer, we recommend the following proceeding:

1. Configure segments (including end segment).  
Details: [▶ Segment configuration](#) [104](#)
2. Configure sequences:
  - a) Assign the segments to the single steps of a sequence.
  - b) Set the number of cycles for the respective sequence.Details: [▶ Sequence configuration](#) [115](#)
3. Make the basic setting of the sequencer:
  - a) Set the desired operating mode (time and/or step operation).
  - b) Optionally adjust the sequence end mode and the sequence start mode.Details: [▶ Sequencer basic settings](#) [119](#)
4. Configure the control of the sequencer:
  - a) Assign the functions for selecting a sequence to suitable triggers (e. g. digital inputs).
  - b) Assign the functions for controlling the sequencer (start, stop, cancel, ...) to suitable triggers.Details: [▶ Sequencer control functions](#) [122](#)

## Control

The sequencer can be controlled with the following function. For details, see chapter "[Sequencer control functions](#)". [122](#)

Function	Information
Select sequence (bit 0) ... Select sequence (bit 3)	Bit coded selection of the sequence to be started.
Start sequence	The selected sequence is started. The start can take place edge or status-controlled depending on the configuration.
Next sequence step	Immediate jump to the next step irrespective of the time set for the segment.
Pause sequence	The sequencer stops in the current step. The elapsing time set for the segment is stopped. The sequencer setpoint remains active.
Suspend sequence	There is a temporary return to the normal setpoint control. The sequence is then continued at the point where it was suspended.
Stop sequence	Direct jump to the end segment. The further execution depends on the selected end of sequence mode.
Abort sequence	Immediate return to the normal setpoint control. The end segment is not executed anymore.

## Diagnostics

For diagnosing the sequencer, the diagnostic parameters listed in chapter "[Sequencer diagnostics](#)" are available. [126](#)

## Internal status signals

The sequencer provides different internal status signals (see the following table). These status signals can be assigned to the relay, the digital outputs or the status word NetWordOUT1.

[▶ Configure digital outputs](#) [292](#)

Internal status signal	Information
"Sequencer controlled [100]"	The control is executed via the sequencer (according to the configuration of the digital outputs for the current segment).
"Sequence active [101]"	The sequence is running and is currently not suspended.
"Sequence suspended [102]"	The sequence is currently suspended.
"Sequence done [103]"	The sequence is completed (end segment was passed through).

# Configuring the frequency control

Configure setpoint sources  
Sequencer  
Segment configuration



## 7.2.4.1 Segment configuration

Each step of a sequence can call a "segment". A segment contains, among other things preset setpoints (speed setpoint, PID control value, torque setpoint), a combined acceleration/ deceleration for the speed setpoint and optionally a configuration for the digital and analog outputs.

### Details

As a total, 8 segments and one end segment can be configured.

- The settings are only effective if a sequence is active and the respective segment is executed.
- Only those settings that are relevant for the corresponding operating mode must be made; i.e. if the PID control is not used, no PID setpoint has to be set for the segment.
- The following figure shows the segment settings relevant for the operating mode **0x6060 (P301.00) = "MS: Velocity mode [-2]"**.
- The table below provides a brief overview of the possible settings of the different segments.

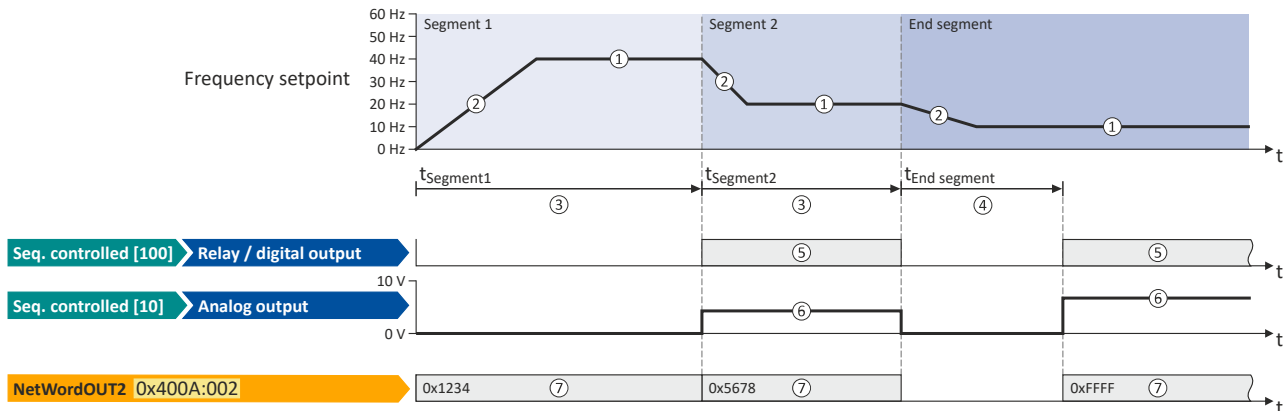

Setting	Info
Frequency setpoint	① Only relevant for the operating mode <b>0x6060 (P301.00) = "MS: Velocity mode [-2]"</b> . The direction of rotation is implemented according to the sign.
Acceleration/deceleration	② Only relevant for the operating mode <b>0x6060 (P301.00) = "MS: Velocity mode [-2]"</b> . The set time refers to the acceleration from standstill to the set maximum frequency. The deceleration is effected with the same ramp.
Time	③ Meaning for segment 1 ... 8: Runtime for the segment after the expiration of which it is switched over to the next step of the sequence. Only relevant for Sequencer mode <b>0x4025 (P800.00) = "Time operation [1]"</b> or "Time & step operation [3]".
	④ Meaning for end segment: Delay time for activating the output states configured for the end segment.
Digital outputs	⑤ Optionally: Set digital outputs to a certain level for the execution time of the segment.
Analog outputs	⑥ Optionally: Set analog outputs to an adjustable voltage value for the execution time of the segment.
PID setpoint	Only relevant if the PID control in <b>0x4020:001 (P600.01)</b> is activated. ▶ <a href="#">Configuring the process controller</a> 128
Torque setpoint	Only relevant for the operating mode <b>0x6060 (P301.00) = "MS: Torque mode [-1]"</b> . ▶ <a href="#">Configuring the torque control</a> 161
NetWordOUT2	⑦ Optionally: Set the NetWordOUT2 data word to an adjustable value for the execution time of the segment. The NetWordOUT2 data word <b>0x400A:002 (P591.02)</b> can be mapped to a network register to transfer the set value as process date. ▶ <a href="#">Output messages of the "sequencer" function via network</a> 336

In the following, all parameters relevant for the segment configuration are given.



If the sequencer is active, write accesses to all parameters are blocked that concern the active segment configuration!





# Configuring the frequency control

Configure setpoint sources  
Sequencer  
Segment configuration

## Parameter

Address	Name / setting range / [default setting]	Information
0x4026:001 (P801.01)	Sequencer segment 1: Frequency setpoint (Segment 1: Frequency setp.) -599.0 ... [0.0] ... 599.0 Hz • From version 03.00	Frequency setpoint for the segment. • Only relevant for operating mode 0x6060 (P301.00) = "MS: Velocity mode [-2]". • Direction of rotation according to sign.
0x4026:002 (P801.02)	Sequencer segment 1: Acceleration/deceleration (Segment 1: Accel./decel.) 0.0 ... [5.0] ... 3600.0 s • From version 03.00	Acceleration/deceleration for the segment. • Only relevant for operating mode 0x6060 (P301.00) = "MS: Velocity mode [-2]". • The set time refers to the acceleration from standstill to the set maximum frequency. The deceleration is effected with the same ramp.
0x4026:003 (P801.03)	Sequencer segment 1: Time (Segment 1: Time) 0.0 ... [0.0] ... 100000.0 s • From version 03.00	Runtime for the segment after the expiry of which it is switched over to the next step of the sequence. • Only relevant for Sequencer mode 0x4025 (P800.00) = "Time operation [1]" or "Time & step operation [3]". • With the setting "0.0", the segment will be skipped.
0x4026:004 (P801.04)	Sequencer segment 1: Digital outputs (Segment 1: Digital outp.) 0 ... [0] ... 255 • From version 03.00	Optionally: Set digital outputs to the level set here for the execution time of the segment.  Note! In order that the control of a digital output is executed by the sequencer, the following assignment must be made for the respective digital output: • Relay: 0x2634:001 (P420.01) = "Sequencer controlled [100]" • Digital output 1: 0x2634:002 (P420.02) = "Sequencer controlled [100]" • Digital output 2: 0x2634:003 (P420.03) = "Sequencer controlled [100]"
	Bit 0 Relay	0 = X9/NO-COM open and NC-COM closed. 1 = X9/NO-COM closed and NC-COM open. An inversion set in 0x2635:001 (P421.01) is taken into consideration here.
	Bit 1 Digital output 1	0 = set digital output 1 to LOW level. 1 = set digital output 1 to HIGH level. An inversion set in 0x2635:002 (P421.02) is taken into consideration here.
	Bit 2 Digital output 2	0 = set digital output 2 to LOW level. 1 = set digital output 2 to HIGH level. An inversion set in 0x2635:003 (P421.03) is taken into consideration here.
0x4026:005 (P801.05)	Sequencer segment 1: Analog outputs (Segment 1: Analog outp.) 0.00 ... [0.00] ... 10.00 VDC • From version 03.00	Optionally: Set analog outputs to the voltage value set here for the execution time of the segment.  Note! In order that the control of an analog output is executed by the sequencer, the following assignment must be made for the respective analog output: • Analog output 1: 0x2639:002 (P440.02) = "Sequencer controlled [10]" • Analog output 2: 0x263A:002 (P441.02) = "Sequencer controlled [10]"
0x4026:006 (P801.06)	Sequencer segment 1: PID setpoint (Segment 1: PID setp.) -300.00 ... [0.00] ... 300.00 PID unit • From version 03.00	PID control value for the segment. • Only relevant if the PID control in 0x4020:001 (P600.01) is activated.
0x4026:007 (P801.07)	Sequencer segment 1: Torque setpoint (Segment 1: Torque setp.) -400.0 ... [100.0] ... 400.0 % • From version 03.00	Torque setpoint for the segment. • Only relevant for operating mode 0x6060 (P301.00) = "MS: Torque mode [-1]".
0x4026:008	Sequencer segment 1: NetWordOUT2 0 ... [0] ... 65535 • From version 03.00	Optionally: Set the NetWordOUT2 data word to the value set here for the execution time of the segment. • The NetWordOUT2 data word 0x400A:002 (P591.02) can be mapped to a network register to transfer the set value as process date.
0x4026:009	Sequencer segment 1: Reserved 0 ... [0] ... 4294967295.0 • From version 03.00	

# Configuring the frequency control

Configure setpoint sources  
Sequencer  
Segment configuration



Address	Name / setting range / [default setting]	Information
0x4027:001 (P802.01)	Sequencer segment 2: Frequency setpoint (Segment 2: Frequency setp.) -599.0 ... [0.0] ... 599.0 Hz • From version 03.00	Frequency setpoint for the segment. • Only relevant for operating mode 0x6060 (P301.00) = "MS: Velocity mode [-2]". • Direction of rotation according to sign.
0x4027:002 (P802.02)	Sequencer segment 2: Acceleration/deceleration (Segment 2: Accel./decel.) 0.0 ... [5.0] ... 3600.0 s • From version 03.00	Acceleration/deceleration for the segment. • Only relevant for operating mode 0x6060 (P301.00) = "MS: Velocity mode [-2]". • The set time refers to the acceleration from standstill to the set maximum frequency. The deceleration is effected with the same ramp.
0x4027:003 (P802.03)	Sequencer segment 2: Time (Segment 2: Time) 0.0 ... [0.0] ... 100000.0 s • From version 03.00	Runtime for the segment after the expiry of which it is switched over to the next step of the sequence. • Only relevant for Sequencer mode 0x4025 (P800.00) = "Time operation [1]" or "Time & step operation [3]". • With the setting "0.0", the segment will be skipped.
0x4027:004 (P802.04)	Sequencer segment 2: Digital outputs (Segment 2: Digital outp.) 0 ... [0] ... 255 • From version 03.00	Optionally: Set digital outputs to the level set here for the execution time of the segment.  Note! In order that the control of a digital output is executed by the sequencer, the following assignment must be made for the respective digital output: • Relay: 0x2634:001 (P420.01) = "Sequencer controlled [100]" • Digital output 1: 0x2634:002 (P420.02) = "Sequencer controlled [100]" • Digital output 2: 0x2634:003 (P420.03) = "Sequencer controlled [100]"
	Bit 0 Relay	0 = X9/NO-COM open and NC-COM closed. 1 = X9/NO-COM closed and NC-COM open. An inversion set in 0x2635:001 (P421.01) is taken into consideration here.
	Bit 1 Digital output 1	0 = set digital output 1 to LOW level. 1 = set digital output 1 to HIGH level. An inversion set in 0x2635:002 (P421.02) is taken into consideration here.
	Bit 2 Digital output 2	0 = set digital output 2 to LOW level. 1 = set digital output 2 to HIGH level. An inversion set in 0x2635:003 (P421.03) is taken into consideration here.
0x4027:005 (P802.05)	Sequencer segment 2: Analog outputs (Segment 2: Analog outp.) 0.00 ... [0.00] ... 10.00 VDC • From version 03.00	Optionally: Set analog outputs to the voltage value set here for the execution time of the segment.  Note! In order that the control of an analog output is executed by the sequencer, the following assignment must be made for the respective analog output: • Analog output 1: 0x2639:002 (P440.02) = "Sequencer controlled [10]" • Analog output 2: 0x263A:002 (P441.02) = "Sequencer controlled [10]"
0x4027:006 (P802.06)	Sequencer segment 2: PID setpoint (Segment 2: PID setp.) -300.00 ... [0.00] ... 300.00 PID unit • From version 03.00	PID control value for the segment. • Only relevant if the PID control in 0x4020:001 (P600.01) is activated.
0x4027:007 (P802.07)	Sequencer segment 2: Torque setpoint (Segment 2: Torque setp.) -400.0 ... [100.0] ... 400.0 % • From version 03.00	Torque setpoint for the segment. • Only relevant for operating mode 0x6060 (P301.00) = "MS: Torque mode [-1]".
0x4027:008	Sequencer segment 2: NetWordOUT2 0 ... [0] ... 65535 • From version 03.00	Optionally: Set the NetWordOUT2 data word to the value set here for the execution time of the segment. • The NetWordOUT2 data word 0x400A:002 (P591.02) can be mapped to a network register to transfer the set value as process date.
0x4027:009	Sequencer segment 2: Reserved 0 ... [0] ... 4294967295.0 • From version 03.00	
0x4028:001 (P803.01)	Sequencer segment 3: Frequency setpoint (Segment 3: Frequency setp.) -599.0 ... [0.0] ... 599.0 Hz • From version 03.00	Frequency setpoint for the segment. • Only relevant for operating mode 0x6060 (P301.00) = "MS: Velocity mode [-2]". • Direction of rotation according to sign.



# Configuring the frequency control

Configure setpoint sources  
Sequencer  
Segment configuration

Address	Name / setting range / [default setting]	Information
0x4028:002 (P803.02)	Sequencer segment 3: Acceleration/deceleration (Segment 3: Accel./decel.) 0.0 ... [5.0] ... 3600.0 s • From version 03.00	Acceleration/deceleration for the segment. • Only relevant for operating mode 0x6060 (P301.00) = "MS: Velocity mode [-2]". • The set time refers to the acceleration from standstill to the set maximum frequency. The deceleration is effected with the same ramp.
0x4028:003 (P803.03)	Sequencer segment 3: Time (Segment 3: Time) 0.0 ... [0.0] ... 100000.0 s • From version 03.00	Runtime for the segment after the expiry of which it is switched over to the next step of the sequence. • Only relevant for Sequencer mode 0x4025 (P800.00) = "Time operation [1]" or "Time & step operation [3]". • With the setting "0.0", the segment will be skipped.
0x4028:004 (P803.04)	Sequencer segment 3: Digital outputs (Segment 3: Digital outp.) 0 ... [0] ... 255 • From version 03.00	Optionally: Set digital outputs to the level set here for the execution time of the segment.  Note! In order that the control of a digital output is executed by the sequencer, the following assignment must be made for the respective digital output: • Relay: 0x2634:001 (P420.01) = "Sequencer controlled [100]" • Digital output 1: 0x2634:002 (P420.02) = "Sequencer controlled [100]" • Digital output 2: 0x2634:003 (P420.03) = "Sequencer controlled [100]"
	Bit 0 Relay	0 = X9/NO-COM open and NC-COM closed. 1 = X9/NO-COM closed and NC-COM open. An inversion set in 0x2635:001 (P421.01) is taken into consideration here.
	Bit 1 Digital output 1	0 = set digital output 1 to LOW level. 1 = set digital output 1 to HIGH level. An inversion set in 0x2635:002 (P421.02) is taken into consideration here.
	Bit 2 Digital output 2	0 = set digital output 2 to LOW level. 1 = set digital output 2 to HIGH level. An inversion set in 0x2635:003 (P421.03) is taken into consideration here.
0x4028:005 (P803.05)	Sequencer segment 3: Analog outputs (Segment 3: Analog outp.) 0.00 ... [0.00] ... 10.00 VDC • From version 03.00	Optionally: Set analog outputs to the voltage value set here for the execution time of the segment.  Note! In order that the control of an analog output is executed by the sequencer, the following assignment must be made for the respective analog output: • Analog output 1: 0x2639:002 (P440.02) = "Sequencer controlled [10]" • Analog output 2: 0x263A:002 (P441.02) = "Sequencer controlled [10]"
0x4028:006 (P803.06)	Sequencer segment 3: PID setpoint (Segment 3: PID setp.) -300.00 ... [0.00] ... 300.00 PID unit • From version 03.00	PID control value for the segment. • Only relevant if the PID control in 0x4020:001 (P600.01) is activated.
0x4028:007 (P803.07)	Sequencer segment 3: Torque setpoint (Segment 3: Torque setp.) -400.0 ... [100.0] ... 400.0 % • From version 03.00	Torque setpoint for the segment. • Only relevant for operating mode 0x6060 (P301.00) = "MS: Torque mode [-1]".
0x4028:008	Sequencer segment 3: NetWordOUT2 0 ... [0] ... 65535 • From version 03.00	Optionally: Set the NetWordOUT2 data word to the value set here for the execution time of the segment. • The NetWordOUT2 data word 0x400A:002 (P591.02) can be mapped to a network register to transfer the set value as process date.
0x4028:009	Sequencer segment 3: Reserved 0 ... [0] ... 4294967295.0 • From version 03.00	
0x4029:001 (P804.01)	Sequencer segment 4: Frequency setpoint (Segment 4: Frequency setp.) -599.0 ... [0.0] ... 599.0 Hz • From version 03.00	Frequency setpoint for the segment. • Only relevant for operating mode 0x6060 (P301.00) = "MS: Velocity mode [-2]". • Direction of rotation according to sign.

# Configuring the frequency control

Configure setpoint sources  
Sequencer  
Segment configuration



Address	Name / setting range / [default setting]	Information
0x4029:002 (P804.02)	Sequencer segment 4: Acceleration/deceleration (Segment 4: Accel./decel.) 0.0 ... [5.0] ... 3600.0 s <ul style="list-style-type: none"> <li>From version 03.00</li> </ul>	Acceleration/deceleration for the segment. <ul style="list-style-type: none"> <li>Only relevant for operating mode 0x6060 (P301.00) = "MS: Velocity mode [-2]".</li> <li>The set time refers to the acceleration from standstill to the set maximum frequency. The deceleration is effected with the same ramp.</li> </ul>
0x4029:003 (P804.03)	Sequencer segment 4: Time (Segment 4: Time) 0.0 ... [0.0] ... 100000.0 s <ul style="list-style-type: none"> <li>From version 03.00</li> </ul>	Runtime for the segment after the expiry of which it is switched over to the next step of the sequence. <ul style="list-style-type: none"> <li>Only relevant for Sequencer mode 0x4025 (P800.00) = "Time operation [1]" or "Time &amp; step operation [3]".</li> <li>With the setting "0.0", the segment will be skipped.</li> </ul>
0x4029:004 (P804.04)	Sequencer segment 4: Digital outputs (Segment 4: Digital outp.) 0 ... [0] ... 255 <ul style="list-style-type: none"> <li>From version 03.00</li> </ul>	Optionally: Set digital outputs to the level set here for the execution time of the segment.  Note! In order that the control of a digital output is executed by the sequencer, the following assignment must be made for the respective digital output: <ul style="list-style-type: none"> <li>Relay: 0x2634:001 (P420.01) = "Sequencer controlled [100]"</li> <li>Digital output 1: 0x2634:002 (P420.02) = "Sequencer controlled [100]"</li> <li>Digital output 2: 0x2634:003 (P420.03) = "Sequencer controlled [100]"</li> </ul>
	Bit 0 Relay	0 = X9/NO-COM open and NC-COM closed. 1 = X9/NO-COM closed and NC-COM open. An inversion set in 0x2635:001 (P421.01) is taken into consideration here.
	Bit 1 Digital output 1	0 = set digital output 1 to LOW level. 1 = set digital output 1 to HIGH level. An inversion set in 0x2635:002 (P421.02) is taken into consideration here.
	Bit 2 Digital output 2	0 = set digital output 2 to LOW level. 1 = set digital output 2 to HIGH level. An inversion set in 0x2635:003 (P421.03) is taken into consideration here.
0x4029:005 (P804.05)	Sequencer segment 4: Analog outputs (Segment 4: Analog outp.) 0.00 ... [0.00] ... 10.00 VDC <ul style="list-style-type: none"> <li>From version 03.00</li> </ul>	Optionally: Set analog outputs to the voltage value set here for the execution time of the segment.  Note! In order that the control of an analog output is executed by the sequencer, the following assignment must be made for the respective analog output: <ul style="list-style-type: none"> <li>Analog output 1: 0x2639:002 (P440.02) = "Sequencer controlled [10]"</li> <li>Analog output 2: 0x263A:002 (P441.02) = "Sequencer controlled [10]"</li> </ul>
0x4029:006 (P804.06)	Sequencer segment 4: PID setpoint (Segment 4: PID setp.) -300.00 ... [0.00] ... 300.00 PID unit <ul style="list-style-type: none"> <li>From version 03.00</li> </ul>	PID control value for the segment. <ul style="list-style-type: none"> <li>Only relevant if the PID control in 0x4020:001 (P600.01) is activated.</li> </ul>
0x4029:007 (P804.07)	Sequencer segment 4: Torque setpoint (Segment 4: Torque setp.) -400.0 ... [100.0] ... 400.0 % <ul style="list-style-type: none"> <li>From version 03.00</li> </ul>	Torque setpoint for the segment. <ul style="list-style-type: none"> <li>Only relevant for operating mode 0x6060 (P301.00) = "MS: Torque mode [-1]".</li> </ul>
0x4029:008	Sequencer segment 4: NetWordOUT2 0 ... [0] ... 65535 <ul style="list-style-type: none"> <li>From version 03.00</li> </ul>	Optionally: Set the NetWordOUT2 data word to the value set here for the execution time of the segment. <ul style="list-style-type: none"> <li>The NetWordOUT2 data word 0x400A:002 (P591.02) can be mapped to a network register to transfer the set value as process date.</li> </ul>
0x4029:009	Sequencer segment 4: Reserved 0 ... [0] ... 4294967295.0 <ul style="list-style-type: none"> <li>From version 03.00</li> </ul>	
0x402A:001 (P805.01)	Sequencer segment 5: Frequency setpoint (Segment 5: Frequency setp.) -599.0 ... [0.0] ... 599.0 Hz <ul style="list-style-type: none"> <li>From version 03.00</li> </ul>	Frequency setpoint for the segment. <ul style="list-style-type: none"> <li>Only relevant for operating mode 0x6060 (P301.00) = "MS: Velocity mode [-2]".</li> <li>Direction of rotation according to sign.</li> </ul>



# Configuring the frequency control

Configure setpoint sources  
Sequencer  
Segment configuration

Address	Name / setting range / [default setting]	Information
0x402A:002 (P805.02)	Sequencer segment 5: Acceleration/deceleration (Segment 5: Accel./decel.) 0.0 ... [5.0] ... 3600.0 s • From version 03.00	Acceleration/deceleration for the segment. • Only relevant for operating mode 0x6060 (P301.00) = "MS: Velocity mode [-2]". • The set time refers to the acceleration from standstill to the set maximum frequency. The deceleration is effected with the same ramp.
0x402A:003 (P805.03)	Sequencer segment 5: Time (Segment 5: Time) 0.0 ... [0.0] ... 100000.0 s • From version 03.00	Runtime for the segment after the expiry of which it is switched over to the next step of the sequence. • Only relevant for Sequencer mode 0x4025 (P800.00) = "Time operation [1]" or "Time & step operation [3]". • With the setting "0.0", the segment will be skipped.
0x402A:004 (P805.04)	Sequencer segment 5: Digital outputs (Segment 5: Digital outp.) 0 ... [0] ... 255 • From version 03.00	Optionally: Set digital outputs to the level set here for the execution time of the segment.  Note! In order that the control of a digital output is executed by the sequencer, the following assignment must be made for the respective digital output: • Relay: 0x2634:001 (P420.01) = "Sequencer controlled [100]" • Digital output 1: 0x2634:002 (P420.02) = "Sequencer controlled [100]" • Digital output 2: 0x2634:003 (P420.03) = "Sequencer controlled [100]"
	Bit 0 Relay	0 = X9/NO-COM open and NC-COM closed. 1 = X9/NO-COM closed and NC-COM open. An inversion set in 0x2635:001 (P421.01) is taken into consideration here.
	Bit 1 Digital output 1	0 = set digital output 1 to LOW level. 1 = set digital output 1 to HIGH level. An inversion set in 0x2635:002 (P421.02) is taken into consideration here.
	Bit 2 Digital output 2	0 = set digital output 2 to LOW level. 1 = set digital output 2 to HIGH level. An inversion set in 0x2635:003 (P421.03) is taken into consideration here.
0x402A:005 (P805.05)	Sequencer segment 5: Analog outputs (Segment 5: Analog outp.) 0.00 ... [0.00] ... 10.00 VDC • From version 03.00	Optionally: Set analog outputs to the voltage value set here for the execution time of the segment.  Note! In order that the control of an analog output is executed by the sequencer, the following assignment must be made for the respective analog output: • Analog output 1: 0x2639:002 (P440.02) = "Sequencer controlled [10]" • Analog output 2: 0x263A:002 (P441.02) = "Sequencer controlled [10]"
0x402A:006 (P805.06)	Sequencer segment 5: PID setpoint (Segment 5: PID setp.) -300.00 ... [0.00] ... 300.00 PID unit • From version 03.00	PID control value for the segment. • Only relevant if the PID control in 0x4020:001 (P600.01) is activated.
0x402A:007 (P805.07)	Sequencer segment 5: Torque setpoint (Segment 5: Torque setp.) -400.0 ... [100.0] ... 400.0 % • From version 03.00	Torque setpoint for the segment. • Only relevant for operating mode 0x6060 (P301.00) = "MS: Torque mode [-1]".
0x402A:008	Sequencer segment 5: NetWordOUT2 0 ... [0] ... 65535 • From version 03.00	Optionally: Set the NetWordOUT2 data word to the value set here for the execution time of the segment. • The NetWordOUT2 data word 0x400A:002 (P591.02) can be mapped to a network register to transfer the set value as process date.
0x402A:009	Sequencer segment 5: Reserved 0 ... [0] ... 4294967295.0 • From version 03.00	
0x402B:001 (P806.01)	Sequencer segment 6: Frequency setpoint (Segment 6: Frequency setp.) -599.0 ... [0.0] ... 599.0 Hz • From version 03.00	Frequency setpoint for the segment. • Only relevant for operating mode 0x6060 (P301.00) = "MS: Velocity mode [-2]". • Direction of rotation according to sign.

# Configuring the frequency control

Configure setpoint sources  
Sequencer  
Segment configuration



Address	Name / setting range / [default setting]	Information
0x402B:002 (P806.02)	Sequencer segment 6: Acceleration/deceleration (Segment 6: Accel./decel.) 0.0 ... [5.0] ... 3600.0 s <ul style="list-style-type: none"> <li>From version 03.00</li> </ul>	Acceleration/deceleration for the segment. <ul style="list-style-type: none"> <li>Only relevant for operating mode 0x6060 (P301.00) = "MS: Velocity mode [-2]".</li> <li>The set time refers to the acceleration from standstill to the set maximum frequency. The deceleration is effected with the same ramp.</li> </ul>
0x402B:003 (P806.03)	Sequencer segment 6: Time (Segment 6: Time) 0.0 ... [0.0] ... 100000.0 s <ul style="list-style-type: none"> <li>From version 03.00</li> </ul>	Runtime for the segment after the expiry of which it is switched over to the next step of the sequence. <ul style="list-style-type: none"> <li>Only relevant for Sequencer mode 0x4025 (P800.00) = "Time operation [1]" or "Time &amp; step operation [3]".</li> <li>With the setting "0.0", the segment will be skipped.</li> </ul>
0x402B:004 (P806.04)	Sequencer segment 6: Digital outputs (Segment 6: Digital outp.) 0 ... [0] ... 255 <ul style="list-style-type: none"> <li>From version 03.00</li> </ul>	Optionally: Set digital outputs to the level set here for the execution time of the segment.  Note! In order that the control of a digital output is executed by the sequencer, the following assignment must be made for the respective digital output: <ul style="list-style-type: none"> <li>Relay: 0x2634:001 (P420.01) = "Sequencer controlled [100]"</li> <li>Digital output 1: 0x2634:002 (P420.02) = "Sequencer controlled [100]"</li> <li>Digital output 2: 0x2634:003 (P420.03) = "Sequencer controlled [100]"</li> </ul>
	Bit 0 Relay	0 = X9/NO-COM open and NC-COM closed. 1 = X9/NO-COM closed and NC-COM open. An inversion set in 0x2635:001 (P421.01) is taken into consideration here.
	Bit 1 Digital output 1	0 = set digital output 1 to LOW level. 1 = set digital output 1 to HIGH level. An inversion set in 0x2635:002 (P421.02) is taken into consideration here.
	Bit 2 Digital output 2	0 = set digital output 2 to LOW level. 1 = set digital output 2 to HIGH level. An inversion set in 0x2635:003 (P421.03) is taken into consideration here.
0x402B:005 (P806.05)	Sequencer segment 6: Analog outputs (Segment 6: Analog outp.) 0.00 ... [0.00] ... 10.00 VDC <ul style="list-style-type: none"> <li>From version 03.00</li> </ul>	Optionally: Set analog outputs to the voltage value set here for the execution time of the segment.  Note! In order that the control of an analog output is executed by the sequencer, the following assignment must be made for the respective analog output: <ul style="list-style-type: none"> <li>Analog output 1: 0x2639:002 (P440.02) = "Sequencer controlled [10]"</li> <li>Analog output 2: 0x263A:002 (P441.02) = "Sequencer controlled [10]"</li> </ul>
0x402B:006 (P806.06)	Sequencer segment 6: PID setpoint (Segment 6: PID setp.) -300.00 ... [0.00] ... 300.00 PID unit <ul style="list-style-type: none"> <li>From version 03.00</li> </ul>	PID control value for the segment. <ul style="list-style-type: none"> <li>Only relevant if the PID control in 0x4020:001 (P600.01) is activated.</li> </ul>
0x402B:007 (P806.07)	Sequencer segment 6: Torque setpoint (Segment 6: Torque setp.) -400.0 ... [100.0] ... 400.0 % <ul style="list-style-type: none"> <li>From version 03.00</li> </ul>	Torque setpoint for the segment. <ul style="list-style-type: none"> <li>Only relevant for operating mode 0x6060 (P301.00) = "MS: Torque mode [-1]".</li> </ul>
0x402B:008	Sequencer segment 6: NetWordOUT2 0 ... [0] ... 65535 <ul style="list-style-type: none"> <li>From version 03.00</li> </ul>	Optionally: Set the NetWordOUT2 data word to the value set here for the execution time of the segment. <ul style="list-style-type: none"> <li>The NetWordOUT2 data word 0x400A:002 (P591.02) can be mapped to a network register to transfer the set value as process date.</li> </ul>
0x402B:009	Sequencer segment 6: Reserved 0 ... [0] ... 4294967295.0 <ul style="list-style-type: none"> <li>From version 03.00</li> </ul>	
0x402C:001 (P807.01)	Sequencer segment 7: Frequency setpoint (Segment 7: Frequency setp.) -599.0 ... [0.0] ... 599.0 Hz <ul style="list-style-type: none"> <li>From version 03.00</li> </ul>	Frequency setpoint for the segment. <ul style="list-style-type: none"> <li>Only relevant for operating mode 0x6060 (P301.00) = "MS: Velocity mode [-2]".</li> <li>Direction of rotation according to sign.</li> </ul>



# Configuring the frequency control

Configure setpoint sources  
Sequencer  
Segment configuration

Address	Name / setting range / [default setting]	Information
0x402C:002 (P807.02)	Sequencer segment 7: Acceleration/deceleration (Segment 7: Accel./decel.) 0.0 ... [5.0] ... 3600.0 s • From version 03.00	Acceleration/deceleration for the segment. • Only relevant for operating mode 0x6060 (P301.00) = "MS: Velocity mode [-2]". • The set time refers to the acceleration from standstill to the set maximum frequency. The deceleration is effected with the same ramp.
0x402C:003 (P807.03)	Sequencer segment 7: Time (Segment 7: Time) 0.0 ... [0.0] ... 100000.0 s • From version 03.00	Runtime for the segment after the expiry of which it is switched over to the next step of the sequence. • Only relevant for Sequencer mode 0x4025 (P800.00) = "Time operation [1]" or "Time & step operation [3]". • With the setting "0.0", the segment will be skipped.
0x402C:004 (P807.04)	Sequencer segment 7: Digital outputs (Segment 7: Digital outp.) 0 ... [0] ... 255 • From version 03.00	Optionally: Set digital outputs to the level set here for the execution time of the segment.  Note! In order that the control of a digital output is executed by the sequencer, the following assignment must be made for the respective digital output: • Relay: 0x2634:001 (P420.01) = "Sequencer controlled [100]" • Digital output 1: 0x2634:002 (P420.02) = "Sequencer controlled [100]" • Digital output 2: 0x2634:003 (P420.03) = "Sequencer controlled [100]"
	Bit 0 Relay	0 = X9/NO-COM open and NC-COM closed. 1 = X9/NO-COM closed and NC-COM open. An inversion set in 0x2635:001 (P421.01) is taken into consideration here.
	Bit 1 Digital output 1	0 = set digital output 1 to LOW level. 1 = set digital output 1 to HIGH level. An inversion set in 0x2635:002 (P421.02) is taken into consideration here.
	Bit 2 Digital output 2	0 = set digital output 2 to LOW level. 1 = set digital output 2 to HIGH level. An inversion set in 0x2635:003 (P421.03) is taken into consideration here.
0x402C:005 (P807.05)	Sequencer segment 7: Analog outputs (Segment 7: Analog outp.) 0.00 ... [0.00] ... 10.00 VDC • From version 03.00	Optionally: Set analog outputs to the voltage value set here for the execution time of the segment.  Note! In order that the control of an analog output is executed by the sequencer, the following assignment must be made for the respective analog output: • Analog output 1: 0x2639:002 (P440.02) = "Sequencer controlled [10]" • Analog output 2: 0x263A:002 (P441.02) = "Sequencer controlled [10]"
0x402C:006 (P807.06)	Sequencer segment 7: PID setpoint (Segment 7: PID setp.) -300.00 ... [0.00] ... 300.00 PID unit • From version 03.00	PID control value for the segment. • Only relevant if the PID control in 0x4020:001 (P600.01) is activated.
0x402C:007 (P807.07)	Sequencer segment 7: Torque setpoint (Segment 7: Torque setp.) -400.0 ... [100.0] ... 400.0 % • From version 03.00	Torque setpoint for the segment. • Only relevant for operating mode 0x6060 (P301.00) = "MS: Torque mode [-1]".
0x402C:008	Sequencer segment 7: NetWordOUT2 0 ... [0] ... 65535 • From version 03.00	Optionally: Set the NetWordOUT2 data word to the value set here for the execution time of the segment. • The NetWordOUT2 data word 0x400A:002 (P591.02) can be mapped to a network register to transfer the set value as process date.
0x402C:009	Sequencer segment 7: Reserved 0 ... [0] ... 4294967295.0 • From version 03.00	
0x402D:001 (P808.01)	Sequencer segment 8: Frequency setpoint (Segment 8: Frequency setp.) -599.0 ... [0.0] ... 599.0 Hz • From version 03.00	Frequency setpoint for the segment. • Only relevant for operating mode 0x6060 (P301.00) = "MS: Velocity mode [-2]". • Direction of rotation according to sign.

# Configuring the frequency control

Configure setpoint sources  
Sequencer  
Segment configuration



Address	Name / setting range / [default setting]	Information
0x402D:002 (P808.02)	Sequencer segment 8: Acceleration/deceleration (Segment 8: Accel./decel.) 0.0 ... [5.0] ... 3600.0 s <ul style="list-style-type: none"> <li>From version 03.00</li> </ul>	Acceleration/deceleration for the segment. <ul style="list-style-type: none"> <li>Only relevant for operating mode 0x6060 (P301.00) = "MS: Velocity mode [-2]".</li> <li>The set time refers to the acceleration from standstill to the set maximum frequency. The deceleration is effected with the same ramp.</li> </ul>
0x402D:003 (P808.03)	Sequencer segment 8: Time (Segment 8: Time) 0.0 ... [0.0] ... 100000.0 s <ul style="list-style-type: none"> <li>From version 03.00</li> </ul>	Runtime for the segment after the expiry of which it is switched over to the next step of the sequence. <ul style="list-style-type: none"> <li>Only relevant for Sequencer mode 0x4025 (P800.00) = "Time operation [1]" or "Time &amp; step operation [3]".</li> <li>With the setting "0.0", the segment will be skipped.</li> </ul>
0x402D:004 (P808.04)	Sequencer segment 8: Digital outputs (Segment 8: Digital outp.) 0 ... [0] ... 255 <ul style="list-style-type: none"> <li>From version 03.00</li> </ul>	Optionally: Set digital outputs to the level set here for the execution time of the segment.  Note! In order that the control of a digital output is executed by the sequencer, the following assignment must be made for the respective digital output: <ul style="list-style-type: none"> <li>Relay: 0x2634:001 (P420.01) = "Sequencer controlled [100]"</li> <li>Digital output 1: 0x2634:002 (P420.02) = "Sequencer controlled [100]"</li> <li>Digital output 2: 0x2634:003 (P420.03) = "Sequencer controlled [100]"</li> </ul>
	Bit 0 Relay	0 = X9/NO-COM open and NC-COM closed. 1 = X9/NO-COM closed and NC-COM open. An inversion set in 0x2635:001 (P421.01) is taken into consideration here.
	Bit 1 Digital output 1	0 = set digital output 1 to LOW level. 1 = set digital output 1 to HIGH level. An inversion set in 0x2635:002 (P421.02) is taken into consideration here.
	Bit 2 Digital output 2	0 = set digital output 2 to LOW level. 1 = set digital output 2 to HIGH level. An inversion set in 0x2635:003 (P421.03) is taken into consideration here.
0x402D:005 (P808.05)	Sequencer segment 8: Analog outputs (Segment 8: Analog outp.) 0.00 ... [0.00] ... 10.00 VDC <ul style="list-style-type: none"> <li>From version 03.00</li> </ul>	Optionally: Set analog outputs to the voltage value set here for the execution time of the segment.  Note! In order that the control of an analog output is executed by the sequencer, the following assignment must be made for the respective analog output: <ul style="list-style-type: none"> <li>Analog output 1: 0x2639:002 (P440.02) = "Sequencer controlled [10]"</li> <li>Analog output 2: 0x263A:002 (P441.02) = "Sequencer controlled [10]"</li> </ul>
0x402D:006 (P808.06)	Sequencer segment 8: PID setpoint (Segment 8: PID setp.) -300.00 ... [0.00] ... 300.00 PID unit <ul style="list-style-type: none"> <li>From version 03.00</li> </ul>	PID control value for the segment. <ul style="list-style-type: none"> <li>Only relevant if the PID control in 0x4020:001 (P600.01) is activated.</li> </ul>
0x402D:007 (P808.07)	Sequencer segment 8: Torque setpoint (Segment 8: Torque setp.) -400.0 ... [100.0] ... 400.0 % <ul style="list-style-type: none"> <li>From version 03.00</li> </ul>	Torque setpoint for the segment. <ul style="list-style-type: none"> <li>Only relevant for operating mode 0x6060 (P301.00) = "MS: Torque mode [-1]".</li> </ul>
0x402D:008	Sequencer segment 8: NetWordOUT2 0 ... [0] ... 65535 <ul style="list-style-type: none"> <li>From version 03.00</li> </ul>	Optionally: Set the NetWordOUT2 data word to the value set here for the execution time of the segment. <ul style="list-style-type: none"> <li>The NetWordOUT2 data word 0x400A:002 (P591.02) can be mapped to a network register to transfer the set value as process date.</li> </ul>
0x402D:009	Sequencer segment 8: Reserved 0 ... [0] ... 4294967295.0 <ul style="list-style-type: none"> <li>From version 03.00</li> </ul>	
0x402E:001 (P822.01)	End segment: Frequency setpoint (End segment: Frequency setp.) -599.0 ... [0.0] ... 599.0 Hz <ul style="list-style-type: none"> <li>From version 03.00</li> </ul>	Frequency setpoint after the sequence has been completed, i. e., after the steps configured for the sequence have been passed through with the set numbers of cycles. <ul style="list-style-type: none"> <li>Only relevant for the operating mode 0x6060 (P301.00) = "MS: Velocity mode [-2]" and if end of sequence mode 0x402F (P824.00) = "Keep running [0]".</li> <li>Direction of rotation according to sign.</li> </ul>





# Configuring the frequency control

Configure setpoint sources  
Sequencer  
Segment configuration

Address	Name / setting range / [default setting]	Information
0x402E:002 (P822.02)	End segment: Acceleration/deceleration (End segment: Accel./decel.) 0.0 ... [5.0] ... 3600.0 s <ul style="list-style-type: none"> <li>From version 03.00</li> </ul>	If end of sequence mode = "continuous operation" (default setting): Acceleration/deceleration for reaching the frequency setpoint set for the end segment after the sequence has been processed. If end of sequence mode = "Stop" or "Stop and abort": Deceleration for reaching standstill after the sequence has been processed. <ul style="list-style-type: none"> <li>Only relevant for operating mode 0x6060 (P301.00) = "MS: Velocity mode [-2]".</li> <li>The set time refers to the acceleration from standstill to the set maximum frequency. The deceleration is effected with the same ramp.</li> </ul>
0x402E:003 (P822.03)	End segment: Time (End segment: Time) 0.0 ... [0.0] ... 100000.0 s <ul style="list-style-type: none"> <li>From version 03.00</li> </ul>	Delay time for activating the output states configured for the end segment. <ul style="list-style-type: none"> <li>This parameter has a different meaning than the time settings for the segments 1 ... 8!</li> <li>The set deceleration time starts when the end segment is started to be processed.</li> </ul> <p>After the deceleration time has elapsed:</p> <ul style="list-style-type: none"> <li>The digital outputs are (if configured accordingly) set to the levels set in 0x402E:004 (P822.04).</li> <li>The analog outputs are (if configured accordingly) set to the voltage value set in 0x402E:005 (P822.05).</li> <li>The NetWordOUT2 data word is set to the value set in 0x402E:008.</li> </ul>
0x402E:004 (P822.04)	End segment: Digital outputs (End segment: Digital outp.) 0 ... [0] ... 255 <ul style="list-style-type: none"> <li>From version 03.00</li> </ul>	Optionally: Set digital outputs to the levels set here after the time set for the end segment.
	Bit 0 Relay	0 = X9/NO-COM open and NC-COM closed. 1 = X9/NO-COM closed and NC-COM open. An inversion set in 0x2635:001 (P421.01) is taken into consideration here.
	Bit 1 Digital output 1	0 = set digital output 1 to LOW level. 1 = set digital output 1 to HIGH level. An inversion set in 0x2635:002 (P421.02) is taken into consideration here.
	Bit 2 Digital output 2	0 = set digital output 2 to LOW level. 1 = set digital output 2 to HIGH level. An inversion set in 0x2635:003 (P421.03) is taken into consideration here.
0x402E:005 (P822.05)	End segment: Analog outputs (End segment: Analog outp.) 0.00 ... [0.00] ... 10.00 VDC <ul style="list-style-type: none"> <li>From version 03.00</li> </ul>	Optionally: Set analog outputs to the voltage value set here after the time set for the end segment.  Note! In order that the control of an analog output is executed by the sequencer, the following assignment must be made for the respective analog output: <ul style="list-style-type: none"> <li>Analog output 1: 0x2639:002 (P440.02) = "Sequencer controlled [10]"</li> <li>Analog output 2: 0x263A:002 (P441.02) = "Sequencer controlled [10]"</li> </ul>
0x402E:006 (P822.06)	End segment: PID setpoint (End segment: PID setp.) -300.00 ... [0.00] ... 300.00 PID unit <ul style="list-style-type: none"> <li>From version 03.00</li> </ul>	PID control value after the sequence has been completed, i. e., after the steps configured for the sequence have been passed through with the set numbers of cycles. <ul style="list-style-type: none"> <li>Only relevant if PID control is activated in 0x4020:001 (P600.01) and end of sequence mode 0x402F (P824.00) = "Keep running [0]".</li> </ul>
0x402E:007 (P822.07)	End segment: Torque setpoint (End segment: Torque setp.) -400.0 ... [100.0] ... 400.0 % <ul style="list-style-type: none"> <li>From version 03.00</li> </ul>	Torque setpoint after the sequence has been completed, i. e., after the steps configured for the sequence have been passed through with the set numbers of cycles. <ul style="list-style-type: none"> <li>Only relevant for the operating mode 0x6060 (P301.00) = "MS: Torque mode [-1]" and if end of sequence mode 0x402F (P824.00) = "Keep running [0]".</li> </ul>
0x402E:008	End segment: NetWordOUT2 0 ... [0] ... 65535 <ul style="list-style-type: none"> <li>From version 03.00</li> </ul>	Optionally: Set NetWordOUT2 data word to the value set here after the time set for the end segment. <ul style="list-style-type: none"> <li>The NetWordOUT2 data word 0x400A:002 (P591.02) can be mapped to a network register to transfer the set value as process date.</li> </ul>

# Configuring the frequency control

Configure setpoint sources  
Sequencer  
Segment configuration



Address	Name / setting range / [default setting]	Information
0x402E:009	End segment: Reserved 0 ... [0] ... 4294967295.0 • From version 03.00	



## 7.2.4.2 Sequence configuration

Overall, sequences with the numbers 1 to 8 can be configured. Each sequence consists of 16 configurable steps. Each step of a sequence can call a segment or a complete sequence (with a higher number).

### Details

The following example shows the configuration based on a nested sequence:

- The sequence 1 is the main sequence which calls further (sub) sequences.
- The main sequence is passed through four times. Afterwards, in the preset "continuous operation" end of sequence mode, the setpoint set for the end segment is continuously transmitted to the motor control until the sequence is aborted.

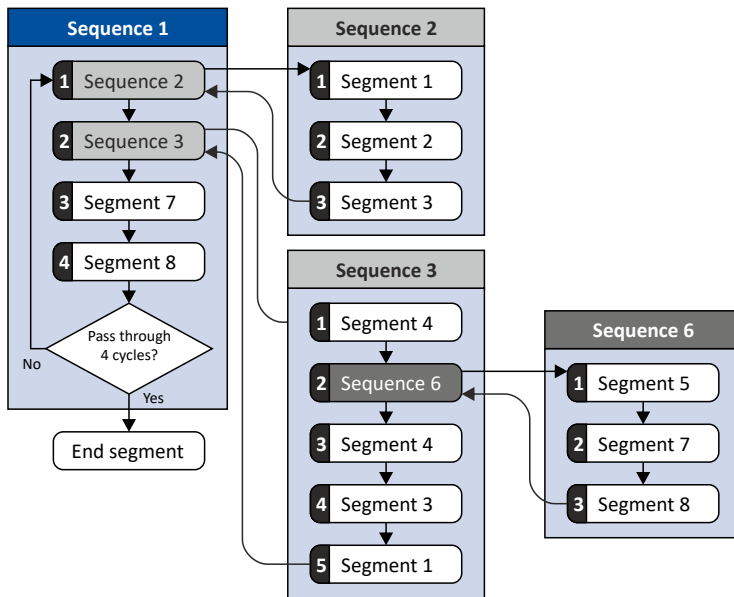

Resulting segment order												
1	2	3	4	5	7	8	4	3	1	7	8	End segment
4 cycles												

Required parameter setting:

	Sequence 1	Sequence 2
Step 1	0x4030:001 (P830.01) = "Sequence 2 [-2]"	0x4032:001 (P835.01) = "Segment 1 [1]"
Step 2	0x4030:002 (P830.02) = "Sequence 3 [-3]"	0x4032:002 (P835.02) = "Segment 2 [2]"
Step 3	0x4030:003 (P830.03) = "Segment 7 [7]"	0x4032:003 (P835.03) = "Segment 3 [3]"
Step 4	0x4030:004 (P830.04) = "Segment 8 [8]"	0x4032:004 (P835.04) = "Skip step [0]"
Step 5	0x4030:005 (P830.05) = "Skip step [0]"	...
Step ...	...	...
Step 16	0x4030:016 (P830.16) = "Skip step [0]"	0x4032:016 (P835.16) = "Skip step [0]"
Number of cycles	0x4031 (P831.00) = 4	0x4033 (P836.00) = 1

	Sequence 3	Sequence 6
Step 1	0x4034:001 (P840.01) = "Segment 4 [4]"	0x403A:001 (P855.01) = "Segment 5 [5]"
Step 2	0x4034:002 (P840.02) = "Sequence 6 [-6]"	0x403A:002 (P855.02) = "Segment 7 [7]"
Step 3	0x4034:003 (P840.03) = "Segment 4 [4]"	0x403A:003 (P855.03) = "Segment 8 [8]"
Step 4	0x4034:004 (P840.04) = "Segment 3 [3]"	0x403A:004 (P855.04) = "Skip step [0]"
Step 5	0x4034:005 (P840.05) = "Segment 1 [1]"	...
Step 6	0x4034:006 (P840.06) = "Skip step [0]"	...
Step ...	...	...
Step 16	0x4034:016 (P840.16) = "Skip step [0]"	0x403A:016 (P855.16) = "Skip step [0]"
Number of cycles	0x4035 (P841.00) = 1	0x403B (P856.00) = 1

# Configuring the frequency control

Configure setpoint sources  
Sequencer  
Sequence configuration



In the following, all parameters relevant for the sequence configuration are given.



If the sequencer is active, write access to all parameters are blocked that concern the active sequence configuration!

## Parameter

Address	Name / setting range / [default setting]	Information
0x4030:001 ... 0x4030:016 (P830.01 ... 16)	Sequence 1: Step 1 ... Step 16 (Sequence 1: Step 1 ... Step 16)	Configuration of the steps 1 ... 16 for sequence 1. <ul style="list-style-type: none"> <li>Alternatively to calling a single segment, a complete sequence (with a higher number) can also be called from one step. This, for instance, serves to configure a main sequence from which several subsequences are called successively.</li> <li>With the setting "0", the respective step is skipped.</li> </ul>
	-8 Sequence 8	
	-7 Sequence 7	
	-6 Sequence 6	
	-5 Sequence 5	
	-4 Sequence 4	
	-3 Sequence 3	
	-2 Sequence 2	
	<b>0 Skip step</b>	
	1 Segment 1	
	2 Segment 2	
	3 Segment 3	
	4 Segment 4	
	5 Segment 5	
	6 Segment 6	
	7 Segment 7	
8 Segment 8		
0x4031 (P831.00)	Number of cycles sequence 1 (Cycl. sequence 1) 1 ... [1] ... 65535 • From version 03.00	Definition of how often the sequence 1 is to be passed through. <ul style="list-style-type: none"> <li>1 = one pass, 2 = two passes, ...</li> <li>65535 = infinite number of cycles.</li> </ul>
0x4032:001 ... 0x4032:016 (P835.01 ... 16)	Sequence 2: Step 1 ... Step 16 (Sequence 2: Step 1 ... Step 16)	Configuration of the steps 1 ... 16 for sequence 2. <ul style="list-style-type: none"> <li>Alternatively to calling a single segment, a complete sequence (with a higher number) can also be called from one step. This, for instance, serves to configure a main sequence from which several subsequences are called successively.</li> <li>With the setting "0", the respective step is skipped.</li> </ul>
	-8 Sequence 8	
	-7 Sequence 7	
	-6 Sequence 6	
	-5 Sequence 5	
	-4 Sequence 4	
	-3 Sequence 3	
	<b>0 Skip step</b>	
	1 Segment 1	
	2 Segment 2	
	3 Segment 3	
	4 Segment 4	
	5 Segment 5	
	6 Segment 6	
	7 Segment 7	
	8 Segment 8	
0x4033 (P836.00)	Number of cycles sequence 2 (Cycl. sequence 2) 1 ... [1] ... 65535 • From version 03.00	Definition of how often the sequence 2 is to be passed through. <ul style="list-style-type: none"> <li>1 = one pass, 2 = two passes, ...</li> <li>65535 = infinite number of cycles.</li> </ul>



# Configuring the frequency control

Configure setpoint sources  
Sequencer  
Sequence configuration

Address	Name / setting range / [default setting]	Information
0x4034:001 ... 0x4034:016 (P840.01 ... 16)	Sequence 3: Step 1 ... Step 16 (Sequence 3: Step 1 ... Step 16)	Configuration of the steps 1 ... 16 for sequence 3. <ul style="list-style-type: none"> <li>Alternatively to calling a single segment, a complete sequence (with a higher number) can also be called from one step. This, for instance, serves to configure a main sequence from which several subsequences are called successively.</li> <li>With the setting "0", the respective step is skipped.</li> </ul>
	-8 Sequence 8	
	-7 Sequence 7	
	-6 Sequence 6	
	-5 Sequence 5	
	-4 Sequence 4	
	<b>0 Skip step</b>	
	1 Segment 1	
	2 Segment 2	
	3 Segment 3	
	4 Segment 4	
	5 Segment 5	
	6 Segment 6	
7 Segment 7		
8 Segment 8		
0x4035 (P841.00)	Number of cycles sequence 3 (Cycl. sequence 3) 1 ... [1] ... 65535 <ul style="list-style-type: none"> <li>From version 03.00</li> </ul>	Definition of how often the sequence 3 is to be passed through. <ul style="list-style-type: none"> <li>1 = one pass, 2 = two passes, ...</li> <li>65535 = infinite number of cycles.</li> </ul>
0x4036:001 ... 0x4036:016 (P845.01 ... 16)	Sequence 4: Step 1 ... Step 16 (Sequence 4: Step 1 ... Step 16)	Configuration of the steps 1 ... 16 for sequence 4. <ul style="list-style-type: none"> <li>Alternatively to calling a single segment, a complete sequence (with a higher number) can also be called from one step. This, for instance, serves to configure a main sequence from which several subsequences are called successively.</li> <li>With the setting "0", the respective step is skipped.</li> </ul>
	-8 Sequence 8	
	-7 Sequence 7	
	-6 Sequence 6	
	-5 Sequence 5	
	<b>0 Skip step</b>	
	1 Segment 1	
	2 Segment 2	
	3 Segment 3	
	4 Segment 4	
	5 Segment 5	
	6 Segment 6	
	7 Segment 7	
8 Segment 8		
0x4037 (P846.00)	Number of cycles sequence 4 (Cycl. sequence 4) 1 ... [1] ... 65535 <ul style="list-style-type: none"> <li>From version 03.00</li> </ul>	Definition of how often the sequence 4 is to be passed through. <ul style="list-style-type: none"> <li>1 = one pass, 2 = two passes, ...</li> <li>65535 = infinite number of cycles.</li> </ul>
0x4038:001 ... 0x4038:016 (P850.01 ... 16)	Sequence 5: Step 1 ... Step 16 (Sequence 5: Step 1 ... Step 16)	Configuration of the steps 1 ... 16 for sequence 5. <ul style="list-style-type: none"> <li>Alternatively to calling a single segment, a complete sequence (with a higher number) can also be called from one step. This, for instance, serves to configure a main sequence from which several subsequences are called successively.</li> <li>With the setting "0", the respective step is skipped.</li> </ul>
	-8 Sequence 8	
	-7 Sequence 7	
	-6 Sequence 6	
	<b>0 Skip step</b>	
	1 Segment 1	
	2 Segment 2	
	3 Segment 3	
	4 Segment 4	
	5 Segment 5	
	6 Segment 6	
	7 Segment 7	
	8 Segment 8	
0x4039 (P851.00)	Number of cycles sequence 5 (Cycl. sequence 5) 1 ... [1] ... 65535 <ul style="list-style-type: none"> <li>From version 03.00</li> </ul>	Definition of how often the sequence 5 is to be passed through. <ul style="list-style-type: none"> <li>1 = one pass, 2 = two passes, ...</li> <li>65535 = infinite number of cycles.</li> </ul>

# Configuring the frequency control

Configure setpoint sources  
Sequencer  
Sequence configuration



Address	Name / setting range / [default setting]	Information
0x403A:001 ... 0x403A:016 (P855.01 ... 16)	Sequence 6: Step 1 ... Step 16 (Sequence 6: Step 1 ... Step 16)	Configuration of the steps 1 ... 16 for sequence 6. <ul style="list-style-type: none"> <li>Alternatively to calling a single segment, a complete sequence (with a higher number) can also be called from one step. This, for instance, serves to configure a main sequence from which several subsequences are called successively.</li> <li>With the setting "0", the respective step is skipped.</li> </ul>
	-8 Sequence 8	
	-7 Sequence 7	
	<b>0 Skip step</b>	
	1 Segment 1	
	2 Segment 2	
	3 Segment 3	
	4 Segment 4	
	5 Segment 5	
	6 Segment 6	
7 Segment 7		
8 Segment 8		
0x403B (P856.00)	Number of cycles sequence 6 (Cycl. sequence 6) 1 ... [1] ... 65535 <ul style="list-style-type: none"> <li>From version 03.00</li> </ul>	Definition of how often the sequence 6 is to be passed through. <ul style="list-style-type: none"> <li>1 = one pass, 2 = two passes, ...</li> <li>65535 = infinite number of cycles.</li> </ul>
0x403C:001 ... 0x403C:016 (P860.01 ... 16)	Sequence 7: Step 1 ... Step 16 (Sequence 7: Step 1 ... Step 16)	Configuration of the steps 1 ... 16 for sequence 7. <ul style="list-style-type: none"> <li>Alternatively to calling a single segment, a complete sequence (with a higher number) can also be called from one step. This, for instance, serves to configure a main sequence from which several subsequences are called successively.</li> <li>With the setting "0", the respective step is skipped.</li> </ul>
	-8 Sequence 8	
	<b>0 Skip step</b>	
	1 Segment 1	
	2 Segment 2	
	3 Segment 3	
	4 Segment 4	
	5 Segment 5	
	6 Segment 6	
	7 Segment 7	
8 Segment 8		
0x403D (P861.00)	Number of cycles sequence 7 (Cycl. sequence 7) 1 ... [1] ... 65535 <ul style="list-style-type: none"> <li>From version 03.00</li> </ul>	Definition of how often the sequence 7 is to be passed through. <ul style="list-style-type: none"> <li>1 = one pass, 2 = two passes, ...</li> <li>65535 = infinite number of cycles.</li> </ul>
0x403E:001 ... 0x403E:016 (P865.01 ... 16)	Sequence 8: Step 1 ... Step 16 (Sequence 8: Step 1 ... Step 16)	Configuration of the steps 1 ... 16 for sequence 8. <ul style="list-style-type: none"> <li>With the setting "0", the respective step is skipped.</li> </ul>
	<b>0 Skip step</b>	
	1 Segment 1	
	2 Segment 2	
	3 Segment 3	
	4 Segment 4	
	5 Segment 5	
	6 Segment 6	
	7 Segment 7	
	8 Segment 8	
0x403F (P866.00)	Number of cycles sequence 8 (Cycl. sequence 8) 1 ... [1] ... 65535 <ul style="list-style-type: none"> <li>From version 03.00</li> </ul>	Definition of how often the sequence 8 is to be passed through. <ul style="list-style-type: none"> <li>65535 = infinite number of cycles.</li> </ul>



## 7.2.4.3 Sequencer basic settings

The sequencer is inhibited by default. The desired sequencer mode (time, step or time-step mode) must first be selected in order for the sequencer to be enabled. The sequence start mode and the sequence end mode must also be set. There are different modes to choose from here.

### Details

Sequencer mode **0x4025 (P800.00)**

- The sequencer can be operated in time, step or time-step operation.
- The following diagram demonstrates the different sequencer modes:

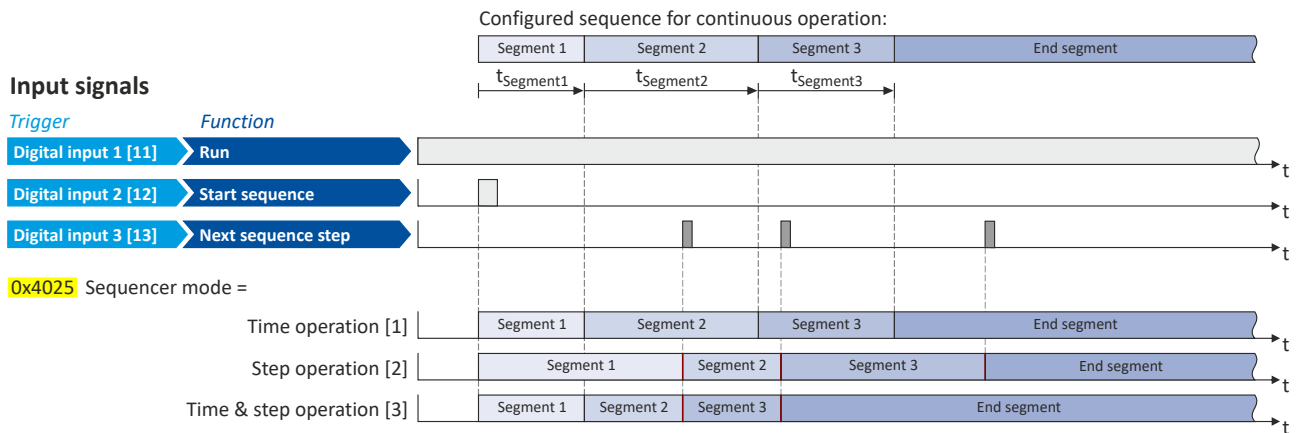

End of sequence mode **0x402F (P824.00)**

- The end of sequence mode defines the action after the end of the sequence.
- In the default setting "Keep running [0]", the setpoint set for the end segment is continuously transmitted to the motor control until the sequence is aborted.
- The following diagram demonstrates the different end of sequence modes:

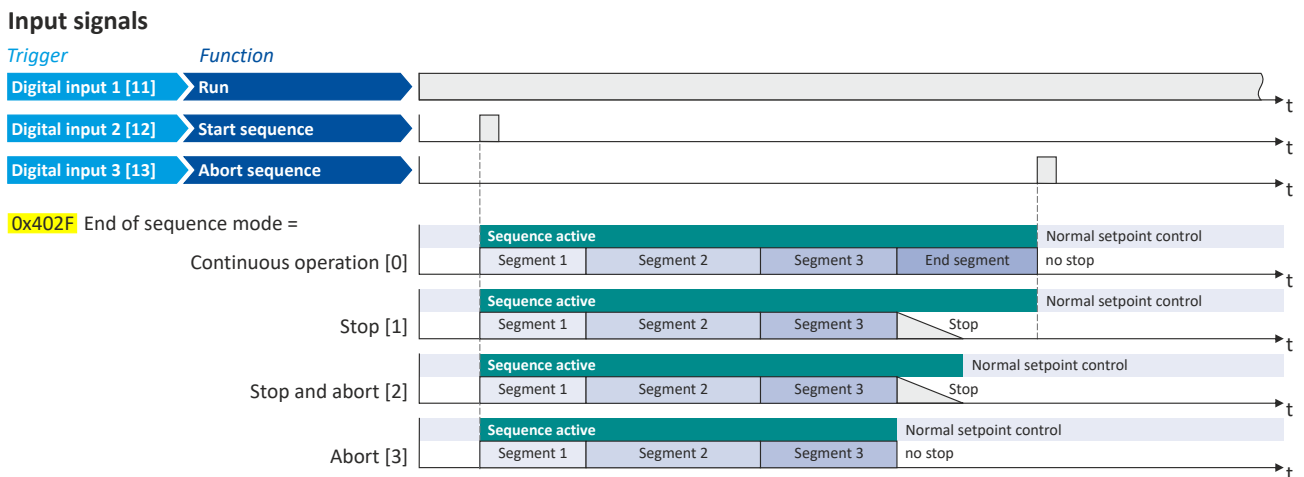

# Configuring the frequency control

Configure setpoint sources  
Sequencer  
Sequencer basic settings



## Start of sequence mode 0x4040 (P820.00)

- The start of sequence mode defines the action after the motor is stopped and restarted or after the motor has been restarted after an error occurred.
- In the default setting "Restart sequencer [0]", the currently selected sequence is restarted.
- The following diagram demonstrates the different start of sequence modes:

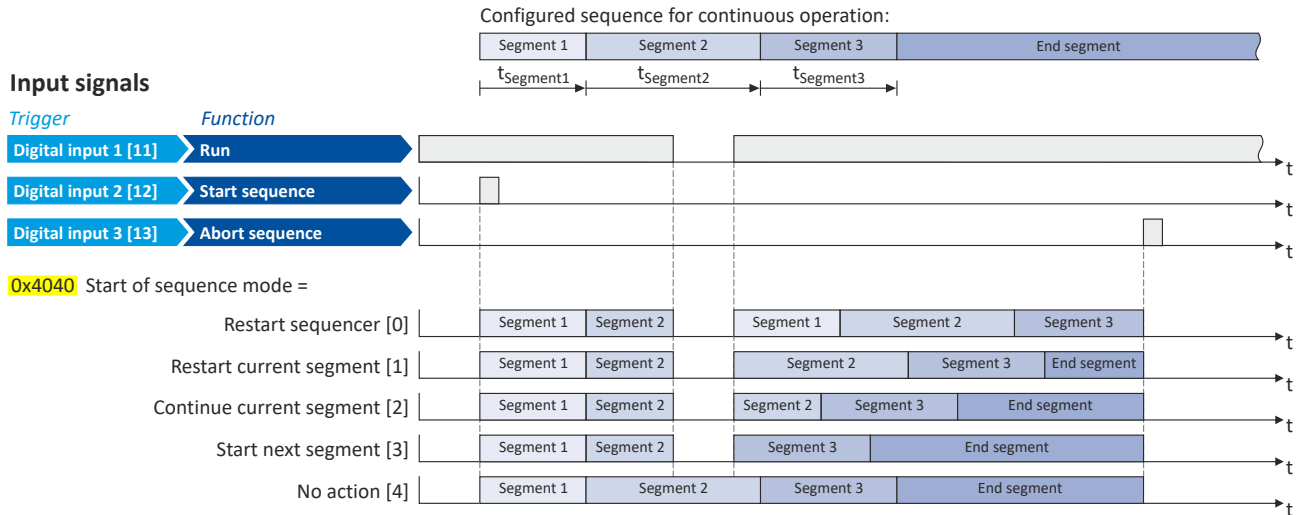

## Parameter

Address	Name / setting range / [default setting]	Information
0x4025 (P800.00)	Sequencer mode (Sequencer mode) • From version 02.00	Selection of the sequencer mode.
	<b>0 Disabled</b>	
	<b>1 Time operation</b> (from version 03.00)	The switch-over to the next step of the sequence is made after the time set for the current segment has elapsed.
	<b>2 Step operation</b> (from version 03.00)	The switch-over to the next step of the sequence is made via the trigger assigned in 0x2631:032 (P400.32) to the "Next sequence step" function.
	<b>3 Time &amp; step operation</b> (from version 03.00)	The switch-over to the next step of the sequence is made via the trigger assigned in 0x2631:032 (P400.32) to the "Next sequence step" function, but no later than after the time set for the current segment has elapsed.
0x402F (P824.00)	End of sequence mode (End of seq. mode) • From version 03.00	Selection of the action after the sequence has been completed, i. e., after the steps configured for the sequence have been passed through with the set numbers of cycles.
	<b>0 Keep running</b>	The setpoint set for the end segment is continuously transmitted to the motor control until the sequence is aborted.
	<b>1 Stop</b>	The motor is stopped with the stop method set in 0x2838:003 (P203.03). The setpoint is continued to be controlled by the sequencer. In order to return to the normal setpoint control, the sequence must be aborted. <b>Note!</b> After returning to the normal setpoint control, a start command is required to restart the motor.
	<b>2 Stop and abort</b>	The motor is stopped with the stop method set in 0x2838:003 (P203.03). After standstill is reached, it is automatically returned to the normal setpoint control. <b>Note!</b> After returning to the normal setpoint control, a start command is required to restart the motor.
	<b>3 Abort</b>	Return to the normal setpoint control without stopping the motor.





# Configuring the frequency control

Configure setpoint sources  
Sequencer  
Sequencer basic settings

Address	Name / setting range / [default setting]	Information
0x4040 (P820.00)	Start of sequence mode (StartOfSeq. mode) • From version 03.00	Selection of the action after the motor has been stopped and restarted or after the motor has been restarted after an error occurred.
	<b>0</b> Restart sequencer	The currently selected sequence is restarted.
	<b>1</b> Restart current segment	The current segment of the selected sequence is restarted.
	<b>2</b> Continue current segment	The current segment of the selected sequence is continued (just like after a break).
	<b>3</b> Start next segment	The next segment of the selected sequence is started.
<b>4</b> No action	For debugging purposes: The sequence is continued to be processed (including output states) even if the motor is stopped.	

# Configuring the frequency control

Configure setpoint sources  
Sequencer  
Sequencer control functions



## 7.2.4.4 Sequencer control functions

The following functions serve to control the sequencer. ▶ [Sequencer](#) 102

### Select sequence

A sequence is selected in a binary-coded fashion via the triggers assigned to the four functions "Select sequence (bit 0)" ... "Select sequence (bit 3)" in compliance with the following truth table:

Select sequence				Selection
Bit 3 0x2631:053 (P400.53)	Bit 2 0x2631:052 (P400.52)	Bit 1 0x2631:051 (P400.51)	Bit 0 0x2631:050 (P400.50)	
FALSE	FALSE	FALSE	FALSE	No sequence selected
FALSE	FALSE	FALSE	TRUE	Sequence 1
FALSE	FALSE	TRUE	FALSE	Sequence 2
FALSE	FALSE	TRUE	TRUE	Sequence 3
FALSE	TRUE	FALSE	FALSE	Sequence 4
FALSE	TRUE	FALSE	TRUE	Sequence 5
FALSE	TRUE	TRUE	FALSE	Sequence 6
FALSE	TRUE	TRUE	TRUE	Sequence 7
TRUE	FALSE	FALSE	FALSE	Sequence 8
TRUE	FALSE	FALSE	TRUE	Invalid selection
...				
TRUE	TRUE	TRUE	TRUE	

### Start sequence

The selected sequence is not started automatically. For starting the sequence, two functions are available:

- [0x2631:030 \(P400.30\)](#): Run/abort sequence (status-controlled start)
- [0x2631:031 \(P400.31\)](#): Start sequence (edge-controlled start)

### Further control functions

The following functions serve to control the started sequence:

- [0x2631:032 \(P400.32\)](#): Next sequence step
- [0x2631:033 \(P400.33\)](#): Pause sequence
- [0x2631:034 \(P400.34\)](#): Suspend sequence
- [0x2631:035 \(P400.35\)](#): Stop sequence
- [0x2631:036 \(P400.36\)](#): Abort sequence

For controlling the sequencer via the network, the sequencer control functions can also be assigned to the NetWordIN1 data word [0x4008:001 \(P590.01\)](#).

### Parameter

Address	Name / setting range / [default setting]	Information
0x2631:030 (P400.30)	Function list: Run/abort sequence (Function list: Seq: Run/abort) <ul style="list-style-type: none"> <li>• Setting can only be changed if the inverter is disabled.</li> <li>• From version 03.00</li> <li>• Further possible settings: ▶ <a href="#">Trigger list</a> 73</li> </ul>	Assignment of a trigger for the "Run/abort sequence" function. Trigger = TRUE: Start selected sequence. Trigger = FALSE: Abort sequence.  Notes: <ul style="list-style-type: none"> <li>• The assigned trigger must remain set to TRUE for the duration of the sequence.</li> <li>• If the trigger bit is reset to FALSE, the sequence is aborted. In this case, the standard setpoint or the setpoint source selected via setpoint change-over is active again.</li> <li>• A sequence is selected in a binary-coded fashion via the trigger assigned to the four functions "Select sequence (bit 0)" <a href="#">0x2631:050 (P400.50)</a> ... "Select sequence (bit 3)" <a href="#">0x2631:053 (P400.53)</a>.</li> <li>• For an edge-controlled start, the function "Start sequence" <a href="#">0x2631:031 (P400.31)</a> is optionally available.</li> </ul>
	<b>0</b> Not connected	No trigger assigned (trigger is constantly FALSE).



# Configuring the frequency control

Configure setpoint sources  
Sequencer  
Sequencer control functions

Address	Name / setting range / [default setting]	Information
0x2631:031 (P400.31)	Function list: Start sequence (Function list: Seq: Start) <ul style="list-style-type: none"> <li>Setting can only be changed if the inverter is disabled.</li> <li>From version 03.00</li> <li>Further possible settings: ▶ <a href="#">Trigger list</a> 73</li> </ul>	Assignment of a trigger for the "Start sequence" function. Trigger = FALSE ↗ TRUE (edge): Start selected sequence. Trigger = TRUE ↘ FALSE (edge): No action.  Notes: <ul style="list-style-type: none"> <li>After the start, the sequencer remains activated until the function "Stop sequence" 0x2631:035 (P400.35) or the function "Abort sequence" 0x2631:036 (P400.36) is executed. A normal stop command does not reset the start command for the sequencer.</li> <li>For a status-controlled start, the function "Run/abort sequence" 0x2631:030 (P400.30) is optionally available.</li> </ul>
	<b>0</b> Not connected	No trigger assigned (trigger is constantly FALSE).
0x2631:032 (P400.32)	Function list: Next sequence step (Function list: Seq: Next step) <ul style="list-style-type: none"> <li>Setting can only be changed if the inverter is disabled.</li> <li>From version 03.00</li> <li>Further possible settings: ▶ <a href="#">Trigger list</a> 73</li> </ul>	Assignment of a trigger for the "Next sequence step" function. Trigger = FALSE ↗ TRUE (edge): Next sequence step. Trigger = TRUE ↘ FALSE (edge): No action.  Notes: <ul style="list-style-type: none"> <li>The execution of the current step is completed even if the time parameterised for the segment has not elapsed yet.</li> <li>The function is only relevant for Sequencer mode 0x4025 (P800.00) = "Step operation [2]" or "Time &amp; step operation [3]".</li> <li>A jump to the next sequence step is not possible if the sequence pauses, the sequence is suspended or the final segment is executed.</li> </ul>
	<b>0</b> Not connected	No trigger assigned (trigger is constantly FALSE).
0x2631:033 (P400.33)	Function list: Pause sequence (Function list: Seq: Pause) <ul style="list-style-type: none"> <li>Setting can only be changed if the inverter is disabled.</li> <li>From version 03.00</li> <li>Further possible settings: ▶ <a href="#">Trigger list</a> 73</li> </ul>	Assignment of a trigger for the "Pause sequence" function. Trigger = TRUE: Pause sequence. Trigger = FALSE: Continue sequence.  Notes: <ul style="list-style-type: none"> <li>During the pause, the sequence stops in the current step. The expiration of the time set for the segment is stopped.</li> <li>The sequencer setpoint continues to remain active.</li> </ul>
	<b>0</b> Not connected	No trigger assigned (trigger is constantly FALSE).
0x2631:034 (P400.34)	Function list: Suspend sequence (Function list: Seq: Suspense) <ul style="list-style-type: none"> <li>Setting can only be changed if the inverter is disabled.</li> <li>From version 03.00</li> <li>Further possible settings: ▶ <a href="#">Trigger list</a> 73</li> </ul>	Assignment of a trigger for the "Suspend sequence" function. Trigger = TRUE: Suspend sequence. Trigger = FALSE: Continue sequence.  Notes: <ul style="list-style-type: none"> <li>This function serves to temporarily change over to the standard setpoint or the setpoint source selected via setpoint change-over.</li> <li>The sequence is continued at the point where it was suspended.</li> </ul>
	<b>0</b> Not connected	No trigger assigned (trigger is constantly FALSE).
0x2631:035 (P400.35)	Function list: Stop sequence (Function list: Seq: Stop) <ul style="list-style-type: none"> <li>Setting can only be changed if the inverter is disabled.</li> <li>From version 03.00</li> <li>Further possible settings: ▶ <a href="#">Trigger list</a> 73</li> </ul>	Assignment of a trigger for the "Stop sequence" function. Trigger = FALSE ↗ TRUE (edge): Stop sequence. Trigger = TRUE ↘ FALSE (edge): No action.  Notes: <ul style="list-style-type: none"> <li>If the sequence is stopped, it is jumped to the final segment.</li> <li>The further execution depends on the selected End of sequence mode 0x402F (P824.00).</li> </ul>
	<b>0</b> Not connected	No trigger assigned (trigger is constantly FALSE).
0x2631:036 (P400.36)	Function list: Abort sequence (Function list: Seq: Abort) <ul style="list-style-type: none"> <li>Setting can only be changed if the inverter is disabled.</li> <li>From version 03.00</li> <li>Further possible settings: ▶ <a href="#">Trigger list</a> 73</li> </ul>	Assignment of a trigger for the "Abort sequence" function. Trigger = FALSE ↗ TRUE (edge): Abort sequence. Trigger = TRUE ↘ FALSE (edge): No action.  Notes: <ul style="list-style-type: none"> <li>This function serves to directly stop the sequence without the final segment being executed. In this case, the standard setpoint or the setpoint source selected via setpoint change-over is active again.</li> </ul>
	<b>0</b> Not connected	No trigger assigned (trigger is constantly FALSE).

# Configuring the frequency control

Configure setpoint sources  
Sequencer  
Sequencer control functions



Address	Name / setting range / [default setting]	Information
0x2631:050 (P400.50)	Function list: Select sequence (bit 0) (Function list: Seq: Select. b0) <ul style="list-style-type: none"> <li>Setting can only be changed if the inverter is disabled.</li> <li>From version 03.00</li> <li>Further possible settings: <a href="#">▶ Trigger list □ 73</a></li> </ul>	Assignment of a trigger for the "Select sequence (bit 0)" function. Selection bit with the valency $2^0$ for bit coded selection of a sequence. Trigger = FALSE: selection bit = "0". Trigger = TRUE: selection bit = "1".  Notes: <ul style="list-style-type: none"> <li>The selected sequence is not started automatically.</li> <li>For a status-controlled start, the function "Run/abort sequence" <a href="#">0x2631:030 (P400.30)</a> is available.</li> <li>For an edge-controlled start, the function "Start sequence" <a href="#">0x2631:031 (P400.31)</a> is available.</li> </ul>
	<b>0</b> <b>Not connected</b>	No trigger assigned (trigger is constantly FALSE).
0x2631:051 (P400.51)	Function list: Select sequence (bit 1) (Function list: Seq: Select. b1) <ul style="list-style-type: none"> <li>Setting can only be changed if the inverter is disabled.</li> <li>From version 03.00</li> <li>Further possible settings: <a href="#">▶ Trigger list □ 73</a></li> </ul>	Assignment of a trigger for the "Select sequence (bit 1)" function. Selection bit with the valency $2^1$ for the bit-coded selection of a sequence. Trigger = FALSE: selection bit = "0". Trigger = TRUE: selection bit = "1".  Notes: <ul style="list-style-type: none"> <li>The selected sequence is not started automatically.</li> <li>For a status-controlled start, the function "Run/abort sequence" <a href="#">0x2631:030 (P400.30)</a> is available.</li> <li>For an edge-controlled start, the function "Start sequence" <a href="#">0x2631:031 (P400.31)</a> is available.</li> </ul>
	<b>0</b> <b>Not connected</b>	No trigger assigned (trigger is constantly FALSE).
0x2631:052 (P400.52)	Function list: Select sequence (bit 2) (Function list: Seq: Select. b2) <ul style="list-style-type: none"> <li>Setting can only be changed if the inverter is disabled.</li> <li>From version 03.00</li> <li>Further possible settings: <a href="#">▶ Trigger list □ 73</a></li> </ul>	Assignment of a trigger for the "Select sequence (bit 2)" function. Selection bit with the valency $2^2$ for the bit-coded selection of a sequence. Trigger = FALSE: selection bit = "0". Trigger = TRUE: selection bit = "1".  Notes: <ul style="list-style-type: none"> <li>The selected sequence is not started automatically.</li> <li>For a status-controlled start, the function "Run/abort sequence" <a href="#">0x2631:030 (P400.30)</a> is available.</li> <li>For an edge-controlled start, the function "Start sequence" <a href="#">0x2631:031 (P400.31)</a> is available.</li> </ul>
	<b>0</b> <b>Not connected</b>	No trigger assigned (trigger is constantly FALSE).
0x2631:053 (P400.53)	Function list: Select sequence (bit 3) (Function list: Seq: Select. b3) <ul style="list-style-type: none"> <li>Setting can only be changed if the inverter is disabled.</li> <li>From version 03.00</li> <li>Further possible settings: <a href="#">▶ Trigger list □ 73</a></li> </ul>	Assignment of a trigger for the "Select sequence (bit 3)" function. Selection bit with the valency $2^3$ for the bit-coded selection of a sequence. Trigger = FALSE: selection bit = "0". Trigger = TRUE: selection bit = "1".  Notes: <ul style="list-style-type: none"> <li>The selected sequence is not started automatically.</li> <li>For a status-controlled start, the function "Run/abort sequence" <a href="#">0x2631:030 (P400.30)</a> is available.</li> <li>For an edge-controlled start, the function "Start sequence" <a href="#">0x2631:031 (P400.31)</a> is available.</li> </ul>
	<b>0</b> <b>Not connected</b>	No trigger assigned (trigger is constantly FALSE).



# Configuring the frequency control

Configure setpoint sources  
Sequencer  
Sequencer control functions

## Example for operating mode

In the following example, the digital inputs 2 and 3 are used for controlling the sequencer.

- The analog input 1 is set as standard setpoint source.
- Switch S1 starts the motor in the forward direction of rotation. Switch S1 in initial position stops the motor again.
- The button S2 starts the sequence, the button S3 cancels the sequence. After the abortion, the normal setpoint control is active again.

Connection diagram	Function
	Potentiometer R1 Frequency setpoint selection
	Switch S1 Run
	Button S2 Start sequence
	Button S3 Abort sequence

Parameter	Name	Setting for this example
0x2631:001 (P400.01)	Enable inverter	Constant TRUE [1]
0x2631:002 (P400.02)	Run	Digital input 1 [11]
0x2631:004 (P400.04)	Reset fault	Not connected [0]
0x2631:013 (P400.13)	Reverse rotational direction	Not connected [0]
0x2631:031 (P400.31)	Start sequence	Digital input 2 [12]
0x2631:036 (P400.36)	Abort sequence	Digital input 3 [13]
0x2631:050 (P400.50)	Select sequence (bit 0)	Constant TRUE [1]
0x2634:001 (P420.01)	Relay	Sequencer controlled [100]
0x2634:002 (P420.02)	Digital output 1	Sequencer controlled [100]

### Segment and sequence configuration

In this example, only the sequence 1 is used. The sequence consists of two steps (segment 1 and segment 2).

0x4026:001 (P801.01)	Sequencer segment 1: Frequency setpoint	40 Hz
0x4026:002 (P801.02)	Sequencer segment 1: Acceleration/deceleration	20 s
0x4026:003 (P801.03)	Sequencer segment 1: Time	18 s
0x4026:004 (P801.04)	Sequencer segment 1: Digital outputs	0x00
0x4027:001 (P802.01)	Sequencer segment 2: Frequency setpoint	30 Hz
0x4027:002 (P802.02)	Sequencer segment 2: Acceleration/deceleration	15 s
0x4027:003 (P802.03)	Sequencer segment 2: Time	14 s
0x4027:004 (P802.04)	Sequencer segment 2: Digital outputs	0x02 (only relay)
0x402E:001 (P822.01)	End segment: Frequency setpoint	10 Hz
0x402E:002 (P822.02)	End segment: Acceleration/deceleration	8 s
0x402E:003 (P822.03)	End segment: Time	10 s
0x402E:004 (P822.04)	End segment: Digital outputs	0x04 (only digital output 1)
0x4030:001 ... 0x4030:016 (P830.01 ... 16)	Sequence 1: Step 1	Segment 1 [1]
	Sequence 1: Step 2	Segment 2 [2]
	Sequence 1: Step 3	Skip step [0]
	...	...
	Sequence 1: Step 16	Skip step [0]

### Sequencer basic settings

0x4025 (P800.00)	Sequencer mode	Time operation [1]
0x402F (P824.00)	End of sequence mode	Keep running [0]
0x4040 (P820.00)	Start of sequence mode	Restart sequencer [0]

# Configuring the frequency control

Configure setpoint sources  
Sequencer  
Sequencer diagnostics

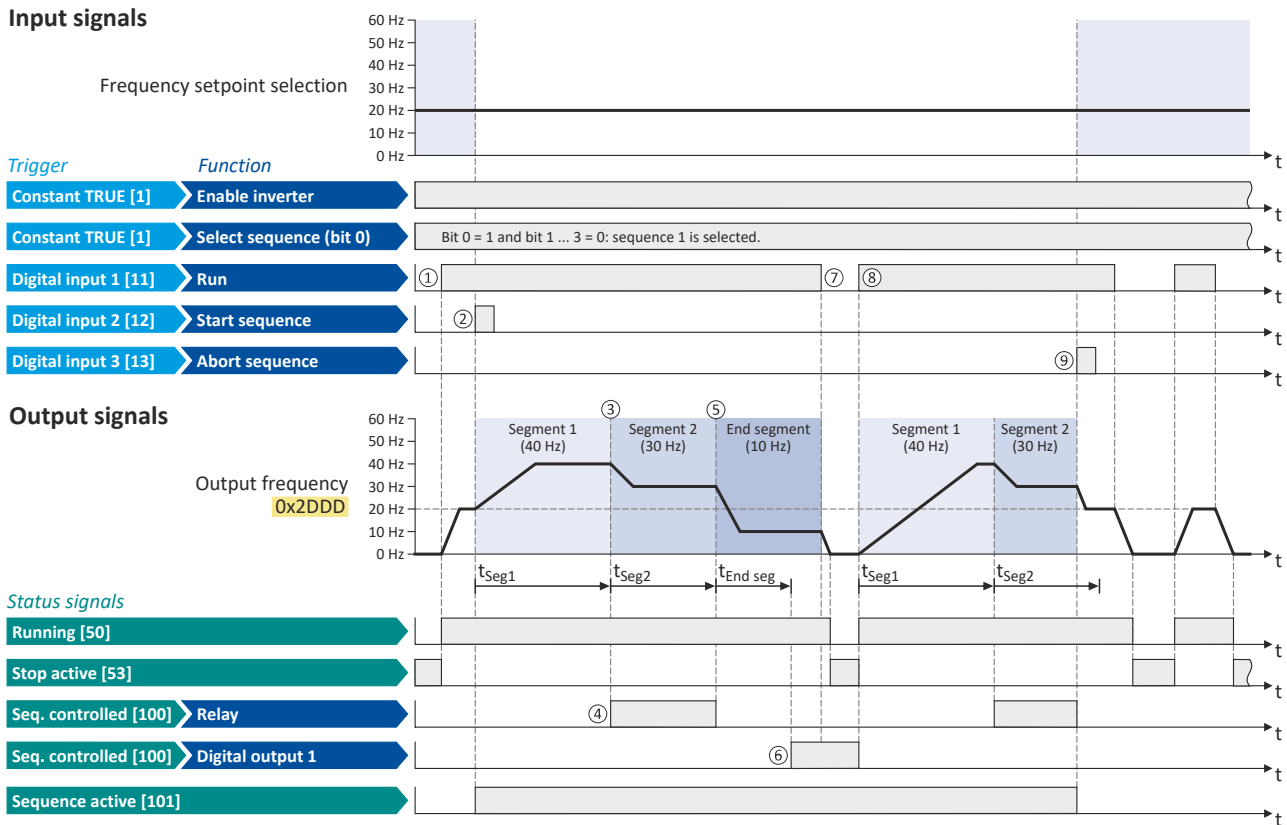

The status signals can be assigned to digital outputs. ▶ [Configure digital outputs](#) 292

- ① If the inverter is enabled and no error is active, the motor can be started with the "Start" function. As the sequence has not been started yet, first the normal setpoint control is active.
- ② The "Start sequence" function is used to start the selected sequence in an edge-controlled way.
- ③ Sequencer mode `0x4025 (P800.00)` = "Time operation [1]":  
The switch-over to the next step of the sequence is made after the time set for the current segment has elapsed.
- ④ The segment 2 is configured here in such a way that the relay will be triggered during the time of processing.
- ⑤ End of sequence mode `0x402F (P824.00)` = "Keep running [0]":  
After the sequence has been processed, the setpoint set for the end segment is continuously transmitted to the motor control until the sequence is cancelled.
- ⑥ In case of the end segment, the time setting determines the delay after which the configured output states are to become active. Here, the end segment is configured in such a way that the digital output 1 is set after 10 s have expired.
- ⑦ If the "Run" function is set to FALSE, the motor is stopped with the stop method set in `0x2838:003 (P203.03)`. The started sequence, however, remains active and the sequencer-controlled outputs keep their state.
- ⑧ Start of sequence mode `0x4040 (P820.00)` = "Restart sequencer [0]":  
If the "Run" function is set to TRUE again, the (still active) sequence is restarted.
- ⑨ The "Abort sequence" function is used to cancel the sequence in an edge-controlled way.  
In this case, the standard setpoint or the setpoint source selected via setpoint change-over is active again.

## 7.2.4.5 Sequencer diagnostics

The following parameters serve to diagnose the "sequencer" function.

### Parameter

Address	Name / setting range / [default setting]	Information
0x2DAE:001 (P140.01)	Sequencer diagnostics: Active step (Sequencer diag: Active Step) • Read only • From version 03.00	Display of the active step. • 0 = no sequence active.
0x2DAE:002 (P140.02)	Sequencer diagnostics: Step time elapsed (Sequencer diag: StepTime elapsed) • Read only: x.x s • From version 03.00	Display of the time that has passed since the start of the current step.



# Configuring the frequency control

Configure setpoint sources  
 Sequencer  
 Sequencer diagnostics

Address	Name / setting range / [default setting]	Information
0x2DAE:003 (P140.03)	Sequencer diagnostics: Step time remaining (Sequencer diag: StepTime remain) <ul style="list-style-type: none"> <li>• Read only: x.x s</li> <li>• From version 03.00</li> </ul>	Display of the remaining time for the current step.
0x2DAE:004 (P140.04)	Sequencer diagnostics: Steps complete (Sequencer diag: Steps complete) <ul style="list-style-type: none"> <li>• Read only</li> <li>• From version 03.00</li> </ul>	Display of the number of steps that have been made since the start of the sequence.
0x2DAE:005 (P140.05)	Sequencer diagnostics: Steps remaining (Sequencer diag: Steps remain) <ul style="list-style-type: none"> <li>• Read only</li> <li>• From version 03.00</li> </ul>	Display of the remaining number of steps until the current sequence is completed. This includes the current step.
0x2DAE:006 (P140.06)	Sequencer diagnostics: Active sequence (Sequencer diag: Active sequence) <ul style="list-style-type: none"> <li>• Read only</li> <li>• From version 03.00</li> </ul>	Display of the active sequence. <ul style="list-style-type: none"> <li>• 0 = no sequence active.</li> </ul>
0x2DAE:007 (P140.07)	Sequencer diagnostics: Active segment (Sequencer diag: Active segment) <ul style="list-style-type: none"> <li>• Read only</li> <li>• From version 03.00</li> </ul>	Display of the active segment. <ul style="list-style-type: none"> <li>• 0 = no sequence active.</li> <li>• 255 = final sequence active.</li> </ul>
0x2DAE:008 (P140.08)	Sequencer diagnostics: Relative sequence time remaining (Sequencer diag: SeqTime remain %) <ul style="list-style-type: none"> <li>• Read only: x %</li> <li>• From version 03.00</li> </ul>	Display of the remaining time of the sequence in [%].
0x2DAE:009 (P140.09)	Sequencer diagnostics: Absolute sequence time remaining (Sequencer diag: SeqTime remain) <ul style="list-style-type: none"> <li>• Read only: x.x s</li> <li>• From version 03.00</li> </ul>	Display of the remaining time of the sequence in [s].
0x2DAE:010	Sequencer diagnostics: Frequency setpoint <ul style="list-style-type: none"> <li>• Read only: x.x Hz</li> <li>• From version 03.00</li> </ul>	Display of the current frequency setpoint of the "sequencer" function.
0x2DAE:011	Sequencer diagnostics: PID setpoint <ul style="list-style-type: none"> <li>• Read only: x.xx PID unit</li> <li>• From version 03.00</li> </ul>	Display of the current PID control value of the "sequencer" function.
0x2DAE:012	Sequencer diagnostics: Torque setpoint <ul style="list-style-type: none"> <li>• Read only: x.x %</li> <li>• From version 03.00</li> </ul>	Display of the current torque setpoints of the "sequencer" function. <ul style="list-style-type: none"> <li>• 100 % = Rated motor torque <a href="#">0x6076 (P325.00)</a></li> </ul>



### 7.3 Configuring the process controller

By means of the process controller, a process variable can be regulated, for instance the pressure of a pump. The process controller is also referred to as "PID controller" (PID controller = proportional, integral and differential controller).

The process controller is part of a closed control loop. The variable to be influenced (controlled variable) is measured continuously by means of a sensor and supplied to the inverter as an analog signal (actual value) which, in the inverter, is then compared to the reference value (setpoint). The system deviation resulting therefrom is supplied to the process controller which, on this basis, decelerates or accelerates the motor speed according to the desired dynamic performance of the control loop, so that, for instance, a pump always generates the desired pressure.

#### Connection plan (example)

The following sample connection plan shows the control of a pump ①. The feedback of the variable (here: pressure) takes place via a pressure transducer ② connected to the analog input 1.

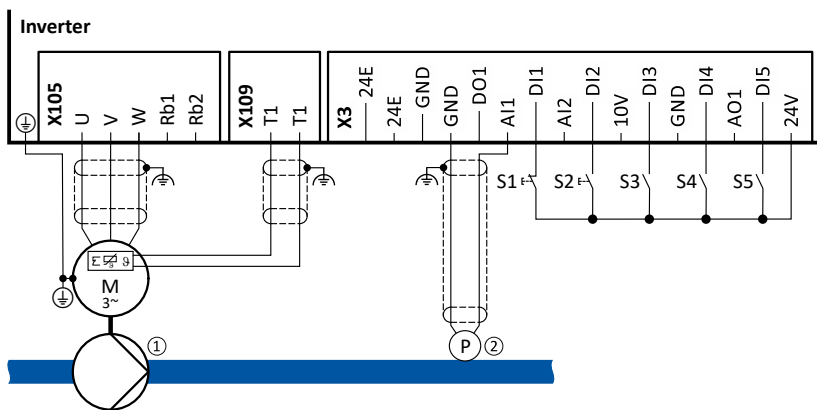

The digital inputs can be used to activate functions of the process controller. The specific assignment of the digital inputs and type of the contacts (switches or buttons, normally-closed contacts or normally-open contacts) depends on the application.

#### General information on the setting

- First implement the basic setting of the frequency control. ▶ [Basic setting](#) 92
- The basic setting of the process controller is described in the following subchapter. ▶ [Basic setting](#) 129
- Optionally, the motor can be put into an energy-saving sleep mode if no power is required. ▶ [Process controller sleep mode](#) 136
- The rinsing function which can be activated in addition accelerates the motor in idle state to a defined speed at regular intervals. The rinsing of a pipe system with a pump that has been in an inactive state for a longer period is a typical application. ▶ [Process controller rinse function](#) 138





## 7.3.1 Basic setting

The process controller is set in two steps:

1. Basic settings
2. Fine adjustment of the PID controller for an optimum control mode

### Basic settings

Based on the default setting, we recommend the following proceeding:

1. Select the standard setpoint source for the frequency control in [0x2860:001 \(P201.01\)](#).
2. Configure the selected standard setpoint source. ▶ [Configure setpoint sources](#) [197](#)
3. Activate the PID control. Set the desired operating mode (normal or reverse operation) in [0x4020:001 \(P600.01\)](#).
4. If the feedback of the variable is to take place via analog input 2 instead of analog input 1: Set [0x4020:002 \(P600.02\)](#) = "analog input 2 [2]".
5. Configure the analog input used:
  - Configure the input range.
  - Configure the setting range for the PID control.
  - Adapt the filter time to minimise the impact of noise on the control variable.
  - Set the monitoring response to "No response [0]".  
▶ [Configure analog inputs](#) [284](#)
6. If a (temporary) change-over to a speed-controlled operation is to be possible via a digital input:
  - Assign a free digital input to the control function "Disable PID controller" in [0x2631:045 \(P400.45\)](#). As long as the digital input provides a TRUE signal, the PID control is ignored and the motor is driven in a speed-controlled way.
  - Set acceleration time [0x4021:001 \(P606.01\)](#) and deceleration time [0x4021:002 \(P606.02\)](#) for speed-controlled drive control.
7. Select the standard setpoint source for the reference value in [0x2860:002 \(P201.02\)](#).
  - Functions for setpoint change-over can be used as well. ▶ [Changing the setpoint source during operation](#) [142](#)
  - The keypad setpoint can be preset in [0x2601:002 \(P202.02\)](#).
  - If process controller presets are used, they have to be set in [0x4022:001 \(P451.01\)](#) ... [0x4022:008 \(P451.08\)](#).
  - If the analog input is used as setpoint source, it must be configured accordingly.  
▶ [Configure analog inputs](#) [284](#)
  - If the motor potentiometer is used as setpoint source, this function must be configured accordingly. ▶ [Motor potentiometer \(MOP\)](#) [100](#)
8. Set the speed range to be controlled in [0x4020:003 \(P600.03\)](#).
9. If the output value of the process controller is to be limited, adapt the following parameters:
  - [0x4020:005 \(P600.05\)](#): Min speed limit
  - [0x4020:006 \(P600.06\)](#): Max speed limit
10. Test the following parameters with the default setting first and only adapt them if required:
  - [0x404B \(P604.00\)](#): Setpoint ramp
  - [0x404C:001 \(P607.01\)](#): acceleration time for showing the process controller influence
  - [0x404C:002 \(P607.02\)](#): deceleration time for hiding the process controller influence
11. Diagnostics: check the current reference value and feedback of the control variable:
  - The current reference value (setpoint) is displayed in [0x401F:001 \(P121.01\)](#).
  - The current variable (actual value) is displayed in [0x401F:002 \(P121.02\)](#).

After the basic setting of the process controller has been carried out, a fine adjustment of the PID controller must be executed for optimum control behaviour (see the following section).

# Configuring the frequency control

Configuring the process controller  
Basic setting



## Fine adjustment of the PID controller

The dynamics of the PID controller are parameterised based on the gain of the P component [0x4048 \(P601.00\)](#), the reset time for the I component [0x4049 \(P602.00\)](#) and the gain of the D component [0x404A \(P603.00\)](#). In the default setting, the process controller operates as a PI controller. The D component is deactivated.

### Basics

- If only the P component is used and the system operates in a steady-state status (the reference value is constant and the process variable is controlled to a fixed value), a certain system deviation always continues to exist. This remaining system deviation is also called "stationary deviation".
- The I component prevents a permanent fluctuation around the setpoint. Here, the reset time [0x4049 \(P602.00\)](#) determines how much the duration of the control deviation influences the control. A high reset time means a lower influence of the I component and vice versa.
- The D component does not respond to the height of the system deviation but to their rate of change only. The D component acts as a "damper" for overshoots. Overshoots may occur if the control tries to respond quickly to changes in the system deviation or the reference value. Thus, the D component reduces the risk of instabilities due to overshoots.



---

For most applications, the setting of the gain of the P component and the reset time for the I component is sufficient for the fine adjustment. The setting of the gain of the D component may be required for a further stabilisation of the system especially if a quick response to system deviations is to take place.

---

### Execute fine adjustment:

1. Set the reset time for the I component to 6000 ms in [0x4049 \(P602.00\)](#) to deactivate the I component.
  - With this setting and the default setting of [0x404A \(P603.00\)](#), the process controller operates as P controller.
2. Increase gain of the P component step by step in [0x4048 \(P601.00\)](#) until the system becomes instable.
3. Reduce the gain again until the system is stable again.
4. Reduce the gain by another 15 %.
5. Set reset time for the I component in [0x4049 \(P602.00\)](#).
  - With this setting it should be noted that a too low reset time may cause overshoots, especially in case of high steps of the system deviation.
6. Optional: set the gain of the D component in [0x404A \(P603.00\)](#).
  - With this setting it should be noted that the D component responds very sensitively to electrical disturbance on the feedback as well as digitisation errors.



# Configuring the frequency control

Configuring the process controller  
Basic setting

## Internal signal flow

The following illustration shows the internal signal flow of the process controller (without the additional functions "idle state" and "rinsing function"):

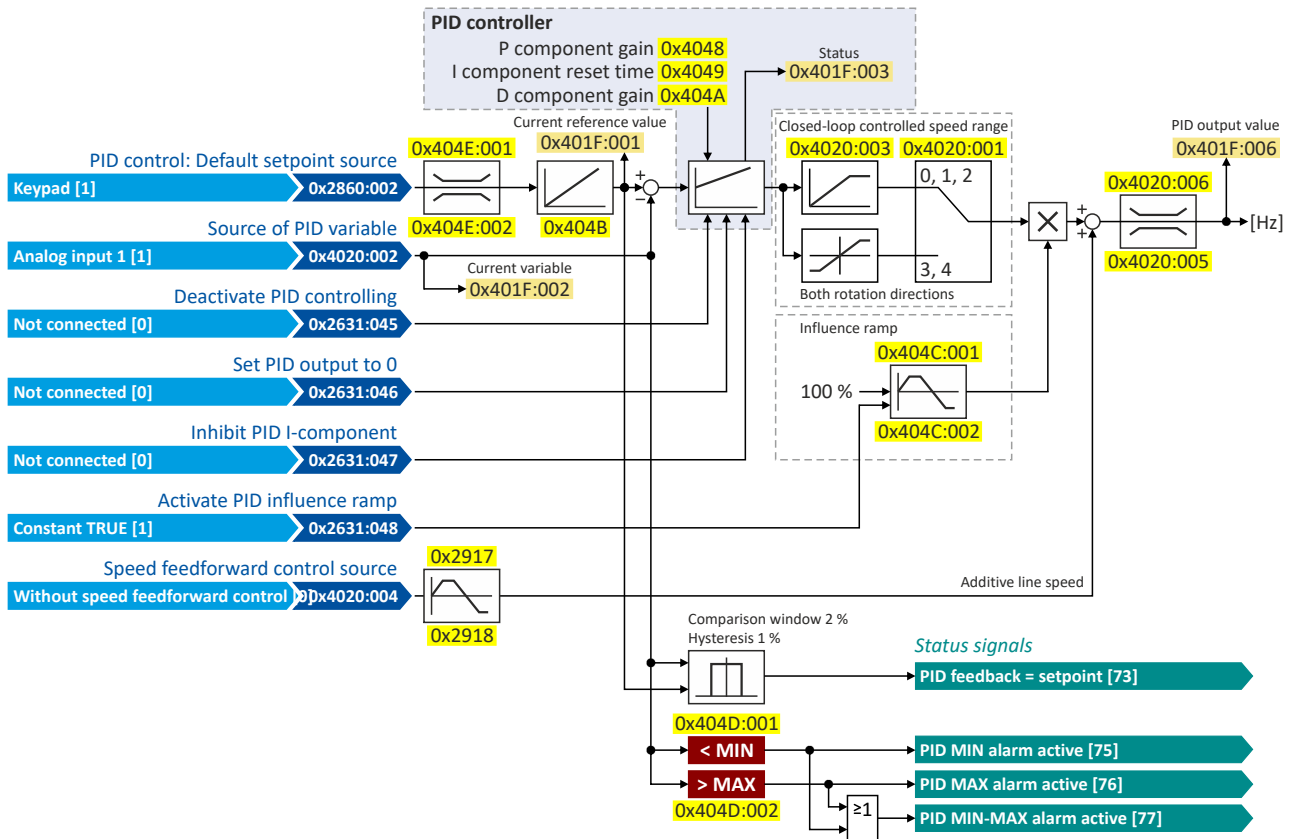

## Control functions

The flexible I/O configuration serves to configure different control functions for the process controller:

- 0x2631:045 (P400.45): Disable PID controller
- 0x2631:046 (P400.46): Set process controller output to 0
- 0x2631:047 (P400.47): Inhibit process controller I-component
- 0x2631:048 (P400.48): Activate PID influence ramp

For details see chapter "Process controller function selection". [138](#)

## Status signals for configurable outputs

The process controller provides different internal status signals. These status signals can be assigned to the relay, the digital outputs or the NetWordOUT1 status word.

For details see chapter "Configure digital outputs". [292](#)

# Configuring the frequency control

Configuring the process controller  
Basic setting



## Parameter

Address	Name / setting range / [default setting]	Information
0x2860:002 (P201.02)	PID control: Default setpoint source (PID setp. src.)	Selection of the standard setpoint source for the reference value of the PID control. <ul style="list-style-type: none"> <li>The selected standard setpoint source is always active with an activated PID control when no setpoint change-over to another setpoint source via corresponding triggers/functions is active.</li> </ul>
	<b>1 Keypad</b>	The setpoint is specified locally by the keypad. <ul style="list-style-type: none"> <li>Default setting: <a href="#">0x2601:002 (P202.02)</a></li> <li>Use the <b>↑</b> and <b>↓</b> navigation keys to change the keypad setpoint (also during running operation).</li> </ul>
	<b>2 Analog input 1</b>	The setpoint is defined as analog signal via the analog input 1. <a href="#">▶ Analog input 1 □ 284</a>
	<b>3 Analog input 2</b>	The setpoint is defined as analog signal via the analog input 2. <a href="#">▶ Analog input 2 □ 289</a>
	<b>4 HTL input</b> (from version 04.00)	The digital inputs DI3 and DI4 can be configured as HTL input to use an HTL encoder as setpoint encoder or define the setpoint as a reference frequency ("pulse train"). <a href="#">▶ HTL encoder □ 176</a> <a href="#">▶ Configure digital inputs DI3/DI4 for detecting a pulse train □ 276</a>
	<b>5 Network</b>	The setpoint is defined as process data object via the network. <a href="#">▶ Define setpoint via network □ 327</a>
	<b>11 PID preset 1</b>	For the setpoint selection, preset values can be parameterised and selected. <a href="#">▶ Setpoint presets □ 98</a>
	<b>12 PID preset 2</b>	
	<b>13 PID preset 3</b>	
	<b>14 PID preset 4</b>	
	<b>15 PID preset 5</b>	
	<b>16 PID preset 6</b>	
	<b>17 PID preset 7</b>	
	<b>18 PID preset 8</b>	
	<b>31 Segment preset 1</b> (from version 03.00)	For the setpoint selection, the segment presets parameterised for the "sequencer" function can be selected as well. <a href="#">▶ Sequencer □ 102</a>
	<b>32 Segment preset 2</b> (from version 03.00)	
	<b>33 Segment preset 3</b> (from version 03.00)	
	<b>34 Segment preset 4</b> (from version 03.00)	
	<b>35 Segment preset 5</b> (from version 03.00)	
	<b>36 Segment preset 6</b> (from version 03.00)	
	<b>37 Segment preset 7</b> (from version 03.00)	
	<b>38 Segment preset 8</b> (from version 03.00)	
	<b>50 Motor potentiometer</b>	The setpoint is generated by the "motor potentiometer" function. This function can be used as an alternative setpoint control which is controlled via two signals: "MOP setpoint up" and "MOP setpoint down". <a href="#">▶ Motor potentiometer (MOP) □ 100</a>
<b>201 Internal value</b> (from version 05.00)	Internal values of the manufacturer.	
<b>202 Internal value</b> (from version 05.00)		
<b>203 Internal value</b> (from version 05.00)		
<b>204 Internal value</b> (from version 05.00)		
<b>205 Internal value</b> (from version 05.00)		
<b>206 Internal value</b> (from version 05.00)		



# Configuring the frequency control

Configuring the process controller  
Basic setting

Address	Name / setting range / [default setting]	Information
0x4020:001 (P600.01)	Process controller setup (PID): Operating mode (PID setup: Operating mode)	Selection of the process controller operating mode.
	<b>0 Inhibited</b>	Process controller deactivated.
	1 Normal operation	The setpoint is higher than the feedback variable (actual value). If the system deviation increases, the motor speed is increased. Example: pressure-controlled booster pumps (increase in the motor speed produces an increase in pressure.)
	2 Reverse operation	The setpoint is lower than the feedback variable (actual value). If the system deviation increases, the motor speed is increased. Example: temperature-controlled cooling water pump (increase in motor speed produces decrease in temperature.)
	3 Normal bi-directional	The direction of rotation corresponds to the sign of the system deviation. If the system deviation increases, the motor speed is increased.
	4 Reverse bi-directional	A negative system deviation causes a positive direction of rotation. If the system deviation increases, the motor speed is increased.
0x4020:002 (P600.02)	Process controller setup (PID): PID process variable (PID setup: PID process var.)	Selection of the source via which the feedback of the controlled variable (actual value) for the process controller is effected.
	<b>1 Analog input 1</b>	
	2 Analog input 2	
	3 DC-bus voltage (from version 02.00)	
	4 Motor Current (from version 02.00)	
	5 Network (from version 02.00)	
	6 HTL input (from version 04.00)	
	201 Internal value	Internal values of the manufacturer.
	202 Internal value	
	203 Internal value	
	204 Internal value	
205 Internal value		
206 Internal value		
0x4020:003 (P600.03)	Process controller setup (PID): Closed-loop controlled speed range (PID setup: PID speed range) 0 ... [100] ... 100 %	Setting of the maximum output frequency up to which the process controller carries out regulation. <ul style="list-style-type: none"> <li>100 % = Maximum frequency 0x2916 (P211.00).</li> </ul>
	0x4020:004 (P600.04)	Process controller setup (PID): Speed feedforward control source (PID setup: PID line speed)
0x4020:004 (P600.04)	<b>0 Without speed addition</b>	Internal values of the manufacturer.
	1 Keypad frequency setpoint	
	2 Analog input 1	
	3 Analog input 2	
	4 Frequency preset 1	
	5 Frequency preset 2	
	6 Frequency preset 3	
	7 Frequency preset 4	
	8 Network	
	9 HTL input	
	201 Internal value	
202 Internal value		
203 Internal value		
204 Internal value		
205 Internal value		
206 Internal value		
0x4020:005 (P600.05)	Process controller setup (PID): Min speed limit (PID setup: Min speed lim) -100.0 ... [-100.0] ... 100.0 % <ul style="list-style-type: none"> <li>From version 03.00</li> </ul>	Configuration of the process controller <ul style="list-style-type: none"> <li>100 % = Maximum frequency 0x2916 (P211.00).</li> <li>The limitation becomes effective after the line speed has been added.</li> <li>The value set here also limits the I component of the PID controller (Integrator-Anti-Windup).</li> </ul>

# Configuring the frequency control

## Configuring the process controller Basic setting



Address	Name / setting range / [default setting]	Information
0x4020:006 (P606.06)	Process controller setup (PID): Max speed limit (PID setup: Max speed lim) -100.0 ... [100.0] ... 100.0 % • From version 03.00	Maximum output value of the process controller. • 100 % = Maximum frequency 0x2916 (P211.00). • The limitation becomes effective after the line speed has been added. • The value set here also limits the I component of the PID controller (Integrator-Anti-Windup).
0x4021:001 (P606.01)	PID speed operation: Acceleration time (PID speed op.: Accel. time) 0.0 ... [1.0] ... 3600.0 s	Acceleration time for (temporary) speed-controlled drive control in process controller mode. • The acceleration time takes effect at the output of the process controller.
0x4021:002 (P606.02)	PID speed operation: Deceleration time (PID speed op.: Decel. time) 0.0 ... [1.0] ... 3600.0 s	Deceleration time for (temporary) speed-controlled drive control in process controller mode. • The deceleration time takes effect at the output of the process controller. • <b>Exception:</b> In case of quick stop, the quick stop delay time is effective.
0x4048 (P601.00)	PID P-component (PID P-component) 0.0 ... [5.0] ... 1000.0 %	Output frequency of the process controller per 1 % system deviation. • 100 % = maximum frequency 0x2916 (P211.00).
0x4049 (P602.00)	PID I- component (PID I- component) 1 ... [400] ... 6000 ms	Reset time for system deviation. • With the setting "6000 ms", the I component is deactivated. • The I component can also be deactivated via the "Inhibit process controller I-component" 0x2631:047 (P400.47) function.
0x404A (P603.00)	PID D-component (PID D-component) 0.0 ... [0.0] ... 20.0 s	D component, does not respond to the rate of the system deviation, but only to its rate of change.
0x404B (P604.00)	PID setpoint ramp (PID setp.ramp) 0.0 ... [20.0] ... 100.0 s	Acceleration time and deceleration time for the process controller setpoint, relating to 100 PID units Example: A setpoint increase from 0 PID units to 100 PID units with the default ramp takes 20s.
0x404C:001 (P607.01)	PID influence: Acceleration time for activation (PID influence: Activation time) 0.0 ... [5.0] ... 999.9 s	If the trigger assigned in 0x2631:048 (P400.48) of the "Activate PID influence ramp" function is TRUE, the influence of the process controller is shown by means of a ramp with the acceleration time set here.
0x404C:002 (P607.02)	PID influence: Deceleration time for masking out (PID influence: Mask out time) 0.0 ... [5.0] ... 999.9 s	If the trigger assigned in 0x2631:048 (P400.48) of the "Activate PID influence ramp" function is FALSE, the influence of the process controller is hidden via a ramp with the deceleration time set here.
0x404C:003 (P607.03)	PID influence: PID influence factor (PID influence: PID infl. factor) 0.0 ... [100.0] ... 200.0 % • From version 06.04	
0x404D:001 (P608.01)	PID alarms: MIN alarm threshold (PID alarms: MIN alarm thrsh.) -300.00 ... [0.00] ... 300.00 PID unit	Trigger threshold for the status signal "PID MIN alarm active [75]". • The "PID MIN alarm active [75]" status signal is TRUE if the feedback variable (with activated PID control) is lower than the threshold set here. • The status signal can be assigned to the relay or to a digital output. ▶ <a href="#">Configure digital outputs</a> □ 292 • The status signal can be assigned to the NetWordOUT1 status word. ▶ <a href="#">Define your own status word format</a> □ 322
0x404D:002 (P608.02)	PID alarms: MAX alarm threshold (PID alarms: MAX alarm thrsh.) -300.00 ... [100.00] ... 300.00 PID unit	Trigger threshold for the status signal "PID MAX alarm active [76]". • The "PID MAX alarm active [76]" status signal is TRUE if the feedback variable (with activated PID control) is higher than the threshold set here. • The status signal can be assigned to the relay or to a digital output. ▶ <a href="#">Configure digital outputs</a> □ 292 • The status signal can be assigned to the NetWordOUT1 status word. ▶ <a href="#">Define your own status word format</a> □ 322



# Configuring the frequency control

Configuring the process controller  
Basic setting

Address	Name / setting range / [default setting]	Information
0x404D:003 (P608.03)	PID alarms: Monitoring bandwidth PID feedback signal (PID alarms: Bandw. feedback) 0.00 ... <b>[2.00]</b> ... 100.00 % <ul style="list-style-type: none"> <li>From version 04.00</li> </ul>	Hysteresis for status signal "PID feedback = setpoint [73]". <ul style="list-style-type: none"> <li>100 % = configured variable input range</li> <li>Example: Variable input range 0 ... 10 V: 2 % = 0.2 V</li> <li>The status signal "PID feedback = setpoint [73]" is TRUE if the controlled variable feedback = process controller setpoint (<math>\pm</math> hysteresis set here).</li> <li>The status signal can be assigned to the relay or to a digital output. <ul style="list-style-type: none"> <li>▶ <a href="#">Configure digital outputs</a> <span style="font-size: small;">□ 292</span></li> </ul> </li> <li>The status signal can be assigned to the NetWordOUT1 status word. <ul style="list-style-type: none"> <li>▶ <a href="#">Define your own status word format</a> <span style="font-size: small;">□ 322</span></li> </ul> </li> </ul>
0x404E:001 (P605.01)	PID setpoint limits: Minimum setpoint (PID setp. limit: Minimum setpoint) -300.00 ... <b>[-300.00]</b> ... 300.00 PID unit	Minimum value of the process controller setpoint.
0x404E:002 (P605.02)	PID setpoint limits: Maximum setpoint (PID setp. limit: Maximum setpoint) -300.00 ... <b>[300.00]</b> ... 300.00 PID unit	Maximum value of the process controller setpoint.

# Configuring the frequency control

Configuring the process controller  
Process controller sleep mode



## 7.3.2 Process controller sleep mode

If the PID control is activated, this function sets the drive in process controller mode to an energy-saving sleep mode when no power is required.

### Details

A typical application for this function is a booster pump for water in a high-rise building. If no tenant opens the water tap or uses the shower for a longer period of time, the pump changes to the energy-saving sleep mode. This usually happens at night. The sleep mode automatically ends as soon as a tenant opens the tap again. The pumps operates normally again until the condition for the sleep mode is pending again.

The conditions for activating and terminating the sleep mode can be set independently of one another in [0x4023:001 \(P610.01\)](#) and [0x4023:006 \(P610.06\)](#) (see the following tables).

In [0x4023:005 \(P610.05\)](#), a delay time can be set for the activation. This is the minimum time the values must fall below or exceed the respective threshold before the sleep mode is activated.

<a href="#">0x4023:001 (P610.01)</a>	Condition for activating the sleep mode			
0	Sleep mode deactivated.			
1	Frequency setpoint <a href="#">0x2B0E (P102.00)</a>	<	Frequency threshold <a href="#">0x4023:003 (P610.03)</a>	( + <a href="#">0x4023:005 (P610.05)</a> )
2	Frequency setpoint <a href="#">0x2B0E (P102.00)</a>	<	Frequency threshold <a href="#">0x4023:003 (P610.03)</a>	( + <a href="#">0x4023:005 (P610.05)</a> )
	OR			
3	Current process variable <a href="#">0x401F:002 (P121.02)</a>	>	Feedback threshold <a href="#">0x4023:004 (P610.04)</a>	( + <a href="#">0x4023:005 (P610.05)</a> )
	OR			
3	Frequency setpoint <a href="#">0x2B0E (P102.00)</a>	<	Frequency threshold <a href="#">0x4023:003 (P610.03)</a>	( + <a href="#">0x4023:005 (P610.05)</a> )
	OR			
3	Current process variable <a href="#">0x401F:002 (P121.02)</a>	<	Feedback threshold <a href="#">0x4023:004 (P610.04)</a>	( + <a href="#">0x4023:005 (P610.05)</a> )
	OR			

<a href="#">0x4023:006 (P610.06)</a>	Condition for terminating the sleep mode			
0	Frequency setpoint <a href="#">0x2B0E (P102.00)</a>	>	Frequency threshold <a href="#">0x4023:003 (P610.03)</a>	( + 2 Hz hysteresis )
	OR			
0	PID error value <a href="#">0x401F:007</a>	>	Bandwidth <a href="#">0x4023:007 (P610.07)</a>	
	OR			
1	Current process variable <a href="#">0x401F:002 (P121.02)</a>	<	Recovery threshold <a href="#">0x4023:008 (P610.08)</a>	
2	Current process variable <a href="#">0x401F:002 (P121.02)</a>	>	Recovery threshold <a href="#">0x4023:008 (P610.08)</a>	





# Configuring the frequency control

Configuring the process controller  
Process controller sleep mode

## Parameter

Address	Name / setting range / [default setting]	Information
0x4023:001 (P610.01)	PID sleep mode: Activation (PID sleep mode: Activation)	Condition for activating the sleep mode.
	<b>0 Disabled</b>	Sleep mode deactivated.
	1 Output frequency < threshold	<a href="#">0x2B0E (P102.00)</a> < <a href="#">0x4023:003 (P610.03)</a> (+ Delay time <a href="#">0x4023:005 (P610.05)</a> )
	2 Output frequency < threshold OR process variable > feedback threshold	<a href="#">0x2B0E (P102.00)</a> < <a href="#">0x4023:003 (P610.03)</a> (+ Delay time <a href="#">0x4023:005 (P610.05)</a> ) OR <a href="#">0x401F:002 (P121.02)</a> > <a href="#">0x4023:004 (P610.04)</a> (+ Delay time <a href="#">0x4023:005 (P610.05)</a> )
3 Output frequency < threshold OR process variable < feedback threshold	<a href="#">0x2B0E (P102.00)</a> < <a href="#">0x4023:003 (P610.03)</a> (+ Delay time <a href="#">0x4023:005 (P610.05)</a> ) OR <a href="#">0x401F:002 (P121.02)</a> < <a href="#">0x4023:004 (P610.04)</a> (+ Delay time <a href="#">0x4023:005 (P610.05)</a> )	
0x4023:002 (P610.02)	PID sleep mode: Stop method (PID sleep mode: Stop method)	Selection of the stop method after activation of the sleep mode.
	<b>0 Coasting</b>	The motor has no torque (coasts down to standstill).
	1 Deceleration to standstill	The motor is brought to a standstill with deceleration time 1 (or deceleration time 2, if activated). <ul style="list-style-type: none"> <li>Deceleration time 1 can be set in <a href="#">0x2918 (P221.00)</a>.</li> <li>Deceleration time 2 can be set in <a href="#">0x291A (P223.00)</a>.</li> </ul> <a href="#">▶ Ramp times □95</a>
2 Stop method set	The stop method set in <a href="#">0x2838:003 (P203.03)</a> is used.	
0x4023:003 (P610.03)	PID sleep mode: Frequency threshold (PID sleep mode: Freq. thresh.) 0.0 ... <b>[0.0]</b> ... 599.0 Hz	Frequency threshold for activating the sleep mode. <ul style="list-style-type: none"> <li>For comparing "output frequency &lt; threshold" in case of selection 1 ... 3 in <a href="#">0x4023:001 (P610.01)</a>.</li> </ul>
0x4023:004 (P610.04)	PID sleep mode: Feedback threshold (PID sleep mode: Feedback thresh.) -300.00 ... <b>[0.00]</b> ... 300.00 PID unit	Feedback threshold for activating the sleep mode. <ul style="list-style-type: none"> <li>For comparing "variable &gt; feedback threshold" in case of selection 2 in <a href="#">0x4023:001 (P610.01)</a>.</li> <li>For comparing "variable &lt; feedback threshold" in case of selection 3 in <a href="#">0x4023:001 (P610.01)</a>.</li> </ul>
0x4023:005 (P610.05)	PID sleep mode: Delay time (PID sleep mode: Delay time) 0.0 ... <b>[0.0]</b> ... 300.0 s	Minimum time for which the respective threshold must be underrun or exceeded before the sleep mode is activated.
0x4023:006 (P610.06)	PID sleep mode: Recovery (PID sleep mode: Recovery)	Condition for terminating the sleep mode.
	<b>0 Setpoint &gt; threshold OR system deviation &gt; bandwidth</b>	<a href="#">0x2B0E (P102.00)</a> > <a href="#">0x4023:003 (P610.03)</a> (+ 2 Hz hysteresis) OR <a href="#">0x401F:007</a> > <a href="#">0x4023:007 (P610.07)</a>
	1 Process variable < recovery threshold	<a href="#">0x401F:002 (P121.02)</a> < <a href="#">0x4023:008 (P610.08)</a>
2 Process variable > recovery threshold	<a href="#">0x401F:002 (P121.02)</a> > <a href="#">0x4023:008 (P610.08)</a>	
0x4023:007 (P610.07)	PID sleep mode: Bandwidth (PID sleep mode: Bandwidth) 0.00 ... <b>[0.00]</b> ... 300.00 PID unit	Range around the process controller setpoint for ending the sleep mode. <ul style="list-style-type: none"> <li>0.00 = bandwidth deactivated.</li> </ul>
0x4023:008 (P610.08)	PID sleep mode: Recovery threshold (PID sleep mode: Recovery thresh.) -300.00 ... <b>[0.00]</b> ... 300.00 PID unit	Termination threshold for sleep mode.

# Configuring the frequency control

Configuring the process controller  
Process controller rinse function



## 7.3.3 Process controller rinse function

This function accelerates the motor in sleep mode of the process controller at regular intervals to a defined speed.

### Details

A typical application for this function is the rinsing of a pipe system with a pump that has been in an inactive state for a longer period to prevent deposits.

- In order to activate the rinsing function, set the selection "Enabled [1]" in [0x4024:001 \(P615.01\)](#).
- The following diagram demonstrates the function:

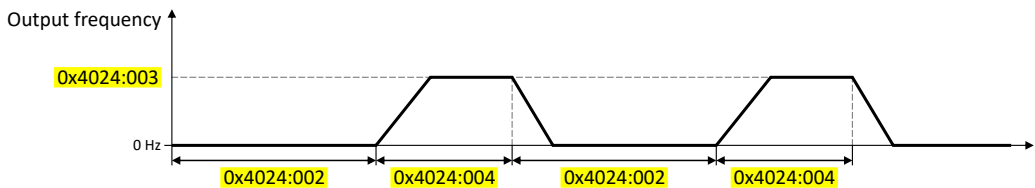

- The rinsing function uses the ramp times set for the "MS: Velocity mode". ▶ [Ramp times](#) □ 95

### Parameter

Address	Name / setting range / [default setting]	Information
0x4024:001 (P615.01)	Automatic rinsing: Rinsing in sleep mode (Auto-rinsing: Rinsing in idle)  0 Inhibited 1 Enabled	1 = activate automatic rinsing in sleep mode.
0x4024:002 (P615.02)	Automatic rinsing: Rinse interval (Auto-rinsing: Rinse interval) 0.0 ... [30.0] ... 6000.0 min	Time interval between two rinsing processes.
0x4024:003 (P615.03)	Automatic rinsing: Rinse speed (Auto-rinsing: Rinse speed) -599.0 ... [0.0] ... 599.0 Hz	Speed setpoint for rinse function.
0x4024:004 (P615.04)	Automatic rinsing: Rinse period (Auto-rinsing: Rinse period) 0.0 ... [0.0] ... 6000.0 s	Duration of a rinsing process.

## 7.3.4 Process controller function selection

By means of the following functions, the response of the inverter can be controlled when PID control is activated.

### Parameter

Address	Name / setting range / [default setting]	Information
0x2631:045 (P400.45)	Function list: Disable PID controller (Function list: PID off) • Further possible settings: ▶ <a href="#">Trigger list</a> □ 73  0 Not connected	Assignment of a trigger for the "Disable PID controller" function. Trigger = TRUE: If PID control is activated, ignore PID control and drive the motor in speed-controlled manner. Trigger = FALSE: If PID control is activated, drive the motor with PID control.  Notes: • The PID control mode can be selected in <a href="#">0x4020:001 (P600.01)</a> .
0x2631:046 (P400.46)	Function list: Set process controller output to 0 (Function list: PID output=0) • Further possible settings: ▶ <a href="#">Trigger list</a> □ 73  0 Not connected	Assignment of a trigger for the "Set process controller output to 0" function. Trigger = TRUE: If PID control is activated, I component and the output of the PID controller are set to 0 and the internal control algorithm is stopped. The PID control remains active. Trigger = FALSE: no action / deactivate function again.
		No trigger assigned (trigger is constantly FALSE).



# Configuring the frequency control

Configuring the process controller  
Process controller function selection

Address	Name / setting range / [default setting]	Information
0x2631:047 (P400.47)	Function list: Inhibit process controller I-component (Function list: PID-I inhibited) • Further possible settings: ▶ <a href="#">Trigger list</a> <a href="#">73</a>	Assignment of a trigger for the "Inhibit process controller I-component" function. Trigger = TRUE: If PID control is activated, the I component of the PID controller is set to 0 and the integration process is stopped. Trigger = FALSE: no action / deactivate function again. Notes: • The reset time can be set in <a href="#">0x4049 (P602.00)</a> .
	<b>0</b> Not connected	No trigger assigned (trigger is constantly FALSE).
0x2631:048 (P400.48)	Function list: Activate PID influence ramp (Function list: PID-Inf ramp on) • Further possible settings: ▶ <a href="#">Trigger list</a> <a href="#">73</a>	Assignment of a trigger for the "Activate PID influence ramp" function. Trigger = TRUE: the influence of the process controller is shown via a ramp. Trigger = FALSE or not connected: the influence of the process controller is hidden via ramp. Notes: • The influence of the process controller is always active (not only when PID control is activated). • Acceleration time for showing the influence of the process controller can be set in <a href="#">0x404C:001 (P607.01)</a> . • Deceleration time for hiding the influence of the process controller can be set in <a href="#">0x404C:002 (P607.02)</a> .
	<b>1</b> Constant TRUE	Trigger is constantly TRUE.

## Example for operating mode

In the following example, the "Disable PID controller" function is used to deactivate the PID control temporarily:

- As standard setpoint source, the frequency preset 1 is set to 20 Hz.
- Switch S1 starts the motor in the forward direction of rotation. Switch S1 in initial position stops the motor again.
- The switch S2 deactivates the PID control. The motor is then driven in a speed-controlled way.

Connection diagram	Function
	Switch S1 Run
	Switch S2 Disable PID controller

Parameter	Name	Setting for this example
<a href="#">0x2631:001 (P400.01)</a>	Enable inverter	Constant TRUE [1]
<a href="#">0x2631:002 (P400.02)</a>	Run	Digital input 1 [11]
<a href="#">0x2631:004 (P400.04)</a>	Reset fault	Not connected [0]
<a href="#">0x2631:045 (P400.45)</a>	Disable PID controller	Digital input 2 [12]
<a href="#">0x2824 (P200.00)</a>	Control selection	Flexible I/O configuration [0]
<a href="#">0x2838:003 (P203.03)</a>	Stop method	Standard ramp [1]
<a href="#">0x2860:001 (P201.01)</a>	Frequency control: Default setpoint source	Frequency preset 1 [11]
<a href="#">0x2911:001 (P450.01)</a>	Frequency setpoint presets: Preset 1	20 Hz
<a href="#">0x2916 (P211.00)</a>	Maximum frequency	50 Hz



The example assumes that the process controller has been configured accordingly.

▶ [Basic setting](#) [129](#)

# Configuring the frequency control

Configuring the process controller  
Process controller diagnostics



## Input signals

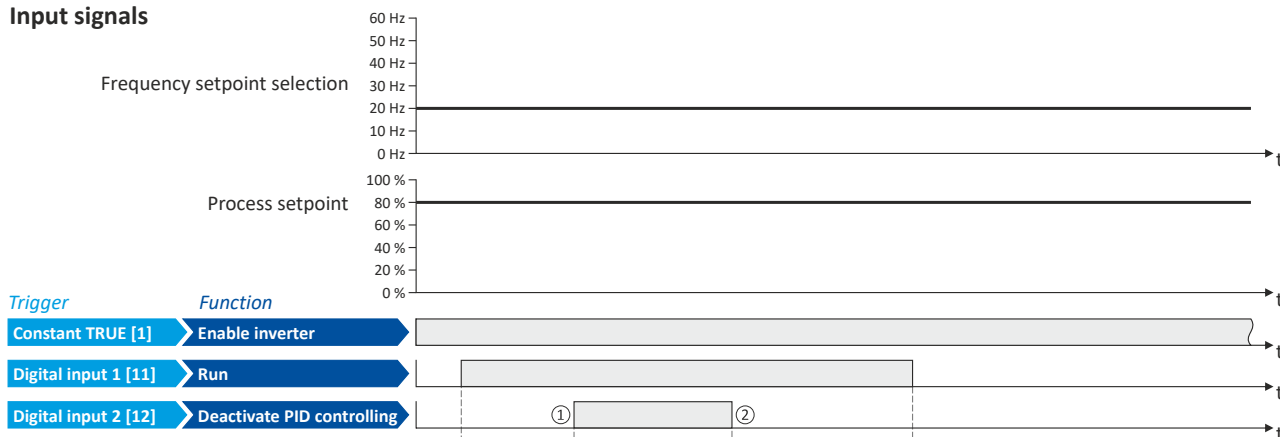

## Output signals

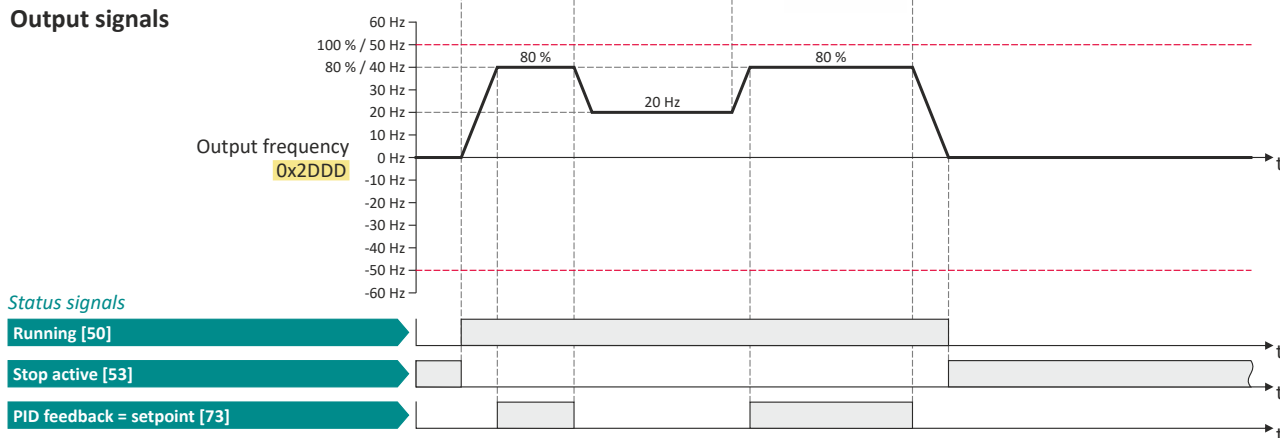

The status signals can be assigned to digital outputs. [▶ Configure digital outputs](#) 292

- ① PID control is deactivated: a changeover is initiated from the configured PID control to speed-controlled operation.
- ② PID control is activated again: a changeover is initiated from speed-controlled operation back to the configured PID control.

## 7.3.5 Process controller diagnostics

The following parameters serve to diagnose the process controller.

### Parameter

Address	Name / setting range / [default setting]	Information
0x401F:001 (P121.01)	Process controller diagnostics: Current setpoint (PID diagnostics: PID setpoint) • Read only: x.xx PID unit	Display of the current reference value (setpoint) for the process controller.
0x401F:002 (P121.02)	Process controller diagnostics: Current process variable (PID diagnostics: PID process var.) • Read only: x.xx PID unit	Display of the current controlled feedback variable (actual value) for the process controller.
0x401F:003 (P121.03)	Process controller diagnostics: Status (PID diagnostics: PID status) • Read only	Bit-coded status display of the process controller.
	Bit 0 Process controller off	
	Bit 1 PID output set to 0	
	Bit 2 PID I-component inhibited	
	Bit 3 PID influence active	
	Bit 4 Setpoint = actual value	
	Bit 5 Sleep mode active	
	Bit 6 Max. alarm	
	Bit 7 Min. alarm	



# Configuring the frequency control

Configuring the process controller  
Process controller diagnostics

Address	Name / setting range / [default setting]	Information
0x401F:004	Process controller diagnostics: PID control value <ul style="list-style-type: none"><li>• Read only: x.x Hz</li><li>• From version 03.00</li></ul>	Display of the output frequency after the PID controller, but without any influencing factor.
0x401F:005	Process controller diagnostics: PID Feedforward value <ul style="list-style-type: none"><li>• Read only: x.x Hz</li><li>• From version 03.00</li></ul>	Display of the feedforward control value for the process controller.
0x401F:006	Process controller diagnostics: PID output value <ul style="list-style-type: none"><li>• Read only: x.x Hz</li><li>• From version 03.00</li></ul>	Display of the current process controller setpoint that is internally transferred to the motor control (considering the feedforward control value).
0x401F:007	Process controller diagnostics: PID error value <ul style="list-style-type: none"><li>• Read only: x.xx PID unit</li><li>• From version 03.00</li></ul>	Display of the difference between reference value (setpoint) and feedback variable (actual value) of the process controller.



### 7.4 Changing the setpoint source during operation

The inverter receives its setpoint from the selected standard setpoint source. For applications requiring a change-over of the setpoint source during operation, the functions listed below must be configured.

#### Details

For further details and examples, see the following subchapters.



In case of an activated network control, the functions for setpoint change-over are not active! If in case of network control no setpoint is defined via the network control word, the standard setpoint source is active.

Function	Info
Activate AI1 setpoint 0x2631:014 (P400.14)	Activate analog input 1 as setpoint source. ▶ Analog input 1 <a href="#">□ 284</a> ▶ Example: Change-over from keypad setpoint to AI1/AI2 setpoint <a href="#">□ 146</a>
Activate AI2 setpoint 0x2631:015 (P400.15)	Activate analog input 2 as setpoint source. ▶ Analog input 2 <a href="#">□ 289</a> ▶ Example: Change-over from keypad setpoint to AI1/AI2 setpoint <a href="#">□ 146</a>
Activate keypad setpoint 0x2631:016 (P400.16)	Activate keypad as setpoint source. • The keypad setpoint can be changed in the operating mode via the navigation keys <b>↑</b> and <b>↓</b> keypad key. ▶ Keypad <a href="#">□ 97</a> ▶ Example: Change-over from AI1 setpoint to keypad setpoint <a href="#">□ 148</a>
Activate network setpoint 0x2631:017 (P400.17)	Activate network as setpoint source. ▶ Define setpoint via network <a href="#">□ 327</a>
Activate preset (bit 0) 0x2631:018 (P400.18)	Activate parameterisable setpoints (presets) as setpoint source. • 15 frequency setpoints and 8 PID setpoints can be set as presets. • A preset can be selected binary-coded via the four functions "Activate preset (bit 0)" ... "Activate preset (bit 3)". ▶ Setpoint presets <a href="#">□ 98</a> ▶ Example: Change-over from keypad setpoint to preset 1 ... 7 <a href="#">□ 150</a>
Activate preset (bit 1) 0x2631:019 (P400.19)	
Activate preset (bit 2) 0x2631:020 (P400.20)	
Activate preset (bit 3) 0x2631:021 (P400.21)	
Activate setpoint via HTL input 0x2631:022 (P400.22)	The digital inputs DI3 and DI4 can be configured as HTL input to evaluate the signal of a cost-effective HTL encoder or a reference frequency ("pulse train"). ▶ HTL encoder <a href="#">□ 176</a> ▶ Configure digital inputs DI3/DI4 for detecting a pulse train <a href="#">□ 276</a>
Activate MOP setpoint 0x2631:025 (P400.25)	The "Motor potentiometer" function can be used as an alternative setpoint control that is controlled via two functions: "MOP setpoint up" and "MOP setpoint down". ▶ Motor potentiometer (MOP) <a href="#">□ 100</a> ▶ Example: Change-over from AI1 setpoint to MOP setpoint <a href="#">□ 153</a>
Activate segment setpoint (bit 0) 0x2631:026 (P400.26)	Activate parameterisable segment setpoints as setpoint source. • The four functions "Activate segment setpoint (bit 0)" ... "Activate segment setpoint (bit 3)" enable a setpoint change-over to a segment setpoint parameterised for the "sequencer" function during normal operation (no sequence active). ▶ Segment configuration <a href="#">□ 104</a>
Activate segment setpoint (bit 1) 0x2631:027 (P400.27)	
Activate segment setpoint (bit 2) 0x2631:028 (P400.28)	
Activate segment setpoint (bit 3) 0x2631:029 (P400.29)	

Diagnostic parameters:

- 0x282B:002 (P125.02): Active setpoint source



## Priority of the setpoint sources

Since only one setpoint source can be active at a time, the following priorities apply:

Flexible I/O configuration or keypad control active 0x2631:037 (P400.37) = FALSE	Network control active 0x2631:017 (P400.17) = FALSE 0x2631:037 (P400.37) = TRUE
<p>Prio 1: Functions for setpoint change-over</p> <p>The priority of the functions results from the assigned triggers (in the order of the selection list):</p> <ol style="list-style-type: none"> <li>1. Constant TRUE [1]</li> <li>2. Digital input 1 [11]</li> <li>3. Digital input 2 [12]</li> <li>4. Digital input 3 [13]</li> <li>5. ...</li> </ol> <p>Prio 2: Set standard setpoint source</p> <ul style="list-style-type: none"> <li>• 0x2860:001 (P201.01): Frequency control: Default setpoint source</li> <li>• 0x2860:002 (P201.02): PID control: Default setpoint source</li> </ul>	<p>Prio 1: Setpoint source selected via network control word</p> <p>▶ <a href="#">Control the inverter via network</a> ☐ 311</p> <p>Prio 2: Set standard setpoint source</p> <ul style="list-style-type: none"> <li>• 0x2860:001 (P201.01): Frequency control: Default setpoint source</li> <li>• 0x2860:002 (P201.02): PID control: Default setpoint source</li> </ul>

## Example of allocating priority

Parameter	Designation	Setting for this example
0x2631:014 (P400.14)	Activate AI1 setpoint	Digital input 5 [15]
0x2631:016 (P400.16)	Activate keypad setpoint	Digital input 4 [14]

Digital input 4	Digital input 5	Active setpoint source
FALSE	FALSE	Standard setpoint source set in 0x2860:001 (P201.01)
FALSE	TRUE	Analog input 1
TRUE	FALSE	Keypad
TRUE	TRUE	Keypad (since "Digital input 4" trigger is higher in the selection list than "Digital input 5" trigger)

## Parameter

Address	Name / setting range / [default setting]	Information
0x2631:014 (P400.14)	Function list: Activate AI1 setpoint (Function list: Setp: AI1) • Further possible settings: ▶ <a href="#">Trigger list</a> ☐ 73	Assignment of a trigger for the "Activate AI1 setpoint" function. Trigger = TRUE: analog input 1 is used as setpoint source (if the trigger assigned has the highest setpoint priority). Trigger = FALSE: no action / deactivate function again.
	0 Not connected	No trigger assigned (trigger is constantly FALSE).
0x2631:015 (P400.15)	Function list: Activate AI2 setpoint (Function list: Setp: AI2) • Further possible settings: ▶ <a href="#">Trigger list</a> ☐ 73	Assignment of a trigger for the "Activate AI2 setpoint" function. Trigger = TRUE: analog input 2 is used as setpoint source (if the trigger assigned has the highest setpoint priority). Trigger = FALSE: no action / deactivate function again.
	0 Not connected	No trigger assigned (trigger is constantly FALSE).
0x2631:016 (P400.16)	Function list: Activate keypad setpoint (Function list: Setp: Keypad) • Further possible settings: ▶ <a href="#">Trigger list</a> ☐ 73	Assignment of a trigger for the "Activate keypad setpoint" function. Trigger = TRUE: the keypad is used as setpoint source (if the trigger assigned has the highest setpoint priority). Trigger = FALSE: no action / deactivate function again.
	0 Not connected	No trigger assigned (trigger is constantly FALSE).  Notes: • The default keypad setpoint can be changed in keypad operating mode via the arrow keys of the keypad.

# Configuring the frequency control

## Changing the setpoint source during operation



Address	Name / setting range / [default setting]	Information
0x2631:017 (P400.17)	Function list: Activate network setpoint (Function list: Setp: Network) <ul style="list-style-type: none"> <li>From version 02.01</li> <li>Further possible settings: <a href="#">▶ Trigger list 73</a></li> </ul>	Assignment of a trigger for the "Activate network setpoint" function. Trigger = TRUE: the network is used as setpoint source (if the trigger assigned has the highest setpoint priority). Trigger = FALSE: no action / deactivate function again.
	<b>0</b> Not connected	No trigger assigned (trigger is constantly FALSE).
	116 Network setpoint active (from version 02.00)	TRUE if a change-over to network setpoint is requested via bit 6 of the AC drive control word <a href="#">0x400B:001 (P592.01)</a> . Otherwise FALSE.  Notes: <ul style="list-style-type: none"> <li>This setting is used if bit 6 of the AC drive control word is to be used independently of bit 5 AC drive control word.</li> <li>The AC drive control word can be used with any communication protocol.</li> </ul> <a href="#">▶ AC drive control word 363</a>
0x2631:018 (P400.18)	Function list: Activate preset (bit 0) (Function list: Setp: Preset b0) <ul style="list-style-type: none"> <li>Further possible settings: <a href="#">▶ Trigger list 73</a></li> </ul>	Assignment of a trigger for the "Activate preset (bit 0)" function. The bit with the valency $2^0$ for bit-coded selection and the activation of a parameterised setpoint (preset). Trigger = FALSE: bit = "0". Trigger = TRUE: bit = "1".
	<b>14</b> Digital input 4	State of X3/DI4, taking an inversion set in <a href="#">0x2632:004 (P411.04)</a> into consideration.
0x2631:019 (P400.19)	Function list: Activate preset (bit 1) (Function list: Setp: Preset b1) <ul style="list-style-type: none"> <li>Further possible settings: <a href="#">▶ Trigger list 73</a></li> </ul>	Assignment of a trigger for the "Activate preset (bit 1)" function. The bit with the valency $2^1$ for bit-coded selection and the activation of a parameterised setpoint (preset). Trigger = FALSE: bit = "0". Trigger = TRUE: bit = "1".
	<b>15</b> Digital input 5	State of X3/DI5, taking an inversion set in <a href="#">0x2632:005 (P411.05)</a> into consideration.
0x2631:020 (P400.20)	Function list: Activate preset (bit 2) (Function list: Setp: Preset b2) <ul style="list-style-type: none"> <li>Further possible settings: <a href="#">▶ Trigger list 73</a></li> </ul>	Assignment of a trigger for the "Activate preset (bit 2)" function. The bit with the valency $2^2$ for bit-coded selection and the activation of a parameterised setpoint (preset). Trigger = FALSE: bit = "0". Trigger = TRUE: bit = "1".
	<b>0</b> Not connected	No trigger assigned (trigger is constantly FALSE).
0x2631:021 (P400.21)	Function list: Activate preset (bit 3) (Function list: Setp: Preset b3) <ul style="list-style-type: none"> <li>Further possible settings: <a href="#">▶ Trigger list 73</a></li> </ul>	Assignment of a trigger for the "Activate preset (bit 3)" function. Selection bit with the valency $2^3$ for the bit-coded selection and activation of a parameterised setpoint (preset value). Trigger = FALSE: selection bit = "0". Trigger = TRUE: selection bit = "1".
	<b>0</b> Not connected	No trigger assigned (trigger is constantly FALSE).
0x2631:022 (P400.22)	Function list: Activate setpoint via HTL input (Function list: Setp: HTL input) <ul style="list-style-type: none"> <li>Further possible settings: <a href="#">▶ Trigger list 73</a></li> </ul>	Assignment of a trigger for the "Activate setpoint via HTL input" function. Trigger = TRUE: HTL input is used as setpoint source (if the trigger assigned has the highest setpoint priority). Trigger = FALSE: no action / deactivate function again.
	<b>0</b> Not connected	No trigger assigned (trigger is constantly FALSE).
0x2631:025 (P400.25)	Function list: Activate MOP setpoint (Function list: Setp: MOP) <ul style="list-style-type: none"> <li>Further possible settings: <a href="#">▶ Trigger list 73</a></li> </ul>	Assignment of a trigger for the "Activate MOP setpoint" function. Trigger = TRUE: the "Motor potentiometer" function is used as setpoint source (if the trigger assigned has the highest setpoint priority). Trigger = FALSE: no action / deactivate function again.
	<b>0</b> Not connected	No trigger assigned (trigger is constantly FALSE).





# Configuring the frequency control

## Changing the setpoint source during operation

Address	Name / setting range / [default setting]	Information
0x2631:026 (P400.26)	Function list: Activate segment setpoint (bit 0) (Function list: Setp: Segment b0) <ul style="list-style-type: none"> <li>From version 03.00</li> <li>Further possible settings: <a href="#">▶ Trigger list</a> <a href="#">73</a></li> </ul>	Assignment of a trigger for the "Activate segment setpoint (bit 0)" function. Selection bit with the valency 2 <sup>0</sup> for the bit-coded selection and activation of a parameterised segment setpoint. Trigger = FALSE: selection bit = "0". Trigger = TRUE: selection bit = "1". Notes: <ul style="list-style-type: none"> <li>During normal operation (no active sequence), this function serves to activate the setpoint of a segment (instead of an entire sequence in the sequencer operation).</li> <li>This function is not intended for the use in the sequencer operation.</li> </ul>
	<b>0</b> Not connected	No trigger assigned (trigger is constantly FALSE).
0x2631:027 (P400.27)	Function list: Activate segment setpoint (bit 1) (Function list: Setp: Segment b1) <ul style="list-style-type: none"> <li>From version 03.00</li> <li>Further possible settings: <a href="#">▶ Trigger list</a> <a href="#">73</a></li> </ul>	Assignment of a trigger for the "Activate segment setpoint (bit 1)" function. Selection bit with the valency 2 <sup>1</sup> for the bit-coded selection and activation of a parameterised segment setpoint. Trigger = FALSE: selection bit = "0". Trigger = TRUE: selection bit = "1". Notes: <ul style="list-style-type: none"> <li>During normal operation (no active sequence), this function serves to activate the setpoint of a segment (instead of an entire sequence in the sequencer operation).</li> <li>This function is not intended for the use in the sequencer operation.</li> </ul>
	<b>0</b> Not connected	No trigger assigned (trigger is constantly FALSE).
0x2631:028 (P400.28)	Function list: Activate segment setpoint (bit 2) (Function list: Setp: Segment b2) <ul style="list-style-type: none"> <li>From version 03.00</li> <li>Further possible settings: <a href="#">▶ Trigger list</a> <a href="#">73</a></li> </ul>	Assignment of a trigger for the "Activate segment setpoint (bit 2)" function. Selection bit with the valency 2 <sup>2</sup> for the bit coded selection and activation of a parameterised segment setpoint. Trigger = FALSE: selection bit = "0". Trigger = TRUE: selection bit = "1". Notes: <ul style="list-style-type: none"> <li>During normal operation (no active sequence), this function serves to activate the setpoint of a segment (instead of an entire sequence in the sequencer operation).</li> <li>This function is not intended for the use in the sequencer operation.</li> </ul>
	<b>0</b> Not connected	No trigger assigned (trigger is constantly FALSE).
0x2631:029 (P400.29)	Function list: Activate segment setpoint (bit 3) (Function list: Setp: Segment b3) <ul style="list-style-type: none"> <li>From version 03.00</li> <li>Further possible settings: <a href="#">▶ Trigger list</a> <a href="#">73</a></li> </ul>	Assignment of a trigger for the "Activate segment setpoint (bit 3)" function. Selection bit with the valency 2 <sup>3</sup> for the bit coded selection and activation of a parameterised segment setpoint. Trigger = FALSE: selection bit = "0". Trigger = TRUE: selection bit = "1". Notes: <ul style="list-style-type: none"> <li>During normal operation (no active sequence), this function serves to activate the setpoint of a segment (instead of an entire sequence in the sequencer operation).</li> <li>This function is not intended for the use in the sequencer operation.</li> </ul>
	<b>0</b> Not connected	No trigger assigned (trigger is constantly FALSE).

# Configuring the frequency control

Changing the setpoint source during operation

Example: Change-over from keypad setpoint to AI1/AI2 setpoint



## 7.4.1 Example: Change-over from keypad setpoint to AI1/AI2 setpoint

- The keypad is set as standard setpoint source.
- Switch S1 starts the motor in the forward direction of rotation. Switch S1 in initial position stops the motor again.
- The switch S2 switches the direction of rotation.
- The switch S3 activates analog input 1 as setpoint source.
- The switch S4 activates analog input 2 as setpoint source.



If S3 and S4 are actuated at the same time, the analog input 1 is active as setpoint source since the digital input 3 assigned to this function has a higher priority than the digital input 4.

Connection diagram	Function	
	Potentiometer R1	Frequency setpoint selection via AI1
	Potentiometer R2	Frequency setpoint selection via AI2
	Switch S1	Run
	Switch S2	Reverse rotational direction
	Switch S3	Activate AI1 setpoint
Switch S4	Activate AI2 setpoint	

Parameter	Name	Setting for this example
0x2631:001 (P400.01)	Enable inverter	Constant TRUE [1]
0x2631:002 (P400.02)	Run	Digital input 1 [11]
0x2631:004 (P400.04)	Reset fault	Not connected [0]
0x2631:013 (P400.13)	Reverse rotational direction	Digital input 2 [12]
0x2631:014 (P400.14)	Activate AI1 setpoint	Digital input 3 [13]
0x2631:015 (P400.15)	Activate AI2 setpoint	Digital input 4 [14]
0x2631:018 (P400.18)	Activate preset (bit 0)	Not connected [0]
0x2824 (P200.00)	Control selection	Flexible I/O configuration [0]
0x2838:003 (P203.03)	Stop method	Standard ramp [1]
0x2860:001 (P201.01)	Frequency control: Default setpoint source	Keypad [1]



# Configuring the frequency control

Changing the setpoint source during operation

Example: Change-over from keypad setpoint to AI1/AI2 setpoint

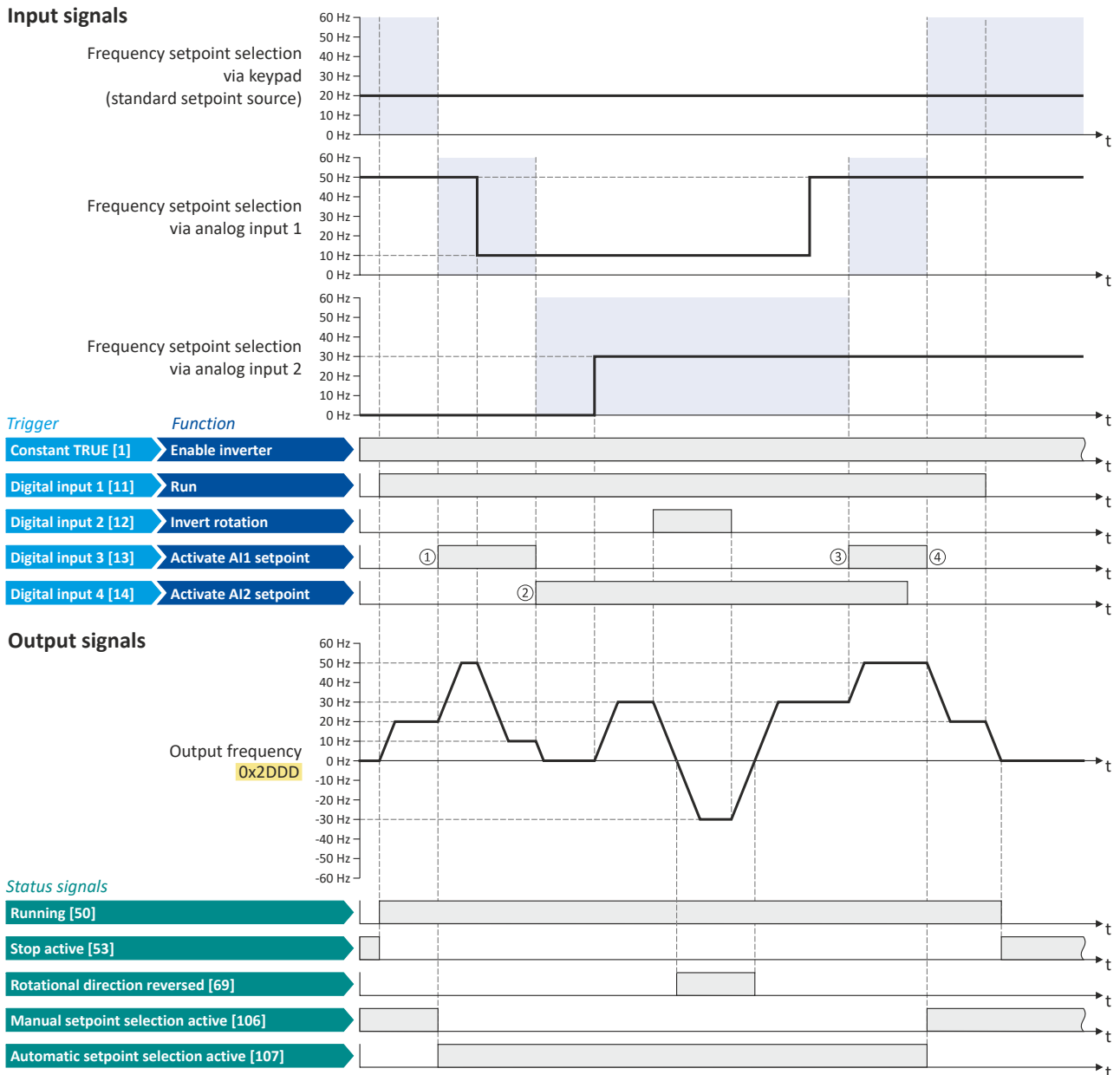

The status signals can be assigned to digital outputs. ▶ [Configure digital outputs](#) 292

- ① The changeover is initiated from keypad setpoint (standard setpoint source) to AI1 setpoint.
- ② The changeover is initiated from AI1 setpoint to AI2 setpoint.
- ③ The changeover is initiated from AI2 setpoint to AI1 setpoint since the digital input 3 has a higher priority than the digital input 4.
- ④ The changeover is initiated to keypad setpoint (standard setpoint source).

# Configuring the frequency control

Changing the setpoint source during operation

Example: Change-over from AI1 setpoint to keypad setpoint



## 7.4.2 Example: Change-over from AI1 setpoint to keypad setpoint

- The analog input 1 is set as standard setpoint source.
- Switch S1 starts the motor in forward direction of rotation. Switch S1 in initial position stops the motor again.
- Switch S2 switches the direction of rotation.
- Switch S3 activates the keypad as setpoint source. The keypad setpoint can be changed in the operating mode via the navigation keys ↑ and ↓.

Connection diagram	Function	
	Potentiometer R1	Frequency setpoint selection
	Switch S1	Run
	Switch S2	Reverse rotational direction
	Switch S3	Activate keypad setpoint

Parameter	Name	Setting for this example
0x2601:001 (P202.01)	Keypad setpoints: Frequency setpoint	20.0 Hz
0x2631:001 (P400.01)	Enable inverter	Constant TRUE [1]
0x2631:002 (P400.02)	Run	Digital input 1 [11]
0x2631:004 (P400.04)	Reset fault	Not connected [0]
0x2631:013 (P400.13)	Reverse rotational direction	Digital input 2 [12]
0x2631:016 (P400.16)	Activate keypad setpoint	Digital input 3 [13]
0x2824 (P200.00)	Control selection	Flexible I/O configuration [0]
0x2838:003 (P203.03)	Stop method	Standard ramp [1]
0x2860:001 (P201.01)	Frequency control: Default setpoint source	Analog input 1 [2]



# Configuring the frequency control

## Changing the setpoint source during operation

Example: Change-over from AI1 setpoint to keypad setpoint

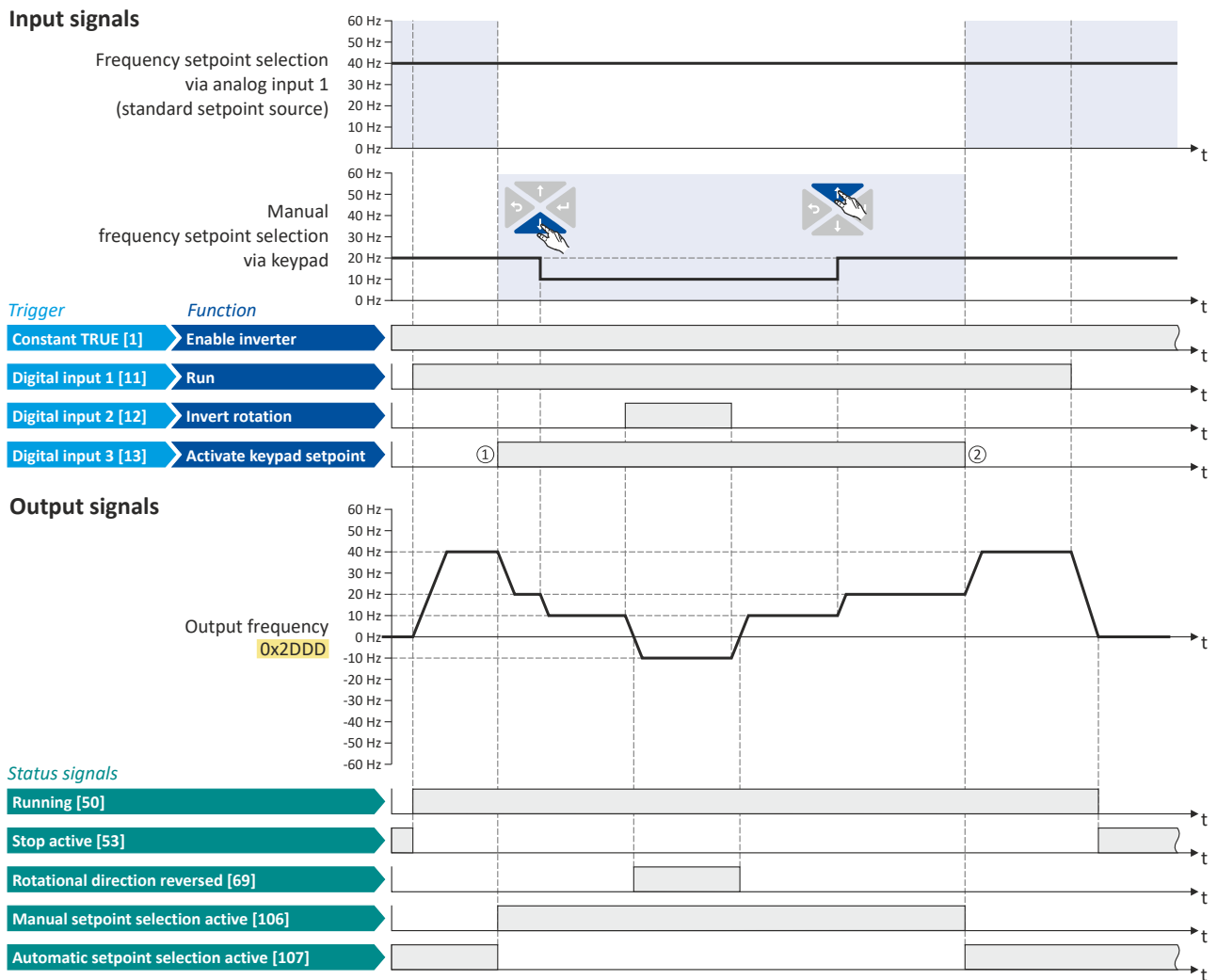

The status signals can be assigned to digital outputs. ▶ [Configure digital outputs](#) 292

- ① Changeover from analog input 1 (standard setpoint source) to keypad setpoint.
- ② Changeover from keypad setpoint back to analog input 1 (standard setpoint source).

# Configuring the frequency control

Changing the setpoint source during operation

Example: Change-over from keypad setpoint to preset 1 ... 7



## 7.4.3 Example: Change-over from keypad setpoint to preset 1 ... 7

The four functions "Activate preset (bit 0)" ... "Activate preset (bit 3)" enable change-over of the setpoint to a parameterisable setpoint (preset value).

### Details

A preset is selected in a binary-coded fashion via the triggers assigned to the four functions "Activate preset (Bit 0)" ... "Activate preset (Bit 3)" in compliance with the following truth table:

Activate preset				Selection			
Bit 3 0x2631:021 (P400.21)	Bit 2 0x2631:020 (P400.20)	Bit 1 0x2631:019 (P400.19)	Bit 0 0x2631:018 (P400.18)	Preset	Frequency setpoint	PID setpoint	Torque setpoint
FALSE	FALSE	FALSE	FALSE	No preset selected			
FALSE	FALSE	FALSE	TRUE	Preset 1	0x2911:001 (P450.01)	0x4022:001 (P451.01)	0x2912:001 (P452.01)
FALSE	FALSE	TRUE	FALSE	Preset 2	0x2911:002 (P450.02)	0x4022:002 (P451.02)	0x2912:002 (P452.02)
FALSE	FALSE	TRUE	TRUE	Preset 3	0x2911:003 (P450.03)	0x4022:003 (P451.03)	0x2912:003 (P452.03)
FALSE	TRUE	FALSE	FALSE	Preset 4	0x2911:004 (P450.04)	0x4022:004 (P451.04)	0x2912:004 (P452.04)
FALSE	TRUE	FALSE	TRUE	Preset 5	0x2911:005 (P450.05)	0x4022:005 (P451.05)	0x2912:005 (P452.05)
FALSE	TRUE	TRUE	FALSE	Preset 6	0x2911:006 (P450.06)	0x4022:006 (P451.06)	0x2912:006 (P452.06)
FALSE	TRUE	TRUE	TRUE	Preset 7	0x2911:007 (P450.07)	0x4022:007 (P451.07)	0x2912:007 (P452.07)
TRUE	FALSE	FALSE	FALSE	Preset 8	0x2911:008 (P450.08)	0x4022:008 (P451.08)	0x2912:008 (P452.08)
TRUE	FALSE	FALSE	TRUE	Preset 9	0x2911:009 (P450.09)		
...				...	...		
TRUE	TRUE	TRUE	TRUE	Preset 15	0x2911:015 (P450.15)		



# Configuring the frequency control

Changing the setpoint source during operation  
 Example: Change-over from keypad setpoint to preset 1 ... 7

## Example for operating mode

- The keypad is set as standard setpoint source.
- Switch S1 starts the motor in forward direction of rotation. Switch S1 in initial position stops the motor again.
- The switches S2 ... S4 serve to switch over to the presets 1 ... 7 (see the following table).

Connection diagram	Function																																				
	Switch S1 Run																																				
	Switch S2 ... S4 Preset selection:																																				
	<table border="1"> <thead> <tr> <th>S2</th> <th>S3</th> <th>S4</th> <th></th> </tr> </thead> <tbody> <tr> <td>Off</td> <td>Off</td> <td>Off</td> <td>Keypad setpoint</td> </tr> <tr> <td>On</td> <td>Off</td> <td>Off</td> <td>Preset value 1</td> </tr> <tr> <td>Off</td> <td>On</td> <td>Off</td> <td>Preset value 2</td> </tr> <tr> <td>On</td> <td>On</td> <td>Off</td> <td>Preset value 3</td> </tr> <tr> <td>Off</td> <td>Off</td> <td>On</td> <td>Preset value 4</td> </tr> <tr> <td>On</td> <td>Off</td> <td>On</td> <td>Preset value 5</td> </tr> <tr> <td>Off</td> <td>On</td> <td>On</td> <td>Preset value 6</td> </tr> <tr> <td>On</td> <td>On</td> <td>On</td> <td>Preset value 7</td> </tr> </tbody> </table>	S2	S3	S4		Off	Off	Off	Keypad setpoint	On	Off	Off	Preset value 1	Off	On	Off	Preset value 2	On	On	Off	Preset value 3	Off	Off	On	Preset value 4	On	Off	On	Preset value 5	Off	On	On	Preset value 6	On	On	On	Preset value 7
	S2	S3	S4																																		
	Off	Off	Off	Keypad setpoint																																	
	On	Off	Off	Preset value 1																																	
	Off	On	Off	Preset value 2																																	
	On	On	Off	Preset value 3																																	
	Off	Off	On	Preset value 4																																	
On	Off	On	Preset value 5																																		
Off	On	On	Preset value 6																																		
On	On	On	Preset value 7																																		

Parameter	Name	Setting for this example
0x2631:001 (P400.01)	Enable inverter	Constant TRUE [1]
0x2631:002 (P400.02)	Run	Digital input 1 [11]
0x2631:004 (P400.04)	Reset fault	Not connected [0]
0x2631:013 (P400.13)	Reverse rotational direction	Not connected [0]
0x2631:018 (P400.18)	Activate preset (bit 0)	Digital input 2 [12]
0x2631:019 (P400.19)	Activate preset (bit 1)	Digital input 3 [13]
0x2631:020 (P400.20)	Activate preset (bit 2)	Digital input 4 [14]
0x2824 (P200.00)	Control selection	Flexible I/O configuration [0]
0x2838:003 (P203.03)	Stop method	Standard ramp [1]
0x2860:001 (P201.01)	Frequency control: Default setpoint source	Keypad [1]
0x2911:001 (P450.01)	Frequency setpoint presets: Preset 1	10 Hz
0x2911:002 (P450.02)	Frequency setpoint presets: Preset 2	15 Hz
0x2911:003 (P450.03)	Frequency setpoint presets: Preset 3	20 Hz
0x2911:004 (P450.04)	Frequency setpoint presets: Preset 4	25 Hz
0x2911:005 (P450.05)	Frequency setpoint presets: Preset 5	30 Hz
0x2911:006 (P450.06)	Frequency setpoint presets: Preset 6	35 Hz
0x2911:007 (P450.07)	Frequency setpoint presets: Preset 7	40 Hz



If the frequency presets 8 ... 15 are required as well, the digital input 5 must be additionally assigned to the "Activate preset (bit 3)" function and the terminal DI5 must be interconnected accordingly.

# Configuring the frequency control

Changing the setpoint source during operation

Example: Change-over from keypad setpoint to preset 1 ... 7

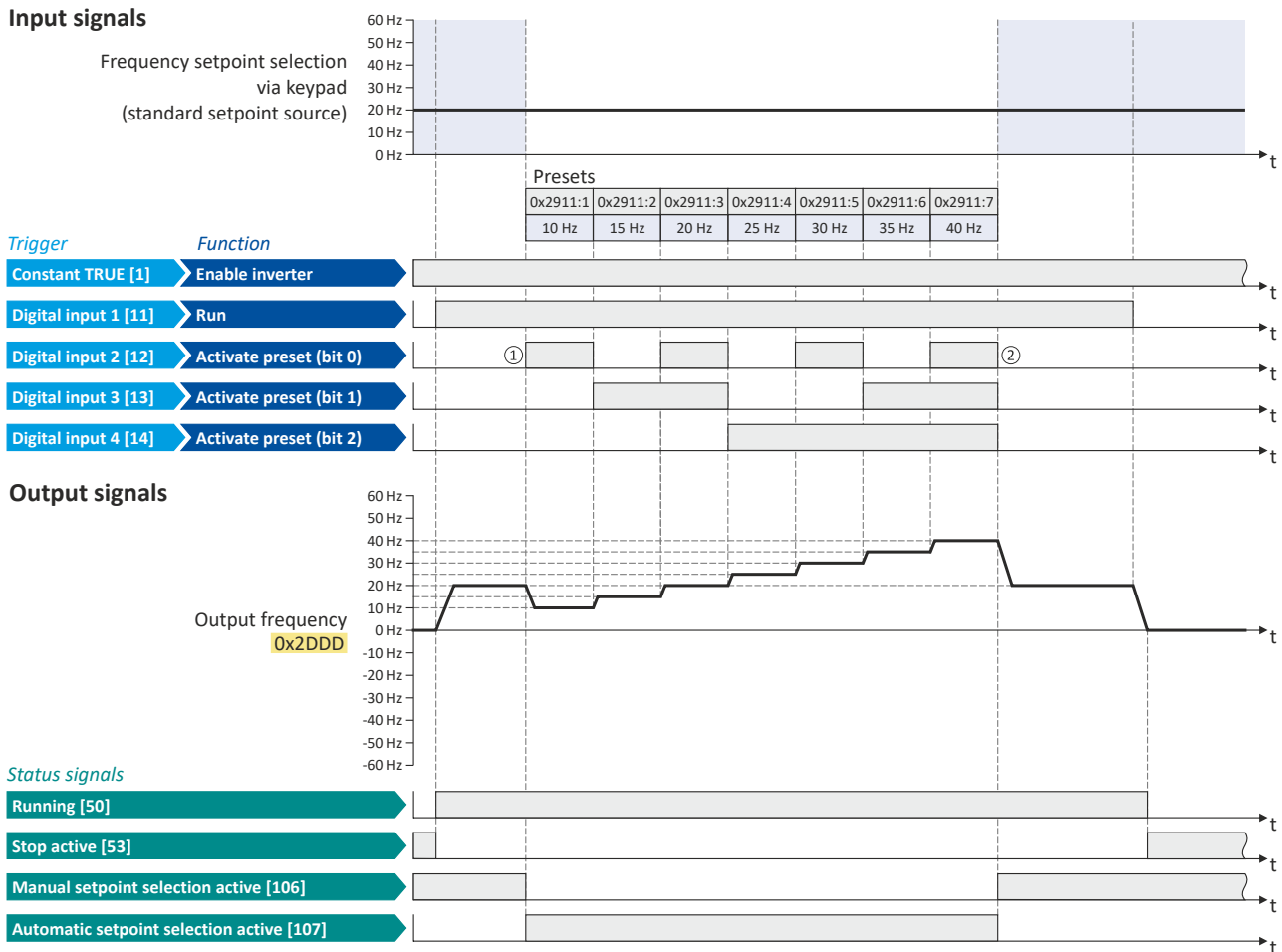

The status signals can be assigned to digital outputs. ▶ [Configure digital outputs](#) 292

- ① Changeover from keypad setpoint (standard setpoint source) to presets (first, preset 1 is selected).
- ② Changeover back to keypad setpoint since no preset is selected anymore (digital inputs 2 ... 4 = FALSE).





## 7.4.4 Example: Change-over from AI1 setpoint to MOP setpoint

The "Activate MOP setpoint" function enables a setpoint change-over to the motor potentiometer during operation.

### Preconditions

A setpoint change-over to the motor potentiometer is only effected if

- no setpoint source with a higher priority has been selected. ▶ [Priority of the setpoint sources](#) 143
- no jog operation is active ("Jog forward (CW)" and "Jog reverse (CCW)" functions).

### Example for operating mode

- The analog input 1 is set as standard setpoint source.
- Switch S1 starts the motor in forward direction of rotation. Switch S1 in initial position stops the motor again.
- Switch S2 activates the motor potentiometer as setpoint source. The MOP setpoint can then be increased via key S3 and decreased via key S4. When both pushbuttons are pressed simultaneously, the MOP setpoint remains unchanged.
- Switch S5 switches the direction of rotation.

Connection diagram	Function
	Potentiometer R1
	Frequency setpoint selection
	Switch S1
	Run
	Switch S2
	Activate MOP setpoint
Button S3	
MOP setpoint up	
Button S4	
MOP setpoint down	
Switch S5	
Reverse rotational direction	

Parameter	Name	Setting for this example
0x2631:001 (P400.01)	Enable inverter	Constant TRUE [1]
0x2631:002 (P400.02)	Run	Digital input 1 [11]
0x2631:025 (P400.25)	Activate MOP setpoint	Digital input 2 [12]
0x2631:023 (P400.23)	MOP setpoint up	Digital input 3 [13]
0x2631:024 (P400.24)	MOP setpoint down	Digital input 4 [14]
0x2631:013 (P400.13)	Reverse rotational direction	Digital input 5 [15]
0x2824 (P200.00)	Control selection	Flexible I/O configuration [0]
0x2838:003 (P203.03)	Stop method	Standard ramp [1]
0x2860:001 (P201.01)	Frequency control: Default setpoint source	Analog input 1 [2]
0x2917 (P220.00)	Acceleration time 1	1.0 s
0x2918 (P221.00)	Deceleration time 1	1.0 s
0x2919 (P222.00)	Acceleration time 2	4.0 s (for MOP setpoint change)
0x291A (P223.00)	Deceleration time 2	4.0 s (for MOP setpoint change)
0x4003 (P413.00)	MOP starting mode	Starting value [1]
0x4004:001 (P414.01)	MOP starting values: Frequency	20 Hz

# Configuring the frequency control

Changing the setpoint source during operation

Example: Change-over from AI1 setpoint to MOP setpoint



## Input signals

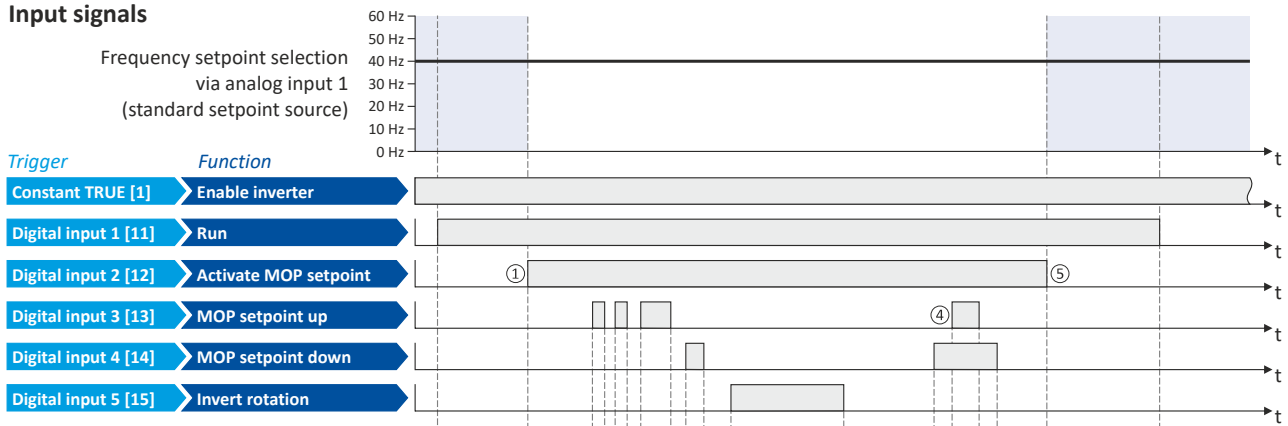

## Output signals

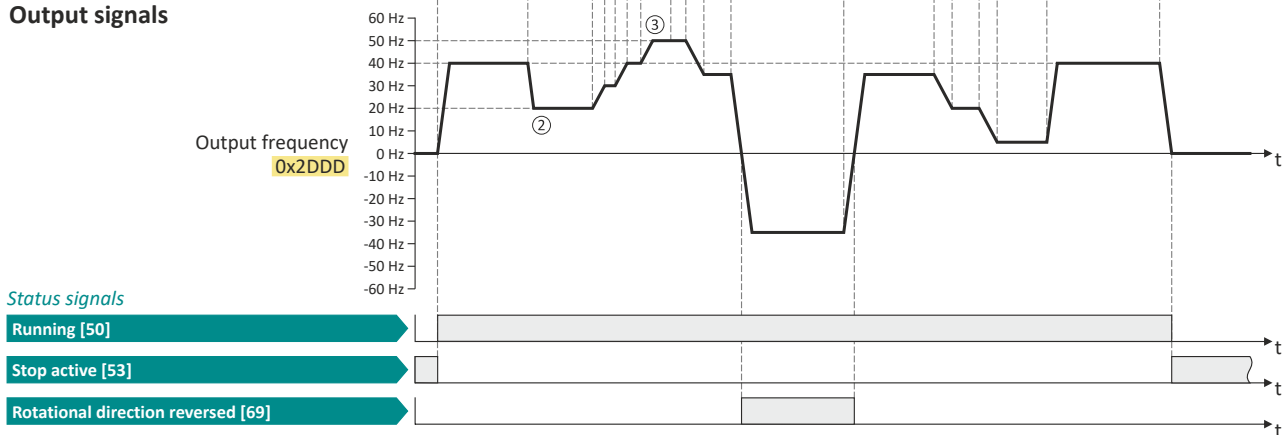

The status signals can be assigned to digital outputs. [▶ Configure digital outputs](#) 292

- ① Changeover from analog input 1 (standard setpoint source) to MOP setpoint.
- ② The initial value for the motor potentiometer function depends on the setting in `0x4003 (P413.00)`. In this example, the "starting value" set in `0x4004:001 (P414.01)` is used (here: 20 Hz).
- ③ The MOP setpoint is increased to a maximum of the maximum frequency set in `0x2916 (P211.00)` (here: 50 Hz).
- ④ If "MOP setpoint up" and "MOP setpoint down" are requested at the same time, the MOP setpoint remains unchanged.
- ⑤ Changeover from MOP setpoint back to analog input 1 (standard setpoint source).



## 7.5 Change over to ramp 2 during operation

Two different ramps can be parameterised for the frequency setpoint. The change-over to the ramp 2 can be initiated manually or automatically.

### Details

For ramp 2, the acceleration time 2 set in [0x2919 \(P222.00\)](#) and the deceleration time 2 set in [0x291A \(P223.00\)](#) apply.

The change-over to ramp 2 is effected automatically if the frequency setpoint (absolute value)  $\geq$  auto-changeover threshold [0x291B \(P224.00\)](#).

### Input signals

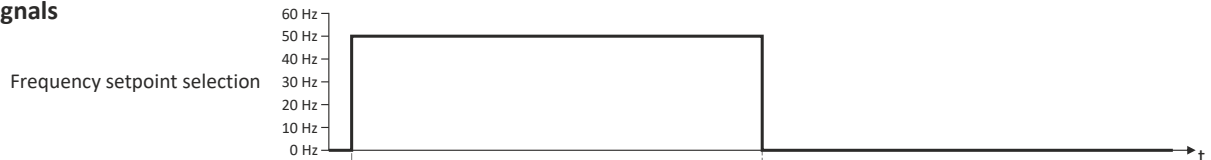

### Output signals

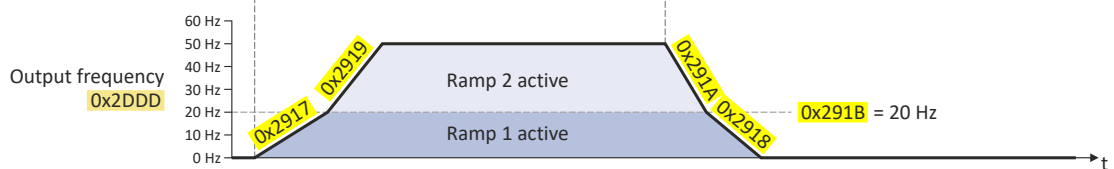

The "Activate ramp 2" [0x2631:039 \(P400.39\)](#) function is used to manually activate the acceleration time 2 and the deceleration time 2.

### Parameter

Address	Name / setting range / [default setting]	Information
0x2919 (P222.00)	Acceleration time 2 (Accelerat.time 2) 0.0 ... [5.0] ... 3600.0 s	Acceleration time 2 for the operating mode "MS: Velocity mode". <ul style="list-style-type: none"> <li>The acceleration time set refers to the acceleration from standstill to the maximum frequency set. In the case of a lower setpoint selection, the actual acceleration time is reduced accordingly.</li> <li>The acceleration time 2 is active if the frequency setpoint (absolute value) <math>\geq</math> auto switching threshold <a href="#">0x291B (P224.00)</a> or the trigger assigned to the function "Activate ramp 2" in <a href="#">0x2631:039 (P400.39)</a> = TRUE.</li> <li>The acceleration time 2 is also used for changing the MOP setpoint generated by the "motor potentiometer" function.</li> <li>Setting is not effective in the operating mode <a href="#">0x6060 (P301.00)</a> = "CiA: Velocity mode (vl) [2]".</li> </ul>
0x291A (P223.00)	Deceleration time 2 (Decelerat.time 2) 0.0 ... [5.0] ... 3600.0 s	Deceleration time 2 for the operating mode "MS: Velocity mode". <ul style="list-style-type: none"> <li>The deceleration time set refers to the deceleration from the maximum frequency set to standstill. In the case of a lower actual frequency, the actual deceleration time is reduced accordingly.</li> <li>The deceleration time 2 is active if the frequency setpoint (absolute value) <math>\geq</math> auto change-over threshold <a href="#">0x291B (P224.00)</a> or the trigger assigned to the function "Activate ramp 2" in <a href="#">0x2631:039 (P400.39)</a> = TRUE.</li> <li>The deceleration time 2 is also used for changing the MOP setpoint generated by the "motor potentiometer" function.</li> <li>Setting is not effective in the operating mode <a href="#">0x6060 (P301.00)</a> = "CiA: Velocity mode (vl) [2]".</li> </ul>
0x291B (P224.00)	Auto-changeover threshold of ramp 2 (Ramp 2 thresh.) 0.0 ... [0.0] ... 599.0 Hz	Threshold for the automatic change-over to acceleration time 2 and deceleration time 2. <ul style="list-style-type: none"> <li>The change-over is effected if the frequency setpoint (absolute value) <math>\geq</math> auto change-over threshold.</li> <li>With the setting 0, the automatic change-over function is deactivated.</li> </ul>

# Configuring the frequency control

Change over to ramp 2 during operation



Address	Name / setting range / [default setting]	Information
0x2631:039 (P400.39)	Function list: Activate ramp 2 (Function list: Activ. ramp 2) • Further possible settings: ▶ <a href="#">Trigger list</a> 73	Assignment of a trigger for the "Activate ramp 2" function. Trigger = TRUE: activate acceleration time 2 and deceleration time 2 manually. Trigger = FALSE: no action / deactivate function again.  Notes: • If the function is used and the assigned trigger = TRUE, the auto change-over threshold <a href="#">0x291B (P224.00)</a> for ramp 2 is deactivated. • Acceleration time 2 can be set in <a href="#">0x2919 (P222.00)</a> . • Deceleration time 2 can be set in <a href="#">0x291A (P223.00)</a> .
	<b>0</b> Not connected	No trigger assigned (trigger is constantly FALSE).

## Example for operating mode

- Switch S1 starts the motor in forward direction of rotation. Switch S1 in initial position stops the motor again.
- Switch S2 activates the acceleration time 2 and deceleration time 2.

Connection plan	Function
	Potentiometer R1 Frequency setpoint selection
	Switch S1 Run
	Switch S2 Activate ramp 2

Parameter	Name	Setting for this example
0x2631:001 (P400.01)	Enable inverter	Constant TRUE [1]
0x2631:002 (P400.02)	Run	Digital input 1 [11]
0x2631:004 (P400.04)	Reset fault	Not connected [0]
0x2631:039 (P400.39)	Activate ramp 2	Digital input 2 [12]
0x2824 (P200.00)	Control selection	Flexible I/O configuration [0]
0x2838:003 (P203.03)	Stop method	Standard ramp [1]
0x2860:001 (P201.01)	Frequency control: Default setpoint source	Analog input 1 [2]
0x2917 (P220.00)	Acceleration time 1	10.0 s
0x2918 (P221.00)	Deceleration time 1	10.0 s
0x2919 (P222.00)	Acceleration time 2	5.0 s
0x291A (P223.00)	Deceleration time 2	5.0 s



# Configuring the frequency control

## Change over to ramp 2 during operation

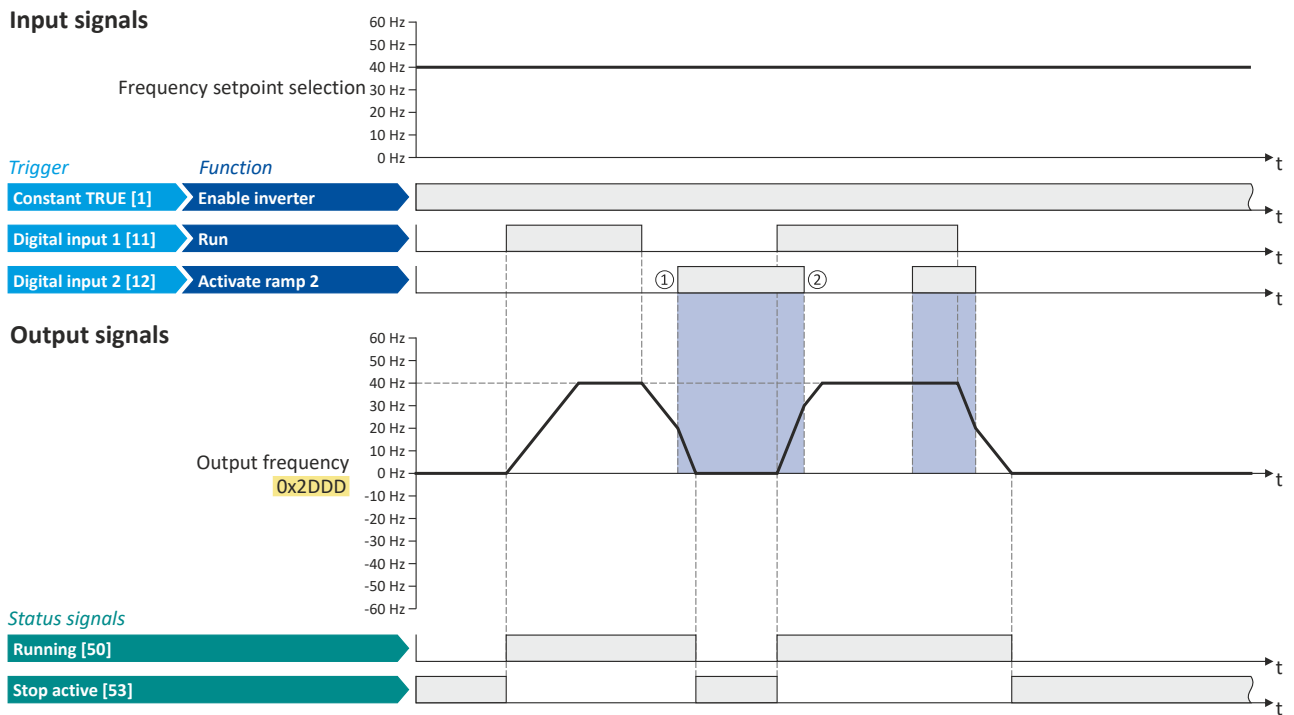

The status signals can be assigned to digital outputs. ▶ [Configure digital outputs](#) 292

- ① Change-over to deceleration time 2 during the deceleration phase.
- ② Change-over to acceleration time 1 during the acceleration phase.



### 7.6 "Switch-off positioning" stop mode

This stopping method is an extension of the stopping method "Standard ramp". A relatively consistent stop position can be achieved regardless of the current motor speed after a stop command using the "switch-off positioning". In this case, depending on the current output frequency, the inverter delays the beginning of the down-ramping so that the number of motor revolutions is always the same from the stop command to standstill.

#### Details

The stop method can be selected in `0x2838:003 (P203.03)`. ▶ [Stop behavior](#) 54

The number of motor revolutions to standstill depends on the rated speed of the motor, the set deceleration time and the set maximum frequency.

Example calculation:

- 4-pole 50 Hz motor with rated speed = 1500 rpm
- Maximum frequency `0x2916 (P211.00)` = 50.0 Hz
- Deceleration time 1 `0x2918 (P221.00)` = 10.0 s

$$\text{motor rotations} = \frac{1500 [\text{rpm}]}{60 [\text{s}]} \cdot \frac{\text{delay time} [\text{s}]}{2} = \frac{25}{[\text{s}]} \cdot \frac{10 [\text{s}]}{2} = 125$$

#### Input signals

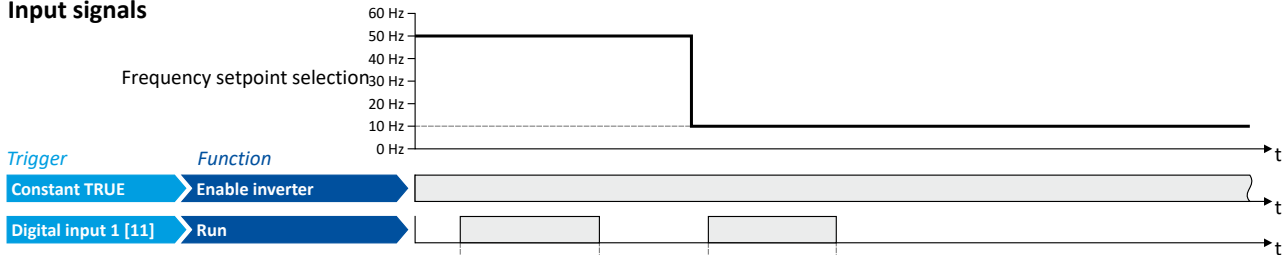

#### Output signals

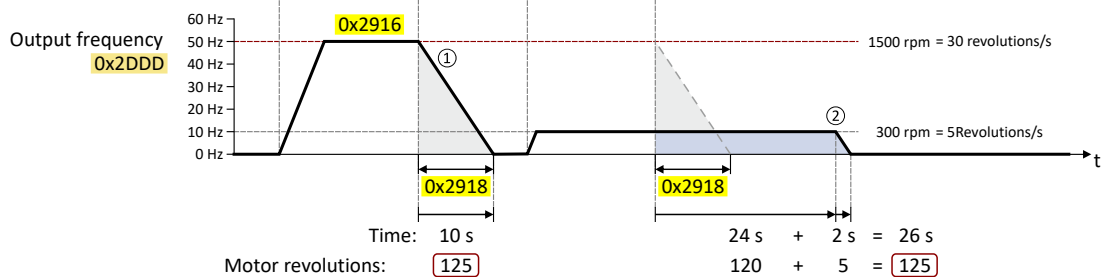

- ① The motor is immediately brought to a standstill with the set deceleration time following a stop command if the output frequency corresponds to the set maximum frequency.  
In the example, the motor reaches a standstill after 125 revolutions.
- ② If the actual output frequency is less than the maximum frequency, the inverter delays the beginning of the down-ramping in order to reach the same number of motor revolutions to standstill, depending on the actual output frequency.  
In the example, the down-ramping is initiated with a delay of 24 seconds in order to reach the number of 125 motor revolutions to a standstill.



## Notes:

- Two different ramps can be parameterized for the frequency setpoint. The speed compensation calculation is based on the deceleration time active at the time of the stop command, either deceleration time 1 or deceleration time 2.
- No speed compensation is implemented if the deceleration time for the quick stop is active.
- No adjustment is made to the speed compensation if the deceleration is changed from deceleration time 1 [0x2918 \(P221.00\)](#) to deceleration time 2 [0x291A \(P223.00\)](#) – or vice versa – during deceleration. The change-over is ignored.
- The threshold for automatic change-over to acceleration time 2 and deceleration time 2 is ignored during deceleration if this stop method is selected.
- If the motor accelerates or decelerates at the time of the stop command, the speed compensation is calculated based on the output frequency at that time.
- There is a configurable Stop threshold [0x291E:003 \(P226.03\)](#) that defines the speed range in which the stop function is active and NOT active. The stop threshold can be set from 0.0% to 100.0%. The percentage refers to the maximum frequency [0x2916 \(P211.00\)](#). The standard setting for the threshold value for the speed compensated stop is 10.0%. The stop function is active when coming to a standstill from a speed greater than or equal to the stop threshold. The stop function is NOT active when coming to a standstill from a speed lower than the stop threshold; in this case, normal deceleration occurs.
- The performance of speed compensation is dependent on several factors: the motor control type, the total capacity of the system mechanics, the mass inertia, the system friction, etc. These factors can influence the calculation of motor revolutions and the consistency. Since the mechanical and physical properties of the system cannot be influenced by the inverter, the system designer has to configure and test the speed compensation for suitability in the actual application.
- The general relative performance can be estimated on the part of the inverter based on the selected motor control type:

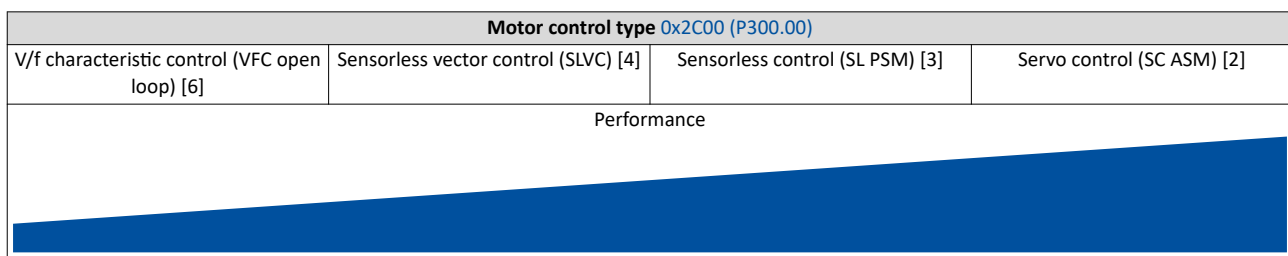

## Parameter

Address	Name / setting range / [default setting]	Information
0x291E:003 (P226.03)	S-Ramp characteristic: Stop threshold (S-ramp char.: Stop threshold) 0.0 ... <b>10.0</b> ... 100.0 % • From version 05.03	<ul style="list-style-type: none"> <li>• Configurable stop threshold value that defines the speed range in which the stop function is active and NOT active.</li> <li>• 100 % = maximum frequency (<a href="#">0x2916 (P211.00)</a>).</li> </ul>

## Related topics

- ▶ [Ramp times](#) 95
- ▶ [Change over to ramp 2 during operation](#) 155



## 7.7 Setpoint diagnostics

The following parameters show the current setpoints of different setpoint sources.

### Parameter

Address	Name / setting range / [default setting]	Information
0x282B:007	Inverter diagnostics: Default frequency setpoint <ul style="list-style-type: none"> <li>• Read only: x.x Hz</li> <li>• From version 03.00</li> </ul>	Display of the frequency setpoint of the standard setpoint source set in <a href="#">0x2860:001 (P201.01)</a> .
0x282B:008	Inverter diagnostics: Preset frequency setpoint <ul style="list-style-type: none"> <li>• Read only: x.x Hz</li> <li>• From version 03.00</li> </ul>	Display of the preset frequency setpoint selected via the four functions "Activate preset (bit 0)" ... "Activate preset (bit 3)". <a href="#">▶ Setpoint presets</a> <a href="#">📄 98</a>
0x282B:009	Inverter diagnostics: Actual frequency setpoint <ul style="list-style-type: none"> <li>• Read only: x.x Hz</li> <li>• From version 03.00</li> </ul>	Display of the currently selected frequency setpoint that is internally transferred to the motor control.
0x282B:010	Inverter diagnostics: Default PID setpoint <ul style="list-style-type: none"> <li>• Read only: x.xx PID unit</li> <li>• From version 03.00</li> </ul>	Display of the PID control value of the standard setpoint source set in <a href="#">0x2860:002 (P201.02)</a> .
0x282B:011	Inverter diagnostics: Preset PID setpoint <ul style="list-style-type: none"> <li>• Read only: x.xx PID unit</li> <li>• From version 03.00</li> </ul>	Display of the preset PID setpoint selected via the four functions "Activate preset (bit 0)" ... "Activate preset (bit 3)". <a href="#">▶ Setpoint presets</a> <a href="#">📄 98</a>





## 8 Configuring the torque control

In general, the inverter is operated in a mode that controls the motor frequency. Alternatively, the inverter can be configured in such a way that it controls a motor torque within a defined frequency range.

Typical applications for such a torque control with frequency limitation are winders and packaging machines.

### Preconditions

A torque control is only possible in the motor control type [0x2C00 \(P300.00\)](#) = "Sensorless vector control (SLVC) [4]" or "Servo control (SC ASM) [2]". Thus, first this motor control type must be configured. For details see the following chapter:

- ▶ [Sensorless vector control \(SLVC\)](#) [191](#)
- ▶ [Servo control for asynchronous motor \(SC-ASM\)](#) [187](#)

After configuration of the motor control type, one of the following optimisations must be carried out for a torque control that is as precise as possible:

- ▶ [Automatic motor identification \(energized\)](#) [241](#)
- ▶ [Automatic motor calibration \(non-energized\)](#) [243](#)



## 8.1 Basic setting

In the following, the steps required for configuring the torque control are described.

1. Select the motor control mode "Sensorless vector control (SLVC) [4]" or "Servo control (SC ASM) [2]" in **0x2C00 (P300.00)**.
2. Carry out motor adjustment. ▶ [Configuring the motor control](#) 185
3. Select the operating mode "MS: Torque mode [-1]" in **0x6060 (P301.00)**.
4. Select the standard setpoint source for the torque control in **0x2860:003 (P201.03)**.
5. Set the rated motor torque in **0x6076 (P325.00)**.
6. Set the torque limits. ▶ [Torque limits](#) 165
7. Set the speed limitation. ▶ [Speed limitation](#) 167
8. [Configure setpoint sources](#) 170
9. Optional: Set the torque setpoint ramp time in **0x2948:002 (P336.02)**.

The following signal flow shows the internal setpoint logics:

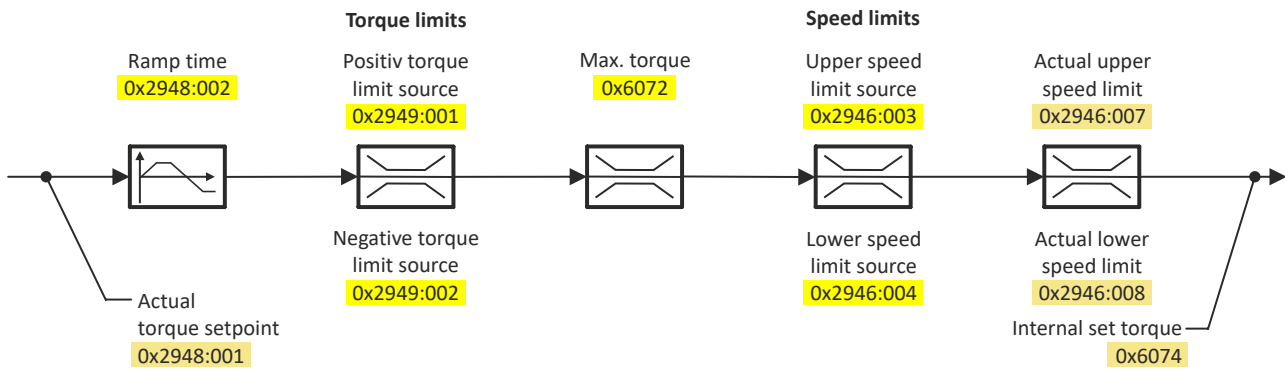

The torque control with frequency limitation is now active and the inverter responds to the torque setpoint given by the selected setpoint source.





## 8.1.1 Standard setpoint source

The selected "setpoint source" serves to provide the inverter with its setpoint. The setpoint source can be selected individually for each operating mode.

Possible setpoint sources:

- Analog inputs
- Keypad
- Network
- Parameterisable setpoints (presets)
- Digital inputs (configured as HTL input for pulse train or HTL encoder)
- "Motor potentiometer" function
- "Sequencer" function

### Details









- For applications only requiring one setpoint, it is sufficient to define the standard setpoint source in [0x2860:003 \(P201.03\)](#).
- For applications requiring a change-over of the setpoint source during operation, the functions for setpoint change-over have to be configured accordingly.
  - ▶ [Changing the setpoint source during operation](#)  142
  - ▶ [Configure setpoint sources](#)  170

# Configuring the torque control

Basic setting  
Standard setpoint source



## Parameter

Address	Name / setting range / [default setting]	Information
0x2860:003 (P201.03)	Torque control: Default setpoint source (Torque setp.src.) • From version 03.00	Selection of the standard setpoint source for operating mode "MS: Torque mode". • The selected standard setpoint source is always active in the operating mode 0x6060 (P301.00) = "MS: Torque mode [-1]" when no setpoint change-over to another setpoint source via corresponding triggers/functions is active.
	1 Keypad	The setpoint is specified locally by the keypad. • Default setting: 0x2601:003 (P202.03) • Use the ↑ and ↓ navigation keys to change the keypad setpoint (also during running operation).
	2 Analog input 1	The setpoint is defined as analog signal via the analog input 1. ▶ <a href="#">Analog input 1</a>  284
	3 Analog input 2	The setpoint is defined as analog signal via the analog input 2. ▶ <a href="#">Analog input 2</a>  289
	4 HTL input (from version 04.00)	The digital inputs DI3 and DI4 can be configured as HTL input to use an HTL encoder as setpoint encoder or define the setpoint as a reference frequency ("pulse train"). ▶ <a href="#">HTL encoder</a>  176 ▶ <a href="#">Configure digital inputs DI3/DI4 for detecting a pulse train</a>  276
	5 Network	The setpoint is defined as process data object via the network. ▶ <a href="#">Define setpoint via network</a>  327
	11 Torque preset 1	For the setpoint selection, preset values can be parameterised and selected. ▶ <a href="#">Setpoint presets</a>  171
	12 Torque preset 2	
	13 Torque preset 3	
	14 Torque preset 4	
	15 Torque preset 5	
	16 Torque preset 6	
	17 Torque preset 7	
	18 Torque preset 8	
	31 Segment preset 1	For the setpoint selection, the segment presets parameterised for the "sequencer" function can be selected as well. ▶ <a href="#">Sequencer</a>  102
	32 Segment preset 2	
	33 Segment preset 3	
	34 Segment preset 4	
	35 Segment preset 5	
	36 Segment preset 6	
	37 Segment preset 7	
	38 Segment preset 8	
	50 Motor potentiometer	The setpoint is generated by the "motor potentiometer" function. This function can be used as an alternative setpoint control which is controlled via two signals: "MOP setpoint up" and "MOP setpoint down". ▶ <a href="#">Motor potentiometer (MOP)</a>  171
	201 Internal value (from version 05.00)	Internal values of the manufacturer.
	202 Internal value (from version 05.00)	
	203 Internal value (from version 05.00)	
	204 Internal value (from version 05.00)	
	205 Internal value (from version 05.00)	
	206 Internal value (from version 05.00)	



## 8.1.2 Torque limits

The necessary parameterizations can be found in the table.

### Details

The positive and negative torque limit can be set independently of each other. The torque limit must be set to the maximum torque. ▶ [0x6072 \(P326.00\)](#)

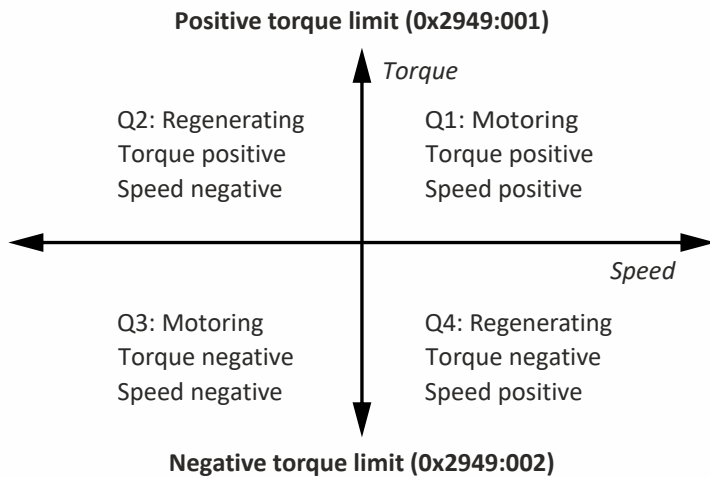

- Display of the current positive torque limit in [0x2949:004 \(P337.04\)](#).
- Display of the current negative torque limit in [0x2949:003 \(P337.03\)](#).

The torque limits are also active in the "Velocity Mode" with the "Servo control (SC-ASM)" motor control mode.



Regardless of the setting in [0x2949:001 \(P337.01\)](#) and [0x2949:002 \(P337.02\)](#), the maximum torque does not exceed the value configured in [0x6072 \(P326.00\)](#).

### Parameter

Address	Name / setting range / [default setting]	Information
0x2949:001 (P337.01)	Torque limit source selection: Positive torque limit source (Trq. lim. source: Pos. torqlim src) • From version 03.00	Selection of the source for the positive torque limit source.
	<b>0</b> Max torque	Positive torque limit source = Max. torque <a href="#">0x6072 (P326.00)</a> .
	1 Fixed Limit 0.0 %	Positive torque limit source = 0.0 %.
	2 Analog Input 1	The positive torque limit source is defined as analog signal via the analog input 1. ▶ <a href="#">Analog input 1 □ 284</a>
	3 Analog Input 2	The positive torque limit source is defined as analog signal via the analog input 2. ▶ <a href="#">Analog input 2 □ 289</a>
	4 Positive torque limit	Positive torque limit source = Positive torque limit <a href="#">0x60E0</a> .
	5 Network target torque	The positive torque limit source is defined as process data object via network. ▶ <a href="#">Mappable parameters for exchanging setpoints and actual values □ 330</a>
	201 Internal value (from version 05.03)	Internal values of the manufacturer.
	202 Internal value (from version 05.03)	
	203 Internal value (from version 05.03)	
	204 Internal value (from version 05.03)	
205 Internal value (from version 05.03)		
206 Internal value (from version 05.03)		

# Configuring the torque control

Basic setting  
Torque limits



Address	Name / setting range / [default setting]	Information
0x2949:002 (P337.02)	Torque limit source selection: Negative torque limit source (Trq. lim. source: Neg. torqlim src) • From version 03.00	Selection of the source for the negative torque limit source.
	<b>0 (-) Max torque</b>	Negative torque limit source = (-) Max. torque <a href="#">0x6072 (P326.00)</a> .
	1 Fixed Limit 0.0 %	Negative torque limit source = 0.0 %.
	2 Analog Input 1	The negative torque limit source is defined as analog signal via the analog input 1. ▶ <a href="#">Analog input 1</a> <a href="#">□ 284</a>
	3 Analog Input 2	The negative torque limit source is defined as analog signal via the analog input 2. ▶ <a href="#">Analog input 2</a> <a href="#">□ 289</a>
	4 Negative torque limit	Negative torque limit source = Negative torque limit <a href="#">0x60E1</a> .
	5 Network target torque	The negative torque limit source is defined as process data object via network. ▶ <a href="#">Mappable parameters for exchanging setpoints and actual values</a> <a href="#">□ 330</a>
	201 Internal value (from version 05.03)	Internal values of the manufacturer.
	202 Internal value (from version 05.03)	
	203 Internal value (from version 05.03)	
204 Internal value (from version 05.03)		
205 Internal value (from version 05.03)		
206 Internal value (from version 05.03)		
0x60E0	Positive torque limit 0.0 ... <b>[250.0]</b> ... 3276.7 % • From version 02.00	Positive torque limit source for speed control with torque limitation. • 100 % = Rated motor torque <a href="#">0x6076 (P325.00)</a>
0x60E1	Negative torque limit 0.0 ... <b>[250.0]</b> ... 3276.7 % • From version 02.00	Negative torque limit source for speed control with torque limitation. • 100 % = Rated motor torque <a href="#">0x6076 (P325.00)</a>



## 8.1.3 Speed limitation

The torque control controls the assigned torque setpoint within the set speed limits. The actual speed results from the load conditions of the application. For example, high speeds may occur in a torque control if no counter torque is available (load-free machine).

When the actual speed reaches the set speed limits, it is kept on the respective limit value. This function is also called "speed limitation".

### Details

The lower and upper speed limit for speed limitation can be set independently of each other. They can also be defined via analog inputs or network.

Required parameter setting:

1. Select the source for the upper speed limit in [0x2946:003 \(P340.03\)](#).
  - Default setting: Maximum frequency-[0] [0x2916 \(P211.00\)](#)
  - In case of selection "Analog input 1 [2]": Set the setting range in [0x2636:002 \(P430.02\)](#) and [0x2636:003 \(P430.03\)](#).
  - In case of selection "Analog input 2 [3]": Set the setting range in [0x2637:002 \(P431.02\)](#) and [0x2637:003 \(P431.03\)](#).
  - In case of selection "Upper frequency limit [4]": Set the upper speed limit in [Hz] in [0x2946:005 \(P340.05\)](#).
  - In case of selection "Upper speed limit [5]": Set the upper speed limit in [vel. unit] in [0x2946:001 \(P340.01\)](#).
  - The current upper speed limit is displayed in [0x2946:007 \(P340.07\)](#).
2. Select the source for the lower speed limit in [0x2946:004 \(P340.04\)](#).
  - Default setting: (-) Maximum frequency-[0] [0x2916 \(P211.00\)](#)
  - In case of selection "Analog input 1 [2]": Set the setting range in [0x2636:002 \(P430.02\)](#) and [0x2636:003 \(P430.03\)](#).
  - In case of selection "Analog input 2 [3]": Set the setting range in [0x2637:002 \(P431.02\)](#) and [0x2637:003 \(P431.03\)](#).
  - In case of selection "Lower frequency limit [4]": Set the lower speed limit in [Hz] in [0x2946:006 \(P340.06\)](#).
  - In case of selection "Lower speed limit [5]": Set the lower speed limit in [vel. unit] in [0x2946:002 \(P340.02\)](#).
  - The output frequency is absolutely limited regardless of the setting [0x2946:003 \(P340.03\)](#) and [0x2946:004 \(P340.04\)](#) by [0x2916 \(P211.00\)](#) in the "Torque mode".
  - The current lower speed limit is displayed in [0x2946:008 \(P340.08\)](#).

### Parameter

Address	Name / setting range / [default setting]	Information
0x2946:001 (P340.01)	Speed limitation: Upper speed limit (Speed limitation: Upper limit) -2147483647 ... [0] ... 2147483647 vel. unit • From version 03.00	Upper limit for the speed limitation. • Setting is only effective with the selection "Upper speed limit [5]" in <a href="#">0x2946:003 (P340.03)</a> . • Entry via keypad and Lenze Tools is in rpm! • Via RPDO, the unit is vel. unit. and the scaling must be taken into account. • $\pm 480000 \text{ rpm} = \pm 2^{\wedge} 31 \text{ [n-unit]}$
0x2946:002 (P340.02)	Speed limitation: Lower speed limit (Speed limitation: Lower limit) -2147483647 ... [0] ... 2147483647 vel. unit • From version 03.00	Lower limit for speed limitation. • Setting is only effective with the selection "Lower speed limit [5]" in <a href="#">0x2946:004 (P340.04)</a> . • Entry via keypad and Lenze Tools is in rpm! • Via RPDO, the unit is vel. unit. and the scaling must be taken into account. • $\pm 480000 \text{ rpm} = \pm 2^{\wedge} 31 \text{ [n-unit]}$

# Configuring the torque control

Basic setting  
Speed limitation



Address	Name / setting range / [default setting]	Information
0x2946:003 (P340.03)	Speed limitation: Upper speed limit source (Speed limitation: Uppspeed lim src) • From version 03.00	Selection of the source for the upper speed limit.
	<b>0</b> <b>Maximum frequency</b>	Upper speed limit = Maximum frequency 0x2916 (P211.00).
	<b>1</b> Fixed Limit 0.0 Hz	Upper speed limit = 0.0 Hz.
	<b>2</b> Analog input 1	The upper speed limit is defined as analog signal via the analog input 1. ▶ <a href="#">Analog input 1</a> 284
	<b>3</b> Analog input 2	The upper speed limit is defined as analog signal via the analog input 2. ▶ <a href="#">Analog input 2</a> 289
	<b>4</b> Upper frequency limit	Upper speed limit = setting in 0x2946:005 (P340.05) in [Hz].
	<b>5</b> Upper speed limit	Upper speed limit = setting in 0x2946:001 (P340.01) in [vel. unit].
	<b>6</b> Network target velocity	The upper speed limit is defined as process data object via network. ▶ <a href="#">Mappable parameters for exchanging setpoints and actual values</a> 330
	<b>201</b> Internal value (from version 05.03)	Internal values of the manufacturer.
	<b>202</b> Internal value (from version 05.03)	
	<b>203</b> Internal value (from version 05.03)	
	<b>204</b> Internal value (from version 05.03)	
<b>205</b> Internal value (from version 05.03)		
<b>206</b> Internal value (from version 05.03)		
0x2946:004 (P340.04)	Speed limitation: Lower speed limit source (Speed limitation: Lowspeed lim src) • From version 03.00	Selection of the source for the lower speed limit.
	<b>0</b> <b>(-) Maximum frequency</b>	Lower speed limit = (-) Maximum frequency 0x2916 (P211.00).
	<b>1</b> Fixed Limit 0.0 Hz	Lower speed limit = 0.0 Hz.
	<b>2</b> Analog input 1	The lower speed limit is defined as analog signal via the analog input 1. ▶ <a href="#">Analog input 1</a> 284
	<b>3</b> Analog input 2	The lower speed limit is defined as analog signal via the analog input 2. ▶ <a href="#">Analog input 2</a> 289
	<b>4</b> Lower frequency limit	Lower speed limit = setting in 0x2946:006 (P340.06) in [Hz].
	<b>5</b> Lower speed limit	Lower speed limit = setting in 0x2946:002 (P340.02) in [vel. unit].
	<b>6</b> Network target velocity	The lower speed limit is defined as process data object via network. ▶ <a href="#">Mappable parameters for exchanging setpoints and actual values</a> 330
	<b>201</b> Internal value (from version 05.03)	Internal values of the manufacturer.
	<b>202</b> Internal value (from version 05.03)	
	<b>203</b> Internal value (from version 05.03)	
	<b>204</b> Internal value (from version 05.03)	
<b>205</b> Internal value (from version 05.03)		
<b>206</b> Internal value (from version 05.03)		
0x2946:005 (P340.05)	Speed limitation: Upper frequency limit (Speed limitation: Upper freq.limit) Device for 50-Hz mains: -1000.0 ... <b>[50.0]</b> ... 1000.0 Hz Device for 60-Hz mains: -1000.0 ... <b>[60.0]</b> ... 1000.0 Hz • From version 03.00	Upper limit for the speed limitation. • Setting is only effective with the selection "Upper frequency limit [4]" in 0x2946:003 (P340.03).
0x2946:006 (P340.06)	Speed limitation: Lower frequency limit (Speed limitation: Lower freq.limit) Device for 50-Hz mains: -1000.0 ... <b>[-50.0]</b> ... 1000.0 Hz Device for 60-Hz mains: -1000.0 ... <b>[-60.0]</b> ... 1000.0 Hz • From version 03.00	Lower limit for speed limitation. • Setting is only effective with the selection "Lower frequency limit [4]" in 0x2946:004 (P340.04).
0x2946:007 (P340.07)	Speed limitation: Actual upper speed limit (Speed limitation: Act uppspeed lim) • Read only: x.x Hz • From version 03.00	Display of the current upper limit for speed limitation.





Address	Name / setting range / [default setting]	Information
0x2946:008 (P340.08)	Speed limitation: Actual lower speed limit (Speed limitation: Act lowspeed lim) <ul style="list-style-type: none"><li>• Read only: x.x Hz</li><li>• From version 03.00</li></ul>	Display of the current lower limit for speed limitation.

## 8.1.4 Ramp time

### Parameter

Address	Name / setting range / [default setting]	Information
0x2948:002 (P336.02)	Torque setpoint: ramp time (Torque setpoint: Ramp time) 0.0 ... [1.0] ... 60.0 s <ul style="list-style-type: none"><li>• From version 03.00</li></ul>	Ramp time for operating mode "MS: Torque mode". <ul style="list-style-type: none"><li>• The torque setpoint is led via a ramp generator. This provides for a "smooth" switch-over between different setpoint sources.</li><li>• The ramp time refers to max. torque <a href="#">0x6072 (P326.00)</a>. At a lower setpoint selection, the actual ramp time is reduced accordingly.</li></ul>



## 8.2 Configure setpoint sources

The standard setpoint source for torque control can be selected in [0x2860:003 \(P201.03\)](#). This chapter describes the setting options for the various setpoint sources.

- Preset torque setpoint source: [Analog input 1](#). Set the setting range in [0x2636:011 \(P430.11\)](#) and [0x2636:012 \(P430.12\)](#) in this selection.
- In case of selection "Analog input 2 [3]": Set setting range in [0x2637:011 \(P431.11\)](#) and [0x2637:012 \(P431.12\)](#).
- Except for the network, the torque setpoint must be specified in percent with regard to the rated motor torque configured in [0x6076 \(P325.00\)](#).
- Via the network, the torque setpoint is specified via the mappable parameter [0x400B:008 \(P592.08\)](#) in [Nm / 2<sup>scaling factor</sup>]. The scaling factor can be set in [0x400B:009 \(P592.09\)](#).
- Corresponding functions make it possible to change over to other setpoint sources during operation. More detailed information on this can be found in the chapter "Configuring frequency control": [▶ Changing the setpoint source during operation](#) [142](#)

The following setpoint sources are described in this chapter:

- [Keypad](#) [170](#)
- [Setpoint presets](#) [171](#)
- [Motor potentiometer \(MOP\)](#) [171](#)

Other setpoint source descriptions can be found here:

- [Sequencer](#) [102](#)
- [Analog input 1](#) [284](#)
- [Analog input 2](#) [289](#)
- HTL input (HTL encoder): [HTL encoder](#) [176](#)
- HTL input (pulse train): [Configure digital inputs DI3/DI4 for detecting a pulse train](#) [276](#)
- Network: [Define setpoint via network](#) [327](#)

### 8.2.1 Keypad

For the manual setpoint selection via keypad, the following default settings are used:

#### Parameter

Address	Name / setting range / [default setting]	Information
0x2601:003 (P202.03)	Keypad setpoints: Torque setpoint (Keypad setpoints: Torque setp.) -400.0 ... [100.0] ... 400.0 % • From version 03.00	Default setting of the keypad setpoint for the operating mode <a href="#">0x6060 (P301.00)</a> = "MS: Torque mode [-1]". • 100 % = Rated motor torque <a href="#">0x6076 (P325.00)</a>

The increment for keypad setpoints can be adapted in [0x2862 \(P701.00\)](#) by pressing a keypad arrow key once.

A switch-over to the keypad during operation is also possible as an alternative to the standard setpoint source setting.

[▶ Example: Change-over from AI1 setpoint to keypad setpoint](#) [148](#)

#### Related topics

[▶ Keypad](#) [632](#)



## 8.2.2 Setpoint presets

8 different torque setpoints (presets) can be parameterised for the torque control.

### Parameter

Address	Name / setting range / [default setting]	Information
0x2912:001 (P452.01)	Torque setpoint presets: Preset 1 (Torque presets: Torque preset 1) -400.0 ... [100.0] ... 400.0 %	Parameterisable torque setpoints (presets) for operating mode "MS: Torque mode". <ul style="list-style-type: none"> <li>• 100 % = Rated motor torque 0x6076 (P325.00)</li> </ul>
0x2912:002 (P452.02)	Torque setpoint presets: Preset 2 (Torque presets: Torque preset 2) -400.0 ... [100.0] ... 400.0 %	
0x2912:003 (P452.03)	Torque setpoint presets: Preset 3 (Torque presets: Torque preset 3) -400.0 ... [100.0] ... 400.0 %	
0x2912:004 (P452.04)	Torque setpoint presets: Preset 4 (Torque presets: Torque preset 4) -400.0 ... [100.0] ... 400.0 %	
0x2912:005 (P452.05)	Torque setpoint presets: Preset 5 (Torque presets: Torque preset 5) -400.0 ... [100.0] ... 400.0 %	
0x2912:006 (P452.06)	Torque setpoint presets: Preset 6 (Torque presets: Torque preset 6) -400.0 ... [100.0] ... 400.0 %	
0x2912:007 (P452.07)	Torque setpoint presets: Preset 7 (Torque presets: Torque preset 7) -400.0 ... [100.0] ... 400.0 %	
0x2912:008 (P452.08)	Torque setpoint presets: Preset 8 (Torque presets: Torque preset 8) -400.0 ... [100.0] ... 400.0 %	

A switch-over to a preset during operation is also possible as an alternative to the standard setpoint source setting.

▶ [Example: Change-over from keypad setpoint to preset 1 ... 7](#) 150

## 8.2.3 Motor potentiometer (MOP)

The "Motor potentiometer" function can be used as an alternative setpoint control that is controlled via two functions: "MOP setpoint up" and "MOP setpoint down".

### Details

The "[Motor potentiometer \(MOP\)](#)" function is described in detail in the chapter "Configuring frequency control". 100

The following parameters of the function are only relevant for torque control.

### Parameter

Address	Name / setting range / [default setting]	Information
0x4004:003 (P414.03)	MOP starting values: Torque (MOP start value: Torque) 0.0 ... [0.0] ... 1000.0 %	Starting value for operating mode "MS: Torque mode". <ul style="list-style-type: none"> <li>• This value is used as initial value if "Starting value [1]" is set in <a href="#">0x4003 (P413.00)</a>.</li> <li>• 100 % = motor rated torque (<a href="#">0x6076 (P325.00)</a>).</li> </ul>
0x4009:003	MOP values saved: Torque <ul style="list-style-type: none"> <li>• Read only: x.x %</li> </ul>	Display of the last MOP value saved internally for the operating mode "MS: Torque mode". <ul style="list-style-type: none"> <li>• This value is used as initial value if "Last value [0]" is set in <a href="#">0x4003 (P413.00)</a>.</li> <li>• 100 % = motor rated torque (<a href="#">0x6076 (P325.00)</a>).</li> </ul>

A switch-over to the motor potentiometer during operation is also possible as an alternative to the standard setpoint source setting.

▶ [Example: Change-over from AI1 setpoint to MOP setpoint](#) 153



## 8.3 Process input data (CiA 402 objects)

These objects can be used for the CiA 402 "MS: Torque mode" operating mode. The CiA 402 operating mode "Profile Torque mode" is not supported.

### Parameter

Address	Name / setting range / [default setting]	Information
0x6060 (P301.00)	CiA: Operation mode (Operation mode) • Setting can only be changed if the inverter is disabled.	CiA: Operation mode
	-2 <b>MS: Velocity mode</b>	Vendor specific velocity mode ▶ <a href="#">Configuring the frequency control</a> □ 92
	-1 MS: Torque mode (from version 03.00)	Vendor specific torque mode • Only possible in motor control type 0x2C00 (P300.00) = "Sensorless vector control (SLVC) [4]" or "Servo control (SC ASM) [2]". ▶ <a href="#">Configuring the torque control</a> □ 161
	0 No selection	No selection
	2 CiA: Velocity mode (vl)	CiA: Velocity mode ▶ <a href="#">CiA 402 device profile</a> □ 341
0x6071	Set torque -3276.8 ... [0.0] ... 3276.7 %	Setting of the setpoint torque for the torque operating modes. • 100 % = Rated motor torque 0x6076 (P325.00) The inverter does not support the CiA 402 torque mode.



## 8.4 Process output data (CiA 402 objects)

These objects can be used for the CiA 402 mode "MS: Torque mode". The CiA 402 mode "Profile Torque mode" is not supported.

### Parameter

Address	Name / setting range / [default setting]	Information
0x6074	Internal set torque <ul style="list-style-type: none"><li>• Read only: x.x %</li><li>• From version 02.00</li></ul>	Display of the internal set torque. <ul style="list-style-type: none"><li>• 100 % = Rated motor torque <a href="#">0x6076 (P325.00)</a></li></ul>
0x6077 (P107.00)	Actual torque (Actual torque) <ul style="list-style-type: none"><li>• Read only: x.x %</li></ul>	Display of the actual torque. <ul style="list-style-type: none"><li>• 100 % = Rated motor torque <a href="#">0x6076 (P325.00)</a></li></ul>



## 8.5 Setpoint diagnostics

The following parameters provide information on the setpoints set for torque control.

### Parameter

Address	Name / setting range / [default setting]	Information
0x282B:012	Inverter diagnostics: Default torque setpoint <ul style="list-style-type: none"> <li>• Read only: x.x %</li> <li>• From version 03.00</li> </ul>	Display of the torque setpoint of the standard setpoint source set in <a href="#">0x2860:003 (P201.03)</a> . <ul style="list-style-type: none"> <li>• 100 % = Rated motor torque <a href="#">0x6076 (P325.00)</a></li> </ul>
0x282B:013	Inverter diagnostics: Preset torque setpoint <ul style="list-style-type: none"> <li>• Read only: x.x %</li> <li>• From version 03.00</li> </ul>	Display of the preset torque setpoint selected via the four functions "Activate preset (bit 0)" ... "Activate preset (bit 3)". <ul style="list-style-type: none"> <li>▶ <a href="#">Setpoint presets</a> <a href="#">171</a></li> </ul>
0x2948:001	Torque setpoint: Actual torque setpoint <ul style="list-style-type: none"> <li>• Read only: x.x %</li> <li>• From version 03.00</li> </ul>	Display of the currently selected torque setpoint that is internally transferred to the motor control. <ul style="list-style-type: none"> <li>• 100 % = Rated motor torque <a href="#">0x6076 (P325.00)</a></li> </ul>
0x2949:003 (P337.03)	Torque limit source selection: Actual positive torque limit (Trq. lim. source: Act postorqlim) <ul style="list-style-type: none"> <li>• Read only: x.x %</li> <li>• From version 03.00</li> </ul>	Display of the current positive torque limit. <ul style="list-style-type: none"> <li>• 100 % = Rated motor torque <a href="#">0x6076 (P325.00)</a></li> </ul>
0x2949:004 (P337.04)	Torque limit source selection: Actual negative torque limit (Trq. lim. source: Act negtorqlim) <ul style="list-style-type: none"> <li>• Read only: x.x %</li> <li>• From version 03.00</li> </ul>	Display of the current negative torque limit. <ul style="list-style-type: none"> <li>• 100 % = Rated motor torque <a href="#">0x6076 (P325.00)</a></li> </ul>
0x2DD5	Torque setpoint <ul style="list-style-type: none"> <li>• Read only: x.xx Nm</li> <li>• From version 03.00</li> </ul>	Display of the current torque setpoint.



## 9 Configuring the feedback system

The Inverter i550 exclusively supports HTL encoders.

An HTL encoder can be used at the Inverter i550 for the following tasks:

- As motor encoder for a motor speed feedback for speed control that is as precise as possible (SC-ASM) ▶ [Servo control for asynchronous motor \(SC-ASM\)](#) [187](#).
- As a setpoint encoder for defining a frequency setpoint ▶ [Standard setpoint source](#) [93](#).
- As setpoint encoder for defining the reference value for the process controller ▶ [Configuring the process controller](#) [128](#).
- As a setpoint encoder for defining a torque setpoint ▶ [Configure setpoint sources](#) [170](#).
- As actual value encoder for the process controller ▶ [Configuring the process controller](#) [128](#).
- As actual value encoder for the "position counter" function ▶ [Process output data](#) [335](#).



---

The HTL encoder connected to the inverter is **not** automatically set as the feedback system for motor control if a motor is selected from the motor catalogue!

---

The information in the following chapters generally applies for the HTL encoder, regardless of its purpose.



## 9.1 HTL encoder

In case of the inverter i550, the digital inputs DI3 and DI4 can be configured as HTL input to evaluate the signal of a cost-effective HTL encoder.

### Preconditions

- Single-track or two-track HTL encoder.
  - A single-track HTL encoder (track A) cannot be used for motor speed feedback.
  - A two-track HTL encoder (track A and B) must have a phase offset of exactly 90° between track A and B (error  $\leq \pm 10^\circ$ ). Inverted tracks are not required.
- Encoder increments:  $\leq 16384$  increments per revolution
- For supplying the encoder, the maximum supply current of the inverter must be considered. If necessary, an external 24-V voltage supply for the encoder is required.
- For using the digital inputs DI3 and DI4 as HTL input, the corresponding input function must be set in [0x2630:002 \(P410.02\)](#).

### Restrictions

- When the digital inputs DI3 and DI4 are configured as HTL input, these two digital inputs are no longer available for other control functions.
- The HTL input can be either used for detecting an HTL encoder signal or a pulse train. They cannot be used at the same time.
- The maximum input frequency of the digital inputs is 100 kHz. If this frequency is exceeded, an error is triggered.

### Intended use

An HTL encoder can be used at the Inverter i550 for the following tasks:

- As motor encoder for a motor speed feedback for speed control that is as precise as possible [▶ Servo control for asynchronous motor \(SC-ASM\) □ 187](#).
- As standard setpoint source (setpoint encoder):

Intended use	Parameter	Setting	Further information
As a setpoint encoder for defining a frequency setpoint.	<a href="#">0x2860:001 (P201.01)</a>	HTL input [4]	Frequency control <a href="#">▶ Standard setpoint source □ 93</a>
As setpoint encoder for defining the reference value for the process controller.	<a href="#">0x2860:002 (P201.02)</a>	HTL input [4]	Frequency control <a href="#">▶ Configuring the process controller □ 128</a>
As a setpoint encoder for defining a torque setpoint.	<a href="#">0x2860:003 (P201.03)</a>	HTL input [4]	Torque control <a href="#">▶ Standard setpoint source □ 163</a>
As an alternative to the setting as a standard setpoint source, the "Activate setpoint via HTL input" <a href="#">0x2631:022 (P400.22)</a> function can be used to enable a setpoint change-over to the HTL input.			

- As actual value source (actual value encoder):

Intended use	Parameter	Setting	Further information
As actual value encoder for the process controller.	<a href="#">0x4020:002 (P600.02)</a>	HTL input [6]	Frequency control <a href="#">▶ Configuring the process controller □ 128</a>
As actual value encoder for the "position counter" function.	<a href="#">0x2C49:001 (P711.01)</a>	Digital inputs DI3/DI4 [1]	Configuring the network <a href="#">▶ Position counter □ 606</a>

- Speed feedforward control source [0x4020:004 \(P600.04\)](#).





## Connection

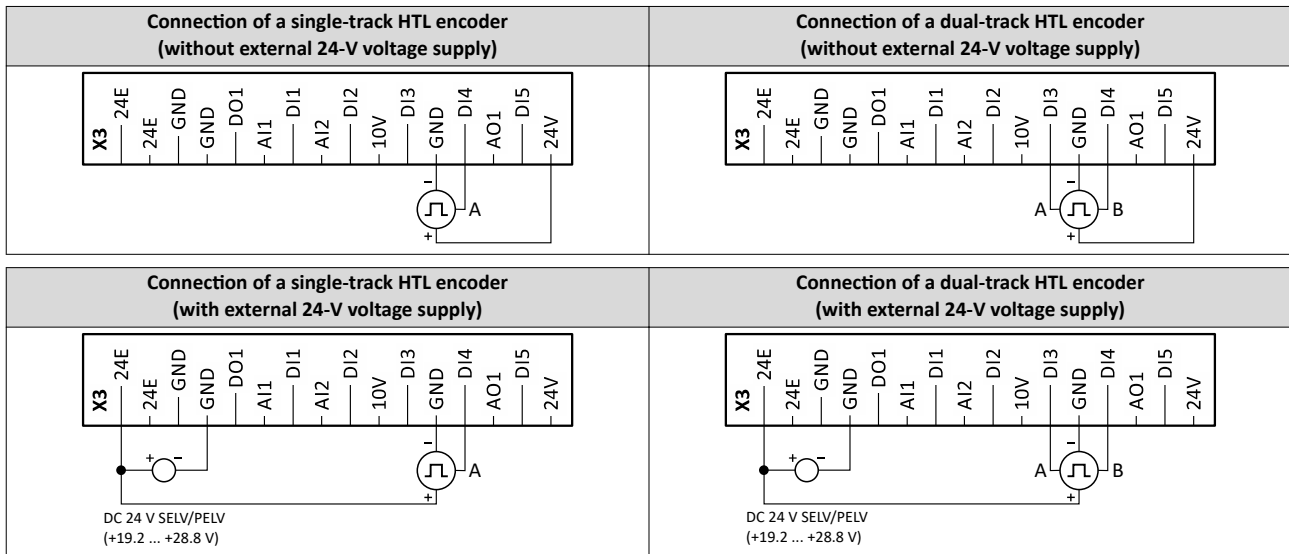

## Details

Encoder dimensioning: Calculate maximum number of increments per revolution of the encoder	
Max. encoder increments = $f_{\max} [\text{Hz}] \cdot 60 \text{ s} / n_{\max} [\text{rpm}]$	
Max. encoder increment = $100000 [\text{Hz}] \cdot 60 \text{ s} / 1500 [\text{rpm}] = 4000$ Increments/revolution	
$f_{\max}$	Maximum input frequency of the digital inputs = 100 kHz = 100000 Hz
$n_{\max}$	Maximum encoder speed (in this example: 1500 rpm)
Max. encoder increments	Maximum number of increments per encoder revolution



Select an encoder with a maximum number of increments per revolution which is lower than or equal to the calculated number. The higher the number of increments per revolution, the more stable the system is.

Basic steps for configuring the encoder in the »EASY Starter«:

1. Set the selection "High resolution HTL encoder [1]" in [0x2630:002 \(P410.02\)](#) to configure the digital inputs DI3 and DI4 as encoder inputs.
2. Set the encoder number of increments per revolution in [0x2C42:001 \(P341.01\)](#) according to the manufacturer data/encoder data sheet.

## Parameter

Address	Name / setting range / [default setting]	Information												
0x2C42:001 (P341.01)	Encoder settings: Increments/revolution (Encoder settings: Enc. Inc/Rev) 1 ... [128] ... 16384 <ul style="list-style-type: none"> <li>• Setting can only be changed if the inverter is disabled.</li> <li>• From version 02.00</li> </ul>	Setting of the encoder number of increments per revolution (according to manufacturer data/encoder data sheet).												
0x2C42:006	Encoder settings: Actual velocity <ul style="list-style-type: none"> <li>• Read only: x rpm</li> <li>• From version 02.00</li> </ul>	Display of the speed currently detected by the encoder.												
0x2C42:011	Encoder settings: Sampling rate <ul style="list-style-type: none"> <li>• From version 06.05</li> </ul> <table border="1"> <tr><td>0</td><td>125 us</td></tr> <tr><td>1</td><td>250 us</td></tr> <tr><td>2</td><td>500 us</td></tr> <tr><td><b>3</b></td><td><b>1 ms</b></td></tr> <tr><td>4</td><td>2 ms</td></tr> <tr><td>5</td><td>4 ms</td></tr> </table>	0	125 us	1	250 us	2	500 us	<b>3</b>	<b>1 ms</b>	4	2 ms	5	4 ms	
0	125 us													
1	250 us													
2	500 us													
<b>3</b>	<b>1 ms</b>													
4	2 ms													
5	4 ms													

# Configuring the feedback system

HTL encoder



## Related topics

- ▶ [Configure digital inputs DI3/DI4 for detecting a pulse train](#)  276



## 9.2 Encoder monitoring

For monitoring the HTL encoder, two monitoring functions are implemented in the inverter firmware:

- a) Encoder signal loss monitoring: Is triggered if a failure of the encoder signal is detected (e. g. due to open circuit or failure of the encoder current supply).
- b) Encoder maximum frequency monitoring: Is triggered if the calculated encoder maximum frequency is beyond the permissible frequency range of the digital inputs.

These monitoring functions are plausibility tests. The hardware circuit of the inverter cannot distinguish whether the motor shaft is blocked or the encoder signal cables are interrupted. Monitoring is restricted to operating points where most likely encoder pulses are to be expected. Another requirement is to avoid false alarms. This especially restricts monitoring at standstill and at low speeds.

Encoder monitoring shows a different behavior for:

Case a) Restrictions if the HTL encoder is set as feedback system for the motor control:

0x2C00 (P300.00) = [2] servo control (SC-ASM)

0x2C00 (P300.00) = [7] V/f characteristic control (VFC closed loop)

In this case, it does not matter whether the HTL encoder is also used as signal source for the "position counter" function.

Case b) The HTL encoder is used as signal source for the "position counter" function

0x2C49:001 (P711.01) and one of the following sensorless motor control modes is set:

0x2C00 (P300.00) = [3] Sensorless control (SL-PSM)

0x2C00 (P300.00) = [4] Sensorless vector control (SLVC)

0x2C00 (P300.00) = [6] V/f characteristic control (VFC open loop)

### Conditions

The encoder signal loss monitoring is only active if the HTL encoder

- is set as feedback system for the motor control or
- used as signal source for the "Position counter" function. [📖 606](#)
- For the encoder signal loss monitoring, the inverter must be enabled and the motor must rotate.

The encoder maximum frequency monitoring is active as soon as the HTL encoder has been configured.



### Restrictions

- The encoder signal loss monitoring does not work while the "DC braking" function is active. [221](#)
- The response time of the encoder signal loss monitoring depends on the setting of the encoder increments per revolution in [0x2C42:001 \(P341.01\)](#).
- The settings of the speed controller can influence the encoder signal loss monitoring. If the reset time of the speed controller is very low or deactivated, an encoder signal loss cannot be detected at switch-on.
- Combined with the "Holding brake control" function:
  - In order that the encoder signal loss monitoring is not triggered by mistake, monitoring is only activated when the holding brake is released.
  - If Brake closing time [0x2820:002 \(P712.02\)](#) and Brake opening time [0x2820:003 \(P712.03\)](#) are not set correctly, the encoder signal loss monitoring can be triggered even though an encoder signal is available.
- [Holding brake control 228](#)
- If the configuration of the digital inputs [0x2630:002 \(P410.02\)](#) is = function [4] low-resolution HTL encoder  $\leq 128$  increments, the interruption of the track A (DI3) is not detected.

### Case a) Restrictions if the HTL encoder is set as feedback system for the motor control:

- Monitoring is only active if the output frequency is higher than 1.5 times of the rated slip frequency of the motor. This applies to the setting [0x2630:002 \(P410.02\)](#) = 1 and [0x2630:002 \(P410.02\)](#) = 4.

### Case b) Restrictions if the HTL encoder is used as signal source for the "Position counter" function ([0x2C49:002](#)).

- Monitoring is only active if the speed [rpm] measured by the encoder is higher than the threshold according to the following table **and the signal is lost!**

Encoder Increments per revolution	<a href="#">0x2630:002</a> = [1] Threshold [rpm]	<a href="#">0x2630:002</a> = [4] Threshold [rpm]
128	117.2	468.8
256	58.6	58.6
512	29.3	117.1
1024	14.6	58.6

- A signal loss is not detected if the encoder signals already disappear when the inverter is enabled (zero speed).



## Details on encoder signal loss monitoring

The encoder signal loss monitoring distinguishes between the following signal failures:

- a) Complete failure (total absence of the encoder signal, e. g. if the encoder power supply fails)
- b) Only one track has failed (track A or track B)

In order to detect a complete failure (a.), the inverter calculates internally two trigger thresholds for monitoring based on the configuration of the HTL encoder:

1. Based on the motor data, the rated motor slip frequency is calculated. Display of parameter [0x2C02:004 \(P351.04\)](#). The minimum output frequency for encoder monitoring is  $1.5 \cdot \text{rated motor slip}$ .
2. The maximum permitted time is calculated in which a new signal edge of the encoder must arrive:

$$\text{time per edge [s]} = \frac{1}{\text{encoder frequency [Hz]} \cdot \frac{\text{encoder increments}}{\text{revolution}}}$$

If the real encoder frequency is lower than the calculated minimum output frequency AND if the new signal edge has not arrived within the maximum permitted time, monitoring is triggered.

The complete failure is displayed via the status bit 4 in [0x2C42:007](#)

If only track A or B fails (b.), signals continue to be detected. In this case, however, the sign of the frequency changes with every new signal edge. In order to detect the failure of only one track, an internal counter is increased by 1 every time the sign between two signal edges changes. If the sign is unchanged in two signal edges in a row, the counter is reset. If the counter reaches the counter content "100", monitoring is triggered. The failure of only one track is displayed via the status bit 5 in [0x2C42:007](#).

Both in case of a complete failure and in case only one track fails, the error message "Encoder open circuit" (error code [29445](#) | [0x7305](#)) is output. The error response can be selected in [0x2C45 \(P342.00\)](#).



### Details on encoder maximum frequency monitoring

After the HTL encoder has been configured (or if the encoder settings are changed), the inverter internally calculates the maximum possible number of encoder pulses per second (hereinafter referred to as "encoder maximum frequency"):

$$\text{encoder maximum frequency [Hz]} = \frac{\text{encoder increments}}{\text{revolution}} \cdot \frac{\text{max. motor speed [rpm]}}{60}$$

If the calculated encoder maximum frequency is beyond the permissible frequency range of the digital inputs, monitoring is triggered:

- The status bit 0 in [0x2C42:007](#) is set to "1".
- The warning "Feedback system: speed limit" (error code [29573](#) | [0x7385](#)) is output.

Calculation example 1:

- Maximum input frequency of the digital inputs = 100 kHz
- Encoder resolution [0x2C42:001 \(P341.01\)](#) = 1024 increments/revolution
- Max. motor speed [0x6080 \(P322.00\)](#) = 3000 rpm

$$\text{encoder maximum frequency [Hz]} = 1024 \frac{\text{encoder increments}}{\text{revolution}} \cdot \frac{3000 \text{ [rpm]}}{60} = 51200 \text{ [Hz]}$$

Result: The encoder maximum frequency monitoring is not triggered because the encoder maximum frequency is within the permissible frequency range of the digital inputs.

Calculation example 2:

- Maximum input frequency of the digital inputs = 100 kHz
- Encoder resolution [0x2C42:001 \(P341.01\)](#) = 4096 increments/revolution
- Max. motor speed [0x6080 \(P322.00\)](#) = 3600 rpm

$$\text{encoder maximum frequency [Hz]} = 4096 \frac{\text{encoder increments}}{\text{revolution}} \cdot \frac{3600 \text{ [rpm]}}{60} = 245760 \text{ [Hz]}$$

Result: The encoder maximum frequency monitoring is triggered because the encoder maximum frequency is beyond the permissible frequency range of the digital inputs.

### Parameter

Address	Name / setting range / [default setting]	Information
0x2C42:007	Encoder settings: Status <ul style="list-style-type: none"> <li>• Read only</li> <li>• From version 02.00</li> </ul>	Bit coded display of the status of encoder monitoring. Display of the encoder status.
	Bit 0 Maximum encoder speed reached	1 = the calculated encoder maximum frequency is beyond the permissible frequency range of the digital inputs.
	Bit 4 No signal detected	1 = a complete failure of the encoder signals has been detected. No pulse detected.
	Bit 5 Encoder track A or B missing	1 = a failure of only one track (track A or track B) has been detected. Weak pulses (one of the tracks A or B is missing).
0x2C45 (P342.00)	Motor feedback error response (Motor feedb. error response) <ul style="list-style-type: none"> <li>• From version 03.00</li> </ul>	Selection of the response to the triggering of the encoder signal loss monitoring.  The monitoring is only active if the HTL encoder <ul style="list-style-type: none"> <li>• is set as feedback system for the motor control or</li> <li>• used as signal source for the "Position counter" function. <a href="#">606</a></li> </ul> Associated event ID: <ul style="list-style-type: none"> <li>• <a href="#">29445</a>   <a href="#">0x7305</a> - Encoder open circuit</li> </ul>
	0 No response	▶ Severity <a href="#">700</a>
	1 <b>Warning</b>	
	3 Fault	



## 9.3 Synchronous motor: Pole position identification (PPI)

For the control of a permanent-magnet synchronous motor, the pole position – the angle between motor phase U and the field axis of the rotor – must be known. The determination of this angle can be done by a so called "Pole Position Identification (PLI)".

### Preconditions

In [0x2C00 \(P300.00\)](#) the motor control type "Sensorless control (SL PSM) [3]" is selected.

The "[Pole position identification \(PPI\) without movement](#)" function is available for the identification of the pole position for the inverter i5xx. [□ 184](#)

### 9.3.1 Monitoring the pole position identification

If an error occurs during the pole position identification,

- the procedure is stopped without the settings being changed.
- the response set in [0x2C60](#) is effected.

#### Parameter

Address	Name / setting range / [default setting]	Information	
0x2C60	PPI monitoring: Response	Selection of the response triggered by the occurrence of an error during the pole position identification (PLI). Associated event ID: <ul style="list-style-type: none"><li>• <a href="#">28961</a>   <a href="#">0x7121</a> - Fault - Pole position identification</li></ul>	
	• From version 04.00		
	0 No response		▶ Severity <a href="#">□ 700</a>
	1 Warning		
	2 Trouble		
3 <b>Fault</b>			

# Configuring the feedback system

Synchronous motor: Pole position identification (PPI)  
Pole position identification (PPI) without movement



## 9.3.2 Pole position identification (PPI) without movement

The "Pole position identification (PLI) without movement" function can also be used if no motor revolution is possible (holding brake active).

### NOTICE

With an incorrect parameter setting and dimensioning of the inverter, the maximum permissible motor current may be exceeded during the pole position identification.

Possible consequences: Irreversible damage of the motor

- ▶ Set the motor data correctly. ▶ [Motor data](#) 57
- ▶ Only use an inverter that is performance-matched to the motor.

### Conditions

- The wiring of the three motor phases and the motor encoder must be carried out according to the specifications from the mounting instructions.
- The inverter is ready for operation (no fault active).
- For the pole position identification (PPI) without movement, the motor must be at standstill.

### Parameter

Address	Name / setting range / [default setting]	Information
0x2C63:001	PPI without movement: Execution <ul style="list-style-type: none"><li>• Setting can only be changed if the inverter is disabled.</li><li>• From version 04.00</li></ul>	Start behavior (with or without pole position identification before the start).
	0 Disabled	No pole position is identified.
	<b>2 After each enable</b>	After every inverter release, the pole position is identified without any movement.
0x2C63:002	PPI without movement: Current adjust factor 50 ... [100] ... 500 % <ul style="list-style-type: none"><li>• Setting can only be changed if the inverter is disabled.</li><li>• From version 06.05</li></ul>	





## 10 Configuring the motor control

This chapter contains all functions and settings relevant for the motor control.

### Basic procedure of commissioning the motor control

In the first step, the rated data of the motor must be set. The other steps depend on the respective application case.

There are several options for setting the motor data and optimising the control loops. Basically, you can select between a manual and an automatic process. Whether a setting can be applied or not depends on the motor (Lenze motor yes/no) and the application. If possible, always use the possible setting listed first in the following diagram since this one leads to the most accurate results.

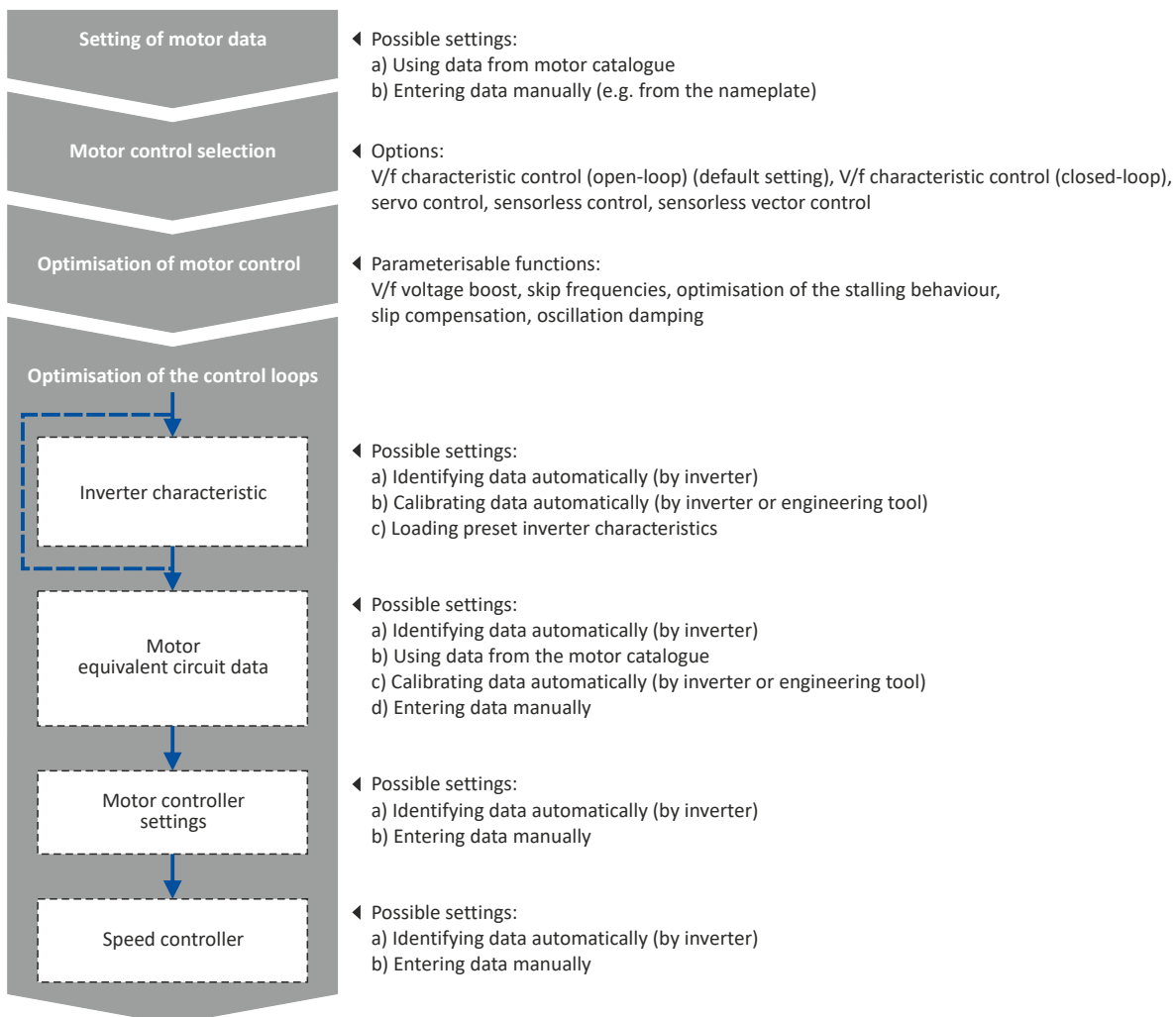

### Related topics

Basic setting ▶ [Motor data](#) 57

Basic setting ▶ [Motor control mode](#) 61



## Guide for this chapter

In the following subchapters, each motor control type is described in detail:

- ▶ [Servo control for asynchronous motor \(SC-ASM\)](#) 187
- ▶ [Sensorless control for synchronous motor \(SL-PSM\)](#) 188
- ▶ [Sensorless vector control \(SLVC\)](#) 191
- ▶ [V/f characteristic control for asynchronous motor \(VFC open loop\)](#) 193
- ▶ [V/f characteristic control for asynchronous motor \(VFC closed loop\)](#) 213
- ▶ [Sensorless control for synchronous motor \(SLSM-PSM\)](#) 215

This chapter also contains information on the following subjects:

- ▶ [Parameterisable motor functions](#) 219
- ▶ [Options for optimizing the control loops](#) 238
- ▶ [Motor protection](#) 256



## 10.1 Servo control for asynchronous motor (SC-ASM)

The field-oriented servo control is based on a separated control of the torque-producing and field-producing current components. The motor control is based on a feedback, field-oriented and cascaded controller structure and enables a dynamic and stable operation in all four quadrants.

### Preconditions

- The servo control (SC ASM) is only suitable for asynchronous motors.
- The servo control (SC-ASM) requires a feedback of the speed. A HTL encoder must be connected to the inverter and set as feedback system for the motor control.

### Details

Fundamentally, the servo control has the same advantages as the sensorless vector control (SLVC). Compared to the V/f characteristic control without feedback, the following can be achieved by means of the servo control:

- A higher maximum torque throughout the entire speed range
- A higher speed accuracy
- A higher concentricity factor
- A higher level of efficiency
- The implementation of torque-actuated operation with speed limitation
- The limitation of the maximum torque in motor and generator mode for speed-actuated operation

### 10.1.1 Required commissioning steps

1. [Configuring the feedback system](#) 175
2. Activate motor control type: `0x2C00 (P300.00) = "Servo control (SC ASM) [2]"`.
3. Carry out optimisation of the control circuits.
  - **An optimum operation of this motor control type requires an optimisation of the control loops!**
  - Details: [Options for optimizing the control loops](#) 238
4. Alternatively, the inverter can be configured in this motor control type in such a way that it controls a motor torque within a defined frequency range. For details, see chapter "[Configuring the torque control](#)". 161
5. Optionally for a speed control with torque limitation in operating mode `0x6060 (P301.00) = "MS: Velocity mode [-2]"`:
  - Select the source in `0x2949:001 (P337.01)` for the positive torque limit source and set it accordingly.
  - Select the source in `0x2949:002 (P337.02)` for the negative torque limit source and set it accordingly.



## 10.2 Sensorless control for synchronous motor (SL-PSM)

The sensorless control for synchronous motors is based on a decoupled, separated control of the torque-producing current and the current aligned with the field. In contrast to the servo control, the actual speed value and rotor position are reconstructed via a motor model.

### NOTICE

In case of this motor control type, an adjustable, constant current is injected in the lower speed range. If this current is higher than the rated motor current, the motor may heat up in the lower speed range. This effect increases if the motor is operated in the lower speed range for a longer period of time.

Possible consequences: Destruction of the motor by overheating

- ▶ Do not operate the motor for a longer period of time in the lower speed range.
- ▶ For detecting and monitoring the motor temperature, we recommend a temperature feedback via PTC thermistor or thermal contact. ▶ [Motor temperature monitoring](#) 261

### Details

The motor model-based speed observer requires a rotating machine. Thus, as a matter of principle, the operational performance of the sensorless control for synchronous motors is divided into two ranges:

1. Low speed range ( $|\text{setpoint speed}| < \text{lower limit } 0x2C11:001$ )
  - In the range of low speeds, the speed of a synchronous motor cannot be observed. In this "Low speed range", controlled operation takes place: During the acceleration phase, the current setpoints of [0x2C12:001](#) and [0x2C12:002](#) are added and injected into the motor.
2. High speed range ( $|\text{setpoint speed}| > \text{lower limit } 0x2C11:001$ )
  - In this range, the rotor flux position and the speed are reconstructed by means of observation. The control is executed in a field-oriented way. Only the current required for generating the necessary torque is injected.

### Pole position identification (PLI)

- For controlling a permanent-magnet synchronous motor, the pole position - the angle between the motor phase U and the field axis of the rotor - must be known.
- If the drive is at a standstill, the "pole position identification (PLI)" function is immediately activated after the inverter is enabled. ▶ [Synchronous motor: Pole position identification \(PPI\)](#) 183

### Flying restart circuit

- A flying restart circuit for the synchronous motor up to speeds lower than half the rated speed is supported.
- If the flying restart circuit is to be used, set the start method "Flying restart circuit [2]" in [0x2838:001 \(P203.01\)](#). Additional settings are not required for the flying restart circuit in the case of a sensorless control of a synchronous motor.

### SL-PSM parameters

The parameters for this motor control type are calculated and set automatically while optimising the control loops.



### 10.2.1 Required commissioning steps

1. Activate motor control type: [0x2C00 \(P300.00\)](#) = "Sensorless control (SL PSM) [3]".
2. Carry out optimization of the control loops.
  - The default setting enables the operation of a power-adapted motor.
  - **An optimum operation of this motor control type requires an optimization of the control loops!**
  - Details: [► Options for optimizing the control loops](#) 238
3. Optionally: activate the flying restart circuit: [0x2838:001 \(P203.01\)](#)
4. Optionally for a speed control with torque limitation in operating mode [0x6060 \(P301.00\)](#) = "MS: Velocity mode [-2]":
  - Select the source in [0x2949:001 \(P337.01\)](#) for the positive torque limit source and set it accordingly.
  - Select the source in [0x2949:002 \(P337.02\)](#) for the negative torque limit source and set it accordingly.
5. Optionally for a speed control with torque limitation in operating mode [0x6060 \(P301.00\)](#) = "CiA: Velocity mode (vI) [2]":
  - Set the positive torque limit in [0x60E0](#)
  - Set the negative torque limit in [0x60E1](#).

### 10.2.2 Stalling protection

The stalling monitoring for the sensorless control of synchronous motors (SL-PSM) switches off the drive if the motor is about to "stall". A possible cause may be an overload of the motor.

#### Preconditions

The stalling monitoring only works in the controlled area and if the motor is not operated in the field weakening range.

#### Details

In order to detect the motor stalling, the cosine phi is used.

Example:

- For the cosine phi, the value "0.9" is set in [0x2C01:008 \(P320.08\)](#) according to the data given on the motor nameplate.
- The limit value for stalling monitoring is set in [0x2C11:006](#) to "80 %".
- Stalling monitoring is triggered if the current cosine phi is lower than 0.72 (80 % of 0.9).



If stalling monitoring is triggered, the "Trouble" error response takes place. If the operating mode "MS: Velocity mode [-2]" is set in [0x6060 \(P301.00\)](#), the motor automatically restarts if the trouble does not exist any more.

#### Parameter

Address	Name / setting range / [default setting]	Information
0x2C11:006	High speed range: Stall monitoring limit 0 ... [50] ... 65535 % • From version 04.00	The stall monitoring limit refers to the cosine phi of the motor in percent.



## 10.2.3 Expert settings

The parameters for this motor control type are calculated and set automatically while optimising the control loops.

### Details

The motor model-based speed observer requires a rotating machine. Thus, the operational performance of the sensorless control for synchronous motors is divided into two ranges:

1. Low speed range ( $|\text{setpoint speed}| < \text{lower limit } 0x2C11:001$ )
  - In the range of low speeds, the speed of a synchronous motor cannot be observed. In this "Low speed range", controlled operation takes place: During the acceleration phase, the current setpoints of [0x2C12:001](#) and [0x2C12:002](#) are added and injected into the motor.
2. High speed range ( $|\text{setpoint speed}| > \text{lower limit } 0x2C11:001$ )
  - In this area, the rotor flux position and the speed are reconstructed by means of an observer. The control is executed in a field-oriented way. Only the current required for generating the necessary torque is injected.

### Parameter

Address	Name / setting range / [default setting]	Information
0x2C11:001	High speed range: Lower limit 5 ... [10] ... 100 % • From version 02.00	Definition of the lower limit of the high speed range. • The lower limit has a permanent hysteresis of 5 %.
0x2C11:002	High speed range: Tracking controller gain 0 ... [200] ... 65535 % • From version 02.00	Gain factor for tracking the rotor position in the motor model.
0x2C11:003	High speed range: Tracking controller reset time 0.00 ... [6.00] ... 655.35 ms • From version 02.00	Reset time for tracking the rotor position in the motor model.
0x2C11:004	High speed range: Tracking controller decouple time 0.0 ... [200.0] ... 6553.5 ms • From version 02.00	Temporal hysteresis for the switching back and forth from the open-loop controlled to the closed-loop controlled operation.
0x2C12:001	SM low speed range: Acceleration current 5 ... [70] ... 400 % • From version 02.00	R.m.s. current value for acceleration processes in the lower velocity range. • 100 % = Rated motor current ( <a href="#">0x6075 (P323.00)</a> ) • In the lower speed range and during the acceleration phase, the current setpoints of <a href="#">0x2C12:001</a> and <a href="#">0x2C12:002</a> are added and injected to the motor.
0x2C12:002	SM low speed range: Standstill current 5 ... [30] ... 400 % • From version 02.00	R.m.s. current value for processes without acceleration (for instance standstill or constant setpoint speed) in the lower velocity range. • 100 % = Rated motor current ( <a href="#">0x6075 (P323.00)</a> ) • In the lower speed range and during the acceleration phase, the current setpoints of <a href="#">0x2C12:001</a> and <a href="#">0x2C12:002</a> are added and injected to the motor.  Note! At the "100 %" setting, a motor current flows at standstill and at constant speed. The r.m.s. value of this motor current is greater than the rated motor current by a factor of $\sqrt{2}$ at standstill. The reason for this is that a DC current is injected into the synchronous motor at a standstill. The correct rated motor current flows when the motor turns.



## 10.3 Sensorless vector control (SLVC)

The sensorless (field-oriented) vector control for asynchronous motors is based on a decoupled control for the torque-producing and the field-producing current component. In addition, the actual speed is reconstructed by means of a motor model so that a speed sensor is not required.

### Preconditions

- Sensorless vector control (SLVC) is only suitable for asynchronous motors.
- Multi-motor operation is not permitted for sensorless vector control (SLVC).

Supported operating modes [0x6060 \(P301.00\)](#):

- "MS: Velocity mode [-2]"
- "MS: Torque mode [-1]"
- "CiA: Velocity mode (vl) [2]"

### Details

Compared to the V/f characteristics, the sensorless vector control (SLVC) serves to achieve improved drive characteristics thanks to:

- higher torque throughout the entire speed range
- higher speed accuracy and smooth running properties
- higher efficiency

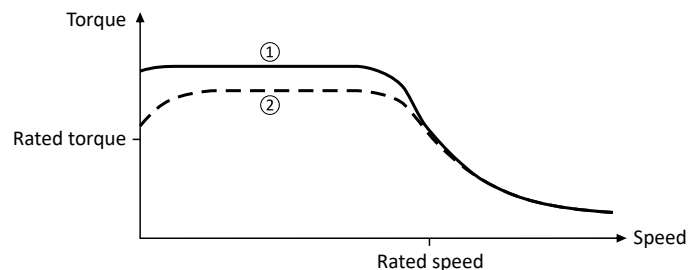

- ① Sensorless vector control (SLVC)
- ② [V/f characteristic control for asynchronous motor \(VFC open loop\)](#) [□ 193](#)

### 10.3.1 Required commissioning steps

1. Activate motor control type: [0x2C00 \(P300.00\)](#) = "Sensorless vector control (SLVC) [4]".
2. Carry out optimisation of the control circuits.
  - **An optimum operation of this motor control type requires an optimisation of the control loops!**
  - Details: [► Options for optimizing the control loops](#) [□ 238](#)
3. Optionally for a speed control with torque limitation in operating mode [0x6060 \(P301.00\)](#) = "MS: Velocity mode [-2]":
  - Select the source in [0x2949:001 \(P337.01\)](#) for the positive torque limit source and set it accordingly.
  - Select the source in [0x2949:002 \(P337.02\)](#) for the negative torque limit source and set it accordingly.
4. Alternatively, the inverter can be configured in this motor control type in such a way that it controls a motor torque within a defined frequency range. For details, see chapter "[Configuring the torque control](#)". [□ 161](#)

# Configuring the motor control

Sensorless vector control (SLVC)  
Expert settings



## 10.3.2 Expert settings

### Parameter

Address	Name / setting range / [default setting]	Information
0x2B40:003	Q-Feedforward 0.00 ... [0.00] ... 10000.00 • From version 03.00	Feedforward control for the SLVC Q controller.
0x2B40:004	D-Feedforward 0.00 ... [0.00] ... 10000.00 • From version 03.00	Feedforward control of the SLVC-D controller.





## 10.4 V/f characteristic control for asynchronous motor (VFC open loop)

The V/f characteristic control is a motor control for conventional frequency inverter applications. It is based on a simple and robust control mode for the operation of asynchronous motors with a linear or square-law load torque characteristic (e.g. fan). Because of the minimal parameterisation effort, such applications can be commissioned easily and quickly.

### Preconditions

- The V/f characteristic control is only suitable for asynchronous motors.
- If you want to actuate a drive with a square-law V/f characteristic: Please always check whether the corresponding application is suitable for operation with a square-law V/f characteristic!
- Set the motor data according to the information on the nameplate of the motor. ▶ [Motor data](#) 57

### 10.4.1 Required commissioning steps

1. Activate motor control type: [0x2C00 \(P300.00\)](#) = "V/f characteristic control (VFC open loop) [6]".
2. Set limiting factors for the V/f characteristic:
  1. Rated mains voltage [0x2540:001 \(P208.01\)](#)
  2. Minimum frequency [0x2915 \(P210.00\)](#)
  3. Maximum frequency [0x2916 \(P211.00\)](#)
3. Set V/f characteristic data:
  1. Base voltage [0x2B01:001 \(P303.01\)](#)
  2. Base frequency [0x2B01:002 \(P303.02\)](#)
4. Select a characteristic shape suitable for the application in [0x2B00 \(P302.00\)](#).
5. Optional settings:
  - [Set voltage boost](#) 202
  - [Set slip compensation](#) 203
  - [Set oscillation damping](#) 205
  - [Optimising the stalling behaviour](#) 206
  - [Flying restart circuit](#) 209
  - [Additive voltage impression](#) 211
6. Optional: carry out optimisation of the control circuits.
  - An optimisation of the control circuits is not mandatory for this motor control type but may lead to better control operation. The control parameters should always be calculated if the motor power does not correspond to the inverter power in order to achieve optimum performance from the slip compensation. (It is sufficient to carry out the "NonEnergized" calculation.)
  - Details: ▶ [Options for optimizing the control loops](#) 238

# Configuring the motor control

V/f characteristic control for asynchronous motor (VFC open loop)  
Basic setting



## 10.4.2 Basic setting

The base voltage and the base frequency define the ratio of the two variables and thus the gradient of the V/f characteristic.

### Parameter

Address	Name / setting range / [default setting]	Information
0x2B01:001 (P303.01)	V/f shape data: Base voltage (V/f shape data: Base voltage) 0 ... [230]* ... 5000 V * Default setting dependent on the model.	Base voltage and base frequency define the V/f ratio and thus the gradient of the V/f characteristic. <ul style="list-style-type: none"><li>The V/f base voltage is usually set to the rated motor voltage <a href="#">0x2C01:007 (P320.07)</a>.</li></ul>
0x2B01:002 (P303.02)	V/f shape data: Base frequency (V/f shape data: Base frequency) Device for 50-Hz mains: 0 ... [50]* ... 1500 Hz Device for 60-Hz mains: 0 ... [60]* ... 1500 Hz * Default setting dependent on the model.	<ul style="list-style-type: none"><li>The V/f base frequency is usually set to the rated motor frequency <a href="#">0x2C01:005 (P320.05)</a>.</li></ul>



## 10.4.3 Define V/f characteristic shape

Various characteristic shapes are available which are described in detail in the following subchapters.

### Parameter

Address	Name / setting range / [default setting]	Information
0x2B00 (P302.00)	V/f characteristic shape (V/f charac.shape) <ul style="list-style-type: none"> <li>Setting can only be changed if the inverter is disabled.</li> </ul>	Selection of the V/f characteristic shape for the adaptation to different load profiles.
	<b>0</b> Linear	Linear characteristic for drives with constant load torque over the speed. <a href="#">▶ Linear V/f characteristic</a> <a href="#">196</a>
	<b>1</b> Quadratic	Square-law characteristic for drives with a square-law load torque over the speed. <ul style="list-style-type: none"> <li>Square-law V/f characteristics are preferably used for centrifugal pumps and fan drives.</li> <li>Please always check whether the corresponding application is suitable for operation with a square-law V/f characteristic!</li> <li>If your pump drive or fan drive is not suitable for operation with a square-law V/f characteristic, use the linear V/f characteristic instead.</li> </ul> <a href="#">▶ Square-law V/f characteristic</a> <a href="#">197</a>
	<b>2</b> Multipoint (from version 03.00)	Multipoint characteristic for the purpose of adaptation to specific load profiles. <a href="#">▶ Multipoint V/f characteristic</a> <a href="#">198</a> Linear characteristic with additional characteristic point for adaptation to applications with special torque characteristics. <a href="#">▶ Multipoint V/f characteristic</a> <a href="#">198</a>
	<b>3</b> ECO (from version 02.00)	Linear characteristic with energy optimisation in the partial load operational range. <a href="#">▶ Energy-saving V/f characteristic (VFC-Eco)</a> <a href="#">199</a>
	<b>4</b> Adaptive (from version 05.04)	User-definable characteristic - adaptive curve. <a href="#">▶ User-definable V/f characteristic</a> <a href="#">200</a> Freely definable characteristic curve with 11 parameterizable grid points (voltage/frequency values). <a href="#">▶ User-definable V/f characteristic</a> <a href="#">200</a>

# Configuring the motor control

V/f characteristic control for asynchronous motor (VFC open loop)  
 Define V/f characteristic shape  
 Linear V/f characteristic



## 10.4.3.1 Linear V/f characteristic

The linear V/f characteristic leads to a constant torque.

### Details

Select V/f characteristic control with linear characteristic:

1. Motor control mode **0x2C00 (P300.00)** = "V/f characteristic control (VFC open loop) [6]"
2. V/f characteristic shape **0x2B00 (P302.00)** = "Linear [0]"

Setting of the V/f characteristic:

- Limiting factors for the V/f characteristic are the rated mains voltage **0x2540:001 (P208.01)**, the minimum frequency **0x2915 (P210.00)** and the maximum frequency **0x2916 (P211.00)**.
- The base voltage **0x2B01:001 (P303.01)** is usually set to the rated motor voltage (motor nameplate data). The base voltage is preset to the rated mains voltage. This in turn is preset according to the product key of the inverter. ▶ [Mains voltage](#) 47
- The base frequency **0x2B01:002 (P303.02)** is usually set to the rated motor frequency (motor nameplate data).

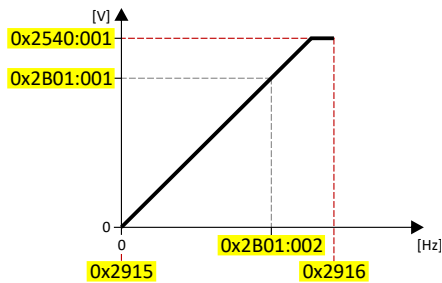

The actual output frequency can exceed the set maximum frequency if the gain for the slip compensation in **0x2B09:001 (P315.01)** is set to a value higher than 0.

### Example

Mot power

- 400 V/50 Hz

Settings

- Maximum frequency 75 Hz
- Minimum frequency 10 Hz

Explanation

- Graphic on the left: The inverter is operated with a rated mains voltage of 400 V.
- Graphic on the right: The inverter is operated with a rated mains voltage of 480 V. This allows the output voltage to further increase above 50 Hz.

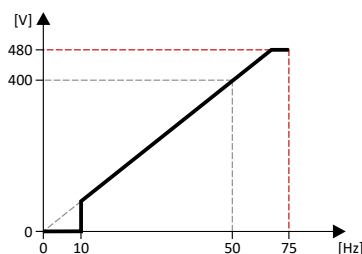
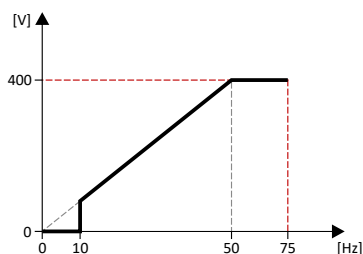

Parameter	Designation	Setting for this example
<b>0x2540:001 (P208.01)</b>	Rated mains voltage	400 Veff [1] (on the left) / 480 Veff [2] (on the right)
<b>0x2915 (P210.00)</b>	Minimum frequency	10 Hz
<b>0x2916 (P211.00)</b>	Maximum frequency	75 Hz
<b>0x2B01:001 (P303.01)</b>	Base voltage	400 V
<b>0x2B01:002 (P303.02)</b>	Base frequency	50 Hz



## 10.4.3.2 Square-law V/f characteristic

The square-law V/f characteristic is typically used in heating, ventilation and climate applications to control the speed of fans and centrifugal pumps.

### Details

Each application that is provided with the features according to the affinity laws may possibly benefit from a square-law V/f characteristic.

The affinity laws describe the relation between the speed and other variables:

- The volume flow increases proportionately to the speed.
- The required pressure behaves proportionately to the square of the speed.
- The power input is proportionately to the cube of the speed. This means that already a minimal reduction of the speed may lead to substantial savings in energy consumption.

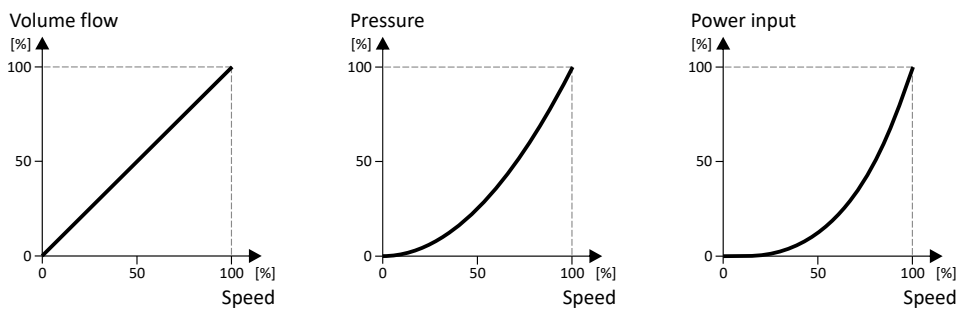

By approximation, the square-law V/f characteristic corresponds to the curve for power input shown above. At low frequencies, the voltage is reduced since due to the type of load a lower voltage is sufficient to generate the required power. All in all, this results in an energy-efficient system.

Select V/f characteristic control with square-law characteristic:

1. Motor control mode **0x2C00 (P300.00)** = "V/f characteristic control (VFC open loop) [6]"
2. V/f characteristic shape **0x2B00 (P302.00)** = "Quadratic [1]"

Setting of the V/f characteristic:

- Limiting factors for the V/f characteristic are the rated mains voltage **0x2540:001 (P208.01)**, the minimum frequency **0x2915 (P210.00)** and the maximum frequency **0x2916 (P211.00)**.
- The base voltage **0x2B01:001 (P303.01)** is usually set to the rated motor voltage (motor nameplate data). The base voltage is preset to the rated mains voltage. This in turn is preset according to the product key of the inverter. ▶ [Mains voltage](#) 47
- The base frequency **0x2B01:002 (P303.02)** is usually set to the rated motor frequency (motor nameplate data).

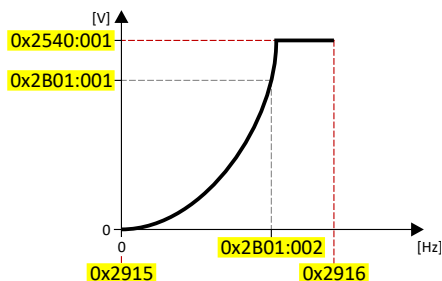

The actual output frequency can exceed the set maximum frequency if the gain for the slip compensation in **0x2B09:001 (P315.01)** is set to a value higher than 0.

# Configuring the motor control

V/f characteristic control for asynchronous motor (VFC open loop)  
 Define V/f characteristic shape  
 Multipoint V/f characteristic



## 10.4.3.3 Multipoint V/f characteristic

The multipoint V/f characteristic is based on the linear V/f characteristic. An additional characteristic point enables the adaptation to applications with special torque properties.

### Details

This characteristic shape is suitable for applications that require a higher torque at lower speeds. The additional characteristic point can be configured in such a way that a higher voltage is provided in the lower frequency range of the characteristic. Otherwise, the same limits apply for the Multipoint characteristic as for the linear characteristic.

Select V/f characteristic control with Multipoint characteristic:

1. Motor control mode **0x2C00 (P300.00)** = "V/f characteristic control (VFC open loop) [6]"
2. V/f characteristic shape **0x2B00 (P302.00)** = "Multipoint [2]"

Setting of the V/f characteristic:

- Limiting factors for the V/f characteristic:
  - Rated mains voltage **0x2540:001 (P208.01)**
  - Minimum frequency **0x2915 (P210.00)**
  - Maximum frequency **0x2916 (P211.00)**
- The rated mains voltage is set as the base voltage **0x2B01:001 (P303.01)**. The rated mains voltage corresponds to the product key of the inverter. The base voltage is set to the rated motor voltage (motor nameplate specification).
- The base frequency **0x2B01:002 (P303.02)** is set to the rated motor frequency (motor nameplate data).
- The additional characteristic point is defined based on the parameters **0x2B01:003 (P303.03)** and **0x2B01:004 (P303.04)**.

Characteristic examples:

- Graphic on the left: the base voltage is set equal to rated mains voltage.
- Graphic on the right: the base voltage is set lower than the rated mains voltage.

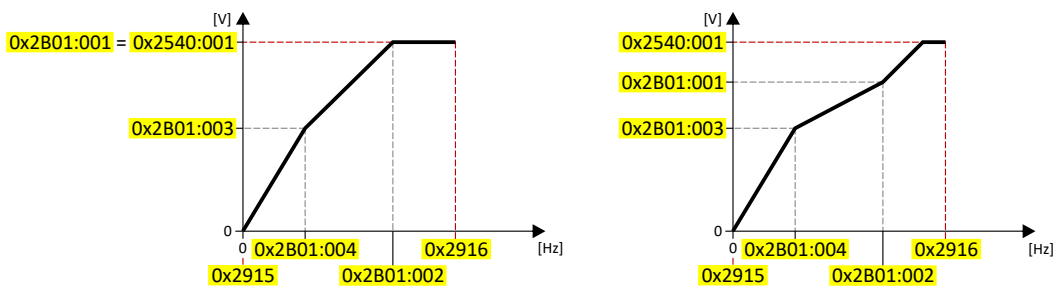

### Parameter

Address	Name / setting range / [default setting]	Information
0x2B01:003 (P303.03)	V/f shape data: Midpoint voltage (V/f shape data: Midpoint voltage) 0 ... [0] ... 5000 V • From version 03.00	Definition of the medium characteristic point for user-definable V/f characteristic. • Only relevant if V/f characteristic shape <b>0x2B00 (P302.00)</b> is set = "Adaptive [2]".
0x2B01:004 (P303.04)	V/f shape data: Midpoint frequency (V/f shape data: Midpoint freq) 0 ... [0] ... 1500 Hz • From version 03.00	



# Configuring the motor control

V/f characteristic control for asynchronous motor (VFC open loop)  
 Define V/f characteristic shape  
 Energy-saving V/f characteristic (VFC-Eco)

## 10.4.3.4 Energy-saving V/f characteristic (VFC-Eco)

In the case of the energy-saving V/f characteristic control (VFC-Eco), the motor voltage of the inverter is ascertained based on a linear characteristic as a function of the rotary field frequency or the motor speed to be generated. In addition, the motor is always operated in the optimum efficiency range by means of a  $\cos\phi$  control and the resulting voltage dip (reduction of copper losses in the asynchronous motor). This is useful for energy efficiency with applications such as conveyors, where the torque and energy requirements are high during acceleration, but lower as soon as the load reaches the stationary speed.

### Details

Select energy-saving V/f characteristic control with linear characteristic:

1. Motor control mode **0x2C00 (P300.00)** = "V/f characteristic control (VFC open loop) [6]"
2. V/f characteristic shape **0x2B00 (P302.00)** = "Eco [3]"

Setting of the V/f characteristic:

- The limiting factors for the V/f characteristic are the rated mains voltage **0x2540:001 (P208.01)**, the minimum frequency **0x2915 (P210.00)** and the maximum frequency **0x2916 (P211.00)**.
- The base voltage **0x2B01:001 (P303.01)** is usually set to the rated motor voltage (motor nameplate data). The base voltage is preset to the rated mains voltage. This in turn is preset according to the product key of the inverter. ▶ [Mains voltage](#) 47
- The base frequency **0x2B01:002 (P303.02)** is usually set to the rated motor frequency (motor nameplate data).

Eco efficiency range:

- The Eco efficiency range (grey) is between the V/f-standard characteristic (black) and the V/f Eco characteristic (green).
- The V/f Eco characteristic (green) is defined by the operating point that results from the minimum voltage **0x2B0D:001 (P330.01)** and the base frequency **0x2B01:002 (P303.02)**.
- The minimum voltage **0x2B0D:001 (P330.01)** has to be set in percent with reference to the base voltage **0x2B01:001 (P303.01)**.

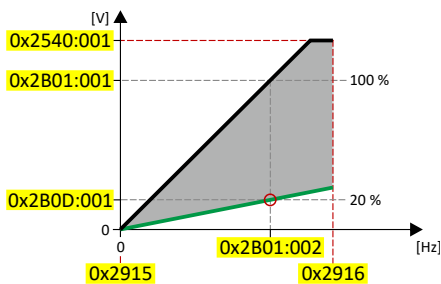

The actual output frequency can exceed the set maximum frequency if the gain for the slip compensation in **0x2B09:001 (P315.01)** is set to a value higher than 0.

### Parameter

Address	Name / setting range / [default setting]	Information
0x2B0D:001 (P330.01)	VFC-ECO: Minimum voltage (VFC-ECO: Min. voltage) 20 ... [20] ... 100 % • From version 02.00	Defining the operating point of the V/f eco characteristic. The V/f eco characteristic defines the lower limit of the eco efficiency range. • 100 % = Base voltage <b>0x2B01:001 (P303.01)</b>
0x2B0D:006 (P330.06)	VFC-ECO: Cos phi actual value (VFC-ECO: Cos Phi actual) • Read only • From version 02.00	

# Configuring the motor control

V/f characteristic control for asynchronous motor (VFC open loop)  
Define V/f characteristic shape  
User-definable V/f characteristic



## 10.4.3.5 User-definable V/f characteristic

The "user-definable V/f characteristic" is provided for the individual adjustment of the motor magnetization to the actual application if linear and square-law characteristics are not suitable.

- The characteristic is defined by means of 11 parameterizable grid points (voltage/frequency values).

### Parameter

Address	Name / setting range / [default setting]	Information
0x2B02:001	Frequency grid points (x) user V/f characteristic: x1 = f01 -1500 ... [0] ... 1500 Hz	Freely parameterizable V/f characteristic (values for X axis). These settings define the adaptive frequency values.
0x2B02:002	Frequency grid points (x) user V/f characteristic: x2 = f02 -1500 ... [0] ... 1500 Hz	
0x2B02:003	Frequency grid points (x) user V/f characteristic: x3 = f03 -1500 ... [0] ... 1500 Hz	
0x2B02:004	Frequency grid points (x) user V/f characteristic: x4 = f04 -1500 ... [0] ... 1500 Hz	
0x2B02:005	Frequency grid points (x) user V/f characteristic: x5 = f05 -1500 ... [0] ... 1500 Hz	
0x2B02:006	Frequency grid points (x) user V/f characteristic: x6 = f06 -1500 ... [0] ... 1500 Hz	
0x2B02:007	Frequency grid points (x) user V/f characteristic: x7 = f07 -1500 ... [0] ... 1500 Hz	
0x2B02:008	Frequency grid points (x) user V/f characteristic: x8 = f08 -1500 ... [0] ... 1500 Hz	
0x2B02:009	Frequency grid points (x) user V/f characteristic: x9 = f09 -1500 ... [0] ... 1500 Hz	
0x2B02:010	Frequency grid points (x) user V/f characteristic: x10 = f10 -1500 ... [0] ... 1500 Hz	
0x2B02:011	Frequency grid points (x) user V/f characteristic: x11 = f11 -1500 ... [0] ... 1500 Hz	





# Configuring the motor control

V/f characteristic control for asynchronous motor (VFC open loop)  
 Define V/f characteristic shape  
 User-definable V/f characteristic

Address	Name / setting range / [default setting]	Information
0x2B03:001	Voltage grid points (y) user V/f characteristic: y1 = U01 (x = f01) 0.00 ... [0.00] ... 5000.00 V	Freely parameterizable V/f characteristic (values for Y axis). These settings define the adaptive voltage values.
0x2B03:002	Voltage grid points (y) user V/f characteristic: y2 = U02 (x = f02) 0.00 ... [0.00] ... 5000.00 V	
0x2B03:003	Voltage grid points (y) user V/f characteristic: y3 = U03 (x = f03) 0.00 ... [0.00] ... 5000.00 V	
0x2B03:004	Voltage grid points (y) user V/f characteristic: y4 = U04 (x = f04) 0.00 ... [0.00] ... 5000.00 V	
0x2B03:005	Voltage grid points (y) user V/f characteristic: y5 = U05 (x = f05) 0.00 ... [0.00] ... 5000.00 V	
0x2B03:006	Voltage grid points (y) user V/f characteristic: y6 = U06 (x = f06) 0.00 ... [0.00] ... 5000.00 V	
0x2B03:007	Voltage grid points (y) user V/f characteristic: y7 = U07 (x = f07) 0.00 ... [0.00] ... 5000.00 V	
0x2B03:008	Voltage grid points (y) user V/f characteristic: y8 = U08 (x = f08) 0.00 ... [0.00] ... 5000.00 V	
0x2B03:009	Voltage grid points (y) user V/f characteristic: y9 = U09 (x = f09) 0.00 ... [0.00] ... 5000.00 V	
0x2B03:010	Voltage grid points (y) user V/f characteristic: y10 = U10 (x = f10) 0.00 ... [0.00] ... 5000.00 V	
0x2B03:011	Voltage grid points (y) user V/f characteristic: y11 = U11 (x = f11) 0.00 ... [0.00] ... 5000.00 V	

# Configuring the motor control

V/f characteristic control for asynchronous motor (VFC open loop)  
Set voltage boost



## 10.4.4 Set voltage boost

The parameterisable voltage boost makes it possible to improve the starting performance for applications requiring a high starting torque.



The function is equally suitable for the closed loop V/f characteristic control.

### Details

- In [0x2B12:001 \(P316.01\)](#), a permanent voltage boost can be set. ①
- In [0x2B12:002 \(P316.02\)](#), an additional voltage boost can be set for acceleration processes ②
- Reference for the percentage setting of the voltage boost is the base voltage [0x2B01:001 \(P303.01\)](#).

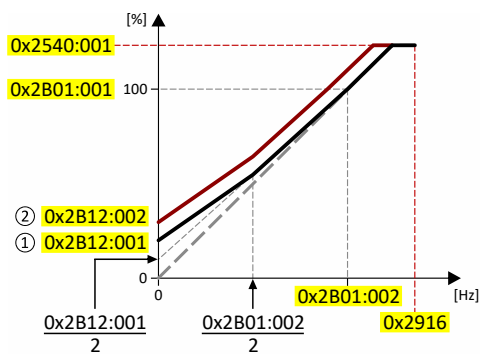

### Parameter

Address	Name / setting range / [default setting]	Information
0x2B12:001 (P316.01)	V/f voltage boost: Fixed boost (V/f boosts: Fixed V/f boost) 0.0 ... [2.5]* ... 20.0 % * Default setting dependent on the model.	Constant voltage boost for V/f characteristic control without feedback. <ul style="list-style-type: none"> <li>• 100 % = V/f base voltage <a href="#">0x2B01:001 (P303.01)</a></li> <li>• For the purpose of optimizing the start behavior for applications requiring a high starting torque.</li> </ul>
0x2B12:002 (P316.02)	V/f voltage boost: Boost at acceleration (V/f boosts: Dynam. V/f boost) 0.0 ... [0.0] ... 20.0 %	Additional voltage boost for V/f characteristic control without feedback. <ul style="list-style-type: none"> <li>• 100 % = V/f base voltage <a href="#">0x2B01:001 (P303.01)</a></li> <li>• This voltage boost is only active while the motor is accelerated. It then acts in addition to the fixed voltage boost set in <a href="#">0x2B12:001 (P316.01)</a>.</li> </ul>



## 10.4.5 Set slip compensation

The speed of an asynchronous motor decreases as load is applied. This load-dependent speed drop is called "slip". The slip compensation serves to counteract the load-dependent speed loss.

### Preconditions

The function is only effective in the motor control type "V/f characteristic control (VFC open loop)".

In order for the function to generate the rated slip correctly the following parameters must be correctly set:

- Rated speed
- Rated frequency
- Number of pole pairs (automatically calculated from Rated speed and Rated frequency)

### Details

The slip compensation increases or decreases the output frequency as a response to a load change. Thus, the slip is counteracted and the speed is kept constant.

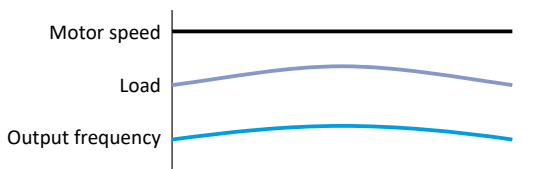

The rated slip required for the slip compensation is calculated by the inverter according to the following formula:

$$\text{Rated slip [\%]} = (1 - (\text{rated motor speed [rpm]} / (120 * \text{rated motor frequency [Hz]} / \text{number of poles}))) * 100$$

Calculation example:

- Rated motor speed = 1750 rpm
- Rated motor frequency = 60 Hz
- Number of poles = 2 \* Number of pole pairs = 2 \* 2 = 4
- Rated slip =  $(1 - (1750 / (120 * 60 / 4))) * 100 = 2.77 \%$

The rated slip represents the reduction of the motor speed due to the motor load. At full speed and full load, the motor given in the example would rotate with 1750 rpm, which means 2.77 % below its synchronous speed of 1800 rpm. In order to compensate for this speed loss, the inverter increases the output frequency by the rated slip multiplied by the rated motor frequency. In the example, there is an increase in the output frequency at full load of  $2.77 \% * 60 \text{ Hz} = 1.66 \text{ Hz}$ .

In order to take into account load changes, the influence of the rated slip on the output frequency can be adapted in [0x2B09:001 \(P315.01\)](#). A setting of 100 % corresponds to the rated slip of the motor in the nominal operating point.

With reference to the example above and a setpoint frequency of 60 Hz:

- If [0x2B09:001 \(P315.01\)](#) = 100 %, the output frequency is = 61.66 Hz (60 Hz + 100 % \* 1.66 Hz).
- If [0x2B09:001 \(P315.01\)](#) = 50 %, the output frequency is = 60.83 Hz (60 Hz + 50 % \* 1.66 Hz).

Additionally, the filter time for the slip compensation can be adapted in [0x2B09:002 \(P315.02\)](#) if required. The preset filter time is adapted to typical motors. If full load or nearly full load oscillations or instabilities occur, we recommend an increase of the filter time.

# Configuring the motor control

V/f characteristic control for asynchronous motor (VFC open loop)  
Set slip compensation



## Parameter

Address	Name / setting range / [default setting]	Information
0x2B09:001 (P315.01)	Slip compensation: Gain (Slip compens.: Slip: gain) -200.00 ... [100.00] ... 200.00 %	Adjustment in percent of the slip calculated. <ul style="list-style-type: none"><li>• For instance required for deviations of the real motor data from the nameplate data.</li><li>• A setting of 100 % corresponds to the rated slip of the machine in the nominal operating point.</li></ul>
0x2B09:002 (P315.02)	Slip compensation: Filter time (Slip compens.: Filter time) 1 ... [100] ... 6000 ms	Filter time for the slip compensation. <ul style="list-style-type: none"><li>• The preset filter time is adapted to typical motors.</li></ul>
0x2C02:004 (P351.04)	Motor parameter (ASM): Slip frequency (ASM motor par.: Slip frequency) <ul style="list-style-type: none"><li>• Read only: x.x Hz</li></ul>	Display of the rated slip determined.



### 10.4.6 Set oscillation damping

The oscillation damping serves to reduce the oscillations during no-load operation which are caused by energy oscillating between the mechanical system (mass inertia) and the electrical system (DC bus). Furthermore, the oscillation damping can also be used to compensate for resonances.



The function is equally suitable for the closed loop V/f characteristic control.

#### Restrictions

Observe the following restrictions:

- Damping is possible only for constant oscillations at a steady-state operating point.
- Oscillations occurring sporadically cannot be damped.
- Oscillation damping is not suitable for oscillations occurring during dynamic processes (e.g. accelerations or load changes).
- Oscillation damping is only active if the setpoint speed is greater than 10 rpm and the DC-bus voltage exceeds a value of 100 V.

#### Details

The determination of the oscillation is based on the active current. In order to obtain the alternating component of the active current, this current is differentiated. This signal is then passed through a PT1 filter.

#### Identification of the oscillation

Before the oscillation damping function can be parameterised, the oscillation has to be identified. One way to do this is to examine the motor current while oscillation damping is switched off (gain = 0 %). At steady-state operation, a constant current flows. If the drive oscillates, these oscillations are also visible on the motor current. It is therefore possible to determine the frequency and the amplitude of the oscillation from the alternating component of the motor current. In the following, this alternating component is referred to as "current oscillation".

#### Parameter setting

Set the gain of the oscillation signal according to the following equation:

$$0x2B0A:001 \text{ (P318.01)} = \text{current amplitude} * 100 \% / (\sqrt{2} * \text{maximum device current})$$

The default time constant of the PT1 filter is sufficient for most applications. If required, it is only possible to adapt the time constant via »EASY Starter«. Generally, the time constant must be set so that the oscillation is dampened and higher-frequency components are filtered from the signal. The time constant is given by the reciprocal value of double the current oscillation frequency:

$$0x2B0A:002 \text{ (P318.02)} = 1 / (2 * \text{oscillation frequency})$$

#### Parameter

Address	Name / setting range / [default setting]	Information
0x2B0A:001 (P318.01)	Oscillation damping: Gain (Oscillat. damp.: Gain) -400 ... [150] ... 400 %	Gain of the oscillation signal. • With the setting 0, oscillation damping is deactivated.
0x2B0A:002 (P318.02)	Oscillation damping: Filter time (Oscillat. damp.: Filter time) 1 ... [30] ... 600 ms	Time constant of the PT1 filter.

# Configuring the motor control

V/f characteristic control for asynchronous motor (VFC open loop)  
Optimising the stalling behaviour



## 10.4.7 Optimising the stalling behaviour

If the motor is driven with frequencies above the rated motor frequency, the operating point is shifted to the "field weakening range". In this range, the motor voltage does not increase proportionately to the output frequency anymore. As a consequence, the inverter automatically reduces the maximum current since the full torque is not available anymore at these frequencies.

For special motors which enable an operation in the field weakening range, the behaviour in the field weakening range can be adapted to the motor with [0x2B0C \(P319.00\)](#).

### DANGER!

Danger by incorrect parameterisation.

Possible consequences: Death, severe injuries or damage to property

- ▶ Only change the default setting (0 Hz) in [0x2B0C \(P319.00\)](#) after consulting the motor manufacturer!
- ▶ Recommendation: Maintain default setting (0 Hz).



---

The function is equally suitable for the closed loop V/f characteristic control.

---



## Details

The operating range of an asynchronous motor consists of the voltage range ① and the field weakening range. The field weakening range is divided into two ranges:

- In the first range ②, the power can be kept constant without the motor stalling.
- The second field weakening range ③ is characterised by the fact that the maximum permissible stator current is decreased to prevent the motor from stalling.

### Speed/torque curve of the asynchronous motor with two field weakening ranges

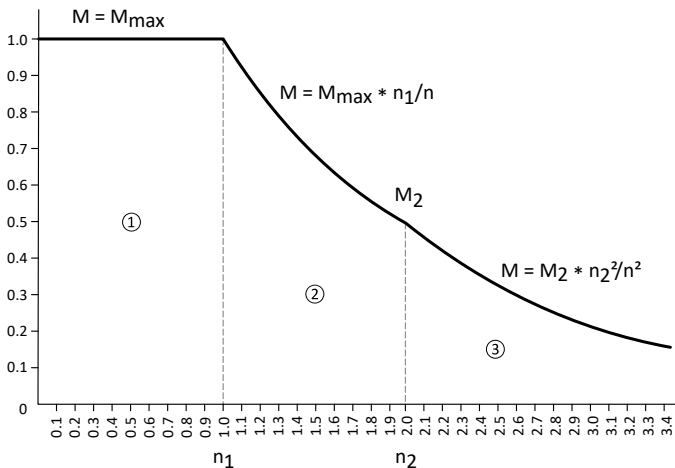

The override point ( $n_2, M_2$ ) can be influenced with `0x2B0C (P319.00)`.

`0x2B0C (P319.00) > 0 Hz:`

- The maximum current characteristic is shifted to higher field frequencies by the frequency entered.
- The maximum permissible current and the maximum torque increase in the field weakening range.
- The risk of motor stalling increases.

`0x2B0C (P319.00) < 0 Hz:`

- The maximum current characteristic is shifted to lower field frequencies by the frequency entered.
- The maximum permissible current and the maximum torque are reduced in the field weakening range.
- The risk of motor stalling is reduced.

## Parameter

Address	Name / setting range / [default setting]	Information
0x2B0C (P319.00)	Override field weakening (Field weak thold) -599.0 ... [0.0] ... 599.0 Hz	Offset of the override point for field weakening.
	Override field weakening (Field weak thold) -599.0 ... [-40.0] ... 599.0 Hz	

# Configuring the motor control

V/f characteristic control for asynchronous motor (VFC open loop)  
Torque limitation setting



## 10.4.8 Torque limitation setting

### Intro

For torque limitation in VFC mode, a maximum torque can be set for the inverter. If the motor torque exceeds the torque limit, the inverter modifies the output frequency to counteract this exceedance.



The quality of the torque limitation depends on the accuracy of the actual torque calculation.

### Preconditions

The VFC torque limiter is only effective for the following motor control types:

- V/f control (open loop)
- V/f control (closed loop)

In order to achieve good performance, it is recommended that the motor/inverter first be identified!

▶ [Options for optimizing the control loops](#) 238

### Details

The VFC torque limiter becomes active in V/f operation when the current motor torque exceeds the maximum torque. The limiter modifies the output frequency to counteract the exceedance.

The VFC torque limitation functions in a manner similar to the VFC I<sub>max</sub> controller, but instead of the total current, the actual torque is taken into account.

When the maximum torque is exceeded:

- During motor operation, the VFC torque limiter reduces the output frequency.
- During generator operation, the VFC torque limiter increases the output frequency.

▶ [Configuring the torque control](#) 161

### Parameter

Address	Name / setting range / [default setting]	Information
0x2B10:001	V/f torque limitation: Gain 0.00 ... [0.00] ... 655.35 %	Gain of the torque limitation. <ul style="list-style-type: none"><li>• 0%: torque limitation is deactivated (standard setting)</li><li>• 100%: same dynamic behaviour as the I<sub>max</sub> controller (recommended setting for VFC torque activation)</li></ul>









### 10.4.9 Flying restart circuit

The flying restart function makes it possible to restart a coasting motor on the fly during operation without speed feedback. Synchronicity between the inverter and the motor is coordinated so that the transition to the rotating drive is effected without jerk at the time of connection.

#### Preconditions

- Drive systems with speed feedback do not need a flying restart circuit because there is always a jerk-free synchronisation to the feedback speed.
- The flying restart circuit operates safely and reliably in case of drives with high centrifugal masses. If several motors with different centrifugal masses are connected to the inverter, the flying restart circuit must not be used.
- The flying restart circuit serves to identify rotating field frequencies of up to maximally  $\pm 200$  Hz.
- Especially at high power, very high mass inertias and mains voltages higher than 440 V, a temporary overvoltage in the DC bus may occur. The use of a brake resistor can prevent this behaviour. ▶ [Use of a brake resistor](#)  589

Required settings before the flying restart circuit is used:

1. The motor data must be set correctly. ▶ [Motor data](#)  57
2. The settings for the current controller and the flying restart controller must be adapted to the motor. The settings are made automatically if one of the following optimisations is carried out:
  - ▶ [Select motor from motor catalog](#)  58
  - ▶ [Automatic motor identification \(energized\)](#)  241
  - ▶ [Automatic motor calibration \(non-energized\)](#)  243

#### Details

The inverter determines synchronicity by identifying the synchronous rotating field frequency. The "search" starts in the positive direction.

Duration:

- The flying restart process is determined within approx. 0.5 ... 1.5 seconds.
- The duration is influenced by the start frequency [0x2BA1:001 \(P718.01\)](#).

Setting the function:

1. As start behavior, set the selection "Flying restart circuit [2]" in [0x2838:001 \(P203.01\)](#).
  - Thus, every inverter enable causes a synchronisation to the rotating or standing motor.
  - After the inverter has been enabled, the motor can temporarily start or reverse if drives with low friction and low mass inertia are used.
  - If the inverter is operated with the default settings, no further settings are required for most applications.
2. If required, adapt the current [0x2BA1:001 \(P718.01\)](#) and the start frequency [0x2BA1:002 \(P718.02\)](#) for the flying restart circuit.
  - Setting notes can be found in the "Info" column for the respective parameter.

For diagnostic purposes, the frequency detected when the motor has been restarted on the fly is displayed in [0x2BA1:008 \(P718.08\)](#).

# Configuring the motor control

V/f characteristic control for asynchronous motor (VFC open loop)  
Flying restart circuit



## Parameter

Address	Name / setting range / [default setting]	Information
0x2BA1:001 (P718.01)	Flying restart circuit: Current (Flying restart: Current) 0 ... [30] ... 100 %	The current set here is injected into the motor during the flying restart process for the identification of the rotating field frequency. <ul style="list-style-type: none"> <li>• 100 % = Rated motor current 0x6075 (P323.00)</li> <li>• Reducing the current causes a reduction of the motor torque during the flying restart process. A short-time starting action or reversing of the motor is prevented with low flying restart currents.</li> <li>• If the current is set too low, the rotating field frequency cannot be identified correctly.</li> <li>• If the current is increased, this improves the robustness of the flying restart circuit.</li> <li>• In case of high mass inertias and high speeds, the flying restart circuit may cause an overvoltage in the DC bus if no brake resistor is connected. In this case, the current must be reduced.</li> </ul>
0x2BA1:002 (P718.02)	Flying restart circuit: Start frequency (Flying restart: Start frequency) -599.0 ... [20.0] ... 599.0 Hz	The frequency set here defines the starting point for the flying restart process. <ul style="list-style-type: none"> <li>• The search starts in positive direction.</li> <li>• The default setting is adjusted to standard asynchronous motors.</li> <li>• In case of systems with a known search speed (e.g. torque-controlled drive systems that are to synchronise to a defined speed), the start frequency can be adapted for reducing the flying restart time.</li> </ul>
0x2BA1:008 (P718.08)	Flying restart circuit: Flying restart frequency (Flying restart: Fl.res.frequency) • Read only: x.x Hz	Display of the found frequency at which the motor has been successfully restarted on the fly.



### 10.4.10 Additive voltage impression

This function serves to boost (or lower) the motor voltage from the process via an additive voltage setpoint in order to realise a load adjustment (for instance in case of winder applications).



The function is equally suitable for the closed loop V/f characteristic control.

#### NOTICE

A too high boost of the motor voltage may cause the motor to heat up strongly due to the resulting current.

► Avoid a too high boost of the motor voltage!

#### Details

At a constant field frequency, the output voltage of the inverter can be changed within a wide range.

Example: Adaptation of the voltage characteristic in case of V/f characteristic control as a function of the load:

- Forward (CW) is operation in motor mode: Boost voltage.
- Reverse (CCW) is operation in generator mode: Lower voltage.

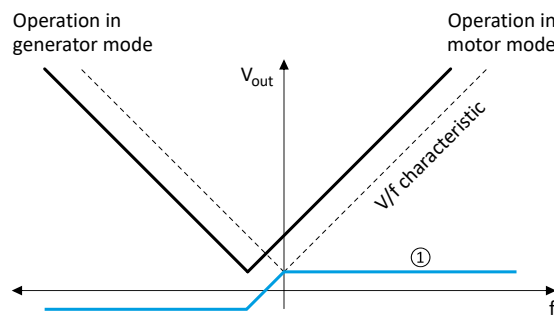

① Selecting an additive voltage setpoint

#### Parameter

Address	Name / setting range / [default setting]	Information
0x2B13:001	Additive voltage impression: Enable Function • From version 02.00	1 = enable function.
	0 Disable 1 Enable	
0x2B13:002	Additive voltage impression: Setpoint source • From version 02.00	Selection of the source for specifying the additive voltage setpoint. • 100 % = Rated voltage <a href="#">0x2C01:007 (P320.07)</a>
	1 Analog input 1	The additive voltage setpoint is defined via the mappable NetWordIN5 <a href="#">0x4008:005 (P590.05)</a> data word.
	2 Analog input 2	
	3 Network	
	201 Internal value (from version 05.03)	Internal values of the manufacturer.
	202 Internal value (from version 05.03)	
	203 Internal value (from version 05.03)	
	204 Internal value (from version 05.03)	
205 Internal value (from version 05.03)		
206 Internal value (from version 05.03)		
0x2B13:003	Additive voltage impression: Actual voltage • Read only: x V • From version 02.00	Display of the current (boosted or lowered) voltage.

# Configuring the motor control

V/f characteristic control for asynchronous motor (VFC open loop)  
Additive voltage impression



Address	Name / setting range / [default setting]	Information
0x2B13:004	Additive voltage impression: Ramp time 0.0 ... [0.0] ... 3600.0 s • From version 06.02	Ramp time for ramping up the required additive voltage setpoint. • The ramp time is effective after each activation of the inverter. • The ramp time refers to the rated voltage 0x2C01:007 (P320.07).

## Example: Using the function with a 400-V inverter

With the settings indicated below, the motor is accelerated after the start to 50 Hz. As the base frequency, however, is set very high (here: 599 Hz), the motor voltage at 50 Hz only amounts to 20 VAC.

Now, the analog input 1 serves to change the motor voltage at constant frequency within a wide range:

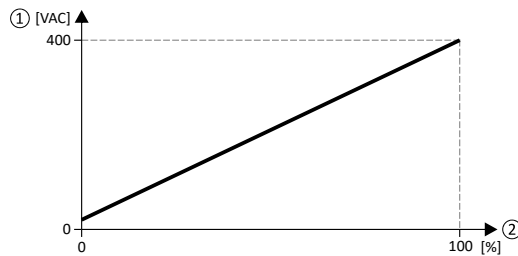

- ① Motor voltage
- ② Selection of an additive voltage setpoint in percent via analog input 1  
The setting range (here: 0 ... 100 %) can be adapted via the parameters "Min PID value" and "Max PID value".

Parameter	Designation	Setting for this example
0x2636:004 (P430.04)	Analog input 1: Min PID value	0 %
0x2636:005 (P430.05)	Analog input 1: Max PID value	100 %
0x2860:001 (P201.01)	Frequency control: Default setpoint source	Frequency preset 1 [11]
0x2911:001 (P450.01)	Frequency setpoint presets: Preset 1	50 Hz
0x2B01:002 (P303.02)	V/f shape data: Base frequency	599 Hz
0x2B13:001	Additive voltage impression: Enable Function	Enable [1]
0x2B13:002	Additive voltage impression: Setpoint source	Analog input 1 [1]



## 10.5 V/f characteristic control for asynchronous motor (VFC closed loop)

The V/f characteristic control with feedback (VFC closed loop) can be used if an asynchronous motor with motor encoder is connected to the inverter.

The speed feedback leads to the following advantages:

- Stationary speed accuracy
- Improved dynamics compared to the V/f characteristic control without feedback (VFC open loop) and to the encoderless vector control (SLVC)

### Preconditions

- The V/f characteristic control (VFC closed loop) is only suitable for asynchronous motors.
- The V/f characteristic control (VFC closed loop) requires a feedback of the speed. A motor encoder must be connected to the inverter and set as feedback system for the motor control.
  - This setting is not made automatically if a motor is selected from the motor catalog.
  - For required settings see chapter "HTL encoder". [📖 176](#)
- If you actuate a drive with a square-law V/f characteristic: check whether the corresponding drive is suitable for operation with a square-law V/f characteristic!
- From the motor nameplate data, at least the rated speed and rated frequency must be entered, so that the inverter can calculate the correct number of pole pairs. [▶ Motor data](#)  
[📖 57](#)

### NOTICE

Motor damage!

Operating the motor above the rated motor frequency/rated voltage will lead to damage to the motor.

- ▶ Only operate above the rated motor frequency / rated voltage with the permission of the motor manufacturer.

### Details

- [0x2B00 \(P302.00\)](#) provides different characteristic shapes.
- Limiting factors for the V/f characteristic are the rated mains voltage [0x2540:001 \(P208.01\)](#), the minimum frequency [0x2915 \(P210.00\)](#) and the maximum frequency [0x2916 \(P211.00\)](#).
- The slip compensation is deactivated in this motor control type. In case of V/f characteristic control with feedback, the slip is calculated and injected by the slip controller. [▶ Slip controller](#) [📖 254](#)
- For more details, see the description of the motor control type:
  - "V/f characteristic control for asynchronous motor (VFC open loop)" [📖 193](#)
  - "Set voltage boost" [📖 202](#)

# Configuring the motor control

V/f characteristic control for asynchronous motor (VFC closed loop)  
Required commissioning steps



## 10.5.1 Required commissioning steps

1. [Configuring the feedback system](#) 175
2. Activate motor control type: **0x2C00 (P300.00)** = "V/f characteristic control (VFC closed loop) [7]".
3. Set limiting factors for the V/f characteristic:
  1. Rated mains voltage **0x2540:001 (P208.01)**
  2. Minimum frequency **0x2915 (P210.00)**
  3. Maximum frequency **0x2916 (P211.00)**
4. Set V/f characteristic data:
  1. Base voltage **0x2B01:001 (P303.01)**
  2. Base frequency **0x2B01:002 (P303.02)**
5. Select a characteristic shape suitable for the application in **0x2B00 (P302.00)**.
6. Optional settings:
  - [Set voltage boost](#) 202
  - [Set oscillation damping](#) 205
  - [Optimising the stalling behaviour](#) 206
  - [Additive voltage impression](#) 211
  - [Slip controller](#) 254
7. Optional: carry out optimisation of the control circuits.
  - A optimisation of the control loops is not mandatory for this motor control type but may lead to a better control mode.
  - Details: [Options for optimizing the control loops](#) 238



## 10.6 Sensorless control for synchronous motor (SLSM-PSM)



---

This control mode is not available in the version with network IO-Link!

---

The sensorless control for synchronous motors is based on a decoupled, separated control of the torque-producing current and the current aligned with the field. In contrast to the servo control with position encoder, the actual speed value and rotor position are reconstructed via a motor model.

Compared to the sensorless "SL-PSM" control, the "SLSM-PSM" control offers the following advantages:

- Lower power consumption and more torque through HF injection in the lower speed range
- Easier commissioning by supporting automatic identification/calibration of the motor



## Details

The operating behavior of sensorless control for synchronous motors is divided into two areas due to its principle:

- Low speed range: An unobservable range of low speeds.
- High speed range: Range with high speeds in which the rotor position can be calculated for field-oriented control by means of an observer.

The motor model-based approach to control includes two different methods for the low-speed range:

- Low-speed method [0x2C13](#) = "Carrier based [1]"
  - This method is not suitable for all permanently excited synchronous motors! The position detection requires an anisotropy in the inductors of the motor. From approx. 5 % difference between the inductance  $L_d$  ([0x2C03:005 \(P352.05\)](#)) and the inductance  $L_q$  ([0x2C03:006 \(P352.06\)](#)) this method can be used.
  - Permanently excited synchronous motors with buried magnets and distributed stator winding are particularly suitable. Permanently excited synchronous motors with concentrated windings tend to be less suitable.
  - With this method, a high-frequency carrier signal is applied in the low-speed range ("HF injection"). With this active method it is possible to detect the rotor position and to operate the motor speed controlled. This results in a higher starting torque with lower power consumption. The control is field oriented.



---

Motor phase failure detection is deactivated if HF injection is active in the low-speed range.

---

- Low-speed method [0x2C13](#) = "i/f based [2]"
  - This method is suitable for all permanently excited synchronous motors.
  - With this method, a controlled start-up occurs in the low-speed range.

Behavior in the high-speed range

- In the high-speed range ( $|\text{setpoint speed}| > \text{lower limit } \text{0x2C11:001}$  or ( $|\text{actual speed}| > \text{0x2C10:008}$ ) the rotor flux position and the speed is reconstructed by means of observation.
- The control is field oriented. Only the current required for generating the necessary torque is injected.

Pole position identification (PPI)

- For controlling a permanent-magnet synchronous motor, the pole position - the angle between the motor phase U and the field axis of the rotor - must be known.
- If the drive is at standstill, the "pole position identification (PPI)" function is immediately activated after the inverter is enabled. ▶ [Synchronous motor: Pole position identification \(PPI\)](#) 183

Flying restart circuit

- A flying restart circuit for the synchronous motor up to the rated speed is supported.
- If the flying restart circuit is to be used, set the start method "Flying restart circuit [2]" in [0x2838:001 \(P203.01\)](#). Additional settings are not required for the flying restart circuit in the case of a sensorless control of a synchronous motor.





## 10.6.1 Required commissioning steps

1. Activate motor control type: [0x2C00 \(P300.00\)](#) = "Sensorless control for synchronous motors (SLSM-PSM) [8]".
2. [Automatic motor identification \(energized\)](#) [□ 241](#)
  - **Mandatory for this motor control mode in order to determine the equivalent circuit data and calculate the parameters for encoderless operation with HF injection.**
3. Optionally for a speed control with torque limitation in operating mode [0x6060 \(P301.00\)](#) = "MS: Velocity mode [-2]":
  - Select the source in [0x2949:001 \(P337.01\)](#) for the positive torque limit source and set it accordingly.
  - Select the source in [0x2949:002 \(P337.02\)](#) for the negative torque limit source and set it accordingly.
4. Optionally for a speed control with torque limitation in operating mode [0x6060 \(P301.00\)](#) = "CiA: Velocity mode (vl) [2]":
  - Set the positive torque limit in [0x60E0](#)
  - Set the negative torque limit in [0x60E1](#).



## 10.6.2 Expert settings

For the motor model-based approach to control, two different methods are available for the low-speed range in [0x2C13](#).

Low-speed method [0x2C13](#) = "Carrier based [1]"

- In the unobservable range of low speeds ( $|\text{actual speed}| < \text{0x2C10:008}$ ), a high-frequency carrier signal is switched on ("HF injection").
- The amplitude of this carrier signal is set in [0x2C10:001](#). Larger values lead to better position detection. If the value is set too small, then the amplitude of the carrier signal is automatically increased after controller release. This ensures that HF injection always works regardless of the setting in [0x2C10:001](#).
- The two parameters [0x2C10:001](#) and [0x2C10:008](#) can be identified automatically or set manually. The settings for the two parameters are not provided by the motor catalog!

Low-speed method [0x2C13](#) = "i/f based [2]"

- A controlled start-up takes place when  $|\text{setpoint speed}| < \text{lower limit 0x2C11:001}$ .
- During the acceleration phase, the [0x2C12:001](#) and [0x2C12:002](#) current setpoints are added and impressed on the motor.
- This method is suitable for all permanently excited synchronous motors.

### NOTICE

With the Low-Speed method [0x2C13](#) = "i/f based [2]", an adjustable constant current is impressed in the lower speed range. If this current is higher than the rated motor current, the motor may heat up in the lower speed range. This effect increases if the motor is operated in the lower speed range for a longer period of time.

Possible consequences: Irreversible damage of the motor

- ▶ Do not operate the motor for a longer period of time in the lower speed range.
- ▶ For detecting and monitoring the motor temperature, we recommend a temperature feedback via PTC thermistor or thermal contact. ▶ [Motor temperature monitoring](#) 261

### Parameter

Address	Name / setting range / [default setting]	Information
0x2C13	SLSM-PSM low speed method • From version 03.00	Selection of the method for the lower speed range in sensorless control for synchronous motor (SLSM-PSM).
	1 Carrier based	Encoderless operation with HF injection. Not suitable for MCS motors!
	2 i/f based	Encoderless operation with controlled start-up. Universally suitable for all motors. Note! With this low-speed method, the set torque limits are only active in the higher speed range (closed-loop mode)!
0x2C10:001	HF amplitude 0.0 ... [50.0] ... 400.0 V • From version 02.00	Setting of the HF amplitude for low speed method "Carrier based".
0x2C10:008	HF injection range 0.5 ... [6.0] ... 50.0 % • From version 05.03	Setting of the speed range with HF injection for low speed method "Carrier based".

### Related topics

- ▶ [Stalling protection](#) 189



## 10.7 Parameterisable motor functions

### 10.7.1 Skip frequencies

By means of the three parameterisable skip frequencies, critical frequencies can be suppressed which lead to mechanical resonances in the system.

#### Details

A blocking zone is active as soon as the frequency for this blocking zone is set to a value  $\neq$  "0 Hz".

- The frequency defines the center of the range to be masked out. ①
- The bandwidth defines its total size. ②

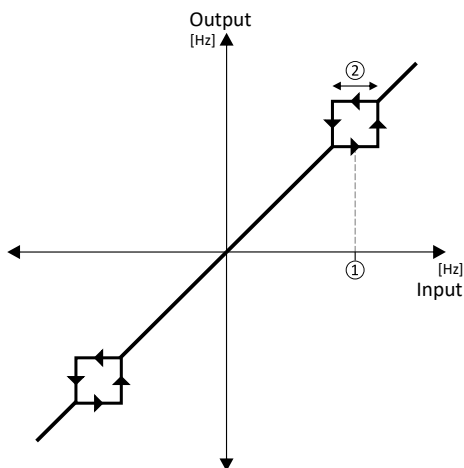

Example: For a blocking zone, the frequency is set to 20 Hz and the bandwidth to 10 Hz. These settings mask out the range from 15 Hz to 25 Hz.

#### Notes:

- Skip frequencies are absolute values. With the setting "20 Hz", at the same time also the skip frequency "-20 Hz" is defined.
- The inverter accelerates/decelerates the motor through the range to be masked out. Continuous operation within this range is not possible.
- A blocking zone is not active if its bandwidth is set to "0 Hz".

#### Adjacent and overlapping areas:

- Example on the left: If the ranges are closely spaced, the ranges are passed through as shown.
- Example on the right: If the ranges overlap, the lowest and highest value form a new range. In the status display `0x291F:016`, both ranges are shown as active.

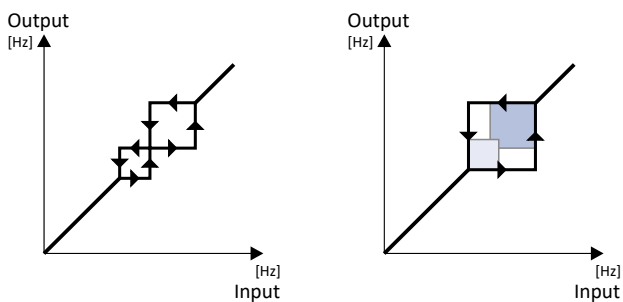

# Configuring the motor control

Parameterisable motor functions  
Skip frequencies



Valid and invalid ranges:

- Example on the left: Skip frequency = 5 Hz, bandwidth = 10 Hz  
→ Valid range (starts at  $\geq 0$ )
- Example on the right: Skip frequency = 4 Hz, bandwidth = 10 Hz  
→ Invalid range (starts at  $< 0$ ); is thus ignored.

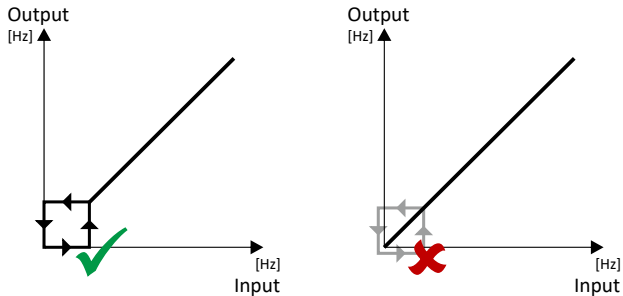

## Parameter

Address	Name / setting range / [default setting]	Information
0x291F:001 (P317.01)	Skip frequencies: Skip frequency 1 (Skip frequencies: Skip frequency 1) 0.0 ... [0.0] ... 599.0 Hz	Center of frequency range 1 which is to be skipped.
0x291F:002 (P317.02)	Skip frequencies: Skip bandwidth 1 (Skip frequencies: Skip bandwidth 1) 0.0 ... [0.0] ... 10.0 Hz	Size of frequency range 1 which is to be skipped.
0x291F:003 (P317.03)	Skip frequencies: Skip frequency 2 (Skip frequencies: Skip frequency 2) 0.0 ... [0.0] ... 599.0 Hz	Center of frequency range 2 which is to be skipped.
0x291F:004 (P317.04)	Skip frequencies: Skip bandwidth 2 (Skip frequencies: Skip bandwidth 2) 0.0 ... [0.0] ... 10.0 Hz	Size of frequency range 2 which is to be skipped.
0x291F:005 (P317.05)	Skip frequencies: Skip frequency 3 (Skip frequencies: Skip frequency 3) 0.0 ... [0.0] ... 599.0 Hz	Center of frequency range 3 which is to be skipped.
0x291F:006 (P317.06)	Skip frequencies: Skip bandwidth 3 (Skip frequencies: Skip bandwidth 3) 0.0 ... [0.0] ... 10.0 Hz	Size of frequency range 3 which is to be skipped.
0x291F:016	Skip frequencies: Status • Read only Bit 0 Blocking zone 1 active Bit 1 Blocking zone 2 active Bit 2 Blocking zone 3 active Bit 4 Frequency above blocking zone 1 Bit 5 Frequency above blocking zone 2 Bit 6 Frequency above blocking zone 3 Bit 8 Blocking zone 1 invalid Bit 9 Blocking zone 2 invalid Bit 10 Blocking zone 3 invalid	Bit-coded status display of the skip frequencies.
0x291F:032	Skip frequencies: Input frequency • Read only: x.xx Hz	Display of the skip filter input frequency.
0x291F:033	Skip frequencies: Output frequency • Read only: x.xx Hz	Display of the skip filter output frequency.



## 10.7.2 DC braking

The "DC braking" function generates a braking torque by injecting a DC current into the motor. The function can be used to shorten the braking of a load with high mass inertia. Another application is holding the motor shaft before starting or while stopping.

### NOTICE

Avoid long-time activation of the "DC braking" function with a high braking current or a high braking voltage!

Possible consequences: thermal motor overload

- ▶ Only use the "DC braking" function with applications in which the load is only occasionally stopped.
- ▶ Do not activate the "DC braking" function longer than necessary.

### Preconditions

The "DC braking" function can only be activated if the inverter is enabled.

This function is not available for the SL-PSM motor control mode [0x2C00 \(P300.00\)](#).

### Details

The function can be used as follows:

1. Automatically when the motor is started.
2. Automatically when the motor is stopped.
3. Manually (via the flexible I/O configuration).

The three options can also be combined, for instance automatic DC braking when starting and stopping the motor.

For further details and configuration examples, see the following subchapter:

- ▶ [Example: Automatic DC braking when starting the motor](#) 222
- ▶ [Example: Automatic DC braking when stopping the motor](#) 223
- ▶ [Activating DC braking manually](#) 225
- ▶ [Migration of Lenze Inverter Drives 8200/8400](#) 227

### Parameter

Address	Name / setting range / [default setting]	Information
0x2B84:001 (P704.01)	DC braking: Current (DC braking: Current) 0.0 ... [0.0] ... 200.0 %	Braking current for DC braking. • 100 % = Rated motor current <a href="#">0x6075 (P323.00)</a>
0x2B84:002 (P704.02)	DC braking: Automatic hold time (DC braking: Hold time autom.) 0.0 ... [0.0] ... 1000.0 s	Hold time for automatic DC braking. • The "Automatic DC braking" function is active for the time set here. • 1000.0 = infinite Note! Do not set this parameter to the value "1000.0" (infinite) if the DC braking is used during the start. The "Infinite" setting can be used to lock the rotor for an indefinite time while a stop is active. However, ensure here that the longer DC braking does not cause a thermal overload of the motor!
0x2B84:003 (P704.03)	DC braking: Automatic operating threshold (DC braking: Threshold autom.) 0.0 ... [0.0] ... 599.0 Hz	Operating threshold for automatic DC braking. • With the setting 0, the "Automatic DC braking" function is deactivated.
0x2B84:004 (P704.04)	DC braking: Demagnetization time (DC braking: Demagnet. time) 0 ... [100] ... 150 % • From version 04.00	In the default setting, the DC braking is activated after the standard demagnetising time has elapsed. This parameter can be used to adapt the time. • 100 % = Default demagnetization time <a href="#">0x2B84:005 (P704.05)</a> Note! A too short demagnetising time can cause an overcurrent error!

# Configuring the motor control

Parameterisable motor functions

DC braking

Example: Automatic DC braking when starting the motor



Address	Name / setting range / [default setting]	Information
0x2B84:005 (P704.05)	DC braking: Default demagnetization time (DC braking: Def. demag. time) • Read only: x ms • From version 04.00	Display of the standard demagnetising time as a setting help for the user. • This time is calculated by the inverter: Demagnetising time = 7 * rotor time constant
0x2B84:006 (P704.06)	DC braking: Inverter disable (DC braking: Inverter disable)	1 = behaviour in case of automatic DC braking as with the Lenze Inverter Drives 8200/8400. The behaviour of the Lenze Inverter Drives 8200/8400 in case of automatic DC braking is different: In case of these inverters, after the auto DCB hold time has elapsed, the motor is deenergised (by means of pulse inhibit) until the setpoint exceeds the auto DCB operating threshold. In order to make a migration to the i500 inverter series easier, the setting "1" serves to activate the same behaviour in the i500.
	0 Disabled 1 Activated	

## 10.7.2.1 Example: Automatic DC braking when starting the motor

In order that the DC braking is automatically active when the motor is started, the start method "DC braking [1]" must be set in [0x2838:001 \(P203.01\)](#).

- The DC braking is carried out with the braking current set in [0x2B84:001 \(P704.01\)](#).
- Only after the hold time [0x2B84:002 \(P704.02\)](#) has elapsed, the motor is accelerated to the setpoint.

Parameter	Designation	Setting for this example
<a href="#">0x2631:001 (P400.01)</a>	Enable inverter	Digital input 1 [11]
<a href="#">0x2631:002 (P400.02)</a>	Run	Digital input 2 [12]
<a href="#">0x2631:004 (P400.04)</a>	Reset fault	Not connected [0]
<a href="#">0x2838:001 (P203.01)</a>	Start method	DC braking [1]
<a href="#">0x2860:001 (P201.01)</a>	Frequency control: Default setpoint source	Frequency preset 1 [11]
<a href="#">0x2911:001 (P450.01)</a>	Frequency setpoint presets: Preset 1	40 Hz
<a href="#">0x2B84:001 (P704.01)</a>	Current	50 %
<a href="#">0x2B84:002 (P704.02)</a>	Automatic hold time	10 s

### Input signals

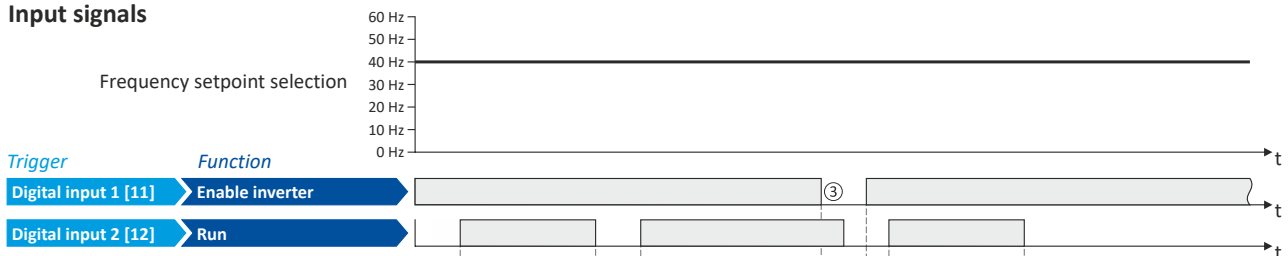

### Output signals

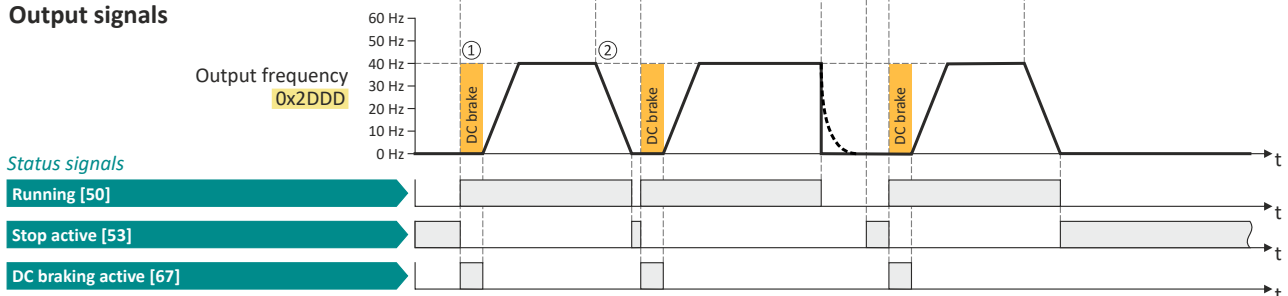

The status signals can be assigned to digital outputs. ▶ [Configure digital outputs](#) 292

- ① After the start command, the DC braking is active. Only after the hold time [0x2B84:002 \(P704.02\)](#) has elapsed, the motor is accelerated to the setpoint.
- ② The motor is stopped with the stop method set in [0x2838:003 \(P203.03\)](#). In the example: Stop with standard ramp.
- ③ If the inverter is disabled, the motor coasts.



# Configuring the motor control

Parameterisable motor functions

DC braking

Example: Automatic DC braking when stopping the motor

## 10.7.2.2 Example: Automatic DC braking when stopping the motor

In order that the DC braking is automatically active when the motor is stopped, the corresponding operating threshold must be set in [0x2B84:003 \(P704.03\)](#).

- After a stop command, the motor is first decelerated as set. Once the output frequency falls below the set operating threshold, the inverter stops the deceleration and activates DC braking.
- DC braking is carried out with the braking current set in [0x2B84:001 \(P704.01\)](#) for the hold time set in [0x2B84:002 \(P704.02\)](#).
- The exact behavior depends on the stop method set in [0x2838:003 \(P203.03\)](#).

### Stop method = "Standard ramp [1]"

Parameter	Name	Setting for this example
<a href="#">0x2631:001 (P400.01)</a>	Enable inverter	Digital input 1 [11]
<a href="#">0x2631:002 (P400.02)</a>	Run	Digital input 2 [12]
<a href="#">0x2631:004 (P400.04)</a>	Reset fault	Not connected [0]
<a href="#">0x2838:003 (P203.03)</a>	Stop method	Standard ramp [1]
<a href="#">0x2860:001 (P201.01)</a>	Frequency control: Default setpoint source	Frequency preset 1 [11]
<a href="#">0x2911:001 (P450.01)</a>	Frequency setpoint presets: Preset 1	40 Hz
<a href="#">0x2B84:001 (P704.01)</a>	Current	50%
<a href="#">0x2B84:002 (P704.02)</a>	Automatic hold time	10 s
<a href="#">0x2B84:003 (P704.03)</a>	Automatic operating threshold	15 Hz

#### Input signals

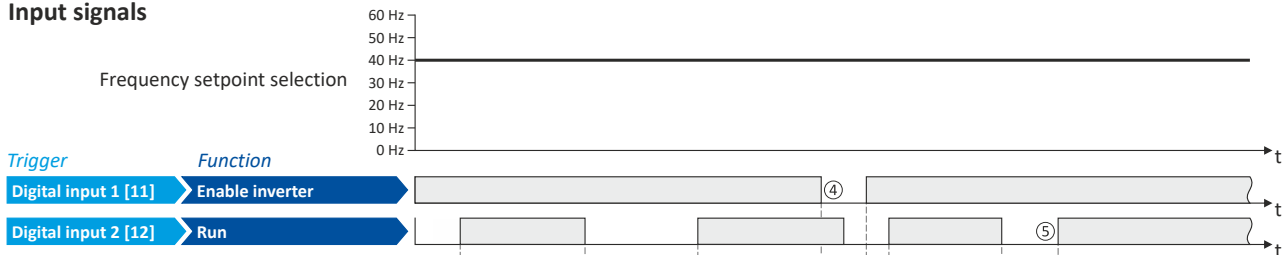

#### Output signals

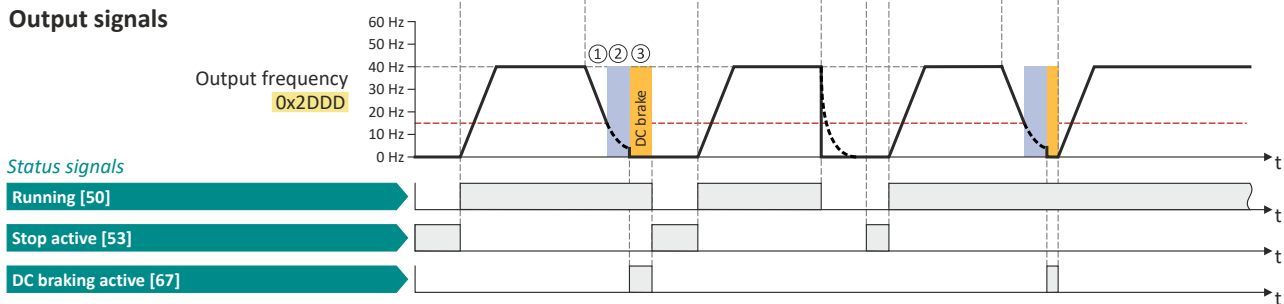

The status signals can be assigned to digital outputs. [▶ Configure digital outputs](#) 292

- ① With the stop method "Standard ramp [1]", the motor is first decelerated normally until the value falls below the operating threshold set in [0x2B84:003 \(P704.03\)](#).
- ② The motor coasts down for a specified time. This "demagnetizing time" serves to reduce the induced voltage.
- ③ The DC braking becomes active for the hold time set in [0x2B84:002 \(P704.02\)](#).
- ④ If the inverter is disabled, the motor coasts. (DC braking is only possible if the inverter is enabled).
- ⑤ If there is a new start command within the hold time, the DC braking is cancelled. The motor is accelerated to the setpoint again.

### Stop method = "Quick stop ramp [2]"

Same behavior as with the stop method "Standard ramp [1]", except that the motor is decelerated with the quick stop ramp instead of the standard ramp.

# Configuring the motor control

Parameterisable motor functions

DC braking

Example: Automatic DC braking when stopping the motor



## Stop method = "Coasting [0]"

Parameter	Name	Setting for this example
0x2631:001 (P400.01)	Enable inverter	Digital input 1 [11]
0x2631:002 (P400.02)	Run	Digital input 2 [12]
0x2838:003 (P203.03)	Stop method	Coasting [0]
0x2860:001 (P201.01)	Frequency control: Default setpoint source	Frequency preset 1 [11]
0x2911:001 (P450.01)	Frequency setpoint presets: Preset 1	40 Hz
0x2B84:001 (P704.01)	Current	50%
0x2B84:002 (P704.02)	Automatic hold time	10 s
0x2B84:003 (P704.03)	Automatic operating threshold	15 Hz

### Input signals

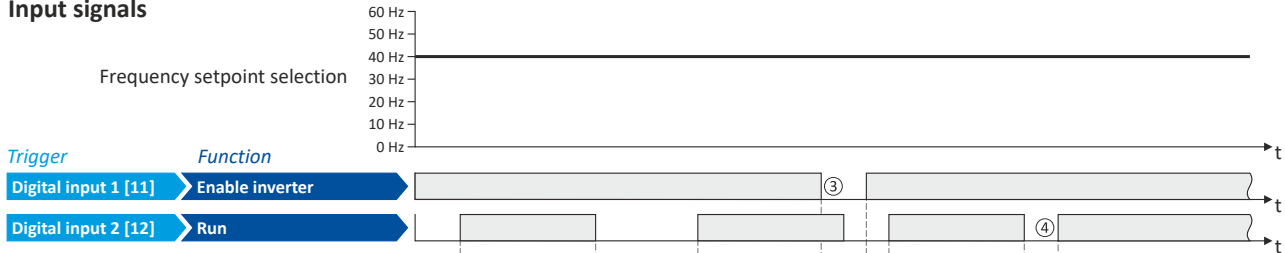

### Output signals

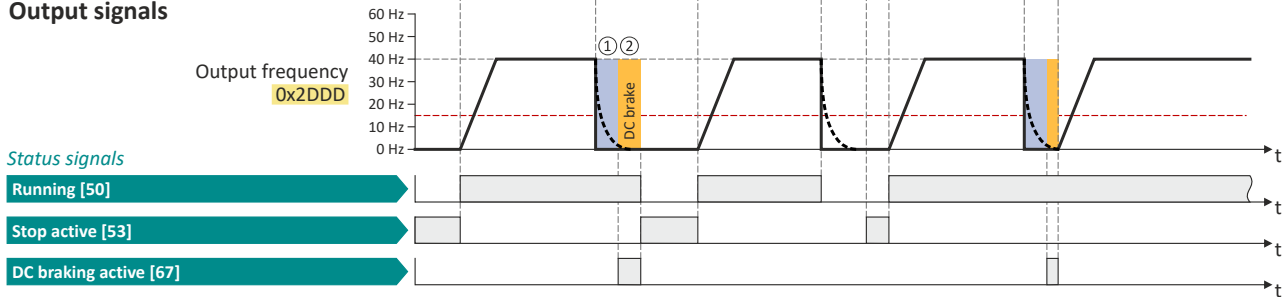

The status signals can be assigned to digital outputs. [▶ Configure digital outputs](#) 292

- ① With the stop method "Coasting [0]", the motor first coasts down for a specified time. This "demagnetizing time" serves to reduce the induced voltage.
- ② The DC braking becomes active for the hold time set in 0x2B84:002 (P704.02).
- ③ If the inverter is disabled, the motor coasts. (DC braking is only possible if the inverter is enabled).
- ④ If there is a new start command within the hold time, the DC braking is cancelled. The motor is accelerated to the setpoint again.





# Configuring the motor control

Parameterisable motor functions  
DC braking  
Activating DC braking manually

## 10.7.2.3 Activating DC braking manually

By means of the "Activate DC braking" function, DC braking can be activated manually.

### Preconditions

The current for DC braking must be set > 0 % so that the function can be executed.

### Parameter

Address	Name / setting range / [default setting]	Information
0x2631:005 (P400.05)	Function list: Activate DC braking (Function list: DC braking) • Further possible settings: ▶ <a href="#">Trigger list</a> 73	Assignment of a trigger for the "Activate DC braking" function. Trigger = TRUE: Activate DC braking. Trigger = FALSE: Deactivate DC braking. <b>⚠ CAUTION!</b> DC braking remains active as long as the trigger is set to TRUE. ▶ <a href="#">DC braking</a> 221
	<b>0</b> Not connected	No trigger assigned (trigger is constantly FALSE).

### Example for operating mode

- Switch S1 starts the motor in forward direction of rotation. De-asserting switch S1 stops the motor again.
- Switch S2 activates DC braking.

Connection plan	Function	
	Potentiometer R1	Frequency setpoint selection
	Switch S1	Run
	Switch S2	Activate DC braking

Parameter	Designation	Setting for this example
<a href="#">0x2631:001 (P400.01)</a>	Enable inverter	Constant TRUE [1]
<a href="#">0x2631:002 (P400.02)</a>	Run	Digital input 1 [11]
<a href="#">0x2631:004 (P400.04)</a>	Reset fault	Not connected [0]
<a href="#">0x2631:005 (P400.05)</a>	Activate DC braking	Digital input 2 [12]
<a href="#">0x2824 (P200.00)</a>	Control selection	Flexible I/O configuration [0]
<a href="#">0x2838:003 (P203.03)</a>	Stop method	Standard ramp [1]
<a href="#">0x2860:001 (P201.01)</a>	Frequency control: Default setpoint source	Analog input 1 [2]
<a href="#">0x2B84:001 (P704.01)</a>	DC braking: Current	10 %

# Configuring the motor control

Parameterisable motor functions  
DC braking  
Activating DC braking manually

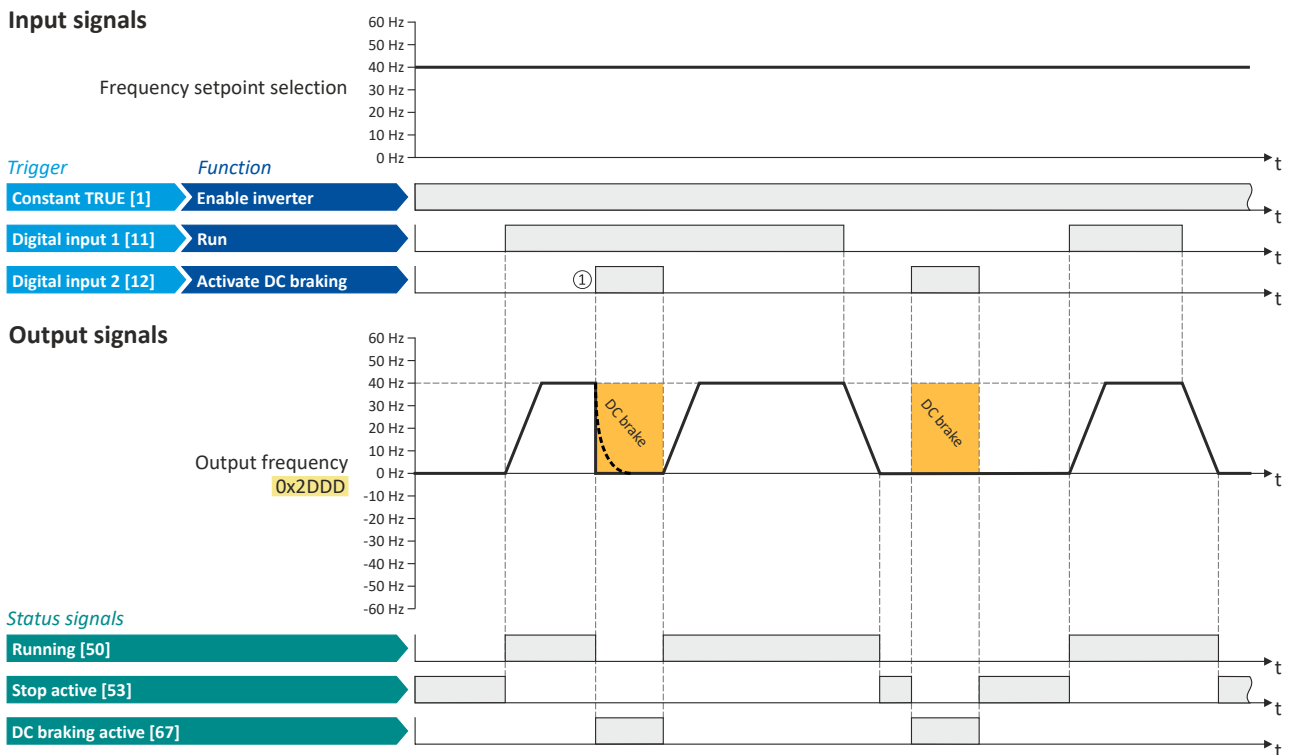

The status signals can be assigned to digital outputs. ▶ [Configure digital outputs](#) 292

- ① If DC braking is activated while the motor is running, the output pulses of the inverter are disabled immediately. For stopping the motor, the current set in 0x2B84:001 (P704.01) is injected. The exact drive behaviour depends on the settings for the "DC braking" function and the load properties.



# Configuring the motor control

Parameterisable motor functions

DC braking

Migration of Lenze Inverter Drives 8200/8400

## 10.7.2.4 Migration of Lenze Inverter Drives 8200/8400

The behavior of the Lenze Inverter Drives 8200/8400 in case of automatic DC braking is different: In case of these inverters, after the auto DCB hold time has elapsed, the motor is deenergized (by means of pulse inhibit) until the setpoint exceeds the auto DCB operating threshold. In order to make a migration to the i500 inverter series easier, the setting [0x2B84:006 \(P704.06\)](#) = "1" serves to activate the same behavior in the i500.

The following example illustrates the behavior of the function if [0x2B84:006 \(P704.06\)](#) = "1".

Parameter	Name	Setting for this example
0x2631:001 (P400.01)	Enable inverter	Constant TRUE [1]
0x2631:002 (P400.02)	Run	Digital input 1 [11]
0x2631:013 (P400.13)	Reverse rotational direction	Digital input 3 [13]
0x2838:003 (P203.03)	Stop method	Standard ramp [1]
0x2B84:001 (P704.01)	Current	50%
0x2B84:002 (P704.02)	Automatic hold time	10 s
0x2B84:003 (P704.03)	Automatic operating threshold	10 Hz
0x2B84:006 (P704.06)	Inverter disable	1

### Input signals

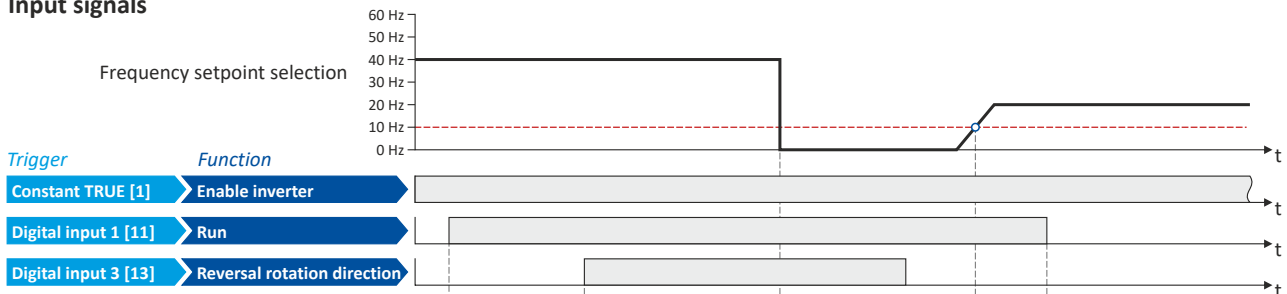

### Output signals

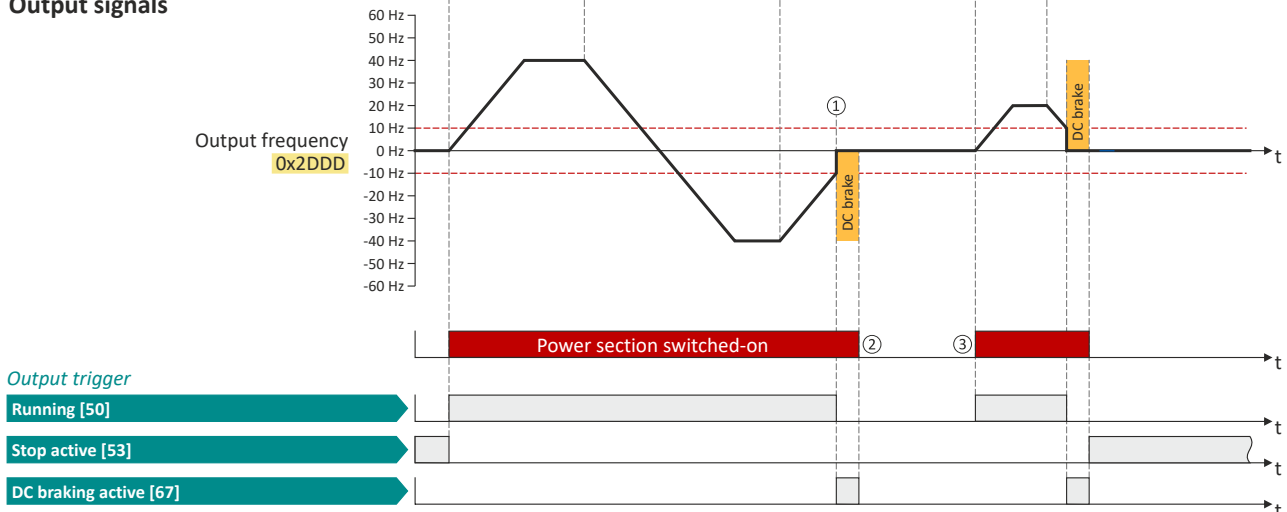

The status signals can be assigned to digital outputs. [▶ Configure digital outputs](#) 292

- ① If the setpoint falls below the operating threshold set in [0x2B84:003 \(P704.03\)](#), the DC braking gets active for the hold time set in [0x2B84:002 \(P704.02\)](#).
- ② After the hold time has elapsed, the power section is switched off.
- ③ If the setpoint exceeds the operating threshold again, the power section is switched on again. The motor is accelerated to the setpoint again.



## 10.7.3 Holding brake control

This function serves as a low-wear control of a holding brake. The holding is usually mounted to the motor as an option. The holding brake can be automatically released via the start command for the inverter or manually via an external control signal, for instance, by a higher-level Controller. The interaction of higher-level Controller and holding brake is especially important for vertical applications. Horizontal applications need a less demanding holding brake control.

### Preconditions

- Observe that the holding brake is an important element of the machine's safety concept as a whole. Therefore be sure to carry out commissioning of this system part with particular care!
- Holding brakes are not intended for braking during operation. The increased wear caused by braking during operation may destroy the holding brake prematurely!
- **Automatic DC braking must be deactivated if a holding brake is used.**
- The holding brake control itself only outputs a digital trigger for releasing the holding brake. This trigger "Release holding brake [115]" must be assigned to a digital output or, in the simplest case, to the relay when then switches the brake supply. ▶ [Configure digital outputs](#) 292
- If the holding brake is to be controlled via a digital output, the use of an additional relay or power contactor is required. The digital output is not suited for direct control of a holding brake.
- If, instead of an electrically releasing (self-holding) holding brake, an electrically holding (self-releasing) holding brake is to be controlled, a signal inversion for the digital output used or for the relay must be set! ▶ [Configure digital outputs](#) 292



## 10.7.3.1 Basic setting

The following parameters must be set for the activation and basic configuration of the holding brake control.



When a power contactor is used, the response time and release time of the contactor are added to the brake application and release time. Both times must also be taken into consideration for parameterising the brake application time and brake opening time!



Deactivate automatic DC braking, if a holding brake is used.

### Parameter

Address	Name / setting range / [default setting]	Information
0x2820:001 (P712.01)	Holding brake control: Brake mode (Brake control: Brake mode)	Selecting how the "Release holding brake" command is to be triggered.
	0 Automatically (via device state)	"Automatic operation": The "Release holding brake" command is automatically carried out as a function of the device state and further conditions. CAUTION! In automatic operation, a manual release of the holding brake is also possible! For details see the following information for selection "Manually [1]".
	1 Manually	The "Release holding brake" command can also be initiated by the following external triggers: <ul style="list-style-type: none"> <li>Via the trigger assigned to the "Release holding brake" function in <a href="#">0x2631:049 (P400.49)</a> if the network control is not active.</li> <li>Via bit 14 in the CiA control word <a href="#">0x6040</a> if the network control is active.</li> </ul> CAUTION! <ul style="list-style-type: none"> <li>The manually triggered "Release holding brake" command has a direct impact on the "Release holding brake [115]" trigger. Thus, the holding brake can be manually released if the power section is switched off!</li> <li>The ramp function generator only starts up when the brake is released in the case of manual control.</li> <li>The responsibility for a manual release of the holding brake has the external trigger source for the "Release holding brake" command!</li> </ul>
	2 Off	The holding brake is deactivated.
0x2820:002 (P712.02)	Holding brake control: Brake closing time (Brake control: Closing time) 0 ... [100] ... 10000 ms	Application time (engagement time) of the holding brake. <ul style="list-style-type: none"> <li>Only effective in automatic operation.</li> </ul>
0x2820:003 (P712.03)	Holding brake control: Brake opening time (Brake control: Opening time) 0 ... [100] ... 10000 ms	Release time (disengagement time) of the holding brake. <ul style="list-style-type: none"> <li>Only effective in automatic operation.</li> </ul>
0x2820:015 (P712.15)	Holding brake control: Brake status (Brake control: Brake status) <ul style="list-style-type: none"> <li>Read only</li> </ul>	Display of the holding brake status. <ul style="list-style-type: none"> <li>The status is also displayed via bit 14 in the CiA status word <a href="#">0x6041 (P780.00)</a>.</li> </ul>
	0 Brake closed	Holding brake is applied.
	1 Brake released	Holding brake is released.

For examples and details on more possible settings, see the following subchapter:

- ["Automatic" brake mode \(automatic operation\)](#) 230
- [Brake holding load](#) 231
- [Brake closing threshold](#) 233
- [Manual release of the holding brake](#) 235

# Configuring the motor control

Parameterisable motor functions

Holding brake control

"Automatic" brake mode (automatic operation)



## 10.7.3.2 "Automatic" brake mode (automatic operation)

In automatic operation, the inverter automatically released the holding brake when the motor is started. In the stopped state, the holding brake is closed.

### **⚠ DANGER!**

Manual release of the holding brake

In automatic operation, a manual release of the holding brake is also possible. The manually triggered "Release holding brake" command has a direct impact on the "Release holding brake [115]" trigger. Thus, the holding brake can be manually released if the power section is switched off.

Possible consequences: Death, severe injuries or damage to property

- The responsibility for a manual release of the holding brake has the external trigger source for the "Release holding brake" command!

### General mode of operation

The following diagram demonstrates the general functioning of the automatic operation:

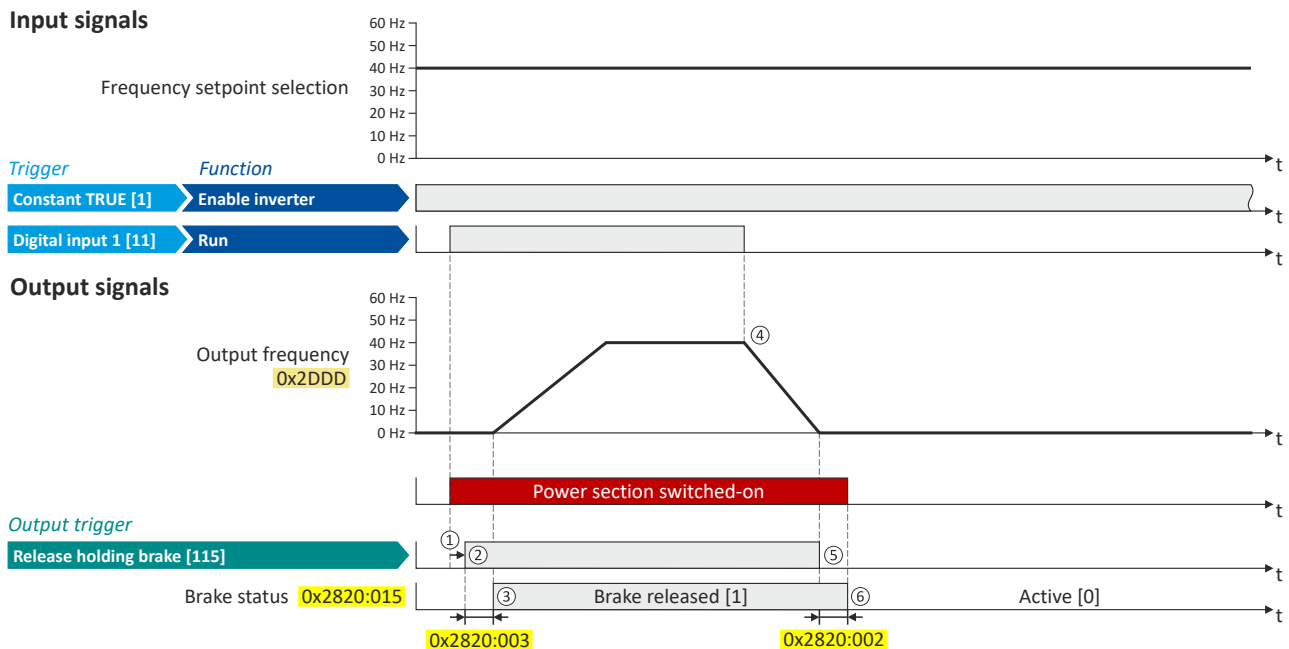

- ① If the inverter is enabled and no error is active, the motor can be started with the "Run" function in forward rotating direction. The power section is switched on and the motor is magnetized first.
- ② The holding brake is released. In this case, the output trigger "Release holding brake [115]" is set to TRUE. This trigger must be assigned to a digital output or, in the simplest case, to the relay which then switches the brake supply.
- ③ After the release time 0x2820:003 (P712.03) has elapsed, the motor is accelerated to the setpoint. In 0x2820:015 (P712.15), the brake status "Brake released [1]" is displayed.
- ④ If "Run" is set to FALSE, the motor is stopped with the stop method set in 0x2838:003 (P203.03). In the example: Stop with standard ramp.
- ⑤ Then the holding brake is closed again.
- ⑥ After the closing time 0x2820:002 (P712.02) has elapsed, the brake status "Brake closed [0]" is displayed in 0x2820:015 (P712.15).



If the power section is disabled, the holding brake is closed. Reasons for this can be an error, a fault, or the activation of the "Safe torque off (STO)" safety function.



### 10.7.3.3 Brake holding load

Depending on the application, a torque at the motor may be required at speed "0" of the motor shaft:

- In order to hold loads in vertical applications and prevent "sagging".
- In order to prevent a position loss in horizontal applications.

For this purpose, a brake holding load can be set. The brake holding load can be optionally generated via a ramp to reduce a vibration stimulation that may be caused by the brake holding load.

#### Preconditions

Ensure that the inverter builds up a sufficient torque in the motor when releasing and applying the holding, in order to hold the load.

- For this purpose, a V/f voltage boost can be set for the V/f characteristic control. ▶ [Set voltage boost](#)  202
- The parameters for the V/f voltage boost are automatically set when you carry out an automatic identification of the motor.

#### Details

Relevant parameters:

- [0x2820:008 \(P712.08\)](#): Brake holding load
- [0x2820:013 \(P712.13\)](#): Holding load ramptime

Setting notes:

- In case of applications with constant load, a constant value is suitable for the brake holding load.
- If the load changes, an approximate value for the brake holding load has to be considered.
- Start with the setting "0 %" if you do not know the correct direction, otherwise with, for instance, "30 %". Afterwards change the setting upwards or downwards in 10-% steps.

#### Parameter

Address	Name / setting range / [default setting]	Information
0x2820:008 (P712.08)	Holding brake control: Brake holding load (Brake control: Holding load) -500.0 ... [0.0] ... 500.0 % • Setting can only be changed if the inverter is disabled.	By setting a holding load, the load can be held against the force of gravity in case of vertical applications, and a position loss can be prevented in case of horizontal applications. • The setting of "100 %" approximately corresponds to rated motor torque and slip frequency.  Note! The torque for creating the holding load depends on the selected motor control type and its settings. Before using this function, make sure that you have set the motor control type correctly.
0x2820:013 (P712.13)	Holding brake control: Holding load ramptime (Brake control: HoldLoad ramptim) 0 ... [0] ... 100 ms • Setting can only be changed if the inverter is disabled. • From version 03.00	By setting a ramp time, a vibration stimulation can be reduced that might be caused by the brake holding load <a href="#">0x2820:008 (P712.08)</a> .

# Configuring the motor control

Parameterisable motor functions  
Holding brake control  
Brake holding load



## General mode of operation

The following diagram demonstrates the general functioning in automatic operation:

### Input signals

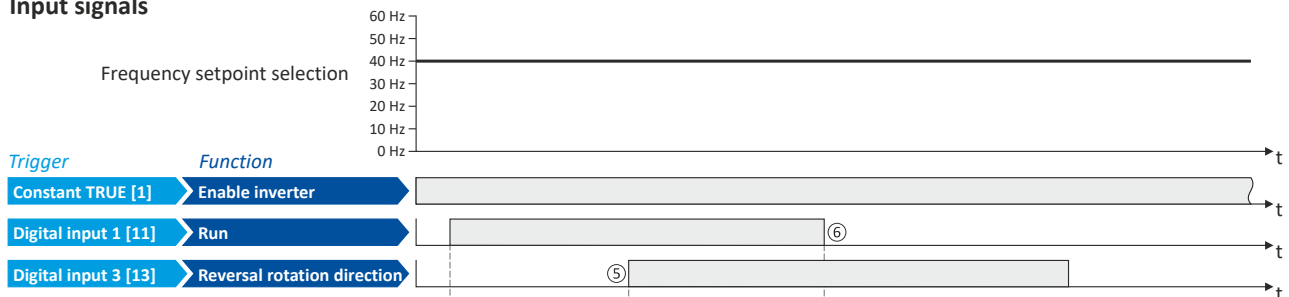

### Output signals

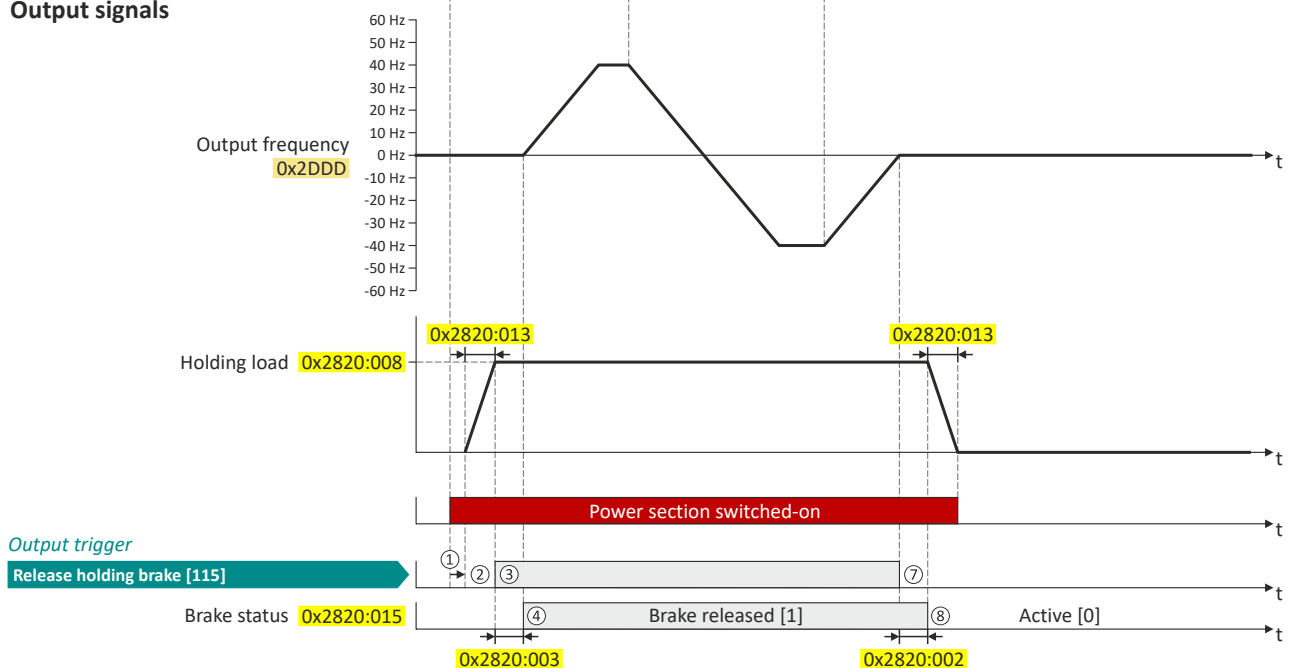

- ① If the inverter is enabled and no error is active, the motor can be started with the "Run" function in forward rotating direction. The power section is switched on and the motor is magnetized first.
- ② The brake holding load set in 0x2820:008 (P712.08) is build up via the ramp set in 0x2820:013 (P712.13).
- ③ The holding brake is released. In this case, the output trigger "Release holding brake [115]" is set to TRUE. This trigger must be assigned to a digital output or, in the simplest case, to the relay which then switches the brake supply.
- ④ After the release time 0x2820:003 (P712.03) has elapsed, the motor is accelerated to the setpoint. In 0x2820:015 (P712.15), the brake status "Brake released [1]" is displayed.
- ⑤ In case the direction of rotation reverses, the holding brake remains released.
- ⑥ If "Run" is set to FALSE, the motor is stopped with the stop method set in 0x2838:003 (P203.03). In the example: Stop with standard ramp.
- ⑦ Then the holding brake is closed again.
- ⑧ After the closing time 0x2820:002 (P712.02) has elapsed, the brake status "Brake closed [0]" is displayed in 0x2820:015 (P712.15). The brake holding load is reduced again via the ramp.





## 10.7.3.4 Brake closing threshold

In some cases, a low speed does not make any sense from the application point of view. This includes applications with unfavorable load features, such as static friction. In such applications and depending on the type of control, a low speed may cause an unwanted behaviour. In order to prevent such an operating situation, a closing threshold can be set. The power section will only be switched on and the holding brake is opened if the setpoint is higher than the closing threshold. In order to prevent the holding brake from being closed if the setpoint only shortly falls below the closing threshold during operation, a delay time can be set in addition.

### Preconditions

If the holding brake is controlled manually via an external control signal: It must be ensured that the motor does not move while the motor control is deactivated by this function.

### Details

The function is part of the holding brake control and does not have independent functionality.

Relevant parameters:

- [0x2820:007 \(P712.07\)](#): Brake closing threshold
- [0x2820:012 \(P712.12\)](#): Closing threshold delay

Setting notes:

- The function is active if the brake closing threshold is higher than 0 Hz.
- In order that the brake can work correctly, the brake closing threshold must be set to a value that is greater than or equals the minimum frequency [0x2915 \(P210.00\)](#).
- The brake closing threshold has a permanent hysteresis of 1 Hz in order to prevent an unwanted change-over. Exception: If the brake closing threshold is set to 0 Hz, the hysteresis is also 0 Hz.
- If the brake closing threshold is set to 0 Hz, a start command is only required to release the holding brake during automatic operation.
- This function can be combined with the setting of a holding load.

### Parameter

Address	Name / setting range / [default setting]	Information
0x2820:007 (P712.07)	Holding brake control: Brake closing threshold (Brake control: Closing thresh.) 0.0 ... [0.2] ... 599.0 Hz	Threshold for closing the holding brake. <ul style="list-style-type: none"> <li>• The power section will only be switched on and the holding brake will be opened if the setpoint is higher than the threshold set here.</li> <li>• In order that the brake can work correctly, the brake closing threshold must be set to a value that is greater than or equals the minimum frequency <a href="#">0x2915 (P210.00)</a>.</li> <li>• The brake closing threshold has a permanent hysteresis of 1 Hz in order to prevent an unwanted change-over. Exception: If the brake closing threshold is set to 0 Hz, the hysteresis is also 0 Hz.</li> <li>• In case of a setting of "0 Hz", only a start command is required to release the holding break during automatic operation.</li> </ul>
0x2820:012 (P712.12)	Holding brake control: Closing threshold delay (Brake control: ClosingThr delay) 0 ... [0] ... 10000 ms <ul style="list-style-type: none"> <li>• From version 03.00</li> </ul>	By setting a deceleration, a closing of the holding brake can be prevented if the frequency only temporarily falls below the brake closing threshold <a href="#">0x2820:007 (P712.07)</a> .

# Configuring the motor control

Parameterisable motor functions  
Holding brake control  
Brake closing threshold



## General mode of operation

The following diagram demonstrates the general functioning in automatic operation:

### Input signals

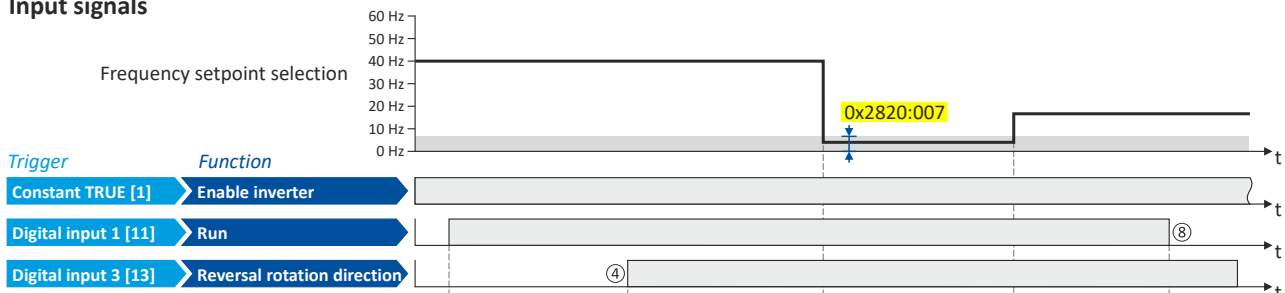

### Output signals

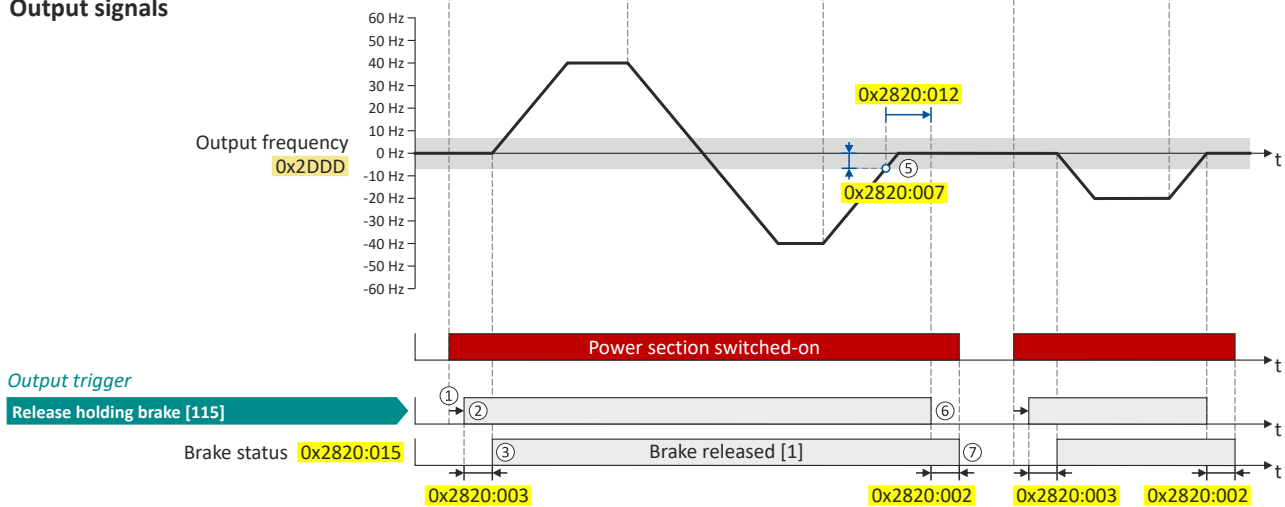

- ① If the inverter is enabled and no error is active, the motor can be started with the "Run" function in forward rotating direction. The power section is switched on and the motor is magnetized first.
- ② The holding brake is released. In this case, the output trigger "Release holding brake [115]" is set to TRUE. This trigger must be assigned to a digital output or, in the simplest case, to the relay which then switches the brake supply.
- ③ After the release time `0x2820:003` (P712.03) has elapsed, the motor is accelerated to the setpoint. In `0x2820:015` (P712.15), the brake status "Brake released [1]" is displayed.
- ④ If the direction of rotation reverses, the holding brake remains released (even if the closing threshold delay is running.)
- ⑤ If the setpoint selection and the internal setpoint for the motor control fall below the brake closing threshold set in `0x2820:007` (P712.07), the output frequency is ramped down to "0 Hz". At the same time the closing threshold delay set in `0x2820:012` (P712.12) starts to run.
- ⑥ If the values fall below the closing threshold longer than the closing threshold delay, the holding brake is closed again.
- ⑦ After the closing time `0x2820:002` (P712.02) has elapsed, the brake status "Brake closed [0]" is displayed in `0x2820:015` (P712.15).
- ⑧ If "Run" is set to FALSE, the motor is stopped with the stop method set in `0x2838:003` (P203.03). In the example: Stop with standard ramp. In this case, closing threshold and closing threshold delay are not effective anymore.



# Configuring the motor control

Parameterisable motor functions  
Holding brake control  
Manual release of the holding brake

## 10.7.3.5 Manual release of the holding brake

The "Open holding brake" function serves to release the holding brake immediately. Brake application time and brake opening time as well as the conditions for the automatic operation are not effective.

### Preconditions

- Observe setting and application notes in the "[Holding brake control](#)" chapter! [📖 228](#)
- The brake mode "Automatic [0]" or "Manual [1]" must be set in [0x2820:001 \(P712.01\)](#).
- The trigger "Release holding brake [115]" must be assigned to a digital output or, in the simplest case, to the relay which then switches the brake supply.

### Details

A manual opening of the holding brake is possible in the modes "Automatic [0]" and "Manual [1]" via the following external triggers:

- Via bit 14 in the CiA control word [0x6040](#).
- Via the trigger in [0x2631:049 \(P400.49\)](#) assigned to the "Open holding brake" function.
  - ▶ [Example for operating mode](#) [📖 235](#)

### Parameter

Address	Name / setting range / [default setting]	Information
0x2631:049 (P400.49)	Function list: Open holding brake (Function list: Open brake) <ul style="list-style-type: none"> <li>• Setting can only be changed if the inverter is disabled.</li> <li>• Further possible settings: ▶ <a href="#">Trigger list</a> <a href="#">📖 73</a></li> </ul>	Assignment of a trigger for the "Open holding brake" function. Trigger = TRUE: open holding brake (immediately). Trigger = FALSE: no action.  Notes: <ul style="list-style-type: none"> <li>• Function is only executed if the brake mode <a href="#">0x2820:001 (P712.01)</a> is set to "Automatic [0]" or "Manual [1]".</li> </ul> <p><b>⚠ CAUTION!</b></p> <ul style="list-style-type: none"> <li>• The manually triggered "Open holding brake" command has a direct impact on the "Release holding brake [115]" trigger. Thus, the holding brake can be manually released if the power section is switched off!</li> <li>• The responsibility for a manual opening of the holding brake lies with the external trigger source for the "Open holding brake" command!</li> </ul>
	<b>0</b> Not connected	No trigger assigned (trigger is constantly FALSE).

### Example for operating mode

- Switch S1 starts the motor in forward direction of rotation. Switch S1 in initial position stops the motor again.
- Switch S2 opens the holding brake. For this purpose, in this example, trigger "Release holding brake [115]" is assigned to the relay that switches the brake supply.

Connection diagram	Function
	Potentiometer R1: Frequency setpoint selection
	Switch S1: Run
	Switch S2: Open holding brake

Parameter	Name	Setting for this example
<a href="#">0x2631:001 (P400.01)</a>	Enable inverter	Constant TRUE [1]
<a href="#">0x2631:002 (P400.02)</a>	Run	Digital input 1 [11]
<a href="#">0x2631:004 (P400.04)</a>	Reset fault	Not connected [0]
<a href="#">0x2631:049 (P400.49)</a>	Open holding brake	Digital input 2 [12]
<a href="#">0x2634:001 (P420.01)</a>	Relay	Release holding brake [115]
<a href="#">0x2824 (P200.00)</a>	Control selection	Flexible I/O configuration [0]
<a href="#">0x2838:003 (P203.03)</a>	Stop method	Standard ramp [1]
<a href="#">0x2860:001 (P201.01)</a>	Frequency control: Default setpoint source	Analog input 1 [2]

# Configuring the motor control

Parameterisable motor functions  
Holding brake control  
Manual release of the holding brake

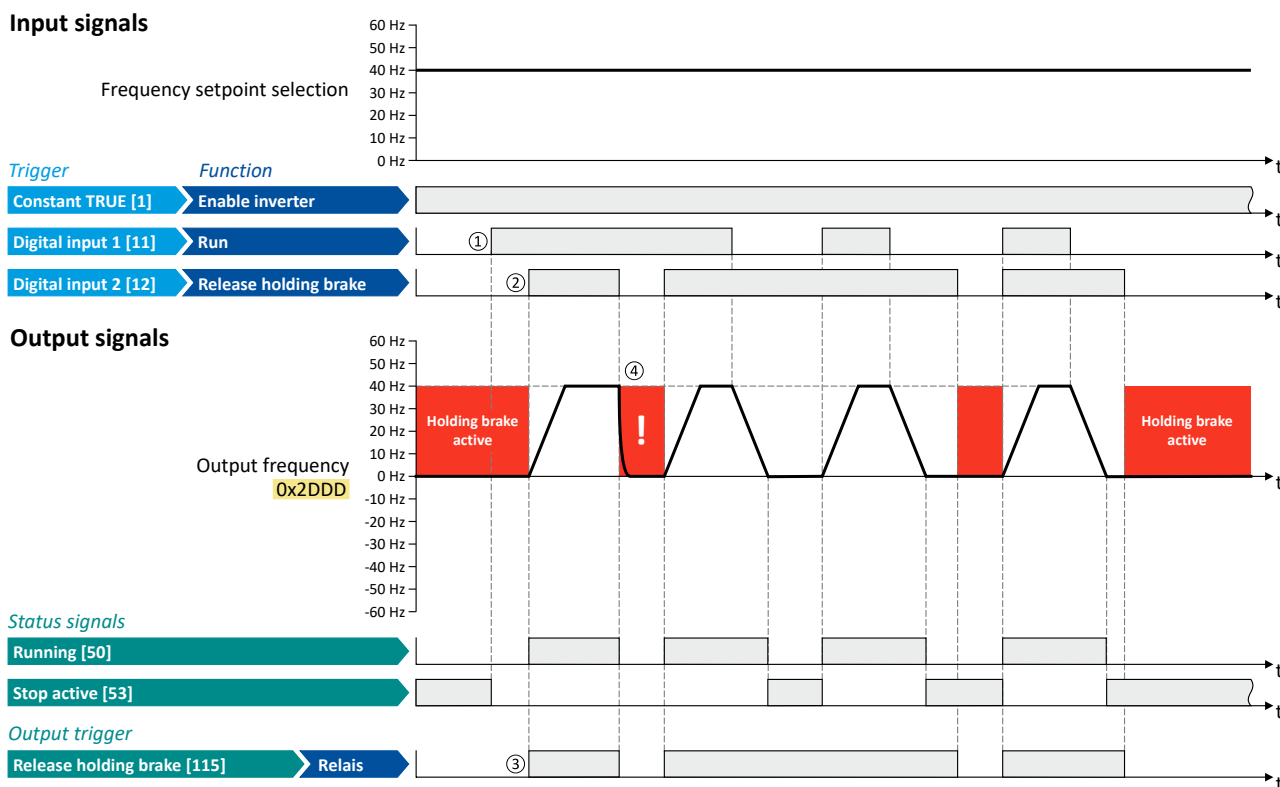

The status signals can be assigned to digital outputs. [▶ Configure digital outputs](#) 292

- ① As the holding brake is active, the motor does not yet start to rotate after the start command.
- ② The holding brake is opened. The motor is led to the setpoint.
- ③ In this example, the "Release holding brake [115]" trigger is assigned to the relay that switches the brake supply. In the sleep mode, the holding brake is applied. If the relay is energized, the holding brake is opened.
- ④ **Note:** Holding brakes are not intended for braking during operation. The increased wear caused by braking during operation may destroy the holding brakes prematurely!



## 10.7.4 Load loss detection

This function serves to detect a load loss during operation and to then activate a specific function, for instance the switching of the relay.

### Details

If, during operation, the current motor current falls below the threshold set in [0x4006:001 \(P710.01\)](#) for at least the time set in [0x4006:002 \(P710.02\)](#), the internal status signal "Load loss detected [83]" is set to TRUE:

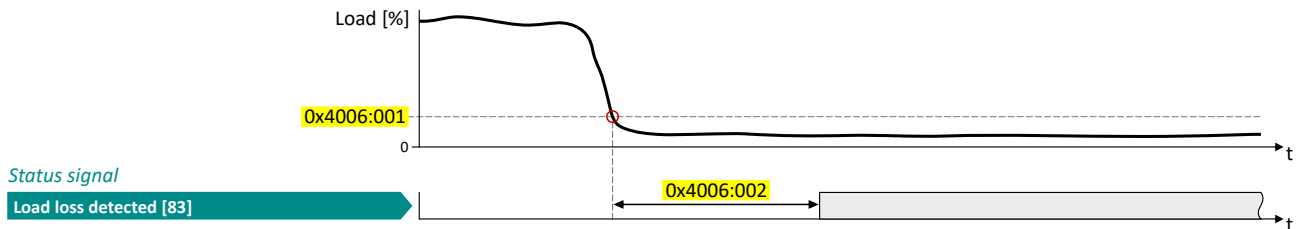

- The threshold is set in percent with reference to the rated motor current "Rated motor current" [0x6075 \(P323.00\)](#).
- The status signal "Load loss detected [83]" can be assigned, for instance, to a digital output or the relay via the flexible I/O configuration. ▶ [Configure digital outputs](#) 292
- An error response can be selected in [0x4006:003 \(P710.03\)](#).
- The load loss detection is not active with active DC braking.

### Parameter

Address	Name / setting range / [default setting]	Information
0x4006:001 (P710.01)	Load loss detection: Threshold (Load loss detect: Threshold) 0.0 ... [0.0] ... 200.0 %	Threshold for load loss detection. • 100 % = rated motor current <a href="#">0x6075 (P323.00)</a>
0x4006:002 (P710.02)	Load loss detection: Delay time (Load loss detect: Delay time) 0.0 ... [0.0] ... 300.0 s	Tripping delay for load loss detection.
0x4006:003 (P710.03)	Load loss detection: Error response (Load loss detect: Error response) • From version 05.01	Selection of the response following the detection of a load loss. Associated event ID: • 65336   0xFF38 - Load loss detected
	0 No response	▶ <a href="#">Severity</a> 700
	1 Warning	
	2 Trouble	
	3 Fault	



### 10.8 Options for optimizing the control loops

Various options are available for optimizing the control:

- a) [Select motor from motor catalog](#) 58
- b) [Automatic motor identification \(energized\)](#) 241
- c) [Automatic motor calibration \(non-energized\)](#) 243
- d) [Tuning of the motor and the speed controller](#) 244

#### Details

The option to be selected depends on the respective application. Depending on the selected option, different procedures become active and thus different parameter groups are influenced:

- Rated motor data
- Inverter characteristic
- Motor equivalent circuit diagram data
- Motor controller settings
- Speed controller settings

The optimization can be carried out via the keypad or the engineering tools.

Option 1: [Performing optimization with engineering tool](#) 239

Option 2: [Performing optimization with keypad](#) 240



## Performing optimization with engineering tool

The following flow diagram shows the optimization process with an engineering tool (e. g. »EASY Starter«):

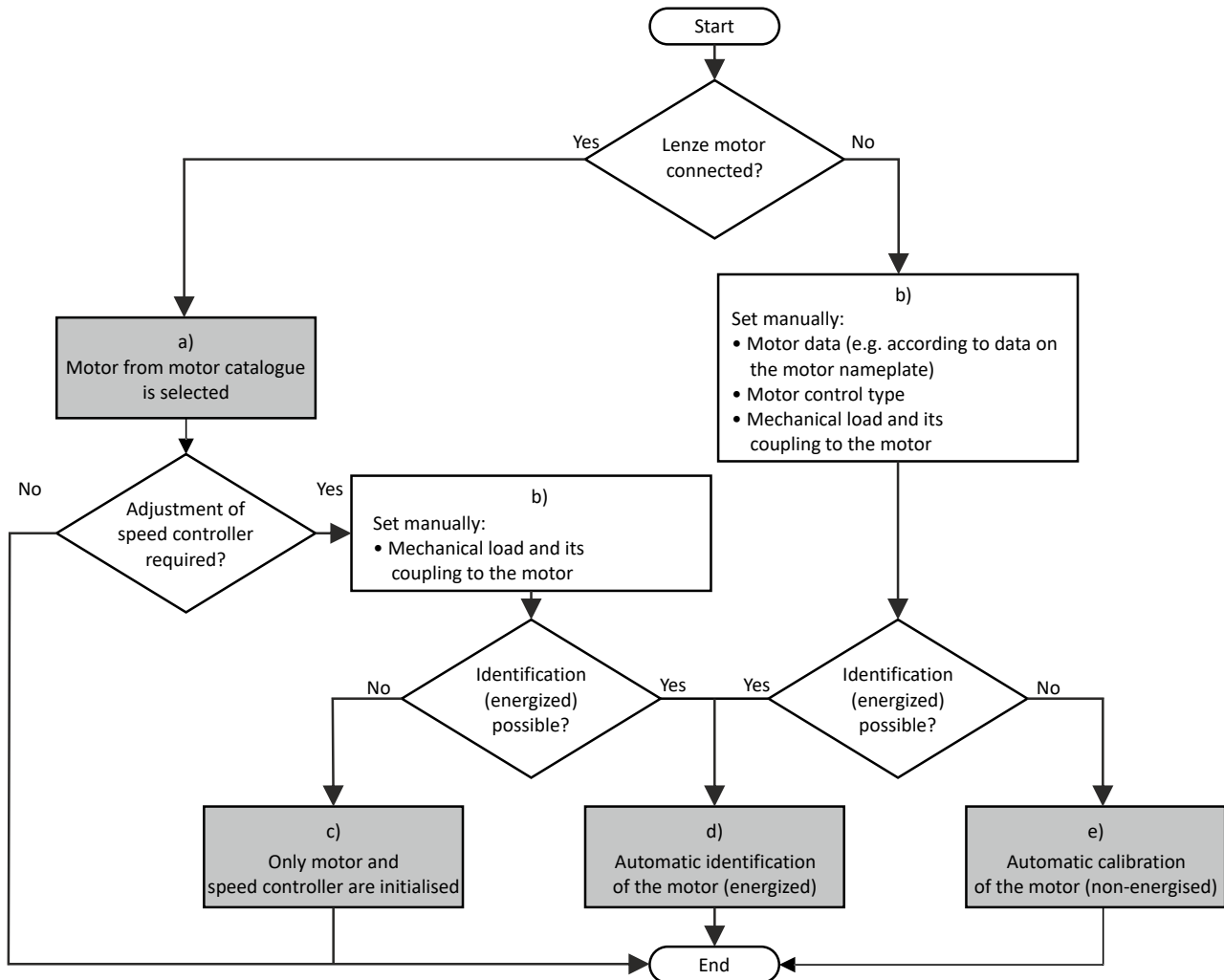

- The relevant motor data must be set first. You benefit from very precise motor equivalent circuit diagram data by selecting the motor from the motor catalogue.  
▶ [Select motor from motor catalog](#) 58
- Manually set the motor data in accordance with the manufacturer's information / motor data sheet when a third-party motor is connected to the inverter.  
▶ [Manual setting of the motor data](#) 59
- The speed controller must be first reinitialised alone if the load adjustment in the optimized system has changed.  
▶ [Tuning of the motor and the speed controller](#) 244
- If the application enables you to energise the system during the optimization procedure, carry out an automatic identification. This procedure results in the best possible parameter settings.  
▶ [Automatic motor identification \(energized\)](#) 241
- If the application does **not** enable you to energise the system during the optimization procedure, carry out an automatic calibration.  
▶ [Automatic motor calibration \(non-energized\)](#) 243



### Performing optimization with keypad

Since there is no access with the keypad to the motor catalogue, first the motor data must be set manually with the keypad according to the manufacturer data/motor data sheet.

▶ [Manual setting of the motor data](#) □ 59

The following flow diagram shows the optimisation process with the keypad:

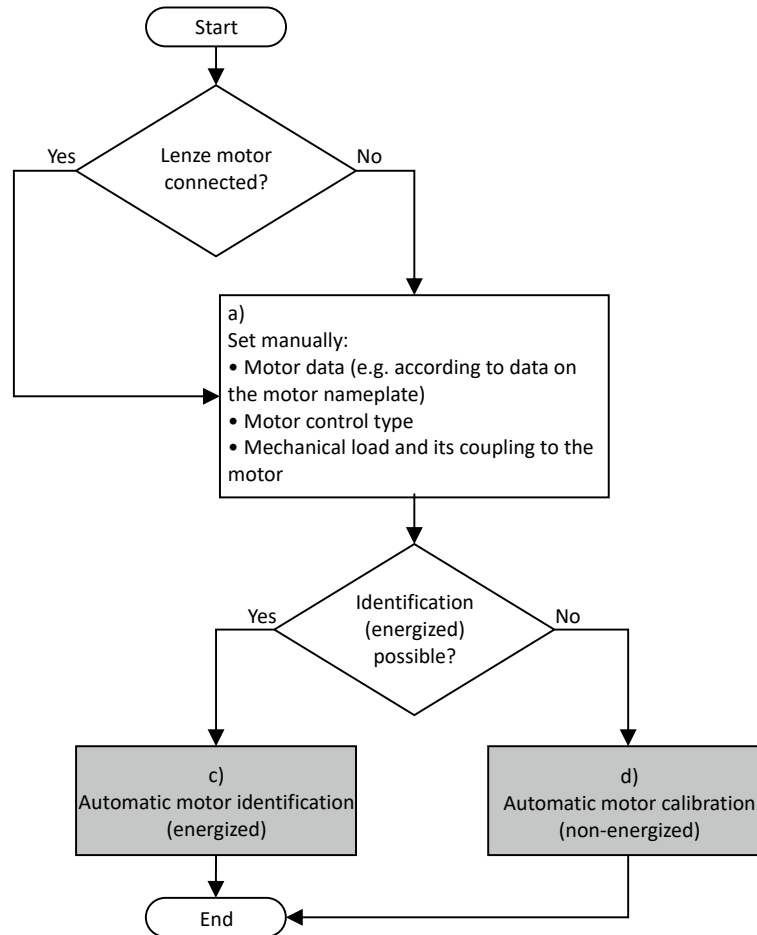

- a) Manually set the motor data in accordance with the manufacturer's information / motor data sheet when a third-party motor is connected to the inverter.  
▶ [Manual setting of the motor data](#) □ 59
- c) If the application enables you to energise the system during the optimization procedure, carry out an automatic identification. This procedure results in the best possible parameter settings.  
▶ [Automatic motor identification \(energized\)](#) □ 241
- d) If the application does not enable you to energise the system during the optimization procedure, carry out an automatic calibration.  
▶ [Automatic motor calibration \(non-energized\)](#) □ 243





## 10.8.1 Automatic motor identification (energized)

The automatic identification of the motor results in the best possible parameter settings. If the application enables you to energise the system during the optimization, carry out this optimization.

### Conditions



The motor must be cold and at a standstill.

- All rated motor data are known and set in the inverter, either by selecting the motor from the motor catalog or manually:
  - ▶ [Select motor from motor catalog](#) 58
  - ▶ [Manual setting of the motor data](#) 59
- In [0x2C00 \(P300.00\)](#), the motor control type required is suitable for the motor selected.
- In [0x6060 \(P301.00\)](#), the operating mode "MS: Velocity mode [-2]" or "CiA: Velocity mode (vI) [2]" is set.
- DC-bus voltage is available.
- The inverter is error-free and in the "Ready to switch on" or "Switched on" device state.
- The motor is stopped (no start enable).
- No inverter disable is active.
- No quick stop is active.
- No other axis command is active.

### General information on the identification

- The automatic identification can take from some seconds to minutes.
- The procedure can be aborted any time by inverter disable or cancellation of the start enable without settings being changed.
- During calibration and after the calibration has been completed successfully, the blue LED display is constantly on. As soon as the identification has been executed and the device is deactivated, the LED changes to a blinking mode.
- After completion, a renewed start command is required to start the motor.

### Required steps

Optimization with engineering tool (e. g. »EASY Starter«):

1. Go to the "Settings" tab and navigate to the parameterization dialog "Advanced motor setting".
2. Press the **Energized** button under "motor calibration".
3. Follow the instructions of the engineering tool.

Optimization with keypad:

1. Request automatic identification: Set [0x2822:004 \(P327.04\)](#) = "1".
2. Issue the start command to start the procedure.
3. The motor calibration is performed.
4. After completion, issue the start command again.

In order to achieve the most optimum behavior for the user, the parameters listed below can be used to influence the motor identification.

### Parameter

Address	Name / setting range / [default setting]	Information
0x2822:004 (P327.04)	Identify motor data (energized) (Identify mot.) 0 ... [0] ... 1	1 = start automatic identification of the motor data. <ul style="list-style-type: none"> <li>• Inverter characteristics, motor equivalent circuit diagram data and controller settings are identified and set automatically.</li> <li>• During the procedure, the motor is energized!</li> </ul>

# Configuring the motor control

Options for optimizing the control loops  
Automatic motor identification (energized)



Address	Name / setting range / [default setting]	Information
0x2DE0:009	Service settings: Motor identification settings 0 ... [0] ... 65535 <ul style="list-style-type: none"><li>Setting can only be changed if the inverter is disabled.</li><li>From version 05.03</li></ul>	Setting for motor identification.
	Bit 0 Activate switching frequency (0x2939)	Bit 0 = 0: the identification algorithm uses the 4 kHz switching frequency (standard). Bit 0 = 1: the identification algorithm uses the switching frequency configured in the parameter <a href="#">0x2939 (P305.00)</a> .

## Optimization process

As soon as the process has been started, the following steps are initiated:

1. The inverter characteristic is automatically identified by the inverter.
2. The motor equivalent circuit diagram data are automatically identified by the inverter.
3. The motor controller settings are automatically calculated.
4. The speed controller settings are automatically calculated.



## 10.8.2 Automatic motor calibration (non-energized)

If the application does not enable you to energise the system during the optimization, carry out this optimization.

### Preconditions

- All rated motor data is known and set in the inverter, either by selecting the motor from the motor catalogue or manually.
  - ▶ [Select motor from motor catalog](#) 58
  - ▶ [Manual setting of the motor data](#) 59
- In **0x2C00 (P300.00)**, the motor control type required and suitable for the motor is selected.
- The inverter is error-free and in the "Ready to switch on" or "Switched on" device state.
- The inverter is disabled or the motor is stopped (no start enable).
- No other axis command is active anymore.

### Required steps

Optimization with engineering tool (e. g. »EASY Starter«):

1. Go to the "Settings" tab and navigate to the parameterisation dialog "Advanced motor setting".
2. Click the **Non-energized** button under "motor calibration".
3. Follow the instructions of the engineering tool.

Optimization with keypad:

- **0x2822:005 (P327.05)** Set = "1" to start the process.

### Parameter

Address	Name / setting range / [default setting]	Information
0x2822:005 (P327.05)	Calibrate motor data (non-energized) (Calibrate mot.) 0 ... [0] ... 1	1 = start automatic calibration of the motor data. <ul style="list-style-type: none"><li>• A default inverter characteristic is loaded.</li><li>• the motor equivalent circuit diagram data and controller settings are calculated on the basis of the currently set rated motor data.</li><li>• The motor is not energised.</li></ul>

### Optimization process

As soon as the process has been started, the following steps are initiated:

1. A default inverter characteristic is loaded.
2. The motor equivalent circuit diagram data is calculated based on the currently set rated motor data.
3. The motor controller settings are automatically calculated.
4. The speed controller settings are automatically calculated.

# Configuring the motor control

Options for optimizing the control loops  
Tuning of the motor and the speed controller



## 10.8.3 Tuning of the motor and the speed controller

The following describes in general how to optimize the speed controller. This may be required if some parameters on the load side of the drive system have changed or have not been set yet, such as:

- Motor moment of inertia
- Load moment of inertia
- Type of coupling between motor moment of inertia and load moment of inertia

### Preconditions

- All rated motor data is known and set in the inverter, either by selecting the motor from the motor catalog or manually.
  - ▶ [Select motor from motor catalog](#) 58
  - ▶ [Manual setting of the motor data](#) 59
- All further options for optimization have been executed before if possible.
  - ▶ [Automatic motor identification \(energized\)](#) 241
  - ▶ [Automatic motor calibration \(non-energized\)](#) 243
- Optimization is possible online or offline (with or without connected motor).

### Required steps

Adapt the following parameters to your drive system using the engineering tool. Since this only changes load-dependent data, the other parameter groups do not need to be calculated again.

In the engineering tool, the speed control settings can be confirmed via the **Initialise** button.

The screenshot displays the EASY Starter V1.16.0.12216 software interface. The main window is titled "Overview\Motor control\Motor control selection". The "Controller Settings" section is expanded, showing the following parameters:

- Current controller:**
  - Gain:  ? V/A
  - Reset time:  ? ms
- Field weakening controller:**
  - Gain:  ? Vs/V
  - Volt. reserve range:  %
- Speed controller:**
  - Load inertia:  ? kg cm<sup>2</sup>
  - Coupling:  (dropdown)
  - Actual speed filter time:  2,0 ms
  - Gain:  ? Nm/rpm
  - Reset time:  ? ms

An "Initialize" button is highlighted with a red box. Below it, a warning message reads: "Ensure correct parameterization of current controller, load and feedback system before initializing speed controller settings!".

The bottom of the interface shows a status bar with "No connection" and "Application changed". Below that is a row of monitoring indicators: DC-bus voltage, Motor current, Motor voltage, Velocity actual val..., Output frequency, Status words: Devi..., and Error code. The bottom right corner contains a "Drag&Drop Parameter" button.



This function is not available via the keypad.

## Parameter

Address	Name / setting range / [default setting]	Information
0x2910:001 (P335.01)	Inertia settings: Motor moment of inertia (Moment of inert.: Motor inertia) 0.00 ... [3.70]* ... 20000000.00 kg cm <sup>2</sup> * Default setting dependent on the model.	Setting of the moment of inertia of the motor, relating to the motor.
0x2910:002 (P335.02)	Inertia settings: Scaled load inertia (Moment of inert.: Scal load inert.) 0.00 ... [0.00] ... 20000000.00 kg cm <sup>2</sup>	Setting of the moment of inertia of the load. <ul style="list-style-type: none"> <li>Always adjust the setting to the current load, otherwise the optimisation process for the speed controller cannot be executed successfully.</li> </ul>
0x2910:003	Inertia settings: Coupling	Selection of the type of coupling between the moment of inertia of the motor and that of the load.
	0 Stiff	
	1 Elastic	
	2 <b>With backlash</b>	

For further details on the speed controller, see chapter "Speed controller". [248](#)

## 10.8.4 Inverter characteristic

The inverter characteristic is automatically set if one of the following optimizations is carried out:

- ▶ Automatic motor identification (energized) [241](#)
- ▶ Automatic motor calibration (non-energized) [243](#)



The settings made can be seen if required, but should not be changed. A wrong setting may influence the control negatively!

## Parameter

Address	Name / setting range / [default setting]	Information
0x2947:001 ... 0x2947:017	Inverter characteristic: Value y1 ... Value y17 0.00 ... [0.00]* ... 20.00 V * Default setting dependent on the model.	The inverter characteristic (consisting of 17 values) is calculated and set during the automatic identification of the motor data. If only an automatic calibration of the motor data is carried out, a default inverter characteristic is loaded instead.  Note! Changing these values is not recommended by the manufacturer.

# Configuring the motor control

Options for optimizing the control loops  
Motor equivalent circuit diagram data



## 10.8.5 Motor equivalent circuit diagram data

The motor equivalent circuit diagram data are automatically set if one of the following optimizations is carried out:

- ▶ [Select motor from motor catalog](#) 58
- ▶ [Automatic motor identification \(energized\)](#) 241
- ▶ [Automatic motor calibration \(non-energized\)](#) 243

If you use a motor of a different manufacturer, you must adapt the data, e. g. from the motor data sheet according to the sizes and units mentioned if required.

### Parameter

Address	Name / setting range / [default setting]	Information
0x2C01:002	Motor parameters: Stator resistance 0.0000 ... [10.1565]* ... 125.0000 Ω * Default setting dependent on the model.	General motor data. Carry out settings as specified by manufacturer data/motor data sheet.
0x2C01:003	Motor parameters: Stator leakage inductance 0.000 ... [23.566]* ... 500.000 mH * Default setting dependent on the model.	Note! When you enter the motor nameplate data, take into account the phase connection implemented for the motor (star or delta connection). Only enter the data applying to the connection type selected.
0x2C02:001 (P351.01)	Motor parameter (ASM): Rotor resistance (ASM motor par.: Rotor resistance) 0.0000 ... [8.8944]* ... 200.0000 Ω * Default setting dependent on the model.	Equivalent circuit data required for the motor model of the asynchronous machine.
0x2C02:002 (P351.02)	Motor parameter (ASM): Mutual inductance (ASM motor par.: Mutual induct.) 0.0 ... [381.9]* ... 50000.0 mH * Default setting dependent on the model.	
0x2C02:003 (P351.03)	Motor parameter (ASM): Magnetising current (ASM motor par.: Magn. current) 0.00 ... [0.96]* ... 500.00 A * Default setting dependent on the model.	
0x2C03:001 (P352.01)	Motor parameter (PSM): Back EMF constant (PSM motor par.: BEMF constant) 0.0 ... [41.8] ... 100000.0 V/1000rpm • From version 02.00	Voltage induced by the motor (rotor voltage / 1000 rpm). For permanently excited synchronous motors, the e.m.f. constant describes the r.m.s. value of the line-to-line voltage (phase voltage) induced in idle state by the motor (reference: 1000 rpm, 20 °C). Measured: Line to Line (L - L)
0x2C03:005 (P352.05)	Motor parameter (PSM): D-axis inductance Ld (PSM motor par.: D-axis Ld) 0.000 ... [20.000]* ... 500.000 mH * Default setting dependent on the model. • From version 05.03	Presetting the inductance of the D-axis Ld.
0x2C03:006 (P352.06)	Motor parameter (PSM): Q-axis inductance Lq (PSM motor par.: Q-axis Lq) 0.000 ... [20.000]* ... 500.000 mH * Default setting dependent on the model. • From version 05.03	Presetting the inductance of the Q-axis Lq.



## 10.8.6 Motor control settings

After the motor settings have been made, the different control loops must be set. For a quick commissioning, the calculations and settings are made automatically if one of the following optimizations is carried out:

- ▶ [Select motor from motor catalog](#) 58
- ▶ [Automatic motor identification \(energized\)](#) 241
- ▶ [Automatic motor calibration \(non-energized\)](#) 243

### Details

The following controllers have an influence in the respective motor control type:

Controller	Motor control type					
	VFC open loop	VFC closed loop	SC-ASM	SL-PSM	SLSM-PSM	SLVC
<a href="#">Speed controller</a> <span style="float: right;">248</span>			●	●	●	●
<a href="#">Current controller</a> <span style="float: right;">249</span>	●	●	●	●		●
<a href="#">Current controller (field-oriented control)</a> <span style="float: right;">250</span>					●	
<a href="#">ASM field controller</a> <span style="float: right;">250</span>			●			●
<a href="#">ASM field weakening controller</a> <span style="float: right;">251</span>			●			●
<a href="#">PSM operation outside the voltage range</a> <span style="float: right;">251</span>				●	●	
<a href="#">Imax controller</a> <span style="float: right;">252</span>	●	●				
<a href="#">Flying restart controller</a> <span style="float: right;">253</span>	●			●		●
<a href="#">SLVC controller</a> <span style="float: right;">253</span>						●
<a href="#">Slip controller</a> <span style="float: right;">254</span>		●				
VFC open loop = V/f characteristic control VFC closed loop = V/f characteristic control with speed feedback SC-ASM = servo control for asynchronous motor SL-PSM/SLSM-PSM = sensorless control for synchronous motor SLVC = sensorless vector control						

# Configuring the motor control

Options for optimizing the control loops  
Motor control settings  
Speed controller



## 10.8.6.1 Speed controller

For a quick commissioning, the calculations and settings are made automatically during the optimization.



For typical applications, a manual adaptation of the parameters of the speed controller is not recommended. A wrong setting may have a negative effect on the control. For special applications, contact the manufacturer before adapting the parameters.

The automatically calculated settings for the speed controller enable an optimal control behaviour for typical load requirements. The oscillographed actual speed value (red) shows the control mode.

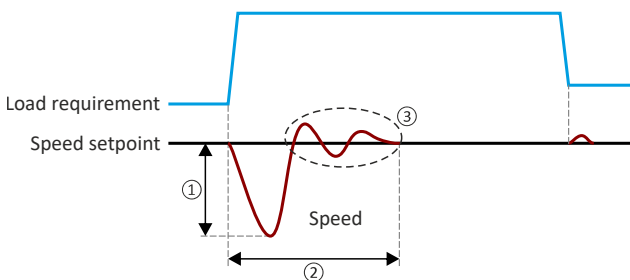

- 1 Minimum speed loss
- 2 Minimum settling time
- 3 Minimum overshoot

### Setting notes

If oscillations occur during operation after high loads:

- Reduce gain of the speed controller in [0x2900:001 \(P332.01\)](#).
- Increase reset time of the speed controller in [0x2900:002 \(P332.02\)](#).

If the speed loss is too high or the settling time too long during operation with high loads:

- Increase gain of the speed controller in [0x2900:001 \(P332.01\)](#).



If the gain is set too high or the reset time too low, the speed control loop can become unstable!

### Parameter

Address	Name / setting range / [default setting]	Information
0x2900:001 (P332.01)	Speed controller settings: Gain (Speed controller: Gain) 0.00000 ... [0.00193]* ... 20000.00000 Nm/rpm * Default setting dependent on the model.	Gain factor $V_p$ of the speed controller.
0x2900:002 (P332.02)	Speed controller settings: Reset time (Speed controller: Reset time) 1.0 ... [80.0]* ... 6000.0 ms * Default setting dependent on the model.	Reset time $T_i$ of the speed controller.
0x2901	Speed controller gain adaption 0.00 ... [100.00] ... 200.00 % • From version 04.00	Mappable parameter for adaptive adjustment of the speed controller gain.
0x2904	Actual speed filter time 0.0 ... [2.0] ... 50.0 ms	Time constant for the actual speed value filter.





## 10.8.6.2 Current controller

For a quick commissioning, the calculations and settings are made automatically during the motor calibration.



For typical applications, a manual adaptation of the parameters of the current controller is not recommended. A wrong setting may have a negative effect on the control. For special applications, contact the manufacturer before adapting the parameters.

### Preconditions

The current controller parameters are calculated based on the stator resistance and leakage inductance. Thus, the following parameters must be set correctly, either via optimization or manually (according to manufacturer-data/motor data sheet):

- **0x2C01:002**: Stator resistance
- **0x2C01:003**: Stator leakage inductance

▶ [Motor equivalent circuit diagram data](#) 246

### Parameter

Address	Name / setting range / [default setting]	Information
0x2942:001 (P334.01)	Current controller parameters: Gain (Current contr.: Gain) 0.00 ... [42.55]* ... 750.00 V/A * Default setting dependent on the model.	Gain factor $V_p$ of the current controller.
0x2942:002 (P334.02)	Current controller parameters: Reset time (Current contr.: Reset time) 0.01 ... [4.50]* ... 2000.00 ms * Default setting dependent on the model.	Reset time $T_n$ of the current controller.

# Configuring the motor control

Options for optimizing the control loops  
Motor control settings  
Current controller (field-oriented control)



## 10.8.6.3 Current controller (field-oriented control)

For quick commissioning, the calculations and settings are made automatically during the motor calibration.



For typical applications, a manual adaptation of the parameters of the current controller is not recommended. An incorrect setting may have a negative effect on the control. For special applications, contact the manufacturer before adapting the parameters.

### Preconditions

The current controller described here is only effective in the following motor control mode:

- Sensorless control for synchronous motors (SLSM-PSM)

The current controller parameters are calculated based on the stator resistance and leakage inductance. Thus, the following parameters must be set correctly, either via optimization or manually (according to manufacturer-data/motor data sheet):

- [0x2C01:002](#): Stator resistance
- [0x2C03:005 \(P352.05\)](#): D-axis inductance  $L_d$
- [0x2C03:006 \(P352.06\)](#): Q-axis inductance  $L_q$

▶ [Motor equivalent circuit diagram data](#) [□ 246](#)

### Parameter

Address	Name / setting range / [default setting]	Information
0x2942:004	Current controller parameters: d-axis gain 0.00 ... <b>[26.00]</b> * ... 750.00 V/A * Default setting dependent on the model.	Current controller parameters for "SLSM-PSM" motor control mode. ▶ <a href="#">Sensorless control for synchronous motor (SLSM-PSM)</a> <a href="#">□ 215</a>
0x2942:005	Current controller parameters: d-axis reset time 0.01 ... <b>[3.00]</b> * ... 2000.00 ms * Default setting dependent on the model.	
0x2942:006	Current controller parameters: q-axis gain 0.00 ... <b>[26.00]</b> * ... 750.00 V/A * Default setting dependent on the model.	
0x2942:007	Current controller parameters: q-axis reset time 0.01 ... <b>[3.00]</b> * ... 2000.00 ms * Default setting dependent on the model.	

## 10.8.6.4 ASM field controller

For a quick commissioning, the calculations and settings are made automatically during the motor calibration.

### Preconditions

The field controller is only effective in the following motor control types:

- Servo control (SC ASM)
- Sensorless vector control (SLVC)

### Parameter

Address	Name / setting range / [default setting]	Information
0x29C0:001	Field controller settings: Gain 0.00 ... <b>[59.68]</b> * ... 50000.00 A/Vs * Default setting dependent on the model.	Gain factor $V_p$ of the field controller.
0x29C0:002	Field controller settings: Reset time 1.0 ... <b>[45.5]</b> * ... 6000.0 ms * Default setting dependent on the model.	Reset time $T_n$ of the field controller.



# Configuring the motor control

Options for optimizing the control loops  
 Motor control settings  
 ASM field weakening controller

## 10.8.6.5 ASM field weakening controller

For a quick commissioning, the calculations and settings are made automatically during the motor calibration.

### Preconditions

The field weakening controller is only effective in the following motor control types:

- Servo control (SC ASM)
- Sensorless vector control (SLVC)

### Parameter

Address	Name / setting range / [default setting]	Information
0x29E0:001	Field weakening controller settings: Gain (ASM) 0.000 ... [0.000]* ... 2000000.000 Vs/V * Default setting dependent on the model.	Gain factor $V_p$ of the field weakening controller.
0x29E0:002	Field weakening controller settings: Reset time (ASM) 1.0 ... [1478.3]* ... 240000.0 ms * Default setting dependent on the model.	Reset time $T_n$ of the field weakening controller.
0x29E1	Field weakening controller Field limitation 5.00 ... [100.00] ... 100.00 % • From version 04.00	Field limitation of the field weakening controller.

## 10.8.6.6 ASM field weakening controller (extended)

For a quick commissioning, the calculations and settings are made automatically during the motor calibration.

### Preconditions

The field weakening controller is only effective in the following motor control types:

- Servo control (SC ASM)
- Sensorless vector control (SLVC)

### Parameter

Address	Name / setting range / [default setting]	Information
0x29E2	DC-bus filter time 1.0 ... [25.0] ... 1000.0 ms	Filter time for the current DC-bus voltage used for field weakening.
0x29E3	Motor voltage filter time 1.0 ... [25.0] ... 1000.0 ms	Filter time for the current motor voltage used for field weakening.
0x29E4 (P354.00)	Voltage reserve range (Voltage reserve) 0 ... [5] ... 20 %	Voltage reserve at the transition point to the field weakening, with reference to the current value of the DC-bus voltage. Effective with Servo control (SC ASM) (0x2C00 (P300.00) = 2), Sensorless control (SL PSM) (0x2C00 (P300.00) = 3) and with Sensorless vector control (SLVC) (0x2C00 (P300.00) = 4). • 100% = DC-bus voltage 0x2D87 (P105.00)

## 10.8.6.7 PSM operation outside the voltage range

### Parameter

Address	Name / setting range / [default setting]	Information
0x29E0:003	Field weakening controller settings: Reset time (PSM) 1.0 ... [800.0]* ... 240000.0 ms * Default setting dependent on the model. • From version 05.02	In the time configured (default 800 ms), the swivel control rotates the current phasor by 90°. Increasing the time makes the system smoother at the voltage limit. At the same time, it also reduces the dynamics.

# Configuring the motor control

Options for optimizing the control loops  
Motor control settings  
Imax controller



## 10.8.6.8 Imax controller

For a quick commissioning, the calculations and settings are made automatically during the motor calibration.



For typical applications, a manual adaptation of the parameters of the Imax controller is not recommended. A wrong setting may have a negative effect on the control. For special applications, contact the manufacturer before adapting the parameters.

### Preconditions

The Imax controller is only effective in the following motor control types:

- V/f characteristic control (VFC open loop)
- V/f characteristic control (VFC closed loop)

### Details

The Imax controller becomes active in the V/f operation if the actual motor current exceeds the maximum current "Max. current". The Imax controller changes the output frequency to counteract the exceedance.

The maximum current "Max. current" is defined in [0x6073 \(P324.00\)](#) in percent with regard to the rated motor current "Rated motor current" [0x6075 \(P323.00\)](#).

If the maximum current is exceeded:

- During operation in motor mode, the Imax controller reduces the output frequency.
- During operation in generator mode, the Imax controller increases the output frequency.

### Setting notes

If oscillations occur at the current limit during operation:

- Reduce gain of the Imax controller in [0x2B08:001 \(P333.01\)](#).
- Increase reset time of the Imax controller in [0x2B08:002 \(P333.02\)](#).
- Carry out the changes in small steps only (by 2 ... 3 % of the set value) until the oscillations do not exist anymore.

If the Imax controller does not respond fast enough after the maximum current has been exceeded:

- Increase gain of the Imax controller in [0x2B08:001 \(P333.01\)](#).
- Reduce reset time of the Imax controller in [0x2B08:002 \(P333.02\)](#).
- Carry out the changes in small steps only (by 2 ... 3 % of the set value in each case) until the response time is acceptable.

### Parameter

Address	Name / setting range / [default setting]	Information
0x2B08:001 (P333.01)	V/f Imax controller: Gain (V/f Imax contr.: Gain) 0.000 ... <b>[0.284]</b> * ... 1000.000 Hz/A * Default setting dependent on the model.	Gain factor $V_p$ of the Imax controller.
0x2B08:002 (P333.02)	V/f Imax controller: Reset time (V/f Imax contr.: Reset time) 1.0 ... <b>[2.3]</b> * ... 2000.0 ms * Default setting dependent on the model.	Reset time $T_i$ of the Imax controller.



## 10.8.6.9 Flying restart controller

For a quick commissioning, the calculations and settings are made automatically during the motor calibration.

### Preconditions

The flying restart controller is only effective in the following motor control types:

- V/f characteristic control (VFC open loop)
- Sensorless control (SL PSM)
- Sensorless vector control (SLVC)

### Details

The following parameter is only relevant for the flying restart circuit if an asynchronous motor is controlled. In case of a sensorless control of a synchronous motor (SL-PSM) the parameter has no meaning.

### Parameter

Address	Name / setting range / [default setting]	Information
0x2BA1:003 (P718.03)	Flying restart circuit: Restart time (Flying restart: Restart time) 1 ... [5911]* ... 60000 ms * Default setting dependent on the model.	Integration time for controlling the flying restart circuit.

## 10.8.6.10 SLVC controller

For a quick commissioning, the calculations and settings are made automatically during the motor calibration.

### Preconditions

The SLVC controller is only effective in the motor control type "Sensorless vector control (SLVC)".

### Parameter

Address	Name / setting range / [default setting]	Information
0x2B40:001	Gain 0.0000 ... [0.2686]* ... 1000.0000 Hz/A * Default setting dependent on the model.	Gain of the SLVC-Q controller.
0x2B40:002	Reset time 1.0 ... [2.3]* ... 2000.0 ms * Default setting dependent on the model.	Reset time of the SLVC-Q controller.

# Configuring the motor control

Options for optimizing the control loops  
Motor control settings  
Slip controller



## 10.8.6.11 Slip controller

In case of V/f characteristic control with feedback (VFC closed loop), the slip is calculated and injected by the slip controller. The default setting of the slip controller provides robustness and moderate dynamics.

### Preconditions

In **0x2C00 (P300.00)**, the motor control type "V/f characteristic control (VFC closed loop) [7]" is selected and configured. For details, see chapter "[V/f characteristic control for asynchronous motor \(VFC closed loop\)](#)". [□ 213](#)

### Details

- The slip controller is designed as a PI controller.
- In order to improve the response to setpoint changes, the setpoint speed or setpoint frequency is added as a feedforward control value to the output (correcting variable) of the slip controller.
- With the setting **0x2B14:003** = 0 Hz, the slip controller is deactivated.

### Controller gain Vp

The gain setting range of the slip controller **Vp 0x2B14:001**, which causes a stable operating power, mainly depends on the resolution of the speed sensor. There is a direct relation between the encoder resolution and the gain:

- The higher the encoder resolution, the higher the gain can be set. The following table contains the required gains for the encoder with standard encoder increments:

Encoder increment [increments / revolution]	recommended
8	0.06
64	0.31
100	0.47
120	0.57
128	0.6
256	0.77
386	0.98
512	1.18
640	1.38
768	1.59
896	1.79
1014	2
1536	2.81
2048	3.63
3072	5.26
4096	6.9

### Parameter

Address	Name / setting range / [default setting]	Information
0x2B14:001	Slip controller: Gain 0.000 ... [0.100] ... 65.535	Gain of the slip controller.
0x2B14:002	Slip controller: Reset time 0.0 ... [100.0] ... 6553.5 ms	Reset time of the slip controller.
0x2B14:003	Slip controller: Frequency limitation 0.00 ... [10.00] ... 100.00 Hz	Frequency limitation of the slip controller. <ul style="list-style-type: none"><li>• With the setting of 0 Hz, the slip controller is deactivated.</li></ul>



## 10.8.6.12 General optimizations

### Parameter

Address	Name / setting range / [default setting]	Information
0x2DE0:010	Service settings: Motor control behavior 0 ... [0] ... 65535 <ul style="list-style-type: none"> <li>Setting can only be changed if the inverter is disabled.</li> <li>From version 05.03</li> </ul>	Optimization of the behavior of the motor control.
	Bit 0 Slip compensation via equivalent circuit diagram	Bit 0 = 0: calculation via motor data label (standard). Bit 0 = 1: calculation of magnetising current based on equivalent circuit diagram (response <= SW 05.02.00).
	Bit 1 I <sub>max</sub> controller without clamp detection	Bit x = 1: Activation of the respective option.
	Bit 2 Motor reference temperatur 20 degree celsius	
	Bit 3 Enhanced SLVC stop behavior	
	Bit 4 Earth fault detection disabled (from version 06.02)	



### 10.9 Motor protection

Many monitoring functions integrated in the inverter can detect errors and thus protect the device or motor from being destroyed or overloaded.





## 10.9.1 Motor overload monitoring (i<sup>2</sup>t)

This function monitors the thermal overload of the motor, taking the motor currents recorded and a mathematical model as a basis.

### DANGER!

Fire hazard by overheating of the motor.

Possible consequences: Death or severe injuries

- ▶ To achieve full motor protection, an additional temperature monitoring function with a separate evaluation must be installed.
- ▶ When operating motors that are equipped with PTC thermistors or thermal contacts, always activate the PTC input. When used alone (without i<sup>2</sup>T monitoring), PTC thermistors or thermal contacts do not fulfil NEC conformity requirements according to article 430.

### Details

This function only serves to functionally protect the motor. It is not suitable for safety-relevant protection against energy-induced hazards, since the function is not fail-safe.

- When the thermal motor utilisation calculated reaches the threshold set in [0x2D4B:001 \(P308.01\)](#), the response set in [0x2D4B:003 \(P308.03\)](#) is triggered.
- With the setting [0x2D4B:003 \(P308.03\)](#) = "No response [0]", the monitoring function is deactivated.



For NEC Article 430-compliant operation with motor overload protection, do not change default settings [0x2D4B:002 \(P308.02\)](#) and [0x2D4B:003 \(P308.03\)](#)! ([0x2D4B:002 \(P308.02\)](#) = "On [0]", [0x2D4B:003 \(P308.03\)](#) = "error [3]"). With these settings, the calculated thermal motor load is stored internally when the inverter is switched off and reloaded when it is switched back on. If monitoring is deactivated with setting [0x2D4B:003 \(P308.03\)](#) = "No response [0]" or "Warning [1]", the motor overload protection is deactivated. For NEC Article 430-compliant operation in this mode, external overload protection must be provided by the end user.



When monitoring the motor temperature with a suitable temperature sensor at terminals X109/T1 and X109/T2: if the motor temperature monitoring is set ([0x2D4B:002 \(P308.02\)](#) to "Error [3]"), the motor overload monitoring ([0x2D4B:003 \(P308.03\)](#)) can also be set differently to "Error [3]". If the monitoring has the setting ([0x2D4B:003 \(P308.03\)](#) = "No reaction [0]" or "Warning [1]"), the motor overload protection is deactivated. For NEC Article 430-compliant operation in this mode, external overload protection must be provided by the end user.

▶ [Motor temperature monitoring](#)  261

# Configuring the motor control

Motor protection  
Motor overload monitoring ( $i^2xt$ )



The following two diagrams show the relation between the motor load and tripping time of the monitoring under the following conditions:

- Maximum utilization **0x2D4B:001 (P308.01)** = 150 %
- Speed compensation **0x2D4B:002 (P308.02)** = "Off [1]" or output frequency  $\geq 40$  Hz

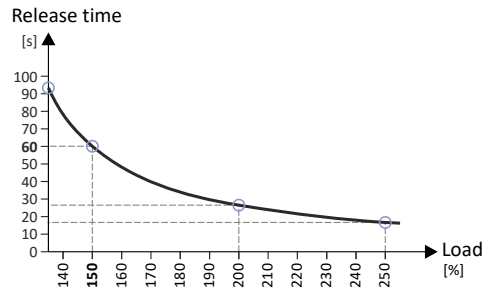
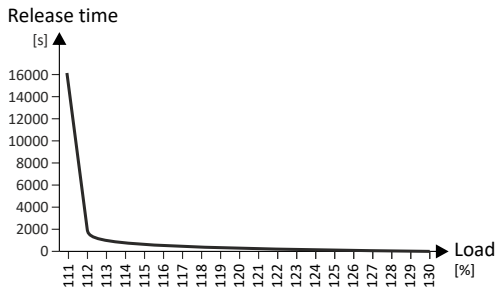

Maximum utilization 60s [%] ▶ <b>0x2D4B:001 (P308.01)</b>	Load ratio [%]	Tripping time [s]
150	110	Indefinite
150	135	93
150	150	60
150	200	26
150	250	17

Calculation
Load ratio: Load ratio = actual motor current <b>0x2D88 (P104.00)</b> / rated motor current <b>0x6075 (P323.00)</b>
Maximum load ratio for continuous operation at an output frequency $\geq 40$ Hz: Maximum load ratio for continuous operation [%] = $0.73 * \text{maximum utilization } \mathbf{0x2D4B:001 (P308.01)}$
Release time at an output frequency $\geq 40$ Hz and a load ratio > maximum load ratio for continuous operation: Tripping time [s] $\approx 15.9 / ((\text{load ratio}/\text{maximum utilization } \mathbf{0x2D4B:001 (P308.01)}) - 0.724)$ [s]



## Speed compensation for protecting motors at low speed

The inverter has implemented a compensation for low speeds. If the motor is operated with frequencies below 40 Hz, the speed compensation in [0x2D4B:002 \(P308.02\)](#) must be set to "On [0]" (default). This setting ensures that the tripping time for the monitoring is reduced at low speeds, in order to take the reduced self-cooling of AC motors into account.



For UL-compliant operation, speed compensation must also be activated.  
[0x2D4B:002 \(P308.02\)](#) = "On [0]".

If speed compensation is activated, the **maximum load ratio for continuous operation** is reduced as follows:

Calculation
Output frequency < 40 Hz: <b>Maximum load ratio for continuous operation</b> = 62.5 % + 37.5 % * output frequency [Hz] / 40 [Hz]
Output frequency ≥ 40 Hz: No reduction

The following diagram shows the reduced release time with activated speed compensation.

- Maximum utilization [0x2D4B:001 \(P308.01\)](#) = 150 %
- Speed compensation [0x2D4B:002 \(P308.02\)](#) = "On [0]"
- Load ratio = 150 %

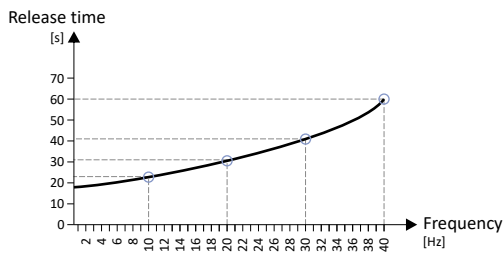

Output frequency	Release time
40 Hz	60 s
30 Hz	≈ 41 s
20 Hz	≈ 31 s
10 Hz	≈ 23 s

The following diagram shows the possible permanent load with activated speed compensation without the monitoring being triggered.

- Maximum utilization [0x2D4B:001 \(P308.01\)](#) = 150 %
- Speed compensation [0x2D4B:002 \(P308.02\)](#) = "On [0]"

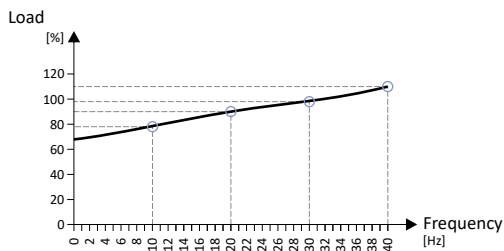

Output frequency	Possible permanent load
40 Hz	110 %
30 Hz	99 %
20 Hz	90 %
10 Hz	79 %

At 0 Hz, only a load of max. 62.7 % (≈ 62.5 %) is possible. Reference: Load at 40 Hz (69 / 110 \* 100 % = 62.7 %). The maximum possible motor load changes proportionally to the setting in [0x2D4B:001 \(P308.01\)](#).

Calculation
Maximum load ratio for continuous operation at an output frequency < 40 Hz: Maximum load ratio for continuous operation = $k_f = 0.625 + 0.375/40 * \text{output frequency}$
Release time at maximum load ratio for continuous operation: Release time at maximum load ratio for continuous operation [%] = $0.73 * k_f * \text{maximum utilization } 0x2D4B:001 (P308.01)$
Release time at an output frequency < 40 Hz and a load ratio > <b>maximum load ratio for continuous operation</b> : Release time [s] ≈ $15.9 / ((\text{load ratio}/\text{maximum utilization } 0x2D4B:001 (P308.01) * k_f) - 0.724)$ [s]

# Configuring the motor control

Motor protection  
Motor overload monitoring (i<sup>2</sup>xt)



## Parameter

Address	Name / setting range / [default setting]	Information
0x2D4B:001 (P308.01)	Motor overload monitoring (i <sup>2</sup> xt): Maximum utilisation [60 s] (Motor overload: Max.load.for 60s) 30 ... [150] ... 200 %	Maximum permissible thermal motor utilisation (max. permissible motor current for 60 seconds). <ul style="list-style-type: none"> <li>100 % = Rated motor current <a href="#">0x6075 (P323.00)</a></li> <li>If the motor is actuated with the current set here for 60 seconds, the maximum permissible thermal motor utilisation is reached and the response set in <a href="#">0x2D4B:003 (P308.03)</a> is executed.</li> <li>If the motor is actuated with a different current, the time period until the motor overload monitoring function is activated is different. Generally the following applies: the lower the current, the lower the thermal utilisation and the later the monitoring function is triggered.</li> </ul>
0x2D4B:002 (P308.02)	Motor overload monitoring (i <sup>2</sup> xt): Speed compensation (Motor overload: Speed comp.)	Use this function to protect motors that are actuated at a speed below 40 Hz. <ul style="list-style-type: none"> <li>UL-compliant operation with motor overload protection requires the setting "On [0]"!</li> </ul>
	0 On	Release time for motor overload monitoring is reduced in order to compensate for the reduced cooling of naturally ventilated AC induction motors during operation at low speed.
	1 Off	Function deactivated, no reduction of the motor overload monitoring release time. May require an external motor overload protection for the UL-compliant operation.
0x2D4B:003 (P308.03)	Motor overload monitoring (i <sup>2</sup> xt): Response (Motor overload: Response)	Selection of the response to the triggering of motor overload monitoring. <ul style="list-style-type: none"> <li>UL-compliant operation with motor overload protection requires the setting "error [3]"!</li> <li>If monitoring is deactivated by the setting <a href="#">0x2D4B:003 (P308.03)</a> = "No response [0]", no motor overload protection is active. In this case, an external motor overload protection can be provided by the user for a UL-compliant operation.</li> </ul> Associated event ID: <ul style="list-style-type: none"> <li>9040   0x2350 - CiA: i<sup>2</sup>xt overload (thermal state)</li> </ul>
	0 No response	▶ Severity <a href="#">□ 700</a>
	1 Warning	
	2 Trouble	
	3 Fault	
0x2D4B:005	Motor overload monitoring (i <sup>2</sup> xt): Thermal load <ul style="list-style-type: none"> <li>Read only</li> </ul>	Display of the value of the internal i <sup>2</sup> *t integrator. <ul style="list-style-type: none"> <li>37500 = 100 % thermal load</li> <li>When power is switched off, this value is saved in the internal EEPROM.</li> <li>When power is switched on, the saved value is reloaded into the i<sup>2</sup>*t integrator.</li> <li>The internal i<sup>2</sup>*t integrator detects the thermal load based on the load conditions even if the motor overload monitoring is deactivated.</li> </ul>
0x2D4F (P123.00)	Motor utilisation (i <sup>2</sup> xt) (Mot. i2t utilis.) <ul style="list-style-type: none"> <li>Read only: x %</li> </ul>	Display of the current thermal motor utilisation.



## 10.9.2 Motor temperature monitoring

In order to record and monitor the motor temperature, a PTC thermistor (single sensor according to DIN 44081 or triple sensor according to DIN 44082) or thermal contact (normally-closed contact) can be connected to the terminals T1 and T2. This measure helps to prevent the motor from being destroyed by overheating.

### Preconditions

- The inverter can only evaluate one PTC thermistor! Do not connect several PTC thermistors in series or parallel.
- If several motors are actuated on one inverter, thermal contacts (NC contacts) (TCO) connected in series are to be used.
- To achieve full motor protection, an additional temperature monitoring function with a separate evaluation must be installed.
- By default, a wire jumper is installed between terminals X109/T1 and X109/T2, which must be removed when the PTC thermistor or thermal contact (TCO) is connected.

### Details

If  $1.6\text{ k}\Omega < R < 4\text{ k}\Omega$  at terminals X109/T1 and X109/T2, the monitoring function will be activated; see functional test below.

- If the monitoring function is activated, the response set in [0x2D49:002 \(P309.02\)](#) will be effected.
- The setting [0x2D49:002 \(P309.02\)](#) = 0 deactivates the monitoring function.



---

If a suitable motor temperature sensor is connected to the terminals X109/T1 and X109/T2 and the response in [0x2D49:002 \(P309.02\)](#) is set to "Fault [3]", the response of the motor overload monitoring may be set other than "Fault [3]" in [0x2D4B:003 \(P308.03\)](#).

▶ [Motor overload monitoring \(i<sup>2</sup>xt\)](#) [📄 257](#)

---

### Functional test

Connect a fixed resistor to the PTC input:

- $R > 4\text{ k}\Omega$  : The monitoring function must be activated.
- $R < 1\text{ k}\Omega$  : The monitoring function must not be activated.

### Parameter

Address	Name / setting range / [default setting]	Information
0x2D49:002 (P309.02)	Motor temperature monitoring: Response (Mot.temp.monit.: Response)	Selection of the response to the triggering of the motor temperature monitoring.  Associated event ID: • <a href="#">17168</a>   <a href="#">0x4310</a> - Motor overtemperature
	0 No response	▶ <a href="#">Severity</a> <a href="#">📄 700</a>
	1 Warning	
	2 Trouble	
	<b>3 Fault</b>	



## 10.9.3 Overcurrent monitoring

This function monitors the instantaneous value of the motor current and serves as motor protection.

### NOTICE

With an incorrect parameterization, the maximum permissible motor current may be exceeded in the process.

Possible consequences: Irreversible damage of the motor

Avoid motor damages by using the overcurrent monitoring function as follows:

- ▶ The setting of the threshold for the overcurrent monitoring in [0x2D46:001 \(P353.01\)](#) must be adapted to the connected motor.
- ▶ Set the maximum current of the inverter in [0x6073 \(P324.00\)](#) much lower than the threshold for overcurrent monitoring for a dynamic limitation of the motor current.

### Details

The inverter monitors its output current. This monitoring is independent of the maximum overload current setting. ▶ [Maximum overload current of the inverter](#) [□ 267](#)

- If the instantaneous value of the motor current exceeds the threshold set in [0x2D46:001 \(P353.01\)](#), the response set in [0x2D46:002 \(P353.02\)](#) takes place.
- With the setting [0x2D46:002 \(P353.02\)](#) = "No response [0]", the monitoring function is deactivated.

The threshold for the overcurrent monitoring is preset to four times the rated motor current. This presetting is overwritten in case a motor in the engineering tool is selected from the "motor catalog" or the automatic identification or calibration of the motor data is carried out. For a suitable protection, the automatically adapted setting should be used. If disturbances occur during operation, the value can be increased.

### Parameter

Address	Name / setting range / [default setting]	Information
0x2D46:001 (P353.01)	Overcurrent monitoring: Threshold (Overcurr. monit.: Threshold) 0.0 ... [ <b>6.8</b> ]* ... 1000.0 A * Default setting dependent on the model. <ul style="list-style-type: none"> <li>• From version 02.00</li> </ul>	Warning/error threshold for overcurrent monitoring of the motor. <ul style="list-style-type: none"> <li>• If the active motor current exceeds the set threshold, the response set in <a href="#">0x2D46:002 (P353.02)</a> is triggered.</li> <li>• The parameter is calculated and set in the course of the automatic identification of the motor.</li> <li>• The parameter can also be set and overwritten by selecting a motor from the "motor catalogue" of the engineering tool or performing an automatic calibration of the motor.</li> </ul> ▶ <a href="#">Options for optimizing the control loops</a> <a href="#">□ 238</a>
0x2D46:002 (P353.02)	Overcurrent monitoring: Response (Overcurr. monit.: Response)	Selection of the response to the triggering of motor current monitoring. Associated event ID: <ul style="list-style-type: none"> <li>• <a href="#">29056</a>   <a href="#">0x7180</a> - Motor overcurrent</li> </ul> ▶ <a href="#">Severity</a> <a href="#">□ 700</a>
	0 No response	
	1 Warning	
	2 Trouble	
	<b>3</b> <b>Fault</b>	



## 10.9.4 Motor phase failure detection

The motor phase failure detection function can be activated for both synchronous and asynchronous motors.



In the "SLSM-PSM" motor control mode, detection for motor phase failure is deactivated if HF injection is active in the low-speed range.

### Preconditions

Motor phase failure detection during operation is suitable for applications which are operated with a constant load and speed. In other cases, transient processes or unfavourable operating points can cause erroneous triggering to occur.

### Details

If a current-carrying motor phase (U, V, W) fails during operation, the response selected in [0x2D45:001 \(P310.01\)](#) is tripped and a logbook entry is made.

Exception: With the setting "No response [0]", no logbook entry is made.

A motor phase failure can only be detected if

1. the rated motor current is higher than 10 % of the rated inverter current and
2. the output frequency is not lower than 0.1 Hz (standstill).

The lower the output frequency the longer the detection of the motor phase failure.

### Parameter

Address	Name / setting range / [default setting]	Information
0x2D45:001 (P310.01)	Motor phase failure detection: Response - Motor phase 1 (Mot.phase.fail.: Response)	Selection of the response following the detection of a motor phase failure during operation.  Associated event IDs: <ul style="list-style-type: none"> <li>• <a href="#">65289</a>   <a href="#">0xFF09</a> - Motor phase missing</li> <li>• <a href="#">65290</a>   <a href="#">0xFF0A</a> - Motor phase failure phase U</li> <li>• <a href="#">65291</a>   <a href="#">0xFF0B</a> - Motor phase failure phase V</li> <li>• <a href="#">65292</a>   <a href="#">0xFF0C</a> - Motor phase failure phase W</li> </ul>
	<b>0</b> No response	▶ Severity <a href="#">□ 700</a>
	<b>1</b> Warning	
	<b>2</b> Trouble	
	<b>3</b> Fault	
0x2D45:002 (P310.02)	Motor phase failure detection: Current threshold (Mot.phase.fail.: Current thresh.) 1.0 ... <b>[5.0]</b> ... 25.0 %	Current threshold for the activation of the motor phase failure detection function. <ul style="list-style-type: none"> <li>• 100 % = Rated motor current <a href="#">0x6075 (P323.00)</a></li> <li>• Display of the present motor current in <a href="#">0x2D88 (P104.00)</a>.</li> </ul>
0x2D45:003 (P310.03)	Motor phase failure detection: Voltage threshold (Mot.phase.fail.: Voltage thresh.) 0.0 ... <b>[10.0]</b> ... 100.0 V	Voltage threshold for motor phase monitoring for the VFC control mode ( <a href="#">0x2C00 (P300.00)</a> = 6). <ul style="list-style-type: none"> <li>• The monitoring function is triggered if the motor current exceeds the rated motor current-dependent current threshold for longer than 20 ms. Rated motor current <a href="#">0x6075 (P323.00)</a></li> <li>• In case of the V/f characteristic control, the voltage threshold is considered additionally for the motor phase failure detection. If the motor voltage is higher than the voltage threshold, monitoring is combined with the motor current.</li> </ul>



## 10.9.5 Motor speed monitoring

This function monitors the motor speed during operation.

### Conditions

- In order to detect the current motor speed, the inverter must be enabled and the motor must rotate.
- For an exact monitoring, rated motor speed [0x2C01:004 \(P320.04\)](#) and rated motor frequency [0x2C01:005 \(P320.05\)](#) must be set correctly.
- For motor speed monitoring, it must be ensured that the speed limitation ([0x6080 \(P322.00\)](#) / max. motor speed) has a higher value than the actual monitoring ([0x2D44:001 \(P350.01\)](#)).

### Details

- If the motor speed reaches the threshold set in [0x2D44:001 \(P350.01\)](#), the response set in [0x2D44:002 \(P350.02\)](#) takes place.
- With the setting [0x2D44:002 \(P350.02\)](#) = "No response [0]", the monitoring function is deactivated.

### Parameter

Address	Name / setting range / [default setting]	Information
0x2D44:001 (P350.01)	Overspeed monitoring: Threshold (Overspeed monit.: Threshold) 50 ... [8000] ... 50000 rpm	Warning/error threshold for motor speed monitoring. <ul style="list-style-type: none"> <li>• If the motor speed reaches the threshold set, the response selected in <a href="#">0x2D44:002 (P350.02)</a> takes place.</li> <li>• The parameter can be set and thus overwritten by selecting a motor in the engineering tool from the "motor catalog".</li> <li>• Depending on the parameter setting of <a href="#">0x2D44:001 (P350.01)</a> (Overspeed monitoring: threshold), the speed limitation (0x6080 / Max. motor speed) may become active before speed monitoring.</li> </ul> <a href="#">▶ Options for optimizing the control loops ¶ 238</a>
0x2D44:002 (P350.02)	Overspeed monitoring: Response (Overspeed monit.: Response)	Selection of the response to the triggering of motor speed monitoring. Associated event ID: <ul style="list-style-type: none"> <li>• <a href="#">65286</a>   <a href="#">0xFF06</a> - Motor overspeed</li> </ul>
	0 No response	<a href="#">▶ Severity ¶ 700</a>
	1 Warning	
	2 Trouble	
	<b>3 Fault</b>	





## 10.9.6 Motor torque monitoring

This function limits the motor torque during operation.

### Preconditions

The motor torque monitoring can only be used for the following motor control types with speed controller:

- Servo control (SC ASM)
- Sensorless control (SL PSM)
- Sensorless vector control (SLVC)

### Details

This function sets the internal status signal "Torque limit reached [79]" = TRUE when the maximum possible torque has been reached.

The limits of the monitoring function are selected via [0x2949:001 \(P337.01\)](#) (positive torque limit) and [0x2949:002 \(P337.02\)](#) (negative torque limit). The actual limits can be seen in [0x2949:003 \(P337.03\)](#) (actual positive torque limit), [0x2949:004 \(P337.04\)](#) (actual negative torque limit).

#### ▶ Torque limits [165](#)

- The status signal is set irrespective of the response [0x2D67:001 \(P329.01\)](#) and the delay time [0x2D67:002 \(P329.02\)](#) set for this monitoring.
- The status signal can be used by the user to
  - activate certain functions. ▶ [Flexible I/O configuration \[64\]\(#\)](#)
  - set a digital output. ▶ [Configure digital outputs \[292\]\(#\)](#)
  - set a bit of the NetWordOUT1 mappable data word. ▶ [Motor speed monitoring \[264\]\(#\)](#)

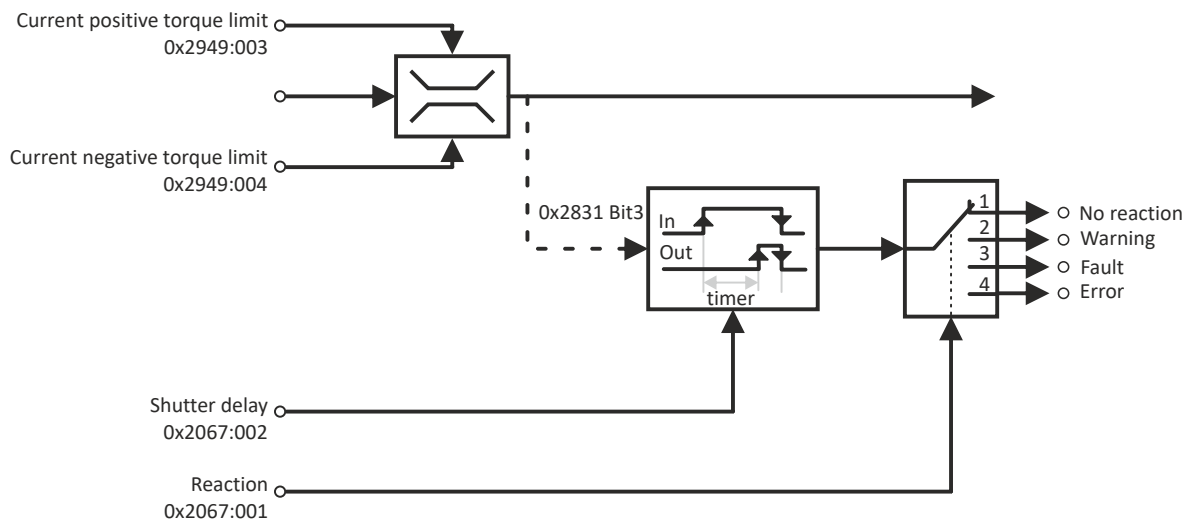

# Configuring the motor control

Motor protection  
Motor torque monitoring



## Parameter

Address	Name / setting range / [default setting]	Information
0x2D67:001 (P329.01)	Maximum torque monitoring: Response (MaxTrq.Monitor: Response) <ul style="list-style-type: none"> <li>From version 02.00</li> </ul>	Selection of response to reaching the maximum possible torque. <ul style="list-style-type: none"> <li>The selected response takes place if the status signal "Torque limit reached [79]" = TRUE and the deceleration time set in <a href="#">0x2D67:002 (P329.02)</a> has elapsed.</li> </ul> Associated event ID: <ul style="list-style-type: none"> <li><a href="#">33553</a>   <a href="#">0x8311</a> - Torque limit reached</li> </ul>
	<b>0</b> No response	▶ Severity <a href="#">700</a>
	1 Warning	
	2 Trouble	
	3 Fault	
0x2D67:002 (P329.02)	Maximum torque monitoring: Triggering delay (MaxTrq.Monitor: Triggering delay) 0.000 ... <b>[0.000]</b> ... 10.000 s <ul style="list-style-type: none"> <li>From version 02.00</li> </ul>	Optional setting of a deceleration for triggering the response selected in <a href="#">0x2D67:001 (P329.01)</a> .  Typical application: <ul style="list-style-type: none"> <li>The motor should be driven at the torque limit for a short time without triggering the selected response.</li> <li>Only after a longer operation (&gt; set deceleration) at the torque limit, the selected response is to take place.</li> </ul>
0x6072 (P326.00)	Max. torque (Max. torque) 0.0 ... <b>[250.0]</b> ... 3000.0 % <ul style="list-style-type: none"> <li>From version 02.00</li> </ul>	Symmetrical selection of the maximum permissible torque. <ul style="list-style-type: none"> <li>100 % = Rated motor torque <a href="#">0x6076 (P325.00)</a></li> <li>This parameter serves to implement a static and bipolar torque limitation. This can be used, for instance, as overload protection of the mechanical transmission path/elements starting at the motor shaft.</li> <li>This limitation acts irrespective of the torque limitations acting in unipolar mode that are set in <a href="#">0x60E0</a> and <a href="#">0x60E1</a>.</li> </ul>



## 10.9.7 Maximum overload current of the inverter

For the purpose of current limitation, a maximum overload current can be set for the inverter. If the current consumption of the motor exceeds this current limit, the inverter changes its dynamic behaviour, in order to counteract this exceedance.

### Details

- The maximum current of the inverter can be set in [0x6073 \(P324.00\)](#).
- Reference for the percentage setting of the maximum overload current is the rated motor current set in [0x6075 \(P323.00\)](#).
- The actual motor current is displayed in [0x2D88 \(P104.00\)](#).



If the change in the dynamic behavior carried out by the inverter does not result in exiting the overcurrent state, the inverter outputs an error.

If [0x6078 \(P103.00\)](#) (actual value in %) exceeds [0x6073 \(P324.00\)](#) (max. actual value in %), a message 0x238A is displayed. The status is also indicated in the following network status word bits:

- 0x400C:001 bit 14
- 0x400C:002 bit 2

Load response	Impact
Overload during acceleration in motor mode	A longer time than is required for reaching the frequency setpoint is set.
Overload during deceleration in generator mode	A longer time than is required for reaching standstill is set.
Increasing load at constant frequency	If the motor current limit value is reached: <ul style="list-style-type: none"> <li>• The inverter reduces the effective speed setpoint until a stable working point is set or an effective speed setpoint of 0 rpm is reached.</li> <li>• If the load is reduced, the inverter increases the effective speed setpoint until the setpoint speed is reached or the load reaches the current limit value again.</li> </ul>
	When the generator current limit value is reached: <ul style="list-style-type: none"> <li>• The inverter increases the effective speed setpoint until a stable working point is reached or up to the maximum permissible output frequency <a href="#">0x2916 (P211.00)</a>.</li> <li>• If the load is reduced, the inverter reduces the effective speed setpoint until the setpoint speed is reached or the load reaches the current limit value again.</li> </ul>
	If an abrupt load is building at the motor shaft (e.g. drive is blocked), the overcurrent switch-off function may respond.

# Configuring the motor control

Motor protection  
Maximum overload current of the inverter



## Example: Overcurrent switch-off in case of a sudden load at the motor shaft

Frequency setpoint selection

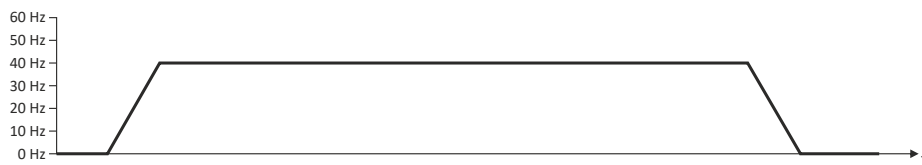

Output frequency

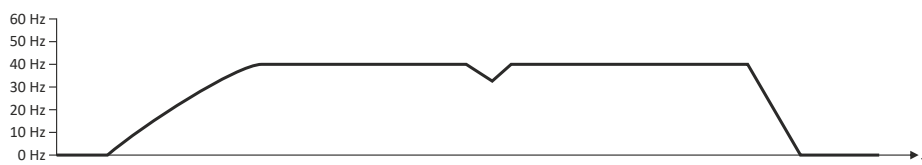

Motor load

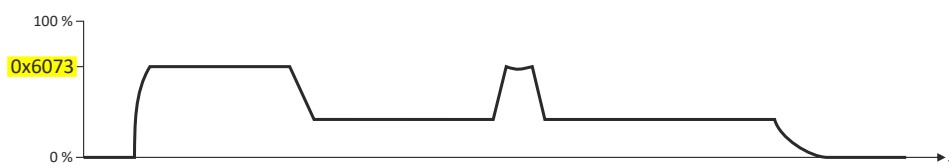

## Parameter

Address	Name / setting range / [default setting]	Information
0x6073 (P324.00)	Max. current (Max. current) 0.0 ... [200.0] ... 3000.0 %	<p>Max. current of the inverter.</p> <ul style="list-style-type: none"> <li>• 100 % = Rated motor current (0x6075 (P323.00))</li> <li>• If the current consumption of the motor exceeds this current limit, the inverter changes its dynamic behaviour in order to counteract this exceedance.</li> <li>• If the modified dynamic behaviour fails to eliminate the excess current consumption, the inverter outputs an error.</li> </ul> <p>When 0x6078 (P103.00) (current actual value in %) exceeds 0x6073 (P324.00) (max. current actual value in %) the message 0x238A is displayed. This status is also displayed in the following network status word bits:</p> <ul style="list-style-type: none"> <li>• 0x400C:001 bit 14</li> <li>• 0x400C:002 bit 2</li> </ul> <p>Note! This parameter is not identical to the ultimate motor current <math>I_{ULT}</math>.</p> <ul style="list-style-type: none"> <li>• The value set in 0x2D46:001 (P353.01) (Threshold) is a limit value for synchronous motors to protect their magnets.</li> <li>• The value to be set here should always be considerably below the ultimate motor current.</li> </ul>



## 10.9.8 Heavy load monitoring

If the apparent current of the motor exceeds a defined threshold value due to a heavy duty state, a configurable error is triggered (incl. logbook entry).

### Conditions

Monitoring is activated as soon as the motor is running. Monitoring can be deactivated with the setting "No response".

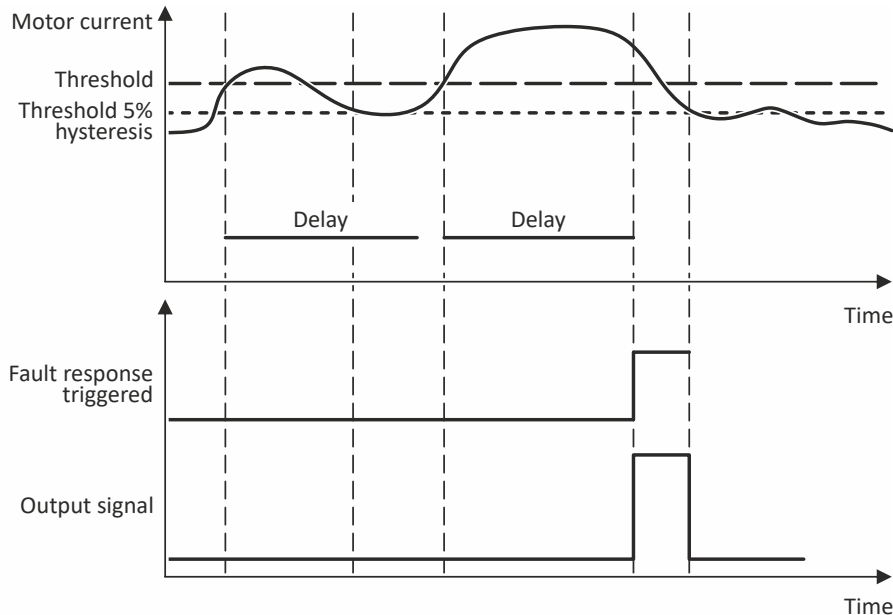

### Details

Exceedance of the defined threshold:

- If the actual apparent current exceeds the configured threshold value, the delay time encoder is started.
- If the actual apparent motor current falls below the threshold value minus 5 % (hysteresis - not adjustable), the delay time encoder is set to zero.

Independent of the error response, the output signal (Heavy duty monitoring [84]) is triggered:

- If the actual apparent current of the motor exceeds the threshold for longer than the delay time, the output signal is set to TRUE.
- If the actual apparent current of the motor falls below the threshold value minus 5 % (hysteresis), the output signal is set to FALSE.
- If the delay time is set to 0 seconds, the output signal is immediately set to TRUE.

The error response is activated according to its settings:

- If the actual apparent current of the motor exceeds the threshold value for longer than the configured delay time, the selected error response is activated.
- When the error response is triggered, an entry is generated in the logbook (exception: Error response - Selection [0]): "Motor overload" (error code [65337](#) | [0xFF39](#))

### Parameter

Address	Name / setting range / [default setting]	Information
0x4007:001	Heavy load monitoring: Error threshold 0.0 ... <b>[200.0]</b> ... 300.0 % • From version 05.02	When the threshold value for the apparent current of the motor is exceeded, the delay time encoder is started. • 100 % = of rated motor current <a href="#">0x6075 (P323.00)</a>
0x4007:002	Heavy load monitoring: Delay time 0.0 ... <b>[3.0]</b> ... 999.9 s • From version 05.02	Setting of the delay time.

# Configuring the motor control

Motor protection  
Heavy load monitoring



Address	Name / setting range / [default setting]	Information
0x4007:003	Heavy load monitoring: Error response	Setting of the error response.
	• From version 05.02	Associated event ID:
		• <a href="#">65337</a>   <a href="#">0xFF39</a> - Motor overload
	<b>0</b> No response	▶ Severity <a href="#">□ 700</a>
	1 Warning	
2 Trouble		
3 Fault		



## 10.10 Monitoring settings

### Parameter

Address	Name / setting range / [default setting]	Information
0x2D52:001	Monitoring settings: Hysteresis for speed setpoint reached 0.0 ... [0.0] ... 200.0 %	Hysteresis for detecting the "target speed reached" status. <ul style="list-style-type: none"><li>• 100 % = rated motor frequency</li></ul>



## 11 I/O extensions and control connections

### 11.1 Configure digital inputs

Settings for digital inputs 1 ... 7.

#### Preconditions

Digital input 6 and digital input 7 are only available for a Control Unit (CU) with application I/O.

#### Details

The digital inputs are used for control tasks. For this purpose, the digital inputs are available as selectable triggers for functions.

The following settings are possible for the digital inputs:

- Assertion level "HIGH active" or "LOW active" ①
- Debounce time ②
- Inversion ③

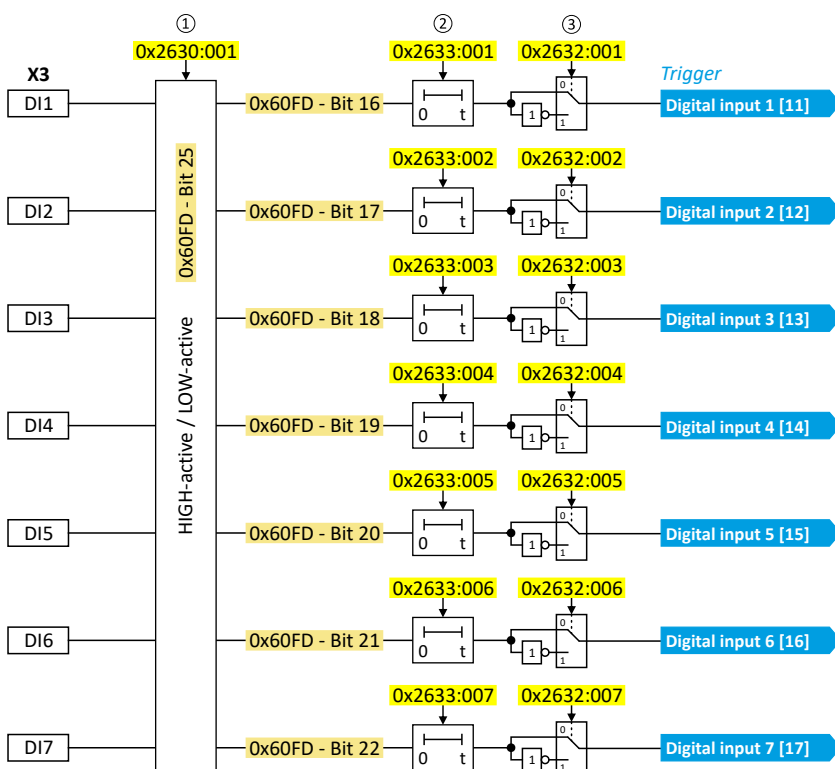

Diagnostic parameters:

- The logic status of the digital inputs is displayed in `0x60FD (P118.00)`.





## Assertion level "HIGH active" or "LOW active"

The digital inputs can be configured in [0x2630:001 \(P410.01\)](#) HIGH active (default setting) or LOW active:

HIGH active (default setting)	LOW active
<ul style="list-style-type: none"> <li>Internally, the digital input terminals are set to LOW level via pull-down resistors.</li> <li>The current flows from the current supply (e.g. X3/24V) through the contact to the digital input terminal (and internally via the pull-down resistor to GND).</li> <li>If the contact is closed, the digital input is set to HIGH level and is thus HIGH active.</li> </ul>	<ul style="list-style-type: none"> <li>Internally, the digital input terminals are set to HIGH level via pull-up resistors.</li> <li>The current flows from the digital input terminal through the contact to GND.</li> <li>If the contact is closed, the digital input is set to LOW level and is thus LOW active.</li> </ul>
Connection plan (example): 	Connection plan (example): 

## Debounce time

For minimising interference pulses, a debounce time of 1 ms is set for all digital inputs. Via »EASY Starter« (or network), the debounce time for can be increased individually for each digital input to maximally 50 ms.

## Inversion

Each digital input can be configured in such a way that the status pending at the terminal is internally inverted logically. This way, a closed contact, for instance, serves to deactivate an assigned function instead of activating it. Thus, the control of the inverter can be flexibly adapted to the requirements of the actual application.

## Parameter

Address	Name / setting range / [default setting]	Information
0x2630:001 (P410.01)	Settings for digital inputs: Assertion level (DI settings: Assertion level)	Definition of the internal hardware interconnection of the digital inputs.
	0 LOW active	Digital inputs are internally set to HIGH level via pull-up resistors.
	1 HIGH active	Digital inputs are internally set to LOW level via pull-down resistors.



Address	Name / setting range / [default setting]	Information
0x2630:002 (P410.02)	Settings for digital inputs: Input function (DI settings: Input function)	Input function of the digital terminals DI3 and DI4.
	<b>0</b> Digital input	DI3 = digital input DI4 = digital input
	<b>1</b> High resolution HTL encoder (from version 02.00)	DI3 = HTL input for encoder track A DI4 = HTL input for encoder track B <ul style="list-style-type: none"> <li>This method is well suited for encoders with a high signal quality (scanning ratio 1:1).</li> <li>Not suited for encoders with poor signal quality (high error rate)</li> <li>Exact 90°-phase offset between track A and B (error &lt;= 10°)</li> <li>Wiring according to EMC (e.g. motor and encoder cable shielding) is required.</li> </ul> <a href="#">▶ HTL encoder □ 176</a>
	<b>2</b> Pulse train (from version 03.00)	DI3 = digital input DI4 = HTL input for pulse train <ul style="list-style-type: none"> <li><a href="#">▶ Configure digital inputs DI3/DI4 for detecting a pulse train □ 276</a></li> </ul>
	<b>3</b> Pulse train/direction (from version 03.00)	DI3 = HTL input for direction specification; HIGH level = counter-clockwise (CCW) DI4 = HTL input for pulse train <ul style="list-style-type: none"> <li><a href="#">▶ Configure digital inputs DI3/DI4 for detecting a pulse train □ 276</a></li> </ul>
	<b>4</b> Low resolution HTL encoder (from version 05.03)	For the evaluation of a HTL encoder with low resolution (≤ 128 increments per revolution). <ul style="list-style-type: none"> <li>This evaluation method is suitable for encoders with poor signal quality, e.g. encoders with a high error rate in sampling ratio and phase offset.</li> <li>The prerequisite is an equidistant period length per encoder increment.</li> <li>An interruption of track A is not detected.</li> </ul> <a href="#">▶ HTL encoder □ 176</a>
0x2632:001 (P411.01)	Inversion of digital inputs: Digital input 1 (DI inversion: DI1 inversion)	Inversion of digital input 1
	<b>0</b> Not inverted	
	<b>1</b> Inverted	
0x2632:002 (P411.02)	Inversion of digital inputs: Digital input 2 (DI inversion: DI2 inversion)	Inversion of digital input 2
	<b>0</b> Not inverted	
	<b>1</b> Inverted	
0x2632:003 (P411.03)	Inversion of digital inputs: Digital input 3 (DI inversion: DI3 inversion)	Inversion of digital input 3
	<b>0</b> Not inverted	
	<b>1</b> Inverted	
0x2632:004 (P411.04)	Inversion of digital inputs: Digital input 4 (DI inversion: DI4 inversion)	Inversion of digital input 4
	<b>0</b> Not inverted	
	<b>1</b> Inverted	
0x2632:005 (P411.05)	Inversion of digital inputs: Digital input 5 (DI inversion: DI5 inversion)	Inversion of digital input 5
	<b>0</b> Not inverted	
	<b>1</b> Inverted	
0x2632:006 (P411.06)	Inversion of digital inputs: Digital input 6 (DI inversion: DI6 inversion)	Inversion of digital input 6
	<b>0</b> Not inverted	
	<b>1</b> Inverted	
0x2632:007 (P411.07)	Inversion of digital inputs: Digital input 7 (DI inversion: DI7 inversion)	Inversion of digital input 7
	<b>0</b> Not inverted	
	<b>1</b> Inverted	



Address	Name / setting range / [default setting]	Information
0x2633:001	Digital input debounce time: Digital input 1 1 ... [1] ... 50 ms	Debounce time of digital input 1
0x2633:002	Digital input debounce time: Digital input 2 1 ... [1] ... 50 ms	Debounce time of digital input 2
0x2633:003	Digital input debounce time: Digital input 3 1 ... [1] ... 50 ms	Debounce time of digital input 3
0x2633:004	Digital input debounce time: Digital input 4 1 ... [1] ... 50 ms	Debounce time of digital input 4
0x2633:005	Digital input debounce time: Digital input 5 1 ... [1] ... 50 ms	Debounce time of digital input 5
0x2633:006	Digital input debounce time: Digital input 6 1 ... [1] ... 50 ms	Debounce time of digital input 6
0x2633:007	Digital input debounce time: Digital input 7 1 ... [1] ... 50 ms	Debounce time of digital input 7

### Example: Activating two functions simultaneously via digital input 4

The principle of assigning triggers to functions also enables a digital input to be assigned to several functions. The wiring complexity is reduced since there is no necessity to interconnect several digital inputs.

If, for instance, the frequency preset 1 is to be selected via the digital input 4 and a change-over to the acceleration time 2 and deceleration time 2 is to take place at the same time, this can be easily realised by the following parameter setting:

Parameter	Designation	Setting for this example
0x2631:018 (P400.18)	Activate preset (bit 0)	Digital input 4 [14]
0x2631:039 (P400.39)	Activate ramp 2	Digital input 4 [14]



In order to achieve the desired behaviour, the digital input 4 must not be assigned to any further functions!

# I/O extensions and control connections

Configure digital inputs

Configure digital inputs DI3/DI4 for detecting a pulse train



## 11.1.1 Configure digital inputs DI3/DI4 for detecting a pulse train

In case of the inverter, the digital inputs DI3 and DI4 can be configured as HTL input to evaluate the signal of a cost-effective HTL encoder or a reference frequency ("pulse train").

The inverter can adopt a reference frequency (also referred to as pulse train) as a setpoint signal.



---

The digital inputs which are able to assume a frequency setpoint are generally the same digital inputs that are able to accept an HTL encoder. Therefore, it is not possible to use the frequency input and the encoder input at the same time.

---



---

The digital inputs of the inverter have a maximum frequency limit. Exceeding the maximum frequency input leads to an error. See details in chapter "Settings of the encoder monitoring". [📖 179](#)

---

### Preconditions

In order to use the digital inputs DI3 and DI4 as HTL input, the corresponding input function must be set. ▶ [0x2630:002 \(P410.02\)](#)



## Details

The digital inputs must be configured such that they detect the frequency input signal. This happens in [0x2630:002 \(P410.02\)](#).

- a) Input function [0x2630:002 \(P410.02\)](#) = "Pulse train [2]"  
(DI4 = input for pulse train, DI3 = normal digital input)

This selection configures the digital inputs to detect the frequency signal, whereby DI4 is configured to detect the frequency input signal (pulse train).

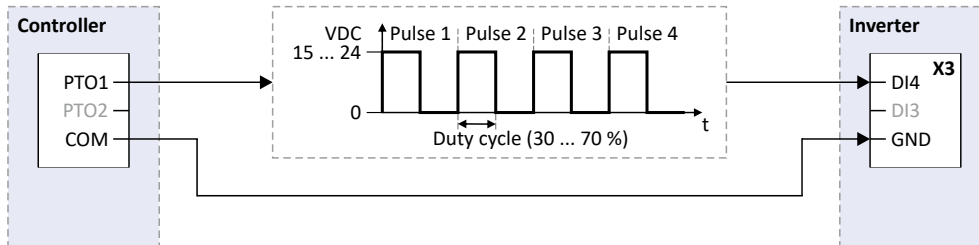

- b) Input function [0x2630:002 \(P410.02\)](#) = "Pulse train/direction [3]"  
(DI4 = input for pulse train, DI3 = input for specification of direction)

This selection configures the digital inputs to detect the frequency and directional signals, whereby the digital input DI4 is configured to detect the frequency input signal (pulse train) and DI3 is configured to detect the directional signal.

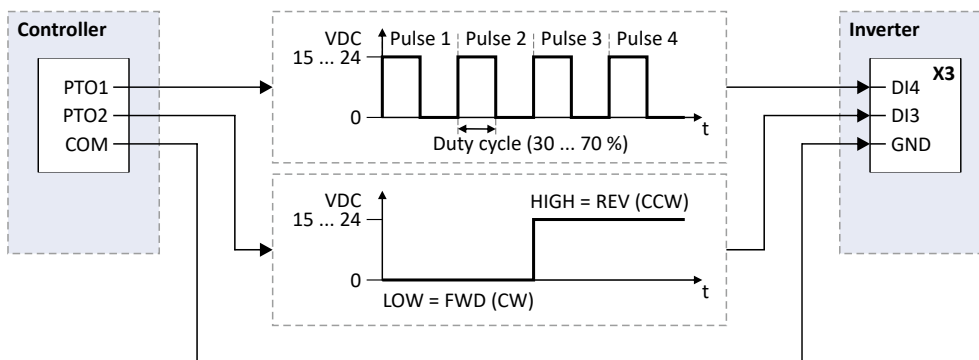

## Scaling

The scaling of the frequency signal in relation to the setpoint range takes place in two steps can be configured as follows:

- Identify the minimum and maximum frequency of the frequency signal (pulse train).
- Set the minimum frequency value (Hz). ▶ [0x2640:001 \(P415.01\)](#)



When DI3 is used to control the pulse train [0x2630:002 \(P410.02\)](#) = [3], this value must be configured to the corresponding **NEGATIVE** pulse frequency value.

- Set the maximum frequency value (Hz). ▶ [0x2640:002 \(P415.02\)](#)

## Range

Configure the range for the setpoint, which corresponds to the minimum and maximum frequency of the frequency signal (pulse train).

Frequency setpoint:

- Set minimum desired motor frequency (Hz). ▶ [0x2640:003 \(P415.03\)](#)
- Set maximum desired motor frequency (Hz). ▶ [0x2640:004 \(P415.04\)](#)

Process control:

- Set minimum desired PID setpoint (PID controller). ▶ [0x2640:005 \(P415.05\)](#)
- Set maximum desired PID setpoint (PID controller). ▶ [0x2640:006 \(P415.06\)](#)

Torque setpoint:

# I/O extensions and control connections

Configure digital inputs  
Configure digital inputs DI3/DI4 for detecting a pulse train



- Set minimum desired torque setpoint (% torque). ▶ [0x2640:007 \(P415.07\)](#)
- Set maximum desired torque setpoint (% torque). ▶ [0x2640:008 \(P415.08\)](#)

## Filter

Filter time constant: in normal operation, the standard value is sufficient for executing this function. ▶ [0x2640:009 \(P415.09\)](#)

## Monitoring

It is also possible for the inverter to monitor the frequency input and generate a response when the frequency input falls below a predetermined frequency value and / or rises above a predetermined frequency value.

Configuration of inverter monitoring:

- Set minimum frequency threshold to the lowest valid input frequency (in Hz).  
▶ [0x2641:001 \(P416.01\)](#)
- Set maximum frequency threshold to the highest valid input frequency (in Hz).  
▶ [0x2641:003 \(P416.03\)](#)
- Set minimum deceleration threshold to the time period for which the input frequency needs to fall below the minimum threshold in order to cause an error status.  
▶ [0x2641:002 \(P416.02\)](#)
- Set maximum deceleration threshold to the time period for which the input frequency needs to exceed the maximum threshold in order to cause an error status. ▶ [0x2641:004 \(P416.04\)](#)
- Set monitoring conditions. ▶ [0x2641:005 \(P416.05\)](#)
- Set the error response to the desired action that occurs when the error "Frequency input monitoring error" is triggered. ▶ [0x2641:006 \(P416.06\)](#)

## The following settings are possible for the HTL input:

- Definition of the input range ①
- Filter time for low-pass filters ②
- Definition of the setting range ③
- Monitoring of the input signal ④

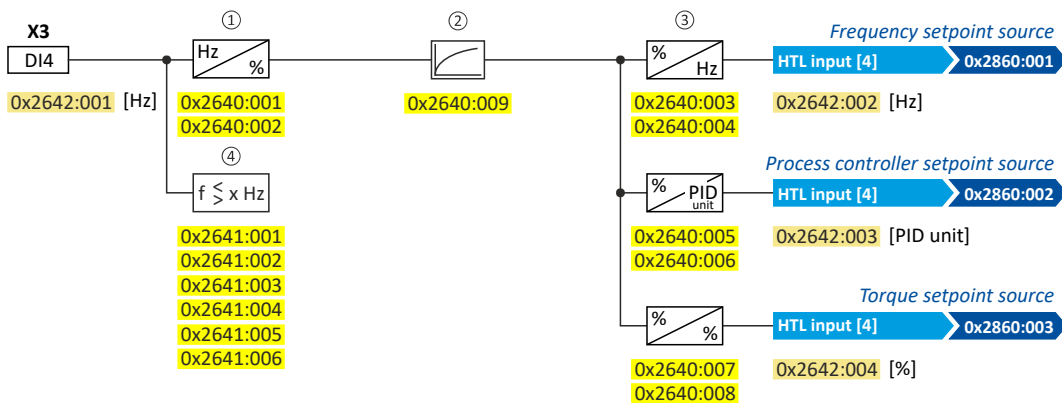



## Intended use

The HTL input can be used for the following tasks:

- As a standard setpoint source

Intended use	Parameter	Setting	Further information
As a setpoint source for specifying a frequency setpoint.	<a href="#">0x2860:001 (P201.01)</a>	HTL input [4]	Frequency control ▶ <a href="#">Standard setpoint source</a> <a href="#">128</a>
As setpoint source for defining the reference value for the process controller.	<a href="#">0x2860:002 (P201.02)</a>	HTL input [4]	Frequency control ▶ <a href="#">Configuring the process controller</a> <a href="#">128</a>
As a setpoint source for specifying a torque setpoint.	<a href="#">0x2860:003 (P201.03)</a>	HTL input [4]	Torque control ▶ <a href="#">Standard setpoint source</a> <a href="#">163</a>
As an alternative to the setting as a standard setpoint source, the "Activate setpoint via HTL input" <a href="#">0x2631:022 (P400.22)</a> function can be used to enable a setpoint change-over to the HTL input.			

- As an actual value source or feedforward source for the following functions:

Intended use	Parameter	Setting	Further information
As an actual value source for the process controller.	<a href="#">0x4020:002 (P600.02)</a>	HTL input [6]	Frequency control ▶ <a href="#">Configuring the process controller</a> <a href="#">128</a>
As a speed feedforward source for the process controller.	<a href="#">0x4020:004 (P600.04)</a>	HTL input [9]	

## Configuration examples

Detailed configuration examples can be found in the following subchapters:

- ▶ [Example 1: Input range 10 ... 85 kHz = setting range 0 ... 50 Hz](#) [128](#)
- ▶ [Example 2: Input range 10 ... 85 kHz = setting range -50 ... 50 Hz](#) [128](#)
- ▶ [Example 3: Pulse train as frequency setpoint source](#) [128](#)

## Parameter

Address	Name / setting range / [default setting]	Information
<a href="#">0x2640:001 (P415.01)</a>	HTL input settings: Minimum frequency (HTL inp. setting: Min.frequency) -100000.0 ... <b>[0.0]</b> ... 100000.0 Hz • From version 04.00	Definition of the input range of the HTL input. When DI3 is used to control the pulse train [0x2630: 002 = 3], this value must be configured to the corresponding NEGATIVE pulse frequency value.
<a href="#">0x2640:002 (P415.02)</a>	HTL input settings: Maximum frequency (HTL inp. setting: Max. frequency) -100000.0 ... <b>[0.0]</b> ... 100000.0 Hz • From version 04.00	Definition of the input range of the HTL input.
<a href="#">0x2640:003 (P415.03)</a>	HTL input settings: Minimum motor frequency (HTL inp. setting: Min.motor.freq) -1000.0 ... <b>[0.0]</b> ... 1000.0 Hz • From version 04.00	Definition of the setting range for operating mode "MS: Velocity mode". • Direction of rotation according to sign. • The standard setpoint source for operating mode <a href="#">0x6060 (P301.00)</a> = "MS: Velocity mode [-2]" is selected in <a href="#">0x2860:001 (P201.01)</a> .
<a href="#">0x2640:004 (P415.04)</a>	HTL input settings: Maximum motor frequency (HTL inp. setting: Max.motor.freq) Device for 50-Hz mains: -1000.0 ... <b>[50.0]</b> ... 1000.0 Hz Device for 60-Hz mains: -1000.0 ... <b>[60.0]</b> ... 1000.0 Hz • From version 04.00	▶ <a href="#">Configuring the frequency control</a> <a href="#">92</a>
<a href="#">0x2640:005 (P415.05)</a>	HTL input settings: Minimum PID setpoint (HTL inp. setting: Min.PID setpoint) -300.00 ... <b>[0.00]</b> ... 300.00 PID unit • From version 04.00	Definition of the setting range for PID control. • The standard setpoint source for the reference value of PID control is selected in <a href="#">0x2860:002 (P201.02)</a> . ▶ <a href="#">Configuring the process controller</a> <a href="#">128</a>
<a href="#">0x2640:006 (P415.06)</a>	HTL input settings: Maximum PID setpoint (HTL inp. setting: Max.PID setpoint) -300.00 ... <b>[100.00]</b> ... 300.00 PID unit • From version 04.00	

# I/O extensions and control connections

Configure digital inputs

Configure digital inputs DI3/DI4 for detecting a pulse train



Address	Name / setting range / [default setting]	Information
0x2640:007 (P415.07)	HTL input settings: Minimum torque setpoint (HTL inp. setting: Min.torque setp.) -400.0 ... [0.0] ... 400.0 % • From version 04.00	Definition of the setting range for operating mode "MS: Torque mode". • 100 % = Rated motor torque 0x6076 (P325.00) • Direction of rotation according to sign.
0x2640:008 (P415.08)	HTL input settings: Maximum torque setpoint (HTL inp. setting: Max.torque setp.) -400.0 ... [100.0] ... 400.0 % • From version 04.00	• The standard setpoint source for operating mode 0x6060 (P301.00) = "MS: Torque mode [-1]" is selected in 0x2860:003 (P201.03). ▶ <a href="#">Configuring the torque control</a> □ 161
0x2640:009 (P415.09)	HTL input settings: IN1 Filter time constant (HTL inp. setting: IN1 Filter time) 0 ... [10] ... 10000 ms • From version 04.00	PT1 time constant for low-pass filter.
0x2641:001 (P416.01)	HTL input monitoring: IN1 Minimal frequency threshold (HTL inp. monit.: In1min.f.thresh.) -214748364.8 ... [0.0] ... 214748364.7 Hz • From version 04.00	Settings for the minimum frequency threshold for the monitoring of the HTL input.
0x2641:002 (P416.02)	HTL input monitoring: IN1 Minimum delay threshold (HTL inp. monit.: In1min.d thres) 0.0 ... [5.0] ... 300.0 s • From version 04.00	Settings for the minimum deceleration threshold for the monitoring of the HTL input.
0x2641:003 (P416.03)	HTL input monitoring: IN1 Maximal frequency threshold (HTL inp. monit.: In1max.f.thresh.) -214748364.8 ... [0.0] ... 214748364.7 Hz • From version 04.00	Settings for the maximum frequency threshold for the monitoring of the HTL input.
0x2641:004 (P416.04)	HTL input monitoring: IN1 Maximum delay threshold (HTL inp. monit.: In1max.d thres) 0.0 ... [5.0] ... 300.0 s • From version 04.00	Settings for the maximum deceleration threshold for the monitoring of the HTL input.
0x2641:005 (P416.05)	HTL input monitoring: IN1 Monitoring conditions (HTL inp. monit.: In1 condition) • From version 04.00	Monitoring condition for HTL input. • If the selected condition is fulfilled, the response set in 0x2641:006 (P416.06) takes place.
	1 Below minimum frequency	Input frequency < minimum frequency threshold 0x2641:001 (P416.01) longer than the deceleration 0x2641:002 (P416.02).
	2 Above maximum frequency	Input frequency > maximum frequency threshold 0x2641:003 (P416.03) longer than the deceleration 0x2641:004 (P416.04).
	3 Below min. or above max. frequency	Input frequency < minimum frequency threshold 0x2641:001 (P416.01) longer than the deceleration 0x2641:002 (P416.02) OR input frequency > maximum frequency threshold 0x2641:003 (P416.03) longer than the deceleration 0x2641:004 (P416.04).
0x2641:006 (P416.06)	HTL input monitoring: IN1 Error response (HTL inp. monit.: In1Err response) • From version 04.00	Selection of the response to the triggering of the HTL input monitoring. Associated event ID: • 28803   0x7083 - HTL input fault
	0 No response	▶ <a href="#">Severity</a> □ 700
	1 Warning	
	2 Trouble	
	3 Fault	
0x2642:001 (P115.01)	HTL input diagnostics: Input frequency (HTL inp. diag.: Input frequency) • Read only: x.x Hz • From version 04.00	Display of the current input value at the HTL input.
0x2642:002 (P115.02)	HTL input diagnostics: Frequency setpoint (HTL inp. diag.: Freq. setpoint) • Read only: x.x Hz • From version 04.00	Display of the current input value at the HTL input scaled as frequency value. • The standard setpoint source for operating mode 0x6060 (P301.00) = "MS: Velocity mode [-2]" is selected in 0x2860:001 (P201.01).
0x2642:003 (P115.03)	HTL input diagnostics: PID setpoint (HTL inp. diag.: PID setpoint) • Read only: x.xx PID unit • From version 04.00	Display of the current input value at the HTL input scaled as process controller value. • The standard setpoint source for the reference value of PID control is selected in 0x2860:002 (P201.02).





# I/O extensions and control connections

Configure digital inputs

Configure digital inputs DI3/DI4 for detecting a pulse train

Example 1: Input range 10 ... 85 kHz = setting range 0 ... 50 Hz

Address	Name / setting range / [default setting]	Information
0x2642:004 (P115.04)	HTL input diagnostics: Torque setpoint (HTL inp. diag.: Torque setpoint) <ul style="list-style-type: none"> <li>Read only: x.x %</li> <li>From version 04.00</li> </ul>	Display of the current input value at the HTL input scaled as torque value in percent. <ul style="list-style-type: none"> <li>100 % = Rated motor torque 0x6076 (P325.00)</li> <li>The standard setpoint source for operating mode 0x6060 (P301.00) = "MS: Torque mode [-1]" is selected in 0x2860:003 (P201.03).</li> </ul>

## 11.1.1.1 Example 1: Input range 10 ... 85 kHz = setting range 0 ... 50 Hz

In this configuration, a frequency setpoint between 0 and 50 Hz can be set with an HTL input frequency between 10 and 85 kHz.

Parameter	Name	Setting for this example
0x2640:001 (P415.01)	HTL input settings: Minimum frequency	10000.0 Hz
0x2640:002 (P415.02)	HTL input settings: Maximum frequency	85000.0 Hz
0x2640:003 (P415.03)	HTL input settings: Minimum motor frequency	0.0 Hz
0x2640:004 (P415.04)	HTL input settings: Maximum motor frequency	50.0 Hz
0x2640:009 (P415.09)	HTL input settings: IN1 Filter time constant	10 ms

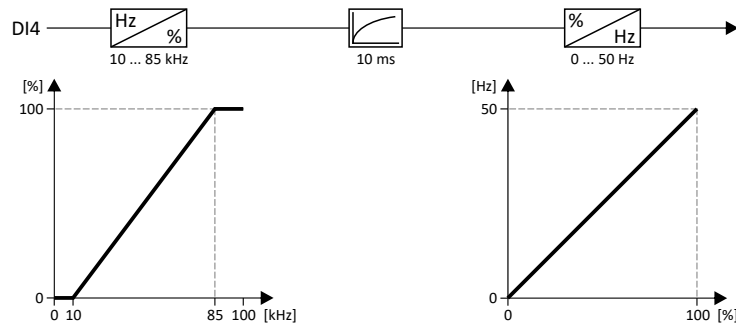

## 11.1.1.2 Example 2: Input range 10 ... 85 kHz = setting range -50 ... 50 Hz

In this configuration, a frequency setpoint between -50 and 50 Hz can be set with an HTL input frequency between 10 and 85 kHz.

Parameter	Name	Setting for this example
0x2640:001 (P415.01)	HTL input settings: Minimum frequency	10000.0 Hz
0x2640:002 (P415.02)	HTL input settings: Maximum frequency	85000.0 Hz
0x2640:003 (P415.03)	HTL input settings: Minimum motor frequency	-50.0 Hz
0x2640:004 (P415.04)	HTL input settings: Maximum motor frequency	50.0 Hz
0x2640:009 (P415.09)	HTL input settings: IN1 Filter time constant	10 ms

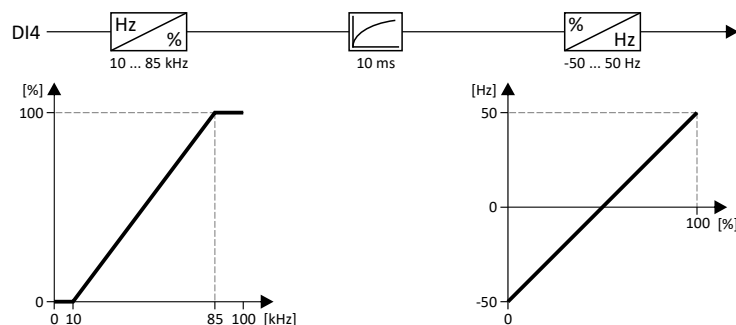

# I/O extensions and control connections

Configure digital inputs  
 Configure digital inputs DI3/DI4 for detecting a pulse train  
 Example 3: Pulse train as frequency setpoint source



## 11.1.1.3 Example 3: Pulse train as frequency setpoint source

This example shows a configuration to control the frequency setpoint of the inverter via pulse train:

- Switch S1 starts the motor. Switch S1 in initial position stops the motor again.
- Scaling of the pulse train signal: Input range -85 ... 85 kHz = setting range -50 ... 50 Hz
- HTL input monitoring is configured in such a way that a warning is output if the pulse train signal falls below the minimum input frequency of 10 kHz for longer than 2 s.

Connection plan	Function
	Switch S1 Run
	PTO1 Pulse train output of the controller
	PTO2 Specification of direction of rotation of the controller

Parameter	Name	Setting for this example
0x2631:001 (P400.01)	Enable inverter	Constant TRUE [1]
0x2631:002 (P400.02)	Run	Digital input 1 [11]
0x2630:002 (P410.02)	Settings for digital inputs: Input function	Pulse train/direction [3]
0x2860:001 (P201.01)	Frequency control: Default setpoint source	HTL input [4]
HTL input settings		
0x2640:001 (P415.01)	Minimum frequency	-85000.0 Hz
0x2640:002 (P415.02)	Maximum frequency	85000.0 Hz
0x2640:003 (P415.03)	Minimum motor frequency	-50.0 Hz
0x2640:004 (P415.04)	Maximum motor frequency	50.0 Hz
HTL input monitoring		
0x2641:001 (P416.01)	IN1 Minimal frequency threshold	10000.0 Hz
0x2641:002 (P416.02)	IN1 Minimum delay threshold	2.0 s
0x2641:005 (P416.05)	IN 1Monitoring conditions	Below minimum frequency [1]
0x2641:006 (P416.06)	IN1 Error response	Warning



# I/O extensions and control connections

Configure digital inputs  
 Configure digital inputs DI3/DI4 for detecting a pulse train  
 Example 3: Pulse train as frequency setpoint source

## Input signals

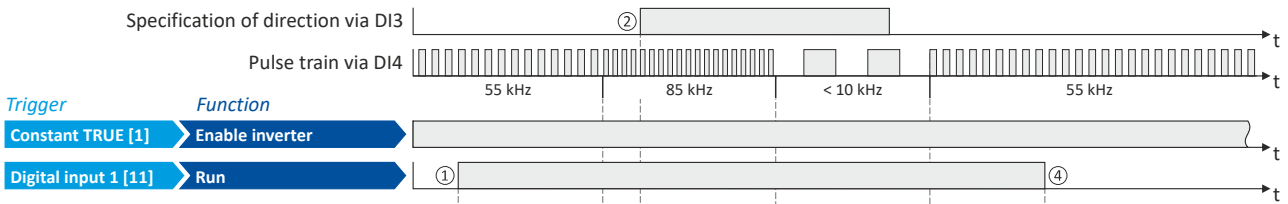

## Output signals

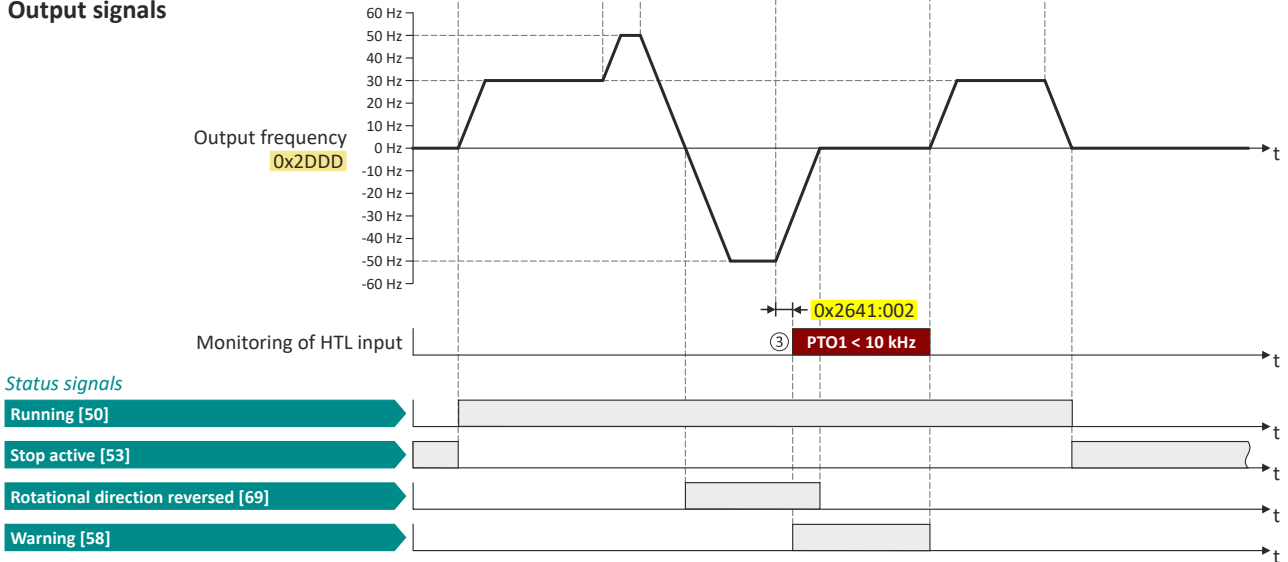

The status signals can be assigned to digital outputs. ▶ [Configure digital outputs](#) 292

- If the inverter is enabled and no error is active, the motor can be started with the "Run" function. The motor follows the pulse train according to the set input and setting range.
- The "counter-clockwise (CCW)" direction of rotation is requested externally (controller; PTO2) via digital input DI3.
- If the pulse train signal falls below the input frequency of 10 kHz, for longer than 2 s, a warning is output.
- If "Run" is set to FALSE, the motor is stopped with the stop method set in `0x2838:003 (P203.03)`. In the example: Stop with standard ramp.



## 11.2 Configure analog inputs

### 11.2.1 Analog input 1

Settings for analog input 1.

#### Intended use

The analog input 1 can be used for the following tasks:

- As a standard setpoint source

Intended use	Parameter	Setting	Further information
As a setpoint source for specifying a frequency setpoint.	0x2860:001 (P201.01)	Analog input 1 [2]	Frequency control ▶ <a href="#">Standard setpoint source</a> 93
As setpoint source for defining the reference value for the process controller.	0x2860:002 (P201.02)	Analog input 1 [2]	Frequency control ▶ <a href="#">Configuring the process controller</a> 128
As a setpoint source for defining a torque setpoint.	0x2860:003 (P201.03)	Analog input 1 [2]	Torque control ▶ <a href="#">Standard setpoint source</a> 163
As an alternative to the setting as a standard setpoint source, the "Activate AI1 setpoint" 0x2631:014 (P400.14) function can be used to enable a setpoint change-over to the analog input 1.			

- As an actual value source or speed feedforward source for the process controller:

Intended use	Parameter	Setting	Further information
As an actual value source for the process controller.	0x4020:002 (P600.02)	Analog input 1 [1]	Frequency control ▶ <a href="#">Configuring the process controller</a> 128
As a speed feedforward source for the process controller.	0x4020:004 (P600.04)	Analog input 1 [2]	

#### Configuration examples

Detailed configuration examples can be found in the following subchapters:

- ▶ [Example: Input range 0 ... 10 V = setting range 0 ... 50 Hz](#) 287
- ▶ [Example: Input range 0 ... 10 V = setting range -40 ... +40 Hz](#) 287
- ▶ [Example: Input range -10 ... +10 V = setting range -40 ... +40 Hz](#) 288
- ▶ [Example: Error detection](#) 288



## Details

The following settings are possible for the analog input:

- Definition of the input range ①
- Filter time for low-pass filters ②
- Monitoring of the input signal ③
- Dead band for eliminating the smallest signal levels ④
- Definition of the setting range ⑤

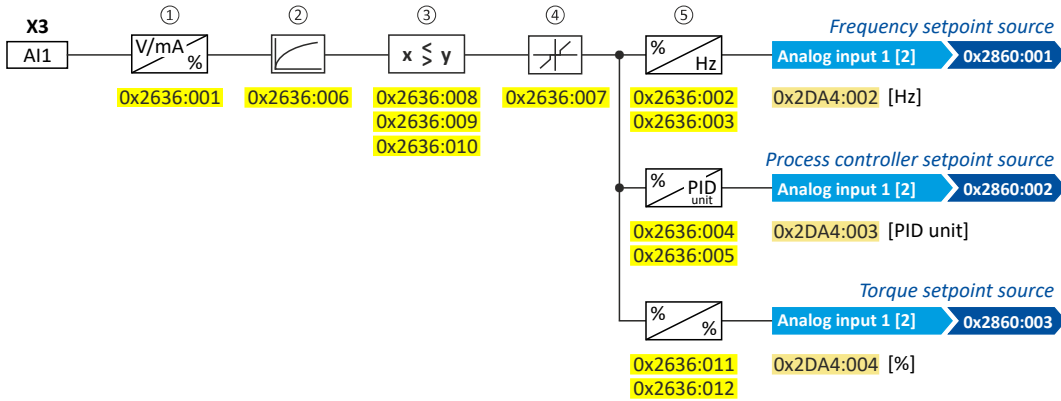

Diagnostic parameters:

- The frequency value is displayed in [0x2DA4:002 \(P110.02\)](#).
- The process controller value is displayed in [0x2DA4:003 \(P110.03\)](#).
- The torque value is displayed in [0x2DA4:004 \(P110.04\)](#).

## Definition of the input range

The analog input can be configured as voltage or current input. Internally, the signal is always converted to a value in percent.

## Definition of the setting range

The setting range results from the set min and max value for the respective mode.

## Parameter

Address	Name / setting range / [default setting]	Information
0x2636:001 (P430.01)	Analog input 1: Input range (Analog input 1: AI1 input range)  0 0 ... 10 VDC 1 0 ... 5 VDC 2 2 ... 10 VDC 3 -10 ... +10 VDC 4 4 ... 20 mA 5 0 ... 20 mA	Definition of the input range.
0x2636:002 (P430.02)	Analog input 1: Min frequency value (Analog input 1: AI1 freq @ min) -1000.0 ... [0.0] ... 1000.0 Hz	Scaling of the input signal to the frequency value.
0x2636:003 (P430.03)	Analog input 1: Max frequency value (Analog input 1: AI1 freq @ max) Device for 50-Hz mains: -1000.0 ... [50.0] ... 1000.0 Hz Device for 60-Hz mains: -1000.0 ... [60.0] ... 1000.0 Hz	<ul style="list-style-type: none"> <li>• Direction of rotation according to sign.</li> <li>• The standard setpoint source for operating mode <a href="#">0x6060 (P301.00)</a> = "MS: Velocity mode [-2]" is selected in <a href="#">0x2860:001 (P201.01)</a>.</li> </ul> <a href="#">▶ Configuring the frequency control □ 92</a>
0x2636:004 (P430.04)	Analog input 1: Min PID value (Analog input 1: AI1 PID @ min) -300.00 ... [0.00] ... 300.00 PID unit	Scaling of the input signal to the PID value.
0x2636:005 (P430.05)	Analog input 1: Max PID value (Analog input 1: AI1 PID @ max) -300.00 ... [100.00] ... 300.00 PID unit	<ul style="list-style-type: none"> <li>• The standard setpoint source for the reference value of PID control is selected in <a href="#">0x2860:002 (P201.02)</a>.</li> </ul> <a href="#">▶ Configuring the process controller □ 128</a>

# I/O extensions and control connections

Configure analog inputs

Analog input 1



Address	Name / setting range / [default setting]	Information		
0x2636:006 (P430.06)	Analog input 1: Filter time (Analog input 1: AI1 filter time) 0 ... [10] ... 10000 ms	PT1 time constant for low-pass filter. <ul style="list-style-type: none"> <li>By the use of a low-pass filter, the impacts of noise to an analog signal can be minimised.</li> <li>For an optimum filter effect, first the noise frequency has to be determined. The time constant then has to be set so that it equals the reciprocal value of the double frequency.</li> </ul>		
0x2636:007 (P430.07)	Analog input 1: Dead band (Analog input 1: AI1 dead band) 0.0 ... [0.0] ... 100.0 %	Optional setting of a dead band that is placed symmetrically around the frequency zero point. <ul style="list-style-type: none"> <li>If the analog input value is within the dead band, the output value for the motor control is set to "0".</li> <li>100 % = maximum value of analog input (0x2636:003 (P430.03), 0x2636:005 (P430.05), 0x2636:012 (P430.12))</li> <li>Example: Dead band 10 % of 50 Hz: -10 V ... 10 V, Dead band -5 Hz ... 5 Hz, 0 V ... 10 V, Dead band 0 Hz ... 5 Hz</li> </ul>		
0x2636:008 (P430.08)	Analog input 1: Monitoring threshold (Analog input 1: AI1 monit.level) -100.0 ... [0.0] ... 100.0 %	Monitoring threshold for analog input 1. <ul style="list-style-type: none"> <li>100 % = 10 V (with configuration as voltage input)</li> <li>100 % = 20 mA (with configuration as current loop)</li> </ul> <p>Exception: In the case of a configured input range 4...20 mA (0x2636:001 [4]), the monitoring is triggered at 2 mA with a monitoring threshold of 0.0 %.</p>		
0x2636:009 (P430.09)	Analog input 1: Monitoring condition (Analog input 1: Monitoring cond.)	Monitoring condition for analog input 1. <ul style="list-style-type: none"> <li>If the selected condition is met, the "Error of analog input 1 active [81]" trigger is set to TRUE. The trigger can be assigned to a function or a digital output.</li> <li>If the selected condition is met, the error response set in 0x2636:010 (P430.10) takes place.</li> </ul>		
	<table border="1"> <tr> <td>0</td> <td>Input value &lt; trigger threshold</td> </tr> <tr> <td>1</td> <td>Input value &gt; trigger threshold</td> </tr> </table>		0	Input value < trigger threshold
0	Input value < trigger threshold			
1	Input value > trigger threshold			
0x2636:010 (P430.10)	Analog input 1: Error response (Analog input 1: AI1 error resp.)	Error response for analog input 1. <ul style="list-style-type: none"> <li>The selected response takes place if the monitoring condition selected in 0x2636:009 (P430.09) is met.</li> </ul> <p>Associated event ID:</p> <ul style="list-style-type: none"> <li>28801   0x7081 - Fault - Analog input 1</li> </ul>		
	0	No response	▶ Severity □ 700	
	1	Warning		
	2	Trouble		
0x2636:011 (P430.11)	Analog input 1: Min torque value (Analog input 1: Min. torque) -400.0 ... [0.0] ... 400.0 % <ul style="list-style-type: none"> <li>From version 03.00</li> </ul>	Scaling of the input signal to the torque value. <ul style="list-style-type: none"> <li>100 % = permissible maximum torque 0x6072 (P326.00)</li> <li>Direction of rotation according to sign.</li> </ul>		
0x2636:012 (P430.12)	Analog input 1: Max torque value (Analog input 1: Max. torque) -400.0 ... [100.0] ... 400.0 % <ul style="list-style-type: none"> <li>From version 03.00</li> </ul>	<ul style="list-style-type: none"> <li>The standard setpoint source for operating mode 0x6060 (P301.00) = "MS: Torque mode [-1]" is selected in 0x2860:003 (P201.03).</li> </ul> <p>▶ Configuring the torque control □ 161</p>		



# I/O extensions and control connections

Configure analog inputs

Analog input 1

Example: Input range 0 ... 10 V = setting range 0 ... 50 Hz

## 11.2.1.1 Example: Input range 0 ... 10 V = setting range 0 ... 50 Hz

In this configuration, for instance, a frequency setpoint between 0 and 50 Hz can be set with a potentiometer connected to the analog input.

Connection plan	Function
	Potentiometer R1 Frequency setpoint definition (Input voltage 1 V = 5 Hz)

Parameter	Designation	Setting for this example
0x2636:001 (P430.01)	Analog input 1: Input range	0 ... 10 VDC [0]
0x2636:002 (P430.02)	Analog input 1: Min frequency value	0.0 Hz
0x2636:003 (P430.03)	Analog input 1: Max frequency value	50.0 Hz
0x2636:006 (P430.06)	Analog input 1: Filter time	10 ms

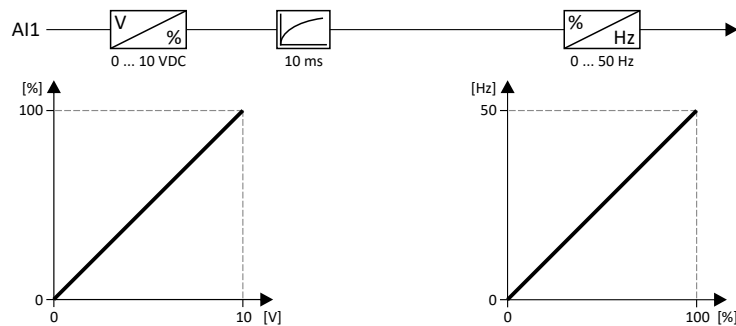

## 11.2.1.2 Example: Input range 0 ... 10 V = setting range -40 ... +40 Hz

In this example, a bipolar setting range and a dead band with 2 % are configured.

Parameter	Designation	Setting for this example
0x2636:001 (P430.01)	Analog input 1: Input range	0 ... 10 VDC [0]
0x2636:002 (P430.02)	Analog input 1: Min frequency value	-40.0 Hz
0x2636:003 (P430.03)	Analog input 1: Max frequency value	40.0 Hz
0x2636:006 (P430.06)	Analog input 1: Filter time	10 ms
0x2636:007 (P430.07)	Analog input 1: Dead band	2.0 %

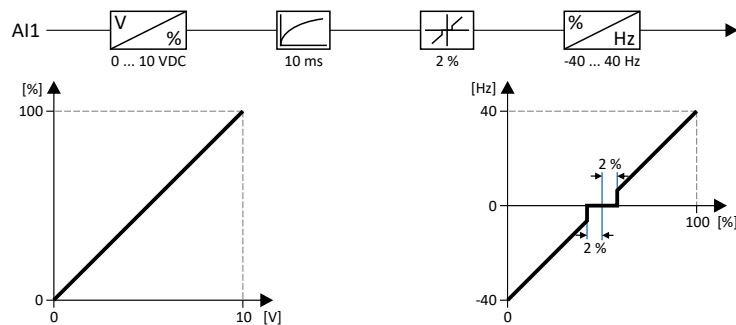

# I/O extensions and control connections

Configure analog inputs

Analog input 1

Example: Input range -10 ... +10 V = setting range -40 ... +40 Hz



## 11.2.1.3 Example: Input range -10 ... +10 V = setting range -40 ... +40 Hz

In this example, the input range of the analog input is bipolar. For the setting range that is bipolar as well, a dead band with 2 % is configured.

Parameter	Designation	Setting for this example
0x2636:001 (P430.01)	Analog input 1: Input range	-10 ... +10 VDC [3]
0x2636:002 (P430.02)	Analog input 1: Min frequency value	-40.0 Hz
0x2636:003 (P430.03)	Analog input 1: Max frequency value	40.0 Hz
0x2636:006 (P430.06)	Analog input 1: Filter time	10 ms
0x2636:007 (P430.07)	Analog input 1: Dead band	2.0 %

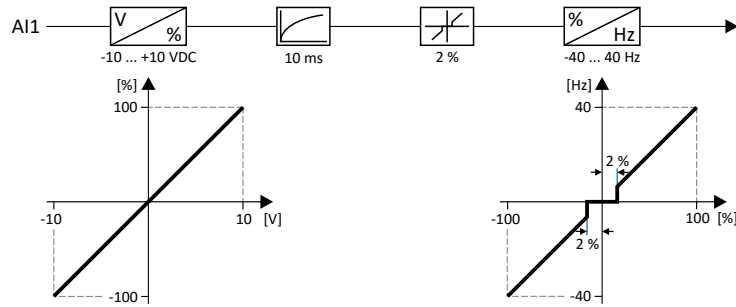

## 11.2.1.4 Example: Error detection

In this example, the digital output 1 is set via the trigger "Error of analog input 1 active [81]" if the percentage input value is lower than 10 %. Additionally, a warning is output.

Parameter	Designation	Setting for this example
0x2634:002 (P420.02)	Digital outputs function: Digital output 1	Error of analog input 1 active [81]
0x2636:001 (P430.01)	Analog input 1: Input range	0 ... 10 VDC [0]
0x2636:002 (P430.02)	Analog input 1: Min frequency value	0.0 Hz
0x2636:003 (P430.03)	Analog input 1: Max frequency value	40.0 Hz
0x2636:006 (P430.06)	Analog input 1: Filter time	10 ms
0x2636:008 (P430.08)	Analog input 1: Monitoring threshold	10.0 %
0x2636:009 (P430.09)	Analog input 1: Monitoring condition	Input value < trigger threshold [0]
0x2636:010 (P430.10)	Analog input 1: Error response	Warning [1]

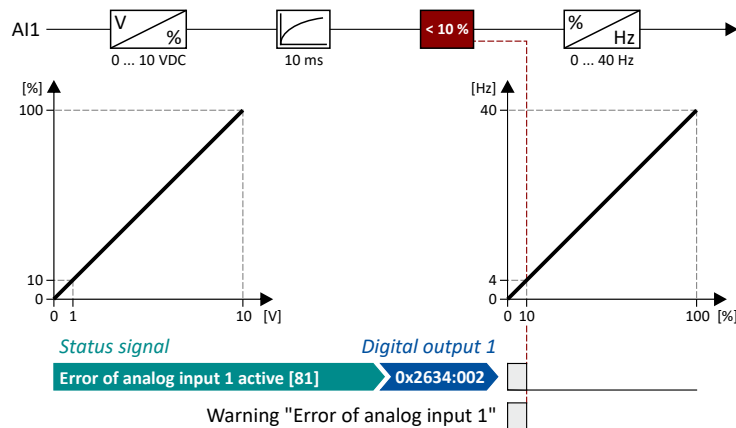





## 11.2.2 Analog input 2

Settings for analog input 2.

### Intended use

The analog input 2 can be used for the following tasks:

- As a standard setpoint source

Intended use	Parameter	Setting	Further information
As a setpoint source for specifying a frequency setpoint.	0x2860:001 (P201.01)	Analog input 1 [3]	Frequency control ▶ <a href="#">Standard setpoint source</a> 93
As setpoint source for defining the reference value for the process controller.	0x2860:002 (P201.02)	Analog input 1 [3]	Frequency control ▶ <a href="#">Configuring the process controller</a> 128
As a setpoint source for defining a torque setpoint.	0x2860:003 (P201.03)	Analog input 1 [3]	Torque control ▶ <a href="#">Standard setpoint source</a> 163

As an alternative to the setting as a standard setpoint source, the "Activate AI2 setpoint" 0x2631:015 (P400.15) function can be used to enable a setpoint change-over to the analog input 2.

- As an actual value source or speed feedforward source for the process controller:

Intended use	Parameter	Setting	Further information
As an actual value source for the process controller.	0x4020:002 (P600.02)	Analog input 2 [2]	Frequency control ▶ <a href="#">Configuring the process controller</a> 128
As a speed feedforward source for the process controller.	0x4020:004 (P600.04)	Analog input 2 [3]	

### Details

The following settings are possible for the analog input:

- Definition of the input range ①
- Filter time for low-pass filters ②
- Monitoring of the input signal ③
- Dead band for eliminating the smallest signal levels ④
- Definition of the setting range ⑤

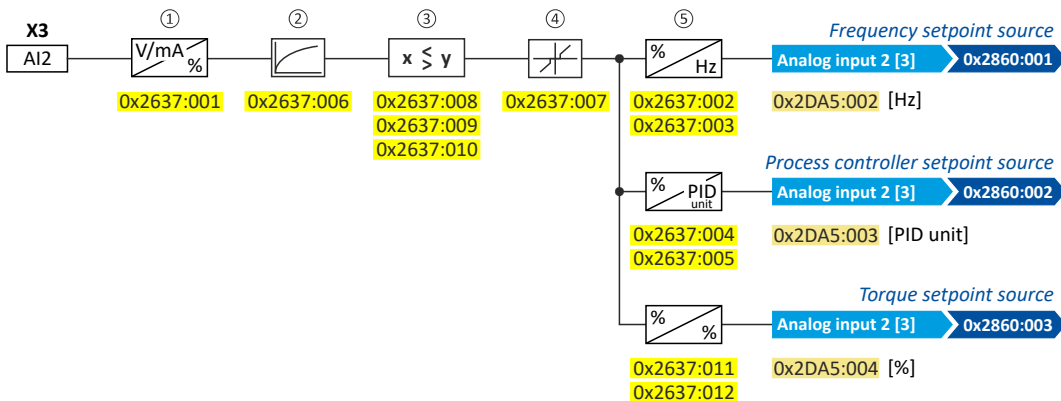

Diagnostic parameters:

- The frequency value is displayed in 0x2DA5:002 (P111.02).
- The process controller value is displayed in 0x2DA5:003 (P111.03).
- The torque value is displayed in 0x2DA5:004 (P111.04).

For further details and configuration examples, see chapter "Analog input 1". 284

# I/O extensions and control connections

Configure analog inputs  
Analog input 2



## Parameter

Address	Name / setting range / [default setting]	Information
0x2637:001 (P431.01)	Analog input 2: Input range (Analog input 2: AI2 input range)	Definition of the input range.
	0 0 ... 10 VDC	
	1 0 ... 5 VDC	
	2 2 ... 10 VDC	
	3 -10 ... +10 VDC	
	4 4 ... 20 mA	
5 0 ... 20 mA		
0x2637:002 (P431.02)	Analog input 2: Min frequency value (Analog input 2: AI2 freq @ min) -1000.0 ... [0.0] ... 1000.0 Hz	Scaling of the input signal to the frequency value. <ul style="list-style-type: none"> <li>Direction of rotation according to sign.</li> <li>The standard setpoint source for operating mode 0x6060 (P301.00) = "MS: Velocity mode [-2]" is selected in 0x2860:001 (P201.01).</li> </ul>
0x2637:003 (P431.03)	Analog input 2: Max frequency value (Analog input 2: AI2 freq @ max) Device for 50-Hz mains: -1000.0 ... [50.0] ... 1000.0 Hz Device for 60-Hz mains: -1000.0 ... [60.0] ... 1000.0 Hz	<ul style="list-style-type: none"> <li>▶ <a href="#">Configuring the frequency control</a> □ 92</li> </ul>
0x2637:004 (P431.04)	Analog input 2: Min PID value (Analog input 2: AI2 PID @ min) -300.00 ... [0.00] ... 300.00 PID unit	Scaling of the input signal to the PID value. <ul style="list-style-type: none"> <li>The standard setpoint source for the reference value of PID control is selected in 0x2860:002 (P201.02).</li> </ul>
0x2637:005 (P431.05)	Analog input 2: Max PID value (Analog input 2: AI2 PID @ max) -300.00 ... [100.00] ... 300.00 PID unit	<ul style="list-style-type: none"> <li>▶ <a href="#">Configuring the process controller</a> □ 128</li> </ul>
0x2637:006 (P431.06)	Analog input 2: Filter time (Analog input 2: AI2 filter time) 0 ... [10] ... 10000 ms	PT1 time constant for low-pass filter. <ul style="list-style-type: none"> <li>By the use of a low-pass filter, the impacts of noise to an analog signal can be minimised.</li> <li>For an optimum filter effect, first the noise frequency has to be determined. The time constant then has to be set so that it equals the reciprocal value of the double frequency.</li> </ul>
0x2637:007 (P431.07)	Analog input 2: Dead band (Analog input 2: AI2 dead band) 0.0 ... [0.0] ... 100.0 %	Optional setting of a dead band that is placed symmetrically around the frequency zero point. <ul style="list-style-type: none"> <li>If the analog input value is within the dead band, the output value for the motor control is set to "0".</li> <li>100 % = maximum value of analog input (0x2636:003 (P430.03), 0x2636:005 (P430.05), 0x2636:012 (P430.12))</li> <li>Example: Dead band 10 % of 50 Hz: -10 V ... 10 V, Dead band -5 Hz ... 5 Hz, 0 V ... 10 V, Dead band 0 Hz ... 5 Hz</li> </ul>
0x2637:008 (P431.08)	Analog input 2: Monitoring threshold (Analog input 2: AI2 monit.level) -100.0 ... [0.0] ... 100.0 %	Monitoring threshold for analog input 2. <ul style="list-style-type: none"> <li>100 % = 10 V (with configuration as voltage input)</li> <li>100 % = 20 mA (with configuration as current loop)</li> </ul> <p>Exception: In the case of a configured input range 4...20 mA (0x2636:001 [4]), the monitoring is triggered at 2 mA with a monitoring threshold of 0.0 %.</p>
0x2637:009 (P431.09)	Analog input 2: Monitoring condition (Analog input 2: Monitoring cond.)	Monitoring condition for analog input 2. <ul style="list-style-type: none"> <li>If the selected condition is met, the "Error of analog input 2 active [82]" trigger is set to TRUE. The trigger can be assigned to a function or a digital output.</li> <li>If the selected condition is met for at least 500 ms, the error response set in 0x2637:010 (P431.10) takes place.</li> </ul>
	0 Input value < trigger threshold 1 Input value > trigger threshold	
0x2637:010 (P431.10)	Analog input 2: Error response (Analog input 2: AI2 error resp.)	Error response for analog input 2. <ul style="list-style-type: none"> <li>The selected response takes place if the monitoring condition selected in 0x2637:009 (P431.09) is met for at least 500 ms.</li> </ul> <p>Associated event ID:</p> <ul style="list-style-type: none"> <li>28802   0x7082 - Analog input 2 fault</li> </ul>
	0 No response	<ul style="list-style-type: none"> <li>▶ <a href="#">Severity</a> □ 700</li> </ul>
	1 Warning	
	2 Trouble	
	3 <b>Fault</b>	



# I/O extensions and control connections

Configure analog inputs  
Analog input 2

Address	Name / setting range / [default setting]	Information
0x2637:011 (P431.11)	Analog input 2: Min torque value (Analog input 2: Min. torque) -400.0 ... [0.0] ... 400.0 % <ul style="list-style-type: none"><li>• From version 03.00</li></ul>	Scaling of the input signal to the torque value. <ul style="list-style-type: none"><li>• 100 % = permissible maximum torque <a href="#">0x6072 (P326.00)</a></li><li>• Direction of rotation according to sign.</li><li>• The standard setpoint source for operating mode <a href="#">0x6060 (P301.00)</a> = "MS: Torque mode [-1]" is selected in <a href="#">0x2860:003 (P201.03)</a>.</li></ul>
0x2637:012 (P431.12)	Analog input 2: Max torque value (Analog input 2: Max. torque) -400.0 ... [100.0] ... 400.0 % <ul style="list-style-type: none"><li>• From version 03.00</li></ul>	<a href="#">▶ Configuring the torque control</a> <a href="#">□ 161</a>



## 11.3 Configure digital outputs

### 11.3.1 Relay output

Settings for the relay.



Relay only switches if the inverter is supplied with 240 V or 400 V.

Use a corresponding suppressor circuit in case of an inductive or capacitive load!

#### Details

The relay is controlled with the trigger selected in [0x2634:001 \(P420.01\)](#).

The following settings are possible for the relay:

- Inversion ①
- Switch-on delay ②
- Cutout delay ③

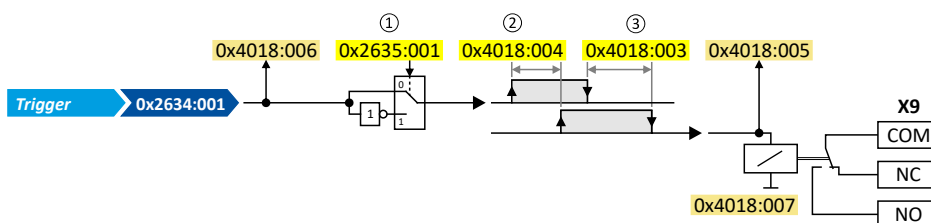

Diagnostic parameters:

- The logic status of the trigger signal is displayed in [0x4018:006](#).
- The logic status of the relay is displayed in [0x4018:005](#).
- The current switching cycles of the relay are shown in [0x4018:007](#).

#### Parameter

Address	Name / setting range / [default setting]	Information
0x2634:001 (P420.01)	Digital outputs function: Relay (Dig.out.function: Relay function)	Assignment of a trigger to the relay. Trigger = FALSE: X9/NO-COM open and NC-COM closed. Trigger = TRUE: X9/NO-COM closed and NC-COM open.  Notes: • An inversion set in <a href="#">0x2635:001 (P421.01)</a> is taken into consideration here.
0	Not connected	No trigger assigned (trigger is constantly FALSE).
1	Constant TRUE	Trigger is constantly TRUE.
11	Digital input 1	State of X3/DI1, taking an inversion set in <a href="#">0x2632:001 (P411.01)</a> into consideration.
12	Digital input 2	State of X3/DI2, taking an inversion set in <a href="#">0x2632:002 (P411.02)</a> into consideration.
13	Digital input 3	State of X3/DI3, taking an inversion set in <a href="#">0x2632:003 (P411.03)</a> into consideration.
14	Digital input 4	State of X3/DI4, taking an inversion set in <a href="#">0x2632:004 (P411.04)</a> into consideration.
15	Digital input 5	State of X3/DI5, taking an inversion set in <a href="#">0x2632:005 (P411.05)</a> into consideration.
16	Digital input 6	State of X3/DI6, taking an inversion set in <a href="#">0x2632:006 (P411.06)</a> into consideration. Digital input 6 is only available in the Control Unit (CU) with application I/O.
17	Digital input 7	State of X3/DI7, taking an inversion set in <a href="#">0x2632:007 (P411.07)</a> into consideration. Digital input 7 is only available in the Control Unit (CU) with application I/O.



# I/O extensions and control connections

Configure digital outputs  
Relay output

Address	Name / setting range / [default setting]	Information
30	NetWordIN1 - bit 12	State of NetWordIN1/bit 12 ... 15.
31	NetWordIN1 - bit 13	• Display of NetWordIN1 in <a href="#">0x4008:001 (P590.01)</a> .
32	NetWordIN1 - bit 14	• For implementing an individual control word format, NetWordIN1 can be mapped to a process data input word.
33	NetWordIN1 - bit 15	
34	NetWordIN2 - bit 0	State of NetWordIN2/bit 0 ... bit 15.
35	NetWordIN2 - bit 1	• Display of NetWordIN2 in <a href="#">0x4008:002 (P590.02)</a> .
36	NetWordIN2 - bit 2	• For controlling the digital outputs via network, NetWordIN2 can be mapped to a process data input word.
37	NetWordIN2 - bit 3	
38	NetWordIN2 - bit 4	
39	NetWordIN2 - bit 5	
40	NetWordIN2 - bit 6	
41	NetWordIN2 - bit 7	
42	NetWordIN2 - bit 8	
43	NetWordIN2 - bit 9	
44	NetWordIN2 - bit 10	
45	NetWordIN2 - bit 11	
46	NetWordIN2 - bit 12	
47	NetWordIN2 - bit 13	
48	NetWordIN2 - bit 14	
49	NetWordIN2 - bit 15	
50	Running	TRUE if inverter and start are enabled and output frequency > 0 Hz. Otherwise FALSE. Exception, quick stop mode: TRUE if inverter and start are enabled and output frequency > 0.2 Hz. Otherwise FALSE.
51	<b>Ready for operation</b>	TRUE if inverter is ready for operation (no error active, no STO active and DC-bus voltage ok). Otherwise FALSE.
52	Operation enabled	TRUE if inverter and start are enabled. Otherwise FALSE.
53	Stop active	TRUE if inverter is enabled and motor is not started and output frequency = 0.
54	Quick stop active	TRUE if quick stop is active. Otherwise FALSE.
55	Inverter disabled (safety)	TRUE if the integrated safety system has inhibited the inverter. Otherwise FALSE. ▶ <a href="#">Safe torque off (STO)</a> <a href="#">□ 627</a>
56	Fault active	TRUE if error is active. Otherwise FALSE.
57	Error (non-resettable) active	TRUE if non-resettable error is active. Otherwise FALSE.
58	Device warning active	TRUE if warning is active. Otherwise FALSE. • A warning has no impact on the operating status of the inverter. • A warning is reset automatically if the cause has been eliminated.
59	Device trouble active	TRUE if a fault is active. Otherwise FALSE. • In the event of a fault, the motor is brought to a standstill with the quick stop ramp. The inverter is then disabled. • Exception: In case of a serious fault, the inverter is disabled immediately. The motor has no torque (coasts). • The error state will be left automatically if the error condition is not active anymore. • The restart behaviour after trouble can be configured. ▶ <a href="#">Automatic restart after a fault</a> <a href="#">□ 579</a>
60	Heatsink temperature warning active	TRUE if current heatsink temperature > warning threshold for temperature monitoring. Otherwise FALSE. • Display of the current heatsink temperature in <a href="#">0x2D84:001 (P117.01)</a> . • Setting of the warning threshold in <a href="#">0x2D84:002</a> .
65	Motor PTC error active	TRUE if an error of the motor PTC has been detected. Otherwise FALSE. • The trigger is set irrespective of the response set in <a href="#">0x2D49:002 (P309.02)</a> when the motor temperature monitoring is triggered. ▶ <a href="#">Motor temperature monitoring</a> <a href="#">□ 261</a>
66	Flying restart circuit active	TRUE if flying restart circuit active is active. Otherwise FALSE. ▶ <a href="#">Flying restart circuit</a> <a href="#">□ 209</a>

# I/O extensions and control connections

Configure digital outputs

Relay output



Address	Name / setting range / [default setting]	Information
67	DC braking active	TRUE if DC braking is active. Otherwise FALSE. ▶ <a href="#">DC braking</a> <a href="#">□ 221</a>
68	Stop command active	TRUE if delay to standstill active. Otherwise FALSE.
69	Rotational direction reversed	TRUE if output frequency is negative. Otherwise FALSE.
70	Frequency threshold exceeded	TRUE if current output frequency > frequency threshold. Otherwise FALSE. • Display of the current output frequency in <a href="#">0x2DDD (P100.00)</a> . • Setting Frequency threshold in <a href="#">0x4005 (P412.00)</a> . ▶ <a href="#">Trigger action if a frequency threshold is exceeded</a> <a href="#">□ 604</a>
71	Actual speed = 0	TRUE if actual output frequency = 0 Hz ( $\pm 0.3$ Hz), irrespective of the operating mode. Otherwise FALSE. • Display of the current output frequency in <a href="#">0x2DDD (P100.00)</a> .
72	Setpoint speed reached	TRUE if frequency setpoint reached. Otherwise FALSE.
73	PID feedback = setpoint	TRUE if the controlled feedback variable = process controller setpoint ( $\pm$ in <a href="#">0x404D:003 (P608.03)</a> set hysteresis). Otherwise FALSE. ▶ <a href="#">Configuring the process controller</a> <a href="#">□ 128</a>
74	PID sleep mode active	TRUE if the inverter is in "PID sleep mode". Otherwise FALSE. ▶ <a href="#">Process controller sleep mode</a> <a href="#">□ 136</a>
75	PID MIN alarm active	TRUE if feedback variable (with activated PID control) < MIN alarm threshold. Otherwise FALSE. • Setting of MIN alarm threshold in <a href="#">0x404D:001 (P608.01)</a> . ▶ <a href="#">Configuring the process controller</a> <a href="#">□ 128</a>
76	PID MAX alarm active	TRUE if the feedback variable (with activated PID control) > MAX alarm threshold. Otherwise FALSE. • Setting of MAX alarm threshold in <a href="#">0x404D:002 (P608.02)</a> . ▶ <a href="#">Configuring the process controller</a> <a href="#">□ 128</a>
77	PID MIN-MAX alarm active	TRUE if no PID alarm is active with activated PID control (MIN alarm threshold < feedback variable < MAX alarm threshold). Otherwise FALSE. • Setting of MIN alarm threshold in <a href="#">0x404D:001 (P608.01)</a> . • Setting of MAX alarm threshold in <a href="#">0x404D:002 (P608.02)</a> . ▶ <a href="#">Configuring the process controller</a> <a href="#">□ 128</a>
78	Current limit reached	TRUE if current motor current $\geq$ maximum current. Otherwise FALSE. • Display of the present motor current in <a href="#">0x2D88 (P104.00)</a> . • Setting for the maximum current in <a href="#">0x6073 (P324.00)</a> .
79	Torque limit reached	TRUE if torque limit has been reached or exceeded. Otherwise FALSE. • Setting "Actual positive torque limit" in <a href="#">0x2949:003 (P337.03)</a> . • Setting "Actual negative torque limit" in <a href="#">0x2949:004 (P337.04)</a> . ▶ <a href="#">Motor torque monitoring</a> <a href="#">□ 265</a>
81	Error of analog input 1 active	TRUE if the monitoring of the input signal at the analog input 1 has responded. Otherwise FALSE.  This trigger is set as a function of the following settings: • Monitoring threshold <a href="#">0x2636:008 (P430.08)</a> • Monitoring condition <a href="#">0x2636:009 (P430.09)</a>  The setting of the Error response in <a href="#">0x2636:010 (P430.10)</a> has no effect on this trigger. ▶ <a href="#">Analog input 1</a> <a href="#">□ 284</a>
82	Error of analog input 2 active	TRUE if the monitoring of the input signal at the analog input 2 has responded. Otherwise FALSE.  This trigger is set as a function of the following settings: • Monitoring threshold <a href="#">0x2637:008 (P431.08)</a> • Monitoring condition <a href="#">0x2637:009 (P431.09)</a>  The setting of the Error response in <a href="#">0x2637:010 (P431.10)</a> has no effect on this trigger. ▶ <a href="#">Analog input 2</a> <a href="#">□ 289</a>



# I/O extensions and control connections

Configure digital outputs  
Relay output

Address	Name / setting range / [default setting]	Information
83	Load loss detected	TRUE if actual motor current < threshold for load loss detection after delay time of the load loss detection has elapsed. Otherwise FALSE. <ul style="list-style-type: none"> <li>• Display of the actual current in <a href="#">0x6078 (P103.00)</a>.</li> <li>• Setting Threshold in <a href="#">0x4006:001 (P710.01)</a>.</li> <li>• Setting Delay time in <a href="#">0x4006:002 (P710.02)</a>.</li> </ul> <p>▶ <a href="#">Load loss detection</a> <a href="#">□ 237</a></p>
84	Heavy load monitoring	TRUE if the actual apparent current of the motor exceeds the threshold for longer than the delay time. FALSE if the actual apparent current of the motor falls below the threshold value minus 5 % (hysteresis). <p>▶ <a href="#">Heavy load monitoring</a> <a href="#">□ 269</a></p>
100	Sequencer controlled (from version 03.00)	The control is executed via the sequencer (according to the configuration of the digital outputs for the current segment). <p>▶ <a href="#">Segment configuration</a> <a href="#">□ 104</a></p>
101	Sequence active (from version 03.00)	Status signal of the "sequencer" function: TRUE if the sequence is running and is currently not suspended. <p>▶ <a href="#">Sequencer</a> <a href="#">□ 102</a></p>
102	Sequence suspended (from version 03.00)	Status signal of the "sequencer" function: TRUE if the sequence is currently suspended. <p>▶ <a href="#">Sequencer</a> <a href="#">□ 102</a></p>
103	Sequence done (from version 03.00)	Status signal of the "sequencer" function: TRUE if the sequence is completed (final segment has been passed through). <p>▶ <a href="#">Sequencer</a> <a href="#">□ 102</a></p>
104	Local control active	TRUE if local keypad control ("LOC") active. Otherwise FALSE.
105	Remote control active	TRUE if remote control ("REM") via terminals, network, etc. active. Otherwise FALSE.
106	Manual setpoint selection active	TRUE if manual setpoint selection ("MAN") via keypad active. Otherwise FALSE. <ul style="list-style-type: none"> <li>• Selection of the trigger for the "Activate keypad setpoint" function in <a href="#">0x2631:016 (P400.16)</a>.</li> </ul>
107	Automatic setpoint selection active	TRUE if automatic setpoint selection ("AUTO") via terminals, network, etc. active. Otherwise FALSE.
108	Parameter set 1 active	TRUE if parameter set 1 is loaded and active. Otherwise FALSE.
109	Parameter set 2 active	TRUE if parameter set 2 is loaded and active. Otherwise FALSE.
110	Parameter set 3 active	TRUE if parameter set 3 is loaded and active. Otherwise FALSE.
111	Parameter set 4 active	TRUE if parameter set 4 is loaded and active. Otherwise FALSE.
112	Parameter set load OK	TRUE after any parameter set has been loaded. Otherwise FALSE.
113	Parameter set load fail	TRUE if any of the parameter sets could not be loaded. Otherwise FALSE.
115	Release holding brake	Trigger signal for releasing the holding brake (TRUE = release holding brake). Note! If this trigger is assigned to the relay or a digital output, the deceleration times set for the respective output are not effective (are internally set to "0"). Only the deceleration time set in <a href="#">0x2820:012 (P712.12)</a> for closing the holding brake influences in this case the time-dependent behaviour of the output. <p>▶ <a href="#">Holding brake control</a> <a href="#">□ 228</a></p>
117	Motor phase failure	TRUE if a motor phase failure has been detected. Otherwise FALSE. Note! In the "SLSM-PSM" motor control mode, detection for motor phase failure is deactivated if HF injection is active in the low-speed range. <p>▶ <a href="#">Motor phase failure detection</a> <a href="#">□ 263</a></p>
118	UPS operation active	TRUE if UPS operation is active. Otherwise FALSE. <p>▶ <a href="#">Operation with UPS</a> <a href="#">□ 614</a></p>
155	STO active	TRUE if the integrated safety system has triggered the "Safe torque off (STO)" function and if the safe inputs SIA and SIB = LOW (simultaneously). Otherwise FALSE. <p>▶ <a href="#">Safe torque off (STO)</a> <a href="#">□ 627</a></p>
160	Assist pump 1	Trigger signal of the cascade function for the activation of additional pump 1 (TRUE = activate additional pump 1). <p>▶ <a href="#">Cascade function for pumps and fans</a> <a href="#">□ 617</a></p>

# I/O extensions and control connections

Configure digital outputs

Relay output



Address	Name / setting range / [default setting]	Information
	161 Assist pump 2	Trigger signal of the cascade function for the activation of additional pump 2 (TRUE = activate additional pump 2). ▶ <a href="#">Cascade function for pumps and fans</a> □ 617
	201 Internal value	Internal values of the manufacturer.
	202 Internal value	
	203 Internal value	
	204 Internal value	
	205 Internal value	
	206 Internal value	
0x2635:001 (P421.01)	Inversion of digital outputs: Relay (DO inversion: Relay inverted)	Relay inversion
	<b>0</b> Not inverted	
	1 Inverted	
0x4018:003	Relay: Switch-off delay 0.000 ... [0.000] ... 65.535 s	Switch-off delay for the relay. Note! The set delay time is not effective (internally set to "0") if the relay is assigned to the trigger "Release holding brake [115]". Only the deceleration time set in <a href="#">0x2820:012 (P712.12)</a> for closing the holding brake influences the time-dependent behaviour of the relay.
0x4018:004	Relay: Switch-on delay 0.000 ... [0.000] ... 65.535 s	Switch-on delay for the relay. Note! The set delay time is not effective (internally set to "0") if the relay is assigned to the trigger "Release holding brake [115]". Only the deceleration time set in <a href="#">0x2820:012 (P712.12)</a> for closing the holding brake influences the time-dependent behaviour of the relay.
0x4018:005	Relay: Relay state • Read only	Display of the logic state of the relay.
	0 FALSE	
	1 TRUE	
0x4018:006	Relay: Trigger signal state • Read only	Display of the logic state of the trigger signal for the relay (without taking a ON/OFF delay set and inversion into consideration).
	0 FALSE	
	1 TRUE	
0x4018:007	Relay: Switching cycles • Read only	Display of the previous relay switching cycles.





## 11.3.2 Digital output 1

Settings for digital output 1.

### Details

The digital output 1 is controlled with the trigger selected in [0x2634:002 \(P420.02\)](#).

The following settings are possible for the digital output:

- Inversion ①
- Switch-on delay ②
- Cutout delay ③

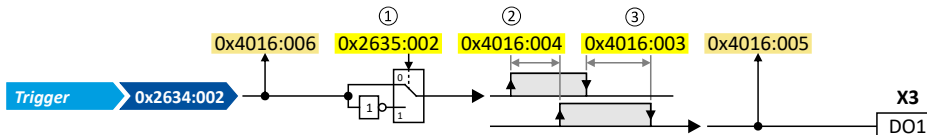

Diagnostic parameters:

- The logic status of the trigger signal is displayed in [0x4016:006](#).
- The logic status of the digital output is displayed in [0x4016:005](#).

### Parameter

Address	Name / setting range / [default setting]	Information
0x2634:002 (P420.02)	Digital outputs function: Digital output 1 (Dig.out.function: DO1 function) • For further possible settings, see parameter <a href="#">0x2634:001 (P420.01)</a> . <a href="#">□ 292</a>	Assignment of a trigger to digital output 1. Trigger = FALSE: X3/DO1 set to LOW level. Trigger = TRUE: X3/DO1 set to HIGH level.  Notes: • An inversion set in <a href="#">0x2635:002 (P421.02)</a> is taken into consideration here.
	<b>115 Release holding brake</b>	Trigger signal for releasing the holding brake (TRUE = release holding brake). Note! If this trigger is assigned to the relay or a digital output, the deceleration times set for the respective output are not effective (are internally set to "0"). Only the deceleration time set in <a href="#">0x2820:012 (P712.12)</a> for closing the holding brake influences in this case the time-dependent behaviour of the output. <a href="#">▶ Holding brake control □ 228</a>
	100 Sequencer controlled (from version 03.00)	The control is executed via the sequencer (according to the configuration of the digital outputs for the current segment). <a href="#">▶ Segment configuration □ 104</a>
0x2635:002 (P421.02)	Inversion of digital outputs: Digital output 1 (DO inversion: DO1 inversion) <b>0 Not inverted</b> 1 Inverted	Inversion of digital output 1
0x4016:003	Digital output 1: Switch-off delay 0.000 ... <b>[0.000]</b> ... 65.535 s	Switch-off delay for digital output 1. Note! The set delay time is not effective (internally set to "0") if the digital output is assigned to the trigger "Release holding brake [115]". Only the deceleration time set in <a href="#">0x2820:012 (P712.12)</a> for closing the holding brake influences the time-dependent behaviour of the digital output.
0x4016:004	Digital output 1: Switch-on delay 0.000 ... <b>[0.000]</b> ... 65.535 s	Switch-on delay for digital output 1. Note! The set delay time is not effective (internally set to "0") if the digital output is assigned to the trigger "Release holding brake [115]". Only the deceleration time set in <a href="#">0x2820:012 (P712.12)</a> for closing the holding brake influences the time-dependent behaviour of the digital output.
0x4016:005	Digital output 1: Terminal state • Read only	Display of the logic state of output terminal X3/DO1.
	0 FALSE	
	1 TRUE	

# I/O extensions and control connections

Configure digital outputs  
Digital output 1



Address	Name / setting range / [default setting]	Information
0x4016:006	Digital output 1: Trigger signal state	Display of the logic state of the trigger signal for digital output 1 (without taking a ON/OFF delay set and inversion into consideration).
	• Read only	
	0 FALSE	
1 TRUE		



## 11.3.2.1 Configure the digital output 1 as pulse train output

The digital output 1 can be configured for the output of a reference frequency ("pulse train") to transfer an internal actual value signal (e. g. current output frequency or current torque) to a higher-level Controller or other inverters.

### Preconditions

In order to output an optimum rectangular signal, a "pulldown" resistor of 1 kOhm is recommended at the digital output. The resistor can be directly connected to the terminals DO1 and GND.

### Restrictions

- When the digital output 1 is configured as pulse train output, this digital output is not available anymore for the output of digital status signals.
- Minimum output frequency: 1 Hz
- Maximum output frequency: 10 kHz

### Details

Typical applications:

- a) An inverter acts as a master and transfers its current output frequency in the form of a pulse train signal to one or several other inverters (slaves). The slaves use the pulse train signal with a corresponding scaling as a frequency setpoint.

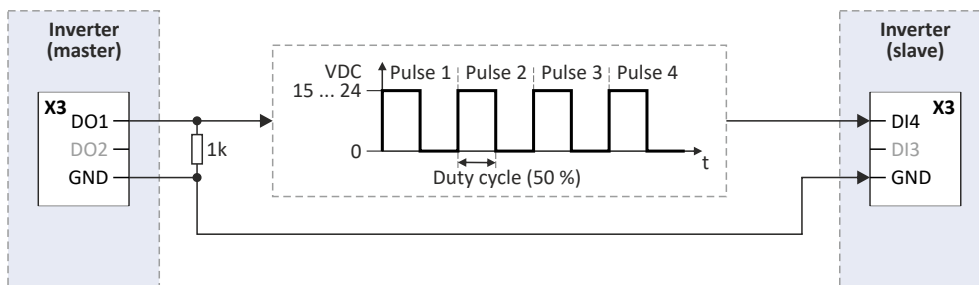

- b) The inverter transfers the current torque or another internal variable as a pulse train signal to a higher-level controller. Then, the controller can evaluate the signal accordingly.

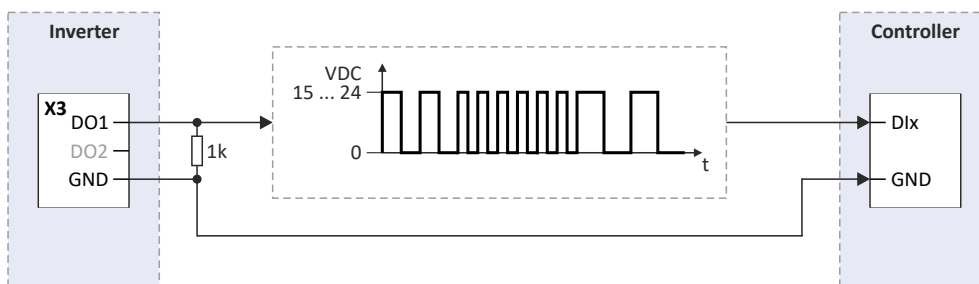

# I/O extensions and control connections

Configure digital outputs

Digital output 1

Configure the digital output 1 as pulse train output



## Configuration

In the default setting [0x2644:003 \(P423.03\)](#) = "Not connected [0]", the digital output 1 is configured as a "normal" digital output: The digital output 1 is controlled with the trigger selected in [0x2634:002 \(P420.02\)](#).

In order to configure the digital output 1 as pulse train output, the desired signal to be output as pulse train must be selected in [0x2644:003 \(P423.03\)](#). The trigger assigned to the digital output 1 in [0x2634:002 \(P420.02\)](#) is then not effective anymore.

The following settings are possible for the pulse train output:

- Definition of the signal range ①
- Definition of the output range ②

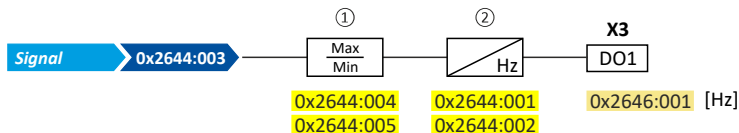

Diagnostic parameters:

- The current frequency of the pulse train signal is displayed in [0x2646:001 \(P114.01\)](#).

## Definition of the signal range

The signal range results from the resolution of the selected signal multiplied by the set min and max signal value. Signals outside the signal range are cut off. For examples, see the following table:

Signal <a href="#">0x2644:003 (P423.03)</a>	Resolution	Minimum signal <a href="#">0x2644:004 (P423.04)</a>	Maximum signal <a href="#">0x2644:005 (P423.05)</a>	Signal range
Output frequency	0.1 Hz	0	1000	0 ... 100.0 Hz
Frequency setpoint	0.1 Hz	0	1000	0 ... 100.0 Hz
Analog input 1	0.1 %	0	1000	0 ... 100.0 %
Analog input 2	0.1 %	0	1000	0 ... 100.0 %
Motor current	0.1 A	0	100	0 ... 10.0 A
Output power	0.001 kW	0	250	0 ... 0.250 kW
Torque actual value	0.1 % *	0	1000	0 ... 100.0 % *
NetWordIN3	0.1 %	200	500	20.0 ... 50.0 %
NetWordIN4	0.1 %	0	250	0 ... 25.0 %

\* 100 % = Rated motor torque [0x6076 \(P325.00\)](#)

## Definition of the output range

The frequency output range defined in [0x2644:001 \(P423.01\)](#) and [0x2644:002 \(P423.02\)](#) corresponds to the configured signal range.

## Configuration examples

Detailed configuration examples can be found in the following subchapters:

- ▶ [Example 1: Pulse train 0: ... 10 kHz = output frequency 0 ... 100 Hz](#) [302](#)
- ▶ [Example 2: Pulse train 2 ... 10 kHz = output frequency 30 ... 60 Hz](#) [303](#)

## Parameter

Address	Name / setting range / [default setting]	Information
<a href="#">0x2644:001 (P423.01)</a>	DO1 frequency setup: Minimum frequency (DO1 freq. setup: Min. frequency) 0.0 ... <b>[0.0]</b> ... 10000.0 Hz • From version 05.00	Definition of the frequency output range. Note! Regardless of this setting, the output frequency at the pulse train output is $\geq 1$ Hz!
<a href="#">0x2644:002 (P423.02)</a>	DO1 frequency setup: Maximum frequency (DO1 freq. setup: Max. frequency) 0.0 ... <b>[10000.0]</b> ... 10000.0 Hz • From version 05.00	



# I/O extensions and control connections

Configure digital outputs

Digital output 1

Configure the digital output 1 as pulse train output

Address	Name / setting range / [default setting]	Information
0x2644:003 (P423.03)	DO1 frequency setup: Function (DO1 freq. setup: Function) <ul style="list-style-type: none"> <li>From version 05.00</li> <li>For further possible settings, see parameter <a href="#">0x2639:002 (P440.02)</a>. <a href="#">📄 306</a></li> </ul>	Selection of the signal to be provided at the digital output 1 as pulse train.
	<b>0</b>   <b>Not active</b>	No output signal.
0x2644:004 (P423.04)	DO1 frequency setup: Minimum signal (DO1 freq. setup: Min. signal) -2147483648 ... <b>[0]</b> ... 2147483647 <ul style="list-style-type: none"> <li>From version 05.00</li> </ul>	Definition of the signal value that corresponds to the Minimum frequency at the digital output 1.
0x2644:005 (P423.05)	DO1 frequency setup: Maximum signal (DO1 freq. setup: Max. signal) -2147483648 ... <b>[1000]</b> ... 2147483647 <ul style="list-style-type: none"> <li>From version 05.00</li> </ul>	Definition of the signal value that corresponds to the maximum frequency at the digital output 1.
0x2646:001 (P114.01)	DO actual frequency: Digital output 1 (DO actual freq.: Digital output 1) <ul style="list-style-type: none"> <li>Read only: x.x Hz</li> <li>From version 05.00</li> </ul>	Display of the current frequency of the pulse train signal at the digital output 1.

# I/O extensions and control connections

Configure digital outputs

Digital output 1

Configure the digital output 1 as pulse train output



## Example 1: Pulse train 0: ... 10 kHz = output frequency 0 ... 100 Hz

In this configuration, a pulse train is provided at the digital output 1 proportionately to the actual output frequency of the inverter (1 kHz pulse train = 10 Hz output frequency, resolution 0.1 Hz).

Parameter	Name	Setting for this example
0x2644:001 (P423.01)	DO1 frequency setup: Minimum frequency	0.0 Hz
0x2644:002 (P423.02)	DO1 frequency setup: Maximum frequency	10000.0 Hz
0x2644:003 (P423.03)	DO1 frequency setup: Function	Output frequency [1]
0x2644:004 (P423.04)	DO1 frequency setup: Minimum signal	0
0x2644:005 (P423.05)	DO1 frequency setup: Maximum signal	1000

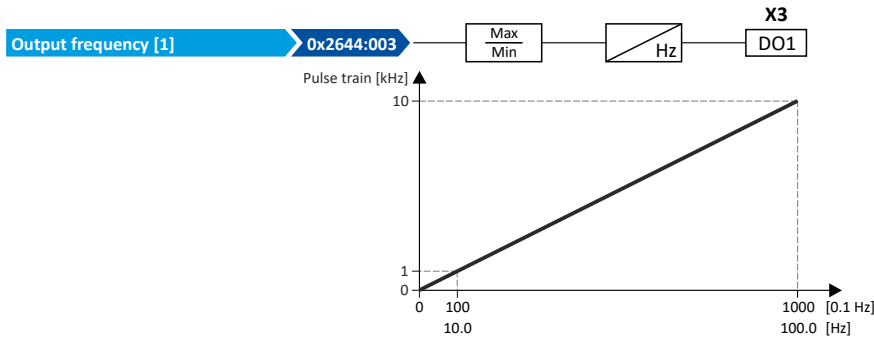

## Use pulse train as setpoint source for other inverters (slaves)

The pulse train can be transferred to one or several other i5xx inverters (slaves) and be configured in the respective slave as a frequency setpoint source:

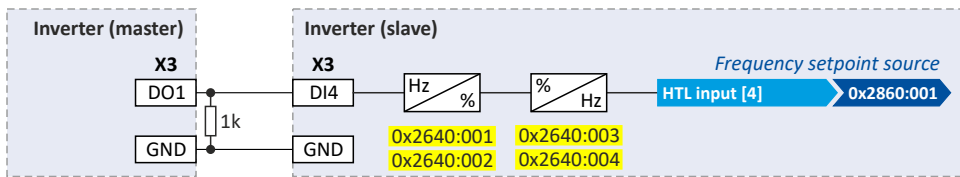

For this purpose, the following settings are required for the i5xx slave:

Parameter	Name	Setting for this example
0x2630:002 (P410.02)	Settings for digital inputs: Input function	Pulse train [2]
0x2640:001 (P415.01)	HTL input settings: Minimum frequency	0.0 Hz
0x2640:002 (P415.02)	HTL input settings: Maximum frequency	10000.0 Hz
0x2640:003 (P415.03)	HTL input settings: Minimum motor frequency	0.0 Hz
0x2640:004 (P415.04)	HTL input settings: Maximum motor frequency	100.0 Hz
0x2860:001 (P201.01)	Frequency control: Default setpoint source	HTL input [4]



## Example 2: Pulse train 2 ... 10 kHz = output frequency 30 ... 60 Hz

In this configuration, the output range 2 ... 10 kHz is used for the output of the output frequency (resolution: 0.1 Hz). The example shows how the signals outside the signal range (here: 30 ... 60 Hz) are cut off.

Parameter	Designation	Setting for this example
0x2644:001 (P423.01)	DO1 frequency setup: Minimum frequency	2000.0 Hz
0x2644:002 (P423.02)	DO1 frequency setup: Maximum frequency	10000.0 Hz
0x2644:003 (P423.03)	DO1 frequency setup: Function	Output frequency [1]
0x2644:004 (P423.04)	DO1 frequency setup: Minimum signal	300
0x2644:005 (P423.05)	DO1 frequency setup: Maximum signal	600

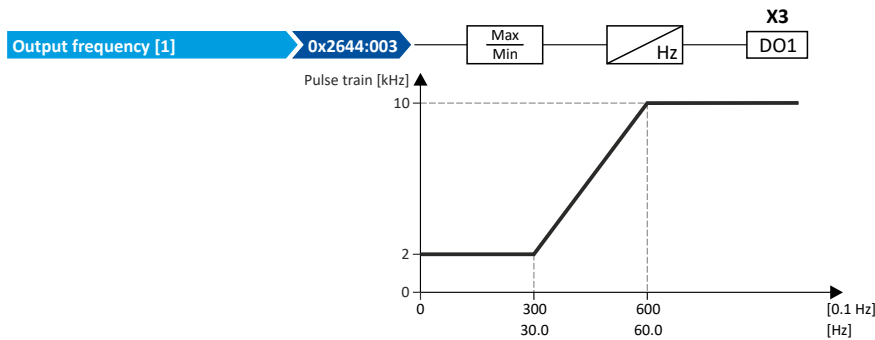

## 11.3.3 Digital output 2

Settings for digital output 2.

### Preconditions

Control Unit (CU) with application I/O

### Details

The digital output 2 is controlled with the trigger selected in 0x2634:003 (P420.03).

The following settings are possible for the digital output:

- Inversion ①
- Switch-on delay ②
- Cutout delay ③

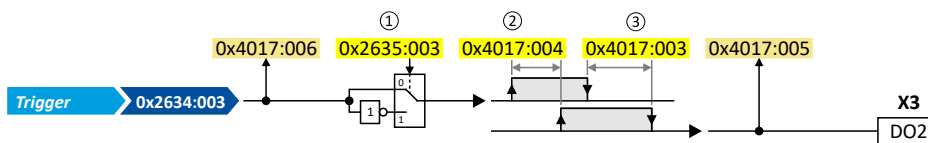

Diagnostic parameters:

- The logic status of the trigger signal is displayed in 0x4017:006.
- The logic status of the digital output is displayed in 0x4017:005.

### Parameter

Address	Name / setting range / [default setting]	Information
0x2634:003 (P420.03)	Digital outputs function: Digital output 2 (Dig.out.function: DO2 function) • For further possible settings, see parameter 0x2634:001 (P420.01). <a href="#">□ 292</a>	Assignment of a trigger to digital output 2. Trigger = FALSE: X3/DO2 set to LOW level. Trigger = TRUE: X3/DO2 set to HIGH level.  Notes: • An inversion set in 0x2635:003 (P421.03) is taken into consideration here.
56	<b>Fault active</b>	TRUE if error is active. Otherwise FALSE.
100	Sequencer controlled (from version 03.00)	The control is executed via the sequencer (according to the configuration of the digital outputs for the current segment). <a href="#">▶ Segment configuration □ 104</a>

# I/O extensions and control connections

Configure digital outputs

Digital output 2



Address	Name / setting range / [default setting]	Information
0x2635:003 (P421.03)	Inversion of digital outputs: Digital output 2 (DO inversion: DO2 inversion)	Inversion of digital output 2
	0 Not inverted	
	1 Inverted	
0x4017:003	Digital output 2: Switch-off delay 0.000 ... [0.000] ... 65.535 s	Switch-off delay for digital output 2. Note! The set delay time is not effective (internally set to "0") if the digital output is assigned to the trigger "Release holding brake [115]". Only the deceleration time set in <a href="#">0x2820:012 (P712.12)</a> for closing the holding brake influences the time-dependent behaviour of the digital output.
0x4017:004	Digital output 2: Switch-on delay 0.000 ... [0.000] ... 65.535 s	Switch-on delay for digital output 2. Note! The set delay time is not effective (internally set to "0") if the digital output is assigned to the trigger "Release holding brake [115]". Only the deceleration time set in <a href="#">0x2820:012 (P712.12)</a> for closing the holding brake influences the time-dependent behaviour of the digital output.
0x4017:005	Digital output 2: Terminal state • Read only	Display of the logic state of output terminal X3/DO2.
	0 FALSE	
	1 TRUE	
0x4017:006	Digital output 2: Trigger signal state • Read only	Display of the logic state of the trigger signal for digital output 2 (without taking a ON/OFF delay set and inversion into consideration).
	0 FALSE	
	1 TRUE	





## 11.4 Configure analog outputs

### 11.4.1 Analog output 1

Settings for analog output 1.

#### Details

The analog output 1 is controlled with the signal selected in [0x2639:002 \(P440.02\)](#).

The following settings are possible for the analog output:

- Definition of the signal range ①
- Definition of the output range ②

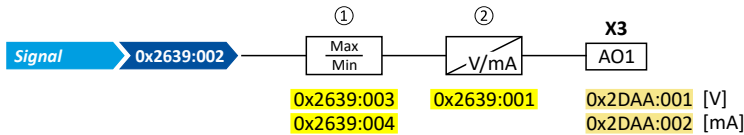

Diagnostic parameters:

- The current output voltage is displayed in [0x2DAA:001 \(P112.01\)](#).
- The actual output current is displayed in [0x2DAA:002 \(P112.02\)](#).

#### Definition of the signal range

The signal range results from the resolution of the selected signal multiplied by the set min and max signal value. Signals outside the signal range are cut off. For examples, see the following table:

Signal <a href="#">0x2639:002 (P440.02)</a>	Resolution	Min. signal <a href="#">0x2639:003 (P440.03)</a>	Max. signal <a href="#">0x2639:004 (P440.04)</a>	Signal range
Output frequency	0.1 Hz	0	1000	0 ... 100.0 Hz
Frequency setpoint	0.1 Hz	0	1000	0 ... 100.0 Hz
Analog input 1	0.1 %	0	1000	0 ... 100.0 %
Analog input 2	0.1 %	0	1000	0 ... 100.0 %
Motor current	0.1 A	0	100	0 ... 10.0 A
Output power	0.001 kW	0	250	0 ... 0.250 kW
Actual torque	0.1 % *	0	1000	0 ... 100.0 % *
NetWordIN3	0.1 %	200	500	20.0 ... 50.0 %
NetWordIN4	0.1 %	0	250	0 ... 25.0 %

\* 100 % = Rated motor torque [0x6076 \(P325.00\)](#)

#### Definition of the output range

The analog output can be configured as voltage source or current source. The output range selected in [0x2639:001 \(P440.01\)](#) then corresponds to the configured signal range.

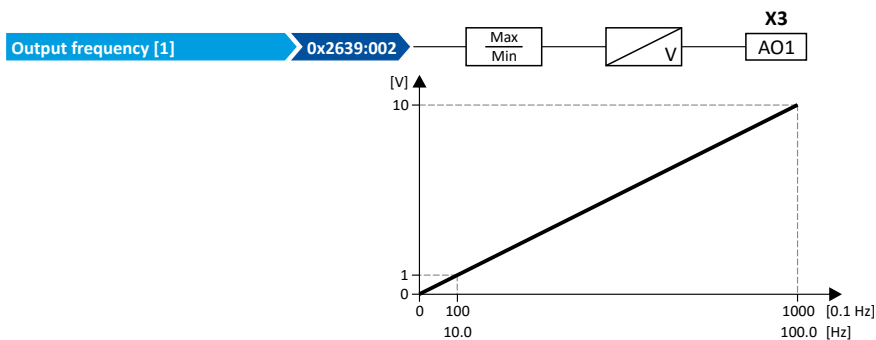

# I/O extensions and control connections

Configure analog outputs  
Analog output 1



## Configuration examples

Detailed configuration examples can be found in the following subchapters:

- ▶ [Example: Output voltage 0 ... 10 V = output frequency 0 ... 100 Hz](#) [□ 307](#)
- ▶ [Example: Output voltage 2 ... 10 V = output frequency 30 ... 60 Hz](#) [□ 307](#)
- ▶ [Example: mirrored output range](#) [□ 308](#)

## Parameter

Address	Name / setting range / [default setting]	Information	
0x2639:001 (P440.01)	Analog output 1: Output range (Analog output 1: AO1 outp. range)	Definition of the output range.	
	0 Inhibited		
	<b>1 0 ... 10 VDC</b>		
	2 0 ... 5 VDC		
	3 2 ... 10 VDC		
	4 4 ... 20 mA		
	5 0 ... 20 mA		
	11 0 ... 10 VDC (mirrored)	In these configurations, negative analog output values are symmetrically mirrored on the Y axis. ▶ <a href="#">Example: mirrored output range</a> <a href="#">□ 308</a>	
	12 0 ... 5 VDC (mirrored)		
	13 2 ... 10 VDC (mirrored)		
	14 4 ... 20 mA (mirrored)		
	15 0 ... 20 mA (mirrored)		
	0x2639:002 (P440.02)	Analog output 1: Function (Analog output 1: AO1 function)	Selection of the signal to be shown at analog output 1.
		0 Not active	No output signal.
		<b>1 Output frequency</b>	Actual output frequency (resolution: 0.1 Hz).
2 Frequency setpoint		Current frequency setpoint (resolution: 0.1 Hz).	
3 Analog input 1		Input signal of analog input 1 (resolution: 0.1 %).	
4 Analog input 2		Input signal of analog input 2 (resolution: 0.1 %).	
5 Motor current		Actual motor current (resolution: 0.1 A).	
6 Output power		Actual output power (resolution: 0.001 kW).	
7 Torque actual value (from version 03.00)		Current torque (resolution: 0.1 %). • 100 % = permissible maximum torque <a href="#">0x6072 (P326.00)</a>	
8 Actual motor frequency		Actual motor output frequency (resolution: 0.1 Hz).	
10 Sequencer controlled (from version 03.00)		Voltage value which has been set for the currently executed sequencer segment (resolution: 0.01 V). ▶ <a href="#">Sequencer</a> <a href="#">□ 102</a>	
11 DC-bus voltage		Current DC-bus voltage (resolution: 1 V).	
12 Device utilisation (ixt)		Current device utilization (resolution: 1 %).	
20 NetWordIN3		Actual value of the NetWordIN3 data word (resolution: 0.1 %). ▶ <a href="#">Control analog outputs via network</a> <a href="#">□ 333</a>	
21 NetWordIN4		Actual value of the NetWordIN4 data word (resolution: 0.1 %). ▶ <a href="#">Control analog outputs via network</a> <a href="#">□ 333</a>	
201 Internal value (from version 05.00)		Internal values of the manufacturer.	
202 Internal value (from version 05.00)			
203 Internal value (from version 05.00)			
204 Internal value (from version 05.00)			
205 Internal value (from version 05.00)			
206 Internal value (from version 05.00)			
0x2639:003 (P440.03)	Analog output 1: Min. signal (Analog output 1: AO1 min. signal) -2147483648 ... <b>[0]</b> ... 2147483647	Definition of the signal value that corresponds to the minimum value at analog output 1. Example: configuration of analog output 1 as a 4 ... 20 mA current loop: output current 4 mA = 0x2639:003	
0x2639:004 (P440.04)	Analog output 1: Max. signal (Analog output 1: AO1 max. signal) -2147483648 ... <b>[1000]</b> ... 2147483647	Definition of the signal value that corresponds to the maximum value at analog output 1. Example: configuration of analog output 1 as a 4 ... 20 mA current loop: output current 20 mA = 0x2639:004	



# I/O extensions and control connections

Configure analog outputs

Analog output 1

Example: Output voltage 0 ... 10 V = output frequency 0 ... 100 Hz

Address	Name / setting range / [default setting]	Information
0x2639:006 (P440.06)	Analog output 1: Filter time (Analog output 1: AO1 filter time) 0 ... [250] ... 10000 ms	Delay time for the output value of the analog output.

## 11.4.1.1 Example: Output voltage 0 ... 10 V = output frequency 0 ... 100 Hz

In this configuration, a voltage is provided at the analog output proportionately to the actual output frequency of the inverter (1 V = 10 Hz, resolution 0.1 Hz).

Parameter	Name	Setting for this example
0x2639:001 (P440.01)	Analog output 1: Output range	0 ... 10 VDC [1]
0x2639:002 (P440.02)	Analog output 1: Function	Output frequency [1]
0x2639:003 (P440.03)	Analog output 1: Min. signal	0
0x2639:004 (P440.04)	Analog output 1: Max. signal	1000

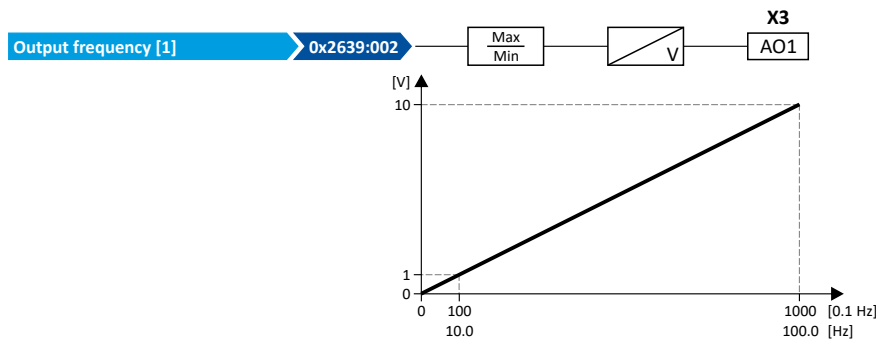

## 11.4.1.2 Example: Output voltage 2 ... 10 V = output frequency 30 ... 60 Hz

In this configuration, the output range 2 ... 10 V is used for the output of the output frequency (resolution: 0.1 Hz). The example shows how the signals outside the signal range (here: 30 ... 60 Hz) are cut off.

Parameter	Designation	Setting for this example
0x2639:001 (P440.01)	Analog output 1: Output range	2 ... 10 VDC [3]
0x2639:002 (P440.02)	Analog output 1: Function	Output frequency [1]
0x2639:003 (P440.03)	Analog output 1: Min. signal	300
0x2639:004 (P440.04)	Analog output 1: Max. signal	600

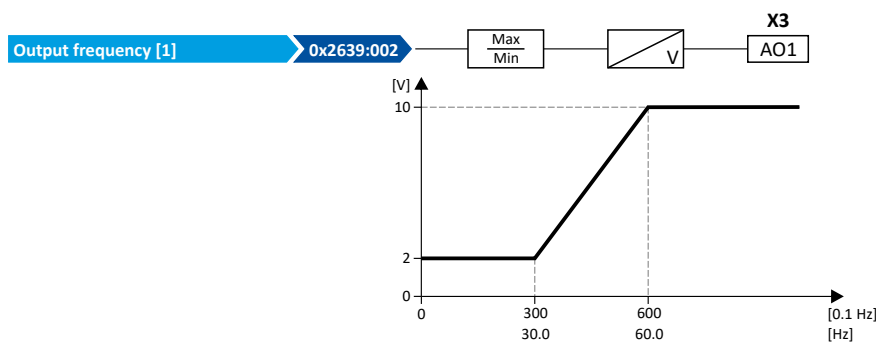

# I/O extensions and control connections

Configure analog outputs

Analog output 1

Example: mirrored output range



## 11.4.1.3 Example: mirrored output range

For the definition of the output range, configurations are also available in [0x2639:001](#)

([P440.01](#)) where negative analog output values are mirrored symmetrically on the Y axis. This makes it possible to realize an absolute value generation.

The following examples illustrate the function:

### Example 1: Minimum value = 0

Parameter	Name	Setting for this example
<a href="#">0x2639:001 (P440.01)</a>	Analog output 1: Output range	0 ... 10 VDC (mirrored) [11]
<a href="#">0x2639:003 (P440.03)</a>	Analog output 1: Min. signal	0
<a href="#">0x2639:004 (P440.04)</a>	Analog output 1: Max. signal	> 0

Diagram on the left: without mirroring, diagram on the right: with mirroring of the negative output values on the Y axis

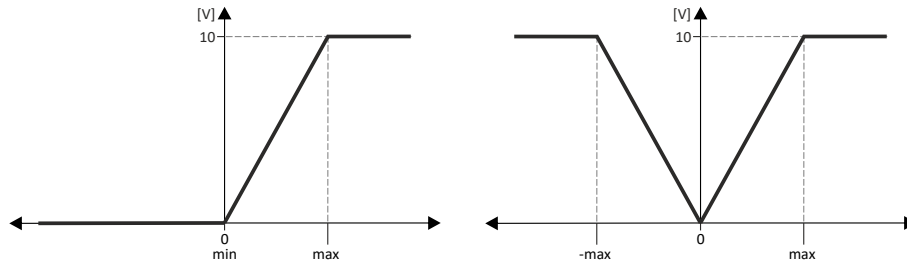

### Example 2: Minimum value lower than 0

Parameter	Name	Setting for this example
<a href="#">0x2639:001 (P440.01)</a>	Analog output 1: Output range	0 ... 10 VDC (mirrored) [11]
<a href="#">0x2639:003 (P440.03)</a>	Analog output 1: Min. signal	< 0
<a href="#">0x2639:004 (P440.04)</a>	Analog output 1: Max. signal	> 0

Diagram on the left: without mirroring, diagram on the right: with mirroring of the negative output values on the Y axis

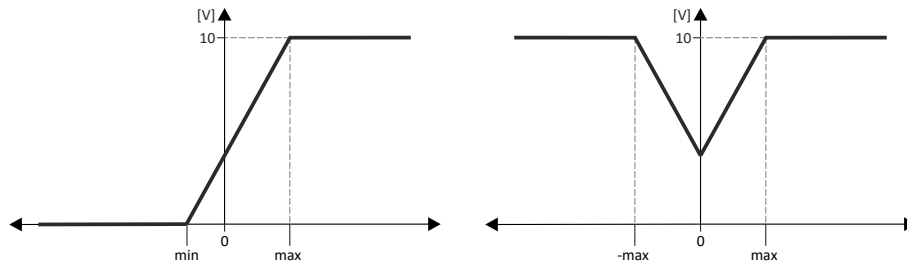

### Example 3: Minimum value higher than 0

Parameter	Name	Setting for this example
<a href="#">0x2639:001 (P440.01)</a>	Analog output 1: Output range	0 ... 10 VDC (mirrored) [11]
<a href="#">0x2639:003 (P440.03)</a>	Analog output 1: Min. signal	> 0
<a href="#">0x2639:004 (P440.04)</a>	Analog output 1: Max. signal	> Min. signal <a href="#">0x2639:003 (P440.03)</a>

Diagram on the left: without mirroring, diagram on the right: with mirroring of the negative output values on the Y axis

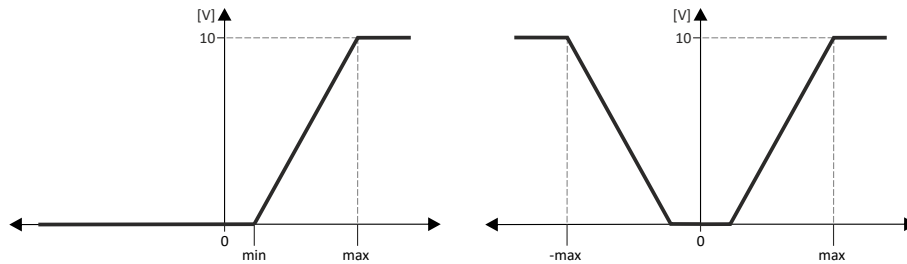



## 11.4.2 Analog output 2

Settings for analog output 2.

### Preconditions

Control Unit (CU) with application I/O

### Details

The analog output 2 is controlled with the signal selected in [0x263A:002 \(P441.02\)](#).

The following settings are possible for the analog output:

- Definition of the signal range ①
- Definition of the output range ②

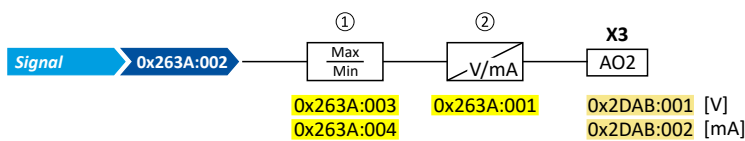

Diagnostic parameters:

- The current output voltage is displayed in [0x2DAB:002 \(P113.02\)](#).
- The actual output current is displayed in [0x2DAB:001 \(P113.01\)](#).

For further details and configuration examples, see chapter "Analog output 1". [305](#)

### Parameter

Address	Name / setting range / [default setting]	Information	
0x263A:001 (P441.01)	Analog output 2: Output range (Analog output 2: AO2 outp. range)	Definition of the output range.	
	0 Inhibited		
	<b>1 0 ... 10 VDC</b>		
	2 0 ... 5 VDC		
	3 2 ... 10 VDC		
	4 4 ... 20 mA		
	5 0 ... 20 mA		
	11 0 ... 10 VDC (mirrored)		In these configurations, negative analog output values are symmetrically mirrored on the Y axis. ▶ Example: mirrored output range <a href="#">308</a>
	12 0 ... 5 VDC (mirrored)		
	13 2 ... 10 VDC (mirrored)		
14 4 ... 20 mA (mirrored)			
15 0 ... 20 mA (mirrored)			
0x263A:002 (P441.02)	Analog output 2: Function (Analog output 2: AO2 function)	Selection of the signal to be shown at analog output 2.	
	• For further possible settings, see parameter <a href="#">0x2639:002 (P440.02)</a> . <a href="#">306</a>		
	<b>5 Motor current</b>	Actual motor current (resolution: 0.1 A).	
0x263A:003 (P441.03)	Analog output 2: Min. signal (Analog output 2: AO2 min. signal) -2147483648 ... [0] ... 2147483647	Definition of the signal value that corresponds to the minimum value at analog output 2. Example: configuration of analog output 1 as a 4 ... 20 mA current loop: output current 4 mA = 0x263A:003	
0x263A:004 (P441.04)	Analog output 2: Max. signal (Analog output 2: AO2 max. signal) -2147483648 ... [1000] ... 2147483647	Definition of the signal value that corresponds to the maximum value at analog output 2. Example: configuration of analog output 1 as a 4 ... 20 mA current loop: output current 20 mA = 0x263A:004	
0x263A:006 (P441.06)	Analog output 2: Filter time (Analog output 2: AO2 filter time) 0 ... [250] ... 10000 ms	Delay time for the output value of the analog output.	



## 12 Configuring the network

The inverter has various basic functions for network control. The inverter also supports multiple device profiles and is available in versions with different network options.

### Basic functions for network control

- ▶ [Control the inverter via network](#) 311
- ▶ [Define setpoint via network](#) 327
- ▶ [Further mappable parameters](#) 332
- ▶ [Parameter access monitoring \(PAM\)](#) 337
- ▶ [Process data handling in the event of error](#) 339

### Supported device profiles

- ▶ [CiA 402 device profile](#) 341
- ▶ [AC drive profile](#) 470
- ▶ [Lenze LECOM profile](#) 365

### Network options

- ▶ [CANopen](#) 366
- ▶ [EtherCAT](#) 445
- ▶ [EtherNet/IP](#) 470
- ▶ [Modbus RTU](#) 391
- ▶ [Modbus TCP](#) 509
- ▶ [POWERLINK](#) 530
- ▶ [PROFIBUS](#) 423
- ▶ [PROFINET](#) 543
- ▶ [IO-Link](#) 405



The monitoring functions of the respective network are only active when network control is activated.

- ▶ [Activate network control](#) 311
- 



The following conventions are used in this documentation for specifying the parameter address:

- The index is specified as a hexadecimal value.
  - The subindex is specified as a decimal value.
-



## 12.1 Control the inverter via network

### 12.1.1 Activate network control

In order to be able to control the inverter via network, a trigger must be first assigned in [0x2631:037 \(P400.37\)](#) the "Activate network control" function.

- This trigger can for instance be the constant value "TRUE" or a digital input.
- If the assigned trigger is = TRUE, the motor can only be started via the network control word.

Exception: jog operation; see chapter "[Start, stop and rotating direction commands](#)". [□ 62](#)

In order to control the inverter from the network, the network share [0x2631:037 \(P400.37\)](#) must be configured.

In case of an activated network control, the following functions are still active:

- [0x2631:001 \(P400.01\)](#): Enable inverter
- [0x2631:002 \(P400.02\)](#): Run
- [0x2631:003 \(P400.03\)](#): Activate quick stop
- [0x2631:004 \(P400.04\)](#): Reset error
- [0x2631:005 \(P400.05\)](#): DC braking
- [0x2631:010 \(P400.10\)](#): Jog forward (CW)
- [0x2631:011 \(P400.11\)](#): Jog reverse (CCW)\*
- [0x2631:012 \(P400.12\)](#): Activate keypad control\*
- [0x2631:037 \(P400.37\)](#): Activate network control\*
- [0x2631:043 \(P400.43\)](#): Activate fault 1
- [0x2631:044 \(P400.44\)](#): Activate fault 2
- [0x2631:054 \(P400.54\)](#): Reset position counter

(\*Not active in case of network operation in CiA402 mode 0x6060=2).

In case of an activated network control, the following functions are also still active if they are not configured in the NetWordIN1 bit functionality:

- [0x2631:048 \(P400.48\)](#): Activate PID influence ramp
- [0x2631:041 \(P400.41\)](#): Select parameter set (bit 0)
- [0x2631:042 \(P400.42\)](#): Select parameter set (bit 1)

All other functions configurable via [0x2631:xx \(P400.xx\)](#) are deactivated in case of network control.

#### Parameter

Address	Name / setting range / [default setting]	Information
0x2631:037 (P400.37)	Function list: Activate network control (Function list: Network control) • Further possible settings: <a href="#">▶ Trigger list □ 73</a>	Assignment of a trigger for the "Activate network control" function. Trigger = TRUE: Activate network control. Trigger = FALSE: no action / deactivate network control again.
	<b>0</b> <b>Not connected</b>	No trigger assigned (trigger is constantly FALSE).
	114 Network control active (from version 02.00)	TRUE if the network control is requested via bit 5 of the AC drive control word <a href="#">0x400B:001 (P592.01)</a> . Otherwise FALSE.  Notes: • Set this selection if the network control is to be activated via bit 5 of the AC drive control word. • The AC drive control word can be used with any communication protocol.  <a href="#">▶ AC drive control word □ 363</a>



## 12.1.2 Predefined control and status words

For establishing a simple network connection, the inverter provides predefined control and status words for the device profile CiA 402, the AC drive profile as well as in the LECOM format.

### Details

Process data are exchanged via cyclic data exchange between the network master and the inverter.

For the cyclic data exchange, the inverter is provided with 24 network registers.

- 12 network registers are provided as input registers for data words from the network master to the inverter.
- 12 network registers are provided as output registers for data words from the inverter to the network master.
- Each network register is provided with a corresponding code that defines which parameters (or other data codes) are mapped to the network register.
- The input and output registers are divided into three blocks (A, B, C) in each case, featuring 4 successive data words, respectively:

Network register	
Input register	Output register
Network IN A0	Network OUT A0
Network IN A1	Network OUT A1
Network IN A2	Network OUT A2
Network IN A3	Network OUT A3
Network IN B0	Network OUT B0
Network IN B1	Network OUT B1
Network IN B2	Network OUT B2
Network IN B3	Network OUT B3
Network IN C0	Network OUT C0
Network IN C1	Network OUT C1
Network IN C2	Network OUT C2
Network IN C3	Network OUT C3

The terms "input" and "output" refer to the point of view of the inverter:

- Input data are transmitted by the network master and received by the inverter.
- Output data are transmitted by the inverter and received by the network master.



The assignment of the network registers and the number of data words that can be transmitted cyclically varies according to the network/communication protocol. Detailed information can be found in the documentation for the respective communication protocol.

Data mapping cannot be applied to all parameters. The mappable parameters are indicated accordingly in the "Parameter attribute list". [▶ Parameter attribute list](#) [731](#)





The following table lists the predefined control and status words. These can be mapped to network registers for the cyclic exchange of data:

Name	Parameter	Associated mapping entry *	Further information
CiA control word	0x6040	0x60400010	▶ CiA 402 device profile <a href="#">□ 341</a>
CiA status word	0x6041 (P780.00)	0x60410010	
AC Drive control word	0x400B:001 (P592.01)	0x400B0110	▶ AC drive <a href="#">□ 363</a>
AC Drive status word	0x400C:001 (P593.01)	0x400C0110	
LECOM control word	0x400B:002 (P592.02)	0x400B0210	▶ Lenze LECOM profile <a href="#">□ 365</a>
LECOM status word	0x400C:002 (P593.02)	0x400C0210	

\* A mapping entry consists of index, subindex and data length in bits of the parameter to be mapped.

There are also additional mappable data words to individually control the inverter:

- ▶ [Define your own control word format □ 314](#)
- ▶ [Define your own status word format □ 322](#)
- ▶ [Further mappable parameters □ 332](#)

General information about the process of data mapping can be found in the chapter of the same name for the corresponding network.

# Configuring the network

Control the inverter via network  
Define your own control word format



## 12.1.3 Define your own control word format

The mappable data word NetWordIN1 is available for implementing a separate control word format.

### Details

Designation	Parameter	Associated mapping entry *	Further information
NetWordIN1	<a href="#">0x4008:001 (P590.01)</a>	0x40080110	The functions that are to be triggered via bits 0 ... 15 of the NetWordIN1 data word are defined in <a href="#">0x400E:001 (P505.01)</a> ... <a href="#">0x400E:016 (P505.16)</a> .

\* A mapping entry consists of index, subindex and data length in bits of the parameter to be mapped.

General information about the process of data mapping can be found in the chapter of the same name for the corresponding network.



# Configuring the network

Control the inverter via network  
Define your own control word format

## Parameter

Address	Name / setting range / [default setting]	Information
0x4008:001 (P590.01)	Process input words: NetWordIN1 (NetWordINx: NetWordIN1) 0x0000 ... [0x0000] ... 0xFFFF	Mappable data word for flexible control of the inverter via network.
	Bit 0 Mapping bit 0	Assignment of the function: 0x400E:001 (P505.01)
	Bit 1 Mapping bit 1	Assignment of the function: 0x400E:002 (P505.02)
	Bit 2 Mapping bit 2	Assignment of the function: 0x400E:003 (P505.03)
	Bit 3 Mapping bit 3	Assignment of the function: 0x400E:004 (P505.04)
	Bit 4 Mapping bit 4	Assignment of the function: 0x400E:005 (P505.05)
	Bit 5 Mapping bit 5	Assignment of the function: 0x400E:006 (P505.06)
	Bit 6 Mapping bit 6	Assignment of the function: 0x400E:007 (P505.07)
	Bit 7 Mapping bit 7	Assignment of the function: 0x400E:008 (P505.08)
	Bit 8 Mapping bit 8	Assignment of the function: 0x400E:009 (P505.09)
	Bit 9 Mapping bit 9	Assignment of the function: 0x400E:010 (P505.10)
	Bit 10 Mapping bit 10	Assignment of the function: 0x400E:011 (P505.11)
	Bit 11 Mapping bit 11	Assignment of the function: 0x400E:012 (P505.12)
	Bit 12 Mapping bit 12	Assignment of the function: 0x400E:013 (P505.13) Alternatively, this mapping bit can be used for controlling the digital outputs.  Assignment of the digital outputs: <ul style="list-style-type: none"> <li>Relay: 0x2634:001 (P420.01) / selection [30]</li> <li>Digital output 1: 0x2634:002 (P420.02) / selection [30]</li> <li>Digital output 2: 0x2634:003 (P420.03) / selection [30]</li> </ul> <b>Note!</b> Do not assign the mapping bit to a function and a digital output at the same time. A double assignment can cause an unpredictable drive behaviour!
	Bit 13 Mapping bit 13	Assignment of the function: 0x400E:014 (P505.14) Alternatively, this mapping bit can be used for controlling the digital outputs.  Assignment of the digital outputs: <ul style="list-style-type: none"> <li>Relay: 0x2634:001 (P420.01) / selection [31]</li> <li>Digital output 1: 0x2634:002 (P420.02) / selection [31]</li> <li>Digital output 2: 0x2634:003 (P420.03) / selection [31]</li> </ul> <b>Note!</b> Do not assign the mapping bit to a function and a digital output at the same time. A double assignment can cause an unpredictable drive behaviour!
	Bit 14 Mapping bit 14	Assignment of the function: 0x400E:015 (P505.15) Alternatively, this mapping bit can be used for controlling the digital outputs.  Assignment of the digital outputs: <ul style="list-style-type: none"> <li>Relay: 0x2634:001 (P420.01) / selection [32]</li> <li>Digital output 1: 0x2634:002 (P420.02) / selection [32]</li> <li>Digital output 2: 0x2634:003 (P420.03) / selection [32]</li> </ul> <b>Note!</b> Do not assign the mapping bit to a function and a digital output at the same time. A double assignment can cause an unpredictable drive behaviour!
Bit 15 Mapping bit 15	Assignment of the function: 0x400E:016 (P505.16) Alternatively, this mapping bit can be used for controlling the digital outputs.  Assignment of the digital outputs: <ul style="list-style-type: none"> <li>Relay: 0x2634:001 (P420.01) / selection [33]</li> <li>Digital output 1: 0x2634:002 (P420.02) / selection [33]</li> <li>Digital output 2: 0x2634:003 (P420.03) / selection [33]</li> </ul> <b>Note!</b> Do not assign the mapping bit to a function and a digital output at the same time. A double assignment can cause an unpredictable drive behaviour!	

# Configuring the network

Control the inverter via network  
Define your own control word format



Address	Name / setting range / [default setting]	Information
0x400E:001 (P505.01)	NetWordIN1 function: Bit 0 (NetWordIN1 fct.: NetWordIN1.00) <ul style="list-style-type: none"> <li>Setting can only be changed if the inverter is disabled.</li> </ul>	Definition of the function that is to be triggered via bit 0 of the mappable NetWordIN1 data word.
	<b>0 Not active</b>	Trigger bit without any function.
	<b>1 Disable inverter</b>	<p>Trigger bit = 0-1 edge: The inverter is disabled.                      Trigger bit = 0: The inverter is enabled (unless there is another cause for inverter disable).</p> <p>Notes:</p> <ul style="list-style-type: none"> <li>In all device states, a 0-1 edge causes an immediate change to the inhibited state with one exception: If the inverter is in the error status and the error condition still exists, the inverter remains in the error status.</li> <li>Changing to the disabled state causes an immediate stop of the motor, regardless of the stop method set in <a href="#">0x2838:003 (P203.03)</a>. The motor coasts down as a function of the mass inertia of the machine.</li> <li>In the disabled state, the motor cannot be started.</li> <li>After the inverter disable is deactivated, a renewed start command is required to restart the motor.</li> <li>The cause(s) that are active for the disabled state are shown in <a href="#">0x282A:001 (P126.01)</a>.</li> </ul>
	<b>2 Stopping</b>	<p>Trigger bit = 1: Motor is stopped.                      Trigger bit = 0: No action / Deactivate stop again.</p> <p>Notes:</p> <ul style="list-style-type: none"> <li>The stop method can be selected in <a href="#">0x2838:003 (P203.03)</a>.</li> </ul>
	<b>3 Activate quick stop</b>	<p>Trigger bit = 1: "Quick stop" function activated.                      Trigger bit = 0: no action / deactivate function again.</p> <p>Notes:</p> <ul style="list-style-type: none"> <li>The "Quick stop" function brings the motor to a standstill within the deceleration time set in <a href="#">0x291C (P225.00)</a>.</li> <li>The "Quick stop" function has a higher priority than the "Run" function.</li> </ul>
	<b>4 Reset error</b>	<p>Trigger bit = 0-1 edge: Active error is reset (acknowledged) if the error condition is not active anymore and the error is resettable.                      Trigger bit = 0: No action.</p> <p>Notes:</p> <ul style="list-style-type: none"> <li>After resetting the error, a new enable/start command is required to restart the motor.</li> </ul> <p>▶ <a href="#">Error reset □ 702</a></p>
	<b>5 Activate DC braking</b>	<p>Trigger bit = 1: "DC braking" function activated.                      Trigger bit = 0: no action / deactivate function again.</p> <p>▶ <a href="#">DC braking □ 221</a></p>
	<b>8 Run forward (CW)</b>	<p>Trigger bit = 0-1 edge: Motor is started in forward rotating direction (CW).                      Trigger bit = 1-0 edge: Motor is stopped again.</p> <p>Notes:</p> <ul style="list-style-type: none"> <li>The stop method can be selected in <a href="#">0x2838:003 (P203.03)</a>.</li> <li>In the case of a bipolar setpoint selection (e.g. ±10 V), the function is executed irrespective of the rotating direction. The rotating direction is determined by the sign of the setpoint.</li> <li>The function also serves to realise an automatic start after switch-on.                      ▶ <a href="#">Start behavior □ 51</a></li> <li>The "Reverse rotational direction [13]" function can be used in connection with this function.</li> </ul>



# Configuring the network

Control the inverter via network  
Define your own control word format

Address	Name / setting range / [default setting]	Information
9	Run reverse (CCW)	<p>Trigger bit = 0-1 edge: Motor is started in the reverse rotating direction (CCW).</p> <p>Trigger bit = 1-0 edge: Motor is stopped again.</p> <p>Notes:</p> <ul style="list-style-type: none"> <li>The stop method can be selected in <a href="#">0x2838:003 (P203.03)</a>.</li> <li>In the case of a bipolar setpoint selection (e.g. <math>\pm 10</math> V), the function is executed irrespective of the rotating direction. The rotating direction is determined by the sign of the setpoint.</li> <li>The function also serves to realise an automatic start after switch-on. <ul style="list-style-type: none"> <li>▶ <a href="#">Start behavior</a> <a href="#">1051</a></li> </ul> </li> <li>The "Reverse rotational direction [13]" function can be used in connection with this function.</li> </ul>
13	Reverse rotational direction	<p>Trigger bit = 1: the setpoint specified is inverted (i. e. the sign is inverted).</p> <p>Trigger bit = 0: no action / deactivate function again.</p>
14	Activate AI1 setpoint	<p>Trigger bit = 1: analog input 1 is used as setpoint source (if the trigger bit assigned has the highest setpoint priority).</p> <p>Trigger bit = 0: no action / deactivate function again.</p> <p>▶ <a href="#">Analog input 1</a> <a href="#">10284</a></p>
15	Activate AI2 setpoint	<p>Trigger bit = 1: analog input 2 is used as setpoint source (if the trigger bit assigned has the highest setpoint priority).</p> <p>Trigger bit = 0: no action / deactivate function again.</p> <p>▶ <a href="#">Analog input 2</a> <a href="#">10289</a></p>
17	Activate network setpoint	<p>Trigger bit = 1: the network is used as setpoint source (if the trigger bit assigned has the highest setpoint priority).</p> <p>Trigger bit = 0: no action / deactivate function again.</p>
18	Activate preset (bit 0)	<p>Selection bits for bit coded selection and activation of a parameterised setpoint (preset).</p> <p>▶ <a href="#">Setpoint presets</a> <a href="#">1098</a></p>
19	Activate preset (bit 1)	
20	Activate preset (bit 2)	
21	Activate preset (bit 3)	
26	Activate segment 1 setpoint (from version 03.00)	<p>Selection bits for bit coded selection and activation of a parameterised segment setpoint.</p>
27	Activate segment 2 setpoint (from version 03.00)	<p>Notes:</p> <ul style="list-style-type: none"> <li>During normal operation (no active sequence), this function serves to activate the setpoint of a segment (instead of an entire sequence in the sequencer operation).</li> <li>This function is not intended for the use in the sequencer operation.</li> </ul> <p>▶ <a href="#">Segment configuration</a> <a href="#">10104</a></p>
28	Activate segment 3 setpoint (from version 03.00)	
29	Activate segment 4 setpoint (from version 03.00)	
30	Run/abort sequence (from version 03.00)	<p>Trigger bit = 1: Start selected sequence.</p> <p>Trigger bit = 0: Abort sequence.</p> <p>Notes:</p> <ul style="list-style-type: none"> <li>The assigned trigger bit must remain set to "1" for the duration of the sequence.</li> <li>If the trigger bit is reset to "0", the sequence is aborted. In this case, the standard setpoint or the setpoint source selected via setpoint change-over is active again.</li> <li>A sequence is selected in a binary-coded fashion via the trigger bits assigned to the four functions "Select sequence (bit 0) [50]" ... "Select sequence (bit 3) [53]".</li> </ul> <p>▶ <a href="#">Sequencer</a> <a href="#">10102</a></p>
32	Next sequence step (from version 03.00)	<p>Trigger bit = 0<math>\bar{1}</math>1 (edge): Next sequence step.</p> <p>Trigger bit = 1<math>\bar{0}</math>0 (edge): No action.</p> <p>Notes:</p> <ul style="list-style-type: none"> <li>The execution of the current step is completed even if the time parameterised for the segment has not elapsed yet.</li> <li>The function is only relevant for Sequencer mode <a href="#">0x4025 (P800.00)</a> = "Step operation [2]" or "Time &amp; step operation [3]".</li> <li>A jump to the next sequence step is not possible if the sequence pauses, the sequence is suspended or the final segment is executed.</li> </ul> <p>▶ <a href="#">Sequencer</a> <a href="#">10102</a></p>

# Configuring the network

Control the inverter via network  
Define your own control word format



Address	Name / setting range / [default setting]	Information
33	Pause sequence (from version 03.00)	<p>Trigger bit = 1: Pause sequence. Trigger bit = 0: Continue sequence.</p> <p>Notes:</p> <ul style="list-style-type: none"> <li>• During the pause, the sequence stops in the current step. The expiration of the time set for the segment is stopped.</li> <li>• The sequencer setpoint continues to remain active.</li> </ul> <p>▶ <a href="#">Sequencer</a> <a href="#">102</a></p>
34	Suspend sequence (from version 03.00)	<p>Trigger bit = 1: Suspend sequence. Trigger bit = 0: Continue sequence.</p> <p>Notes:</p> <ul style="list-style-type: none"> <li>• This function serves to temporarily change over to the standard setpoint or the setpoint source selected via setpoint change-over.</li> <li>• The sequence is continued at the point where it was suspended.</li> </ul> <p>▶ <a href="#">Sequencer</a> <a href="#">102</a></p>
35	Stop sequence (from version 03.00)	<p>Trigger bit = 0↗1 (edge): Stop sequence. Trigger bit = 1↘0 (edge): No action.</p> <p>Notes:</p> <ul style="list-style-type: none"> <li>• If the sequence is stopped, it is jumped to the final segment.</li> <li>• The further execution depends on the selected End of sequence mode <a href="#">0x402F (P824.00)</a>.</li> </ul> <p>▶ <a href="#">Sequencer</a> <a href="#">102</a></p>
36	Abort sequence (from version 03.00)	<p>Trigger bit = 0↗1 (edge): Abort sequence. Trigger bit = 1↘0 (edge): No action.</p> <p>Notes:</p> <ul style="list-style-type: none"> <li>• This function serves to directly stop the sequence without the final segment being executed. In this case, the standard setpoint or the setpoint source selected via setpoint change-over is active again.</li> </ul> <p>▶ <a href="#">Sequencer</a> <a href="#">102</a></p>
39	Activate ramp 2	<p>Trigger bit = 1: activate acceleration time 2 and deceleration time 2 manually. Trigger bit = 0: no action / deactivate function again.</p> <p>▶ <a href="#">Ramp times</a> <a href="#">95</a></p>
40	Load parameter set	<p>Trigger bit = 0-1 edge: parameter change-over to the value set selected via "Select parameter set (bit 0)" and "Select parameter set (bit 1)". Trigger bit = 0: no action.</p> <p>Notes:</p> <ul style="list-style-type: none"> <li>• The activation method for the "Parameter change-over" function can be selected in <a href="#">0x4046 (P755.00)</a>.</li> </ul> <p>▶ <a href="#">Parameter change-over</a> <a href="#">593</a></p>
41	Select parameter set (bit 0)	<p>Selection bits for the "Parameter change-over" function.</p> <p>▶ <a href="#">Parameter change-over</a> <a href="#">593</a></p>
42	Select parameter set (bit 1)	
43	Activate fault 1	<p>Trigger bit = 1: Trigger user-defined error 1. Trigger bit = 0: no action.</p> <p>Notes:</p> <ul style="list-style-type: none"> <li>• After the error is triggered, the motor is brought to a standstill with the quick stop ramp. The inverter is then disabled.</li> </ul> <p>Associated error code:</p> <ul style="list-style-type: none"> <li>• <a href="#">25249</a>   <a href="#">0x62A1</a> - Network: user fault 1</li> </ul>
44	Activate fault 2	<p>Trigger bit = 1: Trigger user-defined error 2. Trigger bit = 0: no action.</p> <p>Notes:</p> <ul style="list-style-type: none"> <li>• After the error is triggered, the motor is brought to a standstill with the quick stop ramp. The inverter is then disabled.</li> </ul> <p>Associated error code:</p> <ul style="list-style-type: none"> <li>• <a href="#">25250</a>   <a href="#">0x62A2</a> - Network: user fault 2</li> </ul>



# Configuring the network

Control the inverter via network  
Define your own control word format

Address	Name / setting range / [default setting]	Information
	45 Disable PID controlling	<p>Trigger bit = 1: If PID control is activated, ignore PID control and drive the motor in speed-controlled manner.</p> <p>Trigger bit = 0: If PID control is activated, drive the motor with PID control.</p> <p>Notes:</p> <ul style="list-style-type: none"> <li>The PID control can be activated in <a href="#">0x4020:001 (P600.01)</a>.</li> </ul> <p>▶ <a href="#">Configuring the process controller</a> <a href="#">128</a></p>
	46 Set PID output to 0	<p>Trigger bit = 1: If PID control is activated, I component and the output of the PID controller are set to 0 and the internal control algorithm is stopped. The PID control remains active.</p> <p>Trigger bit = 0: No action / deactivate function again.</p> <p>▶ <a href="#">Configuring the process controller</a> <a href="#">128</a></p>
	47 Inhibit PID I-component	<p>Trigger bit = 1: If the PID control is activated, the I component of the PID controller is set to 0 and the integration process is stopped.</p> <p>Trigger bit = 0: No action / deactivate function again.</p> <p>▶ <a href="#">Configuring the process controller</a> <a href="#">128</a></p>
	48 Activate PID influence ramp	<p>Trigger bit = 1: the influence of the process controller is shown by means of a ramp.</p> <p>Trigger bit = 0 or not connected: the influence of the process controller is shown by means of a ramp.</p> <p>Notes:</p> <ul style="list-style-type: none"> <li>The influence of the process controller is always active (not only when PID control is activated).</li> <li>Acceleration time for showing the influence of the process controller can be set in <a href="#">0x404C:001 (P607.01)</a>.</li> <li>Deceleration time for hiding the influence of the process controller can be set in <a href="#">0x404C:002 (P607.02)</a>.</li> </ul> <p>▶ <a href="#">Configuring the process controller</a> <a href="#">128</a></p>
	49 Release holding brake	<p>Trigger bit = 1: Release holding brake manually.</p> <p>Trigger bit = 0: No action.</p> <p>Notes:</p> <ul style="list-style-type: none"> <li>The manually triggered "Release holding brake" command has a direct impact on the "Release holding brake [115]" trigger. Thus, the holding brake can be manually released if the power section is switched off.</li> <li>The responsibility for a manual release of the holding brake has the external trigger source for the "Release holding brake" command.</li> </ul> <p>▶ <a href="#">Holding brake control</a> <a href="#">228</a></p>
	50 Select sequence (bit 0)	Selection bits for bit coded selection of a sequence.
	51 Select sequence (bit 1)	<p>Notes:</p> <ul style="list-style-type: none"> <li>The selected sequence is not started automatically.</li> <li>For a status-controlled start, the function "Run/abort sequence [30]" is available.</li> </ul> <p>▶ <a href="#">Sequencer control functions</a> <a href="#">122</a></p>
	52 Select sequence (bit 2)	
	53 Select sequence (bit 3)	
	54 Position counter reset	<p>Trigger bit = 1: Reset position counter manually.</p> <p>Trigger bit = 0: No action.</p> <p>▶ <a href="#">Position counter</a> <a href="#">606</a></p>
	55 Activate UPS operation	<p>Trigger bit = 1: Activate UPS operation.</p> <p>Trigger bit = 0: No action / deactivate function again.</p> <p>▶ <a href="#">Operation with UPS</a> <a href="#">614</a></p>
0x400E:002 (P505.02)	<p>NetWordIN1 function: Bit 1 (NetWordIN1 fct.: NetWordIN1.01)</p> <ul style="list-style-type: none"> <li>Setting can only be changed if the inverter is disabled.</li> <li>For further possible settings, see parameter <a href="#">0x400E:001 (P505.01)</a>. <a href="#">1316</a></li> </ul>	<p>Definition of the function that is to be triggered via bit 1 of the mappable NetWordIN1 data word.</p>
	<b>0 Not active</b>	Trigger bit without any function.

# Configuring the network

Control the inverter via network  
Define your own control word format



Address	Name / setting range / [default setting]	Information
0x400E:003 (P505.03)	NetWordIN1 function: Bit 2 (NetWordIN1 fct.: NetWordIN1.02) <ul style="list-style-type: none"> <li>Setting can only be changed if the inverter is disabled.</li> <li>For further possible settings, see parameter <a href="#">0x400E:001 (P505.01)</a>. <a href="#">□ 316</a></li> </ul>	Definition of the function that is to be triggered via bit 2 of the mappable NetWordIN1 data word.
	<b>3 Activate quick stop</b>	Trigger bit = 1: "Quick stop" function activated. Trigger bit = 0: no action / deactivate function again.  Notes: <ul style="list-style-type: none"> <li>The "Quick stop" function brings the motor to a standstill within the deceleration time set in <a href="#">0x291C (P225.00)</a>.</li> <li>The "Quick stop" function has a higher priority than the "Run" function.</li> </ul>
0x400E:004 (P505.04)	NetWordIN1 function: Bit 3 (NetWordIN1 fct.: NetWordIN1.03) <ul style="list-style-type: none"> <li>Setting can only be changed if the inverter is disabled.</li> <li>For further possible settings, see parameter <a href="#">0x400E:001 (P505.01)</a>. <a href="#">□ 316</a></li> </ul>	Definition of the function that is to be triggered via bit 3 of the mappable NetWordIN1 data word.
	<b>0 Not active</b>	Trigger bit without any function.
0x400E:005 (P505.05)	NetWordIN1 function: Bit 4 (NetWordIN1 fct.: NetWordIN1.04) <ul style="list-style-type: none"> <li>Setting can only be changed if the inverter is disabled.</li> <li>For further possible settings, see parameter <a href="#">0x400E:001 (P505.01)</a>. <a href="#">□ 316</a></li> </ul>	Definition of the function that is to be triggered via bit 4 of the mappable NetWordIN1 data word.
	<b>8 Run forward (CW)</b>	Trigger bit = 0-1 edge: Motor is started in forward rotating direction (CW). Trigger bit = 1-0 edge: Motor is stopped again.  Notes: <ul style="list-style-type: none"> <li>The stop method can be selected in <a href="#">0x2838:003 (P203.03)</a>.</li> <li>In the case of a bipolar setpoint selection (e.g <math>\pm 10</math> V), the function is executed irrespective of the rotating direction. The rotating direction is determined by the sign of the setpoint.</li> <li>The function also serves to realise an automatic start after switch-on. <ul style="list-style-type: none"> <li>▶ <a href="#">Start behavior □ 51</a></li> </ul> </li> <li>The "Reverse rotational direction [13]" function can be used in connection with this function.</li> </ul>
0x400E:006 (P505.06)	NetWordIN1 function: Bit 5 (NetWordIN1 fct.: NetWordIN1.05) <ul style="list-style-type: none"> <li>Setting can only be changed if the inverter is disabled.</li> <li>For further possible settings, see parameter <a href="#">0x400E:001 (P505.01)</a>. <a href="#">□ 316</a></li> </ul>	Definition of the function that is to be triggered via bit 5 of the mappable NetWordIN1 data word.
	<b>18 Activate preset (bit 0)</b>	Selection bits for bit coded selection and activation of a parameterised setpoint (preset). ▶ <a href="#">Setpoint presets □ 98</a>
0x400E:007 (P505.07)	NetWordIN1 function: Bit 6 (NetWordIN1 fct.: NetWordIN1.06) <ul style="list-style-type: none"> <li>Setting can only be changed if the inverter is disabled.</li> <li>For further possible settings, see parameter <a href="#">0x400E:001 (P505.01)</a>. <a href="#">□ 316</a></li> </ul>	Definition of the function that is to be triggered via bit 6 of the mappable NetWordIN1 data word.
	<b>19 Activate preset (bit 1)</b>	Selection bits for bit coded selection and activation of a parameterised setpoint (preset). ▶ <a href="#">Setpoint presets □ 98</a>





# Configuring the network

Control the inverter via network  
Define your own control word format

Address	Name / setting range / [default setting]	Information
0x400E:008 (P505.08)	NetWordIN1 function: Bit 7 (NetWordIN1 fct.: NetWordIN1.07) <ul style="list-style-type: none"> <li>Setting can only be changed if the inverter is disabled.</li> <li>For further possible settings, see parameter <a href="#">0x400E:001 (P505.01)</a>. <a href="#">316</a></li> </ul>	Definition of the function that is to be triggered via bit 7 of the mappable NetWordIN1 data word.
	<b>4 Reset error</b>	Trigger bit = 0-1 edge: Active error is reset (acknowledged) if the error condition is not active anymore and the error is resettable. Trigger bit = 0: No action.  Notes: <ul style="list-style-type: none"> <li>After resetting the error, a new enable/start command is required to restart the motor.</li> </ul> <a href="#">▶ Error reset 702</a>
0x400E:009 (P505.09)	NetWordIN1 function: Bit 8 (NetWordIN1 fct.: NetWordIN1.08) <ul style="list-style-type: none"> <li>Setting can only be changed if the inverter is disabled.</li> <li>For further possible settings, see parameter <a href="#">0x400E:001 (P505.01)</a>. <a href="#">316</a></li> </ul>	Definition of the function that is to be triggered via bit 8 of the mappable NetWordIN1 data word.
	<b>0 Not active</b>	Trigger bit without any function.
0x400E:010 (P505.10)	NetWordIN1 function: Bit 9 (NetWordIN1 fct.: NetWordIN1.09) <ul style="list-style-type: none"> <li>Setting can only be changed if the inverter is disabled.</li> <li>For further possible settings, see parameter <a href="#">0x400E:001 (P505.01)</a>. <a href="#">316</a></li> </ul>	Definition of the function that is to be triggered via bit 9 of the mappable NetWordIN1 data word.
	<b>5 Activate DC braking</b>	Trigger bit = 1: "DC braking" function activated. Trigger bit = 0: no action / deactivate function again. <a href="#">▶ DC braking 221</a>
0x400E:011 (P505.11)	NetWordIN1 function: Bit 10 (NetWordIN1 fct.: NetWordIN1.10) <ul style="list-style-type: none"> <li>Setting can only be changed if the inverter is disabled.</li> <li>For further possible settings, see parameter <a href="#">0x400E:001 (P505.01)</a>. <a href="#">316</a></li> </ul>	Definition of the function that is to be triggered via bit 10 of the mappable NetWordIN1 data word.
	<b>0 Not active</b>	Trigger bit without any function.
0x400E:012 (P505.12)	NetWordIN1 function: Bit 11 (NetWordIN1 fct.: NetWordIN1.11) <ul style="list-style-type: none"> <li>Setting can only be changed if the inverter is disabled.</li> <li>For further possible settings, see parameter <a href="#">0x400E:001 (P505.01)</a>. <a href="#">316</a></li> </ul>	Definition of the function that is to be triggered via bit 11 of the mappable NetWordIN1 data word.
	<b>0 Not active</b>	Trigger bit without any function.
0x400E:013 (P505.13)	NetWordIN1 function: Bit 12 (NetWordIN1 fct.: NetWordIN1.12) <ul style="list-style-type: none"> <li>Setting can only be changed if the inverter is disabled.</li> <li>For further possible settings, see parameter <a href="#">0x400E:001 (P505.01)</a>. <a href="#">316</a></li> </ul>	Definition of the function that is to be triggered via bit 12 of the mappable NetWordIN1 data word.
	<b>13 Reverse rotational direction</b>	Trigger bit = 1: the setpoint specified is inverted (i. e. the sign is inverted). Trigger bit = 0: no action / deactivate function again.
0x400E:014 (P505.14)	NetWordIN1 function: Bit 13 (NetWordIN1 fct.: NetWordIN1.13) <ul style="list-style-type: none"> <li>Setting can only be changed if the inverter is disabled.</li> <li>For further possible settings, see parameter <a href="#">0x400E:001 (P505.01)</a>. <a href="#">316</a></li> </ul>	Definition of the function that is to be triggered via bit 13 of the mappable NetWordIN1 data word.
	<b>0 Not active</b>	Trigger bit without any function.

# Configuring the network

Control the inverter via network  
Define your own status word format



Address	Name / setting range / [default setting]	Information
0x400E:015 (P505.15)	NetWordIN1 function: Bit 14 (NetWordIN1 fct.: NetWordIN1.14) <ul style="list-style-type: none"> <li>Setting can only be changed if the inverter is disabled.</li> <li>For further possible settings, see parameter <a href="#">0x400E:001 (P505.01)</a>. <a href="#">316</a></li> </ul>	Definition of the function that is to be triggered via bit 14 of the mappable NetWordIN1 data word.
	<b>0</b>   <b>Not active</b>	Trigger bit without any function.
0x400E:016 (P505.16)	NetWordIN1 function: Bit 15 (NetWordIN1 fct.: NetWordIN1.15) <ul style="list-style-type: none"> <li>Setting can only be changed if the inverter is disabled.</li> <li>For further possible settings, see parameter <a href="#">0x400E:001 (P505.01)</a>. <a href="#">316</a></li> </ul>	Definition of the function that is to be triggered via bit 15 of the mappable NetWordIN1 data word.
	<b>0</b>   <b>Not active</b>	Trigger bit without any function.

## 12.1.4 Define your own status word format

The mappable data word NetWordOUT1 is available for implementing a separate status word format.

### Details

Designation	Parameter	Associated mapping entry *	Further information
NetWordOUT1	<a href="#">0x400A:001 (P591.01)</a>	0x400A0110	The triggers for bits 0 ... 15 of the NetWordOUT1 data word are defined in <a href="#">0x2634:010 (P420.10)</a> ... <a href="#">0x2634:025 (P420.25)</a> .

\* A mapping entry consists of index, subindex and data length in bits of the parameter to be mapped.

General information about the process of data mapping can be found in the chapter of the same name for the corresponding network.

### Parameter

Address	Name / setting range / [default setting]	Information
0x2634:010 (P420.10)	Digital outputs function: NetWordOUT1 - bit 0 (Dig.out.function: NetWordOUT1.00) <ul style="list-style-type: none"> <li>For further possible settings, see parameter <a href="#">0x2634:001 (P420.01)</a>. <a href="#">292</a></li> </ul>	Assignment of a trigger to bit 0 of NetWordOUT1. Trigger = FALSE: bit set to 0. Trigger = TRUE: bit set to 1.
	<b>51</b>   <b>Ready for operation</b>	TRUE if inverter is ready for operation (no error active, no STO active and DC-bus voltage ok). Otherwise FALSE.
0x2634:011 (P420.11)	Digital outputs function: NetWordOUT1 - bit 1 (Dig.out.function: NetWordOUT1.01) <ul style="list-style-type: none"> <li>For further possible settings, see parameter <a href="#">0x2634:001 (P420.01)</a>. <a href="#">292</a></li> </ul>	Assignment of a trigger to bit 1 of NetWordOUT1. Trigger = FALSE: bit set to 0. Trigger = TRUE: bit set to 1.
	<b>0</b>   <b>Not connected</b>	No trigger assigned (trigger is constantly FALSE).
0x2634:012 (P420.12)	Digital outputs function: NetWordOUT1 - bit 2 (Dig.out.function: NetWordOUT1.02) <ul style="list-style-type: none"> <li>For further possible settings, see parameter <a href="#">0x2634:001 (P420.01)</a>. <a href="#">292</a></li> </ul>	Assignment of a trigger to bit 2 of NetWordOUT1. Trigger = FALSE: bit set to 0. Trigger = TRUE: bit set to 1.
	<b>52</b>   <b>Operation enabled</b>	TRUE if inverter and start are enabled. Otherwise FALSE.
0x2634:013 (P420.13)	Digital outputs function: NetWordOUT1 - bit 3 (Dig.out.function: NetWordOUT1.03) <ul style="list-style-type: none"> <li>For further possible settings, see parameter <a href="#">0x2634:001 (P420.01)</a>. <a href="#">292</a></li> </ul>	Assignment of a trigger to bit 3 of NetWordOUT1. Trigger = FALSE: bit set to 0. Trigger = TRUE: bit set to 1.
	<b>56</b>   <b>Fault active</b>	TRUE if error is active. Otherwise FALSE.
0x2634:014 (P420.14)	Digital outputs function: NetWordOUT1 - bit 4 (Dig.out.function: NetWordOUT1.04) <ul style="list-style-type: none"> <li>For further possible settings, see parameter <a href="#">0x2634:001 (P420.01)</a>. <a href="#">292</a></li> </ul>	Assignment of a trigger to bit 4 of NetWordOUT1. Trigger = FALSE: bit set to 0. Trigger = TRUE: bit set to 1.
	<b>0</b>   <b>Not connected</b>	No trigger assigned (trigger is constantly FALSE).



# Configuring the network

Control the inverter via network  
Define your own status word format

Address	Name / setting range / [default setting]	Information
0x2634:015 (P420.15)	Digital outputs function: NetWordOUT1 - bit 5 (Dig.out.function: NetWordOUT1.05) • For further possible settings, see parameter <a href="#">0x2634:001 (P420.01)</a> . <a href="#">□ 292</a>	Assignment of a trigger to bit 5 of NetWordOUT1. Trigger = FALSE: bit set to 0. Trigger = TRUE: bit set to 1.
	<b>54 Quick stop active</b>	TRUE if quick stop is active. Otherwise FALSE.
0x2634:016 (P420.16)	Digital outputs function: NetWordOUT1 - bit 6 (Dig.out.function: NetWordOUT1.06) • For further possible settings, see parameter <a href="#">0x2634:001 (P420.01)</a> . <a href="#">□ 292</a>	Assignment of a trigger to bit 6 of NetWordOUT1. Trigger = FALSE: bit set to 0. Trigger = TRUE: bit set to 1.
	<b>50 Running</b>	TRUE if inverter and start are enabled and output frequency > 0 Hz. Otherwise FALSE. Exception, quick stop mode: TRUE if inverter and start are enabled and output frequency > 0.2 Hz. Otherwise FALSE.
0x2634:017 (P420.17)	Digital outputs function: NetWordOUT1 - bit 7 (Dig.out.function: NetWordOUT1.07) • For further possible settings, see parameter <a href="#">0x2634:001 (P420.01)</a> . <a href="#">□ 292</a>	Assignment of a trigger to bit 7 of NetWordOUT1. Trigger = FALSE: bit set to 0. Trigger = TRUE: bit set to 1.
	<b>58 Device warning active</b>	TRUE if warning is active. Otherwise FALSE. • A warning has no impact on the operating status of the inverter. • A warning is reset automatically if the cause has been eliminated.
0x2634:018 (P420.18)	Digital outputs function: NetWordOUT1 - bit 8 (Dig.out.function: NetWordOUT1.08) • For further possible settings, see parameter <a href="#">0x2634:001 (P420.01)</a> . <a href="#">□ 292</a>	Assignment of a trigger to bit 8 of NetWordOUT1. Trigger = FALSE: bit set to 0. Trigger = TRUE: bit set to 1.
	<b>0 Not connected</b>	No trigger assigned (trigger is constantly FALSE).
0x2634:019 (P420.19)	Digital outputs function: NetWordOUT1 - bit 9 (Dig.out.function: NetWordOUT1.09) • For further possible settings, see parameter <a href="#">0x2634:001 (P420.01)</a> . <a href="#">□ 292</a>	Assignment of a trigger to bit 9 of NetWordOUT1. Trigger = FALSE: bit set to 0. Trigger = TRUE: bit set to 1.
	<b>0 Not connected</b>	No trigger assigned (trigger is constantly FALSE).
0x2634:020 (P420.20)	Digital outputs function: NetWordOUT1 - bit 10 (Dig.out.function: NetWordOUT1.10) • For further possible settings, see parameter <a href="#">0x2634:001 (P420.01)</a> . <a href="#">□ 292</a>	Assignment of a trigger to bit 10 of NetWordOUT1. Trigger = FALSE: bit set to 0. Trigger = TRUE: bit set to 1.
	<b>72 Setpoint speed reached</b>	TRUE if frequency setpoint reached. Otherwise FALSE.
0x2634:021 (P420.21)	Digital outputs function: NetWordOUT1 - bit 11 (Dig.out.function: NetWordOUT1.11) • For further possible settings, see parameter <a href="#">0x2634:001 (P420.01)</a> . <a href="#">□ 292</a>	Assignment of a trigger to bit 11 of NetWordOUT1. Trigger = FALSE: bit set to 0. Trigger = TRUE: bit set to 1.
	<b>78 Current limit reached</b>	TRUE if current motor current $\geq$ maximum current. Otherwise FALSE. • Display of the present motor current in <a href="#">0x2D88 (P104.00)</a> . • Setting for the maximum current in <a href="#">0x6073 (P324.00)</a> .
0x2634:022 (P420.22)	Digital outputs function: NetWordOUT1 - bit 12 (Dig.out.function: NetWordOUT1.12) • For further possible settings, see parameter <a href="#">0x2634:001 (P420.01)</a> . <a href="#">□ 292</a>	Assignment of a trigger to bit 12 of NetWordOUT1. Trigger = FALSE: bit set to 0. Trigger = TRUE: bit set to 1.
	<b>71 Actual speed = 0</b>	TRUE if actual output frequency = 0 Hz ( $\pm$ 0.3 Hz), irrespective of the operating mode. Otherwise FALSE. • Display of the current output frequency in <a href="#">0x2DDD (P100.00)</a> .
0x2634:023 (P420.23)	Digital outputs function: NetWordOUT1 - bit 13 (Dig.out.function: NetWordOUT1.13) • For further possible settings, see parameter <a href="#">0x2634:001 (P420.01)</a> . <a href="#">□ 292</a>	Assignment of a trigger to bit 13 of NetWordOUT1. Trigger = FALSE: bit set to 0. Trigger = TRUE: bit set to 1.
	<b>69 Rotational direction reversed</b>	TRUE if output frequency is negative. Otherwise FALSE.

# Configuring the network

Control the inverter via network  
Define your own status word format



Address	Name / setting range / [default setting]	Information
0x2634:024 (P420.24)	Digital outputs function: NetWordOUT1 - bit 14 (Dig.out.function: NetWordOUT1.14) • For further possible settings, see parameter <a href="#">0x2634:001 (P420.01)</a> . <a href="#">□ 292</a>	Assignment of a trigger to bit 14 of NetWordOUT1. Trigger = FALSE: bit set to 0. Trigger = TRUE: bit set to 1.
	<b>115 Release holding brake</b>	Trigger signal for releasing the holding brake (TRUE = release holding brake). Note! If this trigger is assigned to the relay or a digital output, the deceleration times set for the respective output are not effective (are internally set to "0"). Only the deceleration time set in <a href="#">0x2820:012 (P712.12)</a> for closing the holding brake influences in this case the time-dependent behaviour of the output. <a href="#">▶ Holding brake control □ 228</a>
0x2634:025 (P420.25)	Digital outputs function: NetWordOUT1 - bit 15 (Dig.out.function: NetWordOUT1.15) • For further possible settings, see parameter <a href="#">0x2634:001 (P420.01)</a> . <a href="#">□ 292</a>	Assignment of a trigger to bit 15 of NetWordOUT1. Trigger = FALSE: bit set to 0. Trigger = TRUE: bit set to 1.
	<b>55 Inverter disabled (safety)</b>	TRUE if the integrated safety system has inhibited the inverter. Otherwise FALSE. <a href="#">▶ Safe torque off (STO) □ 627</a>
0x2635:010	Inversion of digital outputs: NetWordOUT1.00	Inversion of bit 0 of NetWordOUT1.
	<b>0 Not inverted</b> 1 Inverted	
0x2635:011	Inversion of digital outputs: NetWordOUT1.01	Inversion of bit 1 of NetWordOUT1.
	<b>0 Not inverted</b> 1 Inverted	
0x2635:012	Inversion of digital outputs: NetWordOUT1.02	Inversion of bit 2 of NetWordOUT1.
	<b>0 Not inverted</b> 1 Inverted	
0x2635:013	Inversion of digital outputs: NetWordOUT1.03	Inversion of bit 3 of NetWordOUT1.
	<b>0 Not inverted</b> 1 Inverted	
0x2635:014	Inversion of digital outputs: NetWordOUT1.04	Inversion of bit 4 of NetWordOUT1.
	<b>0 Not inverted</b> 1 Inverted	
0x2635:015	Inversion of digital outputs: NetWordOUT1.05	Inversion of bit 5 of NetWordOUT1.
	<b>0 Not inverted</b> 1 Inverted	
0x2635:016	Inversion of digital outputs: NetWordOUT1.06	Inversion of bit 6 of NetWordOUT1.
	<b>0 Not inverted</b> 1 Inverted	
0x2635:017	Inversion of digital outputs: NetWordOUT1.07	Inversion of bit 7 of NetWordOUT1.
	<b>0 Not inverted</b> 1 Inverted	
0x2635:018	Inversion of digital outputs: NetWordOUT1.08	Inversion of bit 8 of NetWordOUT1.
	<b>0 Not inverted</b> 1 Inverted	
0x2635:019	Inversion of digital outputs: NetWordOUT1.09	Inversion of bit 9 of NetWordOUT1.
	<b>0 Not inverted</b> 1 Inverted	
0x2635:020	Inversion of digital outputs: NetWordOUT1.10	Inversion of bit 10 of NetWordOUT1.
	<b>0 Not inverted</b> 1 Inverted	
0x2635:021	Inversion of digital outputs: NetWordOUT1.11	Inversion of bit 11 of NetWordOUT1.
	<b>0 Not inverted</b> 1 Inverted	



## Configuring the network

Control the inverter via network  
Define your own status word format

Address	Name / setting range / [default setting]	Information
0x2635:022	Inversion of digital outputs: NetWordOUT1.12	Inversion of bit 12 of NetWordOUT1.
	<b>0 Not inverted</b>	
	1 Inverted	
0x2635:023	Inversion of digital outputs: NetWordOUT1.13	Inversion of bit 13 of NetWordOUT1.
	<b>0 Not inverted</b>	
	1 Inverted	
0x2635:024	Inversion of digital outputs: NetWordOUT1.14	Inversion of bit 14 of NetWordOUT1.
	<b>0 Not inverted</b>	
	1 Inverted	
0x2635:025	Inversion of digital outputs: NetWordOUT1.15	Inversion of bit 15 of NetWordOUT1.
	<b>0 Not inverted</b>	
	1 Inverted	

# Configuring the network

Control the inverter via network  
Define your own status word format



Address	Name / setting range / [default setting]	Information
0x400A:001 (P591.01)	Process output words: NetWordOUT1 (NetWordOUTx: NetWordOUT1) • Read only	Mappable data word for the output of status messages of the inverter via network.
Bit 0	Mapping bit 0	Mappable data word for the output of status messages of the inverter via network. Assignment of the status message: <a href="#">0x2634:010 (P420.10)</a>
Bit 1	Mapping bit 1	Mappable data word for the output of status messages of the inverter via network. Assignment of the status message: <a href="#">0x2634:011 (P420.11)</a>
Bit 2	Mapping bit 2	Mappable data word for the output of status messages of the inverter via network. Assignment of the status message: <a href="#">0x2634:012 (P420.12)</a>
Bit 3	Mapping bit 3	Mappable data word for the output of status messages of the inverter via network. Assignment of the status message: <a href="#">0x2634:013 (P420.13)</a>
Bit 4	Mapping bit 4	Mappable data word for the output of status messages of the inverter via network. Assignment of the status message: <a href="#">0x2634:014 (P420.14)</a>
Bit 5	Mapping bit 5	Mappable data word for the output of status messages of the inverter via network. Assignment of the status message: <a href="#">0x2634:015 (P420.15)</a>
Bit 6	Mapping bit 6	Mappable data word for the output of status messages of the inverter via network. Assignment of the status message: <a href="#">0x2634:016 (P420.16)</a>
Bit 7	Mapping bit 7	Mappable data word for the output of status messages of the inverter via network. Assignment of the status message: <a href="#">0x2634:017 (P420.17)</a>
Bit 8	Mapping bit 8	Mappable data word for the output of status messages of the inverter via network. Assignment of the status message: <a href="#">0x2634:018 (P420.18)</a>
Bit 9	Mapping bit 9	Mappable data word for the output of status messages of the inverter via network. Assignment of the status message: <a href="#">0x2634:019 (P420.19)</a>
Bit 10	Mapping bit 10	Mappable data word for the output of status messages of the inverter via network. Assignment of the status message: <a href="#">0x2634:020 (P420.20)</a>
Bit 11	Mapping bit 11	Mappable data word for the output of status messages of the inverter via network. Assignment of the status message: <a href="#">0x2634:021 (P420.21)</a>
Bit 12	Mapping bit 12	Mappable data word for the output of status messages of the inverter via network. Assignment of the status message: <a href="#">0x2634:022 (P420.22)</a>
Bit 13	Mapping bit 13	Mappable data word for the output of status messages of the inverter via network. Assignment of the status message: <a href="#">0x2634:023 (P420.23)</a>
Bit 14	Mapping bit 14	Mappable data word for the output of status messages of the inverter via network. Assignment of the status message: <a href="#">0x2634:024 (P420.24)</a>
Bit 15	Mapping bit 15	Mappable data word for the output of status messages of the inverter via network. Assignment of the status message: <a href="#">0x2634:025 (P420.25)</a>



## 12.2 Define setpoint via network

The network setpoint must be explicitly selected if the setpoint is to be specified via the network.

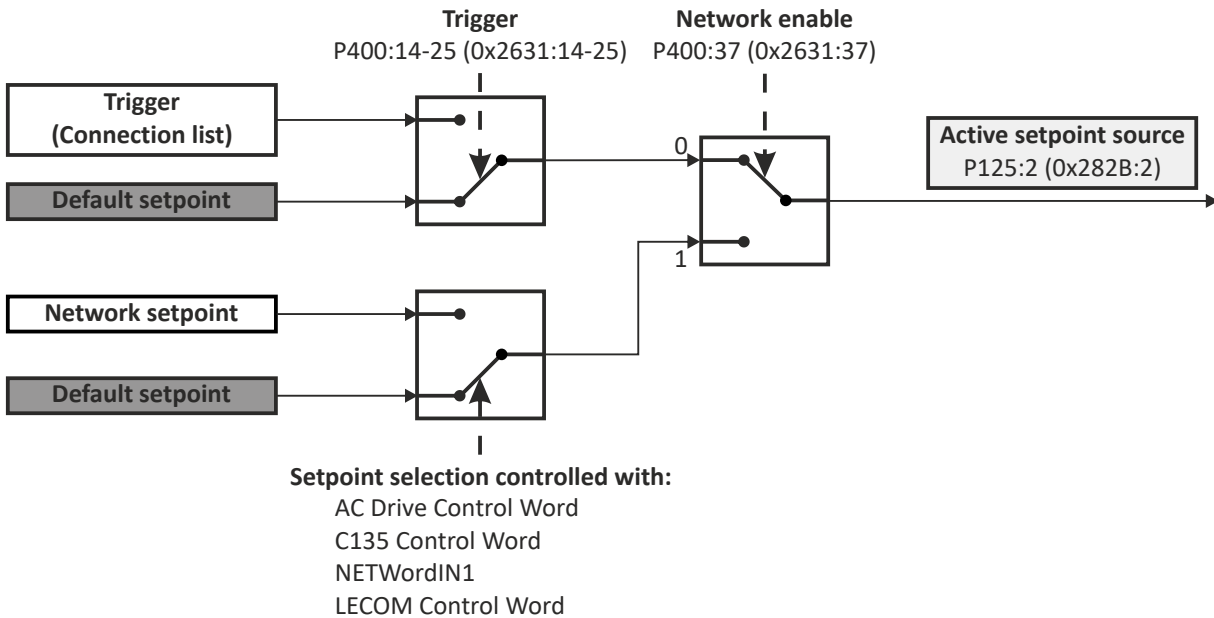

▶ [Option 1: Define network as standard setpoint source](#) [328](#)

▶ [Option 2: Change over to the network setpoint during operation](#) [329](#)

### Mappable parameters

The following mappable parameters are available, among others, for specifying the setpoint.

- The parameters are always available irrespective of the network option.
- Additional mappable parameters with different resolutions are available for selection to transfer the frequency setpoint and actual frequency value. ▶ [Mappable parameters for exchanging setpoints and actual values](#) [330](#)

### Parameter

Address	Name / setting range / [default setting]	Information
0x400B:006 (P592.06)	Process input data: Velocity mode setpoint (Process data IN: Veloc. mode setp) -599.0 ... [0.0] ... 599.0 Hz	Mappable parameter for defining the setpoint for operating mode "MS: Velocity mode" via network. <ul style="list-style-type: none"> <li>• If this parameter is to be used as standard setpoint source, the selection "Network [5]" must be set in 0x2860:001 (P201.01).</li> <li>• If this bipolar setpoint is used, the direction of rotation cannot be controlled via the network control word. The direction of rotation is determined by the sign of the setpoint.</li> </ul>
0x400B:007 (P592.07)	Process input data: PID setpoint (Process data IN: PID setpoint) -300.00 ... [0.00] ... 300.00 PID unit	Mappable parameter for defining the setpoint for the PID control via network. <ul style="list-style-type: none"> <li>• If this parameter is to be used as standard setpoint source, the selection "Network [5]" must be set in 0x2860:002 (P201.02).</li> </ul>

# Configuring the network

Define setpoint via network

Option 1: Define network as standard setpoint source



Address	Name / setting range / [default setting]	Information
0x400B:008 (P592.08)	Process input data: Torque mode setpoint (Process data IN: Torque mode setp) -32768 ... [0] ... 32767 Nm	<p>Mappable parameter for defining the setpoint for operating mode "MS: Torque mode" via network.</p> <ul style="list-style-type: none"> <li>If this parameter is to be used as standard setpoint source, the selection "Network [5]" must be set in 0x2860:003 (P201.03).</li> <li>The scaling factor can be set in 0x400B:009 (P592.09).</li> <li>Scaled torque setpoint = torque setpoint (0x400B:008) / 2<sup>scaling factor</sup></li> </ul> <p>Example:</p> <ul style="list-style-type: none"> <li>Torque setpoint (0x400B:008) = 345 [Nm]</li> <li>Scaling factor (0x400B:009) = 3</li> <li>Scaled torque setpoint = 345 [Nm] / 2<sup>3</sup> = 43.125 [Nm]</li> </ul>

## 12.2.1 Option 1: Define network as standard setpoint source

If the setpoint is to be specified exclusively via the network, the network for the corresponding control can be simply set as the standard setpoint source.

- Setting for the frequency control: 0x2860:001 (P201.01) = "Network [5]".
- See the following table for settings for additional controls.

Control: size	Parameter	Setting	Further information
Frequency control: frequency setpoint	0x2860:001 (P201.01)	Network [5]	Frequency control ▶ <a href="#">Standard setpoint source</a> <a href="#">193</a>
PID control: reference value	0x2860:002 (P201.02)	Network [5]	Frequency control ▶ <a href="#">Configuring the process controller</a> <a href="#">128</a>
PID control: feedback of the control variable (actual value)	0x4020:002 (P600.02)	Network [5]	
PID control: speed feedforward control	0x4020:004 (P600.04)	Network [8]	
Torque control: torque setpoint	0x2860:003 (P201.03)	Network [5]	Torque control ▶ <a href="#">Standard setpoint source</a> <a href="#">163</a>





## 12.2.2 Option 2: Change over to the network setpoint during operation

There are several options for change-over to the network setpoint.

Example 1: Independent of the network used, a change-over from the standard setpoint source to the network setpoint is to be possible via a digital trigger (e. g. digital input).

1. Set a standard setpoint source different than "Network [5]" in [0x2860:001 \(P201.01\)](#).
2. Set the desired digital trigger (e. g. digital input) in via which the change-over to the network setpoint is to take place.

The current setpoint source is shown in [0x282B:002 \(P125.02\)](#).



The setpoint change-over by means of the network control words is only possible if the controller is activated via the network [0x2631:037 \(P400.37\)](#).

The following table describes the change-over to the network setpoint via the different network control words:

Network control word	Change-over to network setpoint		
NetWordIN1 data word <a href="#">0x4008:001 (P590.01)</a>	Assign the function "Activate network setpoint [17]" to the bit that is to be used for activating the network setpoint.		
	<ul style="list-style-type: none"> <li>• The functions that are to be triggered via bits 0 ... 15 of the NetWordIN1 data word are defined in <a href="#">0x400E:001 (P505.01)</a> ... <a href="#">0x400E:016 (P505.16)</a>.</li> </ul>		
	Bit x	Selection:	
	0	Standard setpoint source selected in <a href="#">0x2860:001 (P201.01)</a> .	
	1	Network setpoint	
AC drive control word <a href="#">0x400B:001 (P592.01)</a>	The network setpoint is activated via bit 6 of the AC Drive control word:		
	Bit 6	Selection:	
	0	Standard setpoint source selected in <a href="#">0x2860:001 (P201.01)</a> .	
	1	Network setpoint	
In order that the activation via bit 6 works, "Activate network control" bit 5 must be TRUE. (Standard)! If control is to be initiated via bit 6 without "Activate network control" bit 5, the selection "Network setpoint active [116]" must be set in <a href="#">0x2631:017 (P400.17)</a> .			
LECOM control word <a href="#">0x400B:002 (P592.02)</a>	The setpoint is selected via bit 0 and bit 1 of the LECOM control word:		
	Bit 1	Bit 0	Selection:
	0	0	Standard setpoint source selected in <a href="#">0x2860:001 (P201.01)</a> .
	0	1	Frequency setpoint preset 1 <a href="#">0x2911:001 (P450.01)</a>
	1	0	Frequency setpoint preset 2 <a href="#">0x2911:002 (P450.02)</a>
1	1	Frequency setpoint preset 3 <a href="#">0x2911:002 (P450.02)</a>	
CiA control word <a href="#">0x6040</a>	In case of control via the device profile CiA 402:		
	<ul style="list-style-type: none"> <li>• In operating mode "CiA: Velocity mode (vl) [2]", the setpoint speed defined via the "Set speed" <a href="#">0x6042 (P781.00)</a> parameter is used.</li> <li>• A changeover to an alternative setpoint source via the CiA control word is not possible.</li> </ul>		

# Configuring the network

Define setpoint via network

Mappable parameters for exchanging setpoints and actual values



## 12.2.3 Mappable parameters for exchanging setpoints and actual values

The parameters listed in the following can also be mapped to network registers, in order to transfer set points and actual values via the network.

- The parameters are always available irrespective of the network option.
- Several parameters with different resolutions are available for selection to transfer the frequency setpoint and actual value.
- The use of these parameters for the transmission of process data is optional. It is also possible to use only a selection of the parameters.

### Parameter

Address	Name / setting range / [default setting]	Information
0x400B:003 (P592.03)	Process input data: Network setpoint frequency (0.1) (Process data IN: Net.freq. 0.1) 0.0 ... [0.0] ... 599.0 Hz	Mappable parameter for specifying the frequency setpoint in [0.1 Hz] via network. <ul style="list-style-type: none"> <li>• The specification is made without sign (irrespective of the rotating direction).</li> <li>• The rotating direction is specified via the control word.</li> <li>• Example: 456 = 45.6 Hz</li> </ul>
0x400B:004 (P592.04)	Process input data: Network setpoint speed (Process data IN: Net.setp. speed) 0 ... [0] ... 50000 rpm	Mappable parameter for specifying the setpoint as speed in [rpm] via network. <ul style="list-style-type: none"> <li>• The specification is made without sign (irrespective of the rotating direction).</li> <li>• The rotating direction is specified via the control word.</li> <li>• Example: 456 = 456 rpm</li> </ul>
0x400B:005 (P592.05)	Process input data: Network setpoint frequency (0.01) (Process data IN: Net.freq. 0.01) 0.00 ... [0.00] ... 599.00 Hz	Mappable parameter for specifying the frequency setpoint in [0.01 Hz] via network. <ul style="list-style-type: none"> <li>• The specification is made without sign (irrespective of the rotating direction).</li> <li>• The rotating direction is specified via the control word.</li> <li>• Example: 456 = 4.56 Hz</li> </ul>
0x400B:009 (P592.09)	Process input data: Torque scaling (Process data IN: Torque scaling) -128 ... [0] ... 127 <ul style="list-style-type: none"> <li>• From version 02.00</li> </ul>	Scaling factor for torque setpoint 0x400B:008 (P592.08) and actual torque value 0x400C:007 (P593.07) via network. <ul style="list-style-type: none"> <li>• With the setting 0, no scaling takes place.</li> </ul> Example: <ul style="list-style-type: none"> <li>• Scaled actual torque value (0x400C:007) = 345 [Nm]</li> <li>• Scaling factor (0x400B:009) = 3</li> <li>• Actual torque value = 345 [Nm] / 23 = 43.125 [Nm]</li> </ul>
0x400B:012 (P592.12)	Process input data: Network setpoint frequency [0.02Hz] (Process data IN: NetSetfreq0.02Hz) -29950 ... [0] ... 29950 Hz <ul style="list-style-type: none"> <li>• From version 04.00</li> </ul>	Mappable parameter for specifying the frequency setpoint in [0.02 Hz] via network. <ul style="list-style-type: none"> <li>• The specification is made without sign (irrespective of the rotating direction).</li> <li>• The rotating direction is specified via the control word.</li> <li>• Examples: 50 = 1 Hz, 100 = 2 Hz</li> </ul>
0x400B:013 (P592.13)	Process input data: Network frequency setpoint [+/-16384] (Process data IN: N.FrqSet+/-16384) -16384 ... [0] ... 16384 <ul style="list-style-type: none"> <li>• From version 05.00</li> </ul>	Mappable parameter for specifying the frequency setpoint via network. <ul style="list-style-type: none"> <li>• <math>\pm 16384 = \pm 100\%</math> Maximum frequency 0x2916 (P211.00)</li> </ul>
0x400C:003 (P593.03)	Process output data: Frequency (0.1) (Process data OUT: Frequency (0.1)) <ul style="list-style-type: none"> <li>• Read only: x.x Hz</li> </ul>	Mappable parameter for the output of the actual frequency value in [0.1 Hz] via network. <ul style="list-style-type: none"> <li>• The output is effected without sign (irrespective of the rotating direction).</li> <li>• The rotating direction is specified via the status word.</li> <li>• Example: 456 = 45.6 Hz</li> </ul>
0x400C:004 (P593.04)	Process output data: Motor speed (Process data OUT: Motor speed) <ul style="list-style-type: none"> <li>• Read only: x rpm</li> </ul>	Mappable parameter for the output of the actual value as speed in [rpm] via network. <ul style="list-style-type: none"> <li>• The output is made without sign (irrespective of the rotating direction).</li> <li>• The rotating direction is specified via the status word.</li> <li>• Example: 456 = 456 rpm</li> </ul>



# Configuring the network

Define setpoint via network

Mappable parameters for exchanging setpoints and actual values

Address	Name / setting range / [default setting]	Information
0x400C:006 (P593.06)	Process output data: Frequency (0.01) (Process data OUT: Frequency 0.01) <ul style="list-style-type: none"> <li>Read only: x.xx Hz</li> </ul>	Mappable parameter for the output of the actual frequency value in [0.01 Hz] via network. <ul style="list-style-type: none"> <li>The output is made without sign (irrespective of the rotating direction).</li> <li>The rotating direction is specified via the status word.</li> <li>Example: 456 = 4.56 Hz</li> </ul>
0x400C:007 (P593.07)	Process output data: Torque scaled (Process data OUT: Torque scaled) <ul style="list-style-type: none"> <li>Read only</li> <li>From version 02.00</li> </ul>	Mappable parameter for the output of the actual torque value in [Nm / 2 <sup>scaling factor</sup> ] via network. <ul style="list-style-type: none"> <li>The scaling factor can be set in <a href="#">0x400B:009 (P592.09)</a>.</li> <li>Actual torque value = scaled actual torque value (0x400C:007) / 2<sup>scaling factor</sup></li> </ul> <p>Example:</p> <ul style="list-style-type: none"> <li>Scaled actual torque value (0x400C:007) = 345 [Nm]</li> <li>Scaling factor (0x400B:009) = 3</li> <li>Actual torque value = 345 [Nm] / 2<sup>3</sup> = 43.125 [Nm]</li> </ul>
0x400C:008 (P593.08)	Process output data: Frequency [0.02 Hz] (Process data OUT: Frequency 0.02Hz) <ul style="list-style-type: none"> <li>Read only: Hz</li> <li>From version 04.00</li> </ul>	Mappable parameter for the output of the actual frequency value in [0.02 Hz] via network. <ul style="list-style-type: none"> <li>The output is effected without sign (irrespective of the rotating direction).</li> <li>The rotating direction is specified via the status word.</li> <li>Examples: 50 = 1 Hz, 100 = 2 Hz</li> </ul>
0x400C:009 (P593.09)	Process output data: Frequency [±16384] (Process data OUT: Freq. [±16384]) <ul style="list-style-type: none"> <li>Read only</li> <li>From version 05.00</li> </ul>	Mappable parameter for the output of the actual frequency value via network. <ul style="list-style-type: none"> <li>±16384 = ±100 % Maximum frequency <a href="#">0x2916 (P211.00)</a></li> </ul>



## 12.3 Further mappable parameters

The parameters listed in the following can also be mapped to network registers to transmit, for example, control and status information as process data or to control outputs of the inverter via the network.

- The parameters are always available irrespective of the network option.
- The use of these parameters for the transmission of process data is optional. It is also possible to use only a selection of the parameters.

### Process input data

Address	Designation	Info
0x400B:011 (P592.11)	Process input data: PID feedback	▶ Feedback of PID variable via network <a href="#">□ 333</a>
0x4008:002 (P590.02)	Process input words: NetWordIN2	▶ Control digital outputs via network <a href="#">□ 333</a>
0x4008:003 (P590.03)	Process input words: NetWordIN3	▶ Control analog outputs via network <a href="#">□ 333</a>
0x4008:004 (P590.04)	Process input words: NetWordIN4	
0x4008:005 (P590.05)	Process input words: NetWordIN5	▶ Additive voltage impression via network <a href="#">□ 334</a>

### Process output data

Address	Designation	Info
0x400C:005 (P593.05)	Process output data: Drive status	▶ Drive status <a href="#">□ 335</a>
0x2C49:003 (P711.03)	Position counter: Actual position	▶ Position counter <a href="#">□ 606</a>
0x400A:002 (P591.02)	Process output words: NetWordOUT2	▶ Output messages of the "sequencer" function via network <a href="#">□ 336</a>



## 12.3.1 Process input data

### 12.3.1.1 Feedback of PID variable via network

The feedback of the control variable (actual value) can also be initiated via the network for the process controller. In this case, the following mappable parameter is available.

#### Parameter

Address	Name / setting range / [default setting]	Information
0x400B:011 (P592.11)	Process input data: PID feedback (Process data IN: PID feedback) -300.00 ... [0.00] ... 300.00 PID unit • From version 03.00	Mappable parameter for the feedback of the variable (actual value) via network. • Only effective with the selection "Network[5]" in 0x4020:002 (P600.02).

#### Related topics

▶ [Configuring the process controller](#) 128

### 12.3.1.2 Control digital outputs via network

The mappable data word NetWordIN2 is available for controlling the digital outputs via the network.

#### Parameter

Address	Name / setting range / [default setting]	Information
0x4008:002 (P590.02)	Process input words: NetWordIN2 (NetWordINx: NetWordIN2) 0x0000 ... [0x0000] ... 0xFFFF	Mappable data word for optional control of the digital outputs via network.  Assignment of the digital outputs: • Relay: 0x2634:001 (P420.01) / selection [34] ... [49] • Digital output 1: 0x2634:002 (P420.02) / selection [34] ... [49] • Digital output 2: 0x2634:003 (P420.03) / selection [34] ... [49]
	Bit 0 Mapping bit 0	
	Bit 1 Mapping bit 1	
	Bit 2 Mapping bit 2	
	Bit 3 Mapping bit 3	
	Bit 4 Mapping bit 4	
	Bit 5 Mapping bit 5	
	Bit 6 Mapping bit 6	
	Bit 7 Mapping bit 7	
	Bit 8 Mapping bit 8	
	Bit 9 Mapping bit 9	
	Bit 10 Mapping bit 10	
	Bit 11 Mapping bit 11	
	Bit 12 Mapping bit 12	
	Bit 13 Mapping bit 13	
	Bit 14 Mapping bit 14	
Bit 15 Mapping bit 15		

#### Related topics

▶ [Configure digital outputs](#) 292

### 12.3.1.3 Control analog outputs via network

The mappable data words NetWordIN3 and NetWordIN4 are available for controlling the analog outputs via the network.

#### Parameter

Address	Name / setting range / [default setting]	Information
0x4008:003 (P590.03)	Process input words: NetWordIN3 (NetWordINx: NetWordIN3) 0.0 ... [0.0] ... 100.0 %	Mappable data word for optional control of an analog output via network.  Assignment of the analog outputs: • Analog output 1: 0x2639:002 (P440.02) = "NetWordIN3 [20]" • Analog output 2: 0x263A:002 (P441.02) = "NetWordIN3 [20]"

# Configuring the network

Further mappable parameters

Process input data

Additive voltage impression via network



Address	Name / setting range / [default setting]	Information
0x4008:004 (P590.04)	Process input words: NetWordIN4 (NetWordINx: NetWordIN4) 0.0 ... [0.0] ... 100.0 %	Mappable data word for optional control of an analog output via network.  Assignment of the analog outputs: <ul style="list-style-type: none"><li>• Analog output 1: 0x2639:002 (P440.02) = "NetWordIN4 [21]"</li><li>• Analog output 2: 0x263A:002 (P441.02) = "NetWordIN4 [21]"</li></ul>

## Related topics

▶ [Configure analog outputs](#) 305

### 12.3.1.4 Additive voltage impression via network

The mappable data word NetWordIN5 is available for the optional specification of an additive voltage setpoint via the network.

## Parameter

Address	Name / setting range / [default setting]	Information
0x4008:005 (P590.05)	Process input words: NetWordIN5 (NetWordINx: NetWordIN5) -100.0 ... [0.0] ... 100.0 %	Mappable data word for optionally specifying an additive voltage setpoint via network. <ul style="list-style-type: none"><li>• 100 % = Rated voltage 0x2C01:007 (P320.07)</li><li>• This value is used if "Network [3]" is selected in 0x2B13:002.</li></ul>

## Related topics

▶ [Additive voltage impression](#) 211



## 12.3.2 Process output data

### 12.3.2.1 Drive status

The following mappable parameter is available for the output of the drive status via the network.

#### Parameter

Address	Name / setting range / [default setting]	Information
0x400C:005 (P593.05)	Process output data: Drive status (Process data OUT: Drive status) • Read only	Mappable status word (Modbus Legacy Register 2003).
	0 Error (non-resettable) active	
	1 Fault active	
	2 Waiting for start	
	3 Identification not executed	
	4 Inverter disabled	
	5 Stop active	
	7 Identification active	
	8 Running	
	9 Acceleration active	
	10 Deceleration active	
	11 Deceleration override active	
	12 DC braking active	
	13 Flying start active	
	14 Current limit reached	
	16 Process controller sleep mode	

# Configuring the network

Further mappable parameters  
Process output data  
Output messages of the "sequencer" function via network



## 12.3.2.2 Output messages of the "sequencer" function via network

The mappable data word NetWordOUT2 is available to output messages of the "Sequencer" function via the network.

- An individual message (16 bit value) can be configured for each sequencer segment.
  - ▶ [Segment configuration](#) 104
- The NetWordOUT2 data word is set to the value set for the execution time of the segment.

### Parameter

Address	Name / setting range / [default setting]	Information	
0x400A:002 (P591.02)	Process output words: NetWordOUT2 (NetWordOUTx: NetWordOUT2) <ul style="list-style-type: none"><li>• Read only</li></ul>	Mappable data word for the output of messages of the "Sequencer" function via network.  Configuration of the messages: <ul style="list-style-type: none"><li>• <a href="#">0x4026:008</a>: NetWordOUT2 value for sequencer segment 1</li><li>• <a href="#">0x4027:008</a>: NetWordOUT2 value for sequencer segment 2</li><li>• <a href="#">0x4028:008</a>: NetWordOUT2 value for sequencer segment 3</li><li>• <a href="#">0x4029:008</a>: NetWordOUT2 value for sequencer segment 4</li><li>• <a href="#">0x402A:008</a>: NetWordOUT2 value for sequencer segment 5</li><li>• <a href="#">0x402B:008</a>: NetWordOUT2 value for sequencer segment 6</li><li>• <a href="#">0x402C:008</a>: NetWordOUT2 value for sequencer segment 7</li><li>• <a href="#">0x402D:008</a>: NetWordOUT2 value for sequencer segment 8</li><li>• <a href="#">0x402E:008</a>: NetWordOUT2 value for final segment</li></ul>	
	Bit 0	Mapping bit 0	
	Bit 1	Mapping bit 1	
	Bit 2	Mapping bit 2	
	Bit 3	Mapping bit 3	
	Bit 4	Mapping bit 4	
	Bit 5	Mapping bit 5	
	Bit 6	Mapping bit 6	
	Bit 7	Mapping bit 7	
	Bit 8	Mapping bit 8	
	Bit 9	Mapping bit 9	
	Bit 10	Mapping bit 10	
	Bit 11	Mapping bit 11	
	Bit 12	Mapping bit 12	
	Bit 13	Mapping bit 13	
	Bit 14	Mapping bit 14	
Bit 15	Mapping bit 15		

### Related topics

- ▶ [Sequencer](#) 102





## 12.4 Parameter access monitoring (PAM)

The parameter access monitoring can be used as basic protection against a control loss of the inverter. Monitoring is triggered if a parameter write access to a certain index does not take place at regular intervals via the established communication connection.

### Preconditions

This monitoring only works when the network control is activated.

Except for the keypad, the monitoring can be used for all communication connections, for instance:

- PC/Engineering Tool <--> inverter with USB module
- PC/Engineering Tool <--> inverter with WLAN module
- Controller <--> network <--> inverter with network option

### Details

For monitoring purposes, a non-zero value must be written into the "Keep-alive register" [0x2552:002 \(P595.02\)](#) at regular intervals. The first write access with a non-zero value activates monitoring. The intervals between the write accesses must not be higher than the time-out time set in [0x2552:003 \(P595.03\)](#). If no parameter write access takes place within the time-out time, monitoring is triggered: The response selected in [0x2552:004 \(P595.05\)](#) takes place and the action selected in [0x2552:005 \(P595.05\)](#). In addition, the status bit 1 in [0x2552:006 \(P595.06\)](#) is set to "1".

The error status can be left by a normal "error reset". Since monitoring continues to be active and the time-out time is not reset by the error reset, the inverter immediately changes again to the error status. In order to prevent this, you have the following options:

- Restore communication exchange.
- Set the monitoring response in [0x2552:004 \(P595.04\)](#) to "No response [0]" or "Warning [1]".
- Change over to local or flexible control.

### Parameter

Address	Name / setting range / [default setting]	Information								
0x2552:002 (P595.02)	Parameter access monitoring: Keep alive register (PAM monitoring: Keep alive reg.) 0 ... [0] ... 65535 <ul style="list-style-type: none"> <li>• From version 04.00</li> </ul>	Register for cyclic parameter write accesses for monitoring the communication link. <ul style="list-style-type: none"> <li>• If the setting is non-zero, the monitoring is active.</li> <li>• In order that the monitoring is not tripped, a non-zero value has to be entered into this index at regular intervals. The temporal distances of the write accesses must not be higher than the time-out time set in <a href="#">0x2552:003 (P595.03)</a>.</li> </ul>								
0x2552:003 (P595.03)	Parameter access monitoring: Time-out time (PAM monitoring: Time-out time) 0.0 ... [10.0] ... 6553.5 s <ul style="list-style-type: none"> <li>• From version 04.00</li> </ul>	Maximum permitted time between two write accesses to the "keep-alive-register". In case of a time-out <ul style="list-style-type: none"> <li>• the error response selected in <a href="#">0x2552:004 (P595.04)</a> is effected,</li> <li>• the action selected in <a href="#">0x2552:005 (P595.05)</a> is effected,</li> <li>• the status bit 1 in <a href="#">0x2552:006 (P595.06)</a> is set to "1".</li> </ul>								
0x2552:004 (P595.04)	Parameter access monitoring: Response (PAM monitoring: Response) <ul style="list-style-type: none"> <li>• From version 04.00</li> </ul>	Selection of the response to the triggering of the parameter access monitoring. Associated event ID: <ul style="list-style-type: none"> <li>• <a href="#">33045</a>   <a href="#">0x8115</a> - Time-out (PAM)</li> </ul>								
	<table border="1"> <tr> <td>0</td> <td>No response</td> </tr> <tr> <td>1</td> <td>Warning</td> </tr> <tr> <td>2</td> <td>Trouble</td> </tr> <tr> <td>3</td> <td>Fault</td> </tr> </table>	0	No response	1	Warning	2	Trouble	3	Fault	<ul style="list-style-type: none"> <li>▶ Severity <a href="#">□ 700</a></li> </ul>
0	No response									
1	Warning									
2	Trouble									
3	Fault									

# Configuring the network

## Parameter access monitoring (PAM)



Address	Name / setting range / [default setting]	Information
0x2552:005 (P595.05)	Parameter access monitoring: Action (PAM monitoring: Action) <ul style="list-style-type: none"> <li>From version 04.00</li> </ul>	Selection of the action to be executed if the parameter access monitoring is triggered.
	0 No action	
	1 Reserved	
	2 Write parameter	The value set in <a href="#">0x2552:009 (P595.09)</a> is written to the parameter set in <a href="#">0x2552:008 (P595.08)</a> .
0x2552:006 (P595.06)	Parameter access monitoring: Parameter Access Monitoring-Status (PAM monitoring: PAM status) <ul style="list-style-type: none"> <li>Read only</li> <li>From version 04.00</li> </ul>	Bit coded display of the status of parameter access monitoring.
	Bit 0 Monitoring activated	1 = parameter access monitoring is active.
	Bit 1 Timeout	1 = within the time-out time set in <a href="#">0x2552:003 (P595.03)</a> , no successful parameter write access to the "keep-alive register" <a href="#">0x2552:002 (P595.02)</a> was made.
	Bit 2 WLAN time-out	
0x2552:007 (P595.07)	Parameter access monitoring: WLAN reset time-out time (PAM monitoring: WLAN reset t.out) 0 ... [0] ... 65535 s <ul style="list-style-type: none"> <li>From version 05.00</li> </ul>	Time after which the WLAN network with the current settings of the WLAN parameters is restarted if no "keep alive" messages are received. <ul style="list-style-type: none"> <li>0 s = function deactivated (no WLAN restart).</li> <li>With a setting &gt; 0 s and a time-out, the control units sets <a href="#">0x2440 = "Restart with current values [1]"</a>.</li> </ul>
0x2552:008 (P595.08)	Parameter access monitoring: Mapped parameter (PAM monitoring: Mapped par) 0x00000000 ... [ <a href="#">0x400B0100</a> ] ... 0xFFFFFFFF	If the "Write parameter[2]" action is selected in <a href="#">0x2552:005 (P595.05)</a> , the value set in <a href="#">0x2552:009 (P595.09)</a> is written to the parameter set in <a href="#">0x2552:008 (P595.08)</a> .
0x2552:009 (P595.09)	Parameter access monitoring: Value to be written (PAM monitoring: Value to write) 0 ... [0] ... 4294967295	
0x2552:010 (P595.10)	Parameter access monitoring: Write status (PAM monitoring: Write status) <ul style="list-style-type: none"> <li>Read only</li> </ul>	Write status if the "Write parameter [2]" action is selected in <a href="#">0x2552:005 (P595.05)</a> .
	0 Ready/Success	
	1 In progress	
	2 Failed	



## 12.5 Process data handling in the event of error

Received invalid process data is not used. The inverter uses the last valid process data received. You can optionally set that the contents of the process data in the inverter are set to the value "0" after invalid process data has been received.



The setting in 0x24E5:001 is independent of the response selected in 0x2859:005 if invalid process data has been received!

If the application requires that the drive keeps moving with the last valid process data when receiving invalid process data, set the response "No response" or "Warning" in 0x2859:005. In addition, the selection "Clear data [1]" must not be set in 0x24E5:001. Deleting the process data would stop the motor.

### Parameter

Address	Name / setting range / [default setting]	Information
0x24E5:001	Process data handling in case of error: Procedure	Selection which process data the inverter is to use after receiving invalid process data.
	0 Keep last data	The last valid process data of the master are used.
	1 Clear data	The contents of the process data in the inverter is set to the value "0".
	2 Reset control word (from version 05.04)	The RUN command is reset. All other parameters keep their current value. All control words linked via the PDO mappings are set to 0.



### 12.6 Suppress certain alarm / emergency messages to the master

To simplify the error handling between a master and the inverter, a function for suppressing diagnostic or alarm messages is implemented. If desired, the user can suppress the display of alarm responses in the master.

Usually, all errors occurring in the device are reported to a connected PLC if an alarm / emergency mechanism with the connected communication system is supported. In order to suppress certain alarm / emergency messages, this filter mechanism selects the error messages that shall not be reported to the PLC.

In object 0x285C, the corresponding error numbers are given in n subindex. Up to n = 10 error numbers can be selected.



If the "0xFFFFFFFF" error code is found in one of the subindices, all messages are blocked.

#### Parameter

Address	Name / setting range / [default setting]	Information
0x285C:001	Alarm supression: Entry 1 0x00000000 ... [0x00000000] ... 0xFFFFFFFF	Definition of error numbers that shall not be sent as alarm, emergency, or diagnostic message to the connected master. "0xFFFFFFFF"= suppression of all messages to the master.
0x285C:002	Alarm supression: Entry 2 0x00000000 ... [0x00000000] ... 0xFFFFFFFF	
0x285C:003	Alarm supression: Entry 3 0x00000000 ... [0x00000000] ... 0xFFFFFFFF	
0x285C:004	Alarm supression: Entry 4 0x00000000 ... [0x00000000] ... 0xFFFFFFFF	
0x285C:005	Alarm supression: Entry 5 0x00000000 ... [0x00000000] ... 0xFFFFFFFF	
0x285C:006	Alarm supression: Entry 6 0x00000000 ... [0x00000000] ... 0xFFFFFFFF	
0x285C:007	Alarm supression: Entry 7 0x00000000 ... [0x00000000] ... 0xFFFFFFFF	
0x285C:008	Alarm supression: Entry 8 0x00000000 ... [0x00000000] ... 0xFFFFFFFF	
0x285C:009	Alarm supression: Entry 9 0x00000000 ... [0x00000000] ... 0xFFFFFFFF	
0x285C:010	Alarm supression: Entry 10 0x00000000 ... [0x00000000] ... 0xFFFFFFFF	



## 12.7 CiA 402 device profile

The CiA® 402 device profile defines the functional behaviour of stepping motors, servo drives, and frequency inverters. In order to be able to describe the different drive types, various operating modes and device parameters are specified in the device profile. Each operating mode provides objects (e.g. for the setpoint speed, acceleration and deceleration) to generate the desired drive behaviour.

- CiA® is a registered community trademark of the CAN in Automation e. V user organization.
- More information can be found in the CiA 402 specification (CANopen device profile for drives and Motion Control) of the CAN in Automation (CiA) user organization: <https://www.can-cia.org>

### 12.7.1 Supported operating modes

#### Details

In the following, the steps required for configuring the operating mode "CiA: Velocity mode (vl)" are described.

1. Set the operating mode "CiA: Velocity mode (vl) [2]" in 0x6060 (P301.00).
2. Set speed is specified via the parameter "Set speed" 0x6042 (P781.00).
3. Process input data and process output data are available for the control in the CiA402.

The following signal flow shows the internal setpoint logics:

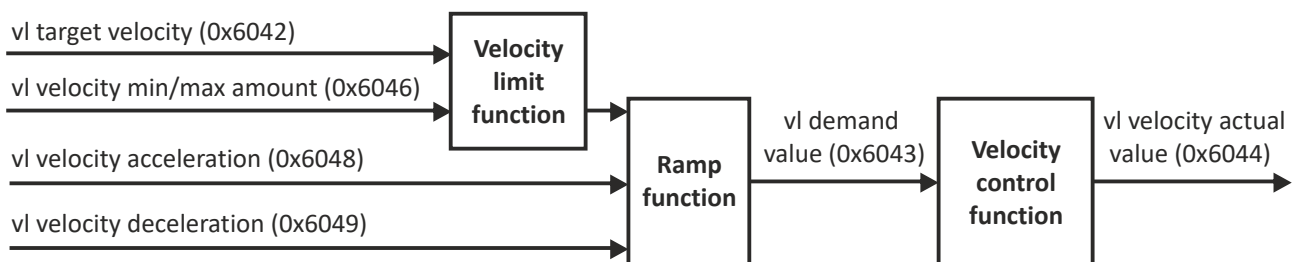

The "CiA: Velocity mode (vl)" operating mode is now active and the inverter reacts to the setpoint speed specified via the network.

The inverter only supports the CiA 402 operating mode "CiA: Velocity mode (vl)".

#### Parameter

Address	Name / setting range / [default setting]	Information
0x6060 (P301.00)	CiA: Operation mode (Operation mode) • Setting can only be changed if the inverter is disabled.	CiA: Operation mode
	-2 MS: Velocity mode	Vendor specific velocity mode ▶ <a href="#">Configuring the frequency control</a> 92
	-1 MS: Torque mode (from version 03.00)	Vendor specific torque mode • Only possible in motor control type 0x2C00 (P300.00) = "Sensorless vector control (SLVC) [4]" or "Servo control (SC ASM) [2]". ▶ <a href="#">Configuring the torque control</a> 161
	0 No selection	No selection
	2 CiA: Velocity mode (vl)	CiA: Velocity mode ▶ <a href="#">CiA 402 device profile</a> 341
0x6061 (P788.00)	CiA: Active operation mode (Act. op. mode) • Read only	CiA: Active operation mode
	-2 MS: Velocity mode	Vendor specific velocity mode
	-1 MS: Torque mode (from version 03.00)	Manufacturer-specific torque mode
	0 No selection	No selection
	2 CiA: Velocity mode (vl)	CiA: Velocity mode

# Configuring the network

CiA 402 device profile  
Basic setting



Address	Name / setting range / [default setting]	Information
0x6502 (P789.00)	Supported drive modes (Supported modes) • Read only	Bit coded display of the operating modes supported.
	Bit 0 Reserved	-
	Bit 1 CiA: Velocity mode	1 = CiA: velocity mode is supported.
	Bit 2 Reserved	-
	Bit 3 Reserved	-
	Bit 5 Reserved	-
	Bit 6 Reserved	-
	Bit 7 Cyclic sync position mode	Always 0 (not supported).
	Bit 8 Cyclic sync velocity mode	-
	Bit 9 Cyclic sync torque mode	-
	Bit 17 MS: Velocity mode	1 = vendor specific velocity mode is supported.
Bit 18 MS: Torque mode	- 1 = Manufacturer-specific torque mode.	

## 12.7.2 Basic setting

Set the following parameters.

### Parameter

Address	Name / setting range / [default setting]	Information
0x605A	CiA: Quick stop mode	Device status after exiting the quick stop ramp. • Setting is only effective in the operating mode 0x6060 (P301.00) = "CiA: Velocity mode (vl) [2]".
	2 Ramp > switch on disabled	Automatic change to the "Switch-on inhibited" device state. • The "Quick stop active [54]" status is reset to FALSE after ramp-down to standstill.
	6 Ramp > quick stop active	The inverter remains in the "Quick stop active" device state. • The "Quick stop active [54]" status remains TRUE until the "Quick stop" function is activated.
0x605B	Shutdown option code • From version 05.02	Defines the transition from the status "Operation enabled" to "Ready to start".
	0 Disable drive function	0: Immediate inverter disable (standard setting)
	1 Slow down on quick stop ramp and disable drive function	1: "Quick stop" with subsequent inverter disable.
0x2826	Timeout for error response -> quickstop 0.0 ... [6.0] ... 100.0 s	This timer is started when a change-over to the "Fault reaction active" device status takes place. If the motor is still rotating after the time-out time has elapsed, a change-over to the "Fault" device status takes place. • In case of a serious error, an immediate change-over to the "Fault" device status takes place.  ⚠ CAUTION! Changing this parameter may cause a longer ramp time in the event of an error. This must be considered when changing this parameter.
0x6085 (P790.00)	Quick stop deceleration (Quick stop dec.) 0 ... [546000] ... 2147483647 inc/s <sup>2</sup>	Change in velocity used for deceleration to a standstill if quick stop is activated. • Setting is only effective in the operating mode 0x6060 (P301.00) = "CiA: Velocity mode (vl) [2]". • In operating mode 0x6060 (P301.00) = "MS: Velocity mode [-2]", the deceleration time set in 0x291C (P225.00) is effective.  0x6085 = (initial speed of the motor [rpm] / duration of the ramp until standstill [s]) * 1092



## 12.7.3 Process input data

The following diagram demonstrates the relationship of the parameters [0x6048:001 \(P785.01\)](#) and [0x6048:002 \(P785.02\)](#).

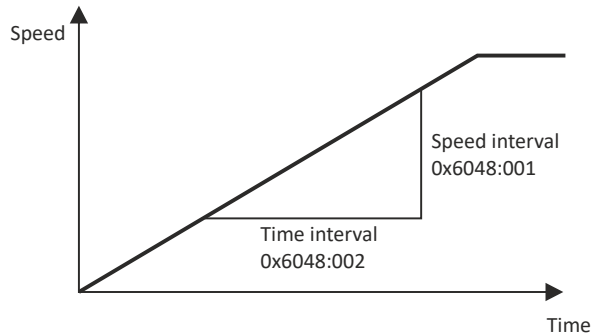

### Parameter

Address	Name / setting range / [default setting]	Information
0x6042 (P781.00)	Set speed (Set speed) -32768 ... [0] ... 32767 rpm	Set speed (velocity mode).
0x6046:001 (P784.01)	Speed limits: Min. speed (Speed limits: Min. speed) 0 ... [0] ... 480000 rpm	Min. speed (velocity mode).
0x6046:002 (P784.02)	Speed limits: Max. speed (Speed limits: Max. speed) 0 ... [2147483647] ... 2147483647 rpm	Max. speed (velocity mode).
0x6048:001 (P785.01)	Acceleration ramp: CiA acceleration: Delta speed (Accel. ramp: Delta speed) 0 ... [3000] ... 2147483647 rpm	CiA acceleration: Delta speed
0x6048:002 (P785.02)	Acceleration ramp: CiA acceleration: Delta time (Accel. ramp: Delta time) 0 ... [10] ... 65535 s	CiA acceleration: Delta time
0x6049:001 (P786.01)	Deceleration ramp: CiA deceleration: Delta speed (Decel. ramp: Delta speed) 0 ... [3000] ... 2147483647 rpm	CiA deceleration: Delta speed
0x6049:002 (P786.02)	Deceleration ramp: CiA deceleration: Delta time (Decel. ramp: Delta time) 0 ... [10] ... 65535 s	CiA deceleration: Delta time
0x6071	Set torque -3276.8 ... [0.0] ... 3276.7 %	Setting of the setpoint torque for the torque operating modes. <ul style="list-style-type: none"> <li>100 % = Rated motor torque <a href="#">0x6076 (P325.00)</a></li> </ul> The inverter does not support the CiA 402 torque mode.
0x60FF	Set speed -2147483648 ... [0] ... 2147483647 rpm	Setting of the set speed. <ul style="list-style-type: none"> <li>Alternative option for specifying the setpoint speed as a 32-bit value.</li> <li>The parameter is only visible in connection with EtherCAT network.</li> </ul>

## 12.7.4 Process output data

### Parameter

Address	Name / setting range / [default setting]	Information
0x6043 (P782.00)	Internal set speed (Int. set speed) <ul style="list-style-type: none"> <li>Read only: x rpm</li> </ul>	Display of the internal set speed (velocity demand).
0x6044 (P783.00)	Actual speed (Actual speed) <ul style="list-style-type: none"> <li>Read only: x rpm</li> </ul>	Display of the actual speed (velocity mode).
0x6074	Internal set torque <ul style="list-style-type: none"> <li>Read only: x.x %</li> <li>From version 02.00</li> </ul>	Display of the internal set torque. <ul style="list-style-type: none"> <li>100 % = Rated motor torque <a href="#">0x6076 (P325.00)</a></li> </ul>



## 12.7.5 Commands for device state control

0x6040 (CiA control word) can be used to trigger commands to put the inverter into a certain device state.

Command	Bit pattern in the CiA control word (0x6040)							
	Bit 7	Bit 6	Bit 5	Bit 4	Bit 3	Bit 2	Bit 1	Bit 0
	Reset fault	Dependent on the operating mode			Operation enable	Activating quick stop	Establish readiness for operation	Switch-on
Switch-off <a href="#">□ 346</a>	0	X	X	X	X	1	1	0
Switch on <a href="#">□ 347</a>	0	X	X	X	0	1	1	1
Enable operation <a href="#">□ 348</a>	0	X	X	X	1	1	1	1
Activate quick stop <a href="#">□ 349</a>	0	X	X	X	X	0	1	X
Disable operation <a href="#">□ 350</a>	0	X	X	X	0	1	1	1
Pulse inhibit <a href="#">□ 351</a>	0	X	X	X	X	X	0	X
Reset fault <a href="#">□ 352</a>	0/1	X	X	X	X	X	X	X

X = state is not relevant

### More Lenze-specific control bits (bit 8 ... 15)

Command	Bit pattern in the CiA control word (0x6040)							
	Bit 15	Bit 14	Bit 13	Bit 12	Bit 11	Bit 10	Bit 9	Bit 8
	Reserved	Release brake	Reserved	Dependent on the operating mode				Stop motor
Apply brake	X	0	X	X	X	X	X	X
Release brake	X	1	X	X	X	X	X	X
Stop motor	X	X	X	X	X	X	X	1

X = state is not relevant

Detailed information on the various commands can be found in the following sections.

### Parameter

Address	Name / setting range / [default setting]	Information	
0x6040	CiA control word 0 ... [0] ... 65535	Mappable CiA control word with bit assignment according to device profile CiA 402.	
	Bit 0	Switch on 1 = switch-on	
	Bit 1	Enable voltage 1 = Enable voltage	
	Bit 2	Disable quick stop 0 = activate quick stop	
	Bit 3	Enable operation 1 = Enable operation	
	Bit 4	Operation mode specific	Operation mode specific
	Bit 5	Operation mode specific	
	Bit 6	Operation mode specific	
	Bit 7	Fault reset 0-1 edge = fault reset	
	Bit 8	Halt (from version 04.00) 1 = stop motor (ramping down to frequency setpoint 0 Hz)	
	Bit 9	Operation mode specific Operating mode specific	
	Bit 14	Release holding brake 1 = release holding brake <b>⚠ CAUTION!</b> • The manually triggered "Release holding brake" command has a direct impact on the "Release holding brake [115]" trigger. Thus, the holding brake can be manually released if the power section is switched off. • The responsibility for a manual opening of the holding brake lies with the user of the external trigger source for the "Release holding brake" command. <a href="#">▶ Holding brake control □ 228</a>	





## Example

A PLC program of a PLCopen control can, for instance, trigger several commands for state changes in a row by the level change at the *bRegulatorOn* input of the "MC\_Power" block.

In the mentioned example, these device commands are "Switch-off" and "Switch on" in this order.

# Configuring the network

CiA 402 device profile  
 Commands for device state control  
 Switch-off



## 12.7.5.1 Switch-off

This command serves to change the "Switch-on inhibited" device state to the "Ready to switch on" device state.

If the pulse inhibit has already been deactivated and the device status of the inverter is "Operation enabled", this command sets the pulse inhibit again.

- If automatic brake operation is activated, the parameterized Brake closing time (0x2820:002 (P712.02)) is observed: The system waits until the brake is applied before the pulse inhibit is set. In the CiA 402 "CiA: Velocity mode", the Brake closing time is not observed.
- The motor has no torque.
- The device state "Switched on" or "Operation enabled" changes back to the "Ready to switch on" state.

### ⚠ DANGER!

Uncontrolled motor movements by pulse inhibit.

If the motor has no torque, a load that is connected to motors without a holding brake may cause uncontrolled movements! Without a load, the motor will coast.

Possible consequences: Death or severe injuries

- ▶ Only operate the inverter under permissible load conditions.

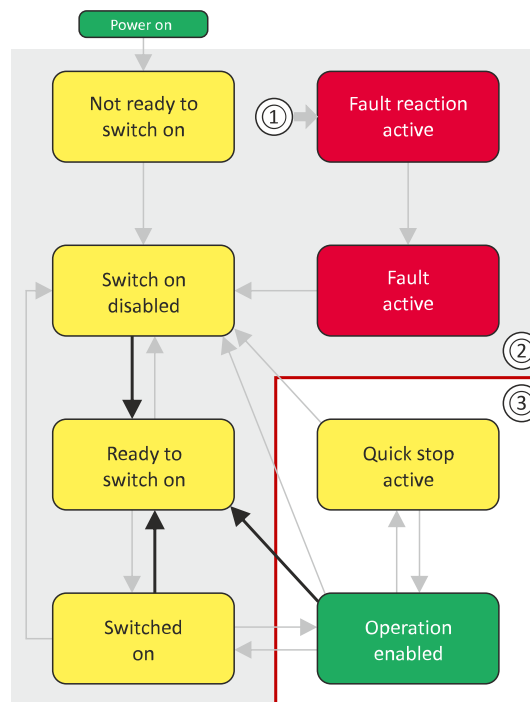

- 1 From all states
- 2 Power section disabled (pulse inhibit)
- 3 Power section enabled

Bit pattern in the CiA control word (0x6040)								
Bit 15 ... 8	Bit 7	Bit 6	Bit 5	Bit 4	Bit 3	Bit 2	Bit 1	Bit 0
Reserved (specific)	Reset fault	Operating mode dependent			Operation enabled	Activate quick stop	Establish readiness for operation	Switch-on
X	0	X	X	X	X	1	1	0

X = state is not relevant



## 12.7.5.2 Switch on

This command serves to deactivate the switch on inhibit which is active after switch on or after the reset (acknowledgement) of an error.

A changeover to the "Switched on" device status takes place.

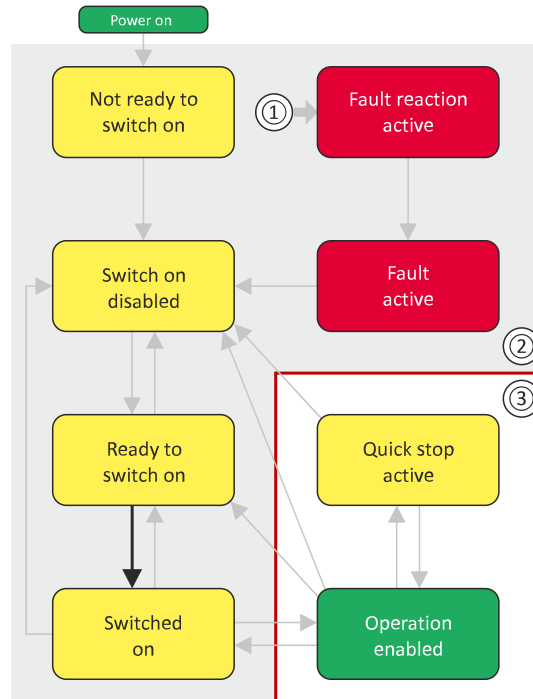

- 1 From all states
- 2 Power section inhibited (pulse inhibit)
- 3 Power section enabled

Bit pattern in the CiA control word (0x6040)								
Bit 15 ... 8	Bit 7	Bit 6	Bit 5	Bit 4	Bit 3	Bit 2	Bit 1	Bit 0
Reserved (specific)	Reset fault	Operating mode-dependent			Operation enabled	Activate quick stop	Establish readiness for operation	Switch-on
X	0	X	X	X	0	1	1	1

X = state is not relevant

# Configuring the network

CiA 402 device profile  
 Commands for device state control  
 Enable operation



## 12.7.5.3 Enable operation

This command enables the operation and stop an active quick stop again.

- A changeover to the "Operation enabled" device status takes place.
- The output stages of the inverter become active.

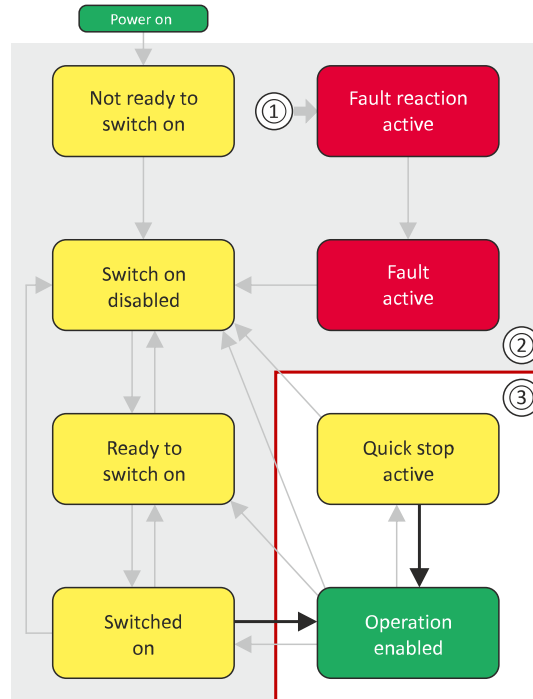

- 1 From all states
- 2 Power section inhibited (pulse inhibit)
- 3 Power section enabled

Bit pattern in the CiA control word (0x6040)								
Bit 15 ... 8	Bit 7	Bit 6	Bit 5	Bit 4	Bit 3	Bit 2	Bit 1	Bit 0
Reserved (specific)	Reset fault	Operating mode dependent			Operation enabled	Activate quick stop	Establish readiness for operation	Switch-on
X	0	X	X	X	1	1	1	1

X = state is not relevant

If the device status "Operation enabled" is signalled in the CiA status word, the inverter is ready to accept set points from the network master.



## 12.7.5.4 Activate quick stop

This command activates quick stop when the operation is enabled.

- The drive is brought to a standstill irrespective of the setpoint specified with the deceleration (0x6085 (P790.00)) set for quick stop.
- A changeover to the "Quick stop active" device status takes place.
- Then, state change to "Switch-on inhibited" parameter 0x605A "CiA: Quick stop mode".

If the operation is not enabled (device state "Ready to switch on" or "Switched on"), this command changes the state to "operation disabled".

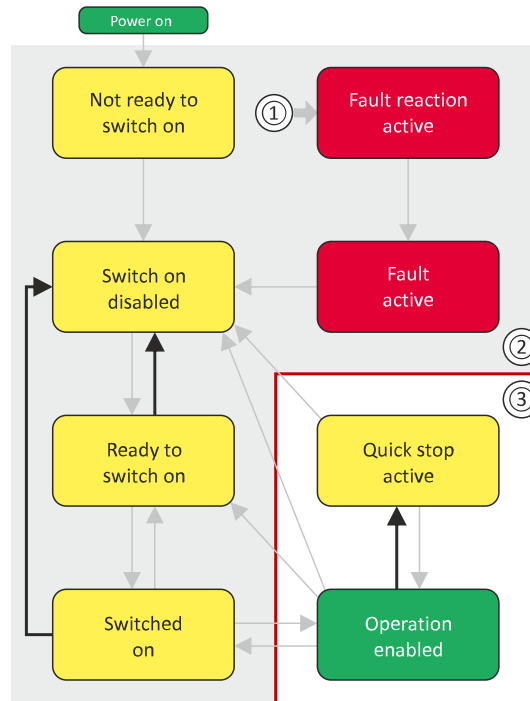

- 1 From all states
- 2 Power section disabled (pulse inhibit)
- 3 Power section enabled

Bit pattern in the CiA control word (0x6040)								
Bit 15 ... 8	Bit 7	Bit 6	Bit 5	Bit 4	Bit 3	Bit 2	Bit 1	Bit 0
Reserved (specific)	Reset fault	Operating mode dependent			Operation enabled	Activate quick stop	Establish readiness for operation	Switch-on
X	0	X	X	X	X	0	1	X

X = state is not relevant

- During quick stop, the inverter executes the setpoint generation and no longer follows the setpoint defined by the network master.
- If several inverters execute a chained synchronous motion, the quick stop function has to be coordinated by the network master by means of a quick stop profile (master function). In this case, quick stop cannot be activated via the control bit 2.
- During the quick stop, the maximum current (0x6073 (P324.00)) and the maximum torque (0x6072 (P326.00)) are active. The lower of the two limits determines the motor torque output. The torque limits from 0x60E0 and 0x60E1 are not effective during the quick stop.

# Configuring the network

CiA 402 device profile  
 Commands for device state control  
 Disable operation



## 12.7.5.5 Disable operation

This command disables the enabled operation again.

- The pulse inhibit is set (pulses of the inverter are inhibited).
- If automatic brake operation is activated, the parameterized Brake closing time (0x2820:002 (P712.02)) is observed: The system waits until the brake is applied before the pulse inhibit is set. In the CiA 402 "CiA: Velocity mode", the Brake closing time is not observed.
- A changeover to the "Switched on" device state takes place.

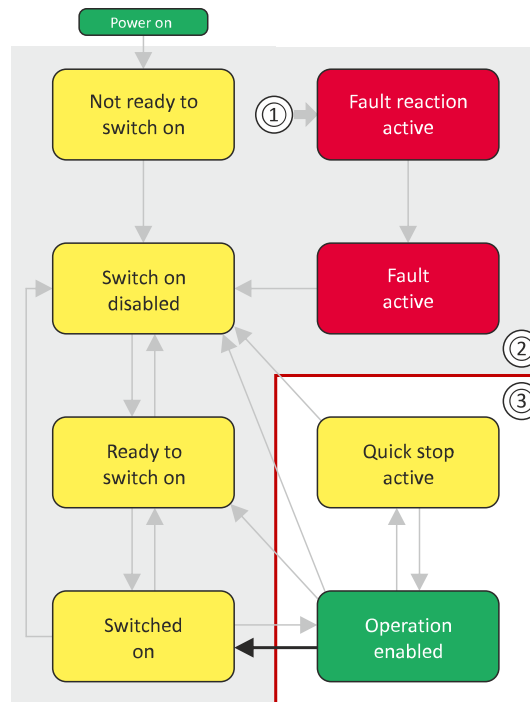

- 1 From all states
- 2 Power section disabled (pulse inhibit)
- 3 Power section enabled

Bit pattern in the CiA control word (0x6040)								
Bit 15 ... 8	Bit 7	Bit 6	Bit 5	Bit 4	Bit 3	Bit 2	Bit 1	Bit 0
Reserved (specific)	Reset fault	Operating mode dependent			Operation enabled	Activate quick stop	Establish readiness for operation	Switch-on
X	0	X	X	X	0	1	1	1

X = state is not relevant



## 12.7.5.6 Pulse inhibit

This command disables the output stages of the inverter.

- The pulse inhibit is activated (pulses of the inverter are inhibited) if not already active.
- The motor has no torque.
- A changeover to the "Switch-on inhibited" device state takes place.

**⚠ DANGER!**

Uncontrolled motor movements by pulse inhibit.

If the motor has no torque, a load that is connected to motors without a holding brake may cause uncontrolled movements! Without a load, the motor will coast.

Possible consequences: Death or severe injuries

► Only operate the inverter under permissible load conditions.

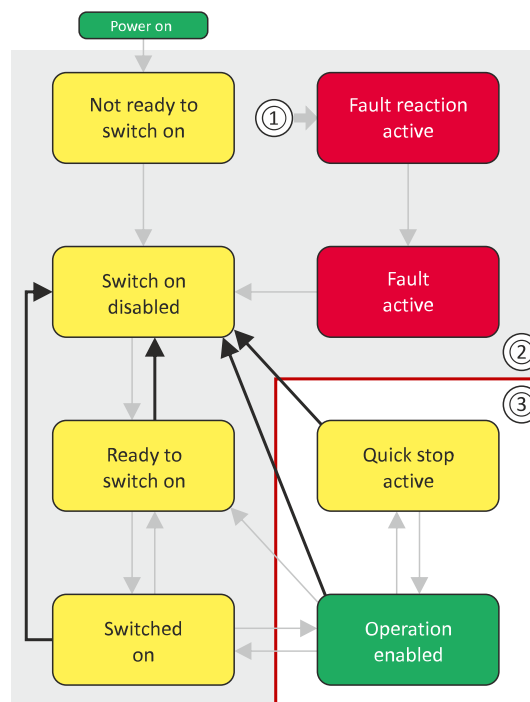

- 1 From all states
- 2 Power section inhibited (pulse inhibit)
- 3 Power section enabled

Bit pattern in the CiA control word (0x6040)								
Bit 15 ... 8	Bit 7	Bit 6	Bit 5	Bit 4	Bit 3	Bit 2	Bit 1	Bit 0
Reserved (specific)	Reset fault	Operating mode dependent			Operation enabled	Activate quick stop	Establish readiness for operation	Switch-on
X	0	X	X	X	X	X	0	X

X = state is not relevant

# Configuring the network

CiA 402 device profile  
 Commands for device state control  
 Reset fault



## 12.7.5.7 Reset fault

This command resets a pending fault if the cause of the fault has been eliminated.

- The pulse inhibit remains active (pulses of the inverter are inhibited).
- A changeover to the "Switch-on inhibited" device status takes place (switch-on inhibit remains active).

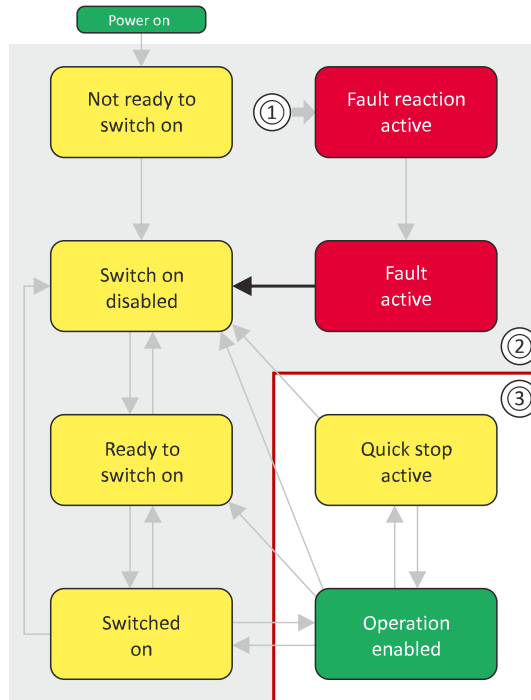

- 1 From all states
- 2 Power section inhibited (pulse inhibit)
- 3 Power section enabled

Bit pattern in the CiA control word (0x6040)								
Bit 15 ... 8	Bit 7	Bit 6	Bit 5	Bit 4	Bit 3	Bit 2	Bit 1	Bit 0
Reserved (specific)	Reset fault	Operating mode dependent			Operation enabled	Activating quick stop	Establish readiness for operation	Switch-on
X	0/1	X	X	X	X	X	X	X

X = state is not relevant





## 12.7.6 Device states

**0x6041 (P780.00)** (CiA status word) displays the current device status of the inverter.

### Status bit 7: "Warning active"

Status bit 7 indicates a warning.

- A warning does **not** cause a state change.
- Warnings do not need to be reset.

### More Lenze-specific status bits (bit 8 ... 15)

Device status	Bit pattern in the CiA status word (0x6041 (P780.00))							
	Bit 15	Bit 14	Bit 13	Bit 12	Bit 11	Bit 10	Bit 9	Bit 8
	STO (Safe Torque Off) Not active	Brake released	Reserved	Reserved	Internal limitation is active	Target position reached	Control word processed successfully	RPDOs deactivated
Brake applied	X	0	0	0	X	X	X	X
Brake released	X	1	0	0	X	X	X	X
STO (Safe Torque Off) active	0	X	0	0	X	X	X	X
STO (Safe Torque Off) not active	1	X	0	0	X	X	X	X
X = state is not relevant								

Detailed information on the various device states can be found in the following sections.

### Parameter

Address	Name / setting range / [default setting]	Information	
0x6041 (P780.00)	CiA status word (CiA status word)	Mappable CiA status word with bit assignment according to device profile CiA 402.	
	• Read only		
	Bit 0	Ready to switch on	1 = drive ready to start
	Bit 1	Switched on	1 = drive switched-on
	Bit 2	Operation enabled	1 = operation enabled
	Bit 3	Fault	1 = fault or trouble active
	Bit 4	Voltage enabled	1 = DC bus ready for operation
	Bit 5	Quick stop disabled	0 = quick stop active
	Bit 6	Switch on disabled	1 = operation inhibited
	Bit 7	Warning	1 = warning active
	Bit 8	RPDOs disabled	1 = cyclic PDOs have been deactivated
	Bit 9	CiA control enabled	1 = inverter can receive commands via network. • Bit is not set in the operating mode 0x6060 (P301.00) = "MS: Velocity mode [-2]".
	Bit 10	Setpoint reached	1 = the actual speed is in the window.
	Bit 11	Internal limit active	1 = internal limitation of a setpoint active
Bit 14	Holding brake released	1 = holding brake released	
Bit 15	STO not active	0 = STO is active or impermissible state at the safe inputs SIA and SIB (inverter disabled) 1 = STO is not active (inverter enabled)	

# Configuring the network

CiA 402 device profile  
 Device states  
 Not ready to switch on



## 12.7.6.1 Not ready to switch on

This is the device state of the inverter directly after switching on the supply voltage.

- In this device status, the device is initialised.
- Communication is not possible yet.
- The inverter cannot be parameterised yet and no device commands can be carried out yet.
- The motor brake, if available, is closed.
- Operation is inhibited.

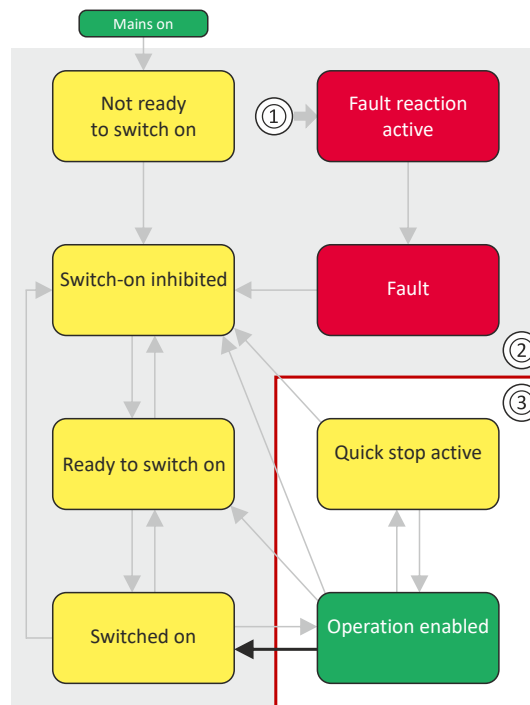

- 1 From all states
- 2 Power section inhibited (pulse inhibit)
- 3 Power section enabled

Bit pattern in the CiA status word (0x6041 (P780.00))								
Bit 15 ... 8	Bit 7	Bit 6	Bit 5	Bit 4	Bit 3	Bit 2	Bit 1	Bit 0
Reserved (specific)	Warning active	Operation inhibited	Quick stop active	DC bus ready for operation	Fault active	Operation enabled	Switched on	Ready to switch on
X	X	0	X	X	0	0	0	0

X = state is not relevant



## 12.7.6.2 Switch-on inhibited

This is the device state of the inverter after the device has been initialised successfully.

A change to this state also takes place when the EtherCAT bus is in "Operational" state or the PDO communication via **0x2824 (P200.00)** (Control selection) is deactivated.

- Process data monitoring is active.
- Communication is possible.
- The DC-bus voltage can be present.
- The inverter can be parameterised.
- If the internal holding brake control (**0x2820:001 (P712.01)**) is active in the inverter, the motor brake is closed.
- Operation is inhibited.

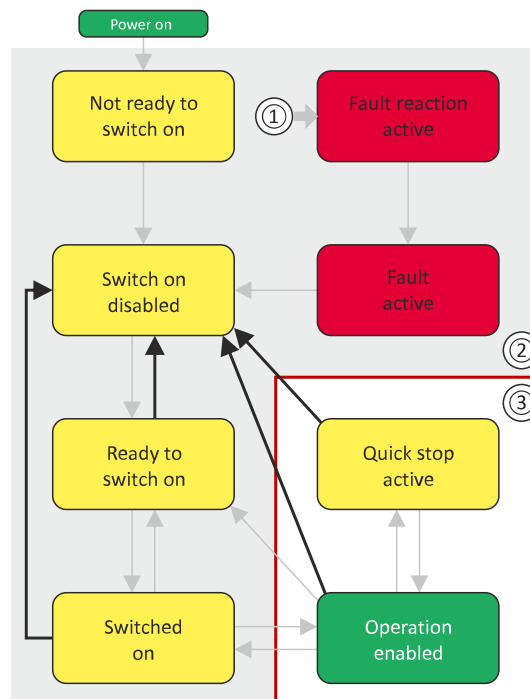

- 1 From all states
- 2 Power section inhibited (pulse inhibit)
- 3 Power section enabled

Bit pattern in the CiA status word (0x6041 (P780.00))								
Bit 15 ... 8	Bit 7	Bit 6	Bit 5	Bit 4	Bit 3	Bit 2	Bit 1	Bit 0
Reserved (specific)	Warning active	Operation inhibited	Quick stop active	DC bus ready for operation	Fault active	Operation enabled	Switched on	Ready to switch on
X	X	1	X	X	0	0	0	0

X = state is not relevant

# Configuring the network

CiA 402 device profile  
 Device states  
 Ready to switch on



## 12.7.6.3 Ready to switch on

This is the device state of the inverter after the device has been initialised successfully and after the **Switch-off** command has been triggered.

A change to this device state also takes place if the "Switch-off" command was triggered in the states "Switched on" or "Enable operation".

- Process data monitoring is active.
- Communication is possible.
- The DC-bus voltage is available.
- The inverter can be parameterised.
- If the internal holding brake control (0x2820:001 (P712.01)) is active in the inverter, the motor brake is closed.
- Operation is inhibited.

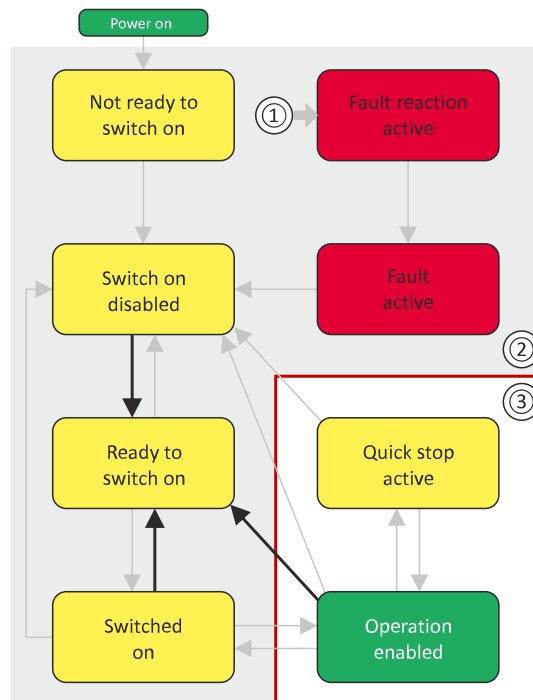

- 1 From all states
- 2 Power section inhibited (pulse inhibit)
- 3 Power section enabled

Bit pattern in the CiA status word (0x6041 (P780.00))								
Bit 15 ... 8	Bit 7	Bit 6	Bit 5	Bit 4	Bit 3	Bit 2	Bit 1	Bit 0
Reserved (specific)	Warning active	Operation inhibited	Quick stop active	DC bus ready for operation	Fault active	Operation enabled	Switched on	Ready to switch on
X	X	0	1	X	0	0	0	1

X = state is not relevant



## 12.7.6.4 Switched on

This is the device state of the inverter after the "Switch on" command has been triggered in the "Ready to switch on" device state.

- Process data monitoring is active.
- Communication is possible.
- The DC-bus voltage is available.
- The inverter can be parameterized.
- If the internal holding brake control (0x2820:001 (P712.01)) is active in the inverter, the motor brake is closed.
- Operation is disabled.

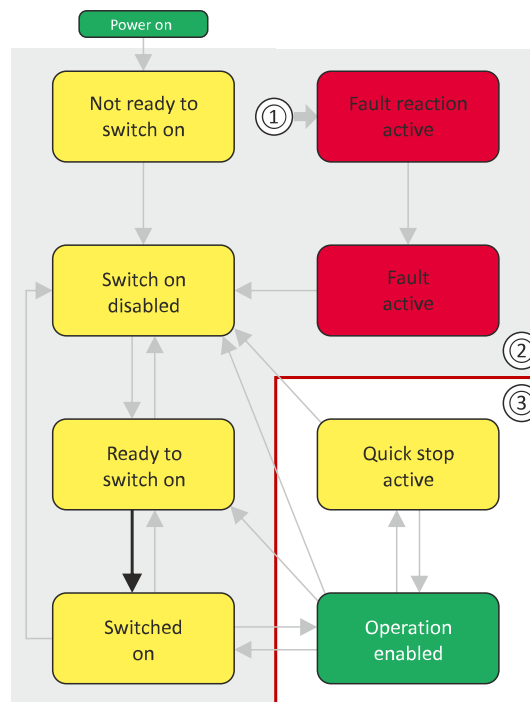

- 1 From all states
- 2 Power section disabled (pulse inhibit)
- 3 Power section enabled

Bit pattern in the CiA status word (0x6041 (P780.00))								
Bit 15 ... 8	Bit 7	Bit 6	Bit 5	Bit 4	Bit 3	Bit 2	Bit 1	Bit 0
Reserved (specific)	Warning active	Operation disabled	Quick stop active	DC bus ready for operation	Fault active	Operation enabled	Switched on	Ready to switch on
X	X	0	1	X	0	0	1	1

X = state is not relevant

# Configuring the network

CiA 402 device profile  
 Device states  
 Operation enabled



## 12.7.6.5 Operation enabled

This device state represents normal operation. Operation in the selected operating mode is enabled and no errors have occurred.

- Only the parameters of the inverter can be changed that do not require an inverter disable.
- A motor brake, if any, is open if the automatic operation of the holding brake control is activated ( $0x2820:001$  (P712.01) = 0).
- The drive control is active.

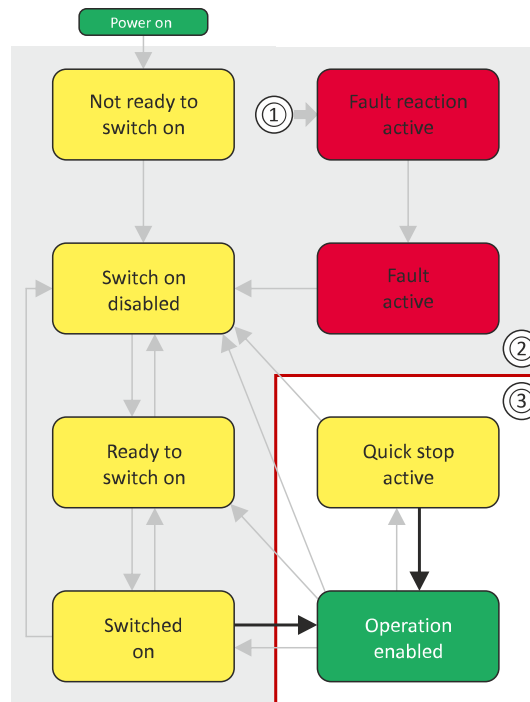

- 1 From all states
- 2 Power section inhibited (pulse inhibit)
- 3 Power section enabled

Bit pattern in the CiA status word ( $0x6041$ (P780.00))								
Bit 15 ... 8	Bit 7	Bit 6	Bit 5	Bit 4	Bit 3	Bit 2	Bit 1	Bit 0
Reserved (specific)	Warning active	Operation inhibited	Quick stop active	DC bus ready for operation	Fault active	Operation enabled	Switched on	Ready to switch on
X	X	0	1	X	0	1	1	1

X = state is not relevant

If the device status "Operation enabled" is signalled in the CiA status word, the inverter is ready to accept set points from the network master.



## 12.7.6.6 Quick stop active

This device state is active if quick stop is executed or active.

- Only the parameters of the inverter can be changed that do not require an inverter disable.
- If the internal holding brake control (0x2820:001 (P712.01)) is active in the inverter, the motor brake is closed.
- The drive control is active.

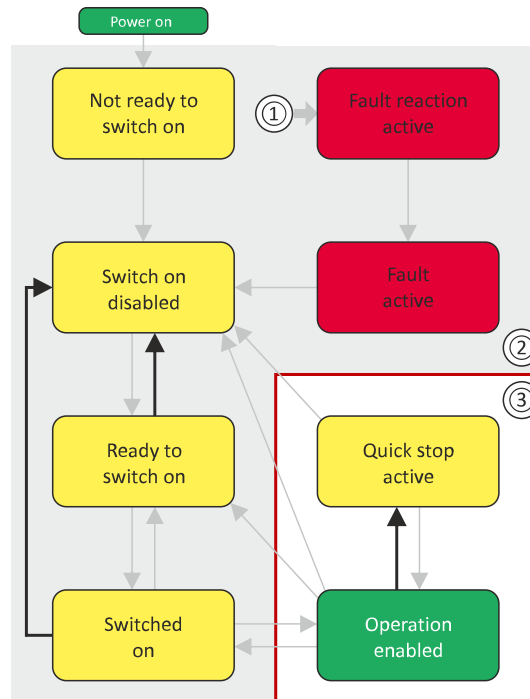

- 1 From all states
- 2 Power section inhibited (pulse inhibit)
- 3 Power section enabled

Bit pattern in the CiA status word (0x6041 (P780.00))								
Bit 15 ... 8	Bit 7	Bit 6	Bit 5	Bit 4	Bit 3	Bit 2	Bit 1	Bit 0
Reserved (specific)	Warning active	Operation inhibited	Quick stop active	DC bus ready for operation	Fault active	Operation enabled	Switched on	Ready to switch on
X	X	0	0	X	0	1	1	1

X = state is not relevant

The "Enable operation" command stops an active quick stop.

# Configuring the network

CiA 402 device profile  
 Device states  
 Fault reaction active



## 12.7.6.7 Fault reaction active

This device state becomes active if a minor fault occurs. This means that the inverter is still able to drive the motor in a controlled way.

- The inverter is brought to a standstill irrespective of the setpoint specified with the deceleration (0x6085 (P790.00)) set for quick stop.

If the inverter is at standstill, a change to the "Trouble" device state take place automatically.

- Only the parameters of the inverter can be changed that do not require an inverter disable.
- If the internal holding brake control (0x2820:001 (P712.01)) is active in the inverter, the motor brake is closed.
- The drive control is active.

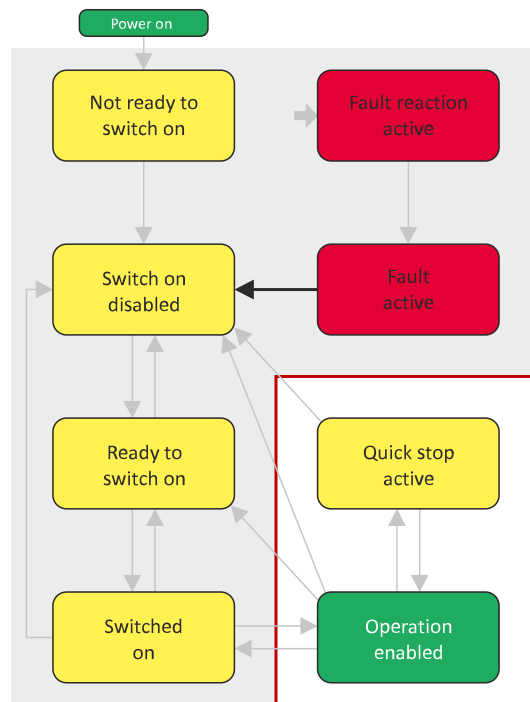

- 1 From all states
- 2 Power section inhibited (pulse inhibit)
- 3 Power section enabled

Bit pattern in the CiA status word (0x6041 (P780.00))								
Bit 15 ... 8	Bit 7	Bit 6	Bit 5	Bit 4	Bit 3	Bit 2	Bit 1	Bit 0
Reserved (specific)	Warning active	Operation inhibited	Quick stop active	DC bus ready for operation	Fault active	Operation enabled	Switched on	Ready to switch on
X	X	0	X	X	1	1	1	1

X = state is not relevant





## 12.7.6.8 Trouble

This device state becomes active if a serious system fault occurs. This means that the inverter is no longer able to drive the motor in a controlled way. The inverter is switched off immediately.

- The pulse inhibit is active (pulses of the inverter are inhibited).
- The motor is torqueless.
- The motor brake, if available, is closed.
- Operation is inhibited.
- The inverter can be parameterised.

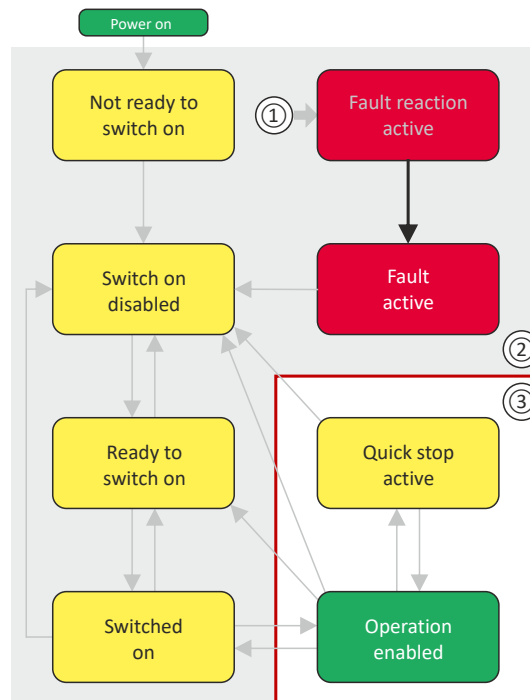

- 1 From all states
- 2 Power section inhibited (pulse inhibit)
- 3 Power section enabled

Bit pattern in the CiA status word (0x6041 (P780.00))								
Bit 15 ... 8	Bit 7	Bit 6	Bit 5	Bit 4	Bit 3	Bit 2	Bit 1	Bit 0
Reserved (specific)	Warning active	Operation inhibited	Quick stop active	DC bus ready for operation	Fault active	Operation enabled	Switched on	Ready to switch on
X	X	0	X	X	1	0	0	0

X = state is not relevant

This device state can only be left with the "[Reset fault](#)" command if the cause of the fault has been removed.

# Configuring the network

CiA 402 device profile  
Device states  
STO (Safe Torque Off)



## 12.7.6.9 STO (Safe Torque Off)

The status of the STO activity is included in bit 15 of the CiA status word ([0x6041 \(P780.00\)](#)).

This status information is required since the activation of STO causes all integral control parts to be deleted.

In case of hoists, for instance, the inverter would be sagging without any corrective measures after completing STO.

In order to prevent this unwanted state, the control has to be preloaded with a starting value after completing STO:

- In case of a control type with encoder, the integral-action component of the speed controller must be preloaded.
- In case of [V/f characteristic control for asynchronous motor \(VFC closed loop\)](#), the slip frequency must be preloaded.



---

If STO is inhibited, a changeover to the "Ready to switch on" device state takes place and a warning is output.

---



## 12.8 AC drive

For control via the AC drive profile, the parameters listed in the following can be mapped to network registers.

- Mapping entry for the AC Drive control word (0x400B:001 (P592.01)): 0x400B0110
- Mapping entry for the AC Drive status word (0x400C:001 (P593.01)): 0x400C0110
- Detailed information on the data mapping can be found in the chapter of the corresponding network.

### 12.8.1 AC drive control word

The AC drive control word (0x400B:001 (P592.01)) will only be processed if the network control in 0x2631:037 (P400.37) has been activated and the network is also active as the control source.

▶ [Changing the control source during operation](#) [□ 86](#)

Moreover, some bits in the control word are ignored if the bit 5 "Activate network control" is not set. For details see the parameter description for 0x400B:001 (P592.01).

The following logic applies to bit 0 "Run forward (CW)" and bit 1 "Run reverse (CCW)":

Bit 0 "Run forward (CW)"	Bit 1 "Run reverse (CCW)"	Action
0	0	Stopping with stop method set in 0x2838:003 (P203.03).
0↗1 (edge)	0	Run forward (CW)
0	0↘1 (edge)	Run reverse (CCW)
0↗1 (edge)	0↘1 (edge)	No action / last action is continued to be executed.
1	1	
1	0	
0	1	
1↘0 (edge)	1	Run reverse (CCW)
1	1↘0 (edge)	Run forward (CW)

### Parameter

Address	Name / setting range / [default setting]	Information
0x400B:001 (P592.01)	Process input data: AC Drive control word (Process data IN: AC control word) 0x0000 ... [0x0000] ... 0xFFFF	Mappable control word with bit assignment in compliance with EtherNet/IP™ AC drive profile.
	Bit 0 Run forward (CW)	Bits are only evaluated if bit 5 = "1".
	Bit 1 Run reverse (CCW)	For the exact logic, see the above truth table.
	Bit 2 Reset error (0-1 edge)	
	Bit 5 Activate network control	If bit 5 = "1" and 0x2631:037 (P400.37) = "Network control active [114]": All bits of the AC Drive control word are evaluated.  If bit 5 = "0" or 0x2631:037 (P400.37) = "Not connected [0]": • Bit 0, 1, 6, 12, 13, 14, 15 of the AC drive control word are not evaluated (ignored). • Active control source is the "Flexible I/O configuration". ▶ <a href="#">Changing the control source during operation</a> <a href="#">□ 86</a>
	Bit 6 Activate network setpoint	0 = the standard setpoint source selected in 0x2860:001 (P201.01) is used. 1 = network setpoint is used. Bit 6 is only evaluated if bit 5 = "1". For control without bit 5, the "Network setpoint active [116]" selection must be set in 0x2631:017 (P400.17).
	Bit 12 Disable inverter	Bits are only evaluated if bit 5 = "1".
	Bit 13 Activate quick stop	
Bit 14 Disable PID controlling		
Bit 15 Activate DC braking		



## 12.8.2 AC drive status word

### Parameter

Address	Name / setting range / [default setting]	Information	
0x400C:001 (P593.01)	Process output data: AC Drive status word (Process data OUT: AC status word) • Read only	Mappable status word with bit assignment in compliance with EtherNet/IP™ AC drive profile.	
	Bit 0	Fault/Trip active	
	Bit 1	Warning active	
	Bit 2	Running forward	
	Bit 3	Running reverse	
	Bit 4	Ready	
	Bit 5	Network control active	
	Bit 6	Network setpoint active	
	Bit 7	At Reference	
	Bit 8	Profile-State bit 0	The drive status is coded as follows: 0: Manufacturer-specific (reserved) 1: Startup (drive initialisation) 2: Not_Ready (mains voltage switched off) 3: Ready (mains voltage switched on) 4: Enabled (drive has received run command) 5: Stopping (drive has received stop command and is stopped) 6: Fault_Stop (drive is stopped due to a fault) 7: Faulted (faults have occurred)
	Bit 9	Profile-State bit 1	
	Bit 10	Profile-State bit 2	
	Bit 11	Profile-State bit 3	
	Bit 12	Process controller active	
	Bit 13	Torque mode active	
	Bit 14	Current limit reached	
Bit 15	DC braking active		



## 12.9 Lenze LECOM profile

For connection to Lenze inverters with a LECOM control word (C135) and LECOM status word (C150), the parameters listed in the following can be mapped to network registers.

### Details

Mapping entries

- LECOM control word (0x400B:002 (P592.02)): 0x400B0210
- LECOM status word (0x400C:002 (P593.02)): 0x400C0210
- Detailed information on the data mapping can be found in the chapter of the corresponding network.

### Parameter

Address	Name / setting range / [default setting]	Information
0x400B:002 (P592.02)	Process input data: LECOM control word (Process data IN: LECOM ctrl word) 0x0000 ... [0x0000] ... 0xFFFF	Mappable control word with bit assignment in compliance with code C135 of the 8200 Lenze inverter.
	Bit 0 Activate preset (bit 0)	
	Bit 1 Activate preset (bit 1)	
	Bit 2 Reverse rotational direction	
	Bit 3 Activate quick stop	
	Bit 9 Disable inverter	
	Bit 10 Activate user fault	
	Bit 11 Reset error (0-1 edge)	
0x400C:002 (P593.02)	Process output data: LECOM status word (Process data OUT: LECOM stat. word) • Read only	Mappable status word with bit assignment in compliance with code C150 of the 8200 Lenze inverter.
	Bit 0 Active parameter set (0 = set 1 or 3; 1 = set 2 or 4)	
	Bit 1 Power section inhibited	
	Bit 2 Current or Torque limit reached	
	Bit 3 Frequency setpoint reached	
	Bit 4 Ramp generator (input = output)	
	Bit 5 Frequency < frequency threshold	
	Bit 6 Actual frequency = 0	
	Bit 7 Inverter disabled	
	Bit 8 Coded status bit 0	
	Bit 9 Coded status bit 1	
	Bit 10 Coded status bit 2	
	Bit 11 Coded status bit 3	
	Bit 12 Overtemperature warning	
	Bit 13 DC-bus overvoltage	
Bit 14 Rotational direction reversed		
Bit 15 Ready for Operation		



## 12.10 CANopen



CANopen® is an internationally approved communication protocol which is designed for commercial and industrial automation applications.

- CANopen® is a registered community trademark of the CAN in Automation e. V user organisation.
- Detailed information on CANopen can be found on the web page of the CAN in Automation (CiA) user organisation: <https://www.can-cia.org>
- Information about the dimensioning of a CANopen network can be found in the configuration document for the inverter.

### Preconditions

- The control unit (CU) of the inverter is provided with CANopen.
- The network is terminated by one bus terminating resistor each at the first and last physical node. See "Typical topologies".
- The DIP switches for node address, baud rate and bus terminating resistor are correctly set, see: ▶ [Basic setting and options](#) 371
- The required EDS device description files for the inverters to be put into operation are loaded in the master (PLC).



Device description files for Lenze products can be found on the Internet: [www.Lenze.com](http://www.Lenze.com) → Downloads → Product-related Application Knowledge Base articles

### Details

- The implementation of the CANopen communication profile (CiA DS301, version 4.02) enables baud rates of 20 kbps to 1 Mbps.
- For establishing a simple network connection, the inverter provides predefined control and status words for these profiles.

- ▶ [CiA 402 device profile](#) 341
- ▶ [AC drive](#) 363
- ▶ [Lenze LECOM profile](#) 365

There are also additional mappable data words to individually control the inverter:

- The inverter control is preconfigured via a CiA control word.

### Typical topology

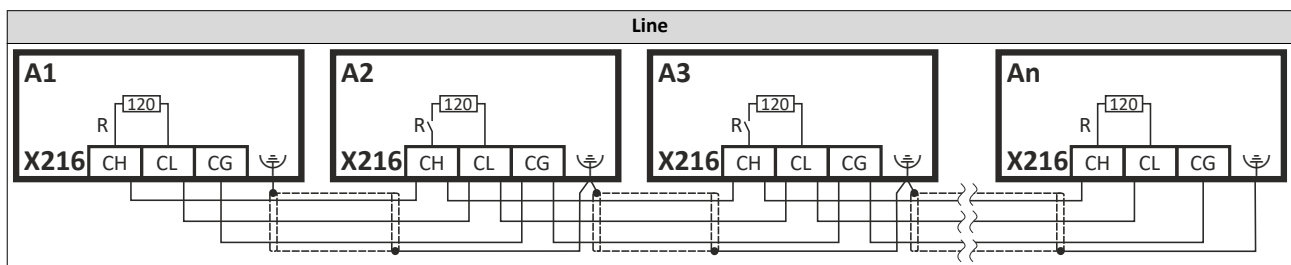







## 12.10.1 Commissioning

In the following, the steps required for controlling the inverter via CANopen are described.

### Parameterization required

1. Set the CANopen node address.
  - Each network node must be provided with a unique node address.
  - Details: [▶ Node address setting](#)  371
2. Set the CANopen baud rate.
  - Default setting: 500 = kbit/s
  - Details: [▶ Baud rate setting](#)  372
3. Optional: Configure inverter as "mini master".
  - Required if the initialization of the CANopen network and the associated status change from "Pre-Operational" to "Operational" is not effected by a higher-level host system.
  - Details: [▶ Configuring the device as mini master](#)  373
4. Optional: Change the response of the inverter to the triggering of the RPDO time monitoring.
  - Default setting: In case of missing RPDOs, an error is triggered.
  - Details: [▶ Error responses](#)  385
5. Save parameter settings: `0x2022:003 (P700.03) = "On / start = [1]"`.
6. Switch the inverter off and then on again in order that the changed communication settings can get effective.
7. Program the master so that the following SDO messages are sent to the inverter:
  1. `0x2631:037 (P400.37) = 1` (activate network control)
  2. `0x2860:001 (P201.01) = 5` (set network as standard setpoint source)
  3. PDO mapping and configuration of the process data objects RPDO1 and TPDO1 (see the sections "[RPDO1 mapping modification](#)" and "[TPDO1 mapping modification](#)").
8. Control inverter via RPDO1 (and evaluate the current status via TPDO1).
  - For assignment of the control word and setpoint selection, see section "[RPDO1 mapping modification](#)".
  - For assignment of the status word and actual value output, see section "[TPDO1 mapping modification](#)".
  - Acceleration `0x2917 (P220.00)` and deceleration `0x2918 (P221.00)` can be set/changed via SDO messages.



---

In the default setting, the digital input DI1 is assigned the "Run" function. If the network control is activated, this function serves as "start enable" for start commands via network. Hence, the digital input DI1 must be set to the HIGH level in order that the motor can be started via the network.

[▶ Flexible I/O configuration of the start, stop and rotating direction commands](#)  67

---



## RPDO1 mapping modification

The RPDO1 is used to control the inverter.

Changing the identifier (COB-ID) and the PDO mapping only allows the following procedure:

1. Set RPDO1 to "invalid": Set bit 31 in the identifier [0x1400:001 \(P540.01\)](#) = 1.
2. Set RPDO1 mapping to "invalid": set [0x1600:000](#) = 0
3. Map NetWordIN1 data word [0x4008:001 \(P590.01\)](#) to RPDO1: set [0x1600:001](#) = 0x40080110.
4. Network setpoint frequency (0.1) [0x400B:003 \(P592.03\)](#) to RPDO1: set [0x1600:002](#) = 0x400B0310.
5. Set RPDO1 mapping to "valid" again: set [0x1600:000](#) = 2 (number of mapped parameters).
6. Optional: Set timeout time for monitoring the data reception in [0x1400:005 \(P540.05\)](#) in [ms].
  - Default setting: 100 ms
7. Change identifier for RPDO1 (optional) and set RPDO1 to "valid" again: Write the new identifier into [0x1400:001 \(P540.01\)](#) and simultaneously set bit 31 to "0".
  - Default setting: 0x200 + node address (hex)
  - Example: Node address = 10 (0xA) and basic identifier = default setting:  
Identifier to be written into = 0x200 + 0xA = 0x20A = (0b0011 0000 1010)

## Function assignment of the NetWordIN1 data word (byte 1+2 of the RPDO1)

Bit	Default setting	For details and configuration, see
0	Not active (reserve)	<a href="#">0x400E:001 (P505.01)</a>
1	Not active (reserve)	<a href="#">0x400E:002 (P505.02)</a>
2	Activate quick stop	<a href="#">0x400E:003 (P505.03)</a>
3	Not active (reserve)	<a href="#">0x400E:004 (P505.04)</a>
4	Run forward (CW)	<a href="#">0x400E:005 (P505.05)</a>
5	Activate preset (bit 0)	<a href="#">0x400E:006 (P505.06)</a>
6	Activate preset (bit 1)	<a href="#">0x400E:007 (P505.07)</a>
7	Reset error	<a href="#">0x400E:008 (P505.08)</a>
8	Not active (reserve)	<a href="#">0x400E:009 (P505.09)</a>
9	Activate DC braking	<a href="#">0x400E:010 (P505.10)</a>
10	Not active (reserve)	<a href="#">0x400E:011 (P505.11)</a>
11	Not active (reserve)	<a href="#">0x400E:012 (P505.12)</a>
12	Reverse rotational direction	<a href="#">0x400E:013 (P505.13)</a>
13	Not active (reserve)	<a href="#">0x400E:014 (P505.14)</a>
14	Not active (reserve)	<a href="#">0x400E:015 (P505.15)</a>
15	Not active (reserve)	<a href="#">0x400E:016 (P505.16)</a>

Specifying the frequency setpoint (byte 3+4 of the RPDO1)

- The specification is made unsigned (independent of the direction of rotation) as integer in the resolution [0.1 Hz].
- The direction of rotation is defined in the default setting via bit 12 of the NetWordIN1 data word.
- Example: 456 = 45.6 Hz





### TPDO1 mapping modification

The TPDO1 is used for the output of status information and the actual frequency value.

Changing the identifier (COB-ID) and the PDO mapping only allows the following procedure:

1. Set TPDO1 to "invalid": Set bit 31 in the identifier [0x1800:001 \(P550.01\)](#) = 1.
2. Set TPDO1 mapping to "invalid": set [0x1A00:000](#) = 0.
3. Map NetWordOUT1 data word [0x400A:001 \(P591.01\)](#) to TPDO1:  
set [0x1A00:001](#) = 0x400A0110.
4. Frequency (0.1) [0x400B:003 \(P592.03\)](#) to TPDO1: set [0x1A00:002](#) = 0x400C0310.
5. Set TPDO1 mapping to "valid" again: set [0x1A00:000](#) = 2 (number of mapped parameters).
6. Option: Transmission type in [0x1800:002 \(P550.02\)](#) Event timer in [0x1800:005 \(P550.05\)](#).
  - Default setting: Cyclic transmission every 20 ms.
7. Change identifier for TPDO1 (optional) and set TPDO1 to "valid" again: Write the new identifier into [0x1800:001 \(P550.01\)](#) and simultaneously set bit 31 to "0".
  - Default setting: 0x40000180 + node address (hex)
  - Example: Node address = 10 (0xA) and TPDO1 basic identifier = default setting:  
Identifier to be written into [0x1800:001 \(P550.01\)](#) = 0x40000180 + 0xA = 0x4000018A  
(0b0100 0000 0000 0000 0000 0001 1000 1010)

### Status assignment of the NetWordOUT1 data word (byte 1+2 of the TPDO1)

Bit	Default setting	For details and configuration, see
0	Ready for operation	<a href="#">0x2634:010 (P420.10)</a>
1	Not connected	<a href="#">0x2634:011 (P420.11)</a>
2	Operation enabled	<a href="#">0x2634:012 (P420.12)</a>
3	Fault active	<a href="#">0x2634:013 (P420.13)</a>
4	Not connected	<a href="#">0x2634:014 (P420.14)</a>
5	Quick stop active	<a href="#">0x2634:015 (P420.15)</a>
6	Running	<a href="#">0x2634:016 (P420.16)</a>
7	Device warning active	<a href="#">0x2634:017 (P420.17)</a>
8	Not connected	<a href="#">0x2634:018 (P420.18)</a>
9	Not connected	<a href="#">0x2634:019 (P420.19)</a>
10	Setpoint speed reached	<a href="#">0x2634:020 (P420.20)</a>
11	Current limit reached	<a href="#">0x2634:021 (P420.21)</a>
12	Actual speed = 0	<a href="#">0x2634:022 (P420.22)</a>
13	Rotational direction reversed	<a href="#">0x2634:023 (P420.23)</a>
14	Release holding brake	<a href="#">0x2634:024 (P420.24)</a>
15	Inverter disabled (safety)	<a href="#">0x2634:025 (P420.25)</a>

Output of the actual frequency value (byte 3+4 of the TPDO1)

- The output is made unsigned (independent of the direction of rotation) as integer in the resolution [0.1 Hz].
- An active reversal is displayed via bit 13 of the NetWordOUT1 data word.
- Example: 456 = 45.6 Hz

### Restart of the communication

A restart of communication is required after changes of the interface configuration (e. g. node address and baud rate) in order that the changed settings become effective.

For restarting communication, there are two options:

- a) Switch inverter off and on again.
- b) [0x2300 \(P508.00\)](#) Set = "Restart with current values [1]".

The following parameter can be used to restart or stop communication.

Optionally it is also possible to reset all communication parameters to the default status.

# Configuring the network

CANopen  
Commissioning



## Parameter

Address	Name / setting range / [default setting]	Information
0x2300 (P508.00)	CANopen communication (CANopen comm.) <ul style="list-style-type: none"> <li>Setting can only be changed if the inverter is disabled.</li> </ul>	Restart / stop communication. <ul style="list-style-type: none"> <li>After successful execution, the value 0 is shown.</li> </ul>
	<b>0</b> No action/no error	Only status feedback
	1 Restart with current values	Restart communication with the current values of the CANopen parameters.
	2 Restart with default values	Restart communication with the standard values of the CANopen parameters.
	5 Stop network communication	Stop communication. <ul style="list-style-type: none"> <li>The "Stop Remote Node" NMT command is executed. After successful execution of this command, only the reception of network management frames is possible.</li> </ul>
	10 In progress	Only status feedback
	11 Action cancelled	
12 Fault		



## 12.10.2 Basic setting and options

These settings are required to operate the inverter in the CANopen network:

- Activation of the bus terminating resistor if the inverter is integrated as the first or last physical node in the network.
  - ▶ [Activating the bus terminating resistor](#) 371
- Setting of a unique node address and the baud rate.
  - ▶ [Node address setting](#) 371
  - ▶ [Baud rate setting](#) 372
- Optional configuration of the inverter as a "mini-master".
  - ▶ [Configuring the device as mini master](#) 373

### 12.10.2.1 Activating the bus terminating resistor

If the inverter is the first or last physical node in the network, the bus terminating resistor must be activated using the DIP switch marked "R" on the device.

#### View of the DIP switch

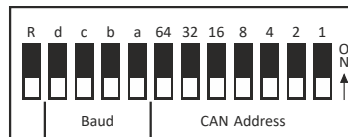

### 12.10.2.2 Node address setting

Each network node must be provided with a unique node address.

#### Details

- The node address of the inverter can be optionally set in [0x2301:001 \(P510.01\)](#) or using the DIP switches on the device labelled with "1" ... "64".
- The setting that is active when the inverter is switched on is the effective setting.
- The labelling of the DIP switches corresponds to the values of the individual DIP switches for determining the node address (see the following example).
- The active node address is displayed in [0x2302:001 \(P511.01\)](#).

#### Example of how the node address is set via the DIP switches

DIP switch	64	32	16	8	4	2	1
Setting	OFF	OFF	ON	OFF	ON	ON	ON
Value	0	0	16	0	4	2	1
Node address	= sum of all values = 16 + 4 + 2 + 1 = <b>23</b>						

#### Parameter

Address	Name / setting range / [default setting]	Information
0x2301:001 (P510.01)	CANopen settings: Node ID (CANopen sett.: Node ID) 1 ... [1] ... 127	Optionally setting of the node address (instead of setting via DIP switches 1 ... 64). <ul style="list-style-type: none"> <li>• The node address set here only becomes effective if DIP switches 1 ... 64 have been set to OFF before mains switching.</li> <li>• A change in the node address will not be effective until a CAN Reset Node is performed.</li> </ul>

# Configuring the network

CANopen  
Basic setting and options  
Baud rate setting



## 12.10.2.3 Baud rate setting

All network nodes must be set to the same baud rate.

### Details

- The baud rate can be optionally set in [0x2301:002 \(P510.02\)](#) or using the DIP switches on the device labelled with "a" ... "d" (see the following table).
- The setting that is active when the inverter is switched on is the effective setting.
- The active baud rate is displayed in [0x2302:002 \(P511.02\)](#).

### View of the DIP switch

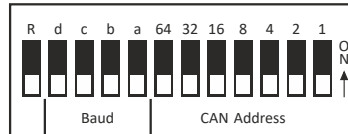

d	c	b	a	Baud rate
OFF	ON	OFF	ON	20 kbps
OFF	OFF	ON	ON	50 kbps
OFF	OFF	ON	OFF	125 kbps
OFF	OFF	OFF	ON	250 kbps
<b>OFF</b>	<b>OFF</b>	<b>OFF</b>	<b>OFF</b>	<b>500 kbps</b>
OFF	ON	OFF	OFF	1 Mbps

When a combination is set that is not in the list, the baud rate is set to 500 kbps.

### Parameter

Address	Name / setting range / [default setting]	Information
0x2301:002 (P510.02)	CANopen settings: Baud rate (CANopen sett.: Baud rate)	Optionally, setting of the baud rate (instead of setting via DIP switches a ... d). • The parameterised baud rate is only effective if DIP switches a ... d and 1 ... 64 were set to before mains switching. • A change in the baud rate will not be effective until a CAN reset node is performed.
	0 Automatic (from version 03.00)	
	1 20 kbps	
	2 50 kbps	
	3 125 kbps	
	4 250 kbps	
	<b>5 500 kbps</b>	
	6 800 kbps	
7 1 Mbps		



## 12.10.2.4 Configuring the device as mini master

If the initialisation of the CANopen network and the associated status change from "Pre-Operational" to "Operational" is not effected by a master (PLC), the inverter can instead be defined as a "mini master" to execute this task.

### Details

The inverter is configured as mini master in [0x2301:003 \(P510.03\)](#).

- In the default setting, the inverter is configured as slave and waits for the NMT telegram "Start Remote Node" from the master (PLC) in the "Pre-Operational" state after being switched on.
- Configured as mini master, the inverter changes to the "Operational" state after being switched on and sets all nodes connected to the CAN bus (broadcast telegram) to the "Operational" communication state using the "Start Remote Node" NMT telegram after the deceleration time set in [0x2301:004 \(P510.04\)](#) has elapsed. Only this communication status enables data exchange via the process data objects.



---

The change of the master/slave operation only becomes effective by renewed mains switching of the inverter or by sending the NMT telegram "Reset Node" or "Reset Communication" to the inverter. Alternatively, the CAN communication can be restarted via [0x2300 \(P508.00\)](#).

---

### Parameter

Address	Name / setting range / [default setting]	Information
0x2301:003 (P510.03)	CANopen settings: Slave/Master (CANopen sett.: Slave/Master)	1 = after mains switching, inverter starts as mini-master.
	<b>0</b> Slave	
	1 Mini-master	
0x2301:004 (P510.04)	CANopen settings: Start remote delay (CANopen sett.: Start rem. delay) 0 ... <b>[3000]</b> ... 65535 ms	If the inverter has been defined as mini-master, a delay time can be set here, which has to elapse after mains switching before the inverter deposits the "Start Remote Node" NMT telegram on the CAN bus.



## 12.10.3 Process data transfer

Process data objects (PDOs) are used for the cyclic transmission of (process) data via CANopen. PDOs only contain data and an identifier. They do not contain any information about the sender or receiver and are therefore very efficient.

### Details

- Process data objects which the inverter receives via the network are referred to as "Receive PDOs" (RPDOs).
- Process data objects which the inverter sends via the network are referred to as "Transmit PDOs" (TPDOs).
- The maximum length of a PDO is 8 bytes (4 data words).
- Each PDO requires a unique identifier ("COB-ID") for the purpose of identification within the network.
- Communication parameters such as the transmission type and cycle time for each PDO can be set freely and independently of the settings of other PDOs

### Transmission type

Process data objects can be transmitted in an event-controlled or time-controlled manner. The below table shows that it is possible to combine the different methods by means of logic operations (AND, OR):

- Event-controlled: The PDO is sent if a special device-internal event has occurred, for instance, if the data contents of the TPDO have changed or if a transmission cycle time has elapsed.
- Synchronous transmission: Transmission of a TPDOs or reception of an RPDO is effected after the inverter has received a sync telegram (COB-ID 0x80).
- Cyclic transmission: The cyclic transmission of PDOs is effected when the transmission cycle time has elapsed.
- Polled via RTR: Transmission of a TPDO is carried out on request by another device via data request frame (RTR remote transmit request). For this, the data requester (e.g. master) sends the data request frame with the COB-ID of the TPDO that is to be requested to transmit. The receiver recognises the RTR and carries out the transmission.

Transmission type	PDO transmission			Logic combination of different transmission types
	cyclic	synchronous	event-controlled	
0		●	●	AND
1 ... 240		●		-
254, 255	●		●	OR

Transmission type	Description
0	Synchronous and acyclic <ul style="list-style-type: none"> <li>• The PDO is transmitted on an event-controlled basis with every sync (e.g. when a bit change occurs in the PDO).</li> </ul>
1 ... 240	Synchronous and cyclic (sync-controlled with a response) <ul style="list-style-type: none"> <li>• Selection n = 1: The PDO is transmitted with every sync.</li> <li>• Selection 1 &lt; n ≤ 240: The PDO is transmitted with every n-th sync.</li> </ul>
241 ... 251	Reserved
252	Synchronous - RTR only
253	Asynchronous - RTR only
254, 255	Asynchronous - manufacturer-specific / device profile-specific <ul style="list-style-type: none"> <li>• If the value 255 is entered, sending and receiving takes place in the set cycle time. Linked signals are also sent and received every time the PDO is changed. The PDO is event-driven and cyclically transmitted.</li> <li>• If the value 254 is entered, sending and receiving takes place in the set cycle time. A change in the PDO linked signals has no influence.</li> </ul>



## Synchronisation of PDOs via sync telegram

During cyclic transmission, one or more PDOs are transmitted/received in fixed time intervals. An additional specific telegram, the so-called sync telegram, is used for synchronising cyclic process data.

- The sync telegram is the trigger point for the transmission of process data from the slaves to the master and for the acceptance of process data from the master in the slaves.
- For sync-controlled process data processing, the sync telegram must be generated accordingly.
- The response to a sync telegram is determined by the transmission type selected.

Generating the sync telegram:

- [0x1005](#) can be used to activate the generation of sync telegrams and to write the identifier value.
- Sync telegrams are created when bit 30 (see below) is set to "1".
- The interval between sync telegrams is to be set in [0x1006](#).

Writing identifiers:

- To receive sync telegrams, the value 0x80 must be entered in the 11-bit identifier in the default setting (and in compliance with the CANopen specification). This means that all inverters are set to the same sync telegram by default.
- If sync telegrams are only to be received by specific nodes, their identifiers can be entered with a value of up to and including 0x07FF.
- The identifier can only be changed if the inverter does not send any sync telegrams ([0x1005](#), Bit 30 = "0").

## Data telegram assignment

8th byte (data 4)		7th byte (data 3)	6th byte (data 2)	5th byte (data 1)
Bit 31	Bit 30	Bit 29 ... bit 11		Bit 10 ... bit 0
x	0/1	Extended identifier*		11-bit identifier

\* The extended identifier is not supported. Bit 11 ... bit 29 must be set to "0".

## Parameter

Address	Name / setting range / [default setting]	Information
0x1005	COB-ID SYNC 0x00000000 ... [0x00000080] ... 0xFFFFFFFF	Identifier for sync telegram. How to change the identifier: 1. Deactivate Sync: Set bit 30 to "0". 2. Change identifier. 3. Activate Sync: Set bit 30 to "1".
0x1006	Communication cyclic period 0 ... [0] ... 65535000 µs	Cycle time for sync telegrams. Display of the identifier for emergency telegrams. <ul style="list-style-type: none"> <li>• With the setting "0", no sync telegrams are generated.</li> <li>• The set time is internally rounded up to the next multiple of 10 ms. The shortest possible cycle time thus is 10 ms.</li> </ul>
0x1400:000	RPDO1 communication parameter: Highest sub-index supported <ul style="list-style-type: none"> <li>• Read only</li> </ul>	

# Configuring the network

CANopen  
Process data transfer



Address	Name / setting range / [default setting]	Information
0x1400:001 (P540.01)	RPDO1 communication parameter: COB-ID (RPDO1 config.: COB-ID) 0x00000000 ... [0x0000200] ... 0xFFFFFFFF	RPDO1: identifier  How to change the identifier: 1. Set PDO to "invalid": Set bit 31 to "1". 2. Change identifier and reset PDO to "valid" (bit 31 = "0").
	Bit 0 COB-ID bit 0	
	Bit 1 COB-ID bit 1	
	Bit 2 COB-ID bit 2	
	Bit 3 COB-ID bit 3	
	Bit 4 COB-ID bit 4	
	Bit 5 COB-ID bit 5	
	Bit 6 COB-ID bit 6	
	Bit 7 COB-ID bit 7	
	Bit 8 COB-ID bit 8	
	Bit 9 COB-ID bit 9	
	Bit 10 COB-ID bit 10	
Bit 31 PDO invalid		
0x1400:002 (P540.02)	RPDO1 communication parameter: Transmission type (RPDO1 config.: Transm. type) 0 ... [255] ... 255	RPDO1: transmission type in compliance with DS301 V4.02
0x1400:005 (P540.05)	RPDO1 communication parameter: Event timer (RPDO1 config.: Event timer) 0 ... [100] ... 65535 ms	RPDO1: time-out for the monitoring of data reception. • With setting "0" the monitoring is deactivated.
0x1401:001 (P541.01)	RPDO2 communication parameter: COB-ID (RPDO2 config.: COB-ID) 0x00000000 ... [0x8000300] ... 0xFFFFFFFF	RPDO2: identifier  How to change the identifier: 1. Set PDO to "invalid": Set bit 31 to "1". 2. Change identifier and reset PDO to "valid" (bit 31 = "0").
	Bit 0 COB-ID bit 0	
	Bit 1 COB-ID bit 1	
	Bit 2 COB-ID bit 2	
	Bit 3 COB-ID bit 3	
	Bit 4 COB-ID bit 4	
	Bit 5 COB-ID bit 5	
	Bit 6 COB-ID bit 6	
	Bit 7 COB-ID bit 7	
	Bit 8 COB-ID bit 8	
	Bit 9 COB-ID bit 9	
	Bit 10 COB-ID bit 10	
Bit 31 PDO invalid		
0x1401:002 (P541.02)	RPDO2 communication parameter: Transmission type (RPDO2 config.: Transm. type) 0 ... [255] ... 255	RPDO2: transmission type in compliance with DS301 V4.02
0x1401:005 (P541.05)	RPDO2 communication parameter: Event timer (RPDO2 config.: Event timer) 0 ... [100] ... 65535 ms	RPDO2: time-out for the monitoring of data reception. • With setting "0" the monitoring is deactivated.
0x1402:001 (P542.01)	RPDO3 communication parameter: COB-ID (RPDO3 config.: COB-ID) 0x00000000 ... [0x8000400] ... 0xFFFFFFFF	RPDO3: identifier  How to change the identifier: 1. Set PDO to "invalid": Set bit 31 to "1". 2. Change identifier and reset PDO to "valid" (bit 31 = "0").
	Bit 0 COB-ID bit 0	
	Bit 1 COB-ID bit 1	
	Bit 2 COB-ID bit 2	
	Bit 3 COB-ID bit 3	
	Bit 4 COB-ID bit 4	
	Bit 5 COB-ID bit 5	
	Bit 6 COB-ID bit 6	
	Bit 7 COB-ID bit 7	
	Bit 8 COB-ID bit 8	
	Bit 9 COB-ID bit 9	
	Bit 10 COB-ID bit 10	
Bit 31 PDO invalid		





Address	Name / setting range / [default setting]	Information																										
0x1402:002 (P542.02)	RPDO3 communication parameter: Transmission type (RPDO3 config.: Transm. type) 0 ... [255] ... 255	RPDO3: transmission type in compliance with DS301 V4.02																										
0x1402:005 (P542.05)	RPDO3 communication parameter: Event timer (RPDO3 config.: Event timer) 0 ... [100] ... 65535 ms	RPDO3: time-out for the monitoring of data reception. <ul style="list-style-type: none"> <li>With setting "0" the monitoring is deactivated.</li> </ul>																										
0x1800:000	TPDO1 communication parameter: Highest sub-index supported <ul style="list-style-type: none"> <li>Read only</li> </ul>	The value "5" is permanently set.																										
0x1800:001 (P550.01)	TPDO1 communication parameter: COB-ID (TPDO1 config.: COB-ID) 0x00000001 ... [0x40000180] ... 0xFFFFFFFF <table border="1"> <tr><td>Bit 0</td><td>COB-ID bit 0</td></tr> <tr><td>Bit 1</td><td>COB-ID bit 1</td></tr> <tr><td>Bit 2</td><td>COB-ID bit 2</td></tr> <tr><td>Bit 3</td><td>COB-ID bit 3</td></tr> <tr><td>Bit 4</td><td>COB-ID bit 4</td></tr> <tr><td>Bit 5</td><td>COB-ID bit 5</td></tr> <tr><td>Bit 6</td><td>COB-ID bit 6</td></tr> <tr><td>Bit 7</td><td>COB-ID bit 7</td></tr> <tr><td>Bit 8</td><td>COB-ID bit 8</td></tr> <tr><td>Bit 9</td><td>COB-ID bit 9</td></tr> <tr><td>Bit 10</td><td>COB-ID bit 10</td></tr> <tr><td>Bit 30</td><td>RTR not allowed</td></tr> <tr><td>Bit 31</td><td>PDO invalid</td></tr> </table>	Bit 0	COB-ID bit 0	Bit 1	COB-ID bit 1	Bit 2	COB-ID bit 2	Bit 3	COB-ID bit 3	Bit 4	COB-ID bit 4	Bit 5	COB-ID bit 5	Bit 6	COB-ID bit 6	Bit 7	COB-ID bit 7	Bit 8	COB-ID bit 8	Bit 9	COB-ID bit 9	Bit 10	COB-ID bit 10	Bit 30	RTR not allowed	Bit 31	PDO invalid	TPDO1: identifier How to change the identifier: 1. Set PDO to "invalid": Set bit 31 to "1". 2. Change identifier and reset PDO to "valid" (bit 31 = "0").
Bit 0	COB-ID bit 0																											
Bit 1	COB-ID bit 1																											
Bit 2	COB-ID bit 2																											
Bit 3	COB-ID bit 3																											
Bit 4	COB-ID bit 4																											
Bit 5	COB-ID bit 5																											
Bit 6	COB-ID bit 6																											
Bit 7	COB-ID bit 7																											
Bit 8	COB-ID bit 8																											
Bit 9	COB-ID bit 9																											
Bit 10	COB-ID bit 10																											
Bit 30	RTR not allowed																											
Bit 31	PDO invalid																											
0x1800:002 (P550.02)	TPDO1 communication parameter: Transmission type (TPDO1 config.: Transm. type) 0 ... [255] ... 255	TPDO1: transmission type in compliance with DS301 V4.02																										
0x1800:003 (P550.03)	TPDO1 communication parameter: Inhibit time (TPDO1 config.: Inhibit time) 0.0 ... [0.0] ... 6553.5 ms	TPDO1: minimum time between the transmission of two identical PDOs in compliance with DS301 V4.02 <ul style="list-style-type: none"> <li>The set time is rounded up internally to the nearest multiple of 10 ms.</li> </ul>																										
0x1800:005 (P550.05)	TPDO1 communication parameter: Event timer (TPDO1 config.: Event timer) 0 ... [20] ... 65535 ms	TPDO1: Cycle time for PDO transmission with transmission type "254" or "255". <ul style="list-style-type: none"> <li>The set time is internally rounded up to the next multiple of 10 ms.</li> </ul>																										
0x1801:000	TPDO2 communication parameter: Highest sub-index supported <ul style="list-style-type: none"> <li>Read only</li> </ul>	The value "5" is permanently set.																										
0x1801:001 (P551.01)	TPDO2 communication parameter: COB-ID (TPDO2 config.: COB-ID) 0x00000001 ... [0xC0000280] ... 0xFFFFFFFF <table border="1"> <tr><td>Bit 0</td><td>COB-ID bit 0</td></tr> <tr><td>Bit 1</td><td>COB-ID bit 1</td></tr> <tr><td>Bit 2</td><td>COB-ID bit 2</td></tr> <tr><td>Bit 3</td><td>COB-ID bit 3</td></tr> <tr><td>Bit 4</td><td>COB-ID bit 4</td></tr> <tr><td>Bit 5</td><td>COB-ID bit 5</td></tr> <tr><td>Bit 6</td><td>COB-ID bit 6</td></tr> <tr><td>Bit 7</td><td>COB-ID bit 7</td></tr> <tr><td>Bit 8</td><td>COB-ID bit 8</td></tr> <tr><td>Bit 9</td><td>COB-ID bit 9</td></tr> <tr><td>Bit 10</td><td>COB-ID bit 10</td></tr> <tr><td>Bit 30</td><td>RTR not allowed</td></tr> <tr><td>Bit 31</td><td>PDO invalid</td></tr> </table>	Bit 0	COB-ID bit 0	Bit 1	COB-ID bit 1	Bit 2	COB-ID bit 2	Bit 3	COB-ID bit 3	Bit 4	COB-ID bit 4	Bit 5	COB-ID bit 5	Bit 6	COB-ID bit 6	Bit 7	COB-ID bit 7	Bit 8	COB-ID bit 8	Bit 9	COB-ID bit 9	Bit 10	COB-ID bit 10	Bit 30	RTR not allowed	Bit 31	PDO invalid	TPDO2: identifier How to change the identifier: 1. Set PDO to "invalid": Set bit 31 to "1". 2. Change identifier and reset PDO to "valid" (bit 31 = "0").
Bit 0	COB-ID bit 0																											
Bit 1	COB-ID bit 1																											
Bit 2	COB-ID bit 2																											
Bit 3	COB-ID bit 3																											
Bit 4	COB-ID bit 4																											
Bit 5	COB-ID bit 5																											
Bit 6	COB-ID bit 6																											
Bit 7	COB-ID bit 7																											
Bit 8	COB-ID bit 8																											
Bit 9	COB-ID bit 9																											
Bit 10	COB-ID bit 10																											
Bit 30	RTR not allowed																											
Bit 31	PDO invalid																											
0x1801:002 (P551.02)	TPDO2 communication parameter: Transmission type (TPDO2 config.: Transm. type) 0 ... [255] ... 255	TPDO2: transmission type in compliance with DS301 V4.02																										
0x1801:003 (P551.03)	TPDO2 communication parameter: Inhibit time (TPDO2 config.: Inhibit time) 0.0 ... [0.0] ... 6553.5 ms	TPDO2: minimum time between the transmission of two identical PDOs in compliance with DS301 V4.02																										

# Configuring the network

CANopen  
Process data transfer



Address	Name / setting range / [default setting]	Information
0x1801:005 (P551.05)	TPDO2 communication parameter: Event timer (TPDO2 config.: Event timer) 0 ... [0] ... 65535 ms	TPDO2: Cycle time for PDO transmission with transmission type "254" or "255". • The set time is internally rounded up to the next multiple of 10 ms.
0x1802:000	TPDO3 communication parameter: Highest sub-index supported • Read only	The value "5" is permanently set.
0x1802:001 (P552.01)	TPDO3 communication parameter: COB-ID (TPDO3 config.: COB-ID) 0x00000001 ... [0xC0000380] ... 0xFFFFFFFF	TPDO3: identifier How to change the identifier: 1. Set PDO to "invalid": Set bit 31 to "1". 2. Change identifier and reset PDO to "valid" (bit 31 = "0").
	Bit 0 COB-ID bit 0	
	Bit 1 COB-ID bit 1	
	Bit 2 COB-ID bit 2	
	Bit 3 COB-ID bit 3	
	Bit 4 COB-ID bit 4	
	Bit 5 COB-ID bit 5	
	Bit 6 COB-ID bit 6	
	Bit 7 COB-ID bit 7	
	Bit 8 COB-ID bit 8	
	Bit 9 COB-ID bit 9	
	Bit 10 COB-ID bit 10	
	Bit 30 RTR not allowed	
	Bit 31 PDO invalid	
0x1802:002 (P552.02)	TPDO3 communication parameter: Transmission type (TPDO3 config.: Transm. type) 0 ... [255] ... 255	TPDO3: transmission type in compliance with DS301 V4.02
0x1802:003 (P552.03)	TPDO3 communication parameter: Inhibit time (TPDO3 config.: Inhibit time) 0.0 ... [0.0] ... 6553.5 ms	TPDO3: minimum time between the transmission of two identical PDOs in compliance with DS301 V4.02
0x1802:005 (P552.05)	TPDO3 communication parameter: Event timer (TPDO3 config.: Event timer) 0 ... [0] ... 65535 ms	TPDO3: Cycle time for PDO transmission with transmission type "254" or "255". • The set time is internally rounded up to the next multiple of 10 ms.
0x2301:006 (P510.06)	CANopen settings: COB-ID Configuration - PDO (CANopen sett.: COB-IDConfig PDO) • From version 03.00	Selection of the process for assigning the identifiers. Irrespective of this selection, these are the following bits of the identifiers: • Bit 30: "RTR not allowed" (only in case of TPDO) • Bit 31: "PDO invalid"
	0 Base + node-ID	Identifier = set (basic) identifiers + set node address
	1 Freely configurable	Identifier = set identifiers
	2 Legacy base + node ID	Identifier = inherited (basic) identifier + set node address



### 12.10.3.1 Data mapping

Data mapping serves to define which process data are transmitted cyclically via the process data channels.

#### Details

Data mapping (in the case of CANopen also referred to as "PDO mapping") is preconfigured for control of the inverter via the device profile CiA 402:

- RPDO1 = **0x6040** (CiA control word) and **0x6042 (P781.00)** (Set speed).
- TPDO1 = **0x6041 (P780.00)** (CiA status word) and **0x6044 (P783.00)** (Actual speed).

#### Variable PDO mapping

The inverter supports variable PDO mapping for individual drive solutions. With 8 mapping entries each, 8-bit, 16-bit and 32-bit parameters can be assigned to a PDO in any order.



The total length of the mapped parameters must not exceed 8 bytes. The PDO mapping cannot be applied to all parameters. The mappable parameters are marked correspondingly in the parameter attribute list. [▶ Parameter attribute list](#) [731](#)

The process of variable PDO mapping only allows the following procedure:

1. Set PDO to "invalid": set bit 31 in the corresponding identifier to "1".  
Identifiers:  
**0x1400:001 (P540.01) ... 0x1402:001 (P542.01)** or  
**0x1800:001 (P550.01) ... 0x1802:001 (P552.01)**
2. Set PDO mapping to "invalid": set subindex 0 in the mapping parameter to "0".  
Mapping parameters:  
**0x1600:000 ... 0x1602:000** or  
**0x1A00:000 ... 0x1A02:000**
3. Set desired PDO mapping via the corresponding mapping entries.  
Format: Oxiiiissl  
(iiii = hexadecimal index,  
ss = hexadecimal subindex,  
ll = hexadecimal data length)
4. Set subindex 0 in the mapping parameter to valid value (number of mapped parameters).  
Mapping parameters:  
**0x1600:000 ... 0x1602:000** or  
**0x1A00:000 ... 0x1A02:000**
5. Set PDO back to "valid": set bit 31 in the corresponding identifier to "0".  
Identifiers:  
**0x1400:001 (P540.01) ... 0x1402:001 (P542.01)** or  
**0x1800:001 (P550.01) ... 0x1802:001 (P552.01)**

#### Parameter

Address	Name / setting range / [default setting]	Information
0x1600:000	RPDO1 mapping parameter: Number of mapped application objects in PDO 0 ... [2] ... 8	Number of objects mapped in RPDO1.
0x1600:001	RPDO1 mapping parameter: Application object 1 0x00000000 ... [0x60400010] ... 0xFFFFFFFF	Mapping entry 1 for RPDO1.
0x1600:002	RPDO1 mapping parameter: Application object 2 0x00000000 ... [0x60420010] ... 0xFFFFFFFF	Mapping entry 2 for RPDO1.
0x1600:003	RPDO1 mapping parameter: Application object 3 0x00000000 ... [0x00000000] ... 0xFFFFFFFF	Mapping entry 3 for RPDO1.
0x1600:004	RPDO1 mapping parameter: Application object 4 0x00000000 ... [0x00000000] ... 0xFFFFFFFF	Mapping entry 4 for RPDO1.
0x1600:005	RPDO1 mapping parameter: Application object 5 0x00000000 ... [0x00000000] ... 0xFFFFFFFF	Mapping entry 5 for RPDO1.

# Configuring the network

CANopen  
Process data transfer  
Data mapping



Address	Name / setting range / [default setting]	Information
0x1600:006	RPDO1 mapping parameter: Application object 6 0x00000000 ... [0x00000000] ... 0xFFFFFFFF	Mapping entry 6 for RPDO1.
0x1600:007	RPDO1 mapping parameter: Application object 7 0x00000000 ... [0x00000000] ... 0xFFFFFFFF	Mapping entry 7 for RPDO1.
0x1600:008	RPDO1 mapping parameter: Application object 8 0x00000000 ... [0x00000000] ... 0xFFFFFFFF	Mapping entry 8 for RPDO1.
0x1601:000	RPDO2 mapping parameter: Number of mapped application objects in PDO 0 ... [0] ... 8	Number of objects mapped in RPDO2.
0x1601:001	RPDO2 mapping parameter: Application object 1 0x00000000 ... [0x00000000] ... 0xFFFFFFFF	Mapping entry 1 for RPDO2.
0x1601:002	RPDO2 mapping parameter: Application object 2 0x00000000 ... [0x00000000] ... 0xFFFFFFFF	Mapping entry 2 for RPDO2.
0x1601:003	RPDO2 mapping parameter: Application object 3 0x00000000 ... [0x00000000] ... 0xFFFFFFFF	Mapping entry 3 for RPDO2.
0x1601:004	RPDO2 mapping parameter: Application object 4 0x00000000 ... [0x00000000] ... 0xFFFFFFFF	Mapping entry 4 for RPDO2.
0x1601:005	RPDO2 mapping parameter: Application object 5 0x00000000 ... [0x00000000] ... 0xFFFFFFFF	Mapping entry 5 for RPDO2.
0x1601:006	RPDO2 mapping parameter: Application object 6 0x00000000 ... [0x00000000] ... 0xFFFFFFFF	Mapping entry 6 for RPDO2.
0x1601:007	RPDO2 mapping parameter: Application object 7 0x00000000 ... [0x00000000] ... 0xFFFFFFFF	Mapping entry 7 for RPDO2.
0x1601:008	RPDO2 mapping parameter: Application object 8 0x00000000 ... [0x00000000] ... 0xFFFFFFFF	Mapping entry 8 for RPDO2.
0x1602:000	RPDO3 mapping parameter: Number of mapped application objects in PDO 0 ... [0] ... 8	Number of objects mapped in RPDO3.
0x1602:001	RPDO3 mapping parameter: Application object 1 0x00000000 ... [0x00000000] ... 0xFFFFFFFF	Mapping entry 1 for RPDO3.
0x1602:002	RPDO3 mapping parameter: Application object 2 0x00000000 ... [0x00000000] ... 0xFFFFFFFF	Mapping entry 2 for RPDO3.
0x1602:003	RPDO3 mapping parameter: Application object 3 0x00000000 ... [0x00000000] ... 0xFFFFFFFF	Mapping entry 3 for RPDO3.
0x1602:004	RPDO3 mapping parameter: Application object 4 0x00000000 ... [0x00000000] ... 0xFFFFFFFF	Mapping entry 4 for RPDO3.
0x1602:005	RPDO3 mapping parameter: Application object 5 0x00000000 ... [0x00000000] ... 0xFFFFFFFF	Mapping entry 5 for RPDO3.
0x1602:006	RPDO3 mapping parameter: Application object 6 0x00000000 ... [0x00000000] ... 0xFFFFFFFF	Mapping entry 6 for RPDO3.
0x1602:007	RPDO3 mapping parameter: Application object 7 0x00000000 ... [0x00000000] ... 0xFFFFFFFF	Mapping entry 7 for RPDO3.
0x1602:008	RPDO3 mapping parameter: Application object 8 0x00000000 ... [0x00000000] ... 0xFFFFFFFF	Mapping entry 8 for RPDO3.
0x1A00:000	TPDO1 mapping parameter: Number of mapped application objects in TPDO 0 ... [2] ... 8	Number of objects mapped in TPDO1.
0x1A00:001	TPDO1 mapping parameter: Application object 1 0x00000000 ... [0x60410010] ... 0xFFFFFFFF	Mapping entry 1 for TPDO1.
0x1A00:002	TPDO1 mapping parameter: Application object 2 0x00000000 ... [0x60440010] ... 0xFFFFFFFF	Mapping entry 2 for TPDO1.
0x1A00:003	TPDO1 mapping parameter: Application object 3 0x00000000 ... [0x00000000] ... 0xFFFFFFFF	Mapping entry 3 for TPDO1.
0x1A00:004	TPDO1 mapping parameter: Application object 4 0x00000000 ... [0x00000000] ... 0xFFFFFFFF	Mapping entry 4 for TPDO1.
0x1A00:005	TPDO1 mapping parameter: Application object 5 0x00000000 ... [0x00000000] ... 0xFFFFFFFF	Mapping entry 5 for TPDO1.
0x1A00:006	TPDO1 mapping parameter: Application object 6 0x00000000 ... [0x00000000] ... 0xFFFFFFFF	Mapping entry 6 for TPDO1.
0x1A00:007	TPDO1 mapping parameter: Application object 7 0x00000000 ... [0x00000000] ... 0xFFFFFFFF	Mapping entry 7 for TPDO1.



# Configuring the network

CANopen  
Process data transfer  
Data mapping

Address	Name / setting range / [default setting]	Information
0x1A00:008	TPDO1 mapping parameter: Application object 8 0x00000000 ... [0x00000000] ... 0xFFFFFFFF	Mapping entry 8 for TPDO1.
0x1A01:000	TPDO2 mapping parameter: Number of mapped application objects in TPDO 0 ... [0] ... 8	Number of objects mapped in TPDO2.
0x1A01:001	TPDO2 mapping parameter: Application object 1 0x00000000 ... [0x00000000] ... 0xFFFFFFFF	Mapping entry 1 for TPDO2.
0x1A01:002	TPDO2 mapping parameter: Application object 2 0x00000000 ... [0x00000000] ... 0xFFFFFFFF	Mapping entry 2 for TPDO2.
0x1A01:003	TPDO2 mapping parameter: Application object 3 0x00000000 ... [0x00000000] ... 0xFFFFFFFF	Mapping entry 3 for TPDO2.
0x1A01:004	TPDO2 mapping parameter: Application object 4 0x00000000 ... [0x00000000] ... 0xFFFFFFFF	Mapping entry 4 for TPDO2.
0x1A01:005	TPDO2 mapping parameter: Application object 5 0x00000000 ... [0x00000000] ... 0xFFFFFFFF	Mapping entry 5 for TPDO2.
0x1A01:006	TPDO2 mapping parameter: Application object 6 0x00000000 ... [0x00000000] ... 0xFFFFFFFF	Mapping entry 6 for TPDO2.
0x1A01:007	TPDO2 mapping parameter: Application object 7 0x00000000 ... [0x00000000] ... 0xFFFFFFFF	Mapping entry 7 for TPDO2.
0x1A01:008	TPDO2 mapping parameter: Application object 8 0x00000000 ... [0x00000000] ... 0xFFFFFFFF	Mapping entry 8 for TPDO2.
0x1A02:000	TPDO3 mapping parameter: Number of mapped application objects in TPDO 0 ... [0] ... 8	Number of objects mapped in TPDO3.
0x1A02:001	TPDO3 mapping parameter: Application object 1 0x00000000 ... [0x00000000] ... 0xFFFFFFFF	Mapping entry 1 for TPDO3.
0x1A02:002	TPDO3 mapping parameter: Application object 2 0x00000000 ... [0x00000000] ... 0xFFFFFFFF	Mapping entry 2 for TPDO3.
0x1A02:003	TPDO3 mapping parameter: Application object 3 0x00000000 ... [0x00000000] ... 0xFFFFFFFF	Mapping entry 3 for TPDO3.
0x1A02:004	TPDO3 mapping parameter: Application object 4 0x00000000 ... [0x00000000] ... 0xFFFFFFFF	Mapping entry 4 for TPDO3.
0x1A02:005	TPDO3 mapping parameter: Application object 5 0x00000000 ... [0x00000000] ... 0xFFFFFFFF	Mapping entry 5 for TPDO3.
0x1A02:006	TPDO3 mapping parameter: Application object 6 0x00000000 ... [0x00000000] ... 0xFFFFFFFF	Mapping entry 6 for TPDO3.
0x1A02:007	TPDO3 mapping parameter: Application object 7 0x00000000 ... [0x00000000] ... 0xFFFFFFFF	Mapping entry 7 for TPDO3.
0x1A02:008	TPDO3 mapping parameter: Application object 8 0x00000000 ... [0x00000000] ... 0xFFFFFFFF	Mapping entry 8 for TPDO3.



## 12.10.4 Parameter data transfer

Service data objects (SDOs) make it possible to read and write all parameters of the inverter via CANopen.

### Details

- Two independent SDO channels are provided at the same time. SDO channel 1 is always active. SDO channel 2 can be activated via [0x2301:005 \(P510.05\)](#).
- An SDO is always transmitted with confirmation, i. e. the reception of an SDO frame is acknowledged by the receiver.
- The identifiers for SDO1 and SDO2 are generated from the basic identifier (in compliance with the "Predefined Connection Set") and the node address set:

Object	Direction		Identifier
	to the device	from the device	
SDO1	●		Basic identifier 0x600 + node address
		●	Basic identifier 0x580 + node address
SDO2	●		Basic identifier 0x640 + node address
		●	Basic identifier 0x5C0 + node address

### Structure of the SDO frame user data

The user data are shown in Motorola format:

1st byte	2nd byte	3rd byte	4th byte	5th byte	6th byte	7th byte	8th byte
Command	Index		Subindex	Data 1	Data 2	Data 3	Data 4
See table below.	LOW byte	HIGH byte		LOW word		HIGH word	
	Address of the parameter to be read or written.			LOW byte	HIGH byte	LOW byte	HIGH byte

The following commands can be transmitted or received for writing and reading the parameters:

Command	1st byte		Data length	Info
	hex	dec		
Write request	0x23	35	4 bytes	Writing of a parameter to the inverter.
	0x2B	43	2 bytes	
	0x2F	47	1 byte	
	0x21	33	Block	
Write response	0x60	96	4 bytes	Inverter acknowledges a write request.
Read request	0x40	64	4 bytes	Reading of a parameter from the inverter.
Read response	0x43	67	4 bytes	Inverter response to a read request with the current parameter value.
	0x4B	75	2 bytes	
	0x4F	79	1 byte	
	0x41	65	Block	
Error response	0x80	128	4 bytes	Inverter response to the incorrect execution of the read/write request.

More precisely, the command byte comprises the following information:

Command	1st byte							
	Command specifier (cs)			Toggle (t)	Length*		e	s
	Bit 7	Bit 6	Bit 5	Bit 4	Bit 3	Bit 2	Bit 1	Bit 0
Write request	0	0	1	0	0/1	0/1	1	1
Write response	0	1	1	0	0	0	0	0
Read request	0	1	0	0	0	0	0	0
Read response	0	1	0	0	0/1	0/1	1	1
Error response	1	0	0	0	0	0	0	0

\*Bit coding of the length: 00 = 4 bytes, 01 = 3 bytes, 10 = 2 bytes, 11 = 1 byte  
e: expedited (shortened block service)  
s: segmented (normal block service)

More commands are defined in the DS301 V4.02 CANopen specification (e. g. segmented transfer).



Up to 4 bytes are available for parameter value entries. Depending on the data format, they are assigned as follows:

5th byte	6th byte	7th byte	8th byte
Parameter value (1 byte)	0x00	0x00	0x00
Parameter value (2 bytes)		0x00	0x00
LOW byte	HIGH byte		
Parameter value (4 bytes)			
LOW word		HIGH word	
LOW byte	HIGH byte	LOW byte	HIGH byte



The parameter attribute list in the annex also specifies a so-called “scaling factor”. The scaling factor is relevant to the transmission of parameter values which are represented with one or several decimal positions in the parameter list. If the scaling factor is > 1, the value must be multiplied with the scaling factor specified before the transmission, so that the value can be transferred completely (as an integer value). On the SDO client side, the integer value must then be divided by the scaling factor again, in order to receive the original value with decimal positions.

## Parameter

Address	Name / setting range / [default setting]	Information
0x1200:000	SDO1 server parameter: Highest sub-index supported • Read only	
0x1200:001	SDO1 server parameter: COB-ID client > server (rx) • Read only	Display of the receive identifier for SDO server channel 1 (basic SDO channel). • According to DS301 V4.02, the basic SDO channel can neither be changed nor deactivated.
0x1200:002	SDO1 server parameter: COB-ID server > client (tx) • Read only	Display of the transmit identifier for SDO server channel 1 (basic SDO channel). • According to DS301 V4.02, the basic SDO channel can neither be changed nor deactivated.
0x1201:000	SDO2 server parameter: Highest sub-index supported • Read only	
0x1201:001	SDO2 server parameter: COB-ID client > server (rx) 0x00000000 ... [0x80000640] ... 0xFFFFFFFF	Specification of the receive identifier for SDO server channel 2. • If SDO server channel 2 is activated via 0x2301:005 (P510.05), this parameter is set to the value "node address + 0x640". This default setting can be changed.
0x1201:002	SDO2 server parameter: COB-ID server > client (tx) 0x00000000 ... [0x800005C0] ... 0xFFFFFFFF	Specification of the transmit identifier for SDO server channel 2. • If SDO server channel 2 is activated via 0x2301:005 (P510.05), this parameter is set to the value "node address + 0x5C0". This default setting can be changed.
0x1201:003	SDO2 server parameter: Node-ID of the SDO client 1 ... [0] ... 127	Specification of the node address for the SDO client.
0x2301:005 (P510.05)	CANopen settings: Activate SDO2 channel (CANopen sett.: SDO2 channel)	1 = activate SDO server channel 2.
	0 Not active 1 Active	
0x2301:007 (P510.07)	CANopen settings: COB-ID Configuration - SDO2 (CANopen sett.: COB-IDConfigSDO2)	1 = COB-ID configuration -SDO 2 freely configurable.
	0 Base + node-ID 1 Freely configurable	



## 12.10.5 Monitoring

### 12.10.5.1 Emergency telegram

If the error status changes when an internal device error occurs or is remedied, an emergency telegram is sent to the NMT master once.

#### Details

- The identifier for the emergency telegram is fixedly defined and is shown in [0x1014](#).
- In [0x1015](#), a blocking time can be set, in order to limit the bus load in the case of emergency telegrams following quickly in succession.

#### Parameter

Address	Name / setting range / [default setting]	Information
0x1014	COB-ID Emergency telegram (EMCY) • Read only	
0x1015	Inhibit time EMCY 0.0 ... [0.0] ... 6553.5 ms	Blocking time which can be set in order to limit the bus load in the case of emergency telegrams following quickly in succession.

### 12.10.5.2 Heartbeat protocol

The heartbeat protocol can be used for node monitoring purposes within a CAN network.

#### Basic procedure

1. A heartbeat producer cyclically sends a heartbeat telegram to one or several receivers (consumers).
2. The consumer(s) monitor(s) the heartbeat telegram for arrival on a regular basis.

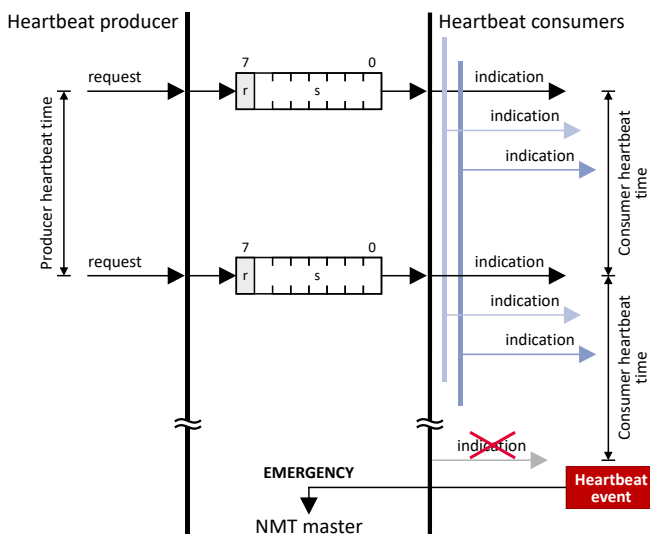

The inverter can be configured as producer or as consumer to monitor up to four other nodes.

#### Parameter

Address	Name / setting range / [default setting]	Information
0x1016:000 (P520.00)	Consumer heartbeat time: Highest sub-index supported (Cons. heartbeat: Highest subindex) • Read only	Highest subindex, permanently set to 4. Corresponds at the same time to the maximum possible number of nodes to be monitored.
0x1016:001 (P520.01)	Consumer heartbeat time: Consumer heartbeat time 1 (Cons. heartbeat: Cons. heartbeat1) 0x00000000 ... [0x00000000] ... 0x00FFFFFF	Node ID and heartbeat time of node 1 which is to be monitored. • Format: 0x00nnhhhh (nn = node ID, hhhh = heartbeat time in [ms])
0x1016:002 (P520.02)	Consumer heartbeat time: Consumer heartbeat time 2 (Cons. heartbeat: Cons. heartbeat2) 0x00000000 ... [0x00000000] ... 0x00FFFFFF	Node ID and heartbeat time of node 2 which is to be monitored. • Format: 0x00nnhhhh (nn = node ID, hhhh = heartbeat time in [ms])





Address	Name / setting range / [default setting]	Information
0x1016:003 (P520.03)	Consumer heartbeat time: Consumer heartbeat time 3 (Cons. heartbeat: Cons. heartbeat3) 0x00000000 ... [0x00000000] ... 0x00FFFFFF	Node ID and heartbeat time of node 3 which is to be monitored. • Format: 0x00nnhhhh (nn = node ID, hhhh = heartbeat time in [ms])
0x1016:004 (P520.04)	Consumer heartbeat time: Consumer heartbeat time 4 (Cons. heartbeat: Cons. heartbeat4) 0x00000000 ... [0x00000000] ... 0x00FFFFFF	Node ID and heartbeat time of node 4 which is to be monitored. • Format: 0x00nnhhhh (nn = node ID, hhhh = heartbeat time in [ms])
0x1017 (P522.00)	Producer heartbeat time (Prod. heartbeat) 0 ... [0] ... 65535 ms	Time interval for the transmission of the heartbeat telegram to the consumer(s). • The heartbeat telegram is sent automatically as soon as a time > 0 ms is set. • The set time is internally rounded up to the next multiple of 10 ms.

### 12.10.5.3 Error responses

The responses to CANopen errors such as missing PDOs or heartbeat frames can be configured via the following parameters.

#### Parameter

Address	Name / setting range / [default setting]	Information
0x1029:000	Error behavior: Highest sub-index supported • Read only	
0x1029:001	Error behavior: Communication error	Selection of the NMT state to which the inverter is to change automatically if a failure of a CANopen node or an internal error is detected in the "Operational" state.  These also include the following communication errors: • Change-over of the CAN interface to the "Bus-off" state. • Occurrence of a "Heartbeat Event".
	<b>0</b> Status > Pre-operational	In the "Pre-operational" state, network management, sync, and emergency telegrams as well as parameter data can be received; process data, however, are ignored.
	<b>1</b> No status change	
	<b>2</b> Status > Stopped	In the "Stopped" state, only network management telegrams can be received.
0x2857:001	CANopen monitoring: RPDO1-Timeout	Selection of the response to triggering the RPDO1 time monitoring.  Associated event ID: • 33425   0x8291 - CAN: RPDO1 time-out
	<b>0</b> No response	▶ Severity <a href="#">□ 700</a>
	<b>1</b> Warning	
	<b>2</b> Trouble	
	<b>3</b> Fault	
0x2857:002	CANopen monitoring: RPDO2-Timeout	Selection of the response to triggering the RPDO2 time monitoring.  Associated event ID: • 33426   0x8292 - CAN: RPDO2 time-out
	<b>0</b> No response	▶ Severity <a href="#">□ 700</a>
	<b>1</b> Warning	
	<b>2</b> Trouble	
	<b>3</b> Fault	
0x2857:003	CANopen monitoring: RPDO3-Timeout	Selection of the response to triggering the RPDO3 time monitoring.  Associated event ID: • 33427   0x8293 - CAN: RPDO3 time-out
	<b>0</b> No response	▶ Severity <a href="#">□ 700</a>
	<b>1</b> Warning	
	<b>2</b> Trouble	
	<b>3</b> Fault	

# Configuring the network

CANopen  
Monitoring  
Error responses



Address	Name / setting range / [default setting]	Information
0x2857:005	CANopen monitoring: Heartbeat-Timeout Consumer 1	
	Selection of the response with "Heartbeat Event" in consumer 1. Associated event ID: • 33156   0x8184 - CAN: heartbeat time-out consumer 1	
	0	No response ▶ Severity <a href="#">700</a>
	1	Warning
	2	Trouble
	<b>3 Fault</b>	
0x2857:006	CANopen monitoring: Heartbeat-Timeout Consumer 2	
	Selection of the response with "Heartbeat Event" in consumer 2. Associated event ID: • 33157   0x8185 - CAN: heartbeat time-out consumer 2	
	0	No response ▶ Severity <a href="#">700</a>
	1	Warning
	2	Trouble
	<b>3 Fault</b>	
0x2857:007	CANopen monitoring: Heartbeat-Timeout Consumer 3	
	Selection of the response with "Heartbeat Event" in consumer 3. Associated event ID: • 33158   0x8186 - CAN: heartbeat time-out consumer 3	
	0	No response ▶ Severity <a href="#">700</a>
	1	Warning
	2	Trouble
	<b>3 Fault</b>	
0x2857:008	CANopen monitoring: Heartbeat-Timeout Consumer 4	
	Selection of the response with "Heartbeat Event" in consumer 4. Associated event ID: • 33159   0x8187 - CAN: heartbeat time-out consumer 4	
	0	No response ▶ Severity <a href="#">700</a>
	1	Warning
	2	Trouble
	<b>3 Fault</b>	
0x2857:010	CANopen monitoring: "Bus-off" state change	
	Selection of the response to changing to the "Bus off" state. Associated event ID: • 33154   0x8182 - CAN: bus off	
	0	No response ▶ Severity <a href="#">700</a>
	1	Warning
	<b>2 Trouble</b>	
	3 Fault	
0x2857:011	CANopen monitoring: Warning	
	Selection of the response that is executed in the case of too many incorrectly sent or received CAN telegrams (> 96). Associated event ID: • 33155   0x8183 - CAN: warning	
	0	No response ▶ Severity <a href="#">700</a>
	<b>1 Warning</b>	
	2	Trouble
	3 Fault	





## 12.10.6 Diagnostics

### 12.10.6.1 Status LEDs

Information about the CAN bus status can be obtained quickly via the "CAN-RUN" and "CAN-ERR" LED displays on the front of the inverter.



The meaning can be seen from the tables below.

#### Inverter not active on the CAN bus (yet)



LED "CAN-RUN"	LED "CAN-ERR"	Meaning
off	off	Inverter is not active on the CAN bus.
	 on	"Bus Off" state.
 Both LEDs are flickering alternately		Automatic baud rate detection active.

#### Inverter active on the CAN bus

The green "CAN-RUN" LED indicates the CANopen state:

LED "CAN-RUN"	CANopen state
 blinking fast (5 Hz)	Pre-Operational
 on	Operational
 blinking 1x, then goes off for 1 s	Stopped

The red "CAN-ERR" LED indicates a CANopen error:

LED "CAN-ERR"	CANopen error
 blinking 1x, then goes off for 1 s	Warning Limit reached
 blinking 2x, then goes off for 1 s	Heartbeat Event
 blinking 3x, then goes off for 1 s	Sync message error (only possible in the "Operational" state)

### 12.10.6.2 Information on the network

The inverter has various diagnostic parameters for displaying ...

- the active node address, baud rate and current DIP switch settings;
- the network status, the CAN master status and the status of various time monitors;
- telegram counters.

The telegram counters are free-running, i. e. after reaching the maximum value, the respective counter starts again at 0.

The following parameters show information on the network.

#### Parameter

Address	Name / setting range / [default setting]	Information
0x1001	Error register • Read only	Bit-coded error status. • Bit 0 is set if an error is active.  The other bits signalise which group the active error belongs to: • Bit 1: Current error • Bit 2: Voltage error • Bit 3: Temperature error • Bit 4: Communication error • Bit 5: Device profile-specific error • Bit 6: Reserved (always 0) • Bit 7: Manufacturer-specific error

# Configuring the network

CANopen  
Diagnostics  
Information on the network



Address	Name / setting range / [default setting]	Information
0x2302:001 (P511.01)	Active CANopen settings: Active node ID (CANopen diag.: Active node ID) • Read only	Display of the active node address.
0x2302:002 (P511.02)	Active CANopen settings: Active baud rate (CANopen diag.: Active baud rate) • Read only	Display of the active baud rate.
	0 Automatic (from version 03.00)	
	1 20 kbps	
	2 50 kbps	
	3 125 kbps	
	4 250 kbps	
	5 500 kbps	
	6 800 kbps	
7 1 Mbps		
0x2303 (P509.00)	CANopen switch position (CANopen switch) • Read only	Display of the DIP switch setting at the last mains power-on.
0x2307 (P515.00)	CANopen time-out status (Time-out status) • Read only	Bit-coded status display of the CAN time monitoring functions.
	Bit 0 RPDO1-Timeout	1 = RPDO1 was not received within the monitoring time or not with the sync configured. • Status is reset automatically after the RPDO has been received again. • Setting of monitoring time for RPDO1 in <a href="#">0x1400:005 (P540.05)</a> .
	Bit 1 RPDO2-Timeout	1 = RPDO2 was not received within the monitoring time or not with the sync configured. • Status is reset automatically after the RPDO has been received again. • Setting of monitoring time for RPDO2 in <a href="#">0x1401:005 (P541.05)</a> .
	Bit 2 RPDO3-Timeout	1 = RPDO3 was not received within the monitoring time or not with the sync configured. • Status is reset automatically after the RPDO has been received again. • Setting of monitoring time for RPDO3 in <a href="#">0x1402:005 (P542.05)</a> .
	Bit 8 Heartbeat-Timeout Consumer 1	1 = within the "Heartbeat Consumer Time", no heartbeat telegram was received from node 1 to be monitored. • Status can only be reset by mains switching or error reset. • "Heartbeat Consumer Time" setting in <a href="#">0x1016:001 (P520.01)</a> .
	Bit 9 Heartbeat-Timeout Consumer 2	1 = within the "Heartbeat Consumer Time", no heartbeat telegram was received from node 2 to be monitored. • Status can only be reset by mains switching or error reset. • "Heartbeat Consumer Time" setting in <a href="#">0x1016:002 (P520.02)</a> .
	Bit 10 Heartbeat-Timeout Consumer 3	1 = within the "Heartbeat Consumer Time", no heartbeat telegram was received from node 3 to be monitored. • Status can only be reset by mains switching or error reset. • "Heartbeat Consumer Time" setting in <a href="#">0x1016:003 (P520.03)</a> .
	Bit 11 Heartbeat-Timeout Consumer 4	1 = within the "Heartbeat Consumer Time", no heartbeat telegram was received from node 4 to be monitored. • Status can only be reset by mains switching or error reset. • "Heartbeat Consumer Time" setting in <a href="#">0x1016:004 (P520.04)</a> .



# Configuring the network

CANopen  
Diagnostics  
Information on the network

Address	Name / setting range / [default setting]	Information
0x2308 (P516.00)	CANopen status (CANopen status) • Read only	Display of the current state.
	0 Initialisation	Initialisation active. • The initialisation is started automatically at mains connection. During this phase, the inverter is not involved in the data exchange process on the CAN bus. • All CAN-relevant parameters are initialised with the saved settings. • When the initialisation process has been completed, the inverter automatically adopts the "Pre-Operational" state.
	1 Reset node	"Reset Node" NMT command active. • All parameters are initialised with the saved settings (not only the CAN-relevant parameters).
	2 Reset communication	"Reset Communication" NMT command active. • Initialization of all CANopen-relevant parameters with the saved settings.
	4 Stopped	"Stop remote node" NMT command active. • Only network management telegrams can be received.
	5 Operational	Parameter data and process data can be received. If defined, process data is sent as well.
	127 Pre-Operational	Parameter data can be received, process data are ignored.
0x2309 (P517.00)	CANopen controller status (CAN contr.status) • Read only	Status display of the internal CANopen controller.
	1 Error active	The inverter is a fully-fledged communication node at the CANopen network. It is able to transmit and receive data and to report faults.
	2 Error passive	The inverter can only passively indicate faulty reception via the ACK field.
	3 Bus off	The inverter is electrically separated from the CANopen network. In order to exit this state, the CANopen interface must be reset. An automatic restart is implemented.
0x230A:000	CANopen statistics: Highest subindex • Read only	Number of frame and error counters.
0x230A:001 (P580.01)	CANopen statistics: PDO1 received (CAN statistics: PDO1 received) • Read only	Display of the number of PDO1 telegrams received.
0x230A:002 (P580.02)	CANopen statistics: PDO2 received (CAN statistics: PDO2 received) • Read only	Display of the number of PDO2 telegrams received.
0x230A:003 (P580.03)	CANopen statistics: PDO3 received (CAN statistics: PDO3 received) • Read only	Display of the number of PDO3 telegrams received.
0x230A:005 (P580.05)	CANopen statistics: PDO1 transmitted (CAN statistics: PDO1 transmitted) • Read only	Display of the number of PDO1 telegrams sent.
0x230A:006 (P580.06)	CANopen statistics: PDO2 transmitted (CAN statistics: PDO2 transmitted) • Read only	Display of the number of PDO2 telegrams sent.
0x230A:007 (P580.07)	CANopen statistics: PDO3 transmitted (CAN statistics: PDO3 transmitted) • Read only	Display of the number of PDO3 telegrams sent.
0x230A:009 (P580.09)	CANopen statistics: SDO1 telegrams (CAN statistics: SDO1 counter) • Read only	Display of the number of SDO1 telegrams.
0x230A:010 (P580.10)	CANopen statistics: SDO2 telegrams (CAN statistics: SDO2 counter) • Read only	Display of the number of SDO2 telegrams.
0x230B (P518.00)	CANopen error counter (CAN errorcounter) • Read only	Display of the total number of CAN faults that have occurred.



## 12.10.6.3 Device identification

For device identification in the network, the inverter provides the parameters listed in the following.

### Parameter

Address	Name / setting range / [default setting]	Information
0x1000	Device type • Read only	CANopen device profile according CANopen specification CiA 301/ CiA 402.  Specifies the axis type: • 0x01010192 = single axis • 0x02010192 = double axis • 0x01020192 = servo single axis • 0x02020192 = servo double axis • 0x01030192 = stepper single axis • 0x02030192 = stepper double axis
0x1008	Manufacturer device name • Read only	Display of the manufacturer device name.
0x1009	Manufacturer hardware version • Read only	Display of the manufacturer hardware version.
0x100A	Manufacturer software version • Read only	Display of the manufacturer software version.
0x1018:001	Identity object: Vendor ID • Read only	Display of the manufacturer's identification number.
0x1018:002	Identity object: Product ID • Read only	Display of the product code of the inverter.
0x1018:003	Identity object: Revision number • Read only	Display of the main and subversion of the firmware.
0x1018:004	Identity object: Serial number • Read only	Display of the serial number of the inverter.



## 12.11 Modbus RTU



Modbus is an internationally approved, asynchronous, serial communication protocol, designed for commercial and industrial automation applications.

- Detailed information on the Modbus can be found on the web page of the international Modbus Organization, USA, who also further develop the Modbus protocol: <https://www.modbus.org>
- Information about the dimensioning of a Modbus network can be found in the configuration document for the inverter.

### Preconditions

- The control unit (CU) of the inverter is provided with Modbus.

### Details

- The process of data transmission distinguishes between three different operating modes: Modbus ASCII, Modbus RTU, and Modbus TCP. This chapter describes the Modbus RTU operating mode ("Remote Terminal Unit").
- The Modbus protocol is based on a master/slave architecture where the inverter always works as slave.
- The Modbus network only permits one master sending commands and requests. The master is also the sole instance to be allowed to initiate Modbus communication. No direct communication takes place between the slaves.
- The physical interface corresponds to TIA/EIA-485-A which is very common and suitable for the industrial environment. This interface enables baud rates from 2400 to 115200 kbps.
- The inverter supports Modbus function codes 3, 6, 16 (0x10) and 23 (0x17).

### Typical topology

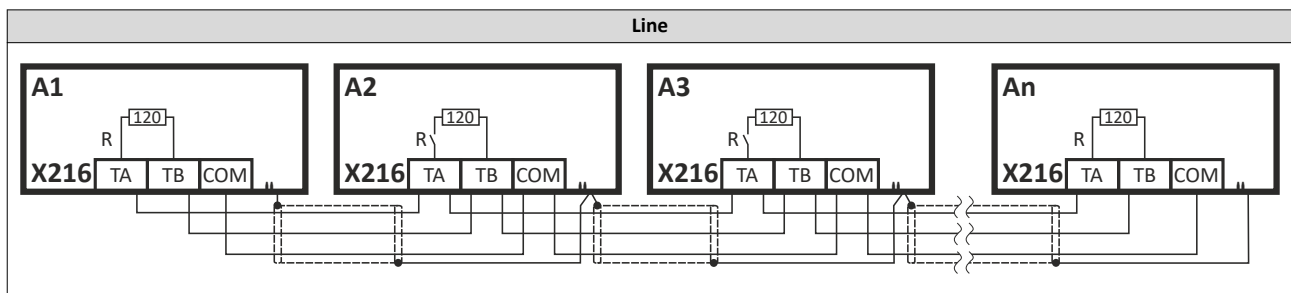



## 12.11.1 Commissioning

In the following, the steps required for controlling the inverter via Modbus are described.

### Parameterization required

1. Activate network control: **0x2631:037 (P400.37)** = "TRUE [1]"
2. Set network as standard setpoint source: **0x2860:001 (P201.01)** = "Network [5]"
3. Set Modbus node address.
  - Each network node must be provided with a unique node address.
  - See: [Basic setting and options](#) 394
4. Set Modbus baud rate.
  - Default setting: Automatic detection.
  - If the automatic baud rate detection function is activated, the first 5 to 10 messages are lost after switch-on.
  - See: [Basic setting and options](#) 394
5. Set Modbus data format.
  - Default setting: Automatic detection.
  - If the automatic data format detection function is activated, the first 5 to 10 messages are lost after switch-on.
  - See: [Basic setting and options](#) 394
6. Save parameter settings: **0x2022:003 (P700.03)** = "on / start [1]".
7. Switch the inverter off and then on again in order that the changed communication settings can get effective.



In the default setting, the "Run" function is assigned to digital input DI1. If network control is activated, this function serves as the "start enable" for starting commands via the network. Hence, digital input DI1 must be set to the HIGH level so the motor can be started via the network.

[Flexible I/O configuration of the start, stop and rotating direction commands](#) 67

### Starting/stopping the drive via Modbus

For starting/stopping the drive, Modbus register 42101 can be used.

- The Modbus register 42101 is permanently assigned to the parameter **0x400B:001 (P592.01)** (AC Drive control word).
- In the frame, the leading 4 is omitted in the addressing process. The numbering of the registers starts with 1; addressing, however, starts with 0. Therefore the address 2100 (0x0834) is used in the frame when register 42101 is written.

Bits set in the AC Drive control word:

- Bit 0 = Run forward (CW)
- Bit 5 = Activate network control
- Bit 6 = Activate network setpoint

Example of an inverter with the node address 1:

Request frame by the master					
Slave address	Function code	Data			
		Register address		AC Drive control word	
0x01	0x06	0x08	0x34	0x00	0x61

If the digital input DI1 ("Start enable") is set to HIGH level, the drive should start and the inverter should respond with the same frame as confirmation:

Response message from the inverter					
Slave address	Function code	Data			
		Register address		AC Drive control word	
0x01	0x06	0x08	0x34	0x00	0x61





## Write the speed of the drive via Modbus

The drive speed can be changed via the modbus register 42102, see:

▶ [Data mapping](#) 399

Example of an inverter with the node address 1:

Request frame by the master					
Slave address	Function code	Data			
		Register address		Network setpoint frequency (0.01)	
0x01	0x06	0x08	0x35	0x04	0xD2

Response message from the inverter					
Slave address	Function code	Data			
		Register address		Network setpoint frequency (0.01)	
0x01	0x06	0x08	0x35	0x04	0xD2

The drive now rotates with a frequency of 12.34 Hz.

## Read the drive speed via Modbus

The drive speed can be read via the Modbus register 42002, see:

▶ [Data mapping](#) 399

The function code 3 is used to read a single register or several interrelated register blocks, see:

▶ [Function codes](#) 397

Example of an inverter with the node address 1:

Request frame by the master					
Slave address	Function code	Data			
		Register address		Number of words	
0x01	0x03	0x07	0xD1	0x00	0x01

Response message from the inverter					
Slave address	Function code	Data			
		Read bytes		Frequency (0.01)	
0x01	0x03	0x02		0x04	0xD1

The drive rotates with a frequency of 12.33 Hz.

## Restart of the communication

A restart of communication is required after changes of the interface configuration (e. g. node address and baud rate) in order that the changed settings become effective.

For restarting communication, there are two options:

- a) Switch inverter off and on again.
- b) **0x2320 (P508.00)** Set = "Restart with current values [1]".

## Parameter

Address	Name / setting range / [default setting]	Information
0x2320 (P508.00)	Modbus communication (Modbus comm.)	1 = restart communication in order that changed settings of the interface configuration become effective.
	<b>0</b> No action/no error	
	<b>1</b> Restart with current values	

# Configuring the network

Modbus RTU  
Basic setting and options  
Node address setting



## 12.11.2 Basic setting and options

### 12.11.2.1 Node address setting

Each network node must be provided with a unique node address.

- The node address of the inverter can be optionally set in [0x2321:001 \(P510.01\)](#) or using the DIP switches on the device labelled with "1" ... "128".
- The setting that is active when the inverter is switched on is the effective setting.
- The labelling of the DIP switches corresponds to the values of the individual DIP switches for determining the node address (see the following example).
- The node address 0 is reserved for messages to all nodes ("Broadcast").
- The active node address is shown in [0x2322:001 \(P511.01\)](#).

#### Example of how the node address is set via the DIP switches

DIP switch	128	64	32	16	8	4	2	1
Setting	OFF	OFF	OFF	ON	OFF	ON	ON	ON
Value	0	0	0	16	0	4	2	1
Node address	= sum of all values = 16 + 4 + 2 + 1 = 23							

#### Parameter

Address	Name / setting range / [default setting]	Information
0x2321:001 (P510.01)	Modbus settings: Node ID (Modbus sett.: Node ID) 1 ... [1] ... 247	Optionally setting of the node address (instead of setting via DIP switches 1 ... 128). <ul style="list-style-type: none"> <li>• The node address set here only becomes effective if DIP switches 1 ... 128 have been set to OFF before mains switching.</li> <li>• A change in the node address only becomes effective after a restart of Modbus communication.</li> </ul>

### 12.11.2.2 Baud rate setting

All network nodes must be set to the same baud rate.

- If the DIP switch labelled with "b" is in the OFF position at switch-on, the automatic baud rate detection function is active. If it is in the ON position, the setting in [0x2321:002 \(P510.02\)](#) applies instead.
- If the automatic baud rate detection function is activated, the first 5 ... 10 messages are lost after switch-on.
- The active baud rate is displayed in [0x2322:002 \(P511.02\)](#).

#### Parameter

Address	Name / setting range / [default setting]	Information
0x2321:002 (P510.02)	Modbus settings: Baud rate (Modbus sett.: Baud rate)	Optionally setting of the baud rate (instead of setting via DIP switch b). <ul style="list-style-type: none"> <li>• The baud rate set here is only effective if DIP switch b was set to ON before mains switching. Otherwise automatic baud rate detection is active.</li> <li>• A change in the baud rate only becomes effective after a restart of Modbus communication.</li> <li>• If the automatic baud rate detection function is activated, the first 5 ... 10 messages are lost after switch-on.</li> </ul>
	0 Automatic	
	1 2400 bps	
	2 4800 bps	
	3 9600 bps	
	4 19200 bps	
	5 38400 bps	
	6 57600 bps	
7 115200 bps		



### 12.11.2.3 Data format setting

All network nodes must be set to the same data format.

- If the DIP switch labelled with "a" is in the OFF position at switch-on, the automatic data format detection function is active. If it is in the ON position, the setting in [0x2321:003 \(P510.03\)](#) applies instead.
- If the automatic data format detection function is activated, the first 5 ... 10 messages are lost after switch-on.
- The active data format is displayed in [0x2322:003 \(P511.03\)](#).

#### Parameter

Address	Name / setting range / [default setting]	Information
0x2321:003 (P510.03)	Modbus settings: Data format (Modbus sett.: Data format)	Definition of the parity and stop bits.
	<b>0 Automatic</b>	Automatic data format detection. <ul style="list-style-type: none"><li>• With this setting, the first 5 ... 10 messages are lost after switch-on.</li></ul>
	1 8, E, 1	8 data bits, even parity, 1 stop bit
	2 8, O, 1	8 data bits, odd parity, 1 stop bit
	3 8, N, 2	8 data bits, no parity bit, 2 stop bits
	4 8, N, 1	8 data bits, no parity bit, 1 stop bit

### 12.11.2.4 Minimum response time setting

Some Modbus masters have issues turning around their transceiver at higher baud rates. To resolve integration issues the user may use Modbus: Minimum Response Time ([0x2321:004](#)) to set a minimum time delay to be observed between the receipt of a valid Modbus message and the drive's response. Time is entered in milliseconds [0x2321:004 \(P510.04\)](#).

#### Parameter

Address	Name / setting range / [default setting]	Information
0x2321:004 (P510.04)	Modbus settings: Minimum response time (Modbus sett.: Min. resp. time) 0 ... [0] ... 1000 ms	Minimum time delay between the reception of a valid message and the response of the drive.



## 12.11.3 Data transfer

The mode of access to inverter data (parameters) is controlled via function codes.



## 12.11.3.1 Function codes

The inverter supports the following function codes:

Function code		Function name	Description
3	0x03	Read Holding Registers	Read one or more 16-bit data words.
6	0x06	Preset Single Register	Write a 16-bit data word.
16	0x10	Preset Multiple Registers	Write one or more 16-bit data words.
23	0x17	Read/Write 4X Registers	Within a transaction <ul style="list-style-type: none"> <li>• write into a group of connected 4X holding registers.</li> <li>• read from a group of connected 4X holding registers.</li> </ul>

### Addressing

- The function codes listed above exclusively refer to 4X registers in Modbus addressing.
- All data in the inverter can only be accessed via 4X registers, i.e. via register addresses from 40001.
- The 4xxxx reference is implicit, i. e. given by the function code used. In the frame therefore the leading 4 is omitted in the addressing process.
- Lenze supports the basic 1 addressing of Modbus, i.e. the numbering of the registers starts with 1 whereas addressing starts with 0. For example, the address 0 is used in the frame when register 40001 is read.

### Frame structure

Communication is established on the basis of the central medium access method. Communication is always started by a master request. The inverter (slave) then either gives a valid response or outputs an error code (provided that the request has been received and evaluated as a valid Modbus frame). Error causes can be invalid CRC checksums, function codes that are not supported, or impermissible data access.

All Modbus frames have the following basic structure:

- A "frame" consists of a PDU (Protocol Data Unit) and an ADU (Application Data Unit).
- The PDU contains the function code and the data belonging to the function code.
- The ADU serves the purposes of addressing and error detection.
- The data are represented in Big Endian format (most significant byte first).

ADU (Application Data Unit)			
Slave address	Function code	Data	Checksum (CRC)
	PDU (Protocol Data Unit)		

# Configuring the network

Modbus RTU  
Data transfer  
Function codes



## Error codes

In the event of an error, the Modbus node responds with a function code associated with the message:

Function code	Associated function code in the event of an error	Supported error codes
0x03	0x83	0x01, 0x02, 0x03, 0x04
0x06	0x86	0x01, 0x02, 0x03, 0x04
0x10	0x90	0x01, 0x02, 0x03, 0x04
0x17	0x97	0x01, 0x02, 0x03, 0x04

Error code	Designation	Cause(s)
0x01	Invalid function code	The function code is not supported by the inverter, or the inverter is in a state in which the request is not permissible or in which it cannot be processed.
0x02	Invalid data address	The combination of a start address and the length of the data to be transmitted is invalid. Example: If you have a slave with 100 registers, the first register has the address 0 and the last register has the address 99. If there is a request of four registers now, from the start address 96, the request can be processed successfully (for registers 96, 97, 98, and 99). If, however, five registers from the start address 96 are queried, this error code is returned, since the slave has no register with the address 100.
0x03	Invalid data value	Error in the reset structure of a complex request, e. g. because the data length that has resulted implicitly is not correct. The cause, however, is not that a (parameter) value is written outside the valid setting range. As a matter of principle, the Modbus protocol has no information on valid setting ranges of single registers or their meaning.
0x04	Slave device failure	A non-correctable error has occurred while the request was processed in the inverter.



## 12.11.3.2 Data mapping

The process of data mapping is used for defining which Modbus registers read or write to which inverter parameters.

- There are pre-defined Modbus registers for common control and status words, which are located in coherent blocks, in order to facilitate communication with OPC servers and other Modbus masters. In order to access all relevant data of the inverter, only a minimum number of commands is required.
- In addition, 24 registers are provided for variable mapping, i. e. free assignment to inverter parameters.

### Predefined Modbus control registers

- These registers are provided with write and read access.
- The cross-reference in column 2 leads to the detailed parameter description.

Modbus registers	Permanently assigned parameter	
	Address	Designation
42101	<a href="#">0x400B:001 (P592.01)</a>	AC Drive control word
42102	<a href="#">0x400B:005 (P592.05)</a>	Network setpoint frequency (0.01)
42103	<a href="#">0x4008:002 (P590.02)</a>	NetWordIN2
42104	<a href="#">0x4008:003 (P590.03)</a>	NetWordIN3
42105	<a href="#">0x400B:007 (P592.07)</a>	PID setpoint
42106	<a href="#">0x6071</a>	Set torque
42107	<a href="#">0x4008:001 (P590.01)</a>	NetWordIN1
42108	<a href="#">0x4008:004 (P590.04)</a>	NetWordIN4
42109 ... 42121	-	Reserved

### Predefined Modbus status registers

- These registers are only provided with read access.
- The cross-reference in column 2 leads to the detailed parameter description.

Modbus registers	Permanently assigned parameter	
	Address	Designation
42001	<a href="#">0x400C:001 (P593.01)</a>	AC Drive status word
42002	<a href="#">0x400C:006 (P593.06)</a>	Frequency (0.01)
42003	<a href="#">0x603F (P150.00)</a>	Error code
42004	<a href="#">0x400C:005 (P593.05)</a>	Drive status
42005	<a href="#">0x2D89 (P106.00)</a>	Motor voltage
42006	<a href="#">0x2D88 (P104.00)</a>	Motor current
42007	<a href="#">0x6078 (P103.00)</a>	Actual current
42008	<a href="#">0x2DA2:002 (P108.02)</a>	Apparent power (42008 = High Word, 42009 = Low Word)
42009		
42010	<a href="#">0x2D84:001 (P117.01)</a>	Heatsink temperature
42011	<a href="#">0x2D87 (P105.00)</a>	DC-bus voltage
42012	<a href="#">0x60FD (P118.00)</a>	Digital input status (only bit 16 ... bit 31)
42013	<a href="#">0x6077 (P107.00)</a>	Actual torque
42014 ... 42021	-	Reserved

# Configuring the network

Modbus RTU  
Monitoring  
Data mapping



## Variable mapping

- Via **0x232B:001 ... 0x232B:024 (P530.01 ... 24)**, 24 registers can be mapped to parameters of the inverter. Format:  
0xiiii00  
(iiii = index hexadecimal,  
ss = subindex hexadecimal)
- The display of the internal Modbus register numbers in **0x232C:001 ... 0x232C:024 (P531.01 ... 24)** is generated automatically. Since 32-bit parameters require two registers, there is no 1:1 assignment.
- For the mappable registers, a CRC (Cyclic Redundancy Check) is executed. The checksum determined is displayed in **0x232D (P532.00)**. The user can read this "validation code" and use it for comparison in the Modbus master. In this way it can be checked whether the inverter currently queried is configured correctly for the respective application.

## Parameter

Address	Name / setting range / [default setting]	Information
0x232B:001 ... 0x232B:024 (P530.01 ... 24)	Modbus parameter mapping: Parameter 1 ... Parameter 24 (Para. mapping: Parameter 1 ... Parameter 24) 0x00000000 ... [0x00000000] ... 0xFFFFFFFF00	Mapping entries for the variable mapped Modbus registers. • Format: 0xiiii00 (iiii = index, ss = subindex)
0x232C:001 ... 0x232C:024 (P531.01 ... 24)	Modbus register assignment: Register 1 ... Register 24 (Reg. assigned: Register 1 ... Register 24) • Read only	Display of the internal Modbus register number starting from which the parameter mapped in <b>0x232B:001 ... 0x232B:024 (P530.01 ... 24)</b> is stored. • For the first parameter mapped, always 2500. • From the second parameter mapped, 2500 + offset. The offset results from the data types of the previously mapped parameters.
0x232D (P532.00)	Modbus verification code (Verificationcode) • Read only	

## 12.11.4 Monitoring

The parameters for setting network monitoring functions are described below.

## Parameter

Address	Name / setting range / [default setting]	Information
0x2858:001 (P515.01)	Modbus monitoring: Response to time-out (Modbus monit.: Resp. Time-out)	Selection of the response executed if no valid messages have been received via the Modbus for a longer time than the time-out period set in <b>0x2858:002 (P515.02)</b> . Associated event ID: • <b>33185   0x81A1 - Modbus: network time-out</b>
	0 No response	▶ Severity  700
	1 Warning	
	2 Trouble	
3 <b>Fault</b>		
0x2858:002 (P515.02)	Modbus monitoring: Time-out time (Modbus monit.: Time-out time) 0.0 ... [2.0] ... 300.0 s	Time-out period for monitoring the message reception via Modbus.







## 12.11.5 Diagnostics

### 12.11.5.1 Status LEDs

Information on the Modbus status can be obtained quickly via the "COMM" and "ERR" LED displays on the front of the inverter.

The meaning can be seen from the tables below.

#### Inverter not active on the Modbus bus (yet)

LED "COMM"	LED "ERR"	Meaning
off	 on	Internal error
	Both LEDs are flickering alternately	Automatic detection of baud rate and data format active.

#### Inverter active on the Modbus

The green "COMM" LED indicates the communication status:

LED "COMM"	Communication status
off	No reception / no transmission
 on	Reception / transmission active

The red "ERR" LED indicates an error:

LED "ERR"	Fault
off	No fault
 blinking	Communication error

### 12.11.5.2 Information on the network

The following parameters serve to diagnose the communication activities between the inverter and the Modbus network.

The following parameters show information on the network.

#### Parameter

Address	Name / setting range / [default setting]	Information
0x2322:001 (P511.01)	Active Modbus settings: Active node ID (Modbus diag.: Active node ID) • Read only	Display of the active node address.
0x2322:002 (P511.02)	Active Modbus settings: Active baud rate (Modbus diag.: Active baud rate) • Read only	Display of the active baud rate.
	0 Automatic	Optionally setting of the baud rate (instead of setting via DIP switch b).
	1 2400 bps	• The baud rate set here is only effective if DIP switch b was set to ON before mains switching. Otherwise automatic baud rate detection is active.
	2 4800 bps	• A change in the baud rate only becomes effective after a restart of Modbus communication.
	3 9600 bps	• If the automatic baud rate detection function is activated, the first 5 ... 10 messages are lost after switch-on.
	4 19200 bps	
	5 38400 bps	
	6 57600 bps	
7 115200 bps		
0x2322:003 (P511.03)	Active Modbus settings: Data format (Modbus diag.: Data format) • Read only	Display of the active data format.
	0 Automatic	Automatic data format detection. • With this setting, the first 5 ... 10 messages are lost after switch-on.
	1 8, E, 1	8 data bits, even parity, 1 stop bit
	2 8, O, 1	8 data bits, odd parity, 1 stop bit
	3 8, N, 2	8 data bits, no parity bit, 2 stop bits
	4 8, N, 1	8 data bits, no parity bit, 1 stop bit

# Configuring the network

Modbus RTU

Diagnostics

Information on the network



Address	Name / setting range / [default setting]	Information
0x2323 (P509.00)	Modbus switch position (Modbus switch) • Read only	Display of the DIP switch setting at the last mains power-on. • The value displayed corresponds to the sum of all DIP switch values (except for DIP switches for terminating resistor).
0x232A:001 (P580.01)	Modbus statistics: Messages received (Modbus statistic: Mess. received) • Read only	Display of the total number of messages received. • This counter counts both valid and invalid messages. • After the maximum value has been reached, the counter starts again "0".
0x232A:002 (P580.02)	Modbus statistics: Valid messages received (Modbus statistic: Val. mess. rec.) • Read only	Display of the number of valid messages received. • After the maximum value has been reached, the counter starts again "0".
0x232A:003 (P580.03)	Modbus statistics: Messages with exceptions (Modbus statistic: Mess. w. exc.) • Read only	Display of the number of messages with exceptions that have been received. • After the maximum value has been reached, the counter starts again "0".
0x232A:004 (P580.04)	Modbus statistics: Messages with errors (Modbus statistic: Mess. w. errors) • Read only	Display of the number of messages received with a faulty data integrity (parity, CRC). • After the maximum value has been reached, the counter starts again "0".
0x232A:005 (P580.05)	Modbus statistics: Messages sent (Modbus statistic: Messages sent) • Read only	Display of the total number of messages sent. • After the maximum value has been reached, the counter starts again "0".
0x232E:001 (P583.01)	Modbus diagnostics of last Rx data: Offset (Rx data diagn.: Rx data offset) 0 ... [0] ... 240	For purposes of diagnostics, the last message received (max. 16 bytes) is shown in <a href="#">0x232E:002 (P583.02)</a> ... <a href="#">0x232E:017 (P583.17)</a> . For longer messages, an offset can be specified here, indicating from which byte of the message the display of the 16 bytes is to start.



# Configuring the network

Modbus RTU  
Diagnostics  
Information on the network

Address	Name / setting range / [default setting]	Information
0x232E:002 (P583.02)	Modbus diagnostics of last Rx data: Data byte 0 (Rx data diagn.: Last RxD byte0) • Read only	Display of the message received last.
0x232E:003 (P583.03)	Modbus diagnostics of last Rx data: Data byte 1 (Rx data diagn.: Last RxD byte1) • Read only	
0x232E:004 (P583.04)	Modbus diagnostics of last Rx data: Data byte 2 (Rx data diagn.: Last RxD byte2) • Read only	
0x232E:005 (P583.05)	Modbus diagnostics of last Rx data: Data byte 3 (Rx data diagn.: Last RxD byte3) • Read only	
0x232E:006 (P583.06)	Modbus diagnostics of last Rx data: Data byte 4 (Rx data diagn.: Last RxD byte4) • Read only	
0x232E:007 (P583.07)	Modbus diagnostics of last Rx data: Data byte 5 (Rx data diagn.: Letzt RxD-Byte5) • Read only	
0x232E:008 (P583.08)	Modbus diagnostics of last Rx data: Data byte 6 (Rx data diagn.: Last RxD byte6) • Read only	
0x232E:009 (P583.09)	Modbus diagnostics of last Rx data: Data byte 7 (Rx data diagn.: Last RxD byte7) • Read only	
0x232E:010 (P583.10)	Modbus diagnostics of last Rx data: Data byte 8 (Rx data diagn.: Last RxD byte8) • Read only	
0x232E:011 (P583.11)	Modbus diagnostics of last Rx data: Data byte 9 (Rx data diagn.: Last RxD byte9) • Read only	
0x232E:012 (P583.12)	Modbus diagnostics of last Rx data: Data byte 10 (Rx data diagn.: Last RxD byte10) • Read only	
0x232E:013 (P583.13)	Modbus diagnostics of last Rx data: Data byte 11 (Rx data diagn.: Last RxD byte11) • Read only	
0x232E:014 (P583.14)	Modbus diagnostics of last Rx data: Data byte 12 (Rx data diagn.: Last RxD byte12) • Read only	
0x232E:015 (P583.15)	Modbus diagnostics of last Rx data: Data byte 13 (Rx data diagn.: Last RxD byte13) • Read only	
0x232E:016 (P583.16)	Modbus diagnostics of last Rx data: Data byte 14 (Rx data diagn.: Last RxD byte14) • Read only	
0x232E:017 (P583.17)	Modbus diagnostics of last Rx data: Data byte 15 (Rx data diagn.: Last RxD byte15) • Read only	
0x232F:001 (P585.01)	Modbus diagnostics of last Tx data: Offset (Tx data diagn.: Tx data offset) 0 ... [0] ... 240	For purposes of diagnostics, the last message sent (max. 16 bytes) is shown in <a href="#">0x232F:002 (P585.02)</a> ... <a href="#">0x232F:017 (P585.17)</a> . For longer messages, an offset can be specified here, indicating from which byte of the message the display of the 16 bytes is to start.

# Configuring the network

Modbus RTU

Diagnostics

Information on the network



Address	Name / setting range / [default setting]	Information
0x232F:002 (P585.02)	Modbus diagnostics of last Tx data: Data byte 0 (Tx data diagn.: Last TxD byte0) • Read only	Display of the message sent last.
0x232F:003 (P585.03)	Modbus diagnostics of last Tx data: Data byte 1 (Tx data diagn.: Last TxD Byte1) • Read only	
0x232F:004 (P585.04)	Modbus diagnostics of last Tx data: Data byte 2 (Tx data diagn.: Last TxD byte2) • Read only	
0x232F:005 (P585.05)	Modbus diagnostics of last Tx data: Data byte 3 (Tx data diagn.: Last TxD byte3) • Read only	
0x232F:006 (P585.06)	Modbus diagnostics of last Tx data: Data byte 4 (Tx data diagn.: Last TxD byte4) • Read only	
0x232F:007 (P585.07)	Modbus diagnostics of last Tx data: Data byte 5 (Tx data diagn.: Last TxD byte5) • Read only	
0x232F:008 (P585.08)	Modbus diagnostics of last Tx data: Data byte 6 (Tx data diagn.: Last TxD byte6) • Read only	
0x232F:009 (P585.09)	Modbus diagnostics of last Tx data: Data byte 7 (Tx data diagn.: Last TxD byte7) • Read only	
0x232F:010 (P585.10)	Modbus diagnostics of last Tx data: Data byte 8 (Tx data diagn.: Last TxD byte8) • Read only	
0x232F:011 (P585.11)	Modbus diagnostics of last Tx data: Data byte 9 (Tx data diagn.: Last TxD byte9) • Read only	
0x232F:012 (P585.12)	Modbus diagnostics of last Tx data: Data byte 10 (Tx data diagn.: Last TxD byte10) • Read only	
0x232F:013 (P585.13)	Modbus diagnostics of last Tx data: Data byte 11 (Tx data diagn.: Last TxD byte11) • Read only	
0x232F:014 (P585.14)	Modbus diagnostics of last Tx data: Data byte 12 (Tx data diagn.: Last TxD byte12) • Read only	
0x232F:015 (P585.15)	Modbus diagnostics of last Tx data: Data byte 13 (Tx data diagn.: Last TxD byte13) • Read only	
0x232F:016 (P585.16)	Modbus diagnostics of last Tx data: Data byte 14 (Tx data diagn.: Last TxD byte14) • Read only	
0x232F:017 (P585.17)	Modbus diagnostics of last Tx data: Data byte 15 (Tx data diagn.: Last TxD byte15) • Read only	



## 12.12 IO-Link

### IO-Link

IO-Link is a registered trademark. It may only be used by members of the IO-Link community and non-members that have purchased the corresponding license. Detailed information on the usage can be found in the IO-Link Community Rules: <https://io-link.com>

IO-Link is the standardized IO technology (IEC 61131-9) for communication with sensors and actuators. Point-to-point communication is based on the three-wire sensor and actuator connection without additional requirements concerning the cable material.

IO-Link is no fieldbus but the further development of the existing connection technology for sensors and actuators.

#### Preconditions

The control unit (CU) of the inverter is provided with IO-Link.

#### Scheme of the IO-Link architecture

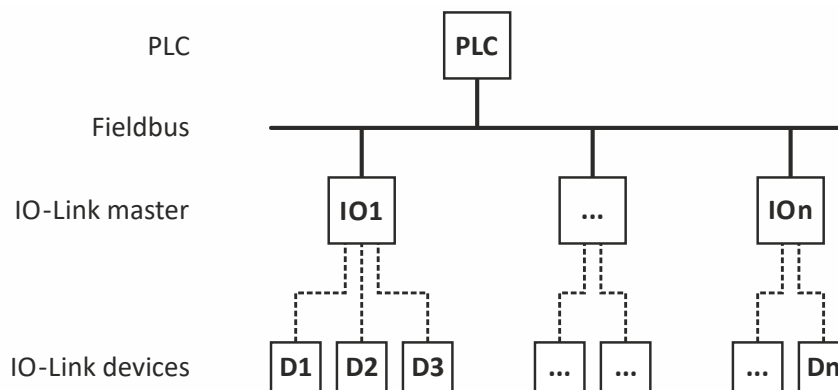

Device	Explanation	Meaning in the IO-Link network
PLC	Connection from the IO-Link master to the fieldbus level (PLC). Any Ethernet-based fieldbus can be used.	-
IO-Link master	Gateway to the fieldbus level, connection point for all IO-Link devices in this specific network. Some support 4 IO-Link devices, others 8 or 16 devices.	All brands are possible and compatible (class A plug is required).
IO-Link device	Examples: Sensors, RFID readers, valves, motor starters or I/O modules.	Specific IO-Link hardware, control unit for the IO-Link protocol



### Basic components

IO-Link consists of the following basic components:

- IO-Link master
- IO-Link device (e.g. sensors, RFID readers, valves, motor starters, I/O modules).
- Unshielded 3-wire or 5-wire standard cables.
- Engineering tool for configuring and parameterizing the IO-Link device.

The IO-Link master establishes the connection between the IO-Link device and the automation system. As a component of an I/O system, the IO-Link master is installed either in the control cabinet or directly in the field as remote I/O in degree of protection IP 65/67.

The IO-Link master communicates over various fieldbuses. An IO-Link master can have several IO-Link ports (channels). A IO-Link device can be connected to each port (point-to-point communication).



---

In principle, any combination of IO-Link masters and IO-Link devices is possible.

---

If IO-Link devices different IO-Link specifications are combined, the following must be noted:

- IO-Link V1.0 and V1.1 devices with the IODD version V1.0 can be operated on an IO-Link master according to V1.0.
- IO-Link devices according to V1.0 and V1.1 can be operated on an IO-Link master according to V1.1.
- The most important extensions of version 1.1 are:
  - Parameterization "Data Storage" function
  - Data transfer rate 230.4 kbaud
  - Process data width per port up to 32 bytes
  - Automatic verification of the compatibility in case of replacement

### Transmission types

The transmission is divided into three types.

- **Process data: Cyclic data**
  - The process data of the IO-Link device is transmitted cyclically and the process data size is also determined by the IO-Link device. Depending on the device process, data from 0 to 12 bytes are possible (for both, input and output).
- **IO-Link device data (parameter): Acyclic data**
  - IO-Link device data can be parameters, identification data and diagnostic information. They are exchanged acyclically and at the request of the IO-Link master. IO-Link device data can be written to the IO-Link device and read from the IO-Link device.
- **Events: Acyclic data**
  - In case of an event, the IO-Link device signals the occurrence of the event to the IO-Link master. The master then reads out the event. Events can be error messages (e.g. short circuit) and warnings or maintenance data (e.g. contamination, overheating). Error messages are transferred from the IO-Link device via the IO-Link master to the controller or HMI. The IO-Link master can also transfer events and conditions of the IO-Link device. Events include, for example, cable break or communication errors. The transmission of IO-Link device parameters or events takes place independently of the cyclic transmission of the process data. Transmissions do not influence or impair each other.



## Transmission rate of the IO-Link protocol

Three transmission rates are specified for the IO-Link modus:

- COM 1 - 4.8 kBaud
- COM 2 - 38.4 kBaud
- COM 3 - 230.4 kBaud

The IO-Link master supports all three data transmission rates and adapts itself automatically to the transmission rate of the IO-Link device. The i550 supports COM 3 (230.4 kBaud)

If transmissions fail, the message is repeated two more times. Only after the failure of the third attempt will the IO-Link master detect a communication failure and will signal it to the higher-level controller.

## Typical topology

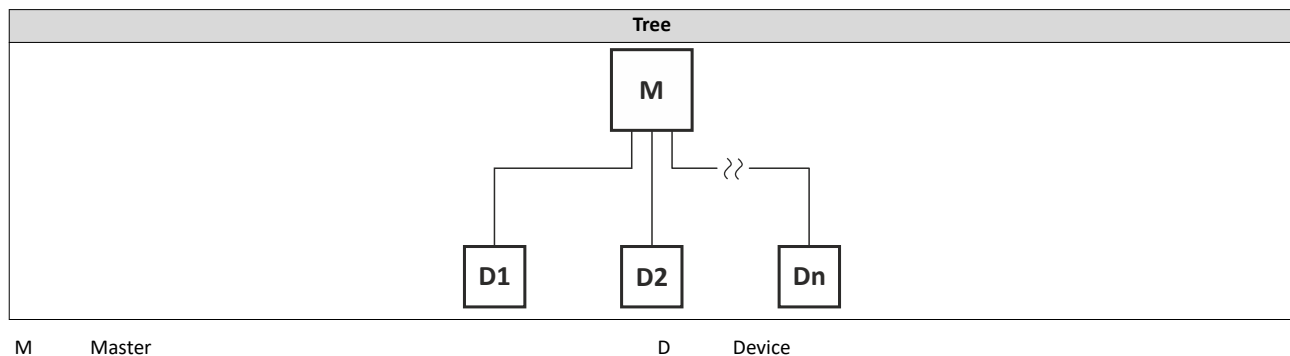

### 12.12.1 Commissioning

#### Online commissioning

Usually, the IO-Link device is configured and parameterized by means of engineering tools. After the user has assigned values to the parameters, these are loaded into the IO-Link device and become active. These parameters are uploaded to the Data Storage within the IO-Link master by means of a system command.

#### Off-site commissioning

Another option is to configure and parameterize the IO-Link devices by means of additional tools, such as the "USB master," outside of the machine or plant. The USB master tool loads the parameter set to the IO-Link device according to configuration, parameter setting and validation (to become "active"). After the installation in the machine or plant has been completed, these parameters are automatically uploaded to the Data Storage of the IO-Link master.

#### Preconditions

- The inverter is connected as an IO-Link device to an IO-Link master.
- The entire wiring has been checked for completeness, short circuit and earth fault.
- All IO-Link nodes are supplied with voltage and are switched on.
- The functional test described in the mounting and switch-on instructions has been completed successfully (without any errors or faults).
- The IO-Link master is configured for Data Storage.



#### 12.12.2 Basic setting and options

Compared to an i550 inverter without IO-Link, an i550 inverter with IO-Link has some different default settings:

Parameter	Standard value
<a href="#">0x2631:037 (P400.37)</a>	Network control: = TRUE
<a href="#">0x2631:002 (P400.02)</a>	Constant TRUE [1]
<a href="#">0x2860:001 (P201.01)</a>	Standard frequency setpoint source = Network [5]
<a href="#">0x2860:002 (P201.02)</a>	PID control Standard setpoint source = Network = [5]
<a href="#">0x2860:003 (P201.03)</a>	Torque control Standard setpoint source = [5]
<a href="#">0x2634:001 (P420.01)</a>	NetWordIN2.15 [49]
<a href="#">0x2634:002 (P420.02)</a>	NetWordIN2.14 [48]
<a href="#">0x2639:002 (P440.02)</a>	NetWordIN3 [20]





## Error responses or events

When an event occurs, the IO-Link device reports an "Event Flag" to the IO-Link master. The IO-Link master recognizes the "Event Flag" and reads the reported event. While an event is read, no parameter data can be exchanged, because the "on-request data" time block (Device reply message) is used for transmitting the event data. Three event categories are defined:

- Error messages (error)
- Maintenance data (warnings)
- IO-Link device functions (notifications)

## Recording error information

There are two options to record error information on IO-Link:

- Via the IO-Link "event" mechanism
- Via the "Read-out of the device history buffer" device function (SDO communication)

## IO-Link "event" mechanism

Three different event categories (according to IO-Link specification) are transmitted to the PLC via the IO-Link master. Each "Event" IO-Link category has an "error response" of a particular IO-Link device.

IO-Link event	IO-Link device (error response)
Error messages (error)	Errors and problems
Maintenance data (warnings)	Warning
IO-Link device functions (notifications)	No response

Example:

#	Title	IO-Link device "Error code"	IO-Link "error code"	IO-Link device (Error response)	IO-Link event
1	No memory module	0c7681	0x1843	Error	Error messages (Error)
2	Cooling fan warning	0x4281	0x1813	Warning	Maintenance data (Warnings)
3	Max. current reached	0x238A	0x1809	No response	IO-Link device functions (Notifications)

## IO-Link error codes

Error messages that are transmitted to the PLC via the IO-Link master do not have the same error coding as the IO-Link device. In accordance with the IO-Link specification, the following manufacturer-specific "error codes" are given:

- 0x1800 to 0x18FF

In order to obtain a clear identification for each IO-Link error, a unique IO-Link "error code" is assigned to each of them.

See the example in previous table or [IO-Link event IDs](#). [📄 420](#)

## Reading out the device protocol buffer (SDO communication)

This mechanism allows you to access and read out all logbook data. In order to address the respective parameter, the SDO channel must be used.

- ▶ [Read out error history buffer](#) [📄 686](#)



## 12.12.3 Process data transfer

The process data is used to control the inverter.

- The process data is transmitted automatically and cyclically between the IO-Link master and the IO-Link device.
- To be able to optimize the process data transfer to the current application, the total PDO data length can optionally be configured to 6 bytes or 12 bytes. Two different IO-DD's ("IO-Link Device Descriptions") are available for this purpose.
- Output data direction: From IO-Link master to IO-Link device.
- Input data direction: From IO-Link device to IO-Link master.

### Changeover of the PDO data length to be transmitted

The changeover can be automatic or manual:

- Automatic (IO-Link master setting "Type compatible"): If a device ID other than the one configured in the IO-Link master is detected in the inverter when the IO-Link master starts up, the IO-Link master forces this device ID in the inverter (provided this device ID is compatible with the inverter). The inverter then automatically changes to the corresponding PDO data length.
- Manually: The PDO data length can also be changed manually by rewriting the device ID in [0x2310:009](#) via the "EASY Starter" engineering tool or directly via IO-Link:
  - 12 Bytes PDO data length: Set [0x2310:009](#) = "1"
  - 6 Bytes PDO data length: Set [0x2310:009](#) = "3"

To apply the changed PDO data length:

1. Save parameter settings: [0x2022:003 \(P700.03\)](#) = "On / start [1]".
2. Switch the inverter off and then on again in order that the changed communication settings can get effective.

Afterwards, the mapping can be set via the following parameters:

- Selection of PDO set: [0x231D](#)
- Internal mapping of the process input data: [0x24E0:001 ... 0x24E0:012](#)
- Internal mapping of the process output data: [0x24E1:001 ... 0x24E1:012](#)

Regardless of the number of mapped parameters, the fixed length of the process data for the corresponding device ID is always transferred (excess data is ignored).

### Parameter

Address	Name / setting range / [default setting]	Information
0x231C:001	Process data: Last valid input data • Read only • From version 05.04	Last valid process data on the IO-Link communication channel.
0x231C:002	Process data: Last valid output data • Read only • From version 05.04	
0x231D	PDO set selection • From version 05.04	Display of the process data selection.
	0 PDO set 0 (generic)	Generic data assignment set. Is used if the PDO configuration differs from the default selection (change via controller or engineering tool).
	1 PDO set 1 - 12 byte	Standard mapping for 12 byte data transmission • Corresponds to Device ID "1" ( <a href="#">0x2310:009</a> )
	3 PDO set 3 - 6 byte	Standard mapping for 6 byte data transmission • Corresponds to Device ID "3" ( <a href="#">0x2310:009</a> )



## 12.12.3.1 Data mapping

Data mapping defines which process data is exchanged cyclically between IO-Link master and IO-Link device. The PDO mapping process cannot be applied to all parameters.

The mapping objects are saved in the IO-Link device:

- Internal mapping of the process input data: [0x24E0:001](#) ... [0x24E0:012](#)
- Internal mapping of the process output data: [0x24E1:001](#) ... [0x24E1:012](#)

### Definition of the process input data

#	Description	R/W	Index
1	RPDO mapping entry 1	R/W	<a href="#">0x24E0:001</a>
2	RPDO mapping entry 2	R/W	<a href="#">0x24E0:002</a>
3	RPDO mapping entry 3	R/W	<a href="#">0x24E0:003</a>
4	RPDO mapping entry 4	R/W	<a href="#">0x24E0:004</a>
5	RPDO mapping entry 5	R/W	<a href="#">0x24E0:005</a>
6	RPDO mapping entry 6	R/W	<a href="#">0x24E0:006</a>
7	RPDO mapping entry 7	R/W	<a href="#">0x24E0:007</a>
8	RPDO mapping entry 8	R/W	<a href="#">0x24E0:008</a>
9	RPDO mapping entry 9	R/W	<a href="#">0x24E0:009</a>
10	RPDO mapping entry 10	R/W	<a href="#">0x24E0:010</a>
11	RPDO mapping entry 11	R/W	<a href="#">0x24E0:011</a>
12	RPDO mapping entry 12	R/W	<a href="#">0x24E0:012</a>

### Definition of the process output data

#	Description	R/W	Index
1	TPDO mapping entry 1	R/W	<a href="#">0x24E1:001</a>
2	TPDO mapping entry 2	R/W	<a href="#">0x24E1:002</a>
3	TPDO mapping entry 3	R/W	<a href="#">0x24E1:003</a>
4	TPDO mapping entry 4	R/W	<a href="#">0x24E1:004</a>
5	TPDO mapping entry 5	R/W	<a href="#">0x24E1:005</a>
6	TPDO mapping entry 6	R/W	<a href="#">0x24E1:006</a>
7	TPDO mapping entry 7	R/W	<a href="#">0x24E1:007</a>
8	TPDO mapping entry 8	R/W	<a href="#">0x24E1:008</a>
9	TPDO mapping entry 9	R/W	<a href="#">0x24E1:009</a>
10	TPDO mapping entry 10	R/W	<a href="#">0x24E1:010</a>
11	TPDO mapping entry 11	R/W	<a href="#">0x24E1:011</a>
12	TPDO mapping entry 12	R/W	<a href="#">0x24E1:012</a>



## Data mapping via controller or Engineering Tool (EASY Starter)

Dynamic PDO mapping (receive and transmit data) can be carried out in two ways:

- Via the Lenze user interface → [EASY Starter](#)
- Via the acyclic data transmission.

How to configure dynamic PDO mapping parameters via the SDO channel:

### 1. Deactivate PDO communication

1. Deactivate RPDO:
  - a) Via controller or Lenze Engineering Tool: `0x24E0:000` = 0
  - b) Via IO-Link master tool : `0x24E0:020` = 0
2. Deactivate TPDO:
  - a) Via controller or Lenze Engineering Tool: `0x24E1:000` = 0
  - b) Via IO-Link master tool : `0x24E1:020` = 0

### 2. Define mapping.

1. Assign parameters to the RPDOs in `0x24E0` in the format "Oxiiiiissll".  
(iiii= Index hexadecimal, ss= subindex hexadecimal, ll= data length hexadecimal)
2. Assign parameters to the TPDOs in `0x24E1` in the format "Oxiiiiissll".  
(iiii= Index hexadecimal, ss= subindex hexadecimal, ll= data length hexadecimal)

Example:

Assign index `0x4008:001` with data length 16 bit to RPDO 1:

iiii = 4008, ss = 01, ll = 10 → `0x24E0:001` = `0x40080110`

### 3. Reactivate PDO communication.

1. Activate RPDO:
  - a) Via controller or Lenze Engineering Tool: `0x24E0:000` = Number of mapped parameters
  - b) Via IO-Link master tool : `0x24E0:020` = Number of mapped parameters
2. Activate TPDO:
  - a) Via controller or Lenze Engineering Tool: `0x24E1:000` = Number of mapped parameters
  - b) Via IO-Link master tool : `0x24E1:020` = Number of mapped parameters



---

The mapping value must cover the device index, not the IO-Link index. Only parameters that are marked as "mappable" with the attribute "r,t" or "rt" can be mapped. ▶ [Parameter attribute list](#) [731](#)

---



## Standard RPDO mapping



The assignment of different bits with the same function is not permissible.

For the process data from IO-Link master to the inverter, the following data mapping is preset in the IO-Link device description file (IODD):

IO-Link master --> IO-Link device		
	0x231D = [3]: 6 Byte PDO	0x231D = [1]: 12 Byte PDO
RPDO mapping entry 1	NetWordIN1 data word 0x4008:001 (P590.01)	NetWordIN1 data word 0x4008:001 (P590.01)
RPDO mapping entry 2	Setpoint frequency 0x400B:005 (P592.05)	NetWordIN2 data word 0x4008:002 (P590.02)
RPDO mapping entry 3	NetWordIN2 data word 0x4008:002 (P590.02)	NetWordIN3 data word 0x4008:003 (P590.03)
RPDO mapping entry 4	-	Setpoint frequency 0x400B:005 (P592.05)
RPDO mapping entry 5	-	PID setpoints 0x400B:007 (P592.07)
RPDO mapping entry 6	-	Torque setpoint 0x400B:008 (P592.08)

Function assignment of the NetWordIN1 data word

▶ [Define your own control word format](#) 314

## Standard TPDO mapping



The assignment of different bits with the same function is not permissible.

For the process data from IO-Link master to the inverter, the following data mapping is preset in the IO-Link device description file (IODD):

IO-Link device --> IO-Link master		
	0x231D = [3]: 6 Byte PDO	0x231D = [1]: 12 Byte PDO
TPDO mapping entry 1	NetWordOUT1 0x400A:001 (P591.01)	NetWordOUT1 0x400A:001 (P591.01)
TPDO mapping entry 2	Digital input status 0x60FD (P118.00)	Device actual utilisation 0x2D40:004 (P135.04)
TPDO mapping entry 3	-	Motor current 0x2D88 (P104.00)
TPDO mapping entry 4	-	Output frequency 0x2DDD (P100.00)
TPDO mapping entry 5	-	Current process variable 0x401F:002 (P121.02)
TPDO mapping entry 6	-	Actual torque 0x6077 (P107.00)

Function assignment of the NetWordOUT1 data word:

▶ [Define your own status word format](#) 322



## 12.12.4 Acyclic data transfer

All parameters from the device description are available via this IO-Link channel. It is always possible to configure the entire function set of the IO-Link device via this channel.

### IO-Link device parameter (data objects on request)

IO-Link device parameters are transmitted acyclically upon request of the IO-Link master. The IO-Link master always first sends a request to the IO-Link device which is acknowledged by the IO-Link device. This procedure is the same both for "writing" and "reading".

### Address range

There is a parameter address offset between the IO-Link and the Lenze parameter indices (according to the IO-Link specification).

IO-Link parameter range from	IO-Link parameter range to	Index offset	Subindex offset	Lenze parameter range from	Lenze parameter range to
0x1000	0x1FFF	0x3000	0	0x4000	0x4FFF
0x2000	0x2FFF	0x0000	0	0x2000	0x2FFF
0x3000	0x3FFF	0x3000	0	0x6000	0x6FFF

### Subindex restriction

In IO-Link, an index (parameter with all subindices) must not exceed 232 bytes.

The following indices are too high: 0x2000 and 0x2006.

In IO-Link, each subindex of these parameters is represented by a separate index:

IO-Link index	IO-Link subindex	Lenze OBD index	Lenze OBD subindex
0x201	0x0	0x2000	0x1
...	...	...	...
0x211	0x0	0x2000	0x11 (17)
0x301	0x0	0x2006	0x1
...	...	...	...
0x325	0x0	0x2006	0x25 (37)



## 12.12.5 Data Storage

The "Data Storage" mechanism allows for a consistent and current buffering of IO-Link device parameters on higher levels such as PLC programs or IO-Link fieldbus master. The data storage between IO-Link master and IO-Link device is defined in the IO-Link standard whereas the adjacent upper "Data Storage" mechanisms depend on the respective fieldbus or system. A IO-Link device is provided with a standardised set of objects which contains information on parameters for data storage, e.g. requirements regarding the memory size and control and status information of the "Data Storage" mechanism. Revisions of "Data Storage" parameter sets are identified via a parameter checksum.

### Purpose and aims

The main purpose of the "Data Storage" mechanism is to automatically configure the new device correctly when the IO-Link device is replaced.

After a "Backup" level is activated, a "defective" IO-Link device can be replaced by a compatible IO-Link device or one appropriate to the type. In only a few exceptional cases, user intervention is required to ensure the same functionality and performance.

### Preconditions for the activation of the "Data Storage" mechanism

- IO-Link device and IO-Link master must be implemented according to the IO-Link specification V1.1.
- The "Backup" level of this master port must either be "Backup/Restore" or "Restore".

### "Data Storage" class 1: automatic data storage

The configured IO-Link device supports the data storage in such a way that the replacement IO-Link device takes over the role of the predecessor fully automatically and if possible with the same performance (motor identification might be required).

### Preconditions for parameter sets

Each IO-Link device operates with the configured active parameters. The related set of safety parameters stored in the system (IO-Link master and/or higher-level system, e.g. PLC) may differ from the set of active parameters.

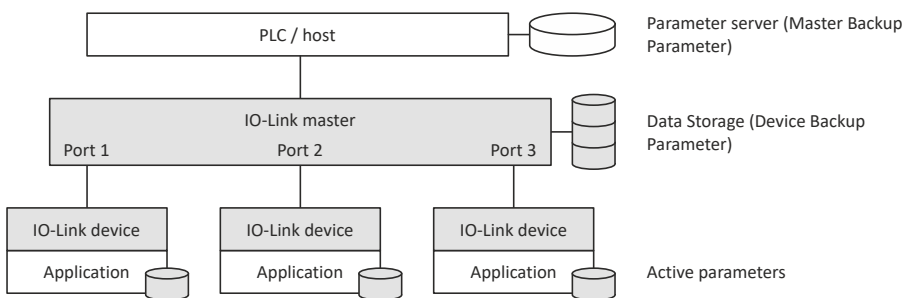

A replacement of the IO-Link device in operation causes the available parameters to be overwritten by the backup parameters within the newly connected IO-Link devices.

### General principle of the data storage

The "DS\_UPLOAD\_FLAG" bit shows parameter changes in an IO-Link device,

- "DS\_UPLOAD\_FLAG" = FALSE: No change to the parameter set of the IO-Link device.
- "DS\_UPLOAD\_FLAG" = TRUE: Change to the parameter set of the IO-Link device.



## States of the "DS\_UPLOAD\_FLAG" bit

"DS_UPLOAD_FLAG"	Condition	Note
TRUE	The "Save user data" device command is activated, <a href="#">0x2022:003 (P700.03)</a> = TRUE	The save command sets "DS_UPLOAD_FLAG" from "FALSE" to "TRUE".
FALSE	After a complete parameter backup process, IO-Link master "DS_UPLOAD_FLAG" is set automatically to "FALSE".	General behavior of the IO-Link master.
FALSE	The sequential device commands "Load default settings" ( <a href="#">0x2022:001 (P700.01)</a> = TRUE) and "Save user data" ( <a href="#">0x2022:003 (P700.03)</a> = TRUE) set "DS_UPLOAD_FLAG" to "FALSE".	"Device replacement" application where an IO-Link device is loaded with a different parameter set than "standard settings".

## "Backup" level in detail

The data memory function is controlled by the user via "Backup" level.



The "Backup" level are always set in the IO-Link master.

The IO-Link master has these "Backup" levels:

	IO-Link master Variant 1	IO-Link master Variant 2
Available "Backup" level	"Disable"	"Disable"
	"Backup"	"Backup/Restore"
	"Restore"	"Restore"

## Relationship "Backup" level ↔ "DS\_UPLOAD\_FLAG" (IO-Link master Variant 1)

Application	Description	"Backup" level	"DS_UPLOAD_FLAG"
Commissioning	The "Data Storage" is deactivated in the commissioning phase where configurations, parameter settings and PLC programs are coordinated, tested and reviewed. Data exchange between IO-Link master and IO-Link device is not supported.	"Disable"	Not relevant
Change from commissioning to production	The "Data Storage" will be activated after successful commissioning. The parameters currently active in the IO-Link device are copied and saved as backup parameters on the IO-Link master. Start backup: Execute the "Save user data" device command, <a href="#">0x2022:003 (P700.03)</a> = TRUE	"Backup"	TRUE Will be set to FALSE again by the master when backup is successful.
Production	While the IO-Link device is monitored or operated, no parameter changes in the IO-Link device are accepted.	"Restore"	Not relevant
IO-Link device replacement	The stored backup parameters in the IO-Link master overwrite the active parameters (e.g. default settings) in the replaced compatible IO-Link device of the same type. After a restart, the new IO-Link device operates with the same parameters as its predecessor.	"Restore"	Not relevant





The user must observe the status of the "DS\_UPLOAD\_FLAG" in every single application listed below:

### Relationship "Backup" level ↔ "DS\_UPLOAD\_FLAG" (IO-Link master Variant 2)

Application	Description	"Backup" level	"DS_UPLOAD_FLAG"
Commissioning	The "Data Storage" is deactivated in the commissioning phase where configurations, parameter settings and PLC programs are coordinated, tested and reviewed. Data exchange between IO-Link master and IO-Link device is not supported.	"Disable"	Not relevant
Change from commissioning to production	The "Data Storage" will be activated after successful commissioning. The parameters currently active in the IO-Link device are copied and saved as backup parameters on the IO-Link master. Start backup: Execute the "Save user data" device command, <code>0x2022:003 (P700.03) = TRUE</code>	»Backup/Restore«	TRUE
Production	While the IO-Link device is monitored or operated, no parameter changes in the IO-Link device are accepted.	"Backup/Restore"	FALSE
IO-Link device replacement	The stored backup parameters in the IO-Link master overwrite the active parameters (e.g. default settings) in the replaced compatible IO-Link device of the same type. After a restart, the new IO-Link device operates with the same parameters as its predecessor.	"Backup/Restore"	
	Application 1: IO-Link device "Out of the Box": After a restart, the new IO-Link device operates with the same parameters as its predecessor.		FALSE
	Application 2: IO-Link device with parameter set deviating from the default settings: "DS_UPLOAD_FLAG" = TRUE The sequential device commands "Load default settings" ( <code>0x2022:001 (P700.01) = TRUE</code> ) and "Save user data" ( <code>0x2022:003 (P700.03) = TRUE</code> ) set "DS_UPLOAD_FLAG" to "FALSE". After a restart, the new IO-Link device operates with the same parameters as its predecessor.		TRUE »FALSE

### Device access lock

The device access lock serves to deactivate various IO-Link device functions according to the IO-Link standard. The i550 only knows one function:

- "Data Storage" (required if the device supports data storage)

If the bit is set in the IO-Link device, the "data storage" mechanism is deactivated. The IO-Link device reacts to a write access with a negative service response - access denied. The read access is not affected.

### Parameter

Address	Name / setting range / [default setting]	Information
0x2315	Device access locks 0 ... [0] ... 65535 • From version 05.04	Device access locks allow for the control of the device behaviour. The parameter is optional.
	Bit 1   Data storage locked	

## 12.12.6 Monitoring

The parameters for setting network monitoring functions are described below.

### Parameter

Address	Name / setting range / [default setting]	Information
0x2859:002	IO-Link monitoring: Data exchange exited • From version 05.04	Data exchange interrupted (wire breakage, loose connector, or similar).  ▶ Severity  700
	0   No response	
	1   <b>Warning</b>	
	2   Trouble	
	3   Fault	

# Configuring the network

IO-Link  
Diagnostics  
Status LEDs



Address	Name / setting range / [default setting]	Information
0x2859:005	IO-Link monitoring: Invalid process data	Cyclic data is invalid or no data is received. The error response can be set.  ▶ Severity  700
	• From version 05.04	
	0 No response	
	1 <b>Warning</b>	
	2 Trouble	
3 Fault		

## 12.12.7 Diagnostics

### 12.12.7.1 Status LEDs

The LEDs indicate the connection status to the network:

LED "RUN" (green)	Status/meaning
Off	No data transfer.
	Active data transfer.
Blinking	

### 12.12.7.2 Information on protocol identification

#### Parameter

Address	Name / setting range / [default setting]	Information
0x2310:001	Direct Parameter Page1: Master command • Read only • From version 05.04	Status display of the "Master Command".
0x2310:002	Direct Parameter Page1: Master cycle time • Read only • From version 05.04	Current cycle time with which the master responds to the device. Can be used as parameter for monitoring the process data transfer.
0x2310:003	Direct Parameter Page1: Minimum cycle time • Read only • From version 05.04	Minimum cycle time supported by the device. This is a performance feature of the device and depends on its technology and implementation.
0x2310:004	Direct Parameter Page1: M-sequence capability • Read only • From version 05.04	Information on the implemented options with regard to the M sequences and the physical configuration.
0x2310:005	Direct Parameter Page1: Revision ID • Read only • From version 05.04	ID of the IO-Link protocol version used for the implementation. 0x11 (used version 1.1)
0x2310:006	Direct Parameter Page1: Process data input • Read only • From version 05.04	Input data from the IO-Link device to the IO-Link master.
0x2310:007	Direct Parameter Page1: Process data output • Read only • From version 05.04	Output data from the IO-Link master to the IO-Link device.
0x2310:008	Direct Parameter Page1: Vendor ID • Read only • From version 05.04	Display of the manufacturer ID.
0x2310:009	Direct Parameter Page1: Device ID 0 ... [0] ... 4294967295 • From version 05.04	Display of the device ID.



Address	Name / setting range / [default setting]	Information
0x2310:010	Direct Parameter Page1: Function ID <ul style="list-style-type: none"> <li>• Read only</li> <li>• From version 05.04</li> </ul>	Display of the function ID.

### 12.12.7.3 Device identification

For device identification, the inverter provides the parameters listed in the following.

#### Parameter

Address	Name / setting range / [default setting]	Information
0x2319:001	Device information: Vendor name <ul style="list-style-type: none"> <li>• Read only</li> <li>• From version 05.04</li> </ul>	Display of the manufacturer name.
0x2319:002	Device information: Vendor text <ul style="list-style-type: none"> <li>• Read only</li> <li>• From version 05.04</li> </ul>	Display of the vendor text.
0x2319:003	Device information: Product name <ul style="list-style-type: none"> <li>• Read only</li> <li>• From version 05.04</li> </ul>	Display of the product name.
0x2319:004	Device information: Product ID <ul style="list-style-type: none"> <li>• Read only</li> <li>• From version 05.04</li> </ul>	Display of the product ID.
0x2319:005	Device information: Product text <ul style="list-style-type: none"> <li>• Read only</li> <li>• From version 05.04</li> </ul>	Display of the product text.
0x2319:006	Device information: Application specific tag ["My Device"] <ul style="list-style-type: none"> <li>• From version 05.04</li> </ul>	Display of the application-specific name. Identical with parameter <a href="#">0x2001 (P191.00)</a> .

### 12.12.7.4 IODD and Engineering

An electronic device description, the IODD file, is available for each device and provides information on the system integration:

- Communication features
- Device parameters with name, value range and standard value
- Identification, process and diagnostic data
- Picture of the IO-Link device

The structure of the IODDs is the same for all devices of all manufacturers. The structure of the IODD is always represented in the same way by the IO-Link configuration tools of the IO-Link master manufacturers. This ensures the same handling of all IO-Link devices irrespective of the manufacturer. For IO-Link devices that support both V1.0 and V1.1 functionality, two different IODD versions are available.

#### IODDfinder

The IODDfinder is a service of the IO-Link Community. IODDfinder is a non-proprietary central database for description files (IODDs). Moreover, this platform provides an overview of all IO-Link devices. ->[Download](#)

#### IO-Link configuration tools

The IO-Link configuration tools of the IO-Link master manufacturers are able to read IODDs. The main tasks of the IO-Link configuration tools include:

- Assignment of the devices to the ports of the IO-Link master
- Easy parameterization of the IO-Link devices

In addition, the connected devices must have diagnostics capability. This allows the IO-Link configuration tool to provide a transparent visualization of the IO-Link system down to the field level.

# Configuring the network

IO-Link  
Diagnostics  
IO-Link event IDs



## 12.12.7.5 IO-Link event IDs

The IO-Link error codes differ from the Lenze error codes. According to the IO-Link specification, manufacturer-specific "error codes" are listed in the following table.

- Clicking the details of the error code shows you a detailed description of the error message.
- If the inverter indicates an "internal error" that is not listed here, restart the inverter. If the error persists, make a note of the error code and contact the manufacturer.

Event ID	Event	Severity	Details
0x1801	CIA: Continuous over current (internal)	Fault	<a href="#">▶ 8784</a>
0x1802	Short circuit or earth leakage at the motor end	Fault	<a href="#">▶ 8992</a>
0x1803	Short circuit at the motor end	Fault	<a href="#">▶ 9024</a>
0x1804	CIA: i <sup>2</sup> xt overload (thermal state)	Fault	<a href="#">▶ 9040</a>
0x1805	Fault - Device utilization (ixt) too high	Fault	<a href="#">▶ 9090</a>
0x1806	Warning - Device utilization (ixt) too high	Warning	<a href="#">▶ 9091</a>
0x1807	Clamp responded too often	Fault	<a href="#">▶ 9095</a>
0x1808	SL-PSM stall detection active	Trouble	<a href="#">▶ 9096</a>
0x1809	Maximum current reached	Information	<a href="#">▶ 9098</a>
0x180A	Mains phase fault	Fault	<a href="#">▶ 12576</a>
0x180B	UPS operation active	Warning	<a href="#">▶ 12672</a>
0x180C	Fault - DC bus overvoltage	Fault	<a href="#">▶ 12816</a>
0x180D	DC bus overvoltage warning	Warning	<a href="#">▶ 12817</a>
0x180E	Fault - DC bus undervoltage	Trouble	<a href="#">▶ 12832</a>
0x180F	DC bus undervoltage warning	Warning	<a href="#">▶ 12833</a>
0x1810	DC-bus voltage to low for power up	Warning	<a href="#">▶ 12834</a>
0x1811	Fault - Power unit overtemperature	Fault	<a href="#">▶ 16912</a>
0x1812	Fault - Heat sink temperature sensor	Fault	<a href="#">▶ 17024</a>
0x1813	Heat sink fan warning	Warning	<a href="#">▶ 17025</a>
0x1814	PU overtemperature warning	Warning	<a href="#">▶ 17029</a>
0x1815	Motor overtemperature	Fault	<a href="#">▶ 17168</a>
0x1816	External supply voltage critical	Warning	<a href="#">▶ 20754</a>
0x1817	Overload 24 V supply	Warning	<a href="#">▶ 20864</a>
0x1818	OEM hardware incompatible	Fault	<a href="#">▶ 21376</a>
0x1820	Warning - Internal fan	Warning	<a href="#">▶ 24970</a>
0x182A	Trigger/functions connected incorrectly	Trouble	<a href="#">▶ 25216</a>
0x182B	User-defined fault 1	Fault	<a href="#">▶ 25217</a>
0x182C	User-defined fault 2	Fault	<a href="#">▶ 25218</a>
0x182D	Warning invert rotation	Warning	<a href="#">▶ 25232</a>
0x182E	Maximum allowed troubles exceeded	Fault	<a href="#">▶ 25233</a>
0x182F	User-defined fault (LECOM)	Fault	<a href="#">▶ 25248</a>
0x1830	Network: user fault 1	Fault	<a href="#">▶ 25249</a>
0x1831	Network: user fault 2	Fault	<a href="#">▶ 25250</a>
0x1832	NetWordIN1 configuration incorrect	Trouble	<a href="#">▶ 25265</a>
0x1890	Changed device ID not yet active	Fault	<a href="#">▶ 25266</a>
0x1891	Default settings not yet active	Fault	<a href="#">▶ 25267</a>
0x1834	CU: load error ID tag	Fault	<a href="#">▶ 25505</a>
0x1835	PU: load error ID tag	Fault	<a href="#">▶ 25506</a>
0x1836	Power unit unknown	Fault	<a href="#">▶ 25507</a>
0x1838	Assertion level monitoring (Low/High)	Fault	<a href="#">▶ 28800</a>
0x1839	Fault - Analog input 1	Fault	<a href="#">▶ 28801</a>
0x183A	Analog input 2 fault	Fault	<a href="#">▶ 28802</a>
0x183B	HTL input fault	No response	<a href="#">▶ 28803</a>
0x183C	Analog output 1 fault	Warning	<a href="#">▶ 28833</a>
0x183D	Analog output 2 fault	Warning	<a href="#">▶ 28834</a>
0x183E	Fault - Pole position identification	Fault	<a href="#">▶ 28961</a>



# Configuring the network

IO-Link  
Diagnostics  
IO-Link event IDs

Event ID	Event	Severity	Details
0x183F	Motor overcurrent	Fault	<a href="#">▶ 29056</a>
0x1840	Encoder open circuit	Warning	<a href="#">▶ 29445</a>
0x1841	Feedback system: speed limit	Warning	<a href="#">▶ 29573</a>
0x1842	Memory module is full	Warning	<a href="#">▶ 30336</a>
0x1843	Memory module not present	Fault	<a href="#">▶ 30337</a>
0x1844	Invalid user data	Fault	<a href="#">▶ 30338</a>
0x1845	Data not compl. saved before powerdown	Warning	<a href="#">▶ 30340</a>
0x1848	Memory module: invalid OEM data	Warning	<a href="#">▶ 30345</a>
0x1849	Memory module: wrong type	Fault	<a href="#">▶ 30346</a>
0x184A	EPM firmware version incompatible	Fault	<a href="#">▶ 30352</a>
0x184B	EPM data: firmware type incompatible	Fault	<a href="#">▶ 30353</a>
0x184C	EPM data: new firmware type detected	Fault	<a href="#">▶ 30354</a>
0x184D	EPM data: PU size incompatible	Fault	<a href="#">▶ 30355</a>
0x184E	EPM data: new PU size detected	Fault	<a href="#">▶ 30356</a>
0x184F	Invalid parameter changeover configuration	Warning	<a href="#">▶ 30357</a>
0x1850	EPM data: unknown parameter found	Information	<a href="#">▶ 30358</a>
0x1851	Parameter changes lost	Fault	<a href="#">▶ 30359</a>
0x1852	Network - Time-out explicit message	Warning	<a href="#">▶ 33042</a>
0x1853	Network - Overall communication time-out	Warning	<a href="#">▶ 33044</a>
0x1854	Time-out (PAM)	No response	<a href="#">▶ 33045</a>
0x1855	Modbus TCP master time-out	Fault	<a href="#">▶ 33046</a>
0x1856	Modbus TCP Keep Alive time-out	Fault	<a href="#">▶ 33047</a>
0x1858	CAN: bus off	Trouble	<a href="#">▶ 33154</a>
0x1859	CAN: warning	Warning	<a href="#">▶ 33155</a>
0x185A	CAN: heartbeat time-out consumer 1	Fault	<a href="#">▶ 33156</a>
0x185B	CAN: heartbeat time-out consumer 2	Fault	<a href="#">▶ 33157</a>
0x185C	CAN: heartbeat time-out consumer 3	Fault	<a href="#">▶ 33158</a>
0x185D	CAN: heartbeat time-out consumer 4	Fault	<a href="#">▶ 33159</a>
0x185E	Network - Watchdog time-out	Trouble	<a href="#">▶ 33168</a>
0x185F	Network - Disruption of cyclic data exchange	No response	<a href="#">▶ 33169</a>
0x1860	Network - Initialization error	Trouble	<a href="#">▶ 33170</a>
0x1861	Network - Invalid cyclic process data	Trouble	<a href="#">▶ 33171</a>
0x1863	Modbus: network time-out	Fault	<a href="#">▶ 33185</a>
0x1864	Modbus: incorrect request by master	Warning	<a href="#">▶ 33186</a>
0x1865	Network communication faulty	Trouble	<a href="#">▶ 33200</a>
0x1866	POWERLINK: Loss of SoC	Trouble	<a href="#">▶ 33381</a>
0x1867	POWERLINK: CRC error	Trouble	<a href="#">▶ 33382</a>
0x1868	Network - PDO mapping error	Trouble	<a href="#">▶ 33414</a>
0x1869	CAN: RPDO1 time-out	Fault	<a href="#">▶ 33425</a>
0x186A	CAN: RPDO2 time-out	Fault	<a href="#">▶ 33426</a>
0x186B	CAN: RPDO3 time-out	Fault	<a href="#">▶ 33427</a>
0x186C	Torque limit reached	No response	<a href="#">▶ 33553</a>
0x186D	Function not allowed in selected operating mode	Warning	<a href="#">▶ 33664</a>
0x186E	Keypad removed	Fault	<a href="#">▶ 36992</a>
0x186F	Fault - Brake resistor overload	Fault	<a href="#">▶ 65282</a>
0x1870	Safety option - Internal error	Fault	<a href="#">▶ 65285</a>
0x1871	Motor overspeed	Fault	<a href="#">▶ 65286</a>
0x1872	Motor phase missing	No response	<a href="#">▶ 65289</a>
0x1873	Motor phase failure phase U	No response	<a href="#">▶ 65290</a>
0x1874	Motor phase failure phase V	No response	<a href="#">▶ 65291</a>
0x1875	Motor phase failure phase W	No response	<a href="#">▶ 65292</a>
0x1876	Motor parameter identification fault	Fault	<a href="#">▶ 65305</a>
0x1877	FMF Error	Fault	<a href="#">▶ 65311</a>

# Configuring the network

IO-Link  
Diagnostics  
IO-Link event IDs



Event ID	Event	Severity	Details
0x188F	Cascading overload	Warning	<a href="#">▶ 65317</a>
0x187E	Warning - Brake resistor overload	Warning	<a href="#">▶ 65334</a>
0x187F	Automatic start disabled	Fault	<a href="#">▶ 65335</a>
0x1880	Load loss detected	No response	<a href="#">▶ 65336</a>
0x1881	Motor overload	No response	<a href="#">▶ 65337</a>
0x1882	Maximum motor frequency reached	Warning	<a href="#">▶ 65366</a>
0x188c	Manual mode disabled	Warning	<a href="#">▶ 65370</a>
0x188d	Manual mode activated	Warning	<a href="#">▶ 65371</a>
0x188e	Manual mode time-out	Fault	<a href="#">▶ 65372</a>
0x1883	Wrong password	Warning	<a href="#">▶ 65393</a>
0x1884	Warning	Warning	<a href="#">▶ 65394</a>
0x1885	Fatal Error	Fault	<a href="#">▶ 65395</a>
0x1886	Power unit fatal error	Fault	<a href="#">▶ 65396</a>
0x1888	Keypad full control active	Warning	<a href="#">▶ 65413</a>



## 12.13 PROFIBUS



PROFIBUS® (Process Field Bus) is a widely-used fieldbus system for the automation of machines and production plants.

- PROFIBUS® is a registered trademark and patented technology licensed by the PROFIBUS & PROFINET International (PI) user organisation.
- Detailed information on PROFIBUS can be found on the web page of the PROFIBUS & PROFINET International (PI) user organisation: <https://www.profibus.com>
- Information about the dimensioning of a PROFIBUS network can be found in the configuration document for the inverter.

### Preconditions

- The control unit (CU) of the inverter is provided with PROFIBUS.
- The DIP switch for the node address is set correctly, see: ▶ [Basic setting and options](#) 427
- The device description file of the inverter is imported into the configuration software for the control.



---

Device description files for Lenze products can be found on the Internet: [www.Lenze.com](http://www.Lenze.com) → Downloads → Product-related Application Knowledge Base articles

---

### Details

The inverter is integrated into a PROFIBUS-DP network as slave. It is only allowed to receive and acknowledge messages and to respond to requests by a master. The master is also referred to as an active bus node. Two different types are distinguished:

- Class 1 DP master: central control (PLC or PC) which cyclically exchanges process data with the slave. Acyclic data exchange via a separate transmission channel is also possible.
- Class 2 DP master: engineering, configuration, or operator device (HMI) which only exchanges data with the slave acyclically, e.g. for the purposes of configuration, maintenance, or diagnostics.

### Communication protocols (PROFIBUS DP)



---

PROFIBUS DP-V2 is not supported by the inverter.

---

Functions of the communication protocol PROFIBUS DP:

- DP-V0: cyclic data exchange, diagnostics (all devices).
- DP-V1: acyclic data exchange, process alarm processing (process automation). Note: The inverter does not support any alarm diagnostics.
- DP-V2: cycle synchronisation and time stamp, slave-to-slave communication.

A class 1 DP master connection (DPV1 C1) between a cyclic master and slave is established automatically when the "Data Exchange" state has been established. In byte 7 of the parameterisation frame, the "DPV1\_Enable" bit must be set. Furthermore, a class 2 DP master connection (DPV1 C2) with the slave can be defined by another master connected. This connection must be established via the "MSAC2\_Initiate" service.

The inverter supports the following acyclic DPV1 services:

- MSAC1\_Read/Write: C1 read/write request for a data block.
- MSAC2\_Initiate/Abort: connection or disconnection for acyclic data exchange between a class 2 DP master and the slave.
- MSAC2\_Read/Write: C2 read/write request for a data block.



## Communication time

The communication time is the time between the start of a request and the arrival of the corresponding response.

The communication times in the PROFIBUS network depend on the ...

- processing time in the inverter
- Telegram runtime (baud rate/telegram length),
- nesting depth of the network.

In the case of the inverter, the processing time for process data is approx. 2 ... 3 ms, and for parameter data (DPV1) it is approx. 10 ms. There are no interdependencies between parameter data and process data.

## Typical topology

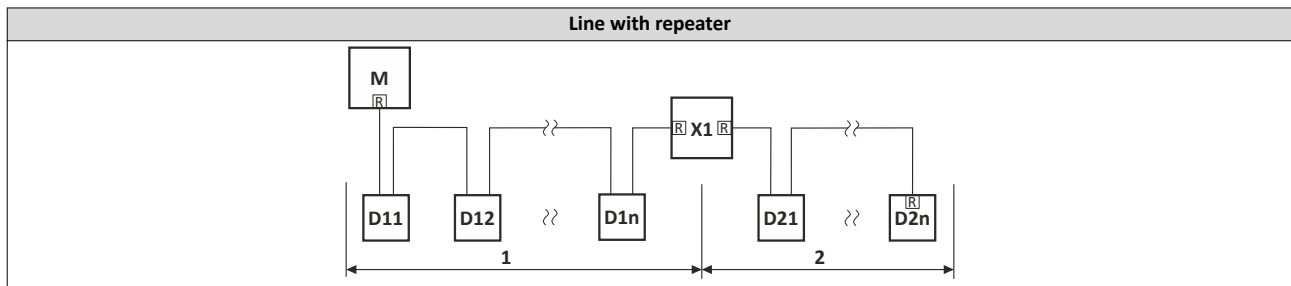

M	Master	X	Repeater
D	Device (Slave)	R	Activated bus terminating resistor





### 12.13.1 Commissioning

In the following, the steps required for controlling the inverter via PROFIBUS are described.

#### Parameterization required

1. Activate network control: [0x2631:037 \(P400.37\)](#) = "TRUE [1]"
2. Set network as standard setpoint source: [0x2860:001 \(P201.01\)](#) = "Network [5]"
3. Set PROFIBUS station address.
  - Each network node must be provided with a unique station address.
  - See: [▶ Station address setting](#) [427](#)
4. Optional: Change the response of the inverter if the communication to the PROFIBUS master is interrupted.
  - Default setting: If communication is interrupted, an error is triggered.
  - See: [▶ Monitoring](#) [441](#)
5. Save parameter settings: [0x2022:003 \(P700.03\)](#) = "On / start [1]".
6. Switch the inverter off and then on again in order that the changed communication settings can get effective.
7. Configure the host system (master) in order to enable communication with the inverter.  
See: [Configuring the host system \(master\)](#) [425](#)
8. Control inverter via RPDO (and evaluate in the current status via TPDO).
  - For assignment of the control word and setpoint selection, see [▶ Define your own control word format](#) [314](#).
  - For assignment of the status word and actual value output, see [▶ Define your own status word format](#) [322](#).
  - Acceleration [0x2917 \(P220.00\)](#) and deceleration [0x2918 \(P221.00\)](#) can be set/changed via the acyclic parameter data transfer.



---

In the default setting, the digital input DI1 is assigned the "Run" function. If the network control is activated, this function serves as "start enable" for start commands via network. Hence, the digital input DI1 must be set to the HIGH level in order that the motor can be started via the network.

[▶ Flexible I/O configuration of the start, stop and rotating direction commands](#) [67](#)

---

#### Configuring the host system (master)

Configure the host system (master) with a configuration software as follows in order to enable communication with the inverter.

1. Import the device description file of the inverter into the master.  
[Download of the GSD file](#)  
The following language versions of the device description file can be used:
  - LENZE[product type].GSD (source file, English), e.g. LENZE550.GSD for i550
  - LENZE[product type].GSG (German), e. g. LENZE550.GSG for i550
  - LENZE[product type].GSE (English), e. g. LENZE550.GSE for i550
2. Define the user data length.
  - The user data length is defined during the initialization phase of the master.
  - The inverter supports the configuration of max. 16 process data words (max. 32 bytes).
  - The user data length for process input data and process output data is the same.
3. Adapt data mapping in the configuration software.  
See: [▶ Standard mapping](#) [430](#)
4. Save configuration.



## Start-up of the host system (master)

- After the start-up, the master communicates the structure of the cyclic frames to the inverter (slave) via the configuration frame (CHK\_CFG).
- The inverter checks the configuration. If the configuration is accepted, the inverter changes from the "Wait Configuration" state to the "Data Exchange" state. It is now possible to exchange user data with the master.
- The internal mapping of the process data is set in [0x24E0:001 ... 0x24E0:016](#) (direction Master → Inverter) and [0x24E1:001 ... 0x24E1:016](#) (direction Inverter → Master). Format: 0xiiiiissll (iiii= Index hexadecimal, ss= subindex hexadecimal, ll= data length hexadecimal)

▶ [Process data transfer](#)  429



## 12.13.2 Basic setting and options

### 12.13.2.1 Station address setting

Each network node must be provided with a unique station address.

#### Details

- The station address of the inverter can be optionally set via the DIP switches on the device labelled with "1" ... "64" or in [0x2341:001 \(P510.01\)](#). (The DIP switches have priority.)
- The setting that is active when the inverter is switched on is the effective setting.
- The labelling of the DIP switches corresponds to the values of the individual DIP switches for determining the station address (see the following example).
- The active station address is shown in [0x2342:001 \(P511.01\)](#).

#### View of the DIP switch

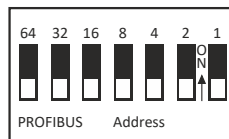

#### Example of how the station address is set via the DIP switches

DIP switch	64	32	16	8	4	2	1
Setting	OFF	OFF	ON	OFF	ON	ON	ON
Value	0	0	16	0	4	2	1
Station address	= sum of all values = 16 + 4 + 2 + 1 = 23						

#### Parameter

Address	Name / setting range / [default setting]	Information
0x2341:001 (P510.01)	PROFIBUS settings: Station address (PROFIBUS sett.: Station address) 1 ... [3] ... 125	Optional setting of the station address (instead of setting via DIP switches 1 ... 64). <ul style="list-style-type: none"> <li>• The station address set here only becomes effective if DIP switches 1 ... 64 have been set to OFF before mains switching.</li> <li>• A change in the station address only becomes effective after a restart of PROFIBUS communication.</li> </ul>

### 12.13.2.2 Baud rate setting

At the class 1 DP master, the desired baud rate is set. All masters at the bus must be set to the same baud rate.

#### Details

- The inverter detects the baud rate automatically.
- The active baud rate is displayed in [0x2342:002 \(P511.02\)](#).
- The status of automatic detection is displayed in [0x2348:002 \(P516.02\)](#).

# Configuring the network

PROFIBUS

Basic setting and options

Suppress diagnostic messages to the master



## 12.13.2.3 Suppress diagnostic messages to the master

The alarm message on the master can be optionally suppressed for certain error responses of the inverter to facilitate suitable error handling between master and slave (inverter). Alarm responses programmed in the master can be avoided if they are not wanted in this case.

### Details

Inverter errors and warnings are sent to the Master as alarm messages. This function is used to suppress, for example, the fact that the "undervoltage DC link" warning triggers an alarm and the associated control switches to the stop mode if there is no associated alarm block or has been programmed manually. It should be noted here, that an alarm block not programmed in the control can pose risks to the machine. A reduction of possible alarm messages initially helps when the machine is commissioned. Later on, however, more effort should be made to program the alarm blocks.

### Parameter

Address	Name / setting range / [default setting]	Information
0x285A:001	Diagnostic configuration: Alarm suppression 0 ... [0] ... 65535 • From version 05.01	Bit coded selection of error responses in the inverter which suppress the alarm message to the PROFIBUS master. • Bit x = 1 = suppress alarm message. • In the default setting "0", an alarm message is displayed for all error responses.
	Bit 0 Information	
	Bit 1 Warning	
	Bit 2 -	
	Bit 3 Trouble	
	Bit 4 -	
	Bit 5 -	
	Bit 6 -	
Bit 7 Fault		



### 12.13.3 Process data transfer

Data mapping is used to define which process data is exchanged cyclically between master and slave.

The data mapping is defined via the configuration software of the PROFIBUS master.

▶ [Commissioning](#)  425

The configuration of the process data is automatically sent to the inverter. The same applies to the bit configuration of the data words NetWordIN1 and NetWordOUT1.



## 12.13.3.1 Standard mapping

### RPDO mapping

For the process data from the master to the inverter, the following data mapping is preset in the device description file:

1. NetWordIN1 data word [0x4008:001 \(P590.01\)](#)
2. Network setpoint frequency (0.01) [0x400B:005 \(P592.05\)](#)
3. 16 bit selectable output data, mapped to: "Keypad setpoints: Process controller setpoint" [0x2601:002 \(P202.02\)](#)

### Function assignment of the NetWordIN1 data word

Bit	Default setting	For details and configuration, see
0	Not active (reserve)	<a href="#">0x400E:001 (P505.01)</a>
1	Not active (reserve)	<a href="#">0x400E:002 (P505.02)</a>
2	Activate quick stop	<a href="#">0x400E:003 (P505.03)</a>
3	Not active (reserve)	<a href="#">0x400E:004 (P505.04)</a>
4	Run forward (CW)	<a href="#">0x400E:005 (P505.05)</a>
5	Activate preset (bit 0)	<a href="#">0x400E:006 (P505.06)</a>
6	Activate preset (bit 1)	<a href="#">0x400E:007 (P505.07)</a>
7	Reset error	<a href="#">0x400E:008 (P505.08)</a>
8	Not active (reserve)	<a href="#">0x400E:009 (P505.09)</a>
9	Activate DC braking	<a href="#">0x400E:010 (P505.10)</a>
10	Not active (reserve)	<a href="#">0x400E:011 (P505.11)</a>
11	Not active (reserve)	<a href="#">0x400E:012 (P505.12)</a>
12	Reverse rotational direction	<a href="#">0x400E:013 (P505.13)</a>
13	Not active (reserve)	<a href="#">0x400E:014 (P505.14)</a>
14	Not active (reserve)	<a href="#">0x400E:015 (P505.15)</a>
15	Not active (reserve)	<a href="#">0x400E:016 (P505.16)</a>

### Specifying the frequency setpoint

- The specification is made unsigned (independent of the direction of rotation) as integer in the resolution [0.01 Hz].
- The direction of rotation is defined in the default setting via bit 12 of the NetWordIN1 data word.
- Example: 4560 = 45.60 Hz



## TPDO mapping

For the process data from the inverter to the master, the following data mapping is preset in the device description file:

1. NetWordOUT1 data word [0x400A:001 \(P591.01\)](#)
2. Network setpoint frequency (0.01) [0x400B:005 \(P592.05\)](#)
3. Motor current [0x2D88 \(P104.00\)](#)

## Status assignment of the NetWordOUT1 data word

Bit	Default setting	For details and configuration, see
0	Ready for operation	<a href="#">0x2634:010 (P420.10)</a>
1	Not connected	<a href="#">0x2634:011 (P420.11)</a>
2	Operation enabled	<a href="#">0x2634:012 (P420.12)</a>
3	Fault active	<a href="#">0x2634:013 (P420.13)</a>
4	Not connected	<a href="#">0x2634:014 (P420.14)</a>
5	Quick stop active	<a href="#">0x2634:015 (P420.15)</a>
6	Running	<a href="#">0x2634:016 (P420.16)</a>
7	Device warning active	<a href="#">0x2634:017 (P420.17)</a>
8	Not connected	<a href="#">0x2634:018 (P420.18)</a>
9	Not connected	<a href="#">0x2634:019 (P420.19)</a>
10	Setpoint speed reached	<a href="#">0x2634:020 (P420.20)</a>
11	Current limit reached	<a href="#">0x2634:021 (P420.21)</a>
12	Actual speed = 0	<a href="#">0x2634:022 (P420.22)</a>
13	Rotational direction reversed	<a href="#">0x2634:023 (P420.23)</a>
14	Release holding brake	<a href="#">0x2634:024 (P420.24)</a>
15	Inverter disabled (safety)	<a href="#">0x2634:025 (P420.25)</a>

### Output of the actual frequency value

- The output is made unsigned (independent of the direction of rotation) as integer in the resolution [0.01 Hz].
- An active reversal is displayed via bit 13 of the NetWordOUT1 data word.
- Example: 4560 = 45.60 Hz



#### 12.13.4 Parameter data transfer

Data communication with PROFIBUS DP-V0 is characterised by cyclic diagnostics and cyclic process data transfer. An optional service expansion is the acyclic parameter data transfer of PROFIBUS DP-V1. This service does not impair the functionality of the PROFIBUS standard services under PROFIBUS DP-V0.

##### Details

- PROFIBUS DP-V0 and PROFIBUS DP-V1 can be operated simultaneously in the same network. This enables the expansion or modification of a system.
- The services of PROFIBUS DP-V1 can be used by the class 1 master (PLC) and the class 2 DP master (diagnostics master, etc.).
- Integration of the acyclic service into the fixed bus cycle depends on the corresponding configuration of the class 1 master:
  - With configuration, a time slot is reserved.
  - Without configuration, the acyclic service is appended when a class 2 DP master acyclically accesses a DP-V1 slave.

##### Features

- 16 bits each for addressing the parameter index and subindex.
- Several parameter requests can be combined to one request (multi-parameter requests).
- Only one request is processed at a time (no pipelining).
- A request or response must fit into one data block (max. 240 bytes). Requests or responses cannot be split into several data blocks.
- No spontaneous messages are transferred.
- There are only acyclic parameter requests.
- Profile-specific parameters can be read independently of the slave state.
- A class 1 DP master can always request parameters from a slave if the slave is in the "Data Exchange" state.
- In addition to a class 1 DP master, a class 2 DP master can establish communication with a slave:





## Transmission directions for acyclic data transfer

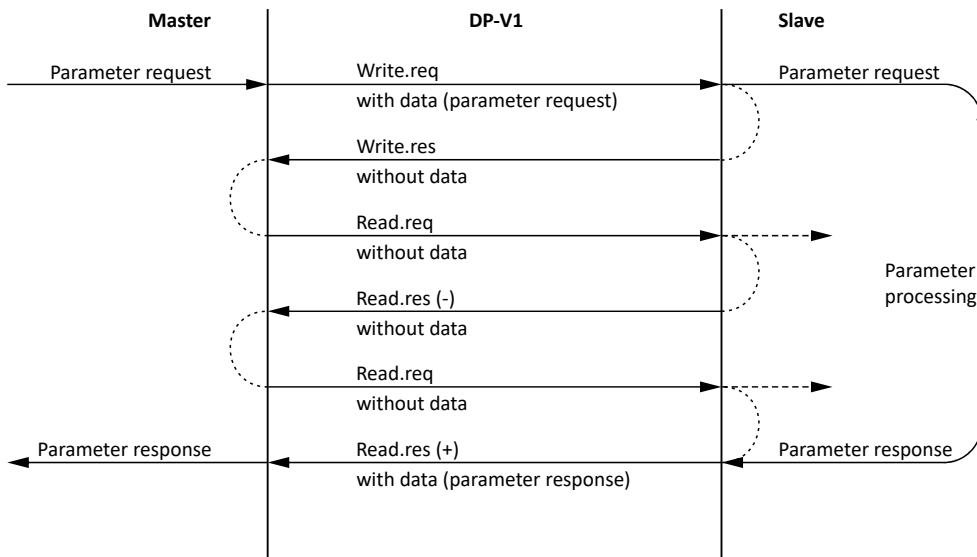

Procedure:

1. A "Write.req" is used to pass the data set (DB47) to the slave in the form of a parameter request.
2. With "Write.res" the master receives the confirmation for the receipt of the message.
3. The master requests the response of the slave with "Read.req".
4. The slave responds with "Read.res (-)" if processing has not been completed yet.
5. After parameter processing, the parameter request is completed by transmitting the parameter response to the master with "Read.res (+)".

## Frame structure

SD	LE	LEr	SD	DA	SA	FC	DSAP	SSAP	Data Unit (DU)	FCS	ED
----	----	-----	----	----	----	----	------	------	----------------	-----	----

The Data Unit (DU) contains the DP-V1 header and the parameter request or the parameter response. The DP V1 header consists of the function detection, slot number, data set, and the length of the user data. More information about the DP-V1 header can be found in the corresponding PROFIBUS specification. A detailed description of the parameter request and parameter response can be found in the following subchapters.

## Assignment of the user data depending on the data type

Depending on the data type used, the user data is assigned as follows:

Data type	Length	User data assignment				
		Byte 1	Byte 2	Byte 3	Byte 4	Byte ...
String	x bytes	Data (x bytes)				
U8	1 byte	Data	0x00			
U16	2 bytes	HIGH byte	LOW byte			
		Data	Data			
U32	4 bytes	HIGH word		LOW word		
		HIGH byte	LOW byte	HIGH byte	LOW byte	
		Data	Data	Data	Data	

# Configuring the network

PROFIBUS

Parameter data transfer

Read parameter data acyclically



## 12.13.4.1 Read parameter data acyclically

This section describes the request and response for the acyclic reading of a parameter.

### Details

- When a read request is processed, no parameter value is written to the slave.
- When a read request is transmitted by multi-parameters, the parameter attribute, index and subindex are repeated.
- A read request must not exceed the maximum data length of 240 bytes.

### Request header

Byte 1	Byte 2	Byte 3	Byte 4
Request reference	Request identification	Axis	Number of indices

Field	Data type	Values
Request reference	U8	This value is defined by the master.
Request identification	U8	0x01: Request parameters for reading.
Axis	U8	0x00 or 0x01
Number of indices	U8	0x"n" (n = number of parameters requested)

### Parameter attribute

Byte 5	Byte 6
Attribute	Number of subindices

Field	Data type	Values
Attribute	U8	0x10: Value
Number of subindices	U8	0x00

### Index and subindex

Byte 7	Byte 8	Byte 9	Byte 10
Index		Subindex	
HIGH byte	LOW byte	HIGH byte	LOW byte

Field	Data type	Values
Index	U16	0x0001 ... 0xFFFF (1 ... 65535)
Subindex	U16	0x0000 ... 0x00FF (0 ... 255)

### Response to a correctly executed read request

Responses to a read request do not contain parameter attributes, indices and subindices.

### Response header

Byte 1	Byte 2	Byte 3	Byte 4
Request reference (mirrored)	Response identification	Axis (mirrored)	Number of indices

Field	Data type	Values
Request reference	U8	Mirrored value of the parameter request.
Response identification	U8	0x01: Parameter has been read.
Axis	U8	0x00 or 0x01
Number of indices	U8	0x"n" (n = number of parameters requested)



## Parameter format

Byte 5	Byte 6	
Format	Number of values	

Field	Data type	Values
Format	U8	0x02: integer8 (1 byte with sign) 0x03: Integer16 (2 bytes with sign) 0x04: Integer32 (4 bytes with sign) 0x05: Unsigned8 (1 byte without sign) 0x06: Unsigned16 (2 bytes without sign) 0x07: Unsigned32 (4 bytes without sign) 0x09: Visible String (with n characters) 0x0A: Octet String (with n characters) 0x40: Zero 0x41: Byte 0x42: Word 0x43: Double word
Number of values	U8	0x01 or number of characters (n) for string parameters.

## Parameter value

Byte 7	Byte 8	Byte 9	Byte 10
Value (Integer8 / Unsigned8 / byte)			
Value (Integer16 / Unsigned16 / word)			
Value (Integer32 / Unsigned32 / double word)			

Byte 7	Byte 8	Byte 9	Byte ...
String (Visible string / octet string with an optional length)			

Field	Data type	Values
Value	U8/U16/U32	Value range/length depends on the parameter format (see table above).
String	U8	Visible string / octet string with an optional length (n characters = n bytes)

## Response to a read error

In the case of a multi-parameter request, correct and possible faulty messages are summarised in one telegram. They have the following data contents:

Correct message

- Format: data type of the value requested
- Number of values: as described above.
- Parameter value: value requested

Faulty message

- Format: 0x44
- Number of values: 0x01 or 0x02
- Error code without additional information (for number of values = 0x01) or error code with additional information (for number of values = 0x02)

A faulty access to a parameter "n" is indicated at the nth position in the response telegram of a multi-parameter request.

# Configuring the network

PROFIBUS

Parameter data transfer

Read parameter data acyclically



## Response header

Byte 1	Byte 2	Byte 3	Byte 4
Request reference (mirrored)	Response identification	Axis (mirrored)	Number of indices

Field	Data type	Values
Request reference	U8	Mirrored value of the parameter request.
Response identification	U8	0x81: Parameter has not been read. The data in bytes 7 + 8 must be interpreted as an error code.
Axis	U8	0x00 or 0x01
Number of indices	U8	0x"n" (n = number of parameters requested)

## Parameter format

Byte 5	Byte 6
Format	Number of values

Field	Data type	Values
Format	U8	0x44: Error
Number of values	U8	0x01: Error code without additional information. 0x02: Error code with additional information.

## Error code

Byte 7	Byte 8	Byte 9	Byte 10
Error code		Additional information (if available)	
HIGH byte	LOW byte	HIGH byte	LOW byte

Field	Data type	Values
Error code	U16	0x0000 ... 0xFFFF
Additional information (if available)	U16	



## 12.13.4.2 Write parameter data acyclically

This section describes the request and response for the acyclic writing of a parameter.

### Details

- When a multi-parameter write request is transmitted, the parameter attribute, index and subindex and then the parameter format and parameter value are repeated "n" times, "n" being the number of parameters addressed.
- A write request must not exceed the maximum data length of 240 bytes.

### Request header

Byte 1	Byte 2	Byte 3	Byte 4
Request reference	Request identification	Axis	Number of indices

Field	Data type	Values
Request reference	U8	This value is defined by the master.
Request identification	U8	0x02: Write parameters.
Axis	U8	0x00 or 0x01
Number of indices	U8	0x"n" (n = number of parameters addressed)

### Parameter attribute

Byte 5	Byte 6
Attribute	Number of subindices

Field	Data type	Values
Attribute	U8	0x10: Value
Number of subindices	U8	0x00

### Index and subindex

Byte 7	Byte 8	Byte 9	Byte 10
Index		Subindex	
HIGH byte	LOW byte	HIGH byte	LOW byte

Field	Data type	Values
Index	U16	0x0001 ... 0xFFFF (1 ... 65535)
Subindex	U16	0x0000 ... 0x00FF (0 ... 255)

### Parameter format

Byte 11	Byte 12
Format	Number of values

Field	Data type	Values
Format	U8	0x02: integer8 (1 byte with sign) 0x03: Integer16 (2 bytes with sign) 0x04: Integer32 (4 bytes with sign) 0x05: Unsigned8 (1 byte without sign) 0x06: Unsigned16 (2 bytes without sign) 0x07: Unsigned32 (4 bytes without sign) 0x09: Visible String (with n characters) 0x0A: Octet String (with n characters) 0x40: Zero 0x41: Byte 0x42: Word 0x43: Double word
Number of values	U8	0x01 or number of characters (n) for string parameters.

# Configuring the network

PROFIBUS

Parameter data transfer

Write parameter data acyclically



## Parameter value

Byte 13	Byte 14	Byte 15	Byte 16
Value (Integer8 / Unsigned8 / byte)			
Value (Integer16 / Unsigned16 / word)			
Value (Integer32 / Unsigned32 / double word)			
Byte 13	Byte 14	Byte 15	Byte ...
String (Visible string / octet string with an optional length)			
Field	Data type	Values	
Value	U8/U16/U32	Value range/length depends on the parameter format (see table above).	
String	U8	Visible string / octet string with an optional length (n characters = n bytes)	

## Response to a correctly executed write request

With an error-free multi-parameter request, only the response header is transmitted, and the complete data area is omitted.

### Response header

Byte 1	Byte 2	Byte 3	Byte 4
Request reference (mirrored)	Response identification	Axis (mirrored)	Number of indices
Field	Data type	Values	
Request reference	U8	Mirrored value of the parameter request.	
Response identification	U8	0x02: Parameter has been written.	
Axis	U8	0x00 or 0x01	
Number of indices	U8	0x"n" (n = number of parameters addressed)	

## Response to a write error

In the case of a multi-parameter request, correct and possible faulty messages are summarised in one telegram. They have the following data contents:

Correct message

- Format: 0x40
- Number of values: 0x00

Faulty message

- Format: 0x44
- Number of values: 0x01 or 0x02
- Error code without additional information (for number of values = 0x01) or error code with additional information (for number of values = 0x02)

A faulty access to a parameter "n" is indicated at the nth position in the response telegram of a multi-parameter request.

### Response header

Byte 1	Byte 2	Byte 3	Byte 4
Request reference (mirrored)	Response identification	Axis (mirrored)	Number of indices
Field	Data type	Values	
Request reference	U8	Mirrored value of the parameter request.	
Response identification	U8	0x82: Parameter has not been written. The data in bytes 7 + 8 must be interpreted as an error code.	
Axis	U8	0x00 or 0x01	
Number of indices	U8	0x"n" (n = number of parameters addressed)	



## Parameter format

Byte 5	Byte 6	
Format	Number of values	

Field	Data type	Values
Format	U8	0x44: Error
Number of values	U8	0x01: Error code without additional information. 0x02: Error code with additional information.

## Error code

Byte 7	Byte 8	Byte 9	Byte 10
Error code		Additional information (if available)	
HIGH byte	LOW byte	HIGH byte	LOW byte

Field	Data type	Values
Error code	U16	0x0000 ... 0xFFFF
Additional information (if available)	U16	



## 12.13.4.3 Event IDs

The following table lists all possible error codes for the acyclic data exchange:

Error code	Description	Explanation	Additional information
0x0000	Parameter number impermissible	Access to non-available parameter.	-
0x0001	Parameter value cannot be changed	Change access to a parameter value that cannot be changed.	Subindex
0x0002	Lower or upper value limit exceeded	Change access with value beyond the value limits.	Subindex
0x0003	Subindex impermissible	Access to non-available subindex.	Subindex
0x0004	No array	Access with subindex to non-indicated parameter.	-
0x0005	Incorrect data type	Change access with value that does not match the data type of the parameter.	-
0x0006	No setting permitted (only resettable)	Change access with a non-zero value where it is not permitted.	Subindex
0x0007	Description element cannot be changed	Change access to a description element that cannot be changed.	Subindex
0x0008	Reserved	(PROFIdrive profile V2: PPO-Write requested in IR is not available.)	-
0x0009	Description data not available	Access to non-available description (parameter value is available).	-
0x000A	Reserved	(PROFIdrive profile V2: Wrong access group.)	-
0x000B	No parameter change rights	Change access with missing parameter change rights.	-
0x000C	Reserved	(PROFIdrive profile V2: Wrong password.)	-
0x000D	Reserved	(PROFIdrive profile V2: Text cannot be read in cyclic data transfer.)	-
0x000E	Reserved	(PROFIdrive profile V2: Name cannot be read in cyclic data transfer.)	-
0x000F	No text array available	Access to non-available text array (parameter value is available).	-
0x0010	Reserved	(PROFIdrive profile V2: No PPO-Write.)	-
0x0011	Request cannot be executed due to the operating state	Access is not possible for temporary reasons that are not specified in detail.	-
0x0012	Reserved	(PROFIdrive profile V2: Other error.)	-
0x0013	Reserved	(PROFIdrive profile V2: Date cannot be read in cyclic data transfer.)	-
0x0014	Value impermissible	Change access with the value that is within the value limits but that is impermissible for other permanent reasons (parameters with defined individual values).	Subindex
0x0015	Response too long	The length of the current response exceeds the maximum length transferrable.	-
0x0016	Parameter address impermissible	Impermissible value or value which is not supported for the attribute, number of subindexes, parameter number, or subindex, or a combination.	-
0x0017	Format impermissible	Write request: Impermissible or non-supported format of parameter data.	-
0x0018	Number of values not consistent	Write request: Number of parameter data values does not match the number of subindexes in the parameter address.	-
0x0019	Axis impermissible	Access to non-available axis. For double axis, only 0x00 or 0x01 permitted.	-
0x001A	Reserved	-	-
...			
0x00FF			





## 12.13.5 Monitoring

The inverter can give a parameterisable response to various PROFIBUS errors.

### Details

The following table lists the PROFIBUS errors that can be set for a response.

Event	Display in	Response can be set in	Default setting
Communication to the PROFIBUS master is continuously interrupted.	0x2349 (P517.00), Bit 0	0x2859:001 (P515.01)	Fault
Data exchange via PROFIBUS has been terminated.	0x2349 (P517.00), Bit 1	0x2859:002 (P515.02)	No response
The inverter has received invalid configuration data from the master.	0x2349 (P517.00), Bit 2	0x2859:003 (P515.03)	Fault
An error has occurred during the initialisation of the PROFIBUS interface.	0x2349 (P517.00), Bit 3	0x2859:004 (P515.04)	Fault
The process data received are invalid.	0x2349 (P517.00), Bit 4	0x2859:005 (P515.05)	Trouble

The parameters for setting network monitoring functions are described below.

### Parameter

Address	Name / setting range / [default setting]	Information
0x2859:001 (P515.01)	PROFIBUS monitoring: Watchdog elapsed (PROFIBUS monit.: WD elapsed)	Selection of the response to the continuous interruption of communication to the PROFIBUS master, e. g. by cable break or failure of the PROFIBUS master.  Associated event ID: • 33168   0x8190 - Network - Watchdog time-out
	0 No response	▶ Severity <input type="checkbox"/> 700
	1 Warning	
	2 <b>Trouble</b>	
	3 Fault	
0x2859:002 (P515.02)	PROFIBUS monitoring: Data exchange exited (PROFIBUS monit.: Data exch.exited)	Selection of the response to exiting the "Data Exchange" state.  Associated event ID: • 33169   0x8191 - Network - Disruption of cyclic data exchange
	0 <b>No response</b>	▶ Severity <input type="checkbox"/> 700
	1 Warning	
	2 Trouble	
	3 Fault	
0x2859:003 (P515.03)	PROFIBUS monitoring: Invalid configuration (PROFIBUS monit.: Invalid config)	Selection of the response triggered by the reception of invalid configuration data.  Associated event ID: • 33414   0x8286 - Network - PDO mapping error
	0 No response	▶ Severity <input type="checkbox"/> 700
	1 Warning	
	2 <b>Trouble</b>	
	3 Fault	
0x2859:004 (P515.04)	PROFIBUS monitoring: Initialisation error (PROFIBUS monit.: Init. error)	Selection of the response triggered by the occurrence of an error during the initialisation of the PROFIBUS module.  Associated event ID: • 33170   0x8192 - Network - Initialization error
	0 No response	▶ Severity <input type="checkbox"/> 700
	1 Warning	
	2 <b>Trouble</b>	
	3 Fault	

# Configuring the network

PROFIBUS  
Diagnostics  
Status LEDs









Address	Name / setting range / [default setting]	Information
0x2859:005 (P515.05)	PROFIBUS monitoring: Invalid process data (PROFIBUS monit.: Inval. proc.data)	Selection of the response triggered by the reception of invalid process data. <ul style="list-style-type: none"> <li>If the master changes to the "Stop" state, no cyclic process data are sent to the inverter (slave) anymore; the length of the process data then is 0.</li> </ul> Associated event ID: <ul style="list-style-type: none"> <li><a href="#">33171</a>   <a href="#">0x8193</a> - Network - Invalid cyclic process data</li> </ul>
	0 No response	▶ Severity <a href="#">700</a>
	1 Warning	
	2 <b>Trouble</b>	
	3 Fault	

## 12.13.6 Diagnostics

### 12.13.6.1 Status LEDs

Information about the PROFIBUS status can be obtained quickly via the "NS" and "NE" LED displays on the front of the inverter.

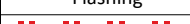
The meaning can be seen from the table below.

LED "NS" (green)	LED "NE" (red)	Status/meaning
off	off	No supply voltage available, network deactivated, not initialised, or firmware download active.
 on		Connected with master, control running, "Data Exchange" state active.
 blinking		Not connected, control stopped, or no data exchange.
 blinking	 blinking	Watchdog monitoring time elapsed.
Any	 Flashing	PROFIBUS parameterisation error.
	 Flashing 2 x	PROFIBUS configuration error.
off	 on	Invalid station address set or non-correctable error.

### 12.13.6.2 Information on the network

The following parameters show information on the network.

#### Parameter

Address	Name / setting range / [default setting]	Information
0x2342:001 (P511.01)	Active PROFIBUS settings: Active station address (PROFIBUS diag.: Act.station addr) • Read only	Display of the active station address.
0x2342:002 (P511.02)	Active PROFIBUS settings: Active baud rate (PROFIBUS diag.: Active baud rate) • Read only	Display of the active baud rate.
	0 12 Mbps	
	1 6 Mbps	
	2 3 Mbps	
	3 1.5 Mbps	
	4 500 kbps	
	5 187.5 kbps	
	6 93.75 kbps	
	7 45.45 kbps	
	8 19.2 kbps	
	9 9.6 kbps	
	15 Search	Automatic baud rate detection active.



# Configuring the network

PROFIBUS  
Diagnostics  
Information on the network

Address	Name / setting range / [default setting]	Information
0x2342:003 (P511.03)	Active PROFIBUS settings: Watchdog time (PROFIBUS diag.: Watchdog time) • Read only	Display of the watchdog monitoring time specified by the master. • Monitoring starts with the arrival of the first telegram. • When a value of "0" is displayed, the monitoring function is deactivated. • A change in the watchdog monitoring time in the master is effective immediately.
0x2343 (P509.00)	PROFIBUS switch position (PROFIBUS switch) • Read only	Display of the DIP switch setting at the last mains power-on. • The displayed value corresponds to the sum of the individual DIP switch values 1 ... 64.
0x2344:001 (P512.01)	PROFIBUS Configuration: Extended diagnostic bit (PROFIBUS Config.: Ext. diag. bit)	1 = set external diagnostic bit ("Diag Bit"). • The diagnostic bit is sent to the master where it is evaluated separately.
	0 Delete	
0x2348:001 (P516.01)	PROFIBUS Status: Bus status (PROFIBUS Status: Bus status) • Read only	Display of the current DP state machine state (DP-STATE).
	0 WAIT_PRM	After the run-up, the inverter (slave) is waiting for parameter data (CHK_PRM) from the master. All other frame types are not processed. Exchanging user data with the master is not possible yet.
	1 WAIT_CFG	The inverter (slave) is waiting for configuration data (CHK_CFG) from the master that define the structure of the cyclic frames.
	2 DATA_EXCH	Parameter and configuration data have been received and accepted by the inverter (slave). The inverter is in the "Data Exchange" state. It is now possible to exchange user data with the master.
0x2348:002 (P516.02)	PROFIBUS Status: Watchdog status (PROFIBUS Status: Watchdog status) • Read only	Display of the current state of the watchdog state machine (WD-STATE).
	0 BAUD_SEARCH	The inverter (slave) is able to detect the baud rate automatically.
	1 BAUD_CONTROL	After detecting the correct baud rate, the inverter (slave) status changes to BAUD_CONTROL, and the baud rate is monitored.
	2 DP_CONTROL	The DP_CONTROL state serves to the response monitoring of the master.

# Configuring the network

PROFIBUS  
Diagnostics  
Information on the network



Address	Name / setting range / [default setting]	Information
0x2349 (P517.00)	PROFIBUS error (PROFIBUS error) • Read only	Bit-coded display of PROFIBUS errors.
	Bit 0 Watchdog elapsed	Communication with the PROFIBUS master is continuously interrupted, e. g. by cable break or failure of the PROFIBUS master. • No process data are sent to the inverter (slave) in the "Data Exchange" state. • When the watchdog monitoring time specified by the master has elapsed, the response set in <a href="#">0x2859:001 (P515.01)</a> is triggered in the inverter.  Preconditions for a response by the inverter (slave): • The slave is in the "Data Exchange" state. • The watchdog monitoring time is configured correctly in the master (1 ... 65535 ms).  If one of these preconditions is not met, the response to the absence of cyclic process data telegrams from the master is not executed.
	Bit 1 Data exchange completed	Data exchange via PROFIBUS has been terminated. • The inverter (slave) can be instructed by the master to exit the "Data Exchange" state. • If this state change is to be treated as an error in the inverter, the desired response can be set in <a href="#">0x2859:002 (P515.02)</a> .
	Bit 2 Incorrect configuration data	The inverter (slave) has received invalid configuration data from the master. • The response set in <a href="#">0x2859:003 (P515.03)</a> is effected.
	Bit 3 Initialisation error	An error has occurred during the initialisation of the PROFIBUS interface. • The response set in <a href="#">0x2859:004 (P515.04)</a> is effected.
	Bit 4 Invalid process data	The inverter (slave) has received invalid process data from the master, e.g. no process data or deleted process data are sent by the "Stop" operating status in the master. • The response set in <a href="#">0x2859:005 (P515.05)</a> is effected.
0x234A:001 (P580.01)	PROFIBUS statistics: Data cycles per second (PROFIBUS counter: Data cycles/sec.) • Read only	Display of the data cycles per second.
0x234A:002 (P580.02)	PROFIBUS statistics: Parameterization events (PROFIBUS counter: PRM events) • Read only	Display of the number of parameterisation events.
0x234A:003 (P580.03)	PROFIBUS statistics: Configuration events (PROFIBUS counter: CFG events) • Read only	Display of the number of configuration events.
0x234A:004 (P580.04)	PROFIBUS statistics: Diagnostics events (PROFIBUS counter: DIAG events) • Read only	Display of the number of diagnostic telegrams sent.
0x234A:005 (P580.05)	PROFIBUS statistics: C1 messages (PROFIBUS counter: C1 messages) • Read only	Display of the number of requests by the class 1 DPV1 master.
0x234A:006 (P580.06)	PROFIBUS statistics: C2 messages (PROFIBUS counter: C2 messages) • Read only	Display of the number of requests by the class 2 DPV1 master.
0x234A:007 (P580.07)	PROFIBUS statistics: Watchdog events (PROFIBUS counter: WD events) • Read only	Display of the number of watchdog events.
0x234A:008 (P580.08)	PROFIBUS statistics: Data exchange aborts (PROFIBUS counter: DataEx.event) • Read only	Display of the number of "Data Exchange exited" events.
0x234A:009 (P580.09)	PROFIBUS statistics: Total data cycles (PROFIBUS counter: Tot. data cycles) • Read only	Display of the number of cyclic process data received.



## 12.14 EtherCAT



EtherCAT® (Ethernet for Controller and Automation Technology) is an Ethernet-based fieldbus system which fulfils the application profile for industrial realtime systems.

- EtherCAT® is a registered trademark and patented technology, licensed by Beckhoff Automation GmbH, Germany.
- Detailed information on EtherCAT can be found on the web page of EtherCAT Technology Group (ETG): <https://www.ethercat.org>
- Information about the dimensioning of an EtherCAT network can be found in the configuration document.

### Preconditions

- The control unit (CU) of the inverter is provided with EtherCAT.
- For commissioning, load the current device description files for Lenze EtherCAT devices via the »Package Manager« to your Engineering PC.

### Typical topology

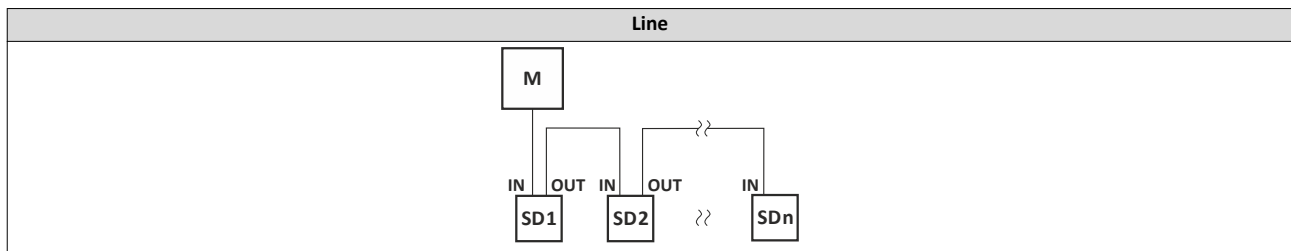

M     Master  
SD     Slave Device



## 12.14.1 Commissioning

In the following, the required steps are described to control the device with an EtherCAT master.

### Preconditions

- The inverter is networked as EtherCAT slave to an EtherCAT master and, if necessary, further EtherCAT devices.
- The entire wiring has already been checked for completeness, short circuit and earth fault.
- All EtherCAT devices are supplied with voltage and are switched on.
- An Engineering PC with installed »PLC Designer« is connected to the master.
  - [Download »PLC Designer«](#)
- A »PLC Designer« project with current device description files for EtherCAT is available.
  - [Download XML/ESI files for Lenze devices](#)
  - The files are installed via the device repository of the »PLC Designer« (menu command "Tools → Device repository").

### Holding brake

The holding brake must be activated via the CiA control word (0x6040).

1. Set the brake mode to manual in the "Overview / advanced - motor brake control set" mask.

The holding brake can now be released via bit 14 of the CiA control word.

### DC-injection brake



The DC-injection brake must be activated via the NetWordIn1 interface. The **L\_MC1P\_BasicActuatingSpeed** function block can be used to definitively trigger the brake, whereby the wLControlword property is available. This property corresponds to the NetwordIN1 parameter.

A further configuration of the DC-injection brake itself can be undertaken with the usual device parameters. Change the other parameters of the axis if necessary.

▶ [Holding brake control](#)  228

▶ [DC braking](#)  221

### Details

- When using the »PLC Designers«, the CiA 402 operating mode "CiA: Velocity mode (v)" is automatically activated.
- In the operating mode "CiA: Velocity mode (v)", the set speed defined via the "Set speed" ([0x6042 \(P781.00\)](#)) parameter is used.
- A changeover to an alternative setpoint source via [0x6040](#) (CiA control word) is not possible.
- [0x6040](#) (CiA control word) serves to start/stop the EtherCAT device.
- Further information:
  - ▶ [Process input data \(CiA 402 objects\)](#)  172
  - ▶ [Process output data \(CiA 402 objects\)](#)  173
  - ▶ [CiA 402 device profile](#)  341



## Commissioning steps

How to configure the network:



---

In the default setting, the digital input DI1 is assigned the "Run" function. If the network control is activated, this function serves as "start enable" for start commands via network. Hence, the digital input DI1 must be set to the HIGH level in order that the motor can be started via the network.

▶ [Flexible I/O configuration of the start, stop and rotating direction commands](#) 67

---



## 1. Configure gateway function of the master

1. Start »PLC Designer«.
2. Open or recreate a »PLC Designer« project.
3. Open the "Communication settings" tab of the master.
4. Click "Add gateway".

Do the following in the appearing dialog window:

- a) Enter the IP address of the master.
  - b) Confirm the entry with "OK".
5. Click "Search network".
  6. Select the corresponding master for the previously entered IP address.
  7. Click "Set active path".
  8. Log into the master using the "Online → Log in" menu command or with <Alt>+<F8>. Now you can access the slaves from the Engineering PC via the EtherCAT master as gateway.

## 2. Carry out network scan

1. Execute the "Start Search" command in the context menu of the master. The appearing dialog box lists all available EtherCAT devices according to the physical order in the network.
2. Click "Copy all devices into the project". The physical network structure is reproduced in the »PLC Designer« project.



---

A proper operation requires that the network topology generated in the project corresponds to the physical order of the EtherCAT nodes in the network. Otherwise, an error message displays which slave (product code) is to be expected at which position.

---





### 3. Integrate **L\_MC1P\_BasicActuatingSpeed** functional module

1. Open the PLC program code (PLC\_PRG).
2. Open the **Input Help** in the lower input area by right clicking via the context menu.
3. Open the category **Function blocks**.
4. Select the element  
**L\_MC1\_P** → **L\_MC1\_P\_MotionControlBasic** → **1\_POUs** → **PLCopenAdditional** and then the function block **L\_MC1P\_BasicActuatingSpeed**. Click OK.
5. Enter a variable name in the "Declare variables" dialog box.
6. Close the dialog box by clicking on the **OK** button.

The **L\_MC1P\_BasicActuatingSpeed** function block together with its data structure is now integrated in the PLC program code.

7. Open the **L\_MC1P\_BasicActuatingSpeed** function block and set the reference to the axis data structure (Axis:=i550\_Motion\_Axis).



Fig. 1: Assign axis

8. Open the Application context menu in the device tree for **Application**, select the command **Add object** → **Visualization ...** and insert the visualization of the function block.
9. Insert a frame into the visualization using the **Frame tool** (Basic tab).
10. To the frame visualization, add the function block **L\_MC1P\_BasicActuatingSpeed** and close the dialog box by clicking the **OK** button.
11. Under **Properties**, select the reference of the function block with which the visualization should be linked.

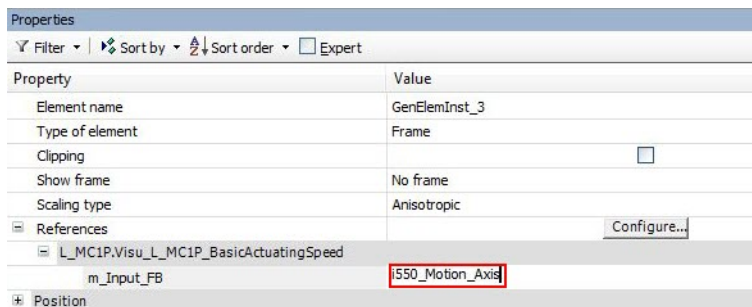

Fig. 2: Select reference



## 4. Adapt EtherCAT device to the application

1. Select the axis movement of the i550.

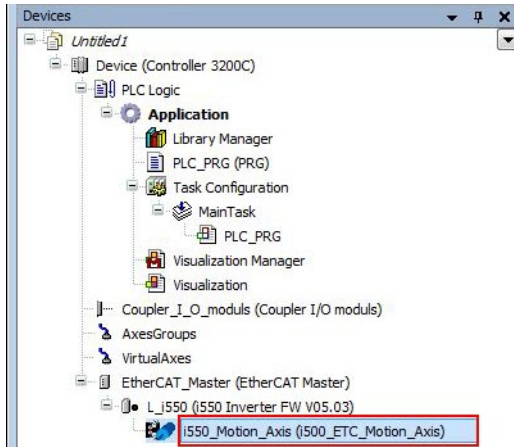

Fig. 3: Select i550

2. In case of "Switch on axis", select **Simple [0]** for the use of the axis L\_MC1P\_BasicActuatingSpeed.
3. The following parameters need to be configured:
  - a) Modes of operation 0x6060 (P301.00) = "CiA: Velocity mode [2]"
  - b) Function list: Start 0x2631:002 (P400.02) = "Constant TRUE [1]"

## 5. Adjust the parameter values of the inverter

1. Adapt parameter values under the "Settings" and "Parameter list" tabs.
2. Set the PDO mapping under the "Process data" tab.
3. Assign variable names under the "EtherCAT I/O image" by double-clicking the variable fields.

## 6. Load the network configuration into the master

1. Log off: Menu command "Online → Log off" or <Ctrl>+<F8>.
2. Compiling: Menu command "Build → Build" or <F11>.
3. Log in: Menu command "Online → Log in" or <Alt>+<F8>.

The configuration, the parameter settings and the PLC program are loaded into the master. Afterwards, all EtherCAT slaves are initialized.



These steps must be carried out after each change within the »PLC Designer« project. An already available configuration and an available PLC program in the master will then be overwritten.

## Restart of the communication

The communication needs to be restarted after the EtherCAT configuration is changed, so that the changed settings can take effect.

For restarting communication, there are two options:

- a) Switch inverter off and on again.
- b) 0x2360 (P508.00) Set = "Restart with current values [1]".



## Parameter

Address	Name / setting range / [default setting]	Information
0x2360 (P508.00)	EtherCAT communication (EtherCAT comm.)	Restart communication.
	• From version 02.00	• When the device command has been executed successfully, the value 0 is shown.
	<b>0</b> No action/no error	Only status feedback
	1 Restart with current values	Execute command
	10 In process	Only status feedback
	11 Action cancelled	
12 Fault		

## 12.14.2 Basic setting and options

### Addressing the EtherCAT devices

The EtherCAT devices are normally addressed via a permanent 16-bit address defined by the master. At the start, this address is assigned automatically to each node by the master, depending on the physical order in the network. The address is not saved and gets lost when the device is switched off.

### "Explicit Device Identification" via rotary encoder switch or parameter

"Explicit Device Identification" is required if the device is part of a "Hot Connect" group or the device is operated within a modular Lenze machine application. Each slave receives an *unambiguous* identifier for being identified by the master.

Setting	Assignment of the identifier
0x00	Identifier via the parameter 0x2361:004 (P510.04).
0x01 ... 0xFF	Identifier via the rotary encoder switches. <b>Example:</b> Setting for the value 52 $(3 \times 16) + (4 \times 1) = 52$

The value set via the rotary encoder switches is used once when the mains is switched on or after a network restart with 0x2360 (P508.00) = 1. A changed value during operation will only become valid after the network has been restarted.

As an alternative, a master can also use station alias addresses of the slaves that are configured and *unambiguous* in the network. For this purpose, a station alias address must be saved in the EEPROM of the device by setting the corresponding register.

## Parameter

Address	Name / setting range / [default setting]	Information
0x2361:004 (P510.04)	EtherCAT settings: Device identifier (EtherCAT sett.: Device ident.) 0 ... [0] ... 65535 • From version 02.00	Setting of the identifier <i>unambiguous</i> in the network (Explicit Device Identification). This setting is only valid for rotary encoder switch setting 0 (0x00).



## 12.14.3 Process data transfer

- Process data is cyclically transferred between the EtherCAT master and the slaves (permanent exchange of current input and output data).
- The transfer of process data is time-critical.
- The process data serve to control the EtherCAT slaves.
- The process data can be directly accessed by the master. The data in the PLC, for instance, are directly stored in the I/O area.
- The contents of the process data are defined via I/O Data mapping (definition of the EtherCAT objects that are to be transmitted cyclically).
- Process data is not saved in the device.
- Process data is, e. g. setpoints, actual values, control and status words.

### Configuration

- The available objects can be mapped in the CiA 402 operating mode "CiA: Velocity mode (vl)" (0x6060 (P301.00) = 2) and as dynamic (free) configuration. The contents can be selected from all mappable objects.
  - Standard mapping objects for the CiA 402 operating mode "CiA: Velocity mode (vl)":  
[▶ Standard mapping](#) 452
  - Mapping objects for a dynamic (free) assignment: [▶ Dynamic \(free\) configuration](#) 453
- Mapping is executed in the master configuration and automatically transferred to the slave.
- Format: 0xiiiiSSL (iiii = Index hexadecimal, ss = subindex hexadecimal, ll = data length hexadecimal)

#### 12.14.3.1 Standard mapping

##### Standard mapping of the RPDOs in the CiA 402 operating mode "CiA: Velocity mode (vl)"

Master → slave	
0x1603:001 RPDO mapping entry 1 (CiA: Velocity mode (vl))	CiA control word (0x6040)
0x1603:002 RPDO mapping entry 2 (CiA: Velocity mode (vl))	CiA 402 parameter "Set speed" (0x6042 (P781.00))
0x1605:001 RPDO mapping Entry 1 (freely configurable)	Not assigned.

##### Standard mapping of the TPDOs in the CiA 402 operating mode "CiA: Velocity mode (vl)"

Slave → master	
0x1A03:001 TPDO mapping entry 1 (CiA: Velocity mode (vl))	CiA status word (0x6041 (P780.00))
0x1A03:002 TPDO mapping entry 2 (CiA: Velocity mode (vl))	CiA 402 parameter "Actual speed" (0x6044 (P783.00))
0x1A03:003 TPDO mapping entry 3 (CiA: Velocity mode (vl))	Error code (0x603F (P150.00))
0x1A05:001 TPDO mapping entry 1 (freely configurable)	Digital inputs

### Parameter

Address	Name / setting range / [default setting]	Information
0x1603:001	RPDO (A) vl: Velocity mode (vl): RPDO (A) vl: Mapping Entry 1 • Read only • From version 02.00	Predefined mapping entry 0x60400010 of "CiA control word" (0x6040) for the CiA 402 operating mode "CiA: Velocity mode (vl)".
0x1603:002	RPDO (A) vl: Velocity mode (vl): RPDO (A) vl: Mapping Entry 2 • Read only • From version 02.00	Predefined mapping entry 0x60420010 of "Set speed" (0x6042 (P781.00)) for the CiA 402 operating mode "CiA: Velocity mode (vl)".
0x1A03:001	TPDO (A) vl: Velocity mode (vl): TPDO (A) vl: Mapping Entry 1 • Read only • From version 02.00	Predefined mapping entry 0x60410010 of "CiA status word" (0x6041 (P780.00)) for the CiA 402 operating mode "CiA: Velocity mode (vl)".
0x1A03:002	TPDO (A) vl: Velocity mode (vl): TPDO (A) vl: Mapping Entry 2 • Read only • From version 02.00	Predefined mapping entry 0x60440010 of "Actual speed" (0x6044 (P783.00)) for the CiA 402 operating mode "CiA: Velocity mode (vl)".



Address	Name / setting range / [default setting]	Information
0x1A03:003	TPDO (A) vl: Velocity mode (vl): TPDO (A) vl: Mapping Entry 3 <ul style="list-style-type: none"> <li>Read only</li> <li>From version 02.00</li> </ul>	Predefined mapping entry 0x603F0010 of "Error code" (0x603F (P150.00)) for the CiA 402 operating mode "CiA: Velocity mode (vl)".

### 12.14.3.2 Dynamic (free) configuration

Display of the dynamic (free) mapping configuration transferred from the EtherCAT master to the inverter (slave).



The total size of the PDO telegrams must be a multiple of 2 bytes (i.e. 2 bytes, 4 bytes, 6 bytes, 8 bytes etc.).

For "padding" a 2-byte structure the 8-bit dummy entry "0x00050008" is available (index = 0x0005, subindex = 0x00, data length = 8 bits).

An odd size of the PDO telegram leads to an error message in the Sync manager of the EtherCAT master.

#### Parameter

Address	Name / setting range / [default setting]	Information
0x1605:000	RPDO (A) user: Free configuration: RPDO (A) user: Number of mapped objects in PDO <ul style="list-style-type: none"> <li>Read only</li> </ul>	Number of mapping entries for RPDO (A) user.
0x1605:001	RPDO (A) user: Free configuration: RPDO (A) user: Mapping Entry 1 <ul style="list-style-type: none"> <li>Read only</li> <li>From version 02.00</li> </ul>	Mapping entry 1 for the selection of an object to be received. <ul style="list-style-type: none"> <li>Format: 0xiiiiisll (iiii = index, ss = subindex, ll = data length hexadecimal)</li> </ul>
0x1605:002	RPDO (A) user: Free configuration: RPDO (A) user: Mapping Entry 2 <ul style="list-style-type: none"> <li>Read only</li> <li>From version 02.00</li> </ul>	Mapping entry 2 for the selection of an object to be received. <ul style="list-style-type: none"> <li>Format: 0xiiiiisll (iiii = index, ss = subindex, ll = data length hexadecimal)</li> </ul>
0x1605:003	RPDO (A) user: Free configuration: RPDO (A) user: Mapping Entry 3 <ul style="list-style-type: none"> <li>Read only</li> <li>From version 02.00</li> </ul>	Mapping entry 3 for the selection of an object to be received. <ul style="list-style-type: none"> <li>Format: 0xiiiiisll (iiii = index, ss = subindex, ll = data length hexadecimal)</li> </ul>
0x1605:004	RPDO (A) user: Free configuration: RPDO (A) user: Mapping Entry 4 <ul style="list-style-type: none"> <li>Read only</li> <li>From version 02.00</li> </ul>	Mapping entry 4 for the selection of an object to be received. <ul style="list-style-type: none"> <li>Format: 0xiiiiisll (iiii = index, ss = subindex, ll = data length hexadecimal)</li> </ul>
0x1605:005	RPDO (A) user: Free configuration: RPDO (A) user: Mapping Entry 5 <ul style="list-style-type: none"> <li>Read only</li> <li>From version 02.00</li> </ul>	Mapping entry 5 for the selection of an object to be received. <ul style="list-style-type: none"> <li>Format: 0xiiiiisll (iiii = index, ss = subindex, ll = data length hexadecimal)</li> </ul>
0x1605:006	RPDO (A) user: Free configuration: RPDO (A) user: Mapping Entry 6 <ul style="list-style-type: none"> <li>Read only</li> <li>From version 02.00</li> </ul>	Mapping entry 6 for the selection of an object to be received. <ul style="list-style-type: none"> <li>Format: 0xiiiiisll (iiii = index, ss = subindex, ll = data length hexadecimal)</li> </ul>
0x1605:007	RPDO (A) user: Free configuration: RPDO (A) user: Mapping Entry 7 <ul style="list-style-type: none"> <li>Read only</li> <li>From version 02.00</li> </ul>	Mapping entry 7 for the selection of an object to be received. <ul style="list-style-type: none"> <li>Format: 0xiiiiisll (iiii = index, ss = subindex, ll = data length hexadecimal)</li> </ul>
0x1605:008	RPDO (A) user: Free configuration: RPDO (A) user: Mapping Entry 8 <ul style="list-style-type: none"> <li>Read only</li> <li>From version 02.00</li> </ul>	Mapping entry 8 for the selection of an object to be received. <ul style="list-style-type: none"> <li>Format: 0xiiiiisll (iiii = index, ss = subindex, ll = data length hexadecimal)</li> </ul>
0x1605:009	RPDO (A) user: Free configuration: RPDO (A) user: Mapping Entry 9 <ul style="list-style-type: none"> <li>Read only</li> <li>From version 02.00</li> </ul>	Mapping entry 9 for the selection of an object to be received. <ul style="list-style-type: none"> <li>Format: 0xiiiiisll (iiii = index, ss = subindex, ll = data length hexadecimal)</li> </ul>

# Configuring the network

EtherCAT  
Process data transfer  
Dynamic (free) configuration



Address	Name / setting range / [default setting]	Information
0x1605:010	RPDO (A) user: Free configuration: RPDO (A) user: Mapping Entry 10 • Read only • From version 02.00	Mapping entry 10 for the selection of an object to be received. • Format: 0xiiiiisll (iiii = index, ss = subindex, ll = data length hexadecimal)
0x1605:011	RPDO (A) user: Free configuration: RPDO (A) user: Mapping Entry 11 • Read only • From version 02.00	Mapping entry 11 for the selection of an object to be received. • Format: 0xiiiiisll (iiii = index, ss = subindex, ll = data length hexadecimal)
0x1605:012	RPDO (A) user: Free configuration: RPDO (A) user: Mapping Entry 12 • Read only • From version 02.00	Mapping entry 12 for the selection of an object to be received. • Format: 0xiiiiisll (iiii = index, ss = subindex, ll = data length hexadecimal)
0x1605:013	RPDO (A) user: Free configuration: RPDO (A) user: Mapping Entry 13 • Read only • From version 02.00	Mapping entry 13 for the selection of an object to be received. • Format: 0xiiiiisll (iiii = index, ss = subindex, ll = data length hexadecimal)
0x1605:014	RPDO (A) user: Free configuration: RPDO (A) user: Mapping Entry 14 • Read only • From version 02.00	Mapping entry 14 for the selection of an object to be received. • Format: 0xiiiiisll (iiii = index, ss = subindex, ll = data length hexadecimal)
0x1605:015	RPDO (A) user: Free configuration: RPDO (A) user: Mapping Entry 15 • Read only • From version 02.00	Mapping entry 15 for the selection of an object to be received. • Format: 0xiiiiisll (iiii = index, ss = subindex, ll = data length hexadecimal)
0x1605:016	RPDO (A) user: Free configuration: RPDO (A) user: Mapping Entry 16 • Read only • From version 02.00	Mapping entry 16 for the selection of an object to be received. • Format: 0xiiiiisll (iiii = index, ss = subindex, ll = data length hexadecimal)
0x1A05:000	TPDO (A) user: Free configuration: TPDO (A) user: number of mapped objects • Read only • From version 02.00	Number of mapping entries for TPDO (A) user.
0x1A05:001	TPDO (A) user: Free configuration: TPDO (A) user: Mapping Entry 1 • Read only • From version 02.00	Mapping entry 1 for the selection of an object to be sent. • Format: 0xiiiiisll (iiii = index, ss = subindex, ll = data length hexadecimal)
0x1A05:002	TPDO (A) user: Free configuration: TPDO (A) user: Mapping Entry 2 • Read only • From version 02.00	Mapping entry 2 for the selection of an object to be sent. • Format: 0xiiiiisll (iiii = index, ss = subindex, ll = data length hexadecimal)
0x1A05:003	TPDO (A) user: Free configuration: TPDO (A) user: Mapping Entry 3 • Read only • From version 02.00	Mapping entry 3 for the selection of an object to be sent. • Format: 0xiiiiisll (iiii = index, ss = subindex, ll = data length hexadecimal)
0x1A05:004	TPDO (A) user: Free configuration: TPDO (A) user: Mapping Entry 4 • Read only • From version 02.00	Mapping entry 4 for the selection of an object to be sent. • Format: 0xiiiiisll (iiii = index, ss = subindex, ll = data length hexadecimal)
0x1A05:005	TPDO (A) user: Free configuration: TPDO (A) user: Mapping Entry 5 • Read only • From version 02.00	Mapping entry 5 for the selection of an object to be sent. • Format: 0xiiiiisll (iiii = index, ss = subindex, ll = data length hexadecimal)
0x1A05:006	TPDO (A) user: Free configuration: TPDO (A) user: Mapping Entry 6 • Read only • From version 02.00	Mapping entry 6 for the selection of an object to be sent. • Format: 0xiiiiisll (iiii = index, ss = subindex, ll = data length hexadecimal)



Address	Name / setting range / [default setting]	Information
0x1A05:007	TPDO (A) user: Free configuration: TPDO (A) user: Mapping Entry 7 • Read only • From version 02.00	Mapping entry 7 for the selection of an object to be sent. • Format: 0xiiiiisll (iiii = index, ss = subindex, ll = data length hexadecimal)
0x1A05:008	TPDO (A) user: Free configuration: TPDO (A) user: Mapping Entry 8 • Read only • From version 02.00	Mapping entry 8 for the selection of an object to be sent. • Format: 0xiiiiisll (iiii = index, ss = subindex, ll = data length hexadecimal)
0x1A05:009	TPDO (A) user: Free configuration: TPDO (A) user: Mapping Entry 9 • Read only • From version 02.00	Mapping entry 9 for the selection of an object to be sent. • Format: 0xiiiiisll (iiii = index, ss = subindex, ll = data length hexadecimal)
0x1A05:010	TPDO (A) user: Free configuration: TPDO (A) user: Mapping Entry 10 • Read only • From version 02.00	Mapping entry 10 for the selection of an object to be sent. • Format: 0xiiiiisll (iiii = index, ss = subindex, ll = data length hexadecimal)
0x1A05:011	TPDO (A) user: Free configuration: TPDO (A) user: Mapping Entry 11 • Read only • From version 02.00	Mapping entry 11 for the selection of an object to be sent. • Format: 0xiiiiisll (iiii = index, ss = subindex, ll = data length hexadecimal)
0x1A05:012	TPDO (A) user: Free configuration: TPDO (A) user: Mapping Entry 12 • Read only • From version 02.00	Mapping entry 12 for the selection of an object to be sent. • Format: 0xiiiiisll (iiii = index, ss = subindex, ll = data length hexadecimal)
0x1A05:013	TPDO (A) user: Free configuration: TPDO (A) user: Mapping Entry 13 • Read only • From version 02.00	Mapping entry 13 for the selection of an object to be sent. • Format: 0xiiiiisll (iiii = index, ss = subindex, ll = data length hexadecimal)
0x1A05:014	TPDO (A) user: Free configuration: TPDO (A) user: Mapping Entry 14 • Read only • From version 02.00	Mapping entry 14 for the selection of an object to be sent. • Format: 0xiiiiisll (iiii = index, ss = subindex, ll = data length hexadecimal)
0x1A05:015	TPDO (A) user: Free configuration: TPDO (A) user: Mapping Entry 15 • Read only • From version 02.00	Mapping entry 15 for the selection of an object to be sent. • Format: 0xiiiiisll (iiii = index, ss = subindex, ll = data length hexadecimal)
0x1A05:016	TPDO (A) user: Free configuration: TPDO (A) user: Mapping Entry 16 • Read only • From version 02.00	Mapping entry 16 for the selection of an object to be sent. • Format: 0xiiiiisll (iiii = index, ss = subindex, ll = data length hexadecimal)

### 12.14.3.3 Expert settings

- The sync managers are configured for the cyclic data transfer and the mailbox communication (display in [0x1C00:001](#) ... [0x1C00:004](#)).
- For the communication, the I/O data mapping must be configured via ... [0x1C12:002](#) (for RPDOs) and ... [0x1C13:002](#) (for TPDOs).
- The basic settings for the sync managers are made via [0x1C32:001](#) ... [0x1C32:005](#) and [0x1C33:001](#) ... [0x1C33:005](#).

#### Parameter

Address	Name / setting range / [default setting]	Information
0x1C00:001	Sync manager type: SM0 communication type • Read only	The communication type SM1 is used for the mailbox input (MbxIn).
0x1C00:002	Sync manager type: SM1 communication type • Read only	The communication type SM2 is used for the mailbox output (MbxOut).
0x1C00:003	Sync manager type: SM2 communication type • Read only	The communication type SM3 is used for the input process data (RPDOs).

# Configuring the network

EtherCAT  
Process data transfer  
Expert settings



Address	Name / setting range / [default setting]	Information
0x1C00:004	Sync manager type: SM3 communication type • Read only	The communication type SM4 is used for the output process data (TPDOs).
0x1C12:001	SM2 PDO assignment: PDO mapping object index of 1. assigned RPDO • Read only	Display of the mapping object index of RPDO1.
0x1C12:002	SM2 PDO assignment: PDO mapping object index of 2. assigned RPDO • Read only	Display of the mapping object index of RPDO2.
0x1C13:001	SM2 PDO assignment: PDO mapping object index of 1. assigned TPDO • Read only	Display of the mapping object index of TPDO1.
0x1C13:002	SM2 PDO assignment: PDO mapping object index of 2. assigned TPDO • Read only	Display of the mapping object index of TPDO2.
0x1C32:001	Sync Manager 2: Synchronization type • Read only • From version 02.00	Settings of the synchronisation method for the mailbox communication.
0x1C32:002	Sync Manager 2: Cycle time • Read only: x ns • From version 02.00	Display of the cycle time for the mailbox communication.
0x1C32:003	Sync Manager 2: Shift time • Read only: x ns • From version 02.00	Display of the time shift for the mailbox communication.
0x1C32:004	Sync Manager 2: Sync modes supported • Read only • From version 02.00	Display of the available synchronisation method for the mailbox communication. • Bit 0 (free run)
0x1C32:005	Sync Manager 2: Minimum cycle time • Read only: x ns • From version 02.00	Display of the minimum cycle time for the mailbox communication.
0x1C33:001	Sync Manager 3: Synchronization type • Read only • From version 02.00	Setting of the synchronisation method for the input process data (RPDO).
0x1C33:002	Sync Manager 3: Cycle time • Read only: x ns • From version 02.00	Display of the cycle time for the input process data (RPDO).
0x1C33:003	Sync Manager 3: Shift time • Read only: x ns • From version 02.00	Display of the time shift for the input process data (RPDO).
0x1C33:004	Sync Manager 3: Sync modes supported • Read only • From version 02.00	Display of the available synchronisation method for the input process data (RPDO). • Bit 0 (free run)
0x1C33:005	Sync Manager 3: Minimum cycle time • Read only: x ns • From version 02.00	Display of the minimum cycle time for the input process data (RPDO).





## 12.14.4 Parameter data transfer

- For configuring and diagnosing the EtherCAT devices, the parameters are accessed by means of acyclic communication.
- Parameter data is transferred as SDOs (Service Data Objects).
- The SDO services enable the writing and reading access to parameters, EtherCAT objects and CiA 402 objects.
  - [Process input data](#) [□ 343](#)
  - [Process output data](#) [□ 343](#)
- The transfer of parameter data is usually not time-critical.
- Parameter data is, for instance, operating parameters, motor data and diagnostic information.

### SDO return values

If an SDO request is evaluated negatively, a corresponding error code is output:

Index	Description
0x00000000	No fault.
0x05030000	The state of the toggle bit has not changed.
0x05040000	SDO protocol time-out.
0x05040001	Invalid or unknown specification symbol for the client/server command.
0x05040005	The space in the main memory is not sufficient.
0x06010000	Unsupported access to an object.
0x06010001	Read access to a write-only object.
0x06010002	Write access to a read-only object.
0x06020000	An object is not available in the object directory.
0x06040041	An object cannot be mapped into the PDO.
0x06040042	The number and/or length of the mapped objects would exceed the PDO length.
0x06040043	General parameter incompatibility.
0x06040047	General internal incompatibility in the device.
0x06060000	The access has failed due to errors in the hardware.
0x06070010	The data type or the parameter length do not match.
0x06070012	Wrong data type: The parameter length is too big.
0x06070013	Wrong data type: The parameter length is too small.
0x06090011	A subindex is not available.
0x06090030	The value range for parameters is too big (only in case of write access).
0x06090031	The parameter value is too high.
0x06090032	The parameter value is too low.
0x06090036	The maximum value is smaller than the minimum value.
0x08000000	General fault.
0x08000020	Data cannot be transferred to the application or saved in the application.
0x08000021	Due to local control, the data cannot be transferred to the application or saved in the application.
0x08000022	Due to the current device state, the data cannot be transferred to the application or saved in the application.
0x08000023	The dynamic object directory generation has failed or no object directory is available.



## 12.14.5 Parameter download

Parameter settings are not stored in a power failure safe manner when using the inverter as a system drive in the Lenze system. All inverter settings that deviate from the Lenze default setting are held centrally in the Lenze controller and saved there persistently. All parameters are transferred from the Lenze controller to the inverter during initialization upon start-up.



---

All size-dependent parameters are not downloaded.

---

The parameters of the inverter are managed in the »PLC Designer« project. The »PLC Designer« project, including the parameters, is saved on the engineering PC using the storage function of »PLC Designer«. The »PLC Designer« transfers the parameters to the Lenze controller when the controller is logged on to. The controller passes the parameter sets to the subordinate controller. The parameter sets are written back to the inverter by the Lenze controller every time the system starts.

There are three application for managing and modifying parameters:

- Modifying the parameters of an inverter online:
  - If a parameter is modified online, the »PLC Designer« writes the parameter directly to the corresponding inverter and simultaneously modifies the parameter in the »PLC Designer«- project.



---

The parameter modification is not registered in the Lenze controller. The parameter modification in the inverter is lost when the controller is cold-started. Log out and log back in again with the »PLC Designer« to avoid this. (**Menu commands: Online → Log out / Online → Log in**)

---

- In this case, the complete parameter set is written to the controller and transferred to the inverter.
- The parameter set is only available in the inverter and controller after the transfer by logging in until the system is next shut down (not stored in a power failure safe manner).
- Modifying the parameters of an inverter offline:
  - If a parameter is modified offline, the »PLC Designer« modifies the value directly in the »PLC Designer« project. When logging into the Lenze controller, the complete parameter set is written to the controller. It then transfers the parameter set to the inverter.
  - The parameter set is only available in the inverter and controller after the transfer by logging in until the system is next shut down (not stored in a power failure safe manner).
- Saving the parameters of the inverter in the Lenze controller so that they remain in the device after switching off:
  - A separate parameter set for the subordinate inverters is available in the boot project of the Lenze controller. It is only updated if the "Create boot project" function is executed via the »PLC Designer«. The current parameterisation is then saved and is available after the mains connection. The stored parameter set is automatically written to the inverter by the controller at boot-up following mains connection.
  - If a boot project exists on the Lenze controller, the parameters of the inverter can also be modified with »EASY Starter« and stored permanently.



Modifying parameters and permanently storing them.

1. Open »EASY Starter«.
2. Connect to the inverter online



3. Modify desired parameters.
4. Connect to the Lenze controller online.
5. Select 'Safe parameter set in the device (F6)'.  

The Lenze controller then starts uploading the parameters of all its EtherCAT slaves (including i550 EtherCAT) and stores these parameters together with its own parameter set in its boot project. The stored parameter set for the i550 EtherCAT is automatically written to the inverter by the controller when the Lenze controller powers up after mains connection.

If the modified parameter set from the inverter should correspond to the »PLC Designer« project:

6. Log in to the Lenze controller.
7. If the dialogue displays differences in the parameter selection, select **Upload all**.
8. Save the »PLC Designer« project.

## 12.14.6 Monitoring

The parameters for setting network monitoring functions are described below.

### Parameter

Address	Name / setting range / [default setting]	Information
0x10F3:001	Diagnosis History: Maximum Messages • Read only • From version 03.00	Maximum number of messages that can be stored in the history buffer (from subindex 6).
0x10F3:002	Diagnosis History: Newest Message • Read only • From version 03.00	Subindex of the latest message.
0x10F3:003	Diagnosis History: Newest Acknowledged Message 0 ... [0] ... 255 • From version 03.00	Subindex of the latest message acknowledged by the EtherCAT master.
0x10F3:004	Diagnosis History: New message available • Read only • From version 03.00	TRUE if messages are available that have not been acknowledged yet by the EtherCAT master.
0x10F3:005	Diagnosis History: Flags 0 ... [1] ... 65535 • From version 03.00	Settings for sending and saving of the messages.

# Configuring the network

EtherCAT  
Monitoring



Address	Name / setting range / [default setting]	Information
0x10F3:006	Diagnosis History: Diagnosis message 0 • Read only • From version 03.00	
0x10F3:007	Diagnosis History: Diagnosis message 1 • Read only • From version 03.00	
0x10F3:008	Diagnosis History: Diagnosis message 2 • Read only • From version 03.00	
0x10F3:009	Diagnosis History: Diagnosis message 3 • Read only • From version 03.00	
0x10F3:010	Diagnosis History: Diagnosis message 4 • Read only • From version 03.00	
0x10F3:011	Diagnosis History: Diagnosis message 5 • Read only • From version 03.00	
0x10F3:012	Diagnosis History: Diagnosis message 6 • Read only • From version 03.00	
0x10F3:013	Diagnosis History: Diagnosis message 7 • Read only • From version 03.00	
0x10F3:014	Diagnosis History: Diagnosis message 8 • Read only • From version 03.00	
0x10F3:015	Diagnosis History: Diagnosis message 9 • Read only • From version 03.00	
0x10F3:016	Diagnosis History: Diagnosis message 10 • Read only • From version 03.00	
0x10F3:017	Diagnosis History: Diagnosis message 11 • Read only • From version 03.00	
0x10F3:018	Diagnosis History: Diagnosis message 12 • Read only • From version 03.00	
0x10F3:019	Diagnosis History: Diagnosis message 13 • Read only • From version 03.00	
0x10F3:020	Diagnosis History: Diagnosis message 14 • Read only • From version 03.00	
0x10F3:021	Diagnosis History: Diagnosis message 15 • Read only • From version 03.00	
0x10F3:022	Diagnosis History: Diagnosis message 16 • Read only • From version 03.00	
0x10F3:023	Diagnosis History: Diagnosis message 17 • Read only • From version 03.00	



Address	Name / setting range / [default setting]	Information
0x10F3:024	Diagnosis History: Diagnosis message 18 • Read only • From version 03.00	
0x10F3:025	Diagnosis History: Diagnosis message 19 • Read only • From version 03.00	
0x10F3:026	Diagnosis History: Diagnosis message 20 • Read only • From version 03.00	
0x10F3:027	Diagnosis History: Diagnosis message 21 • Read only • From version 03.00	
0x10F3:028	Diagnosis History: Diagnosis message 22 • Read only • From version 03.00	
0x10F3:029	Diagnosis History: Diagnosis message 23 • Read only • From version 03.00	
0x10F3:030	Diagnosis History: Diagnosis message 24 • Read only • From version 03.00	
0x10F3:031	Diagnosis History: Diagnosis message 25 • Read only • From version 03.00	
0x10F3:032	Diagnosis History: Diagnosis message 26 • Read only • From version 03.00	
0x10F3:033	Diagnosis History: Diagnosis message 27 • Read only • From version 03.00	
0x10F3:034	Diagnosis History: Diagnosis message 28 • Read only • From version 03.00	
0x10F3:035	Diagnosis History: Diagnosis message 29 • Read only • From version 03.00	
0x10F3:036	Diagnosis History: Diagnosis message 30 • Read only • From version 03.00	
0x10F3:037	Diagnosis History: Diagnosis message 31 • Read only • From version 03.00	
0x2859:001 (P515.01)	EtherCAT monitoring: Watchdog elapsed (EtherCAT monit.: WD elapsed) • From version 02.00	<p>Selection of the response to the continuous interruption of communication to the EtherCAT master, e. g. by cable break or failure of the EtherCAT master.</p> <p>Associated event ID: • 33168   0x8190 - Network - Watchdog time-out</p> <p>► Severity <a href="#">700</a></p>
	0 No response	
	1 Warning	
	<b>2 Trouble</b>	
	3 Fault	

# Configuring the network

EtherCAT  
Monitoring







Address	Name / setting range / [default setting]	Information
0x2859:003 (P515.03)	EtherCAT monitoring: Invalid configuration (EtherCAT monit.: Invalid config) <ul style="list-style-type: none"> <li>From version 02.00</li> </ul>	Selection of the response triggered by the reception of invalid configuration data. Associated event ID: <ul style="list-style-type: none"> <li><a href="#">33414</a>   <a href="#">0x8286</a> - Network - PDO mapping error</li> </ul>
	0 No response	▶ Severity <a href="#">700</a>
	1 Warning	
	<b>2 Trouble</b>	
3 Fault		
0x2859:004 (P515.04)	EtherCAT monitoring: Initialisation error (EtherCAT monit.: Init. error) <ul style="list-style-type: none"> <li>From version 02.00</li> </ul>	Selection of the response triggered by the occurrence of an error during the initialisation of the network component. Associated event ID: <ul style="list-style-type: none"> <li><a href="#">33170</a>   <a href="#">0x8192</a> - Network - Initialization error</li> </ul>
	0 No response	▶ Severity <a href="#">700</a>
	1 Warning	
	<b>2 Trouble</b>	
3 Fault		
0x2859:005 (P515.05)	EtherCAT monitoring: Invalid process data (EtherCAT monit.: Inval. proc.data) <ul style="list-style-type: none"> <li>From version 02.00</li> </ul>	Selection of the response triggered by the reception of invalid process data. Associated event ID: <ul style="list-style-type: none"> <li><a href="#">33171</a>   <a href="#">0x8193</a> - Network - Invalid cyclic process data</li> </ul>
	0 No response	▶ Severity <a href="#">700</a>
	1 Warning	
	<b>2 Trouble</b>	
3 Fault		





## 12.14.7 Diagnostics

### 12.14.7.1 Status LEDs



Information on the network status can be obtained quickly via the "RUN" and "ERR" LED displays on the front of the inverter.

"RUN" LED (green)	EtherCAT status	Status/meaning
off	off / Init	The network option is not active at the network or is in the "Init" status.
 blinking	Pre-Operational	Access to parameters and objects possible. No process data exchange.
 blinking	Safe-Operational	The data is not active yet in the standard device.
 on	Operational	The network option works correctly.
 flickers	Bootstrap	Firmware update of the network option active.

"ERR" LED (red)	Status/meaning
off	No fault
 flickers	Local error. The network option changes automatically to the "Safe-Operational" status.
 on (red)	A "Sync Manager Watchdog Timeout" has occurred.
 blinking	The configuration is invalid/incorrect.

Notes on the EtherCAT connection status and the data transfer can be obtained via the LED "L/A" at the RJ45 sockets.

#### "L/A" LED (green)

Blinking pattern	State	Meaning
off	Not connected	Network not available
 on	Connected	Network available No data transfer
 blinking	Traffic	Data transfer

### 12.14.7.2 Information on the network

The following parameters show information on the network.

#### Parameter

Address	Name / setting range / [default setting]	Information
0x2362:004 (P511.04)	Active EtherCAT settings: Device identifier (EtherCAT diag.: Device ident.) • Read only • From version 02.00	Display of the clear device address in the network which is defined via rotary encoder switch or object <a href="#">0x2361:004 (P510.04)</a> .
0x2362:006 (P511.06)	Active EtherCAT settings: Station address (EtherCAT diag.: Station address) • Read only • From version 02.00	Display of the active station address.
0x2362:007 (P511.07)	Active EtherCAT settings: Tx length (EtherCAT diag.: Tx length) • Read only • From version 02.00	Display of the length of the transmitted cyclic data in bytes.
0x2362:008 (P511.08)	Active EtherCAT settings: Rx length (EtherCAT diag.: Rx length) • Read only • From version 02.00	Display of the length of the received cyclic data in bytes.

# Configuring the network

EtherCAT  
Diagnostics  
Device identification



Address	Name / setting range / [default setting]	Information
0x2363 (P509.00)	EtherCAT switch position (EtherC. switch) • Read only • From version 02.00	Display of the current rotary encoder switch settings.
0x2368 (P516.00)	EtherCAT status (EtherCAT status) • Read only • From version 02.00	Display of the current network status.
	1 Initialization	Network initialization is active. • No PDO/SDO transmission. • Device identification is possible by network scan.
	2 Pre-Operational	The network is active. • SDO transmission (CoE communication via mailbox) is possible. • No PDO transmission.
	3 Bootstrap	Firmware update active. • For the firmware update, the FoE protocol is used. • No PDO transmission.
	4 Safe-Operational	• SDO transmission (CoE communication via mailbox) is possible. • PDO transmission: - The input data in the process image are updated. - The output data from the process image are not transmitted.
	8 Operational	Normal operation • PDO/SDO transmission is possible. • Network synchronisation is successful (if used).
0x2369 (P517.00)	EtherCAT error (EtherCAT error) • Read only • From version 02.00	Bit coded display of EtherCAT errors.
	Bit 0 Watchdog elapsed	
	Bit 2 Invalid configuration	
	Bit 3 Stack init error	
	Bit 4 Invalid process data	

## 12.14.7.3 Device identification

For device identification in the network, the inverter provides the EtherCAT objects listed in the following.

The objects can only be accessed via the EtherCAT network.

### Parameter

Address	Name / setting range / [default setting]	Information
0x1000	Device type • Read only • From version 02.00	CANopen device profile according CANopen specification CiA 301/ CiA 402.
0x1008	Manufacturer device name • Read only • From version 02.00	Display of the manufacturer device name.
0x1009	Manufacturer hardware version • Read only • From version 02.00	Display of the manufacturer hardware version.
0x100A	Manufacturer software version • Read only • From version 02.00	Display of the manufacturer software version.
0x1018:001	Identity object: Vendor ID • Read only • From version 02.00	Display of the manufacturer's identification number.





# Configuring the network

EtherCAT  
Diagnostics  
Device identification

Address	Name / setting range / [default setting]	Information
0x1018:002	Identity object: Product Code • Read only • From version 02.00	Display of the product code of the inverter.
0x1018:003	Identity object: Revision number • Read only • From version 02.00	Display of the main and subversion of the firmware.
0x1018:004	Identity object: Serial number • Read only • From version 02.00	Display of the serial number of the inverter.



## 12.14.8 EoE communication

The "Ethernet over EtherCAT (EoE)" is used to send standard Ethernet telegrams via the EtherCAT network without affecting the real-time communication of the EtherCAT process data. This extension facilitates the set-up of parameter communication (SDO communication) with the inverters on the EtherCAT bus by means of a standard Ethernet connection (e.g. from a PC with »EASY Starter«).

### System architecture

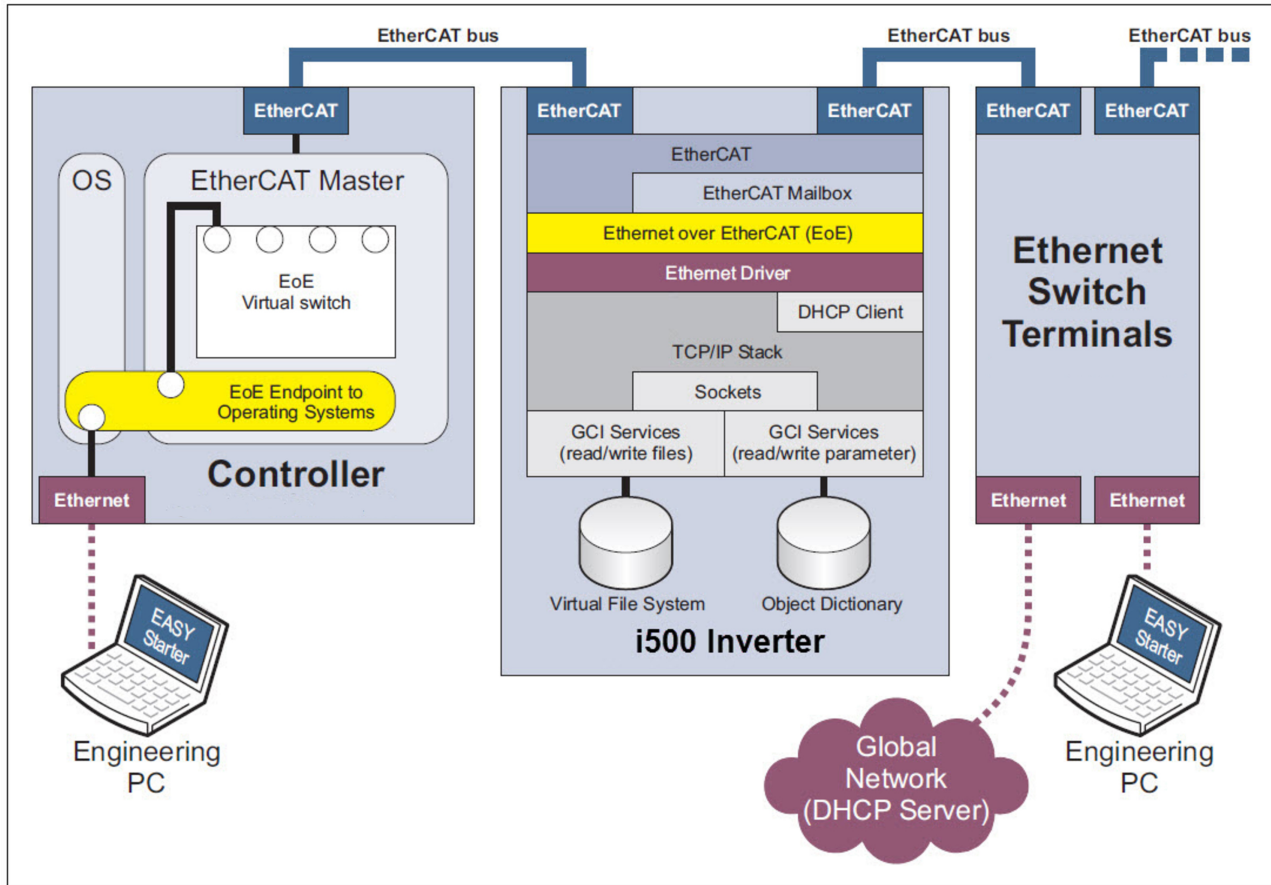

Beckhoff controller	Lenze / other controllers	ESD - Slave bridge

### Supported protocols and services

- ARP
- DHCP
- ICMP (ping)
- UDP/TCP
- GCI-SDO communication



## Display of EoE-specific information

The following table can be used to read EoE-specific information for diagnostic purposes.

### Parameter

Address	Name / setting range / [default setting]	Information
0x2362:001 (P511.01)	Active EtherCAT settings: EoE IP address (EtherCAT diag.: EoE IP address) <ul style="list-style-type: none"><li>• Read only</li></ul>	
0x2362:002 (P511.02)	Active EtherCAT settings: EoE subnet mask (EtherCAT diag.: EoE subnet mask) <ul style="list-style-type: none"><li>• Read only</li><li>• From version 05.01</li></ul>	
0x2362:003 (P511.03)	Active EtherCAT settings: EoE gateway (EtherCAT diag.: EoE gateway) <ul style="list-style-type: none"><li>• Read only</li></ul>	
0x2362:005 (P511.05)	Active EtherCAT settings: EoE virtual MAC address (EtherCAT diag.: EoE virt MAC add) <ul style="list-style-type: none"><li>• Read only</li><li>• From version 02.00</li></ul>	



## 12.14.9 Automatic firmware download with Lenze Controller

The firmware of the inverter can be saved together with the »PLC Designer«-project. During start-up, the Lenze controller checks whether the firmware version in the inverter corresponds with the firmware version stored in the project for this device. If this is not the case, the controller loads the firmware version stored in the project to the inverter. In doing so, a "device replacement" can be ensured for service purposes, whereby the replacement device also functions with the same firmware version stored in the project, as the original device did previously.

### Main version check

An automatic firmware download from the PLC to the inverter is only undertaken under the following conditions:

- Required firmware version 05.01.x.x or higher
- Identical main version 05.01.x.x in the inverter and in the PLC project
- Bootloader version 00.00.00.18 or higher

### Main version check from firmware version 07.x.x.x

Restrictions as of firmware version 07.x.x.x:

- There is no automatic firmware download if an inverter firmware version 07.x.x.x ("PLC Designer" project) has been stored on the Lenze controller and the replacement device contains firmware version 07.x.x.x in the "Device replacement" service case.
- The EtherCAT network remains in the "Pre-Operational" status if an inverter firmware version 07.x.x.x ("PLC Designer" project) has been stored on the Lenze controller and the replacement device contains firmware version 07.x.x.x in the "Device replacement" service case.

To get out of the "Pre-Operational" status, a manual intervention is required. For detailed information, refer to the commissioning document of the Lenze controller.

### Main version check from firmware version 06.02.x.x

Restrictions from firmware version 06.02.x.x:

- There is no automatic firmware download if an inverter firmware version 05.x.x.x ("PLC Designer" project) has been stored on the Lenze controller and the replacement device contains firmware version 06.x.x.x in the "Device replacement" service case.
- The EtherCAT network remains in the "Pre-Operational" status if an inverter firmware version 06.x.x.x ("PLC Designer" project) has been stored on the Lenze controller and the replacement device contains firmware version 05.x.x.x in the "Device replacement" service case.

To get out of the "Pre-Operational" status, a manual intervention is required. For detailed information, refer to the commissioning document of the Lenze controller.



## Restrictions

### **Power failure during firmware download: iCIF connection lost [33200]**

In the event of a power failure, the inverter switches to a fault state. There is then only one means for recovery:

- Load the firmware using the Firmware-Loader via the USB diagnostic module.
- Restart the inverter.

It may occur that the inverter switches to a fault state after a successful firmware download.

### **Behavior after successful firmware download: Network: interruption of cyclic data exchange [33169]**

- Acknowledge the error via »PLC Designer« ,»Easy Starter« or via the mains switch.

### **Engineering tool access during firmware download:**

During the firmware download via the Controller, no simultaneous connection to an engineering tool shall be active (Easy Starter / PLC Designer). In the event of an error, the is only one way to restore the connection:

- Load the firmware with the firmware loader via the USB diagnostic module.
- Restart the inverter.



## 12.15 EtherNet/IP



EtherNet/IP™ (EtherNet Industrial Protocol) is a fieldbus system based on Ethernet which uses the Common Industrial Protocol™ (CIP™) for data exchange.

- EtherNet/IP™ and Common Industrial Protocol™ (CIP™) are trademarks and patented technologies, licensed by the user organisation ODVA (Open DeviceNet Vendor Association).
- Detailed information on EtherNet/IP can be found on the web page of the user organisation: <https://www.odva.org>
- Information about the dimensioning of a EtherNet/IP network can be found in the planning manual for the inverter.

The inverter can be controlled by every CIP Generic Master that either uses "Class 1 Messaging" or "Class 3 Messaging". For this purpose, the inverter must be configured as AC-Drive-Adapter with the software »Studio 5000 Logix Designer®« from Rockwell Automation® Corporation. ▶ [Commissioning](#) 483

Registered trademarks used or trademarks of the Rockwell Automation® Corporation, USA:

- »Studio 5000 Logix Designer®«, »Studio 5000®«
- »Allen-Bradley®«
- »CompactLogix™«, »ControlLogix®«, »SoftLogix™«, »GuardLogix®«

### Preconditions

- The control unit (CU) of the inverter is provided with EtherNet/IP (from firmware 02.01).

### Typical topologies

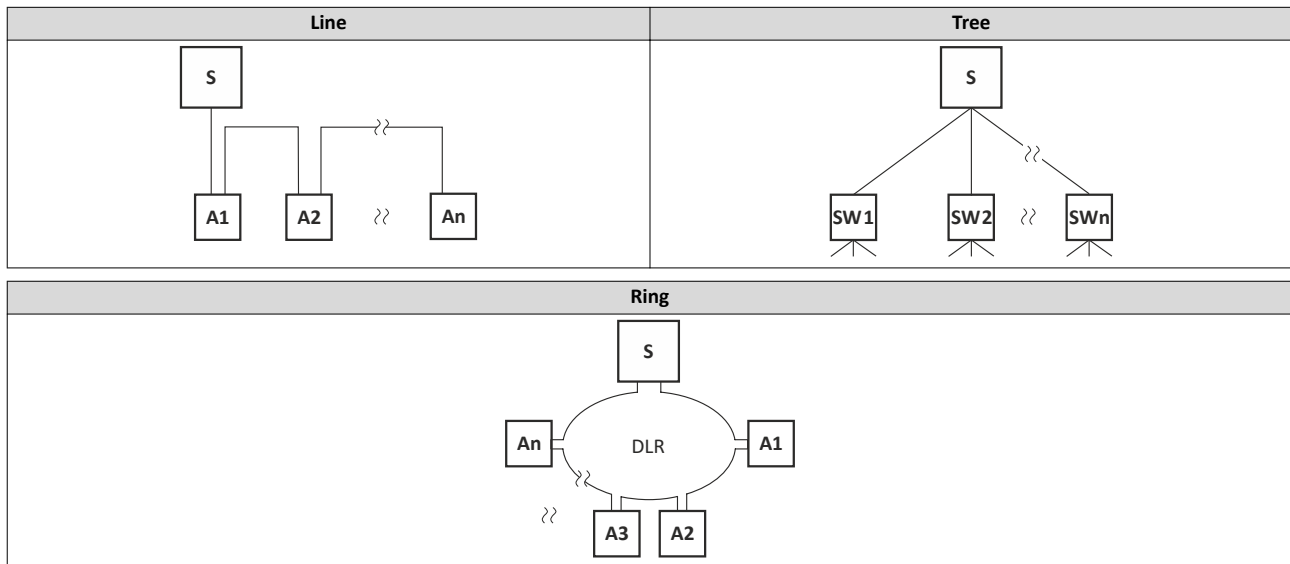

S Scanner  
A Adapter  
SW Switch

### 12.15.1 AC drive profile

For control via the AC drive profile, the parameters listed in the following can be mapped to network registers.

- Mapping entry for the AC Drive control word (0x400B:001 (P592.01)): 0x400B0110
- Mapping entry for the AC Drive status word (0x400C:001 (P593.01)): 0x400C0110
- Detailed information on the data mapping can be found in the chapter of the corresponding network.



## 12.15.2 Supported CIP objects

An object is described by its class, instances and attributes. Various services, such as reading or writing services, can be applied to the objects.



This chapter only describes the CIP objects implemented by Lenze and their supported features (attributes).

Not all object features as described in the "Common Industrial Protocol Specification" of the ODVA are supported.

### 12.15.2.1 0x01-Identity Object

The "Identity Object" provides the identification and the general information on the device.

Attribute (Instance ID)	Name	Information
1	Vendor ID	Lenze
2	Device Type	2 (AC Drive)
3	Product Code	550
4	Revision	E.g.: "1.5"
5	Status	
6	Serial Number	
7	Product Name	IOFW51AGXX
8	State	



## 12.15.2.2 0x04-Assembly Object

The inverter contains EtherNet/IP assembly object instances which refer to the following »Studio 5000 Logix Designer®« connection parameters:

- Inputs (actual value such as actual speed, actual position, etc.)
- Outputs (enable and reference value for the drive)
- Configuration



---

The inputs and outputs refer to the view of the Scanner (PLC).

- Output data/assemblies are created by the Scanner (PLC) and transmitted to the Adapter (inverter).
  - Input data/assemblies are created by the Adapter (inverter) and transmitted to the Scanner (PLC).
- 

The assembly object instances can be accessed via "Class 1 Messaging" (Implicit Messaging) and "Class 3 Messaging" (Explicit Messaging).



---

Customer specific configurations with the assembly object instances 110 and 111 are only possible with PLCs (Scanner) that support "Class 1 Messaging".

---

See also the following chapters:

- ▶ [Process data transfer](#) 489 (Implicit Messaging)
- ▶ [Parameter data transfer](#) 500 (Explicit Messaging)

The Ethernet connection object offers the following common services for accessing the assembly object instances:

- 0x0E: Get\_Attribute\_Single (read parameter/assembly data)
- 0x10: Set\_Attribute\_Single (write parameter/assembly data)





The following predefined assembly object instances can be used according to the "CIP™ Network Library":

Attribute (Instance ID)	Name	Info / parameter
Assembly output object instances according to AC Drive profile		
20	Basic Speed Control Output	LSB of the AC Drive control word <a href="#">0x400B:001 (P592.01)</a> (some bits are masked) ▶ <a href="#">0x400B:004 (P592.04)</a> Network setpoint speed
21	Extended Speed Control Output	LSB of the AC-Drive control word <a href="#">0x400B:001 (P592.01)</a> ▶ <a href="#">0x400B:004 (P592.04)</a> Network setpoint speed
22	Speed and Torque Control Output	LSB of the AC Drive control word <a href="#">0x400B:001 (P592.01)</a> (some bits are masked) ▶ <a href="#">0x400B:004 (P592.04)</a> Network setpoint speed ▶ <a href="#">0x400B:008 (P592.08)</a> Torque mode setpoint
23	Extended Speed and Torque Control Output	LSB of the AC-Drive control word <a href="#">0x400B:001 (P592.01)</a> ▶ <a href="#">0x400B:004 (P592.04)</a> Network setpoint speed ▶ <a href="#">0x400B:008 (P592.08)</a> Torque mode setpoint
Assembly input object instances according to the AC Drive profile		
70	Basic Speed Control Input	LSB of the AC Drive status word <a href="#">0x400C:001 (P593.01)</a> (some bits are masked) ▶ <a href="#">0x400C:004 (P593.04)</a> Motor speed
71	Extended Speed Control Input	LSB of the AC-Drive status word <a href="#">0x400C:001 (P593.01)</a> ▶ <a href="#">0x400C:004 (P593.04)</a> Motor speed
72	Speed and Torque Control Input	LSB of the AC-Drive status word <a href="#">0x400C:001 (P593.01)</a> ▶ <a href="#">0x400C:004 (P593.04)</a> Motor speed ▶ <a href="#">0x400C:007 (P593.07)</a> Torque scaled
73	Extended Speed and Torque Control Input	LSB of the AC-Drive status word <a href="#">0x400C:001 (P593.01)</a> MSB Drive State of the AC Drive status word (mask bits 12 ... 15) ▶ <a href="#">0x400C:004 (P593.04)</a> Motor speed ▶ <a href="#">0x400C:007 (P593.07)</a> Torque scaled
Assembly object instances for customer specific configurations		
110	Custom Output	Customized
111	Custom Input	The inverter must be registered with an EDS device description file in »Studio 5000 Logix Designer®« to be able to assign data to these assembly object instances.
Assembly object instances according to the CIP Safety profile		
161	Safety Output with STO	CIP Safety output data
171	Safety Input with STO	CIP Safety input data

# Configuring the network

EtherNet/IP  
Supported CIP objects  
0x04-Assembly Object



## Assembly output objects (outputs)

Assembly output objects are usually used to enable the inverter (Adapter) and define a speed or torque setpoint.

Depending on the data length defined by the PLC (Scanner) the memory map of the I/O data may vary in size.

In case of assembly output objects, a 32-bit-run/idle header is assumed. When the assemblies are mapped, this header is inserted automatically into the data flow by most of the Allen-Bradley PLC/SLC devices. For this purpose, no adaptations are required.

If your PLC does not support the 32-bit run/idle header, complement the output image by a leading 32-bit header. Set the data in the header to 0.

Bit 0 of the header can be defined in the process image of your PLC:

- Status 0 Idle mode
- Status 1 Run mode

## Structure of the output objects

Attribute (Instance ID)	Byte	Bit 7	Bit 6	Bit 5	Bit 4	Bit 3	Bit 2	Bit 1	Bit 0
20 (0x14)	0						FaultRst		RunFwd (CW)
	1								
	2	Speed Reference (low byte)							
	3	Speed Reference (high byte)							
21 (0x15)	0		NetRef	NetCtrl			FaultRst	RunRev (CCW)	RunFwd (CW)
	1								
	2	Speed Reference (low byte)							
	3	Speed Reference (high byte)							
22 (0x16)	0						FaultRst		RunFwd (CW)
	1								
	2	Speed Reference (low byte)							
	3	Speed Reference (high byte)							
	4	Torque Reference (low byte)							
	5	Torque Reference (high byte)							
23 (0x17)	0		NetRef	NetCtrl			FaultRst	RunRev (CCW)	RunFwd (CW)
	1								
	2	Speed Reference (low byte)							
	3	Speed Reference (high byte)							
	4	Torque Reference (low byte)							
	5	Torque Reference (high byte)							
110 (0x6E)	0 ... 31	Custom Output							



## Assembly input objects (inputs)

Assembly input objects are usually used to monitor the status of the inverter (Adapter) and request current actual values (e. g. the current speed).

The input objects are mapped in the Adaptermemory from byte 0 and transmitted "modeless".

The inverter does not use a 32-bit header for the real time status. Thus, the start address in the assembly memory map is the real start of the first assembly data element.



When the assembly input objects are mapped to the control memory, observe the real assembly lengths.

## Structure of the input objects

Attribute (Instance ID)	Byte	Bit 7	Bit 6	Bit 5	Bit 4	Bit 3	Bit 2	Bit 1	Bit 0
70 (0x46)	0						Running1 (Fwd, CW)		Faulted
	1								
	2	Speed Actual (low byte)							
	3	Speed Actual (high byte)							
71 (0x47)	0	AtReference	RefFromNet	CtrlFromNet	Ready	Running2 (Rev, CCW)	Running1 (Fwd, CW)	Warning	Faulted
	1	Drive State							
	2	Speed Actual (low byte)							
	3	Speed Actual (high byte)							
72 (0x48)	0						Running1 (Fwd, CW)		Faulted
	1								
	2	Speed Actual (low byte)							
	3	Speed Actual (high byte)							
	4	Torque Actual (low byte)							
	5	Torque Actual (high byte)							
73 (0x49)	0	AtReference	RefFromNet	CtrlFromNet	Ready	Running2 (Rev, CCW)	Running1 (Fwd, CW)	Warning	Faulted
	1	Drive State							
	2	Speed Actual (low byte)							
	3	Speed Actual (high byte)							
	4	Torque Actual (low byte)							
	5	Torque Actual (high byte)							
111 (0x6F)	0 ... 31	Custom Input							

# Configuring the network

EtherNet/IP  
Supported CIP objects  
0x04-Assembly Object



## Configuration Assembly 130 (68 bytes)

Name	Value	Size [byte]
Input 1	Input parameter	2
Input 2	Input parameter	2
Input 3	Input parameter	2
Input 4	Input parameter	2
Input 5	Input parameter	2
Input 6	Input parameter	2
Input 7	Input parameter	2
Input 8	Input parameter	2
Input 9	Input parameter	2
Input 10	Input parameter	2
Input 11	Input parameter	2
Input 12	Input parameter	2
Input 13	Input parameter	2
Input 14	Input parameter	2
Input 15	Input parameter	2
Input 16	Input parameter	2
Input Trailing Data	'100'	2
Output 1	Output parameter	2
Output 2	Output parameter	2
Output 3	Output parameter	2
Output 4	Output parameter	2
Output 5	Output parameter	2
Output 6	Output parameter	2
Output 7	Output parameter	2
Output 8	Output parameter	2
Output 9	Output parameter	2
Output 10	Output parameter	2
Output 11	Output parameter	2
Output 12	Output parameter	2
Output 13	Output parameter	2
Output 14	Output parameter	2
Output 15	Output parameter	2
Output 16	Output parameter	2
Output Trailing Data	'101'	2



## Selection for "Input parameter" and "Output parameter" of the Configuration Assembly 130

Selection for "Input parameter"			Selection for "Output parameter"		
Value	Name	Size [byte]	Value	Name	Size [byte]
0	ignore	N/A	0	ignore	N/A
1	Generic SINT Input *	1	51	Generic SINT Output *	1
2	Generic INT Input *	2	52	Generic INT Output *	2
3	Generic DINT Input *	4	53	Generic DINT Output *	4
4	2B0B/0 Freq Setpoint Hz	2	54	2946/1 Trq Mode Hi Spd	4
5	2D40/4 Device Load Act.	2	55	2946/2 Trq Mode Lo Spd	4
6	2D4F/0 Motor i2t utiliz.	2	56	4008/1 NetWordIN1	2
7	2D82/0 Motor voltage	4	57	4008/2 NetWordIN2	2
8	2D88/0 Motor current	2	58	4008/3 NetWordIN3	2
9	2DA2/1 Effective Power	4	59	4008/4 NetWordIN4	2
10	2DA2/2 Apparent Power	4	60	400B/1 AC Drv Ctrl Word	2
11	2DA3/1 Energy Out Motor	4	61	400B/2 C0135 Ctrl Word	2
12	2DA3/2 Energy Out Gen.	4	62	400B/3 Net Spd Stpnt Hz	2
13	2DA4/1 Anlg In1 %	2	63	400B/4 Net Spd Stpnt RPM	2
14	2DA4/2 Anlg In1 Freq	2	64	400B/5 Net Spd 0.01 Hz	2
15	2DA4/3 Anlg In1 PidVal	2	65	400B/6 NetSpdSign 0.1Hz	2
16	2DA4/4 Anlg In1 TorqVal	2	66	400B/7 Net PID Stpnt	2
17	2DA5/1 Anlg In2 %	2	67	400B/8 Net Torque Stpnt	2
18	2DA5/2 Anlg In2 Freq	2	68	6040/0 Control Word	2
19	2DA5/3 Anlg In2 PidVal	2	69	6042/0 Target Velocity	2
20	2DA5/4 Anlg In2 TorqVal	2	70	6046/1 Velocity Min	4
21	2DAA/1 AO1 Value (VDC)	2	71	6046/2 Velocity Max	4
22	2DAA/2 AO1 Value (IDC)	2	72	6048/1 Delta Speed	4
24	2DD3/1 Speed set	4	73	6048/2 Delta Time	2
26	2DDD/0 Actual Frequency	2	74	6049/1 Delta Speed	4
27	400A/1 NetWordOUT1	2	75	6049/2 Delta Time	2
28	400A/2 NetWordOUT2	2	76	6060/0 402 Control Modes	1
29	400C/1 AC Drv Stat Word	2	77	6071/0 402 Target Torque	2
30	400C/2 C0150 Stat Word	2	78	6080/0 Motor Max Speed	4
31	400C/3 Actual Speed Hz	2	79	60E0/0 Pos Torque Limit	2
32	400C/4 Actual Speed RPM	2	80	60E1/0 Neg Torque Limit	2
33	400C/5 Drive State	2	82	400B/13 Process Input Freq.	2
34	400C/6 Act Speed 0.01Hz	2			
35	400C/7 Actual Torque Scaled	2			
36	400D/0 Scaled Speed	2			
37	401F/1 Actual PID Stpnt	2			
38	401F/2 Actual PID Fbk	2			
39	401F/3 PID bits	1			
40	603F/0 Current Fault	2			
41	6041/0 Status Word	2			
42	6043/0 Velocity Demand	2			
43	6044/0 Velocity Actual	2			
44	6061/0 402 Mode Display	1			
45	6077/0 402 ActualTorq %	2			
46	6078/0 402 ActualCur %	2			
47	6079/0 402 Dclink Volt	4			
48	60FD/0 Dig Inputs Stat	4			
50	400C/9 Process Output Freq.	2			

\* Selection can be used to specify only the data size of the parameters in the PLC (Scanner). The desired parameters with the corresponding data size can then be assigned manually for the inverter (Adapter) in the »EASY Starter«:  
"Settings" tab → Overview → Fieldbus EtherNet/IP → Mapping fieldbus data

Data format of the parameters: [▶ Parameter attribute list 731](#)

# Configuring the network

EtherNet/IP  
Supported CIP objects  
0x28-Motor Data Object



## 12.15.2.3 0x28-Motor Data Object

The "Motor Data Object" provides a data basis for motor parameters.

### Instance attributes

Attribute ID	Name	Info / parameter
3	Motor Type	Motor type (0x6402) Default setting: Squirrel cage induction
6	Rated Current [mA]	Rated motor current (0x6075 (P323.00))
7	Rated Voltage [V]	Rated voltage (0x2C01:007 (P320.07))

## 12.15.2.4 0x29-Control Supervisor Object

The "Control Supervisor Object" describes all management functions of the device for the motor control.

Attribute (Instance ID)	Name	Info / parameter
3	Run1	AC drive control word 0x400B:001 (P592.01): Bit 0 (run forward, CW)
4	Run2	AC drive control word 0x400B:001 (P592.01): Bit 1 (run backward, CCW)
5	NetCtrl	AC Drive control word 0x400B:001 (P592.01): Bit 5 (activate network control: 0x2631:037 (P400.37) = 114)
6	State	AC drive status word 0x400C:001 (P593.01): Bits 8 ... 11 (profile status/Drive State) Bits 12 ... 15 masked
7	Running1	AC drive status word 0x400C:001 (P593.01): Bit 2 (run forward active, CW)
8	Running2	AC drive status word 0x400C:001 (P593.01): Bit 3 (run backward active, CCW)
9	Ready	AC drive status word 0x400C:001 (P593.01): Bit 4 (ready)
10	Faulted	AC drive status word 0x400C:001 (P593.01): Bit 0 (fault/trouble active)
11	Warning	AC drive status word 0x400C:001 (P593.01): Bit 1 (warning active)
12	FaultRst	AC drive control word 0x400B:001 (P592.01): Bit 2 (error reset)
13	FaultCode	Error code 0x603F (P150.00)
15	CtrlFromNet	AC drive status word 0x400C:001 (P593.01): Bit 5 (network control active)

### Assignment of "CiA 402 plus States" to "AC Drive Profile Drive States"

CiA 402 plus States	AC Drive Profile Drive States
INIT (0, 1)	0: Manufacturer-specific
NOT_READY_TO_SWITCH_ON (2)	1: Startup (drive initialization)
SWITCH_ON_DISABLED (3)	2: Not_Ready (mains voltage switched off)
READY_TO_SWITCH_ON (4)	3: Ready (mains voltage switched on)
SWITCHED_ON (5)	4: Enabled (drive has received run command)
OPERATION_ENABLED (6)	5: Stopping (drive has received stop command and is stopped)
DISABLE_OPERATION (7)	
SHUT_DOWN (8)	
QUICK_STOP (9)	6: Fault_Stop (drive is stopped due to a fault)
FAULT_REACTION_ACTIVE (10)	
FAULT (11)	
	7: Faulted (faults have occurred)



## 12.15.2.5 0x2A-AC Drive Object

The "AC Drive Object" describes the device-specific functions of the inverter, e. g. speed ramps, torque control etc.

Attribute (Instance ID)	Name	Info / parameter
3	AtReference	AC drive status word 0x400C:001 (P593.01): Bit 7 (At Reference)
4	NetRef	AC drive control word 0x400B:001 (P592.01): Bit 6 (activate network setpoint) Activate network setpoint: 0x2631:017 (P400.17) = 116
6	DriveMode	AC Drive mode 0x400B:010
7	SpeedActual [rpm / 2 <sup>SpeedScale</sup> ]	Current motor speed 0x400C:004 (P593.04) A speed scale parameter is not supported.
8	SpeedRef [rpm / 2 <sup>SpeedScale</sup> ]	Setpoint speed 0x400B:004 (P592.04) A speed scale parameter is not supported.
11	TorqueActual [Nm / 2 <sup>TorqueScale</sup> ]	Current torque (scaled) 0x400C:007 (P593.07)
12	TorqueRef [Nm / 2 <sup>TorqueScale</sup> ]	Torque setpoint 0x400B:008 (P592.08) The scaling factor can be set with 0x400B:009 (P592.09).  Example: <ul style="list-style-type: none"> <li>• Torque setpoint (0x400B:008) = 345 [Nm]</li> <li>• Scaling factor (0x400B:009) = 3</li> <li>• Scaled torque setpoint = 345 [Nm] / 2<sup>3</sup> = 43.125 [Nm]</li> </ul>
22	SpeedScale	Not implemented. Use the value "0" for SpeedScale .
24	TorqueScale	0x400B:009 (P592.09) = torque scaling of TorqueRef (0x400B:008 (P592.08)) and TorqueActual (0x400C:007 (P593.07))
29	RefFromNet	AC drive status word 0x400C:001 (P593.01): Bit 6 (Reference from Network)

The following table shows the negative influence of an AC Drive mode on the mode selection parameters of the inverter.

### Impacts of the AC Drive mode on the mode selection parameters of the inverter

0x400B:010 AC Drive mode 0x2A: AC Drive Object Attribute 6: Drive Mode	0x6402 Motor type	0x6060 (P301.00) CiA: Operation mode	0x2C00 (P300.00) Motor control mode	0x4020:001 (P600.01) Operating mode
0: Vendor specific	Unchanged	Unchanged	Unchanged	Unchanged
1: Speed control (open loop)	7: Squirrel cage induction	2: MS: Velocity mode	6: V/f characteristic control (VFC open loop)	0: Inhibited
2: Speed control (closed loop)	7: Squirrel cage induction	2: MS: Velocity mode	2: Servo control (SC ASM)	0: Inhibited
3: Torque control	7: Squirrel cage induction	1: MS: Torque mode	Unchanged	0: Inhibited

# Configuring the network

EtherNet/IP

Supported CIP objects

0x47-Device Level Ring (DLR) Object



## 12.15.2.6 0x47-Device Level Ring (DLR) Object

The "Device Level Ring (DLR) Object" provides status information for the DLR protocol. The DLR protocol is a "layer 2" protocol enabling the use of an Ethernet ring topology.

### Instance attributes

Attribute ID	Name	Information
1	Network Topology	Current network topology <ul style="list-style-type: none"><li>• 0: Line topology</li><li>• 1 Ring topology</li></ul>
2	Network Status	Current network status <ul style="list-style-type: none"><li>• 0: Normal</li><li>• 1 Ring Fault (only for ring topology)</li><li>• 2: Unexpected Loop Detected (only for line topology)</li><li>• 3: Partial Network Fault</li><li>• 4: Rapid Fault/Restore Cycle</li></ul>
10	Active Supervisor Address	IP address and MAC address of the active ring supervisor
12	Capability Flags	Telegram processing method for the ring node implementation <ul style="list-style-type: none"><li>• 2: Beacon-based ring node</li></ul>

## 12.15.2.7 0x48-Quality of Service (QoS) Object

The "Quality of Service (QoS) Object" enables different classifications and prioritizations of the data packets for the EtherNet/IP communication. For this purpose the EtherNet/IP messages are marked with "Differentiated Services Codepoints" (DSCP).

### Instance attributes

Attribute ID	Name	Information
4	DSCP Urgent	Default: 55: Urgent/imperative messages
5	DSCP Scheduled	Default: 47 (Scheduled messages)
6	DSCP High	Default: 43 (Messages with high priority)
7	DSCP Low	Default: 31 (Messages with low priority)
8	DSCP Explicit	Default: 27 ("Explicit Messages"/parameter data)

## 12.15.2.8 0x67-Lenze Class Object 103

The "Lenze Class (0x67)" provides the image of the input data of the scanner.

The input data for the Scanner is sent to the Scanner via the configured assembly input object instance.

### Instance attributes

Attribute ID	Name	Information
3	I/O image of produced data	Image of the scanner input data

## 12.15.2.9 0x68-Lenze Class Object 104

The "Lenze Class (0x68)" provides the image of the output data of the scanner.

The output data of the scanner is sent via the configured assembly output object instance.

### Instance attributes

Attribute ID	Name	Information
3	I/O image of consumed data	Image of the scanner output data





## 12.15.2.10 0x6E-Lenze Class Object 110

The "Lenze Class (0x6E)" enables read or write access to Lenze parameters of the inverter.

The Lenze parameter must be specified as "Instance" and its subindex as "Attribute".



- If there is no subindex, the attribute must be set to "0". If the engineering tool used does not support the attribute value "0", the value "1" must be entered.
- Configuration of a display parameter by "Set\_Attribute\_Single" is not possible.

Service Type	Instance	Attribute ID	Data
Get_Attribute_Single	Index number of the Lenze parameter	Subindex number of the Lenze parameter	Value of the parameter
Set_Attribute_Single			

## 12.15.2.11 0xF5-TCP/IP Interface Object

The "TCP/IP Interface Object" is used to configure the TCP/IP network interface of the device.

### Instance attributes

Attribute ID	Name	Info / parameter
1	Status	Current status of the TCP/IP network interface
2	Configuration Capability	Possible options for TCP/IP configuration <ul style="list-style-type: none"> <li>• DHCP client</li> <li>• Config. Settable</li> <li>• ACD capable</li> </ul>
3	Configuration Control	Type of the TCP/IP configuration <a href="#">0x23A1:005 (P510.05)</a> Possible values for bit 0 ... 3 <ul style="list-style-type: none"> <li>• 0000: Static TCP/IP configuration</li> <li>• 0010: TCP/IP configuration via DHCP</li> </ul>
4	Physical Link Object	Path to "Physical Link Object"
5	Interface Configuration	Current TCP/IP configuration <ul style="list-style-type: none"> <li>• IP address: <a href="#">0x23A1:001 (P510.01)</a></li> <li>• Subnetwork: <a href="#">0x23A1:002 (P510.02)</a></li> <li>• Gateway: <a href="#">0x23A1:003 (P510.03)</a></li> </ul> "Interface Configuration Change Requires Reset" is not supported, i.e. a write access to attribute 5 is implemented immediately!
6	Host Name	Host name: <a href="#">0x23A1:004 (P510.04)</a>
8	TTL Value	TTL value for EtherNet/IP multicast data packages: <a href="#">0x23A1:006 (P510.06)</a>
9	Mcast Config	Multicast settings <ul style="list-style-type: none"> <li>• Multicast assignment: <a href="#">0x23A1:007 (P510.07)</a></li> <li>• Multicast IP address: <a href="#">0x23A1:008 (P510.08)</a></li> <li>• Multicast number: <a href="#">0x23A1:009 (P510.09)</a></li> </ul>
10	SelectAcid	Activate address conflict detection (ACD) <a href="#">0x23A7 (P514.00)</a> <ul style="list-style-type: none"> <li>• 0: Deactivate ACD</li> <li>• 1 Activate ACD</li> </ul>
11	LastConflictDetected	ACD diagnostic information about the last address conflict that occurred.
13	Encapsulation Inactivity Timeout	Number of seconds of inactivity before the TCP connection session is closed.

# Configuring the network

EtherNet/IP  
AC motor type  
0xF6-Ethernet Link Object



## 12.15.2.12 0xF6-Ethernet Link Object

The "Ethernet Link Object" provides general information and status information of the Ethernet interfaces (IEEE 802.3)

Instance 1 for interface X266, instance 2 for interface X267.

### Instance attributes

Attribute ID	Name	Info / parameter
1	Interface Speed	Current baud rate <ul style="list-style-type: none"> <li>• 10 Mbps</li> <li>• 100 Mbps</li> </ul>
2	Interface Flags	Status bits of the Ethernet interface The change of an attribute of the interface configuration becomes effective immediately.
3	Physical Address	MAC address of the Ethernet interface: <a href="#">0x23A2:005 (P511.05)</a>
4	Interface Counters	Interface-specific counter
5	Media Counters	Media-specific counter
6	Interface Control	Interface settings <ul style="list-style-type: none"> <li>• Port 1: <a href="#">0x23A4:001 (P512.01)</a></li> <li>• Port 2: <a href="#">0x23A4:002 (P512.02)</a></li> </ul>
7	Interface Type	Twisted Pair is supported.
8	Interface State	Interface status
9	Admin State	Administrative setting of the interface status <ul style="list-style-type: none"> <li>• Enable interface</li> <li>• Disable interface</li> </ul>
10	Interface Label	Text for the identification/designation of the Ethernet interface <ul style="list-style-type: none"> <li>• X266 (instance 1)</li> <li>• X267 (instance 2)</li> </ul>
11	Interface Capability	<ul style="list-style-type: none"> <li>• Manual settings are effective immediately (no reset required).</li> <li>• Autonegotiation is supported.</li> <li>• Auto-MDIX is supported.</li> <li>• Manual setting of Speed and Duplex is supported.</li> </ul>

## 12.15.3 AC motor type

### Parameter

Address	Name / setting range / [default setting]	Information
0x6402	Motor type <ul style="list-style-type: none"> <li>• From version 02.00</li> </ul>	AC motor type <ul style="list-style-type: none"> <li>• Motor Data Object (0x28) - instance attribute 3</li> </ul>
	3 PM synchronous	
	7 <b>Squirrel cage induction</b>	



## 12.15.4 Commissioning

The steps required to control the device as an EtherNet/IP adapter with a Rockwell EtherNet/IP scanner are described below.

### Preconditions

- The inverter is provided with EtherNet/IP.
- The inverter is networked as EtherNet/IP Adapter with an EtherNet/IP Scanner and, if necessary, further EtherNet/IP nodes.
  - Typically, an EtherNet/IP network consists of segments that contain point-to-point connections in a star configuration.
  - See also "Typical topologies" under: [EtherNet/IP](#) 470
- An Engineering PC with the software »Studio 5000 Logix Designer®« (from version 30) is connected to the Scanner.
- Current device description files for EtherNet/IP are available.
  - [Download of EDS files](#)
  - The files are installed via the "EDS Hardware Installation Tool" of the »Studio 5000 Logix Designer®«.
  - Allen-Bradley control systems do not need any EDS files to add devices to their configuration.
- An »Studio 5000 Logix Designer®« project has been created and is in the offline state.
- The CPU and Ethernet adapter of the PLC (Scanner) have been configured.
- All EtherNet/IP nodes are supplied with voltage and are switched on.



An internal web server is supported. It can be accessed via the IP address defined in the parameter `0x23A1:001 (P510.01)`. Protect access to the web server with e.g. a "firewall" and follow your internal IT security guidelines.

---



A firmware download from the PLC to the inverter via the network (also via FTP) only takes place under the following conditions:

- Required firmware version 05.01.x.x or higher
  - Bootloader version 00.00.00.18 or higher
-



## Commissioning with »Studio 5000 Logix Designer®« (from version 30)

How to configure the network:

### 1. Configure IP communication

1. Make IP basic settings at the Engineering PC.

The PC with the software »Studio 5000 Logix Designer®« must be in the same network as the devices to be configured.

2. Set IP address of the inverter (adapter) via rotary encoder switch and parameter [0x23A1:001 \(P510.01\)](#).
3. Set subnet mask: [0x23A1:002 \(P510.02\)](#)
4. Set gateway address: [0x23A1:003 \(P510.03\)](#)

The configuration of the IP communication is now completed.

### 2. Activate network control in the inverter

1. Activate network control: [0x2631:037 \(P400.37\)](#) = "Network control active [114]"
2. Set network as standard setpoint source: [0x2860:001 \(P201.01\)](#) = "Network [5]"

If another default setpoint source is set, switching to the network setpoint is possible via the AC drive control word [0x400B:001 \(P592.01\)](#) when network control is activated.

The network control is now activated.

3. Save parameter settings: [0x2022:003 \(P700.03\)](#) = "On / start [1]"

### 3. Execute I/O configuration with »Studio 5000 Logix Designer®«

1. Start the »Studio 5000 Logix Designer®«.
2. Open or recreate a »Studio 5000 Logix Designer®« project.
3. Configure the cyclic data transfer (Implicit Messaging).

▶ [Process data transfer](#)  489

4. Configure the acyclic data transfer (Explicit Messaging).

▶ [Parameter data transfer](#)  500

The configuration of the network is now completed.

### 4. Save »Studio 5000 Logix Designer®« project

1. Click ""File"" in the upper toolbar.
2. Execute the "Save" menu command.  
The configuration is saved in a file on your PC.

### 5. Load configuration into the scanner:

1. Click "Communications" in the upper toolbar.
2. Execute the "Download" menu command.  
The "Download" dialog box is opened.
3. Click "Download".

The configuration is loaded into the Scanner. If the download has been completed successfully, »Studio 5000 Logix Designer®« changes to the online mode. The I/O-OK field in the upper left area of the screen is green.

### 6. Complete the commissioning

1. Restart communication, when the EtherNet/IP configuration has been changed:
  - a) Switch inverter off and on again or
  - b) Set [0x23A0 \(P508.00\)](#) = "Restart with current values [1]".

Commissioning is completed.



## Control the inverter via the network



In the default setting, the digital input DI1 is assigned the "Run" function. If the network control is activated, this function serves as "start enable" for start commands via network. Hence, the digital input DI1 must be set to the HIGH level in order that the motor can be started via the network.

► [Flexible I/O configuration of the start, stop and rotating direction commands](#) 67

In order that the inverter can be controlled via the network, activate the network control:  
[0x2631:037 \(P400.37\)](#) = "Network control active [114]"

Select "Network [5]" in [0x2860:001 \(P201.01\)](#) to use the network generally as a standard setpoint source. If another standard setpoint source is set, a change-over to the network setpoint via the AC Drive control word [0x400B:001 \(P592.01\)](#) is possible in case the network control is activated:

Change-over to network setpoint	
The network setpoint is activated via bit 6 (NetRef) of the AC Drive control word:	
Bit 6	Selection:
0	Standard setpoint source selected in <a href="#">0x2860:001 (P201.01)</a> .
1	Network setpoint
<b>Note!</b> In order that the activation via bit 6 works, the selection "Network setpoint active [116]" must be set in <a href="#">0x2631:017 (P400.17)</a> .	

Optionally, a change-over from the standard setpoint source to the network setpoint is also possible via a digital input:

- Set a standard setpoint source different than Network" [5]" in [0x2860:001 \(P201.01\)](#).
- Set the desired digital input in [0x2631:017 \(P400.17\)](#) via which the change-over to the network setpoint is to take place.



Bits 5 (NetCtrl) and 6 (NetRef) of byte 0 in the assembly output objects 21 and 23 must be transmitted to the inverter in order that control and speed reference commands are accepted by the network.

If the network control is active ([0x400B:001 \(P592.01\)](#)/bit 5 = 1 and [0x2631:037 \(P400.37\)](#) = 114), all bits of the AC drive control word ([0x400B:001 \(P592.01\)](#)) are processed.

If the network control is not active ([0x400B:001 \(P592.01\)](#)/bit 5 = 0 or [0x2631:037 \(P400.37\)](#) = 0), the control bits 0, 1, 12, 13, 14, 15 are *not* processed. Their states are ignored and the drive is in local control.

# Configuring the network

EtherNet/IP

Basic setting and options

Restarting or stopping the communication



## 12.15.4.1 Restarting or stopping the communication

The communication needs to be restarted after the EtherNet/IP configuration is changed, so that the changed settings can take effect.

For restarting communication, there are two options:

- Switch inverter off and on again.
- Set **0x23A0 (P508.00)** = "Restart with current values [1]".

### Parameter

Address	Name / setting range / [default setting]	Information
0x23A0 (P508.00)	EtherNet/IP communication (EtherN/IP comm.)	Restart / stop communication.
	<ul style="list-style-type: none"> <li>• From version 02.00</li> </ul>	<ul style="list-style-type: none"> <li>• When the device command has been executed successfully, the value 0 is shown.</li> <li>• A communication restart has nothing to do with the acceptance of the described operating modes. For this purpose, a restart of the device is required!</li> </ul>
	<b>0</b> No action/no error	Only status feedback
	<b>1</b> Restart with current values	Restart communication with the current values.
	<b>2</b> Restart with default values	Restart communication with the standard values.
	<b>5</b> Stop network communication	Stop communication.
	<b>10</b> In process	Only status feedback
<b>11</b> Action cancelled		
<b>12</b> Fault		

## 12.15.5 Basic setting and options



An internal web server is supported. It can be addressed via the IP address defined in the **0x23A1:001 (P510.01)** parameter. Protect access to the web server, e.g. with a firewall, and follow your internal IT security guidelines.

### Parameter

Address	Name / setting range / [default setting]	Information
0x23A3 (P509.00)	EtherNet/IP switch position (EtherN. switch)	Display of the rotary encoder switch settings at the last mains power-on.
	<ul style="list-style-type: none"> <li>• Read only</li> <li>• From version 02.00</li> </ul>	
0x23A1:001 (P510.01)	EtherNet/IP settings: IP address (EtherN/IP sett.: IP address)	Set IP address.
	0.0.0.0 ... <b>[192.168.124.16]</b> ... 255.255.255.255	
	<ul style="list-style-type: none"> <li>• From version 02.00</li> </ul>	
0x23A1:005 (P510.05)	EtherNet/IP settings: IP configuration (EtherN/IP sett.: IP configuration)	Set IP configuration.
	<ul style="list-style-type: none"> <li>• From version 02.00</li> </ul>	
	<b>0</b> Stored IP	The currently saved IP configuration is used.
	<b>1</b> BOOTP	The IP configuration is assigned by the Scanner via BOOTP.
	<b>2</b> DHCP	The IP configuration is assigned by the Scanner via DHCP. The assignment of a gateway address that is not in the same subnetwork as the IP address, is denied.
0x23A1:002 (P510.02)	EtherNet/IP settings: Subnet (EtherN/IP sett.: Subnet)	Set subnet mask.
	0.0.0.0 ... <b>[255.255.255.0]</b> ... 255.255.255.255	
	<ul style="list-style-type: none"> <li>• From version 02.00</li> </ul>	
0x23A1:003 (P510.03)	EtherNet/IP settings: Gateway (EtherN/IP sett.: Gateway)	Set gateway address.
	0.0.0.0 ... <b>[0.0.0.0]</b> ... 255.255.255.255	
	<ul style="list-style-type: none"> <li>• From version 02.00</li> </ul>	
0x23A1:004 (P510.04)	EtherNet/IP settings: Host name (EtherN/IP sett.: Host name)	Set host name.
	<ul style="list-style-type: none"> <li>• From version 02.00</li> <li>• String with up to 64 characters.</li> </ul>	



# Configuring the network

EtherNet/IP  
Basic setting and options

Address	Name / setting range / [default setting]	Information		
0x23A1:006 (P510.06)	EtherNet/IP settings: Multicast TTL (EtherN/IP sett.: Multicast TTL) 1 ... [1] ... 255 • From version 02.00	Setting of the multicast TTL value for the validity period of data packets in the network. The TTL value defines the number of hops that the multicast message can distribute via routers.		
0x23A1:007 (P510.07)	EtherNet/IP settings: Multicast allocation (EtherN/IP sett.: Mcast allocation) • From version 02.00	Selection for multicast-IP addressing.		
	<table border="1"> <tr> <td><b>0</b></td> <td><b>Default allocation</b></td> </tr> <tr> <td>1</td> <td>Multicast number/start address</td> </tr> </table>		<b>0</b>	<b>Default allocation</b>
<b>0</b>	<b>Default allocation</b>			
1	Multicast number/start address			
0x23A1:008 (P510.08)	EtherNet/IP settings: Multicast IP address (EtherN/IP sett.: Mcast IP addr.) 0.0.0.0 ... [239.64.2.224] ... 255.255.255.255 • From version 02.00	Set multicast IP address.		
0x23A1:009 (P510.09)	EtherNet/IP settings: Multicast number (EtherN/IP sett.: Multicast number) 1 ... [1] ... 8 • From version 02.00	Set multicast number.		
0x23A4:001 (P512.01)	Port settings: Port 1 (Port settings: Port 1) • From version 02.00	Set baud rate for Ethernet port 1.		
	<b>0</b> <b>Auto-Negotiation</b>			
	1 10 Mbps			
	2 100 Mbps			
	3 Reserved			
	4 Reserved			
	5 10 Mbps/Half Duplex			
	6 10 Mbps/Full Duplex			
	7 100 Mbps/Half Duplex			
	8 100 Mbps/Full Duplex			
	9 Reserved			
	10 Reserved			
	11 Reserved			
12 Reserved				
0x23A4:002 (P512.02)	Port settings: Port 2 (Port settings: Port 2) • From version 02.00	Set baud rate for Ethernet port 2.		
	<b>0</b> <b>Auto-Negotiation</b>			
	1 10 Mbps			
	2 100 Mbps			
	3 Reserved			
	4 Reserved			
	5 10 Mbps/Half Duplex			
	6 10 Mbps/Full Duplex			
	7 100 Mbps/Half Duplex			
	8 100 Mbps/Full Duplex			
	9 Reserved			
	10 Reserved			
	11 Reserved			
12 Reserved				
0x23A7 (P514.00)	Address conflict detection (AddrConflictDetec) • From version 02.00	Activate address conflict detection (ACD) (enable). • If this value is changed, the device must be reset ("Power off/on" or "Type 0 Reset").		
	<table border="1"> <tr> <td>0</td> <td>Disabled</td> </tr> <tr> <td><b>1</b></td> <td><b>Enabled</b></td> </tr> </table>	0	Disabled	<b>1</b>
0	Disabled			
<b>1</b>	<b>Enabled</b>			

# Configuring the network

EtherNet/IP

Basic setting and options



Address	Name / setting range / [default setting]	Information
0x400B:010	Process input data: AC Drive mode	Selection of the AC drive mode.
	0 Vendor specific	
	<b>1 Speed control (open loop)</b>	
	2 Speed control (closed loop)	
	3 Torque control (from version 03.00)	





## 12.15.6 Process data transfer

The I/O configuration of the Allen-Bradley CompactLogix controller 1769-L32E with the »Studio 5000 Logix Designer®« software (from version 30) is described below as an example.



---

As of »Studio 5000 Logix Designer®« version 30, I/O configuration is performed with the aid of EDS files.

[Download of EDS files](#)

---

# Configuring the network

EtherNet/IP  
Process data transfer



Configure the cyclical data transfer (Implicit Messaging) in the »Studio 5000 Logix Designer®« (from version 30):

1. Use the "EDS Hardware Installation Tool" to import the EDS files of the EtherNet/IP nodes.

In the »Studio 5000 Logix Designer®«, the dialog for the "EDS Hardware Installation Tool" is self-explanatory and is not described further here.

2. Click on the "I/O Configuration" folder in the configuration tree.

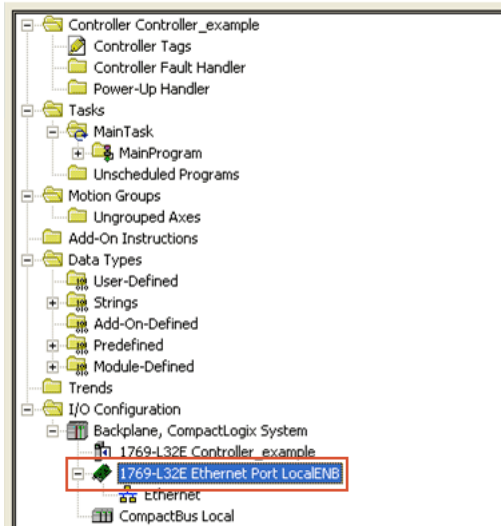

For the 1769-L32E CompactLogix controller, the I/O configuration already includes a local Ethernet port. If a SoftLogic or ControlLogix controller is used, an Ethernet port scanner must be added to the configuration.

3. Click with the right mouse button on "Ethernet" and execute the command "New Module ..." in the context menu.

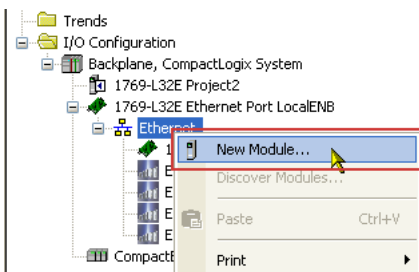



4. Open the dialog "Select Module Type".

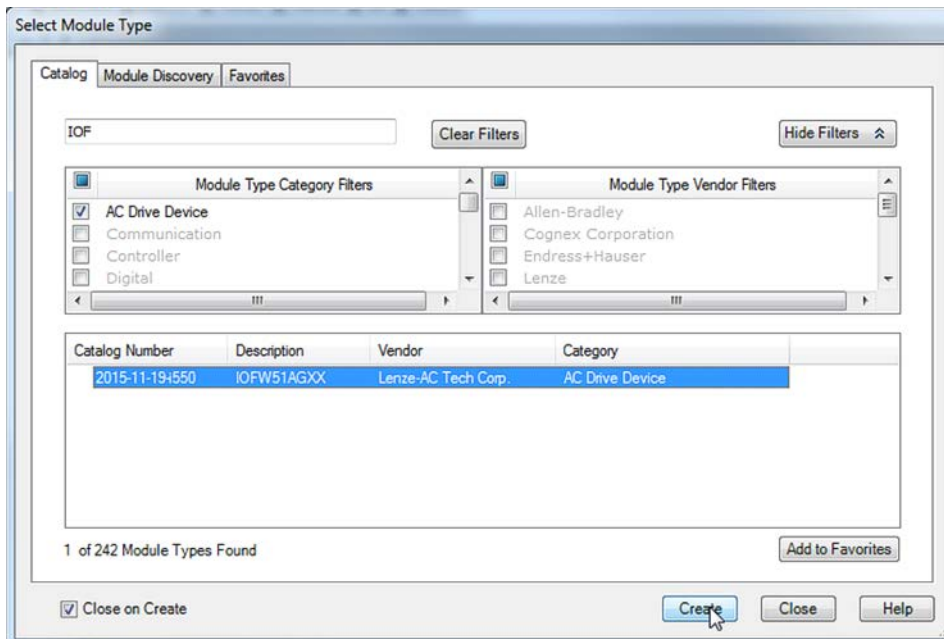

5. Under the "Catalog" tab ...

- select the "AC Drive Device" module type category.
- select the appropriate catalog number and description for your hardware.



6. Click "Create".

The "New Module" dialog box is opened.

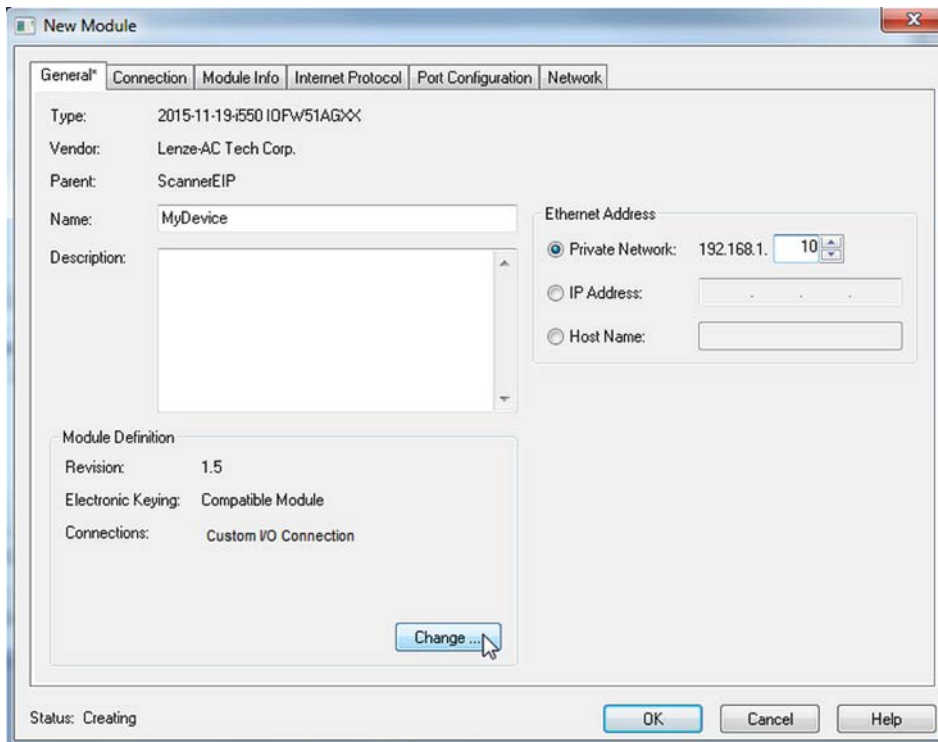

- a) The name to be entered should refer to the process or device.
- b) When entering the IP address, make sure that the inverter (adapter) is located in the same network as the PLC (scanner). The subnet corresponds to the first three bytes of the IP address.



---

DNS is not supported.

The host name only describes the device.

---



## 7. Set other properties under the Connection tab.

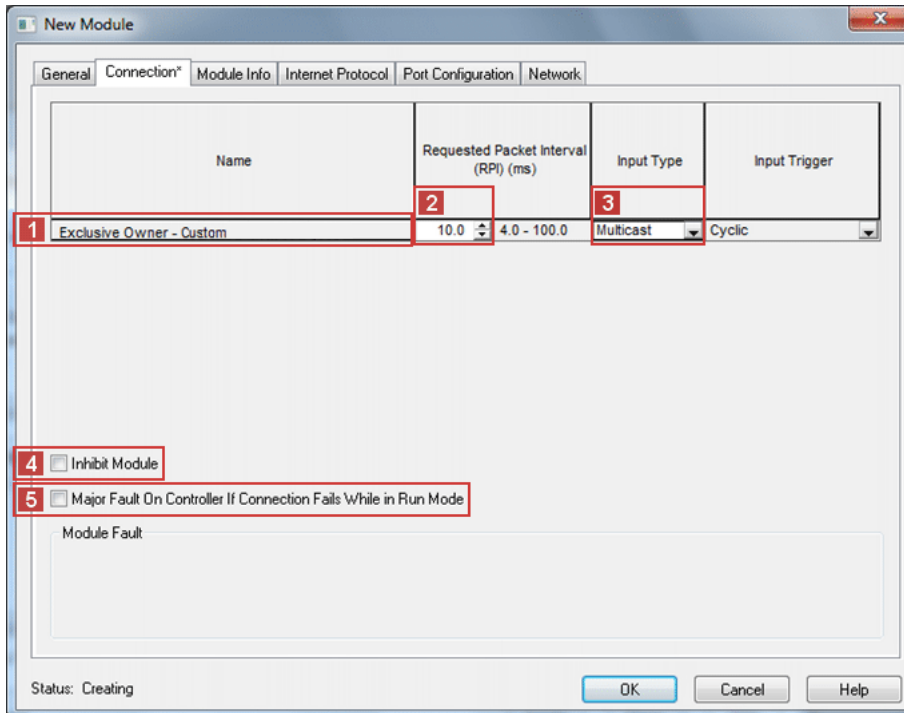

Under [1] "Name" the designation of the set connection is displayed.

In the example, an "Exclusive Owner - Custom" connection is displayed. Accordingly, the designation of an "AC Drive Profile" connection can also be displayed here.

### Required settings:

[2] "Requested Packet Interval (RPI)": Set  $RPI \geq 4.0$  ms. (Standard: 10 ms). The RPI specifies the intervals at which the I/O data is exchanged between the inverter (adapter) and PLC (scanner).

[3] "Input Type": Select input type "Multicast". The input data is sent from the adapter to the scanner by means of multicast telegrams. In addition to the scanner currently being configured, other scanners can access the data ("Listen only" or "Input only" connections).

### Optional settings:

[4] "Inhibit Module": This option allows you to interrupt or block communication to the adapter.

[5] "Major Fault On...": You can also use this option to set the PLC to error status if the EtherNet/IP connection to the inverter fails while the PLC is in operation.

## 8. Click "Change".

## 9. Open the "Module Definition" dialog box.

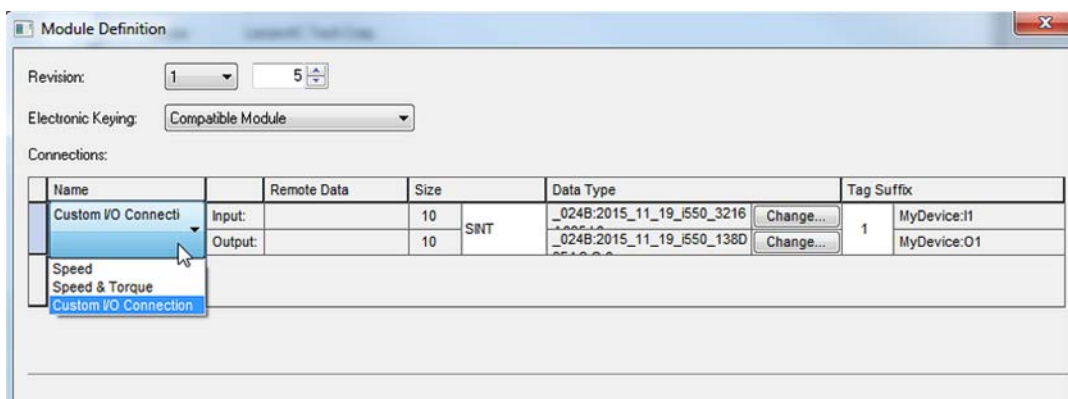

# Configuring the network

EtherNet/IP  
Process data transfer



10. Here the access to the I/O data for the technology applications "Speed" and "Torque" or a freely definable I/O process data set is defined.

a) Select connection "Speed", "Speed & Torque" or "Custom I/O Connection".

"Speed" and "Torque" correspond to the ODVA "AC Drive Speed/Torque" profile.

"Custom I/O Connection" provides a freely definable I/O process data set.

b) Set data type to the corresponding value (SINT, INT, DINT).

The actual data length of each object mapped in the I/O data is determined by the inverter OBD object.

INT and SINT prevent an uneven data length.

DINT prevent an uneven number of data words.

11. Click "Input" in the line "Output" or "Change" to adapt the corresponding mapping individually.

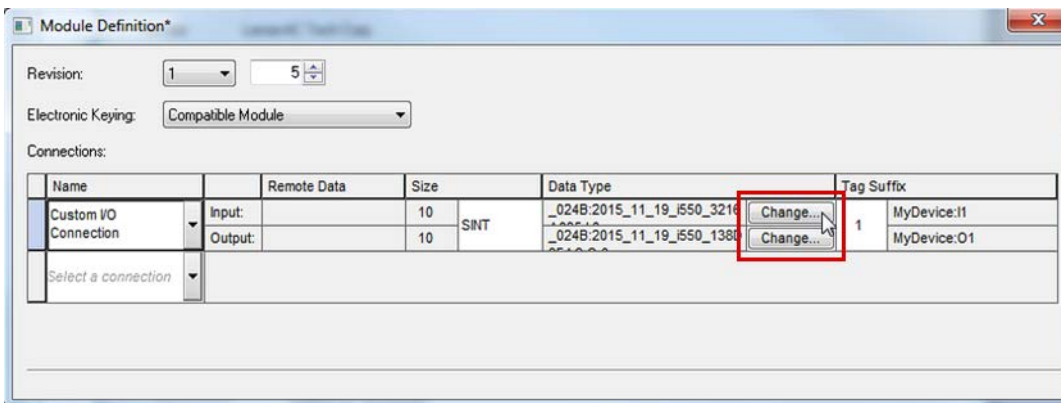

This example shows a mapping selection for inputs:

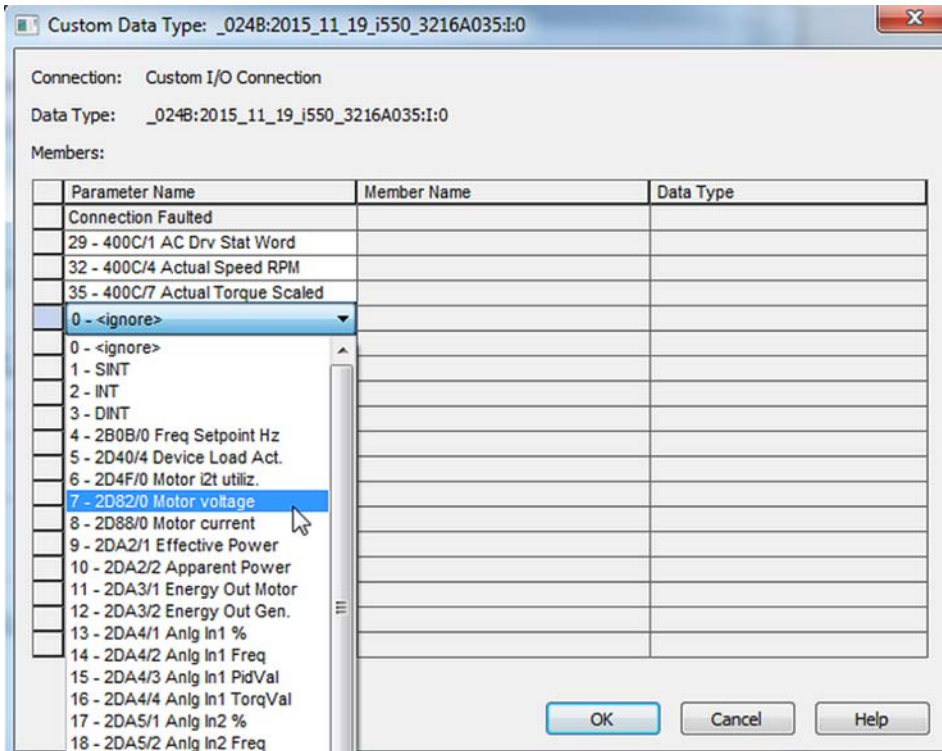



12. Group the process data according to their data length to prevent gaps.

Example:

1. All required DINT data
2. All required INT data
3. All required SINT data

At the end, a DINT value is automatically added to prevent tool zero-length problems.

Data types are provided according to the input or output data length.

Thus, e.g., no DINT type is provided at 10 bytes of input data:

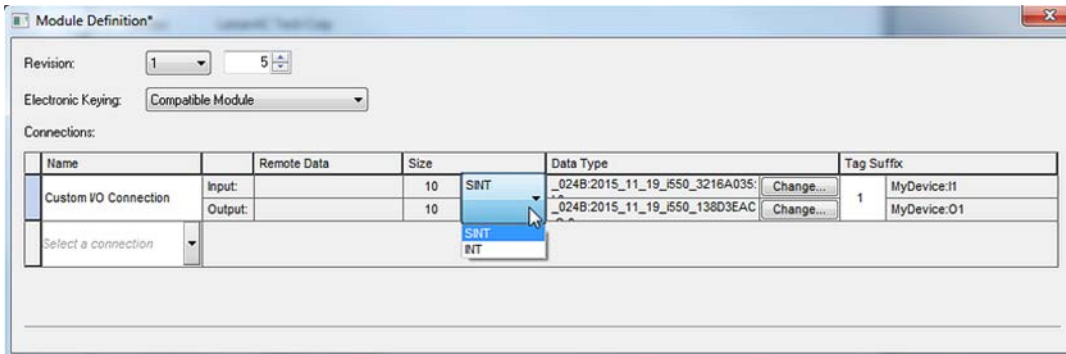

The customer specific configuration is now completed.

# Configuring the network

EtherNet/IP  
Process data transfer



## Parameter configuration

The configuration defines the parameters to be transmitted by means of the assembly objects 110 and 111.

Information on the assembly objects: [► 0x04-Assembly Object](#) [□ 472](#)

Two methods are available:

- a) Supporting scanners of class 1 can configure the data assignment in the inverter with the procedure described before.
- b) Alternatively, other masters can be used that do not support this data mapping for the user-defined assembly objects 110 and 111. However, the data assignment must then be configured in the inverter itself and in assembly object 130 (Configuration).
  - Parameterization dialog in the »EASY Starter«: "Settings" tab → Overview → Fieldbus EtherNet/IP → Mapping Fieldbus data
  - Parameters for internal mapping of process output data (assembly 110): [0x24E0:001 ... 0x24E0:016](#)
  - Parameters for internal mapping of process input data (assembly 111): [0x24E1:001 ... 0x24E1:016](#)

The user can also set up the module for one of the predefined assembly configurations in the ODVA AC Drive profile:

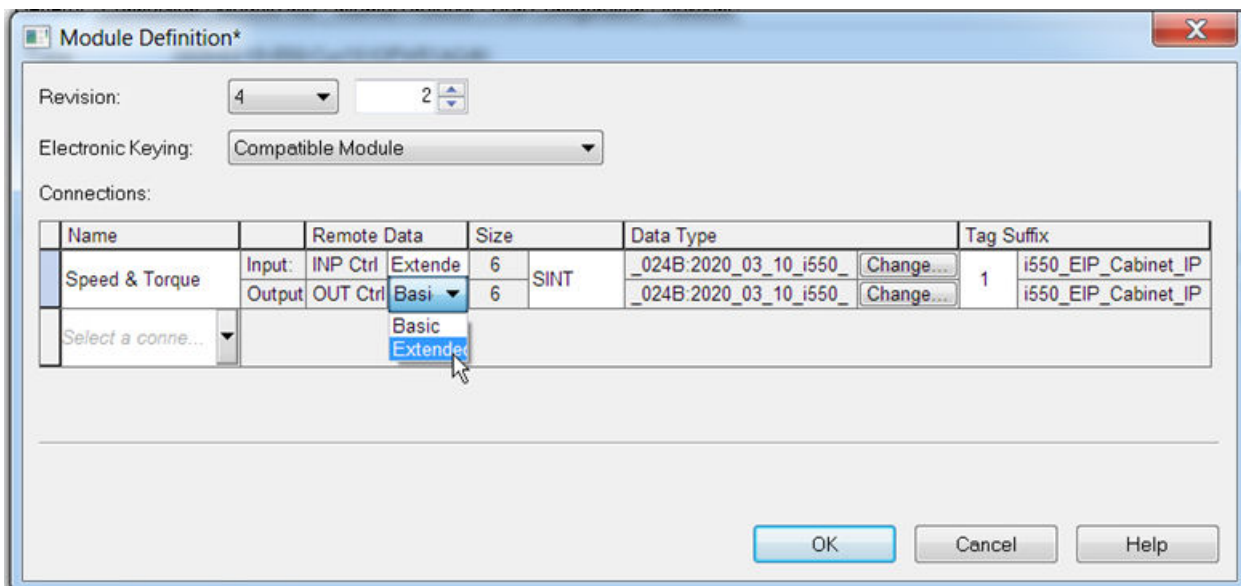
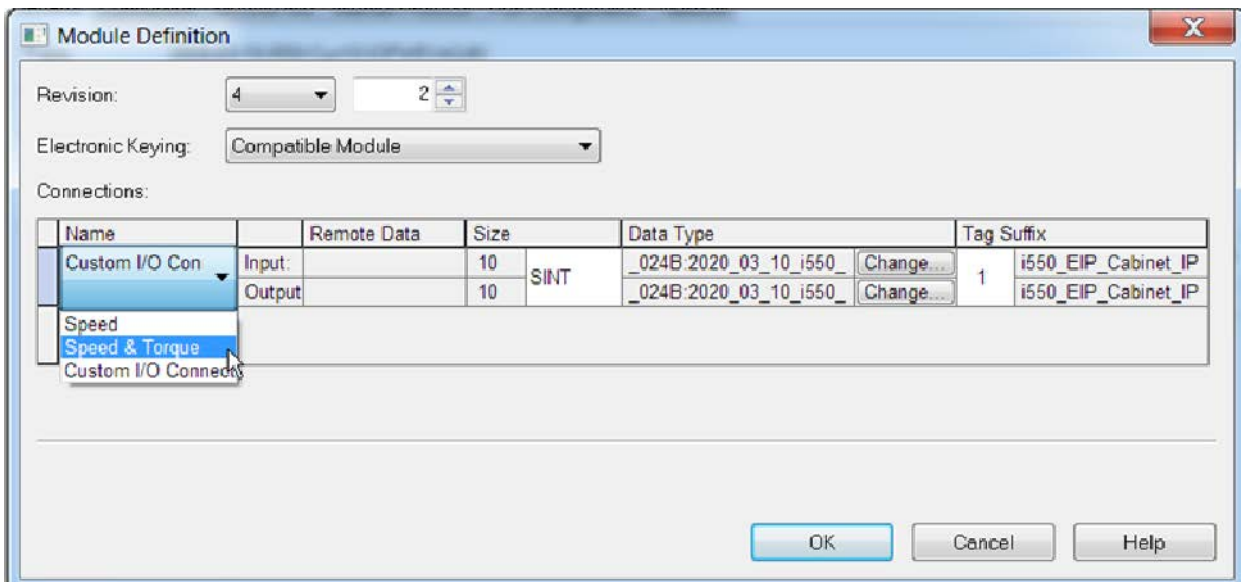





In the example, the assembly input object 73 is used for reading status information of the inverter and the assembly output object 23 is used for controlling the inverter.

The assembly objects 73 (Extended Speed and Torque Control Input) and 23 (Extended Speed and Torque Control Output) can be used for most of the applications.



- 
- The inverter (adapter) must be in the same subnet as the PLC (scanner). The subnetwork corresponds to the first 3 bytes of the IP address.
  - The size of the assembly input and output objects must comply with the number of words that are actually used.
  - Bits 5 (NetCtrl) and 6 (NetRef) of byte 0 in the assembly output object 23 must be transmitted for the inverter in order that the control and speed reference commands are accepted by the network.
  - If the network control is active ([0x400B:001 \(P592.01\)](#)/bit 5 = 1 and [0x2631:037 \(P400.37\)](#) = 114), all bits of the AC drive control word ([0x400B:001 \(P592.01\)](#)) are processed.
  - If the network control is not active ([0x400B:001 \(P592.01\)](#)/bit 5 = 0 or [0x2631:037 \(P400.37\)](#) = 0), the control bits 0, 1, 12, 13, 14, 15 are *not* processed. Their states are ignored and the drive is in local control.
-

# Configuring the network

EtherNet/IP  
Process data transfer



Further steps after setting up the module

1. Click "OK" in the "Module Definition" dialog.  
The network configuration of the inverter is now complete.

In the navigation tree ("Controller Organizer") under "Controller → Controller Tags", assembly tags are generated.

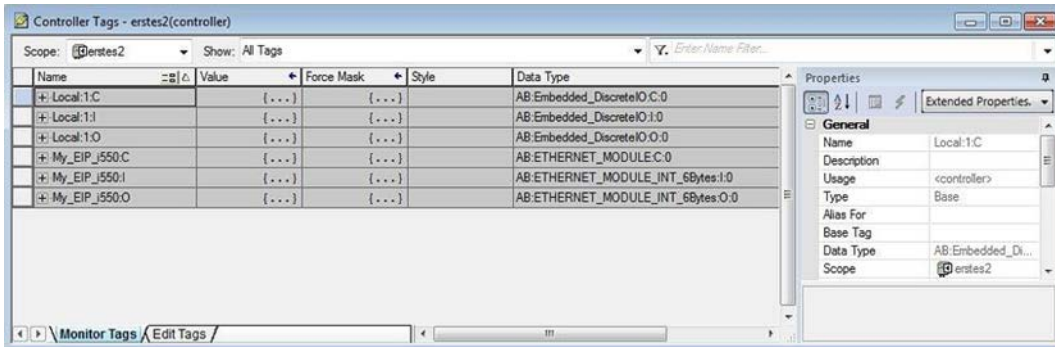

In the sample configuration with the "My\_EIP\_i550" inverter, these three assembly tags are generated:

"My\_EIP\_i550:C" for the configuration assembly

"My\_EIP\_i550:I" for the input assembly

"My\_EIP\_i550:O" for the output assembly

By clicking [+] in front of the assembly names, the display of the assemblies is extended.

Here, for instance, the four words are displayed, the output assembly "My\_EIP\_i550:O" consists of:

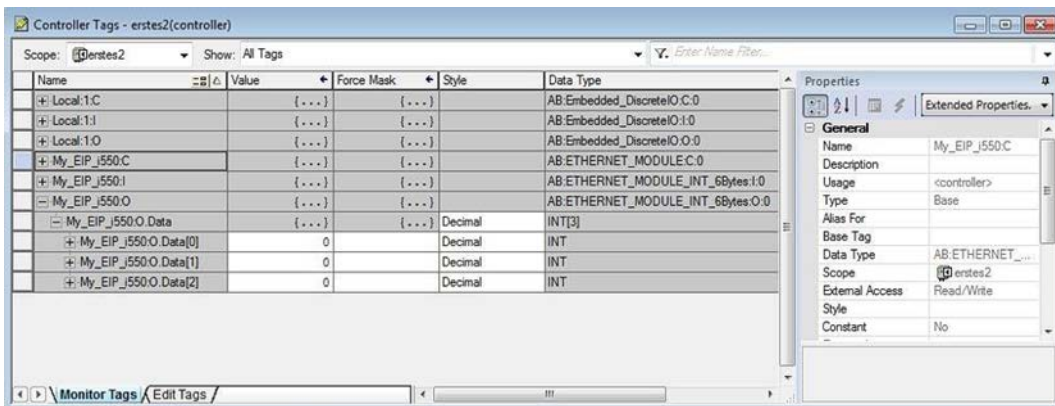

2. In the navigation tree (Controller Organizer) under "Controller", open the "Controller Tags".



3. Right-click any tag to execute the "New Tag" context menu command.  
The "New Tag" dialog box is opened.

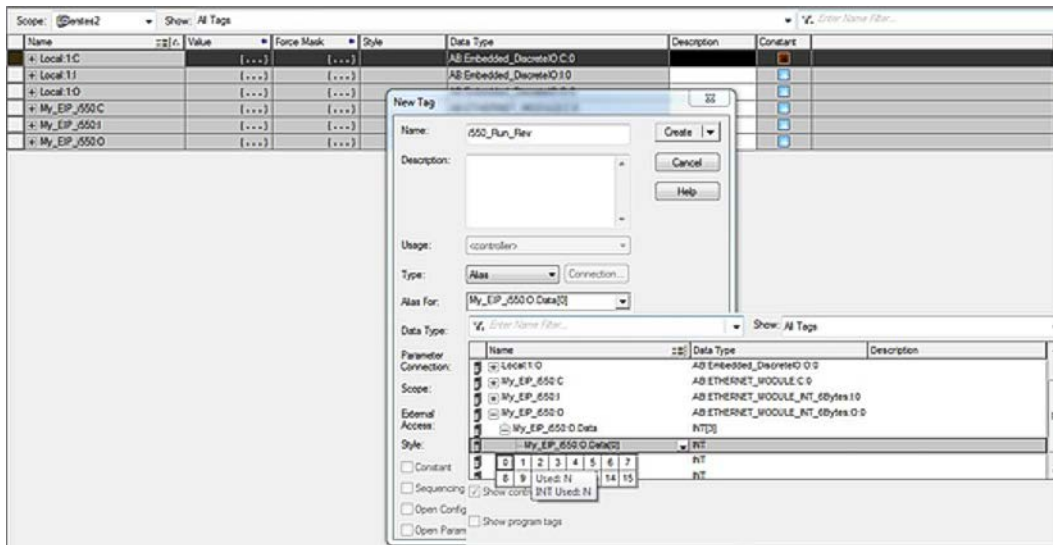

4. Fill in input fields.  
In the example ...
  - a) the name "i550\_Run\_Rev" is entered.
  - b) the "Alias" type is selected.
  - c) in the output assembly word "My\_EIP\_i550:O.Data[0]", bit 1 is assigned to "Run\_Rev".
5. Click "Create".  
The new alias tag is added to the database.  
The configuration is now completed.

# Configuring the network

EtherNet/IP  
Parameter data transfer



## 12.15.7 Parameter data transfer

- The acyclic/non-cyclic data access (service access) provides a procedure for the PLC (scanner) to access any drive or device parameter.
- This type of parameter access is typically used for ...
  - monitoring or the not time-controlled parameter access with low priority;
  - writing parameter data of the inverter (adapter).
- For this purpose, the inverter supports several methods.

### Explicit Messaging

An explicit message is a logic instruction in the PLC program for the message transfer. It can be used to read or write a parameter setting or the data of an EtherNet/IP node (assembly data).

If the Allen-Bradley control systems »CompactLogix™«, »ControlLogix®« and »SoftLogix™« are used, the "Explicit Message" instruction provides the functionalities described in the following sections. Further PLC types can be found in the programming documentation of the PLC.

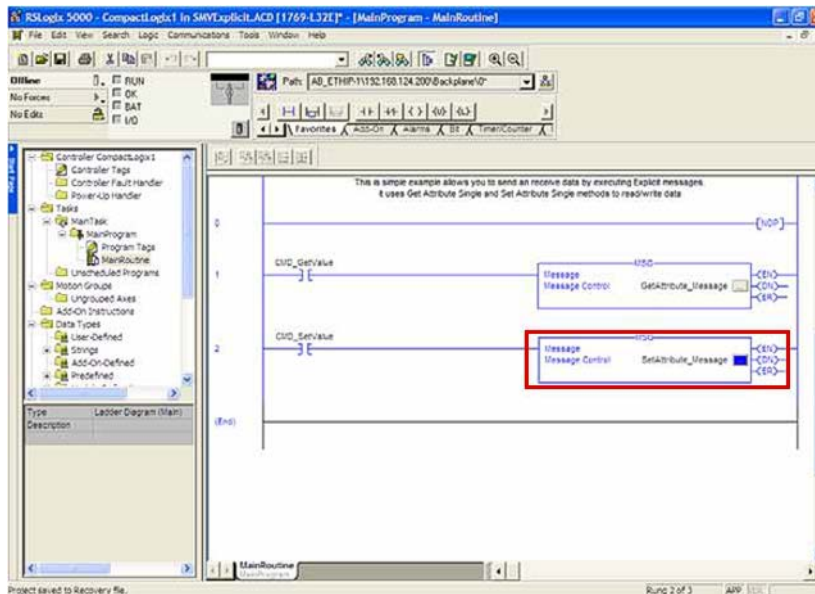

General drive variables (parameters and subindices) are contained in class "0x6E". The instance is the index number of the parameter and the attribute is the subindex number. If no subindex is available, the attribute must be set to "0". The attribute value "1" is only supported for those clients that do not support the attribute value "0".

All these variables have the data type SINT (8 bit, 1-byte objects), INT (16 bit, 2-byte objects) or DINT (32 bit, 4-byte objects).

The device parameters and the PLC program variables must have the same data lengths!



## Read parameter value

Definitions to read a parameter value (Adapter → Scanner):

- Message Type = CIP Generic
- Service Code = 0x0E (read parameter, Get\_Attribute\_Single)
- Class= 0x6E (hex)
- Instance= index number of the parameter
- Attribute= parameter subindex number (or 0x01 in case of no subindex)
- Destination Element= target variable in the PLC (scanner) for the parameter data to be read.

The variable must have the same format and data length as the parameter!

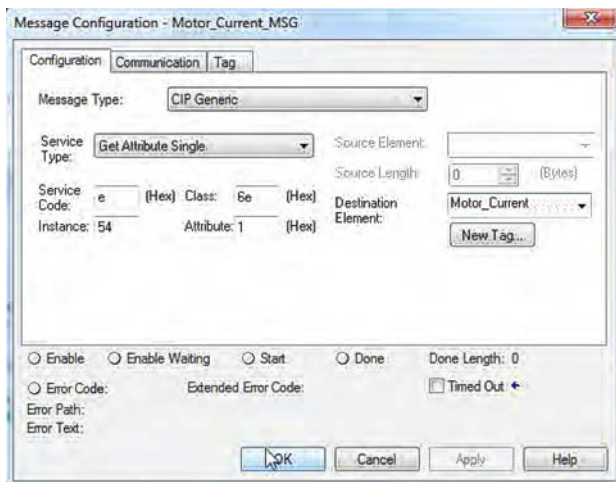

## Write parameter value

Definitions to write a parameter value (Scanner → Adapter):

- Message Type = CIP Generic
- Service Code = 0x10 (write parameter, Set\_Attribute\_Single)
- Class= 0x6E
- Instance= index number of the parameter
- Attribute= parameter subindex number (or 0x01 in case of no subindex)
- Source Element = variable in the PLC (scanner) which is used as source of the parameter data to be written.
- Source Length= data length (bytes) of the data to be written

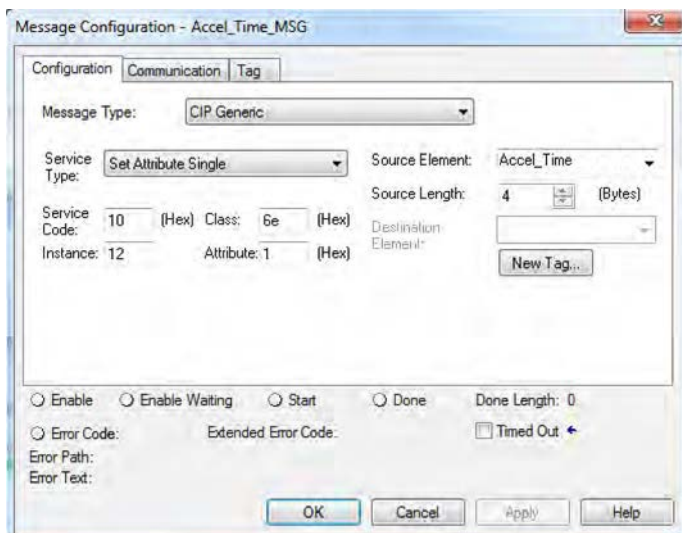

# Configuring the network

EtherNet/IP  
Parameter data transfer



## Write variables "TorqueScale" and "Drive\_Mode"

The variables "TorqueScale" and "Drive\_Mode" are AC drive profile objects

They are defined in the CIP library:

Variable	Class	Instance	Attribute	Data type	Size
Drive_Mode	2a	1	6	SINT	1 byte
TorqueScale	2a	1	18	SINT	1 byte

- Drive\_Mode

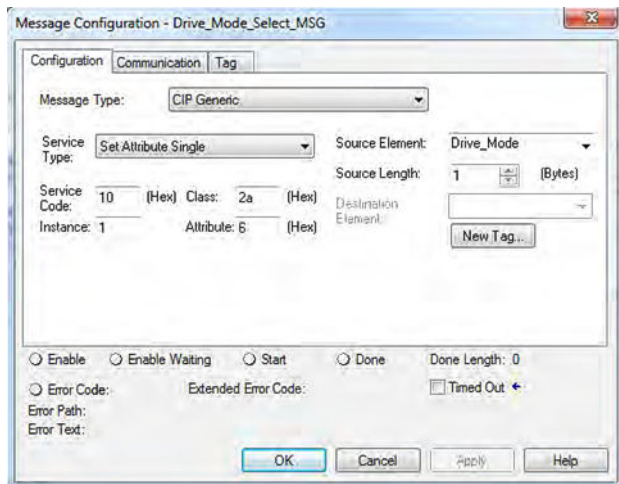

The variable "Drive\_Mode" has two valid settings:

- 1: Velocity Mode
- 3: Torque Mode

- TorqueScale

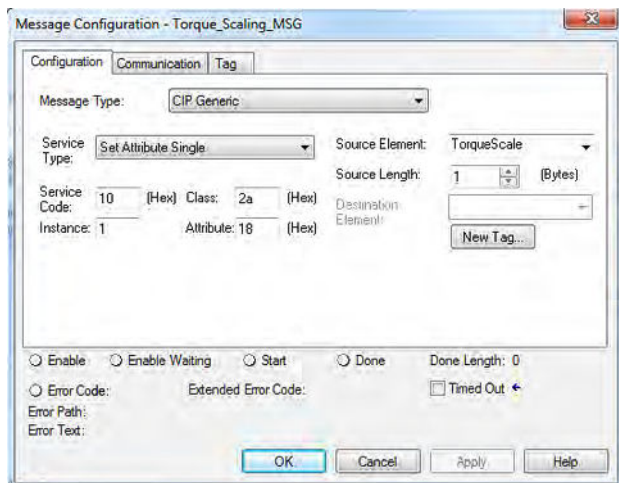

The variable "TorqueScale" refers to the real torque command by the following equation:

$$\text{Torque reference in TorqueScale} = \text{Nm} * 2\text{TorqueScale}$$

Due to the setting of TorqueScale = 0, the torque reference (assembly output object 23, bytes 4/5) is the real torque (= Nm \* 20 = Nm \* 1 = Nm).

Loading the value "2" as torque reference determines a torque limit of the drive of 2 Nm.



## CIP Generic Master(read/write assembly data)

For "CIP Generic Master" that do not support the Implicit Messaging (class 1), the assembly data can be read or written via Explicit Messaging (class 3).

Definitions to read assembly data (Adapter → Scanner):

- Message Type = CIP Generic
- Service Code = 0x0E (read assembly data, Get\_Attribute\_Single)
- Class= 0x04
- Instance= assembly number in the desired device (e. g. 73 for assembly "73")
- Attribute= 0x03
- Destination Element= target array in the PLC (scanner) for the assembly data to be read.  
The array must have the INT format and the same data length as the desired assembly!

Definitions to write assembly data (Scanner → Adapter):

- Message Type = CIP Generic
- Service Code = 0x10 (write assembly data, Set\_Attribute\_Single)
- Class= 0x04 (hex)
- Instance= assembly number in the desired device (e. g. 23 for assembly "23")
- Attribute= 0x03
- Source Element = INT array in the PLC (scanner), that is used as source of the assembly data to be written.
- Source Length= data length (bytes) of the INT array to be written (the assembly "23" contains e. g. 3 words which corresponds to 6 bytes.)

## Explicit Message Path

For each explicit message, the path must be specified in order to forward the message from the Ethernet port of the PLC (scanner) to the IP address of the inverter (adapter). This path depends on the used PLC. If required, contact the PLC manufacturer to find out how the path is specified.

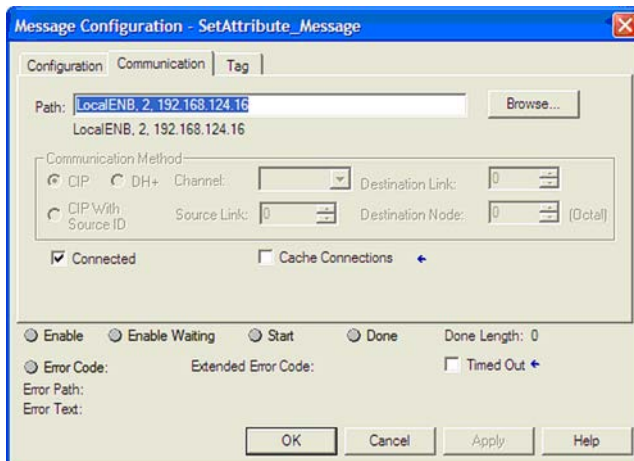

## Explicit Messaging Timeout

In order to prevent that the inverter runs continuously, a time-out error state can be set.

For this purpose, set these parameters:

- 0x23A1:010 (P510.10): Timeout
- 0x2859:007 (P515.07): Timeout communication

# Configuring the network

EtherNet/IP  
Monitoring  
EtherNet/IP communication monitoring



## 12.15.8 Monitoring

The parameters for setting network monitoring functions are described below.

### 12.15.8.1 EtherNet/IP communication monitoring

#### Parameter

Address	Name / setting range / [default setting]	Information
0x23A1:010 (P510.10)	EtherNet/IP settings: Timeout (EtherN/IP sett.: Timeout) 500 ... [10000] ... 65535 ms • From version 02.00	Setting of the maximum permissible time-out for the CIP communication. When the specified monitoring time has elapsed, the response set in <a href="#">0x2859:007 (P515.07)</a> is triggered in the inverter.
0x2859:001 (P515.01)	EtherNet/IP monitoring: Watchdog elapsed (EtherN/IP monit.: WD elapsed) • From version 02.00	Selection of the response to a permanent interruption of the communication to the Scanner, e. g. by cable break or failure of the Scanner.  Associated event ID: • 33168   0x8190 - Network - Watchdog time-out
	0 No response	▶ Severity <a href="#">□ 700</a>
	1 Warning	
	2 Trouble	
0x2859:006 (P515.06)	EtherNet/IP monitoring: Time-out explicit message (EtherN/IP monit.: Timeout ExplMsg) • From version 02.00	Selection of the response to time-outs during the transfer of Explicit Messages.  Associated event ID: • 33042   0x8112 - Network - Time-out explicit message
	0 No response	▶ Severity <a href="#">□ 700</a>
	1 <b>Warning</b>	
	2 Trouble	
0x2859:007 (P515.07)	EtherNet/IP monitoring: Timeout communication (EtherN/IP monit.: Timeout Comm.) • From version 02.00	Selection of the response to the time-out during the CIP communication. The monitoring time for the CIP communication is defined in <a href="#">0x23A1:010 (P510.10)</a> .  Associated event ID: • 33044   0x8114 - Network - Overall communication time-out
	0 No response	▶ Severity <a href="#">□ 700</a>
	1 <b>Warning</b>	
	2 Trouble	
0x2859:004 (P515.04)	EtherNet/IP monitoring: Initialisation error (EtherN/IP monit.: Init. error) • From version 02.00	Selection of the response triggered by the occurrence of an error during the initialisation of the network component.  Associated event ID: • 33170   0x8192 - Network - Initialization error
	0 No response	▶ Severity <a href="#">□ 700</a>
	1 Warning	
	2 <b>Trouble</b>	
0x2859:003 (P515.03)	EtherNet/IP monitoring: Invalid configuration (EtherN/IP monit.: Invalid config) • From version 02.00	Selection of the response triggered by the reception of invalid configuration data.  Associated event ID: • 33414   0x8286 - Network - PDO mapping error
	0 No response	▶ Severity <a href="#">□ 700</a>
	1 Warning	
	2 <b>Trouble</b>	
0x2859:004 (P515.04)	EtherNet/IP monitoring: Initialisation error (EtherN/IP monit.: Init. error) • From version 02.00	Selection of the response triggered by the occurrence of an error during the initialisation of the network component.  Associated event ID: • 33170   0x8192 - Network - Initialization error
	0 No response	▶ Severity <a href="#">□ 700</a>
	1 Warning	
	2 <b>Trouble</b>	
0x2859:003 (P515.03)	EtherNet/IP monitoring: Invalid configuration (EtherN/IP monit.: Invalid config) • From version 02.00	Selection of the response triggered by the reception of invalid configuration data.  Associated event ID: • 33414   0x8286 - Network - PDO mapping error
	0 No response	▶ Severity <a href="#">□ 700</a>
	1 Warning	
	2 <b>Trouble</b>	

### 12.15.8.2 Other monitoring

#### Parameter

Address	Name / setting range / [default setting]	Information
0x2859:003 (P515.03)	EtherNet/IP monitoring: Invalid configuration (EtherN/IP monit.: Invalid config) • From version 02.00	Selection of the response triggered by the reception of invalid configuration data.  Associated event ID: • 33414   0x8286 - Network - PDO mapping error
	0 No response	▶ Severity <a href="#">□ 700</a>
	1 Warning	
	2 <b>Trouble</b>	
0x2859:004 (P515.04)	EtherNet/IP monitoring: Initialisation error (EtherN/IP monit.: Init. error) • From version 02.00	Selection of the response triggered by the occurrence of an error during the initialisation of the network component.  Associated event ID: • 33170   0x8192 - Network - Initialization error
	0 No response	▶ Severity <a href="#">□ 700</a>
	1 Warning	
	2 <b>Trouble</b>	





# Configuring the network

EtherNet/IP  
Monitoring  
Other monitoring

Address	Name / setting range / [default setting]	Information
0x2859:005 (P515.05)	EtherNet/IP monitoring: Invalid process data (EtherN/IP monit.: Inval. proc.data) <ul style="list-style-type: none"><li>• From version 02.00</li></ul>	Selection of the response triggered by the reception of invalid process data. Associated event ID: <ul style="list-style-type: none"><li>• <a href="#">33171</a>   <a href="#">0x8193</a> - Network - Invalid cyclic process data</li></ul>
	0 No response	▶ Severity <a href="#">700</a>
	1 Warning	
	<b>2 Trouble</b>	
3 Fault		

# Configuring the network

EtherNet/IP  
Diagnostics  
Status LEDs







## 12.15.9 Diagnostics





### 12.15.9.1 Status LEDs

Information on the CIP status can be obtained quickly via the "MS" and "NS" LED displays on the front of the inverter. In addition, the LEDs at the RJ45 sockets indicate the connection status.

The "MS" LED indicate the CIP module status.

LED "MS" (green/red)	CIP module status	Status/meaning
off	Nonexistent	The network option is not supplied with voltage.
 On (green)	Operational	The network option works correctly.
 Blinking green	Standby	The network option is not configured completely or the configuration is incorrect.
 Blinking red	Major recoverable fault	The network option contains a correctable error.
 on (red)	Major unrecoverable fault	The network option contains a non-correctable error.
 Blinking green/red	Device self testing	The network option executes a self-test.

The "NS" LED indicate the CIP network status.

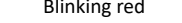
LED "NS" (green/red)	CIP network status	Status/meaning
off	No IP address	The network option is not supplied with voltage or has not received an IP address yet.
 On (green)	Connected	The network option works correctly and has established a connection to the scanner.
 Blinking green	No connections	The network option <ul style="list-style-type: none"> <li>works correctly,</li> <li>has been assigned to an IP address,</li> <li>has not been implemented into the network yet by the scanner.</li> </ul>
 Blinking red	Connection timeout	A time-out has occurred.
 on (red)	Duplicate IP	The network option cannot access the network (IP address conflict).
 Blinking green/red	Device self testing	The network option executes a self-test.

### Status displays at the RJ45 sockets

The LEDs at the RJ45 sockets indicate the connection status to the network:

LED "Link" (green)	Status/meaning
off	No connection to the network.
 on	A physical connection to the network is available.

LED "Activity" (yellow)	Status/meaning
off	No data transfer.
 on or flickers	Data is exchanged via the network.

### 12.15.9.2 Information on the network

The following parameters show information on the network.

#### Parameter

Address	Name / setting range / [default setting]	Information
0x23A2:001 (P511.01)	Active EtherNet/IP settings: IP address (EtherN/IP diag.: IP address) <ul style="list-style-type: none"> <li>Read only</li> <li>From version 02.00</li> </ul>	Display of the active IP address.



# Configuring the network

EtherNet/IP  
Diagnostics  
Information on the network

Address	Name / setting range / [default setting]	Information
0x23A2:002 (P511.02)	Active EtherNet/IP settings: Subnet (EtherN/IP diag.: Subnet) • Read only • From version 02.00	Display of the active subnet mask.
0x23A2:003 (P511.03)	Active EtherNet/IP settings: Gateway (EtherN/IP diag.: Gateway) • Read only • From version 02.00	Display of the active gateway address.
0x23A2:005 (P511.05)	Active EtherNet/IP settings: MAC address (EtherN/IP diag.: MAC address) • Read only • From version 02.00	Display of the active MAC address.
0x23A2:006 (P511.06)	Active EtherNet/IP settings: Multicast address (EtherN/IP diag.: Mcast address) • Read only • From version 02.00	Display of the active Multicast IP address.
0x23A5:001 (P519.01)	Active port settings: Port 1 (X266) (Port diagnostics: Port 1 (X266)) • Read only • From version 02.00	Display of the active configuration for Ethernet port 1.
	0 Not connected	
	1 10 Mbps/Half Duplex	
	2 10 Mbps/Full Duplex	
	3 100 Mbps/Half Duplex	
	4 100 Mbps/Full Duplex	
0x23A5:002 (P519.02)	Active port settings: Port 2 (X267) (Port diagnostics: Port 2 (X267)) • Read only • From version 02.00	Display of the active configuration for Ethernet port 2.
	0 Not connected	
	1 10 Mbps/Half Duplex	
	2 10 Mbps/Full Duplex	
	3 100 Mbps/Half Duplex	
	4 100 Mbps/Full Duplex	
	5 Reserved	
	6 Reserved	
0x23A6 (P513.00)	Quality of service (QualityOfService) • Read only • From version 02.00	Display if the QoS tag for prioritising the data packages to be transmitted is used.
	0 802.1Q Tag disable	
	1 802.1Q Tag enable	
0x23A7 (P514.00)	Address conflict detection (AddrConflictDetec) • From version 02.00	Activate address conflict detection (ACD) (enable). • If this value is changed, the device must be reset ("Power off/on" or "Type 0 Reset").
	0 Disabled	
	1 <b>Enabled</b>	
0x23A8 (P516.00)	CIP module status (CIP module stat.) • Read only • From version 02.00	Display of the active CIP module status.
	0 Nonexistent	
	1 Device self testing	
	2 Standby	
	3 Operational	
	4 Major recoverable fault	
5 Major unrecoverable fault		

# Configuring the network

EtherNet/IP

Diagnostics

Information on the network



Address	Name / setting range / [default setting]	Information
0x23A9 (P517.00)	EtherNet/IP status (EtherN/IP status) <ul style="list-style-type: none"><li>• Read only</li><li>• From version 02.00</li></ul>	Display of the active network status.
	0 No IP address	
	1 No connections	
	2 Connected	
	3 Connection timeout	
	4 Duplicate IP	
	5 Device self testing	



## 12.16 Modbus TCP



Modbus is an internationally approved, asynchronous, serial communication protocol, designed for commercial and industrial automation applications.

- Detailed information on the Modbus can be found on the web page of the international Modbus Organization, USA, who also further develop the Modbus protocol: <https://www.modbus.org>
- Information about the dimensioning of a Modbus network can be found in the configuration document for the inverter.

### Preconditions

The control unit (CU) of the inverter is provided with Modbus TCP.

### Details

- The process of data transmission distinguishes between three different operating modes: Modbus ASCII, Modbus RTU and Modbus TCP/IP. This chapter describes the Modbus TCP/IP operating mode.
- The Modbus protocol is based on a client/server architecture where the inverter always works as server (formerly known as a "slave").
- In the Modbus TCP/IP network, a client (formerly known as a "master") can only address one server at a time. However, several clients can be available in the network.
- Only a client can initiate the Modbus communication.
- No direct communication takes place between the servers.
- The network option supports the baud rates 10 Mbps (10 BaseT) and 100 Mbps (100 BaseT). The baud rate in the network is automatically detected.
- The inverter supports the function codes 3, 6, 16 (0x10) and 23 (0x17).

### Typical topologies

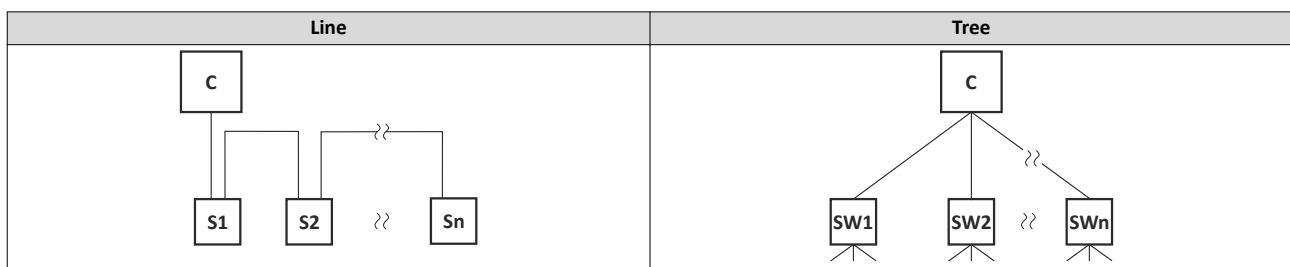

C Client  
S Server

SW Switch



## 12.16.1 Commissioning

In the following, the steps required for controlling the inverter via Modbus are described.

### Parameterization required

1. Activate network control: `0x2631:037 (P400.37) = "TRUE [1]"`
2. Set network as standard setpoint source: `0x2860:001 (P201.01) = "Network [5]"`
3. Implement the IP settings of the inverter (server).  
See: [▶ IP settings](#) 513
4. Set Modbus baud rate.
  - Default setting: Automatic detection.
  - See: [▶ Baud rate setting](#) 515
5. Save parameter settings: `0x2022:003 (P700.03) = "on / start [1]"`.
6. Switch the inverter off and then on again in order that the changed communication settings can get effective.



---

In the default setting, the "Run" function is assigned to digital input DI1. If network control is activated, this function serves as the "start enable" for starting commands via the network. Hence, digital input DI1 must be set to the HIGH level so the motor can be started via the network.

[▶ Flexible I/O configuration of the start, stop and rotating direction commands](#) 67

---



An internal web server is supported. It can be addressed via the IP address defined in the `0x23A1:001 (P510.01)` parameter. Protect access to the web server, e.g. with a firewall, and follow your internal IT security guidelines.

---



A firmware download from the PLC to the inverter via the network (also via FTP) only takes place under the following conditions:

- Required firmware version 05.01.x.x or higher
  - Bootloader version 00.00.00.18 or higher
-



## Starting/stopping the drive via Modbus

For starting/stopping the drive, Modbus register 42101 can be used.

- The Modbus register 42101 is permanently assigned to the parameter **0x400B:001 (P592.01)** (AC Drive control word).
- In the frame, the leading 4 is omitted in the addressing process. The numbering of the registers starts with 1; addressing, however, starts with 0. Therefore the address 2100 (0x0834) is used in the frame when register 42101 is written.

Bits set in the AC Drive control word:

- Bit 0 = Run forward (CW)
- Bit 5 = Activate network control
- Bit 6 = Activate network setpoint
- Function code 6, i. e. writing into a single register.

Example of an inverter with the node address 1:

Request frame by the client					
Unit identifier	Function code	Register address		AC Drive control word Data: 0b1100001 ≙ 0x0061	
0x01	0x06	0x08	0x34	0x00	0x61

If the digital input DI1 ("Start enable") is set to HIGH level, the drive should start and the inverter should respond with the same frame as confirmation:

Response message from the server (inverter)					
Unit identifier	Function code	Register address		AC Drive control word Data: 0b1100001 ≙ 0x0061	
0x01	0x06	0x08	0x34	0x00	0x61

## Write the speed of the drive via Modbus

The drive speed can be changed via the modbus register 42102, see:

▶ [Data mapping](#) 523

Example of an inverter with the node address 1:

Request frame by the client					
Unit identifier	Function code	Data			
		Register address		Network setpoint frequency (0.01)	
0x01	0x06	0x08	0x35	0x04	0xD2

Response message from the server (inverter)					
Unit identifier	Function code	Data			
		Register address		Network setpoint frequency (0.01)	
0x01	0x06	0x08	0x35	0x04	0xD2

The drive now rotates with a frequency of 12.34 Hz.



## Read the drive speed via Modbus

The drive speed can be read via the Modbus register 42002, see:

▶ [Data mapping](#) 523

The function code 3 is used to read a single register or several interrelated register blocks, see:

▶ [Function codes](#) 517

Example of an inverter with the node address 1:

Request frame by the client					
Unit identifier	Function code	Data			
		Register address		Number of words	
0x01	0x03	0x07	0xD1	0x00	0x01

Response message from the server (inverter)					
Unit identifier	Function code	Data			
		Read bytes		Frequency (0.01)	
0x01	0x03	0x02		0x04	0xD1

The drive rotates with a frequency of 12.33 Hz.

## Restart of the communication

A restart of communication is required after changes of the interface configuration (e. g. node address and baud rate) in order that the changed settings become effective.

For restarting communication, there are two options:

- a) Switch inverter off and on again.
- b) **0x23B0 (P508.00)** Set = "Restart with current values [1]".

## Parameter

Address	Name / setting range / [default setting]	Information
0x23B0 (P508.00)	Modbus TCP communication (MBTCP comm.) • From version 04.00	Restart / stop communication
	<b>0</b> No action/no error	Only status feedback.
	1 Restart with current values	Restart communication in order that changed settings of the interface configuration become effective.
	2 Restart with default values	Restart communication with the standard values.
	5 Stop network communication	Stop communication.
	10 In progress	Only status feedback
	11 Action cancelled	
12 Fault		





## 12.16.2 Basic setting and options

### 12.16.2.1 IP settings

#### IP basic settings

The basic IP settings are required to let the engineering software access the network nodes (PLC, inverter) directly via Ethernet.

The PC with the engineering software must be in the same network as the devices to be configured.

First, configure the PC so that this condition is fulfilled.

The required steps are described by the example of the operating system Microsoft® Windows® 7.

How to define the IP basic settings:

1. Call the "Network and sharing center" under "Control panel".
2. Select "Change adapter settings" (observe administrator rights!).
3. Select the network to be configured (double-click), e. g.:

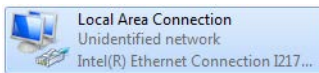

---

The network nodes (PLC, inverter) must be connected to the network.

---



---

An internal web server is supported. It can be addressed via the IP address defined in the parameter. Protect access to the web server, e.g. with a firewall, and follow your internal IT security guidelines.

---

The status dialog box of the network is opened.

4. Click "Properties".

The properties dialog box of the network is opened.

5. Select "Internet protocol version 4 (TCP/IPv4)" and click "Properties".

The properties dialog box of the "Internet protocol version 4 (TCP/IPv4)" is opened.

6. Enter the IP address, the subnet mask and, if required, the gateway address under "Use the following addresses".
7. Click "OK".

The IP basic settings are now completed.

# Configuring the network

Modbus TCP  
Basic setting and options  
IP settings



## Set IP address

The two rotary encoder switches at the front of the device serve to set the IP address in terms of hardware.

Setting	Addressing
0x00	IP address via the parameter <b>0x23B1:001 (P510.01)</b> .
0x01 ... 0xFF	<p>Setting of the 4th byte of the IP address via the rotary encoder switch. 192.168.124.[setting] <b>Example:</b> Setting for the value 52 (3 × 16) + (4 × 1) = 52</p> <div style="text-align: center;"> </div>

The value set via the rotary encoder switches is used when the mains is switched on or after a network restart with **0x23B0 (P508.00)** = 1. A changed value during operation will only become valid after the network has been restarted.

- **0x23B3 (P509.00)** shows the switch setting at the last mains connection.
- **0x23B2:001 (P511.01)** shows the active IP address.

## Time-To-Live (TTL)

The TTL value (8-bit value) limits the number of routers a sent package passes on the way to its target.

- **0x23A1:006 (P510.06):** Time-to-live value (TTL)

The parameters for the IP settings of the inverter are described below.

## Parameter

Address	Name / setting range / [default setting]	Information
0x23B1:001 (P510.01)	Modbus -TCP/IP settings: IP address (MBTCP settings: IP address) 0.0.0.0 ... [ <b>192.168.124.16</b> ] ... 255.255.255.255 • From version 04.00	Set IP address. The default setting 276605120 corresponds to the IP address 192.168.124.16. • 276605120 = 0x107CA8C0 → 0xC0.0xA8.0x7C.0x10 = 192.168.124.16
0x23B1:002 (P510.02)	Modbus -TCP/IP settings: Subnet (MBTCP settings: Subnet) 0.0.0.0 ... [ <b>255.255.255.0</b> ] ... 255.255.255.255 • From version 04.00	Set subnet mask. The default setting 16777215 corresponds to the subnet mask 255.255.255.0. • 16777215 = 0xFFFFF → 0xFF.0xFF.0xFF.0x00 = 255.255.255.0
0x23B1:003 (P510.03)	Modbus -TCP/IP settings: Gateway (MBTCP settings: Gateway) 0.0.0.0 ... [ <b>0.0.0.0</b> ] ... 255.255.255.255 • From version 04.00	Set gateway address. Example The setting 276344004 corresponds to the gateway address 196.172.120.16. • 276344004 = 0x1078ACC4 → 0xC4.0xAC.0x78.0x10 = 196.172.120.16
0x23B1:005 (P510.05)	Modbus -TCP/IP settings: IP configuration (MBTCP settings: IP configuration) • From version 04.00	Set IP configuration.
	<b>0</b> Stored IP	The currently saved IP configuration is used.
	<b>1</b> BOOTP	The IP configuration is assigned by the client via BOOTP.
	<b>2</b> DHCP	The IP configuration is assigned by the client via DHCP. The assignment of a gateway address that is not in the same subnetwork as the IP address, is denied.
0x23B1:006 (P510.06)	Modbus -TCP/IP settings: Time-to-live value (TTL) (MBTCP settings: TTL value) 1 ... [ <b>32</b> ] ... 255 • From version 04.00	Setting of the TTL value for the validity of data packages in the network.
0x23B1:011 (P510.11)	Modbus -TCP/IP settings: Secondary port (MBTCP settings: Secondary port) 0 ... [ <b>502</b> ] ... 65535 • From version 04.00	Set port number for a second port.



## 12.16.2.2 Baud rate setting

- Set the baud rate for port 1 in [0x23B4:001 \(P512.01\)](#) and for port 2 in [0x23B4:002 \(P512.02\)](#).
- The automatic detection of the baud rate is preset for the ports.
- The active baud rate is displayed for port 1 in [0x23B5:001 \(P513.01\)](#) and for port 2 in [0x23B5:002 \(P513.02\)](#).

### Parameter

Address	Name / setting range / [default setting]	Information
0x23B4:001 (P512.01)	Port settings: Port 1 (Port settings: Port 1) • From version 04.00	Set baud rate for the port 1.
	<b>0 Auto-Negotiation</b>	
	1 10 Mbps	
	2 100 Mbps	
	5 10 Mbps/Half Duplex	
	6 10 Mbps/Full Duplex	
	7 100 Mbps/Half Duplex	
	8 100 Mbps/Full Duplex	
0x23B4:002 (P512.02)	Port settings: Port 2 (Port settings: Port 2) • From version 04.00	Set baud rate for the port 2.
	<b>0 Auto-Negotiation</b>	
	1 10 Mbps	
	2 100 Mbps	
	5 10 Mbps/Half Duplex	
	6 10 Mbps/Full Duplex	
	7 100 Mbps/Half Duplex	
	8 100 Mbps/Full Duplex	

# Configuring the network

Modbus TCP  
Data transfer



## 12.16.3 Data transfer

The mode of access to inverter data (parameters) is controlled via function codes.



## 12.16.3.1 Function codes

The inverter supports the following function codes:

Function code	Function name	Info
3	0x03	Read Holding Registers
6	0x06	Preset Single Register
16	0x10	Preset Multiple Registers
23	0x17	Read/Write 4X Registers

### Frame structure

Modbus Application Header (MBAP)				Protocol Data Unit (PDU)	
Transaction number	Protocol characters (always 0x0000)	Number of the bytes still to follow	Unit identifier	Function code	Data / error code
2 bytes	2 bytes	2 bytes	1 byte	1 byte	n byte

Tab. 1: ADU (Application Data Unit)

Communication is established on the basis of the client/server mode. Communication is always started by a client request.

The server (inverter) then either gives a valid response or outputs an error code (provided that the request has been received and evaluated as valid message).

In case of a valid answer, the function code is returned. In the event of an error, a function code assigned to the request is returned.

Error causes can be invalid CRC checksums, non-supported function codes or impermissible data accesses.

Elements of the ADU:

- MBAP (7 bytes)
  - Number of the bytes still to follow in the message.
  - Address of the inverter.
  - The other bytes of the header are not described here.
- Function code
  - The function codes exclusively refer to "4X registers", i. e. registers from the address 4000.
  - All data in the inverter can only be accessed via these 4X registers, see: [Data mapping](#) [523](#)
  - The 4xxx reference is implicit, i. e. given by the function code used. In the frame therefore the leading 4 is omitted in the addressing process.
  - Lenze supports the basic 1 addressing of Modbus, i.e. the numbering of the registers starts with 1 whereas addressing starts with 0. For example, the address 0 is used in the frame when register 40001 is read.
- Data or error code
- Checksum

All ADU contents are represented in the Big Endian format (most significant byte first).

# Configuring the network

Modbus TCP  
Data transfer  
Function codes



## Error codes

In the event of an error, the server (inverter) responds with a function code associated with the message:

Function code	Associated function code in the event of an error	Supported error codes
0x03	0x83	0x01, 0x02, 0x03, 0x04
0x06	0x86	0x01, 0x02, 0x03, 0x04
0x10	0x90	0x01, 0x02, 0x03, 0x04
0x17	0x97	0x01, 0x02, 0x03, 0x04

Error code	Designation	Cause(s)
0x01	Invalid function code	The function code is not supported by the inverter, or the inverter is in a state in which the request is not permissible or in which it cannot be processed.
0x02	Invalid data address	The combination of a start address and the length of the data to be transmitted is invalid. Example: If you have a server with 100 registers, the first register has the address 0 and the last register has the address 99. If there is a request of four registers now, from the start address 96, the request can be processed successfully (for registers 96, 97, 98, and 99). If, however, five registers from the start address 96 are queried, this error code is returned, since the server has no register with the address 100.
0x03	Invalid data value	Error in the reset structure of a complex request, e. g. because the data length that has resulted implicitly is not correct. The cause, however, is not that a (parameter) value is written outside the valid setting range. As a matter of principle, the Modbus protocol has no information on valid setting ranges of single registers or their meaning.
0x04	Server device failure	A non-correctable error has occurred while the request was processed in the inverter.

## Data transfer with function code 3

Request	
Function code	0x03
Start address	0x0000 ... 0xFFFF
Number of registers (n)	0x01 ... 0x7D (1 ... 125)

Response	
Function code	0x03
Number of bytes	2 x (number of registers)
Register value	Data in (n) register of 2 bytes each

Error message	
Function code in the event of an error	0x83
Error code	01 ... 04



### Example for data transfer with function code 3

The data from the registers 40108 to 40110 are to be read.

Request		Info
Function code	0x03	Function code 3
Start address (High)	0x00	Start address 107 (0x006B)
Start address (Low)	0x6B	
Number of registers (High)	0x00	Number of registers = 3 (0x0003)
Number of registers (Low)	0x03	

Response		Info
Function code	0x03	Function code 3
Number of bytes	0x06	6 bytes are read.
Value in registers 40108 (High)	0x02	Data in register 40108: 0x022B (555).
Value in registers 40108 (Low)	0x2B	
Value in registers 40109 (High)	0x00	Data in register 40109: 0x0000 (0).
Value in registers 40109 (Low)	0x00	
Value in registers 40110 (High)	0x00	Data in register 40110: 0x0064 (100).
Value in registers 40110 (Low)	0x64	

### Data transfer with function code 6

Request	
Function code	0x06
Register address	0x0000 ... 0xFFFF
Register value	0x0000 ... 0xFFFF

Response	
Function code	0x06
Register address	0x0000 ... 0xFFFF
Register value	0x0000 ... 0xFFFF

Error message	
Function code in the event of an error	<b>0x86</b>
Error code	01 ... 04

### Example for data transfer with function code 6

The value "3" (0x0003) is to be written into the register 40002.

Request		Info
Function code	0x06	Function code 6
Register address (High)	0x00	Register address for register 40002: 1 (0x0001)
Register address (Low)	0x01	
Register value (High)	0x00	Value to be written into the register: 3 (0x0003)
Register value (Low)	0x03	

Response		Info
Function code	0x06	Function code 6
Register address (High)	0x00	Register address: 1 (0x0001)
Register address (Low)	0x01	
Register value (High)	0x00	Register value: 3 (0x0003)
Register value (Low)	0x03	

# Configuring the network

Modbus TCP  
Data transfer  
Function codes



## Data transfer with function code 16

Request	
Function code	0x10
Start address	0x0000 ... 0xFFFF
Number of registers (n)	0x0001 ... 0x7D (0d125)
Number of bytes	2 x (number of registers)
Register values	Data in (n) register of 2 bytes each
Response	
Function code	0x10
Number of bytes	2 x (number of registers)
Register values	Data in (n) register of 2 bytes each
Error message	
Function code in the event of an error	<b>0x90</b>
Error code	01 ... 04

## Example for data transfer with function code 16

In a transaction, the value "10" is to be written into the register 40002 and the value "258" is to be written into the adjacent register 40003.

Request		Info
Function code	0x10	Function code 16
Start address (High)	0x00	Start address is the register 40002: 1 (0x0001)
Start address (Low)	0x01	
Number of registers (High)	0x00	Number of registers: 2 (0x0002)
Number of registers (Low)	0x02	
Number of bytes	0x04	4 bytes (0x0004) are to be written.
Register value (High)	0x00	The value "10" (0x000A) is written into the register with the start address 1 (= register 40002).
Register value (Low)	0x0A	
Register value (High)	0x01	The value "258" (0x0102) is written into the following register (= register 40003).
Register value (Low)	0x02	
Response		Info
Function code	0x10	Function code 16
Start address (High)	0x00	Start address: 1 (0x0001)
Start address (Low)	0x01	
Number of registers (High)	0x00	Number of registers: 2 (0x0002)
Number of registers (Low)	0x02	





## Data transfer with function code 23

Request	
Function code	<b>0x17</b>
Start address for reading (High)	0x0000 ... 0xFFFF
Start address for reading (Low)	0x0000 ... 0xFFFF
Number of registers for reading (High)	0x00 ... 0xFF
Number of registers for reading (Low)	0x00 ... 0xFF
Start address for writing (High)	0x0000 ... 0xFFFF
Start address for writing (Low)	0x0000 ... 0xFFFF
Number of registers for writing (High)	0x00 ... 0xFF
Number of registers for writing (Low)	0x00 ... 0xFF
Number of bytes for writing	2 x (number of registers)
Written value 1 (High)	0x00 ... 0xFF
Written value 1 (Low)	0x00 ... 0xFF
....	...
Written value n (High)	0x00 ... 0xFF
Written value n (Low)	0x00 ... 0xFF
Response	
Function code	<b>0x17</b>
Number of bytes for reading	2 x (number of registers)
Read value 1 (High)	0x00 ... 0xFF
Read value 1 (Low)	0x00 ... 0xFF
...	...
Read value x (High)	0x00 ... 0xFF
Read value x (Low)	0x00 ... 0xFF
Error message	
Function code in the event of an error	<b>0x97</b>
Error code	02 ... 04

# Configuring the network

Modbus TCP  
Data transfer  
Function codes



## Example for data transfer with function code 23

The following tasks are to be executed with a transaction:

- The values from six connected registers, starting with register 40005, are to be read.
- The value "255" is to be written into each of three connected registers, starting with register 40016.

Request		Info
Function code	0x17	Function code 23
Start address for reading (High)	0x00	Start address for reading is the register 40005: 4 (0x0004)
Start address for reading (Low)	0x04	
Number of registers for reading (High)	0x00	Number of registers for reading: 6 (0x0006)
Number of registers for reading (Low)	0x06	
Start address for writing (High)	0x00	Start address for writing is the register 40016: 15 (0x000F)
Start address for writing (Low)	0x0F	
Number of registers for writing (High)	0x00	Number of registers for writing: 3 (0x0003)
Number of registers for writing (Low)	0x03	
Number of bytes for writing	0x06	6 bytes (0x06) must be provided in 3 registers.
Written value 1 (High)	0x00	Data: 255 (0x00FF)
Written value 1 (Low)	0xFF	
Written value 2 (High)	0x00	Data: 255 (0x00FF)
Written value 2 (Low)	0xFF	
Written value 3 (High)	0x00	Data: 255 (0x00FF)
Written value 3 (Low)	0xFF	

Response		Info
Function code	0x17	Function code 23
Number of bytes for reading	0x0C	12 bytes (0x0C) from 6 registers are read.
Read value 1 (High)	0x00	1. written value Data: 254 (0x00FE)
Read value 1 (Low)	0xFE	
Read value 2 (High)	0x0A	2. written value Data: 2765 (0x0ACD)
Read value 2 (Low)	0xCD	
Read value 3 (High)	0x00	3. read value Data: 1 (0x0001)
Read value 3 (Low)	0x01	
Read value 4 (High)	0x00	4. read value Data: 3 (0x0003)
Read value 4 (Low)	0x03	
Read value 5 (High)	0x00	5. read value Data: 13 (0x000D)
Read value 5 (Low)	0x0D	
Read value 6 (High)	0x00	6. read value Data: 255 (0x00FF)
Read value 6 (Low)	0xFF	



## 12.16.3.2 Data mapping

The process of data mapping is used for defining which Modbus registers read or write to which inverter parameters.

- There are pre-defined Modbus registers for common control and status words, which are located in coherent blocks, in order to facilitate communication with OPC servers and other Modbus masters. In order to access all relevant data of the inverter, only a minimum number of commands is required.
- In addition, 24 registers are provided for variable mapping, i. e. free assignment to inverter parameters.

### Overview

The following table provides an overview of the Modbus register with variable and permanent assignment:

Register	Register address	Info
40103	0102	Variable mapping 0x23BB:001 ... 0x23BB:024 (P530.01 ... 24) serves to map these 24 registers to parameters of the inverter.
40104	0103	
...	...	
40149	0148	
42001	2000	Predefined Modbus status registers For details see the following section "Predefined Modbus status registers".
...	...	
42021	2020	
42101	2100	Predefined Modbus control registers For details see the following section "Predefined Modbus control registers".
...	...	
42121	2120	

### Predefined Modbus control registers

- These registers are provided with write and read access.
- The cross-reference in column 2 leads to the detailed parameter description.

Modbus registers	Permanently assigned parameter	
	Address	Designation
42101	<a href="#">0x400B:001 (P592.01)</a>	AC Drive control word
42102	<a href="#">0x400B:005 (P592.05)</a>	Network setpoint frequency (0.01)
42103	<a href="#">0x4008:002 (P590.02)</a>	NetWordIN2
42104	<a href="#">0x4008:003 (P590.03)</a>	NetWordIN3
42105	<a href="#">0x400B:007 (P592.07)</a>	PID setpoint
42106	<a href="#">0x6071</a>	Set torque
42107	<a href="#">0x4008:001 (P590.01)</a>	NetWordIN1
42108	<a href="#">0x4008:004 (P590.04)</a>	NetWordIN4
42109 ... 42121	-	Reserved

# Configuring the network

Modbus TCP  
Data transfer  
Data mapping



## Predefined Modbus status registers

- These registers are only provided with read access.
- The cross-reference in column 2 leads to the detailed parameter description.

Modbus registers	Permanently assigned parameter	
	Address	Designation
42001	<a href="#">0x400C:001 (P593.01)</a>	AC Drive status word
42002	<a href="#">0x400C:006 (P593.06)</a>	Frequency (0.01)
42003	<a href="#">0x603F (P150.00)</a>	Error code
42004	<a href="#">0x400C:005 (P593.05)</a>	Drive status
42005	<a href="#">0x2D89 (P106.00)</a>	Motor voltage
42006	<a href="#">0x2D88 (P104.00)</a>	Motor current
42007	<a href="#">0x6078 (P103.00)</a>	Actual current
42008	<a href="#">0x2DA2:002 (P108.02)</a>	Apparent power (42008 = High Word, 42009 = Low Word)
42009		
42010	<a href="#">0x2D84:001 (P117.01)</a>	Heatsink temperature
42011	<a href="#">0x2D87 (P105.00)</a>	DC-bus voltage
42012	<a href="#">0x60FD (P118.00)</a>	Digital input status (only bit 16 ... bit 31)
42013	<a href="#">0x6077 (P107.00)</a>	Actual torque
42014 ... 42021	-	Reserved

## Variable mapping

- Via [0x23BB:001 ... 0x23BB:024 \(P530.01 ... 24\)](#), 24 registers can be mapped to parameters of the inverter. Format:  
Oxiiiiiss00  
(iiii = index,  
ss = subindex)
- The display of the internal Modbus register numbers in [0x23BC:001 ... 0x23BC:024 \(P531.01 ... 24\)](#) is generated automatically. Since 32-bit parameters require two registers, there is no 1:1 assignment.
- For the mappable registers, a CRC (Cyclic Redundancy Check) is executed. The checksum determined is displayed in [0x23BD \(P532.00\)](#). The user can read this "validation code" and use it for comparison in the Modbus client. In this way it can be checked whether the inverter currently queried is configured correctly for the respective application.

## Parameter

Address	Name / setting range / [default setting]	Information
0x23BB:001 ... 0x23BB:024 (P530.01 ... 24)	Modbus TCP/IP parameter mapping: Parameter 1 ... Parameter 24 (MBTCP param.mapp: Parameter 1 ... Parameter 24) 0x00000000 ... [0x00000000] ... 0xFFFFFFFF	Mapping entries for the variable mapped Modbus registers. • Format: Oxiiiiiss00 (iiii = index, ss = subindex)
0x23BC:001 ... 0x23BC:024 (P531.01 ... 24)	Register assignment: Register 1 ... Register 24 (Register assignm: Register 1 ... Register 24) • Read only	Display of the internal Modbus register number starting from which the parameter mapped in <a href="#">0x23BB:001 ... 0x23BB:024 (P530.01 ... 24)</a> is stored. • For the first parameter mapped, always 2500. • From the second parameter mapped, 2500 + offset. The offset results from the data types of the previously mapped parameters.
0x23BD (P532.00)	Verification code (Verificat. code) • Read only • From version 04.00	



## 12.16.4 Monitoring

The parameters for setting network monitoring functions are described below.

### Parameter

Address	Name / setting range / [default setting]	Information
0x23B1:010 (P510.10)	Modbus -TCP/IP settings: Ethernet time-out (MBTCP settings: Ethernet timeout) 0 ... <b>[10]</b> ... 65535 s • From version 04.00	Setting of the maximum permissible time-out of the TCP communication. When the specified monitoring time has elapsed, the response set in <a href="#">0x2859:007 (P515.07)</a> is triggered in the inverter.
0x23B6:001 (P514.01)	Time-out monitoring: Time-out time (MBTCP t-out mon: Time-out time) 0.0 ... <b>[2.0]</b> ... 300.0 s • From version 04.00	Monitoring is active if the first valid write command arrives at the Modbus client. Each further valid write/read message resets the watchdog timer. Monitoring responds if within the time set here no valid message has been received by the Modbus client.
0x23B6:002 (P514.02)	Time-out monitoring: Keep alive time-out time (MBTCP t-out mon: Keep al t-out) 0.0 ... <b>[2.0]</b> ... 300.0 s • From version 04.00	Monitoring is active after a valid value is written into the keep alive register <a href="#">0x23B6:005 (P514.05)</a> via the Modbus for the first time. Keep alive monitoring responds if no value (range 1 ... 65535) has been written into the keep alive register within the time set here.
0x23B6:005 (P514.05)	Time-out monitoring: Keep alive register (MBTCP t-out mon: Keep al register) 0 ... <b>[0]</b> ... 65535 • From version 04.00	Time-out monitoring of the keep alive register is active after a value has been written into the keep alive register for the first time. In order to prevent that time-out monitoring for the keep alive register responds, the keep alive register must be written as follows: • With a value of 1 ... 65535 <b>and</b> • an interval that is shorter than the time set in <a href="#">0x23B6:002 (P514.02)</a> .
0x2859:003 (P515.03)	Modbus TCP/IP monitoring: Configuration error (MBTCP monitoring: Config error) • From version 04.00	Selection of the response triggered by the reception of invalid configuration data.  Associated event ID: • <a href="#">33414</a>   <a href="#">0x8286</a> - Network - PDO mapping error
	0 No response	▶ Severity <a href="#">□ 700</a>
	1 Warning	
	<b>2 Trouble</b>	
	3 Fault	
0x2859:004 (P515.04)	Modbus TCP/IP monitoring: Initialisation error (MBTCP monitoring: Init error) • From version 04.00	Selection of the response triggered by the occurrence of an error during the initialisation of the network component.  Associated event ID: • <a href="#">33170</a>   <a href="#">0x8192</a> - Network - Initialization error
	0 No response	▶ Severity <a href="#">□ 700</a>
	1 Warning	
	<b>2 Trouble</b>	
	3 Fault	
0x2859:007 (P515.07)	Modbus TCP/IP monitoring: Fault response to network timeout (MBTCP monitoring: Resp netw t-out) • From version 04.00	If monitoring detects a time-out of the TCP communication with an existing TCP connection, the error response to be selected with this parameter occurs. The maximum permissible time-out of the TCP communication is defined in <a href="#">0x23B1:010 (P510.10)</a> .  Associated event ID: • <a href="#">33044</a>   <a href="#">0x8114</a> - Network - Overall communication time-out
	0 No response	▶ Severity <a href="#">□ 700</a>
	<b>1 Warning</b>	
	2 Trouble	
	3 Fault	
0x2859:008 (P515.08)	Modbus TCP/IP monitoring: Fault response to master timeout (MBTCP monitoring: Resp mast t-out) • From version 04.00	Selection of the response if within the time set in <a href="#">0x23B6:001 (P514.01)</a> no valid message has arrived at the Modbus client.  Associated event ID: • <a href="#">33046</a>   <a href="#">0x8116</a> - Modbus TCP master time-out
	0 No response	▶ Severity <a href="#">□ 700</a>
	1 Warning	
	2 Trouble	
	<b>3 Fault</b>	

# Configuring the network

Modbus TCP  
Monitoring



Address	Name / setting range / [default setting]	Information
0x2859:009 (P515.09)	Modbus TCP/IP monitoring: Fault response to keep alive timeout (MBTCP monitoring: Resp t-out kp-al) <ul style="list-style-type: none"><li>From version 04.00</li></ul>	Selection of the response if within the time set in <a href="#">0x23B6:002 (P514.02)</a> no valid message has been written into the keep alive register. Associated event ID: <ul style="list-style-type: none"><li><a href="#">33047</a>   <a href="#">0x8117</a> - Modbus TCP Keep Alive time-out</li></ul>
	0 No response	▶ Severity <a href="#">700</a>
	1 Warning	
	2 Trouble	
	<b>3 Fault</b>	







## 12.16.5 Diagnostics





### 12.16.5.1 Status LEDs

Information on the CIP status can be obtained quickly via the "MS" and "NS" LED displays on the front of the inverter. In addition, the LEDs at the RJ45 sockets indicate the connection status.

The "MS" LED indicate the CIP module status.

LED "MS" (green/red)	CIP module status	Status/meaning
off	Nonexistent	The network option is not supplied with voltage.
 On (green)	Operational	The network option works correctly.
 Blinking green	Standby	The network option is not configured completely or the configuration is incorrect.
 Blinking red	Major recoverable fault	The network option contains a correctable error.
 on (red)	Major unrecoverable fault	The network option contains a non-correctable error.
 Blinking green/red	Device self testing	The network option executes a self-test.

The "NS" LED indicate the CIP network status.

LED "NS" (green/red)	CIP network status	Status/meaning
off	No IP address	The network option is not supplied with voltage or has not received an IP address yet.
 On (green)	Connected	The network option works correctly an has established a connection to the master.
 Blinking green	No connections	The network option <ul style="list-style-type: none"> <li>works correctly,</li> <li>has been assigned to an IP address,</li> <li>has not been implemented into the network yet by the client.</li> </ul>
 Blinking red	Connection timeout	A time-out has occurred.
 on (red)	Duplicate IP	The network option cannot access the network (IP address conflict).
 Blinking green/red	Device self testing	The network option executes a self-test.

### Status displays at the RJ45 sockets

The LEDs at the RJ45 sockets indicate the connection status to the network:

LED "Link" (green)	Status/meaning
off	No connection to the network.
 on	A physical connection to the network is available.

LED "Activity" (yellow)	Status/meaning
off	No data transfer.
 on or flickers	Data is exchanged via the network.

# Configuring the network

Modbus TCP  
Diagnostics  
Information on the network



## 12.16.5.2 Information on the network

The following parameters serve to diagnose the communication activities between the inverter and the Modbus network.

The following parameters show information on the network.

### Parameter

Address	Name / setting range / [default setting]	Information
0x23B2:001 (P511.01)	Active Modbus TCP settings: Active IP address (Act. MBTCP sett.: Act. IP address) • Read only • From version 04.00	Display of the active IP address.
0x23B2:002 (P511.02)	Active Modbus TCP settings: Active subnet (Act. MBTCP sett.: Act. subnet) • Read only • From version 04.00	Display of the active subnet mask.
0x23B2:003 (P511.03)	Active Modbus TCP settings: Active gateway (Act. MBTCP sett.: Act. gateway) • Read only • From version 04.00	Display of the active gateway address. Example The setting 276344004 corresponds to the gateway address 196.172.120.16. • 276344004 = 0x1078ACC4 → 0xC4.0xAC.0x78.0x10 = 196.172.120.16
0x23B2:005 (P511.05)	Active Modbus TCP settings: MAC address (Act. MBTCP sett.: MAC address) • Read only • From version 04.00	Display of the active MAC address.
0x23B3 (P509.00)	Switch position (Switch position) • Read only • From version 04.00	Display of the rotary encoder switch setting at the last mains power-on.
0x23B5:001 (P513.01)	Active port settings: Port 1 (Act. port sett.: Port 1) • Read only • From version 04.00	Display of the baud rate set for Port 1 in <a href="#">0x23B4:001 (P512.01)</a> .
	0   Not connected	
	1   10 Mbps/Half Duplex	
	2   10 Mbps/Full Duplex	
	3   100 Mbps/Half Duplex	
	4   100 Mbps/Full Duplex	
0x23B5:002 (P513.02)	Active port settings: Port 2 (Act. port sett.: Port 2) • Read only • From version 04.00	Display of the baud rate set for Port 2 in <a href="#">0x23B4:001 (P512.01)</a> .
	0   Not connected	
	1   10 Mbps/Half Duplex	
	2   10 Mbps/Full Duplex	
	3   100 Mbps/Half Duplex	
	4   100 Mbps/Full Duplex	
0x23B8 (P516.00)	Modbus TCP module status (MBTCP modul. stat) • Read only • From version 04.00	Display of the TCP module state.
	0   Power off	
	1   Initialization	
	2   Warning	
	3   Fault	
	4   No configuration	
5   Operational		





# Configuring the network

Modbus TCP  
Diagnostics  
Information on the network

Address	Name / setting range / [default setting]	Information
0x23B9 (P517.00)	Modbus TCP/IP network status (MBTCP netw stat)	Display of the active network status.
	<ul style="list-style-type: none"> <li>• Read only</li> <li>• From version 04.00</li> </ul>	
	0 No configuration	
	1 Initialization	
	2 Connection time-out	
	3 Configuration error	
4 Not connected		
5 Connection established		
0x23BA:001 (P580.01)	Modbus TCP statistics: Messages received (MBTCP statistics: Rx messages)	Display of the total number of messages received.
<ul style="list-style-type: none"> <li>• Read only</li> <li>• From version 04.00</li> </ul>	<ul style="list-style-type: none"> <li>• This counter counts both valid and invalid messages.</li> <li>• After the maximum value has been reached, the counter starts again "0".</li> </ul>	
0x23BA:002 (P580.02)	Modbus TCP statistics: Valid messages received (MBTCP statistics: Valid Rx messag.)	Display of the number of valid messages received.
<ul style="list-style-type: none"> <li>• Read only</li> <li>• From version 04.00</li> </ul>	<ul style="list-style-type: none"> <li>• After the maximum value has been reached, the counter starts again "0".</li> </ul>	
0x23BA:003 (P580.03)	Modbus TCP statistics: Messages with exceptions (MBTCP statistics: Mess. w. except)	Display of the number of messages with exceptions that have been received.
<ul style="list-style-type: none"> <li>• Read only</li> <li>• From version 04.00</li> </ul>	<ul style="list-style-type: none"> <li>• After the maximum value has been reached, the counter starts again "0".</li> </ul>	
0x23BA:005 (P580.05)	Modbus TCP statistics: Messages sent (MBTCP statistics: Tx messages)	Display of the total number of messages sent.
<ul style="list-style-type: none"> <li>• Read only</li> <li>• From version 04.00</li> </ul>	<ul style="list-style-type: none"> <li>• After the maximum value has been reached, the counter starts again "0".</li> </ul>	
0x23BE:001 (P585.01)	Modbus TCP/IP diagnostics of last Rx/Tx data: Receive offset (MBTCP Tx/Rx diag: Rx offset)	For diagnostic purposes, the last received message (max. 16 bytes) is displayed in <a href="#">0x23BE:002 (P585.02)</a> . For longer messages, an offset can be specified here, indicating from which byte of the message the display of the 16 bytes is to start.
0 ... [0] ... 240	<ul style="list-style-type: none"> <li>• From version 04.00</li> </ul>	
0x23BE:002 (P585.02)	Modbus TCP/IP diagnostics of last Rx/Tx data: Last Rx message (MBTCP Tx/Rx diag: Last Rx message)	Display of the message received last.
<ul style="list-style-type: none"> <li>• Read only</li> <li>• From version 04.00</li> </ul>		
0x23BE:003 (P585.03)	Modbus TCP/IP diagnostics of last Rx/Tx data: Transmit offset (MBTCP Tx/Rx diag: Tx offset)	For diagnostic purposes, the last sent message (max. 16 bytes) is displayed in <a href="#">0x23BE:004 (P585.04)</a> . For longer messages, an offset can be specified here, indicating from which byte of the message the display of the 16 bytes is to start.
0 ... [0] ... 240	<ul style="list-style-type: none"> <li>• From version 04.00</li> </ul>	
0x23BE:004 (P585.04)	Modbus TCP/IP diagnostics of last Rx/Tx data: Last Tx message (MBTCP Tx/Rx diag: Last Tx message)	Display of the message sent last.
<ul style="list-style-type: none"> <li>• Read only</li> <li>• From version 04.00</li> </ul>		



## 12.17 POWERLINK

ETHERNET 

### POWERLINK

POWERLINK is a real-time capable fieldbus system based on Ethernet.

- Detailed information on POWERLINK can be found on the web page of the Ethernet POWERLINK Standardization Group (EPG): <http://www.ethernet-powerlink.org>
- Information about the dimensioning of a POWERLINK network can be found in the configuration document for the inverter.

#### Preconditions

- The control unit (CU) of the inverter is provided with POWERLINK.

#### Features

The inverter is implemented as a controlled node (CN) in a POWERLINK network. It may only respond to poll-request messages of a managing node (MN). See "Typical topologies" section.

- The network option can both be supplied internally by the standard device and externally by a separate voltage source.
- Real time Ethernet with the Ethernet POWERLINK V2 communication profile for Motion and general applications
- A line topology can be set up by the integrated 2-port hub.
- Supported functionalities: POWERLINK CN
- Very short CN response times for optimum network performance
- Access to all inverter parameters

The following is not supported:

- Firmware download via POWERLINK
- PDO crosslinks for the managing node or the controlled node for setting up systems with "distributed intelligence"

#### Typical topology

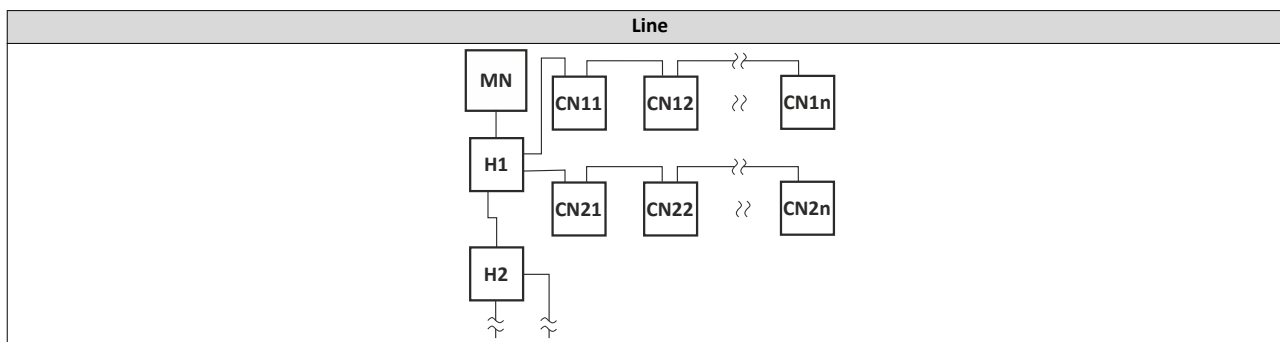

Mnated Managing Node  
CN Controlled Node

H Hub



## 12.17.1 Commissioning

In the following, the steps required for controlling the inverter via POWERLINK are described.

### Parameterisation required

1. Activate network control: **0x2631:037 (P400.37)** = "TRUE [1]"
2. Set network as standard setpoint source: **0x2860:001 (P201.01)** = "Network [5]"
3. Set the node address.
  - Each network node must be provided with a unique node address (node ID).
  - Details: [▶ Basic setting and options](#) 532
4. Save parameter settings: **0x2022:003 (P700.03)** = "On / start [1]"
5. Switch the inverter off and then on again in order that the changed communication settings can get effective.
6. Check the readiness for operation of the inverter by means of the LED status displays.
  - The red LEDs must be off, otherwise an error has occurred.
  - The green LED at the RJ45 socket is on if a physical POWERLINK connection is available.
  - Details: [▶ Status LEDs](#) 537



In the default setting, the digital input DI1 is assigned the "Run" function. If the network control is activated, this function serves as "start enable" for start commands via network. Hence, the digital input DI1 must be set to the HIGH level in order that the motor can be started via the network.

[▶ Flexible I/O configuration of the start, stop and rotating direction commands](#) 67

### Start network

The network is automatically started if you first set all controlled nodes (as described above) and then the managing node.

Otherwise, there are the following two options:

- a) Switch all network nodes off and then on again or
- b) make a fault reset at the managing node (node ID 240).

### Parameter

Address	Name / setting range / [default setting]	Information
0x23C0	POWERLINK communication • From version 05.00	Restart / stop communication. • When the device command has been executed successfully, the value 0 is shown.
	<b>0</b> No action/no error	Only status feedback
	<b>1</b> Restart with current values	Restart communication with the current values.
	<b>2</b> Restart with default values	Restart communication with the standard values.
	<b>10</b> In progress	Only status feedback
	<b>11</b> Action cancelled	
	<b>12</b> Fault	



## 12.17.2 Basic setting and options

Each network node must be provided with a unique node address (node ID).

### Setting the node address

The node address can be set in **0x23C1:004** or via the two rotary encoder switches on the front of the inverter.

- If both rotary encoder switches are set to "0", the value set in **0x23C1:004** is used as node address.
- The setting that is active when the inverter is switched on is the effective setting.
- A value changed during operation only gets valid when the device is restarted.
- Valid node addresses for controlled nodes: 1 ... 239
- The resulting IP address is "192.168.100.[node address]".

Example: Setting of the node address 52 via the rotary encoder switches

- $52 = 3 \times 16 + 4 \times 1$

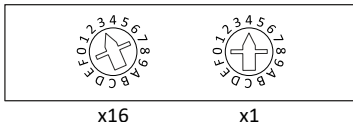

- The resulting IP address is "192.168.100.52".

Note: If the value set via the rotary encoder switches is higher than 239, the node address is set to 239.

Diagnostic parameters:

- **0x23C2:004** displays the active node address.
- **0x23C3** displays the switch setting at the last mains switching.

### Parameter

Address	Name / setting range / [default setting]	Information
0x1006	NMT_CycleLen_U32 0 ... [0] ... 4294967295 • From version 05.00	Length of the POWERLINK cycle in $\mu$ s. • The selected value must correspond to the real bus cycle time in order that the internal monitoring modes operate correctly. • In the configured state, all POWERLINK nodes must be set to an identical value.
0x1F98:007	NMT_CycleTiming_REC: MultipleCycleCnt_U8 0 ... [0] ... 255 • From version 05.00	Setting of the maximum number of multiplexed cycles. • In case of the setting "3", the multiplexed cycle is repeated every 3 cycles. • Within one multiplexed cycle, the nodes are queried according to the values in 0x1F9B:xxx. If, for instance, the value "2" is entered for a node in 0x1F9B:xxx, it is always only queried in the 2nd of 3 multiplexed cycles.
0x1F98:009	NMT_CycleTiming_REC: Prescaler_U16 0 ... [2] ... 1000 • From version 05.00	Configuration of the switching rate of the SoC-PS flag.
0x1F99	NMT_CNBasicEthernetTimeout_u32 0 ... [0] ... 4294967295 • From version 05.00	Setting of the maximum time the booting controlled node waits for the managing node. • If the controlled node detects a managing node within the time, the controlled node changes to the "NMT_CS_PREOPERATIONAL_1" state. Otherwise, the controlled node changes to the "Basic Ethernet Mode" state.



Address	Name / setting range / [default setting]	Information
0x1F9A	NMT_HostName_VSTR <ul style="list-style-type: none"> <li>From version 05.00</li> </ul>	<p>Setting of a DNS-compatible device name.</p> <ul style="list-style-type: none"> <li>The length is limited to 20 characters.</li> <li>The device name must be clear within the network domain.</li> <li>The device name starts with a letter ends with a letter or a number.</li> </ul> <p>Permitted characters:</p> <ul style="list-style-type: none"> <li>Letter (A ... Z, a ... z)</li> <li>Numbers (0 ... 9)</li> <li>Hyphen (-)</li> </ul>
0x1F9E	NMT_ResetCmd_U8 <ul style="list-style-type: none"> <li>Read only</li> <li>From version 05.00</li> </ul>	<p>This object enables the managing node to execute a reset command in the controlled node.</p> <p>Note! A reset command at a single POWERLINK node in the network can cause cycle and monitoring errors.</p>
0x23C1:004	POWERLINK settings: Node ID 0 ... [0] ... 239 <ul style="list-style-type: none"> <li>From version 05.00</li> </ul>	<p>Setting of the unique node address (node ID) in the network.</p> <ul style="list-style-type: none"> <li>The node address set here is only effective if both rotary encoder switches are set to "0".</li> <li>In the default setting "0", the rotary encoder switch setting is used.</li> <li>The resulting IP address is "192.168.100.[node address]".</li> <li>A changed node address only becomes effective after a restart of the device.</li> </ul>



## 12.17.3 Process data transfer

POWERLINK transfers process data, parameter data, configuration data and diagnostic data between the managing node and the involved controlled nodes in the network. Depending on their time-critical behaviour, the data is transmitted via corresponding communication channels.

### Details

- Process data is transmitted cyclically between the managing node and the controlled node (permanent exchange of current input and output data).
- The transfer of process data is time-critical.
- The process data serves to control the POWERLINK nodes.
- The process data can be directly accessed by the managing node. The data in the PLC, for instance, are directly stored in the I/O area.
- The contents of the process data are defined via I/O data mapping.
- Process data is not saved in the device.

### Default mapping

Process data (RxPDO):

- **0x4008:001 (P590.01)** (NetWordIN1)
- **0x400B:013 (P592.13)** (Network frequency setpoint [ +/--16384])

Process data (TxPDO):

- **0x400A:001 (P591.01)** (NetWordOUT1)
- **0x400C:009 (P593.09)** (Frequency [ +/--16384])
- **0x2D88 (P104.00)** (Motor current)
- **0x4050:002** (internal parameters)

Dynamic mapping is supported (displayed by bit 6 of the NMT\_FeatureFlags\_U32 **0x1F82**).

### Dynamic mapping

Dynamic mapping is processed in the "Automation Suite" (engineering software) by displaying a list of possible parameters "Sent" and "Received". From this list, a dedicated configuration must be selected and saved on the master system. When the system is started, the desired mapping is written from the master into the slave (inverter).

### Parameter

Address	Name / setting range / [default setting]	Information
0x1400:001	PDO_RxCommParam_00h_REC: NodeID_U8 0 ... [0] ... 255 • From version 05.00	Setting of the node ID for RPDO1.
0x1400:002	PDO_RxCommParam_00h_REC: MappingVersion_U8 • Read only • From version 05.00	Display of the version of the RPDO1 mapping.
0x1600:001 ... 0x1600:016	PDO_RxMappParam_00h_REC: ObjectMapping_U64 1 ... ObjectMapping_U64 16 0 ... [0] ... 18446744073709551615	Mapping entries 1 ... 16 for RPDO1.
0x1800:001	PDO_TxCommParam_00h_REC: NodeID_U8 • Read only • From version 05.00	Display of the node ID of the TPDO1 receiver.
0x1800:002	PDO_TxCommParam_00h_REC: MappingVersion_U8 • Read only • From version 05.00	Display of the TPDO1 mapping version.
0x1A00:001 ... 0x1A00:016	PDO_TxMappParam_00h_REC: ObjectMapping_U64 1 ... ObjectMapping_U64 16 0 ... [0] ... 18446744073709551615	Mapping entries 1 ... 16 for TPDO1.



Address	Name / setting range / [default setting]	Information
0x1F98:004	NMT_CycleTiming_REC: PReqActPayload_U16 36 ... [36] ... 1490 • From version 05.00	Setting of the data size to be maximally received by the controlled node via PReq for the current network configuration. • The set value is an upper limit value for the total size of the PDO mapping for the PReq frame. • In the configured state, the value must be identical to the entry valid for the POWERLINK node for a response.
0x1F98:005	NMT_CycleTiming_REC: PResActPayload_U16 36 ... [36] ... 1490 • From version 05.00	Setting of the PDO data size to be maximally sent by the POWERLINK node for the current network configuration. • The PDO mapping may assign data with a total size higher/equal to the value set here. • In the configured state, the value must be identical to the entry valid for the POWERLINK node in 0x1F8D:xxx.

### 12.17.4 Parameter data transfer

#### Parameter

Address	Name / setting range / [default setting]	Information
0x1300	SDO_SequLayerTimeout_U32 100 ... [15000] ... 4294967295 ms • From version 05.00	Time-out time for detecting an aborted connection of an SDO transfer.
0x1301	SDO_CmdLayerTimeout_U32 100 ... [30000] ... 4294967295 ms • From version 05.00	Time-out time for detecting an aborted connection in the SDO command layer.
0x1F98:006	NMT_CycleTiming_REC: ASndMaxLatency_U32 • Read only: x ns • From version 05.00	Display of the asynchronous response delay.
0x1F98:008	NMT_CycleTiming_REC: AsyncMTUSize_U16 300 ... [300] ... 1500 • From version 05.00	Setting of the maximum user data size for asynchronous frames. • Protocol-specific headers for POWERLINK, UDP/IP and others as well as service-specified headers can be seen as part of the user data. • In the configured state, all POWERLINK nodes must be set to an identical value.



## 12.17.5 Monitoring

The response to POWERLINK errors such as the lack of PDOs can be configured via the following parameters.

In the "Operational" state, the controlled node detects an interruption of the POWERLINK communication, e. g. by cable breakage or failure of the managing node.

The response to the interrupted communication is controlled by the following settings:

1. The watchdog monitoring time defined in the managing node is transferred to the controlled node when the POWERLINK communication is initialised.
2. If the controlled node does not receive any valid process data in the "Operational" state, the process data are handled in a general (not network-specific) object according to the setting. Thus, the data sent last by the managing node can be used or the process data is set to zero.
3. 'After the communication has failed...
  - the controlled node changes to the "Pre-Operational" state.
  - the red "BE" LED on the front of the inverter is permanently on. ▶ [Status LEDs](#) □ 537
  - the error response set in [0x2859:001](#) is effected (default setting: "Trouble").

The parameters for setting network monitoring functions are described below.

### Parameter

Address	Name / setting range / [default setting]	Information
0x2859:001	POWERLINK monitoring: Watchdog elapsed • From version 05.00	Selection of the error response when the "Operational" communication status (watchdog elapsed) has been left.  Associated event ID: • <a href="#">33168</a>   <a href="#">0x8190</a> - Network - Watchdog time-out
	0 No response	▶ <a href="#">Severity</a> <span style="font-size: 0.8em;">□ 700</span>
	1 Warning	
	<b>2 Trouble</b>	
3 Fault		
0x2859:010	POWERLINK monitoring: CRC error • From version 05.00	Selection of the error response in case of CRC error.  Associated event ID: • <a href="#">33382</a>   <a href="#">0x8266</a> - POWERLINK: CRC error
	0 No response	▶ <a href="#">Severity</a> <span style="font-size: 0.8em;">□ 700</span>
	1 Warning	
	<b>2 Trouble</b>	
3 Fault		
0x2859:011	POWERLINK monitoring: Loss of SoC • From version 05.00	Selection of the error response in case of SoC loss.  Associated event ID: • <a href="#">33381</a>   <a href="#">0x8265</a> - POWERLINK: Loss of SoC
	0 No response	▶ <a href="#">Severity</a> <span style="font-size: 0.8em;">□ 700</span>
	1 Warning	
	<b>2 Trouble</b>	
3 Fault		





## 12.17.6 Diagnostics





Errors and warnings of the inverter and the network option are sent as extended diagnostic messages to the managing node:

Bytes	Meaning	Value [hex]
1 ... 6	Diagnostic block header	0x0010 001C 0100
7 ... 8	Alarm type	0x0001 (diagnostics)
9 ... 12	API (Application Programming Interface)	0x0000 0000
13, 14	Slot number	0x0001 / 0x0002
15, 16	Subslot number	0x0001
17 ... 20	Module ID	ID according to module
21 ... 24	Submodule number	ID according to module
25, 26	Alarm specification	0xB000
27, 28	User structure ID	0x0001
29 ... 32	Error code	<a href="#">▶ Events, causes and remedies □ 705</a>

### 12.17.6.1 Status LEDs

Information on the network status can be obtained quickly via the "Status" and "Error" LED displays on the front of the inverter. In addition, the LEDs at the RJ45 sockets indicate the POWERLINK connection status .

The meaning can be seen from the table below.

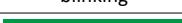

LED "Status" (green)	NMT communication status	Meaning
off	-	The network option is not supplied with voltage, is not active at the network or is in the INIT state.
 Flashing	NMT_CS_PREOPERATIONAL_1	The POWERLINK network is in the initialisation phase.
 Flashing 2 x	NMT_CS_PREOPERATIONAL_2	The POWERLINK network is in the initialisation phase with cyclic traffic.
 Flashing 3 x	NMT_CS_READY_TO_OPERATE	The network option waits for the start signal.
 flickers	NMT_CS_BASIC_ETHERNET	The network option has not found a managing node and is in the "Basic Ethernet Mode" mode.
 blinking	NMT_CS_STOPPED	The network option is in the "Stopped" state (waiting for switch-off).
 on	NMT_CS_OPERATIONAL	The network option is in the operating phase.

LED "Error" (red)	Status/meaning
 on	POWERLINK network error

### Status displays at the RJ45 sockets

The LEDs at the RJ45 sockets indicate the connection status to the network:

LED (green)	Status/meaning
off	No connection to the network.
 on	A physical connection to the network is available.
 flickers	Data is exchanged via the network.

LED (red)	Status/meaning
 on	POWERLINK collision

# Configuring the network

POWERLINK  
Diagnostics  
Information on the network



## 12.17.6.2 Information on the network

The following parameters show information on the network.

### Parameter

Address	Name / setting range / [default setting]	Information
0x1C0A:001	DLL_CNCollision_REC: CumulativeCnt_U32 0 ... [0] ... 4294967295 • From version 05.00	Display of the number of "collision" errors detected by the controlled node. • The counter content is increased each time by 1 if the controlled node has detected a "collision" error.
0x1C0B:001	DLL_CNLossSoC_REC: CumulativeCnt_U32 0 ... [0] ... 4294967295 • From version 05.00	Display of the number of SoC losses detected by the controlled node. • The counter content is increased each time by 1 if the controlled node has detected an SoC loss.
0x1C0B:002	DLL_CNLossSoC_REC: ThresholdCnt_U32 • Read only • From version 05.00	Display of the network quality with regard to SoC losses. • The counter content is increased each time by 8 if the controlled node has detected an SoC loss and decreased by 1 at every error-free cycle.
0x1C0B:003	DLL_CNLossSoC_REC: Threshold_U32 0 ... [0] ... 4294967295 • From version 05.00	Error threshold for monitoring SoC losses. • If the counter content displayed in <a href="#">0x1C0B:002</a> reaches the set threshold, the error response selected in <a href="#">0x2859:011</a> is effected. • If the setting is "0", this monitoring is not active.
0x1C0F:001	DLL_CNCRCErrREC_REC: CumulativeCnt_U32 0 ... [0] ... 4294967295 • From version 05.00	Display of the number of CRC errors detected by the controlled node. • The counter content is increased each time by 1 if the controlled node has detected a "CRC" error.
0x1C0F:002	DLL_CNCRCErrREC_REC: ThresholdCnt_U32 • Read only • From version 05.00	Display of the network quality with regard to CRC errors. • The counter content is increased each time by 8 if the controlled node has detected a CRC error and decreased by 1 at every error-free cycle.
0x1C0F:003	DLL_CNCRCErrREC_REC: Threshold_U32 0 ... [0] ... 4294967295 • From version 05.00	Error threshold for monitoring CRC errors. • If the counter content displayed in <a href="#">0x1C0F:002</a> reaches the set threshold, the error response selected in <a href="#">0x2859:010</a> is effected. • If the setting is "0", this monitoring is not active.
0x1C10	DLL_CNLossOfLinkCum_U32 0 ... [0] ... 4294967295 • From version 05.00	Display of the number of connection losses detected by the controlled node. • The counter content is increased each time by 1 if the controlled node has detected a connection loss. • A connection loss may occur if the connection is interrupted, for instance due to a cable break/unplugging the network cable or a defect hub/switch in the POWERLINK network.
0x1F82	NMT_FeatureFlags_U32 • Read only • From version 05.00	Bit coded display of the POWERLINK functions implemented by the POWERLINK nodes.  The single bits have the following meaning: • Bit 0 = 1 = node with this ID exists. • Bit 1 = 1 = node with this ID is a controlled node. • Bit 2 = 1 = If a booting controlled node is detected, this is reported to the application and the controlled node is started. • Bit 3 = 1 = controlled node is mandatory. • Bit 4 = 1 = managing node must not send any reset commands. • Bit 5 = 1 = software version verification of the controlled node required. • Bit 6 = 1 = automatic software update of the application permitted. • Bit 7 = reserved (no function) • Bit 8 = 1 = controlled node is addressed asynchronously. • Bit 9 = 1 = controlled node is addressed in a multiplexed way. • Bit 10 = 1 = device is router (type 1) • Bit 11 = 1 = device is router (type 2) • Bit 12 = 1 = managing node sends PRes frames. • Bit 13 ... 30 = reserved (no function) • Bit 31 = 1 = bits 0 ... 30 are enabled.
0x1F83	NMT_EPLVers_U8 • Read only • From version 05.00	Display of the POWERLINK version.



# Configuring the network

## POWERLINK Diagnostics Information on the network

Address	Name / setting range / [default setting]	Information
0x1F8C	NMT_CurrState_U8 <ul style="list-style-type: none"> <li>• Read only</li> <li>• From version 05.00</li> </ul>	Display of the current NMT state of the POWERLINK node (according to the Ethernet POWERLINK specification).
0x1F93:001	NMT_EPLNodeID_REC: NodeID_U8 <ul style="list-style-type: none"> <li>• Read only</li> <li>• From version 05.00</li> </ul>	Display of the currently valid node address (node ID).
0x1F93:002	NMT_EPLNodeID_REC: NodeIDByHW_BOOL <ul style="list-style-type: none"> <li>• Read only</li> <li>• From version 05.00</li> </ul>	Display whether the node address (node ID) has been set via rotary encoder switch or via software.
0x1F98:001	NMT_CycleTiming_REC: IsochrTxMaxPayload_U16 <ul style="list-style-type: none"> <li>• Read only</li> <li>• From version 05.00</li> </ul>	Display of the size of the isochronous transmit memory.
0x1F98:002	NMT_CycleTiming_REC: IsochrRxMaxPayload_U16 <ul style="list-style-type: none"> <li>• Read only</li> <li>• From version 05.00</li> </ul>	Display of the size of the isochronous receive memory.
0x1F98:003	NMT_CycleTiming_REC: PResMaxLatency_U32 <ul style="list-style-type: none"> <li>• Read only: x ns</li> <li>• From version 05.00</li> </ul>	Display of the isochronous response delay.
0x23C2:001	Active POWERLINK settings: IP address <ul style="list-style-type: none"> <li>• Read only</li> <li>• From version 05.00</li> </ul>	Display of the active IP address.
0x23C2:002	Active POWERLINK settings: Subnet <ul style="list-style-type: none"> <li>• Read only</li> <li>• From version 05.00</li> </ul>	Display of the active subnet mask.
0x23C2:003	Active POWERLINK settings: Gateway <ul style="list-style-type: none"> <li>• Read only</li> <li>• From version 05.00</li> </ul>	Display of the IP address of the router that connects the POWERLINK segment to the higher-level network.
0x23C2:004	Active POWERLINK settings: Node ID <ul style="list-style-type: none"> <li>• Read only</li> <li>• From version 05.00</li> </ul>	Display of the active node address (node ID) in the network.
0x23C2:005	Active POWERLINK settings: MAC Address <ul style="list-style-type: none"> <li>• Read only</li> <li>• From version 05.00</li> </ul>	Display of the active MAC address.
0x23C2:007	Active POWERLINK settings: Tx length <ul style="list-style-type: none"> <li>• Read only</li> <li>• From version 05.00</li> </ul>	Display of the length of the transmitted cyclic data in bytes.
0x23C2:008	Active POWERLINK settings: Rx length <ul style="list-style-type: none"> <li>• Read only</li> <li>• From version 05.00</li> </ul>	Display of the length of the received cyclic data in bytes.
0x23C3	POWERLINK switch position <ul style="list-style-type: none"> <li>• Read only</li> <li>• From version 05.00</li> </ul>	Display of the rotary encoder switch setting at the last mains power-on.
0x23C8:001	POWERLINK status: Network management <ul style="list-style-type: none"> <li>• Read only</li> <li>• From version 05.00</li> </ul>	Display of the current bus status.
	9 NMT_CS_INITIALISATION	
	28 NMT_CS_NOT_ACTIVE	
	29 NMT_CS_PRE_OPERATIONAL_1	
	30 NMT_CS_BASIC_ETHERNET	
	77 NMT_CS_STOPPED	
	93 NMT_CS_PRE_OPERATIONAL_2	
	109 NMT_CS_READY_TO_OPERATE	
	253 NMT_CS_OPERATIONAL	

# Configuring the network

POWERLINK

Diagnostics

Information on the Ethernet interface



Address	Name / setting range / [default setting]	Information
0x23C9:001	POWERLINK error: Activation	Bit coded display of the bus error state reported by the LED "BE" (Bus Error). <ul style="list-style-type: none"> <li>Bit 0 = 0 (0x0000) = no bus error</li> <li>Bit 0 = 1 (0x0001) = active bus error</li> </ul>
	• Read only	
	• From version 05.00	
	0 Disabled	
	1 Activated	

## 12.17.6.3 Information on the Ethernet interface

### Parameter

Address	Name / setting range / [default setting]	Information
0x1030:001	NMT_InterfaceGroup_0h_REC: InterfaceIndex_U16 <ul style="list-style-type: none"> <li>Read only</li> <li>From version 05.00</li> </ul>	Display of the interface number of the Ethernet interface.
0x1030:002	NMT_InterfaceGroup_0h_REC: InterfaceDescription_VSTR <ul style="list-style-type: none"> <li>Read only</li> <li>From version 05.00</li> </ul>	Display of the description of the Ethernet interface.
0x1030:003	NMT_InterfaceGroup_0h_REC: InterfaceType_U8 <ul style="list-style-type: none"> <li>Read only</li> <li>From version 05.00</li> </ul>	Display of the interface type.
0x1030:004	NMT_InterfaceGroup_0h_REC: InterfaceMtu_U32 <ul style="list-style-type: none"> <li>Read only</li> <li>From version 05.00</li> </ul>	Display of the maximum frame size.
0x1030:005	NMT_InterfaceGroup_0h_REC: InterfacePhysAddress_OSTR <ul style="list-style-type: none"> <li>Read only</li> <li>From version 05.00</li> </ul>	Display of the MAC address of the Ethernet interface.
0x1030:006	NMT_InterfaceGroup_0h_REC: InterfaceName_VSTR <ul style="list-style-type: none"> <li>Read only</li> <li>From version 05.00</li> </ul>	Symbolic name of the Ethernet interface.
0x1030:007	NMT_InterfaceGroup_0h_REC: InterfaceOperState_U8 <ul style="list-style-type: none"> <li>Read only</li> <li>From version 05.00</li> </ul>	Display of the operation status of the Ethernet interface.
0x1030:008	NMT_InterfaceGroup_0h_REC: InterfaceAdminState_U8 0 ... [0] ... 1 <ul style="list-style-type: none"> <li>From version 05.00</li> </ul>	Administration status of the Ethernet interface.
0x1030:009	NMT_InterfaceGroup_0h_REC: Valid_BOOL 0 ... [0] ... 1 <ul style="list-style-type: none"> <li>From version 05.00</li> </ul>	Release of the interface description.
0x1E40:001	NWL_IpAddrTable_0h_REC: IfIndex_U16 <ul style="list-style-type: none"> <li>Read only</li> <li>From version 05.00</li> </ul>	Display of the LF index which clearly identifies the Ethernet interface.
0x1E40:002	NWL_IpAddrTable_0h_REC: Addr_IPAD <ul style="list-style-type: none"> <li>Read only</li> <li>From version 05.00</li> </ul>	Display of the IP address of the Ethernet interface.
0x1E40:003	NWL_IpAddrTable_0h_REC: NetMask_IPAD <ul style="list-style-type: none"> <li>Read only</li> <li>From version 05.00</li> </ul>	Display of the network mask of the Ethernet interface.
0x1E40:004	NWL_IpAddrTable_0h_REC: ReasmMaxSize_U16 <ul style="list-style-type: none"> <li>Read only</li> <li>From version 05.00</li> </ul>	Display of the maximum frame size which can be reconstructed by frames that arrive in a fragmented way.
0x1E40:005	NWL_IpAddrTable_0h_REC: DefaultGateway_IPAD 0 ... [0] ... 4294967295 <ul style="list-style-type: none"> <li>From version 05.00</li> </ul>	Display of the IP address of the router that connects the POWERLINK segment to the higher-level network.



Address	Name / setting range / [default setting]	Information
0x1E4A:001	NWL_IpGroup_REC: Forwarding_BOOL <ul style="list-style-type: none"> <li>• Read only</li> <li>• From version 05.00</li> </ul>	Display whether the IP router function ("Forwarding") is supported or not.
0x1E4A:002	NWL_IpGroup_REC: DefaultTTL_U16 0 ... <b>[64]</b> ... 65535 <ul style="list-style-type: none"> <li>• From version 05.00</li> </ul>	Time-to-live value which is entered into the IP header of frames to be sent. <ul style="list-style-type: none"> <li>• If the frame passes a router or a gateway, the time-to-live value in the IP header is reduced by 1. As soon as the value is set to 0, the frame is not valid anymore and is discarded.</li> </ul>
0x1E4A:003	NWL_IpGroup_REC: ForwardingDatagrams_U32 <ul style="list-style-type: none"> <li>• Read only</li> <li>• From version 05.00</li> </ul>	Display of the number of frames received that were determined for a different IP address. <ul style="list-style-type: none"> <li>• As the device does not support the IP router function, this value is always 0.</li> </ul>

## 12.17.6.4 Declaration of all nodes and their properties

### Parameter

Address	Name / setting range / [default setting]	Information
0x1F81:001 ... 0x1F81:254	NMT_NodeAssignment: Node assignment 1 ... Node assignment 254 0 ... <b>[0]</b> ... 4294967295	Bit coded declaration of the controlled nodes, routers, managing nodes and their properties.  Subindex = node address: <ul style="list-style-type: none"> <li>• 1 ... 239 = controlled nodes with address 1 ... 239</li> <li>• 240 = managing node with standard address 240</li> <li>• 254 = router (type 1) with standard address 254</li> </ul> The single bits have the following meaning: <ul style="list-style-type: none"> <li>• Bit 0 = 1 = isochronous access</li> <li>• Bit 1 = 1 = SDO via UDP/IP</li> <li>• Bit 2 = 1 = SDO via EPL "ASnd"</li> <li>• Bit 3 = 1 = SDO integrated in PDO</li> <li>• Bit 4 = 1 = support of "NMT Info Services"</li> <li>• Bit 5 = 1 = support of extended "NMT State Commands"</li> <li>• Bit 6 = 1 = support of the dynamic PDO mapping</li> <li>• Bit 7 = reserved (no function)</li> <li>• Bit 8 = 1 = configuration manager function</li> <li>• Bit 9 = 1 = isochronous multiplexed access possible</li> <li>• Bit 10 = 1 = address assignment via software</li> <li>• Bit 11 = reserved (no function)</li> <li>• Bit 12 = 1 = device is router (type 1)</li> <li>• Bit 13 = 1 = device is router (type 2)</li> <li>• Bit 14 ... Bit 31 = reserved (no function)</li> </ul>

## 12.17.6.5 Display of the multiplexed cycles of all nodes

### Parameter

Address	Name / setting range / [default setting]	Information
0x1F9B:001 ... 0x1F9B:100	NMT_MultiplCycleAssign_AU8: NMT_MultiplCycleAssign_AU8 1 ... NMT_MultiplCycleAssign_AU8 100 <ul style="list-style-type: none"> <li>• Read only</li> </ul>	Display in which multiplexed cycle the respective controlled node is queried. <ul style="list-style-type: none"> <li>• Subindex 1 ... 100 = node address 1 ... 100</li> <li>• The value must not exceed the setting in <a href="#">0x1F98:007</a>.</li> </ul> Example: <ul style="list-style-type: none"> <li>• <a href="#">0x1F98:007</a> = "3": The multiplexed cycle is repeated every three cycles.</li> <li>• If the value "2" is now entered in 0x1F9B:xxx for a node, it is always only queried in the 2nd of 3 multiplexed cycles.</li> </ul>



## 12.17.6.6 Device identification

For device identification, the inverter provides the parameters listed in the following.

### Parameter

Address	Name / setting range / [default setting]	Information
0x1000	NMT_DeviceType_U32 • Read only • From version 05.00	CANopen device profile according to CANopen specification CiA 301/CiA 402.
0x1008	NMT_ManufactDevName_VS • Read only • From version 05.00	Display of the manufacturer device name.
0x1018:001	NMT_IdentityObject_REC: VendorId_U32 • Read only • From version 05.00	Display of the manufacturer's identification number.

## 12.17.6.7 Error history buffer

### Parameter

Address	Name / setting range / [default setting]	Information
0x1001	ERR_ErrorRegister_U8 • Read only • From version 05.00	Error register
0x1003:001	ERR_History_ADOM: ErrorEntry_DOM 1 • Read only	Error memory • Further information on the error memory can be found in the current Ethernet POWERLINK specification.
0x1003:002	ERR_History_ADOM: ErrorEntry_DOM 2 • Read only	
0x1003:003	ERR_History_ADOM: ErrorEntry_DOM 3 • Read only	
0x1003:004	ERR_History_ADOM: ErrorEntry_DOM 4 • Read only	
0x1003:005	ERR_History_ADOM: ErrorEntry_DOM 5 • Read only	
0x1003:006	ERR_History_ADOM: ErrorEntry_DOM 6 • Read only	
0x1003:007	ERR_History_ADOM: ErrorEntry_DOM 7 • Read only	
0x1003:008	ERR_History_ADOM: ErrorEntry_DOM 8 • Read only	
0x1003:009	ERR_History_ADOM: ErrorEntry_DOM 9 • Read only	
0x1003:010	ERR_History_ADOM: ErrorEntry_DOM 10 • Read only	



## 12.18 PROFINET



PROFINET® (Process Field Network) is a real-time capable network based on Ethernet.

- PROFINET® is a registered trademark and patented technology licensed by the PROFIBUS & PROFINET International (PI) user organization.
- Detailed information on PROFINET can be found on the web page of the user organization: <https://www.profibus.com>
- PROFINET transmits, between the IO-Devices and a IO-Controller (PLC), parameter data, configuration data, diagnostic data, alarm messages, and process data.
- The data is transmitted as a function of its time-critical behavior via corresponding communication channels.
- The device is implemented as a PROFINET IO-Device in a PROFINET RT network.
- The PROFINET connections are realized as standard RJ45 sockets.
- Information about the dimensioning of a PROFINET network can be found in the configuration document.

### Preconditions

- The control unit (CU) of the inverter is provided with PROFINET.
- The required GSDML device description files for PROFINET are installed in the engineering tool for configuring the network.



---

Device description files for Lenze products can be found on the Internet:  
[www.Lenze.com](http://www.Lenze.com) → Downloads → Product-related Application Knowledge Base articles

---

### PROFINET connection

- PROFINET is connected via the RJ45 sockets. **X256** and **X257**.
- An Ethernet cable CAT 5/5e can be used for the connection to the network, 2-pair with AWG22 (American Wire Gauge) or 4-pair with AWG22/24.



---

More information about connections can be found on the Internet:  
[www.profibus.com](http://www.profibus.com) → PROFINET Cabling and Interconnection Technology

---



## Typical topologies

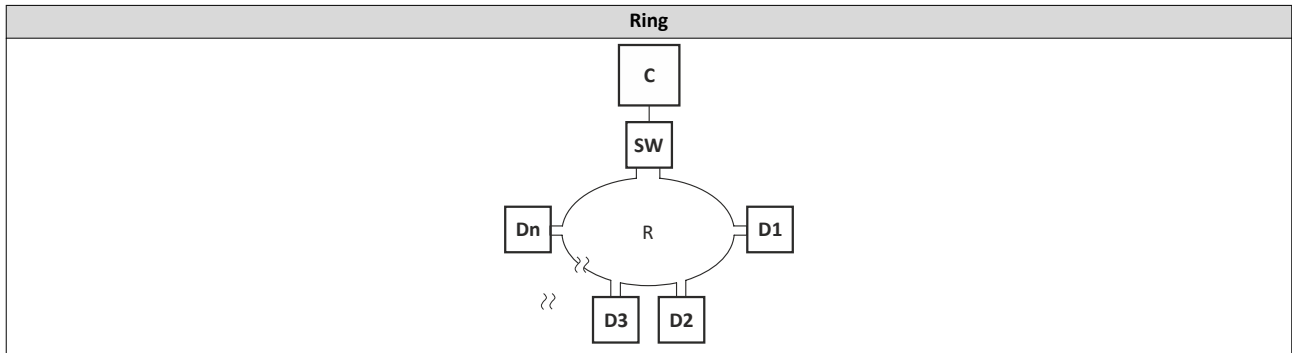
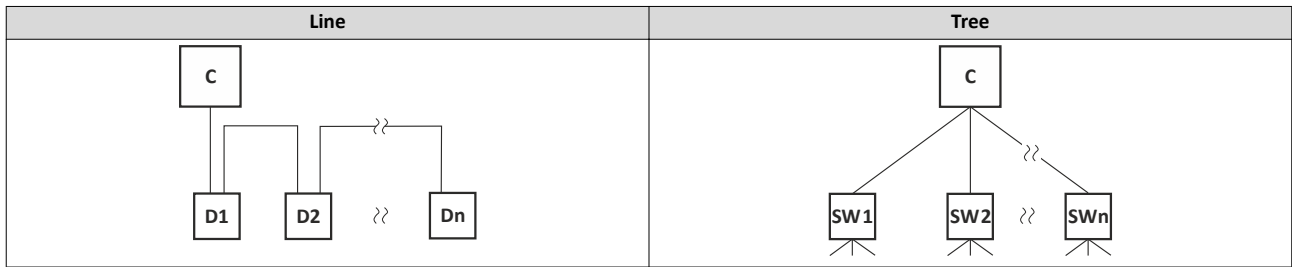

C IO controller  
D IO device

SW Switch SCALANCE (MRP capable)  
R Redundant domain





### 12.18.1 Commissioning

In the following chapters, the steps required for controlling the inverter with a IO-Controller via PROFINET are described.

#### Preconditions

- As an IO-Device, the inverter is connected to an IO-Controller and further PROFINET nodes if required.

See "Typical topologies" under: [► PROFINET !\[\]\(003082e50e3009141f59bd5df831749f\_img.jpg\) 543](#)

- The entire wiring has been checked for completeness, short circuit and earth fault.
- All PROFINET devices are supplied with voltage and are switched on.
- The functional test described in the mounting and switch-on instructions has been completed successfully (without any errors or faults).
- The inverter is commissioned with the »EASY Starter«.
  - [Download »EASY Starter«](#)
- The IO-Controller is commissioned with a different engineering tool, e. g. Siemens »TIA Portal«.

For this purpose, install the required GSDML device description file in the engineering tool for the IO-Controller for configuring the inverter.

We always recommend the use of the current device description.

- [Download of GSDML files](#)
- Please observe the necessary system requirements and the notes regarding the inverter.

[► Device description file !\[\]\(4b7a79268f6ba26c1471d4232fffa85a\_img.jpg\) 547](#)



---

A firmware download from the PLC to the inverter via the network only takes place under the following conditions:

- Required firmware version 05.01.x.x or higher
  - Bootloader version 00.00.00.18 or higher
- 

#### Settings in the »EASY Starter«

1. Activate network control: [0x2631:037 \(P400.37\)](#) = "TRUE [1]"
  2. Set network as standard setpoint source: [0x2860:001 \(P201.01\)](#) = "Network [5]"
- 



In the default setting, the digital input DI1 is assigned the "Run" function. If the network control is activated, this function serves as "start enable" for start commands via network. Hence, the digital input DI1 must be set to the HIGH level in order that the motor can be started via the network.

[► Flexible I/O configuration of the start, stop and rotating direction commands !\[\]\(5a351309c3b87e4420622c1f0e57efc0\_img.jpg\) 67](#)

---

3. Set the IP address and the station name ("PROFINET device name").  
See: [► Station name and IP configuration !\[\]\(fbea698cdd18bad28d8e6b87acf959be\_img.jpg\) 548](#)
4. Adjust data mapping for process data.  
Observe the information about data mapping and the example below:
5. Save the project in the engineering tool.
6. Save the mapping and all other parameters in the inverter [0x2022:003 \(P700.03\)](#) with mains failure protection.

See: [► Saving the parameter settings !\[\]\(23a2e9ddc7bb0ef55393d38b772a848d\_img.jpg\) 45](#)



## Settings in the »Siemens TIA Portal«

Here, commissioning with the »Siemens TIA Portal« is described.



Please note that in the standard setting of the »Siemens TIA Portal« changes of network parameters carried out by a Lenze engineering tool (e. g. »EASY Starter«) may be overwritten.

1. Go to the device configuration and open the "net view" to drag the inverter from the catalog to the net view of the PROFINET.
2. Assign the inverter to the associated IO-Controller.
3. Mark the inverter and change to the "device view".
4. Set the IP address and the station name ("PROFINET device name") in "Properties".



In order that the inverter can be identified via Ethernet when the IO controller is switched off, it is necessary that the IP address is saved in the inverter with mains failure protection via the separate entry with the »EASY Starter«.

Use the [0x2022:003 \(P700.03\)](#) parameter to save the settings. More information:

▶ [Saving the parameter settings](#) 45

5. Below the module name and the name of the device description file, the device view shows the pre-assignment of three output and input process data words:

Module
▼ LENZE-I550-DRIVE_2
▶ IOFW51ARXX
L-Controlword 0x4008:01 _1
Netwfreq. 0.01Hz 0x400B:05 _1
16Bit selectable OUT-Data _1
L-Statusword 0x400A:01 _1
Act.freq. 0.01Hz 0x400C:06 _1
Act.mot.current 0x2D88:00 _1

- Additional process data words can be added or pre-allocated process data words can be changed in the device view.
  - The length of the process data can be selected based on the GSDML device description file.
  - All addresses of the input and output data words must follow each other without interruption.
  - Observe the information about data mapping and the example below:
6. Save the project in the engineering tool.
  7. Load the configuration into the IO-Controller.
  8. Place the IO-Controller in "RUN", e. g. by setting bit 4 in the NetWordIN1 control word ([0x400E:005 \(P505.05\)](#)).
    - The start-up causes the current configuration to be transferred to the inverter.
    - If required, save mapping and all other parameters in the inverter with [0x2022:003 \(P700.03\)](#) with mains failure protection, see ▶ [Saving the parameter settings](#) 45



### Restart or stop communication

The [0x2380 \(P508.00\)](#) parameter can be used to restart or stop communication. Optionally it is also possible to reset all communication parameters to the default status.

A restart of communication is required after changes of the interface configuration (e. g. station address and baud rate) in order that the changed settings become effective.

For restarting communication, there are two options:

1. Switch inverter off and on again.
2. [0x2380 \(P508.00\)](#) Set = 1 (Restart with current values).

#### 12.18.1.1 Restarting or stopping the communication

### Restart or stop communication

The [0x2380 \(P508.00\)](#) parameter can be used to restart or stop communication. Optionally, it is also possible to reset all communication parameters to the last saved state.

A restart of communication is required after changes of the interface configuration (e. g. station address and baud rate) in order that the changed settings become effective.

For restarting communication, there are two options:

1. Switch inverter off and on again.
2. Set [0x2380 \(P508.00\)](#) = 1 (Restart with current values).

### Parameter

Address	Name / setting range / [default setting]	Information
0x2380 (P508.00)	PROFINET communication (PROFINET comm.) • From version 02.00	Restart / stop communication • When the device command has been executed successfully, the value 0 is shown.
	<b>0</b> No action/no error	Only status feedback
	1 Restart with current values	Restart communication with the current values.
	2 Restart with stored values	Restart communication with the values of the PROFINET parameters that have been saved last (0x2381:001 ... 0x2381:009).
	5 Stop network communication	Stop communication
	10 In progress	Only status feedback
	11 Action cancelled	
	12 Fault	

#### 12.18.1.2 Device description file

The device description file must be installed in the engineering tool for configuring the network (e. g. Siemens »TIA Portal«).

- [Download of GSDML files](#)

The name of the device description file is as follows:

"GSDML-V<x>.<zz>-Lenze-I<NNN>PN<Version>-<yyyy><mm><dd>.xml".

Wildcard	Info
x	Major version of the used GSDML scheme
zz	One-digit or two-digit minor version of the used GSDML scheme
NNN	Specifying the inverter name, e. g. i<550>, i<950>, ...
Version	First software version that can be used with this GSDML.
yyyy	Year of publication
mm	Month of publication
dd	Day of publication



## 12.18.2 Basic setting and options

### 12.18.2.1 Station name and IP configuration

The station name and the IP configuration can be assigned by the IO-Controller. These settings enable the IO-Controller to identify the devices in the network and manage the data exchange.

The station name and the IP configuration can also be assigned by the »Engineering Tool«.

- The station name of the IO device must be entered with permissible characters according to the PROFINET specification. [▶ 0x2381:004 \(P510.04\)](#)
- Display of the currently used station name: [▶ 0x2382:004 \(P511.04\)](#)
- The IP configuration comprises the assignments of:
  - IP address [▶ 0x2381:001 \(P510.01\)](#)
  - Subnet mask [▶ 0x2381:002 \(P510.02\)](#)
  - Gateway address [▶ 0x2381:003 \(P510.03\)](#)
- Display of the actual IP configuration: [▶ 0x2382:001 \(P511.01\) ... 0x2382:003 \(P511.03\)](#)



Save the station name and the IP configuration in the IO Device with line voltage failure protection so the IO Device can be identified via PROFINET if the IO controller is switched off. [0x2022:003 \(P700.03\)](#)

[▶ Saving the parameter settings](#) 45



An invalid station name or the assignment of invalid combinations of the IP address, subnet mask, and gateway address can have the consequence that no connection to PROFINET can be established.

In case of impermissible settings, the red LED "bus ERR" is blinking and the error message "PROFINET: Stack initialization error [0x8192]" is output.

[▶ Status LEDs](#) 556

### Parameter

Address	Name / setting range / [default setting]	Information
0x2381:001 (P510.01)	PROFINET settings: IP address (PROFINET sett.: IP address) 0.0.0.0 ... [0.0.0.0] ... 255.255.255.255 • From version 02.00	Set IP address • A changed value will only be effective after the PROFINET communication is restarted ( <a href="#">0x2380 (P508.00)</a> = 1).
0x2381:002 (P510.02)	PROFINET settings: Subnet (PROFINET sett.: Subnet) 0.0.0.0 ... [0.0.0.0] ... 255.255.255.255 • From version 02.00	Set subnet mask • A changed value will only be effective after the PROFINET communication is restarted ( <a href="#">0x2380 (P508.00)</a> = 1).
0x2381:003 (P510.03)	PROFINET settings: Gateway (PROFINET sett.: Gateway) 0.0.0.0 ... [0.0.0.0] ... 255.255.255.255 • From version 02.00	Set gateway address • A changed value will only be effective after the PROFINET communication is restarted ( <a href="#">0x2380 (P508.00)</a> = 1). • The gateway address is valid if the network address of the IP address is identical to the gateway address. In this case, no gateway functionality is used. • DHCP is not supported.
0x2381:004 (P510.04)	PROFINET settings: Station name (PROFINET sett.: Stationsname) • From version 02.00	Set station name • A changed value will only be effective after the PROFINET communication is restarted ( <a href="#">0x2380 (P508.00)</a> = 1).
0x2381:005	PROFINET settings: I&M1 System designation • From version 02.00	Input/output of the I&M1 system designation • The default setting is an empty string.
0x2381:006	PROFINET settings: I&M1 Installation site • From version 02.00	Input/output of the I&M1 location identification code • The default setting is an empty string.
0x2381:007	PROFINET settings: I&M2 Installation date • From version 02.00	Input/output of the I&M2 date of installation • The default setting is an empty string.
0x2381:008	PROFINET settings: I&M3 additional information • From version 02.00	Input/output of the I&M3 additional information • The default setting is an empty string.



Address	Name / setting range / [default setting]	Information
0x2381:009	PROFINET settings: I&M4 signature code <ul style="list-style-type: none"><li>• From version 02.00</li></ul>	Input/output of the I&M4 signature <ul style="list-style-type: none"><li>• The default setting is an empty string.</li></ul>

### 12.18.2.2 Suppress diagnostic messages to the IO controller

Inverter errors and warnings are sent to the IO controller as alarm messages. This function is used to suppress, for example, the fact that the "undervoltage DC link" warning triggers an alarm and the associated control switches to the stop mode if there is no associated alarm block or has been programmed manually. It should be noted here, that an alarm block not programmed in the control can pose risks to the machine. A reduction of possible alarm messages initially helps when the machine is commissioned. Later on, however, more effort should be made to program the alarm blocks.



Please note that an unprogrammed alarm block in the IO controller can pose risks to the machine. A reduction of possible alarm messages initially helps when the machine is commissioned. Later on, however, more effort should be made to program the alarm blocks.

► [0x285A:001](#) serves to set which error response in the device suppresses the alarm message to the IO-Controller.

#### Parameter

Address	Name / setting range / [default setting]	Information	
0x285A:001	Diagnostic configuration: Alarm suppression 0 ... [0] ... 65535 <ul style="list-style-type: none"><li>• From version 05.01</li></ul>	Bit coded selection of error responses which suppress the alarm message to the IO controller. <ul style="list-style-type: none"><li>• Bit x = 1 = suppress alarm message.</li><li>• In the default setting "0", an alarm message is displayed for all error responses.</li></ul>	
	Bit 0		Information
	Bit 1		Warning
	Bit 3		Trouble
	Bit 7		Fault > inverter disabled



## 12.18.3 Process data transfer

The process data is used to control the inverter.

- The process data is transmitted cyclically between the IO-Controller and the IO-Devices participating in PROFINET.
- The process data can be directly accessed by the IO controller. The data in the PLC, for instance, are directly stored in the I/O area.
- The available 27 network registers ("slots") serve to maximally exchange 16 process data words (data types 8-bit or 16-bit) or 8 process data double words (data type 32-bit) for each direction.
- Output data direction: From IO-Controller to IO-Device.
- Input data direction: From IO-Device to IO-Controller.

### Data mapping

Data mapping is used to define which process data is exchanged cyclically between IO-Controller and IO-Device.

- If the inverter is known as IO-Device in the PROFINET network and the IO-Controller connects to the inverter for the first time, the mapping objects are automatically transmitted to the inverter.
- Internal mapping of the process output data: [0x24E0:001 ... 0x24E0:016](#)
- Internal mapping of the process input data: [0x24E1:001 ... 0x24E1:016](#)



---

All subsequent changes in the objects 0x24E0 and 0x24E1 can cause PROFINET alarms according to the deviation from the automatically set configurations.

---



## RPDO mapping



The assignment of different bits with the same function is not permissible.

For the process data from the IO-Controller to the inverter, this data mapping is preset in the device description file:

1. NetWordIN1 data word [0x4008:001 \(P590.01\)](#)
2. Network setpoint frequency (0.01) [0x400B:005 \(P592.05\)](#)
3. 16 bit selectable output data, mapped to: "Keypad setpoints: Process controller setpoint" [0x2601:002 \(P202.02\)](#)

### Function assignment of the NetWordIN1 data word

Bit	Default setting	For details and configuration, see
0	Not active (reserve)	<a href="#">0x400E:001 (P505.01)</a>
1	Not active (reserve)	<a href="#">0x400E:002 (P505.02)</a>
2	Activate quick stop	<a href="#">0x400E:003 (P505.03)</a>
3	Not active (reserve)	<a href="#">0x400E:004 (P505.04)</a>
4	Run forward (CW)	<a href="#">0x400E:005 (P505.05)</a>
5	Activate preset (bit 0)	<a href="#">0x400E:006 (P505.06)</a>
6	Activate preset (bit 1)	<a href="#">0x400E:007 (P505.07)</a>
7	Reset error	<a href="#">0x400E:008 (P505.08)</a>
8	Not active (reserve)	<a href="#">0x400E:009 (P505.09)</a>
9	Activate DC braking	<a href="#">0x400E:010 (P505.10)</a>
10	Not active (reserve)	<a href="#">0x400E:011 (P505.11)</a>
11	Not active (reserve)	<a href="#">0x400E:012 (P505.12)</a>
12	Reverse rotational direction	<a href="#">0x400E:013 (P505.13)</a>
13	Not active (reserve)	<a href="#">0x400E:014 (P505.14)</a>
14	Not active (reserve)	<a href="#">0x400E:015 (P505.15)</a>
15	Not active (reserve)	<a href="#">0x400E:016 (P505.16)</a>

### Specifying the frequency setpoint

- The specification is made unsigned (independent of the direction of rotation) as integer in the resolution [0.01 Hz].
- The direction of rotation is defined in the default setting via bit 12 of the NetWordIN1 data word.
- Example: 4560 = 45.60 Hz



## TPDO mapping



The assignment of different bits with the same function is not permissible.

For the process data from the inverter to the IO-Controller, the following data mapping is preset in the device description file:

1. NetWordOUT1 data word [0x400A:001 \(P591.01\)](#)
2. Frequency (0.01) [0x400C:006 \(P593.06\)](#)
3. Motor current [0x2D88 \(P104.00\)](#)

### Status assignment of the NetWordOUT1 data word

Bit	Default setting	For details and configuration, see
0	Ready for operation	<a href="#">0x2634:010 (P420.10)</a>
1	Not connected	<a href="#">0x2634:011 (P420.11)</a>
2	Operation enabled	<a href="#">0x2634:012 (P420.12)</a>
3	Fault active	<a href="#">0x2634:013 (P420.13)</a>
4	Not connected	<a href="#">0x2634:014 (P420.14)</a>
5	Quick stop active	<a href="#">0x2634:015 (P420.15)</a>
6	Running	<a href="#">0x2634:016 (P420.16)</a>
7	Device warning active	<a href="#">0x2634:017 (P420.17)</a>
8	Not connected	<a href="#">0x2634:018 (P420.18)</a>
9	Not connected	<a href="#">0x2634:019 (P420.19)</a>
10	Setpoint speed reached	<a href="#">0x2634:020 (P420.20)</a>
11	Current limit reached	<a href="#">0x2634:021 (P420.21)</a>
12	Actual speed = 0	<a href="#">0x2634:022 (P420.22)</a>
13	Rotational direction reversed	<a href="#">0x2634:023 (P420.23)</a>
14	Release holding brake	<a href="#">0x2634:024 (P420.24)</a>
15	Inverter disabled (safety)	<a href="#">0x2634:025 (P420.25)</a>

### Output of the actual frequency value

- The output is made unsigned (independent of the direction of rotation) as integer in the resolution [0.01 Hz].
- An active reversal is displayed via bit 13 of the NetWordOUT1 data word.
- Example: 4560 = 45.60 Hz





## Example for changing a pre-assigned mapping

The assignment of the third output word is to be changed. Due to the device description file, this output word (designation "16 bit selectable OUT-data\_1") has already been assigned with the keypad setpoint.

The keypad setpoint is to be replaced by the acceleration ramp.

1. Mark the 3rd output word in the "Device view".
2. Select the "Module parameter" dialog in "Properties".
  - a) Display in "Index": 9729 (decimal form of the index 0x2601)
  - b) Display in "Subindex": 2
3. Replace the keypad setpoint in [0x2601:002 \(P202.02\)](#) with the acceleration ramp in [0x2917 \(P220.00\)](#).
  - a) Check whether mapping is permitted for the current parameter to be mapped and the data type is complied with.  
For this, see: [▶ Parameter attribute list](#) [□ 731](#)
  - b) Entry in "Index": 10519 (decimal form of the index 0x2917)
  - c) Entry in "Subindex": 0



---

The acceleration time must be defined later, e. g. at the FB LCB\_ActuatorSpeed, input wFreeCtrl, with the factor 10 (10 s = 100).

---



## 12.18.4 Parameter data transfer

Data communication with PROFINET is characterised by the simultaneous operation of cyclic and acyclic services in the network. As an optional extension, the parameter data transfer belongs to the acyclic services, which provides access to all device parameters.

### Details

- The access to the device data depends on the PROFIdrive profile.
- Only one parameter request is processed at a time (no pipelining).
- No spontaneous messages are transferred.
- There are only acyclic parameter requests.

Basically, a IO-Controller can always be used to request parameters from IO-Device if the IO-Device is in the DATA\_EXCHANGE state.

### Transmission directions for acyclic data transfer

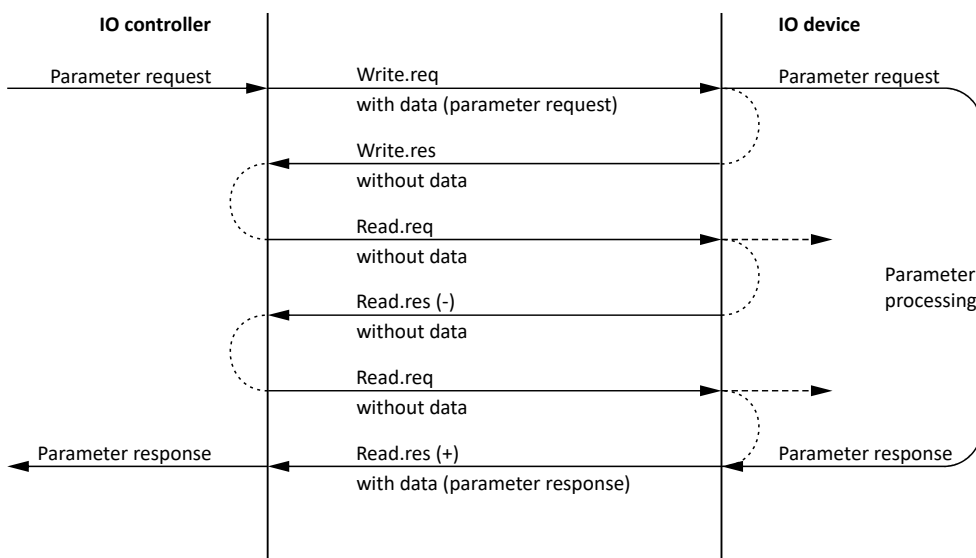

1. A "Write.req" is used to transmit the data set (DB47) as parameter request to the IO-Device.
2. "Write.res" is used to confirm the input of the message for IO-Controller.
3. With Read.req, the IO-Controller requests the response of the IO-Device
4. The IO-Device responds with a "Read.res (-)" if processing has not been completed yet.
5. After parameter processing, the parameter request is completed by transmitting the parameter response to the IO-Controller by "Read.res (+)".

### Frame structure

Destr	ScrAddr	VLAN	Type 0x0800	RPC	NDR	Read/Write Block	Data	FCS
6 bytes	6 bytes	4 bytes	4 bytes	80 bytes	64 bytes	64 bytes	0 ... 240 bytes	4 bytes

In the "Read / Write Block field", the initiator specifies the access to the "DB47" data set. The data that is written on this index or read by it, contain a header and the parameter request or the parameter response. The read data or the data to be written are contained in the "Data" field.



## Assignment of the user data depending on the data type

Depending on the data type used, the user data is assigned as follows:

Data type	Length	User data assignment				
		Byte 1	Byte 2	Byte 3	Byte 4	Byte ...
String	x bytes	Data (x bytes)				
U8	1 byte	Data	0x00			
U16	2 bytes	HIGH byte	LOW byte			
		Data	Data			
U32	4 bytes	HIGH word		LOW word		
		HIGH byte	LOW byte	HIGH byte	LOW byte	
		Data	Data	Data	Data	

## 12.18.5 Monitoring

The parameters for setting network monitoring functions are described below.

### Parameter

Address	Name / setting range / [default setting]	Information
0x2859:001 (P515.01)	PROFINET monitoring: Watchdog elapsed (PROFINET monit.: WD elapsed) • From version 02.00	Selection of the response to a permanent interruption of the communication to the IO controller. Corresponding error code: 33168   0x8190 "PROFINET: Watchdog time-out"  Associated event ID: • 33168   0x8190 - Network - Watchdog time-out
	0 No response	▶ Severity <a href="#">700</a>
	1 Warning	
	2 <b>Trouble</b>	
	3 Fault	
0x2859:002 (P515.02)	PROFINET monitoring: Data exchange exited (PROFINET monit.: Data exch.exited)	Selection of the response to exiting the "Data Exchange" state.
	0 <b>No response</b>	▶ Severity <a href="#">700</a>
	1 Warning	
	2 Trouble	
	3 Fault	
0x2859:003 (P515.03)	PROFINET monitoring: Invalid configuration (PROFINET monit.: Invalid config) • From version 02.00	Selection of the response triggered by the reception of invalid configuration data.  Associated event ID: • 33414   0x8286 - Network - PDO mapping error
	0 No response	▶ Severity <a href="#">700</a>
	1 Warning	
	2 <b>Trouble</b>	
	3 Fault	
0x2859:004 (P515.04)	PROFINET monitoring: Initialisation error (PROFINET monit.: Init. error) • From version 02.00	Selection of the response triggered by the occurrence of an error during the initialisation of the network component.  Associated event ID: • 33170   0x8192 - Network - Initialization error
	0 No response	▶ Severity <a href="#">700</a>
	1 Warning	
	2 <b>Trouble</b>	
	3 Fault	





Address	Name / setting range / [default setting]	Information	
0x2859:005 (P515.05)	PROFINET monitoring: Invalid process data (PROFINET monit.: Inval. proc.data)	Process data marked as invalid (IOPS is "BAD") are received by the IO Controller. Typically in case of <ul style="list-style-type: none"> <li>• a PLC in STOP state,</li> <li>• alarms,</li> <li>• acyclic demand data.</li> </ul> Selection of the response triggered by the reception of invalid process data.  Associated event ID: <ul style="list-style-type: none"> <li>• <a href="#">33171</a>   <a href="#">0x8193</a> - Network - Invalid cyclic process data</li> </ul>	
	0 No response		▶ Severity <a href="#">700</a>
	1 Warning		
	<b>2 Trouble</b>		
	3 Fault		



## 12.18.6 Diagnostics

### 12.18.6.1 Status LEDs

Notes on the connection status with IO-Controller can be obtained via the LEDs "BUS RDY" and "BUS ERR" of the PROFINET option (front of the device).

In addition, the LEDs "L/A" at the RJ45 sockets indicate the connection status to the network.

"BUS RDY" LED (green)	State	Meaning
Off	Not connected	No connection to the IO-Controller
 Blinking	Connected	IO-Controller in STOP
 On	Data exchange	IO-Controller in RUN (DATA_EXCHANGE)

"BUS ERR" LED (red)	State	Meaning
Off	No fault	No fault
 Blinking fast	IO-Device identifies (localises)	The PROFINET function "node flashing test" is triggered by IO-Controller. The flickering LED serves to identify (locate) an accessible IO-Device.
 Blinking	Impermissible settings	Impermissible settings: Stack, station name or IP parameters are invalid.
 On (red)	Fault	Communication error (e. g. Ethernet cable removed)

LED "L" (Link, green)	Status	Meaning
Off	Not connected	No connection to the network
 On	Connected	A physical connection to the network is available

LED "A" (Activity, yellow)	Status	Meaning
 On or flickers	Traffic	Data is exchanged via the network

### 12.18.6.2 Information on the network

The following parameters show information on the network.

#### Parameter

Address	Name / setting range / [default setting]	Information
0x2382:001 (P511.01)	Active PROFINET settings: IP address (PROFINET diag.: IP address)	Display of the active IP address.
	<ul style="list-style-type: none"> <li>• Read only</li> <li>• From version 02.00</li> </ul>	



# Configuring the network

PROFINET  
Diagnostics  
Information on the network

Address	Name / setting range / [default setting]	Information
0x2382:002 (P511.02)	Active PROFINET settings: Subnet (PROFINET diag.: Subnet) • Read only • From version 02.00	Display of the active subnet mask.
0x2382:003 (P511.03)	Active PROFINET settings: Gateway (PROFINET diag.: Gateway) • Read only • From version 02.00	Display of the gateway address.
0x2382:004 (P511.04)	Active PROFINET settings: Station name (PROFINET diag.: Station name) • Read only • From version 02.00	Display of the active station name.
0x2382:005 (P511.05)	Active PROFINET settings: MAC Address (PROFINET diag.: MAC Address) • Read only • From version 02.00	Display of the active MAC address.
0x2388 (P516.00)	PROFINET status (PROFINET status) • Read only • From version 02.00	Bit coded display of the current Bus status.
	Bit 0 Initialized	The network component is initialised.
	Bit 1 Online	After initialisation, the network component waits for a communication partner and the system power-up.
	Bit 2 Connected	The network component has established a cyclic I/O communication relationship to a communication partner.
	Bit 3 IP address error	The IP address is invalid. Valid IP addresses are defined according to RFC 3330.
	Bit 4 Hardware fault	
	Bit 6 Watchdog elapsed	PROFINET communication is continuously interrupted in the "Data_Exchange" state, e.g. by cable break or failure of the IO Controller. • PROFINET communication changes to the "No_Data_Exchange" state. When the watchdog monitoring time specified by the IO Controller has elapsed, the response set in 0x2859:001 (P515.01) is triggered in the inverter.
	Bit 7 Protocol error	
	Bit 8 PROFINET stack ok	
	Bit 9 PROFINET stack not configured	
Bit 10 Ethernet controller fault		
Bit 11 UDP stack fault		
0x2389:001 (P517.01)	PROFINET error: Error 1 (PROFINET error: Error 1) • Read only • From version 02.00	The parameter currently contains the error detected on the network. • The error values may occur in combination with the error values from parameter 0x2389:002 (P517.02).
	0 No error	
	1 Reserved	
	2 Unit ID unknown	
	3 Max. units exceeded	
	4 Invalid size	
	5 Unit type unknown	
	6 Runtime plug error	
	7 Invalid argument	
	8 Service pending	
	9 Stack not ready	
	10 Command unknown	
	11 Invalid address descriptor	

# Configuring the network

PROFINET  
PROFlenergy  
Supported measured values



Address	Name / setting range / [default setting]	Information
0x2389:002 (P517.02)	PROFINET error: Error 2 (PROFINET error: Error 2)	The parameter currently contains the error detected on the network. <ul style="list-style-type: none"> <li>The error values may occur in combination with the error values from parameter <a href="#">0x2389:001 (P517.01)</a>.</li> </ul>
	Bit 7 IP address error	The IP address is invalid. Valid IP addresses are defined according to RFC 3330.
	Bit 8 Station name problem	The station name must be assigned according to the PROFINET specification.
	Bit 9 DataExch left	PROFINET communication is continuously interrupted in the "Data_Exchange" state, e. g. by cable break. <ul style="list-style-type: none"> <li>PROFINET communication changes to the "No_Data_Exchange" state.</li> <li>When the watchdog monitoring time specified by the IO Controller has elapsed, the response set in <a href="#">0x2859:001 (P515.01)</a> is triggered in the device.</li> </ul>
	Bit 10 Stack boot error	
	Bit 11 Stack online error	
	Bit 12 Stack state error	
	Bit 13 Stack revision error	
Bit 14 Initialization problem	The stack cannot be initiated with the user specifications. A reason might be, e. g., a station name that does not correspond to the PROFINET specification.	
Bit 15 Stack init error		

## 12.18.7 PROFlenergy

### 12.18.7.1 Supported measured values

#### Parameter

Address	Name / setting range / [default setting]	Information
0x2DA2:001 (P108.01)	Output power: Effective power (Output power: Effective power)	Display of the active output power for an energy analysis in the respective application.
0x2DA2:002 (P108.02)	Output power: Apparent power (Output power: Apparent power)	Display of the apparent output power for an energy analysis in the respective application.
0x2DA3:001 (P109.01)	Output energy: Motor (Output energy: Motor)	Display of the output power in motor mode for an energy analysis in the respective application.
0x2DA3:002 (P109.02)	Output energy: Generator (Output energy: Generator)	Display of the output power in generator mode for an energy analysis in the respective application.



## 12.19 Internal mapping of the process data

The data mapping defines which process data are cyclically exchanged between network master and inverter.



The assignment of the network registers and the number of data words that can be transmitted cyclically varies according to the network/communication protocol. You can find detailed information in the documentation for the respective communication protocol.

For the EtherNet/IP, PROFIBUS, PROFINET and IO-Link networks, the internal mapping of the process data is set in the following parameters.

### Parameter

Address	Name / setting range / [default setting]	Information
0x24E0:000	Generic RPDO mapping: Highest subindex 0 ... [2] ... 16 • From version 02.00	Number of mapping entries for RPDO.
0x24E0:001	Generic RPDO mapping: Entry 1 0x00000000 ... [0x60400010] ... 0xFFFFFFFF • From version 02.00	Mapping entry 1 for RPDO.
0x24E0:002	Generic RPDO mapping: Entry 2 0x00000000 ... [0x60420010] ... 0xFFFFFFFF • From version 02.00	Mapping entry 2 for RPDO.
0x24E0:003	Generic RPDO mapping: Entry 3 0x00000000 ... [0x00000000] ... 0xFFFFFFFF • From version 02.00	Mapping entry 3 for RPDO.
0x24E0:004	Generic RPDO mapping: Entry 4 0x00000000 ... [0x00000000] ... 0xFFFFFFFF • From version 02.00	Mapping entry 4 for RPDO.
0x24E0:005	Generic RPDO mapping: Entry 5 0x00000000 ... [0x00000000] ... 0xFFFFFFFF • From version 02.00	Mapping entry 5 for RPDO.
0x24E0:006	Generic RPDO mapping: Entry 6 0x00000000 ... [0x00000000] ... 0xFFFFFFFF • From version 02.00	Mapping entry 6 for RPDO.
0x24E0:007	Generic RPDO mapping: Entry 7 0x00000000 ... [0x00000000] ... 0xFFFFFFFF • From version 02.00	Mapping entry 7 for RPDO.
0x24E0:008	Generic RPDO mapping: Entry 8 0x00000000 ... [0x00000000] ... 0xFFFFFFFF • From version 02.00	Mapping entry 8 for RPDO.
0x24E0:009	Generic RPDO mapping: Entry 9 0x00000000 ... [0x00000000] ... 0xFFFFFFFF • From version 02.00	Mapping entry 9 for RPDO.
0x24E0:010	Generic RPDO mapping: Entry 10 0x00000000 ... [0x00000000] ... 0xFFFFFFFF • From version 02.00	Mapping entry 10 for RPDO.
0x24E0:011	Generic RPDO mapping: Entry 11 0x00000000 ... [0x00000000] ... 0xFFFFFFFF • From version 02.00	Mapping entry 11 for RPDO.
0x24E0:012	Generic RPDO mapping: Entry 12 0x00000000 ... [0x00000000] ... 0xFFFFFFFF • From version 02.00	Mapping entry 12 for RPDO.
0x24E0:013	Generic RPDO mapping: Entry 13 0x00000000 ... [0x00000000] ... 0xFFFFFFFF • From version 02.00	Mapping entry 13 for RPDO.
0x24E0:014	Generic RPDO mapping: Entry 14 0x00000000 ... [0x00000000] ... 0xFFFFFFFF • From version 02.00	Mapping entry 14 for RPDO.

# Configuring the network

## Internal mapping of the process data



Address	Name / setting range / [default setting]	Information
0x24E0:015	Generic RPDO mapping: Entry 15 0x00000000 ... [0x00000000] ... 0xFFFFFFFF • From version 02.00	Mapping entry 15 for RPDO.
0x24E0:016	Generic RPDO mapping: Entry 16 0x00000000 ... [0x00000000] ... 0xFFFFFFFF • From version 02.00	Mapping entry 16 for RPDO.
0x24E1:000	Generic TPDO mapping: Highest subindex 0 ... [3] ... 16 • From version 02.00	Number of mapping entries for TPDO.
0x24E1:001	Generic TPDO mapping: Entry 1 0x00000000 ... [0x60410010] ... 0xFFFFFFFF • From version 02.00	Mapping entry 1 for TPDO.
0x24E1:002	Generic TPDO mapping: Entry 2 0x00000000 ... [0x60440010] ... 0xFFFFFFFF • From version 02.00	Mapping entry 2 for TPDO.
0x24E1:003	Generic TPDO mapping: Entry 3 0x00000000 ... [0x603F0010] ... 0xFFFFFFFF • From version 02.00	Mapping entry 3 for TPDO.
0x24E1:004	Generic TPDO mapping: Entry 4 0x00000000 ... [0x00000000] ... 0xFFFFFFFF • From version 02.00	Mapping entry 4 for TPDO.
0x24E1:005	Generic TPDO mapping: Entry 5 0x00000000 ... [0x00000000] ... 0xFFFFFFFF • From version 02.00	Mapping entry 5 for TPDO.
0x24E1:006	Generic TPDO mapping: Entry 6 0x00000000 ... [0x00000000] ... 0xFFFFFFFF • From version 02.00	Mapping entry 6 for TPDO.
0x24E1:007	Generic TPDO mapping: Entry 7 0x00000000 ... [0x00000000] ... 0xFFFFFFFF • From version 02.00	Mapping entry 7 for TPDO.
0x24E1:008	Generic TPDO mapping: Entry 8 0x00000000 ... [0x00000000] ... 0xFFFFFFFF • From version 02.00	Mapping entry 8 for TPDO.
0x24E1:009	Generic TPDO mapping: Entry 9 0x00000000 ... [0x00000000] ... 0xFFFFFFFF • From version 02.00	Mapping entry 9 for TPDO.
0x24E1:010	Generic TPDO mapping: Entry 10 0x00000000 ... [0x00000000] ... 0xFFFFFFFF • From version 02.00	Mapping entry 10 for TPDO.
0x24E1:011	Generic TPDO mapping: Entry 11 0x00000000 ... [0x00000000] ... 0xFFFFFFFF • From version 02.00	Mapping entry 11 for TPDO.
0x24E1:012	Generic TPDO mapping: Entry 12 0x00000000 ... [0x00000000] ... 0xFFFFFFFF • From version 02.00	Mapping entry 12 for TPDO.
0x24E1:013	Generic TPDO mapping: Entry 13 0x00000000 ... [0x00000000] ... 0xFFFFFFFF • From version 02.00	Mapping entry 13 for TPDO.
0x24E1:014	Generic TPDO mapping: Entry 14 0x00000000 ... [0x00000000] ... 0xFFFFFFFF • From version 02.00	Mapping entry 14 for TPDO.
0x24E1:015	Generic TPDO mapping: Entry 15 0x00000000 ... [0x00000000] ... 0xFFFFFFFF • From version 02.00	Mapping entry 15 for TPDO.
0x24E1:016	Generic TPDO mapping: Entry 16 0x00000000 ... [0x00000000] ... 0xFFFFFFFF • From version 02.00	Mapping entry 16 for TPDO.





## 13 Device functions

### 13.1 Optical device identification

For applications including several interconnected inverters it may be difficult to locate a device that has been connected online. The "Optical device identification" function serves to locate the inverter by means of blinking LEDs.

#### Details

In order to start the visual tracking,

- click the button in the toolbar of the »EASY Starter«  or
- set `0x2021:001 (P230.01)` = "Start [1]".

After the start, both LEDs "RDY" and "ERR" on the front of the inverter synchronously blink very fast.

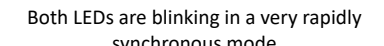
"RDY" LED (blue)	"ERR" LED (red)	Status/meaning
		"Visual tracking" function is active.
Both LEDs are blinking in a very rapidly synchronous mode		

The blinking duration can be set in `0x2021:002 (P230.02)` or selected in the »EASY Starter« in the dropdown list field:

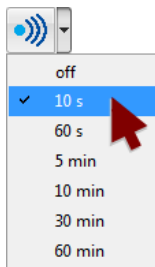

#### Parameter

Address	Name / setting range / [default setting]	Information
0x2021:001 (P230.01)	Optical tracking: Start detection (Optical tracking: Start detection)	1 = start optical device identification. <ul style="list-style-type: none"> <li>• After the start, the two LEDs "RDY" and "ERR" on the front of the inverter are blinking with a blinking frequency of 20 Hz for the blinking duration set in <code>0x2021:002 (P230.02)</code>. The setting is then automatically reset to "0" again.</li> <li>• If the function is reactivated within the blinking time set, the time is extended correspondingly.</li> <li>• A manual reset to "0" makes it possible to stop the function prematurely.</li> </ul>
	<b>0</b> Stop	
	1 Start	
0x2021:002 (P230.02)	Optical tracking: Blinking duration (Optical tracking: Blink. duration) 0 ... [5] ... 3600 s	Setting of the blinking duration for the visual tracking.



## 13.2 Reset parameters to default

With the "Load default settings" device command, all parameters can be reset to the default setting.



By executing this device command, all parameter settings made by the user are lost!

### Details

- All current parameters in the RAM memory of the device are overwritten by the default parameters stored in the firmware. The persistent parameters in the memory module remain unaffected by this measure.

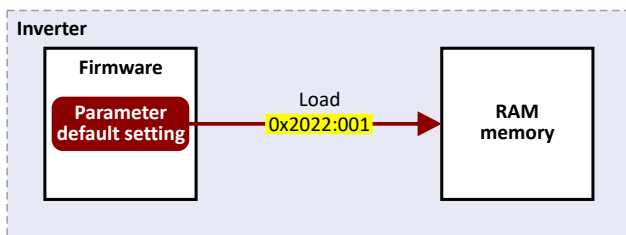

- Afterwards, the device can be parameterized again on the basis of this initial state.
- Typical application: Incorrect or unknown parameter settings.
- The device command only has an effect on the RAM. For a permanent acceptance of the changes made, the data must subsequently be saved in memory. [▶ Saving/loading the parameter settings](#) 564

### Parameter

Address	Name / setting range / [default setting]	Information
0x2022:001 (P700.01)	Device commands: Load default settings (Device commands: Load def. sett.) <ul style="list-style-type: none"> <li>Setting can only be changed if the inverter is disabled.</li> </ul>	1 = reset all parameters in the RAM memory of the inverter to the default setting that is stored in the inverter firmware. <ul style="list-style-type: none"> <li>All parameter changes made by the user are lost during this process!</li> <li>It may take some seconds to execute the task. When the task has been executed successfully, the value 0 is shown.</li> <li>Loading parameters has a direct effect on the cyclic communication: The data exchange for control is interrupted and a communication error is generated.</li> </ul>
	<b>0</b> Off / ready	Only status feedback
	1 On / start	Execute device command
	2 In progress	Only status feedback
	3 Action cancelled	
	4 No access	
	5 No access (Device disabled)	



### 13.2.1 Configure reset behaviour

Customers who set their IP address/baud configuration using DIP switches will lose these settings if they load the preset from [0x2022:001 \(P700.01\)](#).

For some customers it is a common method to always have the same starting conditions of the parameters.

This function allows a user to exclude certain parameter groups from being reset to the default settings using the "Load default settings" device command.

#### Details

By default, all parameters are reset when the default settings are loaded.

▶ [0x2022:001 \(P700.01\)](#)

The user can reconfigure this function.

▶ [0x2024:001](#)

Thus, certain parameter groups can be excluded.

The following cannot be selected for the reset:

- address of the communication bus,
- data format,
- baud rate,
- subnet mask,

and for WLAN:

- channel,
- safety,
- network password,
- SSID name.

Your setting values remain stored.

Please make sure that bit 0 must be set to 1 in the parameter [0x2024:001](#) before executing the default settings in order that the network parameters are excluded from the reset.

Note that the purpose of this function is to enable the master to restore the connection to an inverter after loading the default settings. Because all data mapping and functional settings are reset, the user must let the master reconfigure the settings of the inverter before it operates the inverter.

#### Parameter

Address	Name / setting range / [default setting]	Information
0x2024:001	Special settings: Configure default setting 0 ... [0] ... 65535	By default, all parameters are reset when the default settings are loaded (0x2022: 001). The user has the option of reconfiguring this function with the parameter. This allows certain parameter groups to be excluded.
	Bit 0 Exclude network	1 = Exclude network parameters: <ul style="list-style-type: none"> <li>• Address of the communication bus, data format, baud rate and subnet mask.</li> <li>• For WLAN: SSID, password, security and channel.</li> </ul>
	Bit 1 Exclude internal registers	1 = Exclude internal registers.



## 13.3 Saving/loading the parameter settings

If parameter settings of the inverter are changed, these changes at first are only made in the RAM memory of the inverter. In order to save the parameter settings with mains failure protection, the inverter is provided with a pluggable memory module and corresponding device commands.

### Details

The memory module is provided with two memories, the user memory and the OEM memory.

#### User memory

The user memory is used as power-failure-proof storage of parameter settings made by the user during commissioning/operation.

- The SET display blinks on the keypad if a parameter setting has been changed but has not been saved in the memory module with mains failure protection. In order to save parameter settings in the user memory of the memory module, press and hold the enter key for longer than 3 s.

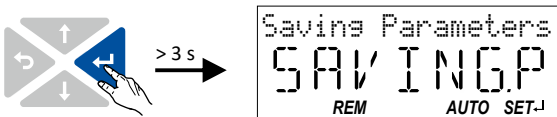

- Parameter settings carried out with »EASY Starter« or via network must be explicitly saved in the user memory by means of the "Save user data" device command, so that the changes carried out are not lost when the mains of the inverter are switched.
- Saving can also be made in the »EASY Starter« via the button or the <F6> function key.
- The device command "Load user data" serves to reload the data from the user memory into the RAM.

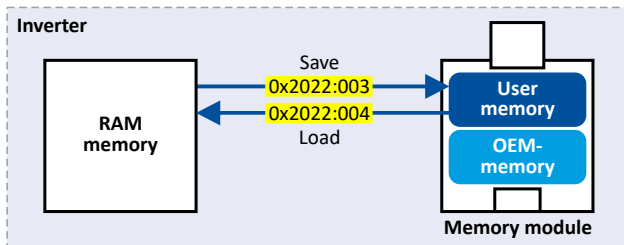

#### OEM memory

The OEM memory is provided for the storage of customised parameter settings by the OEM/engineer. If the user carries out parameter settings with the keypad, they are always saved in the user memory if the enter key is pressed and held for longer than 3 s. The OEM memory remains unaffected by these changes.

- With the "Load OEM data" device command, the parameter settings preconfigured by the OEM/engineer can be reloaded to the RAM memory of the inverter at any time if required.
- For saving parameter settings in the OEM memory, the "Save OEM data" device command must be executed explicitly. The parameter settings are simultaneously saved in the user memory.

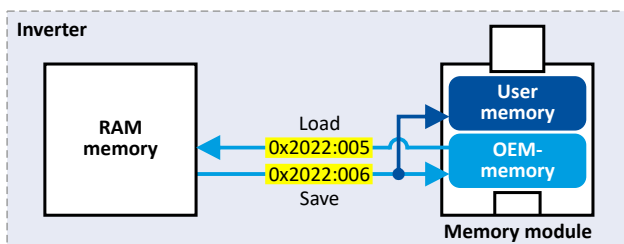



## Response after initial switch-on of the inverter

After switch-on, the inverter first tries to load the parameter settings stored in the user memory. If the user memory is empty or damaged, an error message is output and the user must intervene:

- Case 1 = user memory empty: → default setting is loaded automatically from the firmware → data are saved automatically in the user memory of the memory module.
- Case 2 = user memory damaged: → Error message → default setting is loaded automatically → data are saved automatically in the user memory of the memory module.
- Case 3 = OEM memory empty/damaged: → error message → data are loaded automatically from the user memory of the memory module.

## Parameter

Address	Name / setting range / [default setting]	Information
0x2022:003 (P700.03)	Device commands: Save user data (Device commands: Save user data)	1 = save current parameter settings in the user memory of the memory module with mains failure protection. <ul style="list-style-type: none"> <li>• This process may take some seconds. When the device command has been executed successfully, the value 0 is shown.</li> <li>• Do not switch off the supply voltage during the saving process and do not unplug the memory module from the device!</li> <li>• When the device is switched on, all parameters are automatically loaded from the user memory of the memory module to the RAM memory of the device.</li> </ul>
	<b>0</b> Off / ready	Only status feedback
	1 On / start	Execute device command
	2 In progress	Only status feedback
	3 Action cancelled	
	4 No access	
5 No access (Device disabled)		
0x2022:004 (P700.04)	Device commands: Load user data (Device commands: Load user data) <ul style="list-style-type: none"> <li>• Setting can only be changed if the inverter is disabled.</li> </ul>	1 = load data from the user memory of the memory module to the RAM memory of the inverter. <ul style="list-style-type: none"> <li>• When the device command has been executed successfully, the value 0 is shown.</li> <li>• Loading parameters has a direct effect on the cyclic communication: The data exchange for control is interrupted and a communication error is generated.</li> </ul>
	<b>0</b> Off / ready	Only status feedback
	1 On / start	Execute device command
	2 In progress	Only status feedback
	3 Action cancelled	
	4 No access	
5 No access (Device disabled)		
0x2022:005 (P700.05)	Device commands: Load OEM data (Device commands: Load OEM data) <ul style="list-style-type: none"> <li>• Setting can only be changed if the inverter is disabled.</li> </ul>	1 = load data from the OEM memory of the memory module to the RAM memory of the inverter. <ul style="list-style-type: none"> <li>• When the device command has been executed successfully, the value 0 is shown.</li> <li>• Loading parameters has a direct effect on the cyclic communication: The data exchange for control is interrupted and a communication error is generated.</li> </ul>
	<b>0</b> Off / ready	Only status feedback
	1 On / start	Execute device command
	2 In progress	Only status feedback
	3 Action cancelled	
	4 No access	
5 No access (Device disabled)		

# Device functions

Saving/loading the parameter settings



Address	Name / setting range / [default setting]	Information
0x2022:006 (P700.06)	Device commands: Save OEM data (Device commands: Save OEM data)	1 = save current parameter settings in the OEM memory of the memory module with mains failure protection. <ul style="list-style-type: none"><li>• At the same time, the parameter settings are saved in the main memory of the memory module.</li><li>• When the device command has been executed successfully, the value 0 is shown.</li></ul>
	<b>0</b> Off / ready	Only status feedback
	<b>1</b> On / start	Execute device command
	<b>2</b> In progress	Only status feedback
	<b>3</b> Action cancelled	
	<b>4</b> No access	
	<b>5</b> No access (Device disabled)	

## Related topics

► [Behaviour of the inverter in case of incompatible data in the memory module](#) 583



## 13.4 Access protection

### 13.4.1 Write access protection

Optionally a write access protection can be installed for the inverter parameters.



Write access protection via network is not restricted. Irrespective of the write access protection that is currently set, a higher-level controller, OPC-UA server, or any other communication partner connected to the inverter is always provided with full read/write access to all parameters of the inverter.



After activating the write access protection, you have to enter a valid PIN to remove the write access protection. Note down the defined PIN(s) and keep this information in a safe place! If you lose the PIN(s), the inverter can only be disabled by resetting it to the delivery status. This means, all parameter settings made by the user get lost! [▶ Reset parameters to default](#) 562

#### Details

Usually the write access protection function is implemented by the engineer/OEM, for example to protect the inverter against incorrect parameterization by non-authorized persons. For diagnostic purposes, a read access to all parameters is always possible.

The write access protection allows for the following configurations:

- Full write access
- Write access only to favorites or (when knowing PIN1) to all parameters
- No write access or (when knowing PIN2) full write access
- No write access or (when knowing PIN1) write access only to favorites or (when knowing PIN2) to all parameters

The following table compares the four possible configurations:

PIN1 setting	PIN2 setting	Log-in	Status display after log-in	Active write access protection (via keypad/»EASY Starter«)
0x203D (P730.00)	0x203E (P731.00)	0x203F	0x2040 (P197.00)	
0	0	-	0	No access protection configured.
		Access →		
		Diagnostics (read access)	Favorites	All parameters
> 0	0	0 or wrong PIN	2	Write access only possible to favorites.
		Correct PIN1	0	Write access to all parameters possible.
		Access →		
		Diagnostics (read access)	Favorites	<b>PIN1</b> All parameters
0	> 0	0 or wrong PIN	1	No write access.
		Correct PIN2	0	Write access to all parameters possible.
		Access →		
		Diagnostics (read access)	<b>PIN2</b> Favorites	All parameters
> 0	> 0	0 or wrong PIN	1	No write access.
		Correct PIN1	2	Write access only possible to favorites.
		Correct PIN2	0	Write access to all parameters possible.
		Access →		
		Diagnostics (read access)	<b>PIN1</b> Favorites	<b>PIN2</b> All parameters
If PIN1 and PIN2 are set identically, a write access to all parameters is possible after the PIN has been entered correctly.				

# Device functions

Access protection  
Write access protection



Notes:

- The access protection is realised by the keypad and engineering tools as "clients" themselves based on the current protection status [0x2040 \(P197.00\)](#).

More details on how to configure the write access protection with the respective client can be found in the following subchapters:

- ▶ [Write access protection in the »EASY Starter«](#) [569](#)
- ▶ [Write access protection in the keypad](#) [572](#)

## Parameter



Address	Name / setting range / [default setting]	Information
0x203D (P730.00)	PIN1 access protection (PIN1 protection) -1 ... [0] ... 9999	PIN definition for write access protection. <ul style="list-style-type: none"><li>• 1 ... 9999 = set/change PIN.</li><li>• 0 = delete PIN (deactivate access protection).</li></ul>
0x203E (P731.00)	PIN2 access protection (PIN2 protection) -1 ... [0] ... 9999	<ul style="list-style-type: none"><li>• When the PIN has been set successfully, the value -1 is shown; otherwise 0.</li><li>• Setting/changing the PIN via keypad/»EASY Starter« only possible if no write access protection is active.</li><li>• Settings/changes via »EASY Starter« become effective immediately; via keypad they only become effective when the parameter group has been exited.</li></ul>
0x203F	PIN1/PIN2 log-in -32768 ... [0] ... 32767	Parameter for PIN entry for the purpose of deactivating an active access protection temporarily. <ul style="list-style-type: none"><li>• 1 ... 9999 = log-in (deactivate access protection temporarily).</li><li>• 0 = logout (reactivate access protection).</li><li>• After having logged in successfully, the value -1 is shown; otherwise 0.</li><li>• After 10 invalid entries, the log-in function is inhibited. In order to remove the log-in inhibit, the inverter must be switched off and on again.</li></ul>





### 13.4.1.1 Write access protection in the »EASY Starter«

If a write access protection is active for the online connected inverter, it is displayed in the status bar of the »EASY Starter«:

Display	Representation of the parameters in the »EASY Starter«
 No write access	All parameters in all dialogs are displayed as read-only parameters.
 Only favorites	Except for the favorites, all parameters in all dialogs are displayed as read-only parameters.

An active write access protection can be removed when the PIN is known.

How to remove an active write access protection temporarily:

1. Click the symbol  in the toolbar.

The "Log in / Log off" dialog box is displayed:

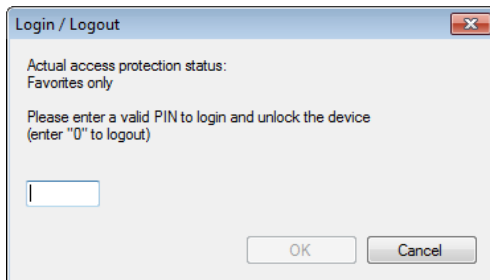

2. Enter the valid PIN and confirm with **OK**.



---

After 10 invalid entries, the log-in function is inhibited. In order to remove the log-in inhibit, the inverter must be switched off and on again.

---

The write access protection gets active again:

- Automatically 10 minutes after the last login or after the last active write access. It takes max. 10 minutes to be automatically logged out again after each write access.
- Automatically after the mains voltage is switched on again.
- Manually by entering a "0" in the dialog box "Log in / Log off" (see above).

# Device functions

Access protection  
Write access protection  
Write access protection in the »EASY Starter«



## Configuring the write access protection with »EASY Starter«

The write access protection is activated by specifying PIN1 and/or PIN2 (depending on the desired configuration of the write access protection).

How to activate the write access protection:

1. Go to the "Settings" tab and navigate to the "Access protection" parameterisation dialog:

The write access to the parameter set in the inverter can be fully or partially protected.  
If a configuration with write access protection is selected, the inverter starts with protection immediately. It can be temporarily canceled by using the login button from toolbar and enter a valid PIN.

 10 min after login, logout or after a restart of the inverter the maximum configured access protection is activated again.

There are 4 different configurations available: (Can only be changed online)

<input type="radio"/> Full write access			
<input type="radio"/> Favorites only or full write access	Power ON Login with PIN1	➔	Favorites only Full write access
<input type="radio"/> No or full write access	Power ON Login with PIN2	➔	No write access Full write access
<input type="radio"/> No, favorites only or full write access	Power ON Login with PIN1 Login with PIN2	➔	No write access Favorites only Full write access

2. Select the desired configuration of the write access protection.

The "PIN definition" dialog box is displayed. The possible entries depend on the selected configuration.

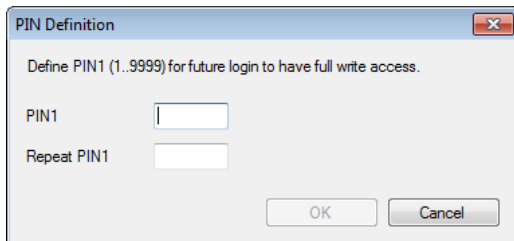



3. Enter the desired PIN(s) and confirm with **OK**.



After successful execution, the write access protection is immediately effective and is displayed in the »EASY Starter« status bar.

4. For a permanent acceptance of the configuration:  Save parameter settings in the device.

How to change already defined PIN(s):

1.  Remove the active write access protection temporarily (see above).
2. Select the "Full write access" configuration in the "Access protection" parameterisation dialog.
3. Select again the desired configuration of the write access protection.
4. Enter new PIN(s) and confirm with **OK**.
5.  Save parameter settings in the device.

How to remove a configured write access protection permanently:

1.  Remove the active write access protection temporarily (see above).
2. Select the "Full write access" configuration in the "Access protection" parameterisation dialog.
3.  Save parameter settings in the device.



### Impact of the write access protection on »EASY Starter« functions

The following »EASY Starter« functions are not supported when write access protection is active:

- Parameter set download
- Definition of the "Favorites" parameters.
- Definition of the parameters for the "Parameter change-over" function

The following »EASY Starter« functions are supported irrespective of whether write access protection is active:

- Optical device identification [0x2021:001 \(P230.01\)](#)
- Enable/inhibit inverter
- Resetting parameters to default [0x2022:001 \(P700.01\)](#)
- Save parameter set [0x2022:003 \(P700.03\)](#)
- Load user parameter [0x2022:004 \(P700.04\)](#)
- Load OEM parameter [0x2022:005 \(P700.05\)](#)
- Error reset [0x2631:004 \(P400.04\)](#)

# Device functions

Access protection  
Write access protection  
Write access protection in the keypad



## 13.4.1.2 Write access protection in the keypad

If a write access protection is active for the inverter, the keypad automatically displays a log-in when changing to the parameterisation mode. You can either skip the log-in and thus keep the access protection active or remove it temporarily by entering a valid PIN.

### Option 1 - skip log-in and keep access protection active

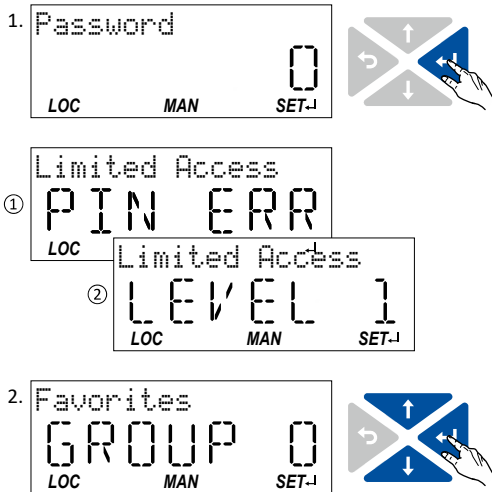

1. Use the **→** key to skip the log-in.  
The configured access protection remains active and is briefly displayed:  
① PIN ERR: No write access  
② LEVEL 1: Write access only to favorites  
You are now in the group level.
2. You can now use the navigation keys **↑** and **↓** to select the desired group and with key **→** navigate one level lower to the parameter level.  
Note: By using the **↶** key you can navigate one level upwards again anytime.

### Option 2 - remove access protection temporarily by entering a valid PIN

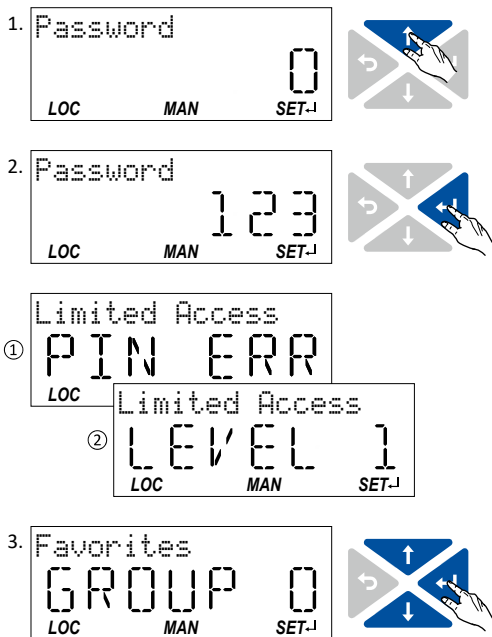

1. Use the **↑** key to enter the defined PIN.
2. Use the **→** key to accept the changed setting.  
If the access remains restricted, it is briefly displayed:  
① PIN ERR: No write access  
② LEVEL 1: Write access only to favorites  
You are now in the group level.
3. You can now use the navigation keys **↑** and **↓** to select the desired group and with key **→** navigate one level lower to the parameter level.  
Note: By using the **↶** key you can navigate one level upwards again anytime.



After 10 invalid entries, the log-in function is inhibited. In order to remove the log-in inhibit, the inverter must be switched off and on again.

The write access protection gets active again:







- Automatically 10 minutes after the last log-in or the last keypad entry.
- Automatically after the mains voltage is switched on again.



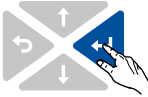







## Configuring the write access protection with the keypad

The write access protection is activated by defining PIN1 in P730.00 and/or PIN2 in P731.00 (depending on the desired configuration of the write access protection).

In the following example, the write access protection is configured in such a way that a write access to the favorites only is possible or (when knowing PIN) to all parameters. This configuration only requires the definition of PIN1 (here: "123").

1. VEL:FLEX#AIN1  
STOP  
REM AUTO SET-I 
2. Favorites  
GROUP 0  
REM AUTO SET-I 
3. Addit. functions  
GROUP 7  
REM AUTO SET-I 
4. Device commands  
P700.XX  
REM AUTO SET-I 
5. Protection PIN1  
P73000  
REM AUTO SET-I 
6. P730.00  
0  
REM AUTO SET-I 
7. P730.00  
123  
REM AUTO SET-I 

### Defining PIN1:







1. Use the  key in the operating mode to navigate to the parameterisation mode one level below.  
You are now in the group level.  
Note: By using the  key you can navigate one level upwards again anytime.
2. Use the  navigation key to select group 7.
3. Use the  key to navigate to one level below.  
You are now in the parameter level of the group selected.
4. Use the  navigation key to select the P730.00 parameter.
5. Use the  key to navigate to one level below.  
You are now in the editing mode.
6. Use the  navigation key to set PIN1 to the value "123".
7. Use the  key to accept the changed setting.  
The editing mode is exited.  
Note: The configured access protection only gets effective after the parameter group is quit.

# Device functions

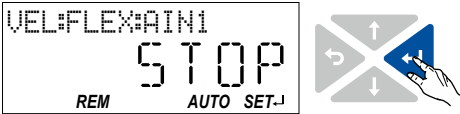
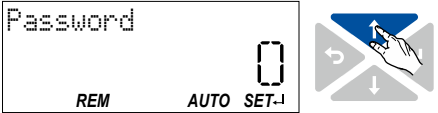

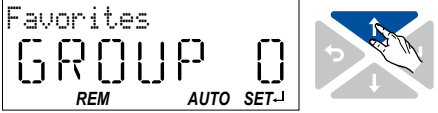
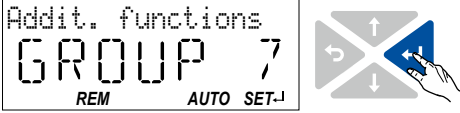
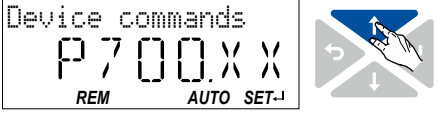

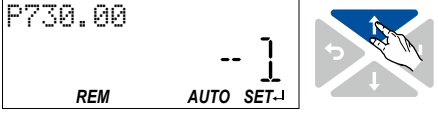
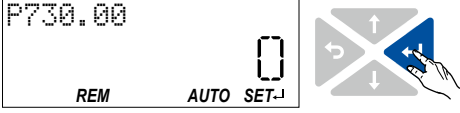
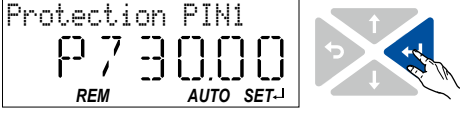







Access protection  
Write access protection  
Write access protection in the keypad



In the following example, PIN1 is changed from "123" to "456". For this purpose, the defined PIN must first be deleted by the setting "0".

1. 
2. 
3. 
4. 
5. 
6. 
7. 
8. 
9. 
10. 
11. 
12. 

## Change defined PIN1:

1. Use the  key in the operating mode to navigate to the parameterisation mode one level below. Since the access protection is active, the input dialog for the PIN is displayed.
  2. Use the  navigation key to set PIN "123" to remove the access protection temporarily.
  3. Use the  key to accept the entered PIN. You are now in the group level.
  4. Use the  navigation key to select group 7.
  5. Use the  key to navigate to one level below. You are now in the parameter level of the group selected.
  6. Use the  navigation key to select the P730.00 parameter.
  7. Use the  key to navigate to one level below. You are now in the editing mode.
  8. Use the  key to set PIN1 to the value "0". This setting first deletes PIN1.
  9. Use the  key to accept the changed setting. The editing mode is exited.
  10. Use the  key to navigate again one level below to the editing mode.
  11. Use the  navigation key to set the previously deleted PIN1 to the new value "456".
  12. Use the  key to accept the changed setting. The editing mode is exited.
- Note: The configured access protection only gets effective after the parameter group is quit.



## Device functions

Access protection

Write access protection

Write access protection in the keypad

How to remove a configured write access protection permanently:

1. Remove the active write access protection temporarily (see above).
2. Set PIN1 (P730.00) and PIN2 (P731.00) to the value "0" (see instructions for changing the PIN).

### **Impact of the write access protection to the keypad functions**

The following keypad functions are supported irrespective of the active write access protection:

- Optical device identification [0x2021:001 \(P230.01\)](#)
- Resetting parameters to default [0x2022:001 \(P700.01\)](#)
- Load user parameter [0x2022:004 \(P700.04\)](#)
- Load OEM parameter [0x2022:005 \(P700.05\)](#)



### 13.5 Switching frequency changeover

The output voltage of the inverter is a DC voltage with sine-coded pulse width modulation (PWM). This corresponds by approximation to an AC voltage with variable frequency. The frequency of the PWM pulses is adjustable and is called "switching frequency".

Not all products support all options.

#### Details

The switching frequency has an impact on the smooth running performance and the noise generation in the motor connected as well as on the power loss in the inverter. The lower the switching frequency, the better the concentricity factor, the smaller the power loss and the higher the audible noise .

#### Parameter

Address	Name / setting range / [default setting]	Information
0x2939 (P305.00)	Switching frequency (Switching freq.) * Default setting dependent on the model.	Selection of the inverter switching frequency.  Abbreviations used:
	1 4 kHz variable / drive-optimised	<ul style="list-style-type: none"> <li>• "Variable": Adaptation of the switching frequency as a function of the current. The carrier frequency is reduced depending on the heat sink temperature and the ixt load.</li> <li>• "Fixed": The carrier frequency is fixed, no frequency reduction.</li> <li>• "Drive-optimised": reduces the capacitive currents from the motor to the earth.</li> <li>• "Min. Pv": reduces the capacitive currents from the motor to the earth and optimizes power dissipation.</li> </ul>
	2 8 kHz variable / drive-optimised	
	3 16 kHz variable / drive-optimised	
	5 2 kHz fixed / drive-optimised	
	6 4 kHz fixed / drive-optimised	
	7 8 kHz fixed / drive-optimised	
	8 16 kHz fixed / drive-optimised	
	11 4 kHz variable / min. Pv	
	12 8 kHz variable / min. Pv	
	13 16 kHz variable / min. Pv	
	15 2 kHz fixed / min. Pv	
	16 4 kHz fixed / min. Pv	
	17 8 kHz fixed / min. Pv	
	18 16 kHz fixed / min. Pv	
	21 8 kHz variable / drive-optimised / 4 kHz min.	
	22 16 kHz variable / drive-optimised / 4 kHz min.	
23 16 kHz variable / drive-optimised / 8 kHz min.		
31 8 kHz variable /min. Pv / 4 kHz min.		
32 16 kHz variable /min. Pv / 4 kHz min.		
33 16 kHz variable /min. Pv / 8 kHz min.		
0x293A (P116.00)	Actual switching frequency (Actual sw. freq.) • Read only	Display of the currently active switching frequency of the inverter.  Example:
	1 2 kHz drive-optimized	<ul style="list-style-type: none"> <li>• "16 kHz variable / drive-optimised / 4 kHz min. [22]" is selected as switching frequency in <a href="#">0x2939 (P305.00)</a>.</li> <li>• An increase of the ambient temperature and/or the load have caused a decrease of the switching frequency to 8 kHz. In this case, this parameter indicates the selection "8 kHz power loss-optimized [7]".</li> </ul>
	2 4 kHz drive-optimized	
	3 8 kHz drive-optimized	
	4 16 kHz drive-optimized	
	5 2 kHz power loss-optimized	
	6 4 kHz power loss-optimized	
	7 8 kHz power loss-optimized	
	8 16 kHz power loss-optimized	





## 13.6 Device overload monitoring (ixt)

The inverter calculates the  $i^*t$  utilisation in order to protect itself against thermal overload. In simple terms: a higher current or an overcurrent that continues for a longer time causes a higher  $i^*t$  utilisation.

### DANGER!

Uncontrolled motor movements by pulse inhibit.

When the device overload monitoring function is activated, pulse inhibit is set and the motor has no torque. A load that is connected to motors without a holding brake may therefore cause uncontrolled movements! Without a load, the motor will coast.

Possible consequences: Death or severe injuries

► Only operate the inverter under permissible load conditions.

### Details

The device overload monitoring function primarily offers protection to the power section. Indirectly, also other components such as filter chokes, circuit-board conductors, and terminals are protected against overheating. Short-time overload currents followed by recovery periods (times of smaller current utilisation) are permissible. The monitoring function during operation checks whether these conditions are met, taking into consideration that higher switching frequencies and lower stator frequencies as well as higher DC voltages cause a greater device utilisation.

- If the device utilisation exceeds the warning threshold set in [0x2D40:002](#) (default setting: 95 %), the inverter outputs a warning.
- If the device utilisation exceeds the permanent error threshold 100 %, the inverter is disabled immediately and any further operation is stopped.
- Device overload monitoring depends on the inverter load characteristic (heavy duty/light duty). ► [Dual rating](#)  49
- The device overload can be obtained from the configuration document.

### Parameter

Address	Name / setting range / [default setting]	Information
0x2D40:002	Device utilisation ixt: Power unit warning threshold 0 ... [95] ... 101 %	If the device utilisation exceeds the threshold set, the inverter outputs a warning. <ul style="list-style-type: none"> <li>• With the setting 0 % or <math>\geq 100</math> %, the warning is deactivated.</li> </ul>
0x2D40:004 (P135.04)	Device utilisation ixt: Device actual utilisation (Device utilisat.: ixt utilisation) <ul style="list-style-type: none"> <li>• Read only: x %</li> </ul>	Display of the current device utilisation.
0x2D40:005 (P135.05)	Device utilisation ixt: Error response (Device utilisat.: Error response)	Selection of the response to be executed when the device overload monitoring function is triggered. <p>Associated event ID:</p> <ul style="list-style-type: none"> <li>• <a href="#">9090</a>   <a href="#">0x2382</a> - Fault - Device utilization (ixt) too high</li> </ul>
	2 Trouble	► <a href="#">Severity</a>  700
	3 <b>Fault</b>	



## 13.7 Heatsink temperature monitoring

### Parameter

Address	Name / setting range / [default setting]	Information
0x2D84:001 (P117.01)	Heatsink temperature: Heatsink temperature (Heatsink temp.: Heatsink temp.) • Read only: x.x °C	Display of the current heatsink temperature.
0x2D84:002	Heatsink temperature: Warning threshold 50.0 ... [80.0]* ... 100.0 °C * Default setting dependent on the model.	Warning threshold for temperature monitoring. <ul style="list-style-type: none"> <li>• If the heatsink temperature exceeds the threshold set here, the inverter outputs a warning.</li> <li>• The warning is reset with a hysteresis of approx. 5 °C.</li> <li>• If the heatsink temperature increases further and exceeds the non-adjustable error threshold (100 °C), the inverter changes to the "Fault" device status. The inverter is disabled and thus any further operation is stopped.</li> </ul>



## 13.8 Automatic restart after a fault

Configuration of the restart behaviour after a fault.



The settings have no impact on errors and warnings of the inverter.

### Parameter

Address	Name / setting range / [default setting]	Information
0x2839:002 (P760.02)	Fault configuration: Restart delay (Fault config.: Restart delay) 0.0 ... [3.0] ... 1000.0 s	If a fault occurs, a restart is possible at the earliest after the time set here has elapsed.
0x2839:003 (P760.03)	Fault configuration: Number of restart attempts (Fault config.: Restart counter) 0 ... [5] ... 255	Number of restart attempts after a fault. <ul style="list-style-type: none"><li>• 255 = unlimited number of restart attempts.</li></ul>
0x2839:004 (P760.04)	Fault configuration: Trouble counter reset time (Fault config.: Tro.count r.time) 0.1 ... [40.0] ... 3600.0 s	Time of trouble-free operation after which the fault counter is decreased by 1.
0x2839:005 (P760.05)	Fault configuration: Trouble counter (Fault config.: Trouble counter) <ul style="list-style-type: none"><li>• Read only</li></ul>	Display of the current fault counter content. <ul style="list-style-type: none"><li>• The counter content is increased by 1 after each restart attempt.</li></ul>

### Related topics

▶ [Event handling](#) 699

▶ [Timeout for error response](#) 701



## 13.9 User-defined error triggering

The "Activate fault 1" and "Activate fault 2" functions serve to set the inverter from the process to the error status.

### Details

If, for instance, sensors or switches are provided for process monitoring, which are designed to stop the process (and thus the drive) under certain conditions, these sensors/switches can be connected to free digital inputs of the inverter. The digital inputs used for the sensors/switches then have to be assigned to the functions "Activate fault 1" and "Activate fault 2" as triggers.

### Parameter

Address	Name / setting range / [default setting]	Information
0x2631:043 (P400.43)	Function list: Activate fault 1 (Function list: Fault 1) • Further possible settings: ▶ <a href="#">Trigger list</a> 73	Assignment of a trigger for the "Activate fault 1" function. Trigger = TRUE: Trigger user-defined error 1. Trigger = FALSE: no action.  Notes: • After the error is triggered, the reaction set in 0x2842:001 takes place.  Associated event ID: • <a href="#">25217</a>   <a href="#">0x6281</a> - User-defined fault 1
	<b>0</b> Not connected	No trigger assigned (trigger is constantly FALSE).
0x2631:044 (P400.44)	Function list: Activate fault 2 (Function list: Fault 2) • Further possible settings: ▶ <a href="#">Trigger list</a> 73	Assignment of a trigger for the "Activate fault 2" function. Trigger = TRUE: Trigger user-defined error 2. Trigger = FALSE: no action.  Notes: • After the error is triggered, the reaction set in 0x2842:003 takes place.  Associated event ID: • <a href="#">25218</a>   <a href="#">0x6282</a> - User-defined fault 2
	<b>0</b> Not connected	No trigger assigned (trigger is constantly FALSE).

### Example

An example of the operating mode can be found in the chapter "[Error reset](#)". 702

### Related topics

▶ [Event handling](#) 699



## 13.10 Update device firmware

The device firmware is continuously improved by the manufacturer. New firmware versions contain error corrections, function extensions and simplify the handling.

A new firmware is always compatible with the older version:

- A device with updated firmware and unchanged parameter settings shows the same behaviour as before.
- Parameter settings must only be adapted if new functions are used.

### Details

The inverter i550 supports the manual firmware download with the »EASY Starter (Firmware loader)« as well as the automatic firmware download via EtherCAT. The main reason for an automatic firmware download is the simultaneous update of firmware and parameter settings for an already finished machine.

Typical applications for an automatic firmware download:

- Series production: All machines automatically receive the firmware released for the machine including parameter settings.
- Device replacement: If a device replacement is required, the device automatically gets the suitable firmware including parameter settings without the need for an intervention or special knowledge of the machine operator.
- Device update: Due to function extensions or error corrections, an update of the firmware is almost automatically possible for the machine manufacturer or end user.

# Device functions

Update device firmware  
Firmware download with »EASY Starter (firmware loader)«



## 13.10.1 Firmware download with »EASY Starter (firmware loader)«

The »EASY Starter (firmware loader)« is a PC software which serves to update the firmware of the device.

### Preconditions

- For the firmware download, we recommend a direct USB connection to the device. For this purpose, the USB module and a USB 2.0 cable (A plug on Micro-B plug) are required. The voltage supply of the control electronics also takes place via the USB connection.
- The control electronics of the inverter must be supplied with voltage. Either via the USB connection or via the external 24-V voltage supply.
- Voltage supply and communication must not be interrupted during the firmware download.

### Details

Together with the »EASY Starter« engineering tool, the following tools are installed as well:

Tool	Brief description
»EASY Navigator«	Helps you to find the right tool for your application.
»EASY Package Manager«	Enables the automatic download and the installation of files for the engineering tools. <ul style="list-style-type: none"><li>• For this purpose, the »EASY Package Manager« is provided with current files by the manufacturer and enables the user to install them.</li><li>• The files also include new firmware versions for inverters.</li></ul>
»EASY Starter (firmware loader)«	Enables the update of the firmware for inverters. <ul style="list-style-type: none"><li>• The update can be made by the mechanical engineer or the end user depending on the access protection set for the device.</li></ul>

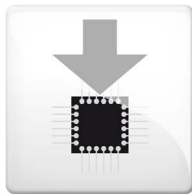

### Carry out the firmware download with the »EASY Starter (firmware loader)«:

1. Start »EASY Navigator« (All programs → Lenze → EASY Navigator).
2. In the »EASY Navigator«, change to the "Ensuring productivity" engineering phase.
3. Click the »EASY Starter (firmware loader)« icon (see on the left).
4. Follow the instructions of the »EASY Starter (firmware loader)«.

### Notes:

- The firmware download will not take more than 20 seconds. The progress is shown in the »EASY Starter (firmware loader)«.
- After the firmware download, the connection to the device gets lost for some second and is then restored again automatically.
- Device settings are not changed by the firmware download.
- The brand protection does not get lost by the firmware download.
- The firmware can neither be exported from the device nor be deleted from the device.

If the connection is aborted during the firmware download, this may have the following consequences:

- The device starts with the old firmware. The firmware download can be restarted.
- The firmware in the device is damaged. Consultation with the manufacturer is required.



### 13.11 Behaviour of the inverter in case of incompatible data in the memory module

Below you will find a description of the inverter behaviour when the data on the memory module does not match the inverter hardware or firmware.

The following points are described in detail here:

- Automatic loading of the parameter settings when the inverter is switched on
- Manual loading of the user data via device command
- Manual loading of the OEM data via device command
- Manual saving of the parameter settings via device command
- Hardware and firmware updates/downgrades

#### Automatic loading of the parameter settings when the inverter is switched on

Process when the inverter is switched on:

1. The default setting saved in the inverter firmware is loaded.
2. If a memory module with valid data is available, the data is loaded from the user memory.

Otherwise a corresponding error message is output:

Error message	Info
<b>0x7681:</b> Memory module not present	The default setting saved in the inverter firmware is loaded. The error cannot be reset by the user.  Remedy: <ol style="list-style-type: none"> <li>1. Switch off inverter.</li> <li>2. Plug the memory module into the inverter.</li> <li>3. Switch the inverter on again.</li> </ol> Note: The memory module cannot be replaced during ongoing operation!
<b>0x7682:</b> Invalid user data	The user parameter settings in the memory module are invalid. Thus, the user parameter settings get lost. The default setting is loaded automatically.  Remedy: <ol style="list-style-type: none"> <li>1. Execute user parameter settings again.</li> <li>2. Execute device command "Save user data" <a href="#">0x2022:003 (P700.03)</a>.</li> </ol>
<b>0x7684:</b> Data not compl. saved before powerdown	Saving the parameter settings was interrupted by an unexpected disconnection. The user parameter settings were not saved completely. When the inverter is switched on the next time, the backup data is copied to the user memory.  Remedy: <ol style="list-style-type: none"> <li>1. Check user parameter settings. (The loaded backup is an older version.)</li> <li>2. If required, repeat the changes made last.</li> <li>3. Execute device command "Save user data" <a href="#">0x2022:003 (P700.03)</a>.</li> </ol>
<b>0x7689:</b> Memory module: invalid OEM data	The OEM memory contains invalid parameter settings or is empty. The user parameter settings are loaded automatically.  Remedy: <ul style="list-style-type: none"> <li>• Execute device command "Save OEM data" <a href="#">0x2022:006 (P700.06)</a>.</li> <li>• Thus, the user parameter settings get lost!</li> </ul>

Notes:

- If the memory module contains invalid data, the device commands "Load user data" [0x2022:004 \(P700.04\)](#) and "Load OEM data" [0x2022:005 \(P700.05\)](#) are not executed. The status feedback "Action cancelled" takes place.
- If the memory module is empty, the default setting saved in the inverter firmware is loaded. No action is required by the user. The memory module remains empty until the device command "Save user data" [0x2022:003 \(P700.03\)](#) or "Save OEM data" [0x2022:006 \(P700.06\)](#) is executed.
- Irrespective of the data on the memory module, the device command "Load default settings" [0x2022:001 \(P700.01\)](#) is always enabled.

# Device functions

Behaviour of the inverter in case of incompatible data in the memory module



## Manual loading of the user data via device command

Device command: "Load user data" [0x2022:004 \(P700.04\)](#)

- If the user memory contains invalid parameter settings, the default setting saved in the inverter firmware is automatically loaded.
- For possible error messages, see the table above.

## Manual loading of the OEM data via device command

Device command: "Load OEM data" [0x2022:005 \(P700.05\)](#)

- If the OEM memory contains invalid parameter settings, the user parameter settings are loaded automatically.
- If the OEM memory is empty, the status feedback "Action cancelled" takes place. The current parameter settings remain unchanged.

## Manual saving of the parameter settings via device command

Device command: "Save user data" [0x2022:003 \(P700.03\)](#)

- It may happen that the parameter settings cannot be saved because the user memory is full. In this case, the following error message appears:

Error message	Info
<a href="#">0x7680</a> : Memory module is full	The memory module contains too many parameter settings. The parameter settings were not saved in the memory module. Remedy: Execute device command "Save user data" <a href="#">0x2022:003 (P700.03)</a> again. This reinitialises the user memory with the current parameter settings. By this means, parameter settings no longer required are deleted automatically.





### Hardware and firmware upgrades/downgrades

By "taking along" the memory module, all parameter settings of a device can be transferred to another device, for instance, in case of a device replacement. When switched on, the inverter checks whether the parameter settings saved in the memory module match the inverter hardware and firmware. In case of an incompatibility, a corresponding error message is output.

The following table contains details on different scenarios:

Prio	Compatibility check User data ↔ device	Error message	Info
1	Device has a newer firmware Example: Version 2.x → version 3.x	-	The "firmware upgrade" is recognised. <ul style="list-style-type: none"> <li>The user parameter settings are loaded without an action being required by the user.</li> <li>If the parameter settings are saved afterwards, the user memory is reinitialised with the current parameter settings. By this means, parameter settings no longer required are deleted automatically.</li> </ul>
	Device has an older firmware Example: Version 4.x → version 3.x	<b>0x7690:</b> EPM firmware version incompatible	The data is loaded into the RAM memory but are incompatible. Remedy:
2	Firmware type is different	<b>0x7691:</b> EPM data: firmware type incompatible	<ol style="list-style-type: none"> <li>Execute device command "Load default settings" <b>0x2022:001 (P700.01)</b>.</li> <li>Execute "Save user data" <b>0x2022:003 (P700.03)</b> or "Save OEM data" <b>0x2022:006 (P700.06)</b> device command.</li> </ol>
	Power unit is different (and incompatible with saved data)	<b>0x7693:</b> EPM data: PU size incompatible	
	Country code is different Example: EU → USA	<b>0x7691:</b> EPM data: firmware type incompatible	
	Device has less functionality Examples: i550 → i510 Application I/O → Standard I/O		
3	Network option is different Example: CANopen → PROFIBUS	<b>0x7692:</b> EPM data: new firmware type detected	The data is loaded into the RAM memory and is compatible. However, the settings must be accepted by the user: <ol style="list-style-type: none"> <li>Check parameter settings.</li> <li>Reset error.</li> <li>Execute "Save user data" <b>0x2022:003 (P700.03)</b> or "Save OEM data" <b>0x2022:006 (P700.06)</b> device command.</li> </ol>
4	Device has more functionality Examples: i510 → i550 Standard I/O → application I/O	-	The "hardware upgrade" is recognised. <ul style="list-style-type: none"> <li>The user parameter settings are loaded without an action being required by the user.</li> <li>If the parameter settings are saved afterwards, the user memory is reinitialised with the current parameter settings. By this means, parameter settings no longer required are deleted automatically.</li> </ul>
5	Power unit is different (but compatible with saved data) Example: 230 V/0.75 kW → 400 V/5.5 kW	<b>0x7694:</b> EPM data: new PU size detected	The data is loaded into the RAM memory and is compatible. However, the settings must be accepted by the user: <ol style="list-style-type: none"> <li>Check parameter settings.</li> <li>Reset error.</li> <li>Execute "Save user data" <b>0x2022:003 (P700.03)</b> or "Save OEM data" <b>0x2022:006 (P700.06)</b> device command.</li> </ol>



## 14 Additional functions

### 14.1 Brake energy management

When braking electrical motors, the kinetic energy of the drive train is fed back regeneratively to the DC bus. This energy causes a DC-bus voltage boost. If the energy fed back is too high, the inverter reports an error.

Several different strategies can serve to avoid DC-bus overvoltage:

- Use of a brake resistor
- Stopping the deceleration ramp function generator when the active voltage threshold for the brake operation is exceeded
- Use of the "Inverter motor brake" function
- Combination of the above named options
- DC-bus connection



## Details

The voltage threshold for braking operation results on the basis of the rated mains voltage set:

Rated mains voltage	Voltage thresholds for braking operation	
	Braking operation on	Braking operation off
230 V	DC 390 V	DC 380 V
400 V	DC 725 V	DC 710 V
480 V	DC 780 V	DC 765 V

The voltage threshold for braking operation can be reduced by 0 ... 100 V. The reduction required must be set in [0x2541:003 \(P706.03\)](#). However, the reduction must be made to such an extent that the reduced voltage threshold is still above the normal stationary DC-bus voltage. The active voltage threshold for the braking operation is displayed in [0x2541:002 \(P706.02\)](#).

If the DC-bus voltage exceeds the voltage threshold for braking operation, the braking method selected in [0x2541:001 \(P706.01\)](#) is applied.

- Optimum following of the actual frequency value to the frequency setpoint (e. g. quick stop of the motor) can always be achieved by the use of a brake resistor.
- Stopping the deceleration ramp function generator enables smoother deceleration with lower torque oscillation.
- The "Inverter motor brake" function allows for quick braking without using a brake resistor. For process-related reasons, torque oscillations may occur.

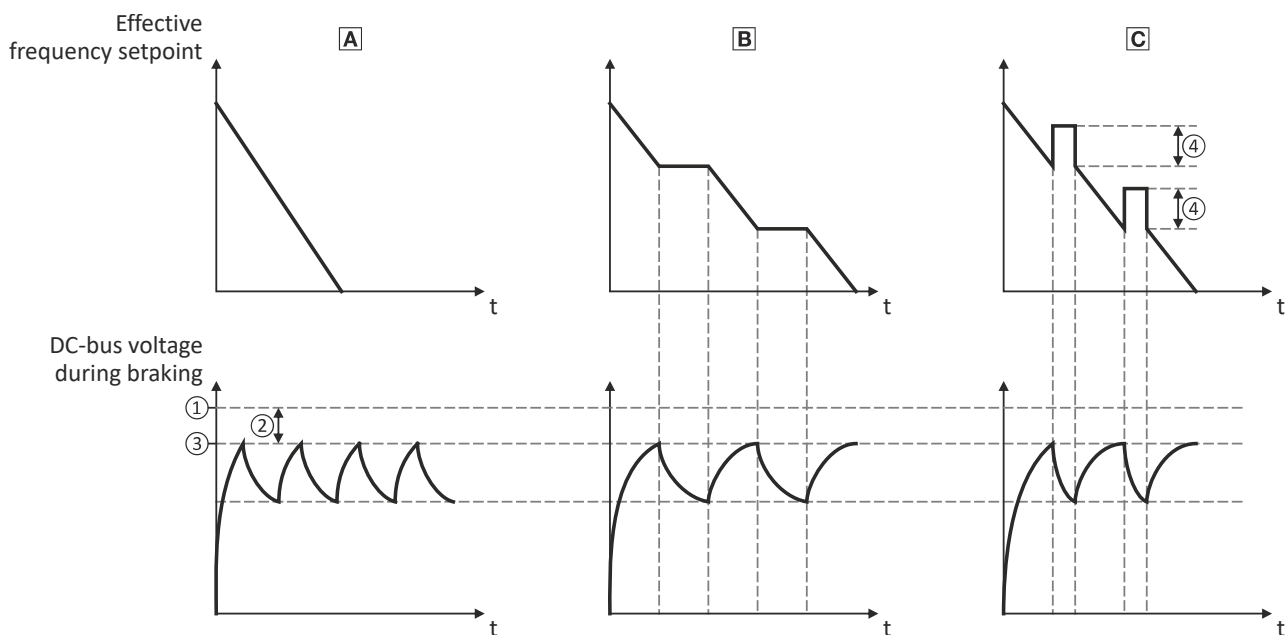

- ① Voltage threshold for braking operation
- ② Reduced threshold [0x2541:003 \(P706.03\)](#)
- ③ Active threshold [0x2541:002 \(P706.02\)](#)
- ④ Additional frequency [0x2541:004 \(P706.04\)](#)

- A Use of a brake resistor [589](#)
- B Stopping the deceleration ramp function generator [591](#)
- C Inverter motor brake [592](#)



### Parameter

Address	Name / setting range / [default setting]	Information
0x2541:001 (P706.01)	Brake energy management: Operating mode (Brake management: Operating mode)	Selection of the braking method. <ul style="list-style-type: none"> <li>The braking method(s) selected is/are activated if the DC-bus voltage exceeds the voltage threshold for the braking operation shown in <a href="#">0x2541:002 (P706.02)</a>.</li> </ul>
	0 Brake resistor	The integrated brake chopper (brake transistor) is used. <ul style="list-style-type: none"> <li>▶ <a href="#">Use of a brake resistor</a> <a href="#">□ 589</a></li> </ul>
	1 <b>Ramp function generator stop (RFGS)</b>	The deceleration ramp function generator is stopped. <ul style="list-style-type: none"> <li>▶ <a href="#">Stopping the deceleration ramp function generator</a> <a href="#">□ 591</a></li> </ul>
	2 Brake resistor + RFGS	The brake resistor is supplied with current and the deceleration ramp function generator is stopped.
	3 Inverter motor brake (IMB) + RFGS	Braking with the "Inverter motor brake" braking method in connection with "Deceleration ramp function generator stop" is executed. <ul style="list-style-type: none"> <li>▶ <a href="#">Inverter motor brake</a> <a href="#">□ 592</a></li> </ul>
	4 Brake resistor + IMB + RFGS	Braking is performed by combining all three braking procedures.
0x2541:002 (P706.02)	Brake energy management: Active threshold (Brake management: Active threshold) <ul style="list-style-type: none"> <li>Read only: x V</li> </ul>	Display of the active voltage threshold for the braking operation. <ul style="list-style-type: none"> <li>The voltage threshold shown depends on the mains voltage selected in <a href="#">0x2540:001 (P208.01)</a> and the voltage value set in <a href="#">0x2541:003 (P706.03)</a>.</li> <li>The voltage threshold must be higher than the stationary DC voltage in the DC bus.</li> </ul>
0x2541:003 (P706.03)	Brake energy management: Reduced threshold (Brake management: Red. threshold) 0 ... [0] ... 100 V	The voltage threshold for the braking operation is reduced by the voltage value set here.
0x2541:005 (P706.05)	Brake energy management: Deceleration override time (Brake management: Del. overr. time) 0.0 ... [2.0] ... 60.0 s	Maximum permissible time for the deceleration override by means of the braking method selected in <a href="#">0x2541:001 (P706.01)</a> . <ul style="list-style-type: none"> <li>If the DC-bus voltage does not fall below the voltage threshold for braking operation shown in <a href="#">0x2541:002 (P706.02)</a> within this time, the motor is decelerated further.</li> <li>The time is only reset if the voltage threshold shown in <a href="#">0x2541:002 (P706.02)</a> is not reached.</li> </ul>



## 14.1.1 Use of a brake resistor

For braking operation, optionally the brake chopper integrated in the inverter (brake transistor) can be used.

### Preconditions

In order that the integrated brake chopper is activated in the braking operation, one of the following braking methods must be set in [0x2541:001 \(P706.01\)](#):

- "Brake resistor [0]"
- "Brake resistor + RFGS [2]"
- "Brake resistor + IMB + RFGS [4]"

In the default setting of [0x2541:001 \(P706.01\)](#), the integrated brake chopper is not activated in the brake operation!

### Details

- The brake resistor required is to be connected to terminals  $R_{B1}$  and  $R_{B2}$  of the inverter.
- In [0x2541:001 \(P706.01\)](#), additionally the stopping function for the deceleration ramp function generator can be set when the brake resistor is controlled, in order to avoid overvoltage disconnection in the case of lower deceleration times.
- In the default setting and with a disabled inverter and an error status ("Error active"), the brake chopper is switched off. This behaviour can be changed in [0x2541:006 \(P706.06\)](#).  
Example: In a DC-bus connection with several inverters, only one brake resistor is used. It is connected to the most powerful inverter in the DC-bus connection. This inverter then serves to change the behaviour so that inverter disable and/or an error does not cause a switch-off of the brake chopper.

### Internal protective function

The following protective function prevents the brake chopper from being switched on permanently, e.g. due to too high voltages or wrong settings:

- The brake chopper is switched off if it was switched on over a period of 4 s.
- If the DC-bus voltage again falls below the voltage threshold for braking operation, the brake chopper can again be switched on for maximally 4 s without interruption.

### Brake resistor monitoring

The inverter calculates and monitors the thermal load of the brake resistor to ensure that the brake resistor will not be overloaded.

A correct calculation required the following settings according to the data on the nameplate of the brake resistor:

- [0x2550:002 \(P707.02\)](#): Resistance value
- [0x2550:003 \(P707.03\)](#): Rated power
- [0x2550:004 \(P707.04\)](#): Maximum thermal load

The calculated thermal load is not displayed in [0x2550:007 \(P707.07\)](#).

The brake resistor monitoring is designed with two stages:

- If the calculated thermal load exceeds the warning threshold set in [0x2550:008 \(P707.08\)](#) (default setting: 90 %), the response set in [0x2550:010 \(P707.10\)](#) takes place (default setting: "Warning"). The warning status will be reset if the thermal load falls below the warning threshold - 20 %.
- If the calculated thermal load exceeds the warning threshold set in [0x2550:009 \(P707.09\)](#) (default setting: 100 %), the response set in [0x2550:011 \(P707.11\)](#) takes place (default setting: "Fault"). The error status will be reset if the thermal load falls below the error threshold - 20 %.

# Additional functions

Brake energy management  
Use of a brake resistor



## Parameter

Address	Name / setting range / [default setting]	Information
0x2541:006 (P706.06)	Brake energy management: Brake resistor response (Brake management: Brk. res. behav) <ul style="list-style-type: none"> <li>Setting can only be changed if the inverter is disabled.</li> </ul>	Behaviour of the integrated brake chopper if the inverter is disabled and if the error status is active.
	<b>0</b> Off: disable / Off: error	If the inverter is disabled and the error status is active, the brake chopper is switched off.
	<b>1</b> On: disable / off: error	Brake chopper is switched off if the error status is active, but not if the inverter is disabled.
	<b>2</b> Off: disable / on: error	Brake chopper is switched off if the inverter is disabled but not if the error status is active.
	<b>3</b> On: disable / On: error	Brake chopper is not switched off if the inverter disabled and the error status is active.
0x2550:002 (P707.02)	Brake resistor: Resistance value (Brake resistor: Resistance value) 0.0 ... [180.0]* ... 500.0 Ω * Default setting dependent on the model.	Resistance value of the brake resistor connected. <ul style="list-style-type: none"> <li>The value to be entered can be obtained from the brake resistor nameplate.</li> </ul>
0x2550:003 (P707.03)	Brake resistor: Rated power (Brake resistor: Rated power) 0 ... [50]* ... 800000 W * Default setting dependent on the model.	Rated power of the brake resistor connected. <ul style="list-style-type: none"> <li>The value to be entered can be obtained from the brake resistor nameplate.</li> </ul>
0x2550:004 (P707.04)	Brake resistor: Maximum thermal load (Brake resistor: Maximum heat) 0.0 ... [8.0]* ... 100000.0 kW * Default setting dependent on the model.	Thermal capacity of the brake resistor connected. <ul style="list-style-type: none"> <li>The value to be entered can be obtained from the brake resistor nameplate.</li> </ul>
0x2550:007 (P707.07)	Brake resistor: Thermal load (Brake resistor: Thermal load) <ul style="list-style-type: none"> <li>Read only: x.x %</li> </ul>	Display of the utilisation of the brake resistor connected.
0x2550:008 (P707.08)	Brake resistor: Warning threshold (Brake resistor: Warning thresh.) 50.0 ... [90.0] ... 150.0 %	Warning threshold for brake resistor monitoring. <ul style="list-style-type: none"> <li>If the utilisation shown in 0x2541:004 (P706.04) reaches the threshold set, the response selected in 0x2550:010 (P707.10) is effected.</li> <li>The warning is reset with a hysteresis of 20 %.</li> </ul>
0x2550:009 (P707.09)	Brake resistor: Error threshold (Brake resistor: Error thresh.) 50.0 ... [100.0] ... 150.0 %	Error threshold for brake resistor monitoring. <ul style="list-style-type: none"> <li>If the utilisation shown in 0x2541:004 (P706.04) reaches the threshold set, the response selected in 0x2550:011 (P707.11) is effected.</li> <li>Resetting the error is only possible if the hysteresis is lower than 20 %.</li> </ul>
0x2550:010 (P707.10)	Brake resistor: Response to warning (Brake resistor: Warning resp.)	Selection of the response that is executed when the warning threshold for brake resistor monitoring is reached.  Associated event ID: <ul style="list-style-type: none"> <li>65334   0xFF36 - Warning - Brake resistor overload</li> </ul>
	<b>0</b> No response	▶ Severity <span style="color: blue;">□</span> 700
	<b>1</b> Warning	
	<b>2</b> Trouble	
	<b>3</b> Fault	
0x2550:011 (P707.11)	Brake resistor: Response to error (Brake resistor: Error response)	Selection of the response to be executed when the error threshold for brake resistor monitoring is reached.  Associated event ID: <ul style="list-style-type: none"> <li>65282   0xFF02 - Fault - Brake resistor overload</li> </ul>
	<b>0</b> No response	▶ Severity <span style="color: blue;">□</span> 700
	<b>1</b> Warning	
	<b>2</b> Trouble	
	<b>3</b> Fault	



## 14.1.2 Stopping the deceleration ramp function generator

The deceleration ramp function generator is stopped for a short time if the voltage threshold for braking operation is exceeded.

### Details

When this braking method is selected, the maximum permissible time for the deceleration override has to be set in [0x2541:005 \(P706.05\)](#).

- If the DC-bus voltage does not fall below the voltage threshold for braking operation shown in [0x2541:002 \(P706.02\)](#) within this time, the motor is decelerated further.
- The time is only reset if the voltage threshold shown in [0x2541:002 \(P706.02\)](#) is not reached.

### Precondition



---

The "inverter motor brake" braking method only works in operating mode [0x6060 \(P301.00\)](#) = "MS: Velocity mode [-2]".

---



## 14.1.3 Inverter motor brake

### NOTICE

If it is braked too frequently, there is a risk of the motor being thermally overloaded or the motor overload monitoring does not work properly!

The "Inverter motor brake" braking method must not be used with vertical conveyors (hoists) or with active loads!

Avoid activating the "Inverter motor brake" function over a longer time!

- ▶ The "inverter motor brake" braking method only works in operating mode [0x6060 \(P301.00\)](#) = "MS: Velocity mode [-2]".
- ▶ In applications with a high mass inertia and long braking times (> 2 s), use the "DC braking" function.

With this braking method, which can be selected in [0x2541:001 \(P706.01\)](#), the regenerative energy is converted into heat in the motor as a result of rapid acceleration/deceleration with down-ramping of the ramp function generator.

### Conditions



The "inverter motor brake" braking method only works in operating mode [0x6060 \(P301.00\)](#) = "MS: Velocity mode [-2]".

- When this braking method is used, the motor overload monitoring is not adapted. A too frequent use of the inverter motor brake may cause an incorrect operation of the motor overload monitoring. ▶ [Motor overload monitoring \(i<sup>2</sup>xt\)](#) □ 257

### Details

During the deceleration process, the ramp function generator is stopped. The frequency set in [0x2541:004 \(P706.04\)](#) is added to the frequency setpoint, taking the sign of the current actual frequency into consideration. Furthermore the ramp function generator is stopped in a state of overvoltage. If the DC-bus voltage falls below a defined DC-bus voltage potential, the additional frequency connected is reduced again and the ramp function generator is re-activated. By the alternating acceleration and deceleration resulting from this circuit, the energy is converted thermally in the motor. For process-related reasons, torque oscillations may occur.

### Setting instructions

Generally, the smallest value possible required by the application for being able to still traverse the load to be moved in a controlled fashion should be set as additional frequency. Greater mass inertia values require an increase in the rated motor frequency set. Increasing the rated motor frequency, however, causes greater torque oscillations. A possible consequence is the reduced service life of mechanical components. Furthermore an increase in the rated motor frequency also increases the energy converted into heat in the motor. A possible consequence is the reduced service life of the motor.

### Parameter

Address	Name / setting range / [default setting]	Information
0x2541:004 (P706.04)	Brake energy management: Additional frequency (Brake management: Add.frequency) 0.0 ... [0.0] ... 10.0 Hz	Frequency deviation which is connected to the deceleration ramp in a pulsative fashion when the "Inverter motor brake" braking method is used.





## 14.2 Parameter change-over

For up to 32 freely selectable parameters, this function provides a change-over between four sets with different parameter values.

### **DANGER!**

Unexpected response of the motor shaft while the inverter is enabled.

Changed parameter settings can become effective immediately depending on the activating method set in [0x4046 \(P755.00\)](#).



Possible consequences: Death, severe injuries or damage to property

- ▶ If possible, only carry out parameter changes while the inverter is disabled.
  - ▶ Certain device commands or settings which might cause a critical state of the drive behaviour can generally only be carried out when the inverter is inhibited.
- 

### Details

The parameter list is compiled in the same way as that of the "Favorites" via configuration. »EASY Starter« provides a user-friendly parameterisation dialog for this purpose.

Change-over to another value set can optionally be effected via corresponding device commands and/or special functions/triggers:

- ▶ [Device commands for parameter change-over](#)  596
- ▶ [Functions for parameter change-over](#)  598

# Additional functions

Parameter change-over

Example: Selective control of several motors with one inverter



## 14.2.1 Example: Selective control of several motors with one inverter

A typical application for the parameter change-over is an application/machine in which several axes must be triggered successively but a simultaneous operation of several motors is not required. In this case, one and the same inverter can trigger the motors in succession.

Advantages of this solution are the reduced amount of components (inverters) and a reduced energy consumption.

Principle:

- The motor to be currently controlled is connected to the inverter via motor contactors. (The contactor system can, for instance, be controlled via the digital outputs of the inverter.)
- At the same time, the motor and control settings suitable for motor are activated in the inverter by means of parameter change-over.

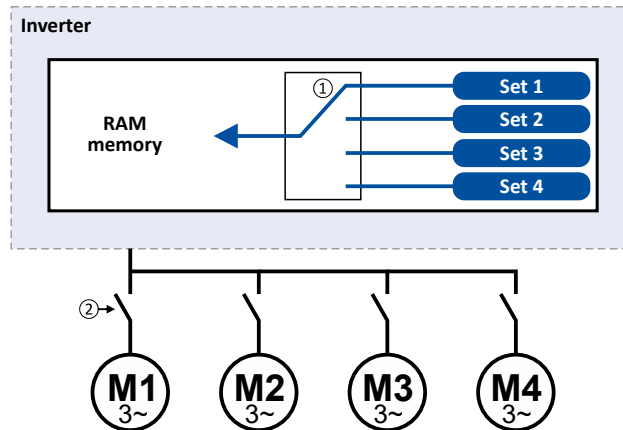

- Motor data change-over (via the "parameter change-over" function)
- Motor change-over (e.g. via motor contactors)

The following table lists all parameters that require different settings for the four motors:

#	Parameter	Name	Setting			
			M1	M2	M3	M4
1	0x2B00 (P302.00)	V/f characteristic shape	Linear [0]	Square-law [1]	Linear [0]	Linear [0]
2	0x2B01:002 (P303.02)	Base frequency	60 Hz	60 Hz	60 Hz	50 Hz
3	0x2D4B:001 (P308.01)	Maximum utilisation [60 s]	150 %	120 %	150 %	150 %
4	0x2B12:001 (P316.01)	Fixed boost	2.5 %	0.0 %	4.0 %	2.0 %
5	0x2C01:004 (P320.04)	Rated speed	1745	3450	1750	1450
6	0x2C01:005 (P320.05)	Rated frequency	60.0 Hz	60.0 Hz	60.0 Hz	50.0 Hz
7	0x2C01:006 (P320.06)	Rated power	0.75 kW	0.75 kW	0.75 kW	1.50 kW
8	0x2C01:007 (P320.07)	Rated voltage	480 V	480 V	480 V	400 V
9	0x6075 (P323.00)	Rated motor current	2,200 A	2,100 A	2,200 A	3,500 A
10	0x6073 (P324.00)	Max. current	200.0 %	150.0 %	200.0 %	200.0 %



## Settings required for the "parameter change-over" function

The easiest way to make the required settings is via the parameterization dialog in the »EASY Starter«:

1. Click the button to first select the 10 relevant parameters.
2. Set values for motor M1 ... M4 in the corresponding fields:

Line	Address	Display parameter	Name	Unit	Active value	Value 1	Value 2	Value 3	Value 4
1	0x2B00:000	P302:000	V/f characteristic shape		Linear [0]	Linear [0]	Quadratic [1]	Linear [0]	Linear [0]
2	0x2B01:002	P303:002	V/f shape data: Base frequency	Hz	50	60	60	60	50
3	0x2D4B:001	P308:001	Motor overload monit. (%): Maxim...	%	150	150	150	150	150
4	0x2B12:001	P316:001	V/f voltage boost: Fixed boost	%	0,0	0,0	0,0	4,0	2,0
5	0x2C01:004	P320:004	Motor parameters: Rated speed	rpm	1450	1745	3450	1450	1450
6	0x2C01:005	P320:005	Motor parameters: Rated frequency	Hz	50,0	60,0	60,0	60,0	50,0
7	0x2C01:006	P320:006	Motor parameters: Rated power	kW	0,00	0,75	0,75	0,75	1,50
8	0x2C01:007	P320:007	Motor parameters: Rated voltage	V	0	480	480	480	400
9	0x6075:000	P323:000	Rated motor current	A	0,001	2,200	2,100	2,200	3,500
10	0x6073:000	P324:000	Max. current	%	200,0	200,0	150,0	200,0	200,0

In case of a direct setting in the parameters of the "parameter change-over" function:

- The addresses must be set in the following: 0xiiiiis00 (iiii = hexadecimal index, ss = hexadecimal subindex) The keypad can be used to select the desired parameter from a list.
- The values for the motors must be set as integer values. The integer value results from the multiplication of the actual setting value by the factor of the respective parameter. In the table of attributes, the factor for each parameter must be given.

The following table shows the required settings:

#	Address 0x4041:x (PAR 750/x)		Name	Value 1 0x4042:x (PAR 752/x)	Value 2 0x4043:x (PAR 753/x)	Value 3 0x4044:x (PAR 754/x)	Value 4 0x4045:x (PAR 755/x)
	hex	decimal					
1	0x2B000000	721420288	V/f characteristic shape	0	1	0	0
2	0x2B010200	721486336	Base frequency	60	60	60	50
3	0x2D4B0100	759890176	Maximum utilisation [60 s]	150	120	150	150
4	0x2B120100	722600192	Fixed boost	25	0	40	20
5	0x2C010400	738264064	Rated speed	1745	3450	1750	1450
6	0x2C010500	738264320	Rated frequency	600	600	600	500
7	0x2C010600	738264576	Rated power	75	75	75	150
8	0x2C010700	738264832	Rated voltage	480	480	480	400
9	0x60750000	1618280448	Rated motor current	2200	2100	2200	3500
10	0x60730000	1618149376	Max. current	2000	1500	2000	2000

## 14.2.2 Parameter set configuration

### Parameter

Address	Name / setting range / [default setting]	Information
0x4041:001 ... 0x4041:032 (P750.01 ... 32)	Parameter change-over: Parameter 1 ... Parameter 32 (Param.set setup: Parameter 1 ... Parameter 32) 0x00000000 ... [0x00000000] ... 0xFFFFF00	Definition of the parameter list for the "Parameter change-over" function. • Format: 0xiiiiis00 (iiii = hexadecimal index, ss = hexadecimal subindex) • The lowest byte is always 0x00.
0x4042:001 ... 0x4042:032 (P751.01 ... 32)	Parameter value set 1: Value of parameter 1 ... Value of parameter 32 (Par. value set 1: Set 1 - Value 1 ... Set 1 - Value 32) -2147483648 ... [0] ... 2147483647	Value set 1 for the parameter list defined in 0x4041:001 ... 0x4041:032 (P750.01 ... 32).

# Additional functions

Parameter change-over  
Device commands for parameter change-over



Address	Name / setting range / [default setting]	Information																								
0x4043:001 ... 0x4043:032 (P752.01 ... 32)	Parameter value set 2: Value of parameter 1 ... Value of parameter 32 (Par. value set 2: Set 2 - Value 1 ... Set 2 - Value 32) -2147483648 ... [0] ... 2147483647	Value set 2 for the parameter list defined in 0x4041:001 ... 0x4041:032 (P750.01 ... 32).																								
0x4044:001 ... 0x4044:032 (P753.01 ... 32)	Parameter value set 3: Value of parameter 1 ... Value of parameter 32 (Par. value set 3: Set 3 - Value 1 ... Set 3 - Value 32) -2147483648 ... [0] ... 2147483647	Value set 3 for the parameter list defined in 0x4041:001 ... 0x4041:032 (P750.01 ... 32).																								
0x4045:001 ... 0x4045:032 (P754.01 ... 32)	Parameter value set 4: Value of parameter 1 ... Value of parameter 32 (Par. value set 4: Set 4 - Value 1 ... Set 4 - Value 32) -2147483648 ... [0] ... 2147483647	Value set 4 for the parameter list defined in 0x4041:001 ... 0x4041:032 (P750.01 ... 32).																								
0x4047:001 (P756.01)	Parameter change-over error message: Status (PSet error msg.: Status) • Read only <table border="1" style="width: 100%; border-collapse: collapse;"> <tr><td style="text-align: center;">0</td><td>No fault</td></tr> <tr><td style="text-align: center;">33803</td><td>Invalid data type</td></tr> <tr><td style="text-align: center;">33804</td><td>Range violation</td></tr> <tr><td style="text-align: center;">33806</td><td>Invalid index</td></tr> <tr><td style="text-align: center;">33813</td><td>No element selected</td></tr> <tr><td style="text-align: center;">33815</td><td>Writing impermissible</td></tr> <tr><td style="text-align: center;">33816</td><td>Device not inhibited</td></tr> <tr><td style="text-align: center;">33829</td><td>Invalid subindex</td></tr> <tr><td style="text-align: center;">33837</td><td>Access impermissible</td></tr> <tr><td style="text-align: center;">33860</td><td>Parameter not mappable</td></tr> <tr><td style="text-align: center;">33865</td><td>No subindexes</td></tr> <tr><td style="text-align: center;">33876</td><td>Parameter not changeable</td></tr> </table>	0	No fault	33803	Invalid data type	33804	Range violation	33806	Invalid index	33813	No element selected	33815	Writing impermissible	33816	Device not inhibited	33829	Invalid subindex	33837	Access impermissible	33860	Parameter not mappable	33865	No subindexes	33876	Parameter not changeable	Error message for the "parameter change-over" function. <ul style="list-style-type: none"> <li>In the event of an error, an error status is shown here, and in 0x4047:002 (P756.02) the number of the list entry in which the error has occurred is displayed (in connection with the value set selected).</li> <li>If several errors occur at the same time, only the first incorrect list entry will be displayed. Hence, after elimination of the displayed error and repeated activation, more errors may be displayed.</li> <li>The parameter list will always be processed from beginning to end, even if errors occur in the meantime.</li> </ul>
0	No fault																									
33803	Invalid data type																									
33804	Range violation																									
33806	Invalid index																									
33813	No element selected																									
33815	Writing impermissible																									
33816	Device not inhibited																									
33829	Invalid subindex																									
33837	Access impermissible																									
33860	Parameter not mappable																									
33865	No subindexes																									
33876	Parameter not changeable																									
0x4047:002 (P756.02)	Parameter change-over error message: List entry (PSet error msg.: List entry) • Read only	Error message for the "Parameter set changeover" function. <ul style="list-style-type: none"> <li>In the event of an error, the number of the list entry for which the error displayed in 0x4047:001 (P756.01) has occurred is shown here.</li> </ul>																								

## 14.2.3 Device commands for parameter change-over

The parameter set can be selected with the device commands "Load parameter set 1" ... "Load parameter set 4".

### Details

The change-over via the device commands depends on the activation method set in 0x4046 (P755.00):

- Activation method = 1 or 3: Change-over takes place immediately.
- Activation method = 0 or 2: The respective device command is only executed if the inverter is disabled.

### Parameter

Address	Name / setting range / [default setting]	Information																								
0x2022:007 (P700.07)	Device commands: Load parameter set 1 (Device commands: Load par. set 1)  <table border="1" style="width: 100%; border-collapse: collapse;"> <tr><td style="text-align: center;"><b>0</b></td><td><b>Off / ready</b></td></tr> <tr><td style="text-align: center;">1</td><td>On / start</td></tr> <tr><td style="text-align: center;">2</td><td>In progress</td></tr> <tr><td style="text-align: center;">3</td><td>Action cancelled</td></tr> <tr><td style="text-align: center;">4</td><td>No access</td></tr> <tr><td style="text-align: center;">5</td><td>No access (Device disabled)</td></tr> </table>	<b>0</b>	<b>Off / ready</b>	1	On / start	2	In progress	3	Action cancelled	4	No access	5	No access (Device disabled)	1 = load value set 1 of the "Parameter change-over" function. <ul style="list-style-type: none"> <li>The parameters specified in 0x4041/1...32 are set to the values set in 0x4042/1...32.</li> <li>When the device command has been executed successfully, the value 0 is shown.</li> </ul> <table border="1" style="width: 100%; border-collapse: collapse;"> <tr><td style="text-align: center;">0</td><td>Only status feedback</td></tr> <tr><td style="text-align: center;">1</td><td>Execute device command</td></tr> <tr><td style="text-align: center;">2</td><td>Only status feedback</td></tr> <tr><td style="text-align: center;">3</td><td></td></tr> <tr><td style="text-align: center;">4</td><td></td></tr> <tr><td style="text-align: center;">5</td><td></td></tr> </table>	0	Only status feedback	1	Execute device command	2	Only status feedback	3		4		5	
<b>0</b>	<b>Off / ready</b>																									
1	On / start																									
2	In progress																									
3	Action cancelled																									
4	No access																									
5	No access (Device disabled)																									
0	Only status feedback																									
1	Execute device command																									
2	Only status feedback																									
3																										
4																										
5																										



# Additional functions

## Parameter change-over Device commands for parameter change-over

Address	Name / setting range / [default setting]	Information
0x2022:008 (P700.08)	Device commands: Load parameter set 2 (Device commands: Load par. set 2)	1 = load value set 2 of the "Parameter change-over" function. <ul style="list-style-type: none"> <li>The parameters specified in 0x4041/1...32 are set to the values set in 0x4043/1...32.</li> <li>When the device command has been executed successfully, the value 0 is shown.</li> </ul>
	<b>0 Off / ready</b>	Only status feedback
	1 On / start	Execute device command
	2 In progress	Only status feedback
	3 Action cancelled	
	4 No access	
5 No access (Device disabled)		
0x2022:009 (P700.09)	Device commands: Load parameter set 3 (Device commands: Load par. set 3)	1 = load value set 3 of the "Parameter change-over" function. <ul style="list-style-type: none"> <li>The parameters specified in 0x4041/1...32 are set to the values set in 0x4044/1...32.</li> <li>When the device command has been executed successfully, the value 0 is shown.</li> </ul>
	<b>0 Off / ready</b>	Only status feedback
	1 On / start	Execute device command
	2 In progress	Only status feedback
	3 Action cancelled	
	4 No access	
5 No access (Device disabled)		
0x2022:010 (P700.10)	Device commands: Load parameter set 4 (Device commands: Load par. set 4)	1 = load value set 4 of the "Parameter change-over" function. <ul style="list-style-type: none"> <li>The parameters specified in 0x4041/1...32 are set to the values set in 0x4045/1...32.</li> <li>When the device command has been executed successfully, the value 0 is shown.</li> </ul>
	<b>0 Off / ready</b>	Only status feedback
	1 On / start	Execute device command
	2 In progress	Only status feedback
	3 Action cancelled	
	4 No access	
5 No access (Device disabled)		
0x2022:011 (P700.11)	Device commands: Save parameter set 1 (Device commands: Save par. set 1)	1 = save value set 1 of the "Parameter change-over" function. <ul style="list-style-type: none"> <li>When the device command has been executed successfully, the value 0 is shown.</li> </ul>
	<b>0 Off / ready</b>	Only status feedback
	1 On / start	Execute device command
	2 In progress	Only status feedback
	3 Action cancelled	
	4 No access	
5 No access (Device disabled)		
0x2022:012 (P700.12)	Device commands: Save parameter set 2 (Device commands: Save par. set 2)	1 = save value set 2 of the "Parameter change-over" function. <ul style="list-style-type: none"> <li>When the device command has been executed successfully, the value 0 is shown.</li> </ul>
	<b>0 Off / ready</b>	Only status feedback
	1 On / start	Execute device command
	2 In progress	Only status feedback
	3 Action cancelled	
	4 No access	
5 No access (Device disabled)		

# Additional functions

Parameter change-over  
Functions for parameter change-over



Address	Name / setting range / [default setting]	Information
0x2022:013 (P700.13)	Device commands: Save parameter set 3 (Device commands: Save par. set 3)	1 = save value set 3 of the "Parameter change-over" function. • When the device command has been executed successfully, the value 0 is shown.
	0 Off / ready	Only status feedback
	1 On / start	Execute device command
	2 In progress	Only status feedback
	3 Action cancelled	
	4 No access	
5 No access (Device disabled)		
0x2022:014 (P700.14)	Device commands: Save parameter set 4 (Device commands: Save par. set 4)	1 = save value set 3 of the "Parameter change-over" function. • When the device command has been executed successfully, the value 0 is shown.
	0 Off / ready	Only status feedback
	1 On / start	Execute device command
	2 In progress	Only status feedback
	3 Action cancelled	
	4 No access	
5 No access (Device disabled)		

## 14.2.4 Functions for parameter change-over

The parameter set can be selected with the functions "Select parameter set (bit 0)" and "Select parameter set (bit 1)".

### Details

A value set is selected in a binary-coded fashion via the triggers assigned to the two Select parameter set (bit 0)" and " Select parameter set (bit 1)" functions in compliance with the following truth table:

Select parameter set (bit 1) 0x2631:042 (P400.42)	Select parameter set (bit 0) 0x2631:041 (P400.41)	Selection
FALSE	FALSE	Value set 1
FALSE	TRUE	Value set 2
TRUE	FALSE	Value set 3
TRUE	TRUE	Value set 4

Change-over is effected depending on the activation method selected in 0x4046 (P755.00) when a state change of the selection inputs takes place or via the trigger assigned to the "Load parameter set" function.

### Parameter

Address	Name / setting range / [default setting]	Information
0x2631:040 (P400.40)	Function list: Load parameter set (Function list: Load param.set) • Setting can only be changed if the inverter is disabled. • Further possible settings: ▶ <a href="#">Trigger list</a> 73	Assignment of a trigger for the "Load parameter set" function. Trigger = FALSE-TRUE edge: parameter change-over to the value set selected via "Select parameter set (bit 0)" and "Select parameter set (bit 1)". Trigger = FALSE: no action.  Notes: • The activation method for the "Parameter change-over" function can be selected in 0x4046 (P755.00).
	0 Not connected	No trigger assigned (trigger is constantly FALSE).
0x2631:041 (P400.41)	Function list: Select parameter set (bit 0) (Function list: Sel. paramset b0) • Setting can only be changed if the inverter is disabled. • Further possible settings: ▶ <a href="#">Trigger list</a> 73	Assignment of a trigger for the "Select parameter set (bit 0)" function. Selection bit with the valency 2 <sup>0</sup> for "Parameter change-over" function. Trigger = FALSE: selection bit = "0". Trigger = TRUE: selection bit = "1".
	0 Not connected	No trigger assigned (trigger is constantly FALSE).



# Additional functions

Parameter change-over  
Functions for parameter change-over

Address	Name / setting range / [default setting]	Information
0x2631:042 (P400.42)	Function list: Select parameter set (bit 1) (Function list: Sel. paramset b1) <ul style="list-style-type: none"> <li>Setting can only be changed if the inverter is disabled.</li> <li>Further possible settings: ▶ <a href="#">Trigger list</a> ☐ 73</li> </ul>	Assignment of a trigger for the "Select parameter set (bit 1)" function. Selection bit with the valency 2 <sup>1</sup> for "Parameter change-over" function. Trigger = FALSE: selection bit = "0". Trigger = TRUE: selection bit = "1".
	<b>0 Not connected</b>	No trigger assigned (trigger is constantly FALSE).
0x4046 (P755.00)	Activation of parameter set (PSet activation)	Selection of the activation method for the parameter change-over. <ul style="list-style-type: none"> <li>If the selection is changed from "Via command... [0]/[1]" to "If the selection is changed...[2]/[3]" after switch-on, the parameter set selected via the functions "Select parameter set (bit 0)" and "Select parameter set (bit 1)" is activated immediately. In case of selection [2], however, this only takes place if the inverter is disabled, the motor is stopped or an error is active.</li> </ul>
	<b>0 Via command (disable required)</b>	The parameter set selected via the functions "Select parameter set (bit 0)" and "Select parameter set (bit 1)" is activated if the trigger assigned to the "Load parameter set" function in <a href="#">0x2631:040 (P400.40)</a> provides a FALSE-TRUE edge AND the inverter is inhibited, the motor is stopped or an error is active. ▶ <a href="#">Example: Activation via command (only when disabled)</a> ☐ 600
	1 Via command (immediately)	The parameter set selected via the functions "Select parameter set (bit 0)" and "Select parameter set (bit 1)" is immediately activated if the trigger assigned to the "Load parameter set" function in <a href="#">0x2631:040 (P400.40)</a> provides a FALSE-TRUE edge. ▶ <a href="#">Example: Activation via command (immediately)</a> ☐ 601
	2 If the selection is changed (disable required)	The parameter set selected via the functions "Select parameter set (bit 0)" and "Select parameter set (bit 1)" is activated if the state of these selection bits changes AND the inverter is inhibited, the motor is stopped or an error is active. ▶ <a href="#">Example: Activation if the selection is changed (only if the inverter is disabled)</a> ☐ 602
	3 If the selection is changed (immediately)	The parameter set selected via the functions "Select parameter set (bit 0)" and "Select parameter set (bit 1)" is activated immediately if the state of these selection bits is changed. ▶ <a href="#">Example: Activation if the selection is changed (immediately)</a> ☐ 603

# Additional functions

Parameter change-over  
 Functions for parameter change-over  
 Example: Activation via command (only when disabled)



## 14.2.4.1 Example: Activation via command (only when disabled)

Activation method 0x4046 (P755.00) = "Via command (disable required) [0]":

- Switches S3 and S4 serve to select the parameter set (see the following table).
- Switch S2 activates the change-over. Since the change-over is activated with a rising edge, a button (normally-open contact) can be used instead of a switch.
- Change-over is only possible if the motor is not started (switch S1 open).

Connection plan	Function															
	Switch S1 Run															
	Switch S2 Load parameter set															
	Switches S3 ... S4 Parameter set selection:															
	<table border="1"> <thead> <tr> <th>S3</th> <th>S4</th> <th>Parameter set</th> </tr> </thead> <tbody> <tr> <td>Off</td> <td>Off</td> <td>Parameter set 1</td> </tr> <tr> <td>On</td> <td>Off</td> <td>Parameter set 2</td> </tr> <tr> <td>Off</td> <td>On</td> <td>Parameter set 3</td> </tr> <tr> <td>On</td> <td>On</td> <td>Parameter set 4</td> </tr> </tbody> </table>	S3	S4	Parameter set	Off	Off	Parameter set 1	On	Off	Parameter set 2	Off	On	Parameter set 3	On	On	Parameter set 4
	S3	S4	Parameter set													
Off	Off	Parameter set 1														
On	Off	Parameter set 2														
Off	On	Parameter set 3														
On	On	Parameter set 4														

Parameter	Designation	Setting for this example
0x2631:001 (P400.01)	Enable inverter	Constant TRUE [1]
0x2631:002 (P400.02)	Run	Digital input 1 [11]
0x2631:004 (P400.04)	Reset fault	Not connected [0]
0x2631:013 (P400.13)	Reverse rotational direction	Not connected [0]
0x2631:018 (P400.18)	Activate preset (bit 0)	Not connected [0]
0x2631:040 (P400.40)	Load parameter set	Digital input 2 [12]
0x2631:041 (P400.41)	Select parameter set (bit 0)	Digital input 3 [13]
0x2631:042 (P400.42)	Select parameter set (bit 1)	Digital input 4 [14]
0x2824 (P200.00)	Control selection	Flexible I/O configuration [0]
0x4046 (P755.00)	Activation of parameter set	Via command (disable required) [0]

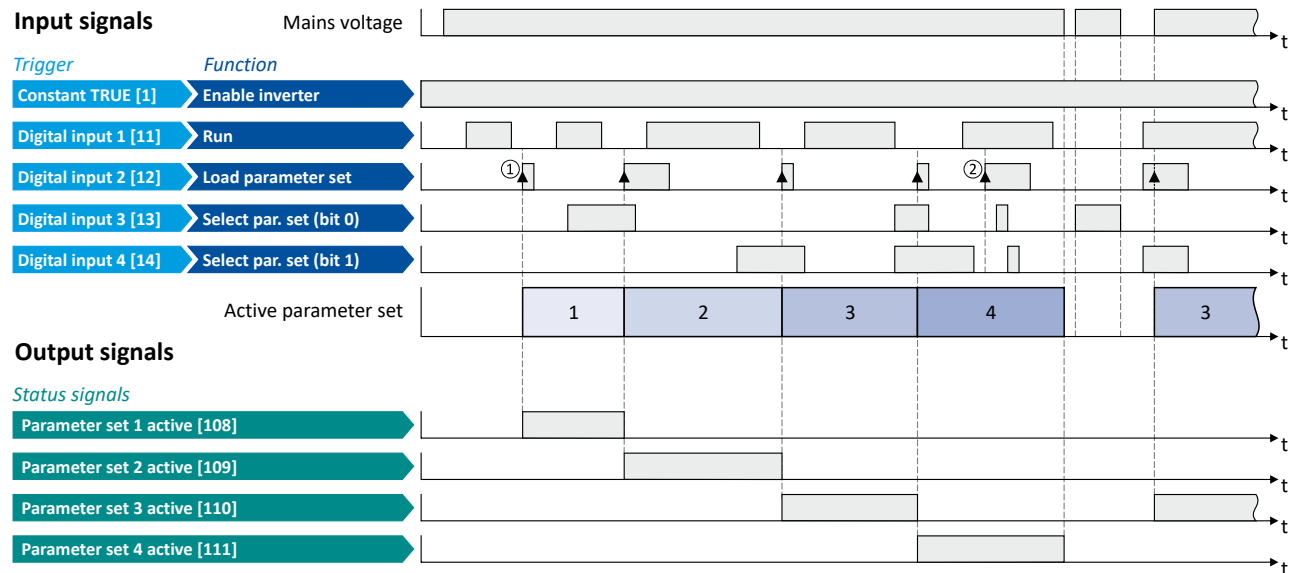

The status signals can be assigned to digital outputs. ▶ [Configure digital outputs](#) 292

- ① The change-over is activated with the "Load parameter set" function (FALSE/TRUE edge).
- ② If the inverter is enabled and the motor is started, a change-over is not possible.





# Additional functions

Parameter change-over  
 Functions for parameter change-over  
 Example: Activation via command (immediately)

## 14.2.4.2 Example: Activation via command (immediately)

Activation method **0x4046 (P755.00)** = "Via command (immediately) [1]":

- Switches S3 and S4 serve to select the parameter set (see the following table).
- Switch S2 activates the change-over. Since the change-over is activated with a rising edge, a button (normally-open contact) can be used instead of a switch.
- Change-over takes place immediately, even if the motor is started (switch S1 closed).

Connection plan	Function															
	Switch S1   Run															
	Switch S2   Load parameter set															
	Switches S3 ... S4   Parameter set selection:															
	<table border="1"> <thead> <tr> <th>S3</th> <th>S4</th> <th>Parameter set</th> </tr> </thead> <tbody> <tr> <td>Off</td> <td>Off</td> <td>Parameter set 1</td> </tr> <tr> <td>On</td> <td>Off</td> <td>Parameter set 2</td> </tr> <tr> <td>Off</td> <td>On</td> <td>Parameter set 3</td> </tr> <tr> <td>On</td> <td>On</td> <td>Parameter set 4</td> </tr> </tbody> </table>	S3	S4	Parameter set	Off	Off	Parameter set 1	On	Off	Parameter set 2	Off	On	Parameter set 3	On	On	Parameter set 4
	S3	S4	Parameter set													
Off	Off	Parameter set 1														
On	Off	Parameter set 2														
Off	On	Parameter set 3														
On	On	Parameter set 4														

Parameter	Designation	Setting for this example
0x2631:001 (P400.01)	Enable inverter	Constant TRUE [1]
0x2631:002 (P400.02)	Run	Digital input 1 [11]
0x2631:004 (P400.04)	Reset fault	Not connected [0]
0x2631:018 (P400.18)	Activate preset (bit 0)	Not connected [0]
0x2631:018 (P400.18)	Activate preset (bit 0)	Not connected [0]
0x2631:040 (P400.40)	Load parameter set	Digital input 2 [12]
0x2631:041 (P400.41)	Select parameter set (bit 0)	Digital input 3 [13]
0x2631:042 (P400.42)	Select parameter set (bit 1)	Digital input 4 [14]
0x2824 (P200.00)	Control selection	Flexible I/O configuration [0]
0x4046 (P755.00)	Activation of parameter set	Via command (immediately) [1]

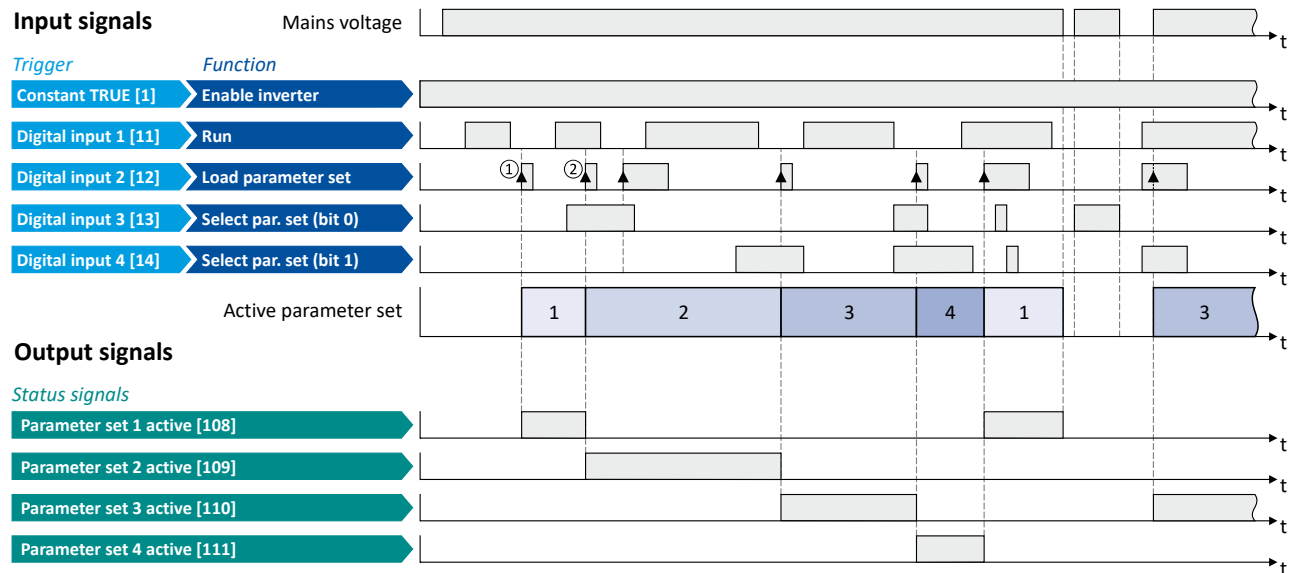

The status signals can be assigned to digital outputs. ▶ [Configure digital outputs](#) 292

- ① The change-over is activated with the "Load parameter set" function (FALSE/TRUE edge).
- ② Change-over is also possible if the inverter is enabled and the motor is started.

# Additional functions

Parameter change-over

Functions for parameter change-over

Example: Activation if the selection is changed (only if the inverter is disabled)



## 14.2.4.3 Example: Activation if the selection is changed (only if the inverter is disabled)

Activation method 0x4046 (P755.00) = "If the selection is changed (disable required) [2]":

- Switches S3 and S4 serve to select the parameter set (see the following table). At the same time, the change-over is activated by a status change of the selection inputs.
- Change-over is only possible if the motor is not started (switch S1 open).
- Switch S2 ("Load parameter set") is ignored in this configuration.

Connection plan	Function															
	Switch S1   Run															
	Switch S2   Load parameter set (is ignored in this configuration)															
	Switches S3 ... S4   Parameter set selection and activation at the same time:															
	<table border="1"> <thead> <tr> <th>S3</th> <th>S4</th> <th></th> </tr> </thead> <tbody> <tr> <td>Off</td> <td>Off</td> <td>Parameter set 1</td> </tr> <tr> <td>On</td> <td>Off</td> <td>Parameter set 2</td> </tr> <tr> <td>Off</td> <td>On</td> <td>Parameter set 3</td> </tr> <tr> <td>On</td> <td>On</td> <td>Parameter set 4</td> </tr> </tbody> </table>	S3	S4		Off	Off	Parameter set 1	On	Off	Parameter set 2	Off	On	Parameter set 3	On	On	Parameter set 4
	S3	S4														
Off	Off	Parameter set 1														
On	Off	Parameter set 2														
Off	On	Parameter set 3														
On	On	Parameter set 4														

Parameter	Designation	Setting for this example
0x2631:001 (P400.01)	Enable inverter	Constant TRUE [1]
0x2631:002 (P400.02)	Run	Digital input 1 [11]
0x2631:004 (P400.04)	Reset fault	Not connected [0]
0x2631:013 (P400.13)	Reverse rotational direction	Not connected [0]
0x2631:018 (P400.18)	Activate preset (bit 0)	Not connected [0]
0x2631:040 (P400.40)	Load parameter set	Digital input 2 [12]
0x2631:041 (P400.41)	Select parameter set (bit 0)	Digital input 3 [13]
0x2631:042 (P400.42)	Select parameter set (bit 1)	Digital input 4 [14]
0x2824 (P200.00)	Control selection	Flexible I/O configuration [0]
0x4046 (P755.00)	Activation of parameter set	If the selection is changed (disable required) [2]

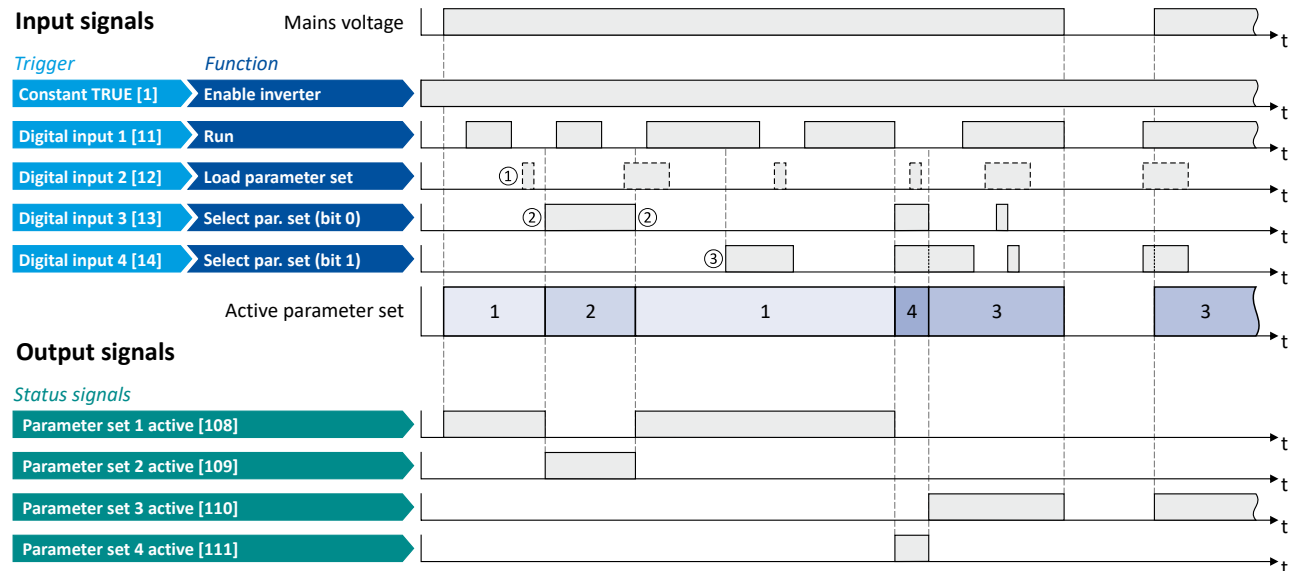

The status signals can be assigned to digital outputs. [▶ Configure digital outputs 292](#)

- ① The "Load parameter set" function is ignored in this configuration.
- ② Change-over takes place by a status change of the selection inputs.
- ③ If the inverter is enabled and the motor is started, a change-over is not possible.



# Additional functions

Parameter change-over  
 Functions for parameter change-over  
 Example: Activation if the selection is changed (immediately)

## 14.2.4.4 Example: Activation if the selection is changed (immediately)

Activation method 0x4046 (P755.00) = "If the selection is changed (immediately) [3]":

- Switches S3 and S4 serve to select the parameter set (see the following table). At the same time, the change-over is activated by a status change of the selection inputs.
- Change-over takes place immediately, even if the motor is started (switch S1 closed).
- Switch S2 ("Load parameter set") is ignored in this configuration.

Connection plan	Function															
	Switch S1   Run															
	Switch S2   Load parameter set (is ignored in this configuration)															
	Switches S3 ... S4   Parameter set selection and activation at the same time:															
	<table border="1"> <thead> <tr> <th>S3</th> <th>S4</th> <th></th> </tr> </thead> <tbody> <tr> <td>Off</td> <td>Off</td> <td>Parameter set 1</td> </tr> <tr> <td>On</td> <td>Off</td> <td>Parameter set 2</td> </tr> <tr> <td>Off</td> <td>On</td> <td>Parameter set 3</td> </tr> <tr> <td>On</td> <td>On</td> <td>Parameter set 4</td> </tr> </tbody> </table>	S3	S4		Off	Off	Parameter set 1	On	Off	Parameter set 2	Off	On	Parameter set 3	On	On	Parameter set 4
	S3	S4														
Off	Off	Parameter set 1														
On	Off	Parameter set 2														
Off	On	Parameter set 3														
On	On	Parameter set 4														

Parameter	Designation	Setting for this example
0x2631:001 (P400.01)	Enable inverter	Constant TRUE [1]
0x2631:002 (P400.02)	Run	Digital input 1 [11]
0x2631:004 (P400.04)	Reset fault	Not connected [0]
0x2631:013 (P400.13)	Reverse rotational direction	Not connected [0]
0x2631:018 (P400.18)	Activate preset (bit 0)	Not connected [0]
0x2631:040 (P400.40)	Load parameter set	Digital input 2 [12]
0x2631:041 (P400.41)	Select parameter set (bit 0)	Digital input 3 [13]
0x2631:042 (P400.42)	Select parameter set (bit 1)	Digital input 4 [14]
0x2824 (P200.00)	Control selection	Flexible I/O configuration [0]
0x4046 (P755.00)	Activation of parameter set	If the selection is changed (immediately) [3]

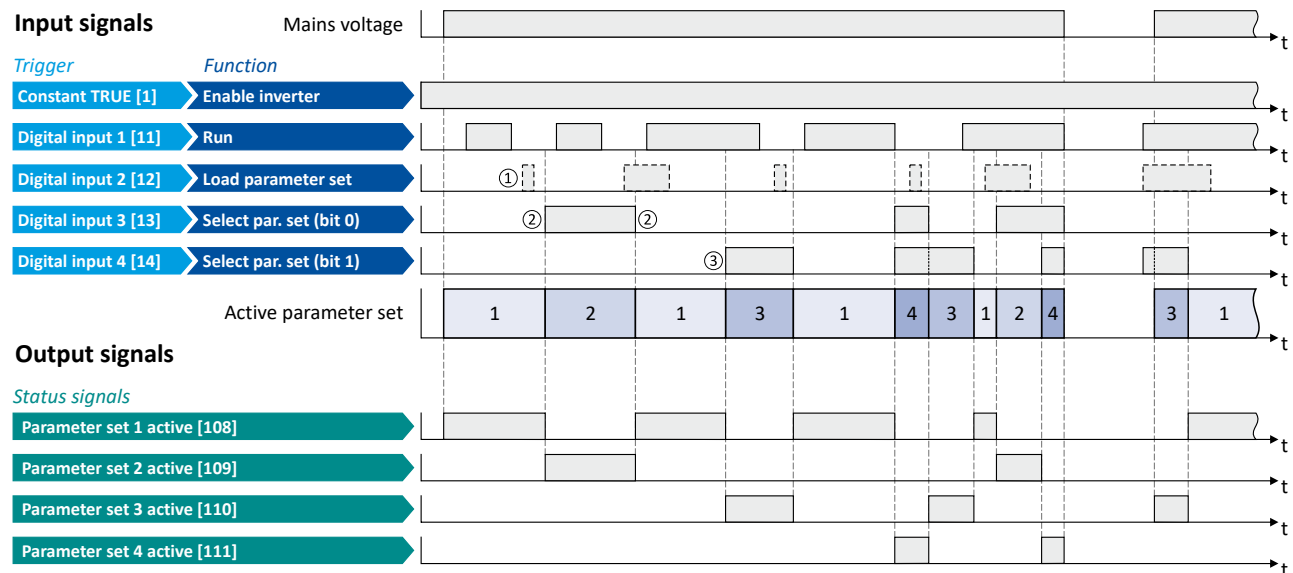

The status signals can be assigned to digital outputs. ▶ [Configure digital outputs](#) 292

- ① The "Load parameter set" function is ignored in this configuration.
- ② Change-over takes place by a status change of the selection inputs.
- ③ Change-over is also possible if the inverter is enabled and the motor is started.



## 14.3 Trigger action if a frequency threshold is exceeded

As a function of the current output frequency, the adjustable frequency threshold serves to trigger a certain function or set a digital output.

### Parameter

Address	Name / setting range / [default setting]	Information
0x4005 (P412.00)	Frequency threshold (Freq. threshold) 0.0 ... [0.0] ... 599.0 Hz	Threshold for the "Frequency threshold exceeded [70]" trigger. <ul style="list-style-type: none"> <li>The "Frequency threshold exceeded [70]" trigger is TRUE if the current output frequency is higher than the set threshold.</li> <li>The trigger can be assigned to a function or to a digital output.</li> </ul>

### Example for operating mode

In the following example, the digital output 1 is set to TRUE if the output frequency is higher than 20 Hz.

- The analog input 1 is set as standard setpoint source.
- Switch S1 starts the motor in forward direction of rotation. De-Asserting switch S1 stops the motor again.

Connection plan	Function	
	Potentiometer R1	Frequency setpoint selection
	Switch S1	Run

Parameter	Designation	Setting for this example
0x2631:001 (P400.01)	Enable inverter	Constant TRUE [1]
0x2631:002 (P400.02)	Run	Digital input 1 [11]
0x2634:002 (P420.02)	Digital outputs function: Digital output 1	Frequency threshold exceeded [70]
0x2824 (P200.00)	Control selection	Flexible I/O configuration [0]
0x2860:001 (P201.01)	Frequency control: Default setpoint source	Analog input 1 [2]
0x4005 (P412.00)	Frequency threshold	20 Hz

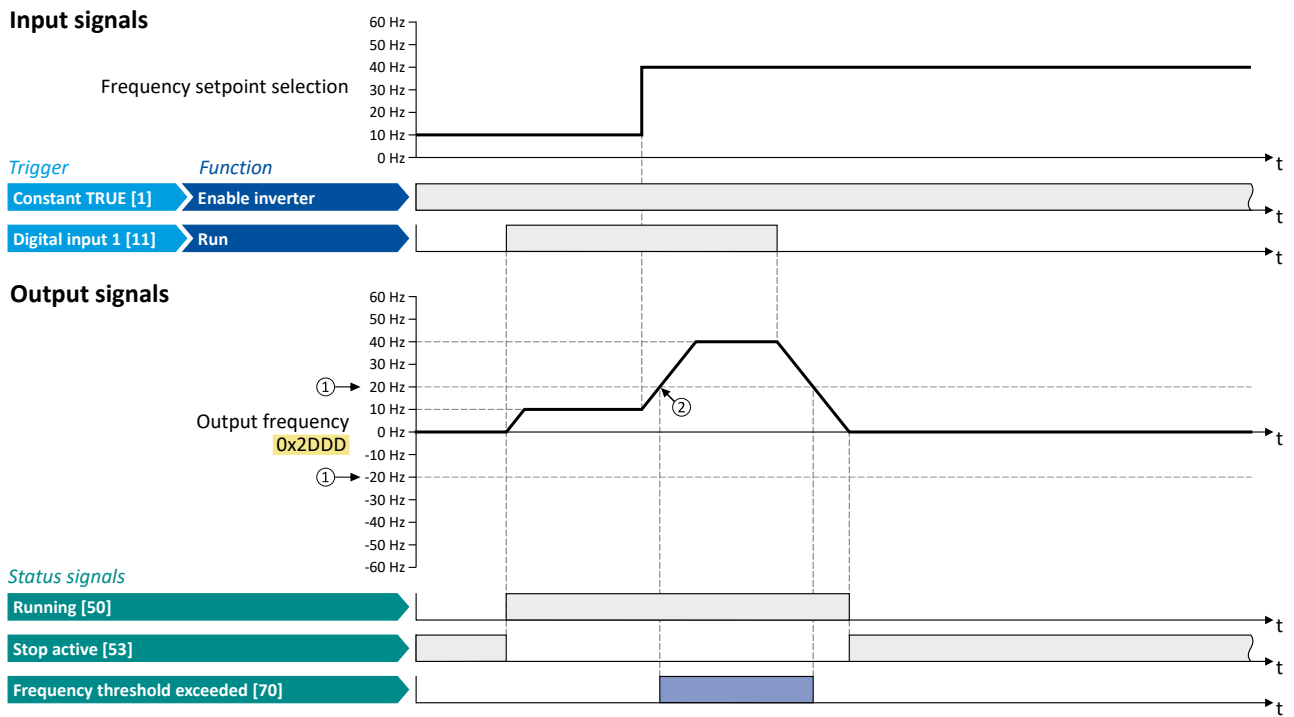

The status signals can be assigned to digital outputs. ▶ [Configure digital outputs](#) 292

- ① Frequency threshold 0x4005 (P412.00)
- ② Frequency threshold exceeded: Via trigger "Frequency threshold exceeded [70]", the digital output 1 is set to TRUE.



### 14.4 Position counter

This function counts the number of motor revolutions. The current counter content (actual position) can be output as process data value via network to implement a simple position control in a higher-level Controller.

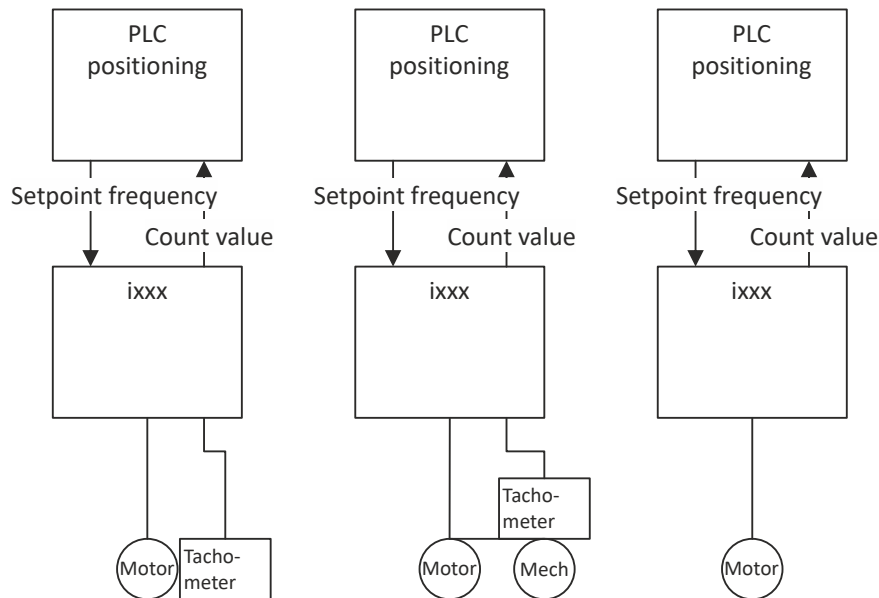

#### Preconditions

- An HTL encoder must be connected to and set at the digital inputs DI3/DI4. ▶ [HTL encoder](#) 176
- As an alternative, the number of motor revolutions from the motor model can be reconstructed. For this purpose, the motor control type "Sensorless control (SL PSM) [3]" must be selected and set in 0x2C00 (P300.00). ▶ [Sensorless control for synchronous motor \(SL-PSM\)](#) 188
- The position control must be implemented in the Controller.



## Details

The signal source for the position counter is selected in [0x2C49:001 \(P711.01\)](#). The position counter can count forwards and backwards. The current counter content (actual position) is displayed in [0x2C49:003 \(P711.03\)](#). After the maximum or minimum value has been reached, an overflow takes place.

Overview\Additional functions\Position counter Search parameters in dialogs

This function counts the number of motor turns and display it in a parameter.  
The value can be transferred to the network and used to make a basic positioning on a PLC.  
The control loop needs to be implemented in the PLC.

Signal source:  → [Counter Icon] → Actual position

Actual position: High WORD (Nr. of turns)   
Low WORD (1 tum)

Reset mode:   
Position counter reset:  → [Counter Icon]

[Configuring the network](#) [Network Diagram Icon]

Reset position counter:

- The position counter is reset when the supply voltage is switched on.
- The position counter can be reset manually via the "Set position counter" [0x2631:054 \(P400.54\)](#) function or the NetWordIN1 [0x4008:001 \(P590.01\)](#) data word. For a reset via NetWordIN1, the "Position counter reset [54]" function must be assigned to a bit of the data word. Depending on the selection in [0x2C49:002 \(P711.02\)](#), the reset can be made either edge-controlled or status-controlled.

## Parameter

Address	Name / setting range / [default setting]	Information
0x2631:054 (P400.54)	Function list: Set position counter (Function list: Set pos counter) <ul style="list-style-type: none"> <li>• From version 03.00</li> <li>• Further possible settings: <a href="#">▶ Trigger list ☰ 73</a></li> </ul>	Assignment of a trigger for the "Set position counter" function. Trigger = FALSE-TRUE edge: Reset position counter manually. Trigger = FALSE: no action.  Notes: <ul style="list-style-type: none"> <li>• In <a href="#">0x2C49:002 (P711.02)</a> it can be selected whether the reset is to be effected edge-controlled (default setting) or status-controlled.</li> </ul>
	<b>0 Not connected</b>	No trigger assigned (trigger is constantly FALSE).



Address	Name / setting range / [default setting]	Information
0x2C49:001 (P711.01)	Position counter: Signal source (Position counter: Signal source) • From version 03.00	Selection of the signal source for the position counter.
	<b>0 Disabled</b>	Position counter is deactivated.
	1 Digital inputs DI3/DI4	The motor revolutions are counted that are provided by an HTL encoder connected to the digital inputs DI3/DI4. • A motor revolution always equals to the increments/revolution set in <a href="#">0x2C42:001 (P341.01)</a> for the HTL encoder. This applies to all types of HTL encoders that can be set in <a href="#">0x2630:002 (P410.02)</a> : "High resolution HTL encoder [1]", "Pulse train [2]" and "Pulse train/direction [3]". • The counter content will be updated as well if the power section is switched off. • If an HTL encoder is used without detecting the direction of rotation, it is only counted forwards.
5 Internal motor model	The motor revolutions reconstructed from the internal motor model of the sensorless control (SL PSM) are counted. • The counter content will not be updated if the power section is switched off. • After restarting the power section, the counting of the last counter content is continued.	
0x2C49:002 (P711.02)	Position counter: Set position (Position counter: Set position) • From version 03.00	Selection if the manual reset of the position counter is to be effected edge-controlled or status-controlled.
	<b>0 By rising edge</b>	
	1 By signal state TRUE	
0x2C49:003 (P711.03)	Position counter: Actual position (Position counter: Actual position) • Read only • From version 03.00	Mappable parameter for providing the current counter content (actual position) via network.  Scaling (applies to every measuring method or encoder resolution): • Upper 16 bits: Counted revolutions (0 ... 65535, overflow possible) • Lower 16 bits: Current position within the revolution (0 ... 65535)





## 14.5 Mains failure control

In case of power failure, this function can decelerate the motor and use its rotational energy to maintain the DC-bus voltage for a certain period of time. This makes it possible to continue to let the drive run during a short-term failure of the mains voltage. After mains recovery, the operating status that was active before the failure is adopted again.

### Details

A failure of the mains voltage causes a continuous DC-bus voltage drop. If the mains failure control is enabled in [0x2D66:001 \(P721.01\)](#), it will get active if the DC-bus voltage falls below the activation threshold set in [0x2D66:002 \(P721.02\)](#).

As soon as the mains failure control is active, the motor is decelerated. Now the rotational energy of the motor is used to maintain the DC-bus voltage above the error threshold for undervoltage until the motor is decelerated to standstill in a controlled way. This process is controlled by the DC-bus voltage controller.

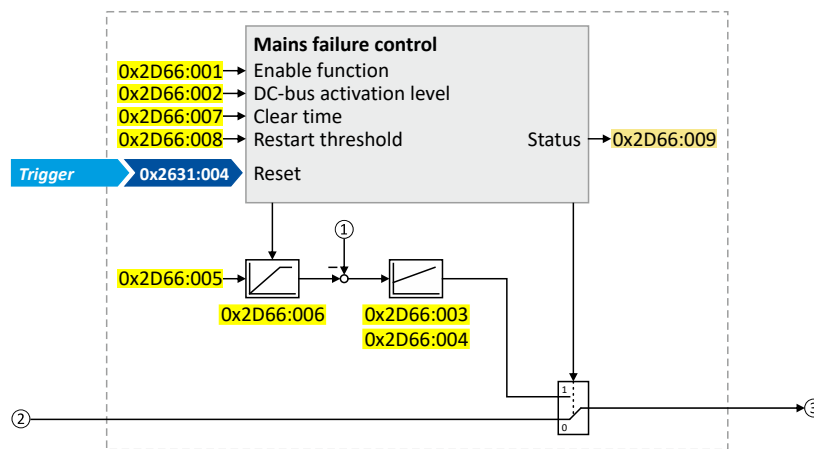

- ① Current DC-bus voltage
- ② Frequency setpoint (internal input signal)
- ③ Frequency setpoint (internal output signal for motor control)

The activation and commissioning of the mains failure control are described in detail in the following subchapters.

### Parameter

Address	Name / setting range / [default setting]	Information
0x2D66:001 (P721.01)	Mains failure control: Enable function (Mains fail. ctrl: Enable function) • From version 02.00	Enable mains failure control.
	<b>0</b> Disabled	Operation without mains failure control.
	<b>1</b> Enabled	Operation with mains failure control.
0x2D66:002 (P721.02)	Mains failure control: DC-bus activation level (Mains fail. ctrl: DC-bus act.level) 60 ... <b>[0]</b> * ... 90 % * Default setting dependent on the model. • From version 02.00	Threshold below which the mains failure control is activated if it is enabled ( <a href="#">0x2D66:001 (P721.01)</a> = 1). • 100 % = nominal DC-bus voltage  Recommended setting: • In general: 5 ... 10 % above the error threshold for undervoltage (display in <a href="#">0x2540:003 (P208.03)</a> ). • 230-V devices: 72 % • 400/480-V devices: 82 %
0x2D66:003 (P721.03)	Mains failure control: Gain V-controller (Mains fail. ctrl: Gain V-ctrl) 0.00001 ... <b>[0.01000]</b> ... 0.50000 Hz/V • From version 02.00	Proportional gain of the DC-bus voltage controller.

# Additional functions

## Mains failure control



Address	Name / setting range / [default setting]	Information
0x2D66:004 (P721.04)	Mains failure control: Reset time V-controller (Mains fail. ctrl: Res. time V-ctrl) 5 ... [20] ... 2000 ms • From version 02.00	Reset time of the DC-bus voltage controller.
0x2D66:005 (P721.05)	Mains failure control: DC voltage setpoint (Mains fail. ctrl: DC voltage setp.) 80 ... [100] ... 110 % • From version 02.00	Voltage setpoint onto which the DC-bus voltage is to be maintained. • 100 % = nominal DC-bus voltage
0x2D66:006 (P721.06)	Mains failure control: Setpoint ramp (Mains fail. ctrl: Setp. ramp) 1 ... [20] ... 16000 ms • From version 02.00	Acceleration time for the voltage setpoint set in <a href="#">0x2D66:005 (P721.05)</a> . • The set acceleration time refers to the acceleration from 0 to 100 % of the nominal DC-bus voltage.
0x2D66:007 (P721.07)	Mains failure control: Clear time (Mains fail. ctrl: Clear time) 1 ... [20] ... 60000 ms • From version 02.00	After the DC-bus voltage has exceeded the activation threshold <a href="#">0x2D66:002 (P721.02)</a> (+hysteresis) again, the time set here must be elapsed before the mains failure control is deactivated again if the restart protection is not activated (default setting).
0x2D66:008 (P721.08)	Mains failure control: Restart threshold (Mains fail. ctrl: Restart level) 0.0 ... [0.0] ... 599.0 Hz • From version 02.00	Threshold for restart protection. Below the threshold set here no restart takes place after mains recovery.
0x2D66:009 (P721.09)	Mains failure control: Status mains failure control (Mains fail. ctrl: RERT:Status) • Read only • From version 02.00	Bit coded display of the mains failure control status.
	Bit 0 Control active	1 = mains failure control active. • The DC-bus voltage has fallen below the activation threshold <a href="#">0x2D66:002 (P721.02)</a> . • The bit is reset to 0 after the DC-bus voltage has exceeded the activation threshold (+hysteresis) again and the clear time set in <a href="#">0x2D66:007 (P721.07)</a> has elapsed.
	Bit 1 I-Reset active	1 = I component of the speed controller of the motor control is reset. • Bit is set to 1 if bit 0 is set to 1 (mains failure control active). • Bit is reset to 0 if the frequency setpoint falls below 0.1 Hz.



### 14.5.1 Activating the mains failure control

1. Set the selection "Enabled [1]" in [0x2D66:001 \(P721.01\)](#).
2. Set the activation threshold in [%] with reference to the nominal DC-bus voltage in [0x2D66:002 \(P721.02\)](#).
  - Recommended setting: 5 ... 10 % above the error threshold for undervoltage (display in [0x2540:003 \(P208.03\)](#)).
3. Set the voltage setpoint onto which the DC-bus voltage is to be maintained in [0x2D66:005 \(P721.05\)](#).
  - Recommended setting: 95 ... 100 % (of the nominal DC-bus voltage).

The mains failure control gets active with these settings if the DC-bus voltage falls below the activation threshold. The DC-bus voltage controller now generates the required operational energy from the rotational energy of the motor. The motor is decelerated by the mains failure control. Thus, the deceleration ramp is shorter than the one of a non-guided system (coasting drive).

After the mains failure control has been activated:

1. The DC-bus voltage is controlled with the acceleration time set in [0x2D66:006 \(P721.06\)](#) to the setpoint set in [0x2D66:005 \(P721.05\)](#).
2. An internally generated frequency setpoint is transferred to the motor control which enables the motor (via the frequency setpoint) to be decelerated to a frequency close to "0 Hz".
  - Starting value for the guided deceleration is the current output frequency.
  - The deceleration ramp (and hence the braking torque) results from the moment of inertia of the load machine(s), the power loss of the drive (system) and the set parameterisation.

#### Behaviour after mains recovery

If, after mains recovery, the DC-bus voltage has exceeded the activation threshold (+hysteresis) again, an internal timing element is started. After the time period set in [0x2D66:007 \(P721.07\)](#) has elapsed, the mains failure control is stopped if the restart protection is not activated (default setting).

- ▶ [Restart protection](#) 612
- ▶ [Fast mains recovery](#) 612



## 14.5.2 Restart protection

The integrated restart protection prevents a restart in the lower frequency range if the mains voltage was only interrupted briefly (mains recovery before the motor stands still).

- In the default setting [0x2D66:008 \(P721.08\)](#) = 0 Hz, the restart protection is deactivated.
- In order to activate the restart protection, set the restart threshold in [Hz] in [0x2D66:008 \(P721.08\)](#) below which no automatic start shall take place after mains recovery.
- If, in case of mains recovery, the output frequency is below the restart threshold, the restart protection gets active:
  - If the current DC-bus voltage is lower than the voltage setpoint [0x2D66:005 \(P721.05\)](#), the motor is continued to be decelerated (until frequency 0 Hz).
  - If the current DC-bus voltage is higher than the voltage setpoint [0x2D66:005 \(P721.05\)](#), the motor is accelerated in a controlled way until the output frequency exceeds the restart threshold.
- If, in case of mains recovery, the output frequency is above the restart threshold, the motor is accelerated again to the frequency setpoint. ▶ [Fast mains recovery](#)  612

Diagnostic parameters:

- An active restart protection is displayed via the status bit 0 in [0x2D66:009 \(P721.09\)](#) if the mains failure control is not active.

### Terminating the active restart protection

If, after mains recovery, the restart protection is active, it can be terminated by the following actions:

- Error reset via the trigger set in [0x2631:004 \(P400.04\)](#).
- Short-time inverter disable via the trigger set in [0x2631:001 \(P400.01\)](#).
- Restart via the trigger set in [0x2631:002 \(P400.02\)](#).

## 14.5.3 Fast mains recovery

A fast mains recovery is caused by a short interruption at the energy supply company (for instance due to a thunderstorm) and by faulty components in the supply cables (for instance slip rings).

The fast mains recovery causes a restart of the motor

- if the restart protection is deactivated ([0x2D66:008 \(P721.08\)](#) = 0 Hz, default setting)  
or
- the restart protection does not get active (output frequency > [0x2D66:008 \(P721.08\)](#)).

If this behaviour is not desired, you can delay the restart by setting a switch-off time in [0x2D66:007 \(P721.07\)](#) or prevent it in connection with the restart protection. ▶ [Restart protection](#)  612



## 14.5.4 Commissioning the mains failure control

Commissioning should be executed with motors without load:

1. Let the motor rotate with a rated frequency of 100 %.
2. Disable the inverter and measure the time until the motor has reached standstill.
  - The time can be measured with a stop watch or similar.
  - If a motor encoder is connected to the inverter and set as feedback system for the motor control, this signal can be output at the analog output and measured with an oscilloscope.
3. Set the acceleration time for the voltage setpoint in [0x2D66:006 \(P721.06\)](#) to approx. 1/10 of the time measured before.
4. Set the switch-off time n [0x2D66:007 \(P721.07\)](#) to the time measured before.

### Fine adjustment of the mains failure control

For the fine adjustment, you must repeat the following points several times:

1. An end frequency as low as possible should be reached before the inverter reaches the error threshold for undervoltage:
  - Increase the proportional gain of the DC-bus voltage controller in [0x2D66:003 \(P721.03\)](#).
  - Reduce the reset time of the DC-bus voltage controller in [0x2D66:004 \(P721.04\)](#).
2. If, during the mains failure control, monitoring for overvoltage in the DC bus is triggered:
  - Increase the reset time again in [0x2D66:004 \(P721.04\)](#) until monitoring is not triggered anymore.
  - If required, additionally reduce the voltage setpoint in [0x2D66:005 \(P721.05\)](#) onto which the DC-bus voltage is to be controlled.
3. Increasing the delay time or reducing the braking torque is only possible to a limited extent:
  - Increasing the acceleration time in [0x2D66:006 \(P721.06\)](#) reduces the initial braking torque and simultaneously increases the deceleration time.
  - Increasing the reset time of the DC-bus voltage controller in [0x2D66:004 \(P721.04\)](#) reduces the braking torque and simultaneously increases the deceleration time. If the reset time is too high, the inverter reaches the error threshold for undervoltage before standstill is reached. From this point on, the motor is not guided anymore.

Signal flow - DC-bus voltage controller

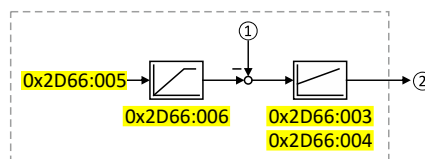

① Current DC-bus voltage

② Internally generated frequency setpoint that is transferred to the motor control in case of an active mains failure control.



### 14.6 Operation with UPS

This function enables the operation of a 3x400-V inverter with an uninterruptible 1x230-V power supply (UPD) to be able to operate the motor with reduced load for a certain period in the event of a power failure.

#### NOTICE

UPS operation is not suitable for a continuous operation.

Possible consequences: Device overload

► Prevent a too frequent use of this function.



In case of UL, CSA or other North American applications with this function, the standards of the end application must be taken into account.

#### Restrictions

- UPS operation is only available for 3x400/480 V devices up to 11 kW.
- For UPS operation, one reduced output current and one reduced overload are available only:
  - Output current: 60 % of the 400/480 V rated current
  - Overload: 80 %/5 min, 120 %/3 s of the 400/480 V rated current
- In order to change over to UPS operation, a minimum delay of 10 s is required.



### Details

The following figure shows the principal connection of the UPS to the inverter. For further technical details, please contact the inverter manufacturer.

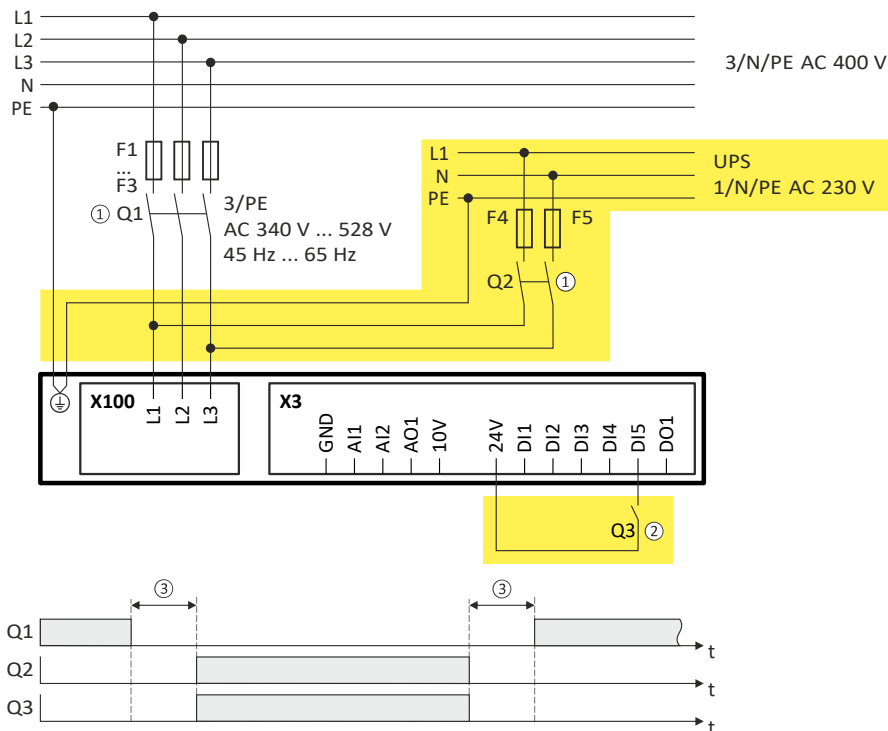

- ① A mutual locking is required for the contactors Q1 and Q2.
- ② In this example, the digital input DI5 is used to activate the UPS operation. For this purpose, the function "Activate UPS operation" [0x2631:055 \(P400.55\)](#) must be assigned to trigger "Digital input 5 [15]".
- ③ In order to change over to UPS operation, a minimum delay of 10 s is required.

The UPS operation can be alternatively activated via network. In this case, a bit of the mappable data word NetWordIN1 [0x4008:001 \(P590.01\)](#) must be assigned to the "Activate UPS operation [55]" function.

If the UPS operation is active,

- the device overload monitoring (i\*t) is adapted accordingly.
- the DC limit values are reduced.
- the phase failure detection is switched off.
- the warning "UPS operation active" (error code [12672 | 0x3180](#)) is output.
- trigger "UPS operation active [118]" is set to TRUE. The trigger can be assigned to a digital output.
- bit 15 ("UPS operation active") in the inverter status word 2 [0x2833](#) is set to "1".

Notes:

- An additional limitation of speed, current, etc. can be realised via the application with the "Parameter change-over" function. [593](#)

### Parameter

Address	Name / setting range / [default setting]	Information
0x2631:055 (P400.55)	Function list: Activate UPS operation (Function list: Activ. UPS oper.) • Further possible settings: ▶ <a href="#">Trigger list 73</a>	Assignment of a trigger to the "Activate UPS operation" function. Trigger = TRUE: Activate UPS operation. Trigger = FALSE: no action / deactivate function again.
	<b>0</b> Not connected	No trigger assigned (trigger is constantly FALSE).



## Example for operating mode

Parameter	Designation	Setting for this example
0x2631:001 (P400.01)	Enable inverter	Constant TRUE [1]
0x2631:002 (P400.02)	Run	Digital input 1 [11]
0x2631:055 (P400.55)	Activate UPS operation	Digital input 5 [15]

### Input signals

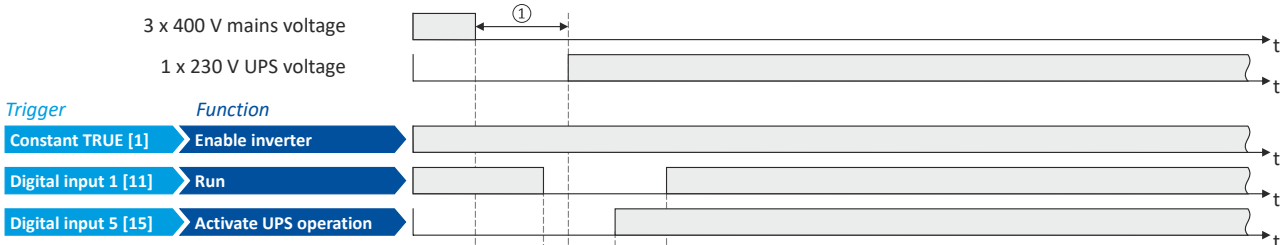

### Output signals

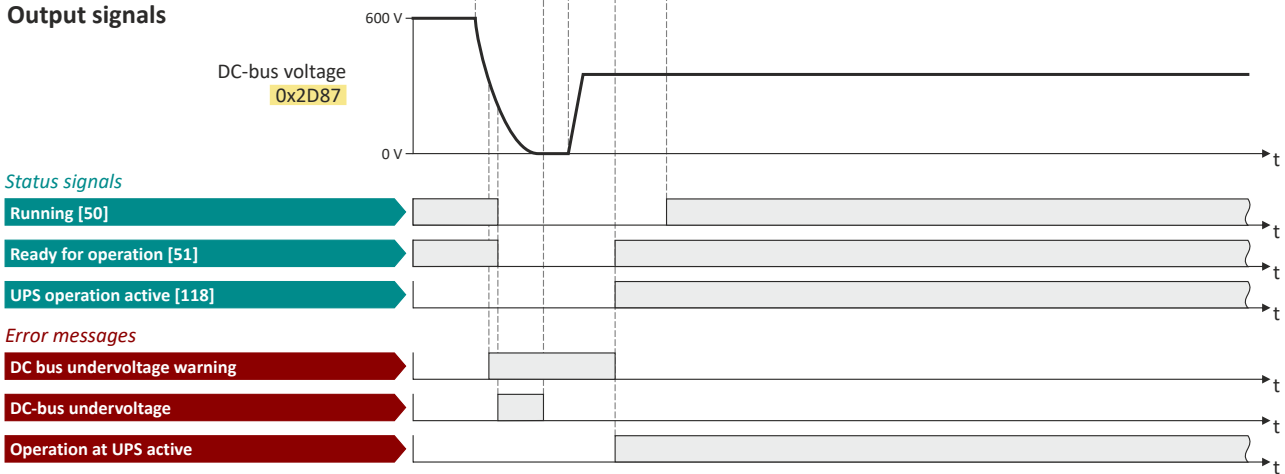

The status signals can be assigned to digital outputs. [▶ Configure digital outputs](#) 292

- ① In order to change over to UPS operation, a minimum delay is required.





## 14.7 Cascade function for pumps and fans

This feature allows you to control multiple drives in fan and pump applications. The main drive is controlled by the inverter and the (maximum two) auxiliary drives are switched on directly via contactors if required. The main drive is controlled by the PID controller or another alternative setpoint source (digital/analog inputs, keypad, network) The switching cycles of the auxiliary drives are triggered depending on the actual load (PID controller).

### Preconditions

The process controller has been configured. ▶ [Configuring the process controller](#) 128

### Possible configurations

Inverter	Drive
i5xx with standard IO (with or without network)	1 main drive (controlled via this inverter)
	2 auxiliary drives (controlled via relay/digital output)

Example with i550 cabinet frequency inverter:

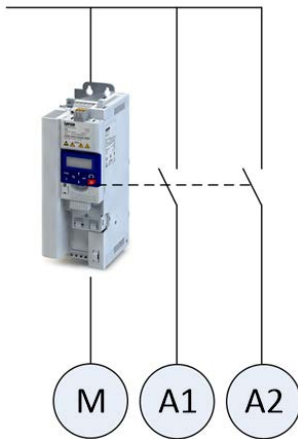

- M Main drive
- A1 Auxiliary drive 1
- A2 Auxiliary drive 2



Additional relays may be required to control the power contactors if the current/voltage range from the relay/digital output is not sufficient for direct control.



## Operating modes

Two operating modes are available for the cascade function, "without ramp" and "with ramp". The following diagrams illustrate the respective behavior.

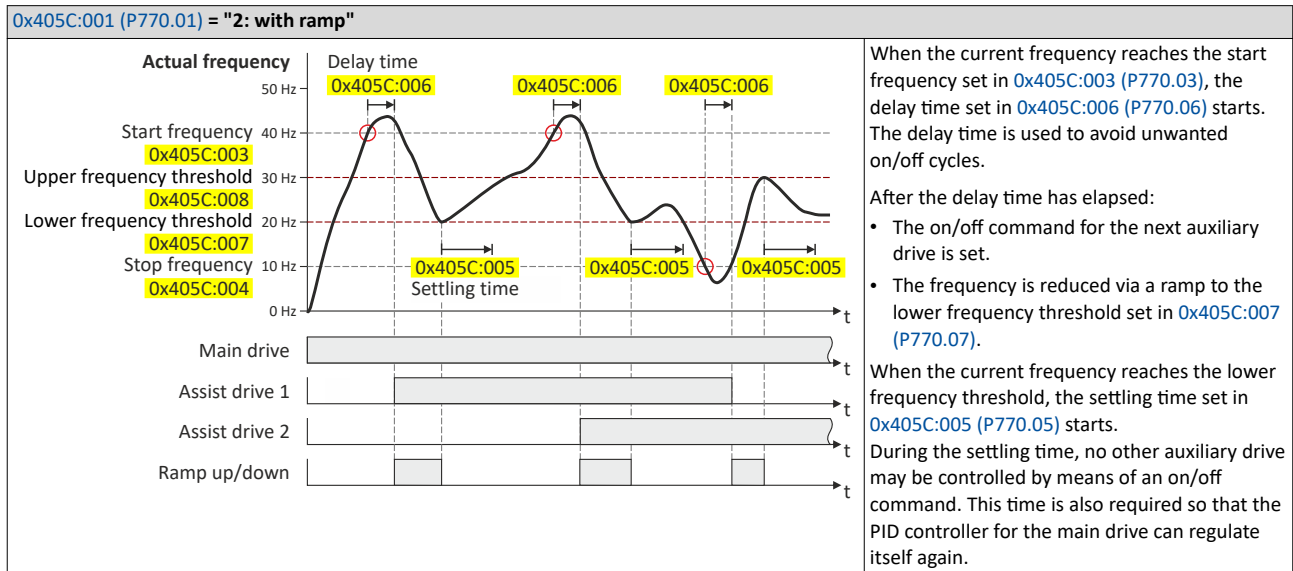
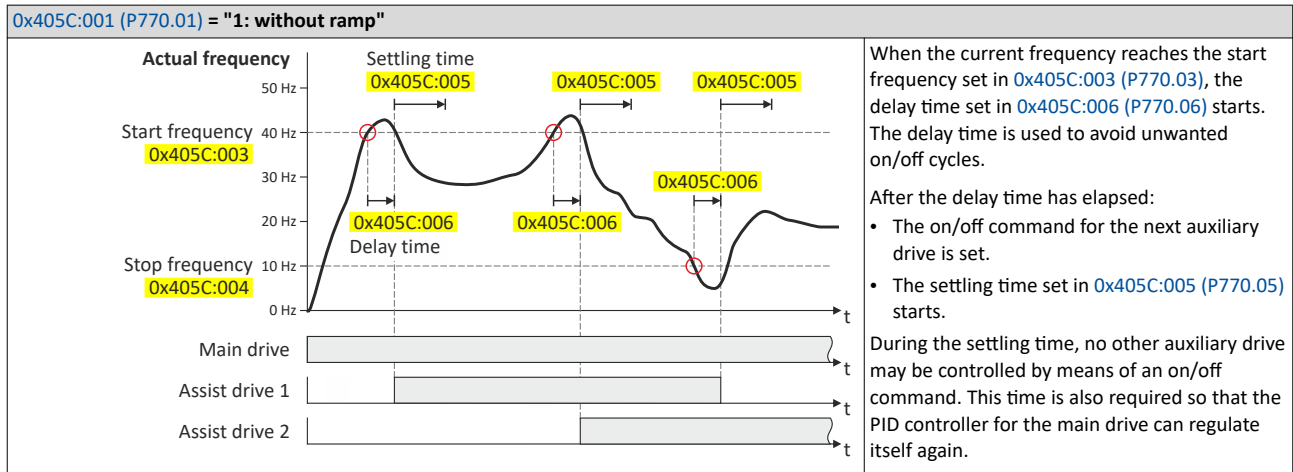



## Transition mode configuration

To ensure equal operating times of both auxiliary drives, a specific transition behavior from one add-on drive to the second add-on drive can be configured by setting the "Automatic reversing time" in [0x405C:010 \(P770.10\)](#).

The following three transition modes are possible:

Transition mode	Information	Required setting
Direct transition	The active auxiliary drive switches off, the other auxiliary drive switches on. Note that this may cause undesirable behavior in your system.	<a href="#">0x405C:010 (P770.10)</a> = 0.0 s (default setting)
Sequential transition	The active auxiliary drive switches off. The other auxiliary drive only switches on after the reversing time set in <a href="#">0x405C:010 (P770.10)</a> has elapsed.	<a href="#">0x405C:010 (P770.10)</a> > 0.0 s
Overlapping transition	The other auxiliary drive switches on immediately. The auxiliary drive that is already switched on does not switch off until the (negative) reversing time set in <a href="#">0x405C:010 (P770.10)</a> has elapsed.	<a href="#">0x405C:010 (P770.10)</a> < 0.0 s

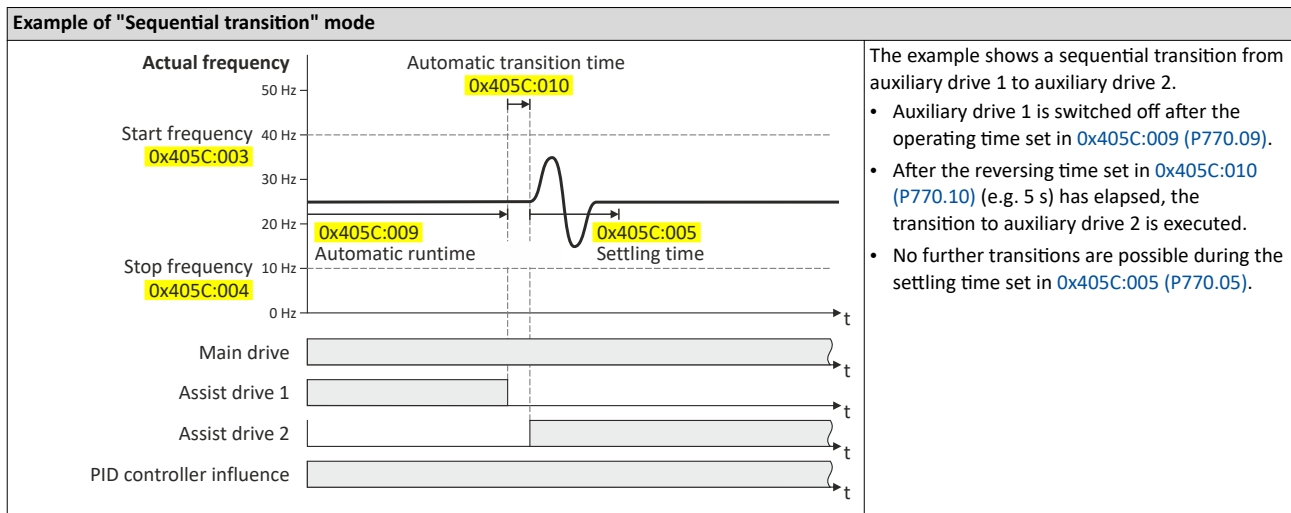



## Basic settings



In the following description and in the parameter designations, the term "additional pump", which is more unambiguous for a pump cascade, is used instead of "auxiliary drive". Of course, the function can be used in the same way for a fan cascade.

Based on the default setting, we recommend the following proceeding:

1. [Configuring the process controller](#) [128](#)
2. Activate one or both additional pumps for the cascade function:
  - Activate additional 1: [0x2631:056 \(P400.56\)](#) = "constant TRUE [1]"
  - Activate additional pump 2: [0x2631:057 \(P400.57\)](#) = "constant TRUE [1]"
3. Configure control of the additional pumps via digital output 1 or the relay:
  - Digital output 1 switches additional pump 1: [0x2634:001 \(P420.01\)](#) = "additional pump 1 [160]"
  - Digital output 1 switches additional pump 2: [0x2634:001 \(P420.01\)](#) = "additional pump 2 [161]"
  - Relay switches additional pump 1: [0x2634:002 \(P420.02\)](#) = "additional pump 1 [160]"
  - Relay switches additional pump 2: [0x2634:002 \(P420.02\)](#) = "additional pump 2 [161]"
4. Set operating mode ("without ramp" or "with ramp") in [0x405C:001 \(P770.01\)](#).
5. Set transition mode by setting the automatic reversing time in [0x405C:010 \(P770.10\)](#).
6. Adjust other parameters of the function (start/stop frequency, delay time, settling time, frequency thresholds, etc.) according to the application.

## Parameter

Address	Name / setting range / [default setting]	Information
0x2631:056 (P400.56)	Function list: Assist pump 1 (Function list: Assist pump 1) • Further possible settings: <a href="#">▶ Trigger list</a> <a href="#">73</a>	Assignment of a trigger to the "Additional pump 1" function. Trigger = TRUE: Cascade function uses additional pump 1. Trigger = FALSE: No action.
	<b>0</b> Not connected	No trigger assigned (trigger is constantly FALSE).
0x2631:057 (P400.57)	Function list: Assist pump 2 (Function list: Assist pump 2) • Further possible settings: <a href="#">▶ Trigger list</a> <a href="#">73</a>	Assignment of a trigger to the "Additional pump 2" function. Trigger = TRUE: Cascade function uses additional pump 2. Trigger = FALSE: No action.
	<b>0</b> Not connected	No trigger assigned (trigger is constantly FALSE).
0x2631:058 (P400.58)	Function list: Reset operating time (Function list: Reset oper.time) • Further possible settings: <a href="#">▶ Trigger list</a> <a href="#">73</a>	Assignment of a trigger to the "Reset power-on time" function. Trigger = TRUE: Both counters for the power-on time of the additional pumps are reset to zero. Trigger = FALSE: No action.
	<b>0</b> Not connected	No trigger assigned (trigger is constantly FALSE).
0x405C:001 (P770.01)	Pump cascading: Operating mode (Pump cascading: Operating mode)	Selection of the operating mode for the cascade function.
	<b>0</b> Disabled	Cascade function is deactivated.
	1 Without ramp	After reaching the start or stop frequency, the cascade function has no influence on the frequency setpoint.
	2 With ramp	After reaching the start or stop frequency, the cascade function leads the frequency setpoint via a ramp to the lower or upper frequency threshold, respectively.  The active auxiliary pump switches on/off: <ul style="list-style-type: none"> <li>• When the start or stop frequency is reached.</li> <li>• When the delay time has elapsed.</li> </ul>
0x405C:002 (P770.02)	Pump cascading: Priority at startup (Pump cascading: Prior.at startup)	
	<b>1</b> By operating time	The auxiliary pump with the fewest operating hours starts first.



Address	Name / setting range / [default setting]	Information	
0x405C:003 (P770.03)	Pump cascading: Start frequency (Pump cascading: Start frequency) 0.0 ... <b>[40.0]</b> ... 599.0 Hz		
0x405C:004 (P770.04)	Pump cascading: Stop frequency (Pump cascading: Stop frequency) 0.0 ... <b>[10.0]</b> ... 599.0 Hz		
0x405C:005 (P770.05)	Pump cascading: Settling time (Pump cascading: Settling time) 0.0 ... <b>[5.0]</b> ... 3600.0 s		
0x405C:006 (P770.06)	Pump cascading: Delay time (Pump cascading: Delay time) 0.0 ... <b>[2.0]</b> ... 3600.0 s		
0x405C:007 (P770.07)	Pump cascading: Lower frequency threshold (Pump cascading: Low F threshold) 0.0 ... <b>[20.0]</b> ... 599.0 Hz		
0x405C:008 (P770.08)	Pump cascading: Upper frequency threshold (Pump cascading: Up. F threshold) 0.0 ... <b>[30.0]</b> ... 599.0 Hz		
0x405C:009 (P770.09)	Pump cascading: Automatic runtime (Pump cascading: Auto runtime) 0 ... <b>[0]</b> ... 1000 h		
0x405C:010 (P770.10)	Pump cascading: Automatic transition time (Pump cascading: Auto trans.time) -10.0 ... <b>[0.0]</b> ... 10.0 s		The reversing time also defines the transition mode: <ul style="list-style-type: none"> <li>Reversing time = 0.0 s: Direct transition</li> <li>Reversing time &gt; 0.0 s: Sequential transition</li> <li>Reversing time &lt; 0.0 s: Overlapping transition</li> </ul>
0x405C:011 (P770.11)	Pump cascading: Reset operating time (Pump cascading: Reset oper.time)  <b>0</b> Disabled  <b>1</b> Activate		1 = Both counters for the power-on time of the additional pumps are reset to zero.
0x405C:012 (P770.12)	Pump cascading: Status word (Pump cascading: Status word) • Read only		
	Bit 0 Assist pump 1 activated	Additional pump 1 was activated for the cascade function via <a href="#">0x2631:056 (P400.56)</a> .	
	Bit 1 Assist pump 2 activated	Additional pump 2 was activated for the cascade function via <a href="#">0x2631:057 (P400.57)</a> .	
	Bit 3 Assist pump 1 running		
	Bit 4 Assist pump 2 running		
	Bit 6 Start frequency reached	The start frequency set in <a href="#">0x405C:003 (P770.03)</a> has been reached.	
	Bit 7 Stop frequency reached	The stop frequency set in <a href="#">0x405C:004 (P770.04)</a> has been reached.	
	Bit 8 Cascading overload	The maximum frequency in <a href="#">0x2916 (P211.00)</a> has been reached and no free additional pump is available. Associated error code: <a href="#">65317</a>   <a href="#">0xFF25</a>	
0x405C:013 (P770.13)	Pump cascading: Operating time pump 1 (Pump cascading: Operatingtime p1) • Read only: x s		
0x405C:014 (P770.14)	Pump cascading: Operating time pump 2 (Pump cascading: Operatingtime p2) • Read only: x s		



## 15 Functional safety

### 15.1 General information and basics

Functional safety describes the necessary measures that need to be taken by means of electrical or electronic equipment to prevent or eliminate dangers due to functional errors.

Protective devices prevent any human access to dangerous areas during normal operation. However, persons may have to be in the danger areas in certain operating modes. The machine operator is protected by internal drive and control measures in these operating modes.

#### Integrated functional safety

Integrated functional safety provides the conditions in the controls and drives to implement protective functions. Planning and installation expenditure is reduced. Using integrated functional safety increases machine functionality and availability. Integrated functional safety can be used for the protection of persons working on machines in accordance with the Machinery Directive.

#### Safety component

The safety component in the inverter provides the safe interfaces (e.g. safe inputs or safe network interfaces). If the STO safety function is requested, the safety component immediately brings about the torque-free state according to EN 61800-5-2.

Safety components and the respective terminals are marked in yellow.

#### Standards

Safety regulations are confirmed by laws and other governmental guidelines and measures and the prevailing opinion among experts, e.g. by technical regulations.

The regulations and rules to be applied must be observed in accordance with the application.

#### Risk assessment

This documentation can only accentuate the need for a risk assessment. The user of the integrated functional safety must read up on standards and the legal situation.

Before a machine can be put into circulation, the manufacturer of the machine has to conduct a risk assessment according to the 2006/42/EC: Machinery Directive [UKCA: S.I. 2008/1597 - The Supply of Machinery (Safety) Regulations 2008] to determine the hazards associated with the use of the machine.

The Machinery Directive refers to three basic principles for the highest possible level of safety:

- Hazard elimination / minimisation by the construction itself.
- Taking the protective measures required against hazards that cannot be removed.
- Existing residual hazards must be documented and the user must be informed of them.

Detailed information on the risk assessment is provided in the DIN EN ISO 12100:2013-08: Safety of machinery – General principles for design – Risk assessment and risk reduction. The result of the risk assessment determines the category for safety-related control systems according to EN ISO 13849-1. Safety-oriented parts of the machine control must be compliant.



### Mission time

The mission time of the used components must be complied with.

In case of a defect or when the mission time of a component has expired, the complete component must be replaced. Continued operation is not permitted!



---

The mission time for the safety functions cannot be reset by a special proof test.

---

The specified mission time starts at the date of manufacture.

Mission time ► [Safety-related data](#) 631

### 15.1.1 Acceptance

The machine manufacturer must check and prove the operability of the safety functions used.

- The machine manufacturer must authorize a person as an inspector who can carry out the test on the basis of their technical training and knowledge of the safety functions.
- The inspector must document and sign the result of the test of each safety function in a test report.

A complete test includes:

- Document the installation including the safety functions:
  - Create an overview image of the installation.
  - Describe the installation.
  - Describe safety devices.
  - Document the safety functions used.
  - Complete validation of the safety functions used.  
(The validation must also include tests under fault conditions.)
- Create test report:
  - Document the functional test.
  - Check parameters.
  - Sign test report.
- Create an annex with test records:
  - Protocols for the installation.
  - External recordings

### 15.1.2 Periodic inspections

After installation and after every modification, the user must check and validate the safety function.

The user must document these tests.

The correct sequence of the safety-oriented functions must be checked in periodic inspections. The risk analysis or applicable regulations determine the time distances between the tests.

The inspection interval should not exceed one year.

### 15.1.3 Device exchange

Exchange a maximum of one safe device before recommissioning.



## 15.2 Safe interfaces

### Overview: Safe interfaces in Lenze inverters

Functional safety design	Products	Safe inputs	Safe output	Safe network interfaces		
				PROFIsafe	FSoE	CIP Safety™
Basic Safety - STO	i550, i750, i950	1 (STO)				
Advanced Safety - L	i750 cabinet				•	
Extended Safety - L	i750 cabinet				•	
Extended Safety - LT	i950 cabinet	4	•	•	•	

Abbreviations used:

CIP	Common Industrial Protocol	-
FSoE	FailSafe over EtherCAT	-
PROFIsafe	Process field safety	-
STO	Safe torque off (STO)	<a href="#">627</a>

The i550 cabinet frequency inverter is available in the following functional safety versions:

- Basic Safety - STO





### 15.2.1 Safe inputs

The components used must comply with the risk reduction required for the application.

#### Passive sensors

Passive sensors are 2-channel switching elements with contacts.

Please note the following:

- The switches must be wired according to the closed-circuit principle.
- Passive sensors are connected to the inverter via a safety switching device.
- An external safety component must monitor the connecting cables and the function of the sensors if complete exclusion of faults cannot be guaranteed.

The contacts must switch at the same time (equivalent). Safety functions will be activated if only one channel is switched. Switching of only one channel points to faulty sensors or impermissible wiring.

Examples of passive sensors:

- Door contact switch
- Emergency stop control units

#### Active sensors

Active sensors are units with 2-channel semiconductor outputs (OSSD outputs).

Test pulses for monitoring the outputs and cables are permissible.

P/M-switching sensors switch the positive and negative cable or the signal and ground cable of a sensor signal.

Please note the following:

- The maximum permissible connection capacity of the outputs.
- Active sensors are connected directly to the inverter.
- Monitoring for short circuits must be carried out by the active sensor.

The outputs must switch at the same time (equivalent). Safety functions will be activated if only one channel is switched. The active control of only one channel points to faulty sensors or impermissible wiring.

Examples of active sensors:

- Lightgrid
- Laser scanner
- Controllers

#### Further information



---

Further information on connecting passive and active sensors can be found in the corresponding project planning document.

---



## 15.3 Safety functions

### Overview: Safety functions in Lenze inverters

Functional safety design	Products	Stop functions							Monitoring functions							Operation and diagnostics				
		Without feedback					With feedback		Without feedback			With feedback				MUT	Safety bus	I/Os		
		STO	SS1	SSE	SBC	CAS	SS2	SOS	SMS	SLS	SSM	SDI	SLI	PDSS	SLP				SCA	
Basic Safety - STO	i550, i750, i950	•																		•
Advanced Safety - L	i750 cabinet	•	•		•													•	•	
Extended Safety - L	i750 cabinet	•	•	•	•		•	•	•	•	•	•	•	•	•	•	•	•	•	
Extended Safety - LT	i950 cabinet	•	•	•	•	•	•	•	•	•	•	•	•	•	•	•	•	•	•	•

Abbreviations used:

STO	Safe torque off (STO)	<a href="#">627</a>
SS1	Safe stop 1 (SS1)	-
SSE	Safe stop emergency (SSE)	-
SBC	Safe brake control (SBC)	-
CAS	STO cascading (CAS)	-
SS2	Safe stop 2 (SS2)	-
SOS	Safe operating stop (SOS)	-
SMS	Safe maximum speed (SMS)	-
SLS	Safely-limited speed (SLS)	-
SSM	Safe speed monitor (SSM)	-
SDI	Safe direction (SDI)	-
SLI	Safely-limited increment (SLI)	-
PDSS	Position-dependent safe speed (PDSS)	-
SLP	Safely-limited position (SLP)	-
SCA	Safe cam (SCA)	-
MUT	Safe Muting (MUT)	-
I/Os	Safe inputs	<a href="#">625</a>
	Safe output	-

The i550 cabinet frequency inverter is available in the following functional safety versions:

- Basic Safety - STO



### 15.3.1 Safe torque off (STO)

The "Safe Torque Off (STO)" safety function safely switches off the drive. The drive coasts down.

STO corresponds to an uncontrolled shutdown according to EN 60204-1, category 0.

With STO, additional measures are required for an "emergency switching off" according to EN 60204-1.

# Functional safety

Safety functions  
Safe torque off (STO)  
Basic Safety - STO



## 15.3.1.1 Basic Safety - STO

Function included in variant:	Umrichter mit Sicherheitsmodul ISMASA000
-------------------------------	--

### Preconditions

- Additional measures are required to prevent movement caused by external forces.
- When assessing risk, also take into account overtravel distances.

### Important notes

#### **DANGER!**

No "emergency switching off" in terms with EN 60204-1

With the "Safe torque off" (STO) function, no "emergency switching off" in terms with EN 60204-1 can be executed without additional measures. There is no electrical isolation between the motor and inverter and no service switch or maintenance switch!

Possible consequences: Death or severe injuries

- ▶ "Emergency switching off" requires electrical isolation, e. g. by a central mains contactor.

#### **DANGER!**

The power supply is not safely disconnected.

Possible consequences: Death or severe injuries due to electrical voltage.

- ▶ Turn off the power supply.

#### **DANGER!**

Uncontrolled rotation of the motor possible.

Possible consequences: Death or severe injuries

- ▶ Set the motor to standstill mechanically.

#### **DANGER!**

Automatic restart can occur if the request of the safety function is deactivated.

Possible consequences: Death or severe injuries

- ▶ You must provide external measures according to EN ISO 13849-1 which ensure that the drive only restarts after a confirmation.



## Functional description

### STO

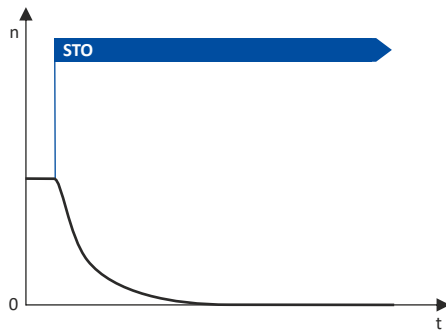

- The transmission of the pulse width modulation is safely switched off by STO. The power drivers do not generate a rotating field anymore.
- The motor is safely switched to torqueless operation.

### Activation

STO is activated via the safe input X1 with the channels SIA and SIB:

Safe input X1		Inverter device state
SIA	SIB	
LOW	LOW	STO active
LOW	HIGH	Impermissible state (drive disabled)
HIGH	LOW	
HIGH	HIGH	Drive enabled



If the GS connection is interrupted, or in case of a short circuit/cross-circuit of GS to SIA/SIB, STO is active.

# Functional safety

Safety functions  
Safe torque off (STO)  
Basic Safety - STO



## Status messages

### Status message via network



This status message is sent via **non-secure** interfaces. The status message must not be used to control other safety functions!

The inverter status word ([0x282A:004](#)) and the CiA status word ([0x6041 \(P780.00\)](#)) contain the status of the STO function according to the following truth table. These two parameter objects can be read via non-secure network interfaces.

Status			Status message		
Safe input / channel		Inverter device state	Inverter status word (Object 0x282A:004)		CiA status word (Object 0x6041)
SIA	SIB		Bit 10	Bit 11	Bit 15
LOW	LOW	STO active	1	1	0
LOW	HIGH	Impermissible state (drive disabled)	1	0	0
HIGH	LOW		1	0	0
HIGH	HIGH	Drive enabled	0	0	1

### Status message via digital outputs



This status message is sent via **non-secure** interfaces. The status message must not be used to control other safety functions!

In [0x2634:xxx](#) you set the function of the digital outputs. By selecting [55], you can output the "Inverter disabled (safety)" status and by selecting [155], you can output the "STO active" status via a non-safe output (e.g. digital output 1).

Status			Status message	
Safe input / channel		Inverter device state	Function of digital outputs 0x2634:xxx	
SIA	SIB		"Inverter disabled (safety)" [55]	"STO active" [155]
LOW	LOW	STO active	1	1
LOW	HIGH	Impermissible state (drive disabled)	1	0
HIGH	LOW		1	0
HIGH	HIGH	Drive enabled	0	0

## Setting

Functional sequence and error response have no adjustable parameters.

## Parameter

Address	Name / setting range / [default setting]	Information
0x2024:002	Special settings: Configure STO 0 ... [0] ... 65535 <ul style="list-style-type: none"> <li>Setting can only be changed if the inverter is disabled.</li> <li>From version 05.03</li> </ul>	
	Bit 0 Activate STO locked	0 = standard behavior: After STO is activated, the device status changes to "Switched on". 1 = Behavior as with the i700 servo inverter: After STO is activated, the device status changes to "Switch-on disabled". <a href="#">▶ Device states</a> <a href="#">353</a>



## 15.4 Safety-related data

### 15.4.1 Safety-related characteristics Basic Safety - STO



The data applies to products delivered **after** 1st September 2016.

#### Safety-related characteristics according to EN 61508, Part 1-7 and EN 62061

Specification	Value	Comment
Safety Integrity Level	SIL 3	
PFH [1/h]	1.71 E-09	1.71 % of SIL 3
PFD <sub>avg</sub> (T)	1.49 E-04	14.9 % of SIL 3 after T = 20 years
Proof test interval	20 years	Mission time

#### Safety-related characteristics according to EN ISO 13849-1

Specification	Value	Comment
Performance Level	e	
Category	4	
MTTF <sub>d</sub>	High	3200 years
Mean diagnostic coverage DC <sub>av</sub>	High	99 %

#### Basics of the safety-related characteristics

Basics	Value	Comment
Source of failure rates	SN 29500	When no values from the component manufacturers were available.
Average max. ambient temperature	40 °C	



Further data and information can be found in the corresponding project planning document in the "Electrical installation" chapter.



## 16 Using accessories

### 16.1 Keypad

The keypad is an easy means for the local operation, parameterisation, and diagnostics of the inverter.



- The keypad is simply connected to the diagnostic module interface on the front of the inverter.
- The keypad can also be connected and removed during operation.





## 16.1.1 Keypad basic settings

For the keypad various settings can be made, which are described in detail in the following subchapters.

### 16.1.1.1 Select language

#### Parameter

Address	Name / setting range / [default setting]	Information
0x2863 (P705.00)	Keypad language selection (KP language)	Language selection for the keypad display.
	0 No language selected	
	<b>1 English</b>	
	2 German	

### 16.1.1.2 Change setpoint increment

#### Parameter

Address	Name / setting range / [default setting]	Information
0x2862 (P701.00)	Keypad setpoint increment (KP setp. incr.) 1 ... [1] ... 100	<p>Adaptation of the increment for keypad setpoints when a keypad arrow key is pressed once. The value set serves as a multiplier for the preset increments.</p> <p>Setting 1 corresponds to the following increments:</p> <ul style="list-style-type: none"> <li>• 0.1 Hz for frequency setpoint <a href="#">0x2601:001 (P202.01)</a>.</li> <li>• 0.01 PUnit for process controller setpoint <a href="#">0x2601:002 (P202.02)</a>.</li> <li>• 0.1 % for torque setpoint <a href="#">0x2601:003 (P202.03)</a>.</li> </ul> <p>Notes:</p> <ul style="list-style-type: none"> <li>• With a setting &gt; 1, the option of repeatedly changing the setpoint by pressing the key for a longer time is deactivated.</li> <li>• The setting only has an impact on the keypad setpoints.</li> </ul> <p>Example: with the setting "5", the keypad frequency setpoint is increased/decreased by 0.5 Hz every time the key is pressed.</p>

### 16.1.1.3 Configure status display - Custom units

During operation, the keypad displays the output frequency of the inverter, or with an active PID control it shows the process controller setpoint. Alternatively, an optional diagnostic parameter can be displayed during operation.

#### Parameter

Address	Name / setting range / [default setting]	Information
0x2864 (P703.00)	Keypad status display (KP status displ.) 0x00000000 ... [0x00000000] ... 0xFFFFF00	<p>0 = normal display depending on the operating mode</p> <ul style="list-style-type: none"> <li>• In case of an active frequency control, the keypad displays the output frequency of the inverter.</li> <li>• In case of active PID control, the keypad displays the current Process controller setpoint in [P-Unit].</li> </ul> <p>As an alternative, an optional diagnostic parameter can be set here, which is to be shown on the keypad during operation.</p> <ul style="list-style-type: none"> <li>• Format: 0xiiii00 (iiii = hexadecimal index, ss = hexadecimal subindex)</li> <li>• The lowest byte is always 0x00.</li> <li>• The keypad can be used to select the desired diagnostics parameter from a list.</li> </ul>
0x2865:001 (P709.01)	Keypad display setup: User unit MS velocity mode (KP disp. setup: User MS velocity)	<p>Optional setting of an individual unit for the keypad operation display of the output frequency.</p> <ul style="list-style-type: none"> <li>• Setting is only possible with »EASY Starter«.</li> <li>• Maximum text length = 6 ASCII characters.</li> </ul>
0x2865:002 (P709.02)	Keypad display setup: User unit PID control (KP disp. setup: User PID control)	<p>Optional setting of an individual unit for the keypad operation display of the current process controller setpoint.</p> <ul style="list-style-type: none"> <li>• Setting is only possible with »EASY Starter«.</li> <li>• Maximum text length = 6 ASCII characters.</li> </ul>

# Using accessories

Keypad

Keypad basic settings

Configure status display - Custom units







Address	Name / setting range / [default setting]	Information
0x2865:003 (P709.03)	Keypad display setup: Speed display decimal point location (KP disp. setup: Speed dec.point) 0 ... [0] ... 5 • From version 06.02	Position of the decimal point when displaying the current speed on the keypad.
0x2865:004 (P709.04)	Keypad display setup: PID display decimal point location (KP disp. setup: PID dec.point) 0 ... [2] ... 5 • From version 06.02	Position of the decimal point when displaying the current process controller setpoint on the keypad.
0x4002 (P702.00)	Speed display scaling (Scal.speed fact.) 0.00 ... [0.00] ... 650.00	Factor for the scaling of the speed display in <a href="#">0x400D (P101.00)</a> . • With the setting "0.00", no scaling takes place. • Example: with the "16.50" and the actual frequency = 50 Hz, <a href="#">0x400D (P101.00)</a> shows the speed "825 units".





## 16.1.1.4 Configure R/F and CTRL keys

### Keypad rotation setup

Use the  keypad to reverse the rotation direction at local keypad control.

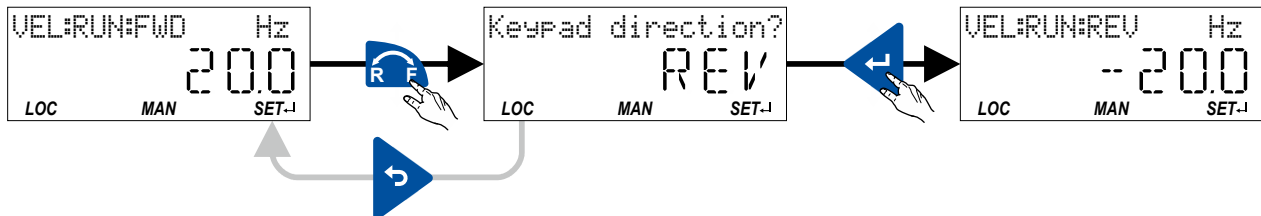
- After the  key has been pressed, the reversal of rotation direction must be confirmed with the  key. (The  key serves to cancel the action.)



The keypad key 

- directly changes the keypad rotation setup in [0x2602:002 \(P708.02\)](#).
- has no function in case of a bipolar setpoint selection (e. g.  $\pm 10$  V). In this case, the direction of rotation is determined by the sign of the setpoint.
- has no function if the rotation limitation "Only clockwise (CW) [0]" is set in [0x283A \(P304.00\)](#).
- has no function in the operating mode [0x6060 \(P301.00\)](#) = "MS: Torque mode [-1]".
- has no function if the PID control is activated.
- can be deactivated in [0x2602:001 \(P708.01\)](#).

### Keypad Full Control

The "Keypad Full Control" control mode can be activated with the keypad key "CTRL". Both the control and the setpoint selection are then made via the keypad. This special control mode can be, for instance, used during the commissioning phase if external control and setpoint sources are not ready to use yet.

For details see chapter "Overview of the control options: [Keypad full control](#)". [66](#)

The keypad key CTRL

- directly changes the setting in [0x2602:003 \(P708.03\)](#).
- can be deactivated in [0x2602:001 \(P708.01\)](#).

### Parameter

Address	Name / setting range / [default setting]	Information
0x2602:001 (P708.01)	Manual control: Keypad setting (Manual control: Keypad setting)	Disable/enable CTRL and F/R key of the keypad.
	• From version 03.00	
	0 CTRL & F/R disable	
	1 <b>CTRL &amp; F/R enable</b>	
	2 CTRL enable F/R disable	
3 CTRL disable F/R enable		
0x2602:002 (P708.02)	Manual control: Keypad rotational direction (Manual control: Keypad rot.dir.)	Instructed direction of rotation if local keypad control is active.
	• From version 03.00	
	0 <b>Forward</b>	
1 Reverse	<ul style="list-style-type: none"> <li>• If the local keypad control is active, this setting can be directly changed via the keypad key  if the key in <a href="#">0x2602:001 (P708.01)</a> has not been disabled.</li> <li>• When the remote control is changed over to local keypad control and vice versa, this parameter is set to "Forward [0]".</li> </ul>	

# Using accessories

Keypad  
Keypad basic settings  
Configure R/F and CTRL keys



Address	Name / setting range / [default setting]	Information
0x2602:003 (P708.03)	Manual control: Mode (Manual control: Mode) <ul style="list-style-type: none"><li>From version 03.00</li></ul>	Activate/deactivate full keypad control. <ul style="list-style-type: none"><li>This setting can be changed directly via the keypad key <b>CTRL</b> if the key in <a href="#">0x2602:001 (P708.01)</a> has not been disabled.</li><li>When the control mode is changed over, the motor is stopped and the "Forward" direction of rotation is set.</li></ul>
	<b>0</b> <b>Manual control off</b>	
	<b>1</b> Keypad full control on	
	<b>2</b> Manual mode	<ul style="list-style-type: none"><li>Access via engineering tools only.</li><li>The active control is removed from the current control source / setpoint source.</li><li>Start and stop command as well as the setpoint are controlled via a special dialog.</li><li>A connection control is active (engineering tool &lt;-&gt; inverter)</li><li>The operator is responsible for the safety and impact of this function.</li></ul>



## 16.1.2 Keypad operating mode

After switching on the inverter, the keypad plugged in is in "Operating mode" after a short initialisation phase.

### 16.1.2.1 Keypad status display

In the operating mode, the keypad displays information on the status of the inverter.

Keypad display	Display	Meaning																																											
<p>If the inverter is inhibited, the keypad shows "STOP":</p> <p>If the inverter is enabled, the keypad shows the output frequency of the inverter:</p> <ul style="list-style-type: none"> <li>In the process controller mode, instead of the output frequency, the process controller setpoint is displayed.</li> <li>The display can be configured in <a href="#">0x2864 (P703.00)</a>.</li> <li>The language for the keypad display is preset to "English". The language can be changed in <a href="#">0x2863 (P705.00)</a>.</li> </ul>	<p>① Active control mode:</p> <table border="1"> <tr><td>VEL</td><td>Speed mode</td></tr> <tr><td>PID</td><td>Process controller mode</td></tr> <tr><td>TRQ</td><td>Torque mode</td></tr> <tr><td>JOG</td><td>Manual mode</td></tr> </table> <p>② Active control source:</p> <table border="1"> <tr><td>FLEX</td><td>Flexible I/O configuration</td></tr> <tr><td>KPD</td><td>Keypad</td></tr> <tr><td>KPDF</td><td>Keypad (complete control via keypad including setpoint selection)</td></tr> <tr><td>NET</td><td>Network</td></tr> </table> <p>③ Active setpoint source:</p> <table border="1"> <tr><td>AINx</td><td>Analog input x</td></tr> <tr><td>KPD</td><td>Keypad</td></tr> <tr><td>NET</td><td>Network</td></tr> <tr><td>FREQ</td><td>Digital frequency</td></tr> <tr><td>PRx</td><td>Preset setpoint x</td></tr> <tr><td>SEGx</td><td>Segment x</td></tr> <tr><td>MOP</td><td>Motor potentiometer</td></tr> </table> <p>④ Current direction of rotation:</p> <table border="1"> <tr><td>FWD</td><td>Motor is rotating forwards</td></tr> <tr><td>REV</td><td>Motor is rotating backwards</td></tr> </table> <p>⑤ Lower status line:</p> <table border="1"> <tr><td>LOC</td><td>Local keypad control active.</td></tr> <tr><td>REM</td><td>Remote control via terminals, network, etc. active.</td></tr> <tr><td>MAN</td><td>Manual setpoint selection via keypad active.</td></tr> <tr><td>AUTO</td><td>Automatic setpoint selection via terminals, network, etc. active.</td></tr> <tr><td>SET</td><td>Blinking if one parameter setting has been changed but has not been saved in the memory module with mains failure protection. Save settings: Press keypad enter key longer than 3 s.</td></tr> </table>	VEL	Speed mode	PID	Process controller mode	TRQ	Torque mode	JOG	Manual mode	FLEX	Flexible I/O configuration	KPD	Keypad	KPDF	Keypad (complete control via keypad including setpoint selection)	NET	Network	AINx	Analog input x	KPD	Keypad	NET	Network	FREQ	Digital frequency	PRx	Preset setpoint x	SEGx	Segment x	MOP	Motor potentiometer	FWD	Motor is rotating forwards	REV	Motor is rotating backwards	LOC	Local keypad control active.	REM	Remote control via terminals, network, etc. active.	MAN	Manual setpoint selection via keypad active.	AUTO	Automatic setpoint selection via terminals, network, etc. active.	SET	Blinking if one parameter setting has been changed but has not been saved in the memory module with mains failure protection. Save settings: Press keypad enter key longer than 3 s.
VEL	Speed mode																																												
PID	Process controller mode																																												
TRQ	Torque mode																																												
JOG	Manual mode																																												
FLEX	Flexible I/O configuration																																												
KPD	Keypad																																												
KPDF	Keypad (complete control via keypad including setpoint selection)																																												
NET	Network																																												
AINx	Analog input x																																												
KPD	Keypad																																												
NET	Network																																												
FREQ	Digital frequency																																												
PRx	Preset setpoint x																																												
SEGx	Segment x																																												
MOP	Motor potentiometer																																												
FWD	Motor is rotating forwards																																												
REV	Motor is rotating backwards																																												
LOC	Local keypad control active.																																												
REM	Remote control via terminals, network, etc. active.																																												
MAN	Manual setpoint selection via keypad active.																																												
AUTO	Automatic setpoint selection via terminals, network, etc. active.																																												
SET	Blinking if one parameter setting has been changed but has not been saved in the memory module with mains failure protection. Save settings: Press keypad enter key longer than 3 s.																																												
<p>If an error is pending, the keypad shows the following information:</p> <ul style="list-style-type: none"> <li>Faults (F) and trouble (T) are displayed continuously.</li> <li>Warnings (W) are only displayed every 2 seconds for a short time.</li> </ul>	<p>① Error text</p> <p>② Error type:</p> <table border="1"> <tr><td>F</td><td>Fault</td></tr> <tr><td>T</td><td>Trouble</td></tr> <tr><td>W</td><td>Warning</td></tr> </table> <p>③ Error code (hexadecimal)</p> <ul style="list-style-type: none"> <li>▶ <a href="#">Events, causes and remedies</a> <a href="#">□ 705</a></li> <li>▶ <a href="#">Event handling</a> <a href="#">□ 699</a></li> <li>▶ <a href="#">Error reset with keypad</a> <a href="#">□ 639</a></li> </ul>	F	Fault	T	Trouble	W	Warning																																						
F	Fault																																												
T	Trouble																																												
W	Warning																																												
<p>Restart Pending</p>	<p>After a disturbance, a restart is possible if the error condition is not active anymore. The keypad shows this by the "Restart Pending" note. The note is displayed in a 1-second interval alternating with the error text.</p> <ul style="list-style-type: none"> <li>▶ <a href="#">Automatic restart after a fault</a> <a href="#">□ 579</a></li> </ul>																																												

# Using accessories

Keypad  
Keypad operating mode  
Function of keypad keys in operating mode



## 16.1.2.2 Function of keypad keys in operating mode

In the operating mode, the keypad can be used for local control and for manual setpoint selection.

Function of keypad keys in operating mode			
Key	Actuation	Condition	Action
	Briefly	Local keypad control active. Display "LOC"	Run motor.
		Remote control active Display "REM" Display "KSTOP"	Deactivate keypad triggered stop. The motor remains at standstill. Display changes from "KSTOP" to "STOP".
	Briefly	No Jog operation	Stop motor. Display "KSTOP"
	Briefly	Operating mode	Change to parameterisation mode. ▶ <a href="#">Keypad parameterisation mode</a> 640
	Longer than 3 s	None (anytime possible)	Save parameter settings in the user memory of the memory module.
	Briefly	During operation	Scroll through information in the above status line.
 	Briefly	Manual setpoint selection via keypad active. Display "MAN"	Change frequency setpoint.
	Briefly	Operating mode	Activate full keypad control Display "ON?" → Confirm with Control and setpoint selection can now only be carried out via keypad. Renewed clicking: Exit full keypad control. Display "OFF?" → Confirm with ▶ <a href="#">Keypad full control</a> 66
	Briefly	Local keypad control active. Display "LOC"	Reversal of rotation direction. Display "REV?" → Confirm with ▶ <a href="#">Configure R/F and CTRL keys</a> 635

### Example: Change setpoint

If the setpoints are selected manually via keypad, the frequency setpoint can be changed in the operating mode via the arrow keys (even while the motor is running):

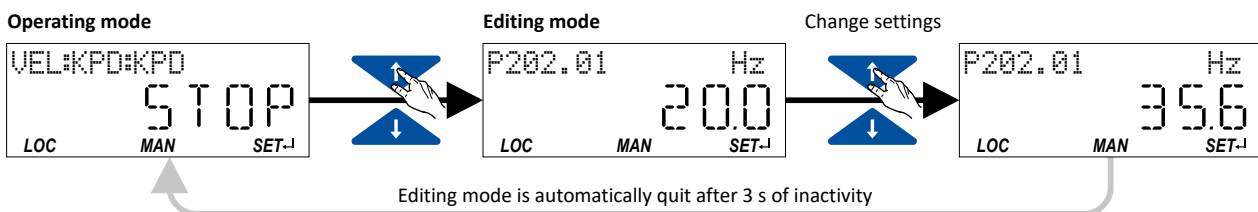



### 16.1.2.3 Error reset with keypad

Use the  keypad key to reset a resettable error if the error condition no longer exists and no blocking time is active.

- The "Events, causes and remedies" table gives the blocking time (if available) for each error. [705](#)

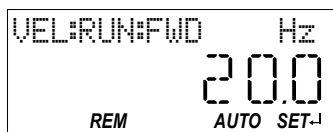
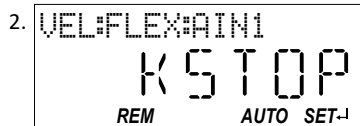
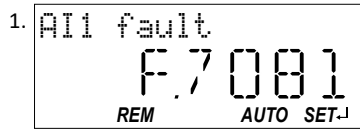

1. Press  keypad key.

The error is reset. The motor remains stopped via keypad (display "KSTOP").

2. In order to cancel the stop via keypad again: Press  keypad key.

# Using accessories

Keypad  
Keypad parameterisation mode  
Parameter groups



## 16.1.3 Keypad parameterisation mode

In the parameterisation mode of the keypad you can have actual values of the inverter displayed for purposes of diagnostics and change settings of the inverter.

Use the **←** to change from operating mode to the parameterisation mode.

- If a write access protection is active for the inverter, the keypad automatically displays a log-in when changing to the parameterisation mode. You can either skip the log-in and thus keep the access protection active or remove it temporarily by entering a valid PIN. ▶ [Write access protection](#) [□ 567](#)
- Use the **↵** to return to the operating mode.

### 16.1.3.1 Parameter groups

In order to provide for quick access, all parameters of the inverter are divided into different groups according to their function.

- Group 0 contains the configurable "Favorites". In the default setting these are the most common parameters for the solution of typical applications. ▶ [Favorites](#) [□ 39](#)
- Based on the hundreds digit of the display code (Pxxx) you can quickly see in which group the parameter is to be found on the keypad:

Parameter	Group/name	Description
P1xx	Group 1 - Diagnostics	Diagnostic/display parameters for displaying device-internal process factors, current actual values, and status messages. ▶ <a href="#">Diagnostic parameters</a> <a href="#">□ 687</a>
P2xx	Group 2 - Basic setting	Setting of the mains voltage, selection of the control and setpoint source, start and stop behavior, frequency limits and ramp times. ▶ <a href="#">Basic setting</a> <a href="#">□ 46</a>
P3xx	Group 3 - Motor control	Configuration of the motor and motor control ▶ <a href="#">Configuring the motor control</a> <a href="#">□ 185</a>
P4xx	Group 4 - I/O setting	Function assignment and configuration of the inputs and outputs ▶ <a href="#">Start, stop and rotating direction commands</a> <a href="#">□ 62</a> ▶ <a href="#">Configure digital inputs</a> <a href="#">□ 272</a> ▶ <a href="#">Configure analog inputs</a> <a href="#">□ 284</a> ▶ <a href="#">Configure digital outputs</a> <a href="#">□ 292</a> ▶ <a href="#">Configure analog outputs</a> <a href="#">□ 305</a>
P5xx	Group 5 - Network setting	Configuration of the network (if available) ▶ <a href="#">Configuring the network</a> <a href="#">□ 310</a>
P6xx	Group 6 - Process controller	Configuration of the process controller ▶ <a href="#">Configuring the process controller</a> <a href="#">□ 128</a>
P7xx	Group 7 - Additional functions	Parameterisable additional functions ▶ <a href="#">Additional functions</a> <a href="#">□ 586</a>
P8xx	Group 8 - Sequencer	The "sequencer" function serves to define a programmed sequence of speed setpoints, PID setpoints or torque setpoints for the motor control. Switching to the next setpoint can be executed in a time-based or event-based manner. ▶ <a href="#">Sequencer</a> <a href="#">□ 102</a>





### 16.1.3.2 Function of the keypad keys in the parameterisation mode

In the parameterisation mode of the keypad you can have actual values of the inverter displayed for purposes of diagnostics and change settings of the inverter.

Function of the keypad keys in the parameterisation mode			
Key	Actuation	Condition	Action
	Shortly	Local keypad control active. Display "LOC"	Run motor.
		Remote control active Display "REM" Display "KSTOP"	Deactivate keypad triggered stop. The motor remains at standstill. Display changes from "KSTOP" to "STOP".
	Shortly	No Jog operation	Stop motor. Display "KSTOP"
	Shortly	Parameterisation mode	Navigate to one level below. Group level → Parameter level → [SUB parameter level] → Editing mode
	Longer than 3 s	None (anytime possible)	Exit editing mode and accept new setting. Save parameter settings in the user memory of the memory module.
	Shortly	Parameterisation mode	Navigate to one level above. [SUB parameter level] → Parameter level → Group level → Operating mode
		Editing mode	Abort: Exit editing mode without accepting new setting.
	Shortly	Group level/Parameter level	Navigate: Select group/parameter.
		Editing mode	Change parameter setting.
			Without function
			Without function

# Using accessories

Keypad  
Keypad parameterisation mode  
Save parameter settings with keypad



## Changing inverter settings by means of the keypad (general operation)

Operating mode

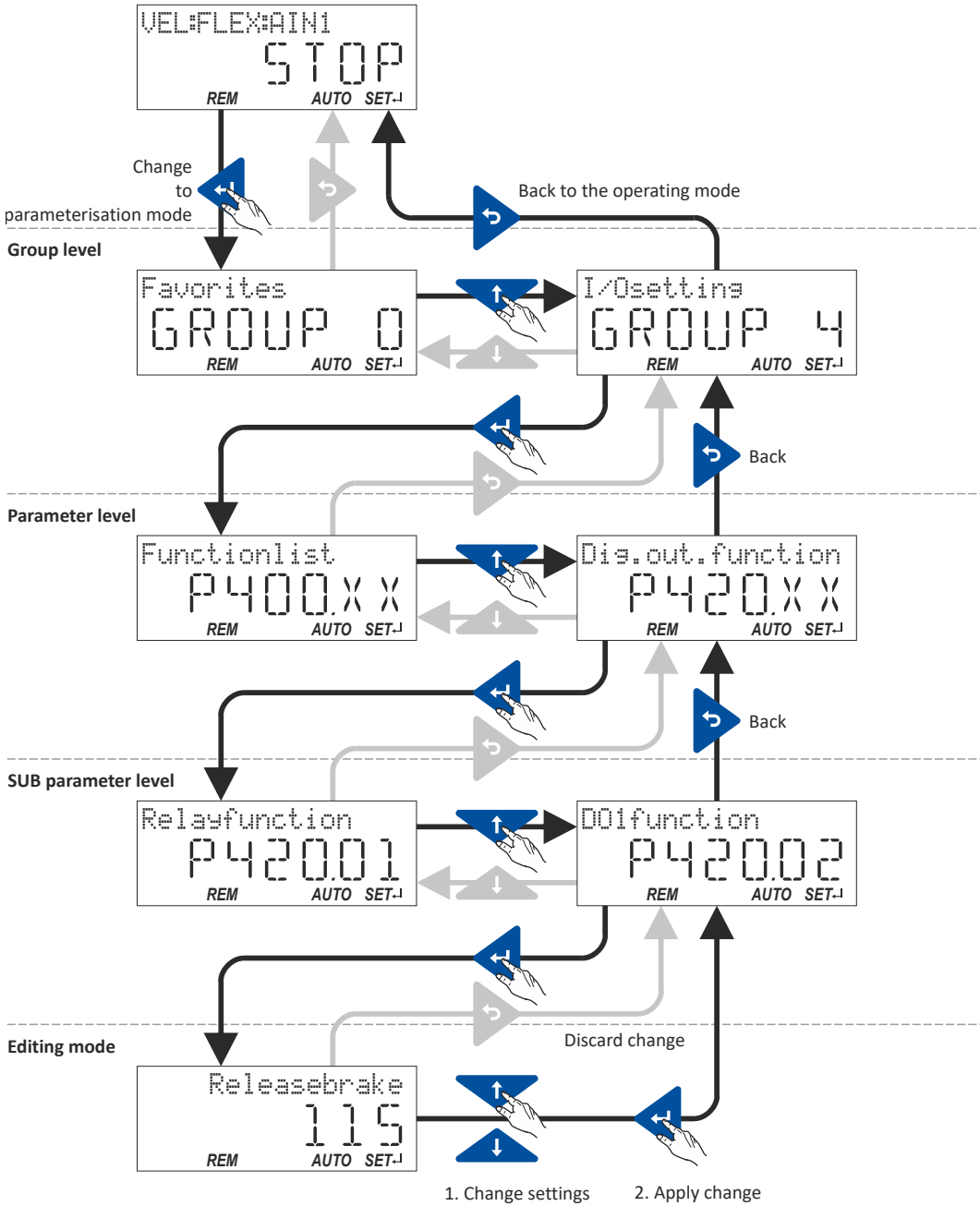

### 16.1.3.3 Save parameter settings with keypad

If one parameter setting has been changed with the keypad but has not been saved in the memory module with mains failure protection, the SET display is blinking.

In order to save parameter settings in the user memory of the memory module, press and hold the enter key for longer than 3 s.





## 16.1.3.4 Display of status words on keypad

Some diagnostics parameters contain bit-coded status words. Each single bit has a certain meaning.

### Display of 16-bit status words on the keypad

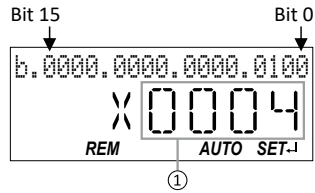

- ① Hexadecimal value

### Display of 32-bit status words on the keypad

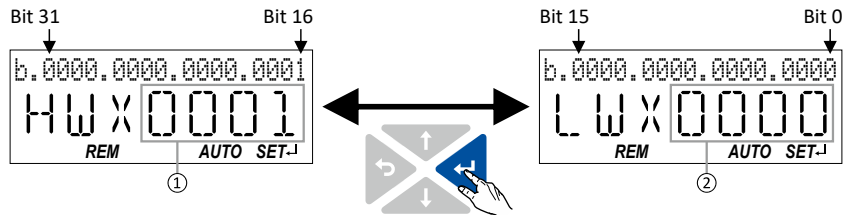

- ① Hexadecimal value High word (HW)
- ② Hexadecimal value Low word (LW)

# Using accessories

Keypad  
Keypad parameterisation mode  
Keypad parameter list



## 16.1.3.5 Keypad parameter list

For commissioning or diagnostics using the keypad, all parameters of the inverter that can be accessed by means of the keypad are listed in the following "Keypad parameter list".

- The keypad parameter list is sorted in ascending order in compliance with the "display code" (Pxxx).
- In order to provide for quick access, all parameters of the inverter are divided into different groups according to their function. ▶ [Parameter groups](#) 640
- Group 0 contains the configurable "Favorites". In the default setting these are the most common parameters for the solution of typical applications. ▶ [Favorites](#) 39



A complete overview of all parameter indexes can be found in the annex in the [Parameter attribute list](#). 731

### Frequently used abbreviations in the short keypad designations of the parameters:

Abbreviation	Meaning
AI	Analog input
AO	Analog output
B0, B1, ...	Bit 0, bit 1, ...
CU	Control unit
DI	Digital input
DO	Digital output
LU	Undervoltage
MOP	Motor potentiometer
NET	Network
OU	Overvoltage
PID	Process controller
PU	Power unit
QSP	Quick stop
Setp	Setpoint
WD	Watchdog

### How to read the keypad parameter list:

Column	Meaning
Display code	Parameter number on the keypad. Format: Number.Subindex
Short designation	Short keypad designation limited to 16 characters.
Default setting	Default setting of the parameter.
Setting range	Possible setting range for the parameter. Format: minimum value ... maximum value [unit]
Address	Address of the parameter in the object directory. Format: Index:Subindex
Category	Functional assignment of the parameter, for example "motor control" or "CANopen".

### Keypad parameter list (short overview of all parameters with display code)

Display code	Short designation	Default setting	Setting range	Address	Category
P100.00	Inv. outp. freq.	x.x Hz	- (Read only)	0x2DDD	general
P101.00	Scaled act value	x Unit	- (Read only)	0x400D	general
P102.00	Freq. setpoint	x.x Hz	- (Read only)	0x2B0E	general
P103.00	Actual current	x.x %	- (Read only)	0x6078	general
P104.00	Motor current	x.x A	- (Read only)	0x2D88	general
P105.00	DC-bus voltage	x V	- (Read only)	0x2D87	general
P106.00	Motor voltage	x VAC	- (Read only)	0x2D89	general
P107.00	Actual torque	x.x %	- (Read only)	0x6077	general
P108.xx	Output power				
<sup>L</sup> P108.01	Effective power	x.xxx kW	- (Read only)	0x2DA2:001	general

\* Default setting dependent on the model.



# Using accessories

Keypad  
Keypad parameterisation mode  
Keypad parameter list

Display code	Short designation	Default setting	Setting range	Address	Category
↳ P108.02	Apparent power	x.xxx kVA	- (Read only)	0x2DA2:002	general
P109.xx	Output energy				
↳ P109.01	Motor	x.xx kWh	- (Read only)	0x2DA3:001	general
↳ P109.02	Generator	x.xx kWh	- (Read only)	0x2DA3:002	general
P110.xx	AI1 diagnostics				
↳ P110.01	AI1 terminal %	x.x %	- (Read only)	0x2DA4:001	general
↳ P110.02	AI1 scaled freq.	x.x Hz	- (Read only)	0x2DA4:002	general
↳ P110.03	AI1 scaled PID	x.xx PID unit	- (Read only)	0x2DA4:003	general
↳ P110.04	AI1 scaled torq.	x.x %	- (Read only)	0x2DA4:004	general
↳ P110.16	AI1 status	-	- (Read only)	0x2DA4:016	general
P111.xx	AI2 diagnostics				
↳ P111.01	AI2 terminal %	x.x %	- (Read only)	0x2DA5:001	general
↳ P111.02	AI2 scaled freq.	x.x Hz	- (Read only)	0x2DA5:002	general
↳ P111.03	AI2 scaled PID	x.xx PID unit	- (Read only)	0x2DA5:003	general
↳ P111.04	AI2 scaled torq.	x.x %	- (Read only)	0x2DA5:004	general
↳ P111.16	AI2 status	-	- (Read only)	0x2DA5:016	general
P112.xx	AO1 diagnostics				
↳ P112.01	AO1 Voltage	x.xx V	- (Read only)	0x2DAA:001	general
↳ P112.02	AO1 Current	x.xx mA	- (Read only)	0x2DAA:002	general
P113.xx	AO2 diagnostics				
↳ P113.01	AO2 Current	x.xx V	- (Read only)	0x2DAB:001	Appl. I/O
↳ P113.02	AO2 Voltage	x.xx mA	- (Read only)	0x2DAB:002	Appl. I/O
P114.xx	DO actual freq.				
↳ P114.01	Digital output 1	x.x Hz	- (Read only)	0x2646:001	general
P115.xx	HTL inp. diag.				
↳ P115.01	Input frequency	x.x Hz	- (Read only)	0x2642:001	general
↳ P115.02	Freq. setpoint	x.x Hz	- (Read only)	0x2642:002	general
↳ P115.03	PID setpoint	x.xx PID unit	- (Read only)	0x2642:003	general
↳ P115.04	Torque setpoint	x.x %	- (Read only)	0x2642:004	general
P116.00	Actual sw. freq.	-	- (Read only)	0x293A	general
P117.xx	Heatsink temp.				
↳ P117.01	Heatsink temp.	x.x °C	- (Read only)	0x2D84:001	general
P118.00	Digital inputs	-	- (Read only)	0x60FD	general
P119.00	Keypad status	-	- (Read only)	0x2DAC	general
P120.00	Int. HW states	-	- (Read only)	0x2DAD	general
P121.xx	PID diagnostics				
↳ P121.01	PID setpoint	x.xx PID unit	- (Read only)	0x401F:001	general
↳ P121.02	PID process var.	x.xx PID unit	- (Read only)	0x401F:002	general
↳ P121.03	PID status	-	- (Read only)	0x401F:003	general
P123.00	Mot. i2t utilis.	x %	- (Read only)	0x2D4F	MCTRL
P125.xx	Inverter diag.				
↳ P125.01	Active control	-	- (Read only)	0x282B:001	general
↳ P125.02	Active setpoint	-	- (Read only)	0x282B:002	general
↳ P125.03	Keypad LCD stat.	-	- (Read only)	0x282B:003	general
↳ P125.04	Drive mode	-	- (Read only)	0x282B:004	general
↳ P125.05	Netw. contr.reg.	-	- (Read only)	0x282B:005	general
↳ P125.06	Netw. setp.reg.	-	- (Read only)	0x282B:006	general
P126.xx	Status words				
↳ P126.01	Cause of disable	-	- (Read only)	0x282A:001	general
↳ P126.02	Cause of QSP	-	- (Read only)	0x282A:002	general
↳ P126.03	Cause of stop	-	- (Read only)	0x282A:003	general
↳ P126.05	Device status	-	- (Read only)	0x282A:005	general
P135.xx	Device utilisat.				
↳ P135.04	ixt utilisation	x %	- (Read only)	0x2D40:004	general

\* Default setting dependent on the model.

# Using accessories

Keypad  
Keypad parameterisation mode  
Keypad parameter list



Display code	Short designation	Default setting	Setting range	Address	Category
L P135.05	Error response	<b>Fault [3]</b>	Selection list	0x2D40:005	general
P140.xx	Sequencer diag				
L P140.01	Active Step	-	-(Read only)	0x2DAE:001	Sequencer
L P140.02	StepTime elapsed	x.x s	-(Read only)	0x2DAE:002	Sequencer
L P140.03	StepTime remain	x.x s	-(Read only)	0x2DAE:003	Sequencer
L P140.04	Steps complete	-	-(Read only)	0x2DAE:004	Sequencer
L P140.05	Steps remain	-	-(Read only)	0x2DAE:005	Sequencer
L P140.06	Active sequence	-	-(Read only)	0x2DAE:006	Sequencer
L P140.07	Active segment	-	-(Read only)	0x2DAE:007	Sequencer
L P140.08	SeqTime remain %	x %	-(Read only)	0x2DAE:008	Sequencer
L P140.09	SeqTime remain	x.x s	-(Read only)	0x2DAE:009	Sequencer
P150.00	Error code	-	-(Read only)	0x603F	general
P151.xx	Life-diagnosis				
L P151.01	Operating time	x s	-(Read only)	0x2D81:001	general
L P151.02	Power-on time	x s	-(Read only)	0x2D81:002	general
L P151.03	CU oper. time	x ns	-(Read only)	0x2D81:003	general
L P151.04	Switching cycles	-	-(Read only)	0x2D81:004	general
L P151.05	Relay cycles	-	-(Read only)	0x2D81:005	general
L P151.06	Short-circ.count	-	-(Read only)	0x2D81:006	general
L P151.07	Earthfault count	-	-(Read only)	0x2D81:007	general
L P151.08	Clamp active	-	-(Read only)	0x2D81:008	general
L P151.09	Fan oper. time	x s	-(Read only)	0x2D81:009	general
P155.xx	Fault memory				
P155.00	Error memory	-	-(Read only)	0x2006:000	general
P190.xx	Device data				
L P190.01	Product code	-	-(Read only)	0x2000:001	general
L P190.02	Serial number	-	-(Read only)	0x2000:002	general
L P190.04	CU firmware ver.	-	-(Read only)	0x2000:004	general
L P190.05	CU firmware type	-	-(Read only)	0x2000:005	general
L P190.06	CU bootldr ver.	-	-(Read only)	0x2000:006	general
L P190.07	CU bootldr type	-	-(Read only)	0x2000:007	general
L P190.08	OBD version	-	-(Read only)	0x2000:008	general
L P190.10	PU firmware ver.	-	-(Read only)	0x2000:010	general
L P190.11	PU firmware type	-	-(Read only)	0x2000:011	general
L P190.12	PU bootldr ver.	-	-(Read only)	0x2000:012	general
L P190.13	PU bootldr type	-	-(Read only)	0x2000:013	general
L P190.14	Mod. firmware	-	-(Read only)	0x2000:014	general
L P190.15	Com. FW rev no.	-	-(Read only)	0x2000:015	general
L P190.16	ComBootldrRevNo	-	-(Read only)	0x2000:016	general
L P190.17	CU FW subtype	-	-(Read only)	0x2000:017	general
P191.00	Device name	<b>"My Device"</b>	Text	0x2001	general
P192.xx	Device module				
L P192.04	CU type code	-	-(Read only)	0x2002:004	general
L P192.05	PU type code	-	-(Read only)	0x2002:005	general
L P192.06	CU serial number	-	-(Read only)	0x2002:006	general
L P192.07	PU serial number	-	-(Read only)	0x2002:007	general
P197.00	Protect. status	-	-(Read only)	0x2040	general
P198.00	Status load. par	-	-(Read only)	0x2827	general
P200.00	Control select.	<b>Flexible I/O [0]</b>	Selection list	0x2824	general
P201.xx	Stnd. setpoints				
L P201.01	Freq. setp. src.	<b>Analog input 1 [2]</b>	Selection list	0x2860:001	general
L P201.02	PID setp. src.	<b>Keypad [1]</b>	Selection list	0x2860:002	general
L P201.03	Torque setp.src.	<b>Analog input 1 [2]</b>	Selection list	0x2860:003	general
P202.xx	Keypad setpoints				
* Default setting dependent on the model.					



# Using accessories

Keypad  
Keypad parameterisation mode  
Keypad parameter list

Display code	Short designation	Default setting	Setting range	Address	Category
L P202.01	KP freq.setpoint	<b>20.0 Hz</b>	0.0 ... 599.0 Hz	0x2601:001	general
L P202.02	KP PID setpoint	<b>0.00 PID unit</b>	-300.00 ... 300.00 PID unit	0x2601:002	general
L P202.03	Torque setp.	<b>100.0 %</b>	-400.0 ... 400.0 %	0x2601:003	general
P203.xx	Start/stop config				
L P203.01	Start method	<b>Normal [0]</b>	Selection list	0x2838:001	MCTRL
L P203.02	Start at powerup	<b>Off [0]</b>	Selection list	0x2838:002	general
L P203.03	Stop method	<b>Standard ramp [1]</b>	Selection list	0x2838:003	general
P208.xx	Mains settings				
L P208.01	Mains voltage	<b>230 Veff [0]</b>	Selection list	0x2540:001	general
L P208.02	LU warn. thresh.	<b>0 V *</b>	0 ... 1000 V	0x2540:002	general
L P208.03	LU error thresh.	x V	- (Read only)	0x2540:003	general
L P208.04	LU reset thresh.	x V	- (Read only)	0x2540:004	general
L P208.05	OU warn. thresh.	<b>0 V *</b>	0 ... 1000 V	0x2540:005	general
L P208.06	OU error thresh.	x V	- (Read only)	0x2540:006	general
L P208.07	OU reset thresh.	x V	- (Read only)	0x2540:007	general
P210.00	Min. frequency	<b>0.0 Hz</b>	0.0 ... 599.0 Hz	0x2915	general
P211.00	Max. frequency	Device for 50-Hz mains: <b>50.0 Hz</b> Device for 60-Hz mains: <b>60.0 Hz</b>	0.0 ... 599.0 Hz	0x2916	general
P220.00	Accelerat.time 1	<b>5.0 s</b>	0.0 ... 3600.0 s	0x2917	general
P221.00	Decelerat.time 1	<b>5.0 s</b>	0.0 ... 3600.0 s	0x2918	general
P222.00	Accelerat.time 2	<b>5.0 s</b>	0.0 ... 3600.0 s	0x2919	general
P223.00	Decelerat.time 2	<b>5.0 s</b>	0.0 ... 3600.0 s	0x291A	general
P224.00	Ramp 2 thresh.	<b>0.0 Hz</b>	0.0 ... 599.0 Hz	0x291B	general
P225.00	QSP dec. time	<b>1.0 s</b>	0.0 ... 3600.0 s	0x291C	general
P226.xx	S-ramp char.				
L P226.01	Smoothing factor	<b>0.0 %</b>	0.0 ... 100.0 %	0x291E:001	general
L P226.03	Stop threshold	<b>10.0 %</b>	0.0 ... 100.0 %	0x291E:003	general
P230.xx	Optical tracking				
L P230.01	Start detection	<b>Stop [0]</b>	Selection list	0x2021:001	general
L P230.02	Blink. duration	<b>5 s</b>	0 ... 3600 s	0x2021:002	general
P300.00	Motor ctrl mode	<b>VFC open loop [6]</b>	Selection list	0x2C00	MCTRL
P301.00	Operation mode	<b>MS: Velocitymode [-2]</b>	Selection list	0x6060	MCTRL
P302.00	V/f charac.shape	<b>Linear [0]</b>	Selection list	0x2B00	MCTRL
P303.xx	V/f shape data				
L P303.01	Base voltage	<b>230 V *</b>	0 ... 5000 V	0x2B01:001	MCTRL
L P303.02	Base frequency	Device for 50-Hz mains: <b>50 Hz *</b> Device for 60-Hz mains: <b>60 Hz *</b>	0 ... 1500 Hz	0x2B01:002	MCTRL
L P303.03	Midpoint voltage	<b>0 V</b>	0 ... 5000 V	0x2B01:003	MCTRL
L P303.04	Midpoint freq	<b>0 Hz</b>	0 ... 1500 Hz	0x2B01:004	MCTRL
P304.00	Limit. rotation	<b>Both rot. direct [1]</b>	Selection list	0x283A	general
P305.00	Switching freq.	<b>0 *</b>	1 ... 33	0x2939	general
P306.xx	Inv. load char.				
L P306.01	Duty selection	<b>Heavy Duty [0]</b>	Selection list	0x2D43:001	general
P308.xx	Motor overload				
L P308.01	Max.load.for 60s	<b>150 %</b>	30 ... 200 %	0x2D4B:001	MCTRL
L P308.02	Speed comp.	<b>On [0]</b>	Selection list	0x2D4B:002	MCTRL
L P308.03	Response	<b>Fault [3]</b>	Selection list	0x2D4B:003	general
P309.xx	Mot.temp.monit.				
L P309.02	Response	<b>Fault [3]</b>	Selection list	0x2D49:002	general
P310.xx	Mot.phase.fail.				
L P310.01	Response	<b>No response [0]</b>	Selection list	0x2D45:001	general

\* Default setting dependent on the model.

# Using accessories

Keypad  
Keypad parameterisation mode  
Keypad parameter list



Display code	Short designation	Default setting	Setting range	Address	Category
L P310.02	Current thresh.	5.0 %	1.0 ... 25.0 %	0x2D45:002	MCTRL
L P310.03	Voltage thresh.	10.0 V	0.0 ... 100.0 V	0x2D45:003	MCTRL
P315.xx	Slip compens.				
L P315.01	Slip: gain	100.00 %	-200.00 ... 200.00 %	0x2B09:001	MCTRL
L P315.02	Filter time	100 ms	1 ... 6000 ms	0x2B09:002	MCTRL
P316.xx	V/f boosts				
L P316.01	Fixed V/f boost	2.5 % *	0.0 ... 20.0 %	0x2B12:001	MCTRL
L P316.02	Dynam. V/f boost	0.0 %	0.0 ... 20.0 %	0x2B12:002	general
P317.xx	Skip frequencies				
L P317.01	Skip frequency 1	0.0 Hz	0.0 ... 599.0 Hz	0x291F:001	general
L P317.02	Skip bandwidth 1	0.0 Hz	0.0 ... 10.0 Hz	0x291F:002	general
L P317.03	Skip frequency 2	0.0 Hz	0.0 ... 599.0 Hz	0x291F:003	general
L P317.04	Skip bandwidth 2	0.0 Hz	0.0 ... 10.0 Hz	0x291F:004	general
L P317.05	Skip frequency 3	0.0 Hz	0.0 ... 599.0 Hz	0x291F:005	general
L P317.06	Skip bandwidth 3	0.0 Hz	0.0 ... 10.0 Hz	0x291F:006	general
P318.xx	Oscillat. damp.				
L P318.01	Gain	150 %	-400 ... 400 %	0x2B0A:001	MCTRL
L P318.02	Filter time	30 ms	1 ... 600 ms	0x2B0A:002	MCTRL
P319.00	Field weak thold	0.0 Hz	-599.0 ... 599.0 Hz	0x2B0C	MCTRL
P319.00	Field weak thold	-40.0 Hz	-599.0 ... 599.0 Hz	0x2B0C	MCTRL
P320.xx	Motor parameters				
L P320.04	Rated speed	Device for 50-Hz mains: 1450 rpm Device for 60-Hz mains: 1750 rpm	50 ... 50000 rpm	0x2C01:004	MCTRL
L P320.05	Rated frequency	Device for 50-Hz mains: 50.0 Hz Device for 60-Hz mains: 60.0 Hz	1.0 ... 1000.0 Hz	0x2C01:005	MCTRL
L P320.06	Rated power	0.25 kW *	0.00 ... 655.35 kW	0x2C01:006	MCTRL
L P320.07	Rated voltage	230 V *	0 ... 65535 V	0x2C01:007	MCTRL
L P320.08	Cosine phi	0.80	0.00 ... 1.00	0x2C01:008	MCTRL
P322.00	Max. motor speed	6075 rpm	0 ... 480000 rpm	0x6080	MCTRL
P323.00	Rated mot.curr.	1.700 A *	0.001 ... 500.000 A	0x6075	MCTRL
P324.00	Max. current	200.0 %	0.0 ... 3000.0 %	0x6073	MCTRL
P325.00	Rated mot torque	1.650 Nm *	0.001 ... 4294967.295 Nm	0x6076	MCTRL
P326.00	Max. torque	250.0 %	0.0 ... 3000.0 %	0x6072	MCTRL
L P327.04	Identify mot.	0	0 ... 1	0x2822:004	general
L P327.05	Calibrate mot.	0	0 ... 1	0x2822:005	general
P329.xx	MaxTrq.Monitor				
L P329.01	Response	No response [0]	Selection list	0x2D67:001	MCTRL
L P329.02	Triggering delay	0.000 s	0.000 ... 10.000 s	0x2D67:002	MCTRL
P330.xx	VFC-ECO				
L P330.01	Min. voltage	20 %	20 ... 100 %	0x2B0D:001	MCTRL
L P330.06	Cos Phi actual	-	-(Read only)	0x2B0D:006	MCTRL
P332.xx	Speed controller				
L P332.01	Gain	0.00193 Nm/rpm *	0.00000 ... 20000.00000 Nm/rpm	0x2900:001	MCTRL
L P332.02	Reset time	80.0 ms *	1.0 ... 6000.0 ms	0x2900:002	MCTRL
P333.xx	V/f I <sub>max</sub> contr.				
L P333.01	Gain	0.284 Hz/A *	0.000 ... 1000.000 Hz/A	0x2B08:001	MCTRL
L P333.02	Reset time	2.3 ms *	1.0 ... 2000.0 ms	0x2B08:002	MCTRL
P334.xx	Current contr.				
L P334.01	Gain	42.55 V/A *	0.00 ... 750.00 V/A	0x2942:001	MCTRL
L P334.02	Reset time	4.50 ms *	0.01 ... 2000.00 ms	0x2942:002	MCTRL

\* Default setting dependent on the model.





# Using accessories

Keypad  
Keypad parameterisation mode  
Keypad parameter list

Display code	Short designation	Default setting	Setting range	Address	Category
P335.xx	Moment of inert.				
L P335.01	Motor inertia	<b>3.70 kg cm<sup>2</sup> *</b>	0.00 ... 20000000.00 kg cm <sup>2</sup>	0x2910:001	MCTRL
L P335.02	Scal load inert.	<b>0.00 kg cm<sup>2</sup></b>	0.00 ... 20000000.00 kg cm <sup>2</sup>	0x2910:002	MCTRL
P336.xx	Torque setpoint				
L P336.02	Ramp time	<b>1.0 s</b>	0.0 ... 60.0 s	0x2948:002	general
P337.xx	Trq. lim. source				
L P337.01	Pos. torqlim src	<b>Max torque [0]</b>	Selection list	0x2949:001	general
L P337.02	Neg. torqlim src	<b>(-) Max torque [0]</b>	Selection list	0x2949:002	general
L P337.03	Act postorqlim	x.x %	- (Read only)	0x2949:003	general
L P337.04	Act negtorqlim	x.x %	- (Read only)	0x2949:004	general
P340.xx	Speed limitation				
L P340.01	Upper limit	<b>0 vel. unit</b>	-2147483647 ... 2147483647 vel. unit	0x2946:001	general
L P340.02	Lower limit	<b>0 vel. unit</b>	-2147483647 ... 2147483647 vel. unit	0x2946:002	general
L P340.03	Uppspped lim src	<b>Max. frequency [0]</b>	Selection list	0x2946:003	general
L P340.04	Lowspeed lim src	<b>(-) Max. freq. [0]</b>	Selection list	0x2946:004	general
L P340.05	Upper freq.limit	Device for 50-Hz mains: <b>50.0 Hz</b> Device for 60-Hz mains: <b>60.0 Hz</b>	-1000.0 ... 1000.0 Hz	0x2946:005	general
L P340.06	Lower freq.limit	Device for 50-Hz mains: <b>-50.0 Hz</b> Device for 60-Hz mains: <b>-60.0 Hz</b>	-1000.0 ... 1000.0 Hz	0x2946:006	general
L P340.07	Act uppspeed lim	x.x Hz	- (Read only)	0x2946:007	general
L P340.08	Act lowspped lim	x.x Hz	- (Read only)	0x2946:008	general
P341.xx	Encoder settings				
L P341.01	Enc. Inc/Rev	<b>128</b>	1 ... 16384	0x2C42:001	general
P342.00	Motor feedb. error response	<b>Warning [1]</b>	Selection list	0x2C45	general
P350.xx	Overspeed monit.				
L P350.01	Threshold	<b>8000 rpm</b>	50 ... 50000 rpm	0x2D44:001	MCTRL
L P350.02	Response	<b>Fault [3]</b>	Selection list	0x2D44:002	general
P351.xx	ASM motor par.				
L P351.01	Rotor resistance	<b>8.8944 Ω *</b>	0.0000 ... 200.0000 Ω	0x2C02:001	MCTRL
L P351.02	Mutual induct.	<b>381.9 mH *</b>	0.0 ... 50000.0 mH	0x2C02:002	MCTRL
L P351.03	Magn. current	<b>0.96 A *</b>	0.00 ... 500.00 A	0x2C02:003	MCTRL
L P351.04	Slip frequency	x.x Hz	- (Read only)	0x2C02:004	MCTRL
P352.xx	PSM motor par.				
L P352.01	BEMF constant	<b>41.8 V/1000rpm</b>	0.0 ... 100000.0 V/1000rpm	0x2C03:001	MCTRL
L P352.05	D-axis Ld	<b>20.000 mH *</b>	0.000 ... 500.000 mH	0x2C03:005	MCTRL
L P352.06	Q-axis Lq	<b>20.000 mH *</b>	0.000 ... 500.000 mH	0x2C03:006	MCTRL
P353.xx	Overcurr. monit.				
L P353.01	Threshold	<b>6.8 A *</b>	0.0 ... 1000.0 A	0x2D46:001	MCTRL
L P353.02	Response	<b>Fault [3]</b>	Selection list	0x2D46:002	general
P354.00	Voltage reserve	<b>5 %</b>	0 ... 20 %	0x29E4	MCTRL
P400.xx	Function list				
L P400.01	Enable inverter	<b>TRUE [1]</b>	<a href="#">Trigger list</a>  73	0x2631:001	general
L P400.02	Run	<b>Digital input 1 [11]</b>	<a href="#">Trigger list</a>  73	0x2631:002	general
L P400.03	Quick stop	<b>Not connected [0]</b>	<a href="#">Trigger list</a>  73	0x2631:003	general
L P400.04	Reset fault	<b>Digital input 2 [12]</b>	<a href="#">Trigger list</a>  73	0x2631:004	general
L P400.05	DC braking	<b>Not connected [0]</b>	<a href="#">Trigger list</a>  73	0x2631:005	general
L P400.06	Start forward	<b>Not connected [0]</b>	<a href="#">Trigger list</a>  73	0x2631:006	general
L P400.07	Start reverse	<b>Not connected [0]</b>	<a href="#">Trigger list</a>  73	0x2631:007	general
L P400.08	Run forward	<b>Not connected [0]</b>	<a href="#">Trigger list</a>  73	0x2631:008	general

\* Default setting dependent on the model.

# Using accessories

Keypad  
Keypad parameterisation mode  
Keypad parameter list



Display code	Short designation	Default setting	Setting range	Address	Category
L P400.09	Run reverse	Not connected [0]	Trigger list  73	0x2631:009	general
L P400.10	Jog forward	Not connected [0]	Trigger list  73	0x2631:010	general
L P400.11	Jog reverse	Not connected [0]	Trigger list  73	0x2631:011	general
L P400.12	Keypad control	Not connected [0]	Trigger list  73	0x2631:012	general
L P400.13	Reverse rot.dir.	Digital input 3 [13]	Trigger list  73	0x2631:013	general
L P400.14	Setp: AI1	Not connected [0]	Trigger list  73	0x2631:014	general
L P400.15	Setp: AI2	Not connected [0]	Trigger list  73	0x2631:015	general
L P400.16	Setp: Keypad	Not connected [0]	Trigger list  73	0x2631:016	general
L P400.17	Setp: Network	Not connected [0]	Trigger list  73	0x2631:017	general
L P400.18	Setp: Preset b0	Digital input 4 [14]	Trigger list  73	0x2631:018	general
L P400.19	Setp: Preset b1	Digital input 5 [15]	Trigger list  73	0x2631:019	general
L P400.20	Setp: Preset b2	Not connected [0]	Trigger list  73	0x2631:020	general
L P400.21	Setp: Preset b3	Not connected [0]	Trigger list  73	0x2631:021	general
L P400.22	Setp: HTL input	Not connected [0]	Trigger list  73	0x2631:022	general
L P400.23	MOP up	Not connected [0]	Trigger list  73	0x2631:023	general
L P400.24	MOP down	Not connected [0]	Trigger list  73	0x2631:024	general
L P400.25	Setp: MOP	Not connected [0]	Trigger list  73	0x2631:025	general
L P400.26	Setp: Segment b0	Not connected [0]	Trigger list  73	0x2631:026	Sequencer
L P400.27	Setp: Segment b1	Not connected [0]	Trigger list  73	0x2631:027	Sequencer
L P400.28	Setp: Segment b2	Not connected [0]	Trigger list  73	0x2631:028	Sequencer
L P400.29	Setp: Segment b3	Not connected [0]	Trigger list  73	0x2631:029	Sequencer
L P400.30	Seq: Run/abort	Not connected [0]	Trigger list  73	0x2631:030	Sequencer
L P400.31	Seq: Start	Not connected [0]	Trigger list  73	0x2631:031	Sequencer
L P400.32	Seq: Next step	Not connected [0]	Trigger list  73	0x2631:032	Sequencer
L P400.33	Seq: Pause	Not connected [0]	Trigger list  73	0x2631:033	Sequencer
L P400.34	Seq: Suspense	Not connected [0]	Trigger list  73	0x2631:034	Sequencer
L P400.35	Seq: Stop	Not connected [0]	Trigger list  73	0x2631:035	Sequencer
L P400.36	Seq: Abort	Not connected [0]	Trigger list  73	0x2631:036	Sequencer
L P400.37	Network control	Not connected [0]	Trigger list  73	0x2631:037	general
L P400.39	Activ. ramp 2	Not connected [0]	Trigger list  73	0x2631:039	general
L P400.40	Load param.set	Not connected [0]	Trigger list  73	0x2631:040	general
L P400.41	Sel. paramset b0	Not connected [0]	Trigger list  73	0x2631:041	general
L P400.42	Sel. paramset b1	Not connected [0]	Trigger list  73	0x2631:042	general
L P400.43	Fault 1	Not connected [0]	Trigger list  73	0x2631:043	general
L P400.44	Fault 2	Not connected [0]	Trigger list  73	0x2631:044	general
L P400.45	PID off	Not connected [0]	Trigger list  73	0x2631:045	general
L P400.46	PID output=0	Not connected [0]	Trigger list  73	0x2631:046	general
L P400.47	PID-I inhibited	Not connected [0]	Trigger list  73	0x2631:047	general
L P400.48	PID-Inf ramp on	TRUE [1]	Trigger list  73	0x2631:048	general
L P400.49	Open brake	Not connected [0]	Trigger list  73	0x2631:049	general
L P400.50	Seq: Select. b0	Not connected [0]	Trigger list  73	0x2631:050	Sequencer
L P400.51	Seq: Select. b1	Not connected [0]	Trigger list  73	0x2631:051	Sequencer
L P400.52	Seq: Select. b2	Not connected [0]	Trigger list  73	0x2631:052	Sequencer
L P400.53	Seq: Select. b3	Not connected [0]	Trigger list  73	0x2631:053	Sequencer
L P400.54	Set pos counter	Not connected [0]	Trigger list  73	0x2631:054	general
L P400.55	Activ. UPS oper.	Not connected [0]	Trigger list  73	0x2631:055	general
L P400.56	Assist pump 1	Not connected [0]	Trigger list  73	0x2631:056	
L P400.57	Assist pump 2	Not connected [0]	Trigger list  73	0x2631:057	
L P400.58	Reset oper.time	Not connected [0]	Trigger list  73	0x2631:058	
P410.xx	DI settings				
L P410.01	Assertion level	HIGH active [1]	Selection list	0x2630:001	general
L P410.02	Input function	Digital Input [0]	Selection list	0x2630:002	general
P411.xx	DI inversion				
L P411.01	DI1 inversion	Not inverted [0]	Selection list	0x2632:001	general

\* Default setting dependent on the model.



# Using accessories

Keypad  
Keypad parameterisation mode  
Keypad parameter list

Display code	Short designation	Default setting	Setting range	Address	Category
L P411.02	DI2 inversion	Not inverted [0]	Selection list	0x2632:002	general
L P411.03	DI3 inversion	Not inverted [0]	Selection list	0x2632:003	general
L P411.04	DI4 inversion	Not inverted [0]	Selection list	0x2632:004	general
L P411.05	DI5 inversion	Not inverted [0]	Selection list	0x2632:005	general
L P411.06	DI6 inversion	Not inverted [0]	Selection list	0x2632:006	Appl. I/O
L P411.07	DI7 inversion	Not inverted [0]	Selection list	0x2632:007	Appl. I/O
P412.00	Freq. threshold	0.0 Hz	0.0 ... 599.0 Hz	0x4005	general
P413.00	MOP startmode	Last value [0]	Selection list	0x4003	general
P414.xx	MOP start value				
L P414.01	Frequency	0.0 Hz	0.0 ... 599.0 Hz	0x4004:001	general
L P414.02	PID value	0.00 PID unit	-300.00 ... 300.00 PID unit	0x4004:002	general
L P414.03	Torque	0.0 %	0.0 ... 1000.0 %	0x4004:003	general
P415.xx	HTL inp. setting				
L P415.01	Min.frequency	0.0 Hz	-100000.0 ... 100000.0 Hz	0x2640:001	general
L P415.02	Max. frequency	0.0 Hz	-100000.0 ... 100000.0 Hz	0x2640:002	general
L P415.03	Min.motor.freq	0.0 Hz	-1000.0 ... 1000.0 Hz	0x2640:003	general
L P415.04	Max.motor.freq	Device for 50-Hz mains: 50.0 Hz Device for 60-Hz mains: 60.0 Hz	-1000.0 ... 1000.0 Hz	0x2640:004	general
L P415.05	Min.PID setpoint	0.00 PID unit	-300.00 ... 300.00 PID unit	0x2640:005	general
L P415.06	Max.PID setpoint	100.00 PID unit	-300.00 ... 300.00 PID unit	0x2640:006	general
L P415.07	Min.torque setp.	0.0 %	-400.0 ... 400.0 %	0x2640:007	general
L P415.08	Max.torque setp	100.0 %	-400.0 ... 400.0 %	0x2640:008	general
L P415.09	IN1 Filter time	10 ms	0 ... 10000 ms	0x2640:009	general
P416.xx	HTL inp. monit.				
L P416.01	In1min.f.thresh.	0.0 Hz	-214748364.8 ... 214748364.7 Hz	0x2641:001	general
L P416.02	In1min.d thres	5.0 s	0.0 ... 300.0 s	0x2641:002	general
L P416.03	In1max.f.thresh.	0.0 Hz	-214748364.8 ... 214748364.7 Hz	0x2641:003	general
L P416.04	In1max.d thres	5.0 s	0.0 ... 300.0 s	0x2641:004	general
L P416.05	In1 condition	< min. frequency [1]	Selection list	0x2641:005	general
L P416.06	In1Err response	No response [0]	Selection list	0x2641:006	general
P420.xx	Dig.out.function				
L P420.01	Relay function	Rdy for operat. [51]	Selection list	0x2634:001	general
L P420.02	DO1 function	Release brake [115]	Selection list	0x2634:002	general
L P420.03	DO2 function	Fault [56]	Selection list	0x2634:003	Appl. I/O
L P420.10	NetWordOUT1.00	Rdy for operat. [51]	Selection list	0x2634:010	general
L P420.11	NetWordOUT1.01	Not connected [0]	Selection list	0x2634:011	general
L P420.12	NetWordOUT1.02	Operat. enabled [52]	Selection list	0x2634:012	general
L P420.13	NetWordOUT1.03	Fault [56]	Selection list	0x2634:013	general
L P420.14	NetWordOUT1.04	Not connected [0]	Selection list	0x2634:014	general
L P420.15	NetWordOUT1.05	Quick stop [54]	Selection list	0x2634:015	general
L P420.16	NetWordOUT1.06	Running [50]	Selection list	0x2634:016	general
L P420.17	NetWordOUT1.07	Device warning [58]	Selection list	0x2634:017	general
L P420.18	NetWordOUT1.08	Not connected [0]	Selection list	0x2634:018	general
L P420.19	NetWordOUT1.09	Not connected [0]	Selection list	0x2634:019	general
L P420.20	NetWordOUT1.10	Speed - setp=act [72]	Selection list	0x2634:020	general
L P420.21	NetWordOUT1.11	At current limit [78]	Selection list	0x2634:021	general
L P420.22	NetWordOUT1.12	Actual speed=0 [71]	Selection list	0x2634:022	general
L P420.23	NetWordOUT1.13	Rot.dir.reversed [69]	Selection list	0x2634:023	general
L P420.24	NetWordOUT1.14	Release brake [115]	Selection list	0x2634:024	general
L P420.25	NetWordOUT1.15	Inv.dis.safety [55]	Selection list	0x2634:025	general
P421.xx	DO inversion				
* Default setting dependent on the model.					

# Using accessories

Keypad  
Keypad parameterisation mode  
Keypad parameter list



Display code	Short designation	Default setting	Setting range	Address	Category
L P421.01	Relay inverted	<b>Not inverted [0]</b>	Selection list	0x2635:001	general
L P421.02	DO1 inversion	<b>Not inverted [0]</b>	Selection list	0x2635:002	general
L P421.03	DO2 inversion	<b>Not inverted [0]</b>	Selection list	0x2635:003	Appl. I/O
P423.xx	DO1 freq. setup				
L P423.01	Min. frequency	<b>0.0 Hz</b>	0.0 ... 10000.0 Hz	0x2644:001	general
L P423.02	Max. frequency	<b>10000.0 Hz</b>	0.0 ... 10000.0 Hz	0x2644:002	general
L P423.03	Function	<b>Not active [0]</b>	Selection list	0x2644:003	general
L P423.04	Min. signal	<b>0</b>	-2147483648 ... 2147483647	0x2644:004	general
L P423.05	Max. signal	<b>1000</b>	-2147483648 ... 2147483647	0x2644:005	general
P430.xx	Analog input 1				
L P430.01	AI1 input range	<b>0 ... 10 VDC [0]</b>	Selection list	0x2636:001	general
L P430.02	AI1 freq @ min	<b>0.0 Hz</b>	-1000.0 ... 1000.0 Hz	0x2636:002	general
L P430.03	AI1 freq @ max	Device for 50-Hz mains: <b>50.0 Hz</b> Device for 60-Hz mains: <b>60.0 Hz</b>	-1000.0 ... 1000.0 Hz	0x2636:003	general
L P430.04	AI1 PID @ min	<b>0.00 PID unit</b>	-300.00 ... 300.00 PID unit	0x2636:004	general
L P430.05	AI1 PID @ max	<b>100.00 PID unit</b>	-300.00 ... 300.00 PID unit	0x2636:005	general
L P430.06	AI1 filter time	<b>10 ms</b>	0 ... 10000 ms	0x2636:006	general
L P430.07	AI1 dead band	<b>0.0 %</b>	0.0 ... 100.0 %	0x2636:007	general
L P430.08	AI1 monit.level	<b>0.0 %</b>	-100.0 ... 100.0 %	0x2636:008	general
L P430.09	Monitoring cond.	<b>IN &lt; threshold [0]</b>	Selection list	0x2636:009	general
L P430.10	AI1 error resp.	<b>Fault [3]</b>	Selection list	0x2636:010	general
L P430.11	Min. torque	<b>0.0 %</b>	-400.0 ... 400.0 %	0x2636:011	general
L P430.12	Max. torque	<b>100.0 %</b>	-400.0 ... 400.0 %	0x2636:012	general
P431.xx	Analog input 2				
L P431.01	AI2 input range	<b>0 ... 10 VDC [0]</b>	Selection list	0x2637:001	general
L P431.02	AI2 freq @ min	<b>0.0 Hz</b>	-1000.0 ... 1000.0 Hz	0x2637:002	general
L P431.03	AI2 freq @ max	Device for 50-Hz mains: <b>50.0 Hz</b> Device for 60-Hz mains: <b>60.0 Hz</b>	-1000.0 ... 1000.0 Hz	0x2637:003	general
L P431.04	AI2 PID @ min	<b>0.00 PID unit</b>	-300.00 ... 300.00 PID unit	0x2637:004	general
L P431.05	AI2 PID @ max	<b>100.00 PID unit</b>	-300.00 ... 300.00 PID unit	0x2637:005	general
L P431.06	AI2 filter time	<b>10 ms</b>	0 ... 10000 ms	0x2637:006	general
L P431.07	AI2 dead band	<b>0.0 %</b>	0.0 ... 100.0 %	0x2637:007	general
L P431.08	AI2 monit.level	<b>0.0 %</b>	-100.0 ... 100.0 %	0x2637:008	general
L P431.09	Monitoring cond.	<b>IN &lt; threshold [0]</b>	Selection list	0x2637:009	general
L P431.10	AI2 error resp.	<b>Fault [3]</b>	Selection list	0x2637:010	general
L P431.11	Min. torque	<b>0.0 %</b>	-400.0 ... 400.0 %	0x2637:011	general
L P431.12	Max. torque	<b>100.0 %</b>	-400.0 ... 400.0 %	0x2637:012	general
P440.xx	Analog output 1				
L P440.01	AO1 outp. range	<b>0 ... 10 VDC [1]</b>	Selection list	0x2639:001	general
L P440.02	AO1 function	<b>Outp. frequency [1]</b>	Selection list	0x2639:002	general
L P440.03	AO1 min. signal	<b>0</b>	-2147483648 ... 2147483647	0x2639:003	general
L P440.04	AO1 max. signal	<b>1000</b>	-2147483648 ... 2147483647	0x2639:004	general
L P440.06	AO1 filter time	<b>250 ms</b>	0 ... 10000 ms	0x2639:006	general
P441.xx	Analog output 2				
L P441.01	AO2 outp. range	<b>0 ... 10 VDC [1]</b>	Selection list	0x263A:001	Appl. I/O
L P441.02	AO2 function	<b>Motors current [5]</b>	Selection list	0x263A:002	Appl. I/O
L P441.03	AO2 min. signal	<b>0</b>	-2147483648 ... 2147483647	0x263A:003	Appl. I/O
L P441.04	AO2 max. signal	<b>1000</b>	-2147483648 ... 2147483647	0x263A:004	Appl. I/O
L P441.06	AO2 filter time	<b>250 ms</b>	0 ... 10000 ms	0x263A:006	Appl. I/O
P450.xx	Freq. presets				
L P450.01	Freq. preset 1	<b>20.0 Hz</b>	0.0 ... 599.0 Hz	0x2911:001	general

\* Default setting dependent on the model.



# Using accessories

Keypad  
Keypad parameterisation mode  
Keypad parameter list

Display code	Short designation	Default setting	Setting range	Address	Category
L P450.02	Freq. preset 2	<b>40.0 Hz</b>	0.0 ... 599.0 Hz	0x2911:002	general
L P450.03	Freq. preset 3	Device for 50-Hz mains: <b>50.0 Hz</b> Device for 60-Hz mains: <b>60.0 Hz</b>	0.0 ... 599.0 Hz	0x2911:003	general
L P450.04	Freq. preset 4	<b>0.0 Hz</b>	0.0 ... 599.0 Hz	0x2911:004	general
L P450.05	Freq. preset 5	<b>0.0 Hz</b>	0.0 ... 599.0 Hz	0x2911:005	general
L P450.06	Freq. preset 6	<b>0.0 Hz</b>	0.0 ... 599.0 Hz	0x2911:006	general
L P450.07	Freq. preset 7	<b>0.0 Hz</b>	0.0 ... 599.0 Hz	0x2911:007	general
L P450.08	Freq. preset 8	<b>0.0 Hz</b>	0.0 ... 599.0 Hz	0x2911:008	general
L P450.09	Freq. preset 9	<b>0.0 Hz</b>	0.0 ... 599.0 Hz	0x2911:009	general
L P450.10	Freq. preset 10	<b>0.0 Hz</b>	0.0 ... 599.0 Hz	0x2911:010	general
L P450.11	Freq. preset 11	<b>0.0 Hz</b>	0.0 ... 599.0 Hz	0x2911:011	general
L P450.12	Freq. preset 12	<b>0.0 Hz</b>	0.0 ... 599.0 Hz	0x2911:012	general
L P450.13	Freq. preset 13	<b>0.0 Hz</b>	0.0 ... 599.0 Hz	0x2911:013	general
L P450.14	Freq. preset 14	<b>0.0 Hz</b>	0.0 ... 599.0 Hz	0x2911:014	general
L P450.15	Freq. preset 15	<b>0.0 Hz</b>	0.0 ... 599.0 Hz	0x2911:015	general
P451.xx	PID presets				
L P451.01	PID preset 1	<b>0.00 PID unit</b>	-300.00 ... 300.00 PID unit	0x4022:001	general
L P451.02	PID preset 2	<b>0.00 PID unit</b>	-300.00 ... 300.00 PID unit	0x4022:002	general
L P451.03	PID preset 3	<b>0.00 PID unit</b>	-300.00 ... 300.00 PID unit	0x4022:003	general
L P451.04	PID preset 4	<b>0.00 PID unit</b>	-300.00 ... 300.00 PID unit	0x4022:004	general
L P451.05	PID preset 5	<b>0.00 PID unit</b>	-300.00 ... 300.00 PID unit	0x4022:005	general
L P451.06	PID preset 6	<b>0.00 PID unit</b>	-300.00 ... 300.00 PID unit	0x4022:006	general
L P451.07	PID preset 7	<b>0.00 PID unit</b>	-300.00 ... 300.00 PID unit	0x4022:007	general
L P451.08	PID preset 8	<b>0.00 PID unit</b>	-300.00 ... 300.00 PID unit	0x4022:008	general
P452.xx	Torque presets				
L P452.01	Torque preset 1	<b>100.0 %</b>	-400.0 ... 400.0 %	0x2912:001	general
L P452.02	Torque preset 2	<b>100.0 %</b>	-400.0 ... 400.0 %	0x2912:002	general
L P452.03	Torque preset 3	<b>100.0 %</b>	-400.0 ... 400.0 %	0x2912:003	general
L P452.04	Torque preset 4	<b>100.0 %</b>	-400.0 ... 400.0 %	0x2912:004	general
L P452.05	Torque preset 5	<b>100.0 %</b>	-400.0 ... 400.0 %	0x2912:005	general
L P452.06	Torque preset 6	<b>100.0 %</b>	-400.0 ... 400.0 %	0x2912:006	general
L P452.07	Torque preset 7	<b>100.0 %</b>	-400.0 ... 400.0 %	0x2912:007	general
L P452.08	Torque preset 8	<b>100.0 %</b>	-400.0 ... 400.0 %	0x2912:008	general
P500.xx	Module ID				
L P500.01	Active module ID	-	- (Read only)	0x231F:001	general
L P500.02	Module ID conn.	-	- (Read only)	0x231F:002	general
P505.xx	NetWordIN1 fct.				
L P505.01	NetWordIN1.00	<b>Not active [0]</b>	Selection list	0x400E:001	general
L P505.02	NetWordIN1.01	<b>Not active [0]</b>	Selection list	0x400E:002	general
L P505.03	NetWordIN1.02	<b>Quick stop [3]</b>	Selection list	0x400E:003	general
L P505.04	NetWordIN1.03	<b>Not active [0]</b>	Selection list	0x400E:004	general
L P505.05	NetWordIN1.04	<b>Run forward [8]</b>	Selection list	0x400E:005	general
L P505.06	NetWordIN1.05	<b>Setp: Preset b0 [18]</b>	Selection list	0x400E:006	general
L P505.07	NetWordIN1.06	<b>Setp: Preset b1 [19]</b>	Selection list	0x400E:007	general
L P505.08	NetWordIN1.07	<b>Reset error [4]</b>	Selection list	0x400E:008	general
L P505.09	NetWordIN1.08	<b>Not active [0]</b>	Selection list	0x400E:009	general
L P505.10	NetWordIN1.09	<b>DC braking [5]</b>	Selection list	0x400E:010	general
L P505.11	NetWordIN1.10	<b>Not active [0]</b>	Selection list	0x400E:011	general
L P505.12	NetWordIN1.11	<b>Not active [0]</b>	Selection list	0x400E:012	general
L P505.13	NetWordIN1.12	<b>Reverse rot.dir. [13]</b>	Selection list	0x400E:013	general
L P505.14	NetWordIN1.13	<b>Not active [0]</b>	Selection list	0x400E:014	general
L P505.15	NetWordIN1.14	<b>Not active [0]</b>	Selection list	0x400E:015	general
L P505.16	NetWordIN1.15	<b>Not active [0]</b>	Selection list	0x400E:016	general

\* Default setting dependent on the model.

# Using accessories

Keypad  
Keypad parameterisation mode  
Keypad parameter list



Display code	Short designation	Default setting	Setting range	Address	Category
P508.00	CANopen comm.	No action [0]	Selection list	0x2300	CANopen
P508.00	EtherCAT comm.	No action [0]	Selection list	0x2360	EtherCAT
P508.00	EtherN/IP comm.	No action [0]	Selection list	0x23A0	EtherNet/IP
P508.00	Modbus comm.	No action [0]	Selection list	0x2320	Modbus RTU
P508.00	MBTCP comm.	No action [0]	Selection list	0x23B0	Modbus TCP
P508.00	PROFINET comm.	No action [0]	Selection list	0x2380	PROFINET
P509.00	CANopen switch	-	- (Read only)	0x2303	CANopen
P509.00	EtherC. switch	-	- (Read only)	0x2363	EtherCAT
P509.00	EtherN. switch	-	- (Read only)	0x23A3	EtherNet/IP
P509.00	Modbus switch	-	- (Read only)	0x2323	Modbus RTU
P509.00	Switch position	-	- (Read only)	0x23B3	Modbus TCP
P509.00	PROFIBUS switch	-	- (Read only)	0x2343	PROFIBUS
P510.xx	CANopen sett.				
↳ P510.01	Node ID	1	1 ... 127	0x2301:001	CANopen
↳ P510.02	Baud rate	500 kbps [5]	Selection list	0x2301:002	CANopen
↳ P510.03	Slave/Master	Slave [0]	Selection list	0x2301:003	CANopen
↳ P510.04	Start rem. delay	3000 ms	0 ... 65535 ms	0x2301:004	CANopen
↳ P510.05	SDO2 channel	Not active [0]	Selection list	0x2301:005	CANopen
↳ P510.06	COB-IDConfig PDO	Base + node-ID [0]	Selection list	0x2301:006	CANopen
↳ P510.07	COB-IDConfigSDO2	Freely config. [1]	Selection list	0x2301:007	CANopen
P510.xx	EtherCAT sett.				
↳ P510.04	Device ident.	0	0 ... 65535	0x2361:004	EtherCAT
P510.xx	EtherNet/IP sett.				
↳ P510.01	IP address	192.168.124.16	0.0.0.0 ... 255.255.255.255	0x23A1:001	EtherNet/IP
↳ P510.02	Subnet	255.255.255.0	0.0.0.0 ... 255.255.255.255	0x23A1:002	EtherNet/IP
↳ P510.03	Gateway	0.0.0.0	0.0.0.0 ... 255.255.255.255	0x23A1:003	EtherNet/IP
↳ P510.04	Host name		Text	0x23A1:004	EtherNet/IP
↳ P510.05	IP configuration	BOOTP [1]	Selection list	0x23A1:005	EtherNet/IP
↳ P510.06	Multicast TTL	1	1 ... 255	0x23A1:006	EtherNet/IP
↳ P510.07	Mcast allocation	Default alloc. [0]	Selection list	0x23A1:007	EtherNet/IP
↳ P510.08	Mcast IP addr.	239.64.2.224	0.0.0.0 ... 255.255.255.255	0x23A1:008	EtherNet/IP
↳ P510.09	Multicast number	1	1 ... 8	0x23A1:009	EtherNet/IP
↳ P510.10	Timeout	10000 ms	500 ... 65535 ms	0x23A1:010	EtherNet/IP
P510.xx	Modbus sett.				
↳ P510.01	Node ID	1	1 ... 247	0x2321:001	Modbus RTU
↳ P510.02	Baud rate	Automatic [0]	Selection list	0x2321:002	Modbus RTU
↳ P510.03	Data format	Automatic [0]	Selection list	0x2321:003	Modbus RTU
↳ P510.04	Min. resp. time	0 ms	0 ... 1000 ms	0x2321:004	Modbus RTU
P510.xx	MBTCP settings				
↳ P510.01	IP address	192.168.124.16	0.0.0.0 ... 255.255.255.255	0x23B1:001	Modbus TCP
↳ P510.02	Subnet	255.255.255.0	0.0.0.0 ... 255.255.255.255	0x23B1:002	Modbus TCP
↳ P510.03	Gateway	0.0.0.0	0.0.0.0 ... 255.255.255.255	0x23B1:003	Modbus TCP
↳ P510.05	IP configuration	Stored IP [0]	Selection list	0x23B1:005	Modbus TCP
↳ P510.06	TTL value	32	1 ... 255	0x23B1:006	Modbus TCP
↳ P510.10	Ethernet timeout	10 s	0 ... 65535 s	0x23B1:010	Modbus TCP
↳ P510.11	Secondary port	502	0 ... 65535	0x23B1:011	Modbus TCP
P510.xx	PROFIBUS sett.				
↳ P510.01	Station address	3	1 ... 125	0x2341:001	PROFIBUS
P510.xx	PROFINET sett.				
↳ P510.01	IP address	0.0.0.0	0.0.0.0 ... 255.255.255.255	0x2381:001	PROFINET
↳ P510.02	Subnet	0.0.0.0	0.0.0.0 ... 255.255.255.255	0x2381:002	PROFINET
↳ P510.03	Gateway	0.0.0.0	0.0.0.0 ... 255.255.255.255	0x2381:003	PROFINET
↳ P510.04	Stationsname		Text	0x2381:004	PROFINET
P511.xx	CANopen diag.				

\* Default setting dependent on the model.



# Using accessories

Keypad  
Keypad parameterisation mode  
Keypad parameter list

Display code	Short designation	Default setting	Setting range	Address	Category
↳ P511.01	Active node ID	-	- (Read only)	0x2302:001	CANopen
↳ P511.02	Active baud rate	-	- (Read only)	0x2302:002	CANopen
P511.xx	EtherCAT diag.				
↳ P511.01	EoE IP address	-	- (Read only)	0x2362:001	EtherCAT
↳ P511.02	EoE subnet mask	-	- (Read only)	0x2362:002	EtherCAT
↳ P511.03	EoE gateway	-	- (Read only)	0x2362:003	EtherCAT
↳ P511.04	Device ident.	-	- (Read only)	0x2362:004	EtherCAT
↳ P511.05	EoE virt MAC add	-	- (Read only)	0x2362:005	EtherCAT
↳ P511.06	Station address	-	- (Read only)	0x2362:006	EtherCAT
↳ P511.07	Tx length	-	- (Read only)	0x2362:007	EtherCAT
↳ P511.08	Rx length	-	- (Read only)	0x2362:008	EtherCAT
P511.xx	EtherN/IP diag.				
↳ P511.01	IP address	-	- (Read only)	0x23A2:001	EtherNet/IP
↳ P511.02	Subnet	-	- (Read only)	0x23A2:002	EtherNet/IP
↳ P511.03	Gateway	-	- (Read only)	0x23A2:003	EtherNet/IP
↳ P511.05	MAC address	-	- (Read only)	0x23A2:005	EtherNet/IP
↳ P511.06	Mcast address	-	- (Read only)	0x23A2:006	EtherNet/IP
P511.xx	Modbus diag.				
↳ P511.01	Active node ID	-	- (Read only)	0x2322:001	Modbus RTU
↳ P511.02	Active baud rate	-	- (Read only)	0x2322:002	Modbus RTU
↳ P511.03	Data format	-	- (Read only)	0x2322:003	Modbus RTU
P511.xx	Act. MBTCP sett.				
↳ P511.01	Act. IP address	-	- (Read only)	0x23B2:001	Modbus TCP
↳ P511.02	Act. subnet	-	- (Read only)	0x23B2:002	Modbus TCP
↳ P511.03	Act. gateway	-	- (Read only)	0x23B2:003	Modbus TCP
↳ P511.05	MAC address	-	- (Read only)	0x23B2:005	Modbus TCP
P511.xx	PROFIBUS diag.				
↳ P511.01	Act.station addr	-	- (Read only)	0x2342:001	PROFIBUS
↳ P511.02	Active baud rate	-	- (Read only)	0x2342:002	PROFIBUS
↳ P511.03	Watchdog time	-	- (Read only)	0x2342:003	PROFIBUS
P511.xx	PROFINET diag.				
↳ P511.01	IP address	-	- (Read only)	0x2382:001	PROFINET
↳ P511.02	Subnet	-	- (Read only)	0x2382:002	PROFINET
↳ P511.03	Gateway	-	- (Read only)	0x2382:003	PROFINET
↳ P511.04	Station name	-	- (Read only)	0x2382:004	PROFINET
↳ P511.05	MAC Address	-	- (Read only)	0x2382:005	PROFINET
P512.xx	Port settings				
↳ P512.01	Port 1	<b>Auto-Negotiation [0]</b>	Selection list	0x23A4:001	EtherNet/IP
↳ P512.02	Port 2	<b>Auto-Negotiation [0]</b>	Selection list	0x23A4:002	EtherNet/IP
P512.xx	Port settings				
↳ P512.01	Port 1	<b>Auto-Negotiation [0]</b>	Selection list	0x23B4:001	Modbus TCP
↳ P512.02	Port 2	<b>Auto-Negotiation [0]</b>	Selection list	0x23B4:002	Modbus TCP
P512.xx	PROFIBUS Config.				
↳ P512.01	Ext. diag. bit	<b>Delete [0]</b>	Selection list	0x2344:001	PROFIBUS
P513.00	QualityOfService	-	- (Read only)	0x23A6	EtherNet/IP
P513.xx	Act. port sett.				
↳ P513.01	Port 1	-	- (Read only)	0x23B5:001	Modbus TCP
↳ P513.02	Port 2	-	- (Read only)	0x23B5:002	Modbus TCP
P514.00	AddrConfIctDetec	<b>Enabled [1]</b>	Selection list	0x23A7	EtherNet/IP
P514.xx	MBTCP t-out mon				
↳ P514.01	Time-out time	<b>2.0 s</b>	0.0 ... 300.0 s	0x23B6:001	Modbus TCP
↳ P514.02	Keep al t-out	<b>2.0 s</b>	0.0 ... 300.0 s	0x23B6:002	Modbus TCP
↳ P514.05	Keep al register	<b>0</b>	0 ... 65535	0x23B6:005	Modbus TCP
P515.00	Time-out status	-	- (Read only)	0x2307	CANopen
* Default setting dependent on the model.					

# Using accessories

Keypad  
Keypad parameterisation mode  
Keypad parameter list



Display code	Short designation	Default setting	Setting range	Address	Category
P515.xx	EtherCAT monit.				
↳ P515.01	WD elapsed	<b>Trouble [2]</b>	Selection list	0x2859:001	EtherCAT
↳ P515.03	Invalid config	<b>Trouble [2]</b>	Selection list	0x2859:003	EtherCAT
↳ P515.04	Init. error	<b>Trouble [2]</b>	Selection list	0x2859:004	EtherCAT
↳ P515.05	Inval. proc.data	<b>Trouble [2]</b>	Selection list	0x2859:005	EtherCAT
P515.xx	EtherN/IP monit.				
↳ P515.01	WD elapsed	<b>Fault [3]</b>	Selection list	0x2859:001	EtherNet/IP
↳ P515.03	Invalid config	<b>Trouble [2]</b>	Selection list	0x2859:003	EtherNet/IP
↳ P515.04	Init. error	<b>Trouble [2]</b>	Selection list	0x2859:004	EtherNet/IP
↳ P515.05	Inval. proc.data	<b>Trouble [2]</b>	Selection list	0x2859:005	EtherNet/IP
↳ P515.06	Timeout ExpIMsg	<b>Warning [1]</b>	Selection list	0x2859:006	EtherNet/IP
↳ P515.07	Timeout Comm.	<b>Warning [1]</b>	Selection list	0x2859:007	EtherNet/IP
P515.xx	Modbus monit.				
↳ P515.01	Resp. Time-out	<b>Fault [3]</b>	Selection list	0x2858:001	Modbus RTU
↳ P515.02	Time-out time	<b>2.0 s</b>	0.0 ... 300.0 s	0x2858:002	Modbus RTU
P515.xx	MBTCP monitoring				
↳ P515.03	Config error	<b>Trouble [2]</b>	Selection list	0x2859:003	Modbus TCP
↳ P515.04	Init error	<b>Trouble [2]</b>	Selection list	0x2859:004	Modbus TCP
↳ P515.07	Resp netw t-out	<b>Warning [1]</b>	Selection list	0x2859:007	Modbus TCP
↳ P515.08	Resp mast t-out	<b>Fault [3]</b>	Selection list	0x2859:008	Modbus TCP
↳ P515.09	Resp t-out kp-al	<b>Fault [3]</b>	Selection list	0x2859:009	Modbus TCP
P515.xx	PROFIBUS monit.				
↳ P515.01	WD elapsed	<b>Trouble [2]</b>	Selection list	0x2859:001	PROFIBUS
↳ P515.02	Data exch.exited	<b>No response [0]</b>	Selection list	0x2859:002	PROFIBUS
↳ P515.03	Invalid config	<b>Trouble [2]</b>	Selection list	0x2859:003	PROFIBUS
↳ P515.04	Init. error	<b>Trouble [2]</b>	Selection list	0x2859:004	PROFIBUS
↳ P515.05	Inval. proc.data	<b>Trouble [2]</b>	Selection list	0x2859:005	PROFIBUS
P515.xx	PROFINET monit.				
↳ P515.01	WD elapsed	<b>Trouble [2]</b>	Selection list	0x2859:001	PROFINET
↳ P515.02	Data exch.exited	<b>No response [0]</b>	Selection list	0x2859:002	PROFINET
↳ P515.03	Invalid config	<b>Trouble [2]</b>	Selection list	0x2859:003	PROFINET
↳ P515.04	Init. error	<b>Trouble [2]</b>	Selection list	0x2859:004	PROFINET
↳ P515.05	Inval. proc.data	<b>Trouble [2]</b>	Selection list	0x2859:005	PROFINET
P516.00	CANopen status	-	-(Read only)	0x2308	CANopen
P516.00	EtherCAT status	-	-(Read only)	0x2368	EtherCAT
P516.00	CIP module stat.	-	-(Read only)	0x23A8	EtherNet/IP
P516.00	MBTCP modul. stat	-	-(Read only)	0x23B8	Modbus TCP
P516.xx	PROFIBUS Status				
↳ P516.01	Bus status	-	-(Read only)	0x2348:001	PROFIBUS
↳ P516.02	Watchdog status	-	-(Read only)	0x2348:002	PROFIBUS
P516.00	PROFINET status	-	-(Read only)	0x2388	PROFINET
P517.00	CAN contr.status	-	-(Read only)	0x2309	CANopen
P517.00	EtherCAT error	-	-(Read only)	0x2369	EtherCAT
P517.00	EtherN/IP status	-	-(Read only)	0x23A9	EtherNet/IP
P517.00	MBTCP netw stat	-	-(Read only)	0x23B9	Modbus TCP
P517.00	PROFIBUS error	-	-(Read only)	0x2349	PROFIBUS
P517.xx	PROFINET error				
↳ P517.01	Error 1	-	-(Read only)	0x2389:001	PROFINET
↳ P517.02	Error 2	-	-(Read only)	0x2389:002	PROFINET
P518.00	CAN errorcounter	-	-(Read only)	0x230B	CANopen
P519.xx	Port diagnostics				
↳ P519.01	Port 1 (X266)	-	-(Read only)	0x23A5:001	EtherNet/IP
↳ P519.02	Port 2 (X267)	-	-(Read only)	0x23A5:002	EtherNet/IP
P520.xx	Cons. heartbeat				
* Default setting dependent on the model.					





# Using accessories

Keypad  
Keypad parameterisation mode  
Keypad parameter list

Display code	Short designation	Default setting	Setting range	Address	Category
P520.00	Highest subindex	-	- (Read only)	0x1016:000	CANopen
↳ P520.01	Cons. heartbeat1	0x00000000	0x00000000 ... 0x00FFFFFF	0x1016:001	CANopen
↳ P520.02	Cons. heartbeat2	0x00000000	0x00000000 ... 0x00FFFFFF	0x1016:002	CANopen
↳ P520.03	Cons. heartbeat3	0x00000000	0x00000000 ... 0x00FFFFFF	0x1016:003	CANopen
↳ P520.04	Cons. heartbeat4	0x00000000	0x00000000 ... 0x00FFFFFF	0x1016:004	CANopen
P522.00	Prod. heartbeat	0 ms	0 ... 65535 ms	0x1017	CANopen
P530.xx	Para. mapping				
↳ P530.01 ... 24	Parameter 1 ... Parameter 24	0x00000000	0x00000000 ... 0xFFFFF00	0x232B:001 ... 0x232B:024	Modbus RTU
P530.xx	MBTCP param.mapp				
↳ P530.01 ... 24	Parameter 1 ... Parameter 24	0x00000000	0x00000000 ... 0xFFFFFFFF	0x23BB:001 ... 0x23BB:024	Modbus TCP
P531.xx	Reg. assigned				
↳ P531.01 ... 24	Register 1 ... Register 24	-	- (Read only)	0x232C:001 ... 0x232C:024	Modbus RTU
P531.xx	Register assignm				
↳ P531.01 ... 24	Register 1 ... Register 24	-	- (Read only)	0x23BC:001 ... 0x23BC:024	Modbus TCP
P532.00	Verificationcode	-	- (Read only)	0x232D	Modbus RTU
P532.00	Verificat. code	-	- (Read only)	0x23BD	Modbus TCP
P540.xx	RPDO1 config.				
↳ P540.01	COB-ID	0x00000200	0x00000000 ... 0xFFFFFFFF	0x1400:001	CANopen
↳ P540.02	Transm. type	255	0 ... 255	0x1400:002	CANopen
↳ P540.05	Event timer	100 ms	0 ... 65535 ms	0x1400:005	CANopen
P541.xx	RPDO2 config.				
↳ P541.01	COB-ID	0x80000300	0x00000000 ... 0xFFFFFFFF	0x1401:001	CANopen
↳ P541.02	Transm. type	255	0 ... 255	0x1401:002	CANopen
↳ P541.05	Event timer	100 ms	0 ... 65535 ms	0x1401:005	CANopen
P542.xx	RPDO3 config.				
↳ P542.01	COB-ID	0x80000400	0x00000000 ... 0xFFFFFFFF	0x1402:001	CANopen
↳ P542.02	Transm. type	255	0 ... 255	0x1402:002	CANopen
↳ P542.05	Event timer	100 ms	0 ... 65535 ms	0x1402:005	CANopen
P550.xx	TPDO1 config.				
↳ P550.01	COB-ID	0x40000180	0x00000001 ... 0xFFFFFFFF	0x1800:001	CANopen
↳ P550.02	Transm. type	255	0 ... 255	0x1800:002	CANopen
↳ P550.03	Inhibit time	0.0 ms	0.0 ... 6553.5 ms	0x1800:003	CANopen
↳ P550.05	Event timer	20 ms	0 ... 65535 ms	0x1800:005	CANopen
P551.xx	TPDO2 config.				
↳ P551.01	COB-ID	0xC0000280	0x00000001 ... 0xFFFFFFFF	0x1801:001	CANopen
↳ P551.02	Transm. type	255	0 ... 255	0x1801:002	CANopen
↳ P551.03	Inhibit time	0.0 ms	0.0 ... 6553.5 ms	0x1801:003	CANopen
↳ P551.05	Event timer	0 ms	0 ... 65535 ms	0x1801:005	CANopen
P552.xx	TPDO3 config.				
↳ P552.01	COB-ID	0xC0000380	0x00000001 ... 0xFFFFFFFF	0x1802:001	CANopen
↳ P552.02	Transm. type	255	0 ... 255	0x1802:002	CANopen
↳ P552.03	Inhibit time	0.0 ms	0.0 ... 6553.5 ms	0x1802:003	CANopen
↳ P552.05	Event timer	0 ms	0 ... 65535 ms	0x1802:005	CANopen
P580.xx	CAN statistics				
↳ P580.01	PDO1 received	-	- (Read only)	0x230A:001	CANopen
↳ P580.02	PDO2 received	-	- (Read only)	0x230A:002	CANopen
↳ P580.03	PDO3 received	-	- (Read only)	0x230A:003	CANopen
↳ P580.05	PDO1 transmitted	-	- (Read only)	0x230A:005	CANopen
↳ P580.06	PDO2 transmitted	-	- (Read only)	0x230A:006	CANopen
↳ P580.07	PDO3 transmitted	-	- (Read only)	0x230A:007	CANopen
↳ P580.09	SDO1 counter	-	- (Read only)	0x230A:009	CANopen

\* Default setting dependent on the model.

# Using accessories

Keypad  
Keypad parameterisation mode  
Keypad parameter list



Display code	Short designation	Default setting	Setting range	Address	Category
↳ P580.10	SDO2 counter	-	-(Read only)	0x230A:010	CANopen
P580.xx	Modbus statistic				
↳ P580.01	Mess. received	-	-(Read only)	0x232A:001	Modbus RTU
↳ P580.02	Val. mess. rec.	-	-(Read only)	0x232A:002	Modbus RTU
↳ P580.03	Mess. w. exc.	-	-(Read only)	0x232A:003	Modbus RTU
↳ P580.04	Mess. w. errors	-	-(Read only)	0x232A:004	Modbus RTU
↳ P580.05	Messages sent	-	-(Read only)	0x232A:005	Modbus RTU
P580.xx	MBTCP statistics				
↳ P580.01	Rx messages	-	-(Read only)	0x23BA:001	Modbus TCP
↳ P580.02	Valid Rx messag.	-	-(Read only)	0x23BA:002	Modbus TCP
↳ P580.03	Mess. w. except	-	-(Read only)	0x23BA:003	Modbus TCP
↳ P580.05	Tx messages	-	-(Read only)	0x23BA:005	Modbus TCP
P580.xx	PROFIBUS counter				
↳ P580.01	Data cycles/sec.	-	-(Read only)	0x234A:001	PROFIBUS
↳ P580.02	PRM events	-	-(Read only)	0x234A:002	PROFIBUS
↳ P580.03	CFG events	-	-(Read only)	0x234A:003	PROFIBUS
↳ P580.04	DIAG events	-	-(Read only)	0x234A:004	PROFIBUS
↳ P580.05	C1 messages	-	-(Read only)	0x234A:005	PROFIBUS
↳ P580.06	C2 messages	-	-(Read only)	0x234A:006	PROFIBUS
↳ P580.07	WD events	-	-(Read only)	0x234A:007	PROFIBUS
↳ P580.08	DataEx.event	-	-(Read only)	0x234A:008	PROFIBUS
↳ P580.09	Tot. data cycles	-	-(Read only)	0x234A:009	PROFIBUS
P583.xx	Rx data diagn.				
↳ P583.01	Rx data offset	<b>0</b>	0 ... 240	0x232E:001	Modbus RTU
↳ P583.02	Last RxD byte0	-	-(Read only)	0x232E:002	Modbus RTU
↳ P583.03	Last RxD byte1	-	-(Read only)	0x232E:003	Modbus RTU
↳ P583.04	Last RxD byte2	-	-(Read only)	0x232E:004	Modbus RTU
↳ P583.05	Last RxD byte3	-	-(Read only)	0x232E:005	Modbus RTU
↳ P583.06	Last RxD byte4	-	-(Read only)	0x232E:006	Modbus RTU
↳ P583.07	Letzt RxD-Byte5	-	-(Read only)	0x232E:007	Modbus RTU
↳ P583.08	Last RxD byte6	-	-(Read only)	0x232E:008	Modbus RTU
↳ P583.09	Last RxD byte7	-	-(Read only)	0x232E:009	Modbus RTU
↳ P583.10	Last RxD byte8	-	-(Read only)	0x232E:010	Modbus RTU
↳ P583.11	Last RxD byte9	-	-(Read only)	0x232E:011	Modbus RTU
↳ P583.12	Last RxD byte10	-	-(Read only)	0x232E:012	Modbus RTU
↳ P583.13	Last RxD byte11	-	-(Read only)	0x232E:013	Modbus RTU
↳ P583.14	Last RxD byte12	-	-(Read only)	0x232E:014	Modbus RTU
↳ P583.15	Last RxD byte13	-	-(Read only)	0x232E:015	Modbus RTU
↳ P583.16	Last RxD byte14	-	-(Read only)	0x232E:016	Modbus RTU
↳ P583.17	Last RxD byte15	-	-(Read only)	0x232E:017	Modbus RTU
P585.xx	Tx data diagn.				
↳ P585.01	Tx data offset	<b>0</b>	0 ... 240	0x232F:001	Modbus RTU
↳ P585.02	Last TxD byte0	-	-(Read only)	0x232F:002	Modbus RTU
↳ P585.03	Last TxD Byte1	-	-(Read only)	0x232F:003	Modbus RTU
↳ P585.04	Last TxD byte2	-	-(Read only)	0x232F:004	Modbus RTU
↳ P585.05	Last TxD byte3	-	-(Read only)	0x232F:005	Modbus RTU
↳ P585.06	Last TxD byte4	-	-(Read only)	0x232F:006	Modbus RTU
↳ P585.07	Last TxD byte5	-	-(Read only)	0x232F:007	Modbus RTU
↳ P585.08	Last TxD byte6	-	-(Read only)	0x232F:008	Modbus RTU
↳ P585.09	Last TxD byte7	-	-(Read only)	0x232F:009	Modbus RTU
↳ P585.10	Last TxD byte8	-	-(Read only)	0x232F:010	Modbus RTU
↳ P585.11	Last TxD byte9	-	-(Read only)	0x232F:011	Modbus RTU
↳ P585.12	Last TxD byte10	-	-(Read only)	0x232F:012	Modbus RTU
↳ P585.13	Last TxD byte11	-	-(Read only)	0x232F:013	Modbus RTU

\* Default setting dependent on the model.



# Using accessories

Keypad  
Keypad parameterisation mode  
Keypad parameter list

Display code	Short designation	Default setting	Setting range	Address	Category
L P585.14	Last TxD byte12	-	-(Read only)	0x232F:014	Modbus RTU
L P585.15	Last TxD byte13	-	-(Read only)	0x232F:015	Modbus RTU
L P585.16	Last TxD byte14	-	-(Read only)	0x232F:016	Modbus RTU
L P585.17	Last TxD byte15	-	-(Read only)	0x232F:017	Modbus RTU
P585.xx	MBTCP Tx/Rx diag				
L P585.01	Rx offset	0	0 ... 240	0x23BE:001	Modbus TCP
L P585.02	Last Rx message	-	-(Read only)	0x23BE:002	Modbus TCP
L P585.03	Tx offset	0	0 ... 240	0x23BE:003	Modbus TCP
L P585.04	Last Tx message	-	-(Read only)	0x23BE:004	Modbus TCP
P590.xx	NetWordINx				
L P590.01	NetWordIN1	0x0000	0x0000 ... 0xFFFF	0x4008:001	general
L P590.02	NetWordIN2	0x0000	0x0000 ... 0xFFFF	0x4008:002	general
L P590.03	NetWordIN3	0.0 %	0.0 ... 100.0 %	0x4008:003	general
L P590.04	NetWordIN4	0.0 %	0.0 ... 100.0 %	0x4008:004	general
L P590.05	NetWordIN5	0.0 %	-100.0 ... 100.0 %	0x4008:005	general
P591.xx	NetWordOUTx				
L P591.01	NetWordOUT1	-	-(Read only)	0x400A:001	general
L P591.02	NetWordOUT2	-	-(Read only)	0x400A:002	general
P592.xx	Process data IN				
L P592.01	AC control word	0x0000	0x0000 ... 0xFFFF	0x400B:001	general
L P592.02	LECOM ctrl word	0x0000	0x0000 ... 0xFFFF	0x400B:002	general
L P592.03	Net.freq. 0.1	0.0 Hz	0.0 ... 599.0 Hz	0x400B:003	general
L P592.04	Net.setp. speed	0 rpm	0 ... 50000 rpm	0x400B:004	general
L P592.05	Net.freq. 0.01	0.00 Hz	0.00 ... 599.00 Hz	0x400B:005	general
L P592.06	Veloc. mode setp	0.0 Hz	-599.0 ... 599.0 Hz	0x400B:006	general
L P592.07	PID setpoint	0.00 PID unit	-300.00 ... 300.00 PID unit	0x400B:007	general
L P592.08	Torque mode setp	0 Nm	-32768 ... 32767 Nm	0x400B:008	general
L P592.09	Torque scaling	0	-128 ... 127	0x400B:009	general
L P592.11	PID feedback	0.00 PID unit	-300.00 ... 300.00 PID unit	0x400B:011	general
L P592.12	NetSetfreq0.02Hz	0 Hz	-29950 ... 29950 Hz	0x400B:012	general
L P592.13	N.FrqSet+/-16384	0	-16384 ... 16384	0x400B:013	general
P593.xx	Process data OUT				
L P593.01	AC status word	-	-(Read only)	0x400C:001	general
L P593.02	LECOM stat. word	-	-(Read only)	0x400C:002	general
L P593.03	Frequency (0.1)	x.x Hz	-(Read only)	0x400C:003	general
L P593.04	Motor speed	x rpm	-(Read only)	0x400C:004	general
L P593.05	Drive status	-	-(Read only)	0x400C:005	general
L P593.06	Frequency 0.01	x.xx Hz	-(Read only)	0x400C:006	general
L P593.07	Torque scaled	-	-(Read only)	0x400C:007	general
L P593.08	Frequency 0.02Hz	Hz	-(Read only)	0x400C:008	general
L P593.09	Freq. [+/-16384]	-	-(Read only)	0x400C:009	general
P595.xx	PAM monitoring				
L P595.02	Keep alive reg.	0	0 ... 65535	0x2552:002	general
L P595.03	Time-out time	10.0 s	0.0 ... 6553.5 s	0x2552:003	general
L P595.04	Response	No response [0]	Selection list	0x2552:004	general
L P595.05	Action	No action [0]	Selection list	0x2552:005	general
L P595.06	PAM status	-	-(Read only)	0x2552:006	general
L P595.07	WLAN reset t.out	0 s	0 ... 65535 s	0x2552:007	general
L P595.08	Mapped par	0x400B0100	0x00000000 ... 0xFFFFFFFF	0x2552:008	
L P595.09	Value to write	0	0 ... 4294967295	0x2552:009	
L P595.10	Write status	-	-(Read only)	0x2552:010	
P600.xx	PID setup				
L P600.01	Operating mode	Inhibited [0]	Selection list	0x4020:001	general
L P600.02	PID process var.	Analog input 1 [1]	Selection list	0x4020:002	general

\* Default setting dependent on the model.

# Using accessories

Keypad  
Keypad parameterisation mode  
Keypad parameter list



Display code	Short designation	Default setting	Setting range	Address	Category
L P600.03	PID speed range	100 %	0 ... 100 %	0x4020:003	general
L P600.04	PID line speed	w/o speed.add. [0]	Selection list	0x4020:004	general
L P600.05	Min speed lim	-100.0 %	-100.0 ... 100.0 %	0x4020:005	general
L P600.06	Max speed lim	100.0 %	-100.0 ... 100.0 %	0x4020:006	general
P601.00	PID P-component	5.0 %	0.0 ... 1000.0 %	0x4048	general
P602.00	PID I- component	400 ms	1 ... 6000 ms	0x4049	general
P603.00	PID D-component	0.0 s	0.0 ... 20.0 s	0x404A	general
P604.00	PID setp.ramp	20.0 s	0.0 ... 100.0 s	0x404B	general
P605.xx	PID setp. limit				
L P605.01	Minimum setpoint	-300.00 PID unit	-300.00 ... 300.00 PID unit	0x404E:001	general
L P605.02	Maximum setpoint	300.00 PID unit	-300.00 ... 300.00 PID unit	0x404E:002	general
P606.xx	PID speed op.				
L P606.01	Accel. time	1.0 s	0.0 ... 3600.0 s	0x4021:001	general
L P606.02	Decel. time	1.0 s	0.0 ... 3600.0 s	0x4021:002	general
P607.xx	PID influence				
L P607.01	Activation time	5.0 s	0.0 ... 999.9 s	0x404C:001	general
L P607.02	Mask out time	5.0 s	0.0 ... 999.9 s	0x404C:002	general
L P607.03	PID infl. factor	100.0 %	0.0 ... 200.0 %	0x404C:003	general
P608.xx	PID alarms				
L P608.01	MIN alarm thrsh.	0.00 PID unit	-300.00 ... 300.00 PID unit	0x404D:001	general
L P608.02	MAX alarm thrsh.	100.00 PID unit	-300.00 ... 300.00 PID unit	0x404D:002	general
L P608.03	Bandw. feedback	2.00 %	0.00 ... 100.00 %	0x404D:003	general
P610.xx	PID sleep mode				
L P610.01	Activation	Disabled [0]	Selection list	0x4023:001	general
L P610.02	Stop method	Coasting [0]	Selection list	0x4023:002	general
L P610.03	Freq. thresh.	0.0 Hz	0.0 ... 599.0 Hz	0x4023:003	general
L P610.04	Feedback thresh.	0.00 PID unit	-300.00 ... 300.00 PID unit	0x4023:004	general
L P610.05	Delay time	0.0 s	0.0 ... 300.0 s	0x4023:005	general
L P610.06	Recovery	Setp. > P610.3 [0]	Selection list	0x4023:006	general
L P610.07	Bandwidth	0.00 PID unit	0.00 ... 300.00 PID unit	0x4023:007	general
L P610.08	Recovery thresh.	0.00 PID unit	-300.00 ... 300.00 PID unit	0x4023:008	general
P615.xx	Auto-rinsing				
L P615.01	Rinsing in idle	Inhibited [0]	Selection list	0x4024:001	general
L P615.02	Rinse interval	30.0 min	0.0 ... 6000.0 min	0x4024:002	general
L P615.03	Rinse speed	0.0 Hz	-599.0 ... 599.0 Hz	0x4024:003	general
L P615.04	Rinse period	0.0 s	0.0 ... 6000.0 s	0x4024:004	general
P700.xx	Device commands				
L P700.01	Load def. sett.	Off / ready [0]	Selection list	0x2022:001	general
L P700.03	Save user data	Off / ready [0]	Selection list	0x2022:003	general
L P700.04	Load user data	Off / ready [0]	Selection list	0x2022:004	general
L P700.05	Load OEM data	Off / ready [0]	Selection list	0x2022:005	general
L P700.06	Save OEM data	Off / ready [0]	Selection list	0x2022:006	general
L P700.07	Load par. set 1	Off / ready [0]	Selection list	0x2022:007	general
L P700.08	Load par. set 2	Off / ready [0]	Selection list	0x2022:008	general
L P700.09	Load par. set 3	Off / ready [0]	Selection list	0x2022:009	general
L P700.10	Load par. set 4	Off / ready [0]	Selection list	0x2022:010	general
L P700.11	Save par. set 1	Off / ready [0]	Selection list	0x2022:011	general
L P700.12	Save par. set 2	Off / ready [0]	Selection list	0x2022:012	general
L P700.13	Save par. set 3	Off / ready [0]	Selection list	0x2022:013	general
L P700.14	Save par. set 4	Off / ready [0]	Selection list	0x2022:014	general
L P700.15	Delete logbook	Off / ready [0]	Selection list	0x2022:015	general
P701.00	KP setp. incr.	1	1 ... 100	0x2862	general
P702.00	Scal.speed fact.	0.00	0.00 ... 650.00	0x4002	general
P703.00	KP status displ.	0x00000000	0x00000000 ... 0xFFFFFFF0	0x2864	general

\* Default setting dependent on the model.



# Using accessories

Keypad  
Keypad parameterisation mode  
Keypad parameter list

Display code	Short designation	Default setting	Setting range	Address	Category
P704.xx	DC braking				
L P704.01	Current	0.0 %	0.0 ... 200.0 %	0x2B84:001	MCTRL
L P704.02	Hold time autom.	0.0 s	0.0 ... 1000.0 s	0x2B84:002	general
L P704.03	Threshold autom.	0.0 Hz	0.0 ... 599.0 Hz	0x2B84:003	general
L P704.04	Demagnet. time	100 %	0 ... 150 %	0x2B84:004	general
L P704.05	Def. demag. time	x ms	- (Read only)	0x2B84:005	general
L P704.06	Inverter disable	Disabled [0]	Selection list	0x2B84:006	general
P705.00	KP language	English [1]	Selection list	0x2863	general
P706.xx	Brake management				
L P706.01	Operating mode	Rfg stop (RFGS) [1]	Selection list	0x2541:001	general
L P706.02	Active threshold	x V	- (Read only)	0x2541:002	general
L P706.03	Red. threshold	0 V	0 ... 100 V	0x2541:003	general
L P706.04	Add.frequency	0.0 Hz	0.0 ... 10.0 Hz	0x2541:004	general
L P706.05	Del.overr.time	2.0 s	0.0 ... 60.0 s	0x2541:005	general
L P706.06	Brk. res. behav	Off:disa/Off:err [0]	Selection list	0x2541:006	general
P707.xx	Brake resistor				
L P707.02	Resistance value	180.0 Ω *	0.0 ... 500.0 Ω	0x2550:002	general
L P707.03	Rated power	50 W *	0 ... 800000 W	0x2550:003	general
L P707.04	Maximum heat	8.0 kW * *	0.0 ... 100000.0 kW	0x2550:004	general
L P707.07	Thermal load	x.x %	- (Read only)	0x2550:007	general
L P707.08	Warning thresh.	90.0 %	50.0 ... 150.0 %	0x2550:008	general
L P707.09	Error thresh.	100.0 %	50.0 ... 150.0 %	0x2550:009	general
L P707.10	Warning resp.	Warning [1]	Selection list	0x2550:010	general
L P707.11	Error response	Fault [3]	Selection list	0x2550:011	general
P708.xx	Manual control				
L P708.01	Keypad setting	CTRL&F/R enable [1]	Selection list	0x2602:001	general
L P708.02	Keypad rot.dir.	Forward [0]	Selection list	0x2602:002	general
L P708.03	Mode	Man. control off [0]	Selection list	0x2602:003	general
P709.xx	KP disp. setup				
L P709.01	User MS velocity		Text	0x2865:001	general
L P709.02	User PID control		Text	0x2865:002	general
L P709.03	Speed dec.point	0	0 ... 5	0x2865:003	
L P709.04	PID dec.point	2	0 ... 5	0x2865:004	
P710.xx	Load loss detect				
L P710.01	Threshold	0.0 %	0.0 ... 200.0 %	0x4006:001	general
L P710.02	Delay time	0.0 s	0.0 ... 300.0 s	0x4006:002	general
L P710.03	Error response	No response [0]	Selection list	0x4006:003	general
P711.xx	Position counter				
L P711.01	Signal source	Disabled [0]	Selection list	0x2C49:001	general
L P711.02	Set position	Rising edge [0]	Selection list	0x2C49:002	general
L P711.03	Actual position	-	- (Read only)	0x2C49:003	general
P712.xx	Brake control				
L P712.01	Brake mode	Off [2]	Selection list	0x2820:001	general
L P712.02	Closing time	100 ms	0 ... 10000 ms	0x2820:002	general
L P712.03	Opening time	100 ms	0 ... 10000 ms	0x2820:003	general
L P712.07	Closing thresh.	0.2 Hz	0.0 ... 599.0 Hz	0x2820:007	general
L P712.08	Holding load	0.0 %	-500.0 ... 500.0 %	0x2820:008	general
L P712.12	ClosingThr delay	0 ms	0 ... 10000 ms	0x2820:012	general
L P712.13	HoldLoad ramptim	0 ms	0 ... 100 ms	0x2820:013	general
L P712.15	Brake status	-	- (Read only)	0x2820:015	general
P718.xx	Flying restart				
L P718.01	Current	30 %	0 ... 100 %	0x2BA1:001	MCTRL
L P718.02	Start frequency	20.0 Hz	-599.0 ... 599.0 Hz	0x2BA1:002	MCTRL
L P718.03	Restart time	5911 ms *	1 ... 60000 ms	0x2BA1:003	MCTRL

\* Default setting dependent on the model.

# Using accessories

Keypad  
Keypad parameterisation mode  
Keypad parameter list



Display code	Short designation	Default setting	Setting range	Address	Category
L P718.08	Fl.res.frequency	x.x Hz	- (Read only)	0x2BA1:008	MCTRL
P721.xx	Mains fail. ctrl				
L P721.01	Enable function	Disabled [0]	Selection list	0x2D66:001	general
L P721.02	DC-bus act.level	0 % *	60 ... 90 %	0x2D66:002	general
L P721.03	Gain V-ctrl	0.01000 Hz/V	0.00001 ... 0.50000 Hz/V	0x2D66:003	general
L P721.04	Res. time V-ctrl	20 ms	5 ... 2000 ms	0x2D66:004	general
L P721.05	DC voltage setp.	100 %	80 ... 110 %	0x2D66:005	general
L P721.06	Setp. ramp	20 ms	1 ... 16000 ms	0x2D66:006	general
L P721.07	Clear time	20 ms	1 ... 60000 ms	0x2D66:007	general
L P721.08	Restart level	0.0 Hz	0.0 ... 599.0 Hz	0x2D66:008	general
L P721.09	RERT:Status	-	- (Read only)	0x2D66:009	general
P730.00	PIN1 protection	0	-1 ... 9999	0x203D	general
P731.00	PIN2 protection	0	-1 ... 9999	0x203E	general
P732.00	Auto-Save EPM	Inhibit [0]	Selection list	0x2829	general
P740.xx	Favorites sett.				
L P740.01	Parameter 1	0x2DDD0000	0x00000000 ... 0xFFFFFFFF00	0x261C:001	general
L P740.02	Parameter 2	0x60780000	0x00000000 ... 0xFFFFFFFF00	0x261C:002	general
L P740.03	Parameter 3	0x2D890000	0x00000000 ... 0xFFFFFFFF00	0x261C:003	general
L P740.04	Parameter 4	0x603F0000	0x00000000 ... 0xFFFFFFFF00	0x261C:004	general
L P740.05	Parameter 5	0x28240000	0x00000000 ... 0xFFFFFFFF00	0x261C:005	general
L P740.06	Parameter 6	0x28600100	0x00000000 ... 0xFFFFFFFF00	0x261C:006	general
L P740.07	Parameter 7	0x28380100	0x00000000 ... 0xFFFFFFFF00	0x261C:007	general
L P740.08	Parameter 8	0x28380300	0x00000000 ... 0xFFFFFFFF00	0x261C:008	general
L P740.09	Parameter 9	0x25400100	0x00000000 ... 0xFFFFFFFF00	0x261C:009	general
L P740.10	Parameter 10	0x29150000	0x00000000 ... 0xFFFFFFFF00	0x261C:010	general
L P740.11	Parameter 11	0x29160000	0x00000000 ... 0xFFFFFFFF00	0x261C:011	general
L P740.12	Parameter 12	0x29170000	0x00000000 ... 0xFFFFFFFF00	0x261C:012	general
L P740.13	Parameter 13	0x29180000	0x00000000 ... 0xFFFFFFFF00	0x261C:013	general
L P740.14	Parameter 14	0x2C000000	0x00000000 ... 0xFFFFFFFF00	0x261C:014	general
L P740.15	Parameter 15	0x2B000000	0x00000000 ... 0xFFFFFFFF00	0x261C:015	general
L P740.16	Parameter 16	0x2B010100	0x00000000 ... 0xFFFFFFFF00	0x261C:016	general
L P740.17	Parameter 17	0x2B010200	0x00000000 ... 0xFFFFFFFF00	0x261C:017	general
L P740.18	Parameter 18	0x283A0000	0x00000000 ... 0xFFFFFFFF00	0x261C:018	general
L P740.19	Parameter 19	0x29390000	0x00000000 ... 0xFFFFFFFF00	0x261C:019	general
L P740.20	Parameter 20	0x2D430100	0x00000000 ... 0xFFFFFFFF00	0x261C:020	general
L P740.21	Parameter 21	0x2D4B0100	0x00000000 ... 0xFFFFFFFF00	0x261C:021	general
L P740.22	Parameter 22	0x2B120100	0x00000000 ... 0xFFFFFFFF00	0x261C:022	general
L P740.23	Parameter 23	0x60750000	0x00000000 ... 0xFFFFFFFF00	0x261C:023	general
L P740.24	Parameter 24	0x60730000	0x00000000 ... 0xFFFFFFFF00	0x261C:024	general
L P740.25	Parameter 25	0x26310100	0x00000000 ... 0xFFFFFFFF00	0x261C:025	general
L P740.26	Parameter 26	0x26310200	0x00000000 ... 0xFFFFFFFF00	0x261C:026	general
L P740.27	Parameter 27	0x26310300	0x00000000 ... 0xFFFFFFFF00	0x261C:027	general
L P740.28	Parameter 28	0x26310400	0x00000000 ... 0xFFFFFFFF00	0x261C:028	general
L P740.29	Parameter 29	0x26310500	0x00000000 ... 0xFFFFFFFF00	0x261C:029	general
L P740.30	Parameter 30	0x26310600	0x00000000 ... 0xFFFFFFFF00	0x261C:030	general
L P740.31	Parameter 31	0x26310700	0x00000000 ... 0xFFFFFFFF00	0x261C:031	general
L P740.32	Parameter 32	0x26310800	0x00000000 ... 0xFFFFFFFF00	0x261C:032	general
L P740.33	Parameter 33	0x26310900	0x00000000 ... 0xFFFFFFFF00	0x261C:033	general
L P740.34	Parameter 34	0x26310D00	0x00000000 ... 0xFFFFFFFF00	0x261C:034	general
L P740.35	Parameter 35	0x26311200	0x00000000 ... 0xFFFFFFFF00	0x261C:035	general
L P740.36	Parameter 36	0x26311300	0x00000000 ... 0xFFFFFFFF00	0x261C:036	general
L P740.37	Parameter 37	0x26311400	0x00000000 ... 0xFFFFFFFF00	0x261C:037	general
L P740.38	Parameter 38	0x26340100	0x00000000 ... 0xFFFFFFFF00	0x261C:038	general
L P740.39	Parameter 39	0x26340200	0x00000000 ... 0xFFFFFFFF00	0x261C:039	general

\* Default setting dependent on the model.



# Using accessories

Keypad  
Keypad parameterisation mode  
Keypad parameter list

Display code	Short designation	Default setting	Setting range	Address	Category
↳ P740.40	Parameter 40	<b>0x26360100</b>	0x00000000 ... 0xFFFFFFFF00	0x261C:040	general
↳ P740.41	Parameter 41	<b>0x26360200</b>	0x00000000 ... 0xFFFFFFFF00	0x261C:041	general
↳ P740.42	Parameter 42	<b>0x26360300</b>	0x00000000 ... 0xFFFFFFFF00	0x261C:042	general
↳ P740.43	Parameter 43	<b>0x26390100</b>	0x00000000 ... 0xFFFFFFFF00	0x261C:043	general
↳ P740.44	Parameter 44	<b>0x26390200</b>	0x00000000 ... 0xFFFFFFFF00	0x261C:044	general
↳ P740.45	Parameter 45	<b>0x26390300</b>	0x00000000 ... 0xFFFFFFFF00	0x261C:045	general
↳ P740.46	Parameter 46	<b>0x26390400</b>	0x00000000 ... 0xFFFFFFFF00	0x261C:046	general
↳ P740.47	Parameter 47	<b>0x29110100</b>	0x00000000 ... 0xFFFFFFFF00	0x261C:047	general
↳ P740.48	Parameter 48	<b>0x29110200</b>	0x00000000 ... 0xFFFFFFFF00	0x261C:048	general
↳ P740.49	Parameter 49	<b>0x29110300</b>	0x00000000 ... 0xFFFFFFFF00	0x261C:049	general
↳ P740.50	Parameter 50	<b>0x29110400</b>	0x00000000 ... 0xFFFFFFFF00	0x261C:050	general
P750.xx	Param.set setup				
↳ P750.01 ... 32	Parameter 1 ... Parameter 32	<b>0x00000000</b>	0x00000000 ... 0xFFFFFFFF00	0x4041:001 ... 0x4041:032	general
P751.xx	Par. value set 1				
↳ P751.01 ... 32	Set 1 - Value 1 ... Set 1 - Value 32	<b>0</b>	-2147483648 ... 2147483647	0x4042:001 ... 0x4042:032	general
P752.xx	Par. value set 2				
↳ P752.01 ... 32	Set 2 - Value 1 ... Set 2 - Value 32	<b>0</b>	-2147483648 ... 2147483647	0x4043:001 ... 0x4043:032	general
P753.xx	Par. value set 3				
↳ P753.01 ... 32	Set 3 - Value 1 ... Set 3 - Value 32	<b>0</b>	-2147483648 ... 2147483647	0x4044:001 ... 0x4044:032	general
P754.xx	Par. value set 4				
↳ P754.01 ... 32	Set 4 - Value 1 ... Set 4 - Value 32	<b>0</b>	-2147483648 ... 2147483647	0x4045:001 ... 0x4045:032	general
P755.00	PSet activation	<b>On op. disabled [0]</b>	Selection list	0x4046	general
P756.xx	PSet error msg.				
↳ P756.01	Status	-	- (Read only)	0x4047:001	general
↳ P756.02	List entry	-	- (Read only)	0x4047:002	general
P760.xx	Fault config.				
↳ P760.02	Restart delay	<b>3.0 s</b>	0.0 ... 1000.0 s	0x2839:002	general
↳ P760.03	Restart counter	<b>5</b>	0 ... 255	0x2839:003	general
↳ P760.04	Tro.count r.time	<b>40.0 s</b>	0.1 ... 3600.0 s	0x2839:004	general
↳ P760.05	Trouble counter	-	- (Read only)	0x2839:005	general
↳ P760.06	FaultStateChange	<b>Reset fault [0]</b>	Selection list	0x2839:006	general
P770.xx	Pump cascading				
↳ P770.01	Operating mode	<b>Disabled [0]</b>	Selection list	0x405C:001	
↳ P770.02	Prior.at startup	<b>By oper. time [1]</b>	Selection list	0x405C:002	
↳ P770.03	Start frequency	<b>40.0 Hz</b>	0.0 ... 599.0 Hz	0x405C:003	
↳ P770.04	Stop frequency	<b>10.0 Hz</b>	0.0 ... 599.0 Hz	0x405C:004	
↳ P770.05	Settling time	<b>5.0 s</b>	0.0 ... 3600.0 s	0x405C:005	
↳ P770.06	Delay time	<b>2.0 s</b>	0.0 ... 3600.0 s	0x405C:006	
↳ P770.07	Low F threshold	<b>20.0 Hz</b>	0.0 ... 599.0 Hz	0x405C:007	
↳ P770.08	Up. F threshold	<b>30.0 Hz</b>	0.0 ... 599.0 Hz	0x405C:008	
↳ P770.09	Auto runtime	<b>0 h</b>	0 ... 1000 h	0x405C:009	
↳ P770.10	Auto trans.time	<b>0.0 s</b>	-10.0 ... 10.0 s	0x405C:010	
↳ P770.11	Reset oper.time	<b>Disabled [0]</b>	Selection list	0x405C:011	
↳ P770.12	Status word	-	- (Read only)	0x405C:012	
↳ P770.13	Operatingtime p1	x s	- (Read only)	0x405C:013	
↳ P770.14	Operatingtime p2	x s	- (Read only)	0x405C:014	
P780.00	CiA status word	-	- (Read only)	0x6041	general
P781.00	Set speed	<b>0 rpm</b>	-32768 ... 32767 rpm	0x6042	MCTRL
P782.00	Int. set speed	x rpm	- (Read only)	0x6043	general
P783.00	Actual speed	x rpm	- (Read only)	0x6044	general

\* Default setting dependent on the model.

# Using accessories

Keypad  
Keypad parameterisation mode  
Keypad parameter list



Display code	Short designation	Default setting	Setting range	Address	Category
P784.xx	Speed limits				
↳ P784.01	Min. speed	<b>0 rpm</b>	0 ... 480000 rpm	0x6046:001	MCTRL
↳ P784.02	Max. speed	<b>2147483647 rpm</b>	0 ... 2147483647 rpm	0x6046:002	MCTRL
P785.xx	Accel. ramp				
↳ P785.01	Delta speed	<b>3000 rpm</b>	0 ... 2147483647 rpm	0x6048:001	MCTRL
↳ P785.02	Delta time	<b>10 s</b>	0 ... 65535 s	0x6048:002	MCTRL
P786.xx	Decel. ramp				
↳ P786.01	Delta speed	<b>3000 rpm</b>	0 ... 2147483647 rpm	0x6049:001	MCTRL
↳ P786.02	Delta time	<b>10 s</b>	0 ... 65535 s	0x6049:002	MCTRL
P788.00	Act. op. mode	-	- (Read only)	0x6061	MCTRL
P789.00	Supported modes	-	- (Read only)	0x6502	general
P790.00	Quick stop dec.	<b>546000 inc/s<sup>2</sup></b>	0 ... 2147483647 inc/s <sup>2</sup>	0x6085	MCTRL
P800.00	Sequencer mode	<b>Disabled [0]</b>	Selection list	0x4025	Sequencer
P801.xx	Segment 1				
↳ P801.01	Frequency setp.	<b>0.0 Hz</b>	-599.0 ... 599.0 Hz	0x4026:001	Sequencer
↳ P801.02	Accel./decel.	<b>5.0 s</b>	0.0 ... 3600.0 s	0x4026:002	Sequencer
↳ P801.03	Time	<b>0.0 s</b>	0.0 ... 100000.0 s	0x4026:003	Sequencer
↳ P801.04	Digital outp.	<b>0</b>	0 ... 255	0x4026:004	Sequencer
↳ P801.05	Analog outp.	<b>0.00 VDC</b>	0.00 ... 10.00 VDC	0x4026:005	Sequencer
↳ P801.06	PID setp.	<b>0.00 PID unit</b>	-300.00 ... 300.00 PID unit	0x4026:006	Sequencer
↳ P801.07	Torque setp.	<b>100.0 %</b>	-400.0 ... 400.0 %	0x4026:007	Sequencer
P802.xx	Segment 2				
↳ P802.01	Frequency setp.	<b>0.0 Hz</b>	-599.0 ... 599.0 Hz	0x4027:001	Sequencer
↳ P802.02	Accel./decel.	<b>5.0 s</b>	0.0 ... 3600.0 s	0x4027:002	Sequencer
↳ P802.03	Time	<b>0.0 s</b>	0.0 ... 100000.0 s	0x4027:003	Sequencer
↳ P802.04	Digital outp.	<b>0</b>	0 ... 255	0x4027:004	Sequencer
↳ P802.05	Analog outp.	<b>0.00 VDC</b>	0.00 ... 10.00 VDC	0x4027:005	Sequencer
↳ P802.06	PID setp.	<b>0.00 PID unit</b>	-300.00 ... 300.00 PID unit	0x4027:006	Sequencer
↳ P802.07	Torque setp.	<b>100.0 %</b>	-400.0 ... 400.0 %	0x4027:007	Sequencer
P803.xx	Segment 3				
↳ P803.01	Frequency setp.	<b>0.0 Hz</b>	-599.0 ... 599.0 Hz	0x4028:001	Sequencer
↳ P803.02	Accel./decel.	<b>5.0 s</b>	0.0 ... 3600.0 s	0x4028:002	Sequencer
↳ P803.03	Time	<b>0.0 s</b>	0.0 ... 100000.0 s	0x4028:003	Sequencer
↳ P803.04	Digital outp.	<b>0</b>	0 ... 255	0x4028:004	Sequencer
↳ P803.05	Analog outp.	<b>0.00 VDC</b>	0.00 ... 10.00 VDC	0x4028:005	Sequencer
↳ P803.06	PID setp.	<b>0.00 PID unit</b>	-300.00 ... 300.00 PID unit	0x4028:006	Sequencer
↳ P803.07	Torque setp.	<b>100.0 %</b>	-400.0 ... 400.0 %	0x4028:007	Sequencer
P804.xx	Segment 4				
↳ P804.01	Frequency setp.	<b>0.0 Hz</b>	-599.0 ... 599.0 Hz	0x4029:001	Sequencer
↳ P804.02	Accel./decel.	<b>5.0 s</b>	0.0 ... 3600.0 s	0x4029:002	Sequencer
↳ P804.03	Time	<b>0.0 s</b>	0.0 ... 100000.0 s	0x4029:003	Sequencer
↳ P804.04	Digital outp.	<b>0</b>	0 ... 255	0x4029:004	Sequencer
↳ P804.05	Analog outp.	<b>0.00 VDC</b>	0.00 ... 10.00 VDC	0x4029:005	Sequencer
↳ P804.06	PID setp.	<b>0.00 PID unit</b>	-300.00 ... 300.00 PID unit	0x4029:006	Sequencer
↳ P804.07	Torque setp.	<b>100.0 %</b>	-400.0 ... 400.0 %	0x4029:007	Sequencer
P805.xx	Segment 5				
↳ P805.01	Frequency setp.	<b>0.0 Hz</b>	-599.0 ... 599.0 Hz	0x402A:001	Sequencer
↳ P805.02	Accel./decel.	<b>5.0 s</b>	0.0 ... 3600.0 s	0x402A:002	Sequencer
↳ P805.03	Time	<b>0.0 s</b>	0.0 ... 100000.0 s	0x402A:003	Sequencer
↳ P805.04	Digital outp.	<b>0</b>	0 ... 255	0x402A:004	Sequencer
↳ P805.05	Analog outp.	<b>0.00 VDC</b>	0.00 ... 10.00 VDC	0x402A:005	Sequencer
↳ P805.06	PID setp.	<b>0.00 PID unit</b>	-300.00 ... 300.00 PID unit	0x402A:006	Sequencer
↳ P805.07	Torque setp.	<b>100.0 %</b>	-400.0 ... 400.0 %	0x402A:007	Sequencer
P806.xx	Segment 6				
* Default setting dependent on the model.					





# Using accessories

Keypad  
Keypad parameterisation mode  
Keypad parameter list

Display code	Short designation	Default setting	Setting range	Address	Category
L P806.01	Frequency setp.	0.0 Hz	-599.0 ... 599.0 Hz	0x402B:001	Sequencer
L P806.02	Accel./decel.	5.0 s	0.0 ... 3600.0 s	0x402B:002	Sequencer
L P806.03	Time	0.0 s	0.0 ... 100000.0 s	0x402B:003	Sequencer
L P806.04	Digital outp.	0	0 ... 255	0x402B:004	Sequencer
L P806.05	Analog outp.	0.00 VDC	0.00 ... 10.00 VDC	0x402B:005	Sequencer
L P806.06	PID setp.	0.00 PID unit	-300.00 ... 300.00 PID unit	0x402B:006	Sequencer
L P806.07	Torque setp.	100.0 %	-400.0 ... 400.0 %	0x402B:007	Sequencer
P807.xx	Segment 7				
L P807.01	Frequency setp.	0.0 Hz	-599.0 ... 599.0 Hz	0x402C:001	Sequencer
L P807.02	Accel./decel.	5.0 s	0.0 ... 3600.0 s	0x402C:002	Sequencer
L P807.03	Time	0.0 s	0.0 ... 100000.0 s	0x402C:003	Sequencer
L P807.04	Digital outp.	0	0 ... 255	0x402C:004	Sequencer
L P807.05	Analog outp.	0.00 VDC	0.00 ... 10.00 VDC	0x402C:005	Sequencer
L P807.06	PID setp.	0.00 PID unit	-300.00 ... 300.00 PID unit	0x402C:006	Sequencer
L P807.07	Torque setp.	100.0 %	-400.0 ... 400.0 %	0x402C:007	Sequencer
P808.xx	Segment 8				
L P808.01	Frequency setp.	0.0 Hz	-599.0 ... 599.0 Hz	0x402D:001	Sequencer
L P808.02	Accel./decel.	5.0 s	0.0 ... 3600.0 s	0x402D:002	Sequencer
L P808.03	Time	0.0 s	0.0 ... 100000.0 s	0x402D:003	Sequencer
L P808.04	Digital outp.	0	0 ... 255	0x402D:004	Sequencer
L P808.05	Analog outp.	0.00 VDC	0.00 ... 10.00 VDC	0x402D:005	Sequencer
L P808.06	PID setp.	0.00 PID unit	-300.00 ... 300.00 PID unit	0x402D:006	Sequencer
L P808.07	Torque setp.	100.0 %	-400.0 ... 400.0 %	0x402D:007	Sequencer
P820.00	StartOfSeq. mode	Restart sequencer [0]	Selection list	0x4040	Sequencer
P822.xx	End segment				
L P822.01	Frequency setp.	0.0 Hz	-599.0 ... 599.0 Hz	0x402E:001	Sequencer
L P822.02	Accel./decel.	5.0 s	0.0 ... 3600.0 s	0x402E:002	Sequencer
L P822.03	Time	0.0 s	0.0 ... 100000.0 s	0x402E:003	Sequencer
L P822.04	Digital outp.	0	0 ... 255	0x402E:004	Sequencer
L P822.05	Analog outp.	0.00 VDC	0.00 ... 10.00 VDC	0x402E:005	Sequencer
L P822.06	PID setp.	0.00 PID unit	-300.00 ... 300.00 PID unit	0x402E:006	Sequencer
L P822.07	Torque setp.	100.0 %	-400.0 ... 400.0 %	0x402E:007	Sequencer
P824.00	End of seq. mode	Keep running [0]	Selection list	0x402F	Sequencer
P830.xx	Sequence 1				
L P830.01 ... 16	Step 1 ... Step 16	Skip step [0]	Selection list	0x4030:001 ... 0x4030:016	Sequencer
P831.00	Cycl. sequence 1	1	1 ... 65535	0x4031	Sequencer
P835.xx	Sequence 2				
L P835.01 ... 16	Step 1 ... Step 16	Skip step [0]	Selection list	0x4032:001 ... 0x4032:016	Sequencer
P836.00	Cycl. sequence 2	1	1 ... 65535	0x4033	Sequencer
P840.xx	Sequence 3				
L P840.01 ... 16	Step 1 ... Step 16	Skip step [0]	Selection list	0x4034:001 ... 0x4034:016	Sequencer
P841.00	Cycl. sequence 3	1	1 ... 65535	0x4035	Sequencer
P845.xx	Sequence 4				
L P845.01 ... 16	Step 1 ... Step 16	Skip step [0]	Selection list	0x4036:001 ... 0x4036:016	Sequencer
P846.00	Cycl. sequence 4	1	1 ... 65535	0x4037	Sequencer
P850.xx	Sequence 5				
L P850.01 ... 16	Step 1 ... Step 16	Skip step [0]	Selection list	0x4038:001 ... 0x4038:016	Sequencer
P851.00	Cycl. sequence 5	1	1 ... 65535	0x4039	Sequencer
P855.xx	Sequence 6				
* Default setting dependent on the model.					

# Using accessories

Keypad  
Keypad parameterisation mode  
Keypad parameter list



Display code	Short designation	Default setting	Setting range	Address	Category
<a href="#">L P855.01 ... 16</a>	Step 1 ... Step 16	<b>Skip step [0]</b>	Selection list	<a href="#">0x403A:001 ...</a> <a href="#">0x403A:016</a>	Sequencer
<a href="#">P856.00</a>	Cycl. sequence 6	<b>1</b>	1 ... 65535	<a href="#">0x403B</a>	Sequencer
P860.xx	Sequence 7				
<a href="#">L P860.01 ... 16</a>	Step 1 ... Step 16	<b>Skip step [0]</b>	Selection list	<a href="#">0x403C:001 ...</a> <a href="#">0x403C:016</a>	Sequencer
<a href="#">P861.00</a>	Cycl. sequence 7	<b>1</b>	1 ... 65535	<a href="#">0x403D</a>	Sequencer
P865.xx	Sequence 8				
<a href="#">L P865.01 ... 16</a>	Step 1 ... Step 16	<b>Skip step [0]</b>	Selection list	<a href="#">0x403E:001 ...</a> <a href="#">0x403E:016</a>	Sequencer
<a href="#">P866.00</a>	Cycl. sequence 8	<b>1</b>	1 ... 65535	<a href="#">0x403F</a>	Sequencer

\* Default setting dependent on the model.



## 16.2 WLAN module

The pluggable WLAN module enables

- an easy access to inverters that are installed in difficult access areas,
- an easy parameter setting without cable and instead of the keypad,
- a comfortable monitoring and adaptation of the machine.

The inverter can be accessed via WLAN with the following devices:

- Engineering PC (with WLAN functionality) and the »EASY Starter« engineering tool.
- Android smartphone with Lenze Smart Keypad App.

The Lenze Smart Keypad App is recommended for the adaptation of simple applications. The Lenze Smart Keypad App can be found in the Google Play Store and in the Apple App Store.



Android



iOS



Default settings: Access-Point mode, WLAN-SSID = "i5", WLAN password = "password"

If the WLAN module is to be plugged onto the inverter for a longer period of time, it is important to select a safe password in `0x2441:008`. Otherwise, a potential attacker might connect to the WLAN access point and attack the device and other connected devices or networks.

### 16.2.1 WLAN LED status displays

Information on the WLAN module status can be obtained quickly via the LED displays "Power", "TX/RX" and "WLAN" on the front of the WLAN module.

The meaning can be seen from the table below.

LED "Power" (green)	LED "TX/RX" (yellow)	LED "WLAN" (green)	Status/meaning
off	off	off	No supply voltage.
on	on	on	Self-test (duration approx. 1 s)
	off	off	Ready for operation — no active WLAN connection.
	Flashing	on	Communication active.
	off	blinking	Client mode — waiting for connection.
blinking	off	off	Trouble



After being plugged in, the WLAN module needs approx. 20 seconds until it is ready for operation.



## 16.2.2 WLAN basic settings

The WLAN functionality can be configured via the following parameters.

### Preconditions

WLAN module has been plugged onto the diagnostic module interface on the front of the inverter.

### Details

- The WLAN module can be connected and removed during operation.
- The WLAN module can either create an own WLAN network (access point mode, default setting) or implement itself as a WLAN client in an already existing WLAN network. For details see the following subchapters.
- The WLAN connection is encrypted. The WLAN encryption can be selected in [0x2441:009](#).
- [0x2441:012](#) can be used to set the name of the WLAN network, called SSID, so that it is not visible for other WLAN devices. As a result, the number of WLAN networks displayed on smartphone or PC can be reduced.
- Two data sources are possible for the WLAN settings: Inverter and WLAN module.
  - Data source - inverter: The WLAN settings saved in the inverter are used. Each inverter has its own WLAN settings.
  - Data source - WLAN module: The WLAN settings saved in the WLAN module are used. In this "stand-alone" mode, the WLAN module can be plugged onto another inverter and then be used with the same settings (irrespective of the WLAN settings of the inverter).
  - The data source is activated with [0x2440](#).
  - The currently active data source is displayed in [0x2442:004](#).

### Parameter

Address	Name / setting range / [default setting]	Information
0x2440	Initiate WLAN • From version 02.00	Restart WLAN network with default setting or current settings.
	<b>0</b> No action/no error	Only status display.
	<b>1</b> Restart with current values (from version 04.00)	Restart WLAN network with current settings of the WLAN parameters. • The WLAN settings of the active data source (inverter or WLAN module) are used. • The active data source is displayed in <a href="#">0x2442:004</a> . • The data source is not changed by this selection. Note! This selection is currently not supported by the WLAN module V1.0.
	<b>2</b> Restart with default values	Restart WLAN network with default setting of the WLAN parameters. • The WLAN settings saved in the WLAN module are deleted. • Active data source for the WLAN settings is now the inverter.
	<b>11</b> Save settings in WLAN module	Restart WLAN network with current settings of the WLAN parameters. • The current settings are saved in the WLAN module. • Active data source for the WLAN settings is now the WLAN module.
0x2441:004	WLAN settings: DHCP • From version 02.00	1 = Dynamic Host Configuration Protocol (DHCP) is enabled. • In the access point mode, the DHCP server of the WLAN module is activated. • In the client mode, the DHCP-client function is activated.
	<b>0</b> Disabled	
	<b>1</b> Enabled	
0x2441:005	WLAN settings: DHCP start address 0.0.0.0 ... [ <b>0.0.0.0</b> ] ... 255.255.255.255 • From version 02.00	Definition of the start address when the Dynamic Host Configuration Protocol (DHCP) is used. • Only relevant for access point mode. • When 0 is set, the active IP address + 1 is used as start address.



# Using accessories

WLAN module  
WLAN basic settings

Address	Name / setting range / [default setting]	Information
0x2441:006	WLAN settings: WLAN operation mode • From version 02.00	Definition of the operating mode of the WLAN module.
	0 <b>Access point mode</b>	For a direct connection to another WLAN device, the WLAN module creates an own WLAN network. ▶ <a href="#">WLAN access point mode</a> <a href="#">□ 671</a>
	1 Client mode	The WLAN module can be integrated as WLAN client into an already existing WLAN network. ▶ <a href="#">WLAN client mode</a> <a href="#">□ 677</a>
0x2441:007	WLAN settings: WLAN SSID ["i5"] • From version 02.00	Name (Service Set Identifier, SSID) of the WLAN network. • The preset name consists of the device name (iXXX) and the last 10 digits of the serial number of the Control Unit. • Example: "i550_0123456789" • The serial number is displayed in <a href="#">0x2000:002 (P190.02)</a> .
0x2441:008	WLAN settings: WLAN password ["password"] • From version 02.00	Password (WLAN network key) of the WLAN network. • This password serves to secure the WLAN connections. • The password must have a minimum length of 8 characters. Although shorter passwords are accepted and saved, the WLAN module cannot be operated with such a password. • The character "*" is not allowed. <b>Note!</b> If the WLAN module is to be plugged onto the inverter for a longer period of time, it is important to select a safe password. Otherwise, a potential attacker might connect to the WLAN access point and attack the device and other connected devices or networks. Currently (status: 2016), a WLAN is considered as safe if the password • consists of more than 20 characters, • contains capital and small letters, numbers and special characters and • cannot be found in any dictionary.
0x2441:009	WLAN settings: WLAN security • From version 02.00	Selection of the WLAN encryption.
	0 WPA	
	1 <b>WPA2</b>	
0x2441:010	WLAN settings: WLAN access • From version 02.00	Switch on/off WLAN.
	0 Disabled (WLAN off)	
	1 <b>Enabled (WLAN on)</b>	
0x2441:011	WLAN settings: WLAN channel • From version 02.00	Selection of the WLAN channel.
	1 <b>Channel 1</b>	
	2 Channel 2	
	3 Channel 3	
	4 Channel 4	
	5 Channel 5	
	6 Channel 6	
	7 Channel 7	
	8 Channel 8	
	9 Channel 9	
	10 Channel 10	
	11 Channel 11	
0x2441:012	WLAN settings: WLAN SSID broadcast • From version 02.00	1 = the name of the WLAN network, called SSID, is not visible for other WLAN devices.
	0 <b>Activated</b>	
	1 Disabled	

# Using accessories

WLAN module  
WLAN basic settings  
Resetting WLAN settings to default setting



Address	Name / setting range / [default setting]	Information
0x2442:004	Active WLAN settings: Active module mode <ul style="list-style-type: none"><li>• Read only</li><li>• From version 02.00</li></ul>	Display of the active data source for the WLAN settings. <ul style="list-style-type: none"><li>• This parameter indicates whether the settings used come from the inverter or from the WLAN module.</li></ul>
	0 Inverter	The WLAN settings saved in the inverter are used.
	1 Standalone	The WLAN settings saved in the WLAN module are used.
0x2442:005	Active WLAN settings: MAC address <ul style="list-style-type: none"><li>• Read only</li><li>• From version 02.00</li></ul>	Display of the MAC address of the WLAN module.

## 16.2.2.1 Resetting WLAN settings to default setting

Possible reasons:

- Password is not known anymore.
- WLAN SSID is not visible and not known anymore.
- WLAN module mode "stand-alone" shall be deactivated.

[0x2440](#) serves to reset all WLAN settings to the default setting. For this purpose, the inverter must be connected to the »EASY Starter« via the USB module or an existing network.

### Option 1: Reset via USB module

How to reset the WLAN settings to default setting by means of the USB module:

Requirements:

- The inverter is ready for operation (supplied with voltage).

Required accessories:

- USB module
  - USB 2.0 cable (A-plug on micro B-plug)
  - PC with installed »EASY Starter« software
1. Remove the WLAN module from the inverter and plug in the USB module instead.
  2. Establish a connection between inverter and »EASY Starter« via the USB module.
  3. Set the parameter [0x2440](#) to "Restart with default values [2]".
  4. Remove the USB module from the inverter and plug in the WLAN module instead again.

The default setting is loaded.

### Option 2: Reset via network

How to reset the WLAN settings to default setting via network:

Requirements:

- The inverter is ready for operation (supplied with voltage).
- The inverter is connected to a functioning network.

Required accessories:

- PC with installed »EASY Starter«. In addition, the PC must be connected to the network which also implements the inverter.
1. Establish a connection between the inverter and »EASY Starter« via the used network.
  2. Set the parameter [0x2440](#) to "Restart with default values [2]".

The default setting is loaded.



## 16.2.3 WLAN access point mode

By default, the WLAN module is configured as a WLAN access point because this is the most frequent application. In this operating mode, the WLAN module creates its own WLAN network for a direct connection to other WLAN devices.

The supported WLAN devices are:

- Android smartphone with Lenze Smart Keypad App.
- Engineering PC (with WLAN functionality) and the »EASY Starter« engineering tool.

### Details

- By default, every inverter with WLAN functionality comes with an individual network name, called "SSID".
- The preset network name consists of the device name (iXXX) and the first 10 digits of the serial number (example: "i550\_0123456789").
- By default, the password for the WLAN network is "password" and can be changed in [0x2441:008](#).



If the WLAN module is to be plugged onto the inverter for a longer period of time, it is important to select a safe password. Otherwise, a potential attacker might connect to the WLAN access point and attack the device and other connected devices or networks. Currently (status: 2016), a WLAN is considered as safe if the password consists of more than 20 characters, contains capital and small letters, numbers and special characters and cannot be found in any dictionary.

The following illustration displays the SSIDs as examples only:

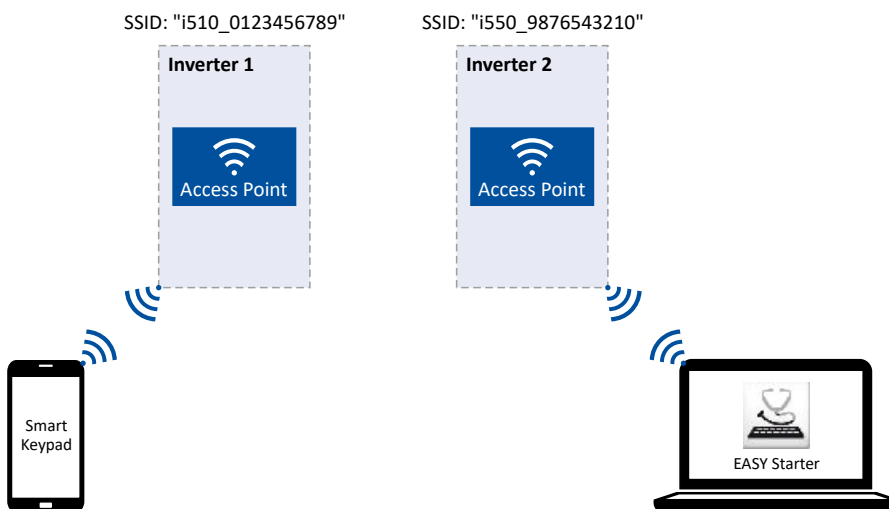

For establishing a WLAN connection, only a few settings are required. The respective setting is described in the following subchapters:

- [Establish a WLAN connection between smartphone and inverter](#) [672](#)
- [Using the smartphone as "Smart Keypad"](#) [673](#)
- [Establish a WLAN connection between Engineering PC and inverter](#) [674](#)

# Using accessories

WLAN module

WLAN access point mode

Establish a WLAN connection between smartphone and inverter



## 16.2.3.1 Establish a WLAN connection between smartphone and inverter

How to establish a direct WLAN connection to the inverter on the smartphone:

Requirements:

- The functional test described in the mounting and switch-on instructions has been completed successfully (without any errors or faults).
- The inverter is ready for operation (supplied with voltage).

Required accessories:

- WLAN module
  - Android smartphone
  - Lenze Smart Keypad App (available free of charge in the Google Play Store)
1. Plug the WLAN module onto the diagnostic module interface on the front of the inverter.
  2. Unless already activated, activate the WLAN function on the smartphone under "Settings" → "WLAN".  
The WLAN networks available in your range are now displayed.
  3. Select the WLAN network established by the inverter.
  4. Enter the password for the WLAN network (default setting "password") and click "Connect".  
The connection to the WLAN network of the inverter is now established.
  5. Start the Lenze Smart Keypad App on the Android smartphone.

If a WLAN connection to the inverter has been established, the Lenze Smart Keypad App serves to

- read out diagnostics parameters of the inverter,
- change parameter settings of the inverter and
- transmit parameter sets.





## 16.2.3.2 Using the smartphone as "Smart Keypad"

In the default setting, the WLAN settings of the inverters are used. If the WLAN module is plugged onto another inverter, the WLAN connection must be set up again because the replugging causes a change of the network name.

For using the smartphone as "Smart Keypad", the WLAN module can be configured such that the WLAN settings are saved locally in the WLAN module and only these settings are used. In this "standalone" mode, the WLAN module remains permanently coupled to the smartphone because after replugging onto another inverter, the login data for the WLAN network (SSID and password) is the same:

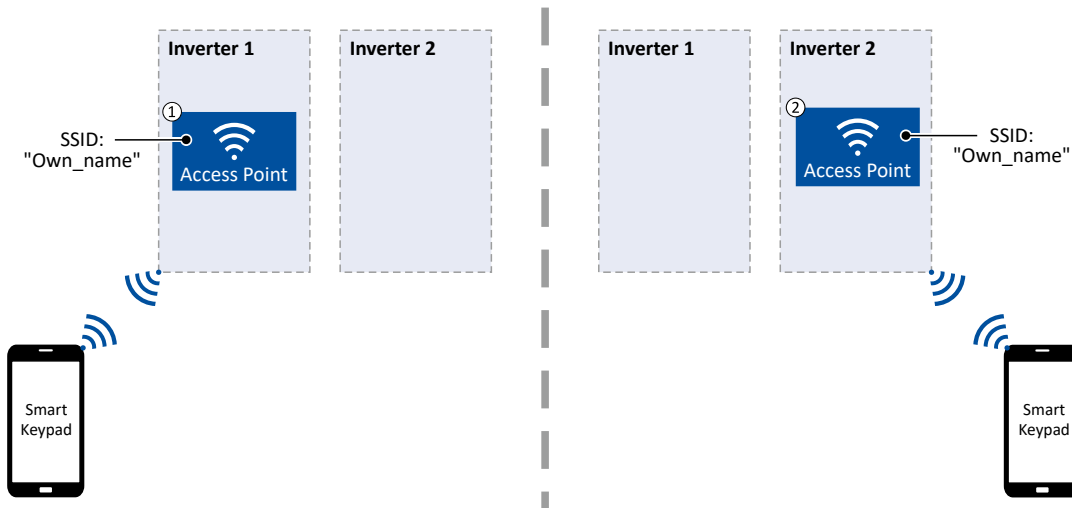

- ① WLAN module is plugged onto the inverter 1. After the connection to the smartphone has been established, the inverter 1 can be diagnosed or parameterised with the Lenze Smart Keypad App.
- ② WLAN module is plugged onto the inverter 2. After the WLAN network is restarted, a connection is established again to the smartphone because the WLAN settings are identical. Now, the inverter 2 can be diagnosed or parameterised with the Lenze Smart Keypad App.

How to configure the WLAN module for a "Smart Keypad" use:

Requirements:

- The WLAN settings of the inverter can be accessed via the Lenze Smart Keypad App or »EASY Starter«.
1. Define your own network name (SSID) in [0x2441:007](#).
  2. Define your own password in [0x2441:008](#).
  3. Set the selection "Save settings in WLAN module [11]" in [0x2440](#).

The defined network name and the password are saved locally in the WLAN module. The WLAN network is restarted with the current settings.

If the WLAN module is then plugged onto another inverter, the settings that are locally saved in the WLAN module are used (irrespective of the WLAN settings of the inverter).

- The active mode ("Inverter" or "Standalone") is displayed in [0x2442:004](#).
- In order to return to the standard mode "Inverter", the selection "Restart with default values [2]" must be set in [0x2440](#).

# Using accessories

WLAN module

WLAN access point mode

Establish a WLAN connection between Engineering PC and inverter



## 16.2.3.3 Establish a WLAN connection between Engineering PC and inverter

How to establish a direct WLAN connection to the inverter on the Engineering PC:

Requirements:

- The functional test described in the mounting and switch-on instructions has been completed successfully (without any errors or faults).
- The inverter is ready for operation (supplied with voltage).

Required accessories:

- WLAN module



## Using accessories

WLAN module

WLAN access point mode

Establish a WLAN connection between Engineering PC and inverter

- PC (with WLAN functionality) and installed »EASY Starter«
1. Plug the WLAN module onto the diagnostic module interface on the front of the inverter.
  2. Open the network settings on the Engineering PC: "Control panel" → "Network and sharing center".
  3. Select the "Set up a new connection or network" option under "Change your network settings".  
The "Set Up a Connection or Network" dialog box is displayed.
  4. Select the "Manually connect to a wireless network" connection option and click the "Next" button.  
The "Manually connect to a wireless network" dialog box is displayed.
  5. Enter the SSID of the inverter as network name.
  6. Select "WPA2-Personal" as safety type.
  7. Select "AES" as encryption type.
  8. Enter the password as safety key for the WLAN network (default setting "password").
  9. Tick "Start this connection automatically".
  10. Click "Next".  
A note indicates that the connection has been added successfully.
  11. Click "Close".
  12. Start »EASY Starter«.  
The "Add devices" dialog is shown.
  13. Select connection "WLAN - WLAN with module i5MADU0000000S":

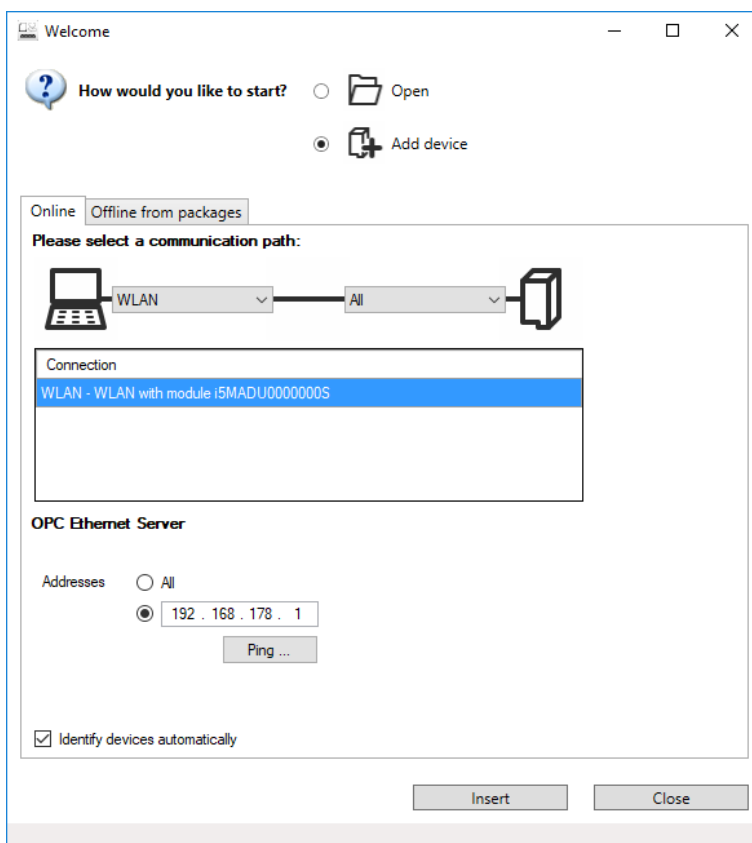

14. Set the address to the WLAN IP address of the drive. The default IP address of the WLAN module is: 192.168.178.1. The active WLAN address is in [0x2442:001](#).
15. Click the **Insert** button.  
»EASY Starter« searches for connected devices via the communication path selected.  
When the connection has been established successfully, the inverter is displayed in the device list of »EASY Starter«. The inverter parameters can now be accessed via the tabs of »EASY Starter«.

# Using accessories

WLAN module

WLAN access point mode

Establish a WLAN connection between Engineering PC and inverter



Recommendation: Click the button in the toolbar of the »EASY Starter«  to start visual tracking. This function serves to quickly check whether the connection to the correct device has been established. [▶ Optical device identification !\[\]\(f5c463b8c1554ac5049d611bd8e33a51\_img.jpg\) 561](#)



## 16.2.4 WLAN client mode

The WLAN module can be optionally configured as a WLAN client. In this operating mode, the WLAN module can be implemented into an already existing WLAN network.

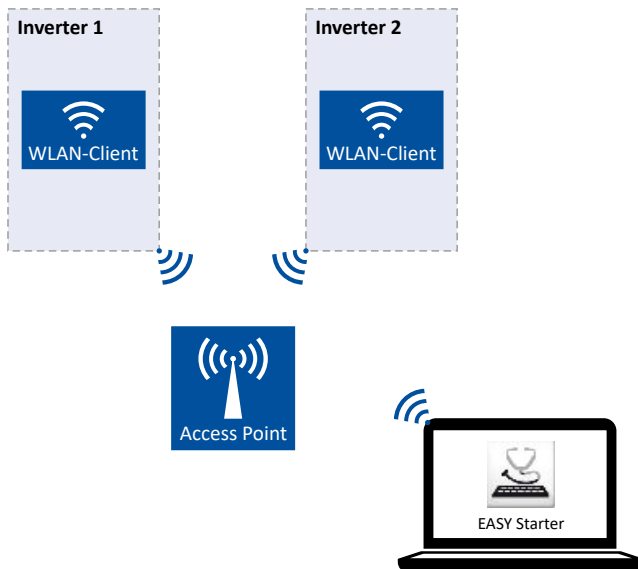

How to configure the WLAN module as WLAN client:

Requirements:

- The WLAN settings of the inverter can be accessed via »EASY Starter«.
  - Name (SSID) and password of the external WLAN network are known.
1. Set the selection "Client mode [1]" in [0x2441:006](#).
  2. Set the name (SSID) of the external WLAN network in [0x2441:007](#).
  3. Set the password of the external WLAN network in [0x2441:008](#).
  4. [Saving the parameter settings.](#) [45](#)



---

Before activating the changed WLAN settings in the next step: Make sure that the name (SSID) and the password of the external WLAN network are set correctly. The restart of the WLAN module in the client mode causes a termination of an existing WLAN connection in the access point mode!

---

5. Restart the inverter or remove and replug the WLAN module to activate the changed WLAN settings.

The WLAN module now tries as a client to establish a connection to the set external WLAN network.

Notes:

- In the default setting, the WLAN client is configured as DHCP client in [0x2441:004](#).
  - Settings as IP address, subnetwork mask and gateway are automatically made by the DHCP server of the external WLAN network.
  - The active settings are displayed in [0x2442:001](#), [0x2442:002](#) and [0x2442:003](#).
- A static IP configuration can be made via the parameters [0x2441:001](#), [0x2441:002](#) and [0x2441:003](#).

# Using accessories

WLAN module  
WLAN diagnostics



## Parameter

Address	Name / setting range / [default setting]	Information
0x2441:001	WLAN settings: IP address 0.0.0.0 ... [192.168.178.1] ... 255.255.255.255 • From version 02.00	Definition of the IP address for the WLAN access point. • In the client mode, a static IP address can be set here for the WLAN client. In order that the static configuration becomes effective, DHCP must be disabled in 0x2441:004. • Byte order is "Big-Endian": 192.168.178.01 = 0x01B2A8C0 (= 28485824)
0x2441:002	WLAN settings: Netmask 0.0.0.0 ... [255.255.255.0] ... 255.255.255.255 • From version 02.00	Definition of the network mask for the WLAN access point. • In the client mode, a static network mask can be set here for the WLAN client. In order that the static configuration becomes effective, DHCP must be disabled in 0x2441:004. • Byte order is "Big-Endian": 255.255.255.0 = 0x00FFFFFF (= 16777215)
0x2441:003	WLAN settings: Gateway 0.0.0.0 ... [192.168.178.1] ... 255.255.255.255 • From version 02.00	Definition of the gateway for the WLAN access point. • In the client mode, a static gateway can be set here for the WLAN client. In order that the static configuration becomes effective, DHCP must be disabled in 0x2441:004. • Byte order is "Big-Endian": 192.168.178.1 = 0x01B2A8C0 (= 28485824)
0x2442:001	Active WLAN settings: Active IP address • Read only • From version 02.00	Display of the active IP address. • If DHCP is activated, the active IP address usually derives from the configured static IP address of the device.
0x2442:002	Active WLAN settings: Active netmask • Read only • From version 02.00	Display of the active netmask.
0x2442:003	Active WLAN settings: Active gateway • Read only • From version 02.00	Display of the active gateway IP address.

## 16.2.5 WLAN diagnostics

The following parameters serve to diagnose the WLAN module and the WLAN communication.

### Preconditions

WLAN module has been plugged onto the diagnostic module interface on the front of the inverter.

## Parameter

Address	Name / setting range / [default setting]	Information
0x2448:001	WLAN status: Connection time • Read only • From version 02.00	Display of the connection time in [s] since the current connection was established.
0x2448:002	WLAN status: Number of connections • Read only • From version 02.00	In access point mode: Display of the number of currently connected clients. In client mode: 0 = not connected; 1 = connected with external WLAN network.
0x2448:003	WLAN status: Rx frame counter • Read only • From version 02.00	Display of the number of request received via WLAN.
0x2448:004	WLAN status: Error statistics • Read only • From version 02.00	Display of the quality of the WLAN connection. A display value > 0 indicates communication problemsn.



Address	Name / setting range / [default setting]	Information
0x2449	WLAN error <ul style="list-style-type: none"><li>• Read only</li><li>• From version 02.00</li></ul>	Bit coded display of WLAN errors.
	Bit 2 WLAN error	
	Bit 3 Memory problem	
	Bit 4 WLAN connection problem	
	Bit 7 WLAN off	
	Bit 9 Client mode off	
	Bit 12 TCP/IP configuration error	
	Bit 13 Password length	
Bit 14 Access denied		



## 17 Diagnostics and fault elimination





















This section contains information on error handling, drive diagnostics and fault analysis.





## 17.1 Status LEDs

The "RDY" and "ERR" LED status displays on the front of the inverter provide some quick information about certain operating states.

"RDY" LED (blue)	"ERR" LED (red)	Status/meaning
off	off	No supply voltage
 on	 on	Initialisation (inverter is started)
 blinking (1 Hz)	off	Safe torque off (STO) active. The inverter has been disabled by the integrated functional safety. ▶ <a href="#">Safe torque off (STO)</a>  627
	 blinking fast (4 Hz)	Safe torque off (STO) active, warning present. The inverter has been disabled by the integrated functional safety. ▶ <a href="#">Safe torque off (STO)</a>  627
 blinking (2 Hz)	off	Inverter disabled
	 blinking fast (4 Hz)	Inverter disabled, warning present. ▶ <a href="#">Event handling</a>  699
	 on	Inverter disabled, error active. ▶ <a href="#">Event handling</a>  699
	 on briefly every 1.5 s	Inverter disabled, no DC-bus voltage.
	 on briefly every 1 s	USB module is connected, 5-V supply voltage for the USB module is available.
 on	off	Inverter enabled. The motor rotates according to the specified setpoint or quick stop active.
	 blinking fast (4 Hz)	Inverter enabled, warning present. The motor rotates according to the specified setpoint or quick stop active.
	 blinking (1 Hz)	Inverter enabled, quick stop as response to fault active. ▶ <a href="#">Event handling</a>  699
 Both LEDs are blinking in a rapidly alternating mode		Firmware update is active ▶ <a href="#">Update device firmware</a>  581
 Both LEDs are blinking in a very rapidly synchronous mode		"Visual tracking" function is active ▶ <a href="#">Optical device identification</a>  561



## 17.2 Logbook

With the logbook, the controller has access to the last 32 messages of the inverter.

- The logbook is saved persistently in the inverter.
- The logbook has a ring buffer structure:
  - As long as free memory is available in the logbook, a message is entered following the next free memory unit.
  - When all memory units are occupied, the oldest message is deleted for a new message.
  - Always the most recent messages remain available.
- On the basis of the "Diag code" (32-bit word) of each individual message it can be seen which axis the message refers to.

### Parameter

Address	Name / setting range / [default setting]	Information
0x2022:015 (P700.15)	Device commands: Delete logbook (Device commands: Delete logbook)	<ul style="list-style-type: none"> <li>• When the device command has been executed successfully, the value 0 is shown.</li> <li>• Do not switch off the supply voltage during the deletion process and do not unplug the memory module!</li> </ul>
	<b>0</b> Off / ready	
	1 On / start	Execute device command



## 17.3 Error history buffer

For purposes of diagnostics, the error history buffer contains the last 32 error and warning messages of the inverter, which have occurred during operation. The error history buffer can be read out using the keypad via P155.00 and provides a limited view on the logbook.

### Details

- For each event that is recorded, the error history buffer contains the message text, the error code, the time of occurrence as well as a counter for successive, identical events. If an event that has already been recorded occurs repeatedly, only the counter is incremented.
- The error history buffer can be reset by the user. In order to prevent the buffer from being reset by the user, this function can be protected by means of a password.
- Observe that the error history buffer only presents a snapshot at the time the data are read out. If a new event occurs, the error history buffer must be read out again via P155.00 so that the new event becomes visible.

### Accessing the error history buffer with the keypad

1. Use the **←** key in the operating mode to navigate to the parameterisation mode one level below. You are now in the group level. All parameters of the inverter are divided into different groups according to their function.  
Note: By using the **↶** key you can navigate one level upwards again anytime.
2. Use the **↑** navigation key to select group 1 ("Diagnostics").
3. Use the **←** key to navigate to one level below. You are now in the parameter level of the group selected.
4. Use the **↑** and **↓** select the P155.00 parameter.
5. Use the **←** key to navigate to one level below. You are now in the error history buffer.
6. Use the **↑** and **↓** navigation keys you can now scroll through the error history buffer entries. Use the **←** key, you can switch over the display.

#### Information displayed (page 1):

- ① Message text
- ② No. of the entry (01 = latest event)
- ③ Response (W = warning, T = trouble, F = fault)
- ④ Error code

#### Information displayed (page 2):

- ⑤ Time of occurrence
- ⑥ No. of the entry (01 = latest event)
- ⑦ Counter for successive, identical events

Note: By using the **↶** key you can exit the error history buffer again.



### Parameter

Address	Name / setting range / [default setting]	Information
0x2006:000 (P155.00)	Error history buffer: Keypad display (Fault memory: Error memory) • Read only	Display of the error history buffer on the keypad.
0x2006:001	Error history buffer: Maximum number of messages • Read only	Display of the maximum number of messages which can be stored in the history buffer (from subindex 6).
0x2006:002	Error history buffer: Latest message • Read only	Display of the subindex of the most recent message.
0x2006:003	Error history buffer: Latest acknowledgement message 0 ... [0] ... 37	0 = delete all entries in the error history buffer.
0x2006:004	Error history buffer: New message • Read only	Reserved for future extensions.
0x2006:005	Error history buffer: Configuration/Status 0 ... [1] ... 65535	Bit 0 ... bit 4 = 0. Bit 5 = 1 = overflow (after recording the 33rd event in the error history buffer.
	Bit 0   Send emergency message	
	Bit 1   Disable info message	
	Bit 2   Disable warning message	
	Bit 3   Disable error message	
	Bit 4   Mode selection	
Bit 5   Message overwritten		
0x2006:006	Error history buffer: Message 0 • Read only	Error history buffer entry 01 (latest event)
0x2006:007	Error history buffer: Message 1 • Read only	Error history buffer entry 02
0x2006:008	Error history buffer: Message 2 • Read only	Error history buffer entry 03
0x2006:009	Error history buffer: Message 3 • Read only	Error history buffer entry 04
0x2006:010	Error history buffer: Message 4 • Read only	Error history buffer entry 05
0x2006:011	Error history buffer: Message 5 • Read only	Error history buffer entry 06
0x2006:012	Error history buffer: Message 6 • Read only	Error history buffer entry 07
0x2006:013	Error history buffer: Message 7 • Read only	Error history buffer entry 08
0x2006:014	Error history buffer: Message 8 • Read only	Error history buffer entry 09
0x2006:015	Error history buffer: Message 9 • Read only	Error history buffer entry 10
0x2006:016	Error history buffer: Message 10 • Read only	Error history buffer entry 11
0x2006:017	Error history buffer: Message 11 • Read only	Error history buffer entry 12
0x2006:018	Error history buffer: Message 12 • Read only	Error history buffer entry 13
0x2006:019	Error history buffer: Message 13 • Read only	Error history buffer entry 14
0x2006:020	Error history buffer: Message 14 • Read only	Error history buffer entry 15
0x2006:021	Error history buffer: Message 15 • Read only	Error history buffer entry 16
0x2006:022	Error history buffer: Message 16 • Read only	Error history buffer entry 17
0x2006:023	Error history buffer: Message 17 • Read only	Error history buffer entry 18



Address	Name / setting range / [default setting]	Information
0x2006:024	Error history buffer: Message 18 • Read only	Error history buffer entry 19
0x2006:025	Error history buffer: Message 19 • Read only	Error history buffer entry 20
0x2006:026	Error history buffer: Message 20 • Read only	Error history buffer entry 21
0x2006:027	Error history buffer: Message 21 • Read only	Error history buffer entry 22
0x2006:028	Error history buffer: Message 22 • Read only	Error history buffer entry 23
0x2006:029	Error history buffer: Message 23 • Read only	Error history buffer entry 24
0x2006:030	Error history buffer: Message 24 • Read only	Error history buffer entry 25
0x2006:031	Error history buffer: Message 25 • Read only	Error history buffer entry 26
0x2006:032	Error history buffer: Message 26 • Read only	Error history buffer entry 27
0x2006:033	Error history buffer: Message 27 • Read only	Error history buffer entry 28
0x2006:034	Error history buffer: Message 28 • Read only	Error history buffer entry 29
0x2006:035	Error history buffer: Message 29 • Read only	Error history buffer entry 30
0x2006:036	Error history buffer: Message 30 • Read only	Error history buffer entry 31
0x2006:037	Error history buffer: Message 31 • Read only	Error history buffer entry 32

### Structure of the messages

The following example shows the detailed structure of one of the following messages (parameter 0x2006:006 ... 0x2006:037):

Message:	00E010431201990000520B0473FC0100050001					
	00E01043	1201	9900	00520B0473FC0100	0500	01
Meaning:	Diag code	Message type	Text ID	Time stamp in [ns]	Flag param. 1	Parameter 1
Data type:	U32	U16	U16	U64	U16	U8
Hex value:	0x4310 E000	0x0112	0x0099	0x0001 FC73 040B 5200	0x0005	0x01

### Notes:

- The upper 16 bits of the "Diag Code" contain the error code (in the example "0x4310").
- Bit 0 ... 3 of the message type contain the error type (0: Info, 1: Warning, 2: Trouble, 3: Fault).
- Convert time stamp: 0x0001 FC73 040B 5200 = 559045896000000 ns = 6 days, 11 hours, 17 minutes, 25 seconds
- The flag for parameter 1 has no meaning for decoding the message.
- The parameter 1 contains the counter for successive, identical events.



## 17.3.1 Read out error history buffer

There are two different options to read individual messages of the "error history memory" (in the logbook) from an external control or visualization system:

- a) Via the standard path defined by "ETG 1020" (EtherCat Technology Group)
- b) Via simple parameter access to messages in the "error history memory"

Option (b) is described here.

You read diagnostic messages via simple parameter access to the "error history memory".

### Parameter

Address	Name / setting range / [default setting]	Information
0x2007:001	Error history buffer: Message number 1 ... [1] ... 32	
0x2007:002	Error history buffer: Time stamp • Read only: x.xx s	
0x2007:003	Error history buffer: Response to error • Read only	
	0 Info (from version 05.01)	
	1 Warning (from version 05.01)	
	2 Error (from version 05.01)	
0x2007:004	Error history buffer: Message ID • Read only	
0x2007:005	Error history buffer: Diag Code Ident • Read only	
0x2007:006	Error history buffer: Message counter • Read only	
0x2007:007	Error history buffer: IO-Link message number • Read only • From version 05.04	



## 17.4 Diagnostic parameters

The inverter provides many diagnostic parameters which are helpful for operation, maintenance, error diagnosis, error correction, etc.

- The following overview lists the most common diagnostic parameters.
- Further parameters for more specific diagnostic purposes are described in the following subchapters.
- The diagnostic parameters can only be read and cannot be written to.
- The diagnostic parameters in group 1 are found on the keypad.

### Parameter

Address	Name / setting range / [default setting]	Information
0x2030	CRC parameter set 0 ... [0] ... 4294967295	Display of the 32-bit hash sum for the integrity check of the parameter set.
0x2B0B	Ramp generator frequency • Read only: x.x Hz • From version 03.00	Display of the current frequency setpoint. The frequency setpoint is internally transferred to the motor control (based on scaling and ramp generator). The frequency setpoint is internally transferred to the motor control (based on scaling and ramp generator).
0x2B0E (P102.00)	Frequency setpoint (Freq. setpoint) • Read only: x.x Hz	Display of the frequency setpoint currently assigned. • Depending on the present operating conditions, this value may differ from the current output frequency 0x2DDD (P100.00).
0x2B0F	Output frequency motor • Read only: x.x Hz	The inverter controls the motor so that the motor output frequency 0x2B0F corresponds to the frequency setpoint 0x2B0E (P102.00). (Motor output frequency = output frequency of inverter - motor slip)
0x2D4F (P123.00)	Motor utilisation (i <sup>2</sup> t) (Mot. i <sup>2</sup> t utilis.) • Read only: x %	Display of the current thermal motor utilisation.
0x2D87 (P105.00)	DC-bus voltage (DC-bus voltage) • Read only: x V	Display of the current DC-bus voltage.
0x2D88 (P104.00)	Motor current (Motor current) • Read only: x.x A	Display des present current-r.m.s. value.
0x2D89 (P106.00)	Motor voltage (Motor voltage) • Read only: x VAC	Display of the current motor voltage.
0x2DA2:001 (P108.01)	Output power: Effective power (Output power: Effective power) • Read only: x.xxx kW	Display of the active output power for an energy analysis in the respective application.
0x2DA2:002 (P108.02)	Output power: Apparent power (Output power: Apparent power) • Read only: x.xxx kVA	Display of the apparent output power for an energy analysis in the respective application.
0x2DA3:001 (P109.01)	Output energy: Motor (Output energy: Motor) • Read only: x.xx kWh	Display of the output power in motor mode for an energy analysis in the respective application.
0x2DA3:002 (P109.02)	Output energy: Generator (Output energy: Generator) • Read only: x.xx kWh	Display of the output power in generator mode for an energy analysis in the respective application.
0x2DD1:001	Motor currents: Actual D-current (id) • Read only: x.xx A	Display of the actual D current.
0x2DD1:002	Motor currents: Actual Q-current (iq) • Read only: x.xx A	Display of the actual Q current.
0x2DD1:003	Motor currents: Setpoint D-current (id) • Read only: x.xx A	Display of the setpoint D current.
0x2DD1:004	Motor currents: Setpoint Q-current (iq) • Read only: x.xx A	Display of the setpoint Q current.
0x2DD1:005	Motor currents: Motor current (Ieff) • Read only: x.xx A	Display of the effective motor current.



Address	Name / setting range / [default setting]	Information
0x2DD3:003	Speed setpoint limited • Read only: x rpm	Display of the limited speed setpoint.
0x2DDD (P100.00)	Output frequency (Inv. outp. freq.) • Read only: x.x Hz	Display of the current output frequency of the inverter.
0x2DDF:001	Axis information: Rated current • Read only: x.xx A	Display of the rated current of the axis.
0x2DDF:002	Axis information: Maximum current • Read only: x.xx A	Display of the maximum current of the axis.
0x400D (P101.00)	Scaled actual value (Scaled act value) • Read only: x Unit	Display of the current speed in application units.
0x6077 (P107.00)	Actual torque (Actual torque) • Read only: x.x %	Display of the actual torque. • 100 % = Rated motor torque <a href="#">0x6076 (P325.00)</a>
0x6078 (P103.00)	Actual current (Actual current) • Read only: x.x %	Display of the motor actual current. • 100 % = Rated motor current <a href="#">0x6075 (P323.00)</a>
0x6079	DC-bus voltage • Read only: x.xxx V • From version 02.00	Display of the current DC-bus voltage.

## 17.4.1 Inverter diagnostics

The following parameters supply some information about the current operating status of the inverter.

This includes the following information:

- Active access protection after log-in by means of PIN1/PIN2
- Currently loaded parameter settings
- Cause(s) for disable, quick stop and stop
- Active control source and active setpoint source
- Active operating mode
- Status of the internal motor control
- Keypad status

Some of the following parameters contain bit-coded status words. Each single bit has a certain meaning.

▶ [Display of status words on keypad](#) [643](#)

### Parameter

Address	Name / setting range / [default setting]	Information
0x2040 (P197.00)	Access protection status (Protect. status) • Read only	Bit-coded display of the active access protection after login by PIN1/ PIN2.
	Bit 0 No write access	
	Bit 1 Only favorites changeable	
0x2827 (P198.00)	Currently loaded parameter settings (Status load. par) • Read only	Display of the parameter settings currently loaded. ▶ <a href="#">Behaviour of the inverter in case of incompatible data in the memory module</a> <a href="#">583</a> ▶ <a href="#">Saving/loading the parameter settings</a> <a href="#">564</a>
	0 User settings	User parameter settings of the memory module
	1 Reset 60 Hz setting	Delivery status (default setting) for 50-Hz device
	2 Reset 50 Hz setting	Delivery status (default setting) for 60-Hz device
	3 OEM default settings	OEM parameter settings of the memory module





# Diagnostics and fault elimination

Diagnostic parameters  
Inverter diagnostics

Address	Name / setting range / [default setting]	Information
0x282A:001 (P126.01)	Status words: Cause of disable (Status words: Cause of disable) • Read only	Bit-coded display of the cause(s) for disabled inverter.
	Bit 0 Flexible I/O configuration	1 = the inverter was disabled by the trigger set in <a href="#">0x2631:001 (P400.01)</a> .
	Bit 1 Network	1 = the inverter was disabled via network.
	Bit 2 Axis command	1 = the inverter was disabled via axis command .
	Bit 6 Fault DC-bus	1 = The inverter was disabled due to a DC-bus error.
	Bit 7 Drive not ready	1 = the inverter was disabled internally since the drive was not ready for operation.  Possible causes: • Under/overvoltage in the DC bus • Defective device hardware
	Bit 8 Quick stop active	1 = the inverter was disabled by the "Quick stop" function.
	Bit 9 Motor data identification	1 = the inverter was disabled by the "Automatic identification of the motor data" function.
	Bit 10 Holding brake	1 = the inverter was disabled by the "Holding brake control" function.
	Bit 11 DC braking	- 1 = DC braking active.
	Bit 12 CiA402 Inverter disabled	1 = the inverter was disabled by the internal state machine.  The bit is only set if • Operating mode <a href="#">0x6060 (P301.00)</a> = "CiA: Velocity mode (vl) [2]" and • state machine in the "Switch on disabled" state and • the state change has not been carried out via the "Disable operation" command.
	Bit 13 CiA402 Quick stop option code 2	1 = the inverter was disabled by the "Quick stop" function.
	Bit 14 Safety	1 = the inverter has been disabled by the integrated safety system.
	Bit 15 CiA402 operation mode 0	1 = the inverter has been disabled because the selection "No selection [0]" is set in <a href="#">0x6060 (P301.00)</a> .
0x282A:002 (P126.02)	Status words: Cause of quick stop (Status words: Cause of QSP) • Read only	Bit coded display of the cause(s) of quick stop.
	Bit 0 Flexible I/O configuration	1 = quick stop was activated by the trigger set in <a href="#">0x2631:003 (P400.03)</a> .
	Bit 1 Network	1 = quick stop was activated via network.
	Bit 2 Axis command	1 = quick stop was activated via axis command <a href="#">0x2822:003</a> .
	Bit 6 Error response	1 = quick stop has been activated as a response to an error.
0x282A:003 (P126.03)	Status words: Cause of stop (Status words: Cause of stop) • Read only	Bit coded display of the cause(s) of stop.
	Bit 0 Flexible I/O: Start disabled	1 = stop was activated by the trigger set in <a href="#">0x2631:002 (P400.02)</a> .
	Bit 1 Flexible I/O: Run forward	1 = stop has been activated due to cancellation of the command "Run forward (CW)".
	Bit 2 Flexible I/O: Run reverse	1 = stop has been activated due to cancellation of the command "Run reverse (CCW)".
	Bit 3 Flexible I/O: Jog forward	1 = stop has been activated due to cancellation of the command "Jog forward (CW)".
	Bit 4 Flexible I/O: Jog reverse	1 = stop has been activated due to cancellation of the command "Jog reverse (CCW)".
	Bit 5 Network	1 = stop was activated via network.
	Bit 6 Keypad	1 = stop was activated via keypad.
	Bit 7 Control mode transition	1 = stop has been activated due to a change of the operating mode.
	Bit 8 End of sequence	1 = stop was activated by the "sequencer" function since the sequence is completed.  • The bit is only set after the sequence is completed if End of sequence mode <a href="#">0x402F (P824.00)</a> is set = "Stop [1]" or "Stop and abort [2]".
	Bit 9 Manual mode	1 = Stop was activated by the "Manual mode" function.
	Bit 15 Waiting for start	1 = stop is active as a start command is not yet available (e. g. after enabling the inverter).

# Diagnostics and fault elimination

## Diagnostic parameters

### Inverter diagnostics



Address	Name / setting range / [default setting]	Information
0x282A:004	Status words: Extended status word • Read only	Bit-coded status word.
	Bit 8 Reverse rotational direction	1 = reversal active.
	Bit 10 Inverter disabled (safety)	1 = The safety system integrated in the inverter has disabled the inverter/drive.
	Bit 11 STO active	1 = "Safe Torque Off (STO)" safety function is active. Safe inputs SIA and SIB = LOW (simultaneously).
0x282A:005 (P126.05)	Status words: Device status (Status words: Device status) • Read only	Display of the current inverter device state.
	0 Initialisation	
	2 Not ready to switch on	
	3 Switch on disabled	
	4 Ready to switch on	
	5 Switched on	
	6 Operation enabled	
	7 Disable operation	
	8 Shut down	
	9 Quick stop active	
	10 Fault reaction active	
	11 Fault	
0x282B:001 (P125.01)	Inverter diagnostics: Active control source (Inverter diag.: Active control) • Read only	Display of the control source that is currently active.
	0 Flexible I/O configuration	
	1 Network	
	2 Keypad	
	8 Keypad full control	
	9 Manual mode	
0x282B:002 (P125.02)	Inverter diagnostics: Active setpoint source (Inverter diag.: Active setpoint) • Read only	Display of the setpoint source that is currently active.
	0 Not selected	
	1 Analog input 1	
	2 Analog input 2	
	3 Keypad Setpoint	
	4 HTL input	
	5 Network Setpoint	
	9 Manual mode: setpoint	
	11 Setpoint preset 1	
	12 Setpoint preset 2	
	13 Setpoint preset 3	
	14 Setpoint preset 4	
	15 Setpoint preset 5	
	16 Setpoint preset 6	
	17 Setpoint preset 7	
	18 Setpoint preset 8	
	19 Setpoint preset 9	
	20 Setpoint preset 10	
	21 Setpoint preset 11	
	22 Setpoint preset 12	
	23 Setpoint preset 13	
	24 Setpoint preset 14	
	25 Setpoint preset 15	
	31 Segment preset 1	
	32 Segment preset 2	



# Diagnostics and fault elimination







Diagnostic parameters  
Inverter diagnostics

Address	Name / setting range / [default setting]	Information
	33 Segment preset 3	
	34 Segment preset 4	
	35 Segment preset 5	
	36 Segment preset 6	
	37 Segment preset 7	
	38 Segment preset 8	
	39 Last segment	
	50 Motor potentiometer	
	51 PID setpoint (from version 04.00)	
	201 Internal value (from version 05.00)	Internal values of the manufacturer.
	202 Internal value (from version 05.00)	
	203 Internal value (from version 05.00)	
	204 Internal value (from version 05.00)	
	205 Internal value (from version 05.00)	
	206 Internal value (from version 05.00)	
0x282B:003 (P125.03)	Inverter diagnostics: Keypad LCD status (Inverter diag.: Keypad LCD stat.) • Read only	Bit-coded state of the keypad status displays.
	Bit 0 LOC	1 = local keypad control active.
	Bit 1 REM	1 = remote control via terminals, network, etc. active.
	Bit 2 MAN	1 = manual setpoint selection via keypad active.
	Bit 3 Auto	1 = automatic setpoint selection via terminals, network, etc. active.
	Bit 4 Set	1 = a parameter setting has been changed but not been saved yet in the memory module with mains failure protection .
0x282B:004 (P125.04)	Inverter diagnostics: Active drive mode (Inverter diag.: Drive mode) • Read only	Display of the active drive mode.
	0 Velocity mode	"Velocity mode" active.
	1 PID control	PID control active.
	2 Torque mode (from version 03.00)	"Torque mode" active.
	4 Jog operation	"Jog forward (CW)" or "Jog reverse (CCW)" function active.
0x2831	Inverter status word • Read only	Bit coded status word of the internal motor control.
	Bit 1 Speed setpoint 1 limited	1 = input of speed controller 1 in limitation.
	Bit 2 Speed controller in limitation	1 = output of speed controller 1 in limitation.
	Bit 3 Torque setpoint limited	1 = setpoint torque in limitation.
	Bit 4 Q-current setpoint limited	1 = setpoint current in limitation.
	Bit 5 Speed setpoint 2 limited	1 = input of speed controller 2 in "torque mode" in limitation.
	Bit 6 Upper speed limit active	1 = in "torque mode", the speed is limited to upper speed limit <a href="#">0x2946:001 (P340.01)</a> .
	Bit 7 Lower speed limit active	1 = in "torque mode", the speed is limited to lower speed limit <a href="#">0x2946:002 (P340.02)</a> .
	Bit 8 Flying restart active	-
	Bit 10 Output frequency limited	1 = setpoint frequency with V/f operation in limitation.
	Bit 11 Magnetization completed	1 = Magnetisation completed during V/f operation. Otherwise 0.
	Bit 12 Motor phase error	1 = motor phase failure detection active.
	Bit 14 Error reset blocking time active	1 = the error can only be reset when the blocking time has elapsed.
0x2833	Inverter status word 2 • Read only	Bit-coded status word 2 of the inverter.
	Bit 1 Manual test mode active	1 = manual test mode active.
	Bit 2 Manual control active	1 = manual control active.
	Bit 6 DC braking active	1 = DC braking active.
	Bit 15 UPS operation active	1 = UPS operation active.

# Diagnostics and fault elimination

Diagnostic parameters  
Inverter diagnostics



Address	Name / setting range / [default setting]	Information
0x293A (P116.00)	Actual switching frequency (Actual sw. freq.) • Read only	Display of the currently active switching frequency of the inverter.  Example: • "16 kHz variable / drive-optimized / 4 kHz min. [22]" is selected as switching frequency in 0x2939 (P305.00). • An increase of the ambient temperature and/or the load have caused a decrease of the switching frequency to 8 kHz. In this case, this parameter indicates the selection "8 kHz power loss-optimized [7]".
	1 2 kHz drive-optimized	
	2 4 kHz drive-optimized	
	3 8 kHz drive-optimized	
	4 16 kHz drive-optimized	
	5 2 kHz power loss-optimized	
	6 4 kHz power loss-optimized	
	7 8 kHz power loss-optimized	
8 16 kHz power loss-optimized		
0x2DAC (P119.00)	Keypad status (Keypad status) • Read only	Bit-coded display of the keypad status.
	Bit 0 Start Key	1 = keypad start key  pressed.
	Bit 1 Stop Key	1 = keypad stop key  pressed.
	Bit 2 Up arrow	1 = keypad up-arrow key  pressed.
	Bit 3 Down arrow	1 = keypad down-arrow key  pressed.
	Bit 4 Enter Key	1 = keypad enter key  pressed.
Bit 5 Back key	1 = keypad back key  pressed.	
0x2DAD (P120.00)	Internal hardware states (Int. HW states) • Read only	Bit-coded display of internal hardware states.
	Bit 0 Relay	0 = X9/NO-COM open and NC-COM closed. 1 = X9/NO-COM closed and NC-COM open.
	Bit 1 Digital output 1	0 = LOW level, 1 = HIGH level.
	Bit 2 Digital output 2	
Bit 10 Charge Relay	1 = precharging of the DC bus via charge relay is active.	
0x603F (P150.00)	Error code (Error code) • Read only	Error message
0x6061 (P788.00)	CiA: Active operation mode (Act. op. mode) • Read only	CiA: Active operation mode
	-2 MS: Velocity mode	Vendor specific velocity mode
	-1 MS: Torque mode (from version 03.00)	Manufacturer-specific torque mode
	0 No selection	No selection
2 CiA: Velocity mode (vl)	CiA: Velocity mode	



## 17.4.2 Network diagnostics

The following parameters show some general information with regard to the network option available and the network.

### Parameter

Address	Name / setting range / [default setting]	Information	
0x231F:001 (P500.01)	Communication module ID: Active module ID (Module ID: Active module ID) <ul style="list-style-type: none"> <li>Read only</li> </ul>	Display of the network options currently configured in the device. <ul style="list-style-type: none"> <li>With the help of this module ID, the keypad only shows the communication parameters relevant to the respective network.</li> </ul> <b>Note!</b> When switched on, the device checks whether the parameter settings saved in the memory module match the device hardware and firmware. In case of an incompatibility, a corresponding error message is output. For details see chapter " <a href="#">Behaviour of the inverter in case of incompatible data in the memory module</a> " (section "Hardware and firmware updates/downgrades"). <a href="#">583</a>	
	48	No network	
	67	CANopen	
	71	EtherNet/IP (from version 02.00)	
	72	BACnet	
	73	IO-Link	
	78	POWERLINK (from version 05.00)	
	80	PROFIBUS	
	82	PROFINET (from version 02.00)	
	84	EtherCAT (from version 02.00)	
	86	Modbus TCP/IP	
87	Modbus		
0x231F:002 (P500.02)	Communication module ID: Module ID connected (Module ID: Module ID conn.) <ul style="list-style-type: none"> <li>Read only</li> <li>For the meaning of the display, see parameter <a href="#">0x231F:001 (P500.01)</a>. <a href="#">693</a></li> </ul>	Display of the network options currently available in the device.  <b>Note!</b> When switched on, the device checks whether the parameter settings saved in the memory module match the device hardware and firmware. In case of an incompatibility, a corresponding error message is output. For details see chapter " <a href="#">Behaviour of the inverter in case of incompatible data in the memory module</a> " (section "Hardware and firmware updates/downgrades"). <a href="#">583</a>	
0x282B:005 (P125.05)	Inverter diagnostics: Most recently used control register (Inverter diag.: Netw. contr.reg.) <ul style="list-style-type: none"> <li>Read only</li> </ul>	Display of the network register for the control that was accessed last (e. g. 0x6040 or 0x400B:1). <ul style="list-style-type: none"> <li>Format: 0xiiii00 (iiii = hexadecimal index, ss = hexadecimal subindex)</li> <li>The lowest byte is always 0x00.</li> </ul>	
0x282B:006 (P125.06)	Inverter diagnostics: Most recently used setpoint register (Inverter diag.: Netw. setp.reg.) <ul style="list-style-type: none"> <li>Read only</li> </ul>	Display of the network register for setpoint selection that was accessed last (e. g. 0x6042 or 0x400B:3). <ul style="list-style-type: none"> <li>Format: 0xiiiiss00 (iiii = hexadecimal index, ss = hexadecimal subindex)</li> <li>The lowest byte is always 0x00.</li> </ul>	

### Related topics

► [Configuring the network](#) [310](#)

# Diagnostics and fault elimination

Diagnostic parameters  
I/O diagnostics  
Digital inputs and outputs



## 17.4.3 I/O diagnostics

This section describes the diagnostics of the analog and digital inputs and outputs that can be found on the control terminal X3.

### 17.4.3.1 Digital inputs and outputs

The following parameters serve to diagnose the digital inputs and outputs of the inverter.

#### Parameter

Address	Name / setting range / [default setting]	Information
0x60FD (P118.00)	Digital input status (Digital inputs) • Read only	Bit coded display of the current status of the digital inputs
	Bit 16 Digital input 1	0 = LOW level, 1 = HIGH level.
	Bit 17 Digital input 2	Digital input 6 and digital input 7 are only available with application I/O.
	Bit 18 Digital input 3	
	Bit 19 Digital input 4	
	Bit 20 Digital input 5	
	Bit 21 Digital input 6	
	Bit 22 Digital input 7	
	Bit 25 Internal interconnection of digital inputs	0 = digital inputs are internally set to HIGH (NPN) level via pull-up resistors. 1 = digital inputs are internally set to LOW (PNP) level via pull-down resistors.
0x2DAD (P120.00)	Internal hardware states (Int. HW states) • Read only	Bit-coded display of internal hardware states.
	Bit 0 Relay	0 = X9/NO-COM open and NC-COM closed. 1 = X9/NO-COM closed and NC-COM open.
	Bit 1 Digital output 1	0 = LOW level, 1 = HIGH level.
	Bit 2 Digital output 2	
	Bit 10 Charge Relay	1 = precharging of the DC bus via charge relay is active.
0x4016:005	Digital output 1: Terminal state • Read only	Display of the logic state of output terminal X3/DO1.
	0 FALSE	
	1 TRUE	
0x4016:006	Digital output 1: Trigger signal state • Read only	Display of the logic state of the trigger signal for digital output 1 (without taking a ON/OFF delay set and inversion into consideration).
	0 FALSE	
	1 TRUE	
0x4017:005	Digital output 2: Terminal state • Read only	Display of the logic state of output terminal X3/DO2.
	0 FALSE	
	1 TRUE	
0x4017:006	Digital output 2: Trigger signal state • Read only	Display of the logic state of the trigger signal for digital output 2 (without taking a ON/OFF delay set and inversion into consideration).
	0 FALSE	
	1 TRUE	
0x4018:005	Relay: Relay state • Read only	Display of the logic state of the relay.
	0 FALSE	
	1 TRUE	



Address	Name / setting range / [default setting]	Information
0x4018:006	Relay: Trigger signal state	Display of the logic state of the trigger signal for the relay (without taking a ON/OFF delay set and inversion into consideration).
	• Read only	
	0 FALSE	
	1 TRUE	

## Related topics

▶ [Configure digital inputs](#) 272

▶ [Configure digital outputs](#) 292

### 17.4.3.2 Analog inputs and outputs

The following parameters serve to diagnose the analog inputs and outputs of the inverter.

#### Parameter

Address	Name / setting range / [default setting]	Information
0x2DA4:001 (P110.01)	Diagnostics of analog input 1: Value in percent (AI1 diagnostics: AI1 terminal %) • Read only: x.x %	Display of the current input value at X3/AI1 scaled as value in percent. • 100 % = 10 V or 20 mA or 5 V
0x2DA4:002 (P110.02)	Diagnostics of analog input 1: Frequency value (AI1 diagnostics: AI1 scaled freq.) • Read only: x.x Hz	Display of the current input value at X3/AI1 scaled as a frequency value. • The standard setpoint source for operating mode 0x6060 (P301.00) = "MS: Velocity mode [-2]" is selected in 0x2860:001 (P201.01).
0x2DA4:003 (P110.03)	Diagnostics of analog input 1: Process controller value (AI1 diagnostics: AI1 scaled PID) • Read only: x.xx PID unit	Display of the current input value at X3/AI1 scaled as a process controller value. • The standard setpoint source for the reference value of PID control is selected in 0x2860:002 (P201.02).
0x2DA4:004 (P110.04)	Diagnostics of analog input 1: Torque value (AI1 diagnostics: AI1 scaled torq.) • Read only: x.x %	Display of the current input value at X3/AI1 scaled as a percentage torque value. • 100 % = permissible maximum torque 0x6072 (P326.00) • The standard setpoint source for operating mode 0x6060 (P301.00) = "MS: Torque mode [-1]" is selected in 0x2860:003 (P201.03).
0x2DA4:016 (P110.16)	Diagnostics of analog input 1: Status (AI1 diagnostics: AI1 status) • Read only • From version 04.00	Bit coded display of the status of analog input 1 (X3/AI1).
	Bit 0 Mode 0: 0 ... 10 VDC active	
	Bit 1 Mode 1: 0 ... 5 VDC active	
	Bit 2 Mode 2: 2 ... 10 VDC active	
	Bit 3 Mode 3: -10 ... 10 VDC active	
	Bit 4 Mode 4: 4 ... 20 mA active	
	Bit 5 Mode 5: 0 ... 20 mA active	
	Bit 6 24 V supply OK	
	Bit 7 Calibration successful	
	Bit 8 Monitoring threshold exceeded/not reached	
	Bit 9 Input current too low (mode 4)	
	Bit 10 Input voltage too low (mode 2)	
	Bit 11 Input voltage too high (mode 4)	
0x2DA5:001 (P111.01)	Diagnostics of analog input 2: Value in percent (AI2 diagnostics: AI2 terminal %) • Read only: x.x %	Display of the current input value at X3/AI2 scaled as a value in percent. • 100 % = 10 V or 20 mA or 5 V
0x2DA5:002 (P111.02)	Diagnostics of analog input 2: Frequency value (AI2 diagnostics: AI2 scaled freq.) • Read only: x.x Hz	Display of the current input value at X3/AI2 scaled as a frequency value. • The standard setpoint source for operating mode 0x6060 (P301.00) = "MS: Velocity mode [-2]" is selected in 0x2860:001 (P201.01).
0x2DA5:003 (P111.03)	Diagnostics of analog input 2: Process controller value (AI2 diagnostics: AI2 scaled PID) • Read only: x.xx PID unit	Display of the current input value at X3/AI2 scaled as a process controller value. • The standard setpoint source for the reference value of PID control is selected in 0x2860:002 (P201.02).

# Diagnostics and fault elimination

Diagnostic parameters  
Service life diagnostics  
Analog inputs and outputs



Address	Name / setting range / [default setting]	Information
0x2DA5:004 (P111.04)	Diagnostics of analog input 2: Torque value (AI2 diagnostics: AI2 scaled torq.) • Read only: x.x %	Display of the current input value at X3/AI2 scaled as a percentage torque value. • 100 % = permissible maximum torque <a href="#">0x6072 (P326.00)</a>
0x2DA5:016 (P111.16)	Diagnostics of analog input 2: Status (AI2 diagnostics: AI2 status) • Read only • From version 04.00	Bit-coded display of the status of analog input 2 (X3/AI2).
Bit 0	Mode 0: 0 ... 10 VDC active	
Bit 1	Mode 1: 0 ... 5 VDC active	
Bit 2	Mode 2: 2 ... 10 VDC active	
Bit 3	Mode 3: -10 ... 10 VDC active	
Bit 4	Mode 4: 4 ... 20 mA active	
Bit 5	Mode 5: 0 ... 20 mA active	
Bit 6	24 V supply OK	
Bit 7	Calibration successful	
Bit 8	Monitoring threshold exceeded/not reached	
Bit 9	Input current too low	
Bit 10	Input voltage too low	
Bit 11	Input voltage too high	
0x2DAA:001 (P112.01)	Diagnostics of analog output 1: Voltage (AO1 diagnostics: AO1 Voltage) • Read only: x.xx V	Display of the current output voltage at X3/AO1.
0x2DAA:002 (P112.02)	Diagnostics of analog output 1: Current (AO1 diagnostics: AO1 Current) • Read only: x.xx mA	Display of the present output current at X3/AO1.
0x2DAB:002 (P113.02)	Diagnostics of analog output 2: Current (AO2 diagnostics: AO2 Voltage) • Read only: x.xx mA	Display of the present output current at X3/AO2.
0x2DAB:001 (P113.01)	Diagnostics of analog output 2: Voltage (AO2 diagnostics: AO2 Current) • Read only: x.xx V	Display of the current output voltage at X3/AO2.

## Related topics

▶ [Configure analog inputs](#) 284

▶ [Configure analog outputs](#) 305

## 17.4.4 Service life diagnostics

The following parameters provide some information about the use of the inverter.

This includes the following information:

- Operating and power-on time of the inverter/control unit
- Operating time of the internal fan
- Number of switching cycles of the mains voltage
- Number of switching cycles of the relay
- Number of short-circuits and earth faults that have occurred
- Display of the number of "Clamp responded too often" errors that have occurred.

## Parameter

Address	Name / setting range / [default setting]	Information
0x2D81:001 (P151.01)	Life-diagnosis: Operating time (Life-diagnosis: Operating time) • Read only: x s	Display showing for how long the device has been running so far (device status "operation enabled").
0x2D81:002 (P151.02)	Life-diagnosis: Power-on time (Life-diagnosis: Power-on time) • Read only: x s	Display showing for how long the device has been supplied with line voltage so far.





Address	Name / setting range / [default setting]	Information
0x2D81:003 (P151.03)	Life-diagnosis: Control unit operating time (Life-diagnosis: CU oper. time) • Read only: x ns	Display showing for how long the control unit has been supplied with voltage so far. This includes the external 24-V supply and voltage supply via USB module.
0x2D81:004 (P151.04)	Life-diagnosis: Main switching cycles (Life-diagnosis: Switching cycles) • Read only	Display of the number of switching cycles of the mains voltage.
0x2D81:005 (P151.05)	Life-diagnosis: Relay switching cycles (Life-diagnosis: Relay cycles) • Read only	Display of the number of switching cycles of the relay.
0x2D81:006 (P151.06)	Life-diagnosis: Short-circuit counter (Life-diagnosis: Short-circ.count) • Read only	Display of the number of short circuits that have occurred.
0x2D81:007 (P151.07)	Life-diagnosis: Earth fault counter (Life-diagnosis: Earthfault count) • Read only	Display of the number of earth faults that have occurred.
0x2D81:008 (P151.08)	Life-diagnosis: Clamp active (Life-diagnosis: Clamp active) • Read only	Display of the number of "Clamp responded too often" errors that have occurred. • "Clamp" = short-time inhibit of the inverter in V/f operation when the current limit shown in 0x2DDF:002 is reached.
0x2D81:009 (P151.09)	Life-diagnosis: Fan operating time (Life-diagnosis: Fan oper. time) • Read only: x s	Display showing for how long the internal fan has been running so far.

## 17.4.5 Device identification

The following parameters show some general information about the inverter.

### Parameter

Address	Name / setting range / [default setting]	Information
0x2000:001 (P190.01)	Device data: Product code (Device data: Product code) • Read only	Product code of the complete device. Example: "I55AE155D10V10017S" • If control unit and power unit were ordered separately, the product code "XXXXXXXXXXXXXXXXXXXX" is displayed.
0x2000:002 (P190.02)	Device data: Serial number (Device data: Serial number) • Read only	Serial number of the complete device. Example: "0000000000000000XYZYXZ" • If control unit and power unit were ordered separately, the serial number "XXXXXXXXXXXXXXXXXXXX" is displayed.
0x2000:004 (P190.04)	Device data: CU firmware version (Device data: CU firmware ver.) • Read only	Firmware version of the control unit. Example: "01.00.01.00"
0x2000:005 (P190.05)	Device data: CU firmware type (Device data: CU firmware type) • Read only	Firmware type of the control unit. Example: "IOFW51AC10"
0x2000:006 (P190.06)	Device data: CU bootloader version (Device data: CU bootlader ver.) • Read only	Bootloader version of the control unit. Example: "2015.10-20180517"
0x2000:007 (P190.07)	Device data: CU bootloader type (Device data: CU bootlader type) • Read only	Bootloader type of the control unit. Example: "IOBL51AOnn"
0x2000:008 (P190.08)	Device data: Object directory version (Device data: OBD version) • Read only	Example: "108478"
0x2000:010 (P190.10)	Device data: PU firmware version (Device data: PU firmware ver.) • Read only	Firmware version of the power unit. Example: "00202"
0x2000:011 (P190.11)	Device data: PU firmware type (Device data: PU firmware type) • Read only	Firmware type of the power unit. Example: "IDFW5AA"

# Diagnostics and fault elimination

Diagnostic parameters

Device identification



Address	Name / setting range / [default setting]	Information
0x2000:012 (P190.12)	Device data: PU bootloader version (Device data: PU bootlder ver.) <ul style="list-style-type: none"><li>• Read only</li></ul>	Bootloader version of the power unit.
0x2000:013 (P190.13)	Device data: PU bootloader type (Device data: PU bootlder type) <ul style="list-style-type: none"><li>• Read only</li></ul>	Bootloader type of the power unit.
0x2000:014 (P190.14)	Device data: Module - firmware version (Device data: Mod. firmware) <ul style="list-style-type: none"><li>• Read only</li></ul>	Firmware version of the plugged-in module (e.g. WLAN module).
0x2000:015 (P190.15)	Device data: Communication firmware revision number (Device data: Com. FW rev no.) <ul style="list-style-type: none"><li>• Read only</li></ul>	Firmware version of the network option.
0x2000:016 (P190.16)	Device data: Communication bootloader revision number (Device data: ComBootlderRevNo) <ul style="list-style-type: none"><li>• Read only</li></ul>	Bootloader version of the network option.
0x2000:017 (P190.17)	Device data: CU firmware subtype (Device data: CU FW subtype) <ul style="list-style-type: none"><li>• Read only</li></ul>	Additional information on the firmware.
0x2002:004 (P192.04)	Device module: CU type code (Device module: CU type code) <ul style="list-style-type: none"><li>• Read only</li></ul>	Type code of the control unit
0x2002:005 (P192.05)	Device module: PU type code (Device module: PU type code) <ul style="list-style-type: none"><li>• Read only</li></ul>	Type code of the power unit.
0x2002:006 (P192.06)	Device module: CU serial number (Device module: CU serial number) <ul style="list-style-type: none"><li>• Read only</li></ul>	Serial number of the control unit.
0x2002:007 (P192.07)	Device module: PU serial number (Device module: PU serial number) <ul style="list-style-type: none"><li>• Read only</li></ul>	Serial number of the power unit.



## 17.5 Event handling

The inverter has various monitoring functions that protect the drive against impermissible operating conditions.

If monitoring functions respond, events with different levels of severity are triggered.



## 17.5.1 Severity

The severity of an event determines the response of the inverter.

The events are logged in different places.

### Severity "No response"

The event is completely ignored (does not affect the running process).

### Severity "Warning"

The event does not severely affect the process and may be also ignored in consideration of safety aspects.

### Severity "Fault"

The motor is brought to a standstill with the quick stop ramp.

- The inverter will only be disabled after the quick stop is executed (motor at standstill) or after the time-out time set in [0x2826](#) has been elapsed. ▶ [Timeout for error response](#)  
[701](#)
- **Exception:** In case of a serious fault, the inverter is disabled immediately. The motor has no torque (coasts). For details see the table "[Event ID overview](#)". [705](#)

### Severity "Trouble"

Just like "Fault", but the error state will be left automatically if the error condition is not active anymore.



- **Exception:** In case of a severe trouble, the inverter is disabled immediately. The motor has no torque (coasts). For details see the table "[Event ID overview](#)". [705](#)
- The restart behaviour after trouble can be configured. ▶ [Automatic restart after a fault](#) [579](#)



In the operating mode [0x6060 \(P301.00\)](#) = "CiA: Velocity mode (vl) [2]", the behaviour in case of "Trouble" is just like in case of "Fault"!

## Comparison of the severities

The following table compares the main differences of the severities:

Severity	Logging in the Error history buffer / Logbook	Display in the CiA status word <a href="#">0x6041 (P780.00)</a>	Inverter disable	Motor stop	Error reset is required	"ERR" LED (red)
No response	No	No	No	No	No	off
Warning	Yes	yes, bit 7	No	No	No	 blinking fast (4 Hz)
Trouble	Yes	yes, bit 3	after quick stop or immediately.	quick stop ramp or coasting.	No	 blinking (1 Hz)
Fault	Yes	yes, bit 3	For details see table " <a href="#">Event ID overview</a> ". <a href="#">705</a>		Yes	 on



## 17.5.1.1 Timeout for error response

If an error occurs that does not immediately cause a switch-off, the "Fault reaction active" device status initially becomes active. The motor is brought to a standstill with quick stop ramp. The change to the device status "Fault" is only made after the quick stop (motor at standstill) has been executed or after an adjustable timeout time has expired.



Disabling the inverter interrupts the quick stop ramp. The drive coasts immediately.

### Details

In the device status "Fault reaction active"

- only the parameters of the inverter can be changed that do not require an inverter disable.
- If a holding brake in brake mode `0x2820:001 (P712.01)` = "Automatically (via device state) [0]" is triggered for closing,
- the motor control continues to be operable.

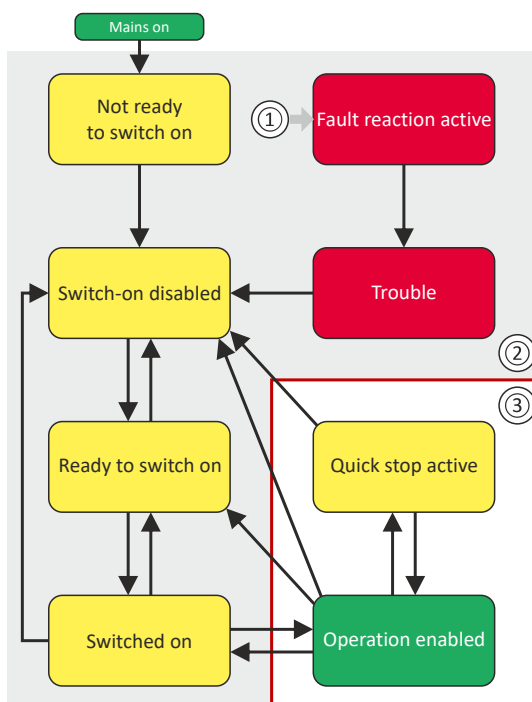

- ① From all states
- ② Power section disabled (pulse inhibit)
- ③ Power section enabled

Diagnostic parameters:

- `0x282A:005 (P126.05)` displays the current device status of the inverter

### Parameter

Address	Name / setting range / [default setting]	Information
0x2826	Timeout for error response -> quickstop 0.0 ... [6.0] ... 100.0 s	This timer is started when a change-over to the "Fault reaction active" device status takes place. If the motor is still rotating after the time-out time has elapsed, a change-over to the "Fault" device status takes place. <ul style="list-style-type: none"> <li>• In case of a serious error, an immediate change-over to the "Fault" device status takes place.</li> </ul> <b>⚠ CAUTION!</b> Changing this parameter may cause a longer ramptime in the event of an error. This must be considered when changing this parameter.

### Related topics

- ▶ [Automatic restart after a fault](#) 579



## 17.5.2 Configuring the severity

For certain events, the severity level can be configured via parameters. This allows the response to be adapted to the application.

In the overview of event IDs you will find the preset for each event and, if necessary, the parameter with which you can adjust the severity.

▶ [Event ID overview](#) 705

## 17.5.3 Error reset

An event with the severity level "Error" must be reset so that inverter operation can be continued.

Resetting is possible only when the cause of triggering the event has been eliminated.

Options for resetting an error:

- Via the keypad key . ▶ [Error reset with keypad](#) 639
- Via the trigger assigned to the "Reset fault" function.
- Via the button in the »EASY Starter« ("Diagnostics" tab).
- In the default setting of [0x400E:008 \(P505.08\)](#) via bit 7 in the mappable data word [NetWordIN1 0x4008:001 \(P590.01\)](#).
- Via bit 7 in the mappable CiA control word [0x6040](#).
- Via bit 2 in the mappable AC Drive control word [0x400B:001 \(P592.01\)](#).
- Via bit 11 in the mappable LECOM control word [0x400B:002 \(P592.02\)](#).

Notes:

- Certain errors can only be reset by mains switching.
- Certain errors (e. g. earth fault or short circuit of the motor phases) may cause a blocking time. In this case, the error can be reset only after the blocking time has elapsed. An active blocking time is displayed via bit 14 in the inverter status word [0x2831](#).

The "[Events, causes and remedies](#)" table gives the blocking time (if available) for each error.

This table also shows whether mains switching is required for the error reset. 705

### Parameter

Address	Name / setting range / [default setting]	Information
0x2631:004 (P400.04)	Function list: Reset fault (Function list: Reset fault) • Further possible settings: ▶ <a href="#">Trigger list</a> 73	Assignment of a trigger for the "Reset fault" function. Trigger = FALSE↗TRUE (edge): The active error is reset (acknowledged) if the error condition no longer exists and the error is resettable. Trigger = FALSE: no action.
	<b>12</b> Digital input 2	State of X3/DI2, taking an inversion set in <a href="#">0x2632:002 (P411.02)</a> into consideration.



Address	Name / setting range / [default setting]	Information
0x2839:006 (P760.06)	Fault configuration: Fault handling in case of state change (Fault config.: FaultStateChange)	Selection whether a pending error is to be reset via the functions "Enable inverter" 0x2631:001 (P400.01) and "Run" 0x2631:002 (P400.02) as well.
	<b>0</b> Reset fault	
	1 Do not reset fault	

### Example for operating mode

- Switch S1 starts the motor in forward direction of rotation. De-asserting switch S1 stops the motor again.
- Switch S2 resets the current error if the error condition is not active anymore and the error is resettable.
- The switches/sensors S3 and S4 serve to set the inverter from the process to the error status. ▶ [User-defined error triggering](#) 580

Connection plan	Function
	Potentiometer R1 Frequency setpoint selection
	Switch S1 Run
	Switch S2 Reset fault
	Switch S3 Activate fault 1
	Switch S4 Activate fault 2

Parameter	Designation	Setting for this example
0x2631:001 (P400.01)	Enable inverter	Constant TRUE [1]
0x2631:002 (P400.02)	Run	Digital input 1 [11]
0x2631:004 (P400.04)	Reset fault	Digital input 2 [12]
0x2631:013 (P400.13)	Reverse rotational direction	Not connected [0]
0x2631:018 (P400.18)	Activate preset (bit 0)	Not connected [0]
0x2631:043 (P400.43)	Activate fault 1	Digital input 3 [13]
0x2631:044 (P400.44)	Activate fault 2	Digital input 4 [14]
0x2824 (P200.00)	Control selection	Flexible I/O configuration [0]
0x2838:003 (P203.03)	Stop method	Standard ramp [1]
0x2860:001 (P201.01)	Frequency control: Default setpoint source	Analog input 1 [2]
0x2918 (P221.00)	Deceleration time 1	5.0 s
0x291C (P225.00)	Quick stop deceleration time	1.0 s

# Diagnostics and fault elimination

Event handling  
Error reset



The following signal flow illustrates the reset of an error both with the "Reset error" function ② and by cancelling the start command ④:

## Input signals

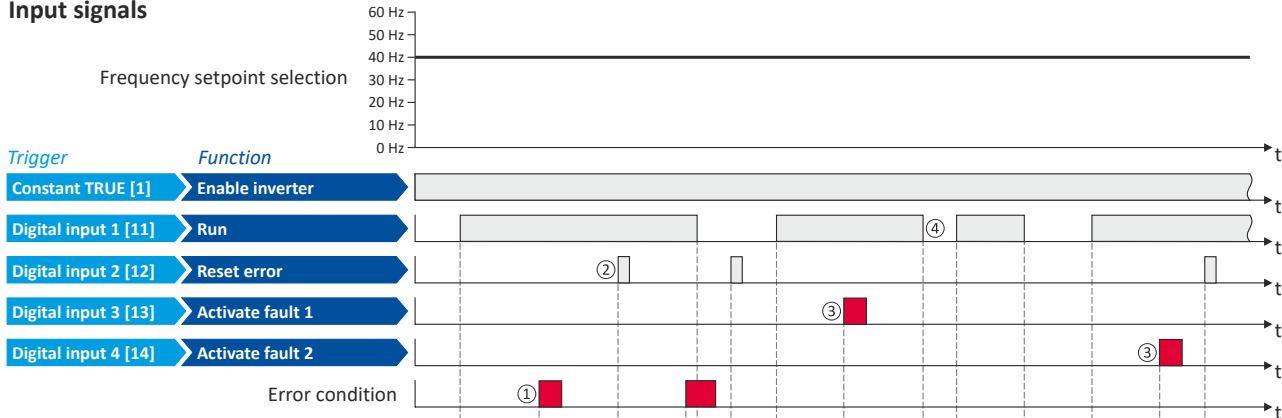

## Output signals

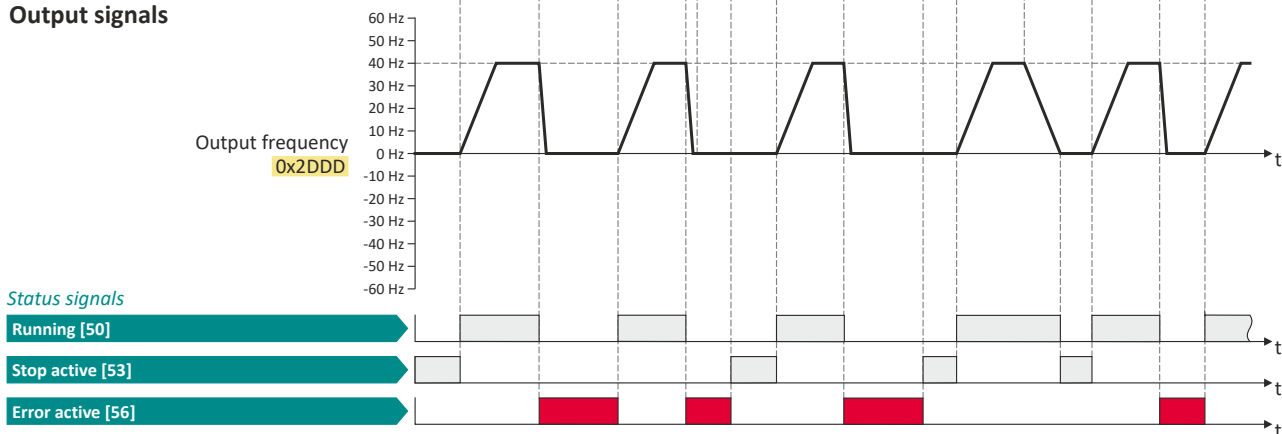

The status signals can be assigned to digital outputs. ▶ [Configure digital outputs](#) 292

- ① If an error condition is active in the inverter, the motor is brought to a standstill with the quick stop ramp. The inverter is then disabled.  
Exception: In case of a serious error, the inverter is disabled immediately. The motor has no torque (coasts).
- ② If the error can be reset, the error state can be left again with the "Reset fault" function (if the error condition no longer exists). The motor accelerates again to the setpoint since the start command is still active.
- ③ The functions "Activate fault 1" and "Activate fault 2" serve to set the inverter from the process to the error status.
- ④ If the error can be reset, the cancelled start command results in leaving the error state (if the error condition no longer exists).





## 17.6 Events, causes and remedies



The monitoring functions of the respective network are only active when network control is activated.

▶ [Activate network control](#) 311



If the message "KP.Error" is displayed on the keypad, this is due to one of the following causes:

- Firmware update not completed successfully.
- Internal error

Remedy:

- Update the inverter firmware to the latest version.
- If the error persists, the control unit or the device must be replaced. For this purpose, please contact the manufacturer.

### 17.6.1 Event ID overview

The following table contains the most important event IDs of the device in ascending order.

- Clicking the event ID shows you a detailed description of the event.
- If the device displays an "internal event" that is not listed here, restart the device. If the event persists, make a note of the event ID and contact the manufacturer.

Event ID	Event	Severity	Configurable in
8784	0x2250 CiA: Continuous over current (internal)	Fault	-
8992	0x2320 Short circuit or earth leakage at the motor end	Fault	-
9024	0x2340 Short circuit at the motor end	Fault	-
9040	0x2350 CiA: i <sup>2</sup> t overload (thermal state)	Fault	<a href="#">0x2D4B:003 (P308.03)</a>
9090	0x2382 Fault - Device utilization (ixt) too high	Fault	<a href="#">0x2D40:005 (P135.05)</a>
9091	0x2383 Warning - Device utilization (ixt) too high	Warning	-
9095	0x2387 Clamp responded too often	Fault	-
9096	0x2388 SL-PSM stall detection active	Trouble	-
9098	0x238A Maximum current reached	Information	-
12576	0x3120 Mains phase fault	Fault	-
12672	0x3180 UPS operation active	Warning	-
12816	0x3210 Fault - DC bus overvoltage	Fault	-
12817	0x3211 DC bus overvoltage warning	Warning	-
12832	0x3220 Fault - DC bus undervoltage	Trouble	-
12833	0x3221 DC bus undervoltage warning	Warning	-
12834	0x3222 DC-bus voltage to low for power up	Warning	-
16912	0x4210 Fault - Power unit overtemperature	Fault	-
17024	0x4280 Fault - Heat sink temperature sensor	Fault	-
17025	0x4281 Heat sink fan warning	Warning	-
17029	0x4285 PU overtemperature warning	Warning	-
17168	0x4310 Motor overtemperature	Fault	<a href="#">0x2D49:002 (P309.02)</a>
20754	0x5112 External supply voltage critical	Warning	-
20864	0x5180 Overload 24 V supply	Warning	-
21376	0x5380 OEM hardware incompatible	Fault	-
24970	0x618A Warning - Internal fan	Warning	-
25216	0x6280 Trigger/functions connected incorrectly	Trouble	-
25217	0x6281 User-defined fault 1	Fault	-
25218	0x6282 User-defined fault 2	Fault	-
25232	0x6290 Warning invert rotation	Warning	-
25233	0x6291 Maximum allowed troubles exceeded	Fault	-
25248	0x62A0 User-defined fault (LECOM)	Fault	-
25249	0x62A1 Network: user fault 1	Fault	-

# Diagnostics and fault elimination

Events, causes and remedies

Event ID overview



Event ID	Event	Severity	Configurable in
25250	0x62A2 Network: user fault 2	Fault	-
25265	0x62B1 NetWordIN1 configuration incorrect	Trouble	-
25266	0x62B2 Changed device ID not yet active	Fault	-
25267	0x62B3 Default settings not yet active	Fault	-
25505	0x63A1 CU: load error ID tag	Fault	-
25506	0x63A2 PU: load error ID tag	Fault	-
25507	0x63A3 Power unit unknown	Fault	-
28800	0x7080 Assertion level monitoring (Low/High)	Fault	-
28801	0x7081 Fault - Analog input 1	Fault	<a href="#">0x2636:010 (P430.10)</a>
28802	0x7082 Analog input 2 fault	Fault	<a href="#">0x2637:010 (P431.10)</a>
28803	0x7083 HTL input fault	No response	<a href="#">0x2641:006 (P416.06)</a>
28833	0x70A1 Analog output 1 fault	Warning	-
28834	0x70A2 Analog output 2 fault	Warning	-
28961	0x7121 Fault - Pole position identification	Fault	<a href="#">0x2C60</a>
29056	0x7180 Motor overcurrent	Fault	<a href="#">0x2D46:002 (P353.02)</a>
29445	0x7305 Encoder open circuit	Warning	<a href="#">0x2C45 (P342.00)</a>
29573	0x7385 Feedback system: speed limit	Warning	-
30336	0x7680 Memory module is full	Warning	-
30337	0x7681 Memory module not present	Fault	-
30338	0x7682 Invalid user data	Fault	-
30340	0x7684 Data not compl. saved before powerdown	Warning	-
30345	0x7689 Memory module: invalid OEM data	Warning	-
30346	0x768A Memory module: wrong type	Fault	-
30352	0x7690 EPM firmware version incompatible	Fault	-
30353	0x7691 EPM data: firmware type incompatible	Fault	-
30354	0x7692 EPM data: new firmware type detected	Fault	-
30355	0x7693 EPM data: PU size incompatible	Fault	-
30356	0x7694 EPM data: new PU size detected	Fault	-
30357	0x7695 Invalid parameter changeover configuration	Warning	-
30358	0x7696 EPM data: unknown parameter found	Information	-
30359	0x7697 Parameter changes lost	Fault	-
33042	0x8112 Network - Time-out explicit message	Warning	<a href="#">0x2859:006 (P515.06)</a>
33044	0x8114 Network - Overall communication time-out	Warning	<a href="#">See details for 33044</a>
33045	0x8115 Time-out (PAM)	No response	<a href="#">0x2552:004 (P595.04)</a>
33046	0x8116 Modbus TCP master time-out	Fault	<a href="#">0x2859:008 (P515.08)</a>
33047	0x8117 Modbus TCP Keep Alive time-out	Fault	<a href="#">0x2859:009 (P515.09)</a>
33154	0x8182 CAN: bus off	Trouble	<a href="#">0x2857:010</a>
33155	0x8183 CAN: warning	Warning	<a href="#">0x2857:011</a>
33156	0x8184 CAN: heartbeat time-out consumer 1	Fault	<a href="#">0x2857:005</a>
33157	0x8185 CAN: heartbeat time-out consumer 2	Fault	<a href="#">0x2857:006</a>
33158	0x8186 CAN: heartbeat time-out consumer 3	Fault	<a href="#">0x2857:007</a>
33159	0x8187 CAN: heartbeat time-out consumer 4	Fault	<a href="#">0x2857:008</a>
33168	0x8190 Network - Watchdog time-out	Trouble	<a href="#">See details for 33168</a>
33169	0x8191 Network - Disruption of cyclic data exchange	No response	<a href="#">0x2859:002 (P515.02)</a>
33170	0x8192 Network - Initialization error	Trouble	<a href="#">See details for 33170</a>
33171	0x8193 Network - Invalid cyclic process data	Trouble	<a href="#">See details for 33171</a>
33185	0x81A1 Modbus: network time-out	Fault	<a href="#">0x2858:001 (P515.01)</a>
33186	0x81A2 Modbus: incorrect request by master	Warning	-
33200	0x81B0 Network communication faulty	Trouble	-
33381	0x8265 POWERLINK: Loss of SoC	Trouble	<a href="#">0x2859:011</a>
33382	0x8266 POWERLINK: CRC error	Trouble	<a href="#">0x2859:010</a>
33414	0x8286 Network - PDO mapping error	Trouble	<a href="#">See details for 33414</a>
33425	0x8291 CAN: RPDO1 time-out	Fault	<a href="#">0x2857:001</a>
33426	0x8292 CAN: RPDO2 time-out	Fault	<a href="#">0x2857:002</a>
33427	0x8293 CAN: RPDO3 time-out	Fault	<a href="#">0x2857:003</a>



# Diagnostics and fault elimination

Events, causes and remedies

Event ID overview

Event ID	Event	Severity	Configurable in
33553	0x8311 Torque limit reached	No response	0x2D67:001 (P329.01)
33664	0x8380 Function not allowed in selected operating mode	Warning	-
36992	0x9080 Keypad removed	Fault	-
65282	0xFF02 Fault - Brake resistor overload	Fault	0x2550:011 (P707.11)
65285	0xFF05 Safety option - Internal error	Fault	-
65286	0xFF06 Motor overspeed	Fault	0x2D44:002 (P350.02)
65289	0xFF09 Motor phase missing	No response	0x2D45:001 (P310.01)
65290	0xFF0A Motor phase failure phase U	No response	0x2D45:001 (P310.01)
65291	0xFF0B Motor phase failure phase V	No response	0x2D45:001 (P310.01)
65292	0xFF0C Motor phase failure phase W	No response	0x2D45:001 (P310.01)
65305	0xFF19 Motor parameter identification fault	Fault	-
65311	0xFF1F FMF Error	Fault	-
65317	0xFF25 Cascading overload	Warning	-
65334	0xFF36 Warning - Brake resistor overload	Warning	0x2550:010 (P707.10)
65335	0xFF37 Automatic start disabled	Fault	-
65336	0xFF38 Load loss detected	No response	0x4006:003 (P710.03)
65337	0xFF39 Motor overload	No response	0x4007:003
65366	0xFF56 Maximum motor frequency reached	Warning	-
65370	0xFF5A Manual mode disabled	Warning	-
65371	0xFF5B Manual mode activated	Warning	-
65372	0xFF5C Manual mode time-out	Fault	-
65393	0xFF71 Wrong password	Warning	-
65394	0xFF72 Warning	Warning	-
65395	0xFF73 Fatal Error	Fault	-
65396	0xFF74 Power unit fatal error	Fault	-
65413	0xFF85 Keypad full control active	Warning	-



## 17.6.2 Causes and remedies

8784 | 0x2250 **CiA: Continuous over current (internal)**

Keypad display: **PU over current**

Cause	Remedy	Severity/response
<ul style="list-style-type: none"> <li>Continuous overcurrent on the inverter/motor side.</li> <li>Overcurrent at the brake chopper (brake transistor).</li> <li>DC bus relay has not been closed due to a malfunction.</li> </ul>	<ul style="list-style-type: none"> <li>Check motor and wiring for short circuits.</li> <li>Check brake resistor and wiring.</li> <li>Check motor switching.</li> <li>Check settings of the motor data.</li> </ul>	Fault <ul style="list-style-type: none"> <li>The inverter is disabled immediately. The motor has no torque (is coasting).</li> <li>The event can only be reset after a blocking time.</li> </ul>
		Blocking time: 2 s

8992 | 0x2320 **Short circuit or earth leakage at the motor end**

Keypad display: **Earth leak**

Cause	Remedy	Severity/response
<ul style="list-style-type: none"> <li>Short circuit/earth fault of motor cable</li> <li>Capacitive charging current of the motor cable too high.</li> </ul>	<ul style="list-style-type: none"> <li>Check motor cable.</li> <li>Check length of the motor cable.</li> <li>Use shorter or lower-capacitance motor cable.</li> </ul>	Fault <ul style="list-style-type: none"> <li>The inverter is disabled immediately. The motor has no torque (is coasting).</li> <li>The event can only be reset after a blocking time.</li> </ul>
		Blocking time: 2 s

9024 | 0x2340 **Short circuit at the motor end**

Keypad display: **Motor shorted**

Cause	Remedy	Severity/response
Short circuit of motor cable	Check motor cable for short circuit.	Fault <ul style="list-style-type: none"> <li>The inverter is disabled immediately. The motor has no torque (is coasting).</li> <li>The event can only be reset after a blocking time.</li> </ul>
		Blocking time: 2 s

9040 | 0x2350 **CiA: i<sup>2</sup>t overload (thermal state)**

Keypad display: **i2t motor**

Cause	Remedy	Severity/response
Motor thermally overloaded, e. g. by an impermissible continuous current or by frequent or too long acceleration processes.	<ul style="list-style-type: none"> <li>Check drive sizing.</li> <li>Check machine/driven mechanics for excessive load.</li> <li>Check settings of the motor data.</li> <li>Reduce values for slip compensation <a href="#">0x2B09:001 (P315.01)</a>, <a href="#">0x2B09:002 (P315.02)</a> and oscillation damping <a href="#">0x2B0A:001 (P318.01)</a>, <a href="#">0x2B0A:002 (P318.02)</a>.</li> </ul>	Fault (configurable) <ul style="list-style-type: none"> <li>The event can only be reset after a blocking time.</li> </ul>
		Blocking time: 2 s
		Setting parameters: <a href="#">0x2D4B:003 (P308.03)</a>

Related topics

▶ [Motor overload monitoring \(i<sup>2</sup>t\)](#) 257

9090 | 0x2382 **Fault - Device utilization (ixt) too high**

Keypad display: **Ixt error**

Cause	Remedy	Severity/response
Device utilisation (ixt) too high by frequent and too long acceleration processes.	<ul style="list-style-type: none"> <li>Check drive sizing.</li> <li>Reduce the maximum current of the inverter <a href="#">0x6073 (P324.00)</a>.</li> <li>In case of high mass inertias, reduce maximum current of the inverter <a href="#">0x6073 (P324.00)</a> to 150 %.</li> </ul>	Fault (configurable) <ul style="list-style-type: none"> <li>The event can only be reset after a blocking time.</li> </ul>
		Blocking time: 2 s
		Setting parameters: <a href="#">0x2D40:005 (P135.05)</a>

Related topics

▶ [Device overload monitoring \(ixt\)](#) 577



9091 | 0x2383 **Warning - Device utilization (ixt) too high**

Keypad display: **Ixt warning**

Cause	Remedy	Severity/response
Device utilisation (ixt) too high by frequent and too long acceleration processes.	Check drive dimensioning.	Warning

Related topics

▶ [Device overload monitoring \(ixt\)](#) 📄 577

9095 | 0x2387 **Clamp responded too often**

Keypad display: **Clamp timeout**

Cause	Remedy	Severity/response
Maximum current of the axis (display in <a href="#">0x2DDF:002</a> ) has been reached too often in succession.	<ul style="list-style-type: none"> <li>• Select a flatter speed ramp.</li> <li>• Reduce the load.</li> <li>• Set I<sub>max</sub> controller more dynamically.</li> </ul>	Fault

Related topics

▶ [I<sub>max</sub> controller](#) 📄 252

9096 | 0x2388 **SL-PSM stall detection active**

Keypad display: **SL-PSM stall det.**

Cause	Remedy	Severity/response
Overload of the motor with sensorless control for synchronous motors (SL-PSM).	<ul style="list-style-type: none"> <li>• Reduce load at the axis.</li> <li>• Check settings of the SL-PSM parameters.</li> </ul>	Trouble <ul style="list-style-type: none"> <li>• The inverter is disabled immediately. The motor has no torque (is coasting).</li> </ul>

Related topics

▶ [Sensorless control for synchronous motor \(SL-PSM\)](#) 📄 188

9098 | 0x238A **Maximum current reached**

Keypad display: **I<sub>max</sub> reached**

Cause	Remedy	Severity/response
The actual current <a href="#">0x6078 (P103.00)</a> is equal to or higher than the max. current <a href="#">0x6073 (P324.00)</a> .	<ul style="list-style-type: none"> <li>• Reduce the load on the motor or change the settings for the maximum current. <a href="#">0x6073 (P324.00)</a></li> </ul>	Information

12576 | 0x3120 **Mains phase fault**

Keypad display: **Mains Phase fail**

Cause	Remedy	Severity/response
Mains phase failure	<ul style="list-style-type: none"> <li>• Check wiring of the mains connection.</li> <li>• Check fuses.</li> </ul>	Fault

12672 | 0x3180 **UPS operation active**

Keypad display: **UPS oper. active**

Cause	Remedy	Severity/response
Operation on uninterrupted 1x230V current supply (UPS) has been activated: Only a reduced output current is provided.	Switch back to operation with regular mains voltage.	Warning

Related topics

[Operation with UPS](#) 📄 614

# Diagnostics and fault elimination

Events, causes and remedies  
Causes and remedies





12816 | 0x3210 **Fault - DC bus overvoltage**

Keypad display: **DC Bus OV**

Cause	Remedy	Severity/response
DC-bus voltage has exceeded the error threshold for overvoltage due to a too high braking energy or a too high mains voltage. The error threshold (display in <a href="#">0x2540:006 (P208.06)</a> ) results from the setting of the rated mains voltage in <a href="#">0x2540:001 (P208.01)</a> .	<ul style="list-style-type: none"><li>• Reduce dynamic performance of the load profile.</li><li>• Check mains voltage.</li><li>• Check settings for brake energy management.</li><li>• <a href="#">0x2541:001 (P706.01)</a> = [0]: Connect brake resistor to the power unit and activate the integrated brake chopper.</li></ul>	Fault

Related topics



- ▶ [Mains voltage](#)  47
- ▶ [Brake energy management](#)  586

12817 | 0x3211 **DC bus overvoltage warning**

Keypad display: **Warn.DC Bus OV**

Cause	Remedy	Severity/response
DC-bus voltage has exceeded the warning threshold for overvoltage set in <a href="#">0x2540:005 (P208.05)</a> due to a too high braking energy or a too high mains voltage.	<ul style="list-style-type: none"><li>• Reduce dynamic performance of the load profile.</li><li>• Check mains voltage.</li><li>• Check settings for brake energy management.</li><li>• <a href="#">0x2541:001 (P706.01)</a> = [0]: Connect brake resistor to the power unit and activate the integrated brake chopper.</li></ul>	Warning

Related topics

- ▶ [Mains voltage](#)  47
- ▶ [Brake energy management](#)  586

12832 | 0x3220 **Fault - DC bus undervoltage**

Keypad display: **DC Bus UV**

Cause	Remedy	Severity/response
DC-bus voltage has fallen below the error threshold for undervoltage. The error threshold (display in <a href="#">0x2540:003 (P208.03)</a> ) results from the setting of the rated mains voltage in <a href="#">0x2540:001 (P208.01)</a> .	<ul style="list-style-type: none"><li>• Check mains voltage.</li><li>• <a href="#">0x2D87 (P105.00)</a> Check DC-bus voltage.</li><li>• Check mains settings.</li><li>• Check fuses.</li></ul>	Trouble

Related topics

- ▶ [Mains voltage](#)  47

12833 | 0x3221 **DC bus undervoltage warning**

Keypad display: **Warn.DC Bus UV**

Cause	Remedy	Severity/response
DC-bus voltage has fallen below the warning threshold for undervoltage set in <a href="#">0x2540:002 (P208.02)</a> .	<ul style="list-style-type: none"><li>• Check mains voltage.</li><li>• <a href="#">0x2D87 (P105.00)</a> Check DC-bus voltage.</li><li>• Check mains settings.</li><li>• Check fuses.</li></ul>	Warning

Related topics

- ▶ [Mains voltage](#)  47



12834 | 0x3222 **DC-bus voltage to low for power up**

Keypad display: **DC-bus on-UV**

Cause	Remedy	Severity/response
The input voltage is too low to switch on the inverter.	<ul style="list-style-type: none"> <li>• Check mains voltage.</li> <li>• Check mains settings.</li> <li>• Check fuses.</li> </ul>	Warning

Related topics

▶ [Mains voltage](#) 47

16912 | 0x4210 **Fault - Power unit overtemperature**

Keypad display: **PU Overtemp.**

Cause	Remedy	Severity/response
<p>The heatsink temperature of the power unit (display in <a href="#">0x2D84:001 (P117.01)</a>) has exceeded the fixed error threshold (100 °C).</p> <ul style="list-style-type: none"> <li>• Ambient temperature too high.</li> <li>• Fan or ventilation slots are polluted.</li> <li>• Fan is defective.</li> </ul>	<ul style="list-style-type: none"> <li>• Check mains voltage.</li> <li>• Provide for a sufficient cooling of the device. In case of a 100 % load, 60 C to +70°C are normal. Display of the heatsink temperature in <a href="#">0x2D84:001 (P117.01)</a>.</li> <li>• Clean fan and ventilation slots. If required, replace fan.</li> <li>• Reduce switching frequency <a href="#">0x2939 (P305.00)</a></li> </ul>	Fault

17024 | 0x4280 **Fault - Heat sink temperature sensor**

Keypad display: **Heatsink sensor**

Cause	Remedy	Severity/response
Sensor for the temperature monitoring of the power unit is defective. The failure of the temperature monitoring function poses the risk of overheating!	Hardware error: it is necessary to contact the manufacturer, since the device must be replaced.	Fault

17025 | 0x4281 **Heat sink fan warning**

Keypad display: **Heatsink fan**

Cause	Remedy	Severity/response
Warning of the heatsink fan.	Clean fan and ventilation slots. If required, replace fan. The fans can be unlocked via locking hooks and can then be removed.	Warning

17029 | 0x4285 **PU overtemperature warning**

Keypad display: **Warn.PU Overtemp**

Cause	Remedy	Severity/response
<p>The heatsink temperature of the power unit (display in <a href="#">0x2D84:001 (P117.01)</a>) has exceeded the warning threshold set in <a href="#">0x2D84:002</a>.</p> <ul style="list-style-type: none"> <li>• Ambient temperature too high.</li> <li>• Fan or ventilation slots are polluted.</li> <li>• Fan is defective.</li> </ul>	<ul style="list-style-type: none"> <li>• Provide for a sufficient cooling of the device.</li> <li>• Clean fan and ventilation slots.</li> <li>• If required, replace fan.</li> </ul>	Warning

Related topics

▶ [Heatsink temperature monitoring](#) 578

# Diagnostics and fault elimination

Events, causes and remedies  
Causes and remedies



17168 | 0x4310 **Motor overtemperature**

Keypad display: **Overtemp. motor**

Cause	Remedy	Severity/response
The motor temperature sensor connected to terminals X109/T1 and X109/T2 measures a too high motor temperature. <ul style="list-style-type: none"> <li>Motor too hot by impermissibly high currents.</li> <li>Motor too hot by frequent and too long acceleration processes.</li> </ul>	<ul style="list-style-type: none"> <li>Check drive dimensioning.</li> <li>Check motor temperature sensor and wiring.</li> </ul>	Fault (configurable) <ul style="list-style-type: none"> <li>The event can only be reset after a blocking time.</li> </ul>
		Blocking time: 2 s
		Setting parameters: <a href="#">0x2D49:002 (P309.02)</a>

Related topics

▶ [Motor temperature monitoring](#) □ 261

20754 | 0x5112 **External supply voltage critical**

Keypad display: **Ext. supply low**

Cause	Remedy	Severity/response
External supply voltage failed or too low.	<ul style="list-style-type: none"> <li>Check optional external 24V voltage supply (terminal X3/24E), if connected.</li> <li>Check mains voltage.</li> </ul>	Warning

20864 | 0x5180 **Overload 24 V supply**

Keypad display: **Overload 24V**

Cause	Remedy	Severity/response
Output current at the 24V output or at the digital outputs too high.	Check 24V output and digital outputs for earth fault or overload.	Warning

21376 | 0x5380 **OEM hardware incompatible**

Keypad display: **Incomp. OEM HW**

Cause	Remedy	Severity/response
The control unit (OEM hardware) is not compatible with the power unit (OEM hardware).	<ul style="list-style-type: none"> <li>Use compatible hardware.</li> <li>Contact the OEM.</li> </ul>	Fault <ul style="list-style-type: none"> <li>The inverter is disabled immediately. The motor has no torque (is coasting).</li> <li>The event can only be reset by mains switching.</li> </ul>

24970 | 0x618A **Warning - Internal fan**

Keypad display: **Internal fan**

Cause	Remedy	Severity/response
Warning of the internal fan.	Check/replace internal fan.	Warning

25216 | 0x6280 **Trigger/functions connected incorrectly**

Keypad display: **P400 config err**

Cause	Remedy	Severity/response
The assignment directives have not been observed. <ul style="list-style-type: none"> <li>If the "flexible I/O configuration" is active as control source, the "Enable inverter" or "Run" function must be connected to a digital input in order that the motor can be stopped again any time!</li> <li>The use of the "Start forward (CW)" and "Start reverse (CCW)" functions excludes the use of the "Run forward (CW)" and "Run reverse (CCW)" functions, and vice versa.</li> </ul>	Check and correct the assignment of the triggers to the functions. <ul style="list-style-type: none"> <li>With keypad or network control, the two "Enable inverter <a href="#">0x2631:001 (P400.01)</a>" and "Run <a href="#">0x2631:002 (P400.02)</a>" functions can also be set to "Constant TRUE [1]" to start the motor.</li> </ul>	Trouble

Related topics

▶ [Start, stop and rotating direction commands](#) □ 62





25217 | 0x6281 **User-defined fault 1**

Keypad display: **User fault 1**

Cause	Remedy	Severity/response
Flexible I/O configuration: the "Activate fault 1" function was activated via the trigger selected in <a href="#">0x2631:043 (P400.43)</a> .	Eliminate error cause and then reset error.	Fault

Related topics

▶ [User-defined error triggering](#) 580

25218 | 0x6282 **User-defined fault 2**

Keypad display: **User fault 2**

Cause	Remedy	Severity/response
Flexible I/O configuration: the "Activate fault 2" function was activated via the trigger selected in <a href="#">0x2631:044 (P400.44)</a> .	Eliminate error cause and then reset error.	Fault

Related topics

▶ [User-defined error triggering](#) 580

25232 | 0x6290 **Warning invert rotation**

Keypad display: **Invert rotation**

Cause	Remedy	Severity/response
<ul style="list-style-type: none"> <li>Negative setpoint selection with an active limitation of rotation <a href="#">0x283A (P304.00)</a>.</li> <li>The "Reverse rotational direction" <a href="#">0x2631:013 (P400.13)</a> function was requested with an active limitation of rotation <a href="#">0x283A (P304.00)</a>.</li> </ul>	<ul style="list-style-type: none"> <li>Check setpoint selection and trigger.</li> <li>Check setting in <a href="#">0x283A (P304.00)</a>.</li> </ul>	Warning <ul style="list-style-type: none"> <li>The motor is brought to a standstill, since a reversal of the rotating direction is not permissible.</li> </ul>

Related topics

▶ [Control/restrict direction of rotation of the motor](#) 85

25233 | 0x6291 **Maximum allowed troubles exceeded**

Keypad display: **Trouble overflow**

Cause	Remedy	Severity/response
The number of permitted restart attempts after a fault set in <a href="#">0x2839:003 (P760.03)</a> was exceeded. The fault occurred to frequently and could not be reset.	Check and the eliminate the fault.	Fault <ul style="list-style-type: none"> <li>The motor remains at a standstill, no automatic restart is executed.</li> </ul>

Related topics

▶ [Automatic restart after a fault](#) 579

25248 | 0x62A0 **User-defined fault (LECOM)**

Keypad display: **UserFault(LECOM)**

Cause	Remedy	Severity/response
The "Activate fault" function was triggered via bit 10 of the LECOM control word <a href="#">0x400B:002 (P592.02)</a> .	Eliminate error cause and then reset error.	Fault

25249 | 0x62A1 **Network: user fault 1**

Keypad display: **Netw.UserFault 1**

Cause	Remedy	Severity/response
The "Activate fault 1" function was triggered via the NetWordIN1 data word <a href="#">0x4008:001 (P590.01)</a> .	Eliminate error cause and then reset error.	Fault

Related topics

▶ [Define your own control word format](#) 314

# Diagnostics and fault elimination

Events, causes and remedies  
Causes and remedies



25250 | 0x62A2 **Network: user fault 2**

Keypad display: **Netw.UserFault 2**

Cause	Remedy	Severity/response
The "Activate fault 2" function was triggered via the NetWordIN1 data word <a href="#">0x4008:001 (P590.01)</a> .	Eliminate error cause and then reset error.	Fault

Related topics

▶ [Define your own control word format](#) 314

25265 | 0x62B1 **NetWordIN1 configuration incorrect**

Keypad display: **NetWordIN1 error**

Cause	Remedy	Severity/response
Two bits of the NetWordIN1 data word <a href="#">0x4008:001 (P590.01)</a> were assigned to the same function.	Check and correct configuration of the NetWordIN1 data word. <ul style="list-style-type: none"> <li>The functions that are to be triggered via bits 0 ... 15 of the NetWordIN1 data word are defined in <a href="#">0x400E:001 (P505.01)</a> ... <a href="#">0x400E:016 (P505.16)</a>.</li> </ul>	Trouble

Related topics

▶ [Define your own control word format](#) 314

25266 | 0x62B2 **Changed device ID not yet active**

Keypad display: **Dev-ID changed**

Cause	Remedy	Severity/response
The device ID of the device was changed manually.	<ol style="list-style-type: none"> <li>Execute device command "Save user data" <a href="#">0x2022:003 (P700.03)</a>.</li> <li>Switch inverter off and on again.</li> </ol>	Fault

Related topics

▶ [Saving/loading the parameter settings](#) 564

25267 | 0x62B3 **Default settings not yet active**

Keypad display: **Settings error**

Cause	Remedy	Severity/response
The "Back-to-Box" system command has been executed. The standard parameter set has been written and saved. Communication is deactivated and the device is in stop status.	Switch inverter off and on again.	Fault

25505 | 0x63A1 **CU: load error ID tag**

Keypad display: **CU ID tag error**

Cause	Remedy	Severity/response
Calibration data of the control unit not compatible or faulty.	<ul style="list-style-type: none"> <li>Update firmware of the inverter to the most recent version.</li> <li>If the error persists, the control unit or the device has to be replaced. In this case, please contact the manufacturer.</li> </ul>	Fault <ul style="list-style-type: none"> <li>The inverter is disabled immediately. The motor has no torque (is coasting).</li> <li>The event can only be reset by mains switching.</li> </ul>

25506 | 0x63A2 **PU: load error ID tag**

Keypad display: **PU ID tag error**

Cause	Remedy	Severity/response
Calibration data of the power unit not compatible or faulty.	<ul style="list-style-type: none"> <li>Update firmware of the inverter to the most recent version.</li> <li>If the error persists, the power unit or the device has to be replaced. In this case, please contact the manufacturer.</li> </ul>	Fault <ul style="list-style-type: none"> <li>The inverter is disabled immediately. The motor has no torque (is coasting).</li> <li>The event can only be reset by mains switching.</li> </ul>



25507 | 0x63A3 **Power unit unknown**

Keypad display: **PU unknown**

Cause	Remedy	Severity/response
The power unit installed is not supported by the software.	Update firmware of the inverter to the most recent version.	Fault <ul style="list-style-type: none"> <li>The inverter is disabled immediately. The motor has no torque (is coasting).</li> <li>The event can only be reset by mains switching.</li> </ul>

28800 | 0x7080 **Assertion level monitoring (Low/High)**

Keypad display: **Assertionlevel**

Cause	Remedy	Severity/response
The last setting of the connection level differs from the saved setting.	<ol style="list-style-type: none"> <li>Execute device command "Save user data" <a href="#">0x2022:003 (P700.03)</a>.</li> <li>Switch inverter off and on again.</li> </ol>	Fault

28801 | 0x7081 **Fault - Analog input 1**

Keypad display: **AI1 fault**

Cause	Remedy	Severity/response
The monitoring function of the input signal configured for analog input 1 in <a href="#">0x2636:008 (P430.08)</a> and <a href="#">0x2636:009 (P430.09)</a> has been triggered.	<ul style="list-style-type: none"> <li>Check input signal at analog input 1.</li> <li>Check configuration of the monitoring function.</li> </ul>	Fault (configurable)
		Setting parameters: <a href="#">0x2636:010 (P430.10)</a>

Related topics

▶ [Analog input 1](#) [📄 284](#)

28802 | 0x7082 **Analog input 2 fault**

Keypad display: **AI2 fault**

Cause	Remedy	Severity/response
The monitoring function of the input signal configured for analog input 2 in <a href="#">0x2637:008 (P431.08)</a> and <a href="#">0x2637:009 (P431.09)</a> has been triggered.	<ul style="list-style-type: none"> <li>Check input signal at analog input 2.</li> <li>Check configuration of the monitoring function.</li> </ul>	Fault (configurable)
		Setting parameters: <a href="#">0x2637:010 (P431.10)</a>

Related topics

▶ [Analog input 2](#) [📄 289](#)

28803 | 0x7083 **HTL input fault**

Keypad display: **HTL input fault**

Cause	Remedy	Severity/response
		No response (configurable)
		Setting parameters: <a href="#">0x2641:006 (P416.06)</a>

Related topics

▶ [Configure digital inputs DI3/DI4 for detecting a pulse train](#) [📄 276](#)

28833 | 0x70A1 **Analog output 1 fault**

Keypad display: **AO1 fault**

Cause	Remedy	Severity/response
Open circuit or short circuit at analog output 1.	<ul style="list-style-type: none"> <li>Check wiring of analog output 1.</li> <li>Check definition of the output range in <a href="#">0x2639:001 (P440.01)</a>.</li> </ul>	Warning

Related topics

▶ [Analog output 1](#) [📄 305](#)

# Diagnostics and fault elimination

Events, causes and remedies  
Causes and remedies



28834 | 0x70A2 **Analog output 2 fault**

Keypad display: **AO2 fault**

Cause	Remedy	Severity/response
Open circuit or short circuit at analog output 2.	<ul style="list-style-type: none"> <li>Check wiring of analog output 2.</li> <li>Check definition of the output range in <a href="#">0x263A:001 (P441.01)</a>.</li> </ul>	Warning

Related topics

▶ [Analog output 2](#) [□ 309](#)

28961 | 0x7121 **Fault - Pole position identification**

Keypad display: **Pole pos. error**

Cause	Remedy	Severity/response
<ul style="list-style-type: none"> <li>Too many deviations during the pole position identification.</li> <li>Compared to the inverter, the rated motor current is too high or too low.</li> </ul>	<ul style="list-style-type: none"> <li>Check setting of the motor data.</li> <li>Ensure that the motor is at a standstill during the pole position identification process.</li> <li>Ensure that the motor and inverter match each other in terms of power.</li> </ul>	Fault (configurable) Setting parameters: <a href="#">0x2C60</a>

29056 | 0x7180 **Motor overcurrent**

Keypad display: **Mot max current**

Cause	Remedy	Severity/response
The motor current has exceeded the warning/error threshold for the motor current monitoring set in <a href="#">0x2D46:001 (P353.01)</a> .	<ul style="list-style-type: none"> <li>Check motor load.</li> <li>Check drive dimensioning.</li> <li>Check warning threshold or error threshold set in <a href="#">0x2D46:001 (P353.01)</a>.</li> </ul>	Fault (configurable) <ul style="list-style-type: none"> <li>The event can only be reset after a blocking time.</li> </ul> Blocking time: 1 s Setting parameters: <a href="#">0x2D46:002 (P353.02)</a>

Related topics

▶ [Overcurrent monitoring](#) [□ 262](#)

29445 | 0x7305 **Encoder open circuit**

Keypad display: **Encoder error**

Cause	Remedy	Severity/response
The encoder signal loss monitoring function has detected a failure of the encoder signal.	<ul style="list-style-type: none"> <li>Check the encoder connection.</li> <li>Check encoder cable for wire breakage.</li> <li>Check encoder current supply.</li> </ul>	Warning (configurable) Setting parameters: <a href="#">0x2C45 (P342.00)</a>

Related topics

▶ [Encoder monitoring](#) [□ 179](#)

29573 | 0x7385 **Feedback system: speed limit**

Keypad display: **F.fdb spd limit**

Cause	Remedy	Severity/response
The feedback system exceeds the maximum permissible frequency range of the digital inputs.	Check feedback system.	Warning

Related topics

▶ [Encoder monitoring](#) [□ 179](#)

30336 | 0x7680 **Memory module is full**

Keypad display: **EPM full**

Cause	Remedy	Severity/response
The memory module contains too many parameter settings.	Execute "Save user data" <a href="#">0x2022:003 (P700.03)</a> device command again. This reinitialises the user memory with the current parameter settings. In this way, parameter settings that are no longer required are automatically deleted.	Warning <ul style="list-style-type: none"> <li>The parameter settings were not saved in the memory module.</li> </ul>



# Diagnostics and fault elimination

Events, causes and remedies  
Causes and remedies

30337 | 0x7681 **Memory module not present**

Keypad display: **EPM not present**

Cause	Remedy	Severity/response
The inverter memory module was removed.	<ol style="list-style-type: none"> <li>1. Switch off inverter.</li> <li>2. Plug the memory module into the inverter.</li> <li>3. Switch the inverter on again.</li> </ol> <p>Note: The memory module cannot be replaced during ongoing operation!</p>	Fault <ul style="list-style-type: none"> <li>• The default setting stored in the inverter firmware has been loaded.</li> <li>• The error cannot be reset by the user.</li> </ul>

30338 | 0x7682 **Invalid user data**

Keypad display: **EPM invalid data**

Cause	Remedy	Severity/response
The user parameter settings in the memory module are invalid.	<ol style="list-style-type: none"> <li>1. Execute user parameter settings again.</li> <li>2. Execute device command "Save user data" <a href="#">0x2022:003 (P700.03)</a>.</li> </ol>	Fault <ul style="list-style-type: none"> <li>• The user parameter settings are lost.</li> <li>• The default settings were automatically loaded.</li> </ul>

30340 | 0x7684 **Data not compl. saved before powerdown**

Keypad display: **Save incomplete**

Cause	Remedy	Severity/response
Saving of the parameter settings was interrupted by an unexpected disconnection.	<ol style="list-style-type: none"> <li>1. Check user parameter settings. (The loaded backup is an older version.)</li> <li>2. If required, repeat the changes made last.</li> <li>3. Execute device command "Save user data" <a href="#">0x2022:003 (P700.03)</a>.</li> </ol>	Warning <ul style="list-style-type: none"> <li>• The user parameter settings were not fully saved.</li> <li>• At the next switch-on, the data stored are copied to the user memory.</li> </ul>

30345 | 0x7689 **Memory module: invalid OEM data**

Keypad display: **OEM data invalid**

Cause	Remedy	Severity/response
The OEM memory contains invalid parameter settings or is empty.	<ul style="list-style-type: none"> <li>• Execute device command "Save OEM data" <a href="#">0x2022:006 (P700.06)</a>.</li> <li>• Thus, the user parameter settings get lost!</li> </ul>	Warning <ul style="list-style-type: none"> <li>• The user parameter settings were automatically loaded.</li> </ul>

30346 | 0x768A **Memory module: wrong type**

Keypad display: **Wrong EPM**

Cause	Remedy	Severity/response
The memory module connected is not supported by the inverter.	<ol style="list-style-type: none"> <li>1. Switch off inverter.</li> <li>2. Replace plugged-in memory module by a memory module that matches the inverter.</li> <li>3. Switch the inverter on again.</li> </ol>	Fault <ul style="list-style-type: none"> <li>• The default setting stored in the inverter firmware has been loaded.</li> <li>• The error cannot be reset by the user.</li> </ul>

30352 | 0x7690 **EPM firmware version incompatible**

Keypad display: **EPM-FW incompat.**

Cause	Remedy	Severity/response
The parameter settings saved in the memory module are incompatible with the firmware version.	<ol style="list-style-type: none"> <li>1. Execute device command "Load default settings" <a href="#">0x2022:001 (P700.01)</a>.</li> <li>2. Execute "Save user data" <a href="#">0x2022:003 (P700.03)</a> or "Save OEM data" <a href="#">0x2022:006 (P700.06)</a> device command.</li> </ol>	Fault <ul style="list-style-type: none"> <li>• The data have been loaded into the RAM memory, but they are incompatible.</li> </ul>

# Diagnostics and fault elimination

Events, causes and remedies  
Causes and remedies



30353 | 0x7691 **EPM data: firmware type incompatible**

Keypad display: **EPM: FW incompat.**

Cause	Remedy	Severity/response
The parameter settings saved in the memory module are incompatible with the firmware type. Example: Memory module of an inverter with an application I/O is used in an inverter with a standard I/O.	<ol style="list-style-type: none"> <li>Execute device command "Load default settings" <a href="#">0x2022:001 (P700.01)</a>.</li> <li>Execute "Save user data" <a href="#">0x2022:003 (P700.03)</a> or "Save OEM data" <a href="#">0x2022:006 (P700.06)</a> device command.</li> </ol>	Fault <ul style="list-style-type: none"> <li>The data have been loaded into the RAM memory, but they are incompatible.</li> </ul>

30354 | 0x7692 **EPM data: new firmware type detected**

Keypad display: **UserCU not match**

Cause	Remedy	Severity/response
The parameter settings saved in the memory module do not match the inverter hardware.	<ol style="list-style-type: none"> <li>Check parameter settings.</li> <li>Reset error.</li> <li>Execute "Save user data" <a href="#">0x2022:003 (P700.03)</a> or "Save OEM data" <a href="#">0x2022:006 (P700.06)</a> device command.</li> </ol>	Fault <ul style="list-style-type: none"> <li>The data have been loaded into the RAM memory without being modified, and they are compatible.</li> <li>The settings loaded must be accepted by the user (see remedy).</li> </ul>

30355 | 0x7693 **EPM data: PU size incompatible**

Keypad display: **EPM PU size inco**

Cause	Remedy	Severity/response
The parameter settings saved in the memory module are incompatible with the inverter.	<ol style="list-style-type: none"> <li>Execute device command "Load default settings" <a href="#">0x2022:001 (P700.01)</a>.</li> <li>Execute "Save user data" <a href="#">0x2022:003 (P700.03)</a> or "Save OEM data" <a href="#">0x2022:006 (P700.06)</a> device command.</li> </ol>	Fault <ul style="list-style-type: none"> <li>The data have been loaded into the RAM memory, but they are incompatible.</li> </ul>

30356 | 0x7694 **EPM data: new PU size detected**

Keypad display: **EPM new PU size**

Cause	Remedy	Severity/response
The parameter settings saved in the memory module comply with a different hardware. Example: Memory module of an inverter with a power of 3 kW is used in an inverter with a power of 18.5 kW.	<ol style="list-style-type: none"> <li>Check parameter settings.</li> <li>Reset error.</li> <li>Execute "Save user data" <a href="#">0x2022:003 (P700.03)</a> or "Save OEM data" <a href="#">0x2022:006 (P700.06)</a> device command.</li> </ol>	Fault <ul style="list-style-type: none"> <li>The data have been loaded into the RAM memory without being modified, and they are compatible.</li> <li>The settings loaded must be accepted by the user (see remedy).</li> </ul>

30357 | 0x7695 **Invalid parameter changeover configuration**

Keypad display: **InvalidChgovrCfg**

Cause	Remedy	Severity/response
One or more parameters can no longer be used for the "Parameter change-over" function.	<ol style="list-style-type: none"> <li>Check error message for parameter change-over in <a href="#">0x4047:001 (P756.01)</a>.</li> <li>Correct the list entry shown in <a href="#">0x4047:002 (P756.02)</a>.</li> </ol>	Warning <ul style="list-style-type: none"> <li>The parameter change-over function is deactivated.</li> </ul>

30358 | 0x7696 **EPM data: unknown parameter found**

Keypad display: **Unkn. Par in EPM**

Cause	Remedy	Severity/response
The memory module contains parameter settings for one or several parameters that are not known to the inverter.	Execute the "Save user data" <a href="#">0x2022:003 (P700.03)</a> device command. This reinitialises the user memory with the current parameter settings. In this way, parameter settings that are no longer required are automatically deleted.	Information



33039 | 0x7697 **Parameter changes lost**

Keypad display: **Parameter loss**

Cause	Remedy	Severity/response
A voltage failure has occurred and changed parameter settings that had not been saved yet were available.	<ol style="list-style-type: none"> <li>Execute parameter settings again.</li> <li>Execute device command "Save user data" <a href="#">0x2022:003 (P700.03)</a>.</li> </ol>	Fault <ul style="list-style-type: none"> <li>The parameter settings changed have been lost.</li> </ul>

33042 | 0x8112 **Network - Time-out explicit message**

Keypad display: **TO expl. msg**

Cause	Remedy	Severity/response
<ul style="list-style-type: none"> <li>Within the time-out period for explicit messages, which has been parameterised by the scanner, no "explicit message" was received.</li> <li>The connection to the scanner has been interrupted.</li> <li>Failure of an explicit connection.</li> </ul>	<ul style="list-style-type: none"> <li>Check cables and terminals.</li> <li>Plug network cables into the Ethernet port.</li> <li>Check the requested package interval (RPI) of the explicit connection.</li> <li>Increase time limit for explicit messages in the scanner.</li> </ul>	Warning (configurable) Setting parameters: <a href="#">0x2859:006 (P515.06)</a>

33044 | 0x8114 **Network - Overall communication time-out**

Keypad display: **TO overall comm**

Cause	Remedy	Severity/response
<ul style="list-style-type: none"> <li>EtherNet/IP: the maximum permissible time-out period for the CIP communication set in <a href="#">0x23A1:010 (P510.10)</a> has been exceeded.</li> <li>Modbus TCP/IP: the maximum permissible time-out period for the TCP communication set in <a href="#">0x23B1:010 (P510.10)</a> has been exceeded.</li> </ul>	<ul style="list-style-type: none"> <li>Check cables and terminals.</li> <li>Connect network cable.</li> </ul>	Warning (configurable) Setting parameters: <a href="#">0x2859:007 (P515.07)</a> (EtherNet/IP) <a href="#">0x2859:007 (P515.07)</a> (Modbus TCP)

33045 | 0x8115 **Time-out (PAM)**

Keypad display: **Time-out (PAM)**

Cause	Remedy	Severity/response
The parameter access monitoring (PAM) function has been activated. For a time longer than the time-out period set in <a href="#">0x2552:003 (P595.03)</a> , no value was entered into the "Keep-alive-Register" <a href="#">0x2552:002 (P595.02)</a> .	<ul style="list-style-type: none"> <li>Check communication.</li> <li>Check settings of the parameter access monitoring (PAM) function.</li> </ul>	No response (configurable) Setting parameters: <a href="#">0x2552:004 (P595.04)</a>

Related topics

▶ [Parameter access monitoring \(PAM\)](#) 337

33046 | 0x8116 **Modbus TCP master time-out**

Keypad display: **MBTCP mast t-out**

Cause	Remedy	Severity/response
No valid messages have been received by the Modbus master for a time longer than the time-out period set in <a href="#">0x23B6:001 (P514.01)</a> .	Check communication with the master.	Fault (configurable) Setting parameters: <a href="#">0x2859:008 (P515.08)</a>

Related topics

▶ [Monitoring](#) 525

33047 | 0x8117 **Modbus TCP Keep Alive time-out**

Keypad display: **MB.Keep Alive TO**

Cause	Remedy	Severity/response
For a time longer than the time-out period set in <a href="#">0x23B6:002 (P514.02)</a> , no value was entered into the Keep alive register <a href="#">0x23B6:005 (P514.05)</a> .	Check communication with the master.	Fault (configurable) Setting parameters: <a href="#">0x2859:009 (P515.09)</a>

Related topics

▶ [Monitoring](#) 525

# Diagnostics and fault elimination

Events, causes and remedies  
Causes and remedies



33154 | 0x8182 **CAN: bus off**

Keypad display: **CAN: bus off**

Cause	Remedy	Severity/response
Too many faulty frames have been received. <ul style="list-style-type: none"><li>Defective cable (e. g. loose contact).</li><li>Two nodes with the same node address.</li></ul>	<ul style="list-style-type: none"><li>Check wiring of the network.</li><li>Check bus terminating resistor.</li><li>Set the identical baud rate for each node of the network.</li><li>Assign a unique node address to each node of the network.</li><li>Eliminate EMC interferences.</li></ul>	Trouble (configurable) <ul style="list-style-type: none"><li>Change to the "Bus-Off" communication status.</li></ul>
		Setting parameters: <a href="#">0x2857:010</a>

33155 | 0x8183 **CAN: warning**

Keypad display: **CAN bus warning**

Cause	Remedy	Severity/response
Too many faulty frames have been received. <ul style="list-style-type: none"><li>Defective cable (e. g. loose contact).</li><li>Two nodes with the same node address.</li></ul>	<ul style="list-style-type: none"><li>Check wiring of the network.</li><li>Check bus terminating resistor.</li><li>Set the identical baud rate for each node of the network.</li><li>Assign a unique node address to each node of the network.</li><li>Eliminate EMC interferences.</li></ul>	Warning (configurable)
		Setting parameters: <a href="#">0x2857:011</a>

33156 | 0x8184 **CAN: heartbeat time-out consumer 1**

Keypad display: **CAN heartb. C1**

Cause	Remedy	Severity/response
Within the heartbeat time <a href="#">0x1016:001 (P520.01)</a> , no heartbeat telegram was received by node 1 to be monitored.	<ul style="list-style-type: none"><li>Check communication with the heartbeat producer.</li><li>Reactivate heartbeat producer.</li></ul>	Fault (configurable)
		Setting parameters: <a href="#">0x2857:005</a>

Related topics

▶ [Heartbeat protocol](#) [384](#)

33157 | 0x8185 **CAN: heartbeat time-out consumer 2**

Keypad display: **CAN heartb. C2**

Cause	Remedy	Severity/response
Within the heartbeat time <a href="#">0x1016:002 (P520.02)</a> , no heartbeat telegram was received by node 2 to be monitored.	<ul style="list-style-type: none"><li>Check communication with the heartbeat producer.</li><li>Reactivate heartbeat producer.</li></ul>	Fault (configurable)
		Setting parameters: <a href="#">0x2857:006</a>

Related topics

▶ [Heartbeat protocol](#) [384](#)

33158 | 0x8186 **CAN: heartbeat time-out consumer 3**

Keypad display: **CAN heartb. C3**

Cause	Remedy	Severity/response
Within the heartbeat time <a href="#">0x1016:003 (P520.03)</a> , no heartbeat telegram was received by node 3 to be monitored.	<ul style="list-style-type: none"><li>Check communication with the heartbeat producer.</li><li>Reactivate heartbeat producer.</li></ul>	Fault (configurable)
		Setting parameters: <a href="#">0x2857:007</a>

Related topics

▶ [Heartbeat protocol](#) [384](#)





33159 | 0x8187 **CAN: heartbeat time-out consumer 4**

Keypad display: **CAN heartb. C4**

Cause	Remedy	Severity/response
Within the heartbeat time <a href="#">0x1016:004 (P520.04)</a> , no heartbeat telegram was received by node 4 to be monitored.	<ul style="list-style-type: none"> <li>Check communication with the heartbeat producer.</li> <li>Reactivate heartbeat producer.</li> </ul>	Fault (configurable) Setting parameters: <a href="#">0x2857:008</a>

Related topics

▶ [Heartbeat protocol](#) 384

33168 | 0x8190 **Network - Watchdog time-out**

Keypad display: **Watchdog timeout**

Cause	Remedy	Severity/response
Time-out during cyclic data reception, e.g. due to an interrupted communication link to the master or missing cyclic data.	<ul style="list-style-type: none"> <li>Check wiring of the network.</li> <li>Eliminate EMC interferences.</li> </ul>	Trouble (configurable) Setting parameters: <a href="#">0x2859:001 (P515.01)</a> (PROFIBUS) <a href="#">0x2859:001 (P515.01)</a> (EtherCAT) <a href="#">0x2859:001 (P515.01)</a> (EtherNet/IP) <a href="#">0x2859:001 (P515.01)</a> (PROFINET) <a href="#">0x2859:001 (P515.01)</a> (POWERLINK)

33169 | 0x8191 **Network - Disruption of cyclic data exchange**

Keypad display: **Cycl data error**

Cause	Remedy	Severity/response
The communication partner has interrupted the cyclic data exchange.	<ul style="list-style-type: none"> <li>Check wiring of the network.</li> <li>The slave must receive new parameterisation and configuration files by the master, in order to be able to exchange data again.</li> </ul>	No response (configurable) Setting parameters: <a href="#">0x2859:002 (P515.02)</a>

33170 | 0x8192 **Network - Initialization error**

Keypad display: **Net. Init. error**

Cause	Remedy	Severity/response
The initialisation of the communication stack has been interrupted due to an incorrect address setting or communication configuration.	Check master/slave configuration and restart the devices.	Trouble (configurable) Setting parameters: <a href="#">0x2859:004 (P515.04)</a> (PROFIBUS) <a href="#">0x2859:004 (P515.04)</a> (EtherCAT) <a href="#">0x2859:004 (P515.04)</a> (EtherNet/IP) <a href="#">0x2859:004 (P515.04)</a> (PROFINET) <a href="#">0x2859:004 (P515.04)</a> (Modbus TCP)

33171 | 0x8193 **Network - Invalid cyclic process data**

Keypad display: **Inv. cyclic data**

Cause	Remedy	Severity/response
The cyclic process data received are invalid.	Check cyclic process data sent by the master.	Trouble (configurable) Setting parameters: <a href="#">0x2859:005 (P515.05)</a> (PROFIBUS) <a href="#">0x2859:005 (P515.05)</a> (EtherCAT) <a href="#">0x2859:005 (P515.05)</a> (EtherNet/IP) <a href="#">0x2859:005 (P515.05)</a> (PROFINET)

33185 | 0x81A1 **Modbus: network time-out**

Keypad display: **Modbus time-out**

Cause	Remedy	Severity/response
No valid messages have been received via the Modbus for a longer time than the time-out time set in <a href="#">0x2858:002 (P515.02)</a> .	<ul style="list-style-type: none"> <li>Check communication with the master.</li> <li>Check wiring.</li> <li>Check bus termination.</li> </ul>	Fault (configurable) Setting parameters: <a href="#">0x2858:001 (P515.01)</a>

# Diagnostics and fault elimination

Events, causes and remedies  
Causes and remedies



33186 | 0x81A2 **Modbus: incorrect request by master**

Keypad display: **Modbus request**

Cause	Remedy	Severity/response
The request by the master is invalid, e. g. invalid CRC checksum, non-supported function code, or impermissible data access.	Check request by the master: <ul style="list-style-type: none"> <li>Value in the valid range?</li> <li>Function code valid?</li> <li>No impermissible write access? (e. g. with regard to read-only parameters)</li> </ul>	Warning The inverter (slave) responds to the master with an error code: <ul style="list-style-type: none"> <li>0x01 = invalid function code</li> <li>0x02 = invalid data address</li> <li>0x03 = invalid data value</li> <li>0x04 = slave device failure</li> </ul>

33200 | 0x81B0 **Network communication faulty**

Keypad display: **Comm. faulty**

Cause	Remedy	Severity/response
In case of the Ethernet communication interface, an internal software error has occurred.	<ul style="list-style-type: none"> <li>Switch inverter off and on again.</li> <li>In the event of a power failure during a firmware download, it is required to reload the firmware via the USB module and then restart the inverter.</li> </ul>	Trouble

Related topics

► [Firmware download with »EASY Starter \(firmware loader\)«](#) [□ 582](#)

33381 | 0x8265 **POWERLINK: Loss of SoC**

Keypad display: **POWERLINK SoC**

Cause	Remedy	Severity/response
SoC of master was not received.	Check configuration and system setup.	Trouble (configurable) Setting parameters: <a href="#">0x2859:011</a>

33382 | 0x8266 **POWERLINK: CRC error**

Keypad display: **POWERLINK CRC**

Cause	Remedy	Severity/response
CRC frame defective.	Check system setup.	Trouble (configurable) Setting parameters: <a href="#">0x2859:010</a>

33414 | 0x8286 **Network - PDO mapping error**

Keypad display: **PDO map error**

Cause	Remedy	Severity/response
<ul style="list-style-type: none"> <li>Invalid PDO assignment by the master.</li> <li>Internal PDO assignment was changed and does not comply with the configuration available in the master.</li> </ul>	Check data mapping in the master and slave.	Trouble (configurable) Setting parameters: <a href="#">0x2859:003 (P515.03)</a> (PROFIBUS) <a href="#">0x2859:003 (P515.03)</a> (EtherCAT) <a href="#">0x2859:003 (P515.03)</a> (EtherNet/IP) <a href="#">0x2859:003 (P515.03)</a> (PROFINET) <a href="#">0x2859:003 (P515.03)</a> (Modbus TCP)

33425 | 0x8291 **CAN: RPDO1 time-out**

Keypad display: **Timeout RPDO1**

Cause	Remedy	Severity/response
RPDO1 was not received within the time-out period set in <a href="#">0x1400:005 (P540.05)</a> or with the sync configured.		Fault (configurable) Setting parameters: <a href="#">0x2857:001</a>

Related topics

► [Process data transfer](#) [□ 374](#)



33426 | 0x8292 **CAN: RPDO2 time-out**

Keypad display: **Timeout RPDO2**

Cause	Remedy	Severity/response
RPDO2 was not received within the time-out period set in <a href="#">0x1401:005 (P541.05)</a> or with the sync configured.		Fault (configurable)
		Setting parameters: <a href="#">0x2857:002</a>

Related topics

▶ [Process data transfer](#) 374

33427 | 0x8293 **CAN: RPDO3 time-out**

Keypad display: **Timeout RPDO3**

Cause	Remedy	Severity/response
RPDO3 was not received within the time-out period set in <a href="#">0x1402:005 (P542.05)</a> or with the sync configured.		Fault (configurable)
		Setting parameters: <a href="#">0x2857:003</a>

Related topics

▶ [Process data transfer](#) 374

33553 | 0x8311 **Torque limit reached**

Keypad display: **Torque limit**

Cause	Remedy	Severity/response
Motor has reached the torque limit: <ul style="list-style-type: none"> <li>• <a href="#">0x2949:003 (P337.03)</a>: Actual positive torque limit</li> <li>• <a href="#">0x2949:004 (P337.04)</a>: Actual negative torque limit</li> </ul>	<ul style="list-style-type: none"> <li>• Observe load requirements.</li> <li>• Reduce motor load.</li> <li>• Check set torque limits and sources for the torque limits.</li> </ul>	No response (configurable)
		Setting parameters: <a href="#">0x2D67:001 (P329.01)</a>

Related topics

▶ [Motor torque monitoring](#) 265

33664 | 0x8380 **Function not allowed in selected operating mode**

Keypad display: **Func. n. allowed**

Cause	Remedy	Severity/response
The selected function is not permissible in the chosen operating mode. <ul style="list-style-type: none"> <li>• Selection of torque mode [-1] in <a href="#">0x6060 (P301.00)</a> with incompatible motor control in <a href="#">0x2C00 (P300.00)</a>.</li> <li>• Selection of invalid drive mode [0] in <a href="#">0x6060 (P301.00)</a>.</li> </ul>	<ul style="list-style-type: none"> <li>• Note: selection of torque mode [-1] in <a href="#">0x6060 (P301.00)</a> with incompatible motor control in <a href="#">0x2C00 (P300.00)</a>.</li> <li>• Check settings of operation modes.</li> <li>• <a href="#">0x6060 (P301.00)</a></li> </ul>	Warning

36992 | 0x9080 **Keypad removed**

Keypad display: **Keypad removed**

Cause	Remedy	Severity/response
The keypad was removed while the keypad control was activated.	<ul style="list-style-type: none"> <li>• Plug keypad back in or activate another control source.</li> </ul>	Fault

Related topics

▶ [Changing the control source during operation](#) 86

# Diagnostics and fault elimination

Events, causes and remedies  
Causes and remedies



65282 | 0xFF02 **Fault - Brake resistor overload**

Keypad display: **BrkResistor OL.F**

Cause	Remedy	Severity/response
The calculated thermal load of the brake resistor has reached the error threshold set in <a href="#">0x2550:009 (P707.09)</a> . The regenerative energy is too high.	<ul style="list-style-type: none"> <li>• Check drive dimensioning.</li> <li>• Check settings for the brake energy management.</li> </ul> <p>Note: The error status will be reset if the thermal load falls below the error threshold - 20 %.</p>	Fault (configurable)
		<ul style="list-style-type: none"> <li>• The event can only be reset after a blocking time.</li> </ul>
		Blocking time: 2 s Setting parameters: <a href="#">0x2550:011 (P707.11)</a>

Related topics

▶ [Use of a brake resistor](#) 589

65285 | 0xFF05 **Safety option - Internal error**

Keypad display: **Safety int.Error**

Cause	Remedy	Severity/response
The safety module or safety circuit of the device was detected as being defective. The integrated safety technology is defective.	Hardware error: it is necessary to contact the manufacturer since the device must be replaced. The inverter must be replaced. Note! The user is not allowed to change inverters that come with integrated safety technology.	Fault
	<ul style="list-style-type: none"> <li>• The safety module must not be removed.</li> <li>• The user must not carry out any repairs on the safety module.</li> <li>• The safety module is not a spare part.</li> </ul>	<ul style="list-style-type: none"> <li>• The inverter is disabled immediately. The motor has no torque (is coasting).</li> <li>• The event can only be reset by mains switching.</li> </ul>

65286 | 0xFF06 **Motor overspeed**

Keypad display: **Motor overspeed**

Cause	Remedy	Severity/response
The motor speed has reached the error threshold for overspeed set in <a href="#">0x2D44:001 (P350.01)</a> .	Adapt the maximum motor speed <a href="#">0x6080 (P322.00)</a> and the warning threshold or error threshold <a href="#">0x2D44:001 (P350.01)</a> .	Fault (configurable)
		<ul style="list-style-type: none"> <li>• The event can only be reset after a blocking time.</li> </ul>
		Blocking time: 1 s Setting parameters: <a href="#">0x2D44:002 (P350.02)</a>

Related topics

▶ [Motor speed monitoring](#) 264

65289 | 0xFF09 **Motor phase missing**

Keypad display: **Mot.Phase miss.**

Cause	Remedy	Severity/response
A failure of several motor phases has been detected.	<ul style="list-style-type: none"> <li>• Check wiring between inverter and motor.</li> <li>• In case of a false tripping, adapt the settings for the motor phase failure detection.</li> </ul>	No response (configurable)
		<ul style="list-style-type: none"> <li>• The event can only be reset after a blocking time.</li> </ul>
		Blocking time: 2 s Setting parameters: <a href="#">0x2D45:001 (P310.01)</a>

Related topics

▶ [Motor phase failure detection](#) 263



65290 | 0xFF0A **Motor phase failure phase U**

Keypad display: **Phase U failure**

Cause	Remedy	Severity/response
A failure of the motor phase U has been detected.	<ul style="list-style-type: none"> <li>Check wiring between inverter and motor.</li> <li>In case of a false tripping, adapt the settings for the motor phase failure detection.                             <ul style="list-style-type: none"> <li>0x2D45:002 (P310.02) (Current threshold)</li> <li>0x2D45:003 (P310.03) (Voltage threshold)</li> </ul> </li> </ul>	No response (configurable)
		<ul style="list-style-type: none"> <li>The event can only be reset after a blocking time.</li> </ul>
		Blocking time: 2 s Setting parameters: <a href="#">0x2D45:001 (P310.01)</a>

Related topics

▶ [Motor phase failure detection](#) 263

65291 | 0xFF0B **Motor phase failure phase V**

Keypad display: **Phase V failure**

Cause	Remedy	Severity/response
A failure of the motor phase V has been detected.	<ul style="list-style-type: none"> <li>Check wiring between inverter and motor.</li> <li>In case of a false tripping, adapt the settings for the motor phase failure detection.                             <ul style="list-style-type: none"> <li>0x2D45:002 (P310.02) (Current threshold)</li> <li>0x2D45:003 (P310.03) (Voltage threshold)</li> </ul> </li> </ul>	No response (configurable)
		<ul style="list-style-type: none"> <li>The event can only be reset after a blocking time.</li> </ul>
		Blocking time: 2 s Setting parameters: <a href="#">0x2D45:001 (P310.01)</a>

Related topics

▶ [Motor phase failure detection](#) 263

65292 | 0xFF0C **Motor phase failure phase W**

Keypad display: **Phase W failure**

Cause	Remedy	Severity/response
		No response (configurable)
		<ul style="list-style-type: none"> <li>The event can only be reset after a blocking time.</li> </ul>
		Blocking time: 2 s Setting parameters: <a href="#">0x2D45:001 (P310.01)</a>

Related topics

▶ [Motor phase failure detection](#) 263

65305 | 0xFF19 **Motor parameter identification fault**

Keypad display: **Motor ID fault**

Cause	Remedy	Severity/response
During the automatic identification of the motor, an error has occurred.	<ul style="list-style-type: none"> <li>Set motor data so that they comply with the data on the motor nameplate.</li> <li>Check wiring of the motor.</li> </ul>	Fault

65311 | 0xFF1F **FMF Error**

Keypad display: **FMF Error**

Cause	Remedy	Severity/response
Configuration or runtime error	<ul style="list-style-type: none"> <li>Check configuration</li> <li>Check FMF error code 0x4050:002 to determine the error cause.</li> </ul>	Fault

# Diagnostics and fault elimination

Events, causes and remedies  
Causes and remedies



65317 | 0xFF25 **Cascading overload**

Keypad display: **Cascad. overload**

Cause	Remedy	Severity/response
Cascade function for pumps and fans The maximum frequency in <a href="#">0x2916 (P211.00)</a> has been reached and no free additional pump is available.	<ul style="list-style-type: none"> <li>• Check configuration of the cascade function.</li> <li>• Check drive sizing.</li> </ul>	Warning

Related topics

▶ [Cascade function for pumps and fans](#) [□ 617](#)

65334 | 0xFF36 **Warning - Brake resistor overload**

Keypad display: **BrkResistor OL.W**

Cause	Remedy	Severity/response
The calculated thermal load of the brake resistor has reached the warning threshold set in <a href="#">0x2550:008 (P707.08)</a> . The regenerative energy is too high.	<ul style="list-style-type: none"> <li>• Check drive dimensioning.</li> <li>• Check settings for the brake energy management.</li> </ul> <p>Note: The warning status is reset if the thermal load falls below the warning threshold of - 20 %.</p>	Warning (configurable)
		Setting parameters: <a href="#">0x2550:010 (P707.10)</a>

Related topics

▶ [Use of a brake resistor](#) [□ 589](#)

65335 | 0xFF37 **Automatic start disabled**

Keypad display: **Auto start disab**

Cause	Remedy	Severity/response
At mains connection, a start command was already available and the automatic start at power-up is set in <a href="#">0x2838:002 (P203.02)</a> to "Off [0]".	Deactivate starting command and reset error.	Fault

65336 | 0xFF38 **Load loss detected**

Keypad display: **Load loss**

Cause	Remedy	Severity/response
In a running motor, the motor load (current) is monitored. When the motor load falls below the threshold value specified in Load loss detection: threshold ( <a href="#">0x4006:001 (P710.01)</a> ) for the period of time specified in Load loss detection: delay time ( <a href="#">0x4006:002 (P710.02)</a> ), load loss protection is triggered.	Check utilisation	No response (configurable)
		Setting parameters: <a href="#">0x4006:003 (P710.03)</a>

65337 | 0xFF39 **Motor overload**

Keypad display: **Motor overload**

Cause	Remedy	Severity/response
If the apparent motor current exceeds a defined threshold value <a href="#">0x4007:002</a> for a certain amount of time <a href="#">0x4007:001</a> , heavy duty monitoring is triggered.	Check the motor load.	No response (configurable)
		Setting parameters: <a href="#">0x4007:003</a>



65366 | 0xFF56 **Maximum motor frequency reached**

Keypad display: **Max. motor freq.**

Cause	Remedy	Severity/response
<ul style="list-style-type: none"> <li>The limitation of the maximum motor speed set in <b>0x6080 (P322.00)</b> is active.</li> <li>The maximum output frequency of the inverter has been reached.</li> <li>Depending on the parameter setting of <b>0x2D44:001 (P350.01)</b> (Overspeed monitoring: threshold), the speed limitation (0x6080 / Max. motor speed) may become active before speed monitoring.</li> </ul>	Check application.	Warning

65370 | 0xFF5A **Manual mode disabled**

Keypad display: **Man. mode disabl**

Cause	Remedy	Severity/response
Indicates the deactivation of the manual speed control.		Warning

65371 | 0xFF5B **Manual mode activated**

Keypad display: **Man. mode act.**

Cause	Remedy	Severity/response
Indicates the activation of the manual speed control.		Warning

65372 | 0xFF5C **Manual mode time-out**

Keypad display: **ManMode time-out**

Cause	Remedy	Severity/response
If "manual operation" is active, an error is generated in case the communication links get lost.	The error can be only be reset if the connection is restored or the control mode is changed to a different value than "manual operation".	Fault

65393 | 0xFF71 **Wrong password**

Keypad display: **Wrong password**

Cause	Remedy	Severity/response
A wrong password has been entered several times.	Wait until the blocking time has elapsed and then enter the correct password.	Warning <ul style="list-style-type: none"> <li>The blocking time for entering a password is more than 10 seconds. (The blocking time is doubled every time an incorrect password is entered.)</li> <li>No password can be entered as long as the blocking time is active.</li> </ul>

Related topics

▶ [Access protection](#) 567

65394 | 0xFF72 **Warning**

Keypad display: **Warning**

Cause	Remedy	Severity/response
Inverter is not compatible with the Controller/PLC (brand protection). <ul style="list-style-type: none"> <li>The Controller has not written a deactivation password in the parameter yet.</li> <li>The deactivation password written by the Controller is incorrect.</li> </ul>	Use corresponding (compatible) OEM components.	Warning <ul style="list-style-type: none"> <li>No response from the inverter.</li> <li>The decision on whether the machine will be commissioned or not is made by the Controller.</li> </ul>

Related topics

▶ [Access protection](#) 567

# Diagnostics and fault elimination

Events, causes and remedies  
Causes and remedies



65395 | 0xFF73 **Fatal Error**

Keypad display: **Fatal Error**

Cause	Remedy	Severity/response
Error when reading the data from the control unit.	<ul style="list-style-type: none"><li>• Switch inverter off and on again.</li><li>• If the error occurs again, the manufacturer must be contacted, since the control unit or the device has to be replaced.</li></ul>	Fault <ul style="list-style-type: none"><li>• Operation of the inverter is not possible.</li></ul>

65396 | 0xFF74 **Power unit fatal error**

Keypad display: **PU fatal error**

Cause	Remedy	Severity/response
Error when reading the data from the power unit.	<ul style="list-style-type: none"><li>• Switch inverter off and on again.</li><li>• If the error occurs again, the manufacturer must be contacted, since the power unit or the device has to be replaced.</li></ul>	Fault <ul style="list-style-type: none"><li>• Operation of the inverter is not possible.</li></ul>

65413 | 0xFF85 **Keypad full control active**

Keypad display: **Keypad full ctrl**

Cause	Remedy	Severity/response
If the "Keypad Full Control" control mode is active.	To exit the control mode, press the keypad key <b>CTRL</b> .	Warning <ul style="list-style-type: none"><li>• Both the activity of controlling and the setpoint selection are carried out via the keypad.</li></ul>

Related topics

▶ [Keypad full control](#) 66





## 18 Technical data



---

The technical data for the device (dimensions, rated data, standards and operating conditions) can be found in the associated project planning document.

---



## 19 Environmental notes and recycling

Lenze has been certified to the worldwide environmental management standard for many years (DIN EN ISO 14001). As part of our environmental policy and the associated climate responsibility, please note the following information on hazardous ingredients and the recycling of Lenze products and their packaging:



Lenze products are partly subject to the EU Directive on the restriction of certain hazardous substances in electrical and electronic equipment 2011/65/EU: RoHS Directive [UKCA: S.I. 2012/3032 - The Restriction of the Use of Certain Hazardous Substances in Electrical and Electronic Equipment Regulations 2012] . This is documented accordingly in the EU declaration of conformity and with the CE mark.



The crossed-out wheeled bin symbol is located on the equipment. This information indicates that used electrical and electronic products must not be disposed of with normal household waste.

The EU Directive 2012/19/EU: Directive on waste electrical and electronic equipment (WEEE) [UKCA: S.I. 2013/3113 - The Waste Electrical and Electronic Equipment Regulations 2013] , which has been transposed into national law by the respective EU member states, applies to the disposal of equipment. As a customer, you have the option of disposing of the electrical and electronic equipment that you have purchased from us and that is subject to WEEE via the Lenze branch in your country.

Lenze addresses in Europe: <https://www.lenze.com/en-de/company/global-presence>

Some Lenze products contain batteries/rechargeable batteries in accordance with EU Directive 2006/66/EC: Battery Directive [UKCA: S.I. 2009/890 - The Waste Batteries and Accumulators Regulations 2009] . Any batteries/rechargeable batteries included are designed to last the life of the product and do not need to be replaced or otherwise removed by the end user.



Lenze products are usually sold with cardboard or plastic packaging. This packaging complies with EU Directive 94/62/EC: Directive on packaging and packaging waste [UKCA: S.I. 1997/648 - The Producer Responsibility Obligations (Packaging Waste) Regulations 1997] . The required disposal route is indicated by material-specific labels with the "recycling triangle". Example: "21 - other cardboard"



Lenze products are subject to REGULATION (EC) No 1907/2006: REACH Regulation [UKCA: S.I. 2008/2852 - The REACH Enforcement Regulations 2008] . When used as intended, exposure of substances to humans, animals and the environment is excluded.

Lenze products are industrial electrical and electronic products and are disposed of professionally. Both the mechanical and electrical components such as electric motors, gearboxes or inverters contain valuable raw materials that can be recycled and reused. Proper recycling and thus maintaining the highest possible level of recyclability is therefore important and sensible from an economic and ecological point of view.

- Coordinate professional disposal with your waste disposal company.
- Separate mechanical and electrical components, packaging, hazardous waste (e.g. gear oils) and batteries/rechargeable batteries wherever possible.
- Dispose of the separated waste in an environmentally sound and proper manner (no household waste or municipal bulky waste).

What?	Material	Disposal instructions
Pallets	Wood	Return to manufacturers, freight forwarders or reusable materials collection system
Packaging material	Paper, cardboard, pasteboard, plastics	Collect and dispose of separately
Products		
Electronic devices	Metal, plastics, circuit boards, heatsinks	As electronic waste give to professional disposer for recycling
Gearbox	Oil	Drain oil and dispose of separately
	Casting, steel, aluminium	Dispose as metal scrap
Motors	Casting, copper, rotors, magnets, potting compound	As engine scrap give to professional disposer for recycling
Dry-cell batteries/rechargeable batteries		As used batteries give to professional disposer for recycling



Further information on Lenze's environmental and climate responsibility and on the topic of energy efficiency can be found on the Internet:

[www.Lenze.com](http://www.Lenze.com) → search word: "Sustainability"



## 20 Appendix

### 20.1 Parameter attribute list

The parameter attribute list in particular contains some information required for reading and writing parameters via network.



The following conventions are used in this documentation for specifying the parameter address:

- The index is specified as a hexadecimal value.
  - The subindex is specified as a decimal value.
- 
- The parameter attribute list contains all parameters of the inverter.
  - The parameter attribute list is sorted by addresses (index:subindex) in ascending order.

#### How to read the parameter attribute list:

Column	Meaning
Address	Address of the parameter in the object directory. Format: index:subindex If the parameter can also be accessed via keypad, the "Display Code" is given in addition in brackets.
Name	Parameter name
Default setting	Default setting of the parameter
Category	Functional assignment of the parameter, for example "motor control" or "CANopen".
Data type	Data type of the parameter:
	I8      1 byte, with sign
	I16     2 bytes with sign
	I32     4 bytes with sign
	I64     8 bytes with sign
	U8      1 byte without sign
	U16     2 bytes without sign
	U32     4 bytes without sign
	U64     8 bytes without sign
	REAL32 4 bytes floating point
	STRING[xx] ASCII string (with character length xx)
	OCTET[xx] OCTET string (with xx bytes)
	IDX     4 bytes without sign. Is used specially for addressing parameters.
Factor	Factor for data transmission via network, depending on the number of decimal positions:
	1        No decimal positions
	10       1 decimal position
	100      2 decimal positions
	1000     3 decimal positions
	10000   4 decimal positions
A	Attributes (combinations of several attributes also possible):
	C        Setting can only be changed if the inverter is inhibited.
	E        Value is displayed as IP address on the keypad.
	H        Value is displayed as hexadecimal value on the keypad.
	I        Parameter is not displayed.
	k        Parameter is only displayed on the keypad.
	O        Parameter can be recorded with the oscilloscope function.
	P        Setting is saved in the memory module.
	X        Parameter is not displayed in the engineering tools.
M	Mapping:
	r        Receive mapping permissible.
	t        Transmit mapping permissible.
	rt       Receive and transmit mapping permissible.
	-        Mapping not permissible.



Parameter attribute list (short overview of all parameter indexes)

Address	Name	Default setting	Category	Data type	Factor	A	M
0x1000	Device type	- (Read only)	CANopen	U32	1	H	-
0x1000	Device type	- (Read only)	EtherCAT	U32	1	X	-
0x1000	NMT_DeviceType_U32	- (Read only)	POWERLINK	U32	1	X	-
0x1001	Error register	- (Read only)	CANopen	U8	1	H	t
0x1001	ERR_ErrorRegister_U8	- (Read only)	POWERLINK	U8	1	X	-
0x1003:001	ERR_History_ADOM: ErrorEntry_DOM 1	- (Read only)	POWERLINK	U32	1	X	-
0x1003:002	ERR_History_ADOM: ErrorEntry_DOM 2	- (Read only)	POWERLINK	U32	1	X	-
0x1003:003	ERR_History_ADOM: ErrorEntry_DOM 3	- (Read only)	POWERLINK	U32	1	X	-
0x1003:004	ERR_History_ADOM: ErrorEntry_DOM 4	- (Read only)	POWERLINK	U32	1	X	-
0x1003:005	ERR_History_ADOM: ErrorEntry_DOM 5	- (Read only)	POWERLINK	U32	1	X	-
0x1003:006	ERR_History_ADOM: ErrorEntry_DOM 6	- (Read only)	POWERLINK	U32	1	X	-
0x1003:007	ERR_History_ADOM: ErrorEntry_DOM 7	- (Read only)	POWERLINK	U32	1	X	-
0x1003:008	ERR_History_ADOM: ErrorEntry_DOM 8	- (Read only)	POWERLINK	U32	1	X	-
0x1003:009	ERR_History_ADOM: ErrorEntry_DOM 9	- (Read only)	POWERLINK	U32	1	X	-
0x1003:010	ERR_History_ADOM: ErrorEntry_DOM 10	- (Read only)	POWERLINK	U32	1	X	-
0x1005	COB-ID SYNC	<b>0x00000080</b>	CANopen	U32	1	PH	-
0x1006	Communication cyclic period	<b>0 μs</b>	CANopen	U32	1	P	-
0x1006	NMT_CycleLen_U32	<b>0</b>	POWERLINK	U32	1	X	-
0x1008	Manufacturer device name	- (Read only)	CANopen	STRING[50]	1	-	-
0x1008	Manufacturer device name	- (Read only)	EtherCAT	STRING[50]	1	X	-
0x1008	NMT_ManufactDevName_VS	- (Read only)	POWERLINK	STRING[32]	1	X	-
0x1009	Manufacturer hardware version	- (Read only)	CANopen	STRING[50]	1	-	-
0x1009	Manufacturer hardware version	- (Read only)	EtherCAT	STRING[50]	1	X	-
0x100A	Manufacturer software version	- (Read only)	CANopen	STRING[50]	1	-	-
0x100A	Manufacturer software version	- (Read only)	EtherCAT	STRING[50]	1	X	-
0x1014	COB-ID Emergency telegram (EMCY)	- (Read only)	CANopen	U32	1	H	-
0x1015	Inhibit time EMCY	<b>0.0 ms</b>	CANopen	U16	10	P	-
0x1016:000 (P520.00)	Consumer heartbeat time: Highest sub-index supported	- (Read only)	CANopen	U8	1	-	-
0x1016:001 (P520.01)	Consumer heartbeat time: Consumer heartbeat time 1	<b>0x00000000</b>	CANopen	U32	1	PH	-
0x1016:002 (P520.02)	Consumer heartbeat time: Consumer heartbeat time 2	<b>0x00000000</b>	CANopen	U32	1	PH	-
0x1016:003 (P520.03)	Consumer heartbeat time: Consumer heartbeat time 3	<b>0x00000000</b>	CANopen	U32	1	PH	-
0x1016:004 (P520.04)	Consumer heartbeat time: Consumer heartbeat time 4	<b>0x00000000</b>	CANopen	U32	1	PH	-
0x1017 (P522.00)	Producer heartbeat time	<b>0 ms</b>	CANopen	U16	1	P	-
0x1018:001	Identity object: Vendor ID	- (Read only)	CANopen	U32	1	-	-
0x1018:002	Identity object: Product ID	- (Read only)	CANopen	U32	1	H	-
0x1018:003	Identity object: Revision number	- (Read only)	CANopen	U32	1	-	-
0x1018:004	Identity object: Serial number	- (Read only)	CANopen	U32	1	-	-
0x1018:001	Identity object: Vendor ID	- (Read only)	EtherCAT	U32	1	X	-
0x1018:002	Identity object: Product Code	- (Read only)	EtherCAT	U32	1	X	-
0x1018:003	Identity object: Revision number	- (Read only)	EtherCAT	U32	1	X	-
0x1018:004	Identity object: Serial number	- (Read only)	EtherCAT	U32	1	X	-
0x1018:001	NMT_IdentityObject_REC: VendorId_U32	- (Read only)	POWERLINK	U32	1	X	-
0x1029:000	Error behavior: Highest sub-index supported	- (Read only)	CANopen	U8	1	-	-
0x1029:001	Error behavior: Communication error	<b>Status &gt; Pre-operational [0]</b>	CANopen	U8	1	P	-
0x1030:001	NMT_InterfaceGroup_0h_REC: InterfaceIndex_U16	- (Read only)	POWERLINK	U16	1	X	-
0x1030:002	NMT_InterfaceGroup_0h_REC: InterfaceDescription_VSTR	- (Read only)	POWERLINK	STRING[32]	1	X	-
0x1030:003	NMT_InterfaceGroup_0h_REC: InterfaceType_U8	- (Read only)	POWERLINK	U8	1	X	-

\* Default setting dependent on the model.



Address	Name	Default setting	Category	Data type	Factor	A	M
0x1030:004	NMT_InterfaceGroup_0h_REC: InterfaceMtu_U32	- (Read only)	POWERLINK	U32	1	X	-
0x1030:005	NMT_InterfaceGroup_0h_REC: InterfacePhysAddress_OSTR	- (Read only)	POWERLINK	OCTET[6]	1	X	-
0x1030:006	NMT_InterfaceGroup_0h_REC: InterfaceName_VSTR	- (Read only)	POWERLINK	STRING[32]	1	X	-
0x1030:007	NMT_InterfaceGroup_0h_REC: InterfaceOperState_U8	- (Read only)	POWERLINK	U8	1	X	-
0x1030:008	NMT_InterfaceGroup_0h_REC: InterfaceAdminState_U8	0	POWERLINK	U8	1	X	-
0x1030:009	NMT_InterfaceGroup_0h_REC: Valid_BOOL	0	POWERLINK	U8	1	X	-
0x10F3:001	Diagnosis History: Maximum Messages	- (Read only)	EtherCAT	U8	1	X	-
0x10F3:002	Diagnosis History: Newest Message	- (Read only)	EtherCAT	U8	1	X	-
0x10F3:003	Diagnosis History: Newest Acknowledged Message	0	EtherCAT	U8	1	X	-
0x10F3:004	Diagnosis History: New message available	- (Read only)	EtherCAT	U8	1	X	t
0x10F3:005	Diagnosis History: Flags	1	EtherCAT	U16	1	X	-
0x10F3:006	Diagnosis History: Diagnosis message 0	- (Read only)	EtherCAT	OCTET[19]	1	X	-
0x10F3:007	Diagnosis History: Diagnosis message 1	- (Read only)	EtherCAT	OCTET[19]	1	X	-
0x10F3:008	Diagnosis History: Diagnosis message 2	- (Read only)	EtherCAT	OCTET[19]	1	X	-
0x10F3:009	Diagnosis History: Diagnosis message 3	- (Read only)	EtherCAT	OCTET[19]	1	X	-
0x10F3:010	Diagnosis History: Diagnosis message 4	- (Read only)	EtherCAT	OCTET[19]	1	X	-
0x10F3:011	Diagnosis History: Diagnosis message 5	- (Read only)	EtherCAT	OCTET[19]	1	X	-
0x10F3:012	Diagnosis History: Diagnosis message 6	- (Read only)	EtherCAT	OCTET[19]	1	X	-
0x10F3:013	Diagnosis History: Diagnosis message 7	- (Read only)	EtherCAT	OCTET[19]	1	X	-
0x10F3:014	Diagnosis History: Diagnosis message 8	- (Read only)	EtherCAT	OCTET[19]	1	X	-
0x10F3:015	Diagnosis History: Diagnosis message 9	- (Read only)	EtherCAT	OCTET[19]	1	X	-
0x10F3:016	Diagnosis History: Diagnosis message 10	- (Read only)	EtherCAT	OCTET[19]	1	X	-
0x10F3:017	Diagnosis History: Diagnosis message 11	- (Read only)	EtherCAT	OCTET[19]	1	X	-
0x10F3:018	Diagnosis History: Diagnosis message 12	- (Read only)	EtherCAT	OCTET[19]	1	X	-
0x10F3:019	Diagnosis History: Diagnosis message 13	- (Read only)	EtherCAT	OCTET[19]	1	X	-
0x10F3:020	Diagnosis History: Diagnosis message 14	- (Read only)	EtherCAT	OCTET[19]	1	X	-
0x10F3:021	Diagnosis History: Diagnosis message 15	- (Read only)	EtherCAT	OCTET[19]	1	X	-
0x10F3:022	Diagnosis History: Diagnosis message 16	- (Read only)	EtherCAT	OCTET[19]	1	X	-
0x10F3:023	Diagnosis History: Diagnosis message 17	- (Read only)	EtherCAT	OCTET[19]	1	X	-
0x10F3:024	Diagnosis History: Diagnosis message 18	- (Read only)	EtherCAT	OCTET[19]	1	X	-
0x10F3:025	Diagnosis History: Diagnosis message 19	- (Read only)	EtherCAT	OCTET[19]	1	X	-
0x10F3:026	Diagnosis History: Diagnosis message 20	- (Read only)	EtherCAT	OCTET[19]	1	X	-
0x10F3:027	Diagnosis History: Diagnosis message 21	- (Read only)	EtherCAT	OCTET[19]	1	X	-
0x10F3:028	Diagnosis History: Diagnosis message 22	- (Read only)	EtherCAT	OCTET[19]	1	X	-
0x10F3:029	Diagnosis History: Diagnosis message 23	- (Read only)	EtherCAT	OCTET[19]	1	X	-
0x10F3:030	Diagnosis History: Diagnosis message 24	- (Read only)	EtherCAT	OCTET[19]	1	X	-
0x10F3:031	Diagnosis History: Diagnosis message 25	- (Read only)	EtherCAT	OCTET[19]	1	X	-
0x10F3:032	Diagnosis History: Diagnosis message 26	- (Read only)	EtherCAT	OCTET[19]	1	X	-
0x10F3:033	Diagnosis History: Diagnosis message 27	- (Read only)	EtherCAT	OCTET[19]	1	X	-
0x10F3:034	Diagnosis History: Diagnosis message 28	- (Read only)	EtherCAT	OCTET[19]	1	X	-
0x10F3:035	Diagnosis History: Diagnosis message 29	- (Read only)	EtherCAT	OCTET[19]	1	X	-
0x10F3:036	Diagnosis History: Diagnosis message 30	- (Read only)	EtherCAT	OCTET[19]	1	X	-
0x10F3:037	Diagnosis History: Diagnosis message 31	- (Read only)	EtherCAT	OCTET[19]	1	X	-
0x1200:000	SDO1 server parameter: Highest sub-index supported	- (Read only)	CANopen	U8	1	-	-
0x1200:001	SDO1 server parameter: COB-ID client > server (rx)	- (Read only)	CANopen	U32	1	H	-
0x1200:002	SDO1 server parameter: COB-ID server > client (tx)	- (Read only)	CANopen	U32	1	H	-
0x1201:000	SDO2 server parameter: Highest sub-index supported	- (Read only)	CANopen	U8	1	-	-
0x1201:001	SDO2 server parameter: COB-ID client > server (rx)	0x80000640	CANopen	U32	1	PH	-
0x1201:002	SDO2 server parameter: COB-ID server > client (tx)	0x800005C0	CANopen	U32	1	PH	-

\* Default setting dependent on the model.



Address	Name	Default setting	Category	Data type	Factor	A	M
0x1201:003	SDO2 server parameter: Node-ID of the SDO client	0	CANopen	U8	1	P	-
0x1300	SDO_SeqLayerTimeout_U32	15000 ms	POWERLINK	U32	1	X	-
0x1301	SDO_CmdLayerTimeout_U32	30000 ms	POWERLINK	U32	1	X	-
0x1400:000	RPDO1 communication parameter: Highest sub-index supported	- (Read only)	CANopen	U8	1	-	-
0x1400:001 (P540.01)	RPDO1 communication parameter: COB-ID	0x00000200	CANopen	U32	1	PH	-
0x1400:002 (P540.02)	RPDO1 communication parameter: Transmission type	255	CANopen	U8	1	P	-
0x1400:005 (P540.05)	RPDO1 communication parameter: Event timer	100 ms	CANopen	U16	1	P	-
0x1400:001	PDO_RxCommParam_00h_REC: NodeID_U8	0	POWERLINK	U8	1	X	-
0x1400:002	PDO_RxCommParam_00h_REC: MappingVersion_U8	- (Read only)	POWERLINK	U8	1	X	-
0x1401:001 (P541.01)	RPDO2 communication parameter: COB-ID	0x80000300	CANopen	U32	1	PH	-
0x1401:002 (P541.02)	RPDO2 communication parameter: Transmission type	255	CANopen	U8	1	P	-
0x1401:005 (P541.05)	RPDO2 communication parameter: Event timer	100 ms	CANopen	U16	1	P	-
0x1402:001 (P542.01)	RPDO3 communication parameter: COB-ID	0x80000400	CANopen	U32	1	PH	-
0x1402:002 (P542.02)	RPDO3 communication parameter: Transmission type	255	CANopen	U8	1	P	-
0x1402:005 (P542.05)	RPDO3 communication parameter: Event timer	100 ms	CANopen	U16	1	P	-
0x1600:000	RPDO1 mapping parameter: Number of mapped application objects in PDO	2	CANopen	U8	1	P	-
0x1600:001	RPDO1 mapping parameter: Application object 1	0x60400010	CANopen	U32	1	PH	-
0x1600:002	RPDO1 mapping parameter: Application object 2	0x60420010	CANopen	U32	1	PH	-
0x1600:003	RPDO1 mapping parameter: Application object 3	0x00000000	CANopen	U32	1	PH	-
0x1600:004	RPDO1 mapping parameter: Application object 4	0x00000000	CANopen	U32	1	PH	-
0x1600:005	RPDO1 mapping parameter: Application object 5	0x00000000	CANopen	U32	1	PH	-
0x1600:006	RPDO1 mapping parameter: Application object 6	0x00000000	CANopen	U32	1	PH	-
0x1600:007	RPDO1 mapping parameter: Application object 7	0x00000000	CANopen	U32	1	PH	-
0x1600:008	RPDO1 mapping parameter: Application object 8	0x00000000	CANopen	U32	1	PH	-
0x1600:001 ... 0x1600:016	PDO_RxMappParam_00h_REC: ObjectMapping_U64 1 ... ObjectMapping_U64 16	0	POWERLINK	U64	1	X	-
0x1601:000	RPDO2 mapping parameter: Number of mapped application objects in PDO	0	CANopen	U8	1	P	-
0x1601:001	RPDO2 mapping parameter: Application object 1	0x00000000	CANopen	U32	1	PH	-
0x1601:002	RPDO2 mapping parameter: Application object 2	0x00000000	CANopen	U32	1	PH	-
0x1601:003	RPDO2 mapping parameter: Application object 3	0x00000000	CANopen	U32	1	PH	-
0x1601:004	RPDO2 mapping parameter: Application object 4	0x00000000	CANopen	U32	1	PH	-
0x1601:005	RPDO2 mapping parameter: Application object 5	0x00000000	CANopen	U32	1	PH	-
0x1601:006	RPDO2 mapping parameter: Application object 6	0x00000000	CANopen	U32	1	PH	-
0x1601:007	RPDO2 mapping parameter: Application object 7	0x00000000	CANopen	U32	1	PH	-
0x1601:008	RPDO2 mapping parameter: Application object 8	0x00000000	CANopen	U32	1	PH	-
0x1602:000	RPDO3 mapping parameter: Number of mapped application objects in PDO	0	CANopen	U8	1	P	-
0x1602:001	RPDO3 mapping parameter: Application object 1	0x00000000	CANopen	U32	1	PH	-
0x1602:002	RPDO3 mapping parameter: Application object 2	0x00000000	CANopen	U32	1	PH	-
0x1602:003	RPDO3 mapping parameter: Application object 3	0x00000000	CANopen	U32	1	PH	-
0x1602:004	RPDO3 mapping parameter: Application object 4	0x00000000	CANopen	U32	1	PH	-
0x1602:005	RPDO3 mapping parameter: Application object 5	0x00000000	CANopen	U32	1	PH	-
0x1602:006	RPDO3 mapping parameter: Application object 6	0x00000000	CANopen	U32	1	PH	-
0x1602:007	RPDO3 mapping parameter: Application object 7	0x00000000	CANopen	U32	1	PH	-

\* Default setting dependent on the model.



Address	Name	Default setting	Category	Data type	Factor	A	M
0x1602:008	RPDO3 mapping parameter: Application object 8	0x00000000	CANopen	U32	1	PH	-
0x1603:001	RPDO (A) vl: Velocity mode (vl): RPDO (A) vl: Mapping Entry 1	-(Read only)	EtherCAT	U32	1	XH	-
0x1603:002	RPDO (A) vl: Velocity mode (vl): RPDO (A) vl: Mapping Entry 2	-(Read only)	EtherCAT	U32	1	XH	-
0x1605:000	RPDO (A) user: Free configuration: RPDO (A) user: Number of mapped objectscts in PDO	-(Read only)	EtherCAT	U8	1	X	-
0x1605:001	RPDO (A) user: Free configuration: RPDO (A) user: Mapping Entry 1	-(Read only)	EtherCAT	U32	1	XH	-
0x1605:002	RPDO (A) user: Free configuration: RPDO (A) user: Mapping Entry 2	-(Read only)	EtherCAT	U32	1	XH	-
0x1605:003	RPDO (A) user: Free configuration: RPDO (A) user: Mapping Entry 3	-(Read only)	EtherCAT	U32	1	XH	-
0x1605:004	RPDO (A) user: Free configuration: RPDO (A) user: Mapping Entry 4	-(Read only)	EtherCAT	U32	1	XH	-
0x1605:005	RPDO (A) user: Free configuration: RPDO (A) user: Mapping Entry 5	-(Read only)	EtherCAT	U32	1	XH	-
0x1605:006	RPDO (A) user: Free configuration: RPDO (A) user: Mapping Entry 6	-(Read only)	EtherCAT	U32	1	XH	-
0x1605:007	RPDO (A) user: Free configuration: RPDO (A) user: Mapping Entry 7	-(Read only)	EtherCAT	U32	1	XH	-
0x1605:008	RPDO (A) user: Free configuration: RPDO (A) user: Mapping Entry 8	-(Read only)	EtherCAT	U32	1	XH	-
0x1605:009	RPDO (A) user: Free configuration: RPDO (A) user: Mapping Entry 9	-(Read only)	EtherCAT	U32	1	XH	-
0x1605:010	RPDO (A) user: Free configuration: RPDO (A) user: Mapping Entry 10	-(Read only)	EtherCAT	U32	1	XH	-
0x1605:011	RPDO (A) user: Free configuration: RPDO (A) user: Mapping Entry 11	-(Read only)	EtherCAT	U32	1	XH	-
0x1605:012	RPDO (A) user: Free configuration: RPDO (A) user: Mapping Entry 12	-(Read only)	EtherCAT	U32	1	XH	-
0x1605:013	RPDO (A) user: Free configuration: RPDO (A) user: Mapping Entry 13	-(Read only)	EtherCAT	U32	1	XH	-
0x1605:014	RPDO (A) user: Free configuration: RPDO (A) user: Mapping Entry 14	-(Read only)	EtherCAT	U32	1	XH	-
0x1605:015	RPDO (A) user: Free configuration: RPDO (A) user: Mapping Entry 15	-(Read only)	EtherCAT	U32	1	XH	-
0x1605:016	RPDO (A) user: Free configuration: RPDO (A) user: Mapping Entry 16	-(Read only)	EtherCAT	U32	1	XH	-
0x1800:000	TPDO1 communication parameter: Highest sub-index supported	-(Read only)	CANopen	U8	1	-	-
0x1800:001 (P550.01)	TPDO1 communication parameter: COB-ID	0x40000180	CANopen	U32	1	PH	-
0x1800:002 (P550.02)	TPDO1 communication parameter: Transmission type	255	CANopen	U8	1	P	-
0x1800:003 (P550.03)	TPDO1 communication parameter: Inhibit time	0.0 ms	CANopen	U16	10	P	-
0x1800:005 (P550.05)	TPDO1 communication parameter: Event timer	20 ms	CANopen	U16	1	P	-
0x1800:001	PDO_TxCommParam_00h_REC: NodeID_U8	-(Read only)	POWERLINK	U8	1	X	-
0x1800:002	PDO_TxCommParam_00h_REC: MappingVersion_U8	-(Read only)	POWERLINK	U8	1	X	-
0x1801:000	TPDO2 communication parameter: Highest sub-index supported	-(Read only)	CANopen	U8	1	-	-
0x1801:001 (P551.01)	TPDO2 communication parameter: COB-ID	0xC0000280	CANopen	U32	1	PH	-
0x1801:002 (P551.02)	TPDO2 communication parameter: Transmission type	255	CANopen	U8	1	P	-
0x1801:003 (P551.03)	TPDO2 communication parameter: Inhibit time	0.0 ms	CANopen	U16	10	P	-

\* Default setting dependent on the model.



Address	Name	Default setting	Category	Data type	Factor	A	M
0x1801:005 (P551.05)	TPDO2 communication parameter: Event timer	0 ms	CANopen	U16	1	P	-
0x1802:000	TPDO3 communication parameter: Highest sub-index supported	- (Read only)	CANopen	U8	1	-	-
0x1802:001 (P552.01)	TPDO3 communication parameter: COB-ID	0xC0000380	CANopen	U32	1	PH	-
0x1802:002 (P552.02)	TPDO3 communication parameter: Transmission type	255	CANopen	U8	1	P	-
0x1802:003 (P552.03)	TPDO3 communication parameter: Inhibit time	0.0 ms	CANopen	U16	10	P	-
0x1802:005 (P552.05)	TPDO3 communication parameter: Event timer	0 ms	CANopen	U16	1	P	-
0x1A00:000	TPDO1 mapping parameter: Number of mapped application objects in TPDO	2	CANopen	U8	1	P	-
0x1A00:001	TPDO1 mapping parameter: Application object 1	0x60410010	CANopen	U32	1	PH	-
0x1A00:002	TPDO1 mapping parameter: Application object 2	0x60440010	CANopen	U32	1	PH	-
0x1A00:003	TPDO1 mapping parameter: Application object 3	0x00000000	CANopen	U32	1	PH	-
0x1A00:004	TPDO1 mapping parameter: Application object 4	0x00000000	CANopen	U32	1	PH	-
0x1A00:005	TPDO1 mapping parameter: Application object 5	0x00000000	CANopen	U32	1	PH	-
0x1A00:006	TPDO1 mapping parameter: Application object 6	0x00000000	CANopen	U32	1	PH	-
0x1A00:007	TPDO1 mapping parameter: Application object 7	0x00000000	CANopen	U32	1	PH	-
0x1A00:008	TPDO1 mapping parameter: Application object 8	0x00000000	CANopen	U32	1	PH	-
0x1A00:001 ... 0x1A00:016	PDO_TxMappParam_00h_REC: ObjectMapping_U64 1 ... ObjectMapping_U64 16	0	POWERLINK	U64	1	X	-
0x1A01:000	TPDO2 mapping parameter: Number of mapped application objects in TPDO	0	CANopen	U8	1	P	-
0x1A01:001	TPDO2 mapping parameter: Application object 1	0x00000000	CANopen	U32	1	PH	-
0x1A01:002	TPDO2 mapping parameter: Application object 2	0x00000000	CANopen	U32	1	PH	-
0x1A01:003	TPDO2 mapping parameter: Application object 3	0x00000000	CANopen	U32	1	PH	-
0x1A01:004	TPDO2 mapping parameter: Application object 4	0x00000000	CANopen	U32	1	PH	-
0x1A01:005	TPDO2 mapping parameter: Application object 5	0x00000000	CANopen	U32	1	PH	-
0x1A01:006	TPDO2 mapping parameter: Application object 6	0x00000000	CANopen	U32	1	PH	-
0x1A01:007	TPDO2 mapping parameter: Application object 7	0x00000000	CANopen	U32	1	PH	-
0x1A01:008	TPDO2 mapping parameter: Application object 8	0x00000000	CANopen	U32	1	PH	-
0x1A02:000	TPDO3 mapping parameter: Number of mapped application objects in TPDO	0	CANopen	U8	1	P	-
0x1A02:001	TPDO3 mapping parameter: Application object 1	0x00000000	CANopen	U32	1	PH	-
0x1A02:002	TPDO3 mapping parameter: Application object 2	0x00000000	CANopen	U32	1	PH	-
0x1A02:003	TPDO3 mapping parameter: Application object 3	0x00000000	CANopen	U32	1	PH	-
0x1A02:004	TPDO3 mapping parameter: Application object 4	0x00000000	CANopen	U32	1	PH	-
0x1A02:005	TPDO3 mapping parameter: Application object 5	0x00000000	CANopen	U32	1	PH	-
0x1A02:006	TPDO3 mapping parameter: Application object 6	0x00000000	CANopen	U32	1	PH	-
0x1A02:007	TPDO3 mapping parameter: Application object 7	0x00000000	CANopen	U32	1	PH	-
0x1A02:008	TPDO3 mapping parameter: Application object 8	0x00000000	CANopen	U32	1	PH	-
0x1A03:001	TPDO (A) vl: Velocity mode (vl): TPDO (A) vl: Mapping Entry 1	- (Read only)	EtherCAT	U32	1	XH	-
0x1A03:002	TPDO (A) vl: Velocity mode (vl): TPDO (A) vl: Mapping Entry 2	- (Read only)	EtherCAT	U32	1	XH	-
0x1A03:003	TPDO (A) vl: Velocity mode (vl): TPDO (A) vl: Mapping Entry 3	- (Read only)	EtherCAT	U32	1	XH	-
0x1A05:000	TPDO (A) user: Free configuration: TPDO (A) user: number of mapped objects	- (Read only)	EtherCAT	U8	1	X	-
0x1A05:001	TPDO (A) user: Free configuration: TPDO (A) user: Mapping Entry 1	- (Read only)	EtherCAT	U32	1	XH	-
0x1A05:002	TPDO (A) user: Free configuration: TPDO (A) user: Mapping Entry 2	- (Read only)	EtherCAT	U32	1	XH	-

\* Default setting dependent on the model.





Address	Name	Default setting	Category	Data type	Factor	A	M
0x1A05:003	TPDO (A) user: Free configuration: TPDO (A) user: Mapping Entry 3	- (Read only)	EtherCAT	U32	1	XH	-
0x1A05:004	TPDO (A) user: Free configuration: TPDO (A) user: Mapping Entry 4	- (Read only)	EtherCAT	U32	1	XH	-
0x1A05:005	TPDO (A) user: Free configuration: TPDO (A) user: Mapping Entry 5	- (Read only)	EtherCAT	U32	1	XH	-
0x1A05:006	TPDO (A) user: Free configuration: TPDO (A) user: Mapping Entry 6	- (Read only)	EtherCAT	U32	1	XH	-
0x1A05:007	TPDO (A) user: Free configuration: TPDO (A) user: Mapping Entry 7	- (Read only)	EtherCAT	U32	1	XH	-
0x1A05:008	TPDO (A) user: Free configuration: TPDO (A) user: Mapping Entry 8	- (Read only)	EtherCAT	U32	1	XH	-
0x1A05:009	TPDO (A) user: Free configuration: TPDO (A) user: Mapping Entry 9	- (Read only)	EtherCAT	U32	1	XH	-
0x1A05:010	TPDO (A) user: Free configuration: TPDO (A) user: Mapping Entry 10	- (Read only)	EtherCAT	U32	1	XH	-
0x1A05:011	TPDO (A) user: Free configuration: TPDO (A) user: Mapping Entry 11	- (Read only)	EtherCAT	U32	1	XH	-
0x1A05:012	TPDO (A) user: Free configuration: TPDO (A) user: Mapping Entry 12	- (Read only)	EtherCAT	U32	1	XH	-
0x1A05:013	TPDO (A) user: Free configuration: TPDO (A) user: Mapping Entry 13	- (Read only)	EtherCAT	U32	1	XH	-
0x1A05:014	TPDO (A) user: Free configuration: TPDO (A) user: Mapping Entry 14	- (Read only)	EtherCAT	U32	1	XH	-
0x1A05:015	TPDO (A) user: Free configuration: TPDO (A) user: Mapping Entry 15	- (Read only)	EtherCAT	U32	1	XH	-
0x1A05:016	TPDO (A) user: Free configuration: TPDO (A) user: Mapping Entry 16	- (Read only)	EtherCAT	U32	1	XH	-
0x1C00:001	Sync manager type: SM0 communication type	- (Read only)	EtherCAT	U8	1	X	-
0x1C00:002	Sync manager type: SM1 communication type	- (Read only)	EtherCAT	U8	1	X	-
0x1C00:003	Sync manager type: SM2 communication type	- (Read only)	EtherCAT	U8	1	X	-
0x1C00:004	Sync manager type: SM3 communication type	- (Read only)	EtherCAT	U8	1	X	-
0x1C0A:001	DLL_CNCollision_REC: CumulativeCnt_U32	0	POWERLINK	U32	1	X	-
0x1C0B:001	DLL_CNLossSoC_REC: CumulativeCnt_U32	0	POWERLINK	U32	1	X	-
0x1C0B:002	DLL_CNLossSoC_REC: ThresholdCnt_U32	- (Read only)	POWERLINK	U32	1	X	-
0x1C0B:003	DLL_CNLossSoC_REC: Threshold_U32	0	POWERLINK	U32	1	X	-
0x1C0F:001	DLL_CNCRCErrREC_REC: CumulativeCnt_U32	0	POWERLINK	U32	1	X	-
0x1C0F:002	DLL_CNCRCErrREC_REC: ThresholdCnt_U32	- (Read only)	POWERLINK	U32	1	X	-
0x1C0F:003	DLL_CNCRCErrREC_REC: Threshold_U32	0	POWERLINK	U32	1	X	-
0x1C10	DLL_CNLossOfLinkCum_U32	0	POWERLINK	U32	1	X	-
0x1C12:001	SM2 PDO assignment: PDO mapping object index of 1. assigned RPDO	- (Read only)	EtherCAT	U16	1	XH	-
0x1C12:002	SM2 PDO assignment: PDO mapping object index of 2. assigned RPDO	- (Read only)	EtherCAT	U16	1	XH	-
0x1C13:001	SM2 PDO assignment: PDO mapping object index of 1. assigned TPDO	- (Read only)	EtherCAT	U16	1	XH	-
0x1C13:002	SM2 PDO assignment: PDO mapping object index of 2. assigned TPDO	- (Read only)	EtherCAT	U16	1	XH	-
0x1C32:001	Sync Manager 2: Synchronization type	- (Read only)	EtherCAT	U16	1	X	-
0x1C32:002	Sync Manager 2: Cycle time	x ns (Read only)	EtherCAT	U32	1	X	-
0x1C32:003	Sync Manager 2: Shift time	x ns (Read only)	EtherCAT	U32	1	X	-
0x1C32:004	Sync Manager 2: Sync modes supported	- (Read only)	EtherCAT	U16	1	X	-
0x1C32:005	Sync Manager 2: Minimum cycle time	x ns (Read only)	EtherCAT	U32	1	X	-
0x1C33:001	Sync Manager 3: Synchronization type	- (Read only)	EtherCAT	U16	1	X	-
0x1C33:002	Sync Manager 3: Cycle time	x ns (Read only)	EtherCAT	U32	1	X	-
0x1C33:003	Sync Manager 3: Shift time	x ns (Read only)	EtherCAT	U32	1	X	-
0x1C33:004	Sync Manager 3: Sync modes supported	- (Read only)	EtherCAT	U16	1	X	-

\* Default setting dependent on the model.



Address	Name	Default setting	Category	Data type	Factor	A	M
0x1C33:005	Sync Manager 3: Minimum cycle time	x ns (Read only)	EtherCAT	U32	1	X	-
0x1E40:001	NWL_IpAddrTable_0h_REC: Ifindex_U16	-(Read only)	POWERLINK	U32	1	X	-
0x1E40:002	NWL_IpAddrTable_0h_REC: Addr IPAD	-(Read only)	POWERLINK	U32	1	X	-
0x1E40:003	NWL_IpAddrTable_0h_REC: NetMask_IPAD	-(Read only)	POWERLINK	U32	1	X	-
0x1E40:004	NWL_IpAddrTable_0h_REC: ReasmMaxSize_U16	-(Read only)	POWERLINK	U32	1	X	-
0x1E40:005	NWL_IpAddrTable_0h_REC: DefaultGateway_IPAD	0	POWERLINK	U32	1	X	-
0x1E4A:001	NWL_IpGroup_REC: Forwarding_BOOL	-(Read only)	POWERLINK	U8	1	X	-
0x1E4A:002	NWL_IpGroup_REC: DefaultTTL_U16	64	POWERLINK	U16	1	X	-
0x1E4A:003	NWL_IpGroup_REC: ForwardingDatagrams_U32	-(Read only)	POWERLINK	U32	1	X	-
0x1F81:001 ... 0x1F81:254	NMT_NodeAssignment: Node assignment 1 ... Node assignment 254	0	POWERLINK	U32	1	X	-
0x1F82	NMT_FeatureFlags_U32	-(Read only)	POWERLINK	U32	1	X	-
0x1F83	NMT_EPLVers_U8	-(Read only)	POWERLINK	U8	1	X	-
0x1F8C	NMT_CurrState_U8	-(Read only)	POWERLINK	U8	1	X	-
0x1F93:001	NMT_EPLNodeID_REC: NodeID_U8	-(Read only)	POWERLINK	U8	1	X	-
0x1F93:002	NMT_EPLNodeID_REC: NodeIDByHW_BOOL	-(Read only)	POWERLINK	U8	1	X	-
0x1F98:001	NMT_CycleTiming_REC: IsochrTxMaxPayload_U16	-(Read only)	POWERLINK	U16	1	X	-
0x1F98:002	NMT_CycleTiming_REC: IsochrRxMaxPayload_U16	-(Read only)	POWERLINK	U16	1	X	-
0x1F98:003	NMT_CycleTiming_REC: PResMaxLatency_U32	x ns (Read only)	POWERLINK	U32	1	X	-
0x1F98:004	NMT_CycleTiming_REC: PReqActPayload_U16	36	POWERLINK	U16	1	X	-
0x1F98:005	NMT_CycleTiming_REC: PResActPayload_U16	36	POWERLINK	U16	1	X	-
0x1F98:006	NMT_CycleTiming_REC: ASndMaxLatency_U32	x ns (Read only)	POWERLINK	U32	1	X	-
0x1F98:007	NMT_CycleTiming_REC: MultipleCycleCnt_U8	0	POWERLINK	U8	1	X	-
0x1F98:008	NMT_CycleTiming_REC: AsyncMTUSize_U16	300	POWERLINK	U16	1	X	-
0x1F98:009	NMT_CycleTiming_REC: Prescaler_U16	2	POWERLINK	U16	1	X	-
0x1F99	NMT_CNBasicEthernetTimeout_u32	0	POWERLINK	U32	1	X	-
0x1F9A	NMT_HostName_VSTR		POWERLINK	STRING[32]	1	X	-
0x1F9B:001 ... 0x1F9B:100	NMT_MultiplCycleAssign_AU8: NMT_MultiplCycleAssign_AU8 1 ... NMT_MultiplCycleAssign_AU8 100	-(Read only)	POWERLINK	U8	1	X	-
0x1F9E	NMT_ResetCmd_U8	-(Read only)	POWERLINK	U8	1	X	-
0x2000:001 (P190.01)	Device data: Product code	-(Read only)	general	STRING[18]	1	-	-
0x2000:002 (P190.02)	Device data: Serial number	-(Read only)	general	STRING[50]	1	-	-
0x2000:004 (P190.04)	Device data: CU firmware version	-(Read only)	general	STRING[50]	1	-	-
0x2000:005 (P190.05)	Device data: CU firmware type	-(Read only)	general	STRING[50]	1	-	-
0x2000:006 (P190.06)	Device data: CU bootloader version	-(Read only)	general	STRING[50]	1	-	-
0x2000:007 (P190.07)	Device data: CU bootloader type	-(Read only)	general	STRING[50]	1	-	-
0x2000:008 (P190.08)	Device data: Object directory version	-(Read only)	general	U32	1	-	-
0x2000:010 (P190.10)	Device data: PU firmware version	-(Read only)	general	STRING[50]	1	-	-
0x2000:011 (P190.11)	Device data: PU firmware type	-(Read only)	general	STRING[50]	1	-	-
0x2000:012 (P190.12)	Device data: PU bootloader version	-(Read only)	general	STRING[50]	1	-	-
0x2000:013 (P190.13)	Device data: PU bootloader type	-(Read only)	general	STRING[50]	1	-	-
0x2000:014 (P190.14)	Device data: Module - firmware version	-(Read only)	general	STRING[11]	1	-	-
0x2000:015 (P190.15)	Device data: Communication firmware revision number	-(Read only)	general	STRING[50]	1	-	-

\* Default setting dependent on the model.



Address	Name	Default setting	Category	Data type	Factor	A	M
0x2000:016 (P190.16)	Device data: Communication bootloader revision number	- (Read only)	general	STRING[50]	1	-	-
0x2000:017 (P190.17)	Device data: CU firmware subtype	- (Read only)	general	STRING[50]	1	-	-
0x2001 (P191.00)	Device name	"My Device"	general	STRING[128]	1	P	-
0x2002:004 (P192.04)	Device module: CU type code	- (Read only)	general	STRING[19]	1	-	-
0x2002:005 (P192.05)	Device module: PU type code	- (Read only)	general	STRING[19]	1	-	-
0x2002:006 (P192.06)	Device module: CU serial number	- (Read only)	general	STRING[23]	1	-	-
0x2002:007 (P192.07)	Device module: PU serial number	- (Read only)	general	STRING[23]	1	-	-
0x2006:000 (P155.00)	Error history buffer: Keypad display	- (Read only)	general	U8	1	-	-
0x2006:001	Error history buffer: Maximum number of messages	- (Read only)	general	U8	1	-	-
0x2006:002	Error history buffer: Latest message	- (Read only)	general	U8	1	-	-
0x2006:003	Error history buffer: Latest acknowledgement message	0	general	U8	1	-	-
0x2006:004	Error history buffer: New message	- (Read only)	general	U8	1	-	t
0x2006:005	Error history buffer: Configuration/Status	1	general	U16	1	-	-
0x2006:006	Error history buffer: Message 0	- (Read only)	general	OCTET[19]	1	-	-
0x2006:007	Error history buffer: Message 1	- (Read only)	general	OCTET[19]	1	-	-
0x2006:008	Error history buffer: Message 2	- (Read only)	general	OCTET[19]	1	-	-
0x2006:009	Error history buffer: Message 3	- (Read only)	general	OCTET[19]	1	-	-
0x2006:010	Error history buffer: Message 4	- (Read only)	general	OCTET[19]	1	-	-
0x2006:011	Error history buffer: Message 5	- (Read only)	general	OCTET[19]	1	-	-
0x2006:012	Error history buffer: Message 6	- (Read only)	general	OCTET[19]	1	-	-
0x2006:013	Error history buffer: Message 7	- (Read only)	general	OCTET[19]	1	-	-
0x2006:014	Error history buffer: Message 8	- (Read only)	general	OCTET[19]	1	-	-
0x2006:015	Error history buffer: Message 9	- (Read only)	general	OCTET[19]	1	-	-
0x2006:016	Error history buffer: Message 10	- (Read only)	general	OCTET[19]	1	-	-
0x2006:017	Error history buffer: Message 11	- (Read only)	general	OCTET[19]	1	-	-
0x2006:018	Error history buffer: Message 12	- (Read only)	general	OCTET[19]	1	-	-
0x2006:019	Error history buffer: Message 13	- (Read only)	general	OCTET[19]	1	-	-
0x2006:020	Error history buffer: Message 14	- (Read only)	general	OCTET[19]	1	-	-
0x2006:021	Error history buffer: Message 15	- (Read only)	general	OCTET[19]	1	-	-
0x2006:022	Error history buffer: Message 16	- (Read only)	general	OCTET[19]	1	-	-
0x2006:023	Error history buffer: Message 17	- (Read only)	general	OCTET[19]	1	-	-
0x2006:024	Error history buffer: Message 18	- (Read only)	general	OCTET[19]	1	-	-
0x2006:025	Error history buffer: Message 19	- (Read only)	general	OCTET[19]	1	-	-
0x2006:026	Error history buffer: Message 20	- (Read only)	general	OCTET[19]	1	-	-
0x2006:027	Error history buffer: Message 21	- (Read only)	general	OCTET[19]	1	-	-
0x2006:028	Error history buffer: Message 22	- (Read only)	general	OCTET[19]	1	-	-
0x2006:029	Error history buffer: Message 23	- (Read only)	general	OCTET[19]	1	-	-
0x2006:030	Error history buffer: Message 24	- (Read only)	general	OCTET[19]	1	-	-
0x2006:031	Error history buffer: Message 25	- (Read only)	general	OCTET[19]	1	-	-
0x2006:032	Error history buffer: Message 26	- (Read only)	general	OCTET[19]	1	-	-
0x2006:033	Error history buffer: Message 27	- (Read only)	general	OCTET[19]	1	-	-
0x2006:034	Error history buffer: Message 28	- (Read only)	general	OCTET[19]	1	-	-
0x2006:035	Error history buffer: Message 29	- (Read only)	general	OCTET[19]	1	-	-
0x2006:036	Error history buffer: Message 30	- (Read only)	general	OCTET[19]	1	-	-
0x2006:037	Error history buffer: Message 31	- (Read only)	general	OCTET[19]	1	-	-
0x2007:001	Error history buffer: Message number	1	general	U8	1	-	-
0x2007:002	Error history buffer: Time stamp	x.xx s (Read only)	general	U32	100	-	-

\* Default setting dependent on the model.



Address	Name	Default setting	Category	Data type	Factor	A	M
0x2007:003	Error history buffer: Response to error	- (Read only)	general	U8	1	-	-
0x2007:004	Error history buffer: Message ID	- (Read only)	general	U16	1	-	-
0x2007:005	Error history buffer: Diag Code Ident	- (Read only)	general	U16	1	-	-
0x2007:006	Error history buffer: Message counter	- (Read only)	general	U8	1	-	-
0x2007:007	Error history buffer: IO-Link message number	- (Read only)	IO-Link	U16	1	-	-
0x2021:001 (P230.01)	Optical tracking: Start detection	<b>Stop [0]</b>	general	U8	1	-	-
0x2021:002 (P230.02)	Optical tracking: Blinking duration	<b>5 s</b>	general	U16	1	-	-
0x2022:001 (P700.01)	Device commands: Load default settings	<b>Off / ready [0]</b>	general	U8	1	C	-
0x2022:003 (P700.03)	Device commands: Save user data	<b>Off / ready [0]</b>	general	U8	1	-	-
0x2022:004 (P700.04)	Device commands: Load user data	<b>Off / ready [0]</b>	general	U8	1	C	-
0x2022:005 (P700.05)	Device commands: Load OEM data	<b>Off / ready [0]</b>	general	U8	1	C	-
0x2022:006 (P700.06)	Device commands: Save OEM data	<b>Off / ready [0]</b>	general	U8	1	-	-
0x2022:007 (P700.07)	Device commands: Load parameter set 1	<b>Off / ready [0]</b>	general	U8	1	-	-
0x2022:008 (P700.08)	Device commands: Load parameter set 2	<b>Off / ready [0]</b>	general	U8	1	-	-
0x2022:009 (P700.09)	Device commands: Load parameter set 3	<b>Off / ready [0]</b>	general	U8	1	-	-
0x2022:010 (P700.10)	Device commands: Load parameter set 4	<b>Off / ready [0]</b>	general	U8	1	-	-
0x2022:011 (P700.11)	Device commands: Save parameter set 1	<b>Off / ready [0]</b>	general	U8	1	-	-
0x2022:012 (P700.12)	Device commands: Save parameter set 2	<b>Off / ready [0]</b>	general	U8	1	-	-
0x2022:013 (P700.13)	Device commands: Save parameter set 3	<b>Off / ready [0]</b>	general	U8	1	-	-
0x2022:014 (P700.14)	Device commands: Save parameter set 4	<b>Off / ready [0]</b>	general	U8	1	-	-
0x2022:015 (P700.15)	Device commands: Delete logbook	<b>Off / ready [0]</b>	general	U8	1	C	-
0x2024:001	Special settings: Configure default setting	<b>0</b>	general	U16	1	-	-
0x2024:002	Special settings: Configure STO	<b>0</b>	general	U16	1	PC	-
0x2030	CRC parameter set	<b>0</b>	general	U32	1	P	-
0x203D (P730.00)	PIN1 access protection	<b>0</b>	general	I16	1	-	-
0x203E (P731.00)	PIN2 access protection	<b>0</b>	general	I16	1	-	-
0x203F	PIN1/PIN2 log-in	<b>0</b>	general	I16	1	-	-
0x2040 (P197.00)	Access protection status	- (Read only)	general	U16	1	-	-
0x2300 (P508.00)	CANopen communication	<b>No action/no error [0]</b>	CANopen	U8	1	C	-
0x2301:001 (P510.01)	CANopen settings: Node ID	<b>1</b>	CANopen	U8	1	P	-
0x2301:002 (P510.02)	CANopen settings: Baud rate	<b>500 kbps [5]</b>	CANopen	U8	1	P	-
0x2301:003 (P510.03)	CANopen settings: Slave/Master	<b>Slave [0]</b>	CANopen	U8	1	P	-
0x2301:004 (P510.04)	CANopen settings: Start remote delay	<b>3000 ms</b>	CANopen	U16	1	P	-
0x2301:005 (P510.05)	CANopen settings: Activate SDO2 channel	<b>Not active [0]</b>	CANopen	U8	1	-	-

\* Default setting dependent on the model.



Address	Name	Default setting	Category	Data type	Factor	A	M
0x2301:006 (P510.06)	CANopen settings: COB-ID Configuration - PDO	Base + node-ID [0]	CANopen	U8	1	P	-
0x2301:007 (P510.07)	CANopen settings: COB-ID Configuration - SDO2	Freely configurable [1]	CANopen	U8	1	P	-
0x2302:001 (P511.01)	Active CANopen settings: Active node ID	-(Read only)	CANopen	U8	1	-	-
0x2302:002 (P511.02)	Active CANopen settings: Active baud rate	-(Read only)	CANopen	U8	1	-	-
0x2303 (P509.00)	CANopen switch position	-(Read only)	CANopen	U16	1	-	-
0x2307 (P515.00)	CANopen time-out status	-(Read only)	CANopen	U32	1	-	-
0x2308 (P516.00)	CANopen status	-(Read only)	CANopen	U16	1	-	-
0x2309 (P517.00)	CANopen controller status	-(Read only)	CANopen	U16	1	-	-
0x230A:000	CANopen statistics: Highest subindex	-(Read only)	CANopen	U8	1	-	-
0x230A:001 (P580.01)	CANopen statistics: PDO1 received	-(Read only)	CANopen	U16	1	-	-
0x230A:002 (P580.02)	CANopen statistics: PDO2 received	-(Read only)	CANopen	U16	1	-	-
0x230A:003 (P580.03)	CANopen statistics: PDO3 received	-(Read only)	CANopen	U16	1	-	-
0x230A:005 (P580.05)	CANopen statistics: PDO1 transmitted	-(Read only)	CANopen	U16	1	-	-
0x230A:006 (P580.06)	CANopen statistics: PDO2 transmitted	-(Read only)	CANopen	U16	1	-	-
0x230A:007 (P580.07)	CANopen statistics: PDO3 transmitted	-(Read only)	CANopen	U16	1	-	-
0x230A:009 (P580.09)	CANopen statistics: SDO1 telegrams	-(Read only)	CANopen	U16	1	-	-
0x230A:010 (P580.10)	CANopen statistics: SDO2 telegrams	-(Read only)	CANopen	U16	1	-	-
0x230B (P518.00)	CANopen error counter	-(Read only)	CANopen	U16	1	-	-
0x2310:001	Direct Parameter Page1: Master command	-(Read only)	IO-Link	U8	1	-	-
0x2310:002	Direct Parameter Page1: Master cycle time	-(Read only)	IO-Link	U8	1	-	-
0x2310:003	Direct Parameter Page1: Minimum cycle time	-(Read only)	IO-Link	U8	1	-	-
0x2310:004	Direct Parameter Page1: M-sequence capability	-(Read only)	IO-Link	U8	1	-	-
0x2310:005	Direct Parameter Page1: Revision ID	-(Read only)	IO-Link	U8	1	-	-
0x2310:006	Direct Parameter Page1: Process data input	-(Read only)	IO-Link	U8	1	-	-
0x2310:007	Direct Parameter Page1: Process data output	-(Read only)	IO-Link	U8	1	-	-
0x2310:008	Direct Parameter Page1: Vendor ID	-(Read only)	IO-Link	U16	1	-	-
0x2310:009	Direct Parameter Page1: Device ID	0	IO-Link	U32	1	P	-
0x2310:010	Direct Parameter Page1: Function ID	-(Read only)	IO-Link	U16	1	-	-
0x2315	Device access locks	0	IO-Link	U16	1	-	-
0x2319:001	Device information: Vendor name	-(Read only)	IO-Link	STRING[64]	1	-	-
0x2319:002	Device information: Vendor text	-(Read only)	IO-Link	STRING[64]	1	-	-
0x2319:003	Device information: Product name	-(Read only)	IO-Link	STRING[64]	1	-	-
0x2319:004	Device information: Product ID	-(Read only)	IO-Link	STRING[64]	1	-	-
0x2319:005	Device information: Product text	-(Read only)	IO-Link	STRING[64]	1	-	-
0x2319:006	Device information: Application specific tag	"My Device"	IO-Link	STRING[32]	1	-	-
0x231C:001	Process data: Last valid input data	-(Read only)	IO-Link	OCTET[12]	1	-	-
0x231C:002	Process data: Last valid output data	-(Read only)	IO-Link	OCTET[12]	1	-	-
0x231D	PDO set selection	PDO set 3 - 6 byte [3]	IO-Link	U8	1	-	-
0x231F:001 (P500.01)	Communication module ID: Active module ID	-(Read only)	general	U8	1	P	-

\* Default setting dependent on the model.



Address	Name	Default setting	Category	Data type	Factor	A	M
0x231F:002 (P500.02)	Communication module ID: Module ID connected	- (Read only)	general	U8	1	-	-
0x2320 (P508.00)	Modbus communication	<b>No action/no error [0]</b>	Modbus RTU	U8	1	-	-
0x2321:001 (P510.01)	Modbus settings: Node ID	<b>1</b>	Modbus RTU	U8	1	P	-
0x2321:002 (P510.02)	Modbus settings: Baud rate	<b>Automatic [0]</b>	Modbus RTU	U8	1	P	-
0x2321:003 (P510.03)	Modbus settings: Data format	<b>Automatic [0]</b>	Modbus RTU	U8	1	P	-
0x2321:004 (P510.04)	Modbus settings: Minimum response time	<b>0 ms</b>	Modbus RTU	U16	1	P	-
0x2322:001 (P511.01)	Active Modbus settings: Active node ID	- (Read only)	Modbus RTU	U8	1	-	-
0x2322:002 (P511.02)	Active Modbus settings: Active baud rate	- (Read only)	Modbus RTU	U8	1	-	-
0x2322:003 (P511.03)	Active Modbus settings: Data format	- (Read only)	Modbus RTU	U8	1	-	-
0x2323 (P509.00)	Modbus switch position	- (Read only)	Modbus RTU	U16	1	-	-
0x232A:001 (P580.01)	Modbus statistics: Messages received	- (Read only)	Modbus RTU	U32	1	-	-
0x232A:002 (P580.02)	Modbus statistics: Valid messages received	- (Read only)	Modbus RTU	U32	1	-	-
0x232A:003 (P580.03)	Modbus statistics: Messages with exceptions	- (Read only)	Modbus RTU	U32	1	-	-
0x232A:004 (P580.04)	Modbus statistics: Messages with errors	- (Read only)	Modbus RTU	U32	1	-	-
0x232A:005 (P580.05)	Modbus statistics: Messages sent	- (Read only)	Modbus RTU	U32	1	-	-
0x232B:001 ... 0x232B:024 (P530.01 ... 24)	Modbus parameter mapping: Parameter 1 ... Parameter 24	<b>0x00000000</b>	Modbus RTU	IDX	1	PH	-
0x232C:001 ... 0x232C:024 (P531.01 ... 24)	Modbus register assignment: Register 1 ... Register 24	- (Read only)	Modbus RTU	U16	1	-	-
0x232D (P532.00)	Modbus verification code	- (Read only)	Modbus RTU	U16	1	-	-
0x232E:001 (P583.01)	Modbus diagnostics of last Rx data: Offset	<b>0</b>	Modbus RTU	U8	1	-	-
0x232E:002 (P583.02)	Modbus diagnostics of last Rx data: Data byte 0	- (Read only)	Modbus RTU	U8	1	-	-
0x232E:003 (P583.03)	Modbus diagnostics of last Rx data: Data byte 1	- (Read only)	Modbus RTU	U8	1	-	-
0x232E:004 (P583.04)	Modbus diagnostics of last Rx data: Data byte 2	- (Read only)	Modbus RTU	U8	1	-	-
0x232E:005 (P583.05)	Modbus diagnostics of last Rx data: Data byte 3	- (Read only)	Modbus RTU	U8	1	-	-
0x232E:006 (P583.06)	Modbus diagnostics of last Rx data: Data byte 4	- (Read only)	Modbus RTU	U8	1	-	-
0x232E:007 (P583.07)	Modbus diagnostics of last Rx data: Data byte 5	- (Read only)	Modbus RTU	U8	1	-	-
0x232E:008 (P583.08)	Modbus diagnostics of last Rx data: Data byte 6	- (Read only)	Modbus RTU	U8	1	-	-
0x232E:009 (P583.09)	Modbus diagnostics of last Rx data: Data byte 7	- (Read only)	Modbus RTU	U8	1	-	-
0x232E:010 (P583.10)	Modbus diagnostics of last Rx data: Data byte 8	- (Read only)	Modbus RTU	U8	1	-	-
0x232E:011 (P583.11)	Modbus diagnostics of last Rx data: Data byte 9	- (Read only)	Modbus RTU	U8	1	-	-

\* Default setting dependent on the model.



Address	Name	Default setting	Category	Data type	Factor	A	M
0x232E:012 (P583.12)	Modbus diagnostics of last Rx data: Data byte 10	- (Read only)	Modbus RTU	U8	1	-	-
0x232E:013 (P583.13)	Modbus diagnostics of last Rx data: Data byte 11	- (Read only)	Modbus RTU	U8	1	-	-
0x232E:014 (P583.14)	Modbus diagnostics of last Rx data: Data byte 12	- (Read only)	Modbus RTU	U8	1	-	-
0x232E:015 (P583.15)	Modbus diagnostics of last Rx data: Data byte 13	- (Read only)	Modbus RTU	U8	1	-	-
0x232E:016 (P583.16)	Modbus diagnostics of last Rx data: Data byte 14	- (Read only)	Modbus RTU	U8	1	-	-
0x232E:017 (P583.17)	Modbus diagnostics of last Rx data: Data byte 15	- (Read only)	Modbus RTU	U8	1	-	-
0x232F:001 (P585.01)	Modbus diagnostics of last Tx data: Offset	<b>0</b>	Modbus RTU	U8	1	-	-
0x232F:002 (P585.02)	Modbus diagnostics of last Tx data: Data byte 0	- (Read only)	Modbus RTU	U8	1	-	-
0x232F:003 (P585.03)	Modbus diagnostics of last Tx data: Data byte 1	- (Read only)	Modbus RTU	U8	1	-	-
0x232F:004 (P585.04)	Modbus diagnostics of last Tx data: Data byte 2	- (Read only)	Modbus RTU	U8	1	-	-
0x232F:005 (P585.05)	Modbus diagnostics of last Tx data: Data byte 3	- (Read only)	Modbus RTU	U8	1	-	-
0x232F:006 (P585.06)	Modbus diagnostics of last Tx data: Data byte 4	- (Read only)	Modbus RTU	U8	1	-	-
0x232F:007 (P585.07)	Modbus diagnostics of last Tx data: Data byte 5	- (Read only)	Modbus RTU	U8	1	-	-
0x232F:008 (P585.08)	Modbus diagnostics of last Tx data: Data byte 6	- (Read only)	Modbus RTU	U8	1	-	-
0x232F:009 (P585.09)	Modbus diagnostics of last Tx data: Data byte 7	- (Read only)	Modbus RTU	U8	1	-	-
0x232F:010 (P585.10)	Modbus diagnostics of last Tx data: Data byte 8	- (Read only)	Modbus RTU	U8	1	-	-
0x232F:011 (P585.11)	Modbus diagnostics of last Tx data: Data byte 9	- (Read only)	Modbus RTU	U8	1	-	-
0x232F:012 (P585.12)	Modbus diagnostics of last Tx data: Data byte 10	- (Read only)	Modbus RTU	U8	1	-	-
0x232F:013 (P585.13)	Modbus diagnostics of last Tx data: Data byte 11	- (Read only)	Modbus RTU	U8	1	-	-
0x232F:014 (P585.14)	Modbus diagnostics of last Tx data: Data byte 12	- (Read only)	Modbus RTU	U8	1	-	-
0x232F:015 (P585.15)	Modbus diagnostics of last Tx data: Data byte 13	- (Read only)	Modbus RTU	U8	1	-	-
0x232F:016 (P585.16)	Modbus diagnostics of last Tx data: Data byte 14	- (Read only)	Modbus RTU	U8	1	-	-
0x232F:017 (P585.17)	Modbus diagnostics of last Tx data: Data byte 15	- (Read only)	Modbus RTU	U8	1	-	-
0x2341:001 (P510.01)	PROFIBUS settings: Station address	<b>3</b>	PROFIBUS	U8	1	P	-
0x2342:001 (P511.01)	Active PROFIBUS settings: Active station address	- (Read only)	PROFIBUS	U8	1	-	-
0x2342:002 (P511.02)	Active PROFIBUS settings: Active baud rate	- (Read only)	PROFIBUS	U8	1	-	-
0x2342:003 (P511.03)	Active PROFIBUS settings: Watchdog time	- (Read only)	PROFIBUS	U16	1	-	-
0x2343 (P509.00)	PROFIBUS switch position	- (Read only)	PROFIBUS	U16	1	-	-
0x2344:001 (P512.01)	PROFIBUS Configuration: Extended diagnostic bit	<b>Delete [0]</b>	PROFIBUS	U8	1	P	-
0x2348:001 (P516.01)	PROFIBUS Status: Bus status	- (Read only)	PROFIBUS	U8	1	-	-

\* Default setting dependent on the model.



Address	Name	Default setting	Category	Data type	Factor	A	M
0x2348:002 (P516.02)	PROFIBUS Status: Watchdog status	- (Read only)	PROFIBUS	U8	1	-	-
0x2349 (P517.00)	PROFIBUS error	- (Read only)	PROFIBUS	U32	1	-	-
0x234A:001 (P580.01)	PROFIBUS statistics: Data cycles per second	- (Read only)	PROFIBUS	U32	1	-	-
0x234A:002 (P580.02)	PROFIBUS statistics: Parameterization events	- (Read only)	PROFIBUS	U32	1	-	-
0x234A:003 (P580.03)	PROFIBUS statistics: Configuration events	- (Read only)	PROFIBUS	U32	1	-	-
0x234A:004 (P580.04)	PROFIBUS statistics: Diagnostics events	- (Read only)	PROFIBUS	U32	1	-	-
0x234A:005 (P580.05)	PROFIBUS statistics: C1 messages	- (Read only)	PROFIBUS	U32	1	-	-
0x234A:006 (P580.06)	PROFIBUS statistics: C2 messages	- (Read only)	PROFIBUS	U32	1	-	-
0x234A:007 (P580.07)	PROFIBUS statistics: Watchdog events	- (Read only)	PROFIBUS	U32	1	-	-
0x234A:008 (P580.08)	PROFIBUS statistics: Data exchange aborts	- (Read only)	PROFIBUS	U32	1	-	-
0x234A:009 (P580.09)	PROFIBUS statistics: Total data cycles	- (Read only)	PROFIBUS	U32	1	-	-
0x2360 (P508.00)	EtherCAT communication	<b>No action/no error [0]</b>	EtherCAT	U8	1	-	-
0x2361:004 (P510.04)	EtherCAT settings: Device identifier	<b>0</b>	EtherCAT	U16	1	P	-
0x2362:001 (P511.01)	Active EtherCAT settings: EoE IP address	- (Read only)	EtherCAT	U32	1	E	-
0x2362:002 (P511.02)	Active EtherCAT settings: EoE subnet mask	- (Read only)	EtherCAT	U32	1	E	-
0x2362:003 (P511.03)	Active EtherCAT settings: EoE gateway	- (Read only)	EtherCAT	U32	1	E	-
0x2362:004 (P511.04)	Active EtherCAT settings: Device identifier	- (Read only)	EtherCAT	U16	1	-	-
0x2362:005 (P511.05)	Active EtherCAT settings: EoE virtual MAC address	- (Read only)	EtherCAT	OCTET[6]	1	-	-
0x2362:006 (P511.06)	Active EtherCAT settings: Station address	- (Read only)	EtherCAT	U16	1	-	-
0x2362:007 (P511.07)	Active EtherCAT settings: Tx length	- (Read only)	EtherCAT	U16	1	-	-
0x2362:008 (P511.08)	Active EtherCAT settings: Rx length	- (Read only)	EtherCAT	U16	1	-	-
0x2363 (P509.00)	EtherCAT switch position	- (Read only)	EtherCAT	U16	1	-	-
0x2368 (P516.00)	EtherCAT status	- (Read only)	EtherCAT	U16	1	-	-
0x2369 (P517.00)	EtherCAT error	- (Read only)	EtherCAT	U16	1	-	-
0x2380 (P508.00)	PROFINET communication	<b>No action/no error [0]</b>	PROFINET	U8	1	-	-
0x2381:001 (P510.01)	PROFINET settings: IP address	<b>0.0.0.0</b>	PROFINET	U32	1	PE	-
0x2381:002 (P510.02)	PROFINET settings: Subnet	<b>0.0.0.0</b>	PROFINET	U32	1	PE	-
0x2381:003 (P510.03)	PROFINET settings: Gateway	<b>0.0.0.0</b>	PROFINET	U32	1	PE	-
0x2381:004 (P510.04)	PROFINET settings: Station name		PROFINET	STRING[240]	1	P	-
0x2381:005	PROFINET settings: I&M1 System designation		PROFINET	STRING[32]	1	P	-
0x2381:006	PROFINET settings: I&M1 Installation site		PROFINET	STRING[22]	1	P	-

\* Default setting dependent on the model.





Address	Name	Default setting	Category	Data type	Factor	A	M
0x2381:007	PROFINET settings: I&M2 Installation date		PROFINET	STRING[16]	1	P	-
0x2381:008	PROFINET settings: I&M3 additional information		PROFINET	STRING[54]	1	P	-
0x2381:009	PROFINET settings: I&M4 signature code		PROFINET	OCTET[54]	1	P	-
0x2382:001 (P511.01)	Active PROFINET settings: IP address	- (Read only)	PROFINET	U32	1	E	-
0x2382:002 (P511.02)	Active PROFINET settings: Subnet	- (Read only)	PROFINET	U32	1	E	-
0x2382:003 (P511.03)	Active PROFINET settings: Gateway	- (Read only)	PROFINET	U32	1	E	-
0x2382:004 (P511.04)	Active PROFINET settings: Station name	- (Read only)	PROFINET	STRING[240]	1	-	-
0x2382:005 (P511.05)	Active PROFINET settings: MAC Address	- (Read only)	PROFINET	OCTET[6]	1	-	-
0x2388 (P516.00)	PROFINET status	- (Read only)	PROFINET	U16	1	-	-
0x2389:001 (P517.01)	PROFINET error: Error 1	- (Read only)	PROFINET	U16	1	-	-
0x2389:002 (P517.02)	PROFINET error: Error 2	- (Read only)	PROFINET	U16	1	-	-
0x23A0 (P508.00)	EtherNet/IP communication	<b>No action/no error [0]</b>	EtherNet/IP	U8	1	-	-
0x23A1:001 (P510.01)	EtherNet/IP settings: IP address	<b>192.168.124.16</b>	EtherNet/IP	U32	1	PE	-
0x23A1:002 (P510.02)	EtherNet/IP settings: Subnet	<b>255.255.255.0</b>	EtherNet/IP	U32	1	PE	-
0x23A1:003 (P510.03)	EtherNet/IP settings: Gateway	<b>0.0.0.0</b>	EtherNet/IP	U32	1	PE	-
0x23A1:004 (P510.04)	EtherNet/IP settings: Host name		EtherNet/IP	STRING[64]	1	P	-
0x23A1:005 (P510.05)	EtherNet/IP settings: IP configuration	<b>BOOTP [1]</b>	EtherNet/IP	U8	1	P	-
0x23A1:006 (P510.06)	EtherNet/IP settings: Multicast TTL	<b>1</b>	EtherNet/IP	U8	1	P	-
0x23A1:007 (P510.07)	EtherNet/IP settings: Multicast allocation	<b>Default allocation [0]</b>	EtherNet/IP	U8	1	P	-
0x23A1:008 (P510.08)	EtherNet/IP settings: Multicast IP address	<b>239.64.2.224</b>	EtherNet/IP	U32	1	PE	-
0x23A1:009 (P510.09)	EtherNet/IP settings: Multicast number	<b>1</b>	EtherNet/IP	U8	1	P	-
0x23A1:010 (P510.10)	EtherNet/IP settings: Timeout	<b>10000 ms</b>	EtherNet/IP	U16	1	P	-
0x23A2:001 (P511.01)	Active EtherNet/IP settings: IP address	- (Read only)	EtherNet/IP	U32	1	E	-
0x23A2:002 (P511.02)	Active EtherNet/IP settings: Subnet	- (Read only)	EtherNet/IP	U32	1	E	-
0x23A2:003 (P511.03)	Active EtherNet/IP settings: Gateway	- (Read only)	EtherNet/IP	U32	1	E	-
0x23A2:005 (P511.05)	Active EtherNet/IP settings: MAC address	- (Read only)	EtherNet/IP	OCTET[6]	1	-	-
0x23A2:006 (P511.06)	Active EtherNet/IP settings: Multicast address	- (Read only)	EtherNet/IP	U32	1	E	-
0x23A3 (P509.00)	EtherNet/IP switch position	- (Read only)	EtherNet/IP	U8	1	-	-
0x23A4:001 (P512.01)	Port settings: Port 1	<b>Auto-Negotiation [0]</b>	EtherNet/IP	U16	1	P	-
0x23A4:002 (P512.02)	Port settings: Port 2	<b>Auto-Negotiation [0]</b>	EtherNet/IP	U16	1	P	-
0x23A5:001 (P519.01)	Active port settings: Port 1 (X266)	- (Read only)	EtherNet/IP	U16	1	-	-

\* Default setting dependent on the model.



Address	Name	Default setting	Category	Data type	Factor	A	M
0x23A5:002 (P519.02)	Active port settings: Port 2 (X267)	- (Read only)	EtherNet/IP	U16	1	-	-
0x23A6 (P513.00)	Quality of service	- (Read only)	EtherNet/IP	U8	1	-	-
0x23A7 (P514.00)	Address conflict detection	<b>Enabled [1]</b>	EtherNet/IP	U8	1	P	-
0x23A8 (P516.00)	CIP module status	- (Read only)	EtherNet/IP	U16	1	-	-
0x23A9 (P517.00)	EtherNet/IP status	- (Read only)	EtherNet/IP	U16	1	-	-
0x23B0 (P508.00)	Modbus TCP communication	<b>No action/no error [0]</b>	Modbus TCP	U8	1	-	-
0x23B1:001 (P510.01)	Modbus -TCP/IP settings: IP address	<b>192.168.124.16</b>	Modbus TCP	U32	1	PE	-
0x23B1:002 (P510.02)	Modbus -TCP/IP settings: Subnet	<b>255.255.255.0</b>	Modbus TCP	U32	1	PE	-
0x23B1:003 (P510.03)	Modbus -TCP/IP settings: Gateway	<b>0.0.0.0</b>	Modbus TCP	U32	1	PE	-
0x23B1:005 (P510.05)	Modbus -TCP/IP settings: IP configuration	<b>Stored IP [0]</b>	Modbus TCP	U8	1	P	-
0x23B1:006 (P510.06)	Modbus -TCP/IP settings: Time-to-live value (TTL)	<b>32</b>	Modbus TCP	U8	1	P	-
0x23B1:010 (P510.10)	Modbus -TCP/IP settings: Ethernet time-out	<b>10 s</b>	Modbus TCP	U16	1	P	-
0x23B1:011 (P510.11)	Modbus -TCP/IP settings: Secondary port	<b>502</b>	Modbus TCP	U16	1	P	-
0x23B2:001 (P511.01)	Active Modbus TCP settings: Active IP address	- (Read only)	Modbus TCP	U32	1	E	-
0x23B2:002 (P511.02)	Active Modbus TCP settings: Active subnet	- (Read only)	Modbus TCP	U32	1	E	-
0x23B2:003 (P511.03)	Active Modbus TCP settings: Active gateway	- (Read only)	Modbus TCP	U32	1	E	-
0x23B2:005 (P511.05)	Active Modbus TCP settings: MAC address	- (Read only)	Modbus TCP	OCTET[6]	1	-	-
0x23B3 (P509.00)	Switch position	- (Read only)	Modbus TCP	U8	1	-	-
0x23B4:001 (P512.01)	Port settings: Port 1	<b>Auto-Negotiation [0]</b>	Modbus TCP	U16	1	P	-
0x23B4:002 (P512.02)	Port settings: Port 2	<b>Auto-Negotiation [0]</b>	Modbus TCP	U16	1	P	-
0x23B5:001 (P513.01)	Active port settings: Port 1	- (Read only)	Modbus TCP	U16	1	-	-
0x23B5:002 (P513.02)	Active port settings: Port 2	- (Read only)	Modbus TCP	U16	1	-	-
0x23B6:001 (P514.01)	Time-out monitoring: Time-out time	<b>2.0 s</b>	Modbus TCP	U16	10	P	-
0x23B6:002 (P514.02)	Time-out monitoring: Keep alive time-out time	<b>2.0 s</b>	Modbus TCP	U16	10	P	-
0x23B6:005 (P514.05)	Time-out monitoring: Keep alive register	<b>0</b>	Modbus TCP	U16	1	K	r
0x23B8 (P516.00)	Modbus TCP module status	- (Read only)	Modbus TCP	U16	1	-	-
0x23B9 (P517.00)	Modbus TCP/IP network status	- (Read only)	Modbus TCP	U16	1	-	-
0x23BA:001 (P580.01)	Modbus TCP statistics: Messages received	- (Read only)	Modbus TCP	U32	1	-	-
0x23BA:002 (P580.02)	Modbus TCP statistics: Valid messages received	- (Read only)	Modbus TCP	U32	1	-	-
0x23BA:003 (P580.03)	Modbus TCP statistics: Messages with exceptions	- (Read only)	Modbus TCP	U32	1	-	-

\* Default setting dependent on the model.



Address	Name	Default setting	Category	Data type	Factor	A	M
0x23BA:005 (P580.05)	Modbus TCP statistics: Messages sent	- (Read only)	Modbus TCP	U32	1	-	-
0x23BB:001 ... 0x23BB:024 (P530.01 ... 24)	Modbus TCP/IP parameter mapping: Parameter 1 ... Parameter 24	<b>0x00000000</b>	Modbus TCP	IDX	1	PH	-
0x23BC:001 ... 0x23BC:024 (P531.01 ... 24)	Register assignment: Register 1 ... Register 24	- (Read only)	Modbus TCP	U16	1	-	-
0x23BD (P532.00)	Verification code	- (Read only)	Modbus TCP	U16	1	-	-
0x23BE:001 (P585.01)	Modbus TCP/IP diagnostics of last Rx/Tx data: Receive offset	<b>0</b>	Modbus TCP	U8	1	-	-
0x23BE:002 (P585.02)	Modbus TCP/IP diagnostics of last Rx/Tx data: Last Rx message	- (Read only)	Modbus TCP	OCTET[64]	1	-	-
0x23BE:003 (P585.03)	Modbus TCP/IP diagnostics of last Rx/Tx data: Transmit offset	<b>0</b>	Modbus TCP	U8	1	-	-
0x23BE:004 (P585.04)	Modbus TCP/IP diagnostics of last Rx/Tx data: Last Tx message	- (Read only)	Modbus TCP	OCTET[64]	1	-	-
0x23C0	POWERLINK communication	<b>No action/no error [0]</b>	POWERLINK	U8	1	-	-
0x23C1:004	POWERLINK settings: Node ID	<b>0</b>	POWERLINK	U8	1	P	-
0x23C2:001	Active POWERLINK settings: IP address	- (Read only)	POWERLINK	U32	1	E	-
0x23C2:002	Active POWERLINK settings: Subnet	- (Read only)	POWERLINK	U32	1	E	-
0x23C2:003	Active POWERLINK settings: Gateway	- (Read only)	POWERLINK	U32	1	E	-
0x23C2:004	Active POWERLINK settings: Node ID	- (Read only)	POWERLINK	U8	1	-	-
0x23C2:005	Active POWERLINK settings: MAC Address	- (Read only)	POWERLINK	OCTET[6]	1	-	-
0x23C2:007	Active POWERLINK settings: Tx length	- (Read only)	POWERLINK	U8	1	-	-
0x23C2:008	Active POWERLINK settings: Rx length	- (Read only)	POWERLINK	U8	1	-	-
0x23C3	POWERLINK switch position	- (Read only)	POWERLINK	U8	1	-	-
0x23C8:001	POWERLINK status: Network management	- (Read only)	POWERLINK	U8	1	-	-
0x23C9:001	POWERLINK error: Activation	- (Read only)	POWERLINK	U16	1	-	-
0x2440	Initiate WLAN	<b>No action/no error [0]</b>	WLAN	U8	1	-	-
0x2441:001	WLAN settings: IP address	<b>192.168.178.1</b>	WLAN	U32	1	PE	-
0x2441:002	WLAN settings: Netmask	<b>255.255.255.0</b>	WLAN	U32	1	PE	-
0x2441:003	WLAN settings: Gateway	<b>192.168.178.1</b>	WLAN	U32	1	PE	-
0x2441:004	WLAN settings: DHCP	<b>Enabled [1]</b>	WLAN	U8	1	P	-
0x2441:005	WLAN settings: DHCP start address	<b>0.0.0.0</b>	WLAN	U32	1	PE	-
0x2441:006	WLAN settings: WLAN operation mode	<b>Access point mode [0]</b>	WLAN	U8	1	P	-
0x2441:007	WLAN settings: WLAN SSID	<b>"i5"</b>	WLAN	STRING[32]	1	P	-
0x2441:008	WLAN settings: WLAN password	<b>"password"</b>	WLAN	STRING[64]	1	P	-
0x2441:009	WLAN settings: WLAN security	<b>WPA2 [1]</b>	WLAN	U8	1	P	-
0x2441:010	WLAN settings: WLAN access	<b>Enabled (WLAN on) [1]</b>	WLAN	U8	1	P	-
0x2441:011	WLAN settings: WLAN channel	<b>Channel 1 [1]</b>	WLAN	U8	1	P	-
0x2441:012	WLAN settings: WLAN SSID broadcast	<b>Activated [0]</b>	WLAN	U8	1	P	-
0x2442:001	Active WLAN settings: Active IP address	- (Read only)	WLAN	U32	1	E	-
0x2442:002	Active WLAN settings: Active netmask	- (Read only)	WLAN	U32	1	E	-
0x2442:003	Active WLAN settings: Active gateway	- (Read only)	WLAN	U32	1	E	-
0x2442:004	Active WLAN settings: Active module mode	- (Read only)	WLAN	U8	1	-	-
0x2442:005	Active WLAN settings: MAC address	- (Read only)	WLAN	OCTET[6]	1	-	-
0x2448:001	WLAN status: Connection time	- (Read only)	WLAN	U32	1	-	-
0x2448:002	WLAN status: Number of connections	- (Read only)	WLAN	U16	1	-	-
0x2448:003	WLAN status: Rx frame counter	- (Read only)	WLAN	U16	1	-	-
0x2448:004	WLAN status: Error statistics	- (Read only)	WLAN	U16	1	-	-
0x2449	WLAN error	- (Read only)	WLAN	U16	1	-	-
0x24E0:000	Generic RPDO mapping: Highest subindex	<b>2</b>	Mapping	U8	1	PI	-
0x24E0:001	Generic RPDO mapping: Entry 1	<b>0x60400010</b>	Mapping	U32	1	PH	-
0x24E0:002	Generic RPDO mapping: Entry 2	<b>0x60420010</b>	Mapping	U32	1	PH	-

\* Default setting dependent on the model.



Address	Name	Default setting	Category	Data type	Factor	A	M
0x24E0:003	Generic RPDO mapping: Entry 3	0x00000000	Mapping	U32	1	PH	-
0x24E0:004	Generic RPDO mapping: Entry 4	0x00000000	Mapping	U32	1	PH	-
0x24E0:005	Generic RPDO mapping: Entry 5	0x00000000	Mapping	U32	1	PH	-
0x24E0:006	Generic RPDO mapping: Entry 6	0x00000000	Mapping	U32	1	PH	-
0x24E0:007	Generic RPDO mapping: Entry 7	0x00000000	Mapping	U32	1	PH	-
0x24E0:008	Generic RPDO mapping: Entry 8	0x00000000	Mapping	U32	1	PH	-
0x24E0:009	Generic RPDO mapping: Entry 9	0x00000000	Mapping	U32	1	PH	-
0x24E0:010	Generic RPDO mapping: Entry 10	0x00000000	Mapping	U32	1	PH	-
0x24E0:011	Generic RPDO mapping: Entry 11	0x00000000	Mapping	U32	1	PH	-
0x24E0:012	Generic RPDO mapping: Entry 12	0x00000000	Mapping	U32	1	PH	-
0x24E0:013	Generic RPDO mapping: Entry 13	0x00000000	Mapping	U32	1	PH	-
0x24E0:014	Generic RPDO mapping: Entry 14	0x00000000	Mapping	U32	1	PH	-
0x24E0:015	Generic RPDO mapping: Entry 15	0x00000000	Mapping	U32	1	PH	-
0x24E0:016	Generic RPDO mapping: Entry 16	0x00000000	Mapping	U32	1	PH	-
0x24E1:000	Generic TPDO mapping: Highest subindex	3	Mapping	U8	1	PI	-
0x24E1:001	Generic TPDO mapping: Entry 1	0x60410010	Mapping	U32	1	PH	-
0x24E1:002	Generic TPDO mapping: Entry 2	0x60440010	Mapping	U32	1	PH	-
0x24E1:003	Generic TPDO mapping: Entry 3	0x603F0010	Mapping	U32	1	PH	-
0x24E1:004	Generic TPDO mapping: Entry 4	0x00000000	Mapping	U32	1	PH	-
0x24E1:005	Generic TPDO mapping: Entry 5	0x00000000	Mapping	U32	1	PH	-
0x24E1:006	Generic TPDO mapping: Entry 6	0x00000000	Mapping	U32	1	PH	-
0x24E1:007	Generic TPDO mapping: Entry 7	0x00000000	Mapping	U32	1	PH	-
0x24E1:008	Generic TPDO mapping: Entry 8	0x00000000	Mapping	U32	1	PH	-
0x24E1:009	Generic TPDO mapping: Entry 9	0x00000000	Mapping	U32	1	PH	-
0x24E1:010	Generic TPDO mapping: Entry 10	0x00000000	Mapping	U32	1	PH	-
0x24E1:011	Generic TPDO mapping: Entry 11	0x00000000	Mapping	U32	1	PH	-
0x24E1:012	Generic TPDO mapping: Entry 12	0x00000000	Mapping	U32	1	PH	-
0x24E1:013	Generic TPDO mapping: Entry 13	0x00000000	Mapping	U32	1	PH	-
0x24E1:014	Generic TPDO mapping: Entry 14	0x00000000	Mapping	U32	1	PH	-
0x24E1:015	Generic TPDO mapping: Entry 15	0x00000000	Mapping	U32	1	PH	-
0x24E1:016	Generic TPDO mapping: Entry 16	0x00000000	Mapping	U32	1	PH	-
0x24E5:001	Process data handling in case of error: Procedure	Keep last data [0]	general	U8	1	P	-
0x2540:001 (P208.01)	Mains settings: Rated mains voltage	230 Veff [0]	general	U8	1	PC	-
0x2540:002 (P208.02)	Mains settings: Undervoltage warning threshold	0 V *	general	U16	1	P	-
0x2540:003 (P208.03)	Mains settings: Undervoltage error threshold	x V (Read only)	general	U16	1	-	-
0x2540:004 (P208.04)	Mains settings: Undervoltage reset threshold	x V (Read only)	general	U16	1	-	-
0x2540:005 (P208.05)	Mains settings: Overvoltage warning threshold	0 V *	general	U16	1	P	-
0x2540:006 (P208.06)	Mains settings: Overvoltage error threshold	x V (Read only)	general	U16	1	-	-
0x2540:007 (P208.07)	Mains settings: Overvoltage reset threshold	x V (Read only)	general	U16	1	-	-
0x2541:001 (P706.01)	Brake energy management: Operating mode	Ramp function generator stop (RFGS) [1]	general	U8	1	P	-
0x2541:002 (P706.02)	Brake energy management: Active threshold	x V (Read only)	general	U16	1	P	-
0x2541:003 (P706.03)	Brake energy management: Reduced threshold	0 V	general	U16	1	P	-
0x2541:004 (P706.04)	Brake energy management: Additional frequency	0.0 Hz	general	U16	10	P	-
0x2541:005 (P706.05)	Brake energy management: Deceleration override time	2.0 s	general	U16	10	P	-

\* Default setting dependent on the model.



Address	Name	Default setting	Category	Data type	Factor	A	M
0x2541:006 (P706.06)	Brake energy management: Brake resistor response	<b>Off: disable / Off: error [0]</b>	general	U8	1	PC	-
0x2550:002 (P707.02)	Brake resistor: Resistance value	<b>180.0 Ω *</b>	general	U16	10	P	-
0x2550:003 (P707.03)	Brake resistor: Rated power	<b>50 W *</b>	general	U32	1	P	-
0x2550:004 (P707.04)	Brake resistor: Maximum thermal load	<b>8.0 kW * *</b>	general	U32	10	P	-
0x2550:007 (P707.07)	Brake resistor: Thermal load	x.x % (Read only)	general	U16	10	O	-
0x2550:008 (P707.08)	Brake resistor: Warning threshold	<b>90.0 %</b>	general	U16	10	P	-
0x2550:009 (P707.09)	Brake resistor: Error threshold	<b>100.0 %</b>	general	U16	10	P	-
0x2550:010 (P707.10)	Brake resistor: Response to warning	<b>Warning [1]</b>	general	U8	1	P	-
0x2550:011 (P707.11)	Brake resistor: Response to error	<b>Fault [3]</b>	general	U8	1	P	-
0x2552:002 (P595.02)	Parameter access monitoring: Keep alive register	<b>0</b>	general	U16	1	K	-
0x2552:003 (P595.03)	Parameter access monitoring: Time-out time	<b>10.0 s</b>	general	U16	10	P	-
0x2552:004 (P595.04)	Parameter access monitoring: Response	<b>No response [0]</b>	general	U8	1	P	-
0x2552:005 (P595.05)	Parameter access monitoring: Action	<b>No action [0]</b>	general	U8	1	P	-
0x2552:006 (P595.06)	Parameter access monitoring: Parameter Access Monitoring-Status	- (Read only)	general	U16	1	O	-
0x2552:007 (P595.07)	Parameter access monitoring: WLAN reset time-out time	<b>0 s</b>	general	U16	1	P	-
0x2552:008 (P595.08)	Parameter access monitoring: Mapped parameter	<b>0x400B0100</b>		IDX	1	PH	-
0x2552:009 (P595.09)	Parameter access monitoring: Value to be written	<b>0</b>		U32	1	P	-
0x2552:010 (P595.10)	Parameter access monitoring: Write status	- (Read only)		U8	1	-	-
0x2601:001 (P202.01)	Keypad setpoints: Frequency setpoint	<b>20.0 Hz</b>	general	U16	10	P	r
0x2601:002 (P202.02)	Keypad setpoints: Process controller setpoint	<b>0.00 PID unit</b>	general	I16	100	P	r
0x2601:003 (P202.03)	Keypad setpoints: Torque setpoint	<b>100.0 %</b>	general	I16	10	P	r
0x2602:001 (P708.01)	Manual control: Keypad setting	<b>CTRL &amp; F/R enable [1]</b>	general	U8	1	P	-
0x2602:002 (P708.02)	Manual control: Keypad rotational direction	<b>Forward [0]</b>	general	U8	1	P	-
0x2602:003 (P708.03)	Manual control: Mode	<b>Manual control off [0]</b>	general	U8	1	-	-
0x261C:001 (P740.01)	Favorites settings: Parameter 1	<b>0x2DDD0000</b>	general	IDX	1	PH	-
0x261C:002 (P740.02)	Favorites settings: Parameter 2	<b>0x60780000</b>	general	IDX	1	PH	-
0x261C:003 (P740.03)	Favorites settings: Parameter 3	<b>0x2D890000</b>	general	IDX	1	PH	-
0x261C:004 (P740.04)	Favorites settings: Parameter 4	<b>0x603F0000</b>	general	IDX	1	PH	-
0x261C:005 (P740.05)	Favorites settings: Parameter 5	<b>0x28240000</b>	general	IDX	1	PH	-
0x261C:006 (P740.06)	Favorites settings: Parameter 6	<b>0x28600100</b>	general	IDX	1	PH	-

\* Default setting dependent on the model.

# Appendix

## Parameter attribute list



Address	Name	Default setting	Category	Data type	Factor	A	M
0x261C:007 (P740.07)	Favorites settings: Parameter 7	0x28380100	general	IDX	1	PH	-
0x261C:008 (P740.08)	Favorites settings: Parameter 8	0x28380300	general	IDX	1	PH	-
0x261C:009 (P740.09)	Favorites settings: Parameter 9	0x25400100	general	IDX	1	PH	-
0x261C:010 (P740.10)	Favorites settings: Parameter 10	0x29150000	general	IDX	1	PH	-
0x261C:011 (P740.11)	Favorites settings: Parameter 11	0x29160000	general	IDX	1	PH	-
0x261C:012 (P740.12)	Favorites settings: Parameter 12	0x29170000	general	IDX	1	PH	-
0x261C:013 (P740.13)	Favorites settings: Parameter 13	0x29180000	general	IDX	1	PH	-
0x261C:014 (P740.14)	Favorites settings: Parameter 14	0x2C000000	general	IDX	1	PH	-
0x261C:015 (P740.15)	Favorites settings: Parameter 15	0x2B000000	general	IDX	1	PH	-
0x261C:016 (P740.16)	Favorites settings: Parameter 16	0x2B010100	general	IDX	1	PH	-
0x261C:017 (P740.17)	Favorites settings: Parameter 17	0x2B010200	general	IDX	1	PH	-
0x261C:018 (P740.18)	Favorites settings: Parameter 18	0x283A0000	general	IDX	1	PH	-
0x261C:019 (P740.19)	Favorites settings: Parameter 19	0x29390000	general	IDX	1	PH	-
0x261C:020 (P740.20)	Favorites settings: Parameter 20	0x2D430100	general	IDX	1	PH	-
0x261C:021 (P740.21)	Favorites settings: Parameter 21	0x2D4B0100	general	IDX	1	PH	-
0x261C:022 (P740.22)	Favorites settings: Parameter 22	0x2B120100	general	IDX	1	PH	-
0x261C:023 (P740.23)	Favorites settings: Parameter 23	0x60750000	general	IDX	1	PH	-
0x261C:024 (P740.24)	Favorites settings: Parameter 24	0x60730000	general	IDX	1	PH	-
0x261C:025 (P740.25)	Favorites settings: Parameter 25	0x26310100	general	IDX	1	PH	-
0x261C:026 (P740.26)	Favorites settings: Parameter 26	0x26310200	general	IDX	1	PH	-
0x261C:027 (P740.27)	Favorites settings: Parameter 27	0x26310300	general	IDX	1	PH	-
0x261C:028 (P740.28)	Favorites settings: Parameter 28	0x26310400	general	IDX	1	PH	-
0x261C:029 (P740.29)	Favorites settings: Parameter 29	0x26310500	general	IDX	1	PH	-
0x261C:030 (P740.30)	Favorites settings: Parameter 30	0x26310600	general	IDX	1	PH	-
0x261C:031 (P740.31)	Favorites settings: Parameter 31	0x26310700	general	IDX	1	PH	-
0x261C:032 (P740.32)	Favorites settings: Parameter 32	0x26310800	general	IDX	1	PH	-
0x261C:033 (P740.33)	Favorites settings: Parameter 33	0x26310900	general	IDX	1	PH	-
0x261C:034 (P740.34)	Favorites settings: Parameter 34	0x26310D00	general	IDX	1	PH	-
0x261C:035 (P740.35)	Favorites settings: Parameter 35	0x26311200	general	IDX	1	PH	-
0x261C:036 (P740.36)	Favorites settings: Parameter 36	0x26311300	general	IDX	1	PH	-

\* Default setting dependent on the model.



Address	Name	Default setting	Category	Data type	Factor	A	M
0x261C:037 (P740.37)	Favorites settings: Parameter 37	0x26311400	general	IDX	1	PH	-
0x261C:038 (P740.38)	Favorites settings: Parameter 38	0x26340100	general	IDX	1	PH	-
0x261C:039 (P740.39)	Favorites settings: Parameter 39	0x26340200	general	IDX	1	PH	-
0x261C:040 (P740.40)	Favorites settings: Parameter 40	0x26360100	general	IDX	1	PH	-
0x261C:041 (P740.41)	Favorites settings: Parameter 41	0x26360200	general	IDX	1	PH	-
0x261C:042 (P740.42)	Favorites settings: Parameter 42	0x26360300	general	IDX	1	PH	-
0x261C:043 (P740.43)	Favorites settings: Parameter 43	0x26390100	general	IDX	1	PH	-
0x261C:044 (P740.44)	Favorites settings: Parameter 44	0x26390200	general	IDX	1	PH	-
0x261C:045 (P740.45)	Favorites settings: Parameter 45	0x26390300	general	IDX	1	PH	-
0x261C:046 (P740.46)	Favorites settings: Parameter 46	0x26390400	general	IDX	1	PH	-
0x261C:047 (P740.47)	Favorites settings: Parameter 47	0x29110100	general	IDX	1	PH	-
0x261C:048 (P740.48)	Favorites settings: Parameter 48	0x29110200	general	IDX	1	PH	-
0x261C:049 (P740.49)	Favorites settings: Parameter 49	0x29110300	general	IDX	1	PH	-
0x261C:050 (P740.50)	Favorites settings: Parameter 50	0x29110400	general	IDX	1	PH	-
0x2630:001 (P410.01)	Settings for digital inputs: Assertion level	HIGH active [1]	general	U8	1	P	-
0x2630:002 (P410.02)	Settings for digital inputs: Input function	Digital input [0]	general	U8	1	P	-
0x2631:001 (P400.01)	Function list: Enable inverter	Constant TRUE [1]	general	U8	1	PC	-
0x2631:002 (P400.02)	Function list: Run	Digital input 1 [11]	general	U8	1	PC	-
0x2631:003 (P400.03)	Function list: Activate quick stop	Not connected [0]	general	U8	1	PC	-
0x2631:004 (P400.04)	Function list: Reset fault	Digital input 2 [12]	general	U8	1	P	-
0x2631:005 (P400.05)	Function list: Activate DC braking	Not connected [0]	general	U8	1	P	-
0x2631:006 (P400.06)	Function list: Start forward (CW)	Not connected [0]	general	U8	1	PC	-
0x2631:007 (P400.07)	Function list: Start reverse (CCW)	Not connected [0]	general	U8	1	PC	-
0x2631:008 (P400.08)	Function list: Run forward (CW)	Not connected [0]	general	U8	1	PC	-
0x2631:009 (P400.09)	Function list: Run reverse (CCW)	Not connected [0]	general	U8	1	PC	-
0x2631:010 (P400.10)	Function list: Jog forward (CW)	Not connected [0]	general	U8	1	PC	-
0x2631:011 (P400.11)	Function list: Jog reverse (CCW)	Not connected [0]	general	U8	1	PC	-
0x2631:012 (P400.12)	Function list: Activate keypad control	Not connected [0]	general	U8	1	P	-
0x2631:013 (P400.13)	Function list: Reverse rotational direction	Digital input 3 [13]	general	U8	1	PC	-
0x2631:014 (P400.14)	Function list: Activate AI1 setpoint	Not connected [0]	general	U8	1	P	-

\* Default setting dependent on the model.



Address	Name	Default setting	Category	Data type	Factor	A	M
0x2631:015 (P400.15)	Function list: Activate AI2 setpoint	Not connected [0]	general	U8	1	P	-
0x2631:016 (P400.16)	Function list: Activate keypad setpoint	Not connected [0]	general	U8	1	P	-
0x2631:017 (P400.17)	Function list: Activate network setpoint	Not connected [0]	general	U8	1	P	-
0x2631:018 (P400.18)	Function list: Activate preset (bit 0)	Digital input 4 [14]	general	U8	1	P	-
0x2631:019 (P400.19)	Function list: Activate preset (bit 1)	Digital input 5 [15]	general	U8	1	P	-
0x2631:020 (P400.20)	Function list: Activate preset (bit 2)	Not connected [0]	general	U8	1	P	-
0x2631:021 (P400.21)	Function list: Activate preset (bit 3)	Not connected [0]	general	U8	1	P	-
0x2631:022 (P400.22)	Function list: Activate setpoint via HTL input	Not connected [0]	general	U8	1	P	-
0x2631:023 (P400.23)	Function list: MOP setpoint up	Not connected [0]	general	U8	1	P	-
0x2631:024 (P400.24)	Function list: MOP setpoint down	Not connected [0]	general	U8	1	P	-
0x2631:025 (P400.25)	Function list: Activate MOP setpoint	Not connected [0]	general	U8	1	P	-
0x2631:026 (P400.26)	Function list: Activate segment setpoint (bit 0)	Not connected [0]	Sequencer	U8	1	P	-
0x2631:027 (P400.27)	Function list: Activate segment setpoint (bit 1)	Not connected [0]	Sequencer	U8	1	P	-
0x2631:028 (P400.28)	Function list: Activate segment setpoint (bit 2)	Not connected [0]	Sequencer	U8	1	P	-
0x2631:029 (P400.29)	Function list: Activate segment setpoint (bit 3)	Not connected [0]	Sequencer	U8	1	P	-
0x2631:030 (P400.30)	Function list: Run/abort sequence	Not connected [0]	Sequencer	U8	1	PC	-
0x2631:031 (P400.31)	Function list: Start sequence	Not connected [0]	Sequencer	U8	1	PC	-
0x2631:032 (P400.32)	Function list: Next sequence step	Not connected [0]	Sequencer	U8	1	PC	-
0x2631:033 (P400.33)	Function list: Pause sequence	Not connected [0]	Sequencer	U8	1	PC	-
0x2631:034 (P400.34)	Function list: Suspend sequence	Not connected [0]	Sequencer	U8	1	PC	-
0x2631:035 (P400.35)	Function list: Stop sequence	Not connected [0]	Sequencer	U8	1	PC	-
0x2631:036 (P400.36)	Function list: Abort sequence	Not connected [0]	Sequencer	U8	1	PC	-
0x2631:037 (P400.37)	Function list: Activate network control	Not connected [0]	general	U8	1	P	-
0x2631:039 (P400.39)	Function list: Activate ramp 2	Not connected [0]	general	U8	1	P	-
0x2631:040 (P400.40)	Function list: Load parameter set	Not connected [0]	general	U8	1	PC	-
0x2631:041 (P400.41)	Function list: Select parameter set (bit 0)	Not connected [0]	general	U8	1	PC	-
0x2631:042 (P400.42)	Function list: Select parameter set (bit 1)	Not connected [0]	general	U8	1	PC	-
0x2631:043 (P400.43)	Function list: Activate fault 1	Not connected [0]	general	U8	1	P	-
0x2631:044 (P400.44)	Function list: Activate fault 2	Not connected [0]	general	U8	1	P	-
0x2631:045 (P400.45)	Function list: Disable PID controller	Not connected [0]	general	U8	1	P	-

\* Default setting dependent on the model.





Address	Name	Default setting	Category	Data type	Factor	A	M
0x2631:046 (P400.46)	Function list: Set process controller output to 0	Not connected [0]	general	U8	1	P	-
0x2631:047 (P400.47)	Function list: Inhibit process controller I-component	Not connected [0]	general	U8	1	P	-
0x2631:048 (P400.48)	Function list: Activate PID influence ramp	Constant TRUE [1]	general	U8	1	P	-
0x2631:049 (P400.49)	Function list: Open holding brake	Not connected [0]	general	U8	1	PC	-
0x2631:050 (P400.50)	Function list: Select sequence (bit 0)	Not connected [0]	Sequencer	U8	1	PC	-
0x2631:051 (P400.51)	Function list: Select sequence (bit 1)	Not connected [0]	Sequencer	U8	1	PC	-
0x2631:052 (P400.52)	Function list: Select sequence (bit 2)	Not connected [0]	Sequencer	U8	1	PC	-
0x2631:053 (P400.53)	Function list: Select sequence (bit 3)	Not connected [0]	Sequencer	U8	1	PC	-
0x2631:054 (P400.54)	Function list: Set position counter	Not connected [0]	general	U8	1	P	-
0x2631:055 (P400.55)	Function list: Activate UPS operation	Not connected [0]	general	U8	1	P	-
0x2631:056 (P400.56)	Function list: Assist pump 1	Not connected [0]		U8	1	P	-
0x2631:057 (P400.57)	Function list: Assist pump 2	Not connected [0]		U8	1	P	-
0x2631:058 (P400.58)	Function list: Reset operating time	Not connected [0]		U8	1	P	-
0x2632:001 (P411.01)	Inversion of digital inputs: Digital input 1	Not inverted [0]	general	U8	1	P	-
0x2632:002 (P411.02)	Inversion of digital inputs: Digital input 2	Not inverted [0]	general	U8	1	P	-
0x2632:003 (P411.03)	Inversion of digital inputs: Digital input 3	Not inverted [0]	general	U8	1	P	-
0x2632:004 (P411.04)	Inversion of digital inputs: Digital input 4	Not inverted [0]	general	U8	1	P	-
0x2632:005 (P411.05)	Inversion of digital inputs: Digital input 5	Not inverted [0]	general	U8	1	P	-
0x2632:006 (P411.06)	Inversion of digital inputs: Digital input 6	Not inverted [0]	Appl. I/O	U8	1	P	-
0x2632:007 (P411.07)	Inversion of digital inputs: Digital input 7	Not inverted [0]	Appl. I/O	U8	1	P	-
0x2633:001	Digital input debounce time: Digital input 1	1 ms	general	U8	1	P	-
0x2633:002	Digital input debounce time: Digital input 2	1 ms	general	U8	1	P	-
0x2633:003	Digital input debounce time: Digital input 3	1 ms	general	U8	1	P	-
0x2633:004	Digital input debounce time: Digital input 4	1 ms	general	U8	1	P	-
0x2633:005	Digital input debounce time: Digital input 5	1 ms	general	U8	1	P	-
0x2633:006	Digital input debounce time: Digital input 6	1 ms	Appl. I/O	U8	1	P	-
0x2633:007	Digital input debounce time: Digital input 7	1 ms	Appl. I/O	U8	1	P	-
0x2634:001 (P420.01)	Digital outputs function: Relay	Ready for operation [51]	general	U8	1	P	-
0x2634:002 (P420.02)	Digital outputs function: Digital output 1	Release holding brake [115]	general	U8	1	P	-
0x2634:003 (P420.03)	Digital outputs function: Digital output 2	Fault active [56]	Appl. I/O	U8	1	P	-
0x2634:010 (P420.10)	Digital outputs function: NetWordOUT1 - bit 0	Ready for operation [51]	general	U8	1	P	-
0x2634:011 (P420.11)	Digital outputs function: NetWordOUT1 - bit 1	Not connected [0]	general	U8	1	P	-
0x2634:012 (P420.12)	Digital outputs function: NetWordOUT1 - bit 2	Operation enabled [52]	general	U8	1	P	-

\* Default setting dependent on the model.



Address	Name	Default setting	Category	Data type	Factor	A	M
0x2634:013 (P420.13)	Digital outputs function: NetWordOUT1 - bit 3	<b>Fault active [56]</b>	general	U8	1	P	-
0x2634:014 (P420.14)	Digital outputs function: NetWordOUT1 - bit 4	<b>Not connected [0]</b>	general	U8	1	P	-
0x2634:015 (P420.15)	Digital outputs function: NetWordOUT1 - bit 5	<b>Quick stop active [54]</b>	general	U8	1	P	-
0x2634:016 (P420.16)	Digital outputs function: NetWordOUT1 - bit 6	<b>Running [50]</b>	general	U8	1	P	-
0x2634:017 (P420.17)	Digital outputs function: NetWordOUT1 - bit 7	<b>Device warning active [58]</b>	general	U8	1	P	-
0x2634:018 (P420.18)	Digital outputs function: NetWordOUT1 - bit 8	<b>Not connected [0]</b>	general	U8	1	P	-
0x2634:019 (P420.19)	Digital outputs function: NetWordOUT1 - bit 9	<b>Not connected [0]</b>	general	U8	1	P	-
0x2634:020 (P420.20)	Digital outputs function: NetWordOUT1 - bit 10	<b>Setpoint speed reached [72]</b>	general	U8	1	P	-
0x2634:021 (P420.21)	Digital outputs function: NetWordOUT1 - bit 11	<b>Current limit reached [78]</b>	general	U8	1	P	-
0x2634:022 (P420.22)	Digital outputs function: NetWordOUT1 - bit 12	<b>Actual speed = 0 [71]</b>	general	U8	1	P	-
0x2634:023 (P420.23)	Digital outputs function: NetWordOUT1 - bit 13	<b>Rotational direction reversed [69]</b>	general	U8	1	P	-
0x2634:024 (P420.24)	Digital outputs function: NetWordOUT1 - bit 14	<b>Release holding brake [115]</b>	general	U8	1	P	-
0x2634:025 (P420.25)	Digital outputs function: NetWordOUT1 - bit 15	<b>Inverter disabled (safety) [55]</b>	general	U8	1	P	-
0x2635:001 (P421.01)	Inversion of digital outputs: Relay	<b>Not inverted [0]</b>	general	U8	1	P	-
0x2635:002 (P421.02)	Inversion of digital outputs: Digital output 1	<b>Not inverted [0]</b>	general	U8	1	P	-
0x2635:003 (P421.03)	Inversion of digital outputs: Digital output 2	<b>Not inverted [0]</b>	Appl. I/O	U8	1	P	-
0x2635:010	Inversion of digital outputs: NetWordOUT1.00	<b>Not inverted [0]</b>	general	U8	1	P	-
0x2635:011	Inversion of digital outputs: NetWordOUT1.01	<b>Not inverted [0]</b>	general	U8	1	P	-
0x2635:012	Inversion of digital outputs: NetWordOUT1.02	<b>Not inverted [0]</b>	general	U8	1	P	-
0x2635:013	Inversion of digital outputs: NetWordOUT1.03	<b>Not inverted [0]</b>	general	U8	1	P	-
0x2635:014	Inversion of digital outputs: NetWordOUT1.04	<b>Not inverted [0]</b>	general	U8	1	P	-
0x2635:015	Inversion of digital outputs: NetWordOUT1.05	<b>Not inverted [0]</b>	general	U8	1	P	-
0x2635:016	Inversion of digital outputs: NetWordOUT1.06	<b>Not inverted [0]</b>	general	U8	1	P	-
0x2635:017	Inversion of digital outputs: NetWordOUT1.07	<b>Not inverted [0]</b>	general	U8	1	P	-
0x2635:018	Inversion of digital outputs: NetWordOUT1.08	<b>Not inverted [0]</b>	general	U8	1	P	-
0x2635:019	Inversion of digital outputs: NetWordOUT1.09	<b>Not inverted [0]</b>	general	U8	1	P	-
0x2635:020	Inversion of digital outputs: NetWordOUT1.10	<b>Not inverted [0]</b>	general	U8	1	P	-
0x2635:021	Inversion of digital outputs: NetWordOUT1.11	<b>Not inverted [0]</b>	general	U8	1	P	-
0x2635:022	Inversion of digital outputs: NetWordOUT1.12	<b>Not inverted [0]</b>	general	U8	1	P	-
0x2635:023	Inversion of digital outputs: NetWordOUT1.13	<b>Not inverted [0]</b>	general	U8	1	P	-
0x2635:024	Inversion of digital outputs: NetWordOUT1.14	<b>Not inverted [0]</b>	general	U8	1	P	-
0x2635:025	Inversion of digital outputs: NetWordOUT1.15	<b>Not inverted [0]</b>	general	U8	1	P	-
0x2636:001 (P430.01)	Analog input 1: Input range	<b>0 ... 10 VDC [0]</b>	general	U8	1	P	-
0x2636:002 (P430.02)	Analog input 1: Min frequency value	<b>0.0 Hz</b>	general	I16	10	P	-
0x2636:003 (P430.03)	Analog input 1: Max frequency value	Device for 50-Hz mains: <b>50.0 Hz</b> Device for 60-Hz mains: <b>60.0 Hz</b>	general	I16	10	P	-
0x2636:004 (P430.04)	Analog input 1: Min PID value	<b>0.00 PID unit</b>	general	I16	100	P	-

\* Default setting dependent on the model.



Address	Name	Default setting	Category	Data type	Factor	A	M
0x2636:005 (P430.05)	Analog input 1: Max PID value	100.00 PID unit	general	I16	100	P	-
0x2636:006 (P430.06)	Analog input 1: Filter time	10 ms	general	U16	1	P	-
0x2636:007 (P430.07)	Analog input 1: Dead band	0.0 %	general	U16	10	P	-
0x2636:008 (P430.08)	Analog input 1: Monitoring threshold	0.0 %	general	I16	10	P	-
0x2636:009 (P430.09)	Analog input 1: Monitoring condition	Input value < trigger threshold [0]	general	U8	1	P	-
0x2636:010 (P430.10)	Analog input 1: Error response	Fault [3]	general	U8	1	P	-
0x2636:011 (P430.11)	Analog input 1: Min torque value	0.0 %	general	I16	10	P	-
0x2636:012 (P430.12)	Analog input 1: Max torque value	100.0 %	general	I16	10	P	-
0x2637:001 (P431.01)	Analog input 2: Input range	0 ... 10 VDC [0]	general	U8	1	P	-
0x2637:002 (P431.02)	Analog input 2: Min frequency value	0.0 Hz	general	I16	10	P	-
0x2637:003 (P431.03)	Analog input 2: Max frequency value	Device for 50-Hz mains: 50.0 Hz Device for 60-Hz mains: 60.0 Hz	general	I16	10	P	-
0x2637:004 (P431.04)	Analog input 2: Min PID value	0.00 PID unit	general	I16	100	P	-
0x2637:005 (P431.05)	Analog input 2: Max PID value	100.00 PID unit	general	I16	100	P	-
0x2637:006 (P431.06)	Analog input 2: Filter time	10 ms	general	U16	1	P	-
0x2637:007 (P431.07)	Analog input 2: Dead band	0.0 %	general	U16	10	P	-
0x2637:008 (P431.08)	Analog input 2: Monitoring threshold	0.0 %	general	I16	10	P	-
0x2637:009 (P431.09)	Analog input 2: Monitoring condition	Input value < trigger threshold [0]	general	U8	1	P	-
0x2637:010 (P431.10)	Analog input 2: Error response	Fault [3]	general	U8	1	P	-
0x2637:011 (P431.11)	Analog input 2: Min torque value	0.0 %	general	I16	10	P	-
0x2637:012 (P431.12)	Analog input 2: Max torque value	100.0 %	general	I16	10	P	-
0x2639:001 (P440.01)	Analog output 1: Output range	0 ... 10 VDC [1]	general	U8	1	P	-
0x2639:002 (P440.02)	Analog output 1: Function	Output frequency [1]	general	U8	1	P	-
0x2639:003 (P440.03)	Analog output 1: Min. signal	0	general	I32	1	P	-
0x2639:004 (P440.04)	Analog output 1: Max. signal	1000	general	I32	1	P	-
0x2639:006 (P440.06)	Analog output 1: Filter time	250 ms	general	U16	1	P	-
0x263A:001 (P441.01)	Analog output 2: Output range	0 ... 10 VDC [1]	Appl. I/O	U8	1	P	-
0x263A:002 (P441.02)	Analog output 2: Function	Motor current [5]	Appl. I/O	U8	1	P	-
0x263A:003 (P441.03)	Analog output 2: Min. signal	0	Appl. I/O	I32	1	P	-
0x263A:004 (P441.04)	Analog output 2: Max. signal	1000	Appl. I/O	I32	1	P	-

\* Default setting dependent on the model.



Address	Name	Default setting	Category	Data type	Factor	A	M
0x263A:006 (P441.06)	Analog output 2: Filter time	<b>250 ms</b>	Appl. I/O	U16	1	P	-
0x2640:001 (P415.01)	HTL input settings: Minimum frequency	<b>0.0 Hz</b>	general	I32	10	P	-
0x2640:002 (P415.02)	HTL input settings: Maximum frequency	<b>0.0 Hz</b>	general	I32	10	P	-
0x2640:003 (P415.03)	HTL input settings: Minimum motor frequency	<b>0.0 Hz</b>	general	I16	10	P	-
0x2640:004 (P415.04)	HTL input settings: Maximum motor frequency	Device for 50-Hz mains: <b>50.0 Hz</b> Device for 60-Hz mains: <b>60.0 Hz</b>	general	I16	10	P	-
0x2640:005 (P415.05)	HTL input settings: Minimum PID setpoint	<b>0.00 PID unit</b>	general	I16	100	P	-
0x2640:006 (P415.06)	HTL input settings: Maximum PID setpoint	<b>100.00 PID unit</b>	general	I16	100	P	-
0x2640:007 (P415.07)	HTL input settings: Minimum torque setpoint	<b>0.0 %</b>	general	I16	10	P	-
0x2640:008 (P415.08)	HTL input settings: Maximum torque setpoint	<b>100.0 %</b>	general	I16	10	P	-
0x2640:009 (P415.09)	HTL input settings: IN1 Filter time constant	<b>10 ms</b>	general	U16	1	P	-
0x2641:001 (P416.01)	HTL input monitoring: IN1 Minimal frequency threshold	<b>0.0 Hz</b>	general	I32	10	P	-
0x2641:002 (P416.02)	HTL input monitoring: IN1 Minimum delay threshold	<b>5.0 s</b>	general	U16	10	P	-
0x2641:003 (P416.03)	HTL input monitoring: IN1 Maximal frequency threshold	<b>0.0 Hz</b>	general	I32	10	P	-
0x2641:004 (P416.04)	HTL input monitoring: IN1 Maximum delay threshold	<b>5.0 s</b>	general	U16	10	P	-
0x2641:005 (P416.05)	HTL input monitoring: IN1 Monitoring conditions	<b>Below minimum frequency [1]</b>	general	U8	1	P	-
0x2641:006 (P416.06)	HTL input monitoring: IN1 Error response	<b>No response [0]</b>	general	U8	1	P	-
0x2642:001 (P115.01)	HTL input diagnostics: Input frequency	x.x Hz (Read only)	general	I32	10	O	t
0x2642:002 (P115.02)	HTL input diagnostics: Frequency setpoint	x.x Hz (Read only)	general	I16	10	O	t
0x2642:003 (P115.03)	HTL input diagnostics: PID setpoint	x.xx PID unit (Read only)	general	I16	100	O	t
0x2642:004 (P115.04)	HTL input diagnostics: Torque setpoint	x.x % (Read only)	general	I16	10	O	t
0x2644:001 (P423.01)	DO1 frequency setup: Minimum frequency	<b>0.0 Hz</b>	general	I32	10	P	-
0x2644:002 (P423.02)	DO1 frequency setup: Maximum frequency	<b>10000.0 Hz</b>	general	I32	10	P	-
0x2644:003 (P423.03)	DO1 frequency setup: Function	<b>Not active [0]</b>	general	U8	1	P	-
0x2644:004 (P423.04)	DO1 frequency setup: Minimum signal	<b>0</b>	general	I32	1	P	-
0x2644:005 (P423.05)	DO1 frequency setup: Maximum signal	<b>1000</b>	general	I32	1	P	-
0x2646:001 (P114.01)	DO actual frequency: Digital output 1	x.x Hz (Read only)	general	I32	10	O	t
0x2811:003	Motor mounting direction	<b>Not inverted [0]</b>	MCTRL	U8	1	PC	-
0x2820:001 (P712.01)	Holding brake control: Brake mode	<b>Off [2]</b>	general	U8	1	P	r
0x2820:002 (P712.02)	Holding brake control: Brake closing time	<b>100 ms</b>	general	U16	1	P	-

\* Default setting dependent on the model.



Address	Name	Default setting	Category	Data type	Factor	A	M
0x2820:003 (P712.03)	Holding brake control: Brake opening time	100 ms	general	U16	1	P	-
0x2820:007 (P712.07)	Holding brake control: Brake closing threshold	0.2 Hz	general	U16	10	P	-
0x2820:008 (P712.08)	Holding brake control: Brake holding load	0.0 %	general	I16	10	PC	-
0x2820:012 (P712.12)	Holding brake control: Closing threshold delay	0 ms	general	U16	1	P	-
0x2820:013 (P712.13)	Holding brake control: Holding load ramp time	0 ms	general	U16	1	PC	-
0x2820:015 (P712.15)	Holding brake control: Brake status	- (Read only)	general	U8	1	O	-
0x2822:004 (P327.04)	Identify motor data (energized)	0	general	U8	1	-	-
0x2822:005 (P327.05)	Calibrate motor data (non-energized)	0	general	U8	1	-	-
0x2822:006	Motor identification	0	general	U8	1	-	-
0x2822:010	Identify inverter characteristic	0	general	U8	1	-	-
0x2822:019	Calculate I <sub>max</sub> controller parameter	0	general	U8	1	-	-
0x2824 (P200.00)	Control selection	Flexible I/O configuration [0]	general	U8	1	P	-
0x2826	Timeout for error response -> quickstop	6.0 s	general	U16	10	P	-
0x2827 (P198.00)	Currently loaded parameter settings	- (Read only)	general	U8	1	O	-
0x2829 (P732.00)	Automatic storage in the memory module	Inhibit [0]	general	U8	1	P	-
0x282A:001 (P126.01)	Status words: Cause of disable	- (Read only)	general	U32	1	O	-
0x282A:002 (P126.02)	Status words: Cause of quick stop	- (Read only)	general	U16	1	O	-
0x282A:003 (P126.03)	Status words: Cause of stop	- (Read only)	general	U16	1	O	-
0x282A:004	Status words: Extended status word	- (Read only)	general	U16	1	O	t
0x282A:005 (P126.05)	Status words: Device status	- (Read only)	general	U8	1	O	t
0x282B:001 (P125.01)	Inverter diagnostics: Active control source	- (Read only)	general	U8	1	O	t
0x282B:002 (P125.02)	Inverter diagnostics: Active setpoint source	- (Read only)	general	U8	1	O	t
0x282B:003 (P125.03)	Inverter diagnostics: Keypad LCD status	- (Read only)	general	U8	1	O	-
0x282B:004 (P125.04)	Inverter diagnostics: Active drive mode	- (Read only)	general	U8	1	O	t
0x282B:005 (P125.05)	Inverter diagnostics: Most recently used control register	- (Read only)	general	U32	1	H	-
0x282B:006 (P125.06)	Inverter diagnostics: Most recently used setpoint register	- (Read only)	general	U32	1	H	-
0x282B:007	Inverter diagnostics: Default frequency setpoint	x.x Hz (Read only)	general	I16	10	-	-
0x282B:008	Inverter diagnostics: Preset frequency setpoint	x.x Hz (Read only)	general	I16	10	-	-
0x282B:009	Inverter diagnostics: Actual frequency setpoint	x.x Hz (Read only)	general	I16	10	O	-
0x282B:010	Inverter diagnostics: Default PID setpoint	x.xx PID unit (Read only)	general	I16	100	-	-
0x282B:011	Inverter diagnostics: Preset PID setpoint	x.xx PID unit (Read only)	general	I16	100	-	-
0x282B:012	Inverter diagnostics: Default torque setpoint	x.x % (Read only)	general	I16	10	-	-
0x282B:013	Inverter diagnostics: Preset torque setpoint	x.x % (Read only)	general	I16	10	-	-
0x2831	Inverter status word	- (Read only)	MCTRL	U16	1	O	t
0x2833	Inverter status word 2	- (Read only)	MCTRL	U16	1	O	t
0x2838:001 (P203.01)	Start/stop configuration: Start method	Normal [0]	MCTRL	U8	1	PC	-

\* Default setting dependent on the model.



Address	Name	Default setting	Category	Data type	Factor	A	M
0x2838:002 (P203.02)	Start/stop configuration: Start at power-up	Off [0]	general	U8	1	P	-
0x2838:003 (P203.03)	Start/stop configuration: Stop method	Standard ramp [1]	general	U8	1	P	-
0x2839:002 (P760.02)	Fault configuration: Restart delay	3.0 s	general	U16	10	P	-
0x2839:003 (P760.03)	Fault configuration: Number of restart attempts	5	general	U8	1	P	-
0x2839:004 (P760.04)	Fault configuration: Trouble counter reset time	40.0 s	general	U16	10	P	-
0x2839:005 (P760.05)	Fault configuration: Trouble counter	- (Read only)	general	U8	1	O	-
0x2839:006 (P760.06)	Fault configuration: Fault handling in case of state change	Reset fault [0]	general	U8	1	P	-
0x283A (P304.00)	Limitation of rotation	Both rotational directions [1]	general	U8	1	P	-
0x2857:001	CANopen monitoring: RPDO1-Timeout	Fault [3]	CANopen	U8	1	P	-
0x2857:002	CANopen monitoring: RPDO2-Timeout	Fault [3]	CANopen	U8	1	P	-
0x2857:003	CANopen monitoring: RPDO3-Timeout	Fault [3]	CANopen	U8	1	P	-
0x2857:005	CANopen monitoring: Heartbeat-Timeout Consumer 1	Fault [3]	CANopen	U8	1	P	-
0x2857:006	CANopen monitoring: Heartbeat-Timeout Consumer 2	Fault [3]	CANopen	U8	1	P	-
0x2857:007	CANopen monitoring: Heartbeat-Timeout Consumer 3	Fault [3]	CANopen	U8	1	P	-
0x2857:008	CANopen monitoring: Heartbeat-Timeout Consumer 4	Fault [3]	CANopen	U8	1	P	-
0x2857:010	CANopen monitoring: "Bus-off" state change	Trouble [2]	CANopen	U8	1	P	-
0x2857:011	CANopen monitoring: Warning	Warning [1]	CANopen	U8	1	P	-
0x2858:001 (P515.01)	Modbus monitoring: Response to time-out	Fault [3]	Modbus RTU	U8	1	P	-
0x2858:002 (P515.02)	Modbus monitoring: Time-out time	2.0 s	Modbus RTU	U16	10	P	-
0x2859:001 (P515.01)	EtherCAT monitoring: Watchdog elapsed	Trouble [2]	EtherCAT	U8	1	P	-
0x2859:003 (P515.03)	EtherCAT monitoring: Invalid configuration	Trouble [2]	EtherCAT	U8	1	P	-
0x2859:004 (P515.04)	EtherCAT monitoring: Initialisation error	Trouble [2]	EtherCAT	U8	1	P	-
0x2859:005 (P515.05)	EtherCAT monitoring: Invalid process data	Trouble [2]	EtherCAT	U8	1	P	-
0x2859:001 (P515.01)	EtherNet/IP monitoring: Watchdog elapsed	Fault [3]	EtherNet/IP	U8	1	P	-
0x2859:003 (P515.03)	EtherNet/IP monitoring: Invalid configuration	Trouble [2]	EtherNet/IP	U8	1	P	-
0x2859:004 (P515.04)	EtherNet/IP monitoring: Initialisation error	Trouble [2]	EtherNet/IP	U8	1	P	-
0x2859:005 (P515.05)	EtherNet/IP monitoring: Invalid process data	Trouble [2]	EtherNet/IP	U8	1	P	-
0x2859:006 (P515.06)	EtherNet/IP monitoring: Time-out explicit message	Warning [1]	EtherNet/IP	U8	1	P	-
0x2859:007 (P515.07)	EtherNet/IP monitoring: Timeout communication	Warning [1]	EtherNet/IP	U8	1	P	-
0x2859:001	POWERLINK monitoring: Watchdog elapsed	Trouble [2]	POWERLINK	U8	1	P	-
0x2859:010	POWERLINK monitoring: CRC error	Trouble [2]	POWERLINK	U8	1	P	-
0x2859:011	POWERLINK monitoring: Loss of SoC	Trouble [2]	POWERLINK	U8	1	P	-
0x2859:002	IO-Link monitoring: Data exchange exited	Warning [1]	IO-Link	U8	1	P	-
0x2859:005	IO-Link monitoring: Invalid process data	Warning [1]	IO-Link	U8	1	P	-

\* Default setting dependent on the model.



Address	Name	Default setting	Category	Data type	Factor	A	M
0x2859:003 (P515.03)	Modbus TCP/IP monitoring: Configuration error	<b>Trouble [2]</b>	Modbus TCP	U8	1	P	-
0x2859:004 (P515.04)	Modbus TCP/IP monitoring: Initialisation error	<b>Trouble [2]</b>	Modbus TCP	U8	1	P	-
0x2859:007 (P515.07)	Modbus TCP/IP monitoring: Fault response to network timeout	<b>Warning [1]</b>	Modbus TCP	U8	1	P	-
0x2859:008 (P515.08)	Modbus TCP/IP monitoring: Fault response to master timeout	<b>Fault [3]</b>	Modbus TCP	U8	1	P	-
0x2859:009 (P515.09)	Modbus TCP/IP monitoring: Fault response to keep alive timeout	<b>Fault [3]</b>	Modbus TCP	U8	1	P	-
0x2859:001 (P515.01)	PROFIBUS monitoring: Watchdog elapsed	<b>Trouble [2]</b>	PROFIBUS	U8	1	P	-
0x2859:002 (P515.02)	PROFIBUS monitoring: Data exchange exited	<b>No response [0]</b>	PROFIBUS	U8	1	P	-
0x2859:003 (P515.03)	PROFIBUS monitoring: Invalid configuration	<b>Trouble [2]</b>	PROFIBUS	U8	1	P	-
0x2859:004 (P515.04)	PROFIBUS monitoring: Initialisation error	<b>Trouble [2]</b>	PROFIBUS	U8	1	P	-
0x2859:005 (P515.05)	PROFIBUS monitoring: Invalid process data	<b>Trouble [2]</b>	PROFIBUS	U8	1	P	-
0x2859:001 (P515.01)	PROFINET monitoring: Watchdog elapsed	<b>Trouble [2]</b>	PROFINET	U8	1	P	-
0x2859:002 (P515.02)	PROFINET monitoring: Data exchange exited	<b>No response [0]</b>	PROFINET	U8	1	P	-
0x2859:003 (P515.03)	PROFINET monitoring: Invalid configuration	<b>Trouble [2]</b>	PROFINET	U8	1	P	-
0x2859:004 (P515.04)	PROFINET monitoring: Initialisation error	<b>Trouble [2]</b>	PROFINET	U8	1	P	-
0x2859:005 (P515.05)	PROFINET monitoring: Invalid process data	<b>Trouble [2]</b>	PROFINET	U8	1	P	-
0x285A:001	Diagnostic configuration: Alarm suppression	<b>0</b>	PROFIBUS	U16	1	P	-
0x285A:001	Diagnostic configuration: Alarm suppression	<b>0</b>	PROFINET	U16	1	P	-
0x285C:001	Alarm suppression: Entry 1	<b>0x00000000</b>	Fieldbus	U32	1	PH	-
0x285C:002	Alarm suppression: Entry 2	<b>0x00000000</b>	Fieldbus	U32	1	PH	-
0x285C:003	Alarm suppression: Entry 3	<b>0x00000000</b>	Fieldbus	U32	1	PH	-
0x285C:004	Alarm suppression: Entry 4	<b>0x00000000</b>	Fieldbus	U32	1	PH	-
0x285C:005	Alarm suppression: Entry 5	<b>0x00000000</b>	Fieldbus	U32	1	PH	-
0x285C:006	Alarm suppression: Entry 6	<b>0x00000000</b>	Fieldbus	U32	1	PH	-
0x285C:007	Alarm suppression: Entry 7	<b>0x00000000</b>	Fieldbus	U32	1	PH	-
0x285C:008	Alarm suppression: Entry 8	<b>0x00000000</b>	Fieldbus	U32	1	PH	-
0x285C:009	Alarm suppression: Entry 9	<b>0x00000000</b>	Fieldbus	U32	1	PH	-
0x285C:010	Alarm suppression: Entry 10	<b>0x00000000</b>	Fieldbus	U32	1	PH	-
0x2860:001 (P201.01)	Frequency control: Default setpoint source	<b>Analog input 1 [2]</b>	general	U8	1	P	-
0x2860:002 (P201.02)	PID control: Default setpoint source	<b>Keypad [1]</b>	general	U8	1	P	-
0x2860:003 (P201.03)	Torque control: Default setpoint source	<b>Analog input 1 [2]</b>	general	U8	1	P	-
0x2862 (P701.00)	Keypad setpoint increment	<b>1</b>	general	U16	1	P	-
0x2863 (P705.00)	Keypad language selection	<b>English [1]</b>	general	U8	1	P	-
0x2864 (P703.00)	Keypad status display	<b>0x00000000</b>	general	IDX	1	PH	-
0x2865:001 (P709.01)	Keypad display setup: User unit MS velocity mode		general	STRING[6]	1	P	-
0x2865:002 (P709.02)	Keypad display setup: User unit PID control		general	STRING[6]	1	P	-

\* Default setting dependent on the model.



Address	Name	Default setting	Category	Data type	Factor	A	M
0x2865:003 (P709.03)	Keypad display setup: Speed display decimal point location	0		U8	1	P	-
0x2865:004 (P709.04)	Keypad display setup: PID display decimal point location	2		U8	1	P	-
0x2900:001 (P332.01)	Speed controller settings: Gain	0.00193 Nm/rpm *	MCTRL	U32	100000	P	-
0x2900:002 (P332.02)	Speed controller settings: Reset time	80.0 ms *	MCTRL	U16	10	P	-
0x2901	Speed controller gain adaption	100.00 %	MCTRL	U16	100	P	r
0x2904	Actual speed filter time	2.0 ms	MCTRL	U16	10	P	-
0x2910:001 (P335.01)	Inertia settings: Motor moment of inertia	3.70 kg cm <sup>2</sup> *	MCTRL	U32	100	P	-
0x2910:002 (P335.02)	Inertia settings: Scaled load inertia	0.00 kg cm <sup>2</sup>	MCTRL	U32	100	P	-
0x2910:003	Inertia settings: Coupling	With backlash [2]	MCTRL	U8	1	P	-
0x2911:001 (P450.01)	Frequency setpoint presets: Preset 1	20.0 Hz	general	U16	10	OP	-
0x2911:002 (P450.02)	Frequency setpoint presets: Preset 2	40.0 Hz	general	U16	10	OP	-
0x2911:003 (P450.03)	Frequency setpoint presets: Preset 3	Device for 50-Hz mains: 50.0 Hz Device for 60-Hz mains: 60.0 Hz	general	U16	10	OP	-
0x2911:004 (P450.04)	Frequency setpoint presets: Preset 4	0.0 Hz	general	U16	10	OP	-
0x2911:005 (P450.05)	Frequency setpoint presets: Preset 5	0.0 Hz	general	U16	10	OP	-
0x2911:006 (P450.06)	Frequency setpoint presets: Preset 6	0.0 Hz	general	U16	10	OP	-
0x2911:007 (P450.07)	Frequency setpoint presets: Preset 7	0.0 Hz	general	U16	10	OP	-
0x2911:008 (P450.08)	Frequency setpoint presets: Preset 8	0.0 Hz	general	U16	10	OP	-
0x2911:009 (P450.09)	Frequency setpoint presets: Preset 9	0.0 Hz	general	U16	10	OP	-
0x2911:010 (P450.10)	Frequency setpoint presets: Preset 10	0.0 Hz	general	U16	10	OP	-
0x2911:011 (P450.11)	Frequency setpoint presets: Preset 11	0.0 Hz	general	U16	10	OP	-
0x2911:012 (P450.12)	Frequency setpoint presets: Preset 12	0.0 Hz	general	U16	10	OP	-
0x2911:013 (P450.13)	Frequency setpoint presets: Preset 13	0.0 Hz	general	U16	10	OP	-
0x2911:014 (P450.14)	Frequency setpoint presets: Preset 14	0.0 Hz	general	U16	10	OP	-
0x2911:015 (P450.15)	Frequency setpoint presets: Preset 15	0.0 Hz	general	U16	10	OP	-
0x2912:001 (P452.01)	Torque setpoint presets: Preset 1	100.0 %	general	I16	10	OP	-
0x2912:002 (P452.02)	Torque setpoint presets: Preset 2	100.0 %	general	I16	10	OP	-
0x2912:003 (P452.03)	Torque setpoint presets: Preset 3	100.0 %	general	I16	10	OP	-
0x2912:004 (P452.04)	Torque setpoint presets: Preset 4	100.0 %	general	I16	10	OP	-
0x2912:005 (P452.05)	Torque setpoint presets: Preset 5	100.0 %	general	I16	10	OP	-
0x2912:006 (P452.06)	Torque setpoint presets: Preset 6	100.0 %	general	I16	10	OP	-

\* Default setting dependent on the model.





Address	Name	Default setting	Category	Data type	Factor	A	M
0x2912:007 (P452.07)	Torque setpoint presets: Preset 7	100.0 %	general	I16	10	OP	-
0x2912:008 (P452.08)	Torque setpoint presets: Preset 8	100.0 %	general	I16	10	OP	-
0x2915 (P210.00)	Minimum frequency	0.0 Hz	general	U16	10	P	-
0x2916 (P211.00)	Maximum frequency	Device for 50-Hz mains: 50.0 Hz Device for 60-Hz mains: 60.0 Hz	general	U16	10	P	-
0x2917 (P220.00)	Acceleration time 1	5.0 s	general	U16	10	P	rt
0x2918 (P221.00)	Deceleration time 1	5.0 s	general	U16	10	P	rt
0x2919 (P222.00)	Acceleration time 2	5.0 s	general	U16	10	P	-
0x291A (P223.00)	Deceleration time 2	5.0 s	general	U16	10	P	-
0x291B (P224.00)	Auto-changeover threshold of ramp 2	0.0 Hz	general	U16	10	P	-
0x291C (P225.00)	Quick stop deceleration time	1.0 s	general	U16	10	P	-
0x291E:001 (P226.01)	S-Ramp characteristic: Smoothing factor	0.0 %	general	U16	10	P	r
0x291E:003 (P226.03)	S-Ramp characteristic: Stop threshold	10.0 %	general	U16	10	P	-
0x291F:001 (P317.01)	Skip frequencies: Skip frequency 1	0.0 Hz	general	U16	10	P	-
0x291F:002 (P317.02)	Skip frequencies: Skip bandwidth 1	0.0 Hz	general	U8	10	P	-
0x291F:003 (P317.03)	Skip frequencies: Skip frequency 2	0.0 Hz	general	U16	10	P	-
0x291F:004 (P317.04)	Skip frequencies: Skip bandwidth 2	0.0 Hz	general	U8	10	P	-
0x291F:005 (P317.05)	Skip frequencies: Skip frequency 3	0.0 Hz	general	U16	10	P	-
0x291F:006 (P317.06)	Skip frequencies: Skip bandwidth 3	0.0 Hz	general	U8	10	P	-
0x291F:016	Skip frequencies: Status	- (Read only)	general	U16	1	O	-
0x291F:032	Skip frequencies: Input frequency	x.xx Hz (Read only)	general	I32	100	O	-
0x291F:033	Skip frequencies: Output frequency	x.xx Hz (Read only)	general	I32	100	O	-
0x2939 (P305.00)	Switching frequency	0 *	general	U8	1	P	-
0x293A (P116.00)	Actual switching frequency	- (Read only)	general	U8	1	O	t
0x2942:001 (P334.01)	Current controller parameters: Gain	42.55 V/A *	MCTRL	U32	100	P	-
0x2942:002 (P334.02)	Current controller parameters: Reset time	4.50 ms *	MCTRL	U32	100	P	-
0x2942:004	Current controller parameters: d-axis gain	26.00 V/A *	MCTRL	U32	100	P	-
0x2942:005	Current controller parameters: d-axis reset time	3.00 ms *	MCTRL	U32	100	P	-
0x2942:006	Current controller parameters: q-axis gain	26.00 V/A *	MCTRL	U32	100	P	-
0x2942:007	Current controller parameters: q-axis reset time	3.00 ms *	MCTRL	U32	100	P	-
0x2946:001 (P340.01)	Speed limitation: Upper speed limit	0 vel. unit	general	I32	480000 /2 <sup>31-1</sup>	P	r
0x2946:002 (P340.02)	Speed limitation: Lower speed limit	0 vel. unit	general	I32	480000 /2 <sup>31-1</sup>	P	r
0x2946:003 (P340.03)	Speed limitation: Upper speed limit source	Maximum frequency [0]	general	U8	1	P	-

\* Default setting dependent on the model.



Address	Name	Default setting	Category	Data type	Factor	A	M
0x2946:004 (P340.04)	Speed limitation: Lower speed limit source	(-) <b>Maximum frequency [0]</b>	general	U8	1	P	-
0x2946:005 (P340.05)	Speed limitation: Upper frequency limit	Device for 50-Hz mains: <b>50.0 Hz</b> Device for 60-Hz mains: <b>60.0 Hz</b>	general	I16	10	P	-
0x2946:006 (P340.06)	Speed limitation: Lower frequency limit	Device for 50-Hz mains: <b>-50.0 Hz</b> Device for 60-Hz mains: <b>-60.0 Hz</b>	general	I16	10	P	-
0x2946:007 (P340.07)	Speed limitation: Actual upper speed limit	x.x Hz (Read only)	general	I16	10	-	-
0x2946:008 (P340.08)	Speed limitation: Actual lower speed limit	x.x Hz (Read only)	general	I16	10	-	-
0x2947:001 ... 0x2947:017	Inverter characteristic: Value y1 ... Value y17	<b>0.00 V *</b>	MCTRL	U16	100	P	-
0x2948:001	Torque setpoint: Actual torque setpoint	x.x % (Read only)	general	I16	10	O	-
0x2948:002 (P336.02)	Torque setpoint: ramp time	<b>1.0 s</b>	general	U16	10	P	-
0x2949:001 (P337.01)	Torque limit source selection: Positive torque limit source	<b>Max torque [0]</b>	general	U8	1	P	-
0x2949:002 (P337.02)	Torque limit source selection: Negative torque limit source	(-) <b>Max torque [0]</b>	general	U8	1	P	-
0x2949:003 (P337.03)	Torque limit source selection: Actual positive torque limit	x.x % (Read only)	general	I16	10	O	-
0x2949:004 (P337.04)	Torque limit source selection: Actual negative torque limit	x.x % (Read only)	general	I16	10	O	-
0x29C0:001	Field controller settings: Gain	<b>59.68 A/Vs *</b>	MCTRL	U32	100	P	-
0x29C0:002	Field controller settings: Reset time	<b>45.5 ms *</b>	MCTRL	U16	10	P	-
0x29E0:001	Field weakening controller settings: Gain (ASM)	<b>0.000 Vs/V *</b>	MCTRL	U32	1000	P	-
0x29E0:002	Field weakening controller settings: Reset time (ASM)	<b>1478.3 ms *</b>	MCTRL	U32	10	P	-
0x29E0:003	Field weakening controller settings: Reset time (PSM)	<b>800.0 ms *</b>	MCTRL	U32	10	P	-
0x29E1	Field weakening controller Field limitation	<b>100.00 %</b>	MCTRL	U16	100	P	r
0x29E2	DC-bus filter time	<b>25.0 ms</b>	MCTRL	U16	10	P	-
0x29E3	Motor voltage filter time	<b>25.0 ms</b>	MCTRL	U16	10	P	-
0x29E4 (P354.00)	Voltage reserve range	<b>5 %</b>	MCTRL	U8	1	P	-
0x2B00 (P302.00)	V/f characteristic shape	<b>Linear [0]</b>	MCTRL	U8	1	PC	-
0x2B01:001 (P303.01)	V/f shape data: Base voltage	<b>230 V *</b>	MCTRL	U16	1	P	-
0x2B01:002 (P303.02)	V/f shape data: Base frequency	Device for 50-Hz mains: <b>50 Hz</b> Device for 60-Hz mains: <b>60 Hz *</b>	MCTRL	U16	1	P	-
0x2B01:003 (P303.03)	V/f shape data: Midpoint voltage	<b>0 V</b>	MCTRL	U16	1	P	-
0x2B01:004 (P303.04)	V/f shape data: Midpoint frequency	<b>0 Hz</b>	MCTRL	U16	1	P	-
0x2B02:001	Frequency grid points (x) user V/f characteristic: x1 = f01	<b>0 Hz</b>		I16	1	P	-
0x2B02:002	Frequency grid points (x) user V/f characteristic: x2 = f02	<b>0 Hz</b>		I16	1	P	-
0x2B02:003	Frequency grid points (x) user V/f characteristic: x3 = f03	<b>0 Hz</b>		I16	1	P	-
0x2B02:004	Frequency grid points (x) user V/f characteristic: x4 = f04	<b>0 Hz</b>		I16	1	P	-

\* Default setting dependent on the model.



Address	Name	Default setting	Category	Data type	Factor	A	M
0x2B02:005	Frequency grid points (x) user V/f characteristic: x5 = f05	0 Hz		I16	1	P	-
0x2B02:006	Frequency grid points (x) user V/f characteristic: x6 = f06	0 Hz		I16	1	P	-
0x2B02:007	Frequency grid points (x) user V/f characteristic: x7 = f07	0 Hz		I16	1	P	-
0x2B02:008	Frequency grid points (x) user V/f characteristic: x8 = f08	0 Hz		I16	1	P	-
0x2B02:009	Frequency grid points (x) user V/f characteristic: x9 = f09	0 Hz		I16	1	P	-
0x2B02:010	Frequency grid points (x) user V/f characteristic: x10 = f10	0 Hz		I16	1	P	-
0x2B02:011	Frequency grid points (x) user V/f characteristic: x11 = f11	0 Hz		I16	1	P	-
0x2B03:001	Voltage grid points (y) user V/f characteristic: y1 = U01 (x = f01)	0.00 V		I32	100	P	-
0x2B03:002	Voltage grid points (y) user V/f characteristic: y2 = U02 (x = f02)	0.00 V		I32	100	P	-
0x2B03:003	Voltage grid points (y) user V/f characteristic: y3 = U03 (x = f03)	0.00 V		I32	100	P	-
0x2B03:004	Voltage grid points (y) user V/f characteristic: y4 = U04 (x = f04)	0.00 V		I32	100	P	-
0x2B03:005	Voltage grid points (y) user V/f characteristic: y5 = U05 (x = f05)	0.00 V		I32	100	P	-
0x2B03:006	Voltage grid points (y) user V/f characteristic: y6 = U06 (x = f06)	0.00 V		I32	100	P	-
0x2B03:007	Voltage grid points (y) user V/f characteristic: y7 = U07 (x = f07)	0.00 V		I32	100	P	-
0x2B03:008	Voltage grid points (y) user V/f characteristic: y8 = U08 (x = f08)	0.00 V		I32	100	P	-
0x2B03:009	Voltage grid points (y) user V/f characteristic: y9 = U09 (x = f09)	0.00 V		I32	100	P	-
0x2B03:010	Voltage grid points (y) user V/f characteristic: y10 = U10 (x = f10)	0.00 V		I32	100	P	-
0x2B03:011	Voltage grid points (y) user V/f characteristic: y11 = U11 (x = f11)	0.00 V		I32	100	P	-
0x2B08:001 (P333.01)	V/f I <sub>max</sub> controller: Gain	0.284 Hz/A *	MCTRL	U32	1000	P	-
0x2B08:002 (P333.02)	V/f I <sub>max</sub> controller: Reset time	2.3 ms *	MCTRL	U32	10	P	-
0x2B09:001 (P315.01)	Slip compensation: Gain	100.00 %	MCTRL	I16	100	P	-
0x2B09:002 (P315.02)	Slip compensation: Filter time	100 ms	MCTRL	U16	1	P	-
0x2B0A:001 (P318.01)	Oscillation damping: Gain	150 %	MCTRL	I16	1	P	-
0x2B0A:002 (P318.02)	Oscillation damping: Filter time	30 ms	MCTRL	U16	1	P	-
0x2B0B	Ramp generator frequency	x.x Hz (Read only)	general	I16	10	O	t
0x2B0C (P319.00)	Override field weakening	0.0 Hz	MCTRL	I16	10	P	-
0x2B0C (P319.00)	Override field weakening	-40.0 Hz	MCTRL	I16	10	P	-
0x2B0D:001 (P330.01)	VFC-ECO: Minimum voltage	20 %	MCTRL	I16	1	P	-
0x2B0D:006 (P330.06)	VFC-ECO: Cos phi actual value	- (Read only)	MCTRL	I16	100	-	t
0x2B0E (P102.00)	Frequency setpoint	x.x Hz (Read only)	general	I16	10	O	t
0x2B0F	Output frequency motor	x.x Hz (Read only)	MCTRL	I16	10	O	t

\* Default setting dependent on the model.



Address	Name	Default setting	Category	Data type	Factor	A	M
0x2B10:001	V/f torque limitation: Gain	0.00 %	MCTRL	U16	100	P	-
0x2B12:001 (P316.01)	V/f voltage boost: Fixed boost	2.5 % *	MCTRL	U8	10	P	-
0x2B12:002 (P316.02)	V/f voltage boost: Boost at acceleration	0.0 %	general	U8	10	P	-
0x2B13:001	Additive voltage impression: Enable Function	Disable [0]	general	U8	1	P	-
0x2B13:002	Additive voltage impression: Setpoint source	Analog input 1 [1]	general	U8	1	P	-
0x2B13:003	Additive voltage impression: Actual voltage	x V (Read only)	general	I16	1	O	-
0x2B13:004	Additive voltage impression: Ramp time	0.0 s	general	U16	10	P	-
0x2B14:001	Slip controller: Gain	0.100	MCTRL	U16	1000	P	-
0x2B14:002	Slip controller: Reset time	100.0 ms	MCTRL	U16	10	P	-
0x2B14:003	Slip controller: Frequency limitation	10.00 Hz	MCTRL	U16	100	P	-
0x2B40:001	Gain	0.2686 Hz/A *	MCTRL	U32	10000	P	-
0x2B40:002	Reset time	2.3 ms *	MCTRL	U32	10	P	-
0x2B40:003	Q-Feedforward	0.00	MCTRL	U32	100	P	-
0x2B40:004	D-Feedforward	0.00	MCTRL	U32	100	P	-
0x2B84:001 (P704.01)	DC braking: Current	0.0 %	MCTRL	U16	10	P	-
0x2B84:002 (P704.02)	DC braking: Automatic hold time	0.0 s	general	U16	10	P	-
0x2B84:003 (P704.03)	DC braking: Automatic operating threshold	0.0 Hz	general	U16	10	P	-
0x2B84:004 (P704.04)	DC braking: Demagnetization time	100 %	general	U8	1	P	-
0x2B84:005 (P704.05)	DC braking: Default demagnetization time	x ms (Read only)	general	U16	1	-	-
0x2B84:006 (P704.06)	DC braking: Inverter disable	Disabled [0]	general	U8	1	P	-
0x2BA1:001 (P718.01)	Flying restart circuit: Current	30 %	MCTRL	U16	1	P	-
0x2BA1:002 (P718.02)	Flying restart circuit: Start frequency	20.0 Hz	MCTRL	I16	10	P	-
0x2BA1:003 (P718.03)	Flying restart circuit: Restart time	5911 ms *	MCTRL	U16	1	P	-
0x2BA1:008 (P718.08)	Flying restart circuit: Flying restart frequency	x.x Hz (Read only)	MCTRL	I16	10	O	t
0x2C00 (P300.00)	Motor control mode	V/f characteristic control (VFC open loop) [6]	MCTRL	U8	1	PC	-
0x2C01:001	Motor parameters: Number of pole pairs	- (Read only)	MCTRL	U8	1	-	-
0x2C01:002	Motor parameters: Stator resistance	10.1565 Ω *	MCTRL	U32	10000	P	-
0x2C01:003	Motor parameters: Stator leakage inductance	23.566 mH *	MCTRL	U32	1000	P	-
0x2C01:004 (P320.04)	Motor parameters: Rated speed	Device for 50-Hz mains: 1450 rpm Device for 60-Hz mains: 1750 rpm	MCTRL	U16	1	P	-
0x2C01:005 (P320.05)	Motor parameters: Rated frequency	Device for 50-Hz mains: 50.0 Hz Device for 60-Hz mains: 60.0 Hz	MCTRL	U16	10	P	-
0x2C01:006 (P320.06)	Motor parameters: Rated power	0.25 kW *	MCTRL	U16	100	P	-
0x2C01:007 (P320.07)	Motor parameters: Rated voltage	230 V *	MCTRL	U16	1	P	-
0x2C01:008 (P320.08)	Motor parameters: Cosine phi	0.80	MCTRL	U16	100	P	-
0x2C01:010	Motor parameters: Motor name		MCTRL	STRING[25]	1	P	-
0x2C02:001 (P351.01)	Motor parameter (ASM): Rotor resistance	8.8944 Ω *	MCTRL	U32	10000	P	-

\* Default setting dependent on the model.



Address	Name	Default setting	Category	Data type	Factor	A	M
0x2C02:002 (P351.02)	Motor parameter (ASM): Mutual inductance	<b>381.9 mH *</b>	MCTRL	U32	10	P	-
0x2C02:003 (P351.03)	Motor parameter (ASM): Magnetising current	<b>0.96 A *</b>	MCTRL	U16	100	P	-
0x2C02:004 (P351.04)	Motor parameter (ASM): Slip frequency	x.x Hz (Read only)	MCTRL	U16	10	O	-
0x2C03:001 (P352.01)	Motor parameter (PSM): Back EMF constant	<b>41.8 V/1000rpm</b>	MCTRL	U32	10	P	-
0x2C03:005 (P352.05)	Motor parameter (PSM): D-axis inductance Ld	<b>20.000 mH *</b>	MCTRL	U32	1000	P	-
0x2C03:006 (P352.06)	Motor parameter (PSM): Q-axis inductance Lq	<b>20.000 mH *</b>	MCTRL	U32	1000	P	-
0x2C10:001	HF amplitude	<b>50.0 V</b>	MCTRL	U16	10	P	-
0x2C10:008	HF injection range	<b>6.0 %</b>	MCTRL	U16	10	P	-
0x2C11:001	High speed range: Lower limit	<b>10 %</b>	MCTRL	U16	1	P	-
0x2C11:002	High speed range: Tracking controller gain	<b>200 %</b>	MCTRL	U16	1	P	-
0x2C11:003	High speed range: Tracking controller reset time	<b>6.00 ms</b>	MCTRL	U16	100	P	-
0x2C11:004	High speed range: Tracking controller decouple time	<b>200.0 ms</b>	MCTRL	U16	10	P	-
0x2C11:006	High speed range: Stall monitoring limit	<b>50 %</b>	MCTRL	U16	1	P	-
0x2C12:001	SM low speed range: Acceleration current	<b>70 %</b>	MCTRL	U16	1	P	-
0x2C12:002	SM low speed range: Standstill current	<b>30 %</b>	MCTRL	U16	1	P	-
0x2C13	SLSM-PSM low speed method	<b>Carrier based [1]</b>	MCTRL	U8	1	P	-
0x2C42:001 (P341.01)	Encoder settings: Increments/revolution	<b>128</b>	general	U32	1	PC	-
0x2C42:006	Encoder settings: Actual velocity	x rpm (Read only)	general	I32	1	O	t
0x2C42:007	Encoder settings: Status	- (Read only)	general	U32	1	O	-
0x2C42:011	Encoder settings: Sampling rate	<b>1 ms [3]</b>	general	U8	1	-	-
0x2C45 (P342.00)	Motor feedback error response	<b>Warning [1]</b>	general	U8	1	P	-
0x2C49:001 (P711.01)	Position counter: Signal source	<b>Disabled [0]</b>	general	U8	1	P	-
0x2C49:002 (P711.02)	Position counter: Set position	<b>By rising edge [0]</b>	general	U8	1	P	-
0x2C49:003 (P711.03)	Position counter: Actual position	- (Read only)	general	U32	1	OH	t
0x2C60	PPI monitoring: Response	<b>Fault [3]</b>	general	U8	1	P	-
0x2C63:001	PPI without movement: Execution	<b>After each enable [2]</b>	MCTRL	U8	1	PC	-
0x2C63:002	PPI without movement: Current adjust factor	<b>100 %</b>	MCTRL	U16	1	PC	-
0x2D40:002	Device utilisation ixt: Power unit warning threshold	<b>95 %</b>	general	U16	1	P	-
0x2D40:004 (P135.04)	Device utilisation ixt: Device actual utilisation	x % (Read only)	general	U16	1	O	t
0x2D40:005 (P135.05)	Device utilisation ixt: Error response	<b>Fault [3]</b>	general	U8	1	P	-
0x2D43:001 (P306.01)	Inverter load characteristic: Duty selection	<b>Heavy Duty [0]</b>	general	U8	1	PC	-
0x2D44:001 (P350.01)	Overspeed monitoring: Threshold	<b>8000 rpm</b>	MCTRL	U16	1	P	-
0x2D44:002 (P350.02)	Overspeed monitoring: Response	<b>Fault [3]</b>	general	U8	1	P	-
0x2D45:001 (P310.01)	Motor phase failure detection: Response - Motor phase 1	<b>No response [0]</b>	general	U8	1	P	-
0x2D45:002 (P310.02)	Motor phase failure detection: Current threshold	<b>5.0 %</b>	MCTRL	U8	10	P	-
0x2D45:003 (P310.03)	Motor phase failure detection: Voltage threshold	<b>10.0 V</b>	MCTRL	U16	10	P	-
0x2D46:001 (P353.01)	Overcurrent monitoring: Threshold	<b>6.8 A *</b>	MCTRL	U16	10	P	-

\* Default setting dependent on the model.



Address	Name	Default setting	Category	Data type	Factor	A	M
0x2D46:002 (P353.02)	Overcurrent monitoring: Response	<b>Fault [3]</b>	general	U8	1	P	-
0x2D49:002 (P309.02)	Motor temperature monitoring: Response	<b>Fault [3]</b>	general	U8	1	P	-
0x2D4B:001 (P308.01)	Motor overload monitoring (i <sup>2</sup> xt): Maximum utilisation [60 s]	<b>150 %</b>	MCTRL	U16	1	P	-
0x2D4B:002 (P308.02)	Motor overload monitoring (i <sup>2</sup> xt): Speed compensation	<b>On [0]</b>	MCTRL	U8	1	P	-
0x2D4B:003 (P308.03)	Motor overload monitoring (i <sup>2</sup> xt): Response	<b>Fault [3]</b>	general	U8	1	P	-
0x2D4B:005	Motor overload monitoring (i <sup>2</sup> xt): Thermal load	- (Read only)	general	U16	1	O	-
0x2D4F (P123.00)	Motor utilisation (i <sup>2</sup> xt)	x % (Read only)	MCTRL	U16	1	O	t
0x2D52:001	Monitoring settings: Hysteresis for speed setpoint reached	<b>0.0 %</b>	general	U16	10	P	-
0x2D66:001 (P721.01)	Mains failure control: Enable function	<b>Disabled [0]</b>	general	U8	1	P	-
0x2D66:002 (P721.02)	Mains failure control: DC-bus activation level	<b>0 % *</b>	general	U8	1	P	-
0x2D66:003 (P721.03)	Mains failure control: Gain V-controller	<b>0.01000 Hz/V</b>	general	U16	100000	P	-
0x2D66:004 (P721.04)	Mains failure control: Reset time V-controller	<b>20 ms</b>	general	U16	1	P	-
0x2D66:005 (P721.05)	Mains failure control: DC voltage setpoint	<b>100 %</b>	general	U8	1	P	-
0x2D66:006 (P721.06)	Mains failure control: Setpoint ramp	<b>20 ms</b>	general	U16	1	P	-
0x2D66:007 (P721.07)	Mains failure control: Clear time	<b>20 ms</b>	general	U16	1	P	-
0x2D66:008 (P721.08)	Mains failure control: Restart threshold	<b>0.0 Hz</b>	general	U16	10	P	-
0x2D66:009 (P721.09)	Mains failure control: Status mains failure control	- (Read only)	general	U8	1	O	t
0x2D67:001 (P329.01)	Maximum torque monitoring: Response	<b>No response [0]</b>	MCTRL	U8	1	P	-
0x2D67:002 (P329.02)	Maximum torque monitoring: Triggering delay	<b>0.000 s</b>	MCTRL	U16	1000	P	-
0x2D81:001 (P151.01)	Life-diagnosis: Operating time	x s (Read only)	general	U32	1	T	-
0x2D81:002 (P151.02)	Life-diagnosis: Power-on time	x s (Read only)	general	U32	1	T	-
0x2D81:003 (P151.03)	Life-diagnosis: Control unit operating time	x ns (Read only)	general	U64	1	T	-
0x2D81:004 (P151.04)	Life-diagnosis: Main switching cycles	- (Read only)	general	U32	1	O	-
0x2D81:005 (P151.05)	Life-diagnosis: Relay switching cycles	- (Read only)	general	U32	1	O	-
0x2D81:006 (P151.06)	Life-diagnosis: Short-circuit counter	- (Read only)	general	U16	1	O	-
0x2D81:007 (P151.07)	Life-diagnosis: Earth fault counter	- (Read only)	general	U16	1	O	-
0x2D81:008 (P151.08)	Life-diagnosis: Clamp active	- (Read only)	general	U16	1	O	-
0x2D81:009 (P151.09)	Life-diagnosis: Fan operating time	x s (Read only)	general	U32	1	OT	-
0x2D84:001 (P117.01)	Heatsink temperature: Heatsink temperature	x.x °C (Read only)	general	I16	10	O	t
0x2D84:002	Heatsink temperature: Warning threshold	<b>80.0 °C *</b>	general	I16	10	P	-
0x2D87 (P105.00)	DC-bus voltage	x V (Read only)	general	U16	1	O	t

\* Default setting dependent on the model.



Address	Name	Default setting	Category	Data type	Factor	A	M
0x2D88 (P104.00)	Motor current	x.x A (Read only)	general	I16	10	O	t
0x2D89 (P106.00)	Motor voltage	x VAC (Read only)	general	U16	1	O	t
0x2DA2:001 (P108.01)	Output power: Effective power	x.xxx kW (Read only)	general	I32	1000	O	t
0x2DA2:002 (P108.02)	Output power: Apparent power	x.xxx kVA (Read only)	general	I32	1000	O	t
0x2DA3:001 (P109.01)	Output energy: Motor	x.xx kWh (Read only)	general	I32	100	O	t
0x2DA3:002 (P109.02)	Output energy: Generator	x.xx kWh (Read only)	general	I32	100	O	t
0x2DA4:001 (P110.01)	Diagnostics of analog input 1: Value in percent	x.x % (Read only)	general	I16	10	O	t
0x2DA4:002 (P110.02)	Diagnostics of analog input 1: Frequency value	x.x Hz (Read only)	general	I16	10	O	t
0x2DA4:003 (P110.03)	Diagnostics of analog input 1: Process controller value	x.xx PID unit (Read only)	general	I16	100	O	t
0x2DA4:004 (P110.04)	Diagnostics of analog input 1: Torque value	x.x % (Read only)	general	I16	10	O	t
0x2DA4:016 (P110.16)	Diagnostics of analog input 1: Status	- (Read only)	general	U16	1	O	-
0x2DA5:001 (P111.01)	Diagnostics of analog input 2: Value in percent	x.x % (Read only)	general	I16	10	O	t
0x2DA5:002 (P111.02)	Diagnostics of analog input 2: Frequency value	x.x Hz (Read only)	general	I16	10	O	t
0x2DA5:003 (P111.03)	Diagnostics of analog input 2: Process controller value	x.xx PID unit (Read only)	general	I16	100	O	t
0x2DA5:004 (P111.04)	Diagnostics of analog input 2: Torque value	x.x % (Read only)	general	I16	10	O	t
0x2DA5:016 (P111.16)	Diagnostics of analog input 2: Status	- (Read only)	general	U16	1	O	-
0x2DAA:001 (P112.01)	Diagnostics of analog output 1: Voltage	x.xx V (Read only)	general	U16	100	O	t
0x2DAA:002 (P112.02)	Diagnostics of analog output 1: Current	x.xx mA (Read only)	general	U16	100	O	t
0x2DAB:001 (P113.01)	Diagnostics of analog output 2: Voltage	x.xx V (Read only)	Appl. I/O	U16	100	O	t
0x2DAB:002 (P113.02)	Diagnostics of analog output 2: Current	x.xx mA (Read only)	Appl. I/O	U16	100	O	t
0x2DAC (P119.00)	Keypad status	- (Read only)	general	U16	1	O	t
0x2DAD (P120.00)	Internal hardware states	- (Read only)	general	U16	1	O	-
0x2DAE:001 (P140.01)	Sequencer diagnostics: Active step	- (Read only)	Sequencer	U8	1	O	t
0x2DAE:002 (P140.02)	Sequencer diagnostics: Step time elapsed	x.x s (Read only)	Sequencer	I32	10	O	t
0x2DAE:003 (P140.03)	Sequencer diagnostics: Step time remaining	x.x s (Read only)	Sequencer	I32	10	O	t
0x2DAE:004 (P140.04)	Sequencer diagnostics: Steps complete	- (Read only)	Sequencer	I32	1	O	t
0x2DAE:005 (P140.05)	Sequencer diagnostics: Steps remaining	- (Read only)	Sequencer	I32	1	O	t
0x2DAE:006 (P140.06)	Sequencer diagnostics: Active sequence	- (Read only)	Sequencer	U8	1	O	t
0x2DAE:007 (P140.07)	Sequencer diagnostics: Active segment	- (Read only)	Sequencer	U8	1	O	t
0x2DAE:008 (P140.08)	Sequencer diagnostics: Relative sequence time remaining	x % (Read only)	Sequencer	U8	1	O	t

\* Default setting dependent on the model.



Address	Name	Default setting	Category	Data type	Factor	A	M
0x2DAE:009 (P140.09)	Sequencer diagnostics: Absolute sequence time remaining	x.x s (Read only)	Sequencer	I32	10	O	t
0x2DAE:010	Sequencer diagnostics: Frequency setpoint	x.x Hz (Read only)	Sequencer	I16	10	-	-
0x2DAE:011	Sequencer diagnostics: PID setpoint	x.xx PID unit (Read only)	Sequencer	I16	100	-	-
0x2DAE:012	Sequencer diagnostics: Torque setpoint	x.x % (Read only)	Sequencer	I16	10	-	-
0x2DD1:001	Motor currents: Actual D-current (id)	x.xx A (Read only)	MCTRL	I32	100	O	t
0x2DD1:002	Motor currents: Actual Q-current (iq)	x.xx A (Read only)	general	I32	100	O	t
0x2DD1:003	Motor currents: Setpoint D-current (id)	x.xx A (Read only)	general	I32	100	O	t
0x2DD1:004	Motor currents: Setpoint Q-current (iq)	x.xx A (Read only)	MCTRL	I32	100	O	t
0x2DD1:005	Motor currents: Motor current (Ieff)	x.xx A (Read only)	MCTRL	I32	100	O	t
0x2DD3:003	Speed setpoint limited	x rpm (Read only)	MCTRL	I32	1	O	t
0x2DD5	Torque setpoint	x.xx Nm (Read only)	general	I32	100	-	t
0x2DDD (P100.00)	Output frequency	x.x Hz (Read only)	general	I16	10	O	t
0x2DDF:001	Axis information: Rated current	x.xx A (Read only)	MCTRL	U16	100	O	t
0x2DDF:002	Axis information: Maximum current	x.xx A (Read only)	MCTRL	U16	100	O	t
0x2DE0:009	Service settings: Motor identification settings	<b>0</b>	general	U16	1	PC	-
0x2DE0:010	Service settings: Motor control behavior	<b>0</b>	general	U16	1	PC	-
0x4002 (P702.00)	Speed display scaling	<b>0.00</b>	general	U16	100	P	-
0x4003 (P413.00)	MOP starting mode	<b>Last value [0]</b>	general	U8	1	P	-
0x4004:001 (P414.01)	MOP starting values: Frequency	<b>0.0 Hz</b>	general	U16	10	P	-
0x4004:002 (P414.02)	MOP starting values: PID value	<b>0.00 PID unit</b>	general	I16	100	P	-
0x4004:003 (P414.03)	MOP starting values: Torque	<b>0.0 %</b>	general	U16	10	P	-
0x4005 (P412.00)	Frequency threshold	<b>0.0 Hz</b>	general	U16	10	P	-
0x4006:001 (P710.01)	Load loss detection: Threshold	<b>0.0 %</b>	general	U16	10	P	-
0x4006:002 (P710.02)	Load loss detection: Delay time	<b>0.0 s</b>	general	U16	10	P	-
0x4006:003 (P710.03)	Load loss detection: Error response	<b>No response [0]</b>	general	U8	1	P	-
0x4007:001	Heavy load monitoring: Error threshold	<b>200.0 %</b>	general	U16	10	P	-
0x4007:002	Heavy load monitoring: Delay time	<b>3.0 s</b>	general	U16	10	P	-
0x4007:003	Heavy load monitoring: Error response	<b>No response [0]</b>	general	U8	1	P	-
0x4008:001 (P590.01)	Process input words: NetWordIN1	<b>0x0000</b>	general	U16	1	HK	r
0x4008:002 (P590.02)	Process input words: NetWordIN2	<b>0x0000</b>	general	U16	1	HK	r
0x4008:003 (P590.03)	Process input words: NetWordIN3	<b>0.0 %</b>	general	U16	10	K	r
0x4008:004 (P590.04)	Process input words: NetWordIN4	<b>0.0 %</b>	general	U16	10	K	r
0x4008:005 (P590.05)	Process input words: NetWordIN5	<b>0.0 %</b>	general	I16	10	K	r
0x4009:001	MOP values saved: Frequency	x.x Hz (Read only)	general	U16	10	-	t
0x4009:002	MOP values saved: PID value	x.xx PID unit (Read only)	general	I16	100	-	t
0x4009:003	MOP values saved: Torque	x.x % (Read only)	general	U16	10	-	t
0x400A:001 (P591.01)	Process output words: NetWordOUT1	- (Read only)	general	U16	1	OH	t
0x400A:002 (P591.02)	Process output words: NetWordOUT2	- (Read only)	general	U16	1	O	t
0x400B:001 (P592.01)	Process input data: AC Drive control word	<b>0x0000</b>	general	U16	1	HK	r

\* Default setting dependent on the model.





Address	Name	Default setting	Category	Data type	Factor	A	M
0x400B:002 (P592.02)	Process input data: LECOM control word	0x0000	general	U16	1	HK	r
0x400B:003 (P592.03)	Process input data: Network setpoint frequency (0.1)	0.0 Hz	general	U16	10	K	r
0x400B:004 (P592.04)	Process input data: Network setpoint speed	0 rpm	general	U16	1	K	r
0x400B:005 (P592.05)	Process input data: Network setpoint frequency (0.01)	0.00 Hz	general	U16	100	K	r
0x400B:006 (P592.06)	Process input data: Velocity mode setpoint	0.0 Hz	general	I16	10	K	r
0x400B:007 (P592.07)	Process input data: PID setpoint	0.00 PID unit	general	I16	100	K	r
0x400B:008 (P592.08)	Process input data: Torque mode setpoint	0 Nm	general	I16	1	K	r
0x400B:009 (P592.09)	Process input data: Torque scaling	0	general	I8	1	K	r
0x400B:010	Process input data: AC Drive mode	Speed control (open loop) [1]	EtherNet/IP	U8	1	IK	-
0x400B:011 (P592.11)	Process input data: PID feedback	0.00 PID unit	general	I16	100	K	r
0x400B:012 (P592.12)	Process input data: Network setpoint frequency [0.02Hz]	0 Hz	general	I16	50	K	r
0x400B:013 (P592.13)	Process input data: Network frequency setpoint [±16384]	0	general	I16	1	-	r
0x400C:001 (P593.01)	Process output data: AC Drive status word	- (Read only)	general	U16	1	-	t
0x400C:002 (P593.02)	Process output data: LECOM status word	- (Read only)	general	U16	1	-	t
0x400C:003 (P593.03)	Process output data: Frequency (0.1)	x.x Hz (Read only)	general	U16	10	-	t
0x400C:004 (P593.04)	Process output data: Motor speed	x rpm (Read only)	general	U16	1	-	t
0x400C:005 (P593.05)	Process output data: Drive status	- (Read only)	general	U16	1	-	t
0x400C:006 (P593.06)	Process output data: Frequency (0.01)	x.xx Hz (Read only)	general	U16	100	-	t
0x400C:007 (P593.07)	Process output data: Torque scaled	- (Read only)	general	I16	1	-	t
0x400C:008 (P593.08)	Process output data: Frequency [0.02 Hz]	Hz (Read only)	general	I16	50	-	t
0x400C:009 (P593.09)	Process output data: Frequency [±16384]	- (Read only)	general	I16	1	-	t
0x400D (P101.00)	Scaled actual value	x Unit (Read only)	general	I16	1	O	t
0x400E:001 (P505.01)	NetWordIN1 function: Bit 0	Not active [0]	general	U8	1	PC	-
0x400E:002 (P505.02)	NetWordIN1 function: Bit 1	Not active [0]	general	U8	1	PC	-
0x400E:003 (P505.03)	NetWordIN1 function: Bit 2	Activate quick stop [3]	general	U8	1	PC	-
0x400E:004 (P505.04)	NetWordIN1 function: Bit 3	Not active [0]	general	U8	1	PC	-
0x400E:005 (P505.05)	NetWordIN1 function: Bit 4	Run forward (CW) [8]	general	U8	1	PC	-
0x400E:006 (P505.06)	NetWordIN1 function: Bit 5	Activate preset (bit 0) [18]	general	U8	1	PC	-
0x400E:007 (P505.07)	NetWordIN1 function: Bit 6	Activate preset (bit 1) [19]	general	U8	1	PC	-
0x400E:008 (P505.08)	NetWordIN1 function: Bit 7	Reset error [4]	general	U8	1	PC	-

\* Default setting dependent on the model.



Address	Name	Default setting	Category	Data type	Factor	A	M
0x400E:009 (P505.09)	NetWordIN1 function: Bit 8	Not active [0]	general	U8	1	PC	-
0x400E:010 (P505.10)	NetWordIN1 function: Bit 9	Activate DC braking [5]	general	U8	1	PC	-
0x400E:011 (P505.11)	NetWordIN1 function: Bit 10	Not active [0]	general	U8	1	PC	-
0x400E:012 (P505.12)	NetWordIN1 function: Bit 11	Not active [0]	general	U8	1	PC	-
0x400E:013 (P505.13)	NetWordIN1 function: Bit 12	Reverse rotational direction [13]	general	U8	1	PC	-
0x400E:014 (P505.14)	NetWordIN1 function: Bit 13	Not active [0]	general	U8	1	PC	-
0x400E:015 (P505.15)	NetWordIN1 function: Bit 14	Not active [0]	general	U8	1	PC	-
0x400E:016 (P505.16)	NetWordIN1 function: Bit 15	Not active [0]	general	U8	1	PC	-
0x4016:003	Digital output 1: Switch-off delay	0.000 s	general	U16	1000	P	-
0x4016:004	Digital output 1: Switch-on delay	0.000 s	general	U16	1000	P	-
0x4016:005	Digital output 1: Terminal state	- (Read only)	general	U8	1	O	-
0x4016:006	Digital output 1: Trigger signal state	- (Read only)	general	U8	1	O	-
0x4017:003	Digital output 2: Switch-off delay	0.000 s	Appl. I/O	U16	1000	P	-
0x4017:004	Digital output 2: Switch-on delay	0.000 s	Appl. I/O	U16	1000	P	-
0x4017:005	Digital output 2: Terminal state	- (Read only)	Appl. I/O	U8	1	O	-
0x4017:006	Digital output 2: Trigger signal state	- (Read only)	Appl. I/O	U8	1	O	-
0x4018:003	Relay: Switch-off delay	0.000 s	general	U16	1000	P	-
0x4018:004	Relay: Switch-on delay	0.000 s	general	U16	1000	P	-
0x4018:005	Relay: Relay state	- (Read only)	general	U8	1	O	-
0x4018:006	Relay: Trigger signal state	- (Read only)	general	U8	1	O	-
0x4018:007	Relay: Switching cycles	- (Read only)	general	U32	1	O	-
0x401F:001 (P121.01)	Process controller diagnostics: Current setpoint	x.xx PID unit (Read only)	general	I16	100	O	t
0x401F:002 (P121.02)	Process controller diagnostics: Current process variable	x.xx PID unit (Read only)	general	I16	100	O	t
0x401F:003 (P121.03)	Process controller diagnostics: Status	- (Read only)	general	U8	1	O	t
0x401F:004	Process controller diagnostics: PID control value	x.x Hz (Read only)	general	I16	10	O	-
0x401F:005	Process controller diagnostics: PID Feedforward value	x.x Hz (Read only)	general	I16	10	O	-
0x401F:006	Process controller diagnostics: PID output value	x.x Hz (Read only)	general	I16	10	O	t
0x401F:007	Process controller diagnostics: PID error value	x.xx PID unit (Read only)	general	I32	100	O	-
0x4020:001 (P600.01)	Process controller setup (PID): Operating mode	Inhibited [0]	general	U8	1	P	-
0x4020:002 (P600.02)	Process controller setup (PID): PID process variable	Analog input 1 [1]	general	U8	1	P	-
0x4020:003 (P600.03)	Process controller setup (PID): Closed-loop controlled speed range	100 %	general	U16	1	P	rt
0x4020:004 (P600.04)	Process controller setup (PID): Speed feedforward control source	Without speed addition [0]	general	U8	1	P	-
0x4020:005 (P600.05)	Process controller setup (PID): Min speed limit	-100.0 %	general	I16	10	P	-
0x4020:006 (P600.06)	Process controller setup (PID): Max speed limit	100.0 %	general	I16	10	P	-
0x4021:001 (P606.01)	PID speed operation: Acceleration time	1.0 s	general	U16	10	P	-
0x4021:002 (P606.02)	PID speed operation: Deceleration time	1.0 s	general	U16	10	P	-
0x4022:001 (P451.01)	PID setpoint presets: Preset 1	0.00 PID unit	general	I16	100	OP	-

\* Default setting dependent on the model.



Address	Name	Default setting	Category	Data type	Factor	A	M
0x4022:002 (P451.02)	PID setpoint presets: Preset 2	0.00 PID unit	general	I16	100	OP	-
0x4022:003 (P451.03)	PID setpoint presets: Preset 3	0.00 PID unit	general	I16	100	OP	-
0x4022:004 (P451.04)	PID setpoint presets: Preset 4	0.00 PID unit	general	I16	100	OP	-
0x4022:005 (P451.05)	PID setpoint presets: Preset 5	0.00 PID unit	general	I16	100	OP	-
0x4022:006 (P451.06)	PID setpoint presets: Preset 6	0.00 PID unit	general	I16	100	OP	-
0x4022:007 (P451.07)	PID setpoint presets: Preset 7	0.00 PID unit	general	I16	100	OP	-
0x4022:008 (P451.08)	PID setpoint presets: Preset 8	0.00 PID unit	general	I16	100	OP	-
0x4023:001 (P610.01)	PID sleep mode: Activation	Disabled [0]	general	U8	1	P	-
0x4023:002 (P610.02)	PID sleep mode: Stop method	Coasting [0]	general	U8	1	P	-
0x4023:003 (P610.03)	PID sleep mode: Frequency threshold	0.0 Hz	general	U16	10	P	-
0x4023:004 (P610.04)	PID sleep mode: Feedback threshold	0.00 PID unit	general	I16	100	P	-
0x4023:005 (P610.05)	PID sleep mode: Delay time	0.0 s	general	U16	10	P	-
0x4023:006 (P610.06)	PID sleep mode: Recovery	Setpoint > threshold OR system deviation > bandwidth [0]	general	U8	1	P	-
0x4023:007 (P610.07)	PID sleep mode: Bandwidth	0.00 PID unit	general	U16	100	P	-
0x4023:008 (P610.08)	PID sleep mode: Recovery threshold	0.00 PID unit	general	I16	100	P	-
0x4024:001 (P615.01)	Automatic rinsing: Rinsing in sleep mode	Inhibited [0]	general	U8	1	P	-
0x4024:002 (P615.02)	Automatic rinsing: Rinse interval	30.0 min	general	U16	10	P	-
0x4024:003 (P615.03)	Automatic rinsing: Rinse speed	0.0 Hz	general	I16	10	P	-
0x4024:004 (P615.04)	Automatic rinsing: Rinse period	0.0 s	general	U16	10	P	-
0x4025 (P800.00)	Sequencer mode	Disabled [0]	Sequencer	U8	1	P	-
0x4026:001 (P801.01)	Sequencer segment 1: Frequency setpoint	0.0 Hz	Sequencer	I16	10	P	-
0x4026:002 (P801.02)	Sequencer segment 1: Acceleration/deceleration	5.0 s	Sequencer	U16	10	P	-
0x4026:003 (P801.03)	Sequencer segment 1: Time	0.0 s	Sequencer	U32	10	P	-
0x4026:004 (P801.04)	Sequencer segment 1: Digital outputs	0	Sequencer	U8	1	P	-
0x4026:005 (P801.05)	Sequencer segment 1: Analog outputs	0.00 VDC	Sequencer	U16	100	P	-
0x4026:006 (P801.06)	Sequencer segment 1: PID setpoint	0.00 PID unit	Sequencer	I16	100	P	-
0x4026:007 (P801.07)	Sequencer segment 1: Torque setpoint	100.0 %	Sequencer	I16	10	P	-
0x4026:008	Sequencer segment 1: NetWordOUT2	0	Sequencer	U16	1	P	-
0x4026:009	Sequencer segment 1: Reserved	0	Sequencer	U32	1	P	-
0x4027:001 (P802.01)	Sequencer segment 2: Frequency setpoint	0.0 Hz	Sequencer	I16	10	P	-

\* Default setting dependent on the model.



Address	Name	Default setting	Category	Data type	Factor	A	M
0x4027:002 (P802.02)	Sequencer segment 2: Acceleration/deceleration	5.0 s	Sequencer	U16	10	P	-
0x4027:003 (P802.03)	Sequencer segment 2: Time	0.0 s	Sequencer	U32	10	P	-
0x4027:004 (P802.04)	Sequencer segment 2: Digital outputs	0	Sequencer	U8	1	P	-
0x4027:005 (P802.05)	Sequencer segment 2: Analog outputs	0.00 VDC	Sequencer	U16	100	P	-
0x4027:006 (P802.06)	Sequencer segment 2: PID setpoint	0.00 PID unit	Sequencer	I16	100	P	-
0x4027:007 (P802.07)	Sequencer segment 2: Torque setpoint	100.0 %	Sequencer	I16	10	P	-
0x4027:008	Sequencer segment 2: NetWordOUT2	0	Sequencer	U16	1	P	-
0x4027:009	Sequencer segment 2: Reserved	0	Sequencer	U32	1	P	-
0x4028:001 (P803.01)	Sequencer segment 3: Frequency setpoint	0.0 Hz	Sequencer	I16	10	P	-
0x4028:002 (P803.02)	Sequencer segment 3: Acceleration/deceleration	5.0 s	Sequencer	U16	10	P	-
0x4028:003 (P803.03)	Sequencer segment 3: Time	0.0 s	Sequencer	U32	10	P	-
0x4028:004 (P803.04)	Sequencer segment 3: Digital outputs	0	Sequencer	U8	1	P	-
0x4028:005 (P803.05)	Sequencer segment 3: Analog outputs	0.00 VDC	Sequencer	U16	100	P	-
0x4028:006 (P803.06)	Sequencer segment 3: PID setpoint	0.00 PID unit	Sequencer	I16	100	P	-
0x4028:007 (P803.07)	Sequencer segment 3: Torque setpoint	100.0 %	Sequencer	I16	10	P	-
0x4028:008	Sequencer segment 3: NetWordOUT2	0	Sequencer	U16	1	P	-
0x4028:009	Sequencer segment 3: Reserved	0	Sequencer	U32	1	P	-
0x4029:001 (P804.01)	Sequencer segment 4: Frequency setpoint	0.0 Hz	Sequencer	I16	10	P	-
0x4029:002 (P804.02)	Sequencer segment 4: Acceleration/deceleration	5.0 s	Sequencer	U16	10	P	-
0x4029:003 (P804.03)	Sequencer segment 4: Time	0.0 s	Sequencer	U32	10	P	-
0x4029:004 (P804.04)	Sequencer segment 4: Digital outputs	0	Sequencer	U8	1	P	-
0x4029:005 (P804.05)	Sequencer segment 4: Analog outputs	0.00 VDC	Sequencer	U16	100	P	-
0x4029:006 (P804.06)	Sequencer segment 4: PID setpoint	0.00 PID unit	Sequencer	I16	100	P	-
0x4029:007 (P804.07)	Sequencer segment 4: Torque setpoint	100.0 %	Sequencer	I16	10	P	-
0x4029:008	Sequencer segment 4: NetWordOUT2	0	Sequencer	U16	1	P	-
0x4029:009	Sequencer segment 4: Reserved	0	Sequencer	U32	1	P	-
0x402A:001 (P805.01)	Sequencer segment 5: Frequency setpoint	0.0 Hz	Sequencer	I16	10	P	-
0x402A:002 (P805.02)	Sequencer segment 5: Acceleration/deceleration	5.0 s	Sequencer	U16	10	P	-
0x402A:003 (P805.03)	Sequencer segment 5: Time	0.0 s	Sequencer	U32	10	P	-
0x402A:004 (P805.04)	Sequencer segment 5: Digital outputs	0	Sequencer	U8	1	P	-
0x402A:005 (P805.05)	Sequencer segment 5: Analog outputs	0.00 VDC	Sequencer	U16	100	P	-
0x402A:006 (P805.06)	Sequencer segment 5: PID setpoint	0.00 PID unit	Sequencer	I16	100	P	-

\* Default setting dependent on the model.



Address	Name	Default setting	Category	Data type	Factor	A	M
0x402A:007 (P805.07)	Sequencer segment 5: Torque setpoint	100.0 %	Sequencer	I16	10	P	-
0x402A:008	Sequencer segment 5: NetWordOUT2	0	Sequencer	U16	1	P	-
0x402A:009	Sequencer segment 5: Reserved	0	Sequencer	U32	1	P	-
0x402B:001 (P806.01)	Sequencer segment 6: Frequency setpoint	0.0 Hz	Sequencer	I16	10	P	-
0x402B:002 (P806.02)	Sequencer segment 6: Acceleration/deceleration	5.0 s	Sequencer	U16	10	P	-
0x402B:003 (P806.03)	Sequencer segment 6: Time	0.0 s	Sequencer	U32	10	P	-
0x402B:004 (P806.04)	Sequencer segment 6: Digital outputs	0	Sequencer	U8	1	P	-
0x402B:005 (P806.05)	Sequencer segment 6: Analog outputs	0.00 VDC	Sequencer	U16	100	P	-
0x402B:006 (P806.06)	Sequencer segment 6: PID setpoint	0.00 PID unit	Sequencer	I16	100	P	-
0x402B:007 (P806.07)	Sequencer segment 6: Torque setpoint	100.0 %	Sequencer	I16	10	P	-
0x402B:008	Sequencer segment 6: NetWordOUT2	0	Sequencer	U16	1	P	-
0x402B:009	Sequencer segment 6: Reserved	0	Sequencer	U32	1	P	-
0x402C:001 (P807.01)	Sequencer segment 7: Frequency setpoint	0.0 Hz	Sequencer	I16	10	P	-
0x402C:002 (P807.02)	Sequencer segment 7: Acceleration/deceleration	5.0 s	Sequencer	U16	10	P	-
0x402C:003 (P807.03)	Sequencer segment 7: Time	0.0 s	Sequencer	U32	10	P	-
0x402C:004 (P807.04)	Sequencer segment 7: Digital outputs	0	Sequencer	U8	1	P	-
0x402C:005 (P807.05)	Sequencer segment 7: Analog outputs	0.00 VDC	Sequencer	U16	100	P	-
0x402C:006 (P807.06)	Sequencer segment 7: PID setpoint	0.00 PID unit	Sequencer	I16	100	P	-
0x402C:007 (P807.07)	Sequencer segment 7: Torque setpoint	100.0 %	Sequencer	I16	10	P	-
0x402C:008	Sequencer segment 7: NetWordOUT2	0	Sequencer	U16	1	P	-
0x402C:009	Sequencer segment 7: Reserved	0	Sequencer	U32	1	P	-
0x402D:001 (P808.01)	Sequencer segment 8: Frequency setpoint	0.0 Hz	Sequencer	I16	10	P	-
0x402D:002 (P808.02)	Sequencer segment 8: Acceleration/deceleration	5.0 s	Sequencer	U16	10	P	-
0x402D:003 (P808.03)	Sequencer segment 8: Time	0.0 s	Sequencer	U32	10	P	-
0x402D:004 (P808.04)	Sequencer segment 8: Digital outputs	0	Sequencer	U8	1	P	-
0x402D:005 (P808.05)	Sequencer segment 8: Analog outputs	0.00 VDC	Sequencer	U16	100	P	-
0x402D:006 (P808.06)	Sequencer segment 8: PID setpoint	0.00 PID unit	Sequencer	I16	100	P	-
0x402D:007 (P808.07)	Sequencer segment 8: Torque setpoint	100.0 %	Sequencer	I16	10	P	-
0x402D:008	Sequencer segment 8: NetWordOUT2	0	Sequencer	U16	1	P	-
0x402D:009	Sequencer segment 8: Reserved	0	Sequencer	U32	1	P	-
0x402E:001 (P822.01)	End segment: Frequency setpoint	0.0 Hz	Sequencer	I16	10	P	-
0x402E:002 (P822.02)	End segment: Acceleration/deceleration	5.0 s	Sequencer	U16	10	P	-
0x402E:003 (P822.03)	End segment: Time	0.0 s	Sequencer	U32	10	P	-

\* Default setting dependent on the model.



Address	Name	Default setting	Category	Data type	Factor	A	M
0x402E:004 (P822.04)	End segment: Digital outputs	0	Sequencer	U8	1	P	-
0x402E:005 (P822.05)	End segment: Analog outputs	0.00 VDC	Sequencer	U16	100	P	-
0x402E:006 (P822.06)	End segment: PID setpoint	0.00 PID unit	Sequencer	I16	100	P	-
0x402E:007 (P822.07)	End segment: Torque setpoint	100.0 %	Sequencer	I16	10	P	-
0x402E:008	End segment: NetWordOUT2	0	Sequencer	U16	1	P	-
0x402E:009	End segment: Reserved	0	Sequencer	U32	1	P	-
0x402F (P824.00)	End of sequence mode	Keep running [0]	Sequencer	U8	1	P	-
0x4030:001 ... 0x4030:016 (P830.01 ... 16)	Sequence 1: Step 1 ... Step 16	Skip step [0]	Sequencer	I8	1	P	-
0x4031 (P831.00)	Number of cycles sequence 1	1	Sequencer	U16	1	P	-
0x4032:001 ... 0x4032:016 (P835.01 ... 16)	Sequence 2: Step 1 ... Step 16	Skip step [0]	Sequencer	I8	1	P	-
0x4033 (P836.00)	Number of cycles sequence 2	1	Sequencer	U16	1	P	-
0x4034:001 ... 0x4034:016 (P840.01 ... 16)	Sequence 3: Step 1 ... Step 16	Skip step [0]	Sequencer	I8	1	P	-
0x4035 (P841.00)	Number of cycles sequence 3	1	Sequencer	U16	1	P	-
0x4036:001 ... 0x4036:016 (P845.01 ... 16)	Sequence 4: Step 1 ... Step 16	Skip step [0]	Sequencer	I8	1	P	-
0x4037 (P846.00)	Number of cycles sequence 4	1	Sequencer	U16	1	P	-
0x4038:001 ... 0x4038:016 (P850.01 ... 16)	Sequence 5: Step 1 ... Step 16	Skip step [0]	Sequencer	I8	1	P	-
0x4039 (P851.00)	Number of cycles sequence 5	1	Sequencer	U16	1	P	-
0x403A:001 ... 0x403A:016 (P855.01 ... 16)	Sequence 6: Step 1 ... Step 16	Skip step [0]	Sequencer	I8	1	P	-
0x403B (P856.00)	Number of cycles sequence 6	1	Sequencer	U16	1	P	-
0x403C:001 ... 0x403C:016 (P860.01 ... 16)	Sequence 7: Step 1 ... Step 16	Skip step [0]	Sequencer	I8	1	P	-
0x403D (P861.00)	Number of cycles sequence 7	1	Sequencer	U16	1	P	-
0x403E:001 ... 0x403E:016 (P865.01 ... 16)	Sequence 8: Step 1 ... Step 16	Skip step [0]	Sequencer	I8	1	P	-
0x403F (P866.00)	Number of cycles sequence 8	1	Sequencer	U16	1	P	-
0x4040 (P820.00)	Start of sequence mode	Restart sequencer [0]	Sequencer	U8	1	P	-
0x4041:001 ... 0x4041:032 (P750.01 ... 32)	Parameter change-over: Parameter 1 ... Parameter 32	0x00000000	general	IDX	1	PH	-
0x4042:001 ... 0x4042:032 (P751.01 ... 32)	Parameter value set 1: Value of parameter 1 ... Value of parameter 32	0	general	I32	1	P	-

\* Default setting dependent on the model.



Address	Name	Default setting	Category	Data type	Factor	A	M
0x4043:001 ... 0x4043:032 (P752.01 ... 32)	Parameter value set 2: Value of parameter 1 ... Value of parameter 32	0	general	I32	1	P	-
0x4044:001 ... 0x4044:032 (P753.01 ... 32)	Parameter value set 3: Value of parameter 1 ... Value of parameter 32	0	general	I32	1	P	-
0x4045:001 ... 0x4045:032 (P754.01 ... 32)	Parameter value set 4: Value of parameter 1 ... Value of parameter 32	0	general	I32	1	P	-
0x4046 (P755.00)	Activation of parameter set	<b>Via command (disable required) [0]</b>	general	U8	1	P	-
0x4047:001 (P756.01)	Parameter change-over error message: Status	- (Read only)	general	U16	1	O	-
0x4047:002 (P756.02)	Parameter change-over error message: List entry	- (Read only)	general	U8	1	O	-
0x4048 (P601.00)	PID P-component	<b>5.0 %</b>	general	U16	10	P	rt
0x4049 (P602.00)	PID I- component	<b>400 ms</b>	general	U16	1	P	rt
0x404A (P603.00)	PID D-component	<b>0.0 s</b>	general	U8	10	P	rt
0x404B (P604.00)	PID setpoint ramp	<b>20.0 s</b>	general	U16	10	P	-
0x404C:001 (P607.01)	PID influence: Acceleration time for activation	<b>5.0 s</b>	general	U16	10	P	-
0x404C:002 (P607.02)	PID influence: Deceleration time for masking out	<b>5.0 s</b>	general	U16	10	P	-
0x404C:003 (P607.03)	PID influence: PID influence factor	<b>100.0 %</b>	general	I16	10	P	r
0x404D:001 (P608.01)	PID alarms: MIN alarm threshold	<b>0.00 PID unit</b>	general	I16	100	P	-
0x404D:002 (P608.02)	PID alarms: MAX alarm threshold	<b>100.00 PID unit</b>	general	I16	100	P	-
0x404D:003 (P608.03)	PID alarms: Monitoring bandwidth PID feedback signal	<b>2.00 %</b>	general	U16	100	P	-
0x404E:001 (P605.01)	PID setpoint limits: Minimum setpoint	<b>-300.00 PID unit</b>	general	I16	100	P	-
0x404E:002 (P605.02)	PID setpoint limits: Maximum setpoint	<b>300.00 PID unit</b>	general	I16	100	P	-
0x405C:001 (P770.01)	Pump cascading: Operating mode	<b>Disabled [0]</b>		U8	1	P	-
0x405C:002 (P770.02)	Pump cascading: Priority at startup	<b>By operating time [1]</b>		U8	1	P	-
0x405C:003 (P770.03)	Pump cascading: Start frequency	<b>40.0 Hz</b>		U16	10	P	-
0x405C:004 (P770.04)	Pump cascading: Stop frequency	<b>10.0 Hz</b>		U16	10	P	-
0x405C:005 (P770.05)	Pump cascading: Settling time	<b>5.0 s</b>		U16	10	P	-
0x405C:006 (P770.06)	Pump cascading: Delay time	<b>2.0 s</b>		U16	10	P	-
0x405C:007 (P770.07)	Pump cascading: Lower frequency threshold	<b>20.0 Hz</b>		U16	10	P	-
0x405C:008 (P770.08)	Pump cascading: Upper frequency threshold	<b>30.0 Hz</b>		U16	10	P	-
0x405C:009 (P770.09)	Pump cascading: Automatic runtime	<b>0 h</b>		U16	1	P	-
0x405C:010 (P770.10)	Pump cascading: Automatic transition time	<b>0.0 s</b>		I16	10	P	-

\* Default setting dependent on the model.



Address	Name	Default setting	Category	Data type	Factor	A	M
0x405C:011 (P770.11)	Pump cascading: Reset operating time	Disabled [0]		U8	1	P	-
0x405C:012 (P770.12)	Pump cascading: Status word	- (Read only)		U16	1	-	-
0x405C:013 (P770.13)	Pump cascading: Operating time pump 1	x s (Read only)		U32	1	T	-
0x405C:014 (P770.14)	Pump cascading: Operating time pump 2	x s (Read only)		U32	1	T	-
0x603F (P150.00)	Error code	- (Read only)	general	U16	1	O	t
0x6040	CiA control word	0	general	U16	1	O	r
0x6041 (P780.00)	CiA status word	- (Read only)	general	U16	1	O	t
0x6042 (P781.00)	Set speed	0 rpm	MCTRL	I16	1	OK	r
0x6043 (P782.00)	Internal set speed	x rpm (Read only)	general	I16	1	O	t
0x6044 (P783.00)	Actual speed	x rpm (Read only)	general	I16	1	O	t
0x6046:001 (P784.01)	Speed limits: Min. speed	0 rpm	MCTRL	U32	1	P	r
0x6046:002 (P784.02)	Speed limits: Max. speed	2147483647 rpm	MCTRL	U32	1	P	r
0x6048:001 (P785.01)	Acceleration ramp: CiA acceleration: Delta speed	3000 rpm	MCTRL	U32	1	P	r
0x6048:002 (P785.02)	Acceleration ramp: CiA acceleration: Delta time	10 s	MCTRL	U16	1	P	r
0x6049:001 (P786.01)	Deceleration ramp: CiA deceleration: Delta speed	3000 rpm	MCTRL	U32	1	P	r
0x6049:002 (P786.02)	Deceleration ramp: CiA deceleration: Delta time	10 s	MCTRL	U16	1	P	r
0x605A	CiA: Quick stop mode	Ramp > switch on disabled [2]	general	I16	1	P	-
0x605B	Shutdown option code	Disable drive function [0]	general	I16	1	P	-
0x6060 (P301.00)	CiA: Operation mode	MS: Velocity mode [-2]	MCTRL	I8	1	PC	-
0x6061 (P788.00)	CiA: Active operation mode	- (Read only)	MCTRL	I8	1	O	t
0x6071	Set torque	0.0 %	general	I16	10	K	r
0x6072 (P326.00)	Max. torque	250.0 %	MCTRL	U16	10	P	r
0x6073 (P324.00)	Max. current	200.0 %	MCTRL	U16	10	P	r
0x6074	Internal set torque	x.x % (Read only)	MCTRL	I16	10	O	-
0x6075 (P323.00)	Rated motor current	1.700 A *	MCTRL	U32	1000	PC	-
0x6076 (P325.00)	Rated motor torque	1.650 Nm *	MCTRL	U32	1000	PC	-
0x6077 (P107.00)	Actual torque	x.x % (Read only)	general	I16	10	O	t
0x6078 (P103.00)	Actual current	x.x % (Read only)	general	I16	10	O	t
0x6079	DC-bus voltage	x.xxx V (Read only)	general	U32	1000	O	t
0x6080 (P322.00)	Max. motor speed	6075 rpm	MCTRL	U32	1	P	r
0x6085 (P790.00)	Quick stop deceleration	546000 inc/s <sup>2</sup>	MCTRL	U32	1	P	-
0x60E0	Positive torque limit	250.0 %	MCTRL	U16	10	P	r
0x60E1	Negative torque limit	250.0 %	MCTRL	U16	10	P	r

\* Default setting dependent on the model.





Address	Name	Default setting	Category	Data type	Factor	A	M
0x60FD (P118.00)	Digital input status	- (Read only)	general	U32	1	O	t
0x60FF	Set speed	<b>0 rpm</b>	EtherCAT	I32	1	O	r
0x6402	Motor type	<b>Squirrel cage induction [7]</b>	MCTRL	U16	1	P	-
0x6502 (P789.00)	Supported drive modes	- (Read only)	general	U32	1	-	-

\* Default setting dependent on the model.



## 20.2 Glossary

### Definitions in functional safety

Abbreviation	Meaning
AIE	Acknowledge In Error, error acknowledgement
AIS	Acknowledge In Stop, restart acknowledgement
OFF state	Triggered signal status of the safety sensors
CCF	Common Cause Error (also $\beta$ -value)
EC_FS	Error Class Fail Safe
EC_SS1	Error Class Safe Stop 1
EC_SS2	Error Class Safe Stop 2
EC_STO	Error Class Safe Torque Off Stop 0
ON state	Signal status of the safety sensors in normal operation
FIT	Failure In Time, 1 FIT = $10^{-9}$ Error/h
FMEA	Failure Mode and Effect Analysis
FSoE	FailSafe over EtherCAT
GSDML	Device description file with PROFINET-specific data to integrate the configuring software of a PROFINET controller.
HFT	Hardware Failure Tolerance
Cat.	Category according to EN ISO 13849-1
nBD	Speed value Base-Drive, internally determined actual speed from standard application
nSD	Safe-Drive speed value, internally determined actual speed from the safety application
n_safe	Actual speed determined from validation of nBD and nSD. Enters the further processing of the speed-dependent safety functions.
OSSD	Output Signal Switching Device, tested signal output
pBD	Base-Drive position value, internally determined actual position from standard application
pSD	Safe-Drive position value, internally determined actual position from the safety application
p_safe	Actual position determined from validation of pBD and pSD. Enters the further processing of the position-dependent safety functions.
PELV	Protective Extra Low Voltage
PL	Performance Level according to EN ISO 13849-1
PM	Plus-Minus – switched signal paths
PP	Plus-Plus – switched signal paths
PS	PROFIsafe
PWM	Pulse Width Modulation
SCS	Safe Creeping Speed
SD-In	Safe Digital Input
SD-Out	Safe Digital Output
SELV	Safety Extra Low Voltage
SFF	Safe Failure Fraction
SIL	Safety Integrity Level according to EN IEC 61508

