

PowerFlex 400 Adjustable Frequency AC Drive for Fan & Pump Applications

Catalog Numbers 22C, Series B



Important User Information

Read this document and the documents listed in the additional resources section about installation, configuration, and operation of this equipment before you install, configure, operate, or maintain this product. Users are required to familiarize themselves with installation and wiring instructions in addition to requirements of all applicable codes, laws, and standards.

Activities including installation, adjustments, putting into service, use, assembly, disassembly, and maintenance are required to be carried out by suitably trained personnel in accordance with applicable code of practice.

If this equipment is used in a manner not specified by the manufacturer, the protection provided by the equipment may be impaired.

In no event will Rockwell Automation, Inc. be responsible or liable for indirect or consequential damages resulting from the use or application of this equipment.

The examples and diagrams in this manual are included solely for illustrative purposes. Because of the many variables and requirements associated with any particular installation, Rockwell Automation, Inc. cannot assume responsibility or liability for actual use based on the examples and diagrams.

No patent liability is assumed by Rockwell Automation, Inc. with respect to use of information, circuits, equipment, or software described in this manual.

Reproduction of the contents of this manual, in whole or in part, without written permission of Rockwell Automation, Inc., is prohibited

Throughout this manual, when necessary, we use notes to make you aware of safety considerations.



WARNING: Identifies information about practices or circumstances that can cause an explosion in a hazardous environment, which may lead to personal injury or death, property damage, or economic loss.



ATTENTION: Identifies information about practices or circumstances that can lead to personal injury or death, property damage, or economic loss. Attentions help you identify a hazard, avoid a hazard, and recognize the consequence.

IMPORTANT Identifies information that is critical for successful application and understanding of the product.

Labels may also be on or inside the equipment to provide specific precautions.



SHOCK HAZARD: Labels may be on or inside the equipment, for example, a drive or motor, to alert people that dangerous voltage may be present.



BURN HAZARD: Labels may be on or inside the equipment, for example, a drive or motor, to alert people that surfaces may reach dangerous temperatures.



ARC FLASH HAZARD: Labels may be on or inside the equipment, for example, a motor control center, to alert people to potential Arc Flash. Arc Flash will cause severe injury or death. Wear proper Personal Protective Equipment (PPE). Follow ALL Regulatory requirements for safe work practices and for Personal Protective Equipment (PPE).

Important User Information	2
Summary of Changes	5
Preface	7
Overview	7
Who Should Use This Manual?	7
Additional Resources	7
Manual Conventions	8
Drive Frame Sizes	8
General Precautions	9
Catalog Number Explanation	10

Installation/Wiring

Chapter 1	
Opening the Cover	12
Frame C Drives	12
Frame D Drives	12
Frame E Drives	13
Frame F Drives	13
Frame G Drives	14
Frame H Drives	14
Mounting Considerations	15
Maximum Surrounding Air Temperature	15
Minimum Mounting Clearances	16
Debris Protection	17
Storage	18
AC Supply Source Considerations	18
Ungrounded Distribution Systems	18
Input Power Conditioning	19
General Grounding Requirements	19
Ground Fault Monitoring	20
Safety Ground - (PE)	20
Motor Ground	20
Shield Termination - SHLD	20
RFI Filter Grounding	20
Fuses and Circuit Breakers	21
Fusing	21
Bulletin 140M (Self-Protected Combination Controller)/UL489	
Circuit Breakers	21
Power Wiring	22
Motor Cable Types Acceptable for 200...600 Volt Installations	23
Reflected Wave Protection	24
Output Disconnect	24
Power Terminal Block	25
I/O Wiring Recommendations	28
Motor Start/Stop Precautions	28

Control Wire Types	28
I/O Terminal Block	28
Maximum Control Wire Recommendations.....	29
I/O Wiring Examples.....	32
Typical Multiple Drive Connection Examples	36
Start and Speed Reference Control	37
Accel/Decel Selection.....	38
RS485 Network Wiring	38
On Drive Connections.....	39
EMC Instructions.....	39
CE Conformity	39
Low Voltage Directive (2014/35/EU).....	39
EMC Directive (2014/30/EU)	39
General Notes.....	40
Essential Requirements for CE Compliance.....	40
FCC Instructions	42
FCC Compliance	42
Essential Requirements for FCC Compliance.....	42

Chapter 2

Start Up

Prepare For Drive Start-Up	45
Before Applying Power to the Drive.....	45
Applying Power to the Drive	46
Start, Stop, Direction and Speed Control	46
Integral Keypad	47
Operator Keys.....	47
LED Status Indicators	48
LCD Display.....	48
Viewing and Editing Parameters.....	49
Keypad Hand-Off-Auto Functions	50
Hand-Off-Auto Mode.....	50
Local/Remote Mode.....	51
Auto/Manual Mode	52
No Function Mode	53

Chapter 3

Programming and Parameters

About Parameters	55
Parameter Organization	56
Basic Display Group.....	58
Basic Program Group.....	61
Terminal Block Group.....	66
Communications Group.....	79
Advanced Program Group	83
Aux Relay Card Group	98
Advanced Display Group	102
Parameter Cross Reference by Name.....	110

	Chapter 4	
Troubleshooting	Drive Status	113
	LED Indications.....	113
	Faults	113
	Manually Clearing Faults.....	114
	Auto Restart (Reset/Run).....	115
	Fault Descriptions.....	115
	Common Symptoms and Corrective Actions	117
	Motor does not Start.....	117
	Drive does not Start from Start or Run Inputs wired to the terminal block.....	118
	Drive does not Start from Integral Keypad.....	118
	Motor and/or drive will not accelerate to commanded speed..	119
	Motor operation is unstable.....	119
	Drive will not reverse motor direction.....	119
	Drive does not power up.....	120
	Appendix A	
Supplemental Drive Information	Drive, Fuse & Circuit Breaker Ratings	121
	Fusing.....	121
	Circuit Breakers.....	121
	Specifications	122
	PowerFlex 400 Watts Loss (Rated Load, Speed & PWM)....	127
	Input Power Connections.....	128
	Appendix B	
Accessories and Dimensions	Product Selection	129
	Product Dimensions.....	136
	Appendix C	
RJ45 DSI Splitter Cable	Connectivity Guidelines	153
	DSI Cable Accessories	153
	Connectivity Examples	154
	Appendix D	
Application Notes	Damper Control Setup	157
	PID Setup	157
	PID Control Loop.....	157
	Exclusive Control	158
	Trim Control	159
	PID Reference and Feedback	159
	Analog PID Reference Signals	161
	PID Deadband.....	162
	PID Preload.....	162
	PID Limits.....	162

PID Gains 162
 Guidelines for Adjusting the PID Gains 163
 Auxiliary Motor Control Setup..... 165

Appendix E

Modbus RTU Protocol

Network Wiring 169
 Parameter Configuration 170
 Supported Modbus Function Codes 170
 Writing (06) Logic Command Data 170
 Writing (06) Reference 171
 Reading (03) Logic Status Data..... 172
 Reading (03) Feedback 172
 Reading (03) Drive Error Codes..... 172
 Reading (03) and Writing (06) Drive Parameters 173
 Additional Information..... 173

Appendix F

Metasys N2

Understanding Metasys N2 175
 Metasys N2 Virtual Objects 175
 Metasys N2 Data Types 176
 Network Points 177
 Using Percent (%) for the Reference 180
 Using Metasys Configurable Objects to Access Parameters..... 181
 Reading Parameter Values 181
 Writing Parameter Values 182

Appendix G

P1 – Floor Level Network (FLN)

Understanding P1-FLN 183
 P1-FLN Points 183
 Network Points 184
 Using Percent (%) for the Reference 188
 Using P1 Configurable Points to Access Parameters..... 188
 Reading Parameter Values 188
 Writing Parameter Values 189

Index 191

This manual contains new and updated information as indicated in the following table.

Topic	Page
CE Conformity updated	39
Programming options updated	55
UL and CE certification updated	123
Internal DC Bus Choke specification for 380–480V AC Input updated from "18.5-160 kW (25-250 HP)" to "11-160 kW (15-250 HP)".	124
Connected Components Workbench and DriveExecutive software compatibility updated	134

New Parameters

No new parameters have been added with the release of Firmware Release Number (FRN) 8.xx.

Notes:

Overview

The purpose of this manual is to provide you with the basic information needed to install, start-up and troubleshoot the PowerFlex 400 Adjustable Frequency AC Drive.

Who Should Use This Manual?

This manual is intended for qualified personnel. You must be able to program and operate Adjustable Frequency AC Drive devices. In addition, you must have an understanding of the parameter settings and functions.

Additional Resources

These documents contain additional information concerning related products from Rockwell Automation.

Resource	Description
Wiring and Grounding Guidelines for Pulse Width Modulated (PWM) AC Drives, publication DRIVES-IN001	Provides basic information to install, protect, wire, and ground pulse width modulated (PWM) AC drives.
Preventive Maintenance of Industrial Control and Drive System Equipment, publication DRIVES-TD001	Provides a checklist as a guide in performing preventive maintenance.
Safety Guidelines for the Application, Installation, and Maintenance of Solid-State Control, publication SGI-1.1	Provide general guidelines for the application, installation, and maintenance of solid-state control in the form of individual devices or packaged assemblies incorporating solid-state components.
Industrial Automation Wiring and Grounding Guidelines, publication 1770-4.1	Provides general guidelines for installing a Rockwell Automation industrial system.
Product Certifications website, http://www.rockwellautomation.com/global/certification/overview.page	Provides declarations of conformity, certificates, and other certification details.

You can view or download publications at <http://www.rockwellautomation.com/global/literature-library/overview.page>. To order paper copies of technical documentation, contact your local Allen-Bradley distributor or Rockwell Automation sales representative.

Manual Conventions

- In this manual we refer to the PowerFlex 400 Adjustable Frequency AC Drive as; drive, PowerFlex 400 or PowerFlex 400 Drive.
- Parameter numbers and names are shown in this format:

P031 [Motor NP Volts]

		Name
		Number
Group		
b = Basic Display Group		
P = Basic Program Group		
T = Terminal Block Group		
C = Communications Group		
A = Advanced Program Group		
R = Aux Relay Card Group		
d = Advanced Display Group		

- The following words are used throughout the manual to describe an action:

Word	Meaning
Can	Possible, able to do something
Cannot	Not possible, not able to do something
May	Permitted, allowed
Must	Unavoidable, you must do this
Shall	Required and necessary
Should	Recommended
Should Not	Not Recommended

Drive Frame Sizes

Similar PowerFlex 400 drive sizes are grouped into frame sizes to simplify spare parts ordering, dimensioning, etc. A cross reference of drive catalog numbers and their respective frame sizes is provided in [Appendix B](#).

General Precautions



ATTENTION: To avoid an electric shock hazard, verify that the voltage on the bus capacitors has discharged before performing any work on the drive. Measure the DC bus voltage at the –DC and +DC terminals or at the –DC and P2 terminals on the Power Terminal Block (refer to [Chapter 1](#) Power Terminal descriptions). The voltage must be zero.

A darkened LCD display and LEDs is not an indication that capacitors have discharged to safe voltage levels.



ATTENTION: Only qualified personnel familiar with adjustable frequency AC drives and associated machinery should plan or implement the installation, start-up and subsequent maintenance of the system. Failure to comply may result in personal injury and/or equipment damage.



ATTENTION: This drive contains ESD (Electrostatic Discharge) sensitive parts and assemblies. Static control precautions are required when installing, testing, servicing or repairing this assembly. Component damage may result if ESD control procedures are not followed. If you are not familiar with static control procedures, reference A-B publication 8000-4.5.2, “Guarding Against Electrostatic Damage” or any other applicable ESD protection handbook.



ATTENTION: An incorrectly applied or installed drive can result in component damage or a reduction in product life. Wiring or application errors, such as, undersizing the motor, incorrect or inadequate AC supply, or excessive ambient temperatures may result in malfunction of the system.



ATTENTION: The bus regulator function is extremely useful for preventing nuisance overvoltage faults resulting from aggressive decelerations, overhauling loads, and eccentric loads. However, it can also cause either of the following two conditions to occur.

1. Fast positive changes in input voltage or imbalanced input voltages can cause uncommanded positive speed changes;
 2. Actual deceleration times can be longer than commanded deceleration times
- However, a “Stall Fault” is generated if the drive remains in this state for 1 minute. If this condition is unacceptable, the bus regulator must be disabled (see parameter [A187](#)).
-

Catalog Number Explanation

1-3	4	5	6-8	9	10	11	12
22C	–	D	038	A	1	0	3
Drive	Dash	Voltage Rating	Rating	Enclosure	HIM	Emission Class	Comm Slot

Code	Drive
22C	PowerFlex 400

Code	Voltage	Ph.
B	240V AC	3
D	480V AC	3

Code	Rating
0	Not Filtered

Code	Version
3	RS485

Code	Interface Module
1	Fixed Keypad

Code	Enclosure
N	Panel Mount - IP20/UL Open-Type ⁽¹⁾
A	Panel Mount - IP30/NEMA 1/UL Type 1 ⁽²⁾
F	Flange Mount - IP20/UL Open Type ⁽³⁾

Output Current @ 200...240V 60Hz Input					Output Current @ 380...480V Input				
Code	Amps	kW	HP	Frame	Code	Amps	kW	HP	Frame
012	12	2.2	3.0	C	6P0	6.0	2.2	3.0	C
017	17.5	3.7	5.0	C	010	10.5	4.0	5.0	C
024	24	5.5	7.5	C	012	12	5.5	7.5	C
033	33	7.5	10	C	017	17	7.5	10	C
049	49	11	15	D	022	22	11	15	C
065	65	15	20	D	030	30	15	20	C
075	75	18.5	25	D	038	38	18.5	25	D
090	90	22	30	D	045	45.5	22	30	D
120	120	30	40	E	060	60	30	40	D
145	145	37	50	E	072	72	37	50	E
					088	88	45	60	E
					105	105	55	75	E
					142	142	75	100	E
					170	170	90	125	F
					208	208	110	150	F
					260	260	132	200	G
					310	310	160	250	G
					370	370	200	300	H
					460	460	250	350	H

(1) Frame C drives only available with IP20/UL Open-Type enclosure. Field installed conversion kit available to achieve IP30/NEMA 1/UL Type 1 rating.

(2) Frame D, E, F, G and H drives only available with IP30/NEMA 1/UL Type 1 enclosure.

(3) Frame C drives only.

Additional accessories, options and adapters are available. See [Appendix B](#) for details.

Installation/Wiring

This chapter provides information on mounting and wiring the PowerFlex 400 Drive.

For information on...	See page
Opening the Cover	12
Mounting Considerations	15
AC Supply Source Considerations	18
General Grounding Requirements	19
Fuses and Circuit Breakers	21
Power Wiring	22
I/O Wiring Recommendations	28
Start and Speed Reference Control	37
RS485 Network Wiring	38
EMC Instructions	39
FCC Instructions	42

Most start-up difficulties are the result of incorrect wiring. Every precaution must be taken to assure that the wiring is done as instructed. All items must be read and understood before the actual installation begins.



ATTENTION: The following information is merely a guide for proper installation. Rockwell Automation, Inc. cannot assume responsibility for the compliance or the noncompliance to any code, national, local or otherwise for the proper installation of this drive or associated equipment. A hazard of personal injury and/or equipment damage exists if codes are ignored during installation.

Opening the Cover

Frame C Drives

1. Press and hold in the tabs on each side of the cover.
2. Pull the cover out and up to release.

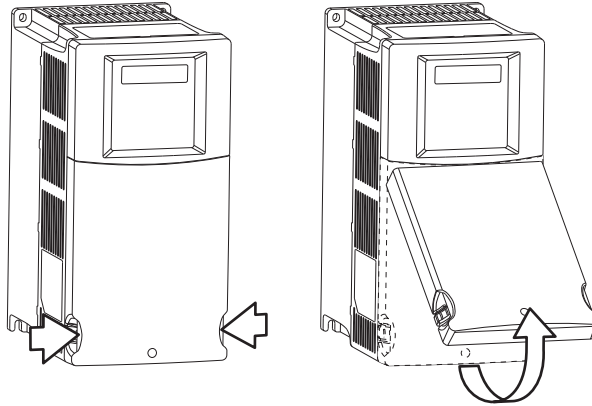

Frame D Drives

1. Loosen the two captive cover screws.
2. Pull the bottom of the cover out and up to release.

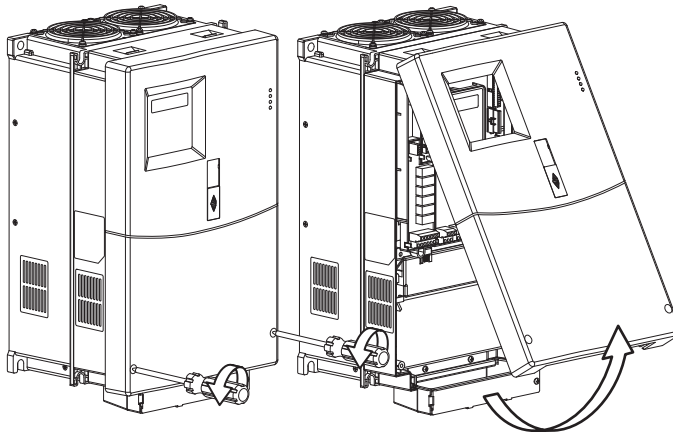

Frame E Drives

1. Loosen the four captive cover screws.
2. Pull the bottom of the cover out and up to release.

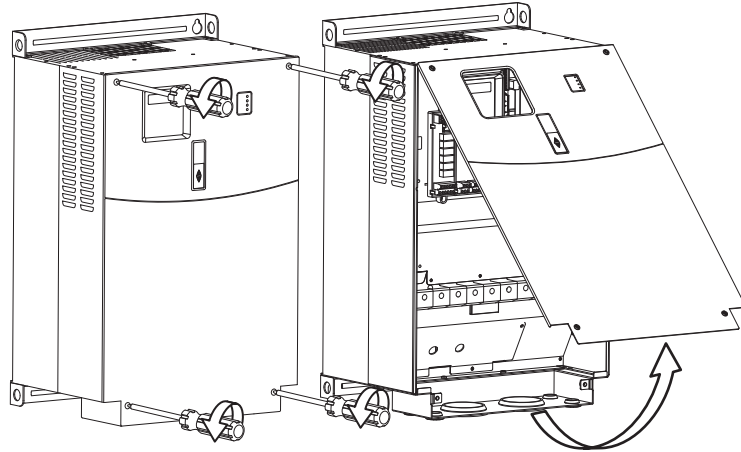

Frame F Drives

1. Turn the latch counterclockwise.
2. Pull on the latch to swing the door open.

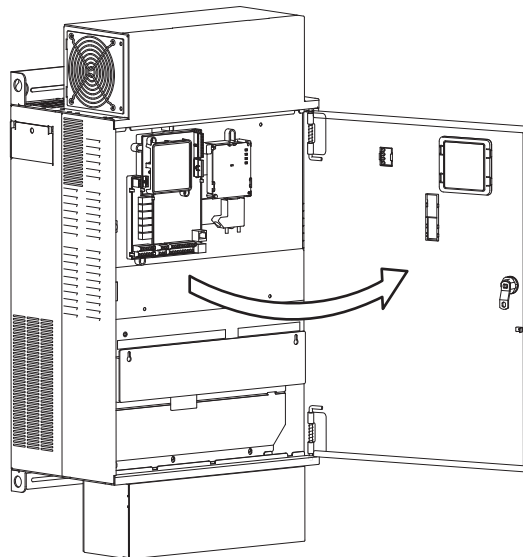

Frame G Drives

1. Loosen the four captive cover screws.
2. Pull the bottom of the cover out and up to release.

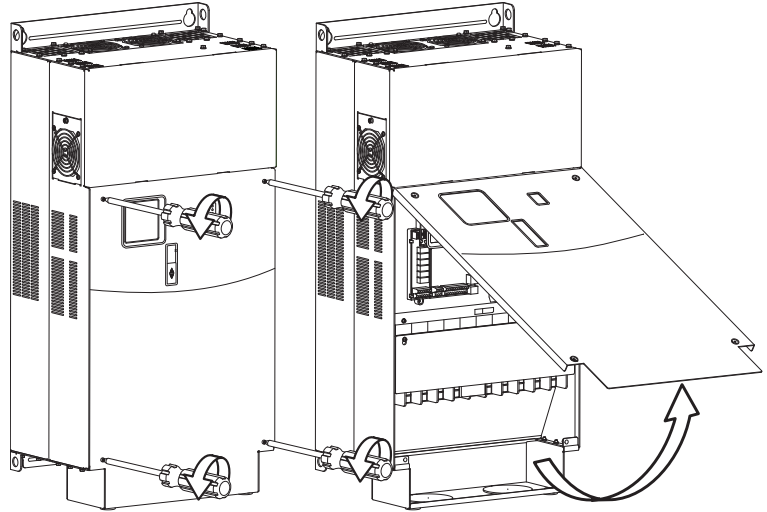

Frame H Drives

1. Loosen the four captive cover screws.
2. Pull the bottom of the cover out and up to release.

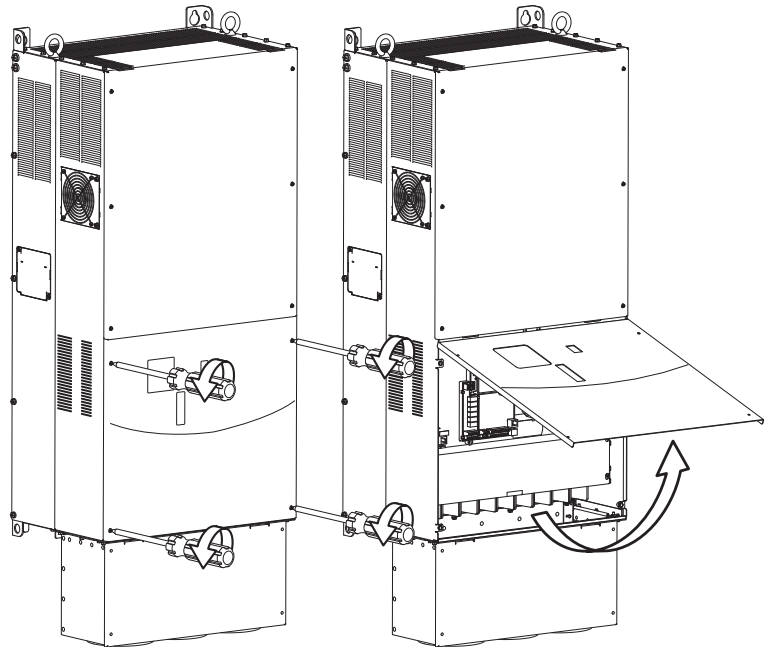

Mounting Considerations

- Mount the drive upright on a flat, vertical and level surface.

Frame	Screw Size	Screw Torque
C	M5 (#10-24)	2.45-2.94 N-m (22-26 lb.-in.)
D	M8 (5/16 in.)	6.0-7.4 N-m (53.2-65.0 lb.-in.)
E	M8 (5/16 in.)	8.8-10.8 N-m (78.0-95.3 lb.-in.)
F	M10 (3/8 in.)	19.6-23.5 N-m (173.6-208.3 lb.-in.)
G	M12 (1/2 in.)	33.5-41.0 N-m (296.5-362.9 lb.-in.)
H	M12 (1/2 in.)	33.5-41.0 N-m (296.5-362.9 lb.-in.)

- Protect the cooling fan by avoiding dust or metallic particles.
- Do not expose to a corrosive atmosphere.
- Protect from moisture and direct sunlight.

Maximum Surrounding Air Temperature

Frame	Enclosure Rating	Temperature Range	Minimum Mounting Clearances
C	IP 20/UL Open-Type	-10° to 45°C (14° to 113°F)	See Figure 1 , Mounting Option A
	IP 30/NEMA 1/UL Type 1 ⁽¹⁾	-10° to 45°C (14° to 113°F)	See Figure 1 , Mounting Option B
	IP 20/UL Open-Type	-10° to 50°C (14° to 122°F)	See Figure 1 , Mounting Option B
D	IP 30/NEMA 1/UL Type 1	-10° to 45°C (14° to 113°F)	See Figure 2
E			
F			See Figure 3
G			See Figure 4
H			

(1) Frame C drives require installation of the PowerFlex 400 IP 30/NEMA 1/UL Type 1 option kit to achieve this rating.

Minimum Mounting Clearances

Refer to [Appendix B](#) for mounting dimensions.

Figure 1 - Frame C Mounting Clearances

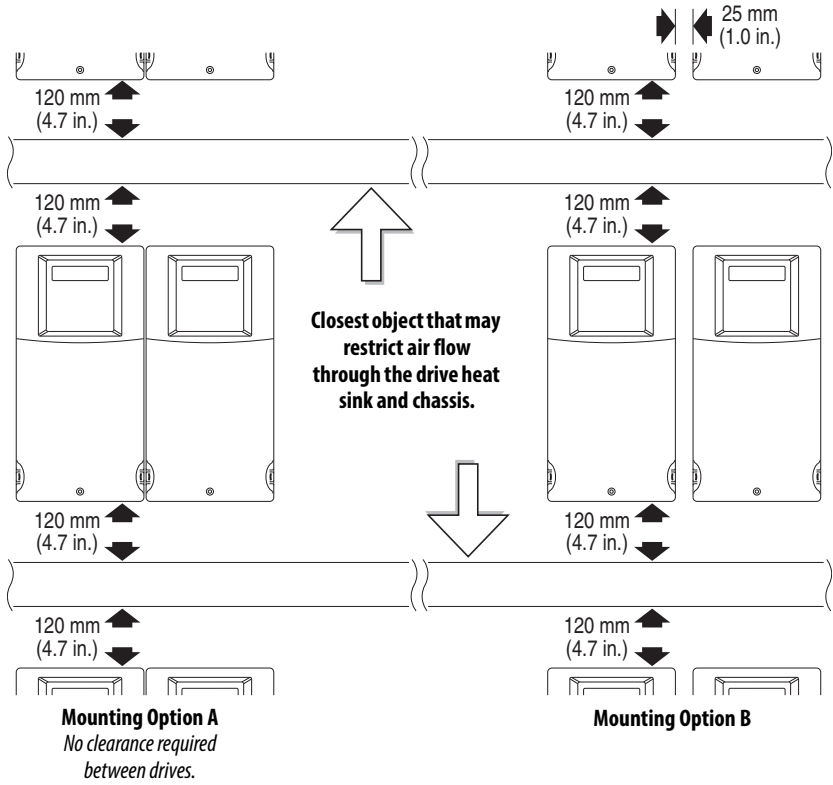

Figure 2 - Frames D & E Mounting Clearances

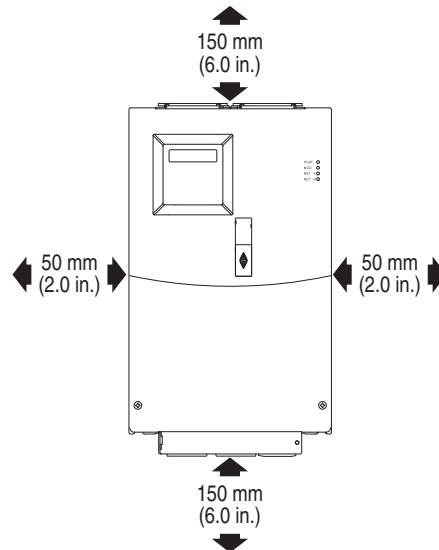
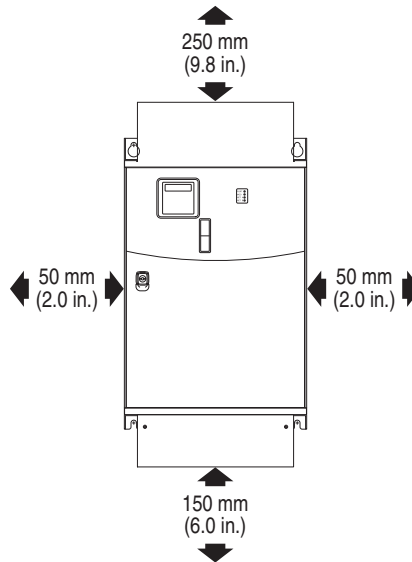
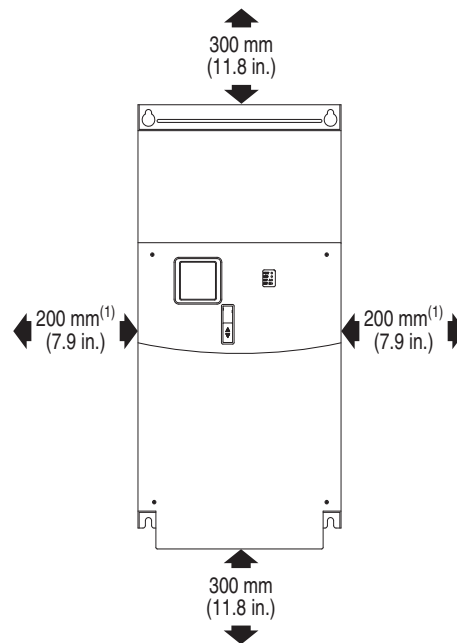

Figure 3 - Frame F Mounting Clearances**Figure 4 - Frames G & H Mounting Clearances**

(1) If the drive is installed with a side gap of 200 mm, it has to be removed from the shelf to change the fan. If the drive is installed with a side gap of 300 mm, it does not need to be removed from the shelf to change the fan.

Debris Protection

Frame C Drives – A plastic top panel is included with the drive. Install the panel to prevent debris from falling through the vents of the drive housing during installation. Remove the panel for IP 20/Open Type applications.

Frame D, E, F, G and H Drives – These drives have built-in debris protection. Installation of a protective panel is not required.

Storage

- Store within an ambient temperature range of -40° to +85°C.
- Store within a relative humidity range of 0% to 95%, non-condensing.
- Do not expose to a corrosive atmosphere.

AC Supply Source Considerations

Ungrounded Distribution Systems



ATTENTION: PowerFlex 400 drive frames contain protective MOVs that are referenced to ground. These devices must be disconnected if the drive is installed on an ungrounded or resistive grounded distribution system.

Disconnecting MOVs (Drive Frames C, E and F only.)

To prevent drive damage, the MOVs connected to ground shall be disconnected if the drive is installed on an ungrounded distribution system where the line-to-ground voltages on any phase could exceed 125% of the nominal line-to-line voltage. To disconnect these devices, remove the jumper shown in [Figure 6](#).

Figure 5 - Phase to Ground MOV Removal

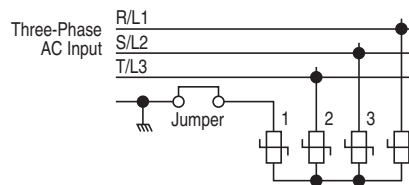
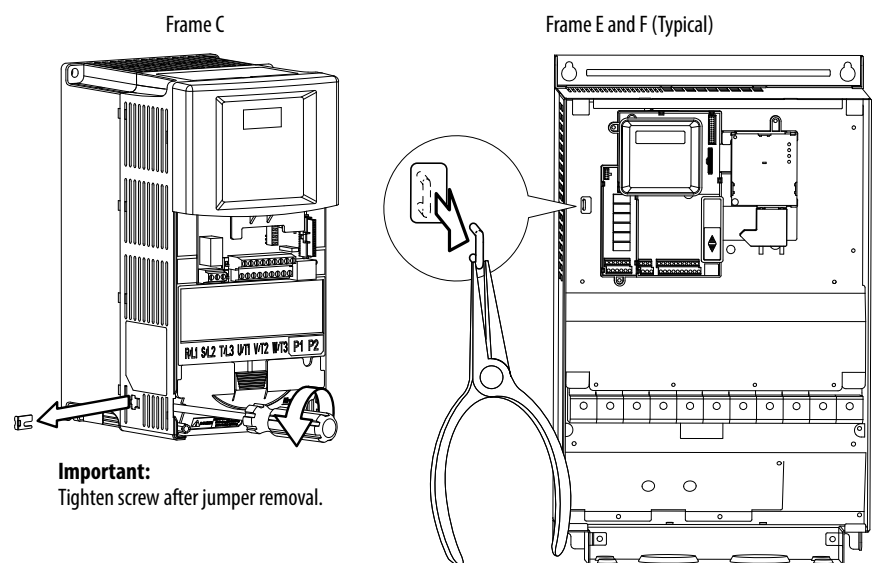

Figure 6 - MOV Jumper Location



Note: Frame D, G and H drives do not contain a MOV to ground connection and are suitable for operation in both grounded and ungrounded distribution systems without modification.

Input Power Conditioning

The drive is suitable for direct connection to input power within the rated voltage of the drive (see [Appendix A](#)). Listed in [Table 1](#) are certain input power conditions which may cause component damage or reduction in product life. If any of the conditions exist, as described in [Table 1](#), install one of the devices listed under the heading *Corrective Action* on the line side of the drive.

IMPORTANT Only one device per branch circuit is required. The device should be mounted closest to the branch and sized to handle the total current of the branch circuit.

Table 1 - Input Power Conditions

Input Power Condition	Corrective Action
Low Line Impedance (less than 1% line reactance)	<ul style="list-style-type: none"> • Install Line Reactor⁽¹⁾ • or Isolation Transformer
Line has power factor correction capacitors	<ul style="list-style-type: none"> • Install Line Reactor⁽¹⁾ • or Isolation Transformer
Line has frequent power interruptions	
Line has intermittent noise spikes in excess of 6000V (lightning)	
Phase to ground voltage exceeds 125% of normal line to line voltage	<ul style="list-style-type: none"> • Remove MOV jumper to ground (Frame C, E and F drives only) • or Install Isolation Transformer with grounded secondary if necessary
Ungrounded distribution system	

(1) Refer to [Appendix B](#) for accessory ordering information.

General Grounding Requirements

The drive Safety Ground - \oplus (PE) must be connected to system ground. Ground impedance must conform to the requirements of national and local industrial safety regulations and/or electrical codes. The integrity of all ground connections should be periodically checked.

Figure 7 - Typical Grounding

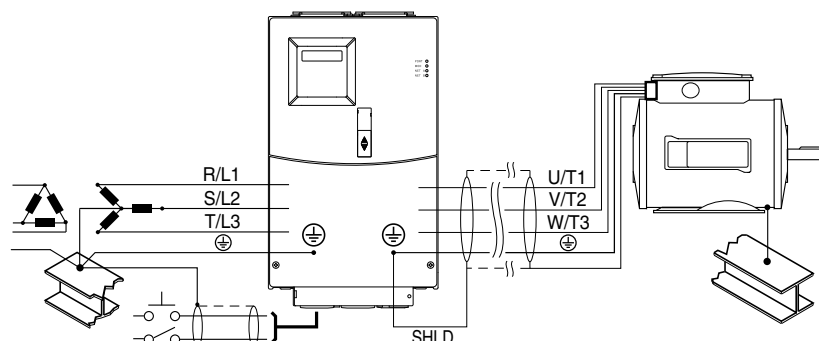

Ground Fault Monitoring

If a system ground fault monitor (RCD) is to be used, only Type B (adjustable) devices should be used to avoid nuisance tripping.

Safety Ground - (PE)

This is the safety ground for the drive that is required by code. One of these points must be connected to adjacent building steel (girder, joist), a floor ground rod or bus bar. Grounding points must comply with national and local industrial safety regulations and/or electrical codes.

Motor Ground

The motor ground must be connected to one of the ground terminals on the drive.

Shield Termination - SHLD

Either of the safety ground terminals located on the power terminal block provides a grounding point for the motor cable shield. The **motor cable** shield connected to one of these terminals (drive end) should also be connected to the motor frame (motor end). Use a shield terminating or EMI clamp to connect the shield to the safety ground terminal. The conduit box may be used with a cable clamp for a grounding point for the cable shield.

When shielded cable is used for **control and signal wiring**, the shield should be grounded at the source end only, not at the drive end.

RFI Filter Grounding

Using an external filter with any drive rating, may result in relatively high ground leakage currents. Therefore, the **filter must only be used in installations with grounded AC supply systems and be permanently installed and solidly grounded** (bonded) to the building power distribution ground. Ensure that the incoming supply neutral is solidly connected (bonded) to the same building power distribution ground. Grounding must not rely on flexible cables and should not include any form of plug or socket that would permit inadvertent disconnection. Some local codes may require redundant ground connections. The integrity of all connections should be periodically checked.

Fuses and Circuit Breakers

The PowerFlex 400 does not provide branch short circuit protection. This product should be installed with either input fuses or an input circuit breaker. National and local industrial safety regulations and/or electrical codes may determine additional requirements for these installations.

Fusing

The ratings in the table that follows are the recommended values for use with each drive rating. The devices listed in this table are provided to serve as a guide.

Bulletin 140M (Self-Protected Combination Controller)/UL489 Circuit Breakers

When using Bulletin 140M or UL489 rated circuit breakers, the guidelines listed below must be followed in order to meet the NEC requirements for branch circuit protection.

- Bulletin 140M can be used in single and group motor applications.
- Bulletin 140M can be used up stream from the drive without the need for fuses.

Table 2 - Recommended Branch Circuit Protective Devices

Voltage Rating	Drive Rating kW (HP)	Fuse Rating⁽¹⁾ Amps	140M Motor Protectors⁽²⁾⁽³⁾ Catalog No.	Recommended MCS Contactors Catalog No.	Min. Enclosure Volume⁽⁴⁾ Inches³
200-240V AC – 3-Phase	2.2 (3.0)	20	140M-F8E-C16	100-C23	5098
	3.7 (5.0)	30	140M-F8E-C25	100-C37	5098
	5.5 (7.5)	35	140M-F8E-C32	100-C37	5098
	7.5 (10)	45	140M-F8E-C45	100-C45	5098
	11 (15)	70	—	100-C60	—
	15 (20)	90	—	100-C85	—
	18.5 (25)	100	—	100-D95	—
	22 (30)	125	—	100-D110	—
	30 (40)	175	—	100-D180	—
37 (50)	200	—	100-D180	—	

Table 2 - Recommended Branch Circuit Protective Devices

Voltage Rating	Drive Rating <i>kW (HP)</i>	Fuse Rating ⁽¹⁾ <i>Amps</i>	140M Motor Protectors ⁽²⁾⁽³⁾ <i>Catalog No.</i>	Recommended MCS Contactors <i>Catalog No.</i>	Min. Enclosure Volume ⁽⁴⁾ <i>Inches³</i>
380-480V AC — 3-Phase	2.2 (3.0)	10	140M-D8E-C10	100-C09	5098
	4.0 (5.0)	20	140M-D8E-C16	100-C16	5098
	5.5 (7.5)	20	140M-D8E-C16	100-C23	5098
	7.5 (10)	25	140M-D8E-C20	100-C23	5098
	11 (15)	30	140M-F8E-C32	100-C30	5098
	15 (20)	40	140M-F8E-C32	100-C37	5098
	18.5 (25)	50	140M-F8E-C45	100-C60	9086
	22 (30)	60	—	100-C60	—
	30 (40)	80	—	100-C85	—
	37 (50)	100	—	100-C85	—
	45 (60)	125	—	100-D110	—
	55 (75)	150	—	100-D140	—
	75 (100)	200	—	100-D180	—
	90 (125)	250	—	100-D210	—
	110 (150)	250	—	100-D250	—
	132 (200)	300	—	100-D300	—
160 (250)	400	—	100-D420	—	
200 (300)	500	—	100-D420	—	
250 (350)	600	—	100-D630	—	

(1) Recommended Fuse Class: UL Class J, CC, T or Type BS88; 600V (550V) or equivalent.

(2) The AIC ratings of the Bulletin 140M Motor Protector Circuit Breakers may vary. See [Bulletin 140M Motor Protection Circuit Breakers Application Ratings](#).

(3) Manual Self-Protected (Type E) Combination Motor Controller, UL listed for 208 Wye or Delta, 240 Wye or Delta, 480Y/277 or 600Y/347. Not UL listed for use on 480V or 600V Delta/Delta, corner ground, or high-resistance ground systems.

(4) When using a Manual Self-Protected (Type E) Combination Motor Controller, the drive must be installed in a ventilated or non-ventilated enclosure with the minimum volume specified in this column. Application specific thermal considerations may require a larger enclosure.

Power Wiring



ATTENTION: National Codes and standards (NEC, VDE, BSI, etc.) and local codes outline provisions for safely installing electrical equipment. Installation must comply with specifications regarding wire types, conductor sizes, branch circuit protection and disconnect devices. Failure to do so may result in personal injury and/or equipment damage.



ATTENTION: To avoid a possible shock hazard caused by induced voltages, unused wires in the conduit must be grounded at both ends. For the same reason, if a drive sharing a conduit is being serviced or installed, all drives using this conduit should be disabled. This will help minimize the possible shock hazard from “cross coupled” power leads.

Motor Cable Types Acceptable for 200...600 Volt Installations

A variety of cable types are acceptable for drive installations. For many installations, unshielded cable is adequate, provided it can be separated from sensitive circuits. As an approximate guide, allow a spacing of 0.3 meters (1 foot) for every 10 meters (32.8 feet) of length. In all cases, long parallel runs must be avoided. Do not use cable with an insulation thickness less than 15 mils (0.4 mm/0.015 in.). Do not route more than three sets of motor leads in a single conduit to minimize “cross talk”. If more than three drive/motor connections per conduit are required, shielded cable must be used.

UL installations must use 600V, 75°C or 90°C wire.

Use copper wire only.

Unshielded

THHN, THWN or similar wire is acceptable for drive installation in dry environments provided adequate free air space and/or conduit fill rates limits are provided. **Do not use THHN or similarly coated wire in wet areas.** Any wire chosen must have a minimum insulation thickness of 15 mils and should not have large variations in insulation concentricity.

Shielded/Armored Cable

Shielded cable contains all of the general benefits of multi-conductor cable with the added benefit of a copper braided shield that can contain much of the noise generated by a typical AC Drive. Strong consideration for shielded cable should be given in installations with sensitive equipment such as weigh scales, capacitive proximity switches and other devices that may be affected by electrical noise in the distribution system. Applications with large numbers of drives in a similar location, imposed EMC regulations or a high degree of communications /networking are also good candidates for shielded cable.

Shielded cable may also help reduce shaft voltage and induced bearing currents for some applications. In addition, the increased impedance of shielded cable may help extend the distance that the motor can be located from the drive without the addition of motor protective devices such as terminator networks. Refer to Reflected Wave in “Wiring and Grounding Guidelines for PWM AC Drives,” publication [DRIVES-IN001A-EN-P](#).

Consideration should be given to all of the general specifications dictated by the environment of the installation, including temperature, flexibility, moisture characteristics and chemical resistance. In addition, a braided shield should be included and be specified by the cable manufacturer as having coverage of at least 75%. An additional foil shield can greatly improve noise containment.

A good example of recommended cable is Belden® 295xx (xx determines gauge). This cable has four (4) XLPE insulated conductors with a 100% coverage foil and an 85% coverage copper braided shield (with drain wire) surrounded by a PVC jacket.

Other types of shielded cable are available, but the selection of these types may limit the allowable cable length. Particularly, some of the newer cables twist 4 conductors of THHN wire and wrap them tightly with a foil shield. This construction can greatly increase the cable charging current required and reduce the overall drive performance. Unless specified in the individual distance tables as tested with the drive, these cables are not recommended and their performance against the lead length limits supplied is not known.

Table 3 - Recommended Shielded Wire

Location	Rating/Type	Description
Standard (Option 1)	600V, 90°C (194°F) XHHW2/RHW-2 Anixter B209500-B209507, Belden 29501-29507, or equivalent	<ul style="list-style-type: none"> Four tinned copper conductors with XLPE insulation. Copper braid/aluminum foil combination shield and tinned copper drain wire. PVC jacket.
Standard (Option 2)	Tray rated 600V, 90°C (194°F) RHH/RHW-2 Anixter OLF-7xxxx or equivalent	<ul style="list-style-type: none"> Three tinned copper conductors with XLPE insulation. 5 mil single helical copper tape (25% overlap min.) with three bare copper grounds in contact with shield. PVC jacket.
Class I & II; Division I & II	Tray rated 600V, 90°C (194°F) RHH/RHW-2 Anixter 7V-7xxxx-3G or equivalent	<ul style="list-style-type: none"> Three bare copper conductors with XLPE insulation and impervious corrugated continuously welded aluminum armor. Black sunlight resistant PVC jacket overall. Three copper grounds on #10 AWG and smaller.

Reflected Wave Protection

The drive should be installed as close to the motor as possible. Installations with long motor cables may require the addition of external devices to limit voltage reflections at the motor (reflected wave phenomena). See [Table 4](#) for recommendations.

The reflected wave data applies to all frequencies 2 to 10 kHz. For 240V ratings, reflected wave effects do not need to be considered.

Table 4 - Maximum Cable Length Recommendations

Reflected Wave		
380...480V Ratings	Motor Insulation Rating	Motor Cable Only ⁽¹⁾
	1000 Vp-p	7.6 meters (25 feet)
	1200 Vp-p	22.9 meters (75 feet)
	1600 Vp-p	152.4 meters (500 feet)

(1) Longer cable lengths can be achieved by installing devices on the output of the drive. Consult factory for recommendations.

Output Disconnect

The drive is intended to be commanded by control input signals that will start and stop the motor. A device that routinely disconnects then reapplies output power to the motor for the purpose of starting and stopping the motor should

not be used. If it is necessary to disconnect power to the motor with the drive outputting power, an auxiliary contact should be used to simultaneously disable drive control run commands.

Power Terminal Block

Frame C, D, F, G and H drives utilize a finger guard over the power wiring terminals. Replace the finger guard when wiring is complete.

Figure 8 - Power Terminal Blocks (Frames C through D)

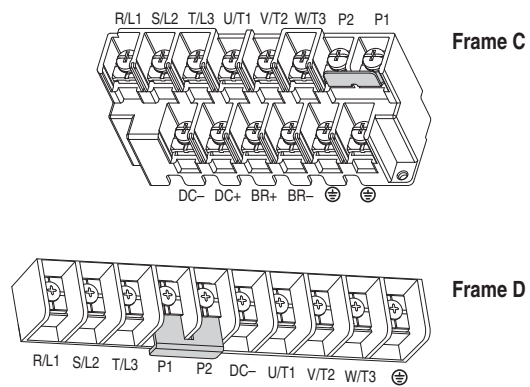
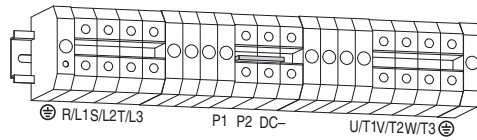
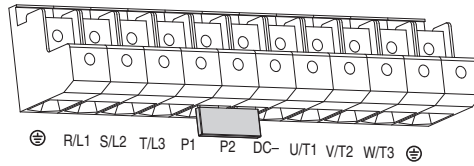

Figure 9 - Power Terminal Blocks (Frames E through H)



Frame E:
480V
37-45 kW
(50-60 HP)



Frame E:
240V 480V
30-37 kW 55-75 kW
(40-50 HP) (75-100 HP)
See note at the bottom
of this page.

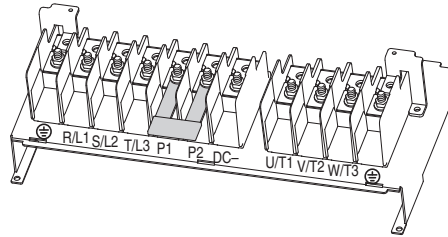

Frame F

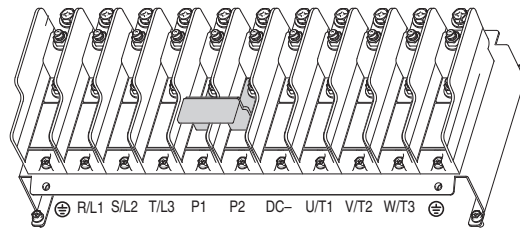

Frame G

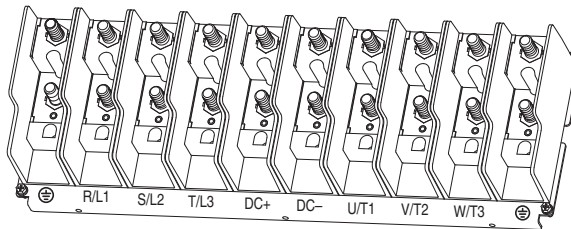

Frame H

IMPORTANT For Frame E, 240V 30...37 kW (40...50 HP) and 480V 55...75 kW (75...100 HP) drives, take care to place the wire beneath the jumper and not above it when connecting to terminals P1 and P2.

Bottom view of terminal block and wire

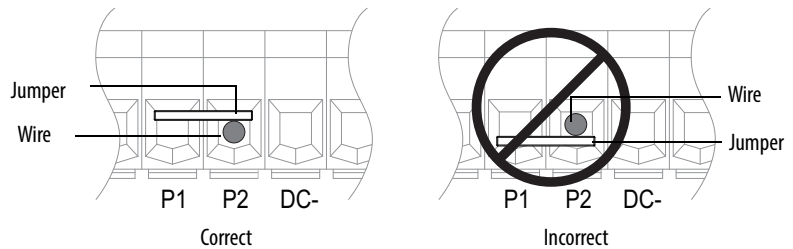

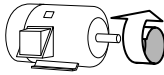

Table 5 - Power Terminal Descriptions

Terminal ⁽¹⁾	Description
R/L1, S/L2, T/L3	3-Phase Input
U/T1	To Motor U/T1
V/T2	To Motor V/T2
W/T3	To Motor W/T3
P2, P1	DC Bus Inductor Connection Drives are shipped with a jumper between Terminals P2 and P1. Remove this jumper only when a DC Bus Inductor will be connected. Drive will not power up without a jumper or inductor connected.
DC-, DC+	DC Bus Connection (Frame C and H Drives)
P2, DC-	DC Bus Connection (Frame D, E, F and G Drives)
BR+, BR-	Not Used
	Safety Ground - PE



Switch any two motor leads to change forward direction.



(1) **Important:** Terminal screws may become loose during shipment. Ensure that all terminal screws are tightened to the recommended torque before applying power to the drive.

Table 6 - Power Terminal Block Specifications

Frame	Maximum Wire Size ⁽¹⁾	Minimum Wire Size ⁽¹⁾	Recommended Torque
C	8.4 mm ² (8 AWG)	1.3 mm ² (16 AWG)	2.9 N-m (26 lb-in)
D	33.6 mm ² (2 AWG)	8.4 mm ² (8 AWG)	5.1 N-m (45 lb-in)
E 480V 37...45 kW (50...60 HP)	33.6 mm ² (2 AWG)	3.5 mm ² (12 AWG)	5.6 N-m (49.5 lb-in)
E 240V 30-37 kW (40...50 HP) 480V 55...75 kW (75...100 HP)	107.2 mm ² (4/0 AWG)	53.5 mm ² (1/0 AWG)	19.5 N-m (173 lb-in)
F	152.0 mm ² (300 MCM)	85.0 mm ² (3/0 AWG)	19.5 N-m (173 lb-in)
G	152.0 mm ² (300 MCM)	107.2 mm ² (4/0 AWG)	29.4 N-m (260 lb-in)
H	253.0 mm ² (500 MCM)	152.0 mm ² (300 MCM)	40.0 N-m (354 lb-in)

(1) Maximum/minimum sizes that the terminal block will accept – these are not recommendations. If national or local codes require sizes outside this range, lugs may be used. Some ratings will require a pair of wires.

I/O Wiring Recommendations Motor Start/Stop Precautions



ATTENTION: A contactor or other device that routinely disconnects and reapplies the AC line to the drive to start and stop the motor can cause drive hardware damage. The drive is designed to use control input signals that will start and stop the motor. If used, the input device must not exceed one operation per minute or drive damage can occur.



ATTENTION: The drive start/stop control circuitry includes solid-state components. If hazards due to accidental contact with moving machinery or unintentional flow of liquid, gas or solids exist, an additional hardwired stop circuit may be required to remove the AC line to the drive. When the AC line is removed, there will be a loss of any inherent regenerative braking effect that might be present - the motor will coast to a stop. An auxiliary braking method may be required.

Important points to remember about I/O wiring:

- Always use copper wire.
- Wire with an insulation rating of 600V or greater is recommended.
- Control and signal wires should be separated from power wires by at least 0.3 meters (1 foot).



ATTENTION: Driving the 4-20 mA analog input from a voltage source could cause component damage. Verify proper configuration prior to applying input signals.

Control Wire Types

Table 7 - Recommended Control and Signal Wire⁽¹⁾

Wire Type(s)	Description	Minimum Insulation Rating
Belden 8760/9460 or equivalent	0.8 mm ² (18 AWG), twisted pair, 100% shield with drain	300V 60 °C (140 °F)
Belden 8770 or equivalent	0.8 mm ² (18 AWG), 3 conductor, shielded for remote pot only.	

(1) If the wires are short and contained within a cabinet which has no sensitive circuits, the use of shielded wire may not be necessary, but is always recommended.

I/O Terminal Block

Table 8 - I/O Terminal Block Specifications

Frame	Maximum Wire Size ⁽¹⁾	Minimum Wire Size ⁽¹⁾	Torque
All	1.3 mm ² (16 AWG)	0.13 mm ² (26 AWG)	0.5...0.8 N-m (4.4...7 lb-in)

(1) Maximum/minimum sizes that the terminal block will accept - these are not recommendations.

Maximum Control Wire Recommendations

Do not exceed control wiring length of 30 meters (100 feet). Control signal cable length is highly dependent on electrical environment and installation practices. To improve noise immunity, the I/O terminal block Common must be connected to ground terminal/protective earth. If using the RS485 (DSI) port, I/O Terminal 20 should also be connected to ground terminal/protective earth.

Figure 10 - Control Wiring Block Diagram

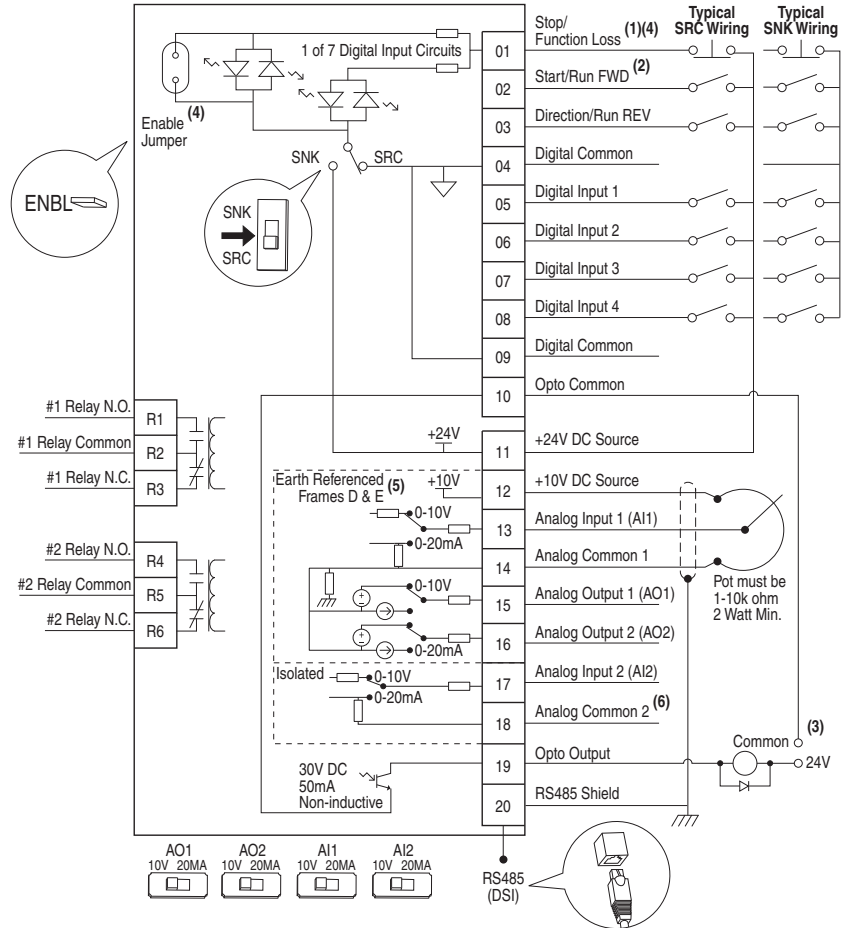

- (1) **Important:** I/O Terminal 01 is always a coast to stop input except when P036 [Start Source] is set to option 1 "3-Wire" or 6 "2-W Lvl/Enbl". In three wire control, I/O Terminal 01 is controlled by P037 [Stop Mode]. All other stop sources are controlled by P037 [Stop Mode].
Important: The drive is shipped with a jumper installed between I/O Terminals 01 and 11. Remove this jumper when using I/O Terminal 01 as a stop or enable input.
- (2) Two wire control shown. For three wire control use a momentary input on I/O Terminal 02 to command a start. If reverse is enabled by A166, use a maintained input for I/O Terminal 03 to change direction.
- (3) When using an opto output with an inductive load such as a relay, install a recovery diode parallel to the relay as shown, to prevent damage to the output.
- (4) When the ENBL enable jumper is removed, I/O Terminal 01 will always act as a hardware enable, causing a coast to stop without software interpretation.
- (5) Most I/O terminals labeled "Common" **are not** referenced to the safety ground (PE) terminal and are designed to greatly reduce common mode interference. Frame D...H drives have Analog Common 1 referenced to ground.

P036 [Start Source]	Stop	I/O Terminal 01 Stop
Keypad	Per P037	Coast
3-Wire	Per P037	Per P037 ⁽⁴⁾
2-Wire	Per P037	Coast
RS485 Port	Per P037	Coast

(6) Common for Analog Input 2 (AI2). Electronically isolated from digital I/O and opto output. Not to be used with Analog Input 1 (AI1), Analog Output 1 (AO1) or Analog Output 2 (AO2). With Analog Input 2, provides one fully isolated analog input channel.

Table 9 - Control I/O Terminal Designations

No.	Signal	Default	Description	Param.
01	Stop ⁽¹⁾ / Function Loss	Coast	Factory installed jumper or a normally closed input must be present for the drive to start. Program with P036 [Start Source].	P036 ⁽¹⁾
02	Start/Run FWD	–	HAND Mode: Command comes from Integral Keypad. AUTO Mode: I/O Terminal 02 is active. Program with P036 [Start Source].	P036 , P037
03	Direction/Run REV	Rev Disabled	To enable reverse operation, program with A166 [Reverse Disable]. Program with P036 [Start Source].	P036 , P037 , A166
04	Digital Common	–	For digital inputs. Tied to I/O Terminal 09. Electronically isolated with digital inputs from analog I/O and opto output.	
05	Digital Input 1	Purge ⁽²⁾	Program with T051 [Digital In1 Sel].	T051
06	Digital Input 2	Local	Program with T052 [Digital In2 Sel].	T052
07	Digital Input 3	Clear Fault	Program with T053 [Digital In3 Sel].	T053
08	Digital Input 4	Comm Port	Program with T054 [Digital In4 Sel].	T054
09	Digital Common	–	For digital inputs. Tied to I/O Terminal 04. Electronically isolated with digital inputs from analog I/O and opto output.	
10	Opto Common	–	For opto-coupled outputs. Electronically isolated with opto output from analog I/O and digital inputs.	
11	+24V DC	–	Drive supplied power for digital inputs. Referenced to Digital Common. Max. Output: 100mA.	
12	+10V DC	–	Drive supplied power for 0-10V external potentiometer. Referenced to Analog Common. Max. Output: 15mA.	P038
13	Analog Input 1	0-10V	External 0-10V (unipolar), 0-20mA or 4-20mA input supply or potentiometer wiper. Default input is 0-10V. For current (mA) input, set AI1 DIP Switch to 20mA. Program with T069 [Analog In 1 Sel]. Input Impedance: 100k ohm (Voltage Mode) 250 ohm (Current Mode)	T069 , T070 , T071 , T072
14	Analog Common 1	–	Common for Analog Input 1 and Analog Output 1 and 2. Electrically isolated from digital I/O and opto output.	
15	Analog Output 1	OutFreq 0-10	Default analog output is 0-10V. For current (mA) value, set AO1 DIP Switch to 20mA. Program with T082 [Analog Out1 Sel]. Maximum Load: 4-20mA = 525 ohm (10.5V) 0-10V = 1k ohm (10mA)	P038 , T051... , T054 , A152
16	Analog Output 2	OutCurr 0-10	Default analog output is 0-10V. For a current (mA) value, set AO2 DIP Switch to 20mA. Program with T085 [Analog Out2 Sel]. Maximum Load: 4-20mA = 525 ohm (10.5V) 0-10V = 1k ohm (10mA)	T082 , T084 , T085 , T086 , T087
17	Analog Input 2	0-10V	Optically isolated external 0-10V (unipolar), ±10V (bipolar), 0-20mA or 4-20mA input supply or potentiometer wiper. Default input is 0-10V. For current (mA) input, set AI2 DIP Switch to 20mA. Program with T073 [Analog In 2 Sel]. Input Impedance: 100k ohm (Voltage Mode) 250 ohm (Current Mode)	T073 , T074 , T075 , T076

Table 9 - Control I/O Terminal Designations

No.	Signal	Default	Description	Param.
18	Analog Common 2	–	For Analog Input 2. Electronically isolated from digital I/O and opto output. With Analog Input 2, provides one fully isolated analog input channel.	
19	Opto Output	At Frequency	Program with T065 [Opto Out Sel].	T065 , T066 , T068
20	RS485 (DSI) Shield	–	Terminal connected to Safety Ground - PE when using the RS485 (DSI) Communication Port.	

(1) See Footnotes (1) and (4) on page 29.

(2) **Important** information regarding Stop commands and the [Digital Inx Sel] Purge option is provided on page 66.

Table 10 - Relay Terminal Designations and DIP Switches

No.	Signal	Default	Description	Param.
R1	#1 Relay N.O.	Ready/Fault	Normally open contact for No. 1 output relay.	T055
R2	#1 Relay Common	–	Common for output relay.	
R3	#1 Relay N.C.	Ready/Fault	Normally closed contact for No. 1 output relay.	T055
R4	#2 Relay N.O.	Motor Running	Normally open contact for No. 2 output relay.	T060
R5	#2 Relay Common	–	Common for output relay.	
R6	#2 Relay N.C.	Motor Running	Normally closed contact for No. 2 output relay.	T060
Selection DIP Switches: Analog Input (AI1 & AI2) Analog Output (AO1 & AO2)		0-10V	Sets analog output to either voltage or current. Settings must match: AI1 & T069 [Analog In 1 Sel] AI2 & T073 [Analog In 2 Sel] AO1 & T082 [Analog Out1 Sel] AO2 & T085 [Analog Out2 Sel]	
Sink/Source DIP Switch		Source (SRC)	Inputs can be wired as Sink (SNK) or Source (SRC) via DIP Switch setting.	

Figure 11 - User Installed Auxiliary Relay Card (Frames D, E, F, G and H Only)

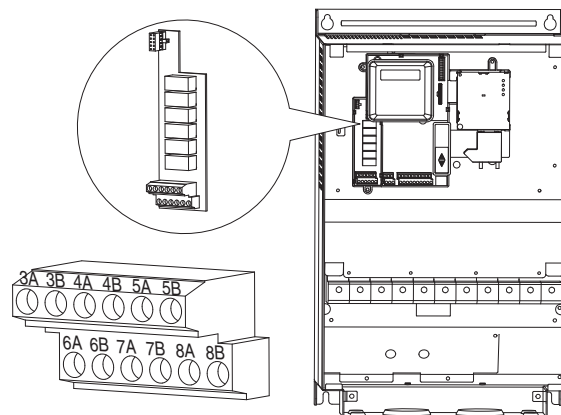

IMPORTANT If using auxiliary motor control, ensure that wiring and parameter configuration are correct before wiring contactor outputs. All relays on the Auxiliary Relay Card will energize on power-up by default. Failure to verify proper wiring and parameter configuration can result in improper motor operation or drive damage. Refer to [Appendix D](#) for more details.

Table 11 - User Installed Relay Board Terminal Designations

No.	Signal	Default	Description	Param.
3A	#3 Relay N.O.	Ready/Fault	Normally open contact for Number 3 Output Relay	R221
3B	#3 Relay Common	—	Common for Number 3 Output Relay	
4A	#4 Relay N.O.	Ready/Fault	Normally open contact for Number 4 Output Relay	R224
4B	#4 Relay Common	—	Common for Number 4 Output Relay	
5A	#5 Relay N.O.	Ready/Fault	Normally open contact for Number 5 Output Relay	R227
5B	#5 Relay Common	—	Common for Number 5 Output Relay	
6A	#6 Relay N.O.	Ready/Fault	Normally open contact for Number 6 Output Relay	R230
6B	#6 Relay Common	—	Common for Number 6 Output Relay	
7A	#7 Relay N.O.	Ready/Fault	Normally open contact for Number 7 Output Relay	R233
7B	#7 Relay Common	—	Common for Number 7 Output Relay	
8A	#8 Relay N.O.	Ready/Fault	Normally open contact for Number 8 Output Relay	R236
8B	#8 Relay Common	—	Common for Number 8 Output Relay	

I/O Wiring Examples

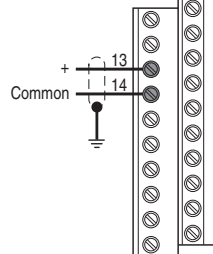
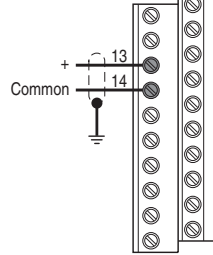
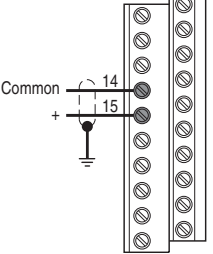
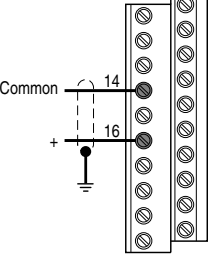
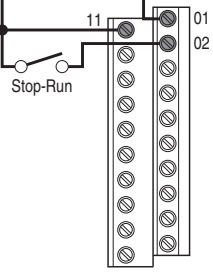

Input/Output	Connection Example	Required Settings
Potentiometer 1-10k Ohm Potentiometer Recommended (2 Watt Minimum)		DIP Switch A11 = 10V Parameters P038 [Speed Reference] = 2 "Analog In1" T069 [Analog In 1 Sel] = 2 "0-10V" Scaling T070 [Analog In 1 Lo] T071 [Analog In 1 Hi] Check Results d305 [Analog In 1]
Analog Input Bipolar Speed Reference, ±10V Input		DIP Switch A12 = 10V Parameters P038 [Speed Reference] = 3 "Analog In2" T073 [Analog In 2 Sel] = 3 "-10 to +10V" Scaling T074 [Analog In 2 Lo] T075 [Analog In 2 Hi] Check Results d306 [Analog In 2]

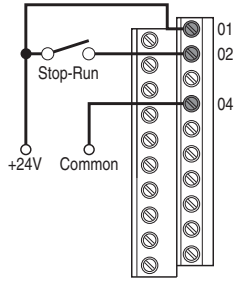
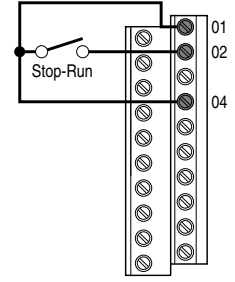
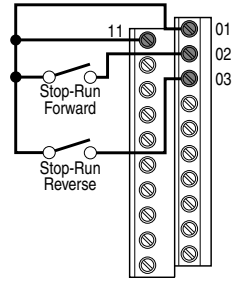
Input/Output	Connection Example	Required Settings
<p>Analog Input Unipolar Speed Reference, 0 to +10V Input</p>		<p>DIP Switch AI1 = 10V</p> <p>Parameters P038 [Speed Reference] = 2 "Analog In1" T069 [Analog In 1 Sel] = 2 "0-10V"</p> <p>Scaling T070 [Analog In 1 Lo] T071 [Analog In 1 Hi]</p> <p>Check Results d305 [Analog In 1]</p>
<p>Analog Input Unipolar Speed Reference, 4-20 mA Input</p>		<p>DIP Switch AI1 = 20mA</p> <p>Parameters P038 [Speed Reference] = 2 "Analog In1" T069 [Analog In 1 Sel] = 1 "4-20 mA"</p> <p>Scaling T070 [Analog In 1 Lo] T071 [Analog In 1 Hi]</p> <p>Check Results d305 [Analog In 1]</p>
<p>Analog Output Unipolar, 0 to +10V Output • 1k Ohm Minimum</p>		<p>DIP Switch AO1 = 10V</p> <p>Parameters T082 [Analog Out1 Sel] = 0 through 6</p> <p>Scaling T083 [Analog Out1 High] T084 [Analog Out1 Setpt]</p>
<p>Analog Output Unipolar, 4-20 mA Output • 525 Ohm Maximum</p>		<p>DIP Switch AO2 = 20MA</p> <p>Parameters T082 [Analog Out1 Sel] = 14 through 20</p> <p>Scaling T083 [Analog Out1 High] T084 [Analog Out1 Setpt]</p>
<p>2 Wire Control Sourcing (SRC), Internal Supply, Non-Reversing</p> <ul style="list-style-type: none"> • Input must be active for the drive to run. • When input is opened, the drive will stop as specified by P037 [Stop Mode]. • Drive will not run if I/O Terminal 01 is open. Drive will coast to stop if opened while running 		<p>DIP Switch SNK/SRC = SRC</p> <p>Parameters P036 [Start Source] = 2, 3, 4 P037 [Stop Mode] = 0 through 7</p>

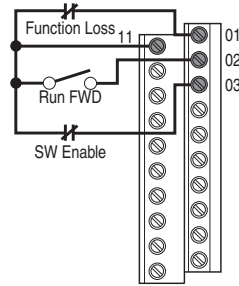
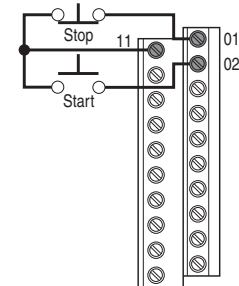
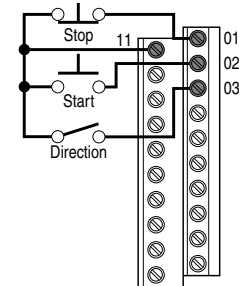
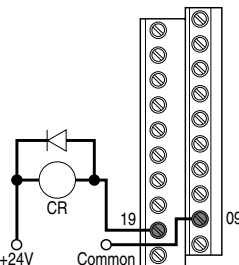
Input/Output	Connection Example	Required Settings
<p>2 Wire Control Sourcing (SRC), External Supply, Non-Reversing</p> <ul style="list-style-type: none"> Input must be active for the drive to run. When input is opened, the drive will stop as specified by P037 [Stop Mode]. User supplied 24V DC power source must be used. Each digital input draws 6 mA. Drive will not run if I/O Terminal 01 is open. Drive will coast to stop if opened while running. 		<p>DIP Switch SNK/SRC = SRC</p> <p>Parameters P036 [Start Source] = 2, 3, 4 P037 [Stop Mode] = 0 through 7</p>
<p>2 Wire Control Sinking (SNK), Internal Supply, Non-Reversing</p> <ul style="list-style-type: none"> Input must be active for the drive to run. When input is opened, the drive will stop as specified by P037 [Stop Mode]. Drive will not run if I/O Terminal 01 is open. Drive will coast to stop if opened while running. 		<p>DIP Switch SNK/SRC = SNK</p> <p>Parameters P036 [Start Source] = 2, 3, 4 P037 [Stop Mode] = 0 through 7</p>
<p>2 Wire Control Sourcing (SRC), Internal Supply, Run FWD/Run REV</p> <ul style="list-style-type: none"> Input must be active for the drive to run. When input is opened, the drive will stop as specified by P037 [Stop Mode]. If both Run FWD and Run REV inputs are closed at the same time, an undetermined state could occur. Drive will not run if I/O Terminal 01 is open. Drive will coast to stop if opened while running. 		<p>DIP Switch SNK/SRC = SRC</p> <p>Parameters P036 [Start Source] = 2, 3, 4 P037 [Stop Mode] = 0 through 7 A166 [Reverse Disable] = 0 "Enabled"</p>

Input/Output	Connection Example	Required Settings
<p>2 Wire Control with Function Loss and SW Enable</p> <p>Sourcing (SRC), Internal Supply, Non-Reversing</p> <ul style="list-style-type: none"> Input must be active for the drive to run. When input is opened, the drive will stop as specified by P037 [Stop Mode]. Drive will not run if I/O Terminal 03 is open. Drive will coast to stop if opened while running. Drive will fault if I/O Terminal 01 is open. Drive will coast to stop if opened while running. Requires drive reset once terminal is closed. 		<p>DIP Switch SNK/SRC = SRC</p> <p>Parameters P036 [Start Source] = 6 "2-W Lvl/Enbl" P037 [Stop Mode] = 0 through 7</p>
<p>3 Wire Control</p> <p>Sourcing (SRC), Internal Supply, Non-Reversing</p> <ul style="list-style-type: none"> A momentary input will start the drive. A stop input to I/O Terminal 01 will stop the drive as specified by P037 [Stop Mode]. 		<p>DIP Switch SNK/SRC = SRC</p> <p>Parameters P036 [Start Source] = 1 "3-Wire" P037 [Stop Mode] = 0 through 7</p>
<p>3 Wire Control</p> <p>Sourcing (SRC), Internal Supply, Reversing</p> <ul style="list-style-type: none"> A momentary input will start the drive. A stop input to I/O Terminal 01 will stop the drive as specified by P037 [Stop Mode]. I/O Terminal 03 determines direction. 		<p>DIP Switch SNK/SRC = SRC</p> <p>Parameters P036 [Start Source] = 1 "3-Wire" P037 [Stop Mode] = 0 through 7 A166 [Reverse Disable] = 0 "Rev Enabled"</p>
<p>Opto Output</p> <ul style="list-style-type: none"> When using Opto Output with an inductive load such as a relay, install a recovery diode parallel to the relay as shown to prevent damage to the output. Opto Output is rated 30V DC, 50 mA (non-inductive). 		<p>Parameters T065 [Opto Out Sel] = 0 through 15 T066 [Opto Out Level] T068 [Opto Out Logic]</p>

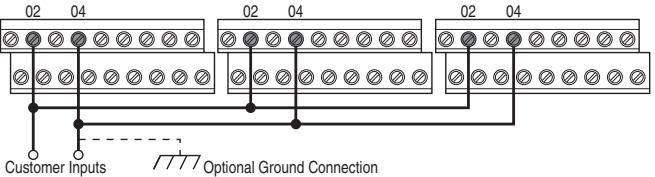
Typical Multiple Drive Connection Examples

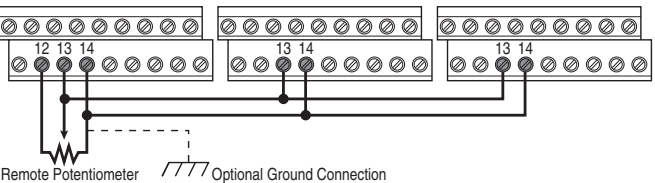
Input/Output	Connection Example
<p>Multiple Digital Input Connections</p> <p>Customer Inputs can be wired per the External Supply (SRC) example on page 34.</p>	 <p>When connecting a single input such as Run, Stop, Reverse or Preset Speeds to multiple drives, it is important to connect I/O Terminal 04 common together for all drives. If they are to be tied into another common (such as earth ground or separate apparatus ground) only one point of the daisy chain of I/O Terminal 04 should be connected.</p> <div style="border: 1px solid black; padding: 5px; margin-top: 10px;">  <p>ATTENTION: Digital inputs on multiple drives should not be tied together when using SNK (Internal Supply) mode. In SNK mode, if power is removed from one drive, inadvertent operation of other drives that share the same I/O Common connection may occur.</p> </div>
<p>Multiple Analog Connections</p>	 <p>When connecting a single potentiometer to multiple drives it is important to connect I/O Terminal 14 common together for all drives. I/O Terminal 14 common and I/O Terminal 13 (potentiometer wiper) should be daisy-chained to each drive. All drives must be powered up for the analog signal to be read correctly.</p>

Start and Speed Reference Control

The drive speed command can be obtained from a number of different sources. The source is normally determined by P038 [Speed Reference]. The drive Start command is normally determined by P036 [Start Source]. However, the settings for these parameters can be overridden by a variety of methods. See the chart below for the override priority.

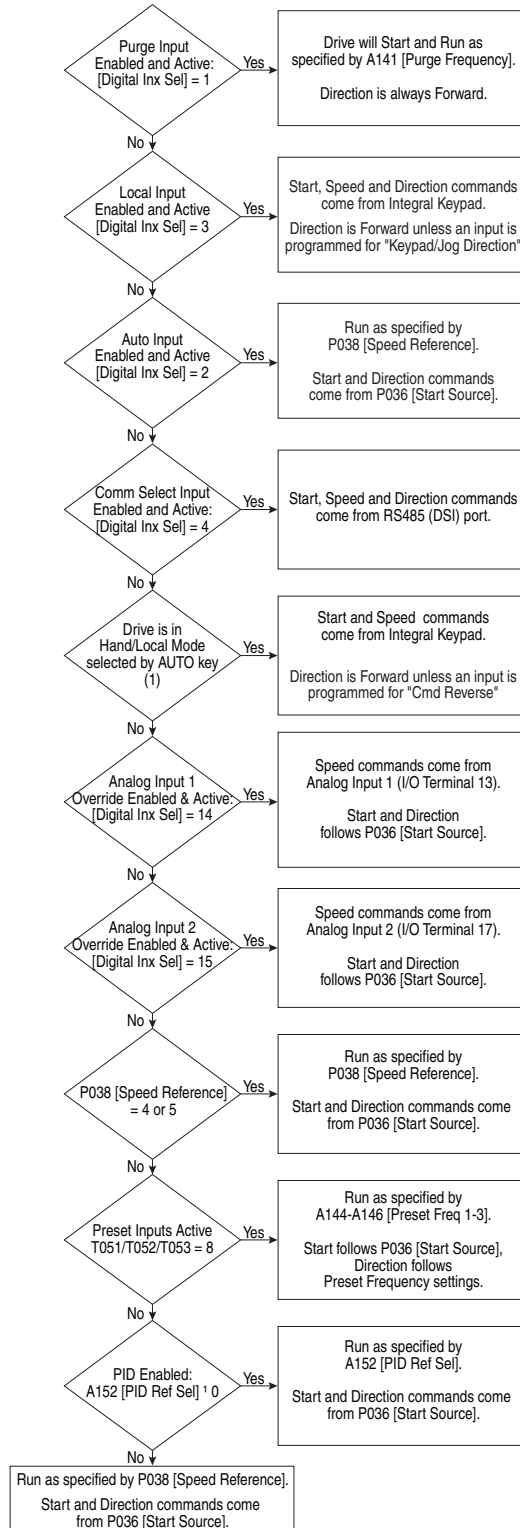

(1) Refer to [page 50](#) for additional information on the operation of the Hand/ Auto Mode.

Accel/Decel Selection

The Accel/Decel rate can be obtained by a variety of methods. The default rate is determined by [P039](#) [Accel Time 1] and [P040](#) [Decel Time 1]. Alternative Accel/Decel rates can be made through digital inputs, RS485 (DSI) communications and/or parameters. See the chart below for the override priority.

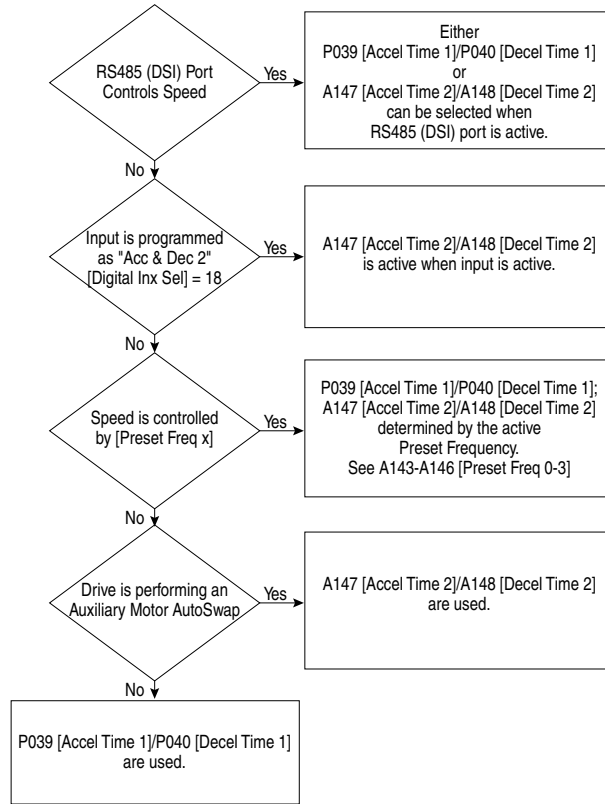

RS485 Network Wiring

Network wiring consists of a shielded 2-conductor cable that is daisy-chained from node to node.

Figure 12 - Network Wiring Diagram

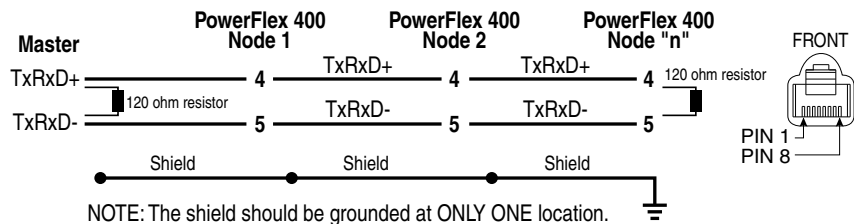

Only pins 4 and 5 on the RJ45 plug should be wired. The other pins on the PowerFlex 400 RJ45 socket contain power, etc. for other Rockwell Automation peripheral devices and must not be connected.

Wiring terminations on the master controller will vary depending on the master controller used and “TxRxD+” and “TxRxD-” are shown for illustration purposes only. Refer to the master controller’s user manual for network terminations. Note that there is no standard for the “+” and “-” wires, and consequently Modbus device manufacturers interpret them differently. If you have problems with initially establishing communications, try swapping the two network wires at the master controller.

On Drive Connections

PowerFlex 400 Frame D, E, F, G and H drives are equipped with two RS485 (DSI) ports. One is accessible via an access door when the cover is on and one is only accessible with the cover off. When one of these ports has a Rockwell DSI device connected, the second port cannot be used.

Figure 13 - Frame D, E, F, G and H RS485 Ports

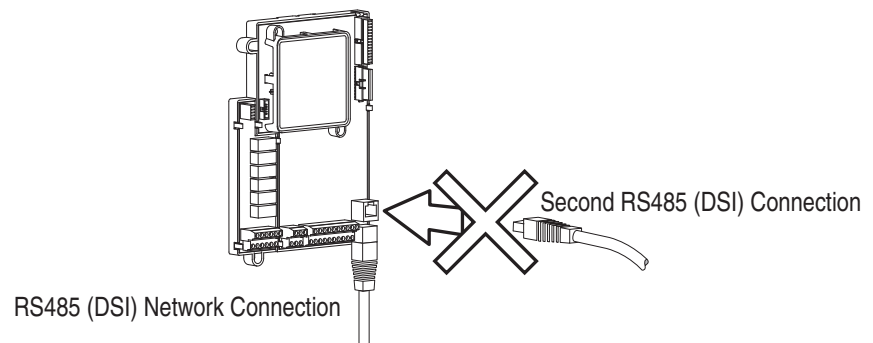

EMC Instructions

CE Conformity

Conformity with the Low Voltage (LV) Directive and Electromagnetic Compatibility (EMC) Directive has been demonstrated using harmonized European Norm (EN) standards published in the Official Journal of the European Communities. PowerFlex Drives comply with the EN standards listed below when installed according to the User Manual.

CE Declarations of Conformity are available online at:
<http://www.rockwellautomation.com/certification/overview.page>.

Low Voltage Directive (2014/35/EU)

- EN 61800-5-1 Electronic equipment for use in power installations.

EMC Directive (2014/30/EU)

- EN61800-3 Adjustable speed electrical power drive systems Part 3: EMC product standard including specific test methods.

General Notes

All Drive Frames

- The motor cable should be kept as short as possible in order to avoid electromagnetic emission as well as capacitive currents.
- Use of line filters in ungrounded systems is not recommended.
- Conformity of the drive with CE EMC requirements does not guarantee an entire machine installation complies with CE EMC requirements. Many factors can influence total machine/installation compliance.

Frame C Drives Only

- If the plastic top panel is removed or the optional conduit box is not installed, the drive must be installed in an enclosure with side openings less than 12.5 mm (0.5 in.) and top openings less than 1.0 mm (0.04 in.) to maintain compliance with the LV Directive.

Essential Requirements for CE Compliance

Conditions 1...4 listed below **must be** satisfied for PowerFlex drives to meet the requirements of **EN61800-3**.

1. Grounding as described in [Figure 14](#). Refer to [page 20](#) for additional grounding recommendations.
2. Output power, control (I/O) and signal wiring must be braided, shielded cable with a coverage of 75% or better, metal conduit or equivalent attenuation.
3. All shielded cables should terminate with the proper shield connector.
4. Conditions in [Table 12](#).

Table 12 - PowerFlex 400 – EN61800-3 Compliance

PowerFlex 400 Drive		First Environment Restricted			First Environment Unrestricted		
kW (HP)	Cat No. 22C-...	Required Filter (Allen-Bradley)	Restrict Motor Cable to (Meters)	Install Drive and Filter in Shielded Enclosure	Required Filter	Restrict Motor Cable to (Meters)	Install Drive and Filter in Shielded Enclosure
200...240 Volts							
2.2 (3.0)	B012N103	22-RF034-CS	10	No	22-RF034-CS	1	Required
3.7 (5.0)	B017N103	22-RF034-CS	10	No	22-RF034-CS	1	Required
5.5 (7.5)	B024N103	22-RF034-CS	10	No	22-RF034-CS	1	Required
7.5 (10)	B033N103	22-RF034-CS	10	No	22-RF034-CS	1	Required
11 (15)	B049A103	22-RFD070	150	Required	Deltron MIF Series	50	Required
15 (20)	B065A103	22-RFD100	150	Required	Deltron MIF Series	50	Required
18.5 (25)	B075A103	22-RFD100	150	Required	Deltron MIF Series	50	Required
22 (30)	B090A103	22-RFD150	150	Required	Deltron MIF Series	50	Required

Table 12 - PowerFlex 400 – EN61800-3 Compliance

PowerFlex 400 Drive		First Environment Restricted			First Environment Unrestricted		
kW (HP)	Cat No. 22C-...	Required Filter (Allen-Bradley)	Restrict Motor Cable to (Meters)	Install Drive and Filter in Shielded Enclosure	Required Filter	Restrict Motor Cable to (Meters)	Install Drive and Filter in Shielded Enclosure
30 (40)	B120A103	22-RFD150	150	No	Deltron MIF Series	50	Required
37 (50)	B145A103	22-RFD180	150	No	Deltron MIF Series	75	Required
380...480 Volts							
2.2 (3.0)	D6P0N103	22-RF018-CS	10	No	22-RF018-CS	1	Required
4.0 (5.0)	D010N103	22-RF018-CS	10	No	22-RF018-CS	1	Required
5.5 (7.5)	D012N103	22-RF018-CS	10	No	22-RF018-CS	1	Required
7.5 (10)	D017N103	22-RF018-CS	10	No	22-RF018-CS	1	Required
11 (15)	D022N103	22-RF026-CS	10	No	22-RF026-CS	1	Required
15 (20)	D030N103	22-RFD036	100	No	Deltron MIF Series	5	Required
18.5 (25)	D038A103	22-RFD050	150	No	Deltron MIF Series	5	Required
22 (30)	D045A103	22-RFD050	150	No	Deltron MIF Series	5	Required
30 (40)	D060A103	22-RFD070	50	No	Deltron MIF Series	5	Required
37 (50)	D072A103	22-RFD100	50	No	Deltron MIF Series	5	Required
45 (60)	D088A103	22-RFD100	50	No	Deltron MIF Series	5	Required
55 (75)	D105A103	22-RFD150	150	No	Deltron MIF Series	5	Required
75 (100)	D142A103	22-RFD180	50	No	Deltron MIF Series	5	Required
90 (125)	D170A103	22-RFD208	50	No	22-RFD208	5	Required
110 (150)	D208A103	22-RFD208	50	No	22-RFD208	5	Required
132 (200)	D260A103	22-RFD323	50	Required	22-RFD323	5	Required
160 (250)	D310A103	22-RFD480	50	Required	22-RFD480	5	Required
200 (300)	D370A103	22-RFD480	50	Required	22-RFD480	5	Required
250 (350)	D460A103	22-RFD480	50	Required	22-RFD480	5	Required

Figure 14 - Connections and Grounding

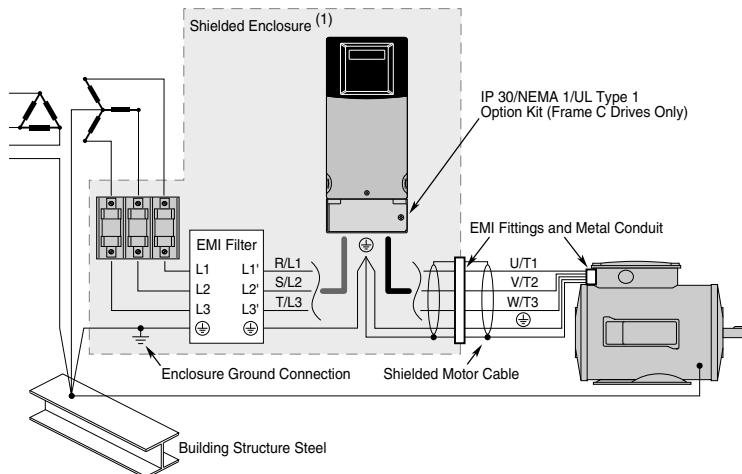

(1) Shielded Enclosure required to meet EN61800-3 First Environment Restricted for 200-240V AC 11-22 kW (15-30 HP) PowerFlex 400 drives and to meet EN61800-3 First Environment Unrestricted for all PowerFlex 400 ratings.

FCC Instructions

FCC Compliance

This equipment has been tested and found to comply with the limits for a Class A digital device, pursuant to Part 15 of the FCC Rules when installed according to the User Manual. These limits are designed to provide reasonable protection against harmful interference when the equipment is operated in a commercial environment. This equipment generates, uses, and can radiate radio frequency energy and if not installed and used in accordance with the User Manual, may cause harmful interference to radio communications. Operation of this equipment in a residential area is likely to cause harmful interference in which case the user will be required to correct the interference at their own expense.

Essential Requirements for FCC Compliance

Conditions 1...4 listed below must be satisfied for PowerFlex 400 drives to meet the requirements of FCC Part 15 Subpart B.

1. Grounding as described in [Figure 15](#). Refer to [page 20](#) for additional grounding recommendations.
2. Output power, control (I/O) and signal wiring must be braided, shielded cable with a coverage of 75% or better, metal conduit or equivalent attenuation.
3. All shielded cables should terminate with the proper shield connector.
4. Conditions in [Table 13](#).

Table 13 - PowerFlex 400 – FCC Part 15 Subpart B Compliance

PowerFlex 400 Drive		Required Filter	Restrict Motor Cable to (Meters)	Install Drive and Filter in Enclosure
kW (HP)	Cat No.			
200...240 Volts				
2.2 (3.0)	22C-B012N103	22-RF034-CS	10	No
3.7 (5.0)	22C-B017N103	22-RF034-CS	10	No
5.5 (7.5)	22C-B024N103	22-RF034-CS	10	No
7.5 (10)	22C-B033N103	22-RF034-CS	10	No
11 (15)	22C-B049A103	22-RFD070	150	Required
15 (20)	22C-B065A103	22-RFD100	150	Required
18.5 (25)	22C-B075A103	22-RFD100	150	Required
22 (30)	22C-B090A103	22-RFD150	150	Required
30 (40)	22C-B120A103	22-RFD150	150	No
37 (50)	22C-B145A103	22-RFD180	150	No
380...480 Volts				
2.2 (3.0)	22C-D6P0N103	22-RF018-CS	10	No
4.0 (5.0)	22C-D010N103	22-RF018-CS	10	No
5.5 (7.5)	22C-D012N103	22-RF018-CS	10	No

Table 13 - PowerFlex 400 – FCC Part 15 Subpart B Compliance

PowerFlex 400 Drive		Required Filter	Restrict Motor Cable to (Meters)	Install Drive and Filter in Enclosure
kW (HP)	Cat No.			
7.5 (10)	22C-D017N103	22-RF018-CS	10	No
11 (15)	22C-D022N103	22-RF026-CS	10	No
15 (20)	22C-D030N103	22-RFD036	100	No
18.5 (25)	22C-D038A103	22-RFD050	150	No
22 (30)	22C-D045A103	22-RFD050	150	No
30 (40)	22C-D060A103	22-RFD070	50	No
37 (50)	22C-D072A103	22-RFD100	50	No
45 (60)	22C-D088A103	22-RFD100	50	No
55 (75)	22C-D105A103	22-RFD150	150	No
75 (100)	22C-D142A103	22-RFD180	50	No
90 (125)	22C-D170A103	22-RFD208	50	No
110 (150)	22C-D208A103	22-RFD208	50	No
132 (200)	22C-D260A103	22-RFD323	50	Required
160 (250)	22C-D310A103	22-RFD480	50	Required
200 (300)	22C-D370A103	22-RFD480	50	Required
250 (350)	22C-D460A103	22-RFD480	50	Required

Figure 15 - Connections and Grounding

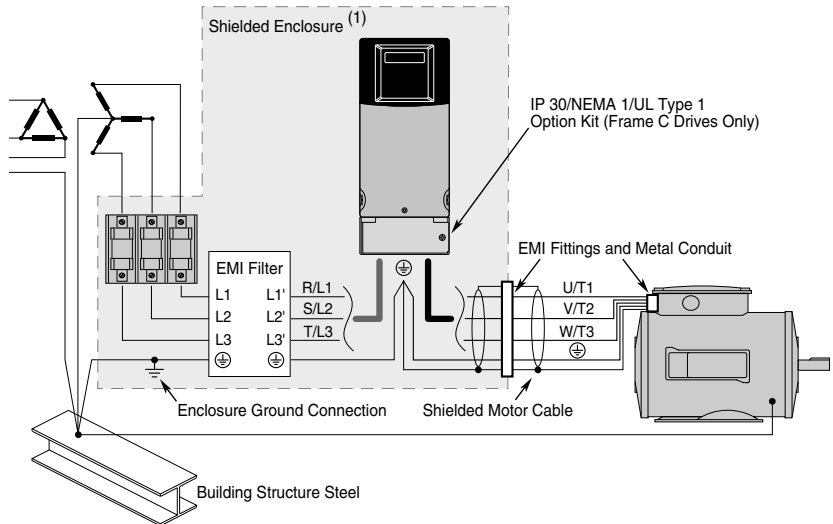

(1) Shielded Enclosure required for 200-240V AC 11-22 kW (15-30 HP) PowerFlex 400 drives.

Notes:

Start Up

This chapter describes how to start up the PowerFlex 400 Drive. To simplify drive setup, the most commonly programmed parameters are organized in a single Basic Program Group.

For information on...	See page
Prepare For Drive Start-Up	45
Integral Keypad	47
Viewing and Editing Parameters	49

IMPORTANT Read the *General Precautions* section before proceeding.



ATTENTION: Power must be applied to the drive to perform the following start-up procedures. Some of the voltages present are at incoming line potential. To avoid electric shock hazard or damage to equipment, only qualified service personnel should perform the following procedure. Thoroughly read and understand the procedure before beginning. If an event does not occur while performing this procedure, **Do Not Proceed. Remove All Power** including user supplied control voltages. User supplied voltages may exist even when main AC power is not applied to the drive. Correct the malfunction before continuing.

Prepare For Drive Start-Up

Before Applying Power to the Drive

1. Confirm that all inputs are connected to the correct terminals and are secure.
2. Verify that AC line power at the disconnect device is within the rated value of the drive.
3. Verify that any digital control power is 24 volts.
4. Verify that the Sink (SNK)/Source (SRC) Setup DIP Switch is set to match your control wiring scheme. See [Table 9 on page 30](#) for location.

IMPORTANT The default control scheme is Source (SRC). The Stop terminal is jumpered (I/O Terminals 01 and 11) to allow starting from the keypad. If the control scheme is changed to Sink (SNK), the jumper must be removed from I/O Terminals 01 and 11 and installed between I/O Terminals 01 and 04.

5. Verify that the Stop input is present or the drive will not start.

IMPORTANT If I/O Terminal 01 is used as a stop input, the jumper between I/O Terminals 01 and 11 must be removed.

6. Verify that the Analog I/O DIP Switches are set to 10 volts.

Applying Power to the Drive

7. Apply AC power and control voltages to the drive.
8. .8. Familiarize yourself with the integral keypad features (see [page 47](#)) before setting any Program Group parameters.

Start, Stop, Direction and Speed Control

Factory default parameter values allow the drive to be controlled from the integral keypad. No programming is required to start, stop, and control speed directly from the integral keypad.

If a fault appears on power up, refer to [Fault Descriptions on page 115](#) for an explanation of the fault code.

Integral Keypad







Operator Keys

Key	Name	Description
	Escape	Back one step in programming menu. Cancel a change to a parameter value and exit Program Mode.
	Select	Advance one step in programming menu. Select a digit when viewing parameter value.
	Up Arrow Down Arrow	Scroll through groups and parameters. Increase/decrease the value of a flashing digit.
	Enter	Advance one step in programming menu. Save a change to a parameter value.
	Digital Speed Increment and Decrement Arrows	Used to control speed of drive. Default is active. Control is activated by parameter P038 [Speed Reference] or P042 [Auto Mode].
	Run/Start & Hand ⁽¹⁾	Used to start the drive. Default is Hand mode as controlled by parameter P042 [Auto Mode]. Control is activated by parameter P036 [Start Source] or P042 [Auto Mode].
	Auto ⁽¹⁾	Used to select Auto control mode. Controlled by parameter P042 [Auto Mode].
	Stop/Off	Used to stop the drive or clear a fault. This key is always active. Controlled by parameter P037 [Stop Mode].

(1) Important: Certain digital input settings can override drive operation. Refer to [Start and Speed Reference Control on page 37](#) for details.

LED Status Indicators

LED	LED State	Description
Program Status 	Steady Red	Indicates parameter value can be changed. Selected digit will flash.
Fault Status 	Flashing Red	Indicates that the drive is faulted.
Speed Status 	Steady Green	Indicates that the digital speed control keys are enabled.
Hand Status 	Steady Green	Indicates that the Run/Start key is enabled.
Auto Status 	Steady Yellow	Indicates that the drive is in Auto mode.

LCD Display

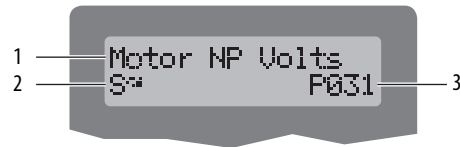



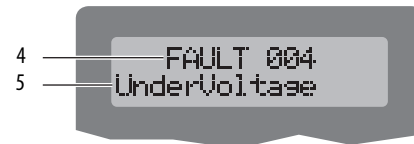







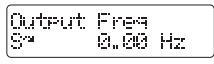



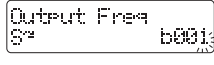

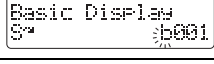

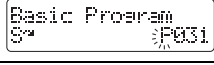

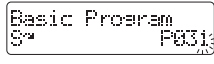





No.	Description
1	Parameter Name
2	Run/Stop Status: = S^{on} & S^{off} Stopped / R^{on} & R^{off} = Running R^{on} or R^{off} flashes to indicate that the drive is stopping, but is still decelerating. R^{on} or R^{off} flashes when DC Injection is commanded. Direction Indication: The Direction Arrow \uparrow & \downarrow indicates the commanded direction of rotation. If the Arrow is flashing, the drive has been commanded to change direction, but is still decelerating. Sleep Mode Indication: R^{on} or R^{off} flashes to indicate that the drive is in sleep mode.
3	Parameter Group and Number: b = Basic Display P = Basic Program T = Terminal Block C = Communications A = Advanced Program R = Aux Relay Card d = Advanced Display



4	Fault Indication and Fault Number
5	Fault Name

Viewing and Editing Parameters

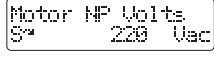
The last user-selected Basic Display Group parameter is saved when power is removed and is displayed by default when power is reapplied. The following is an example of basic integral keypad and display functions. This example provides basic navigation instructions and illustrates how to program the first Basic Program Group parameter.

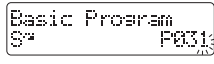
Step	Key(s)	Example Displays
1. When power is applied, the last user-selected Basic Display Group parameter number is displayed with flashing characters. The display then defaults to that parameter's current value. (Example shows the value of b001 [Output Freq] with the drive stopped.)	 HAND	
2. Press the Up Arrow or Down Arrow to scroll through the Basic Display Group parameters. (Only in Display Groups)	 or 	
3. Press Esc once to display the Basic Display Group parameter number shown on power-up. The parameter number will flash.		
4. Press Esc again to enter the group menu. The group menu letter will flash.		
5. Press the Up Arrow or Down Arrow to scroll through the group menu (b, P, T, C, A and d).	 or 	
6. Press Enter or Sel to enter a group. The right digit of the last viewed parameter in that group will flash.	 or 	
7. Press the Up Arrow or Down Arrow to scroll through the parameters that are in the group.	 or 	
8. Press Enter or Sel to view the value of a parameter. If you do not want to edit the value, press Esc to return to the parameter number.	 or 	
9. Press Enter or Sel to enter program mode to edit the parameter value. The right digit will flash and the Program LED will illuminate if the parameter can be edited.	 or 	
10. If desired, press Sel to move from digit to digit or bit to bit. The digit or bit that you can change will flash.		
11. Press the Up Arrow or Down Arrow to change the parameter value.	 or 	
12. Press Esc to cancel a change. The digit will stop flashing, the previous value is restored and the Program LED will turn off. Or Press Enter to save a change. The digit will stop flashing and the Program LED will turn off.	 	
13. Press Esc to return to the parameter list. Continue to press Esc to back out of the programming menu. If pressing Esc does not change the display, then b001 [Output Freq] is displayed. Press Enter or Sel to enter the last group menu viewed.		

The Basic Program Group ([page 61](#)) contains the most commonly changed parameters.

Keypad Hand-Off-Auto Functions

Parameter P042 [Auto Mode] defines the operation mode of the control keys on the integral keypad.

Hand-Off-Auto Mode











In HAND mode:

- Control keys operate as Hand-Off-Auto.
- Start command and speed reference come from the integral keypad Start/Hand and Digital Speed Increment and Decrement keys.
- Auto key switches control from HAND mode to AUTO mode in a bumpless transfer as long as there is an active Run command.

In AUTO mode:

- Auto key LED is illuminated.
- Start command is defined by [P036](#) [Start Source].
- Speed Reference command is defined by [P038](#) [Speed Reference].
- Start/Hand key switches control to the integral keypad in a bumpless transfer and switches the speed reference to the integral keypad.
- Stop key stops the drive and the drive switches to HAND mode.

**Table 14 - P042 [Auto Mode] = 1 “Hnd-Off-Auto” (Default)
T051-T054 [Digital Inx Sel] ≠ 2 “Auto Mode” or 3 “Local”**

Key	HAND Mode		AUTO Mode	
	LED	Key Function	LED	Key Function
	On 	Starts drive. Runs according to Speed Increment/ Decrement keys.	On 	Changes to HAND Mode and Starts drive. Runs according to Speed Increment/ Decrement keys.
	On 	Changes speed.	Off 	Not active. Keys are only active if P038 [Speed Source] = 0 “Drive Pot”.
	Off 	Changes to AUTO Mode.	On 	Not active.
	N/A	Stops drive.	N/A	Changes to HAND Mode and Stops drive.

IMPORTANT Certain digital input settings can override drive operation. Refer to [Start and Speed Reference Control on page 37](#) for details.

Local/Remote Mode

In Local mode:











- Start command and speed reference come from the integral keypad Start/Hand and Digital Speed Increment and Decrement keys.
- Auto key stops the drive and the drive switches to Remote mode.

IMPORTANT If the drive is running and P036 [Start Source] = 3 or 6 (2-Wire Control), the drive will continue to run at reference defined by P038 [Speed Reference] if a valid start command is present

In Remote mode:

- Auto key LED is illuminated.
- Start command is defined by [P036](#) [Start Source].
- Speed Reference command is defined by [P038](#) [Speed Reference].
- Auto key stops the drive and the drive switches to Local mode.

**Table 15 - P042 [Auto Mode] = 2 "Local/Remote"
T051-T054 [Digital Inx Sel] ≠ 2 "Auto Mode" or 3 "Local"**

Key	Local Mode		Remote Mode	
	LED	Key Function	LED	Key Function
	On 	Starts drive. Runs according to Speed Increment/ Decrement keys.	Off 	Not active. Only active if P036 [Start Source] = 0 "Keypad". Starts drive.
	On 	Changes speed.	Off 	Not active. Keys are only active if P038 [Speed Source] = 0 "Drive Pot".
	Off 	Stops drive and changes to Remote Mode.	On 	Stops drive and changes to Local Mode.
	N/A	Stops drive.	N/A	Changes to HAND Mode and Stops drive.

IMPORTANT Certain digital input settings can override drive operation.
Refer to [Start and Speed Reference Control on page 37](#) for details.

Auto/Manual Mode











In Manual mode:

- Start command is defined by [P036](#) [Start Source].
- Speed Reference command is defined by the Digital Speed Increment and Decrement keys.
- Auto key toggles frequency control to AUTO in a bumpless transfer.

In AUTO mode:

- Auto key LED is illuminated.
- Start command is defined by [P036](#) [Start Source].
- Speed Reference command is defined by [P038](#) [Speed Reference].
- Auto key switches frequency control to the integral keypad in a bumpless transfer.

Table 16 - P042 [Auto Mode] = 2 "Auto/Manual" T051-T054 [Digital Inx Sel] ≠ 2 "Auto Mode" or 3 "Local"

Key	Manual Mode		AUTO Mode	
	LED	Key Function	LED	Key Function
	Off 	Not active. Only active if P036 [Start Source] = 0 "Keypad". Starts drive. Runs according to Speed Increment/Decrement keys.	Off 	Not active. Only active if P036 [Start Source] = 0 "Keypad". Starts drive.
	On 	Changes speed.	Off 	Not active. Keys are only active if P038 [Speed Source] = 0 "Drive Pot".
	Off 	Changes to AUTO Mode. If running, drive will continue to run at reference defined by P038 [Speed Reference].	On 	Changes to Manual Mode. If running, drive will continue to run according to Digital Speed Increment and Decrement keys.
	N/A	Stops drive.	N/A	Stops drive.







IMPORTANT Certain digital input settings can override drive operation. Refer to [Start and Speed Reference Control on page 37](#) for details.

No Function Mode

In No Function mode:

- Auto key LED has no function.
- Start command is defined by [P036](#) [Start Source].
- Speed Reference command is defined by [P038](#) [Speed Reference].

**Table 17 - P042 [Auto Mode] = 0 “No Function”
T051-T054 [Digital Inx Sel] ≠ 2 “Auto Mode” or 3 “Local”**

Key	LED	Key Function
	Off 	Not active. Only active if P036 [Start Source] = 0 “Keypad”. Starts drive.
	On 	Not active. Only active if P038 [Speed Reference] = 0 “Drive Pot”. Changes drive speed.
	Off 	Not active.
	N/A	Stops drive.

IMPORTANT Certain digital input settings can override drive operation.
Refer to [Start and Speed Reference Control on page 37](#) for details.

Notes:

Programming and Parameters

This chapter provides a complete listing and description of the PowerFlex 400 parameters. Parameters are programmed (viewed/edited) using the integral keypad. As an alternative, programming can also be performed using DriveExecutive™ software or Connected Components WorkBench™ version 1.0 or greater software, a personal computer and a serial converter module. Refer to [Appendix B](#) for catalog numbers.

In addition programming can also be performed using design software RS Logix 5000 version 16.0 or greater or Studio 5000 version 21.0 or greater with appropriate communication option kits and accessories listed in [Appendix B](#).

For information on...	See page
About Parameters	55
Parameter Organization	56
Basic Display Group	58
Basic Program Group	61
Terminal Block Group	66
Communications Group	79
Advanced Program Group	83
Aux Relay Card Group	98
Advanced Display Group	83
Parameter Cross Reference by Name	110

About Parameters

To configure a drive to operate in a specific way, drive parameters may have to be set. Three types of parameters exist:

- **ENUM**
ENUM parameters allow a selection from 2 or more items. Each item is represented by a number.
- **Numeric Parameters**
These parameters have a single numerical value (0.1V).
- **Bit Parameters**
Bit parameters have four or more individual bits associated with features or conditions. If the bit is 0, the feature is off or the condition is false. If the bit is 1, the feature is on or the condition is true.

Some parameters are marked as follows.



= Stop drive before changing this parameter.



= 32 bit parameter. Parameters marked 32 bit will have two parameter numbers when using RS485 communications and programming software.

Parameter Organization

Refer to [page 110](#) for an alphabetical listing of parameters.

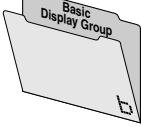
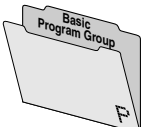
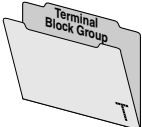
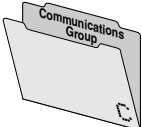
Basic Display 	Output Freq	b001	DC Bus Voltage	b005	Output Power	b010	Torque Current	b013	
	Commanded Freq	b002	Drive Status	b006	Elapsed MWh	b011	Drive Temp	b014	
	Output Current	b003	Fault 1 Code	b007	Elapsed RunTime	b012	Elapsed kWh	b015	
	Output Voltage	b004	Process Display	b008					
Basic Program 	Motor NP Volts	P031	Maximum Freq	P035	Speed Reference	P038	Reset To Defaults	P041	
	Motor NP Hertz	P032	Start Source	P036	Accel Time 1	P039	Auto Mode	P042	
	Motor OL Current	P033	Stop Mode	P037	Decel Time 1	P040	Motor OL Ret	P043	
	Minimum Freq	P034							
Terminal Block 	Digital In1 Sel	T051	Relay 2 On Time	T063	Analog In 2 Lo	T074	Analog Out1 High	T083	
	Digital In2 Sel	T052	Relay 2 Off Time	T064	Analog In 2 Hi	T075	Analog Out1 Setpt	T084	
	Digital In3 Sel	T053	Opto Out Sel	T065	Analog In 2 Loss	T076	Analog Out2 Sel	T085	
	Digital In4 Sel	T054	Opto Out Level	T066	Sleep-Wake Sel	T077	Analog Out2 High	T086	
	Relay Out1 Sel	T055	Opto Out Logic	T068	Sleep Level	T078	Analog Out2 Setpt	T087	
	Relay Out1 Level	T056	Analog In 1 Sel	T069	Sleep Time	T079	Anlg Loss Delay	T088	
	Relay 1 On Time	T058	Analog In 1 Lo	T070	Wake Level	T080	Analog In Filter	T089	
	Relay 1 Off Time	T059	Analog In 1 Hi	T071	Wake Time	T081	Sleep Sel	T090	
	Relay Out2 Sel	T060	Analog In 1 Loss	T072	Analog Out1 Sel	T082	Wake Sel	T091	
	Relay Out2 Level	T061	Analog In 2 Sel	T073					
	Communication 	Language	C101	Comm Node Addr	C104	Comm Loss Time	C106	Start Source 2	C108
		Comm Format	C102	Comm Loss Action	C105	Comm Write Mode	C107	Speed Ref 2	C109
Comm Data Rate		C103							

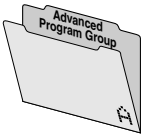
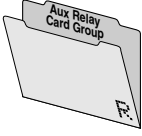
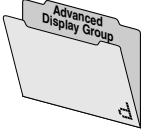
Advanced Program 	Purge Frequency	A141	PID Deadband	A158	DC Brake Level	A177	Compensation	A194
	Internal Freq	A142	PID Preload	A159	DC Brk Time@Strt	A178	Reset Meters	A195
	Preset Freq 0	A143	Process Factor	A160	Current Limit 1	A179	Testpoint Sel	A196
	Preset Freq 1	A144	Auto Rstrt Tries	A163	Current Limit 2	A180	Fault Clear	A197
	Preset Freq 2	A145	Auto Rstrt Delay	A164	Motor OL Select	A181	Program Lock	A198
	Preset Freq 3	A146	Start At PowerUp	A165	Drive OL Mode	A182	Motor NP Poles	A199
	Accel Time 2	A147	Reverse Disable	A166	SW Current Trip	A183	Motor NP FLA	A200
	Decel Time 2	A148	Flying Start En	A167	Load Loss Level	A184	PID Invert Error	A201
	S Curve %	A149	PWM Frequency	A168	Load Loss Time	A185	MOP Reset Sel	A202
	PID Trim Hi	A150	PWM Mode	A169	Stall Fault Time	A186	Wake Deviation	A203
	PID Trim Lo	A151	Boost Select	A170	Bus Reg Mode	A187	ACT1 Input	A204
	PID Ref Sel	A152	Start Boost	A171	Skip Frequency 1	A188	ACT2 Input	A205
	PID Feedback Sel	A153	Break Voltage	A172	Skip Freq Band 1	A189	ACT1 Minimum	A206
	PID Prop Gain	A154	Break Frequency	A173	Skip Frequency 2	A190	ACT1 Maximum	A207
	PID Integ Time	A155	Maximum Voltage	A174	Skip Freq Band 2	A191	ACT2 Minimum	A208
	PID Diff Rate	A156	Slip Hertz @ FLA	A175	Skip Frequency 3	A192	ACT2 Maximum	A209
	PID Setpoint	A157	DC Brake Time	A176	Skip Freq Band 3	A193	Wake PID Preload	A210
Aux Relay Card 	Relay Out3 Sel	R221	Relay Out6 Level	R231	Aux 1 Start Freq	R241	Aux 3 Stop Freq	R248
	Relay Out3 Level	R222	Relay Out7 Sel	R233	Aux 1 Stop Freq	R242	Aux 3 Ref Add	R249
	Relay Out4 Sel	R224	Relay Out7 Level	R234	Aux 1 Ref Add	R243	Aux Start Delay	R250
	Relay Out4 Level	R225	Relay Out8 Sel	R236	Aux 2 Start Freq	R244	Aux Stop Delay	R251
	Relay Out5 Sel	R227	Relay Out8 Level	R237	Aux 2 Stop Freq	R245	Aux Prog Delay	R252
	Relay Out5 Level	R228	Aux Motor Mode	R239	Aux 2 Ref Add	R246	Aux AutoSwap Tme	R253
	Relay Out6 Sel	R230	Aux Motor Qty	R240	Aux 3 Start Freq	R247	Aux AutoSwap Lvl	R254
	Advanced Display 	Control Source	d301	Fault 3 Time-hr	d314	Status @ Fault	d327	Fault 5 Time-hr
Contrl In Status		d302	Fault 3 Time-min	d315	PID Fdbk Display	d328	Fault 5 Time-min	d340
Comm Status		d303	Elapsed Time-hr	d316	DC Bus Ripple V	d329	Fault 6 Time-hr	d341
PID Setpnt Displ		d304	Elapsed Time-min	d317	Fault 4 Code	d330	Fault 6 Time-min	d342
Analog In 1		d305	Output Powr Fctr	d318	Fault 5 Code	d331	Fault 7 Time-hr	d343
Analog In 2		d306	Testpoint Data	d319	Fault 6 Code	d332	Fault 7 Time-min	d344
Fault 1 Code		d307	Control SW Ver	d320	Fault 7 Code	d333	Fault 8 Time-hr	d345
Fault 2 Code		d308	Drive Type	d321	Fault 8 Code	d334	Fault 8 Time-min	d346
Fault 3 Code		d309	Output Speed	d322	Fault 9 Code	d335	Fault 9 Time-hr	d347
Fault 1 Time-hr		d310	Output RPM	d323	Fault 10 Code	d336	Fault 9 Time-min	d348
Fault 1 Time-min		d311	Fault Frequency	d324	Fault 4 Time-hr	d337	Fault10 Time-hr	d349
Fault 2 Time-hr		d312	Fault Current	d325	Fault 4 Time-min	d338	Fault10 Time-min	d350
Fault 2 Time-min		d313	Fault Bus Volts	d326				

Basic Display Group

b001 [Output Freq]

Related Parameter(s): [b002](#), [b008](#), [P034](#), [P035](#), [P038](#)

Output frequency present at T1, T2 & T3 (U, V & W).

Values	Default:	Read Only
	Min/Max:	0.00/ P035 [Maximum Freq]
	Display:	0.01 Hz

b002 [Commanded Freq]

Related Parameter(s): [b001](#), [P034](#), [P035](#), [P038](#), [d302](#)

Value of the active frequency command. Displays the commanded frequency even if the drive is not running.

IMPORTANT The frequency command can come from a number of sources. See [Start and Speed Reference Control on page 37](#) for more information.

Values	Default:	Read Only
	Min/Max:	0.00/ P035 [Maximum Freq]
	Display:	0.01 Hz

b003 [Output Current]

The output current present at T1, T2 & T3 (U, V & W).

Values	Default:	Read Only
	Min/Max:	0.0/(Drive Rated Amps × 2)
	Display:	0.1 Amps

b004 [Output Voltage]

Related Parameter(s): [P031](#), [A170](#), [A174](#)

Output voltage present at terminals T1, T2 & T3 (U, V & W).

Values	Default:	Read Only
	Min/Max:	0/510
	Display:	1 VAC

b005 [DC BusVoltage]

Present DC bus voltage level.

Values	Default:	Read Only
	Min/Max:	0/820
	Display:	1 VDC

b006 [Drive Status]

Related Parameter(s): [A166](#)

Present operating condition of the drive.

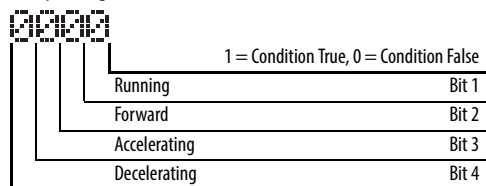

Values	Default:	Read Only
	Min/Max:	0/1
	Display:	1

b007 [Fault 1 Code]

Related Parameter(s): [A186](#), [A197](#), [d307...](#)[d315](#)

A code that represents a drive fault. [Fault 1 Code] is the most recent fault. Repetitive faults will only be recorded once. Refer to [Chapter 4](#) for fault code descriptions.

Values	Default:	Read Only
	Min/Max:	0/122
	Display:	1

b008 [Process Display]

Related Parameter(s): [b001](#), [A160](#)

 32 bit parameter.

Output frequency scaled by A160 [Process Factor]

$$\text{Output Freq} \times \text{Process Factor} = \text{Process Display}$$

Values	Default:	Read Only
	Min/Max:	0.00/9999
	Display:	0.01 – 1

b010 [Output Power]

Output power present at T1, T2 & T3 (U, V & W).

Values	Default:	Read Only
	Min/Max:	0.0/999.9 kW
	Display:	0.1 kW

b011 [Elapsed MWh]

Related Parameter(s): [b015](#), [A195](#)

Accumulated output energy of the drive.

Values	Default:	Read Only
	Min/Max:	0/3276.7 MWh
	Display:	0.1 MWh

b012 [Elapsed Run Time]

Related Parameter(s): [A195](#)

Displays the accumulated time that the drive has output power since the last [A195](#) [Reset Meter]. Time is displayed in 10 hour increments.

Values	Default:	Read Only
	Min/Max:	0/9999 Hrs
	Display:	1 = 10 Hrs

b013 [Torque Current]

Displays the torque portion of the output current.

Values	Default:	Read Only
	Min/Max:	0.0/(Drive Rated Amps × 2)
	Display:	0.1 Amps

b014 [Drive Temp]

Present operating temperature of the drive power section.

Values	Default:	Read Only
	Min/Max:	0/120 degC
	Display:	1 degC

b015 [Elapsed kWh]

Related Parameter(s): [b011](#), [A195](#)

Accumulated output energy of the drive. This parameter works in conjunction with [Elapsed MWh]. When the maximum value of this parameter is reached, this parameter resets to zero and [Elapsed MWh] is incremented.

Values	Default:	Read Only
	Min/Max:	0.0/100.0 kWh
	Display:	0.1 kWh

Basic Program Group

P031 [Motor NP Volts]

Related Parameter(s): [b004](#), [A170](#), [A171](#), [A172](#), [A173](#)

 Stop drive before changing this parameter.

Set to the motor nameplate rated volts.

Values	Default:	Based on Drive Rating
	Min/Max:	20/Drive Rated Volts
	Display:	1 VAC

P032 [Motor NP Hertz]

Related Parameter(s): [A170](#), [A171](#), [A172](#), [A173](#), [A181](#), [A182](#)

 Stop drive before changing this parameter.

Set to the motor nameplate rated frequency.

Values	Default:	60 Hz
	Min/Max:	15/320 Hz
	Display:	1 Hz

P033 [Motor OL Current]

Related Parameter(s): [P042](#), [T055](#), [T060](#), [T065](#), [A175](#), [A179](#), [A180](#), [A181](#), [A183](#)

Set to the maximum allowable motor current. The drive will fault on an F7 [Motor Overload](#) if the value of this parameter is exceeded by 150% for 60 seconds.

Values	Default:	Drive Rated Amps
	Min/Max:	0.0/(Drive Rated Amps × 2)
	Display:	0.1 Amps

P034 [Minimum Freq]

Related Parameter(s): [b001](#), [b002](#), [P035](#), [T070](#), [T074](#), [A171](#), [A172](#), [A173](#), [d302](#)

Set to the maximum allowable motor current. The drive will fault on an F7 [Motor Overload](#) if the value of this parameter is exceeded by 150% for 60 seconds.

Values	Default:	Drive Rated Amps
	Min/Max:	0.0/(Drive Rated Amps × 2)
	Display:	0.1 Amps

P035 [Maximum Freq]

Related Parameter(s): [b001](#), [b002](#), [P034](#), [T071](#), [T075](#), [T082](#), [T083](#), [T085](#), [T086](#), [A171](#), [A172](#), [A173](#), [d302](#)

 Stop drive before changing this parameter.

Sets the highest frequency the drive will output.

Values	Default:	60.0 Hz
	Min/Max:	0.0/320.0 Hz
	Display:	0.1 Hz

P036 [Start Source]

Related Parameter(s): [P037](#), [P042](#), [A166](#), [d301](#)

 Stop drive before changing this parameter.

Sets the control scheme used to start the drive when in Auto/Remote mode.

Refer to [Start and Speed Reference Control on page 37](#) for details about how other drive settings can override the setting of this parameter.

IMPORTANT For all settings except options 3 and 6, the drive must receive a leading edge from the start input for the drive to start after a stop input, loss of power or fault condition.

Options	0 "Keypad"	Integral keypad controls drive operation. <ul style="list-style-type: none"> • I/O Terminal 01 = Stop: Coast to Stop • I/O Terminal 02 = Not Used • I/O Terminal 03 = Not Used
	1 "3-Wire"	I/O Terminal Block controls drive operation. <ul style="list-style-type: none"> • I/O Terminal 01 = Stop: Per P037 [Stop Mode] • I/O Terminal 02 = Start • I/O Terminal 03 = Direction
	2 "2-Wire"	I/O Terminal Block controls drive operation. <ul style="list-style-type: none"> • I/O Terminal 01 = Stop: Coast to Stop • I/O Terminal 02 = Run FWD • I/O Terminal 03 = Run REV
	3 "2-W Lvl Sens" (Default)	I/O Terminal Block controls drive operation. <ul style="list-style-type: none"> • I/O Terminal 01 = Stop: Coast to Stop • I/O Terminal 02 = Run FWD • I/O Terminal 03 = Run REV <p>Drive will restart after a "Stop" command when:</p> <ul style="list-style-type: none"> • Stop is removed and Run FWD is held active



ATTENTION: Hazard of injury exists due to unintended operation. When P036 [Start Source] is set to option 3 or option 6, and the Run input is maintained, the Run inputs do not need to be toggled after a Stop input or a fault clear for the drive to run again. The drive will stop only when the stop command is maintained or the drive is faulted.



ATTENTION: When operating in 2-Wire Level Sense (Run Level), the drive should only be controlled from the Digital Input Terminal Blocks. This should NOT be used with any other DSI or Network device.

	4 "2-W Hi Speed"	I/O Terminal Block controls drive operation. <ul style="list-style-type: none"> • I/O Terminal 01 = Stop: Coast to Stop • I/O Terminal 02 = Run FWD • I/O Terminal 03 = Run REV <p>Outputs are kept in a ready-to-run state. The drive will respond to a "Start" command within 10 ms.</p>
--	------------------	---

IMPORTANT There is greater potential voltage on the output terminals when using this option.

	5 "Comm Port"	Remote communications controls drive operation. <ul style="list-style-type: none"> • I/O Terminal 01 = Stop: Coast to Stop • I/O Terminal 02 = Not Used • I/O Terminal 03 = Not Used
	6 "2-W Lvl/Enbl"	I/O Terminal Block controls drive operation. <ul style="list-style-type: none"> • I/O Terminal 01 = Function Loss: Fault and Coast to Stop • I/O Terminal 02 = Run FWD • I/O Terminal 03 = SW Enable <p>Drive will restart after a "Stop" command when:</p> <ul style="list-style-type: none"> • Stop is removed and Run FWD is held active



ATTENTION: Hazard of injury exists due to unintended operation. When P036 [Start Source] is set to option 3 or option 6, and the Run input is maintained, the Run inputs do not need to be toggled after a Stop input or a fault clear for the drive to run again. The drive will stop only when the stop command is maintained or the drive is faulted.

P037 [Stop Mode]

Related Parameter(s): [P036](#), [C105](#), [A176](#), [A177](#), [A178](#)

Active stop mode for all stop sources [e.g. keypad, run forward (I/O Terminal 02), run reverse (I/O Terminal 03), RS485 port] except as noted below.

IMPORTANT I/O Terminal 01 is always a coast to stop input except when [P036](#) [Start Source] is set for "3-Wire" control. When in three wire control, I/O Terminal 01 is controlled by [P037](#) [Stop Mode].

Hardware Enable Circuitry

By default, I/O Terminal 01 is a coast to stop input. The status of the input is interpreted by drive software. If the application requires the drive to be disabled without software interpretation, a "dedicated" hardware enable configuration can be utilized. This is accomplished by removing the ENBL enable jumper on the control board. See [page 29](#) for details. In this case, the drive will always coast to a stop regardless of the settings of [P036](#) [Start Source] and [P037](#) [Stop Mode].

Options		
0	"Ramp, CF" ⁽¹⁾	Ramp to Stop. "Stop" command clears active fault.
1	"Coast, CF" ⁽¹⁾ (Default)	Coast to Stop. "Stop" command clears active fault.
2	"DC Brake, CF" ⁽¹⁾	DC Injection Braking Stop. "Stop" command clears active fault.
3	"DCBrkAuto, CF" ⁽¹⁾	DC Injection Braking Stop with Auto Shutoff. <ul style="list-style-type: none"> • Standard DC Injection Braking for value set in A176 [DC Brake Time]. OR • Drive shuts off if the drive detects that the motor is stopped. "Stop" command clears active fault.
4	"Ramp"	Ramp to stop.
5	"Coast"	Coast to stop.
6	"DC Brake"	DC Injection Braking Stop.
7	"DC BrakeAuto"	DC Injection Braking Stop with Auto Shutoff. <ul style="list-style-type: none"> • Standard DC Injection Braking for value set in A176 [DC Brake Time] OR • Drive shuts off if the drive detects that the motor is stopped.

(1) Stop input also clears active fault.

P038 [Speed Reference]

Related Parameter(s): [b001](#), [b002](#), [P038](#), [P040](#), [P042](#), [T051...T054](#), [T070](#), [T071](#), [T073](#), [T074](#), [T075](#), [C102](#), [A141](#), [A142](#), [A143...A146](#), [A152](#), [d301](#)

Sets the source of the speed reference to the drive.

The drive speed command can be obtained from a number of different sources. The source is normally determined by [P038](#) [Speed Reference]. However, when [T051...T054](#) [Digital Inx Sel] is set to option 1, 2, 3, 4, 5, 8, 14, 15, 16, 17 and the digital input is active, or if [A152](#) [PID Ref Sel] is not set to option 0, the speed reference commanded by [P038](#) [Speed Reference] will be overridden. Refer to the flowchart on [page 37](#) for more information on speed reference control priority.

Options		
0	"Drive Keypad"	Internal frequency command from the digital speed keys on the integral keypad.
1	"InternalFreq"	Internal frequency command from A142 [Internal Freq]. Must be set when using MOP function.
2	"Analog In 1" (Default)	External frequency command from an analog source as determined by T069 [Analog In 1 Sel] and DIP Switch AI1 on the control board. Default Dip Switch setting is 10V.
3	"Analog In 2"	External frequency command from an analog source as determined by T073 [Analog In 2 Sel] and DIP Switch AI2 on the control board. Default Dip Switch setting is 10V.
4	"Preset Freq"	External frequency command as defined by A141...A146 [Preset Freq x] when T051...T054 [Digital Inx Sel] are programmed as "Preset Frequencies" and the digital inputs are active.
5	"Comm Port"	External frequency command from the communications port. Refer to Appendix E and Appendix G for details. Parameter C102 [Comm Format] is used to select a communications protocol.

P039 [Accel Time 1]

Related Parameter(s): [P038, P040, T051...T054, A141, A143...A146, A147](#)

Sets the rate of acceleration for all speed increases.

$$\frac{\text{Maximum Freq}}{\text{Accel Time}} = \text{Accel Rate}$$

Values	Default:	20.00 Secs	2.2-110 kW (3.0-150 HP)
		60.00 Secs	132-250 kW (200-350 HP)
	Min/Max:	0.00/600.00 Secs	
	Display:	0.01 Secs	

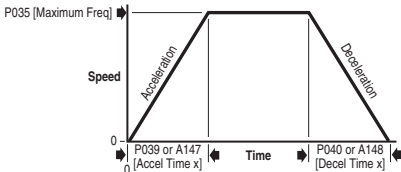

P040 [Decel Time 1]

Related Parameter(s): [P038, P039, T051...T054, A141, A143...A146, A148](#)

Sets the rate of deceleration for all speed decreases.

$$\frac{\text{Maximum Freq}}{\text{Decel Time}} = \text{Decel Rate}$$

Values	Default:	20.00 Secs	2.2-110 kW (3.0-150 HP)
		60.00 Secs	132-250 kW (200-350 HP)
	Min/Max:	0.00/600.00 Secs	
	Display:	0.01 Secs	

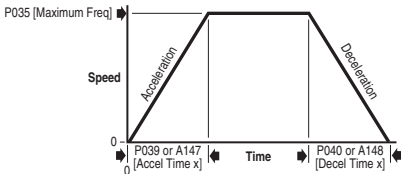

P041 [Reset to Defaults]

Stop drive before changing this parameter.

Resets all parameter values to factory defaults.

IMPORTANT Drives packaged for fan and pump applications ship with custom default settings that differ from Factory Defaults. Setting this parameter to option 1 will require reprogramming of select parameters. Refer to publication [22C-IN002](#) for packaged drive default settings.

Options	0 "Ready/Idle" (Default)	
	1 "Factory Rset"	<ul style="list-style-type: none"> After the reset function is complete, this parameter will set itself back to "0". Causes an F48 Params Defaulted fault.

P042 [Auto Mode]

Related Parameter(s): [P036, P038](#)

Stop drive before changing this parameter.

Determines the operation of the "Auto" key on the integral keypad. Refer to [page 50](#) for details.

Options	0 "No function"	LED above "Auto" key is always dark.
	1 "Hnd-Off-Auto" (Default)	Toggles control start and frequency to and from keypad; starts drive.
	2 "Local/Remote"	Toggles control start and frequency to and from keypad.
	3 "Auto/Manual"	Toggles only the frequency control to and from keypad.

P043 [Motor OL Ret]Related Parameter(s): [P033](#), [A181](#)

Enables/disables the Motor Overload Retention function. When Enabled, the value held in the motor overload counter is saved at power-down and restored at power-up.

Options	0	"Disabled" (Default)
	1	"Enabled"

Terminal Block Group

- T051 [Digital In1 Sel] (I/O Terminal 05)
- T052 [Digital In2 Sel] (I/O Terminal 06)
- T053 [Digital In3 Sel] (I/O Terminal 07)
- T054 [Digital In4 Sel] (I/O Terminal 08)

Related Parameter(s): [P036](#), [P038](#), [P039](#), [P040](#) [A141](#), [A142](#), [A143](#)...[A146](#), [A147](#), [A148](#), [A166](#), [A177](#), [A180](#), [d301](#), [d302](#)

Stop drive before changing this parameter.

Selects the function for the digital inputs. Refer to the flowchart on [page 37](#) for more information on speed reference control priority.

Options		
0	"Not Used"	Terminal has no function but can be read over network communications via d302 [Contrl In Status].
1	"Purge" ⁽¹⁾ (T051 Default)	Starts the drive at Purge speed regardless of the selected start source. Purge can occur, and is operational, at any time whether the drive is running or stopped. If a valid stop condition is present, other than from the Comm Port or SW Enable input (I/O Terminal 03), the drive will not start on the Purge Input Transition.
ATTENTION: A Purge command will take precedence over a stop command from the Comm Port/ Network and over a SW Enable command from the terminal block. Insure that another stop method is available, such as I/O Terminal 01 of the control terminal block, if stopping is necessary during a purge.		
2	"Auto Mode" (1)	When active, forces drive into "Auto" control mode. Start source determined by P036 [Start Source] and speed reference determined by P038 [Speed Reference].
3	"Local" (1) (T052 Default)	When active, sets integral keypad as start source and digital speed keys on the integral keypad as speed source.
4	"Comm Port" (1) (T054 Default)	When active, sets communication device as default start/ speed command source.
5	"PID Disable"	Disables PID function. Drive uses the next valid non-PID speed reference.
6	"PID Hold"	Drive output remains at current value. The integrator for Process PID loop is also clamped at current value.
7	"PID Reset"	The integrator for the Process PID loop is reset to zero and drive output is set to Preload value.
8	"Preset Freq"	Preset speed inputs that enable the use of preset speeds.
9	"Aux Fault"	If input is enable but not active, the drive will immediately fault.
10	"Clear Fault" (T053 Default)	Clears an active fault.
11	"RampStop,CF"	The drive immediately ramps to stop. Can also be used to clear a fault.
12	"CoastStop,CF"	The drive immediately coasts to stop. Can also be used to clear a fault.
13	"DCInjStop,CF"	The drive immediately begins a DC Injection stop. Can also be used to clear a fault.
14	"Anlg1 InCtrl" (1)	Selects Analog Input 1 control for the frequency reference.
15	"Anlg2 InCtrl" (1)	Selects Analog Input 2 control for the frequency reference
16	"MOP Up"	Increases the value of A142 [Internal Freq] at the current Accel rate if P038 [Speed Reference] is set to 1 "InternalFreq". Default for A142 is 60 Hz.
17	"MOP Down"	Decreases the value of A142 [Internal Freq] at the current Decel rate if P038 [Speed Reference] is set to 1 "InternalFreq". Default for A142 is 60 Hz.
18	"Acc & Dec 2" (1)	<ul style="list-style-type: none"> When active, A147 [Accel Time 2] and A148 [Decel Time 2] are used for all ramp rates. Can only be tied to one input. Refer to the flowchart on page 38 for more information on Accel/Decel selection.
19	"Current Lmt2"	When active, A180 [Current Limit 2] determines the drive current limit level.
20	"Force DC"	If the drive is not running, applying this input causes the drive to apply a DC Holding current (use A177 [DC Brake Level], ignoring A176 [DC Brake Time] while the input is applied.
21	"Mtr I-Lock 1"	Can be used as a protective motor interlock in Auxiliary Motor Control mode. When programmed but not active, input will prevent corresponding motor from operating. Refer to Appendix C for details.
22	"Mtr I-Lock 2"	
23	"Mtr I-Lock 3"	
24	"Mtr I-Lock 4"	
25	"Cmd Reverse"	When programmed and active the drive will run in the reverse direction when started from the integral keypad.
31	"Logic In 1"	Input 1 used by digital output settings.
32	"Logic In 2"	Input 2 used by digital output settings.
36	"Damper Input"	<ul style="list-style-type: none"> When active, drive is allowed to run normally. When inactive, drive is forced into sleep mode and is prevented from accelerating to commanded speed.

(1) This function may be tied to one input only.

T055 [Relay Out1 Sel]

Related Parameter(s): [P033](#), [T056](#), [T058](#), [T059](#), [T069](#), [T072](#), [T073](#), [T076](#), [A163](#), [d318](#)

Sets the condition that changes the state of the output relay contacts.

Options	0 "Ready/Fault" (Default)	Relay changes state when power is applied. This indicates that the drive is ready for operation. Relay returns drive to shelf state when power is removed or a fault occurs.
	1 "At Frequency"	Drive reaches commanded frequency
	2 "MotorRunning"	Motor is receiving power from the drive.
	3 "Hand Active"	Active when drive is in local control.
	4 "Motor Overld"	Motor overload condition exists.
	5 "Ramp Reg"	Ramp regulator is modifying the programmed accel/decel times to avoid an overcurrent or overvoltage fault from occurring.
	6 "Above Freq"	<ul style="list-style-type: none"> Drive exceeds the frequency (Hz) value set in T056 [Relay Out1 Level]. Use T056 to set threshold.
	7 "Above Cur"	<ul style="list-style-type: none"> Drive exceeds the current (% Amps) value set in T056 [Relay Out1 Level]. Use T056 to set threshold.
IMPORTANT Value for T056 [Relay Out1 Level] must be entered in percent of drive rated output current.		
	8 "Above DCVolt"	<ul style="list-style-type: none"> Drive exceeds the DC bus voltage value set in T056 [Relay Out1 Level]. Use T056 to set threshold.
	9 "Above Anlg 2"	<ul style="list-style-type: none"> Analog input voltage (I/O Terminal 17) exceeds the value set in T056 [Relay Out1 Level]. Do not use if T073 [Analog In 2 Sel] is set to 3 "Voltage Mode - Bipolar" This parameter setting can also be used to indicate a PTC trip point when the input (I/O Terminal 17) is wired to a PTC and external resistor. Use T056 to set threshold.
	10 "Above PF Ang"	<ul style="list-style-type: none"> Power Factor angle has exceeded the value set in T056 [Relay Out1 Level]. Use T056 to set threshold.
	11 "Anlg In Loss"	Analog input loss has occurred. Program T072 [Analog In 1 Loss] and/or T076 [Analog In 2 Loss] for desired action when input loss occurs.
	12 "ParamControl"	Enables the output to be controlled over network communications by writing to T056 [Relay Out1 Level]. (0 = Off, 1 = On.)
	13 "Retries Exst"	Value set in A163 [Auto Rstrt Tries] is exceeded.
	14 "NonRec Fault"	<ul style="list-style-type: none"> Number of retries for A163 [Auto Rstrt Tries] is exceeded, or Non-resettable fault occurs, or A163 [Auto Rstrt Tries] is not enabled.
	15 "Reverse"	Drive is commanded to run in reverse direction.
	16 "Logic In 1"	An input is programmed as "Logic In 1" and is active.
	17 "Logic In 2"	An input is programmed as "Logic In 2" and is active.
	23 "Aux Motor"	Auxiliary Motor is commanded to run. Refer to Appendix C for details.
	24 "Fault" (with FRN 7.xx and later)	Relay remains in the off state when power is applied to the drive and energizes when a fault occurs. This is inverted from Option 0, "Ready/Fault".

T056 [Relay Out1 Level]

Related Parameter(s): [T055](#), [T058](#), [T059](#), [d318](#)

 32 bit parameter.

Sets the trip point for the digital output relay if the value of [T055](#) [Relay Out1 Sel] is 6, 7, 8, 9, 10 or 12.

T055 Setting	T056 Min/Max
6	0/320 Hz
7	0/180%
8	0/815 Volts
9	0/100%
10	1/180 degs
12	0/1

Values	Default:	0.0
	Min/Max:	0.0/9999
	Display:	0.1

T058 [Relay 1 On Time]

Related Parameter(s): [T055](#), [T056](#), [T059](#)

Sets delay time before Relay energizes after required condition testing.

Values	Default:	0.0 Secs
	Min/Max:	0.0/600.0 Secs
	Display:	0.1 Secs

T059 [Relay 1 Off Time]

Related Parameter(s): [T055](#), [T058](#), [T058](#)

Sets delay time before Relay de-energizes after required condition testing ceases.

IMPORTANT Do not use this parameter with Auxiliary Motor Control mode AutoSwap enabled.

Values	Default:	0.0 Secs
	Min/Max:	0.0/600.0 Secs
	Display:	0.1 Secs

T060 [Relay Out2 Sel]

Related Parameter(s): [P033](#), [T061](#), [T063](#), [T064](#), [T076](#), [A163](#), [d318](#)

Sets the condition that changes the state of the output relay contacts.

Options	0 "Ready/Fault" (Default)	Relay changes state when power is applied. This indicates that the drive is ready for operation. Relay returns drive to shelf state when power is removed or a fault occurs.
	1 "At Frequency"	Drive reaches commanded frequency.
	2 "MotorRunning" (Default)	Motor is receiving power from the drive.
	3 "Hand Active"	Active when drive is in local control.
	4 "Motor Overld"	Motor overload condition exists.
	5 "Ramp Reg"	Ramp regulator is modifying the programmed accel/decel times to avoid an overcurrent or overvoltage fault from occurring.
	6 "Above Freq"	<ul style="list-style-type: none"> Drive exceeds the frequency (Hz) value set in T061 [Relay Out2 Level]. Use T061 to set threshold.
	7 "Above Cur"	<ul style="list-style-type: none"> Drive exceeds the current (% Amps) value set in T061 [Relay Out2 Level]. Use T061 to set threshold.

IMPORTANT Value for [T061](#) [Relay Out2 Level] must be entered in percent of drive rated output current.

8 "Above DCVolt"	<ul style="list-style-type: none"> Drive exceeds the DC bus voltage value set in T061 [Relay Out2 Level]. Use T061 to set threshold.
9 "Above Anlg 2"	<ul style="list-style-type: none"> Analog input voltage (I/O Terminal 17) exceeds the value set in T061 [Relay Out2 Level]. Do not use if T073 [Analog In 2 Sel] is set to 3 "Voltage Mode - Bipolar". This parameter setting can also be used to indicate a PTC trip point when the input (I/O Terminal 17) is wired to a PTC and external resistor. Use T061 to set threshold.
10 "Above PF Ang"	<ul style="list-style-type: none"> Power Factor angle has exceeded the value set in T061 [Relay Out2 Level]. Use T061 to set threshold.
11 "Anlg In Loss"	Analog input loss has occurred. Program T072 [Analog In 1 Loss] and/or T076 [Analog In 2 Loss] for desired action when input loss occurs.
12 "ParamControl"	Enables the output to be controlled over network communications by writing to T061 [Relay Out2 Level]. (0 = Off, 1 = On.)
13 "Retries Exst"	Value set in A163 [Auto Rstrt Tries] is exceeded.
14 "NonRec Fault"	<ul style="list-style-type: none"> Number of retries for A163 [Auto Rstrt Tries] is exceeded OR Non-resettable fault occurs OR A163 [Auto Rstrt Tries] is not enabled.
15 "Reverse"	Drive is commanded to run in reverse direction.
16 "Logic In 1"	An input is programmed as "Logic In 1" and is active.
17 "Logic In 2"	An input is programmed as "Logic In 2" and is active.
23 "Aux Motor"	Auxiliary Motor is commanded to run. Refer to Appendix C for details.
24 "Fault" (with FRN 7.xx and later)	Relay remains in the off state when power is applied to the drive and energizes when a fault occurs. This is inverted from Option 0, "Ready/Fault".

T061 [Relay Out2 Level]

Related Parameter(s): [T060](#), [T063](#), [T064](#), [d318](#)

 32 bit parameter.

Sets the trip point for the digital output relay if the value of T060 [Relay Out2 Sel] is 6, 7, 8, 9, 10 or 12

T060 Setting	T061 Min/Max
6	0/320 Hz
7	0/180%
8	0/815 Volts
9	0/100%
10	1/180 degs
12	0/1

Values	Default:	0.0
	Min/Max:	0.0/9999
	Display:	0.1

T063 [Relay 2 On Time]

Related Parameter(s): [T060](#), [T061](#), [T064](#)

Sets delay time before Relay energizes after required condition testing.

Values	Default:	0.0 Secs
	Min/Max:	0.0/600.0 Secs
	Display:	0.1 Secs

T064 [Relay 2 Off Time]

Related Parameter(s): [T060](#), [T061](#), [T063](#)

Sets delay time before Relay de-energizes after required condition testing ceases.

IMPORTANT Do not use this parameter with Auxiliary Motor Control mode AutoSwap enabled.

Values	Default:	0.0 Secs
	Min/Max:	0.0/600.0 Secs
	Display:	0.1 Secs

T065 [Opto Out Sel]

Related Parameter(s): [P033](#), [T066](#), [T068](#), [T072](#), [T076](#), [A163](#), [d318](#)

Determines the operation of the programmable opto output.

Options	0 "Ready/Fault"	Opto output is active when power is applied. This indicates that the drive is ready for operation. Opto output is inactive when power is removed or a fault occurs.
	1 "At Frequency" (Default)	Drive reaches commanded frequency
	2 "MotorRunning"	Motor is receiving power from the drive.
	3 "Hand Active"	Active when drive is in local control.
	4 "Motor Overld"	Motor overload condition exists.
	5 "Ramp Reg"	Ramp regulator is modifying the programmed accel/decel times to avoid an overcurrent or overvoltage fault from occurring.
	6 "Above Freq"	<ul style="list-style-type: none"> • Drive exceeds the frequency (Hz) value set in T066 [Opto Out Level]. • Use T066 to set threshold.
	7 "Above Cur"	<ul style="list-style-type: none"> • Drive exceeds the current (% Amps) value set in T066 [Opto Out Level]. • Use T066 to set threshold.
IMPORTANT Value for T066 [Opto Out Level] must be entered in percent of drive rated output current.		
	8 "Above DCVolt"	<ul style="list-style-type: none"> • Drive exceeds the DC bus voltage value set in T066 [Opto Out Level]. • Use T066 to set threshold.
	9 "Above Anlg 2"	<ul style="list-style-type: none"> • Analog input voltage (I/O Terminal 17) exceeds the value set in T066 [Opto Out Level]. • Do not use if T073 [Analog In 2 Sel] is set to 3 "Voltage Mode - Bipolar". • This parameter setting can also be used to indicate a PTC trip point when the input (I/O Terminal 17) is wired to a PTC and external resistor. • Use T066 to set threshold.
	10 "Above PF Ang"	<ul style="list-style-type: none"> • Power Factor angle has exceeded the value set in T066 [Opto Out Level]. • Use T066 to set threshold.
	11 "Anlg In Loss"	Analog input loss has occurred. Program T072 [Analog In 1 Loss] and/or T076 [Analog In 2 Loss] for desired action when input loss occurs.
	12 "ParamControl"	Enables the output to be controlled over network communications by writing to T066 [Opto Out Level]. (0 = Off, 1 = On.)
	13 "Retries Exst"	Value set in A163 [Auto Rstrt Tries] is exceeded.
	14 "NonRec Fault"	<ul style="list-style-type: none"> • Number of retries for A163 [Auto Rstrt Tries] is exceeded, or • Non-resettable fault occurs, or • A163 [Auto Rstrt Tries] is not enabled.
	15 "Reverse"	Drive is commanded to run in reverse direction.
	16 "Logic In 1"	An input is programmed as "Logic In 1" and is active.
	17 "Logic In 2"	An input is programmed as "Logic In 2" and is active.
	24 "Fault" (with FRN 7.xx and later)	Relay remains in the off state when power is applied to the drive and energizes when a fault occurs. This is inverted from Option 0, "Ready/Fault".

T066 [Opto Out Level]

Related Parameter(s): [T065](#), [T068](#), [A163](#), [d318](#)

 32 bit parameter.

Determines the on/off point for the opto output when [T065](#) [Opto Out Sel] is set to option 6, 7, 8, 9, 10, or 12.

T066 Setting	T066 Min/Max
6	0/320 Hz
7	0/180%
8	0/815 Volts
9	0/100%
10	1/180 degs
12	0/1

Values	Default:	0.0
	Min/Max:	0.0/9999
	Display:	0.1

T068 [Opto Out Logic]

Related Parameter(s): [T065](#), [T066](#)

Determines the logic (Normally Open/NO or Normally Closed/NC) of the opto output.

T058 Option	Opto Out Logic
0	NO (Normally Open)
1	NC (Normally Closed)

Note: Setting output to NC may cause output to “glitch” on power-up. The off/reset state of all outputs is open.

Values	Default:	0
	Min/Max:	0/1
	Display:	1

T069 [Analog In 1 Sel]

Related Parameter(s): [T055](#), [T070](#), [T071](#), [T072](#)

Sets the analog input signal mode (0-20mA, 4-20mA, or 0-10V). This parameter must match DIP Switch AI1 setting on the control board.

T069 Option	Setting	Input Range	DIP Switch AI1 Setting
0	Current Mode	0-20 mA	20 mA
1	Current Mode	4-20 mA	20 mA
2	Voltage Mode - Unipolar	0-10V	10V
4	Current Mode (Square Root)	0-20 mA	20 mA
5	Current Mode (Square Root)	4-20 mA	20 mA
6	Voltage Mode - Unipolar (Square Root)	0-10V	10V

Values	Default:	2
	Min/Max:	0/6
	Display:	1

T070 [Analog In 1 Lo]

Related Parameter(s): [P034](#), [P038](#), [T069](#), [T071](#), [T072](#), [A152](#), [A153](#)

 Stop drive before changing this parameter.

Sets the analog input level that corresponds to [P034](#) [Minimum Freq].

Analog inversion can be accomplished by setting this value larger than [T071](#) [Analog In 1 Hi].

IMPORTANT If analog inversion is implemented the drive will go to maximum frequency in the event the analog input is lost. It is strongly recommended to activate [T072](#) [Analog In 1 Loss] to protect from this potential occurrence.

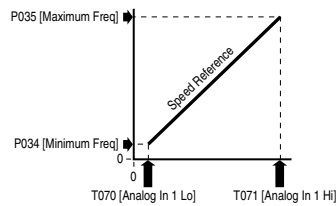

Values	Default:	0.0%
	Min/Max:	0.0/100.0%
	Display:	0.1%

T071 [Analog In 1 Hi]

Related Parameter(s): [P035](#), [P038](#), [T069](#), [T070](#), [T072](#), [A152](#), [A153](#)

 Stop drive before changing this parameter.

Sets the analog input level that corresponds to [P035](#) [Maximum Freq].

Analog inversion can be accomplished by setting this value smaller than [T070](#) [Analog In 1 Lo].

Values	Default:	100.0%
	Min/Max:	0.0/100.0%
	Display:	0.1%

T072 [Analog In 1 Loss]

Related Parameter(s): [T055](#), [T060](#), [T065](#), [T069](#), [T070](#), [T071](#), [A152](#)

 Stop drive before changing this parameter.

Selects drive action when an input signal loss is detected. Signal loss is defined as an analog signal less than 1V or 2mA. The signal loss event ends and normal operation resumes when the input signal level is greater than or equal to 1.5V or 3mA. If using a 0-10V analog input, set [T070](#) [Analog In 1 Lo] to a minimum of 20% (i.e. 2 volts).

The drive will fault on an F29 [Analog Input Loss](#) when the analog signal is lost if this parameter is used for the PID feedback, and this parameter and [A152](#) [PID Ref Sel] are both set to an option other than 0 "Disabled".

Options	0 "Disabled" (Default)	
1	"Fault (F29)"	F29 Analog Input Loss
2	"Stop"	Uses P037 [Stop Mode]
3	"Zero Ref"	Drive runs at zero speed reference.
4	"Min Freq Ref"	Drive runs at minimum frequency.
5	"Max Freq Ref"	Drive runs at maximum frequency.
6	"Preset Freq0"	Drive runs at A143 [Preset Freq 0].
7	"Hold Last" (with FRN 6.xx and later)	Drive uses last frequency command from analog input prior to signal loss, or last PID reference prior to signal loss when used as a PID reference.

T073 [Analog In 2 Sel]

Related Parameter(s): [P038](#), [T055](#), [T065](#), [T074](#), [T075](#), [T076](#), [A152](#)

Sets the analog input signal mode (0-20mA, 4-20mA, 0-10V, -10 to +10V). This parameter must match DIP Switch A12 setting on the control board.

T073 Option	Setting	Input Range	DIP Switch A12 Setting
0	Current Mode	0-20 mA	20 mA
1	Current Mode	4-20 mA	20 mA
2	Voltage Mode - Unipolar	0-10V	10V
3 ⁽¹⁾	Voltage Mode - Bipolar	-10 to +10V	10V
4	Current Mode (Square Root)	0-20 mA	20 mA
5	Current Mode (Square Root)	4-20 mA	20 mA
6	Voltage Mode - Unipolar (Square Root)	0-10V	10V
7	Voltage Mode - Bipolar (Square Root)	-10 to +10V	10V

(1) Setting 3 is only available on [Analog In 2 Sel]. Input 2 is isolated and supports a bi-polar input, so that setting 3 determines if the voltage input is enabled for bipolar control. If bipolar is selected, P034 [Minimum Freq] and T074 [Analog In 2 Lo] are ignored. If input 2 is set up for current control, Bipolar mode is not possible. If the analog input is inverted ([Analog In 2 Lo] > [Analog In 2 Hi]), Bipolar mode is disabled and this input uses unipolar control only (negative values are treated like zero).

Values	Default:	2
	Min/Max:	0/7
	Display:	1

T074 [Analog In 2 Lo]

Related Parameter(s): [P034](#), [P038](#), [T072](#), [T073](#), [T075](#), [T076](#), [A152](#), [A153](#)

 Stop drive before changing this parameter.

Sets the analog input level that corresponds to [P034](#) [Minimum Freq].

Analog inversion can be accomplished by setting this value larger than [T075](#) [Analog In 2 Hi].

IMPORTANT If analog inversion is implemented the drive will go to maximum frequency in the event the analog input is lost. It is strongly recommended to activate [T072](#) [Analog In 1 Loss] to protect from this potential occurrence.

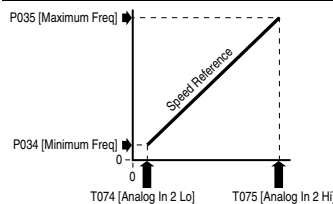

Values	Default:	0.0%
	Min/Max:	0.0/100.0%
	Display:	0.1%

T075 [Analog In 2 Hi]

Related Parameter(s): [P035](#), [P038](#), [T073](#), [T074](#), [T076](#), [A152](#), [A153](#)

 Stop drive before changing this parameter.

Sets the analog input level that corresponds to [P035](#) [Maximum Freq].
Analog inversion can be accomplished by setting this value smaller than [T074](#) [Analog In 2 Lo].

Values	Default:	100.0%
	Min/Max:	0.0/100.0%
	Display:	0.1%

T076 [Analog In 2 Loss]

Related Parameter(s): [T055](#), [T060](#), [T065](#), [T073](#), [T074](#), [T075](#)

 Stop drive before changing this parameter.

Selects drive action when an input signal loss is detected. Signal loss is defined as an analog signal less than 1V or 2mA. The signal loss event ends and normal operation resumes when the input signal level is greater than or equal to 1.5V or 3mA. If using a 0-10V analog input, set [T074](#) [Analog In 2 Lo] to a minimum of 20% (i.e. 2 volts).

The drive will fault on an F29 [Analog Input Loss](#) when the analog signal is lost if this parameter is used for the PID feedback, and this parameter and [A152](#) [PID Ref Sel] are both set to an option other than 0 "Disabled"

Options	0	"Disabled" (Default)	
	1	"Fault (F29)"	F29 Analog Input Loss
	2	"Stop"	Uses P037 [Stop Mode]
	3	"Zero Ref"	Drive runs at zero speed reference.
	4	"Min Freq Ref"	Drive runs at minimum frequency.
	5	"Max Freq Ref"	Drive runs at maximum frequency.
	6	"Preset Freq0"	Drive runs at A143 [Preset Freq 0].
	7	"Hold Last" (with FRN 6.xx and later)	Drive uses last frequency command from analog input prior to signal loss, or last PID reference prior to signal loss when used as a PID reference.

T077 [Sleep-Wake Sel]

Related Parameter(s): [T078](#), [T079](#), [T080](#), [T081](#), [T090](#), [T091](#)

The drive "sleeps" if the appropriate analog input drops below the set [Sleep Level] for the time set in [Sleep Time] and the drive is running. When entering sleep mode the drive will ramp to zero and the run indicator (F_{run} or F_{brk}) on the keypad display will flash indicating the drive is in "sleep" mode. When the appropriate analog input rises above the set [Wake Level] the drive will "wake" and ramp to the commanded frequency.

Inversion can be accomplished by setting [T078](#) [Sleep Level] to a higher setting than [T080](#) [Wake Level].



ATTENTION: Enabling the Sleep-Wake function can cause unexpected machine operation during the Wake mode. Equipment damage and/or personal injury can result if this parameter is used in an inappropriate application. In addition, all applicable local, national & international codes, standards, regulations or industry guidelines must be considered.

Options	0	"Disabled" (Default)	
	1	"Analog In 1"	Sleep and Wake enabled from Analog Input 1.
	2	"Analog In 2"	Sleep and Wake enabled from Analog Input 2.
	3	"Command Freq"	Sleep and Wake enabled based on drive commanded frequency.
	4	"Ind Slp Wake" (with FRN 7.xx and later)	Sleep and Wake enabled independently using parameters T090 [Sleep Sel] and T091 [Wake Sel].

T078 [Sleep Level]

Related Parameter(s): [T077](#), [T079](#), [T080](#), [T081](#)

Sets the analog input level the drive must reach to enter sleep mode.

Values	Default:	10.0%
	Min/Max:	0.0/100.0%
	Display:	0.1%

T079 [Sleep Time]

Related Parameter(s): [T077](#), [T078](#), [T080](#), [T081](#)

Sets the analog input time the drive must stay below to enter sleep mode.

Values	Default:	0.0 Secs
	Min/Max:	0.0/600.0 Secs
	Display:	0.1 Secs

T080 [Wake Level]

Related Parameter(s): [T077](#), [T078](#), [T079](#), [T081](#)

Sets the analog input level the drive must reach to wake from sleep mode.

Values	Default:	15.0%
	Min/Max:	0.0/100.0%
	Display:	0.1%

T081 [Wake Time]

Related Parameter(s): [T077](#), [T078](#), [T079](#), [T080](#)

Sets the analog input time the drive must stay above to wake from sleep mode.

Values	Default:	0.0 Secs
	Min/Max:	0.0/600.0 Secs
	Display:	0.1 Secs

T082 [Analog Out1 Sel]

Related Parameter(s): [P035](#), [T083](#), [T084](#)

Sets the analog output signal mode (0-20 mA, 4-20 mA, or 0-10V). The output is used to provide a signal that is proportional to several drive conditions. This parameter must match DIP Switch A01 setting.

Setting	Output Range	Minimum Output Value	Maximum Output Value = [Analog Output High]	Filter ⁽¹⁾	DIP Switch A01 Setting	Related Parameter
0 OutFreq 0-10	0-10V	0V = 0 Hz	[Maximum Freq]	None	10V	b001
1 OutCurr 0-10	0-10V	0V = 0 Amps	200% Drive Rated FLA	Filter A	10V	b003
2 OutTorq 0-10	0-10V	0V = 0 Amps	200% Drive Rated FLA	Filter A	10V	b013
3 OutVolt 0-10	0-10V	0V = 0 Volts	120% Drive Rated Output V	None	10V	b004
4 OutPowr 0-10	0-10V	0V = 0 kW	200% Drive Rated Power	Filter A	10V	b010
5 Setpnt 0-10	0-10V	0V = 0.0%	100.0% Setting	None	10V	T084
6 TstData 0-10	0-10V	0V = 0000	65535 (Hex FFFF)	None	10V	A196
7 OutFreq 0-20	0-20 mA	0 mA = 0 Hz	[Maximum Freq]	None	20 mA	b001
8 OutCurr 0-20	0-20 mA	0 mA = 0 Amps	200% Drive Rated FLA	Filter A	20 mA	b003
9 OutTorq 0-20	0-20 mA	0 mA = 0 Amps	200% Drive Rated FLA	Filter A	20 mA	b013
10 OutVolt 0-20	0-20 mA	0 mA = 0 Volts	120% Drive Rated Output V	None	20 mA	b004
11 OutPowr 0-20	0-20 mA	0 mA = 0 kW	200% Drive Rated Power	Filter A	20 mA	b010
12 Setpnt 0-20	0-20 mA	0 mA = 0.0%	100.0% Setting	None	20 mA	T084
13 TstData 0-20	0-20 mA	0 mA = 0000	65535 (Hex FFFF)	None	20 mA	A196
14 OutFreq 4-20	4-20 mA	4 mA = 0 Hz	[Maximum Freq]	None	20 mA	b001
15 OutCurr 4-20	4-20 mA	4 mA = 0 Amps	200% Drive Rated FLA	Filter A	20 mA	b003
16 OutTorq 4-20	4-20 mA	4 mA = 0 Amps	200% Drive Rated FLA	Filter A	20 mA	b013
17 OutVolt 4-20	4-20 mA	4 mA = 0 Volts	120% Drive Rated Output V	None	20 mA	b004
18 OutPowr 4-20	4-20 mA	4 mA = 0 kW	200% Drive Rated Power	Filter A	20 mA	b010
19 Setpnt 4-20	4-20 mA	4 mA = 0.0%	100.0% Setting	None	20 mA	T084
20 TstData 4-20	4-20 mA	4 mA = 0000	65535 (Hex FFFF)	None	20 mA	A196
21 MinFreq 0-10	0-10V	0V = Min. Freq	[Maximum Freq]	None	10V	b001
22 MinFreq 0-20	0-20 mA	0 mA = Min. Freq	[Maximum Freq]	None	20 mA	b001
23 MinFreq 4-20	4-20 mA	4 mA = Min. Freq	[Maximum Freq]	None	20 mA	b001
24 AnlGln1 0-10	0-10V	0V = 0.0%	100.0% Setting	Filter A	10V	d305
25 AnlGln1 0-20	0-20 mA	0 mA = 0.0%	100.0% Setting	Filter A	20 mA	d305
26 AnlGln1 4-20	4-20 mA	4 mA = 0.0%	100.0% Setting	Filter A	20 mA	d305
27 AnlGln2 0-10	0-10V	0V = 0.0%	100.0% Setting	Filter A	10V	d306
28 AnlGln2 0-20	0-20 mA	0 mA = 0.0%	100.0% Setting	Filter A	20 mA	d306
29 AnlGln2 4-20	4-20 mA	4 mA = 0.0%	100.0% Setting	Filter A	20 mA	d306

(1) For settings with the filter enabled, if a 0-100% step change occurs, the output will reach 95% in 500 milliseconds, 99% in 810 milliseconds and 100% in 910 milliseconds.

Values	Default:	0
	Min/Max:	0/29
	Display:	1

T083 [Analog Out1 High]

Related Parameter(s): [P035](#), [T082](#), [T084](#)

Scales the Maximum Output Value for the [T082](#) [Analog Out1 Sel] source setting.

Examples:

T083 Setting	T082 Setting	T082 Max. Output Value
50%	1 "OutCurr 0-10"	5V for 200% Drive Rated Output Current
90%	11 "OutPowr 0-20"	18mA for 200% Drive Rated Power

Values	Default:	100%
	Min/Max:	0/800%
	Display:	1%

T084 [Anlg Out1 Setpt]

Related Parameter(s): [T082](#), [T083](#)

Sets direct parameter control over the analog output. If enabled, this sets the percent value of analog output.

Values	Default:	0.0%
	Min/Max:	0.0/100.0%
	Display:	0.1%

T085 [Analog Out2 Sel]

Related Parameter(s): [P035](#), [T086](#), [T087](#)

Sets the analog output signal mode (0-20 mA, 4-20 mA, or 0-10V). The output is used to provide a signal that is proportional to several drive conditions. This parameter must match DIP Switch A02 setting.

Setting	Output Range	Minimum Output Value	Maximum Output Value = [Analog Output High]	Filter ⁽¹⁾	DIP Switch A02 Setting	Related Parameter
0 OutFreq 0-10	0-10V	0V = 0 Hz	[Maximum Freq]	None	10V	b001
1 OutCurr 0-10	0-10V	0V = 0 Amps	200% Drive Rated FLA	Filter A	10V	b003
2 OutTorq 0-10	0-10V	0V = 0 Amps	200% Drive Rated FLA	Filter A	10V	b013
3 OutVolt 0-10	0-10V	0V = 0 Volts	120% Drive Rated Output V	None	10V	b004
4 OutPowr 0-10	0-10V	0V = 0 kW	200% Drive Rated Power	Filter A	10V	b010
5 Setpnt 0-10	0-10V	0V = 0.0%	100.0% Setting	None	10V	T084
6 TstData 0-10	0-10V	0V = 0000	65535 (Hex FFFF)	None	10V	A196
7 OutFreq 0-20	0-20 mA	0 mA = 0 Hz	[Maximum Freq]	None	20 mA	b001
8 OutCurr 0-20	0-20 mA	0 mA = 0 Amps	200% Drive Rated FLA	Filter A	20 mA	b003
9 OutTorq 0-20	0-20 mA	0 mA = 0 Amps	200% Drive Rated FLA	Filter A	20 mA	b013
10 OutVolt 0-20	0-20 mA	0 mA = 0 Volts	120% Drive Rated Output V	None	20 mA	b004
11 OutPowr 0-20	0-20 mA	0 mA = 0 kW	200% Drive Rated Power	Filter A	20 mA	b010
12 Setpnt 0-20	0-20 mA	0 mA = 0.0%	100.0% Setting	None	20 mA	T084
13 TstData 0-20	0-20 mA	0 mA = 0000	65535 (Hex FFFF)	None	20 mA	A196
14 OutFreq 4-20	4-20 mA	4 mA = 0 Hz	[Maximum Freq]	None	20 mA	b001
15 OutCurr 4-20	4-20 mA	4 mA = 0 Amps	200% Drive Rated FLA	Filter A	20 mA	b003
16 OutTorq 4-20	4-20 mA	4 mA = 0 Amps	200% Drive Rated FLA	Filter A	20 mA	b013
17 OutVolt 4-20	4-20 mA	4 mA = 0 Volts	120% Drive Rated Output V	None	20 mA	b004
18 OutPowr 4-20	4-20 mA	4 mA = 0 kW	200% Drive Rated Power	Filter A	20 mA	b010
19 Setpnt 4-20	4-20 mA	4 mA = 0.0%	100.0% Setting	None	20 mA	T084
20 TstData 4-20	4-20 mA	4 mA = 0000	65535 (Hex FFFF)	None	20 mA	A196
21 MinFreq 0-10	0-10V	0V = Min. Freq	[Maximum Freq]	None	10V	b001
22 MinFreq 0-20	0-20 mA	0 mA = Min. Freq	[Maximum Freq]	None	20 mA	b001
23 MinFreq 4-20	4-20 mA	4 mA = Min. Freq	[Maximum Freq]	None	20 mA	b001
24 AnlgIn1 0-10	0-10V	0V = 0.0%	100.0% Setting	Filter A	10V	d305
25 AnlgIn1 0-20	0-20 mA	0 mA = 0.0%	100.0% Setting	Filter A	20 mA	d305
26 AnlgIn1 4-20	4-20 mA	4 mA = 0.0%	100.0% Setting	Filter A	20 mA	d305
27 AnlgIn2 0-10	0-10V	0V = 0.0%	100.0% Setting	Filter A	10V	d306
28 AnlgIn2 0-20	0-20 mA	0 mA = 0.0%	100.0% Setting	Filter A	20 mA	d306
29 AnlgIn2 4-20	4-20 mA	4 mA = 0.0%	100.0% Setting	Filter A	20 mA	d306

(1) For settings with the filter enabled, if a 0-100% step change occurs, the output will reach 95% in 500 milliseconds, 99% in 810 milliseconds and 100% in 910 milliseconds.

Values	Default:	1
	Min/Max:	0/29
	Display:	1

T086 [Analog Out2 High]

Related Parameter(s): [P035](#), [T085](#), [T087](#)

Scales the Maximum Output Value for the A065 [Analog Out Sel] source setting.
Examples:

T086 Setting	T085 Setting	T085 Max. Output Value
50%	1 "OutCurr 0-10"	5V for 200% Drive Rated Output Current
90%	11 "OutPowr 0-20"	18mA for 200% Drive Rated Power

Values	Default:	100%
	Min/Max:	0/800%
	Display:	1%

T087 [Anlg Out2 Setpt]

Related Parameter(s): [T085](#), [T086](#)

Sets direct parameter control over the analog output. If enabled, this sets the percent value of analog output.

Values	Default:	0.0%
	Min/Max:	0.0/100.0%
	Display:	0.1%

T088 [Anlg Loss Delay]

Related Parameter(s): [T069](#), [T070...T076](#)

Sets the length of time after power-up during which the drive will not detect an analog signal loss. The drive response to an analog signal loss is set in [T072](#) or [T076](#) [Analog In x Loss].

Values	Default:	0.0 Secs
	Min/Max:	0.0/20.0 Secs
	Display:	0.1 Secs

T089 [Analog In Filter]

Sets level of additional filtering of the analog input signals. A higher number increases filtering and decreases bandwidth. Each setting doubles the applied filtering (1 = 2x filter, 2 = 4x filter, etc.). No additional filtering is applied when set to "0".

Values	Default:	0
	Min/Max:	0/14
	Display:	1

T090 [Sleep Sel]

Related Parameter(s): [b001](#), [b002](#), [T077](#), [T078](#), [d305](#), [d306](#)

(with FRN 7.xx and later.)

Selects the operation of the sleep function.

Options	0 "AI1 > SlpLvl" (Default)	Sleep enabled from Analog Input 1 (d305 [Analog In 1]) above sleep level.
	1 "AI1 < SlpLvl"	Sleep enabled from Analog Input 1 (d305 [Analog In 1]) below sleep level.
	2 "AI2 > SlpLvl"	Sleep enabled from Analog Input 2 (d306 [Analog In 2]) above sleep level.
	3 "AI2 < SlpLvl"	Sleep enabled from Analog Input 2 (d306 [Analog In 2]) below sleep level.
	4 "OFrq>SlpLvl"	Sleep enabled based on drive output frequency (b001 [Output Freq]) above sleep level.
	5 "OFrq<SlpLvl"	Sleep enabled based on drive output frequency (b001 [Output Freq]) below sleep level.
	6 "CFrq>SlpLvl"	Sleep enabled based on drive command frequency (b002 [Commanded Freq]) above sleep level.
	7 "CFrq<SlpLvl"	Sleep enabled based on drive command frequency (b002 [Commanded Freq]) below sleep level.

T091 [Wake Sel]

Related Parameter(s): [T077](#), [T080](#), [A203](#), [d304](#), [d305](#), [d306](#), [d328](#)

(with FRN 7.xx and later.)

Selects the operation of the wake function.

Options	0 "AI1 > WakLvl" (Default)	Wake enabled from Analog Input 1 (d305 [Analog In 1]) above wake-up level.
	1 "AI1 < WakLvl"	Wake enabled from Analog Input 1 (d305 [Analog In 1]) below wake-up level.
	2 "AI2 > WakLvl"	Wake enabled from Analog Input 2 (d306 [Analog In 2]) above wake-up level.
	3 "AI2 < WakLvl"	Wake enabled from Analog Input 2 (d306 [Analog In 2]) below wake-up level.
	4 "CFrq > WakLvl"	Wake enabled based on drive command frequency (b002 [Commanded Freq]) above wake-up level.
	5 "CFrq < WakLvl"	Wake enabled based on drive command frequency (b002 [Commanded Freq]) below wake-up level.
	6 "FB-SP > WakLvl"	PID Feedback Display minus PID Setpoint Display above wake-up level. If (d328 [PID Fdbk Display] - d304 [PID Setpnt Displ]) > T080 [Wake Level], then wake is enabled.
	7 "SP-FB > WakLvl"	PID Setpoint Display minus PID Feedback Display above wake-up level. If (d304 [PID Setpnt Displ] - d328 [PID Fdbk Display]) > T080 [Wake Level], then wake is enabled.

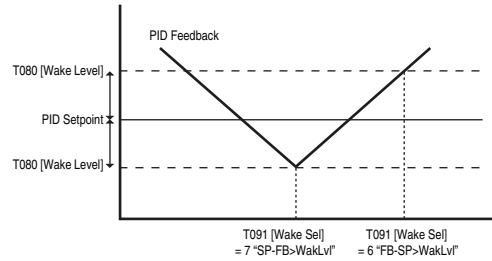

8	"AI1 > WakDev"	Wake enabled from Analog Input 1 above PID Setpoint Display plus wake deviation. If d305 [Analog In 1] > (d304 [PID Setpnt Displ] + A203 [Wake Deviation]), then wake is enabled.
9	"AI1 < WakDev"	Wake enabled from Analog Input 1 below PID Setpoint Display minus wake deviation. If d305 [Analog In 1] < (d304 [PID Setpnt Displ] - A203 [Wake Deviation]), then wake is enabled.
10	"AI2 > WakDev"	Wake enabled from Analog Input 2 above PID Setpoint Display plus wake deviation. If d306 [Analog In 2] > (d304 [PID Setpnt Displ] + A203 [Wake Deviation]), then wake is enabled.
11	"AI2 < WakDev"	Wake enabled from Analog Input 2 below PID Setpoint Display minus wake deviation. If d306 [Analog In 2] < (d304 [PID Setpnt Displ] - A203 [Wake Deviation]), then wake is enabled.
12	"CFrq > WakDev"	Wake enabled based on drive command frequency above PID Setpoint Display plus wake deviation. If b002 [Commanded Freq] > (d304 [PID Setpnt Displ] - A203 [Wake Deviation]), then wake is enabled.
13	"CFrq < WakDev"	Wake enabled based on drive command frequency below PID Setpoint Display minus wake deviation. If b002 [Commanded Freq] < (d304 [PID Setpnt Displ] - A203 [Wake Deviation]), then wake is enabled.

Communications Group

C101 [Language]

Selects the language displayed by the integral LCD display and remote communications option.

Options	1	"English" (Default)
	2	"Français"
	3	"Español"
	4	"Italiano"
	5	"Deutsch"
	6	"Reserved"
	7	"Português"
	8	"Reserved"
	9	"Reserved"
	10	"Nederlands"

C102 [Comm Format]

Related Parameter(s): [d303...d306](#)

Selects the protocol data bits (8 data bits only), parity (None, Even, Odd), and stop bits (1 or 2) used by the RS485 port on the drive.

Refer to [Appendix D](#) and [Appendix E](#) for details on using the drive communication features.

IMPORTANT Power to drive must be cycled before any changes will affect drive operation.

Options	0	"RTU 8-N-1" (Default)
	1	"RTU 8-E-1"
	2	"RTU 8-O-1"
	3	"RTU 8-N-2"
	4	"RTU 8-E-2"
	5	"RTU 8-O-2"
	6	"MetaSys N2"
	7	"P1 8-N-1" Floor Level Network (FLN)
	8	"P1 8-E-1" Floor Level Network (FLN)
	9	"P1 8-O-1" Floor Level Network (FLN)

C103 [Comm Data Rate]

Related Parameter(s): [d303](#)

Sets the serial port rate for the RS485 (DSI) port.

IMPORTANT Power to drive must be cycled before any changes will affect drive operation.

Options	0	"1200"
	1	"2400"
	2	"4800"
	3	"9600" (Default)
	4	"19.2K"
	5	"38.4K"

C104 [Comm Node Addr]

Related Parameter(s): [d303](#)

Sets the drive node address for the RS485 (DSI) port if using a network connection.

IMPORTANT Power to drive must be cycled before any changes will affect drive operation.

Values	Default:	100
	Min/Max:	1/247
	Display:	1

C105 [Comm Loss Action]

Related Parameter(s): [d303](#), [P037](#), [C106](#)

Selects the drive's response to a loss of the communication connection or excessive communication errors.

Options	0 "Fault" (Default)	Drive will fault on an F81 Comm Loss and coast to stop.
	1 "Coast Stop"	Stops drive via coast to stop.
	2 "Stop"	Stops drive via P037 [Stop Mode] setting.
	3 "Continu Last"	Drive continues operating at communication commanded speed saved in RAM.
	4 "Run Preset 0"	Drive will run at preset speed.
	5 "Kypd Inc/Dec"	Drive will run at keypad (digital pot) speed.

C106 [Comm Loss Time]

Related Parameter(s): [d303](#), [C105](#)

Sets the time that the drive will remain in communication loss before implementing the option selected in [C105](#) [Comm Loss Action].

Values	Default:	5.0 Secs
	Min/Max:	0.1/60.0 Secs
	Display:	0.1 Secs

C107 [Comm Write Mode]

Determines whether parameter changes made over communication port are saved and stored in Non-Volatile Storage (NVS) or RAM only. If they are stored in RAM, the values will be lost at power-down.



ATTENTION: Risk of equipment damage exists. If a controller is programmed to write parameter data to Non-Volatile Storage (NVS) frequently, the NVS will quickly exceed its life cycle and cause the drive to malfunction. Do not create a program that frequently uses configurable outputs to write parameter data to NVS unless C107 [Comm Write Mode] is set to option 1.

Options	0 "Save" (Default)
	1 "RAM Only"

C108 [Start Source 2]

Related Parameter(s): [P037](#), [P042](#), [A166](#), [d301](#)

 Stop drive before changing this parameter.

Sets the control scheme used to start the drive when in Comm Control and the communication network commands the drive to run from Local Control. This function is normally used by Point 79 of a P1-FLN. Refer to [Start and Speed Reference Control on page 37](#) for details about how other drive settings can override the setting of this parameter.

IMPORTANT For all settings except options 3 and 6, the drive must receive a leading edge from the start input for the drive to start after a stop input, loss of power or fault condition.

Options	0	"Keypad"	Integral keypad controls drive operation. <ul style="list-style-type: none"> • I/O Terminal 01 = Stop: Coast to Stop • I/O Terminal 02 = Not Used • I/O Terminal 03 = Not Used
	1	"3-Wire"	I/O Terminal Block controls drive operation. <ul style="list-style-type: none"> • I/O Terminal 01 = Stop: Per P037 [Stop Mode] • I/O Terminal 02 = Start • I/O Terminal 03 = Direction
	2	"2-Wire"	I/O Terminal Block controls drive operation. <ul style="list-style-type: none"> • I/O Terminal 01 = Stop: Coast to Stop • I/O Terminal 02 = Run FWD • I/O Terminal 03 = Run REV
	3	"2-W Lvl Sens" (Default)	I/O Terminal Block controls drive operation. <ul style="list-style-type: none"> • I/O Terminal 01 = Stop: Coast to Stop • I/O Terminal 02 = Run FWD • I/O Terminal 03 = Run REV Drive will restart after a "Stop" command when: <ul style="list-style-type: none"> • Stop is removed and Run FWD is held active



ATTENTION: Hazard of injury exists due to unintended operation. When P036 [Start Source] is set to option 3 or option 6, and the Run input is maintained, the Run inputs do not need to be toggled after a Stop input or a fault clear for the drive to run again. The drive will stop only when the stop command is maintained or the drive is faulted.

	4	"2-W Hi Speed"	I/O Terminal Block controls drive operation. <ul style="list-style-type: none"> • I/O Terminal 01 = Stop: Coast to Stop • I/O Terminal 02 = Run FWD • I/O Terminal 03 = Run REV Outputs are kept in a ready-to-run state. The drive will respond to a "Start" command within 10 ms.
--	---	----------------	--

IMPORTANT There is greater potential voltage on the output terminals when using this option.

	5	"Comm Port"	Remote communications controls drive operation. <ul style="list-style-type: none"> • I/O Terminal 01 = Stop: Coast to Stop • I/O Terminal 02 = Not Used • I/O Terminal 03 = Not Used
	6	"2-W Lvl/Enbl"	I/O Terminal Block controls drive operation. <ul style="list-style-type: none"> • I/O Terminal 01 = Function Loss: Fault and Coast to Stop • I/O Terminal 02 = Run FWD • I/O Terminal 03 = SW Enable Drive will restart after a "Stop" command when: <ul style="list-style-type: none"> • Stop is removed and Run FWD is held active



ATTENTION: Hazard of injury exists due to unintended operation. When P036 [Start Source] is set to option 3 or option 6, and the Run input is maintained, the Run inputs do not need to be toggled after a Stop input or a fault clear for the drive to run again. The drive will stop only when the stop command is maintained or the drive is faulted.

C109 [Speed Ref 2] Related Parameter(s): [b001](#), [b002](#), [P038](#), [P040](#), [P042](#), [T051...T054](#), [T070](#), [T071](#), [T073](#), [T074](#), [T075](#), [C102](#), [A141](#), [A142](#), [A143...A146](#), [A152](#), [d301](#)

Sets the source of the speed reference to the drive when in Comm Control and the communication network commands the drive to run from Local Control.

Refer to the flowchart on [page 37](#) for more information on speed reference control priority.

Options	0	"Drive Keypad"	Internal frequency command from the digital speed keys on the integral keypad.
	1	"InternalFreq"	Internal frequency command from A142 [Internal Freq]. Must be set when using MOP function.
	2	"Analog In 1" (Default)	External frequency command from an analog source as determined by T069 [Analog In 1 Sel] and DIP Switch AI1 on the control board. Default Dip Switch setting is 10V.
	3	"Analog In 2"	External frequency command from an analog source as determined by T073 [Analog In 2 Sel] and DIP Switch AI2 on the control board. Default Dip Switch setting is 10V.
	4	"Preset Freq"	External frequency command as defined by A143-A146 [Preset Freq x] when T051-T054 [Digital Inx Sel] are programmed as "Preset Frequencies" and the digital inputs are active.
	5	"Comm Port"	External frequency command from the communications port. Refer to Appendix E and Appendix G for details. Parameter C102 [Comm Format] is used to select a communications protocol.

Advanced Program Group

A141 [Purge Frequency]

Related Parameter(s): [P038](#), [P039](#), [P040](#), [T051...T054](#)

Provides a fixed frequency command value when [T051...T054](#) [Digital Inx Sel] is set to 1 "Purge". An active purge input will override speed command as shown in the flowchart on [page 37](#).

Values	Default:	5.0 Hz
	Min/Max:	0.0/320.0 Hz
	Display:	0.1 Hz

A142 [Internal Freq]

Related Parameter(s): [P038](#), [T051...T054](#)

Provides the frequency command to the drive when [P038](#) [Speed Reference] is set to 1 "Internal Freq". When enabled, this parameter will change the frequency command in "real time" using the digital speed keys when in program mode.

IMPORTANT Once the desired command frequency is reached, the Enter key must be pressed to store this value to EEPROM memory. If the ESC key is used before the Enter key, the frequency will return to the original value following the normal accel/decel curve.

If [T051...T054](#) [Digital Inx Sel] is set to 16 "MOP Up" or 17 "MOP Down" this parameter acts as the MOP frequency reference if [P038](#) [Speed Reference] is set to 1 "InternalFreq".

Values	Default:	60.00 Hz
	Min/Max:	0.00/320.00 Hz
	Display:	0.01 Hz

A143 [Preset Freq 0]⁽¹⁾

Related Parameter(s): [P038](#), [P039](#), [P040](#), [T051...T052](#), [A147](#), [A148](#)

A144 [Preset Freq 1]

A145 [Preset Freq 2]

A146 [Preset Freq 3]

Provides a fixed frequency command value when [T051...T052](#) [Digital Inx Sel] is set to 8 "Preset Freq".

An active preset input will override speed command as shown in the flowchart on [page 37](#).

Input State of Digital In 1 (I/O Terminal 05 when T051 = 8)	Input State of Digital In 2 (I/O Terminal 06 when T052 = 8)	Frequency Source	Accel / Decel Parameter Used ⁽²⁾
0	0	A143 [Preset Freq 0]	[Accel Time 1] / [Decel Time 1]
1	0	A144 [Preset Freq 1]	[Accel Time 1] / [Decel Time 1]
0	1	A145 [Preset Freq 2]	[Accel Time 2] / [Decel Time 2]
1	1	A146 [Preset Freq 3]	[Accel Time 2] / [Decel Time 2]

Values	A143 Default: ⁽¹⁾	0.0 Hz
	A144 Default:	5.0 Hz
	A145 Default:	10.0 Hz
	A146 Default::	20.0 Hz
	Min/Max:	0.0/320.0 Hz
Display:	0.01 Hz	

(1) To activate A143 [Preset Freq 0] set [P038](#) [Speed Reference] to option 4 "Preset Freq"

(2) When a Digital Input is set to "Accel 2 & Decel 2", and the input is active, that input overrides the settings in this table.

A147 [Accel Time 2]

Related Parameter(s): [P039, T051...T054, A143...A146](#)

When active, sets the rate of acceleration for all speed increases. Refer to the flowchart on [page 38](#) for details.

$$\text{Accel Rate} = [\text{Maximum Freq}]/[\text{Accel Time}]$$

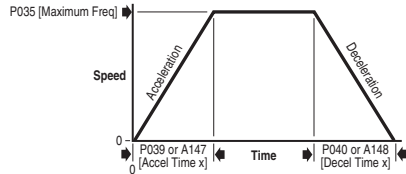

Values	Default:	30.00 Secs
	Min/Max:	0.00/600.00 Secs
	Display:	0.01 Secs

A148 [Decel Time 2]

Related Parameter(s): [P040, T051...T054, A143...A146](#)

When active, sets the rate of deceleration for all speed decreases. Refer to the flowchart on [page 38](#) for details.

$$\text{Maximum Freq}/\text{Decel Time} = \text{Decel Rate}$$

Values	Default:	30.00 Secs
	Min/Max:	0.01/600.00 Secs
	Display:	0.01 Secs

A149 [S Curve %]

Sets the percentage of acceleration or deceleration time that is applied to the ramp as S Curve. Time is added, 1/2 at the beginning and 1/2 at the end of the ramp.

Example:

Accel Time = 10 s
 S-Curve Setting = 50%
 S-Curve Time = 10 x 0.5 = 5 s
 Total Time = 10 + 5 = 15 S

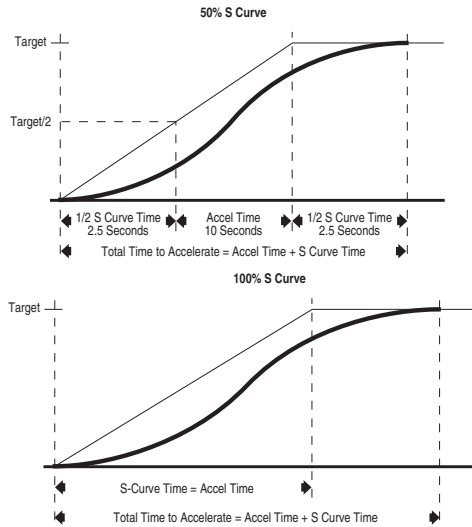

Values	Default:	20%
	Min/Max:	0/100% (A setting of 0% disables this parameter.)
	Display:	1%

A150 [PID Trim Hi]

Sets the maximum positive value that is added to a PID reference when PID trim is used.

Values	Default:	60.0 Hz
	Min/Max:	0.0/320.0 Hz
	Display:	0.1 Hz

A151 [PID Trim Lo]

Sets the minimum positive value that is added to a PID reference when PID trim is used.

Values	Default:	0.0 Hz
	Min/Max:	0.0/320.0 Hz
	Display:	0.1 Hz

A152 [PID Ref Sel]

Related Parameter(s): [P038](#), [T070](#), [T071](#), [T072](#), [T074](#), [T075](#)



Stop drive before changing this parameter.

Enables/disables PID mode and selects the source of the PID reference. Refer to [Appendix D](#) for details.

Note: PID analog reference is scaled through the [Analog In x Hi/Lo] parameters. The invert operation is obtained through programming these two parameters. If A152 [PID Ref Sel] is not set to zero, PID can be disabled by programming a digital input.

Options	0 "PID Disabled" (Default)	
	1 "PID Setpoint	
	2 "Analog In 1"	
	3 "Analog In 2"	
	4 "Comm Port"	
	5 "Setpnt, Trim"	Use PID output as Trim on [Frequency Select]
	6 "A-In 1, Trim"	Use PID output as Trim on [Frequency Select]
	7 "A-In 2, Trim" ⁽¹⁾	Use PID output as Trim on [Frequency Select]
	8 "Comm, Trim"	Use PID output as Trim on [Frequency Select]

(1) The PID will not function with bipolar input. It will ignore any negative voltages and treat them like zero.

A153 [PID Feedback Sel]

Related Parameter(s): [T070](#), [T071](#), [T072](#), [T074](#), [T075](#), [A204](#), [A205](#)

Select the source of the PID feedback. Refer to [Appendix D](#) for details.

Note: PID analog reference is scaled through the [Analog In x Hi/Lo] parameters. The invert operation is obtained through programming these two parameters.

Options	0 "Analog In 1" (Default)	
	1 "Analog In 2"	
	2 "Comm Port" ⁽¹⁾	
	3 "ACT1 - ACT2" (with FRN 7.xx and later)	ACT1 minus ACT2
	4 "ACT1 + ACT2" (with FRN 7.xx and later)	ACT1 plus ACT2
	5 "ACT1 * ACT2" (with FRN 7.xx and later)	ACT1 multiplied by ACT2
	6 "ACT1 / ACT2" (with FRN 7.xx and later)	ACT1 divided by ACT2
	7 "Min A1, A2" (with FRN 7.xx and later)	The smaller of ACT1 or ACT2 is used as the feedback signal.
	8 "Max A1, A2" (with FRN 7.xx and later)	The larger of ACT1 or ACT2 is used as the feedback signal.

(1) The PID will not function with bipolar input. It will ignore any negative voltages and treat them like zero.

A154 [PID Prop Gain]

Sets the value for the PID proportional component when the PID mode is enabled by [A152](#) [PID Ref Sel].

Values	Default:	1.00
	Min/Max:	0.00/99.99
	Display:	0.01

A155 [PID Integ Time]

Sets the value for the PID integral component when the PID mode is enabled by A152 [PID Ref Sel].

Values	Default:	2.0 Secs
	Min/Max:	0.0/999.9 Secs
	Display:	0.1 Secs

A156 [PID Diff Rate]

Sets the value for the PID differential component when the PID mode is enabled by A152 [PID Ref Sel].

Values	Default:	0.00 (1/Secs)
	Min/Max:	0.00/99.99 (1/Secs)
	Display:	0.01 (1/Secs)

A157 [PID Setpoint]

Provides an internal fixed value for process setpoint when the PID mode is enabled by A152 [PID Ref Sel].

Values	Default:	0.0%
	Min/Max:	0.0/100.0%
	Display:	0.1%

A158 [PID Deadband]

Sets the lower limit of the PID output.

Values	Default:	0.0%
	Min/Max:	0.0/10.0%
	Display:	0.1%

A159 [PID Preload]

Sets the value used to preload the integral component on start or enable.

Values	Default:	0.0 Hz
	Min/Max:	0.0/320.0 Hz
	Display:	0.1 Hz

A160 [Process Factor]

Related Parameter(s): [b008](#)

Scales the output frequency value displayed by [b008](#) [Process Display].

Process Display = [Output Freq] x [Process Factor]

Values	Default:	30.0
	Min/Max:	0.1/999.9
	Display:	0.1

A163 [Auto Rstrt Tries]

Related Parameter(s): [T055](#), [T060](#), [T065](#), [T066](#), [A164](#)

Sets the maximum number of times the drive attempts to reset a fault and restart.

Clear a Type 1 fault and restart the drive.

1. Set A163 [Auto Rstrt Tries] to a value other than "0".
2. Set A164 [Auto Rstrt Delay] to a value other than "0".

Clear an OverVoltage, UnderVoltage or Heatsink OvrTmp fault without restarting the drive.

1. Set A163 [Auto Rstrt Tries] to a value other than "0".
2. Set A164 [Auto Rstrt Delay] to "0".

Note: If the parameter is not set to zero and [Auto Rstrt Time] is set to zero, auto fault clear is enabled. This feature automatically clears faults, but does not restart the drive.



ATTENTION: Equipment damage and/or personal injury may result if this parameter is used in an inappropriate application. Do not use this function without considering applicable local, national and international codes, standards, regulations or industry guidelines.

Values	Default:	0
	Min/Max:	0/9
	Display:	1

A164 [Auto Rstrt Delay]

Related Parameter(s): [A163](#)

Sets the time between restart attempts when [A163](#) [Auto Rstrt Tries] is set to a value other than zero.

Note: If the parameter is not set to zero and [Auto Rstrt Time] is set to zero, auto fault clear is enabled. This feature automatically clears faults, but does not restart the drive.

Values	Default:	1.0 Secs
	Min/Max:	0.0/160.0 Secs
	Display:	0.1 Secs

A165 [Start At PowerUp]

Related Parameter(s): [P036](#)

Stop drive before changing this parameter.

Enables/disables a feature that allows a Start or Run command to automatically cause the drive to resume running at commanded speed after drive input power is restored. Requires a digital input configured for Run or Start and a valid start contact.

This parameter will not function if parameter [P036](#) [Start Source] is set to 4 "2-W Hi Speed".



ATTENTION: Equipment damage and/or personal injury may result if this parameter is used in an inappropriate application. Do not use this function without considering applicable local, national and international codes, standards, regulations or industry guidelines.

Options	0	"Disabled" (Default)
	1	"Enabled"

A166 [Reverse Disable]

Related Parameter(s): [b006](#), [P036](#), [T051](#)-[T054](#)

Stop drive before changing this parameter.

Enables/disables the function that allows the direction of motor rotation to be changed. The reverse command may come from a digital or a serial command. All reverse inputs including two-wire Run Reverse will be ignored with reverse disabled.

Options	0	"Rev Enabled"
	1	"Rev Disabled" (Default)

A167 [Flying Start En]

Related Parameter(s): [A200](#)

Sets the condition that allows the drive to reconnect to a spinning motor at actual RPM.

IMPORTANT When this parameter is enabled, verify that [A200](#) [Motor NP FLA] is set to the motor's actual full load amp value.

Options	0	"Disabled" (Default)
	1	"Enabled"

A168 [PWM Frequency]

Related Parameter(s): [A169](#)

Sets the carrier frequency for the PWM output waveform. The chart below provides derating guidelines based on the PWM frequency setting.

IMPORTANT Ignoring derating guidelines can cause reduced drive performance.

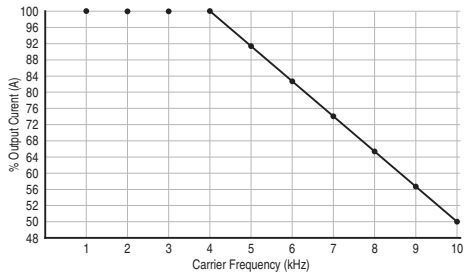

Values	Default:	4.0 kHz
	Min/Max:	2.0/10.0 kHz (Frame C and D drives) 2.0/8.0 kHz (Frame E, F, G and H drives)
	Display:	0.1 kHz

A169 [PWM Mode]

Related Parameter(s): [A168](#)

Selects the PWM algorithm used.

Options	0 "Space Vector"	3-Phase Modulation: Provides quiet operation and produces less motor losses.
	1 "2-Phase" (Default)	2-Phase Modulation: Provides less drive losses and best performance with long motor cable runs.

A170 [Boost Select]

Related Parameter(s): [b004](#), [P031](#), [P032](#), [A171](#), [A172](#), [A173](#)

Sets the boost voltage (% of P031 [Motor NP Volts]) and redefines the Volts per Hz curve.
 Drive may add additional voltage unless Option 5 is selected.

A174 [Maximum Voltage] can be set anywhere.
 Settings greater than P031 [Motor NP Volts] define a point on the V/Hz curve.
 Settings less than P031 [Motor NP Volts] function as limits only and do not change the V/Hz curve.

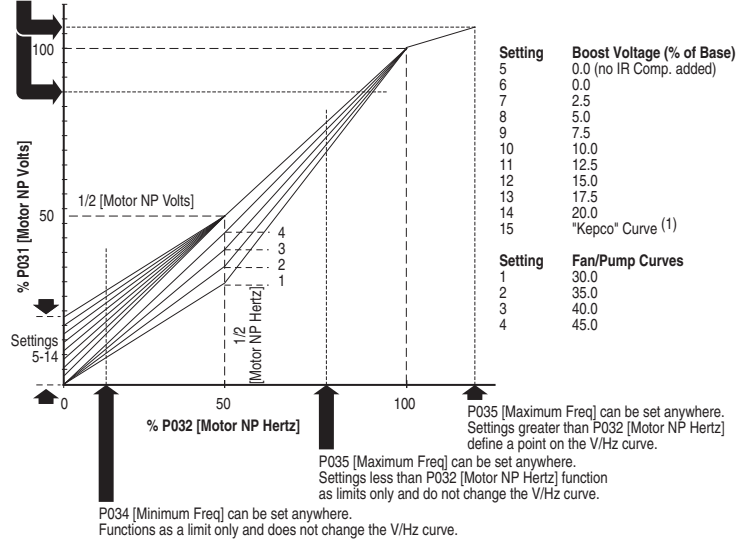

	Frames C-F	Frames G-H	
Options	0 "Custom V/Hz"	0 "Custom V/Hz"	
	1 "30.0, VT"	1 "30.0, VT"	Typical Fan/Pump Curves
	2 "35.0, VT"	2 "35.0, VT"	
	3 "40.0, VT"	3 "40.0, VT"	
	4 "45.0, VT" (Default)	4 "45.0, VT" (Default)	
	5 "0.0 no IR"	5 "0.0 no IR"	
	6 "0.0"	6 "0.0"	Boost Curves
	7 "2.5"	7 "0.2"	
	8 "5.0"	8 "0.5"	
	9 "7.5"	9 "0.8"	
	10 "10.0"	10 "1.0"	
	11 "12.5"	11 "2.0"	
	12 "15.0"	12 "3.0"	
	13 "17.5"	13 "4.0"	
	14 "20.0"	14 "5.0"	
	15 "Kepco" Curve ⁽¹⁾	15 "Kepco" Curve ⁽¹⁾	

(1) Kepco Curve is used in specific systems to meet requirements of the Korean Electric Power Company.

A171 [Start Boost]

Related Parameter(s): [P031](#), [P032](#), [P034](#), [P035](#), [A170](#), [A172](#), [A173](#), [A174](#)

Sets the boost voltage (% of [P031](#) [Motor NP Volts]) and redefines the Volts per Hz curve when [A170](#) [Boost Select] = 0 "Custom V/Hz".

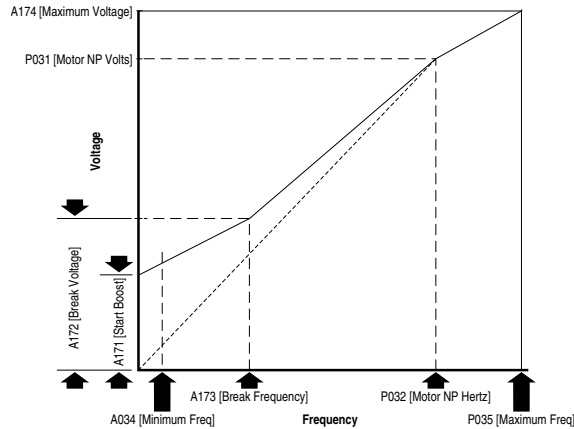

Values	Default:	2.5%
	Min/Max:	0.0/25.0%
	Display:	1.1%

A172 [Break Voltage]

Related Parameter(s): [P031](#), [P032](#), [P034](#), [P035](#), [A170](#), [A171](#), [A173](#), [A174](#)

Sets the break voltage applied at the break frequency when [A170](#) [Boost Select] = 0 "Custom V/Hz".

Values	Default:	25%
	Min/Max:	0.0/100.0%
	Display:	0.1%

A173 [Break Frequency]

Related Parameter(s): [P031](#), [P032](#), [P034](#), [P035](#), [A170](#), [A171](#), [A172](#), [A174](#)

Sets the frequency where break frequency is applied when [A170](#) [Boost Select] = 0 "Custom V/Hz".

Values	Default:	15.0 Hz
	Min/Max:	0.0/320.0 Hz
	Display:	0.1 Hz

A174 [Maximum Voltage]

Related Parameter(s): [b004](#), [A171](#), [A172](#), [A173](#)

Sets the highest voltage the drive will output.

Values	Default:	Drive Rated Volts
	Min/Max:	20/Drive Rated Volts
	Display:	1 VAC

A175 [Slip Hertz @ FLA]

Related Parameter(s): [P033](#)

Compensates for the inherent slip in an induction motor. This frequency is added to the commanded output frequency based on motor current.

Values	Default:	2.0 Hz
	Min/Max:	0.0/10.0 Hz
	Display:	0.1 Hz

A176 [DC Brake Time]

Related Parameter(s): [P037](#), [A177](#)

Sets the length of time that DC brake current is “injected” into the motor when [P037](#) [Stop Mode] is set to either 4 “Ramp” or 6 “DC Brake”. Refer to parameter [A177](#) [DC Brake Level].

Values	Default:	0.0 Secs
	Min/Max:	0.0/99.9 Secs (A setting of 99.9 = Continuous)
	Display:	0.1 Secs

A177 [DC Brake Level]

Related Parameter(s): [P037](#), [T051...T054](#), [A176](#), [A178](#)

Defines the maximum DC brake current, in amps, applied to the motor.

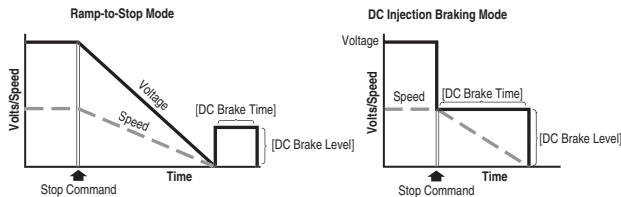

ATTENTION: If a hazard of injury due to movement of equipment or material exists, an auxiliary mechanical braking device must be used.
ATTENTION: This feature should not be used with synchronous or permanent magnet motors. Motors may be demagnetized during braking.

Values	Default:	Drive Rated Amps × 0.05
	Min/Max:	0.0/(Drive Rated Amps × 1.5)
	Display:	0.1 Amps

A178 [DC Brk Time@Strt]

Related Parameter(s): [P037](#), [A177](#)

Sets the length of time that DC brake current is “injected” into the motor after a valid start command is received. Parameter [A177](#) [DC Brake Level] controls the level of braking current used.

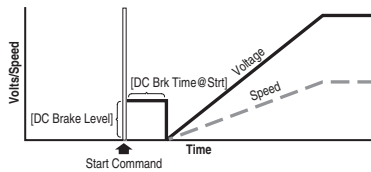

Values	Default:	0.0 Secs
	Min/Max:	0.0/99.9 Secs (A setting of 99.9 = Continuous)
	Display:	0.1 Secs

A179 [Current Limit 1]

Related Parameter(s): [P033](#)

Maximum output current allowed before current limiting occurs.

Values	Default:	Drive Rated Amps × 1.1
	Min/Max:	0.0/(Drive Rated Amps × 1.5)
	Display:	0.1 Amps

A180 [Current Limit 2]

Related Parameter(s): [P033](#)

Maximum output current allowed before current limiting occurs.

Values	Default:	Drive Rated Amps × 1.1
	Min/Max:	0.0/(Drive Rated Amps × 1.5)
	Display:	0.1 Amps

A181 [Motor OL Select]

Related Parameter(s): [P032](#), [P033](#), [P043](#)

Drive provides Class 10 motor overload protection. Settings 0-2 select the derating factor for the I²t overload function.

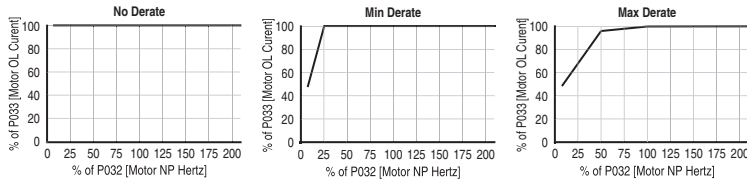

- Options**
- 0 "No Derate" (Default)
 - 1 "Min Derate"
 - 2 "Max Derate"

A182 [Drive OL Mode]

Related Parameter(s): [P032](#), [P033](#)

Determines how the drive handles overload conditions that would otherwise cause the drive to fault.

- Options**
- 0 "Disabled"
 - 1 "Reduce CLim"
 - 2 "Reduce PWM"
 - 3 "Both-PWM 1st" (Default)

A183 [SW Current Trip]

Related Parameter(s): [P033](#)

Enables/disables a software instantaneous (within 100 ms) current trip.

Values	Default:	0.0 (Disabled)
	Min/Max:	0.0/(Drive Rated Amps × 1.8)
	Display:	0.1 Amps

A184 [Load Loss Level]

Related Parameter(s): [P033](#)

Provides a software trip (Load Loss fault) when the current drops below this level for the time specified in [Load Loss Time].

Values	Default:	0.0 (Disabled)
	Min/Max:	0.0/Drive Rated Amps
	Display:	0.1 Amps

A185 [Load Loss Time]

Related Parameter(s): [P033](#)

Sets the required time for the current to be below [Load Loss Level] before a Load Loss fault occurs.

Values	Default:	0 Secs (Disabled)
	Min/Max:	0/9999 Secs
	Display:	1 Secs

A186 [Stall Fault Time]

Sets the time that the drive will remain in stall mode before a fault is issued.

- Options**
- 0 "60 Seconds" (Default)
 - 1 "120 Seconds"
 - 2 "240 Seconds"
 - 3 "360 Seconds"
 - 4 "480 Seconds"
 - 5 "Flt Disabled"

A187 [Bus Reg Mode]

Controls the operation of the drive voltage regulation, which is normally operational at decel or when the bus voltage rises. Refer to the Attention statement on [page 9](#) for important information on bus regulation.

Options	0 "Disabled"
	1 "Enabled" (Default)

A188 [Skip Frequency 1]

Related Parameter(s): [A189](#)

Sets the frequency at which the drive will not operate. A setting of 0 disables this parameter.

Values	Default:	0 Hz
	Min/Max:	0/320 Hz
	Display:	1 Hz

A189 [Skip Freq Band 1]

Related Parameter(s): [A188](#)

Determines the bandwidth around [A188](#) [Skip Frequency 1]. A189 [Skip Freq Band 1] is split applying 1/2 above and 1/2 below the actual skip frequency. A setting of 0.0 disables this parameter.

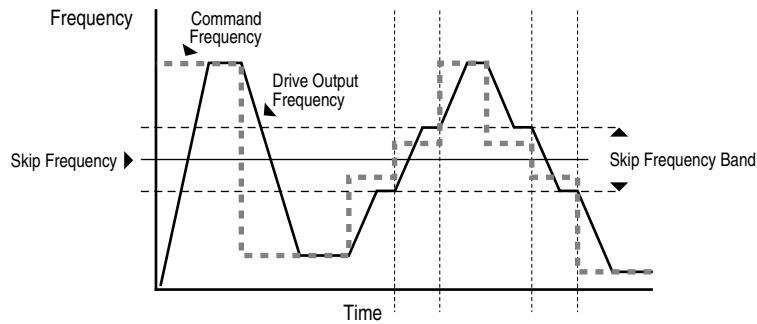

Values	Default:	0 Hz
	Min/Max:	0.0/30.0 Hz
	Display:	0.1 Hz

A190 [Skip Frequency 2]

Related Parameter(s): [A191](#)

Sets the frequency at which the drive will not operate. A setting of 0 disables this parameter.

Values	Default:	0 Hz
	Min/Max:	0/320 Hz
	Display:	1 Hz

A191 [Skip Freq Band 2]

Related Parameter(s): [A190](#)

Determines the bandwidth around A190 [Skip Frequency 2]. A191 [Skip Freq Band 2] is split applying 1/2 above and 1/2 below the actual skip frequency. A setting of 0.0 disables this parameter.

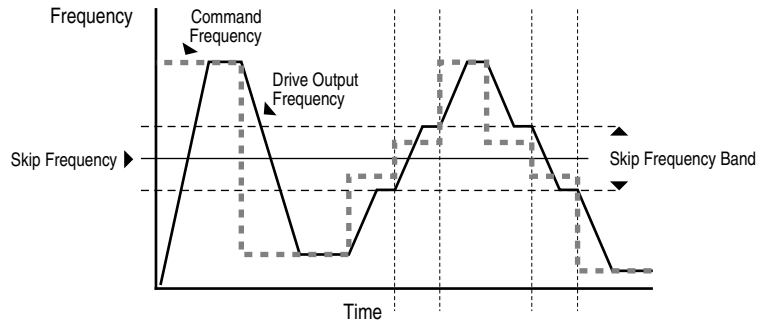

Values	Default:	0 Hz
	Min/Max:	0.0/30.0 Hz
	Display:	0.1 Hz

A192 [Skip Frequency 3]

Related Parameter(s): [A193](#)

Sets the frequency at which the drive will not operate. A setting of 0 disables this parameter.

Values	Default:	0 Hz
	Min/Max:	0/320 Hz
	Display:	1 Hz

A193 [Skip Freq Band 3]

Related Parameter(s): [A192](#)

Determines the bandwidth around [A192](#) [Skip Frequency 3]. A193 [Skip Freq Band 3] is split applying 1/2 above and 1/2 below the actual skip frequency. A setting of 0.0 disables this parameter.

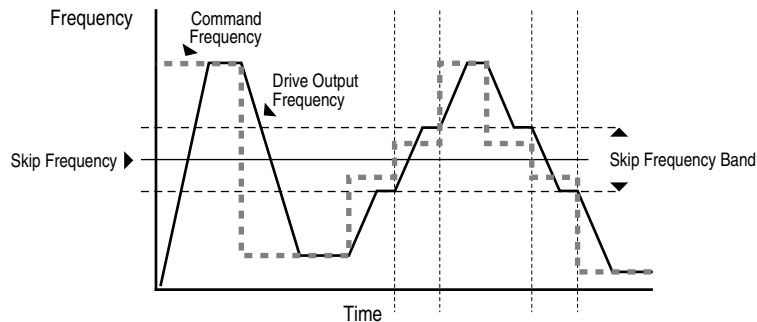

Values	Default:	0 Hz
	Min/Max:	0.0/30.0 Hz
	Display:	0.1 Hz

A194 [Compensation]

Enables/disables correction options that may improve problems with motor instability.

Options	0 "Disabled"	
	1 "Electrical" (Default) ⁽¹⁾	Some drive/motor combinations have inherent instabilities which are exhibited as non-sinusoidal motor currents. This setting attempts to correct this condition.
	2 "Mechanical"	Some motor/load combinations have mechanical resonances which can be excited by the drive current regulator. This setting slows down the current regulator response and attempts to correct this condition.
	3 "Both" ⁽¹⁾	

(1) Use "Dead Time Compensation" algorithm to minimize flat spots in motor current waveforms. Use this solution also to achieve motor stability.

A195 [Reset Meters]

Related Parameter(s): [d310...d317](#)

Resets the marker that indicates Fault Times and Energy usage.

Options	0	"Ready/Idle" (Default)	
	1	"Reset MWh"	Also resets kWh marker.
	2	"Reset Time"	min, hr, and x10hr

A196 [Testpoint Sel]

Related Parameter(s): [d319](#)

Used by Rockwell Automation field service personnel.

Values	Default:	1024
	Min/Max:	1024/65535
	Display:	1

A197 [Fault Clear]

Related Parameter(s): [b007](#), [d307](#), [d308](#), [d309](#)

 Stop drive before changing this parameter.

Resets a fault and clears the fault queue. Used primarily to clear a fault over network communications.

Options	0	"Ready/Idle" (Default)	
	1	"Reset Fault"	
	2	"Clear Buffer"	Clears all fault buffers.

A198 [Program Lock]

Protects parameters against change by unauthorized personnel. Enter a user-selected password to lock the parameters via Option 1. Enter the same password to unlock the parameters.

Options	0	"Unlocked" (Default)	
	1	"Locked"	Locks all parameters.
	2	"Locked"	Parameter edits allowed over communications network.
	3	"Locked"	Locks P035 [Maximum Freq] and A170 [Boost Select].

A199 [Motor NP Poles]

Related Parameter(s): [d323](#)

Sets the motor poles. This is used to calculate [d323](#) [Output RPM].

Values	Default:	4
	Min/Max:	2/40
	Display:	1

A200 [Motor NP FLA]

Related Parameter(s): [A167](#)

Set to the motor nameplate rated full load amps.

Values	Default:	Drive Rated Amps
	Min/Max:	0.1/(Drive Rated Amps × 2)
	Display:	0.1 Amps

A201 [PID Invert Error]

(With FRN 6.xx and later.)

When set to "Inverted", changes the sign of the PID error. This causes an increase in the drive output frequency with PID Feedback greater than PID Setpoint, and a decrease in drive output frequency with PID Feedback less than PID Setpoint.

Options	0	"Not Inverted" (Default)	
	1	"Inverted"	Locks all parameters.

A202 [MOP Reset Sel]

Related Parameter(s): [A142](#)

(With FRN 6.xx and later.)

Set the drive to save the current MOP reference command.

Options	0 "Zero MOP Ref"	This option clamps A142 [Internal Freq] at 0.0 Hz when the drive is not running.
	1 "Save MOP Ref" (Default)	Reference is saved in A142 [Internal Freq].

A203 [Wake Deviation]

Related Parameter(s): [T091](#)

(with FRN 7.xx and later.)

Sets the deviation from PID setpoint the drive must reach to wake from sleep mode.

Values	Default:	0.0%
	Min/Max:	0.0/100.0%
	Display:	0.1%

A204 [ACT1 Input]

Related Parameter(s): [A153](#)

(with FRN 7.xx and later.)

Defines the source of the data used as the actual (ACT) 1 input.

Options	0 "Analog In 1" (Default)	Use Analog Input 1
	1 "Analog In 2"	Use Analog Input 2
	2 "Current"	Use b003 [Output Current]

A205 [ACT2 Input]

Related Parameter(s): [A153](#)

(with FRN 7.xx and later.)

Defines the source of the data used as the actual (ACT) 2 input.

Options	0 "Analog In 1" (Default)	Use Analog Input 1
	1 "Analog In 2"	Use Analog Input 2
	2 "Current"	Use b003 [Output Current]

A206 [ACT1 Minimum]

Related Parameter(s): [A204](#)

(with FRN 7.xx and later.)

Sets the minimum value of the actual (ACT) 1 input. Used with the analog input min/max settings to scale the analog input for use as the PID feedback. Can be used in a normal and inverted mode.

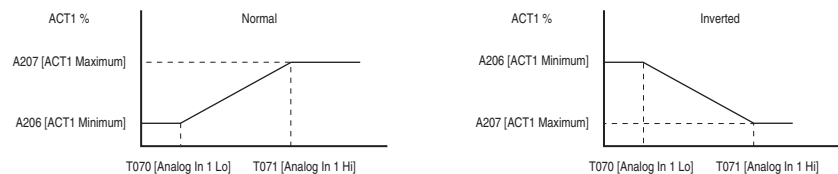

Values	Default:	0.0%
	Min/Max:	0.0/200.0%
	Display:	0.1%

A207 [ACT1 Maximum]

Related Parameter(s): [A204](#)

(with FRN 7.xx and later.)

Sets the maximum value of the actual (ACT) 1 input.

Values	Default:	100.0%
	Min/Max:	0.0/200.0%
	Display:	0.1%

A208 [ACT2 Minimum]

Related Parameter(s): [A205](#)

(with FRN 7.xx and later.)

Sets the minimum value of the actual (ACT) 2 input. Used with the analog input min/max settings to scale the analog input for use as the PID feedback. Can be used in a normal and inverted mode.

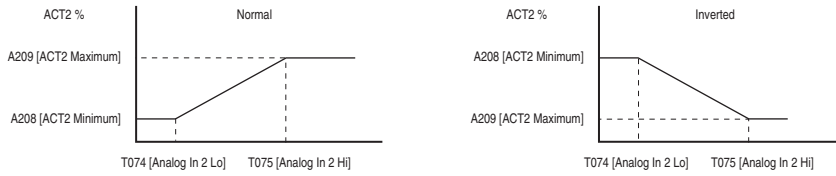

Values	Default:	0.0%
	Min/Max:	0.0/200.0%
	Display:	0.1%

A209 [ACT2 Maximum]

Related Parameter(s): [A205](#)

(with FRN 7.xx and later.)

Sets the maximum value of the actual (ACT) 2 input.

Values	Default:	100.0%
	Min/Max:	0.0/200.0%
	Display:	0.1%

A210 [Wake PID Preload]

Related Parameter(s): [T078](#)

(with FRN 7.xx and later.)

Sets the value used to preload the PID integral component on wake. This value must be greater than T078 [Sleep Level] or drive will not wake up.

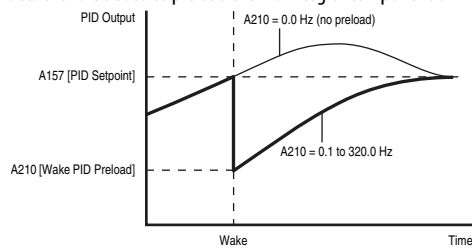

Values	Default:	0.0 Hz (No preload)
	Min/Max:	0.0/320.0 Hz
	Display:	0.1 Hz

Aux Relay Card Group

- R221 [Relay Out3 Sel]
- R224 [Relay Out4 Sel]
- R227 [Relay Out5 Sel]
- R230 [Relay Out6 Sel]
- R233 [Relay Out7 Sel]
- R236 [Relay Out8 Sel]

Related Parameters for the Aux Relay Card Group:
 Aux Parameters
 PID Parameters
 Digital Inputs
 Relays 1 and 2

Note: Auxiliary Relay Card option is not available for Frame C drives.
 Sets the condition that changes the state of the output relay contacts.

Options	0	"Ready/Fault"	Relay changes state when power is applied. This indicates that the drive is ready for operation. Relay returns drive to shelf state when power is removed or a fault occurs.
	1	"At Frequency"	Drive reaches commanded frequency.
	2	"MotorRunning"	Motor is receiving power from the drive.
	3	"Hand Active"	Active when drive is in local control.
	4	"Motor Overld"	Motor overload condition exists.
	5	"Ramp Reg"	Ramp regulator is modifying the programmed accel/decel times to avoid an overcurrent or overvoltage fault from occurring.
	6	"Above Freq"	<ul style="list-style-type: none"> • Drive exceeds the frequency (Hz) value set in [Relay OutX Level]. • Use T056 to set threshold.
	7	"Above Cur"	<ul style="list-style-type: none"> • Drive exceeds the current (% Amps) value set in [Relay OutX Level]. • Use T056 to set threshold.
IMPORTANT Value for [Relay OutX Level] must be entered in percent of drive rated output current.			
	8	"Above DCVolt"	<ul style="list-style-type: none"> • Drive exceeds the DC bus voltage value set in [Relay OutX Level]. • Use T056 to set threshold.
	9	"Above Anlg 2"	<ul style="list-style-type: none"> • Analog input voltage (I/O Terminal 17) exceeds the value set in [Relay OutX Level]. • Do not use if T073 [Analog In 2 Sel] is set to 3 "Voltage Mode - Bipolar". • This parameter setting can also be used to indicate a PTC trip point when the input (I/O Terminal 17) is wired to a PTC and external resistor. • Use T056 to set threshold.
	10	"Above PF Ang"	<ul style="list-style-type: none"> • Power Factor angle has exceeded the value set in [Relay OutX Level]. • Use T056 to set threshold.
	11	"Anlg In Loss"	Analog input loss has occurred. Program T072 [Analog In 1 Loss] and/or T076 [Analog In 2 Loss] for desired action when input loss occurs.
	12	"ParamControl"	Enables the output to be controlled over network communications by writing to [Relay OutX Level]. (0 = Off, 1 = On.)
	13	"Retries Exst"	Value set in A163 [Auto Rstrt Tries] is exceeded.
	14	"NonRec Fault"	<ul style="list-style-type: none"> • Number of retries for A163 [Auto Rstrt Tries] is exceeded OR • Non-resettable fault occurs OR • A163 [Auto Rstrt Tries] is not enabled.
	15	"Reverse"	Drive is commanded to run in reverse direction.
	16	"Logic In 1"	An input is programmed as "Logic In 1" and is active.
	17	"Logic In 2"	An input is programmed as "Logic In 2" and is active.
	23	"Aux Motor" (Default)	Auxiliary Motor is commanded to run. Refer to Appendix D
	24	"Fault" (with FRN 7.xx and later)	Relay output is inactive when power is applied to the drive and is active when a fault occurs. This is inverted from Option 0, "Ready/Fault".

- R222 [Relay Out3 Level]
- R225 [Relay Out4 Level]
- R228 [Relay Out5 Level]
- R231 [Relay Out6 Level]
- R234 [Relay Out7 Level]
- R237 [Relay Out8 Level]

Sets the trip point for the digital output relay if the value of [Relay OutX Sel] is 6, 7, 8, 9, 10 or 12.

[Relay OutX Select] Setting	Relay OutX Level] Min/Max
6	0/320 Hz
7	0/180%
8	0/815 Volts
9	0/100%
10	1/180 degs
12	0/1

Values	Default:	0.0
	Min/Max:	0.0/9999
	Display:	0.1

Refer to [Appendix D](#) for details on the application of parameters R239 through R254.

R239 [Aux Motor Mode]

Enables operation of the auxiliary motor control modes when in PID mode.

Options	0 "Disabled" (Default)
	1 "Enabled"

R240 [Aux Motor Qty]

Sets the number of auxiliary motors used while in Auxiliary Motor Control mode.

R240 Option	Drive Relays		Auxiliary Relay Card Relays					
	#1 Relay	#2 Relay	#3 Relay	#4 Relay	#5 Relay	#6 Relay	#7 Relay	#8 Relay
1	Motor #2 AC Line	—	—	—	—	—	—	—
2	Motor #2 AC Line	Motor #3 AC Line	—	—	—	—	—	—
3	Motor #2 AC Line	Motor #3 AC Line	Motor #4 AC Line	—	—	—	—	—
4	Motor #1 Drive	Motor #1 AC Line	Motor #2 Drive	Motor #2 AC Line	—	—	—	—
5	Motor #1 Drive	Motor #1 AC Line	Motor #2 Drive	Motor #2 AC Line	Motor #3 Drive	Motor #3 AC Line	—	—
6	Motor #1 Drive	Motor #1 AC Line	Motor #2 Drive	Motor #2 AC Line	Motor #3 Drive	Motor #3 AC Line	Motor #4 Drive	Motor #4 AC Line

Options	1 "1 Aux Mtr" (Default)	1 Auxiliary Motor
	2 "2 Aux Mtr"	2 Auxiliary Motors
	3 "3 Aux Mtr"	3 Auxiliary Motors
	4 "1 Mtr + Swap" ⁽¹⁾	1 Auxiliary Motor and AutoSwap Active
	5 "2 Mtr + Swap" ⁽¹⁾	2 Auxiliary Motors and AutoSwap Active
	6 "3 Mtr + Swap" ⁽¹⁾	3 Auxiliary Motors and AutoSwap Active

(1) Important: Proper wiring and parameter configuration of Aux Motor Control functions are especially important when using AutoSwap. Improper wiring or configuration could result in line power being applied to the drive outputs. Verify system operation before connecting auxiliary motor contact or outputs.

R241 [Aux 1 Start Freq]
R244 [Aux 2 Start Freq]
R247 [Aux 3 Start Freq]

Sets the frequency that causes the next available auxiliary motor to turn on.

Values	Default:	50.0 Hz
	Min/Max:	0.0/320.0 Hz
	Display:	0.1 Hz

R242 [Aux 1 Stop Freq]
R245 [Aux 2 Stop Freq]
R248 [Aux 3 Stop Freq]

Sets the frequency that causes the next running auxiliary motor to turn off.

Values	Default:	25.0 Hz
	Min/Max:	0.0/320.0 Hz
	Display:	0.1 Hz

R243 [Aux 1 Ref Add]
R246 [Aux 2 Ref Add]
R249 [Aux 3 Ref Add]

Sets the amount to add to the PID reference once the next auxiliary motor is turned on to compensate for a drop in the pipe due to the increased flow in a typical pump system.

Values	Default:	0.0%
	Min/Max:	0.0/100.0%
	Display:	0.1%

R250 [Aux Start Delay]

Sets the delay time before turning on the next auxiliary motor once the output frequency has risen above the value set in [Aux X Start Freq].

Values	Default:	5.0 Secs
	Min/Max:	0.0/999.9 Secs
	Display:	0.1 Secs

R251 [Aux Stop Delay]

Sets the delay time before turning off the next running auxiliary motor once the output frequency has dropped below the value set in [Aux X Stop Freq].

Values	Default:	3.0 Secs
	Min/Max:	0.0/999.9 Secs
	Display:	0.1 Secs

R252 [Aux Prog Delay]

Sets the time delay between connecting the drive controlled motor contactor and running the drive controlled motor and starting the auxiliary motor control.

Values	Default:	0.50 Secs
	Min/Max:	0.00/60.00 Secs
	Display:	0.01 Secs

R253 [Aux AutoSwap Tme]

Sets the total running time between automatic motor changes.

IMPORTANT Proper wiring and parameter configuration of Aux Motor Control functions are especially important when using AutoSwap. Improper wiring or configuration could result in line power being applied to the drive outputs. Verify system operation before connecting auxiliary motor contactor outputs.

Values	Default:	0.0 Hr
	Min/Max:	0.0/999.9 Hr
	Display:	0.1 Hr

R254 [Aux AutoSwap Lvl]

Sets the maximum level allowable for an AutoSwap to occur. If the PID output is above this level, AutoSwap will be delayed until the PID output drops below this parameter setting.

Values	Default:	50.0%
	Min/Max:	0.0/100.0%
	Display:	0.1%

Advanced Display Group

d301 [Control Source]

Related Parameter(s): [P036](#), [P038](#), [I051...I054](#)

Displays the active source of the Start Command and Speed Command which are normally defined by the settings of [P036](#) [Start Source] and [P038](#) [Speed Reference] but may be overridden by digital inputs. Refer to the flowcharts on [page 37](#) and [page 38](#) for details.

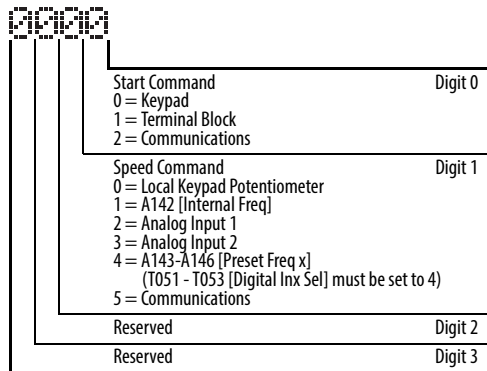

Values	Default:	Read Only
	Min/Max:	0/99
	Display:	1

d302 [Contrl In Status]

Related Parameter(s): [b002](#), [P036](#), [I051...I054](#)

Status of the control terminal block control inputs.

IMPORTANT Actual control commands may come from a source other than the control terminal block.

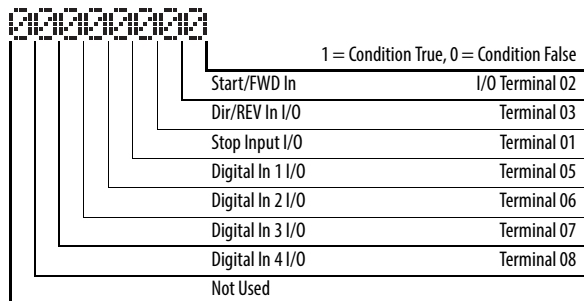

Values	Default:	Read Only
	Min/Max:	0/1
	Display:	1

d303 [Comm Status]

Related Parameter(s): [C102...C103](#)

Status of the communications ports.

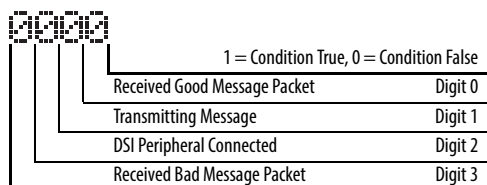

Values	Default:	Read Only
	Min/Max:	0/1111
	Display:	1

d304 [PID Setpnt Displ]

Related Parameter(s): [A152](#)

Displays the active PID Setpoint value.

Values	Default:	0.0%
	Min/Max:	0.0/100.0%
	Display:	0.1%

d305 [Analog In 1]

Related Parameter(s): [T069-T071](#)

Displays the status of Analog Input 1.

Values	Default:	0.0%
	Min/Max:	0.0/120.0%
	Display:	0.1%

d306 [Analog In 2]

Related Parameter(s): [T073...T075](#)

Displays the status of Analog Input 2.

Values	Default:	0.0%
	Min/Max:	0.0/120.0%
	Display:	0.1%

d307 [Fault 1 Code]

Related Parameter(s): [A197](#)

A code that represents a drive fault. The codes will appear in these parameters in the order they occur ([d307](#) [Fault 1 Code] = the most recent fault). Repetitive faults will only be recorded once. Refer to [Chapter 4](#) for fault code descriptions.

Values	Default:	Read Only
	Min/Max:	0/122
	Display:	1

d308 [Fault 2 Code]

Related Parameter(s): [A197](#)

A code that represents the second most recent drive fault. The codes will appear in these parameters in the order they occur ([d307](#) [Fault 1 Code] = the most recent fault). Repetitive faults will only be recorded once. As faults occur, this parameter will be overwritten by [Fault 1 Code]. The value of this parameter is then moved to [Fault 3 Code].

Refer to [Chapter 4](#) for fault code descriptions.

Values	Default:	Read Only
	Min/Max:	0/122
	Display:	1

d309 [Fault 3 Code]

Related Parameter(s): [A197](#)

A code that represents the third most recent drive fault. The codes will appear in these parameters in the order they occur ([d307](#) [Fault 1 Code] = the most recent fault). Repetitive faults will only be recorded once. As faults occur, this parameter will be overwritten by [Fault 2 Code].

Refer to [Chapter 4](#) for fault code descriptions.

Values	Default:	Read Only
	Min/Max:	0/122
	Display:	1

d310 [Fault 1 Time-hr]

Related Parameter(s): [A195](#), [d316](#)

Displays the value of the [d316](#) [Elapsed Time-hr] parameter when the fault occurred.

Values	Default:	Read Only
	Min/Max:	0/32767 Hr
	Display:	1 Hr

d311 [Fault 1 Time-min]

Related Parameter(s): [A195](#), [d317](#)

Displays the value of the [d317](#) [Elapsed Time-min] parameter when the fault occurred.

Values	Default:	Read Only
	Min/Max:	0.0/60.0 Min
	Display:	0.1 Min

d312 [Fault 2 Time-hr]

Related Parameter(s): [A195](#), [d316](#)

Displays the value of the [d316](#) [Elapsed Time-hr] parameter when the fault occurred.

Values	Default:	Read Only
	Min/Max:	0/32767 Hr
	Display:	1 Hr

d313 [Fault 2 Time-min]

Related Parameter(s): [A195](#), [d317](#)

Displays the value of the [d317](#) [Elapsed Time-min] parameter when the fault occurred.

Values	Default:	Read Only
	Min/Max:	0.0/60.0 Min
	Display:	0.1 Min

d314 [Fault 3 Time-hr]

Related Parameter(s): [A195](#), [d316](#)

Displays the value of the [d316](#) [Elapsed Time-hr] parameter when the fault occurred.

Values	Default:	Read Only
	Min/Max:	0/32767 Hr
	Display:	1 Hr

d315 [Fault 3 Time-min]

Related Parameter(s): [A195](#), [d317](#)

Displays the value of the [d317](#) [Elapsed Time-min] parameter when the fault occurred.

Values	Default:	Read Only
	Min/Max:	0.0/60.0 Min
	Display:	0.1 Min

d316 [Elapsed Time-hr]

Related Parameter(s): [A195](#), [d310](#), [d312](#), [d314](#)

Displays the total elapsed powered-up time (in hours) since timer reset. The timer stops when it reaches maximum.

Values	Default:	Read Only
	Min/Max:	0/32767 Hr
	Display:	1 Hr

d317 [Elapsed Time-min]

Related Parameter(s): [A195](#), [d311](#), [d313](#), [d315](#)

Displays the total elapsed powered-up time (in minutes) since timer reset. The timer will increment the hour parameter when appropriate.

Values	Default:	Read Only
	Min/Max:	0.0/60.0 Min
	Display:	0.1 Min

d318 [Output Powr Fctr]

Related Parameter(s): [T055](#), [T056](#), [T060](#), [T061](#), [T065](#), [T066](#)

The angle in electrical degrees between motor voltage and motor current.

Values	Default:	Read Only
	Min/Max:	0.0/180.0 deg
	Display:	0.1 deg

d319 [Testpoint Data]

Related Parameter(s): [A196](#)

The present value of the function selected in A196 [Testpoint Sel].

Values	Default:	Read Only
	Min/Max:	0/FFFF
	Display:	1 Hex

d320 [Control SW Ver]

Main Control Board software version.

Values	Default:	Read Only
	Min/Max:	1.00/99.99
	Display:	0.01

d321 [Drive Type]

Used by Rockwell Automation field service personnel.

d322 [Output Speed]

Related Parameter(s): [P034](#)

Displays current output frequency in percent (%). The scale is 0% at 0.00 Hz to 100.0% at [P034](#) [Maximum Freq].

Values	Default:	Read Only
	Min/Max:	0.0/100.0%
	Display:	0.1%

d323 [Output RPM]

Related Parameter(s): [A199](#)

Displays current output frequency in RPM. The scale is based on [A199](#) [Motor NP Poles].

Values	Default:	Read Only
	Min/Max:	0/24000 RPM
	Display:	1 RPM

d324 [Fault Frequency]

Related Parameter(s): [b001](#)

Displays the value of [b001](#) [Output Freq] when the last fault occurred.

Values	Default:	Read Only
	Min/Max:	0.00/320.00 Hz
	Display:	0.01 Hz

d325 [Fault Current]

Related Parameter(s): [b003](#)

Displays the value of [b003](#) [Output Current] when the last fault occurred.

Values	Default:	Read Only
	Min/Max:	0.0/(Drive Rated Amps × 2)
	Display:	0.1 Amps

d326 [Fault Bus Volts]

Related Parameter(s): [b005](#)

Displays the value of [b005](#) [DC Bus Voltage] when the last fault occurred.

Values	Default:	Read Only
	Min/Max:	0/820 VDC
	Display:	1 VDC

d327 [Status @ Fault]

Related Parameter(s): [b006](#)

Displays the value of [b006](#) [Drive Status] when the last fault occurred.

Values	Default:	Read Only
	Min/Max:	0/1
	Display:	1

d328 [PID Fdbk Display]

Related Parameter(s): [b006](#)

(With FRN 7.xx and later.)

Displays the active PID Feedback value.

Values	Default:	0.0%
	Min/Max:	-200.0/200.0%
	Display:	0.1%

d329 [DC Bus Ripple V]

Related Parameter(s): [b006](#)

(With FRN 6.xx and later.)

Displays the real-time value of DC bus ripple voltage.

Excessive voltage ripple will eventually result in F017 Input Phase Loss fault.

Fault ripple levels are: 30V for 230V rated drives, and 60V for 460V rated drives.

Values	Default:	Read Only
	Min/Max:	0/(410 for 230 VAC drives, 820 for 460 VAC drives) VDC
	Display:	1 VDC

d330 [Fault 4 Code]

Related Parameter(s): [A197](#)

(With FRN 6.xx and later.)

A code that represents the fourth most recent drive fault. The codes will appear in these parameters in the order they occur ([d307](#) [Fault 1 Code] = the most recent fault). Repetitive faults will only be recorded once. As faults occur, this parameter will be overwritten by [Fault 3 Code]. The value of this parameter is then moved to [Fault 3 Code].

Refer to [Chapter 4](#) for fault code descriptions.

Values	Default:	Read Only
	Min/Max:	0/122
	Display:	1

d331 [Fault 5 Code]

Related Parameter(s): [A197](#)

(With FRN 6.xx and later.)

A code that represents the fifth most recent drive fault. The codes will appear in these parameters in the order they occur ([d307](#) [Fault 1 Code] = the most recent fault). Repetitive faults will only be recorded once. As faults occur, this parameter will be overwritten by [Fault 4 Code]. The value of this parameter is then moved to [Fault 3 Code].

Refer to [Chapter 4](#) for fault code descriptions.

Values	Default:	Read Only
	Min/Max:	0/122
	Display:	1

d332 [Fault 6 Code]

Related Parameter(s): [A197](#)

(With FRN 6.xx and later.)

A code that represents the sixth most recent drive fault. The codes will appear in these parameters in the order they occur ([d307](#) [Fault 1 Code] = the most recent fault). Repetitive faults will only be recorded once. As faults occur, this parameter will be overwritten by [Fault 5 Code].

Refer to [Chapter 4](#) for fault code descriptions.

Values	Default:	Read Only
	Min/Max:	0/122
	Display:	1

d333 [Fault 7 Code]Related Parameter(s): [A197](#)

(With FRN 6.xx and later.)

A code that represents the seventh most recent drive fault. The codes will appear in these parameters in the order they occur ([d307](#) [Fault 1 Code] = the most recent fault). Repetitive faults will only be recorded once. As faults occur, this parameter will be overwritten by [Fault 6 Code].

Refer to [Chapter 4](#) for fault code descriptions.

Values	Default:	Read Only
	Min/Max:	0/122
	Display:	1

d333 [Fault 7 Code]Related Parameter(s): [A197](#)

(With FRN 6.xx and later.)

A code that represents the seventh most recent drive fault. The codes will appear in these parameters in the order they occur ([d307](#) [Fault 1 Code] = the most recent fault). Repetitive faults will only be recorded once. As faults occur, this parameter will be overwritten by [Fault 6 Code].

Refer to [Chapter 4](#) for fault code descriptions.

Values	Default:	Read Only
	Min/Max:	0/122
	Display:	1

d334 [Fault 8 Code]Related Parameter(s): [A197](#)

(With FRN 6.xx and later.)

A code that represents the seventh most recent drive fault. The codes will appear in these parameters in the order they occur ([d307](#) [Fault 1 Code] = the most recent fault). Repetitive faults will only be recorded once. As faults occur, this parameter will be overwritten by [Fault 7 Code].

Refer to [Chapter 4](#) for fault code descriptions.

Values	Default:	Read Only
	Min/Max:	0/122
	Display:	1

d335 [Fault 9 Code]Related Parameter(s): [A197](#)

(With FRN 6.xx and later.)

A code that represents the seventh most recent drive fault. The codes will appear in these parameters in the order they occur ([d307](#) [Fault 1 Code] = the most recent fault). Repetitive faults will only be recorded once. As faults occur, this parameter will be overwritten by [Fault 8 Code].

Refer to [Chapter 4](#) for fault code descriptions.

Values	Default:	Read Only
	Min/Max:	0/122
	Display:	1

d336 [Fault 10 Code]Related Parameter(s): [A197](#)

(With FRN 6.xx and later.)

A code that represents the seventh most recent drive fault. The codes will appear in these parameters in the order they occur ([d307](#) [Fault 1 Code] = the most recent fault). Repetitive faults will only be recorded once. As faults occur, this parameter will be overwritten by [Fault 9 Code].

Refer to [Chapter 4](#) for fault code descriptions.

Values	Default:	Read Only
	Min/Max:	0/122
	Display:	1

d337 [Fault 4 Time-hr]Related Parameter(s): [A195](#), [d316](#)

(With FRN 6.xx and later.)

Displays the value of the [d316](#) [Elapsed Time-hr] parameter when the fault occurred.

Values	Default:	Read Only
	Min/Max:	0/32767 Hr
	Display:	1 Hr

d338 [Fault 4 Time-min]

Related Parameter(s): [A195](#), [d317](#)

(With FRN 6.xx and later.)

Displays the value of the [d317](#) [Elapsed Time-min] parameter when the fault occurred.

Values	Default:	Read Only
	Min/Max:	0.0/60.0 Min
	Display:	0.1Min

d339 [Fault 5 Time-hr]

Related Parameter(s): [A195](#), [d316](#)

(With FRN 6.xx and later.)

Displays the value of the [d316](#) [Elapsed Time-hr] parameter when the fault occurred.

Values	Default:	Read Only
	Min/Max:	0/32767 Hr
	Display:	1 Hr

d340 [Fault 5 Time-min]

Related Parameter(s): [A195](#), [d317](#)

(With FRN 6.xx and later.)

Displays the value of the [d317](#) [Elapsed Time-min] parameter when the fault occurred.

Values	Default:	Read Only
	Min/Max:	0.0/60.0 Min
	Display:	0.1Min

d341 [Fault 6 Time-hr]

Related Parameter(s): [A195](#), [d316](#)

(With FRN 6.xx and later.)

Displays the value of the [d316](#) [Elapsed Time-hr] parameter when the fault occurred.

Values	Default:	Read Only
	Min/Max:	0/32767 Hr
	Display:	1 Hr

d342 [Fault 6 Time-min]

Related Parameter(s): [A195](#), [d317](#)

(With FRN 6.xx and later.)

Displays the value of the [d317](#) [Elapsed Time-min] parameter when the fault occurred.

Values	Default:	Read Only
	Min/Max:	0.0/60.0 Min
	Display:	0.1Min

d343 [Fault 7 Time-hr]

Related Parameter(s): [A195](#), [d316](#)

(With FRN 6.xx and later.)

Displays the value of the [d316](#) [Elapsed Time-hr] parameter when the fault occurred.

Values	Default:	Read Only
	Min/Max:	0/32767 Hr
	Display:	1 Hr

d344 [Fault 7 Time-min]

Related Parameter(s): [A195](#), [d317](#)

(With FRN 6.xx and later.)

Displays the value of the [d317](#) [Elapsed Time-min] parameter when the fault occurred.

Values	Default:	Read Only
	Min/Max:	0.0/60.0 Min
	Display:	0.1Min

d345 [Fault 8 Time-hr]

Related Parameter(s): [A195](#), [d316](#)

(With FRN 6.xx and later.)

Displays the value of the [d316](#) [Elapsed Time-hr] parameter when the fault occurred.

Values	Default:	Read Only
	Min/Max:	0/32767 Hr
	Display:	1 Hr

d346 [Fault 8 Time-min]

Related Parameter(s): [A195](#), [d317](#)

(With FRN 6.xx and later.)

Displays the value of the [d317](#) [Elapsed Time-min] parameter when the fault occurred.

Values	Default:	Read Only
	Min/Max:	0.0/60.0 Min
	Display:	0.1Min

d347 [Fault 9 Time-hr]

Related Parameter(s): [A195](#), [d316](#)

(With FRN 6.xx and later.)

Displays the value of the [d316](#) [Elapsed Time-hr] parameter when the fault occurred.

Values	Default:	Read Only
	Min/Max:	0/32767 Hr
	Display:	1 Hr

d348 [Fault 9 Time-min]

Related Parameter(s): [A195](#), [d317](#)

(With FRN 6.xx and later.)

Displays the value of the [d317](#) [Elapsed Time-min] parameter when the fault occurred.

Values	Default:	Read Only
	Min/Max:	0.0/60.0 Min
	Display:	0.1Min

d349 [Fault10 Time-hr]

Related Parameter(s): [A195](#), [d316](#)

(With FRN 6.xx and later.)

Displays the value of the [d316](#) [Elapsed Time-hr] parameter when the fault occurred.

Values	Default:	Read Only
	Min/Max:	0/32767 Hr
	Display:	1 Hr

d350 [Fault10 Time-min]

Related Parameter(s): [A195](#), [d317](#)

(With FRN 6.xx and later.)

Displays the value of the [d317](#) [Elapsed Time-min] parameter when the fault occurred.

Values	Default:	Read Only
	Min/Max:	0.0/60.0 Min
	Display:	0.1Min

Parameter Cross Reference by Name

Parameter Name	Number	Group	Page
Accel Time 1	P039	Basic Program	64
Accel Time 2	A147	Advanced Program	84
ACT1 Input	A204	Advanced Program	96
ACT1 Maximum	A207	Advanced Program	96
ACT1 Minimum	A206	Advanced Program	96
ACT2 Input	A205	Advanced Program	96
ACT2 Maximum	A209	Advanced Program	97
ACT2 Minimum	A208	Advanced Program	97
Analog In 1	d305	Advanced Display	103
Analog In 1 Hi	T071	Terminal Block	71
Analog In 1 Lo	T070	Terminal Block	71
Analog In 1 Loss	T072	Terminal Block	72
Analog In 1 Sel	T069	Terminal Block	71
Analog In 2	d306	Advanced Display	103
Analog In 2 Hi	T075	Terminal Block	73
Analog In 2 Lo	T074	Terminal Block	72
Analog In 2 Loss	T076	Terminal Block	73
Analog In 2 Sel	T073	Terminal Block	72
Analog In Filter	T089	Terminal Block	77
Analog Out1 High	T083	Terminal Block	75
Analog Out1 Sel	T082	Terminal Block	75
Analog Out2 High	T086	Terminal Block	77
Analog Out2 Sel	T085	Terminal Block	76
Anlg Loss Delay	T088	Terminal Block	77
Anlg Out1 Setpt	T084	Terminal Block	76
Anlg Out2 Setpt	T087	Terminal Block	77
Auto Mode	P042	Basic Program	64
Auto Rstrt Delay	A164	Advanced Program	87
Auto Rstrt Tries	A163	Logic	87
Aux 1 Ref Add	R243	Relay Card	100
Aux 2 Ref Add	R246	Relay Card	100
Aux 3 Ref Add	R249	Relay Card	100
Aux 1 Start Freq	R241	Relay Card	100
Aux 2 Start Freq	R244	Relay Card	100
Aux 3 Start Freq	R247	Relay Card	100
Aux 1 Stop Freq	R242	Relay Card	100
Aux 2 Stop Freq	R245	Relay Card	100
Aux 3 Stop Freq	R248	Relay Card	100
Aux AutoSwap Lvl	R254	Relay Card	101
Aux AutoSwap Tme	R253	Relay Card	101
Aux Motor Mode	R239	Relay Card	99
Aux Motor Qty	R240	Relay Card	99
Aux Prog Delay	R252	Relay Card	100
Aux Start Delay	R250	Relay Card	100

Parameter Name	Number	Group	Page
Aux Stop Delay	R251	Relay Card	100
Boost Select	A170	Advanced Program	89
Break Frequency	A173	Advanced Program	90
Break Voltage	A172	Advanced Program	90
Bus Reg Mode	A187	Advanced Program	93
Comm Data Rate	C103	Communications	79
Comm Format	C102	Communications	79
Comm Loss Action	C105	Communications	80
Comm Loss Time	C106	Communications	80
Comm Node Addr	C104	Communications	80
Comm Status	d303	Advanced Display	102
Comm Write Mode	C107	Communications	80
Commanded Freq	b002	Basic Display	58
Compensation	A194	Advanced Program	94
Contrl In Status	d302	Advanced Display	102
Control Source	d301	Advanced Display	102
Control SW Ver	d320	Advanced Display	105
Current Limit 1	A179	Advanced Program	91
Current Limit 2	A180	Advanced Program	91
DC Brake Level	A177	Advanced Program	91
DC Brake Time	A176	Advanced Program	91
DC Bus Voltage	b005	Basic Display	58
DC Bus Ripple V	d329	Advanced Display	106
DC Brk Time@Strt	A178	Advanced Program	91
Decel Time 1	P040	Basic Program	64
Decel Time 2	A148	Advanced Program	84
Digital In1 Sel	T051	Terminal Block	66
Digital In2 Sel	T052	Terminal Block	66
Digital In3 Sel	T053	Terminal Block	66
Digital In4 Sel	T054	Terminal Block	66
Drive OL Mode	A182	Advanced Program	92
Drive Status	b006	Basic Display	58
Drive Temp	b014	Basic Display	59
Drive Type	d321	Advanced Display	105
Elapsed MWh	b011	Basic Display	59
Elapsed Run Time	b012	Basic Display	59
Elapsed Time-hr	d316	Advanced Display	104
Elapsed Time-min	d317	Advanced Display	104
Fault 1 Code	b007	Basic Display	59
Fault 1 Code	d307	Advanced Display	103
Fault 1 Time-hr	d310	Advanced Display	103
Fault 1 Time-min	d311	Advanced Display	104
Fault 2 Code	d308	Advanced Display	103
Fault 2 Time-hr	d312	Advanced Display	104

Parameter Name	Number	Group	Page
Fault 2 Time-min	d313	Advanced Display	104
Fault 3 Code	d309	Advanced Display	103
Fault 3 Time-hr	d314	Advanced Display	104
Fault 3 Time-min	d315	Advanced Display	104
Fault 4 Code	d330	Advanced Display	106
Fault 4 Time-hr	d337	Advanced Display	107
Fault 4 Time-min	d338	Advanced Display	108
Fault 5 Code	d331	Advanced Display	106
Fault 5 Time-hr	d339	Advanced Display	108
Fault 5 Time-min	d340	Advanced Display	108
Fault 6 Code	d332	Advanced Display	106
Fault 6 Time-hr	d341	Advanced Display	108
Fault 6 Time-min	d342	Advanced Display	108
Fault 7 Code	d333	Advanced Display	107
Fault 7 Time-hr	d343	Advanced Display	108
Fault 7 Time-min	d344	Advanced Display	108
Fault 8 Code	d334	Advanced Display	107
Fault 8 Time-hr	d345	Advanced Display	109
Fault 8 Time-min	d346	Advanced Display	109
Fault 9 Code	d335	Advanced Display	107
Fault 9 Time-hr	d347	Advanced Display	109
Fault 9 Time-min	d348	Advanced Display	109
Fault10 Code	d336	Advanced Display	107
Fault10 Time-hr	d349	Advanced Display	109
Fault10 Time-min	d350	Advanced Display	109
Fault Bus Volts	d326	Advanced Display	105
Fault Clear	A197	Advanced Program	95
Fault Current	d325	Advanced Display	105
Fault Frequency	d324	Advanced Display	105
Flying Start En	A167	Advanced Program	87
Internal Freq	A142	Advanced Program	83
Language	C101	Communications	79
Load Loss Level	A184	Advanced Program	92
Load Loss Time	A185	Advanced Program	92
Maximum Freq	P035	Basic Program	61
Maximum Voltage	A174	Advanced Program	90
Minimum Freq	P034	Basic Program	61
MOP Reset Sel	A202	Advanced Program	96
Motor NP FLA	A200	Advanced Program	95
Motor NP Hertz	P032	Basic Program	61
Motor NP Poles	A199	Advanced Program	95
Motor NP Volts	P031	Basic Program	61
Motor OL Current	P033	Basic Program	61
Motor OL Ret	P043	Basic Program	65
Motor OL Select	A181	Advanced Program	92
Opto Out Level	T066	Terminal Block	70

Parameter Name	Number	Group	Page
Opto Out Logic	T068	Terminal Block	71
Opto Out Sel	T065	Terminal Block	70
Output Current	b003	Basic Display	58
Output Freq	b001	Basic Display	58
Output Power	b010	Basic Display	59
Output Powr Fctr	d318	Advanced Display	104
Output RPM	d323	Advanced Display	105
Output Speed	d322	Advanced Display	105
Output Voltage	b004	Basic Display	58
PID Deadband	A158	Advanced Program	86
PID Diff Rate	A156	Advanced Program	86
PID Fdbk Display	d328	Advanced Display	106
PID Feedback Sel	A153	Advanced Program	85
PID Integ Time	A155	Advanced Program	86
PID Invert Error	A201	Advanced Program	95
PID Preload	A159	Advanced Program	86
PID Prop Gain	A154	Advanced Program	85
PID Ref Sel	A152	Advanced Program	85
PID Setpnt Displ	d304	Advanced Display	103
PID Setpoint	A157	Advanced Program	86
PID Trim Hi	A150	Advanced Program	84
PID Trim Lo	A151	Advanced Program	85
Preset Freq 0	A143	Advanced Program	83
Preset Freq 1	A144	Advanced Program	83
Preset Freq 2	A145	Advanced Program	83
Preset Freq 3	A146	Advanced Program	83
Process Display	b008	Basic Display	59
Process Factor	A160	Advanced Program	86
Program Lock	A198	Advanced Program	95
Purge Frequency	A141	Advanced Program	83
PWM Frequency	A168	Advanced Program	88
PWM Mode	A169	Advanced Program	88
Relay 1 Off Time	T059	Terminal Block	68
Relay 1 On Time	T058	Terminal Block	68
Relay 2 Off Time	T064	Terminal Block	69
Relay 2 On Time	T063	Terminal Block	69
Relay Out1 Level	T056	Terminal Block	67
Relay Out1 Sel	T055	Terminal Block	67
Relay Out2 Level	T061	Terminal Block	69
Relay Out2 Sel	T060	Terminal Block	68
Relay Out3 Level	R222	Relay Card	99
Relay Out3 Sel	R221	Relay Card	98
Relay Out4 Level	R225	Relay Card	99
Relay Out4 Sel	R224	Relay Card	98
Relay Out5 Level	R228	Relay Card	99
Relay Out5 Sel	R227	Relay Card	98

Parameter Name	Number	Group	Page
Relay Out6 Level	R231	Relay Card	99
Relay Out6 Sel	R230	Relay Card	98
Relay Out7 Level	R233	Relay Card	98
Relay Out7 Sel	R234	Relay Card	99
Relay Out8 Level	R237	Relay Card	99
Relay Out8 Sel	R236	Relay Card	98
Reset Meters	A195	Advanced Program	95
Reset To Defaults	P041	Basic Program	64
Reverse Disable	A166	Advanced Program	87
S Curve %	A149	Advanced Program	84
Skip Freq Band 1	A189	Advanced Program	93
Skip Freq Band 2	A191	Advanced Program	94
Skip Freq Band 3	A193	Advanced Program	94
Skip Frequency 1	A188	Advanced Program	93
Skip Frequency 2	A190	Advanced Program	93
Skip Frequency 3	A192	Advanced Program	94
Sleep Level	T078	Terminal Block	73
Sleep Sel	T090	Terminal Block	77
Sleep Time	T079	Terminal Block	74
Sleep-Wake Sel	T077	Terminal Block	73

Parameter Name	Number	Group	Page
Slip Hertz @ FLA	A175	Advanced Program	90
Speed Ref 2	C109	Communications	82
Speed Reference	P038	Basic Program	63
Stall Fault Time	A186	Advanced Program	92
Start At PowerUp	A165	Advanced Program	87
Start Boost	A171	Advanced Program	90
Start Source	P036	Basic Program	62
Start Source 2	C108	Communications	81
Status @ Fault	d327	Advanced Display	106
Stop Mode	P037	Basic Program	63
SW Current Trip	A183	Advanced Program	92
Testpoint Data	d319	Advanced Display	105
Testpoint Sel	A196	Advanced Program	95
Torque Current	b013	Basic Display	59
Wake Deviation	A203	Advanced Program	96
Wake Level	T080	Terminal Block	74
Wake PID Preload	A210	Advanced Program	97
Wake Sel	T091	Terminal Block	78
Wake Time	T081	Terminal Block	74

Troubleshooting

This chapter provides information to guide you in troubleshooting the PowerFlex 400 drive. Included is a listing and description of drive faults (with possible solutions, when applicable).

For information on...	See page
Drive Status	113
Faults	113
Fault Descriptions	115
Common Symptoms and Corrective Actions	117

Drive Status

The condition or state of your drive is constantly monitored. Any changes will be indicated through the integral keypad.

LED Indications

See [page 47](#) for information on drive status indicators and controls.

Faults

A fault is a condition that stops the drive. There are two fault types.

Type	Fault Description	
1	Auto-Reset/Run	When this type of fault occurs, and A163 [Auto Rstrt Tries] is set to a value greater than "0," a user-configurable timer, A164 [Auto Rstrt Delay], begins. When the timer reaches zero, the drive attempts to automatically reset the fault. If the condition that caused the fault is no longer present, the fault will be reset and the drive will be restarted.
2	Non-Resettable	This type of fault may require drive or motor repair, or is caused by wiring or programming errors. The cause of the fault must be corrected before the fault can be cleared.

Fault Indication

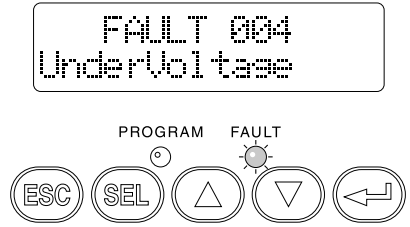
Condition	Display
<p>Drive is indicating a fault.</p> <p>The integral LCD display provides visual notification of a fault condition by displaying the following.</p> <ul style="list-style-type: none"> Flashing fault number Flashing fault indicator <p>Press the Escape key to regain control of the integral keypad.</p>	 <p>The display shows 'FAULT 004' and 'UnderVoltage'. Below the display is a keypad with buttons labeled ESC, SEL, PROGRAM, FAULT, and a set of navigation keys (up, down, left, right).</p>

Manually Clearing Faults

Step	Key(s)
<ol style="list-style-type: none"> Press Esc to acknowledge the fault. The fault information will be removed so that you can use the integral keypad. Access b007 [Fault 1 Code] to view the most recent fault information. Address the condition that caused the fault. The cause must be corrected before the fault can be cleared. See Table 18. After corrective action has been taken, clear the fault by one of these methods. <ul style="list-style-type: none"> Press Stop if P037 [Stop Mode] is set to a value between "0" and "3". Cycle drive power. Set A197 [Fault Clear] to "1" or "2". Cycle digital input if T051...T054[DigIn TermBlk xx] is set to option 10 "Clear Fault". 	 <p>The key(s) column shows an ESC key icon and a Stop button icon labeled 'OFF'.</p>

Automatically Clearing Faults

Option/Step
<p>Clear a Type 1 fault and restart the drive.</p> <ol style="list-style-type: none"> Set A163 [Auto Rstrt Tries] to a value other than "0". Set A164 [Auto Rstrt Delay] to a value other than "0".
<p>Clear an OverVoltage, UnderVoltage or Heatsink OvrTmp fault without restarting the drive.</p> <ol style="list-style-type: none"> Set A163 [Auto Rstrt Tries] to a value other than "0". Set A164 [Auto Rstrt Delay] to "0".

Auto Restart (Reset/Run)

The Auto Restart feature allows the drive to automatically perform a fault reset followed by a start attempt without user or application intervention. This allows remote or “unattended” operation. Only certain faults are allowed to be reset. Certain faults (Type 2) that indicate possible drive component malfunction are not resettable.

Use caution when enabling this feature, since the drive will attempt to issue its own start command based on user selected programming.

Fault Descriptions

Table 18 - Fault Types, Descriptions and Actions

No.	Fault	Type (T)	Description	Action
F2	Auxiliary Input	1	Auxiliary input interlock is open.	<ol style="list-style-type: none"> 1. Check remote wiring. 2. Verify communications programming for intentional fault.
F3	Power Loss	2	FRN 5.03 and earlier only: The DC bus voltage fell below undervoltage level within 200 ms of a start command, DC bus ripple voltage is excessive, or an input phase loss has been detected.	<ol style="list-style-type: none"> 1. Monitor the incoming AC line for low voltage or line power interruption. 2. Check input fuses.
F4	UnderVoltage	1	DC bus voltage fell below the minimum value.	<ol style="list-style-type: none"> 1. Monitor the incoming AC line for low voltage or line power interruption. 2. Check input fuses.
F5	OverVoltage	1	DC bus voltage exceeded maximum value.	Monitor the AC line for high line voltage or transient conditions. Bus overvoltage can also be caused by motor regeneration. Extend the decel time or install dynamic brake chopper.
F6	Motor Stalled	1	Drive is unable to accelerate or decelerate motor.	Increase P039...A147 [Accel Time x] or reduce load so drive output current does not exceed the current set by parameter A179 [Current Limit 1].
F7	Motor Overload	1	Internal electronic overload trip.	<ol style="list-style-type: none"> 1. An excessive motor load exists. Reduce load so drive output current does not exceed the current set by parameter P033 [Motor OL Current]. 2. Verify A170 [Boost Select] setting.
F8	Heatsink OvrTmp	1	Heatsink temperature exceeds a predefined value.	<ol style="list-style-type: none"> 1. Check for blocked or dirty heat sink fins. Verify that ambient temperature has not exceeded 45°C (113°F) for IP 30/NEMA 1/UL Type 1 installations or 50°C (122°F) for IP20/Open type installations. 2. Check fan.

Table 18 - Fault Types, Descriptions and Actions

No.	Fault	Type (1)	Description	Action
F12	HW OverCurrent	2	The drive output current has exceeded the hardware current limit.	Check programming. Check for excess load, improper A170 [Boost Select] setting, DC brake volts set too high or other causes of excess current.
F13	Ground Fault	2	A current path to earth ground has been detected at one or more of the drive output terminals.	Check the motor and external wiring to the drive output terminals for a grounded condition.
F15	Load Loss	1	Output current has dropped below the level set in A184 [Load Loss Level].	Check for load loss (i.e., a broken belt).
F17	Input Phase Loss (FRN 6.xx and later)	2	Excessive DC bus ripple voltage detected. See d329 [DC Bus Ripple V].	Check incoming power for a missing phase or blown fuse. If drive is used intentionally with single phase input, apply output derating to 35% actual drive rating.
F29	Analog Input Loss	1	An analog input is configured to fault on signal loss. A signal loss has occurred. Configure with T072 [Analog In Loss].	<ol style="list-style-type: none"> 1. Check parameters. 2. Check for broken/loose connections at inputs.
F32	Fan Fdbck Loss (FRN 6.xx and later)	2	A loss of cooling fan feedback has been detected. (Frames E and F only)	Make sure cooling fans are clear of debris and spinning freely. Replace fan if necessary.
F33	Auto Rstrt Tries	2	Drive unsuccessfully attempted to reset a fault and resume running for the programmed number of A163 [Auto Rstrt Tries].	Correct the cause of the fault and manually clear.
F38	Phase U to Gnd	2	A phase to ground fault has been detected between the drive and motor in this phase.	<ol style="list-style-type: none"> 1. Check the wiring between the drive and motor. 2. Check motor for grounded phase. 3. Replace drive if fault cannot be cleared.
F39	Phase V to Gnd			
F40	Phase W to Gnd			
F41	Phase UV Short	2	Excessive current has been detected between these two output terminals.	<ol style="list-style-type: none"> 1. Check the motor and drive output terminal wiring for a shorted condition. 2. Replace drive if fault cannot be cleared.
F42	Phase UW Short			
F43	Phase VW Short			
F48	Params Defaulted		The drive was commanded to write default values to EEPROM.	<ol style="list-style-type: none"> 1. Clear the fault or cycle power to the drive. 2. Program the drive parameters as needed.
F63	SW OverCurrent	1	Programmed A183 [SW Current Trip] has been exceeded.	Check load requirements and A183 [SW Current Trip] setting.
F64	Drive Overload	2	Drive rating of 110% for 1 minute or 150% for 3 seconds has been exceeded.	Reduce load or extend Accel Time.
F70	Power Unit	2	Failure has been detected in the drive power section.	<ol style="list-style-type: none"> 1. Cycle power. 2. Replace drive if fault cannot be cleared.
F71	Net Loss		The communication network has faulted.	<ol style="list-style-type: none"> 1. Cycle power. 2. Check communications cabling. 3. Check network adapter setting. 4. Check external network status.

Table 18 - Fault Types, Descriptions and Actions

No.	Fault	Type (1)	Description	Action
F81	Comm Loss	2	RS485 (DSI) port stopped communicating.	<ol style="list-style-type: none"> 1. Check RS485 wiring connection. 2. Check if a communications adapter or HIM was disconnected. 3. Increase C106 [Comm Loss Time] to an appropriate time for application. 4. Change C105 [Comm Loss Action] to a value other than "0" (fault), if appropriate for the application.
F94	Function Loss	2	P036 [Start Source] is set to setting 6. The input to terminal 01 has been opened.	Close input to terminal 01 and restart the drive
F100	Parameter Checksum	2	The checksum read from the board does not match the checksum calculated.	Set P041 [Reset To Defaults] to option 1 "Reset Defaults".
F122	I/O Board Fail	2	Failure has been detected in the drive control and I/O section.	<ol style="list-style-type: none"> 1. Cycle power. 2. Replace drive if fault cannot be cleared.

(1) See [page 113](#) for a description of fault types

Common Symptoms and Corrective Actions

Motor does not Start.

Cause(s)	Indication	Corrective Action
No output voltage to the motor.	None	Check the power circuit. <ul style="list-style-type: none"> • Check the supply voltage. • Check all fuses and disconnects. Check the motor. <ul style="list-style-type: none"> • Verify that the motor is connected properly. Check the control input signals. <ul style="list-style-type: none"> • Verify that a Start signal is present. If 2-Wire control is used, verify that either the Run Forward or Run Reverse signal is active, but not both. • Verify that I/O Terminal 01 is active. • Verify that P036 [Start Source] matches your configuration. • Verify that A166 [Reverse Disable] is not prohibiting movement.
Drive is Faulted	Flashing red status light	Clear fault. <ul style="list-style-type: none"> • Press Stop. • Cycle power. • Set A197 [Fault Clear] to option 1 "Clear Faults". • Cycle digital input if T051...T054 [Digital Inx Sel] is set to option 7 "Clear Fault".

Drive does not Start from Start or Run Inputs wired to the terminal block.

Cause(s)	Indication	Corrective Action
Drive is Faulted	Flashing red status light	Clear fault. <ul style="list-style-type: none"> Press Stop. Cycle power. Set A197 [Fault Clear] to option 1 "Clear Faults". Cycle digital input if T051...T054 [Digital Inx Sel] is set to option 7 "Clear Fault".
Incorrect programming. <ul style="list-style-type: none"> P036 [Start Source] is set to option 0 "Keypad" or option 5 "RS485 (DSI) Port". T051...T054 [Digital Inx Sel] is set to option 5 "Local" and the input is active. 	None	Check parameter settings.
Incorrect input wiring. See page 32 for wiring examples. <ul style="list-style-type: none"> 2 wire control requires Run Forward, Run Reverse or Jog input. 3 wire control requires Start and Stop inputs Stop input is always required. 	None	Wire inputs correctly and/or install jumper.
Incorrect Sink/Source DIP switch setting.	None	Set switch to match wiring scheme.

Drive does not Start from Integral Keypad.

Cause(s)	Indication	Corrective Action
Integral keypad is not enabled.	Green LED above Start key is not illuminated.	<ul style="list-style-type: none"> Set P036 [Start Source] to option 0 "Keypad". Set parameter T051...T054 [Digital Inx Sel] to option 5 "Local" and activate the input.
I/O Terminal 01 "Stop" input is not present.	None	Wire inputs correctly and/or install jumper.

Drive does not respond to changes in speed command.

Cause(s)	Indication	Corrective Action
No value is coming from the source of the command.	The drive "Run" indicator is lit and output is 0 Hz.	<ul style="list-style-type: none"> Check d301 [Control Source] for correct source. If the source is an analog input, check wiring and use a meter to check for presence of signal. Check b002 [Commanded Freq] to verify correct command.
Incorrect reference source is being selected by remote device or digital inputs.	None	<ul style="list-style-type: none"> Check d301 [Control Source] for correct source. Check d302 [Contrl In Status] to see if inputs are selecting an alternate source. Verify settings for T051...T054 [Digital Inx Sel]. Check P038 [Speed Reference] for the source of the speed reference. Reprogram as necessary. Review the Speed Reference Control chart on page 37.

Motor and/or drive will not accelerate to commanded speed.

Cause(s)	Indication	Corrective Action
Acceleration time is excessive.	None	Reprogram P039 [Accel Time 1] or A147 [Accel Time 2].
Excess load or short acceleration times force the drive into current limit, slowing or stopping acceleration.	None	<ul style="list-style-type: none"> Compare b003 [Output Current] with A179 [Current Limit 1]. Remove excess load or reprogram P039 [Accel Time 1] or A147 [Accel Time 2]. Check for improper A170 [Boost Select] setting.
Speed command source or value is not as expected.	None	<ul style="list-style-type: none"> Verify b002 [Commanded Freq]. Check A170 [Control Source] for the proper Speed Command.
Programming is preventing the drive output from exceeding limiting values.	None	Check P035 [Maximum Freq] to ensure that speed is not limited by programming.

Motor operation is unstable.

Cause(s)	Indication	Corrective Action
Motor data was incorrectly entered.	None	<ol style="list-style-type: none"> Correctly enter motor nameplate data into P031, P032 and P033. Enable A194 [Compensation]. Use A170 [Boost Select] to reduce boost level.

Drive will not reverse motor direction.

Cause(s)	Indication	Corrective Action
Digital input is not selected for reversing control.	None	Check T051...T054 [Digital Inx Sel] and P036 [Start Source]. Choose correct input and program for reversing mode.
Digital input is incorrectly wired.	None	Check input wiring (See page 30).
Motor wiring is improperly phased for reverse.	None	Switch two motor leads.
Reverse is disabled.	None	Check A166 [Reverse Disable].

Drive does not power up.

Cause(s)	Indication	Corrective Action
No input power to drive.	None	<ul style="list-style-type: none">• Check the power circuit.• Check the supply voltage.• Check all fuses and disconnects.
Jumper between Power Terminals P2 and P1 not installed and/or DC Bus Inductor not connected.	None	Install jumper or connect DC Bus Inductor.

Supplemental Drive Information

For information on...	See page
Drive, Fuse & Circuit Breaker Ratings	121
Specifications	122
Input Power Connections	128

Drive, Fuse & Circuit Breaker Ratings

The tables on the following pages provide recommended AC line input fuse and circuit breaker information. See Fusing and Circuit Breakers below for UL and IEC requirements. Sizes listed are the recommended sizes based on 40 °C (104 °F) and the U.S. N.E.C. Other country, state or local codes may require different ratings.

Fusing

The recommended fuse types are listed below. If available current ratings do not match those listed in the tables provided, choose the next higher fuse rating.

- IEC – BS88 (British Standard) Parts 1 & 2⁽¹⁾, EN60269-1, Parts 1 & 2, type gG or equivalent should be used.
- UL – UL Class CC, T or J must be used.⁽²⁾

Circuit Breakers

The “non-fuse” listings in the following tables include inverse time circuit breakers, instantaneous trip circuit breakers (motor circuit protectors) and 140M self-protected combination motor controllers. If one of these is chosen as the desired protection method, the following requirements apply:

- IEC – Both types of circuit breakers and 140M self-protected combination motor controllers are acceptable for IEC installations.
- UL – Only inverse time circuit breakers and the specified 140M self-protected combination motor controllers are acceptable for UL installations.

(1) Typical designations include, but may not be limited to the following; Parts 1 & 2: AD, BC, BD, CD, DD, ED, EFS, EF, FF, FG, GF, GG, GH.



(2) Typical designations include; Type CC - KTK-R, FNQ-R
Type J - JKS, LPJ
Type T - JJS, JJN

Specifications

Drive Ratings										
Catalog Number	Output Ratings			Input Ratings			Branch Circuit Protection			
	kW (HP)	Amps		Voltage Range	kVA	Amps	Fuses	140M Motor Protectors ⁽¹⁾⁽²⁾	Contactors	Min. Enclosure Volumes ⁽³⁾ (in. ³)
		45 °C	50 °C							
200...240V AC – 3-Phase Input, 0 - 230V 3-Phase Output										
22C-B012N103	2.2 (3.0)	12	12	180-265	6.5	15.5	20	140M-F8E-C16	100-C23	5098
22C-B017N103	3.7 (5.0)	17.5	17.5	180-265	8.8	21	30	140M-F8E-C25	100-C37	5098
22C-B024N103	5.5 (7.5)	24	24	180-265	10.9	26.1	35	140M-F8E-C32	100-C37	5098
22C-B033N103	7.5 (10)	33	33	180-265	14.4	34.6	45	140M-F8E-C45	100-C45	5098
22C-B049A103	11 (15)	49	49	180-265	21.3	51	70	–	100-C60	–
22C-B065A103	15 (20)	65	65	180-265	28.3	68	90	–	100-C85	–
22C-B075A103	18.5 (25)	75	75	180-265	32.5	78	100	–	100-D95	–
22C-B090A103	22 (30)	90	81	180-265	38.3	92	125	–	100-D110	–
22C-B120A103	30 (40)	120	120	180-265	51.6	124	175	–	100-D180	–
22C-B145A103	37 (50)	145	130	180-265	62.4	150	200	–	100-D180	–
380...480V AC – 3-Phase Input, 0...460V 3-Phase Output										
22C-D6P0N103	2.2 (3.0)	6	6	340-528	6.3	7.5	10	140M-D8E-C10	100-C09	5098
22C-D010N103	4.0 (5.0)	10.5	10.5	340-528	10.9	13	20	140M-D8E-C16	100-C16	5098
22C-D012N103	5.5 (7.5)	12	12	340-528	11.9	14.2	20	140M-D8E-C16	100-C23	5098
22C-D017N103	7.5 (10)	17	17	340-528	15.3	18.4	25	140M-D8E-C20	100-C23	5098
22C-D022N103	11 (15)	22	22	340-528	19.2	23	30	140M-F8E-C32	100-C30	5098
22C-D030N103	15 (20)	30	27	340-528	25.8	31	40	140M-F8E-C32	100-C37	5098
22C-D038A103	18.5 (25)	38	38	340-528	33.3	40	50	140M-F8E-C45	100-C60	9086
22C-D045A103	22 (30)	45.5	45.5	340-528	39.1	47	60	–	100-C60	–
22C-D060A103	30 (40)	60	54	340-528	53.3	64	80	–	100-C85	–
22C-D072A103	37 (50)	72	72	340-528	60.7	73	100	–	100-C85	–
22C-D088A103	45 (60)	88	88	340-528	74.9	90	125	–	100-D110	–
22C-D105A103	55 (75)	105	105	340-528	89	107	150	–	100-D140	–
22C-D142A103	75 (100)	142	128	340-528	124.8	150	200	–	100-D180	–
22C-D170A103	90 (125)	170	170	340-528	142	170	250	–	100-D250	–
22C-D208A103	110 (150)	208	208	340-528	167	200	250	–	100-D250	–
22C-D260A103	132 (200)	260	260	340-528	196	235	300	–	100-D300	–
22C-D310A103	160 (250)	310	290	340-528	242	290	400	–	100-D420	–
22C-D370A103	200 (300)	370	370	340-528	304	365	500	–	100-D420	–
22C-D460A103	250 (350)	460	410	340-528	387	465	600	–	100-D630	–

- (1) The AIC ratings of the Bulletin 140M Motor Protector Circuit Breakers may vary. See [Bulletin 140M Motor Protection Circuit Breakers Application Ratings](#).
- (2) Manual Self-Protected (Type E) Combination Motor Controller, UL listed for 208 Wye or Delta, 240 Wye or Delta, 480Y/277 or 600Y/347. Not UL listed for use on 480V or 600V Delta/Delta, corner ground, or high-resistance ground systems.
- (3) When using a Manual Self-Protected (Type E) Combination Motor Controller, the drive must be installed in a ventilated or non-ventilated enclosure with the minimum volume specified in this column. Application specific thermal considerations may require a larger enclosure.

Agency Certification

Specification	
	Listed to UL508C and CAN/CSA-22.2
	Certified to AS/NZS, 1997 Group 1, Class A
	Marked for all applicable European Directives EMC Directive (2014/30/EU) EN 61800-3 Low Voltage Directive (2014/35/EU) EN 61800-5-1
<p>The drive is also designed to meet the appropriate portions of the following specifications:</p> <p>NFPA 70 - US National Electrical Code</p> <p>NEMA ICS 3.1 - Safety standards for Construction and Guide for Selection, Installation and Operation of Adjustable Speed Drive Systems.</p> <p>IEC 146 - International Electrical Code.</p>	

Protection

Specification	
Bus Overvoltage Trip:	200...240V AC Input: 405V DC bus voltage (equivalent to 290V AC incoming line) 380...460V AC Input: 810V DC bus voltage (equivalent to 575V AC incoming line)
Bus Undervoltage Trip:	200...240V AC Input: 210V DC bus voltage (equivalent to 150V AC incoming line) 380...480V AC Input: 390V DC bus voltage (equivalent to 275V AC incoming line)
Power Ride-Thru:	100 milliseconds
Logic Control Ride-Thru:	0.5 seconds minimum, 2 seconds typical
Electronic Motor Overload Protection:	Provides class 10 motor overload protection according to NEC article 430 and motor over-temperature protection according to NEC article 430.126 (A) (2). UL 508C File 29572.
Overcurrent:	180% hardware limit, 220% instantaneous fault
Ground Fault Trip:	Phase-to-ground on drive output
Short Circuit Trip:	Phase-to-phase on drive output

Environment

Specification	
Altitude:	1000 m (3300 ft) max. without derating. Above 1000 m (3300 ft), derate 1% for every 100 m (328 ft) up to a maximum altitude of 2000 m (6600 ft).
Maximum Surrounding Air Temperature without derating: IP20, Open Type: IP30, NEMA Type 1, UL Type 1:	-10...50 °C (14...122 °F) -10...45 °C (14...113 °F)
Cooling Method:	Fan: All drive ratings
Storage Temperature: 2.2 kW (3.0 HP) to 7.5 kW (10 HP): 11 kW (15 HP) to 250 kW (350 HP):	-40...85 °C (-40...185 °F) -40...70 °C (-40...158 °F)

Specification	
Atmosphere:	Important: Drive must not be installed in an area where the ambient atmosphere contains volatile or corrosive gas, vapors or dust. If the drive is not going to be installed for a period of time, it must be stored in an area where it will not be exposed to a corrosive atmosphere.
Relative Humidity:	0...95% non-condensing
Shock (operating):	15G peak for 11 ms duration (± 1.0 ms)
Vibration (operating):	1G peak, 5...2000 Hz
Seismic Rating:	Meets the seismic requirements of the 2003 International Building Code as specified by AC156. ⁽¹⁾

(1) Drives 75 kW (100 HP) and greater have not been tested.

Electrical

Specification	
Voltage Tolerance:	200...240V $\pm 10\%$ 380...480V $\pm 10\%$
Frequency Tolerance:	48...63 Hz
Input Phases:	Three-phase input provides full rating. Single-phase operation provides 35% rated current.
Displacement Power Factor:	0.98 across entire speed range
Efficiency:	97.5% at rated amps, nominal line voltage
Maximum Short Circuit Rating:	100,000 Amps Symmetrical (Frame C Drives) 200,000 Amps Symmetrical (Frame D–H Drives)
Actual Short Circuit Rating:	Determined by AIC Rating of installed fuse/circuit breaker
Transistor Type:	Isolated Gate Bipolar (IGBT)
Internal DC Bus Choke 200-480V AC Input: 380-480V AC Input:	11-37 kW (15-50 HP) Panel Mount Drives 11-160 kW (15-250 HP) Panel Mount Drives
Internal AC Line Reactor 380-480V AC Input:	200...250 kW (300...350 HP) Panel Mount Drives.

Control

Specification	
Method:	Sinusoidal PWM, Volts/Hertz
Carrier Frequency Frames C and D: Frames E – H:	2...10 kHz, Drive rating based on 4 kHz 2...8 kHz, Drive rating based on 4 kHz
Frequency Accuracy Digital Input: Analog Input: Analog Output:	Within $\pm 0.05\%$ of set output frequency Within 0.5% of maximum output frequency, 10-Bit resolution $\pm 2\%$ of full scale, 10-Bit resolution
Speed Regulation – Open Loop with Slip Compensation:	$\pm 1\%$ of base speed across a 60:1 speed range
Output Frequency:	0...320 Hz (programmable)
Stop Modes:	Multiple programmable stop modes including – Ramp, Coast, DC-Brake, Ramp-to-Hold and S Curve.
Accel/Decel:	Two independently programmable accel and decel times. Each time may be programmed from 0...600 seconds in 0.1 second increments.
Drive Overload:	110% Overload capability for up to 1 minute
Electronic Motor Overload Protection:	Provides class 10 motor overload protection according to NEC article 430 and motor over-temperature protection according to NEC article 430.126 (A) (2). UL 508C File 29572.

Control Inputs

Specification		
Digital	Quantity:	(3) Semi-programmable (4) Programmable
	Type Source Mode (SRC): Sink Mode (SNK):	18...24V = ON, 0...6V = OFF 0...6V = ON, 18...24V = OFF
Analog	Quantity:	(1) Isolated, –10 to 10V or 4-20mA (1) Non-isolated, 0 to 10V or 4-20mA
	Specification Resolution: 0 to 10V DC Analog: 4-20mA Analog: External Pot:	10-bit 100k ohm input impedance 250 ohm input impedance 1...10k ohm, 2 Watt minimum

Control Outputs

Specification		
Relay	Quantity:	(2) Programmable Form C
	Specification Resistive Rating: Inductive Rating:	3.0 A @ 30V DC, 3.0 A @ 125V, 3.0 A @ 240V AC 0.5 A @ 30V DC, 0.5 A @ 125V, 0.5 A @ 240V AC
Optional Relay Card	Quantity:	(6) Optional Programmable Form A (Not available for Frame C drives)
	Specification Resistive Rating: Inductive Rating:	0.1 A @ 30V DC Class II circuits, 3.0 A @ 125V, 3.0 A @ 240V AC 0.1 A @ 30V DC Class II circuits, 3.0 A @ 125V 3.0 A @ 240V AC
Opto	Quantity:	(1) Programmable
	Specification:	30V DC, 50 mA Non-inductive
Analog	Quantity:	(2) Non-Isolated, 0-10V or 4-20mA
	Specification Resolution: 0 to 10V DC Analog: 4-20mA Analog:	10-bit 1k ohm minimum 525 ohm maximum

Keypad

Specification	
Display:	Integral 2 line by 16 character LCD with (5) LED Indicators
Language:	English, Français, Español, Italiano, Deutsch, Português, Nederlands

Communication

Specification	
Type:	Serial (RS485)
Supported Protocols (Standard):	Drive Serial Interface (DSI) Modbus RTU Metasys N2 P1 - Floor Level Network (FLN)
Supported Protocols (Optional):	BACnet DeviceNet EtherNet/IP PROFIBUS DP ControlNet LonWorks
Software (Optional):	Windows Based Pocket PC/Windows Mobile 2003

PowerFlex 400 Watts Loss (Rated Load, Speed & PWM)

Voltage	kW (HP)	Panel Mount Watts	Flange Mount Watts		
		Total	External	Internal	Total
200-240V AC	2.2 (3.0)	146	119	28	146
	3.7 (5.0)	207	174	33	207
	5.5 (7.5)	266	228	39	266
	7.5 (10)	359	315	44	359
	11 (15)	488	–	–	–
	15 (20)	650	–	–	–
	18.5 (25)	734	–	–	–
	22 (30)	778	–	–	–
	30 (40)	1055	–	–	–
	37 (50)	1200	–	–	–
380-480V AC	2.2 (3.0)	105	77	28	105
	4.0 (5.0)	171	143	28	171
	5.5 (7.5)	200	161	39	200
	7.5 (10)	267	229	39	267
	11 (15)	329	285	44	329
	15 (20)	435	380	55	435
	18.5 (25)	606	–	–	–
	22 (30)	738	–	–	–
	30 (40)	764	–	–	–
	37 (50)	1019	–	–	–
	45 (60)	1245	–	–	–
	55 (75)	1487	–	–	–
	75 (100)	2043	–	–	–
	90 (125)	2617	–	–	–
	110 (150)	3601	–	–	–
	132 (200)	3711	–	–	–
	160 (250)	4208	–	–	–
200 (300)	4916	–	–	–	
250 (350)	6167	–	–	–	

Input Power Connections

Figure 16 - Frame C, D, and E Connections

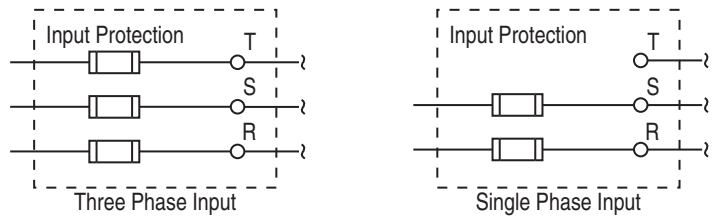
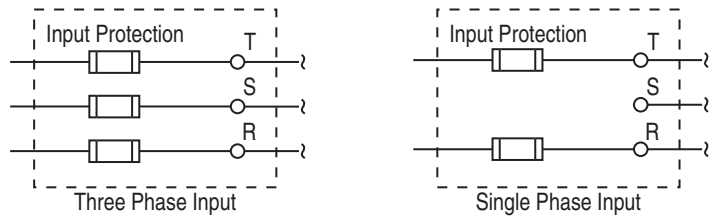

Figure 17 - Frame F Connections



Note: Frames G and H do not support single-phase operation.

Accessories and Dimensions

Product Selection

Table 19 - Catalog Number Description

22C	–	B	024	N	1	0	3
Drive	Dash	Voltage Rating	Rating	Enclosure	HIM	Emission Class	Comm Slot

Table 20 - PowerFlex 400 Drives

Drive Ratings					Catalog Number	Frame Size
Input Voltage	Normal Duty		Output Current (Amps)			
	kW	HP	45°C	50°C		
240V 50/60 Hz 3-Phase	2.2	3.0	12	12	22C-B012N103	C
	3.7	5.0	17.5	17.5	22C-B017N103	C
	5.5	7.5	24	24	22C-B024N103	C
	7.5	10	33	33	22C-B033N103	C
	11	15	49	49	22C-B049A103	D
	15	20	65	65	22C-B065A103	D
	18.5	25	75	75	22C-B075A103	D
	22	30	90	81	22C-B090A103	D
	30	40	120	120	22C-B120A103	E
37	50	145	130	22C-B145A103	E	

Table 20 - PowerFlex 400 Drives

Drive Ratings					Catalog Number	Frame Size
Input Voltage	Normal Duty		Output Current (Amps)			
	kW	HP	45°C	50°C		
480V 50/60 Hz 3-Phase	2.2	3.0	6	6	22C-D6P0N103	C
	4.0	5.0	10.5	10.5	22C-D010N103	C
	5.5	7.5	12	12	22C-D012N103	C
	7.5	10	17	17	22C-D017N103	C
	11	15	22	22	22C-D022N103	C
	15	20	30	27	22C-D030N103	C
	18.5	25	38	38	22C-D038A103	D
	22	30	45.5	45.5	22C-D045A103	D
	30	40	60	54	22C-D060A103	D
	37	50	72	72	22C-D072A103	E
	45	60	88	88	22C-D088A103	E
	55	75	105	105	22C-D105A103	E
	75	100	142	128	22C-D142A103	E
	90	125	170	170	22C-D170A103	F
	110	150	208	208	22C-D208A103	F
	132	200	260	260	22C-D260A103	G
160	250	310	290	22C-D310A103	G	
200	300	370	370	22C-D370A103	H	
250	350	460	410	22C-D460A103	H	

Table 21 - PowerFlex 400 Flange Mount Drives

Drive Ratings					Catalog Number	Frame Size
Input Voltage	kW	HP	Output Current (Amps)			
			45°C	50°C		
240V 50/60 Hz 3-Phase	2.2	3	12A	12A	22C-B012F103	C
	3.7	5	17.5A	17.5A	22C-B017F103	C
	5.5	7.5	24A	24A	22C-B024F103	C
	7.5	10	33A	33A	22C-B033F103	C
480V 50/60 Hz 3-Phase	2.2	3	6.0A	6.0A	22C-D6P0F103	C
	4.0	5	10A	10A	22C-D010F103	C
	5.5	7.5	12A	12A	22C-D012F103	C
	7.5	10	17A	17A	22C-D017F103	C
	11	15	22A	22A	22C-D022F103 ⁽¹⁾	C
	15	20	30A	27A	22C-D030F103 ⁽¹⁾	C

(1) A DC bus inductor is required. See [Table 25](#) for ordering information.

Table 22 - Bulletin 1321-3R Series Line Reactors – 200...240V, 60 Hz, 3-Phase

kW	HP	Fundamental Amps	Maximum Continuous Amps	Inductance mh	Watts Loss	Catalog Number	
						IP00 (Open Style)	IP11 (NEMA Type 1)
3% Impedance							
2.2	3.0	12	18	1.25	26	1321-3R12-A	1321-3RA12-A
3.7	5.0	18	27	0.8	36	1321-3R18-A	1321-3RA18-A
5.5	7.5	25	37.5	0.5	48	1321-3R25-A	1321-3RA25-A
7.5	10	35	52.5	0.4	49	1321-3R35-A	1321-3RA35-A
11	15	45	67.5	0.3	54	1321-3R45-A	1321-3RA45-A
15	20	55	82.5	0.25	64	1321-3R55-A	1321-3RA55-A
18.5	25	80	120	0.2	82	1321-3R80-A	1321-3RA80-A
22	30	80	120	0.2	82	1321-3R80-A	1321-3RA80-A
30	40	100	150	0.15	94	1321-3R100-A	1321-3RA100-A
37	50	130	195	0.1	108	1321-3R130-A	1321-3RA130-A
5% Impedance							
2.2	3.0	12	18	2.5	31	1321-3R12-B	1321-3RA12-B
3.7	5.0	18	27	1.5	43	1321-3R18-B	1321-3RA18-B
5.5	7.5	25	37.5	1.2	52	1321-3R25-B	1321-3RA25-B
7.5	10	35	52.5	0.8	54	1321-3R35-B	1321-3RA35-B
11	15	45	67.5	0.7	62	1321-3R45-B	1321-3RA45-B
15	20	55	82.5	0.5	67	1321-3R55-B	1321-3RA55-B
18.5	25	80	120	0.4	86	1321-3R80-B	1321-3RA80-B
22	30	80	120	0.4	86	1321-3R80-B	1321-3RA80-B
30	40	100	150	0.3	84	1321-3R100-B	1321-3RA100-B
37	50	130	195	0.2	180	1321-3R130-B	1321-3RA130-B

Table 23 - Bulletin 1321-3R Series Line Reactors – 380...480V, 60 Hz, 3-Phase

kW	HP	Fundamental Amps	Maximum Continuous Amps	Inductance	Watts Loss	Catalog Number	
						IP00 (Open Style)	IP11
3% Impedance							
2.2	3.0	8	12	5	25.3	1321-3R8-C	1321-3RA8-C
4.0	5.0	12	18	2.5	31	1321-3R12-B	1321-3RA12-B
5.5	7.5	12	18	2.5	31	1321-3R12-B	1321-3RA12-B
7.5	10	18	27	1.5	43	1321-3R18-B	1321-3RA18-B
11	15	25	37.5	1.2	52	1321-3R25-B	1321-3RA25-B
15	20	35	52.5	0.8	54	1321-3R35-B	1321-3RA35-B
18.5	25	35	52.5	0.8	54	1321-3R35-B	1321-3RA35-B
22	30	45	67.5	0.7	62	1321-3R45-B	1321-3RA45-B
30	40	55	82.5	0.5	67	1321-3R55-B	1321-3RA55-B
37	50	80	120	0.4	86	1321-3R80-B	1321-3RA80-B
45	60	80	120	0.4	86	1321-3R80-B	1321-3RA80-B
55	75	100	150	0.3	84	1321-3R100-B	1321-3RA100-B
75	100	130	195	0.2	180	1321-3R130-B	1321-3RA130-B
90	125	160	240	0.15	149	1321-3R160-B	1321-3RA160-B
110	150	200	300	0.11	168	1321-3R200-B	1321-3RA200-B

Table 23 - Bulletin 1321-3R Series Line Reactors – 380...480V, 60 Hz, 3-Phase

kW	HP	Fundamental Amps	Maximum Continuous Amps	Inductance	Watts Loss	Catalog Number	
						IP00 (Open Style)	IP11
132	200	250	375	0.09	231	1321-3R250-B	1321-3RA250-B
160	250	320	480	0.075	264	1321-3R320-B	1321-3RA320-B
200	300	400	560	0.06	333	1321-3R400-B	1321-3RA400-B
250	350	500	700	0.05	340	1321-3R500-B	1321-3RA500-B
5% Impedance							
2.2	3.0	8	12	7.5	28	1321-3R8-D	1321-3RA8-D
4.0	5.0	12	18	4.2	41	1321-3R12-C	1321-3RA12-C
5.5	7.5	12	18	4.2	41	1321-3R12-C	1321-3RA12-C
7.5	10	18	27	2.5	43	1321-3R18-C	1321-3RA18-C
11	15	25	37.5	2.0	61	1321-3R25-C	1321-3RA25-C
15	20	35	52.5	1.2	54	1321-3R35-C	1321-3RA35-C
18.5	25	35	52.5	1.2	54	1321-3R35-C	1321-3RA35-C
22	30	45	67.5	1.2	65	1321-3R45-C	1321-3RA45-C
30	40	55	82.5	0.85	71	1321-3R55-C	1321-3RA55-C
37	50	80	120	0.7	96	1321-3R80-C	1321-3RA80-C
45	60	80	120	0.7	96	1321-3R80-C	1321-3RA80-C
55	75	100	150	0.45	108	1321-3R100-C	1321-3RA100-C
75	100	130	195	0.3	128	1321-3R130-C	1321-3RA130-C
90	125	160	240	0.23	138	1321-3R160-C	1321-3RA160-C
110	150	200	300	0.185	146	1321-3R200-C	1321-3RA200-C
132	200	250	375	0.15	219	1321-3R250-C	1321-3RA250-C
160	250	320	480	0.125	351	1321-3R320-C	1321-3RA320-C
200	300	400	560	0.105	293	1321-3R400-C	1321-3RA400-C
250	350	500	700	0.085	422	1321-3R500-C	1321-3RA500-C

Table 24 - Bulletin 1321 - DC Series Bus Inductors - 200...240V, 60 Hz, 3-Phase

kW	HP	DC Amps	Inductance mh	Watts Loss	Catalog Number IP00 (Open Style)
2.2	3	12	0.92	5	1321-DC12-1
3.7	5	18	0.63	5	1321-DC18-1
5.5	7.5	32	0.85	11	1321-DC32-1
7.5	10	40	0.75	15	1321-DC40-2

Table 25 - Bulletin 1321 - DC Series Bus Inductors – 380...480V, 60 Hz, 3-Phase

kW	HP	DC Amps	Inductance mh	Watts Loss	Catalog Number IP00 (Open Style)
2.2	3	9	3.68	7	1321-DC9-2
4.0	5	12	2.1	7	1321-DC12-2
5.5	7.5	18	3.75	17	1321-DC18-4

Table 25 - Bulletin 1321 - DC Series Bus Inductors – 380...480V, 60 Hz, 3-Phase

kW	HP	DC Amps	Inductance mh	Watts Loss	Catalog Number IP00 (Open Style)
7.5	10	25	1.75	13	1321-DC25-4
11	15	32	2.68	21	1321-DC32-2 ⁽¹⁾
15	20	40	2.0	29	1321-DC40-4 ⁽¹⁾

(1) Required on 11 and 15 kW (15 and 20 HP) Frame C Flange Mount drive ratings.

Table 26 - EMC Line Filters

Drive Ratings			Catalog Number
Input Voltage	kW	HP	
240V 50/60 Hz 3-Phase	2.2	3.0	22-RF034-CS
	4.0	5.0	22-RF034-CS
	5.5	7.5	22-RF034-CS
	7.5	10	22-RF034-CS
	11	15	22-RFD070
	15	20	22-RFD100
	18.5	25	22-RFD100
	22	30	22-RFD150
	30	40	22-RFD150
	37	50	22-RFD180
480V 50/60 Hz 3-Phase	2.2	3.0	22-RF018-CS
	4.0	5.0	22-RF018-CS
	5.5	7.5	22-RF018-CS
	7.5	10	22-RF018-CS
	11	15	22-RF026-CS
	15	20	22-RFD036
	18.5	25	22-RFD050
	22	30	22-RFD050
	30	40	22-RFD070
	37	50	22-RFD100
	45	60	22-RFD100
	55	75	22-RFD150
	75	100	22-RFD180
	90	125	22-RFD208
	110	150	22-RFD208
	132	200	22-RFD323
	160	250	22-RFD480
200	300	22-RFD480	
250	350	22-RFD480	

Table 27 - Communication Option Kits and Accessories

Item	Description	Catalog Number
BACnet® MS/TP RS-485 Communication Adapter	Embedded communication options for use with the PowerFlex family of drives.	22-COMM-B
ControlNet™ Communication Adapter	Requires a Communication Adapter Cover when used with Frame C PowerFlex 400 drives (Ordered Separately).	22-COMM-C
DeviceNet™ Communication Adapter		22-COMM-D
EtherNet/IP™ Communication Adapter		22-COMM-E
LonWorks™ Communication Adapter		22-COMM-L
PROFIBUS™ DP Communication Adapter		22-COMM-P
External DSI™ Communications Kit		External mounting kit for 22-COMM communication adapter options.
External Comms Power Supply	Optional 100-240V AC Power Supply for External DSI Communications Kit.	20-XCOMM-PS1
Compact I/O Module	3 Channel.	1769-5M2
Communication Adapter Cover	Cover that houses the communication adapter. Frame C Drive	22C-CCC
DSI Cable	2.0 meter RJ45 to RJ45 cable, male to male connectors.	22-RJ45CBL-C20
Serial Cable	2.0 meter serial cable with a locking low profile connector to connect to the serial converter and a 9-pin sub-miniature D female connector to connect to a computer.	1203-SFC
Serial Null Cable Converter	For use when connecting the serial converter to DriveExplorer on a handheld PC.	1203-SNM
Universal Serial Bus™ (USB) Converter	Includes 2m USB, 20-HIM-H10 & 22-HIM-H10 cables.	1203-USB
Splitter Cable	RJ45 one to two port splitter cable	AK-U0-RJ45-SC1
Terminating Resistors	RJ45 120 Ohm resistors (2 pieces)	AK-U0-RJ45-TR1
Terminal Block	RJ45 Two position terminal block (5 pieces)	AK-U0-RJ45-TB2P
Connected Components Workbench Software (Download or DVD-ROM)	Windows based software packages for programming and configuring Allen-Bradley drives and other Rockwell Automation products. Compatibility: Windows XP, 7 Professional (Service Pack 1, 32-bit) and Vista (Service Pack 1 and 2, 32-bit).	http://www.rockwellautomation.com/global/support/connected-components/workbench.page?
DriveExecutive software (CD-ROM) Version 1.01 or later	Windows based software package that provides an intuitive means for monitoring or configuring Allen-Bradley drives and communication adapters online and offline. Compatibility: Windows 98, ME, NT 4.0 (Service Pack 3 or later), 2000, XP, 7 Professional (Service Pack 1, 32-bit), and Vista (Service Pack 1 and 2, 32-bit).	9303-4DTE01ENE
Serial Flash Firmware Kit	Use a PC to update drive firmware.	AK-U9-FLSH1

Table 28 - Human Interface Module (HIM) Option Kits and Accessories

Item	Description	Catalog Number
LCD Display, Remote Panel Mount	LCD Display Digital Speed Control CopyCat Capable IP66 indoor use only Includes 2.0 meter cable	22-HIM-C2S
LCD Display, Remote Handheld	LCD Display Digital Speed Control Full Numeric Keypad CopyCat Capable IP30 Includes 1.0 meter cable Panel Mount with optional Bezel Kit	22-HIM-A3
Bezel Kit	Panel mount for LCD Display, Remote Handheld unit, IP30	22-HIM-B1
DSI HIM Cable (DSI HIM to RJ45 cable)	1.0 Meter (3.3 Feet) 2.9 Meter (9.51 Feet)	22-HIM-H10 22-HIM-H30

Table 29 - Frame C IP30 Kit

Item	Description	Drive Frame	Catalog Number
IP30/NEMA 1/UL Type 1 Kit	Field installed kit. Converts drive to IP30/ NEMA 1/UL Type 1 enclosure. Includes conduit box with mounting screws and plastic top panel.	C	22-JBAC
IP30/NEMA 1/UL Type 1 Kit for Communication Option	Field installed kit. Converts drive to IP30/ NEMA 1/UL Type 1 enclosure. Includes communication option conduit box with mounting screws and plastic top panel.	C	22-JBCC

Table 30 - Field Installed Option

Item	Description	Catalog Number
Auxiliary Relay Board	Field installed kit. Expands drive output capabilities.	AK-U9-RLB1

Product Dimensions

Table 31 - PowerFlex 400 Frames and Weights

Frame	kW (HP)	Drive Weight kg (lbs.)	Packaged Weight kg (lbs.)
240V AC – 3-Phase			
C	2.2 (3.0)	2.89 (6.4)	3.41 (7.5)
C	4.0 (5.0)	2.97 (6.5)	3.49 (7.7)
C	5.5 (7.5)	3.72 (8.2)	4.27 (9.4)
C	7.5 (10)	3.78 (8.3)	4.33 (9.5)
D	11 (15)	12.1 (26.7)	13.4 (29.5)
D	15 (20)	12.7 (28.0)	14 (30.9)
D	18.5 (25)	12.7 (28.0)	14 (30.9)
D	22 (30)	12.7 (28.0)	14 (30.9)
E	30 (40)	38 (83.8)	48.2 (106.3)
E	37 (50)	38 (83.8)	48.2 (106.3)
480V AC – 3-Phase			
C	2.2 (3.0)	2.87 (6.3)	3.39 (7.5)
C	4.0 (5.0)	3.03 (6.7)	3.55 (7.8)
C	5.5 (7.5)	3.65 (8.0)	4.2 (9.3)
C	7.5 (10)	3.75 (8.3)	4.3 (9.5)
C	11 (15)	6.41 (14.1)	7.41 (16.3)
C	15 (20)	6.47 (14.3)	7.49 (16.5)
D	18.5 (25)	12.7 (28.0)	14 (30.9)
D	22 (30)	12.7 (28.0)	14 (30.9)
D	30 (40)	14.3 (31.5)	15.6 (34.4)
E	37 (50)	36 (79.4)	46.2 (101.9)
E	45 (60)	36 (79.4)	46.2 (101.9)
E	55 (75)	41 (90.4)	51.2 (112.9)
E	75 (100)	41 (90.4)	51.2 (112.9)
F	90 (125)	78 (172.0)	88 (194.0)
F	110 (150)	78 (172.0)	88 (194.0)
G	132 (200)	89 (196.2)	106 (233.7)
G	160 (250)	89 (196.2)	106 (233.7)
H	200 (300)	157 (346.1)	177 (390.2)
H	250 (350)	157 (346.1)	177 (390.2)
240V AC – 3-Phase, Plate Drive			
C	2.2 (3.0)	2.66 (5.9)	3.26 (7.2)
C	4.0 (5.0)	2.74 (6.0)	3.34 (7.4)
C	5.5 (7.5)	3.15 (6.9)	3.75 (8.3)
C	7.5 (10)	3.21 (7.1)	3.81 (8.4)
480V AC – 3-Phase, Plate Drive			
C	2.2 (3.0)	2.63 (5.8)	3.23 (7.1)

Table 31 - PowerFlex 400 Frames and Weights

Frame	kW (HP)	Drive Weight kg (lbs.)	Packaged Weight kg (lbs.)
C	4.0 (5.0)	2.77 (6.1)	3.37 (7.4)
C	5.5 (7.5)	3.04 (6.7)	3.64 (8.0)
C	7.5 (10)	3.13 (6.9)	3.73 (8.2)
C	11 (15)	3.19 (7.0)	3.79 (8.4)

Figure 18 - PowerFlex 400 Frame C Drive

Dimensions are in millimeters and (inches)

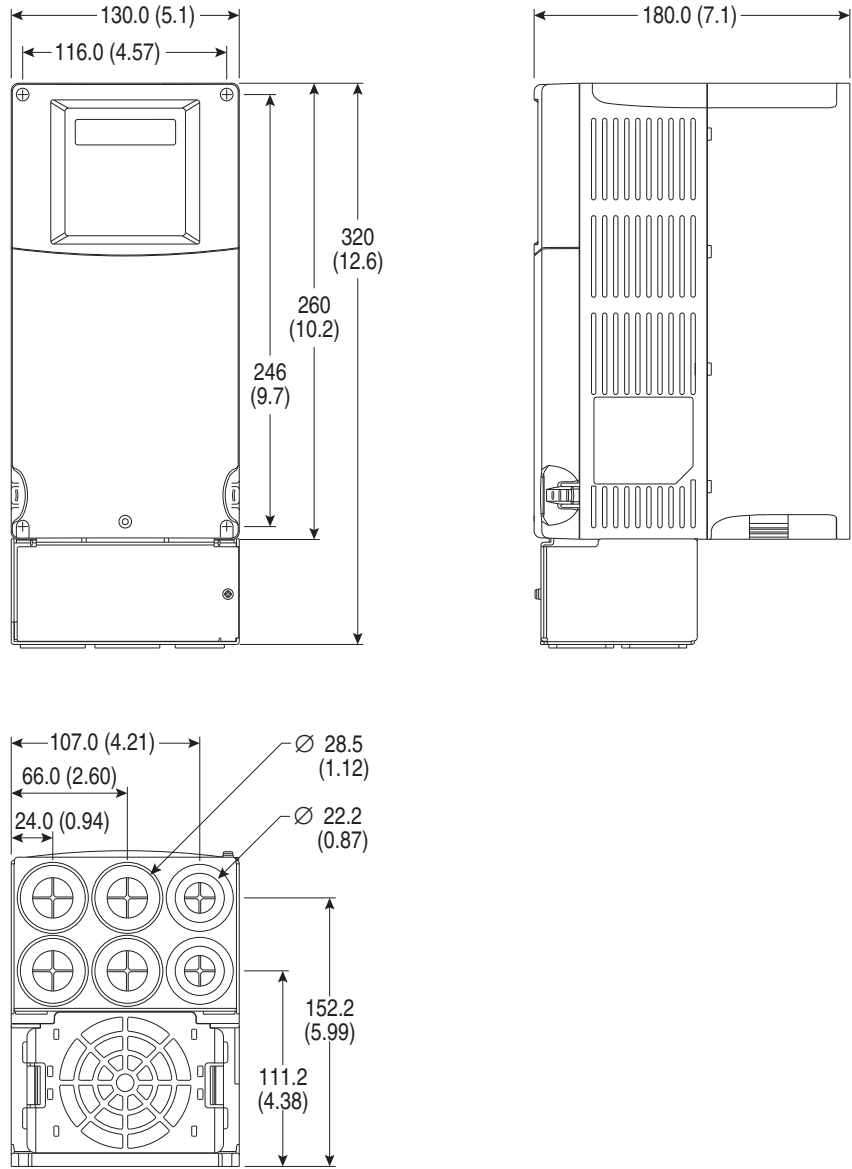

Figure 19 - PowerFlex 400 Frame D Drive

Dimensions are in millimeters and (inches)

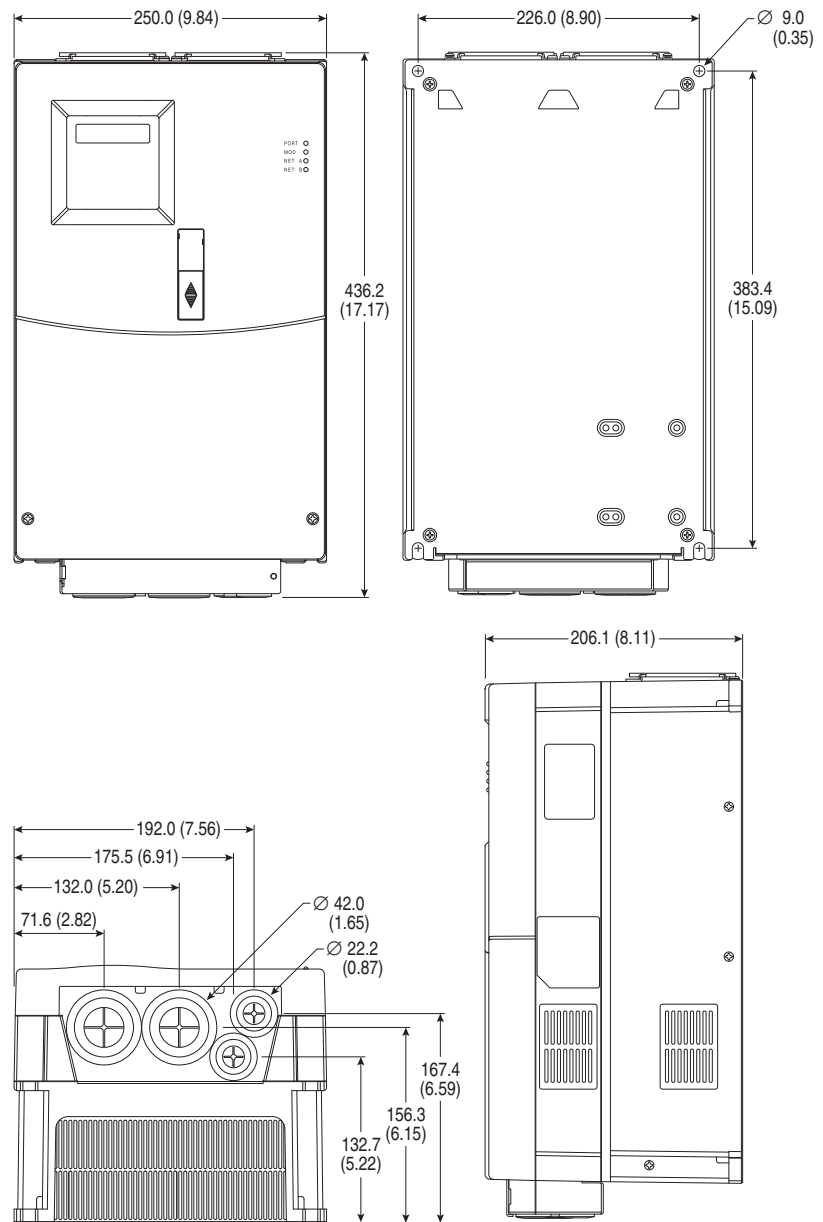

Figure 20 - PowerFlex 400 Frame E Drive

Dimensions are in millimeters and (inches)

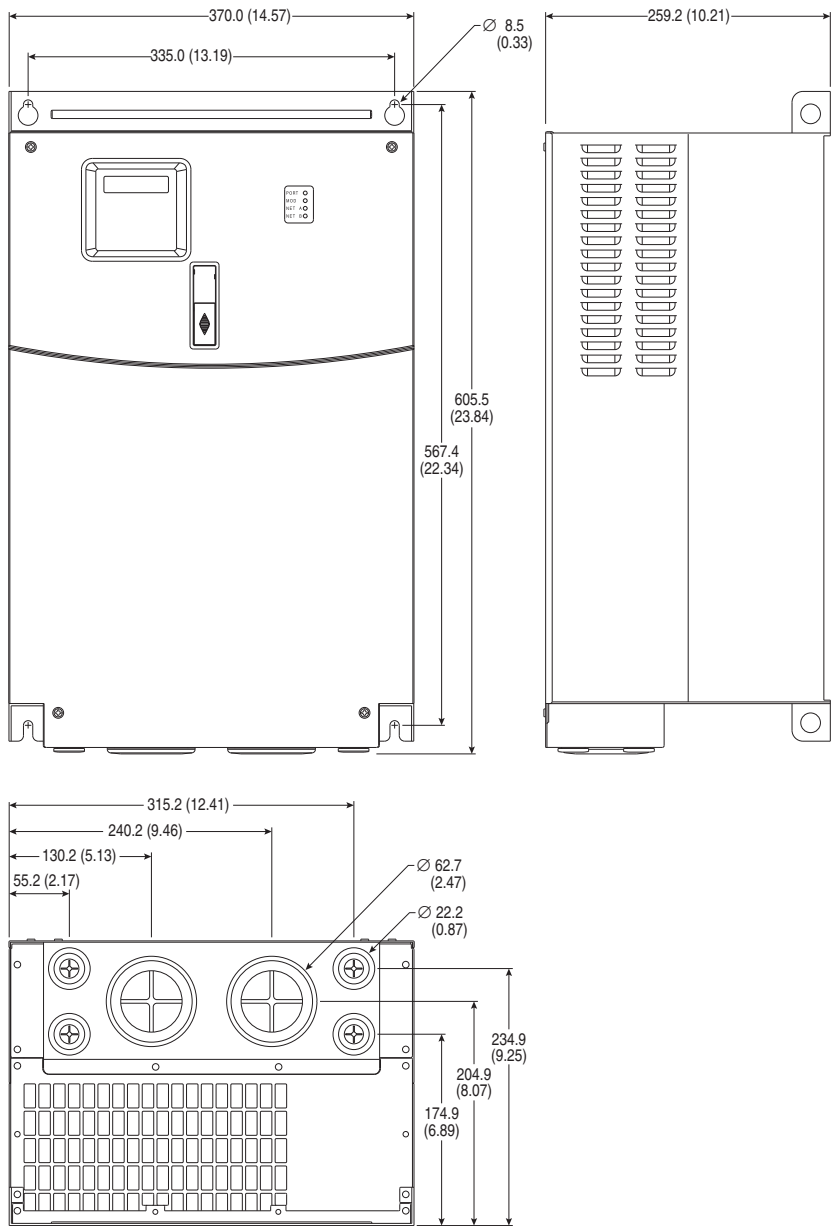

Figure 21 - PowerFlex 400 Frame F Drive

Dimensions are in millimeters and (inches)

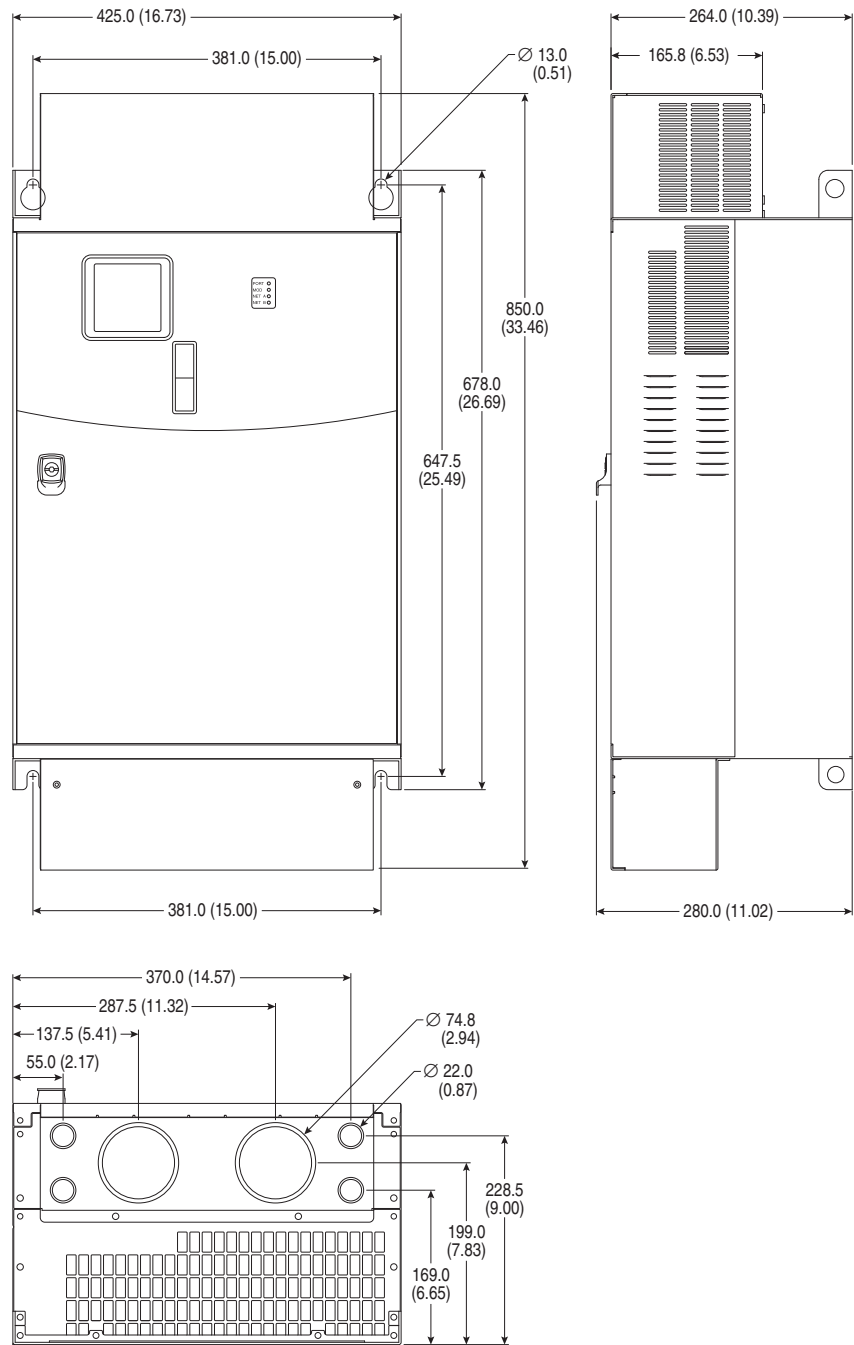

Figure 22 - PowerFlex 400 Frame G Drive

Dimensions are in millimeters and (inches)

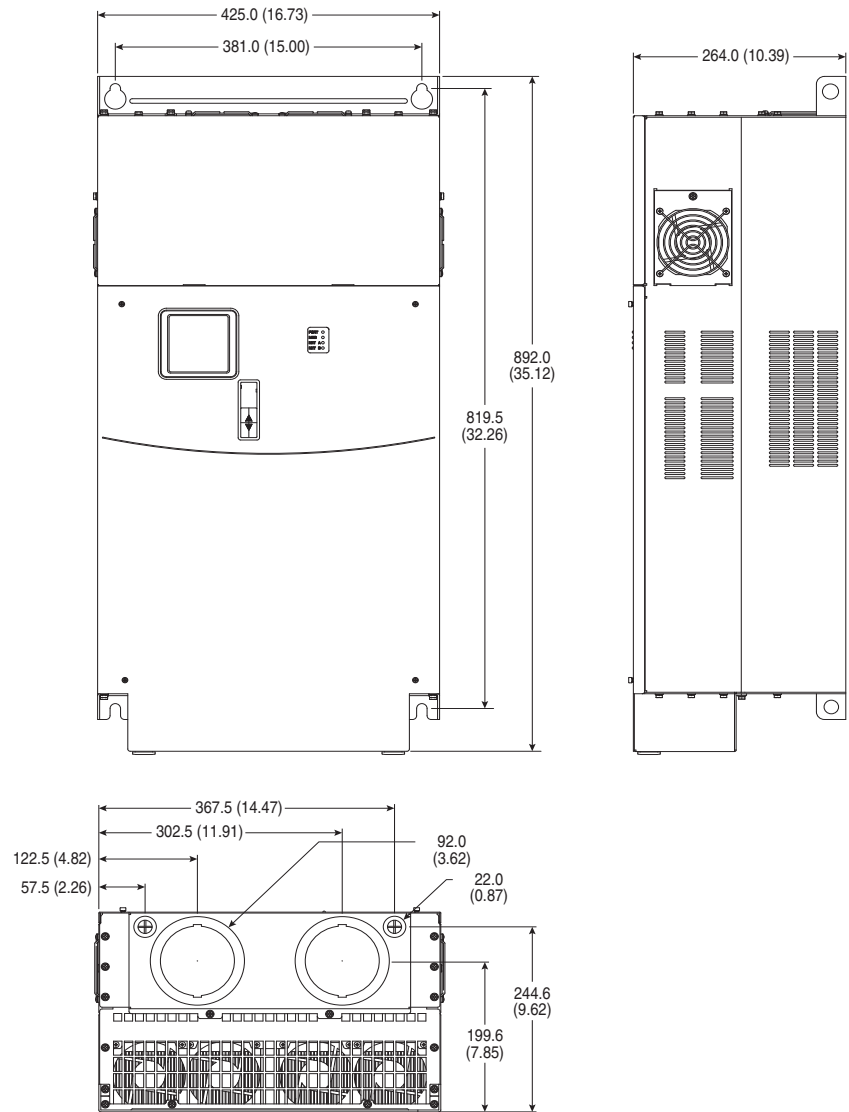

Figure 23 - PowerFlex 400 Frame H Drive

Dimensions are in millimeters and (inches)

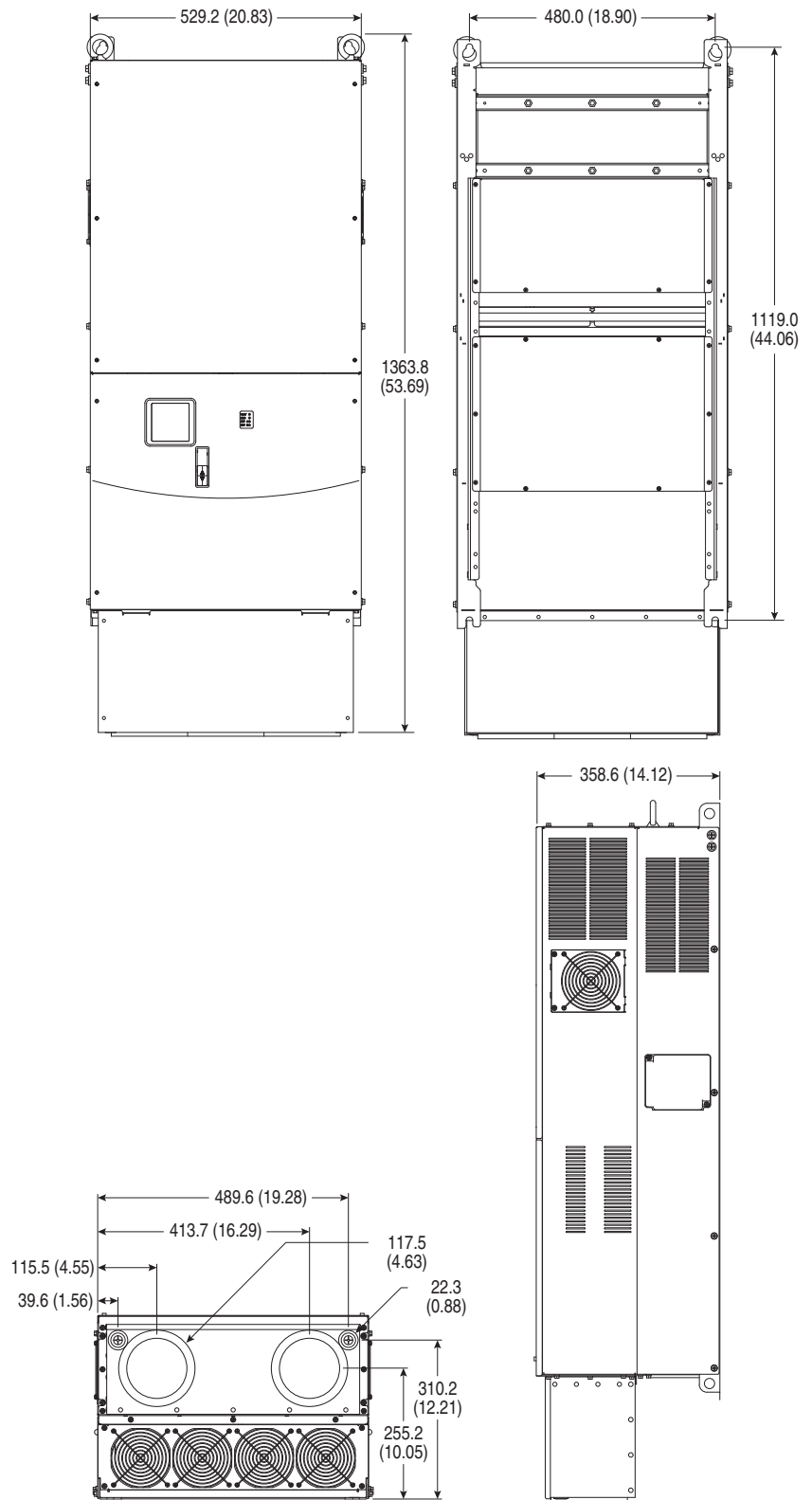
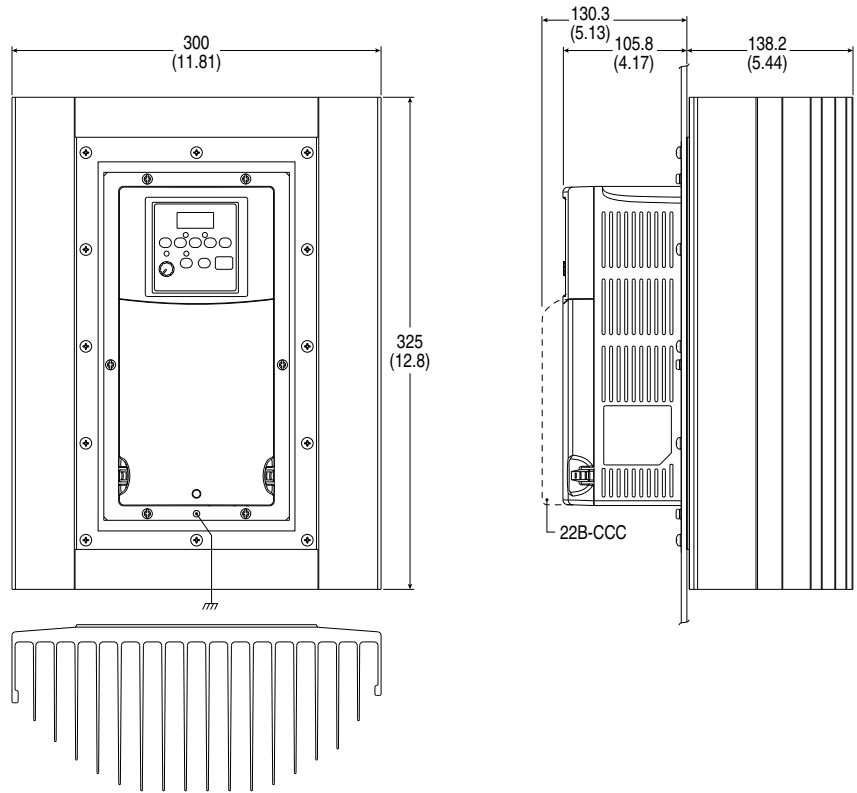

Figure 24 - PowerFlex 400 Frame C Flange Mount Drive

Dimensions are in millimeters and (inches)



Cutout Dimensions

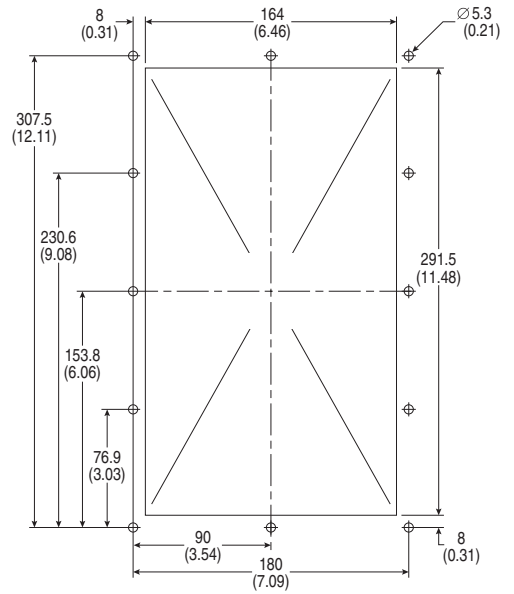
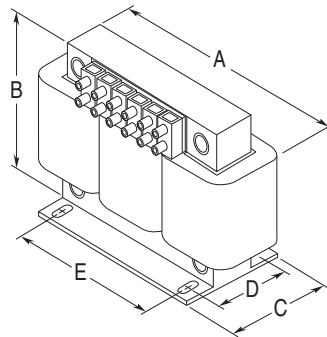
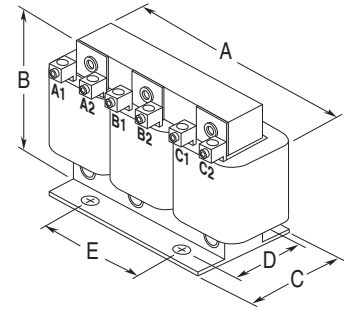

Figure 25 - Bulletin 1321-3R Series Line Reactors

Dimensions are in millimeters and (inches). Weights are in kilograms and (pounds).



IP00 (Open) –
45 Amps (fundamental) and Below



IP00 (Open) –
55 Amps (fundamental) and Above

Catalog Number	A	B	C	D	E	Weight
1321-3R8-C	152 (6.00)	122 (4.80)	86 (3.40)	67 (2.62)	51 (2.00)	5.0 (11)
1321-3R8-D	152 (6.00)	122 (4.80)	86 (3.40)	63 (2.48)	51 (2.00)	5.9 (13)
1321-3R12-A	152 (6.00)	127 (5.00)	84 (3.30)	53 (2.10)	51 (2.00)	4.1 (9)
1321-3R12-B	152 (6.00)	127 (5.00)	76 (3.00)	53 (2.10)	51 (2.00)	4.5 (10)
1321-3R12-C	152 (6.00)	127 (5.00)	91 (3.60)	69 (2.73)	51 (2.00)	8.2 (18)
1321-3R18-B	152 (6.00)	135 (5.30)	89 (3.50)	63 (2.48)	51 (2.00)	5.5 (12)
1321-3R18-C	183 (7.20)	146 (5.76)	92 (3.63)	66 (2.60)	76 (3.00)	7.3 (16)
1321-3R25-A	183 (7.20)	146 (5.76)	85 (3.35)	60 (2.35)	76 (3.00)	4.9 (11)
1321-3R25-B	183 (7.20)	146 (5.76)	85 (3.35)	60 (2.35)	76 (3.00)	6.3 (14)
1321-3R25-C	183 (7.20)	146 (5.76)	105 (4.10)	79 (3.10)	76 (3.00)	8.1 (18)
1321-3R35-A	193 (7.60)	146 (5.76)	91 (3.60)	66 (2.60)	76 (3.00)	6.3 (14)
1321-3R35-B	183 (7.20)	147 (5.80)	95 (3.75)	79 (3.10)	76 (3.00)	7.3 (16)
1321-3R35-C	229 (9.00)	187 (7.35)	118 (4.66)	80 (3.16)	76 (3.00)	13.6 (30)
1321-3R45-A	229 (9.00)	187 (7.35)	118 (4.66)	80 (3.16)	76 (3.00)	10.4 (23)
1321-3R45-B	229 (9.00)	184 (7.25)	118 (4.66)	80 (3.16)	76 (3.00)	12.7 (28)
1321-3R45-C	229 (9.00)	187 (7.35)	135 (5.30)	93 (3.66)	76 (3.00)	17.7 (39)
1321-3R55-A	229 (9.00)	187 (7.35)	118 (4.66)	80 (3.16)	76 (3.00)	10.9 (24)
1321-3R55-B	229 (9.00)	187 (7.35)	118 (4.66)	80 (3.16)	76 (3.00)	12.3 (27)
1321-3R55-C	229 (9.00)	184 (7.25)	142 (5.60)	99 (3.90)	76 (3.00)	18.6 (41)
1321-3R80-A	274 (10.80)	216 (8.50)	139 (5.47)	88 (3.47)	92 (3.63)	19.5 (43)
1321-3R80-B	274 (10.80)	216 (8.50)	139 (5.47)	88 (3.47)	92 (3.63)	23.1 (51)
1321-3R80-C	274 (10.80)	210 (8.26)	156 (6.16)	106 (4.16)	92 (3.63)	25.0 (55)
1321-3R100-A	274 (10.80)	217 (8.55)	139 (5.48)	84 (3.30)	92 (3.63)	21.3 (47)
1321-3R100-B	274 (10.80)	210 (8.26)	144 (5.66)	93 (3.66)	92 (3.63)	23.1 (51)
1321-3R100-C	274 (10.80)	210 (8.26)	156 (6.16)	106 (4.16)	92 (3.63)	33.6 (74)
1321-3R130-A	229 (9.00)	179 (7.04)	118 (4.66)	80 (3.16)	76 (3.00)	13.2 (29)
1321-3R130-B	274 (10.80)	213 (8.40)	144 (5.66)	93 (3.66)	92 (3.63)	25.9 (57)
1321-3R130-C	279 (11.00)	216 (8.50)	156 (6.16)	106 (4.16)	92 (3.63)	29.0 (64)

Catalog Number	A	B	C	D	E	Weight
1321-3R160-A	274 (10.80)	216 (8.50)	172 (6.80)	80 (3.16)	92 (3.63)	19.0 (42)
1321-3R160-B	279 (11.00)	216 (8.50)	178 (7.00)	88 (3.47)	92 (3.63)	23.0 (51)
1321-3R160-C	287 (11.30)	216 (8.50)	229 (9.00)	118 (4.66)	92 (3.63)	33.0 (72)
1321-3R200-B	274 (10.80)	216 (8.50)	210 (8.30)	112 (4.41)	92 (3.63)	31.0 (67)
1321-3R200-C	274 (10.80)	216 (8.50)	254 (10.00)	150 (5.91)	92 (3.63)	46.0 (100)
1321-3R250-B	366 (14.40)	292 (11.50)	292 (11.50)	192 (7.56)	117 (4.60)	53.5 (118)
1321-3R250-C	366 (14.40)	286 (11.25)	260 (10.25)	167 (6.56)	117 (4.60)	57.0 (125)
1321-3R320-B	274 (10.80)	229 (9.00)	254 (10.00)	165 (6.50)	92 (3.63)	46.3 (102)
1321-3R320-C	366 (14.40)	286 (11.25)	267 (10.50)	192 (7.56)	117 (4.60)	72.6 (160)
1321-3R400-B	381 (15.00)	286 (11.25)	292 (11.50)	179 (7.06)	117 (4.60)	53.5 (118)
1321-3R400-C	366 (14.40)	286 (11.25)	318 (12.50)	192 (7.56)	117 (4.60)	67.6 (149)
1321-3R500-B	366 (14.40)	292 (11.50)	292 (11.50)	192 (7.56)	117 (4.60)	53.5 (118)
1321-3R500-C	366 (14.40)	286 (11.25)	254 (10.00)	141 (5.56)	117 (4.60)	54.4 (120)

Figure 26 - Bulletin 1321-DC Series Bus Inductors

Dimensions are in millimeters and (inches). Weights are in kilograms and (pounds).

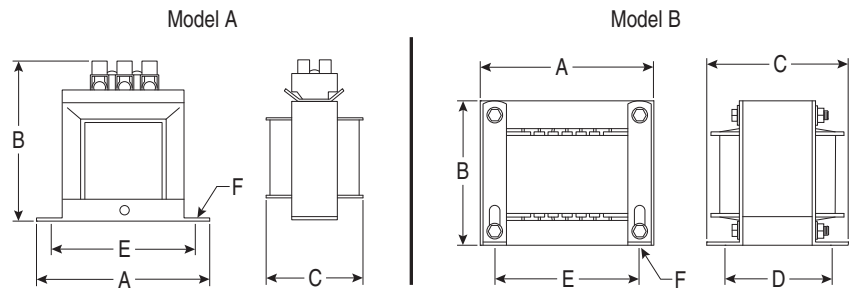

Catalog Number	Model	A	B	C	D	E	F	Weight
1321-DC9-2	A	95 (3.75)	83 (3.25)	51 (2.00)	-	80 (3.13)	4.7 (0.19)	
1321-DC12-1	A	95 (3.75)	83 (3.25)	44 (1.75)	-	80 (3.13)	4.7 (0.19)	
1321-DC12-2	B	97 (3.81)	114 (4.50)	72 (2.82)	51 (2.00)	80 (3.13)	5x8 (.20x.33)	5.9 (13.0)
1321-DC18-1	A	95 (3.75)	83 (3.25)	51 (2.00)	-	80 (3.13)	4.7 (0.19)	
1321-DC18-4	B	118 (4.63)	133 (5.25)	102 (4.00)	64 (2.50)	95 (3.75)	5x8 (.20x.33)	3.6 (8.0)
1321-DC25-4	B	97 (3.81)	114 (4.50)	76 (3.00)	64 (2.50)	80 (3.13)	5x8 (.20x.33)	5.9 (13.0)
1321-DC32-1	B	97 (3.81)	114 (4.50)	84 (3.32)	64 (2.50)	80 (3.13)	5x8 (.20x.33)	2.3 (5.0)
1321-DC32-2	B	118 (4.63)	133 (5.25)	108 (4.25)	76 (3.00)	95 (3.75)	5x8 (.20x.33)	4.5 (10.0)
1321-DC40-2	B	97 (3.81)	114 (4.50)	95 (3.75)	76 (3.00)	80 (3.13)	5x8 (.20x.33)	3.2 (7.0)
1321-DC40-4	B	165 (6.50)	166 (6.55)	152 (6.00)	86 (3.38)	135 (5.31)	7x13 (.28x.52)	9.5 (21.0)

Figure 27 - EMC Line Filters

Dimensions are in millimeters and (inches)

Catalog Numbers: 22-RF018-CS, 22-RF018-CL, 22-RF026-CS, 22-RF026-CL, 22-RF034-CS

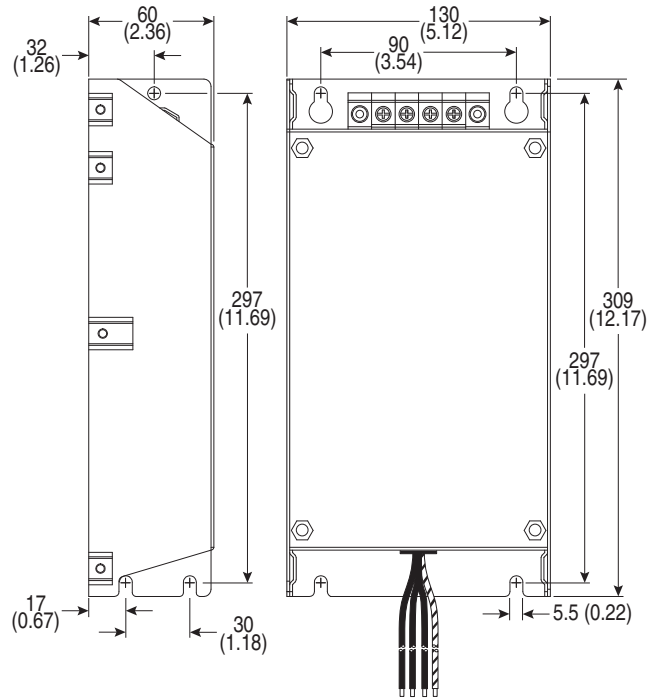

Catalog Numbers: 22-RFD036, 22-RFD050, 22-RFD070, 22-RFD100, 22-RFD150, 22-RFD180

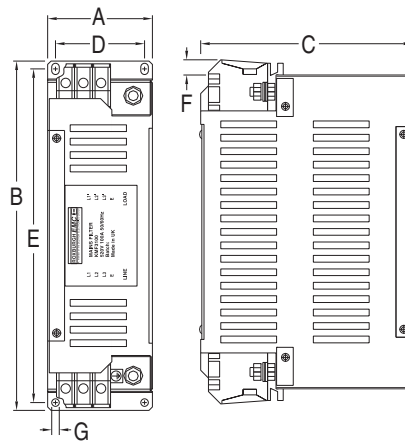

Catalog Number	A	B	C	D	E	F	G
22-RFD036	74 (2.91)	272 (10.71)	161 (6.34)	60 (2.36)	258 (10.16)	7.5 (0.30)	7 (0.28)
22-RFD050	93 (3.66)	312 (12.28)	190 (7.48)	79 (3.11)	298 (11.73)	13.5 (0.53)	7 (0.28)
22-RFD070	93 (3.66)	312 (12.28)	190 (7.48)	79 (3.11)	298 (11.73)	13.5 (0.53)	7 (0.28)
22-RFD100	93 (3.66)	312 (12.28)	190 (7.48)	79 (3.11)	298 (11.73)	13.5 (0.53)	7 (0.28)
22-RFD150	126 (4.96)	312 (12.28)	224 (8.82)	112 (4.41)	298 (11.73)	19.5 (0.77)	7 (0.28)
22-RFD180	126 (4.96)	312 (12.28)	224 (8.82)	112 (4.41)	298 (11.73)	27 (1.06)	7 (0.28)

Catalog Number: 22-RFD208

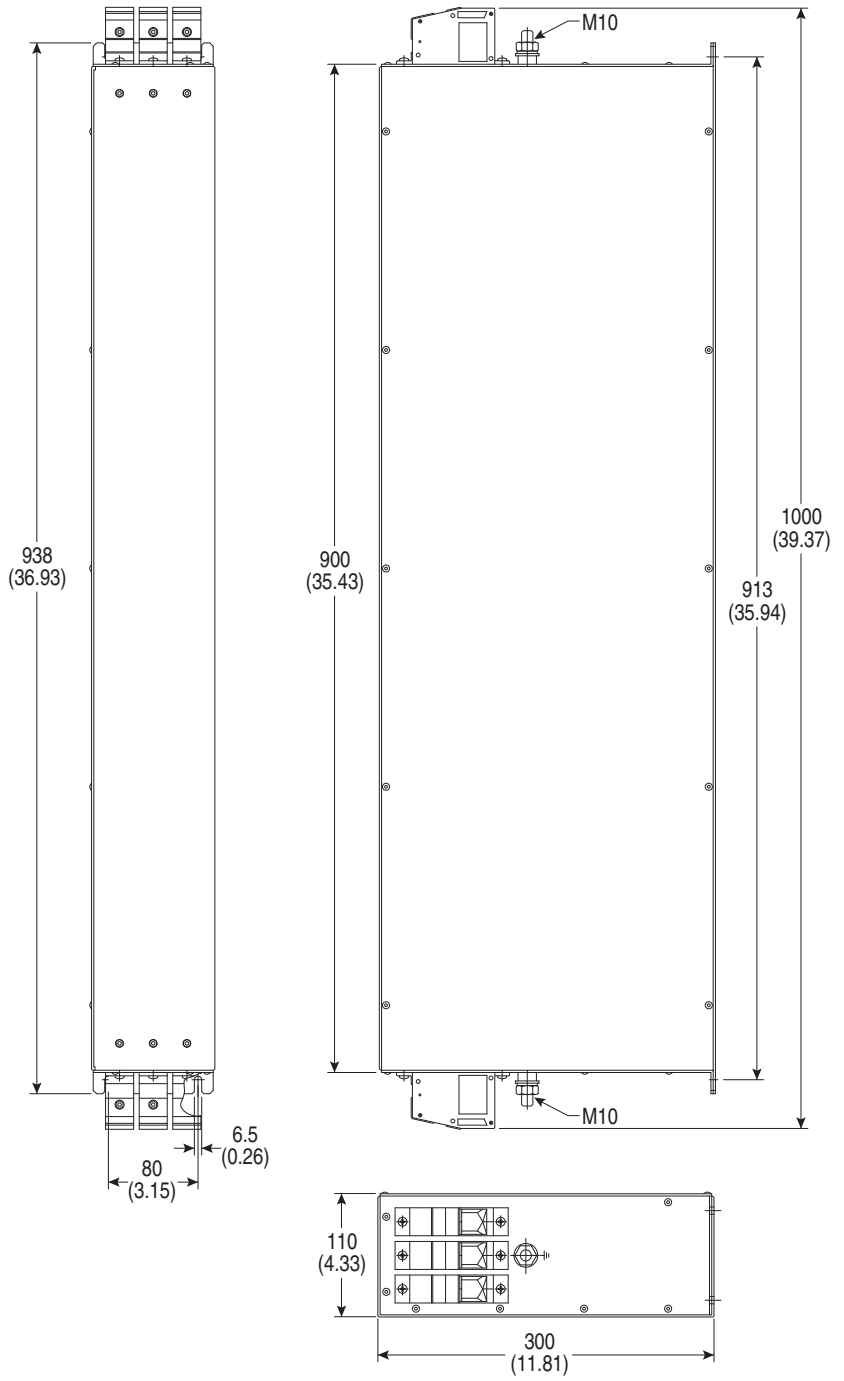

Catalog Numbers: 22-RFD323 and 22-RFD480

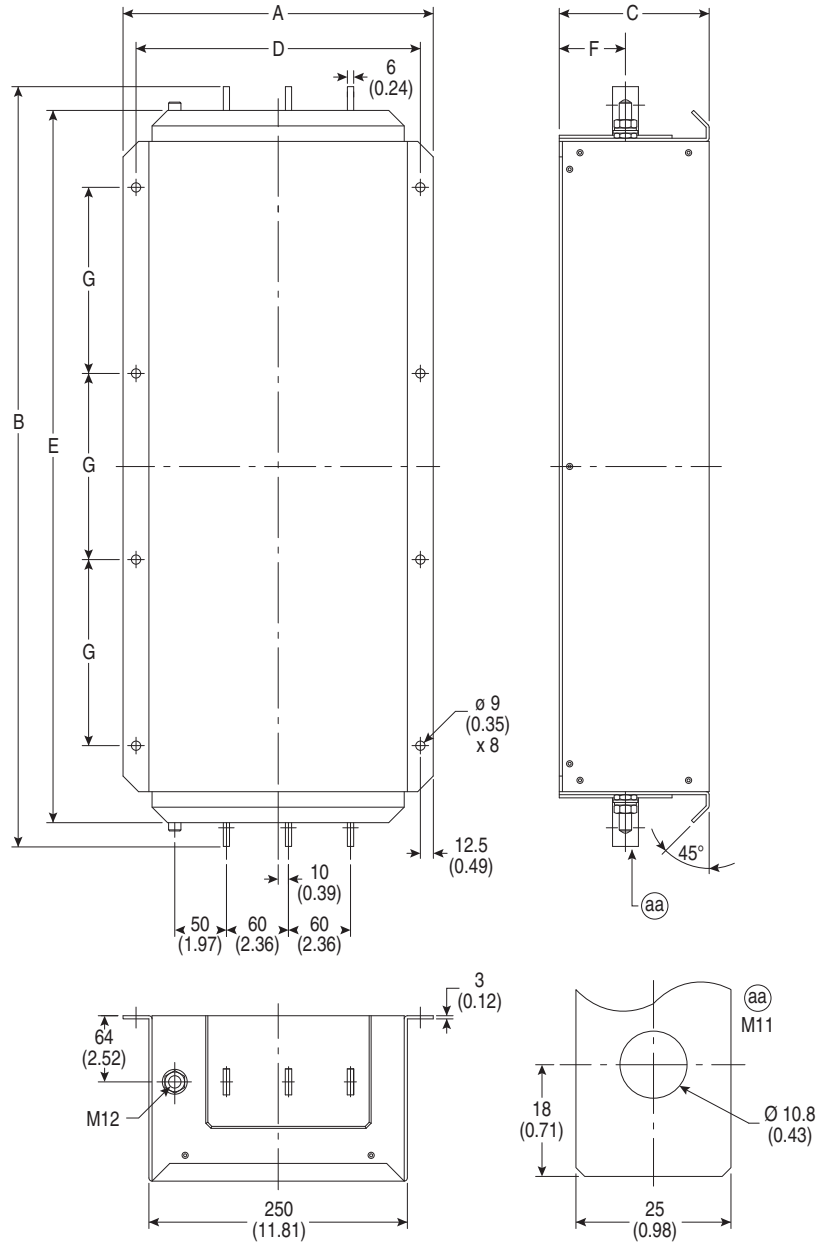

Catalog Number	A	B	C	D	E	F	G
22-RFD323	300 (11.81)	735 (28.94)	145 (5.71)	275 (10.83)	689 (27.13)	64 (2.52)	180 (7.09)
22-RFD480	300 (11.81)	882 (34.72)	145 (5.71)	275 (10.83)	836 (32.91)	64 (2.52)	240 (9.45)

Figure 28 - Remote (Panel Mount) Small HIM

Dimensions are in millimeters and (inches)

Catalog Number: 22-HIM-C2S

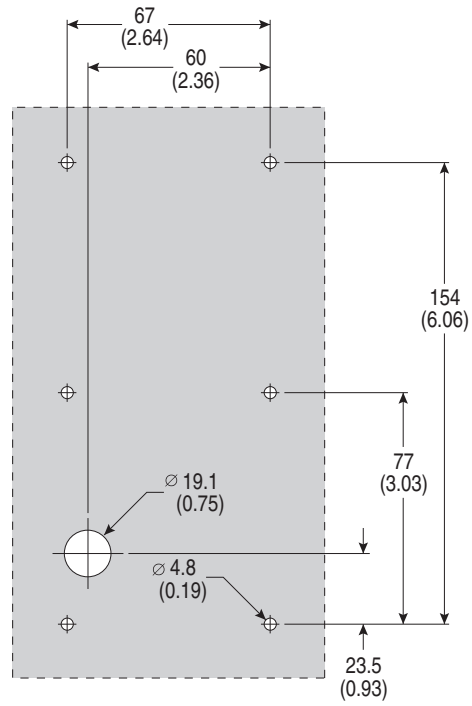
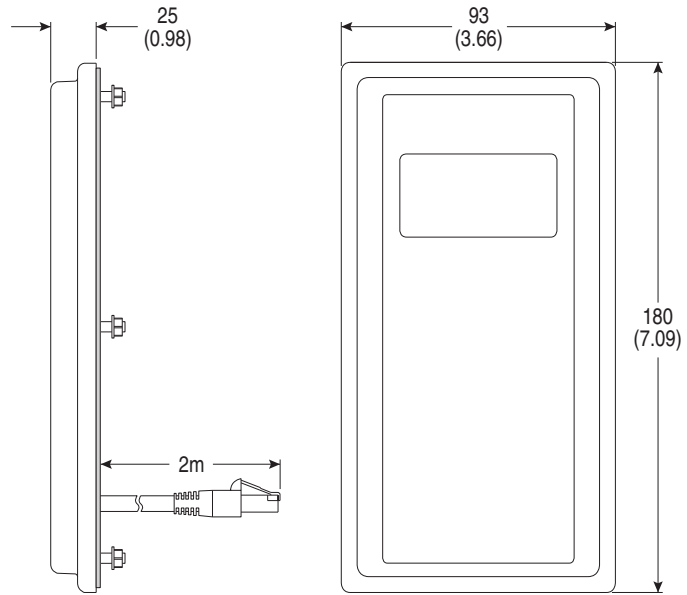
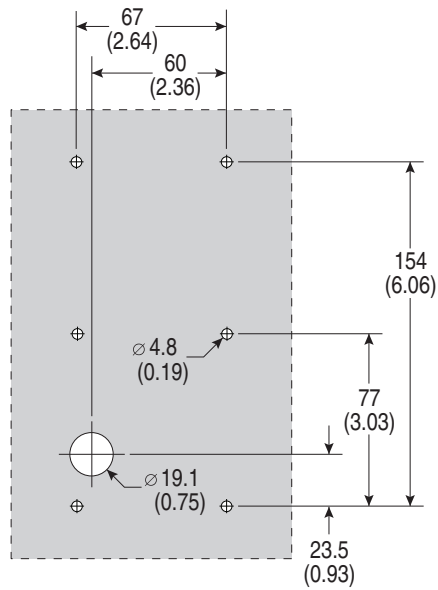
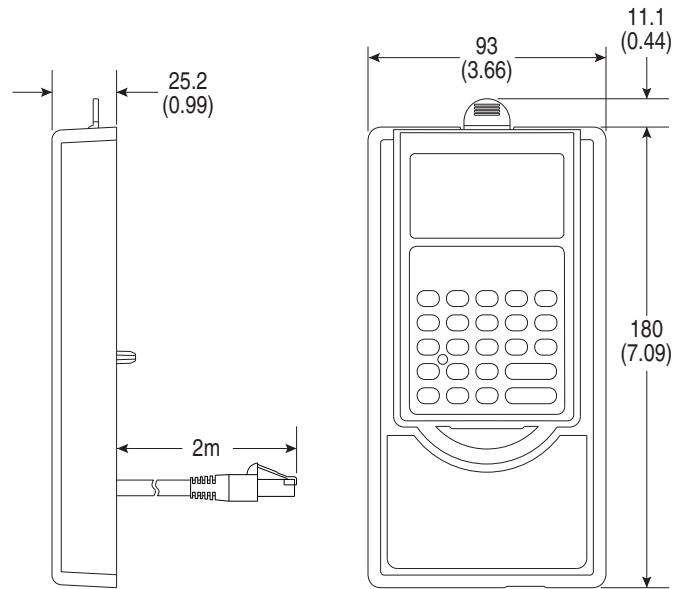

Figure 29 - NEMA Type 1 Bezel

Dimensions are in millimeters and (inches)

Catalog Number: 22-HIM-B1



Notes:

RJ45 DSI Splitter Cable

The PowerFlex 400 drive provides a RJ45 port to allow the connection of a single peripheral device. The RJ45 DSI Splitter Cable can be used to connect a second DSI peripheral device to the drive.

Connectivity Guidelines



ATTENTION: Risk of injury or equipment damage exists. The peripherals may not perform as intended if these Connectivity Guidelines are not followed. Precautions should be taken to follow these Connectivity Guidelines.

- Two peripherals maximum can be attached to a drive.
- If a single peripheral is used, it must be connected to the Master port (M) on the splitter and configured for “Auto” (default) or “Master.” Parameter 9 [Device Type] on the DSI keypads and Parameter 1 [Adapter Cfg] on the Serial Converter are used to select the type (Auto / Master / Slave).
- **Do not use the RJ45 Splitter Cable with a drive that has an internal network communication adapter installed.** Since only one additional peripheral can be added, the second peripheral can be connected directly to the RJ45 port on the drive. The internal Comm is always the Master, therefore the external peripheral must be configured as “Auto” (for temporary connections) or “Slave” (for permanent connections).
- If two peripherals will be powered up at the same time, one must be configured as the “Master” and connected to the Master port (M) and the other must be connected as the “Slave” and connected to the Slave port (S).

DSI Cable Accessories

Figure 30 - RJ45 Splitter Cable

Catalog Number: AK-U0-RJ45-SC1

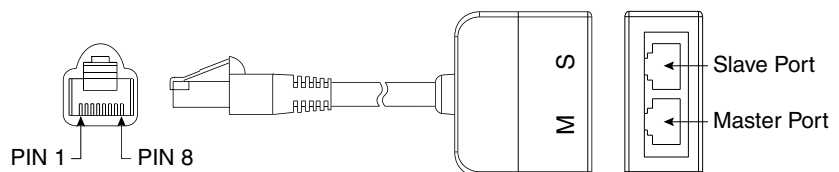

Figure 31 - RJ45 Two-Position Terminal Block Adapter

Catalog Number: AK-U0-RJ45-TB2P

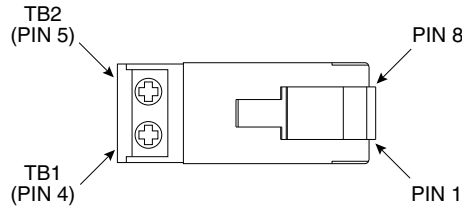
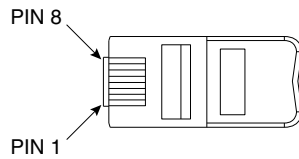

Figure 32 - RJ45 Adapter with Integrated Termination Resistor

Catalog Number: AK-U0-RJ45-TR1



Connectivity Examples

Figure 33 - Connecting One Temporary Peripheral

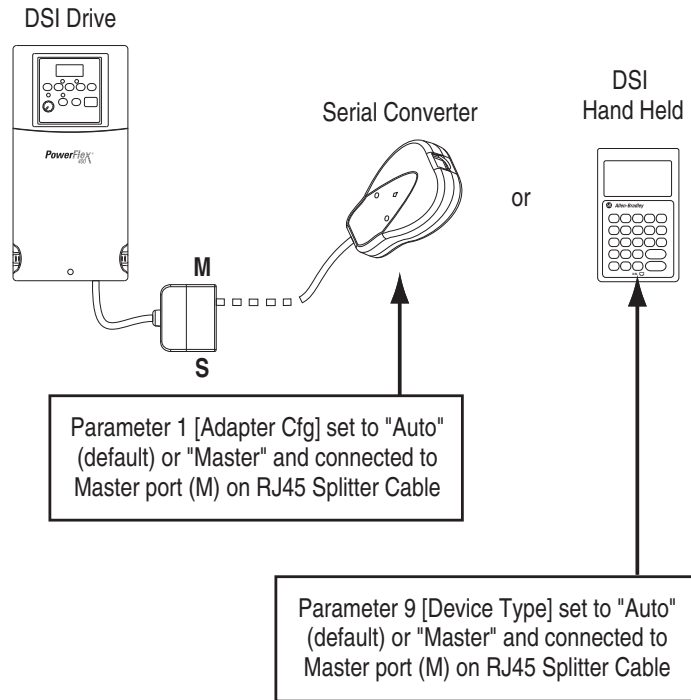

Figure 34 - Connecting One Temporary Peripheral and One Permanent Peripheral

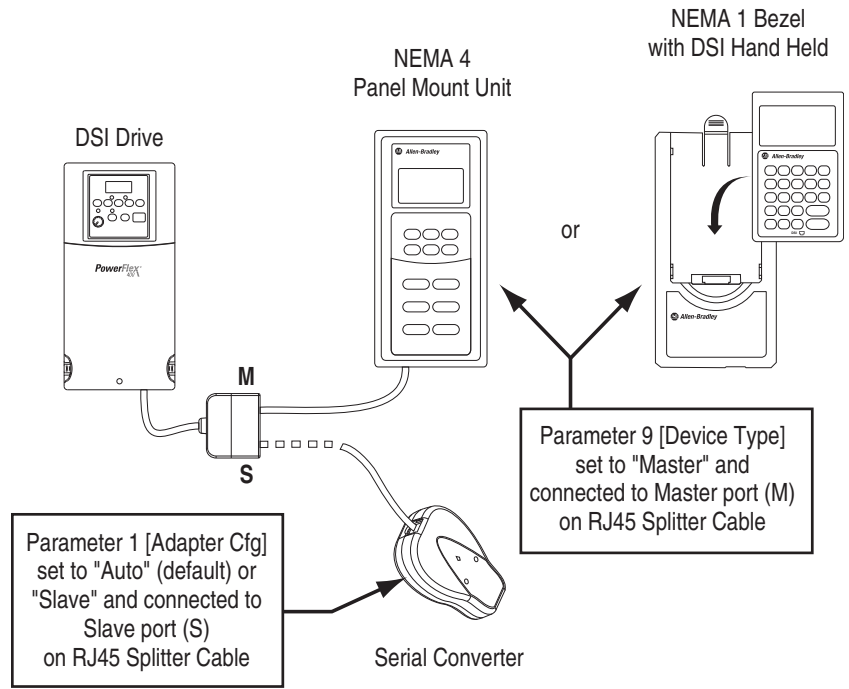

Figure 35 - Connecting Two Permanent Peripherals

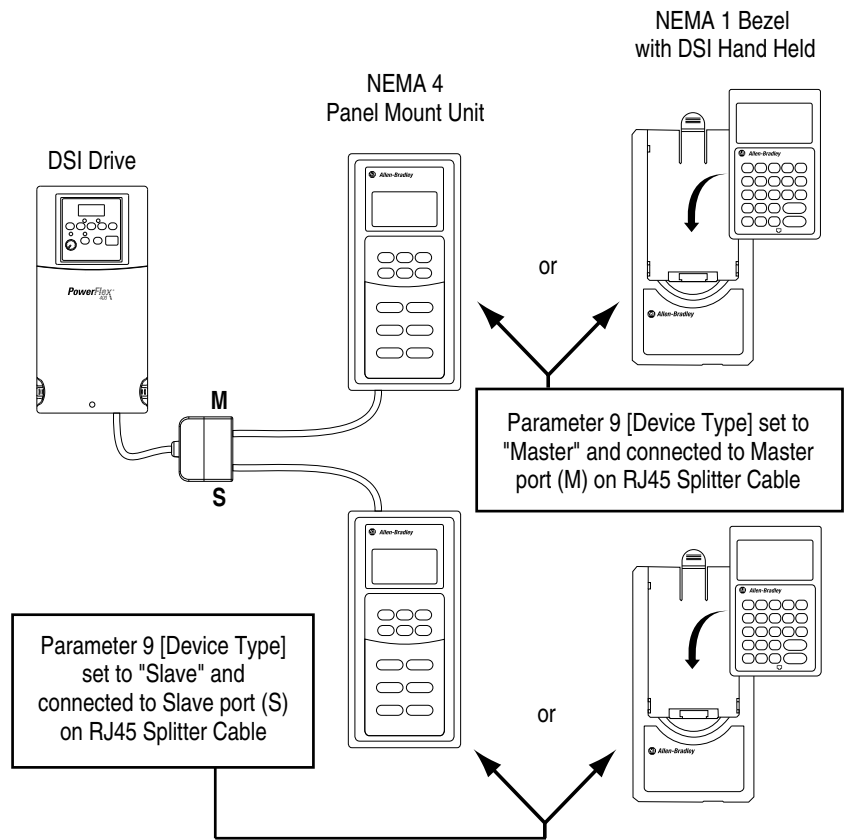
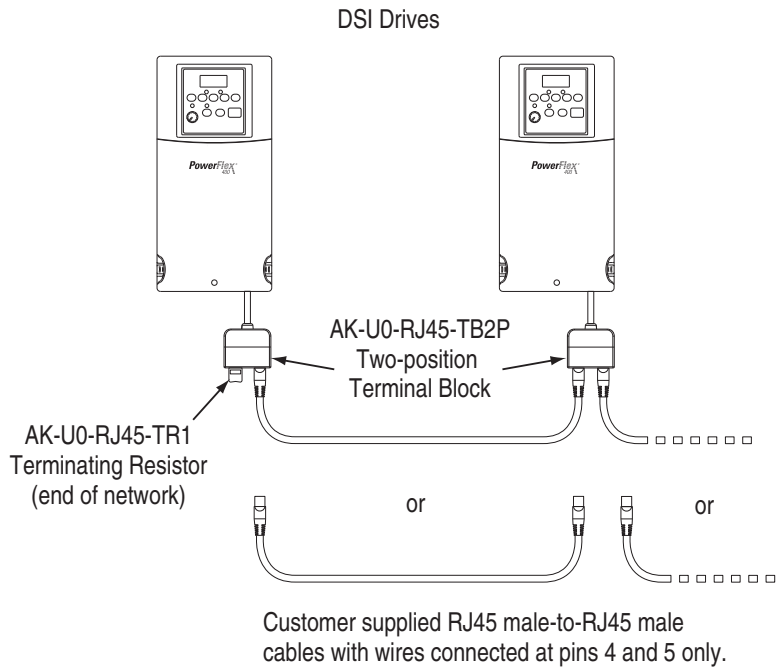

Figure 36 - Connecting an RS-485 Network



Customer supplied RJ45 male-to-RJ45 male cables with wires connected at pins 4 and 5 only.

Both the Master (M) and Slave (S) ports on the RJ45 Splitter Cable operate as standard RS-485 ports in this configuration.

Application Notes

Damper Control Setup

The PowerFlex 400 allows damper control logic to be imbedded within the drive reducing cost associated with external control hardware and software. A system Run command can be wired directly into one of the drive inputs. Relay outputs can be used to energize the damper to either open or close. A damper limit switch can be wired back to the drive providing indication that the damper is in the proper position and that it is safe for the drive to run at commanded speed.

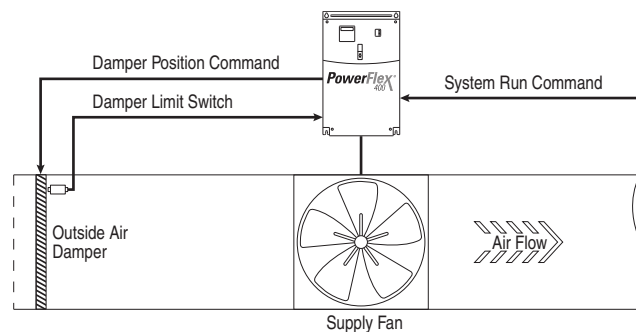

Example

- The System Run Command can come from a terminal block, integral keypad, or communication port. Configure parameter [P036](#) [Start Source] per application requirements.
- Set one of the available digital inputs, parameter [T051...T054](#) [Digital Inx Sel] to option 36 “Damper Input”. The damper end switch or limit switch should be wired into this input.
- Set one of the available relay outputs, parameter [T055/T060](#) [Relay Outx Sel] to option 2 “Motor Running”. This output should be used to energize the damper to either open or close.

PID Setup

PID Control Loop

The PowerFlex 400 has a built-in PID (proportional, integral, differential) control loop. The PID loop is used to maintain a process feedback (such as pressure, flow or tension) at a desired set point. The PID loop works by subtracting the PID feedback from a reference and generating an error value. The PID loop reacts to the error, based on the PID Gains, and outputs a frequency to try to reduce the error value to 0. To enable the PID loop, parameter [A152](#) [PID Ref Sel] must be set to an option other than 0 “PID Disabled”.

Exclusive Control and Trim Control are two basic configurations where the PID loop may be used.

Exclusive Control

In Exclusive Control, the Speed Reference becomes 0, and the PID Output becomes the entire Freq Command. Exclusive Control is used when [A152](#) [PID Ref Sel] is set to option 1, 2, 3 or 4. This configuration does not require a master reference, only a desired set point, such as a flow rate for a pump.

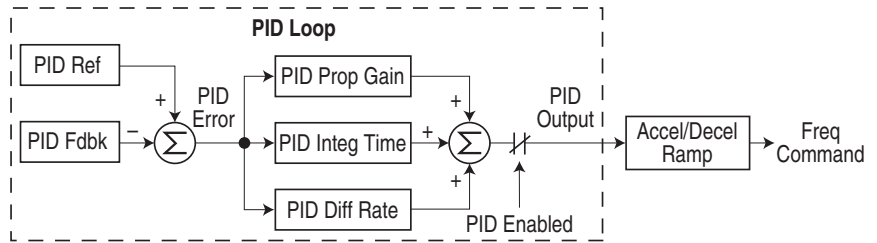

Example

- In a pumping application, the PID Reference equals the Desired System Pressure set point.
- The Pressure Transducer signal provides PID Feedback to the drive. Fluctuations in actual system pressure, due to changes in flow, result in a PID Error value.
- The drive output frequency increases or decreases to vary motor shaft speed to correct for the PID Error value.
- The Desired System Pressure set point is maintained as valves in the system are opened and closed causing changes in flow.
- When the PID Control Loop is disabled, the Commanded Speed is the Ramped Speed Reference.

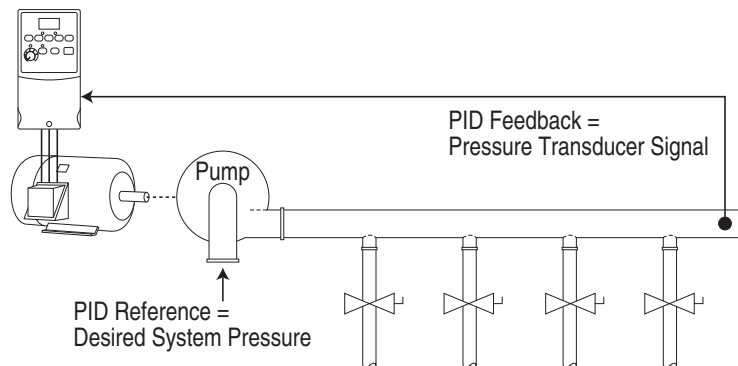

Trim Control

In Trim Control, the PID Output is added to the Speed Reference. In Trim mode, the output of the PID loop bypasses the accel/decel ramp as shown. Trim Control is used when [A152](#) [PID Ref Sel] is set to option 5, 6, 7 or 8.

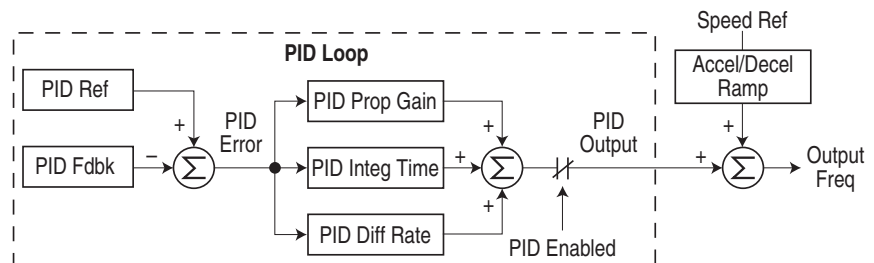

Example

- In a winder application, the PID Reference equals the Equilibrium set point.
- The Dancer Pot signal provides PID Feedback to the drive. Fluctuations in tension result in a PID Error value.
- The Master Speed Reference sets the wind/unwind speed.
- As tension increases or decreases during winding, the Speed Reference is trimmed to compensate. Tension is maintained near the Equilibrium set point.

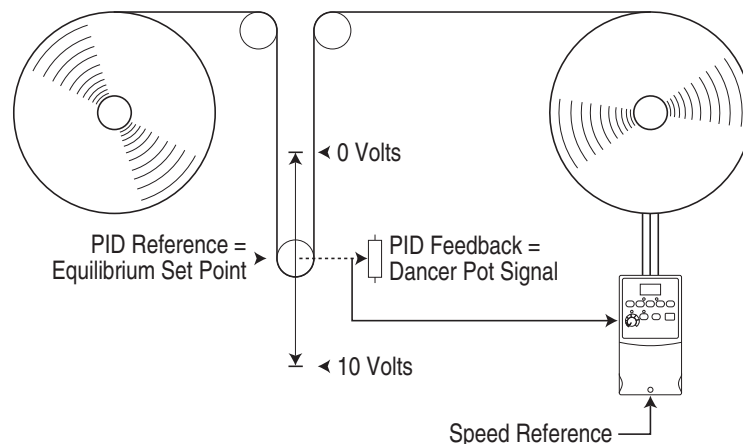

PID Reference and Feedback

Parameter [A152](#) [PID Ref Sel] is used to enable the PID mode ($A152 = 0$ "PID Disabled") and to select the source of the PID Reference. If [A152](#) [PID Ref Sel] is not set to 0 "PID Disabled", PID can still be disabled by select programmable digital input options (parameters [T051...T054](#)) such as "Local" or "PID Disable".

Table 32 - A152 [PID Ref Sel] Options

Option	Description
0 "PID Disabled"	Disables the PID loop (default setting)
1 "PID Setpoint"	Selects Exclusive Control. <A157> [PID Setpoint] will be used to set the value of the PID Reference.
2 "Analog In 1"	Selects Exclusive Control. Selects the Analog In 1 Input.
3 "Analog In 2"	Selects Exclusive Control. Selects the Analog In 2 Input. Note that the PID will not function with a bipolar analog input. It will ignore any negative voltages and treat them like a zero.
4 "Comm Port"	Selects Exclusive Control. The reference word from a communication network (see Appendix C for details on the reference word) such as Modbus RTU or DeviceNet becomes the PID Reference. The value sent over the network is scaled so that $P035$ [Maximum Freq] x 10 = 100% reference. For example, with [Maximum Freq] = 60 Hz, a value of 600 sent over the network would represent 100% reference.
5 "Setpnt, Trim"	Selects Trim Control. A157 [PID Setpoint] will be used to set the value of the PID Reference.
6 "0-10V, Trim"	Selects Trim Control. Selects the 0-10V Input. Note that the PID will not function with a bipolar analog input. It will ignore any negative voltages and treat them like a zero.
7 "4-20mA, Trim"	Selects Trim Control. Selects the 4-20mA Input.
8 "Comm, Trim"	Selects Trim Control. The reference word from a communication network (see Appendix C for details on the reference word) such as Modbus RTU or DeviceNet becomes the PID Reference. The value sent over the network is scaled so that $P035$ [Maximum Freq] x 10 = 100% reference. For example, with [Maximum Freq] = 60 Hz, a value of 600 sent over the network would represent 100% reference.

[A153](#) [PID Feedback Sel] is used to select the source of the PID feedback.

Table 33 - A153 [PID Feedback Sel] Options

Option	Description
0 "Analog In 1"	Selects the Analog In 1 Input (default setting).
1 "Analog In 2"	Selects the Analog In 2 Input. Note that the PID will not function with a bipolar analog input. It will ignore any negative voltages and treat them like a zero.
2 "Comm Port"	The reference word from a communication network (see Appendix E for details on the reference word) such as Modbus RTU or DeviceNet becomes the PID Feedback. The value sent over the network is scaled so that $P035$ [Maximum Freq] x 10 = 100% Feedback. For example, with [Maximum Freq] = 60 Hz, a value of 600 sent over the network would represent 100% Feedback.
3 "ACT1 - ACT2"	Selects actual inputs A204 [ACT1 Input] minus A205 [ACT2 Input] to be used as the feedback signal.
4 "ACT1 + ACT2"	Selects actual inputs A204 [ACT1 Input] plus A205 [ACT2 Input] to be used as the feedback signal.
5 "ACT1 * ACT2"	Selects actual inputs A204 [ACT1 Input] multiplied by A205 [ACT2 Input] to be used as the feedback signal.
6 "ACT1 / ACT2"	Selects actual inputs A204 [ACT1 Input] divided by A205 [ACT2 Input] to be used as the feedback signal.
7 "Min A1, A2"	Selects the smaller of actual inputs A204 [ACT1 Input] or A205 [ACT2 Input] to be used as the feedback signal.
8 "Max A1, A2"	Selects the larger of actual inputs A204 [ACT1 Input] or A205 [ACT2 Input] to be used as the feedback signal.

Analog PID Reference Signals

Parameters [T070](#) [Analog In 1 Lo], [T071](#) [Analog In 1 Hi], [T074](#) [Analog In 2 Lo], and [T075](#) [Analog In 2 Hi] are used to scale or invert an analog PID Reference.

Examples

Scale Function

For a 0...5 volt signal, the following parameter settings are used so that a 0 volt signal = 0% PID Reference and a 5 volt signal = 100% PID Reference.

- [T069](#) [Analog In 1 Sel] or [T073](#) [Analog In 2 Sel] = 2 “Voltage Mode - Unipolar”
- [T070](#) [Analog In 1 Lo] or [T074](#) [Analog In 2 Lo] = 0.0%
- [T071](#) [Analog In 1 Hi] or [T075](#) [Analog In 2 Hi] = 50.0%
- [A152](#) [PID Ref Sel] = 0 “0-10V Input”

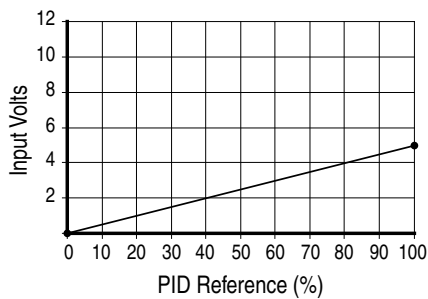

Invert Function

For a 4...20 mA signal, the following parameter settings are used so that a 20 mA signal = 0% PID Reference and a 4 mA signal = 100% PID Reference.

- [T069](#) [Analog In 1 Sel] or [T073](#) [Analog In 2 Sel] = 1 “Current Mode 4-20 mA”
- [T070](#) [Analog In 1 Lo] or [T074](#) [Analog In 2 Lo] = 100.0%
- [T071](#) [Analog In 1 Hi] or [T075](#) [Analog In 2 Hi] = 0.0%
- [A152](#) [PID Ref Sel] = 2 “Analog In 1” or 3 “Analog In 2”

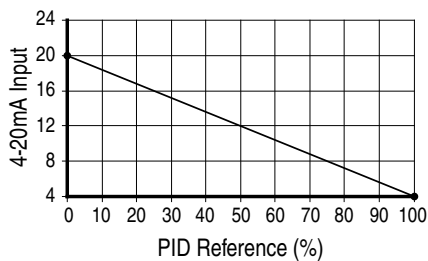

PID Deadband

Parameter [A158](#) [PID Deadband] is used to set a range, in percent, of the PID Reference that the drive will ignore.

Example

- [PID Deadband] is set to 5.0
- The PID Reference is 25.0%
- The PID Regulator will not act on a PID Error that falls between 20.0 and 30.0%

PID Preload

The value set in [A159](#) [PID Preload], in Hertz, will be pre-loaded into the integral component of the PID at any start or enable. This will cause the drive's frequency command to initially jump to that preload frequency, and the PID loop starts regulating from there.

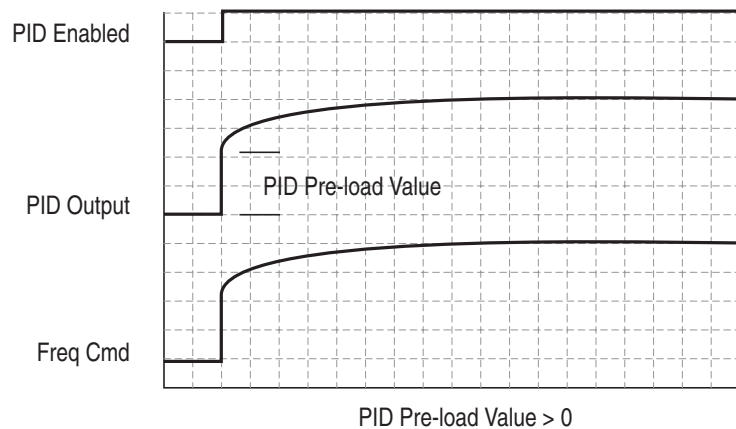

PID Limits

[A150](#) [PID Trim Hi] and [A151](#) [PID Trim Lo] are used to limit the PID output and are only used in trim mode. [PID Trim Hi] sets the maximum frequency for the PID output in trim mode. [PID Trim Lo] sets the reverse frequency limit for the PID output in trim mode. Note that when the PID reaches the Hi or Lo limit, the PID regulator stops integrating so that windup does not occur.

PID Gains

The proportional, integral, and differential gains make up the PID regulator.

- [A154](#) [PID Prop Gain]
The proportional gain (unitless) affects how the regulator reacts to the magnitude of the error. The proportional component of the PID regulator outputs a speed command proportional to the PID error. For example, a proportional gain of 1 would output 100% of max frequency when the PID error is 100% of the analog input range. A larger value for [PID Prop Gain] makes the proportional component more responsive, and a smaller value makes it less responsive. Setting [PID Prop Gain] to 0.00 disables the proportional component of the PID loop.
- [A155](#) [PID Integ Time]
The integral gain (units of seconds) affects how the regulator reacts to error over time and is used to get rid of steady state error. For example, with an integral gain of 2 seconds, the output of the integral gain component would integrate up to 100% of max frequency when the PID error is 100% for 2 seconds. A larger value for [PID Integ Time] makes the integral component less responsive, and a smaller value makes it more responsive. Setting [PID Integ Time] to 0 disables the integral component of the PID loop.
- [A156](#) [PID Diff Rate]
The Differential gain (units of 1/seconds) affects the rate of change of the PID output. The differential gain is multiplied by the difference between the previous error and current error. Thus, with a large error the D has a large effect and with a small error the D has less of an effect. This parameter is scaled so that when it is set to 1.00, the process response is 0.1% of [Maximum Freq] when the process error is changing at 1% / second. A larger value for [PID Diff Rate] makes the differential term have more of an effect and a small value makes it have less of an effect. In many applications, the D gain is not needed. Setting [PID Diff Rate] to 0.00 (factory default) disables the differential component of the PID loop.

Guidelines for Adjusting the PID Gains

1. Adjust the proportional gain. During this step it may be desirable to disable the integral gain and differential gain by setting them to 0.
After a step change in the PID Feedback:
 - If the response is too slow increase [A154](#) [PID Prop Gain].
 - If the response is too quick and/or unstable (see [Figure 37](#)), decrease [A154](#) [PID Prop Gain].
 - Typically, [A154](#) [PID Prop Gain] is set to some value below the point where the PID begins to go unstable.
2. Adjust the integral gain (leave the proportional gain set as in Step 1).
After a step change in the PID Feedback:
 - If the response is too slow (see [Figure 38](#)), or the PID Feedback does not become equal to the PID Reference, decrease [A155](#) [PID Integ Time].

- If there is a lot of oscillation in the PID Feedback before settling out (see [Figure 39](#)), increase [A155](#) [PID Integ Time].
- 3. At this point, the differential gain may not be needed. However, if after determining the values for [A154](#) [PID Prop Gain] and [A155](#) [PID Integ Time]:
 - Response is still slow after a step change, increase [A156](#) [PID Diff Rate].
 - Response is still unstable, decrease [A156](#) [PID Diff Rate].

The following figures show some typical responses of the PID loop at different points during adjustment of the PID Gains.

Figure 37 - Unstable

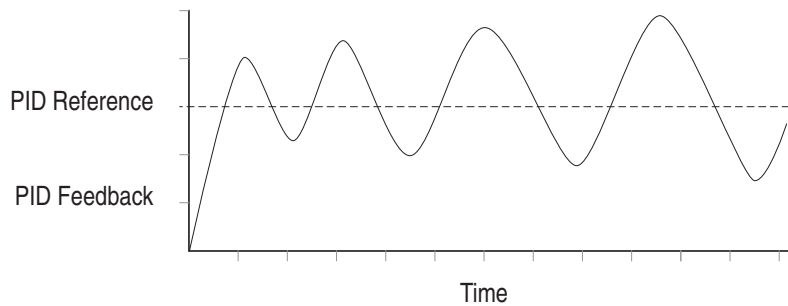

Figure 38 - Slow Response – Over Damped

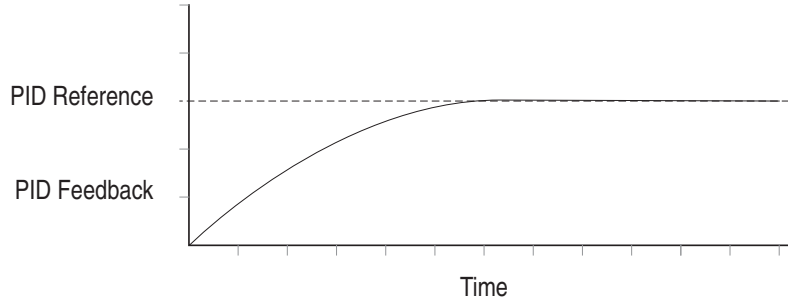

Figure 39 - Oscillation – Under Damped

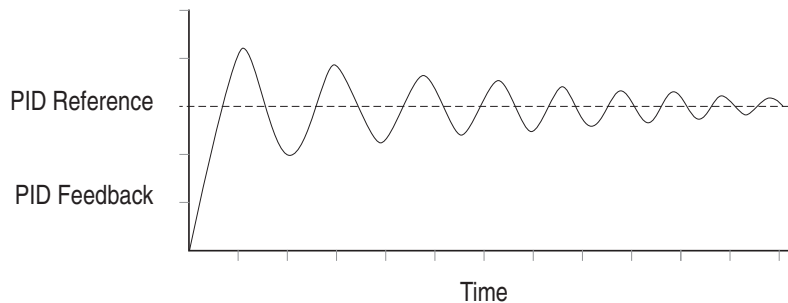
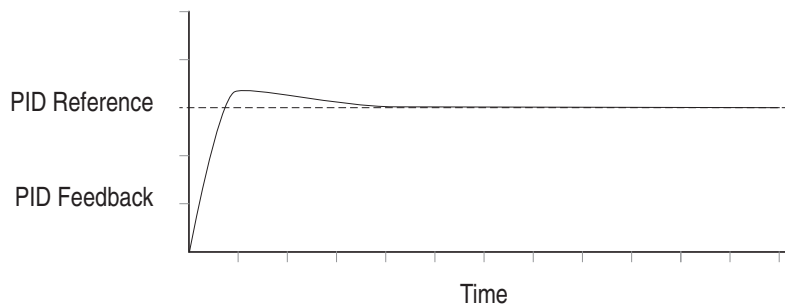

Figure 40 - Good Response – Critically Damped

Auxiliary Motor Control Setup

The PowerFlex 400 has a built in Auxiliary Motor Control feature. This feature allows operation of up to three (3) line-started motors in addition to the motor controlled directly by the PowerFlex 400 drive. System output can vary from 0% (auxiliary motors off and drive-controlled motor at zero speed) to 400% (3 auxiliary motors and drive-controlled motor at full speed). To enable the Auxiliary Motor Control, parameter [R239](#) [Aux Motor Mode] must be set to an option 1 “Enabled.” When enabled, the internal PID controller in the PowerFlex 400 uses a reference and feedback signal to adjust the speed of the drive controlled motor such that the feedback signal follows the reference signal. When demand exceeds the first motors capacity, the PowerFlex 400 Auxiliary Motor Control automatically starts an auxiliary motor. The speed of the drive controlled motor is reduced to account for the auxiliary motors additional output to the system. If demand continues to increase, the PowerFlex Auxiliary Motor Control starts additional motors using the same process. When demand decreases, an auxiliary motor is stopped and the PowerFlex Auxiliary Motor Control increases the speed of the drive controlled motor to account for lost system output. A Motor Interlock input identifies motors that are out of service and causes them to be skipped over to the next available motor.

An AutoSwap function also can be used which allows equal wear to be placed on each motor by periodically swapping the drive controlled and auxiliary motors. Each motor in the system will over time be connected to the PowerFlex 400 drive and also directly to the AC line. During an AutoSwap, the motor directly connected to the PowerFlex 400 drive is stopped and the contactor is opened. The contactor of the next motor that will be controlled by the PowerFlex 400 drive is opened if running across the AC line. A contactor is closed connecting this motor directly to the PowerFlex 400 drive and is started. An additional motor is line started if required.

Example 1

Figure 41 - One External Motor without AutoSwap

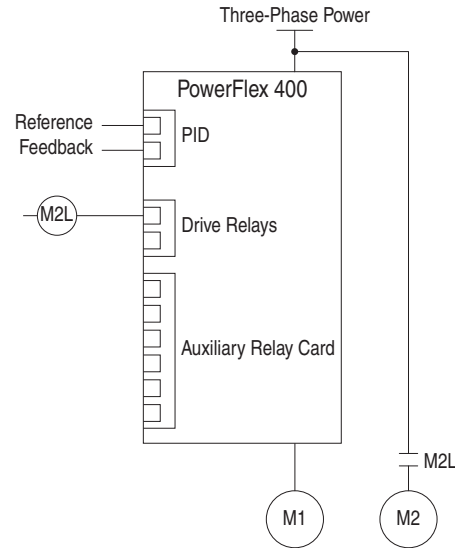

- Auxiliary Motor Control is enabled via Parameter [R239](#) [Aux Motor Mode].
- Number of auxiliary motors is set via Parameter [R240](#) [Aux Motor Qty].
- Relays are configured for Auxiliary Motor Control via parameters [T055](#), [T060](#), [R222](#), and [R225](#).
- The frequency of Motor #1 that Motor #2 turns on at is set via Parameter [R241](#) [Aux 1 Start Freq].
- The time that Motor #1 is above the value set by [R241](#) [Aux 1 Start Freq] before turning on Motor #2 is set via Parameter [R250](#) [Aux Start Delay].
- The frequency of Motor #1 that Motor #2 turns off at is set via Parameter [R242](#) [Aux 1 Stop Freq].
- The time that Motor #1 is below the value set by [R242](#) [Aux 1 Stop Freq] before turning off Motor #2 is set via Parameter [R251](#) [Aux Stop Delay].
- PID setup is done via Parameters [A150](#) through [A159](#). See Appendix D for additional information.

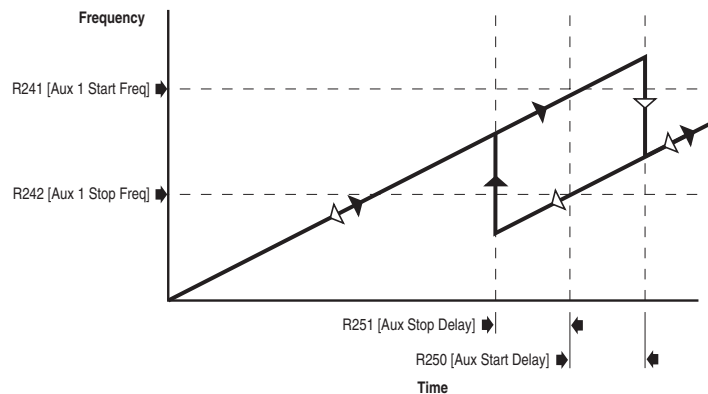

IMPORTANT If using auxiliary motor control, ensure that wiring and parameter configuration are correct before wiring contactor outputs. All relays on the Auxiliary Relay Card will energize on power-up by default. Failure to verify proper wiring and parameter configuration can result in improper motor operation or drive damage.

Example 2

Figure 42 - One External Motor with AutoSwap

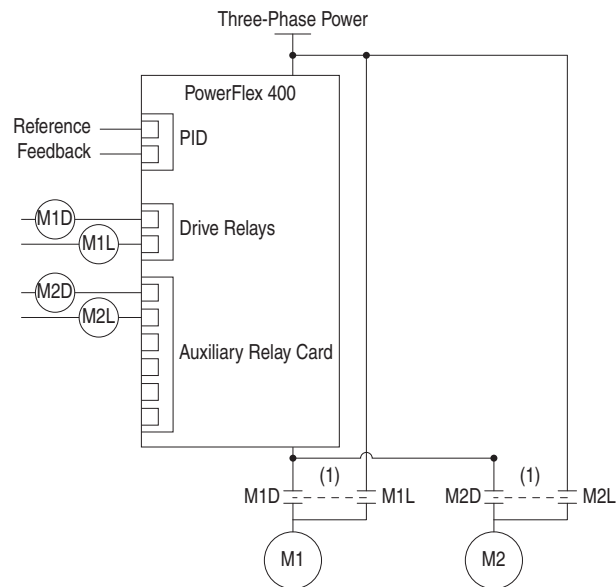

(1) Mechanically interlocked contactors are recommended to ensure that the drive contactor and the line contactor do not close at the same time. If the drive and line contactor close at the same time, drive damage may result.

- Auxiliary Motor Control is enabled via Parameter [R239](#) [Aux Motor Mode].
- Number of auxiliary motors is set via Parameter [R240](#) [Aux Motor Qty].
- Relays are configured for Auxiliary Motor Control via parameters [T055](#), [T060](#), [R222](#), [R225](#), [R228](#), [R231](#), [R234](#), and [R237](#).
- The frequency of Motor #1 that Motor #2 turns on at is set via Parameter [R241](#) [Aux 1 Start Freq].
- The time that Motor #1 is above the value set by [R241](#) [Aux 1 Start Freq] before turning on Motor #2 is set via Parameter [R250](#) [Aux Start Delay].
- The frequency of Motor #1 that Motor #2 turns off at is set via Parameter [R242](#) [Aux 1 Stop Freq].
- The time that Motor #1 is below the value set by [R242](#) [Aux 1 Stop Freq] before turning off Motor #2 is set via Parameter [R251](#) [Aux Stop Delay].
- PID setup is done via Parameters [A150](#) through [A159](#).
- The maximum PID output level that an AutoSwap can occur is set via Parameter [R254](#) [Aux AutoSwap Lvl]. AutoSwap will be delayed until the PID output drops below this parameter setting.

IMPORTANT If using auxiliary motor control, ensure that wiring and parameter configuration are correct before wiring contactor outputs. All relays on the Auxiliary Relay Card will energize on power-up by default. Failure to verify proper wiring and parameter configuration can result in improper motor operation or drive damage.

Modbus RTU Protocol

PowerFlex 400 drives support the RS485 (DSI) protocol to allow efficient operation with Rockwell Automation peripherals. In addition, some Modbus functions are supported to allow simple networking. PowerFlex 400 drives can be multi-dropped on an RS485 network using Modbus protocol in RTU mode.

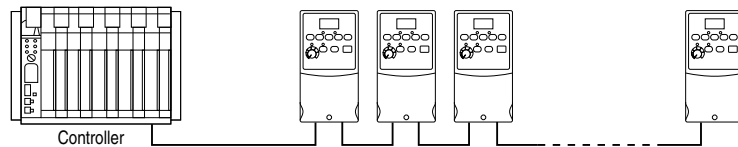

For information regarding DeviceNet or other communication protocols, refer to the appropriate user manual.

Network Wiring

Network wiring consists of a shielded 2-conductor cable that is daisy-chained from node to node.

Figure 43 - Network Wiring Diagram

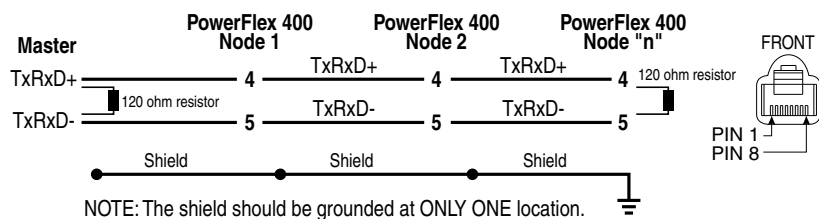

Only pins 4 and 5 on the RJ45 plug should be wired. The other pins on the PowerFlex 400 RJ45 socket contain power, etc. for other Rockwell Automation peripheral devices and must not be connected.

Wiring terminations on the master controller will vary depending on the master controller used and "TxRxD+" and "TxRxD-" are shown for illustration purposes only. Refer to the master controller's user manual for network terminations. Note that there is no standard for the "+" and "-" wires, and consequently Modbus device manufacturers interpret them differently. If you have problems with initially establishing communications, try swapping the two network wires at the master controller.

Standard RS485 wiring practices apply. Termination resistors need to be applied at each end of the network cable. RS485 repeaters may need to be used for long cable runs, or if greater than 32 nodes are needed on the network.

Parameter Configuration

The following PowerFlex 400 parameters are used to configure the drive to operate on a network.

Parameter	Details	Reference
P036 [Start Source]	Set to 5 "RS485 (DSI) Port" if Start is controlled from the network.	page 62
P038 [Speed Reference]	Set to 5 "RS485 (DSI) Port" if the Speed Reference is controlled from the network.	page 63
C102 [Comm Format]	Sets the transmission mode, data bits, parity and stop bits for the RS485 (DSI) Port. All nodes on the network must be set to the same setting.	page 79
C103 [Comm Data Rate]	Sets the data rate for the RS485 (DSI) Port. All nodes on the network must be set to the same data rate.	page 79
C104 [Comm Node Addr]	Sets the node address for the drive on the network. Each device on the network requires a unique node address.	page 80
C105 [Comm Loss Action]	Selects the drive's response to communication problems.	page 80
C106 [Comm Loss Time]	Sets the time that the drive will remain in communication loss before the drive implements C105 [Comm Loss Action].	page 80
C107 [Comm Write Mode]	Determines whether parameter changes made over communication port are saved or stored in RAM only. If they are stored in RAM, the values will be lost at power-down.	page 80

Supported Modbus Function Codes

The peripheral interface (DSI) used on PowerFlex 400 drives supports some of the Modbus function codes.

Modbus Function Code	Command
03	Read Holding Registers
06	Preset (Write) Single Register
16 (10 Hexadecimal)	Preset (Write) Multiple Registers

IMPORTANT Modbus devices can be 0-based (registers are numbered starting at 0) or 1-based (registers are numbered starting at 1). Depending on the Modbus Master used, the register addresses listed on the following pages may need to be offset by +1. For example, Logic Command may be register address 8192 for some master devices (e.g. ProSoft 3150-MCM SLC Modbus scanner) and 8193 for others (e.g. PanelViews).

Writing (06) Logic Command Data

The PowerFlex 400 drive can be controlled via the network by sending Function Code 06 writes to register address 8192 (Logic Command). P036 [Start Source] must be set to 5 "Comm Port" in order to accept the commands.

In addition to being written, register address 8192 can be read using Function Code 03.

Logic Command			
Address (Decimal)	Bit(s)	Description	
8192	0	1 = Stop, 0 = Not Stop	
	1	1 = Start, 0 = Not Start	
	2	1 = Jog, 0 = No Jog	
	3	1 = Clear Faults, 0 = Not Clear Faults	
	5, 4	00	No Command
		01	Forward Command
		10	Reverse Command
		11	No Command
	6	1 = Local Control ⁽¹⁾ , 0 = Comm Control	
	7	1 = MOP Increment, 0 = Not Increment	
	9, 8	00	No Command
		01	Accel Rate 1 Enable
		10	Accel Rate 2 Enable
		11	Hold Accel Rate Selected
	11, 10	00	No Command
01		Decel Rate 1 Enable	
10		Decel Rate 2 Enable	
11		Hold Decel Rate Selected	
14, 13, 12	000	No Command	
	001	Freq. Source = P038 [Speed Reference]	
	010	Freq. Source = A142 [Internal Freq]	
	011	Freq. Source = Comms (Addr 8193)	
	100	A143 [Preset Freq 0]	
	101	A144 [Preset Freq 1]	
	110	A145 [Preset Freq 2]	
	111	A146 [Preset Freq 3]	
15	1 = MOP Decrement, 0 = Not Decrement		

(1) Local Control causes the drive to use [C108](#) [Start Source 2] and [C109](#) [Speed Ref 2] for start and speed reference control.

Writing (06) Reference

The Speed Reference to a PowerFlex 400 drive can be controlled via the network by sending Function Code 06 writes to register address 8193 (Reference). P038 [Speed Reference] must be set to 5 “Comm Port” in order to accept the Speed Reference. In addition to being written, register address 8193 can be read using Function Code 03.

Reference	
Address (Decimal)	Description
8193	A decimal value entered as xxx.xx where the decimal point is fixed. For example, a decimal "1000" equals 10.00 Hz and "543" equals 5.43 Hz.

Reading (03) Logic Status Data

The PowerFlex 400 Logic Status data can be read via the network by sending Function Code 03 reads to register address 8448 (Logic Status).

Logic Status		
Address (Decimal)	Bit(s)	Description
8448	0	1 = Ready, 0 = Not Ready
	1	1 = Active (Running), 0 = Not Active
	2	1 = Cmd Forward, 0 = Cmd Reverse
	3	1 = Rotating Forward, 0 = Rotating Reverse
	4	1 = Accelerating, 0 = Not Accelerating
	5	1 = Decelerating, 0 = Not Decelerating
	6	1 = Alarm, 0 = No Alarm
	7	1 = Faulted, 0 = Not Faulted
	8	1 = At Reference, 0 = Not At Reference
	9	1 = Reference Controlled by Comm
	10	1 = Operation Cmd Controlled by Comm
	11	1 = Parameters have been locked
	12	Digital Input 1 Status
	13	Digital Input 2 Status
	14	Digital Input 3 Status
15	Digital Input 4 Status	

Reading (03) Feedback

The Feedback (Output Frequency) from the PowerFlex 400 drive can be read via the network by sending Function Code 03 reads to register address 8451 (Feedback).

Feedback ⁽¹⁾	
Address (Decimal)	Description
8451	A xxx.xx decimal value where the decimal point is fixed. For example, a decimal "1234" equals 12.34 Hz and "300" equals 3.00 Hz.

(1) Returns the same data as Reading (03) Parameter b001 [Output Freq].

Reading (03) Drive Error Codes

The PowerFlex 400 Error Code data can be read via the network by sending Function Code 03 reads to register address 8449 (Drive Error Codes).

Error Code		
Address (Decimal)	Value (Decimal)	Description
8449	0	No Fault
	2	Auxiliary Input
	3	Power Loss
	4	Undervoltage
	5	Overvoltage
	6	Motor Stalled
	7	Motor Overload
	8	Heatsink Overtemperature
	12	HW Overcurrent (300%)
	13	Ground Fault
	15	Load Loss
	29	Analog Input Loss
	33	Auto Restart Tries
	38	Phase U to Ground Short
	39	Phase V to Ground Short
	40	Phase W to Ground Short
	41	Phase UV Short
	42	Phase UW Short
	43	Phase VW Short
	48	Params Defaulted
	63	Software Overcurrent
	64	Drive Overload
70	Power Unit Fail	
71	Net Loss	
81	Communication Loss	
94	Function Loss	
100	Parameter Checksum Error	
122	I/O Board Fail	

Reading (03) and Writing (06) Drive Parameters

To access drive parameters, the Modbus register address equals the parameter number. For example, a decimal “1” is used to address Parameter b001 [Output Freq] and decimal “39” is used to address Parameter P039 [Accel Time 1].

Additional Information

Refer to <http://www.ab.com/drives/> for additional information.

Notes:

Metasys N2

This appendix provides information about controlling a PowerFlex 400 drive, setting its Reference, and accessing its parameters through configurable objects when the Metasys N2 network protocol is selected.

For information on...	See page
Understanding Metasys N2	175
Network Points	177
Using Percent (%) for the Reference	180
Using Metasys Configurable Objects to Access Parameters	181

Understanding Metasys N2

Metasys nodes are built up by the use of several virtual objects. The Metasys N2 master performs read and write commands to these virtual objects, and the internal Metasys protocol firmware transfers/translates the data between these virtual objects and the drive.

When a read or write command occurs to a certain dedicated virtual object, data in the virtual objects is refreshed from or transferred to the drive.

The Metasys N2 master performs read and write commands to the virtual objects one at a time. The data types that are used in the virtual objects are binary input (BI), binary output (BO), analog input (AI), analog output (AO), and internal integer (ADI).

The Metasys N2 master also performs cyclic polling of all the virtual objects.

Metasys N2 Virtual Objects

A Metasys N2 node may contain up to 256 virtual objects in each of its seven different data types, called regions ([Table 34](#)).



ATTENTION: Risk of equipment damage exists. If a controller is programmed to write parameter data to Non-Volatile Storage (NVS) frequently, the NVS will quickly exceed its life cycle and cause the drive to malfunction. Do not create a program that frequently uses configurable outputs to write parameter data to NVS unless C107 [Comm Write Mode] is set to option 1.

Table 34 - Description of the Regions of a Virtual Object

Region	Type	Short	Description
Region 1	Analog Input	AI	32-bit, IEEE-standard floats
Region 2	Binary Input	BI	1-bit
Region 3	Analog Output	AO	32-bit, IEEE-standard floats
Region 4	Binary Output	BO	1-bit
Region 5	Internal Float	ADF	32-bit, IEEE-standard floats (Analog Data Float)
Region 6	Internal Integer	ADI	16-bit (Analog Data Integer)
Region 7	Internal Byte	DB	8-bit (Analog Data Byte)

Metasys N2 Data Types

Table 35 - Internal Structure of Metasys N2 Analog Input (AI)

Attribute	Type	Description
1	Byte	Object Configuration
2	Byte	Object Status
3	Float	Analog Input Value
8	Float	Low Alarm Limit
9	Float	Low Warning Limit
10	Float	High Warning Limit
11	Float	High Alarm Limit
12	Float	Differential

Table 36 - Internal Structure of Metasys N2 Binary Input (BI)

Attribute	Type	Description
1	Byte	Object Configuration
2	Byte	Object Status

Table 37 - Internal Structure of Metasys N2 Analog Output (AO)

Attribute	Type	Description
1	Byte	Object Configuration
2	Byte	Object Status
3	Float	Current Value

Table 38 - Internal Structure of Metasys N2 Binary Output (BO)

Attribute	Type	Description
1	Byte	Object Configuration
2	Byte	Object Status

Table 38 - Internal Structure of Metasys N2 Binary Output (BO)

Attribute	Type	Description
3	Integer	Minimum On-Time
4	Integer	Minimum Off-Time
5	Integer	Maximum Cycle/Hour

Table 39 - Internal Structure of Metasys N2 Internal Integer (ADI)

Attribute	Type	Description
1	Byte	Object Configuration
2	Integer	Current Value. Signed 16-bit.

Network Points

Table 40 - Binary Inputs

Network Point		Name	Description	ON ("1")	OFF ("0")
Type (NPT)	Address (NPA)				
BI	1	Ready	Logic Status bit 00	Ready	Not Ready
BI	2	Active	Logic Status bit 01	Active	Not Active
BI	3	Cmd Dir	Logic Status bit 02	Forward	Reverse
BI	4	Act Dir	Logic Status bit 03	Forward	Reverse
BI	5	Accel	Logic Status bit 04	Accelerating	Not Accelerating
BI	6	Decel	Logic Status bit 05	Decelerating	Not Decelerating
BI	7	Alarm	Logic Status bit 06	Alarm	No Alarm
BI	8	Fault	Logic Status bit 07	Fault	No Fault
BI	9	At Speed	Logic Status bit 08	At Reference	Not at Reference
BI	10	Main Freq	Logic Status bit 09	Comm Controlled	Not Comm Controlled
BI	11	Oper Cmd	Logic Status bit 10	Comm Controlled	Not Comm Controlled
BI	12	Param Lock	Logic Status bit 11	Locked	Not Locked
BI	13	Digital In 1	Logic Status bit 12 (Drive Terminal #2)	On	Off
BI	14	Digital In 2	Logic Status bit 13 (Drive Terminal #3)	On	Off
BI	15	Digital In 3	Logic Status bit 14 (Drive Terminal #4)	On	Off
BI	16	Digital In 4	Logic Status bit 15 (Drive Terminal #5)	On	Off
BI	17	Digital In 5	Drive Terminal #6	On	Off
BI	18	Digital In 6	Drive Terminal #7	On	Off
BI	19	Digital In 7	Drive Terminal #8	On	Off

Table 41 - Analog Inputs

Network Point		Name	Description	Units	Min/Max
Type (NPT)	Address (NPA)				
AI	1	Feedback	Feedback	%	0/100
AI	2	Speed	d323 [Output RPM]	RPM	0/24000
AI	3	Current	b003 [Output Current]	A	0.00/Rated × 2
AI	4	DC Bus Volts	b005 [DC Bus Voltage]	V	0/820
AI	5	Last Fault	d307 [Fault 1 Code]	1	1/100
AI	6	2nd Fault	d308 [Fault 2 Code]	1	1/100
AI	7	Analog In 1	Drive Analog Input #1 (Drive Terminal #13)	%	–
AI	8	Analog In 2	Drive Analog Input #2 (Drive Terminal #17)	%	–
AI	9	Read Value	Read value of Param. selected by AO 10	Varies by the parameter selected.	
AI	10	User In 1	User-defined Input 1 (Param. selected via ADI 1)		
AI	11	User In 2	User-defined Input 2 (Param. selected via ADI 2)		
AI	12	User In 3	User-defined Input 3 (Param. selected via ADI 3)		
AI	13	User In 4	User-defined Input 4 (Param. selected via ADI 4)		

Table 42 - Binary Outputs

Network Point		Name	Description	ON ("1")	OFF ("0")
Type (NPT)	Address (NPA)				
BO	1	Run Enable	Logic Command bit 00	Enable	Stop (Coast)
BO	2	Start/Stop	Logic Command bit 00 & 01	Start	Stop (Normal)
BO	3	Jog	Logic Command bit 02	Jog	Not Jog
BO	4	Clear Faults	Logic Command bit 03	Clear Flts	Not Clear Flts
BO	5	Fwd/Rev	Logic Command bit 04 & 05	Forward	Reverse
BO	6	Not Used	Logic Command bit 06	–	–
BO	7	MOP Inc	Logic Command bit 07	Increment	Not Increment
BO	8	Accel 1	Logic Command bit 08	Accel Rate 1	Not Accel 1
BO	9	Accel 2	Logic Command bit 09	Accel Rate 2	Not Accel 2
BO	10	Decel 1	Logic Command bit 10	Decel Rate 1	Not Decel 1
BO	11	Decel 2	Logic Command bit 11	Decel Rate 2	Not Decel 2

Table 42 - Binary Outputs

Network Point		Name	Description	ON ("1")	OFF ("0")
Type (NPT)	Address (NPA)				
BO	12	Ref Sel 1	Logic Command bit 12	BO 14 13 12 0 0 0 = No Command 0 0 1 = P038 [Speed Reference] 0 1 0 = A142 [Internal Freq] 0 1 1 = Comm - Address 8193 ⁽¹⁾ 1 0 0 = A143 [Preset Freq 0] 1 0 1 = A144 [Preset Freq 1] 1 1 0 = A145 [Preset Freq 2] 1 1 1 = A146 [Preset Freq 3]	
BO	13	Ref Sel 2	Logic Command bit 13		
BO	14	Ref Sel 3	Logic Command bit 14		
BO	15	MOP Dec	Logic Command bit 15	Decrement	Not Decrement
BO	16	Pnl Lock	Lock-out Drive Front Panel	Lock	Unlock
BO	17	Digital Out 1	Relay #1 on Drive (Drive Terminal R1, R2, R3)	On	Off
BO	18	Digital Out 2	Relay #2 on Drive (Drive Terminal R4, R5, R6)	On	Off
BO	19	Opto Out	Terminal #19	On	Off

(1) See Writing (06) Reference on [page 170](#).

Table 43 - Analog Outputs

Network Point		Name	Description	Units	Min/Max
Type (NPT)	Address (NPA)				
AO	1	Reference	Reference	%	0/100
AO	2	Accel 1	P039 [Accel Time 1]	Secs	0.0/600.0
AO	3	Decel 1	P040 [Decel Time 1]	Secs	0.0/600.0
AO	4	Mtr OL Current	P033 [Motor OL Current]	A	0.0/Rated x 2
AO	5	PID Setpoint	A157 [PID Setpoint]	%	0/100
AO	6	Analog Out 1	Drive Analog Output #1 (T084)	%	–
AO	7	Analog Out 2	Drive Analog Output #2 (T087)	%	–
AO	8	Write Param #	Param. number to write in AO 9	–	0...Max Param.
AO	9	Write Value	Write value of param. selected by AO 8	Based on AO 8 selected param.	
AO	10	Read Param #	Param. number to read in AI 9	–	0...Max Param.
AO	11	User Out 1	User-defined Output 1 (Param. selected via ADI 5)	Varies by the parameter selected.	
AO	12	User Out 2	User-defined Output 2 (Param. selected via ADI 6)		
AO	13	User Out 3	User-defined Output 3 (Param. selected via ADI 7)		
AO	14	User Out 4	User-defined Output 4 (Param. selected via ADI 8)		

Table 44 - Internal Integer

Network Point		Name	Description	Min/Max	Default
Type (NPT)	Address (NPA)				
ADI	1	Param# IN1	User IN 1 (AI 10) Data Source (Param#)	0/Max Drive Params.	b001 [Output Freq] (Hz)
ADI	2	Param# IN2	User IN 2 (AI 11) Data Source (Param#)	0/Max Drive Params.	b011 [Elapsed MWh]
ADI	3	Param# IN3	User IN 3 (AI 12) Data Source (Param#)	0/Max Drive Params.	b012 [Elapsed Run Time]
ADI	4	Param# IN4	User IN 4 (AI 13) Data Source (Param#)	0/Max Drive Params.	b014 [Drive Temperature]
ADI	5	Param# OUT1	User OUT 1 (AO 11) Data Source (Param#)	0/Max Drive Params.	A154 [PID Gain]
ADI	6	Param# OUT2	User OUT 2 (AO 12) Data Source (Param#)	0/Max Drive Params.	A155 [PID Integral Time]
ADI	7	Param# OUT3	User OUT 3 (AO 13) Data Source (Param#)	0/Max Drive Params.	A156 [PID Diff Rate]
ADI	8	Param# OUT4	User OUT 4 (AO 14) Data Source (Param#)	0/Max Drive Params.	A158 [PID Deadband]

Using Percent (%) for the Reference

The Reference (AO 1) for Metasys N2 is set as a percentage from 0% to +100%.

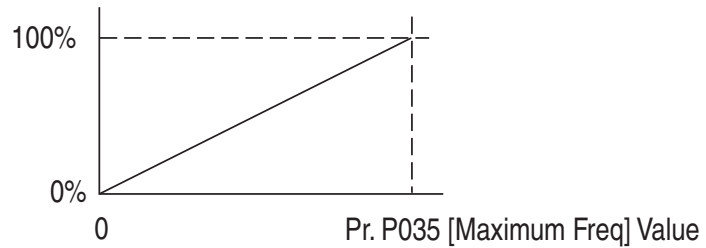

Table 45 - Example Speed Reference and Feedback for a PowerFlex 400 (P035 = 60 Hz)

Reference (AO 1)		Feedback (AI 1)	
Percent	Speed	Speed	Percent
100%	60 Hz	60 Hz	100%
50%	30 Hz	30 Hz	50%
25%	15 Hz	15 Hz	25%
0%	0 Hz	0 Hz	0%

Using Metasys Configurable Objects to Access Parameters

Configurable objects are inputs and outputs that let you read and write parameter values. These objects handle only 16-bit parameter values.

Reading Parameter Values

The configurable points may show any parameter in the drive by configuring the Param# for INx point. The drive reads the value of the parameter configured in the Param# for INx point and shows the result in the User INx point. The Param# for INx's default to commonly accessed parameters and can be changed if desired. A "0" disables the fetching of data and a "0" is returned in the respective User INx. See [Figure 44](#) and [Table 46](#).

Figure 44 - Configurable Input Point Operation Objects Inputs

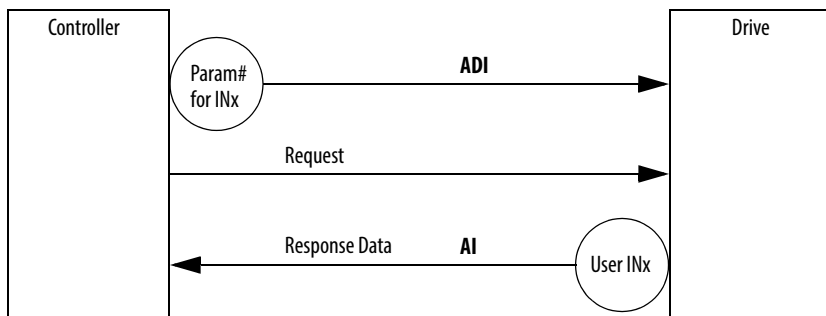

Table 46 - Configurable Objects: Inputs

Network Point		Name	Description	Default
Type (NPT)	Address (NPA)			
AI	10	User IN1	User-defined Input 1	0
AI	11	User IN2	User-defined Input 2	0
AI	12	User IN3	User-defined Input 3	0
AI	13	User IN4	User-defined Input 4	0
ADI	1	Param# for IN1	User IN1 (AI 10) Data Source (Param#)	b001 [Output Freq] (Hz)
ADI	2	Param# for IN2	User IN2 (AI 11) Data Source (Param#)	b011 [Elapsed MWh]
ADI	3	Param# for IN3	User IN3 (AI 12) Data Source (Param#)	b012 [Elapsed Run Time]
ADI	4	Param# for IN4	User IN4 (AI 13) Data Source (Param#)	b014 [Drive Temp]

Writing Parameter Values



ATTENTION: Risk of equipment damage exists. If configurable outputs are programmed to write parameter data to Non-Volatile Storage (NVS) frequently, the NVS will quickly exceed its life cycle and cause the drive to malfunction. Do not create a program that frequently uses configurable outputs to write parameter data to NVS.

These outputs are written each time the User OUTx point is written from the network.

The Param# for OUTx's default to commonly accessed parameters and can be changed if desired. A value of "0" in the Param# for OUTx field disables the writing of data for that specific point.

Figure 45 - Configurable Objects: Outputs

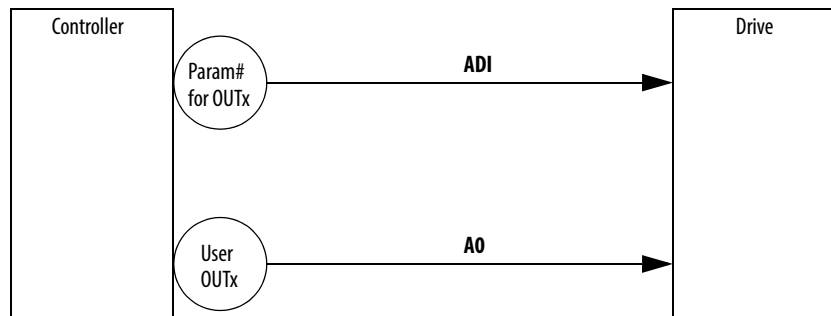

Table 47 - Configurable Objects: Outputs

Network Point		Description	Range	Default
Type (NPT)	Address (NPA)			
AO	6	User OUT1	Varies by the parameter selected by Param# for OUTx.	0
AO	7	User OUT2		0
AO	8	User OUT3		0
AO	9	User OUT4		0
ADI	5	User OUT1 (A06) Destination (Param#)	0 (not in use), 1 to maximum # of drive parameters	A154 [PID Prop Gain]
ADI	6	User OUT2 (A07) Destination (Param#)	0 (not in use), 1 to maximum # of drive parameters	A155 [PID Integ Time]
ADI	7	User OUT3 (A08) Destination (Param#)	0 (not in use), 1 to maximum # of drive parameters	A156 [PID Diff Rate]
ADI	8	User OUT4 (A09) Destination (Param#)	0 (not in use), 1 to maximum # of drive parameters	A158 [PID Deadband]

P1 – Floor Level Network (FLN)

This appendix provides information about controlling a PowerFlex 400 drive, setting its Reference, and accessing its parameters through configurable points when the P1-FLN protocol is selected. The P1-FLN protocol is a serial communication protocol used by the Siemens APOGEE® system.

For information on...	See page
Understanding P1-FLN	183
Network Points	184
Using Percent (%) for the Reference	188
Using P1 Configurable Points to Access Parameters	188

Understanding P1-FLN

The P1-FLN master performs read and write commands to certain points, and the internal P1-FLN protocol firmware transfers/translate the data between these points and the drive.

When a read or write command occurs to a certain point, data in the point is refreshed from or transferred to the drive.

The P1-FLN master also performs cyclic polling of all the virtual objects.

P1-FLN Points

A P1-FLN node may contain up to 99 points.



ATTENTION: Risk of equipment damage exists. If a controller is programmed to write parameter data to Non-Volatile Storage (NVS) frequently, the NVS will quickly exceed its life cycle and cause the drive to malfunction. Do not create a program that frequently uses configurable outputs to write parameter data to NVS unless C107 [Comm Write Mode] is set to option 1.

Network Points

Table 48 - Point Database for Application 2735

Point Number (1) (2)	Point Type	Subpoint Name	Factory Default (SI Units) ⁽⁴⁾	Engineering Units (SI Units) ⁽⁴⁾	Slope (SI Units) ⁽⁴⁾	Intercept (SI Units) ⁽⁴⁾	On Text	Off Text
01	LAO	CTLR ADDRESS	99	–	1	0	–	–
02	LAO	APPLICATION	2735	–	1	0	–	–
{03}	LAI	FREQ OUTPUT	0	Hz	0.01	0	–	–
{04}	LAI	PCT OUTPUT	0	PCT	001	0	–	–
{05}	LAI	SPEED	0	RPM	1	0	–	–
{06}	LAI	CURRENT	0	AMPS	0.1	0	–	–
{07}	LAI	TORQUE	0	AMPS	0.1	0	–	–
{08}	LAI	POWER	0	HP (kW)	0.1333 (0.1)	0 (0)	–	–
{09}	LAI	DRIVE TEMP	0	DEG F (DEG C)	1.8 (1)	32 (0)	–	–
{11}	LAI	DRIVE MWH	0	MWH	0.1	0	–	–
{12}	LAI	RUN TIME	0	HRS	10	0	–	–
{13}	LAI	DC BUS VOLT	0	VOLTS	1	0	–	–
20	LAO	OVRD TIME	1	HRS	1	0	–	–
{21}	LDI	FWD.REV MON	FWD	–	1	0	REV	FWD
{22}	LDO	CMD FWD.REV	FWD	–	1	0	REV	FWD
{23}	LDI	RUN.STOP MON	STOP	–	1	0	RUN	STOP
{24}	LDO	CMD RUN.STOP	STOP	–	1	0	RUN	STOP
{25}	LDI	READY	READY	–	1	0	READY	NOTRDY
{26}	LDO	RUN ENABLE	STOP	–	1	0	ENABLE	STOP
{29}	LDO	DAY NGT	DAY	–	1	0	NIGHT	DAY
30	LAO	CURRENT LIMT ⁽⁵⁾		AMPS	0.1	0	–	–
31	LAO	ACCEL TIME	20	SEC	0.02	0	–	–
32	LAO	DECEL TIME	20	SEC	0.02	0	–	–
33	LDO	KEYPAD LOCK	UNLOCK	–	1	0	LOCK	UNLOCK
{36}	LAO	READ PARAM	0	–	1	0	–	–
{37}	LAI	READ VALUE	0	–	1	0	–	–
{38}	LAO	WRITE PARAM	0	–	1	0	–	–
{39}	LAO	WRITE VALUE	0	–	1	0	–	–
{40}	LDO	DIGITAL OUT1	OFF	–	1	0	ON	OFF
{41}	LDO	DIGITAL OUT2	OFF	–	1	0	ON	OFF
{42}	LDO	DIGITAL OUT3	OFF	–	1	0	ON	OFF
{43}	LDO	OPT RELAY 1	OFF	–	1	0	ON	OFF
{44}	LDO	OPT RELAY 2	OFF	–	1	0	ON	OFF
{45}	LDO	OPT RELAY 3	OFF	–	1	0	ON	OFF
{46}	LDO	OPT RELAY 4	OFF	–	1	0	ON	OFF
{47}	LDO	OPT RELAY 5	OFF	–	1	0	ON	OFF
{48}	LDO	OPT RELAY 6	OFF	–	1	0	ON	OFF
{49}	LDI	DIGITAL IN 1	OFF	–	1	0	ON	OFF

Table 48 - Point Database for Application 2735 (continued)

Point Number (1) (2)	Point Type	Subpoint Name	Factory Default (SI Units) ⁽⁴⁾	Engineering Units (SI Units) ⁽⁴⁾	Slope (SI Units) ⁽⁴⁾	Intercept (SI Units) ⁽⁴⁾	On Text	Off Text
{50}	LDI	DIGITAL IN 2	OFF	–	1	0	ON	OFF
{51}	LDI	DIGITAL IN 3	OFF	–	1	0	ON	OFF
{52}	LDI	DIGITAL IN 4	OFF	–	1	0	ON	OFF
{53}	LDI	DIGITAL IN 5	OFF	–	1	0	ON	OFF
{54}	LDI	DIGITAL IN 6	OFF	–	1	0	ON	OFF
{55}	LDI	DIGITAL IN 7	OFF	–	1	0	ON	OFF
{60}	LAI	INPUT REF 1	0	⁽⁶⁾	0.1	0	–	–
{61}	LAI	INPUT REF 2	0	⁽⁶⁾	0.1	0	–	–
{62}	LAO	ANALOG OUT 1	0	PCT	0.1	0	–	–
{63}	LAO	ANALOG OUT 2	0	PCT	0.1	0	–	–
{64}	LAI	LAST FAULT	0	–	1	0	–	–
65	LAO	PID GAIN	1	PTC	0.01	0	–	–
66	LAO	PID INT TIME	2	SEC	0.1	0	–	–
67	LAO	PID DIFF RATE	0	PERSEC ⁽⁷⁾	0.01	0	–	–
68	LAO	PID SETPOINT	0	PTC	0.1	0	–	–
{70}	LDI	CMD DIR MON	FWD	–	1	0	REV	FWD
{71}	LDI	ACCELERATING	OFF	–	1	0	ON	OFF
{72}	LDI	DECELERATING	OFF	–	1	0	ON	OFF
{73}	LDI	ALARM	NORMAL	–	1	0	ALARM	NORMAL
{74}	LDI	AT SPEED	OFF	–	1	0	ON	OFF
{75}	LDI	MAIN FREQ	OFF	–	1	0	ON	OFF
{76}	LDI	OPER CMD	OFF	–	1	0	ON	OFF
{77}	LDI	PARAM LOCK	UNLOCK	–	1	0	LOCK	UNLOCK
{78}	LDO	JOG	OFF	–	1	0	ON	OFF
{79}	LDO	LOCAL CNTRL ⁽³⁾	OFF	–	1	0	ON	OFF
{80}	LDO	MOP INC	OFF	–	1	0	ON	OFF
{81}	LDO	ACCEL RATE 1	OFF	–	1	0	ON	OFF
{82}	LDO	ACCEL RATE 2	OFF	–	1	0	ON	OFF
{83}	LDO	DECEL RATE 1	OFF	–	1	0	ON	OFF
{84}	LDO	DECEL RATE 2	OFF	–	1	0	ON	OFF
{85}	LDO	REF SELECT 1	OFF	–	1	0	ON	OFF
{86}	LDO	REF SELECT 2	OFF	–	1	0	ON	OFF
{87}	LDO	REF SELECT 3	OFF	–	1	0	ON	OFF
{88}	LDO	MOP DEC	OFF	–	1	0	ON	OFF
{92}	LAO	REFERENCE	0	PCT	0.01	0	–	–
{93}	LDI	OK.FAULT	OK	–	1	0	FAULT	OK
{94}	LDO	RESET FAULT	NORMAL	–	1	0	RESET	NORMAL
{99}	LAO	ERROR STATUS	0	–	1	0	–	–

- (1) Points not listed are not used in this application.
- (2) Point numbers that appear in brackets { } may be unbundled at the field panel.
- (3) Local Control causes the drive to use C108 [Start Source 2] and C109 [Speed Ref 2] for start and speed reference control.
- (4) A single value in a column means that the value is the same in English units and in SI units.
- (5) Depends on drive model.
- (6) Depending on configuration, units can be volts or milliamperes.
- (7) 1 / Secs

Table 49 - Point Database for Application 2735

Point Number	Subpoint Name	Parameter
01	CTRL ADDRESS	C104
02	APPLICATION	–
03	FREQ OUTPUT	b001
04	PCT OUTPUT	d322
05	SPEED	d323
06	CURRENT	b003
07	TORQUE	b013
08	POWER	b010
09	DRIVE TEMP	b014
11	DRIVE MWH	b011
12	RUN TIME	b012
13	DC BUS VOLT	b005
20	OVRD TIME	–
21	FWD.REV MON	–
22	CMD FWD.REV	–
23	RUN.STOP MON	b006, bit 1 (Running)
24	CMD RUN.STOP	–
25	READY	d302, bit 2 (I/O Terminal 01)
26	RUN ENABLE	–
29	DAY NGT	–
30	CURRENT LIMIT	P033
31	ACCEL TIME 1	P039
32	DECEL TIME 1	P040
33	KEYPAD LOCK	A198
36	READ PARAM #	–
37	READ VALUE	–
38	WRITE PARAM #	–
39	WRITE VALUE	–
40	DIGITAL OUT1	T055, T056
41	DIGITAL OUT2	T060, T061
42	DIGITAL OUT3	T065, T066
43	OPT RELAY 1	R221, R222 ⁽¹⁾
44	OPT RELAY 2	R224, R225 ⁽¹⁾

Table 49 - Point Database for Application 2735

Point Number	Subpoint Name	Parameter
45	OPT RELAY 3	R227, R228 ⁽¹⁾
46	OPT RELAY 4	R230, R231 ⁽¹⁾
47	OPT RELAY 5	R233, R234 ⁽¹⁾
48	OPT RELAY 6	R236, R237 ⁽¹⁾
49	DIGITAL IN 1	d302, bit 0 (I/O Terminal 02)
50	DIGITAL IN 2	d302, bit 1 (I/O Terminal 03)
51	DIGITAL IN 3	d302, bit 2 (I/O Terminal 04)
52	DIGITAL IN 4	d302, bit 3 (I/O Terminal 05)
53	DIGITAL IN 5	d302, bit 4 (I/O Terminal 06)
54	DIGITAL IN 6	d302, bit 5 (I/O Terminal 07)
55	DIGITAL IN 7	d302, bit 6 (I/O Terminal 08)
60	INPUT REF 1	d305
61	INPUT REF 2	d306
62	ANALOG OUT 1	T082
63	ANALOG OUT 2	T085
64	LAST FAULT	b007
65	PID GAIN	A154
66	PID INT TIME	A155
67	PID DIFF RATE	A156
68	PID SETPOINT	A157
70	CMD DIR MON	b006, bit 2 (Forward)
71	ACCELERATING	b006, bit 3 (Accelerating)
72	DECELERATING	b006, bit 4 (Decelerating)
73	ALARM	–
74	AT SPEED	–
75	MAIN FREQ	d301 (Digit 0)
76	OPER CMD	d301 (Digit 1)
77	PARAM LOCK	–
78	JOG	–
79	LOCAL CNTRL	–
80	MOP INC	–
81	ACCEL RATE 1	–
82	ACCEL RATE 2	–
83	DECEL RATE 1	–
84	DECEL RATE 2	–
85	REF SELECT 1	–
86	REF SELECT 2	–
87	REF SELECT 3	–
88	MOP DEC	–

Table 49 - Point Database for Application 2735

Point Number	Subpoint Name	Parameter
92	REFERENCE	b002
93	OK.FAULT	–
94	RESET FAULT	–
99	ERROR STATUS	–

(1) These parameters affect the operation of an optional auxiliary relay board.

Using Percent (%) for the Reference

The Reference (Point 92) for P1 is set as a percentage from 0% to +100%.

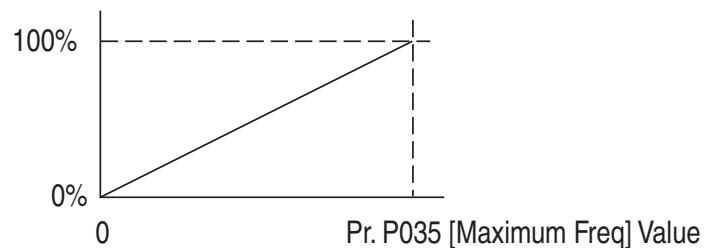

Table 50 - Example Speed Reference and Feedback for a PowerFlex 400 (P035 = 60 Hz)

Reference (Point 92)		PCT Output (Point 4)	
Percent	Speed	Speed	Percent
100%	60 Hz	60 Hz	100%
50%	30 Hz	30 Hz	50%
25%	15 Hz	15 Hz	25%
0%	0 Hz	0 Hz	0%

Using P1 Configurable Points to Access Parameters

Configurable points are inputs and outputs that let you read and write parameter values. These objects handle only 15-bit parameter values (0...32767).

IMPORTANT If a parameter has a decimal point, the value must be properly scaled by the user. For example, Accel Time has two decimal places. To use the value 60.00, the scaled value 6000 must be communicated to the drive. The scaled value 6000 will be returned.

Reading Parameter Values

The configurable points may show any parameter in the drive by configuring the Param# in the Read Param point. The drive reads the value of the parameter configured in the Param# for the Read Param point and shows the result in the Read Value point. The Param# for the Read Param point default to commonly accessed parameters and can be changed if desired. A “0” disables

the fetching of data and a “0” is returned in the Read Value point. See [Figure 46](#) and [Table 51](#).

Figure 46 - Configurable Input Point Operation

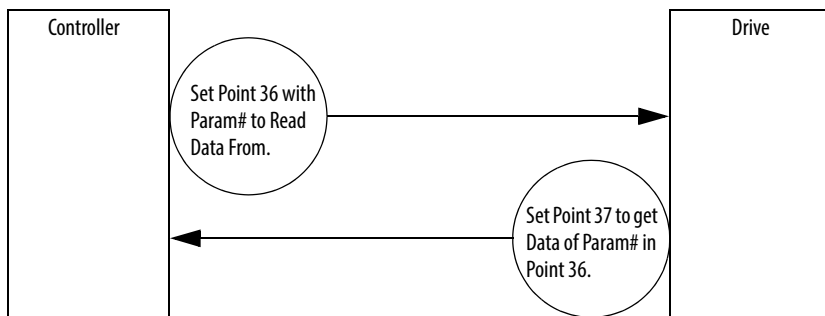

Table 51 - Configurable Objects: Inputs

Point	Name	Description	Default
36	Read Param	Param# to read value	0
37	Read Value	Value of parameter specified by Point 36	0

Writing Parameter Values

These outputs are written each time the Write Value point is written from the network.

The Param# for Write Param point’s default to commonly accessed parameters and can be changed if desired. A value of “0” in the Param# for Write Param point field disables the writing of data.

Figure 47 - Configurable Objects: Outputs

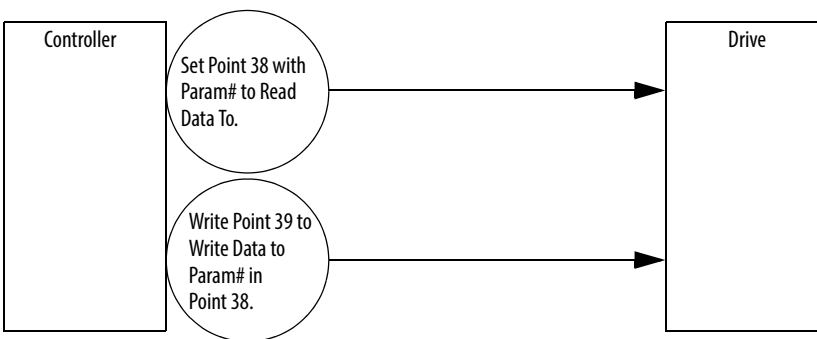

Table 52 - Configurable Objects: Outputs

Point	Name	Description	Default
38	Write Param	Param# to write value	0
38	Write Value	New value of parameter specified by Point 38	0

Notes:

A

AC Supply
 Ground 19
 Source 18
 Ungrounded 18
Analog Input Loss Fault 116
Armored Cable 23
Auto Rstrt Tries Fault 116
Auxiliary Input Fault 115

B

Before Applying Power 45, 46

C

Cable Length 28
Cable, Power 23
Catalog Number Explanation 10
CE Conformity 39
Checklist, Start-Up 45, 46
Circuit Breakers
 Input 21
Comm Loss Fault 117
Command Sources for Start and Speed 37
Contactors, Input 28
Control, 2 and 3 Wire 32, 36
Conventions, Manual 8
Cover, Opening 12

D

Dimensions
 Drive 136
 Minimum Clearances 15
Display 45, 48, 49, 50, 51, 52, 53
Display Group Parameters 58, 79
Distribution Systems, Ungrounded 18
Drive Frame Size 136
Drive Grounding 19
Drive Overload Fault 116
Drive Ratings 10, 121
DriveExecutive 55

E

Earthing, see Grounding
EMC/RFI
 Grounding, Filter 20
 Interference 39
ESD, Static Discharge 9

F

Fan Fdbck Loss Fault 116

Faults

Analog Input Loss 116
 Auto Rstrt Tries 116
 Auxiliary Input 115
 Comm Loss 117
 Drive Overload 116
 Fan Fdbck Loss 116
 Function Loss 117
 Ground Fault 116
 Heatsink OvrTmp 115
 HW OverCurrent 116
 I/O Board Fail 45, 117
 Input Phase Loss 116
 Load Loss 116
 Motor Overload 115
 Motor Stalled 115
 Net Loss 116
 OverVoltage 115
 Parameter Checksum 117
 Params Defaulted 116
 Phase Short 116
 Phase to Ground Short 116
 Power Loss 115
 Power Unit 116
 SW OverCurrent 116
 UnderVoltage 115

Filter, RFI 20**Frame Designations** 136**Function Loss Fault** 117**Fuses**

Input 21
 Ratings 121

G**General Precautions** 9, 55**Ground Fault** 116**Grounding**

Filter 20
 General 19

H**Heatsink OvrTmp Fault** 115**HW OverCurrent Fault** 116**I****I/O**

Wiring 28
 Wiring Examples 32, 36

I/O Board Fail Fault 45, 117**Input Contactor** 28**Input Fusing** 21**Input Phase Loss Fault** 116**Input Power Conditioning** 19**Installation** 11**Integral Keypad** 47**Interference, EMC/RFI** 39

K**Keypad** 47**L****LEDs** 45, 48, 49, 50, 51, 52, 53**Load Loss Fault** 116**M****Metasys N2**

point map 177, 184

Minimum Clearances 15**Motor Cable Length** 24**Motor Overload Fault** 115**Motor Stalled Fault** 115**motor starter** 21**Mounting Options and Clearances** 15**MOVs** 18**N****Net Loss Fault** 116**O****Opening the Cover** 12**Operator Interface** 47**OverVoltage Fault** 115**P****Parameter**

Types 55

Parameter Checksum Fault 117**Parameters**

Display Group 58, 79

Program Group 61

Terminal Block Group 66

Params Defaulted Fault 116**PE Ground** 20**Phase Short Fault** 116**Phase to Ground Fault** 116**point map**

Metasys N2 177, 184

Power Cables/Wiring 22**Power Conditioning, Input** 19**Power Connections, Single-Phase** 128**Power Loss Fault** 115**Power Unit Fault** 116**Powering Up the Drive** 45, 46**Precautions, General** 9, 55**Product Selection** 129**Program Group Parameters** 61**R****Ratings** 121**Reflective Wave Protection** 24**Removing Cover** 12**Repeated Start/Stop** 28**Repeated Start/Stop Precautions** 28**RFI, see EMC/RFI****RWR (Reflective Wave Reducer)** 24**S****Safety Ground** 20**Shielded Power Cables** 23**Short Circuit Protection** 21**Single-Phase Input Power Connections** 128**Start and Speed Reference Selection and****Control** 37, 38**Start/Stop, Repeated** 28**Start-Up Checklist** 45, 46**Static Discharge, ESD** 9**Status LEDs** 45, 48, 49, 50, 51, 52, 53**Supply Source, AC** 18**SW OverCurrent Fault** 116**System Grounding** 19**T****Terminal Block**

I/O 28

Power 27

Terminal Block Group Parameters 66**Three Wire Control** 32, 36**Two Wire Control** 32, 36**U****UnderVoltage Fault** 115**Ungrounded Supply** 18**Unshielded Power Cables** 23**W****Wiring** 11

Block Diagram 29, 30, 31, 32

I/O 28

I/O Examples 32, 36

Power 22

Rockwell Automation Support

Use the following resources to access support information.

Technical Support Center	Knowledgebase Articles, How-to Videos, FAQs, Chat, User Forums, and Product Notification Updates.	https://rockwellautomation.custhelp.com/
Local Technical Support Phone Numbers	Locate the phone number for your country.	http://www.rockwellautomation.com/global/support/get-support-now.page
Direct Dial Codes	Find the Direct Dial Code for your product. Use the code to route your call directly to a technical support engineer.	http://www.rockwellautomation.com/global/support/direct-dial.page
Literature Library	Installation Instructions, Manuals, Brochures, and Technical Data.	http://www.rockwellautomation.com/global/literature-library/overview.page
Product Compatibility and Download Center (PCDC)	Get help determining how products interact, check features and capabilities, and find associated firmware.	http://www.rockwellautomation.com/global/support/pcdc.page

Documentation Feedback

Your comments will help us serve your documentation needs better. If you have any suggestions on how to improve this document, complete the How Are We Doing? form at http://literature.rockwellautomation.com/idc/groups/literature/documents/du/ra-du002_-en-e.pdf.

Rockwell Automation maintains current product environmental information on its website at <http://www.rockwellautomation.com/rockwellautomation/about-us/sustainability-ethics/product-environmental-compliance.page>.

Allen-Bradley, Rockwell Software, PowerFlex, DriveExecutive, SCANport and Rockwell Automation are trademarks of Rockwell Automation, Inc.

Trademarks not belonging to Rockwell Automation are property of their respective companies.

www.rockwellautomation.com

Power, Control and Information Solutions Headquarters

Americas: Rockwell Automation, 1201 South Second Street, Milwaukee, WI 53204-2496 USA, Tel: (1) 414.382.2000, Fax: (1) 414.382.4444

Europe/Middle East/Africa: Rockwell Automation NV, Pegasus Park, De Kleetlaan 12a, 1831 Diegem, Belgium, Tel: (32) 2 663 0600, Fax: (32) 2 663 0640

Asia Pacific: Rockwell Automation, Level 14, Core F, Cyberport 3, 100 Cyberport Road, Hong Kong, Tel: (852) 2887 4788, Fax: (852) 2508 1846

Publication 22C-UM001J-EN-E - January 2017

Supersedes Publication 22C-UM001I-EN-P - August 2014

Copyright © 2017 Rockwell Automation, Inc. All rights reserved.