

User Manual

Original Instructions



PowerFlex 70 Adjustable Frequency AC Drives

Standard Control Firmware, Revision 2.xxx

Enhanced Control Firmware, Revision 2.xxx...5.xxx

Bulletin Number 20A

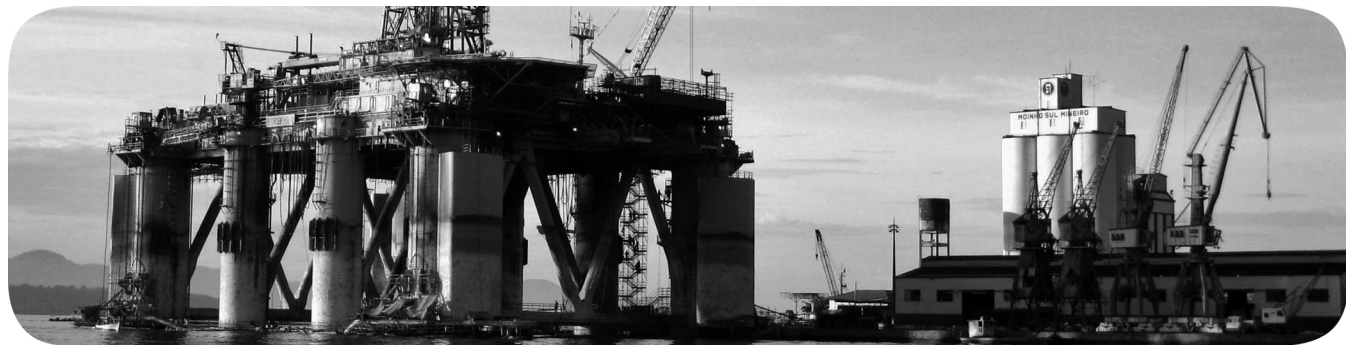

Important User Information

Read this document and the documents listed in the additional resources section about installation, configuration, and operation of this equipment before you install, configure, operate, or maintain this product. Users are required to familiarize themselves with installation and wiring instructions in addition to requirements of all applicable codes, laws, and standards.

Activities including installation, adjustments, putting into service, use, assembly, disassembly, and maintenance are required to be carried out by suitably trained personnel in accordance with applicable code of practice.

If this equipment is used in a manner not specified by the manufacturer, the protection provided by the equipment can be impaired.

In no event will Rockwell Automation, Inc. be responsible or liable for indirect or consequential damages resulting from the use or application of this equipment.

The examples and diagrams in this manual are included solely for illustrative purposes. Because of the many variables and requirements associated with any particular installation, Rockwell Automation, Inc. cannot assume responsibility or liability for actual use based on the examples and diagrams.

No patent liability is assumed by Rockwell Automation, Inc. with respect to use of information, circuits, equipment, or software described in this manual.

Reproduction of the contents of this manual, in whole or in part, without written permission of Rockwell Automation, Inc., is prohibited.

Throughout this manual, when necessary, we use notes to make you aware of safety considerations.



WARNING: Identifies information about practices or circumstances that can cause an explosion in a hazardous environment, which can lead to personal injury or death, property damage, or economic loss.



ATTENTION: Identifies information about practices or circumstances that can lead to personal injury or death, property damage, or economic loss. Attentions help you identify a hazard, avoid a hazard, and recognize the consequence.

IMPORTANT

Identifies information that is critical for successful application and understanding of the product.

Labels can also be on or inside the equipment to provide specific precautions.



SHOCK HAZARD: Labels can be on or inside the equipment, for example, a drive or motor, to alert people that dangerous voltage can be present.



BURN HAZARD: Labels can be on or inside the equipment, for example, a drive or motor, to alert people that surfaces can reach dangerous temperatures.



ARC FLASH HAZARD: Labels can be on or inside the equipment, for example, a motor control center, to alert people to potential Arc Flash. Arc Flash will cause severe injury or death. Wear proper Personal Protective Equipment (PPE). Follow ALL Regulatory requirements for safe work practices and for Personal Protective Equipment (PPE).

Preface

About This Publication..... 5
 What Is Not in This Publication 5
 Summary of Changes..... 5
 Additional Resources..... 6
 Manual Conventions..... 7
 Drive Frame Sizes 7
 General Precautions..... 8
 Qualified Personnel 8
 Personal Safety 8
 Product Safety 8
 Output Contactor Precaution 9
 Catalog Number Explanation 10

Chapter 1

Programming and Parameters

About Parameters 11
 How Parameters Are Organized..... 13
 LED HIM (Human Interface Module)..... 13
 LCD HIM (Human Interface Module) 14
 Basic Parameter View – Standard Control..... 15
 Basic Parameter View – Enhanced Control..... 16
 Advanced Parameter View – Standard Control 17
 Advanced Parameter View – Enhanced Control 19
 Monitor File (File A) 21
 Motor Control File (File B) 23
 Speed Command File (File C)..... 30
 Dynamic Control File (File D) 40
 Utility File (File E) 48
 Communication File (File H) 59
 Inputs and Outputs File
 (File J) 64
 Selected Option Definitions – [Analog Outx Sel], [Digital Inx Sel],
 and [Digital Outx Sel] 70
 Applications File (File K) 71
 Parameter Cross Reference – by Name..... 72

Chapter 2

Troubleshooting

Faults and Alarms 77
 Drive Status 77
 HIM Indication..... 78
 Manually Clearing Faults 78
 Fault Descriptions..... 79
 Clearing Alarms..... 82
 Alarm Descriptions..... 83

	Testpoint Codes and Functions	85
	Common Symptoms and Corrective Actions	86
	Appendix A	
Supplemental Drive Information	Communication Configurations.....	89
	Typical Programmable Controller Configurations.....	89
	Logic Command Word/ Logic Status Word	90
	Output Devices	91
	Appendix B	
HIM Overview	External and Internal Connections	93
	Using the HIM with a 20-HIM-B1 Bezel Kit	94
	LCD Display Elements	95
	ALT Functions.....	95
	Removing the HIM.....	95
	Menu Structure	96
	Viewing and Editing Parameters	97
	LCD HIM.....	98
	Numeric Keypad Shortcut.....	98
	Appendix C	
Application Notes	External Brake Resistor	100
	Skip Frequency.....	101
	Stop Modes	103
	Configuration	104
	Detailed Operation	105
	Motor Overload.....	107
	Motor Overload Memory Retention Per 2005 NEC.....	109
	Start at Powerup	109
	Overspeed	109
	Speed Reference Control.....	110
	“Auto” Speed Sources	110
	“Manual” Speed Sources.....	111
	Changing Speed Sources	111
	Auto/Manual Examples.....	112
	PLC = Auto, HIM = Manual.....	112
	PLC = Auto, Terminal Block = Manual	112
	Auto/Manual Notes	112
	Process PI for Standard Control	113
	PI Enable	113
	Voltage Tolerance	115

The purpose of this manual is to provide you with the basic information that is needed to program and troubleshoot the PowerFlex 70 Adjustable Frequency AC Drive.

Topic	Page
About This Publication	5
What Is Not in This Publication	5
Additional Resources	6
Manual Conventions	7
Drive Frame Sizes	7
General Precautions	8
Catalog Number Explanation	10

About This Publication

This manual is intended for qualified personnel. You must be able to program and operate Adjustable Frequency AC Drive devices. In addition, you must have an understanding of the parameter settings and functions.

What Is Not in This Publication

This manual provides basic start-up, programming, and troubleshooting information; it excludes information for mounting, wiring, and installing the drive. For installation instructions, refer to the PowerFlex 70 Adjustable Frequency AC Drive Installation Instructions, publication [20A-IN009](#). For detailed drive information, refer to the PowerFlex Reference Manuals, publications [PFLEX-RM001](#) and [PFLEX-RM004](#).

Summary of Changes

The information below summarizes the changes to this PowerFlex® 70 Adjustable Frequency AC Drives User Manual since the July 2014 release. The following information has been added, removed, or updated.

Description of New or Updated Information	Page
Removed information about Output Phase Loss - Fault 21.	All
Added Original Instructions to the cover and updated the firmware revision number.	Front Cover
Updated the Catalog Number Explanation to the current standards (made symbols footnotes).	10
Update and added footnotes to catalog variables c5 and l.	10
Updated bit table for parameter 238: Fault Config 1.	57
Added parameter 549: Flux Braking %	59
Changed Value 60 Manual/Auto to Value 68 Manual/Auto for parameters 361...366	67

Additional Resources

These documents contain additional information concerning related products from Rockwell Automation.

Resource	Description
PowerFlex 70 Adjustable Frequency AC Drive Installation Instructions, publication 20A-IN009	Provides the five basic steps that are needed to install and perform a basic startup of the PowerFlex 70 drive.
PowerFlex 70 and 700 Reference Manual - Vol. 1, publication PFLEX-RM001	Provides detailed information for specifications and dimensions, operation, and dynamic brake selection for the drive.
PowerFlex 70 Enhanced Control and 700 Vector Control Reference Manual, publication PFLEX-RM004	Provides detailed drive information including operation, parameter descriptions, and programming.
DriveGuard Safe-Off Option (Series B) for PowerFlex 40P and PowerFlex 70 AC Drives, publication PFLEX-UM003	Provides information for the installation and operation of the DriveGuard Safe Torque Off option.
PowerFlex Comm Adapter Manuals, publication 20COMM-UM...	Provides information for the installation and operation of the various communication protocol adapters available for the drive.
PowerFlex Dynamic Braking Resistor Calculator Application Technique, publication PFLEX-AT001	Provides information for determining dynamic braking requirements and evaluating resistors for dynamic braking.
Wiring and Grounding Guidelines for Pulse Width Modulated (PWM) AC Drives, publication DRIVES-IN001	Provides the basic information that is needed to properly wire and ground Pulse Width Modulated (PWM) AC drives.
Industry Installation Guidelines for Pulse Width Modulated (PWM) AC Drives Application Technique, publication DRIVES-AT003	Provides basic information for enclosure systems and environmental/location considerations (to help protect against environmental contaminants), and power and grounding considerations that are needed to properly install AC drives.
Preventive Maintenance of Industrial Control and Drive System Equipment, publication DRIVES-TD001	Provides a checklist to use as a guide for performing preventive maintenance on industrial control and drive systems.
Safety Guidelines for the Application, Installation, and Maintenance of Solid State Controls, publication SGI-1.1	Describes some important differences between solid-state equipment and hard-wired electromechanical devices
Guarding Against Electrostatic Damage, publication 8000-4.5.2	This data sheet explains the causes of electrostatic damage (ESD), and how you can guard against its effects.
Industrial Automation Wiring and Grounding Guidelines, publication 1770-4.1	Provides general guidelines for installing a Rockwell Automation industrial system.
Product Certifications website, http://ab.rockwellautomation.com	Provides declarations of conformity, certificates, and other certification details.

You can view or download publications at <http://www.rockwellautomation.com/literature/>. To order paper copies of technical documentation, contact your local Allen-Bradley distributor or Rockwell Automation sales representative.

For Allen-Bradley® drives technical support, see [Rockwell Automation Support](#) on the back cover of this manual.

Manual Conventions

In this manual we refer to the PowerFlex 70 Adjustable Frequency AC Drive as; drive, PowerFlex 70, or PowerFlex 70 Drive.

To help differentiate parameter names and Liquid Crystal Display (LCD) text from other text, the following conventions are used:

- Parameter Names appear in [brackets].
For example: [DC Bus Voltage].
- Display Text appears in “quotes.” For example: “Enabled.”

Drive Frame Sizes

Similar PowerFlex 70 drive sizes are grouped into frame sizes to simplify spare parts ordering, dimensioning, and so on. A cross reference of drive catalog numbers and their respective frame size is provided in [Appendix A](#).

General Precautions

Qualified Personnel



ATTENTION: Allow only qualified personnel familiar with adjustable frequency AC drives and associated machinery to plan or implement the installation, start-up and subsequent maintenance of the system. Failure to comply can result in personal injury and/or equipment damage.

Personal Safety



ATTENTION: To avoid an electric shock hazard, verify that the voltage on the bus capacitors has discharged before performing any work on the drive. Measure the DC bus voltage at the +DC terminal of the Power Terminal Block and the -DC test point (refer to PowerFlex 70 Adjustable Frequency AC Drive Installation Instructions, publication [20A-IN009](#) for locations). The voltage must be zero.



ATTENTION: Risk of injury or equipment damage exists. DPI or SCANport host products must not be directly connected together via 1202 cables. Unpredictable behavior can result if two or more devices are connected in this manner.



ATTENTION: The drive start/stop/enable control circuitry includes solid state components. If hazards due to accidental contact with moving machinery or unintentional flow of liquid, gas, or solids exist, an additional hardwired stop circuit may be required to remove the AC line to the drive. An auxiliary braking method may be required.

Product Safety



ATTENTION: An incorrectly applied or installed drive can result in component damage or a reduction in product life. Wiring or application errors, such as, undersizing the motor, incorrect or inadequate AC supply, or excessive ambient temperatures can result in malfunction of the system.



ATTENTION: This drive contains ESD (Electrostatic Discharge) sensitive parts and assemblies. Static control precautions are required when installing, testing, servicing or repairing this assembly. Component damage can result if ESD control procedures are not followed. If you are not familiar with static control procedures, reference A-B publication [8000-4.5.2](#), "Guarding Against Electrostatic Damage" or any other applicable ESD protection handbook.



ATTENTION: Configuring an analog input for 0...20 mA operation and driving it from a voltage source could cause component damage. Verify proper configuration before applying input signals.



ATTENTION: A contactor or other device that routinely disconnects and reapplies the AC line to the drive to start and stop the motor can cause drive hardware damage. The drive is designed to use control input signals to start and stop the motor. If an input device is used, operation must not exceed one cycle per minute or drive damage can occur.



ATTENTION: Nuisance tripping can occur in Standard Control firmware revision 1.011 and earlier due to unstable currents. When using a motor that is connected for a voltage that differs from the drive (for example, by using a 230V connected motor with a 460V drive) the following adjustment must be made to “Stability Gain” by using DriveExplorer software and a personal computer.

$$\frac{\text{Motor Nameplate Voltage}}{\text{Drive Rated Voltage}} \times 128$$

Any adjustment that is made to “Stability Gain” must be manually restored if the drive is reset to defaults or is replaced.

If unstable currents are still present after making the adjustment, contact the factory for assistance.



ATTENTION: The “adjust freq” portion of the bus regulator function is useful for preventing nuisance overvoltage faults resulting from aggressive decelerations, overhauling loads, and eccentric loads. It forces the output frequency to be greater than commanded frequency while the drive’s bus voltage is increasing towards levels that can cause a fault; however, it can also cause either of the following two conditions to occur.

- Fast positive changes in input voltage (more than a 10% increase within 6 minutes) can cause uncommanded positive speed changes; however an F25 “OverSpeed Limit” fault occurs if the speed reaches P82 [Max Speed] + P83 [Overspeed Limit]. If this condition is unacceptable, take action to: 1) limit supply voltages within the specification of the drive and, 2) limit fast positive input voltage changes to less than 10%. Without taking such actions, if this operation is unacceptable, the “adjust freq” portion of the bus regulator function must be disabled (see parameters 161 [Bus Reg Mode A] and 162 [Bus Reg Mode B]).
- Actual deceleration times can be longer than commanded deceleration times; however, a “Decel Inhibit” fault is generated if the drive stops decelerating altogether. If this condition is unacceptable, the “adjust freq” portion of the bus regulator must be disabled (see parameters 161 [Bus Reg Mode A] and 162 [Bus Reg Mode B]). In addition, installing a properly sized dynamic brake resistor provides equal or better performance in most cases.

Note: These faults are not instantaneous and have shown test results that take 2...12 seconds to occur.

Output Contactor Precaution



ATTENTION: To guard against drive damage when using output contactors, the following information must be read and understood. One or more output contactors can be installed between the drive and motor for disconnecting or isolating certain motors/loads. If a contactor is opened while the drive is operating, power is removed from the respective motor, but the drive continues to produce voltage at the output terminals. In addition, reconnecting a motor to an active drive (by closing the contactor) could produce excessive current that can cause the drive to fault. If any of these conditions are determined to be undesirable or unsafe, wire an auxiliary contact on the output contactor to a drive digital input that is programmed as “Enable.” This causes the drive to execute a coast-to-stop (cease output) whenever an output contactor is opened.

Catalog Number Explanation

1...3 4 5...7 8 9 10 11 12 13 14 15 16
 20A B 2P2 A 3 A Y Y N N C O
 a b c d e f g h i j k l

a

Drive	
Code	Type
20 A	PowerFlex 70

b

Voltage Rating		
Code	Voltage	Ph.
B	240V AC	3 (6 pulse)
C	400V AC	3 (6 pulse)
D	480V AC	3 (6 pulse)
E	600V AC	3 (6 pulse)

c1

PowerFlex 70 ND Rating				
208V, 60 Hz Input				
Code	208V Amps	kW	Hp	Frame
2P2	2.5	0.37	0.5	A
4P2	4.8	0.75	1.0	
6P8	7.8	1.5	2.0	B
9P6	11	2.2	3.0	
015	17.5	4.0	5.0	C
022	25.3	5.5	7.5	D
028	32.2	7.5	10	
042	43	11	15	
054	56	15	20	
070	78.2	18.5	25	E

c2

PowerFlex 70 ND Rating				
240V, 60 Hz Input				
Code	Amps	kW	Hp	Frame
2P2	2.2	0.37	0.5	A
4P2	4.2	0.75	1.0	
6P8	6.8	1.5	2.0	B
9P6	9.6	2.2	3.0	
015	15.3	4.0	5.0	C
022	22	5.5	7.5	D
028	28	7.5	10	
042	42	11	15	
054	54	15	20	
070	70	18.5	25	E

h

Internal Brake Resistor	
Code	w/ Resistor
Y	Yes
N	No

j

Comm Slot	
Code	Network Type
C	ControlNet (Coax)
D	DeviceNet
E	EtherNet/IP
N	None

c3

PowerFlex 70 ND Rating				
400V, 50 Hz Input				
Code	Amps	kW	Hp	Frame
1P3	1.3	0.37	0.5	A
2P1	2.1	0.75	1.0	
3P5	3.5	1.5	2.0	
5P0	5.0	2.2	3.0	B
8P7	8.7	4.0	5.0	
011	11.5	5.5	7.5	C
015	15.4	7.5	10	
022	22	11	15	D
030	30	15	20	
037	37	18.5	25	
043	42	22	30	
060	60	30	40	E
072	72	37	50	

c4

PowerFlex 70 ND Rating				
480V, 50 Hz Input				
Code	Amps	kW	Hp	Frame
1P1	1.1	0.37	0.5	A
2P1	2.1	0.75	1.0	
3P4	3.4	1.5	2.0	
5P0	5.0	2.2	3.0	B
8P0	8.0	3.7	5.0	
011	11	5.5	7.5	C
014	14	7.5	10	
022	22	11	15	D
027	27	15	20	
034	34	18.5	25	
040	40	22	30	
052	52	30	40	E
065	65	37	50	

i

Emission Class	
Code	Rating
A	Filtered ⁽¹⁾ A ⁽²⁾ & B Frames (Optional) C, D, & E Frames (Standard)
N	Not Filtered ⁽¹⁾ A & B Frames (Optional) C, D, & E Frames (Standard)

(1) 600V Frames A...D available only without filter (Cat. Code N). 600V Frame E available with filter (Cat. Code A).

(2) Increases size to Frame B.

k

Control and I/O		
Code	Control	Safe-Off
N ⁽¹⁾	Standard	N/A
C	Enhanced	No
G ⁽²⁾	Enhanced	Yes

(1) No longer available for sale.

(2) Not available as a factory installed option for 600V ratings.

c5

PowerFlex 70 ND Rating				
600V, 60 Hz Input ⁽¹⁾				
Code	Amps	kW	Hp	Frame
0P9	0.9	0.37	0.5	A
1P7	1.7	0.75	1.0	
2P7	2.7	1.5	2.0	
3P9	3.9	2.2	3.0	B
6P1	6.1	4.0	5.0	
9P0	9.0	5.5	7.5	C
011	11	7.5	10	
017	17	11	15	D
022	22	15	20	
027	27	18.5	25	
032	32	22	30	
041	41	30	40	E
052	52	37	50	

(1) 600V class drives below 52 Amps (Frames A-E) are declared to meet the Low Voltage Directive. It is the responsibility of the user to determine compliance to the EMC directive.

d

Enclosure	
Code	Enclosure
A	Panel Mount - IP 20, NEMA/UL Type 1
C	Wall/Machine Mount = IP66, NEMA/UL Type 4X/12 for indoor use only
F	Flange Mount - Front Chassis = IP 20, NEMA/UL Type 1; Rear Heatsink = IP66, NEMA/UL Type 4X/12 for indoor use only
G	Wall/Machine Mount - IP54, NEMA/UL Type 12 ⁽¹⁾

(1) Only available on Frame E.

e

HIM	
Code	Interface Module
0	Blank Cover
3	Full Numeric LCD
5	Prog. Only LCD ⁽¹⁾

(1) Only available with NEMA 4X, option C.

f

Documentation	
Code	Type
A	Manual
N	No manual

g

Brake IGBT	
Code	w/Brake
Y	Yes

l

Feedback ⁽¹⁾	
Code	Feedback
0	No Feedback - Enhanced Control
1	5V/12V Encoder w/Enhanced Control

(1) Drive is not CE EMC certified when the encoder interface option is installed.

Programming and Parameters

This chapter provides a complete list and descriptions of the PowerFlex® 70 drive parameters. The parameters are programmed (viewed/edited) by using a Light-emitting Diode (LED) or LCD Human Interface Module (HIM).

You can also use DriveExplorer™ or DriveExecutive™ software and a personal computer to program the drive. Refer to [Appendix B](#) for brief descriptions of the LED and LCD HIMs.

Topic	Page
About Parameters	11
How Parameters Are Organized	13
Monitor File (File A)	21
Motor Control File (File B)	23
Speed Command File (File C)	30
Dynamic Control File (File D)	40
Utility File (File E)	48
Communication File (File H)	59
Inputs and Outputs File (File J)	64
Applications File (File K)	71
Parameter Cross Reference – by Name	72

About Parameters

To configure a drive to operate in a specific way, you set the drive parameters. The drive uses these three types of parameters:

- **ENUM Parameters**

ENUM parameters have selections from two or more items. The LCD HIM displays a text message for each item. The LED HIM Displays a number for each item.

- **Bit Parameters**









Bit parameters have individual bits associated with features or conditions. If the bit is 0 the feature is off, or the condition is false. If the bit is 1 the feature is on, or the condition is true.

- **Numeric Parameters**

These parameters have a single numerical value (for example 0.1 volts).

The example on the following page shows how each parameter type is presented in this manual.

1	2	3	4		5	6																																																																																							
File	Group	No.	Parameter Name and Description	Values	Related																																																																																								
UTILITY (file E)	Drive ...	198	[Load Frm Usr Set] Loads a previously saved set of parameter values from a selected user set location in drive nonvolatile memory to active drive memory.	Default: 0 "Ready" Options: 0 "Ready" 1 "User Set 1" 2 "User Set 2" 3 "User Set 3"	199 ?																																																																																								
	Fault	238	[Fault Config 1] Enables/disables annunciation of the listed faults. <div style="text-align: center;"> <table border="1" style="margin-left: auto; margin-right: auto;"> <tr> <td></td><td></td><td></td><td></td><td></td><td></td><td></td><td></td><td></td><td></td><td></td><td>ShearP/No Acc⁽¹⁾</td><td>Load Loss⁽²⁾</td><td>In Phase Loss⁽²⁾</td><td>Motor Therm⁽¹⁾</td><td>Decel Thrigh⁽³⁾</td><td>AUF/Fsr Thigh</td><td>Shear Pin</td><td>Motor Over Ct</td><td>HIS Low Temp⁽⁴⁾</td><td>Under Voltage</td><td>Power Loss</td> </tr> <tr> <td>x</td><td>x</td><td>x</td><td>x</td><td>0</td><td>x</td><td>0</td><td>0</td><td>1</td><td>0</td><td>0</td><td>1</td><td>x</td><td>1</td><td>0</td><td></td><td></td><td></td><td></td><td></td><td></td><td></td> </tr> <tr> <td>15</td><td>14</td><td>13</td><td>12</td><td>11</td><td>10</td><td>9</td><td>8</td><td>7</td><td>6</td><td>5</td><td>4</td><td>3</td><td>2</td><td>1</td><td>0</td><td colspan="6"></td> </tr> <tr> <td colspan="4">Nibble 4</td><td colspan="4">Nibble 3</td><td colspan="4">Nibble 2</td><td colspan="4">Nibble 1</td><td colspan="6"></td> </tr> </table> <p>Bit # Factory Default Bit Values</p> <p>1 = Enabled 0 = Disable x = Reserved</p> <p>⁽¹⁾ Enhanced firmware 1.001 & later. ⁽²⁾ Enhanced firmware 2.001 & later. ⁽³⁾ Enhanced firmware 4.001 & later. ⁽⁴⁾ Bit 11 enables the shear pin fault to be ignored during acceleration and deceleration. Using Bit 11 with Bit 4 set to '0' will have no effect.</p> </div>												ShearP/No Acc ⁽¹⁾	Load Loss ⁽²⁾	In Phase Loss ⁽²⁾	Motor Therm ⁽¹⁾	Decel Thrigh ⁽³⁾	AUF/Fsr Thigh	Shear Pin	Motor Over Ct	HIS Low Temp ⁽⁴⁾	Under Voltage	Power Loss	x	x	x	x	0	x	0	0	1	0	0	1	x	1	0								15	14	13	12	11	10	9	8	7	6	5	4	3	2	1	0							Nibble 4				Nibble 3				Nibble 2				Nibble 1											
												ShearP/No Acc ⁽¹⁾	Load Loss ⁽²⁾	In Phase Loss ⁽²⁾	Motor Therm ⁽¹⁾	Decel Thrigh ⁽³⁾	AUF/Fsr Thigh	Shear Pin	Motor Over Ct	HIS Low Temp ⁽⁴⁾	Under Voltage	Power Loss																																																																							
	x	x	x	x	0	x	0	0	1	0	0	1	x	1	0																																																																														
	15	14	13	12	11	10	9	8	7	6	5	4	3	2	1	0																																																																													
Nibble 4				Nibble 3				Nibble 2				Nibble 1																																																																																	
Diagnostics	216	[Dig In Status] Status of the digital inputs. <div style="text-align: center;"> <table border="1" style="margin-left: auto; margin-right: auto;"> <tr> <td></td><td></td><td></td><td></td><td></td><td></td><td></td><td></td><td></td><td></td><td></td><td></td><td>Digital In8</td><td>Digital In5</td><td>Digital In4</td><td>Digital In3</td><td>Digital In2</td><td>Digital In1</td> </tr> <tr> <td>x</td><td>x</td><td>0</td><td>0</td><td>0</td><td>0</td><td>0</td><td>0</td><td>0</td><td>x</td><td>x</td><td>0</td><td>0</td><td>0</td><td>0</td><td>0</td><td>0</td><td>0</td> </tr> <tr> <td>15</td><td>14</td><td>13</td><td>12</td><td>11</td><td>10</td><td>9</td><td>8</td><td>7</td><td>6</td><td>5</td><td>4</td><td>3</td><td>2</td><td>1</td><td>0</td><td colspan="2"></td> </tr> <tr> <td colspan="4">Nibble 4</td><td colspan="4">Nibble 3</td><td colspan="4">Nibble 2</td><td colspan="4">Nibble 1</td><td colspan="2"></td> </tr> </table> <p>Bit #</p> <p>1 = Input Present 0 = Input Not Present x = Reserved</p> <p>⁽¹⁾ Enhanced firmware 2.001 & later.</p> </div>													Digital In8	Digital In5	Digital In4	Digital In3	Digital In2	Digital In1	x	x	0	0	0	0	0	0	0	x	x	0	0	0	0	0	0	0	15	14	13	12	11	10	9	8	7	6	5	4	3	2	1	0			Nibble 4				Nibble 3				Nibble 2				Nibble 1																								
												Digital In8	Digital In5	Digital In4	Digital In3	Digital In2	Digital In1																																																																												
x	x	0	0	0	0	0	0	0	x	x	0	0	0	0	0	0	0																																																																												
15	14	13	12	11	10	9	8	7	6	5	4	3	2	1	0																																																																														
Nibble 4				Nibble 3				Nibble 2				Nibble 1																																																																																	
Diag-Motor Cntl	549	[Flux Braking %] Gain adjustment for Flux Braking mode. (Percentage of normal output voltage.) This parameter is only viewable when P196 [Param Access Lvl] = 2 "Reserved."	Default: 125 Min/Max:100/125 Units:%	166																																																																																									
MOTOR ... Torq ...	059	EC [SV Boost Filter] Sets the amount of filtering used to boost voltage during Sensorless Vector operation.	Default: 500 Min/Max: 0/32767 Units: 1																																																																																										

No.	Description															
1	File – Lists the major parameter file category.															
2	Group – Lists the parameter group within a file.															
3	<p>No. – Parameter number  = Parameter value cannot be changed until drive is stopped.</p> <p> = 32 bit parameter.</p> <p> = 32 bit parameter (only in Enhanced Control drive).</p> <p> = Parameter that is displayed when [Motor Cntl Sel] is set to “4.”</p>															
4	<p>Parameter Name and Description – Parameter name as it appears on an LCD HIM, with a brief description of the parameters function.</p> <p> = This parameter is specific to Standard Control drives.</p> <p> = This parameter is only available with Enhanced Control drives.</p>															
5	<p>Values – Defines the various operating characteristics of the parameter. Three types exist.</p> <table border="1"> <tr> <td rowspan="2">ENUM</td> <td>Default:</td> <td>Lists the value that is assigned at the factory. “Read Only” = no default.</td> </tr> <tr> <td>Options:</td> <td>Displays the programming selections available.</td> </tr> <tr> <td>Bit</td> <td>Bit #:</td> <td>Lists the bit place holder and definition for each bit.</td> </tr> <tr> <td rowspan="3">Numeric</td> <td>Default:</td> <td>Lists the value that is assigned at the factory. “Read Only” = no default.</td> </tr> <tr> <td>Min/Max:</td> <td>The range (lowest and highest setting) possible for the parameter.</td> </tr> <tr> <td>Units:</td> <td>Unit of measure and resolution as shown on the LCD HIM.</td> </tr> </table> <p>Important: Some parameters have two unit values:</p> <ul style="list-style-type: none"> Analog inputs can be set for current or voltage with 320 [Anlg In Config]. Values with “.” pertain only to Enhanced Control drive  s. <p>Important: When sending values through DPI ports, simply remove the decimal point to arrive at the correct value (for example, to send “5.00 Hz,” use “500”).</p>	ENUM	Default:	Lists the value that is assigned at the factory. “Read Only” = no default.	Options:	Displays the programming selections available.	Bit	Bit #:	Lists the bit place holder and definition for each bit.	Numeric	Default:	Lists the value that is assigned at the factory. “Read Only” = no default.	Min/Max:	The range (lowest and highest setting) possible for the parameter.	Units:	Unit of measure and resolution as shown on the LCD HIM.
ENUM	Default:		Lists the value that is assigned at the factory. “Read Only” = no default.													
	Options:	Displays the programming selections available.														
Bit	Bit #:	Lists the bit place holder and definition for each bit.														
Numeric	Default:	Lists the value that is assigned at the factory. “Read Only” = no default.														
	Min/Max:	The range (lowest and highest setting) possible for the parameter.														
	Units:	Unit of measure and resolution as shown on the LCD HIM.														
6	<p>Related – Lists parameters (if any) that interact with the selected parameter. The symbol “” indicates that additional parameter information is available in Appendix C.</p>															

How Parameters Are Organized

LED HIM (Human Interface Module)

The LED HIM displays parameters in numbered list order. Access parameters by first selecting the file letter, then a parameter number.

IMPORTANT The PowerFlex 70 Enhanced Control drive does not support the LED HIM.

File Letter Designations

The LED HIM identifies each parameter by file letter and parameter number.

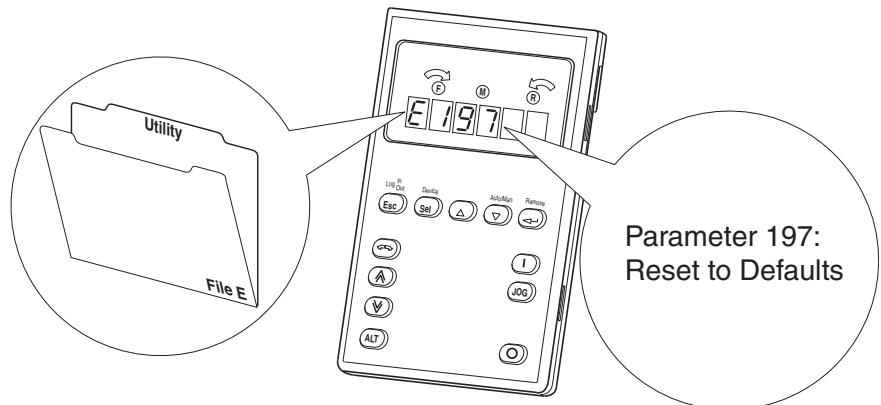

LCD HIM (Human Interface Module)

The LCD HIM displays parameters in a file-group-parameter, or numbered list, view order. To switch display mode, access the Main Menu, press ALT then Sel while the cursor is on the parameter selection. In addition, when you use parameter 196 [[Param Access Lvl](#)], you have the option to display all parameters, commonly used parameters, or diagnostic parameters.

Control Options

Two different control options are available for the PowerFlex 70, standard and enhanced.

- Standard control drives provide volts per hertz and sensorless vector operation.
- Enhanced control drives support the addition of FVC vector control, the DriveGuard Safe Off option, and more.

File-group-parameter View

File-group-parameter view simplifies programming by grouping parameters that are used for similar functions. The parameters are organized into six files in basic parameter view, or seven files in advanced parameter view. Each file is divided into groups, and each parameter is an element in a group. By default, the LCD HIM displays parameters by file-group-parameter view.

Numbered List View

All parameters are in numerical order.

Basic Parameter View – Standard Control

Parameter 196 [Param Access Lvl] set to option 0 “Basic.”

File	Group	Parameters						
	Metering	Output Freq	001					
		Commanded Freq	002					
		Output Current	003					
		DC Bus Voltage	012					
	Motor Data	Motor NP Volts	041	Motor NP RPM	044	Motor OL Hertz	047	
		Motor NP FLA	042	Motor NP Power	045			
		Motor NP Hertz	043	Mtr NP Pwr Units	046			
	Torq Attributes	Torque Perf Mode	053	Maximum Freq	055			
		Maximum Voltage	054	Autotune	061			
	Spd Mode and Limits	Minimum Speed	081					
		Maximum Speed	082					
	Speed References	Speed Ref A Sel	090	Speed Ref B Sel	093	TB Man Ref Sel	096	
		Speed Ref A Hi	091	Speed Ref B Hi	094	TB Man Ref Hi	097	
		Speed Ref A Lo	092	Speed Ref B Lo	095	TB Man Ref Lo	098	
	Discrete Speeds	Jog Speed	100					
		Preset Speed 1...7	101...107					
		Ramp Rates	Accel Time 1	140	Decel Time 1	142	S Curve %	146
			Accel Time 2	141	Decel Time 2	143		
Load Limits		Current Lmt Sel	147					
		Current Lmt Val	148					
Stop/Brake Modes		Stop Mode A	155	DC Brk Lvl Sel	157	Bus Reg Mode A	161	
		Stop Mode B	156	DC Brake Level	158	Bus Reg Mode B	162	
				DC Brake Time	159	DB Resistor Type	163	
Restart Modes		Start At Powerup	168	Auto Rstrt Tries	174	Auto Rstrt Delay	175	
Power Loss		Power Loss Mode	184	Power Loss Time	185			
		Direction Config	Direction Mode	190				
		Drive Memory	Param Access Lvl	196	Load Frm Usr Set	198	Language	201
			Reset To Defaults	197	Save To User Set	199		
		Diagnostics	Start Inhibits	214	Dig In Status	216	Dig Out Status	217
		Faults	Fault Config 1	238				
	Analog Inputs	Anlg In Config	320	Analog In1 Hi	322	Analog In2 Hi	325	
				Analog In1 Lo	323	Analog In2 Lo	326	
	Analog Outputs	Analog Out1 Sel	342					
		Analog Out1 Hi	343					
		Analog Out1 Lo	344					
	Digital Inputs	Digital In1...6 Sel	361...366					
	Digital Outputs	Digital Out1 Sel	380	Digital Out2 Sel	384			
		Dig Out1 Level	381	Dig Out2 Level	385			

Basic Parameter View – Enhanced Control

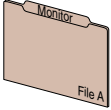
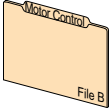
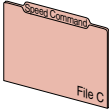
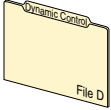
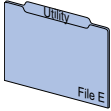
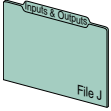

Parameter 196 [Param Access Lvl] set to option 0 “Basic.”

File	Group	Parameters						
	Metering	Output Freq	001					
		Commanded Freq	002					
		Output Current	003					
		Torque Current	004					
		DC Bus Voltage	012					
		Commanded Torque**024						
	Motor Data	Motor NP Volts	041	Motor NP RPM	044	Motor OL Hertz	047	
		Motor NP FLA	042	Motor NP Power	045	Motor Poles	049	
		Motor NP Hertz	043	Mtr NP Pwr Units	046			
	Torq Attributes	Motor Cntl Sel	053	Autotune	061	Torque Ref A Sel**	427	
		Maximum Voltage	054	Autotune Torque**	066	Torque Ref A Hi**	428	
		Maximum Freq	055	Inertia Autotune**	067	Torque Ref A Lo**	429	
						Pos Torque Limit**	436	
						Neg Torque Limit**	437	
	Speed Feedback	Motor Fdbk Type**	412					
		Encoder PPR**	413					
		Spd Mode and Limits	Feedback Select	080	Minimum Speed	081		
						Maximum Speed	082	
Speed References		Speed Ref A Sel	090	Speed Ref B Sel	093	TB Man Ref Sel	096	
		Speed Ref A Hi	091	Speed Ref B Hi	094	TB Man Ref Hi	097	
		Speed Ref A Lo	092	Speed Ref B Lo	095	TB Man Ref Lo	098	
Discrete Speeds		Jog Speed 1	100	Preset Speed 1 . . . 7	101 . . . 107	Jog Speed 2	108	
		Ramp Rates	Accel Time 1	140	Decel Time 1	142	S Curve %	146
			Accel Time 2	141	Decel Time 2	143		
	Load Limits	Current Lmt Sel	147	Current Lmt Val	148			
	Stop/Brake Modes	Stop/Brk Mode A	155	DC Brake Lvl Sel	157	Bus Reg Mode A	161	
		Stop/Brk Mode B	156	DC Brake Level	158	Bus Reg Mode B	162	
				DC Brake Time	159	DB Resistor Type	163	
	Restart Modes	Start At Powerup	168	Auto Rstrt Tries	174	Auto Rstrt Delay	175	
	Power Loss	Power Loss Mode	184	Power Loss Time	185			
		Direction Config	Direction Mode	190				
		Drive Memory	Param Access Lvl	196	Load Frm Usr Set	198	Language	201
Reset To Defaults			197	Save To User Set	199			
Diagnostics		Start Inhibits	214	Dig In Status	216	Dig Out Status	217	
Faults		Fault Config 1	238					
	Analog Inputs	Anlg In Config	320	Analog In 1 Hi	322	Analog In 1 Lo	323	
					Analog In 2 Hi	325	Analog In 2 Lo	326
	Analog Outputs	Analog Out1 Sel	342	Analog Out1 Hi	343			
				Analog Out1 Lo	344			
	Digital Inputs	Digital In1 . . . 6 Sel	361 . . . 366					
	Digital Outputs	Digital Out1 Sel	380	Dig Out1 Level	381			
		Digital Out2 Sel	384	Dig Out2 Level	385			

Advanced Parameter View – Standard Control

Parameter 196 [Param Access Lvl] set to option 1 “Advanced.”

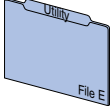

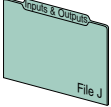
File	Group	Parameters						
 <p>Monitor File A</p>	Metering	Output Freq	001	Output Voltage	006	MOP Frequency	011	
		Commanded Freq	002	Output Power	007	DC Bus Voltage	012	
		Output Current	003	Output Powr Fctr	008	DC Bus Memory	013	
		Torque Current	004	Elapsed MWh	009	Analog In1 Value	016	
		Flux Current	005	Elapsed Run Time	010	Analog In2 Value	017	
	Drive Data	Rated kW	026	Rated Amps	028			
		Rated Volts	027	Control SW Ver	029			
	 <p>Motor Control File B</p>	Motor Data	Motor Type	040	Motor NP RPM	044	Motor OL Factor	048
			Motor NP Volts	041	Motor NP Power	045		
Motor NP FLA			042	Mtr NP Pwr Units	046			
Motor NP Hertz			043	Motor OL Hertz	047			
Torq Attributes		Torque Perf Mode	053	Compensation	056	Autotune	061	
		Maximum Voltage	054	Flux Up Mode	057	IR Voltage Drop	062	
		Maximum Freq	055	Flux Up Time	058	Flux Current Ref	063	
Volts per Hertz		StAcc Boost	069	Break Voltage	071			
		Run Boost	070	Break Frequency	072			
 <p>Speed Command File C</p>		Spd Mode and Limits	Speed Mode	080	Overspeed Limit	083	Skip Frequency 3	086
			Minimum Speed	081	Skip Frequency 1	084	Skip Freq Band	087
			Maximum Speed	082	Skip Frequency 2	085		
		Speed References	Speed Ref A Sel	090	Speed Ref B Sel	093	TB Man Ref Sel	096
	Speed Ref A Hi		091	Speed Ref B Hi	094	TB Man Ref Hi	097	
	Speed Ref A Lo		092	Speed Ref B Lo	095	TB Man Ref Lo	098	
	Discrete Speeds	Jog Speed	100					
		Preset Speed 1 . . . 7	101 . . . 107					
	Speed Trim	Trim In Select	117	Trim Hi	119			
		Trim Out Select	118	Trim Lo	120			
	Slip Comp	Slip RPM @ FLA	121	Slip RPM Meter	123			
		Slip Comp Gain	122					
	Process PI	PI Configuration	124	PI Integral Time	129	PI Status	134	
		PI Control	125	PI Prop Gain	130	PI Ref Meter	135	
		PI Reference Sel	126	PI Lower Limit	131	PI Fdback Meter	136	
		PI Setpoint	127	PI Upper Limit	132	PI Error Meter	137	
		PI Feedback Sel	128	PI Preload	133	PI Output Meter	138	
	 <p>Dynamic Control File D</p>	Ramp Rates	Accel Time 1	140	Decel Time 1	142	S Curve %	146
			Accel Time 2	141	Decel Time 2	143		
Load Limits		Current Lmt Sel	147	Drive OL Mode	150			
		Current Lmt Val	148	PWM Frequency	151			
		Current Lmt Gain	149					
Stop/Brake Modes		Stop Mode A	155	DC Brake Level	158	Bus Reg Mode A	161	
		Stop Mode B	156	DC Brake Time	159	Bus Reg Mode B	162	
		DC Brake Lvl Sel	157	Bus Reg Gain	160	DB Resistor Type	163	
Restart Modes		Start At Powerup	168	Flying StartGain	170	Auto Rstrt Delay	175	
		Flying Start En	169	Auto Rstrt Tries	174			
Power Loss		Power Loss Mode	184					
		Power Loss Time	185					

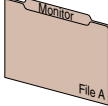
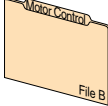
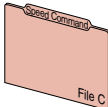

File	Group	Parameters						
 Utility File E	Direction Config	Direction Mode	190					
	HIM Ref Config	Save HIM Ref	192					
		Man Ref Preload	193					
	MOP Config	Save MOP Ref	194					
		MOP Rate	195					
	Drive Memory	Param Access Lvl	196	Save To User Set	199	Voltage Class	202	
		Reset To Defaults	197	Reset Meters	200	Drive Checksum	203	
		Load Frm Usr Set	198	Language	201			
	Diagnostics	Drive Status 1	209	Dig Out Status	217	Status 2 @ Fault	228	
		Drive Status 2	210	Drive Temp	218	Alarm 1 @ Fault	229	
		Drive Alarm 1	211	Drive OL Count	219	Alarm 2 @ Fault	230	
		Drive Alarm 2	212	Motor OL Count	220	Testpoint 1 Sel	234	
		Speed Ref Source	213	Fault Frequency	224	Testpoint 1 Data	235	
		Start Inhibits	214	Fault Amps	225	Testpoint 2 Sel	236	
Last Stop Source		215	Fault Bus Volts	226	Testpoint 2 Data	237		
Dig In Status		216	Status 1 @ Fault	227				
Faults		Fault Config 1	238	Fault Clear Mode	241	Fault 1...4 Code	243...249	
	Fault Clear	240	Power Up Marker	242	Fault 1...4 Time	244...250		
Alarms	Alarm Config 1	259						
 Communication File H	Comm Control	DPI Data Rate	270	Drive Ref Rslt	272			
		Drive Logic Rslt	271	Drive Ramp Rslt	273			
	Masks and Owners	Logic Mask	276	Fault Clr Mask	283	Reference Owner	292	
		Start Mask	277	MOP Mask	284	Accel Owner	293	
		Jog Mask	278	Local Mask	285	Decel Owner	294	
		Direction Mask	279	Stop Owner	288	Fault Clr Owner	295	
		Reference Mask	280	Start Owner	289	MOP Owner	296	
		Accel Mask	281	Jog Owner	290	Local Owner	297	
		Decel Mask	282	Direction Owner	291			
	Datalinks	Data In A1...D2	300...307					
		Data Out A1...D2	310...317					
	 Inputs and Outputs File J	Analog Inputs	Anlg In Config	320	Analog In 1 Hi	322	Analog In 2 Hi	325
			Anlg In Sqr Root	321	Analog In 1 Lo	323	Analog In 2 Lo	326
					Anlg In 1 Loss	324	Anlg In 2 Loss	327
Analog Outputs		Anlg Out Absolut	341	Analog Out1 Hi	343			
		Analog Out1 Sel	342	Analog Out1 Lo	344			
Digital Inputs		Digital In1...6 Sel	361...366					
Digital Outputs		Digital Out1 Sel	380	Digital Out2 Sel	384			
		Dig Out1 Level	381	Dig Out2 Level	385			
		Dig Out1 OnTime	382	Dig Out2 OnTime	386			
		Dig Out1 OffTime	383	Dig Out2 OffTime	387			

Advanced Parameter View – Enhanced Control

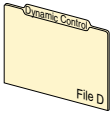
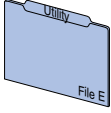
Parameter 196 [Param Access Lvl] set to option 1 “Advanced.”

File	Group	Parameters						
 File A	Metering	Output Freq	001	Output Powr Fctr	008	Torque Estimate	015 ^{3.x}	
		Commanded Freq	002	Elapsed MWh	009	Analog In1 Value	016	
		Output Current	003	Elapsed Run Time	010	Analog In2 Value	017	
		Torque Current	004	MOP Frequency	011	Ramped Speed	022	
		Flux Current	005	DC Bus Voltage	012	Speed Reference	023	
		Output Voltage	006	DC Bus Memory	013	Commanded Torque**	024	
		Output Power	007	Elapsed kWh	014	Speed Feedback	025	
	Drive Data	Rated kW	026	Rated Amps	028			
		Rated Volts	027	Control SW Ver	029			
	 File B	Motor Data	Motor Type	040	Motor NP RPM	044	Motor OL Factor	048
Motor NP Volts			041	Motor NP Power	045	Motor Poles	049	
Motor NP FLA			042	Mtr NP Pwr Units	046	Motor OL Mode	050 ^{3.x}	
Motor NP Hertz			043	Motor OL Hertz	047			
Torq Attributes		Motor Cntl Sel	053	Autotune	061	Torque Ref A Hi**	428	
		Maximum Voltage	054	IR Voltage Drop	062	Torque Ref A Lo**	429	
		Maximum Freq	055	Flux Current Ref	063	Torque Setpoint1**	435	
		Compensation	056	Ixo Voltage Drop	064	Pos Torque Limit**	436	
		Flux Up Mode	057	Autotune Torque**	066	Neg Torque Limit**	437	
		Flux Up Time	058	Inertia Autotune**	067	Control Status**	440	
		SV Boost Filter	059	Torque Ref A Sel**	427	Torq Current Ref**	441	
Volts per Hertz		StAcc Boost*	069	Break Voltage*	071			
		Run Boost*	070	Break Frequency*	072			
Speed Feedback		Motor Fdbk Type	412	Enc Pos Feedback	414	Fdbk Filter Sel**	416	
		Encoder PPR	413	Encoder Speed	415	Notch FilterFreq**	419	
						Notch Filter K**	420	
 File C		Spd Mode and Limits	Feedback Select	080	Skip Frequency 1	084	Skip Freq Band	087
			Minimum Speed	081	Skip Frequency 2	085	Speed/Torque Mod**	088
			Maximum Speed	082	Skip Frequency 3	086	Rev Speed Limit	454
			Overspeed Limit	083				
		Speed References	Speed Ref A Sel	090	Speed Ref B Sel	093	TB Man Ref Sel	096
			Speed Ref A Hi	091	Speed Ref B Hi	094	TB Man Ref Hi	097
			Speed Ref A Lo	092	Speed Ref B Lo	095	TB Man Ref Lo	098
	Discrete Speeds	Jog Speed 1	100	Preset Speed 1...7		Jog Speed 2	108	
				101...107				
	Speed Trim	Trim % Setpoint	116	Trim In Select	117	Trim Hi	119	
				Trim Out Select	118	Trim Lo	120	
	Slip Comp	Slip RPM @ FLA	121	Slip Comp Gain*	122	Slip RPM Meter	123	
	Process PI	PI Configuration	124	PI Lower Limit	131	PI Output Meter	138	
		PI Control	125	PI Upper Limit	132	PI BW Filter	139	
		PI Reference Sel	126	PI Preload	133	PI Deriv Time	459	
		PI Setpoint	127	PI Status	134	PI Reference Hi	460	
		PI Feedback Sel	128	PI Ref Meter	135	PI Reference Lo	461	
		PI Integral Time	129	PI Fdbk Meter	136	PI Feedback Hi	462	
		PI Prop Gain	130	PI Error Meter	137	PI Feedback Lo	463	
	Speed Regulator	Ki Speed Loop**	445	Spd Err Filt BW	448 ^{3.x}	Total Inertia**	450	
		Kp Speed Loop**	446	Speed Desired BW**	449	Speed Loop Meter**	451	
		Kf Speed Loop**	447					

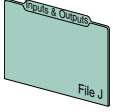
File	Group	Parameters					
 File D	Restart Modes	Powerup Delay	167	Auto Rstrt Tries	174	Wake Level	180
		Start At Powerup	168	Auto Rstrt Delay	175	Wake Time	181
		Flying Start En	169	Sleep Wake Mode	178	Sleep Level	182
		Flying StartGain	170	Sleep Wake Ref	179	Sleep Time	183
	Power Loss	Gnd Warn Level	177	Power Loss Time	185	Load loss Time	188
		Power Loss Mode	184	Load Loss Level	187		
	Ramp Rates	Accel Time 1	140	Decel Time 1	142	S Curve %	146
		Accel Time 2	141	Decel Time 2	143		
	Load Limits	Current Lmt Sel	147	Drive OL Mode	150	Regen Power Lim**	153
		Current Lmt Val	148	PWM Frequency	151	Current Rate Lim**	154
		Current Lmt Gain	149	Droop RPM@FLA	152	Shear Pin Time*	189
	Stop/Brake Modes	DB While Stopped	145	DC Brake Time	159	Bus Reg Kp*	164
		Stop/Brk Mode A	155	Bus Reg Ki*	160	Bus Reg Kd*	165
		Stop/Brk Mode B	156	Bus Reg Mode A	161	Flux Braking	166
		DC Brake Lvl Sel	157	Bus Reg Mode B	162		
DC Brake Level		158	DB Resistor Type	163			
 File E	Direction Config	Direction Mode	190				
	HIM Ref Config	AutoMan Cnfg	192				
	MOP Config	Save MOP Ref	194	MOP Rate	195		
	Drive Memory	Param Access Lvl	196	Reset Meters	200	Dyn UsrSet Cnfg	204
		Reset To Defaults	197	Language	201	Dyn UserSet Sel	205
		Load Frm Usr Set	198	Voltage Class	202	Dyn UserSet Actv	206
		Save To User Set	199	Drive Checksum	203		
	Diagnostics	Drive Status 1	209	Drive Temp	218	Status 1 @ Fault	227
		Drive Status 2	210	Drive OL Count	219	Status 2 @ Fault	228
		Drive Alarm 1	211	Motor OL Count	220	Alarm 1 @ Fault	229
		Drive Alarm 2	212	Mtr OL Trip Time	221 ^{3,x}	Alarm 2 @ Fault	230
		Speed Ref Source	213	Drive Status 3	222 ^{3,x}	Testpoint 1 Sel	234
		Start Inhibits	214	Status 3 @ Fault	223 ^{3,x}	Testpoint 1 Data	235
		Last Stop Source	215	Fault Frequency	224	Testpoint 2 Sel	236
		Dig In Status	216	Fault Amps	225	Testpoint 2 Data	237
Faults	Dig Out Status	217	Fault Bus Volts	226			
	Fault Config 1	238	Fault Clear Mode	241	Fault 1...4 Code	243...249	
	Fault Clear	240	Power Up Marker	242	Fault 1...4 Time	244...250	
Alarms	Alarm Config 1	259					
Scaled Blocks	Scale1 In Value	476	Scale2 In Value	482			
	Scale1 In Hi	477	Scale2 In Hi	483			
	Scale1 In Lo	478	Scale2 In Lo	484			
 File H	Comm Control	DPI Data Rate	270	Drive Ramp Rslt	273	DPI Ref Select	298
		Drive Logic Rslt	271	DPI Port Select	274		
		Drive Ref Rslt	272	DPI Port Value	275		
	Masks and Owners	Logic Mask	276	Fault Clr Mask	283	Reference Owner	292
		Start Mask	277	MOP Mask	284	Accel Owner	293
		Jog Mask	278	Local Mask	285	Decel Owner	294
		Direction Mask	279	Stop Owner	288	Fault Clr Owner	295
		Reference Mask	280	Start Owner	289	MOP Owner	296
		Accel Mask	281	Jog Owner	290	Local Owner	297
	Datalinks	Decel Mask	282	Direction Owner	291		
		Data In A1...D2	300...307	HighRes Ref	308	Data Out A1...D2	310...317
	Security	PortMask Act	595	Write Mask Act	597	Logic Mask Act	598
		Write Mask Cfg	596	Logic Mask	276		









File	Group	Parameters						
 File J	Analog Inputs	Anlg In Config	320	Analog In 1 Lo	323	Analog In 2 Lo	326	
		Anlg In Sqr Root	321	Analog In 1 Loss	324	Analog In 2 Loss	327	
		Analog In 1 Hi	322	Analog In 2 Hi	325			
	Analog Outputs	Anlg Out Config	340	Analog Out1 Hi	343	Anlg Out1 Setpt	377	
		Anlg Out Absolut	341	Analog Out1 Lo	344			
		Analog Out1 Sel	342	Anlg Out Scale	354			
	Digital Inputs	Digital In1...6 Sel	361...366	DigIn DataLogic	411			
	Digital Outputs	Dig Out Setpt	379	Dig Out1 OnTime	382	Dig Out2 Level	385	
		Digital Out1 Sel	380	Dig Out1 OffTime	383	Dig Out2 OnTime	386	
		Dig Out1 Level	381	Digital Out2 Sel	384	Dig Out2 OffTime	387	
	 File K	Fiber Functions ^{3,x}	Fiber Control	620 ^{3,x}	Traverse Inc	623 ^{3,x}	P Jump	626 ^{3,x}
			Fiber Status	621 ^{3,x}	Traverse Dec	624 ^{3,x}		
Sync Time			622 ^{3,x}	Max Traverse	625 ^{3,x}			

* These parameters are available only when parameter 053 [Motor Cntl Sel] is set to option 2 or 3.

** These parameters are available only when parameter 053 [Motor Cntl Sel] is set to option 4.

^{3,x} Firmware revision 3.002 and later.

Monitor File (File A)

File A	Group	No.	Parameter Name and Description ⁽¹⁾	Values	Related
MONITOR (file A) Metering		001	[Output Freq] Output frequency present at T1, T2, and T3 (U, V, and W)	Default: Read Only Min/Max: ± [Maximum Freq] Units: 0.1 Hz	
		002	[Commanded Freq] Value of the active frequency command.	Default: Read Only Min/Max: ± [Maximum Speed] Units: 0.1 Hz	213
		003	 [Output Current] The total output current present at T1, T2, and T3 (U, V, and W).	Default: Read Only Min/Max: 0.0/Drive Rated Amps × 2 Units: 0.1 Amps 0.01 Amps 	
		004	 [Torque Current] The amount of current that is in phase with the fundamental voltage component.	Default: Read Only Min/Max: Drive Rating × -2/+2 Units: 0.1 Amps 0.01 Amps 	
		005	 [Flux Current] The amount of current that is out of phase with the fundamental voltage component.	Default: Read Only Min/Max: Drive Rating × -2/+2 Units: 0.1 Amps 0.01 Amps 	063
		006	[Output Voltage] Output voltage present at terminals T1, T2, and T3 (U, V, and W).	Default: Read Only Min/Max: 0.0/Drive Rated Volts Units: 0.1V AC	054 202
		007	 [Output Power] Output power present at T1, T2, and T3 (U, V, and W). The output power is a calculated value, dependent on autotune values.	Read Only 0.0/Drive Rated kW × 2 0.1 kW 0.01 kW 	
		008	[Output Powr Fctr] Output power factor.	Default: Read Only Min/Max: 0.00/1.00 Units: 0.01	
		009	 [Elapsed MWh] Accumulated output energy of the drive.	Default: Read Only Min/Max: 0.0/429496729.5 MWh Units: 0.1 MWh	

File A	Group	No.	Parameter Name and Description ⁽¹⁾	Values	Related	
MONITOR (file A)		010	[Elapsed Run Time] Accumulated time drive is outputting power.	Default: Read Only Min/Max: 0.0/429496729.5 Hrs Units: 0.1 Hrs		
		011	[MOP Frequency] Value of the signal at MOP (Motor Operated Potentiometer).	Default: Read Only Min/Max: ± [Maximum Frequency] Units: 0.1 Hz	194 195	
		012	[DC Bus Voltage] Present DC bus voltage level.	Default: Read Only Min/Max: 0.0/Drive Rating Based Units: 0.1V DC		
	013	[DC Bus Memory] 6 minute average of DC bus voltage level.	Default: Read Only Min/Max: 0.0/Drive Rating Based Units: 0.1V DC			
	Metering		014	EC [Elapsed kWh] Accumulated output energy of the drive.	Default: Read Only Min/Max: 0.0/429496729.5 kWh Units: 0.1 kWh	
			015	EC v3 [Torque Estimate] Estimated motor torque output as percent of motor rated torque.	Default: Read Only Min/Max: ±800.0% Units: 0.1%	
			016	[Analog In1 Value]	Default: Read Only	320... 327
			017	[Analog In2 Value] Value of the signal at the analog inputs.	Min/Max: 0.000/20.000 mA ±10.000V Units: 0.001 mA 0.001 Volts	
			022	EC [Ramped Speed] The value that is shown is the value after the accel/decel ramp but prior to any corrections supplied by slip comp, Pl, and so on	Default: Read Only Min/Max: ±500.0 Hz Units: 0.1 Hz	
			023	EC [Speed Reference] Summed value of ramped speed and Process Pl.	Default: Read Only Min/Max: ±500.0 Hz Units: 0.1 Hz	053 138 152
			024	EC v2 [Commanded Torque] Final torque reference value after limits and filtering are applied. % motor rated torque.	Default: Read Only Min/Max: ±800.0% Units: 0.1%	053
	025	EC v2 [Speed Feedback] Value of actual motor speed, which is measured by encoder feedback or estimated.	Default: Read Only Min/Max: ±500.0 Hz Units: 0.1 Hz	053		
	Drive Data		026	[Rated kW] Drive power rating.	Default: Read Only Min/Max: 0.37/15.0 kW 0.00/300.00 kW EC Units: 0.01 kW	
			027	[Rated Volts] The drive input voltage class (208, 240, 400, and so on.).	Default: Read Only Min/Max: 208/600 Volt 0.0/6553.5 Volt EC Units: 0.1V AC	
028			[Rated Amps] The drive rated output current.	Default: Read Only Min/Max: 1.1/32.2 Amps 0.0/6553.5 Amps EC Units: 0.1 Amps		
029			[Control SW Ver] Main Control Board software version/firmware revision.	Default: Read Only Min/Max: 0.000/65.256 0.0/65.535 EC Units: 0.001	196	



(1) See [page 13](#) for Symbol Descriptions.

Motor Control File (File B)

File B	Group	No.	Parameter Name and Description ⁽¹⁾	Values	Related
MOTOR CONTROL (file B)	Motor Data	040	[Motor Type] Set to match the type of motor connected. ⁽¹⁾ Important: Selecting option 1 or 2 also requires selection of "Custom V/Hz," option 2 in parameter 53.	Default: 0 "Induction" Options: 0 "Induction" 1 "Synchr Reluc" ⁽¹⁾ 2 "Synchr PM" ⁽¹⁾	053
		041	[Motor NP Volts] Set to the motor nameplate rated volts. • 208/240 => 240.0V • 400/480 => 480.0V • 600/600 => 600.0V	Default: Drive Rating Based Min/Max: 0.0/[Rated Volts] Units: 0.1V AC	
		042	[Motor NP FLA] Set to the motor nameplate rated full load amps.	Default: Drive Rating Based Min/Max: 0.0/[Rated Amps] × 2 Units: 0.1 Amps	047 048 148
		043	[Motor NP Hertz] Set to the motor nameplate rated frequency.	Default: Drive Rating Based Min/Max: 5.0/400.0 Hz 5.0/500.0 Hz EC Units: 0.1 Hz	
		044	[Motor NP RPM] Set to the motor nameplate rated rpm.	Default: Drive Rating Based Min/Max: 60/30000 rpm Units: 1 rpm	049 080 121
		045	[Motor NP Power] Set to the motor nameplate rated power. (1) See [Mtr NP Pwr Units] .	Default: Drive Rating Based Min/Max: 0.00/100.00 0.00/412.48 EC Units: 0.01 kW/Hp ⁽¹⁾	046
		046	[Mtr NP Pwr Units] Selects the motor power units to be used.	Default: Drive Rating Based Options: 0 "Horsepower" 1 "kilowatts"	045
		047	[Motor OL Hertz] Selects a lower output frequency than where the motor operating current is derated. The motor thermal overload generates a fault at lower levels of current.	Default: Motor NP Hz/3 Min/Max: 0.0/500.0 Hz Units: 0.1 Hz	042 220 i
		048	[Motor OL Factor] Sets operating level for motor overload service factor. P42 [Motor NP FLA] x P48 [Motor OL Factor] = Operating Level	Default: 1.00 Min/Max: 0.20/2.00 Units: 0.01	042 220 i
		049	EC [Motor Poles] Defines the number of poles in the motor. Number of Poles = (120 x P43 [Motor NP Hertz]) / P44 [Motor NP RPM]	Default: 4 Min/Max: 2/40 Units: 2 Pole	043 044

File B	Group	No.	Parameter Name and Description ⁽¹⁾	Values	Related
MOTOR CONTROL (file B)	Motor Data	050	<p>EC v3 [Motor OL Mode]</p> <p>If "0" [Motor OL Count], P220 is reset to zero by a drive reset or a power cycle. If "1" the value is maintained. A "1" to "0" transition resets [Motor OL Count], P220 to zero.</p> <p>Bit # Factory Default Bit Values</p>		220
		053	<p>Standard [Torque Perf Mode]</p> <p>Sets the method of motor torque production.</p> <p>EC [Motor Cntl Sel]</p> <p>Sets the method of motor control that is used in the drive.</p> <p>Important: "FVC Vector" mode requires autotuning of the motor, both coupled and uncoupled to the load.</p> <p>⁽¹⁾ Enhanced firmware revision 2.001 and later.</p>	<p>Default: 0 "Sensrls Vect"</p> <p>Options: 0 "Sensrls Vect" 1 "SV Economize" 2 "Custom V/Hz" 3 "Fan/Pmp V/Hz"</p> <p>Default: 0 "Sensrls Vect"</p> <p>Options: 0 "Sensrls Vect" 1 "SV Economize" 2 "Custom V/Hz" 3 "Fan/Pmp V/Hz" 4 "FVC Vector"⁽¹⁾</p>	<p>062</p> <p>063</p> <p>069</p> <p>070</p> <p>?</p>
	Torq Attributes	054	<p>[Maximum Voltage]</p> <p>Sets the highest voltage that the drive can output.</p>	<p>Default: Drive Rated Volts</p> <p>Min/Max: Rated Volts × 0.25/Rated Volts based on high voltage rating, for example:</p> <ul style="list-style-type: none"> • 208/240 ≥ 240.0V • 400/480 ≥ 480.0V • 600/600 ≥ 600.0V <p>0.1V AC</p> <p>Units:</p>	197
		055	<p>[Maximum Freq]</p> <p>Sets the highest frequency that the drive can output.</p> <p>Refer to parameter 083 [Overspeed Limit].</p>	<p>Default: 110.0 Hz or 130.0 Hz</p> <p>Min/Max: 5.0/400.0 Hz 5.0/500.0 Hz EC</p> <p>Units: 0.1 Hz</p>	<p>082</p> <p>083</p> <p>202</p> <p>298</p>

File B	Group	No.	Parameter Name and Description ⁽¹⁾	Values	Related
MOTOR CONTROL (file B)	Torq Attributes	056	<p>[Compensation] Enables/disables correction options.</p> <p>Bit # Factory Default Bit Values</p> <p>⁽¹⁾ Enhanced firmware 1.001 & later. ⁽²⁾ Enhanced firmware 2.001 & later.</p> <p>Option Descriptions:</p> <ul style="list-style-type: none"> • Reflect Wave – Provides reflected wave overvoltage protection for long cable lengths. (typically enabled). • Enable Jerk – In non-FVC Vector modes, disabling jerk removes a short S-curve at the start of the accel/decel ramp. • Ixo AutoCalc – Not functional – reserved for future enhancements. • Xsistor Diag – Power transistor power diagnostic tests run at each start command. • Rs Adapt – only FVC w/Encoder – Disabling can improve torque regulation at lower speeds (typically not needed). • PWM Freq Lock – Keeps the PWM frequency from decreasing to 2 kHz at low operating frequencies in FVC Vector mode without encoder. • DigiN DatLog – Enables logic functions that can be applied to parameter 411 [DigiN DataLogic] and the specified digital input. 		<p>140... 143 411</p>
		057	<p>[Flux Up Mode] Auto = Flux is established for a calculated time period based on motor nameplate data. [Flux Up Time] is not used. Manual = Flux is established for [Flux Up Time] before acceleration.</p>	<p>Default: 0 "Manual" Options: 0 "Manual" 1 "Automatic"</p>	<p>053 058</p>
		058	<p>[Flux Up Time] Sets the amount of time the drive uses to try and achieve full motor stator flux. When a Start command is issued, DC current at current limit level is used to build stator flux before accelerating.</p>	<p>Default: 0.00 s Min/Max: 0.00/5.00 s Units: 0.01 s</p>	<p>053 058</p>
		059	<p>EC [SV Boost Filter] Sets the amount of filtering used to boost voltage during Sensorless Vector operation.</p>	<p>Default: 500 Min/Max: 0/32767 Units: 1</p>	

File B	Group	No.	Parameter Name and Description ⁽¹⁾	Values	Related
MOTOR CONTROL (file B)	Torq Attributes	061	<p> [Autotune] Provides a manual or automatic method for setting P62 [IR Voltage Drop] and P63 [Flux Current Ref] to affect sensorless vector performance. Valid only when P53 is set to "Sensrls Vect", "SV Economize", or "FVC Vector."</p> <p>"Ready" (0) = Parameter returns to this setting following a "Static Tune" or "Rotate Tune." It also permits manually setting P62 [IR Voltage Drop], P64 [Ixo Voltage Drop] and P63 [Flux Current Ref].</p> <p>"Static Tune" (1) = A temporary command that initiates a non-rotational motor stator resistance test for the best possible automatic setting of P62 [IR Voltage Drop] in all valid modes and a non-rotational motor leakage inductance test for the best possible automatic setting of P64 [Ixo Voltage Drop] in "FVC Vector" mode. A start command is required following initiation of this setting. The parameter returns to "Ready" (0) following the test, and then another start transition is required to operate the drive in normal mode. This is used when the motor cannot be rotated.</p> <p>"Rotate Tune" (2) = A temporary command that initiates a "Static Tune" followed by a rotational test for the best possible automatic setting of P63 [Flux Current Ref]. In "FVC Vector" mode, with encoder feedback, a test for the best possible automatic setting of P121 [Slip RPM @ FLA] is also run. A start command is required following initiation of this setting. The parameter returns to "Ready" (0) following the test, and then another start transition is required to operate the drive in normal mode. Important: If you are using rotate tune for "Sensrls Vect" mode, uncouple the motor from the load or results can be invalid. With "FVC Vector," either a coupled or uncoupled load produces a valid result.</p> <hr/> <div style="display: flex; align-items: center;">  <p>ATTENTION: Rotation of the motor in an undesired direction can occur during this procedure. To guard against possible injury and/or equipment damage, it is recommended that the motor is disconnected from the load before proceeding.</p> </div> <hr/> <p>"Calculate" (3) = This setting uses motor nameplate data to automatically set P62 [IR Voltage Drop], P64 [Ixo Voltage Drop], P63 [Flux Current Ref] and P121 [Slip RPM @ FLA].</p>	<p>Default: 3 "Calculate"</p> <p>Options: 0 "Ready" 1 "Static Tune" 2 "Rotate Tune" 3 "Calculate"</p>	<p>053 062</p>
		062	<p>[IR Voltage Drop] Value of voltage drop across the resistance of the motor stator at rated motor current. Used only when parameter 53 is set to "Sensrls Vect", "SV Economize", or "FVC Vector."</p>	<p>Default: Drive Rating Based</p> <p>Min/Max: 0.0/[Motor NP Volts]×0.5</p> <p>Units: 0.1V AC</p>	<p>053 061</p>
		063	<p> [Flux Current Ref] Value of amps for full motor flux. Used only when parameter 53 is set to "Sensrls Vect", "SV Economize", or "FVC Vector."</p>	<p>Default: Drive Rating Based</p> <p>Min/Max: [Motor NP FLA] × 0.05/[Motor NP FLA] × 0.9</p> <p>Units: 0.01 Amps</p>	<p>053 061</p>

File B	Group	No.	Parameter Name and Description ⁽¹⁾	Values	Related
MOTOR CONTROL (file B)	Torq Attributes	064	EC v2 [IXo Voltage Drop] Value of voltage drop across the leakage inductance of the motor at rated motor current. Used only when parameter 53 is set to "FVC Vector."	Default: Based on Drive Rating Min/Max: 0.0/Motor NP Volts Units: 0.1V AC	053 061
		066	EC v2 [Autotune Torque] Specifies motor torque that is applied to the motor during the flux current and inertia tests that are performed during an autotune.	Default: 50.0% Min/Max: 0.0/150.0% Units: 0.1%	053
		067	EC v2 [Inertia Autotune] Provides an automatic method of setting [Total Inertia]. This test is automatically run during Start-Up motor tests. Important: Use this when the motor is coupled to the load. Results can be invalid if the load is not coupled to the motor during this procedure. "Ready" = Parameter returns to this setting following a completed inertia tune. "Inertia Tune" = A temporary command that initiates an inertia test of the motor/load combination. The motor ramps up and down, while the drive measures the amount of inertia.	Default: 0 "Ready" Options: 0 "Ready" 1 "Inertia Tune"	053 066 445 446 449 450
		427	EC v2 [Torque Ref A Sel] Selects the source of the external torque reference to the drive. How this reference is used is dependent upon P88 [Speed/Torque Mod]. ⁽¹⁾ See Appendix B for DPI port locations.	Default: 0 "Torque Setpt" Options: 0 "Torque Setpt" 1 "Analog In 1" 2 "Analog In 2" 3...17 "Reserved" 18...22 "DPI Port 1...5" ⁽¹⁾ 23 "Reserved" 24 "Disabled" 25 "Scale Block1" 26 "Scale Block2"	053 088 320... 327 428... 437
		428	EC v2 [Torque Ref A Hi] Scales the upper value of the [Torque Ref A Sel] selection when the source is an analog input.	Default: 100.0% Min/Max: ±800.0% Units: 0.1%	053 427
		429	EC v2 [Torque Ref A Lo] Scales the lower value of the [Torque Ref A Sel] selection when the source is an analog input.	Default: 0.0% Min/Max: ±800.0% Units: 0.1%	053 427
		435	EC v2 [Torque Setpoint1] Provides an internal fixed value for Torque Setpoint when [Torque Ref Sel] is set to "Torque Setpt."	Default: 0.0% Min/Max: ±800.0% Units: 0.1%	053 427

File B	Group	No.	Parameter Name and Description ⁽¹⁾	Values	Related
MOTOR CONTROL (file B)	Torq Attributes	436	EC v2 [Pos Torque Limit] Defines the torque limit for the positive torque reference value. The reference cannot exceed this value.	Default: 200.0% Min/Max: 0.0/800.0% Units: 0.1%	053
		437	EC v2 [Neg Torque Limit] Defines the torque limit for the negative torque reference value. The reference cannot exceed this value.	Default: -200.0% Min/Max: -800.0/0.0% Units: 0.1%	053
		440	EC v2 [Control Status] Displays a summary status of any condition that can be limiting either the current or the torque reference.	Read Only	053
	441	EC v2 [Torq Current Ref] Displays the torque current reference value that is present at the output of the current rate limiter (parameter 154).	Default: Read Only Min/Max: ±3276.7 Amps Units: 0.1 Amps	053	
	Volts per Hertz	069	[Start/Acc Boost] Sets the voltage boost level for starting and acceleration when “Custom V/Hz” mode is selected. Refer to parameter 083 [Overspeed Limit].	Default: Drive Rating Based Min/Max: 0.0/[Motor NP Volts] × 0.25 Units: 0.1V AC	053 070
		070	[Run Boost] Sets the boost level for steady state or deceleration when “Fan/Pmp V/Hz” or “Custom V/Hz” modes are selected. Refer to the diagram at parameter 083.	Default: Drive Rating Based Min/Max: 0.0/[Motor NP Volts] × 0.25 Units: 0.1V AC	053 069
		071	[Break Voltage] Sets the [Break Frequency] output voltage of the drive. Refer to parameter 083 [Overspeed Limit].	Default: [Motor NP Volts] × 0.25 Min/Max: 0.0/[Motor NP Volts] Units: 0.1V AC	053 072



File B	Group	No.	Parameter Name and Description ⁽¹⁾	Values	Related
MOTOR CONTROL (file B)	Speed Feedback	072	[Break Frequency] Sets the [Break Voltage] output frequency of the drive. Refer to parameter 083 [Overspeed Limit].	Default: [Motor NP Hertz] × 0.25 Min/Max: 0.0/[Maximum Freq] Units: 0.1 Hz	053 071
		412	EC v2 [Motor Fdbk Type] Selects the encoder type; single channel or quadrature. Options 1 and 3 detect a loss of encoder signal (when you are using differential inputs) regardless of the [Feedback Select], param. 080 setting. For FVC Vector mode, use a quadrature encoder only (option 0/1). If a single channel encoder is used (option 2/3) in sensorless vector or V/Hz mode, select "Reverse Dis" (option 2) in param. 190.	Default: 0 "Quadrature" Options: 0 "Quadrature" 1 "Quad Check" 2 "Single Chan" 3 "Single Check"	080 088
		413	EC v2 [Encoder PPR] Contains the encoder pulses per revolution. For improved operation in FVC Vector mode, PPR can be ≥ (64 x motor poles).	Default: 1024 PPR Min/Max: 1/20000 PPR Units: 1 PPR	080
		414	EC v2 [Enc Pos Feedback] Displays raw encoder pulse count. For single channel encoders, this count increases (per rev.) by the amount in [Encoder PPR]. For quadrature encoders this count increases by 4 times the amount that is defined in [Encoder PPR].	Default: Read Only Min/Max: ±2147483647 Units: 1	
		415	EC v2 [Encoder Speed] Provides a monitoring point that reflects speed as seen from the feedback device.	Default: Read Only Min/Max: ±500.0 Hz Units: 0.1 Hz	
		416	FV EC v2 [Fdbk Filter Sel] Selects the type of feedback filter desired. "Light" uses a 35/49 radian feedback filter. "Heavy" uses a 20/40 radian feedback filter.	Default: 0 "None" Options: 0 "None" 1 "Light" 2 "Heavy"	
		419	FV EC v2 [Notch FilterFreq] Sets the center frequency for an optional 2-pole notch filter. Filter is applied to the torque command. "0" disables this filter.	Default: 0.0 Hz Min/Max: 0.0/500.0 Hz Units: 0.1 Hz	053
		420	FV EC v2 [Notch Filter K] Sets the width for the 2-pole notch filter.	Default: 0.3 Min/Max: 0.1/0.9 Units: 0.1	053

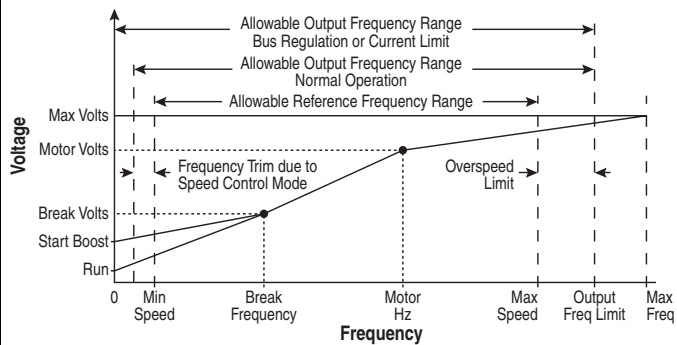

(1) See [page 13](#) for Symbol Descriptions.

Speed Command File (File C)

File C	Group	No.	Parameter Name and Description ⁽¹⁾	Values	Related
SPEED COMMAND (file C)	Spd Mode and Limits	080	<p>Standard [Speed Mode]</p> <p>Sets the method of speed regulation.</p>	Default: 0 "Open Loop" Options: 0 "Open Loop" 1 "Slip Comp" 2 "Process PI"	121... 138 125 412 413
			<p>E C [Feedback Select]</p> <p>Selects the source for motor speed feedback. Note that all selections are available when you are using Process PI.</p> <p>"Open Loop" (0) - no encoder is present, and slip compensation is not needed.</p> <p>"Slip Comp" (1) - tight speed control is needed, and encoder is not present.</p> <p>"Encoder" (3) - an encoder is present.</p> <p>"Simulator" (5) - Simulates a motor for testing drive operation and interface check.</p>	Default: 0 "Open Loop" Options: 0 "Open Loop" 1 "Slip Comp" 2 "Reserved" 3 "Encoder" 4 "Reserved" 5 "Simulator"	
		081	<p>[Minimum Speed]</p> <p>Sets the low limit for speed reference after scaling is applied. Refer to parameter 083 [Overspeed Limit].</p>	Default: 0.0 Hz Min/Max: 0.0/[Maximum Speed] Units: 0.1 Hz	092 095
		082	<p>[Maximum Speed]</p> <p>Sets the high limit for speed reference after scaling is applied. Refer to parameter 083 [Overspeed Limit].</p>	Default: 50.0 Hz or 60.0 Hz (Dependent on voltage class) Min/Max: 5.0/400.0 Hz 5.0/500.0 Hz E C Units: 0.1 Hz	055 083 091 094 202 298
		083	<p>[Overspeed Limit]</p> <p>Sets the incremental amount of the output frequency (greater than [Maximum Speed]) for functions such as slip compensation. P82 [Maximum Speed] + P83 [Overspeed Limit] must be ≤ P55 [Maximum Freq]</p>	Default: 10.0 Hz Min/Max: 0.0/20.0 Hz Units: 0.1 Hz	055 082









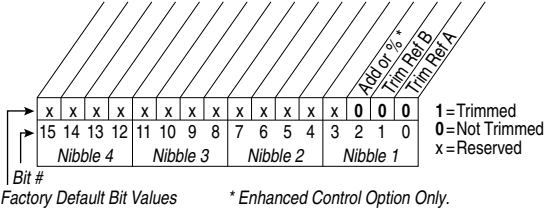

File C	Group	No.	Parameter Name and Description ⁽¹⁾	Values	Related
SPEED COMMAND (file C)	Spd Mode and Limits	084	[Skip Frequency 1]	Default: 0.0 Hz	087 
		085	[Skip Frequency 2]	Default: 0.0 Hz	
		086	[Skip Frequency 3]	Default: 0.0 Hz	
			Sets a frequency where the drive does not operate.	Min/Max: ±500.0 Hz Units: 0.1 Hz	
		087	[Skip Freq Band]	Default: 0.0 Hz Min/Max: 0.0/30.0 Hz Units: 0.1 Hz	084
		088	EC v2 [Speed/Torque Mod]	Default: 1 "Speed Reg"	053 361 ... 366
FV	Selects the torque reference source. "Zero Torque" (0) - torque command = 0. "Speed Reg" (1) - drive operates as a speed regulator. "Torque Reg" (2) - an external torque reference is used for the torque command. "Min Torq/Spd" (3) - selects the smallest algebraic value to regulate to when the torque reference and torque that is generated from the speed regulator are compared. "Max Torq/Spd" (4) - selects the largest algebraic value when the torque reference and the torque that is generated from the speed regulator are compared. "Sum Torq/Spd" (5) - selects the sum of the torque reference and the torque that is generated from the speed regulator.	Options: 0 "Zero Torque" 1 "Speed Reg" 2 "Torque Reg" 3 "Min Torq/Spd" 4 "Max Torq/Spd" 5 "Sum Torq/Spd"			
				ATTENTION: The speed of the drive could reach P82 [Maximum Speed] + P83 [Overspeed Limit] to meet required torque when any of the torque modes have been selected. Equipment damage and/or personal injury can result.	
		454	EC [Rev Speed Limit]	Default: 0.0 Hz Min/Max: -[Max Speed]/0.0 Hz Units: 0.1 Hz	
			Sets a limit on speed in the negative direction. A value of zero disables this parameter and uses [Min Speed] for minimum speed.		

File C	Group	No.	Parameter Name and Description ⁽¹⁾	Values	Related
SPEED COMMAND (file C)	Speed References	090	<p>[Speed Ref A Sel]</p> <p> Selects the source of the speed reference to the drive unless [Speed Ref B Sel] or [Preset Speed 1...7] is selected.</p> <p>For more information on selecting a speed reference source, see Speed Reference Control on page 110.</p> <p>⁽¹⁾ See External and Internal Connections on page 93 for DPI port locations.</p> <p>⁽²⁾ Only Enhanced Control Drives.</p>	Default: 2 "Analog In 2" Options: 1 "Analog In 1" 2 "Analog In 2" 3...7 "Reserved" 8 "Encoder" 9 "MOP Level" 10 "Reserved" 11 "Preset Spd1" 12 "Preset Spd2" 13 "Preset Spd3" 14 "Preset Spd4" 15 "Preset Spd5" 16 "Preset Spd6" 17 "Preset Spd7" 18 "DPI Port 1" ⁽¹⁾ 19 "DPI Port 2" ⁽¹⁾ 20 "DPI Port 3" ⁽¹⁾ 21 "Reserved" 22 "DPI Port 5" ⁽¹⁾ 23, 24 "Reserved" 25 "Scale Block1" 26 "Scale Block2" 27...29 "Reserved" 30 "HighRes Ref" ⁽²⁾	002 091... 093 101... 107 117... 120 192... 194 213 272 273 320 361... 366
		091	<p>[Speed Ref A Hi]</p> <p>Scales the upper value of the [Speed Ref A Sel] selection when the source is an analog input.</p>	Default: [Maximum Speed] Min/Max: ±[Maximum Speed] Units: 0.1 Hz	082 090
		092	<p>[Speed Ref A Lo]</p> <p>Scales the lower value of the [Speed Ref A Sel] selection when the source is an analog input.</p>	Default: 0.0 Hz Min/Max: ±[Maximum Speed] Units: 0.1 Hz	081 090
		093	<p>[Speed Ref B Sel]</p> <p> See [Speed Ref A Sel].</p>	Default: 11 "Preset Spd1" Options: See [Speed Ref A Sel]	See 090
		094	<p>[Speed Ref B Hi]</p> <p>Scales the upper value of the [Speed Ref B Sel] selection when the source is an analog input.</p>	Default: [Maximum Speed] Min/Max: ±[Maximum Speed] Units: 0.1 Hz	093
		095	<p>[Speed Ref B Lo]</p> <p>Scales the lower value of the [Speed Ref B Sel] selection when the source is an analog input.</p>	Default: 0.0 Hz Min/Max: ±[Maximum Speed] Units: 0.1 Hz	090 093

File C	Group	No.	Parameter Name and Description ⁽¹⁾	Values	Related
SPEED COMMAND	Speed References	096	<p>[TB Man Ref Sel]</p> <p>Sets the manual speed reference source when a digital input (parameter 361...366) is configured for "Auto/Manual."</p> <ul style="list-style-type: none"> ⁽¹⁾"Analog In 2" is not a valid selection if it was selected for any of the following: <ul style="list-style-type: none"> - P117 [Trim In Select] - P128 [PI Feedback Sel] - P126 [PI Reference Sel] - P147 [Current Lmt Sel] - P179 [Sleep Wake Ref] <p>⁽²⁾Requires a Series B HIM with firmware revision v5.004.01 or later.</p> <p>Selects the HIM to provide the manual speed reference when a digital input is configured for "Auto/Manual."</p> <p>Additionally, if [Man Ref Preload], parameter 193 is set to "Enabled," the automatic speed reference is preloaded into the HIM when the drive switches to Manual mode from Automatic mode.</p> <ul style="list-style-type: none"> Set [Save HIM Ref], parameter 192, bit 1 (Manual Mode) as desired. Set [TB Man Ref Sel] to the desired drive reference when in Manual Mode. If set to one of the DPI Ports, then [Man Ref Preload] must be set to enable or disable reference preload of the current speed. Connect a HIM to the DPI Port selected. When Manual mode is requested through the terminal block digital input, the drive evaluates if Manual mode can be granted. If [TB Man Ref Sel] is set to a DPI Port and [Man Ref Preload] is enabled, the drive transfers the last value of the automatic speed reference to the HIM. The HIM is now the speed reference source. The terminal block has exclusive control based on [Save HIM Ref], bit 1 (Manual Mode). If [Man Ref Preload] is disabled, the HIM is now the speed reference source. The terminal block has exclusive control based on [Save HIM Ref], bit 1 (Manual Mode). <p>Important: the HIM does not enter Manual mode, it is only the reference source for the terminal block.</p> <p>When Auto mode is requested through the terminal block, the drive changes to Auto mode and returns control and reference to the previous state before Manual mode was requested.</p>	<p>Default: 1 "Analog In 1"</p> <p>Options: 1 "Analog In 1"</p> <p> 2 "Analog In 2"⁽¹⁾</p> <p> 3...8 "Reserved"</p> <p> 9 "MOP Level"</p> <p> 10...17 "Reserved"</p> <p> 18 "DPI Port 1"⁽²⁾</p> <p> 19 "DPI Port 2"⁽²⁾</p> <p> 20 "DPI Port 3"⁽²⁾</p>	<p>097</p> <p>098</p>
		097	<p>[TB Man Ref Hi]</p> <p>Scales the upper value of the [TB Man Ref Sel] selection when the source is an analog input.</p>	<p>Default: [Maximum Speed]</p> <p>Min/Max: ±[Maximum Speed]</p> <p>Units: 0.1 Hz</p>	<p>096</p>
		098	<p>[TB Man Ref Lo]</p> <p>Scales the lower value of the [TB Man Ref Sel] selection when the source is an analog input.</p>	<p>Default: 0.0 Hz</p> <p>Min/Max: ±[Maximum Speed]</p> <p>Units: 0.1 Hz</p>	<p>096</p>

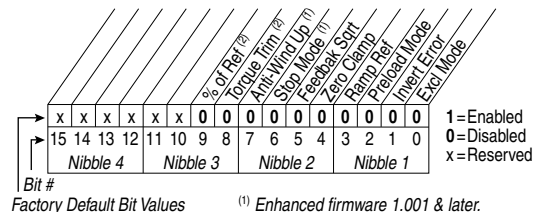
File C	Group	No.	Parameter Name and Description ⁽¹⁾	Values	Related	
SPEED COMMAND (file C)	Discrete Speeds	100	Standard [Jog Speed] Sets the output frequency when a jog command is issued.	Default: 10.0 Hz Min/Max: ±[Maximum Speed] Units: 0.1 Hz	361... 366	
			EC [Jog Speed 1] Sets the output frequency when Jog Speed 1 is selected.	Default: 10.0 Hz Min/Max: ±[Maximum Speed] Units: 0.1 Hz		
		101	[Preset Speed 1]	Default: 5.0 Hz	090	
		102	[Preset Speed 2]	10.0 Hz	093	
		103	[Preset Speed 3]	20.0 Hz	213	
		104	[Preset Speed 3]	30.0 Hz	361...	
		105	[Preset Speed 4]	40.0 Hz	366	
		106	[Preset Speed 5]	50.0 Hz		
		107	[Preset Speed 6] [Preset Speed 7] Provides an internal fixed speed command value. In bipolar mode direction is commanded by the sign of the reference.	60.0 Hz Min/Max: ±[Maximum Speed] Units: 0.1 Hz		
		108	EC [Jog Speed 2] Sets the output frequency when Jog Speed 2 is selected.	Default: 10.0 Hz Min/Max: ±[Maximum Speed] Units: 0.1 Hz	361... 366	
		116	EC [Trim % Setpoint] Adds or subtracts a percentage of the speed reference or maximum speed. Dependent on the setting of [Trim Out Select], parameter 118.	Default: 0.00% Min/Max: ±200.00% Units: 0.01%	090 093 117	
		Speed Trim	117	[Trim In Select]  Specifies the analog input signal to use as a trim input. ⁽¹⁾ See External and Internal Connections on page 93 for DPI port locations.	Default: 2 "Analog In 2" Options: 1 "Analog In 1" 2 "Analog In 2" 3...7 "Reserved" 8 "Encoder" 9 "MOP Level" 10 "Reserved" 11 "Preset Spd1" 12 "Preset Spd2" 13 "Preset Spd3" 14 "Preset Spd4" 15 "Preset Spd5" 16 "Preset Spd6" 17 "Preset Spd7" 18 "DPI Port 1" ⁽¹⁾ 19 "DPI Port 2" ⁽¹⁾ 20 "DPI Port 3" ⁽¹⁾ 21 "Reserved" 22 "DPI Port 5" ⁽¹⁾ 23 "Reserved" 24 "Reserved" 25 "Scale Block1" 26 "Scale Block2"	090 093 116

File C	Group	No.	Parameter Name and Description ⁽¹⁾	Values	Related	
SPEED COMMAND (file C)	Speed Trim	118	[Trim Out Select]  Specifies the speed references to be trimmed. To apply negative trim, P190 [Direction Mode] must be set to 1 "Bipolar."		117 119 120 190	
		119	[Trim Hi] Scales the upper value of the [Trim In Select] selection when the source is an analog input.	Default: 60.0 Hz Min/Max: ±[Maximum Speed] Units: 0.1 Hz 1% 	082 117	
		120	[Trim Lo] Scales the lower value of the [Trim In Select] selection when the source is an analog input.	Default: 0.0 Hz Min/Max: ±[Maximum Speed] Units: 0.1 Hz 1% 	117	
	Important: Parameters in the Slip Comp Group are used to enable and tune the Slip Compensation Regulator. For the Slip Compensation Regulator to control drive operation, set parameter 080 to 1 "Slip Comp".					
	Slip Comp	121	[Slip RPM @ FLA] Sets the amount of compensation to drive output at motor FLA. If the value of parameter 061 [Autotune] = 3 "Calculate" changes made to this parameter are not accepted.	Default: Based on [Motor NP RPM] Min/Max: 0.0/1200.0 rpm Units: 0.1 rpm	044 061 080 122 123	
		122	[Slip Comp Gain] Sets the response time of slip compensation.	Default: 40.0 Min/Max: 1.0/100.0 Units: 0.1	080 121 122	
		123	[Slip RPM Meter] Displays the present amount of adjustment being applied as slip compensation.	Default: Read Only Min/Max: 0.0/300.0 rpm ±300.0 rpm  Units: 0.1 rpm	080 121 122	
	Important: Parameters in the Process PI Group are used to enable and tune the PI Loop.  For the PI Loop to control drive operation, set parameter 080 to 2 "Process PI".					
	Process PI		124	[PI Configuration]  Sets configuration of the PI regulator.		124... 138 140... 143 

File C	Group	No.	Parameter Name and Description ⁽¹⁾	Values	Related																																																												
SPEED COMMAND (file C)	Process PI	125	[PI Control] Controls the PI regulator. <div style="text-align: center;"> <p>Bit # Factory Default Bit Values</p> </div> <p>1 = Enabled 0 = Disabled x = Reserved</p>		080 361... 366 																																																												
		126	[PI Reference Sel] Selects the source of the PI reference. (1) Only Enhanced Control Drives.	Default: 0 "PI Setpoint" Options: See Table	124... 138 460 																																																												
		<table border="1"> <thead> <tr> <th>Options</th> <th>P462 [PI Feedback Hi]</th> <th>P463 [PI Feedback Lo]</th> </tr> </thead> <tbody> <tr> <td>0 "Setpoint"</td> <td>+100</td> <td>-100</td> </tr> <tr> <td>1 "Analog In 1"</td> <td>P322 [Analog In1 Hi]</td> <td>P323 [Analog In1 Lo]</td> </tr> <tr> <td>2 "Analog In 2"</td> <td>P325 [Analog In2 Hi]</td> <td>P326 [Analog In2 Lo]</td> </tr> <tr> <td>3...7 "Reserved"</td> <td></td> <td></td> </tr> <tr> <td>8 "Encoder"</td> <td>+P55 [Maximum Freq]</td> <td>-P55 [Maximum Freq]</td> </tr> <tr> <td>9 "MOP Level"</td> <td>+P55 [Maximum Freq]</td> <td>-P55 [Maximum Freq]</td> </tr> <tr> <td>10 "Master Ref"</td> <td>+P55 [Maximum Freq]</td> <td>-P55 [Maximum Freq]</td> </tr> <tr> <td>11...17 "Preset Spd1...7"</td> <td>+P55 [Maximum Freq]</td> <td>-P55 [Maximum Freq]</td> </tr> <tr> <td>18...20 "DPI Port 1...3"</td> <td>+32767</td> <td>-32676</td> </tr> <tr> <td>21 "Reserved"</td> <td></td> <td></td> </tr> <tr> <td>22 "DPI Port 5"</td> <td>+32767</td> <td>-32676</td> </tr> <tr> <td>23, 24 "Reserved"</td> <td></td> <td></td> </tr> <tr> <td>25 "Scale Block1"</td> <td>P477 [Scale1 In Hi]</td> <td>P478 [Scale1 In Lo]</td> </tr> <tr> <td>26 "Scale Block2"</td> <td>P483 [Scale2 In Hi]</td> <td>P484 [Scale2 In Lo]</td> </tr> <tr> <td>27...29 "Reserved"</td> <td></td> <td></td> </tr> <tr> <td>30 "HighRes Ref"⁽¹⁾</td> <td>+32767 x 2¹⁶</td> <td>-32767 x 2¹⁶</td> </tr> <tr> <td>31 "CommandedTrq"⁽²⁾</td> <td>P436 [Pos Torque Limit]</td> <td>P437 [Neg Torque Limit]</td> </tr> <tr> <td>32 "Torque Est"⁽²⁾</td> <td>P436 [Pos Torque Limit]</td> <td>P437 [Neg Torque Limit]</td> </tr> <tr> <td>33 "Torque Amps"⁽²⁾</td> <td>+P28 [Rated Amps]</td> <td>-P28 [Rated Amps]</td> </tr> </tbody> </table>			Options	P462 [PI Feedback Hi]	P463 [PI Feedback Lo]	0 "Setpoint"	+100	-100	1 "Analog In 1"	P322 [Analog In1 Hi]	P323 [Analog In1 Lo]	2 "Analog In 2"	P325 [Analog In2 Hi]	P326 [Analog In2 Lo]	3...7 "Reserved"			8 "Encoder"	+P55 [Maximum Freq]	-P55 [Maximum Freq]	9 "MOP Level"	+P55 [Maximum Freq]	-P55 [Maximum Freq]	10 "Master Ref"	+P55 [Maximum Freq]	-P55 [Maximum Freq]	11...17 "Preset Spd1...7"	+P55 [Maximum Freq]	-P55 [Maximum Freq]	18...20 "DPI Port 1...3"	+32767	-32676	21 "Reserved"			22 "DPI Port 5"	+32767	-32676	23, 24 "Reserved"			25 "Scale Block1"	P477 [Scale1 In Hi]	P478 [Scale1 In Lo]	26 "Scale Block2"	P483 [Scale2 In Hi]	P484 [Scale2 In Lo]	27...29 "Reserved"			30 "HighRes Ref" ⁽¹⁾	+32767 x 2 ¹⁶	-32767 x 2 ¹⁶	31 "CommandedTrq" ⁽²⁾	P436 [Pos Torque Limit]	P437 [Neg Torque Limit]	32 "Torque Est" ⁽²⁾	P436 [Pos Torque Limit]	P437 [Neg Torque Limit]	33 "Torque Amps" ⁽²⁾	+P28 [Rated Amps]	-P28 [Rated Amps]	
		Options	P462 [PI Feedback Hi]	P463 [PI Feedback Lo]																																																													
		0 "Setpoint"	+100	-100																																																													
		1 "Analog In 1"	P322 [Analog In1 Hi]	P323 [Analog In1 Lo]																																																													
		2 "Analog In 2"	P325 [Analog In2 Hi]	P326 [Analog In2 Lo]																																																													
		3...7 "Reserved"																																																															
		8 "Encoder"	+P55 [Maximum Freq]	-P55 [Maximum Freq]																																																													
		9 "MOP Level"	+P55 [Maximum Freq]	-P55 [Maximum Freq]																																																													
10 "Master Ref"	+P55 [Maximum Freq]	-P55 [Maximum Freq]																																																															
11...17 "Preset Spd1...7"	+P55 [Maximum Freq]	-P55 [Maximum Freq]																																																															
18...20 "DPI Port 1...3"	+32767	-32676																																																															
21 "Reserved"																																																																	
22 "DPI Port 5"	+32767	-32676																																																															
23, 24 "Reserved"																																																																	
25 "Scale Block1"	P477 [Scale1 In Hi]	P478 [Scale1 In Lo]																																																															
26 "Scale Block2"	P483 [Scale2 In Hi]	P484 [Scale2 In Lo]																																																															
27...29 "Reserved"																																																																	
30 "HighRes Ref" ⁽¹⁾	+32767 x 2 ¹⁶	-32767 x 2 ¹⁶																																																															
31 "CommandedTrq" ⁽²⁾	P436 [Pos Torque Limit]	P437 [Neg Torque Limit]																																																															
32 "Torque Est" ⁽²⁾	P436 [Pos Torque Limit]	P437 [Neg Torque Limit]																																																															
33 "Torque Amps" ⁽²⁾	+P28 [Rated Amps]	-P28 [Rated Amps]																																																															
127	[PI Setpoint] Provides an internal fixed value for process setpoint when [PI Reference Sel] is set to "PI Setpoint."	Default: 50.00% Min/Max: ±100.00% of Maximum Process Value Units: 0.01%	124... 138																																																														
128	[PI Feedback Sel] Selects the source of the PI reference.	Default: 2 "Analog In 2" Options: See P126 [PI Reference Sel].	124... 138 462 463																																																														
129	[PI Integral Time] Time that is required for the integral component to reach 100% of [PI Error Meter]. Not functional when the PI Hold bit of [PI Control] = "1" (enabled). A value of zero disables this parameter.	Default: 2.00 s Min/Max: 0.00/100.00 s Units: 0.01 s	124... 138																																																														
130	[PI Prop Gain] Sets the value for the PI proportional component. PI Error × PI Prop Gain = PI Output	Default: 1.00 Min/Max: 0.00/100.00 Units: 0.01	124... 138																																																														
131	[PI Lower Limit] Sets the lower limit of the PI output.	Default: -[Maximum Freq] -100% Min/Max: ±400.0 Hz ±800% Units: 0.1 Hz 0.1%	124... 138																																																														



File C	Group	No.	Parameter Name and Description ⁽¹⁾	Values	Related	
SPEED COMMAND (file C)	Process PI	132	[PI Upper Limit] Sets the upper limit of the PI output.	Default: +[Maximum Freq] 100% EC Min/Max: ±400.0 Hz ±800.0% EC Units: 0.1 Hz 0.1% EC	124... 138	
		133	[PI Preload] Sets the value that is used to preload the integral component on start or enable.	Default: 0.0 Hz 100.0% EC Min/Max: [PI Lower Limit]/ [PI Upper Limit] Units: 0.1 Hz 0.1% EC	124... 138	
		134	[PI Status] Status of the Process PI regulator.	Read Only	124... 138	
		<p>Bit #</p> <p>15 14 13 12 11 10 9 8 7 6 5 4 3 2 1 0</p> <p>Nibble 4 Nibble 3 Nibble 2 Nibble 1</p> <p>PI In Limit PI Reset PI Hold PI Enabled</p> <p>1=Condition True 0=Condition False x=Reserved</p>				
		135	[PI Ref Meter] Present value of the PI reference signal.	Default: Read Only Min/Max: ±100.00% Units: 0.01%	124... 138	
		136	[PI Fdback Meter] Present value of the PI feedback signal.	Default: Read Only Min/Max: ±100.00% Units: 0.01%	124... 138	
		137	[PI Error Meter] Present value of the PI error.	Default: Read Only Min/Max: ±100.00% Units: 0.01%	124... 138	
		138	[PI Output Meter] Present value of the PI output.	Default: Read Only Min/Max: ±100.0 Hz ±800.0% EC Units: 0.1 Hz 0.1% EC	124... 138	
	EC v2 [PI BW Filter] Firmware revision 2.001 and later – Provides filter for Process PI error signal. The output of this filter is displayed in [PI Error Meter]. Zero disables the filter.	Default: 0.0 R/s Min/Max: 0.0/240.0 R/s Units: 0.1 R/s	137			
	EC v2 [PI Deriv Time] Refer to formula below: $PI_{Out} = KD (Sec) \times \frac{dPI_{Error} (\%)}{dt (Sec)}$	Default: 0.00 s Min/Max: 0.00/100.00 s Units: 0.01 s				

File C	Group	No.	Parameter Name and Description ⁽¹⁾	Values	Related	
SPEED COMMAND (file C)	Process PI	460	EC [PI Reference Hi] Scales the upper value of [PI Reference Sel] of the source.	Default: 100.0% Min/Max: ±100.0% Units: 0.1%	126	
		461	EC [PI Reference Lo] Scales the lower value of [PI Reference Sel] of the source.	Default: -100.0% Min/Max: ±100.0% Units: 0.1%	126	
		462	EC [PI Feedback Hi] Scales the upper value of [PI Feedback] of the source.	Default: 100.0% Min/Max: ±100.0% Units: 0.1%	128	
		463	EC [PI Feedback Lo] Scales the lower value of [PI Feedback] of the source.	Default: 0.0% Min/Max: ±100.0% Units: 0.1%		
	Speed Regulator	FV	445	EC v2 [Ki Speed Loop] Controls the integral error gain of the speed regulator. The drive automatically adjusts P445 [Ki Speed Loop] when a non-zero value is entered for P449 [Speed Desired BW] or an autotune is performed. Typically, manual adjustment of this parameter is needed only if system inertia cannot be determined through an autotune. P449 [Speed Desired BW] is set to "0" when a manual adjustment is made to this parameter.	Default: 7.8 Min/Max: 0.0/4000.0 Units: 0.1	053 449 450
			446	EC v2 [Kp Speed Loop] Controls the proportional error gain of the speed regulator. The drive automatically adjusts P446 [Kp Speed Loop] when a non-zero value is entered for P449 [Speed Desired BW] or an auto-tune is performed. Typically, manual adjustment of this parameter is needed only if system inertia cannot be determined through an autotune. P449 [Speed Desired BW] is set to "0" when a manual adjustment is made to this parameter.	Default: 6.3 Min/Max: 0.0/200.0 Units: 0.1	053 449 450
			447	EC v2 [Kf Speed Loop] Controls the feed forward gain of the speed regulator. Setting the Kf gain greater than zero reduces speed feedback overshoot in response to a step change in speed reference.	Default: 0.0 Min/Max: 0.0/0.5 Units: 0.1	053
			448	EC v3 [Spd Err Filt BW] Sets the bandwidth of a speed error filter that is used in FVC Vector mode. A setting of 0.0 disables the filter.	Default: 200.0 R/s Min/Max: 0.0/2000.0 R/s Units: 0.1 R/s	053



File C	Group	No.	Parameter Name and Description ⁽¹⁾	Values	Related
SPEED COMMAND (file C)	Speed Regulator	449	EC v2 [Speed Desired BW] Sets the speed loop bandwidth and determines the dynamic behavior of the speed loop. As bandwidth increases, the speed loop becomes more responsive and can track a faster changing speed reference. Adjusting this parameter causes the drive to calculate and change P445 [Ki Speed Loop] and P446 [Kp Speed Loop] gains.	Default: 0.0 Radians/Sec Min/Max: 0.0/250.0 Radians/Sec Units: 0.1 Radians/Sec	053 067 445 446
		450	EC v2 [Total Inertia] Represents the time in seconds, for a motor that is coupled to a load to accelerate from zero to base speed, at rated motor torque. The drive calculates Total Inertia during the autotune inertia procedure. Adjusting this parameter causes the drive to calculate and change P445 [Ki Speed Loop] and P446 [Kp Speed Loop] gains.	Default: 0.10 s Min/Max: 0.01/600.0 s Units: 0.01 s	053 067 445 446 449
		451	EC v2 [Speed Loop Meter] Value of the speed regulator output. When in FVC mode, units are in percent.	Default: Read Only Min/Max: ±800.0%/Hz Units: 0.1%/Hz	053 121



(1) See [page 13](#) for Symbol Descriptions.



Dynamic Control File (File D)

File D	Group	No.	Parameter Name and Description ⁽¹⁾	Values	Related
DYNAMIC CONTROL (file D)	Ramp Rates	140	[Accel Time 1]	Default: 10.0 s	142
		141	[Accel Time 2] Sets the rate of accel for all speed increases. $\frac{\text{Max Speed}}{\text{Accel Time}} = \text{Accel Rate}$	10.0 s Min/Max: 0.0/3600.0 s Units: 0.1 s	143 146 361... 366
		142	[Decel Time 1]	Default: 10.0 s	140
		143	[Decel Time 2] Sets the rate of decel for all speed decreases. $\frac{\text{Max Speed}}{\text{Decel Time}} = \text{Decel Rate}$	10.0 s Min/Max: 0.0/3600.0 s Units: 0.1 s	141 146 361... 366
		146	[S Curve %] Sets the percentage of accel or decel time that is applied to the ramp as S Curve. Time is added, 1/2 at the beginning and 1/2 at the end of the ramp.	Default: 0.0% Min/Max: 0.0/100.0% Units: 0.1%	056 140... 143
		Load Limits	147	[Current Lmt Sel]  Selects the source for the adjustment of current limit (for example, parameter, analog input, and so on).	Default: 0 "Cur Lim Val" Options: 0 "Cur Lim Val" 1 "Analog In 1" 2 "Analog In 2"
	148		[Current Lmt Val] Defines the current limit value when [Current Lmt Sel] = "Cur Lim Val."	Default: [Rated Amps] × 1.5 (Equation approximates default value.) Min/Max: Drive Rating Based Units: 0.1 Amps	028 147 149
	149		[Current Lmt Gain] Sets the responsiveness of the current limit.	Default: 250 Min/Max: 0/5000 Units: 1	147 148
	150		[Drive OL Mode] Selects the drive's response to increasing drive temperature.	Default: 3 "Both—PWM 1st" Options: 0 "Disabled" 1 "Reduce CLim" 2 "Reduce PWM" 3 "Both—PWM 1st"	219
	151		[PWM Frequency] Sets the carrier frequency for the PWM output. Drive derating can occur at higher carrier frequencies. For derating information, refer to the PowerFlex Reference Manual, publication PFLEX-RM001 .	Default: 4 kHz Min/Max: 2, 3, 4, 5, 6, 7, 8, 9, 10 kHz 2, 4, 8, 12 kHz ⁽¹⁾  Units: 1 kHz ⁽¹⁾ Only Frames A...D.	



File D	Group	No.	Parameter Name and Description ⁽¹⁾	Values	Related
DYNAMIC CONTROL (file D)	Load Limits	152	EC v2 [Droop RPM @ FLA] Selects amount of droop that the speed reference is reduced when at full load torque. Zero disables the droop function. Setting parameter 080 to 0 is recommended when you are using the Droop function.	Default: 0.0 rpm Min/Max: 0.0/200.0 rpm Units: 0.1 rpm	
		153	EC v2 [Regen Power Lim] FV Sets the maximum power limit transfer from the motor to the DC bus. When you are using an external dynamic brake, set this parameter to its minimum (-800.0%) value. Overvoltage trips can occur if set too negative and the connected brake is unable to dissipate the energy.	Default: -50.0% Min/Max: -800.0/0.0% Units: 0.1%	053 161 162 163
		154	EC v2 [Current Rate Lim] FV Sets the largest rate of change for the current reference signal. This number is scaled in percent of maximum motor current every 250 microseconds.	Default: 400.0% Min/Max: 1.0/800.0% Units: 0.1%	053
		189	EC [Shear Pin Time] Sets the time that the drive is at or above current limit before a fault occurs. Zero disables this feature.	Default: 0.0 s Min/Max: 0.0/30.0 s Units: 0.1 s	
	145	EC [DB While Stopped] Enables/disables dynamic brake operation. Disabled = DB operates only when the drive is running. Enable = DB operates whenever the drive is energized.	Default: 0 "Disabled" Options: 0 "Disabled" 1 "Enabled"		
	155	Standard [Stop Mode A]	Default: 1 "Ramp"	157	
	156	Standard [Stop Mode B] Active stop mode. [Stop Mode A] is active unless [Stop Mode B] is selected by digital inputs that are programmed for "Stop Mode B." ⁽¹⁾ When you are using options 1 or 2, refer to the Attention statements at [DC Brake Level].	Default: 0 "Coast" Options: 0 "Coast" 1 "Ramp" ⁽¹⁾ 2 "Ramp to Hold" ⁽¹⁾ 3 "DC Brake"	158 159 161 163 168 361... 366	
		EC v2 [Stop/Brk Mode A] EC v2 [Stop/Brk Mode B] See description above.	Default: 1 "Ramp" Default: 0 "Coast" Options: 0 "Coast" 1 "Ramp" ⁽¹⁾ 2 "Ramp to Hold" ⁽¹⁾ 3 "DC Brake" 4 "Fast Brake" EC v3	361... 366 ?	

File D	Group	No.	Parameter Name and Description ⁽¹⁾	Values	Related	
DYNAMIC CONTROL (file D)	Stop/Brake Modes	157	[DC Brake Lvl Sel] Selects the source for [DC Brake Level].	Default: 0 "DC Brake Lvl" Options: 0 "DC Brake Lvl" 1 "Analog In 1" 2 "Analog In 2"	155 156 158 159	
		158	[DC Brake Level] Defines the DC brake current level that is injected into the motor when "DC Brake" is selected as a stop mode. The DC braking voltage that is used in this function is created by a PWM algorithm and can fail to generate the smooth holding force that is needed for some applications. Refer to the PowerFlex 70 and 700 Adjustable Frequency AC Drive Reference Manual, publication PFLEX-RM001 . Important: Frame E drives can be limited to less than 150% depending on the setting of parameter 151 [PWM Frequency].	Default: [Rated Amps] Min/Max: 0/[Rated Amps] × 1.5 (Equation yields approximate maximum value.) 0.1 Amps Units:	155 156 157	
		 ATTENTION: If a hazard of injury due to movement of equipment or material exists, an auxiliary mechanical braking device must be used.				
		ATTENTION: Do not use this feature with synchronous or permanent magnet motors. Motors can be demagnetized during braking.				
		159	[DC Brake Time] Sets the amount of time DC brake current is "injected" into the motor.	Default: 0.0 s Min/Max: 0.0/90.0 s Units: 0.1 s	155... 158 	
		160	Standard [Bus Reg Gain] E C [Bus Reg Ki] Sets the responsiveness of the bus regulator.	Default: 450 Min/Max: 0/5000 Units: 1	161 162	

File D	Group	No.	Parameter Name and Description ⁽¹⁾	Values	Related
DYNAMIC CONTROL (file D)	Stop/Brake Modes	161	[Bus Reg Mode A]	Default: 1 "Adjust Freq"	155
		162	[Bus Reg Mode B]	Default: 4 "Both-Frq 1st"	156
			Active bus regulation mode. Choices are dynamic brake, frequency adjust or both. Sequence is determined by programmed value or digital input that is programmed for "Bus Reg Md B." <u>Dynamic Brake Setup</u> If a dynamic brake resistor is connected to the drive, both these parameters must be set to either option 2, 3 or 4. Refer to the Attention statement on page 9 for important information on bus regulation.	Options: 0 "Disabled" 1 "Adjust Freq" 2 "Dynamic Brak" 3 "Both-DB 1st" 4 "Both-Frq 1st"	160 163 361... 366
			ATTENTION: The drive does not offer protection for externally mounted brake resistors. A risk of fire exists if external braking resistors are not protected. External resistor packages must be self-protected. from over temperature or the protective circuit that is shown in Figure 1 on page 100 (or equivalent) must be supplied.		
		163	[DB Resistor Type]	Default: 0 "Internal Res" 2 "None" EC	161 162 166
			Selects whether the internal or an external DB resistor used. If a dynamic brake resistor is connected to the drive, P161/162 [Bus Reg Mode x], A, B or Both (if used), must be set to either option 2, 3 or 4.	Options: 0 "Internal Res" 1 "External Res" 2 "None"	
				ATTENTION: The drive does not offer protection for externally mounted brake resistors. A risk of fire exists if external braking resistors are not protected. External resistor packages must be self-protected from over temperature or the protective circuit that is shown in Figure 1 on page 100 , or equivalent, must be supplied.	
			ATTENTION: Equipment damage can result if a drive mounted (internal) resistor is installed and this parameter is set to "External Res." Thermal protection for the internal resistor is disabled, resulting in possible device damage.		
		164	EC [Bus Reg Kp]	Default: 1500 Min/Max: 0/10000 Units: 1	
		165	EC [Bus Reg Kd]	Default: 1000 Min/Max: 0/10000 Units: 1	

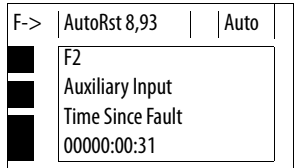
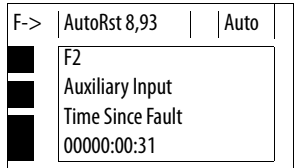
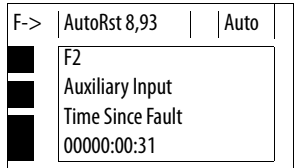
File D	Group	No.	Parameter Name and Description ⁽¹⁾	Values	Related
DYNAMIC CONTROL (file D)	Stop/Brake Modes	166	<p>EC v2 [Flux Braking]</p> <p>Set to use an increase in the motor flux current to increase the motor losses, and enables a faster deceleration time when a chopper brake or regenerative capability is not available. Can be used as a stopping or fast deceleration method.</p> <p>For more information about applying this mode of operation, see Stop Modes on page 103.</p>	<p>Default: 0 "Disabled"</p> <p>Options: 0 "Disabled" 1 "Enabled"</p>	
		167	<p>EC [Powerup Delay]</p> <p>Defines the programmed delay time, in seconds, before a start command is accepted after a powerup.</p>	<p>Default: 0.0 s</p> <p>Min/Max: 0.0/30.0 s</p> <p>Units: 0.1 s</p>	
	Restart Modes	168	<p>[Start At Powerup]</p> <p>Enables/disables a feature to issue a Start or Run command and automatically resume running at commanded speed after drive input power is restored. Requires a digital input that is configured for Run or Start and a valid start contact.</p>	<p>Default: 0 "Disabled"</p> <p>Options: 0 "Disabled" 1 "Enabled"</p>	<p>167</p> <p>169</p> <p>174</p> <p>361...</p> <p>366</p> <p></p>
			<p> ATTENTION: Equipment damage and/or personal injury can result if this parameter is used in an inappropriate application. Do not use this function without considering applicable local, national, and international codes, standards, regulations or industry guidelines.</p>		

File D	Group	No.	Parameter Name and Description ⁽¹⁾	Values	Related				
DYNAMIC CONTROL (file D)	Restart Modes	169	[Flying Start En] Enables/disables the function that reconnects to a spinning motor at actual rpm when a start command is issued.	Default: 0 "Disabled" Options: 0 "Disabled" 1 "Enabled"	170				
		170	[Flying StartGain] Sets the response of the flying start function.	Default: 4000 Min/Max: 20/32767 Units: 1	169				
		174	[Auto Rstrt Tries] Sets the maximum number of times the drive attempts to reset a fault and restart. Refer to the PowerFlex Reference Manual, publication PFLEX-RM004 for additional information.	Default: 0 Min/Max: 0/9 Units: 1	175				
		 ATTENTION: Equipment damage and/or personal injury can result if this parameter is used in an inappropriate application. Do not use this function without considering applicable local, national, and international codes, standards, regulations or industry guidelines.							
		175	[Auto Rstrt Delay] Sets the time between restart attempts when [Auto Rstrt Tries] is set to a value other than zero. The HIM display shows AutoRst X,YY during the restart delay. Where X is the number of restarts that are left and YY is the time that is left before restart. For delay times of 99 seconds or less, YY displays the seconds remaining before restart. For delay times greater than 99 seconds, YY changes to the percent of delay time remaining before restart.	Default: 1.0 s Min/Max: 0.5/6000.0 s Units: 0.1 s	174				
			<table border="1" style="width: 100%;"> <thead> <tr> <th style="width: 50%;">Description</th> <th style="width: 50%;">Example Screen</th> </tr> </thead> <tbody> <tr> <td> Restarts Remaining = 8 Delay Time = 93 seconds </td> <td>  </td> </tr> </tbody> </table>	Description	Example Screen	Restarts Remaining = 8 Delay Time = 93 seconds			
Description	Example Screen								
Restarts Remaining = 8 Delay Time = 93 seconds									

File D	Group	No.	Parameter Name and Description ⁽¹⁾	Values	Related														
DYNAMIC CONTROL (file D)	Restart Modes	178	<p>EC v2 [Sleep Wake Mode]</p> <p>Enables/disables the Sleep/Wake function. Important: When enabled, the following conditions must be met:</p> <ul style="list-style-type: none"> A proper value must be programmed for [Sleep Level] and [Wake Level]. A speed reference must be selected in [Speed Ref A Sel]. At least one of the following must be programmed (and input closed) in [Digital Inx Sel]; "Enable," "Stop=CF," "Run," "Run Forward," "Run Reverse." 	<p>Default: 0 "Disabled"</p> <p>Options: 0 "Disabled" 1 "Direct" (Enabled) 2 "Invert" (Enabled)⁽⁷⁾</p>	<p>179... 183</p> <p></p>														
		<p> ATTENTION: Enabling the Sleep-Wake function can cause unexpected machine operation during the Wake mode. Equipment damage and/or personal injury can result if this parameter is used in an inappropriate application. Do Not use this function without considering the information below and in Appendix C. In addition, all applicable local, national and international codes, standards, regulations or industry guidelines must be considered.</p>																	
<p>Conditions Required to Start Drive⁽¹⁾⁽²⁾⁽³⁾</p> <table border="1"> <thead> <tr> <th rowspan="2">Input</th> <th>After Powerup</th> <th colspan="2">After a Drive Fault</th> <th>After a Stop Command</th> </tr> <tr> <td></td> <td>Reset by Stop-CF, HIM or TB</td> <td>Reset by Clear Faults (TB)</td> <td>HIM or TB</td> </tr> </thead> <tbody> <tr> <td>Stop</td> <td>Stop Closed Wake Signal</td> <td>Stop Closed Wake Signal New Start or Run Cmd.⁽⁴⁾</td> <td>Stop Closed Wake Signal</td> <td>Stop Closed <u>Direct Mode</u> Analog Sig. > Sleep Level⁽⁶⁾ <u>Invert Mode</u> Analog Sig. < Sleep Level⁽⁶⁾ New Start or Run Cmd.⁽⁴⁾</td> </tr> </tbody> </table>						Input	After Powerup	After a Drive Fault		After a Stop Command		Reset by Stop-CF, HIM or TB	Reset by Clear Faults (TB)	HIM or TB	Stop	Stop Closed Wake Signal	Stop Closed Wake Signal New Start or Run Cmd. ⁽⁴⁾	Stop Closed Wake Signal	Stop Closed <u>Direct Mode</u> Analog Sig. > Sleep Level ⁽⁶⁾ <u>Invert Mode</u> Analog Sig. < Sleep Level ⁽⁶⁾ New Start or Run Cmd. ⁽⁴⁾
Input	After Powerup	After a Drive Fault		After a Stop Command															
		Reset by Stop-CF, HIM or TB	Reset by Clear Faults (TB)	HIM or TB															
Stop	Stop Closed Wake Signal	Stop Closed Wake Signal New Start or Run Cmd. ⁽⁴⁾	Stop Closed Wake Signal	Stop Closed <u>Direct Mode</u> Analog Sig. > Sleep Level ⁽⁶⁾ <u>Invert Mode</u> Analog Sig. < Sleep Level ⁽⁶⁾ New Start or Run Cmd. ⁽⁴⁾															
<p>⁽¹⁾ When power is cycled, if all of the above conditions are present after power is restored, a restart occurs.</p> <p>⁽²⁾ If all of the above conditions are present when [Sleep-Wake Mode] is "enabled," the drive starts.</p> <p>⁽³⁾ The active speed reference is determined as explained in Speed Reference Control on page 110. The Sleep/Wake function and the speed reference can be assigned to the same input.</p> <p>⁽⁴⁾ Command must be issued from HIM, TB, or network.</p> <p>⁽⁵⁾ Run Command must be cycled.</p> <p>⁽⁶⁾ Signal does not need to be greater than wake level.</p> <p>⁽⁷⁾ Enhanced firmware revision 2.001 and later. For Invert function, refer to [Analog In x Loss].</p>																			



File D	Group	No.	Parameter Name and Description ⁽¹⁾	Values	Related	
DYNAMIC CONTROL (file D)	Restart Modes	179	EC v2 [Sleep Wake Ref] Selects the source of the input controlling the Sleep-Wake function.	Default: 2 "Analog In 2" Options: 1 "Analog In 1" 2 "Analog In 2"	178 180 183 320... 327	
		180	EC v2 [Wake Level] Defines the analog input level that starts the drive.	Default: 6.000 mA, 6.000 Volts Min/Max: [Sleep Level]/20.000 mA [Sleep Level]/10.000 Volts Units: 0.001 mA 0.001 Volts	178 179 181 183	
		181	EC v2 [Wake Time] Defines the amount of time at or above [Wake Level] before a Start is issued.	Default: 1.0 s Min/Max: 0.0/1000.0 s Units: 0.1 s	178 180	
		182	EC v2 [Sleep Level] Defines the analog input level that stops the drive.	Default: 5.000 mA, 5.000 Volts Min/Max: 4.000 mA/[Wake Level] 0.000 Volts/[Wake Level] Units: 0.001 mA 0.001 Volts	178 180 183	
		183	EC v2 [Sleep Time] Defines the amount of time at or below [Sleep Level] before a Stop is issued.	Default: 1.0 s Min/Max: 0.0/1000.0 s Units: 0.1 s	182	
			177	EC v2 [Gnd Warn Level] Sets the level where a ground warning fault occurs. Configure with [Alarm Config 1].	Default: 3.0 Amps Min/Max: 1.0/5.0 Amps Units: 0.1 Amps	259
	Power Loss		184	[Power Loss Mode] Sets the reaction to a loss of input power. Power loss is recognized when: • DC bus voltage is ≤ 73% of [DC Bus Memory] and [Power Loss Mode] is set to "Coast". • DC bus voltage is ≤ 82% of [DC Bus Memory] and [Power Loss Mode] is set to "Decel". "Coast" = Disable drive and enable the motor to coast. "Decel" = Decelerate the motor at a rate that regulates the DC Bus until the load's Kinetic Energy can no longer power the drive. "Continue" = Enable the drive to power the motor down to 50% of the nominal DC Bus voltage. Refer to the PowerFlex 70EC/700VC Reference Manual, publication PFLEX-RM004 , for additional information.  ATTENTION: To guard against drive damage, a minimum line impedance must be provided to limit inrush current when the power line recovers. Provide an input impedance equal or greater than the equivalent of a 5% transformer with a VA rating 6 times the drive's input VA rating.	Default: 0 "Coast" Options: 0 "Coast" 1 "Decel" 2 "Continue" EC 3 "Reserved" 4 "Reserved" 5 "Decel 2 Stop" EC v4	013 185 361... 366
			185	[Power Loss Time] Sets the time that the drive remains in power loss mode before a fault is issued.	Default: 0.5 s Min/Max: 0.0/60.0 s Units: 0.1 s	184
			187	EC v2 [Load Loss Level] Sets the percentage of motor nameplate torque where a load loss alarm occurs.	Default: 200.0% Min/Max: 0.0/800.0% Units: 0.1%	211 259
			188	EC v2 [Load Loss Time] Sets the time that current is below the level set in [Load Loss Level] before a fault occurs.	Default: 0.0 s Min/Max: 0.0/300.0 s Units: 0.1 s	187

(1) See [page 13](#) for Symbol Descriptions.

Utility File (File E)

File E	Group	No.	Parameter Name and Description ⁽¹⁾	Values	Related								
UTILITY (file E)	Direction Config	190	<p>[Direction Mode]</p> <p>Selects the method for changing drive direction.</p> <table border="1"> <thead> <tr> <th>Mode</th> <th>Direction Change</th> </tr> </thead> <tbody> <tr> <td>Unipolar</td> <td>Drive Logic</td> </tr> <tr> <td>Bipolar</td> <td>Sign of Reference</td> </tr> <tr> <td>Reverse Dis</td> <td>Not Changeable</td> </tr> </tbody> </table>	Mode	Direction Change	Unipolar	Drive Logic	Bipolar	Sign of Reference	Reverse Dis	Not Changeable	Default: 0 "Unipolar" Options: 0 "Unipolar" 1 "Bipolar" 2 "Reverse Dis"	320... 327 361... 366
		Mode	Direction Change										
		Unipolar	Drive Logic										
Bipolar	Sign of Reference												
Reverse Dis	Not Changeable												
192	<p>Standard [Save HIM Ref]</p> <p>Enables a feature to save the present frequency reference value that is issued by the HIM to Drive memory on power loss. Value is restored to the HIM on powerup.</p> <p>Bit # Factory Default Bit Values</p> <p>1 = Save at Power Down 0 = Do Not Save x = Reserved</p>												
193	<p>EC [AutoMan Cnfg]</p> <p>Enables HIM to control only the Speed Reference, or Reference, Start, and Jog in Manual mode including two-wire control. Also enables a feature to save the preset frequency reference value that is issued by the HIM to drive memory on power loss. Value is restored to the HIM on powerup.</p> <p>Bit # Factory Default Bit Values</p> <p>Manual Mode 1 = HIM has exclusive Start & Jog control in Manual mode. 0 = Disabled</p> <p>HIM Disable 1 = HIM does not start drive. 0 = HIM starts drive x = Reserved</p> <p>Save HIM Ref 1 = Saves HIM reference, Reloads HIM reference at power-up. 0 = Disabled</p> <p>ManRefPld 1 = Preloads auto reference into HIM upon Auto to Manual transition. 0 = Disabled</p>												
		193	<p>Standard [Man Ref Preload]</p> <p>Enables/disables a feature to automatically load the present "Auto" frequency reference value into the HIM when "Manual" is selected. Enables smooth speed transition from "Auto" to "Manual."</p>	Default: 0 "Disabled" Options: 0 "Disabled" 1 "Enabled"									

File E	Group	No.	Parameter Name and Description ⁽¹⁾	Values	Related
UTILITY (file E)	MOP Config	194	<p>[Save MOP Ref] Enables/disables the feature that saves the present MOP frequency reference at power down or at stop.</p> <p>Factory Default Bit Values</p>		090 093 096 361... 366
		195	<p>[MOP Rate] Sets rate of change of the MOP reference in response to a digital input.</p>	Default: 1.0 Hz/s Min/Max: 0.2/[Maximum Freq] Units: 0.1 Hz/s	090 093 096 361... 366
	196	<p>[Param Access Lvl] Selects the parameter display level viewable on the HIM. Basic = Reduced param. set Advanced = Full param. set Reserved = Full param. set and Engineering params.</p>	Default: 0 "Basic" Options: 0 "Basic" 1 "Advanced" 2 "Reserved" EC		
	197	<p>[Reset To Defaults] Resets all parameter values (except parameters 196, 201, and 202) to defaults. Option 1 resets drive to factory settings. Options 2 and 3 reset the drive to alternate voltage and current rating.</p>	Default: 0 "Ready" Options: 0 "Ready" 1 "Factory" 2 "Low Voltage" 3 "High Voltage"		
	198	<p>[Load Frm Usr Set] Loads a previously saved set of parameter values from a selected user set location in drive nonvolatile memory to active drive memory.</p>	Default: 0 "Ready" Options: 0 "Ready" 1 "User Set 1" 2 "User Set 2" 3 "User Set 3"	199	
	199	<p>[Save To User Set] Saves the parameter values in active drive memory to a user set in drive nonvolatile memory. To maintain control consistency when you are using the drive inputs (P361...P366), verify that the input settings are identical in each of the user sets.</p>	Default: 0 "Ready" Options: 0 "Ready" 1 "User Set 1" 2 "User Set 2" 3 "User Set 3"	198 361... 366	
	200	<p>[Reset Meters] Resets selected meters to zero.</p>	Default: 0 "Ready" Options: 0 "Ready" 1 "MWh" 2 "Elapsed Time"		

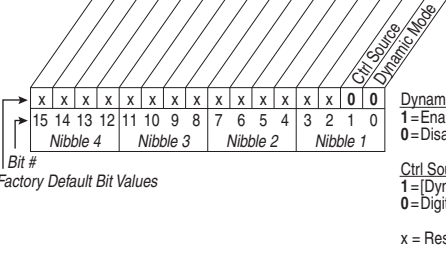
File E	Group	No.	Parameter Name and Description ⁽¹⁾	Values	Related
UTILITY (file E)	Drive Memory	201	[Language] Selects the display language when you are using an LCD HIM. This parameter is not functional with an LED HIM.	Default: 0 "Not Selected" Options: 0 "Not Selected" 1 "English" 2 "Français" 3 "Español" 4 "Italiano" 5 "Deutsch" 6 "Reserved" 7 "Portugués" 8,9 "Reserved" 10 "Nederlands"	
		202	 [Voltage Class] Configures the drive current rating and associates it with the selected voltage (for example, 400V or 480V). This parameter is normally used when downloading parameter sets.	Default: Based on Drive Cat. No. Options: 2 "Low Voltage" 3 "High Voltage"	
		203	[Drive Checksum] Provides a checksum value that indicates if a change in drive programming has occurred.	Default: Read Only Min/Max: 0/65535 Units: 1	
		204	E C v2 [Dyn UsrSet Cnfg] Enables/Disables dynamic selection of user parameter sets. Important: In dynamic mode, changes to the parameters are not saved to nonvolatile storage. Switching user sets restores the values last saved before enabling dynamic mode.	 <p>Dynamic Mode (Digital Inputs) 1 = Enabled 0 = Disabled</p> <p>Ctrl Source (Comms) 1 = [Dyn UsrSet Sel] 0 = Digital Inputs</p> <p>x = Reserved</p>	198 199 361... 366
		205	E C v2 [Dyn UsrSet Sel] Selects user set if [Dyn UsrSet Cnfg] = xxx xx11.	 <p>1 = Enabled 0 = Disabled x = Reserved</p> <p>0 0 User Set 1 0 1 User Set 2 1 0 User Set 3 1 1 User Set 3</p>	204

File E	Group	No.	Parameter Name and Description ⁽¹⁾	Values	Related
UTILITY (file E)	Drive Memory	206	EC v2 [Dyn UserSet Actv] Indicates the active user set and if the operation is dynamic or normal.	Read Only 	198 199 361... 366
		209	[Drive Status 1] Present operating condition of the drive.	Read Only 	210 213
		210	[Drive Status 2] Present operating condition of the drive.	Read Only 	209

Bits ⁽²⁾				Description			Bits ⁽¹⁾			Description		
15	14	13	12				11	10	9			
0	0	0	0	Ref A Auto			0	0	0	Port 0 (TB)		
0	0	0	1	Ref B Auto			0	0	1	Port 1		
0	0	1	0	Preset 2 Auto			0	1	0	Port 2		
0	0	1	1	Preset 3 Auto			0	1	1	Port 3		
0	1	0	0	Preset 4 Auto			1	0	0	Port 4		
0	1	0	1	Preset 5 Auto			1	0	1	Port 5		
0	1	1	0	Preset 6 Auto			1	1	0	Port 6		
0	1	1	1	Preset 7 Auto			1	1	1	No Local Control		
1	0	0	0	TB Manual								
1	0	0	1	Port 1 Manual								
1	0	1	0	Port 2 Manual								
1	0	1	1	Port 3 Manual								
1	1	0	0	Port 4 Manual								
1	1	0	1	Port 5 Manual								
1	1	1	0	Port 6 Manual								
1	1	1	1	Jog Ref								

File E	Group	No.	Parameter Name and Description ⁽¹⁾	Values	Related
UTILITY (file E)	Diagnostics	211	<p>[Drive Alarm 1]</p> <p>Alarm conditions that currently exist in the drive. See Chapter 2 for information on Type 1 alarms.</p> <p>Bit #</p> <p>⁽¹⁾ Enhanced firmware 1.001 & later. ⁽²⁾ Enhanced firmware 2.001 & later.</p>	Read Only	212
		212	<p>[Drive Alarm 2]</p> <p>Alarm conditions that currently exist in the drive. See Chapter 2 for information on Type 2 alarms.</p> <p>Bit #</p> <p>⁽¹⁾ Enhanced firmware 1.001 & later. ⁽²⁾ Enhanced firmware 2.001 & later.</p>	Read Only	211

File E	Group	No.	Parameter Name and Description ⁽¹⁾	Values	Related
UTILITY (file E)	Diagnostics	213	<p>[Speed Ref Source]</p> <p>Displays the source of the speed reference to the drive.</p> <p>⁽¹⁾ Displays after Start is pressed.</p> <p>⁽²⁾ Only Enhanced Control Drives.</p>	Default: Read Only Options: <ul style="list-style-type: none"> 0 "PI Output"⁽¹⁾ 1 "Analog In 1" 2 "Analog In 2" 3...7 "Reserved" 8 "Encoder" 9 "MOP Level" 10 "Reserved" 11 "Preset Spd1" 12 "Preset Spd2" 13 "Preset Spd3" 14 "Preset Spd4" 15 "Preset Spd5" 16 "Preset Spd6" 17 "Preset Spd7" 18 "DPI Port 1" 19 "DPI Port 2" 20 "DPI Port 3" 21 "Reserved" 22 "DPI Port 5" 23,24 "Reserved" 25 "Scale Block1" 26 "Scale Block2" 27...2 "Reserved" 9 "HighRes Ref"⁽²⁾ 30 	002 090 093 096 101
		214	<p>[Start Inhibits]</p> <p>Displays the inputs currently preventing the drive from starting.</p> <div style="text-align: center;"> <p>Bit # 15 14 13 12 11 10 9 8 7 6 5 4 3 2 1 0</p> <p> x x 0 x 0 0 0 0 0 0 0 0 0 0 1 0</p> <p> Nibble 4 Nibble 3 Nibble 2 Nibble 1</p> <p> (1) Enhanced firmware 3.002 & later.</p> </div> <p>1 = Inhibit True 0 = Inhibit False x = Reserved</p>	Read Only	243 361... 366
		215	<p>[Last Stop Source]</p> <p>Displays the source that initiated the most recent stop sequence. The display is cleared (set to 0) during the next start sequence.</p>	Default: Read Only Options: <ul style="list-style-type: none"> 0 "Pwr Removed" 1 "DPI Port 1" 2 "DPI Port 2" 3 "DPI Port 3" 4 "Reserved" 5 "DPI Port 5" 6 "Reserved" 7 "Digital In" 8 "Fault" 9 "Not Enabled" 10 "Sleep" 11 "Jog" 12 "Autotune" EC 13 "Precharge" EC 14 "Safe Off" EC v3 	361... 366

File E	Group	No.	Parameter Name and Description ⁽¹⁾	Values	Related
UTILITY (file E)	Diagnostics	216	[Dig In Status] Status of the digital inputs. <p style="text-align: right;">1 = Input Present 0 = Input Not Present x = Reserved</p> <p style="text-align: center;">⁽¹⁾ Enhanced firmware 2.001 & later.</p>	Read Only	361... 366 411
		217	[Dig Out Status] Status of the digital outputs. <p style="text-align: right;">1 = Output Energized 0 = Output De-energized x = Reserved</p>	Read Only	380... 384
		218	[Drive Temp] Present operating temperature of the drive power section. For heatsink temperature, refer to P234 [Testpoint 1 Sel].	Default: Read Only Min/Max: ±100 degC Units: 1.0 degC	
		219	[Drive OL Count] Accumulated percentage of drive overload. Continuously operating the drive over 100% of its rating increases this value to 100% and cause a drive fault or foldback depending on the setting of [Drive OL Mode].	Default: Read Only Min/Max: 0.0/100.0% Units: 0.1%	150
		220	[Motor OL Count] Accumulated percentage of motor overload. Continuously operating the motor over 100% of the motor overload setting increases this value to 100% and cause a drive fault.	Default: Read Only Min/Max: 0.0/100.0% Units: 0.1%	047 048
		221	E C v3 [Mtr OL Trip Time] Amount of time before a drive Overload fault(f64) occurs if the load condition remains constant. A value of 99999 means that the drive is operating under the overload level.	Default: Read Only Min/Max: 0/99999 Units: 1	220

File E	Group	No.	Parameter Name and Description ⁽¹⁾	Values	Related	
UTILITY (file E)	Diagnostics	222	EC v3 [Drive Status 3] Present operating condition of the drive. Manual Mode - See “Manual” Speed Sources on page 111 . Fast Braking - Fast Braking is active, see [Stop/Brk Mode A] [Stop/Brk Mode B] on page 41 .	Read Only		
		<p>Bit # Factory Default Bit Values</p> <p>1=Condition True 0=Condition False x=Reserved</p>				
		223	EC v3 [Status 3 @ Fault] Captures and displays [Drive Status 3] bit pattern at the time of the last fault.	Read Only		
		<p>Bit # Factory Default Bit Values</p> <p>1=Condition True 0=Condition False x=Reserved</p>				
		224	[Fault Frequency] Captures and displays the output speed of the drive at the time of the last fault.	Default: Read Only Min/Max: 0.0/+[Maximum Freq] Units: 0.1 Hz	225... 230	
		225	[Fault Amps] Captures and displays motor amps at the time of the last fault.	Default: Read Only Min/Max: 0.0/[Rated Amps] × 2 Units: 0.1 Amps	224... 230	
226	[Fault Bus Volts] Captures and displays the DC bus voltage of the drive at the time of the last fault.	Default: Read Only Min/Max: 0.0/Max Bus Volts Units: 0.1V DC	224... 230			
227	[Status 1 @ Fault] Captures and displays [Drive Status 1] bit pattern at the time of the last fault.	Read Only	209 224... 230			
<p>Bit #</p> <p>1=Condition True 0=Condition False x=Reserved</p>						

File E	Group	No.	Parameter Name and Description ⁽¹⁾	Values	Related
UTILITY (file E)	Diagnostics	228	[Status 2 @ Fault] Captures and displays [Drive Status 2] bit pattern at the time of the last fault.	Read Only 	210 224... 230
		229	[Alarm 1 @ Fault] Captures and displays [Drive Alarm 1] at the time of the last fault.	Read Only 	211 224... 230
		230	[Alarm 2 @ Fault] Captures and displays [Drive Alarm 2] at the time of the last fault.	Read Only 	212 224... 230

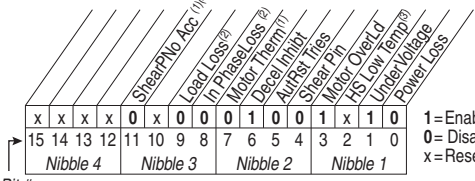
File E	Group	No.	Parameter Name and Description ⁽¹⁾	Values	Related	
UTILITY (file E)	Diagnostics	234	[Testpoint 1 Sel]	Default: 499	235	
		236	[Testpoint 2 Sel] Selects the function whose value is displayed value in [Testpoint x Data]. These are internal values that are not accessible through parameters. See Testpoint Codes and Functions on page 85 for a listing of available codes and functions.	Min/Max: 0/999 0/65535 EC Units: 1	237	
	EC	235	[Testpoint 1 Data]	Default: Read Only	234	
		237	[Testpoint 2 Data] The present value of the function that is selected in [Testpoint x Sel].	Min/Max: 0/65535 ±2147483647 EC Units: 1	236	
	Faults		238	[Fault Config 1] Enables/disables annunciation of the listed faults. 		189
			240	[Fault Clear] Resets a fault and clears the fault queue.	Default: 0 "Ready" Options: 0 "Ready" 1 "Clear Faults" 2 "Clr Flt Que"	
			241	[Fault Clear Mode] Enables/disables a fault reset (clear faults) attempt from any source. This does not apply to fault codes that are cleared indirectly via other actions.	Default: 1 "Enabled" Options: 0 "Disabled" 1 "Enabled"	
242			[Power Up Marker] Elapsed hours from the initial drive powerup. This value rolls over to 0 after the drive has been powered on for more than the max value shown. The parameter value only updates at powerup. For relevance to most recent powerup see [Fault x Time] on page 58 .	Default: Read Only Min/Max: 0.0000/429496.7295 Hrs Units: 0.0001 Hrs	246	









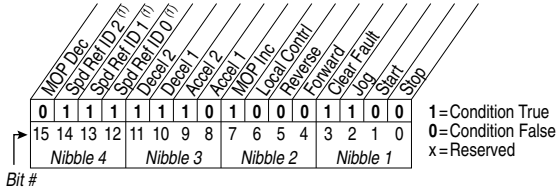

File E	Group	No.	Parameter Name and Description ⁽¹⁾	Values	Related	
UTILITY (file E)	Faults	243	[Fault 1 Code]	Default: Read Only	214	
		245	[Fault 2 Code]	Min/Max: 0/9999		238
		247	[Fault 3 Code]	0/65535 EC		
		249	[Fault 4 Code]	Units: 0		
		244	[Fault 1 Time]	Default: Read Only	242	
		246	[Fault 2 Time]	Min/Max: 0.0000/429496.7295 Hrs		
		248	[Fault 3 Time]	Units: 0.0001 Hrs		
		250	[Fault 4 Time]			
		327	<p>The time between initial drive powerup and the occurrence of the associated trip fault. Can be compared to [Power Up Marker] for the time from the most recent powerup.</p> <p>[Fault x Time] – [Power Up Marker] = Time difference to the most recent powerup. A negative value indicates that a fault occurred before most recent powerup. A positive value indicates that a fault occurred after most recent powerup.</p> <p>To convert this value to the number of days, hours, minutes, and seconds, use the following formulas:</p> <ul style="list-style-type: none"> Fault x Time / 24 hours = (# of days).(remaining time) Remaining Time x 24 hours = (# of hours).(remaining time) Remaining Time x 60 minutes = (# of minutes).(remaining seconds) Remaining Time x 60 seconds = (# of seconds) Result = (# of days).(# of hours).(# of minutes).(# of seconds) <p>Example:</p> <ul style="list-style-type: none"> 1909.2390 Hrs / 1 Day/24 Hrs = 79.551625 Days 0.551625 Days x 24 Hrs/Day = 13.239 Hrs 0.239 Hrs x 60 Min/Hr = 14.34 Min 0.34 Min x 60 Sec/Min = 20.4 Secs 			
	Alarms	259	<p>[Alarm Config 1]</p> <p>Enables/disables alarm conditions that initiate an active drive alarm.</p> <p>Legend: 1 = Enabled, 0 = Disabled, x = Reserved</p> <p>Factory Default Bit Values</p>			
	Scaled Blocks	476	EC v4 [Scale1 In Value]	Default: 0.0	090	
		482	EC v4 [Scale2 In Value]	Min/Max: -3276.8/+3276.7	093	
				Units: 0.1	117	
					126	
					127	
					427	
		477	EC v4 [Scale1 In Hi]	Default: 0.0	091	
		483	EC v4 [Scale2 In Hi]	Min/Max: -3276.8/+3276.7	094	
			Units: 0.1	119		
				428		
				460		
				462		
		478	EC v4 [Scale1 In Lo]	Default: 0.0	092	
		484	EC v4 [Scale2 In Lo]	Min/Max: -3276.8/+3276.7	095	
			Units: 0.1	120		
				429		
				461		
				463		

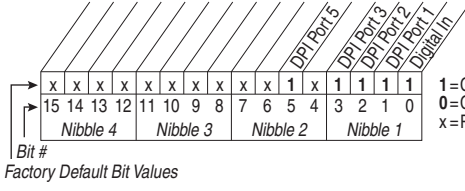
File E	Group	No.	Parameter Name and Description ⁽¹⁾	Values	Related
	Diag-Motor Cntl	549	[Flux Braking %] Gain adjustment for Flux Braking mode. (Percentage of normal output voltage.) This parameter is only viewable when P196 [Param Access Lvl] = 2 "Reserved."	Default: 125 Min/Max:100/250 Units:%	166









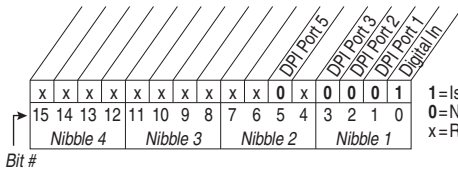

(1) See page 13 for Symbol Descriptions.

Communication File (File H)

File H	Group	No.	Parameter Name and Description ⁽¹⁾	Values	Related																																						
COMMUNICATION (file H)	Comm Control	270	 [DPI Data Rate] Sets the baud rate for attached drive peripherals. When changing this value the drive must be reset for the change to take effect.	Default: 0 "125 kbps" Options: 0 "125 kbps" 1 "500 kbps"																																							
		271	[Drive Logic Rslt] The final logic command resulting from the combination of all DPI and discrete inputs. This parameter has the same structure as the product-specific logic command received via DPI and is used in peer to peer communications.	Read Only																																							
																																											
		<table border="1"> <thead> <tr> <th colspan="3">Bits⁽¹⁾</th> <th rowspan="2">Description</th> </tr> <tr> <th>14</th> <th>13</th> <th>12</th> </tr> </thead> <tbody> <tr> <td>0</td> <td>0</td> <td>0</td> <td>No Command - Man. Mode</td> </tr> <tr> <td>0</td> <td>0</td> <td>1</td> <td>Ref A Auto</td> </tr> <tr> <td>0</td> <td>1</td> <td>0</td> <td>Ref B Auto</td> </tr> <tr> <td>0</td> <td>1</td> <td>1</td> <td>Preset 3 Auto</td> </tr> <tr> <td>1</td> <td>0</td> <td>0</td> <td>Preset 4 Auto</td> </tr> <tr> <td>1</td> <td>0</td> <td>1</td> <td>Preset 5 Auto</td> </tr> <tr> <td>1</td> <td>1</td> <td>0</td> <td>Preset 6 Auto</td> </tr> <tr> <td>1</td> <td>1</td> <td>1</td> <td>Preset 7 Auto</td> </tr> </tbody> </table>			Bits ⁽¹⁾			Description	14	13	12	0	0	0	No Command - Man. Mode	0	0	1	Ref A Auto	0	1	0	Ref B Auto	0	1	1	Preset 3 Auto	1	0	0	Preset 4 Auto	1	0	1	Preset 5 Auto	1	1	0	Preset 6 Auto	1	1	1	Preset 7 Auto
Bits ⁽¹⁾			Description																																								
14	13	12																																									
0	0	0	No Command - Man. Mode																																								
0	0	1	Ref A Auto																																								
0	1	0	Ref B Auto																																								
0	1	1	Preset 3 Auto																																								
1	0	0	Preset 4 Auto																																								
1	0	1	Preset 5 Auto																																								
1	1	0	Preset 6 Auto																																								
1	1	1	Preset 7 Auto																																								
		272	[Drive Ref Rslt] Present frequency reference that is scaled as a DPI reference for peer to peer communications. The value that is shown is the value prior to the accel/decel ramp and any corrections that are supplied by slip comp, PI, and so on.	Default: Read Only Min/Max: ±32767 Units: 1																																							
		273	[Drive Ramp Rslt] Present frequency reference that is scaled as a DPI reference for peer to peer communications. The value that is shown is the value after the accel/decel ramp but prior to any corrections supplied by slip comp, PI, and so on.	Default: Read Only Min/Max: ±32767 Units: 1																																							

File H	Group	No.	Parameter Name and Description ⁽¹⁾	Values	Related	
COMMUNICATION (file H)	Comm Control	274	EC [DPI Port Select] Selects the port reference value that appears in [DPI Port Value].	Default: 0 "Not Used" Options: 0 "Not Used" 1 "DPI Port 1" 2 "DPI Port 2" 3 "DPI Port 3" 4 "Reserved" 5 "DPI Port 5"		
		275	EC [DPI Port Value] Value of the DPI reference that is selected in [DPI Port Sel].	Default: Read Only Min/Max: ±32767 Units: 1		
		298	EC [DPI Ref Select]  Scales DPI on [Maximum Freq] or [Maximum Speed]. This adjusts the resolution of the DPI reference.	Default: 0 "Max Freq" Options: 0 "Max Freq" 1 "Max Speed"	055 082	
	Masks and Owners		276	[Logic Mask]  Determines the adapters that can control the drive when 598, bit 15 is set to "1." If the bit for an adapter is "0," the adapter has no control functions except for stop.  Factory Default Bit Values		288... 297
			277	[Start Mask]  Controls the adapters that can issue start commands.	See P276 [Logic Mask] .	288... 297
			278	[Jog Mask]  Controls the adapters that can issue jog commands.	See P276 [Logic Mask] .	288... 297
			279	[Direction Mask]  Controls the adapters that can issue forward/reverse direction commands.	See P276 [Logic Mask] .	288... 297
			280	[Reference Mask]  Controls the adapters that can select an alternate reference; [Speed Ref A, B Sel] or [Preset Speed 1...7].	See P276 [Logic Mask] .	288... 297
			281	[Accel Mask]  Controls the adapters that can select [Accel Time 1, 2].	See P276 [Logic Mask] .	288... 297
			282	[Decel Mask]  Controls the adapters that can select [Decel Time 1, 2].	See P276 [Logic Mask] .	288... 297
283	[Fault Clr Mask]  Controls the adapters that can clear a fault.	See P276 [Logic Mask] .	288... 297			

File H	Group	No.	Parameter Name and Description ⁽¹⁾	Values	Related
COMMUNICATION (file H)	Masks and Owners	284	[MOP Mask] Controls the adapters that can issue MOP commands to the drive.	See P276 [Logic Mask] .	288... 297
		285	[Local Mask] Controls the adapters that take exclusive control of drive logic commands (except stop). Exclusive "local" control can only be taken while the drive is stopped.	See P276 [Logic Mask] .	288... 297
		288	[Stop Owner] Adapters that are presently issuing a valid stop command. 	Read Only	276... 285
		289	[Start Owner] Adapters that are presently issuing a valid start command.	See P288 [Stop Owner] .	276... 285
		290	[Jog Owner] Adapters that are presently issuing a valid jog command.	See P288 [Stop Owner] .	276... 285
		291	[Direction Owner] Adapter that currently has exclusive control of direction changes.	See P288 [Stop Owner] .	276... 285
		292	[Reference Owner] Adapter that has the exclusive control of the command frequency source selection.	See P288 [Stop Owner] .	276... 285
		293	[Accel Owner] Adapter that has exclusive control of selecting [Accel Time 1, 2].	See P288 [Stop Owner] .	140 276... 285
		294	[Decel Owner] Adapter that has exclusive control of selecting [Decel Time 1, 2].	See P288 [Stop Owner] .	142 276... 285
		295	[Fault Clr Owner] Adapter that is presently clearing a fault.	See P288 [Stop Owner] .	276... 285
296	[MOP Owner] Adapters that are currently issuing increases or decreases in MOP command frequency.	See P288 [Stop Owner] .	276... 285		

File H	Group	No.	Parameter Name and Description ⁽¹⁾	Values	Related
COMMUNICATION (file H)	Masks and Owners	297	[Local Owner] Adapter that has requested exclusive control of all drive logic functions. If an adapter is in local lockout, all other functions (except stop) on all other adapters are locked out and non-functional. Local control can only be obtained when the drive is not running.	See P288 [Stop Owner] .	276... 285
	Datalinks	300 301	 [Data In A1] - Link A Word 1 [Data In A2] - Link A Word 2 Parameter number whose value is written from a communications device data table. Parameters that can be changed only while drive is stopped cannot be used as Datalink inputs. Entering a parameter of this type disables the link. Refer to your communications option manual for datalink information.	Default: 0 (0 = "Disabled") Min/Max: 0/387 0/545  0/598  Units: 1	
		302 303	 [Data In B1] - Link B Word 1 [Data In B2] - Link B Word 2	See [Data In A1] - Link A Word 1 .	
		304 305	 [Data In C1] - Link C Word 1 [Data In C2] - Link C Word 2	See [Data In A1] - Link A Word 1 .	
		306 307	 [Data In D1] - Link D Word 1 [Data In D2] - Link D Word 2	See [Data In A1] - Link A Word 1 .	
		310 311	[Data Out A1] - Link A Word 1 [Data Out A2] - Link A Word 2 Parameter number whose value is written to a communications device data table.	Default: 0 (0 = "Disabled") Min/Max: 0/387 0/545  0/598  Units: 1	
		312 313	[Data Out B1] - Link B Word 1 [Data Out B2] - Link B Word 2	See [Data Out A1] - Link A Word 1 .	
		314 315	[Data Out C1] - Link C Word 1 [Data Out C2] - Link C Word 2	See [Data Out A1] - Link A Word 1 .	
		316 317	[Data Out D1] - Link D Word 1 [Data Out D2] - Link D Word 2	See [Data Out A1] - Link A Word 1 .	
		308	 [HighRes Ref]  Used as a high resolution, 32 bit reference with Datalinks. ±[Maximum Freq] or ±[Maximum Speed] = 2147418112	Default: 0 Min/Max: ±2147483647 Units: 1	090 093 126 128 213 298

File H	Group	No.	Parameter Name and Description ⁽¹⁾	Values	Related
COMMUNICATION (file H)	Security	595	<p>EC v2 [Port Mask Act]</p> <p>Active status for port communication.</p> <p>Bit #</p> <p>Factory Default Bit Values</p> <p>1 = Not Masked 0 = Masked x = Reserved</p>		
		596	<p>EC v2 [Write Mask Cfg]</p> <p>Enables/disables write access (parameters, and so on) for ports. Changes to this parameter are affective after a power cycle, drive reset or when 597, bit 15 transitions from "1" to "0."</p> <p>Bit #</p> <p>Factory Default Bit Values</p> <p>1 = Not Masked 0 = Masked x = Reserved</p>		
		597	<p>EC v2 [Write Mask Act]</p> <p>Active status of write access for ports. Bit 15 determines if network security is controlling the write mask instead of 596.</p>	See [Port Mask Act] .	
		276	<p>[Logic Mask]</p> <p> Determines the adapters that can control the drive when 597, bit 15 is set to "1". If the bit for a port is set to "0," the port has no control functions except for stop.</p> <p>Bit #</p> <p>Factory Default Bit Values</p> <p>1 = Control Permitter 0 = Control Masked x = Reserved</p>		288... 297
		598	<p>EC v2 [Logic Mask Act]</p> <p>Active status of logic mask for ports. Bit 15 determines if network security is controlling the logic mask instead of 276.</p>	See [Port Mask Act] .	

(1) See [page 13](#) for Symbol Descriptions.

Inputs and Outputs File (File J)

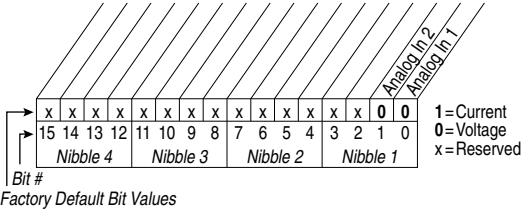
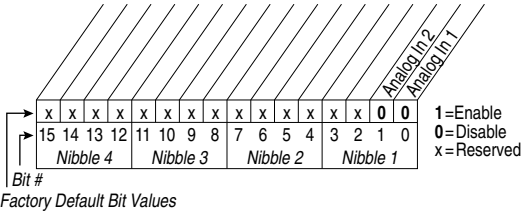
File J	Group	No.	Parameter Name and Description ⁽¹⁾	Values	Related
INPUTS and OUTPUTS (file J)	Analog Inputs	320	[Anlg In Config]  Selects the mode for the analog inputs. 	1=Current 0=Voltage x=Reserved	322 323
		321	[Anlg In Sqr Root] Enables/disables the square root function for each input. 	1=Enable 0=Disable x=Reserved	
		322	[Analog In 1 Hi]	Default: 10.000 Volt	091
		325	[Analog In 2 Hi] Sets the highest input value to the analog input x scaling block.	Default: 10.000 Volt Min/Max: 4.000/20.000 mA <small>Standard</small> , 0.000/20.000 mA <small>EC</small> , ±10.000V, Units: 0.000/10.000V, 0.001 mA, 0.001 Volts	092
		323	[Analog In 1 Lo]	Default: 0.000 Volts	091
		326	[Analog In 2 Lo] Sets the lowest input value to the analog input x scaling block.	Default: 0.000 Volts Min/Max: 4.000/20.000 mA, 0.000/10.000V (No. 323), ±10.000V (No. 326) Units: 0.000/10.000V, 0.001 mA, 0.001 Volts	092
324	[Analog In 1 Loss]	Default: 0 "Disabled"	091		
327	[Analog In 2 Loss] Selects drive action when an analog signal loss is detected. Signal loss is defined as an analog signal less than 1V or 2 mA. The signal loss event ends and normal operations resume when the input signal level is greater than or equal to 1.5V or 3 mA.	Default: 0 "Disabled" Options: 0 "Disabled" 1 "Fault" 2 "Hold Input" 3 "Set Input Lo" 4 "Set Input Hi" 5 "Goto Preset1" 6 "Hold OutFreq"	092		

File J	Group	No.	Parameter Name and Description ⁽¹⁾	Values	Related																																																																
INPUTS and OUTPUTS (file J)	Analog Outputs	340	<p>EC [Anlg Out Config]</p> <p>Selects the mode for the analog outputs.</p> <p style="text-align: center;">Factory Default Bit Values</p>																																																																		
		341	<p>[Anlg Out Absolut]</p> <p>Selects whether the signed value or absolute value of a parameter is used before being scaled to drive the analog output.</p> <p style="text-align: center;">Factory Default Bit Values</p>		342																																																																
		342	<p>[Analog Out1 Sel]</p> <p>Selects the source of the value that drives the analog output.</p>	<p>Default: 0 "Output Freq"</p> <p>Options: See Table</p> <table border="1"> <thead> <tr> <th>Options</th> <th>[Analog Out1 Lo] Value <i>Param. 341 = Signed</i></th> <th>[Analog Out1 Hi] Value <i>Param. 341 = Absolute</i></th> </tr> </thead> <tbody> <tr><td>0 "Output Freq"</td><td>–[Maximum Speed]</td><td>0 Hz</td></tr> <tr><td>1 "Command Freq"</td><td>–[Maximum Speed]</td><td>0 Hz</td></tr> <tr><td>2 "Output Amps"</td><td>0 Amps</td><td>0 Amps</td></tr> <tr><td>3 "Torque Amps"</td><td>–200%</td><td>0 Amps</td></tr> <tr><td>4 "Flux Amps"</td><td>0 Amps</td><td>0 Amps</td></tr> <tr><td>5 "Output Power"</td><td>0 kW</td><td>0 kW</td></tr> <tr><td>6 "Output Volts"</td><td>0 Volts</td><td>0 Volts</td></tr> <tr><td>7 "DC Bus Volts"</td><td>0 Volts</td><td>0 Volts</td></tr> <tr><td>8 "PI Reference"⁽¹⁾</td><td>–100%</td><td>0%</td></tr> <tr><td>9 "PI Feedback"</td><td>–100%</td><td>0%</td></tr> <tr><td>10 "PI Error"</td><td>–100%</td><td>0%</td></tr> <tr><td>11 "PI Output"</td><td>–800%</td><td>0%</td></tr> <tr><td>12 "%Motor OL"</td><td>0%</td><td>0%</td></tr> <tr><td>13 "%Drive OL"</td><td>0%</td><td>0%</td></tr> <tr><td>14 "CommandedTrq."⁽³⁾</td><td>–800%</td><td>0%</td></tr> <tr><td>15 "MtrTrqCurRef"⁽¹⁾⁽³⁾</td><td>–200%</td><td>0 Amps</td></tr> <tr><td>16 "Speed Ref"⁽³⁾</td><td>–[Maximum Speed]</td><td>0 Hz</td></tr> <tr><td>17 "Speed Fdbk"⁽³⁾</td><td>–[Maximum Speed]</td><td>0 Hz</td></tr> <tr><td>19 "Torque Est"⁽¹⁾⁽³⁾</td><td>–800%</td><td>0%</td></tr> <tr><td>24 "Param Cntl"⁽¹⁾⁽²⁾</td><td>–[Maximum Speed]</td><td>0 Hz</td></tr> <tr><td>25 "SpdFdBk NoFlt"⁽¹⁾</td><td>–[Maximum Speed]</td><td>0 Hz</td></tr> </tbody> </table>	Options	[Analog Out1 Lo] Value <i>Param. 341 = Signed</i>	[Analog Out1 Hi] Value <i>Param. 341 = Absolute</i>	0 "Output Freq"	–[Maximum Speed]	0 Hz	1 "Command Freq"	–[Maximum Speed]	0 Hz	2 "Output Amps"	0 Amps	0 Amps	3 "Torque Amps"	–200%	0 Amps	4 "Flux Amps"	0 Amps	0 Amps	5 "Output Power"	0 kW	0 kW	6 "Output Volts"	0 Volts	0 Volts	7 "DC Bus Volts"	0 Volts	0 Volts	8 "PI Reference" ⁽¹⁾	–100%	0%	9 "PI Feedback"	–100%	0%	10 "PI Error"	–100%	0%	11 "PI Output"	–800%	0%	12 "%Motor OL"	0%	0%	13 "%Drive OL"	0%	0%	14 "CommandedTrq." ⁽³⁾	–800%	0%	15 "MtrTrqCurRef" ⁽¹⁾⁽³⁾	–200%	0 Amps	16 "Speed Ref" ⁽³⁾	–[Maximum Speed]	0 Hz	17 "Speed Fdbk" ⁽³⁾	–[Maximum Speed]	0 Hz	19 "Torque Est" ⁽¹⁾⁽³⁾	–800%	0%	24 "Param Cntl" ⁽¹⁾⁽²⁾	–[Maximum Speed]	0 Hz	25 "SpdFdBk NoFlt" ⁽¹⁾	–[Maximum Speed]
Options	[Analog Out1 Lo] Value <i>Param. 341 = Signed</i>	[Analog Out1 Hi] Value <i>Param. 341 = Absolute</i>																																																																			
0 "Output Freq"	–[Maximum Speed]	0 Hz																																																																			
1 "Command Freq"	–[Maximum Speed]	0 Hz																																																																			
2 "Output Amps"	0 Amps	0 Amps																																																																			
3 "Torque Amps"	–200%	0 Amps																																																																			
4 "Flux Amps"	0 Amps	0 Amps																																																																			
5 "Output Power"	0 kW	0 kW																																																																			
6 "Output Volts"	0 Volts	0 Volts																																																																			
7 "DC Bus Volts"	0 Volts	0 Volts																																																																			
8 "PI Reference" ⁽¹⁾	–100%	0%																																																																			
9 "PI Feedback"	–100%	0%																																																																			
10 "PI Error"	–100%	0%																																																																			
11 "PI Output"	–800%	0%																																																																			
12 "%Motor OL"	0%	0%																																																																			
13 "%Drive OL"	0%	0%																																																																			
14 "CommandedTrq." ⁽³⁾	–800%	0%																																																																			
15 "MtrTrqCurRef" ⁽¹⁾⁽³⁾	–200%	0 Amps																																																																			
16 "Speed Ref" ⁽³⁾	–[Maximum Speed]	0 Hz																																																																			
17 "Speed Fdbk" ⁽³⁾	–[Maximum Speed]	0 Hz																																																																			
19 "Torque Est" ⁽¹⁾⁽³⁾	–800%	0%																																																																			
24 "Param Cntl" ⁽¹⁾⁽²⁾	–[Maximum Speed]	0 Hz																																																																			
25 "SpdFdBk NoFlt" ⁽¹⁾	–[Maximum Speed]	0 Hz																																																																			

⁽¹⁾ Refer to Option Definitions on [page 70](#).

⁽²⁾ Enhanced firmware revision 1.001 and later.

⁽³⁾ Enhanced firmware revision 2.002 and later.

File J	Group	No.	Parameter Name and Description ⁽¹⁾	Values	Related
INPUTS and OUTPUTS (file J)	Analog Outputs	343	[Analog Out1 Hi] Sets the analog output value when the source value is at maximum.	Default: 10.00 Volts Min/Max: 0.00/10.00 Volts 0.00/20.00 mA EC Units: 0.01 Volts 0.01 mA EC	340 342
		344	[Analog Out1 Lo] Sets the analog output value when the source value is at minimum.	Default: 0.00 Volts Min/Max: 0.00/10.00 Volts 0.00/20.00 mA EC Units: 0.01 Volts 0.01 mA EC	340 342
		354	EC [Anlg Out1 Scale] Sets the high value for the range of analog out scale. Entering 0.0 disables this scale and max scale is used. Example: If [Analog Out Sel] = "Commanded Trq," a value of 150 = 150% scale in place of the default 800%.	Default: 0.0 Min/Max: [Analog Out1 Sel] Units: 0.01	341 342
		377	EC [Anlg Out1 Setpt] Controls the analog output value from a communication device. Example Set [Data In A1] to "377" as the value from the communication device.	Default: 0.00 Volts Min/Max: 0.00/10.00 Volts 0.00/20.00 mA EC Units: 0.01 Volts 0.01 mA EC	340

File J	Group	No.	Parameter Name and Description ⁽¹⁾	Values	Related																																							
INPUTS and OUTPUTS (file J)	Digital Inputs	361	[Digital In1 Sel]	Default: 4	"Stop – CF" ⁽¹⁾																																							
		362	[Digital In2 Sel]	Default: 5	"Start"																																							
		363	[Digital In3 Sel]	Default: 18	"Auto/ Manual"																																							
		364	[Digital In4 Sel]	Default: 15	"Speed Sel 1"																																							
		365	[Digital In5 Sel]	Default: 16	"Speed Sel 2"																																							
		366	[Digital In6 Sel](7)	Default: 17	"Speed Sel 3"																																							
					Selects the function for the digital inputs. Important: Digital inputs are not designed to work with a pulsed source.	Options: 0	"Not Used"																																					
					(1) When [Digital Inx Sel] is set to option 2 "Clear Faults" the Stop button cannot be used to clear a fault condition.	1	"Enable" ⁽⁶⁾																																					
					(2)	2	"Clear Faults" ⁽¹⁾																																					
					<table border="1" data-bbox="776 569 1068 751"> <thead> <tr> <th>3</th> <th>2</th> <th>1</th> <th><– "Speed Sel 1...3"</th> </tr> </thead> <tbody> <tr><td>0</td><td>0</td><td>0</td><td>Reference A - P90</td></tr> <tr><td>0</td><td>0</td><td>1</td><td>Reference B - P93</td></tr> <tr><td>0</td><td>1</td><td>0</td><td>Preset Speed 2 - P102</td></tr> <tr><td>0</td><td>1</td><td>1</td><td>Preset Speed 3 - P103</td></tr> <tr><td>1</td><td>0</td><td>0</td><td>Preset Speed 4 - P104</td></tr> <tr><td>1</td><td>0</td><td>1</td><td>Preset Speed 5 - P105</td></tr> <tr><td>1</td><td>1</td><td>0</td><td>Preset Speed 6 - P106</td></tr> <tr><td>1</td><td>1</td><td>1</td><td>Preset Speed 7 - P107</td></tr> </tbody> </table>	3	2	1	<– "Speed Sel 1...3"	0	0	0	Reference A - P90	0	0	1	Reference B - P93	0	1	0	Preset Speed 2 - P102	0	1	1	Preset Speed 3 - P103	1	0	0	Preset Speed 4 - P104	1	0	1	Preset Speed 5 - P105	1	1	0	Preset Speed 6 - P106	1	1	1	Preset Speed 7 - P107	3	"Aux Fault"	
		3	2	1	<– "Speed Sel 1...3"																																							
		0	0	0	Reference A - P90																																							
		0	0	1	Reference B - P93																																							
		0	1	0	Preset Speed 2 - P102																																							
		0	1	1	Preset Speed 3 - P103																																							
		1	0	0	Preset Speed 4 - P104																																							
		1	0	1	Preset Speed 5 - P105																																							
		1	1	0	Preset Speed 6 - P106																																							
		1	1	1	Preset Speed 7 - P107																																							
					To access Preset Speed 1, set [Speed Ref A Sel] or [Speed Ref B Sel] to "Preset Speed 1".	4	"Stop – CF" ⁽¹⁾																																					
					(3)	5	"Start" ⁽⁹⁾⁽¹¹⁾																																					
					<table border="1" data-bbox="776 827 1068 1010"> <thead> <tr> <th>3</th> <th>2</th> <th>1</th> <th><– "Spd/Trq Sel1...3"</th> </tr> </thead> <tbody> <tr><td>0</td><td>0</td><td>0</td><td>Zero Torque</td></tr> <tr><td>0</td><td>0</td><td>1</td><td>Spd Reg</td></tr> <tr><td>0</td><td>1</td><td>0</td><td>Torque Reg</td></tr> <tr><td>0</td><td>1</td><td>1</td><td>Min Spd/Trq</td></tr> <tr><td>1</td><td>0</td><td>0</td><td>Max Spd/Trq</td></tr> <tr><td>1</td><td>0</td><td>1</td><td>Sum Spd/Trq</td></tr> <tr><td>1</td><td>1</td><td>0</td><td>Absolute</td></tr> <tr><td>1</td><td>1</td><td>1</td><td>Zero Trq</td></tr> </tbody> </table>	3	2	1	<– "Spd/Trq Sel1...3"	0	0	0	Zero Torque	0	0	1	Spd Reg	0	1	0	Torque Reg	0	1	1	Min Spd/Trq	1	0	0	Max Spd/Trq	1	0	1	Sum Spd/Trq	1	1	0	Absolute	1	1	1	Zero Trq	6	"Fwd/ Reverse" ⁽⁹⁾	
		3	2	1	<– "Spd/Trq Sel1...3"																																							
		0	0	0	Zero Torque																																							
		0	0	1	Spd Reg																																							
		0	1	0	Torque Reg																																							
		0	1	1	Min Spd/Trq																																							
1	0	0	Max Spd/Trq																																									
1	0	1	Sum Spd/Trq																																									
1	1	0	Absolute																																									
1	1	1	Zero Trq																																									
			(4) Only Enhanced Control Drives.	7	"Run" ⁽¹⁰⁾																																							
			(5) Enhanced firmware revision V2.001 and later.	8	"Run Forward" ⁽¹⁰⁾																																							
			(6) Opening an "Enable" input causes the motor to coast-to-stop, ignoring any programmed Stop modes.	9	"Run Reverse" ⁽¹⁰⁾																																							
			(7) A dedicated hardware enable input is available via a jumper selection. Refer to I/O Wiring Examples in the PowerFlex 70 Adjustable Frequency AC Drive Installation Instructions, publication 20A-IN009 .	10	"Jog" ⁽⁹⁾ "Jog 1" ⁽⁴⁾	100																																						
			(8) Configures the input to command a transition between the Manual/Auto or Auto/Manual speed references. Refer to "Auto" Speed Sources on page 110 and "Manual" Speed Sources on page 111 for details. "Manual/Auto" (68) is similar to "Auto/Manual" (18) except that the polarity is opposite.	11	"Jog Forward"																																							
			<table border="1" data-bbox="776 1367 1076 1455"> <thead> <tr> <th>Input State</th> <th>"Auto/Manual" (18)</th> <th>"Manual/Auto" (68)</th> </tr> </thead> <tbody> <tr> <td>Lo</td> <td>Auto</td> <td>Manual</td> </tr> <tr> <td>Hi</td> <td>Manual</td> <td>Auto</td> </tr> </tbody> </table>	Input State	"Auto/Manual" (18)	"Manual/Auto" (68)	Lo	Auto	Manual	Hi	Manual	Auto	12	"Jog Reverse"																														
Input State	"Auto/Manual" (18)	"Manual/Auto" (68)																																										
Lo	Auto	Manual																																										
Hi	Manual	Auto																																										
				13	"Stop Mode B"	156																																						
				14	"Bus Reg Md B"	162																																						
				15..17	"Speed Sel 1-3" ⁽²⁾																																							
				18	"Auto/ Manual" ⁽⁸⁾	096																																						
				19	"Local"																																							
				20	"Acc2 and Dec2"	140																																						
				21	"Accel 2"																																							
				22	"Decel 2"																																							
				23	"MOP Inc" ⁽¹²⁾	194																																						
				24	"MOP Dec" ⁽¹²⁾																																							
				25	"Excl Link" ⁽¹²⁾	380																																						
				26	"PI Enable"	125																																						
				27	"PI Hold"																																							
				28	"PI Reset"																																							
				29	"Reserved"																																							
				30	"Precharge En" ⁽⁴⁾⁽¹²⁾																																							
				31..33	"Spd/Trq Sel1-3" ⁽³⁾⁽¹³⁾	088																																						
				34	"Jog 2" ⁽⁴⁾	108																																						
				35	"PI Invert" ⁽⁴⁾	124																																						
				36..40	"Reserved"																																							
				41,42	"UserSet Sel1-2" ⁽⁵⁾	205																																						
				43	"Run Level" ⁽⁵⁾⁽¹²⁾																																							
				44	"RunFwd Level" ⁽⁵⁾⁽¹²⁾																																							
				45	"RunRev Level" ⁽⁵⁾⁽¹²⁾																																							
				46	"Run w/Comm" ⁽⁵⁾⁽¹²⁾																																							
				47..57	"Reserved"																																							
				58	"Sync Enable" ⁽¹³⁾	620																																						
				59	"Traverse Ena" ⁽¹³⁾																																							
				68	"Manual/Auto" ⁽⁸⁾⁽¹⁴⁾																																							

File J	Group	No.	Parameter Name and Description ⁽¹⁾	Values	Related
INPUTS and OUTPUTS (file J)	Digital Inputs		<p>(9) Typical 3-Wire Inputs - Requires that only 3-wire functions are chosen. Including 2-wire selections causes a type 2 alarm.</p> <p>(10) Typical 2-Wire Inputs - Requires that only 2-wire functions are chosen. Including 3-wire selections causes a type 2 alarm.</p> <p>(11) A "Dig In ConflictB" alarm occurs if a "Start" input is programmed without a "Stop" input. Type 2 Alarms - Some digital input programming can cause conflicts that result in a Type 2 alarm. Example: [Digital In1 Sel] set to 5 "Start" in 3-wire control and [Digital In2 Sel] set to 7 "Run" in 2-wire. Refer to Alarm Descriptions on page 83 for information on resolving this type of conflict.</p> <p>(12) Refer to Option Definitions on page 70.</p> <p>(13) Enhanced firmware revision V3.002 and later.</p> <p>(14) Enhanced firmware revision V5.001 and later.</p>		
		411	<p>EC [DigIn DataLogic]</p> <p>Provides data to the logical operations that are done with the digital inputs when parameter 056 option 9 "DigIn DatLog" is set to 1.</p> <div style="text-align: center;"> <p>Bit #</p> <p>Factory Default Bit Values</p> </div>		056
	Digital Outputs	379	<p>EC [Dig Out Setpt]</p> <p>Controls output relays (CRx) when parameter 380 or 384 is set to option 30 "Param Cntl".</p> <div style="text-align: center;"> <p>Bit #</p> <p>Factory Default Bit Values</p> </div>		

File J	Group	No.	Parameter Name and Description ⁽¹⁾	Values	Related	
INPUTS and OUTPUTS (file J)	Digital Outputs	380	[Digital Out1 Sel] [Digital Out2 Sel] Selects the drive status that energizes a (CRx) output relay. (1) Any relay that is programmed as Fault or Alarm energizes (pick up) when power is applied to drive and deenergize (drop out) when a fault or alarm exists. Relays selected for other functions energize when that condition exists and deenergize when that condition is removed. Refer to I/O Wiring Examples in the PowerFlex 70 Adjustable Frequency AC Drive Installation Instructions, publication 20A-IN009 . (2) Activation level is defined in [Dig Outx Level] below. (3) Only Enhanced Control Drives. (4) Enhanced firmware revision V3.002 and later. (5) Enhanced firmware revision V4.001 and later.	Default: 1 "Fault" 4 "Run" Options: 1 "Fault" ⁽¹⁾ 2 "Alarm" ⁽¹⁾ 3 "Ready" 4 "Run" 5 "Forward Run" 6 "Reverse Run" 7 "Auto Restart" 8 "Powerup Run" 9 "At Speed" 10 "At Freq" ⁽²⁾ 11 "At Current" ⁽²⁾ 12 "At Torque" ⁽²⁾ 13 "At Temp" ⁽²⁾ 14 "At Bus Volts" ⁽²⁾ 15 "At PI Error" ⁽²⁾ 16 "DC Braking" 17 "Curr Limit" 18 "Economize" 19 "Motor Overld" 20 "Power Loss" 21 "Input 1 Link" 22 "Input 2 Link" 23 "Input 3 Link" 24 "Input 4 Link" 25 "Input 5 Link" 26 "Input 6 Link" 27 "PI Enabled" ⁽³⁾ 28 "PI Hold" ⁽³⁾ 29 "Drive Overld" ⁽³⁾ 30 "Param Cntl" ⁽³⁾ 31..57 "Reserved" 58 "Manual Mode" ⁽⁴⁾ 59 "Fast Braking" ⁽⁴⁾ 60 "Reserved" 61 "Speed Fdbk" ⁽²⁾⁽⁵⁾	381 382 383 002 001 003 004 218 012 137 157 147 053 048 184	
		381		[Dig Out1 Level] [Dig Out2 Level] Sets the relay activation level for options 10...15 in [Digital Outx Sel]. Units are assumed to match the above selection (for example, "At Freq" = Hz, "At Torque" = Amps).	Default: 0.0 0.0 Min/Max: 0.0/819.2 Units: 0.1	380
		382		[Dig Out1 OnTime] [Dig Out2 OnTime] Sets the "ON Delay" time for the digital outputs. This is the time between the occurrence of a condition and activation of the relay.	Default: 0.0 s 0.0 s Min/Max: 0.0/600.0 s Units: 0.1 s	380
		383		[Dig Out1 OffTime] [Dig Out2 OffTime] Sets the "OFF Delay" time for the digital outputs. This is the time between the disappearance of a condition and de-activation of the relay.	Default: 0.0 s 0.0 s Min/Max: 0.0/600.0 s Units: 0.1 s	380
		387				

(1) See [page 13](#) for Symbol Descriptions.

Selected Option Definitions – [Analog Outx Sel], [Digital Inx Sel], and [Digital Outx Sel]

Option	Description	Related
At Speed	Relay changes state when drive has reached commanded speed.	380
Excl Link	Links digital input to a digital output if the output is set to "Input 1-6 Link."	361
Input 1...6 Link	When Digital Output 1 is set to of these (for example, Input 3 Link) in conjunction with Digital Input 3 set to "Excl Link," the Digital Input 3 state (on/off) is echoed in the Digital Output 1.	380
Manual Mode	Either the HIM or I/O Terminal Block (analog input) has control of the speed reference.	380
MOP Dec	Decrements speed reference as long as input is closed.	361
MOP Inc	Increments speed reference as long as input is closed.	361
MtrTrqCurRef	Torque producing current reference.	342
Param Cntl	Parameter controlled analog output enables PLC to control analog outputs through data links. Set in [AnlgX Out Setpt], parameters 377 and 378.	342
Param Cntl	Parameter controlled digital output enables PLC to control digital outputs through data links. Set in [Dig Out Setpt], parameter 379.	342
PI Reference	Reference for PI block (see Process PI for Standard Control on page 113).	342
Precharge En	Forces drive into precharge state. Typically controlled by auxiliary contact on the disconnect at the DC input to the drive.	361
Run Level	Provides a run level input. They do not require a transition for enable or fault, but a transition is still required for a stop.	
RunFwd Level		
RunRev Level		
Run w/Comm	Enables the comms start bit to operate like a run with the run input on the terminal block. Ownership rules apply.	
SpdFdBk NoFilt	Provides an unfiltered value to an analog output. The filtered version "Speed Fdbk" includes a 125 ms filter.	342
Sync Enable	The fiber feature Synchronized Speed Change has been enabled. Enables a coordinated change in drive speeds to change machine speed.	622
Torque Est	Calculated percentage of rated motor torque.	342
Traverse Enable	The Traverse function has been enabled. This adds a triangle wave and square wave modulation to the speed reference.	623 624 625 626

Applications File (File K)

File K	Group	No.	Parameter Name and Description <i>See page 13 for Symbol Descriptions</i>	Values	Related
APPLICATIONS (file K)	Fiber Functions	620	EC v3 [Fiber Control] Controls the Sync and Traverse functions. Bit # Factory Default Bit Values		
		621	EC v3 [Fiber Status] Status of Sync and Traverse functions. Bit # Factory Default Bit Values	Read Only	
		622	EC v3 [Sync Time] The time to ramp from the "held speed reference" to the current speed reference, after the Sync input is de-energized.	Default: 0.0 s Min/Max: 0.0/3600.0 s Units: 0.1 s	
		623	EC v3 [Traverse Inc] Sets the time period of increasing frequency.	Default: 0.00 s Min/Max: 0.00/30.00 s Units: 0.01 s	
		624	EC v3 [Traverse Dec] Sets the time period of decreasing frequency.	Default: 0.00 s Min/Max: 0.00/30.00 s Units: 0.01 s	
		625	EC v3 [Max Traverse] Sets the amplitude of the triangle wave speed modulation.	Default: 0.00 Hz Min/Max: 0.00/Maximum Speed Units: 0.01 Hz	
		626	EC v3 [P Jump] Sets the amplitude of the square wave speed modulation.	Default: 0.00 Hz Min/Max: 0.00/Maximum Speed Units: 0.01 Hz	

Parameter Cross Reference – by Name

Parameter Name	Number	Group	Page
Accel Mask	281	Masks and Owners	60
Accel Owner	293	Masks and Owners	61
Accel Time <i>X</i>	140, 141	Ramp Rates	40
Alarm Config 1	259	Alarms	58
Alarm <i>X</i> @ Fault	229, 230	Diagnostics	56
Analog In <i>X</i> Hi	322, 325	Analog Inputs	64
Analog In <i>X</i> Lo	323, 326	Analog Inputs	64
Analog In <i>X</i> Loss	324, 327	Analog Inputs	64
Analog In1 Value	16	Metering	22
Analog In2 Value	17	Metering	22
Analog Out1 Hi	343	Analog Outputs	66
Analog Out1 Lo	344	Analog Outputs	66
Analog Out1 Sel	342	Analog Outputs	65
Anlg In Config	320	Analog Inputs	64
Anlg In Sqr Root	321	Analog Inputs	64
Anlg Out Absolut	341	Analog Outputs	65
Anlg Out Config	340	Analog Outputs	65
Anlg Out1 Scale	354	Analog Outputs	66
Anlg Out1 Setpt	377	Analog Outputs	66
Auto Rstrt Delay	175	Restart Modes	45
Auto Rstrt Tries	174	Restart Modes	45
AutoMan Cnfg	192	HIM Ref Config	48
Autotune	61	Torq Attributes	26
Autotune Torque	66	Torq Attributes	27
Break Frequency	72	Volts per Hertz	29
Break Voltage	71	Volts per Hertz	28
Bus Reg Gain	160	Stop/Brake Modes	42
Bus Reg Kd	165	Stop/Brake Modes	43
Bus Reg Ki	160	Stop/Brake Modes	42
Bus Reg Kp	164	Stop/Brake Modes	43
Bus Reg Mode <i>X</i>	161, 162	Stop/Brake Modes	43
Commanded Freq	2	Metering	21
Commanded Torque	24	Metering	22
Compensation	56	Torq Attributes	25
Control Status	440	Torq Attributes	28
Control SW Ver	29	Drive Data	22
Current Lmt Gain	149	Load Limits	40
Current Lmt Sel	147	Load Limits	40
Current Lmt Val	148	Load Limits	40
Current Rate Limit	154	Load Limits	41
Data In <i>XX</i>	300...307	Datalinks	62
Data Out <i>XX</i>	310...317	Datalinks	62
DB Resistor Type	163	Stop/Brake Modes	43
DB While Stopped	145	Stop/Brake Modes	41
DC Brake Level	158	Stop/Brake Modes	42
DC Brake Lvl Sel	157	Stop/Brake Modes	42
DC Brake Time	159	Stop/Brake Modes	42
DC Bus Memory	13	Metering	22
DC Bus Voltage	12	Metering	22
Decel Mask	282	Masks and Owners	60
Decel Owner	294	Masks and Owners	61
Decel Time <i>X</i>	142, 143	Ramp Rates	40
Dig In Status	216	Diagnostics	54
Dig Out Setpt	379	Digital Outputs	68
Dig Out Status	217	Diagnostics	54
Dig Out <i>X</i> Level	381, 385	Digital Outputs	69
Dig Out <i>X</i> OffTime	383, 387	Digital Outputs	69
Dig Out <i>X</i> OnTime	382, 386	Digital Outputs	69
DigIn DataLogic	411	Digital Inputs	68
Digital In <i>X</i> Sel	361...366	Digital Inputs	67
Digital Out <i>X</i> Sel	380, 384	Digital Outputs	69
Direction Mask	279	Masks and Owners	60
Direction Mode	190	Direction Config	48
Direction Owner	291	Masks and Owners	61
DPI Data Rate	270	Comm Control	59
DPI Port Select	274	Comm Control	60
DPI Port Value	275	Comm Control	60
DPI Ref Select	298	Comm Control	60
Drive Alarm <i>X</i>	211, 212	Diagnostics	52
Drive Checksum	203	Drive Memory	50
Drive Logic Rslt	271	Comm Control	59
Drive OL Count	219	Diagnostics	54
Drive OL Mode	150	Load Limits	40
Drive Ramp Rslt	273	Comm Control	59
Drive Ref Rslt	272	Comm Control	59
Drive Status 1, 2	209, 210	Diagnostics	51
Drive Status 3	222	Diagnostics	55
Drive Temp	218	Diagnostics	54
Droop RPM @ FLA	152	Stop/Brake Modes	41
Dyn UserSet Actv	206	Drive Memory	51
Dyn UsrSet Cnfg	204	Drive memory	50
Dyn UsrSet Sel	205	Drive memory	50
Elapsed kWh	14	Metering	21
Elapsed MWh	9	Metering	22
Elapsed Run Time	10	Metering	22
Enc Pos Fdbk	414	Speed Feedback	29
Encoder PPR	413	Speed Feedback	29
Encoder Speed	415	Speed Feedback	29
Fault Amps	225	Diagnostics	55
Fault Bus Volts	226	Diagnostics	55
Fault Clear	240	Faults	57
Fault Clear Mode	241	Faults	57
Fault Clr Mask	283	Masks and Owners	60
Fault Clr Owner	295	Masks and Owners	61

Parameter Name	Number	Group	Page
Fault Config 1	238	Faults	53
Fault Frequency	224	Diagnostics	55
Fault X Code	243...249	Faults	58
Fault X Time	244...250	Faults	58
Fdbk Filter Sel	416	Speed Feedback	29
Feedback Select	80	Spd Mode and Limits	30
Fiber Control	620	Fiber Functions	71
Fiber Status	621	Fiber Functions	71
Flux Braking	166	Stop/Brake Modes	44
Flux Current	5	Metering	21
Flux Current Ref	63	Torq Attributes	26
Flux Up Mode	57	Torq Attributes	25
Flux Up Time	58	Torq Attributes	25
Flying Start En	169	Restart Modes	45
Flying StartGain	170	Restart Modes	45
Gnd Warn Level	177	Restart Modes	47
HighRes Ref	308	Datalinks	62
Inertia Autotune	67	Torq Attributes	27
IR Voltage Drop	62	Torq Attributes	26
Ixo Voltage Drop	64	Torq Attributes	27
Jog Mask	278	Masks and Owners	60
Jog Owner	290	Masks and Owners	61
Jog Speed	100	Discrete Speeds	34
Jog Speed 1	100	Discrete Speeds	34
Jog Speed 2	108	Discrete Speeds	34
Kf Speed Loop	447	Speed Regulator	38
Ki Speed Loop	445	Speed Regulator	38
Kp Speed Loop	446	Speed Regulator	38
Language	201	Drive Memory	50
Last Stop Source	215	Diagnostics	53
Load Frm Usr Set	198	Drive Memory	49
Load Loss Level	187	Power Loss	47
Load Loss Time	188	Power Loss	47
Logic Mask Act	598	Security	63
Local Mask	285	Masks and Owners	60
Local Owner	297	Masks and Owners	62
Logic Mask	276	Masks and Owners	60
Man Ref Preload	193	HIM Ref Config	48
Max Traverse	625	Fiber Functions	71
Maximum Freq	55	Torq Attributes	24
Maximum Speed	82	Spd Mode and Limits	30
Maximum Voltage	54	Torq Attributes	24
Minimum Speed	81	Spd Mode and Limits	30
MOP Frequency	11	Metering	22
MOP Mask	284	Masks and Owners	61
MOP Owner	296	Masks and Owners	61

Parameter Name	Number	Group	Page
MOP Rate	195	MOP Config	49
Motor Cntl Sel	53	Torq Attributes	24
Motor Fdbk Type	412	Speed Feedback	29
Motor NP FLA	42	Motor Data	23
Motor NP Hertz	43	Motor Data	23
Motor NP Power	45	Motor Data	23
Motor NP RPM	44	Motor Data	23
Motor NP Volts	41	Motor Data	23
Motor OL Count	220	Diagnostics	54
Motor OL Factor	48	Motor Data	23
Motor OL Hertz	47	Motor Data	23
Motor OL Mode	50	Motor Data	24
Motor Poles	49	Motor Data	23
Motor Type	40	Motor Data	23
Mtr NP Pwr Units	46	Motor Data	23
Mtr OL Trip Time	221	Diagnostics	54
Neg Torque Limit	437	Torq Attributes	28
Notch Filter K	420	Speed Feedback	29
Notch FilterFreq	419	Speed Feedback	29
Output Current	3	Metering	21
Output Freq	1	Metering	21
Output Power	7	Metering	21
Output Powr Fctr	8	Metering	21
Output Voltage	6	Metering	21
Overspeed Limit	83	Spd Mode and Limits	30
P Jump	626	Fiber Functions	71
Param Access Lvl	196	Drive Memory	49
PI BW Filter	139	Process PI	37
PI Configuration	124	Process PI	35
PI Control	125	Process PI	36
PI Deriv Time	459	Process PI	37
PI Error Meter	137	Process PI	37
PI Fdbk Meter	136	Process PI	37
PI Feedback Hi	462	Process PI	38
PI Feedback Lo	463	Process PI	38
PI Feedback Sel	128	Process PI	36
PI Integral Time	129	Process PI	36
PI Lower Limit	131	Process PI	36
PI Output Meter	138	Process PI	37
PI Preload	133	Process PI	37
PI Prop Gain	130	Process PI	36
PI Reference Hi	460	Process PI	38
PI Reference Lo	461	Process PI	38
PI Reference Sel	126	Process PI	36
PI Ref Meter	135	Process PI	37
PI Setpoint	127	Process PI	36
PI Status	134	Process PI	37
PI Upper Limit	132	Process PI	37
Pos Torque Limit	436	Torq Attributes	28
Port Mask Act	595	Security	63
Power Loss Mode	184	Power Loss	47
Power Loss Time	185	Power Loss	47
Power Up Marker	242	Faults	57
Powerup Delay	167	Restart Modes	44
Preset Speed X	101...107	Discrete Speeds	34
PWM Frequency	151	Load Limits	40

Parameter Name	Number	Group	Page
Ramped Speed	22	Metering	22
Rated Amps	28	Drive Data	22
Rated kW	26	Drive Data	22
Rated Volts	27	Drive Data	22
Reference Mask	280	Masks and Owners	60
Reference Owner	292	Masks and Owners	61
Regen Power Lim	153	Load Limits	41
Reset Meters	200	Drive Memory	49
Reset To Defaults	197	Drive Memory	49
Rev Speed Limit	454	Spd Mode and Limits	31
Run Boost	70	Volts per Hertz	28
S Curve %	146	Ramp Rates	40
Save HIM Ref	192	HIM Ref Config	48
Save MOP Ref	194	MOP Config	49
Save To User Set	199	Drive Memory	49
Scale1 In Hi	476	Scaled Blocks	58
Scale1 In Lo	477	Scaled Blocks	58
Scale1 In Value	478	Scaled Blocks	58
Scale2 In Hi	482	Scaled Blocks	58
Scale2 In Lo	483	Scaled Blocks	58
Scale2 In Value	484	Scaled Blocks	58
Shear Pin Time	189	Load Limits	41
Skip Freq Band	87	Spd Mode and Limits	31
Skip Frequency <i>X</i>	84...86	Spd Mode and Limits	31
Sleep Level	182	Restart Modes	47
Sleep Time	183	Restart Modes	47
Sleep Wake Mode	178	Restart Modes	46
Sleep Wake Ref	179	Restart Modes	47
Slip Comp Gain	122	Slip Comp	35
Slip RPM @ FLA	121	Slip Comp	35
Slip RPM Meter	123	Slip Comp	35
Spd Err Filt BW	448	Speed Regulator	38
Speed Desired BW	449	Speed Regulator	39
Speed Feedback	25	Metering	22
Speed Loop Meter	451	Speed Regulator	39
Speed Mode	80	Spd Mode and Limits	30
Speed Ref <i>X</i> Hi	91, 94	Speed Reference	32
Speed Ref <i>X</i> Lo	92, 95	Speed Reference	32
Speed Ref <i>X</i> Sel	90, 93	Speed Reference	32
Speed Reference	23	Metering	22
Speed Ref Source	213	Diagnostics	53
Speed/Torque Mod	88	Spd Mode and Limits	31
Start At Powerup	168	Restart Modes	44
Start Inhibits	214	Diagnostics	53
Start Mask	277	Masks and Owners	60
Start Owner	289	Masks and Owners	61
Start/Acc Boost	69	Volts per Hertz	28

Parameter Name	Number	Group	Page
Status <i>X</i> @ Fault	227, 228	Diagnostics	55
Status 3 @ Fault	223	Diagnostics	55
Stop/Brk Mode <i>X</i>	155, 156	Stop/Brake Modes	41
Stop Owner	288	Masks and Owners	61
SV Boost Filter	59	Torq Attributes	25
Sync Time	622	Fiber Functions	71
TB Man Ref Hi	97	Speed Reference	33
TB Man Ref Lo	98	Speed Reference	33
TB Man Ref Sel	96	Speed Reference	33
Testpoint <i>X</i> Data	235, 237	Diagnostics	57
Testpoint <i>X</i> Sel	234, 236	Diagnostics	57
Torq Current Ref	441	Torq Attributes	28
Torque Current	4	Metering	21
Torque Estimate	15	Metering	22
Torque Perf Mode	53	Torq Attributes	24
Torque Ref A Hi	428	Torq Attributes	27
Torque Ref A Lo	429	Torq Attributes	27
Torque Ref A Sel	427	Torq Attributes	27
Torque Setpoint1	435	Torq Attributes	27
Total Inertia	450	Speed Regulator	39
Traverse Dec	624	Fiber Functions	71
Traverse Inc	623	Fiber Functions	71
Trim % Setpoint	116	Speed Trim	34
Trim Hi	119	Speed Trim	35
Trim In Select	117	Speed Trim	34
Trim Lo	120	Speed Trim	35
Trim Out Select	118	Speed Trim	35
Voltage Class	202	Drive Memory	50
Wake Level	180	Restart Modes	47
Wake Time	181	Restart Modes	47
Write Mask Act	597	Security	63
Write Mask Cfg	596	Security	63

Notes:

Troubleshooting

This chapter provides information for troubleshooting the PowerFlex 70 drive. It includes a list and descriptions of drive faults (with possible solutions, when applicable) and alarms.

Topic	Page
Faults and Alarms	77
Drive Status	77
Clearing Alarms	82
Testpoint Codes and Functions	85
Common Symptoms and Corrective Actions	86

Faults and Alarms

A fault is a condition that stops the drive. There are three fault types.

Type	Fault Description
1	Auto-reset run When this type of fault occurs, and [Auto Rstrt Tries] (see page 45) is set to a value greater than "0," a user-configurable timer, [Auto Rstrt Delay] (see page 45) begins. When the timer reaches zero, the drive attempts to automatically reset the fault. If the condition that caused the fault is no longer present, the fault is reset and the drive is restarted. Drive must remain in Run state. If Stop is initiated, Restart function is aborted.
2	Non-resettable This type of fault normally requires drive or motor repair. The cause of the fault must be corrected before the fault can be cleared. The fault is reset on powerup after repair.
3	User configurable These faults can be enabled/disabled to annunciate or ignore a fault condition.

An alarm is a condition that, if left untreated, can stop the drive. There are two alarm types.

Type	Alarm Description
1	User configurable These alarms can be enabled or disabled by using [Alarm Config 1] on page 58 .
2	Non-configurable These alarms are always enabled.

Drive Status

The condition or state of the drive is constantly monitored. Any changes are indicated through the LEDs and/or the HIM (if present).

HIM Indication

The LCD and LED HIMs also provide visual notification of a fault or alarm condition.

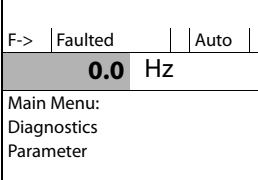
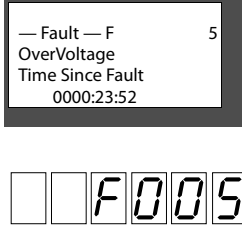
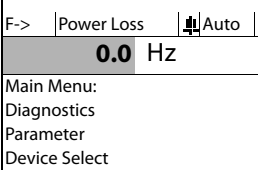
Condition	Display
<p>Drive is indicating a fault. The LCD HIM immediately reports the fault condition by displaying the following information:</p> <ul style="list-style-type: none"> • "Faulted" appears in the status line • Fault number • Fault name • Time that has passed since the fault occurred <p>Press Esc to regain HIM control.</p> <p>The LED HIM reports the fault condition by displaying the specific fault code.</p>	<p>LCD HIM</p>  <p>LED HIM</p> 
<p>Drive is indicating an alarm. The LCD HIM immediately reports the alarm condition by displaying the following information:</p> <ul style="list-style-type: none"> • Alarm name (Type 2 alarms only) • Alarm bell graphic 	<p>LCD HIM</p>  <p>LED HIM</p> <p>No indication.</p>

Manually Clearing Faults

Step	Keys
<ol style="list-style-type: none"> 1. Press Esc to acknowledge the fault. The fault information is removed so that you can use the HIM. 2. Address the condition that caused the fault. The cause must be corrected before the fault can be cleared. 3. After corrective action has been taken, clear the fault by one of these methods: <ul style="list-style-type: none"> • Press Stop. • Cycle power to the drive. • Set parameter 240 [Fault Clear] to "1." • "Clear Faults" on the HIM Diagnostic menu. 	<p>Esc</p> 

Fault Descriptions

Table 1 provides a list of fault messages, descriptions of the cause of the fault, and corrective action to fix the fault.

Table 1 - Fault Types, Descriptions, and Actions

Fault	No.	Type ⁽¹⁾	Description	Action
Analog In Loss	29	1 3	An analog input is configured to fault on signal loss. A signal loss has occurred. Configure with [Anlg In X Loss] on page 64 .	1. Check the parameters. 2. Check for broken/loose connections at inputs.
Anlg Cal Chksum	108		The checksum read from the analog calibration data does not match the checksum that is calculated.	Replace the drive.
Auto Rstrt Tries	33	3	Drive unsuccessfully attempted to reset a fault and resume running for the programmed number of [Flt RstRun Tries]. Enable/Disable with [Fault Config 1] on page 53 .	Correct the cause of the fault and manually clear.
AutoTune Aborted	80		Autotune function was canceled by the user or a fault occurred.	Restart the procedure.
Cntl Bd Overtemp	55		The temperature sensor on the Main Control Board detected excessive heat.	1. Check Main Control Board fan. 2. Check surrounding air temperature. 3. Verify proper mounting/cooling.
Auxiliary Input	2	1	Auxiliary input interlock is open.	Check remote wiring.
DB Resistance	69		The resistance of the internal DB unit is out of range.	Replace the resistor.
Decel Inhibit	24	3	The drive is not following a commanded acceleration or deceleration because it is attempting to limit bus voltage.	1. Verify that input voltage is within drive specified limits. 2. Verify that system ground impedance follows proper grounding techniques. 3. Disable bus regulation and/or add dynamic brake resistor and/or extend deceleration time.
Drive OverLoad	64		Drive rating of 110% for 1 minute or 150% for 3 seconds has been exceeded.	Reduce load or extend Accel Time.
Drive Powerup EC v2	49		No fault is displayed. Used as a Power Up Marker in the Fault Queue indicating that the drive power has been cycled.	
Enable Hardware EC	111		Safe-Off board is not installed and pins 3 and 4 of the Safe-Off Connector are not jumpered. If Safe-Off board is installed, verify that the hardware enable jumper is removed.	Install Safe-Off board or jumper pins 3 and 4. Locate and remove the enable jumper on the main control board. Refer to DriveGuard Safe-Off Option (Series B) for PowerFlex 40P and PowerFlex 70 AC Drives, publication PFLEX-UM003 , for instructions and location.
			Safe-Off board has failed.	Replace Safe-Off board.
			Hardware enable circuitry failed.	Replace control board.
Encoder Loss EC v2	91		One or both encoder channel signals is missing.	1. Check Wiring. 2. Replace encoder.
Encoder Quad Err	90		Both encoder channels changed state within one clock cycle.	1. Check for externally induced noise. 2. Replace encoder.
Hardware Fault	93		Hardware enable is disabled (jumpered high) but logic pin is still low.	1. Check jumper. 2. Replace Main Control Board.
Excessive Load	79		Motor did not come up to speed in the allotted time during autotune.	1. Uncouple load from motor. 2. Repeat Autotune.
Faults Cleared EC v2	52		No fault displayed. Used as a marker in the Fault Queue indicating that the fault clear function was performed.	

Table 1 - Fault Types, Descriptions, and Actions (continued)

Fault	No.	Type	Description	Action
Fatal Faults	900... 930	2	Diagnostic code indicating a drive malfunction.	1. Cycle power. 2. Replace Main Control Board. 3. Contact Tech Support.
Flt Queue Cleared EC v2	51		No fault displayed. Used as a marker in the Fault Queue indicating that the clear queue function was performed.	
FluxAmpsRef Rang	78		The value for flux amps determined by the Autotune procedure exceeds the programmed [Motor NP FLA].	1. Reprogram [Motor NP FLA] with the correct motor nameplate value. 2. Repeat Autotune.
Ground Fault	13	1	A current path to earth ground greater than 25% of drive rating.	Check the motor and external wiring to the drive output terminals for a grounded condition.
Heatsink LowTemp	10	1	Annunciates a too low temperature case or an open NTC (heatsink temperature sensing device) circuit.	1. Verify ambient temperature. 2. In cold ambient temperatures, add space heaters. 3. Check connections to NTC.
Heatsink OvrTemp	8	1	Heatsink temperature exceeds 100% of [Drive Temp].	1. Verify that maximum ambient temperature has not been exceeded. 2. Check fan. 3. Check for excess load.
HW OverCurrent	12	1	The drive output current has exceeded the hardware current limit.	1. Check output of drive or motor for shorts. 2. Check programming. 3. Check for excess load, improper DC boost setting, DC brake volts set too high, or other causes of excess current.
Incompact MCB-PB	106	2	Drive rating information that is stored on the power board is incompatible with the main control board.	Load compatible version files into drive.
Input Phase Loss EC v2	17		The DC bus ripple has exceeded a preset level.	Check incoming power for a missing phase/blown fuse.
IR Volts Range	77		"Calculate" is the autotune default and the value that is determined by the autotune procedure for IR Drop Volts is not in the range of acceptable values.	Re-enter motor nameplate data.
Ixo VoltageRange EC v2	87		Voltage calculated for motor inductive impedance exceeds 25% of [Motor NP Volts].	1. Check for proper motor sizing. 2. Check for correct programming of [Motor NP Volts], parameter 41. 3. Additional output impedance can be required.
Load Loss EC v2	15		Drive output torque current is below [Load Loss Level] for a time period greater than [Load Loss time].	1. Verify connections between motor and load. 2. Verify level and time requirements.
Motor OverLoad	7	1 3	Internal electronic overload trip. Enable/Disable with [Fault Config 1] on page 53 .	An excessive motor load exists. Reduce load so drive output current does not exceed the current set by [Motor NP FLA]. If enabled, check level of flux braking in parameter P549 [Flux Braking %].
Motor Thermistor EC	16		Thermistor output is out of range.	1. Verify that thermistor is connected. 2. Motor is overheated. Reduce load.
Overspeed Limit	25	1	Functions such as Slip Compensation or Bus Regulation have attempted to add an output frequency adjustment greater than that programmed in [Overspeed Limit].	Remove excessive load or overhauling conditions or increase [Overspeed Limit].

Table 1 - Fault Types, Descriptions, and Actions (continued)

Fault	No.	Type ⁽¹⁾	Description	Action
OverVoltage	5	1	DC bus voltage exceeded maximum value.	Monitor the AC line for high line voltage or transient conditions. Bus overvoltage can also be caused by motor regeneration. Extend the decel time or install dynamic brake option.
Parameter Chksum	100	2	The checksum read from the board does not match the checksum that is calculated.	1. Restore defaults. 2. Reload User Set if used.
Params Defaulted	48		The drive was commanded to write default values to EEPROM.	1. Clear the fault or cycle power to the drive. 2. Program the drive parameters as needed.
Phase U to Grnd	38		A phase to ground fault has been detected between the drive and motor in this phase.	1. Check the wiring between the drive and motor. 2. Check motor for grounded phase. 3. Replace drive.
Phase V to Grnd	39			
Phase W to Grnd	40			
Phase UV Short	41		Excessive current has been detected between these two output terminals.	1. Check the motor and drive output terminal wiring for a shorted condition. 2. Replace drive.
Phase VW Short	42			
Phase UW Short	43			
Port 1...5 DPI Loss	81... 85		DPI port stopped communicating. A SCANport device was connected to a drive operating DPI devices at 500k baud.	1. If adapter was not intentionally disconnected, check wiring to the port. Replace wiring, port expander, adapters, Main Control Board, or complete drive as required. 2. Check HIM connection. 3. If an adapter was intentionally disconnected and the [Logic Mask] bit for that adapter is set to "1", this fault occurs. To disable this fault, set the [Logic Mask] bit for the adapter to "0."
Port 1...5 Adapter	71... 75		The communications card has a fault.	Check DPI device event queue and corresponding fault information for the device.
Power Loss	3	1 3	DC bus voltage remained below trigger of nominal for longer than [Power Loss Time]. Enable/Disable with [Fault Config 1] on page 53 .	Monitor the incoming AC line for low voltage or line power interruption.
Pwr Brd Chksum1	104		The checksum read from the EEPROM does not match the checksum that is calculated from the EEPROM data.	Clear the fault or cycle power to the drive.
Pwr Brd Chksum2	105	2	The checksum read from the board does not match the checksum that is calculated.	1. Cycle power to the drive. 2. If problem persists, replace drive.
Power Down Csum	112		EEPROM data is corrupt on drive powerup.	Clear the fault or cycle power to the drive.
Power Unit	70		One or more of the output transistors were operating in the active region instead of desaturation. This can be caused by excessive transistor current or insufficient base drive voltage.	1. Check for damaged output transistors. 2. Replace drive.
Replaced MCB-PB	107	2	Main Control Board was replaced and parameters were not programmed.	1. Restore defaults. 2. Reprogram parameters.
Shear Pin	63	3	Programmed [Current Lmt Val] has been exceeded. Enable/Disable with [Fault Config 1] on page 53 .	Check load requirements and [Current Lmt Val] setting.
SW OverCurrent	36	1	Drive output current has exceeded the 1 ms current rating. This rating is greater than the 3-second current rating and less than the hardware overcurrent fault level. It is typically 200...250% of the drive continuous rating.	Check for excess load, improper DC boost setting. DC brake volts set too high. If enabled, check level of flux braking in parameter P549 [Flux Braking %].

Table 1 - Fault Types, Descriptions, and Actions (continued)

Fault	No.	Type ⁽¹⁾	Description	Action
Trnsistr OvrTemp	9	1	Output transistors have exceeded their maximum operating temperature.	1. Verify that maximum ambient temperature has not been exceeded. 2. Check fan. 3. Check for excessive load.
UnderVoltage	4	1 3	DC bus voltage fell below the minimum value. Standard Control: • 509V DC at 600V input • 407V DC at 400/480V input • 204V DC at 200/240V input Enhanced Control: • 375V DC at 600V input • 300V DC at 400/480 input • 160V DC at 200/240V input Enable/Disable with [Fault Config 1] on page 53 .	Monitor the incoming AC line for low voltage or power interruption.
UserSet1 Chksum	101	2	The checksum read from the user set does not match the checksum that is calculated.	Re-save user set.
UserSet2 Chksum	102	2		
UserSet3 Chksum	103	2		

(1) See [page 77](#) for a description of fault types.

Table 2 - Fault Cross-reference

No. ⁽¹⁾	Fault	No. ⁽¹⁾	Fault	No. ⁽¹⁾	Fault
2	Auxiliary Input	38	Phase U to Grnd	80	AutoTune Aborted
3	Power Loss	39	Phase V to Grnd	81...86	Port 1...6 DPI Loss
4	UnderVoltage	40	Phase W to Grnd	87	IXo VoltageRange
5	OverVoltage	41	Phase UV Short	90	Encoder Quad Error
7	Motor Overload	42	Phase VW Short	91	Encoder Loss
8	Heatsink OvrTemp	43	Phase UW Short	93	Hardware Fault
9	Trnsistr OvrTemp	48	Params Defaulted	100	Parameter Chksum
10	Heatsink LowTemp	49	Drive Powerup	101	UserSet1 Chksum
12	HW OverCurrent	51	Flt QueueCleared	102	UserSet2 Chksum
13	Ground Fault	52	Faults Cleared	103	UserSet3 Chksum
15	Load Loss	55	Cntl Bd Overtemp	104	Pwr Brd Chksum1
16	Motor Thermistor	63	Shear Pin	105	Pwr Brd Chksum2
17	Input Phase Loss	64	Drive Overload	106	Incompat MCB-PB
24	Decel Inhibit	69	DB Resistance	107	Replaced MCB-PB
25	OverSpeed Limit	70	Power Unit	108	Anlg Cal Chksum
29	Analog In Loss	71...75	Port 1...5 Adapter	111	Enable Hardware
33	Auto Rstrt Tries	77	IR Volts Range	112	Power Down Csum
36	SW OverCurrent	78	FluxAmpsRef Rang	900...930	Fatal Faults
		79	Excessive Load		

(1) Fault numbers that are not listed are reserved for future use.

Clearing Alarms

Alarms are automatically cleared when the condition that caused the alarm is no longer present.

Alarm Descriptions

Table 3 provides a list of alarm messages and descriptions of the cause of the alarm.

Table 3 - Alarm Descriptions and Actions

Alarm	No.	Type (1)	Description																																																																																																				
Analog in Loss	5	1	An analog input is configured for "Alarm" on signal loss and signal loss has occurred.																																																																																																				
Bipolar Conflict	20	2	Parameter 190 [Direction Mode] is set to "Bipolar" or "Reverse Dis" and one or more of the following digital input functions is configured: "Fwd/Reverse", "Run Forward", "Run Reverse", "Jog Forward", or "Jog Reverse".																																																																																																				
Decel Inhibit	10	1	Drive is being inhibited from decelerating.																																																																																																				
Dig In ConflictA	17	2	Digital input functions are in conflict. Combinations marked with an "X" will cause an alarm. <table border="1" style="width: 100%; margin-top: 5px;"> <thead> <tr> <th></th> <th>Acc2/Dec2</th> <th>Accel 2</th> <th>Decel 2</th> <th>Jog</th> <th>Jog Fwd</th> <th>Jog Rev</th> <th>Fwd/Rev</th> </tr> </thead> <tbody> <tr> <td>Acc2 / Dec2</td> <td></td> <td>X</td> <td>X</td> <td></td> <td></td> <td></td> <td></td> </tr> <tr> <td>Accel 2</td> <td>X</td> <td></td> <td></td> <td></td> <td></td> <td></td> <td></td> </tr> <tr> <td>Decel 2</td> <td>X</td> <td></td> <td></td> <td></td> <td></td> <td></td> <td></td> </tr> <tr> <td>Jog</td> <td></td> <td></td> <td></td> <td></td> <td>X</td> <td>X</td> <td></td> </tr> <tr> <td>Jog Fwd</td> <td></td> <td></td> <td></td> <td>X</td> <td></td> <td></td> <td>X</td> </tr> <tr> <td>Jog Rev</td> <td></td> <td></td> <td></td> <td>X</td> <td></td> <td></td> <td>X</td> </tr> <tr> <td>Fwd / Rev</td> <td></td> <td></td> <td></td> <td></td> <td>X</td> <td>X</td> <td></td> </tr> </tbody> </table>		Acc2/Dec2	Accel 2	Decel 2	Jog	Jog Fwd	Jog Rev	Fwd/Rev	Acc2 / Dec2		X	X					Accel 2	X							Decel 2	X							Jog					X	X		Jog Fwd				X			X	Jog Rev				X			X	Fwd / Rev					X	X																																					
	Acc2/Dec2	Accel 2	Decel 2	Jog	Jog Fwd	Jog Rev	Fwd/Rev																																																																																																
Acc2 / Dec2		X	X																																																																																																				
Accel 2	X																																																																																																						
Decel 2	X																																																																																																						
Jog					X	X																																																																																																	
Jog Fwd				X			X																																																																																																
Jog Rev				X			X																																																																																																
Fwd / Rev					X	X																																																																																																	
Dig In ConflictB	18	2	A digital Start input has been configured without a Stop input or other functions are in conflict. Combinations that conflict are marked with an "X" and will cause an alarm. <table border="1" style="width: 100%; margin-top: 5px;"> <thead> <tr> <th></th> <th>Start</th> <th>Stop-CF</th> <th>Run</th> <th>Run Fwd</th> <th>Run Rev</th> <th>Jog</th> <th>Jog Fwd</th> <th>Jog Rev</th> <th>Fwd/Rev</th> </tr> </thead> <tbody> <tr> <td>Start</td> <td></td> <td></td> <td>X</td> <td>X</td> <td>X</td> <td></td> <td>X</td> <td>X</td> <td></td> </tr> <tr> <td>Stop-CF</td> <td></td> <td></td> <td></td> <td></td> <td></td> <td></td> <td></td> <td></td> <td></td> </tr> <tr> <td>Run</td> <td>X</td> <td></td> <td></td> <td>X</td> <td>X</td> <td></td> <td>X</td> <td>X</td> <td></td> </tr> <tr> <td>Run Fwd</td> <td>X</td> <td></td> <td>X</td> <td></td> <td></td> <td>X</td> <td></td> <td></td> <td>X</td> </tr> <tr> <td>Run Rev</td> <td>X</td> <td></td> <td>X</td> <td></td> <td></td> <td>X</td> <td></td> <td></td> <td>X</td> </tr> <tr> <td>Jog</td> <td></td> <td></td> <td></td> <td>X</td> <td>X</td> <td></td> <td></td> <td></td> <td></td> </tr> <tr> <td>Jog Fwd</td> <td>X</td> <td></td> <td>X</td> <td></td> <td></td> <td></td> <td></td> <td></td> <td></td> </tr> <tr> <td>Jog Rev</td> <td>X</td> <td></td> <td>X</td> <td></td> <td></td> <td></td> <td></td> <td></td> <td></td> </tr> <tr> <td>Fwd / Rev</td> <td></td> <td></td> <td></td> <td>X</td> <td>X</td> <td></td> <td></td> <td></td> <td></td> </tr> </tbody> </table>		Start	Stop-CF	Run	Run Fwd	Run Rev	Jog	Jog Fwd	Jog Rev	Fwd/Rev	Start			X	X	X		X	X		Stop-CF										Run	X			X	X		X	X		Run Fwd	X		X			X			X	Run Rev	X		X			X			X	Jog				X	X					Jog Fwd	X		X							Jog Rev	X		X							Fwd / Rev				X	X				
	Start	Stop-CF	Run	Run Fwd	Run Rev	Jog	Jog Fwd	Jog Rev	Fwd/Rev																																																																																														
Start			X	X	X		X	X																																																																																															
Stop-CF																																																																																																							
Run	X			X	X		X	X																																																																																															
Run Fwd	X		X			X			X																																																																																														
Run Rev	X		X			X			X																																																																																														
Jog				X	X																																																																																																		
Jog Fwd	X		X																																																																																																				
Jog Rev	X		X																																																																																																				
Fwd / Rev				X	X																																																																																																		
Dig In ConflictC	19	2	More than one physical input has been configured to the same input function. Multiple configurations are not allowed for the following input functions. <table style="width: 100%; margin-top: 5px;"> <tr> <td>Forward/Reverse</td> <td>Run Reverse</td> <td>Bus Regulation Mode B</td> </tr> <tr> <td>Speed Select 1</td> <td>Jog Forward</td> <td>Acc2 / Dec2</td> </tr> <tr> <td>Speed Select 2</td> <td>Jog Reverse</td> <td>Accel 2</td> </tr> <tr> <td>Speed Select 3</td> <td>Run</td> <td>Decel 2</td> </tr> <tr> <td>Run Forward</td> <td>Stop Mode B</td> <td></td> </tr> </table>	Forward/Reverse	Run Reverse	Bus Regulation Mode B	Speed Select 1	Jog Forward	Acc2 / Dec2	Speed Select 2	Jog Reverse	Accel 2	Speed Select 3	Run	Decel 2	Run Forward	Stop Mode B																																																																																						
Forward/Reverse	Run Reverse	Bus Regulation Mode B																																																																																																					
Speed Select 1	Jog Forward	Acc2 / Dec2																																																																																																					
Speed Select 2	Jog Reverse	Accel 2																																																																																																					
Speed Select 3	Run	Decel 2																																																																																																					
Run Forward	Stop Mode B																																																																																																						
Drive OL Level 1	8	1	The calculated IGBT temperature requires a reduction in PWM frequency. If [Drive OL Mode] is disabled and the load is not reduced, an overload fault eventually occurs.																																																																																																				
Drive OL Level 2	9	1	The calculated IGBT temperature requires a reduction in Current Limit. If [Drive OL Mode] is disabled and the load is not reduced, an overload fault eventually occurs.																																																																																																				
FluxAmpsRef Rang	26	2	The calculated or measured Flux Amps value is not within the expected range. Verify motor data and rerun motor tests.																																																																																																				
Ground Warn EC v2	15	1	Ground current has exceeded the level set in [Gnd Warn Level].																																																																																																				
In Phase Loss EC v2	13	1	The DC bus ripple has exceeded the level in [Phase Loss Level].																																																																																																				
IntDBRes OvrHeat	6	1	The drive has temporarily disabled the DB regulator because the resistor temperature has exceeded a predetermined value.																																																																																																				

Table 3 - Alarm Descriptions and Actions (continued)

Alarm	No.	Type ⁽¹⁾	Description
IR Volts Range	25	2	The drive auto tuning default is "Calculate" and the value that is calculated for IR Drop Volts is not in the range of acceptable values. This alarm clears when all motor nameplate data is properly entered.
IXo VoltageRange EC v2	28	2	Motor leakage inductance is out of range.
Load Loss EC v2	14		Output torque current is below [Load Loss Level] for a time period greater than [Load Loss time].
MaxFreq Conflict	23	2	The sum of [Maximum Speed] and [Overspeed Limit] exceeds [Maximum Freq]. Raise [Maximum Freq] or lower [Maximum Speed] and/or [Overspeed Limit] so that the sum is less than or equal to [Maximum Freq].
Motor Thermistor EC	12		[Fault Config 1] or [Alarm Config 1] Bit 7 "Motor Therm" is enabled and the analog Input voltage is <0.2 Volts or >5.0 Volts.
Motor Type Cflct	21	2	[Motor Type] has been set to "Synchr Reluc" or "Synchr PM" and one or more of the following exist: <ul style="list-style-type: none"> • [Torque Perf Mode] = "Sensrls Vect," "SV Economize" or "Fan/Pmp V/Hz." • [Flux Up Time] is greater than 0.0 s • [Speed Mode] is set to "Slip Comp." • [Autotune] = "Static Tune" or "Rotate Tune."
NP Hz Conflict	22	2	Fan/pump mode is selected in [Torq Perf Mode] and the ratio of [Motor NP Hertz] to [Maximum Freq] is greater than 26.
Power Loss	3	1	Drive has sensed a power line loss.
Precharge Active	1	1	Drive is in the initial DC bus precharge state.
PTC Conflict EC	31		[Fault Config 1] or [Alarm Config 1] Bit 7 "Motor Therm" is enabled and Analog In 1 is set to milliamperes.
Sleep Config EC v2	29	2	Sleep/Wake configuration error. With [Sleep-Wake Mode] = "Direct," possible causes include: drive is stopped and [Wake Level] < [Sleep Level]. "Stop=CF," "Run," "Run Forward," or "Run Reverse." is not configured in [Digital Inx Sel].
Speed Ref Cflct	27	2	[Speed Ref x Sel] or [PI Reference Sel] is set to "Reserved".
Start At Powerup	4	1	[Start At Powerup] is enabled. The drive can start at any time within 10 seconds of drive powerup.
TB Man Ref Cflct EC	30		Occurs when: <ul style="list-style-type: none"> • "Auto/Manual" is selected (default) for [Digital In3 Sel], parameter 363 <i>and</i> <ul style="list-style-type: none"> • [TB Man Ref Sel], parameter 96 has been reprogrammed. No other use for the selected analog input can be programmed. Example: If [TB Man Ref Sel] is reprogrammed to "Analog In 2," all of the factory default uses for "Analog In 2" must be reprogrammed (such as parameters 90, 117, 128, and 179). See also Auto/Manual Examples on page 112 . To correct: <ul style="list-style-type: none"> • Verify/reprogram the parameters that reference an analog input <i>or</i> <ul style="list-style-type: none"> • Reprogram [Digital In3] to another function or "Unused."
UnderVoltage	2	1	The bus voltage has dropped below a predetermined value.
UserSet Conflict EC v2	51	2	[Digital Inx Sel] values differ in different user sets.
VHz Neg Slope	24	2	[Torq Perf Mode] = "Custom V/Hz" and the V/Hz slope is negative.
Waking EC v2	11	1	The Wake timer is counting toward a value that will start the drive.

(1) See [page 77](#) for a description of alarm types.

Table 4 - Alarm Cross Reference

No. ⁽¹⁾	Alarm	No. ⁽¹⁾	Alarm	No. ⁽¹⁾	Alarm
1	Precharge Active	12	Motor Thermistor	23	MaxFreq Conflict
2	UnderVoltage	13	In Phase Loss	24	VHz Neg Slope
3	Power Loss	14	Load Loss	25	IR Volts Range
4	Start At Powerup	15	Ground Warn	26	FluxAmpsRef Rang
5	Analog in Loss	17	Dig In ConflictA	27	Speed Ref Cfct
6	IntDBRes OvrHeat	18	Dig In ConflictB	28	Ixo Vlt Rang
8	Drive OL Level 1	19	Dig In ConflictC	29	Sleep Config
9	Drive OL Level 2	20	Bipolar Conflict	30	TB Man Ref Cfct
10	Decel Inhibit	21	Motor Type Cfct	31	PTC Conflict
11	Waking	22	NP Hz Conflict	51	UserSet Conflict

(1) Alarm numbers that are not listed are reserved for future use.

Testpoint Codes and Functions

Table 5 - Testpoint Codes and Functions

Code Selected in [Testpoint x Sel]	Function Whose Value Is Displayed in [Testpoint x Data]
1	DPI Error Status
2	Heatsink Temperature
3	Active Current Limit
4	Active PWM Frequency
5	Lifetime Megawatt Hours ⁽¹⁾
6	Lifetime Run Time
7	Lifetime Powered Up Time
8	Lifetime Power Cycles
9	Life Megawatt Hours Fraction ⁽¹⁾
10	Life Megawatt Hours Fraction Units ⁽¹⁾
11...99	Reserved for Factory Use

(1) Use the equation below to calculate total Lifetime Megawatt Hours.

$$\left(\frac{\text{Value of Code 9}}{\text{Value of Code 10}} \times 0.1 \right) + \text{Value of Code 5} = \text{Total Lifetime MegaWatt Hours}$$

Common Symptoms and Corrective Actions

Table 6 through Table 12 describe the cause, status indication (if applicable), and corrective action of common problem symptoms.

Table 6 - Drive Does Not Start from Start or Run Inputs Wired to the Terminal Block

Causes	Indication	Corrective Action
Drive is faulted	Flashing red status light	Clear fault: 1. Press Stop. 2. Cycle the power. 3. Set [Fault Clear] to 1 (see page 53). 4. "Clear Faults" on the HIM Diagnostic menu.
Incorrect input wiring. Refer to PowerFlex 70 Adjustable Frequency AC Drive Installation Instructions, publication 20A-IN009 , for wiring examples. <ul style="list-style-type: none"> 2-wire control requires Run, Run Forward, Run Reverse, or Jog input. 3-wire control requires Start and Stop inputs Jumper from terminal 7 to 8 is required. 	None	Wire inputs correctly and/or install jumper.
Incorrect digital input programming. <ul style="list-style-type: none"> Mutually exclusive choices have been made (for example, Jog and Jog Forward). 2-wire and 3-wire programming can be conflicting. Exclusive functions (for example, direction control) can have multiple inputs that are configured. Stop is factory default and is not wired. 	None	Program [Digital Inx Sel] for correct inputs (see page 67). Start or Run programming can be missing.
	Flashing yellow status light and "DigIn CflctB" indication on LCD HIM. [Drive Status 2] shows type 2 alarm(s).	Program [Digital Inx Sel] to resolve conflicts (see page 67). Remove multiple selections for the same function. Install stop button to apply a signal at stop terminal.

Table 7 - Drive Does Not Start from HIM

Cause	Indication	Corrective Action
Drive is programmed for 2-wire control. HIM start button is disabled for 2-wire control.	None	If 2-wire control is required, no action is necessary. If 3-wire control is required, program [Digital Inx Sel] for correct inputs (see page 67 .)

Table 8 - Drive Does Not Respond to Changes in Speed Command

Causes	Indication	Corrective Action
No value is coming from the source of the command.	LCD HIM Status Line indicates "At Speed" and output is 0 Hz.	1. If the source is an analog input, check wiring and use a meter to check for presence of signal. 2. Check [Commanded Freq] for correct source (see page 21).
Incorrect reference source has been programmed.	None	1. Check [Speed Ref Source] for the source of the speed reference (see page 53). 2. Reprogram [Speed Ref A Sel] for correct source (see page 32).
Incorrect reference source is being selected via remote device or digital inputs.	None	1. Check [Drive Status 1], bits 12 and 13 for unexpected source selections (see page 51). 2. Check [Dig In Status] to see if inputs are selecting an alternate source (see page 54). 3. Reprogram digital inputs to the correct "Speed Sel x" option in the [Digital Inx Sel] parameter (see page 67).

Table 9 - Motor and/or Drive Does Not Accelerate to Commanded Speed

Causes	Indication	Corrective Action
Acceleration time is excessive.	None	Reprogram [Accel Time x] (see page 40).
Excess load or short acceleration times force the drive into current limit, slowing or stopping acceleration.	None	Check [Drive Status 2], bit 10 to see if the drive is in Current Limit (see page 51). Remove excess load or reprogram [Accel Time x] (see page 40).
Speed command source or value is not as expected.	None	Check for the proper Speed Command by using the steps in Table 8 on page 86 .
Programming is preventing the drive output from exceeding limiting values.	None	Check [Maximum Speed] page 30 and [Maximum Freq] page 24 to assure that speed is not limited by programming.

Table 10 - Motor Operation Is Unstable

Cause	Indication	Corrective Action
Motor data was incorrectly entered or Autotune was not performed.	None	1. Correctly enter motor nameplate data. 2. Perform "Static" or "Rotate" procedures in the Autotune parameter (see page 26).

Table 11 - Drive Does Not Reverse Motor Direction

Causes	Indication	Corrective Action
Digital input is not selected for reversing control.	None	Check [Digital Inx Sel] (see page 67). Choose correct input and program for reversing mode.
Digital input is incorrectly wired.	None	Check input wiring. Refer to PowerFlex 70 Adjustable Frequency AC Drive Installation Instructions, publication 20A-IN009 .
Direction mode parameter is incorrectly programmed.	None	Reprogram the analog "Bipolar" or digital "Unipolar" control in the [Direction Mode] parameter (see page 48).
Motor wiring is improperly phased for reverse.	None	Switch two motor leads.
A bipolar analog speed command input is incorrectly wired or signal is absent.	None	1. Use meter to check that an analog input voltage is present. 2. Check wiring. Refer to PowerFlex 70 Adjustable Frequency AC Drive Installation Instructions, publication 20A-IN009 . Positive voltage commands forward direction. Negative voltage commands reverse direction.

Table 12 - Stopping the Drive Results in a Decel Inhibit Fault

Causes	Indication	Corrective Action
The bus regulation feature is enabled and is halting deceleration due to excessive bus voltage. Excess bus voltage is normally due to excessive regenerated energy or unstable AC line input voltages. Internal timer has halted drive operation.	Decel Inhibit fault screen. LCD Status Line indicates "Faulted".	1. See Attention statement on page 9 . 2. Reprogram bus regulation (parameters 161 and 162) to eliminate any "Adjust Freq" selection. 3. Disable bus regulation (parameters 161 and 162) and add a dynamic brake. 4. Correct AC input line instability or add an isolation transformer. 5. Reset drive.

Notes:

Supplemental Drive Information

This appendix provides certification, specification, and communication information.

Topic	Page
Communication Configurations	89
Output Devices	91

For product certifications and specifications, see the PowerFlex 70 Adjustable Frequency AC Drive Technical Data, publication [20A-TD001](#).

Communication Configurations

Typical Programmable Controller Configurations

This section provides information for programmable controller configurations and bit settings for logic command word and logic status word.

IMPORTANT If block transfers are programmed to continuously write information to the drive, be sure to properly format the block transfer.

If attribute 10 is selected for the block transfer, values are written only to RAM and are not saved by the drive. This is the preferred attribute for continuous transfers.

If attribute 9 is selected, each program scan completes a write to the non-volatile Electrically Erasable Programmable Read-Only Memory (EEPROM) of the drive. Because the EEPROM has a fixed number of writes, continuous block transfers can quickly damage the EEPROM.

Do not assign attribute 9 to continuous block transfers. Refer to the individual communications adapter user manual for additional details.

For a description of logic command word bit settings, see [Table 13 on page 90](#).

For a description of logic status word bit settings, see [Table 14 on page 91](#).

Logic Command Word/ Logic Status Word

Table 13 and Table 14 provide bit settings for logic command word and logic status word.

Table 13 - Logic Command Word

Logic Bits																Command	Description
15	14	13	12	11	10	9	8	7	6	5	4	3	2	1	0		
															x	Stop ⁽¹⁾	0 = Not Stop 1 = Stop
															x	Start ⁽¹⁾⁽²⁾	0 = Not Start 1 = Start
														x		Jog	0 = Not Jog 1 = Jog
													x			Clear Faults	0 = Not Clear Faults 1 = Clear Faults
										x	x					Direction	00 = No Command 01 = Forward Command 10 = Reverse Command 11 = Hold Present Direction
									x							Local Control	0 = No Local Control 1 = Local Control
								x								MOP Increment	0 = Not Increment 1 = Increment
						x	x									Accel Rate	00 = No Command 01 = Use Accel Time 1 10 = Use Accel Time 2 11 = Use Present Time
				x	x											Decel Rate	00 = No Command 01 = Use Decel Time 1 10 = Use Decel Time 2 11 = Use Present Time
	x	x	x													Reference Select ⁽³⁾	000 = No Command 001 = Ref. 1 (Ref A Select) 010 = Ref. 2 (Ref B Select) 011 = Ref. 3 (Preset 3) 100 = Ref. 4 (Preset 4) 101 = Ref. 5 (Preset 5) 110 = Ref. 6 (Preset 6) 111 = Ref. 7 (Preset 7)
x																MOP Decrement	0 = Not Decrement 1 = Decrement

- (1) A “0 = Not Stop” condition (logic 0) must first be present before a “1 = Start” condition starts the drive. The Start command acts as a momentary Start command. A “1” starts the drive, but returning to “0” **does not** stop the drive.
- (2) This Start does not function if a digital input (parameters 361...366) is programmed for 2-Wire Control (option 7, 8, or 9).
- (3) This Reference Select does not function if a digital input (parameters 361...366) is programmed for “Speed Sel 1, 2, or 3” (option 15, 16, or 17). When using the Logic Command Word for the speed reference selection, always set Bit 12, 13, or 14. Note that reference selection is “Exclusive Ownership” see [\[Reference Owner\] on page 61](#).

Table 14 - Logic Status Word

Logic Bits																Status	Description
15	14	13	12	11	10	9	8	7	6	5	4	3	2	1	0		
															x	Ready	0 = Not Ready 1 = Ready
															x	Active	0 = Not Active 1 = Active
														x		Command Direction	0 = Reverse 1 = Forward
												x				Actual Direction	0 = Reverse 1 = Forward
											x					Accel	0 = Not Accelerating 1 = Accelerating
											x					Decel	0 = Not Decelerating 1 = Decelerating
											x					Alarm	0 = No Alarm 1 = Alarm
											x					Fault	0 = No Fault 1 = Fault
											x					At Speed	0 = Not At Reference 1 = At Reference
				x	x	x										Local Control ⁽¹⁾	000 = Port 0 (TB) 001 = Port 1 010 = Port 2 011 = Port 3 100 = Port 4 101 = Port 5 110 = Port 6 111 = No Local
x	x	x	x													Reference Source	0000 = Ref A Auto 0001 = Ref B Auto 0010 = Preset 2 Auto 0011 = Preset 3 Auto 0100 = Preset 4 Auto 0101 = Preset 5 Auto 0110 = Preset 6 Auto 0111 = Preset 7 Auto 1000 = Term Blk Manual 1001 = DPI 1 Manual 1010 = DPI 2 Manual 1011 = DPI 3 Manual 1100 = DPI 4 Manual 1101 = DPI 5 Manual 1110 = DPI 6 Manual 1111 = Jog Ref

(1) See Owners parameters [\[Stop Owner\] on page 61](#) through [\[Local Owner\] on page 62](#) for further information.

Output Devices

For information on output devices such as output contactors, cable terminators, and output reactors, refer to the PowerFlex Reference Manual, publication [PFLEX-RM001](#).

Notes:

HIM Overview

This appendix provides information for connecting the HIM, and using the HIM to view and program the drive parameters.

Topic	Page
External and Internal Connections	93
LCD Display Elements	95
ALT Functions	95
Removing the HIM	95
Menu Structure	96
Viewing and Editing Parameters	97

External and Internal Connections

The PowerFlex 70 drive provides a number of cable connection points (B frame shown).

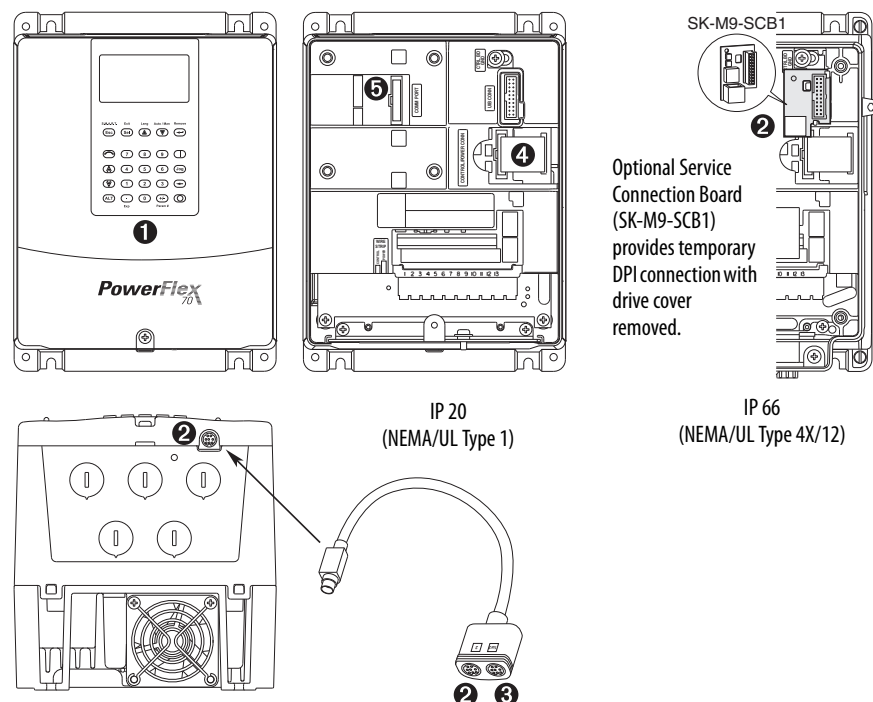

No.	Connector	Description
1	DPI Port 1	HIM connection when installed in cover.
2	DPI Port 2	Cable connection for handheld and remote options.
3	DPI Port 3	Splitter cable that is connected to DPI Port 2 provides additional port.
4	Control / Power Connection	Connection between control and power boards.
5	DPI Port 5	Cable connection for communications adapter.

Using the HIM with a 20-HIM-B1 Bezel Kit

The 20-HIM-B1 bezel kit enables remote HIM or Wireless Interface Module (WIM) operation and provides an additional remote DPI port for accessories.

Use the bezel cradle connection to mount the NEMA/UL 1 HIM or NEMA/UL 1 WIM (port 3).

Use the accessory port on the bottom of the bezel for standard DPI peripherals such as 1203-SSS, 1203-USB, or another handheld HIM (port 2, just like the accessory port on the drive).

Use the internal connection on the back side of the bezel to connect the bezel to the host drive with a standard DPI cable. The 20-HIM-B1 bezel kit cannot be used with a 1203-S03 two-way splitter cable, or a 1203-SG2 two-way or 1203-SG4 four-way splitter module.

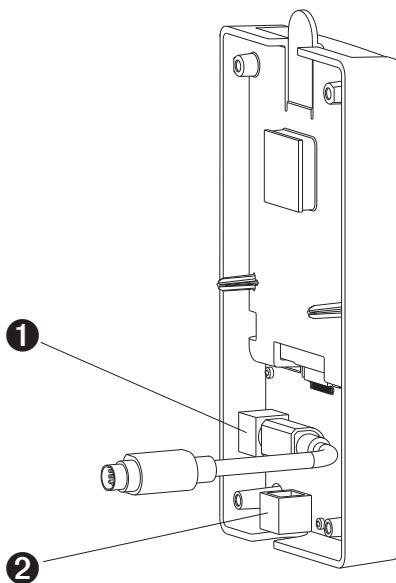

No.	Connector	Description
❶	Upper DPI port	Connects the 20-HIM-B1 bezel to the drive.
❷	Lower DPI port	Connects a 1203-SSS or 1203-USB converter to the drive.

IMPORTANT The bezel’s lower DPI port is always port 2, and the cradle connection port is always port 3.

- If you are using the HIM in the bezel, set parameter 90 [Speed Ref A Sel] or parameter 93 [Speed Ref B Sel] (depending on your application requirements) to option 20 “DPI Port 3.”
- If you are using a remote 20-HIM-C* HIM connected directly into Port 2 on the bottom of the drive, set parameter 90 [Speed Ref A Sel] or parameter 93 [Speed Ref B Sel] to option 19 “DPI Port 2.”

LCD Display Elements

Display	Description
<p>The screenshot shows the LCD display with the following elements: 'F->' on the left, 'Power Loss' in the center, 'Auto' on the right with a small icon, and '0.0 Hz' in a large font below. At the bottom, there is a menu with options: 'Main Menu:', 'Diagnostics', 'Parameter', and 'Device Select'.</p>	<p>Direction Drive Status Alarm Auto/Man Information</p> <p>Commanded or Output Frequency</p> <p>Programming / Monitoring / Troubleshooting</p>

ALT Functions

To use an ALT function, start at the Main Menu and press the ALT key, release it, then press the programming key that is associated with one of the functions that are listed in the table below.

ALT Key and Then ...	Performs This Function ...	HIM Type
S.M.A.R.T.	Displays the S.M.A.R.T. screen.	LCD
Log In/Out	Log in to change parameter settings. Log out to protect parameter settings. Change a password.	LED
View	Enables the selection of how parameters are viewed, or detailed information about a parameter or component.	LCD
Device	Select a connected adapter for editing.	LED
ALT Lang	Displays the language selection screen.	LCD
Auto / Man	Switches between Auto and Manual Modes.	LCD and LED
Remove	Enables HIM removal without causing a fault if the HIM is not the last controlling device and does not have Manual control of the drive.	LCD and LED
Exp	Enables value to be entered as an exponent. (Not available on PowerFlex 70.)	LCD
Param #	Enables the entry of a parameter number for viewing/editing.	LCD

Removing the HIM

The HIM can be removed while the drive is powered. Normally, the drive issues a fault when the HIM is removed because it detects that a device is missing.

IMPORTANT HIM removal is permissible only in Auto mode. If the HIM is removed while in Manual mode, or the HIM is the only remaining control device, a fault occurs.

Menu Structure

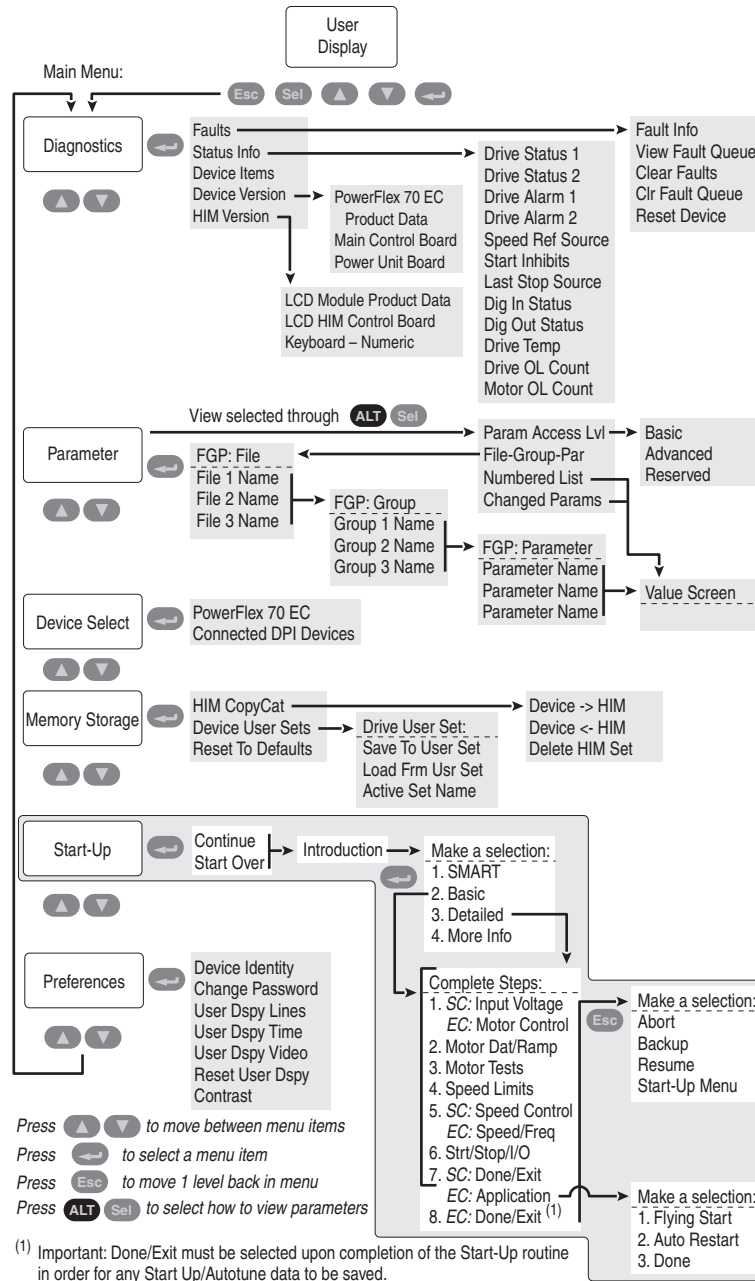

Diagnostics Menu

When a fault trips the drive, use this menu to access detailed data about the drive.

Option	Description
Faults	View fault queue or fault information, clear faults, or reset drive.
Status Info	View parameters that display status information about the drive.
Device Version	View the firmware revision and hardware series of components.
HIM Version	View the firmware revision and hardware series of the HIM.

Parameter Menu

Refer to [Viewing and Editing Parameters on page 97](#).

Device Select Menu

Use this menu to access parameters in connected peripheral devices.

Memory Storage Menu

- Drive data can be saved to, or recalled from, User and HIM sets.
- **User sets** are files that are stored in permanent nonvolatile drive memory.
- **HIM sets** are files that are stored in permanent nonvolatile HIM memory.

Option	Description
HIM Copycat Device -> HIM Device <- HIM	Save data to a HIM set, load data from a HIM set to active drive memory, or delete a HIM set.
Device User Sets	Save data to a user set, load data from a user set to active drive memory, or name a user set.
Reset To Defaults	Restore the drive to its factory-default settings.

Preferences Menu

The HIM and drive have features that you can customize.

Option	Description
Drive Identity	Add text to identify the drive.
Change Password	Enable/disable or modify the password.
User Dspy Lines	Select the display, parameter, scale, and text for the user display. The user display is two lines of user-defined data that appears when the HIM is not being used for programming.
User Dspy Time	Set the wait time for the user display or enable/disable it.
User Dspy Video	Select reverse or normal video for the frequency and user display lines.
Reset User Dspy	Return all the options for the user display to factory default values.



















Viewing and Editing Parameters

The PowerFlex 70 drive is initially set to the basic parameter view. Parameter 196 [Param Access Lvl] controls the parameter views that you can see. The list below describes the different settings and view options for Parameter 196 [Param Access Lvl]:

- **View basic parameters** – To view the basic parameters, set parameter 196 [Param Access Lvl] to option 0 “Basic”.
- **View all parameters** – To view all parameters, set parameter 196 [Param Access Lvl] to option 1 “Advanced”.
- **View engineering parameters** – To view engineering parameters, set parameter 196 [Param Access Lvl] to option 2 “Reserved”.

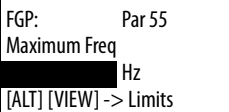
Refer to the PowerFlex 70/700 Reference Manual, publication [PFLEX-RM004](#) for descriptions of these parameters. Parameter 196 is not affected by the Reset to Defaults function.

LCD HIM

Step	Keys	Example Displays
1. In the Main Menu, press the up arrow or down arrow to scroll to "Parameter."	 or 	
2. Press Enter. "FGP File" appears on the top line and the first three files appear below it.		
3. Press the up arrow or down arrow to scroll through the files.	 or 	
4. Press Enter to select a file. The groups in the file are displayed under it.		
5. Repeat steps 3 and 4 to select a group and then a parameter. The parameter value screen appears.		
6. Press Enter to edit the parameter.		
7. Press the up arrow or down arrow to scroll through the parameters. Press Sel to move the cursor down to change the value. If desired, press Sel to move from digit to digit, letter to letter, or bit to bit. The digit or bit that you can change is highlighted.	 or  	
8. Press Enter to save the value. If you want to cancel a change, press Esc.		
9. Press the up arrow or down arrow to scroll through the parameters in the group, or press Esc to return to the group list.	 or  	

Numeric Keypad Shortcut

If you are using a HIM with a numeric keypad, press the ALT key and the +/- key to access the parameter by typing the parameter number.

Application Notes

This appendix provides operational application notes.

Topic	Page
External Brake Resistor	100
Skip Frequency	101
Stop Modes	103
Motor Overload	107
Motor Overload Memory Retention Per 2005 NEC	109
Start at Powerup	109
Overspeed	109
Speed Reference Control	110
Auto/Manual Examples	112
Process PI for Standard Control	113
Voltage Tolerance	115

External Brake Resistor

Figure 1 shows the external brake resistor circuitry.

Figure 1 - External Brake Resistor Circuitry

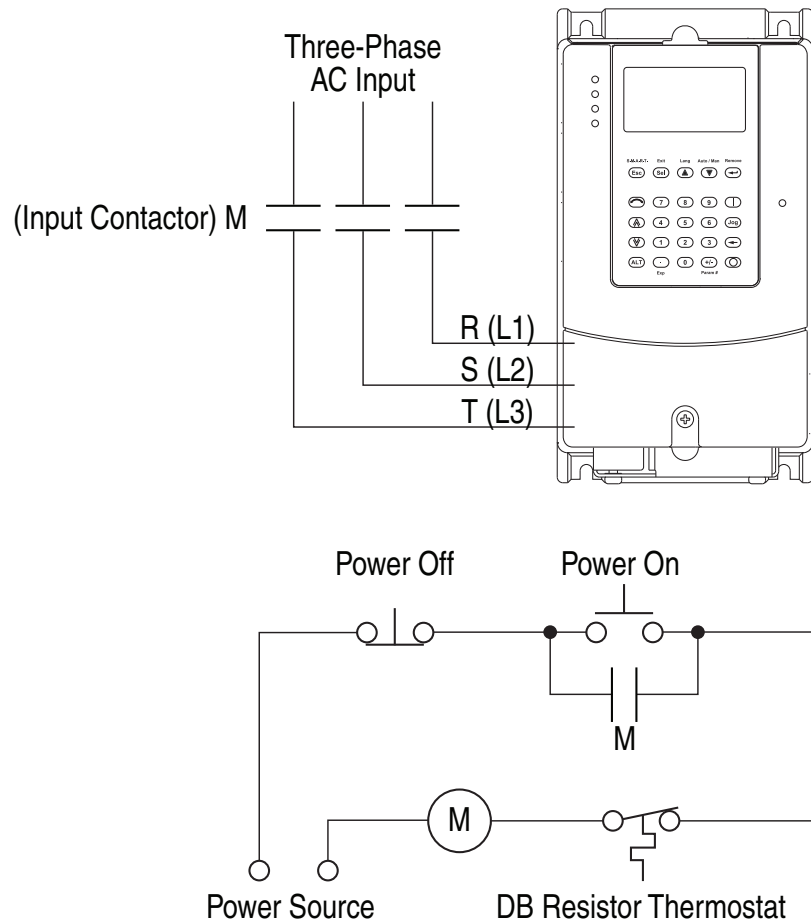

Skip Frequency

[Figure 2](#) shows the skip frequency band parameters.

Figure 2 - Skip Frequency

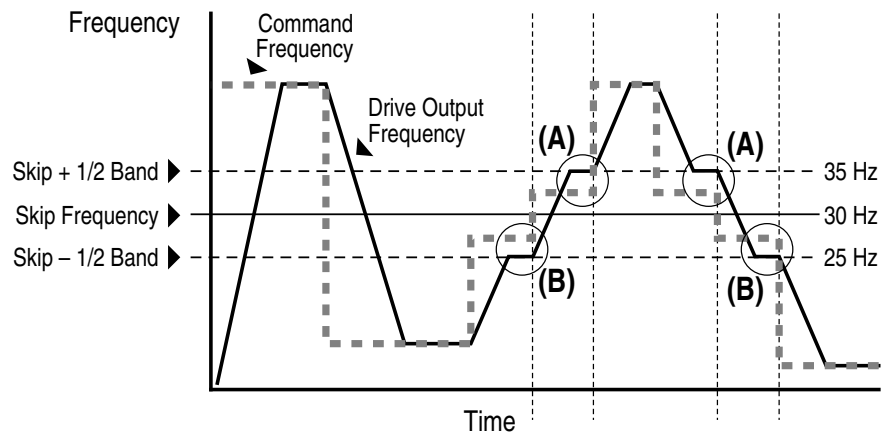

Some machinery can have a resonant operating frequency that must be avoided to minimize the risk of equipment damage. To assure that the motor cannot continuously operate at one or more of the points, skip frequencies are used. parameters 084...086 ([Skip Frequency 1...3]) are available to set the frequencies to be avoided.

The value that is programmed into the skip frequency parameters sets the center point for an entire skip band of frequencies. The width of the band (range of frequency around the center point) is determined by parameter 87, [Skip Freq Band]. The range is split, half above and half below the skip frequency parameter.

If the commanded frequency of the drive is greater than or equal to the skip (center) frequency and less than or equal to the high value of the band (skip plus 1/2 band), the drive sets the output frequency to the high value of the band. See (A) in [Figure 2](#).

If the commanded frequency is less than the skip (center) frequency and greater than or equal to the low value of the band (skip minus 1/2 band), the drive sets the output frequency to the low value of the band. See (B) in [Figure 2](#).

Acceleration and deceleration are not affected by the skip frequencies. Normal accel/decel proceeds through the band once the commanded frequency is greater than the skip frequency. See (A) and (B) in [Figure 2](#). This function affects only continuous operation within the band.

Table 15 - Skip Frequency Examples

Skip Frequency Examples	
<p>The skip frequency has hysteresis so the output does not toggle between high and low values. Three distinct bands can be programmed. If none of the skip bands touch or overlap, each band has its own high/low limit.</p>	
<p>If skip bands overlap or touch, the center frequency is recalculated based on the highest and lowest band values.</p>	
<p>If a skip band(s) extend beyond the max frequency limits, the highest band value is clamped at the max frequency limit. The center frequency is recalculated based on the highest and lowest band values.</p>	
<p>If the band is outside the limits, the skip band is inactive.</p>	

Stop Modes

Several methods are available for braking or stopping a load as described in the table below.

Method	Use When Application Requires . . .	Braking Power
Ramp	<ul style="list-style-type: none"> The fastest stopping time or fastest ramp time for speed changes (external brake resistor or regenerative capability that is required for ramp times faster than the methods below). High duty cycles, frequent stops, or speed changes. (The other methods can result in excessive motor heating). 	Most, if an external resistor or regenerative device is connected.
Fast brake	<ul style="list-style-type: none"> Additional braking capability without the use of an external brake resistor or regenerative unit. Fast brake is effective during stop events, but not during speed changes. <p>Important: For this feature to function properly the active Bus Reg Mode A or B must be set to Adjust "Freq" and not be "Disabled".</p>	More than flux braking or DC brake.
Flux braking	<p>In some applications, Flux Braking can provide a method for fast speed changes or stops. It is not suitable for high inertia loads or high duty cycle operation for applications greater than 1 cycle per minute. This feature supplies additional flux current to the motor and can cause motor thermistor or overvoltage faults in the drive.</p> <ul style="list-style-type: none"> Fast speed changes and fast stopping time. Typical stop from speeds below 50% of base speed ("Flux Braking" typically stops the load faster than "Fast Brake" in this case). <p>Important: This can be used in conjunction with "Ramp" or "Ramp to Hold" for additional braking power or with "Fast Brake" or "DC Brake" for speed changes.</p> <p>Important: For this feature to function properly the active Bus Reg Mode A or B must be set to Adjust "Freq" and not be "Disabled".</p>	More than DC brake.
DC brake	<ul style="list-style-type: none"> Additional braking capability without use of external brake resistor or regenerative units. 	Less than the methods above.

In addition to these modes, the drive can be programmed for "Coast" and "Ramp to Hold," and are described in further detail in [Detailed Operation on page 105](#).

Configuration

- [Stop/Brk Mode A], parameter 155
- [Stop/Brk Mode B], parameter 156
 - 0 = Coast
 - 1 = Ramp
 - 2 = Ramp to Hold
 - 3 = DC Brake
 - 4 = Fast Brake
- [DC Brk Lvl Sel], parameter 157
 - 0 = “DC Brake Lvl” – selects parameter 158 as the source for the DC brake level
 - 1 = “Analog in 1”
 - 2 = “Analog in 2”
- [DC Brake Level], parameter 158 – sets the DC brake level in amps, when parameter 157 = “DC Brake Lvl”
- [DC Brake Time], parameter 159 – sets the amount of time that DC braking is applied after the ramp (if any).
- [Flux Braking], parameter 166 – may need to adjust parameter 549
 - 0 = Disabled
 - 1 = Enabled
- [Digital InX Sel], parameters 361...366
 - 13 = “Stop Mode B” – setting a digital input to this function enables the use of a digital input to switch between Stop Mode A (open input) and Stop Mode B (closed input).

Detailed Operation

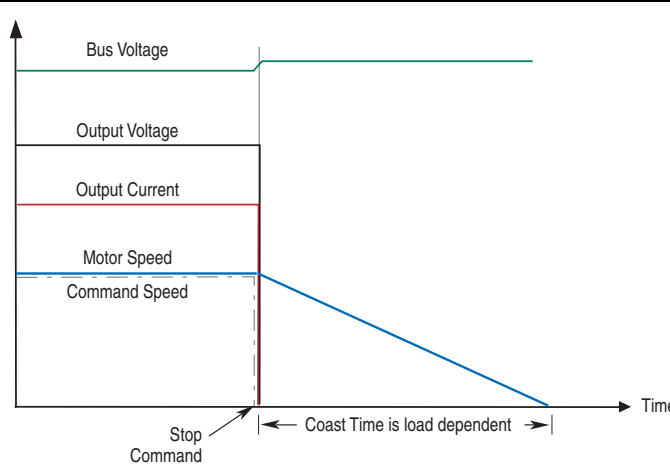
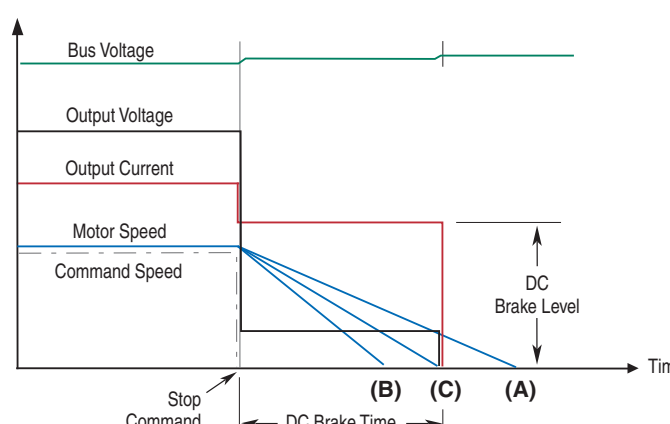
Mode	Description
Coast to Stop	 <p>Coast is selected by setting [Stop Mode A/B] to a value of "0." When in Coast to Stop, the drive acknowledges the Stop command by shutting off the drive output and releasing control of the motor. The load and motor coasts until the kinetic energy is dissipated.</p>
DC Brake to Stop	 <p>This method uses DC injection of the motor to Stop and/or hold the load. DC Brake is selected by setting [Stop Mode A/B] to a value of "3." The amount of time that braking is applied is programmed in [DC Brake Time] and the magnitude of the current used for braking is programmed in and [DC Brake Level]. This mode of braking generates up to 40% of rated motor torque for braking and is typically used for low inertia loads with infrequent Stop cycles.</p> <ol style="list-style-type: none"> 1. On Stop, 3-phase drive output goes to zero (off) 2. Drive outputs DC voltage on the last used phase at the level that is programmed in [DC Brake Level], parameter 158. This voltage causes a "stopping" brake torque. If the voltage is applied for a time that is longer than the actual possible stopping time, the remaining time is used to attempt to hold the motor at zero speed (decel profile "B" on the diagram above). 3. DC voltage to the motor continues for the amount of time that is programmed in [DC Brake Time], parameter 159. Braking ceases after this time expires. 4. After the DC Braking ceases, no further power is supplied to the motor. The motor/load may or may not be stopped. The drive has released control of the motor/load (decel profile "A" on the diagram above). 5. The motor, if rotating, coasts from its present speed for a time that is dependent on the remaining kinetic energy and the mechanics of the system (inertia, friction, and so on). 6. Excess motor current and/or applied duration, could cause motor damage. The user is also cautioned that motor voltage can exist long after the Stop command is issued. The right combination of Brake Level and Brake Time must be determined to provide the safest, most efficient stop (decel profile "C" on the diagram above).

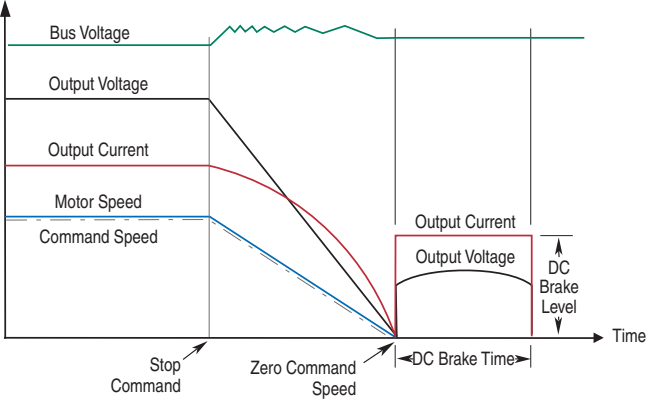
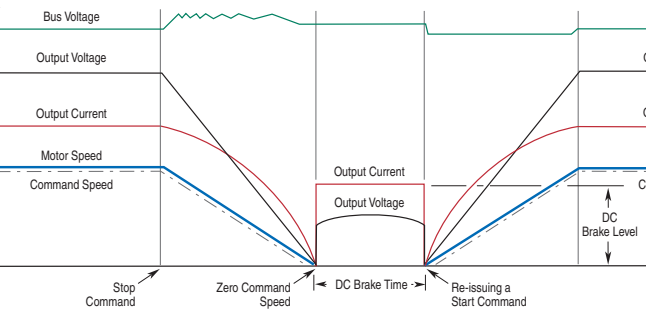
Mode	Description
Ramp	 <p>This method uses drive output reduction to stop the load. Ramp is selected by setting [Stop Mode A/B] to a value of "1". The drive ramps the frequency to zero based on the deceleration time that is programmed into [Decel Time 1/2]. The "normal" mode of machine operation can utilize [Decel Time 1]. If the machine "stop" requires a faster deceleration than desired for normal deceleration, [Decel Time 2] can be activated with a faster rate selected. When in Ramp mode, the drive acknowledges the stop command by decreasing or "ramping" the output voltage and frequency to zero in a programmed period (Decel Time), maintaining control of the motor until the drive output reaches zero. The drive output is then shut off. The load and motor follow the decel ramp. Other factors such as bus regulation and current limit can alter the actual decel rate.</p> <p>Ramp mode can also include a "timed" hold brake. Once the drive has reached zero output hertz on a Ramp-to-Stop and both parameters [DC Brake Time] and [DC Brake Level] are not zero, the drive applies DC to the motor producing current at the DC Brake Level for the DC Brake Time.</p> <ol style="list-style-type: none"> 1. On Stop, drive output decreases according to the programmed pattern from its present value to zero. The pattern can be linear or squared. The output decreases to zero at the rate that is determined by the programmed [Maximum Freq] and the programmed active [Decel Time x]. 2. The reduction in output can be limited by other drive factors such as bus or current regulation. 3. When the output reaches zero, the output is shut off. 4. The motor, if rotating, coasts from its present speed for a time that is dependent on the mechanics of the system (inertia, friction, and so on).
Ramp to Hold	 <p>This method combines two of the methods above. It uses drive output reduction to stop the load and DC injection to hold the load at zero speed once it has stopped.</p> <ol style="list-style-type: none"> 1. On Stop, drive output decreases according to the programmed pattern from its present value to zero. The pattern can be linear or squared. The output decreases to zero at the rate that is determined by the programmed [Maximum Freq] and the programmed active [Decel Time x]. 2. The reduction in output can be limited by other drive factors such as bus or current regulation. 3. When the output reaches zero, 3-phase drive output goes to zero (off) and the drive outputs DC voltage on the last used phase at the level that is programmed in [DC Brake Level], parameter 158. This voltage causes a "holding" brake torque. 4. DC voltage to the motor continues until a Start command is reissued or the drive is disabled. 5. If a Start command is reissued, DC Braking ceases and the drive returns to normal AC operation. If an Enable command is removed, the drive enters a "not ready" state until the enable is restored.

Mode	Description
Fast Brake	<p>This method takes advantage of the characteristic of the induction motor whereby frequencies greater than zero (DC braking) can be applied to a spinning motor that provides more braking torque without causing the drive to regenerate.</p> <ol style="list-style-type: none"> 1. On Stop, the drive output decreases based on the motor speed, keeping the motor out of the regen region. This is accomplished by lowering the output frequency below the motor speed where regeneration does not occur. This causes excess energy to be lost in the motor. 2. The method uses a PI based bus regulator to regulate the bus voltage to a reference (for example 750V) by automatically decreasing output frequency at the proper rate. 3. When the frequency is decreased to a point where the motor no longer causes the bus voltage to increase, the frequency is forced to zero. DC brake is used to complete the stop if the DC Braking Time is non-zero, then the output is shut off. 4. Use of the current regulator ensures that over current trips don't occur and enable an easily adjustable and controllable level of braking torque. 5. Use of the bus voltage regulator results in a smooth, continuous control of the frequency and forces the maximum allowable braking torque to be utilized at all times. 6. Important: For this feature to function properly the active Bus Reg Mode A or B must be set to Adjust "Freq" and NOT be "Disabled".

Motor Overload

For single motor applications, the drive can be programmed to protect the motor from overload conditions. An electronic thermal overload I^2T function emulates a thermal overload relay. This operation is based on these three parameters:

- 042 [Motor NP FLA]
- 047 [Motor OL Hertz]
- 048 [Motor OL Factor]

[Motor NP FLA] is multiplied by [Motor OL Factor] to let you define the continuous level of current allowed by the motor thermal overload.

[Motor OL Hertz] is used to adjust the frequency below where the motor overload is derated.

The motor can operate up to 102% of FLA continuously. If the drive was recently activated, it runs at 150% of FLA for 180 seconds. If the motor had been operating at 100% for over 30 minutes, the drive runs at 150% of FLA for 60 seconds. These values assume that the drive is operating above [Motor OL Hertz], and that [Motor OL Factor] is set to 1.00.

Operation below 100% current causes the temperature calculation to account for motor cooling.

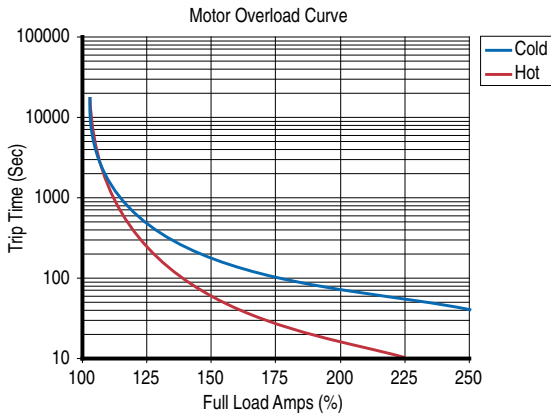

[Motor OL Hertz] defines the frequency where motor overload capacity derate begins. The motor overload capacity is reduced when operating below [Motor OL Hertz]. For all settings of [Motor OL Hertz] other than zero, the overload capacity is reduced to 70% at an output frequency of zero.

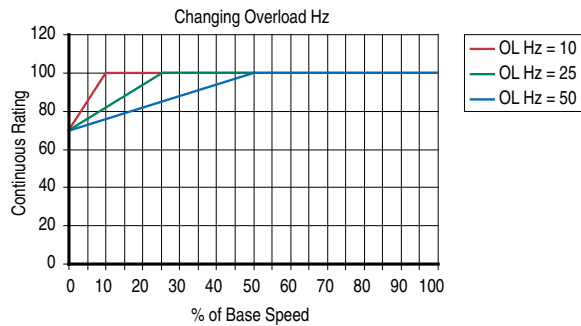

[Motor NP FLA] is multiplied by [Motor OL Factor] to select the rated current for the motor thermal overload. This can be used to raise or lower the level of current that causes the motor thermal overload to trip. The effective overload factor is a combination of [Motor OL Hertz] and [Motor OL Factor].

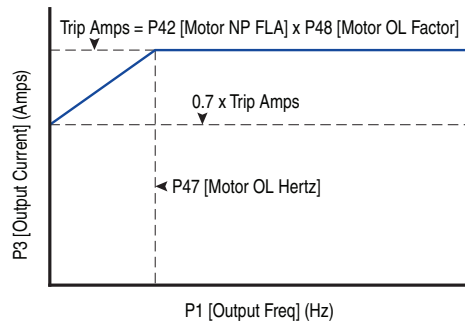

The motor overload, if enabled, enables continuous operation at or below the line. Above the line, the overload trips after a time delay. The further above the line, the shorter the trip time.

Motor Overload Memory Retention Per 2005 NEC

The PowerFlex 70 EC (firmware revision 3.002 or later) has the ability to retain the motor overload count at power down per the 2005 NEC motor overtemp requirement. A parameter has been added to provide this functionality. To enable/disable this feature, refer to the information below.

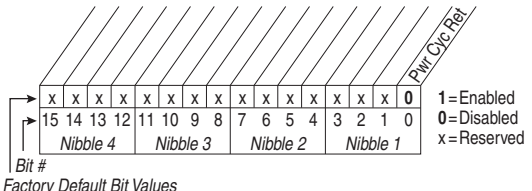
File B	Group	No.	Parameter Name and Description <i>See page 13 for Symbol Descriptions</i>	Values	Related
MOTOR CONTROL (File B)	Motor Data	050	EC v3 [Motor OL Mode]  If "0" [Motor OL Count], P220 is reset to zero by a drive reset or a power cycle. If "1" the value is maintained. A "1" to "0" transition resets [Motor OL Count], P220 to zero.		
			 <p>Bit # Factory Default Bit Values</p>		

Start at Powerup

When Start At Powerup in 2-wire control is configured, the drive starts if all start permissive conditions are met (within 10 seconds of drive power being applied), and the terminal block start input (Run, Run Forward or Run Reverse for 2-wire) is closed. An alarm is annunciated from application of power until the drive actually starts, indicating the powerup start attempt is in progress.

The powerup start attempt is aborted if any of the following occurs anytime during the 10-second start interval:

- A fault condition occurs
- A Type 2 alarm condition occurs
- The terminal block programmed enable input is opened
- All terminal block run, run forward, or run reverse, inputs are canceled
- A Stop request (from any source) is received

If the drive has not started within the 10 second interval, the powerup start attempt is terminated.

Overspeed

Overspeed Limit is a user programmable value that enables operation at maximum speed, but also provides an overspeed band that enables a speed regulator, such as encoder feedback or slip compensation, to increase the output frequency above maximum speed to maintain maximum motor speed.

The figure below illustrates a typical custom V/Hz profile. Minimum speed is entered in Hertz and determines the lower speed reference limit during normal operation. Maximum speed is entered in Hertz and determines the upper speed reference limit. The two speed parameters limit only the speed reference, not the output frequency.

The actual output frequency at maximum speed reference is the sum of the speed reference plus speed adder components from functions such as slip compensation.

The Overspeed Limit is entered in Hertz and added to Maximum Speed and the sum of the two (Speed Limit) limit the output frequency. This sum (Speed Limit) must be compared to Maximum Frequency and an alarm is initiated that prevents operation if the Speed Limit exceeds Maximum Frequency.

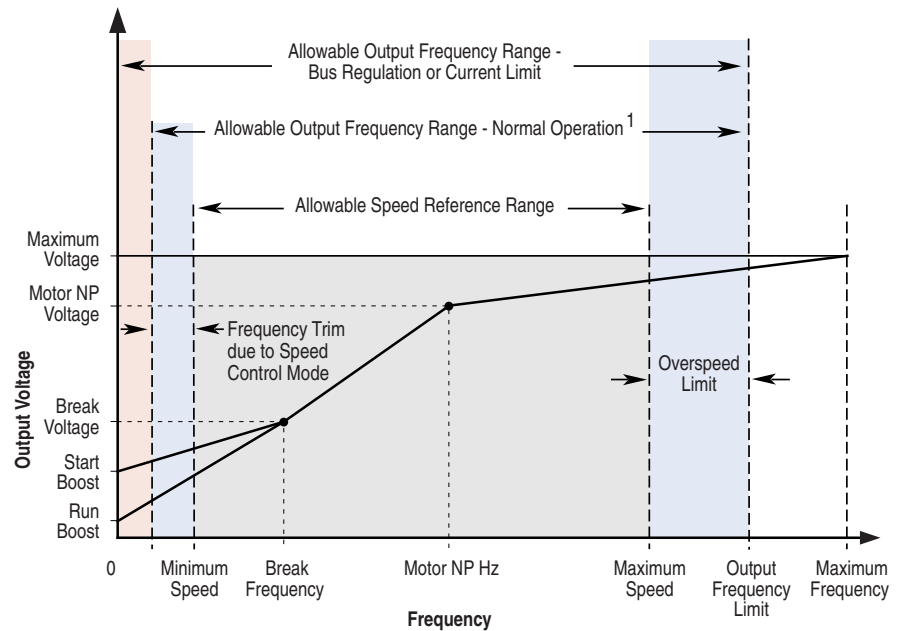

Note 1: The lower limit on this range can be 0 depending on the value of Speed Adder

Speed Reference Control

“Auto” Speed Sources

The drive speed command can be obtained from a number of different sources. The source is determined by drive programming and the condition of the speed select digital inputs, Auto/Manual digital input or reference select bits of a command word.

The default source for a command reference (all speed select inputs open or not programmed) is the selection that is programmed in P90 [Speed Ref A Sel]. If any of the speed select inputs are closed, the drive uses other parameters as the speed command source.

If a communication device is the source of the speed reference, refer to the appropriate communications manual for additional information.

“Manual” Speed Sources

The manual source for speed command to the drive is either the HIM requesting manual control (see [ALT Functions on page 95](#)) or the control terminal block (analog input 1, 2, or MOP based on P96 [TB Man Ref Sel]) if a digital input is programmed to “Auto/Manual”.

Changing Speed Sources

The selection of the active Speed Reference can be made through digital inputs, DPI command, jog button, or Auto/Manual HIM operation.

Figure 3 - Speed Reference Selection Chart (1)

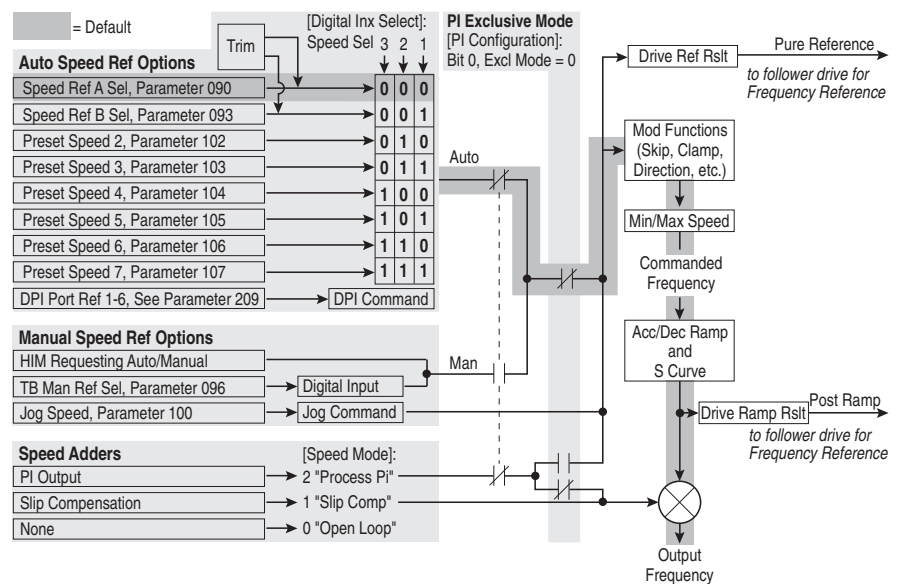

(1) To access Preset Speed 1, set [Speed Ref A Sel] or [Speed Ref B Sel] to “Preset Speed 1”.

Auto/Manual Examples

PLC = Auto, HIM = Manual

A process is run by a PLC when in Auto mode and requires manual control from the HIM during setup. The auto speed reference is issued by the PLC through a communications module that is installed in the drive. Because the internal communications is designated as port 5, P90 [Speed Ref A Sel] is set to “DPI Port 5” with the drive running from the Auto source.

Attain Manual Control

- Press ALT then Auto/Man on the HIM.
When the HIM attains manual control, the drive speed command comes from the HIM speed control keys.

Release to Auto Control

- Press ALT then Auto/Man on the HIM again.
When the HIM releases manual control, the drive speed command returns to the PLC.

PLC = Auto, Terminal Block = Manual

A process is run by a PLC when in Auto mode and requires manual control from an analog potentiometer that is wired to the drive terminal block. The auto speed reference is issued by the PLC through a communications module that is installed in the drive. Because the internal communications is designated as port 5, P90 [Speed Ref A Sel] is set to “DPI Port 5” with the drive running from the Auto source. Because the Manual speed reference is issued by an analog input (“Analog In 1 or 2”), P96 [TB Man Ref Sel] is set to the same input. To switch between Auto and Manual, [Digital In4 Sel] is set to “Auto/ Manual”.

Attain Manual Control

- Close digital input 4.
With the input closed, the speed command comes from the potentiometer.

Release to Auto Control

- Open digital input 4.
With the input open, the speed command returns to the PLC.

Auto/Manual Notes

1. Manual control is exclusive. If a HIM or terminal block takes manual control, no other device can take manual control until the controlling device releases manual control.
2. If a HIM has manual control and power is removed from the drive, the drive returns to Auto mode when power is reapplied.

Process PI for Standard Control

The internal PI function of the PowerFlex 70 provides closed loop process control with proportional and integral control action. The function is designed for use in applications that require simple control of a process without external control devices. The PI function enables the microprocessor of the drive to follow a single process control loop.

The PI function reads a process variable input to the drive and compares it to a desired setpoint stored in the drive. The algorithm then adjusts the output of the PI regulator, changing drive output frequency to try and make the process variable equal the setpoint.

It can operate as trim mode by summing the PI loop output with a master speed reference.

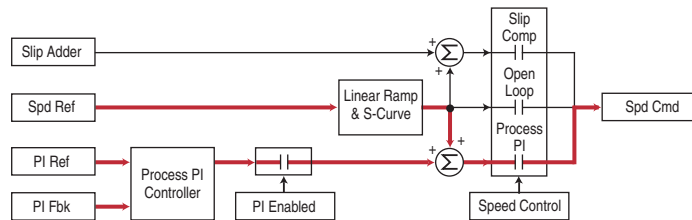

Or, it can operate as control mode by supplying the entire speed reference. This method is identified as Exclusive mode.

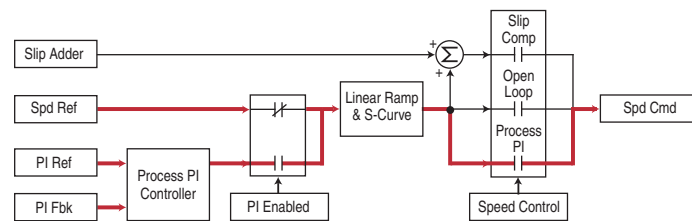

PI Enable

The output of the PI loop can be turned on (enabled) or turned off (disabled). This control enables the user to determine when the PI loop is providing part or all of the commanded speed. The logic for enabling the PI loop is shown in below.

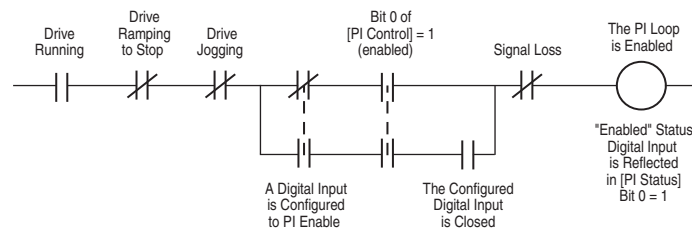

The drive must be running for the PI loop to be enabled. The loop is disabled when the drive is ramping to a stop, jogging, or the signal loss protection for the analog input or inputs is sensing a loss of signal.

If a digital input has been configured to “PI Enable,” two events are required to enable the loop: the digital input must be closed AND bit 0 of the PI Control parameter must be = 1.

If no digital input is configured to “PI Enable,” the Bit 0 = 1 condition must be met. If the bit is permanently set to “1”, the loop is enabled as soon as the drive goes into “run”.

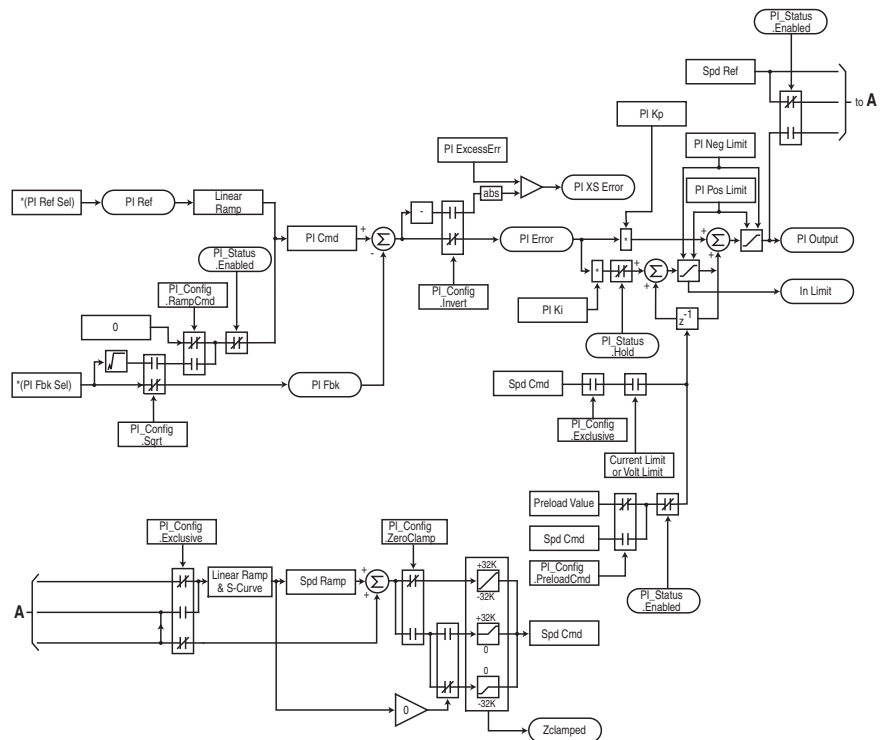
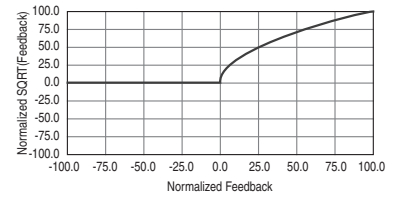
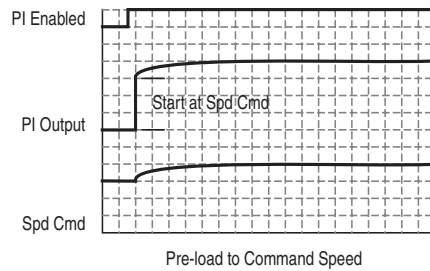
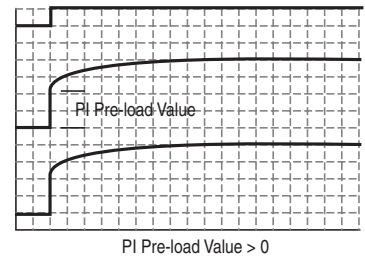
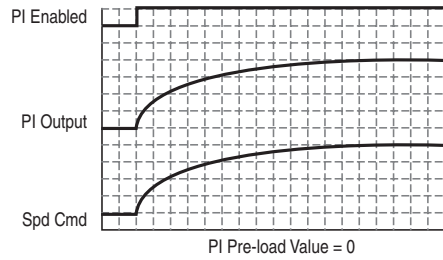

Voltage Tolerance

This section describes voltage tolerances for the different drive ratings.

Drive Rating	Nominal Line Voltage	Nominal Motor Voltage	Drive Full Power Range	Drive Operating Range
200...40	200	200†	200...264	180...264
	208	208	208...264	
	240	230	230...264	
380...400	380	380†	380...528	342...528
	400	400	400...528	
	480	460	460...528	
500...600	600	575†	575...660	432...660

Drive full power range = Nominal motor voltage to drive rated voltage + 10%.
Rated current is available across the entire drive full power range

Drive operating range = Lowest nominal motor voltage - 10% to drive rated voltage + 10%.
Drive output is linearly derated when the actual line voltage is less than the nominal motor voltage.

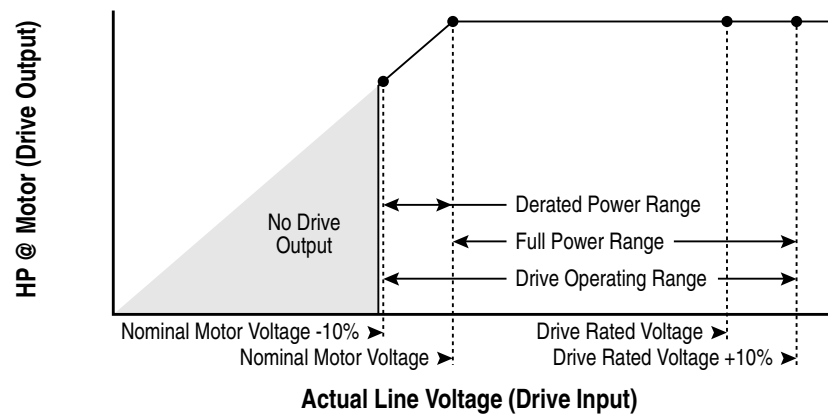

Example:

Calculate the maximum power of a 5 Hp, 460V motor connected to a 480V rated drive supplied with 342V Actual Line Voltage input.

- Actual Line Voltage / Nominal Motor Voltage = 74.3%
- 74.3% × 5 Hp = 3.7 Hp
- 74.3% × 60 Hz = 44.6 Hz

At 342V Actual Line Voltage, the maximum power the 5 Hp, 460V motor can produce is 3.7 Hp at 44.6 Hz.

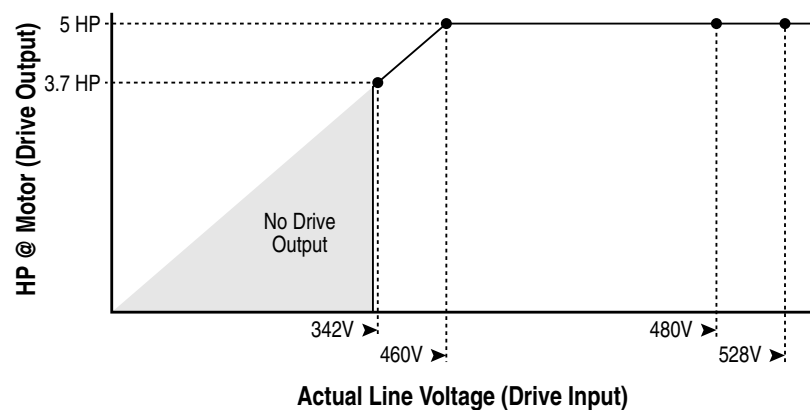

Notes:

Rockwell Automation Support

Use the following resources to access support information.

Technical Support Center	Knowledgebase Articles, How-to Videos, FAQs, Chat, User Forums, and Product Notification Updates.	https://rockwellautomation.custhelp.com/
Local Technical Support Phone Numbers	Locate the phone number for your country.	http://www.rockwellautomation.com/global/support/get-support-now.page
Direct Dial Codes	Find the Direct Dial Code for your product. Use the code to route your call directly to a technical support engineer.	http://www.rockwellautomation.com/global/support/direct-dial.page
Literature Library	Installation Instructions, Manuals, Brochures, and Technical Data.	http://www.rockwellautomation.com/global/literature-library/overview.page
Product Compatibility and Download Center (PCDC)	Get help determining how products interact, check features and capabilities, and find associated firmware.	http://www.rockwellautomation.com/global/support/pcdc.page

Documentation Feedback

Your comments will help us serve your documentation needs better. If you have any suggestions on how to improve this document, complete the How Are We Doing? form at http://literature.rockwellautomation.com/idc/groups/literature/documents/du/ra-du002_-en-e.pdf.

Rockwell Automation maintains current product environmental information on its website at <http://www.rockwellautomation.com/rockwellautomation/about-us/sustainability-ethics/product-environmental-compliance.page>.

Allen-Bradley, CompactLogix, Connected Components Workbench, ControlLogix, ControlFLASH, DPI, MicroLogix, PLC-5, PowerFlex, Rockwell Software, Rockwell Automation, RSLinx, RSLogix, RSLogix 5000, SLC, Stratix, Studio 5000, Studio 5000 Logix Designer, and TotalFORCE are trademarks of Rockwell Automation, Inc. Trademarks not belonging to Rockwell Automation are property of their respective companies.

Rockwell Otomasyon Ticaret A.Ş., Kar Plaza İş Merkezi E Blok Kat:6 34752 İçerenköy, İstanbul, Tel: +90 (216) 5698400

www.rockwellautomation.com

Power, Control and Information Solutions Headquarters

Americas: Rockwell Automation, 1201 South Second Street, Milwaukee, WI 53204-2496 USA, Tel: (1) 414.382.2000, Fax: (1) 414.382.4444

Europe/Middle East/Africa: Rockwell Automation NV, Pegasus Park, De Kleetlaan 12a, 1831 Diegem, Belgium, Tel: (32) 2 663 0600, Fax: (32) 2 663 0640

Asia Pacific: Rockwell Automation, Level 14, Core F, Cyberport 3, 100 Cyberport Road, Hong Kong, Tel: (852) 2887 4788, Fax: (852) 2508 1846