

# DA200A Series AC Servo System



# About us





INVT (Shenzhen INVT Electric Co., Ltd) has been concentrating on industry automation and energy power since its foundation in 2002 and is committed to "Providing the best product and service to allow customers more competitiveness". INVT goes public in 2010 and is the first A-share listed company (002334) in Shenzhen Stock Exchange in the industry. At present, INVT owns 15 subsidiaries and more than 4500 employees, over 40 branches, forming a sales network covering more than 100 overseas countries and regions.

INVT has been awarded as the Key High-tech Enterprise of National Torch Plan based on mastering of key technologies in power electronics, auto control and IT. With business covering industry automation, electric vehicle, network power and rail transit, INVT has established 10 R&D centers nationwide, boasts more than 1400 patents and owns the first lab in the industry awarded ACT qualification from TÜV SÜD, UL-WTDP and CNAS National Lab. The industrial parks in Shenzhen and Suzhou aim to provide customers with advanced integrated product development design management, comprehensive product R&D test and auto informational production. The worldwide INVT branches and warranty service centers are ready to offer customers all-around back-ups including professional solutions, technical trainings and service support.

In the next decade, INVT will continue to take " Sincere Virtuous, Professional Aspiring" as our business philosophy, enhance core business sectors including industrial automation, electric vehicle, network power and rail transit based on the three major technologies in industry automation and energy power fields, and strive to become a leading, responsible and harmonic international professional group armed with proper product structure, leading technologies, efficient management, robust profitability and superior competitiveness.



INVT Guangming  
Technology Building



INVT Shenzhen  
Production Industry Park



INVT Suzhou Industry Park



INVT Zhongshan  
New Energy Industry Base

# Precise drive control, safe and stable

## INVT DA200A series universal AC servo system

DA200A series high-performance AC servo system is the new generation of INVT servo products. It adopts a stable product technology platform and uses dedicated direct drive algorithms, improving its safety functions, product performance, reliability, and ease of use. With excellent products and services, INVT offers you competitive products and solutions.



# Product features

## Safe and reliable

- Support for Safe Torque Off (STO) to ensure personal safety

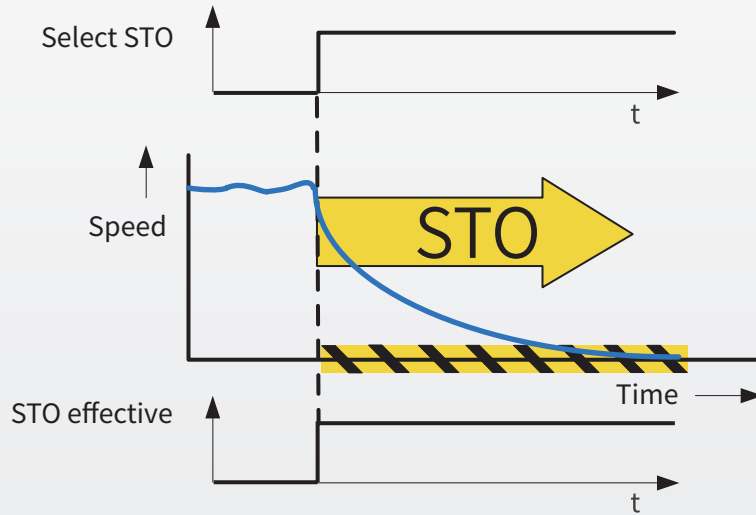

## Enriched communication

- With mature fieldbus technology, application networking is convenient and reliable
- Support Modbus, CANopen, EtherCAT and other bus communication

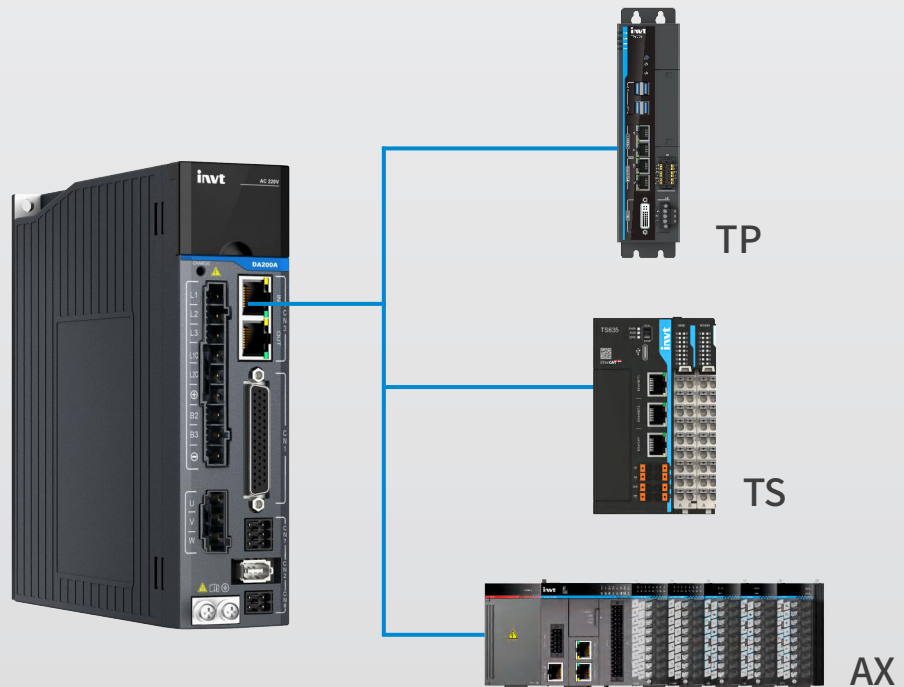

## ▪ Universal drive

- Support for direct-drive motors and rotating motors
- Support for EnDat2.2, BiSS-C encoder protocols

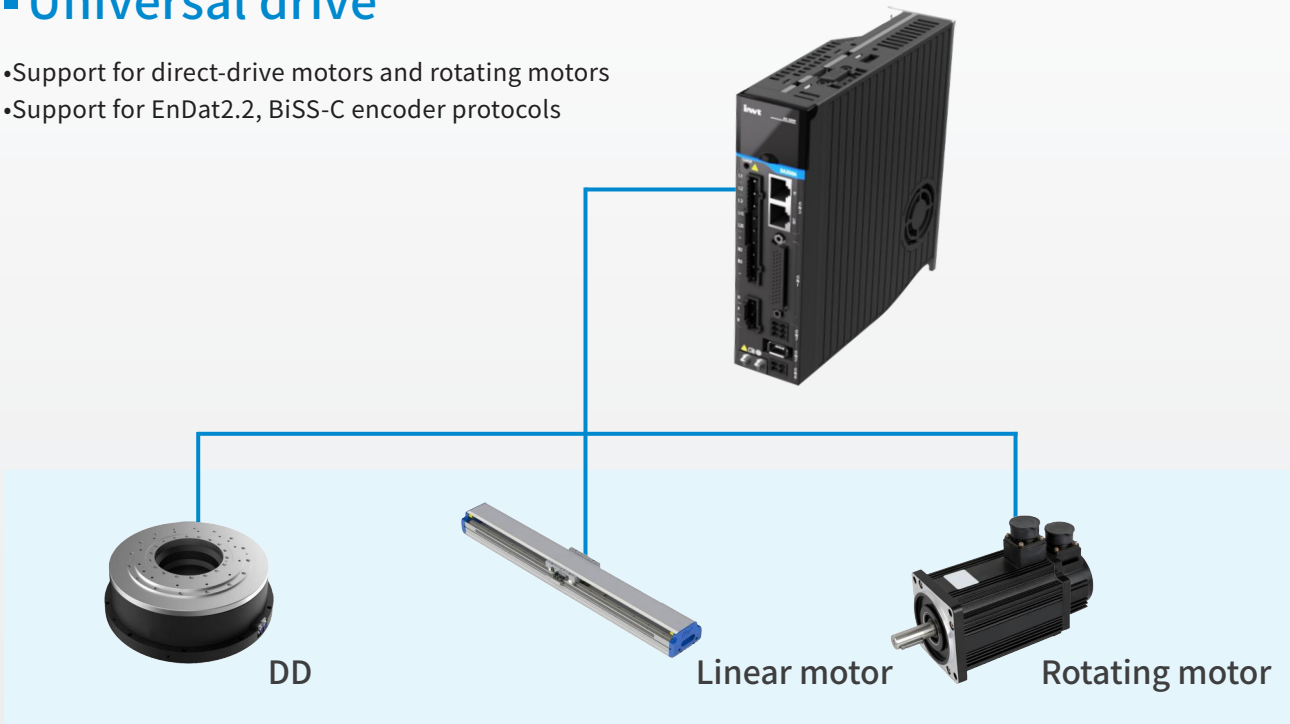

## ▪ Built-in brake output

- No external relay need, saving external space
- Reduce wiring to cut the system cost

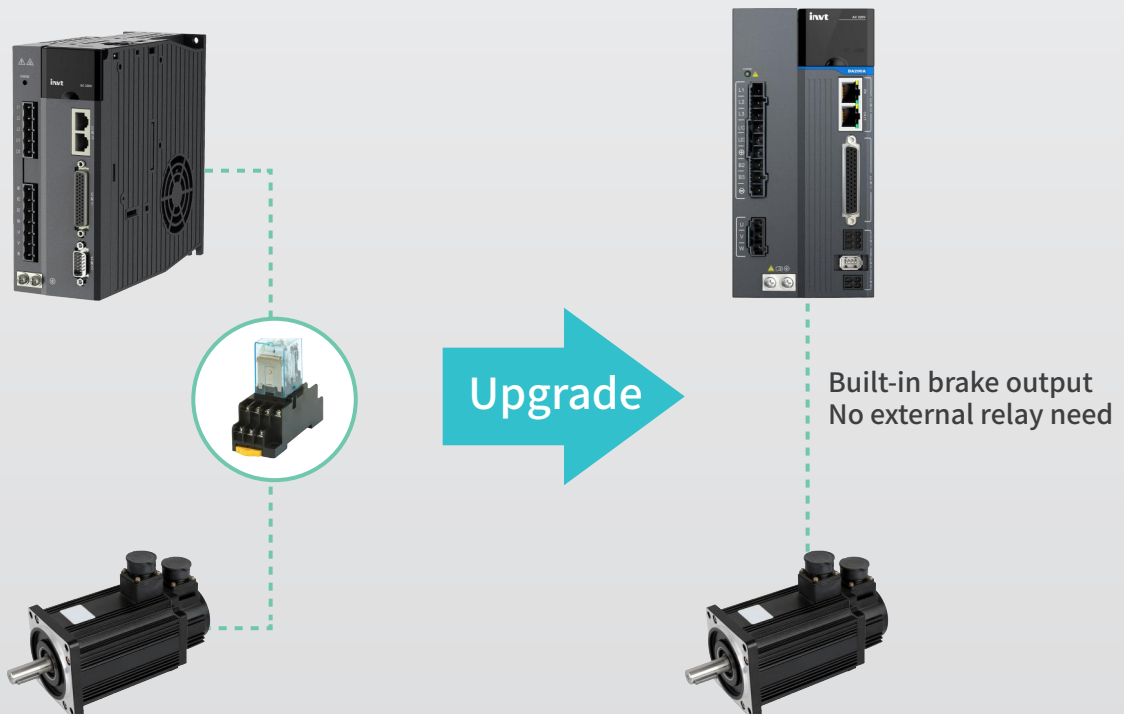

## Dynamic braking

- Dynamic braking as standard configuration. Standard configuration includes dynamic braking, which employs dynamic braking to rapidly halt the motor when emergency stop, fault, or power outage occurs
- Quick stop to avoid mechanical damage and ensure personnel safety
- Dynamic braking as standard configuration
- Quick stop to avoid mechanical damage and ensure personnel safety

Test condition: •Motor power 1.0kW •Rated speed 2500r/min •Inertia disc 10.5 times

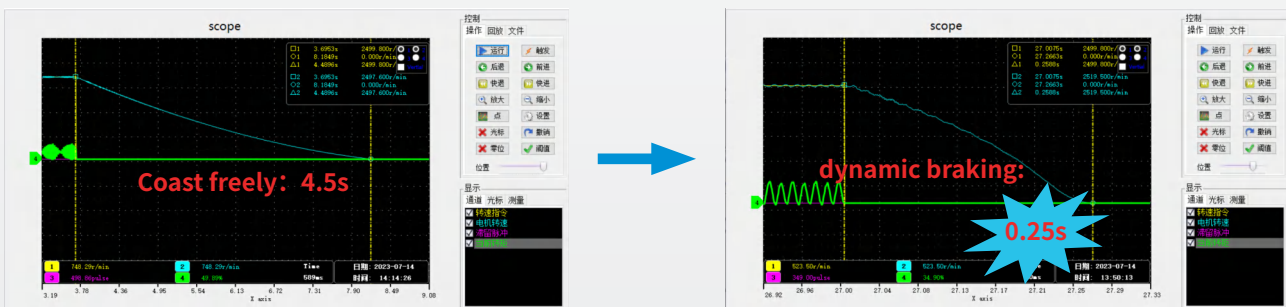

## Fully-closed loop control

- Support for external connection to an encoder or grating ruler installed at the load end, implementing fully-closed loop control
- Reducing back clearance impact caused by mechanical drive, and improving machine-end positioning accuracy

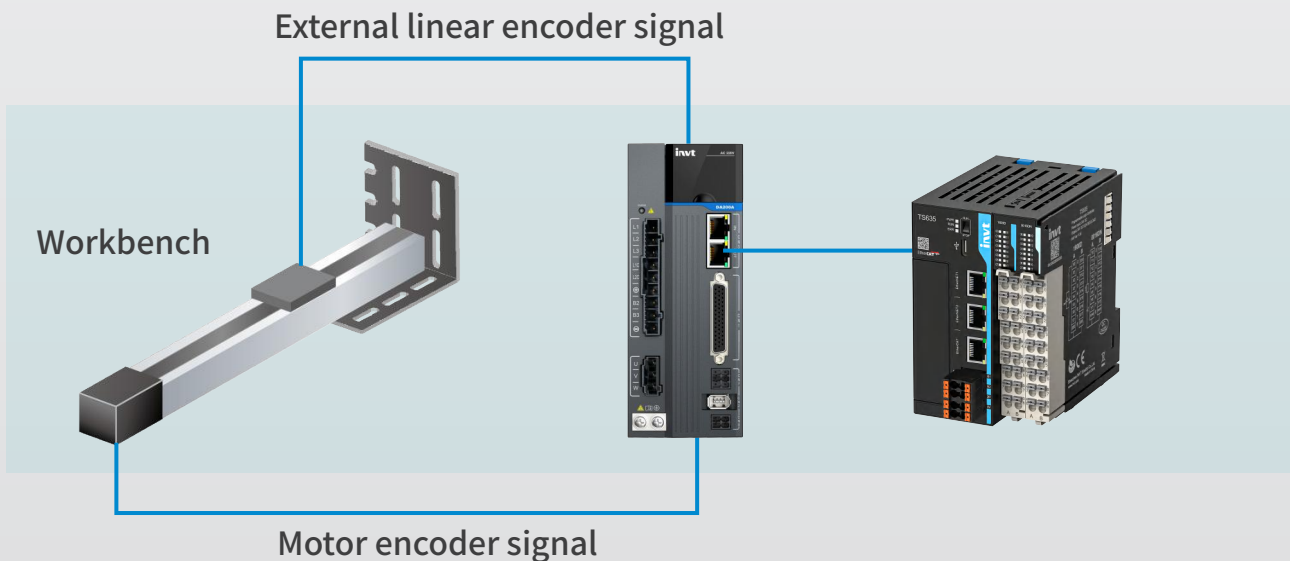

## ▪ Load inertia identification

- Provide online and offline inertia identification. Automatically identify gain parameters in the system, and reduce the system tuning time

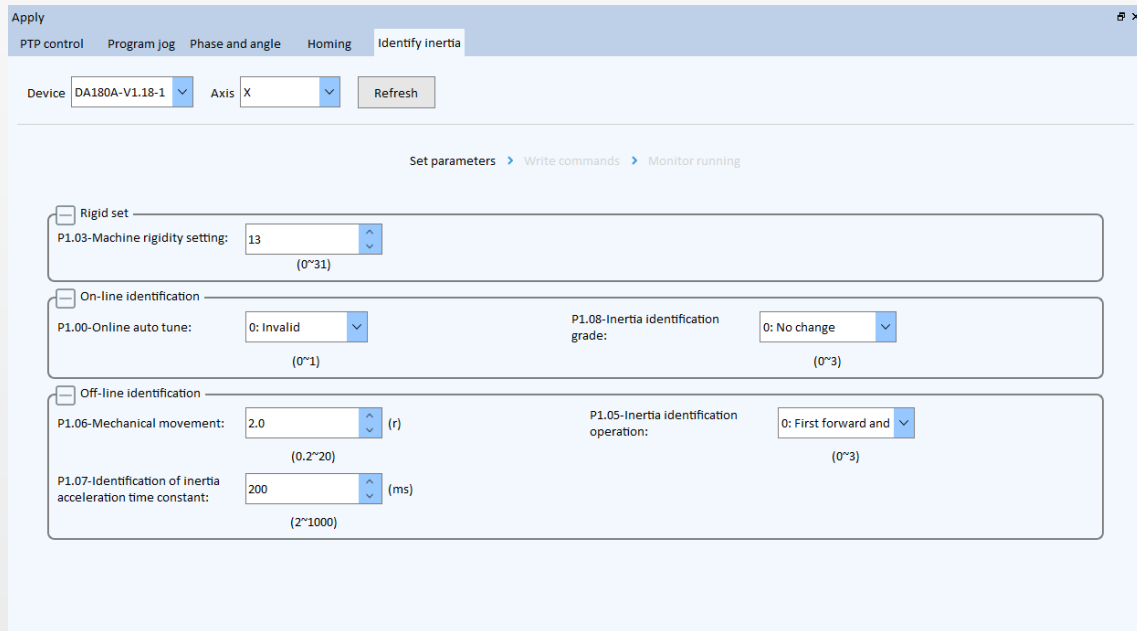

## ▪ Automatic/manual notch filter

- Equipped with a simplified notch filter setup function. Abnormal noise and vibration caused by mechanical devices can be greatly reduced by using a notch filter

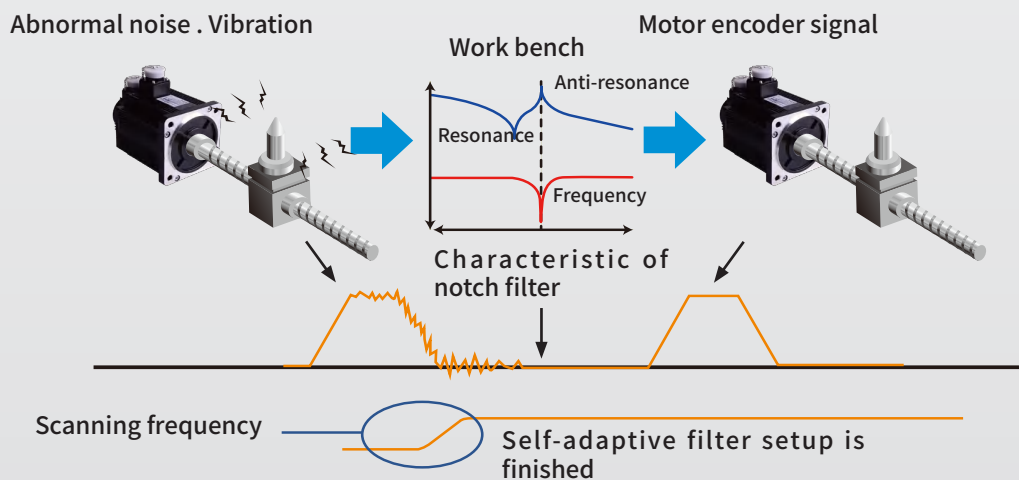



## ▪ Low frequency vibration control

- Advanced low frequency vibration control algorithms can be used to effectively control low frequency mechanical resonance and control oscillation at long swing arm end

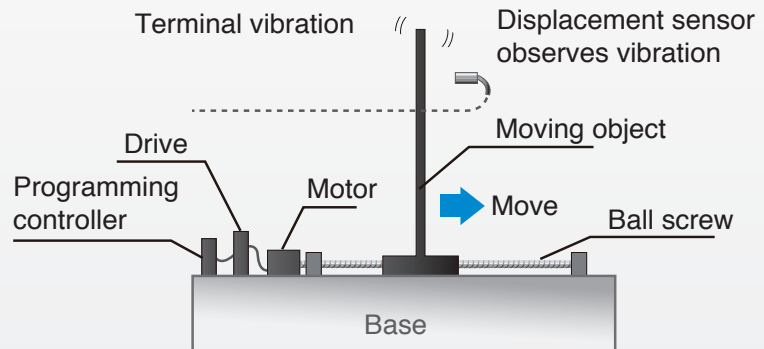
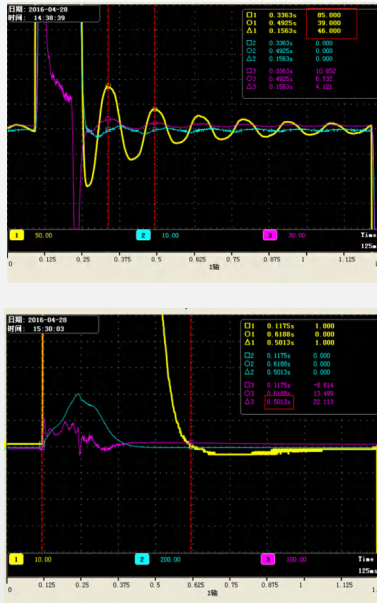

## ▪ Disturbance control

- Equipped with the disturbance control function to compensate for the control performance impact caused by load disturbance and parameter changes, enhancing system robustness and greatly improving command following performance

## ▪ Friction torque compensation

- Equipped with the friction torque compensation function to reduce the impact caused by static friction during motor commutation and improve command following performance at low speed running

## ▪ Simple gain adjusting and switching

- The speed and position loop gains and filter time constant can be automatically adjusted by setting rigidity levels, effectively reducing commissioning complicity. Two groups of gain can be set, and the gains can be switched through I/O input, communication, or internal variables, fulfilling flexible process demands

## ▪ Speed observer

- Use a speed observer to reduce the noise impact and improve command following performance
- Improve the usability of servo to reduce the difficulty of customer commissioning

# Model designation of servo drive

DA200A-E-2R8-S-2-XXXX-XXXX

Item	Description												
Product series	DA200A: Servo drive series												
Product type	E: Pulse type C: CANopen type N: EtherCAT bus type F: PROFINET bus type												
Rated current	<table border="1"> <thead> <tr> <th>220V</th> <th>380V</th> </tr> </thead> <tbody> <tr> <td>2R8: 2.8A</td> <td>5R5: 5.5A</td> </tr> <tr> <td>6R0: 6.0A</td> <td>8R5: 8.5A</td> </tr> <tr> <td>8R0: 8.0A</td> <td>012: 12A</td> </tr> <tr> <td>010: 10A</td> <td>016: 16A</td> </tr> <tr> <td>013: 13A</td> <td>021: 21A</td> </tr> </tbody> </table>	220V	380V	2R8: 2.8A	5R5: 5.5A	6R0: 6.0A	8R5: 8.5A	8R0: 8.0A	012: 12A	010: 10A	016: 16A	013: 13A	021: 21A
220V	380V												
2R8: 2.8A	5R5: 5.5A												
6R0: 6.0A	8R5: 8.5A												
8R0: 8.0A	012: 12A												
010: 10A	016: 16A												
013: 13A	021: 21A												
Voltage class	S: 220V T: 380V												
Encoder category	2: Serial communication encoder												
Product lot number	Digit 1: Product configuration    Empty: Standard version -P: High-spec version Digit 2: Integration level 1: Single axis (omitted by default) Digit3: Installation method B: Substrate installation (omitted by default) Digit 4: Ingress protection (IP) rating  0: IP00  1: IP20 (omitted by default)												
Customized lot number	Digit 1: Hardware Digit 2/3: Function category Digit 4: Software serial No												

Note: PROFINET models are coming soon

# Product specifications

Cabinet	A		B			C		D		
Model	2R8	6R0	8R0	010	5R5	013	8R5	012	016	021
Rated power (kW)	0.4	1	1.5	2	1.5	3	3	4.4	5.5	7.5
Main power supply (V)	220(1P)		220(3P)		380(3P)	220V(3P)	380(3P)	380(3P)		
Control circuit voltage (V)	220(1P)									
Input current (A)	3.6	9	5.6	7.5	3.3	11.2	6.5	9.6	11.9	13
Rated output current (A)	2.8	6	8	10	5.5	13	8.5	12	16	21
Max. output current (A)	8.4	18	24	25	14	32.5	25.5	30	40	52.5
Built-in braking resistor	/	45Ω 60W	30Ω 60W	30Ω 60W	60Ω 60W	30Ω 60W	60Ω 60W	30Ω 120W	30Ω 120W	30Ω 120W
Min. resistance of external braking resistors	60Ω	45Ω	30Ω	30Ω	60Ω	20Ω	60Ω	30Ω	30Ω	30Ω
Recommended filter model	FLT-PS2010 H-B	FLT-PS2010 H-B	FLT-P04016 L-B	FLT-P04016 L-B	FLT-P04006 L-B	FLT-P04032 L-B	FLT-P04006 L-B	FLT-P04016 L-B	FLT-P04016 L-B	FLT-P04032 L-B

# Product configuration

Power range: 400W–7.5KW			Function						Communication		
Model	Symbol	Configuration selection	Pulse input	Analog input/output	2nd encoder	STO	Brake Output	Dynamic braking	RS485	CANopen	EtherCAT
Pulse type	E	Standard	√	√	×	×	×	√	√	×	×
		High-spec	√	√	√	√	√	√	√	×	×
CANopen type	C	High-spec	√	√	√	√	√	√	√	√	×
Bus type	N	Standard	×	×	×	×	×	√	×	×	√
		High-spec	×	×	√	√	√	√	×	×	√
	F	High-spec	×	×	√	√	√	√	×	×	×

Note: Bus type servo ROFINET models are coming soon

# Technical specifications

Specification		Description		
Power supply	System input voltage of 220V	1P/3P AC220V(-15%)~240V(+10%) 47Hz~63Hz		
	System input voltage of 400V	3P AC380V(-15%)~440V(+10%) 47Hz~63Hz		
Port	Control signal	Input of 5V	10 inputs for pulse type and CANopen type, 7 inputs for EtherCAT bus type (the function can be configured by relevant parameters)	
		Output	4 differential outputs (the function can be configured by relevant parameters)	
	Analog	Input	Two 12bit inputs	
		Output	2 outputs (analog monitoring output)	
	Pulse signal	Input	Two groups (mode: differential input or open collector input)	
		Output	Six groups (3 differential outputs, 3 open collector outputs)	
	1st encoder	Input of 5V	Two-wire and four-wire absolute encoder interfaces (Tamagawa, BiSS-C, EnDat2.2)	
	2nd encoder	Input of 5V	Incremental encoder interface (2nd encoder or linear encoder)	
	Communication	USB	1:1 communication upper PC software (standard, Type-C)	
		RS485	1:n communication (standard)	
		CANopen	1:n communication (optional)	
		PROFINET	1:n communication (optional)	
		EtherCAT	1:n communication (optional)	
	Safety terminals	STO	Safe torque off (conform to the latest European safety standards) (optional)	
Control mode		1. Position control; 2. Speed control; 3. Torque control; 4. Position/Speed mode switching; 5. Speed/Torque mode switching; 6. Position/Torque mode switching; 7. Reserved; 8. CANopen mode; 9. EtherCAT mode		
Function	Position control	Control output	1. Retention pulse clearing; 2. Command pulse input disabled; 3. Command frequency division and multiplication switching; 4. Vibration control switching	
		Control output	Positioning completion output, etc	
	Pulse input	Max. pulse input frequency	Optical coupling: differential input 4Mbps, open collector input 200kbps;	
		Pulse input mode	1. Forward/reverse direction; 2. Phase A/B; 3. Command pulse/command direction	
	Electronic gear	1/10000~1000 times		



Specification		Description		
Function	Position control	Pulse input	Filter	1. Command smoothing filter; 2. FIR filter
			Feed-forward forecast	Feed-forward forecast control of pulse command
		Bus input	Interpolation control	Linear interpolation, spline interpolation, and arc interpolation
		Analog input	Torque limit command input	Can independently perform clockwise/counterclockwise torque limit
		Pulse output	1. Can perform arbitrary frequency division settings under the encoder resolution; 2. B-phase reverse function	
	Speed control	Control input	1. Internal command speed 1; 2. Internal command speed 2; 3. Internal command speed 3; 4. Zero speed clamp, etc	
		Control output	Speed reaching, etc	
		Analog input	Speed command input	The speed command input can be set according to the analog voltage DC $\pm 10V$
			Torque limit input	Can independently perform clockwise/counterclockwise torque limit
		Internal speed commands	8 step speed can be switched according to the external control input	
		Speed command filter ACC/DEC adjustment	ACC/DEC time setting and S curve setting	
		Zero-speed clamp	In the speed mode, it can set the operation mode as the speed mode and position mode	
		Speed command filter	A delay filter of analog input speed command	
		Speed command zero drift control	Zero drift control against outside interference with 0.3mV precision	
		Torque control	Control input	Zero speed clamp input, etc
	Control output		Speed reaching, etc	
	Analog input		Torque command input	Analog torque command input, gain and polarity can be set based on analog voltage with 4.88mV precision
			Speed limit input	Analog speed limit
	Speed limit		Set the speed limit by parameters	
	Torque command filter		A delay filter of analog input torque command	
	Special functions	Torque command zero drift control	Zero drift control against outside interference with 4.88mV precision	
		PTP control	128 bits internal position planning, the positioning can be controlled through communication	
		PTP setting	Support multi-point curve planning combination control	
		Homing	1. Limit signal; 2. Z-phase signal; 3. Limit signal+Z-phase signal; 4. Torque limit signal	
		E-CAM	Support manual table creation, S-curve, flying shear, and chasing shear functions	
		Cam setting	Support multi-cam curve planning combination control	



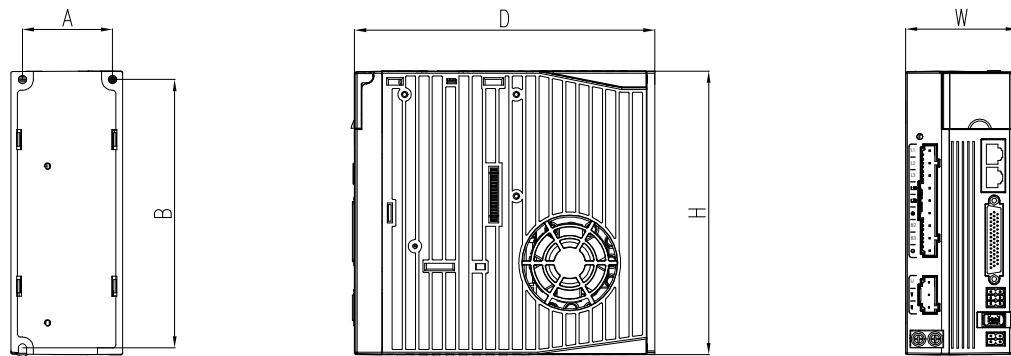

Specification			Description
Functions	Special functions	IO capture	Support IO capture functions, such as color-coded capture
Protection	Hardware protection		Protection against phase loss, overvoltage, undervoltage, overcurrent, drive overload, braking resistor overload, drive overheat, encoder disconnection (ABZ disconnection) and dynamic braking.
	Software protection		Protection against storage fault, initialization fault, I/O distribution abnormalities and large position deviation.
	Dynamic braking		For emergency stop function, including emergency stop and fault stop scenarios.
	Protection and fault record		1. Up to 10 faults can be recorded. 2. Eight key parameters can be recorded when fault occurs, including motor speed, speed command, accumulated feedback pulses, accumulated command pulses, residual pulse, current torque, main circuit DC voltage, output voltage and output current. 3. Support fault analysis and usage reminder
Environment	Working temperature		0–55° C (Derate 80% when the ambient temperature is 45–55° C.)
	Storage temperature		-20° C–70° C (No freezing)
	Working/storage humidity		≤ 90% RH (no condensation)
	IP class		IP20
	Altitude		Lower than 1000m
	Vibration		≤ 5.88m/s <sup>2</sup> , 10–60Hz (Working at the resonance point is not allowed)
Other	Certification requirement		Standard machines comply with CE certification standards (optional filter)
	Installation method		Wall mounting
	Cooling method		Natural cooling for 0.4kW and lower models Others: Forced air cooling

## Size and dimension diagram



Volume	Outline dimensions (mm)			Installation dimensions		Mounting hole diameter (mm)	Weight (kg)
	H(mm)	W(mm)	D(mm)	A(mm)	B(mm)		
A	170	45	170	33	162	M4(Φ5)	1.05
B	170	67	180	54	162	M4(Φ5)	1.45
C	170	84	180	71	162	M4(Φ5)	1.75
D	245	92	190	79	237	M4(Φ5)	3.13

# Servo system configuration table

	SIZE A		SIZE B			SIZE C		SIZE D			
Drive											
	DA200A-*-2R8-S	DA200A-*-6R0-S	DA200A-*-8R0-S	DA200A-*-010-S	DA200A-*-5R5-T	DA200A-*-013-S	DA200A-*-8R5-T	DA200A-*-012-T	DA200A-*-016-T	DA200A-*-021-T	
Voltage class	1PH 220V		3PH 220V			3PH 380V	3PH 220V	3PH 380V	3PH 380V		
Matching motor	IMS20B-04L10B30C-2-***	IMS20B-08M75B30C-2-***	IMS20B-10M15C30C-2-***	IMS20B-10M20C30C-2-***	IMS20B-10M10C30C-4-***	IMS20B-10M25C30C-2-***	IMS20B-10M25C30C-4-***	IMS20B-18M30C15C-4-***	IMS20B-18M44C15C-4-***	IMS20B-18M75C15C-4-***	
	IMS20B-06M20B30C-2-***	IMS20B-08M10C30C-2-***	IMS20B-13M15C20C-2-***	IMS20B-13M20C20C-2-***	IMS20B-10M15C30C-4-***	IMS20B-13M30C20C-2-***	IMS20B-13M30C20C-4-***	/	IMS20B-18M55C15C-4-***	/	
	IMS20B-06M40B30C-2-***	IMS20B-10M10C30C-2-***	/	IMS20B-13H13C15C-2-***	IMS20B-10M20C30C-4-***	IMS20B-13H18C15C-2-***	IMS20B-13H18C15C-4-***	/	/	/	
	/	IMS20B-13M10C20C-2-***	/	/	IMS20B-13M10C20C-4-***	/	/	/	/	/	
	/	IMS20B-13H85B15C-2-***	/	/	IMS20B-13M15C20C-4-***	/	/	/	/	/	
	/	/	/	/	IMS20B-13M20C20C-4-***	/	/	/	/	/	
	/	/	/	/	IMS20B-13H85B15C-4-***	/	/	/	/	/	
	/	/	/	/	IMS20B-13H13C15C-4-***	/	/	/	/	/	

# Servo motor naming

IMS20B-06 M 40B 30C-2-M3 4	
Item	Description
Product series	IMS20B: IMS20B series
Base model No.	04: 40    10: 100    18: 180 06: 60    13: 130
Inertia identification	L: Small inertia M: Medium inertia H: Large inertia
Rated power (W)	Composition of base (number) * magnification (letter) A: *1    B: *10    C: *100    ..... E.g.: 40B: 400W    15C: 1500W
Rated speed (rpm)	Composition of base (number) * magnification (letter) A: *1    B: *10    C: *100    ..... 例: 80B: 800rpm    30C: 3000rpm
Voltage class	2:220    4:380
Encoder	M4: 17-bit multi-turn magnetic encoder    P9: 23-bit multi-turn optical encoder
Optional part	0: With oil seal but no brake (Empty by default)    4: With oil seal and electromagnetic brake



# Servo motor technical parameters

Model	Base model No. (mm)	Power (kW)	Rated torque (Nm)	Max. torque (Nm)	Rated speed (rpm)	Max. speed (rpm)	Voltage (V)	Rated current (A) 220V/3 80V	Inertia (10-4kg·m <sup>2</sup> ) Standard/with brake	Weight (kg) Standard/with brake
IMS20B-04L10B30C-2-***	40	0.1	0.32	1.12	3000	6000	220	0.98	0.031/0.034	0.36/0.55
IMS20B-06M20B30C-2-***	60	0.2	0.64	2.23	3000	6000	220	1.3	0.34/0.35	0.8/1.2
IMS20B-06M40B30C-2-***		0.4	1.27	4.45	3000	6000	220	2.6	0.59/0.6	1.2/1.6
IMS20B-08M75B30C-2-***	80	0.75	2.38	8.36	3000	6000	220	4.6	1.72/1.77	2.2/2.9
IMS20B-08M10C30C-2-***		1	3.18	11.3	3000	6000	220	6.3	2.23/2.28	2.6/3.3
IMS20B-10M10C30C-2(4)-***	100	1	3.18	9.55	3000	6000	220/380	6.6/3.72	1.84/2.59	3.3/4.1
IMS20B-10M15C30C-2(4)-***		1.5	4.78	13.4	3000	6000	220/380	8.8/5.1	2.75/3.5	4.3/5.1
IMS20B-10M20C30C-2(4)-***		2	6.37	19.1	3000	6000	220/380	10.71/6.95	3.65/4.4	5.3/6.1
IMS20B-10M25C30C-2(4)-***		2.5	7.96	26.5	3000	6000	220/380	13.3/8.17	4.36/5.11	6.3/7.1
IMS20B-13M10C20C-2(4)-***	130	1	4.78	14.34	2000	4500	220/380	5.4/3	6.3/7.95	4.4/6.0
IMS20B-13M15C20C-2(4)-***		1.5	7.16	21.48	2000	4500	220/380	7.6/4.8	9.1/10.8	5.6/7.2
IMS20B-13M20C20C-2(4)-***		2	9.55	28.65	2000	4500	220/380	9/5.6	12.9/14.6	6.9/8.5
IMS20B-13M30C20C-2(4)-***		3	14.3	42.9	2000	3000	220/380	13/7.7	21.7/23.4	10.3/11.9
IMS20B-13H85B15C-2(4)-***		0.85	5.4	13.5	1500	4500	220/380	6.2/3.3	13.1/14.3	5.7/7.3
IMS20B-13H13C15C-2(4)-***		1.3	8.4	21	1500	4500	220/380	9.9/5.2	17.9/19.1	7.2/8.8
IMS20B-13H18C15C-2(4)-***		1.8	11.5	28.8	1500	4500	220/380	12.8/7.7	24.3/25.6	9/10.6
IMS20B-18M30C15C-4-***		180	3	19.1	47.8	1500	4500	380	9.7	48.6/49.3
IMS20B-18M44C15C-4-***	4.4		28	70	1500	4500	380	13.5	65.2/65.9	23.2/25.2
IMS20B-18M55C15C-4-***	5.5		35	88.8	1500	4500	380	16.8	84/84.7	27.7/29.7
IMS20B-18M75C15C-4-***	7.5		47.8	119.5	1500	4500	380	20.9	107.4/108.1	32/34
Insulation class	Class F(155° C)									
IP rating	IP67 (base-80 and below, in-line), IP65 (base-100 and above, military-grade aviation plug)									
Application environment	Temperature: 0 ° C--+40 ° C (no freezing for base-80 and below), -10 ° C--+40 ° C (no freezing for base-100 and above); humidity: below 90%RH (no condensation)									

# Servo motor installation dimensions

## Installation dimensions for base-40 motors (unit: mm)

Motor model	L(mm)	
	Without brake	Electromagnetic brake
IMS20B-04L10B30C-2-***	73.4	100.1

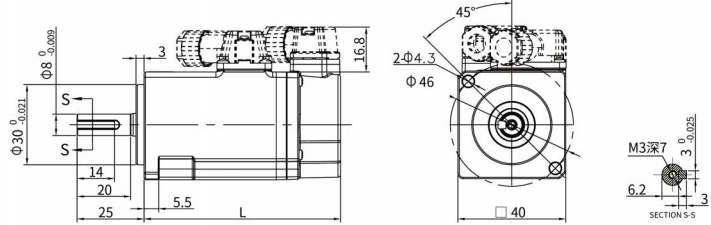

## Installation dimensions for base-60 motors (unit: mm)

Motor model	L(mm)	
	Without brake	Electromagnetic brake
IMS20B-06M20B30C-2-***	70.5	99.7
IMS20B-06M40B30C-2-***	88	117.2

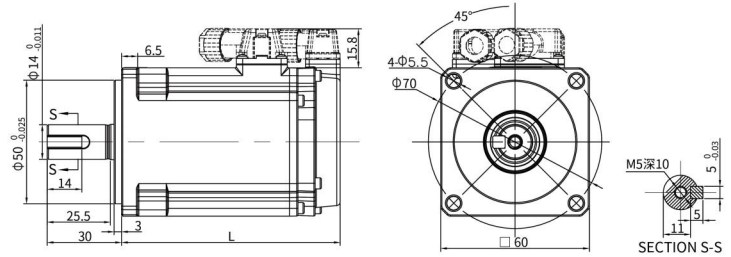

## Installation dimensions for base-80 motors (unit: mm)

Motor model	L(mm)	
	Without brake	Electromagnetic brake
IMS20B-08M75B30C-2-***	94.6	107.9
IMS20B-08M10C30C-2-***	107.9	142.1

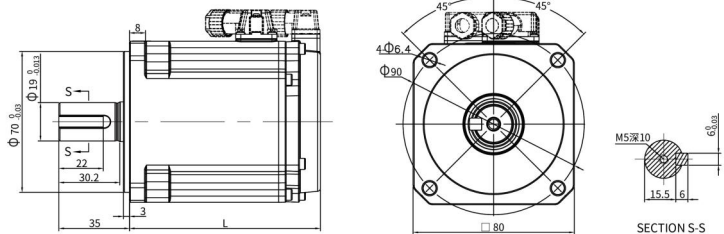

## Installation dimensions for base-100 motors (unit: mm)

Motor model	L(mm)	
	Without brake	Electromagnetic brake
IMS20B-10M10C30C-2(4)-***	127.4	156
IMS20B-10M15C30C-2(4)-***	147.4	176
IMS20B-10M20C30C-2(4)-***	167.4	196
IMS20B-10M25C30C-2(4)-***	184.4	213

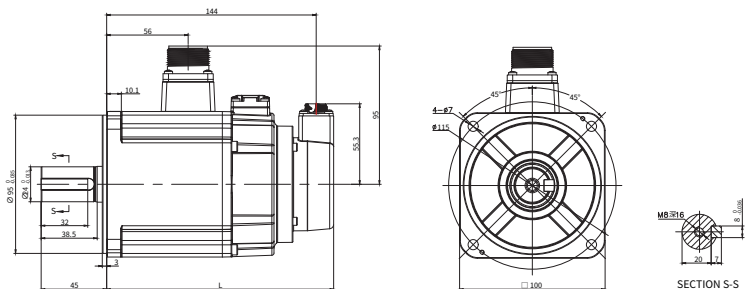

### Installation dimensions for base-130 motors (unit: mm)

Motor model	L(mm)	
	Without brake	Electromagnetic brake
IMS20B-13M10C20C-2(4)-***	130	159
IMS20B-13M15C20C-2(4)-***	143	172
IMS20B-13M20C20C-2(4)-***	160	189
IMS20B-13M30C20C-2(4)-***	210.5	240.2
IMS20B-13H85B15C-2(4)-***	138	167
IMS20B-13H13C15C-2(4)-***	155	184
IMS20B-13H18C15C-2(4)-***	185	215

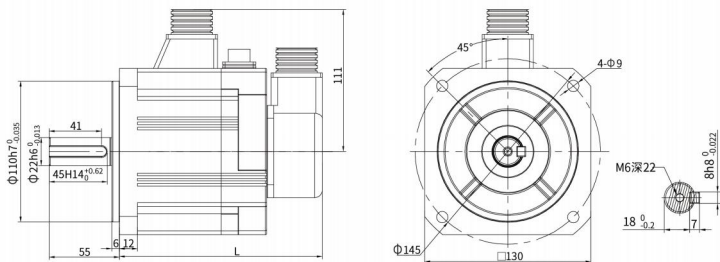

### Installation dimensions for base-180 motors (unit: mm)

Motor model	L(mm)		S(mm)	
	Without brake	Electromagnetic brake	Without brake	Electromagnetic brake
IMS20B-18M30C15C-4-***	223	263	35	75.3
IMS20B-18M44C15C-4-***	248	288	35	75.3

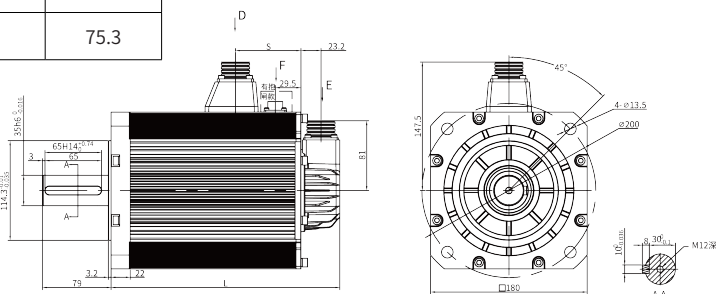

Motor model	L(mm)		S(mm)	
	Without brake	Electromagnetic brake	Without brake	Electromagnetic brake
IMS20B-18M55C15C-4-***	273	313	35	75.3
IMS20B-18M75C15C-4-***	308	348	35	75.3

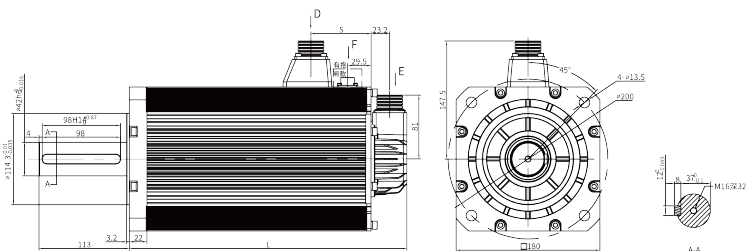

# Servo motor torque-speed characteristics

## Base-40 motor

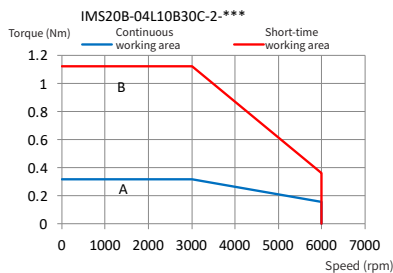

## Base-60 motor

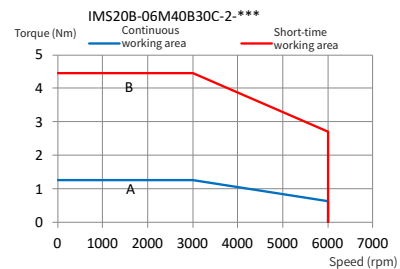
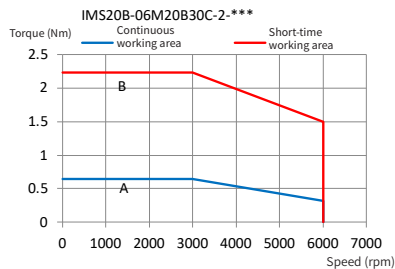

## Base-80 motor

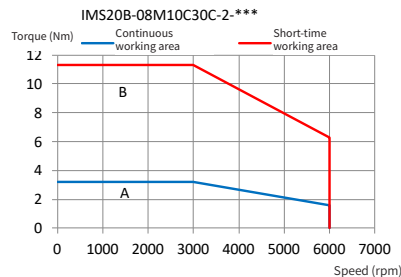
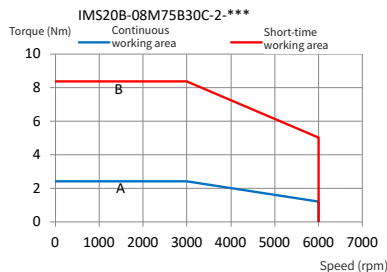

## Base-100 motor

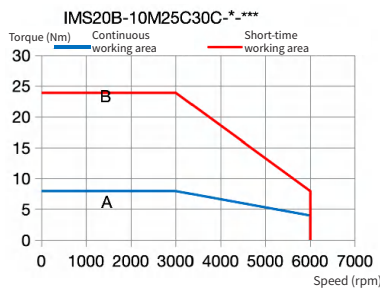
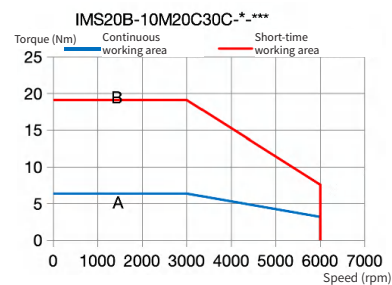
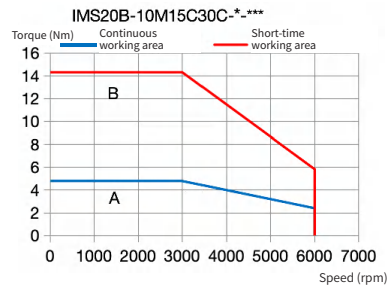
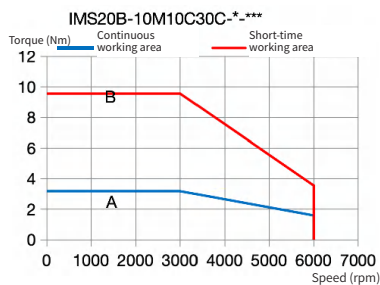



## Base-130 motor

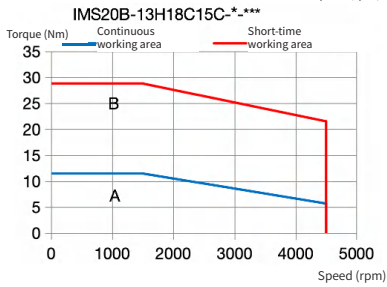
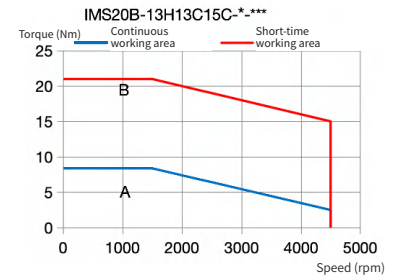
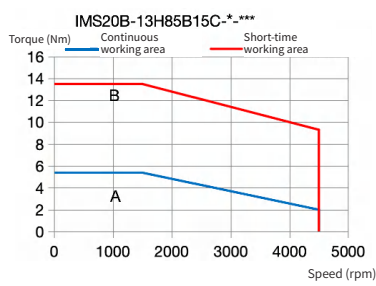
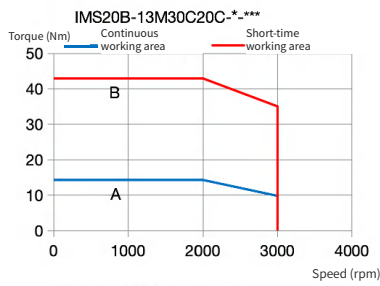
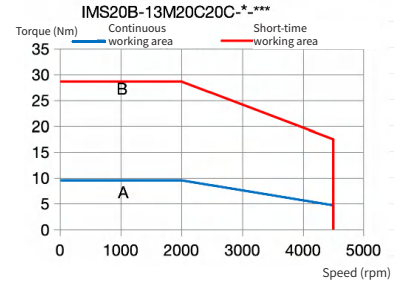
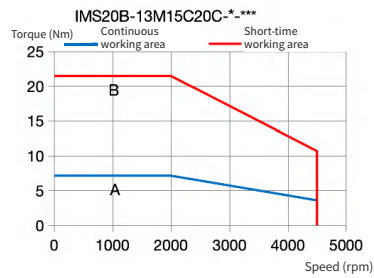
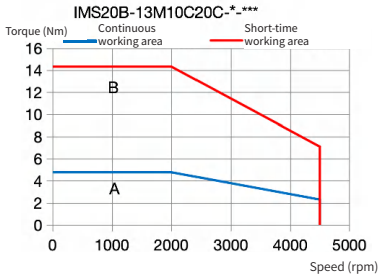

## Base-180 motor

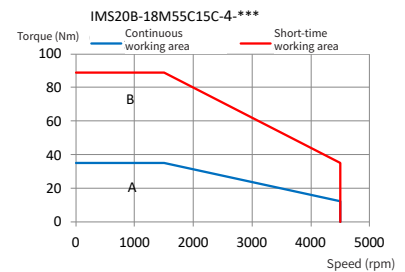
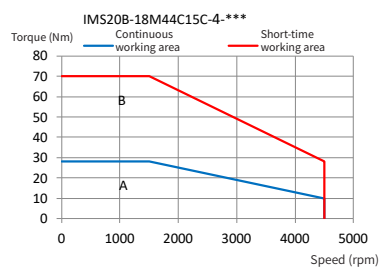
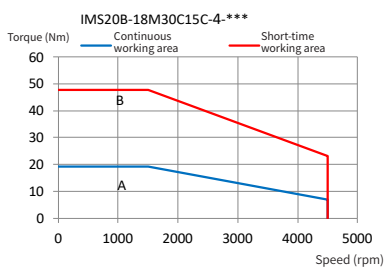

# Servo motor power cable models

## Power cable

DA ML-100-03-B F 0-00

①      ②      ③      ④      ⑤      ⑥      ⑦      ⑧

## Power cable accessories

DA ML - B F

①      ②      ⑤      ⑥

①

Symbol	Supporting series
DA	Manufacturer No.

②

Symbol	Cable type
ML	Power cable accessories

③

Symbol	Cable diameter
050	0.5 mm <sup>2</sup>
100	1.0 mm <sup>2</sup>
250	2.5 mm <sup>2</sup>
400	4.0 mm <sup>2</sup>
600	6.0 mm <sup>2</sup>

④

Symbol	Cable length
03	3m
05	5m
10	10m
...	Other

⑤

Symbol	Plug on motor end
B	4PIN regular aviation plug YD28
N	Regular aviation plug YD32
A	4PIN plastic plug
X	In-line terminal
H	4+2PIN CMS08A18-B6SBI003
G	4PIN CMS3108A18-10SI

⑥

Symbol	Plug on drive end
F	Tube-type terminal
W	Fork-type terminal

⑦

Symbol	Cable material
0	Regular cable
F	Flexible towline cable
A	Shielded regular cable

⑧

Symbol	Lot number
00	Without brake
...	Other

## Brake cable (except base-40/60/80 motor)

BRKL - 03 - B

①      ②      ③

①

Symbol	Product series
BRKL	Motor brake cable

②

Symbol	Cable length
03	3m
...	Other

③

Symbol	Plug on motor end
B	3PIN regular aviation plug
D	2PIN plastic plug

Note: For brake cable, it is recommended that the customer use the internal brake plug inside the motor for welding

# Servo motor power cable wiring

## Power cable for base-40/60/80 motor (in-line + brake)

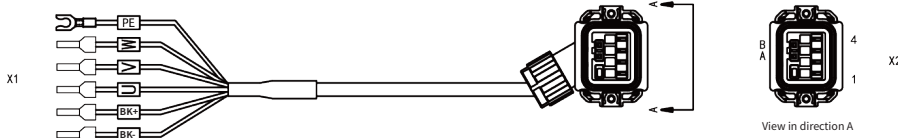

Wiring mapping		
Signal	X1	X2
W	Tube-type terminal	X2.3
V	Tube-type terminal	X2.1
U	Tube-type terminal	X2.2
PE	Fork-type terminal	X2.4
BK+	Tube-type terminal	X2.A
BK-	Tube-type terminal	X2.B

## Power cable for base-100 motor (military-grade aviation plug + brake)

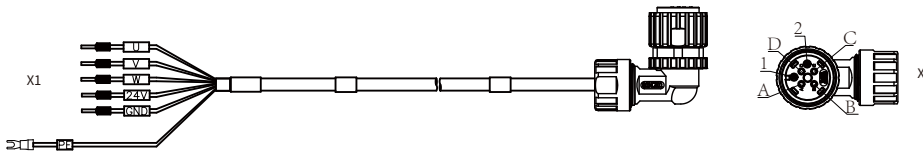

Wiring mapping		
Signal	X1	X2
U	Rod-type terminal	X2.A
V	Rod-type terminal	X2.B
W	Rod-type terminal	X2.C
PE	U-type terminal	X2.D
BK+	Rod-type terminal	X2.1
BK-	Rod-type terminal	X2.2

## Power cable for base-130 motor (YD28 terminal)

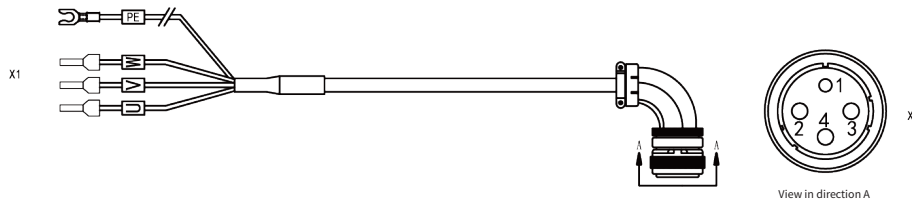

Wiring mapping		
Signal	X1	X2
W	Tube-type/fork-type terminal	X2.4
V	Tube-type/fork-type terminal	X2.3
U	Tube-type/fork-type terminal	X2.2
PE	Fork-type terminal	X2.1

## Power cable for base-180 motor (YD32 terminal)

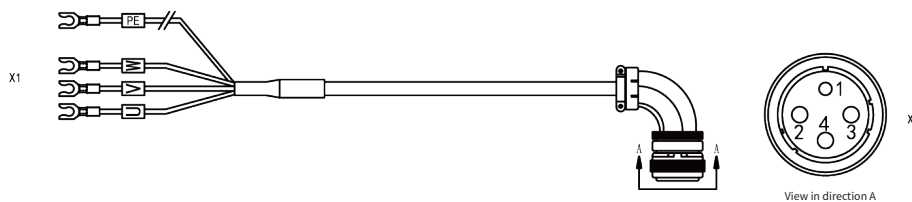

Wiring mapping		
Signal	X1	X2
W	Tube-type/fork-type terminal	X2.4
V	Tube-type/fork-type terminal	X2.3
U	Tube-type/fork-type terminal	X2.2
PE	Fork-type terminal	X2.1

# Servo motor encoder cable models

## Encoder cable

**DB EL - 04 - 03 - B I 0 - 04 A0**

①    ②    ③    ④    ⑤ ⑥ ⑦    ⑧    ⑨

## Encoder cable accessories

**DB EL-B I**

①    ②    ⑤    ⑥

①

Symbol	Supporting series
DB	Manufacturer No.

②

Symbol	Cable type
EL	Encoder cable

③

Symbol	Number of cable cores
06	6
15	15
04	4

④

Symbol	Cable length
03	3m
05	5m
10	10m
...	Other

⑤

Symbol	Plug on motor end
B	15PIN regular aviation plug YD28
D	9PIN plastic plug
X	In-line terminal
H	17PIN 08A
J	10PIN SC-CMV1-SP10CBT

⑥

Symbol	Plug on drive end
I	6PIN plastic plug 1394

⑦

Symbol	Cable material
0	Regular cable
D	Regular cable with battery holder
F	Flexible towline cable
H	Flexible towline cable with battery holder

⑧

Symbol	Encoder type
04	Absolute

⑨

符号	Lot number
A0	Other



# Servo motor encoder cable wiring

## Encoder cable for base-40/60/80 motor (absolute + in-line + battery holder)

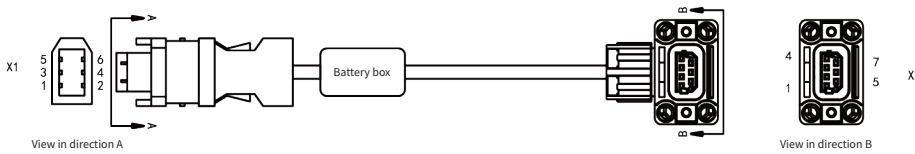

Wiring mapping			
Signal	X1	X2	Core cable structure
SD+	X1.5	X2.1	Twisted pair
SD-	X1.6	X2.2	
5V	X1.1	X2.5	Twisted pair
GND	X1.2	X2.6	Twisted pair
BAT+	/	X2.3	
BAT-	/	X2.4	Twisted pair
Shield	Iron shell	X2.7	Woven

## Encoder cable for base-100 motor (absolute + military-grade aviation plug + battery holder)

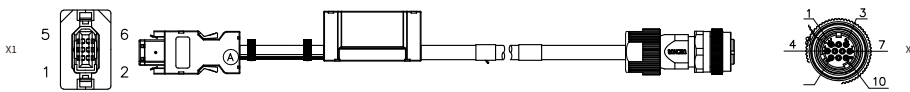

Wiring mapping			
Signal	X1	X2	Core cable structure
SD+	X1.5	X2.1	Twisted pair
SD-	X1.6	X2.2	
5V	X1.1	X2.4	Twisted pair
GND	X1.2	X2.9	Twisted pair
BAT+	/	X2.6	
BAT-	/	X2.5	Twisted pair
Shield	Iron shell	X2.10	Woven

## Encoder cable for base-130/180 motor (absolute + YD28 terminal + battery holder)

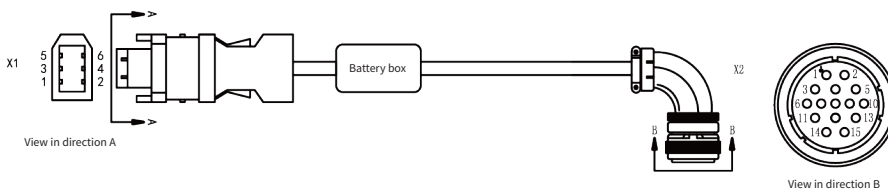

Wiring mapping			
Signal	X1	X2	Core cable structure
SD+	X1.5	X2.2	Twisted pair
SD-	X1.6	X2.3	
5V	X1.1	X2.4	Twisted pair
GND	X1.2	X2.5	Twisted pair
BAT+	/	X2.6	
BAT-	/	X2.7	Twisted pair
Shield	Iron shell	X2.1	Woven

# User interface

Note: Standard-type examples

## Main circuit wiring diagram for size A

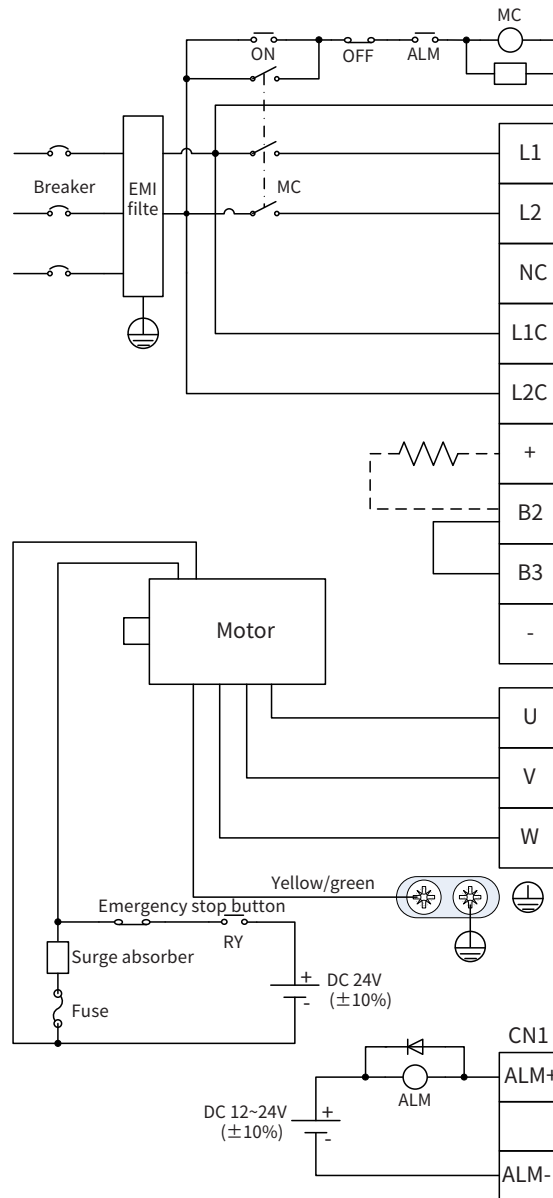

- You need to make this emergency stop protection circuit;
- Add surge absorbing devices on both ends of the electromagnetic contactor winding.

- Input voltage range of 220V system: AC 220V(±15%)
- For main circuit wiring, connect to L1 and L2.
- Note: Use the 3PH input power supply for 1.5kW and higher drives.

- Do not disconnect the short connection wire between B2 and B3 unless the external regenerative braking resistance is used.

- When using an external regenerative braking resistor, disconnect the short connection wire between B2 and B3, and connect according to the dashed line in the figure.

- Connect output U, V and W to the drive according to the motor cable phase sequence of servo motor, wrong phase sequence will cause drive fault.

- Be sure to ground the servo drive to avoid accident of electrical shock.

- The electromagnetic brake uses 24V DC power supply which should be provided by the user. Moreover, it must be isolated from the DC12-24V power supply which is used by the control signal.

- Pay attention to the connection of the freewheeling diode. Reversed polarity may damage the drive.

Main circuit wiring diagram for size B/C/D

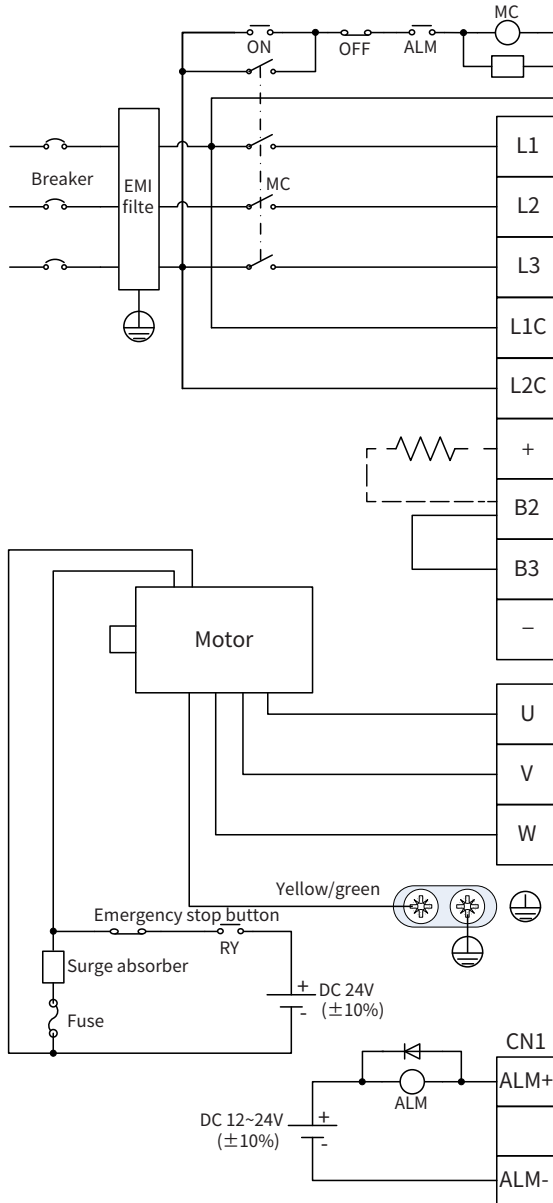

- You need to make this emergency stop protection circuit.
- Add surge absorbing devices on both ends of the electromagnetic contactor winding.
- System input voltage of 220V: AC 220V( $\pm 15\%$ )
- System input voltage of 400V: AC 380V( $\pm 15\%$ )
- Do not disconnect the short connection wire between B2 and B3 unless the external regenerative braking resistance is used.
- When using an external regenerative braking resistor, disconnect the short connection wire between B2 and B3, and connect according to the dashed line in the figure.
- Connect output U, V and W to the drive according to the motor cable phase sequence of servo motor, wrong phase sequence will cause drive fault.
- Be sure to ground the servo drive to avoid accident of electrical shock.
- The electromagnetic brake uses 24V DC power supply which should be provided by the user. Moreover, it must be isolated from the DC12-24V power supply which is used by the control signal.
- Pay attention to the connection of the freewheeling diode. Reversed polarity may damage the drive.

# System wiring

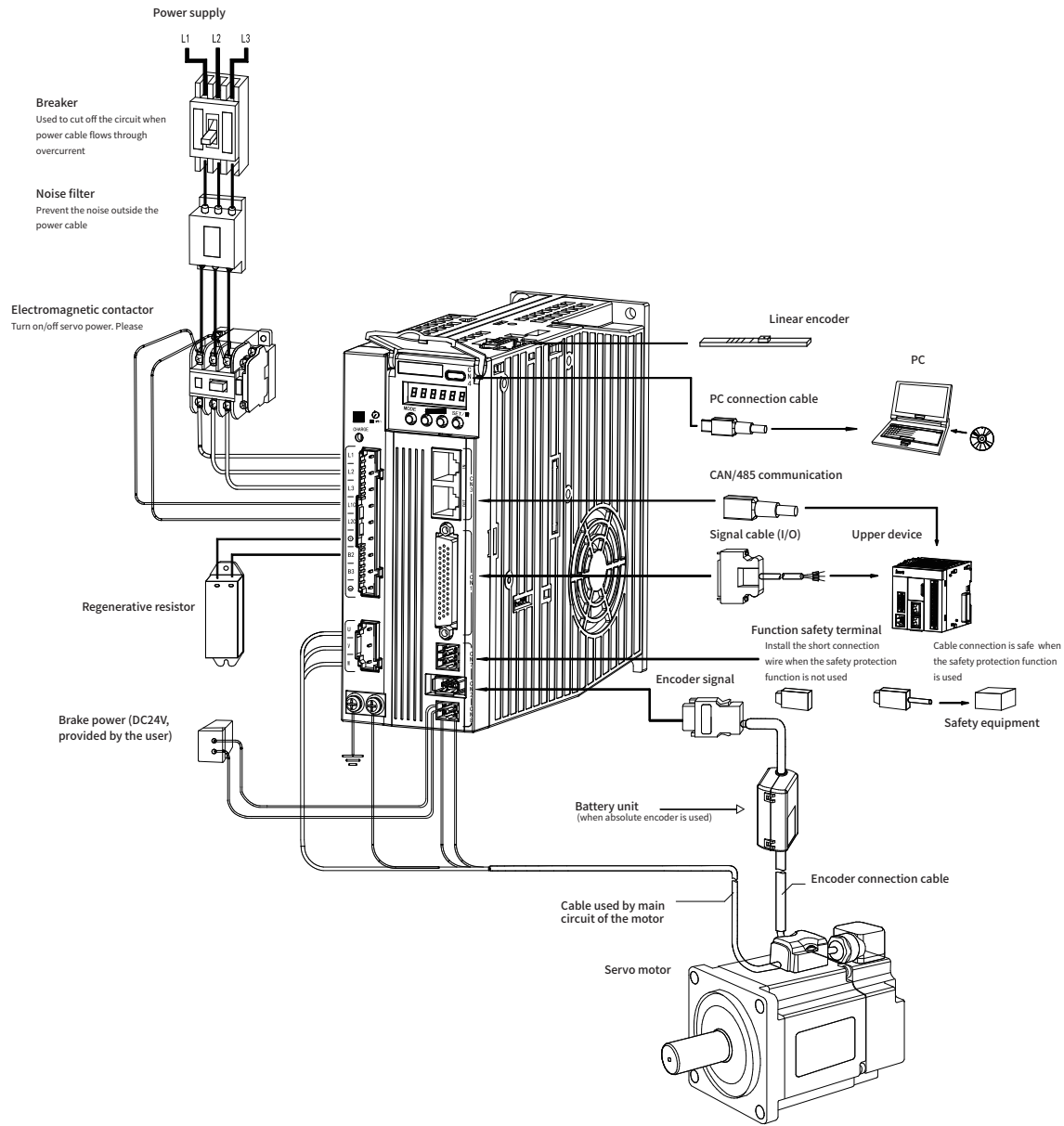

# Drive terminal diagram

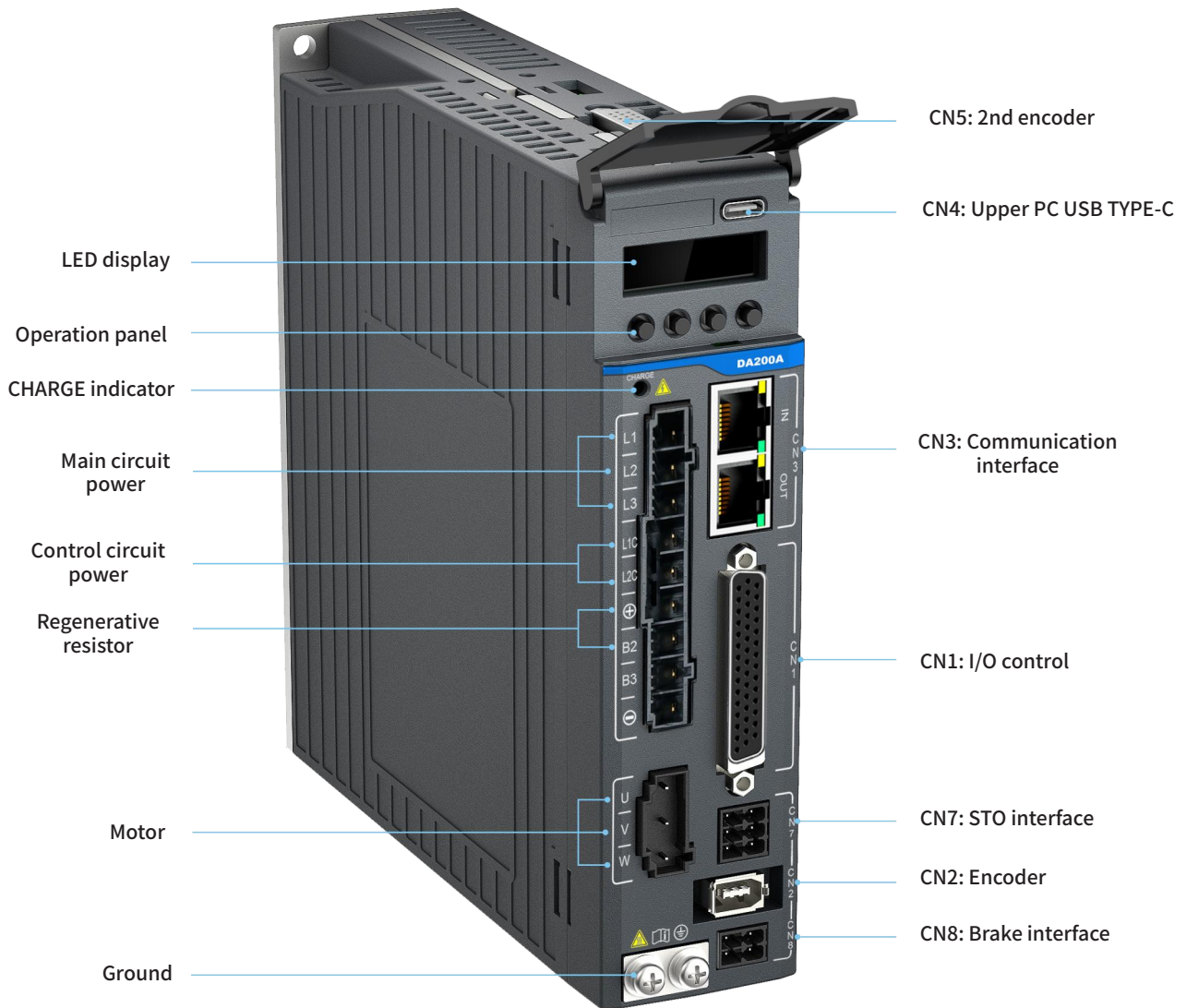

# User interface

Note: Standard-type examples

## CN1terminal

Applicable to standard type (pulse-type CANopen)

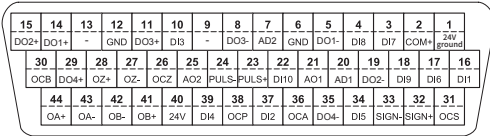

CN1 terminal function					
Pin	Name	Function	Pin	Symbol	Function
1	24V ground	Ground of 24V power supply	23	PULS+	Differential command pulse +
2	COM+	Common terminal of digital input	24	PULS-	Differential command pulse -
3	DI7	Digital input 7	25	AO2	4 channels of analog output
4	DI8	Digital input 8	26	OCZ	Z-phase open collector output
5	DO1-	Digital output 1 -	27	OZ-	Z-phase differential output -
6	GND	Signal ground	28	OZ+	Z-phase differential output +
7	AD2	Analog input	29	DO4+	Digital output 4 +
8	DO3-	Digital output 3 -	30	OCB	B-phase open collector output
9	-	-	31	OCS	Open collector command direction
10	DI3	Digital input 3	32	SIGN+	Differential command direction +
11	DO3+	Digital output 3 +	33	SIGN-	Differential command direction -
12	GND	Signal ground	34	DI5	Digital input 5
13	-	-	35	DO4-	Digital output 4 -
14	DO1+	Digital output 1+	36	OCA	A-phase open collector output
15	DO2+	Digital output 2+	37	DI2	Digital input 2
16	DI1	Digital input 1	38	OCF	Open collector command pulse
17	DI6	Digital input 6	39	DI4	Digital input 4
18	DI9	Digital input 9	40	24V	Power supply 24V ground
19	DO2-	Digital output 2-	41	OB+	B-phase differential output +
20	AD1	Analog input	42	OB-	B-phase differential output -
21	AO1	4 channels of analog output	43	OA-	A-phase differential output -
22	DI10	Digital input 10	44	OA+	A-phase differential output +

Suitable for EtherCAT, PROFINET, CANopen bus drives (bus type)

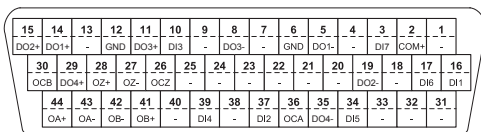

Note: For terminal definition, refer to pulse type

## CN2terminal

CN2 terminal function			
Pin	Name	Function	Remarks
1	5V	5V power supply	Different encoders use different cables
2	GND	Power ground	
3	CLK+	BISS Endat clock output+	
4	CLK-	BISS Endat clock output-	
5	SD+	Serial encoder data+	
6	SD-	Serial encoder data-	

## CN3terminal

CN3 terminal function			
Pin	Name	Function	Remarks
1	CAN_H	CAN data +	485 and CAN use the same interface and each signal has three pins for multiple networking
2	CAN_L	CAN data -	
3	CAN_GND	CAN signal ground	
4	RS485+	RS485 data +	
5	RS485-	RS485 data -	
8	GND	RS485 GND	
6\7	-	-	

CN3 terminal function			
Pin	Name	Function	Remarks
1	Tx+	Transmit data+	The bus drive terminals are defined as standard network ports
2	Tx-	Transmit data-	
3	Rx+	Receive data+	
4	-	-	
5	-	-	
6	Rx-	Receive data-	
7,8	-	-	



### CN4terminal

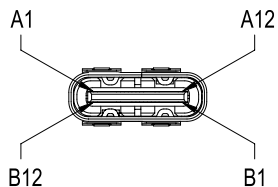

CN4 terminal function			
Pin	Name	Function	Remarks
A7, B7	USB-	Data-	Standard type-c interface
A6, B6	USB+	Data+	
A1, A12, B1, B12	GND	Signal ground	
A4, B4, A5, B5, A9, B9	-	-	

### CN7: STO

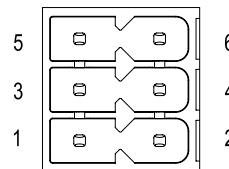

CN7 terminal function			
Pin	Name	Function	Remarks
1	24V	Power supply 24V	DC24V is internally powered. When STO function is unused, it is necessary to short connect pin 1, pin 3 and pin 4. In other cases, 24V power supply cannot be used as external power supply
2	24V_GND	Power supply 24V ground	
3	HWBB1	Safety input 1+	
4	HWBB2	Safety input 2+	
5	EDM+	Safety monitoring output +	
6	EDM-	Safety monitoring output-	

### CN5terminal

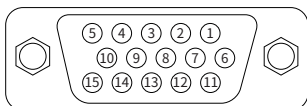

CN5 terminal function			
Pin	Name	Function	Remarks
1	-	-	Connect to linear encoder or 2nd encoder, supporting incremental linear motor encoder
2	-	-	
3	ENC_A+	Incremental encoder A+	
4	ENC_A-	Incremental encoder A-	
5	5V	Power supply +5V	
6	-	-	
7	v	Single-ended hall V-phase signal	
8	W	Single-ended hall W-phase signal	
9	ENC_B-	Incremental encoder B-	
10	ENC_B+	Incremental encoder B+	
11	U	Single-ended hall U-phase signal	
12	GND	Power ground, be connected with internal GND	
13	ENC_Z-	Incremental encoder Z-	
14	ENC_Z+	Incremental encoder Z+	
15	PTC	Motor temperature feedback input	

### CN8 motor brake

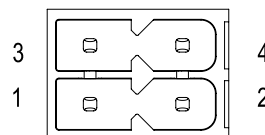

CN8 terminal function			
Pin	Name	Function	Remarks
1	24V_BK	The brake connects to the external 24V power supply.	-
2	COM	The brake connects to the external 24V ground.	
3	BK+	Brake BK+	
4	BK-	Brake BK-	

# Standard wiring diagram

Standard wiring diagram of position mode (suitable for pulse input control)

## Position control mode

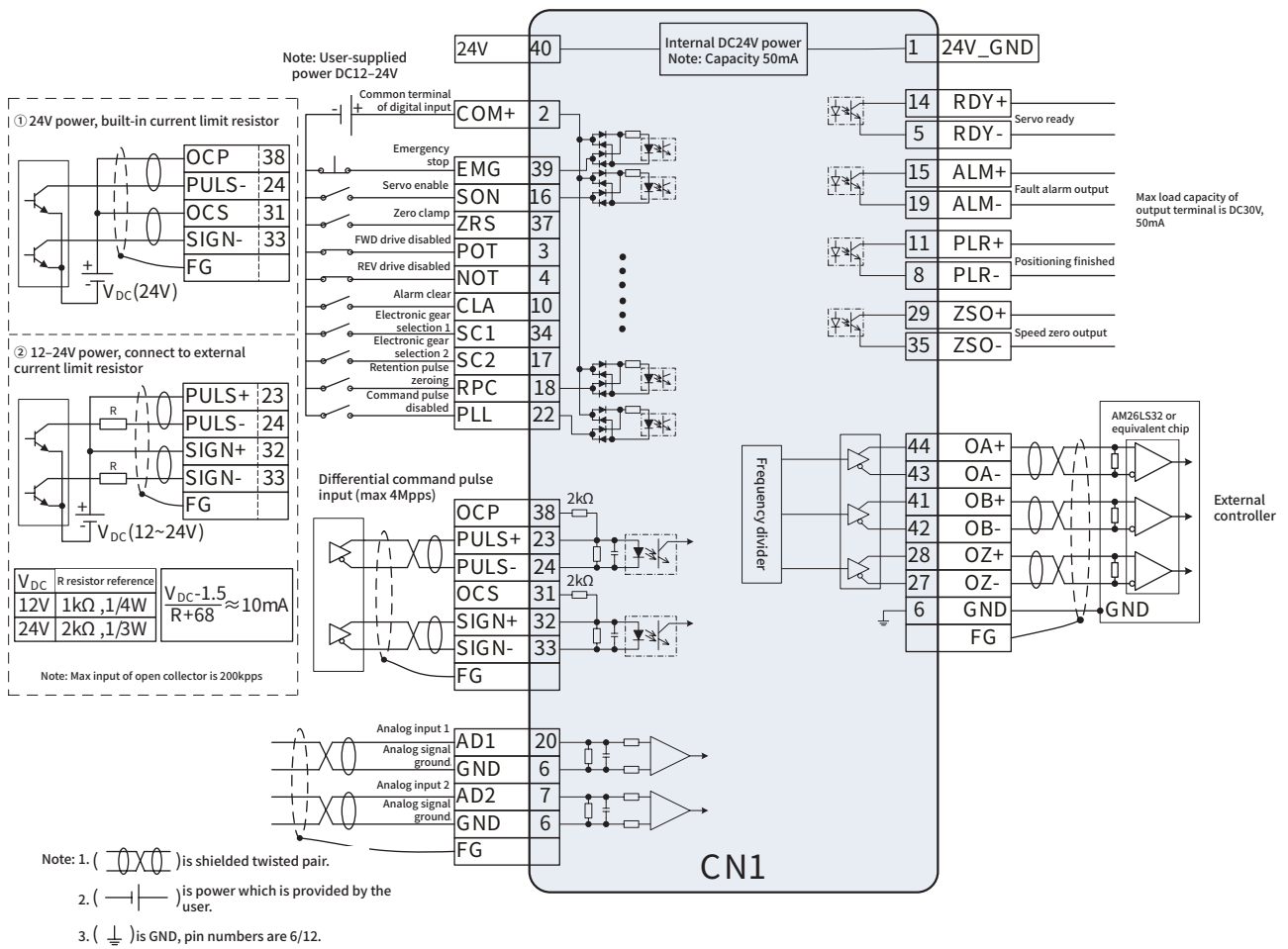

**Standard wiring diagram of speed mode  
(suitable for analog input control)**

**Speed control mode**

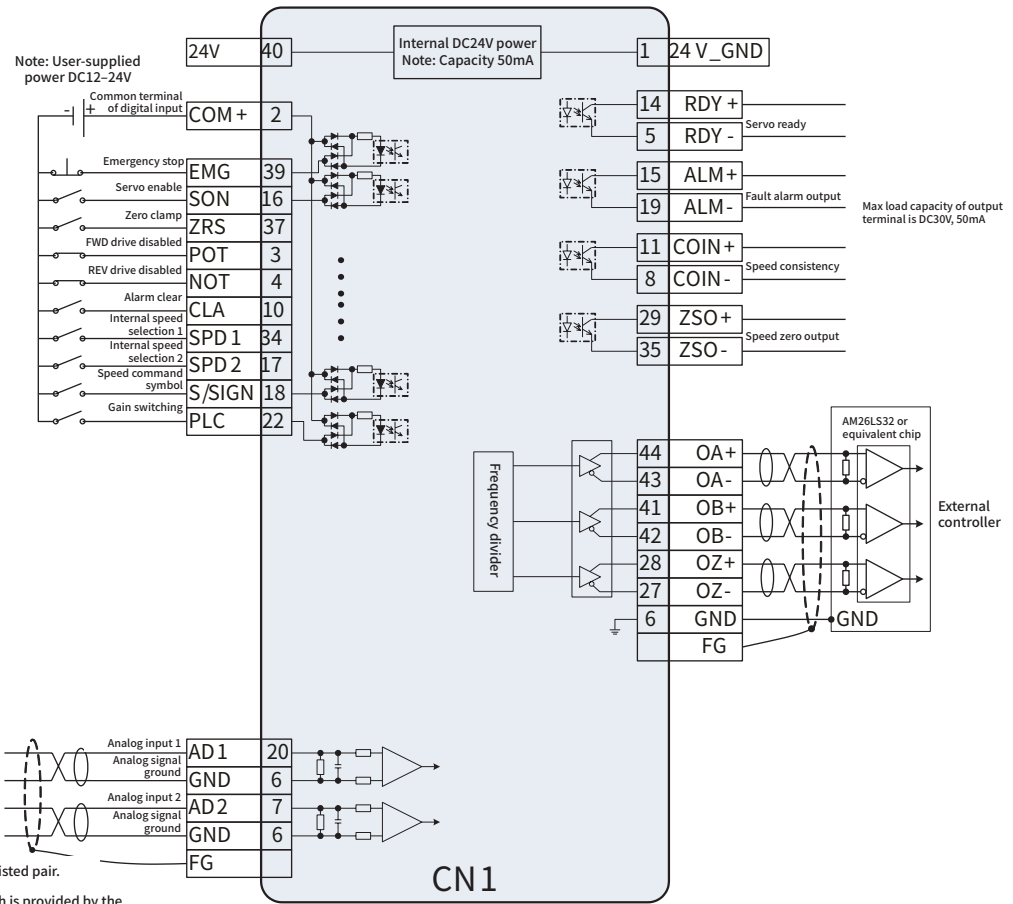

- Note: 1. ( ) is shielded twisted pair.  
 2. ( ) is power which is provided by the user.  
 3. ( ) is GND, pin numbers are 6/12.

# Standard wiring diagram

## Standard wiring diagram of torque mode (suitable for analog input control)

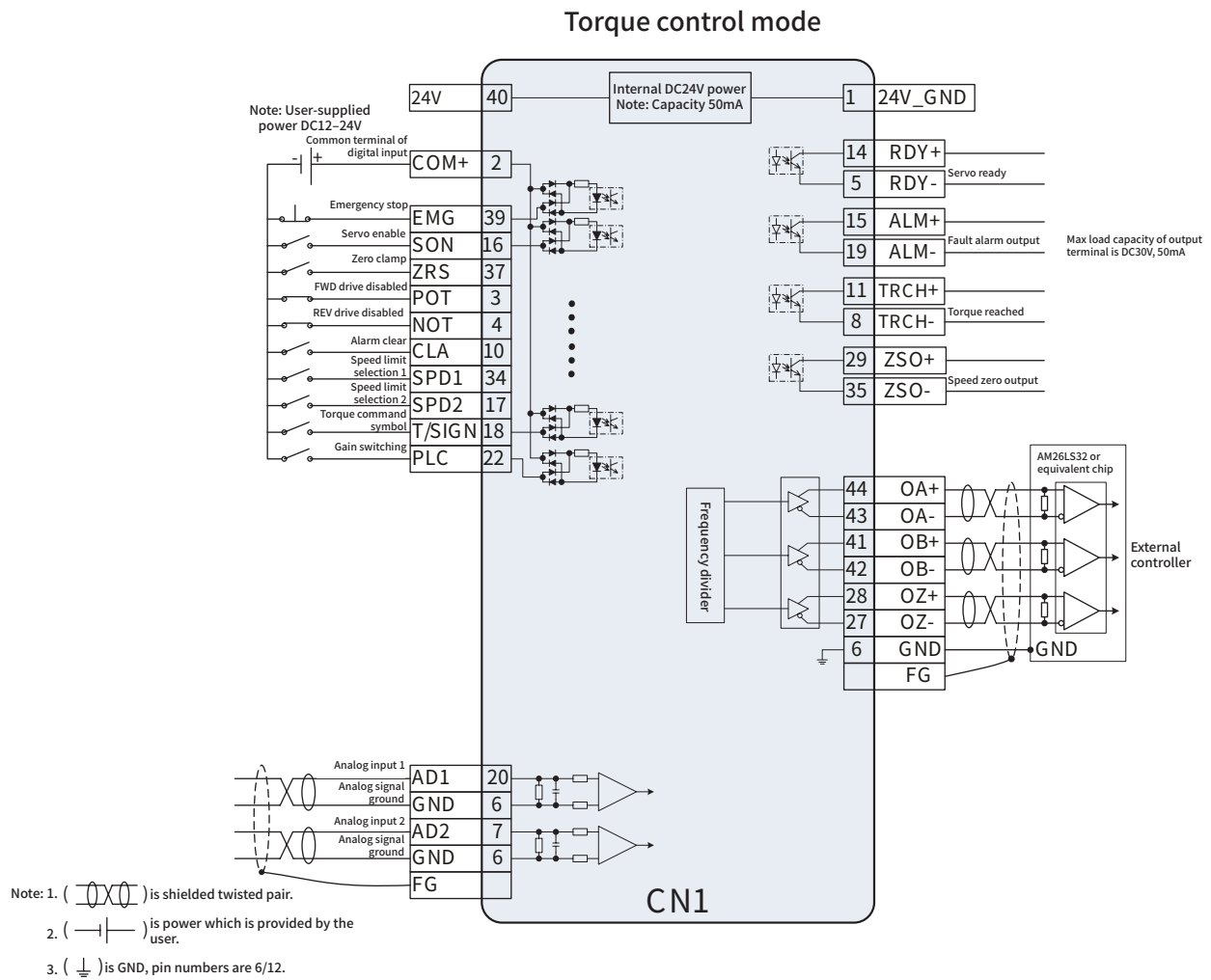

Standard wiring diagram of bus mode

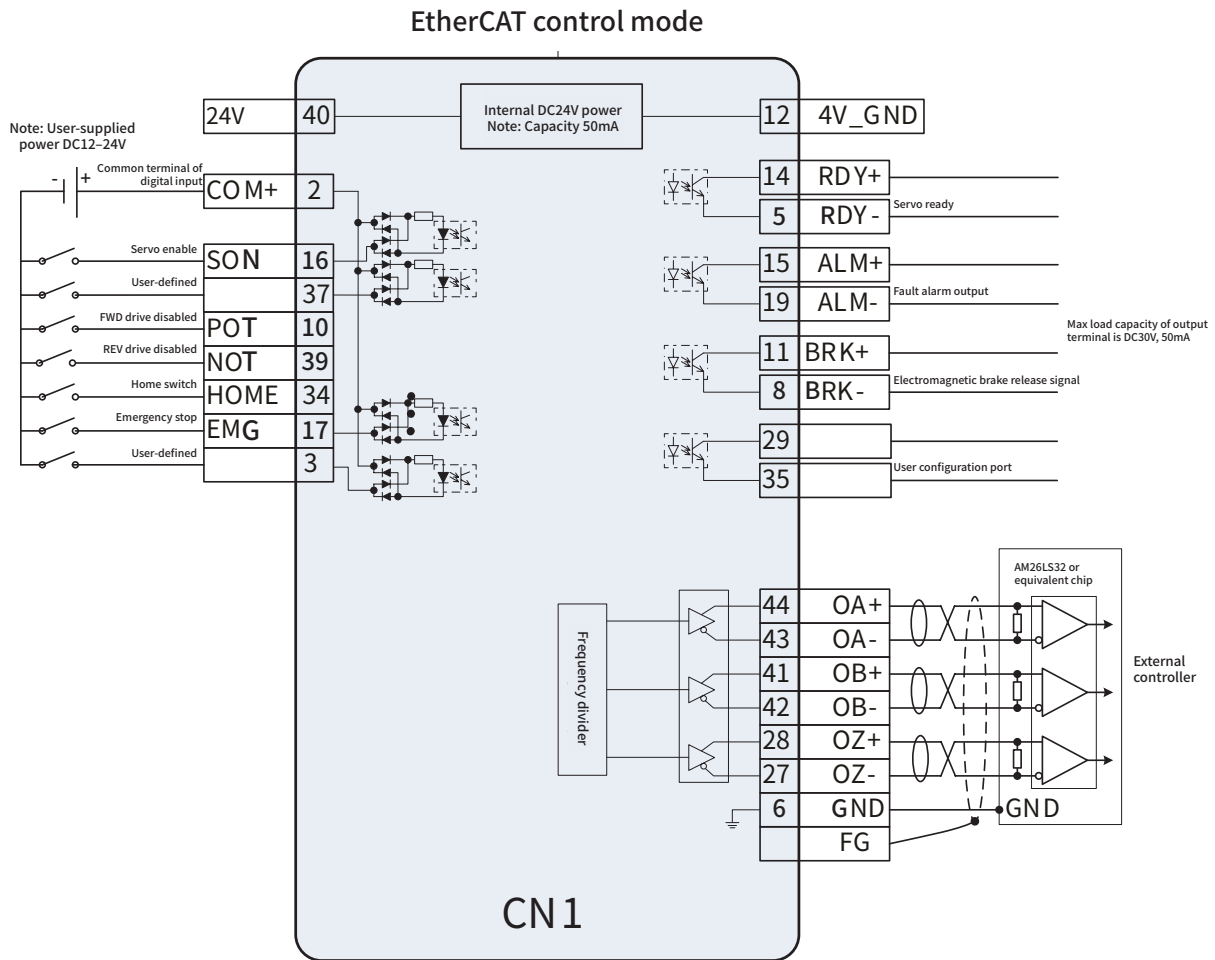

- Note: 1. is shielded twisted pair.
2. is power which is provided by the user.
3. is GND, pin numbers are 6/12.

# Ordering guide

No.	Base model No. (mm)	Voltage (V)	Power (kW)	Rated torque (Nm)	Max. torque (Nm)	Rated speed (rpm)	Max. speed (rpm)	Rated current (A)	Max. current (A)	Inertia (10 <sup>-4</sup> kg·m <sup>2</sup> )	Weight (kg)	Machine length (mm)	Shaft extension/ Shaft diameter (mm)	Bond width (mm)	Material number	Motor model	Encoder	Brake	Terminal type	Adapted drive type	Drive encapsulation	Power cable type Length: 3, 5, 10, 15, 20, 25	Encoder cable type Length: 3, 5, 10, 15, 20, 25
1	40	220	0.1	0.32	1.12	3000	6000	0.98	3.9	0.031	0.36	73.4	25/8	3	91015-00068	IMS20B-04L10B30C-2-M4-J	17-bit multi-turn magnetic encoder	\	In-line	DA200A-*-2R8-S-2-*	A	Without brake Common: DAML-050-xx-XF0-00 Flexible: DAML-050-xx-XFF-00 With brake Common: DAML-050-xx-XF0-01 Flexible: DAML-050-xx-XFF-01 xx represents the length, e.g. 03: 3 m	Without battery Common: DBEL-04-xx-XI0-04A0 Flexible: DBEL-04-xx-XIF-04A0 With battery Common: DBEL-06-xx-XID-04A0 Flexible: DBEL-06-xx-XIH-04A0 xx represents the length, e.g. 03: 3 m
2										0.034	0.55	100.1			91015-00069	IMS20B-04L10B30C-2-M44-J	17-bit multi-turn magnetic encoder	Electromagnetic brake	In-line				
3										0.031	0.36	73.4			91015-00070	IMS20B-04L10B30C-2-P9-J	23-bit multi-turn optical encoder	\	In-line				
4										0.034	0.55	100.1			91015-00071	IMS20B-04L10B30C-2-P94-J	23-bit multi-turn optical encoder	Electromagnetic brake	In-line				
5	60	220	0.2	0.64	2.23	3000	6000	1.3	4.4	0.34	0.8	70.5	30/14	5	91015-00072	IMS20B-06M20B30C-2-M4-J	17-bit multi-turn magnetic encoder	\	In-line				
6										0.35	1.2	99.7			91015-00073	IMS20B-06M20B30C-2-M44-J	17-bit multi-turn magnetic encoder	Electromagnetic brake	In-line				
7										0.34	0.8	70.5			91015-00074	IMS20B-06M20B30C-2-P9-J	23-bit multi-turn optical encoder	\	In-line				
8										0.35	1.2	99.7			91015-00075	IMS20B-06M20B30C-2-P94-J	23-bit multi-turn optical encoder	Electromagnetic brake	In-line				
9		220	0.4	1.27	4.45	3000	6000	2.6	8.6	30/14	5	0.59	1.2	88	91015-00076	IMS20B-06M40B30C-2-M4-J	17-bit multi-turn magnetic encoder	\	In-line				
10												0.6	1.6	117.2	91015-00077	IMS20B-06M40B30C-2-M44-J	17-bit multi-turn magnetic encoder	Electromagnetic brake	In-line				
11												0.59	1.2	88	91015-00078	IMS20B-06M40B30C-2-P9-J	23-bit multi-turn optical encoder	\	In-line				
12												0.6	1.6	117.2	91015-00079	IMS20B-06M40B30C-2-P94-J	23-bit multi-turn optical encoder	Electromagnetic brake	In-line				
13	80	220	0.75	2.38	8.36	3000	6000	4.6	16.3	35/19	6	1.72	2.2	94.6	91015-00080	IMS20B-08M75B30C-2-M4-J	17-bit multi-turn magnetic encoder	\	In-line	DA200A-*-6R0-S-2-*	A		
14												1.77	2.9	107.9	91015-00081	IMS20B-08M75B30C-2-M44-J	17-bit multi-turn magnetic encoder	Electromagnetic brake	In-line				
15												1.72	2.2	94.6	91015-00082	IMS20B-08M75B30C-2-P9-J	23-bit multi-turn optical encoder	\	In-line				
16												1.77	2.9	107.9	91015-00083	IMS20B-08M75B30C-2-P94-J	23-bit multi-turn optical encoder	Electromagnetic brake	In-line				
17		220	1	3.18	11.3	3000	6000	6.3	20.9	35/19	6	2.23	2.6	107.9	91015-00084	IMS20B-08M10C30C-2-M4-J	17-bit multi-turn magnetic encoder	\	In-line				
18												2.28	3.3	142.1	91015-00085	IMS20B-08M10C30C-2-M44-J	17-bit multi-turn magnetic encoder	Electromagnetic brake	In-line				
19												2.23	2.6	107.9	91015-00086	IMS20B-08M10C30C-2-P9-J	23-bit multi-turn optical encoder	\	In-line				
20												2.28	3.3	142.1	91015-00087	IMS20B-08M10C30C-2-P94-J	23-bit multi-turn optical encoder	Electromagnetic brake	In-line				
21	100	220	1	3.18	9.55	3000	6000	6.6	19.8	45/24	8	1.84	3.3	127.4	91015-00088	IMS20B-10M10C30C-2-M4-J	17-bit multi-turn magnetic encoder	\	Military-grade aviation plug	DA200A-*-6R0-S-2-*	A	Without brake Common: DAML-100-xx-GF0-00 Flexible: DAML-100-xx-GFF-00 With brake Common: DAML-100-xx-HF0-01 Flexible: DAML-100-xx-HFF-01 xx represents the length, e.g. 03: 3 m	
22												2.59	4.1	156	91015-00089	IMS20B-10M10C30C-2-M44-J	17-bit multi-turn magnetic encoder	Electromagnetic brake	Military-grade aviation plug				
23												1.84	3.3	127.4	91015-00090	IMS20B-10M10C30C-2-P9-J	23-bit multi-turn optical encoder	\	Military-grade aviation plug				
24												2.59	4.1	156	91015-00091	IMS20B-10M10C30C-2-P94-J	23-bit multi-turn optical encoder	Electromagnetic brake	Military-grade aviation plug				
25		220	1.5	4.78	13.4	3000	6000	8.8	24.39	45/24	8	2.75	4.3	147.4	91015-00096	IMS20B-10M15C30C-2-M4-J	17-bit multi-turn magnetic encoder	\	Military-grade aviation plug	DA200A-*-8R0-S-2-*	B		
26												3.5	5.1	176	91015-00097	IMS20B-10M15C30C-2-M44-J	17-bit multi-turn magnetic encoder	Electromagnetic brake	Military-grade aviation plug				
27												2.75	4.3	147.4	91015-00098	IMS20B-10M15C30C-2-P9-J	23-bit multi-turn optical encoder	\	Military-grade aviation plug				
28												3.5	5.1	176	91015-00099	IMS20B-10M15C30C-2-P94-J	23-bit multi-turn optical encoder	Electromagnetic brake	Military-grade aviation plug				
29		220	2	6.37	19.1	3000	6000	10.71	31.01	45/24	8	3.65	5.3	167.4	91015-00104	IMS20B-10M20C30C-2-M4-J	17-bit multi-turn magnetic encoder	\	Military-grade aviation plug	DA200A-*-010-S-2-*	B		
30												4.4	6.1	196	91015-00105	IMS20B-10M20C30C-2-M44-J	17-bit multi-turn magnetic encoder	Electromagnetic brake	Military-grade aviation plug				
31												3.65	5.3	167.4	91015-00106	IMS20B-10M20C30C-2-P9-J	23-bit multi-turn optical encoder	\	Military-grade aviation plug				
32												4.4	6.1	196	91015-00107	IMS20B-10M20C30C-2-P94-J	23-bit multi-turn optical encoder	Electromagnetic brake	Military-grade aviation plug				
33		220	2.5	7.96	26.5	3000	6000	13.3	38.51	45/24	8	4.36	6.3	184.4	91015-00112	IMS20B-10M25C30C-2-M4-J	17-bit multi-turn magnetic encoder	\	Military-grade aviation plug	DA200A-*-013-S-2-*	C	Common: DAML-250-xx-GF0-01 Flexible: DAML-250-xx-GFF-01 xx represents the length, e.g. 03: 3 m	
34												5.11	7.1	213	91015-00113	IMS20B-10M25C30C-2-M44-J	17-bit multi-turn magnetic encoder	Electromagnetic brake	Military-grade aviation plug				
35												4.36	6.3	184.4	91015-00114	IMS20B-10M25C30C-2-P9-J	23-bit multi-turn optical encoder	\	Military-grade aviation plug				
36												5.11	7.1	213	91015-00115	IMS20B-10M25C30C-2-P94-J	23-bit multi-turn optical encoder	Electromagnetic brake	Military-grade aviation plug				



# Ordering guide

No.	Base model No. (mm)	Voltage (V)	Power (kW)	Rated torque (Nm)	Max. torque (Nm)	Rated speed (rpm)	Max. speed (rpm)	Rated current (A)	Max. current (A)	Inertia (10 <sup>-4</sup> kg·m <sup>2</sup> )	Weight (kg)	Machine length (mm)	Shaft extension/ Shaft diameter (mm)	Bond width (mm)	Material number	Motor model	Encoder	Brake	Terminal type	Adapted drive type	Drive encapsulation	Power cable type Length: 3, 5, 10, 15, 20, 25	Encoder cable type Length: 3, 5, 10, 15, 20, 25												
37	100	380	1	3.18	9.55	3000	6000	3.72	11.34	1.84	3.3	127.4	45/24	8	91015-00092	IMS20B-10M10C30C-4-M4-J	17-bit multi-turn magnetic encoder	\	Military-grade aviation plug	DA200A-*-5R5-T-2-*	B	Without brake Common: DAML-100-xx-GF0-00 Flexible: DAML-100-xx-GFF-00 With brake Common: DAML-100-xx-HF0-01 Flexible: DAML-100-xx-HFF-01 xx represents the length, e.g. 03: 3 m	Without battery Common: DBEL-04-xx-J10-04A0 Flexible: DBEL-04-xx-J1F-04A0 With battery Common: DBEL-06-xx-J10-04A0 Flexible: DBEL-06-xx-J1H-04A0 xx represents the length, e.g. 03: 3 m												
38										91015-00093	IMS20B-10M10C30C-4-M44-J	17-bit multi-turn magnetic encoder			Electromagnetic brake	Military-grade aviation plug																			
39										91015-00094	IMS20B-10M10C30C-4-P9-J	23-bit multi-turn optical encoder			\	Military-grade aviation plug																			
40										91015-00095	IMS20B-10M10C30C-4-P94-J	23-bit multi-turn optical encoder			Electromagnetic brake	Military-grade aviation plug																			
41		380	1.5	4.78	13.4	3000	6000	5.1	14.85	2.75	4.3	147.4	45/24	8	91015-00100	IMS20B-10M15C30C-4-M4-J	17-bit multi-turn magnetic encoder	\	Military-grade aviation plug																
42										91015-00101	IMS20B-10M15C30C-4-M44-J	17-bit multi-turn magnetic encoder			Electromagnetic brake	Military-grade aviation plug																			
43										91015-00102	IMS20B-10M15C30C-4-P9-J	23-bit multi-turn optical encoder			\	Military-grade aviation plug																			
44										91015-00103	IMS20B-10M15C30C-4-P94-J	23-bit multi-turn optical encoder			Electromagnetic brake	Military-grade aviation plug																			
45		380	2	6.37	19.1	3000	6000	6.95	22.2	3.65	5.3	167.4	45/24	8	91015-00108	IMS20B-10M20C30C-4-M4-J	17-bit multi-turn magnetic encoder	\	Military-grade aviation plug																
46										91015-00109	IMS20B-10M20C30C-4-M44-J	17-bit multi-turn magnetic encoder			Electromagnetic brake	Military-grade aviation plug																			
47										91015-00110	IMS20B-10M20C30C-4-P9-J	23-bit multi-turn optical encoder			\	Military-grade aviation plug																			
48										91015-00111	IMS20B-10M20C30C-4-P94-J	23-bit multi-turn optical encoder			Electromagnetic brake	Military-grade aviation plug																			
49		380	2.5	7.96	26.5	3000	6000	8.17	27.8	4.36	6.3	184.4	45/24	8	91015-00116	IMS20B-10M25C30C-4-M4-J	17-bit multi-turn magnetic encoder	\	Military-grade aviation plug					DA200A-*-8R5-T-2-*	C										
50										91015-00117	IMS20B-10M25C30C-4-M44-J	17-bit multi-turn magnetic encoder			Electromagnetic brake	Military-grade aviation plug																			
51										91015-00118	IMS20B-10M25C30C-4-P9-J	23-bit multi-turn optical encoder			\	Military-grade aviation plug																			
52										91015-00119	IMS20B-10M25C30C-4-P94-J	23-bit multi-turn optical encoder			Electromagnetic brake	Military-grade aviation plug																			
53		130	220	0.85	5.4	13.5	1500	4500	6.2	15.7	13.1	5.7	138	55/22	8	11101-01256	IMS20B-13H85B15C-2-M4-A	17-bit multi-turn magnetic encoder	\									YD28	DA200A-*-6R0-S-2-*	A	Common: DBAFM0-L0-0100-**-BF0-00 Flexible: DAML-100-**-BFF-00 xx represents the length, e.g. 03: 3 m				
54											11101-01255	IMS20B-13H85B15C-2-M44-A	17-bit multi-turn magnetic encoder			Electromagnetic brake	YD28																		
55											11101-01257	IMS20B-13H85B15C-2-P9-A	23-bit multi-turn optical encoder			\	YD28																		
56											11101-01259	IMS20B-13H85B15C-2-P94-A	23-bit multi-turn optical encoder			Electromagnetic brake	YD28																		
57	220		1	4.78	14.34	2000	4500	5.4	17.7	6.3	4.4	130	55/22	8	11101-01258	IMS20B-13M10C20C-2-M4-A	17-bit multi-turn magnetic encoder	\	YD28																
58										11101-01253	IMS20B-13M10C20C-2-M44-A	17-bit multi-turn magnetic encoder			Electromagnetic brake	YD28																			
59										11101-01243	IMS20B-13M10C20C-2-P9-A	23-bit multi-turn optical encoder			\	YD28																			
60										11101-01251	IMS20B-13M10C20C-2-P94-A	23-bit multi-turn optical encoder			Electromagnetic brake	YD28																			
61	220		1.5	7.16	21.48	2000	4500	7.6	23.3	9.1	5.6	143	55/22	8	11101-01213	IMS20B-13M15C20C-2-M4-A	17-bit multi-turn magnetic encoder	\	YD28	DA200A-*-8R0-S-2-*	B														
62										11101-01209	IMS20B-13M15C20C-2-M44-A	17-bit multi-turn magnetic encoder			Electromagnetic brake	YD28																			
63										11101-01203	IMS20B-13M15C20C-2-P9-A	23-bit multi-turn optical encoder			\	YD28																			
64										11101-01205	IMS20B-13M15C20C-2-P94-A	23-bit multi-turn optical encoder			Electromagnetic brake	YD28																			
65	220		1.3	8.4	21	1500	4500	9.9	25	17.9	7.2	155	55/22	8	11101-01221	IMS20B-13H13C15C-2-M4-A	17-bit multi-turn magnetic encoder	\	YD28									DA200A-*-010-S-2-*					B	Common: DBML-250-**-BF0-00 Flexible: DBML-250-**-BFF-00 xx represents the length, e.g. 03: 3 m	
66										11101-01220	IMS20B-13H13C15C-2-M44-A	17-bit multi-turn magnetic encoder			Electromagnetic brake	YD28																			
67										11101-01215	IMS20B-13H13C15C-2-P9-A	23-bit multi-turn optical encoder			\	YD28																			
68										11101-01216	IMS20B-13H13C15C-2-P94-A	23-bit multi-turn optical encoder			Electromagnetic brake	YD28																			
69	220		2	9.55	28.65	2000	4500	9	29.2	12.9	6.9	160	55/22	8	11101-01202	IMS20B-13M20C20C-2-M4-A	17-bit multi-turn magnetic encoder	\	YD28																
70										11101-01207	IMS20B-13M20C20C-2-M44-A	17-bit multi-turn magnetic encoder			Electromagnetic brake	YD28																			
71										11101-01198	IMS20B-13M20C20C-2-P9-A	23-bit multi-turn optical encoder			\	YD28																			
72										11101-01201	IMS20B-13M20C20C-2-P94-A	23-bit multi-turn optical encoder			Electromagnetic brake	YD28																			

# Ordering guide

No.	Base model No. (mm)	Voltage (V)	Power (kW)	Rated torque (Nm)	Max. torque (Nm)	Rated speed (rpm)	Max. speed (rpm)	Rated current (A)	Max. current (A)	Inertia (10 <sup>-4</sup> kg·m <sup>2</sup> )	Weight (kg)	Machine length (mm)	Shaft extension/Shaft diameter (mm)	Bond width (mm)	Material number	Motor model	Encoder	Brake	Terminal type	Adapted drive type	Drive encapsulation	Power cable type Length: 3, 5, 10, 15, 20, 25	Encoder cable type Length: 3, 5, 10, 15, 20, 25
73	130	220	1.8	11.5	28.8	1500	4500	12.8	32.7	24.3	9	185	55/22	8	11101-01305	IMS20B-13H18C15C-2-M4-A	17-bit multi-turn magnetic encoder	\	YD28	DA200A*-5R5-T-2-*	C	Common: DBML-250-**-BF0-00 Flexible: DBML-250-**-BFF-00 xx represents the length, e.g. 03: 3 m	
74										25.6	10.6	215			11101-01297	IMS20B-13H18C15C-2-M44-A	17-bit multi-turn magnetic encoder	Electromagnetic brake	YD28				
75										24.3	9	185			11101-01291	IMS20B-13H18C15C-2-P9-A	23-bit multi-turn optical encoder	\	YD28				
76										25.6	10.6	215			11101-01293	IMS20B-13H18C15C-2-P94-A	23-bit multi-turn optical encoder	Electromagnetic brake	YD28				
77		220	3	14.3	42.9	2000	3000	13	39.4	21.7	10.3	210.5	55/22	8	11101-01306	IMS20B-13M30C20C-2-M4-A	17-bit multi-turn magnetic encoder	\	YD28				
78										23.4	11.9	240.2			11101-01301	IMS20B-13M30C20C-2-M44-A	17-bit multi-turn magnetic encoder	Electromagnetic brake	YD28				
79										21.7	10.3	210.5			11101-01294	IMS20B-13M30C20C-2-P9-A	23-bit multi-turn optical encoder	\	YD28				
80										23.4	11.9	240.2			11101-01303	IMS20B-13M30C20C-2-P94-A	23-bit multi-turn optical encoder	Electromagnetic brake	YD28				
81		380	0.85	5.4	13.5	1500	4500	3.3	8.7	13.1	5.7	138	55/22	8	11101-01254	IMS20B-13H85B15C-4-M4-A	17-bit multi-turn magnetic encoder	\	YD28				
82										14.3	7.3	167			11101-01244	IMS20B-13H85B15C-4-M44-A	17-bit multi-turn magnetic encoder	Electromagnetic brake	YD28				
83										13.1	5.7	138			11101-01252	IMS20B-13H85B15C-4-P9-A	23-bit multi-turn optical encoder	\	YD28				
84										14.3	7.3	167			11101-01247	IMS20B-13H85B15C-4-P94-A	23-bit multi-turn optical encoder	Electromagnetic brake	YD28				
85		380	1	4.78	14.34	2000	4500	3	9	6.3	4.4	130	55/22	8	11101-01250	IMS20B-13M10C20C-4-M4-A	17-bit multi-turn magnetic encoder	\	YD28				
86										7.95	6	159			11101-01248	IMS20B-13M10C20C-4-M44-A	17-bit multi-turn magnetic encoder	Electromagnetic brake	YD28				
87										6.3	4.4	130			11101-01246	IMS20B-13M10C20C-4-P9-A	23-bit multi-turn optical encoder	\	YD28				
88										7.95	6	159			11101-01245	IMS20B-13M10C20C-4-P94-A	23-bit multi-turn optical encoder	Electromagnetic brake	YD28				
89	380	1.3	8.4	21	1500	4500	5.2	13.2	17.9	7.2	155	55/22	8	11101-01217	IMS20B-13H13C15C-4-M4-A	17-bit multi-turn magnetic encoder	\	YD28					
90									19.1	8.8	184			11101-01214	IMS20B-13H13C15C-4-M44-A	17-bit multi-turn magnetic encoder	Electromagnetic brake	YD28					
91									17.9	7.2	155			11101-01212	IMS20B-13H13C15C-4-P9-A	23-bit multi-turn optical encoder	\	YD28					
92									19.1	8.8	184			11101-01218	IMS20B-13H13C15C-4-P94-A	23-bit multi-turn optical encoder	Electromagnetic brake	YD28					
93	380	1.5	7.16	21.48	2000	4500	4.8	14.1	9.1	5.6	143	55/22	8	11101-01211	IMS20B-13M15C20C-4-M4-A	17-bit multi-turn magnetic encoder	\	YD28					
94									10.8	7.2	172			11101-01210	IMS20B-13M15C20C-4-M44-A	17-bit multi-turn magnetic encoder	Electromagnetic brake	YD28					
95									9.1	5.6	143			11101-01199	IMS20B-13M15C20C-4-P9-A	23-bit multi-turn optical encoder	\	YD28					
96									10.8	7.2	172			11101-01206	IMS20B-13M15C20C-4-P94-A	23-bit multi-turn optical encoder	Electromagnetic brake	YD28					
97	380	2	9.55	28.65	2000	4500	5.6	16.6	12.9	6.9	160	55/22	8	11101-01200	IMS20B-13M20C20C-4-M4-A	17-bit multi-turn magnetic encoder	\	YD28					
98									14.6	8.5	189			11101-01222	IMS20B-13M20C20C-4-M44-A	17-bit multi-turn magnetic encoder	Electromagnetic brake	YD28					
99									12.9	6.9	160			11101-01223	IMS20B-13M20C20C-4-P9-A	23-bit multi-turn optical encoder	\	YD28					
100									14.6	8.5	189			11101-01224	IMS20B-13M20C20C-4-P94-A	23-bit multi-turn optical encoder	Electromagnetic brake	YD28					
101	380	1.8	11.5	28.8	1500	4500	7.7	18.7	24.3	9	185	55/22	8	11101-01295	IMS20B-13H18C15C-4-M4-A	17-bit multi-turn magnetic encoder	\	YD28					
102									25.6	10.6	215			11101-01304	IMS20B-13H18C15C-4-M44-A	17-bit multi-turn magnetic encoder	Electromagnetic brake	YD28					
103									24.3	9	185			11101-01302	IMS20B-13H18C15C-4-P9-A	23-bit multi-turn optical encoder	\	YD28					
104									25.6	10.6	215			11101-01299	IMS20B-13H18C15C-4-P94-A	23-bit multi-turn optical encoder	Electromagnetic brake	YD28					
105	380	3	14.3	42.9	2000	3000	7.7	22.1	21.7	10.3	210.5	55/22	8	11101-01296	IMS20B-13M30C20C-4-M4-A	17-bit multi-turn magnetic encoder	\	YD28					
106									23.4	11.9	240.2			11101-01300	IMS20B-13M30C20C-4-M44-A	17-bit multi-turn magnetic encoder	Electromagnetic brake	YD28					
107									21.7	10.3	210.5			11101-01298	IMS20B-13M30C20C-4-P9-A	23-bit multi-turn optical encoder	\	YD28					
108									23.4	11.9	240.2			11101-01292	IMS20B-13M30C20C-4-P94-A	23-bit multi-turn optical encoder	Electromagnetic brake	YD28					

# Ordering guide

No.	Base model No. (mm)	Voltage (V)	Power (kW)	Rated torque (Nm)	Max. torque (Nm)	Rated speed (rpm)	Max. speed (rpm)	Rated current (A)	Max. current (A)	Inertia (10 <sup>-4</sup> kg·m <sup>2</sup> )	Weight (kg)	Machine length (mm)	Shaft extension/ Shaft diameter (mm)	Bond width (mm)	Material number	Motor model	Encoder	Brake	Terminal type	Adapted drive type	Drive encapsulation	Power cable type Length: 3, 5, 10, 15, 20, 25	Encoder cable type Length: 3, 5, 10, 15, 20, 25
109	180	380	3	19.1	47.8	1500	4500	9.7	22	48.6	19.2	223	79/35	10	11101-01230	IMS20B-18M30C15C-4-M4-A	17-bit multi-turn magnetic encoder	\	YD32	DA200A-*-012-T-2-*	D		
110										49.3	21.2	263			11101-01241	IMS20B-18M30C15C-4-M44-A	17-bit multi-turn magnetic encoder	Electromagnetic brake	YD32				
111										48.6	19.2	223			11101-01231	IMS20B-18M30C15C-4-P9-A	23-bit multi-turn optical encoder	\	YD32				
112										49.3	21.2	263			11101-01227	IMS20B-18M30C15C-4-P94-A	23-bit multi-turn optical encoder	Electromagnetic brake	YD32				
113		380	4.4	28	70	1500	4500	13.5	29.8	65.2	23.2	248	79/35	10	11101-01228	IMS20B-18M44C15C-4-M4-A	17-bit multi-turn magnetic encoder	\	YD32	DA200A-*-016-T-2-*			
114										65.9	25.2	288			11101-01232	IMS20B-18M44C15C-4-M44-A	17-bit multi-turn magnetic encoder	Electromagnetic brake	YD32				
115										65.2	23.2	248			11101-01234	IMS20B-18M44C15C-4-P9-A	23-bit multi-turn optical encoder	\	YD32				
116										65.9	25.2	288			11101-01229	IMS20B-18M44C15C-4-P94-A	23-bit multi-turn optical encoder	Electromagnetic brake	YD32				
117		380	5.5	35	88.8	1500	4500	16.8	37.7	84	27.7	273	113/42	12	11101-01242	IMS20B-18M55C15C-4-M4-A	17-bit multi-turn magnetic encoder	\	YD32	DA200A-*-016-T-2-*			
118										84.7	29.7	313			11101-01233	IMS20B-18M55C15C-4-M44-A	17-bit multi-turn magnetic encoder	Electromagnetic brake	YD32				
119										84	27.7	273			11101-01235	IMS20B-18M55C15C-4-P9-A	23-bit multi-turn optical encoder	\	YD32				
120										84.7	29.7	313			11101-01237	IMS20B-18M55C15C-4-P94-A	23-bit multi-turn optical encoder	Electromagnetic brake	YD32				
121		380	7.5	47.8	119.5	1500	4500	20.9	46.4	107.4	32	308	113/42	12	11101-01238	IMS20B-18M75C15C-4-M4-A	17-bit multi-turn magnetic encoder	\	YD32	DA200A-*-021-T-2-*			
122										108.1	34	348			11101-01239	IMS20B-18M75C15C-4-M44-A	17-bit multi-turn magnetic encoder	Electromagnetic brake	YD32				
123										107.4	32	308			11101-01236	IMS20B-18M75C15C-4-P9-A	23-bit multi-turn optical encoder	\	YD32				
124										108.1	34	348			11101-01240	IMS20B-18M75C15C-4-P94-A	23-bit multi-turn optical encoder	Electromagnetic brake	YD32				

*Your trusted industry automation solution provider*



E-mail: [overseas@invt.com.cn](mailto:overseas@invt.com.cn) Website: [www.invt.com](http://www.invt.com)

SHENZHEN INVT ELECTRIC CO.,LTD. INVT Guangming Technology Building, Songbai Road, Matian, Guangming District, Shenzhen, China

- Industrial Automation:**
- HMI
  - PLC
  - VFD
  - Servo System
  - Elevator Intelligent Control System
  - Rail Transit Traction System
- Electric Power:**
- UPS
  - DCIM
  - Solar Inverter
  - New Energy Vehicle Powertrain System
  - New Energy Vehicle Charging System
  - New Energy Vehicle Motor

INVT Copyright.  
Information may be subject to change without notice during product improving.

66003-00317 20240730(V1.0)