

# F R E Q U E N C Y   C O N V E R T E R S

*User's manual*

•

"Five in One+"  
-application manual

*Subject to changes without notice.*

## **USER'S MANUAL AND "FIVE IN ONE+" APPLICATION MANUAL**

These two manuals provide you with the general information how to use Vacon frequency converters and, if needed, the "Five in One+" applications.

Vacon CX/CXL/CXS User's Manual give you the necessary information about the installation, start-up and operation of Vacon CX/CXL/CXS frequency converters. We recommend you to read this manual thoroughly before powering up the frequency converter for the first time.

If you need a different I/O configuration or different operational functions see Chapter 12 of the User's Manual, "Five in One+ Application Package" for an application more suitable for your needs. For more detailed information, please read the attached "Five in One+" Application Manual.

If any problems occur, please contact your local distributor. Vacon Plc is not responsible for the use of its products against the given instructions.

## CONTENTS

### VACON CX/CXL/CXS USER'S MANUAL

1	Safety .....	2
2	EU-directive .....	4
3	Receiving .....	11
4	Technical data .....	13
5	Installation .....	23
6	Wiring .....	29
7	Control panel .....	61
8	Commissioning .....	73
9	Fault tracing .....	76
10	Basic application .....	78
11	System parameter group 0 .....	85
12	"Five in One+" -application package .....	87
13	Options .....	89

### VACON CX/CXL/CXS "FIVE IN ONE+" - APPLICATION MANUAL

A	General .....	0-2
B	Application selection .....	0-2
C	Restoring default values of application ..... parameters .....	0-2
D	Language selection .....	0-2
1	Standard Control Application .....	1-1
2	Local/Remote Control Application .....	2-1
3	Multi-step Speed Application .....	3-1
4	PI-control Application .....	4-1
5	Multi-purpose Control Application .....	5-1
6	Pump and Fan Control Application .....	6-1

F R E Q U E N C Y   C O N V E R T E R S

*User's manual*

## HOW TO USE THIS MANUAL

This manual provides you with the information necessary to install, start up and operate the Vacon CX/CXL/CXS frequency converter. We recommend you to read this manual carefully.

At least the following 10 steps of the *Start-up Quick Guide* must be performed during the installation and commissioning.

If any problems occur, please contact your local distributor.

### Start-up Quick Guide

1. Check that the delivery corresponds to your order, see Chapter 3.
2. Before taking any commissioning actions read carefully the safety instructions in Chapter 1.
3. Before the mechanical installation, check the minimum clearances around the unit and check the ambient conditions in Chapter 5.2. and table 4.3-1a.
4. Check the size of the motor cable, mains cable, mains fuses and check the cable connections, read Chapters 6.1.1, 6.1.2 and 6.1.2.
5. Follow the installation instructions, see Chapter 6.1.4.
6. Control cable sizes and the grounding system are explained in chapter 6.2. The signal configuration for the Basic application is in chapter 10.2.

Remember to connect the common terminals of the digital input groups.

7. Read in Chapter 7 how to use of the control panel.
8. The basic application has only 10 parameters in addition to the motor rating plate data, parameter and application package lock. All of them have default values. To ensure proper operation check, however, the rating plate data parameters:
  - nominal voltage of the motor
  - nominal frequency of the motor
  - nominal speed of the motor
  - nominal current of the motor
  - supply voltageParameters are explained in Chapter 10.4.
9. Follow commissioning instructions, see Chapter 8.
10. The Vacon CX/CXL/CXS is now ready for use.

If a different I/O configuration or different operational functions are required, see Chapter 12, "Five in One+" -application package, for a more suitable application. For more detailed data read the attached "Five in One+" -application manual.

Vacon Plc is not responsible for the use of the frequency converters against the instructions.

**VACON CX/CXL/CXS USER'S MANUAL****CONTENTS**

<b>1 Safety</b> .....	<b>2</b>	7.6 Programmable push-button menu	67
1.1 Warnings .....	2	7.7 Active faults menu .....	68
1.2 Safety instructions .....	2	7.8 Active warning display .....	70
1.3 Earthing and earth fault protection	3	7.9 Fault history menu .....	71
1.4 Running the motor .....	3	7.10 Contrast menu .....	71
<b>2 EU-directive</b> .....	<b>4</b>	7.11 Controlling motor from the front panel .....	72
2.1 CE-label .....	4	7.11.1 Control source change from I/O terminals to control panel .....	72
2.2 EMC-directive .....	4	7.11.2 Control source change from control panel to I/O .....	72
2.2.1 General .....	4	<b>8 Commissioning</b> .....	<b>73</b>
2.2.2 Technical criteria .....	4	8.1 Safety precautions .....	73
2.2.3 Vacon EMC-levels .....	4	8.2 Sequence of operation .....	73
2.2.4 Manufacturer's Declaration of Conformity .....	4	<b>9 Fault tracing</b> .....	<b>76</b>
<b>3 Receiving</b> .....	<b>11</b>	<b>10 Basic application</b> .....	<b>78</b>
3.1 Type designation code .....	11	10.1 General .....	78
3.2 Storing .....	12	10.2 Control connections .....	78
3.3 Maintenance .....	12	10.3 Control signal logic .....	79
3.4 Warranty .....	12	10.4 Parameters, group 1 .....	80
<b>4 Technical data</b> .....	<b>13</b>	10.4.1 Descriptions .....	81
4.1 General .....	13	10.5 Motor protection functions in the Basic Application .....	84
4.2 Power ratings .....	14	10.5.1 Motor thermal protection .....	84
4.3 Specifications .....	21	10.5.2 Motor stall warning .....	84
<b>5 Installation</b> .....	<b>23</b>	<b>11 System parameter group 0</b> .....	<b>85</b>
5.1 Ambient conditions .....	23	11.1 Parameter table .....	85
5.2 Cooling .....	23	11.2 Parameter descriptions .....	85
5.3 Mounting .....	26	<b>12 "Five in One+"- application package</b>	<b>87</b>
<b>6 Wiring</b> .....	<b>29</b>	12.1 Application selection .....	87
6.1 Power connections .....	32	12.2 Standard Application .....	87
6.1.1 Mains cable .....	32	12.3 Local/Remote Application .....	87
6.1.2 Motor cable .....	32	12.4 Multi-step Speed Application .....	87
6.1.3 Control cable .....	32	12.5 PI-control Application .....	87
6.1.4 Installation instructions .....	35	12.6 Multi-purpose Control App. ....	88
6.1.4.1 Cable installing according the UL-instructions .....	37	12.7 Pump and Fan Control App. ....	88
6.1.5 Cable and motor insulation checks .....	58	<b>13 Options</b> .....	<b>89</b>
6.2 Control connections .....	58	13.1 Remote control box .....	89
6.2.1 Control cables .....	58	13.2 RFI-filter .....	89
6.2.2 Galvanic isolation barriers .....	58	13.3 Dynamic braking .....	89
6.2.3 Digital input function invers. ....	60	13.4 I/O-expander boards .....	89
<b>7 Control panel</b> .....	<b>61</b>	13.5 Fieldbuses .....	89
7.1 Introduction .....	61	13.6 Graphical control panel .....	89
7.2 Control panel operation .....	62	13.7 Seven-segment control panel ....	89
7.3 Monitoring menu .....	63	13.8 FCDRIE .....	89
7.4 Parameters .....	65	13.9 Panel door installation set .....	90
7.5 Reference menu .....	66	13.10 IP20 cable cover for 55—90CX types .....	90
		13.11 Others .....	90

## 1

## 1 SAFETY



**ONLY A COMPETENT ELECTRICIAN SHOULD CARRY OUT THE ELECTRICAL INSTALLATION**



## 1.1 Warnings

	<b>1</b>	Internal components and circuit boards (except for the isolated I/O terminals) are at mains potential when the Vacon CX/CXL/CXS is connected to the mains. This voltage is extremely dangerous and may cause death or severe injury if you come in contact with it.
	<b>2</b>	When Vacon CX/CXL/CXS is connected to the mains, the motor connections U, V, W and DC-link / brake resistor connections -,+ are live even if the motor is not running.
	<b>3</b>	The control I/O terminals are isolated from the mains potential but the relay outputs and other I/Os (if jumper X4 is in OFF position see figure 6.2.2-1) may have dangerous voltage connected even if the power is disconnected from the Vacon CX/CXL/CXS.
	<b>4</b>	Vacon CX/CXL/CXS has a large capacitive leakage current.
	<b>5</b>	If a frequency converter is used as a part of the machine, the machine manufacture is obliged to take care that the frequency converter has a main switch on the machine (EN60204-1).
	<b>6</b>	Only spare parts delivered by Vacon Plc can be used.

## 1.2 Safety instructions

	<b>1</b>	Frequency converter is meant only for fixed installation. Do not make any connections or measurements when the Vacon CX/CXL/CXS is connected to the mains.
	<b>2</b>	After disconnecting the mains, wait until the unit cooling fan stops and the indicators in the panel go out (if no panel is used check the indicators on the cover). Wait a further 5 minutes before doing any work on Vacon CX/CXL/CXS connections. Do not even open the cover before this time has run out.
	<b>3</b>	Do not make any voltage withstand tests on any part of the device.
	<b>4</b>	Disconnect motor cables before making any measurements on the motor cables.
	<b>5</b>	Do not touch the IC-circuits on the circuit boards. Static voltage discharge may destroy the components.
	<b>6</b>	Before connecting the mains make sure that the cover of the Vacon CX/CXL/CXS is closed
	<b>7</b>	Make sure that no power factor correction capacitors are connected to the motor cable.

**1.3 Earthing and earth fault protection**

The frequency converter must always be earthed with an earthing conductor connected to the earthing terminal (⊕).

The frequency converter's earth fault protection protects only the frequency converter itself against earth faults occurring in the motor or in the motor cable.

Fault current protective switches do not necessarily operate correctly with frequency converters. When using this type of device its function should be tested with the possible earth fault currents arising in a fault situation.

**1.4 Running the motor**

**Warning Symbols**

For your own safety, please pay special attention to the instructions marked with these warning symbols:



= **Dangerous voltage**



= **General warning**

	<p><b>1</b> Before running the motor, make sure that the motor is mounted properly.</p>
	<p><b>2</b> Maximum motor speed (frequency) should always be set according to the motor and machine connected to the motor.</p>
	<p><b>3</b> Before reversing the rotation of the motor shaft, make sure that this can be done safely.</p>



## 2 EU-DIRECTIVE

### 2.1 CE-label

The CE-label on the product guarantees the free movement of the product in the EU-area. It also guarantees that the product has been manufactured in accordance with different directives relating to the product.

Vacon CX/CXL/CXS frequency converters are equipped with the CE-label as required by the Low Voltage Directive (LVD) and the EMC directive. FIMKO has acted as the Competent Body.

### 2.2 EMC-directive

#### 2.2.1 General

The transition period of the EMC directive (Electro Magnetic Compatibility) ended on January 1st, 1996. Practically all electrical equipment is covered by this directive. The directive states that the electrical equipment must not disturb the environment and must be immune to other Electro Magnetic Disturbances in the environment.

A Technical Construction File (TFC) checked and approved by FIMKO (Competent Body) states that Vacon CX/CXL/CXS frequency converters fulfil the requirements of the EMC directive. The Technical Construction File has been used as a statement of conformity with the EMC directive as it is not possible to test all combinations of installation.

#### 2.2.2 Technical criteria

The design intent was to develop a family of converters, which are user-friendly and cost effective, whilst fulfilling the customer's needs. The EMC compliance was a major consideration from the outset of the design.

The Vacon CX/CXL/CXS series is targeted at the world market. As far as the immunity is concerned, all frequency converter models meet even the highest requirements, whilst the emission levels are left to the customers choice.

The code "N" Vacon CX/CXL/CXS inverters are designed for use outside the EU or for use within the EU provided that the end user takes personal responsibility for the EMC compliance.

#### 2.2.3 EMC-levels

For EMC purposes, the frequency converters are divided into three different levels. All the products have the same functions and control electronics, but their EMC properties vary as follows:

##### **CX -level N:**

The frequency converters (level N) do not fulfil any EMC emission requirements without a separate RFI-filter. With the external RFI-filter provided, the product fulfils the EMC emissions requirements in heavy industrial environment (standards EN50081-2, EN61800-3).

##### **CXL, CXS -level I:**

The frequency converters (level I) fulfil the EMC emissions requirements in heavy industrial environment (standards EN50081-2, EN61800-3).

##### **CXL, CXS -level C:**

The frequency converters (level C) fulfil the EMC emission requirements in commercial, residential and light industrial environment (standards 50081-1,-2, EN61800-3 widest range of use).

All products (level N, I, C) fulfil all EMC immunity requirements (standards EN50082-1,-2, EN61800-3).

#### 2.2.4 Manufacturer's Declarations of Conformity

On the following pages you will find copies of the Manufacturer's Declarations of Conformity, which show conformity with the directives for drives with different EMC levels.

**EU DECLARATION OF CONFORMITY**

We

**Manufacturer's Name:** Vaasa Control

**Manufacturer's Address:** P.O. BOX 25  
Runsorintie 5  
FIN-65381 VAASA  
Finland

hereby declares that the product:

**Product name:** Vacon CX Frequency converter  
Vacon CXL Frequency converter  
Vacon CXS Frequency converter

**Model number** Vacon ..CX.....  
Vacon ..CXL.....  
Vacon ..CXS.....

has been designed and manufactured in accordance with the following standards:

**Safety:** EN 50178 (1995) and relevant parts of EN60950  
(1992), Am 1 (1993), Am 2 (1993), Am 3 (1995), EN60204-1 (1996)

**EMC:** EN50082-2 (1995), EN61800-3 (1996)

and conforms to the relevant safety provisions of the Low Voltage Directive (73/23/EEC) as amended by the Directive (93/68/EEC) and EMC Directive 89/336/EEC.

It is ensured through internal measures and quality control that product conforms at all times to the requirements of the current Directive and the relevant standards.

Vaasa 12.05. 1997

Veijo Karppinen

Managing Director

The last two digits of the year the CE marking was affixed 97



2

## EU DECLARATION OF CONFORMITY

We

**Manufacturer's Name:** Vaasa Control

**Manufacturer's Address:** P.O. BOX 25  
Runsorintie 5  
FIN-65381 VAASA  
Finland

hereby declares that the product:

**Product name:** Vacon CX Frequency converter

**Model number** VACON ..CX...N. + .RFI...

has been designed and manufactured in accordance with the following standards:

**Safety:** EN 50178 (1995) and relevant parts of EN60950  
(1992), Am 1 (1993), Am 2 (1993), Am 3 (1995), EN60204-1 (1996)

**EMC:** EN50081-2 (1993), EN50082-2 (1995), EN61800-3 (1996)

Technical construction file

Prepared by: Vaasa Control Oy  
Function: Manufacturer  
Date: 03.05.1996  
TCF no.: RP00012

Competent body

Name: FIMKO LTD  
Address: P.O. Box 30 (Särkiniementie 3)  
FIN-00211 Helsinki  
Country: Finland

and conforms to the relevant safety provisions of the Low Voltage Directive (73/23/EEC) as amended by the Directive (93/68/EEC) and EMC Directive 89/336/EEC.

It is ensured through internal measures and quality control that product conforms at all times to the requirements of the current Directive and the relevant standards.

Vaasa 12.05. 1997

Veijo Karppinen

Managing Director

The last two digits of the year the CE marking was affixed 97

**EU DECLARATION OF CONFORMITY**

We

**Manufacturer's Name:** Vaasa Control**Manufacturer's Address:** P.O. BOX 25  
Runsorintie 5  
FIN-65381 VAASA  
Finland

hereby declares that the product:

**Product name:** Vacon CXL Frequency converter**Model number** VACON ..CXL...I.

has been designed and manufactured in accordance with the following standards:

**Safety:** EN 50178 (1995) and relevant parts of EN60950  
(1992), Am 1 (1993), Am 2 (1993), Am 3 (1995), EN60204-1 (1996)**EMC:** EN50081-2 (1993), EN50082-2 (1995), EN61800-3 (1996)**Technical construction file****Prepared by:** Vaasa Control Oy  
**Function:** Manufacturer  
**Date:** 03.05.1996  
**TCF no.:** RP00013**Competent body****Name:** FIMKO LTD  
**Address:** P.O. Box 30 (Särkiniementie 3)  
FIN-00211 Helsinki  
**Country:** Finland

and conforms to the relevant safety provisions of the Low Voltage Directive (73/23/EEC) as amended by the Directive (93/68/EEC) and EMC Directive 89/336/EEC.

It is ensured through internal measures and quality control that product conforms at all times to the requirements of the current Directive and the relevant standards.

Vaasa 12.05.1997

Veijo Karppinen  
Managing DirectorThe last two digits of the year the CE marking was affixed 97



## EU DECLARATION OF CONFORMITY

We

**Manufacturer's Name:** Vaasa Control

**Manufacturer's Address:** P.O. BOX 25  
Runsorintie 5  
FIN-65381 VAASA  
Finland

hereby declares that the product:

**Product name:** Vacon CXL Frequency converter

**Model number** VACON ..CXL...C.

has been designed and manufactured in accordance with the following standards:

**Safety:** EN 50178 (1995) and relevant parts of EN60950  
(1992), Am 1 (1993), Am 2 (1993), Am 3 (1995), EN60204-1 (1996)

**EMC:** EN50081-1,-2 (1993), EN50082-1,-2 (1995), EN61800-3 (1996)

Technical construction file

Prepared by: Vaasa Control Oy  
Function: Manufacturer  
Date: 03.05.1996  
TCF no.: RP00014

Competent body

Name: FIMKO LTD  
Address: P.O. Box 30 (Särkiniementie 3)  
FIN-00211 Helsinki  
Country: Finland

and conforms to the relevant safety provisions of the Low Voltage Directive (73/23/EEC) as amended by the Directive (93/68/EEC) and EMC Directive 89/336/EEC.

It is ensured through internal measures and quality control that product conforms at all times to the requirements of the current Directive and the relevant standards.

Vaasa 12.05. 1997

Veijo Karppinen

Managing Director

The last two digits of the year the CE marking was affixed 97

**EU DECLARATION OF CONFORMITY**

We

**Manufacturer's Name:** Vaasa Control

**Manufacturer's Address:** P.O. BOX 25  
Runsorintie 5  
FIN-65381 VAASA  
Finland

hereby declares that the product:

**Product name:** Vacon CXS Frequency converter

**Model number** VACON ..CXS...I.

has been designed and manufactured in accordance with the following standards:

**Safety:** EN 50178 (1995) and relevant parts of EN60950  
(1992), Am 1 (1993), Am 2 (1993), Am 3 (1995), EN60204-1 (1996)

**EMC:** EN50081-2 (1993), EN50082-2 (1995), EN61800-3 (1996)

**Technical construction file**

Prepared by: Vaasa Control Oy  
Function: Manufacturer  
Date: 03.05.1996  
TCF no.: RP00015

**Competent body**

Name: FIMKO LTD  
Address: P.O. Box 30 (Särkiniementie 3)  
FIN-00211 Helsinki  
Country: Finland

and conforms to the relevant safety provisions of the Low Voltage Directive (73/23/EEC) as amended by the Directive (93/68/EEC) and EMC Directive 89/336/EEC.

It is ensured through internal measures and quality control that product conforms at all times to the requirements of the current Directive and the relevant standards.

Vaasa 14.11.1997

Veijo Karppinen  
Managing Director

The last two digits of the year the CE marking was affixed 97



## EU DECLARATION OF CONFORMITY

We

**Manufacturer's Name:** Vaasa Control

**Manufacturer's Address:** P.O. BOX 25  
Runsorintie 5  
FIN-65381 VAASA  
Finland

hereby declares that the product:

**Product name:** Vacon CXS Frequency converter

**Model number** VACON ..CXS...C.

has been designed and manufactured in accordance with the following standards:

**Safety:** EN 50178 (1995) and relevant parts of EN60950  
(1992), Am 1 (1993), Am 2 (1993), Am 3 (1995), EN60204-1 (1996)

**EMC:** EN50081-1,-2 (1993), EN50082-1,-2 (1995), EN61800-3 (1996)

### Technical construction file

**Prepared by:** Vaasa Control Oy  
**Function:** Manufacturer  
**Date:** 03.05.1996  
**TCF no.:** RP00016

### Competent body

**Name:** FIMKO LTD  
**Address:** P.O. Box 30 (Särkiniementie 3)  
FIN-00211 Helsinki  
**Country:** Finland

and conforms to the relevant safety provisions of the Low Voltage Directive (73/23/EEC) as amended by the Directive (93/68/EEC) and EMC Directive 89/336/EEC.

It is ensured through internal measures and quality control that product conforms at all times to the requirements of the current Directive and the relevant standards.

Vaasa 14.11. 1997

Veijo Karppinen

Managing Director

The last two digits of the year the CE marking was affixed 97

### 3 RECEIVING

This Vacon CX/CXL/CXS frequency converter has been subjected to demanding factory tests before shipment. After unpacking, check that the device does not show any signs of damage and that the delivery is complete (refer to the type designation code in figure 3-1).

In the event of damage, please contact the insurance company involved or the supplier.

If the delivery does not correspond to your order, please contact the supplier immediately.

**Note!** Do not destroy the export packing. The template printed on the protective cardboard can be used for marking the fixing points of the Vacon CX/CXL/CXS on the wall.



#### 3.1 Type designation code

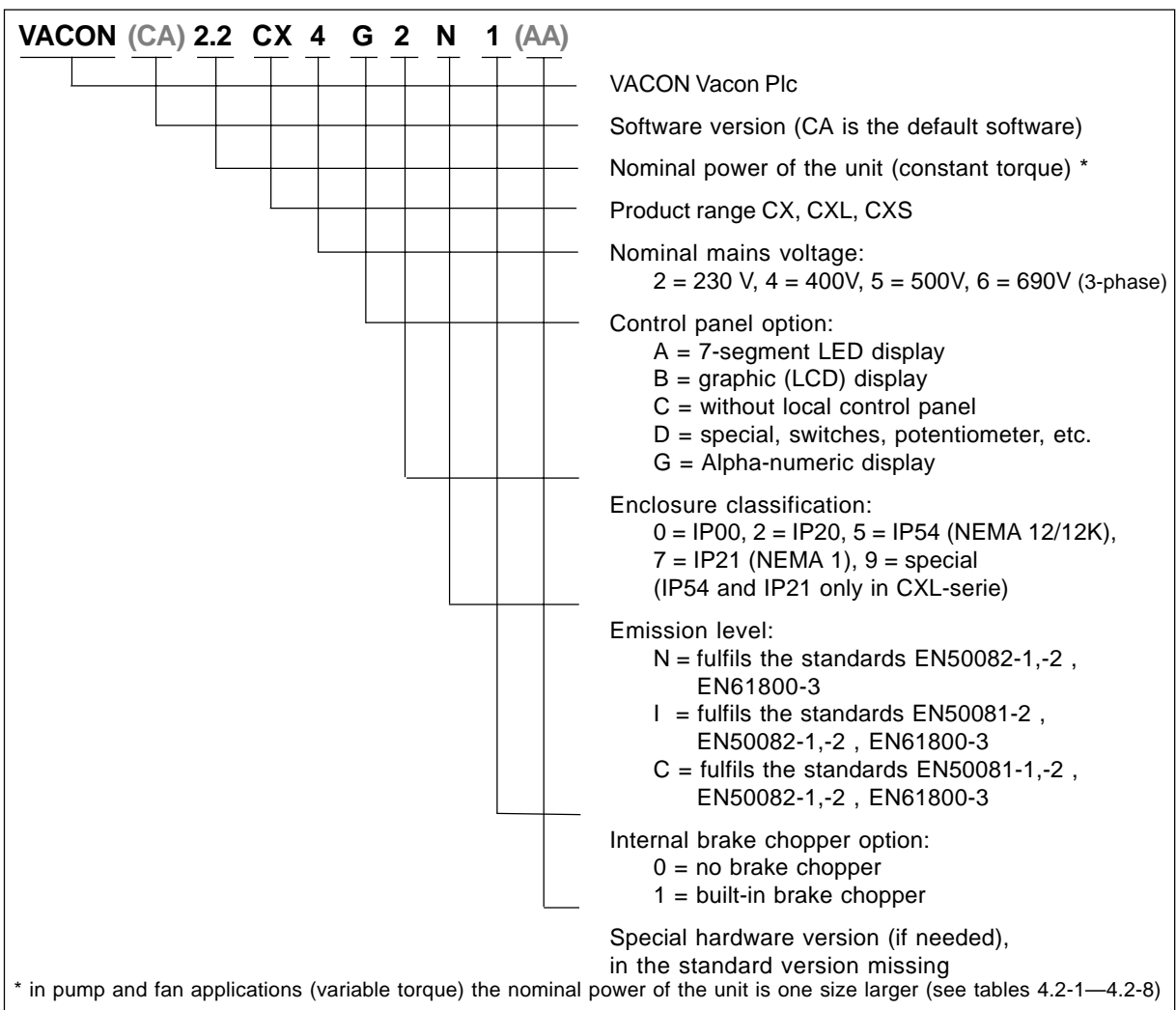

Figure 3-1 Type designation code.



### 3.2 Storing

If the device must be stored before commissioning, check that the ambient conditions in the storage room are acceptable (temperature -40°C—+60°C; relative humidity <95%, no condensation allowed).

### 3.3 Maintenance

In normal conditions, the Vacon CX/CXL/CXS frequency converter is maintenance-free. However, we recommend to clean the heat-sink when necessary with compressed air.

### 3.4 Warranty

The warranty covers defects in manufacture. The manufacturer carries no responsibility for damage occurred during transport or unpacking.

In no event and under no circumstances shall the manufacturer be liable for damages and failures due to misuse, abuse, improper

installation or abnormal conditions of temperature, dust or corrosives or failures due to operation or storage outside the rated specifications.

The manufacturer shall never be liable for consequential damages.

The period of the manufacturer's warranty is 18 months from the date of delivery, ex works, and 12 months from commissioning, whichever expires first (General Conditions NL92/Orgalime S92).

Local distributors may have a different warranty period, which is specified in their sales terms and conditions and warranty terms.

If any queries concerning the warranty arise, please contact your distributor.

## 4 TECHNICAL DATA

### 4.1 General

Figure 4-1 shows a block diagram of the Vacon CX/CXL/CXS frequency converter.

The three-phase *AC-Choke* with the DC-link capacitor produces an LC filter which together with *Diode Bridge* produce the DC voltage for the IGBT *Inverter Bridge* block. The AC-Choke smooths down the HF-disturbances from the mains to the frequency converter and HF-disturbances caused by the frequency converter to the mains. It also improves the waveform of the input current to the frequency converter.

The IGBT bridge produces a symmetrical three-phase PWM modulated AC voltage to the motor. The power drawn from the supply is almost entirely active power.

The *Motor and Application Control* block is based on microprocessor software. The microprocessor controls the motor according to measured signals, parameter value settings and commands from the *Control I/O* block and the *Control Panel*. The Motor and Application Control block gives commands to the *Motor Control ASIC* which calculates the IGBT switching positions. *Gate Drivers* amplify these signals for driving the IGBT inverter bridge.

The Control Panel is a link between the user and the frequency converter. With the panel the

user can set parameter values, read status data and give control commands. The panel is detachable and can be mounted externally and connected via a cable to the frequency converter. A personal computer can be connected to the frequency converter with the control panel cable.

The Control I/O block is isolated from the mains potential and is connected to earth via a 1-MΩ resistor and 4,7-nF capacitor. If needed, the Control I/O block can be earthed without a resistor by changing the position of the jumper X4 (GND ON/OFF) on the control board.

The basic Control interface and parameters (Basic application) make the inverter easy to operate. If a more versatile interface or parameter settings are needed, an optional application can be selected with one parameter from a "Five in One+" application package. The application package manual describes these in more detail.

An optional *Brake Chopper* can be mounted in the unit; at the factory by order or added on the site. Optional I/O-expander boards are also available.

Input and Output EMC-filters do not participate in the functionality of the frequency converter, they are needed for the compliance with the EMC-directive.

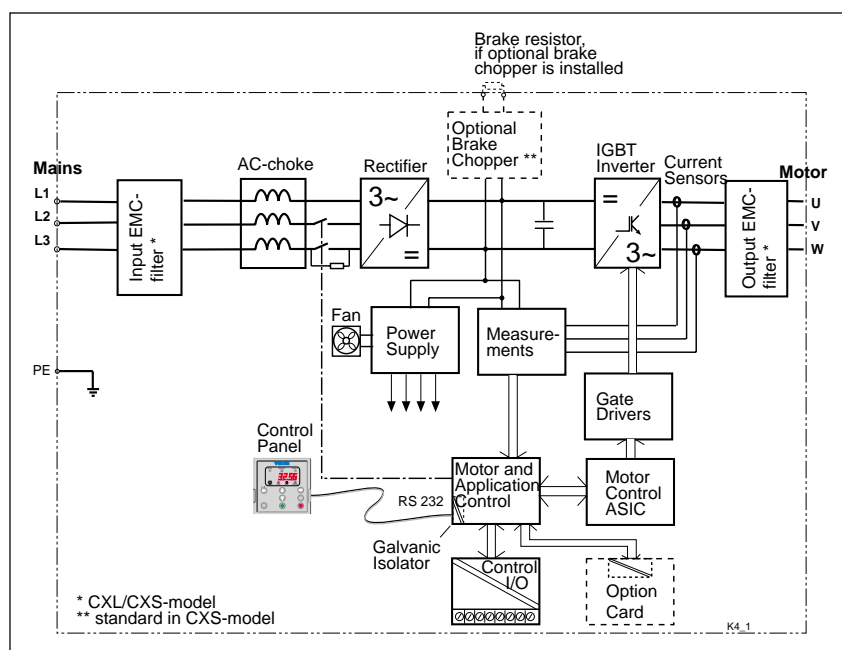

Figure 4-1 Vacon CX/CXL/CXS block diagram.

## 4.2 Power ratings

$I_{CT}$  = rated input and output current (constant torque load, max 50°C ambient)

$I_{CTmax}$  = short term overload current 1min/10min (constant torque load, max 50°C ambient)

$I_{VT}$  = rated input and output current (variable torque load, max 40°C ambient)

\* = IP20 with option, \*\* = cabinet version available, ask factory for details

Mains voltage 380—440 V, 50/60 Hz, 3~							Series CX		
Frequency converter type	Motor shaft power and current						Mech. size/ enclosure class	Dimensions WxHxD (mm)	Weight kg
	Constant torque			Variable torque					
	P (kW)	$I_{CT}$	$I_{CTmax}$	P (kW)	$I_{VT}$				
Vacon 2.2 CX 4	2.2	6.5	10	3	8	M4/IP20	120 x 290 x 215	7	
Vacon 3 CX 4	3	8	12	4	10	M4/IP20	120 x 290 x 215	7	
Vacon 4 CX 4	4	10	15	5.5	13	M4/IP20	120 x 290 x 215	7	
Vacon 5.5 CX 4	5.5	13	20	7.5	18	M4/IP20	120 x 290 x 215	7	
Vacon 7.5 CX 4	7.5	18	27	11	24	M5/IP20	157 x 405 x 238	14.5	
Vacon 11 CX 4	11	24	36	15	32	M5/IP20	157 x 405 x 238	14.5	
Vacon 15 CX 4	15	32	48	18.5	42	M5/IP20	157 x 405 x 238	14.5	
Vacon 18.5 CX 4	18.5	42	63	22	48	M6/IP20	220 x 525 x 290	27	
Vacon 22 CX 4	22	48	72	30	60	M6/IP20	220 x 525 x 290	27	
Vacon 30 CX 4	30	60	90	37	75	M6/IP20	220 x 525 x 290	35	
Vacon 37 CX 4	37	75	113	45	90	M6/IP20	220 x 525 x 290	35	
Vacon 45 CX 4	45	90	135	55	110	M6/IP20	220 x 525 x 290	35	
Vacon 55 CX 4	55	110	165	75	150	M7/IP00*	250 x 800 x 315	61	
Vacon 75 CX 4	75	150	225	90	180	M7/IP00*	250 x 800 x 315	61	
Vacon 90 CX 4	90	180	250	110	210	M7/IP00*	250 x 800 x 315	61	
Vacon 110 CX 4	110	210	315	132	270	M8/IP00	496 x 890 x 353	136	
Vacon 132 CX 4	132	270	405	160	325	M8/IP00	496 x 890 x 353	136	
Vacon 160 CX 4	160	325	472	200	410	M8/IP00	496 x 890 x 353	136	
Vacon 200 CX 4	200	410	615	250	510	M9/IP00	700 x 1000 x 390	211	
Vacon 250 CX 4	250	510	715	315	580	M9/IP00	700 x 1000 x 390	211	
Vacon 315 CX 4	315	600	900	400	750	M10/IP00	989 x 1000 x 390	273	
Vacon 400 CX 4	400	750	1000	500	840	M10/IP00	989 x 1000 x 390	273	
Vacon 500 CX 4	500	840	1200	630	1050	M11/IP00**	(2x700)x1000x390	430	
Vacon 630 CX 4	630	1050	1400	710	1160	M12/IP00**	(2x989)x1000x390	550	
Vacon 710 CX 4	710	1270	1500	800	1330	M12/IP00**	(2x989)x1000x390	550	
Vacon 800 CX 4	800	1330	1600	900	1480	M12/IP00**	(2x989)x1000x390	550	
Vacon 900 CX 4	900	1480	1700	—	—	M12/IP00**	(2x989)x1000x390	550	
Vacon 1000 CX 4	1000	—	—	—	1600	M12/IP00**	(2x989)x1000x390	550	
Vacon 1100 CX 4	1100	1600	2100	—	1900	M13/IP00**	(3x989)x1000x390	825	
Vacon 1250 CX 4	1250	1800	2400	—	2100	M13/IP00**	(3x989)x1000x390	825	
Vacon 1500 CX 4	1500	—	—	—	2270	M13/IP00**	(3x989)x1000x390	825	

Table 4.2-1 Power ratings and dimensions of Vacon CX-series 380—440V.

$I_{CT}$  = rated input and output current (constant torque load, max 50°C ambient)

$I_{CTmax}$  = short term overload current 1min/10min (constant torque load, max 50°C ambient)

$I_{VT}$  = rated input and output current (variable torque load, max 40°C ambient)

\* = IP20 with option, \*\* = cabinet version available, ask factory for details

Mains voltage 440—500 V, 50/60 Hz, 3~						Series CX			
Frequency converter type	Motor shaft power and current					Mech. size/ enclosure class	Dimensions WxHxD (mm)	Weight kg	
	Constant torque			Variable torque					
	P (kW)	$I_{CT}$	$I_{CTmax}$	P (kW)	$I_{VT}$				
Vacon 2.2 CX 5	2.2	5	8	3	6	M4/IP20	120 x 290 x 215	7	
Vacon 3 CX 5	3	6	9	4	8	M4/IP20	120 x 290 x 215	7	
Vacon 4 CX 5	4	8	12	5.5	11	M4/IP20	120 x 290 x 215	7	
Vacon 5.5 CX 5	5.5	11	17	7.5	15	M4/IP20	120 x 290 x 215	7	
Vacon 7.5 CX 5	7.5	15	23	11	21	M5/IP20	157 x 405 x 238	14.5	
Vacon 11 CX 5	11	21	32	15	27	M5/IP20	157 x 405 x 238	14.5	
Vacon 15 CX 5	15	27	41	18.5	34	M5/IP20	157 x 405 x 238	14.5	
Vacon 18.5 CX 5	18.5	34	51	22	40	M6/IP20	220 x 525 x 290	27	
Vacon 22 CX 5	22	40	60	30	52	M6/IP20	220 x 525 x 290	27	
Vacon 30 CX 5	30	52	78	37	65	M6/IP20	220 x 525 x 290	35	
Vacon 37 CX 5	37	65	98	45	77	M6/IP20	220 x 525 x 290	35	
Vacon 45 CX 5	45	77	116	55	96	M6/IP20	220 x 525 x 290	35	
Vacon 55 CX 5	55	96	144	75	125	M7/IP00*	250 x 800 x 315	61	
Vacon 75 CX 5	75	125	188	90	160	M7/IP00*	250 x 800 x 315	61	
Vacon 90 CX 5	90	160	210	110	180	M7/IP00*	250 x 800 x 315	61	
Vacon 110 CX 5	110	180	270	132	220	M8/IP00	496 x 890 x 353	136	
Vacon 132 CX 5	132	220	330	160	260	M8/IP00	496 x 890 x 353	136	
Vacon 160 CX 5	160	260	390	200	320	M8/IP00	496 x 890 x 353	136	
Vacon 200 CX 5	200	320	480	250	400	M9/IP00	700 x 1000 x 390	211	
Vacon 250 CX 5	250	400	571	315	460	M9/IP00	700 x 1000 x 390	211	
Vacon 315 CX 5	315	480	720	400	600	M10/IP00	989 x 1000 x 390	273	
Vacon 400 CX 5	400	600	900	500	672	M10/IP00	989 x 1000 x 390	273	
Vacon 500 CX 5	500	700	960	630	880	M11/IP00**	(2x700)x1000x390	430	
Vacon 630 CX 5	630	880	1120	710	1020	M12/IP00**	(2x989)x1000x390	550	
Vacon 710 CX 5	710	1020	1200	800	1070	M12/IP00**	(2x989)x1000x390	550	
Vacon 800 CX 5	800	1070	1300	900	1200	M12/IP00**	(2x989)x1000x390	550	
Vacon 900 CX 5	900	1200	1400	—	—	M12/IP00**	(2x989)x1000x390	550	
Vacon 1000 CX 5	1000	—	—	—	1300	M12/IP00**	(2x989)x1000x390	550	
Vacon 1100 CX 5	1100	1300	1700	—	1600	M13/IP00**	(3x989)x1000x390	825	
Vacon 1250 CX 5	1250	1530	2000	—	1700	M13/IP00**	(3x989)x1000x390	825	
Vacon 1500 CX 5	1500	—	—	—	1950	M13/IP00**	(3x989)x1000x390	825	

Table 4.2-2 Power ratings and dimensions of Vacon CX-series 440—500V.

$I_{CT}$  = rated input and output current (constant torque load, max 50°C ambient)

$I_{CTmax}$  = short term overload current 1min/10min (constant torque load, max 50°C ambient)

$I_{VT}$  = rated input and output current (variable torque load, max 40°C ambient)

\* IP54 available, \*\* = IP21—IP54 available, \*\*\* = Ask factory for details

Mains voltage 380 V—440 V, 50/60 Hz, 3~						Series CXL			
Frequency converter type	Motor shaft power and current					Mech. size/ enclosure class	Dimensions WxHxD (mm)	Weight kg	
	Constant torque			Variable torque					
	P (kW)	$I_{CT}$	$I_{CTmax}$	P (kW)	$I_{VT}$				
Vacon 0.75 CXL 4	0.75	2.5	3.8	1.1	3.5	M4/IP21*	120 x 390 x 215	6	
Vacon 1.1 CXL 4	1.1	3.5	5.3	1.5	4.5	M4/IP21*	120 x 390 x 215	6	
Vacon 1.5 CXL 4	1.5	4.5	6.8	2.2	6.5	M4/IP21*	120 x 390 x 215	6	
Vacon 2.2 CXL 4	2.2	6.5	10	3	8	M4/IP21*	120 x 390 x 215	8	
Vacon 3 CXL 4	3	8	12	4	10	M4/IP21*	120 x 390 x 215	8	
Vacon 4 CXL 4	4	10	15	5.5	13	M4/IP21*	120 x 390 x 215	8	
Vacon 5.5 CXL 4	5.5	13	20	7.5	18	M4/IP21*	120 x 390 x 215	8	
Vacon 7.5 CXL 4	7.5	18	27	11	24	M5/IP21*	157 x 515 x 238	16	
Vacon 11 CXL 4	11	24	36	15	32	M5/IP21*	157 x 515 x 238	16	
Vacon 15 CXL 4	15	32	48	18.5	42	M5/IP21*	157 x 515 x 238	16	
Vacon 18.5 CXL 4	18.5	42	63	22	48	M6/IP21*	220 x 650 x 290	32	
Vacon 22 CXL 4	22	48	72	30	60	M6/IP21*	220 x 650 x 290	32	
Vacon 30 CXL 4	30	60	90	37	75	M6/IP21*	220 x 650 x 290	38	
Vacon 37 CXL 4	37	75	113	45	90	M6/IP21*	220 x 650 x 290	38	
Vacon 45 CXL 4	45	90	135	55	110	M6/IP21*	220 x 650 x 290	38	
Vacon 55 CXL 4	55	110	165	75	150	M7/IP21*	374 x 1000 x 330	82	
Vacon 75 CXL 4	75	150	225	90	180	M7/IP21*	374 x 1000 x 330	82	
Vacon 90 CXL 4	90	180	250	110	210	M7/IP21*	374 x 1000 x 330	82	
Vacon 110 CXL 4	110	210	315	132	270	M8/IP20**	496 x 1290 x 353	153	
Vacon 132 CXL 4	132	270	405	160	325	M8/IP20**	496 x 1290 x 353	153	
Vacon 160 CXL 4	160	325	472	200	410	M8/IP20**	496 x 1290 x 353	153	
Vacon 200 CXL 4	200	410	615	250	510	M9/IP20**	700 x 1425 x 390	230	
Vacon 250 CXL 4	250	510	715	315	580	M9/IP20**	700 x 1425 x 390	230	
Vacon 315 CXL 4	315	600	900	400	750	M10/ ***	***	***	
Vacon 400 CXL 4	400	750	1000	500	840	M10/ ***	***	***	

Table 4.2-3 Power ratings and dimensions of Vacon CXL-series 380–440V.

Mains voltage 440 V—500 V, 50/60 Hz, 3~							Series CXL		
Frequency converter type	Motor shaft power and current						Mech. size/ enclosure class	Dimensions WxHxD (mm)	Weight kg
	Constant torque			Variable torque					
	P (kW)	I <sub>CT</sub>	I <sub>CTmax</sub>	P (kW)	I <sub>VT</sub>				
Vacon 0.75 CXL 5	0.75	2.5	3.8	1.1	3		M4/IP21*	120x390x215	6
Vacon 1.1 CXL 5	1.1	3	4.5	1.5	3.5		M4/IP21*	120x390x215	7
Vacon 1.5 CXL 5	1.5	3.5	5.3	2.2	5		M4/IP21*	120x390x215	7
Vacon 2.2 CXL 5	2.2	5	8	3	6		M4/IP21*	120 x 390 x 215	8
Vacon 3 CXL 5	3	6	9	4	8		M4/IP21*	120 x 390 x 215	8
Vacon 4 CXL 5	4	8	12	5.5	11		M4/IP21*	120 x 390 x 215	8
Vacon 5.5 CXL 5	5.5	11	17	7.5	15		M4/IP21*	120 x 390 x 215	8
Vacon 7.5 CXL 5	7.5	15	23	11	21		M5/IP21*	157 x 515 x 238	16
Vacon 11 CXL 5	11	21	32	15	27		M5/IP21*	157 x 515 x 238	16
Vacon 15 CXL 5	15	27	41	18.5	34		M5/IP21*	157 x 515 x 238	16
Vacon 18.5 CXL 5	18.5	34	51	22	40		M6/IP21*	220 x 650 x 290	32
Vacon 22 CXL 5	22	40	60	30	52		M6/IP21*	220 x 650 x 290	32
Vacon 30 CXL 5	30	52	78	37	65		M6/IP21*	220 x 650 x 290	38
Vacon 37 CXL 5	37	65	98	45	77		M6/IP21*	220 x 650 x 290	38
Vacon 45 CXL 5	45	77	116	55	96		M6/IP21*	220 x 650 x 290	38
Vacon 55 CXL 5	55	96	144	75	125		M7/IP21*	374 x 1000 x 330	82
Vacon 75 CXL 5	75	125	188	90	160		M7/IP21*	374 x 1000 x 330	82
Vacon 90 CXL 5	90	160	210	110	180		M7/IP21*	374 x 1000 x 330	82
Vacon 110 CXL 5	110	180	270	132	220		M8/IP20**	496 x 1290 x 353	153
Vacon 132 CXL 5	132	220	330	160	260		M8/IP20**	496 x 1290 x 353	153
Vacon 160 CXL 5	160	260	390	200	320		M8/IP20**	496 x 1290 x 353	153
Vacon 200 CXL 5	200	320	480	250	400		M9/IP20**	700 x 1425 x 390	230
Vacon 250 CXL 5	250	400	571	315	460		M9/IP20**	700 x 1425 x 390	230
Vacon 315 CXL 5	315	480	720	400	600		M10/ ***	***	***
Vacon 400 CXL 5	400	600	900	500	672		M10/ ***	***	***



Table 4.2-4 Power ratings and dimensions of Vacon CXL-series 440—500V.

$I_{CT}$  = rated input and output current (constant torque load, max 50°C ambient)

$I_{CTmax}$  = short term overload current 1min/10min (constant torque load, max 50°C ambient)

$I_{VT}$  = rated input and output current (variable torque load, max 40°C ambient)

\* = cabinet version available, ask factory for details

Mains voltage 525 V—690 V, 50/60 Hz, 3~							Series CX			
Frequency converter Type	Motor shaft power and current						Size/ max. prot. class	Dimensions WxHxD (mm)	Weight kg	
	Constant torque			Variable torque						
	P (kW)	$I_{CT}$	$I_{CTmax}$	P (kW)	$I_{VT}$					
Vacon 7,5 CX 6	7,5	10	15	11	14	M5/IP20	157 x 440 x 265	16		
Vacon 11 CX 6	11	14	21	15	19	M5/IP20	157 x 440 x 265	16		
Vacon 15 CX 6	15	19	29	18,5	23	M5/IP20	157 x 440 x 265	16		
Vacon 18,5 CX 6	18,5	23	34	22	26	M5/IP20	157 x 440 x 265	16		
Vacon 22 CX 6	22	26	40	30	35	M5/IP20	157 x 440 x 265	16		
Vacon 30 CX 6	30	35	53	37	42	M6/IP20	220 x 618 x 290	38		
Vacon 37 CX 6	37	42	63	45	52	M6/IP20	220 x 618 x 290	38		
Vacon 45 CX 6	45	52	78	55	62	M6/IP20	220 x 618 x 290	38		
Vacon 55 CX 6	55	62	93	75	85	M6/IP20	220 x 618 x 290	38		
Vacon 75 CX 6	75	85	127	90	100	M6/IP20	220 x 618 x 290	38		
Vacon 90 CX 6	90	100	150	110	122	M8/IP00	496 x 890 x 353	136		
Vacon 110 CX 6	110	122	183	132	145	M8/IP00	496 x 890 x 353	136		
Vacon 132 CX 6	132	145	218	160	185	M8/IP00	496 x 890 x 353	136		
Vacon 160 CX 6	160	185	277	200	222	M9/IP00	700 x 1000 x 390	211		
Vacon 200 CX 6	200	222	333	250	287	M9/IP00	700 x 1000 x 390	211		
Vacon 250 CX 6	250	287	430	315	325	M10/IP00	989 x 1000 x 390	273		
Vacon 315 CX 6	315	325	487	400	390	M10/IP00	989 x 1000 x 390	273		
Vacon 400 CX 6	400	400	560	500	490	M11/IP00*	(2x700)x1000x390	430		
Vacon 500 CX 6	500	490	680	630	620	M12/IP00*	(2x989)x1000x390	550		
Vacon 630 CX 6	630	620	780	710	700	M12/IP00*	(2x989)x1000x390	550		
Vacon 710 CX 6	710	700	870	—	—	M12/IP00*	(2x989)x1000x390	550		
Vacon 800 CX 6	800	—	—	—	780	M12/IP00*	(2x989)x1000x390	550		
Vacon 900 CX 6	900	780	1030	—	900	M13/IP00	(3x989)x1000x390	820		
Vacon 1000 CX 6	1000	880	1160	—	1000	M13/IP00	(3x989)x1000x390	820		
Vacon 1100 CX 6	1100	—	—	—	1100	M13/IP00	(3x989)x1000x390	820		
Vacon 1250 CX 6	1250	—	—	—	1300	M13/IP00	(3x989)x1000x390	820		

Table 4.2-5 Power ratings and dimensions of Vacon CX-serie 690V.

$I_{CT}$  = rated input and output current (constant torque load, max 50°C ambient)

$I_{CTmax}$  = short term overload current 1min/10min (constant torque load, max 50°C ambient)

$I_{VT}$  = rated input and output current (variable torque load, max 40°C ambient)

Mains voltage 380 V—440 V, 50/60 Hz, 3~						Series CXS			
Frequency converter Type	Motor shaft power and current					Size/ max. prot. class	Dimensions WxHxD (mm)	Weight kg	
	Constant torque			Variable torque					
	P (kW)	$I_{CT}$	$I_{CTmax}$	P (kW)	$I_{VT}$				
Vacon 0.75 CXS 4	0.75	2.5	3.8	1.1	3.5	M3/IP20	120 x 305 x 150	4.5	
Vacon 1.1 CXS 4	1.1	3.5	5.3	1.5	4.5	M3/IP20	120 x 305 x 150	4.5	
Vacon 1.5 CXS 4	1.5	4.5	6.8	2.2	6.5	M3/IP20	120 x 305 x 150	4.5	
Vacon 2.2 CXS 4	2.2	6.5	10	3	8	M3/IP20	120 x 305 x 150	4.5	
Vacon 3 CXS 4	3	8	12	4	10	M3/IP20	120 x 305 x 150	4.5	
Vacon 4 CXS 4	4	10	15	5.5	13	M4B/IP20	135 x 390 x 205	7	
Vacon 5.5 CXS 4	5.5	13	20	7.5	18	M4B/IP20	135 x 390 x 205	7	
Vacon 7.5 CXS 4	7.5	18	27	11	24	M4B/IP20	135 x 390 x 205	7	
Vacon 11 CXS 4	11	24	36	15	32	M4B/IP20	135 x 390 x 205	7	
Vacon 15 CXS 4	15	32	48	18.5	42	M5B/IP20	185 x 550 x 215	21	
Vacon 18.5 CXS 4	18.5	42	63	22	48	M5B/IP20	185 x 550 x 215	21	
Vacon 22 CXS 4	22	48	72	30	60	M5B/IP20	185 x 550 x 215	21	
Mains voltage 440 V—500 V, 50/60 Hz, 3~						Series CXS			
Frequency converter Type	Motor shaft power and current					Size/ max. prot. class	Dimensions WxHxD (mm)	Weight kg	
	Constant torque			Variable torque					
	P (kW)	$I_{CT}$	$I_{CTmax}$	P (kW)	$I_{VT}$				
Vacon 0.75 CXS 5	0.75	2.5	3.8	1.1	3	M3/IP20	120 x 305 x 150	4.5	
Vacon 1.1 CXS 5	1.1	3	4.5	1.5	3.5	M3/IP20	120 x 305 x 150	4.5	
Vacon 1.5 CXS 5	1.5	3.5	5.3	2.2	5	M3/IP20	120 x 305 x 150	4.5	
Vacon 2.2 CXS 5	2.2	5	8	3	6	M3/IP20	120 x 305 x 150	4.5	
Vacon 3 CXS 5	3	6	9	4	8	M3/IP20	120 x 305 x 150	4.5	
Vacon 4 CXS 5	4	8	12	5.5	11	M4B/IP20	135 x 390 x 205	7	
Vacon 5.5 CXS 5	5.5	11	17	7.5	15	M4B/IP20	135 x 390 x 205	7	
Vacon 7.5 CXS 5	7.5	15	23	11	21	M4B/IP20	135 x 390 x 205	7	
Vacon 11 CXS 5	11	21	32	15	27	M4B/IP20	135 x 390 x 205	7	
Vacon 15 CXS 5	15	27	41	18.5	34	M5B/IP20	185 x 550 x 215	21	
Vacon 18.5 CXS 5	18.5	34	51	22	40	M5B/IP20	185 x 550 x 215	21	
Vacon 22 CXS 5	22	40	60	30	52	M5B/IP20	185 x 550 x 215	21	

Table 4.2-6 Power ratings and dimensions of Vacon CXS-series 380V—500V.

Mains voltage 230 V, 50/60 Hz, 3~						Series CXS			
Frequency converter Type	Motor shaft power and current					Size/ max. prot. class	Dimensions WxHxD (mm)	Weight kg	
	Constant torque			Variable torque					
	P (kW)	$I_{CT}$	$I_{CTmax}$	P (kW)	$I_{VT}$				
Vacon 0.55 CXS 2	0.55	3.6	5.4	0.75	4.7	M3/IP20	120 x 305 x 150	4.5	
Vacon 0.75 CXS 2	0.75	4.7	7.1	1.1	5.6	M3/IP20	120 x 305 x 150	4.5	
Vacon 1.1 CXS 2	1.1	5.6	8.4	1.5	7	M3/IP20	120 x 305 x 150	4.5	
Vacon 1.5 CXS 2	1.5	7	11	2.2	10	M3/IP20	120 x 305 x 150	4.5	
Vacon 2.2 CXS 2	2.2	10	15	3	13	M4B/IP20	135 x 390 x 205	7	
Vacon 3 CXS 2	3	13	20	4	16	M4B/IP20	135 x 390 x 205	7	
Vacon 4CX S 2	4	16	24	5.5	22	M4B/IP20	135 x 390 x 205	7	
Vacon 5.5 CXS 2	5.5	22	33	7.5	30	M4B/IP20	135 x 390 x 205	7	
Vacon 7.5 CXS 2	7.5	30	45	11	43	M5B/IP20	185 x 550 x 215	21	
Vacon 11CX S 2	11	43	64	15	57	M5B/IP20	185 x 550 x 215	21	
Vacon 15 CXS 2	15	57	85	18.5	60	M5B/IP20	185 x 550 x 215	21	

Table 4.2-7 Power ratings and dimensions of Vacon CXS-serie 230V.



$I_{CT}$  = rated input and output current (constant torque load, max 50°C ambient)

$I_{CTmax}$  = short term overload current 1min/10min (constant torque load, max 50°C ambient)

$I_{VT}$  = rated input and output current (variable torque load, max 40°C ambient)

\* = IP20 with option, \*\* = IP54 available

Mains voltage 230 V, 50/60 Hz, 3~							Series CX		
Frequency converter Type	Motor shaft power and current						Size/ max. prot. class	Dimensions WxHxD (mm)	Weight kg
	Constant torque			Squared torque					
	P (kW)	$I_{CT}$	$I_{CTmax}$	P (kW)	$I_{VT}$				
Vacon 1.5 CX 2	1.5	7	11	2.2	10	M4/IP20	120 x 290 x 215	7	
Vacon 2.2 CX 2	2.2	10	15	3	13	M4/IP20	120 x 290 x 215	7	
Vacon 3 CX 2	3	13	20	4	16	M4/IP20	120 x 290 x 215	7	
Vacon 4 CX 2	4	16	24	5.5	22	M5/IP20	157 x 405 x 238	15	
Vacon 5.5 CX 2	5.5	22	33	7.5	30	M5/IP20	157 x 405 x 238	15	
Vacon 7.5 CX 2	7.5	30	45	11	43	M5/IP20	157 x 405 x 238	15	
Vacon 11 CX 2	11	43	64	15	57	M6/IP20	220 x 525 x 290	35	
Vacon 15 CX 2	15	57	85	18.5	70	M6/IP20	220 x 525 x 290	35	
Vacon 18.5 CX 2	18.5	70	105	22	83	M6/IP20	220 x 525 x 290	35	
Vacon 22 CX 2	22	83	124	30	113	M6/IP20	220 x 525 x 290	35	
Vacon 30 CX 2	30	113	169	37	139	M7/IP00*	250 x 800 x 315	61	
Vacon 37 CX 2	37	139	208	45	165	M7/IP00*	250 x 800 x 315	61	
Vacon 45 CX 2	45	165	247	55	200	M7/IP00*	250 x 800 x 315	61	
Vacon 55 CX 2	55	200	300	75	264	M8/IP00*	496 x 890 x 353	136	

Table 4.2-8 Power ratings and dimensions of Vacon CX-serie 230V.

Mains voltage 230 V, 50/60 Hz, 3~							Series CXL		
Frequency converter Type	Motor shaft power and current						Size/ max. prot. class	Dimensions WxHxD (mm)	Weight kg
	Constant torque			Squared torque					
	P (kW)	$I_{CT}$	$I_{CTmax}$	P (kW)	$I_{VT}$				
Vacon 1.5 CXL 2	1.5	7	11	2.2	10	M4/IP21**	120 x 390 x 215	7	
Vacon 2.2 CXL 2	2.2	10	15	3	13	M4/IP21**	120 x 390 x 215	7	
Vacon 3 CXL 2	3	13	20	4	16	M4/IP21**	120 x 390 x 215	7	
Vacon 4 CXL 2	4	16	24	5.5	22	M5/IP21**	157 x 515 x 238	15	
Vacon 5.5 CXL 2	5.5	22	33	7.5	30	M5/IP21**	157 x 515 x 238	15	
Vacon 7.5 CXL 2	7.5	30	45	11	43	M5/IP21**	157 x 515 x 238	15	
Vacon 11 CXL 2	11	43	64	15	57	M6/IP21**	220 x 650 x 290	35	
Vacon 15 CXL 2	15	57	85	18.5	70	M6/IP21**	220 x 650 x 290	35	
Vacon 18.5 CXL 2	18.5	70	105	22	83	M6/IP21**	220 x 650 x 290	35	
Vacon 22 CXL 2	22	83	124	30	113	M6/IP21**	220 x 650 x 290	35	
Vacon 30 CXL 2	30	113	169	37	139	M7/IP21**	374 x 1000 x 330	82	
Vacon 37 CXL 2	37	139	208	45	165	M7/IP21**	374 x 1000 x 330	82	
Vacon 45 CXL 2	45	165	247	55	200	M7/IP21**	374 x 1000 x 330	82	
Vacon 55 CXL 2	55	200	300	75	264	M8/IP21**	496 x 1290 x 353	153	

Table 4.2-9 Power ratings and dimensions of Vacon CXL-serie 230V.

## 4.3 Specifications

<b>Mains connection</b>	Input voltage $U_{in}$	380—440V, 460—500V, 525—690V, 230V ; -15%—+10%	
	Input frequency	45—66 Hz	
	Connection to the mains	once per minute or less (normally)	
<b>Motor Connection</b>	Output voltage	0 — $U_{in}$	
	Continuous output current	$I_{CT}$ : ambient max +50°C, overload 1.5 x $I_{CT}$ (1min/10 min) $I_{VT}$ : ambient max +40°C, no overloading	
	Starting torque	200%	
	Starting current	2.5 x $I_{CT}$ : 2 s every 20 s if output frequency <30 Hz and if the heatsink temperature <+60°C (up to and incl. M10, from M10 starting current for each case separately)	
	Output frequency	0—500 Hz	
	Frequency resolution	0.01 Hz	
<b>Control characteristics</b>	Control method	Frequency Control (U/f) Open Loop Sensorless Vector Control Closed Loop Vector Control	
	Switching frequency	1—16 kHz (up to 90 kW, 400/500 V series) 1—6 kHz (110—1500 kW, 600 V series)	
	Frequency reference	Analog I/P	Resolution 12 bit, accuracy $\pm 1\%$
		Panel refer.	Resolution 0.01 Hz
	Field weakening point	30—500 Hz	
	Acceleration time	0.1—3000 s	
	Deceleration time	0.1—3000 s	
Braking torque	DC brake: 30%* $T_N$ (without brake option)		
<b>Environmental limits</b>	Ambient operating temperature	-10 (no frost)—+50°C at $I_{CT}$ , (1.5 x $I_{CT}$ max 1min/10min) -10 (no frost)—+40°C at $I_{VT}$ , no overloading	
	Storage temperature	-40°C—+60°C	
	Relative humidity	<95%, no condensation allowed	
	Air quality - chemical vapours - mechanical particles	IEC 721-3-3, unit in operation, class 3C2 IEC 721-3-3, unit in operation, class 3S2	
	Altitude	Max 1000 m at continuous $I_{CT}$ specification Over 1000 m reduce $I_{CT}$ by 1% per each 100 m Absolute maximum altitude 3000 m	
	Vibration (IEC 721-3-3)	Operation: max displacement amplitude 3 mm at 2—9 Hz, Max acceleration amplitude 0.5 G at 9—200 Hz	
	Shock (IEC 68-2-27)	Operation: max 8 G, 11 ms Storage and shipping: max 15 G, 11 ms (in the package)	
<b>Environmental limits</b>	Enclosure (* option IP20)	IP20 2.2—45 CX4/5 , 110—250CXL4/5, 0.75—22 CXS4/5, 7.5—75 CX6 , 1.5—22 CX2, 0.55—15 CXS2 IP00 55—90 CX4/5*, 110—1000CX4/5 , 90—800CX6, 30—55 CX2* IP21—54 2.2—250 CXL4/5, 1.5—55 CXL2	

Table 4.3-1 Specifications (continues on the next page...).

<b>EMC</b>	Noise immunity	Fulfil EN50082-1,-2 , EN61800-3
	Emissions	<p>xx CX xxx N x -series equipped with external RFI-Filter ( x RFI x x x ) fulfils EN50081-2 , EN61800-3</p> <p>xx CXL xxx I x -series fulfils EN50081-2 , EN61800-3</p> <p>xx CXL xxx C x -series fulfils EN50081-1,-2 , EN61800-3</p> <p>xx CXS xxx I x -series fulfils EN50081-2 , EN61800-3</p> <p>xx CXS xxx C x -series fulfils EN50081-1,-2 , EN61800-3</p>
<b>Safety</b>		Fulfil EN50178, EN60204 -1,CE, UL, C-UL, FI, GOST R (check from the unit nameplate specified approvals for each unit)
<b>Control connections</b>	Analogue voltage	0—+10 V, $R_i = 200 \text{ k}\Omega$ , single ended (-10—+10V , joystick control), resolution 12 bit, accur. $\pm 1\%$
	Analogue current	0 (4) — 20 mA, $R_i = 250 \Omega$ , differential
	Digital inputs (6)	Positive or negative logic
	Aux. voltage	+24 V $\pm 20\%$ , max 100 mA
	Pot. meter reference	+10 V -0% — +3%, max 10 mA
	Analogue output	0 (4) — 20 mA, $R_o < 500 \Omega$ , resolution 10 bit, accur. $\pm 3\%$
	Digital output	Open collector output, 50 mA/48 V
	Relay outputs	<p>Max switching voltage: 300 V DC, 250 V AC</p> <p>Max switching load: 8A / 24 V</p> <p>0.4 A / 250 V DC</p> <p>2 kVA / 250 V AC</p> <p>Max continuous load: 2 A rms</p>
<b>Protective functions</b>	Over current protection	Trip limit $4 \times I_{CT}$ (up to M10; in greater classes case by case)
	Overvoltage protection	Mains voltage: 220 V, 230 V, 240 V, 380 V, 400 V
	Trip limit:	$1.47 \times U_n, 1.41 \times U_n, 1.35 \times U_n, 1.47 \times U_n, 1.40 \times U_n$
		Mains voltage: 415 V, 440 V, 460 V, 480 V, 500 V
	Trip limit:	$1.35 \times U_n, 1.27 \times U_n, 1.47 \times U_n, 1.41 \times U_n, 1.35 \times U_n$
		Mains voltage: 525 V, 575 V, 600 V, 660 V, 690 V
	Trip limit:	$1.77 \times U_n, 1.62 \times U_n, 1.55 \times U_n, 1.41 \times U_n, 1.35 \times U_n$
	Undervoltage protection	Trip limit $0.65 \times U_n$
	Earth-fault protection	Protects the inverter from an earth-fault in the output (motor or motor cable)
	Mains supervision	Trip if any of the input phases is missing
Motor phase supervision	Trip if any of the output phases is missing	
Unit over temperature protection	Yes	
Motor overload protection	Yes	
Stall protection	Yes	
Motor underload protection	Yes	
Short-circuit protection of +24V and +10V reference voltages	Yes	

Table 4.3-1 Specifications.

## 5 INSTALLATION

### 5.1 Ambient conditions

The environmental limits mentioned in the table 4.3-1 must not be exceeded.

### 5.2 Cooling

The specified space around the frequency converter unit ensures proper cooling air circulation. See table 5.2-1 for dimensions. If multiple units are to be installed above each other, the distance between the units must be  $b+c$  and air from the outlet of the lower unit must be directed away from the inlet of the upper unit.

With high switching frequencies and high ambient temperatures the maximum continuous output current has to be derated according to figure 5.2-3.

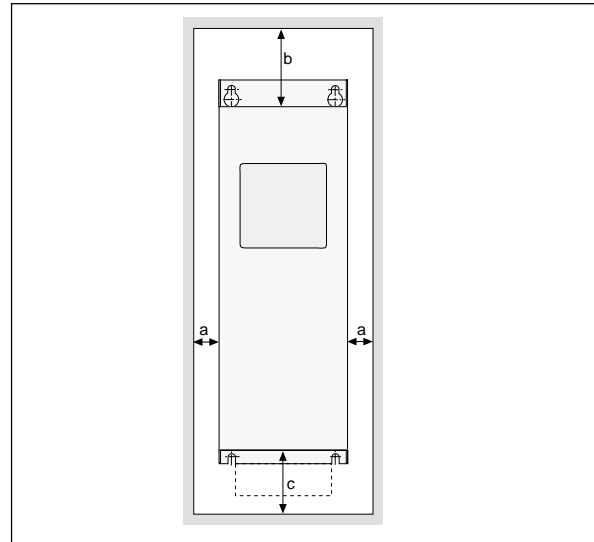

Figure 5.2-1 Installation space.

$a2$  = distance from the frequency converter unit to other the frequency converter unit

\* = no space for fan change

\*\* = space for fan change, the space has to be on either side of the frequency converter

\*\*\* = ask factory for details

Type	Dimensions [mm]			
	a	a2	b	c
0.75—5.5 CX4/CXL4 2.2—5.5 CX5/CXL5 0.75—3 CXS4/CXS5 1.5—3 CX2/CXL2 0.55—1.5 CXS2	20	10	100	50
CXL-series IP21 enclosure	20	20	100	50
7.5—15 CX4/CXL4 7.5—15 CX5/CXL5 2.2—22 CX6 4—22 CXS4/CXS5 4.0—7.5 CX2/CXL2 2.2—15 CXS2	20	10	120	60
CXL-series IP21 enclosure	20	20	120	60
18.5—45 CX4/CXL4 18.5—45 CX5/CXL5 30—75 CX6 11—22 CX2/CXL2	30	10	160	80
CXL-series IP21 enclosure	30	30	160	80
55—90 CX4/CXL4 55—90 CX5/CXL5 30—45 CX2/CXL2	75 (35*)	75 (60*)	300	100
110—160 CX4/CXL4 110—160 CX5/CXL5 90—132 CX6 55 CX2/CXL2	250** (75*)	75	300	-
200—250 CX4/CXL4 200—250 CX5/CXL5 160—200 CX6	200** (75*)	75	300	-
315—400 CX4/CXL4 315—400 CX5/CXL5 250—315 CX6	200** (75*)	75	300	-
500 CX4/CX5 400 CX6	***	***	***	***
630—1500 CX4/CX5 500—1250 CX6	***	***	***	***

Table 5.2-1 Installation space demensions.

Type	Required cooling air (m <sup>3</sup> /h)
0.75—7.5 CX4/CXL4 2.2—7.5 CX5/CXL5 2.2—15 CX6 0.75—5.5 CXS4/CXS5 1.5—3 CX2/CXL2 0.55—1.5 CXS2	70
11—30 CX4/CXL4 11—30 CX5/CXL5 18.5—55 CX6 7.5—18.5 CXS4/CXS5 4—7.5 CX2/CXL2 2.2—11 CXS2	170
37—45 CX4/CXL4 37—45 CX5/CXL5 75 CX6 22 CXS4/CXS5 11—22 CX2/CXL2 15 CXS2	370
55—90 CX4/CXL4 55—90 CX5/CXL5 30—45 CX2/CXL2	650
110—132 CX4/CXL4 110—132 CX5/CXL5 90—110 CX6 55 CX2/CXL2	800
160 CX4/CXL4 160 CX5/CXL5 132 CX6	1300
200—250 CX4/CXL4 200—250 CX5/CXL5 160—200 CX6	1950
315—400 CX4/CXL4 315—400 CX5/CXL5 250—315 CX6	2950
500 CX4/CX5 400 CX6	3900
630—1000 CX4/CX5 500—800 CX6	5900
1150—1500 CX4/CX5 900—1250 CX6	8850

Table 5.2-2 Required cooling air.



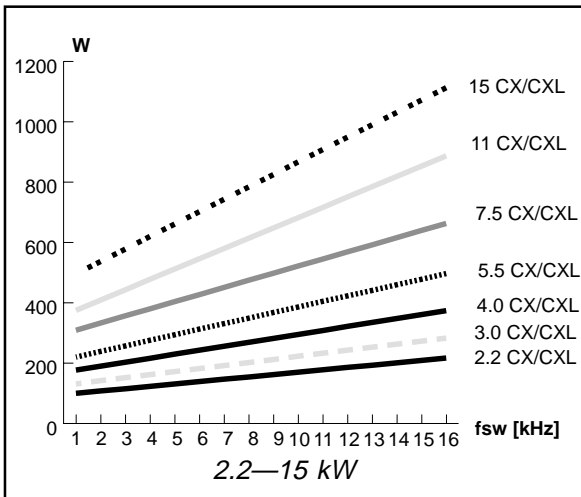

Figure 5.2-2a

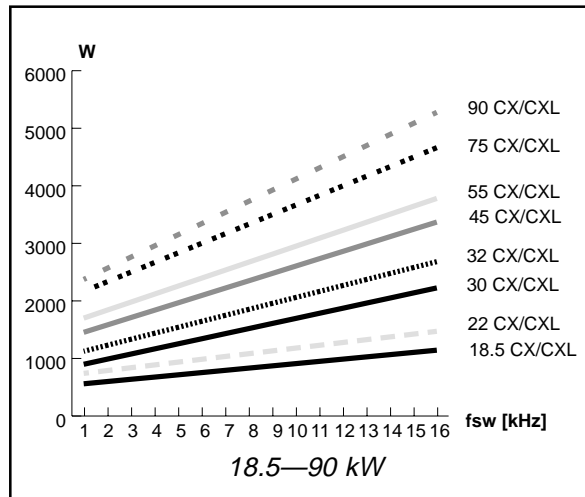

Figure 5.2-2b

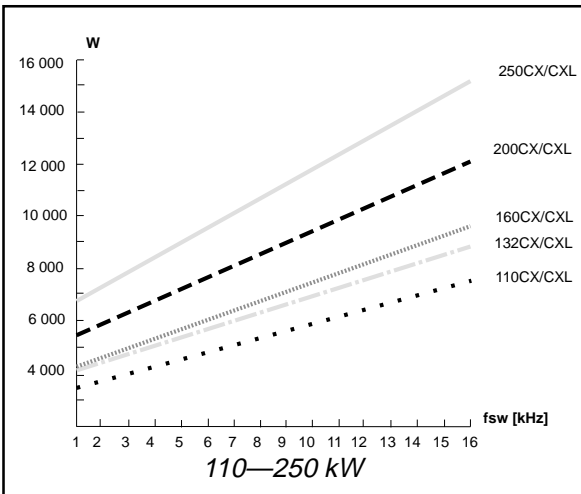

Figure 5.2-2c

Figures 5.2-2a—c Power dissipation as a function of the switching frequency for 400V and 500V ( $I_{VT}$  variable torque).

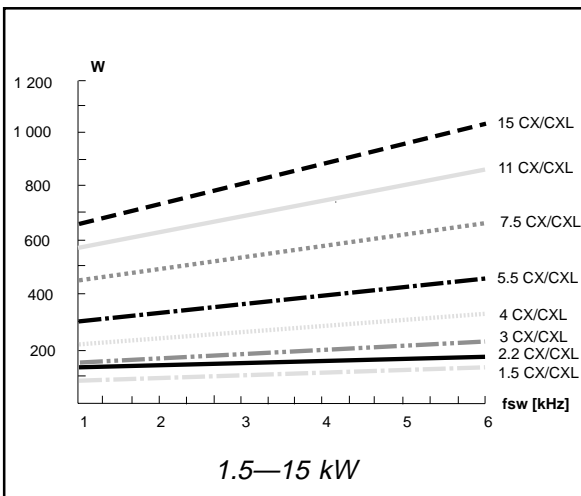

Figure 5.2-2d

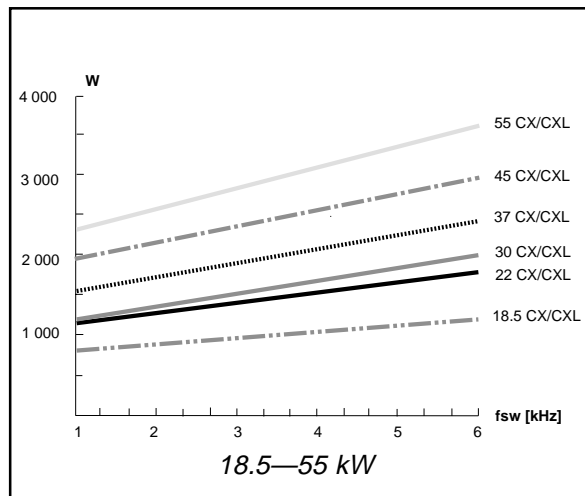

Figure 5.2-2e

Figures 5.2-2d—e Power dissipation as a function of the switching frequency for 230 V ( $I_{VT}$  variable torque).

5

Type (kW)	Curve 3.6 kHz	10 kHz	16 kHz
0.75—4	no derating	no derating	no derating
5.5	no derating	1	2
7.5	no derating	no derating	no derating
11	no derating	no derating	no derating
15	no derating	no derating	3
18.5	no derating	no derating	no derating
22	no derating	no derating	4
30	no derating	5	not allowed
37	no derating	6	not allowed
45	7	8	not allowed
55	no derating	9	not allowed
75	no derating	10	not allowed
90	11	12	not allowed
110	no derating	13	not allowed
132	no derating	14	not allowed
160	15	16	not allowed
200	no derating	17	not allowed
250	18	19	not allowed
315	*	*	*
400	*	*	*
500	*	*	*
630	*	*	*
710	*	*	*
800	*	*	*
900	*	*	*
1000	*	*	*
1100	*	*	*
1250	*	*	*
1500	*	*	*

Table 5.2-3 Constant output current derating curves for 400—500 V ( $I_{VT}$  variable torque).

\* = Ask factory for details

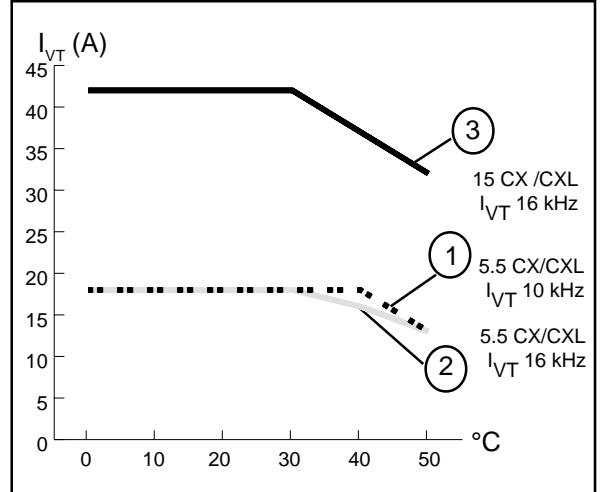

Figure 5.2.3 a

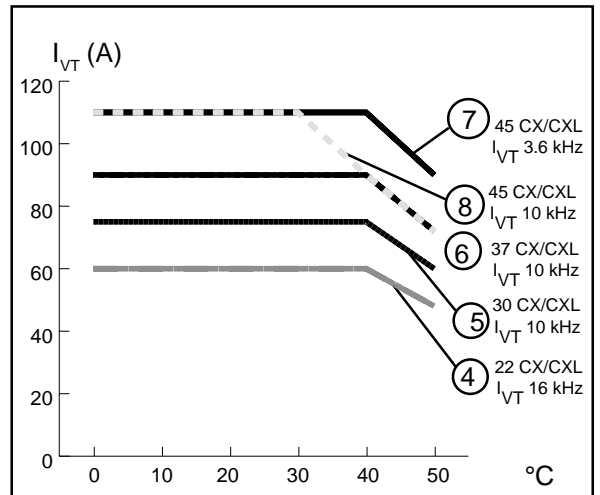

Figure 5.2.3 b

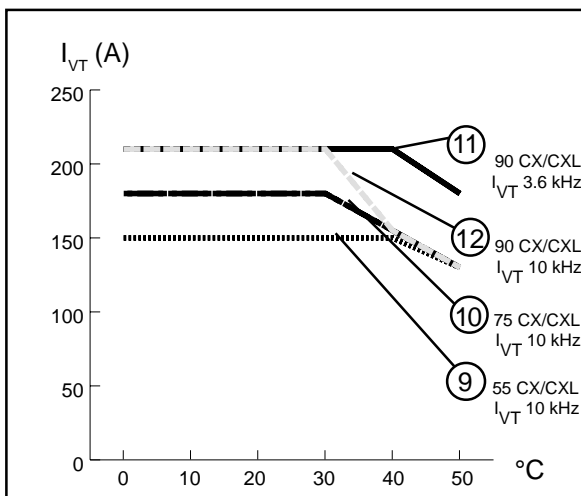

Figure 5.2.3 c

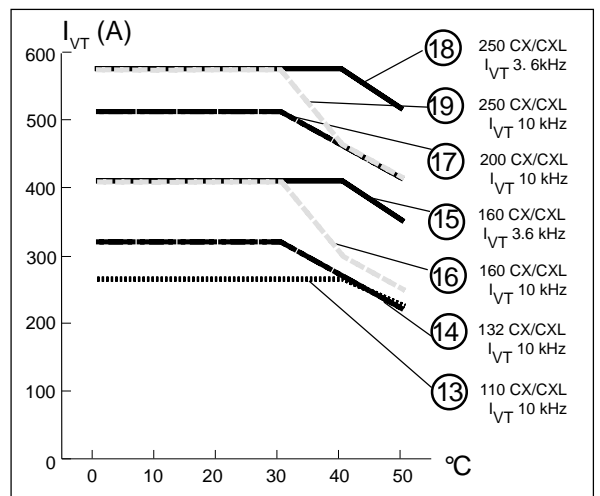

Figure 5.2.3 d

Figure 5.2-3a—d Constant output current ( $I_{VT}$ ) derating curves as a function of ambient temperature and switching frequency.

5

**5.3 Mounting**

The inverter should be mounted in a vertical position on the wall or on the back plane of a cubicle. Follow the requirement for cooling, see table 5.2-1 and figure 5.2-1 for dimensions.

To ensure a safe installation, make sure that the mounting surface is relatively flat. Fixing holes can be marked on the wall using the template on the cover of the cardboard package.

Fixing is done with four screws or bolts depending on the size of the unit, see tables 5.3-1 and 5.3-2, and figure 5.3-1 for dimensions. Units, from 18.5 kW to 400 kW, have special lifting "eyes" which must be used, see figures 5.3-2 and 5.3-3.

**5**

The mounting instructions for 500—1500 CX4/ CX5 and 400—1250 CX6 units are explained in the separate manual for M11/M12 units. Ask the factory for more information if needed.

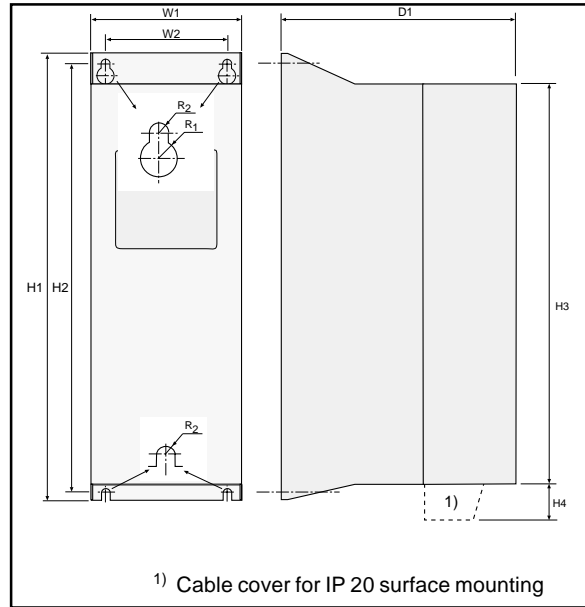

Figure 5.3-1 Mounting dimensions.

Type	Dimensions [mm]								
	W1	W2	H1	H2	H3	H4	D1	R1	R2
0.75—5.5 CX4/CX5 1.5—3 CX2	120	95	323	312	290	40	215	7	3.5
7.5—15 CX4/CX5 4—7.5 CX2 2.2—22 CX6	157	127	452	434	405	45	238	9	4.5
18.5—45 CX4/CX5 11—22 CX2 30—75 CX6	220	180	575	558	525	100	290	9	4.5
55—90 CX4/CX5 30—45 CX2	250	220	854	835	800	*	315	9	4.5
110—160 CX4/CX5 90—132 CX6 55 CX2	496	456	950	926	890	—	353	11.5	6
200—250 CX4/CX5 160—200 CX6	700	660	1045	1021	1000	—	390	11.5	6
315—400 CX4/CX5 250—315 CX6	989	948	1045	1021	1000	—	390	11.5	6
500 CX4/CX5 400 CX6	**	**	**	**	**	**	**	**	**
630—1500 CX4/CX5 500—1250 CX6	**	**	**	**	**	**	**	**	**

Table 5.3-1 Dimensions for CX-series.

\* = IP20 cable cover is on the bottom- (256mm) and on the top of the unit (228mm)  
 \*\* = Ask factory for details

Type	Dimensions [mm]								
	W1	W2	H1	H2	H3	H4	D1	R1	R2
0.75—5.5 CXL4/CXL5 1.5—3 CXL2	120	95	423	412	390	—	215	7	3.5
7.5—15 CXL4/CXL5 4—7.5 CXL2	157	127	562	545	515	—	238	9	4.5
18.5—45 CXL4/CXL5 11—22 CXL2	220	180	700	683	650	—	290	9	4.5
55—90 CXL4/CXL5 30—45 CXL2	374	345	1050	1031	1000	—	330	9	4.5
110—160 CXL4/CXL5 55 CXL2	496	456	1350	926	1290	—	353	11.5	6
200—250 CXL4/CXL5	700	660	1470	1021	1425	—	390	11.5	6
315—400 CXL4/CXL5	989	948	1470	1021	1425	—	390	11.5	6

Table 5.3-2 Dimensions for CXL-series.

\* = Ask factory for details



Type	Dimensions [mm]								
	W1	W2	H1	H2	H3	H4	D1	R1	R2
0.75—3 CXS4/CXS5 0.55—1.5 CXS2	120	95	343	333	305	—	150	7	3.5
4—11 CXS4/CXS5 2.2—5.5 CXS2	135	95	430	420	390	—	205	7	3.5
15—22 CXS4/CXS5 7.5—15 CXS2	185	140	595	580	550	—	215	9	4.5

Table 5.3-3 Dimensions for CXS-series.



5

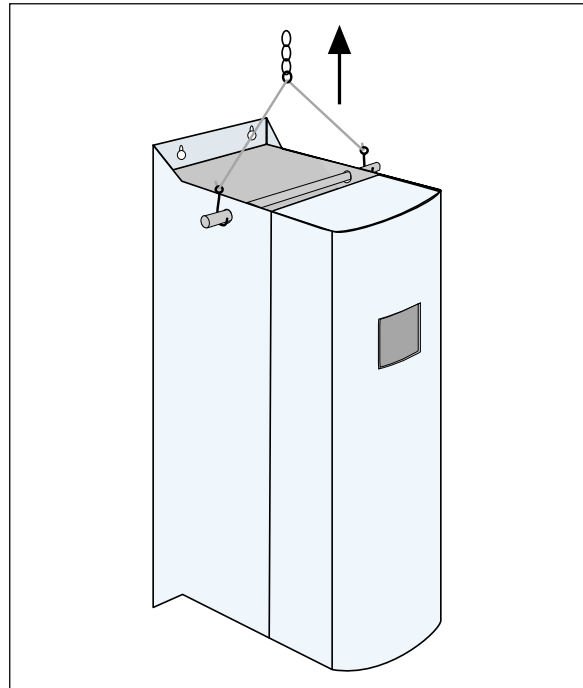

Figure 5.3-2 Lifting of 18.5—90 kW units.

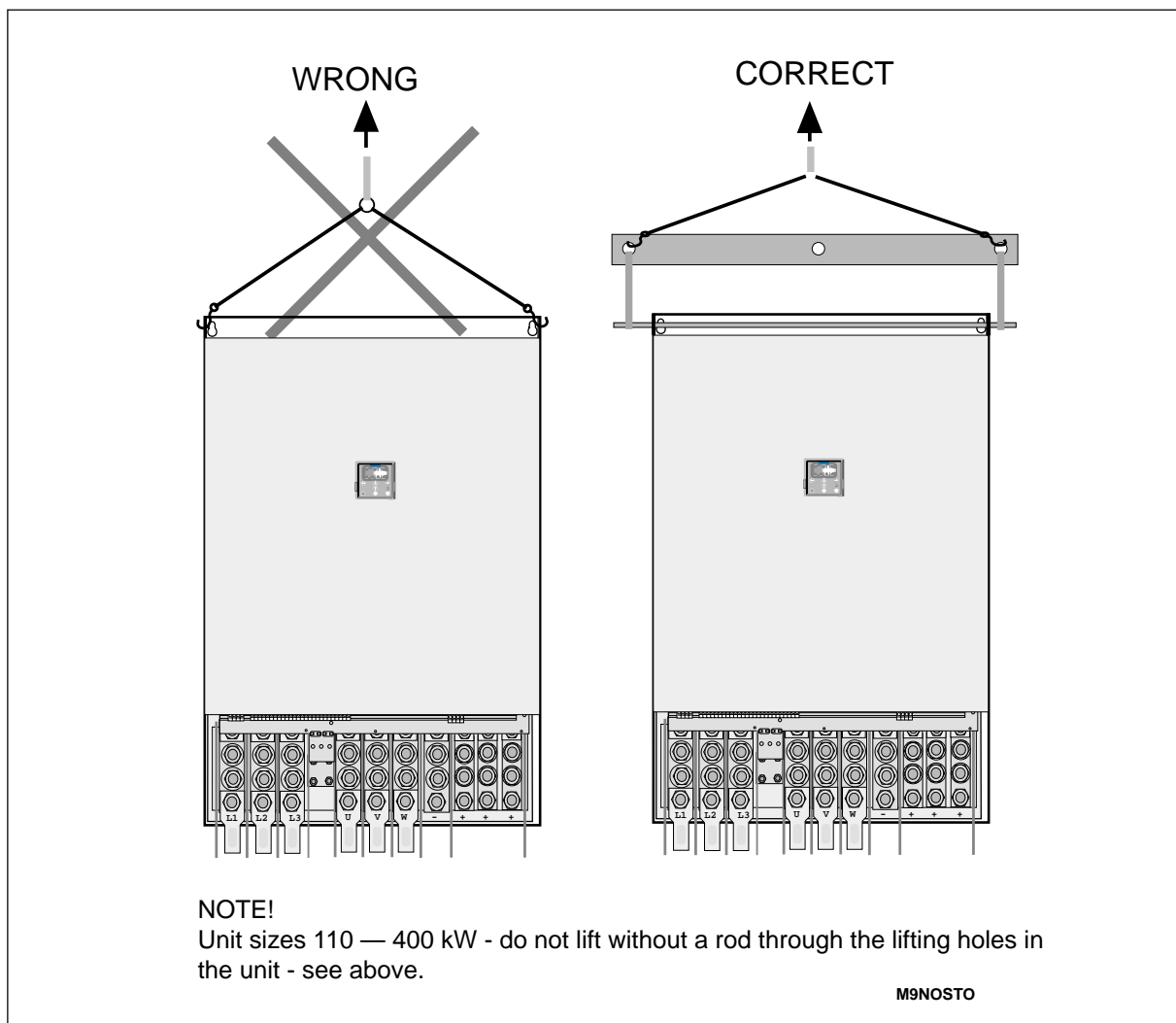

Figure 5.3-3 Lifting of 110—400 kW units.

### 6 WIRING

General wiring diagrams are shown in figures 6-1—6-3. The following chapters have more detailed instructions about wiring and cable connections.

The general wiring diagrams for 500—1500 CX4/CX5 and 400—1250 CX6 units are explained in the separate manual for M11/M12 units. Ask the factory for more information if needed.

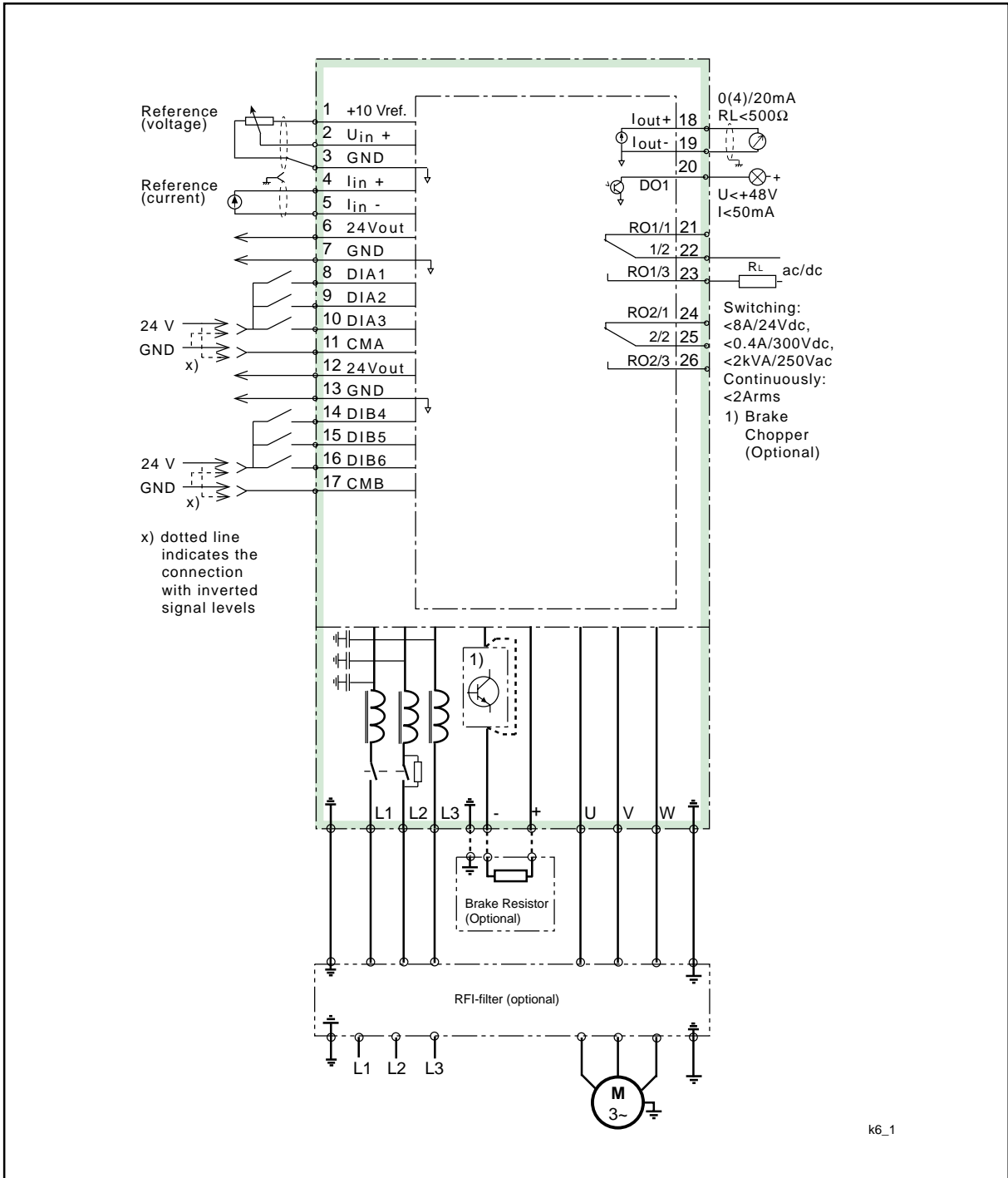

Figure 6-1 General wiring diagram, Vacon CX series (for unit sizes M4—M6).

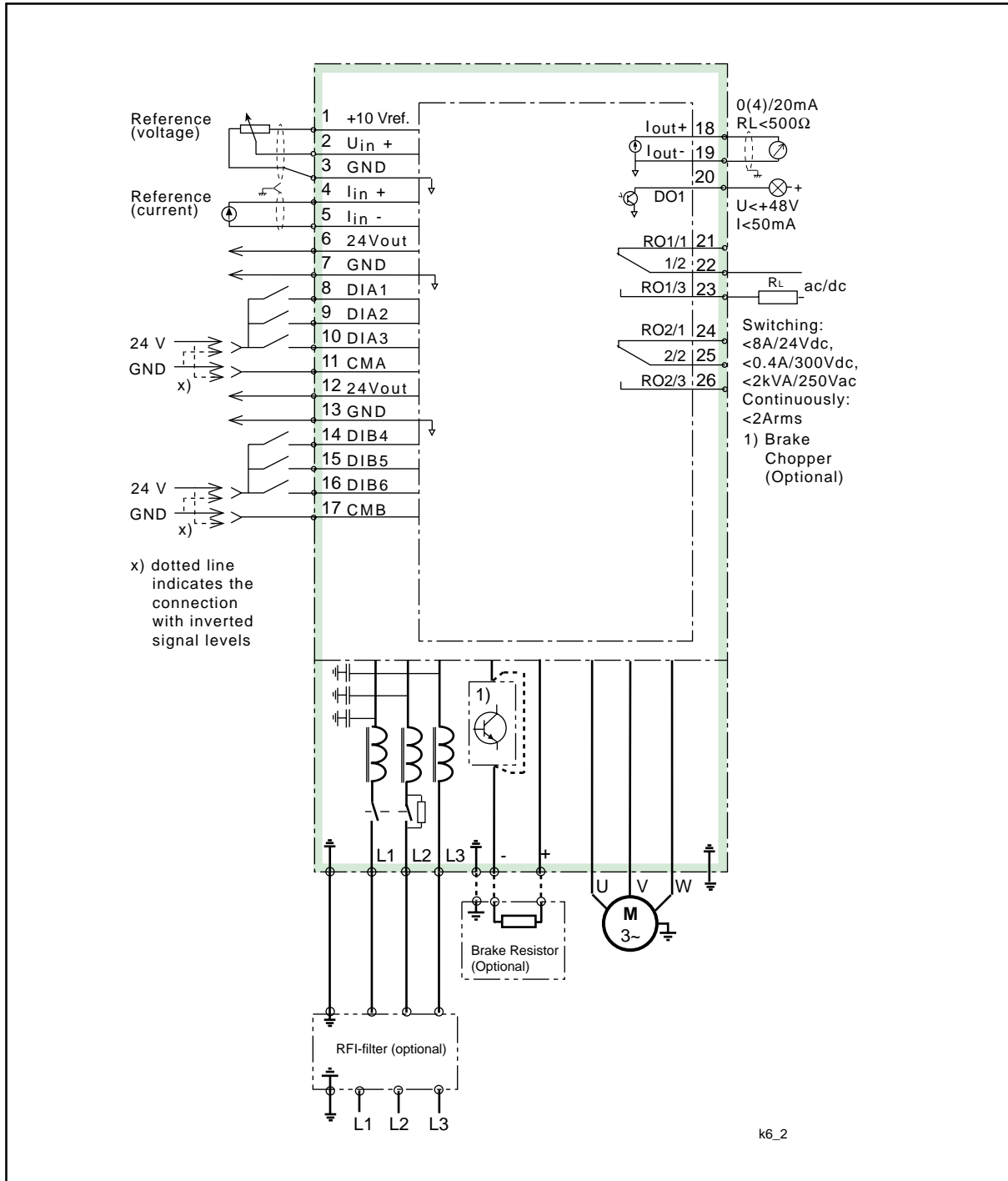
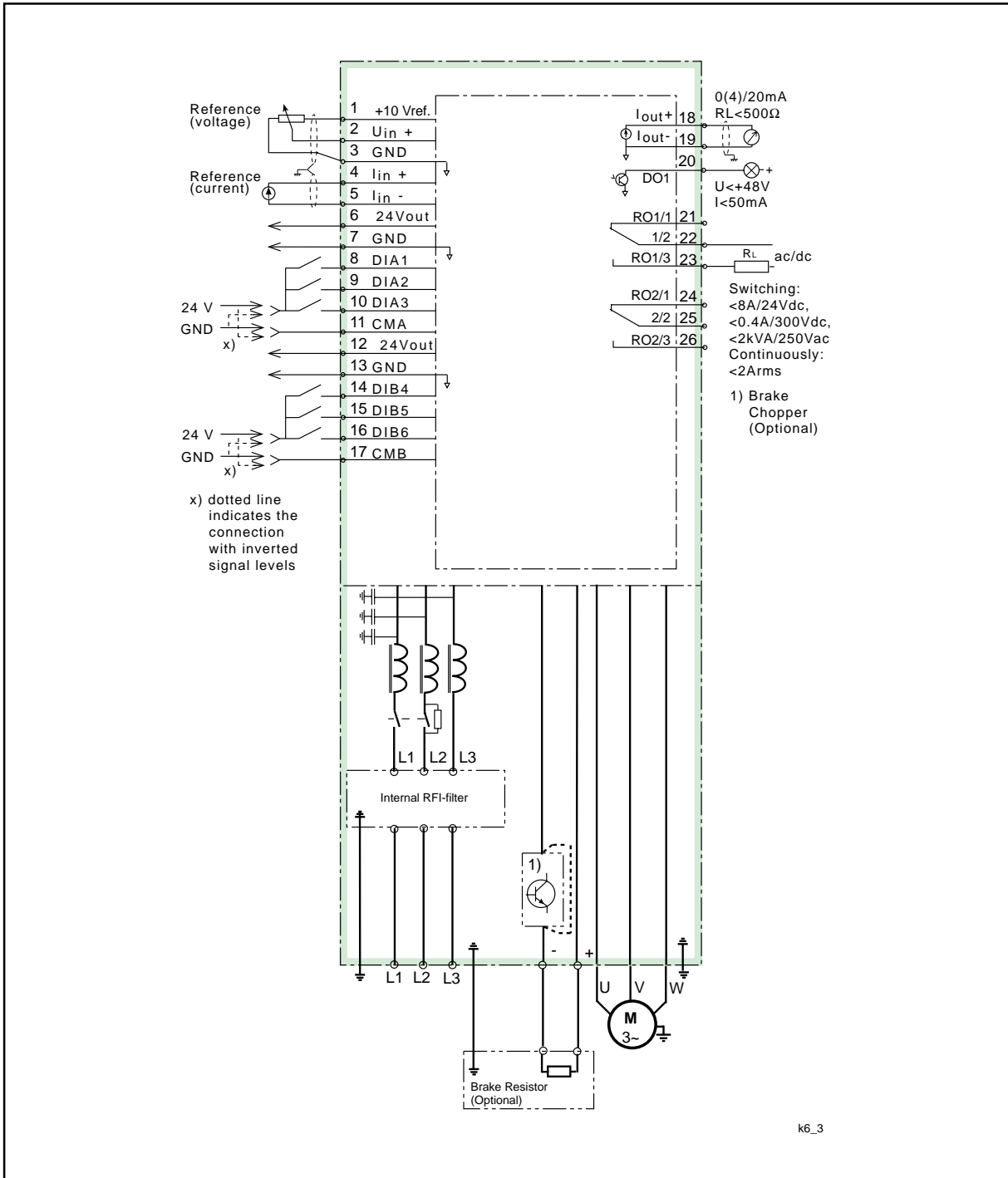

Figure 6-2 General wiring diagram, CX series (for unit sizes  $\geq M7$ ) and Vacon CXL-series (for unit sizes  $\geq M8$ ).



6

Figure 6-3 General wiring diagram, Vacon CXL series (for unit sizes M4—M7) and Vacon CXS series.

## 6.1 Power connections

Use heat-resistant cables, +60°C or higher. The cable (and the fuses) have to be dimensioned in accordance with the rated output current of the unit. Cable installing according to the UL-instructions is explained in Chapter 6.1.4.1.

The minimum dimensions for the Cu-cables and corresponding fuses are given in the tables 6.1-2 — 6.1-5. The fuses are GG/GL-fuses. They have been selected so that they will also function as an overload protection for the cables.

According to the UL-instructions for maximum protection of frequency converter, UL-recognized fuses of type H or K should be used. As for the current ratings of the fuses, see tables 6.1-2 — 6.1-5.

**6**

If the motor temperature protection ( $i^2t$ ) is used as overload protection the cables may be selected accordingly. If 3 or more cables are used in parallel (with the bigger units) note that every cable must have its own overload protection.

These instructions concern the cases in which you have one motor and one cable connection from the frequency converter to the motor. In other cases ask the factory for more information.

Always pay attention to the local authority regulations and installation conditions.

### 6.1.1 Mains cable

Mains cables for the different EMC levels are defined in table 6.1-1.

### 6.1.2 Motor cable

Motor cables for the different EMC levels are defined in table 6.1-1.

### 6.1.3 Control cable

Control cables are defined in Chapter 6.2.1.

Cable	level N	level I	level C
Mains cable	1	1	1
Motor cable	2	2	3
Control cable	4	4	4

Table 6.1-1 Cable types for the different EMC levels.

- 1 = The power cable which is suitable for the fixed installation, specifically for the used voltage.  
Shielded cable is not compulsory (recommendation NOKIA/MCMK or similar)
- 2 = The power cable equipped with concentric protection wire, specifically for the used voltage.  
(recommendation NOKIA/MCMK or similar)
- 3 = The power cable equipped with compact low-impedance shield, specifically for the used voltage.  
(recommendation NOKIA/MCCMK, SAB/ÖZCUY-J or similar)
- 4 = The control cable equipped with compact low-impedance shield, screened cable.  
(recommendation NOKIA/jamak, SAB/ÖZCuY-O or similar)

\* = Follow local regulations/Ask factory for details

Type -CX4 -CXL4 -CXS4	I <sub>CT</sub> [A]	Fuse [A]	Cu-cable [mm <sup>2</sup> ]	I <sub>VT</sub> [A]	Fuse [A]	Cu-cable [mm <sup>2</sup> ]
0.75	2.5	10	3*1.5+1.5	3.5	10	3*1.5+1.5
1.1	3.5	10	3*1.5+1.5	4.5	10	3*1.5+1.5
1.5	4.5	10	3*1.5+1.5	6.5	10	3*1.5+1.5
2.2	6.5	10	3*1.5+1.5	8	10	3*1.5+1.5
3.0	8	10	3*1.5+1.5	10	10	3*1.5+1.5
4.0	10	10	3*1.5+1.5	13	16	3*2.5+2.5
5.5	13	16	3*2.5+2.5	18	20	3*4+4
7.5	18	20	3*4+4	24	25	3*6+6
11	24	25	3*6+6	32	35	3*10+10
15	32	35	3*10+10	42	50	3*10+10
18.5	42	50	3*10+10	48	50	3*10+10
22	48	50	3*10+10	60	63	3*16+16
30	60	63	3*16+16	75	80	3*25+16
37	75	80	3*25+16	90	100	3*35+16
45	90	100	3*35+16	110	125	3*50+25
55	110	125	3*50+25	150	160	3*70+35
75	150	160	3*70+35	180	200	3*95+50
90	180	200	3*95+50	210	250	3*120+70
110	210	250	3*150+70	270	315	3*185+95
132	270	315	3*185+95	325	400	2*(3*120+70)
160	325	400	2*(3*120+70)	410	500	2*(3*185+95)
200	410	500	2*(3*185+95)	510	630	2*(3*240+120)
250	510	630	2*(3*240+120)	580	630	2*(3*240+120)
315—	*	*	*	*	*	*
1000						
1100-	*	*	*	*	*	*
1500						

Table 6.1-2 Mains, motor cables and fuse recommendations according to output currents I<sub>CT</sub> and I<sub>VT</sub>, 400V range.

Type -CX5 -CXL5 -CXS5	I <sub>CT</sub> [A]	Fuse [A]	Cu-cable [mm <sup>2</sup> ]	I <sub>VT</sub> [A]	Fuse [A]	Cu-cable [mm <sup>2</sup> ]
0.75	2.5	10	3*1.5+1.5	3	10	3*1.5+1.5
1.1	3	10	3*1.5+1.5	3.5	10	3*1.5+1.5
1.5	3.5	10	3*1.5+1.5	5	10	3*1.5+1.5
2.2	5	10	3*1.5+1.5	6	10	3*1.5+1.5
3.0	6	10	3*1.5+1.5	8	10	3*1.5+1.5
4.0	8	10	3*1.5+1.5	11	16	3*2.5+2.5
5.5	11	16	3*2.5+2.5	15	20	3*4+4
7.5	15	20	3*4+4	21	25	3*6+6
11	21	25	3*6+6	27	35	3*10+10
15	27	35	3*10+10	34	50	3*10+10
18.5	34	50	3*10+10	40	50	3*10+10
22	40	50	3*10+10	52	63	3*16+16
30	52	63	3*16+16	65	80	3*25+16
37	65	80	3*25+16	77	100	3*35+16
45	77	100	3*35+16	96	125	3*50+25
55	96	125	3*50+25	125	160	3*70+35
75	125	160	3*70+35	160	200	3*95+50
90	160	200	3*95+50	180	200	3*95+50
110	180	200	3*95+50	220	250	3*150+70
132	220	250	3*150+70	260	315	3*185+95
160	260	315	3*185+95	320	400	2*(3*120+70)
200	320	400	2*(3*120+70)	400	500	2*(3*185+95)
250	400	500	2*(3*185+95)	460	630	2*(3*240+120)
315—	*	*	*	*	*	*
1000						
1100-	*	*	*	*	*	*
1500						

Table 6.1-3 Mains, motor cables and fuse recommendations according to output currents I<sub>CT</sub> and I<sub>VT</sub>, 500V range.

Type -CX6	I <sub>CT</sub> [A]	Fuse [A]	Cu-cable [mm <sup>2</sup> ]	I <sub>VT</sub> [A]	Fuse [A]	Cu-cable [mm <sup>2</sup> ]
2.2	3.5	10	3*1.5+1.5	4.5	10	3*1.5+1.5
3	4.5	10	3*1.5+1.5	5.5	10	3*1.5+1.5
4	5.5	10	3*1.5+1.5	7.5	10	3*1.5+1.5
5.5	7.5	10	3*1.5+1.5	10	10	3*1.5+1.5
7.5	10	10	3*1.5+1.5	14	16	3*2.5+2.5
11	14	16	3*2.5+2.5	19	20	3*4+4
15	19	20	3*4+4	23	25	3*6+6
18.5	23	25	3*6+6	26	25	3*6+6
22	26	35	3*10+10	35	35	3*10+10
30	35	35	3*10+10	42	50	3*10+10
37	42	50	3*10+10	52	63	3*16+16
45	52	63	3*16+16	62	63	3*16+16
55	62	63	3*16+16	85	100	3*35+16
75	85	100	3*35+16	100	100	3*35+16
90	100	100	3*35+16	122	125	3*50+25
110	122	125	3*50+25	145	160	3*70+35
132	145	160	3*70+35	185	200	3*95+50
160	185	200	3*95+50	222	250	3*150+70
200	222	250	3*150+70	287	315	3*185+95
250—	*	*	*	*	*	*
800						
1000-	*	*	*	*	*	*
1250						

Table 6.1-4 Mains, motor cables and fuse recommendations according to output currents I<sub>CT</sub> and I<sub>VT</sub>, 690V range.

Type -CX2 -CXL2 -CXS2	I <sub>CT</sub> [A]	Fuse [A]	Cu-cable [mm <sup>2</sup> ]	I <sub>VT</sub> [A]	Fuse [A]	Cu-cable [mm <sup>2</sup> ]
0.55	3.6	10	3*1.5+1.5	4.7	10	3*1.5+1.5
0.75	4.7	10	3*1.5+1.5	5.6	10	3*1.5+1.5
1.1	5.6	10	3*1.5+1.5	7	10	3*1.5+1.5
1.5	7	10	3*1.5+1.5	10	10	3*1.5+1.5
2.2	10	10	3*1.5+1.5	13	16	3*2.5+2.5
3	13	16	3*2.5+2.5	16	16	3*2.5+2.5
4	16	16	3*2.5+2.5	22	25	3*6+6
5.5	22	25	3*6+6	30	35	3*10+10
7.5	30	35	3*10+10	43	50	3*10+10
11	43	50	3*10+10	57	63	3*16+16
15	57	63	3*16+16	70	80	3*25+16
18.5	70	80	3*25+16	83	100	3*35+16
22	83	100	3*35+16	113	125	3*50+25
30	113	125	3*50+25	139	160	3*70+35
37	139	160	3*70+35	165	200	3*95+50
45	165	200	3*95+50	200	200	3*95+50
55	200	200	3*95+50	264	315	3*185+95

Table 6.1-5 Mains, motor cables and fuse recommendations according to output currents I<sub>CT</sub> and I<sub>VT</sub>, 230V range.



Type	Cable [mm <sup>2</sup> ]	
	main terminals	earth terminal
0.75—3 CXS4/CXS5 0.55—1.5 CXS2	2.5	2.5
2.2—5.5 CX4/CX5 0.75—5.5 CXL4/CXL5 1.5—3 CX2/CXL2	6	6
7.5—15 CX4/CX5 7.5—15 CXL4/CXL5 2.2—22 CX6 4—11 CXS4/CXS5 2.2—5.5 CXS2 4—7.5 CX2/CXL2	16	16
18.5—22 CX4/CX5 18.5—22 CXL4/CXL5 30—45 CX6 15—22 CXS4/CXS5 7.5—15 CXS2 11—15 CX2/CXL2	35	70
30—45 CX4/CX5 30—45 CXL4/CXL5 55—75 CX6 18.5—22 CX2/CXL2	50 Cu, 70 Al	70
55—90 CX4/CX5 55—90 CXL4/CXL5 30—45 CX2/CXL2	185 Cu and Al	95
110—160 CX4/CX5 110—160 CXL4/CXL5 90—132 CX6 55 CX2/CXL2	2*185 Cu (1) 2*240 Al	2 * 240 Cu
200—250 CX4/CX5 200—250 CXL4/CXL5 160—200 CX6	2*300 (1) Cu and Al	2 * 240 Cu
315—400 CX4/CX5 315—400 CXL4/CXL5 250—315 CX6	4*240 (1) Cu and Al (2)	2 * 240 Cu
500 CX4/CX5 400 CX6	*	*
630—1000 CX4/CX5 500—800 CX6	*	*
1100—1500 CX4/CX5/ 900—1250 CX6	*	*

(1) Mounting bolt size M12 \*

(2) In CXL versions max. 3 parallel connected cables can be used

\* = Follow local regulations/Ask factory for details

6

Table 6.1-6 Maximum cable sizes of power terminals.

6.1.4 Installation instructions

1

If the Vacon CX frequency converter is to be installed outside a switchgear, separate cubicle or electrical room a protective IP20 cover should be installed for the cable connections, see figure 6.1.4-3. The protective cover may not be needed if the unit is mounted inside a switchgear, separate cubicle or electrical room.

All IP00 class frequency converters should always be mounted inside a switchgear, separate cubicle or electrical room.

2

Place the motor cable away from the other cables:

- Avoid long parallel runs with other cables.
- If the motor cable runs in parallel with the other cables, the minimum distances given in table 6.1.4-1 between the motor cable and control cables should be followed.
- These minimum distances apply also between the motor cable and signal cables of other systems.
- **The maximum length of a motor cable is 200m (except 0.75—1.1CXS max. length 50 m and 1.5CXS max. length 100 m).**
- The power cables should cross other cables at an angle of 90° degrees.

Distance between cables [m]	Screened cable length [m]
0.3	≤50
1.0	≤200

Table 6.1.4-1 Minimum cable distances.

3

See chapter 6.1.5 for cable insulation checks.

4

Connecting cables:

- Motor and mains cables should be stripped according to the figure 6.1.4-2 and table 6.1.4-2.
- Open the cover of Vacon CX/CXL/CXS as shown in figure 6.1.4-2.
- Remove plugs from the cable cover (CX -series) or from the bottom of the unit (CXL/CXS- series) as necessary.
- Pass cables through the holes in the cable cover.
- Connect the main, motor and control cables to the correct terminals (EMC level N: see figures 6.1.4-3—13, 6.1.4-17, 6.1.4-19 EMC levels I and C: see figure 6.1.4-14—16, 6.1.4-18, 6.1.4-20—21 EMC level N + external RFI-filter: see RFI-filter option manual) The installation instructions for 500—1500 CX4/CX5 and 400—1250 CX6 units are given in the separate manual for M11/M12 units. Ask the factory for more information if needed.
- Cable installing according to the UL-instructions is explained in the chapter 6.1.4.1.
- Check that control cable wires do not make contact with electrical components in the device.
- Connect the optional brake resistor cable (if required).
- Ensure the earth cable is connected to the  -terminal of the frequency converter and motor.
- For types 110—400 CX, connect the isolator plates of the protective cover and terminals according to the figure 6.1.4-11.





- Connect the separate shield for the power cables to the protective earth of the frequency converter, motor and supply panel.
- Mount the cable cover (CX -series) and the unit cover.
- Ensure that the control cables and internal wiring are not trapped between the cover and the body of the unit.

# 5

**NOTE:**

The connection of the transformer inside the unit in mechanical constructions M7—M12 has to be changed if other than the default supply voltage of the drive is used. Ask the factory for more information if needed.

Typecode	Default supply voltage
x x CX2 x x x x x x CXL2 x x x x	230V
x x CX4 x x x x x x CXL4 x x x x	400V
x x CX5 x x x x x x CXL5 x x x x	500V
x x CX6 x x x x	690V

6

**6.1.4.1 Cable installing according to the UL- instructions**

For Installation and cable connections the following must be noted. Use only copper wire with temperature permanence of at least 60/75°C.

According to the NEMA enclosure classification Vacon CXL models are either of Type 1 or

Type 12 (see chapter 3.1, Type designation code). Vacon CX and CXS models are Open Type Equipment.

In addition to the connecting information the tightening torque of the terminals are defined in the table 6.1.4.1-2.

Type	Size	Tightening torque in in-lbs.	Tightening torque in Nm
0.75—5.5CX4/CXL4 2.2—5.5CX5/CXL5	M4	7	0,8
7.5—5CX4/CXL4 7.5—15CX5/CXL5	M5	20	2,25
18.5—22CX4/CXL4 18.5—22CX5/CXL5	M6	35	4
30—45CX4/CXL4 30—45CX5/CXL5	M6	44	5
55—90CX4/CXL4 55—90CX5/CXL5	M7	130	15
110—160CX4/CXL4 110—160CX5/CXL5	M8	610 *)	70 *)
200—250CX4/CXL4 200—250CX5/CXL5	M9	610 *)	70 *)

\*) Use a wrench to give the counter torque when tightening. The isolated stand off of the busbar does not withstand the whole tightening torque.

Table 6.1.4.1-2 Tightening torque of the terminals.



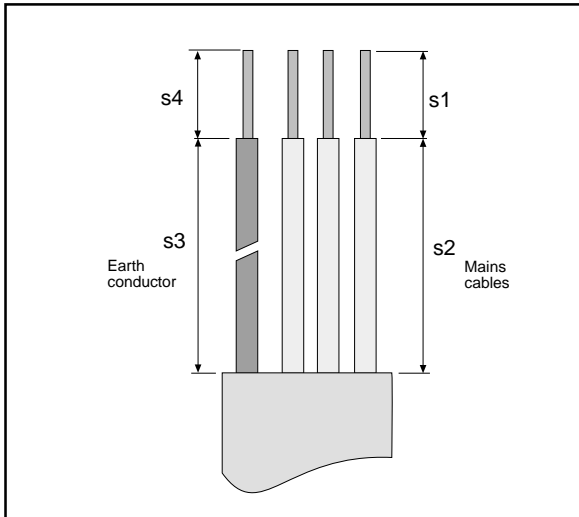

Figure 6.1.4-1 Stripping motor and mains cables.

Type	s1	s2	s3	s4
0.75 — 11 CXS4/CXS5 0.55 — 5.5 CXS2	12	55	55	12
2.2 — 5.5 CX4/CXL4 2.2 — 5.5 CX5/CXL5 1.5 — 3 CX2/CXL2	6	35	60	15
7.5 — 15 CX4/CXL4 7.5 — 15 CX5/CXL5 2.2 — 22 CX6 4 — 7.5 CX2/CXL2	9	40	100	15
18.5 — 22 CX4/CXL4 18.5 — 22 CX5/CXL5 30 — 45 CX6 15 — 22 CX4/CX5 11 — 15 CX2/CXL2 7.5 — 15 CXS2	14	90	100	15
30 — 45 CX4/CXL4 30 — 45 CX5/CXL5 55 — 75 CX6 18.5 — 22 CX2/CXL2	25	90	100	15
55 — 90 CX4/CXL4 55 — 90 CX5/CXL5 30 — 45 CX2/CXL2	50	-	-	25
110 — 160 CX4/CXL4 110 — 160 CX5/CXL5 90 — 132 CX6 55 CX2/CXL2	*	*	*	*
200 — 250 CX4/CXL4 200 — 250 CX5/CXL5 160 — 200 CX6	*	*	*	*
315 — 400 CX4/CXL4 315 — 400 CX5/CXL5 250 — 315 CX6	*	*	*	*
500 CX4/CX5 400 CX6	*	*	*	*
630 — 1500 CX4/CX5 500 — 1250 CX6	*	*	*	*

Table 6.1.4-2 Stripping lengths of the cables (mm).  
(\* = Ask the details from the factory)

- ① Loosen screws (2 pcs)
- ② Pull cover bottom outwards
- ③ Push cover upwards

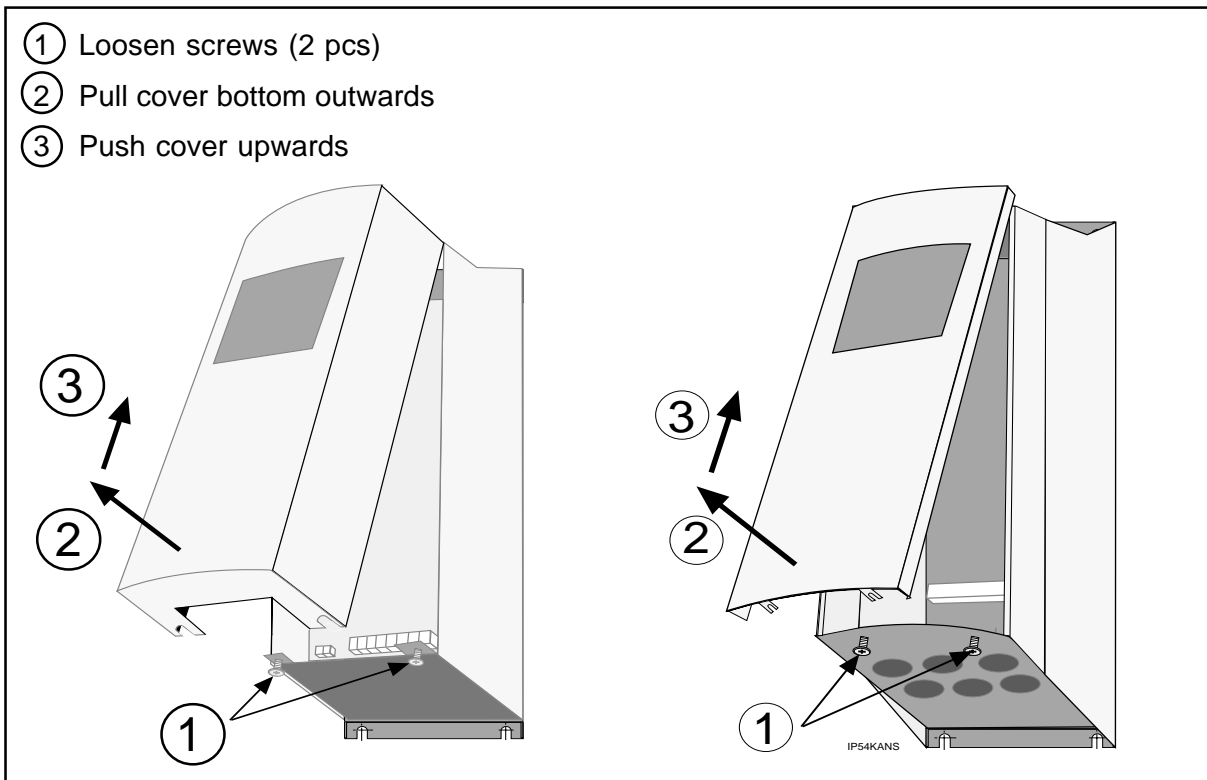

Figure 6.1.4-2 Opening the cover of the Vacon CX/CXL/CXS unit.

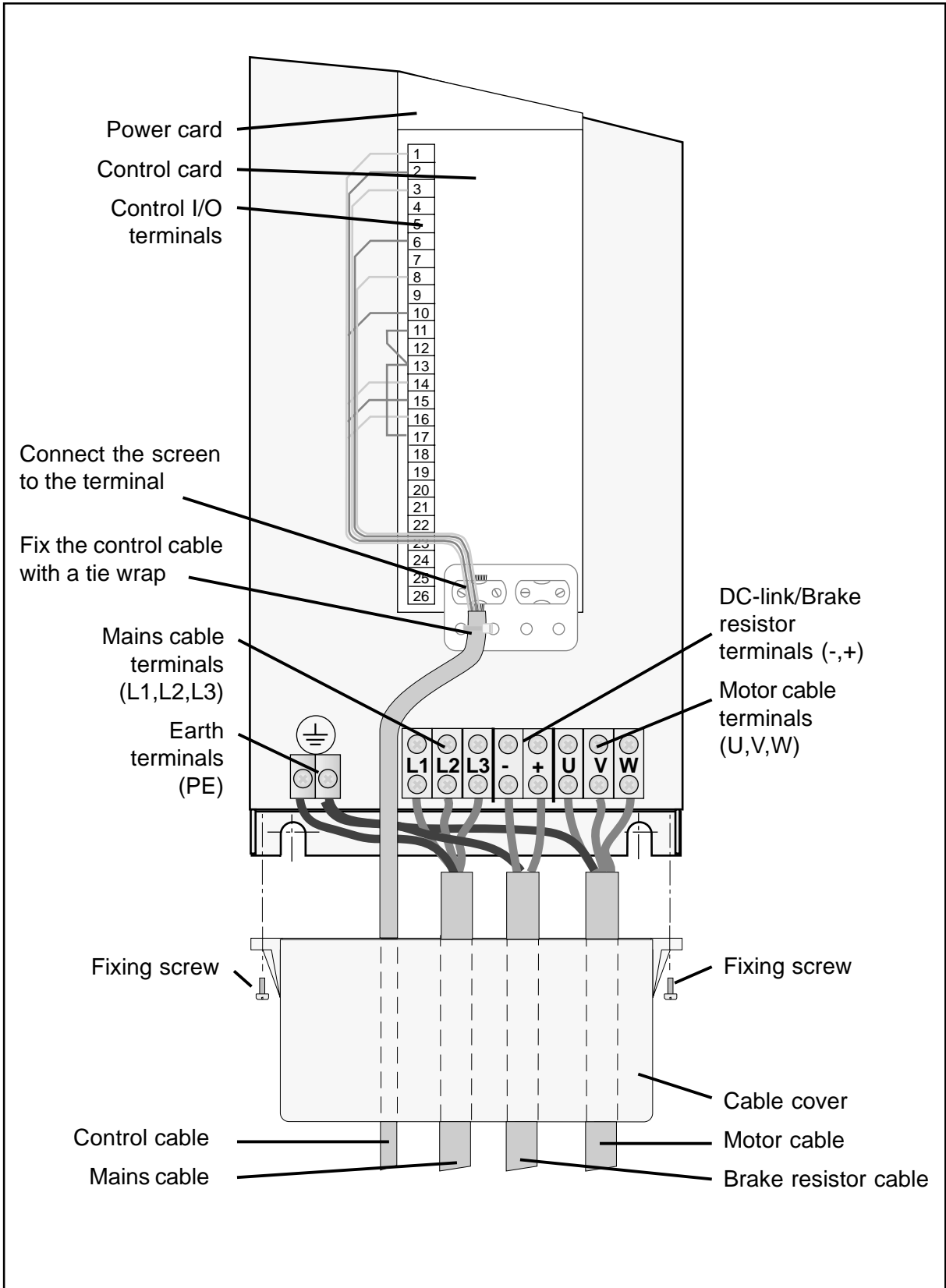

Figure 6.1.4-3 Cable assembly for 2.2—15 CX4/CX5 and 1.5—7.5 CX2 types (EMC level N).

6

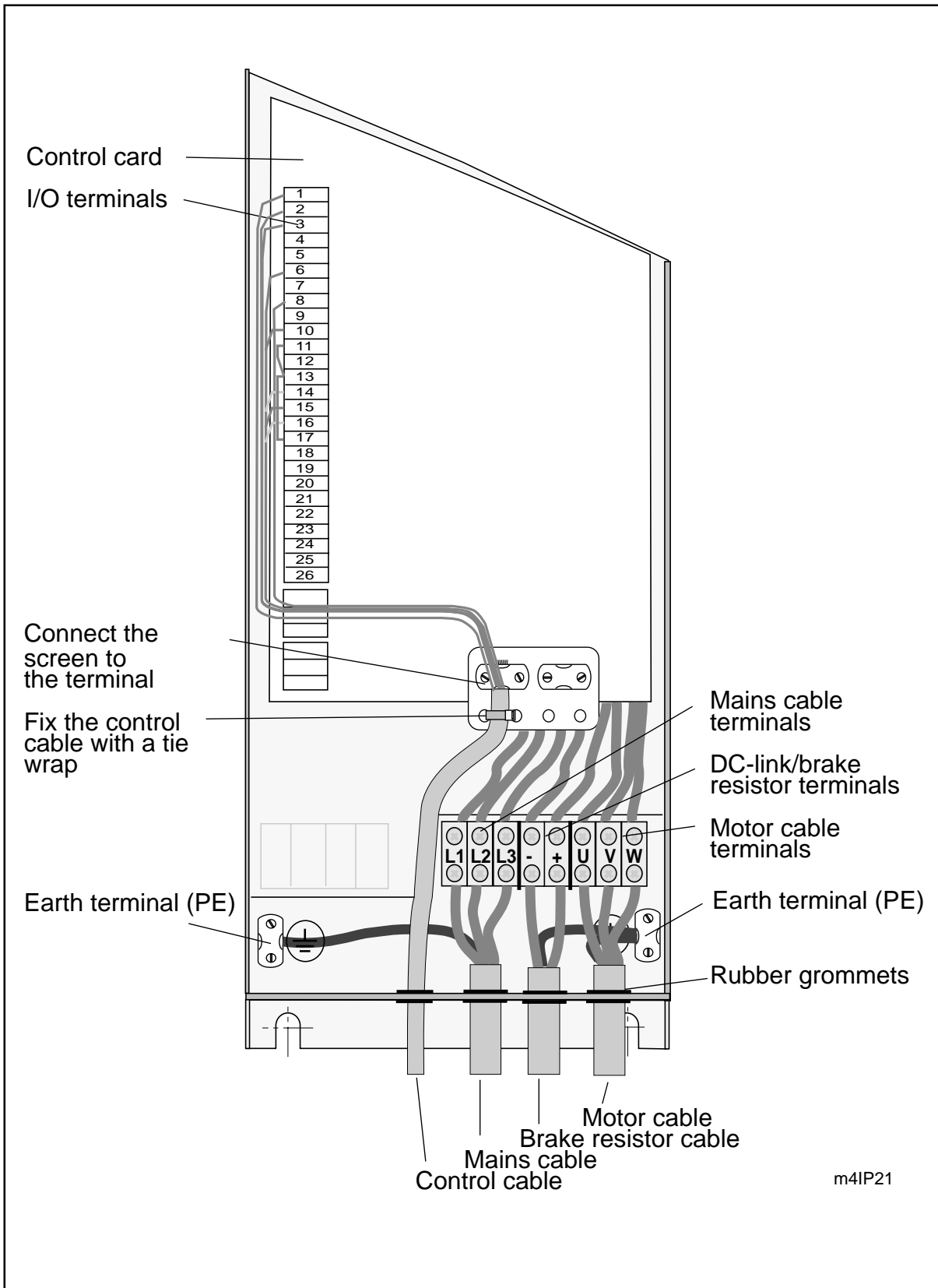

Figure 6.1.4-4 Cable assembly for 2.2—5.5 CXL4/CXL5 and 1.5—3 CXL2 types (EMC level N).

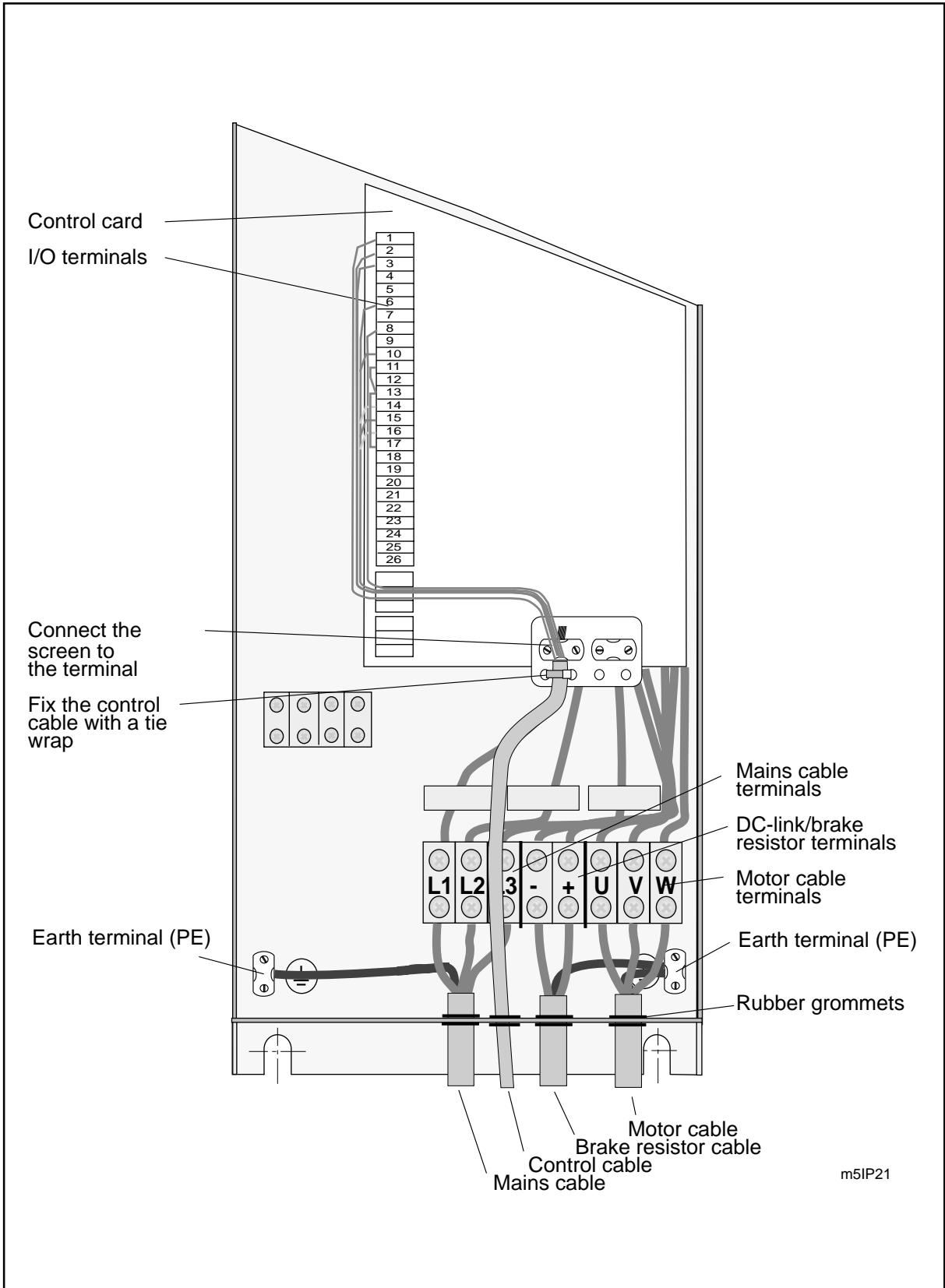

Figure 6.1.4-5 Cable assembly for 7.5—15 CXL4/CXL5 and 4—7.5 CXL2 types (IP21 enclosure EMC level N).

6

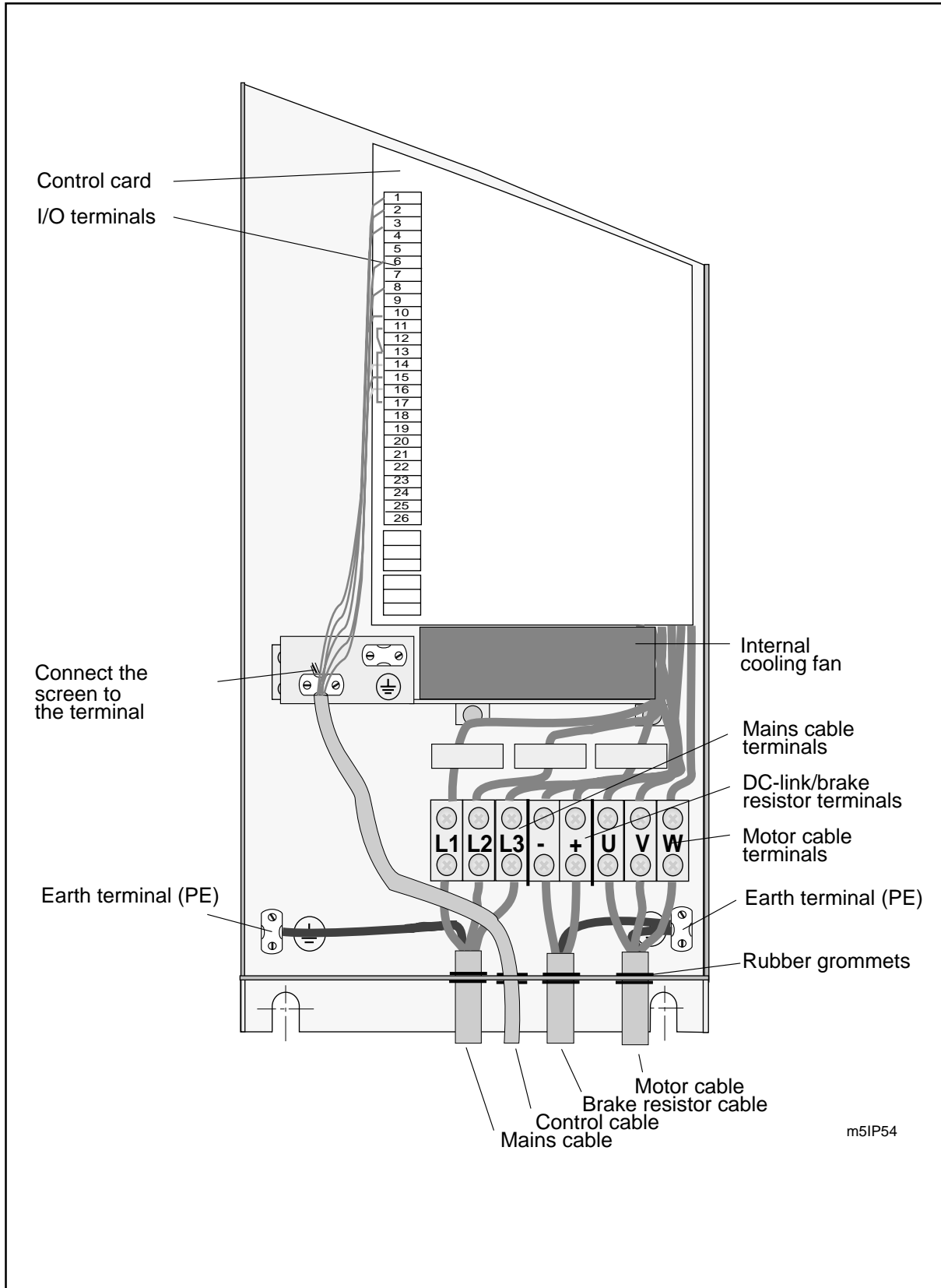

Figure 6.1.4-6 Cable assembly for 7.5—15 CXL4/CXL5 and 4—7.5 CXL2 types (IP54 enclosure EMC level N).

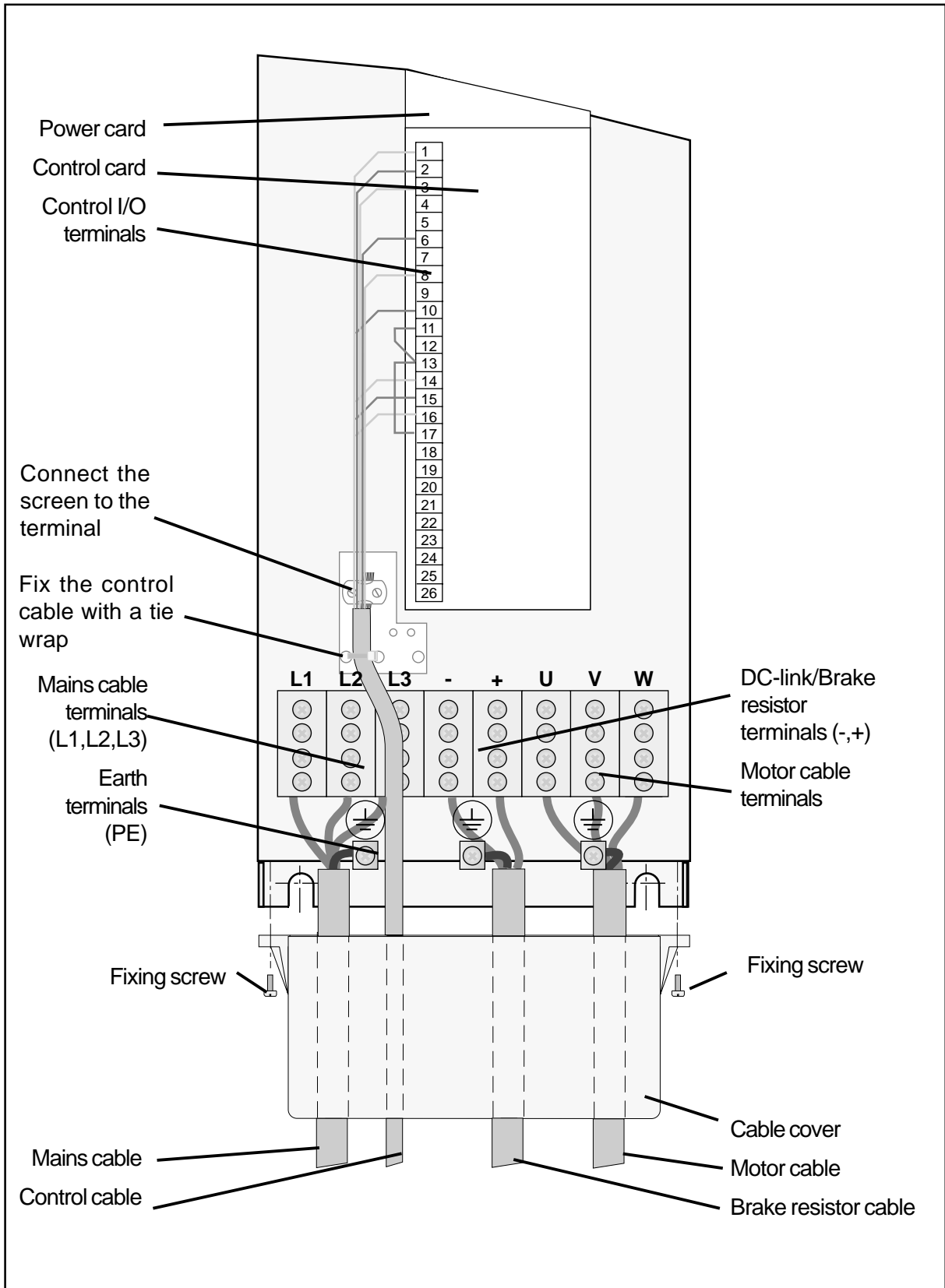

Figure 6.1.4-7 Cable assembly for 18.5—45 CX4/CX5 and 11—22 CX2 types (EMC level N).



6

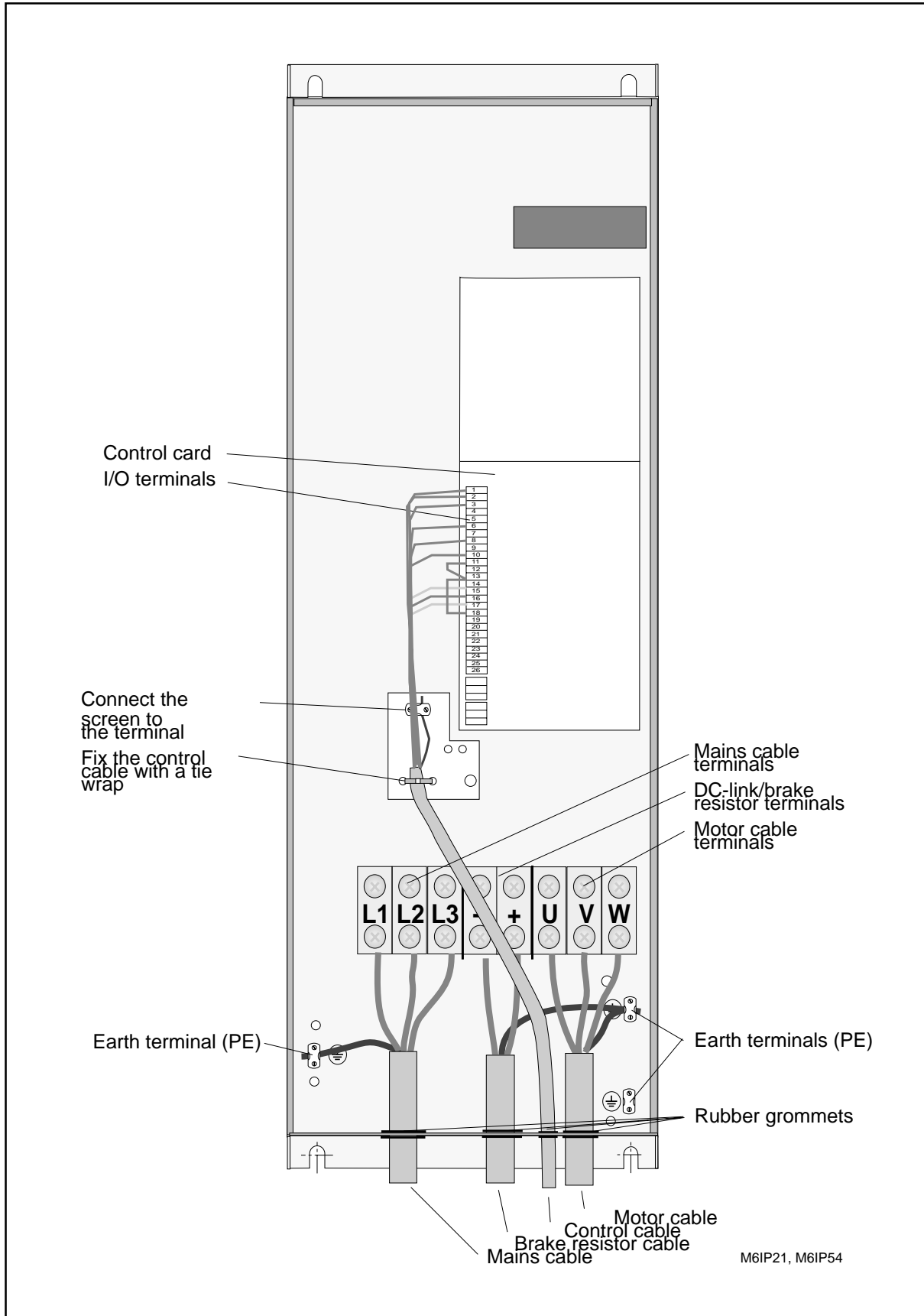
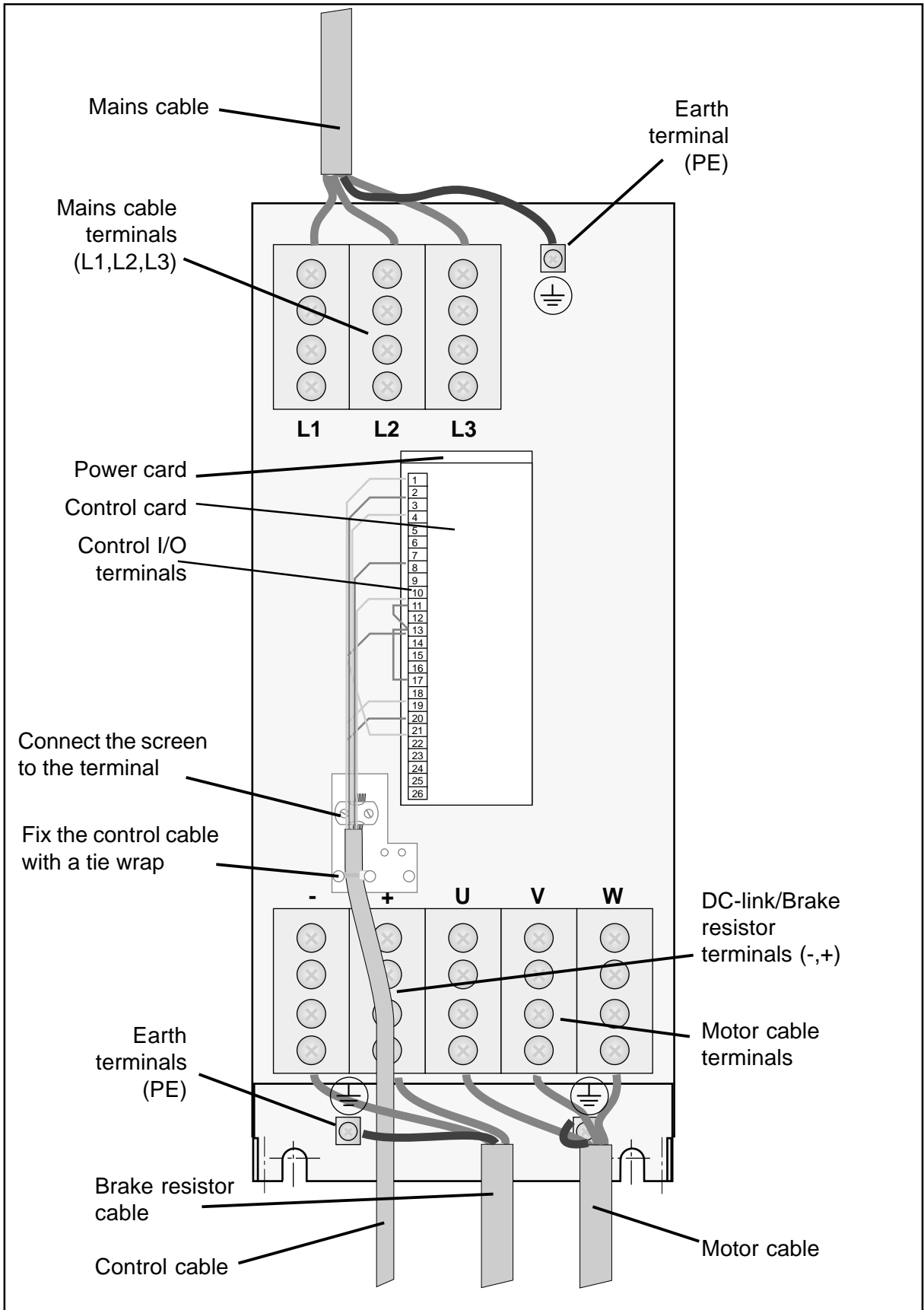

Figure 6.1.4-8 Cable assembly for 18.5—45 CXL4/CXL5 and 11—22 CXL2 types (EMC level N).



6

Figure 6.1.4-9 Cable assembly for 55—90 CX4/CX5 and 30—45 CX2 types (EMC level N).

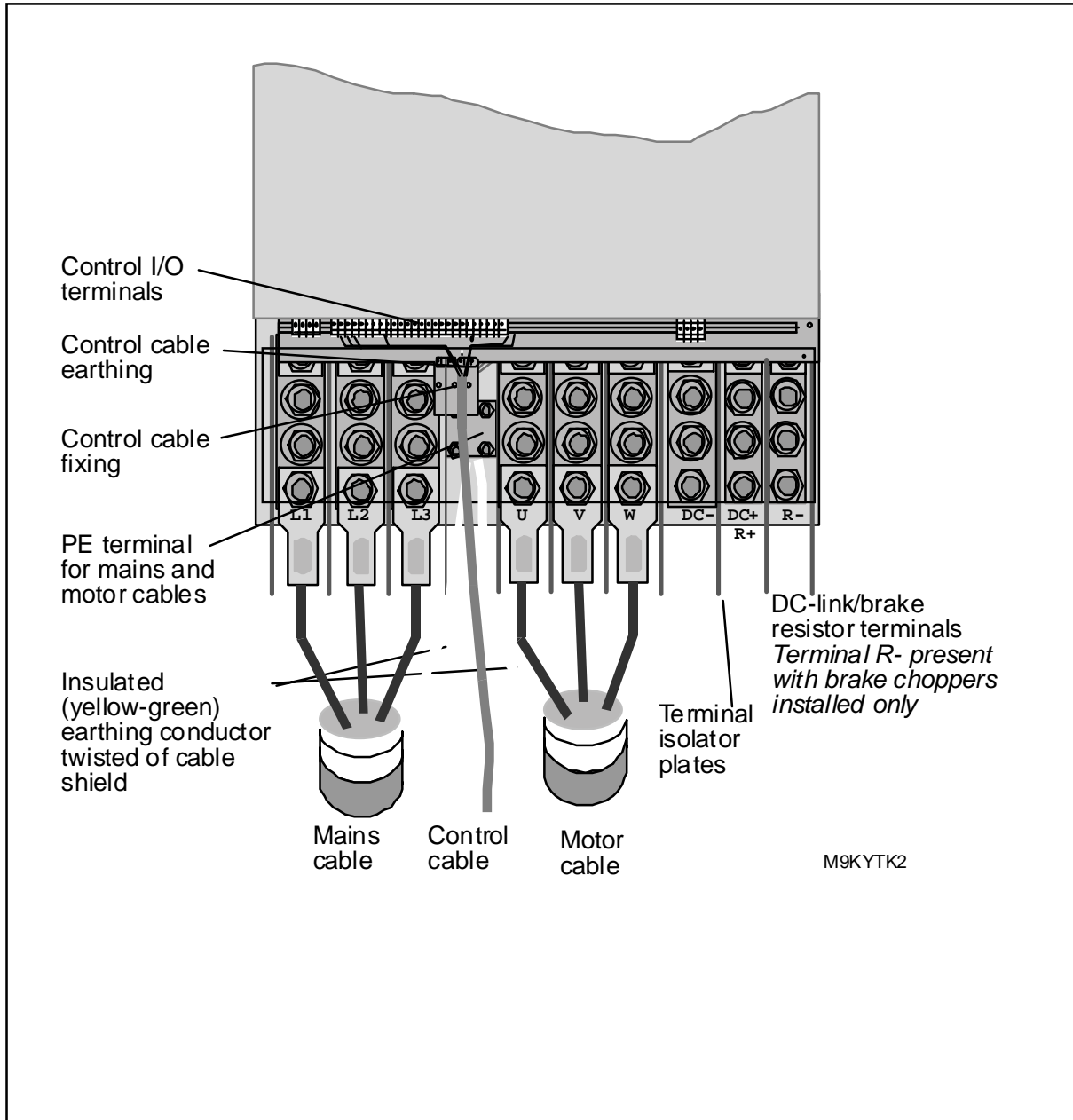

Figure 6.1.4-10 Cable assembly for 110—400 CX4/CX5, 110—400 CXL4/CXL5, 90—315 CX6, 55 CX2 and 55 CXL2 types (EMC level N).

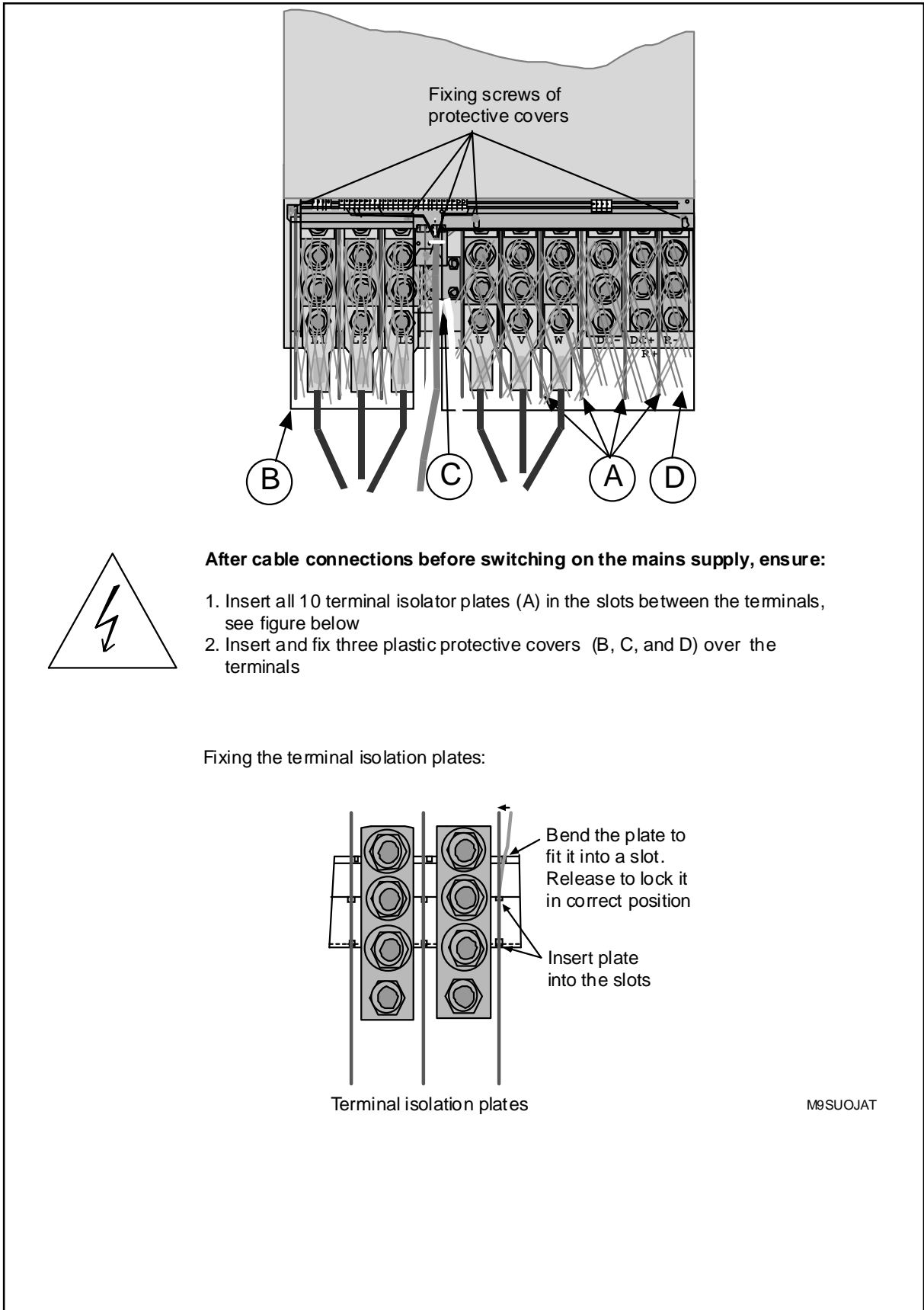

Figure 6.1.4-11 Cable cover and terminals assembly for 110—400 CX4/CX5, 110—400 CXL4/CXL5, 90—315 CX6, 55 CX2 and 55 CXL2 types (EMC level N).

6

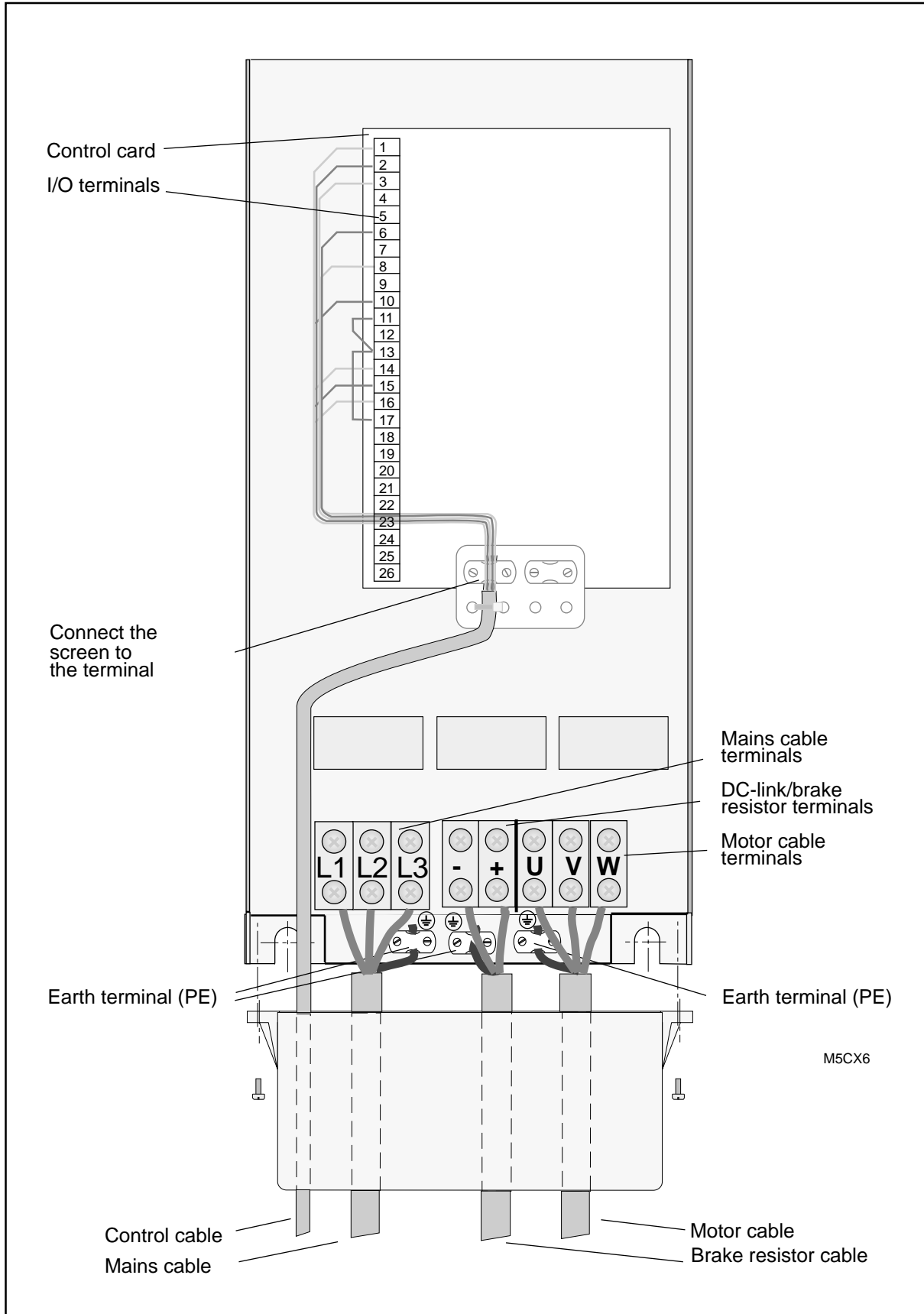

Figure 6.1.4-12 Cable assembly for 2.2—22 CX6 types (EMC level N).

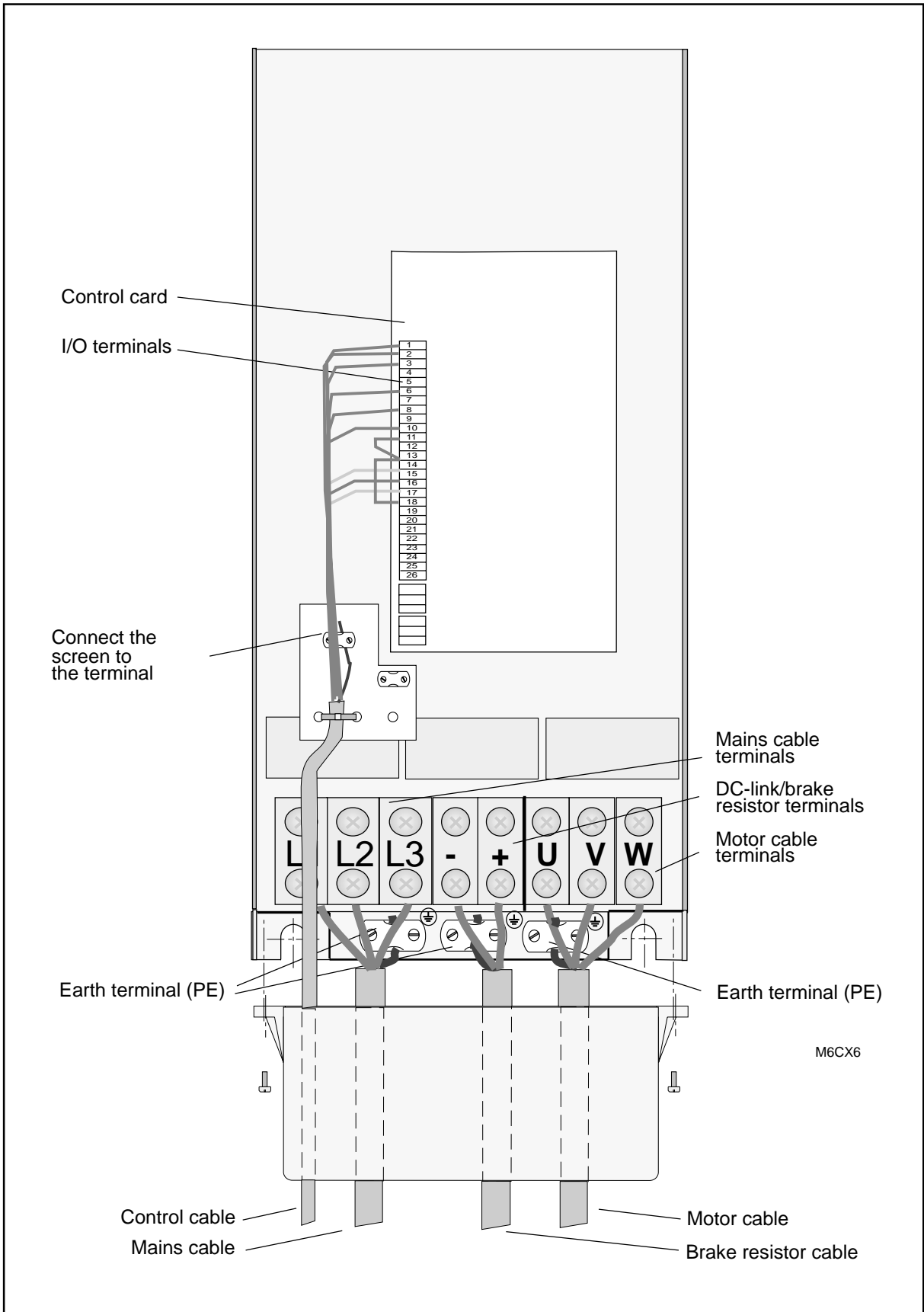

Figure 6.1.4-13 Cable assembly for 30—75 CX6 types (EMC level N).

6

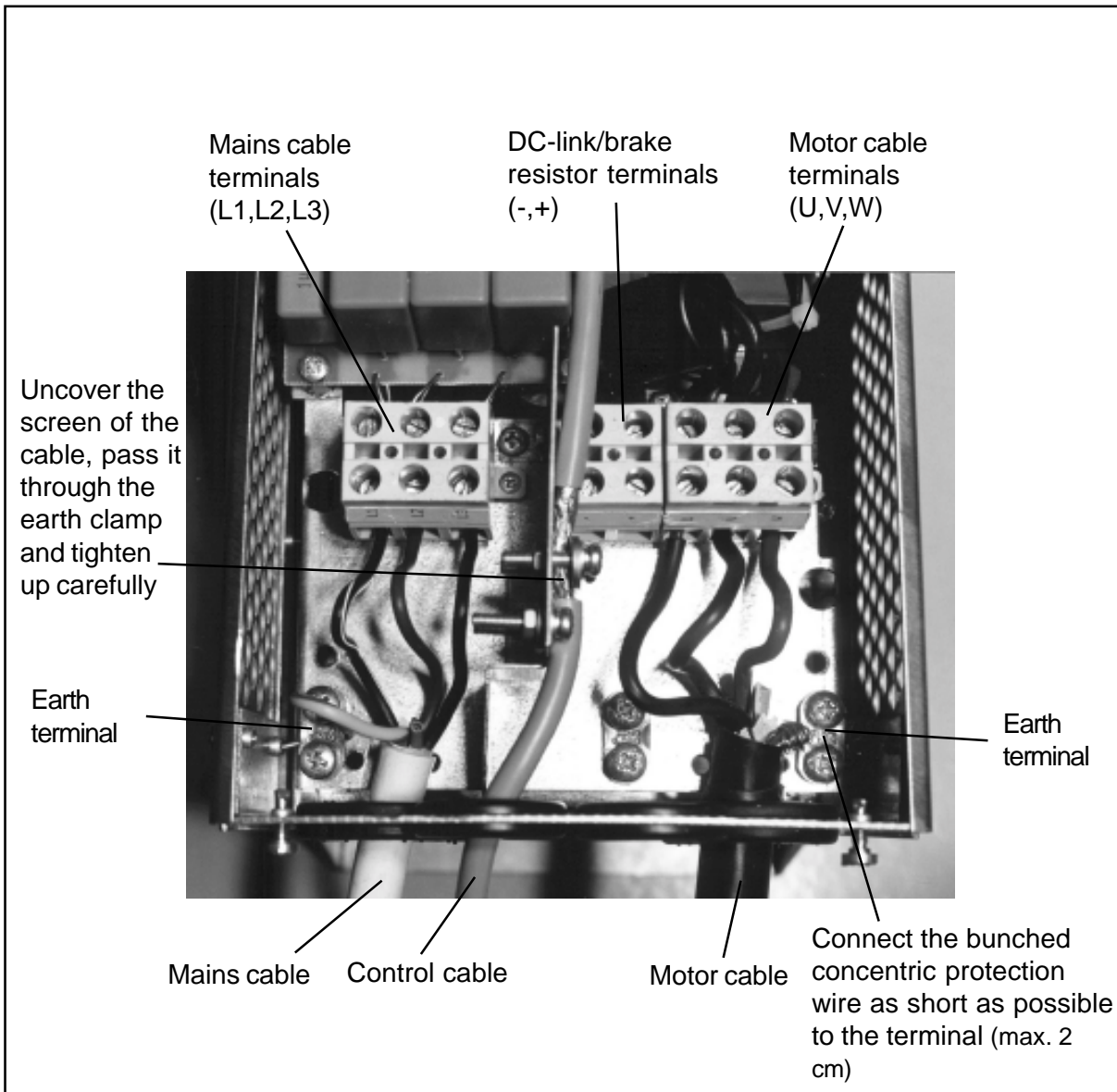
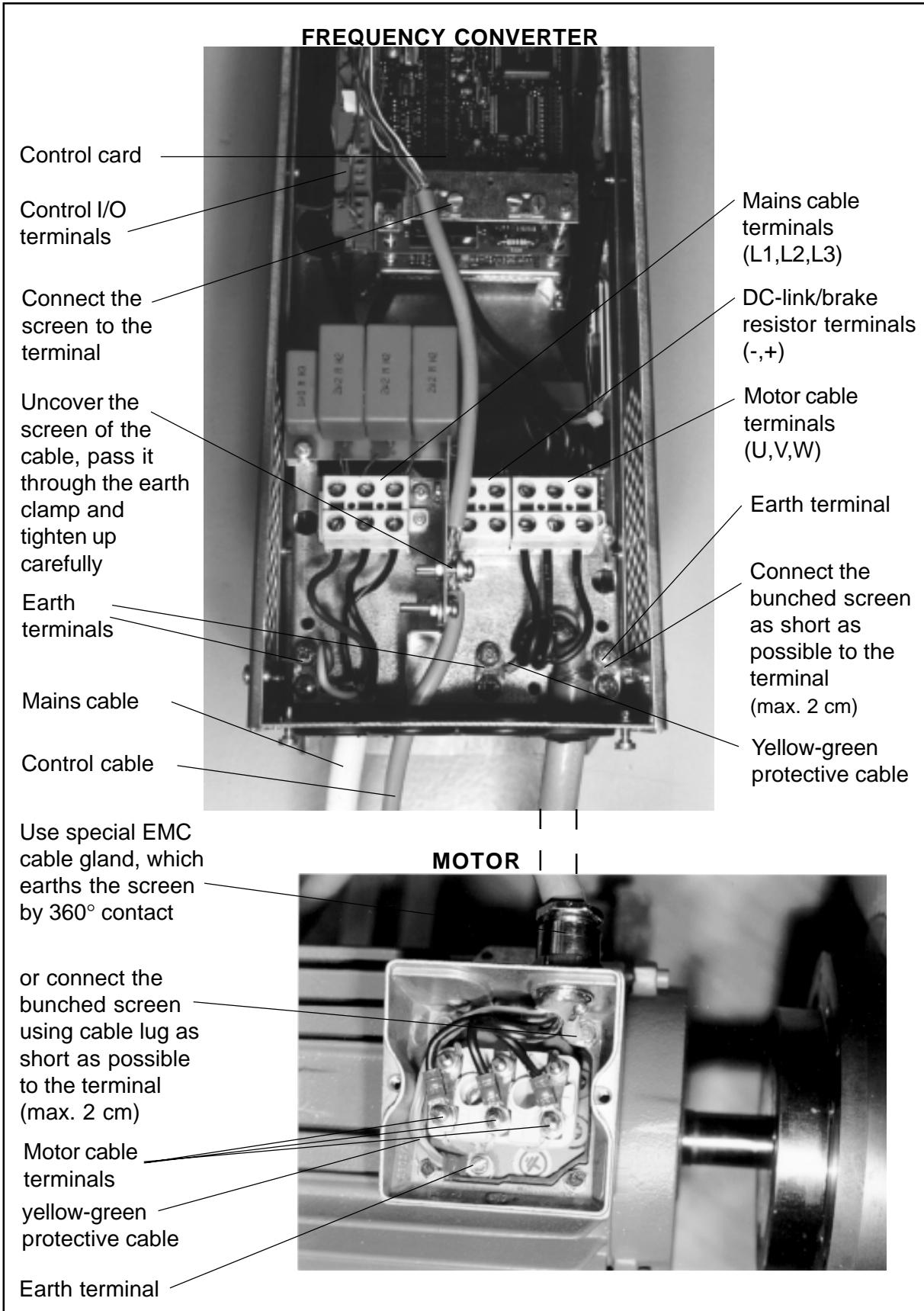

Figure 6.1.4-14 Cable assembly principle for 2.2—45 CXL4/CXL5 types (EMC level I).



6

Figure 6.1.4-15 Cable assembly principle in the frequency converter and in the motor for 2.2—45 CXL4/CXL5 types (EMC levels I and C).



6

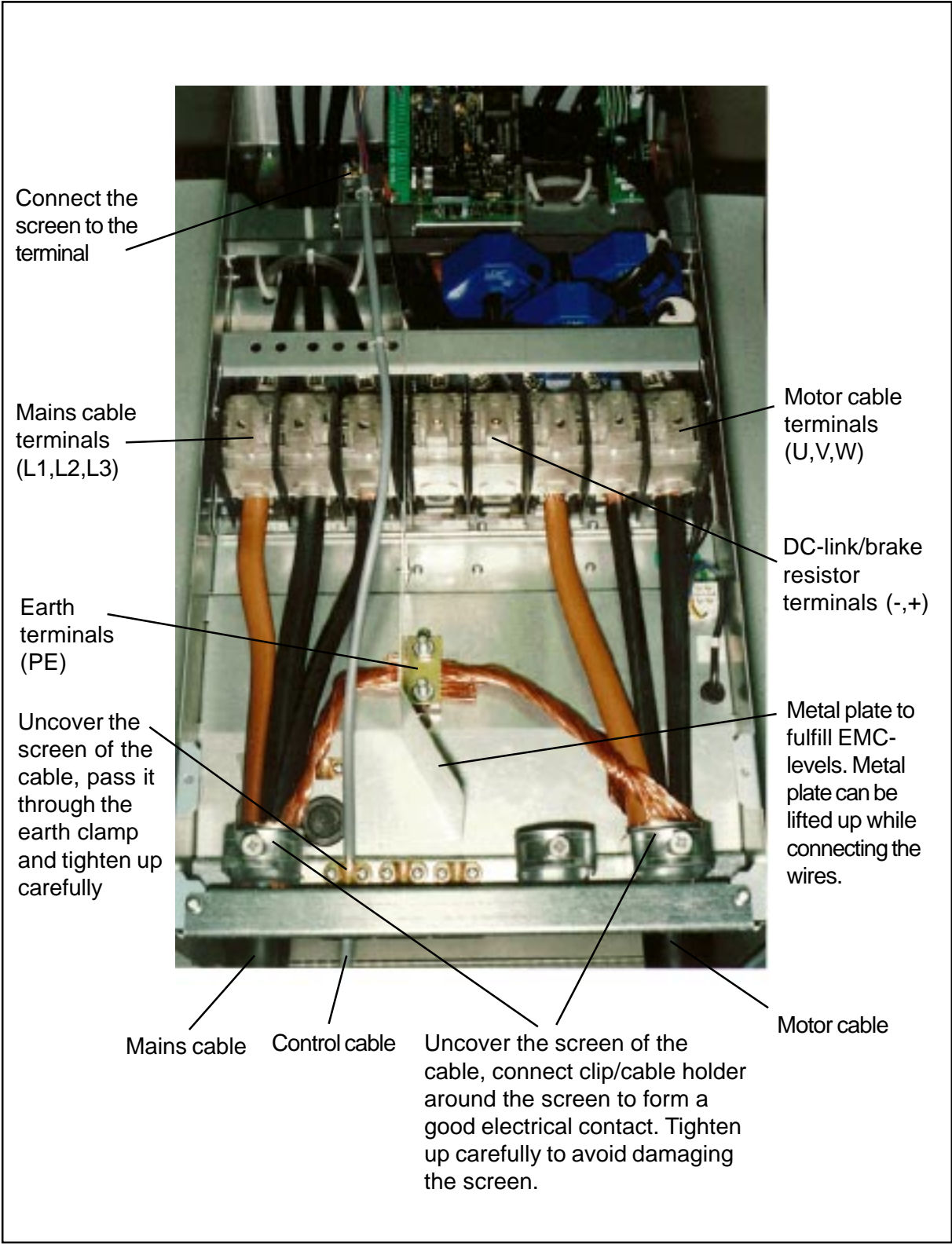

Figure 6.1.4-16 Cable assembly principle for 55—90 CXL4/CXL5 types (EMC levels I and C).

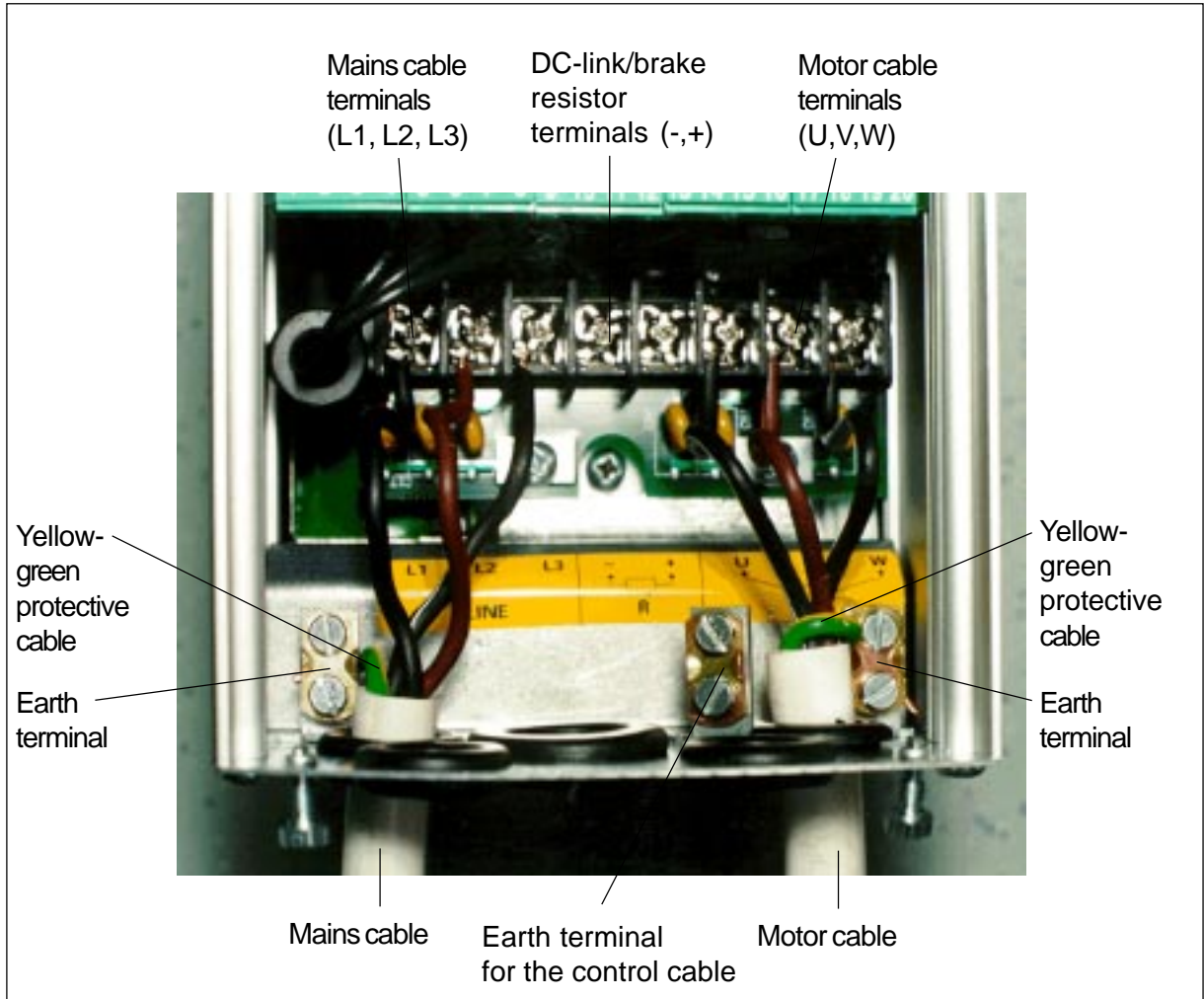

Figure 6.1.4-17 Cable assembly principle for 0.75—3 CXS5 types (EMC level N).

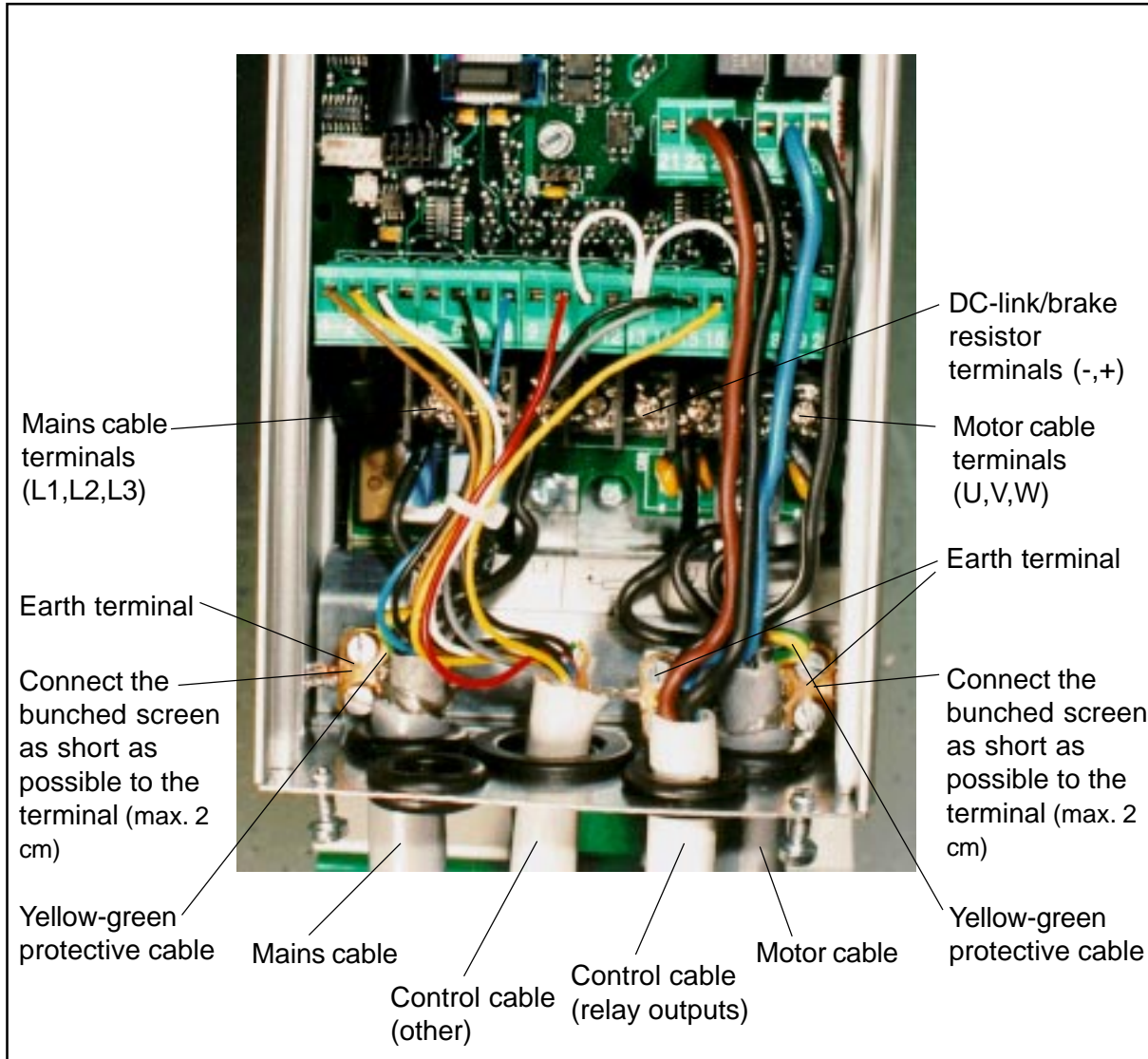
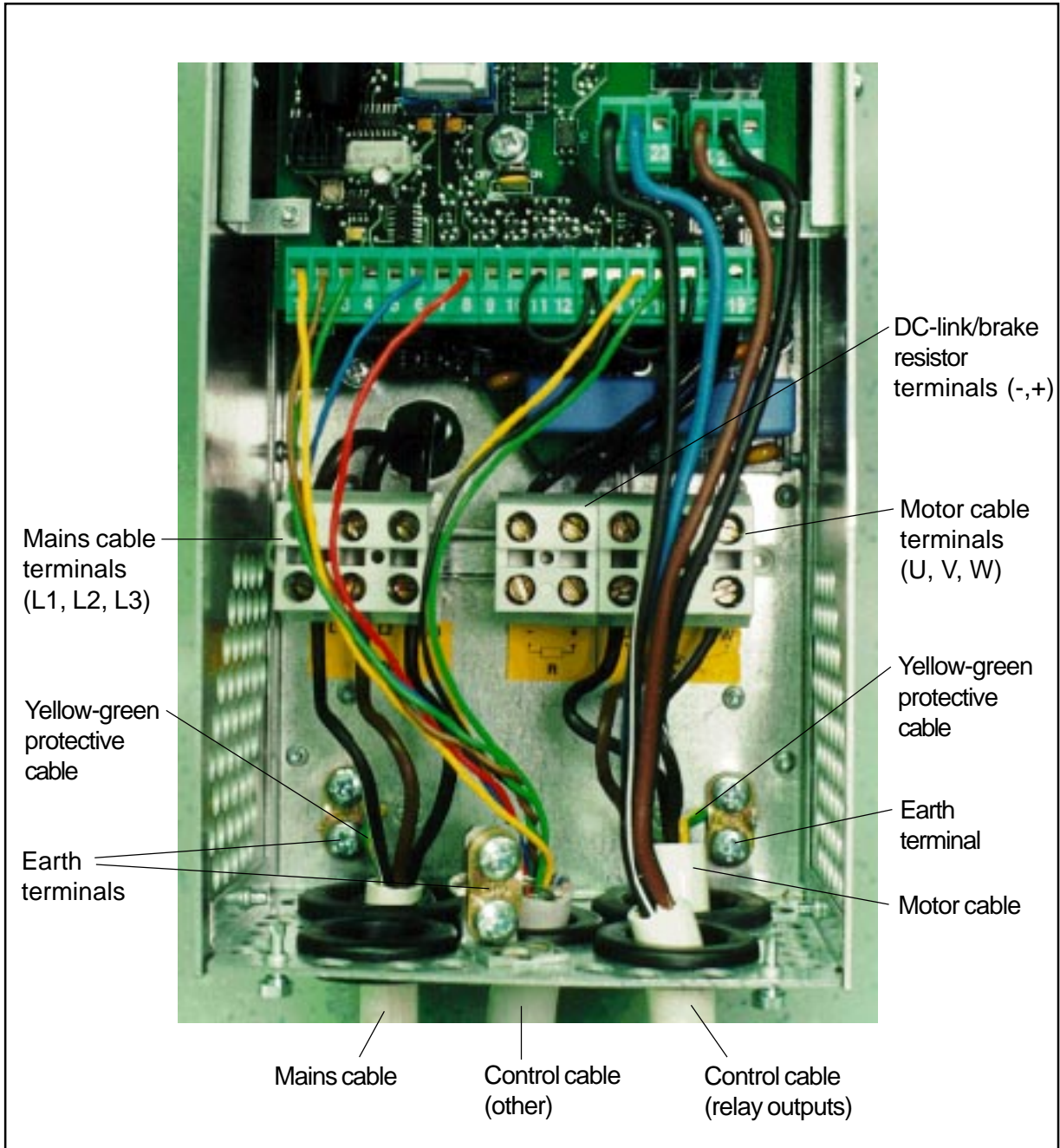

Figure 6.1.4-18 Cable assembly principle for 0.75—3 CXS4 (EMC level I and C), 0.75—3 CXS5 (EMC level I) and 0.55—1.5 CXS2 types (EMC level I and C).





6

Figure 6.1.4-19 Cable assembly principle for 4—11 CXS5 types (EMC level N).

6

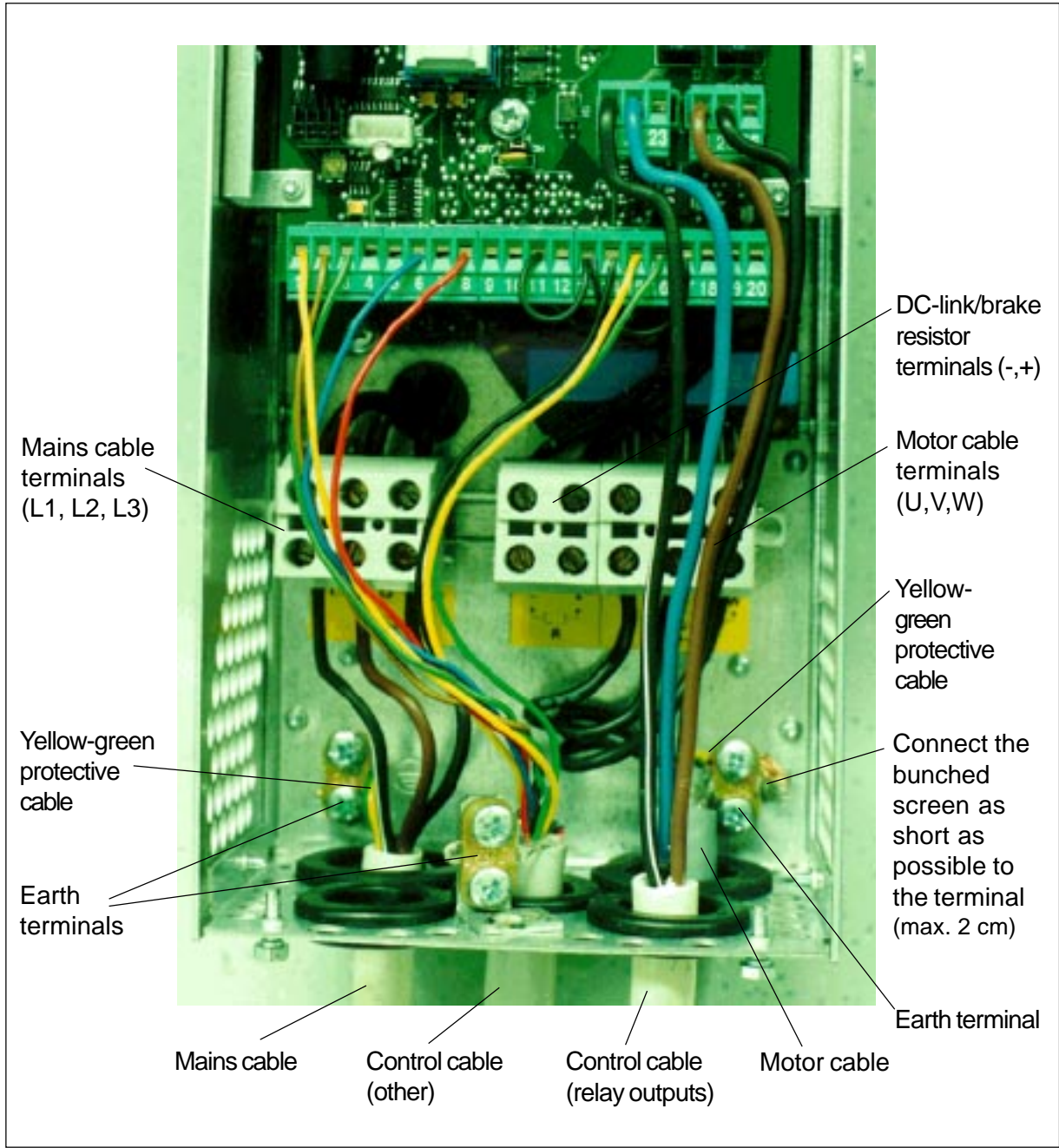
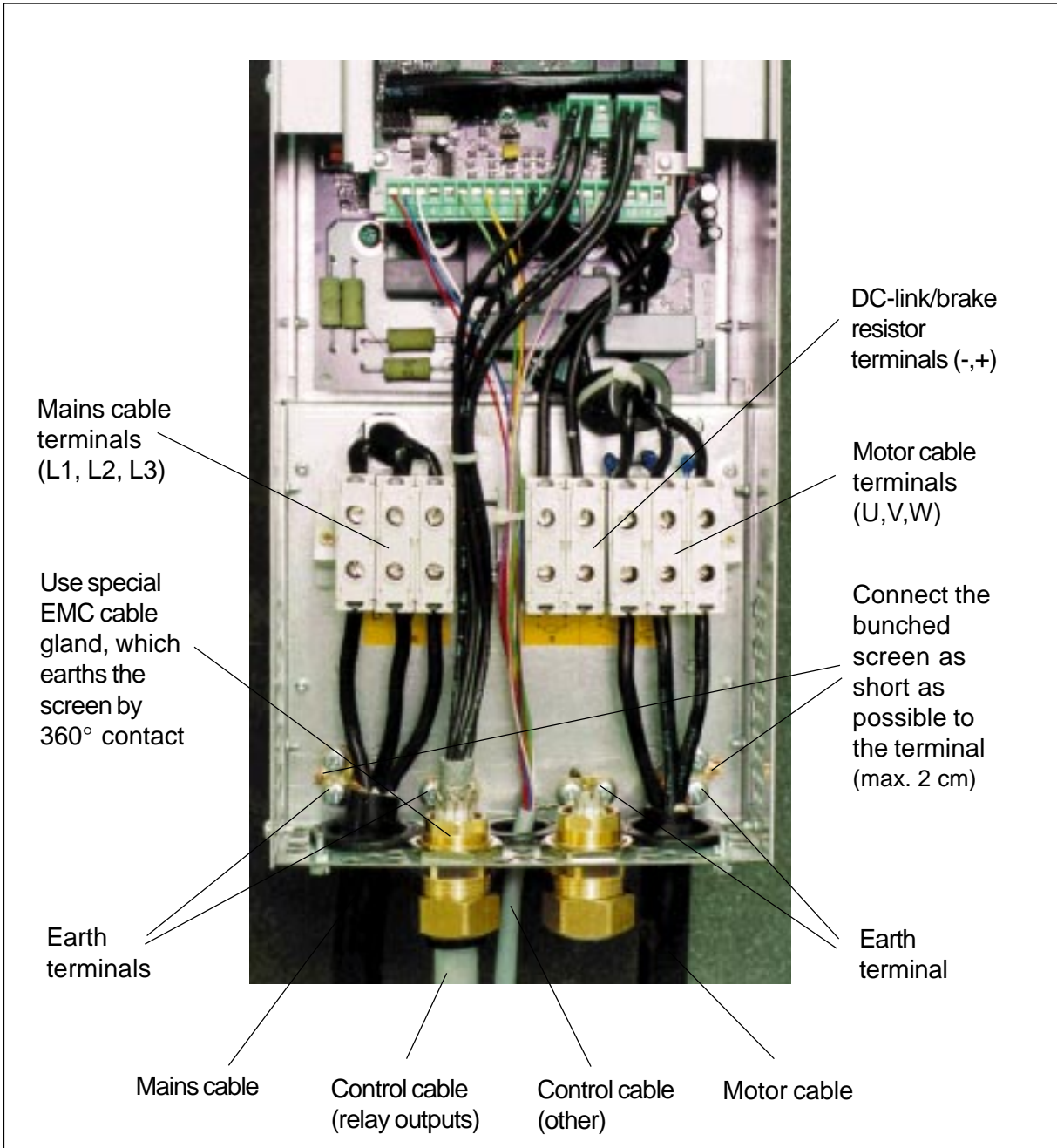

Figure 6.1.4-20 Cable assembly principle for 4—11CXS4 (EMC level I and C), 4—11 CXS5 (EMC level I) and 2.2—5.5 CXS2 types (EMC level I and C).



6

Figure 6.1.4-21 Cable assembly principle for 15—22CXS4 (EMC level I and C), 15—22 CXS5 (EMC level I) and 7.5—15 CXS2 types (EMC level I and C).

### 6.1.5 Cable and motor insulation checks

#### 1 Motor cable insulation checks

Disconnect the motor cable from the terminals U, V and W of the Vacon CX/CXL/CXS unit and from motor.

Measure the insulation resistance of the motor cable between each phase conductor and between each phase conductor and the protective ground conductor.

The insulation resistance must be  $>1\text{M}\Omega$ .

#### 2 Mains cable insulation checks

Disconnect the mains cable from the terminals L1, L2 and L3 of the Vacon CX/CXL/CXS unit and from mains.

Measure the insulation resistance of the mains cable between each phase conductor and between each phase conductor and the protective ground conductor.

The insulation resistance must be  $>1\text{M}\Omega$ .

#### 3 Motor insulation checks

Disconnect the motor cable from the motor and open the bridging connections in the motor connection box.

Measure the insulation resistance of each motor winding. The measurement voltage has to be at least equal to the mains voltage but not exceed 1000V.

The insulation resistance must be  $>1\text{M}\Omega$ .

### 6.2 Control connections

Basic connection diagram is shown in figure 6.2-1.

The functionality of the terminals for the Basic application is explained in Chapter 10.2. If one of the "Five in One+" applications is selected, check the application manual for the functionality of the terminals for that application.

#### 6.2.1 Control cables

The control cables should be at least 0.5 mm<sup>2</sup> screened multicore cables, see table 6.1-1. The maximum wire size fitting in the terminals is 2.5 mm<sup>2</sup>.

#### 6.2.2 Galvanic isolation barriers

The control connections are isolated from the mains potential and the I/O ground is connected to the frame of the device via a 1-M $\Omega$  resistor and 4,7-nF capacitor. The control I/O ground can also be connected directly to the frame by changing the jumper X4 to ON-position, see figure 6.2.2-1.

Digital inputs and relay outputs are isolated from the I/O ground.

Terminal		Function	Specification	
1	+10V <sub>ref</sub>	Reference voltage output	Burden max 10 mA *	
2	U <sub>in+</sub>	Analogue signal input	Signal range -10 V— +10 V DC	
3	GND	I/O ground		
4	I <sub>in+</sub>	Analogue signal (+input)	Signal range 0(4)—20 mA	
5	I <sub>in-</sub>	Analogue signal (-input)		
6	24V out	24V supply voltage	±20%, load max. 100 mA	
7	GND	I/O ground		
8	DIA1	Digital input 1	R <sub>i</sub> = min. 5 kΩ	
9	DIA2	Digital input 2		
10	DIA3	Digital input 3		
11	CMA	Common for DIA1—DIA3	Must be connected to GND or 24V of I/O- terminal or to external 24V or GND	
12	24V out	24V supply voltage	Same as # 6	
13	GND	I/O ground	Same as # 7	
14	DIB4	Digital input 4	R <sub>i</sub> = min. 5 kΩ	
15	DIB5	Digital input 5		
16	DIB6	Digital input 6		
17	CMB	Common for DIB4 — DIB6	Must be connected to GND or 24V of I/O- terminal or to external 24V or GND	
18	I <sub>out+</sub>	Analogue signal (+output)	Signal range 0(4)—20 mA,	
19	I <sub>out-</sub>	Analogue ground (-output)	R <sub>L</sub> max. 500 Ω	
20	DO1	Open collector output	Transistor output, max. U <sub>in</sub> = 48 VDC max. current 50 mA	
21	RO1/1		Relay output 1	Max. switch. voltage 250 VAC, 300 VDC Max switch. current 8 A / 24 VDC, 0.4 A / 250 VDC
22	RO1/2			
23	RO1/3			
24	RO2/1		Relay output 2	Max. switch. power <2 kVA / 250 VAC Max. cont. current <2 A rms
25	RO2/2			
26	RO2/3			

Figure 6.2-1 Control I/O-terminal signals.

\* If the potentiometer reference is used, potentiometer R = 1—10 kΩ



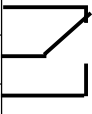
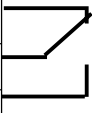
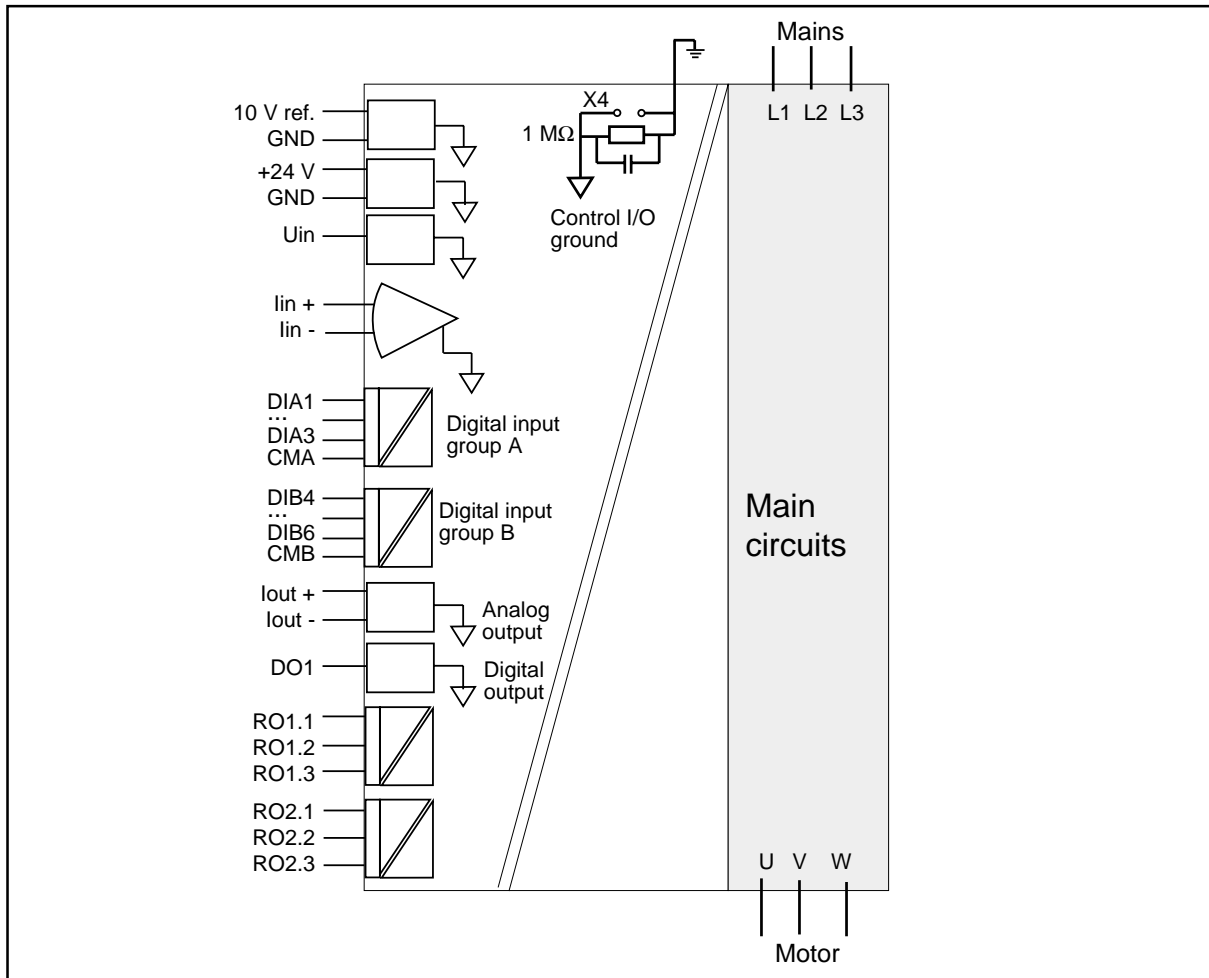

Figure 6.2.2-1 Isolation barriers.

6

### 6.2.3 Digital input function inversion

The active signal level of the digital input logic depends on how the common input (CMA, CMB) of the input group has been connected. The connection can be either to +24 V or to ground. See figure 6.2.3-1.

The +24V or ground for the digital inputs and common terminals (CMA, CMB) can be either external or internal (terminals 6 and 12 of the frequency converter).

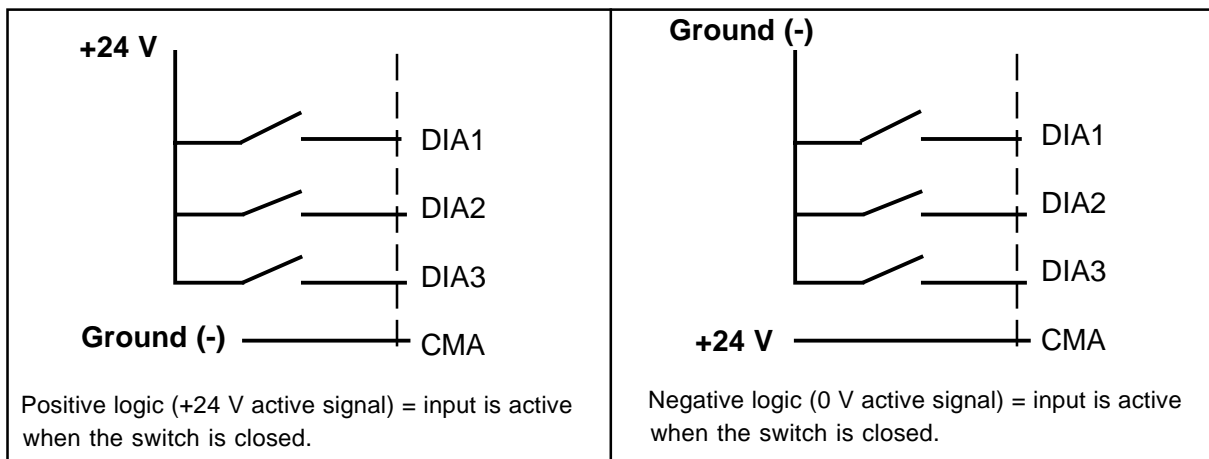



Figure 6.2.3-1 Positive/negative logic.

## 7. CONTROL PANEL

### 7.1 Introduction

The control panel of the CX/CXL/CXS drive features an Alphanumeric Display with seven indicators for the Run status (RUN, , , READY, STOP, ALARM, FAULT) and two indicators for the control source (Panel/Remote). Furthermore, the panel embodies three text lines for the menu location, menu/submenu descriptions and the amount of the submenus or the value of the monitored item. The eight push buttons

on the control panel are used for the control of the frequency converter, parameter setting and value monitoring.

The panel is detachable and isolated from the input line potential.

The display examples in this chapter present the text and numeric lines of the Alphanumeric Display only. The Run status indicators are not included in the examples.

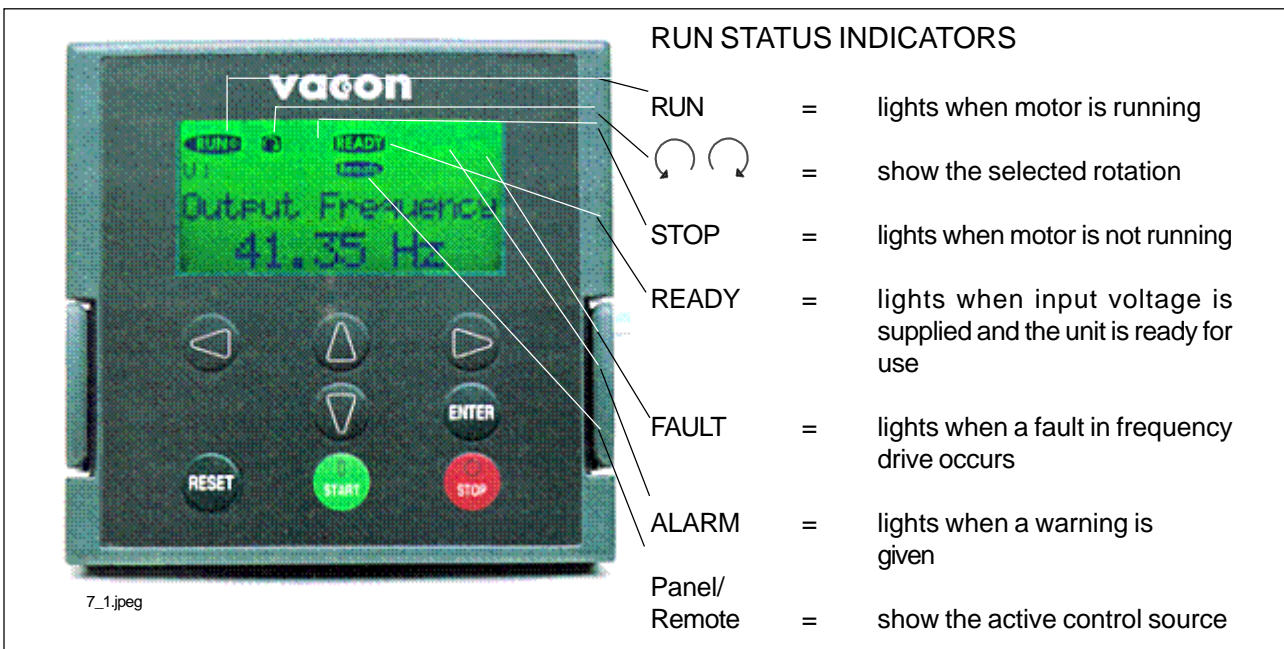









Figure 7-1. Control panel with LCD display.

-  = Menu button (left)  
Move backward in the menu
-  = Menu button (right)  
Move forward in the menu
-  = Browser button (up)  
Move in the main menu and between pages inside the same submenu. Change value.
-  = Browser button (down)  
Move in the main menu and between pages inside the same submenu. Change value.
-  = Enter button  
Acknowledgement of changed value. Fault history reset. Function as programmable button.
-  = Reset button  
Fault resetting
-  = Start button  
Starts the motor if the panel is the active control source
-  = Stop button  
Stops the motor if the panel is the active control source

### 7.2 Control panel operation

The data on the panel are arranged in menus and submenus. The menus are used for the display and editing of measurement and control signals, parameter settings, reference values, and fault displays. Through the menus, you can also adjust the contrast of the display and use the programmable buttons.

The symbol **M** on the first text line stands for the main menu. It is followed by a number that refers to the submenu in question. See the CX/CXL/CXS User's Manual and the Application Manual for the specific parameters available for the needed CX/CXL/CXS setup. The arrow (→) in the lower right corner indicates a further submenu that can be entered by pushing the *Menu button (right)*.

The desired submenu can be entered from the main menu by using the *Menu buttons*.

7

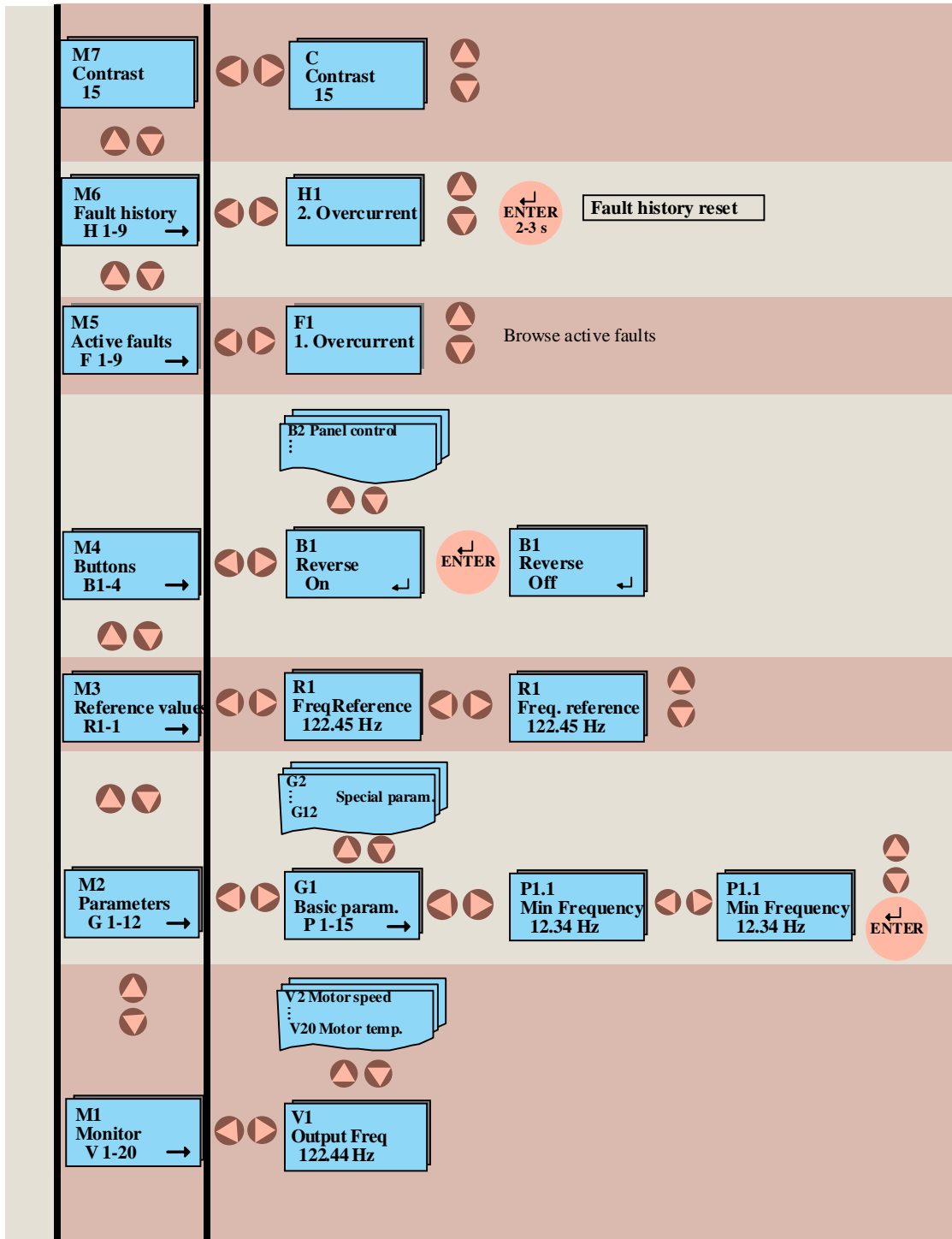

Figure 7-2. Panel operation

7\_2.fh8

### 7.3 Monitoring menu

The monitoring menu can be entered from the main menu by pushing the *Menu button* (right) when the symbol **M1** is visible on the first line of the alpha-numeric display. How to browse through the monitored values is presented in Figure 7-3. All monitored

signals are listed in Table 7-1. The values are updated once every 0.5 seconds. This menu is meant only for signal checking. The values cannot be altered here. See 7.4 Parameters.

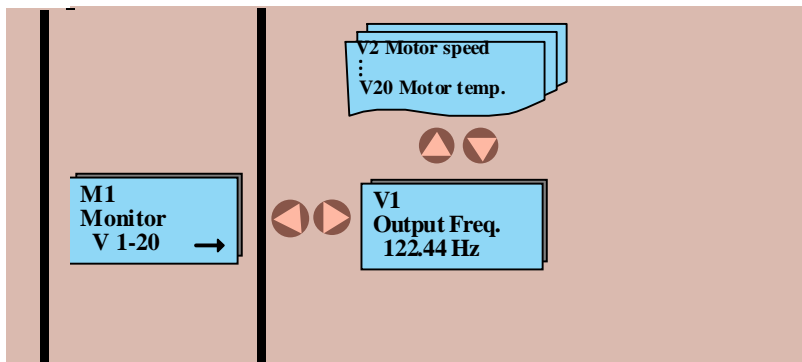

Figure 7-3. Monitoring menu

7\_3.fl8

Code	Signal name	Unit	Description
V1	Output frequency	Hz	Frequency to the motor
V2	Motor speed	rpm	Calculated motor speed
V3	Motor current	A	Measured motor current
V4	Motor torque	%	Calculated actual torque/nominal torque of the unit
V5	Motor power	%	Calculated actual power/nominal power of the unit
V6	Motor voltage	V	Calculated motor voltage
V7	DC-link voltage	V	Measured DC-link voltage
V8	Temperature	°C	Heat sink temperature
V9	Operating day counter	DD.dd	Operating days <sup>1</sup> , not resettable
V10	Operating hours, trip counter	HH.hh	Operating hours <sup>2</sup> , can be reset with programmable button #3
V11	MW hours counter	MWh	Total MWh, not resettable
V12	MW hours, trip counter	MWh	Resettable with programmable button #4
V13	Voltage/analog input	V	Voltage of terminal U <sub>in+</sub> (term. #2)
V14	Current/analog input	mA	Current of terminals I <sub>in+</sub> and I <sub>in-</sub> (term. #4, #5)
V15	Digital input status, gr. A		See Page 63
V16	Digital input status, gr. B		See Page 63
V17	Digital and relay output status		See Page 63
V18	Control program		Version number of the control software
V19	Unit nominal power	kW	Unit power size of the unit
V20	Motor temperature rise	%	100% = nominal motor temperature has been reached

Table 7-1. Monitored signals

<sup>1</sup>DD = full days, dd = decimal part of day

<sup>2</sup>HH = full hours, hh = decimal part of hour

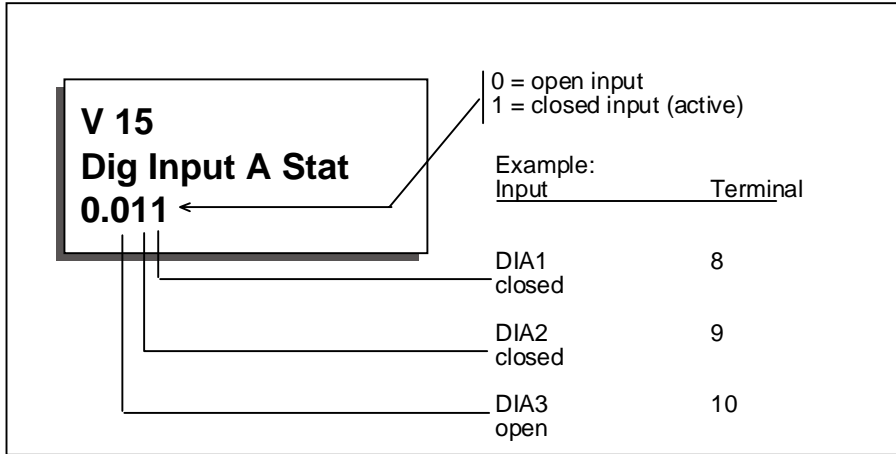

Figure 7-4. Digital inputs, Group A status.

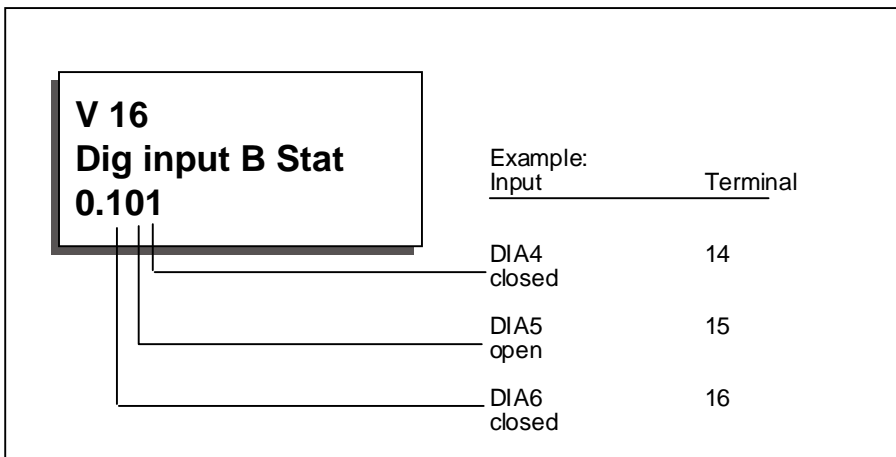

Figure 7-5. Digital inputs, Group B status.

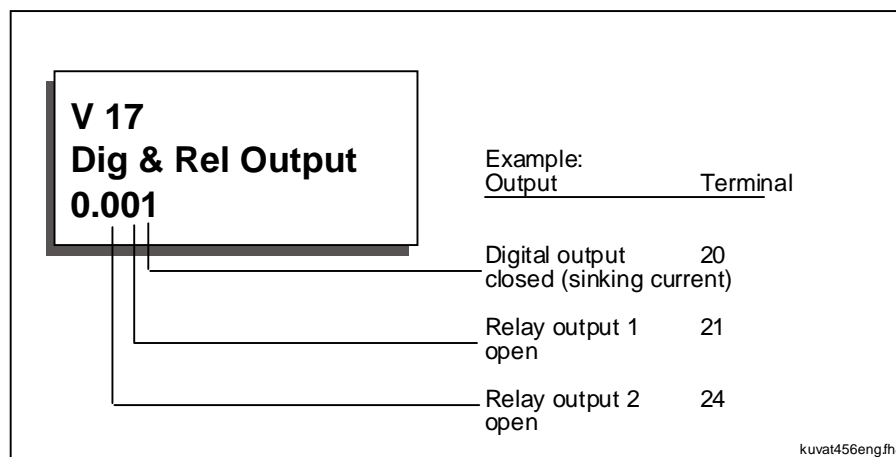

Figure 7-6. Output signal status.

7

7.4 Parameters

The parameter menu can be entered from the main menu by pushing the *Menu button (right)* when the symbol **M2** is visible on the first line of the alpha-numeric display. Parameter values are changed as shown in Figure 7-7:

Push the *Menu button (right)* once to move into the Parameter Group Menu (G) and twice to enter the desired parameter group and the parameters there. Locate the parameter you want to change by using the *Browser buttons*. Push the *Menu button (right)* once again to enter the Edit menu. Once you are in the edit menu, the symbol of the parameter starts to blink. Set the desired new value with the *Browser buttons* and confirm the change by pushing the Enter button. Consequently, the blinking stops and the new value is visible in the value field. The value will not change unless the Enter button is pushed. You can go back in the menu by pressing the *Menu button (left)*.

Several parameters are locked, i.e. uneditable, when the drive is in RUN status. If you try to change the value of such a parameter, the text *\*locked\** will appear on the display.

In the Edit menu when a parameter receiving text values (e.g. Param. 1.16: 0=Parameter changes enabled; 1=Parameter changes disabled) is displayed, it is possible to view the numerical value corresponding to the text value by pressing the *Menu button (right)*. The numerical value remains visible as long as the menu button is held down. You can browse through the numerical values by pressing the *Browser buttons* at the same time with the menu button.

You can return to the main menu anytime by pressing the *Menu button (left)* for 1–2 seconds.

The basic application embodies only those parameters necessary for operating the device (Group 1). The parameter group 0 includes the parameter for selection of "Five In One+" applications. See Chapter 11 of the CX/CXL/CXS User's Manual.

Other applications include more parameter groups.

Once in the last parameter of a parameter group, you can move directly to the first parameter of that group by pressing the *Browser button (up)*.

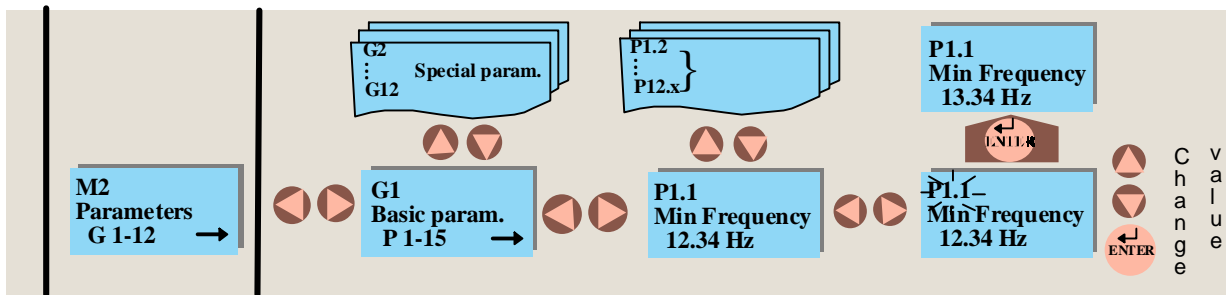

Figure 7-7. Parameter value change procedure

7\_7.fn8

### 7.5 Reference menu

The Reference menu can be entered from the main menu by pushing the *Menu button (right)* when the symbol **M3** is visible on the first line of the alpha-numeric panel.

The frequency reference can be changed by changing the value on the display with the *Browser buttons*. See *Figure 7-8*.

Press the *Menu button (right)* once and the symbol **R1** starts to blink. Now, you are able to alter the frequency reference value with the *Browser buttons*. Pressing the *Enter*

*button* is not necessary. Motor speed changes as soon as the frequency reference changes or the load inertia allows the motor to accelerate or decelerate.

In some applications, there might be several references. In this case, pressing the *Menu button (right)* once brings you to the menu where you can choose (with the *Browser buttons*) the reference you wish to change. Another push on the button takes you to the editing menu.

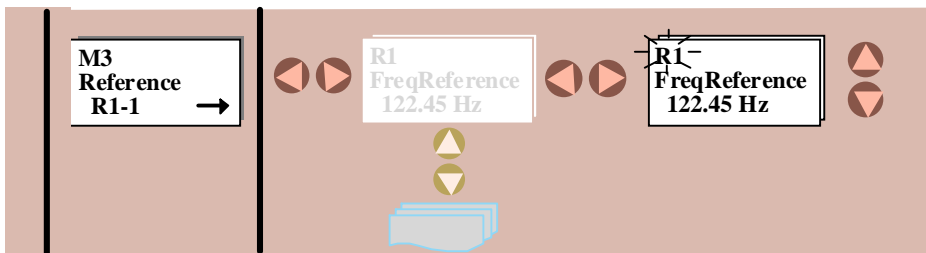

Figure 7-8. Reference setting on the control panel

7\_8.ft8

### 7.6 Programmable push-button menu

The programmable push-button menu can be entered from the main menu by pushing the *Menu button (right)* when the symbol **M4** is visible on the first line of the Alpha-numeric display.

In this menu, there are four functions that can be attached to the *Enter button*. Each function has two positions: On and Off. The functions are available in this menu only. In other menus, the *Enter button* is used for its original purpose. The status of the controlled

function is shown through a feedback signal. Enter the edit menu with the *Menu button (right)*. The function attached to the button is controlled with the *Enter button*. When the Enter button is pushed, the Enter symbol (↵) on the display inverts and the feedback value (On/Off) changes confirming the status change. The Enter symbol remains inverted as long as the Enter button is held down. See Figure 7-9.

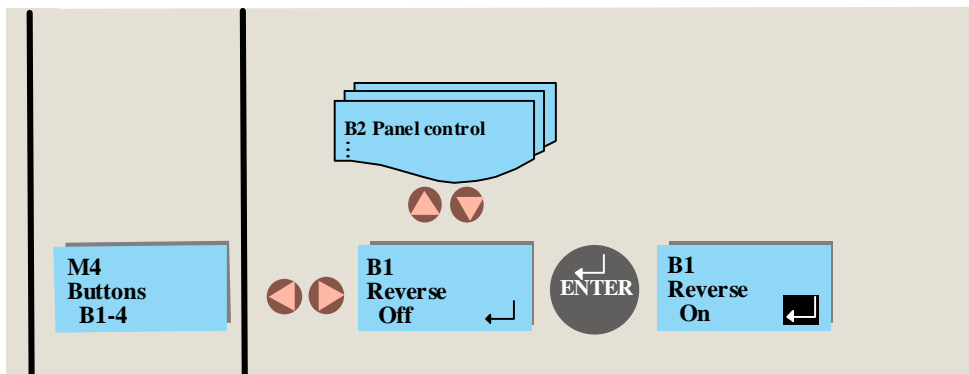

Figure 7-9. Programmable push-button

7\_9.fn8



Button number	Button description	Function	Feedback information		
			0	1	Note
B1	Reverse	Changes the rotation direction of the motor. Available only when the control panel is the active control source	Forward	Backward	Feedback information flashes as long as the direction is different from the reference.
B2	Active control source	Selection between I/O terminals and control panel	Control via I/O terminals	Control from the panel	
B3	Operating hours, trip counter; Reset	Resets the operating hours trip counter when pushed	No resetting	Reset of the operating hours trip counter	
B4	MWh counter, reset	Resets the MWh trip counter when pushed	No resetting	Reset of the MWh trip counter	

Table 7-2. Programmable push-button descriptions



### 7.7 Active faults menu

The Active faults menu can be entered from the main menu by pushing the *Menu button (right)* when the symbol **M5** is visible on the first line of the alpha-numeric display as shown in Figure 7-10.

active faults can be browsed with the *Browser buttons*.

The display can be cleared with the *Reset button* and the read-out will return to the same display it had before the fault trip.

When a fault brings the frequency converter to a stop, the fault symbol **F**, the ordinal number of the fault, the fault code and a short description of the fault are displayed. In addition, the indication **FAULT** will appear on the first line of the display. If there are several faults at the same time, the list of

The fault remains active until it is cleared with the Reset button or with a reset signal from the I/O terminal.

**Note!** Remove external Start signal before resetting the fault to prevent unintended re-start of the drive.



Figure 7-10. Active faults menu

7\_10.fh8

7

Fault codes	Fault	Possible cause	Checking
F1	Overcurrent	The frequency converter has measured too high a current (>4*In) in the motor output: - sudden heavy load increase - short circuit in the motor cables - unsuitable motor	Check loading Check motor size Check cables
F2	Overvoltage	The voltage of the internal DC-link of the frequency converter has exceeded the nominal voltage by 35% - deceleration time is too fast - high overvoltage spikes at utility	Adjust the deceleration time
F3	Ground fault	Current measurement detected that the sum of the motor phase current is not zero - insulation failure in the motor or the cables	Check the motor cables
F4	Inverter fault	The frequency converter has detected faulty operation in the gate drivers or IGBT bridge - interference fault - component failure	Reset the fault and restart again. If the fault occurs again contact your Vacon distributor.
F5	Charging switch	Charging switch open when START command active - interference fault - component failure	Reset the fault and restart again. If the fault occurs again contact your Vacon distributor.
F9	Undervoltage	DC-bus voltage has gone below 65% of the nominal voltage - most common reason is failure of the utility supply - internal failure of the frequency converter can also cause an undervoltage trip	In case of temporary supply voltage break, reset the fault and start again. Check utility input. If utility supply is correct and internal failure has occurred. Contact your Vacon distributor.
F10	Input line supervision	Input line phase is missing	Check the utility connection
F11	Output phase supervision	Current measurement has detected that there is no current in one motor phase	Check motor cables
F12	Brake chopper supervision	- brake resistor not installed - brake resistor broken - brake chopper broken	Check brake resistor - If resistor is OK the chopper is broken. Contact your Vacon distributor
F13	Drive undertemperature	Temperature of heat sink below -10°C	

Table 7-3. Fault codes (continues on next page)

Fault codes	Fault	Possible cause	Checking
F14	Drive overtemperature	Temperature of heat sink over 90°C (CXS series) Temperature of heat sink over 77°C (CX/CXL series up to 75 kW) Temperature of heat sink over 70°C (CX/CXL series from 90 kW)	- Check the cooling air flow - Check that the heat sink is not dirty - Check ambient temperature - Check that the switching frequency is not too high compared with ambient temperature and motor load
F15	Motor stalled	The motor stall protection has tripped	- Check the motor
F16	Motor overtemperature	The frequency converter motor temperature model has detected motor overheat - motor is overloaded	Decrease motor load. Check the temperature model parameters if the motor was not overheated
F17	Motor underload	The motor underload protection has tripped	
F18	Analogue input polarity fault or analogue input hardware fault	Wrong analogue input polarity Component failure on control board	Check the polarity of the analogue input. Contact your Vacon distributor.
F19	Option board identification	Reading of the option board has failed	Check the installation - If installation is correct, contact your Vacon distributor
F20	10 V voltage reference	+10 V reference shorted on control board or option board	Check the cabling from +10 V reference voltage
F21	24 V supply	+24 V supply shorted on control board or option board	Check the cabling from +24 V reference voltage
F22 F23	EEPROM checksum fault	Parameter restoring error - interference fault - component failure	When the fault is reset the frequency drive will automatically load parameter default settings. Check all parameter settings after reset. If the fault occurs again contact your Vacon distributor
F25	Microprocessor watchdog	- interference fault - component failure	Reset the fault and restart. If the fault occurs again contact your Vacon distributor
F26	Panel communication error	The connection between panel and the frequency converter is not working	Check the panel cable
F29	Thermistor protection	Thermistor input of the I/O expander board has detected increase of the motor temperature	- Check motor cooling and loading - Check thermistor connection (If thermistor input of the I/O expander board is not in use it has to be short circuited)
F36	Analog input $I_{in} < 4\text{mA}$ (signal range selected 4-20 mA)	The current in the analog input $I_{in}$ is below 4 mA - signal source has failed - control cable is broken	Check the current loop circuitry
F41	External fault	Fault is detected in external fault digital input	Check the external fault circuit or device

Table 7-3. Fault codes (cont.)

### 7.8 Active warning display

When a warning occurs, a text with a symbol **A#** appears on the display. In addition, the indication ALARM will appear in the top right corner of the display. Warning codes are explained in Table 7-4.

The display does not have to be cleared in any special way.

The warning on the display does not disable the normal functions of the push buttons.

Code	Warning	Checking
<b>A15</b>	Motor stalled (Motor stall protection)	Check motor
<b>A16</b>	Motor overtemperature (Motor thermal protection)	Decrease motor loading
<b>A17</b>	Motor underload (Warning can be activated in Five In One applications)	Check motor loading
<b>A24</b>	The values in the Fault History, MWh counters or operating day/hour counters might have been changed in the previous mains interruption.	No actions necessary. Take a critical attitude to these values.
<b>A28</b>	The change of application has failed.	Choose the application again and push the Enter button.
<b>A30</b>	Unbalance current fault; the load of the segments is not equal.	Contact your Vacon distributor.
<b>A45</b>	The frequency converter overtemperature warning; Overtemperature trip limit minus 5 degrees. See Table 7-3: F14	Check the cooling air flow and the ambient temperature.
<b>A46</b>	Reference warning; the current of input $I_{in+} < 4$ mA (Warning can be activated in Five in One applications)	Check the current loop circuitry.
<b>A47</b>	External warning; (Warning can be activated in Five-InOne applications)	Check the external fault circuit or device.

Table 7-4. Warning codes

### 7.9 Fault history menu

The fault history menu can be entered from the main menu by pushing the *Menu button (right)* when the symbol **M6** is displayed on the first line of the alpha-numeric panel.

The memory of the frequency converter can store the maximum of 9 faults in the order of appearance. The latest fault has the number

1, the second latest number 2 etc. If there are 9 uncleared faults in the memory, the next fault will erase the oldest from the memory.

Pressing the *Enter button* for about 2...3 seconds resets the whole fault history. Then, the symbol H# will change for 0.

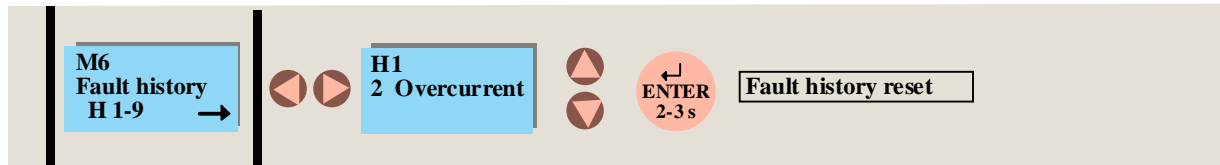

Figure 7-11. Fault history menu

7\_11.fn8

### 7.10 Contrast menu

In case the display is unclear you can adjust the its contrast.

The contrast menu can be entered from the main menu by pushing the *Menu button (right)* when the symbol **M7** is visible on the first line of the alpha-numeric display.

Use the *Menu button (right)* to enter the edit menu. You are in the edit menu when the symbol **C** starts to blink. Then change the contrast using the *Browser buttons*. The changes take effect immediately.

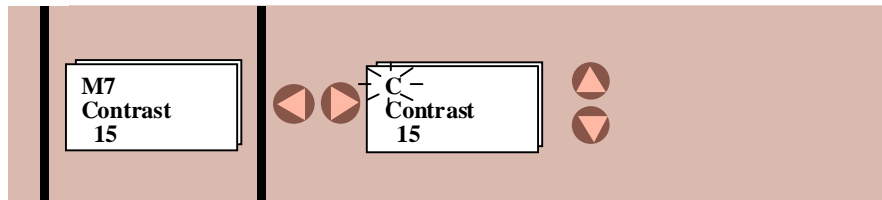

Figure 7-12. Contrast setting

7\_12.fn8



## 7.11 Controlling the motor from the control panel

The CX/CXL/CXS can be controlled from either the I/O terminals or the control panel. The active control source can be changed with the programmable push button b2 (see chapter 7.6). The motor can be started, stopped and the direction of rotation can be changed from the active control source.

### 7.11.1 Control source change from I/O terminals to the control panel

After changing the control source the motor stops. The direction of rotation remains the same as with I/O control.

If the Start button is pushed at the same time as the programmable push button B2, the Run state, direction of rotation and reference value will be copied from the I/O terminals to the control panel.

### 7.11.2 Control source change from the control panel to the I/O terminals



After changing the control source, the I/O terminals determine the run state, direction of rotation and reference value.

If motor potentiometer is used in the application, the panel reference value can be copied for a value of motor potentiometer reference by pushing the start button at the same time as the programmable push button B2. Motor potentiometer function mode must be "resetting at stop state" (Local/Remote Application: param. 1. 5 =4, Multi-purpose Application : param. 1. 5 = 9).

## 8 COMMISSIONING

### 8.1 Safety precautions

*Before the commissioning, observe the following warnings and instructions:*

	<b>1</b>	Internal components and circuit boards (except the isolated I/O terminals) are at mains potential when the Vacon frequency converter is connected to the mains. This voltage is extremely dangerous and may cause death or severe injury if you come in contact with it.
	<b>2</b>	When the Vacon frequency converter is connected to the mains, the motor connections U, V, W and DC-link / brake resistor connections -,+ are live even if the motor is not running.
	<b>3</b>	Do not make any connections when the Vacon frequency converter is connected to the mains.
	<b>4</b>	After disconnecting the mains, wait until the cooling fan on the unit stops and the indicators in the panel are turned off (if no panel is used check the indicators on the cover). Wait at least 5 minutes before doing any work on Vacon frequency converter connections. Do not even open the cover before this time has run out.
	<b>5</b>	The control I/O terminals are isolated from the mains potential but the relay outputs and other I/O:s (if jumper X4 is in OFF position, see fig. 6.2.2-1) may have a dangerous voltage connected even if the power is disconnected from the Vacon frequency converter.
	<b>6</b>	Before connecting the mains make sure that the cover of the Vacon frequency converter is closed.

### 8.2 Sequence of operation

**1** Read and follow the safety precautions

**2** After installation ensure that:

- the frequency converter and motor are connected to ground.
- the mains and motor cables are comply with the installation and connection instructions (chapter 6.1).
- control cables are located as far as possible from the power cables (table 6.1.4-1), shields of the control cables are connected to the protective earth and wires do not have contact with any electrical components in the device.
- the common input of digital input groups is connected to +24 V or ground of the I/O-terminal or external supply

- 3 Check the quantity and quality of the cooling air (chapters 5.1 and 5.2).
- 4 Check that moisture has not condensed inside the frequency converter.
- 5 Check that all Start/stop switches connected to the I/O terminals are in **Stop** position.
- 6 Connect the Vacon frequency converter to the mains and switch the power ON.
- 7 Ensure that the parameters of the Group 1 match the application.

Set the following parameters to match the motor nameplate:

- nominal voltage of the motor
- nominal frequency of the motor
- nominal speed of the motor
- nominal current of the motor
- supply voltage

See values on the rating plate of the motor.





## 8 Start-up test without the motor

Make either test A or B:

**A Controls from the I/O terminals:**

- turn Start/Stop switch to ON position
- change the frequency reference
- check in the control panel's Monitoring menu that the output frequency follows the frequency reference
- turn Start/Stop switch to position OFF

**B Controls from the Control Panel:**

- change controls from the I/O terminals to the Control Panel with the programmable button #2, see Chapter 7.6.
- push the Start button 
- go to the Reference menu and change the frequency reference with the buttons  and , see Chapter 7.5
- go to the Monitoring menu and check that the output frequency follows the reference, see Chapter 7.3.
- push the Stop button 

- 9** If possible, make a start-up test with a motor which is not connected to the process. If the inverter has to be tested on a motor connected to the process, ensure it is safe to be powered up. Inform your co-workers about the tests.
- switch the mains OFF and wait until the Vacon frequency converter has powered down according to Chapter 8.1/ point 4
  - connect the motor cable to the motor and the power terminals of the Vacon frequency converter
  - check that all start/stop switches connected to the I/O terminals are in OFF position
  - switch the mains ON
  - repeat the test **A** or **B** of the start-up test #8.
- 10** Connect the motor to the process (if the previous tests were done without the process)
- ensure that the inverter is safe to be powered up
  - inform your co-workers about the tests.
  - repeat the test **A** or **B** of the start-up test #8.



## 9 FAULT TRACING

When a fault brings the frequency converter to a stop, the fault symbol **F**, the ordinal number of the fault, the fault code and a short description of the fault are displayed. The fault can be cleared with the RESET button or via the I/O terminal. The faults are stored in the fault history which can be browsed (see chapter 7.7). The fault codes are explained in table 9-1.

Fault codes	Fault	Possible cause	Checking
F1	Overcurrent	The frequency converter has measured too high a current ( $>4 \cdot I_n$ ) in the motor output: - sudden heavy load increase - short circuit in the motor cables - unsuitable motor	Check loading Check motor size Check cables
F2	Overvoltage	The voltage of the internal DC-link of the frequency converter has exceeded the nominal voltage by 35% - deceleration time is too fast - high overvoltage spikes at utility	Adjust the deceleration time
F3	Ground fault	Current measurement detected that the sum of the motor phase current is not zero - insulation failure in the motor or the cables	Check the motor cables
F4	Inverter fault	The frequency converter has detected faulty operation in the gate drivers or IGBT bridge - interference fault - component failure	Reset the fault and restart again. If the fault occurs again contact your Vacon distributor.
F5	Charging switch	Charging switch open when START command active - interference fault - component failure	Reset the fault and restart again. If the fault occurs again contact your Vacon distributor.
F9	Undervoltage	DC-bus voltage has gone below 65% of the nominal voltage - most common reason is failure of the utility supply - internal failure of the frequency converter can also cause an undervoltage trip	In case of temporary supply voltage break, reset the fault and start again. Check utility input. If utility supply is correct and internal failure has occurred. Contact your Vacon distributor.
F10	Input line supervision	Input line phase is missing	Check the utility connection
F11	Output phase supervision	Current measurement has detected that there is no current in one motor phase	Check motor cables
F12	Brake chopper supervision	- brake resistor not installed - brake resistor broken - brake chopper broken	Check brake resistor - If resistor is OK the chopper is broken. Contact your Vacon distributor
F13	Drive undertemperature	Temperature of heat sink below $-10^{\circ}\text{C}$	

Table 9-1 Fault codes. (continues on the next page...)

Fault codes	Fault	Possible cause	Checking
F14	Drive overtemperature	Temperature of heat sink over 90°C (CXS series) Temperature of heat sink over 77°C (CX/CXL series up to 75 kW) Temperature of heat sink over 70°C (CX/CXL series from 90 kW)	- Check the cooling air flow - Check that the heat sink is not dirty - Check ambient temperature - Check that the switching frequency is not too high compared with ambient temperature and motor load
F15	Motor stalled	The motor stall protection has tripped	- Check the motor
F16	Motor overtemperature	The frequency converter motor temperature model has detected motor overheat - motor is overloaded	Decrease motor load. Check the temperature model parameters if the motor was not overheated
F17	Motor underload	The motor underload protection has tripped	
F18	Analogue input polarity fault or analog input hardware fault	Wrong analogue input polarity Component failure on control board	Check the polarity of the analogue input. Contact your Vacon distributor.
F19	Option board identification	Reading of the option board has failed	Check the installation - If installation is correct, contact your Vacon distributor
F20	10 V voltage reference	+10 V reference shorted on control board or option board	Check the cabling from +10 V reference voltage
F21	24 V supply	+24 V supply shorted on control board or option board	Check the cabling from +24 V reference voltage
F22 F23	EEPROM checksum fault	Parameter restoring error - interference fault - component failure	When the fault is reset the frequency drive will automatically load parameter default settings. Check all parameter settings after reset. If the fault occurs again contact your Vacon distributor
F25	Microprocessor watchdog	- interference fault - component failure	Reset the fault and restart. If the fault occurs again contact your Vacon distributor
F26	Panel communication error	The connection between panel and the frequency converter is not working	Check the panel cable
F29	Thermistor protection	Thermistor input of the I/O expander board has detected increase of the motor temperature	- Check motor cooling and loading - Check thermistor connection (If thermistor input of the I/O expander board is not in use it has to be short circuited)
F36	Analog input $I_{in}$ < 4mA (signal range selected 4-20 mA)	The current in the analog input $I_{in}$ is below 4 mA - signal source has failed - control cable is broken	Check the current loop circuitry
F41	External fault	Fault is detected in external fault digital input	Check the external fault circuit or device

Table 9-1 Fault codes.

10 BASIC APPLICATION

10.1 General

The Basic Application is the default setting on delivery from the factory. The control I/O signals of the Basic application are fixed (not programmable) and it only has parameter Group 1.

Parameters are explained in Chapter 10.4. The function of motor thermal and stall protection in the Basic Application is explained in Chapter 10.5.

**\* NOTE!** Remember to connect CMA and CMB inputs.

10.2 Control Connections

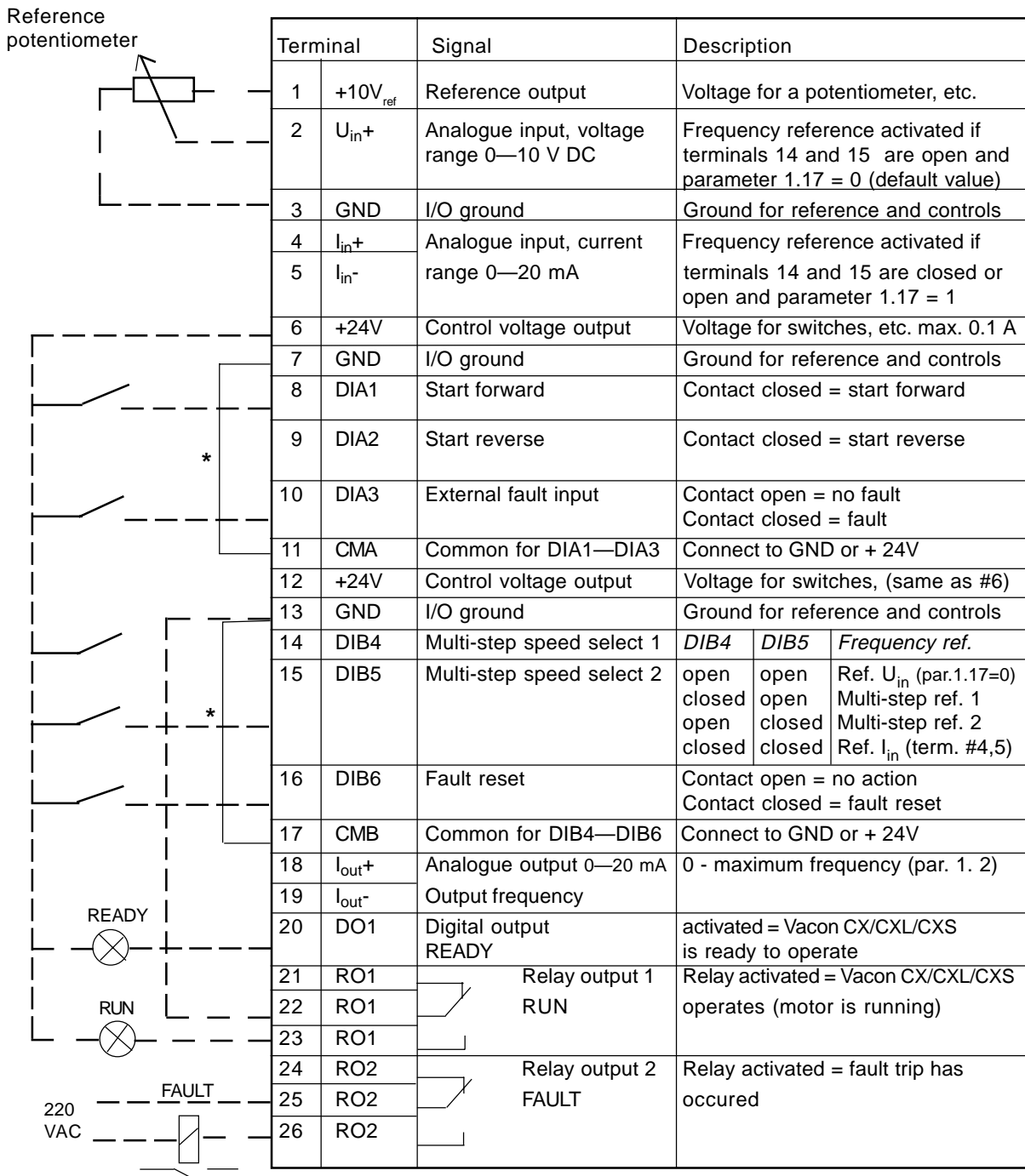

Figure 1.2-1 Control connection example.

### 10.3 Control Signal Logic

Figure 10.3.-1 shows the logic of the I/O control signals and push buttons.

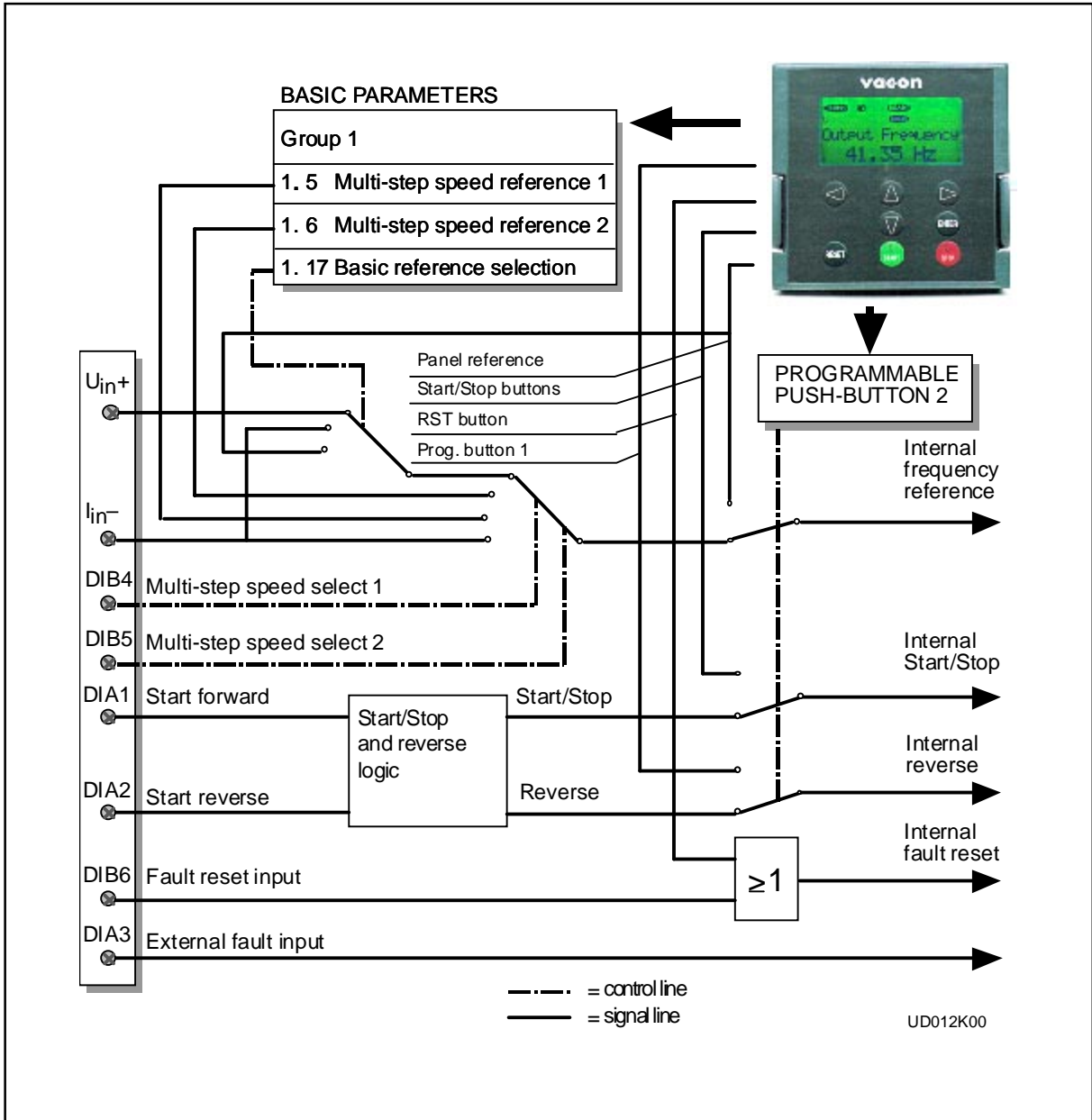

Figure 10.3-1 Control signal logic

If Start forward and Start reverse are both active when the mains is connected to Vacon CX/ CXL/CXS then Start forward will be selected for the direction.

Also if Start forward and Start reverse are both active when the control source is changed from the panel to the I/O-terminal then Start forward will be selected for the direction.

Otherwise the first selected direction has higher priority than the next selected.

## 10.4 Parameters, Group 1









Num.	Parameter	Range	Step	Default	Customer	Description	Page
1.1	Minimum frequency	0— $f_{max}$	1 Hz	0 Hz			77
1.2	Maximum frequency	$f_{min}$ -120/500 Hz	1 Hz	50 Hz		*)	77
1.3	Acceleration time	0.1—3000.0 s	0.1 s	3.0 s		Time from $f_{min}$ (1.1) to $f_{max}$ (1.2)	77
1.4	Deceleration time	0.1—3000.0 s	0.1 s	3.0 s		Time from $f_{max}$ (1.2) to $f_{min}$ (1.1)	77
1.5	Multi-step speed reference 1	$f_{min}$ — $f_{max}$ (1.1) (1.2)	0.1 Hz	10.0 Hz			77
1.6	Multi-step speed reference 2	$f_{min}$ — $f_{max}$ (1.1) (1.2)	0.1 Hz	50.0 Hz			77
1.7	Current limit	0.1—2.5 x $I_{nCX}$	0.1 A	1.5 x $I_{nCX}$		***Output curr. limit [A] of the unit	77
1.8	U/f ratio selection 	0—1	1	0		0 = Linear 1 = Squared	77
1.9	U/f optimization 	0—1	1	0		0 = None 1 = Automatic torque boost	78
1.10	Nominal voltage of the motor 	180—690 V	1 V	230 V 400 V 500 V 690 V		Vacon range CX/CXL/CXS2 Vacon range CX/CXL/CXS4 Vacon range CX/CXL/CXS5 Vacon range CX6	78
1.11	Nominal frequency of the motor 	30—500 Hz	1 Hz	50 Hz		$f_n$ from the rating plate of the motor	78
1.12	Nominal speed of the motor 	1—20000 rpm	1 rpm	1420 rpm **)		$n_n$ from the rating plate of the motor	78
1.13	Nominal current of the motor ( $I_{nMot}$ ) 	2.5 x $I_{nCX}$	0.1 A	$I_{nCX}$		$I_n$ from the rating plate of the motor	79
1.14	Supply voltage 	208—240		230 V		Vacon range CX/CXL/CXS2	79
		380—440		400 V		Vacon range CX/CXL/CXS4	
		380—500		500 V		Vacon range CX/CXL/CXS5	
		525—690		690 V		Vacon range CX6	
1.15	Application package lock	0—1	1	1		0 = package lock open Application is selected by parameter 0.1	79
1.16	Parameter value lock	0—1	1	0		Disables parameter changes: 0 = changes enabled 1 = changes disabled	79
1.17	Basic frequency reference selection 	0—2	1	0		0 = analogue input $U_{in}$ 1 = analogue input $I_{in}$ 2 = reference from the panel	79
1.18	Analogue input $I_{in}$ range	0—1	1	0		0 = 0—20 mA 1 = 4—20 mA	79

Table 10.4-1 Group 1 basic parameters

**Note!**  = Parameter value can be changed only when the Frequency converter is stopped. \*) If 1.2 > motor synchr. speed, check suitability for motor and drive system. \*\*) Default value for a four-pole motor and a nominal size Vacon. \*\*\*) Up to M10. Bigger classes case by case

10.4.1 Descriptions

1. 1, 1. 2 **Minimum/maximum frequency**

Defines frequency limits of the frequency converter.

Default maximum value for parameters 1. 1 and 1. 2 is 120 Hz. By setting 1. 2 = 120 Hz in Stop state (RUN indicator not lit) the maximum value of parameters 1. 1 and 1. 2 is changed to 500 Hz. At the same time, the panel reference resolution is changed from 0.01 Hz to 0.1 Hz.

The max. value is changed from 500 Hz to 120 Hz when parameter 1. 2 = 119 Hz in Stop state.

1. 3, 1. 4 **Acceleration time, deceleration time :**

These limits correspond to the time required for the output frequency to accelerate from the set minimum frequency (par. 1. 1) to the set maximum frequency (par. 1. 2).

1. 5, 1. 6 **Multi-step speed reference 1, Multi-step speed reference 2:**

Parameter values are limited between minimum and maximum frequency.

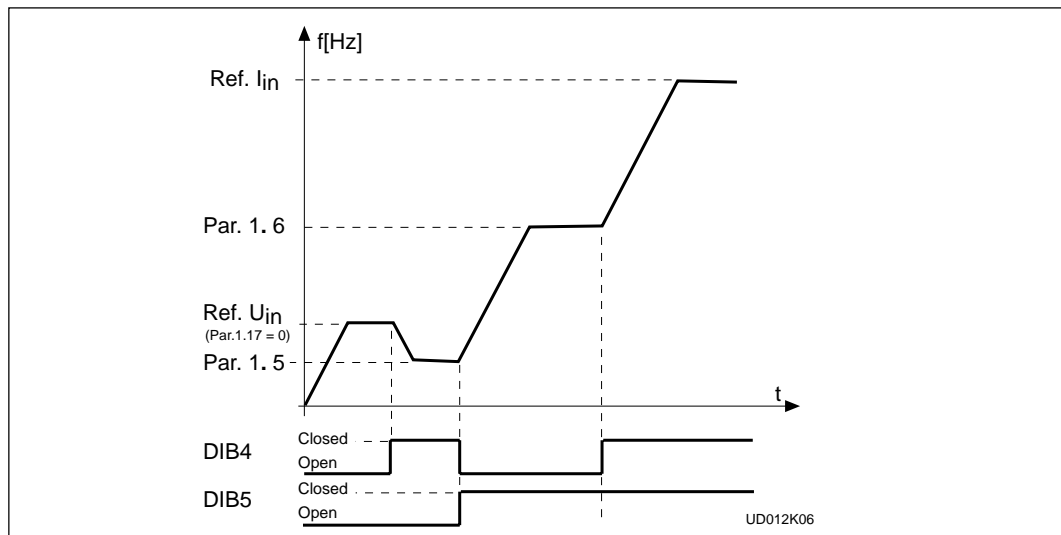

Figure 10.4.1-1 Example of Multi-step speed references.

1. 7 **Current limit**

This parameter determines the maximum motor current that the frequency converter can give momentarily.

1. 8 **U/f ratio selection**

Linear: The voltage of the motor changes linearly with the frequency from 0 Hz to the Nominal frequency of the motor. The Nominal voltage of the motor is supplied at this frequency. See figure 10.4.1-2.

Linear U/f ratio should be used in constant torque applications.

**This default setting should be used if there is no special demand for another setting.**

**Squared:** The voltage of the motor changes following a squared curve from 0 Hz to the nominal frequency of the motor. The Nominal voltage of the motor is supplied at this frequency. See figure 10.4.1-2.

The motor runs undermagnetized below the nominal frequency and it produces less torque and electromechanical noise.

Squared U/f ratio can be used in applications where the torque demand from the load is proportional to the square of the speed, e.g. in centrifugal fans and pumps.

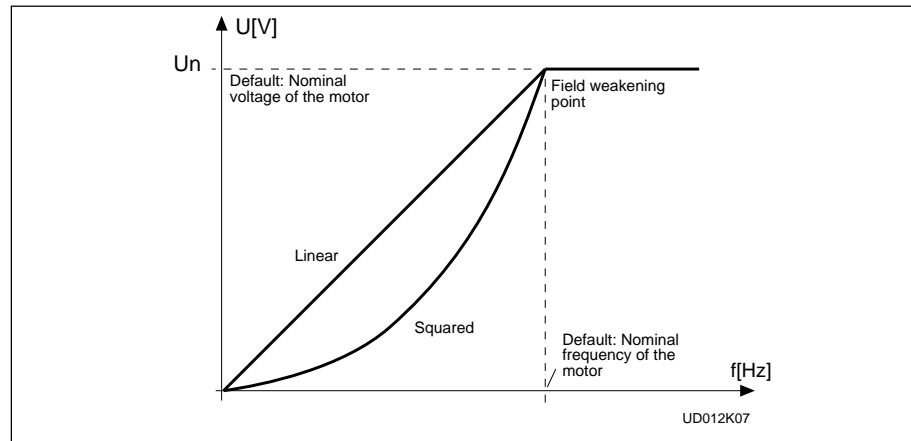

Figure 10.4.1-2 Linear and squared U/f curves.

**1.9 U/f optimization**

**Automatic torque boost** The voltage to the motor changes automatically which makes the motor produce a sufficient torque to start and run at low frequencies. The voltage increase depends on the motor type and power. Automatic torque boost can be used in applications where starting torque due to starting friction is high, e.g. in conveyors.

**NOTE!** *In high torque - low speed applications - the motor is likely to overheat. If the motor has to run for a prolonged time under these conditions, special attention must be paid to motor cooling. Use external cooling for the motor if the temperature tends to rise too high.*



**1.10 Nominal voltage of the motor**

Find setting value  $U_n$  from the rating plate of the motor.

**Note!** If the nominal motor voltage is lower than the supply voltage, check that the insulation strength of the motor is adequate.

**1.11 Nominal frequency of the motor**

Find the value  $f_n$  from the rating plate of the motor.

**1.12 Nominal speed of the motor**

Find the value  $n_n$  from the rating plate of the motor.

**1. 13 Nominal current of the motor**

Find the value  $I_n$  from the rating plate of the motor.

The internal motor protection function uses this value as the reference value.

**1. 14 Supply voltage**

Set parameter value according to the nominal voltage of the supply. Values are predefined for CX/CXL/CXS2, CX/CXL/CXS4, CX/CXL/CXS5 and CX6 ranges, see table 10.4-1.

**1. 15 Application package lock**

The application package lock can be opened by setting the value of the parameter 1.15 to 0. After this it is possible to enter the parameter group 0 from parameter 1.1 by pressing the *Browser button* down (see figure 11-1). The number of the Application can be selected from the table 11-1 and it is selected by giving a value to parameter 0.1. After this the new Application is in use. The parameters are found in the Five in One+ Application Manual.

**1. 16 Parameter value lock**

Defines access to the changes of the parameter values:

- 0 = parameter value changes enabled
- 1 = parameter value changes disabled

**1. 17 Basic frequency reference selection**

- 0 Analogue voltage reference from terminals 2—3, e.g. a potentiometer
- 1 Analogue current reference from terminals 4—5, e.g. a transducer.
- 2 Panel reference is the reference set from the Reference Page (REF), see chapter 7.5.

**1. 18 Analogue input  $I_{in}$  range**

Defines the minimum value of the Analogue input  $I_{in}$  signal (terminals 4,5).



## 10.5 Motor protection functions in the Basic Application

### 10.5.1 Motor thermal protection

Motor thermal protection shall protect the motor from overheating. In the Basic application, Motor thermal protection uses constant settings and always causes a fault trip if the motor is overheated. To switch off the protection or to change the settings, see "Five in One+" -application manual.

Vacon CX/CXL/CXS- frequency converter are capable of supplying higher than nominal current to the motor. If the load requires this high current there is a risk that motor will be thermally overloaded. This is true especially at low frequencies, as the cooling effect and capacity of the motor are reduced. Motor thermal protection is based on a calculated model which uses the output current of the drive to determine the load on the motor.

The thermal current  $I_T$  specifies the load current above which the motor is overloaded. See figure 10.5.1-1. If the motor current is above the curve, the motor temperature increases.

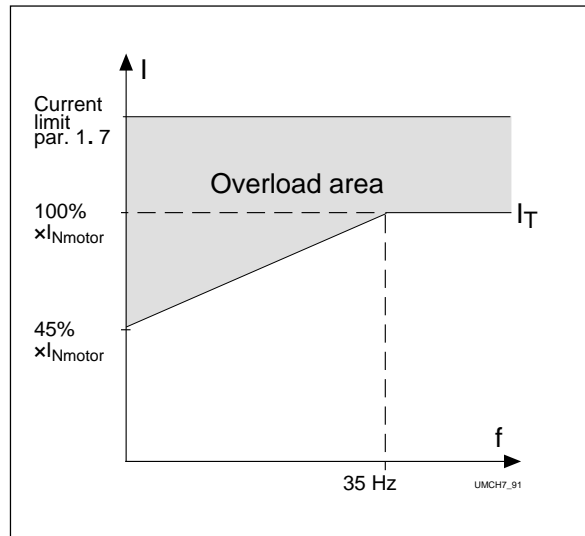
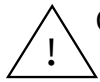

Figure 10.5.1-1 Motor thermal current  $I_T$  curve.



**CAUTION!** The calculated model does not protect the motor if the airflow to the motor is reduced by blocked air intake grill.

### 10.5.2 Motor stall warning

In the Basic application, the motor stall protection gives warning of short time overload situations of the motor e.g. a stalled shaft. The reaction time of the stall protection is shorter than with motor thermal protection. The stall state is defined with Stall Current and Stall Frequency.

Both parameters have constant values. See figure 10.5.2-1. If the current is higher than the set limit and output frequency is lower than the set limit the stall state is true. If the stall state lasts longer than 15 s the stall warning is given on the panel display. To change stall warning to fault or to change protection settings, see the "Five in One+" -application manual.

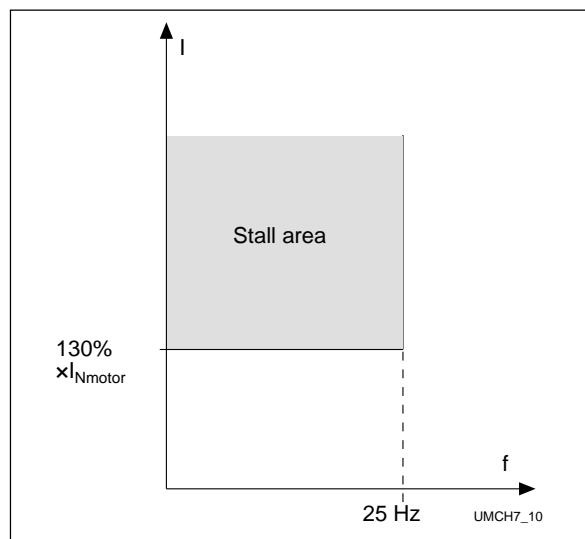

Figure 10.5.2-1 Stall state.

10

## 11 System parameter group 0

When the application package lock is open (par. 1.15 = 0) the system parameter group 0 is reachable as follows:



The parameters of the group 0 are presented in table 11-1.

### 11.1 Parameter table

Number	Parameter	Range	Description	Page
0.1	Application selection	1—7	1 = Basic Application 2 = Standard Application 3 = Local / Remote Control Application 4 = Multi-step Speed Application 5 = PI-control Application 6 = Multi-purpose Control Application 7 = Pump and fan control Application	81
0.2	Parameter loading	0—5	0 = Loading ready / Select loading 1 = Load default setting 2 = Read up parameters to user's set 3 = Load down user's set parameters 4 = Read parameters up to the panel (possible only with the graphical panel) 5 = Load down parameters from the panel (possible only with graphical panel)	82
0.3	Language selection	0—5	0 = English 1 = German 2 = Swedish 3 = Finnish 4 = Italian 5 = French 6 = Spanish	82

Table 11-1 System parameters, Group 0.

### 11.2 Parameter descriptions

#### 0.1 Application selection

With this parameter the Application can be selected. The default setting is the Basic Application. Applications are described in Chapter 12.

## 0.2 Parameter loading

With this parameter it is possible to perform different kind of parameter loading operations.

After the operation is completed the parameter value changes automatically to 0 (loading ready).

**0** Loading ready / Select loading

Loading operation has been completed and the frequency converter is ready to operate.

**1** Load default settings

By setting the value of parameter 0.2 to 1 and then pressing the Enter-button, the parameter default values are set. The default values are according to the application selected with parameter 0.1.

**2** Read up parameters to User's set

By setting the value of parameter 0.2 to 2 and then pressing Enter-button the parameter values are read up to the User's parameter value set. The parameter values can be later loaded by setting parameter 0.2 to 3 and pressing Enter button.

**3** Load down user's set parameters

By setting the value of parameter 0.2 to 3 and then pressing Enter-button the parameter values are set according to the user's parameter set.

**4** Read parameters up to the panel (possible only with graphical panel).

**5** Download parameters from the panel (possible only with graphical panel).

## 0.3 Language selection

Parameter selects the language of the text on the alpha-numerical or graphical panel. If the 7-segment panel is used the parameter has no effect.

## 12 "Five in One+" -application package

### 12.1 Application Selection

To use one of the "Five in One+" -applications, first open the Application package lock (parameter 1.15). Then Group 0 becomes visible (see Figure 11-1). By changing the value of parameter 0.1 changes the active application. See Table 11-1.

Applications are presented in Chapters 12.2 - 12.7 and in more detail in the separate "Five in One+" Application manual.

### 12.2 Standard Application

The Standard Application has the same I/O signals and the same Control logic as the Basic application.

Digital input DIA3 and all outputs are freely programmable.

Additional functions:

- Programmable Start/Stop and Reverse signal logic
- Reference scaling
- One frequency limit supervision
- Second ramps and S-shape programming of ramps
- Programmable start and stop functions
- DC-brake at stop
- One prohibit frequency area
- Programmable U/F curve and switching frequency
- Autorestart function
- Motor Thermal and Stall protection off / warning / fault programming

### 12.3 Local/Remote Application

By utilising the Local/Remote Control Application, it is possible to have two different control sources. The frequency reference sources of the control places are programmable. The active control source is selected with the digital input DIB6. All outputs are freely programmable.

Other additional functions:

- Programmable Start/stop and Reverse signal logic
- Analogue input signal range selection
- Two frequency limit supervisions
- Torque limit supervision
- Reference limit supervision
- Second ramps and S-shape programming of ramps
- DC-brake at start and stop
- Three prohibit frequency areas
- Programmable U/F curve and switching frequency
- Autorestart function
- Motor Thermal and Stall protection fully programmable
- Motor Underload protection
- Free analogue input functions

### 12.4 Multi-step Speed Application

The Multi-step Speed Control Application can be used in applications where fixed speed references are required. Up to nine different speeds can be programmed: one basic speed, 7 multi-step speeds and one jogging speed. The speed steps are selected with digital signals DIB4, DIB5 and DIB6. If jogging speed is used DIA3 can be programmed to jogging speed select

The basic speed reference can be either voltage or current signal via analogue input terminals (2/3 or 4/5). All outputs are freely programmable.

Other additional functions:

- Programmable Start/stop and Reverse signal logic
- Analogue input signal range selection
- Two frequency limit supervisions
- Torque limit supervision
- Reference limit supervision
- Second ramps and S-shape programming of ramps
- DC-brake at start and stop
- Three prohibit frequency areas
- Programmable U/F curve and switching frequency
- Autorestart function
- Motor Thermal and Stall protection fully programmable
- Motor Underload protection
- Free analogue input functions

### 12.5 PI-control Application

In the PI-control Application, there are two I/O-terminal control sources. Source A is a PI-controller and source B is a direct frequency reference. The control source is selected with the DIB6 input.

The PI-controller reference can be selected from the analogue inputs, the motor potentiometer and the panel reference. The actual value can be selected from the analog inputs or from the mathematical function of the analogue inputs.

The direct frequency reference can be used for control without PI-controller. The frequency reference can be selected from the analogue inputs and the panel reference.

All outputs are freely programmable.

Other additional functions:

- Programmable Start/stop and Reverse signal logic
- Analogue input signal range selection
- Two frequency limit supervisions
- Torque limit supervision
- Reference limit supervision
- Second ramps and S-shape programming of ramps
- DC-brake at start and stop
- Three prohibit frequency areas
- Programmable U/F curve and switching frequency
- Autorestart function
- Motor Thermal and Stall protection fully programmable
- Motor Underload protection

### 12.6 Multi-purpose Control Application

In the Multi-purpose Control Application, the frequency reference can be selected from the analogue inputs, the joystick control, the motor potentiometer and the mathematical function of the analogue inputs. Multi-step speeds and jogging speed can also be selected if digital inputs are programmed for these functions

Digital inputs DIA1 and DIA2 are reserved for Start/stop logic. Digital inputs DIA3 - DIB6 are programmable for multi-step speed select, jogging speed select, motor potentiometer, external fault, ramp time select, ramp prohibit, fault reset and DC-brake command function. All outputs are freely programmable.

Additional functions:

- Programmable Start/stop and Reverse signal logic
- Analogue input signal range selection
- Two frequency limit supervisions
- Torque limit supervision
- Reference limit supervision
- Second ramps and S-shape programming of ramps
- DC-brake at start and stop
- Three prohibit frequency areas
- Programmable U/F curve and switching frequency
- Autorestart function
- Motor Thermal and Stall protection fully programmable
- Motor Underload protection
- Free analogue input functions

### 12.7 Pump and Fan Control Application

The Pump and Fan Control Application can be used to control one variable speed drive and 0-3 auxiliary drives. The PI-controller of the frequency converter controls the speed of the variable speed drive and gives control signals to start and stop auxiliary drives to control the total flow.

The application has two control sources on the I/O terminal. Source A is Pump and fan control and source B is direct frequency reference. The control source is selected with DIB6 input.

All outputs are freely programmable.

Other additional functions:

- Programmable Start/stop and reverse signal logic
- Analogue input signal range selection
- Two frequency limit supervisions
- Torque limit supervision
- Reference limit supervision
- Second ramps and S-shape programming for ramps
- DC-brake at start and stop
- Three prohibit frequency areas
- Programmable U/F curve and switching frequency
- Autorestart function
- Motor Thermal and Stall protection fully programmable
- Motor Underload protection

## 13 Options

### 13.1 Remote control box

A remote control box is an external control device connected to the control terminal of the Vacon CX/CXL/CXS. The wires of the box are connected according to the I/O of the Standard control application.

### 13.2 External filters

Information of Vacon CX/CXL/CXS external input and output filters (RFI-, dU/dT- and Sinusoidal-filters) can be found in a separate manual.

### 13.3 Dynamic braking

Effective motor braking and thus short deceleration times are achieved by using an external or internal brake chopper with external brake resistor.

The internal brake chopper is assembled in the factory (see type designation code). It has the same continuous current specification as the unit itself.

Select the correct brake resistor to get the desired braking effect. More information to be found in the separate brake manual.

### 13.4 I/O-expander boards

The available I/O can be increased by using the I/O-expander boards. I/O-expander boards can be installed in the place reserved for option boards inside the Vacon CX and CXL models. In the CXS model, the board needs to be installed in a separate I/O-expander board box.

More information to be found in the I/O-expander board manuals.

### 13.5 Fieldbuses

Vacon frequency converters can be connected to Interbus-S, Modbus (RS485), Profibus-DP and Lonworks fieldbuses using the fieldbus option board.

The fieldbus board can be installed in the place reserved for option boards inside the Vacon CX and CXL models. In the CXS model or when using the LonWorks fieldbus the board needs to be placed into a separate I/O expander board box.

More information to be found in the separate manuals.

### 13.6 Graphical control panel

The Graphical control panel can be used instead of the standard alpha-numeric control panel.

- parameters, monitored items etc. in texts
- 3 monitored items at the same time in display
- one monitored item can be shown in increased text with graph bar
- Shown parameter value is also in graph bar
- 3 monitored items can be shown on the graphical trend display
- the parameters of the frequency converter can be uploaded to the panel and then downloaded to another inverter.

More information can be found in the Graphical panel manual.

### 13.7 Seven-segment control panel

The 7-segment panel is the previous Vacon standard panel and it can be used instead of the alpha-numeric control panel.

- 6-digit LED-display for the display of parameters, monitoring data etc.
- three drive status indicators
- four active menu page indicators
- eight push buttons
- can be used with all Vacon frequency converters

### 13.8 FCDRIVE

FCDRIVE is the PC commissioning tool for control of Vacon frequency converters. With FCDRIVE:

- parameters can be loaded from the Vacon, changed, saved to a file or loaded back to the Vacon
- parameters can be printed to a paper or to file
- references can be set
- motor can be started and stopped
- signals can be examined in graphical form
- actual values can be displayed

Vacon frequency converter can be connected to the PC with a normal RS232-cable. The same cable can be used for downloading the special applications to the frequency converter.

### **13.9 Panel door installation serie**

An adapter is available to mount the alpha-numeric display, the 7-segment display or the graphical panel on the enclosure door.

#### **13.10 IP20 cable cover for 55—90CX types**

This optional cable cover for the 55—90CX raises the IP-rating to IP20.

#### **13.11 Others**

Varnished PC-boards for demanding operating environments, tinned busbars and through panel mounting brackets and floor assembly options for Vacon 110—400 CXL units are also available.

FREQUENCY CONVERTERS

*"Five in One+" -application manual*



**VACON CX/CXL/CXS "FIVE IN ONE+" -APPLICATION MANUAL****CONTENTS**

<b>A</b>	<b>General .....</b>	<b>0-2</b>
<b>B</b>	<b>Application selection .....</b>	<b>0-2</b>
<b>C</b>	<b>Restoring default values of application parameters .....</b>	<b>0-2</b>
<b>D</b>	<b>Language selection .....</b>	<b>0-2</b>
<b>1</b>	<b>Standard Control Application .....</b>	<b>1-1</b>
<b>2</b>	<b>Local/Remote Control Application .....</b>	<b>2-1</b>
<b>3</b>	<b>Multi-step Speed Application .....</b>	<b>3-1</b>
<b>4</b>	<b>PI-control Application .....</b>	<b>4-1</b>
<b>5</b>	<b>Multi-purpose Application .....</b>	<b>5-1</b>
<b>6</b>	<b>Pump and fan control Application .....</b>	<b>6-1</b>

## A General

This manual provides you with the information needed to use the Five in One+ Applications.

Each application is described in its own chapter. Chapter B tells how to select the application.

## B Application selection

If the Basic Application is in use, first open the application package lock (parameter 1.15 = 0) after which Group 0 appears. By changing the value of the parameter 0.1 the desired application can be activated. See table B-1.

The change from one application to another, simply set the value of parameter 0.1 to the application to be activated: see table B-1.

Number	Parameter	Range	Description
0. 1	Application	1 —7	1 = Basic Application 2 = Standard Application 3 = Local / Remote Control Application 4 = Multi-step Speed Application 5 = PI-control Application 6 = Multi-purpose Control Application 7 = Pump and Fan Control Application

Table B-1 Application selection parameters.

Besides the parameter group 1, the applications also have parameter groups 2 — 8 available (see figure B-1).

Parameters follow each other and changing from the last parameter of one group to the first parameter of the same group or vice versa is done simply by pushing the *Browser buttons*.

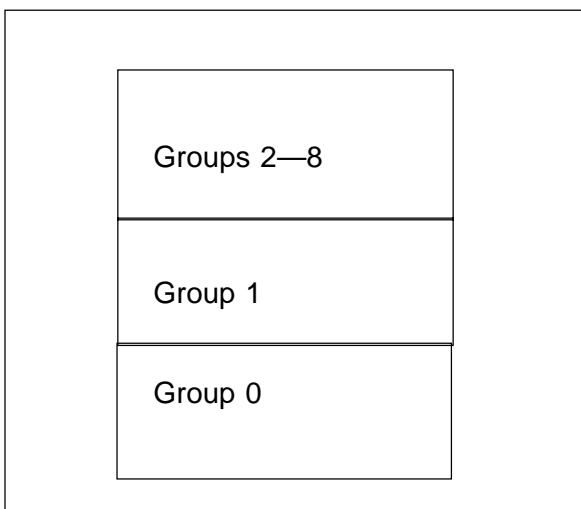

Figure B-1 Parameter Groups.

## C Restoring default values of application parameters

Default values of the parameters of the applications 1 to 7 can be restored by selecting the same application again with parameter 0.1 or by setting the value of parameter 0.2 to 1. See User's manual Chapter 12.

If parameter group 0 is not visible, make it visible as follows:

1. If the parameter lock is set on, open the lock, parameter 1. 16, by setting the value of the parameter to 0.
2. If parameter conceal is set on, open the conceal, parameter 1. 15, by setting the value of the parameter to 0. Group 0 becomes visible.

## D Language selection

The language of the texts on the alpha-numerical and graphical panel can be chosen with parameter 0. 3. See Vacon CX/CXL/XCS Users Manual Chapter 11.

**STANDARD CONTROL APPLICATION**

(par. 0.1 = 2)

**1****CONTENTS**

<b>1 Standard Application .....</b>	<b>1-1</b>
1.1 General .....	1-2
1.2 Control I/O .....	1-2
1.3 Control signal logic .....	1-3
1.4 Parameters Group 1 .....	1-4
1.4.1 Parameter table .....	1-4
1.4.2 Description of Group1 par ...	1-5
1.5 Special parameters, Groups 2-8 ..	1-8
1.5.1 Parameter tables .....	1-8
1.5.2 Description of Groups. ....	1-12

1

1 STANDARD APPLICATION

1.1 General

The Standard application has the same I/O signals and same Control logic as the Basic application. Digital input DIA3 and all outputs are programmable.

The Standard Application can be selected by

setting the value of parameter 0. 1 to 2. Basic connections of inputs and outputs are shown in the figure 1.2-1. The control signal logic is shown in the figure 1.3-1. Programming of I/O terminals are explained in chapter 1.5.

1.2 Control I/O

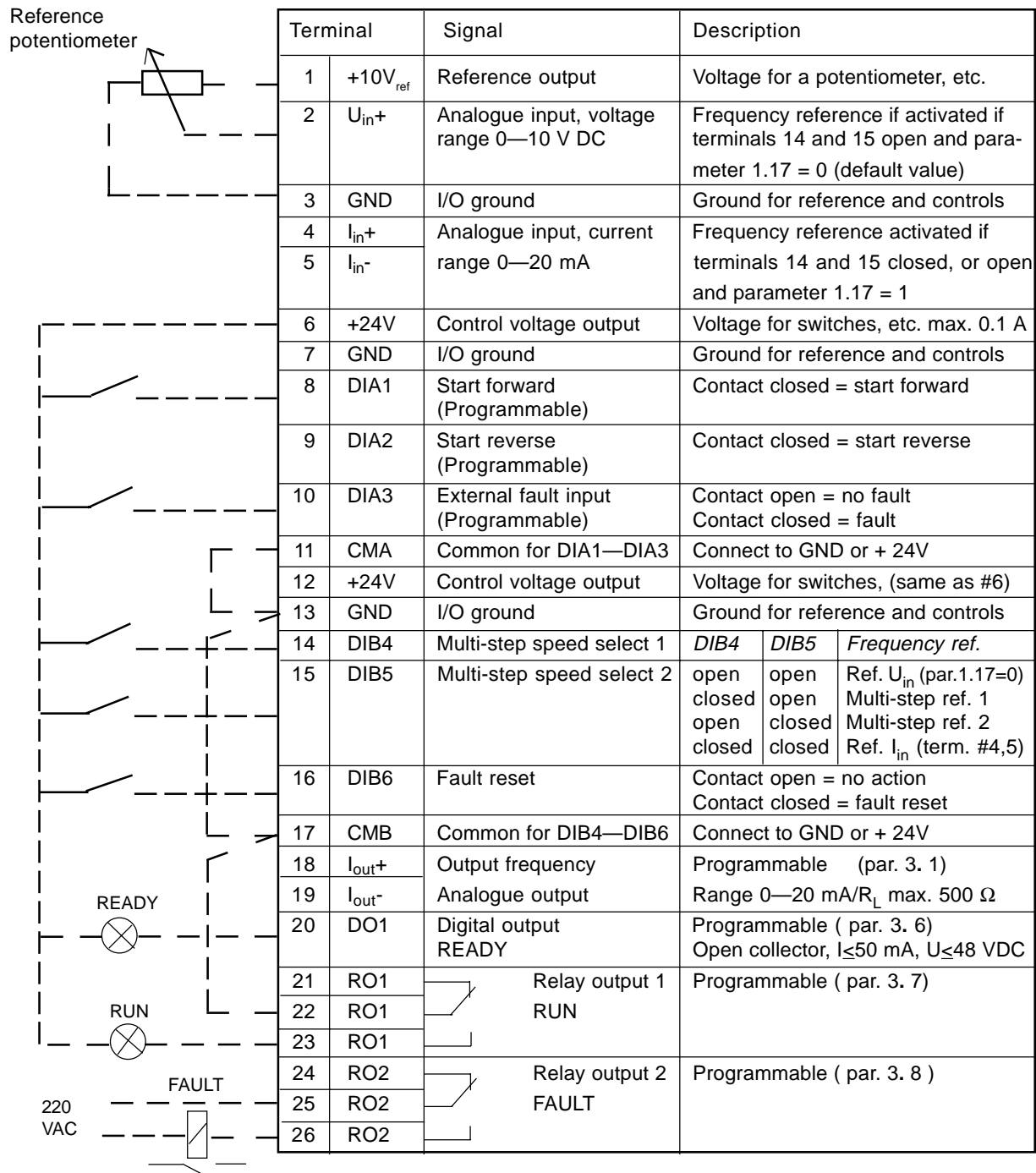

Figure 1.2-1 Default I/O configuration and connection example of the Standard Application.

1.3 Control signal logic

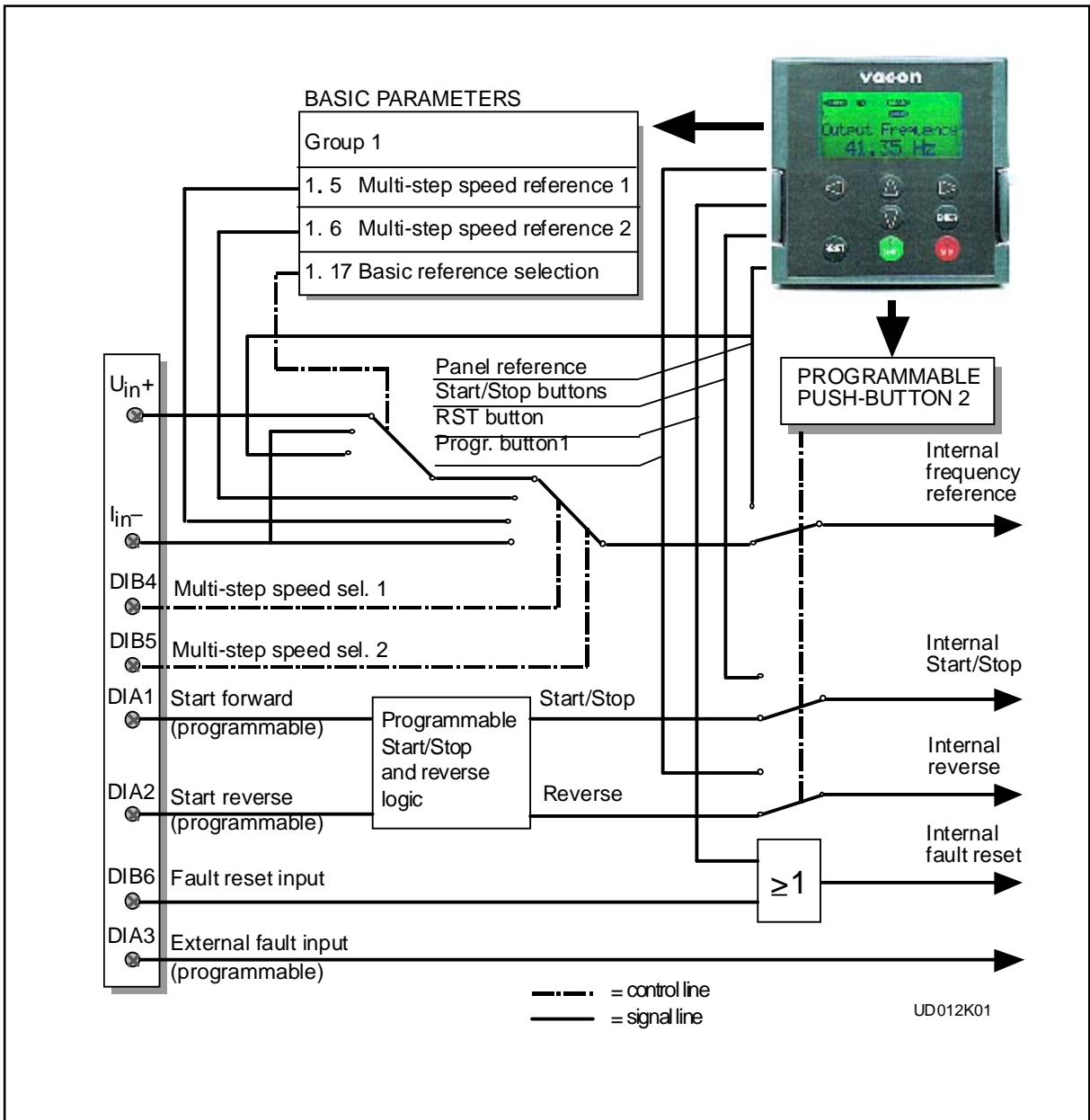

Figure 1.3-1 Control signal logic of the Standard Application.

## 1

## 1.4 PARAMETERS, GROUP 1

## 1.4.1 Parameter table

Code	Parameter	Range	Step	Default	Custom	Description	Page
1.1	Minimum frequency	0— $f_{max}$	1 Hz	0 Hz			1-5
1.2	Maximum frequency	$f_{min}$ -120/500 Hz	1 Hz	50 Hz		*)	1-5
1.3	Acceleration time 1	0,1—3000,0 s	0,1 s	3,0 s		Time from $f_{min}$ (1. 1) to $f_{max}$ (1. 2)	1-5
1.4	Deceleration time 1	0.1—3000,0 s	0,1 s	3,0 s		Time from $f_{max}$ (1. 2) to $f_{min}$ (1. 1)	1-5
1.5	Multi-step speed reference 1	$f_{min}$ — $f_{max}$	0,1 Hz	10,0 Hz			1-5
1.6	Multi-step speed reference 2	$f_{min}$ — $f_{max}$	0.1 Hz	50,0 Hz			1-5
1.7	Current limit	0,1—2,5 x $I_{nCT}$	0.1 A	1.5 x $I_{nCT}$		***Output curr. limit [A] of the unit	1-5
1.8	U/f ratio selection	0—2	1	0		0 = Linear 1 = Squared 2 = Programmable U/f ratio	1-5
1.9	U/f optimisation	0—1	1	0		0 = None 1 = Automatic torque boost	1-6
1.10	Nominal voltage of the motor	180—690 V	1 V	230 V 400 V 500 V 690 V		Vacon range CX/CXL/CXS2 Vacon range CX/CXL/CXS4 Vacon range CX/CXL/CXS5 Vacon range CX6	1-7
1.11	Nominal frequency of the motor	30—500 Hz	1 Hz	50 Hz		$f_n$ from the rating plate of the motor	1-7
1.12	Nominal speed of the motor	300—20000 rpm	1 rpm	1420 rpm **)		$n_n$ from the rating plate of the motor	1-7
1.13	Nominal current of the motor	2,5 x $I_{nCX}$	0,1 A	$I_{nCX}$		$I_n$ from the rating plate of the motor	1-7
1.14	Supply voltage	208—240		230 V		Vacon range CX/CXL/CXS2	1-7
		380—440		400 V		Vacon range CX/CXL/CXS4	
		380—500		500 V		Vacon range CX/CXL/CXS5	
		525—690		690 V		Vacon range CX6	
1.15	Parameter conceal	0—1	1	0		Visibility of the parameters: 0 = all parameter groups visible 1 = only group 1 is visible	1-7
1.16	Parameter value lock	0—1	1	0		Disables parameter changes: 0 = changes enabled 1 = changes disabled	1-7
1.17	Basic frequency reference selection	0—2	1	0		0 = analogue input $U_n$ 1 = analogue input $I_n$ 2 = reference from the panel	1-7

Table 1.4-1 Group 1 basic parameters.

**Note!**  = Parameter value can be changed only when the frequency converter is stopped.

\*) If 1. 2 > motor synchr. speed, check suitability for motor and drive system.

Selecting 120 Hz/500 Hz range see page 1-5.

\*\*) Default value for a four pole motor and a nominal size frequency converter.

\*\*\*)Up to M10. Bigger classes case by case

## 1.4.2 Description of Group 1 parameters

### 1. 1, 1. 2 *Minimum/maximum frequency*

Defines the frequency limits of the frequency converter.

The default maximum value for parameters 1. 1 and 1. 2 is 120 Hz. By setting the value of the parameter 1. 2 to 120 Hz when the device is stopped (RUN indicator not lit) the maximum limit of parameters 1. 1 and 1. 2 is changed to 500 Hz. At the same time the resolution of the panel reference is changed from 0.01 Hz to 0.1 Hz. Changing the max. value from 500 Hz to 120 Hz is done by setting parameter 1. 2 to 119 Hz when the device is stopped.

### 1. 3, 1. 4 *Acceleration time1, deceleration time 1:*

These limits correspond to the time required for the output frequency to accelerate from the set minimum frequency (par. 1. 1) to the set maximum frequency (par. 1. 2).

### 1. 5, 1. 6 *Multi-step speed reference 1, Multi-step speed reference 2:*

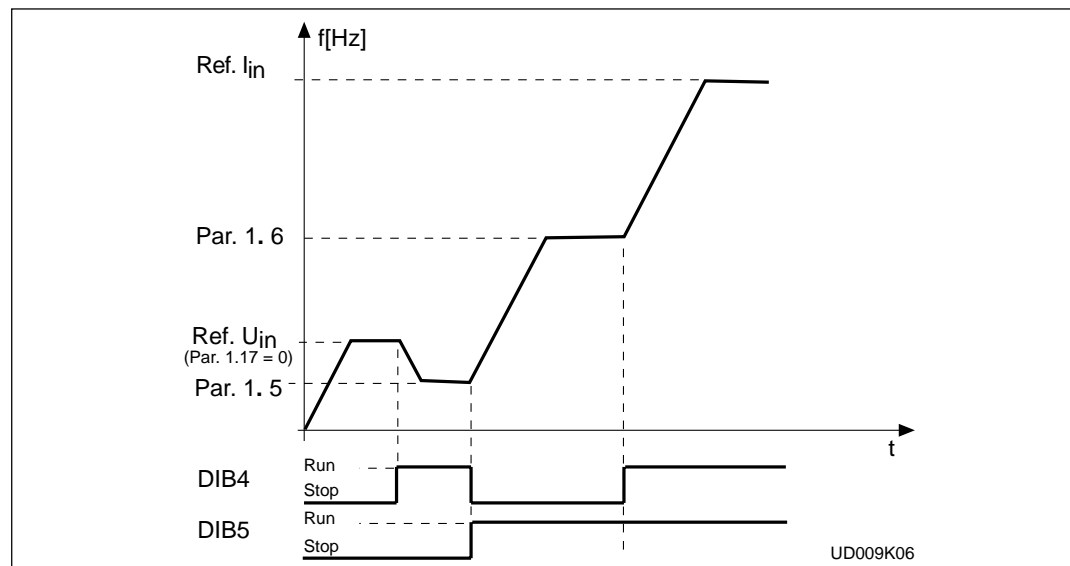

Figure 1.4-1 Example of Multi-step speed references.

Parameter values are automatically limited between the minimum and maximum frequency ( par 1. 1, 1. 2).

### 1. 7 *Current limit*

This parameter determines the maximum motor current that the frequency converter can give momentarily.

### 1. 8 *U/f ratio selection*

Linear: The voltage of the motor changes linearly with the frequency in the constant flux area from 0 Hz to the field weakening point (par. 6. 3) where the nominal voltage is also supplied to the motor. See figure 1.4-2.

Linear U/f ratio should be used in constant torque applications.  
**This default setting should be used if there is no special demand for another setting.**

1

**Squared:** The voltage of the motor changes following a squared curve form with the frequency in the area from 0 Hz to the field weakening point (par. 6. 3) where the nominal voltage is also supplied to the motor. See figure 1.4-2.

The motor runs undermagnetised below the field weakening point and produces less torque and electromechanical noise. Squared U/f ratio can be used in applications where torque demand of the load is proportional to the square of the speed, e.g. in centrifugal fans and pumps.

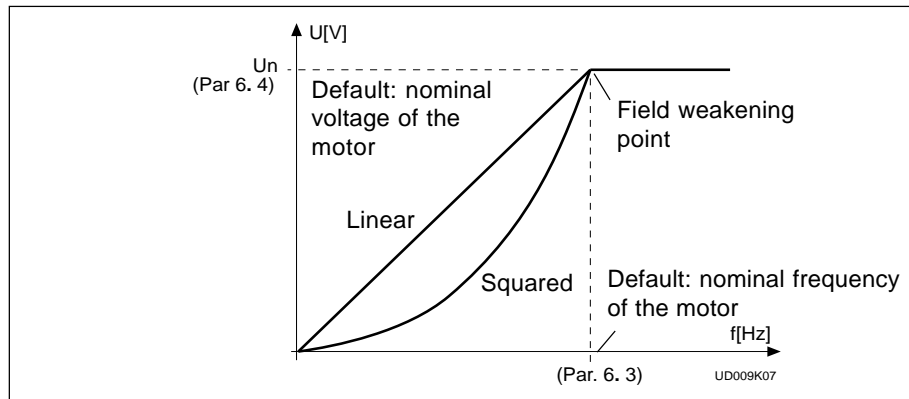

Figure 1.4-2 Linear and squared U/f curves.

**Programmable U/f curve** The U/f curve can be programmed with three different points. The parameters for programming are explained in Chapter 1.5.2. Programmable U/f curve can be used if the other settings do not satisfy the needs of the application. See figure 1.4-3.

2

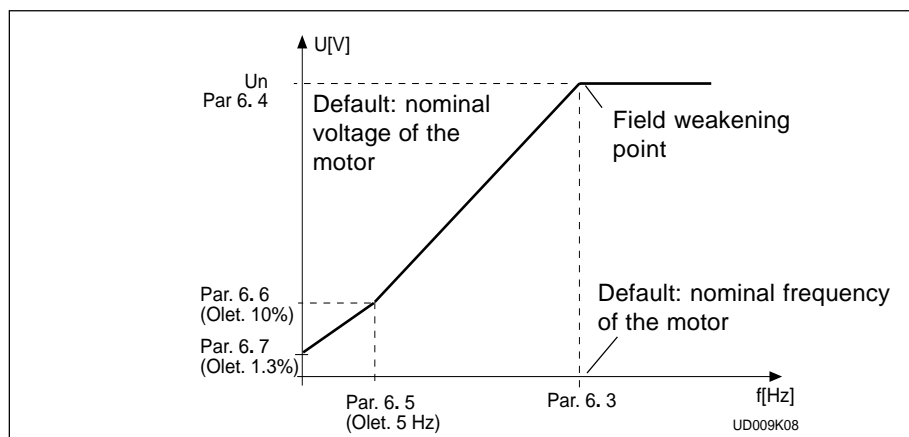

Figure 1.4-3 Programmable U/f curve.

**1.9 U/f optimisation**

**Automatic torque boost** The voltage to the motor changes automatically which enables the motor to produce enough torque to start and run at low frequencies. The voltage increase depends on the motor type and power. Automatic torque boost can be used in applications where starting torque due to starting friction is high, e.g. in conveyors.



**NOTE!**

*In high torque - low speed applications - the motor is likely to overheat. If the motor has to run a prolonged time under these conditions, special attention must be paid to motor cooling. Use external cooling for the motor if the temperature tends to rise too high.*

**1. 10 Nominal voltage of the motor**

Find this value on the rating plate of the motor.

This parameter sets the Voltage at the field weakening point, parameter 6. 4, to 100%  $\times U_{\text{nmotor}}$ .

**Note!** If the nominal motor voltage is lower than the supply voltage, check that the insulation strength of the motor is adequate.

**1. 11 Nominal frequency of the motor**

Find this value  $f_n$  on the rating plate of the motor.

This parameter sets the field weakening point, parameter 6. 3, to the same value.

**1. 12 Nominal speed of the motor**

Find this value  $n_n$  on the rating plate of the motor.

**1. 13 Nominal current of the motor**

Find the value  $I_n$  on the rating plate of the motor.

The internal motor protection function uses this value as a reference value.

**1. 14 Supply voltage**

Set parameter value according to the nominal voltage of the supply.

Values are predefined for CX/CXL/CXS2, CX/CXL/CXS4, CX/CXL/CXS5 and CX6 ranges, see table 1.4-1.

**1. 15 Parameter conceal**

Defines which parameter groups are available:

0 = all groups are visible

1 = group 1 is visible

**1. 16 Parameter value lock**

Defines access to the changes of the parameter values:

0 = parameter value changes enabled

1 = parameter value changes disabled

**1. 17 Basic frequency reference selection**

0 Analogue voltage reference from terminals 2—3, e.g. a potentiometer

1 Analogue current reference from terminals 4—5, e.g. a transducer.



2 Panel reference is the reference set from the Reference Page (REF), see chapter 7.5.

## 1

## 1.5 SPECIAL PARAMETERS, GROUPS 2—8

## 1.5.1 Parameter tables

## Group 2, Input signal parameters

Code	Parameter	Range	Step	Default	Custom	Description	Page
2.1	Start/Stop logic selection 	0—3	1	0		DIA1	1-12
						DIA2	
						0 = Start forward 1 = Start/Stop 2 = Start/Stop 3 = Start pulse	
						Start reverse Reverse Run enable Stop pulse	
2.2	DIA3 function (terminal 10) 	0—5	1	1		0 = Not used 1 = Ext. fault, closing contact 2 = External fault, opening contact 3 = Run enable 4 = Acc./dec. time selection 5 = Reverse (if par. 2. 1 = 3)	1-13
2.3	Reference offset for current input	0—1	1	0		0 = 0—20 mA 1 = 4—20 mA	1-13
2.4	Reference scaling, minimum value	0—par. 2.5	1 Hz	0 Hz		Selects the frequency that corresponds to the minimum reference signal	1-13
2.5	Reference scaling, maximum value	0— $f_{max}$	1 Hz	0 Hz		Selects the frequency that corresponds to the maximum reference signal 0 = Scaling off >0 = Maximum frequency value	1-13
2.6	Reference invert	0—1	1	0		0 = No inversion 1 = Reference inverted	1-14
2.7	Reference filter time	0,00—10,00s	0,01s	0,10s		0 = No filtering	1-14



## Group 3, Output and supervision parameters

Code	Parameter	Range	Step	Default	Custom	Description	Page
3.1	Analogue output function 	0—7	1	1		0 = Not used	1-15
						Scale 100%	
						1 = O/P frequency (0— $f_{max}$ )	
						2 = Motor speed (0—max. speed)	
						3 = O/P current (0— $2.0 \times I_{nCT}$ )	
						4 = Motor torque (0— $2 \times T_{nMot}$ )	
						5 = Motor power (0— $2 \times P_{nMot}$ )	
						6 = Motor voltage (0— $100\% \times U_{nMot}$ )	
						7 = DC-link volt. (0—1000 V)	
3.2	Analogue output filter time	0,00—10,00 s	0,01s	1,00 s		0 = no filtering	1-15
3.3	Analogue output inversion	0—1	1	0		0 = Not inverted 1 = Inverted	1-15
3.4	Analogue output minimum	0—1	1	0		0 = 0 mA 1 = 4 mA	1-15
3.5	Analogue output scale	10—1000%	1%	100%			1-15

**Note**  = Parameter value can be changed only when the frequency converter is stopped.

(Continues)

**Group 3, Output and supervision parameters**

Code	Parameter	Range	Step	Default	Custom	Description	Page
3.6	Digital output function 	0—14	1	1		0 = Not used 1 = Ready 2 = Run 3 = Fault 4 = Fault inverted 5 = Vacon overheat warning 6 = External fault or warning 7 = Reference fault or warning 8 = Warning 9 = Reversed 10 = Multi-step speed selected 11 = At speed 12 = Motor regulator activated 13 = Output frequency limit superv. 14 = Control from I/O-terminal	1-16
3.7	Relay output 1 function 	0—14	1	2		As parameter 3.6	1-16
3.8	Relay output 2 function 	0—14	1	3		As parameter 3.6	1-16
3.9	Output freq. limit supervision function	0—2	1	0		0 = No 1 = Low limit 2 = High limit	1-16
3.10	Output freq. limit supervision value	0,0— $f_{max}$ (par. 1.2)	0,1 Hz	0,0 Hz			1-16
3.11	I/O-expander option board analogue output function	0—7	1	3		As parameter 3.1	1-15
3.12	I/O-expander option board analogue output scale	10—1000%	1%	100%		As parameter 3.5	1-15

**Group 4, Drive control parameters**

Code	Parameter	Range	Step	Default	Custom	Description	Page
4.1	Acc./Dec. ramp 1 shape	0,0—10,0 s	0,1 s	0,0 s		0 = Linear >0 = S-curve acc./dec. time	1-17
4.2	Acc./Dec. ramp 2 shape	0,0—10,0 s	0,1 s	0,0 s		0 = Linear >0 = S-curve acc./dec. time	1-17
4.3	Acceleration time 2	0,1—3000,0 s	0,1 s	10,0 s			1-17
4.4	Deceleration time 2	0,1—3000,0 s	0,1 s	10,0 s			1-17
4.5	Brake chopper 	0—2	1	0		0 = Brake chopper not in use 1 = Brake chopper in use 2 = External brake chopper	1-17
4.6	Start function	0—1	1	0		0 = Ramp 1 = Flying start	1-17
4.7	Stop function	0—1	1	0		0 = Coasting 1 = Ramp	1-18
4.8	DC-braking current	0,15—1,5 x $I_{nCT}$ (A)	0,1 A	0,5 x $I_{nCT}$			1-18
4.9	DC-braking time at Stop	0,00—250,00 s	0,01 s	0,00 s		0 = DC-brake is off	1-18







**Note!**  = Parameter value can be changed only when the frequency converter is stopped.

## 1

**Group 5, Prohibit frequency parameters**

Code	Parameter	Range	Step	Default	Custom	Description	Page
5.1	Prohibit frequency range low limit	$f_{\min}$ — par. 5. 2	0,1 Hz	0,0 Hz			1-19
5.2	Prohibit frequency range high limit	$f_{\min}$ — $f_{\max}$ (1. 1) (1. 2)	0,1 Hz	0,0 Hz		0 = no prohibit frequency range (max limit = par. 1. 2)	1-19

**Group 6, Motor control parameters**

Code	Parameter	Range	Step	Default	Customer	Description	Page
6.1	Motor control mode 	0—1	1	0		0 = Frequency control 1 = Speed control	1-20
6.2	Switching frequency	1,0—16,0 kHz	0,1	10/3,6 kHz		Dependable on kW	1-20
6.3	Field weakening point 	30—500 Hz	1 Hz	Param. 1. 11			1-20
6.4	Voltage at field weakening point 	15—200% $\times U_{\text{nmot}}$	1%	100%			1-20
6.5	U/F-curve mid point frequency 	0,0— $f_{\max}$	0,1 Hz	0,0 Hz			1-20
6.6	U/F-curve mid point voltage 	0,00—100,00% $\times U_{\text{nmot}}$	0,01%	0,00%		Parameter maximum value = param. 6.4	1-20
6.7	Output voltage at zero frequency 	0,00—40,00% $\times U_{\text{nmot}}$	0.01%	0,00%			1-20
6.8	Overtoltage controller	0—1	1	1		0 = Controller is not operating 1 = Controller is operating	1-20
6.9	Undervoltage controller	0—1	1	1		0 = Controller is not operating 1 = Controller is operating	1-20

**Note!**  = Parameter value can be changed only when the frequency converter is stopped.

**Group 7, Protections**

Code	Parameter	Range	Step	Default	Custom	Description	Page
7.1	Response to reference fault	0—3	1	0		0 = No action 1 = Warning 2 = Fault, stop according par. 4.7 3 = Fault, stop with coasting	1-21
7.2	Response to external fault	0—3	1	2		0 = No action 1 = Warning 2 = Fault, stop according par. 4.7 3 = Fault, stop with coasting	1-21
7.3	Phase supervision of the motor	0—2	2	2		0 = No action 2 = Fault	1-21
7.4	Earth fault protection	0—2	2	2		0 = No action 2 = Fault	1-21
7.5	Motor thermal protection	0—2	1	2		0 = No action 1 = Warning 2 = Fault	1-22
7.6	Stall protection	0—2	1	1		0 = No action 1 = Warning 2 = Fault	1-22

**Group 8, Autorestart parameters**

Code	Parameter	Range	Step	Default	Custom	Description	Page
8.1	Automatic restart: number of tries	0—10	1	0		0 = no action	1-23
8.2	Automatic restart: trial time	1—6000 s	1 s	30 s			1-23
8.3	Automatic restart: start function	0—1	1	0		0 = Ramp 1 = Flying start	1-24

*Table 1.5-1 Special parameters, Groups 2—8.*

1

1.5.2 Description of Group 2—8 parameters

2.1 Start/Stop logic selection

- 0 DIA1: closed contact = start forward  
DIA2: closed contact = start reverse,  
See figure 1.5-1.

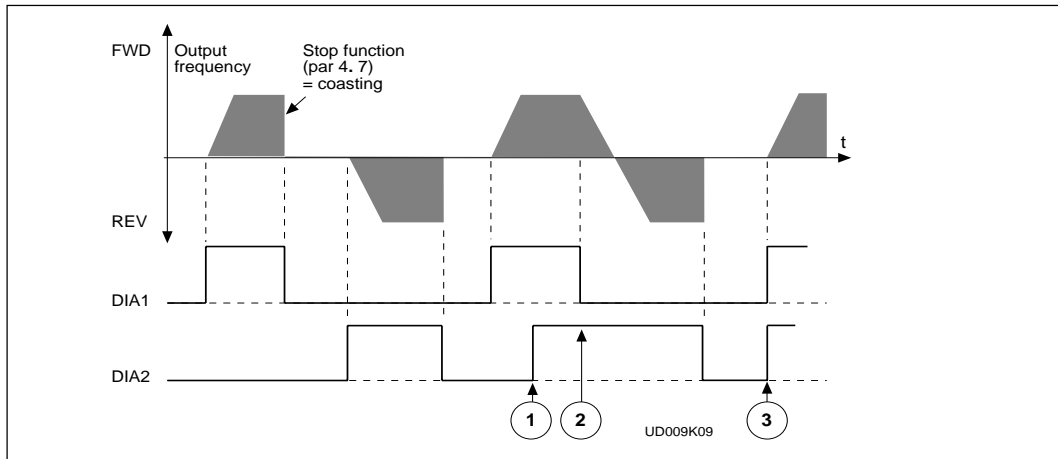

Figure 1.5-1 Start forward/Start reverse.

- ① The first selected direction has the highest priority
  - ② When DIA1 contact opens, the direction of rotation starts to change
  - ③ If Start forward (DIA1) and Start reverse (DIA2) signals are active simultaneously, the Start forward signal (DIA1) has priority.
- 1 DIA1: closed contact = start      open contact = stop  
DIA2: closed contact = reverse    open contact = forward  
See figure 1.5-2.

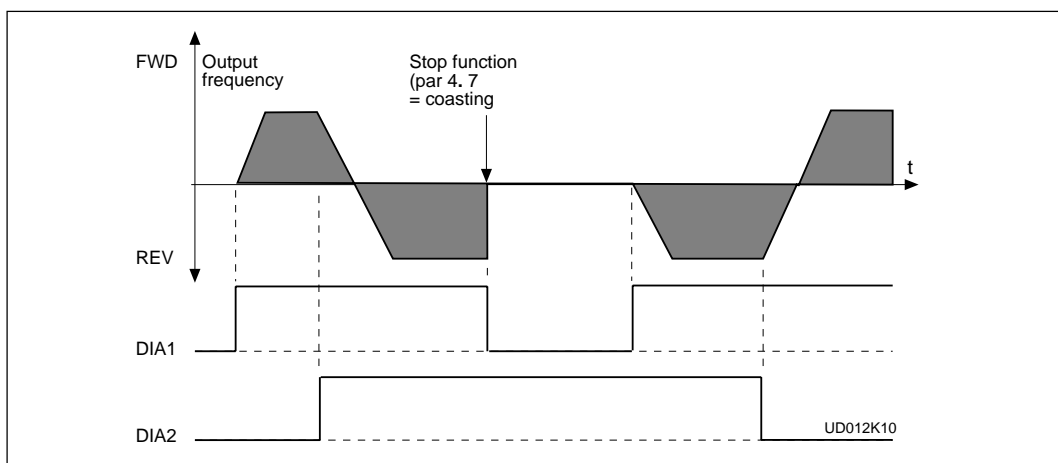

Figure 1.5-2 Start, Stop, reverse.

- 2: DIA1: closed contact = start                      open contact = stop  
    DIA2: closed contact = start enabled        open contact = start disabled
- 3: 3-wire connection (pulse control):  
    DIA1: closed contact = start pulse  
    DIA2: closed contact = stop pulse  
    (DIA3 can be programmed for reverse command)  
    See figure 1.5-3.

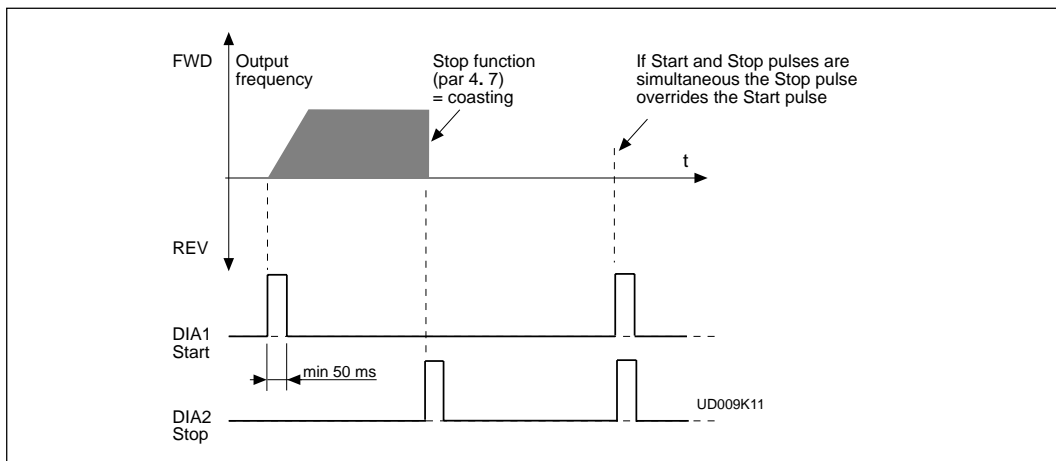

Figure 1.5-3 Start pulse/Stop pulse.

**2. 2 DIA3 function**

- 1: External fault, closing contact = Fault is shown and motor is stopped when the contact is closed.
- 2: External fault, opening contact = Fault is shown and motor is stopped when the contact is open.
- 3: Run enable    contact open    = Start of the motor disabled  
                   contact closed = Start of the motor enabled
- 4: Acc. / Dec    contact open    = Acceleration/Deceleration time 1 selected  
    time select. contact closed = Acceleration/Deceleration time 2 selected
- 5: Reverse        contact open    = Forward        || Can be used for reversing if  
                       contact closed = Reverse            || parameter 2. 1 has value 3

**2.3 Reference offset for current input**

- 0: No offset
- 1: Offset 4 mA ("living zero"), provides supervision of zero level signal.  
    The response to reference fault can be programmed with the parameter 7. 1.

**2.4, 2.5 Reference scaling, minimum value/maximum value**

Setting value limits:  $0 \leq \text{par. 2. 4} \leq \text{par. 2. 5} \leq \text{par. 1. 2}$ .  
 If parameter 2. 5 = 0 scaling is set off. See figures 1.5-4 and 1.5-5.

1

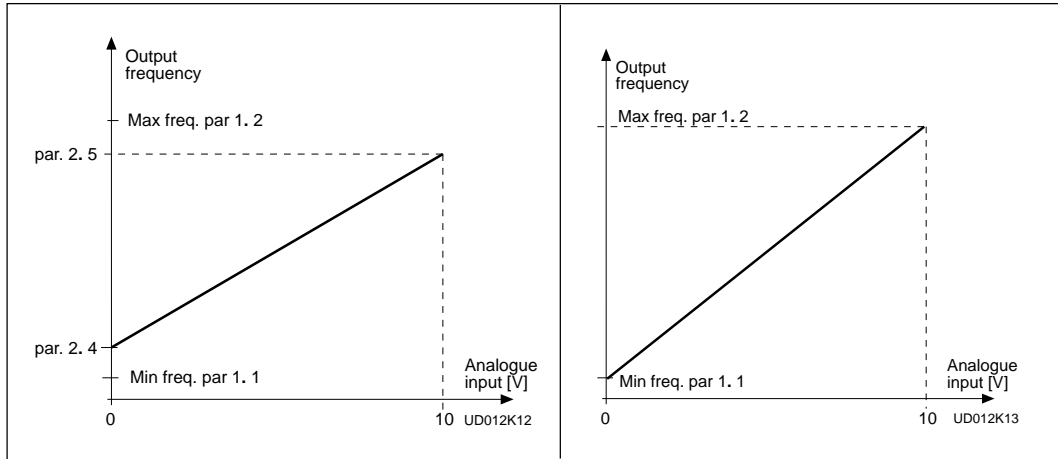

Figure 1.5-4 Reference scaling.

Figure 1.5-5 Reference scaling, parameter 2.5 = 0.

2.6 Reference invert

Inverts reference signal:

- max. ref. signal = min.set freq.
- min. ref. signal = max. set freq.

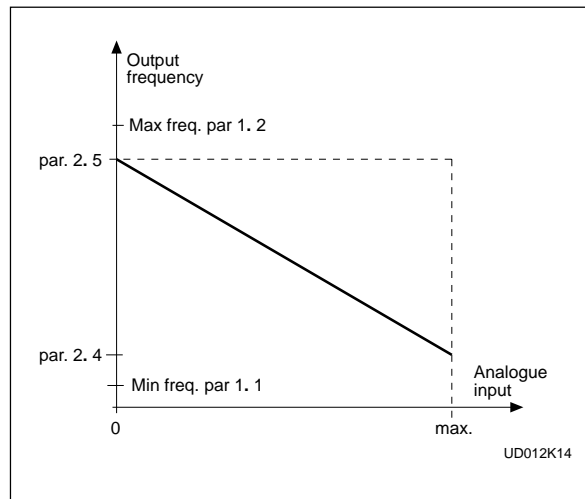

Figure 1.5-6 Reference invert.

2.7 Reference filter time

Filters out disturbances from the incoming reference signal. Long filtering time makes regulation response slower. See figure 1.5-7.

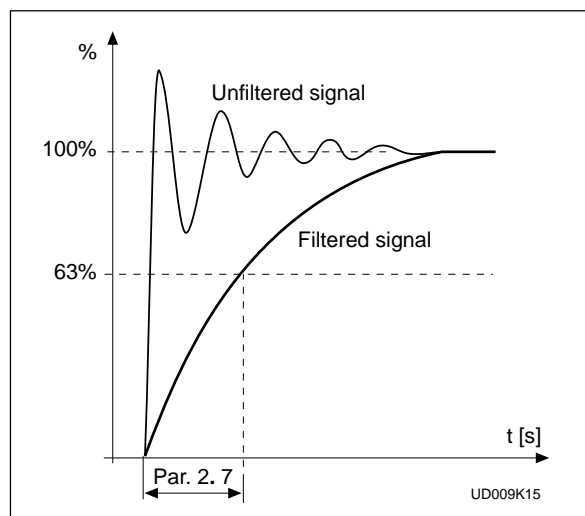

Figure 1.5-7 Reference filtering.



**3.1 Analogue output function**

See table "Group 3, output and supervision parameters" on page 1-8.

**3.2 Analogue output filter time**

Filters the analogue output signal. See figure 1.5-8.

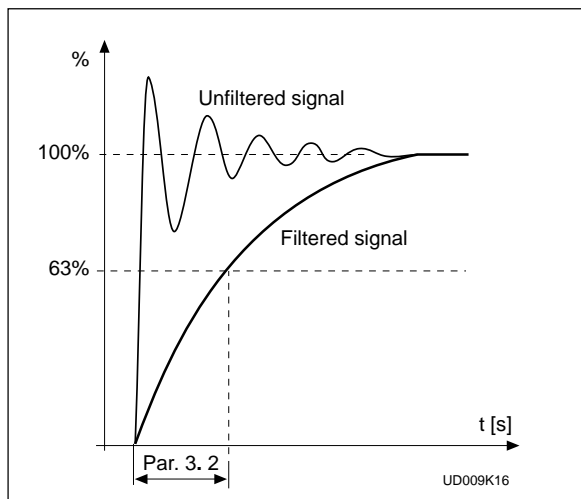

Figure 1.5-8 Analogue output filtering.

**3.3 Analogue output invert**

Inverts analogue output signal:  
 max. output signal = minimum set value  
 min. output signal = maximum set value

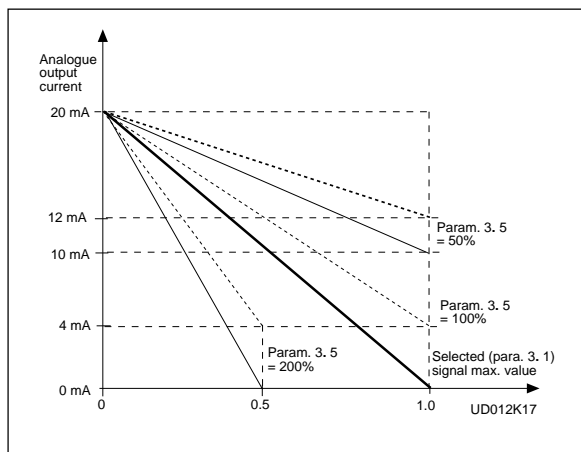

Figure 1.5-9 Analogue output invert.

**3.4 Analogue output minimum**

Defines the signal minimum to be either 0 mA or 4 mA (living zero). See figure 1.5-10.

**3.5 Analog output scale**

Scaling factor for analog output. See figure 1.5-10.

Signal	Max. value of the signal
Output frequency	Max. frequency (p. 1. 2)
Motor speed	Max. speed ( $n_n \times f_{max} / f_n$ )
Output current	$2 \times I_{nFC}$
Motor torque	$2 \times T_{nMot}$
Motor power	$2 \times P_{nMot}$
Motor voltage	$100\% \times U_{nMot}$
DC-link volt.	1000 V

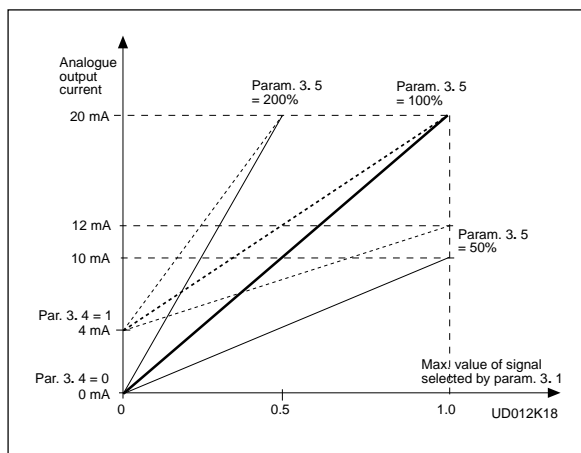

Figure 1.5-10 Analogue output scale.

1

- 3.6 **Digital output function**
- 3.7 **Relay output 1 function**
- 3.8 **Relay output 2 function**

Setting value	Signal content
0 = Not used	Out of operation <u>Digital output DO1 sinks current and programmable relay (RO1, RO2) is activated when:</u>
1 = Ready	The frequency converter is ready to operate
2 = Run	The frequency converter operates
3 = Fault	A fault trip has occurred
4 = Fault inverted	A fault trip <u>has not</u> occurred
5 = Vacon overheat warning	The heat-sink temperature exceeds +70°C
6 = External fault or warning	Fault or warning depending on parameter 7. 2
7 = Reference fault or warning	Fault or warning depending on parameter 7. 1 - if analogue reference is 4—20 mA and signal is <4mA
8 = Warning	Always if a warning exists
9 = Reversed	The reverse command has been selected
10= Multi-step speed selected	A multi-step speed has been selected
11= At speed	The output frequency has reached the set reference
12= Motor regulator activated	Overvoltage or overcurrent regulator was activated
13= Output frequency supervision	The output frequency goes outside of the set supervision low limit/ high limit (par. 3. 9 and 3. 10)
14= Control from I/O terminals	Ext. control mode selected with progr. push-button #2

Table 1.5-2 Output signals via DO1 and output relays RO1 and RO2.

**3.9 Output frequency limit supervision function**

- 0 = No supervision
- 1 = Low limit supervision
- 2 = High limit supervision

If the output frequency goes under/over the set limit (3. 10) this function generates a warning message via the digital output DO1 and via the relay output RO1 or RO2 depending on the settings of parameters 3. 6—3. 8.

**3.10 Output frequency limit supervision value**

The frequency value to be supervised with parameter 3. 9.  
See figure 1.5-11.

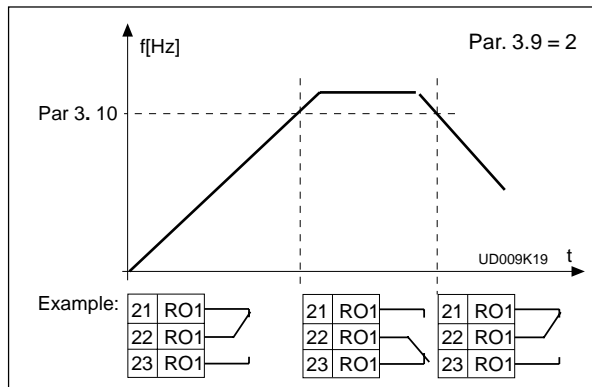

Figure 1.5-11 Output frequency supervision.

**4.1 Acc/Dec ramp 1 shape****4.2 Acc/Dec ramp 2 shape**

Smooth acceleration and deceleration can be programmed with these parameters.

Setting value 0 gives linear ramp shape which causes acceleration and deceleration to act immediately to the changes in the reference signal with the time constant set by the parameter 1.3/1.4 (4.3/4.4).

Setting value 0.1—10 seconds for 4.1 (4.2) causes linear acceleration/deceleration turn towards to the S-shape. Param. 1.3/1.4 (4.3/4.4) determines the time constant of acceleration/deceleration in the middle of the curve. See figure 1.5-12.

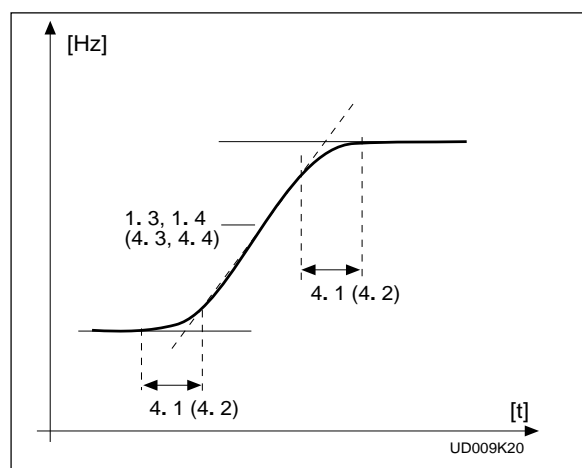

Figure 1.5-12 S-shaped acceleration/deceleration.

**4.3 Acceleration time 2****4.4 Deceleration time 2**

These values correspond to the time required for the output frequency to accelerate from the set minimum frequency (par. 1.1) to the set maximum frequency (par. 1.2). These times give the possibility to set two different acceleration/deceleration time sets for one application. The active set can be selected with the programmable signal DIA3 of this application, see parameter 2.2.

**4.5 Brake chopper**

0 = No brake chopper

1 = Brake chopper and brake resistor installed

2 = External brake chopper

When the frequency converter is decelerating the motor the inertia from the motor and the load is fed into the external brake resistor. This enables the frequency converter to decelerate the load with the torque equal to that of acceleration, if the brake resistor is selected correctly. See separate Brake resistor installation manual.

**4.6 Start function**

Ramp:

- 0** The frequency converter starts from 0 Hz and accelerates to the set reference frequency within the set acceleration time. (Load inertia or starting friction may cause prolonged acceleration times).

Flying start:

- 1 The frequency converter is able to start into running motor by applying a small torque to motor and searching for frequency corresponding to the speed the motor is running. Searching starts from the maximum frequency towards the actual frequency until the the correct value is detected. Thereafter the output frequency will be accelerated/decelerated to the set reference value according to the set acceleration/deceleration parameters.

Use this mode if the motor should coast when the start command is given. With the flying start it is possible to ride through short mains voltage interruptions.

#### 4.7 **Stop function**

Coasting:

- 0 The motor coasts to a halt without any control from the frequency converter, after the Stop command.

Ramp:

- 1 After the Stop command, the speed of the motor is decelerated according to the set deceleration parameters.  
If the regenerated energy is high it may be necessary to use an external braking resistor for faster deceleration.

#### 4.8 **DC braking current**

Defines the current injected into the motor during the DC braking.

#### 4.9 **DC braking time at stop**

Determines if braking is ON or OFF and braking time of the DC-brake when the motor is stopping. The function of the DC-brake depends on the stop function, parameter 4. 7. See figure 1.5-13.

- 0 DC-brake is not used
- >0 DC-brake is in use and its function depends on the stop function, (param. 4. 7), and the time depends on the value of parameter 4. 9:

Stop-function = 0 (coasting):

After the stop command, the motor coasts to a stop without any control from the frequency converter.

With DC-injection, the motor can be electrically stopped in the shortest possible time, without using an optional external braking resistor.

The braking time is scaled according to the frequency when the DC-braking starts. If the frequency is  $\geq$ nominal frequency of the motor (par. 1.11), setting value of parameter 4.9 determines the braking time. When the frequency is  $\leq$ 10% of the nominal, the braking time is 10% of the set value of parameter 4.9. See figure 1.5-13.

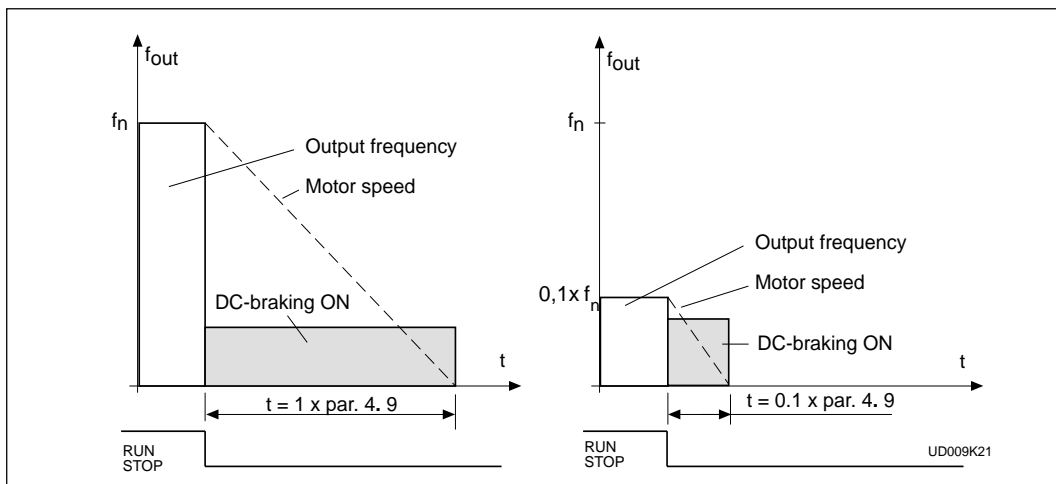

Figure 1.5-13 DC-braking time when stop = coasting.

**Stop-function = 1 (ramp):**

After the stop command, the speed of the motor is reduced according to the set deceleration parameters, as fast as possible, down to 0.5 Hz where the DC-braking starts.

The braking time is defined with par. 4. 9. If high inertia exists it is recommended to use an external braking resistor for faster deceleration.

See figure 1.5-14.

Figure 1.5-14 DC-braking time when stop function = ramp.

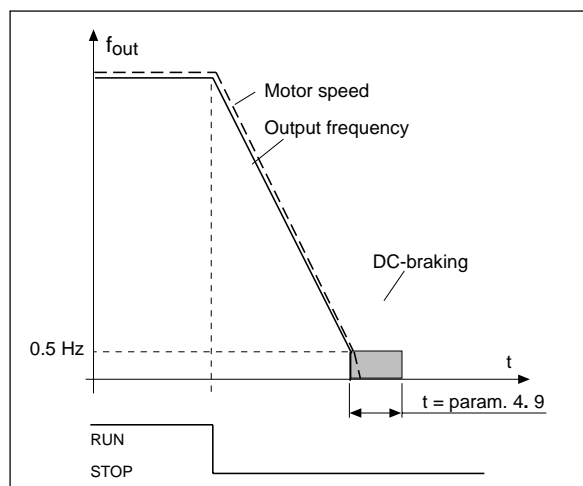

**5. 1 Prohibit frequency area Low limit/High limit**  
**5. 2**

In some systems it may be necessary to avoid certain frequencies because of mechanical resonance problems.

With these parameters it is possible to set limits for one "skip frequency" region between 0 Hz and 120 Hz/500 Hz. Accuracy of the setting is 0.1 Hz. See figure 1.5-15.

Figure 1.5-15 Example of prohibit frequency area setting.

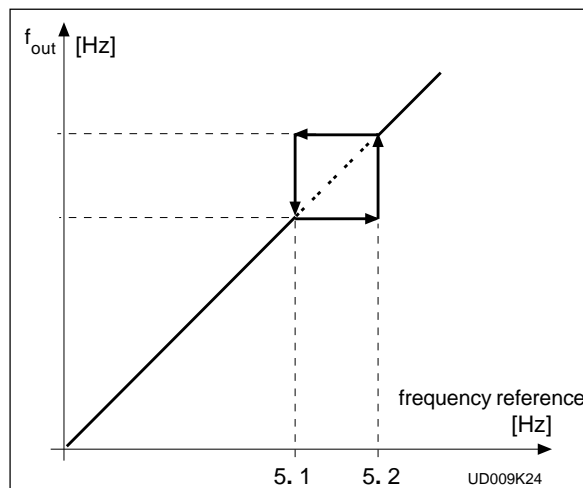

**6.1 Motor control mode**

- 0 = Frequency control: The I/O terminal and panel references are frequency references and the frequency converter controls the output frequency ( output freq. resolution 0.01 Hz)
- 1 = Speed control: The I/O terminal and panel references are speed references and the frequency converter controls the motor speed (regulation accuracy  $\pm 0,5\%$ ).

**6.2 Switching frequency**

Motor noise can be minimized using high switching frequency. Increasing the switching frequency reduces the capacity of the frequency converter unit.

Before changing the frequency from the factory default 10 kHz (3.6 kHz  $\geq 30$  kW) check the curve in figure 5.2-3 in Chapter 5.2 of the User's Manual for the allowed capacity.

**6.3 Field weakening point****6.4 Voltage at the field weakening point**

The field weakening point is the output frequency where the output voltage reaches the set maximum value (par. 6.4). Above that frequency the output voltage remains at the set maximum value. Below that frequency the output voltage depends on the setting of the U/f curve parameters 1.8, 1.9, 6.5, 6.6 and 6.7. See figure 1.5-16.

When the parameters 1.10 and 1.11, nominal voltage and nominal frequency of the motor, are set, also parameters 6.3 and 6.4 are set automatically to the corresponding values. If you need different values for the field weakening point and the maximum output voltage, change these parameters after setting the parameters 1.10 and 1.11.

**6.5 U/f curve, middle point frequency**

If the programmable U/f curve has been selected with the parameter 1.8 this parameter defines the middle point frequency of the curve. See figure 1.5-16.

**6.6 U/f curve, middle point voltage**

If the programmable U/f curve has been selected with the parameter 1.8 this parameter defines the middle point voltage of the curve. See figure 1.5-16.

**6.7 Output voltage at zero frequency**

If the programmable U/f curve has been selected with the parameter 1.8 this parameter defines the zero frequency voltage of the curve. See figure 1.5-16.

**6.8 Overvoltage controller****6.9 Undervoltage controller**

These parameters allow the over-/undervoltage controllers to be switched out of operation. This may be useful, for example, if the mains supply voltage varies more than  $-15\%$ — $+10\%$  and the application will not tolerate this over-/undervoltage, the regulator controls output frequency according to the supply fluctuations.

Over-/undervoltage trips may occur when controllers are switched out of operation.

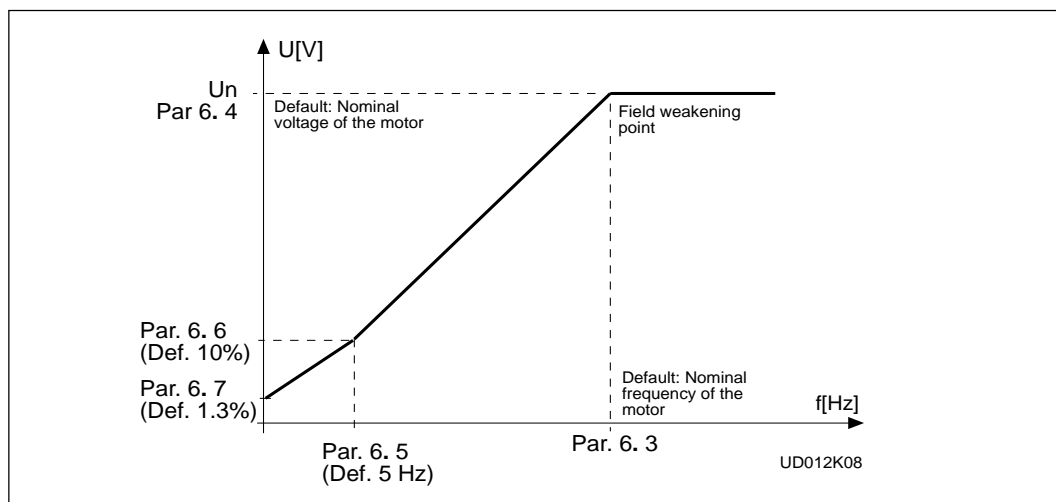

Figure 1.5-16 Programmable U/f curve.

### 7.1 Response to the reference fault

- 0 = No response
- 1 = Warning
- 2 = Fault, stop mode after fault detection according to parameter 4.7
- 3 = Fault, stop mode after fault detection always coasting

A warning or a fault action and message is generated if 4—20 mA reference signal is used and the signal falls below 4 mA.

The information can also be programmed via digital output DO1 and via relay outputs RO1 and RO2.

### 7.2 Response to external fault

- 0 = No response
- 1 = Warning
- 2 = Fault, stop mode after fault detection according to parameter 4.7
- 3 = Fault, stop mode after fault detection always coasting

A warning or a fault action and message is generated from the external fault signal in the digital input DIA3.

The information can also be programmed into digital output DO1 and into relay outputs RO1 and RO2.

### 7.3 Phase supervision of the motor

- 0 = No action
- 2 = Fault

Phase supervision of the motor ensures that the motor phases have an approximately equal current.

### 7.4 Earth fault protection

- 0 = No action
- 2 = Fault

Earth fault protection ensures that the sum of the motor phase currents is zero. The overcurrent protection is always working and protects the frequency converter from earth faults with high currents.

## 1

## 7.5 Motor thermal protection

Operation:

0 = Not in use

1 = Warning

2 = Trip function

Motor thermal protection is to protect the motor from overheating. In the Standard application the Motor thermal protection uses constant settings. In other applications it is possible to set more parameters of thermal protection. Tripping and warning will give display indication with the same message code. If the tripping is selected the drive will stop and activate the fault stage.

Deactivating the protection, setting parameter to 0, will reset the thermal stage of the motor to 0%.

Vacon CX/CXL/CXS drive is capable to give higher than nominal current to the motor. If the load requires this high current there is a risk that motor will be thermally overloaded. This is true especially at low frequencies. With low frequencies the cooling effect of the motor fan is reduced and the capacity of the motor is reduced. Motor thermal protection is based on a calculated model and it uses the output current of the drive to determine the load on the motor.

The thermal current  $I_T$  specifies the load current above which the motor is overloaded. See figure 1.5-17. If the motor current is over the curve the motor temperature is increasing.

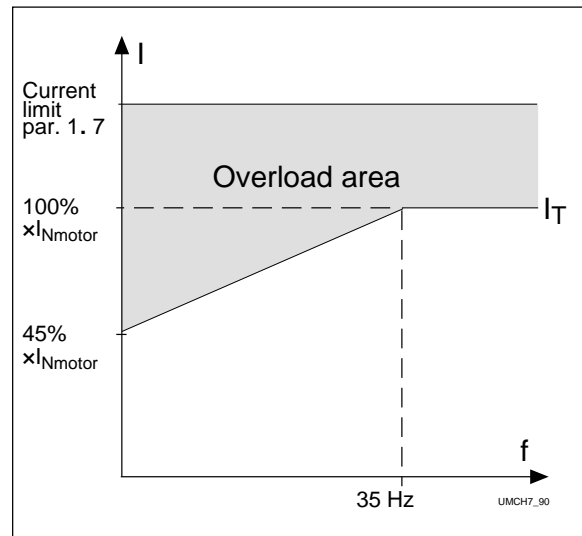

Figure 1.5-17 Motor thermal current  $I_T$  curve.



**CAUTION!** *The calculational model does not protect the motor if the cooling of the motor is reduced either by blocking the airflow or due to dust or dirt.*

## 7.6 Stall protection

Operation:

0 = Not in use

1 = Warning

2 = Trip function

Motor Stall protection gives warning or fault if short time overload situations of the motor, e.g. stalled shaft, occur. The reaction time of the stall protection is shorter than with motor thermal protection. The stall state is defined with Stall Current and Stall Frequency. In the Standard application they both have constant values. See figure 1.5-18. If the current is higher than the set limit and output frequency is lower than the set limit the stall state is true. If the stall state lasts longer than 15 sec. the stall warning is given on the panel display. In other applications it is possible to set more parameters of the Stall protection function. Tripping and warning will give display indication with the same message code. If the tripping is set on, the drive will stop and activate the fault stage.

Deactivating stall protection, by setting parameter to 0, will reset the stall time counter to zero.



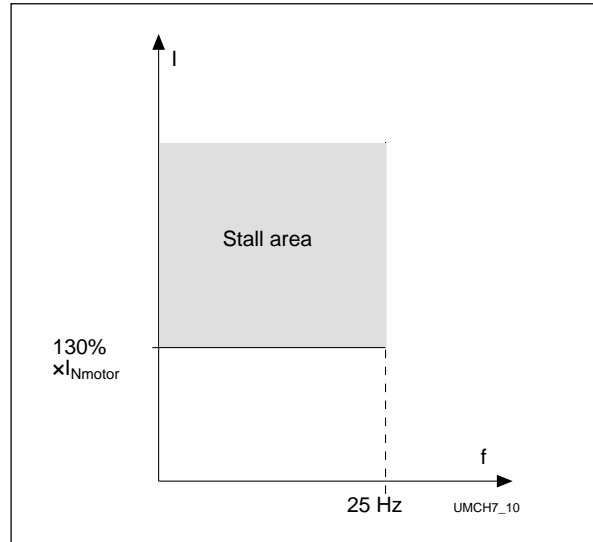

Figure 1.5-18 Stall state.

**8.1 Automatic restart: number of tries**

**8.2 Automatic restart: trial time**

The Automatic restart function restarts the frequency converter after the following faults:

- overcurrent
- overvoltage
- undervoltage
- over/under temperature of the frequency converter
- reference fault

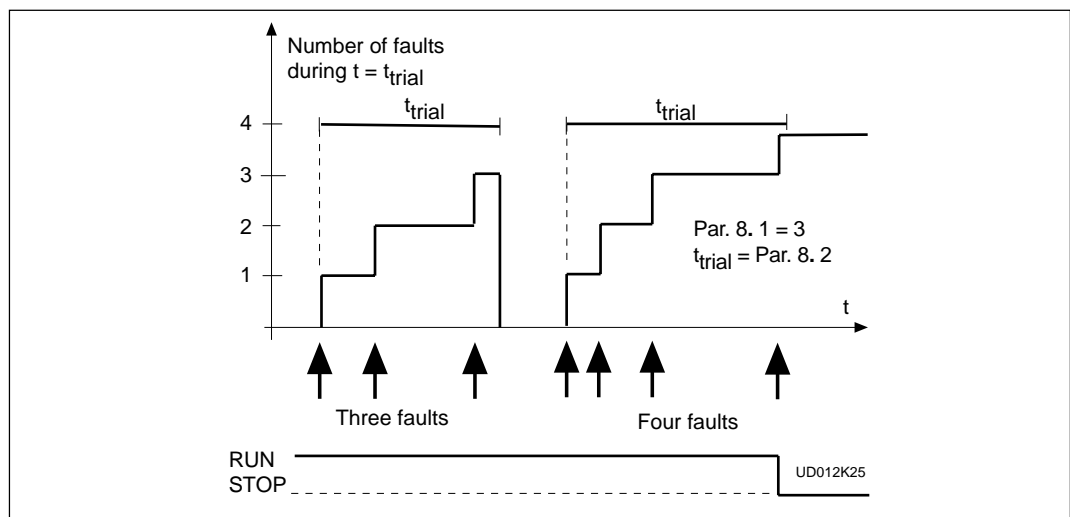

Figure 1.5-19 Automatic restart.

Parameter 8.1 determines how many automatic restarts can be made during the trial time set by the parameter 8.2.

The counting time starts from the first autorestart. If the number of restarts does not exceed the value of the parameter 8.1 during the trial time, the counting is cleared after the time is elapsed and next fault starts the counting again.



---

## LOCAL/REMOTE CONTROL APPLICATION

(par. 0.1 = 3)

### CONTENTS

#### 2 Local/Remote Control Application ..2-1

2.1	General .....	2-2
2.2	Control I/O .....	2-2
2.3	Control signal logic .....	2-3
2.4	Parameters Group 1 .....	2-4
2.4.1	Parameter table .....	2-4
2.4.2	Description of Group1 par...	2-5
2.5	Special parameters, Groups 2—8 ..	2-8
2.5.1	Parameter tables .....	2-8
2.5.2	Description of Group 2 par..	2-15

2.1 General

Utilising the Local/Remote Control Application it is possible to have two different control sources. Frequency reference sources of the control sources are programmable. The active control source is selected with the digital input DIB6.

The Local/Remote Control Application can be

activated from the Group 0 by setting the parameter value of parameter 0. 1 to 3.

Basic connections of inputs and outputs are shown in figure 2.2-1. The control signal logic has shown in the figure 2.3-1. Programming of I/O terminals is explained in Chapter 2.5, Special parameters.

2

2.2 Control I/O

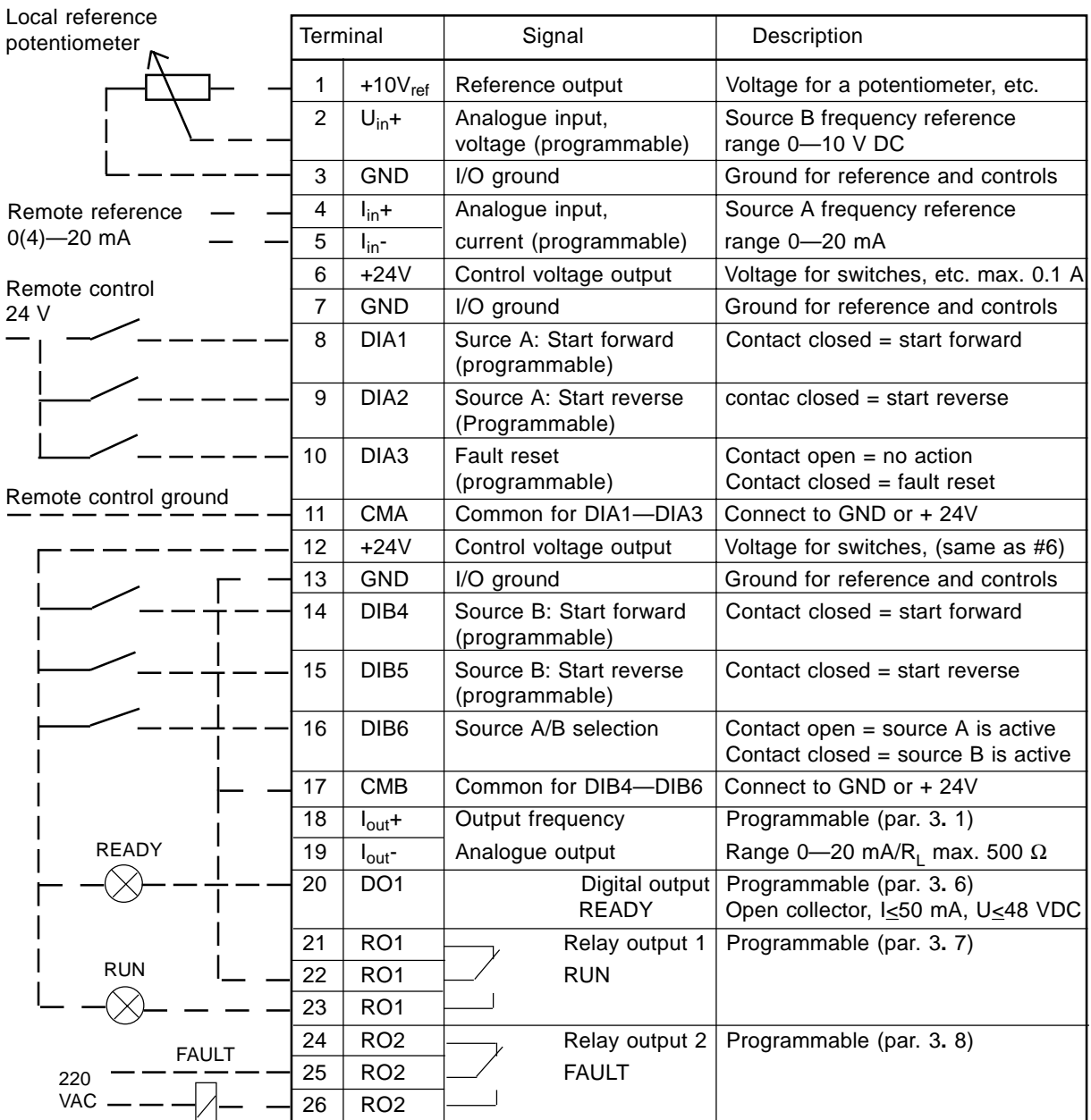

Figure 2.2-1 Default I/O configuration and connection example of the Local/Remote Control Application.

2.3 Control signal logic

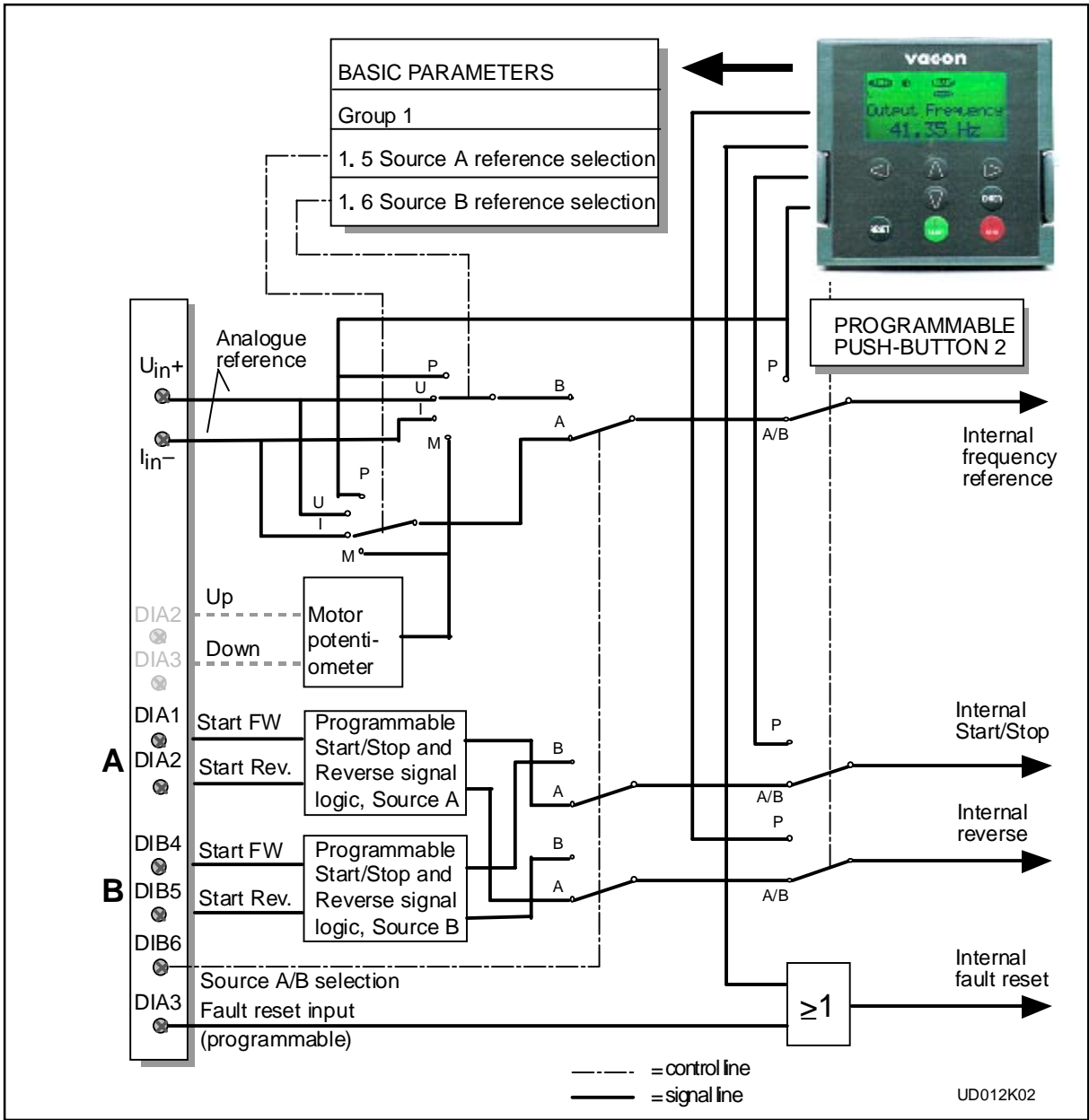

Figure 2.3-1 Control signal logic of the Local/Remote Control Application. Switch positions are shown according to the factory settings.

## 2.4 Basic parameters, Group 1

### 2.4.1 Parameter table











Code	Parameter	Range	Step	Default	Custom	Description	Page
1. 1	Minimum frequency	0— $f_{max}$	1 Hz	0 Hz			2-5
1. 2	Maximum frequency	$f_{min}$ -120/500 Hz	1 Hz	50 Hz		*)	2-5
1. 3	Acceleration time 1	0,1—3000,0 s	0,1 s	3,0 s		Time from $f_{min}$ (1. 1) to $f_{max}$ (1. 2)	2-5
1. 4	Deceleration time 1	0,1—3000,0 s	0,1 s	3,0 s		Time from $f_{max}$ (1. 2) to $f_{min}$ (1. 1)	2-5
1. 5	Source A: reference signal 	0—4	1	1		0 = Anal. voltage input (term. 2) 1 = Anal. current input (term. 4) 2 = Set reference from the panel 3 = Signal from internal motor pot. 4 = Signal from internal motor pot. resetted if Vacon unit is stopped	2-5
1. 6	Source B: reference signal 	0—4	1	0		0 = Anal. voltage input (term. 2) 1 = Anal. current input (term. 4) 2 = Set reference from the panel 3 = Signal from internal motor pot. 4 = Signal from internal motor pot. resetted if Vacon unit is stopped	2-5
1. 7	Current limit	0,1—2,5 $\times I_{nCT}$	0,1	1,5 $\times I_{nCT}$		***Output curr. limit [A] of the unit	2-5
1. 8	U/f ratio selection 	0—2	1	0		0 = Linear 1 = Squared 2 = Programmable U/f ratio	2-5
1. 9	U/f optimisation 	0—1	1	0		0 = None 1 = Automatic torque boost	2-7
1. 10	Nominal voltage of the motor 	180—690 V	1 V	230 V 400 V 500 V 690 V		Vacon range CX/CXL/CXS2 Vacon range CX/CXL/CXS4 Vacon range CX/CXL/CXS5 Vacon range CX6	2-7
1. 11	Nominal frequency of the motor 	30—500 Hz	1 Hz	50 Hz		$f_n$ from the rating plate of the motor	2-7
1. 12	Nominal speed of the motor 	300—20000 rpm	1 rpm	1420 rpm **)		$n_n$ from the rating plate of the motor	2-7
1. 13	Nominal current of the motor 	2,5 $\times I_{nCT}$	0,1 A	$I_{nCT}$		$I_n$ from the rating plate of the motor	2-7
1. 14	Supply voltage 	208—240		230 V		Vacon range CX/CXL/CXS2	2-7
		380—440		400 V		Vacon range CX/CXL/CXS4	
		380—500		500 V		Vacon range CX/CXL/CXS5	
		525—690		690 V		Vacon range CX6	
1. 15	Parameter conceal	0—1	1	0		Visibility of the parameters: 0 = All parameter groups visible 1 = Only group 1 is visible	2-7
1. 16	Parameter value lock	0—1	1	0		Disables parameter changes: 0 = Changes enabled 1 = Changes disabled	2-7

Table 2.4-1 Group 1 basic parameters.

**Note!**  = Parameter value can be changed only when the frequency converter is stopped.

\*) If 1. 2 > motor synchr. speed, check suitability for motor and drive system. Selecting 120 Hz/500 Hz range, see page 2-5.

\*\*\*)Default value for a four pole motor and a nominal size Vacon.

\*\*\*Up to M10. Bigger classes case by case.

## 2.4.2 Description of Group 1 parameters

### 1. 1, 1. 2 *Minimum / maximum frequency*

Defines frequency limits of the frequency converter.

The default maximum value for parameters 1. 1 and 1. 2 is 120 Hz. By setting the value of the parameter 1. 2 to 120 Hz when the device is stopped (RUN indicator not lit) the maximum value of parameters 1. 1 and 1. 2 is changed to 500 Hz. At the same time the resolution of the panel reference is changed from 0.01 Hz to 0.1 Hz.

Changing the max. value from 500 Hz to 120 Hz is done by setting parameter 1. 2 to 119 Hz when the device is stopped.

### 1. 3, 1. 4 *Acceleration time1, deceleration time 1:*

These limits correspond to the time required for the output frequency to accelerate from the set minimum frequency (par. 1. 1) to the set maximum frequency (par. 1. 2). Acceleration/deceleration times can be reduced with a free analogue input signal, see parameters 2. 18 and 2. 19.

### 1. 5 *Source A reference signal*

- 0 Analogue voltage reference from terminals 2—3, e.g. a potentiometer
- 1 Analogue current reference from terminals 4—5, e.g. a transducer.
- 2 Panel reference is the reference set from the Reference Menu, see Chapter 7.5 in the User's Manual.
- 3 Reference value is changed with digital input signals DIA2 and DIA3.
  - switch in DIA2 closed = frequency reference increases
  - switch in DIA3 closed = frequency reference decreasesSpeed of the reference change can be set with the parameter 2. 3.
- 4 Same as setting 3 but the reference value is set to the minimum frequency (par. 2. 14 or par. 1. 1 if par 2. 15 = 0) each time the frequency converter is stopped. When the value of parameter 1. 5 is set to 3 or 4, value of parameter 2. 1 is automatically set to 4 and value of parameter 2. 2 is automatically set to 10.

### 1. 6 *Source B reference signal*

See the values of the parameter 1. 5.

### 1. 7 *Current limit*

This parameter determines the maximum motor current what the frequency converter can give momentary. Current limit can be set lower with a free analog input signal, see parameters 2. 18 and 2. 19.

### 1. 8 *U/f ratio selection*

Linear: The voltage of the motor changes linearly with the frequency in the constant flux area from 0 Hz to the field weakening point (par. 6. 3) where the nominal voltage is also supplied to the motor. See figure 2.4-1.

0

Linear U/f ratio should be used in constant torque applications.

**This default setting should be used if there is no special demand for another setting.**

2

Squared: 1 The voltage of the motor changes following a squared curve form with the frequency in the area from 0 Hz to the field weakening point (par. 6. 3) where the maximum voltage is also supplied to the motor. See figure 2.4-1.

The motor runs undermagnetised below the field weakening point and produces less torque and electromechanical noise. Squared U/f ratio can be used in applications where torque demand of the load is proportional to the square of the speed, e.g. in centrifugal fans and pumps.

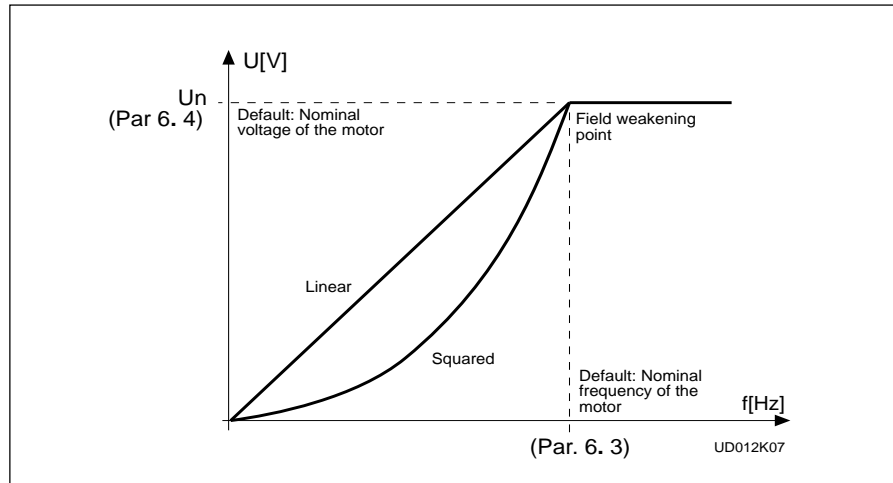

Figure 2.4-1 Linear and squared U/f curves.

Programm. U/f curve 2 The U/f curve can be programmed with three different points. The parameters for programming are explained in the chapter 2.5.2 Programmable U/f curve can be used if the other settings do not satisfy the needs of the application. See figure 2.4-2.

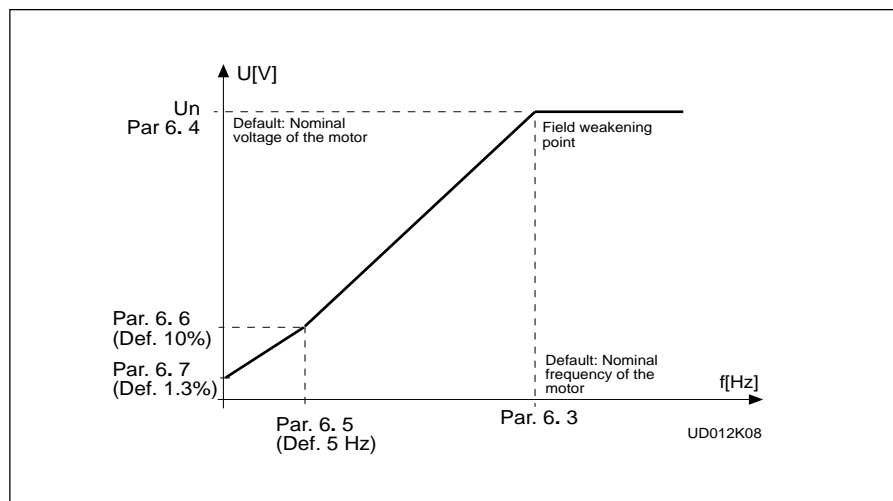

Figure 2.4-2 Programmable U/f curve.



**1. 9 U/f optimisation**

Automatic torque boost The voltage to the motor changes automatically which makes the motor produce torque enough to start and run at low frequencies. The voltage increase depends on the motor type and power.

Automatic torque boost can be used in applications where starting torque due to starting friction is high, e.g. in conveyors.

**NOTE!**

*In high torque - low speed applications - it is likely the motor will overheat.*

*If the motor has to run a prolonged time under these conditions, special attention must be paid to motor cooling. Use external cooling for the motor if the temperature tends to rise too high.*

**1. 10 Nominal voltage of the motor**

Find this value  $U_n$  on the rating plate of the motor.

This parameter sets the Voltage at the field weakening point, parameter 6. 4, to  $100\% \times U_{n\text{motor}}$

**1. 11 Nominal frequency of the motor**

Find this value  $f_n$  on the rating plate of the motor.

This parameter sets the field weakening point, parameter 6. 3, to the same value.

**1. 12 Nominal speed of the motor**

Find this value  $n_n$  on the rating plate of the motor.

**1. 13 Nominal current of the motor**

Find the value  $I_n$  on the rating plate of the motor.

The internal motor protection function uses this value as a reference value.

**1. 14 Supply voltage**

Set parameter value according to the nominal voltage of the supply.

Values are predefined for CX/CXL/CXS2, CX/CXL/CXS4, CX/CXL/CXS5 and CX6 ranges, see table 2.4-1.

**1. 15 Parameter conceal**

Defines which parameter groups are available:

0 = all groups are visible

1 = only group 1 is visible

**1. 16 Parameter value lock**

Defines access to the changes of the parameter values:



0 = parameter value changes enabled

1 = parameter value changes disabled

If you have to adjust more of the functions of the Local/Remote Control Application, see chapter 2.5 to set up parameters of Groups 2—8.

## 2.5 Special parameters, Groups 2—8

### 2.5.1 Parameter tables, Group 2, Input signal parameters



Code	Parameter	Range	Step	Default	Custom	Description	Page				
2. 1	Source A Start/Stop logic selection 	0—4	1	0		<table border="1"> <thead> <tr> <th>DIA1</th> <th>DIA2</th> </tr> </thead> <tbody> <tr> <td>0 = Start forward 1 = Start/Stop 2 = Start/Stop 3 = Start pulse 4 = Start forward</td> <td>Start reverse Reverse Run enable Stop pulse Motor pot. UP</td> </tr> </tbody> </table>	DIA1	DIA2	0 = Start forward 1 = Start/Stop 2 = Start/Stop 3 = Start pulse 4 = Start forward	Start reverse Reverse Run enable Stop pulse Motor pot. UP	2-15
DIA1	DIA2										
0 = Start forward 1 = Start/Stop 2 = Start/Stop 3 = Start pulse 4 = Start forward	Start reverse Reverse Run enable Stop pulse Motor pot. UP										
2. 2	DIA3 function (terminal 10) 	0—10	1	7		0 = Not used 1 = Ext. fault, closing contact 2 = External fault, opening contact 3 = Run enable 4 = Acc./dec. time selection 5 = Reverse (if par. 2. 1 = 3) 6 = Jogging speed 7 = Fault reset 8 = Acc/dec. operation prohibit 9 = DC-braking command 10 = Motor potentiometer DOWN	2-16				
2. 3	U <sub>in</sub> signal range	0—1	1	0		0 = 0—10 V 1 = Custom setting range	2-17				
2. 4	U <sub>in</sub> custom setting min.	0,00—100,00%	0,01%	0,00%			2-17				
2. 5	U <sub>in</sub> custom setting max.	0,00—100,00%	0,01%	100,00%			2-17				
2. 6	U <sub>in</sub> signal inversion	0 — 1	1	0		0 = Not inverted 1 = Inverted	2-18				
2. 7	U <sub>in</sub> signal filter time	0,00 —10,00 s	0,01s	0,10s		0 = No filtering	2-18				
2. 8	I <sub>in</sub> signal range	0—2	1	0		0 = 0—20 mA 1 = 4—20 mA 2 = Custom setting range	2-19				
2. 9	I <sub>in</sub> custom setting minim.	0,00—100,00%	0,01%	0,00%			2-19				
2. 10	I <sub>in</sub> custom setting maxim.	0,00—100,00%	0,01%	100,00%			2-19				
2. 11	I <sub>in</sub> signal inversion	0—1	1	0		0 = Not inverted 1 = Inverted	2-19				
2. 12	I <sub>in</sub> signal filter time	0,01 —10,00 s	0,01s	0,10s		0 = No filtering	2-19				
2. 13	Source B Start/Stop logic selection 	0—3	1	0		<table border="1"> <thead> <tr> <th>DIB4</th> <th>DIB5</th> </tr> </thead> <tbody> <tr> <td>0 = Start forward 1 = Start/Stop 2 = Start/Stop 3 = Start pulse</td> <td>Start reverse Reverse Run enable Stop pulse</td> </tr> </tbody> </table>	DIB4	DIB5	0 = Start forward 1 = Start/Stop 2 = Start/Stop 3 = Start pulse	Start reverse Reverse Run enable Stop pulse	2-20
DIB4	DIB5										
0 = Start forward 1 = Start/Stop 2 = Start/Stop 3 = Start pulse	Start reverse Reverse Run enable Stop pulse										
2. 14	Source A reference scaling minimum value	0—par. 2. 15	1 Hz	0 Hz		Selects the frequency that corresp. to the min. reference signal	2-20				
2. 15	Source A reference scaling maximum value	0—f <sub>max</sub> (1. 2)	1 Hz	0 Hz		Selects the frequency that corresp. to the min. reference signal 0 = Scaling off >0 = Scaled maximum value	2-20				
2. 16	Source B reference scaling minimum value	0—par. 2. 17	1 Hz	0 Hz		Selects the frequency that corresp. to the min. reference signal	2-20				
2. 17	Source B reference scaling maximum value	0—f <sub>max</sub> (1. 2)	1 Hz	0 Hz		Selects the frequency that corresp. to the min. reference signal 0 = Scaling off >0 = Scaled maximum value	2-20				

**Note!**  = Parameter value can be changed only when the frequency converter is stopped.



(Continues)

Code	Parameter	Range	Step	Default	Custom	Description	Page
2. 18	Free analogue input, signal selection	0—2	1	0		0 = Not used 1 = $U_{in}$ (analogue voltage input) 2 = $I_{in}$ (analogue current input)	2-20
2. 19	Free analogue input, function	0—4	1	0		0 = No function 1 = Reduces current limit (par. 1. 7) 2 = Reduces DC-braking current 3 = Reduces acc. and decel. times 4 = Reduces torque supervis. limit	2-20
2. 20	Motor potentiometer ramp time	0,1—2000,0 Hz/s	0,1 Hz/s	10,0 Hz/s			2-22

### Group 3, Output and supervision parameters

Code	Parameter	Range	Step	Default	Custom	Description	Page
3. 1	Analogue output function 	0—7	1	1		0 = Not used      Scale 100% 1 = O/P frequency (0— $f_{max}$ ) 2 = Motor speed (0—max. speed) 3 = O/P current (0— $2.0 \times I_{nFC}$ ) 4 = Motor torque (0— $2 \times T_{nMot}$ ) 5 = Motor power (0— $2 \times P_{nMot}$ ) 6 = Motor voltage (0— $100\% \times U_{nMot}$ ) 7 = DC-link volt. (0—1000 V)	2-22
3. 2	Analogue output filter time	0,00—10.00 s	0,01 s	1,00 s			2-22
3. 3	Analogue output inversion	0—1	1	0		0 = Not inverted 1 = Inverted	2-22
3. 4	Analogue output minimum	0—1	1	0		0 = 0 mA 1 = 4 mA	2-22
3. 5	Analogue output scale	10—1000%	1%	100%			2-22
3. 6	Digital output function 	0—21	1	1		0 = Not used 1 = Ready 2 = Run 3 = Fault 4 = Fault inverted 5 = Vacon overheat warning 6 = External fault or warning 7 = Reference fault or warning 8 = Warning 9 = Reversed 10 = Jogging speed selected 11 = At speed 12 = Motor regulator activated 13 = Output frequency limit superv. 1 14 = Output frequency limit superv. 2 15 = Torque limit supervision 16 = Reference limit supervision 17 = External brake control 18 = Control from I/O terminals 19 = Frequency converter temperature limit supervision 20 = Unrequested rotation direction 21 = External brake control inverted	2-23

**Note!**  = Parameter value can be changed only when the frequency converter is stopped. (Continues)

Code	Parameter	Range	Step	Default	Custom	Description	Page
3. 7	Relay output 1 function 	0—21	1	2		As parameter 3. 6	2-23
3. 8	Relay output 2 function 	0—21	1	3		As parameter 3. 6	2-23
3. 9	Output freq. limit 1 supervision function	0—2	1	0		0 = No 1 = Low limit 2 = High limit	2-24
3. 10	Output freq. limit 1 supervision value	0,0— $f_{max}$ (par. 1. 2)	0,1 Hz	0,0 Hz			2-24
3. 11	Output freq. limit 2 supervision function	0—2	1	0		0 = No 1 = Low limit 2 = High limit	2-24
3. 12	Output freq. limit 2 supervision value	0,0— $f_{max}$ (par. 1. 2)	0,1 Hz	0,0 Hz			2-24
3. 13	Torque limit supervision function	0—2	1	0		0 = No 1 = Low limit 2 = High limit	2-24
3. 14	Torque limit supervision value	0,0—200,0% $\times T_{ncx}$	0,1%	100,0%			2-24
3. 15	Active reference limit supervision	0—2	1	0		0 = No 1 = Low limit 2 = High limit	2-24
3. 16	Active reference limit supervision value	0,0— $f_{max}$ (par. 1. 2)	0,1 Hz	0,0 Hz			2-24
3. 17	External brake OFF delay	0,0—100,0 s	0,1 s	0,5 s			2-25
3. 18	External brake ON delay	0,0—100,0 s	0,1 s	1,5 s			2-25
3. 19	Frequency converter temperature limit supervision function	0—2	1	0		0 = No supervision 1 = Low limit 2 = High limit	2-25
3. 20	Frequency converter temperature limit	-10—+75°C	1	+40°C			2-25
3. 21	I/O-expander board (opt.) analogue output function	0—7	1	3		See parameter 3. 1	2-22
3. 22	I/O-expander board (opt.) analogue output filter time	0,00—10,00 s	0,01 s	1,00 s		See parameter 3. 2	2-22
3. 23	I/O-expander board (opt.) analogue output inversion	0—1	1	0		See parameter 3. 3	2-22
3. 24	I/O-expander board (opt.) analogue output minimum	0—1	1	0		See parameter 3. 4	2-22
3. 25	I/O-expander board (opt.) analogue output scale	10—1000%	1	100%		See parameter 3. 5	2-22

**Note!**  = Parameter value can be changed only when the frequency converter is stopped.

## Group 4, Drive control parameters

Code	Parameter	Range	Step	Default	Custom	Description	Page
4. 1	Acc./Dec. ramp 1 shape	0,0—10,0 s	0,1 s	0,0 s		0 = Linear >0 = S-curve acc./dec. time	2-26
4. 2	Acc./Dec. ramp 2 shape	0,0—10,0 s	0,1 s	0,0 s		0 = Linear >0 = S-curve acc./dec. time	2-26
4. 3	Acceleration time 2	0,1—3000,0 s	0,1 s	10,0 s			2-26
4. 4	Deceleration time 2	0,1—3000,0 s	0,1 s	10,0 s			2-26
4. 5	Brake chopper 	0—2	1	0		0 = Brake chopper not in use 1 = Brake chopper in use 2 = External brake chopper	2-26
4. 6	Start function	0—1	1	0		0 = Ramp 1 = Flying start	2-26
4. 7	Stop function	0—1	1	0		0 = Coasting 1 = Ramp	2-27
4. 8	DC-braking current	0,15—1,5* $I_{nCT}$ (A)	0,1	0,5 x $I_{nCT}$			2-27
4. 9	DC-braking time at Stop	0,00—250,00 s	0,01 s	0,00 s		0 = DC-brake is off at Stop	2-27
4. 10	Execute frequency of DC-brake during ramp Stop	0,1—10,0 Hz	0,1 Hz	1,5 Hz			2-28
4. 11	DC-brake time at Start	0,00—25,00 s	0,01 s	0,00 s		0 = DC-brake is off at Start	2-28
4. 12	Jogging speed reference	$f_{min}$ — $f_{max}$	0,1 Hz	10,0 Hz			2-29

## Group 5, Prohibit frequency parameters







Code	Parameter	Range	Step	Default	Custom	Description	Page
5. 1	Prohibit frequency range 1 low limit	$f_{min}$ — par. 5. 2	0,1 Hz	0,0 Hz			2-29
5. 2	Prohibit frequency range 1 high limit	$f_{min}$ — $f_{max}$ (1. 1) (1. 2)	0,1 Hz	0,0 Hz		0 = Prohibit range 1 is off	2-29
5. 3	Prohibit frequency range 2 low limit	$f_{min}$ — par. 5. 4	0,1 Hz	0,0 Hz			2-29
5. 4	Prohibit frequency range 2 high limit	$f_{min}$ — $f_{max}$ (1. 1) (1. 2)	0,1 Hz	0,0 Hz		0 = Prohibit range 2 is off	2-29
5. 5	Prohibit frequency range 3 low limit	$f_{min}$ — par. 5. 6	0,1 Hz	0,0 Hz			2-29
5. 6	Prohibit frequency range 3 high limit	$f_{min}$ — $f_{max}$ (1. 1) (1. 2)	0,1 Hz	0,0 Hz		0 = Prohibit range 3 is off	2-29

**Note!** =



Parameter value can be changed only when the frequency converter is stopped.

## Group 6, Motor control parameters

Code	Parameter	Range	Step	Default	Custom	Description	Page
6. 1	Motor control mode 	0—1	1	0		0 = Frequency control 1 = Speed control	2-29
6. 2	Switching frequency	1,0—16,0 kHz	0,1 kHz	10/3,6 kHz		Dependant on kW	2-29
6. 3	Field weakening point 	30—500 Hz	1 Hz	Param. 1. 11			2-29
6. 4	Voltage at field weakening point 	15—200% $\times U_{nmot}$	1%	100%			2-29
6. 5	U/F-curve mid point frequency 	0,0— $f_{max}$	0,1 Hz	0,0 Hz			2-30
6. 6	U/F-curve mid point voltage 	0,00—100,00 % $\times U_{nmot}$	0,01%	0,00%		Parameter maximum value = param. 6.4	2-30
6. 7	Output voltage at zero frequency 	0,00—40,00 % $\times U_{nmot}$	0.01%	0,00%			2-30
6. 8	Overvoltage controller	0—1	1	1		0 = Controller is not operating 1 = Controller is operating	2-30
6. 9	Undervoltage controller	0—1	1	1		0 = Controller is not operating 1 = Controller is operating	2-30

**Note!**

= Parameter value can be changed only when the frequency converter is stopped.

2

## Group 7, Protections

Code	Parameter	Range	Step	Default	Custom	Description	Page
7.1	Response to reference fault	0—3	1	0		0 = No action 1 = Warning 2 = Fault, stop according to par. 4.7 3 = Fault, stop always by coasting	2-30
7.2	Response to external fault	0—3	1	0		0 = No action 1 = Warning 2 = Fault, stop according to par. 4.7 3 = Fault, stop always by coasting	2-31
7.3	Phase supervision of the motor	0—2	2	2		0 = No action 2 = Fault	2-31
7.4	Earth fault protection	0—2	2	2		0 = No action 2 = Fault	2-31
7.5	Motor thermal protection	0—2	1	2		0 = No action 1 = Warning 2 = Fault	2-32
7.6	Motor thermal protection break point current	50,0—150,0% $\times I_{nMOTOR}$	1,0%	100,0%			2-32
7.7	Motor thermal protection zero frequency current	5,0—150,0% $\times I_{nMOTOR}$	1,0%	45,0%			2-32
7.8	Motor thermal protection time constant	0,5—300,0 minutes	0,5 min.	17,0 min.		Default value is set according to motor nominal current	2-33
7.9	Motor thermal protection break point frequency	10—500 Hz	1 Hz	35 Hz			2-33
7.10	Stall protection	0—2	1	1		0 = No action 1 = Warning 2 = Fault	2-34
7.11	Stall current limit	5,0—200,0% $\times I_{nMOTOR}$	1,0%	130,0%			2-34
7.12	Stall time	2,0—120,0 s	1,0 s	15,0 s			2-34
7.13	Maximum stall frequency	1— $f_{max}$	1 Hz	25 Hz			2-34
7.14	Underload protection	0—2	1	0		0 = No action 1 = Warning 2 = Fault	2-35
7.15	Underload prot., field weakening area load	10,0—150,0% $\times T_{nMOTOR}$	1,0%	50,0%			2-35
7.16	Underload protection, zero frequency load	5,0—150,0% $\times T_{nMOTOR}$	1,0%	10,0%			2-35
7.17	Underload time	2,0—600,0 s	1,0 s	20,0s			2-36

**Group 8, Autorestart parameters**

Code	Parameter	Range	Step	Default	Custom	Description	Page
8. 1	Automatic restart: number of tries	0—10	1	0		0 = Not in use	2-36
8. 2	Automatic restart: trial time	1—6000 s	1 s	30 s			2-36
8. 3	Automatic restart: start function	0—1	1	0		0 = Ramp 1 = Flying start	2-37
8. 4	Automatic restart of undervoltage	0—1	1	0		0 = No 1 = Yes	2-37
8. 5	Automatic restart of overvoltage	0—1	1	0		0 = No 1 = Yes	2-37
8. 6	Automatic restart of overcurrent	0—1	1	0		0 = No 1 = Yes	2-37
8. 7	Automatic restart of reference fault	0—1	1	0		0 = No 1 = Yes	2-37
8. 8	Automatic restart after over/undertemperature fault	0—1	1	0		0 = No 1 = Yes	2-37

Table 2.5-1 Special parameters, Groups 2—8.



2.5.2 Description of Groups 2—8 parameters

2.1 Start/Stop logic selection

- 0: DIA1: closed contact = start forward  
 DIA2: closed contact = start reverse,  
 See figure 2.5-1.

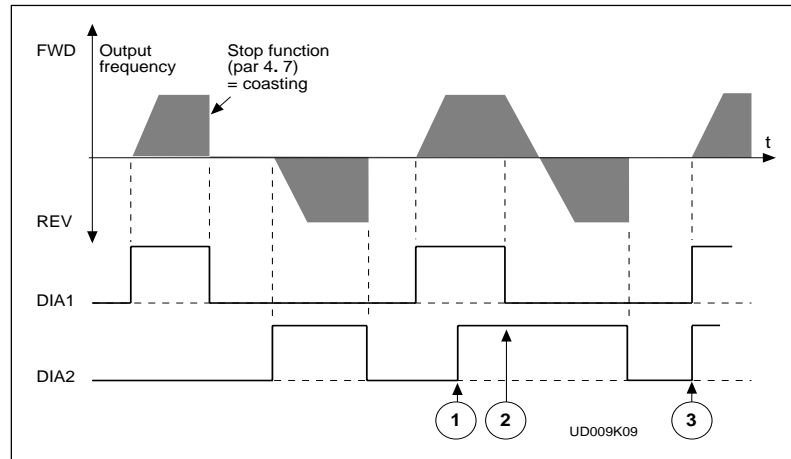

Figure 2.5-1 Start forward/Start reverse.

- ① The first selected direction has the highest priority
- ② When DIA1 contact opens, the direction of rotation starts to change
- ③ If Start forward (DIA1) and Start reverse (DIA2) signals are active simultaneously, the Start forward signal (DIA1) has priority.

- 1: DIA1: closed contact = start      open contact = stop  
 DIA2: closed contact = reverse    open contact = forward  
 See figure 2.5-2.

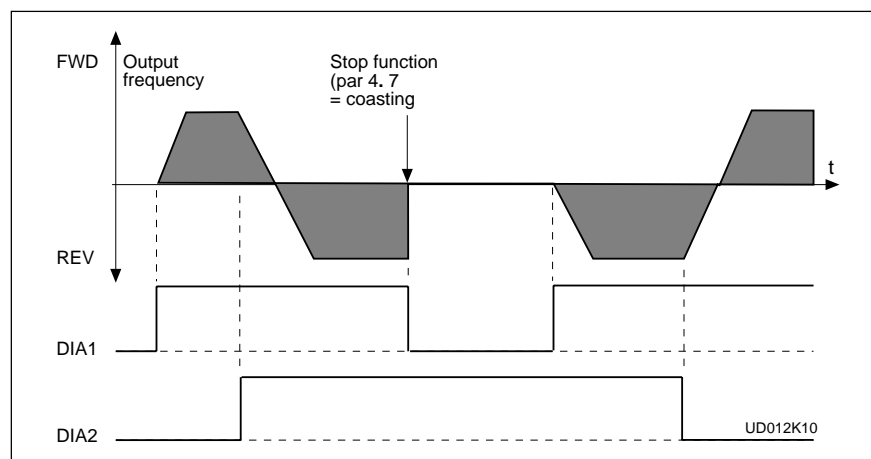

Figure 2.5-2 Start, Stop, reverse.

- 2: DIA1: closed contact = start                      open contact = stop  
    DIA2: closed contact = start enabled        open contact = start disabled
  
- 3: 3-wire connection (pulse control):  
    DIA1: closed contact = start pulse  
    DIA2: closed contact = stop pulse  
    (DIA3 can be programmed for reverse command)  
    See figure 2.5-3.
  
- 4: DIA1: closed contact = start forward  
    DIA2: closed contact = reference increases (motor potentiometer  
    reference, par. 2. 1 is automatically set to 4 if  
    par. 1. 5 is set to 3 or 4).

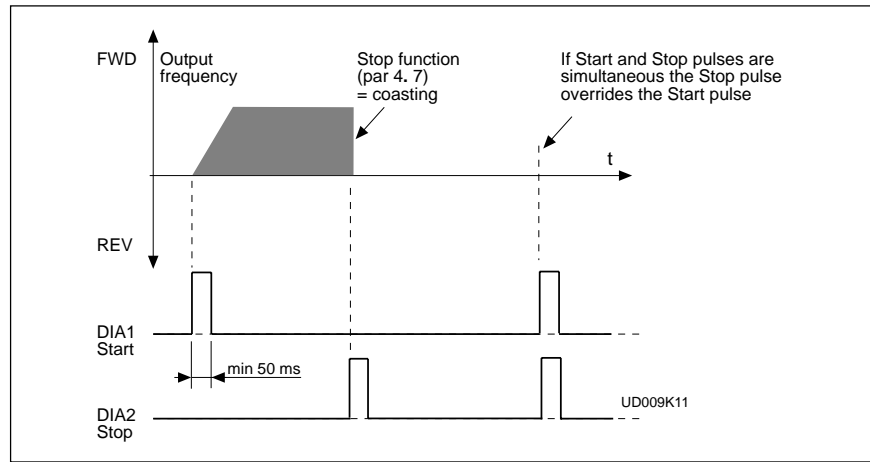

Figure 2.5-3 Start pulse /Stop pulse.

**2. 2 DIA3 function**

- 1: External fault, closing contact = Fault is shown and motor is stopped when the input is active
- 2: External fault, opening contact = Fault is shown and motor is stopped when the input is not active
  
- 3: Run enable        contact open        = Start of the motor disabled  
                           contact closed       = Start of the motor enabled
  
- 4: Acc. / Dec time select.    contact open        = Acceleration/Deceleration time 1 selected  
   contact closed       = Acceleration/Deceleration time 2 selected
  
- 5: Reverse            contact open        = Forward        || Can be used for reversing if parameter 2. 1 has value 3  
   contact closed       = Reverse        ||
  
- 6: Jogging freq.    contact closed       = Jogging frequency selected for freq. refer.
  
- 7: Fault reset        contact closed       = Resets all faults
  
- 8: Acc./Dec. operation prohibited        contact closed       = Stops acceleration and deceleration until the contact is opened
  
- 9: DC-braking command        contact closed       = In the stop mode, the DC-braking operates until the contact is opened, see figure 2.5-4. Dc-brake current is set with parameter 4. 8.
  
- 10: Motor pot. meter down        contact closed       = Reference decreases until the contact is opened

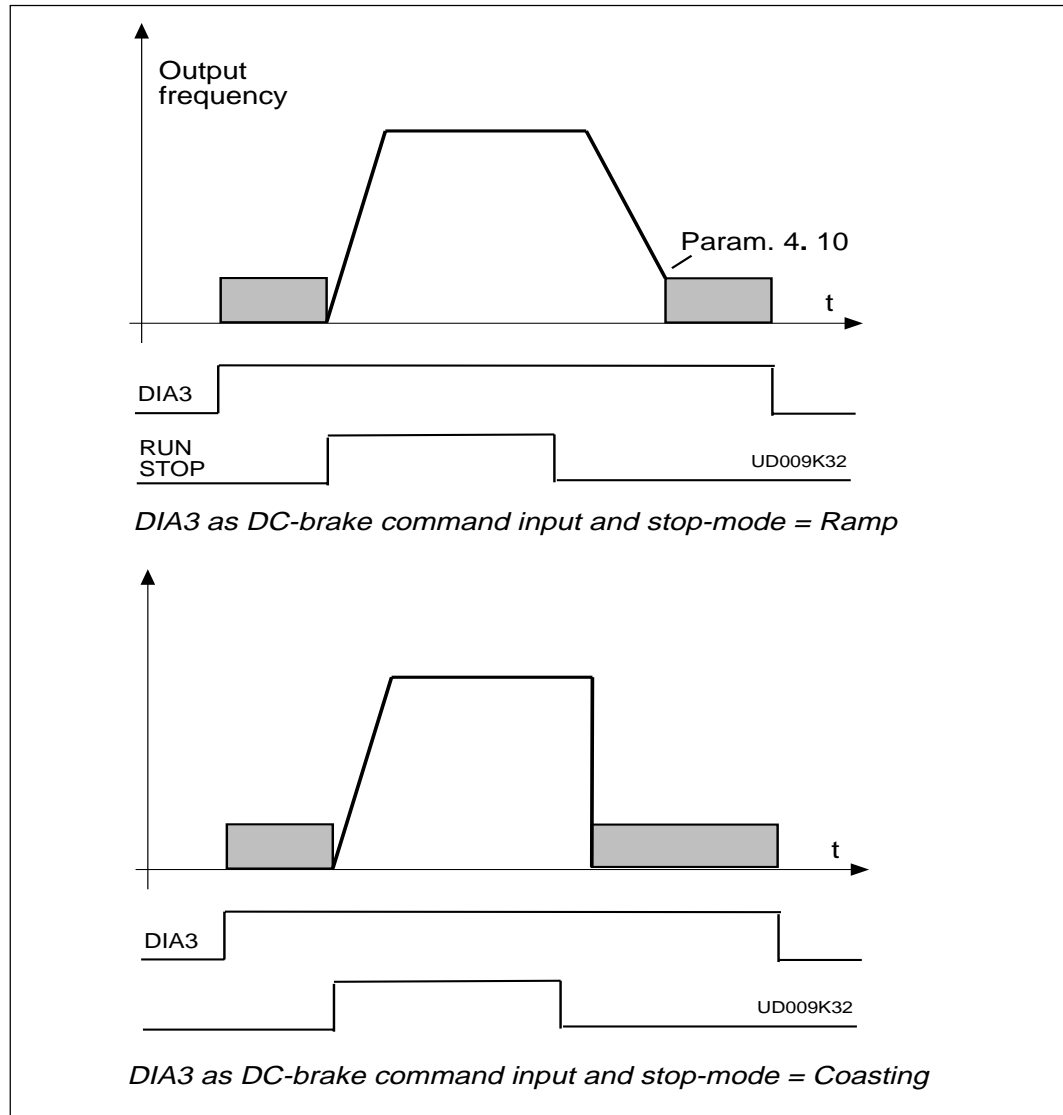

Figure 2.5-4 DIA3 as DC-brake command input: a) Stop-mode = Ramp, b) Stop-mode = Coasting.

**2.3  $U_{in}$  signal range**

- 0 = Signal range 0—10 V
- 1 = Custom setting range from custom minimum (par. 2. 4) to custom maximum (par. 2. 5)

**2.4  $U_{in}$  custom setting minimum/maximum**

**2.5** With these parameters you can set  $U_{in}$  for any input signal span within 0—10 V.

Minimum setting: Set the  $U_{in}$  signal to its minimum level, select parameter 2. 4, press the Enter button

Maximum setting: Set the  $U_{in}$  signal to its maximum level, select parameter 2. 5, press the Enter button

**Note!** The parameter values can only be set through this procedure (not with the *Browser buttons*).

2

**2.6  $U_{in}$  signal inversion**

$U_{in}$  is place B frequency reference, par. 1.6 = 1 (default)

Parameter 2.6 = 0, no inversion of analogue  $U_{in}$  signal.

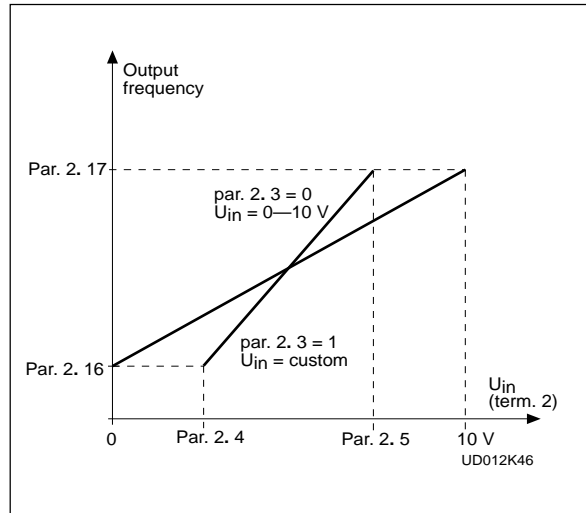

Figure 2.5-5  $U_{in}$  no signal inversion.

Parameter 2.6 = 1, inversion of analogue  $U_{in}$  signal

max.  $U_{in}$  signal = minimum set speed  
 min.  $U_{in}$  signal = maximum set speed

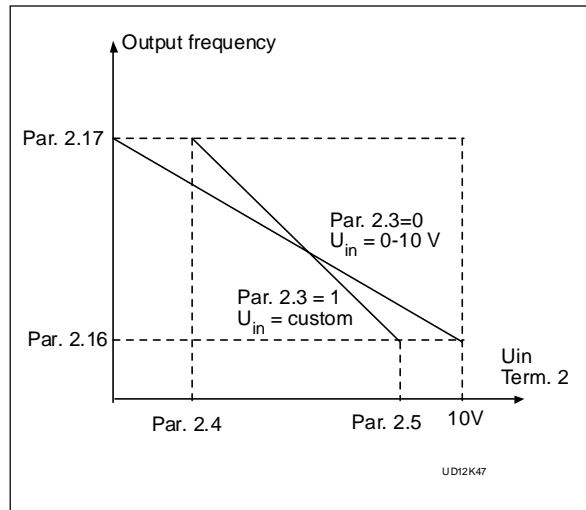

Figure 2.5-6  $U_{in}$  signal inversion.

**2.7  $U_{in}$  signal filter time**

Filters out disturbances from the incoming analogue  $U_{in}$  signal. Long filtering time makes regulation response slower. See figure 2.5-7.

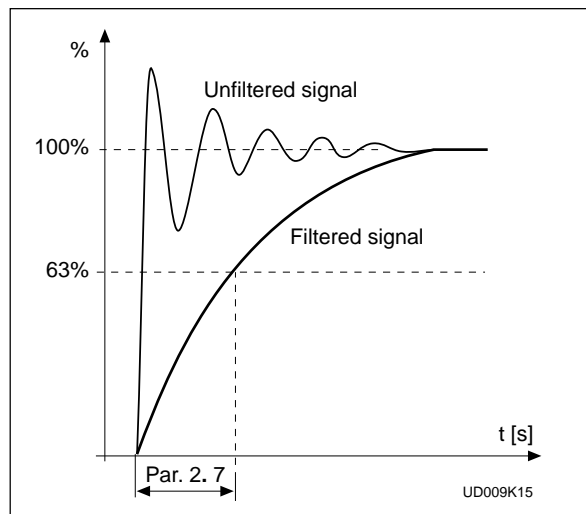

Figure 2.5-7  $U_{in}$  signal filtering.

**2. 8 Analogue input  $I_{in}$  signal range**

- 0 = 0—20 mA
- 1 = 4—20 mA
- 2 = Custom signal span

See figure 2.5-8.

**2. 9 Analogue input  $I_{in}$  custom setting minimum/maximum**

With these parameters you can scale the input current to correspond to the set min. and max. frequency range, see figure 2.5-8.

Minimum setting:  
Set the  $I_{in}$  signal to its minimum level, select parameter 2. 9, press the Enter button  
Maximum setting:  
Set the  $I_{in}$  signal to its maximum level, select parameter 2. 10, press the Enter button

**Note!** The parameter values can only be set through this procedure (not with the *Browser buttons*).

**2. 11 Analogue input  $I_{in}$  inversion**

$I_{in}$  is source A frequency reference, par. 1. 5 = 0 (default)

Parameter 2. 11 = 0, no inversion of  $I_{in}$  input  
Parameter 2. 11 = 1, inversion of  $I_{in}$  input, see figure 2.5-9.

max.  $I_{in}$  signal = minimum set speed  
min.  $I_{in}$  signal = maximum set speed

**2. 12 Analogue input  $I_{in}$  filter time**

Filters out disturbances from the incoming analogue  $I_{in}$  signal. Long filtering time makes regulation response slower. See figure 2.5-10.

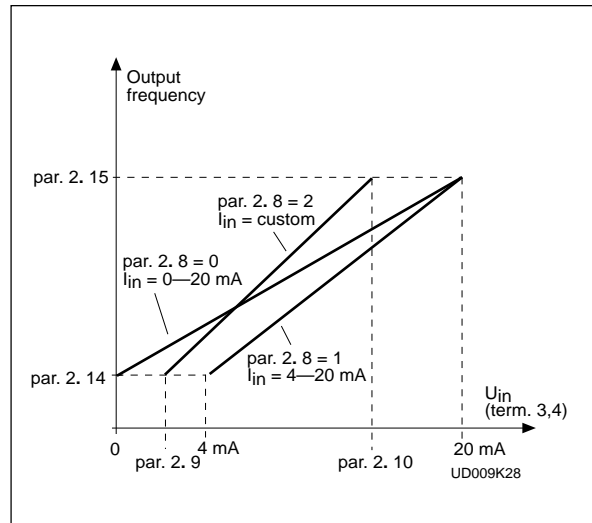

Figure 2.5-8 Analogue input  $I_{in}$  scaling.

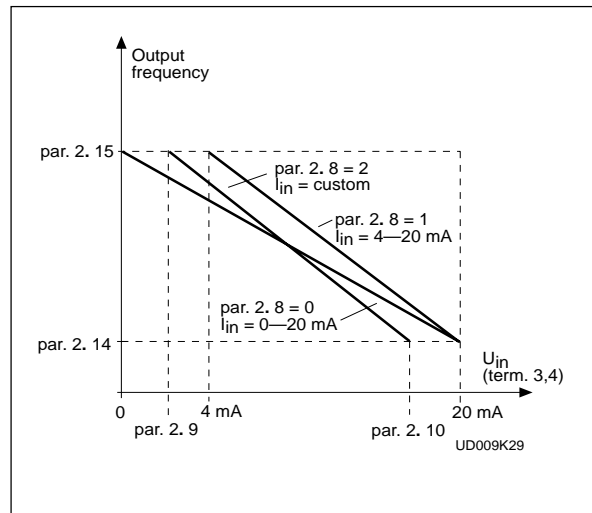

Figure 2.5-9  $I_{in}$  signal inversion.

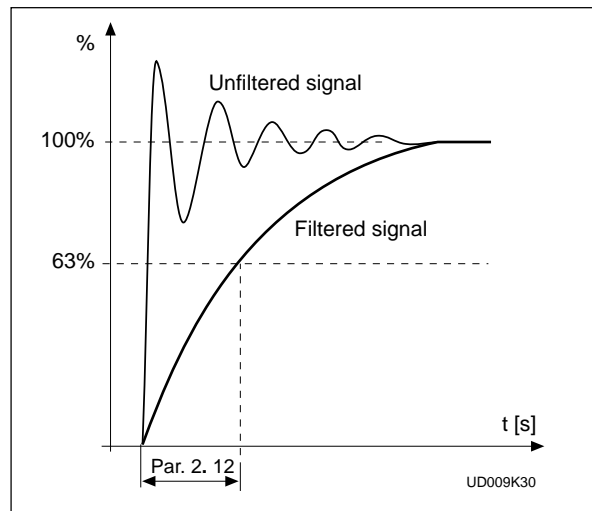

Figure 2.5-10 Analogue input  $I_{in}$  filter time.

2

**2. 13 Source B Start/Stop logic selection**

See parameter 2. 1, settings 0—3.

**2. 14, Source A reference scaling, minimum value/maximum value**

**2. 15** Setting limits:  $0 < \text{par. 2. 14} < \text{par. 2. 15} < \text{par. 1. 2}$ .  
If par. 2. 15 = 0 scaling is set off. See figures 2.5-11 and 2.5-12.

(In figures voltage input  $U_{in}$  with signal range 0—10 V selected for source A reference)

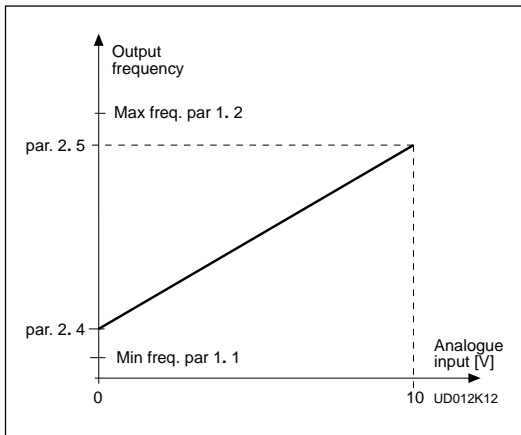

Figure 2.5-11 Reference scaling

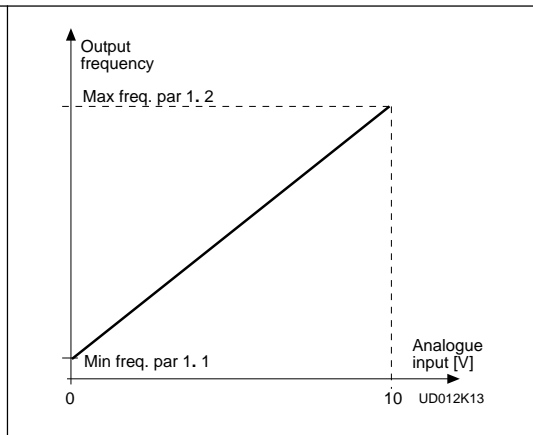

Figure 2.5-12 Reference scaling, par. 2. 15 = 0.

**2. 16, Source B reference scaling, minimum value/maximum value**

See parameters 2. 14 and 2. 15.

**2. 18 Free analogue input signal**

Selection of input signal of free analogue input (an input not used for reference signal):

- 0 = Not in use
- 1 = Voltage signal  $U_{in}$
- 2 = Current signal  $I_{in}$

**2. 19 Free analogue input signal function**

Use this parameter to select a function for a free analogue input signal:

- 0** = Function is not used
- 1** = Reducing motor current limit (par. 1. 7)

This signal will adjust the maximum motor current between 0 and the max. limit set with par. 1. 7. See Figure 2.5-13.

Figure 2.5-13 Scaling of max. motor current.

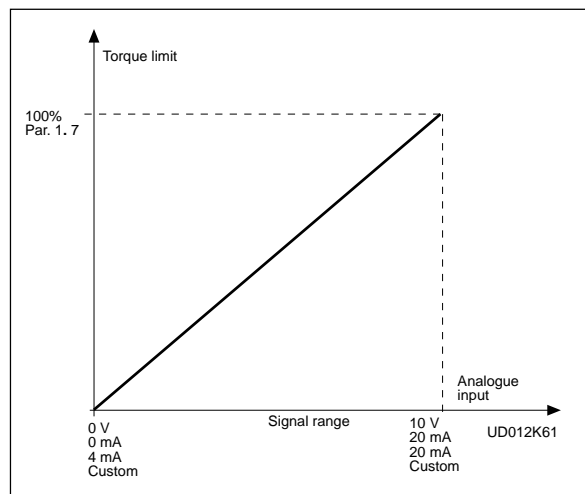

**2 Reducing DC brake current.**

DC braking current can be reduced with the free analogue input signal between current  $0.15 \times I_{nFC}$  and current set by the parameter 4. 8.

See figure 2.5-14.

*Figure 2.5-14 Reducing DC brake current.*

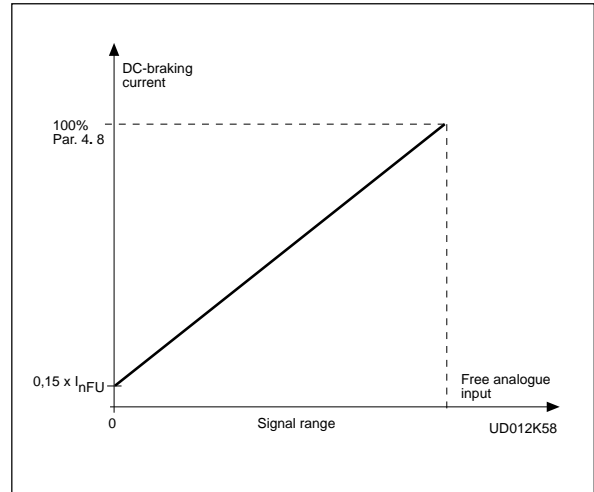

**3 Reducing acceleration and deceleration times.**

Acceleration and deceleration times can be reduced with the free analogue input signal according to the following formulas:

Reduced time = set acc./deceler. time (par. 1. 3, 1. 4; 4. 3, 4. 4) divided by the factor R in Figure 2.5-15.

*Figure 2.5-15 Reducing acceleration and deceleration times.*

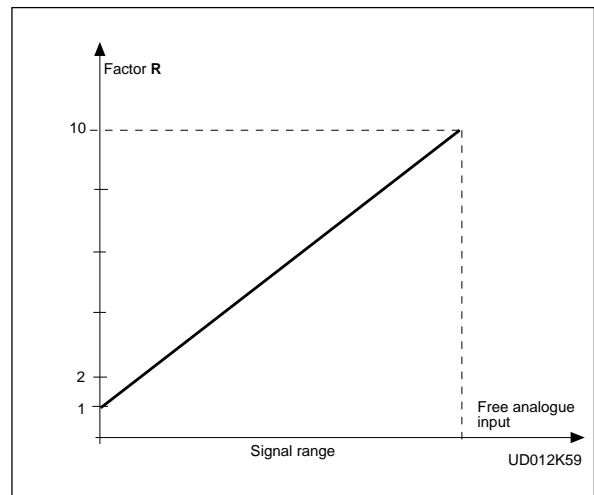

**4 Reducing torque supervision limit.**

Set supervision limit can be reduced with the free analogue input signal between 0 and the set supervision limit (par. 3. 14), see Figure 2.5-16.

*Figure 2.5-16 Reducing torque supervision limit.*

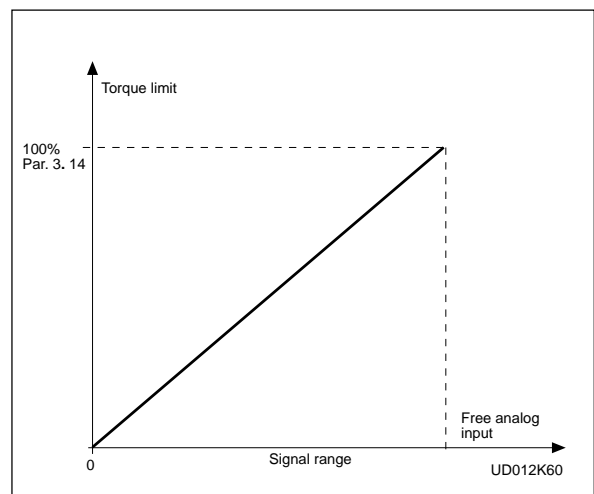

2

**2. 20 Motor potentiometer ramp time**

Defines how fast the electronic motor potentiometer value changes.

**3. 1 Analogue output Content**

See table on page 2-9.

**3. 2 Analogue output filter time**

Filters the analogue output signal. See figure 2.5-17.

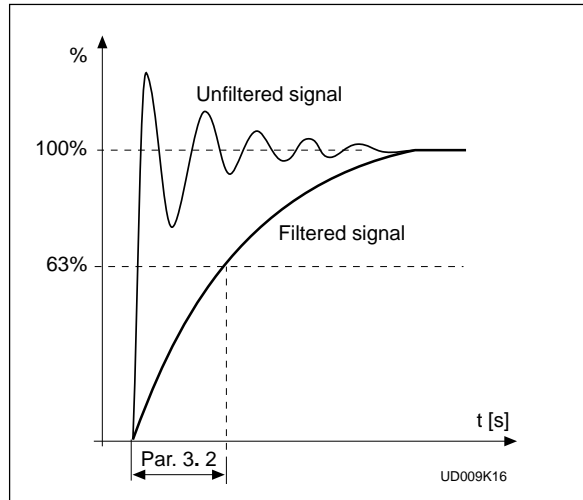

Figure 2.5-17 Analogue output filtering.

**3.3 Analogue output invert**

Inverts analogue output signal:  
 max. output signal = minimum set value  
 min. output signal = maximum set value

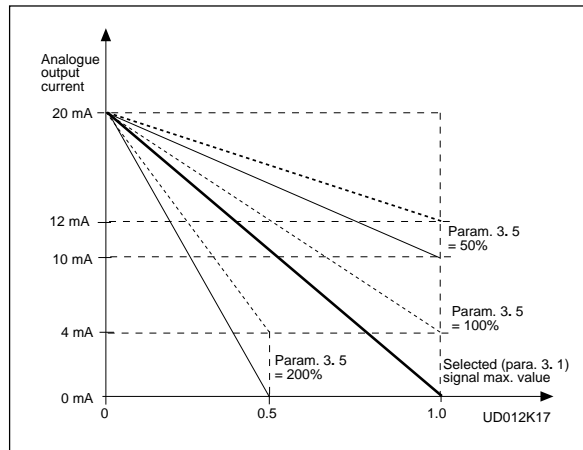

Figure 2.5-18 Analogue output invert.

**3. 4 Analogue output minimum**

Defines the signal minimum to be either 0 mA or 4 mA (living zero). See figure 2.5-19.

**3. 5 Analogue output scale**

Scaling factor for analogue output. See figure 2.5-19.



Signal	Max. value of the signal
Output frequency	Max. frequency (p. 1. 2)
Motor speed	Max. speed ( $n_n \times f_{max} / f_n$ )
Output current	$2 \times I_{nFC}$
Motor torque	$2 \times T_{nMot}$
Motor power	$2 \times P_{nMot}$
Motor voltage	$100\% \times U_{nMot}$
DC-link volt.	1000 V

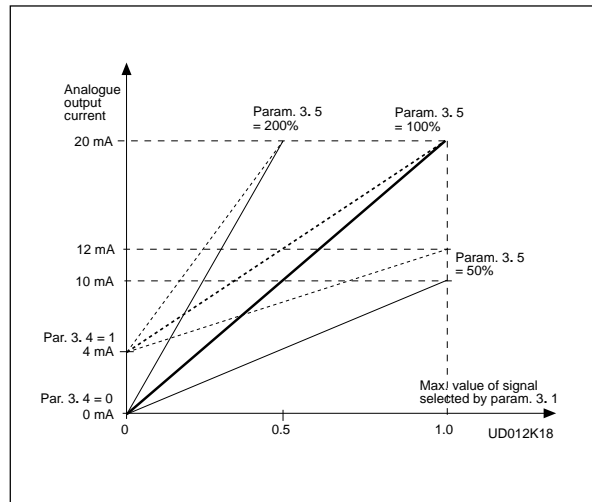

Figure 2.5-19 Analogue output scale.



- 3. 6 **Digital output function**
- 3. 7 **Relay output 1 function**
- 3. 8 **Relay output 2 function**

Setting value	Signal content
0 = Not used	Out of operation <u>Digital output DO1 sinks current and programmable relay (RO1, RO2) is activated when:</u>
1 = Ready	The frequency converter is ready to operate
2 = Run	The frequency converter operates (motor is running)
3 = Fault	A fault trip has occurred
4 = Fault inverted	A fault trip <u>has not</u> occurred
5 = Vacon overheat warning	The heat-sink temperature exceeds +70°C
6 = External fault or warning	Fault or warning depending on parameter 7. 2
7 = Reference fault or warning	Fault or warning depending on parameter 7. 1 - if analogue reference is 4—20 mA and signal is <4mA
8 = Warning	Always if a warning exists
9 = Reversed	The reverse command has been selected
10 = Jogging speed	Jogging speed has been selected with digital input
11 = At speed	The output frequency has reached the set reference
12 = Motor regulator activated	Overvoltage or overcurrent regulator was activated
13 = Output frequency supervision 1	The output frequency goes outside of the set supervision Low limit/ High limit (par. 3. 9 and 3. 10)
14 = Output frequency supervision 2	The output frequency goes outside of the set supervision Low limit/ High limit (par. 3. 11 and 3. 12)
15 = Torque limit supervision	The motor torque goes outside of the set supervision Low limit/ High limit (par. 3. 13 and 3. 14)
16 = Active reference limit supervision	Active reference goes outside of the set supervision Low limit/ High limit (par. 3. 15 and 3. 16)
17 = External brake control	External brake ON/OFF control with programmable delay (par 3. 17 and 3. 18)
18 = Control from I/O terminals	External control mode selected with progr. push button #2
19 = Frequency converter temperature limit supervision	Temperature on frequency converter goes outside the set supervision limits (par. 3. 19 and 3. 20)
20 = Unrequested rotation direction	Rotation direction of the motor shaft is different from the requested one
21 = External brake control inverted	External brake ON/OFF control (par. 3.17 and 3.18), output active when brake control is OFF

Table 2.5-2 Output signals via DO1 and output relays RO1 and RO2.

**3. 9 Output frequency limit 1, supervision function****3. 11 Output frequency limit 2, supervision function**

- 0 = No supervision  
 1 = Low limit supervision  
 2 = High limit supervision

If the output frequency falls below or exceeds the set limit (3. 10, 3. 12) this function generates a warning message via the digital output DO1 or via a relay output RO1 or RO2 depending on the settings of parameters 3. 6—3. 8.

**3. 10 Output frequency limit 1, supervision value****3. 12 Output frequency limit 2, supervision value**

The frequency value to be supervised by parameter 3. 9 (3. 11).  
 See figure 2.5-20.

**3. 13 Torque limit , supervision function**

- 0 = No supervision  
 1 = Low limit supervision  
 2 = High limit supervision

If the calculated torque value falls below or exceeds the set limit (3.14) this function generates a warning message via the digital output DO1 or via a relay output RO1 or RO2 depending on the settings of parameters 3. 6—3. 8.

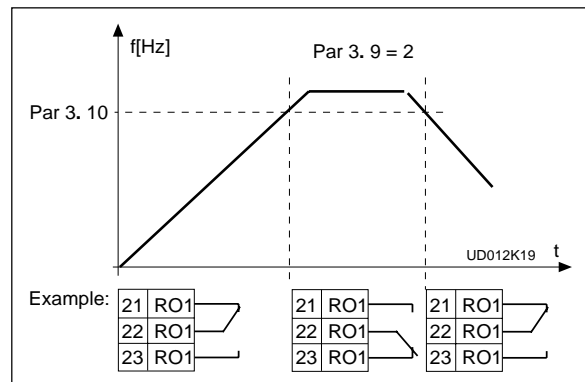

Figure 2.5-20 Output frequency supervision.

**3. 14 Torque limit , supervision value**

The calculated torque value to be supervised by parameter 3. 13.  
 Torque supervision value can be reduced below the setpoint with free analogue input signal, see parameters 2. 18 and 2. 19.

**3. 15 Reference limit , supervision function**

- 0 = No supervision  
 1 = Low limit supervision  
 2 = High limit supervision

If the reference value falls below or exceeds the set limit (3. 16) this function generates a warning message via the digital output DO1 or via a relay output RO1 or RO2 depending on the settings of parameters 3. 6—3. 8. The supervised reference is the current active reference. It can be source A or B reference depending on the DIB6 input or panel reference if panel is the active control source.

**3. 16 Reference limit , supervision value**

The frequency value to be supervised with the parameter 3. 15.

**3. 17 External brake-off delay**  
**3. 18 External brake-on delay**

The function of the external brake can be timed to the start and stop control signals with these parameters. See figure 2.5-21.

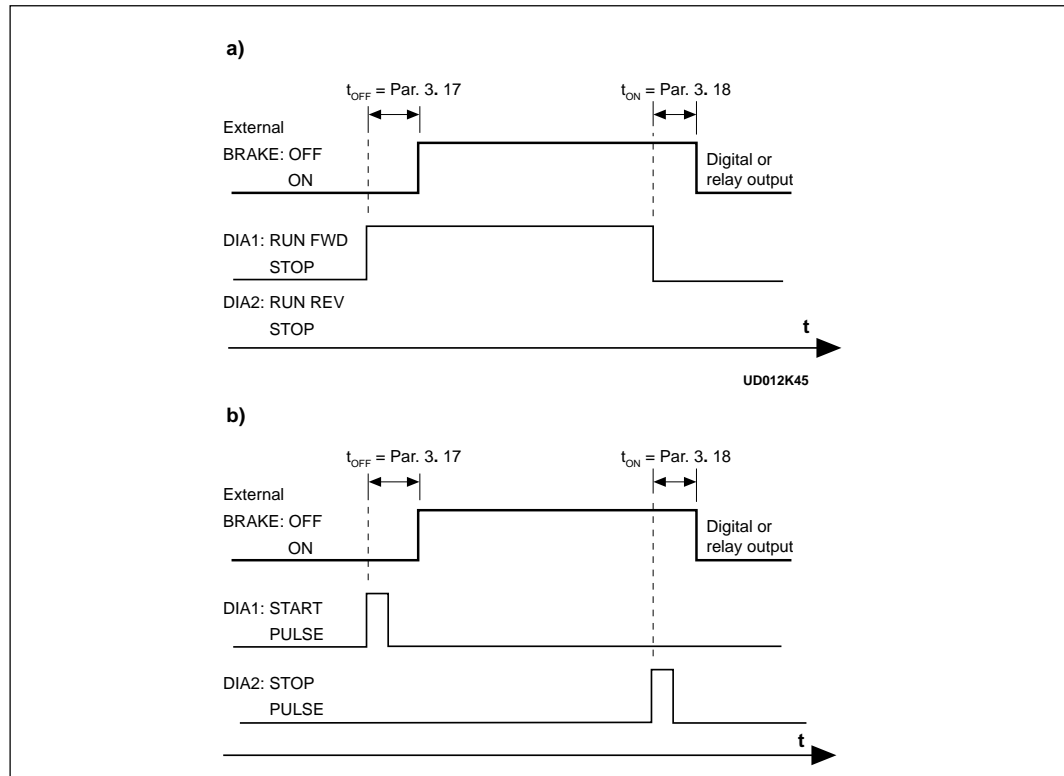

Figure 2.5-21 Ext. brake control: a) Start/Stop logic selection par 2. 1 = 0, 1 or 2  
 b) Start/Stop logic selection par 2. 1 = 3.

The brake control signal can be programmed via the digital output DO1 or via one of the relay outputs RO1 and RO2, see parameters 3. 6—3. 8.

**3. 19 Frequency converter temperature limit supervision**

- 0 = No supervision
- 1 = Low limit supervision
- 2 = High limit supervision

If temperature of the unit falls below or exceeds the set limit (par. 3. 20) this function generates a warning message via the digital output DO1 and via a relay output RO1 or RO2 depending on the settings of the parameters 3. 6—3. 8.

**3. 20 Frequency converter temperature supervision limit value**

The set temperature value to be supervised with parameter 3. 19.

**4.1 Acc/Dec ramp 1 shape****4.2 Acc/Dec ramp 2 shape**

A smooth start and end of acceleration and deceleration can be programmed with these parameters.

Setting value 0 gives linear ramp shape which causes acceleration and deceleration to act immediately to the changes in the reference signal with the time constant set by the parameter 1.3 and 1.4 (4.3 and 4.4).

Setting value 0.1—10 seconds for 4.1 (4.2) causes linear acceleration/deceleration to adopt an the S-shape. Parameter 1.3 and 1.4 (4.3 and 4.4) determines the time constant of acceleration/deceleration in the middle of the curve.

See figure 2.5-22.

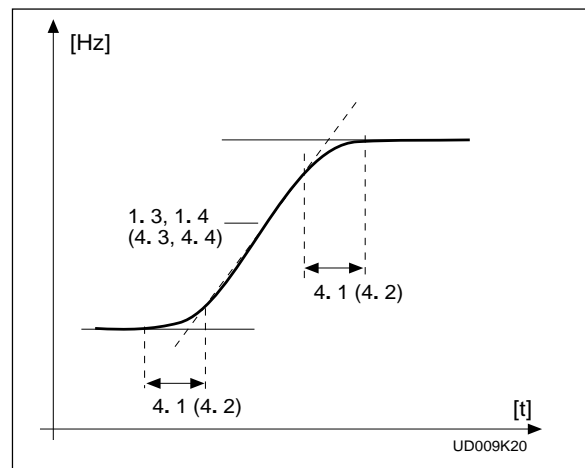

Figure 2.5-22 S-shaped acceleration/deceleration.

**4.3 Acceleration time 2****4.4 Deceleration time 2**

These values correspond to the time required for the output frequency to accelerate from the set minimum frequency (par. 1.1) to the set maximum frequency (par. 1.2). These times give the possibility to set two different acceleration/deceleration times for one application. The active set can be selected with the programmable signal DIA3 of this application, see parameter 2.2. Acceleration/deceleration times can be reduced with the free analogue input signal, see parameters 2.18 and 2.19.

**4.5 Brake chopper**

0 = No brake chopper

1 = Brake chopper and brake resistor installed

2 = External brake chopper

When the frequency converter is decelerating the motor, the inertia from the motor and the load is fed into the external brake resistor. This enables the frequency converter to decelerate the load with the torque equal to that of acceleration, if the brake resistor is selected correctly. See separate Brake resistor installation manual.

**4.6 Start function**

Ramp:

- 0** The frequency converter starts from 0 Hz and accelerates to the set reference frequency within the set acceleration time. (Load inertia or starting friction may cause prolonged acceleration times).

Flying start:

- 1 The frequency converter is able to start into running motor by applying a small torque to motor and searching for frequency corresponding to the speed the motor is running at. Searching starts from the maximum frequency towards the actual frequency until the correct value is detected. Thereafter the output frequency will be accelerated/decelerated to the set reference value according to the set acceleration/deceleration parameters.

Use this mode if the motor should be coasting when the start command is given. With the flying start it is possible to ride through short mains voltage interruptions.

#### 4.7 **Stop function**

Coasting:

- 0 The motor coasts to a halt without any control from the frequency converter, after the Stop command.

Ramp:

- 1 After the Stop command, the speed of the motor is decelerated according to the set deceleration parameters.  
If the regenerated energy is high it may be necessary to use an external braking resistor for faster deceleration.

#### 4.8 **DC braking current**

Defines the current injected into the motor during DC braking.

The DC braking current can be reduced from the setpoint with an external free analogue input signal, see parameters 2. 18 and 2. 19.

#### 4.9 **DC braking time at stop**

Defines if braking is ON or OFF and braking time of the DC-brake when the motor is stopping. The function of the DC-brake depends on the stop function, parameter 4. 7. See figure 2.5-23.

- 0 DC-brake is not used
- >0 DC-brake is in use and its function depends on the Stop function, (parameter 4. 7), and the time depends on the value of parameter 4. 9:

Stop-function = 0 (coasting):

After the stop command, the motor will coast to a stop without any control from the frequency converter.

With DC-injection, the motor can be electrically stopped in the shortest possible time, without using an optional external braking resistor.

The braking time is scaled according to the frequency when the DC-braking starts. If the frequency is  $\geq$  nominal frequency of the motor (par. 1.11), setting value of parameter 4.9 determines the braking time. When the frequency is  $\leq 10\%$  of the nominal, the braking time is 10% of the set value of parameter 4.9. See figure 1.5-13.

Stop-function = 1 (ramp):

After the Stop command, the speed of the motor is reduced according to the set deceleration parameters, as fast as possible, to a speed defined with the parameter 4. 10 where the DC-braking starts.

2

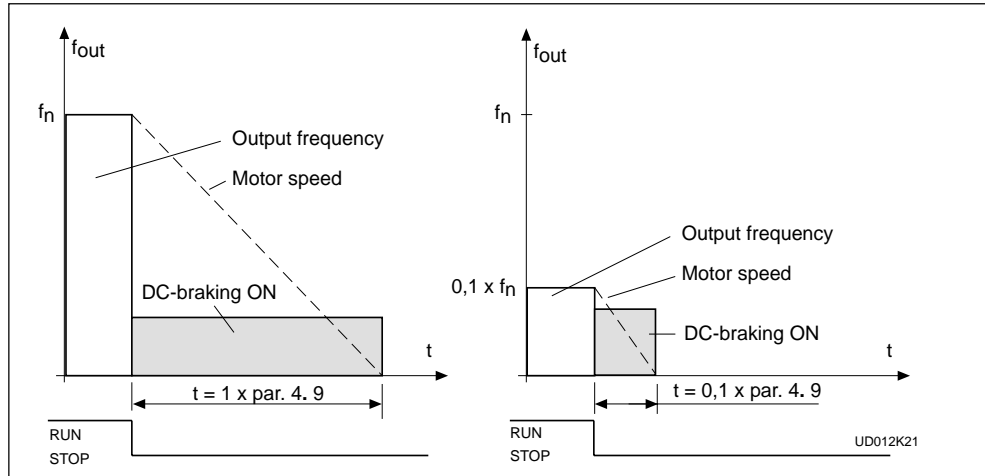

Figure 2.5-23 DC-braking time when par. 4. 7 = 0.

The braking time is defined with parameter 4. 9. If high inertia exists it is recommended to use an external braking resistor for faster deceleration. See Figure 2.5-24.

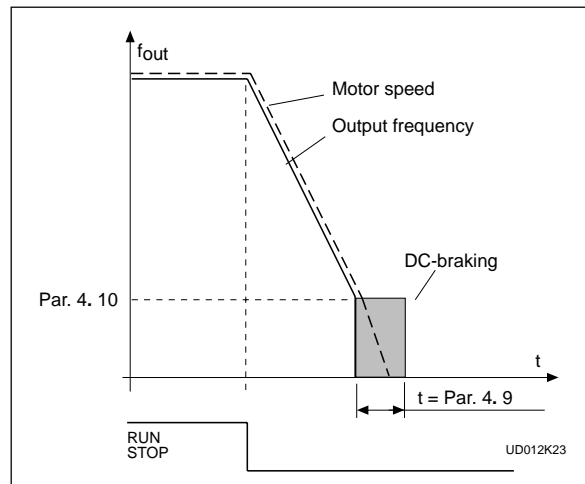

Figure 2.5-24 DC-braking time when par. 4. 7 = 1.

**4. 10 Execute frequency of DC-brake during ramp Stop**

See Figure 2.5-24.

**4. 11 DC-brake time at start**

- 0 DC-brake is not used
- >0 The DC-brake is activated when the start command is given and this parameter defines the time before the brake is released. After the brake is released the output frequency increases according to the set start function parameter 4. 6 and acceleration parameters (1. 3, 4. 1 or 4. 2, 4. 3), see Figure 2.5-25.

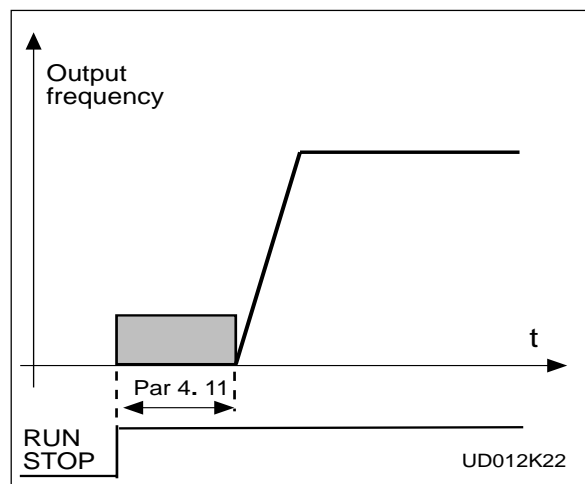

Figure 2.5-25 DC-braking time at start.

#### 4. 12 Jogging speed reference

Parameter value defines the jogging speed selected with the DIA3 digital input which can be programmed for Jogging speed. See parameter 2. 2.

#### 5. 1 Prohibit frequency area Low

#### 5. 2 limit/High limit

#### 5. 3

#### 5. 4

#### 5. 5

#### 5. 6

In some systems it may be necessary to avoid certain frequencies because of mechanical resonance problems. With these parameters it is possible to set limits for three "jump over" regions between 0 Hz and 500 Hz. The accuracy of the setting is 1.0 Hz. See figure 2.5-6.

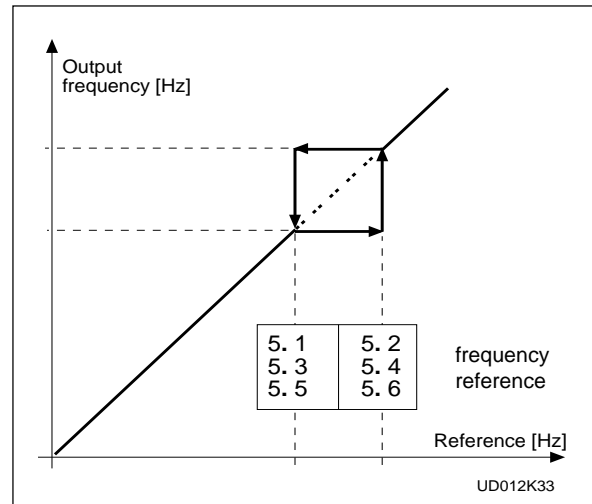

Figure 2.5-26 Example of prohibit frequency area setting.

#### 6. 1 Motor control mode

0 = Frequency control:

The I/O terminal and panel references are frequency references and the frequency converter controls the output frequency (output freq. resolution 0,01 Hz)

1 = Speed control:

The I/O terminal and panel references are speed references and the frequency converter controls the motor speed (regulation accuracy  $\pm 0,5\%$ ).

#### 6. 2 Switching frequency

Motor noise can be minimized using a high switching frequency. Increasing the switching frequency reduces the loadability of the frequency converter.

Before changing the frequency from the factory default 10 kHz (3.6 kHz from 30kW upwards), check the allowed capacity from the curve in Figure 5.2-3 in Chapter 5.2 of the User's manual.

#### 6. 3 Field weakening point

#### 6. 4 Voltage at the field weakening point

The field weakening point is the output frequency where the output voltage reaches the set maximum value. Above that frequency the output voltage remains at the set maximum value.

Below that frequency output voltage depends on the setting of the U/f curve parameters 1. 8, 1. 9, 6. 5, 6. 6 and 6. 7. See figure 2.5-27.

When the parameters 1. 10 and 1. 11, nominal voltage and nominal frequency of the motor, are set, also parameters 6. 3 and 6. 4 are set automatically to the corresponding values. If different values are required for the field weakening point and the maximum output voltage, change these parameters after setting the parameters 1. 10 and 1. 11.

### 6.5 *U/f curve, middle point frequency*

If the programmable U/f curve has been selected with the parameter 1.8 this parameter defines the middle point frequency of the curve. See figure 2.5-27.

### 6.6 *U/f curve, middle point voltage*

If the programmable U/f curve has been selected with the parameter 1.8 this parameter defines the middle point voltage (% from motor nom. voltage) of the curve. See figure 2.5-27.

### 6.7 *Output voltage at zero frequency*

If the programmable U/f curve has been selected with the parameter 1.8 this parameter defines the zero frequency voltage (% from motor nom. voltage) of the curve. See figure 2.5-27.

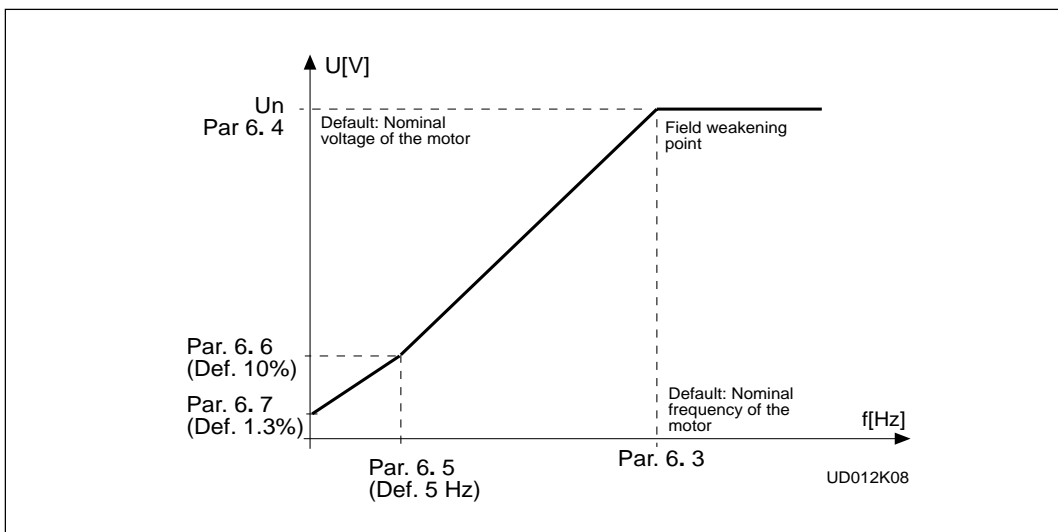

Figure 2.5-27 Programmable U/f curve.

### 6.8 *Overvoltage controller*

### 6.9 *Undervoltage controller*

These parameters allow the over-/undervoltage controllers to be switched out of operation. This may be useful, for example, if the mains supply voltage varies more than -15%...+10% and the application will not tolerate this over-/undervoltage. Then the regulator controls the output frequency according to the supply fluctuations.

Over-/undervoltage trips may occur when controllers are switched out of operation.

### 7.1 *Response to the reference fault*

0 = No response

1 = Warning

2 = Fault, stop mode after fault according to parameter 4.7

3 = Fault, stop mode after fault always by coasting

A warning or a fault action and message is generated if 4—20 mA reference signal is used and the signal falls below 4 mA.

The information can also be programmed via digital output DO1 and via relay outputs RO1 and RO2.



### 7.2 **Response to external fault**

- 0 = No response
- 1 = Warning
- 2 = Fault, stop mode after fault according to parameter 4.7
- 3 = Fault, stop mode after fault always by coasting

A warning or a fault action and message is generated from the external fault signal in the digital input DIA3.

The information can also be programmed into digital output DO1 and into relay outputs RO1 and RO2.

### 7.3 **Phase supervision of the motor**

- 0 = No action
- 2 = Fault

Phase supervision of the motor ensures that the motor phases have an approximately equal current.

### 7.4 **Earth fault protection**

- 0 = No action
- 2 = Fault message

Earth fault protection ensures that the sum of the motor phase currents is zero. The overcurrent protection is always working and protects the frequency converter from earth faults with high currents.

## Parameters 7.5—7.9 Motor thermal protection

### General

Motor thermal protection protects the motor from overheating. The Vacon CX/CXL/CXS drive is capable of supplying higher than nominal current to the motor. If the load requires this high current there is a risk that the motor will be thermally overloaded. This is true especially at low frequencies. With low frequencies the cooling effect of the motor is reduced and the capacity of the motor is reduced. If the motor is equipped with an external fan the load reduction at low speeds is small.

Motor thermal protection is based on a calculated model and it uses the output current of the drive to determine the load on the motor. When the power of is turned on, the calculated model uses the heatsink temperature to determine the initial thermal stage for the motor. The calculated model assumes that the ambient temperature of the motor is 40°C.

Motor thermal protection can be adjusted by setting the parameters. The thermal current  $I_T$  specifies the load current above which the motor is overloaded. This current limit is a function of the output frequency. The curve for  $I_T$  is set with parameters 7.6, 7.7 and 7.9, refer to the figure 2.5-28. The parameters have their default values set according to the motor name plate data.

With the output current at  $I_T$  the thermal stage will reach the nominal value (100%). The thermal stage changes by the square of the current. With an output current at 75% of  $I_T$  the thermal stage will reach a 56% value and with output current at 120% of  $I_T$  the thermal stage would reach a 144% value. The function will trip the device (refer par. 7.5) if the thermal stage will reach a value of 105%. The speed of change in thermal stage is determined with the time constant parameter 7.8. The bigger the motor the longer it takes to reach the final temperature.

The thermal stage of the motor can be monitored through the display. Refer to the table for monitoring items. (User's Manual, table 7.3-1).



**CAUTION!** *The calculated model does not protect the motor if the airflow to the motor is reduced by blocked air intake grill.*

## 7.5 Motor thermal protection

Operation:

- 0 = Not in use
- 1 = Warning
- 2 = Trip function

Tripping and warning will display the same message code. If tripping is selected the drive will stop and activate the fault stage.

Deactivating the protection, setting parameter to 0, will reset the thermal stage of the motor to 0%.

## 7.6 Motor thermal protection, break point current

The current can be set between 50.0—150.0%  $\times I_{nMotor}$ .

This parameter sets the value for thermal current at frequencies above the break point on the thermal current curve. Refer to Figure 2.5-28.

The value is set in percentage which refers to the name plate data of the motor, parameter 1. 13, nominal current of the motor, not to the drive's nominal output current.

The motor's nominal current is the current which the motor can withstand in direct online use without being overheated.

If parameter 1. 13 is adjusted, this parameter is automatically restored to the default value.

Setting this parameter (or parameter 1. 13) does not affect the maximum output current of the drive. Parameter 1. 7 alone determines the maximum output current of the drive.

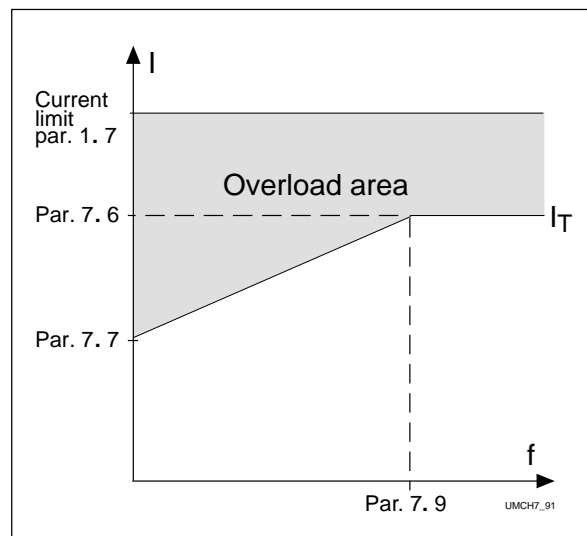

Figure 2.5-28 Motor thermal current  $I_T$  curve.

## 7.7 Motor thermal protection, zero frequency current

The current can be set between 10.0—150.0%  $\times I_{nMotor}$ .

This parameter sets the value for thermal current at zero frequency. See Figure 2.5-28.

The default value is set assuming that there is no external fan cooling the motor. If an external fan is used this parameter can be set to 90% (or even higher).

The value is set as percentage of the motor name plate data, parameter 1. 13, motor's nominal current, not of the drive's nominal output current. The motor's nominal current is the current which the motor can withstand in direct on-line use without being overheated.

If you change the parameter 1. 13 this parameter is automatically restored to the default value.

Setting this parameter (or parameter 1. 13) does not affect to the maximum output current of the drive. Parameter 1. 7 alone determines the maximum output current of the drive.

**7. 8 Motor thermal protection, time constant**

This time can be set between 0.5—300 minutes.

This is the thermal time constant of the motor. The bigger the motor the bigger the time constant. The time constant is the time when the calculated thermal stage has reached 63% of its final value.

The motor thermal time is specific to the motor design and it varies between different motor manufacturers.

The default value for the time constant is calculated basing on the motor name plate data given with parameters 1. 12 and 1. 13. If either of these parameters is set, then this parameter is set to default value.

If the motor's  $t_6$  -time is known (given by the motor manufacturer) the time constant

parameter could be set based on the  $t_6$  -time. As a rule of thumb, the motor thermal time constant in minutes equals to  $2xt_6$  ( $t_6$  in seconds is the time a motor can safely operate at six times the rated current). If the drive is in stop stage the time constant is internally increased to three times the set parameter value. The cooling in the stop stage is based on convection and the time constant is increased.

**7. 9 Motor thermal protection, break point frequency**

Frequency can be set between 10—500 Hz.

This is the break point of thermal current curve. With frequencies above this point the thermal capacity of the motor is assumed to be constant. Refer to Figure 2.5-28.

The default value is based on the motor's name plate data, parameter 1. 11. It is 35 Hz for a 50 Hz motor and 42 Hz for a 60 Hz motor. More generally it is 70% of the frequency at the field weakening point (parameter 6. 3). Changing either parameter 1. 11 or 6. 3 will restore this parameter to the default value.

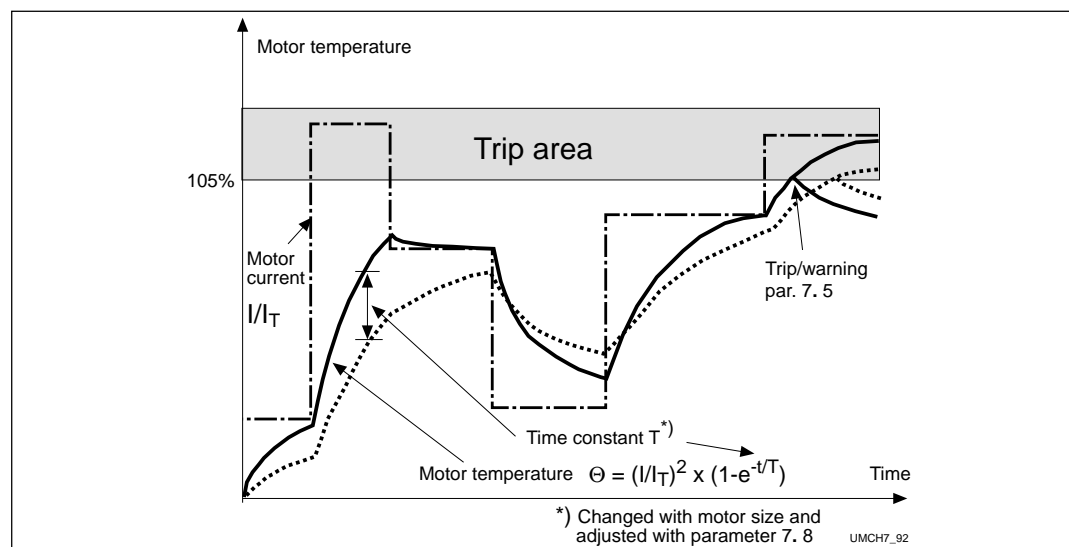

Figure 2.5-29 Calculating motor temperature.

## Parameters 7. 10— 7. 13, Stall protection

### General

Motor stall protection protects the motor from short time overload situations such as a stalled shaft. The reaction of stall protection can be set shorter than with motor thermal protection. The stall state is defined with two parameters, 7.11. Stall Current and 7.13. Stall Frequency. If the current is higher than the set limit and output frequency is lower than the set limit the stall state is true. There is actually no real indication of the shaft rotation. Stall protection is a type of overcurrent protection.

#### 7. 10 **Stall protection**

Operation:

- 0 = Not in use
- 1 = Warning
- 2 = Trip function

Tripping and warning will display the same message code. If tripping is set on, the drive will stop and activate the fault stage. Setting the parameter to 0 will deactivate the protection and will reset the stall time counter to zero.

#### 7. 11 **Stall current limit**

The current can be set between 0.0—200%  $\times I_{nMotor}$ .

In the stall stage the current has to be above this limit. Refer to Figure 2.5-30. The value is set in percentage of the motor's name plate data, parameter 1. 13, motor's nominal current. If parameter 1. 13 is adjusted, this parameter is automatically restored to the default value.

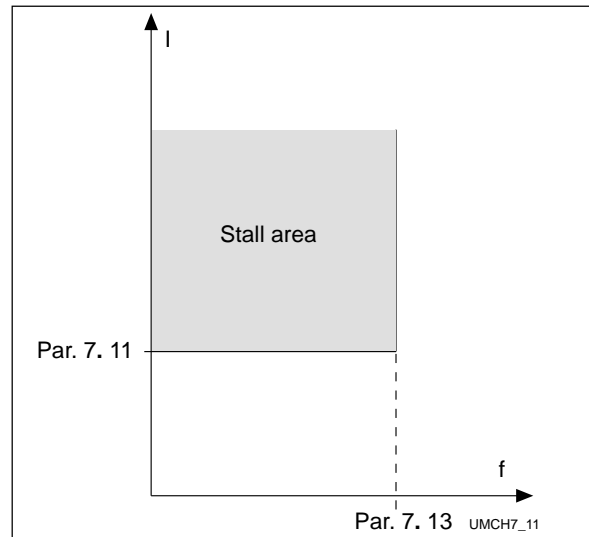

Figure 2.5-30 Setting the stall characteristics.

#### 7. 12 **Stall time**

The time can be set between 2.0—120 s.

This is the maximum allowed time for a stall stage. There is an internal up/down counter to count the stall time. Refer to Figure 2.5-31. If the stall time counter value goes above this limit the protection will cause a trip (refer to parameter 7. 10).

#### 7. 13 **Maximum stall frequency**

The frequency can be set between 1— $f_{max}$  (par. 1. 2). In stall state the output frequency has to be smaller than this limit. Refer to Figure 2.5-30.

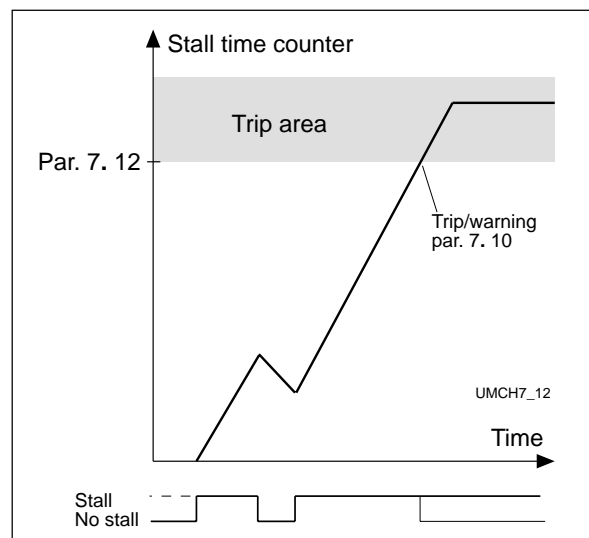

Figure 2.5-31 Counting the stall time.

## Parameters 7. 14— 7. 17, Underload protection

### General

The purpose of motor underload protection is to ensure there is load on the motor whilst the drive is running. If the motor loses its load there might be a problem in the process, e.g. broken belt or dry pump.

Motor underload protection can be adjusted by setting the underload curve with parameters 7. 15 and 7. 16. The underload curve is a squared curve set between zero frequency and the field weakening point. The protection is not active below 5Hz (the underload counter value is stopped). See Figure 2.5-32.

The torque values for setting the underload curve are set in percentage values which refer to the nominal torque of the motor. The motor's name plate data, parameter 1. 13, the motor's nominal current and the drive's nominal current  $I_{CT}$  are used to find the scaling ratio for the internal torque value. If other than a standard motor is used with the drive, the accuracy of the torque calculation is decreased.

#### 7. 14 Underload protection

Operation:

- 0 = Not in use
- 1 = Warning message
- 2 = Fault message

Tripping and warning will display the same message code. If tripping is set active the drive will stop and activate the fault stage.

Deactivating the protection, by setting parameter to 0, will reset the underload time counter to zero.

#### 7. 15 Underload protection, field weakening area load

The torque limit can be set between 20.0—150 % x  $T_{nMotor}$ .

This parameter gives the value for the minimum allowed torque when the output frequency is above the fieldweakening point. See Figure 2.5-32.

If parameter 1. 13 is adjusted, this parameter is automatically restored to the default value.

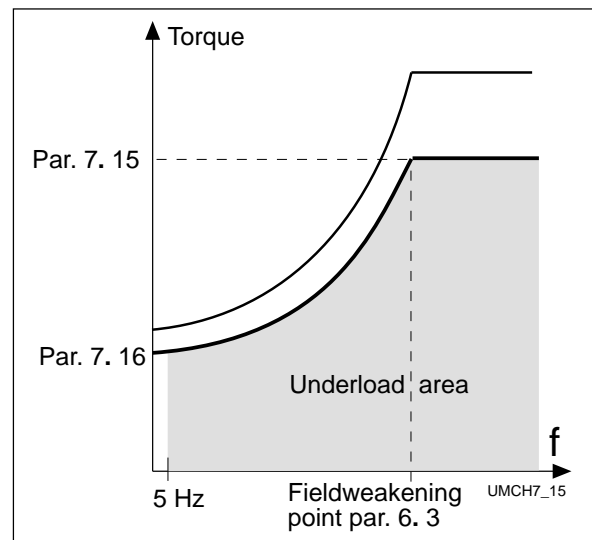

Figure 2.5-32 Setting of minimum load.

#### 7. 16 Underload protection, zero frequency load

The torque limit can be set between 10.0—150 % x  $T_{nMotor}$ .

This parameter gives value for the minimum allowed torque with zero frequency. See Figure 2.5-32. If parameter 1. 13 is adjusted, this parameter is automatically restored to the default value.

**7. 17 Underload time**

This time can be set between 2.0—600.0 s.

This is the maximum time allowed for an underload state. There is an internal up/down counter to accumulate the underload time. Refer to Figure 2.5-33.

If the underload counter value goes above this limit the protection will cause a trip (See parameter 7. 14). If the drive is stopped the underload counter is reset to zero.

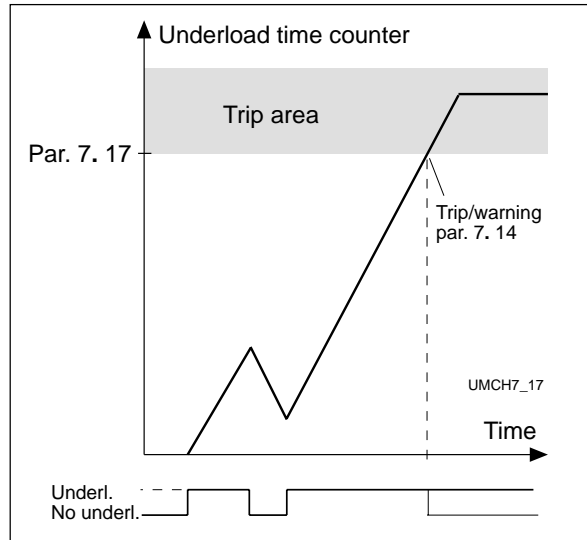

Figure 2.5-33 Counting the underload time.

- 8. 1 Automatic restart: number of tries**
- 8. 2 Automatic restart: trial time**

The Automatic restart function restarts the frequency converter after the faults selected with parameters 8. 4—8. 8. The Start function for Automatic restart is selected with parameter 8. 3. See Figure 2.5-34.

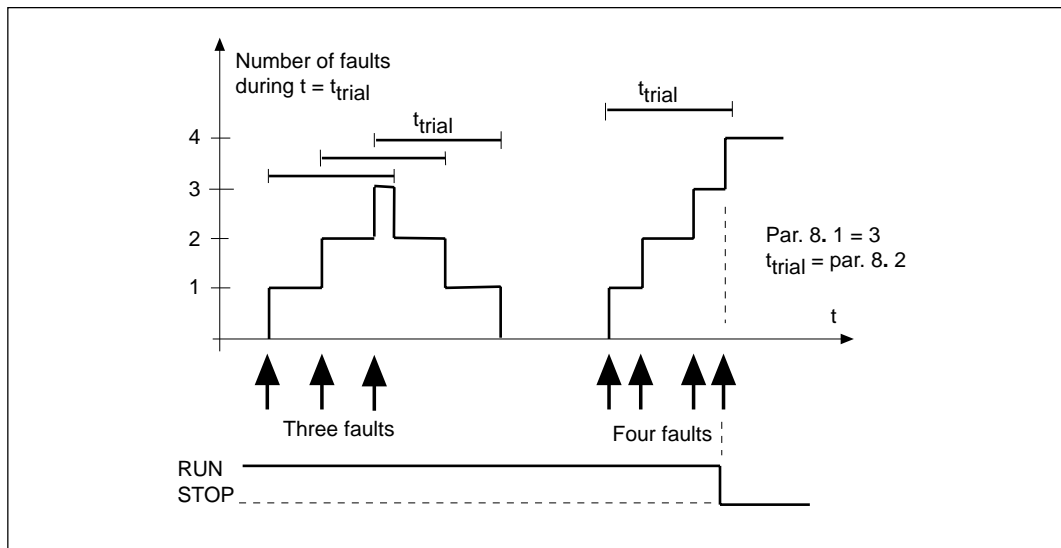

Figure 2.5-34 Automatic restart.

Parameter 8. 1 determines how many automatic restarts can be made during the trial time set by parameter 8. 2.

The time counting starts from the first autorestart. If the number of restarts does not exceed the value of the parameter 8.1 during the trial time, the counting is cleared after the time is elapsed and next fault starts the counting again.

**8.3 Automatic restart, start function**

The parameter defines the start mode:

0 = Start with ramp

1 = Flying start, see parameter 4. 6.

**8.4 Automatic restart after undervoltage**

0 = No automatic restart after undervoltage fault

1 = Automatic restart after undervoltage fault condition returns to the normal condition (DC-link voltage returns to the normal level)

**8.5 Automatic restart after overvoltage**

0 = No automatic restart after overvoltage fault

1 = Automatic restart after overvoltage fault condition returns to the normal condition (DC-link voltage returns to the normal level)

**8.6 Automatic restart after overcurrent**

0 = No automatic restart after overcurrent fault

1 = Automatic restart after overcurrent faults

**8.7 Automatic restart after reference fault**

0 = No automatic restart after reference fault

1 = Automatic restart after analog current reference signal (4—20 mA) returns to the normal level ( $\geq 4$  mA)

**8.8 Automatic restart after over-/undertemperature fault**

0 = No automatic restart after temperature fault

1 = Automatic restart after heatsink temperature has returned to its normal level between  $-10^{\circ}\text{C}$ — $+75^{\circ}\text{C}$ .





## MULTI-STEP SPEED CONTROL APPLICATION

(par. 0.1 = 4)

### CONTENTS

<b>3 Multi-step Speed Control Appl. ....</b>	<b>3-1</b>
3.1 General .....	3-2
3.2 Control I/O .....	3-2
3.3 Control signal logic.....	3-3
3.4 Parameters Group 1 .....	3-4
3.4.1 Parameter table .....	3-4
3.4.2 Description of Group1 par ...	3-5
3.5 Special parameters, Groups 2—8 ..	3-8
3.5.1 Parameter tables .....	3-8
3.5.2 Description of Groups. ....	3-14

3.1 GENERAL

The Multi-step Speed Control Application can be used in applications where fixed speeds are needed. Totally 9 different speeds can be programmed: one basic speed, 7 multi-step speeds and one jogging speed. The speed steps are selected with digital signals DIB4, DIB5 and DIB6. If jogging speed is used DIA3

can be programmed from fault reset to jogging speed select.

The basic speed reference can be either voltage or current signal via analogue input terminals (2/3 or 4/5). The other one of the analogue inputs can be programmed for other purposes

All outputs are freely programmable.

3.2 CONTROL I/O

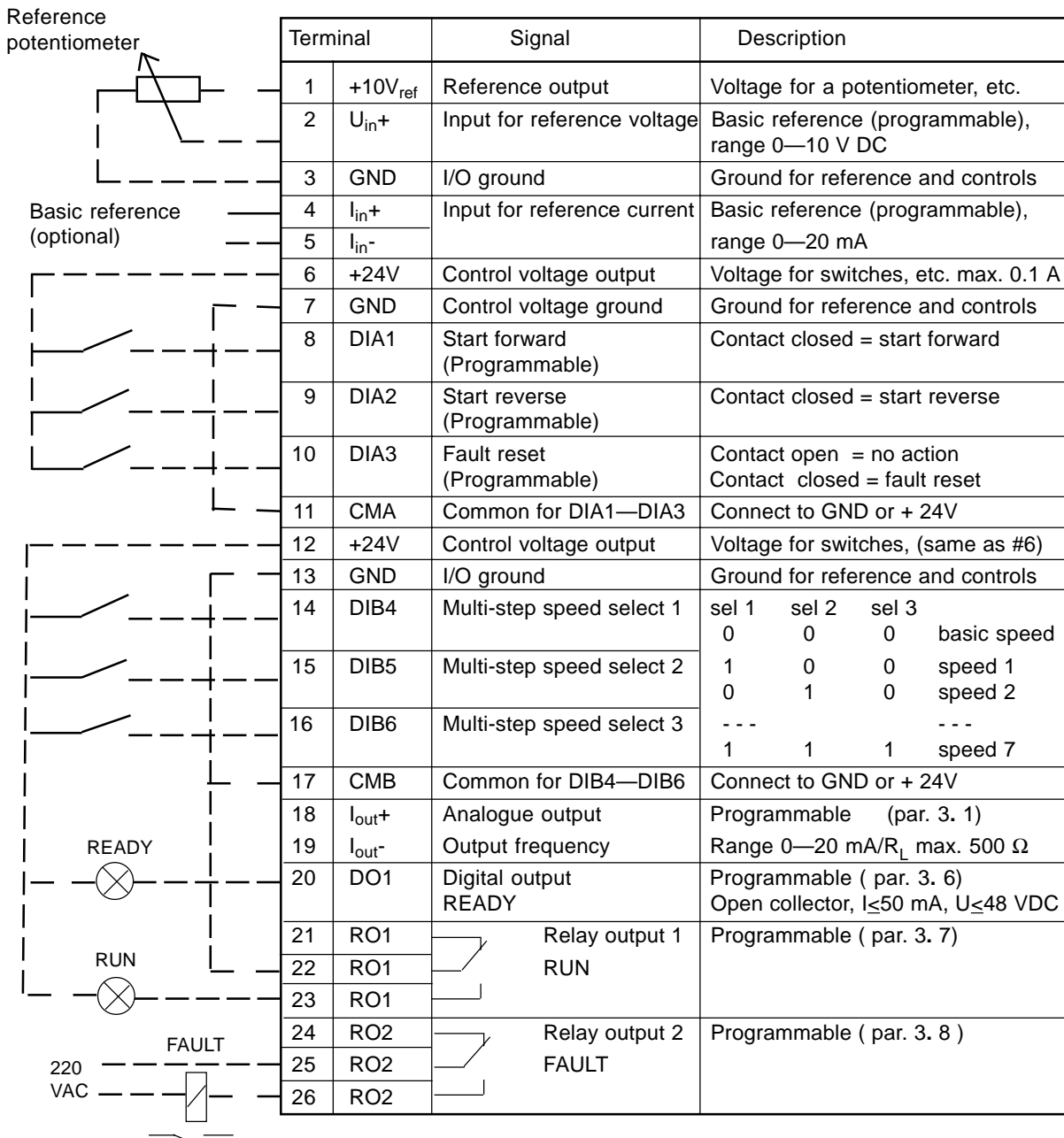

Figure 3.2-1 Default I/O configuration and connection example of the Multi-step speed Control Application.

3.3 Control signal logic

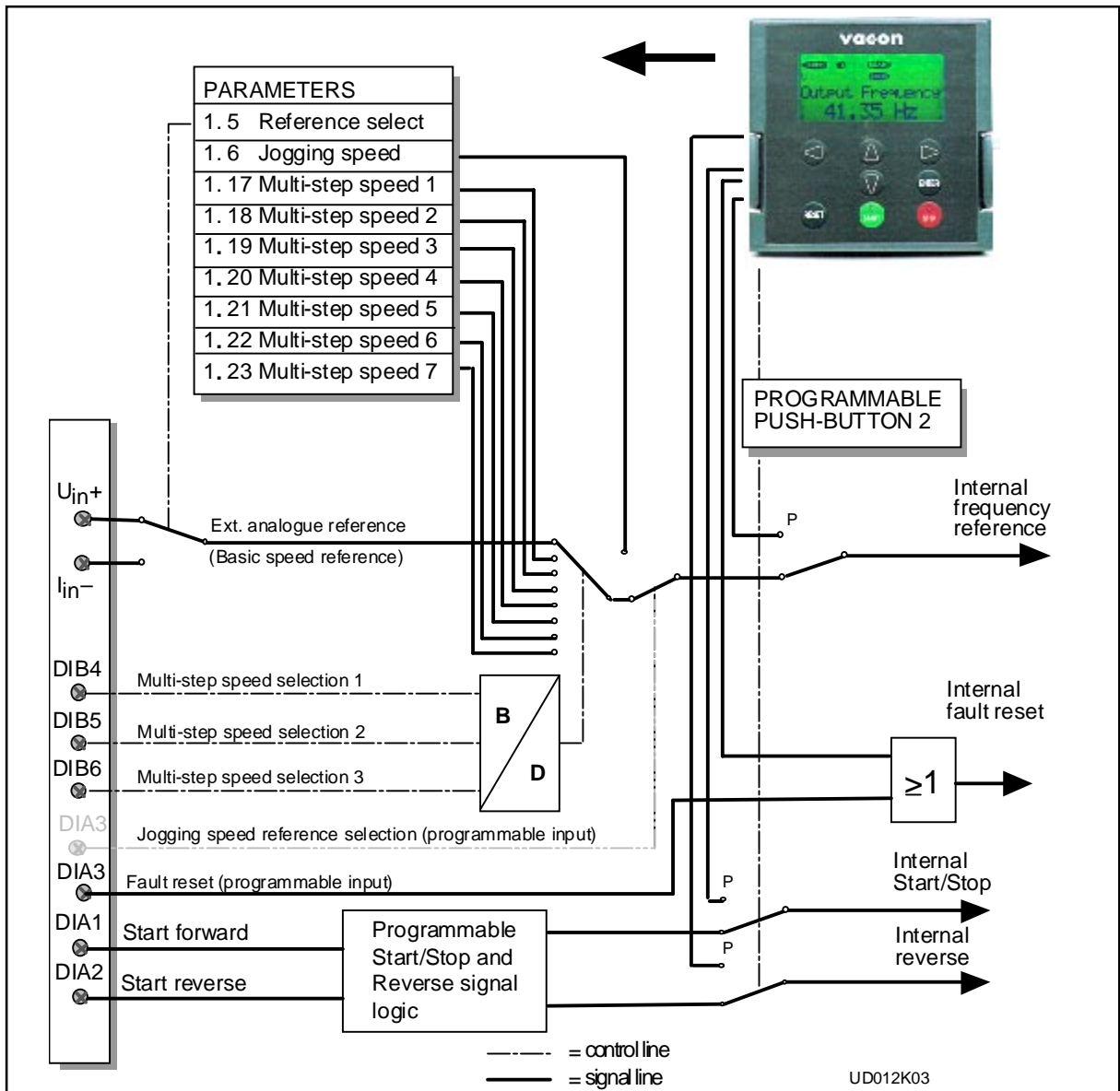



Figure 3.3-1 Control signal logic of the Multi-step Speed Control Application. Switch positions are shown according to the factory settings.

## 3.4 Basic parameters, Group 1

Code	Parameter	Range	Step	Default	Custom	Description	Page
1. 1	Minimum frequency	0— $f_{max}$	1 Hz	0 Hz			3-5
1. 2	Maximum frequency	$f_{min}$ -120/500Hz	1 Hz	50 Hz		*)	3-5
1. 3	Acceleration time 1	0,1—3000,0 s	0,1 s	3,0 s		Time from $f_{min}$ (1. 1) to $f_{max}$ (1. 2)	3-5
1. 4	Deceleration time 1	0,1—3000,0 s	0,1 s	3,0 s		Time from $f_{max}$ (1. 2) to $f_{min}$ (1. 1)	3-5
1. 5	Basic reference selection 	0—1	1	0		0 = Analogue voltage input (term.2) 1 = Analogue current input (term.4)	3-5
1. 6	Jogging speed reference	$f_{min}$ — $f_{max}$ (1. 1) (1. 2)	0,1 Hz	5,0 Hz			3-5
1. 7	Current limit	0,1—2,5 x $I_{nCX}$	0,1A	1,5 x $I_{nCX}$		***Output curr. limit [A] of the unit	3-5
1. 8	U/f ratio selection 	0—2	1	0		0 = Linear 1 = Squared 2 = Programmable U/f ratio	3-6
1. 9	U/f optimisation 	0—1	1	0		0 = None 1 = Automatic torque boost	3-7
1. 10	Nominal voltage of the motor 	180—690 V	1 V	230 V 400 V 500 V 690 V		Vacon range CX/CXL/CXS2 Vacon range CX/CXL/CXS4 Vacon range CX/CXL/CXS5 Vacon range CX6	3-7
1. 11	Nominal frequency of the motor 	30—500 Hz	1 Hz	50 Hz		$f_n$ from the rating plate of the motor	3-7
1. 12	Nominal speed of the motor 	300—20000 rpm	1 rpm	1420 rpm **)		$n_n$ from the rating plate of the motor	3-7
1. 13	Nominal current of the motor 	2,5 x $I_{nCX}$	0,1 A	$I_{nCX}$		$I_n$ from the rating plate of the motor	3-7
1. 14	Supply voltage 	208—240		230 V		Vacon range CX/CXL/CXS2	3-7
		380—440		400 V		Vacon range CX/CXL/CXS4	
		380—500		500 V		Vacon range CX/CXL/CXS5	
		525—690		690 V		Vacon range CX6	
1. 15	Parameter conceal	0—1	1	0		Visibility of the parameters: 0 = all parametergroups visible 1 = only group 1 is visible	3-7
1. 16	Parameter value lock	0—1	1	0		Disables parameter changes: 0 = changes enabled 1 = changes disable	3-7

**Note!**  = Parameter value can be changed only when the frequency converter is stopped.

\*) If 1. 2 > motor synchr. speed, check suitability for motor and drive system

Selecting 120/500 Hz range see page 3-5.

\*\*) Default value for a four pole motor and a nominal size frequency converter.

(Continues)

\*\*\*)Up to M10. Bigger classes case by case

Code	Parameter	Range	Step	Default	Custom	Description	Page
1. 17	Multi-step speed reference 1	$f_{\min}$ — $f_{\max}$ (1. 1) (1. 2)	0,1 Hz	10,0 Hz			3-7
1. 18	Multi-step speed reference 2	$f_{\min}$ — $f_{\max}$ (1. 1) (1. 2)	0,1 Hz	15,0 Hz			3-7
1. 19	Multi-step speed reference 3	$f_{\min}$ — $f_{\max}$ (1. 1) (1. 2)	0,1 Hz	20,0 Hz			3-7
1. 20	Multi-step speed reference 4	$f_{\min}$ — $f_{\max}$ (1. 1) (1. 2)	0,1 Hz	25,0 Hz			3-7
1. 21	Multi-step speed reference 5	$f_{\min}$ — $f_{\max}$ (1. 1) (1. 2)	0,1 Hz	30,0 Hz			3-7
1. 22	Multi-step speed reference 6	$f_{\min}$ — $f_{\max}$ (1. 1) (1. 2)	0,1 Hz	40,0 Hz			3-7
1. 23	Multi-step speed reference 7	$f_{\min}$ — $f_{\max}$ (1. 1) (1. 2)	0,1 Hz	50,0 Hz			3-7

Table 3.4-1 Group 1 basic parameters.

### 3.4.2 Description of Group 1 parameters

#### 1. 1, 1. 2 *Minimum/maximum frequency*

Defines frequency limits of the frequency converter.

The default maximum value for parameters 1. 1 and 1. 2 is 120 Hz. By setting 1. 2 = 120 Hz in the when the device is stopped (RUN indicator not lit) parameters 1. 1 and 1. 2 is changed to 500 Hz. At the same time panel reference resolution is changed from 0.01 Hz to 0.1 Hz.

Changing the max. value from 500 Hz to 120 Hz is done by setting parameter 1. 2 to 119 Hz in the when the device is stopped.

#### 1. 3, 1. 4 *Acceleration time 1, deceleration time 1:*

These limits correspond to the time required for the output frequency to accelerate from the set minimum frequency (par. 1. 1) to the set maximum frequency (par. 1. 2). Acceleration/deceleration times can be reduced with free analog input signal, see parameters 2. 18 and 2. 19.

#### 1. 5 *Basic reference selection*

0: Analogue voltage reference from terminals 2—3, e.g. a potentiometer

1: Analogue current reference from terminals 4—5, e.g. a transducer

#### 1. 6 *Jogging speed reference*

This parameter value defines the jogging speed selected with the DIA3 digital input which can be programmed for Jogging speed. See parameter 2. 2.

Parameter value is automatically limited between minimum and maximum frequency (par 1. 1, 1. 2)

#### 1. 7 *Current limit*

This parameter determines the maximum motor current what the frequency converter can give momentarily. Current limit can be set lower with free analogue input signal, see parameters 2. 18 and 2. 19.

**1.8 U/f ratio selection**

**0** Linear: The voltage of the motor changes linearly with the frequency in the constant flux area from 0 Hz to the field weakening point (par. 6.3) where the nominal voltage is also supplied to the motor. See figure 3.4-1.

Linear U/f ratio should be used in constant torque applications

**This default setting should be used if there is no special demand for another setting.**

**1** Squared: The voltage of the motor changes following a squared curve form with the frequency in the area from 0 Hz to the field weakening point (par. 6.3) where the nominal voltage is also supplied to the motor. See figure 3.4-1.

The motor runs undermagnetised below the field weakening point and produces less torque and electromechanical noise. Squared U/f ratio can be used in applications where torque demand of the load is proportional to the square of the speed, e.g. in centrifugal fans and pumps.

3

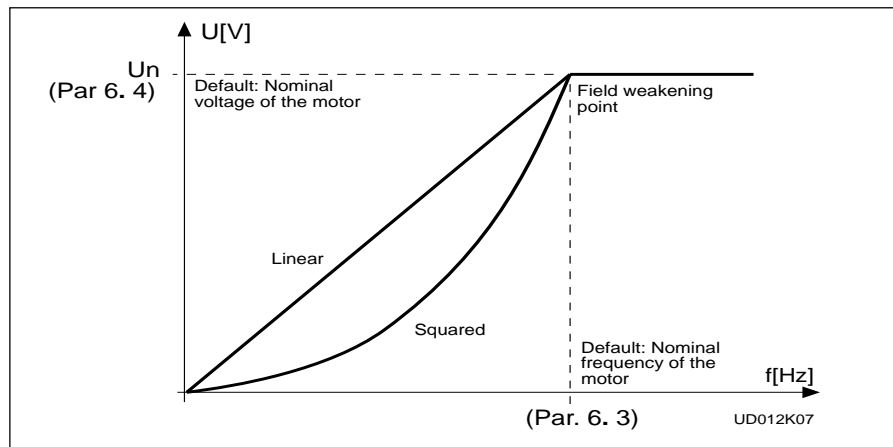

Figure 3.4-1 Linear and squared U/f curves.

**2** Programm. U/f curve: The U/f curve can be programmed with three different points. The parameters for programming are explained in Chapter 3.5.2. The programmable U/f curve can be used if the other settings do not satisfy the needs of the application. See figure 3.4-2.

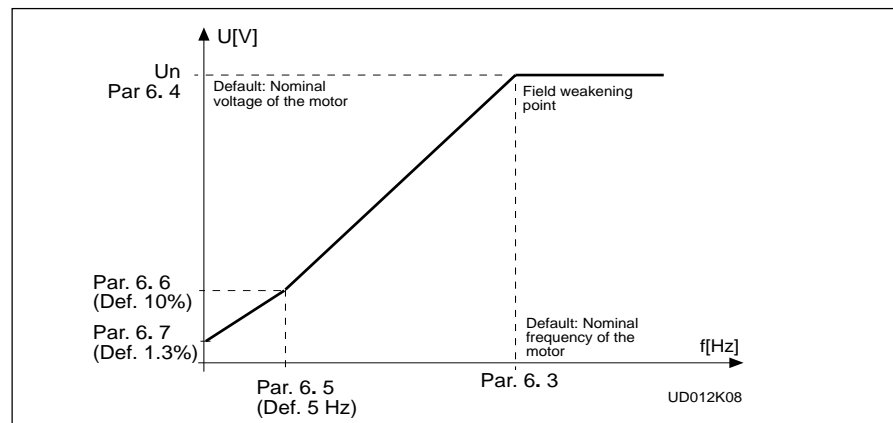

Figure 3.4-2 Programmable U/f curve.

**1. 9 U/f optimisation**

Automatic torque boost The voltage to the motor changes automatically which makes the motor produce enough torque to start and run at low frequencies. The voltage increase depends on the motor type and power. Automatic torque boost can be used in applications where starting torque due to starting friction is high, e.g. in conveyors.

**NOTE!**

*In high torque - low speed applications - it is likely the motor will overheat.*

*If the motor has to run a prolonged time under these conditions, special attention must be paid to cooling the motor. Use external cooling for the motor if the temperature tends to rise too high.*

**1. 10 Nominal voltage of the motor**

Find this value  $U_n$  on the rating plate of the motor.

This parameter sets the Voltage at the field weakening point, parameter 6. 4, to 100% x  $U_{n\text{motor}}$ .

**1. 11 Nominal frequency of the motor**

Find this value  $f_n$  on the rating plate of the motor.

This parameter sets the field weakening point, parameter 6. 3, to the same value.

**1. 12 Nominal speed of the motor**

Find this value  $n_n$  on the rating plate of the motor.

**1. 13 Nominal current of the motor**

Find the value  $I_n$  on the rating plate of the motor.

The internal motor protection function uses this value as a reference value.

**1. 14 Supply voltage**

Set parameter value according to the nominal voltage of the supply.

Values are pre-defined for CX/CXL/CXS2, CX/CXL/CXS4, CX/CXL/CXS5 and CX6 ranges, see table 3.4-1.

**1. 15 Parameter conceal**

Defines which parameter groups are available:

0 = all parameter groups are visible

1 = only group 1 is visible

**1. 16 Parameter value lock**

Defines access to the changes of the parameter values:

0 = parameter value changes enabled

1 = parameter value changes disabled

**1. 17 - 1. 23 Multi-step speed reference 1—7**

Parameter values defines the Multi-step speeds selected with the DIA4, DIB5 and DIB6 digital inputs .

Parameter value is automatically limited between minimum and maximum frequency (par. 1. 1, 1. 2).

Speed reference	Multi-step speed select 1 DIB4	Multi-step speed select 2 DIB5	Multi-step speed select 3 DIB6
Par. 1. 5	0	0	0
Par. 1. 17	1	0	0
Par. 1. 18	0	1	0
Par. 1. 19	1	1	0
Par. 1. 20	0	0	1
Par. 1. 21	1	0	1
Par. 1. 22	0	1	1
Par. 1. 23	1	1	1



*Table 3.4-2 Selection of multi-step speed reference 1—7.*



### 3.5 Special parameters, Groups 2—8

#### 3.5.1 Parameter tables





##### Input signal parameters, Group 2

Code	Parameter	Range	Step	Default	Custom	Description	Page
2. 1	Start/Stop logic selection 	0—3	1	0		DIA1	3-15
						DIA2	
						0 = Start forward 1 = Start/Stop 2 = Start/Stop 3 = Start pulse	
						Start reverse Reverse Run enable Stop pulse	
2. 2	DIA3 function (terminal 10) 	0—9	1	7		0 = Not used 1 = Ext. fault, closing contact 2 = External fault, opening contact 3 = Run enable 4 = Acc./Dec. time selection 5 = Reverse (if par. 2. 1 = 3) 6 = Jogging speed 7 = Fault reset 8 = Acc./Dec. operation prohibit 9 = DC-braking command	3-16
2. 3	U <sub>in</sub> signal range	0—1	1	0		0 = 0—10 V 1 = Custom setting range	3-17
2. 4	U <sub>in</sub> custom setting min.	0,00-100,00%	0,01%	0,00%			3-17
2. 5	U <sub>in</sub> custom setting max.	0,00-100,00%	0,01%	100,00%			3-17
2. 6	U <sub>in</sub> signal inversion	0—1	1	0		0 = Not inverted 1 = Inverted	3-18
2. 7	U <sub>in</sub> signal filter time	0,00 —10,0 s	0,01s	0,10 s		0 = No filtering	3-18
2. 8	I <sub>in</sub> signal range	0—2	1	0		0 = 0—20 mA 1 = 4—20 mA 2 = Custom setting range	3-19
2. 9	I <sub>in</sub> custom setting minim.	0,00-100,00%	0,01%	0,00%			3-19
2. 10	I <sub>in</sub> custom setting maxim.	0,00-100,00%	0,01%	100,00%			3-19
2. 11	I <sub>in</sub> signal inversion	0—1	1	0		0 = Not inverted 1 = Inverted	3-19
2. 12	I <sub>in</sub> signal filter time	0,01 —10,00s	0,01s	0,10 s		0 = No filtering	3-19
2. 13	Reference scaling minimum value	0— par. 2. 14	1 Hz	0 Hz		Selects the frequency that corresponds to the min. reference signal	3-20
2. 14	Reference scaling maximum value	0— f <sub>max</sub> (1. 2)	1 Hz	0 Hz		Selects the frequency that corresponds to the max. reference signal 0 = Scaling off >0 = Scaled maximum value	3-20
2. 15	Free analogue input, signal selection	0—2	1	0		0 = Not use 1 = U <sub>in</sub> (analogue voltage input) 2 = I <sub>in</sub> (analogue current input)	3-20
2. 16	Free analogue input, function	0—4	1	0		0 = No function 1 = Reduces current limit (par. 1.7) 2 = Reduces DC-braking current 3 = Reduces acc. and decel. times 4 = Reduces torque supervis. limit	3-20

**Note!**  = Parameter value can be changed only when the frequency converter is stopped.

(Continues)

## Group 3, Output and supervision parameters

Code	Parameter	Range	Step	Default	Custom	Description	Page
3. 1	Analogue output function 	0—7	1	1		0 = Not used      Scale 100% 1 = O/P frequency (0— $f_{max}$ ) 2 = Motor speed (0—max. speed) 3 = O/P current (0— $2.0 \times I_{nCT}$ ) 4 = Motor torque (0— $2 \times T_{nMot}$ ) 5 = Motor power (0— $2 \times P_{nMot}$ ) 6 = Motor voltage (0— $100\% \times U_{nMot}$ ) 7 = DC-link volt. (0—1000 V)	3-22
3. 2	Analogue output filter time	0,00—10,00 s	0,01 s	1,00 s			3-22
3. 3	Analogue output inversion	0—1	1	0		0 = Not inverted 1 = Inverted	3-22
3. 4	Analogue output minimum	0—1	1	0		0 = 0 mA 1 = 4 mA	3-22
3. 5	Analogue output scale	10—1000%	1%	100%			3-22
3. 6	Digital output function 	0—21	1	1		0 = Not used 1 = Ready 2 = Run 3 = Fault 4 = Fault inverted 5 = Vacon overheat warning 6 = External fault or warning 7 = Reference fault or warning 8 = Warning 9 = Reversed 10 = Jogging speed selected 11 = At speed 12 = Motor regulator activated 13 = Output frequency limit superv. 1 14 = Output frequency limit superv. 2 15 = Torque limit supervision 16 = Reference limit supervision 17 = External brake control 18 = Control from I/O-terminals 19 = Frequency converter temperature limit supervision 20 = Unrequested rotation direction 21 = External brake control inverted	3-23
3. 7	Relay output 1 function 	0—21	1	2		As parameter 3. 6	3-23
3. 8	Relay output 2 function 	0—21	1	3		As parameter 3. 6	3-23
3. 9	Output freq. limit 1 supervision function	0—2	1	0		0 = No 1 = Low limit 2 = High limit	3-23
3. 10	Output freq. limit 1 supervision value	0,0— $f_{max}$ (par. 1. 2)	0,1 Hz	0,0 Hz			3-23

**Note!**  = Parameter value can be changed only when the frequency converter is stopped. (Continues)

Code	Parameter	Range	Step	Default	Custom	Description	Page
3. 11	Output freq. limit 2 supervision function	0—2	1	0		0 = No 1 = Low limit 2 = High limit	3-23
3. 12	Output freq. limit 2 supervision value	0,0— $f_{max}$ (par. 1. 2)	0,1 Hz	0,0 Hz			3-23
3. 13	Torque limit supervision function	0—2	1	0		0 = No 1 = Low limit 2 = High limit	3-24
3. 14	Torque limit supervision value	0,0—200,0 % $\times T_{ncX}$	0,1%	100,0%			3-24
3. 15	Reference limit supervision function	0—2	1	0		0 = No 1 = Low limit 2 = High limit	3-24
3. 16	Reference limit supervision value	0,0— $f_{max}$ (par. 1. 2)	0,1 Hz	0,0 Hz			3-24
3. 17	Extern. brake Off-delay	0,0—100,0 s	0,1 s	0,5 s			3-24
3. 18	Extern. brake On-delay	0,0—100,0 s	0,1 s	1,5 s			3-24
3. 19	Frequency converter temperature limit supervision	0—2	1	0		0 = No 1 = Low limit 2 = High limit	3-25
3. 20	Frequency converter temperature limit value	-10—+75°C	1	40°C			3-25
3. 21	I/O-expander board (opt.) analog output function	0—7	1	3		See parameter 3. 1 	3-22
3. 22	I/O-expander board (opt.) analog output filter time	0,00—10,00 s	0,01 s	1,00 s		See parameter 3. 2	3-22
3. 23	I/O-expander board (opt.) analog output inversion	0—1	1	0		See parameter 3. 3	3-22
3. 24	I/O-expander board (opt.) analog output minimum	0—1	1	0		See parameter 3. 4	3-22
3. 25	I/O-expander board (opt.) analog output scale	10—1000%	1	100%		See parameter 3. 5	3-22

#### Group 4, Drive control parameters

Code	Parameter	Range	Step	Default	Custom	Description	Page
4. 1	Acc./Dec. ramp 1 shape	0,0—10,0 s	0,1 s	0,0 s		0 = Linear >0 = S-curve acc./dec. time	3-25
4. 2	Acc./Dec. ramp 2 shape	0,0—10,0 s	0,1 s	0,0 s		0 = Linear >0 = S-curve acc./dec. time	3-25
4. 3	Acceleration time 2	0,1—3000,0s	0,1 s	10,0 s			3-25
4. 4	Deceleration time 2	0,1—3000,0s	0,1 s	10,0 s			3-25
4. 5	Brake chopper 	0—2	1	0		0 = Brake chopper not in use 1 = Brake chopper in use 2 = External brake chopper	3-26
4. 6	Start function	0—1	1	0		0 = Ramp 1 = Flying start	3-26

**Note!**  = Parameter value can be changed only when the frequency converter is stopped.







Code	Parameter	Range	Step	Default	Custom	Description	Page
4.7	Stop function	0—1	1	0		0 = Coasting 1 = Ramp	3-26
4.8	DC-braking current	0,15—1,5 x $I_{nCT}$ (A)	0,1 A	0,5 x $I_{nCT}$			3-26
4.9	DC-braking time at Stop	0,00-250,00s	0,01 s	0,00 s		0 = DC-brake is off at Stop	3-26
4.10	Execute frequency of DC-brake during ramp Stop	0,1—10,0 Hz	0,1 Hz	1,5 Hz			3-28
4.11	DC-brake time at Start	0,00—25,00 s	0,01 s	0,00 s		0 = DC-brake is off at Start	3-28

### Group 5, Prohibit frequency parameters

Code	Parameter	Range	Step	Default	Custom	Description	Page
5.1	Prohibit frequency range 1 low limit	$f_{min}$ — par. 5.2	0,1 Hz	0,0 Hz			3-28
5.2	Prohibit frequency range 1 high limit	$f_{min}$ — $f_{max}$ (1.1) (1.2)	0,1 Hz	0,0 Hz		0 = Prohibit range 1 is off	3-28
5.3	Prohibit frequency range 2 low limit	$f_{min}$ — par. 5.4	0,1 Hz	0,0 Hz			3-28
5.4	Prohibit frequency range 2 high limit	$f_{min}$ — $f_{max}$ (1.1) (1.2)	0,1 Hz	0,0 Hz		0 = Prohibit range 2 is off	3-28
5.5	Prohibit frequency range 3 low limit	$f_{min}$ — par. 5.6	0,1 Hz	0,0 Hz			3-28
5.6	Prohibit frequency range 3 high limit	$f_{min}$ — $f_{max}$ (1.1) (1.2)	0,1 Hz	0,0 Hz		0 = Prohibit range 3 is of	3-28

3

### Group 6, Motor control parameters

Code	Parameter	Range	Step	Default	Custom	Description	Page
6.1	Motor control mode 	0—1	1	0		0 = Frequency control 1 = Speed control	3-29
6.2	Switching frequency	1,0—16,0 kHz	0,1 kHz	10/3,6 kHz		Dependant on kW	3-29
6.3	Field weakening point 	30—500 Hz	1 Hz	Param. 1.11			3-29
6.4	Voltage at field weakening point 	15—200% x $U_{nmot}$	1%	100%			3-29
6.5	U/f curve, midpoint frequency 	0,0— $f_{max}$	0,1 Hz	0,0 Hz			3-29
6.6	U/F-curve, midpoint voltage 	0,00—100,00% x $U_{nmot}$	0,01%	0,00%		Parameter maximum value = param. 6.4	3-29
6.7	Output voltage at zero frequency 	0,00—40,00% x $U_{nmot}$	0,01%	0,00%			3-29
6.8	Overvoltage controller	0—1	1	1		0 = Controller is turned off 1 = Controller is operating	3-30
6.9	Undervoltage controller	0—1	1	1		0 = Controller is turned off 1 = Controller is operating	3-30

**Note!**



= Parameter value can be changed only when the frequency converter is stopped.

## Group 7, Protections

Code	Parameter	Range	Step	Default	Custom	Description	Page
7. 1	Response to reference fault	0—3	1	0		0 = No action 1 = Warning 2 = Fault, stop according to par. 4.7 3 = Fault, stop always by coasting	3-30
7. 2	Response to external fault	0—3	1	2		0 = No action 1 = Warning 2 = Fault, stop according to par. 4.7 3 = Fault, stop always by coasting	3-30
7. 3	Phase supervision of the motor	0—2	2	2		0 = No action 2 = Fault	3-30
7. 4	Earth fault protection	0—2	2	2		0 = No action 2 = Fault	3-31
7. 5	Motor thermal protection	0—2	1	2		0 = No action 1 = Warning 2 = Fault	3-31
7. 6	Motor thermal protection break point current	50,0—150,0 % $\times I_{nMOTOR}$	1,0 %	100,0%			3-32
7. 7	Motor thermal protection zero frequency current	5,0—150,0% $\times I_{nMOTOR}$	1,0 %	45,0%			3-32
7. 8	Motor thermal protection time constant	0,5—300,0 minutes	0,5 min.	17,0 min.		Default value is set according to motor nominal current	3-33
7. 9	Motor thermal protection break point frequency	10—500 Hz	1 Hz	35 Hz			3-33
7. 10	Stall protection	0—2	1	1		0 = No action 1 = Warning 2 = Fault	3-34
7. 11	Stall current limit	5,0—200,0% $\times I_{nMOTOR}$	1,0%	130,0%			3-34
7. 12	Stall time	2,0—120,0 s	1,0 s	15,0 s			3-34
7. 13	Maximum stall frequency	1— $f_{max}$	1 Hz	25 Hz			3-34
7. 14	Underload protection	0—2	1	0		0 = No action 1 = Warning 2 = Fault	3-35
7. 15	Underload prot., field weakening area load	10,0—150,0 % $\times T_{nMOTOR}$	1,0%	50,0%			3-35
7. 16	Underload protection, zero frequency load	5,0—150,0% $\times T_{nMOTOR}$	1,0%	10,0%			3-35
7. 17	Underload time	2,0—600,0 s	1,0 s	20,0s			3-36

**Group 8, Autorestart parameters**

Code	Parameter	Range	Step	Default	Custom	Description	Page
8.1	Automatic restart: number of tries	0—10	1	0		0 = not in use	3-36
8.2	Automatic restart: trial time	1—6000 s	1 s	30 s			3-36
8.3	Automatic restart: start function	0—1	1	0		0 = Ramp 1 = Flying start	3-37
8.4	Automatic restart after undervoltage trip	0—1	1	0		0 = No 1 = Yes	3-37
8.5	Automatic restart after overvoltage trip	0—1	1	0		0 = No 1 = Yes	3-37
8.6	Automatic restart after overcurrent trip	0—1	1	0		0 = No 1 = Yes	3-37
8.7	Automatic restart after reference fault trip	0—1	1	0		0 = No 1 = Yes	3-37
8.8	Automatic restart after over/undertemperature fault trip	0—1	1	0		0 = No 1 = Yes	3-37

*Table 3.5-1 Special parameters, Groups 2—8.*

3.5.2 Description of Groups 2—8 parameters

2.1 Start/Stop logic selection

- 0: DIA1: closed contact = start forward  
DIA2: closed contact = start reverse,  
See figure 3.5-1.

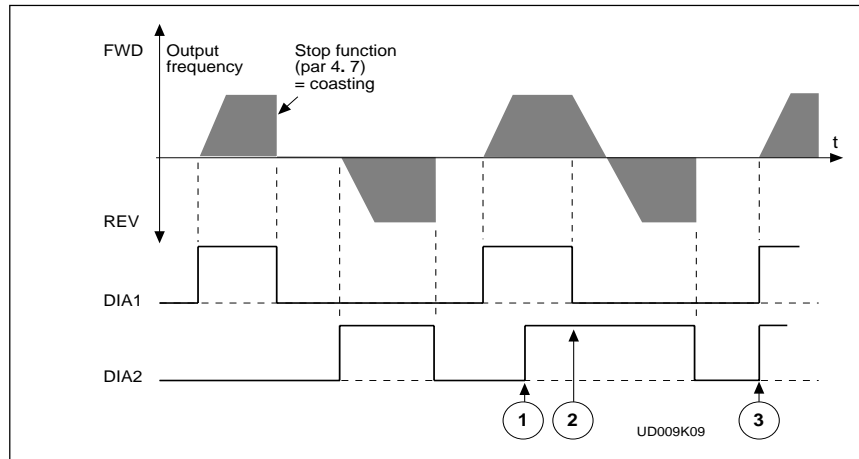

Figure 3.5-1 Start forward/Start reverse.

- ① The first selected direction has the highest priority
- ② When DIA1 contact opens, the direction of rotation starts to change
- ③ If Start forward (DIA1) and start reverse (DIA2) signals are active simultaneously, the start forward signal (DIA1) has priority.

- 1: DIA1: closed contact = start      open contact = stop  
DIA2: closed contact = reverse    open contact = forward  
See figure 3.5-2.

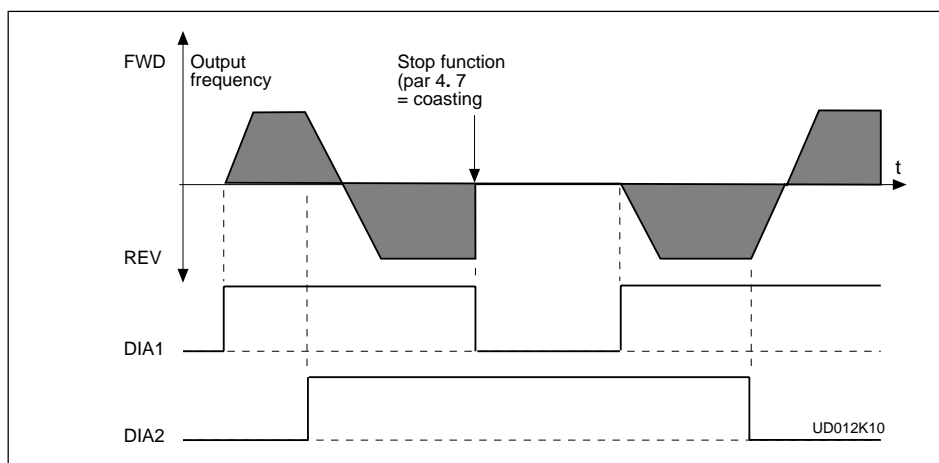

Figure 3.5-2 Start, Stop, reverse.

- 2: DIA1: closed contact = start                      open contact = stop  
 DIA2: closed contact = start enabled      open contact = start disabled
- 3: 3-wire connection (pulse control):  
 DIA1: closed contact = start pulse  
 DIA2: closed contact = stop pulse  
 (DIA3 can be programmed for reverse command)  
 See figure 3.5-3.

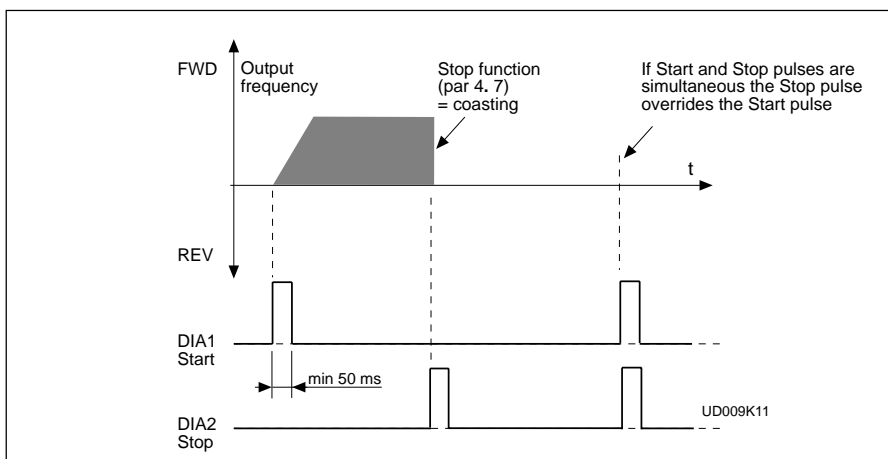

Figure 3.5-3 Start pulse /Stop pulse.

## 2. 2 DIA3 function

- 1: External fault, closing contact = Fault is shown and motor is stopped when the input is active
- 2: External fault, opening contact = Fault is shown and motor is stopped when the input is not active
- 3: Run enable      contact open = Start of the motor disabled  
                           contact closed = Start of the motor enabled
- 4: Acc. / Dec time select.      contact open = Acceleration/Deceleration time 1 selected  
   contact closed = Acceleration/Deceleration time 2 selected
- 5: Reverse            contact open = Forward            || Can be used for reversing if  
                               contact closed = Reverse        || parameter 2. 1 has value 3
- 6: Jogging sp.      contact closed = Jogging speed selected for freq. refer.
- 7: Fault reset      contact closed = Resets all faults
- 8: Acc./Dec. operation prohibited  
                               contact closed = Stops acceleration or deceleration until  
   the contact is opened
- 9: DC-braking command  
                               contact closed = In Stop mode, the DC-braking operates  
   until the contact is opened, see figure 3.5-4.  
   DC-brake current is set with parameter 4. 8.



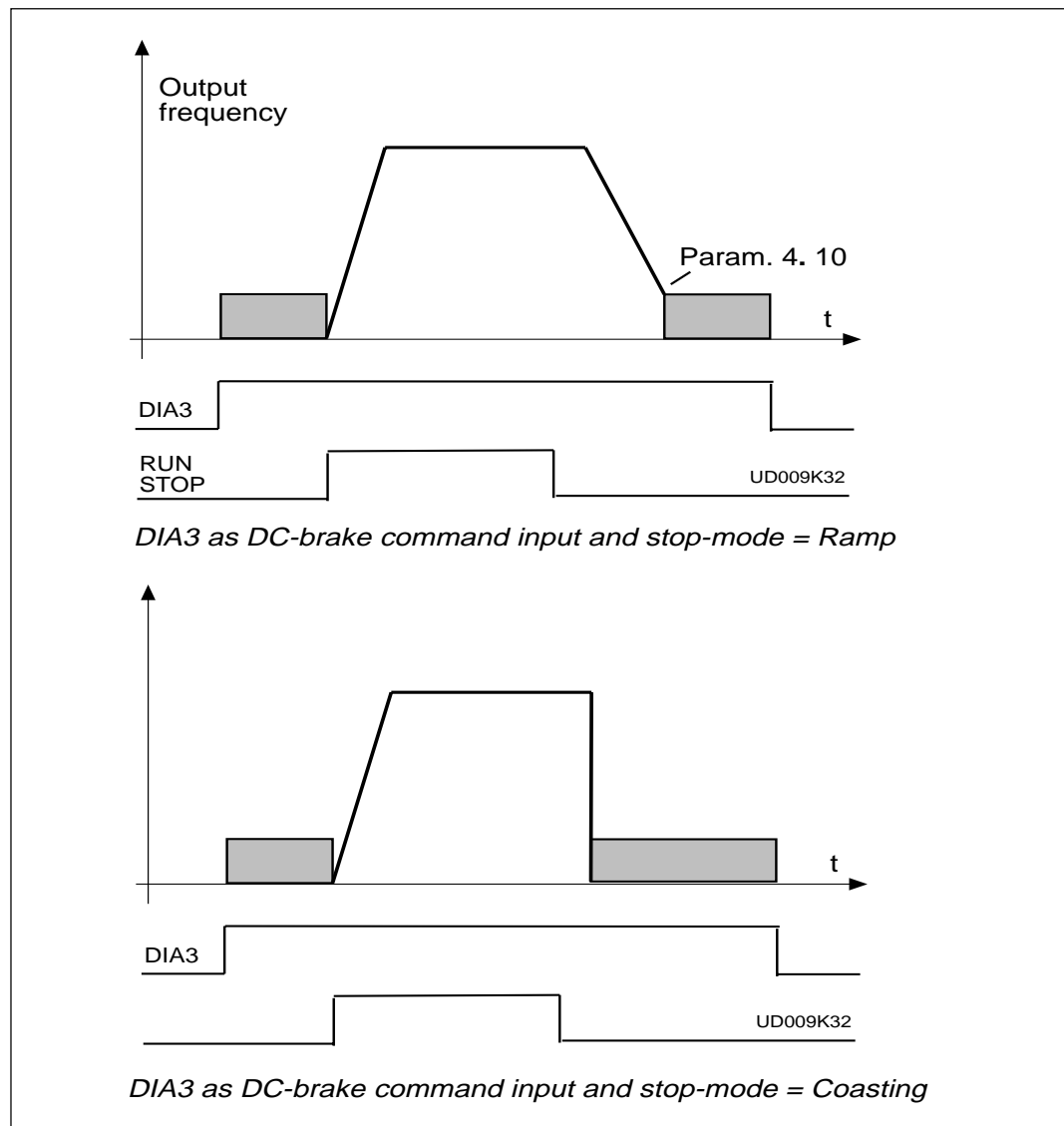

Figure 3.5-4 DIA3 as DC-brake command input: a) Stop mode = Ramp, b) Stop mode = Coasting.

**2.3  $U_{in}$  signal range**

- 0 = Signal range 0—10 V
- 1 = Custom setting range from custom minimum (par. 2. 4) to custom maximum (par. 2. 5)

**2.4  $U_{in}$  custom setting minimum/maximum**

**2.5** These parameters set  $U_{in}$  for any input signal span within 0—10 V.

Minimum setting: Set the  $U_{in}$  signal to its minimum level, select parameter 2. 4, press the Enter button

Maximum setting: Set the  $U_{in}$  signal to its maximum level, select parameter 2. 5, press the Enter button

**Note!** The parameter values can only be set with this procedure (not with the *Browser buttons*).

**2.6  $U_{in}$  signal inversion**

$U_{in}$  is source B frequency reference, par. 1.6 = 1 (default)

Parameter 2.6 = 0, no inversion of analogue  $U_{in}$  signal.

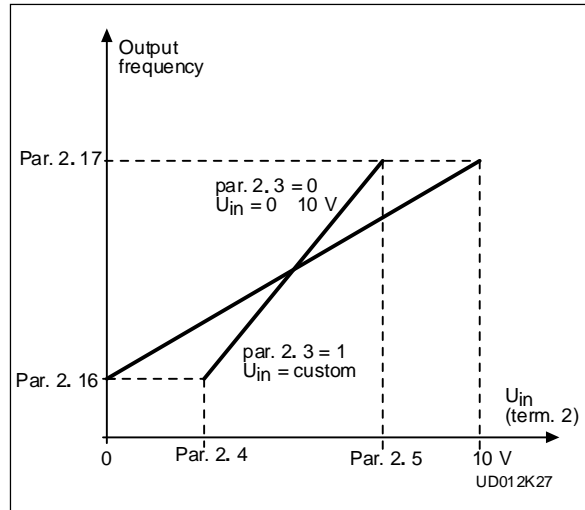

Figure 3.5-5  $U_{in}$  no signal inversion.

Parameter 2.6 = 1, inversion of analogue  $U_{in}$  signal  
 max.  $U_{in}$  signal = minimum set speed  
 min.  $U_{in}$  signal = maximum set speed

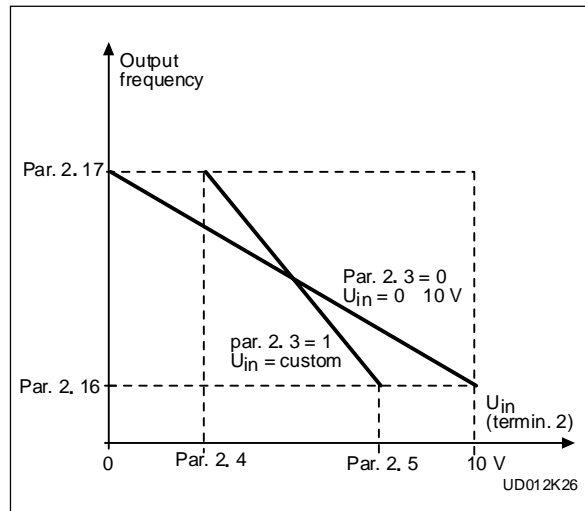

Figure 3.5-6  $U_{in}$  signal inversion.

**2.7  $U_{in}$  signal filter time**

Filters out disturbances from the incoming analogue  $U_{in}$  signal. Long filtering time makes regulation response slower. See figure 3.5-7.

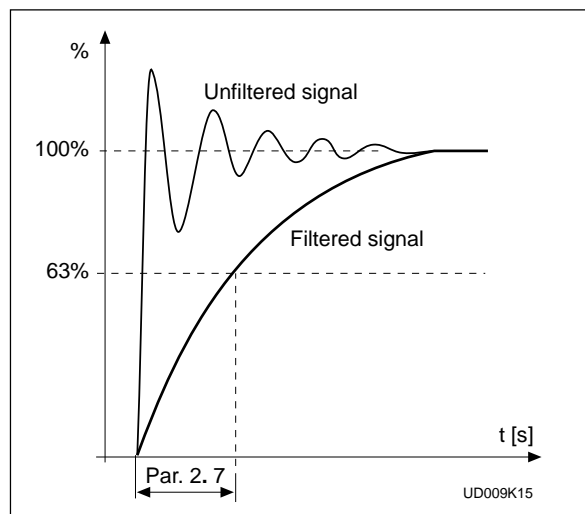

Figure 3.5-7  $U_{in}$  signal filtering.



**2. 8 Analogue input  $I_{in}$  signal range**

- 0 = 0—20 mA
- 1 = 4—20 mA
- 2 = Custom signal span

See figure 3.5-8.

**2. 9 Analogue input  $I_{in}$  custom setting minimum/maximum**

With these parameters you can scale the input current to correspond to set min. and max. frequency range, see figure 3.5-8.

Minimum setting:

Set the  $I_{in}$  signal to its minimum level, select parameter 2. 9, press the *Enter* button

Maximum setting:

Set the  $I_{in}$  signal to its maximum level, select parameter 2. 10, press the *Enter* button

**Note!** The parameter values can only be set with this procedure (not with the *Browser* buttons).

**2. 11 Analog input  $I_{in}$  inversion**

$I_{in}$  is place A frequency reference, par. 1. 5 = 0 (default)

Parameter 2. 11 = 0, no inversion of  $I_{in}$  input

Parameter 2. 11 = 1, inversion of  $I_{in}$  input, see figure 3.5-9.

- max.  $I_{in}$  signal = minimum set speed
- min.  $I_{in}$  signal = maximum set speed

**2. 12 Analogue input  $I_{in}$  filter time**

Filters out disturbances from the incoming analogue  $I_{in}$  signal. Long filtering time makes regulation response slower. See figure 3.5-10.

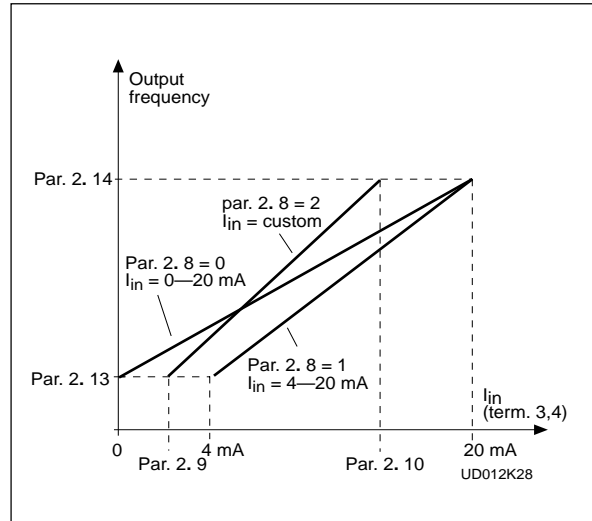

Figure 3.5-8 Analogue input  $I_{in}$  scaling.

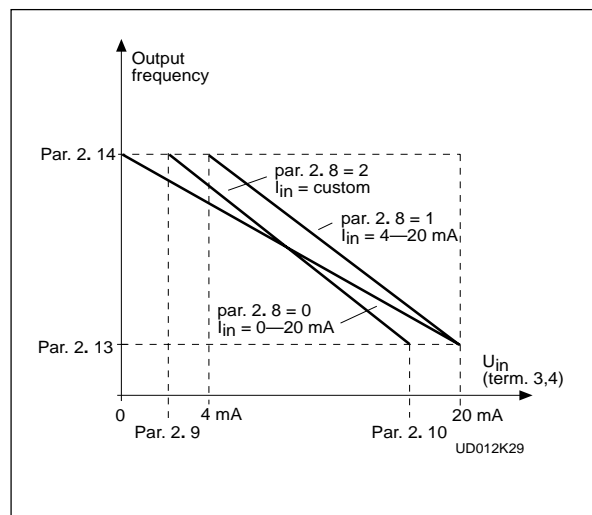

Figure 3.5-9  $I_{in}$  signal inversion.

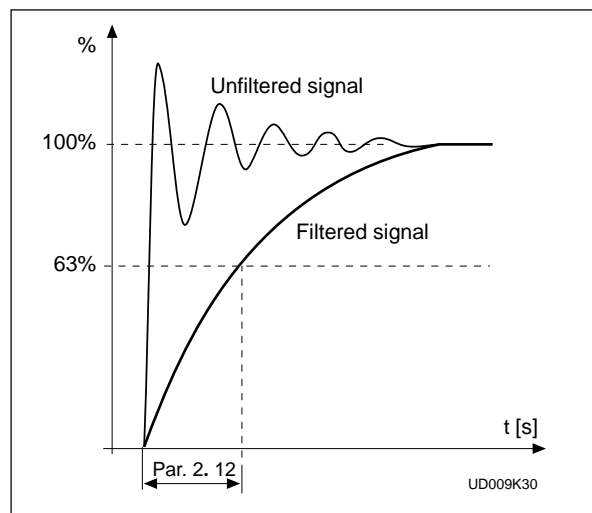

Figure 3.5-10 Analogue input  $I_{in}$  filter time.



**2. 13, 2. 14 Reference scaling, minimum value/maximum value**

Makes the scaling of the basic reference.

Setting limits: par. 1. 1 < par. 2. 13 < par. 2. 14 < par. 1. 2.  
 If par. 2. 14 = 0 scaling is set off. See figures 3.5-11 and 3.5-12.

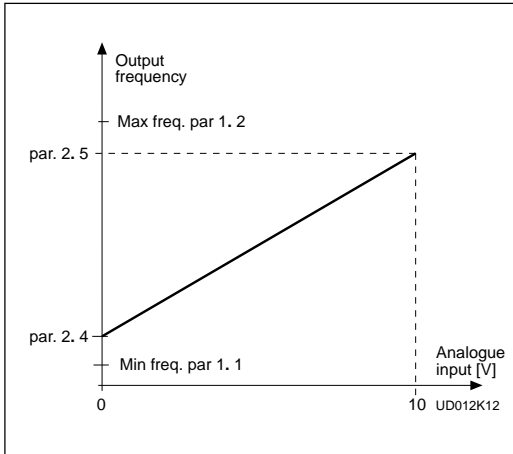

Figure 3.5-11 Reference scaling.

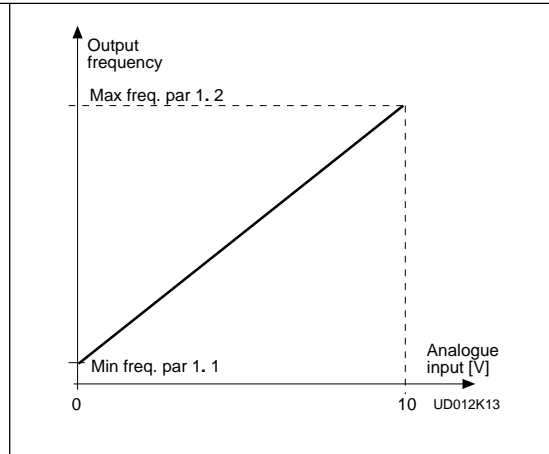

Figure 3.5-12 Reference scaling, par. 2. 14 = 0.

3

**2. 18 Free analogue input signal**

Selection of input signal of a free analogue input (an input not used for reference signal):

- 0 = Not in use
- 1 = Voltage signal  $U_{in}$
- 2 = Current signal  $I_{in}$

**2. 19 Free analogue input signal function**

Use this parameter to select a function for a free analogue input signal:

- 0 = Function is not used
- 1 = Reducing motor current limit (par. 1. 7)

This signal will adjust the maximum motor current between 0 and with parameter 1. 7 set max. limit. See figure 3.5-13.

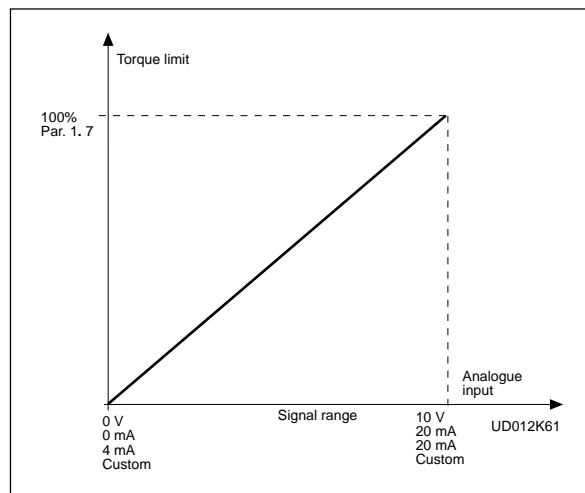

Figure 3.5-13 Reducing of max. motor current.

**2 Reducing DC brake current.**

DC braking current can be reduced with the free analogue input signal between current  $0.15 \times I_{nCT}$  and current set by the parameter 4. 8. See Figure 3.5-14.

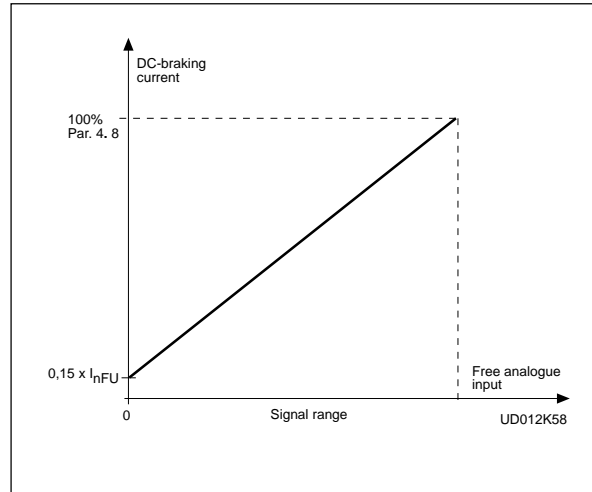

Figure 2.5-14 Reducing DC brake current.

**3 Reducing acceleration and deceleration times.**

Acceleration and deceleration times can be reduced with the free analogue input signal according to the following formulas:

Reduced time = set acc./decel. time (par. 1. 3, 1. 4; 4. 3, 4. 4) divided by the factor R from the figure 3.5-15.

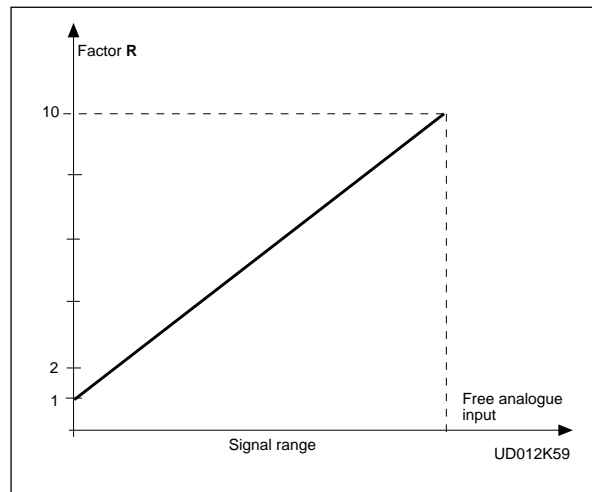

Figure 3.5-15 Reducing acceleration and deceleration times.

**4 Reducing torque supervision limit.**

Set supervision limit can be reduced with the free analogue input signal between 0 and set supervision limit (par. 3. 14), see figure 3.5-16.

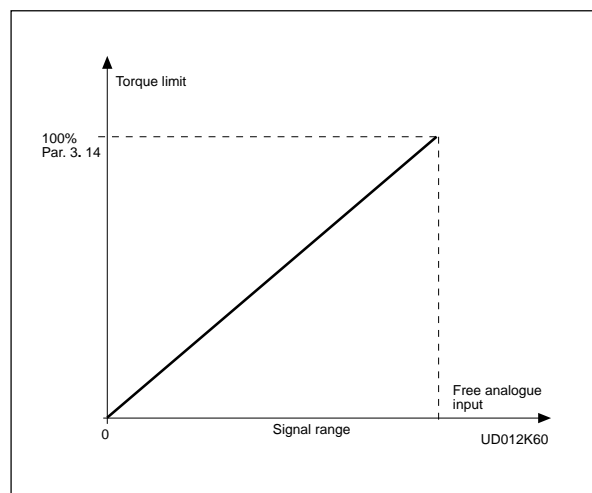

Figure 3.5-16 Reducing torque supervision limit.

**3. 1 Analogue output function**

See table on page 3-10.



**3.2 Analogue output filter time**

Filters the analogue output signal. See figure 3.5-17.

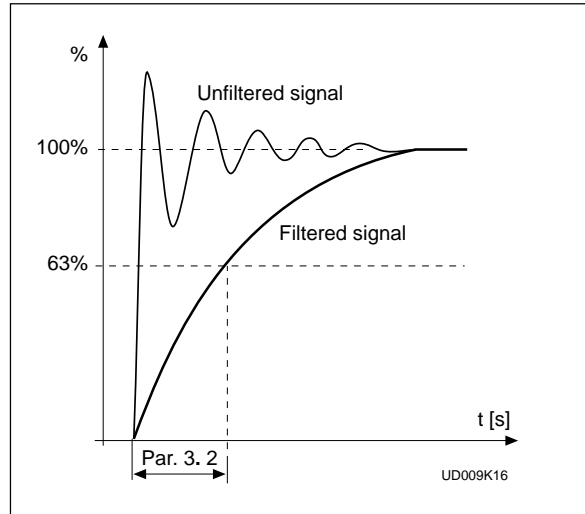

Figure 3.5-17 Analogue output filtering.

**3.3 Analogue output invert**

Inverts analogue output signal:  
 max. output signal = minimum set value  
 min. output signal = maximum set value

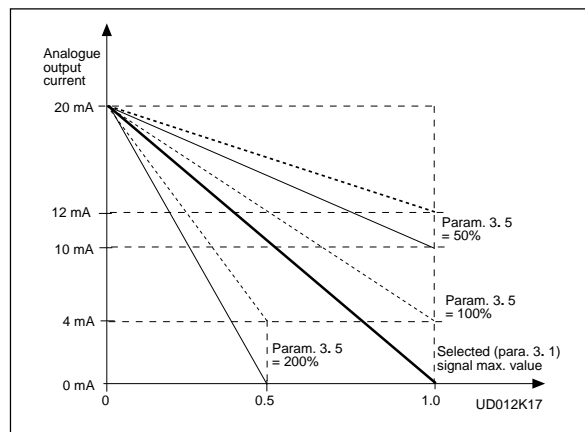

Figure 3.5-18 Analogue output invert.

**3.4 Analogue output minimum**

Defines the signal minimum to be either 0 mA or 4 mA (living zero). See figure 3.5-19.

**3.5 Analogue output scale**

Scaling factor for analogue output. See figure 3.5-19.

Signal	Max. value of the signal
Output frequency	Max. frequency (p. 1. 2)
Output current	$2 \times I_{nCT}$
Motor speed	Max. speed ( $n_n \times f_{max} / f_n$ )
Motor torque	$2 \times T_{nMot}$
Motor power	$2 \times P_{nMot}$
Motor voltage	$100\% \times U_{nMot}$
DC-link volt.	1000 V

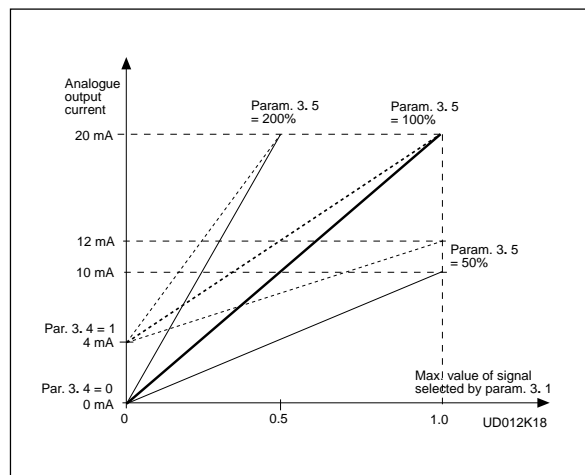

Figure 3.5-19 Analogue output scale.



3. 6 **Digital output function**  
 3. 7 **Relay output 1 function**  
 3. 8 **Relay output 2 function**

Setting value	Signal content
0 = Not used	Out of operation <u>Digital output DO1 sinks current and programmable relay (RO1, RO2) is activated when:</u>
1 = Ready	The frequency converter is ready to operate
2 = Run	The frequency converter operates (motor is running)
3 = Fault	A fault trip has occurred
4 = Fault inverted	A fault trip <u>has not</u> occurred
5 = Vacon overheat warning	The heat-sink temperature exceeds +70°C
6 = External fault or warning	Fault or warning depending on parameter 7. 2
7 = Reference fault or warning	Fault or warning depending on parameter 7. 1 - if analogue reference is 4—20 mA and signal is <4mA
8 = Warning	Always if a warning exists
9 = Reversed	The reverse command has been selected
10= Jogging speed selected	The jogging speed has been selected with digital input
11 = At speed	The output frequency has reached the set reference
12= Motor regulator activated	Overvoltage or overcurrent regulator was activated
13= Output frequency supervision 1	The output frequency goes outside of the set supervision Low limit/ High limit (par. 3. 9 and 3. 10)
14= Output frequency supervision 2	The output frequency goes outside of the set supervision Low limit/ High limit (par. 3. 11 and 3. 12)
15= Torque limit supervision	The motor torque goes outside of the set supervision Low limit/ High limit (par. 3. 13 and 3. 14)
16= Active reference limit supervision	Active reference goes outside of the set supervision Low limit/ High limit (par. 3. 15 and 3. 16)
17= External brake control	External brake ON/OFF control with programmable delay (par 3. 17 and 3. 18)
18= Control from I/O terminals	External control mode selected with progr. push-button #2
19= Frequency converter temperature limit supervision	Temperature on frequency converter goes outside the set supervision limits (par. 3. 19 and 3. 20)
20= Unrequested rotation direction	Rotation direction of the motor shaft is different from the requested one
21= External brake control inverted	External brake ON/OFF control (par 3.17 and 3.18), output active when brake control is OFF

Table 3.5-2 Output signals via DO1 and output relays RO1 and RO2.

3. 9 **Output frequency limit 1, supervision function**  
 3. 11 **Output frequency limit 2, supervision function**

- 0 = No supervision  
 1 = Low limit supervision  
 2 = High limit supervision

If the output frequency falls below/exceeds the set limit (3. 10, 3. 12) this function generates a warning message via the digital output DO1 and via a relay output RO1 or RO2 depending on the settings of parameters 3. 6—3. 8.

3. 10 **Output frequency limit 1, supervision value**  
 3. 12 **Output frequency limit 2, supervision value**

The frequency value to be supervised by parameter 3. 9 (3. 11).  
 See figure 3.5-20.

**3. 13 Torque limit , supervision function**

- 0 = No supervision
- 1 = Low limit supervision
- 2 = High limit supervision

If the calculated torque value falls below or exceeds the set limit (3. 14) this function generates a warning message via the digital output DO1 or via a relay output RO1 or RO2 depending on the settings of parameters 3. 6—3. 8.

Figure 3.5-20 Output frequency supervision.

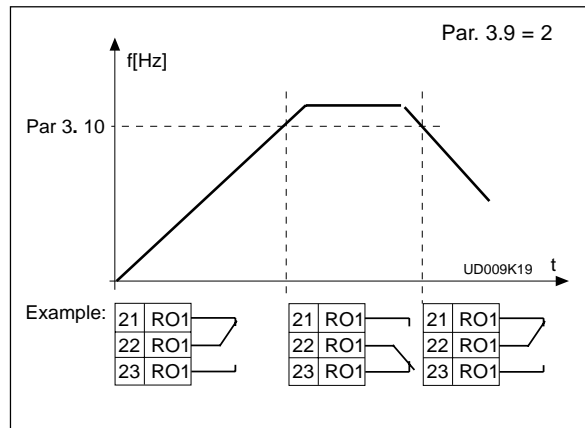

**3. 14 Torque limit , supervision value**

The calculated torque value to be supervised by parameter 3. 13. Torque supervision value can be reduced below the setpoint with external free analogue input signal, see parameters 2. 18 and 2. 19.

**3. 15 Reference limit , supervision function**

- 0 = No supervision
- 1 = Low limit supervision
- 2 = High limit supervision

If the reference value falls below or exceeds the set limit (3. 16) this function generates a warning message via the digital output DO1 and via a relay output RO1 or RO2 depending on the settings of parameters 3. 6—3. 8. The supervised reference is the current active reference. It can be place A or B reference depening on DIB6 input or panel reference if the panel is the active control source.

**3. 16 Reference limit , supervision value**

The frequency value to be supervised by parameter 3.15.

**3. 17 External brake-off delay**

**3. 18 External brake-on delay**

The function of the external brake can be timed to the start and stop control signals with these parameters. See figure 3.5-21.

The brake control signal can be programmed via the digital output DO1 or via one of the relay outputs RO1 and RO2, see parameters 3. 6—3. 8.

Figure 3.5-21 External brake control:  
 a) Start/Stop logic selection par. 2. 1 = 0, 1 or 2  
 b) Start/Stop logic selection par. 2. 1 = 3.

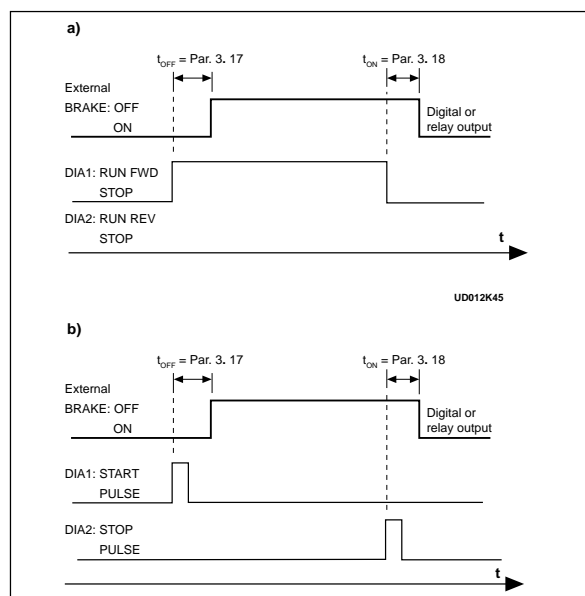



### 3. 19 **Frequency converter temperature limit supervision**

- 0 = No supervision
- 1 = Low limit supervision
- 2 = High limit supervision

If the temperature of the frequency converter unit falls below or exceeds the set limit (3. 20) this function generates a warning message via the digital output DO1 and via a relay output RO1 or RO2 depending on the settings of parameters 3. 6—3. 8.

### 3. 20 **Frequency converter temperature limit value**

The temperature value to be supervised by parameter 3. 19.

### 4. 1 **Acc/Dec ramp 1 shape**

### 4. 2 **Acc/Dec ramp 2 shape**

The smooth start and end of acceleration and deceleration can be programmed with these parameters. Setting value 0 gives linear ramp shape which causes acceleration and deceleration to act immediately to the changes in the reference signal with the time constant set by parameter 1. 3 and 1. 4 (4. 3 and 4. 4).

Setting value 0.1—10 seconds for 4. 1 (4. 2) causes linear acceleration/deceleration to adopt an S-shape. Parameter 1. 3 and 1. 4 (4. 3 and 4. 4) determines the time constant of acceleration/deceleration in the middle of the curve. See figure 3.5-22.

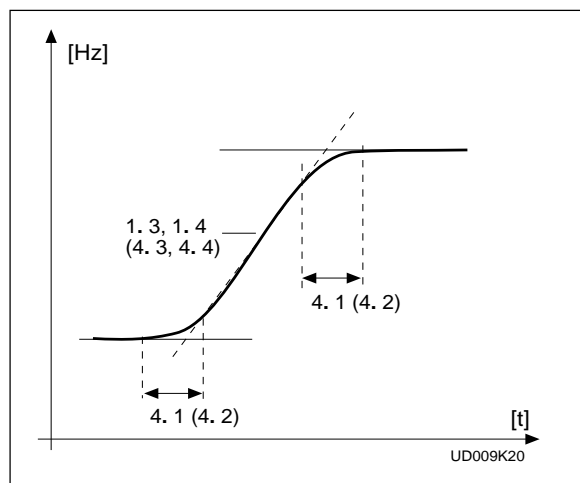

Figure 3.5-22 S-shaped acceleration/deceleration.

### 4. 3 **Acceleration time 2**

### 4. 4 **Deceleration time 2**

These values correspond to the time required for the output frequency to accelerate from the set minimum frequency (par. 1. 1) to the set maximum frequency (par. 1. 2). These times give the possibility to set two different acceleration/deceleration times for one application. The active set can be selected with the programmable signal DIA3 of this application, see parameter 2. 2.

Acceleration/deceleration times can be reduced with external free analogue input signal, see parameters 2. 18 and 2. 19.

#### 4.5 **Brake chopper**

- 0 = No brake chopper
- 1 = Brake chopper and brake resistor installed
- 2 = External brake chopper

When the frequency converter is decelerating the motor, the inertia from the motor and the load is fed into the external brake resistor. This enables the frequency converter to decelerate the load with the torque equal to that of acceleration if the brake resistor is selected correctly. See separate Brake resistor installation manual.

#### 4.6 **Start function**

Ramp:

- 0** The frequency converter starts from 0 Hz and accelerates to the set reference frequency within the set acceleration time. (Load inertia or starting friction may cause prolonged acceleration times).

Flying start:

- 1** The frequency converter is able to start into running motor by applying a small torque to motor and searching for frequency corresponding to the speed the motor is running. Searching starts from the maximum frequency towards the actual frequency until the correct value is detected. Thereafter the output frequency will be increased/decreased to the set reference value according to the set acceleration/deceleration parameters.

Use this mode if the motor should be coasting when the start command is given. With the flying start it is possible to ride through short mains voltage interruptions.

#### 4.7 **Stop function**

Coasting:

- 0** The motor coasts to a halt without any control from the frequency converter, after the Stop command.

Ramp:

- 1** After the Stop command, the speed of the motor is decelerated according to the set deceleration parameters.  
If the regenerated energy is high it may be necessary to use an external braking resistor for faster deceleration.

#### 4.8 **DC braking current**

Defines the current injected into the motor during the DC braking. The DC braking current can be reduced with an external free analogue input signal, see parameters 2. 18 and 2. 19.

#### 4.9 **DC braking time at stop**

Defines if braking is ON or OFF and braking time of the DC-brake when the motor is stopping. The function of the DC-brake depends on the stop function, parameter 4. 7. See figure 3.5-23.

- 0** DC-brake is not used
- >0** DC-brake is in use and its function depends on the Stop function, (param. 4. 7), and the braking time depends on the value of parameter 4. 9:

Stop function = 0 (coasting):

After the stop command, the motor coasts to a stop without any control from the frequency converter.

With DC-injection, the motor can be electrically stopped in the shortest possible time, without using an optional external braking resistor.

The braking time is scaled according to the frequency when the DC-braking starts. If the frequency is  $\geq$  nominal frequency of the motor (par. 1.11), setting value of parameter 4.9 determines the braking time. When the frequency is  $\leq 10\%$  of the nominal, the braking time is 10% of the set value of parameter 4.9.

Stop function = 1 (ramp):

After the stop command, the speed of the motor is reduced according to the set deceleration parameters, as fast as possible, to a speed defined with parameter 4.10 where the DC-braking starts.

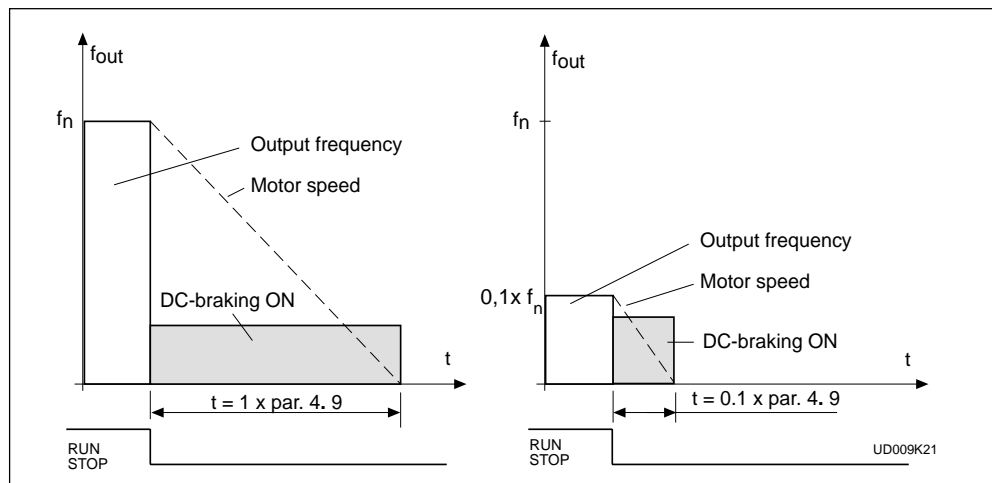

Figure 3.5-23 DC-braking time when stop = coasting.

The braking time is defined with parameter 4.9.

If high inertia exists it is recommended to use an external braking resistor for faster deceleration. See figure 3.5-24.

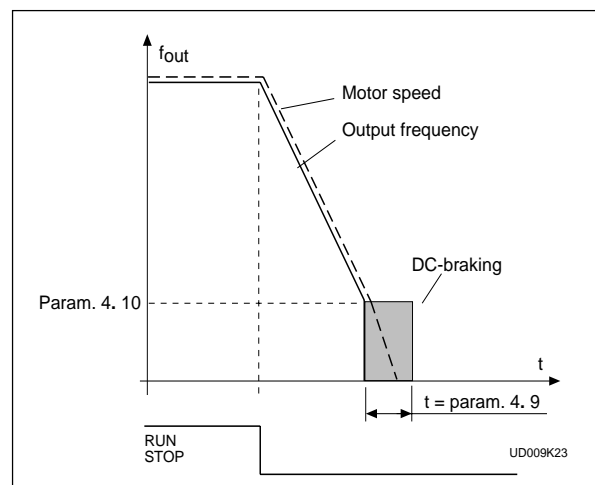

Figure 3.5-24 DC-braking time when stop function = ramp.

**4. 10 Execute frequency of DC-brake during ramp Stop**

See figure 3.5-24.

**4. 11 DC-brake time at start**

- 0 DC-brake is not used
- >0 DC-brake is actived when the start command is given and this parameter defines the time before the brake is released. After the brake is released output frequency increases according to the set start function parameter 4. 6 and acceleration parameters (1.3, 4.1 or 4.2, 4.3), see figure 3.5-25.

Figure 3.5-25 DC-braking time at start.

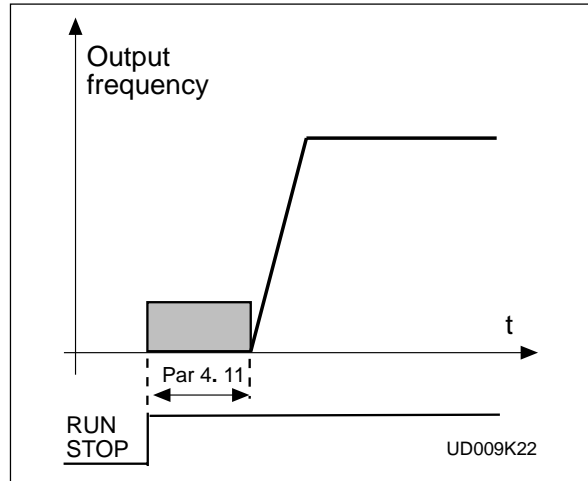

- 5. 1 Prohibit frequency area Low limit/High limit
- 5. 2
- 5. 3
- 5. 4
- 5. 5
- 5. 6

In some systems it may be necessary to avoid certain frequencies because of mechanical resonance problems.

With these parameters it is possible to set limits for three "skip frequency" regions between 0 Hz and 500 Hz. The accuracy of the setting is 1.0 Hz. See figure 3.5-26.

Figure 3.5-26 Example of prohibit frequency area setting.

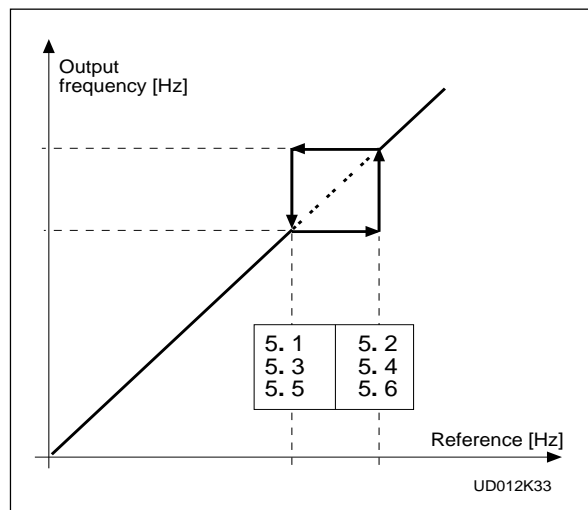

### 6.1 **Motor control mode**

- 0 = Frequency control: The I/O terminal and panel references are frequency references and the frequency converter controls the output frequency (output freq. resolution 0.01 Hz)
- 1 = Speed control: The I/O terminal and panel references are speed references and the frequency converter controls the motor speed (regulation accuracy  $\pm 0,5\%$ ).

### 6.2 **Switching frequency**

Motor noise can be minimized using a high switching frequency. Increasing the switching frequency reduces the capacity of the frequency converter unit.

Before changing the frequency from the factory default 10 kHz (3.6 kHz from 30 kW upwards), check the allowed capacity from the curve in figure 5.2-3 in Chapter 5.2 of the User's manual.

### 6.3 **Field weakening point**

#### 6.4 **Voltage at the field weakening point**

Field weakening point is the output frequency where the output voltage reaches the maximum value. Above that frequency the output voltage remains at the maximum value.

Below that frequency output voltage depends on the setting of the U/f curve parameters 1. 8, 1. 9, 6. 5, 6. 6 and 6. 7. See figure 3.5-27.

When the parameters 1. 10 and 1. 11, nominal voltage and nominal frequency of the motor, are set, also parameters 6. 3 and 6. 4 are set automatically to the corresponding values. If different values for the field weakening point and the maximum output voltage are required, change these parameters after setting the parameters 1. 10 and 1. 11.

#### 6.5 **U/f curve, middle point frequency**

If the programmable U/f curve has been selected with the parameter 1. 8 this parameter defines the middle point frequency of the curve. See figure 3.5-27.

#### 6.6 **U/f curve, middle point voltage**

If the programmable U/f curve has been selected with the parameter 1. 8 this parameter defines the middle point voltage (% of motor nom. voltage) of the curve. See figure 3.5-27.

#### 6.7 **Output voltage at zero frequency**

If the programmable U/f curve has been selected with the parameter 1. 8 this parameter defines the zero frequency voltage of the curve. See figure 3.5-27.

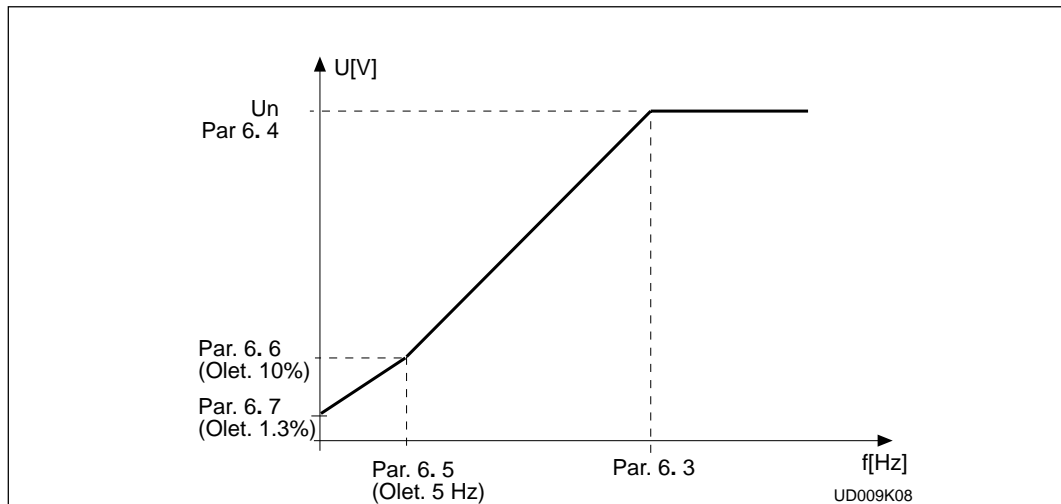

Figure 3.5-27 Programmable U/f curve.

# 3

## 6. 8 **Overvoltage controller** 6. 9 **Undervoltage controller**

These parameters allow the over-/undervoltage controllers to be switched out of operation. This may be useful, for example, if the mains supply voltage varies more than  $-15\%$ — $+10\%$  and the application will not tolerate this over-/undervoltage. Then the regulator controls output frequency according to the supply fluctuations.

Over-/undervoltage trips may occur when controllers are switched out of operation.

### 7. 1 **Response to the reference fault**

- 0 = No response
- 1 = Warning
- 2 = Fault, stop mode after fault according to parameter 4.7
- 3 = Fault, stop mode after fault always by coasting

A warning or a fault action and message is generated if a 4—20 mA reference signal is used and the signal falls below 4 mA. The information can also be programmed via digital output DO1 and via relay outputs RO1 and RO2.

### 7. 2 **Response to external fault**

- 0 = No response
- 1 = Warning
- 2 = Fault, stop mode after fault according to parameter 4.7
- 3 = Fault, stop mode after fault always by coasting

A warning or a fault action and message is generated from the external fault signal in the digital input DIA3. The information can also be programmed into digital output DO1 and into relay outputs RO1 and RO2.

### 7. 3 **Phase supervision of the motor**

- 0 = No action
- 2 = Fault

Phase supervision of the motor ensures that the motor phases have an approximately equal current.

#### 7.4 Earth fault protection

0 = No action  
2 = Fault

Earth fault protection ensures that the sum of the motor phase currents is zero. The overcurrent protection is always working and protects the frequency converter from earth faults with high currents.

### Parameters 7.5—7.9 Motor thermal protection

#### General

Motor thermal protection is to protect the motor from overheating. Vacon CX/CXL/CXS drive is capable of supplying higher than nominal current to the motor. If the load requires this high current there is a risk that motor will be thermally overloaded. This is true especially at low frequencies. With low frequencies the cooling effect of the motor is reduced and the capacity of the motor is reduced. If the motor is equipped with an external fan the load reduction on low speeds is small.

Motor thermal protection is based on a calculated model and it uses the output current of the drive to determine the load on the motor. When the power is turned on, the calculated model uses the heatsink temperature to determine the initial thermal stage for the motor. The calculated model assumes that the ambient temperature of the motor is 40°C.

Motor thermal protection can be adjusted by setting the parameters. The thermal current  $I_T$  specifies the load current above which the motor is overloaded. This current limit is a function of the output frequency. The curve for  $I_T$  is set with parameters 7.6, 7.7 and 7.9, refer to the figure 3.5-28. The parameters have their default values set according to the motor name plate data.

With the output current at  $I_T$  the thermal stage will reach the nominal value (100%). The thermal stage changes by the square of the current. With the output current at 75% of  $I_T$  the thermal stage will reach a 56% value and with the output current at 120% of  $I_T$  the thermal stage would reach 144% value. The function will trip the device (refer par. 7.5) if the thermal stage will reach a value of 105%. The speed of change in thermal stage is determined with the time constant parameter 7.8. The bigger the motor the longer it takes to reach the final temperature.

The thermal stage of the motor can be monitored through the display. Refer to the table for monitoring items. (User's Manual, table 7.3-1).



**CAUTION!** *The calculated model does not protect the motor if the airflow to the motor is reduced by blocked air intake grill.*

#### 7.5 Motor thermal protection

Operation:

0 = Not in use  
1 = Warning  
2 = Trip function

Tripping and warning will display the same message code. If tripping is selected the drive will stop and activate the fault stage.

Deactivating the protection, setting parameter to 0, will reset the thermal stage of the motor to 0%.

### 7.6 Motor thermal protection, break point current

The current can be set between 50.0—150.0%  $\times I_{nMotor}$ .

This parameter sets the value for thermal current at frequencies above the break point on the thermal current curve. Refer to Figure 3.5-28.

The value is set in percentage value which refers to the name plate data of the motor, parameter 1. 13, nominal current of the motor, not to the drive's nominal output current.

The motor's nominal current is the current which the motor can withstand in direct on-line use without being overheated.

If parameter 1. 13 is adjusted, this parameter is automatically restored to the default value.

Setting this parameter (or parameter 1. 13) does not affect the maximum output current of the drive. Parameter 1. 7 alone determines the maximum output current of the drive.

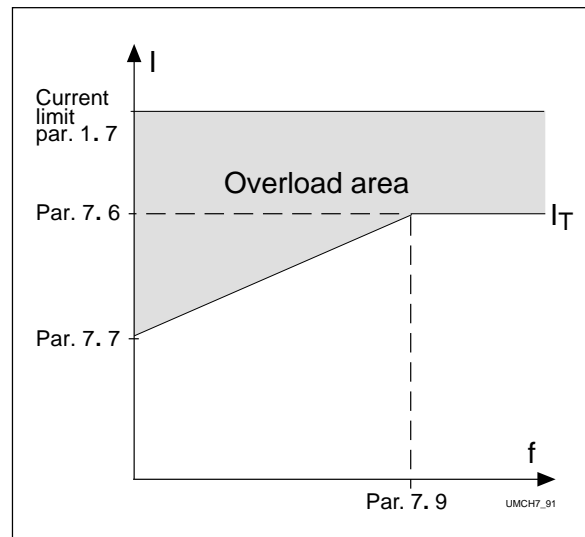

Figure 3.5-28 Motor thermal current  $I_T$  curve.

### 7.7 Motor thermal protection, zero frequency current

The current can be set between 10.0—150.0%  $\times I_{nMotor}$ .

This parameter sets the value for thermal current at zero frequency. See Figure 3.5-28.

The default value is set assuming that there is no external fan cooling the motor. If an external fan is used this parameter can be set to 90% (or even higher).

The value is set in percentage of the motor name plate data, parameter 1. 13, motor's nominal current, not the drive's nominal output current. Motor's nominal current is the current which the motor can stand in direct on-line use without being overheated.

If you change the parameter 1. 13 this

parameter is automatically restored to the default value.

Setting this parameter (or parameter 1. 13) does not affect the maximum output current of the drive. Parameter 1. 7 alone determines the maximum output current of the drive.



**7.8 Motor thermal protection, time constant**

This time can be set between 0.5—300 minutes.

This is the thermal time constant of the motor. The bigger the motor the bigger the time constant. The time constant is the time when the calculated thermal stage has reached 63% of its final value.

The motor thermal time is specific to the motor design and it varies between different motor manufacturers.

The default value for the time constant is calculated basing on the motor name plate data given with parameters 1. 12 and 1. 13. If either of these parameters is set, then this parameter is set to default value.

If the motor's  $t_6$ -time is known (given by the motor manufacturer) the time constant parameter could be set based on  $t_6$ -time. As a rule of thumb, the motor thermal time constant in minutes equals to  $2xt_6$  ( $t_6$  in seconds is the time a motor can safely operate at six times the rated current). If the drive is in stop stage the time constant is internally increased to three times the set parameter value. The cooling in the stop stage is based on convection and the time constant is increased.

**7.9 Motor thermal protection, break point frequency**

The frequency can be set between 10—500 Hz. This is the break point of thermal current curve. With frequencies above this point, the thermal capacity of the motor is assumed to be constant. Refer to Figure 3.5-28.

The default value is based on the motor's name plate data, parameter 1. 11. It is 35 Hz for a 50 Hz motor and 42 Hz for a 60 Hz motor. More generally, it is 70% of the frequency at the field weakening point (parameter 6. 3). Changing either parameter 1. 11 or 6. 3 will restore this parameter to its default value.

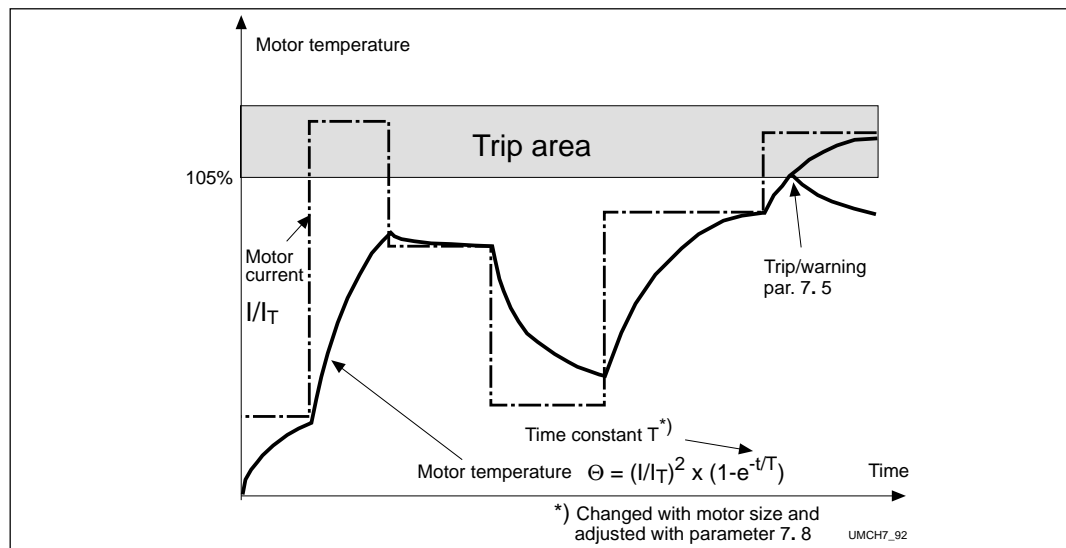

Figure 3.5-29 Calculating motor temperature.

**Parameters 7. 10— 7. 13, Stall protection**

**General**

Motor stall protection protects the motor from short time overload situations such as a stalled shaft. The reaction time of stall protection can be set shorter than that of motor thermal protection. The stall state is defined with two parameters, 7.11. Stall Current and 7.13. Stall Frequency. If the current is higher than the set limit and output frequency is lower than the set limit the stall state is true. There is actually no real indication of the shaft rotation. Stall protection is a type of overcurrent protection.

**7. 10 Stall protection**

Operation:

- 0 = Not in use
- 1 = Warning
- 2 = Trip function

Tripping and warning will display the same message code. If tripping is set on, the drive will stop and activate the fault stage. Setting the parameter to 0 will deactivate the protection and will reset the stall time counter to zero.

**7. 11 Stall current limit**

The current can be set between 0.0—200% x  $I_{nMotor}$ .

In the stall stage the current has to be above this limit. See Figure 3.5-30. The value is set as a percentage value of the motor's name plate data, parameter 1. 13, motor's nominal current. If the parameter 1. 13 is adjusted, this parameter is automatically restored to the default value.

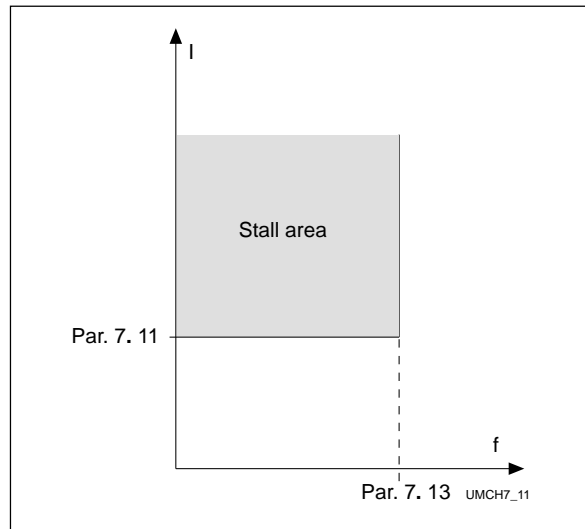

Figure 3.5-30 Setting the stall characteristics.

**7. 12 Stall time**

The time can be set between 2.0—120 s.

This is the maximum allowed time for a stall stage. There is an internal up/down counter to count the stall time. See Figure 3.5-31. If the stall time counter value goes above this limit the protection will cause a trip (see parameter 7. 10).

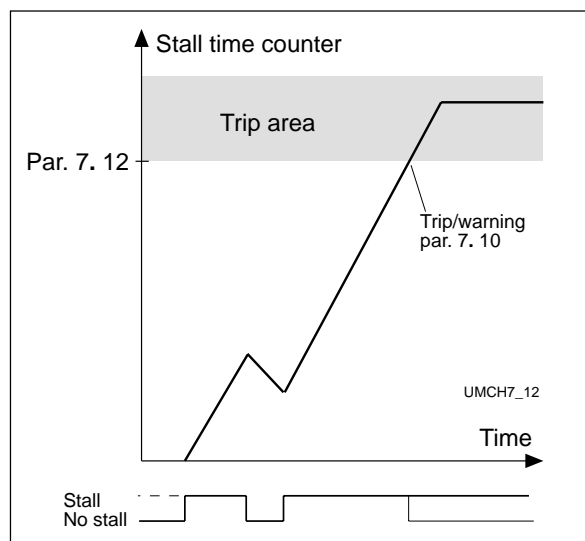

Figure 3.5-31 Counting the stall time.

**7. 13 Maximum stall frequency**

The frequency can be set between 1— $f_{max}$  (par. 1. 2).

In the stall state, the output frequency has to be smaller than this limit. Refer to Figure 3.5-30.

3

## Parameters 7. 14— 7. 17, Underload protection General

The purpose of motor underload protection is to ensure that there is load on the motor whilst the drive is running. If the motor loses its load there might be a problem in the process, e.g. broken belt or dry pump.

Motor underload protection can be adjusted by setting the underload curve with parameters 7. 15 and 7. 16. The underload curve is a squared curve set between zero frequency and the field weakening point. The protection is not active below 5Hz (the underload counter value is stopped). Refer to the figure 3.5-32.

The torque values for setting the underload curve are set with percentage values which refer to the nominal torque of the motor. The motor's name plate data, parameter 1. 13, the motor's nominal current and drive's nominal current  $I_{CT}$  are used to find the scaling ratio for the internal torque value. If other than a standard motor is used with the drive, the accuracy of the torque calculation is decreased.

### 7. 14 Underload protection

Operation:

- 0 = Not in use
- 1 = Warning
- 2 = Fault

Tripping and warning will display the same message code. If tripping is set active the drive will stop and activate the fault stage.

Deactivating the protection, by setting parameter to 0, will reset the underload time counter to zero.

### 7. 15 Underload protection, field weakening area load

The torque limit can be set between 20.0—150 % x  $T_{nMotor}$ .

This parameter gives the value for the minimum allowed torque when the output frequency is above the fieldweakening point. Refer to the figure 3.5-32. If parameter 1. 13 is adjusted, this parameter is automatically restored to the default value.

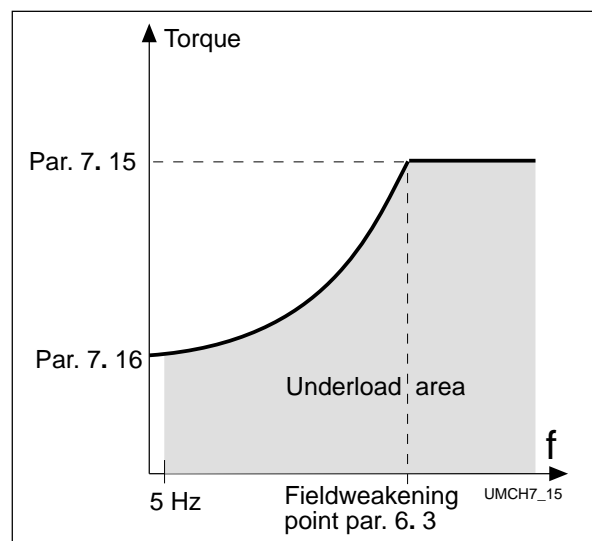

Figure 3.5-32 Setting of minimum load.

### 7. 16 Underload protection, zero frequency load

The torque limit can be set between 10.0—150 % x  $T_{nMotor}$ .

This parameter gives a value to the minimum allowed torque with zero frequency. See Figure 3.5-32. If parameter 1. 13 is adjusted this parameter is automatically restored to the default value.

**7.17 Underload time**

This time can be set between 2.0—600.0 s.

This is the maximum allowed time for an underload state. There is an internal up/down counter to accumulate the underload time. Refer to the figure 3.5-33.

If the underload counter value goes above this limit the protection will cause a trip (See parameter 7.14). If the drive is stopped the underload counter is reset to zero.

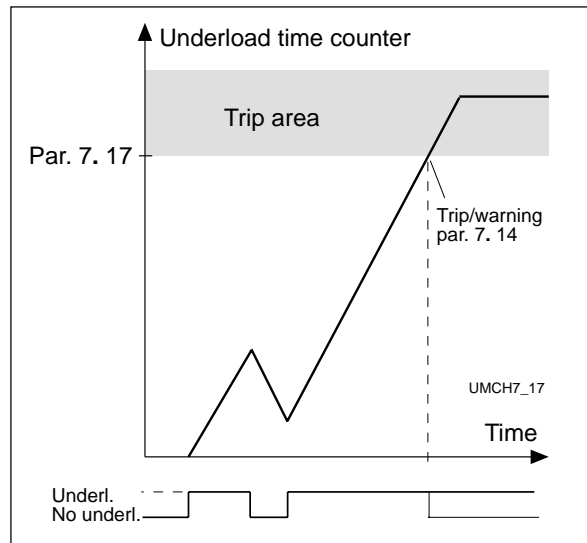

Figure 3.5-33 Counting the underload time.

3

**8.1 Automatic restart: number of tries**

**8.2 Automatic restart: trial time**

The Automatic restart function restarts the frequency converter after the faults selected with parameters 8.4 - 8.8. The Start function for Automatic restart is selected with parameter 8.3. See figure 3.5-34.

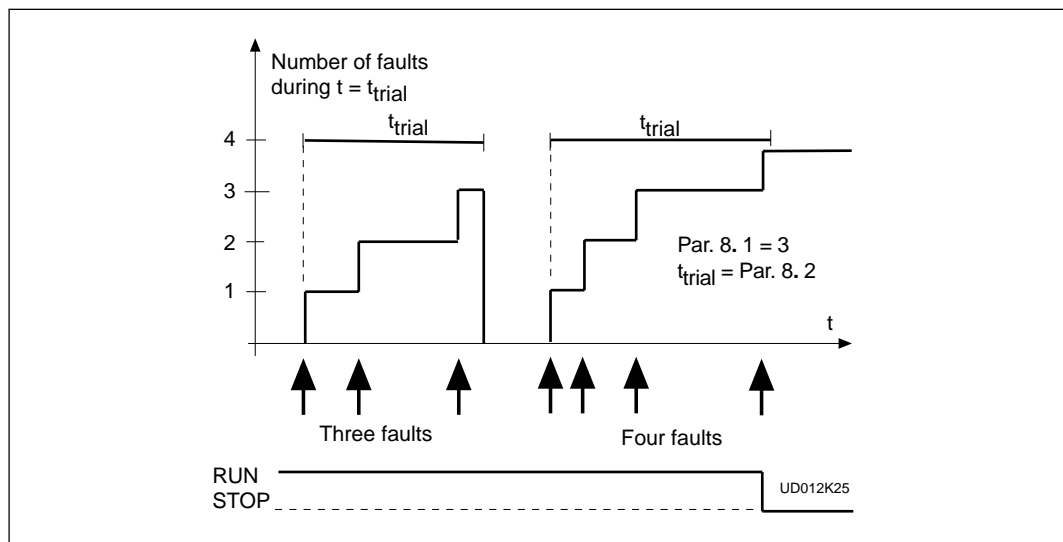

Figure 3.5-34 Automatic restart.

Parameter 8.1 determines how many automatic restarts can be made during the trial time set by the parameter 8.2.

The time counting starts from the first autorestart. If the number of restarts does not exceed the value of the parameter 8.1 during the trial time, the counting is cleared after the time is elapsed and next fault starts the counting again.

**8.3 Automatic restart, start function**

The parameter defines the start mode:

- 0 = Start with ramp
- 1 = Flying start, see parameter 4. 6.

**8.4 Automatic restart after undervoltage trip**

- 0 = No automatic restart after undervoltage fault
- 1 = Automatic restart after undervoltage fault condition returns to the normal condition (DC-link voltage returns to the normal level)

**8.5 Automatic restart after overvoltage trip**

- 0 = No automatic restart after overvoltage fault
- 1 = Automatic restart after overvoltage fault condition returns to the normal condition (DC-link voltage returns to the normal level)

**8.6 Automatic restart after overcurrent trip**

- 0 = No automatic restart after overcurrent fault
- 1 = Automatic restart after overcurrent faults

**8.7 Automatic restart after reference fault trip**

- 0 = No automatic restart after reference fault
- 1 = Automatic restart after analog current reference signal (4—20 mA) returns to the normal level ( $\geq 4$  mA)

**8.8 Automatic restart after over-/undertemperature fault trip**

- 0 = No automatic restart after temperature fault
- 1 = Automatic restart after the heatsink temperature has returned to its normal level between -10°C—+75°C.

Remarks:

---

---

---

---

---

---

---

---

---

---

---

---

---

---

---

---

---

---

---

---

---

---

---

---

---





**PI-CONTROL APPLICATION**

(par. 0.1 = 5)

**CONTENTS**

<b>4 PI-control Application .....</b>	<b>4-1</b>
4.1 General .....	4-2
4.2 Control I/O .....	4-2
4.3 Control signal logic .....	4-3
4.4 Parameters Group 1 .....	4-4
4.4.1 Parameter table .....	4-4
4.4.2 Description of Group1 par ...	4-5
4.5 Special parameters, Groups 2—8 ..	4-8
4.5.1 Parameter tables .....	4-8
4.5.2 Description of Groups. ....	4-15
4.6 Panel reference .....	4-36
4.7 Monitoring data. ....	4-36

4.1 General

In the PI-control application there are two I/O-terminal control sources. Source A is the PI-controller and source B is the direct frequency reference. The control source is selected with DIB6 input.

The PI-controller reference can be selected from analogue inputs, motorised potentiometer and panel reference. The actual value

can be selected from analogue inputs or from mathematical functions of the analogue inputs.

The direct frequency reference can be used for the control without PI-controller. The frequency reference can be selected from analogue inputs and panel reference.

**\* NOTE! Remember to connect CMA and CMB inputs.**

4.2 Control I/O

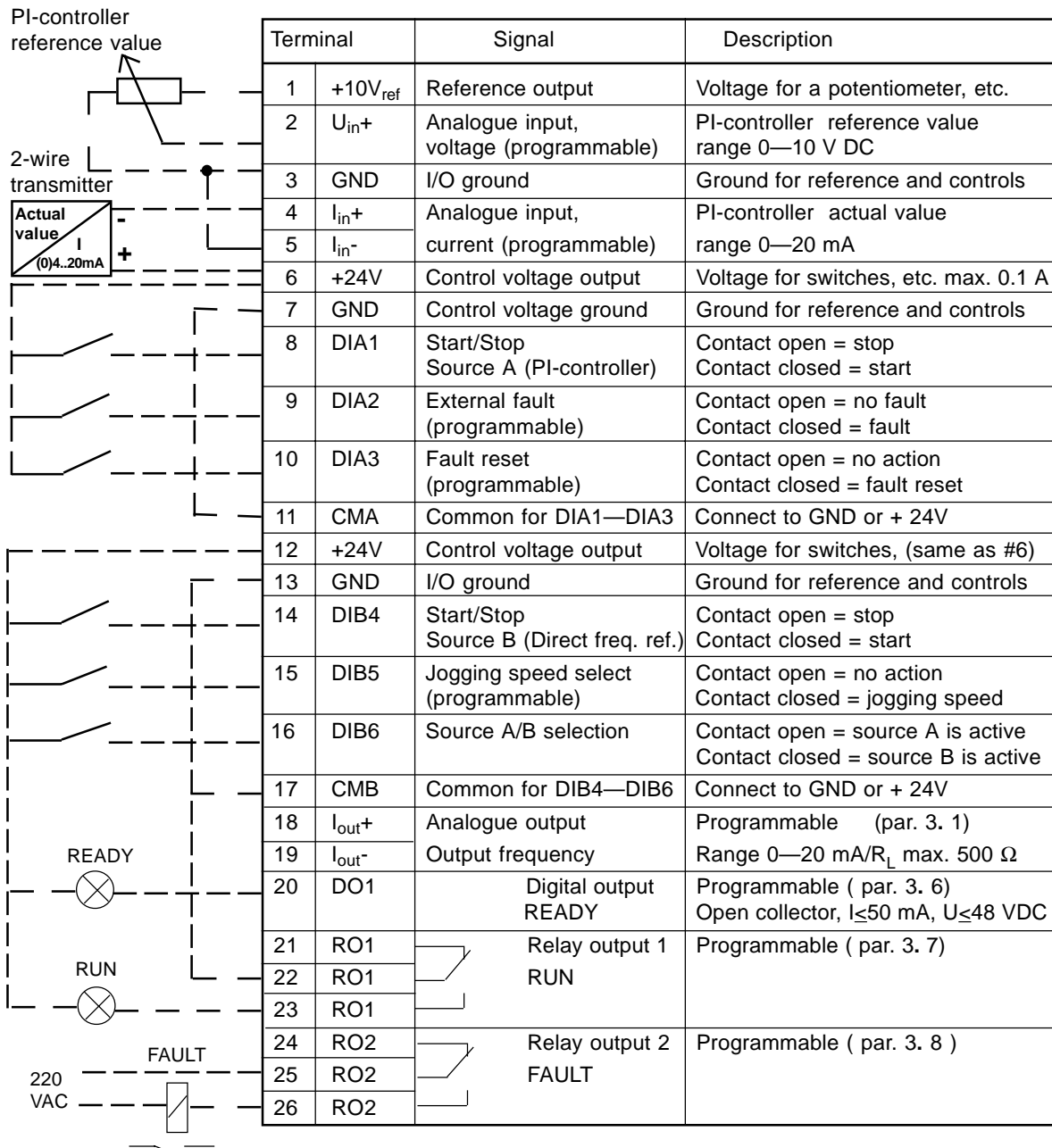

Figure 4.2-1 Default I/O configuration and connection example of the PI-Control Application with 2-wire transmitter.

4



### 4.3 Control signal logic

The logic of I/O-control signals and push button signals from the panel is presented in the figure 4.3-1.

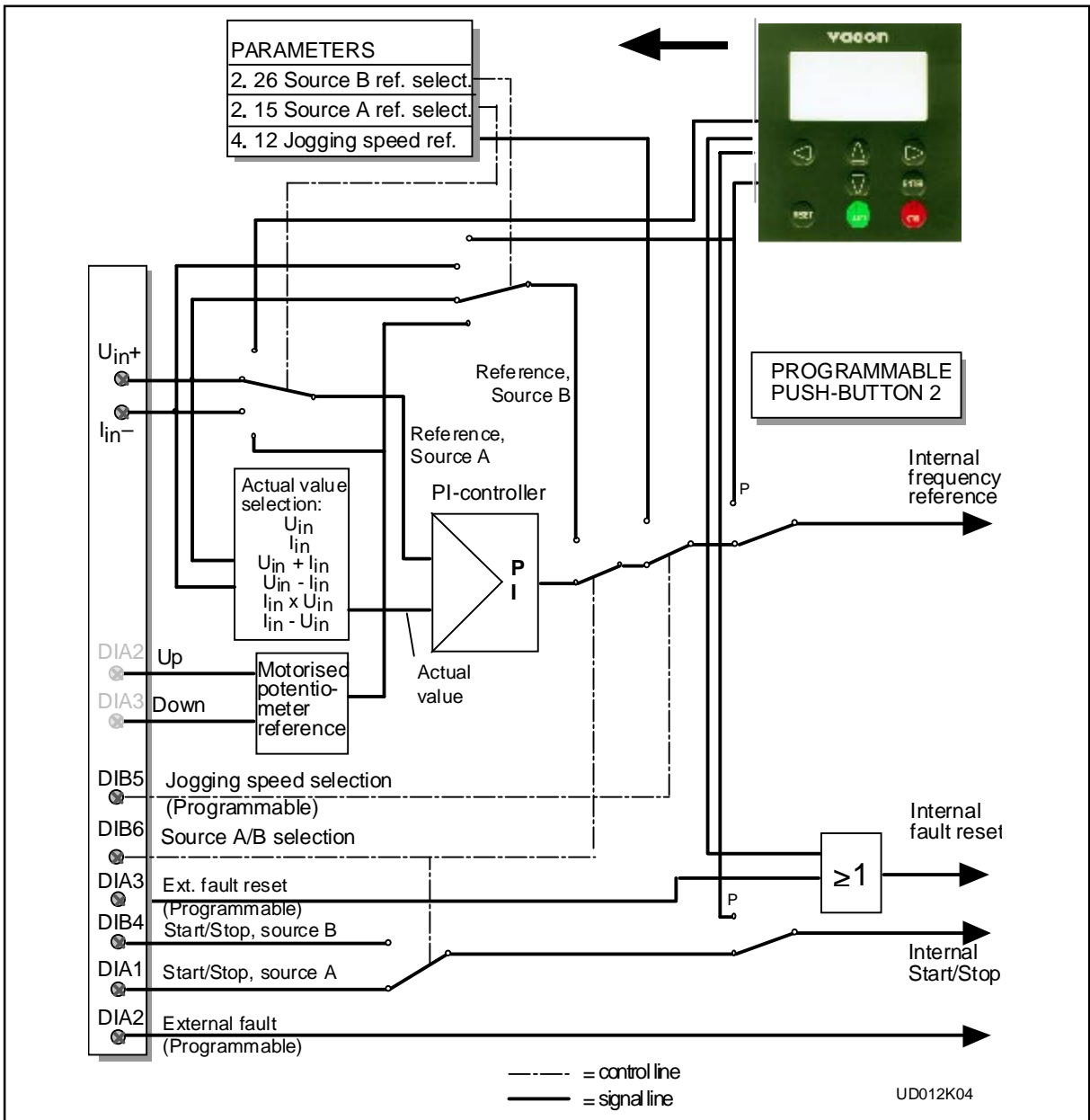



Figure 4.3-1 Control signal logic of the PI- Control Application.  
Switch positions are shown according to the factory settings.

## 4.4 Basic parameters, Group 1

### 4.4.1 Parameter table, Group 1

Code	Parameter	Range	Step	Default	Custom	Description	Page
1. 1	Minimum frequency	0— $f_{max}$	1 Hz	0 Hz			4-5
1. 2	Maximum frequency	$f_{min}$ -120/500 Hz	1 Hz	50 Hz		*)	4-5
1. 3	Acceleration time 1	0,1—3000,0 s	0,1 s	1,0 s		Time from $f_{min}$ (1. 1) to $f_{max}$ (1. 2)	4-5
1. 4	Deceleration time 1	0,1—3000,0 s	0,1 s	1,0 s		Time from $f_{max}$ (1. 2) to $f_{min}$ (1. 1)	4-5
1. 5	PI-controller gain	1—1000%	1 %	100%			4-5
1. 6	PI-controller I-time	0,00—320,00 s	0,01s	10,00 s		0 = no I-part in use	4-5
1. 7	Current limit	0,1—2,5 x $I_{nCT}$	0,1 A	1,5 x $I_{nCT}$		***Output curr. limit [A] of the unit	4-5
1. 8	U/f ratio selection	0—2	1	0		0 = Linear 1 = Squared 2 = Programmable U/f ratio	4-5
1. 9	U/f optimisation	0—1	1	0		0 = None 1 = Automatic torque boost	4-6
1. 10	Nominal voltage of the motor	180—690 V	1 V	230 V 400 V 500 V 690 V		Vacon range CX/CXL/CXS2 Vacon range CX/CXL/CXS4 Vacon range CX/CXL/CXS5 Vacon range CX6	4-7
1. 11	Nominal frequency of the motor	30—500 Hz	1 Hz	50 Hz		$f_n$ from the rating plate of the motor	4-7
1. 12	Nominal speed of the motor	300—20000 rpm	1 rpm	1420 rpm **)		$n_n$ from the rating plate of the motor	4-7
1. 13	Nominal current of the motor	2,5 x $I_{nCT}$	0,1 A	$I_{nCT}$		$I_n$ from the rating plate of the motor	4-7
1. 14	Supply voltage	208—240 380—400 380—500 525—690		230 V 400 V 500 V 690 V		Vacon range CX/CXL/CXS2 Vacon range CX/CXL/CXS4 Vacon range CX/CXL/CXS5 Vacon range CX6	4-7
1. 15	Parameter conceal	0—1	1	0		Visibility of the parameters: 0 = All parametergroups visible 1 = Only group 1 is visible	4-7
1. 16	Parameter value lock	0—1	1	0		Disables parameter changes: 0 = Changes enabled 1 = Changes disabled	4-7

Table 4.4-1 Group 1 basic parameters.

**Note!**  = Parameter value can be changed only when the frequency converter is stopped.

\*) If 1. 2 > motor synchr. speed, check suitability for motor and drive system.  
Selecting 120 Hz/500 Hz range see page 4-5.

\*\*\*) Default value for a four pole motor and a nominal size frequency converter.

\*\*\*\*) Up to M10. Bigger classes case by case.

#### 4.4.2 Description of Group 1 parameters

##### 1. 1, 1. 2 *Minimum / maximum frequency*

Defines frequency limits of the frequency converter.

The default maximum value for parameters 1. 1 and 1. 2 is 120 Hz. By setting 1. 2 = 120 Hz when the device is stopped (RUN indicator not lit) the values of parameters 1. 1 and 1. 2 are changed to 500 Hz. Same time panel reference resolution is changed from 0.01 Hz to 0.1 Hz.

Changing the max. value from 500 Hz to 120 Hz happens by setting parameter 1.2 = 119 Hz when the device is stopped.

##### 1. 3, 1. 4 *Acceleration time 1, deceleration time 1:*

These limits correspond to the time required for the output frequency to accelerate from the set minimum frequency (par. 1. 1) to the set maximum frequency (par. 1. 2).

##### 1. 5 *PI-controller gain*

This parameter defines the gain of the PI-controller.

If this parameter is set to 100%, a 10% change in error value causes a controller output change by 1.0 Hz.

If the parameter value is set to 0 the PI-controller operates as I-controller.

##### 1. 6 *PI-controller I-time*

Defines the integration time of the PI-controller

##### 1. 7 *Current limit*

This parameter determines the maximum motor current that the frequency converter can give momentarily.

##### 1. 8 *U/f ratio selection*

Linear: The voltage of the motor changes linearly with the frequency in the constant flux area from 0 Hz to the field weakening point (par. 6. 3) where the nominal voltage is also supplied to the motor. See figure 4.4-2.

**0** Linear U/f ratio should be used in constant torque applications.

**This default setting should be used if there is no special demand for another setting.**

Squared: The voltage of the motor changes following a squared curve form with the frequency in the area from 0 Hz to the field weakening point (par. 6. 3) where the nominal voltage is also supplied to the motor. See figure 4.4-2.

**1** The motor runs undermagnetised below the field weakening point and produces less torque and electromechanical noise. Squared U/f ratio can be used in applications where torque demand of the load is proportional to the square of the speed, e.g. in centrifugal fans and pumps.

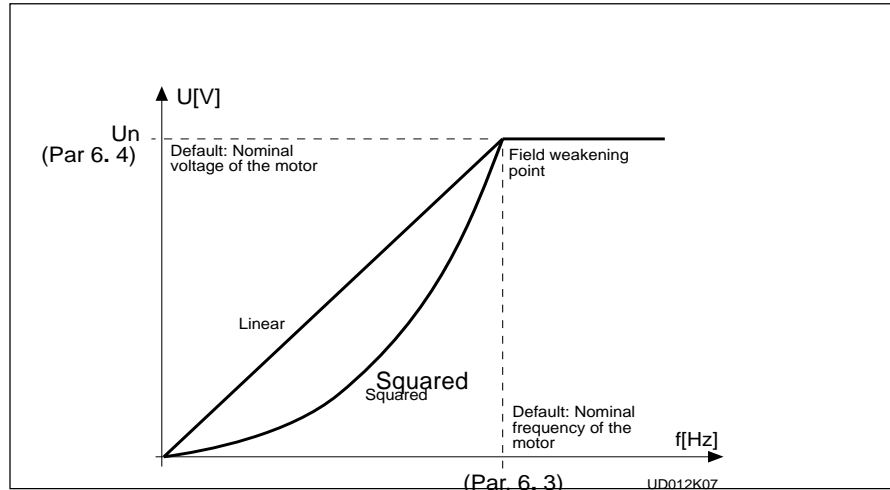

Figure 4.4-2 Linear and squared U/f curves.

Programm. U/f curve 2 The U/f curve can be programmed with three different points. The parameters for programming are explained in Chapter 4.5.2 Programmable U/f curve can be used if the other settings do not satisfy the needs of the application. See figure 4.4-3 .

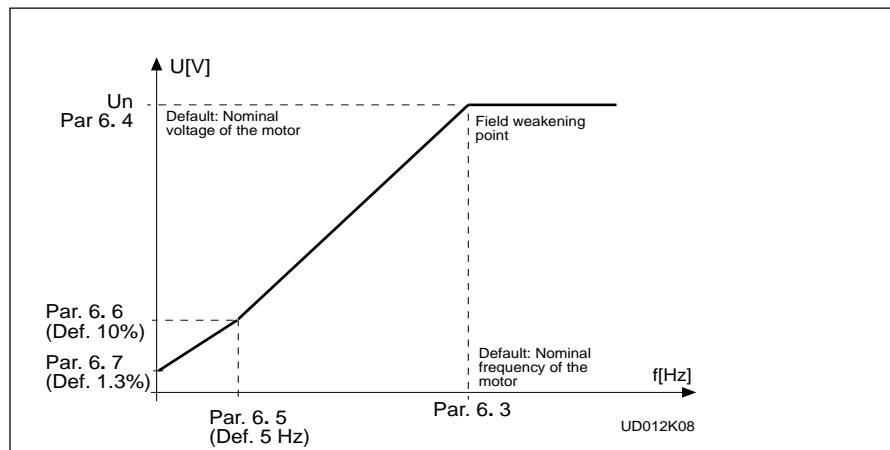

Figure 4.4-3 Programmable U/f curve.

1.9 U/f optimisation

Automatic torque boost The voltage to the motor changes automatically which makes the motor produce enough torque to start and run at low frequencies. The voltage increase depends on the motor type and power.

Automatic torque boost can be used in applications where starting torque due to starting friction is high, e.g. in conveyors.

NOTE!



In high torque - low speed applications - it is likely the motor will overheat. If the motor has to run a prolonged time under these conditions, special attention must be paid to cooling the motor. Use external cooling for the motor if the temperature tends to rise too high.

**1. 10 Nominal voltage of the motor**

Find this value  $U_n$  on the rating plate of the motor.

This parameter sets the Voltage at the field weakening point, parameter 6. 4, to  $100\% \times U_{n_{motor}}$ .

**1. 11 Nominal frequency of the motor**

Find this value  $f_n$  on the rating plate of the motor.

This parameter sets the field weakening point, parameter 6. 3, to the same value.

**1. 12 Nominal speed of the motor**

Find this value  $n_n$  on the rating plate of the motor.

**1. 13 Nominal current of the motor**

Find the value  $I_n$  on the rating plate of the motor.

The internal motor protection function uses this value as a reference value.

**1. 14 Supply voltage**

Set parameter value according to the nominal voltage of the supply.

Values are predefined for CX/CXL/CXS2, CX/CXL/CXS4, CX/CXL/CXS5 and CX6 ranges, see table 4.4-1.

**1. 15 Parameter conceal**

Defines which parameter groups are available:

0 = all parameter groups are visible

1 = only group 1 is visible

**1. 16 Parameter value lock**

Defines access to the changes of the parameter values:

0 = parameter value changes enabled



1 = parameter value changes disabled

To further adjust the functions of the PI-Control application, see Chapter 4.5 for how to set up parameters of Groups 2—8.

## 4.5 Special parameters, Groups 2—8





### 4.5.1 Parameter tables

#### Group 2, Input signal parameters

Code	Parameter	Range	Step	Default	Custom	Description	Page
2. 1	DIA2 function (terminal 9) 	0—10	1	1		0 = Not used 1 = Ext. fault, closing contact 2 = External fault, opening contact 3 = Run enable 4 = Acceler./deceler. time selection 5 = Reverse 6 = Jogging speed 7 = Fault reset 8 = Acc./dec. operation prohibit 9 = DC-braking command 10 = Motor pot. UP	4-15
2. 2	DIA3 function (terminal 10) 	0—10	1	7		0 = Not used 1 = Ext. fault, closing contact 2 = External fault, opening contact 3 = Run enable 4 = Acc./dec. time selection 5 = Reverse 6 = Jogging speed 7 = Fault reset 8 = Acc./dec. operation prohibit 9 = DC-braking command 10 = Motor potentiometer DOWN	4-16
2. 3	U <sub>in</sub> signal range	0—1	1	0		0 = 0—10 V 1 = Custom setting range	4-16
2. 4	U <sub>in</sub> custom setting min.	0,00-100,00%	0,01%	0,00%			4-16
2. 5	U <sub>in</sub> custom setting max.	0,00-100,00%	0,01%	100,00%			4-16
2. 6	U <sub>in</sub> signal inversion	0—1	1	0		0 = Not inverted 1 = Inverted	4-16
2. 7	U <sub>in</sub> signal filter time	0,00 —10,00 s	0,01 s	0,10 s		0 = No filtering	4-17
2. 8	I <sub>in</sub> signal range	0—2	1	0		0 = 0—20 mA 1 = 4—20 mA 2 = Custom setting range	4-17
2. 9	I <sub>in</sub> custom setting minim.	0,00-100,00%	0,01%	0,00%			4-17
2. 10	I <sub>in</sub> custom setting maxim.	0,00-100,00%	0,01%	100,00%			4-17
2. 11	I <sub>in</sub> signal inversion	0—1	1	0		0 = Not inverted 1 = Inverted	4-17
2. 12	I <sub>in</sub> signal filter time	0,01 —10,00 s	0,01s	0,10 s		0 = No filtering	4-18
2. 13	DIB5 function (terminal 15) 	0—9	1	6		0 = Not used 1 = Ext. fault, closing contact 2 = External fault, opening contact 3 = Run enable 4 = Acc./dec. time selection 5 = Reverse 6 = Jogging speed 7 = Fault reset 8 = Acc./dec. operation prohibit 9 = DC-braking command	4-18





**Note!**  = Parameter value can be changed only when the frequency converter is stopped

(Continues)

Code	Parameter	Range	Step	Default	Custom	Description	Page
2. 14	Motor potentiometer ramp time	0,1—2000,0 Hz/s	0,1 Hz/s	10,0 Hz/s			4-18
2. 15	PI-controller reference signal (source A) 	0—4	1	0		0 = Analogue voltage input (term. 2) 1 = Analogue current input (term. 4) 2 = Set reference from the panel (reference r2) 3 = Signal from internal motor pot. 4 = Signal from internal motor pot. reset if Vacon unit is stopped	419
2. 16	PI-controller actual value selection 	0—3	1	0		0 = Actual value1 1 = Actual 1 + Actual 2 2 = Actual 1 - Actual 2 3 = Actual 1 * Actual 2	4-19
2. 17	Actual value 1 input 	0—2	1	2		0 = No 1 = Voltage input 2 = Current input	4-19
2. 18	Actual value 2 input 	0—2	1	0		0 = No 1 = Voltage input 2 = Current input	4-19
2. 19	Actual value 1 min scale	-320.00%—+320.00%	0,01%	0,00%		0 % = No minimum scaling	4-19
2. 20	Actual value 1 max scale	-320.00%—+320.00%	0,01%	100,0%		100 % = No maximum scaling	4-19
2. 21	Actual value 2 min scale	-320.00%—+320.00%	0,01%	0,00%		0 % = No minimum scaling	4-19
2. 22	Actual value 2 max scale	-320.00%—+320.00%	0,01%	100,0%		100 % = No maximum scaling	4-19
2. 23	Error value inversion	0—1	1	0		0 = No 1 = Yes	4-19
2. 24	PI-controller min. limit	$f_{\min}$ — $f_{\max}$ (1. 1) (1. 2)	0,1 Hz	0,0 Hz			4-20
2. 25	PI-controller max. limit	$f_{\min}$ — $f_{\max}$ (1. 1) (1. 2)	0,1 Hz	50,0 Hz			4-20
2. 26	Direct frequency reference, source B 	0—4	1	0		0 = Analogue voltage input (term. 2) 1 = Analogue current input (term. 4) 2 = Set reference from the panel (reference r1) 3 = Signal from internal motor pot. 4 = Signal from internal motor pot. reset if Vacon unit is stopped	4-20
2. 27	Source B reference scaling minimum value	0— par. 2. 28	1 Hz	0 Hz		Selects the frequency that corresponds to the min. reference signal	4-20
2. 28	Source B reference scaling maximum value	0— $f_{\max}$ (1. 2)	1 Hz	0 Hz		Selects the frequency that corresponds to the max. reference signal 0 = Scaling off >0 = Scaled maximum value	4-20

**Note!**  = Parameter value can be changed only when the frequency converter is stopped (Continues)

## Group 3, Output and supervision parameters

Code	Parameter	Range	Step	Default	Custom	Description	Page
3.1	Analog output function 	0—7	1	1		0 = Not used 1 = O/P frequency (Scale 100% 0— $f_{max}$ ) 2 = Motor speed (0—max. speed) 3 = O/P current (0— $2.0 \times I_{nCT}$ ) 4 = Motor torque (0— $2 \times T_{nMot}$ ) 5 = Motor power (0— $2 \times P_{nMot}$ ) 6 = Motor voltage (0—100% $\times U_{nMo}$ ) 7 = DC-link volt. (0—1000 V)	4-21
3.2	Analog output filter time	0,00—10,00 s	0,01s	1,00s			4-21
3.3	Analog output inversion	0—1	1	0		0 = Not inverted 1 = Inverted	4-21
3.4	Analog output minimum	0—1	1	0		0 = 0 mA 1 = 4 mA	4-21
3.5	Analog output scale	10—1000%	1%	100%			4-21
3.6	Digital output function 	0—21	1	1		0 = Not used 1 = Ready 2 = Run 3 = Fault 4 = Fault inverted 5 = Vacon overheat warning 6 = External fault or warning 7 = Reference fault or warning 8 = Warning 9 = Reversed 10 = Jogging speed selected 11 = At speed 12 = Motor regulator activated 13 = Output freq. limit superv. 1 14 = Output freq. limit superv. 2 15 = Torque limit supervision 16 = Reference limit supervision 17 = External brake control 18 = Control from I/O terminals 19 = Frequency converter temperature limit supervision 20 = Unrequested rotation direction 21 = External brake control inverted	4-22
3.7	Relay output 1 function 	0—21	1	2		As parameter 3.6	4-22
3.8	Relay output 2 function 	0—21	1	3		As parameter 3.6	4-22
3.9	Output freq. limit 1 supervision function	0—2	1	0		0 = No 1 = Low limit 2 = High limit	4-22
3.10	Output freq. limit 1 supervision value	0,0— $f_{max}$ (par. 1.2)	0,1 Hz	0,0 Hz			4-22

**Note!**  = Parameter value can be changed only when the frequency converter is stopped. (Continues)



Code	Parameter	Range	Step	Default	Custom	Description	Page
3. 11	Output freq. limit 2 supervision function	0—2	1	0		0 = No 1 = Low limit 2 = High limit	4-22
3. 12	Output freq. limit 2 supervision value	0,0— $f_{max}$ (par. 1. 2)	0,1 Hz	0,0 Hz			4-22
3. 13	Torque limit supervision function	0—2	1	0		0 = No 1 = Low limit 2 = High limit	4-23
3. 14	Torque limit supervision value	0,0—200,0% $\times T_{nC X}$	0,1%	100,0%			4-23
3. 15	Active reference limit supervision function	0—2	1	0		0 = No 1 = Low limit 2 = High limit	4-23
3. 16	Active reference limit supervision value	0,0— $f_{max}$ (par. 1. 2)	0,1 Hz	0,0 Hz			4-23
3. 17	External brake off-delay	0,0—100,0 s	1	0,5 s			4-23
3. 18	External brake on-delay	0,0—100,0 s	1	1,5 s			4-23
3. 19	Frequency converter temperature limit supervision	0—2	1	0		0 = No 1 = Low limit 2 = High limit	4-23
3. 20	Frequency converter temperature limit	-10—+75°C	1	+40°C			4-23
3. 21	I/O-expander board (opt.) analogue output function	0—7	1	3		See parameter 3. 1	4-21
3. 22	I/O-expander board (opt.) analogue output filter time	0,00—10,00 s	0,01s	1,00s		See parameter 3. 2	4-21
3. 23	I/O-expander board (opt.) analogue output inversion	0—1	1	0		See parameter 3. 3	4-21
3. 24	I/O-expander board (opt.) analogue output minimum	0—1	1	0		See parameter 3. 4	4-21
3. 25	I/O-expander board (opt.) analogue output scale	10—1000%	1	100%		See parameter 3. 5	4-21

#### Group 4, Drive control parameters

Code	Parameter	Range	Step	Default	Custom	Description	Page
4. 1	Acc./Dec. ramp 1 shape	0,0—10,0 s	0,1 s	0,0 s		0 = Linear >0 = S-curve acc./dec. time	4-24
4. 2	Acc./Dec. ramp 2 shape	0,0—10,0 s	0,1 s	0,0 s		0 = Linear >0 = S-curve acc./dec. time	4-24
4. 3	Acceleration time 2	0,1—3000,0 s	0,1 s	10,0 s			4-24
4. 4	Deceleration time 2	0,1—3000,0 s	0,1 s	10,0 s			4-24
4. 5	Brake chopper 	0—2	1	0		0 = Brake chopper not in use 1 = Brake chopper in use 2 = External brake chopper	4-25
4. 6	Start function	0—1	1	0		0 = Ramp 1 = Flying start	4-25

**Note!**  = Parameter value can be changed only when the frequency converter is stopped. (Continues)







Code	Parameter	Range	Step	Default	Custom	Description	Page
4.7	Stop function	0—1	1	0		0 = Coasting 1 = Ramp	4-25
4.8	DC-braking current	0,15—1,5 x $I_{nCT}$ (A)	0,1 A	0,5 x $I_{nCT}$			4-25
4.9	DC-braking time at Stop	0,00-250,00s	0,01 s	0,00 s		0 = DC-brake is off at Stop	4-25
4.10	Execute frequency of DC-brake at ramp Stop	0,1-10,0 Hz	0,1 Hz	1,5 Hz			4-26
4.11	DC-brake time at Start	0,00—25,00s	0,01 s	0,00 s		0 = DC-brake is off at Start	4-27
4.12	Jogging speed reference	$f_{min}$ — $f_{max}$ (1. 1) (1. 2)	0,1 Hz	10,0 Hz			4-27

### Group 5, Prohibit frequency parameters

Code	Parameter	Range	Step	Default	Custom	Description	Page
5.1	Prohibit frequency range 1 low limit	$f_{min}$ — par. 5. 2	0,1 Hz	0,0 Hz			4-27
5.2	Prohibit frequency range 2 high limit	$f_{min}$ — $f_{max}$ (1. 1) (1. 2)	0,1 Hz	0,0 Hz		0 = no prohibit frequency range	4-27
5.3	Prohibit frequency range 2 low limit	$f_{min}$ — par. 5. 4	0,1 Hz	0,0 Hz			4-27
5.4	Prohibit frequency range 2 high limit	$f_{min}$ — $f_{max}$ (1. 1) (1. 2)	0,1 Hz	0,0 Hz		0 = no prohibit frequency range	4-27
5.5	Prohibit frequency range 3 low limit	$f_{min}$ — par. 5. 6	0,1 Hz	0,0 Hz			4-27
5.6	Prohibit frequency range 3 high limit	$f_{min}$ — $f_{max}$ (1. 1) (1. 2)	0,1 Hz	0,0 Hz		0 = no prohibit frequency range	4-27

## 4

### Group 6, Motor control parameters

Code	Parameter	Range	Step	Default	Custom	Description	Page
6.1	Motor control mode 	0—1	1	0		0 = Frequency control 1 = Speed control	4-27
6.2	Switching frequency	1,0-16,0 kHz	0,1 kHz	10/3,6kHz		Dependant on kW	4-27
6.3	Field weakening point 	30—500 Hz	1 Hz	Param. 1. 11			4-28
6.4	Voltage at field weakening point 	15—200% x $U_{nmot}$	1%	100%			4-28
6.5	U/F-curve mid point frequency 	0,0— $f_{max}$	0,1 Hz	0,0 Hz			4-28
6.6	U/F-curve mid point voltage 	0,00-100,00% x $U_{nmot}$	0,01%	0,00%		Parameter maximum value = param. 6.4	4-28
6.7	Output voltage at zero frequency 	0,00-40,00% x $U_{nmot}$	0,01%	0,00%			4-28
6.8	Overvoltage controller 	0—1	1	1		0 = Controller is not operating 1 = Controller is in operation	4-28
6.9	Undervoltage controller	0—1	1	1		0 = Controller is not operating 1 = Controller is in operation	4-28

**Note!**  = Parameter value can be changed only when the frequency converter is stopped.

## Group 7, Protections

Code	Parameter	Range	Step	Default	Custom	Description	Page
7. 1	Response to reference fault	0—3	1	0		0 = No action 1 = Warning 2 = Fault, stop according to par. 4.7 3 = Fault. stop always by coasting	4-29
7. 2	Response to external fault	0—3	1	2		0 = No action 1 = Warning 2 = Fault, stop according to par. 4.7 3 = Fault, stop always by coasting	4-29
7. 3	Phase supervision of the motor	0—2	2	2		0 = No action 2 = Fault	4-29
7. 4	Earth fault protection	0—2	2	2		0 = No action 2 = Fault	4-29
7. 5	Motor thermal protection	0—2	1	2		0 = No action 1 = Warning 2 = Fault	4-30
7. 6	Motor thermal protection break point current	50,0—150,0 % $\times I_{nMOTOR}$	1,0 %	100,0%			4-30
7. 7	Motor thermal protection zero frequency current	5,0—150,0% $\times I_{nMOTOR}$	1,0 %	45,0%			4-30
7. 8	Motor thermal protection time constant	0,5—300,0 minutes	0,5 min.	17,0 min.		Default value is set according to motor nominal current	4-31
7. 9	Motor thermal protection break point frequency	10—500 Hz	1 Hz	35 Hz			4-31
7. 10	Stall protection	0—2	1	1		0 = No action 1 = Warning 2 = Fault	4-32
7. 11	Stall current limit	5,0—200,0% $\times I_{nMOTOR}$	1,0%	130,0%			4-32
7. 12	Stall time	2,0—120,0 s	1,0 s	15,0 s			4-33
7. 13	Maximum stall frequency	1— $f_{max}$	1 Hz	25 Hz			4-33
7. 14	Underload protection	0—2	1	0		0 = No action 1 = Warning 2 = Fault	4-33
7. 15	Underload prot., field weakening area load	10,0—150,0 % $\times T_{nMOTOR}$	1,0%	50,0%			4-34
7. 16	Underload protection, zero frequency load	5,0—150,0% $\times T_{nMOTOR}$	1,0%	10,0%			4-34
7. 17	Underload time	2,0—600,0 s	1,0 s	20,0s			4-34

**Group 8, Autorestart parameters**

Code	Parameter	Range	Step	Default	Custom	Description	Page
8. 1	Automatic restart: number of tries	0—10	1	0		0 = not in use	4-34
8. 2	Automatic restart: trial time	1—6000 s	1 s	30 s			4-34
8. 3	Automatic restart: start function	0—1	1	0		0 = Ramp 1 = Flying start	4-35
8. 4	Automatic restart after undervoltage trip	0—1	1	0		0 = No 1 = Yes	4-35
8. 5	Automatic restart after overvoltage trip	0—1	1	0		0 = No 1 = Yes	4-35
8. 6	Automatic restart after overcurrent trip	0—1	1	0		0 = No 1 = Yes	4-35
8. 7	Automatic restart after reference fault trip	0—1	1	0		0 = No 1 = Yes	4-35
8. 8	Automatic restart after over/undertemperature fault trip	0—1	1	0		0 = No 1 = Yes	4-35

*Table 4.5-1 Special parameters, Groups 2—8.*

4.5.2 Description of Groups 2—8 parameters

2.1 DIA2 function

- 1: External fault, closing contact = Fault is shown and motor is stopped when the input is active
- 2: External fault, opening contact = Fault is shown and motor is stopped when the input is not active
- 3: Run enable contact open = Start of the motor disabled  
contact closed = Start of the motor enabled
- 4: Acc. / Dec time select. contact open = Acceleration/Deceleration time 1 selected  
contact closed = Acceleration/Deceleration time 2 selected
- 5: Reverse contact open = Forward  
contact closed = Reverse  

If two or more inputs are programmed to reverse then if one of them is active the direction is reverse
- 6: Jogging sp. contact closed = Jogging speed selected for freq. refer.
- 7: Fault reset contact closed = Resets all faults
- 8: Acc./Dec. operation prohibited contact closed = Stops acceleration and deceleration until the contact is opened
- 9: DC-braking command contact closed = In the stop mode, the DC-braking operates until the contact is opened, see figure 4.5-1. DC-brake current is set with parameter 4. 8.
- 10: Motor pot. UP contact closed = Reference increases until the contact is opened

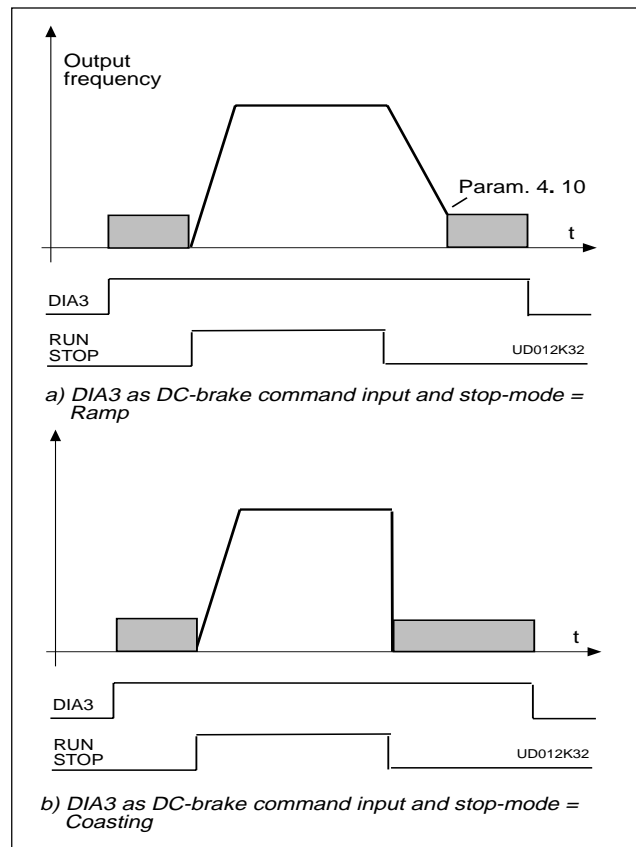

Figure 4.5-1 DIA3 as DC-brake command input:  
 a) Stop-mode = ramp,  
 b) Stop-mode = coasting

## 2. 2 **DIA3 function**

Selections are same as in 2. 1 except :

10: Motor pot. contact closed = Reference decreases until the contact is  
DOWN opened

## 2. 3 **$U_{in}$ signal range**

0 = Signal range 0—10 V

1 = Custom setting range from custom minimum (par. 2. 4) to custom maximum (par. 2. 5)

## 2. 4 **$U_{in}$ custom setting minimum/maximum**

2. 5 These parameters set  $U_{in}$  for any input signal span within 0—10 V.

Minimum setting: Set the  $U_{in}$  signal to its minimum level, select parameter 2. 4, press the Enter button

Maximum setting: Set the  $U_{in}$  signal to its maximum level, select parameter 2. 5, press the Enter button

**Note!** The parameter values can only be set with this procedure (not with the *Browser buttons*)

## 2. 6 **$U_{in}$ signal inversion**

Parameter 2. 6 = 0, no inversion of analogue  $U_{in}$  signal.

Parameter 2. 6 = 1, inversion of analogue  $U_{in}$  signal.

**2. 7  $U_{in}$  signal filter time**

Filters out disturbances from the incoming analog  $U_{in}$  signal. Long filtering time makes regulation response slower. See figure 4.5-2.

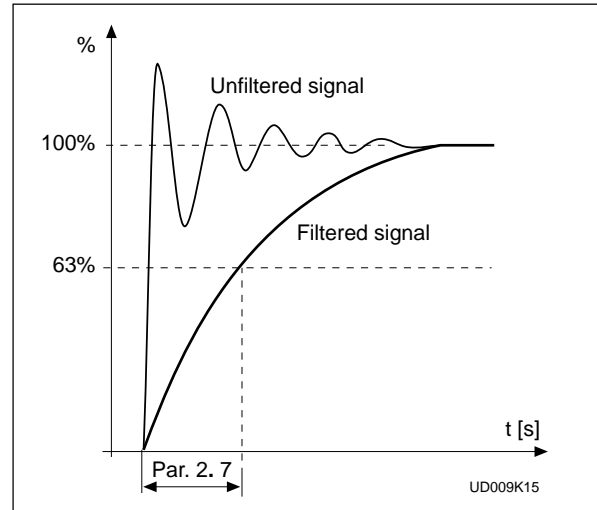

Figure 4.5-2  $U_{in}$  signal filtering.

**2. 8 Analogue input  $I_{in}$  signal range**

0 = 0—20 mA  
 1 = 4—20 mA  
 2 = Custom signal span

**2. 9 Analogue input  $I_{in}$  custom setting minimum/maximum**

With these parameters you can scale the input current signal ( $I_{in}$ ) signal range between 0—20 mA.

Minimum setting:

Set the  $I_{in}$  signal to its minimum level, select parameter 2. 9, press the *Enter* button

Maximum setting:

Set the  $I_{in}$  signal to its maximum level, select parameter 2. 10, press the *Enter* button

**Note!** The parameter values can only be set with this procedure (not with the *Browser buttons*)

**2. 11 Analogue input  $I_{in}$  inversion**

Parameter 2. 11 = 0, no inversion of  $I_{in}$  input.

Parameter 2. 11 = 1, inversion of  $I_{in}$  input.

**2. 12 Analogue input  $I_{in}$  filter time**

Filters out disturbances from the incoming analogue  $I_{in}$  signal. Long filtering time makes regulation response slower. See figure 4.5-3.

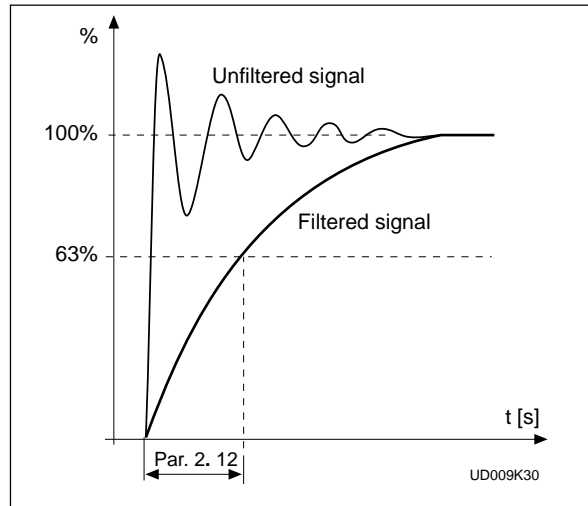

Figure 4.5-3 Analogue input  $I_{in}$  filter time.

**2. 13 DIA5 function**

- 1: External fault, closing contact = Fault is shown and motor is stopped when the input is active
- 2: External fault, opening contact = Fault is shown and motor is stopped when the input is not active
- 3: Run enable contact open = Start of the motor disabled  
contact closed = Start of the motor enabled
- 4: Acc. / Dec time select. contact open = Acceleration/Deceleration time 1 selected  
contact closed = Acceleration/Deceleration time 2 selected
- 5: Reverse contact open = Forward  
contact closed = Reverse  
 ||| If two or more inputs are programmed to reverse then if one of them is active the direction is reverse
- 6: Jogging sp. contact closed = Jogging speed selected for freq. refer.
- 7: Fault reset contact closed = Resets all faults
- 8: Acc./Dec. operation prohibited contact closed = Stops acceleration and deceleration until the contact is opened
- 9: DC-braking command contact closed = In the stop mode, the DC-braking operates until the contact is opened, see figure 4.5-1. Dc-brake current is set with parameter 4. 8.

**2. 14 Motor potentiometer ramp time**

Defines how fast the electronic motor potentiometer value changes.





**2. 15 PI-controller reference signal**

- 0** Analogue voltage reference from terminals 2—3, e.g. a potentiometer
- 1** Analogue current reference from terminals 4—5, e.g. a transducer.
- 2** Panel reference is the reference set from the Reference Page (REF). Reference r2 is the PI-controller reference, see chapter 4.7.
- 3** Reference value is changed with digital input signals DIA2 and DIA3.
  - switch in DIA2 closed = frequency reference increases
  - switch in DIA3 closed = frequency reference decreases
 Speed of the reference change can be set with the parameter 2. 3.
- 4** Same as setting 3 but the reference value is set to the minimum frequency (par. 1. 1) each time the frequency converter is stopped. When value of the parameter 1. 5 is set to 3 or 4, value of the parameter 2. 1 is automatically set to 4 and value of the parameter 2. 2 is automatically set to 10.

**2. 16 PI-controller actual value selection**

**2. 17 Actual value 1**

**2. 18 Actual value 2**

These parameters select the PI-controller actual value.

**2. 19 Actual value 1 minimum scale**

Sets the minimum scaling point for Actual value 1. See figure 4.5-4.

**2. 20 Actual value 1 maximum scale**

Sets the maximum scaling point for Actual value 1. See figure 4.5-4.

**2. 21 Actual value 2 minimum scale**

Sets the minimum scaling point for Actual value 2. See figure 4.5-4.

**2. 22 Actual value 2 maximum scale**

Sets the maximum scaling point for Actual value 2. See figure 4.5-4.

**2. 23 Error value inversion**

This parameter allows you to invert the error value of the PI-controller (and thus the operation of the PI-controller).

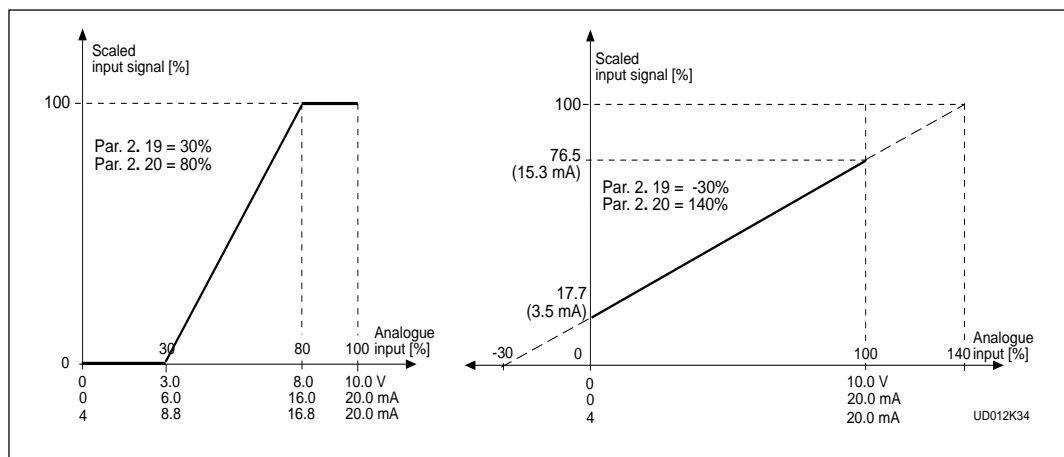

Figure 4.5-4 Examples of actual value scaling of PI-regulator.

- 2. 24 **PI-controller minimum limit**
- 2. 25 **PI-controller maximum limit**

These parameter set the minimum and maximum values of the PI-controller output.  
 Parameter value limits: par 1.1 < par. 2. 24 < par. 2. 2 5.

2. 26 **Direct frequency reference. Place B**

- 0 Analogue voltage reference from terminals 2—3, e.g. a potentiometer
- 1 Analogue current reference from terminals 4—5, e.g. a transducer.
- 2 Panel reference is the reference set from the Reference Page (REF), Reference r1 is the Place B reference, see chapter 6.
- 3 Reference value is changed with digital input signals DIA2 and DIA3.  
 - switch in DIA2 closed = frequency reference increases  
 - switch in DIA3 closed = frequency reference decreases  
 Speed of the reference change can be set with parameter 2. 3.
- 4 Same as setting 3 but the reference value is set to the minimum frequency (par. 1. 1) each time the frequency converter is stopped. When value of the parameter 1. 5 is set to 3 or 4, value of the parameter 2. 1 is automatically set to 4 and value of the parameter 2. 2 is automatically set to 10.

2. 27 **Source B reference scaling, minimum value/maximum value**

- 2. 28 Setting limits: 0 < par. 2. 27 < par. 2. 28 < par. 1. 2.  
 If par. 2. 28 = 0 scaling is set off.  
 See figures 4.5-5 and 4.5-6.

(Below the voltage input  $U_{in}$  with signal range 0—10 V is selected for source B reference)

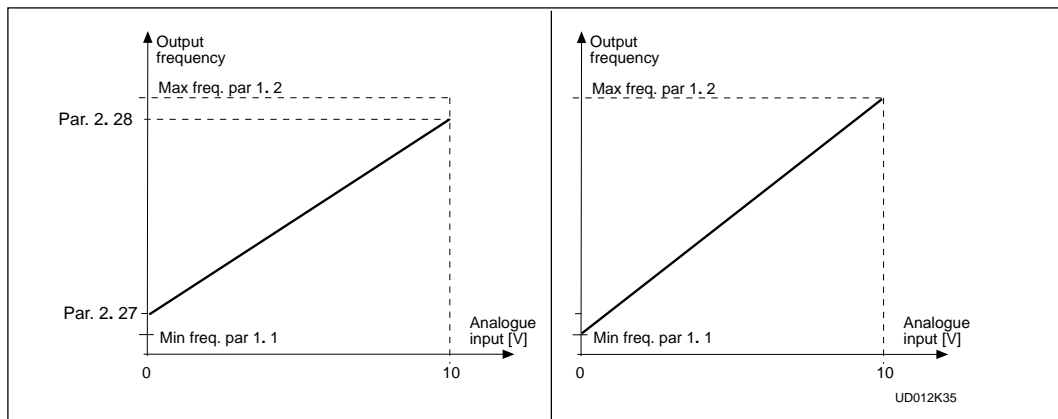

Figure 4.5-5 Reference scaling.

Figure 4.5-6 Reference scaling, par. 2. 28 = 0.



**3.1 Analogue output Content**

See table on page 4-10.

**3.2 Analogue output filter time**

Filters the analogue output signal. See figure 4.5-7.

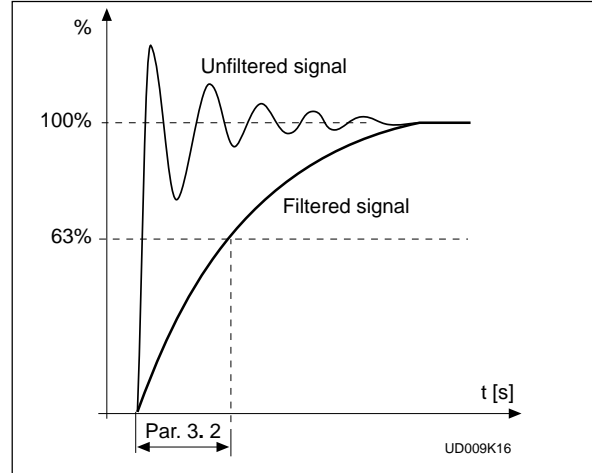

Figure 4.5-7 Analogue output filtering.

**3.3 Analogue output invert**

Inverts analogue output signal:  
 max. output signal = minimum set value  
 min. output signal = maximum set value

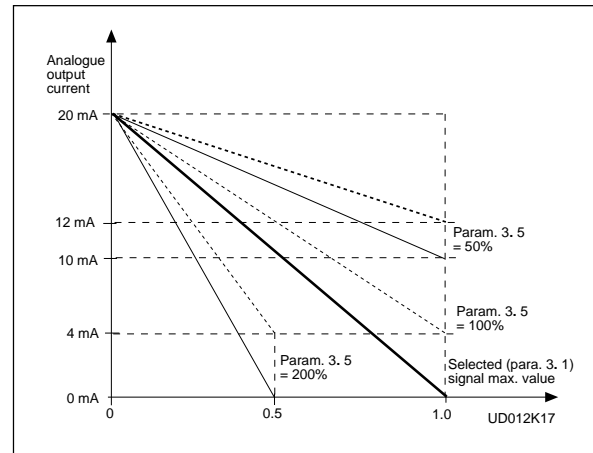

Figure 4.5-8 Analogue output invert.

**3.4 Analogue output minimum**

Defines the signal minimum to be either 0 mA or 4 mA (living zero). See figure 4.5-9.

**3.5 Analogue output scale**

Scaling factor for analogue output. See figure 4.5-9.

Signal	Max. value of the signal
Output frequency	Max. frequency (p. 1. 2)
Motor speed	Max. speed ( $n_n \times f_{max} / f_n$ )
Output current	$2 \times I_{nCT}$
Motor torque	$2 \times T_{nMot}$
Motor power	$2 \times P_{nMot}$
Motor voltage	$100\% \times U_{nMot}$
DC-link volt.	1000 V

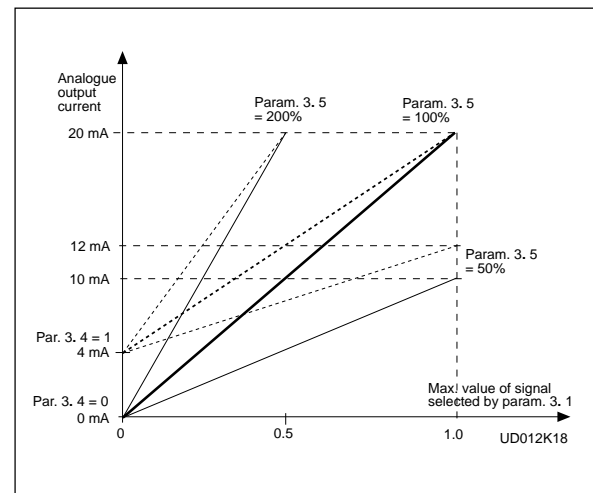

Figure 4.5-9 Analogue output scale.

- 3. 6**     **Digital output function**  
**3. 7**     **Relay output 1 function**  
**3. 8**     **Relay output 2 function**

Setting value	Signal content
0 = Not used	Out of operation <u>Digital output DO1 sinks current and programmable relay (RO1, RO2) is activated when:</u>
1 = Ready	The frequency converter is ready to operate
2 = Run	The frequency converter operates (motor is running)
3 = Fault	A fault trip has occurred
4 = Fault inverted	a fault trip <u>has not</u> occurred
5 = Vacon overheat warning	The heat-sink temperature exceeds +70°C
6 = External fault or warning	Fault or warning depending on parameter 7. 2
7 = Reference fault or warning	Fault or warning depending on parameter 7. 1 - if analogue reference is 4—20 mA and signal is <4mA
8 = Warning	Always if a warning exists
9 = Reversed	The reverse command has been selected
10= Jogging speed	Jogging. speed has been selected with digital input
11 = At speed	The output frequency has reached the set reference
12= Motor regulator activated	Overvoltage or overcurrent regulator was activated
13= Output frequency supervision 1	The output frequency goes outside of the set supervision Low limit/ High limit (par. 3. 9 and 3. 10)
14= Output frequency supervision 2	The output frequency goes outside of the set supervision Low limit/ High limit (par. 3. 11 and 3. 12)
15= Torque limit supervision	The motor torque goes outside of the set supervision Low limit/ High limit (par. 3. 13 and 3. 14)
16= Active reference limit supervision	Active reference goes outside of the set supervision Low limit/ High limit (par. 3. 15 and 3. 16)
17 = External brake control	External brake ON/OFF control with programmable delay (par 3. 17 and 3. 18)
18= Control from I/O terminals	External control mode selected with progr. push-button #2
19= Frequency converter temperature limit supervision	Temperature on frequency converter goes outside the set supervision limits (par. 3. 19 and 3. 20)
20 = Unrequested rotation direction	Rotation direction of the motor shaft is different from the requested one
21 = External brake control inverted	External brake ON/OFF control (par. 3.18 and 3.18) output active when brake control is OFF

Table 4.5-2 Output signals via DO1 and output relays RO1 and RO2.

- 3. 9**     **Output frequency limit 1, supervision function**  
**3. 11**    **Output frequency limit 2, supervision function**

- 0 = No supervision  
1 = Low limit supervision  
2 = High limit supervision

If the output frequency falls below or exceeds the set limit (3. 10, 3. 12) this function generates a warning message via the digital output DO1 and via a relay output RO1 or RO2 depending on the settings of parameters 3. 6—3. 8.

- 3. 10**    **Output frequency limit 1, supervision value**  
**3. 12**    **Output frequency limit 2, supervision value**

The frequency value to be supervised by parameter 3. 9 (3. 11).

See figure 4.5-10.

### 3. 13 **Torque limit , supervision function**

0 = No supervision  
 1 = Low limit supervision  
 2 = High limit supervision

If the calculated torque value falls below or exceeds the set limit (3. 14) this function generates a warning message via the digital output DO1 or via a relay output RO1 or RO2 depending on the settings of parameters 3. 6—3. 8.

Figure 4.5-10 Output frequency supervision.

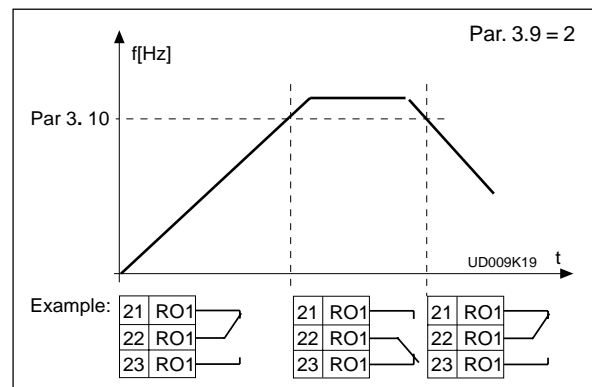

### 3. 14 **Torque limit , supervision value**

The calculated torque value to be supervised by the parameter 3. 13.

### 3. 15 **Reference limit , supervision function**

0 = No supervision  
 1 = Low limit supervision  
 2 = High limit supervision

If reference value falls below or exceeds the set limit (3. 16) this function generates a warning message via the digital output DO1 and via a relay output RO1 or RO2 depending on the settings of parameters 3. 6—3. 8. The supervised reference is the current active reference. It can be place A or B reference depending on DIB6 input or panel reference if panel is the active control place.

### 3. 16 **Reference limit , supervision value**

The frequency value is supervised by parameter 3. 15.

### 3. 17 **External brake-off delay**

### 3. 18 **External brake-on delay**

The function of the external brake can be timed to the start and stop control signals with these parameters. See figure 4.5-11.

The brake control signal can be programmed via the digital output DO1 or via one of the relay outputs RO1 and RO2, see parameters 3. 6—3. 8.

### 3. 19 **Frequency converter temperature limit supervision**

0 = No supervision  
 1 = Low limit supervision  
 2 = High limit supervision

If the temperature of the frequency converter unit falls below or exceeds the set limit (3. 20) this function generates a warning message via the digital output DO1 and via a relay output RO1 or RO2 depending on the settings of parameters 3. 6—3. 8.

### 3. 20 **Frequency converter temperature limit value**

The temperature value supervised by parameter 3. 19.

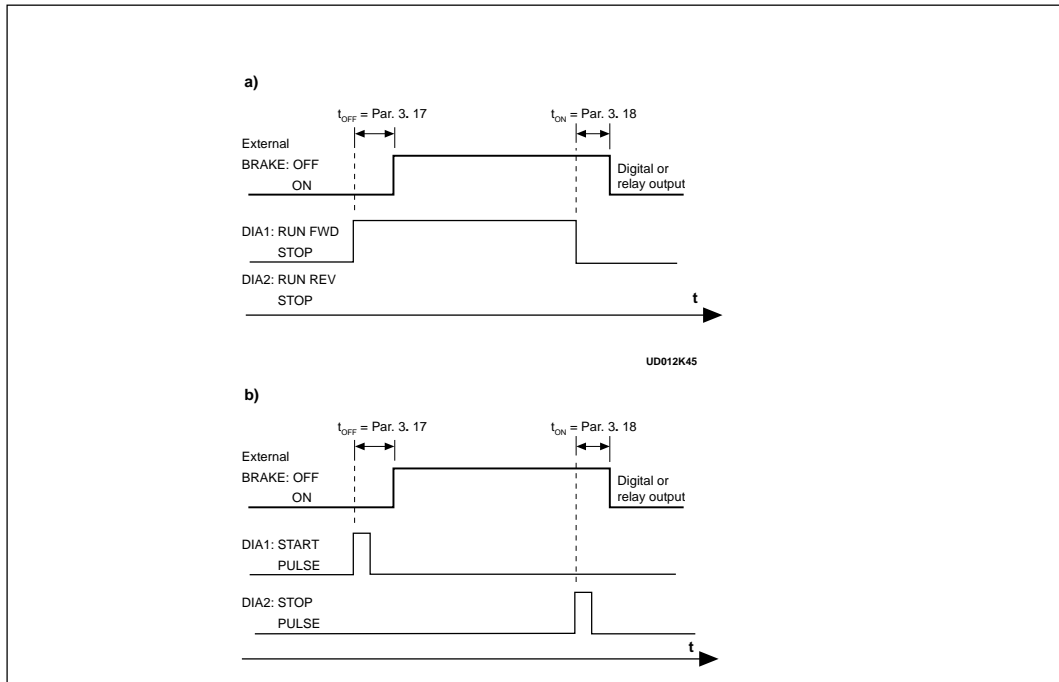

Figure 4.5-11 External brake control: a) Start/Stop logic selection par. 2. 1 = 0, 1 or 2  
b) Start/Stop logic selection par. 2. 1 = 3.

**4.1 Acc/Dec ramp 1 shape**  
**4.2 Acc/Dec ramp 2 shape**

A smooth start and end of acceleration and deceleration can be programmed with these parameters.

Setting value 0 gives linear ramp shape which causes acceleration and deceleration to act immediately to the changes in the reference signal with the time constant set by the parameter 1.3 and 1.4 (4.3 and 4.4).

Setting value 0.1—10 seconds for 4.1 (4.2) causes linear acceleration/deceleration to adopt an S-shape. Parameter 1.3 and 1.4 (4.3 and 4.4) determines the time constant of acceleration/deceleration in the middle of the curve.

See figure 4.5-12.

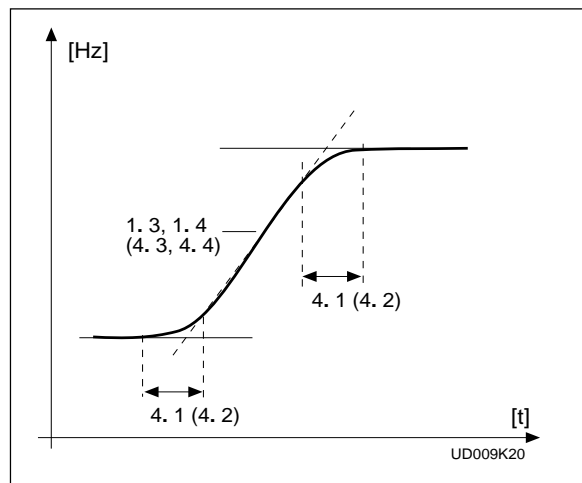

Figure 4.5-12 S-shaped acceleration/deceleration.

**4.3 Acceleration time 2**  
**4.4 Deceleration time 2**

These values correspond to the time required for the output frequency to accelerate from the set minimum frequency (par. 1. 1) to the set maximum frequency (par. 1. 2). These times give the possibility to set two different acceleration/deceleration times for one application. The active set can be selected with the programmable signal DIA3 of this application, see parameter 2. 2.

Acceleration/deceleration times can be reduced with external free analogue input signal, see parameters 2. 18 and 2. 19.



#### 4.5 **Brake chopper**

- 0 = No brake chopper
- 1 = Brake chopper and brake resistor installed
- 2 = External brake chopper

When the frequency converter is decelerating the motor, the inertia from the motor and the load is fed into the external brake resistor. This enables the frequency converter to decelerate the load with the torque equal to that of acceleration, if the brake resistor is selected correctly. See separate Brake resistor installation manual.

#### 4.6 **Start function**

Ramp:

- 0 The frequency converter starts from 0 Hz and accelerates to the set reference frequency within the set acceleration time. (Load inertia or starting friction may cause a prolonged acceleration times).

Flying start:

- 1 The frequency converter is able to start into running motor by applying a small torque to motor and searching for frequency corresponding to the speed the motor is running at. Searching starts from the maximum frequency towards the actual frequency until the correct value is detected. Thereafter the output frequency will be accelerated/decelerated to the set reference value according to the set acceleration/deceleration parameters.

Use this mode if the motor should be coasting when the start command is given. With the flying start it is possible to ride through short mains voltage interruptions.

#### 4.7 **Stop function**

Coasting:

- 0 The motor coasts to a halt without any control from the frequency converter, after the Stop command.

Ramp:

- 1 After the Stop command, the speed of the motor is decelerated according to the set deceleration parameters.  
If the regenerated energy is high it may be necessary to use an external braking resistor for faster deceleration.

#### 4.8 **DC braking current**

Defines the current injected into the motor during the DC braking.

#### 4.9 **DC braking time at stop**

Determines if braking is ON or OFF and braking time of the DC-brake when the motor is stopping. The function of the DC-brake depends on the stop function, parameter 4. 7. See figure 4.5-13.

- 0 DC-brake is not used
- >0 DC-brake is in use and its function depends on the Stop function, (param. 4. 7), and the time depends on the value of parameter 4. 9:

Stop-function = 0 (coasting):

After the stop command, the motor coasts to a stop without any control from the frequency converter.

With DC-injection, the motor can be electrically stopped in the shortest possible time, without using an optional external braking resistor.

The braking time is scaled according to the frequency when the DC-braking starts. If the frequency is  $\geq$  nominal frequency of the motor (par. 1.11), setting value of parameter 4.9 determines the braking time. When the frequency is  $\leq 10\%$  of the nominal, the braking time is 10% of the set value of parameter 4.9.

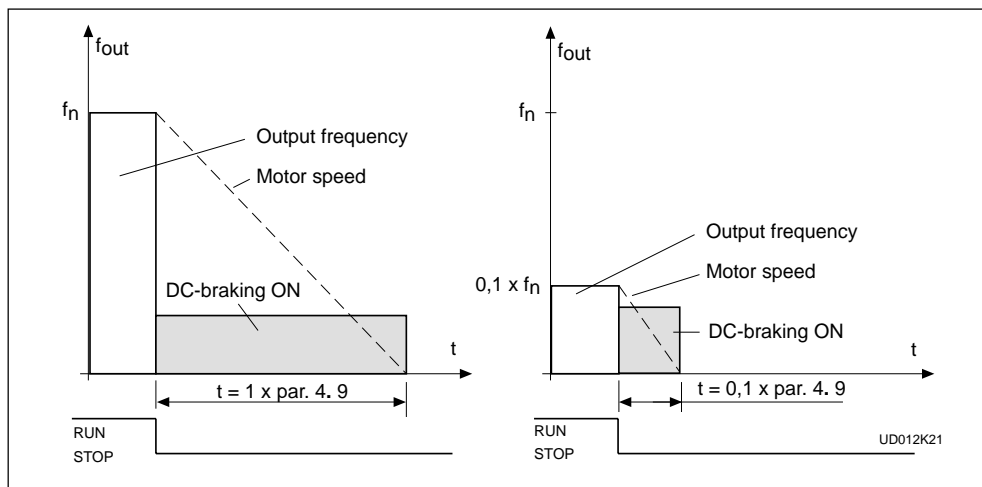

Figure 4.5-13 DC-braking time when par. 4. 7 = 0.

4

Stop-function = 1 (ramp):

After the Stop command, the speed of the motor is reduced according to the set deceleration parameters, as fast as possible, to a speed defined with parameter 4. 10 where the DC-braking starts.

The braking time is defined with parameter 4. 9.

If inertia exists it is recommended to use an external braking resistor for faster deceleration. See figure 4.5-14.

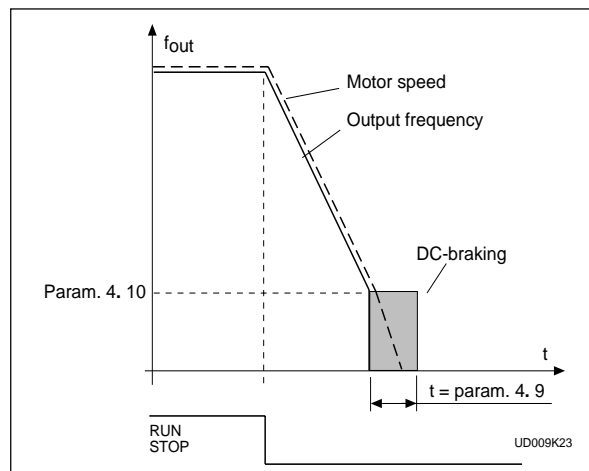

Figure 4.5-14 DC-braking time when par. 4. 7 = 1.

**4. 10 Execute frequency of DC-brake during ramp Stop**

See figure 4.5-14.



**4. 11 DC-brake time at start**

- 0** DC-brake is not used
- >0** DC-brake is activated when the start command is given and this parameter defines the time before the brake is released. After the brake is released output frequency increases according to the set start function parameter 4. 6 and acceleration parameters (1. 3, 4. 1 or 4. 2, 4. 3), see figure 4.5-15.

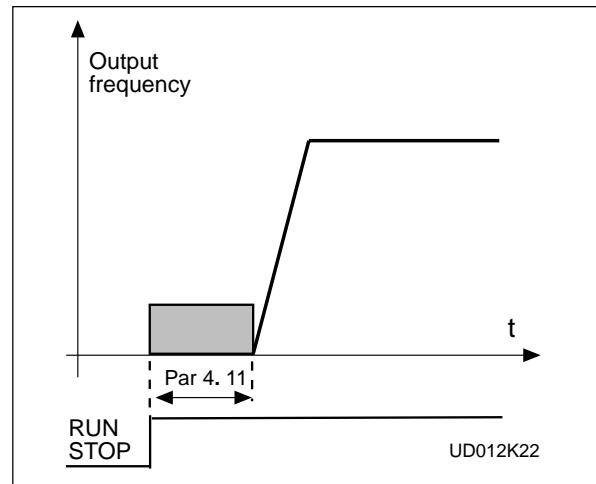

Figure 4.5-15 DC-braking time at start

**4. 12 Jogging speed reference**

Parameter value defines the jogging speed selected with the digital input.

- 5. 1 Prohibit frequency area, Low limit/High limit**
- 5. 2**
- 5. 3**
- 5. 4**
- 5. 5**
- 5. 6**

In some systems it may be necessary to avoid certain frequencies because of mechanical resonance problems.

With these parameters it is possible to set limits for three "skip frequency" regions.

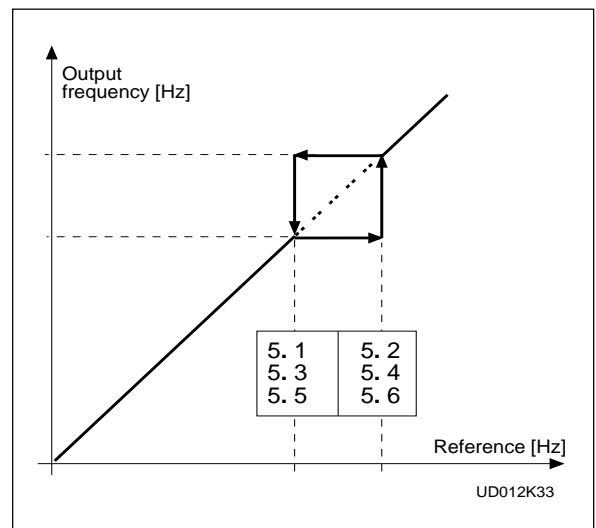

Figure 4.5-16 Example of prohibit frequency area setting.

**6. 1 Motor control mode**

0 = Frequency control:

The I/O terminal and panel references are frequency references and the frequency converter controls the output frequency (output freq. resolution 0,01 Hz)

1 = Speed control:

The I/O terminal and panel references are speed references and the frequency converter controls the motor speed (regulation accuracy  $\pm 0,5\%$ ).

**6. 2 Switching frequency**

Motor noise can be minimized using high switching frequency. Increasing the frequency reduces the capacity of the frequency converter. Before changing the frequency from the factory default 10 kHz (3.6 kHz from 30 kW upwards), check the curves in the figure 5.2-3 of the User's Manual for the allowed capacity .

**6.3 Field weakening point****6.4 Voltage at the field weakening point**

Field weakening point is the output frequency where the output voltage reaches the set maximum value (par. 6.4). Above that frequency, the output voltage remains at the set maximum value.

Below that frequency, the output voltage depends on the setting of the U/f curve parameters 1.8, 1.9, 6.5, 6.6 and 6.7. See figure 4.5-17.

When the parameters 1.10 and 1.11, nominal voltage and nominal frequency of the motor, are set, also parameters 6.3 and 6.4 are set automatically to the corresponding values. If different values for the field weakening point and the maximum output voltage are required, change these parameters after setting the parameters 1.10 and 1.11.

**6.5 U/f curve, middle point frequency**

If the programmable U/f curve has been selected with the parameter 1.8 this parameter defines the middle point frequency of the curve. See figure 4.5-17.

**6.6 U/f curve, middle point voltage**

If the programmable U/f curve has been selected with the parameter 1.8 this parameter defines the middle point voltage (% from motor nom. voltage) of the curve. See figure 4.5-17.

**6.7 Output voltage at zero frequency**

If the programmable U/f curve has been selected with the parameter 1.8 this parameter defines the zero frequency voltage of the curve. See figure 4.5-17.

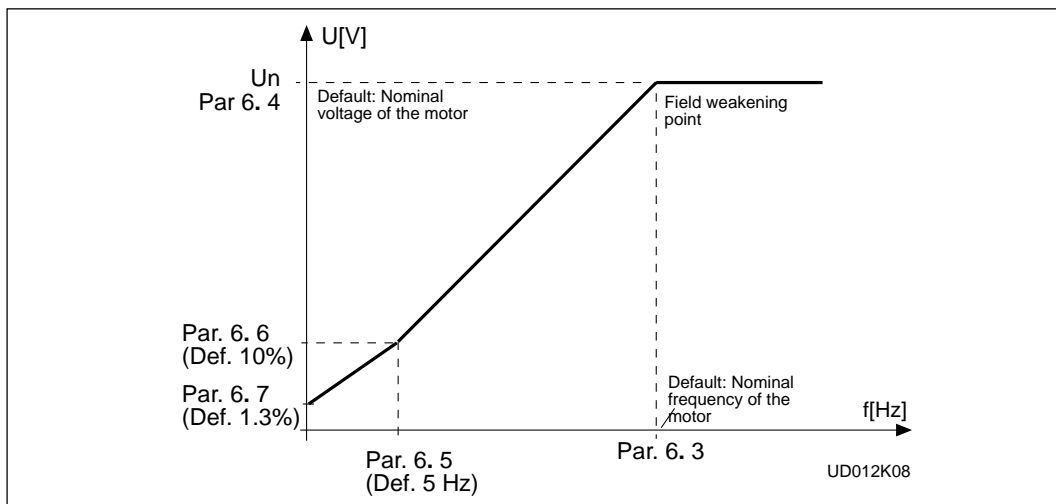

Figure 4.5-17 Programmable U/f curve.

**6.8 Overvoltage controller****6.9 Undervoltage controller**

These parameters allow the over-/undervoltage controllers to be switched out of operation. This may be useful, for example, if the mains supply voltage varies more than  $-15\%$ — $+10\%$  and the application will not tolerate this over-/undervoltage. Then the regulator controls output frequency according to the supply fluctuations.

Over-/undervoltage trips may occur when controllers are switched out of operation.

### 7.1 *Response to the reference fault*

- 0 = No response
- 1 = Warning
- 2 = Fault, stop mode after fault according to parameter 4.7
- 3 = Fault, stop mode after fault always by coasting

A warning or a fault action and message is generated if a 4—20 mA reference signal is used and the signal falls below 4 mA. The information can also be programmed via digital output DO1 and via relay outputs RO1 and RO2.

### 7.2 *Response to external fault*

- 0 = No response
- 1 = Warning
- 2 = Fault, stop mode after fault according to parameter 4.7
- 3 = Fault, stop mode after fault always by coasting

A warning or a fault action and message is generated from the external fault signal in the digital input DIA3. The information can also be programmed into digital output DO1 and into relay outputs RO1 and RO2.

### 7.3 *Phase supervision of the motor*

- 0 = No action
- 2 = Fault

Phase supervision of the motor ensures that the motor phases have an approximately equal current.

### 7.4 *Earth fault protection*

- 0 = No action
- 2 = Fault

Earth fault protection ensures that the sum of the motor phase currents is zero. The overcurrent protection is always working and it protects the frequency converter from earth faults with high currents.

## Parameters 7.5—7.9 Motor thermal protection

### General

Motor thermal protection shall protect the motor from overheating. Vacon CX/CXL/CXS drive is capable of supplying higher than nominal current to the motor. If the load requires this high current there is a risk that motor will be thermally overloaded. This is true especially at low frequencies. With low frequencies the cooling effect of the motor is reduced and the capacity of the motor is reduced. If the motor is equipped with an external fan the load reduction on low speeds is small.

Motor thermal protection is based on a calculated model and it uses the output current of the drive to determine the load on the motor. When the power is turned on, the calculated model uses the heatsink temperature to determine the initial thermal stage for the motor. The calculated model assumes that the ambient temperature of the motor is 40°C.

Motor thermal protection can be adjusted by setting the parameters. The thermal current  $I_T$  specifies the load current above which the motor is overloaded. This current limit is a function of the output frequency. The curve for  $I_T$  is set with parameters 7.6, 7.7 and 7.9, refer to the figure 4.5-18. The parameters have their default values set according to the motor name plate data.

With the output current at  $I_T$  the thermal stage will reach the nominal value (100%). The thermal stage changes by the square of the current. With output current at 75% of  $I_T$  the thermal stage will reach a 56% value and with output current at 120% of  $I_T$  the thermal stage would reach a 144% value. The function will trip the device (refer par. 7. 5) if the thermal stage will reach a value of 105%. The

speed of change in thermal stage is determined with the time constant parameter 7. 8. The bigger the motor the longer it takes to reach the final temperature.

The thermal stage of the motor can be monitored through the display. Refer to the table for monitoring items. (User's Manual, table 7.3-1).



**CAUTION!** *The calculated model does not protect the motor if the airflow to the motor is reduced by blocked air intake grill.*

### 7. 5 **Motor thermal protection**

Operation:

- 0 = Not in use
- 1 = Warning
- 2 = Trip function

Tripping and warning will display the same message code. If the tripping is selected the drive will stop and activate the fault stage.

Deactivating the protection, setting parameter to 0, will reset the thermal stage of the motor to 0%.

### 7. 6 **Motor thermal protection, break point current**

The current can be set between 50.0—150.0% x  $I_{nMotor}$ .

This parameter sets the value for thermal current at frequencies above the break point on the thermal current curve. Refer to the figure 4.5-18.

The value is set in percentage which refers to the name plate data of the motor, parameter 1. 13, nominal current of the motor, not the drive's nominal output current.

The motor's nominal current is the current which the motor can withstand in direct on-line use without being overheated.

If parameter 1. 13 is adjusted, this parameter is automatically restored to the default value.

Setting this parameter (or parameter 1. 13) does not affect the maximum output current of the drive. Parameter 1. 7 alone determines the maximum output current of the drive.

### 7. 7 **Motor thermal protection, zero frequency current**

The current can be set between 10.0—150.0% x  $I_{nMotor}$ . This parameter sets the value for thermal current at zero frequency. Refer to the figure 4.5-18.

The default value is set assuming that there is no external fan cooling the motor. If an external fan is used this parameter can be set to 90% (or even higher).

The value is set in percentage value of the motor name plate data, parameter 1. 13, motor's nominal current, not the drive's nominal output current. Motor's nominal current is the current which the motor can stand in direct on-line use without being overheated.

If you change the parameter 1. 13 this parameter is automatically restored to the default value.

Setting this parameter (or parameter 1. 13) does not affect the maximum output current of the drive. Parameter 1. 7 alone determines the maximum output current of the drive.

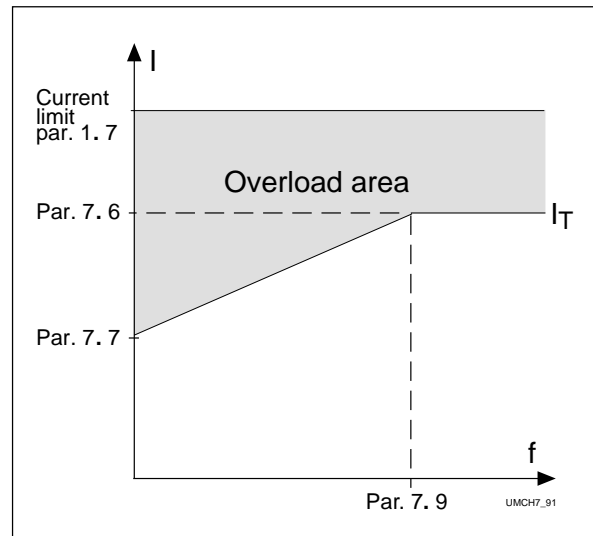

Figure 4.5-18 Motor thermal current  $I_T$  curve.

### 7.8 Motor thermal protection, time constant

This time can be set between 0.5—300 minutes.

This is the thermal time constant of the motor. The bigger the motor the bigger the time constant. The time constant is the time within the calculated thermal stage has reached 63% of its final value.

The motor thermal time is specific to the motor design and it varies between different motor manufacturers.

The default value for the time constant is calculated basing on the motor name plate data given with parameters 1. 12 and 1. 13. If either of these parameters is set, then this parameter is set to default value.

If the motor's  $t_6$  -time is known (given by the motor manufacturer) the time constant

parameter could be set based on  $t_6$  -time. As a rule of thumb, the motor thermal time constant in minutes equals to  $2xt_6$  ( $t_6$  in seconds is the time a motor can safely operate at six times the rated current). If the drive is in stop stage the time constant is internally increased to three times the set parameter value. The cooling in the stop stage is based on convection and the time constant is increased.

### 7.9 Motor thermal protection, break point frequency

This frequency can be set between 10—500 Hz.

This is the break point of thermal current curve. With frequencies above this point the thermal capacity of the motor is assumed to be constant. See Figure 4.5-18.

The default value is based on the motor's name plate data, parameter 1. 11. It is 35 Hz for a 50 Hz motor and 42 Hz for a 60 Hz motor. More generally it is 70% of the frequency at the field weakening point (parameter 6. 3). Changing either parameter 1. 11 or 6. 3 will restore this parameter to its default value.

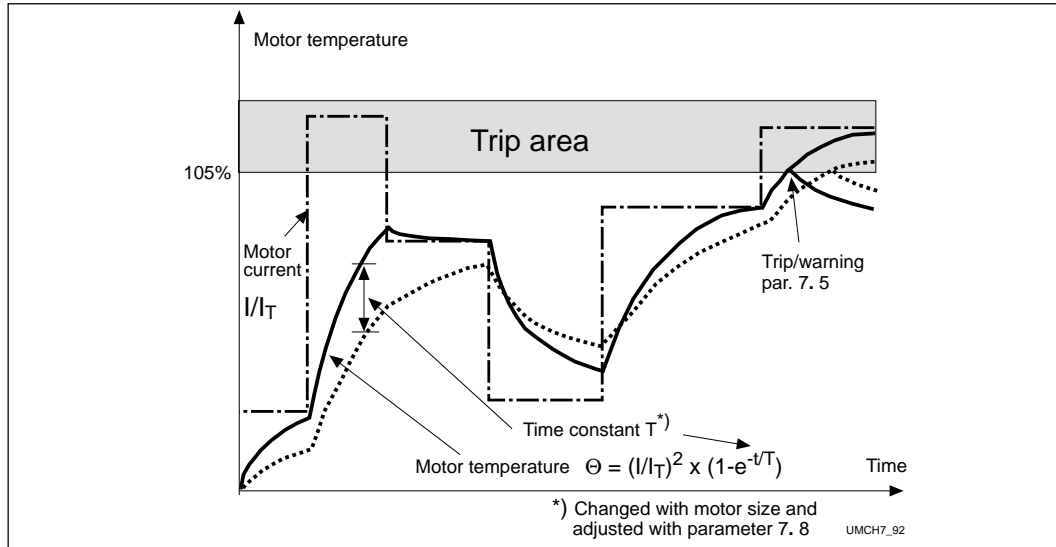

Figure 4.5-19 Calculating motor temperature.

**Parameters 7. 10— 7. 13, Stall protection**

**General**

Motor stall protection protects the motor from short time overload situations like a stalled shaft. The reaction time of stall protection can be set shorter than that of motor thermal protection. The stall state is defined with two parameters, 7.11. Stall Current and 7.13. Stall Frequency. If the current is higher than the set limit and output frequency is lower than the set limit the stall state is true. There is actually no real indication of the shaft rotation. Stall protection is a type of overcurrent protection.

**7. 10 Stall protection**

Operation:

- 0 = Not in use
- 1 = Warning
- 2 = Trip function

Tripping and warning will display the same message code. If tripping is set on, the drive will stop and activate the fault stage. Setting the parameter to 0 will deactivate the protection and will reset the stall time counter to zero.

**7. 11 Stall current limit**

The current can be set between 0.0—200% x  $I_{nMotor}$ .

In the stall stage the current has to be above this limit. See Figure 4.5-20. The value is set in percentage of the motor's name plate data, parameter 1.13, motor's nominal current. If parameter 1.13 is adjusted, this parameter is automatically restored to the default value.

Figure 4.5-20 Setting the stall characteristics.

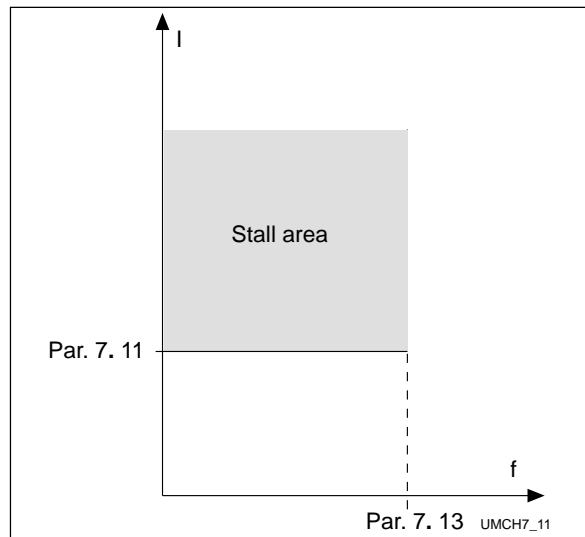

**7. 12 Stall time**

The time can be set between 2.0—120 s.  
 This is the maximum allowed time for a stall stage. There is an internal up/down counter to count the stall time. Refer to the figure 4.5-21.  
 If the stall time counter value goes above this limit the protection will cause a trip (refer to the parameter 7. 10).

**7. 13 Maximum stall frequency**

The frequency can be set between  $1-f_{max}$  (par. 1. 2).  
 In the stall state, the output frequency has to be smaller than this limit. Refer to the figure 4.5-20.

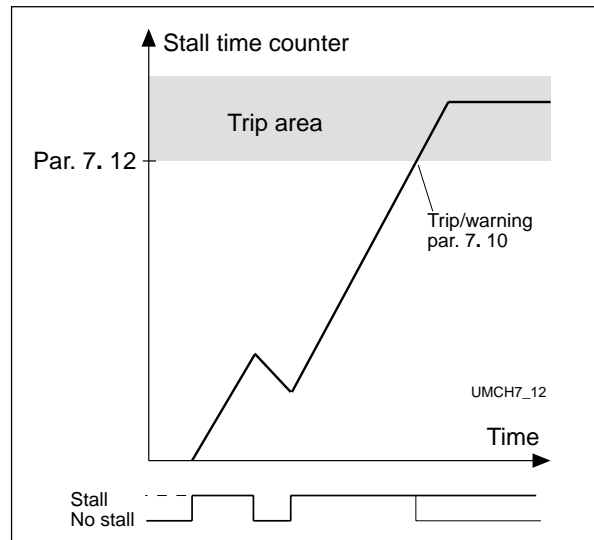

Figure 4.5-21 Counting the stall time.

**Parameters 7. 14— 7. 17, Underload protection General**

The purpose of motor underload protection is to ensure that there is load on the motor whilst the drive is running. If the motor loses its load there might be a problem in the process, e.g. broken belt or dry pump.

Motor underload protection can be adjusted by setting the underload curve with parameters 7. 15 and 7. 16. The underload curve is a squared curve set between zero frequency and the field weakening point. The protection is not active below 5Hz (the underload counter value is stopped). See Figure 4.5-22.

The torque values for setting the underload curve are set in percentage values which refer to the nominal torque of the motor. The motor's name plate data, parameter 1. 13, the motor's nominal current and the drive's nominal current  $I_{CT}$  are used to find the scaling ratio for the internal torque value. If other than a standard motor is used with the drive the accuracy of the torque calculation is decreased.

**7. 14 Underload protection**

- Operation:
- 0 = Not in use
  - 1 = Warning
  - 2 = Fault

Tripping and warning will give display indication with the same message code. If tripping is set active the drive will stop and activate the fault stage.

Deactivating the protection, by setting parameter to 0, will reset the underload time counter to zero.

**7. 15 Underload protection, field weakening area load**

Torque limit can be set between 20.0—150 % x  $T_{nMotor}$ .

This parameter gives the value for the minimum allowed torque when the output frequency is above the field weakening point.

See Figure 4.5-22.

If parameter 1. 13 is adjusted, this parameter is automatically restored to the default value.

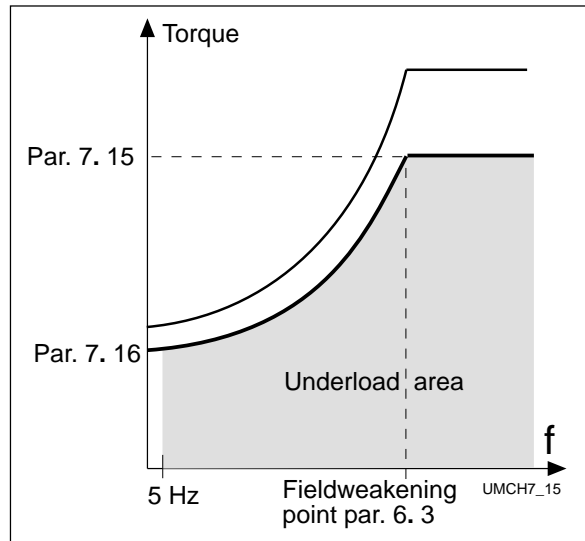

Figure 4.5-22 Setting of minimum load.

**7. 16 Underload protection, zero frequency load**

The torque limit can be set between 10.0—150 % x  $T_{nMotor}$ .

This parameter gives value for the minimum allowed torque with zero frequency. See Figure 4.5-22. If parameter 1. 13 is adjusted this parameter is automatically restored to the default value.

**7. 17 Underload time**

This time can be set between 2.0—600.0 s.

This is the maximum allowed time for an underload state. There is an internal up/down counter to accumulate the underload time. Refer to the figure 4.5-23.

If the underload counter value goes above this limit the protection will cause a trip (refer to the parameter 7. 14). If the drive is stopped the underload counter is reset to zero.

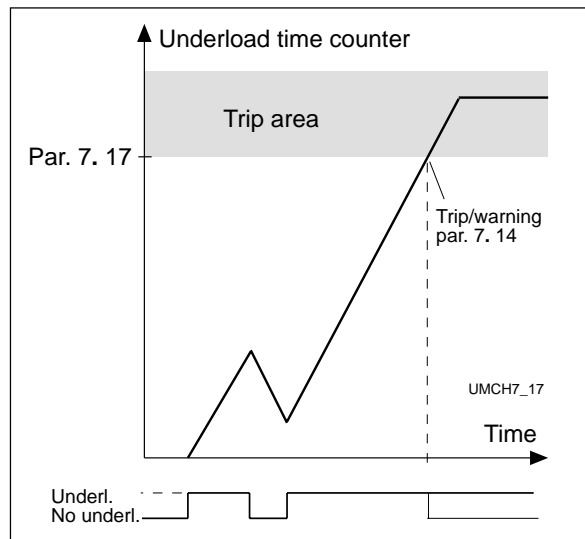

Figure 4.5-23 Counting the underload time.

**8. 1 Automatic restart: number of tries**

**8. 2 Automatic restart: trial time**

The Automatic restart function restarts the frequency converter after the faults selected with parameters 8. 4—8. 8. The Start function for Automatic restart is selected with parameter 8. 3. See figure 4.5-24.



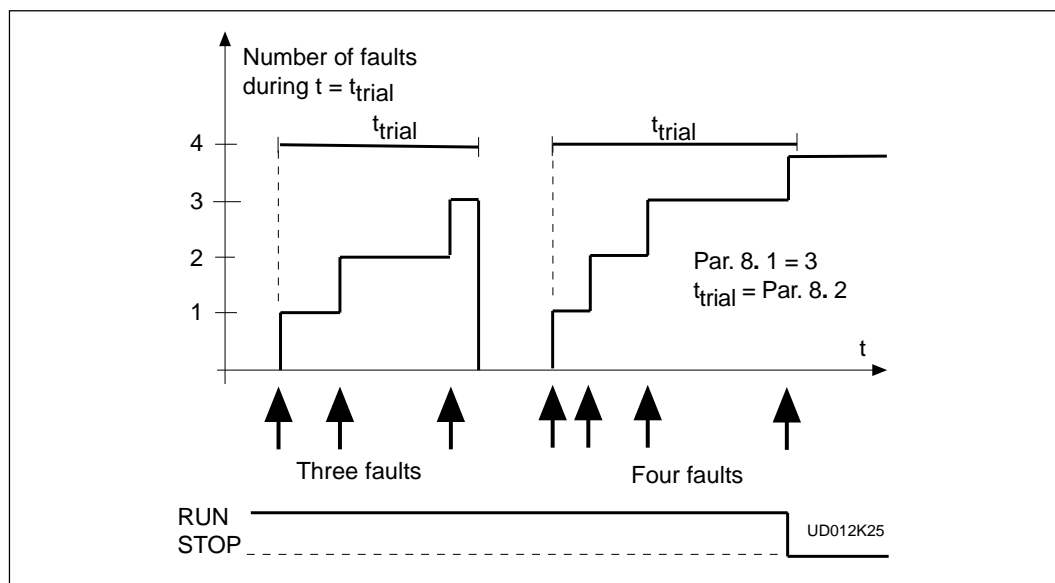

Figure 4.5-24 Automatic restart.

Parameter 8. 1 determines how many automatic restarts can be made during the trial time set by the parameter 8. 2.

The time counting starts from the first autorestart. If the number of restarts does not exceed the value of the parameter 8. 1 during the trial time, the counting is cleared after the time is elapsed and next fault starts the counting again.

### 8. 3 Automatic restart, start function

The parameter defines the start mode:

- 0 = Start with ramp
- 1 = Flying start, see parameter 4. 6.

### 8. 4 Automatic restart after undervoltage trip

- 0 = No automatic restart after undervoltage trip
- 1 = Automatic restart after undervoltage fault condition returns to the normal condition (DC-link voltage returns to the normal level)

### 8. 5 Automatic restart after overvoltage trip

- 0 = No automatic restart after overvoltage trip
- 1 = Automatic restart after overvoltage fault condition returns to the normal condition (DC-link voltage returns to the normal level)

### 8. 6 Automatic restart after overcurrent trip

- 0 = No automatic restart after overcurrent trip
- 1 = Automatic restart after overcurrent faults

### 8. 7 Automatic restart after reference fault trip

- 0 = No automatic restart after reference fault trip
- 1 = Automatic restart after analog current reference signal (4—20 mA) returns to the normal level ( $\geq 4$  mA)

### 8. 8 Automatic restart after over-/undertemperature fault trip

- 0 = No automatic restart after temperature fault trip
- 1 = Automatic restart after heatsink temperature has returned to its normal level between  $-10^{\circ}\text{C}$ — $+75^{\circ}\text{C}$ .

#### 4.6 Panel reference

The PI-control application has an extra reference (r2) for PI-controller on the panel's reference menu. See table 4.6-1.

Reference number	Reference name	Range	Step	Function
r1	Frequency reference	$f_{\min}—f_{\max}$	0.01 Hz	Reference for panel control and I/O terminal Source B reference.
r2	PI-controller reference	0—100%	0.1%	Reference for PI-controller

#### 4.7 Monitoring data

The PI-control application has extra items for monitoring. See table 4.7-1

Number	Data name	Unit	Description
n 1	Output frequency	Hz	Frequency to the motor
n 2	Motor speed	rpm	Calculated motor speed
n 3	Motor current	A	Measured motor current
n 4	Motor torque	%	Calculated actual torque/nominal torque of the unit
n 5	Motor power	%	Calculated actual power/nominal power of the unit
n 6	Motor voltage	V	Calculated motor voltage
n 7	DC-link voltage	V	Measured DC-link voltage
n 8	Temperature	°C	Temperature of the heat sink
n 9	Operating day counter	DD.dd	Operating days <sup>1)</sup> , not resettable
n 10	Operating hours, "trip counter"	HH.hh	Operating hours <sup>2)</sup> , can be reset with programmable button #3
n 11	MW-hours	MWh	Total MW-hours, not resettable
n 12	MW-hours, "trip counter"	MWh	MW-hours, can be reset with programmable button #4
n 13	Voltage/analogue input	V	Voltage of the terminal $U_{in+}$ (term. #2)
n 14	Current/analogue input	mA	Current of terminals $I_{in+}$ and $I_{in-}$ (term. #4, #5)
n 15	Digital input status, gr. A		
n 16	Digital input status, gr. B		
n 17	Digital and relay output status		
n 18	Control programme		Version number of the control software
n 19	Unit nominal power	kW	Shows the power size of the unit
n 20	PI-controller reference	%	Percent of the maximum reference
n 21	PI-controller actual value	%	Percent of the maximum actual value
n 22	PI-controller error value	%	Percent of the maximum error value
n 23	PI-controller output	Hz	
n 24	Motor temperature rise	%	100%= temperature of motor has risen to nominal

<sup>1)</sup> DD = full days, dd = desimal part of a day

<sup>2)</sup> HH = full hours, hh = desimal part of an hour

Table 4.7-1 Monitored items.

**MULTI-PURPOSE CONTROL APPLICATION**

(par. 0.1 = 6)

**CONTENTS**

<b>5 Multi-purpose Control Application .....</b>	<b>5-1</b>
5.1 General .....	5-2
5.2 Control I/O .....	5-2
5.3 Control signal logic .....	5-3
5.4 Parameters Group 1 .....	5-4
5.4.1 Parameter table .....	5-4
5.4.2 Description of Group1 par. ....	5-5
5.5 Special parameters, Groups 2-8 .....	5-9
5.5.1 Parameter tables .....	5-9
5.5.2 Description of Group 2 par. ....	5-16

## 5 Multi-purpose Control Application

### 5.1 General

In the Multi-purpose control application the frequency reference can be selected from the analogue inputs, the joystick control, the motor potentiometer and a mathematical function of the analogue inputs. Multi-step speeds and jogging speed can also be

selected if digital inputs are programmed for these functions.

Digital inputs DIA1 and DIA2 are reserved for Start/stop logic. Digital inputs DIA3—DIB6 are programmable for multi-step speed select, jogging speed select, motor potentiometer, external fault, ramp time select, ramp prohibit, fault reset and DC-brake command function. All outputs are freely programmable.

### 5.2 Control I/O

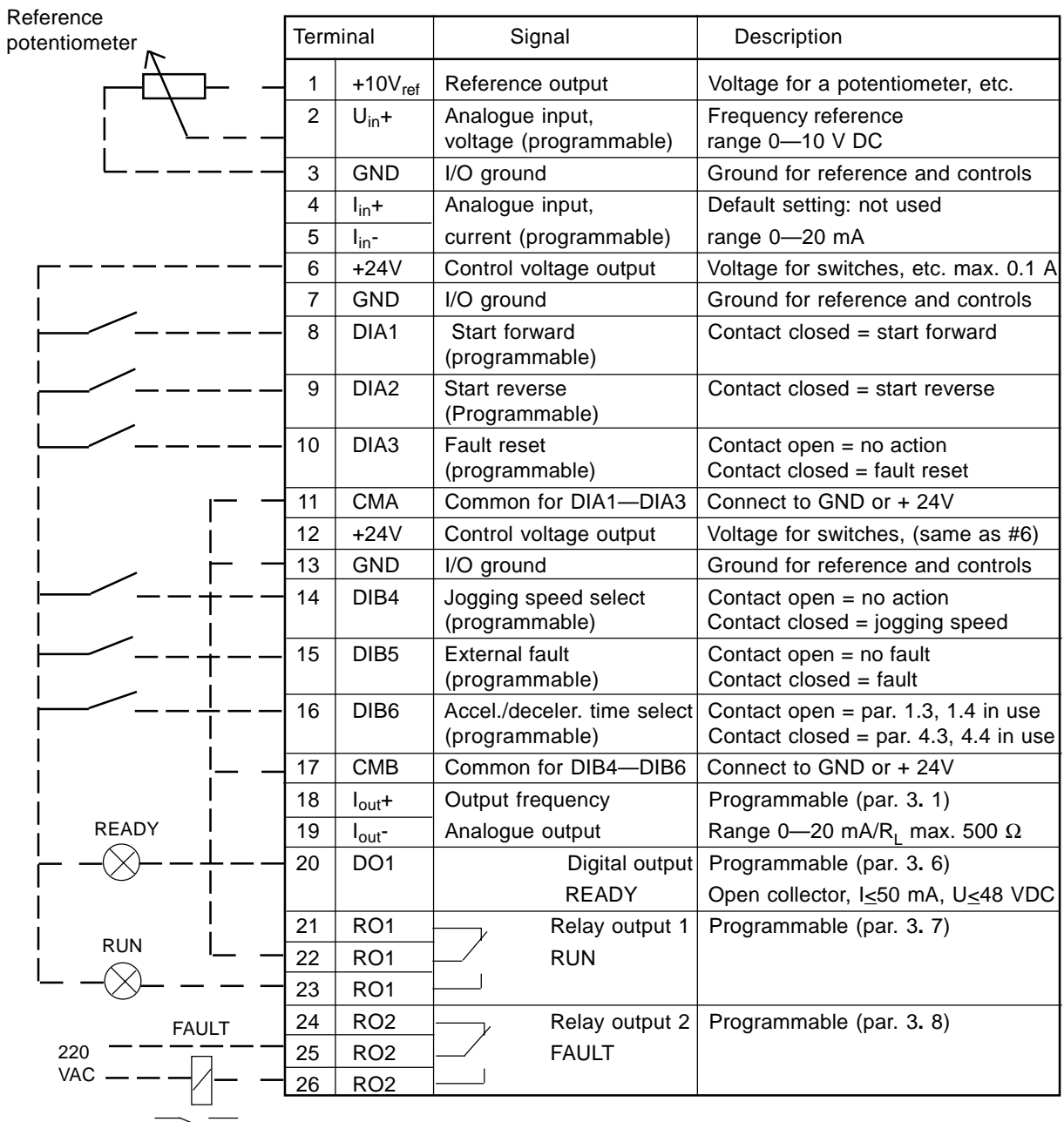

Figure 5.2-1 Default I/O configuration and connection example of the Multi-purpose Control Application.

5

### 5.3 Control signal logic

In figure 5.3-1 the logic of I/O-control signals and push button signals from the panel is presented.

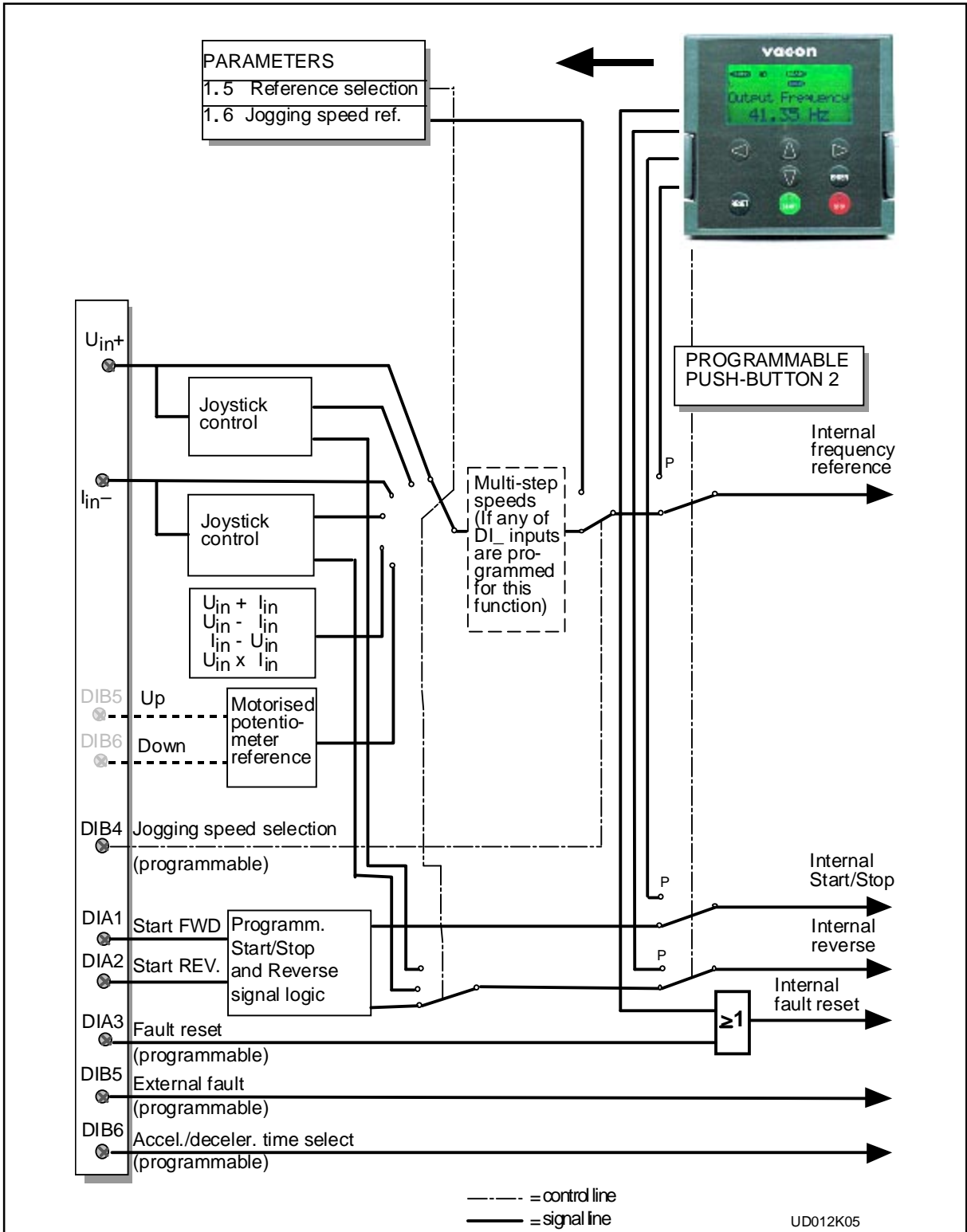



Figure 5.3-1 Control signal logic of the Multipurpose Control Application. Switch positions are shown according to the factory settings.

## 5.4 Basic parameters, Group 1

## 5.4.1 Parameter table

Code	Parameter	Range	Step	Default	Custom	Description	Page														
1. 1	Minimum frequency	0— $f_{max}$	1 Hz	0 Hz			5-5														
1. 2	Maximum frequency	$f_{min}$ -120/500Hz	1 Hz	50 Hz	*)		5-5														
1. 3	Acceleration time 1	0,1—3000,0 s	0,1 s	3,0 s		Time from $f_{min}$ (1. 1) to $f_{max}$ (1. 2)	5-5														
1. 4	Deceleration time 1	0,1—3000,0 s	0,1 s	3,0 s		Time from $f_{max}$ (1. 2) to $f_{min}$ (1. 1)	5-5														
1. 5	Reference selection	0—9	1	0		<table border="1"> <tr> <td>0 = <math>U_{in}</math></td> <td>3 = <math>U_{in} - I_{in}</math></td> </tr> <tr> <td>1 = <math>I_{in}</math></td> <td>4 = <math>I_{in} - U_{in}</math></td> </tr> <tr> <td>2 = <math>U_{in} + I_{in}</math></td> <td>5 = <math>U_{in} * I_{in}</math></td> </tr> <tr> <td colspan="2">6 = <math>U_{in}</math> joystick control</td> </tr> <tr> <td colspan="2">7 = <math>I_{in}</math> joystick control</td> </tr> <tr> <td colspan="2">8 = Signal from internal motor pot.</td> </tr> <tr> <td colspan="2">9 = Signal from internal motor pot. reset if Vacon unit is stopped</td> </tr> </table>	0 = $U_{in}$	3 = $U_{in} - I_{in}$	1 = $I_{in}$	4 = $I_{in} - U_{in}$	2 = $U_{in} + I_{in}$	5 = $U_{in} * I_{in}$	6 = $U_{in}$ joystick control		7 = $I_{in}$ joystick control		8 = Signal from internal motor pot.		9 = Signal from internal motor pot. reset if Vacon unit is stopped		5-5
0 = $U_{in}$	3 = $U_{in} - I_{in}$																				
1 = $I_{in}$	4 = $I_{in} - U_{in}$																				
2 = $U_{in} + I_{in}$	5 = $U_{in} * I_{in}$																				
6 = $U_{in}$ joystick control																					
7 = $I_{in}$ joystick control																					
8 = Signal from internal motor pot.																					
9 = Signal from internal motor pot. reset if Vacon unit is stopped																					
1. 6	Jogging speed reference	$f_{min}$ — $f_{max}$ (1. 1) (1. 2)	0,1 Hz	5,0 Hz			5-6														
1. 7	Current limit	0,1—2,5 x $I_{nCT}$	0,1 A	1,5 x $I_{nCT}$		***Output curr. limit [A] of the unit	5-6														
1. 8	U/f ratio selection	0—2	1	0		0 = Linear 1 = Squared 2 = Programmable U/f ratio	5-6														
1. 9	U/f optimisation	0—1	1	0		0 = None 1 = Automatic torque boost	5-8														
1. 10	Nominal voltage of the motor	180—690 V	1 V	230 V 400 V 500 V 690 V		Vacon range CX/CXL/CXS2 Vacon range CX/CXL/CXS4 Vacon range CX/CXL/CXS5 Vacon range CX6	5-8														
1. 11	Nominal frequency of the motor	30—500 Hz	1 Hz	50 Hz		$f_n$ from the rating plate of the motor	5-8														
1. 12	Nominal speed of the motor	300—20000 rpm	1 rpm	1420 rpm **)		$n_n$ from the rating plate of the motor	5-8														
1. 13	Nominal current of the motor	2,5 x $I_{nCT}$	0,1 A	$I_{nCT}$		$I_n$ from the rating plate of the motor	5-8														
1. 14	Supply voltage	208—240 380—440 380—500 525—690		230 V 400 V 500 V 690 V		Vacon range CX/CXL/CXS2 Vacon range CX/CXL/CXS4 Vacon range CX/CXL/CXS5 Vacon range CX6	5-8														
1. 15	Parameter conceal	0—1	1	0		Visibility of the parameters: 0 = All parametergroups visible 1 = Only group 1 is visible	5-8														
1. 16	Parameter value lock	0—1	1	0		Disables parameter changes: 0 = Changes enabled 1 = Changes disabled	5-8														

**Note!**  = Parameter value can be changed only when the frequency converter is stopped.

\*) If 1. 2 > motor synchr. speed, check suitability for motor and drive system.  
Selecting 120/500 Hz range see page 5-5.

\*\*\*) Default value for a four pole motor and a nominal size frequency converter.

\*\*\*\*) Up to M10. Bigger classes case by case.

Table 5.4-1 Group 1 basic parameters.

## 5.4.2 Description of Group 1 parameters

### 1. 1, 1. 2 *Minimum / maximum frequency*

Defines frequency limits of the frequency converter.

The default maximum value for parameters 1. 1 and 1. 2 is 120 Hz. By setting 1. 2 = 120 Hz when the device is stopped (RUN indicator not lit) parameters 1. 1 and 1. 2 is changed to 500 Hz. At the same time the panel reference resolution is changed from 0.01 Hz to 0.1 Hz.

Changing the max. value from 500 Hz to 120 Hz is done by setting parameter 1. 2 = 119 Hz when the device is stopped.

### 1. 3, 1. 4 *Acceleration time 1, deceleration time 1:*

These limits correspond to the time required for the output frequency to accelerate from the set minimum frequency (par. 1. 1) to the set maximum frequency (par. 1. 2).

### 1. 5 *Reference selection*

- 0** Analogue voltage reference from terminals 2—3, e.g. a potentiometer
- 1** Analogue current reference from terminals 4—5, e.g. a transducer.
- 2** Reference is the formed by adding the values of the analogue inputs
- 3** Reference is the formed by subtracting the voltage input ( $U_{in}$ ) value from the current input ( $I_{in}$ ) value.
- 4** Reference is the formed by subtracting the current input ( $I_{in}$ ) value from the voltage input ( $U_{in}$ ) value.
- 5** Reference is the formed by multiplying the values of the analogue inputs
- 6** Joystick control from the voltage input ( $U_{in}$ ).

Signal range	Max reverse speed	Direction change	Max forward speed
0—10 V	0 V	5 V	+10 V
Custom	Par. 2. 7 x 10V	In the middle of custom range	Par. 2. 8 x 10 V
-10 V—+10 V	-10 V	0 V	+10 V

**Warning!** Use only -10V—+10 V signal range. If a custom or 0—10 V signal range is used, the drive starts to run at the max. reverse speed if the reference signal is lost.



### 7 Joystick control from the current input ( $I_{in}$ ).

Signal range	Max reverse speed	Direction change	Max forward speed
0—20 mA	0 mA	10 mA	20 mA
Custom	Par. 2. 13 x 20 mA	In the middle of custom range	Par. 2. 14 x 20 mA
4—20 mA	4 mA	12 mA	20 mA

**Warning!** Use only 4—20 mA signal range. If custom or 0—20 mA signal range is used, the drive will run at max. reverse speed if the control signal is lost. Set the reference fault (par. 7. 2) active when the 4—20 mA range is used, then the drive will stop at the reference fault if the reference signal is lost.



**Note!** When joystick control is used, the direction control is generated from the joystick reference signal. See figure 5.4-1.

Analogue input scaling, parameters 2. 16—2. 19 are not used when the joystick control is used.

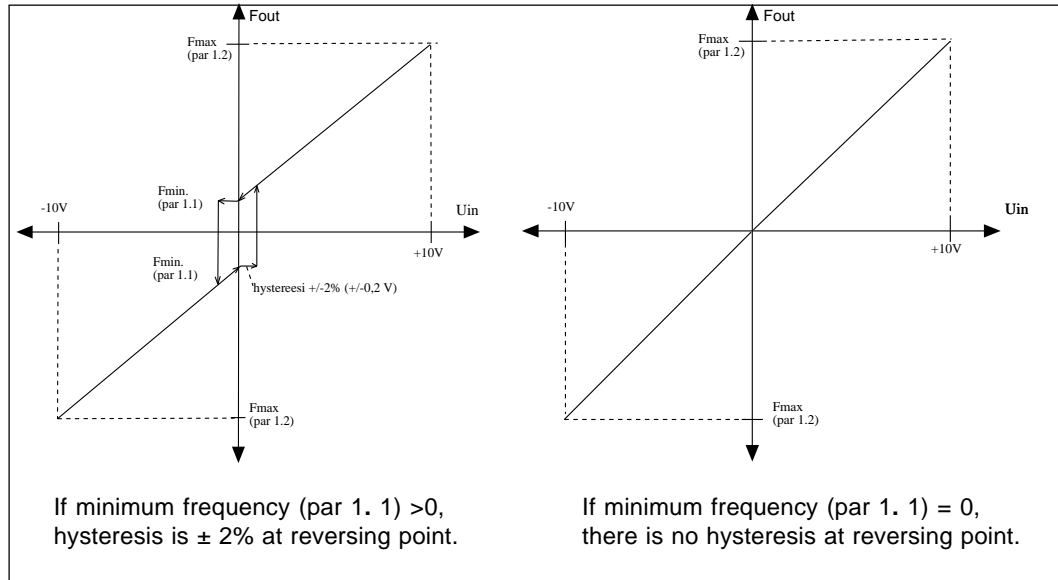

Fig. 5.4-1 Joystick control  $U_{in}$  signal  $-10\text{ V}$ — $+10\text{ V}$ .

- 8 Reference value is changed with digital input signals DIA5 and DIA6.
  - switch in DIA5 closed = frequency reference increases
  - switch in DIA6 closed = frequency reference decreases
 Speed of the reference change can be set with parameter 2. 22.
- 9 Same as setting 8 but the reference value is set to the minimum frequency (par. 1. 1) each time the frequency converter is stopped. When the value of the parameter 1. 5 is set to 8 or 9, value of the parameters 2. 4 and 2. 5 are automatically set to 11.

### 1. 6 Jogging speed reference

Parameter value defines the jogging speed selected with the digital input

### 1. 7 Current limit

This parameter determines the maximum motor current that the frequency converter can give momentarily.

### 1. 8 U/f ratio selection

Linear: The voltage of the motor changes linearly with the frequency in the constant flux area from 0 Hz to the field weakening point (par. 6. 3) where the nominal voltage is also supplied to the motor. See figure 5.4.-2. Linear U/f ratio should be used in constant torque applications.

0

**This default setting should be used if there is no special demand for another setting.**



**Squared:** The voltage of the motor changes following a squared curve form with the frequency in the area from 0 Hz to the field weakening point (par. 6. 3) where the nominal voltage is also supplied to the motor. See figure 5.4.-2.

The motor runs undermagnetised below the field weakening point and produces less torque and electromechanical noise. Squared U/f ratio can be used in applications where torque demand of the load is proportional to the square of the speed, e.g. in centrifugal fans and pumps.

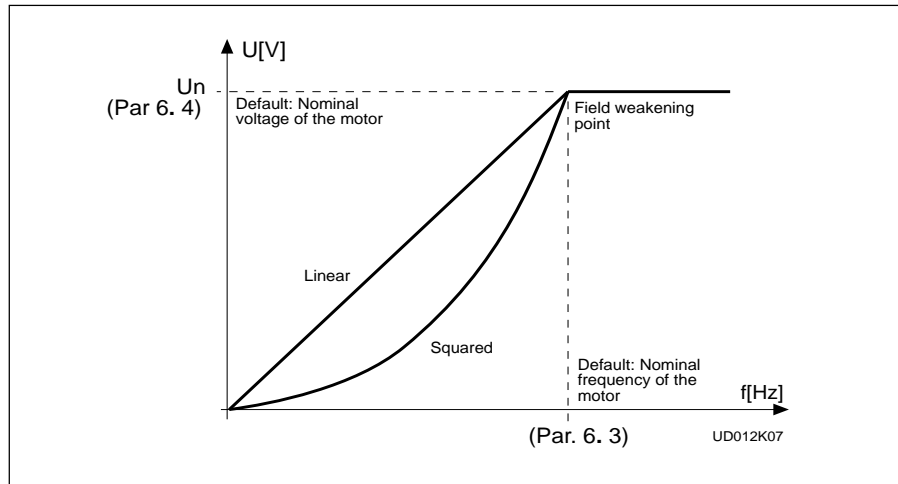

Figure 5.4.-2 Linear and squared U/f curves.

**Programm. U/f curve** The U/f curve can be programmed with three different points. The parameters for programming are explained in Chapter 5.5.2. Programmable U/f curve can be used if the other settings do not satisfy the needs of the application. See figure 5.4.-3.

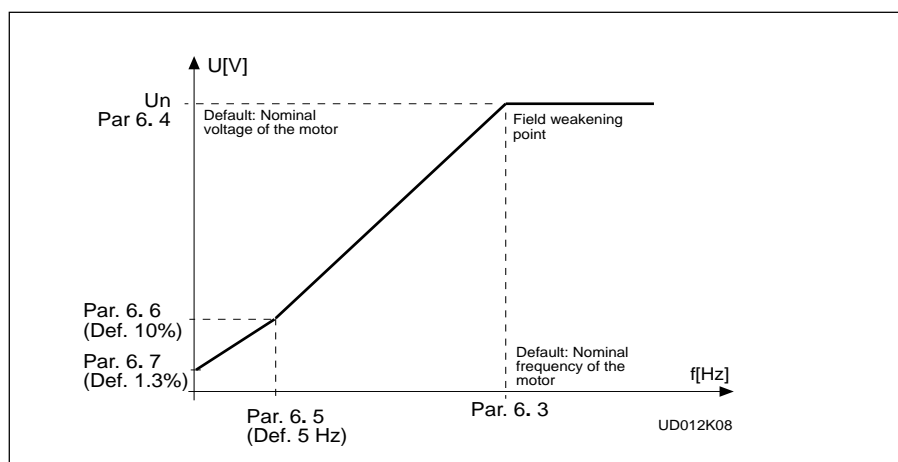

Figure 5.4-3 Programmable U/f curve.

**1. 9 U/f optimisation**

Automatic torque boost The voltage to the motor changes automatically which makes the motor produce sufficient torque to start and run at low frequencies. The voltage increase depends on motor type and power.

Automatic torque boost can be used in applications where starting torque due to starting friction is high, e.g. in conveyors.

**NOTE!**

*In high torque - low speed applications - the motor is likely to overheat.*

*If the motor has to run a prolonged time under these conditions, special attention must be paid to cooling the motor. Use external cooling for the motor if the temperature tends to rise too high.*

**1. 10 Nominal voltage of the motor**

Find this value  $U_n$  on the rating plate of the motor.

This parameter sets the Voltage at the field weakening point, parameter 6. 4, to  $100\% \times U_{n\text{motor}}$

**1. 11 Nominal frequency of the motor**

Find this value  $f_n$  on the rating plate of the motor.

This parameter sets the field weakening point, parameter 6. 3, to the same value.

**1. 12 Nominal speed of the motor**

Find this value  $n_n$  on the rating plate of the motor.

**1. 13 Nominal current of the motor**

Find the value  $I_n$  on the rating plate of the motor.

The internal motor protection function uses this value as a reference value.

**1. 14 Supply voltage**

Set the parameter value according to the nominal voltage of the supply.

Values are predefined for CX/CXL/CXS2, CX/CXL/CXS4, CX/CXL/CXS5 and CX6 ranges, see table 5.4-1.

**1. 15 Parameter conceal**

Defines which parameter groups are available:

0 = all parameter groups are visible

1 = only group 1 is visible

**1. 16 Parameter value lock**

Determines the access to the changes of the parameter values:

0 = parameter value changes enabled





1 = parameter value changes disabled

To further adjust the functions of the Multipurpose application, see Chapter 5.5 to set up parameters of Groups 2—8.

5.5 Special parameters, Groups 2—8

5.5.1 Parameter tables

Group 2, Input signal parameters

Code	Parameter	Range	Step	Default	Custom	Description	Page
2. 1	Start/Stop logic selection 	0—3	1	0		DIA1	5-16
						0 = Start forward 1 = Start/Stop 2 = Start/Stop 3 = Start pulse	
2. 2	DIA3 function (terminal 10) 	0—9	1	7		0 = Not used 1 = Ext. fault, closing contact 2 = External fault, opening contact 3 = Run enable 4 = Acc./dec. time selection 5 = Reverse 6 = Jogging speed 7 = Fault reset 8 = Acc./dec. operation prohibit 9 = DC-braking command	5-17
2. 3	DIB4 function (terminal 14) 	0—10	1	6		0 = Not used 1 = Ext. fault, closing contact 2 = External fault, opening contact 3 = Run enable 4 = Acc./dec. time selection 5 = Reverse 6 = Jogging speed 7 = Fault reset 8 = Acc./dec. operation prohibit 9 = DC-braking command 10 = Multi-Step speed select 1	5-18
2. 4	DIB5 function (terminal 15) 	0—11	1	1		0 = Not used 1 = Ext. fault, closing contact 2 = External fault, opening contact 3 = Run enable 4 = Acc./dec. time selection 5 = Reverse 6 = Jogging speed 7 = Fault reset 8 = Acc./dec. operation prohibit 9 = DC-braking command 10 = Multi-Step speed select 2 11 = Motorised pot. speed up	5-18
2. 5	DIB6 function (terminal 16) 	0—11	1	4		0 = Not used 1 = Ext. fault, closing contact 2 = External fault, opening contact 3 = Run enable 4 = Acc./dec. time selection 5 = Reverse 6 = Jogging speed 7 = Fault reset 8 = Acc./dec. operation prohibit 9 = DC-braking command 10 = Multi-Step speed select 3 11 = Motorised pot. speed down	5-18
2. 6	U <sub>in</sub> signal range	0—2	1	0		0 = 0—10 V 1 = Custom setting range 2 = -10—+10 V (can be used only with Joystick control)	5-19



**Note!**  = Parameter value can be changed only when the frequency converter is stopped. (Continues)

Code	Parameter	Range	Step	Default	Custom	Description	Page
2. 7	U <sub>in</sub> custom setting min.	0,00-100,00%	0,01%	0,00%			5-19
2. 8	U <sub>in</sub> custom setting max.	0,00-100,00%	0,01%	100,00%			5-19
2. 9	U <sub>in</sub> signal inversion	0—1	1	0		0 = Not inverted 1 = Inverted	5-19
2. 10	U <sub>in</sub> signal filter time	0,00 —10,00 s	0,01 s	0,10 s		0 = No filtering	5-19
2. 11	I <sub>in</sub> signal range	0—2	1	0		0 = 0—20 mA 1 = 4—20 mA 2 = Custom setting range	5-19
2. 12	I <sub>in</sub> custom setting minim.	0,00-100,00%	0,01%	0,00%			5-20
2. 13	I <sub>in</sub> custom setting maxim.	0,00-100,00%	0,01%	100,00%			5-20
2. 14	I <sub>in</sub> signal inversion	0—1	1	0		0 = Not inverted 1 = Inverted	5-20
2. 15	I <sub>in</sub> signal filter time	0,01 —10,00 s	0,01 s	0,10 s		0 = No filtering	5-20
2. 16	U <sub>in</sub> minimum scaling	-320,00%— +320,00 %	0,01	0,00%		0% = no minimum scaling	5-20
2. 17	U <sub>in</sub> maximum scaling	-320,00%— +320,00 %	0,01	100,00%		100% = no maximum scaling	5-20
2. 18	I <sub>in</sub> minimum scaling	-320,00%— +320,00 %	0,01	0,00%		0% = no minimum scaling	5-20
2. 19	I <sub>in</sub> maximum scaling	-320,00%— +320,00 %	0,01	100,00%		100% = no maximum scaling	5-20
2. 20	Free analogue input, signal selection	0—2	1	0		0 = Not use 1 = U <sub>in</sub> (analogue voltage input) 2 = I <sub>in</sub> (analogue current input)	5-21
2. 21	Free analogue input, function	0—4	1	0		0 = No function 1 = Reduces current limit (par. 1.7) 2 = Reduces DC-braking current 3 = Reduces acc. and decel. times 4 = Reduces torque supervis. limit	5-21
2. 22	Motorised potentiometer ramp time	0,1—2000,0 Hz/s	0,1 Hz/s	10,0 Hz/s			5-22

### Group 3, Output and supervision parameters

Code	Parameter	Range	Step	Default	Custom	Description	Page
3. 1	Analogue output function 	0—7	1	1		0 = Not used      Scale 100% 1 = O/P frequency (0—f <sub>max</sub> ) 2 = Motor speed (0—max. speed) 3 = O/P current (0—2.0 x I <sub>nCT</sub> ) 4 = Motor torque (0—2 x T <sub>nMot</sub> ) 5 = Motor power (0—2 x P <sub>nMot</sub> ) 6 = Motor voltage (0—100% x U <sub>nMot</sub> ) 7 = DC-link volt. (0—1000 V)	5-23
3. 2	Analogue output filter time	0,00-10,00s	0,01 s	1,00 s			5-23
3. 3	Analogue output inversion	0—1	1	0		0 = Not inverted 1 = Inverted	5-23
3. 4	Analogue output minimum	0—1	1	0		0 = 0 mA 1 = 4 mA	5-23
3. 5	Analogue output scale	10—1000%	1%	100%			5-23

**Note!**  = Parameter value can be changed only when the frequency converter is stopped. (Continues)

Code	Parameter	Range	Step	Default	Custom	Description	Page
3. 6	Digital output function 	0—21	1	1		0 = Not used 1 = Ready 2 = Run 3 = Fault 4 = Fault inverted 5 = Vacon overheat warning 6 = External fault or warning 7 = Reference fault or warning 8 = Warning 9 = Reversed 10 = Jogging speed selected 11 = At speed 12 = Motor regulator activated 13 = Output freq. limit superv. 1 14 = Output freq. limit superv. 2 15 = Torque limit supervision 16 = Reference limit supervision 17 = External brake control 18 = Control from I/O terminals 19 = Frequency converter temperature limit supervision 20 = Unrequested rotation direction 21 = External brake control inverted	5-24
3. 7	Relay output 1 function 	0—21	1	2		As parameter 3. 6	5-24
3. 8	Relay output 2 function 	0—21	1	3		As parameter 3. 6	5-24
3. 9	Output freq. limit 1 supervision function	0—2	1	0		0 = No 1 = Low limit 2 = High limit	5-24
3. 10	Output freq. limit 1 supervision value	0,0— $f_{max}$ (par. 1. 2)	0,1 Hz	0,0 Hz			5-24
3. 11	Output freq. limit 2 supervision function	0—2	1	0		0 = No 1 = Low limit 2 = High limit	5-24
3. 12	Output freq. limit 2 supervision value	0,0— $f_{max}$ (par. 1. 2)	0,1 Hz	0,0 Hz			5-24
3. 13	Torque limit supervision function	0—2	1	0		0 = No 1 = Low limit 2 = High limit	5-25
3. 14	Torque limit supervision value	-200,0—200,0% $\times T_{nCX}$	0,1%	100,0%			5-25
3. 15	Reference limit supervision function	0—2	1	0		0 = No 1 = Low limit 2 = High limit	5-25
3. 16	Reference limit supervision value	0,0— $f_{max}$ (par. 1. 2)	0,1 Hz	0,0 Hz			5-25
3. 17	Extern. brake Off-delay	0,0—100,0 s	0,1 s	0,5 s			5-25
3. 18	Extern. brake On-delay	0,0—100,0 s	0,1 s	1,5 s			5-25
3. 19	Frequency converter temperature limit supervision function	0—2	1	0		0 = No 1 = Low limit 2 = High limit	5-25
3. 20	Frequency converter temperature limit value	-10—+75°C	1°C	+40°C			5-25

**Note!**  = Parameter value can be changed only when the frequency converter is stopped. (Continues)

Code	Parameter	Range	Step	Default	Custom	Description	Page
3. 21	I/O-expander board (opt.) analogue output content	0—7	1	3		See parameter 3. 1	5-23
3. 22	I/O-expander board (opt.) analogue output filter time	0,00—10,00 s	0,01	1,00 s		See parameter 3. 2	5-23
3. 23	I/O-expander board (opt.) analogue output inversion	0—1	1	0		See parameter 3. 3	5-23
3. 24	I/O-expander board (opt.) analogue output minimum	0—1	1	0		See parameter 3. 4	5-23
3. 25	I/O-expander board (opt.) analogue output scale	10—1000%	1	100%		See parameter 3. 5	5-23

### Group 4, Drive control parameters







Code	Parameter	Range	Step	Default	Custom	Description	Page
4. 1	Acc./Dec. ramp 1 shape	0,0—10,0 s	0,1 s	0,0 s		0 = Linear >0 = S-curve acc./dec. time	5-26
4. 2	Acc./Dec. ramp 2 shape	0,0—10,0 s	0,1 s	0,0 s		0 = Linear >0 = S-curve acc./dec. time	5-26
4. 3	Acceleration time 2	0,1—3000,0 s	0,1 s	10,0 s			5-27
4. 4	Deceleration time 2	0,1—3000,0 s	0,1 s	10,0 s			5-27
4. 5	Brake chopper 	0—2	1	0		0 = Brake chopper not in use 1 = Brake chopper in use 2 = External brake chopper	5-27
4. 6	Start function	0—1	1	0		0 = Ramp 1 = Flying start	5-27
4. 7	Stop function	0—1	1	0		0 = Coasting 1 = Ramp	5-27
4. 8	DC-braking current	0,15—1,5 $\times I_{nCT}$ (A)	0,1 A	0,5 $\times I_{nCT}$			5-27
4. 9	DC-braking time at Stop	0,00-250,00s	0,01 s	0,00 s		0 = DC-brake is off at Stop	5-28
4. 10	Execute frequency of DC-brake during ramp Stop	0,1—10,0 Hz	0,1 Hz	1,5 Hz			5-29
4. 11	DC-brake time at Start	0,00-25,00 s	0,01 s	0,00 s		0 = DC-brake is off at Start	5-29
4. 12	Multi-step speed reference 1	$f_{min}$ — $f_{max}$ (1. 1) (1. 2)	0,1 Hz	10,0 Hz			5-29
4. 13	Multi-step speed reference 2	$f_{min}$ — $f_{max}$ (1. 1) (1. 2)	0,1 Hz	15,0 Hz			5-29
4. 14	Multi-step speed reference 3	$f_{min}$ — $f_{max}$ (1. 1) (1. 2)	0,1 Hz	20,0 Hz			5-29
4. 15	Multi-step speed reference 4	$f_{min}$ — $f_{max}$ (1. 1) (1. 2)	0,1 Hz	25,0 Hz			5-29
4. 16	Multi-step speed reference 5	$f_{min}$ — $f_{max}$ (1. 1) (1. 2)	0,1 Hz	30,0 Hz			5-29
4. 17	Multi-step speed reference 6	$f_{min}$ — $f_{max}$ (1. 1) (1. 2)	0,1 Hz	40,0 Hz			5-29
4. 18	Multi-step speed reference 7	$f_{min}$ — $f_{max}$ (1. 1) (1. 2)	0,1 Hz	50,0 Hz			5-29

**Note!**  = Parameter value can be changed only when the frequency converter is stopped.

**Group 5, Prohibit frequency parameters**

Code	Parameter	Range	Step	Default	Custom	Description	Page
5.1	Prohibit frequency range 1 low limit	$f_{\min}$ — par. 5.2	0,1 Hz	0,0 Hz			5-29
5.2	Prohibit frequency range 1 high limit	$f_{\min}$ — $f_{\max}$ (1.1) (1.2)	0,1 Hz	0,0 Hz		0 = Prohibit range 1 is off	5-29
5.3	Prohibit frequency range 2 low limit	$f_{\min}$ — par. 5.4	0,1 Hz	0,0 Hz			5-29
5.4	Prohibit frequency range 2 high limit	$f_{\min}$ — $f_{\max}$ (1.1) (1.2)	0,1 Hz	0,0 Hz		0 = Prohibit range 2 is off	5-29
5.5	Prohibit frequency range 3 low limit	$f_{\min}$ — par. 5.6	0,1 Hz	0,0 Hz			5-29
5.6	Prohibit frequency range 3 high limit	$f_{\min}$ — $f_{\max}$ (1.1) (1.2)	0,1 Hz	0,0 Hz		0 = Prohibit range 3 is off	5-29

**Group 6, Motor control parameters**

Code	Parameter	Range	Step	Default	Custom	Description	Page
6.1	Motor control mode 	0—1	1	0		0 = Frequency control 1 = Speed control	5-29
6.2	Switching frequency	1,0—16,0 kHz	0,1 kHz	10/3,6 kHz		Dependant on kW	5-30
6.3	Field weakening point 	30—500 Hz	1 Hz	Param. 1.11			5-30
6.4	Voltage at field weakening point 	15—200% $\times U_{nmot}$	1%	100%			5-30
6.5	U/F-curve mid point frequency 	0,0— $f_{\max}$	0,1 Hz	0,0 Hz			5-30
6.6	U/F-curve mid point voltage 	0,00—100,00% $\times U_{nmot}$	0,01%	0,00 %		Parameter maximum value = param 6.4	5-30
6.7	Output voltage at zero frequency 	0,00—40,00% $\times U_{nmot}$	0,01%	0,00 %			5-30
6.8	Overvoltage controller	0—1	1	1		0 = Controller is not operating 1 = Controller is operating	5-31
6.9	Undervoltage controller	0—1	1	1		0 = Controller is not operating 1 = Controller is operating	5-31

**Note!**  = Parameter value can be changed only when the frequency converter is stopped.

## Group 7, Protections

Code	Parameter	Range	Step	Default	Custom	Description	Page
7.1	Response to reference fault	0—2	1	0		0 = No action 1 = Warning 2 = Fault, stop according to par 4.7 3 = Fault, stop always by coasting	5-31
7.2	Response to external fault	0—2	1	2		0 = No action 1 = Warning 2 = Fault, stop according to par 4.7 3 = Fault, stop always by coasting	5-31
7.3	Phase supervision of the motor	0—2	2	2		0 = No action 2 = Fault	5-31
7.4	Earth fault protection	0—2	2	2		0 = No action 2 = Fault	5-31
7.5	Motor thermal protection	0—2	1	2		0 = No action 1 = Warning 2 = Fault	5-32
7.6	Motor thermal protection break point current	50,0—150,0 % $\times I_{nMOTOR}$	1,0 %	100,0%			5-32
7.7	Motor thermal protection zero frequency current	5,0—150,0% $\times I_{nMOTOR}$	1,0 %	45,0%			5-33
7.8	Motor thermal protection time constant	0,5—300,0 minutes	0,5 min.	17,0 min.		Default value is set according to motor nominal current	5-33
7.9	Motor thermal protection break point frequency	10—500 Hz	1 Hz	35 Hz			5-34
7.10	Stall protection	0—2	1	1		0 = No action 1 = Warning 2 = Fault	5-34
7.11	Stall current limit	5,0—200,0% $\times I_{nMOTOR}$	1,0%	130,0%			5-35
7.12	Stall time	2,0—120,0 s	1,0 s	15,0 s			5-35
7.13	Maximum stall frequency	1— $f_{max}$	1 Hz	25 Hz			5-35
7.14	Underload protection	0—2	1	0		0 = No action 1 = Warning 2 = Fault	5-36
7.15	Underload prot., field weakening area load	10,0—150,0 % $\times T_{nMOTOR}$	1,0%	50,0%			5-36
7.16	Underload protection, zero frequency load	5,0—150,0% $\times T_{nMOTOR}$	1,0%	10,0%			5-36
7.17	Underload time	2,0—600,0 s	1,0 s	20,0s			5-36



**Group 8, Autorestart parameters**

Code	Parameter	Range	Step	Default	Custom	Description	Page
8. 1	Automatic restart: number of tries	0—10	1	0		0 = not in use	5-37
8. 2	Automatic restart: trial time	1—6000 s	1 s	30 s			5-37
8. 3	Automatic restart: start function	0—1	1	0		0 = Ramp 1 = Flying start	5-38
8. 4	Automatic restart of undervoltage	0—1	1	0		0 = No 1 = Yes	5-38
8. 5	Automatic restart of overvoltage	0—1	1	0		0 = No 1 = Yes	5-38
8. 6	Automatic restart of overcurrent	0—1	1	0		0 = No 1 = Yes	5-38
8. 7	Automatic restart of reference fault	0—1	1	0		0 = No 1 = Yes	5-38
8. 8	Automatic restart after over/undertemperature fault	0—1	1	0		0 = No 1 = Yes	5-38

*Table 5.5-1 Special parameters, Groups 2—8.*

5.5.2 Description of Groups 2—8 parameters

2.1 Start/Stop logic selection

- 0: DIA1: closed contact = start forward  
 DIA2: closed contact = start reverse,  
 See figure 5.5-1.

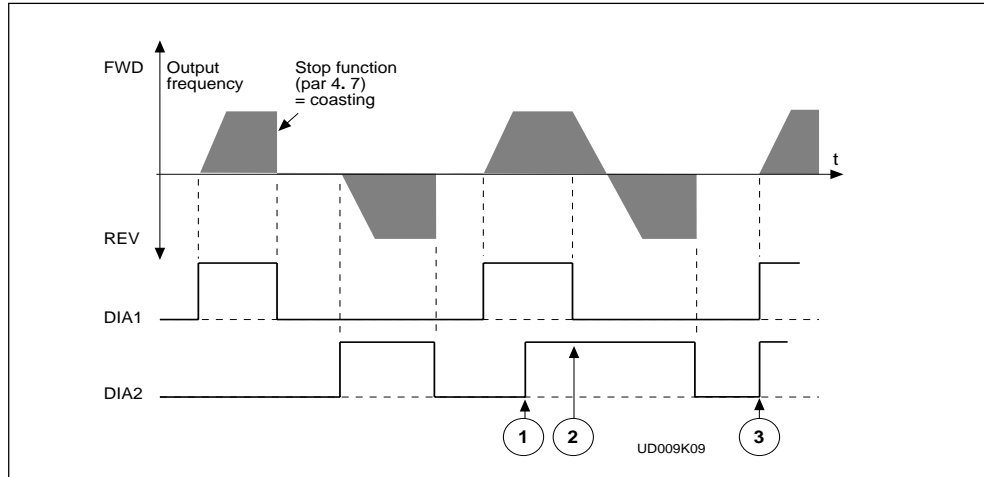

Figure 5.5-1 Start forward/Start reverse.

- ① The first selected direction has the highest priority
  - ② When DIA1 contact opens, the direction of rotation starts to change
  - ③ If Start forward (DIA1) and Start reverse (DIA2) signals are active simultaneously, the Start forward signal (DIA1) has priority.
- 1: DIA1: closed contact = start      open contact = stop  
 DIA2: closed contact = reverse    open contact = forward  
 See figure 5.5-2.

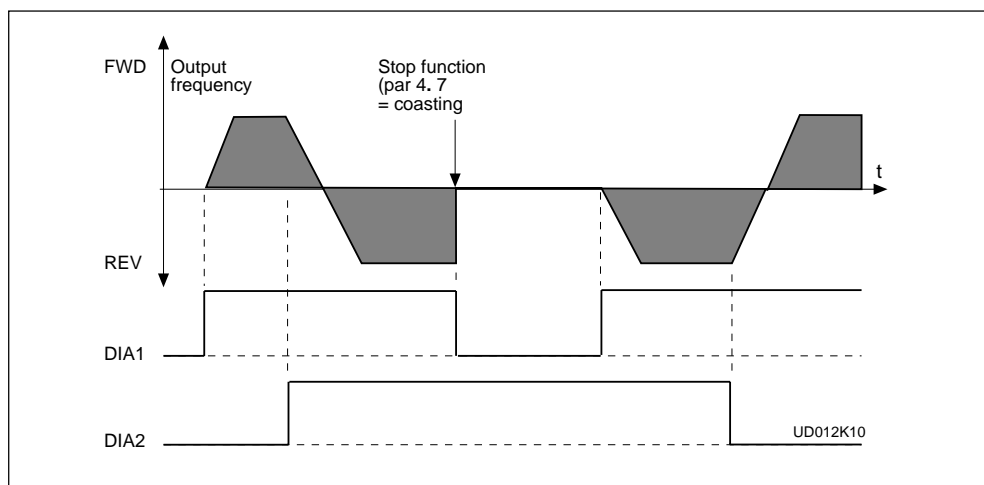

Figure 5.5-2 Start, Stop, reverse.

5



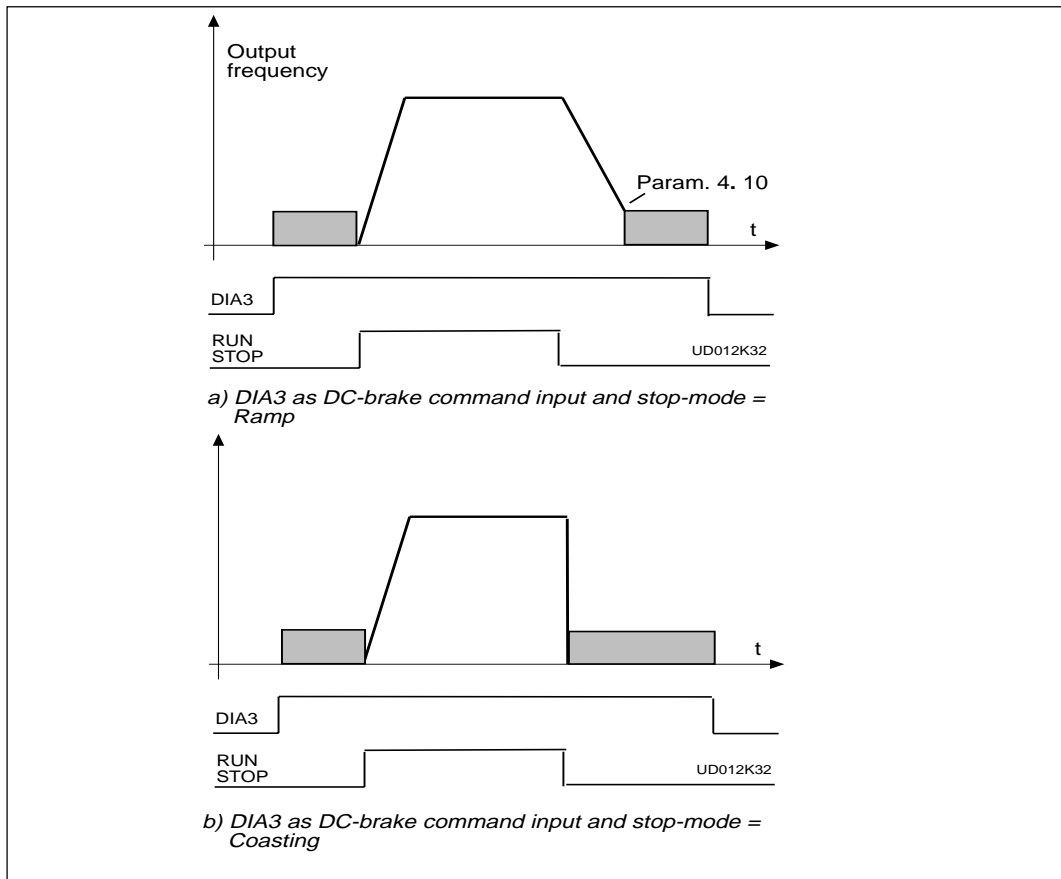

Figure 5.5-4 DIA3 as DC-brake command input: a) Stop-mode = Ramp, b) Stop-mode = Coasting.

**2. 3 DIB4 function**

Selections are same as in 2. 2 except :

10: Multi-Step contact closed = Selection 1 active speed select 1

**2. 4 DIB5 function**

Selections are same as in 2. 2 except :

10: Multi-Step contact closed = Selection 2 active speed select 2

11: Motor pot. UP contact closed = Reference decreases until the contact is opened

**2. 5 DIB6 function**

Selections are same as in 2. 2 except :

10: Multi-Step contact closed = Selection 3 active speed select 3

11: Motor pot. DOWN contact closed = Reference decreases until the contact is opened



**2. 6  $U_{in}$  signal range**

0 = Signal range 0—+10 V

1 = Custom setting range from custom minimum (par. 2. 7) to custom maximum (par. 2. 8)

2 = Signal range -10—+10 V , can be used only with Joystick control

**2. 7  $U_{in}$  custom setting minimum/maximum**

**2. 8** With these parameters,  $U_{in}$  can be set for any input signal span within 0—10 V.

Minimum setting: Set the  $U_{in}$  signal to its minimum level, select parameter 2. 7, press the Enter button

Maximum setting: Set the  $U_{in}$  signal to its maximum level, select parameter 2. 8, press the Enter button

**Note!** These parameters can only be set with this procedure (not with the *Browser buttons*)

**2. 9  $U_{in}$  signal inversion**

Parameter 2. 9 = 0, no inversion of analogue  $U_{in}$  signal.

Parameter 2. 9 = 1, inversion of analogue  $U_{in}$  signal.

**2. 10  $U_{in}$  signal filter time**

Filters out disturbances from the incoming analogue  $U_{in}$  signal. Long filtering time makes regulation response slower. See figure 5.5-5.

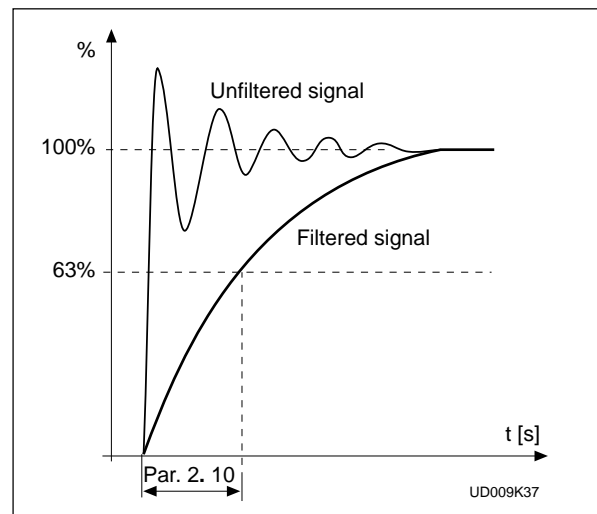

Figure 5.5-5  $U_{in}$  signal filtering.

**2. 11 Analogue input  $I_{in}$  signal range**

0 = 0—20 mA

1 = 4—20 mA

2 = Custom signal span

**2. 12 Analogue input  $I_{in}$  custom setting minimum/maximum**

With these parameters, the scaling of the input current signal ( $I_{in}$ ) range can be set between 0—20 mA.

Minimum setting:

Set the  $I_{in}$  signal to its minimum level, select parameter 2. 12, press the *Enter* button

Maximum setting:

Set the  $I_{in}$  signal to its maximum level, select parameter 2. 13, press the *Enter* button

**Note!** These parameters can only be set with this procedure (not with the *Browser buttons*)

**2. 14 Analogue input  $I_{in}$  inversion**

Parameter 2. 14 = 0, no inversion of  $I_{in}$  input

Parameter 2. 14 = 1, inversion of  $I_{in}$  input.

**2. 15 Analogue input  $I_{in}$  filter time**

Filters out disturbances from the incoming analog  $I_{in}$  signal. Long filtering time makes regulation response slower. See figure 5.5-6.

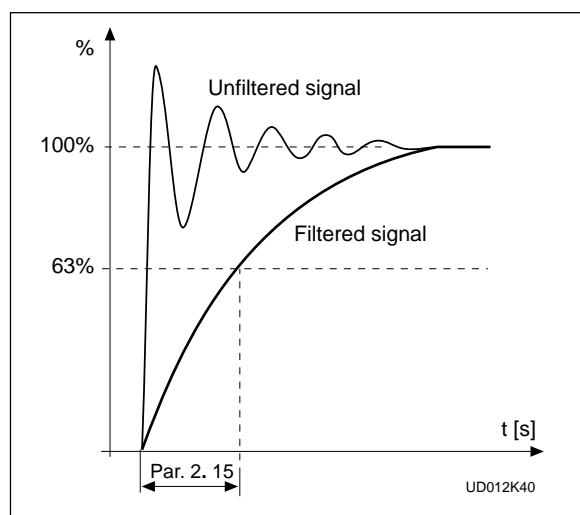

Figure 5.5-6 Analogue input  $I_{in}$  filter time.

**2. 16  $U_{in}$  signal minimum scaling**

Sets the minimum scaling point for  $U_{in}$  signal. See figure 5.5-7.

**2. 17  $U_{in}$  signal maximum scaling**

Sets the maximum scaling point for  $U_{in}$  signal. See figure 5.5-7.

**2. 18  $I_{in}$  signal minimum scaling**

Sets the minimum scaling point for  $I_{in}$  signal. See figure 5.5-7.

**2. 19  $I_{in}$  signal maximum scaling**

Sets the maximum scaling point for  $I_{in}$  signal. See figure 5.5-7.

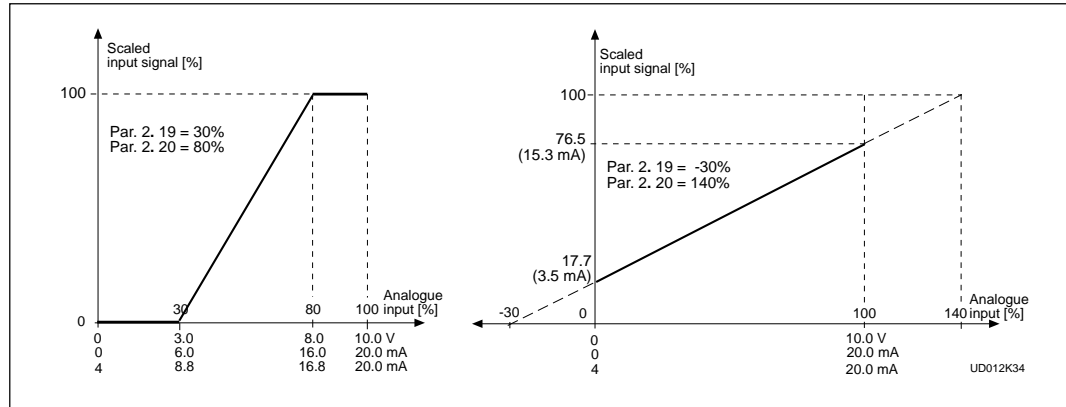

Figure 5.5-7 Examples of the scaling of  $U_{in}$  and  $I_{in}$  inputs .

**2. 20 Free analogue input signal**

Selection of input signal of free analogue input (an input not used for reference signal):

- 0 = Not in use
- 1 = Voltage signal  $U_{in}$
- 2 = Current signal  $I_{in}$

**2. 21 Free analogue input signal function**

This parameter sets the function of the free analogue input:

- 0 = Function is not used
- 1 = Reducing motor current limit (par. 1.7)  
This signal will adjust the maximum motor current between 0 and parameter 1.7 set max. limit. See figure 5.5-8.

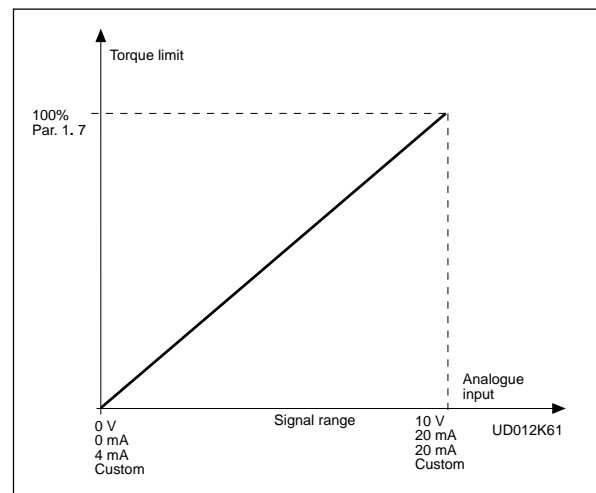

Figure 5.5-8 Reducing of max. motor current.

- 2 = Reducing DC brake current.

The DC braking current can be reduced, with the free analogue input signal, between  $0.15 \times I_{nCT}$  and current set by parameter 4.8. See figure 5.5-9.

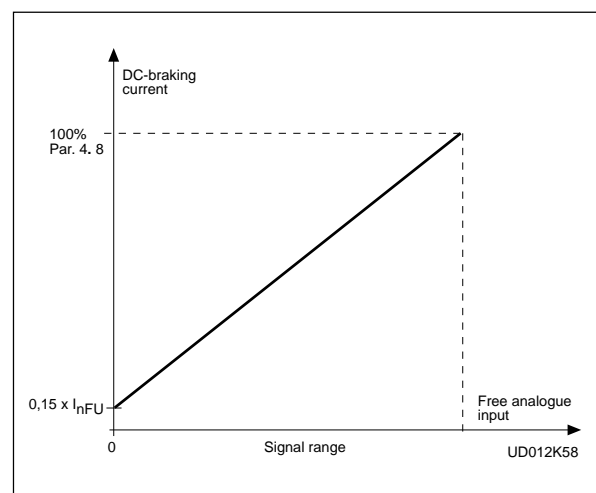

Figure 5.5-9 Reducing DC brake current.

**3 Reducing acceleration and deceleration times.**

The acceleration and deceleration times can be reduced with the free analogue input signal, according to the following formula:

Reduced time = set acc./deceler. time (par. 1. 3, 1. 4; 4. 3, 4. 4) divided by factor R in figure 5.5-10.

*Figure 5.5-10 Reducing acceleration and deceleration times.*

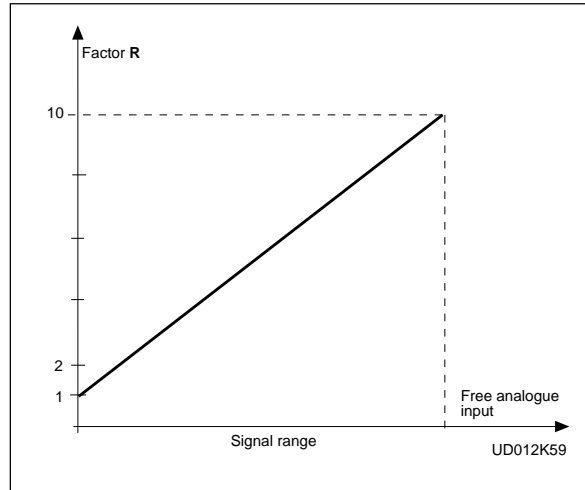

**4 Reducing torque supervision limit.**

The set torque supervision limit can be reduced with the free analogue input signal between 0 and set supervision limit (par. 3. 14), see figure 3.5-11.

*Figure 3.5-11 Reducing torque supervision limit.*

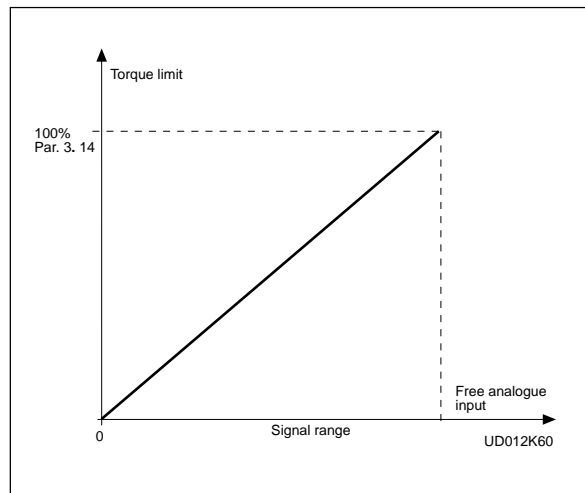

**2. 22 Motor potentiometer ramp time**

Defines how fast the electronic motor potentiometer value changes.





**3.1 Analogue output function**

See table on page 5-10.

**3.2 Analogue output filter time**

Filters the analogue output signal. See figure 5.5-12.

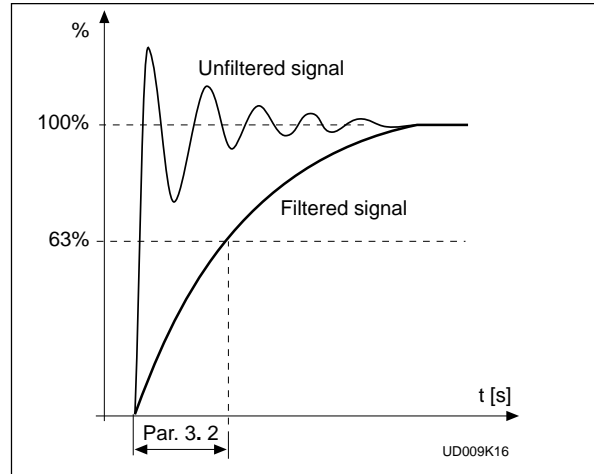

Figure 5.5-12 Analogue output filtering.

**3.3 Analogue output invert**

Inverts analogue output signal:  
 max. output signal = minimum set value  
 min. output signal = maximum set value

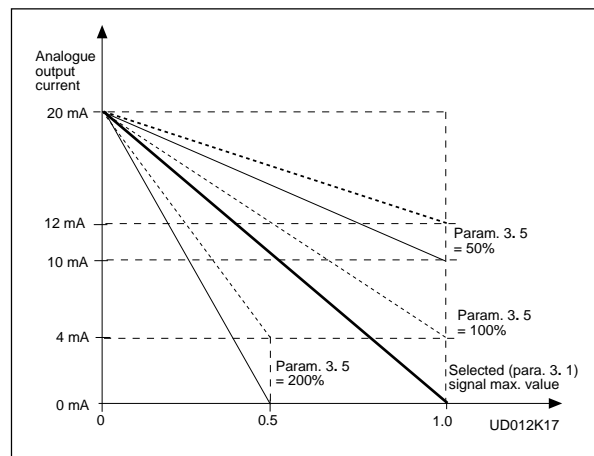

Figure 5.5-13 Analogue output invert.

**3.4 Analogue output minimum**

Defines the signal minimum to be either 0 mA or 4 mA (living zero). See figure 5.5.2-14.

**3.5 Analogue output scale**

Scaling factor for analogue output. See figure 5.5.2-14.

Signal	Max. value of the signal
Output frequency	Max. frequency (p. 1. 2)
Motor speed	Max. speed ( $n_n \times f_{max} / f_n$ )
Output current	$2 \times I_{nCT}$
Motor torque	$2 \times T_{nMot}$
Motor power	$2 \times P_{nMot}$
Motor voltage	$100\% \times U_{nMot}$
DC-link volt.	1000 V

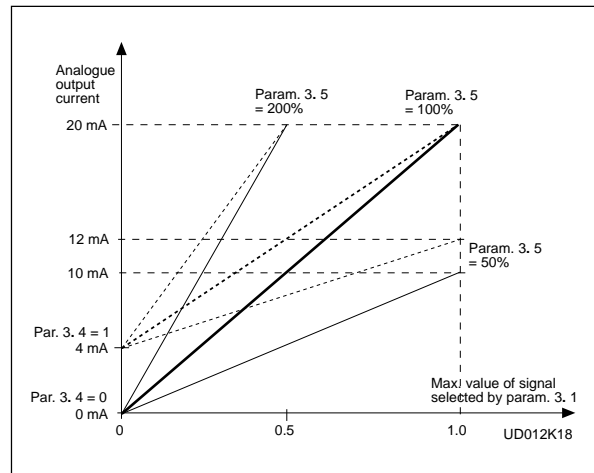

Figure 5.5.2-14 Analogue output scale.

- 3. 6 **Digital output function**
- 3. 7 **Relay output 1 function**
- 3. 8 **Relay output 2 function**

Setting value	Signal content
0 = Not used	Out of operation <u>Digital output DO1 sinks current and programmable relay (RO1, RO2) is activated when:</u>
1 = Ready	The frequency converter is ready to operate
2 = Run	The frequency converter operates (motor is running)
3 = Fault	A fault trip has occurred
4 = Fault inverted	A fault trip <u>has not</u> occurred
5 = Vacon overheat warning	The heat-sink temperature exceeds +70°C
6 = External fault or warning	Fault or warning depending on parameter 7. 2
7 = Reference fault or warning	Fault or warning depending on parameter 7. 1 - if analogue reference is 4—20 mA and signal is <4mA
8 = Warning	Always if a warning exists
9 = Reversed	The reverse command has been selected
10= Jogging speed	Jogging speed has been selected with digital input
11 = At speed	The output frequency has reached the set reference
12= Motor regulator activated	Overvoltage or overcurrent regulator was activated
13= Output frequency supervision 1	The output frequency goes outside of the set supervision Low limit/ High limit (par. 3. 9 and 3. 10)
14= Output frequency supervision 2	The output frequency goes outside of the set supervision Low limit/ High limit (par. 3. 11 and 3. 12)
15= Torque limit supervision	The motor torque goes outside of the set supervision Low limit/ High limit (par. 3. 13 and 3. 14)
16= Reference limit supervision	Reference goes outside of the set supervision Low limit/ High limit (par. 3. 15 and 3. 16)
17 = External brake control	External brake ON/OFF control with programmable delay (par 3. 17 and 3. 18)
18= Control from I/O terminals	External control mode selected with progr. push-button #2
19= Frequency converter temperature limit supervision	Temperature on frequency converter goes outside the set supervision limits (par. 3. 19 and 3. 20)
20= Unrequested rotation direction	Rotation direction of the motor shaft is different from the requested one
21 = External brake control inverted	External brake ON/OFF control (par. 3.17 and 3.18), output active when brake control is OFF

Table 5.5-2 Output signals via DO1 and output relays RO1 and RO2.

- 3. 9 **Output frequency limit 1, supervision function**
- 3. 11 **Output frequency limit 2, supervision function**

- 0 = No supervision
- 1 = Low limit supervision
- 2 = High limit supervision

If the output frequency falls below or exceeds the set limit (3. 10, 3. 12) this function generates a warning message via the digital output DO1 and via a relay output RO1 or RO2 depending on the settings of the parameters 3. 6—3. 8.

- 3. 10 **Output frequency limit 1, supervision value**
- 3. 12 **Output frequency limit 2, supervision value**

The frequency value supervised by the parameter 3. 9 (3. 11).

See figure 5.5-15.



### 3. 13 **Torque limit , supervision function**

0 = No supervision  
 1 = Low limit supervision  
 2 = High limit supervision

If the calculated torque value falls below or exceeds the set limit (3. 14) this function generates a warning message via the digital output DO1, via a relay output RO1 or RO2 depending on the settings of parameters 3. 6—3. 8.

Figure 5.5-15 Output frequency supervision.

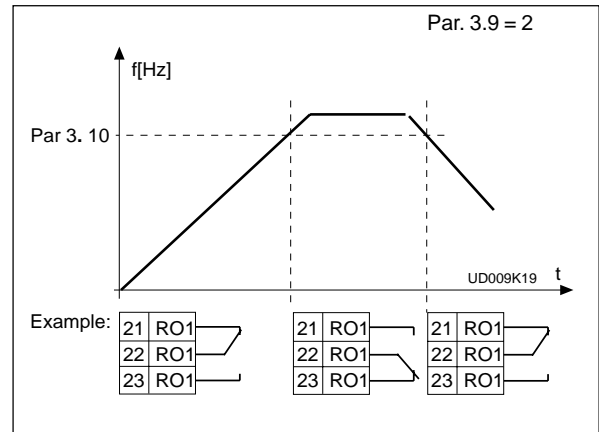

### 3. 14 **Torque limit , supervision value**

The calculated torque value supervised by the parameter 3. 13.

### 3. 15 **Reference limit , supervision function**

0 = No supervision  
 1 = Low limit supervision  
 2 = High limit supervision

If the reference value falls below or exceeds the set limit (3. 16) this function generates a warning message via the digital output DO1 or via a relay output RO1 or RO2 depending on the settings of the parameters 3. 6—3. 8. The supervised reference is the current active reference. It can be source A or B reference depending on DIB6 input or the panel reference if panel is the active control source.

### 3. 16 **Reference limit , supervision value**

The frequency value supervised by the parameter 3. 15.

### 3. 17 **External brake-off delay**

### 3. 18 **External brake-on delay**

With these parameters the timing of external brake can be linked to the Start and Stop control signals, see figure 5.5-16.

The brake control signal can be programmed via the digital output DO1 or via one of relay outputs RO1 and RO2, see parameters 3. 6—3. 8.

### 3. 19 **Frequency converter temperature limit supervision function**

0 = No supervision  
 1 = Low limit supervision  
 2 = High limit supervision

If the temperature of the frequency converter falls below or exceeds the set limit (3. 20) this function generates a warning message via the digital output DO1 or via a relay output RO1 or RO2 depending on the settings of the parameters 3. 6—3. 8.

### 3. 20 **Frequency converter temperature limit value**

The temperature value supervised by the parameter 3. 19.

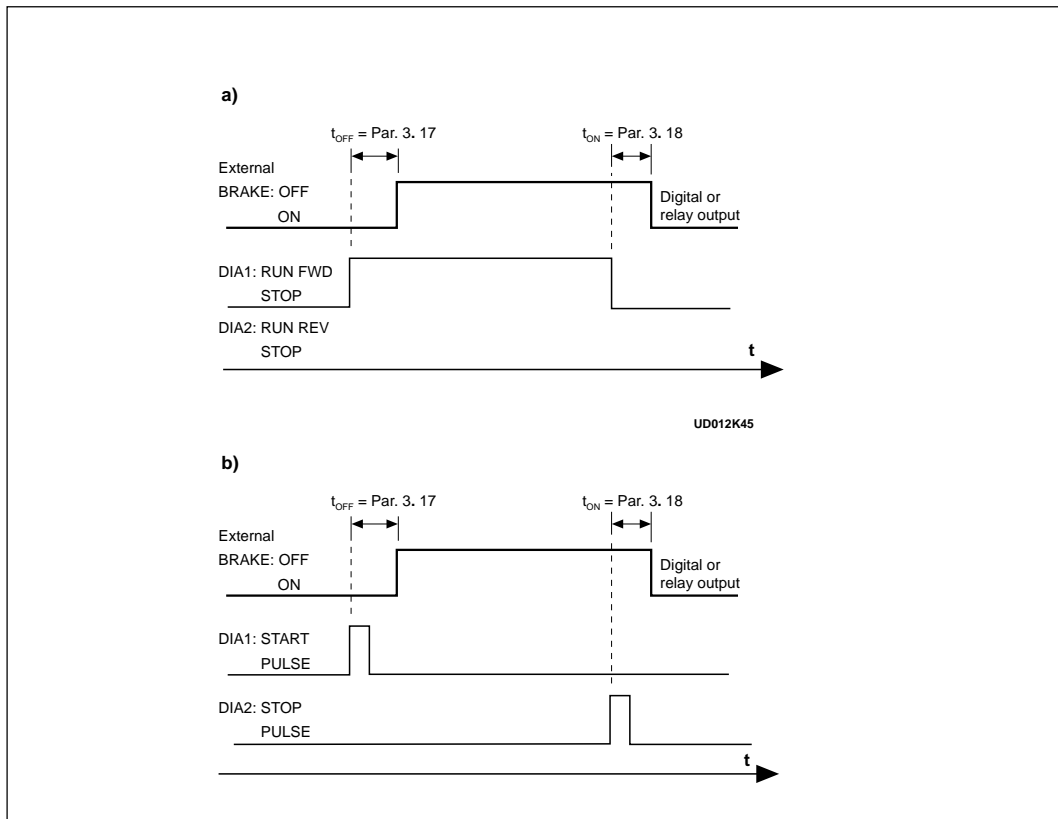

Figure 5.5-16 External brake control: a) Start/Stop logic selection par. 2. 1 = 0, 1 or 2  
 b) Start/Stop logic selection par. 2. 1 = 3.

**4. 1 Acc/Dec ramp 1 shape**  
**4. 2 Acc/Dec ramp 2 shape**

The start and end of the acceleration and deceleration ramps can be smoothed with these parameters. Setting value 0 gives linear ramp shape which causes acceleration and deceleration to act immediately to the changes in the reference signal with the time constant set by parameter 1. 3 and 1. 4 (4. 3 and 4. 4).

Setting value 0.1—10 seconds for 4. 1 (4. 2) causes linear acceleration/deceleration to adopt an S-shape. Parameter 1. 3 and 1. 4 (4. 3 and 4. 4) determines the time constant of acceleration/deceleration in the middle of the curve.

See figure 5.5-17.

Figure 5.5-17 S-shaped acceleration/deceleration.

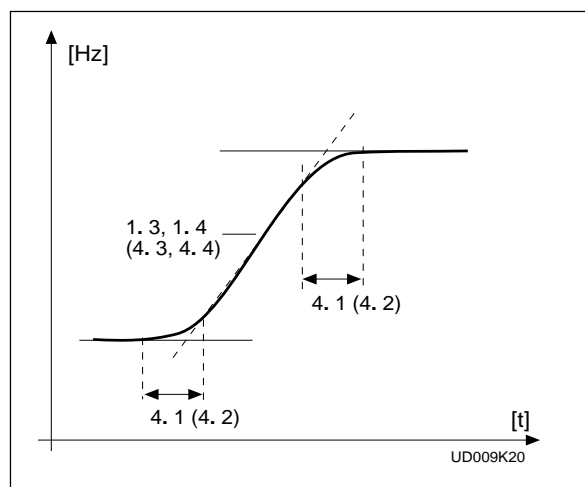

5

**4.3 Acceleration time 2****4.4 Deceleration time 2**

These values correspond to the time required for the output frequency to accelerate from the set minimum frequency (par. 1. 1) to the set maximum frequency (par. 1. 2). These times give the possibility to set two different acceleration/ deceleration time sets for one application. The active set can be selected with the programmable signal DIA3 of this application, see parameter 2. 2.

Acceleration/deceleration times can be reduced with an external free analogue input signal, see parameters 2. 18 and 2. 19.

**4.5 Brake chopper**

0 = No brake chopper

1 = Brake chopper and brake resistor installed

2 = External brake chopper

When the frequency converter is decelerating the motor, the inertia from the motor and the load is fed into the external brake resistor. This enables the frequency converter to decelerate the load with the torque equal to that of acceleration, if the brake resistor is selected correctly. See separate Brake resistor installation manual.

**4.6 Start function**

Ramp:

- 0** The frequency converter starts from 0 Hz and accelerates to the set reference frequency within the set acceleration time. (Load inertia or starting friction may cause a prolonged acceleration times).

Flying start:

- 1** The frequency converter is able to start into running motor by applying a small torque to motor and searching for frequency corresponding to the speed the motor is running. Searching starts from the maximum frequency towards the actual frequency until the correct value is detected. Thereafter the output frequency will be increased/decreased to the set reference value according to the set acceleration/deceleration parameters.

Use this mode if the motor should be coasting when the start command is given. With the flying start it is possible to ride through short mains voltage interruptions.

**4.7 Stop function**

Coasting:

- 0** The motor coasts to a halt without any control from the frequency converter, after the Stop command.

Ramp:

- 1** After the Stop command, the speed of the motor is decelerated according to the set deceleration parameters.

If the regenerated energy is high it may be necessary to use an external braking resistor for faster deceleration.

**4.8 DC braking current**

Defines the current injected into the motor during the DC braking.

**4.9 DC braking time at stop**

Defines if braking is ON or OFF and braking time of the DC-brake when the motor is stopping. The function of the DC-brake depends on the stop function, parameter 4.7. See figure 5.5-18.

- 0 DC-brake is not used
- >0 DC-brake is in use and its function depends on the Stop function, (param. 4.7), and the time depends on the value of parameter 4.9:

Stop-function = 0 (coasting):

After the stop command, the motor coasts to a stop without any control from the frequency converter.

With DC-injection, the motor can be electrically stopped in the shortest possible time, without using an optional external braking resistor.

The braking time is scaled according to the frequency when the DC-braking starts. If the frequency is  $\geq$  nominal frequency of the motor (par. 1.11), setting value of parameter 4.9 determines the braking time. When the frequency is  $\leq 10\%$  of the nominal, the braking time is 10% of the set value of parameter 4.9.

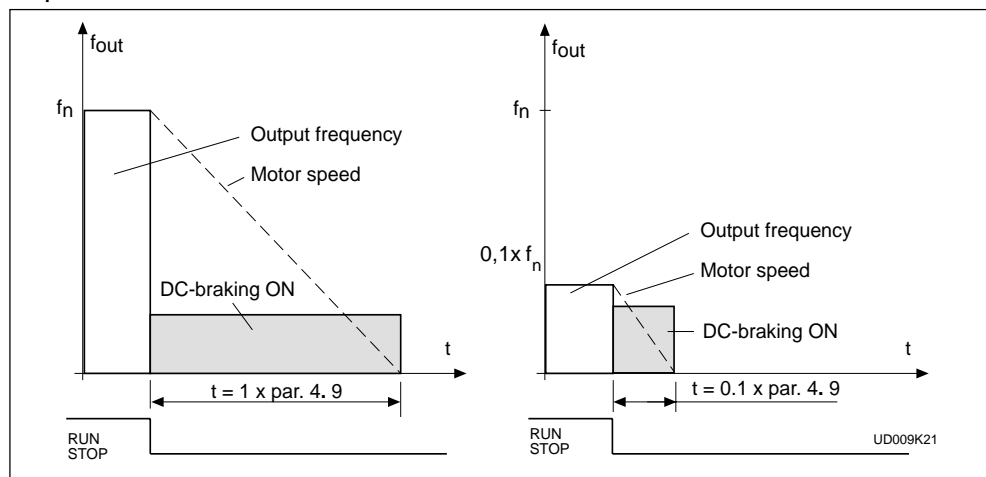

Figure 5.5-18 DC-braking time when stop = coasting.

Stop-function = 1 (ramp):

After the Stop command, the speed of the motor is reduced according to the set deceleration parameters, as fast as possible, to a speed defined with parameter 4.10, where the DC-braking starts.

The braking time is defined with parameter 4.9.

If high inertia exists, it is recommended to use an external braking resistor for faster deceleration. See figure 5.5-19.

Figure 5.5-19 DC-braking time when stop function = ramp.

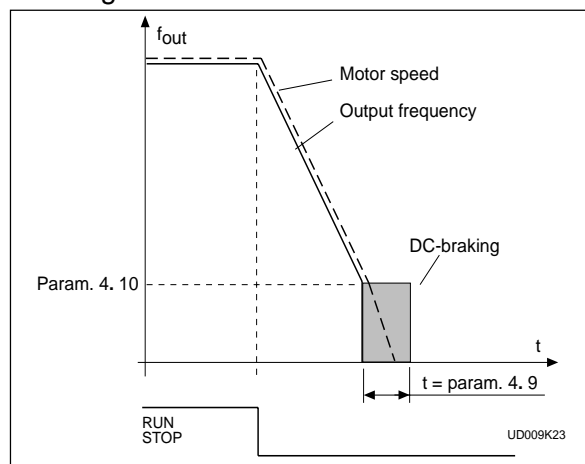

5

**4. 10 Execute frequency of DC-brake during ramp Stop**

See figure 5.5-19.

**4. 11 DC-brake time at start**

- 0** DC-brake is not used
- >0** DC-brake is active when the start command is given and this parameter defines the time before the brake is released. After the brake is released output frequency increases according to the set start function parameter 4. 6 and acceleration parameters (1. 3, 4. 1 or 4. 2, 4. 3), see figure 5.5-20.

Figure 5.5-20 DC-braking at start.

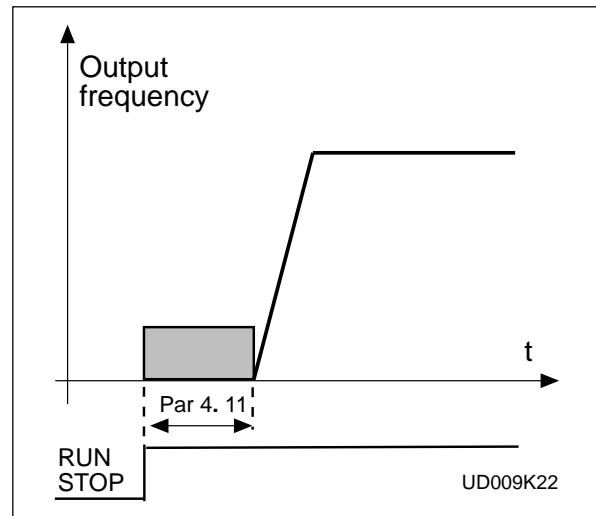

**4. 12 - 4. 18 Multi-Step speeds 1-7**

Parameter values define the Multi-Step speeds selected with the DIA4, DIB5 and DIB6 digital inputs. The selection of Multi-Step speeds will occur similarly as described in the table 3.4-2 page 3-8.

- 5. 1 Prohibit frequency area**
- 5. 2 Low limit/High limit**
- 5. 3**
- 5. 4**
- 5. 5**
- 5. 6**

In some systems it may be necessary to avoid certain frequencies because of mechanical resonance problems.

With these parameters it is possible to set limits for three "skip frequency" regions.

Figure 5.5-21 Example of prohibit frequency area setting.

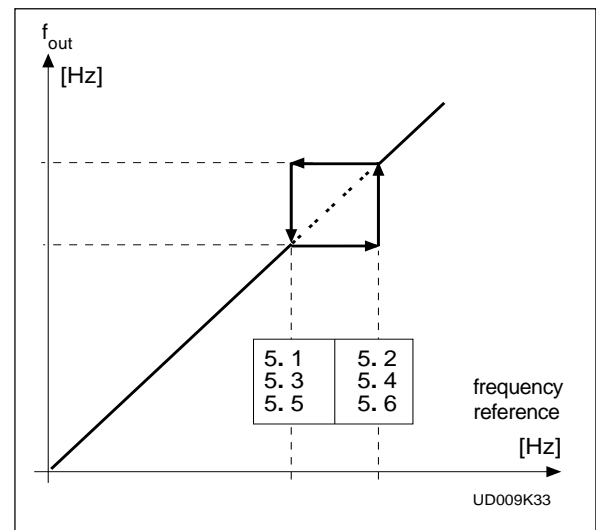

**6. 1 Motor control mode**

0 = Frequency control:

The I/O terminal and panel references are frequency references and the frequency converter controls the output frequency (output frequency resolution = 0.01 Hz)

1 = Speed control:

The I/O terminal and panel references are speed references and the frequency converter controls the motor speed (regulation accuracy ± 0,5%).

## 6.2 Switching frequency

Motor noise can be minimized using a high switching frequency. Increasing the switching frequency reduces the capacity of the frequency converter unit.

Before changing the frequency from the factory default 10 kHz (3.6 kHz from 30 kW upwards), check the allowed capacity from the curve in the figure 5.2-3 of chapter 5.2 of the User's Manual.

## 6.3 Field weakening point

### 6.4 Voltage at the field weakening point

The field weakening point is the output frequency at which the output voltage reaches the set maximum value (par. 6.4). Above that frequency the output voltage remains at the set maximum value.

Below that frequency the output voltage depends on the setting of the U/f curve parameters 1.8, 1.9, 6.5, 6.6 and 6.7. See figure 5.5-22.

When the parameters 1.10 and 1.11, nominal voltage and nominal frequency of the motor, are set, also parameters 6.3 and 6.4 are set automatically to the corresponding values. If different values for the field weakening point and the maximum output voltage are required, change these parameters after setting the parameters 1.10 and 1.11.

### 6.5 U/f curve, middle point frequency

If the programmable U/f curve has been selected with parameter 1.8 this parameter defines the middle point frequency of the curve. See figure 5.5-22.

### 6.6 U/f curve, middle point voltage

If the programmable U/f curve has been selected with the parameter 1.8 this parameter defines the middle point voltage of the curve. See figure 5.5-22.

### 6.7 Output voltage at zero frequency

If the programmable U/f curve has been selected with the parameter 1.8 this parameter defines the zero frequency voltage of the curve. See figure 5.5-22.

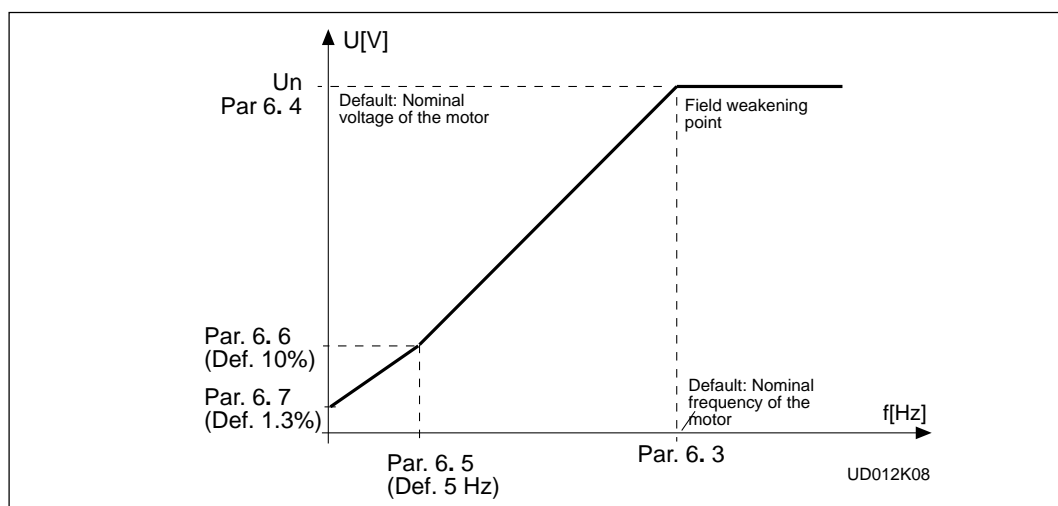

Figure 5.5-22 Programmable U/f curve.



**6. 8     *Overvoltage controller*****6. 9     *Undervoltage controller***

These parameters allow the over-/undervoltage controllers to be switched out of operation. This may be useful, for example, if the mains supply voltage varies more than -15%—+10% and the application will not tolerate this over-/undervoltage, the regulator controls the output frequency according to the supply fluctuations.

Over-/undervoltage trips may occur when controllers are switched out of operation.

**7. 1     *Response to the reference fault***

0 = No response

1 = Warning

2 = Fault, stop mode after fault according to parameter 4.7

3 = Fault, stop mode after fault always by coasting

A warning or a fault action and message is generated if 4—20 mA reference signal is used and the signal falls below 4 mA. The information can also be programmed via digital output DO1 and via relay outputs RO1 and RO2.

**7. 2     *Response to external fault***

0 = No response

1 = Warning

2 = Fault, stop mode after fault according to parameter 4.7

3 = Fault, stop mode after fault always by coasting

A warning or a fault action and message is generated from the external fault signal in the digital input DIA3. The information can also be programmed into digital output DO1 and into relay outputs RO1 and RO2.

**7. 3     *Phase supervision of the motor***

0 = No action

2 = Fault

Phase supervision of the motor ensures that the motor phases have an approximately equal current.

**7. 4     *Earth fault protection***

0 = No action

2 = Fault

Earth fault protection ensures that the sum of the motor phase currents is zero. The overcurrent protection is always working and protects the frequency converter from earth faults with high currents.

**Parameters 7. 5—7. 9 Motor thermal protection****General**

Motor thermal protection shall protect the motor from overheating. Vacon CX/CXL/CXS drive is capable of supplying higher than nominal current to the motor. If the load requires this high current there is a risk that motor will be thermally overloaded. This is true especially at low frequencies. With low frequencies, the cooling effect of the motor is reduced and the capacity of the motor is reduced. If the motor is equipped with an external fan the load reduction on low speeds is small.

Motor thermal protection is based on a calculated model and it uses the output current of the drive to determine the load on the motor. When the power is turned on, the calculated model uses the heatsink temperature to determine the initial thermal stage for the motor. The calculated model assumes that the ambient temperature of the motor is 40°C.

Motor thermal protection can be adjusted by setting the parameters. The thermal current  $I_T$  specifies the load current above which the motor is overloaded. This current limit is a function of the output frequency. The curve for  $I_T$  is set with parameters 7. 6, 7. 7 and 7. 9, see Figure 5.5-23. The parameters have their default values set according to the motor name plate data.

With the output current at  $I_T$  the thermal stage will reach the nominal value (100%). The thermal stage changes by the square of the current. With output current at 75% from  $I_T$  the thermal stage will reach a 56% value and with output current at 120% from  $I_T$  the thermal stage would reach a 144% value. The function will trip the device (refer par. 7. 5) if the thermal stage will reach a value of 105%. The speed of change in thermal stage is determined with the time constant parameter 7. 8. The bigger the motor the longer it takes to reach the final temperature.

The thermal stage of the motor can be monitored with the display. See the table of monitoring items. (User's Manual, table 7.3-1).



**CAUTION!** *The calculated model does not protect the motor if the airflow to the motor is reduced by blocked air intake grill.*

### 7. 5 **Motor thermal protection**

Operation:

- 0 = Not in use
- 1 = Warning
- 2 = Trip function

Tripping and warning will display the same message code. If tripping is selected the drive will stop and activate the fault stage.

Deactivating the protection, setting parameter to 0, will reset the thermal stage of the motor to 0%.

### 7. 6 **Motor thermal protection, break point current**

The current can be set between 50.0—150.0% x  $I_{nMotor}$ .

This parameter sets the value for thermal current at frequencies above the break point on the thermal current curve. See Figure 5.5-23.

The value is set in percentage which refers to the name plate data of the motor, parameter 1. 13, nominal current of the motor, not to the drive's nominal output current.

The motor's nominal current is the current which the motor can withstand in direct on-line use without being overheated.

If parameter 1. 13 is adjusted, this parameter is automatically restored to the default value.

Setting this parameter (or parameter 1. 13) does not affect the maximum output current of the drive. Parameter 1. 7 alone determines the maximum output current of the drive.

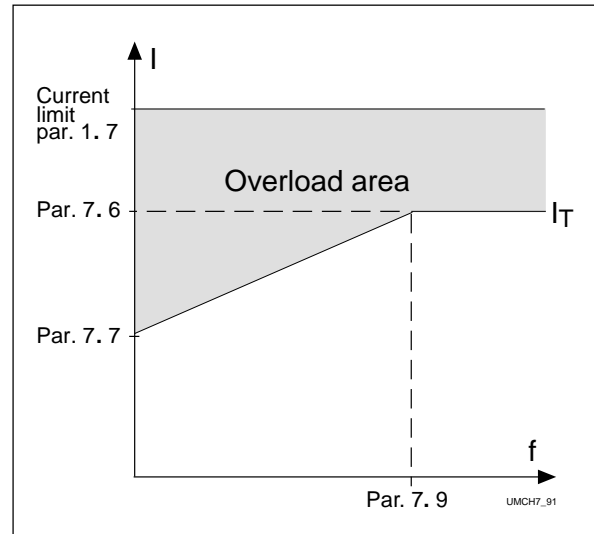

Figure 5.5-23 Motor thermal current  $I_T$  curve.

### 7.7 Motor thermal protection, zero frequency current

The current can be set between 10.0—150.0%  $\times I_{nMotor}$ . This parameter sets the value for thermal current at zero frequency. Refer to the figure 5.5-23.

The default value is set assuming that there is no external fan cooling the motor. If an external fan is used this parameter can be set to 90% (or even higher).

The value is set in percentage of the motor name plate data, parameter 1. 13, motor's nominal current, not the drive's nominal output current. Motor's nominal current is the current which the motor can withstand in direct on-line use without being overheated.

If you change parameter 1. 13 this parameter is automatically restored to the default value.

Setting this parameter (or parameter 1. 13) does not affect the maximum output current of the drive. Parameter 1. 7 alone determines the maximum output current of the drive.

### 7.8 Motor thermal protection, time constant

This time can be set between 0.5—300 minutes.

This is the thermal time constant of the motor. The bigger the motor the bigger the time constant. The time constant is the time within the calculated thermal stage has reached 63% of its final value.

The motor thermal time is specific to the motor design and it varies between different motor manufacturers.

The default value for the time constant is calculated basing on the motor name plate data given with parameters 1. 12 and 1. 13. If either of these parameters is set, then this parameter is set to default value.

If the motor's  $t_6$ -time is known (given by the motor manufacturer) the time constant

parameter could be set based on  $t_6$ -time. As a rule of thumb, the motor thermal time constant in minutes equals to  $2 \times t_6$  ( $t_6$  in seconds is the time a motor can safely operate at six times the rated current). If the drive is in stop stage the time constant is internally increased to three times the set parameter value. The cooling in the stop stage is based on convection and the time constant is increased.

### 7.9 Motor thermal protection, break point frequency

The frequency can be set between 10—500 Hz.

This is the break point of thermal current curve. With frequencies above this point the thermal capacity of the motor is assumed to be constant. See Figure 5.5-23.

The default value is based on motor's name plate data, parameter 1. 11. It is 35 Hz for a 50 Hz motor and 42 Hz for a 60 Hz motor. More generally it is 70% of the frequency at the field weakening point (parameter 6. 3). Changing either parameter 1. 11 or 6. 3 will restore this parameter to its default value.

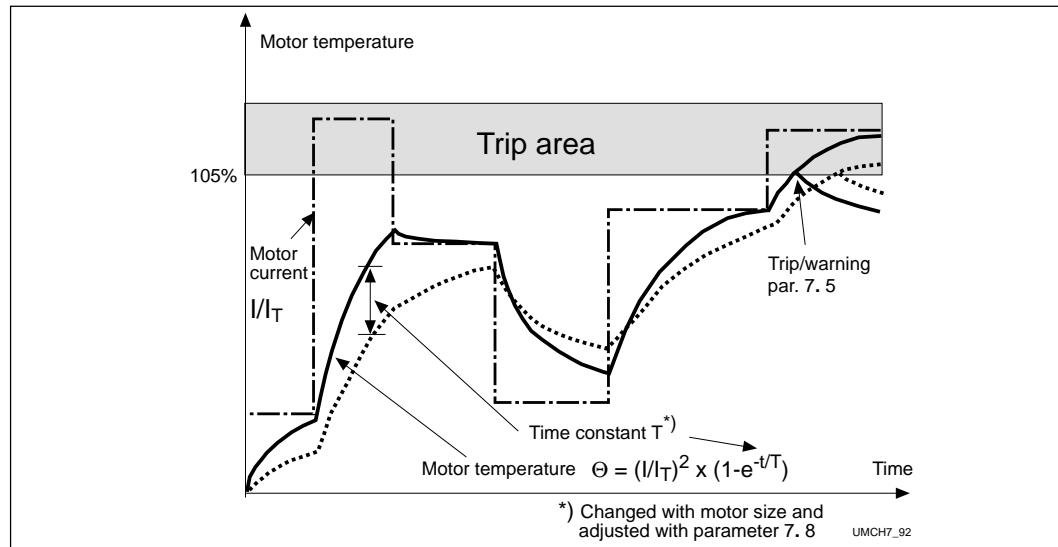

Figure 5.5-24 Calculating motor temperature.

## Parameters 7. 10— 7. 13, Stall protection

### General

Motor stall protection protects the motor from short time overload situations like a stalled shaft. The reaction time of stall protection can be set shorter than with motor thermal protection. The stall state is defined with two parameters, 7.11. Stall Current and 7.13. Stall Frequency. If the current is higher than the set limit and output frequency is lower than the set limit the stall state is true. There is actually no real indication of the shaft rotation. Stall protection is a type of overcurrent protection.

5

### 7. 10 Stall protection

Operation:

- 0 = Not in use
- 1 = Warning
- 2 = Trip function

Tripping and warning will display the same message code. If tripping is set on, the drive will stop and activate the fault stage.

Setting the parameter to 0 will deactivate the protection and will reset the stall time counter to zero.

**7. 11 Stall current limit**

The current can be set between 0.0—200% x  $I_{nMotor}$ .

In the stall stage the current has to be above this limit. Refer to Figure 5.5-25. The value is set in percentage of the motor's name plate data, parameter 1. 13, motor's nominal current. If parameter 1.13 is adjusted, this parameter is automatically restored to the default value.

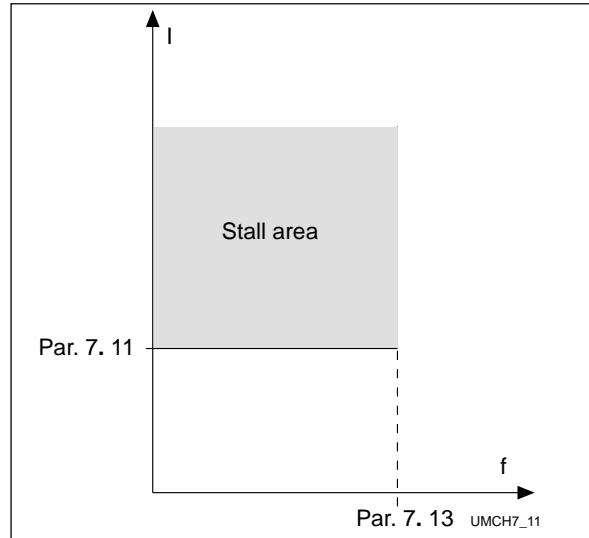

Figure 5.5-25 Setting the stall characteristics.

**7. 12 Stall time**

The time can be set between 2.0—120 s.

This is the maximum allowed time for a stall stage. There is an internal up/down counter to count the stall time. See Figure 5.5-26.

If the stall time counter value goes above this limit the protection will cause a trip (See parameter 7. 10).

**7. 13 Maximum stall frequency**

The frequency can be set between 1— $f_{max}$  (par. 1. 2).

In the stall state, the output frequency has to be lower than this limit. See Figure 5.5-25.

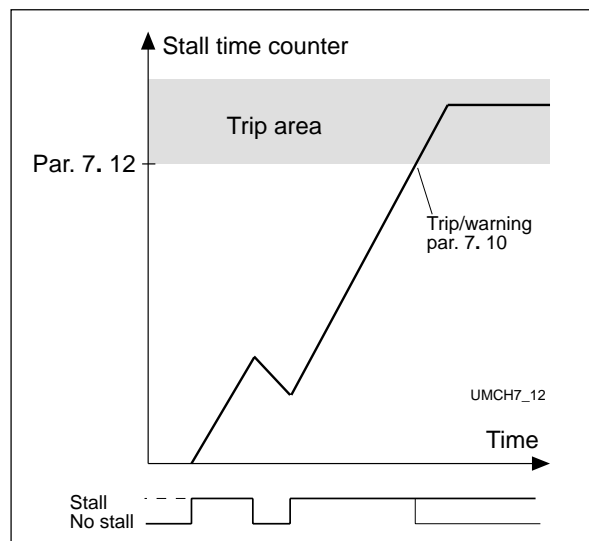

Figure 5.5-26 Counting the stall time.

**Parameters 7. 14— 7. 17, Underload protection General**

The purpose of motor underload protection is to ensure that there is load on the motor whilst the drive is running. If the motor loses its load there might be a problem in the process, e.g. broken belt or dry pump.

Motor underload protection can be adjusted by setting the underload curve with parameters 7. 15 and 7. 16. The underload curve is a squared curve set between zero frequency and the field

weakening point. The protection is not active below 5Hz (the underload counter value is stopped). Refer to Figure 5.5-27.

The torque values for setting the underload curve are set in percentage values which refer to the nominal torque of the motor. The motor's name plate data, parameter 1. 13, the motor's nominal

current and the drive's nominal current  $I_{CT}$  are used to find the scaling ratio for the internal torque value. If other than nominal motor is used with the drive, the accuracy of the torque calculation is decreased.

#### 7. 14 Underload protection

Operation:

- 0 = Not in use
- 1 = Warning
- 2 = Fault

Tripping and warning will display the same message code. If tripping is set active the drive will stop and activate the fault stage.

Deactivating the protection, by setting parameter to 0, will reset the underload time counter to zero.

#### 7. 15 Underload protection, field weakening area load

The torque limit can be set between 20.0—150 % x  $T_{nMotor}$ .

This parameter gives the value for the minimum allowed torque when the output frequency is above the field weakening point.

See figure 4.5-22.

If parameter 1. 13 is adjusted, this parameter is automatically restored to the default value.

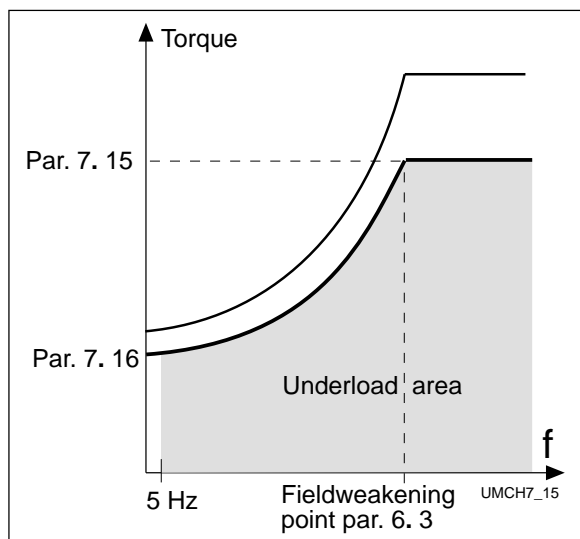

Figure 5.5-27 Setting of minimum load.

#### 7. 16 Underload protection, zero frequency load

The torque limit can be set between 10.0—150 % x  $T_{nMotor}$ .

This parameter gives value for the minimum allowed torque with zero frequency. See Figure 5.5-27. If parameter 1. 13 is adjusted this parameter is automatically restored to the default value.

#### 7. 17 Underload time

This time can be set between 2.0—600.0 s.

This is the maximum time allowed for an underload state. There is an internal up/down counter to accumulate the underload time. See Figure 5.5-28.

If the underload counter value goes above this limit the protection will cause a trip (see parameter 7. 14). If the drive is stopped the underload counter is reset to zero.

Figure 5.5-28 Counting the underload time.

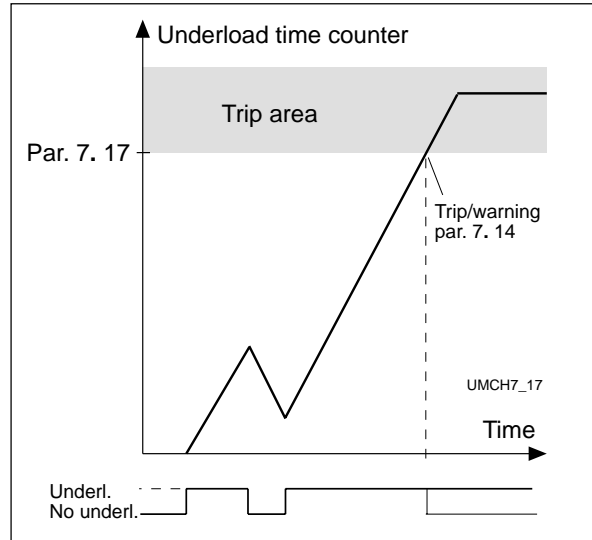

- 8.1 **Automatic restart: number of tries**
- 8.2 **Automatic restart: trial time**

The Automatic restart function restarts the frequency converter after the faults selected with parameters 8.4—8.8. The Start function for Automatic restart is selected with parameter 8.3.

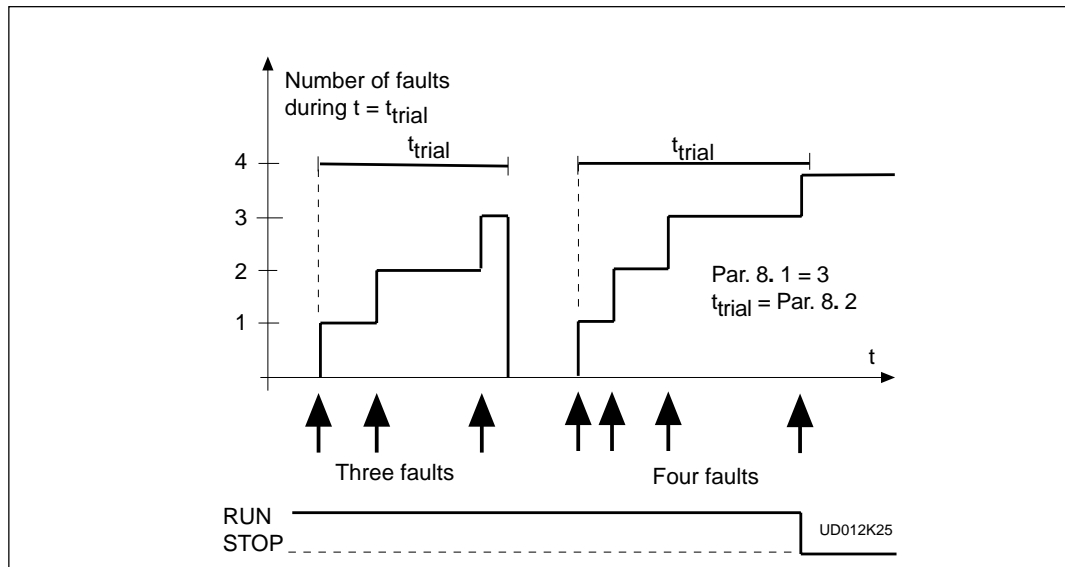

Figure 5.5-29 Automatic restart

Parameter 8.1 determines how many automatic restarts can be made during the trial time set by the parameter 8.2.

The time counting starts from the first autorestart. If the number of restarts does not exceed the value of the parameter 8.1 during the trial time, the counting is cleared after the time is elapsed and next fault starts the counting again.

- 8.3 **Automatic restart, start function**

The parameter defines the start mode:

0 = Start with ramp

1 = Flying start, see parameter 4. 6.

**8. 4 Automatic restart after undervoltage trip**

0 = No automatic restart after undervoltage fault trip

1 = Automatic restart after undervoltage fault condition returns to the normal condition (DC-link voltage returns to the normal level)

**8. 5 Automatic restart after overvoltage trip**

0 = No automatic restart after overvoltage fault trip

1 = Automatic restart after overvoltage fault condition returns to the normal condition (DC-link voltage returns to the normal level)

**8. 6 Automatic restart after overcurrent trip**

0 = No automatic restart after overcurrent fault trip

1 = Automatic restart after overcurrent faults

**8. 7 Automatic restart after reference fault trip**

0 = No automatic restart after reference fault trip

1 = Automatic restart after analogue current reference signal (4—20 mA) returns to the normal level ( $\geq 4$  mA)

**8. 8 Automatic restart after over-/undertemperature fault trip**

0 = No automatic restart after temperature fault trip

1 = Automatic restart after heatsink temperature has returned to its normal level between  $-10^{\circ}\text{C}$ — $+75^{\circ}\text{C}$ .



**PUMP AND FAN CONTROL APPLICATION**

(par. 0.1 = 7)

**CONTENTS**

<b>6 Pump and fan control Application .....</b>	<b>6-1</b>
6.1 General .....	6-2
6.2 Control I/O .....	6-2
6.3 Control signal logic .....	6-3
6.4 Basic parameters, Group 1 .....	6-4
6.4.1 Parameter table, Group 1 .....	6-4
6.4.2 Description of Group1 parameters ....	6-5
6.5 Special parameters, Groups 2—9 .....	6-8
6.5.1 Parameter tables, Groups 2—9 .....	6-8
6.5.2 Description of Groups 2—9 param.	6-16
6.6 Monitoring data .....	6-40
6.7 Panel reference .....	6-41

6.1 General

Pump and fan control can be selected by setting the value of parameter 0.1 to 7.

The application can be used to control one variable speed drive and 0-3 auxiliary drives. The PI-controller of the frequency converter controls the speed of the variable speed drive and gives control signals to Start and Stop auxiliary drives to control the total flow.

The application has two control sources on I/O terminals. Source A is Pump and fan control and source B is direct frequency reference. The control source is selected with DIB6 input.

**\* NOTE! Remember to connect CMA and CMB inputs.**

6.2 Control I/O

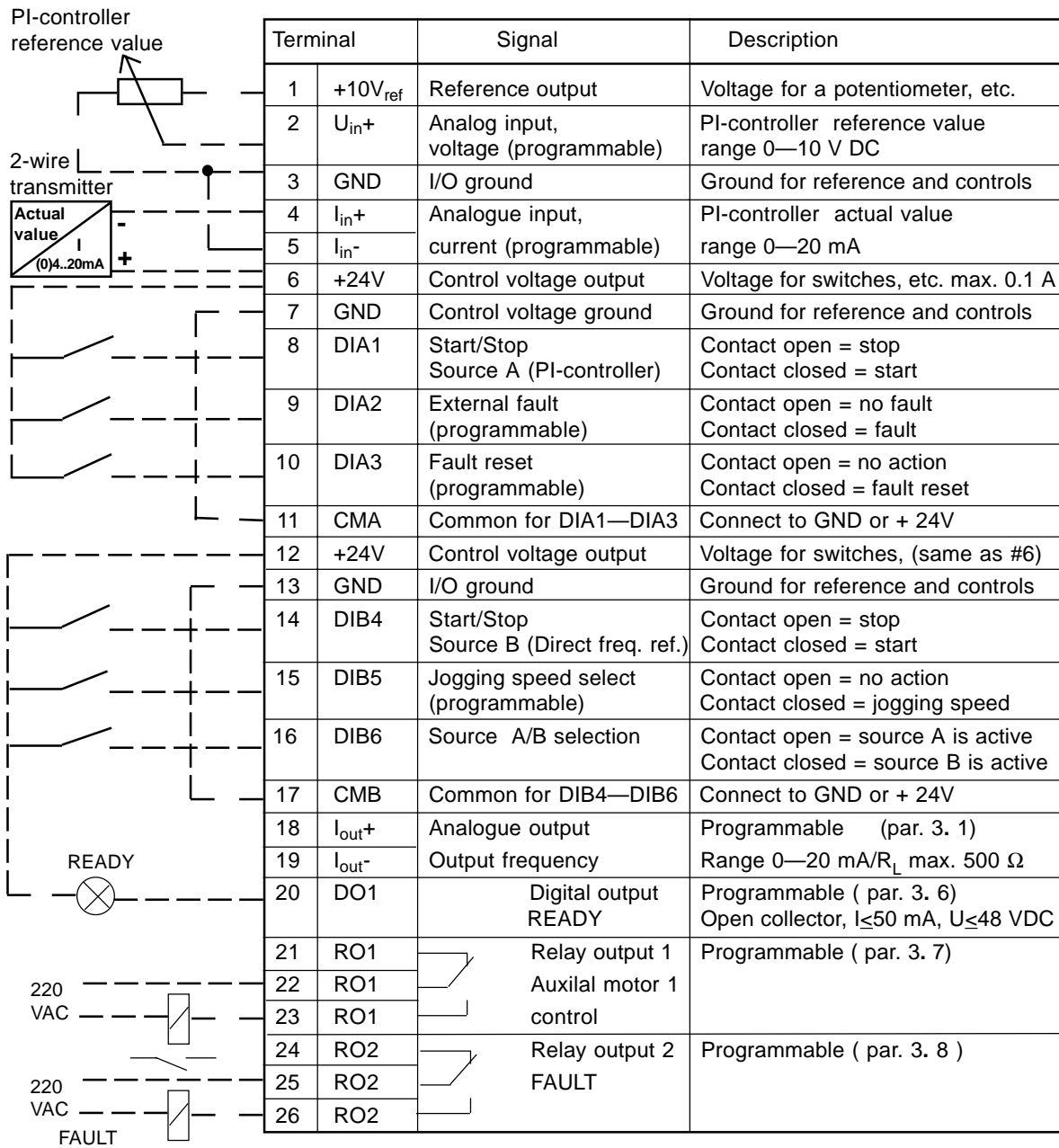

Figure 6.2-1 Default I/O configuration and connection example of the Pump and Fan Control Application with 2-wire transmitter.

### 6.3 Control signal logic

The logic of I/O-control signals and push button signals from the panel is presented in the figure 6.3-1.

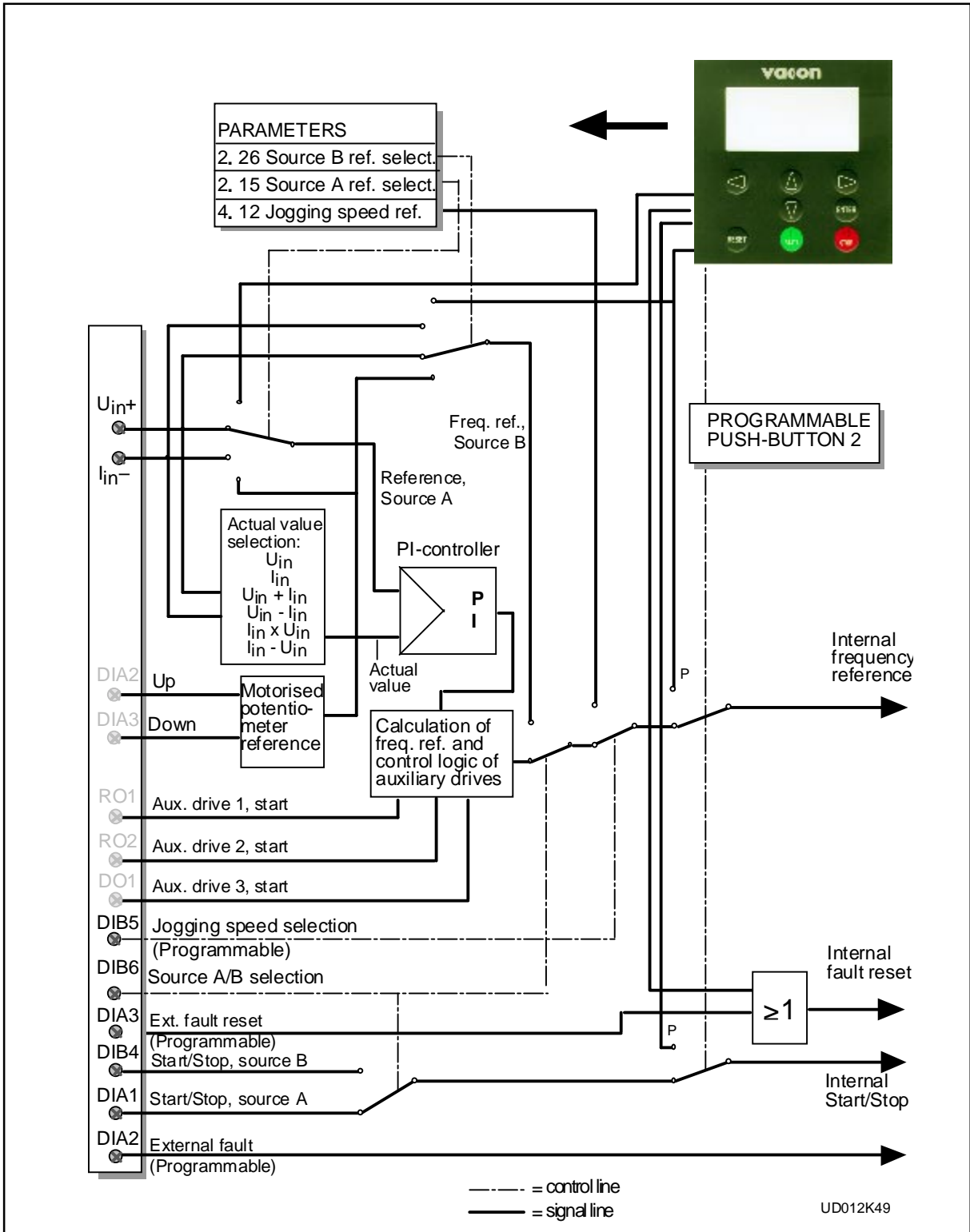



Figure 6.3-1 Control signal logic of the Pump and fan control Application. Switch positions are shown according to the factory settings.

## 6.4 Basic parameters, Group 1

### 6.4.1 Parameter table, Group 1

Code	Parameter	Range	Step	Default	Custom	Description	Page
1. 1	Minimum frequency	0— $f_{max}$	1 Hz	0 Hz			6-5
1. 2	Maximum frequency	$f_{min}$ -120/500 Hz	1 Hz	50 Hz		*)	6-5
1. 3	Acceleration time 1	0,1—3000,0 s	0,1 s	1,0 s		Time from $f_{min}$ (1. 1) to $f_{max}$ (1. 2)	6-5
1. 4	Deceleration time 1	0,1—3000,0 s	0,1 s	1,0 s		Time from $f_{max}$ (1. 2) to $f_{min}$ (1. 1)	6-5
1. 5	PI-controller gain	1—1000%	1 %	100%			6-5
1. 6	PI-controller I-time	0,00—320,00 s	0,01s	10,00s		0= No I-part in use	6-5
1. 7	Current limit	0,1—2,5 x $I_{nCT}$	0,1 A	1,5 x $I_{nCX}$		***Output curr. limit [A] of the unit	6-5
1. 8	U/f ratio selection	0—2	1	0		0 = Linear 1 = Squared 2 = Programmable U/f ratio	6-5
1. 9	U/f optimisation	0—1	1	0		0 = None 1 = Automatic torque boost	6-6
1. 10	Nominal voltage of the motor	180—690 V	1 V	230 V 400 V 500 V 690 V		Vacon range CX/CXL/CXS2 Vacon range CX/CXL/CXS4 Vacon range CX/CXL/CXS5 Vacon range CX6	6-7
1. 11	Nominal frequency of the motor	30—500 Hz	1 Hz	50 Hz		$f_n$ from the rating plate of the motor	6-7
1. 12	Nominal speed of the motor	300—20000 rpm	1 rpm	1420 rpm **)		$n_n$ from the rating plate of the motor	6-7
1. 13	Nominal current of the motor( $I_{nMot}$ )	2,5 x $I_{nCX}$	0,1 A	$I_{nCT}$		$I_n$ from the rating plate of the motor	6-7
1. 14	Supply voltage	208—240		230 V		Vacon range CX/CXL/CXS2	6-7
		380—440		400 V		Vacon range CX/CXL/CXS4	
		380—500		500 V		Vacon range CX/CXL/CXS5	
		525—690		690 V		Vacon range CX6	
1. 15	Parameter conceal	0—1	1	0		Visibility of the parameters: 0 = All parametergroups visible 1 = Only group 1 is visible	6-7
1. 16	Parameter value lock	0—1	1	0		Disables parameter changes: 0 = Changes enabled 1 = Changes disabled	6-7

**Note!**  = Parameter value can be changed only when the frequency converter is stopped.

\*) If 1. 2 > motor synchr. speed, check suitability for motor and drive system  
Selecting 120 Hz/500 Hz range see page 6-5.

\*\*\*) Default value for a four pole motor and a nominal size frequency converter.

\*\*\*) Up to M10. Bigger classes case by case.

# 6

Table 6.4-1 Group 1 basic parameters.

## 6.4.2 Description of Group 1 parameters

### 1. 1, 1. 2 *Minimum / maximum frequency*

Defines the frequency limits of the frequency converter.

The default maximum value for parameters 1. 1 and 1. 2 is 120 Hz. By setting 1. 2 = 120 Hz when the device is stopped (RUN indicator not lit) parameters 1. 1 and 1. 2 is changed to 500 Hz. At the same time the panel reference resolution is changed from 0.01 Hz to 0.1 Hz.

Changing the max. value from 500 Hz to 120 Hz is done by setting parameter 1. 2 = 119 Hz when the device is stopped.

### 1. 3, 1. 4 *Acceleration time 1, deceleration time 1:*

These limits correspond to the time required for the output frequency to accelerate from the set minimum frequency (par. 1. 1) to the set maximum frequency (par. 1. 2).

### 1. 5 *PI-controller gain*

This parameter defines the gain of the PI-controller.

If this parameter is set to 100%, a 10% change in error value causes the controller output to change by 10 Hz.

If the parameter value is set to 0 the PI-controller operates as I-controller.

### 1. 6 *PI-controller I-time*

Defines the integration time of the PI-controller.

### 1. 7 *Current limit*

This parameter determines the maximum motor current that the frequency converter can give momentarily.

### 1. 8 *U/f ratio selection*

Linear: The voltage of the motor changes linearly with the frequency in the constant flux area from 0 Hz to the field weakening point (par. 6. 3) where the nominal voltage is also supplied to the motor. See figure 6.4-1.

**0** Linear U/f ratio should be used in constant torque applications.

**This default setting should be used if there is no special demand for another setting.**

Squared: The voltage of the motor changes following a squared curve form with the frequency in the area from 0 Hz to the field weakening point (par. 6. 3) where the nominal voltage is also supplied to the motor. See figure 6.4-1.

**1** The motor runs undermagnetised below the field weakening point and produces less torque and electromechanical noise. Squared U/f ratio can be used in applications where torque demand of the load is proportional to the square of the speed, e.g. in centrifugal fans and pumps.

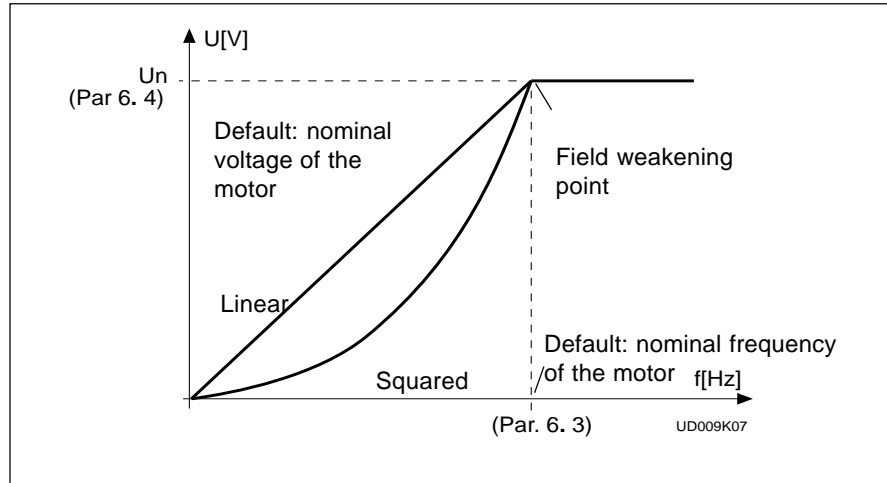

Figure 6.4-1 Linear and squared U/f curves.

Programm. U/f curve 2  
 The U/f curve can be programmed with three different points. The parameters for programming are explained in Chapter 6.5.2. Programmable U/f curve can be used if the other settings do not satisfy the needs of the application. See figure 6.4-2.

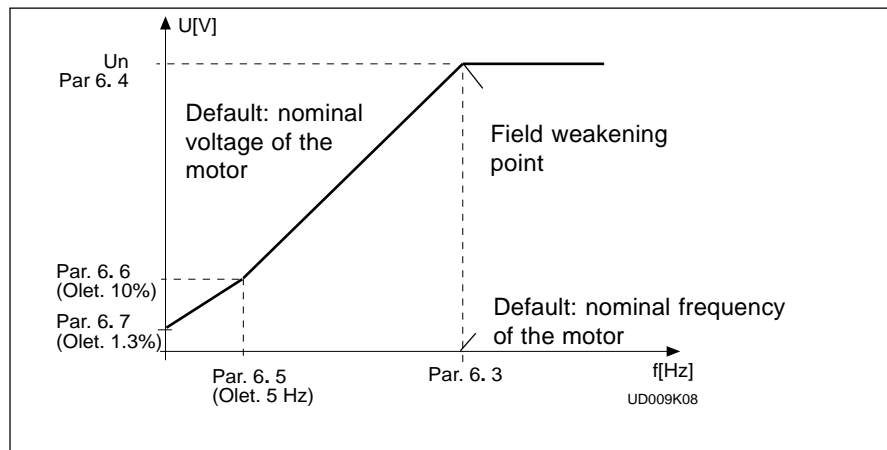

Figure 6.4-2 Programmable U/f curve.

**1.9 U/f optimisation**

Automatic torque boost  
 The voltage to the motor changes automatically which makes the motor to produce torque enough to start and run at low frequencies. The voltage increase depends on motor type and power.

Automatic torque boost can be used in applications where starting torque due to starting friction is high, e.g. in conveyors.

**NOTE!** *In high torque - low speed applications - it is the motor is likely to overheat.*



*If the motor has to run a prolonged time under these conditions, special attention must be paid to cooling the motor. Use external cooling for the motor if the temperature tends to rise too high.*

**1. 10 Nominal voltage of the motor**

Find this value  $U_n$  on the rating plate of the motor.

This parameter sets the Voltage at the field weakening point, parameter 6. 4, to  $100\% \times U_{n_{motor}}$ .

**1. 11 Nominal frequency of the motor**

Find this value  $f_n$  on the rating plate of the motor.

This parameter sets the field weakening point, parameter 6. 3, to the same value.

**1. 12 Nominal speed of the motor**

Find this value  $n_n$  on the rating plate of the motor.

**1. 13 Nominal current of the motor**

Find the value  $I_n$  on the rating plate of the motor.

The internal motor protection function uses this value as a reference value.

**1. 14 Supply voltage**

Set parameter value according to the nominal voltage of the supply.

Values are predefined for CX/CXL/CXS2, CX/CXL/CXS4, CX/CXL/CXS5 and CX6 ranges, see table 6.4-1.

**1. 15 Parameter conceal**

Defines which parameter groups are available:

0 = All parameter groups are visible

1 = Only group 1 is visible

**1. 16 Parameter value lock**

Determines access to the changes of the parameter values:



0 = Parameter value changes enabled

1 = Parameter value changes disabled

## 6.5 Special parameters, Groups 2—9

### 6.5.1 Parameter tables

#### Group 2, Input signal parameters

Code	Parameter	Range	Step	Default	Custom	Description	Page
2. 1	DIA2 function (terminal 9) 	0—10	1	1		0 = Not used 1 = Ext. fault, closing contact 2 = External fault, opening contact 3 = Run enable 4 = Acceler./deceler. time selection 5 = Reverse 6 = Jogging frequency 7 = Fault reset 8 = Acc./dec. operation prohibit 9 = DC-braking command 10 = Motor potentiometer UP	6-16
2. 2	DIA3 function (terminal 10) 	0—10	1	7		0 = Not used 1 = Ext. fault, closing contact 2 = External fault, opening contact 3 = Run enable 4 = Acceler./deceler. time selection 5 = Reverse 6 = Jogging frequency 7 = Fault reset 8 = Acc./dec. operation prohibit 9 = DC-braking command 10 = Motor potentiometer DOWN	6-17
2. 3	U <sub>in</sub> signal range	0—1	1	0		0 = 0—10 V 1 = Custom setting range	6-17
2. 4	U <sub>in</sub> custom setting min.	0,00-100,00%	0,01%	0,00%			6-17
2. 5	U <sub>in</sub> custom setting max.	0,00-100,00%	0,01%	100,00%			6-17
2. 6	U <sub>in</sub> signal inversion	0—1	1	0		0 = Not inverted 1 = Inverted	6-17
2. 7	U <sub>in</sub> signal filter time	0,00—10,00 s	0,01s	1,00s		0 = No filtering	6-17
2. 8	I <sub>in</sub> signal range	0—2	1	0		0 = 0—20 mA 1 = 4—20 mA 2 = Custom setting range	6-17
2. 9	I <sub>in</sub> custom setting minim.	0,00-100,00%	0,01%	0,00%			6-18
2. 10	I <sub>in</sub> custom setting maxim.	0,00-100,00%	0,01%	100,00%			6-18
2. 11	I <sub>in</sub> signal inversion	0—1	1	0		0 = Not inverted 1 = Inverted	6-18
2. 12	I <sub>in</sub> signal filter time	0,01—10,00s	0,01s	1,00 s		0 = No filtering	6-18
2. 13	DIB5 function (terminal 15) 	0—9	1	6		0 = Not used 1 = Ext. fault, closing contact 2 = External fault, opening contact 3 = Run enable 4 = Acc./dec. time selection 5 = Reverse 6 = Jogging speed 7 = Fault reset 8 = Acc./dec. operation prohibit 9 = DC-braking command	6-18





**Note!**



= Parameter value can be changed only when the frequency converter is stopped



(Continues)



Code	Parameter	Range	Step	Default	Custom	Description	Page
2. 14	Motor potentiometer ramp time	0,1—2000,0 Hz/s	0,1 Hz/s	10,0 Hz/s			6-19
2. 15	PI-controller reference signal (source A) 	0—4	1	0		0 = Analogue voltage input (term. 2) 1 = Analogue current input (term. 4) 2 = Set reference from the panel (reference r2) 3 = Signal from internal motor pot. 4 = Signal from internal motor pot. reset if Vacon unit is stopped	619
2. 16	PI-controller actual value selection 	0—3	1	0		0 = Actual value1 1 = Actual 1 + Actual 2 2 = Actual 1 - Actual 2 3 = Actual 1 * Actual 2	6-19
2. 17	Actual value 1 input 	0—2	1	2		0 = No 1 = Voltage input 2 = Current input	6-19
2. 18	Actual value 2 input 	0—2	1	0		0 = No 1 = Voltage input 2 = Current input	6-19
2. 19	Actual value 1 min scale	-320,00%—+320,00%	0,01%	0,00%		0% = no minimum scaling	6-19
2. 20	Actual value 1 max scale	-320,00%—+320,00%	0,01%	100,00%		100% = no maximum scaling	6-19
2. 21	Actual value 2 min scale	-320,00%—+320,00%	0,01%	0,00%		0% = no minimum scaling	6-19
2. 22	Actual value 2 max scale	-320,00%—+320,00%	0,01%	100,00%		100% = no maximum scaling	6-19
2. 23	Error value inversion	0—1	1	0		0 = No 1 = Yes	6-20
2. 24	PI-controller reference value rise time	0,0—100,0 s	0,1 s	60,0 s		Time for reference value change from 0 % to 100 %	6-20
2. 25	PI-controller reference value fall time	0,0—100,0 s	0,1 s	60,0 s		Time for reference value change from 100 % to 0 %	6-20
2. 26	Direct frequency reference, source B 	0—4	1	0		0 = Analogue voltage input (term. 2) 1 = Analogue current input (term. 4) 2 = Set reference from the panel (reference r1) 3 = Signal from internal motor pot. 4 = Signal from internal motor pot. reset if Vacon unit is stopped	6-20
2. 27	Source B reference scaling minimum value	0—par.2. 28	1 Hz	0 Hz		Selects the frequency that corresponds to the min. reference signal	6-20
2. 28	Source B reference scaling maximum value	0— $f_{max}$	1 Hz	0 Hz		Selects the frequency that corresponds to the max. reference signal 0 = Scaling off >0 = Scaled maximum value	6-20

**Note!**  = Parameter value can be changed only when the frequency converter is stopped (Continues)

## Group 3, Output and supervision parameters

Code	Parameter	Range	Step	Default	Custom	Description	Page
3.1	Analogue output function	0—15	1	1		0 = Not used      Scale 100% 1 = O/P frequency (0— $f_{max}$ ) 2 = Motor speed (0—max. speed) 3 = O/P current (0— $2.0 \times I_{nCT}$ ) 4 = Motor torque (0— $2 \times T_{nMot}$ ) 5 = Motor power (0— $2 \times P_{nMot}$ ) 6 = Motor voltage (0— $100\% \times U_{nMot}$ ) 7 = DC-link volt. (0—1000 V) 8—10 = Not in use 11 = PI-controller reference value 12 = PI-controller actual value 1 13 = PI-controller actual value 2 14 = PI-controller error value 15 = PI-controller output	6-21
3.2	Analogue output filter time	0,00—10,00 s	0,01s	1,00s			6-21
3.3	Analogue output inversion	0—1	1	0		0 = Not inverted 1 = Inverted	6-21
3.4	Analogue output minimum	0—1	1	0		0 = 0 mA 1 = 4 mA	6-21
3.5	Analogue output scale	10—1000%	1%	100%			6-21
3.6	Digital output function 	0—30	1	1		0 = Not used 1 = Ready 2 = Run 3 = Fault 4 = Fault inverted 5 = Vacon overheat warning 6 = External fault or warning 7 = Reference fault or warning 8 = Warning 9 = Reversed 10 = Jogging speed selected 11 = At speed 12 = Motor regulator activated 13 = Output freq. limit superv. 1 14 = Output freq. limit superv. 2 15 = Torque limit supervision 16 = Reference limit supervision 17 = External brake control 18 = Control from I/O terminals 19 = Frequency converter temperature limit supervision 20 = Unrequested rotation direction 21 = External brake control inverted 22—27 = Not in use 28 = Auxiliary drive 1 start 29 = Auxiliary drive 2 start 30 = Auxiliary drive 3 start	6-22
3.7	Relay output 1 function 	0—30	1	28		As parameter 3.6	6-22
3.8	Relay output 2 function 	0—30	1	3		As parameter 3.6	6-22
3.9	Output freq. limit 1 supervision function	0—2	1	0		0 = No 1 = Low limit 2 = High limit	6-22
3.10	Output freq. limit 1 supervision value	0,0— $f_{max}$ (par. 1. 2)	0,1 Hz	0,0 Hz			6-22

**Note!**  = Parameter value can be changed only when the frequency converter is stopped. (Continues)

Code	Parameter	Range	Step	Default	Custom	Description	Page
3. 11	Output freq. limit 2 supervision function	0—2	1	0		0 = No 1 = Low limit 2 = High limit	6-22
3. 12	Output freq. limit 2 supervision value	0,0— $f_{max}$ (par. 1. 2)	0,1 Hz	0,0 Hz			6-22
3. 13	Torque limit supervision function	0—2	1	0		0 = No 1 = Low limit 2 = High limit	6-23
3. 14	Torque limit supervision value	0,0—200,0% $\times T_{nCX}$	0,1%	100,0%			6-23
3. 15	Active reference limit supervision function	0—2	1	0		0 = No 1 = Low limit 2 = High limit	6-23
3. 16	Active reference limit supervision value	0,0— $f_{max}$ (par. 1. 2)	0,1 Hz	0,0 Hz			6-23
3. 17	External brake off-delay	0,0—100,0 s	1	0,5 s			6-23
3. 18	External brake on-delay	0,0—100,0 s	1	1,5 s			6-23
3. 19	Frequency converter temperature limit supervision function	0—2	1	0		0 = No 1 = Low limit 2 = High limit	6-23
3. 20	Frequency converter temperature limit	-10—+75°C	1	+40°C			6-23
3. 21	I/O-expander board (opt.) analogue output content	0—7	1	3		See parameter 3. 1	6-21
3. 22	I/O-expander board (opt.) analogue output filter time	0,00—10,00 s	0,01	1,00 s		See parameter 3. 2	6-21
3. 23	I/O-expander board (opt.) analogue output inversion	0—1	1	0		See parameter 3. 3	6-21
3. 24	I/O-expander board (opt.) analogue output minimum	0—1	1	0		See parameter 3. 4	6-21
3. 25	I/O-expander board (opt.) analogue output scale	10—1000%	1	100%		See parameter 3. 5	6-21

#### Group 4, Drive control parameters

Code	Parameter	Range	Step	Default	Custom	Description	Page
4. 1	Acc./dec. ramp 1 shape	0,0—10,0 s	0,1 s	0,0 s		0 = Linear >0 = S-curve acc./dec. time	6-24
4. 2	Acc./dec. ramp 2 shape	0,0—10,0 s	0,1 s	0,0 s		0 = Linear >0 = S-curve acc./dec. time	6-24
4. 3	Acceleration time 2	0,1—3000,0 s	0,1 s	10,0 s			6-25
4. 4	Deceleration time 2	0,1—3000,0 s	0,1 s	10,0 s			6-25
4. 5	Brake chopper 	0—2	1	0		0 = Brake chopper not in use 1 = Brake chopper in use 2 = External brake chopper	6-25
4. 6	Start function	0—1	1	0		0 = Ramp 1 = Flying start	6-25
4. 7	Stop function	0—1	1	0		0 = Coasting 1 = Ramp	6-25







**Note!**  = Parameter value can be changed only when the frequency converter is stopped. (Continues)

Code	Parameter	Range	Step	Default	Custom	Description	Page
4. 8	DC-braking current	0,15—1,5 x $I_{nCT}$ (A)	0,1 A	0,5 x $I_{nCT}$			6-25
4. 9	DC-braking time at Stop	0,00-250,00 s	0,01 s	0,00 s		0 = DC-brake is off at Stop	6-25
4. 10	Execute frequency of DC-brake during ramp Stop	0,1-10,0 Hz	0,1 Hz	1,5 Hz			6-27
4. 11	DC-brake time at Start	0,00-25,00 s	0,01 s	0,00 s		0 = DC-brake is off at Start	6-27
4. 12	Jogging speed reference	$f_{min}$ — $f_{max}$ (1. 1) (1. 2)	0,1 Hz	10,0 Hz			6-27

### Group 5, Prohibit frequency parameters

Code	Parameter	Range	Step	Default	Custom	Description	Page
5. 1	Prohibit frequency range 1 low limit	$f_{min}$ — par. 5. 2	0,1 Hz	0,0 Hz			6-27
5. 2	Prohibit frequency range 2 high limit	$f_{min}$ — $f_{max}$ (1. 1) (1. 2)	0,1 Hz	0,0 Hz		0 = No prohibit frequency range	6-27
5. 3	Prohibit frequency range 2 low limit	$f_{min}$ — par. 5. 4	0,1 Hz	0,0 Hz			6-27
5. 4	Prohibit frequency range 2 high limit	$f_{min}$ — $f_{max}$ (1. 1) (1. 2)	0,1 Hz	0,0 Hz		0 = No prohibit frequency range	6-27
5. 5	Prohibit frequency range 3 low limit	$f_{min}$ — par. 5. 6	0,1 Hz	0,0 Hz			6-27
5. 6	Prohibit frequency range 3 high limit	$f_{min}$ — $f_{max}$ (1. 1) (1. 2)	0,1 Hz	0,0 Hz		0 = No prohibit frequency range	6-27

### Group 6, Motor control parameters

Code	Parameter	Range	Step	Default	Custom	Description	Page
6. 1	Motor control mode 	0—1	1	0		0 = Frequency control 1 = Speed control	6-27
6. 2	Switching frequency	1,0—16,0 kHz	0,1 kHz	10/3,6kHz		Dependant on kW	6-28
6. 3	Field weakening point 	30—500 Hz	1 Hz	Param. 1. 11			6-28
6. 4	Voltage at field weakening point 	15—200% x $U_{nmot}$	1%	100%			6-28
6. 5	U/F-curve mid point frequency 	0,0— $f_{max}$	0,1 Hz	0,0 Hz			6-28
6. 6	U/F-curve mid point voltage 	0,00—100,00% x $U_{nmot}$	0,01%	0,00%		Parameter maximum value = param. 6.4	6-28
6. 7	Output voltage at zero frequency 	0,00—40,00% x $U_{nmot}$	0,01%	0,00%			6-28
6. 8	Overvoltage controller 	0—1	1	1		0 = Controller is not operating 1 = Controller is in operation	6-29
6. 9	Undervoltage controller	0—1	1	1		0 = Controller is not operating 1 = Controller is in operation	6-29

6

#### Note!



= Parameter value can be changed only when the frequency converter is stopped.

## Group 7, Protections

Code	Parameter	Range	Step	Default	Custom	Description	Page
7.1	Response to reference fault	0—3	1	0		0 = No action 1 = Warning 2 = Fault, stop according to par 4.7 3 = Fault, stop always by coasting	6-29
7.2	Response to external fault	0—3	1	2		0 = No action 1 = Warning 2 = Fault, stop according to par 4.7 3 = Fault, stop always by coasting	6-29
7.3	Phase supervision of the motor	0—2	2	2		0 = No action 2 = Fault	6-29
7.4	Earth protection	0—2	2	2		0 = No action 2 = Fault	6-29
7.5	Motor thermal protection	0—2	1	2		0 = No action 1 = Warning 2 = Fault	6-30
7.6	Motor thermal protection break point current	50,0—150,0 % $\times I_{nMOTOR}$	1,0 %	100,0%			6-30
7.7	Motor thermal protection zero frequency current	5,0—150,0% $\times I_{nMOTOR}$	1,0 %	45,0%			6-31
7.8	Motor thermal protection time constant	0,5—300,0 minutes	0,5 min.	17,0 min.		Default value is set according to motor nominal current	6-31
7.9	Motor thermal protection break point frequency	10—500 Hz	1 Hz	35 Hz			6-32
7.10	Stall protection	0—2	1	1		0 = No action 1 = Warning 2 = Fault	6-32
7.11	Stall current limit	5,0—200,0% $\times I_{nMOTOR}$	1,0%	130,0%			6-33
7.12	Stall time	2,0—120,0 s	1,0 s	15,0 s			6-33
7.13	Maximum stall frequency	1— $f_{max}$	1 Hz	25 Hz			6-33
7.14	Underload protection	0—2	1	0		0 = No action 1 = Warning 2 = Fault	6-34
7.15	Underload prot., field weakening area load	10,0—150,0 % $\times T_{nMOTOR}$	1,0%	50,0%			6-34
7.16	Underload protection, zero frequency load	5,0—150,0% $\times T_{nMOTOR}$	1,0%	10,0%			6-34
7.17	Underload time	2,0—600,0 s	1,0 s	20,0 s			6-34

**Group 8, Autorestart parameters**

Code	Parameter	Range	Step	Default	Custom	Description	Page
8.1	Automatic restart: number of tries	0—10	1	0			6-35
8.2	Automatic restart: trial time	1—6000 s	1 s	30 s			6-35
8.3	Automatic restart: start function	0—1	1	0		0 = Ramp 1 = Flying start	6-36
8.4	Automatic restart after undervoltage trip	0—1	1	0		0 = No 1 = Yes	6-36
8.5	Automatic restart after overvoltage trip	0—1	1	0		0 = No 1 = Yes	6-36
8.6	Automatic restart after overcurrent trip	0—1	1	0		0 = No 1 = Yes	6-36
8.7	Automatic restart after reference fault trip	0—1	1	0		0 = No 1 = Yes	6-36
8.8	Automatic restart after over/undertemperature fault trip	0—1	1	0		0 = No 1 = Yes	6-36

## Group 9, Pump and fan control special parameters

Code	Parameter	Range	Step	Default	Custom	Description	Page
9. 1	Number of aux. drives	0—3	1	1			6-37
9. 2	Start frequency of auxiliary drive 1	$I_{min}$ — $I_{max}$	0,1 Hz	51,0 Hz			6-37
9. 3	Stop frequency of auxiliary drive 1	$I_{min}$ — $I_{max}$	0,1 Hz	25,0 Hz			6-37
9. 4	Start frequency of auxiliary drive 2	$I_{min}$ — $I_{max}$	0,1 Hz	51,0 Hz			6-37
9. 5	Stop frequency of auxiliary drive 2	$I_{min}$ — $I_{max}$	0,1 Hz	25,0 Hz			6-37
9. 6	Start frequency of auxiliary drive 3	$I_{min}$ — $I_{max}$	0,1 Hz	51,0 Hz			6-37
9. 7	Stop frequency of auxiliary drive 3	$I_{min}$ — $I_{max}$	0,1 Hz	25,0 Hz			6-37
9. 8							
9. 9							
9. 10	Start delay of the auxiliary drives	0,0—300,0 s	0,1 s	4,0 s			6-37
9. 11	Stop delay of the auxiliary drives	0,0—300,0 s	0,1 s	2,0 s			6-37
9. 12	Reference step after start of the 1 aux. drive	0,0—100,0 %	0,1 %	0,0 %		In % of actual value	6-38
9. 13	Reference step after start of the 2 aux. drive	0,0—100,0 %	0,1 %	0,0 %		In % of actual value	6-38
9. 14	Reference step after start of the 3 aux. drive	0,0—100,0 %	0,1 %	0,0 %		In % of actual value	6-38
9. 15	(Reserved)						
9. 16	Sleep level	0,0—120/500 Hz	0,1 Hz	0.0 Hz		Frequency below which the freq. of the speed controlled motor has to go before starting the sleep delay counting ( 0.0 = not in use)	6-38
9. 17	Sleep delay	0,0—3000,0 s	0,1 s	30,0 s		Time that the freq. has to be below par. 9.16 before stopping Vacon	6-38
9. 18	Wake up level	0,0—100,0 %	0,1 %	0,0 %		Level of the actual value for restarting Vacon	6-38
9. 19	Wake up function	0—1	1	0		0 = Wake up when falling below the wake up level 1 = Wake up when exceeding the wake up level	6-38
9. 20	PI-regulator bypass	0—1	1	0		1 = PI-regulator bypassed	6-39

Table 6.5-1 Special parameters, Groups 2—9.

6.5.2 Description of Groups 2—9 parameters

2.1 DIA2 function

- 1: External fault, closing contact = Fault is shown and motor is stopped when the input is active
- 2: External fault, opening contact = Fault is shown and motor is stopped when the input is not active
- 3: Run enable contact open = Start of the motor disabled  
contact closed = Start of the motor enabled
- 4: Acc. / Dec time select. contact open = Acceleration/Deceleration time 1 selected  
contact closed = Acceleration/Deceleration time 2 selected
- 5: Reverse contact open = Forward  
contact closed = Reverse  
If two or more inputs are programmed to reverse then if one of them is active the direction is reverse
- 6: Jogging freq. contact closed = Jogging frequency selected for freq. refer.
- 7: Fault reset contact closed = Resets all faults
- 8: Acc./Dec. operation prohibited contact closed = Stops acceleration and deceleration until the contact is opened
- 9: DC-braking command contact closed = In the stop mode, the DC-braking operates until the contact is opened, see figure 6.5-1. Dc-brake current is set with parameter 4. 8.
- 10: Motor pot. UP contact closed = Reference increases until the contact is opened

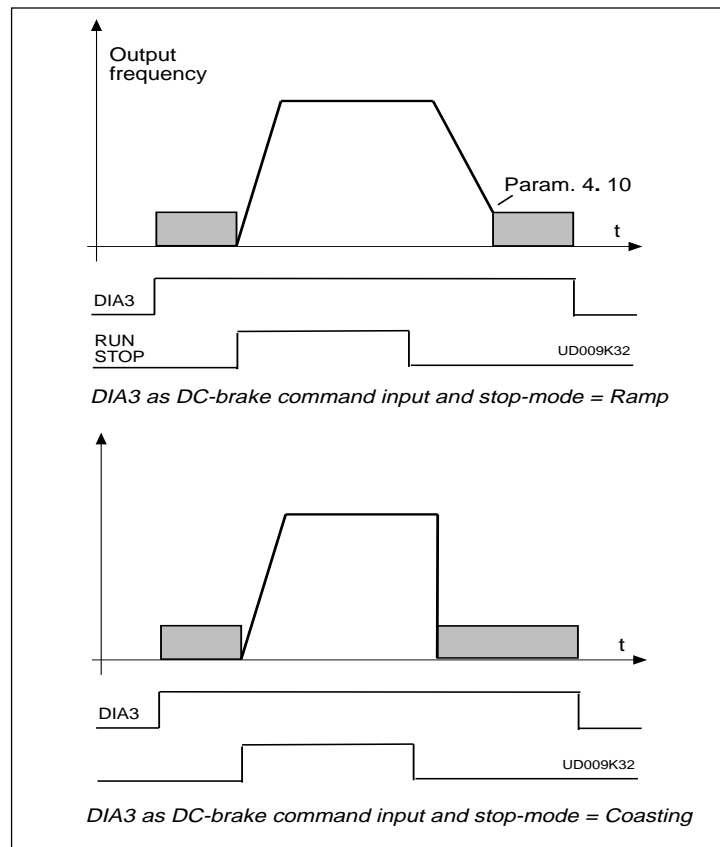

Figure 6.5-1 DIA3 as DC-brake command input:  
a) Stop-mode = ramp,  
b) Stop-mode = coasting



## 2. 2 **DIA3 function**

Selections are same as in 2. 1 except :

10: Motor pot. contact closed = Reference decreases until the contact is  
DOWN opened

## 2. 3 **$U_{in}$ signal range**

0 = Signal range 0—10 V

1 = Custom setting range from custom minimum (par. 2. 4) to custom maximum (par. 2. 5)

## 2. 4 **$U_{in}$ custom setting minimum/maximum**

2. 5 With these parameters you can set  $U_{in}$  for any input signal span within 0—10 V.

Minimum setting: Set the  $U_{in}$  signal to its minimum level, select parameter 2. 4, press the *Enter* button

Maximum setting: Set the  $U_{in}$  signal to its maximum level, select parameter 2. 5, press the *Enter* button

**Note!** The parameter values can only be set with this procedure (not with the *Browser buttons*)

## 2. 6 **$U_{in}$ signal inversion**

Parameter 2. 6 = 0, no inversion of analogue  $U_{in}$  signal

Parameter 2. 6 = 1, inversion of analogue  $U_{in}$  signal.

## 2. 7 **$U_{in}$ signal filter time**

Filters out disturbances from the incoming analogue  $U_{in}$  signal. Long filtering time makes regulation response slower. See figure 6.5-2.

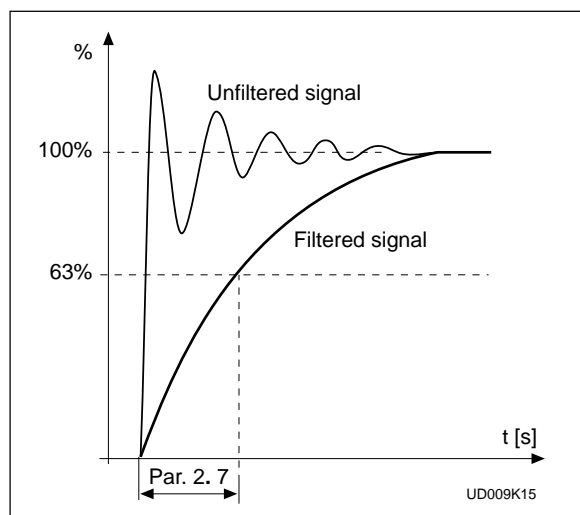

Figure 6.5-2  $U_{in}$  signal filtering

## 2. 8 **Analogue input $I_{in}$ signal range**

0 = 0—20 mA

1 = 4—20 mA

2 = Custom signal span

**2. 9 Analogue input  $I_{in}$  custom setting**  
**2. 10 minimum/maximum**

With these parameters you can scale the input current signal ( $I_{in}$ ) signal range between 0—20 mA.

Minimum setting: Set the  $I_{in}$  signal to its minimum level, select parameter 2. 9, press the Enter button

Maximum setting: Set the  $I_{in}$  signal to its maximum level, select parameter 2. 10, press the Enter button

**Note!** The parameter values can only be set with this procedure (not with the *Browser buttons*)

**2. 11 Analogue input  $I_{in}$  inversion**

Parameter 2. 11 = 0, no inversion of  $I_{in}$  input.

Parameter 2. 11 = 1, inversion of  $I_{in}$  input.

**2. 12 Analogue input  $I_{in}$  filter time**

Filters out disturbances from the incoming analogue  $I_{in}$  signal. Long filtering time makes regulation response slower. See figure 6.5-3.

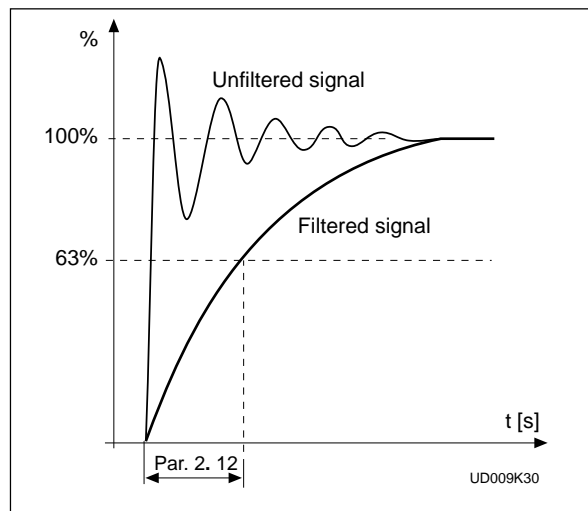

Figure 6.5-3 Analogue input  $I_{in}$  filter time

**2. 13 DIA5 function**

- |  |  |
|--|--|
| <b>1:</b> External fault, closing contact  | = Fault is shown and motor is stopped when the input is active   |
| <b>2:</b> External fault, opening contact  | = Fault is shown and motor is stopped when the input is not active   |
| <b>3:</b> Run enable   | contact open = Start of the motor disabled<br>contact closed = Start of the motor enabled  |
| <b>4:</b> Acc. / Dec time select.  | contact open = Acceleration/Deceleration time 1 selected<br>contact closed = Acceleration/Deceleration time 2 selected                                 |
| <b>5:</b> Reverse  | contact open = Forward<br>contact closed = Reverse   |
| <div style="border-left: 1px solid black; border-right: 1px solid black; padding: 0 5px;">                     If two or more inputs are programmed to reverse then if one of them is active the direction is reverse                 </div> |  |
| <b>6:</b> Jogging freq.  | contact closed = Jogging frequency selected for freq. refer.   |
| <b>7:</b> Fault reset  | contact closed = Resets all faults   |
| <b>8:</b> Acc./Dec. operation prohibited   | contact closed = Stops acceleration and deceleration until the contact is opened   |
| <b>9:</b> DC-braking command   | contact closed = In the stop mode, the DC-braking operates until the contact is opened, see figure 6.5-1. DC-brake current is set with parameter 4. 8. |

**2. 14 Motor potentiometer ramp time**

Defines how fast the electronic motor potentiometer value changes.

**2. 15 PI-controller reference signal**

- 0** Analogue voltage reference from terminals 2—3, e.g. a potentiometer
- 1** Analogue current reference from terminals 4—5, e.g. a transducer.
- 2** Panel reference is the reference set from the Reference menu.  
Reference r2 is the PI-controller reference, see Chapter 6.
- 3** Reference value is changed with digital input signals DIA2 and DIA3.  
- switch in DIA2 closed = frequency reference increases  
- switch in DIA3 closed = frequency reference decreases  
Speed of the reference change can be set with parameter 2. 3.
- 4** Same as setting 3 but the reference value is set to the minimum frequency (par. 1. 1) each time the frequency converter is stopped.  
When the value of parameter 1. 5 is set to 3 or 4, the value of parameter 2.1 is automatically set to 4 and the value of parameter 2. 2 is automatically set to 10.

**2. 16 PI-controller actual value selection****2. 17 Actual value 1****2. 18 Actual value 2**

With these parameters the actual value of the PI-controller is selected.

**2. 19 Actual value 1 minimum scale**

Sets the minimum scaling point for Actual value 1. See figure 6.5-4.

**2. 20 Actual value 1 maximum scale**

Sets the maximum scaling point for Actual value 1. See figure 6.5-4.

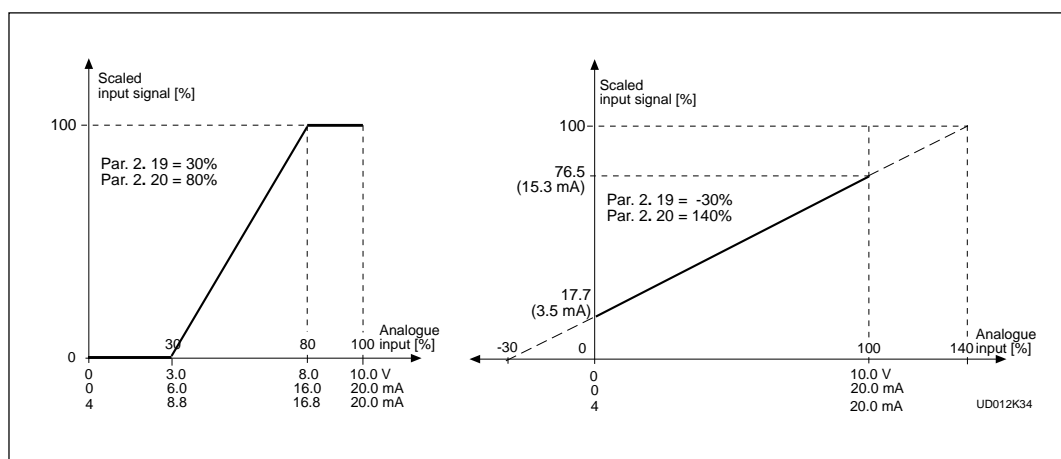

Figure 6.5-4 Examples about the scaling of actual value signal.

**2. 21 Actual value 2 minimum scale**

Sets the minimum scaling point for Actual value 2.

**2. 22 Actual value 2 maximum scale**

Sets the maximum scaling point for Actual value 2.

**2. 23 Error value inversion**

This parameter allows you to invert the error value of the PI-controller (and thus the operation of the PI-controller).

**2. 24 PI-controller reference value rise time****2. 25 PI-controller reference value fall time**

The rise and fall times of the PI-controller reference value can be set with these parameters in the range of 0 to 100% (and vice versa). This prevents the reference values from altering too fast e.g. at start-up.

**2. 26 Direct frequency reference, Place B**

- 0** Analogue voltage reference from terminals 2—3, e.g. a potentiometer
- 1** Analogue current reference from terminals 4—5, e.g. a transducer.
- 2** Panel reference is the reference set from the Reference Menu.  
Reference r1 is the Place B reference, see chapter 6.
- 3** Reference value is changed with digital input signals DIA2 and DIA3.  
- switch in DIA2 closed = frequency reference increases  
- switch in DIA3 closed = frequency reference decreases  
Speed of the reference change can be set with parameter 2. 3.
- 4** Same as setting 3 but the reference value is set to the minimum frequency (par. 1. 1) each time the frequency converter is stopped.  
When the value of parameter 1. 5 is set to 3 or 4, the value of parameter 2. 1 is automatically set to 4 and the value of parameter 2. 2 is automatically set to 10.

**2. 27 Place B reference scaling, minimum value/maximum value**

Setting limits:  $0 < \text{par. 2. 27} < \text{par. 2. 28} < \text{par. 1. 2}$ .

If par. 2. 28 = 0 scaling is set off.

See figures 6.5-5 and 6.5-6.

(In the figures voltage input  $U_{in}$  with signal range 0—10 V selected for source B reference)

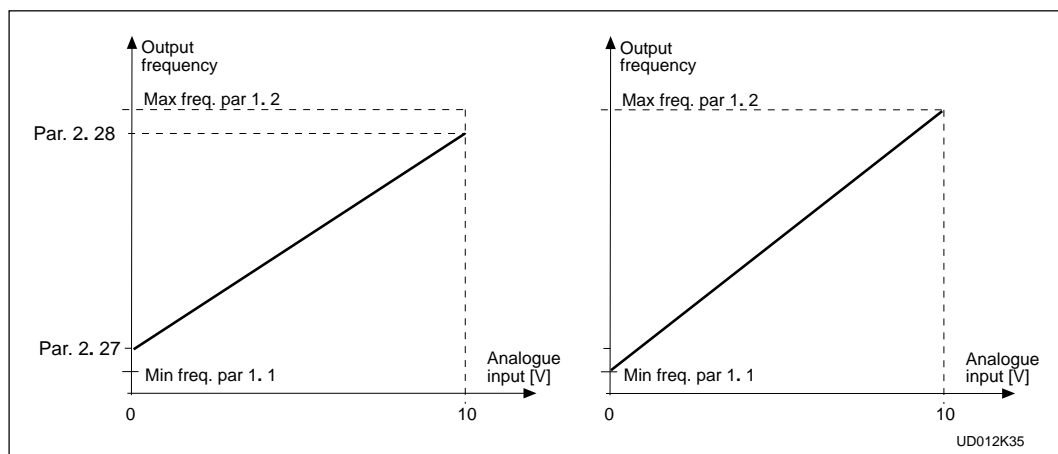

Figure 6.5-5 Reference scaling.

Figure 6.5-6 Reference scaling, par. 2. 15 = 0.

**3.1 Analogue output function**

See table on page 6-10.

**3.2 Analogue output filter time**

Filters the analogue output signal. See figure 6.5-7.

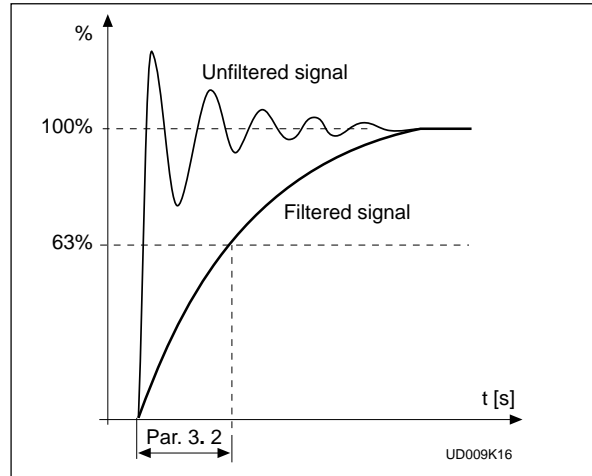

Figure 6.5-7 Analogue output filtering.

**3.3 Analogue output invert**

Inverts the analogue output signal:

- max. output signal = minimum set value
- min. output signal = maximum set value

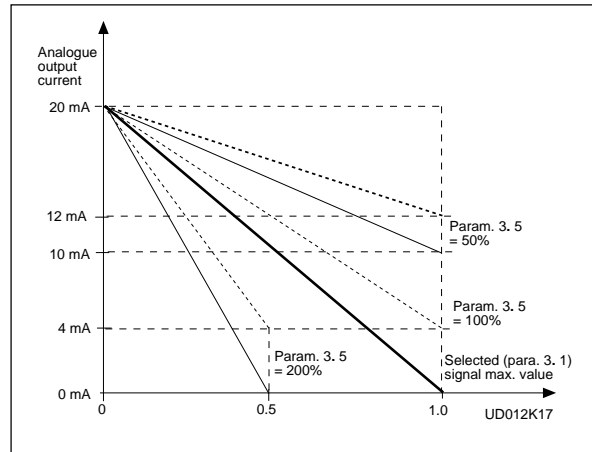

Figure 6.5-8 Analogue output invert.

**3.4 Analogue output minimum**

Defines the signal minimum to be either 0 mA or 4 mA (living zero). See figure 6.5-9.

**3.5 Analogue output scale**

Scaling factor for analogue output. See figure 6.5-9.

Signal	Max. value of the signal
Output freq.	Max. frequency (p. 1. 2)
Motor speed	Max. speed ( $n_n \times f_{max} / f_n$ )
Output current	$2 \times I_{nCT}$
Motor torque	$2 \times T_{nMot}$
Motor power	$2 \times P_{nMot}$
Motor voltage	$100\% \times U_{nMot}$
DC-link volt.	1000 V
PI-act. value	100% x ref. value max.
PI-act. value1	100% x act. value max.
PI-act. value2	100% x act. value max.
PI-error value	100% x error value max.
PI-output	100% x output max.

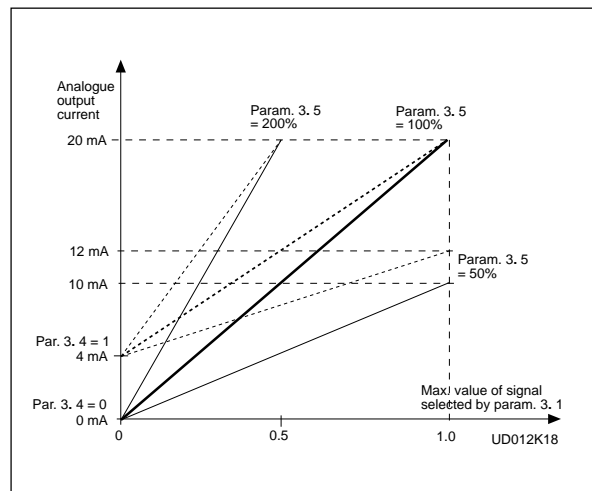

Figure 6.5-9 Analogue output scale.

- 3. 6 **Digital output function**
- 3. 7 **Relay output 1 function**
- 3. 8 **Relay output 2 function**

Setting value	Signal content
0 = Not used	Out of operation <u>Digital output DO1 sinks current and programmable relay (RO1, RO2) is activated when:</u>
1 = Ready	The frequency converter is ready to operate
2 = Run	The frequency converter operates (motor is running)
3 = Fault	A fault trip has occurred
4 = Fault inverted	A fault trip has not occurred
5 = Vacon overheat warning	The heat-sink temperature exceeds +70°C
6 = External fault or warning	Fault or warning depending on parameter 7. 2
7 = Reference fault or warning	Fault or warning depending on parameter 7. 1 - if analogue reference is 4—20 mA and signal is <4mA
8 = Warning	Always if a warning exists
9 = Reversed	The reverse command has been selected
10= Multi-step or jogging speed	Multi-step or jog. speed has been selected with digital inp
11 = At speed	The output frequency has reached the set reference
12= Motor regulator activated	Overvoltage or overcurrent regulator was activated
13= Output frequency supervision 1	The output frequency goes outside of the set supervision Low limit/ High limit (par. 3. 9 and par. 3. 10)
14= Output frequency supervision 2	The output frequency goes outside of the set supervision Low limit/ High limit (par. 3. 11 and par. 3. 12)
15= Torque limit supervision	The motor torque goes outside of the set supervision Low limit/ High limit (par. 3. 13 and par. 3. 14)
16= Active reference limit supervision	Active reference goes outside of the set supervision Low limit/ High limit (par. 3. 15 and par. 3. 16)
17 = External brake control	External brake ON/OFF control with programmable delay (par 3. 17 and 3. 18)
18= Control from I/O terminals	External control mode selected with progr. push-button#2
19= Frequency converter temperature limit supervision	Temperature on frequency converter goes outside the set supervision limits (par. 3. 19 and 3. 20)
20= Unrequested rotation direction	Rotation direction of the motor shaft is different from the requested one
21 = External brake control inverted	External brake ON/OFF control (par. 3.17 and 3.18), output active when brake control is ON
22—27 = Not in use	
28 = Auxiliary drive 1 start	Starts and stops auxiliary drive 1
29 = Auxiliary drive 12start	Starts and stops auxiliary drive 2
30 = Auxiliary drive 3 start	Starts and stops auxiliary drive 3

Table 6.5-2 Output signals via DO1 and output relays RO1 and RO2.

- 3. 9 **Output frequency limit 1, supervision function**
- 3. 11 **Output frequency limit 2, supervision function**

- 0 = No supervision
- 1 = Low limit supervision
- 2 = High limit supervision

If the output frequency falls below or exceeds the set limit (3. 10, 3. 12) this function generates a warning message via the digital output DO1 or via a relay output RO1 or RO2 depending on the settings of parameters 3. 6—3. 8.

- 3. 10 **Output frequency limit 1, supervision value**
- 3. 12 **Output frequency limit 2, supervision value**

The frequency value supervised by parameter 3. 9 (3. 11). See figure 6.5-10.



**3. 13 Torque limit , supervision function**

- 0 = No supervision
- 1 = Low limit supervision
- 2 = High limit supervision

If the calculated torque value falls below or exceeds the set limit (3. 14) this function generates a warning message via the digital output DO1 or via a relay output RO1 or RO2 depending on the settings of parameters 3. 6—3. 8.

Figure 6.5-10 Output frequency supervision.

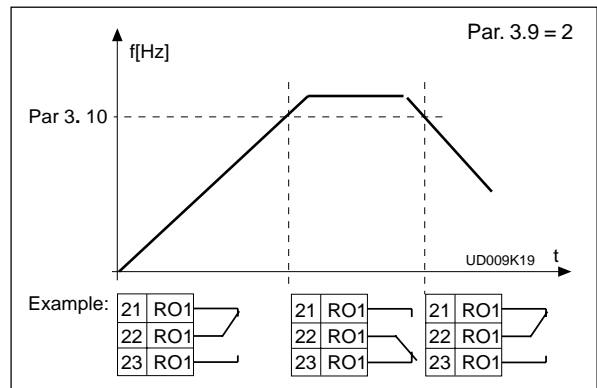

**3. 14 Torque limit , supervision value**

The calculated torque value supervised by parameter 3. 13.

**3. 15 Active reference limit, supervision function**

- 0 = No supervision
- 1 = Low limit supervision
- 2 = High limit supervision

If the reference value falls below or exceeds the set limit (3. 16) this function generates a warning message via the digital output DO1 or via a relay output RO1 or RO2 depending on the settings of parameters 3. 6—3. 8. The supervised reference is the current active reference. It can be source A or B reference depending on DIB6 input or panel reference if the panel is the active control source.

**3. 16 Active reference limit , supervision value**

The frequency value supervised by parameter 3. 15.

**3. 17 External brake-off delay**

**3. 18 External brake-on delay**

With these parameters the timing of external brake can be linked to the Start and Stop control signals, see figure 6.5-11.

The brake control signal can be programmed via the digital output DO1 or via one of relay outputs RO1 and RO2, see parameters 3. 6—3. 8.

The temperature value supervised by the parameter 3. 20.

**3. 19 Frequency converter temperature limit supervision function**

- 0 = No supervision
- 1 = Low limit supervision
- 2 = High limit supervision

If the temperature of the frequency converter falls below or exceeds the set limit (3. 20) this function generates a warning message via the digital output DO1 or via a relay output RO1 or RO2 depending on the settings of parameters 3. 6—3. 8.

**3. 20 Frequency converter temperature limit value**

The temperature value supervised by parameter 3. 19.

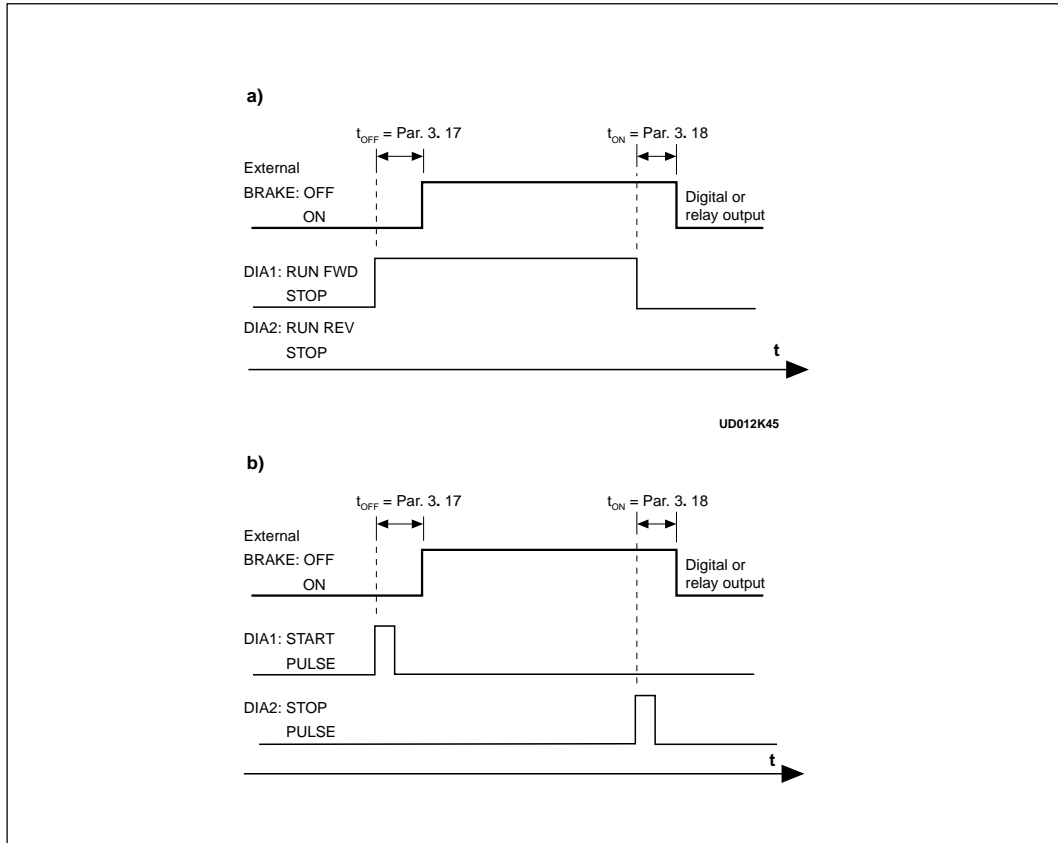

Figure 6.5-11 External brake control: a) Start/Stop logic selection par. 2. 1 = 0, 1 or 2  
b) Start/Stop logic selection par. 2. 1 = 3.

**4. 1 Acc/Dec ramp 1 shape**

**4. 2 Acc/Dec ramp 2 shape**

The start and end of the acceleration and deceleration ramps can be smoothed with these parameters. Setting value 0 gives linear ramp shape which causes acceleration and deceleration to act immediately to the changes in the reference signal with the time constant set by parameter 1. 3 and 1. 4 (4. 3 and 4. 4).

Setting value 0.1—10 seconds for 4. 1 (4. 2) causes linear acceleration/deceleration to adopt an S-shape. Parameter 1. 3 and 1. 4 (4. 3 and 4. 4) determines the time constant of acceleration/deceleration in the middle of the curve.

See figure 6.5-12.

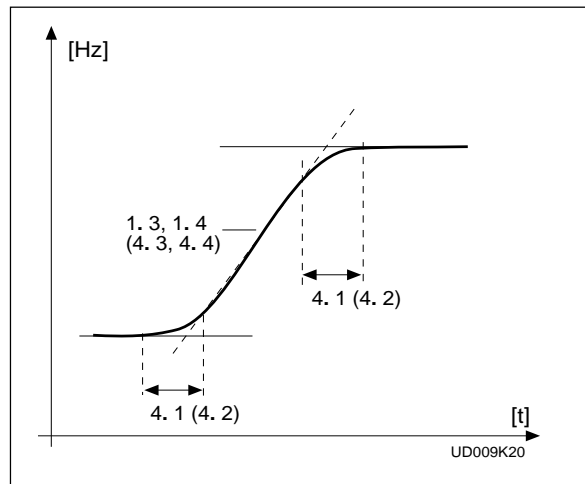

Figure 6.5-12 S-shaped acceleration/deceleration.



**4. 3 Acceleration time 2****4. 4 Deceleration time 2**

These values correspond to the time required for the output frequency to accelerate from the set minimum frequency (par. 1. 1) to the set maximum frequency (par. 1. 2). These times give the possibility to set two different acceleration/ deceleration time sets for one application. The active set can be selected with the programmable signal DIA3 of this application, see parameter 2. 2. Acceleration/ deceleration times can be reduced with an external free analogue input signal, see parameters 2. 18 and 2. 19.

**4. 5 Brake chopper**

0 = No brake chopper

1 = Brake chopper and brake resistor installed

2 = External brake chopper

When the frequency converter is decelerating the motor, the inertia from the motor and the load is fed into the external brake resistor. This enables the frequency converter to decelerate the load with the torque equal to that of acceleration, if the brake resistor is selected correctly. See separate Brake resistor installation manual.

**4. 6 Start function**

Ramp:

- 0** The frequency converter starts from 0 Hz and accelerates to the set reference frequency within the set acceleration time. (Load inertia or starting friction may cause prolonged acceleration times).

Flying start:

- 1** The frequency converter is able to start into running motor by applying a small torque to motor and searching for frequency corresponding to the speed the motor is running at. Searching starts from the maximum frequency towards the actual frequency until the correct value is detected. Thereafter the output frequency will be accelerated/decelerated to the set reference value according to the set acceleration/deceleration parameters.

Use this mode if the motor should be coasting when the start command is given. With the flying start it is possible to ride through short mains voltage interruptions.

**4. 7 Stop function**

Coasting:

- 0** The motor coasts to a halt without any control from the frequency converter, after the Stop command.

Ramp:

- 1** After the Stop command, the speed of the motor is decelerated according to the set deceleration parameters. If the regenerated energy is high it may be necessary to use an external braking resistor for faster deceleration.

**4. 8 DC braking current**

Defines the current injected into the motor during the DC braking.

**4. 9 DC braking time at stop**

Defines if braking is ON or OFF and braking time of the DC-brake when the motor is stopping. The function of the DC-brake depends on the stop function, parameter 4. 7. See figure 6.5-13.

- 0 DC-brake is not used
- >0 DC-brake is in use and its function depends on the Stop function, (param. 4. 7), and the time depends on the value of parameter 4. 9:

Stop-function = 0 (coasting):

After the stop command, the motor coasts to a stop without any control from the frequency converter.

With DC-injection, the motor can be electrically stopped in the shortest possible time, without using an optional external braking resistor.

The braking time is scaled according to the frequency when the DC-braking starts. If the frequency is  $\geq$  nominal frequency of the motor (par. 1.11), setting value of parameter 4.9 determines the braking time. When the frequency is  $\leq 10\%$  of the nominal, the braking time is 10% of the set value of parameter 4.9.

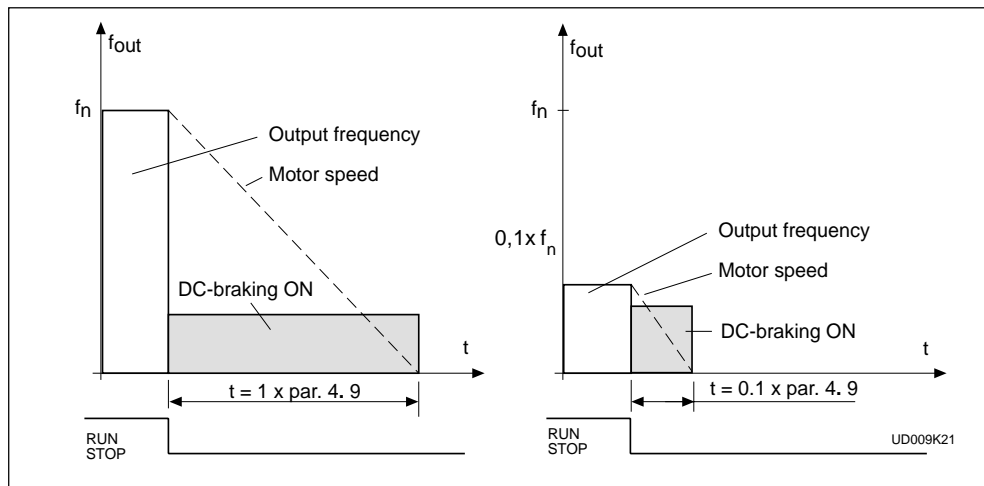

Figure 6.5-13 DC-braking time when par. 4. 7 = 0.

Stop-function = 1 (ramp):

After the Stop command, the speed of the motor is reduced according to the set deceleration parameters, as fast as possible, to a speed defined with parameter 4. 10, where the DC-braking starts.

The braking time is defined with parameter 4. 9.

If high inertia exists, it is recommended to use an external braking resistor for faster deceleration. See figure 6.5-14.

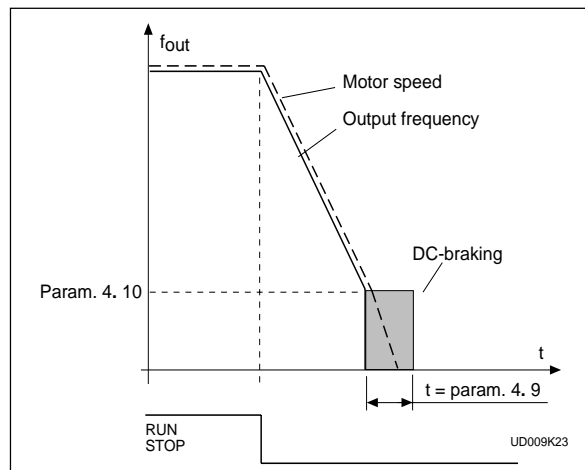

Figure 6.5-14 DC-braking time when par. 4. 7 = 1.

**4. 10 Execute frequency of DC-brake during ramp Stop**

See figure 6.5-14.

**4. 11 DC-brake time at start**

- 0** DC-brake is not used
- >0** DC-brake is activated when the start command is given and this parameter defines the time before the brake is released. After the brake is released output frequency increases according to the set start function parameter 4. 6 and acceleration parameters (1. 3, 4. 1 or 4. 2, 4. 3), see figure 6.5-15.

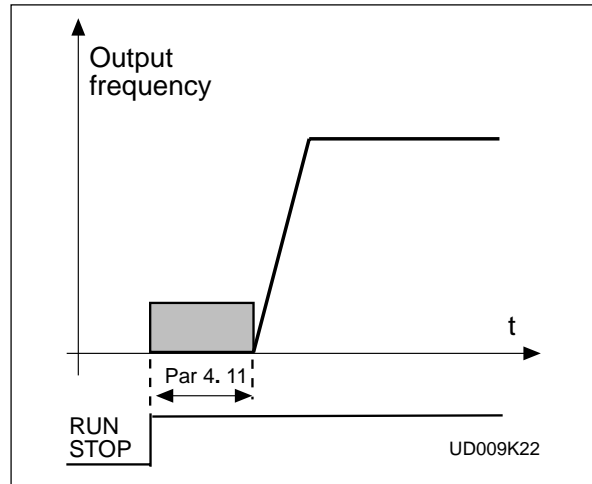

Figure 6.5-15 DC-braking time at start

**4. 12 Jogging speed reference**

Parameter value defines the jogging speed selected with the digital input.

- 5. 1 Prohibit frequency area,**
- 5. 2 Low limit/High limit**
- 5. 3**
- 5. 4**
- 5. 5**
- 5. 6**

In some systems it may be necessary to avoid certain frequencies because of mechanical resonance problems.

With these parameters it is possible to set limits for three "skip frequency" regions.

Figure 6.5-16 Example of prohibit frequency area setting.

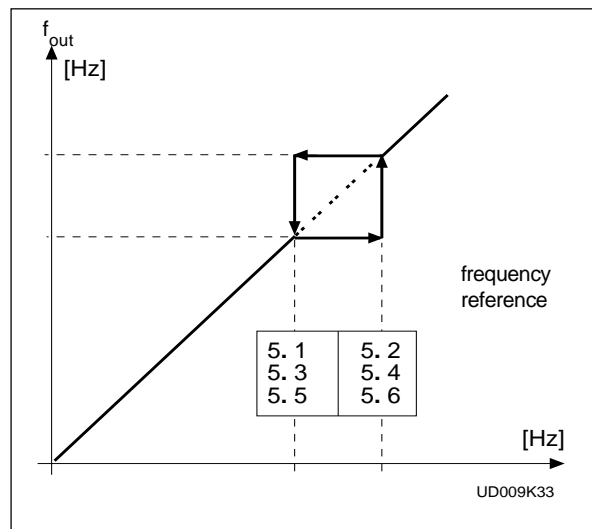

**6. 1 Motor control mode**

0 = Frequency control:

The I/O terminal and panel references are frequency references and the frequency converter controls the output frequency (output freq. resolution 0,01 Hz)

1 = Speed control:

The I/O terminal and panel references are speed references and the frequency converter controls the motor speed (regulation accuracy ± 0,5%).

## 6.2 Switching frequency

Motor noise can be minimized using high switching frequency. Increasing the frequency reduces the capacity of the frequency converter. Before changing the frequency from the factory default 10 kHz (3.6 kHz from 30 kW upwards), check the curves in Figure 5.2-3 of the User's Manual for the allowed capacity.

## 6.3 Field weakening point

### 6.4 Voltage at the field weakening point

Field weakening point is the output frequency where the output voltage reaches the set maximum value (par. 6.4). Above that frequency the output voltage remains at the set maximum value.

Below that frequency the output voltage depends on the setting of the U/f curve parameters 1.8, 1.9, 6.5, 6.6 and 6.7. See figure 6.5-17.

When the parameters 1.10 and 1.11, nominal voltage and nominal frequency of the motor, are set, also parameters 6.3 and 6.4 are set automatically to the corresponding values. If different values for the field weakening point and the maximum output voltage are required, change these parameters after setting the parameters 1.10 and 1.11.

### 6.5 U/f curve, middle point frequency

If the programmable U/f curve has been selected with parameter 1.8 this parameter defines the middle point frequency of the curve. See figure 6.5-17.

### 6.6 U/f curve, middle point voltage

If the programmable U/f curve has been selected with parameter 1.8 this parameter defines the middle point voltage (% of motor nom. voltage) of the curve. See figure 6.5-17.

### 6.7 Output voltage at zero frequency

If the programmable U/f curve has been selected with parameter 1.8 this parameter defines the zero frequency voltage of the curve. See figure 6.5-17.

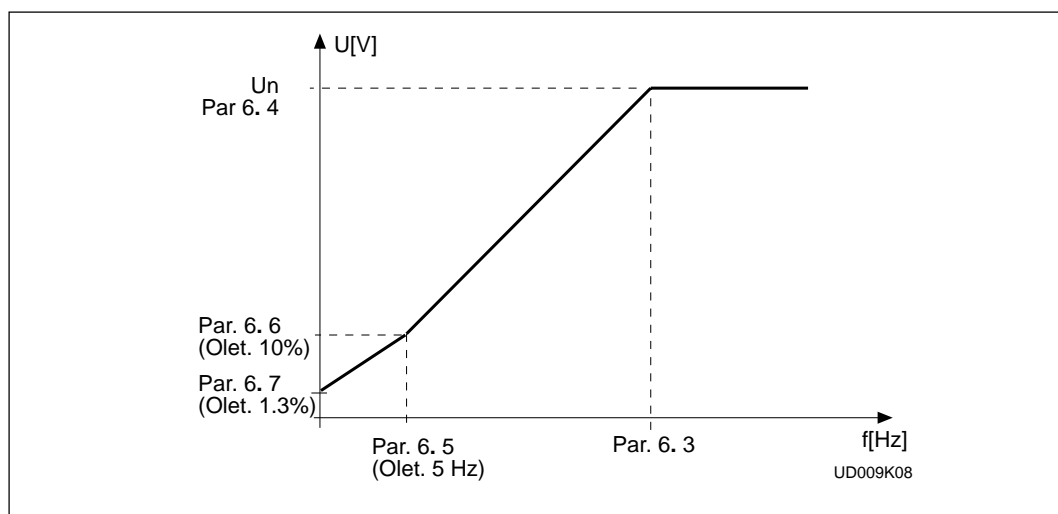

Figure 6.5-17 Programmable U/f curve.

**6. 8      *Overvoltage controller*****6. 9      *Undervoltage controller***

These parameters allow the over-/undervoltage controllers to be switched out of operation. This may be useful, for example, if the mains supply voltage varies more than -15%—+10% and the application will not tolerate this over-/undervoltage. Then the regulator controls the output frequency according to the supply fluctuations.

Over-/undervoltage trips may occur when controllers are switched out of operation.

**7. 1      *Response to the reference fault***

0 = No response

1 = Warning

2 = Fault, stop mode after fault according to parameter 4.7

3 = Fault, stop mode after fault always by coasting

A warning or a fault action and message is generated if a 4—20 mA reference signal is used and the signal falls below 4 mA. The information can also be programmed via digital output DO1 and via relay outputs RO1 and RO2.

**7. 2      *Response to external fault***

0 = No response

1 = Warning

2 = Fault, stop mode after fault according to parameter 4.7

3 = Fault, stop mode after fault always by coasting

A warning or a fault action and message are generated from the external fault signal in the digital input DIA3. The information can also be programmed into digital output DO1 and into relay outputs RO1 and RO2.

**7. 3      *Phase supervision of the motor***

0 = No action

2 = Fault

Phase supervision of the motor ensures that the motor phases have an approximately equal current.

**7. 4      *Earth fault protection***

0 = No action

2 = Fault message

Earth fault protection ensures that the sum of the motor phase currents is zero.

The overcurrent protection is always working and protects the frequency converter from earth faults with high currents.

**Parameters 7. 5—7. 9 Motor thermal protection****General**

Motor thermal protection shall protect the motor from overheating. Vacon CX/CXL/CXS drive is capable of supplying higher than nominal current to the motor. If the load requires this high current there is a risk that motor will be thermally overloaded. This is true especially at low frequencies. With low frequencies the cooling effect of the motor is reduced and the capacity of the motor is reduced. If the motor is equipped with an external fan the load reduction at low speeds is small.

Motor thermal protection is based on a calculated model and it uses the output current of the drive to determine the load on the motor. When the power is turned on, the calculated model uses the heatsink temperature to determine the initial thermal stage for the motor. The calculated model assumes that the ambient temperature of the motor is 40°C.

Motor thermal protection can be adjusted by setting the parameters. The thermal current  $I_T$  specifies the load current above which the motor is overloaded. This current limit is a function of the output frequency. The curve for  $I_T$  is set with parameters 7. 6, 7. 7 and 7. 9, refer to figure 6.5-18. The parameters have their default values set according to the motor name plate data.

With the output current at  $I_T$  the thermal stage will reach the nominal value (100%). The thermal stage changes by the square of the current. With output current at 75% from  $I_T$  the thermal stage will reach a 56% value and with output current at 120% from  $I_T$  the thermal stage would reach a 144% value. The function will trip the device (refer par. 7. 5) if the thermal stage will reach a value of 105%. The speed of change in thermal stage is determined with the time constant parameter 7. 8. The bigger the motor the longer it takes to reach the final temperature.

The thermal stage of the motor can be monitored with the display. See the table of monitoring items. (User's Manual, table 7.3-1).



**CAUTION!** *The calculated model does not protect the motor if the airflow to the motor is reduced by blocked air intake grill.*

### 7. 5 **Motor thermal protection**

Operation:

- 0 = Not in use
- 1 = Warning
- 2 = Trip function

Tripping and warning will display the same message code. If the tripping is selected the drive will stop and activate the fault stage.

Deactivating the protection, setting parameter to 0, will reset the thermal stage of the motor to 0%.

### 7. 6 **Motor thermal protection, break point current**

The current can be set between 50.0—150.0% x  $I_{nMotor}$ .

This parameter sets the value for thermal current at frequencies above the break point on the thermal current curve. See Figure 6.5-18.

The value is set in percentage value which refers to the name plate data of the motor, parameter 1. 13, nominal current of the motor, not to the drive's nominal output current.

The motor's nominal current is the current which the motor can withstand in direct on-line use without being overheated.

If parameter 1. 13 is adjusted, this parameter is automatically restored to the default value.

Setting this parameter (or parameter 1. 13) does not affect the maximum output current of the drive. Parameter 1. 7 alone determines the maximum output current of the drive.

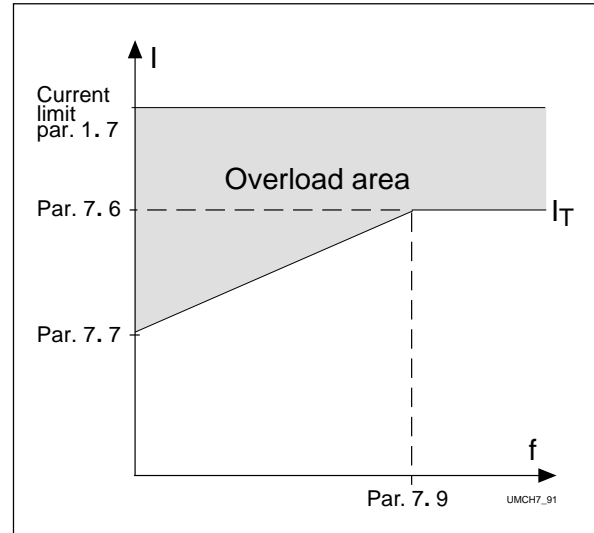

Figure 6.5-18 Motor thermal current  $I_T$  curve.

### 7.7 Motor thermal protection, zero frequency current

The current can be set between 10.0—150.0%  $\times I_{nMotor}$ . This parameter sets the value for thermal current at zero frequency. See Figure 6.5-18.

The default value is set assuming that there is no external fan cooling the motor. If an external fan is used this parameter can be set to 90% (or even higher).

The value is set in percentage of the motor name plate data, parameter 1. 13, motor's nominal current, not the drive's nominal output current. The motor's nominal current is the current which the motor can stand in direct on-line use without being overheated.

If you change parameter 1. 13 this

parameter is automatically restored to the default value.

Setting this parameter (or parameter 1. 13) does not affect the maximum output current of the drive. Parameter 1. 7 alone determines the maximum output current of the drive.

### 7.8 Motor thermal protection, time constant

The time can be set between 0.5—300 minutes.

This is the thermal time constant of the motor. The bigger the motor the bigger the time constant. The time constant is the time when the calculated thermal stage has reached 63% of its final value.

The motor thermal time is specific to the motor design and it varies between different motor manufacturers.

The default value for the time constant is calculated basing on the motor name plate data given with parameters 1. 12 and 1. 13. If either of these parameters is set, then this parameter is set to default value.

If the motor's  $t_6$ -time is known (given by the motor manufacturer) the time constant

parameter could be set based on  $t_6$ -time. As a rule of thumb, the motor thermal time constant in minutes equals to  $2 \times t_6$  ( $t_6$  in seconds is the time a motor can safely operate at six times the rated current). If the drive is in stop stage the time constant is internally increased to three times the set parameter value. The cooling in the stop stage is based on convection and the time constant is increased.

### 7.9 Motor thermal protection, break point frequency

The frequency can be set between 10—500 Hz.

This is the break point of thermal current curve. With frequencies above this point the thermal capacity of the motor is assumed to be constant. See Figure 6.5-18.

The default value is based on the motor's name plate data, parameter 1. 11. It is 35 Hz for a 50 Hz motor and 42 Hz for a 60 Hz motor. More generally it is 70% of the frequency at the field weakening point (parameter 6. 3). Changing either parameter 1. 11 or 6. 3 will restore this parameter to its default value.

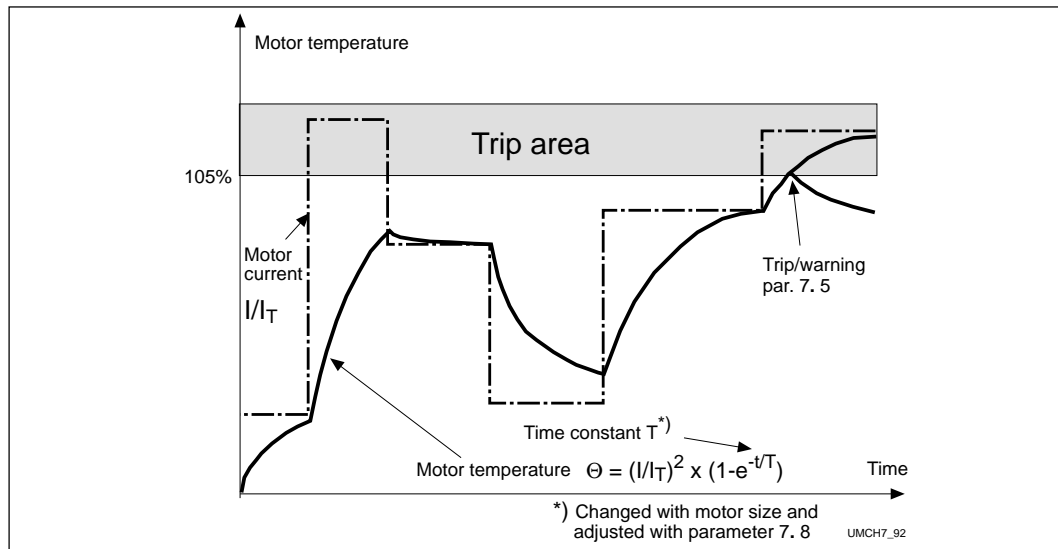

Figure 6.5-19 Calculating motor temperature

## Parameters 7. 10— 7. 13, Stall protection General

Motor stall protection protects the motor from short time overload situations like a stalled shaft. The reaction time of stall protection can be set shorter than with motor thermal protection. The stall state is defined with two parameters, 7.11. Stall Current and 7.13. Stall Frequency. If the current is higher than the set limit and output frequency is lower than the set limit the stall state is true. There is actually no real indication of the shaft rotation. Stall protection is a type of overcurrent protection.

### 7. 10 Stall protection

Operation:

- 0 = Not in use
- 1 = Warning
- 2 = Trip function

Tripping and warning will display the same message code. If the tripping is set on, the drive will stop and activate the fault stage.

Setting the parameter to 0 will deactivate the protection and will reset the stall time counter to zero.



**7. 11 Stall current limit**

The current can be set between 0.0—200% x  $I_{nMotor}$ .

In the stall stage the current has to be above this limit. See Figure 6.5-20. The value is set in percentage of the motor's name plate data, parameter 1. 13, motor's nominal current. If parameter 1. 13 is adjusted, this parameter is automatically restored to the default value.

Figure 6.5-20 Setting the stall characteristics.

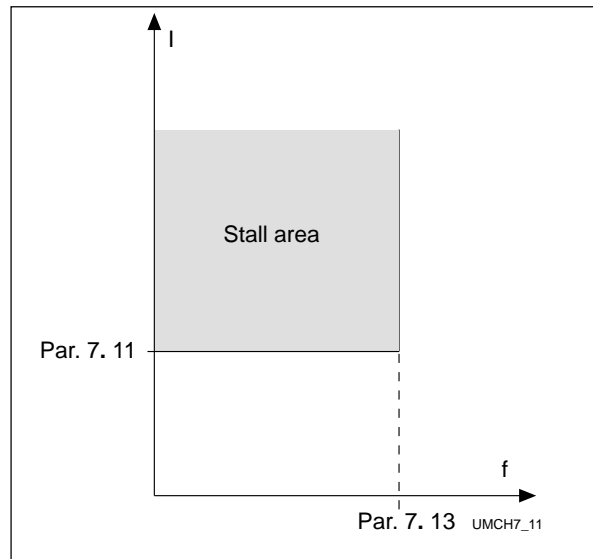

**7. 12 Stall time**

The time can be set between 2.0—120 s.

This is the maximum time allowed for a stall stage. There is an internal up/down counter to count the stall time. See Figure 6.5-21.

If the stall time counter value goes above this limit the protection will cause a trip (See parameter 7. 10).

**7. 13 Maximum stall frequency**

The frequency can be set between 1— $f_{max}$  (par. 1. 2).

In the stall state, the output frequency has to be smaller than this limit. See Figure 6.5-20.

Figure 6.5-21 Counting the stall time.

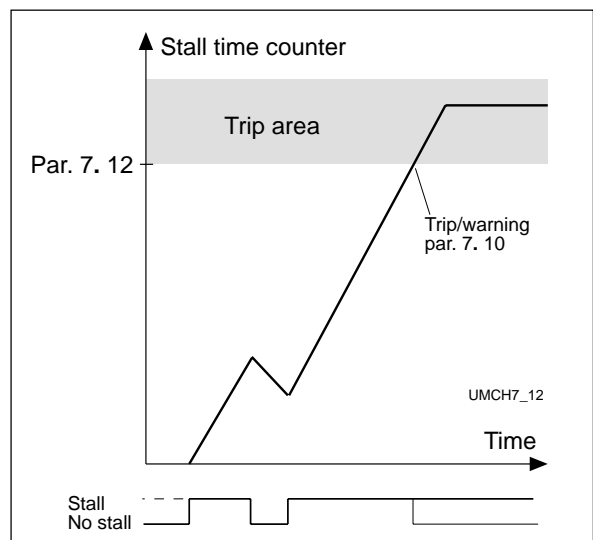

**Parameters 7. 14— 7. 17, Underload protection General**

The purpose of motor underload protection is to ensure that there is load on the motor whilst the drive is running. If the motor loses its load there might be a problem in the process, e.g. broken belt or dry pump.

Motor underload protection can be adjusted by setting the underload curve with parameters 7. 15 and 7. 16. The underload curve is a squared curve set between zero frequency and the field weakening point. The protection is not active below

5Hz (the underload counter value is stopped). Refer to the figure 6.5-22.

The torque values for setting the underload curve are set in percentage values which refer to the

nominal torque of the motor. The motor's name plate data, parameter 1. 13, the motor's nominal current and the drive's nominal current  $I_{CT}$  are used

to find the scaling ratio for the internal torque value. If other than standard motor is used with the drive the accuracy of the torque calculation is decreased.

#### 7. 14 **Underload protection**

Operation:

- 0 = Not in use
- 1 = Warning
- 2 = Fault

Tripping and warning will display the same message code. If tripping is set active the drive will stop and activate the fault stage.

Deactivating the protection, by setting parameter to 0, will reset the underload time counter to zero.

#### 7. 15 **Underload protection, field weakening area load**

The torque limit can be set between 20.0—150 % x  $T_{nMotor}$ .

This parameter gives the value for the minimum torque allowed when the output frequency is above the field weakening point.

See Figure 6.5-22.

If parameter 1. 13 is adjusted, this parameter is automatically restored to the default value.

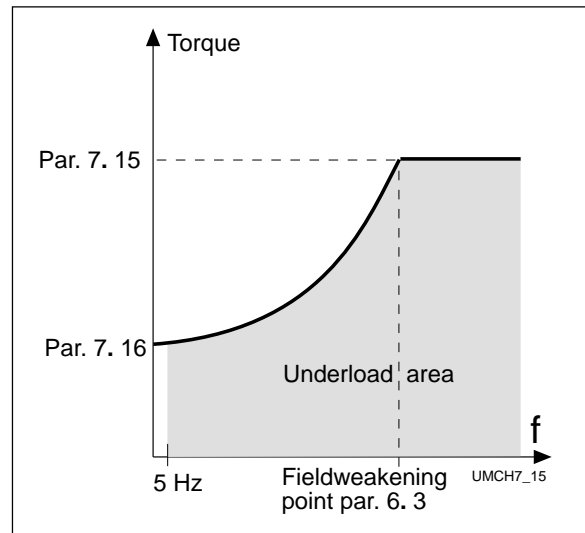

Figure 6.5-22 Setting of minimum load.

#### 7. 16 **Underload protection, zero frequency load**

The torque limit can be set between 10.0—150 % x  $T_{nMotor}$ .

This parameter gives value for the minimum torque allowed with zero frequency. See Figure 6.5-22. If parameter 1. 13 is adjusted, this parameter is automatically restored to the default value.

#### 7. 17 **Underload time**

This time can be set between 2.0—600.0 s.

This is the maximum time allowed for an underload state. There is an internal up/down counter to accumulate the underload time. See Figure 6.5-23.

If the underload counter value goes above this limit the protection will cause a trip (refer to the parameter 7. 14). If the drive is stopped the underload counter is reset to zero.

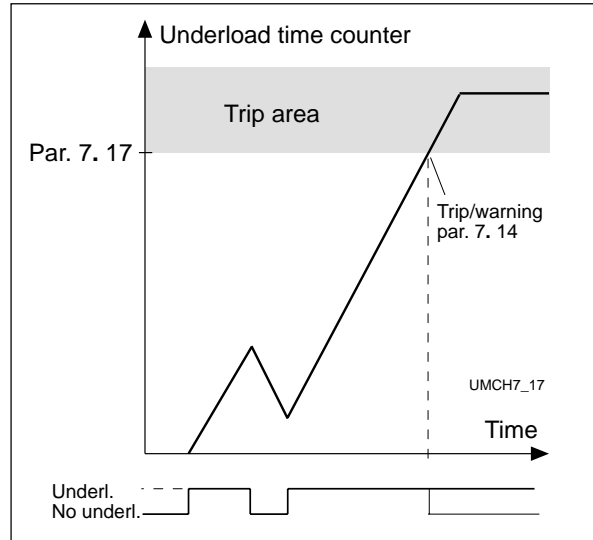

Figure 6.5-23 Counting the underload time.

**8. 1 Automatic restart: number of tries**

**8. 2 Automatic restart: trial time**

The Automatic restart function restarts the frequency converter after the faults selected with parameters 8. 4—8. 8. The Start function for Automatic restart is selected with parameter 8. 3.

Parameter 8. 1 determines how many automatic restarts can be made during the trial time set by the parameter 8. 2.

The time counting starts from the first autorestart. If the number of restarts does not exceed the value of the parameter 8.1 during the trial time, the counting is cleared after the time has elapsed and next fault starts the counting again.

See figure 6.5-24.

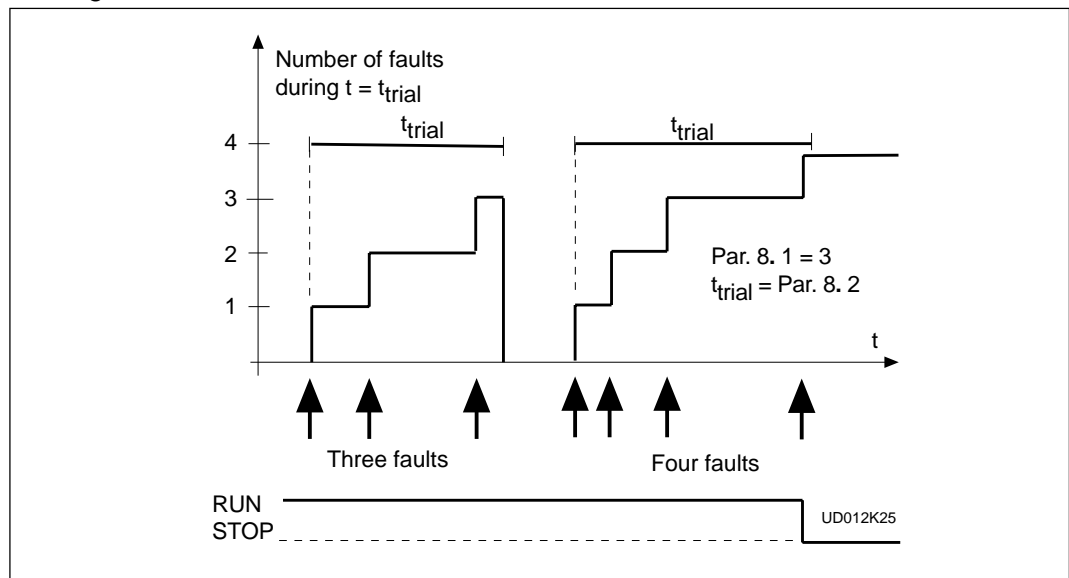

Figure 6.5-24 Automatic restart.

**8.3 Automatic restart, start function**

The parameter defines the start mode:

- 0 = Start with ramp
- 1 = Flying start, see parameter 4. 6.

**8.4 Automatic restart after undervoltage trip**

- 0 = No automatic restart after undervoltage trip
- 1 = Automatic restart after undervoltage fault condition returns to the normal condition (DC-link voltage returns to the normal level)

**8.5 Automatic restart after overvoltage trip**

- 0 = No automatic restart after overvoltage trip
- 1 = Automatic restart after overvoltage fault condition returns to the normal condition (DC-link voltage returns to the normal level)

**8.6 Automatic restart after overcurrent trip**

- 0 = No automatic restart after overcurrent trip
- 1 = Automatic restart after overcurrent faults

**8.7 Automatic restart after reference fault trip**

- 0 = No automatic restart after reference fault trip
- 1 = Automatic restart after analogue current reference signal (4—20 mA) returns to the normal level ( $\geq 4$  mA)

**8.8 Automatic restart after over-/undertemperature fault trip**

- 0 = No automatic restart after temperature fault trip
- 1 = Automatic restart after heatsink temperature has returned to its normal level between  $-10^{\circ}\text{C}$ — $+75^{\circ}\text{C}$ .

**9. 1 Number of auxiliary drives**

With this parameter the number of auxiliary drives in use will be defined. The signals switching the auxiliary drives on and off can be programmed to relay outputs or to digital output with parameters 3. 6 - 3. 8. The default setting is one auxiliary drive in use and it is pre-programmed to relay output RO1.

**9. 2 Start frequency of auxiliary drive 1**

**9. 4 Start frequency of auxiliary drive 2**

**9. 6 Start frequency of auxiliary drive 3**

The frequency of the drive controlled by the frequency converter must exceed the limit defined with these parameters with 1 Hz before the auxiliary drive is started. The 1 Hz overdraft creates a hysteresis to avoid unnecessary starts and stops. See figure 6.5-25.

**9. 3 Stop frequency of auxiliary drive 1**

**9. 5 Stop frequency of auxiliary drive 2**

**9. 7 Stop frequency of auxiliary drive 3**

The frequency of the drive controlled by the frequency converter must fall with 1Hz below the limit defined with these parameters before the auxiliary drive is stopped. The stop frequency limit also defines the frequency to which the frequency of the drive controlled by the frequency converter is dropped after starting the auxiliary drive. See figure 6.5-25.

**9. 10 Start delay of auxiliary drives**

The frequency of the drive controlled by the frequency converter must exceed the start frequency of the auxiliary drive with the time defined with parameter 9. 10 before the drive is started. The delay is the same for all auxiliary drives. This prevents unnecessary starts caused by exceeding the start limit momentarily. See Figure 6.5-25.

**9. 11 Stop delay of auxiliary drives**

The frequency of the drive controlled by the frequency converter must be as much as the time defined with parameter 9. 11 below the stop limit of the auxiliary drive before the drive is stopped. The delay is the same for all auxiliary drives. This prevents the unnecessary stops caused by falling momentarily below the stop limit. See figure 6.5-25.

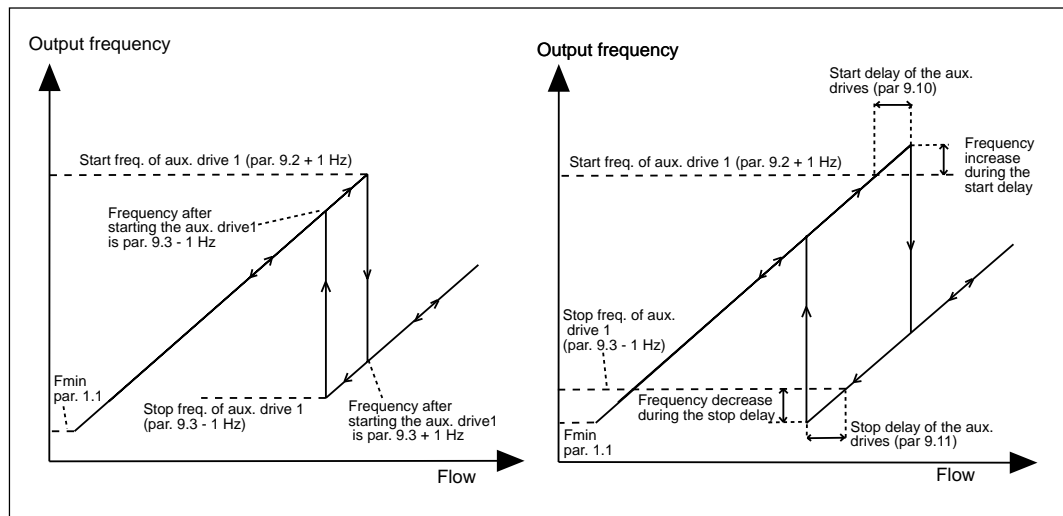

Figure 6.5-25 Example of effect of parameters in variable speed and one auxiliary drive system.

- 9. 12**    **Reference step after start of the auxiliary drive 1**
- 9. 13**    **Reference step after start of the auxiliary drive 2**
- 9. 14**    **Reference step after start of the auxiliary drive 3**

The reference step will be automatically added to the reference value always when the corresponding auxiliary drive is started. With the reference steps e.g. the pressure loss in the piping caused by the increased flow can be compensated. See figure 6.5-26.

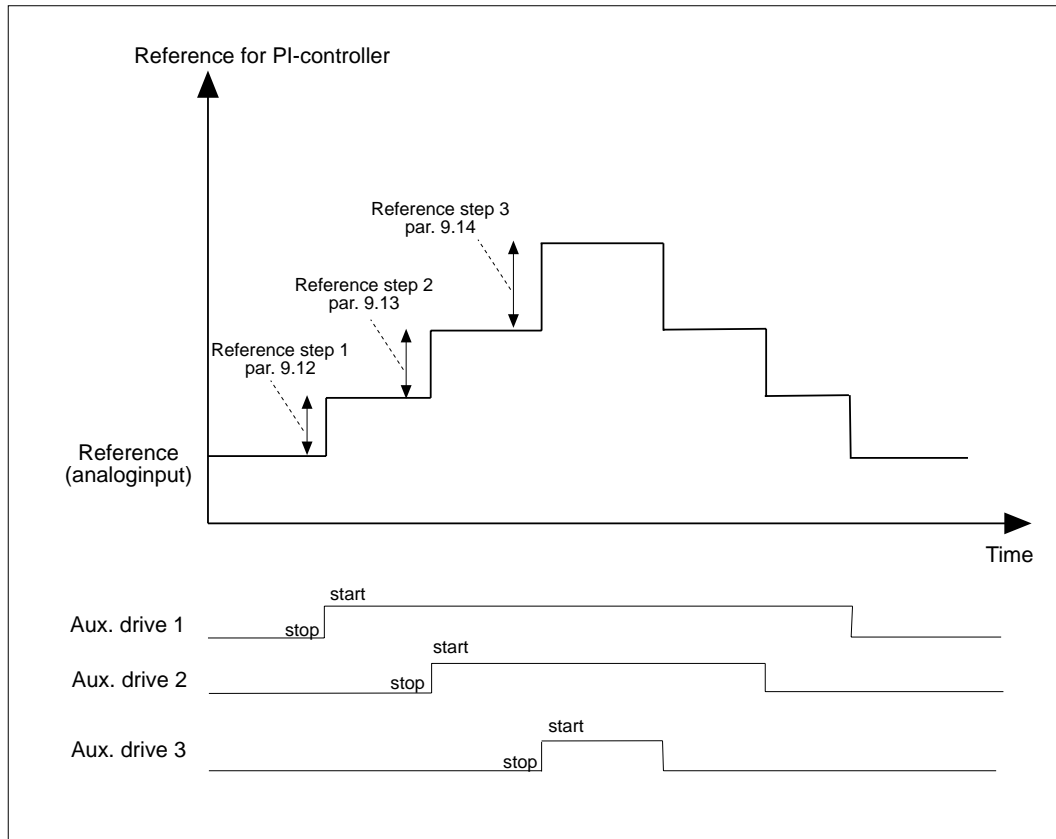

Figure 6.5-26 Reference steps after starting auxiliary drives.

- 9. 16**    **Sleep level**
- 9. 17**    **Sleep delay**

The change of this parameter from value 0.0 Hz activates the sleep function where the frequency converter is stopped automatically when the frequency of the drive controlled by the frequency converter is below the sleep level (par. 9.16) continuously over the sleep delay (9. 17). During the stop state the Pump and fan control is operating and it turns the frequency converter to Run state when the wake-up level defined with parameters 9. 18 and 9. 19 is reached. See Figure 6.5-27.

- 9. 18**    **Wake up level**

The wake up level defines the level below which the actual value must fall or which has to be exceeded before the frequency converter is restored from the sleep function. See Figure 6.5-27.

- 9. 19**    **Wake up function**

This parameter determines if the wake up occurs when the value falls below or exceeds the wake up level (par. 9. 18).

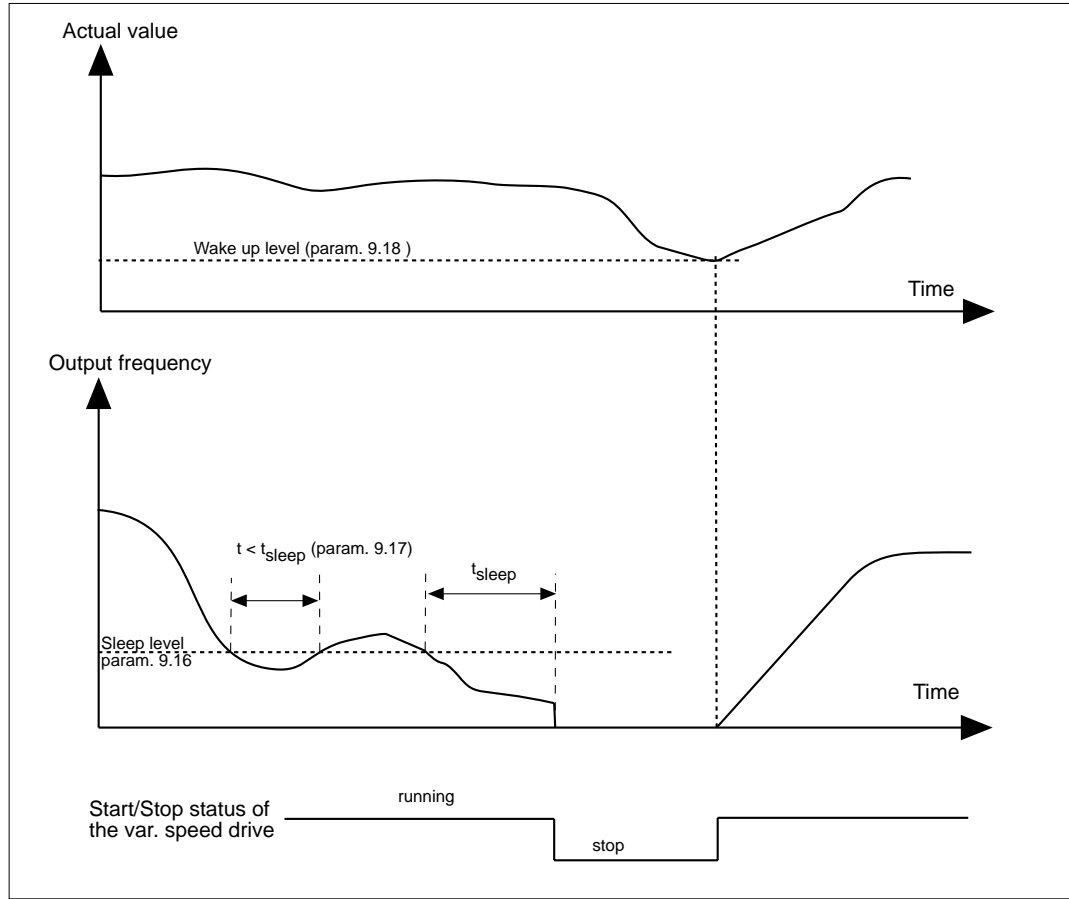

Figure 6.5-27 Example of the sleep function.

**9. 20 PI-regulator bypass**

With this parameter the PI-regulator can be programmed to be bypassed. Then the frequency of the drive controlled by the frequency converter and the starting points of the auxiliary drives are defined according to the actual value signal.

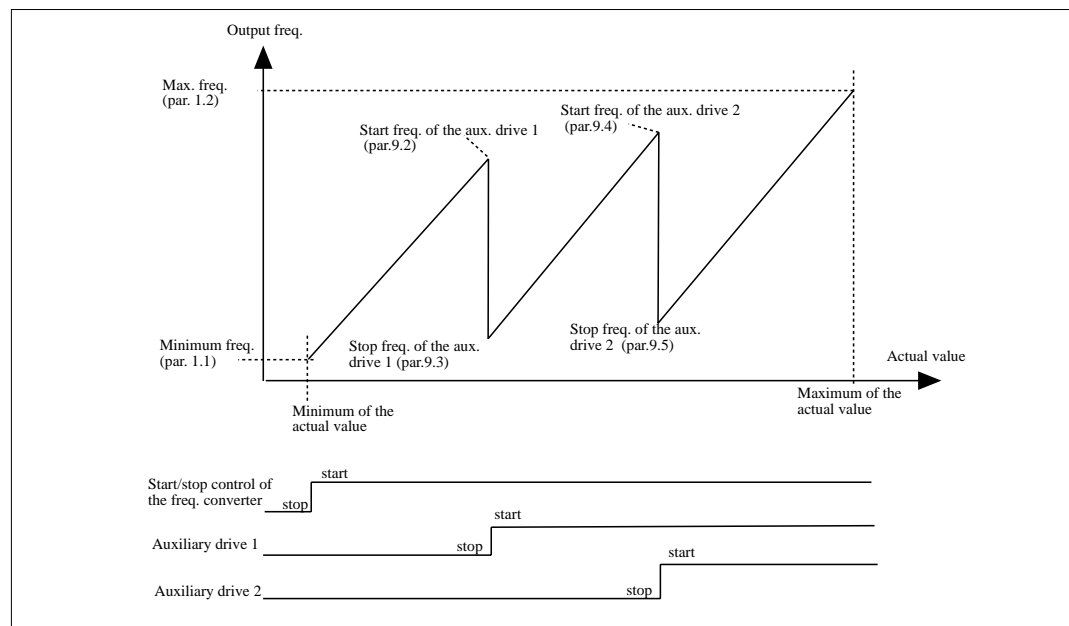

Figure 6.5-28 Example of the function of variable speed drive and two auxiliary drives when PI-regulator is bypassed with parameter 9. 20.

## 6.6 MONITORING DATA

The PI-control application has extra items for monitoring (n20 - n25). See table 6.6-1

Data number	Data name	Unit	Description
n 1	Output frequency	Hz	Frequency to the motor
n 2	Motor speed	rpm	Calculated motor speed
n 3	Motor current	A	Measured motor current
n 4	Motor torque	%	Calculated actual torque/nominal torque of the unit
n 5	Motor power	%	Calculated actual power/nominal power of the unit
n 6	Motor voltage	V	Calculated motor voltage
n 7	DC-link voltage	V	Measured DC-link voltage
n 8	Temperature	°C	Temperature of the heat sink
n 9	Operating day counter	DD.dd	Operating days <sup>1)</sup> , not resettable
n 10	Operating hours, "trip counter"	HH.hh	Operating hours <sup>2)</sup> , can be reset with programmable button #3
n 11	MW-hours	MWh	Total MW-hours, not resettable
n 12	MW-hours, "trip counter"	MWh	MW-hours, can be reset with programmable button #4
n 13	Voltage/analogue input	V	Voltage of the terminal U <sub>in+</sub> (term. #2)
n 14	Current/analogue input	mA	Current of terminals I <sub>in+</sub> and I <sub>in-</sub> (term. #4, #5)
n 15	Digital input status, gr. A		
n 16	Digital input status, gr. B		
n 17	Digital and relay output status		
n 18	Control program		Version number of the control software
n 19	Unit nominal power	kW	Shows the power size of the unit
n 20	PI-controller reference	%	Percent of the maximum reference
n 21	PI-controller actual value	%	Percent of the maximum actual value
n 22	PI-controller error value	%	Percent of the maximum error value
n 23	PI-controller output	Hz	
n 24	Number of running auxiliary drives		
n 25	Motor temperature rise	%	100%= temperature of motor has risen to nominal

Table 6.6-1 Monitored items.

<sup>1)</sup> DD = full days, dd = decimal part of a day

<sup>2)</sup> HH = full hours, hh = decimal part of an hour



## 6.7 Panel reference

The Pump and fan control application has an extra reference (r2) for PI-controller on the panel's Reference menu. See table 6.7-1.

Reference number	Reference name	Range	Step	Function
r1	Frequency reference	$f_{\min}$ — $f_{\max}$	0.01 Hz	Reference for panel control and I/O terminal Source B reference.
r2	PI-controller reference	0—100%	0.1%	Reference for PI-controller

Table 6.7-1 Panel reference.



Monitoring values (MON)		
Num.	Data name	Unit
V 1	Output frequency	Hz
V 2	Motor speed	rpm
V 3	Motor current	A
V 4	Motor torque	%
V 5	Motor power	%
V 6	Motor voltage	V
V 7	DC-link voltage	V
V 8	Temperature	°C
V 9	Operating day counter	DD.dd
V 10	Operating hours, "trip counter"	HH.hh
V 11	MWh-hours	MWh
V 12	MWh-hours, "trip counter"	MWh
V 13	Voltage/analogue input	V
V 14	Current/analogue input	mA
V 15	Digital input stat.,group A	See
V 16	Digital input stat.,group B	figure
V 17	Digital and relay output status	below
V 18	Control program	
V 19	Unit nominal power	kW
V 20	Motor temperature rise	%
<i>Only in PI-controller</i>		
V 20	PI-controller reference	%
V 21	PI-controller actual value	%
V 22	PI-controller error value	%
V 23	PI-controller output	Hz
V 24	Motor temperature rise	%

1.) DD=full days, dd=desimal part of a day  
2.) HH=full hours, hh=desimal part of an hour

**Digital input and output signal statuses**

**V 15**  
**Dig Input A Stat**  
**0.011**

0 = open input  
1 = closed input (active)

Example:

Input	Terminal
DIA1 closed	8
DIA2 closed	9
DIA3 open	10

Faults and warnings	
Code	Fault
F 1	Overcurrent
F 2	Overvoltage
F 3	Earth fault
F 4	Inverter fault
F 5	Charging switch
F 9	Under voltage
F 10	Input line supervision
F 11	Output phase supervision
F 12	Brake chopper supervision
F 13	Vacon under temperature
F 14	Vacon over temperature
F 15	Motor stalled
F 16	Motor over temperature
F 17	Motor underload
F 18	Analogue input hardware fault
	Polarity fault
F 19	Option board identification
F 20	10 V voltage reference
F 21	24 V supply
F 22	EEPROM
F 23	checksum fault
F 24	
F 25	Microprocessor watchdog
F 26	Panel communication error
F 29	Thermistor protection
F 36	Analogue input I <sub>in</sub> 4-20 mA <4 mA
F 41	External fault

**Warnings**

A 15	Motor stalled
A 16	Motor overtemperature
A 17	Motor underload
A 24	The values in the Fault history, MWh-counters or operating day/hour counters might have been changed in the previous mains interrupt
A 28	Change of application has failed
A 30	Unbalance current fault
A 45	Vacon overtemp. warning
A 46	Reference warning, analogue input I <sub>in</sub> + <4 mA
A 47	External warning

Programmable push-buttons (BTNS)		ENTER-button 		
Button number	Button name	Function	Feedback information	
			0	1
b 1	Reverse	Changes the direction of motor rotation. Active only if the panel is the active control source	Direction command forward	Direction command backward Feedback information flashes as long as direction is different from the command
b 2	Active control source	Selects the active control source between the panel and I/O terminals	Control via I/O terminals	Control from the Control Panel
b 3	Clear trip operating hour counter	Clears the trip operating when pressed	No clearing	Clearing accepted
b 4	Clear trip MWh counter	Clears the MWh trip counter when pressed	No clearing	Clearing accepted

M7  
Contrast  
15

C  
Contrast  
15

M6  
Fault history  
H 1-9 →

H1  
2. Overvoltage

ENTER  
2-3 s

Fault history reset

M5  
Active faults  
F 1-9 →

F1  
1. Overcurrent

Browse active faults

B2 Panel control  
1

M4  
Buttons  
B1-4 →

B1  
Reverse  
On

ENTER

B1  
Reverse  
Off

M3  
Reference  
R1-1 →

R1  
Freq Reference  
122.45 Hz

R1  
Freq. reference  
122.45 Hz

G2  
1  
G12 Special param.

M2  
Parameters  
G 1-12 →

G1  
Basic param.  
P 1-15 →

P1.1  
Min Frequency  
12.34 Hz

P1.1  
Min Frequency  
12.34 Hz

ENTER

V2 Motor speed  
1  
V20 Motor temp.

M1  
Monitor  
V 1-20 →

V1  
Output Freq  
122.44 Hz

**VACON SUBSIDIARIES:**

**Vacon Drives UK Ltd**

Unit 11, Sunnyside Park  
Wheatfield Way  
Hinckley Fields Industrial Estate  
Hinckley  
LEICESTERSHIRE, LE10 1PJ  
ENGLAND  
Tel. +44(0)1455 611 515,  
Fax. +44(0) 1455 611 517

**Vacon GmbH**

Alexanderstr. 31,  
D-40210 DÜSSELDORF,  
GERMANY  
Tel. +49 (0)211/876 3470,  
Fax. +49(0)211/ 876 34729

**Vacon AB**

Torget 1,  
S-17267 SUNDBYBERG (Stockholm),  
SWEDEN  
Tel. +46(0)8-293 055  
Fax. +46(0)8-290 755

**Vacon Traction Ltd**

Alasniitynkatu 30,  
FIN-33700 TAMPERE,  
FINLAND  
Tel. +358(0)201 2121,  
Fax. +358 (0)201-212 710

**Vacon SPA**

Via F.lli Guerra, 35  
I-42100 REGGIO EMILIA  
ITALY  
Tel. +39(0) 5 22/ 276 811,  
Fax. +39(0)5 22/ 276 890

**Vacon Benelux BV**

Weide 40,  
NL-4206 CJ GORINCHEM  
NETHERLANDS  
Tel. +31(0)183/ 642 970,  
Fax. +31(0)183/ 642 971

**Vacon Drives Iberica S.A.**

Miguel Servet, 2 P. Ind. Bufalvent  
08240 MANRESA  
SPAIN  
Tel. +34 938 774 506  
Fax. +34 938 770 009

Distributor:

VACON PLC  
P.O.Box 25  
Runsorintie 5  
FIN-65381 VAASA  
FINLAND

Phone: +358-201-2121  
Fax: +358-201-212 205  
Service: +358-40-8371 150  
E-mail: [vacon@vacon.com](mailto:vacon@vacon.com)  
<http://www.vacon.com>