

ENGINEERING
TOMORROW

Danfoss

Selection Guide

VLT® AutomationDrive FC 300 series, VLT® Decentral Drive FCD 302

Versatile, reliable and
consistently **awesome**

Intelligence

to empower
your industrial
applications



Content

Seamlessly into the future	4	Installation made simple	
Consistently awesome.....	5	– Save commissioning time with SmartStart.....	22
Designed for easy integration in any application	6	– Wireless connectivity to the drive.....	23
Designed with fast and easy start-up in mind	7	Access the drive remotely.....	24
Extensive functionality for high-performance operation.....	8	Customized commissioning experience	25
Leveraging digitalization to reduce maintenance costs.....	9	FCD 302 – the One Box Concept	
Flexible, modular and adaptable. Built to last.....	10	reduces your Total Cost of Ownership.....	26
VLT® FlexConcept® – quicker and more cost effective.....	12	FCD 302 – the One Box Concept	
Application flexibility to boost your business	13	All you need is in one box.....	28
Integrated motion controller – for positioning		Modular simplicity – VLT® AutomationDrive	
and synchronization applications.....	14	A, B and C enclosures.....	30
Increase precision, accuracy and speed.....	16	High-power modularity – VLT® AutomationDrive	
Safety that scales with your needs	17	D, E and F enclosures	32
Achieve maximum availability of your system		Extended functionality for high-performance	
– with condition-based monitoring.....	18	operation – VLT® AutomationDrive Enclosed Drives.....	34
Drive as a controller	20	Engineered for cost savings via intelligence,	
A master of all motor technologies.....	21	compactness and protection	36

Consistency, reliability, versatility.

And all the power you need.

Chosen for its versatility, respected for its reliability, the VLT® AutomationDrive family has been providing consistently awesome performance for almost half a century.

The VLT® AutomationDrive family, comprising VLT® AutomationDrive FC 301/302 and VLT® Decentral Drive FCD 302 may have been around for a while. But that doesn't mean it hasn't evolved. Far from it.

The VLT® AutomationDrive family is now tougher and more intelligent than it has ever been before.

Built to last, this robust drive operates effectively and reliably even with the most demanding applications and in the most challenging environments. Read on to find out about the new generation E-frames and the lower temperature rating.

As with all Danfoss drives, the VLT® AutomationDrive family is motor independent giving you the power to choose the motor that best suits your application.

Packed with innovation, it features both hardware and software enhancements that maximize performance, and a new Ethernet platform for improved communication.

VLT® AutomationDrive family takes full advantage of all that the new digital age has to offer to ensure it completely fulfills the requirements of your applications and optimizes your processes throughout the entire lifecycle.

When you need to mount the drive close to the motor, VLT® Decentral Drive FCD 302 offers high performance decentral format with all the control functionality and performance of larger central drives. Its IP 66 enclosure is especially designed to suit multi-motor applications across a wide spectrum of industry.

Back-channel cooling: Efficient and economic heat management of VLT® AutomationDrive.....	37
Optimize performance and grid protection.....	39
Harmonic mitigation: Invest less and save more!.....	40
Harmonic mitigation.....	42
Cost-effective mitigation.....	44
MyDrive® Suite ensures your digital tools are only one click away.....	46
DrivePro® Services.....	48
Connection diagram.....	50
Technical data.....	51
Electrical data – VLT® AutomationDrive A, B, and C enclosures.....	53
Ordering type code VLT® AutomationDrive A, B and C enclosures.....	59
Electrical data – VLT® Decentral Drive FCD 302.....	60
Ordering type code VLT® Decentral Drive FCD 302.....	61

Electrical data	
– VLT® Automation Drive D, E and F enclosures.....	62
Electrical data and dimensions	
– VLT® AutomationDrive 12-Pulse.....	66
Ordering type code	
– VLT® AutomationDrive D, E and F enclosures.....	68
Electrical data and dimensions VLT® Enclosed Drive.....	70
Ordering type code for	
– VLT® AutomationDrive Enclosed Drives.....	74
Electrical data – VLT® AutomationDrive Low Harmonic Drive & VLT® Advanced Active Filter.....	76
A options: Fieldbuses.....	78
B options: Functional extensions.....	80
C options: Relay card and Motion control.....	82
D options: 24 V back-up power supply and RTC.....	83
Power options.....	84
Accessories.....	86



Seamlessly into the future

The fourth Industrial Revolution, or Industry 4.0, builds on the progress of automation by introducing elements of interconnectivity, data acquisition, machine learning and intelligent applications of analytics. AC drives play an important and powerful part in this transition by being the first point of interaction between sensors from the process, the motor in operation and transferring this information via communications bus to a central control location.

At Danfoss Drives, we live and breathe Industry 4.0, with the VLT® AutomationDrive and VLT® Decentral Drive representing the latest and best

technologies in the drives industry. When you choose these drives, you can count on the intelligent drive functions, application know-how, proven quality and reliability, and the support you need to make a seamless transition into Industry 4.0 and beyond.

The VLT® AutomationDrive family offers:

- Web-based configuration, Electronic Data Interchange (EDI), transparent order management
- Access to drawings, engineering diagrams, and ePlan macros
- Simulation tools such as Danfoss HCS for harmonic calculation and MyDrive® ecoSmart™ for motor-drive system efficiency calculations
- Compatibility with all industry-leading motor and fieldbus technologies
- Embedded intelligence for adaptability to evolving application needs
- Flexible interface to the drive data from multiple access points including: directly at the drive, via mobile applications, through an integrated web server and via cloud connectivity



VLT® AutomationDrive FC 302

Consistently **awesome**

It's easy to sum up the qualities of the VLT® AutomationDrive family in just two words – consistently awesome.

Throughout the entire lifecycle of your application, the VLT® AutomationDrive family provides benefits that not only save you time and money, but also help optimize your process while providing the flexibility and reliability to meet your current and future demands.

Awesome versatility

Modular and adaptable, the VLT® AutomationDrive family fits into any environment. It can be relied on to meet all your needs whether you have a single application or a variety of different ones.

Its cutting-edge thermal design and unique back-channel cooling for drives above 90 kW make VLT® AutomationDrive family one of the most compact and cost-efficient drives in the market.

Simple start-up

VLT® AutomationDrive is robust and intelligent, but at the same time quick and easy to install and provides years of reliable operation.

Intelligent operation

VLT® AutomationDrive family has a big brain ready to be put to work to control your applications effectively, efficiently and reliably.

High availability

Once installed, you can trust VLT® AutomationDrive family to provide trouble-free operation. New intelligent maintenance features and a range of DrivePro® services proactively improve productivity, performance and uptime.

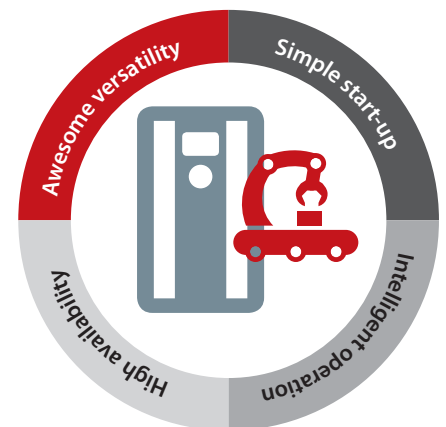

Do it differently

Know-how and experience

Proven quality

DrivePro® services

Awesome versatility

5

reasons to choose
VLT® AutomationDrive or
VLT® Decentral Drive

1. Fits in any environment
2. Modular and adaptable
3. Application flexibility
4. Reduced harmonic impact
5. Compact and efficient



Designed for easy integration in any application

Before any wires are connected or power is applied, your expectations of an AC drive determine whether or not it is the correct fit for your application. An awesome combination of functionality, suitability for your environment and the availability of comprehensive engineering tools mean you can feel absolutely confident selecting a member of this drive family, whatever your needs..

Fits in any environment

Install these VLT® drives wherever it best suits your application – close to the motor, located centrally in an electrical panel or outdoors. Its wide variety of enclosure class, conformal coating and ruggedization options reduce maintenance costs and ensure reliable operation in a range of challenging environments. A wide operating temperature range of -25 °C to +50 °C adds additional peace of mind when your applications take your drive to the extremes.

Modular and adaptable

These drives are built on a flexible, modular design concept that provides an extraordinarily versatile motor control solution. Each drive is equipped with a wide range of industry features that enable optimal process control, higher quality output and reduced costs related to spare parts and service. The book-style mounting of VLT® AutomationDrive takes advantage of this modular construction principle, allowing for more drives to fit into less space.

Application flexibility

When you have a variety of applications, it's best to select an AC drive that you can count on to meet all your needs. Whether operating pumps, conveyors, palletizers or material treatment equipment, the VLT® AutomationDrive family delivers the optimum control you want for reliable operation, all day long.

Reduced harmonic impact

The ability to predict the impact of adding AC drives to your facility is critical to keeping costs low. The Danfoss Harmonic Calculation tool allows you to calculate how much harmonic content to expect before you install your drive and avoid additional costs of harmonics and harmonic mitigation equipment on your facility. The availability of low harmonic drives, 12-pulse drives and low harmonic power options further minimizes harmonic impact.

Compact, efficient, even decentral

Thanks to its cutting-edge thermal design, VLT® AutomationDrive is one of the most compact air-cooled drives on the market in the range of 90 kW to 800 kW at 500 V. Combining this best-in-class power density with unique back-channel cooling further reduces costs associated with cooling while keeping the space required to a minimum. The VLT® FlexConcept combines central and decentral drives to achieve optimal efficiency and effective systems to minimize maintenance costs.

Read more about VLT® FlexConcept

[Read more about VLT® FlexConcept](#)

When you need to mount the drive close to the motor, VLTR Decentral Drive FCD 302 offers high-performance IP66 decentral format with all the control functionality and performance of larger central drives. Well-suited to multi-motor applications.

Designed with fast and easy start-up in mind

Your choice of AC drive should reduce the time it takes to get your application up and running without sacrificing any features or functionality. The VLT® AutomationDrive and VLT® Decentral Drive are designed to simplify every step in the start-up process – from wiring to programming to operation – and reliably deliver what you need for your application.

Easy installation

All I/O terminals are pluggable and spring-loaded and each has dual-connector configuration making wiring easy and flexible. Drives with high environmental enclosure ratings can also be ordered with pre-threaded cable gland openings to allow for an easy and reliable way to install your drive in harsh environments.

Dedicated application functionality

A versatile drive doesn't have to mean that your drive is complicated to commission. Application-dedicated functions in the drive perfectly balance ease and robustness to deliver reliable performance regardless of the application. Features such as droop functionality for load sharing, integrated brake control for the safe operation of hoists and the integrated process controller for demand-based pumping help to save time and money during start-up.

Optimized motor control

Automatic Motor Adaptation (AMA) is a powerful algorithm that tests and adjusts the drive to the unique traits of your motor, improving overall control and operating efficiency. Enhancements to the AMA for induction, PM, and SynRM motors means the process takes place in just a few milliseconds without spinning the motor. This enhanced AMA II, running

before every start, ensures that the motor parameters are always calibrated to the specific operating conditions increasing motor control accuracy.

[!\[\]\(faf942dc3e59ce8eb64b4ac481eca7e0_img.jpg\) Learn more about intelligent control](#)

Tailored and tested

Every drive is delivered from the factory exactly as you have configured it. Every drive is built with care and completely tested at full load against an AC motor prior to shipping, with your selected options already installed, which ensures that your drive will operate just as you expect it to.

Digital design tools

Almost all owners and operators of AC drives aim to reduce the amount of energy used in their applications. That's why understanding and documenting energy savings and energy efficiency are vital steps in engineering a system - and in measuring its performance once up and running.

Use the Danfoss digital tools and intelligence built into the drive, to support your engineering and document performance:

MyDrive® ecoSmart tool calculates and documents the efficiency class of both the drive and system according to IEC/EN 61800-9.

[!\[\]\(3342c215b2a8b663596a81468d5dc314_img.jpg\) Learn more about digital tools](#)

Simple start-up

5

reasons to choose

VLT® AutomationDrive or VLT® Decentral Drive

1. Easy installation
2. Dedicated application functionality
3. Optimized motor control
4. Tailored and tested
5. Powerful PC tools

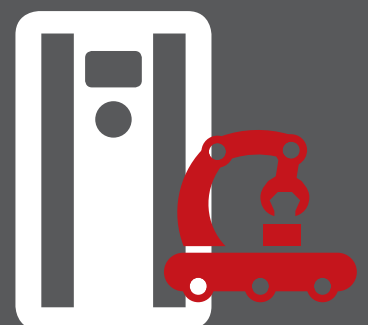

5

reasons to choose

VLT® AutomationDrive
VLT® Decentral Drive

1. Integrated Motion Controller
2. Robust four-quadrant control
3. Low noise operation
4. Easy PLC integration
5. High-efficiency operation



Extensive functionality for high-performance operation

The VLT® AutomationDrive family of drives is installed in a wide variety of demanding applications and environments. Regardless of your application's needs, you can count on these drives to deliver the capabilities for long, worry-free operation in even the most sensitive of environments.

Integrated Motion Controller

Providing motion functionality, high-precision scaled positioning and synchronizing tasks are simple to perform with or without encoder feedback, and commissioning is fast and safe. IMC is configurable by parameters – no special programming language is required. No additional modules or hardware are necessary.

Robust four-quadrant control

Applications, such as extruders and separators, place heavy demands on your AC drive. These drives can meet your demands by providing reliable operation in both motoring and generating phases of operation. Accurate torque controls, especially through zero speed where the key challenges lie, result in smooth and continuous operation, saving both time and money.

Low noise operation

Unfiltered AC drives produce electromagnetic interference (EMI) – both conducted and emitted. This interference can negatively impact sensitive equipment. Built-in EMC/RFI protection with screened motor cables to Residential Category C1 (to 50 m) and C2 (to 150 m) provides the ability to operate without additional and expensive filters, further increasing reliability and reducing interference with sensitive electronics.

Easy PLC integration

VLT® drives compatible with PROFINET, PROFIBUS DP-V1, DeviceNet, EtherNet/IP, EtherCAT, POWERLINK, CANopen and Modbus TCP protocols. All Ethernet options feature dual-ports with a built-in switch or HUB (POWERLINK). Some of the Ethernet technologies also support ring topology for higher availability and fast installation. Pretested function blocks and add-on instructions are available for easy, low-risk, integration into your PLC system.

High-efficiency operation

New standards in Ecodesign have been published focusing on energy efficiency of AC drives and drive-motor systems. As these standards increase the focus on the efficiency of AC drives worldwide, it's important to know that, with VLT® drives, you can count on having a foundation to meet these coming requirements. Using MyDrive® ecoSmart™, you can quickly determine the IE class of your AC drive, and the IES class of your specific motor-drive system and the part-load efficiency of your drive.

Leveraging **digitalization** to reduce **maintenance costs**

Unplanned downtime can be costly – both in terms of maintenance and lost production. Enhancements in the VLT® AutomationDrive provide more information about your devices and their performance, and a range of services optimizes their availability.

Intelligent troubleshooting

When something goes wrong with your process, the more data you have, the easier it is to pinpoint and quickly resolve the cause. New, intelligent maintenance features utilize the VLT® AutomationDrive's various sensors to record and store 2-3 seconds of real-time information around an Alarm, Warning or other defined trigger. This data from up to the last 20 events is then stored in the memory of the drive from where it can be retrieved and inspected within MCT 10. The addition of the Real Time Clock option allows the events to be time and date stamped, providing even more actionable data than ever before.

Wireless connectivity

The new VLT® Wireless Communication Panel LCP 103 provides wireless connectivity to your VLT® AutomationDrive using the MyDrive® Connect app for iOS and Android devices. It allows full and secure access to the drive for easy commissioning, operation and maintenance on your smart devices. Use the advanced LCP copy function to back up parameters to the storage of the LCP 103 or your smart device.

Remote access

Offsite accessibility allows for easier and faster access to both remote facilities or to large numbers of installed drives. Utilizing the integrated and modernized interface of the web server in the Ethernet-based communication options, each drive can be remotely accessed and monitored for operation and diagnostics purposes saving time and costs.

Condition-based monitoring

The VLT® AutomationDrive features condition-based monitoring functions that provide for worry-free operation while reducing maintenance costs and unplanned downtime. Condition-based monitoring functions can be used to schedule proactive maintenance alerts based on running time of the drive and triggering alerts, visible on the LCP and transferable over fieldbus. Condition-based monitoring turn your drive into a configurable smart sensor that continuously monitors the condition of your motor and application based on standards and guidelines such as the ISO 13373 standard for Condition Monitoring and Diagnostics of Machines or the VDMA 24582 guideline for condition monitoring.

 **Learn more about condition-based monitoring**

DrivePro® services

Danfoss Drives' comprehensive portfolio of services spans the entire lifecycle of your drives. As well as traditional service functions that improve productivity, performance and uptime, digitalization and the Internet of Things play valuable roles in our range of support and value-adding services. The drives themselves interact closely with their surrounding systems and processes. Built-in functionality allows them to collect and share data that is visible to maintenance personnel, Danfoss service teams, and 3rd-party service providers for fast and remote monitoring purposes.

Optimized performance

5

reasons to choose VLT® AutomationDrive or VLT® Decentral Drive

1. Intelligent troubleshooting
2. Wireless connectivity
3. Remote access
4. Intuitive maintenance
5. DrivePro® services

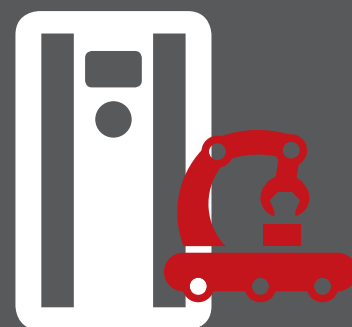

Flexible, modular and adaptable

Built to last

A VLT® AutomationDrive is built on a flexible, modular design to provide an extraordinarily versatile motor control solution. The drive is equipped with a wide range of industry features that enable optimal process control, higher quality output and reduce costs related to spare parts and service.

Free to equip

The VLT® AutomationDrive can optimally control nearly all standard industrial motor technologies, including Asynchronous, IPM, SPM, Synchronous Reluctance and PM assisted Synchronous Reluctance motors. This means that system designers, OEMs and end users are free to connect the drive to their selected

motor and remain confident that the system will perform to the highest possible standards.

As an independent manufacturer of AC drive solutions, you can count on Danfoss to support all commonly used motor types and foster ongoing development as new technologies emerge.

Speaks your language

When it comes to working with advanced technologies, such as AC drives, it is fairly easy to feel lost while navigating through hundreds of parameters. Using a graphical interface makes this process much easier; especially when it lists parameters in your native language. As many as 28 language options are available, including several Cyrillic, Arabic (right to left) and Asian options.

Additionally, the ability to save up to 50 user-selectable parameters further simplifies interactions with key parameter settings for your unique application.



690 V

The 690 V versions of VLT® AutomationDrive FC 302 units for the power range from 1.1 kW up to 1400 kW can control motors down to 0.37 kW without step-down transformer. This enables you to choose from a broad variety of compact, reliable and efficient drives for demanding production facilities operating from 690 V mains networks.

Reduce costs with compact drives

A compact design and efficient heat management enable the drives to take up less space in control rooms and panels, thereby reducing initial costs. Compact dimensions are also an advantage in applications where

drive space is restricted, making it possible for designers to develop smaller applications without being forced to compromise on protection and grid quality. For example, VLT® AutomationDrive FC 302 in a D or E enclosure size is 25-68% smaller than equivalent drives.

Despite the compact dimensions, all units are nevertheless equipped with integrated DC link chokes and EMC filters, which help to reduce grid pollution and reduce cost and efforts for external EMC components and wiring.

The IP20 version is optimized for side-by-side mounting in cabinets to 50 °C without derating and features covered power terminals to prevent

accidental contact. The AC drive can also be ordered with an optional brake chopper in the same package size. Control and power cables are fed in separately at the bottom.

The AC drives combine a flexible system architecture that allows them to be adapted to specific applications, with a uniform user interface across all power classes. This allows you to adapt the drive to the exact needs of your specific application. As a result, project work and costs are subsequently reduced. The easy-to-use interface reduces training requirements. The integrated SmartStart guides users quickly and efficiently through the set-up process, resulting in fewer faults due to configuration and parameterization errors.



VLT® FlexConcept®

– quicker and more cost effective

Effective, ongoing cost reduction requires drive solutions that significantly reduce running costs and the adoption of the latest, high-efficiency technology by both the operator and the system manufacturer.

They should also aim to optimize installation, commissioning, maintenance and service costs by optimizing staff resources and maximizing system availability.

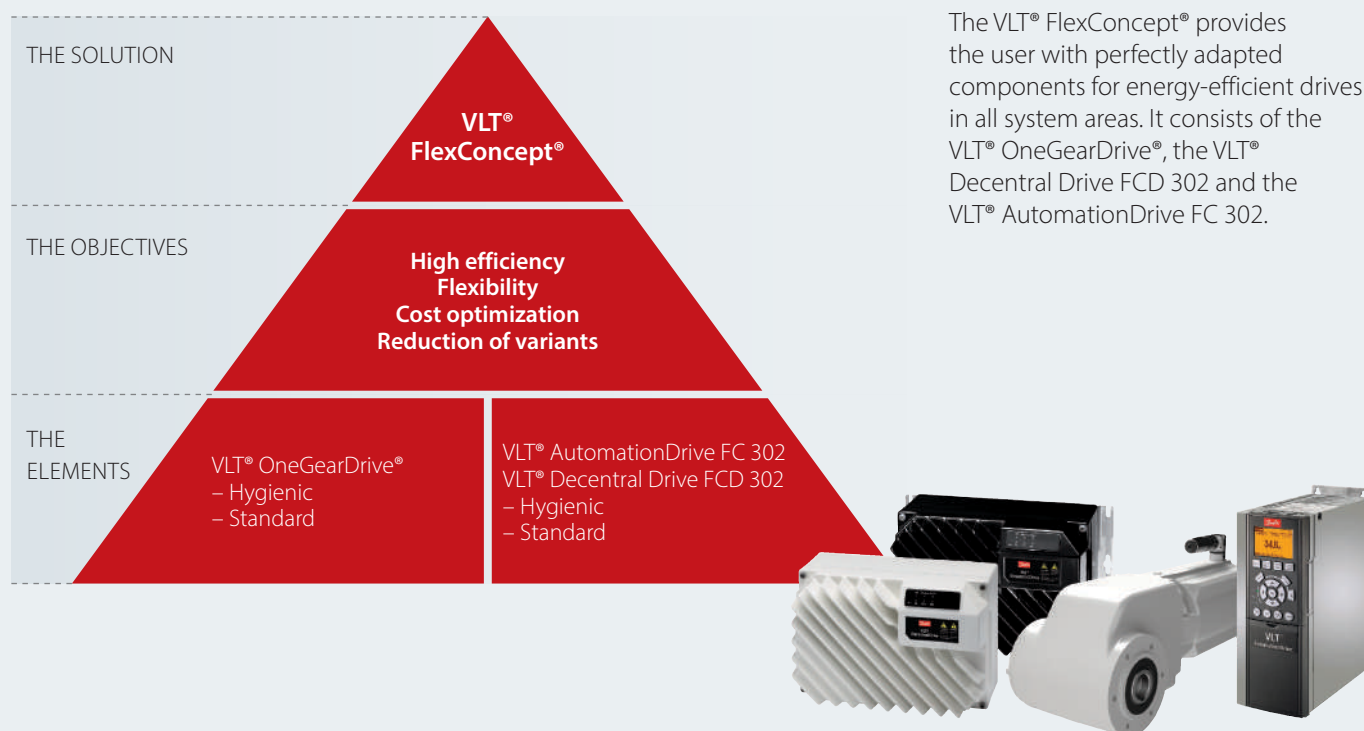

The VLT® FlexConcept® provides the user with perfectly adapted components for energy-efficient drives in all system areas. It consists of the VLT® OneGearDrive®, the VLT® Decentral Drive FCD 302 and the VLT® AutomationDrive FC 302.

4 points of cost optimization

High efficiency

All the drives used in the VLT® FlexConcept® stand out for their high level of efficiency and energy savings. The ultra premium efficient PM motor meets the highest efficiency class defined in IEC TS 60034-30-2 in a smaller frame size than current induction motors. Efficiency is maximized in the system as a whole by the matched design of the motors and the inverters.

Fewer variants

Conveyor solutions can be offered with a vastly reduced number of variants by careful motor selection and optimal AC drive adoption, even in large systems.

This in turn affords a smaller spare parts inventory, particularly for larger systems, along with reduced storage costs and faster component availability compared to current standard drive solutions.

Lower training and maintenance costs

Training expenditure and maintenance staff requirements are greatly reduced by the unified operating design and standard operating scope of VLT® drives, in addition to the simple connection of the VLT® OneGearDrive® Hygienic drive motors via stainless steel connectors.

Flexibility





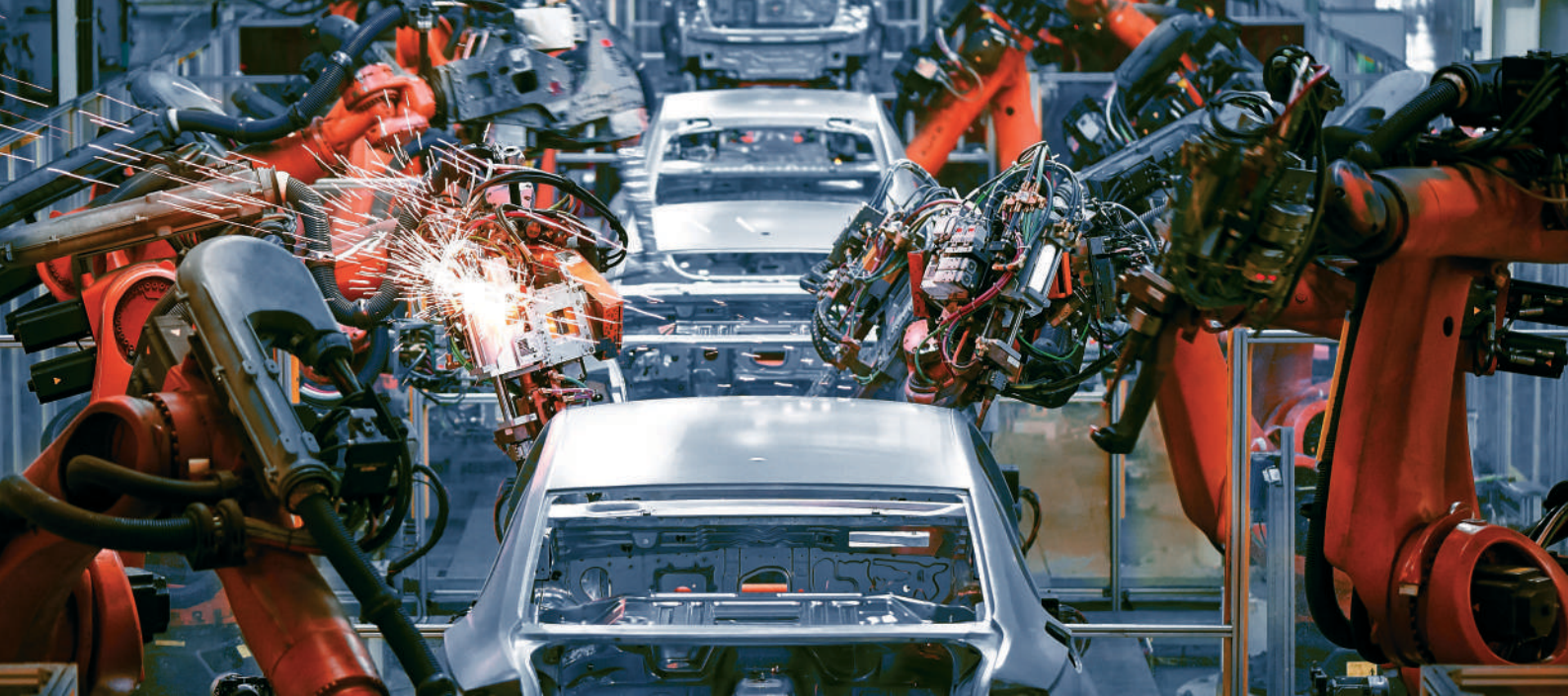







Easily and reliably combine components with existing solutions from other manufacturers on both centralized and decentralized systems.

The open system architecture of the VLT® FlexConcept® means that standard, geared and PM motors can all be controlled and operated at high efficiency by Danfoss VLT® drives.



Application flexibility to boost your business

The VLT® AutomationDrive is optimized to create value for you, enabling maximum performance in all major applications irrespective of industry.

Applications	Industries												
	HVAC	Food and Beverage, Packaging	Water and Wastewater	Refrigeration	Marine and Offshore	Mining and Minerals	Metals	Chemical	Cranes and Hoists	Elevators and Escalators	Material handling	Oil and Gas	Textile
													
Pumps	■	■	■	■	■	■	■	■				■	■
Fans	■	■	■	■	■	■	■	■			■	■	■
Compressors	■	■	■	■	■	■	■	■				■	
Conveyors		■			■	■	■	■			■		
Process, material treatment		■	■			■	■	■				■	■
Mills, drums, kilns						■	■						
Winding, unwinding							■						■
Drilling						■						■	
Propulsion, thrusters					■								
Winches					■								
Vertical and horizontal movement		■	■		■	■	■	■	■	■		■	■
Power conversion generation, smart grids					■				■	■			
Positioning, synchronization		■					■	■			■		■



Integrated Motion Controller – for **positioning** and **synchronization** applications

Perform high-precision positioning and synchronization, simply using an AC drive. With the Integrated Motion Controller (IMC) functionality, the **VLT® AutomationDrive FC 302 and VLT® Decentral Drive FCD 302** more complex positioning and synchronization controllers, to save time and cost.

Positioning and synchronization operations are typically performed using a servo drive and/or a motion controller. However, many of these applications do not actually require the dynamic performance available from a servo drive.

Therefore the VLT® AutomationDrive FC 302 or FCD 302 with IMC are cost-effective, high-performance alternatives to servo in single-axis positioning and synchronizing applications.

Use IMC for many applications that have been solved with servo drives until now, such as:

- Rotary tables
- Cutting machines
- Packaging machines

Use FC 302 or FCD 302 to run an induction or PM motor with **or without motor feedback** – with no need for additional hardware. With sensorless control (no motor feedback) best performance is achieved with a PM motor. The performance of sensorless control of induction motors is however sufficient for less-demanding applications.

With IMC you **save time and cost:**

- No advanced programming and fewer components means fewer hours needed for engineering, installation and commissioning
- Save further cost for a feedback device, cabling and installation by using sensorless control
- To save cost for a home sensor and cabling, use the “homing on torque limit” function

The IMC solution provides **easy and safe set-up:**

- Configuration via parameters, with no advanced programming required. Reduced complexity will minimize the risk of errors
- To add more functionality, use the Smart Logic Controller (SLC), which is fully compatible with IMC
- To realign the home position during operation, use the “home synchronizing” function

Encoder-free

to save costs and reduce complexity

Positioning

In positioning mode, the drive controls movement over a specific distance (*relative positioning*) or to a specific target (*absolute positioning*). The drive calculates the motion profile based on target position, speed reference and ramp settings (see the examples in Fig. 1 and Fig. 2 on the right).

There are 3 positioning types using different references for defining the target position:

- **Absolute positioning**
Target position is relative to the defined zero point of the machine.
- **Relative positioning**
Target position is relative to the actual position of the machine.
- **Touch probe positioning**
Target position is relative to a signal on a digital input

This illustration (Fig. 3) shows the different resulting target with a set target position (reference) of 1000 and starting position of 2000 for each of the positioning types.

Synchronizing

In synchronizing mode, the drive follows the position of a master; multiple drives can follow the same master. The master signal can be an external signal, for example, from an encoder, a virtual master signal generated by a drive or master positions transferred by fieldbus. Gear ratio and position offset is adjustable by parameter.

Homing

With sensorless control and closed loop control with an incremental encoder, homing is required to create a reference for the physical position of

 **Read the IMC programming guide**

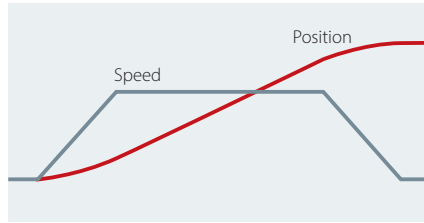

Fig. 1. Motion profile with linear ramps

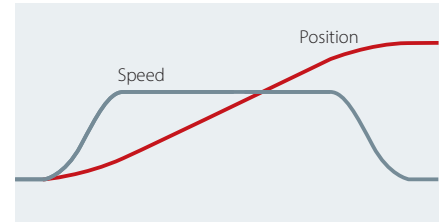

Fig. 2. Motion profile with S-ramps

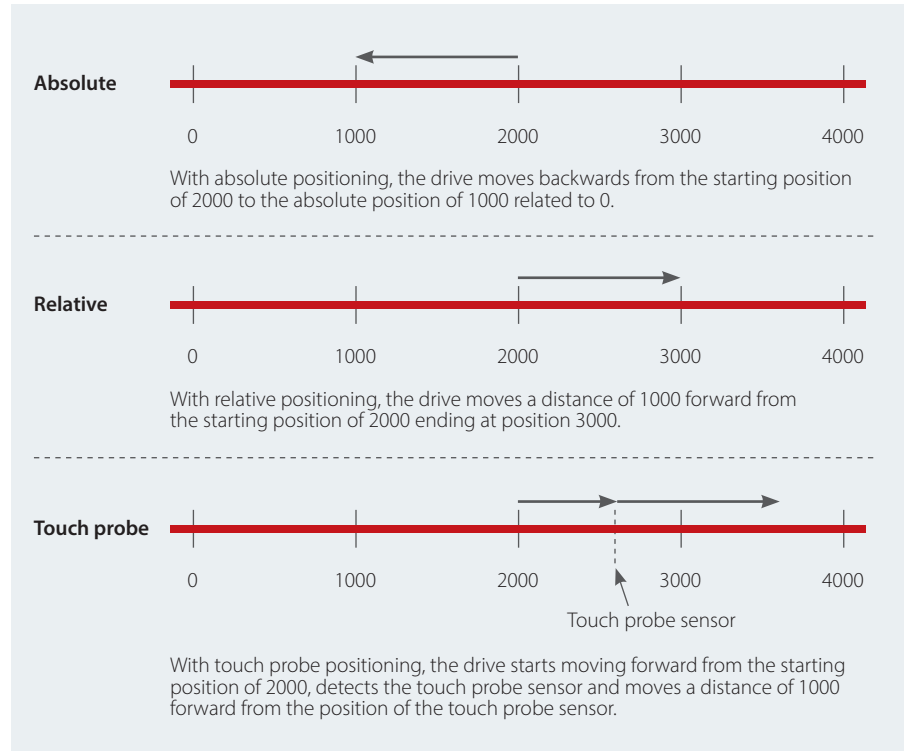

Fig. 3. IMC supports 3 positioning modes

the machine after power up. There are several home functions with and without sensor to choose from. The home synchronizing function can be used to continuously realign the home position during operation when there is some sort of slip in the system. For example in case of sensorless control with an induction motor or in case of slip in the mechanical transmission.



Increase **precision, accuracy** and **speed**

Expand the standard functionality of a VLT® AutomationDrive with energy-enhancing motion control options.

Increase productivity and performance

Replacing mechanical controls with intelligent, energy-saving electronic solutions is an effective way to reduce both installation and daily running costs.

The ability to set and control the packaging application with greater precision also reduces packaging errors and equipment breakdowns.

The result is a reliable, high-quality process that increases both productivity and bottom line performance.

Reduce installation costs

Replacing mechanics by electronic synchronizing or cam control increases flexibility while reducing costs. For example, electronic cam control, a standard feature in the VLT® Motion Control Option MCO 305, both adds

new functionalities and removes the need for mechanical cam discs and boxes.

Increase capacity

In other cases, manufacturers might want to increase the capacity of their packaging application. This can be achieved with the VLT® Synchronizing Controller MCO 350, which offers unparalleled synchronizing control and can be set up easily via the user-friendly control panel on the VLT® AutomationDrive.

As well as increasing the performance, the controller adds extra value by being an intelligent way to simplify the control system.

No matter which option you choose, the benefits of freedom of control and operational efficiency will provide a fast return on your investment.

Add flexibility to applications such as

- Printing lines
- Bottle washers
- Conveyor belts
- Packaging systems
- Material-handling systems
- Palletizers
- Indexing tables
- Storage systems
- Pick-and-place systems
- Positioning on the fly
- Foil wrapping
- Flow packing
- Filling and sealing
- Crane, lift and hoist applications
- Product-rejection systems
- Winder applications

Safety that scales with your needs

Safety Option	FC 302, FCD 302		FC 302	FC 302
	MCB 108	MCB 152	MCB 150 MCB 151	+ MCB 151 + MCB 159
Additional Safe Inputs		✓	✓	✓
Galvanic Isolated Inputs	✓			
Safety Fieldbus (PROFIsafe)		✓		
STO	✓	✓	✓	✓
SS1 (SS1-t, SS1-r)			✓	✓
SLS / SMS			✓	✓
Sensorless SS1, SLS, SMS				✓

Protect both equipment and operators

The VLT® AutomationDrive family is delivered as standard with the STO (Safe Torque Off) function in compliance with ISO 13849-1 PL d and SIL 2, according to IEC 61508/IEC 62061. This safety function can be extended to include SS1, SLS, SMS, safe jog mode, etc. with the VLT® Safety Option MCB 150 Series. The speed monitoring functions are available both with and without speed feedback.

VLT® Safety Option MCB 150 and MCB 151

The MCB 150 and MCB 151 can be integrated directly in the AC drive and is prepared for future connection to common safety bus systems. The

module is certified according to ISO 13849-1 up to PL d as well as IEC 61508/IEC 62061 up to SIL 2 and provides SS1 and SLS (SMS) functionality. The option can be used in low and high demand applications. SS1 offers ramp and time based functionality. SLS can be configured both with and without ramp down on activation.

When MCB 151 is combined with the built-in VLT® Sensorless Safety MCB 159 option, an external sensor is no longer required for safe speed monitoring.

VLT® Safety Option MCB 152

The VLT® Safety Option MCB 152 operates the safety functions of an AC drive via the PROFIsafe fieldbus in

combination with the VLT® PROFINET MCA 120 fieldbus option. Central and decentral drives located at different machinery cells can easily be interconnected with the PROFIsafe safety fieldbus. This interconnection enables activation of Safe Torque Off (STO) irrespective of where a hazard occurs. The safety functions of the MCB 152 are implemented according to EN IEC 61800-5-2.

The MCB 152 supports PROFIsafe functionality to activate integrated safety functions of the VLT® AutomationDrive from any PROFIsafe host, up to Safety Integrity Level SIL 2 according to EN IEC 61508 and EN IEC 62061, Performance Level PL d, Category 3 according to EN ISO 13849-1.

Before

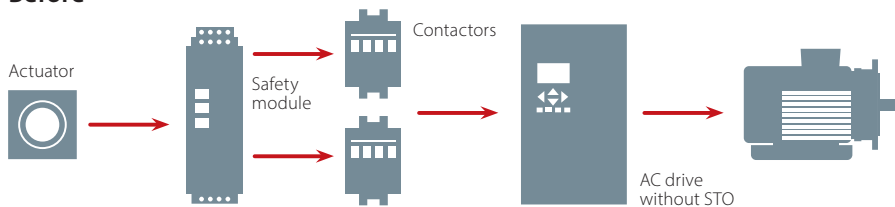

After



Quick commissioning

Parameter configuration is fully integrated into the VLT® Motion Control Tool MCT 10 for simple start-up and easy maintenance. Visual instructions in MCT 10 ensure both fault-free wiring and that safety parameters are correctly transferred from the PC to the drive.

The software also offers easy diagnosis and a dynamic commissioning report which can be used for supplying certification documentation necessary for safety acceptance tests.



Intelligent
 monitoring and
 maintenance
 functions embedded
 in the drive

Achieve maximum availability of your system – with **condition-based monitoring**

Equipped with intelligent monitoring functionality, the VLT® Drive enables you to use the drive as a smart sensor. It can monitor the condition of your motor and application in real time, detect when current operation status is drifting away from the defined limits, and alert the operator to changes before they impact your process.

Condition-based monitoring

During installation, the condition-based monitoring (CBM) function establishes a baseline defining the recorded operation conditions for each monitoring element of the system, and threshold values are defined. During operation, CBM monitors motor stator windings, sensors and load-envelope conditions, all adjusted according to the actual speed of the system. When actual operation conditions exceed the defined limits, CBM sends alerts to notify personnel to take action.

The CBM function complies with relevant standards and guidelines, such as

- ISO 13373 standard for Condition Monitoring and Diagnostics of Machines
- VDMA 24582 guideline for condition monitoring
- ISO 10816/20186 standards for measurement and evaluation of mechanical vibration.

The unique embedded functionality means that the VLT® Drive performs CBM monitoring inside the drive. When required, activate cloud or PLC connectivity to enable monitoring of numerous conditions or to send alerts when required.

Feature	Benefit
Condition-based monitoring functionality embedded in the drive	<ul style="list-style-type: none"> - No cloud connection required: high security level and no subscription fee - Reduced installation costs, since no external controller or PLC required to generate the CBM observation and notification - Documentation of system stability
Motor-stator-winding monitoring	<ul style="list-style-type: none"> - More uptime due to early detection and action on faults in the motor stator winding, before the fault develops into a crippling failure and unscheduled operational stop
Load-envelope monitoring Application baseline (run / online)	<ul style="list-style-type: none"> - Process optimization/maximized efficiency thanks to ability to compare actual system performance with baseline data and trigger maintenance actions
Sensor application monitoring (external) Application baseline (run / online)	<ul style="list-style-type: none"> - More uptime due to early detection and action on signs of mechanical misalignment, wear-out and looseness - Higher precision since sensor monitoring relates to motor speed

[Read the white paper here](#)

Motor-stator-winding condition monitoring

Motor-winding failures do not occur suddenly; they develop over time. They start with a small single-turn shortcircuit fault which causes additional heating. The damage then spreads to a level where the overcurrent protection activates, and the operation stops, causing unwanted downtime.

The unique winding condition monitoring function allows you to shift from reactively performing corrective maintenance of faulty motors, to proactively detecting motor isolation faults at an early stage and dealing with them during scheduled maintenance. In this way, you can avoid unwanted and potentially costly machine downtime caused by 'burned' motors.

Sensor selection

Four condition-based monitoring sensor inputs are defined by the analogue inputs. Using condition-based monitoring parameterization, you can scale the inputs to monitor the sensor signals where the vibration sensor is the most commonly used sensor type. Pressure and flow sensors could also be selected, provided that sensor selection is related to the drive speed of the system.

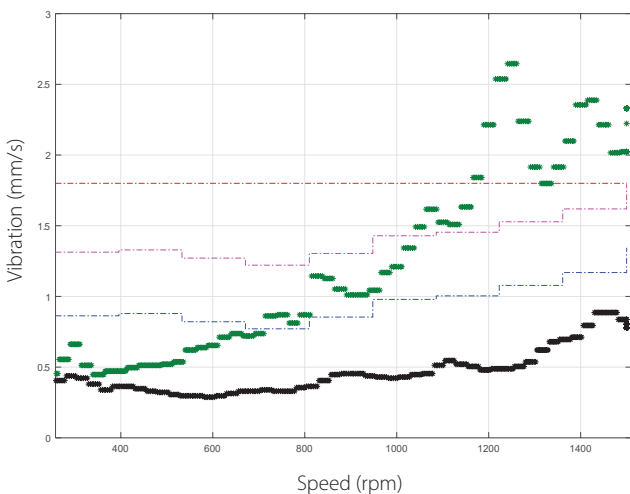

Application example showing changes in vibration signal

- Baseline data
- Faulty data
- - - Alarm Level
- - - Warning Stage 2 Level
- - - Warning Stage 1 Level

Mechanical-vibration monitoring

Avoid accelerated wear of the mechanical parts of a drive system by using CBM together with an external vibration transducer, to monitor the vibration level in a motor or application, related to the actual speed or rotation of the system.

Vibration monitoring is performed using standardized methods and threshold levels given in standards such as ISO13373 for Condition Monitoring and Diagnostics of Machines or ISO10816/20816 for Measurement and Classification of Mechanical Vibration.

Baseline measurement of min/max and average values indicate the stability of a system at different speeds and are very useful as a hand-over test from contractor to end-user.

Load-envelope monitoring

Use the VLT® Drive to compare the actual load curve to the initial values determined during commissioning. This empowers you to detect unexpected operating conditions, such as

- leakage in an HVAC system. Inadequate or excessive power consumption indicates a problem, defined at individual speeds.
- pumps which have become fouled or sanded
- clogged air filters in ventilation systems

When a part has worn out, the load curve changes compared to the initial baseline, and a maintenance warning is triggered allowing you to quickly and effectively remedy the issue. Load-envelope monitoring can also help you to save energy by ensuring the equipment always runs in optimal conditions.

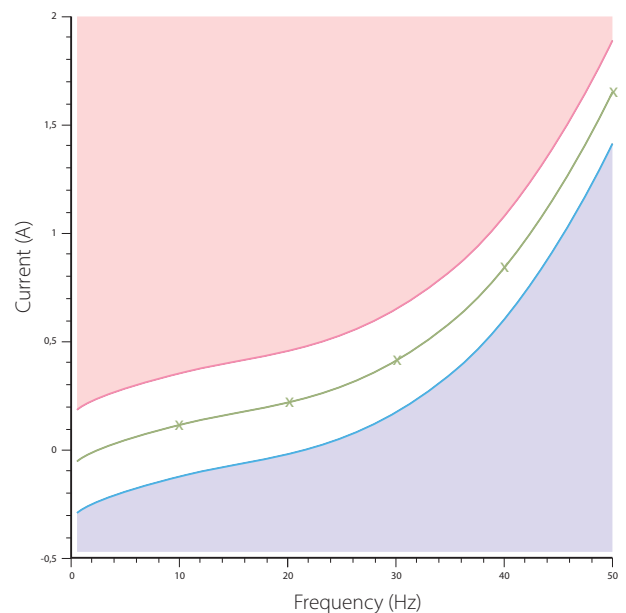

Baseline - Load envelope monitoring of energy consumption.

- Energy consumption above the limit
- Energy consumption below the limit



Drive as a **controller**

Customize with SLC

Use the built-in Smart Logic Controller (SLC) to customize drive functionality, and optimize how the drive, motor and application work together. The VLT® Drive features 4 different SLC loops which operate independently. Create new functions via simple, intuitive drop-down selections that give you numerous options for setting the drive to specific application needs. Most logic functions run independently of the sequence control, meaning the drive monitors variables or signal-defined events in an easy and flexible way, independently of the motor control.

Use freely programmable options and I/O modules to increase the control area of the drive even more.

Use these programmable options to control air handling functions with fans, valves and dampers to reduce and free up valuable control capacity for the building management system. Advanced local programmability and programming of the LCP for user interaction reduces the overall complexity of an AHU/RTU installation, and future-proofs it, ready for IoT and cloud integration.

Time-based functionality and real-time clock

Integrated date, day and time-based functionality means you can easily program the drive to change operation mode, start functions or even make specific actions, right on time. The real-time clock option ensures you are always in control of the time and date - even after power cycling of the drive.

Functional safety

The VLT® Drive is able to provide the STO (Safe Torque Off) function in compliance with ISO 13849-1 PL d and SIL 2, according to IEC 61508 / IEC 62061. Optional integrated lockable mains disconnect protects staff working inside the installation.

Extended I/O

Extend the I/O interfaces using a wide variety of options to match application needs, such as standard digital I/O and relays; analog I/O, and special interfaces for temperature sensors. Connect the extensions inside the drive enclosure or via a bus system to external I/O modules, with protection ratings IP20 to IP66.

Drive as I/O interface in remote installations

The ruggedized enclosure of the VLT® Drive makes it possible to install the drive fully exposed to a harsh environment: close to the motors, sensors, and other control components. The drive I/O interface and control functions reduce installation complexity. The drive connects directly to all the local components in the installation, and connects via fieldbus to the BMS system or other SCADA systems which control the complete application.

Local I/O connection covers a variety of interfaces: the built-in I/O functions, and optional internal and external I/O modules via BACnet or Modbus. These installations are often used in tunnel projects or in renovation projects where standalone systems are integrated into a larger BMS which monitors the application.

PID controllers & autotuning

Four proportional-integral-derivative (PID) controllers are built into the drive to ensure optimal internal and external control and to eliminate the need for auxiliary control devices. The PID controllers maintain constant control of closed loop systems enabling the drive to adjust motor speed to regulate pressure, flow, temperature or other system requirements.

A master of all motor technologies

Save commissioning time and fine-tune for optimal system control. The choice of motor is all yours - use VLT® Drive with the motor technology you prefer.

Free choice of motor

Danfoss gives you a free choice of motor supplier and supports all commonly used motor types. The VLT® Drive offers control algorithms for high efficiency and trouble-free operation with standard induction motors, permanent magnet (PM) motors, induction and synchronous reluctance motors. This means you can combine a VLT® Drive with your favorite motor technology to achieve a masterclass performance.

Straight into action with Automatic Motor Adaption

Allowing you to access optimal, dynamic motor performance with just a few clicks, the AMA function saves you a lot of time and effort when setting up the system. Guided by the SmartStart start-up wizard, just enter the basic motor data, such as currency and voltage, which are found on the motor name plate, and you are straight into action.

Motor control for general & advanced applications

The drive uses standard VVC+ motor control, an easy and perfect choice for most variable torque applications. However in some circumstances, the more advanced Flux mode motor control is required to gain faster motor control of the application and to handle unstable mains power supply. Advanced Flux control also demands a higher degree of alignment of the motor parameters for optimal control, where the AMA function helps to create the best operation platform.

Automatic Energy Optimization

With the AEO feature we have made a complex task easy and available with only a few clicks. The integrated AEO function ensures optimal energy-efficient speed control of the pump, while adapting the voltage exactly to the current load situation to reduce energy consumption.

Super-easy commissioning with Auto Tuning

Auto tuning fine-tunes your system to optimal performance, while cutting down on programming. The auto tuning function measures a series of system characteristics and automatically finds the settings of the process controller for stable and precise system control.

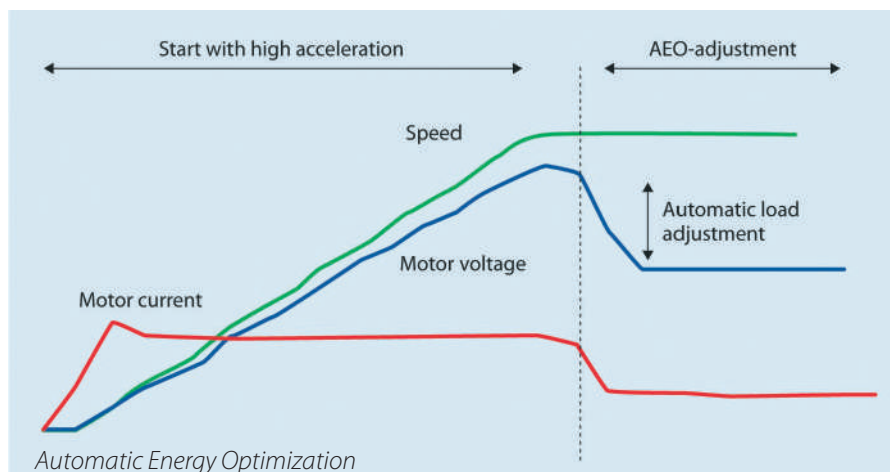

IM
Three-phase induction motor with copper rotor

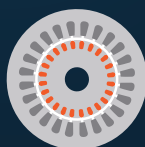

LSPM
Line-start PM motor with buried magnets and rotor cage

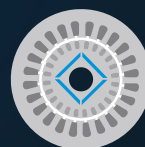

SynRM
Synchronous reluctance motor



IPM
PM motor with buried magnets

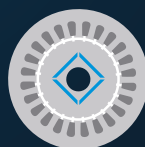

SPM
PM motor with surface-mounted magnets

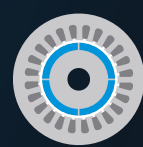

Installation made simple

– Save commissioning time with SmartStart



SmartStart is a setup wizard that is activated at the first power up of the drive, or after a factory reset. Using easy-to-understand language, SmartStart guides you through a series of simple steps to ensure correct and efficient motor control and alignment for the application operation.

Start the wizard directly via the Quick Menu on the graphical control panel, and choose your preference amongst 27 languages.

Additionally, the ability to save up to 50 user-selectable parameters further simplifies interactions with key parameter settings for your unique application. The graphical local control panel (GLCP) featured in VLT® drives is hot-pluggable and can be mounted remotely when your application requires.

Remote LCP Mounting

When the drive is difficult to access, it is often convenient to install a remote LCP for easy operation and programming. The LCP Remote Mounting Kit is specially developed for easy installation for cabinets of up to 90 mm wall thickness.

Additionally, the cover on the kit will hold itself up, blocking the sun while you program the LCP, or you can close and lock it while keeping the On/Alarm/Warning LEDs visible. Read more under 'Accessories'.

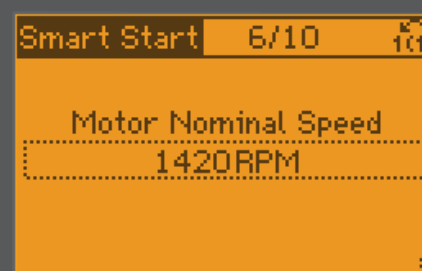
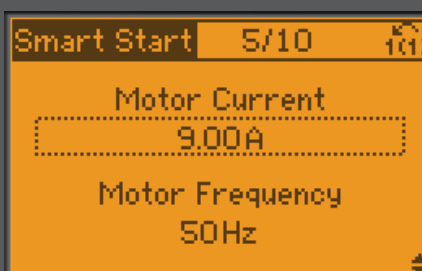
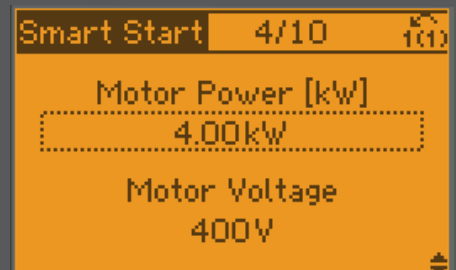
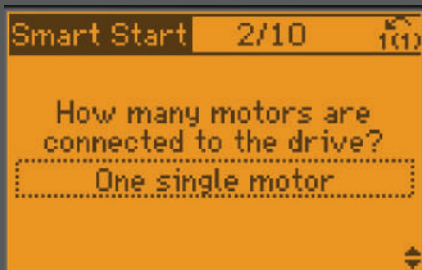

Installation made simple

– Wireless connectivity to the drive

Wireless connection to the drive via your smartphone makes commissioning and troubleshooting easier and faster when drives are outdoor protected and located in hard-to-access spots.

The VLT® Wireless Communication Panel LCP 103 communicates with MyDrive® Connect – an app which you can download to iOS and Android-based smart devices. MyDrive® Connect gives you full access to the drive, making it easier to perform commissioning, operation, monitoring and maintenance tasks.

Instant access to vital information

The VLT® Wireless Communication Panel LCP 103 displays the current drive status (On, Warning, Alarm, Wi-Fi Connectivity) through built-in LEDs. Via MCT 10 on a laptop or via the MyDrive® Connect app you can then use your smart device to access detailed information, such as status messages, start-up menus and alarm/warning events. This means you can configure your drive wirelessly on IP55 and IP66 without compromising the tight enclosure for USB connection.

The app will also visualize various data with graphs to document the behavior of a drive over time. Utilizing the active point-to-point wireless connection or via an access point and local network, maintenance personnel can receive real-time error messages via the app to enable quick response to potential issues and reduce downtime.

Sharing data

The advanced LCP copy function allows you to store copies of the drive parameters, either to the internal memory of the VLT® Wireless Communication Panel LCP 103 or to your smart device. Log details can be shared from MyDrive® Connect, so that the service team can provide relevant support for troubleshooting. The safe control parameter allows the user to decide the drive behavior in case of crash/connection-loss from app to drive.



Free to connect

Real time information is becoming increasingly important in building management systems (BMS) as well as industrial applications with Industry 4.0. Immediate access to data increases transparency in production facilities, while making it possible to optimize system performance, collect and analyze system data and provide remote support around the clock from anywhere in the world.

Today, drives are more than simple power processors. With the ability to act as sensors and sensor hubs, to process, store and analyze data, along with connectivity capabilities, drives are vital elements in modern BMS and

automation systems using Industrial IoT. This means Danfoss drives are valuable tools in **condition monitoring**.

Regardless of your application or your preferred communication protocol, Danfoss drives have an extremely wide variety of communication protocols to select from. In this way you can ensure that the AC drive integrates seamlessly into your chosen system providing you the freedom to communicate however you see fit.

Increase productivity

Fieldbus communication reduces capital costs in production plants. In addition to the initial savings achieved

through the significant reduction in wiring and control boxes, fieldbus networks are easier to maintain, while providing improved systems performance.

User friendly and fast set-up

Danfoss fieldbuses can be configured via the drive's local control panel, which features a user friendly interface with support for many user languages. The drive and fieldbus can also be configured using the software tools that support each drive family. Danfoss Drives offers fieldbus drivers and PLC examples for free from the Danfoss Drives website to make integration to your system even easier.



Access the drive remotely

Commission and operate the drive either locally via the LCP or remotely using the MyDrive® Connect tool. Today it is common to connect drives via a fieldbus system or a wireless network connection, for convenient access from a remote location.

Connect via wireless network

Use the VLT® Wireless Control Panel LCP 103 to create a Wi-Fi network for direct access between a smart device and the drive, or via an access point where multiple smart devices can access the drive, one at a time.

The MyDrive® Connect app shows the drives that are accessible on the network, each displayed with a user-defined name created in the parameter settings.

Both LCP 103 and MyDrive® Connect give you full access to all information inside the drive. You can change parameter settings and control the drive to start and stop remotely.

Integrated webserver in Ethernet-based fieldbuses

A webserver interface is available in all Ethernet-based VLT® fieldbus options. Using a standard browser, you can access the drive after entering the correct IP address and password. This interface is perfect for smartphone, tablet and desktop screens, where the webserver supports a variety of different browser interfaces.

Which information you can access is pre-defined in menus and widgets to improve the user experience.

These data include the normal status information of the drive (readout, I/O, Alarm Log, Trend charts, statistics), and maintenance and energy efficiency information and trends.

You can also subscribe to e-mail notifications from the drive, when an e-mail server is connected to the same network.

Cloud-based solution for smart buildings

Generate IoT and smart cloud solutions to suit your needs. In the HVAC industry a “smart building” trend with MQTT connection is gradually replacing conventional BMS systems, where a master BMS controller is in control of all the building applications. The new approach is towards a multitude of “sub-master” systems, each of which controls the operation of a smaller application.

A good example of the sub-master approach is to use VLT® Drive to control a complete AHU. Then different control systems can access the drive directly

to incorporate the complete AHU into the new generation of BMS solutions. One of the expert systems may focus on comfort in the building, a second system on the energy consumption, and a third system deal with maintenance and filter replacement. Danfoss offers drives solutions with the ability to support these different cloud solutions, with built-in security at a very high level to secure the connection between the drive and the “broker” and cloud- servers; all depending on the internet-cloud concept that the user has selected.

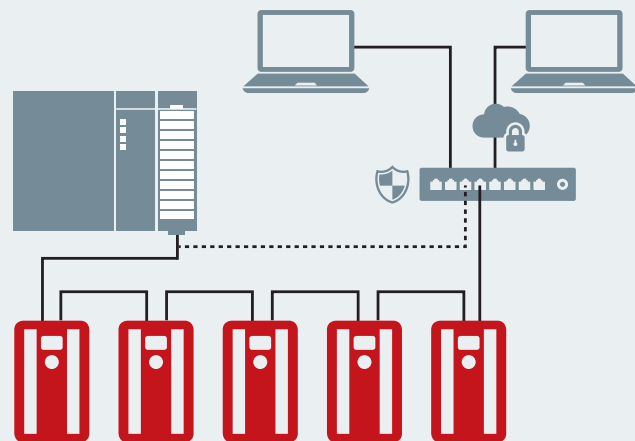

Web server dashboard



Customized commissioning experience

The VLT® Motion Control Tool MCT 10 is an interactive tool for quick and easy online/offline configuration of a VLT® drive or soft starter using a PC. You can also use the tool to configure the communication network and to back up all your relevant parameter settings. With MCT 10, you can control and configure your system simultaneously and monitor your entire system more effectively for faster monitoring, diagnosis, troubleshooting (alarms/warnings) and better preventive maintenance. Starting with version 4.00, MCT 10 includes even more features that enhance usability.

Status plug-in

The readouts for various status and control words, relay inputs and outputs that are available over the fieldbus have been greatly improved. We have combined these signals into a single plug-in that shows you much more information. You'll be able to see right away if a certain relay or bit is on or off, and what exact command the drive has been configured with, saving you time.

VLT® Software Customizer

VLT® Software Customizer allows you to customize the commissioning experience to best fit your needs. It is a tool that enables you to simply and quickly create and test your desired setup using the simulator before uploading it to a real drive.

The VLT® Software Customizer consists of three main features:

- **SplashScreen** allows you to create a custom splash screen for when the drive starts up. You can use the built-in editor to create an image from blank or import an existing image from a library or from your computer and adapt it to the VLT®.
- **InitialValues** allows you to set a new default value for virtually any parameter.
- **SmartStart** allows you to create a custom start-up wizard to go through exactly the parameters you need.



Motor plug-in

The motor plug-in makes it easier to select the needed motor type and to parameterize the drive accordingly. Simply select the required motor type, and the corresponding parameters are listed together with a description guiding you on how to set the correct value. The motor types supported by the motor plug-in are:

- IM, induction
- PM, non-salient SPM
- PM, salient IPM
- Synchronous Reluctance (SynRM)
- PMSynRM

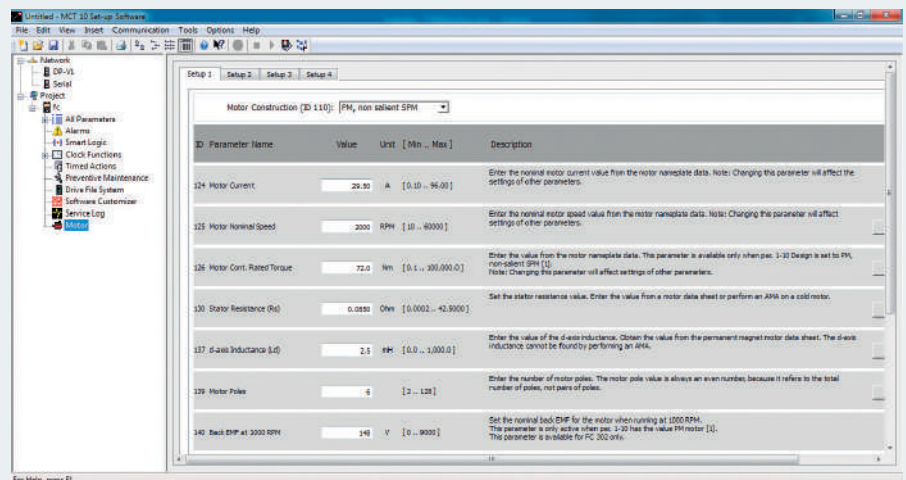

FCD 302 – the One Box Concept reduces your Total Cost of Ownership

Total Cost of Ownership, TCO, is a primary focus in the decision making process when buying complex technical equipment. A lower first cost is no longer the smart way to buy. The price has to be sensible, but alongside the price there are a whole host of factors that influence the overall cost of the equipment during its lifetime. Those factors, from the costs of ordering, through to the running and maintenance costs, can combine to total more than the original purchase price, turning a cheap buy into a very costly ownership.

The all new VLT® Decentral Drive FCD 302 completes the transition of the VLT® drive to a true One Box Concept with the lowest Total Cost of Ownership (TCO).

It's really that simple – everything needed to control the motor is contained within the IP 66 drive enclosure. Just loop the mains cable into the box, and out to the next box, connect a cable to the motor and you're ready to run. Add a high speed fieldbus cable and your drives are an integral part of the whole drives control network. No need for an external 24 V DC power supply, no need for an external controller or motor switch – it's all in the FCD 302.

Every aspect of the FCD 302 contributes to the lowest TCO.

Its unique design is intended to simplify ordering, installation, commissioning, operation and maintenance.

Performance and operation

In performance and operation terms, the FCD 302 shares a common platform with the Danfoss VLT® AutomationDrive range, meaning there's no new learning involved and less time spent discussing the application with Danfoss' drives specialists.

Documentation and parts

There's less documentation and fewer parts and no need for field distribution or drop-down boxes and it's a global product design with local approvals and documentation available in a wide selection of languages.

Simple interface

There's a clear interface between the installation box and the control section. That means just one drawing detailing the electric assembly/installation box.



Order handling

Ordering is simplified by the limited number of ordering lines required. This means there is less maintenance of purchasing orders and reduced risk of ordering the wrong parts – or missing parts altogether.

At incoming goods there are fewer parts to check-in so less time taken to compare delivery to original order, less risk of missing parts, fewer inventory locations and less space required for storage.

Installation

With fewer numbers of boxes to be mounted, in fewer locations, that's a saving in time and man-hours. Fewer cables cut time and cost and less money spent on cable management systems. No external 24 V DC supply is required so that's another cable less and the cost of a central dc power supply out of the equation. Fewer connections and terminations also reduces labour cost at installation and lowers the likelihood of failure due to poor or wrong connectivity.

Commissioning

The One Box Concept means that commissioning time is significantly reduced. A multi-lingual graphical display with on-board manual means no lost time searching for the manual. The HMI (human machine interface), based upon the award winning VLT® display, has a customized display to display just the parameters you decide are important to you.

The FCD 302 also makes use of the VLT® Motion Control Tool MCT 10, proven in use in the field with thousands of VLT® drives. Programmes can be stored and shared, drive to drive; OEMs can pre-commission drives prior to despatch, making for faster

commissioning of the completed installation on-site. Flexible PC connection through USB, RS485 and HPPF and a capability facilitate programme is available as download via internet to update the OEM's factory settings at the end-user's plant, which simplifies and reduces cost of commissioning.

Service

The FCD 302 is probably the simplest and easiest drive to service which Danfoss has ever developed. Self-diagnostic troubleshooting combined with an on-board manual accessed through the graphical display makes faultfinding and troubleshooting easy. All alarms and operations are logged in the memory for easy access and interpretation of past events.

The twin part design dramatically reduces the time necessary to locate any failure area and replace the failed part, minimising downtime. The failed part can be replaced by untrained personnel and spares inventory is dramatically reduced. No longer shelves loaded with vulnerable printed circuit boards (and never the right one available). Just two parts – a top and a bottom to make service fast and reliable.



Six LEDs indicate the current device status – for further programming and configuration a graphical control panel identical to the displays of the FC-series can be connected from the outside.

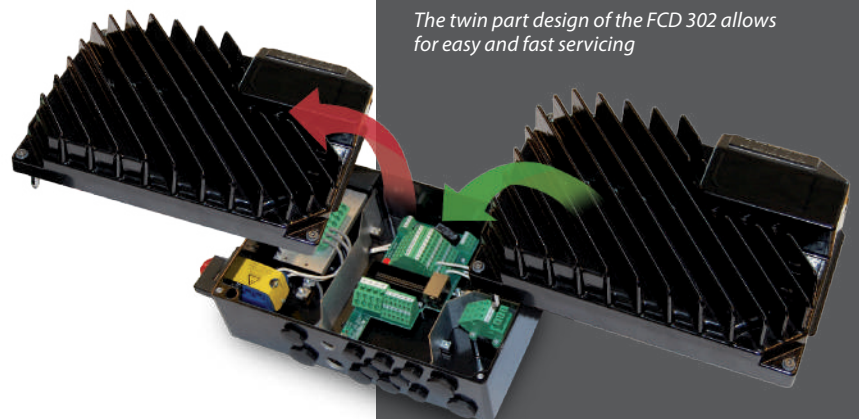

The twin part design of the FCD 302 allows for easy and fast servicing

FCD 302 – the One Box Concept

All you need is in one box

Integrated 24 V supply

24 V DC control supply is provided by the drive supplying remote I/Os distribution.

Power looping

The new FCD 302 facilitates internal power looping. Terminals for 6 mm² (big box) or 4 mm² (small box) power cable inside the enclosure allows connection of multiple units in the same branch.

Ethernet switch

Integrated Ethernet switch/ hub with the two RJ-45 ports are available in the drive for easy daisy-chaining of Ethernet communication.

Fieldbuses are routed easily, without adding commissioning time, by connecting Ethernet or Profibus based field buses to a M12 pluggable interface.

PROFIBUS communication

Straight and easy access to the spring-loaded terminals for daisy-chaining.

Decentral I/O

Connection of all input/output devices is via IP 67 rated M12 connectors on the FCD 302.

Control terminals

Specially developed spring-loaded cage clamps enhance reliability and facilitate easy commissioning and service.

EMC and Network effects

The VLT® Decentral Drive complies as standard with EMC limits A1 according to the EN 55011 norm.

The standard integrated DC coils also ensure low harmonic load on the network according to EN 61000-3-12 and increase the lifespan of the drive.

Display connection

The same award-winning Local Control Panel as for FC-drives, can also be used with the FCD302. Connection can be made from the outside, without the need for opening the box, through the built-in LCP plug.

The info button makes the printed manual virtually redundant. The Automatic Motor Adaptation, Quick Set-Up menu and large graphic display make commissioning and operation a breeze.

Built-in Smart Logic Controller

The Smart Logic Controller is a simple but clever way to keep your drive, motor and application working together. The controller monitors a specified event. When an event occurs, the controller triggers a specified act and starts monitoring the next event continuing for up to 20 steps before returning to step one.

Safety

The drive is delivered as standard with the Safe Torque Off (Safe Stop) function in compliance with EN ISO 13849-1 Category 3 PL d and SIL 2 according to IEC 61508 low demand and high demand mode.

This feature prevents the drive from starting unintentionally. Enhanced safety features are available as options.

PC-software

The drive can also be commissioned via the built-in USB/RS485 connection or a fieldbus from the VLT® Motion Control Tool MCT 10. Access to the USB-port is made from the outside, without the need for opening the box, just by removing the cap on the dedicated hole.

Built-in DC coils to limit harmonic distortion

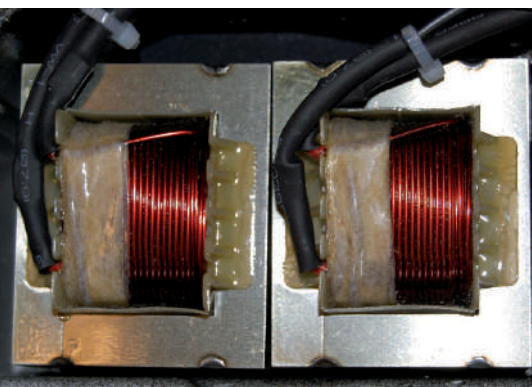

Easy accessible terminals for internal looping

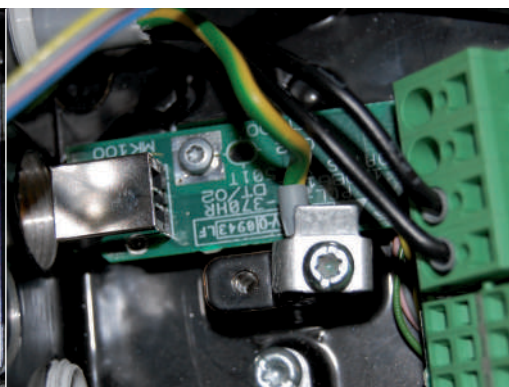

Easy access for PC software connection



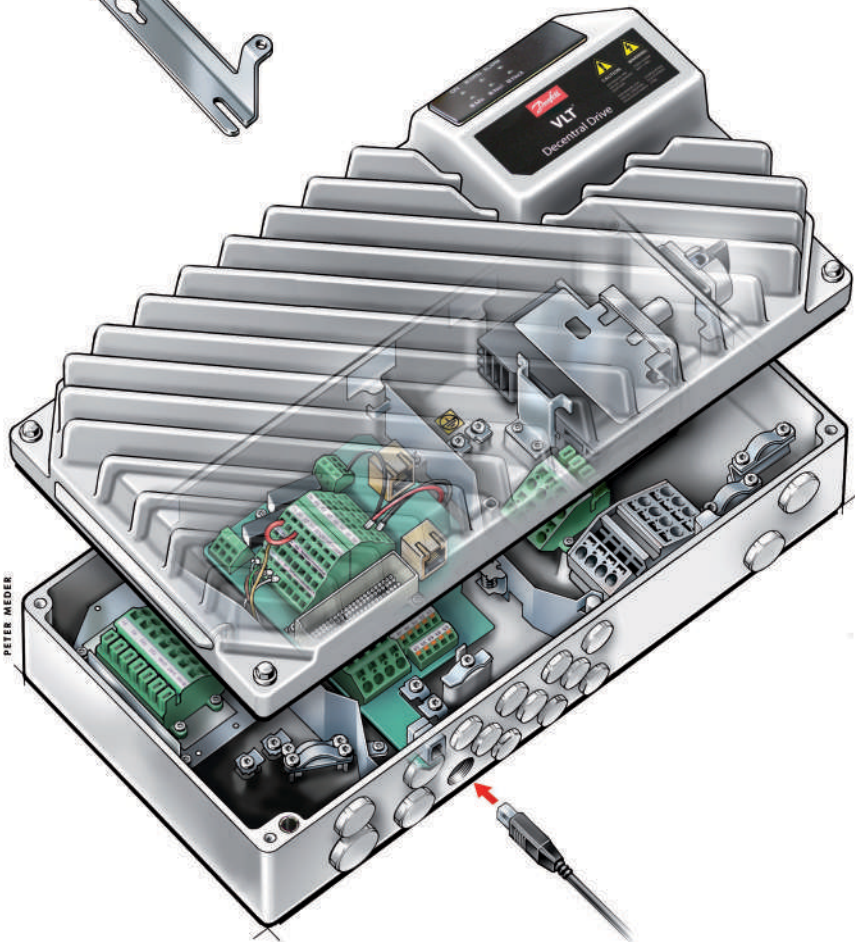
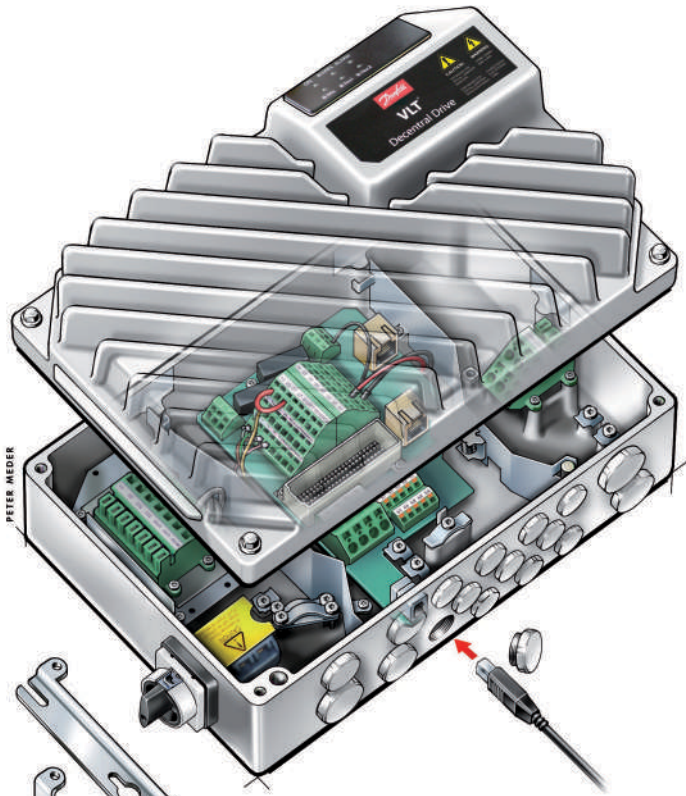

Two dimensions

The VLT® Decentral Drive FCD 302 is available in two enclosure sizes.

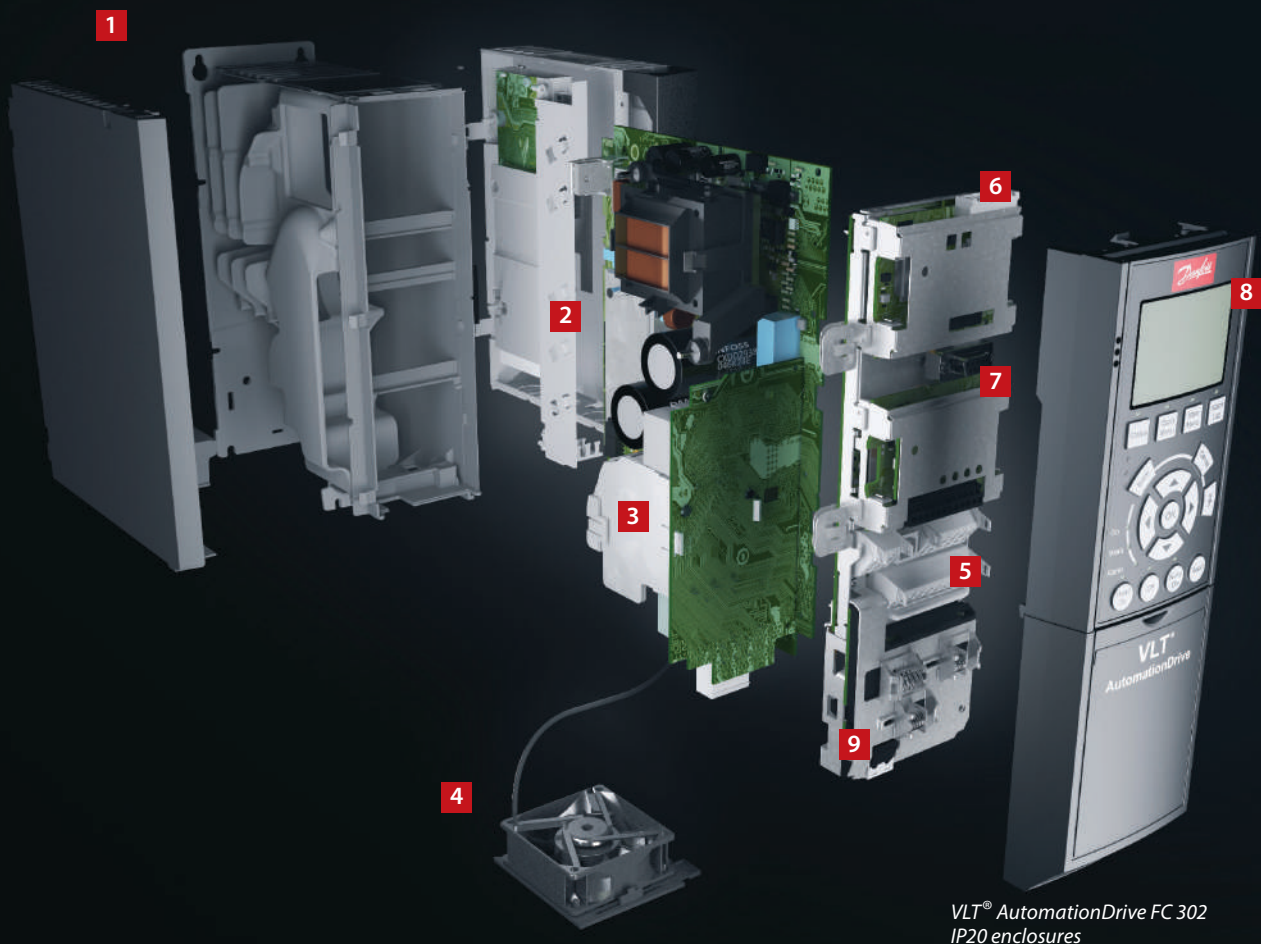

VLT® AutomationDrive FC 302
IP20 enclosures

Modular simplicity – VLT® AutomationDrive A, B and C enclosures

Delivered fully assembled and tested to meet your specific requirements

1. Enclosure

The drive meets requirements for enclosure class IP20/Chassis. IP21/UL Type 1, IP54/UL Type 12, IP55/UL Type 12 or IP66/UL Type 4X.

2. EMC and Network effects

All versions of VLT® AutomationDrive comply as standard with EMC limits B, A1 or A2 according to the EN 55011 norm and IEC61800-3 Category C1, C2 and C3. The standard integrated DC coils ensure low harmonic load on the network according to EN 61000-3-12 and increase the lifetime of the DC link capacitors.

3. Protective coating

The electronic components are, as standard, coated as per IEC 60721-3-3, class 3C2. For harsh and aggressive environments, coating as per IEC 60721-3-3, class 3C3 is available.

4. Removable fan

Like most of the elements, the fan can be quickly removed and remounted for easy cleaning.

5. Control terminals

Specially developed removable spring-loaded cage clamps add to reliability and facilitate easy commissioning and service.

6. Fieldbus option

All major industrial fieldbuses are supported. See complete list of available fieldbus options on page 41.

7. I/O options

The general purpose I/O, relay, safety and thermistor expands the flexibility of the drives.

8. Display option

Danfoss drives' renowned removable Local Control Panel (LCP) has an improved user interface. Choose between 28 built-in languages (including Chinese) or have it customized with your own. Languages can be changed by the user. Wireless version available.

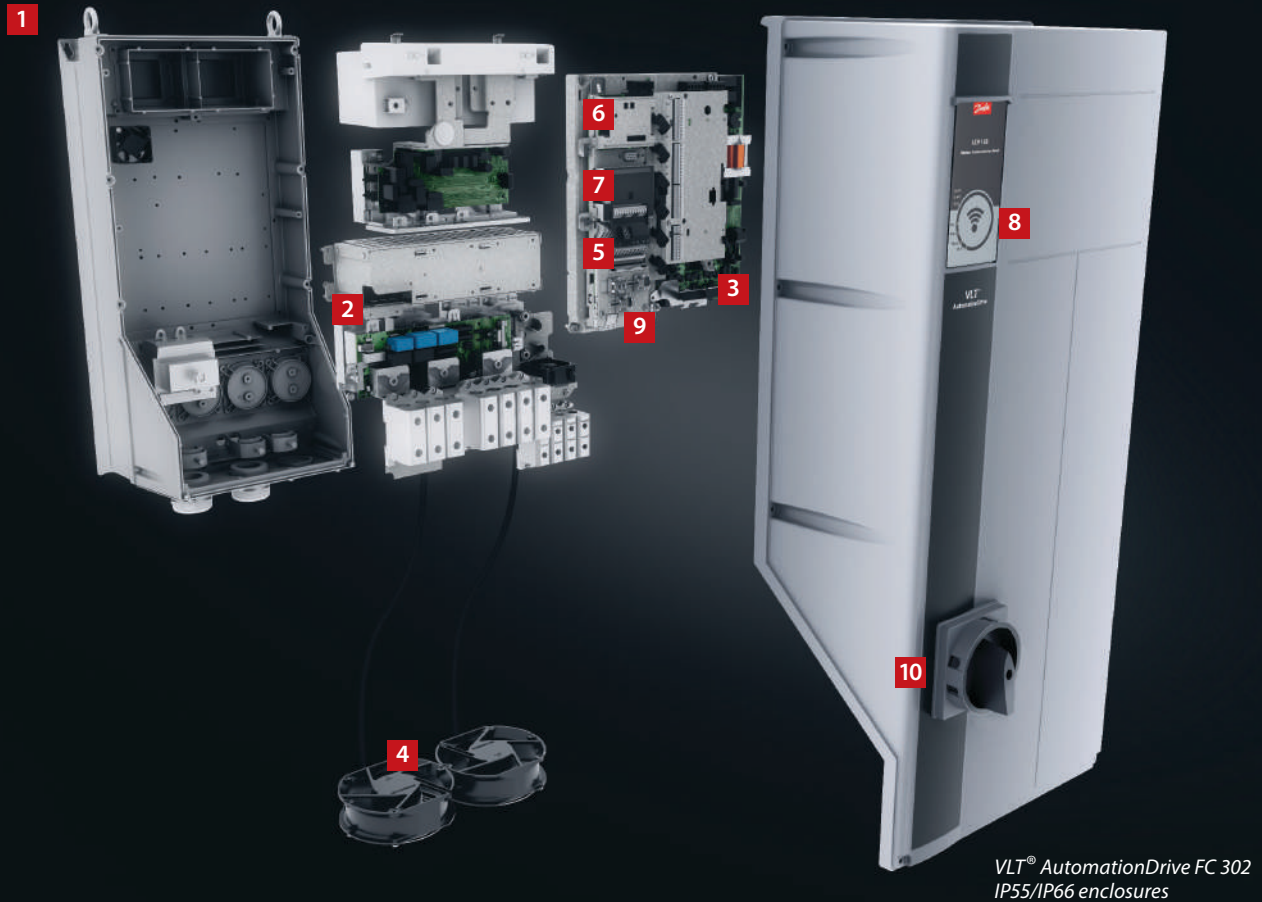

VLT® AutomationDrive FC 302
IP55/IP66 enclosures

Alternatively the drive can be commissioned via the built-in USB/RS485 connection or through fieldbus options with the VLT® Motion Control Tool MCT 10 PC tool.

9. 24 V supply or RTC

A 24 V supply option to keep the control section and any installed option functioning during power failure. An extended version combines a Real-time Clock with a battery in one D-option.

10. Mains switch

This switch interrupts the mains supply and has a free useable auxiliary contact.

Safety

Extended range of integrated functional safety. Please see chapter "Tailored safety" on page 17.

The VLT® Real-time Clock MCB 117 option

The VLT® Real-time Clock MCB 117 option provides accurate time control functions and time stamp of logging data.



High-power modularity

– VLT® AutomationDrive D, E and F enclosures

The high-power VLT® AutomationDrive modules are all built on a modular platform allowing for highly customized drives which are mass produced, tested, and delivered from the factory.

Upgrades and further options dedicated to your industry are a matter of plug-and-play. Once you know one, you know them all.

1. Display options

Danfoss drives' renowned removable Local Control Panel (LCP) has an improved user interface. Choose between 28 built-in languages (including Chinese) or have it customized with your own. Languages can be changed by the user.

2. Hot pluggable LCP

The LCP can be plugged in or unplugged during operation (enclosure size D and E). Settings are easily transferred via the control panel from one drive to another or from a PC with MCT 10 set-up software.

3. Integrated manual

The info button makes the printed manual virtually redundant. Users have been involved throughout development to ensure optimum overall functionality of the drive. The user group has significantly influenced the design and functionality of the LCP.

The Automatic Motor Adaptation (AMA), the Quick Set-Up menu and the large graphic display make commissioning and operation a breeze.

4. Fieldbus options

See complete list of available fieldbus options on page 46.

5. I/O options

The general purpose I/O, relay and thermistor expands the flexibility of the drives.

6. Control terminals

Specially developed removable spring-loaded cage clamps add to reliability and facilitate easy commissioning and service.

7. 24 V supply

A 24 V supply keeps the VLT® drives logically "alive" in situations when the

AC power supply is removed.

This power supply is available in an extended version which supports Real Time Clock (RTC) functionality.

8. RFI filter suitable for IT grids

All high-power drives come standard with RFI filtering according to EN 61800-3 Cat. C3/EN 55011 class A2. A1/C2 RFI filters according to IEC 61000 and EN 61800 standards as integrated options.

9. Modular construction and ease of maintenance

All components are easily accessible from the front of the drive, allowing for ease of maintenance and side-by-side mounting of drives. The drives are constructed using a modular design that allows for the easy replacement of modular sub-assemblies.

10. Programmable options

A freely programmable motion control option for user-specific control algorithms and programs allows the integration of PLC programs.

11. Conformally coated and ruggedized circuit boards

All high-power drive circuit boards are equipped as standard with conformal coating to withstand the salt mist test. Meets IEC 60721-3-3

Class 3C3. The conformal coating complies with ISA (International Society of Automation) standard S71.04 1985, class G3. Additionally, drives in D & E enclosures are available with optional ruggedization to withstand high-vibration environments.

12. Back-channel cooling

The unique design uses a back channel to pass cooling air over heat sinks. This design allows up to 90% of the heat losses to be exhausted directly outside of the enclosure with minimal

air passing through the electronics area. This reduces temperature rise and contamination of the electronic components for improved reliability and increased functional life. It also dramatically reduces temperature rise inside control room and installation cost for additional cooling components. Various back-channel cooling kits are available to redirect the airflow based on application needs.

The back-channel cooling kit is available in a corrosion-resistant variant. This option provides a degree of protection against aggressive environments such as ocean air containing salt.

13. Enclosure

The drive meets relevant requirements for all possible installation conditions. Enclosure class IP20/chassis, IP21/UL Type 1, and IP54/UL Type 12. A kit is available to increase the enclosure class on enclosure size D and E drives to UL Type 3R.

14. DC-link reactor

The built-in DC-link reactor ensures low harmonic disturbance of the power supply in accordance with IEC-61000-3-12. The result is a more compact design with higher efficiencies than competitive systems with external-mounted AC chokes.

15. Input mains option

Various input configurations are available, including fuses, mains disconnect switch, or RFI filter.

16. Front USB connector

Front USB connector gives IP54 access to the drive data with no impact on drive operation. Open the front door to access the internal USB port.



Efficiency is vital for high-power drives

Efficiency is essential in the design of the high-power VLT® drive series. Innovative design and exceptionally high-quality components have resulted in unsurpassed energy efficiency.

VLT® drives pass more than 98 % of the supplied electrical energy on to the motor. Only 2 % or less is left in the power electronics as heat to be removed.

Energy is saved and electronics last longer because they are not exposed to high temperatures within the enclosure.

Safety

Please see chapter "Integrate Safely".

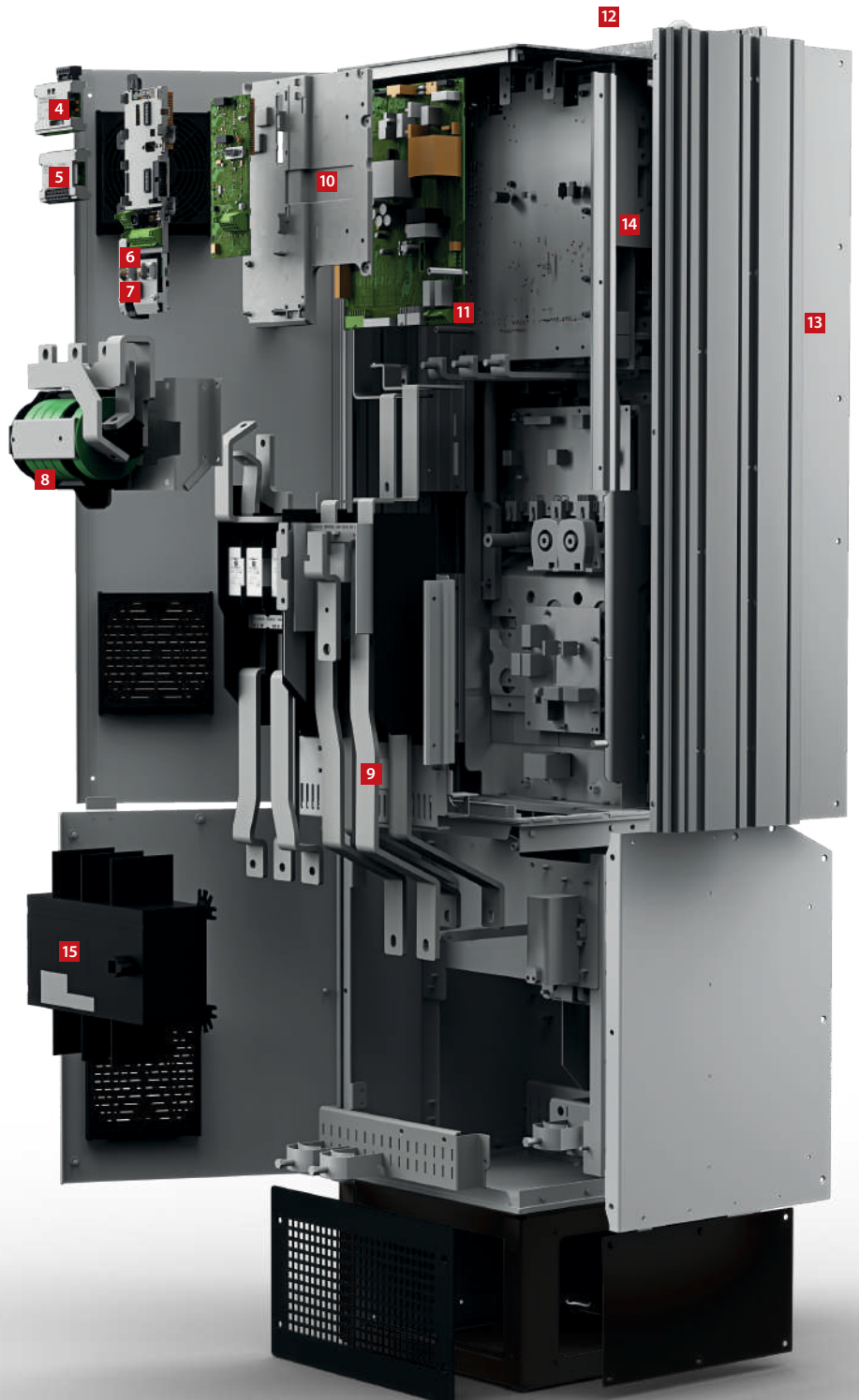

VLT® AutomationDrive FC 302, enclosure size T5

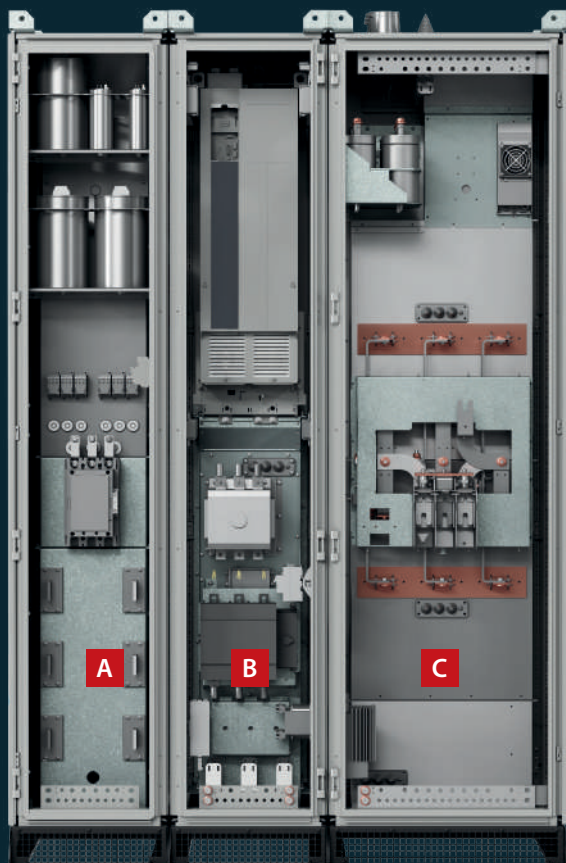

- A** Input filter cabinet
- B** Drive cabinet
- C** Output filter cabinet

VLT® Enclosed Drive (PLV 302) with optional input and output options cabinet in enclosure size D9H

Extended functionality for **high-performance operation** **VLT® AutomationDrive Enclosed Drives**

The high-power VLT® AutomationDrive Enclosed Drives have been designed to meet the most demanding requirements for flexibility, robustness, compactness and ease of service. Each enclosed drive is precisely configured in flexible mass production, then individually tested and delivered from the factory.

1. Door-mounted control compartment

separate from the main power terminals ensures safe accessibility to control terminals, also during operation of the drive.

2. VLT® AutomationDrive

high-power drive in enclosure size D or E, with selectable control options.

3. Back-channel cooling assembly for power options

ensures utilization of the drive's back-channel cooling concept in the cabinet and efficient cooling of the integrated selectable power options.

4. Mains contactor

is a selectable mains power option.

5. Mains switch disconnect

is a selectable mains power option.

6. Bottom entry establishment

ensures IP54/NEMA12 connections of the enclosed drive mains terminals to the power supply.

7. Mains reactor assembly

of the selectable passive harmonic filter ensures absolute minimum harmonics content of the mains currents: **THDi <5%**.

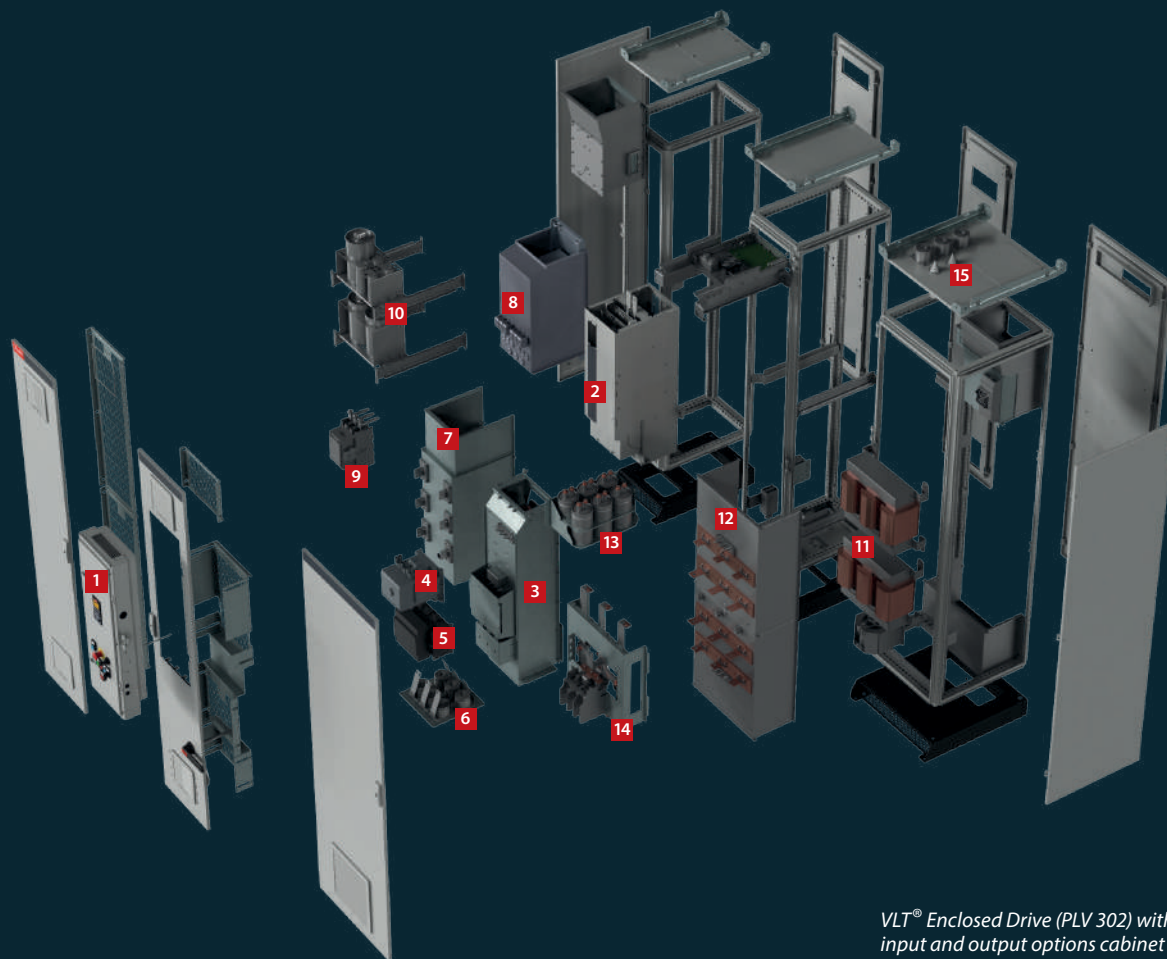

VLT® Enclosed Drive (PLV 302) with optional input and output options cabinet in enclosure size D9H

8. Passive filter magnetics

and the mains reactor of the passive filter are integrated into the back-channel cooling assembly of the cabinet.

9. Contactor

to control the passive harmonic filter of the drive.

10. Capacitor assembly

for the mains current passive harmonics filter.

11. Sine-wave filter magnetics

of the output filter, as a selectable power option.

12. Back-channel cooling assembly

for magnetics of the output sine-wave filter.

13. Capacitor assembly

for the sine-wave filter.

14. Motor connection terminals

are located in the sine-wave filter cabinet.

15. Top exit establishment

ensures IP54/NEMA12 connections of motor cables from the top.

Engineered for **cost savings** via **intelligence**, compactness and **protection**

All Danfoss VLT® drives follow the same design principle for fast, flexible and fault-free installation, and efficient cooling.

The AC drives are available in a broad range of enclosure sizes and protection ratings from IP20 to IP66 (NEMA Chassis to Type 4X) to enable easy installation in all environments: mounted in panels, switch rooms or as stand-alone units in the production area.

Smart software increases uptime

The drive is an important part of production systems dependent on absolute reliability. One of the key priorities in drive selection is high resistance to unforeseen grid fluctuations that would otherwise interrupt operations. To improve ride-

through, the drive relies on a robust overvoltage controller, kinetic backup and an improved flying start which ensures reliable operation when it's needed most.

Designed to protect

Intelligent algorithms ensure that the drive continues to operate as expected, despite spikes and dips in voltage. The drive is SEMI F47-certified to document its performance. The drive is SEMI F47-certified to document its performance.

Because the drive may be connected to a system that experiences a short circuit which could potentially destroy the connected drive, the VLT® Drive is designed to be shortcircuit-proof with a 100 kA prospective short circuit current capability for reliable operation, no matter what the challenge.

Design for 10+ years operation between part replacements

High quality components are selected for use in the design of the VLT® Drive, in order to ensure minimum 10 years normal operation before first replacement of service components. A built-in maintenance program helps you to monitor the drive installation, to ensure the drive operates within its specification.

Coated circuit boards

The drive conforms as standard to class 3C3 (IEC 60721-3-3) to ensure long lifetime even in harsh environments. However, drives rated below 75 kW conform to 3C2 as standard, with 3C3 conformance available as an option.

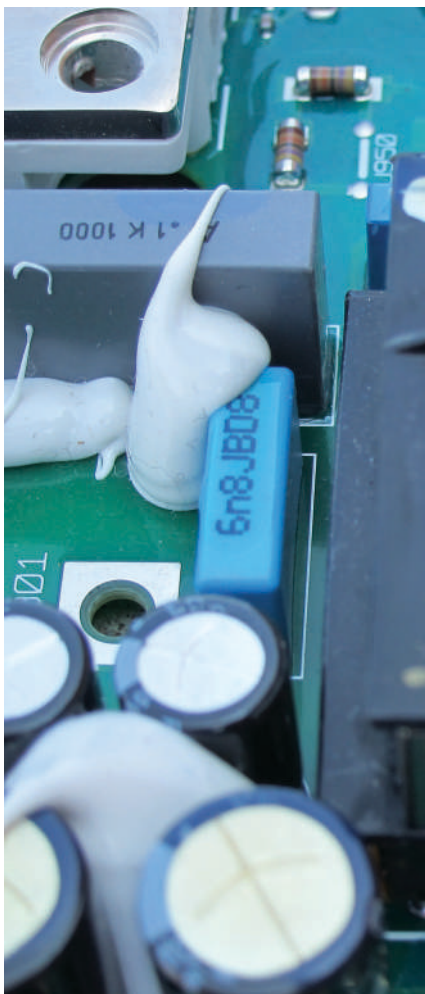

Ruggedized for extra protection

In order to reduce the potential negative effects of vibration, the drives have been 'ruggedized'. It is a process that ensures that critical components on the PCB have increased protection, significantly reducing the risk of malfunction while at sea.

The printed circuit boards in the drives are also all coated in accordance with IEC 60721-3-3 class 3C3, providing additional protection against moisture and dust.

Reliable operation at engine room temperatures up to 55 °C (130 °F)

VLT® drives can operate at full load in engine rooms with 50 °C temperature and 55 °C at reduced power close to,

for example, pumps and thrusters. There is no need for installation in air-conditioned control rooms with long motor cables.

Spark-free design

The VLT® drives conform to the Limited Explosion Risk requirements in The European Agreement concerning the International Carriage of Dangerous Goods by Inland Waterways, as they do not create any sparks during normal operation and the temperature does not exceed 200 °C (390 °F).

Back-channel cooling: Efficient and economic heat management of VLT® AutomationDrive

The Danfoss back-channel cooling system is a masterclass in thermodynamics that delivers efficient cooling using a minimal amount of energy.

Cost-saving heat management

A compact design that exhausts 90% of system heat outside the building makes it possible to reduce the size of your cooling system in the panel or switch room. These remarkable savings are achieved with Danfoss' panel-through cooling system or the extremely efficient back-channel cooling concept. Both methods considerably reduce the installation costs of the panel or

switch room, as designers can shrink the size of the air conditioning system, or even eliminate it entirely. In daily operation, the benefits are equally clear as the energy consumption related to cooling is brought down to an absolute minimum. Combined installation and energy savings result in up to 30 % cost savings in the first year of your drive investment.

Revolutionary design

The proprietary back-channel cooling concept available for the VLT® Drive is based on a unique heatsink design, with heat pipes that conduct heat 20,000 times more efficiently than traditional solutions. Using a minimal amount of energy, the concept exploits the heat differentials in materials and air temperature to effectively cool high performing electronics.

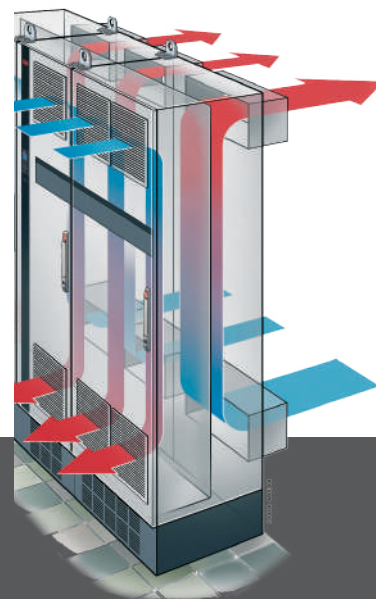
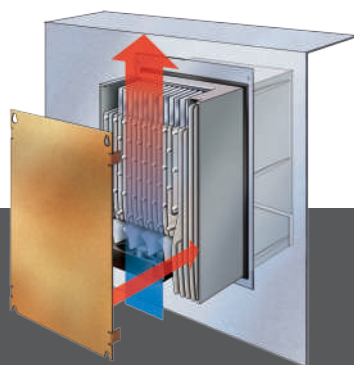
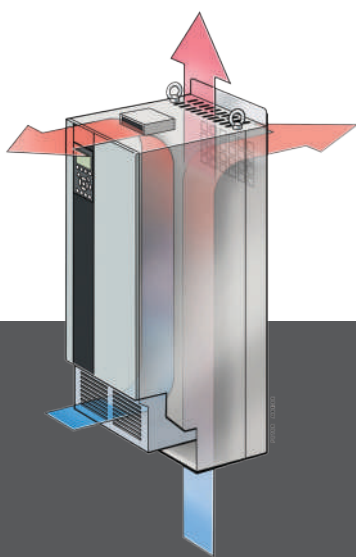

VLT® AutomationDrive FC 302

90% reduction in air conditioning system investment

90% reduction in energy use for air conditioning

1 Reduced dust over electronics

Complete separation between cooling air and internal electronics, ensures trouble-free operation and longer intervals between service.

2 Panel-through cooling

An accessory mounting kit for small and mid-range drives enables heat losses to be directed directly outside the panel room and into designated air ducts.

3 Back-channel cooling

By directing air through a rear cooling channel up to 90% of the drive's heat loss is removed directly outside the installation room.



Optimize performance and grid protection

Built-in protection

The AC drive contains all the modules necessary for compliance with EMC standards.

A built-in, scalable RFI filter minimizes electromagnetic interference, and the integrated DC link chokes reduce the harmonic distortion in the mains network, in accordance with IEC 61000-3-12. Furthermore, they increase the

lifetime of the DC link capacitors and therefore the overall efficiency of the drive.

These built-in components save cabinet space, as they are integrated in the drive from the factory. Efficient EMC mitigation also enables the use of cables with smaller cross-sections, which reduces installation costs.

Expand grid and motor protection with filter solutions

Danfoss' wide range of solutions for harmonic mitigation ensures a clean power supply and optimal equipment protection, and includes:

- VLT® Advanced Harmonic Filter AHF
- VLT® Advanced Active Filter AAF
- VLT® Low Harmonic Drives
- VLT® 12-pulse Drives

Provide extra motor protection with:

- VLT® Sine-wave Filter
- VLT® dU/dt Filter
- VLT® Common Mode Filters

Achieve optimum performance for your application, even where the grid is weak or unstable.

Use motor cables up to 300 m

The design of the AC drive makes it a perfect choice in applications that require long motor cables. Without needing additional components, the drive provides trouble-free operation with cable lengths of up to 150 m shielded or 300 m unshielded. This allows the drive to be installed in a central control room, away from the application without affecting motor performance.

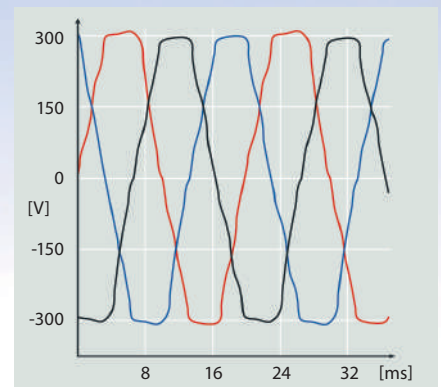

Harmonic distortion
Electrical interference reduces efficiency and risks harming equipment.

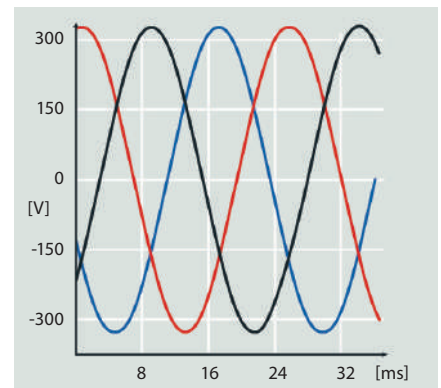

Optimized harmonic performance
Efficient harmonic mitigation protects electronics and increases efficiency.

EMC Standards		Conducted emission		
Standards and requirements	EN 55011 Facility operators must comply with EN 55011	Class B Housing and light industries	Class A Group 1 Industrial environment	Class A Group 2 Industrial environment
	EN/IEC 61800-3 Converter manufacturers must conform to EN 61800-3	Category C1 First environment, home and office	Category C2 First environment, home and office	Category C3 Second environment
Compliance ¹⁾		■	■	■

¹⁾ Compliance to mentioned EMC classes depends on the selected filter. For further details see the design guides.

Harmonic mitigation: **Invest less and save more!**

The Danfoss masterclass solution for harmonic mitigation is a simple space and cost-saving design that increases efficiency to provide long-term energy savings and trouble-free operation.

How an advanced active filter works – simply and reliably

An active filter works in a similar way to that which noise cancelling headphones filter out extraneous sound.

Using external current transformers, the active filter monitors the supply current, including any distortion.

From this signal, the control system identifies the required compensation and creates a switching pattern for the IGBT switches.

This creates a low impedance path in the filter and harmonics flow into the filter instead of proceeding in the direction of the power supply.

By cancelling out the harmonic current distortion almost completely, voltage distortion of the transformer or generator is no longer a concern.

The filter carries out its current evaluation and cancellation continuously so that plant load variations, second-to-second or day-to-day, make no difference to the active filter's performance.

Meeting new standards

Efficient harmonic mitigation protects electronics and increases system efficiency. The prescribed standard for harmonics mitigation is specified, for example in the IEEE-519 Guide, as limits for the harmonic voltage distortion and current waveforms that may exist in the system to minimize interference between electrical equipment. The latest update to this guide (2014) focuses on keeping down costs and on maintaining the voltage THD within acceptable limits at the Point of Common Coupling – defined as the interface between sources and loads. The Danfoss masterclass solution for harmonic mitigation is developed to meet the standards specified, for example in the IEEE-519 2014 Guide.

Minimizing costs using advanced active filters

Danfoss offers solutions to harmonics mitigation based on either active front end or passive filter, which may be appropriate in some applications. But to achieve the ambition of ensuring the necessary harmonics mitigation, while minimizing cost and energy consumption, most applications will benefit from our central solution using advanced active filter (AAF) technology;

- It takes up less space
- It costs less to install
- It uses less energy in operation
- It reduces heat loss
- It ensures higher uptime

Use less energy with central advanced active filter (AAF) mitigation

Our central advanced active filter solution encompasses up to 50 drives, ensuring harmonic noise is kept under 3% on all AC drives in the system. Connected in parallel and working in a similar way to noise cancellation headphones, advanced active filters are only active whenever necessary to maintain this level. This saves a lot of energy in comparison with Active Front End (AFE), installed in the drive itself, and requiring a voltage boost of approximately 10%.

Minimizing heat loss for maximum installed efficiency

The Danfoss master class design for harmonics mitigation combines AAF technology with our unique back-channel cooling concept to achieve a 50% reduction in heat loss in the system, compared to a traditional AFE setup.

A future proof solution

An upcoming amendment to the IEEE-519 Guide is very likely to include demands for harmonic components of order greater than the 50th. Already in the 2014 guide it states that "Harmonic components of order greater than 50 may be included in THD and TDD when necessary." With the Danfoss AAF solution you are prepared for this, as high-order harmonic issues are already solved.

Only install filters, where needed

The savings gained on the installation costs and the installed efficiency of the Danfoss master class solution for harmonics mitigation exceed the improved energy efficiency achieved by investing in IE3 motors instead of IE2 motors.

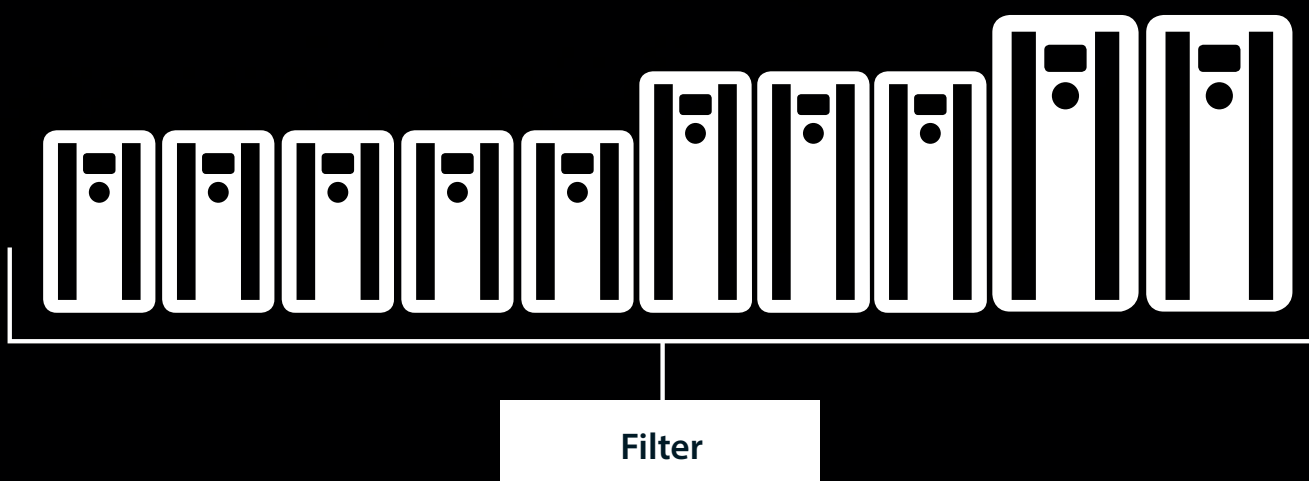
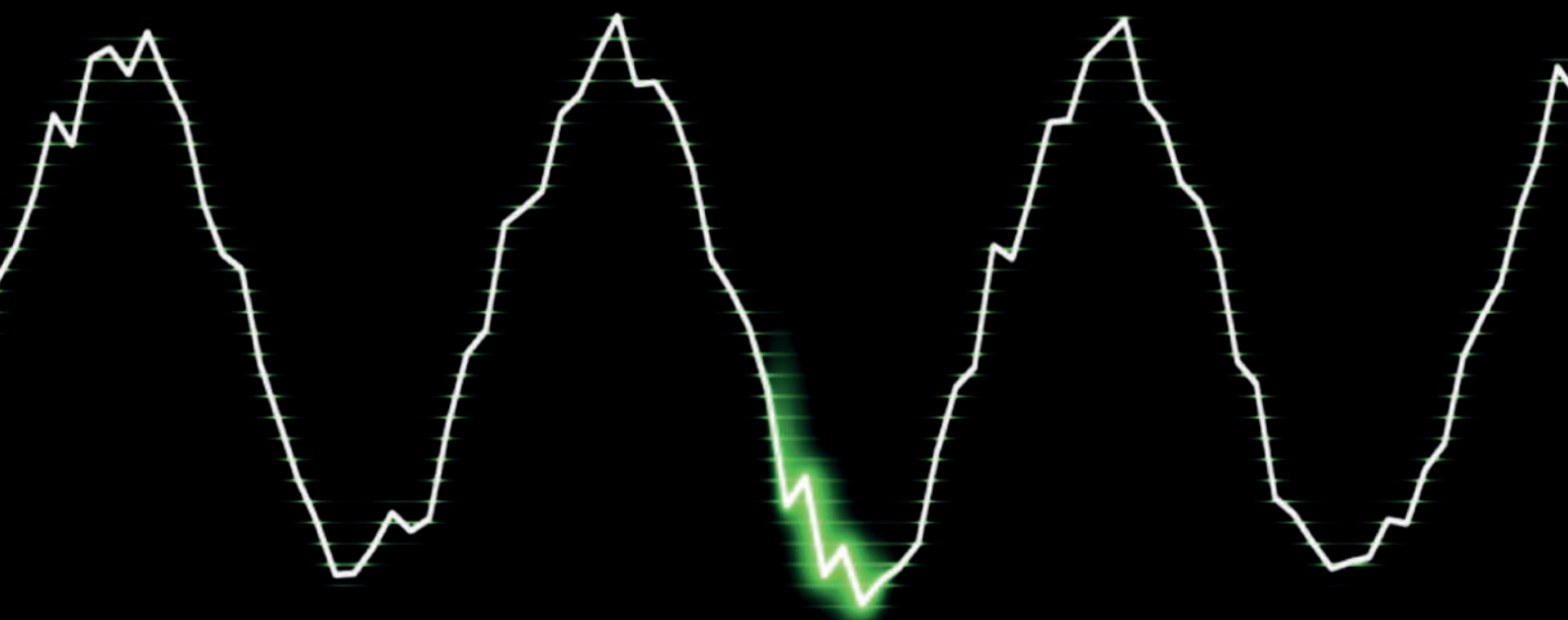



Certified solutions to control harmonics

- Advanced active filters
- Advanced harmonic filters
- Low harmonic drives
- 12-pulse drives
- Active front end drives

Adverse effects of harmonics

- Limitations on supply and network utilization
- Increased transformer, motor and cable heating
- Reduced equipment lifetime
- Costly equipment downtime
- Control system malfunctions
- Pulsating and reduced motor torque
- Audible noise

Harmonic mitigation

While AC drives increase precision, save energy and extend application lifetime, they also introduce harmonic currents to the on-board grid. If not kept under control, this can affect the performance and reliability of generators and other equipment and, ultimately, compromise safety.

Danfoss offers harmonic mitigation solutions to comply with the regulations.

Danfoss has developed a wide range of mitigation solutions which can help restore weak networks, increase network capacity, and meet compact retrofit demands – or secure sensitive environments.

Low harmonic drives

The VLT® low harmonic drives continuously regulate the network and load conditions without affecting the connected motor. The drives combine the well-known performance and reliability of standard VLT® drives with an Advanced Active Filter. The result is a powerful, motor-friendly solution that provides the highest possible harmonic mitigation with total harmonic current distortion (THDi) of maximum 5%.

IEC 61000-2-4 requirements for harmonics up to 9 kHz

To meet the requirements of IEC 61000-2-4 for harmonics up to 9 kHz, the VLT® Enclosed Drive with built-in passive filter is the right choice.

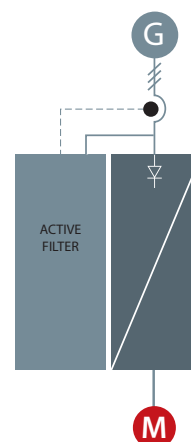

Advanced active filters

Advanced active filters identify harmonic distortion from non-linear loads and inject counter-phase harmonic and reactive currents into the AC line to cancel out the distortion. The result is distortion levels of no more than 5% THDi. The optimal sinusoidal waveform of the AC power is restored and the power factor of the system is re-established at 1.

Advanced active filters follow the same design principles as all our other drives. The modular platform provides high energy efficiency, user-friendly operation, efficient cooling and high enclosure ratings.

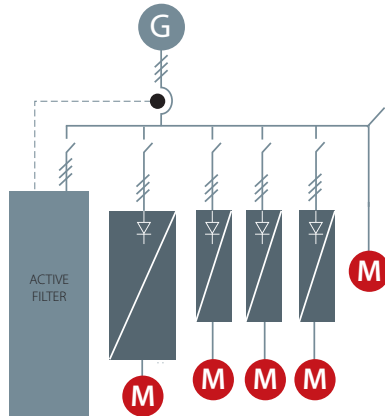

12-pulse drives

A robust and cost-effective harmonic solution for the higher power range, the Danfoss 12-pulse drive variants offer reduced harmonics for demanding industry applications above 250 kW.

VLT® 12-pulse drives are high efficiency AC drives which are built with the same modular design as the popular 6-pulse drives. The 12-pulse variant is available with similar drive options and accessories and can be configured according to your specific needs.

The VLT® 12-pulse drives provide harmonic reduction without adding capacitive or inductive components which often require network analysis to avoid potential system resonance problems.

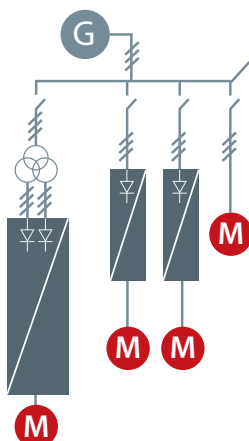

Advanced harmonic filters

The Danfoss harmonic filters are specially designed to be connected in front of a VLT® drive, and ensure that the harmonic current distortion generated back to the mains is reduced to a minimum.

Easy commissioning saves installation costs, and due to the maintenance-free design, running expenses for the units are eliminated.

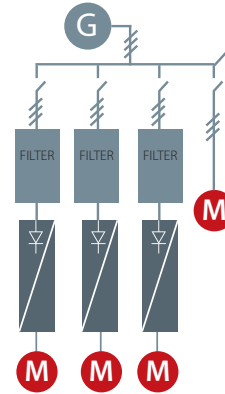

VLT® Enclosed Drive

The VLT® Enclosed Drive is designed to provide harmonic mitigation in two ways. Use either a built-in passive filter to form a low harmonic drive, or alternatively, build in additional AC coils, to suit your application.

Active front-end drives

An AFE system is a regenerative power converter located at the front end of a common DC bus drive line-up, and is suitable in applications where:

- Regenerative power generation is the goal
- Low harmonics are required
- The frequency inverter load is up to 100% of the total generator capacity

An active front-end (AFE) system comprises two identical inverters with a common DC bus. There is one motor inverter and one supply inverter. The supply inverter works together with a tuned sinus filter, and the current distortion (THDi) at the supply is about 3-4%.

When an AFE system is installed, then the motor voltage can be increased above that of the network, because adjustment of the DC link voltage is enabled. Any excessive energy can be returned to the network as clean (active) power, rather than reactive power, which only produces heat.



Cost-effective mitigation

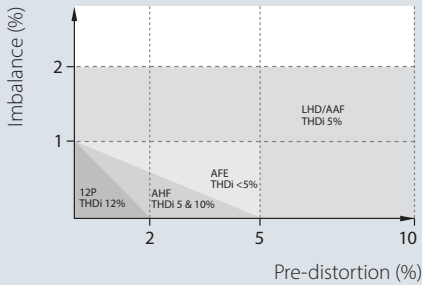

Imbalance and pre-distortion

The harmonic mitigation performance of the different solutions depends on the grid quality. The higher the imbalance and pre-distortion, the more harmonics the equipment has to suppress. The graph shows at what pre-distortion and imbalance level each technology can keep its guaranteed THDi performance.

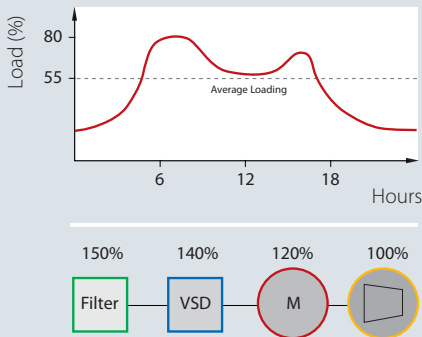
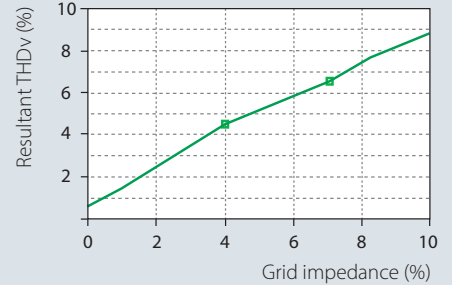

Over-sizing

Published filter data are all given at 100% loading but filters are seldom run at full load due to over-sizing and load profile. Serial mitigation equipment must always be sized for the maximum current, but be aware of the duration of part load operation and evaluate the different filter types accordingly. Over-sizing gives poor mitigation performance and high running costs. It is also a waste of money.

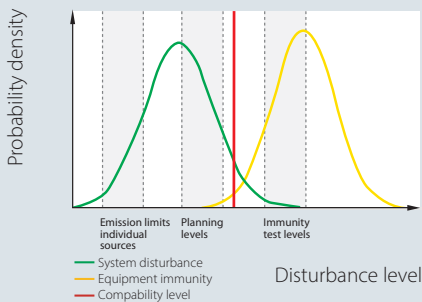
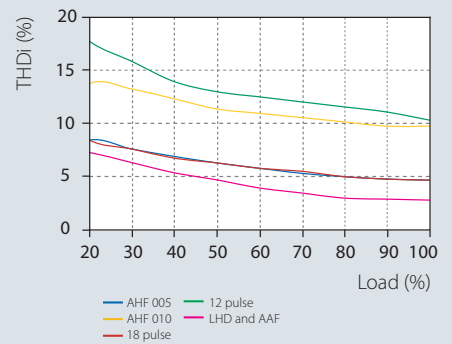

Standards compliance

Keeping equipment immunity higher than system distortion ensures trouble free operation. Most standards set restrictions on total voltage distortion according to a planned level, often between 5% and 8%. Equipment immunity is, in most cases, far higher: for drives, between 15-20%. However, this influences product life adversely.

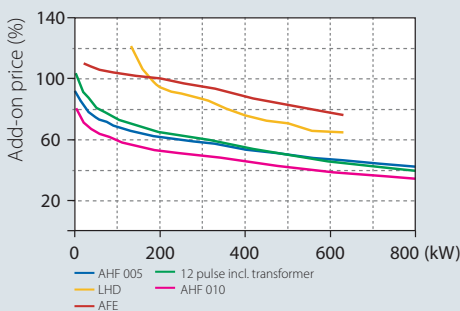
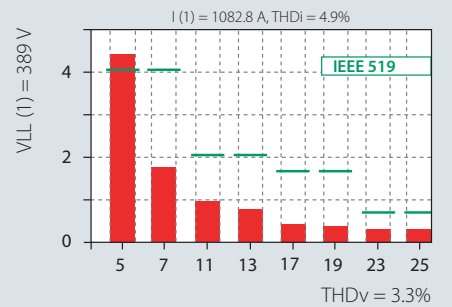

Power size vs. initial costs

Compared to the AC drive, the different solutions have different add-on prices depending on power size. The passive solutions in general offer the lowest initial cost and as the complexity of the solutions increase, so does the price.

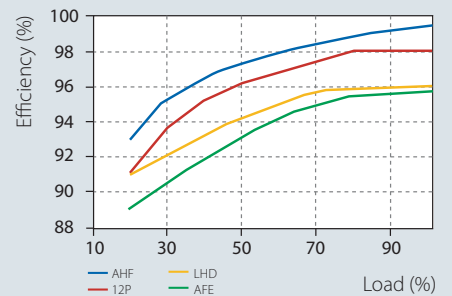

System impedance

As an example, a 400 kW FC 202 drive on a 1000 kVA transformer with 5% impedance results in ~5% THDv (total harmonic voltage distortion) at ideal grid conditions, whereas the same drive on a 1000 kVA, 8% imp. transformer leads to 50% higher THDv, namely 7.5%.

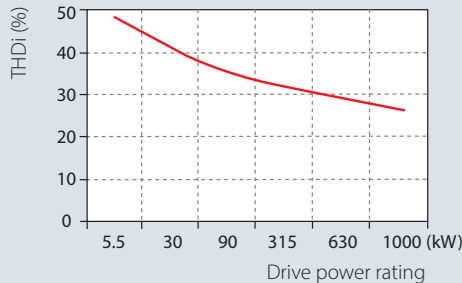

Total Harmonic distortion

Each drive generates its own total harmonic current distortion (THDi) which depends on the grid conditions. The bigger the drive is in relation to the transformer the smaller the THDi.

Harmonic performance

Each harmonic mitigation technology has its own THDi characteristic which is load dependent. These characteristics are set at ideal grid conditions without pre-distortion and with balanced phases. Variations hereof will result in higher THDi values.

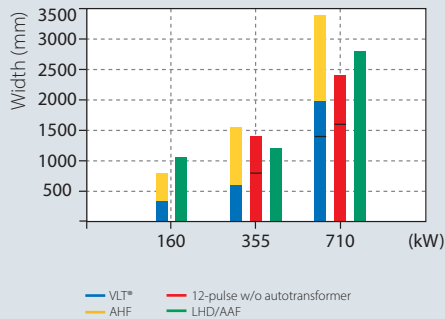

Wall space

In many applications the amount of available wall space is limited and must be utilized to the greatest extent possible. Based on different technologies, the various harmonic solutions each have their optimum size and power relationship.

Fulfilling the standards

To determine whether or not the harmonic pollution of a given application/grid exceeds a specific standard, many complex calculations must be done. With the help from free Danfoss MCT31 harmonic calculation software, this is made easy and less time consuming.

System efficiency

The running cost is mainly determined by the overall system efficiency. This depends on the individual products, true power-factors and efficiencies. Active solutions tend to keep the true power-factor independent of load and grid variations. On the other hand, active solutions are less efficient than passive solutions.



MyDrive® Suite ensures your digital tools are only one click away

MyDrive® Suite brings all your tools together to support you during engineering, operation and service. What is MyDrive® Suite? It's a tool providing a single point of access for the other digital tools supporting you during engineering, operation and service, thereby covering the whole life cycle of the drive.

Based on your needs, the tools are accessible via different platforms. They can be integrated into your system and business processes to enable a world-class end-to-end experience with full flexibility. Your data is synchronized between the tools, and by sharing the same data backend, information is always correct and up to date.

Our suite of software tools is designed to ensure you easy operation and the highest level of customization of your

AC drives. Whether you're a beginner or a pro, you have everything you need to go from selecting to programmability of a drive.

Try MyDrive® Suite today:
<https://mydrive.danfoss.com/>

Easy to use

- One tool suite
- One common look and feel
- Single login to all tools
- Seamless usage across devices and touchpoints
- Platform enables coherent workflows
- Data synchronization between tools. There is no need to enter information twice, which means your information is always correct and up to date
- Search and smart filtering
- Tutorials and documentation

Keeps your data safe

- Data security through user levels and authentication
- End-to-end secure communication

Fits your needs

- Data integration into your tools and systems
- APIs and open interfaces facilitate third-party applications or branded versions
- The tools are available as web app, desktop application, dedicated tablet and smartphone app, all with offline functionality. No internet connection is required once the tool is installed to your device

Convenient and fast – Digital tools empower you

Need help to design your application, or select, set up, and maintain your drive? Danfoss provides a palette of digital tools to give you the information you need, at your fingertips. No matter which stage of the project you are at.

Select and configure your drives

- Select the right AC drive based on motor and load characteristics
- Find general product, segment and application information of VLT® and VACON® drives

Available tools:

- **MyDrive® Select**
Select and dimension your drive based on calculated motor load currents as well as current, temperature and ambient limitations. MyDrive® Select matches your business needs with Danfoss Drives products.

- **MyDrive® Portfolio**

This smart device app gives you a full overview of all Danfoss Drives products and their documentation.

Set up and service your drives

- Set up your drives to operate according to your requirements
- Monitor drive performance throughout the entire lifecycle of your drive

Available tools:

- **MyDrive® Connect**
Connect to one or more drives over a secure Wi-Fi connection. Provides a simple and intuitive interface for easy commissioning.

- **VLT® Motion Control Tool MCT 10**

Configure the drive from a PC. With functionality for drive firmware update and configuration of functional safety using the safe plugin.

Customize your drives

- Optimize performance & behavior
- Emphasize your brand by defining own parameter names
- Get PLC-based functionality based on IEC61131-3
- Enable license-based functions

Available tools:

- **VLT® Software Customizer**
Emphasize your brand by modifying the splash screen and create your own smart start wizard.

Validate performance of your drives

- Analyze the performance of your drives in relation to harmonics content
- Calculate the energy savings to be achieved when using drives
- Validate compliance to norms and standards

Available online tools:

- **MyDrive® ecoSmart™**
Now it's easy to determine IE and IES classes according to IEC/EN 61800-9, for VLT®, VACON®, iC2 and iC7 series drives alone and in combination with a motor. MyDrive® ecoSmart™ uses nameplate data to perform the efficiency calculations, and produces a pdf report for documentation.

with the most recognized harmonic norms, and mitigation recommendations.

- **VLT® EnergyBox**

This advanced energy calculation tool captures actual energy data from the drives, to document It also monitors energy consumption and overall system efficiency.

- **MyDrive® Harmonics**

Estimate the benefits of adding harmonic mitigation solutions from the Danfoss product portfolio and calculate predicted system harmonic distortion. This tool provides a quick indication of installation compliance



DrivePro® Services

Delivering a customized service experience!



Every AC drive application is different. DrivePro® Services is a collection of **tailor-made products designed around your needs.**

From optimized spare part packages to condition-monitoring solutions, we deliver customized service offerings to **support your business through the different lifecycle stages of your AC drive.**



DrivePro® Site Assessment

Optimize your maintenance strategy with a complete onsite survey and risk analysis of all your AC drives collected in one detailed report. Together with a Danfoss expert, you can build a tailored plan for future maintenance, retrofits, and upgrades.



DrivePro® Start-up

DrivePro® Start-up includes a full range of operating health checks and parameters adjustments. Based on a manufacturer's commissioning checklist, our experts will inspect and test your AC drive and its motor performance to ensure the best configuration of your AC drives.



DrivePro® Preventive Maintenance

With a structured maintenance program tailored to your needs, you can boost operational efficiency and reduce the effects of wear and tear with DrivePro® Preventive Maintenance.



DrivePro® Spare Parts

Maximize uptime and maintain peak performance throughout the lifetime of your AC drives with DrivePro® Spare Parts by making sure you are equipped with the original spare parts from Danfoss Drives.

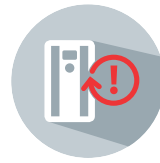

DrivePro® Exchange

Maintain uptime with a fast alternative to repair when there is a time critical situation. If an AC drive fails, the DrivePro® Exchange service can quickly exchange any AC drive to a new unit of the same type to ensure as little production delay as possible.



DrivePro® Remote Expert Support

Save time and costs by replacing avoidable service visits with fast troubleshooting and commissioning support via remote access. Our experts can find the relevant data and resolve issues quickly for better uptime. Since only authorized engineers can access your AC drives and all information is strongly encrypted, your data remains secure.



DrivePro® Extended Warranty

Even the best performing AC drives need protection. DrivePro® Extended Warranty offers a wide range of warranty options and provides the longest coverage in the industry up to 72 months.



DrivePro® Retrofit

The DrivePro® Retrofit service prepares you for the end of the lifecycle of your AC drives. We can provide you with the most optimal product for the replacement of outdated drives and a conversion plan recommendation while ensuring minimal unexpected downtime.



DrivePro® Remote Monitoring

DrivePro® Remote Monitoring is a digital service that provides real-time remote monitoring by collecting drives performance parameter and fault values, storing it in the cloud, and representing analytics in an easily accessible and simplified way.

To learn which products are available in your region, please reach out to your local Danfoss Drives sales office or visit our website.



Read more about DrivePro®



Local contacts

Connection diagram

The numbers represent the terminals on the drive

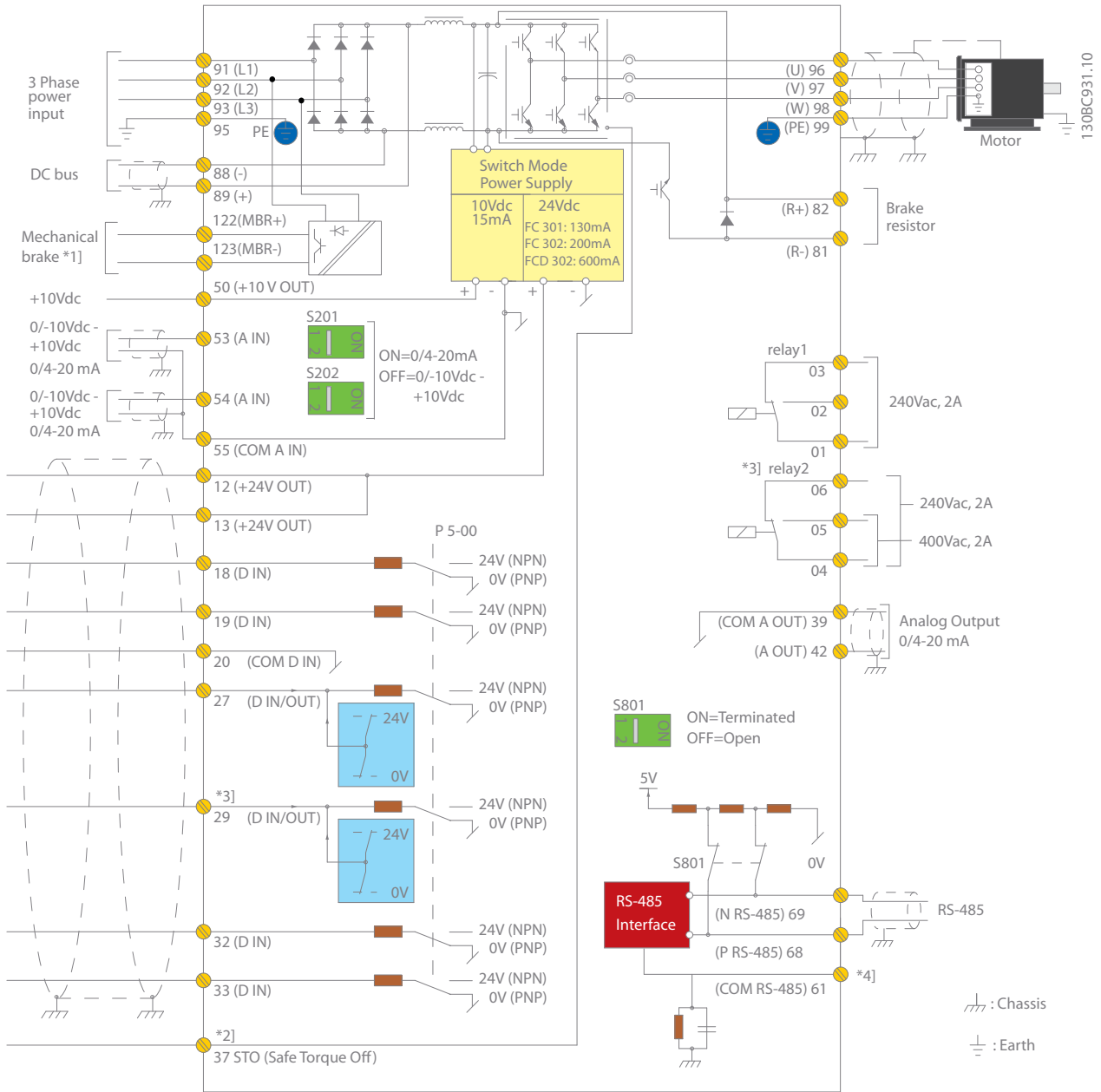

A = Analog, D = Digital

- 1] Optional, only available for FCD 302
- 2] For more detailed information about this function refer to the Safe Torque Off Operating Instructions for Danfoss VLT(R) Frequency Converters
- 3] Relay2 with terminals 04, 05, 06 and D IN/OUT with terminal 29 have no function in FC 301
- 4] Do not connect cable screen

Power is connected to the terminals 91 (L1), 92 (L2) and 93 (L3) and the motor is connected to 96 (U), 97 (V) and 98 (W).

Terminals 88 and 89 can be used for load sharing between drives. Analog signals can be connected to terminal 53 and/or terminal 54. Both inputs can be configured either as reference, feedback or thermistor inputs.

There are 6 digital inputs to be connected to terminals 18, 19, 27, 29,

32, and 33. Two digital input/output terminals (27 and 29) can be set up as digital outputs to show an actual status or warning or can be used as a pulse reference signal.

The terminal 42 analog output can show process values such as 0 - I_{max}.

The RS 485 interface with terminals 68 and 69 can be used to control and monitor the drive via serial communication.

Technical data

Basic unit without extensions

Main supply (L1, L2, L3)	FC 301	FC 302	FCD 302
Power range 200-240 V AC	0.25-37 kW / 0.35-50 hp	0.25-150 kW / 0.35-200 hp	–
Power range 380-(480) 500 V AC	0.37-75 kW / 0.5-100 hp		0.37-3 kW / 0.5-4 hp
Power range 380-500 V AC	–	0.37-800 kW / 0.50-1200 hp	–
Power range 525-600 V AC	–	0.75-75 kW / 1.0-100 hp	–
Power range 525-690 V AC	–	1.1-1200 kW / 1.5-1600 hp	–
Supply frequency	50/60 Hz		
Displacement power factor (cos ϕ) near unity	> 0.98		
Switching on input supply L1, L2, L3	1-2 times/min.		2 times/min
Output data (U, V, W)			
Output voltage	0-100% of supply voltage		
Output frequency	0-590 Hz (0-300 Hz in FluxMode)		
Output frequency (OL)	0.2-590 Hz	0-590 Hz, (600-1000 Hz)*	0-590 Hz, (600-1000 Hz)*
Switching on output	Unlimited		
Motor control and supported motor types			
Ramp times	0.01-3600 s		
EMC and motor cable length			
Cable length – screened/unscreened	25/50m (A1 only), 50/75m	150/300 m	10/10 m
Functional Safety			
Safety function Safe Torque Off (STO – EN 61800-5-2)	Optional (A1 only)	standard	standard
Digital inputs			
Programmable digital inputs	5	6	
Changeable to digital output	1 (terminal 27)	2 (terminal 27, 29)	
Logic	PNP or NPN		
Voltage level	0-24 V DC		
Maximum voltage on input	28 V DC		
Input resistance, Ri	Approx. 4 k Ω		
Scan interval	5 ms	1 ms	
* For frequency >590 Hz please contact your local Danfoss partner..			
Analog inputs			
Analog inputs	2		
Modes	Voltage or current		
Voltage level	0 to +10V (scaleable)	-10 to +10 V (scaleable)	
Current level	0/4 to 20 mA (scaleable)		
Accuracy of analog inputs	Max. error: 0.5% of full scale		
Pulse inputs / Encoder inputs			
Programmable pulse inputs	1	2	
Voltage level	0-24 V DC (PNP positive logic)		
Pulse input accuracy (0.1-1 kHz)	Max. error: 0.1% of full scale		
* Two of the digital inputs can be used for pulse inputs.			
Digital outputs			
Programmable digital/pulse outputs	2		
Voltage level at digital/frequency output	0-24 V DC		
Max. output current (sink or source)	40 mA		
Maximum output frequency at frequency output	32 kHz		
Accuracy on frequency output	Max. error: 0.1% of full scale		

Technical data

Basic unit without extensions

Analog outputs	FC 301	FC 302	FCD 302
Programmable analog outputs		1	
Current range at analog output		0/4-20 mA	
Max. load to common at analog output (clamp 30)		500 Ω	
Accuracy on analog output		Max. error: 0.5% of full scale	
Relay outputs			
Programmable relay outputs	1		2
Max. terminal load (AC) on 1-3 (NC), 1-2 (NO), 4-6 (NC) power card		240 V AC, 2 A	
Max. terminal load (AC -1) on 4-5 (NO) power card		400 V AC, 2 A	
Min. terminal load on 1-3 (NC), 1-2 (NO), 4-6 (NC), 4-5 (NO) power card		24 V DC 10 mA, 24 V AC 20 mA	
Control card			
USB interface		1.1 (Full Speed)	
USB plug		Type "B"	
RS485 interface		Up to 115 kBaud	
Max. load (10 V)		15 mA	
Max. load (24 V)	130 mA	200 mA	600 mA
Surroundings/external			
Ingress protection class	IP: 20/21/54/55/66 UL Type: Chassis/1/12/3R/4X		IP: 66 UL Type: 4X (indoor)
Vibration test	0.7 g		1.7 g
Max. relative humidity	5-95% (IEC 721-3-3); Class 3K3 (non-condensing) during operation		
Ambient temperature	Max. 50 °C without derating, – Operating temperature range is -25 °C to 50 °C without derating Max 55 °C with derating		Max. 40 °C without derating
Galvanic isolation of all	I/O supplies according to PELV		
Aggressive environment	Designed for 3C3 (IEC 60721-3-3) A, B, C - optional		
Fieldbus communication			
Standard built-in: FC Protocol Modbus RTU	Optional with separate Fieldbus communication card: PROFIBUS DP V1 DeviceNet CANopen PROFINET EtherNet/IP Modbus TCP POWERLINK EtherCAT	Optional with separate Fieldbus communication card: PROFIBUS DP V1 DeviceNet CANopen PROFINET EtherNet/IP Modbus TCP POWERLINK EtherCAT VLT® 3000 PROFIBUS Converter VLT® 5000 PROFIBUS Converter VLT® 5000 DeviceNet Converter	Factory option as control card variant: PROFIBUS DP V1 PROFINET EtherNet/IP POWERLINK EtherCAT VLT® FCD 300 PROFIBUS Converter
Inbuilt protection			
– Electronic motor thermal protection against overload			
– Protection against overtemperature			
– The AC drive is protected against short circuits on motor terminals U, V, W			
– The AC drive is protected against ground faults on motor terminals U, V, W			
– Protection against mains phase loss			

Agency approvals



Electrical data – VLT® AutomationDrive A, B, and C enclosures

[T2] 3 x 200-240 VAC

High overload (160% 1 min/10 min)							Enclosure size						
Type code	Output current (3 x 200-240 V)		Typical shaft output power		Continous input current	Estimated power loss	IP20 No C/D option	IP20	IP21	IP55 No C/D option	IP55	IP66 No C/D option	IP66
FC-301	Con. I _N	Inter. I _{MAX} (60 s)	kW @ 208 V	hp @ 230 V	[A]	[W]	Chassis	Chassis	Type 1	Type 12	Type 12	Type 4X	Type 4X
PK25	1.8	2	0.25	0.34	1.6	21	A1	A2		A4	A5	A4	A5
PK37	2.4	2.6	0.37	0.5	2.2	29	A1	A2		A4	A5	A4	A5
PK55	3.5	3.6	0.55	0.75	3.2	42	A1	A2		A4	A5	A4	A5
PK75	4.6	5.1	0.75	1	4.1	54	A1	A2		A4	A5	A4	A5
P1K1	6.6	7.3	1.1	1.5	5.9	63	A1	A2		A4	A5	A4	A5
P1K5	7.5	8.3	1.5	2	6.8	82	A1	A2		A4	A5	A4	A5
P2K2	10.6	11.7	2.2	3	9.5	116		A2		A4	A5	A4	A5
P3K0	12.5	13.8	3	4	11.3	155		A3			A5		A5
P3K7	16.7	18.4	3.7	5	15	185		A3			A5		A5
P5K5	30.8	33.9	5.5	7.5	28	310		B3	B1		B1		B1
P7K5	46.2	50.8	7.5	10	42	514		B3	B1		B1		B1
P11K	59.4	65.3	11	15	54	602		B4	B2		B2		B2
P15K	74.8	82.3	15	20	68	737		B4	C1		C1		C1
P18K	88	96.3	18.5	25	80	845		C3	C1		C1		C1
P22K	115	127	22	30	104	1140		C3	C1		C1		C1
P30K	143	157	30	40	130	1353		C4	C2		C2		C2
P37K	170	187	37	50	154	1636		C4	C2		C2		C2

[T4] 3 x 380-480 VAC

High overload (160% 1 min/10 min)							Enclosure size						
Type code	Output current (3 x 200-240 V)		Typical shaft output power		Continous input current	Estimated power loss	IP20 No C/D option	IP20	IP21	IP55 No C/D option	IP55	IP66 No C/D option	IP66
FC-301	Con. I _N	Inter. I _{MAX} (60 s)	kW @ 400 V	hp @ 460 V	[A]	[W]	Chassis	Chassis	Type 1	Type 12	Type 12	Type 4X	Type 4X
PK25													
PK37	1.3	2.1	0.37	0.5	1.2	35	A1	A2	A5	A4	A5	A4	A5
PK55	1.8	2.9	0.55	0.75	1.6	42	A1	A2	A5	A4	A5	A4	A5
PK75	2.4	3.8	0.75	1	2.2	46	A1	A2	A5	A4	A5	A4	A5
P1K1	3	4.8	1.1	1.5	2.7	58	A1	A2	A5	A4	A5	A4	A5
P1K5	4.1	6.6	1.5	2	3.7	62	A1	A2	A5	A4	A5	A4	A5
P2K2	5.6	9	2.2	3	5	88		A2	A5	A4	A5	A4	A5
P3K0	7.2	11.5	3	4	6.5	116		A2	A5	A4	A5	A4	A5
P3K7	10	16	4	5	9	124		A2	A5	A4	A5	A4	A5
P5K5	13	20.8	5.5	7.5	11.7	187		A3	A5		A5		A5
P7K5	16	25.6	7.5	10	14.4	255		A3	A5		A5		A5
P11K	24	38.4	11	15	22	291		B3	B1		B1		B1
P15K	32	51.2	15	20	29	379		B3	B1		B1		B1
P18K	37.5	60	18.5	25	34	444		B4	B2		B2		B2
P22K	44	70.4	22	30	40	547		B4	B2		B2		B2
P30K	61	91.5	30	40	55	570		B4	C1		C1		C1
P37K	73	110	37	50	66	697		C3	C1		C1		C1
P45K	90	135	45	60	82	891		C3	C1		C1		C1
P55K	106	159	55	75	96	1022		C4	C2		C2		C2
P75K	147	221	75	100	133	1232		C4	C2		C2		C2

Electrical data – VLT® Automation Drive A, B, and C enclosures

[T2] 3 x 200-240 V AC – high overload

High overload (160% 1 min/10 min)							Enclosure size			
Type code	Output current (3 x 200-240 V)		Typical shaft output power		Continuous input current	Estimated power loss	Protection rating [IEC/UL]			
	Con. I _N	Inter. I _{MAX} (60 s)	kW @ 208 V	hp @ 230 V			IP20/21	IP21	IP55	IP66
FC 302	Con. I _N	Inter. I _{MAX} (60 s)	kW @ 208 V	hp @ 230 V	[A]	[W]	Chassis	Type 1	Type 12	Type 4X
PK25	1.8	2.9	0.25	0.35	1.6	21	A2	A2	A4/A5	A4/A5
PK37	2.4	3.8	0.37	0.5	2.2	29	A2	A2	A4/A5	A4/A5
PK55	3.5	5.6	0.55	0.75	3.2	42	A2	A2	A4/A5	A4/A5
PK75	4.6	7.4	0.75	1	4.1	54	A2	A2	A4/A5	A4/A5
P1K1	6.6	10.6	1.1	1.5	5.9	63	A2	A2	A4/A5	A4/A5
P1K5	7.5	12	1.5	2	6.8	82	A2	A2	A4/A5	A4/A5
P2K2	10.6	17	2.2	3	9.5	116	A2	A2	A4/A5	A4/A5
P3K0	12.5	20	3	4	11.3	155	A3	A3	A5	A5
P3K7	16.7	26.7	3.7	5	15	185	A3	A3	A5	A5
P5K5	24.2	38.7	5.5	7.5	22	239	B3	B1	B1	B1
P7K5	30.8	49.3	7.5	10	28	371	B3	B1	B1	B1
P11K	46.2	73.9	11	15	42	463	B4	B2	B2	B2
P15K	59.4	89.1	15	20	54	624	B4	C1	C1	C1
P18K	74.8	112	18.5	25	68	740	C3	C1	C1	C1
P22K	88	132	22	30	80	874	C3	C1	C1	C1
P30K	115	173	30	40	104	1143	D3h	C2	C2	C2
P37K	143	215	37	50	130	1400	D3h	C2	C2	C2

[T2] 3 x 200-240 V AC – normal overload

Normal overload (110% 1 min/10 min)							Enclosure size			
Type code	Output current (3 x 200-240 V)		Typical shaft output power		Continuous input current	Estimated power loss	Protection rating [IEC/UL]			
	Con. I _N	Inter. I _{MAX} (60 s)	kW @ 208 V	hp @ 230V			IP20/21	IP21	IP55	IP66
FC 302	Con. I _N	Inter. I _{MAX} (60 s)	kW @ 208 V	hp @ 230V	[A]	[W]	Chassis	Type 1	Type 12	Type 4X
PK25	1.8	2.9	0.25	0.35	1.6	21	A2	A2	A4/A5	A4/A5
PK37	2.4	3.8	0.37	0.5	2.2	29	A2	A2	A4/A5	A4/A5
PK55	3.5	5.6	0.55	0.75	3.2	42	A2	A2	A4/A5	A4/A5
PK75	4.6	7.4	0.75	1	4.1	54	A2	A2	A4/A5	A4/A5
P1K1	6.6	10.6	1.1	1.5	5.9	63	A2	A2	A4/A5	A4/A5
P1K5	7.5	12	1.5	2	6.8	82	A2	A2	A4/A5	A4/A5
P2K2	10.6	17	2.2	3	9.5	116	A2	A2	A4/A5	A4/A5
P3K0	12.5	20	3	4	11.3	155	A3	A3	A5	A5
P3K7	16.7	26.7	3.7	5	15	185	A3	A3	A5	A5
P5K5	30.8	33.9	7.5	10	28	310	B3	B1	B1	B1
P7K5	46.2	50.8	11	15	42	514	B3	B1	B1	B1
P11K	59.4	65.3	15	20	54	602	B4	B2	B2	B2
P15K	74.8	82.3	18.5	25	68	737	B4	C1	C1	C1
P18K	88	96.8	22	30	80	845	C3	C1	C1	C1
P22K	115	127	30	40	104	1140	C3	C1	C1	C1
P30K	143	157	37	50	130	1353	C4	C2	C2	C2
P37K	170	187	45	60	154	1636	C4	C2	C2	C2

[T5] 3 x 380-500 V AC – high overload

Type code	High overload (160% 1 min/10 min)								Enclosure size			
	Output current				Typical shaft output power		Continuous input current	Estimated power loss	Protection rating [IEC/UL]			
	(3 x 380-440 V)		(3 x 441-500 V)		kW @ 400 V	hp @ 460 V			IP20/21	IP21	IP55	IP66
FC 302	Con. I _N	Inter. I _{MAX} (60 s)	Con. I _N	Inter. I _{MAX} (60 s)			[A] @ 400 V	[W]				
PK37	1.3	2.1	1.2	1.9	0.37	0.5	1.2	35	A2	A2	A4/A5	A4/A5
PK55	1.8	2.9	1.6	2.6	0.55	0.75	1.6	42	A2	A2	A4/A5	A4/A5
PK75	2.4	3.8	2.1	3.4	0.75	1	2.2	46	A2	A2	A4/A5	A4/A5
P1K1	3	4.8	2.7	4.3	1.1	1.5	2.7	58	A2	A2	A4/A5	A4/A5
P1K5	4.1	6.6	3.4	5.4	1.5	2	3.7	62	A2	A2	A4/A5	A4/A5
P2K2	5.6	9	4.8	7.7	2.2	3	5	88	A2	A2	A4/A5	A4/A5
P3K0	7.2	11.5	6.3	10.1	3	4	6.5	116	A2	A2	A4/A5	A4/A5
P4K0	10	16	8.2	13.1	4	5	9	124	A2	A2	A4/A5	A4/A5
P5K5	13	20.8	11	17.6	5.5	7.5	11.7	187	A3	A3	A5	A5
P7K5	16	25.6	14.5	23.2	7.5	10	14.4	255	A3	A3	A5	A5
P11K	24	38.4	21	33.6	11	15	22	291	B3	B1	B1	B1
P15K	32	51.2	27	43.2	15	20	29	379	B3	B1	B1	B1
P18K	37.5	60	34	54.4	18.5	25	34	444	B4	B2	B2	B2
P22K	44	70.4	40	64	22	30	40	547	B4	B2	B2	B2
P30K	61	91.5	52	78	30	40	55	570	B4	C1	C1	C1
P37K	73	110	65	97.5	37	50	66	697	C3	C1	C1	C1
P45K	90	135	80	120	45	60	82	891	C3	C1	C1	C1
P55K	106	159	105	158	55	75	96	1022	C4	C2	C2	C2
P75K	147	221	130	195	75	100	133	1232	C4	C2	C2	C2

[T5] 3 x 380-500 V AC – normal overload

Type code	Normal overload (110% 1 min/10 min)								Enclosure size			
	Output current				Typical shaft output power		Continuous input current	Estimated power loss	Protection rating [IEC/UL]			
	(3 x 380-440 V)		(3 x 441-500 V)		kW @ 400 V	hp @ 460 V			IP20/21	IP21	IP55	IP66
FC 302	Con. I _N	Inter. I _{MAX} (60 s)	Con. I _N	Inter. I _{MAX} (60 s)			[A] @ 400 V	[W]				
PK37	1.3	2.1	1.2	1.9	0.37	0.5	1.2	35	A2	A2	A4/A5	A4/A5
PK55	1.8	2.9	1.6	2.6	0.55	0.75	1.6	42	A2	A2	A4/A5	A4/A5
PK75	2.4	3.8	2.1	3.4	0.75	1	2.2	46	A2	A2	A4/A5	A4/A5
P1K1	3	4.8	2.7	4.3	1.1	1.5	2.7	58	A2	A2	A4/A5	A4/A5
P1K5	4.1	6.6	3.4	5.4	1.5	2	3.7	62	A2	A2	A4/A5	A4/A5
P2K2	5.6	9	4.8	7.7	2.2	3	5	88	A2	A2	A4/A5	A4/A5
P3K0	7.2	11.5	6.3	10.1	3	4	6.5	116	A2	A2	A4/A5	A4/A5
P4K0	10	16	8.2	13.1	4	5	9	124	A2	A2	A4/A5	A4/A5
P5K5	13	20.8	11	17.6	5.5	7.5	11.7	187	A3	A3	A5	A5
P7K5	16	25.6	14.5	23.2	7.5	10	14.4	255	A3	A3	A5	A5
P11K	32	35.2	27	29.7	15	20	29	392	B3	B1	B1	B1
P15K	37.5	41.3	34	37.4	18.5	25	34	465	B3	B1	B1	B1
P18K	44	48.4	40	44	22	30	40	525	B4	B2	B2	B2
P22K	61	67.1	52	57.2	30	40	55	739	B4	B2	B2	B2
P30K	73	80.3	65	71.5	37	50	66	698	B4	C1	C1	C1
P37K	90	99	80	88	45	60	82	843	C3	C1	C1	C1
P45K	106	117	105	116	55	75	96	1083	C3	C1	C1	C1
P55K	147	162	130	143	75	100	133	1384	C4	C2	C2	C2
P75K	177	195	160	176	90	125	161	1474	C4	C2	C2	C2

[T6] 3 x 525-600 V AC – high overload

High overload (160% 1 min/10 min)							Enclosure size			
Type code	Output current (3 x 525-600 V)		Typical shaft output power		Continuous input current [A] @ 575 V	Estimated power loss [W]	Protection rating [IEC/UL]			
	Con. I _N	Inter. I _{MAX} (60 s)	kW @ 575 V	hp @ 575 V			IP20	IP21	IP55	IP66
FC 302	Con. I _N	Inter. I _{MAX} (60 s)	kW @ 575 V	hp @ 575 V	[A] @ 575 V	[W]	Chassis	Type 1	Type 12	Type 4X
PK75	1.7	2.7	0.75	1	1.7	35	A3	A3	A5	A5
P1K1	2.4	3.8	1.1	1.5	2.4	50	A3	A3	A5	A5
P1K5	2.7	4.3	1.5	2	2.7	65	A3	A3	A5	A5
P2K2	3.9	6.2	2.2	3	4.1	92	A3	A3	A5	A5
P3K0	4.9	7.8	3	4	5.2	122	A3	A3	A5	A5
P4K0	6.1	9.8	4	5	5.8	145	A3	A3	A5	A5
P5K5	9	14.4	5.5	7.5	8.6	195	A3	A3	A5	A5
P7K5	11	17.6	7.5	10	10.4	261	A3	A3	A5	A5
P11K	18	29	11	15	16	220	B3	B1	B1	B1
P15K	22	35	15	20	20	300	B3	B1	B1	B1
P18K	27	43	18.5	25	24	370	B4	B2	B2	B2
P22K	34	54	22	30	31	440	B4	B2	B2	B2
P30K	41	62	30	40	37	600	B4	C1	C1	C1
P37K	52	78	37	50	47	740	C3	C1	C1	C1
P45K	62	93	45	60	56	900	C3	C1	C1	C1
P55K	83	125	55	75	75	1100	C4	C2	C2	C2
P75K	100	150	75	100	91	1500	C4	C2	C2	C2

[T6] 3 x 525-600 V AC – normal overload

Normal overload (110% 1 min/10 min)							Enclosure size			
Type code	Output current (3 x 525-600 V)		Typical shaft output power		Continuous input current [A] @ 575 V	Estimated power loss [W]	Protection rating [IEC/UL]			
	Con. I _N	Inter. I _{MAX} (60 s)	kW @ 575 V	hp @ 575 V			IP20	IP21	IP55	IP66
FC 302	Con. I _N	Inter. I _{MAX} (60 s)	kW @ 575 V	hp @ 575 V	[A] @ 575 V	[W]	Chassis	Type 1	Type 12	Type 4X
PK75	1.7	2.7	0.75	1	1.7	35	A3	A3	A5	A5
P1K1	2.4	3.8	1.1	1.5	2.4	50	A3	A3	A5	A5
P1K5	2.7	4.3	1.5	2	2.7	65	A3	A3	A5	A5
P2K2	3.9	6.2	2.2	3	4.1	92	A3	A3	A5	A5
P3K0	4.9	7.8	3	4	5.2	122	A3	A3	A5	A5
P4K0	6.1	9.8	4	5	5.8	145	A3	A3	A5	A5
P5K5	9	14.4	5.5	7.5	8.6	195	A3	A3	A5	A5
P7K5	11	17.6	7.5	10	10.4	261	A3	A3	A5	A5
P11K	22	24	15	20	20	300	B3	B1	B1	B1
P15K	27	30	18.5	25	24	370	B3	B1	B1	B1
P18K	34	37	22	30	31	440	B4	B2	B2	B2
P22K	41	45	30	40	37	600	B4	B2	B2	B2
P30K	52	57	37	50	47	740	B4	C1	C1	C1
P37K	62	68	45	60	56	900	C3	C1	C1	C1
P45K	83	91	55	74	75	1100	C3	C1	C1	C1
P55K	100	110	75	100	91	1500	C4	C2	C2	C2
P75K	131	144	90	120	119	1800	C4	C2	C2	C2

[T7] 3 x 525-690 V AC – high overload

Type code	High overload (160% 1 min/10 min)								Enclosure size		
	Output current				Typical shaft output power		Continuous input current	Estimated power loss	Protection rating [IEC]		
	(3 x 525-550 V)		(3 x 551-690 V)						IP20	IP21	IP55
FC 302	Con. I _N	Inter. I _{MAX} (60 s)	Con. I _N	Inter. I _{MAX} (60 s)	kW @ 690 V	hp @ 575 V	[A] @ 690 V	[W]	*	*	*
P1K1	2.1	3.4	1.6	2.6	1.1	1.5	1.4	44	A3	A3	A5
P1K5	2.7	4.3	2.2	3.5	1.5	2	2	60	A3	A3	A5
P2K2	3.9	6.2	3.2	5.1	2.2	3	2.9	88	A3	A3	A5
P3K0	4.9	7.8	4.5	7.2	3	4	4	120	A3	A3	A5
P4K0	6.1	9.8	5.5	8.8	4	5	4.9	160	A3	A3	A5
P5K5	9	14.4	7.5	12	5.5	7.5	6.7	220	A3	A3	A5
P7K5	11	17.6	10	16	7.5	10	9	300	A3	A3	A5
P11K	14	22.4	13	20.8	11	10	14.5	150	B4	B2	B2
P15K	19	30.4	18	28.8	15	15	19.5	220	B4	B2	B2
P18K	23	36.8	22	35.2	18.5	20	24	300	B4	B2	B2
P22K	28	44.8	27	43.2	22	25	29	370	B4	B2	B2
P30K	36	54	34	51	30	30	36	600	B4	C2	C2
P37K	43	64.5	41	61.5	37	40	48	740	C3	C2	C2
P45K	54	81	52	78	45	50	58	900	C3	C2	C2
P55K	65	97.5	62	93	55	60	70	1100	C4	C2	C2
P75K	87	130.5	83	124.5	75	75	129	1500	C4	C2	C2

*Note: T7 drives are not UL certified. Select T6 for UL certification.

[T7] 3 x 525-690 V AC – normal overload

Type code	Normal overload (110% 1 min/10 min)								Enclosure size		
	Output current				Typical shaft output power		Continuous input current	Estimated power loss	Protection rating [IEC]		
	(3 x 525-550 V)		(3 x 551-690 V)						IP20	IP21	IP55
FC 302	Con. I _N	Inter. I _{MAX} (60 s)	Con. I _N	Inter. I _{MAX} (60 s)	kW @ 690 V	hp @ 575 V	[A] @ 690 V	[W]	*	*	*
P1K1	2.1	3.4	1.6	2.6	1.1	1.5	1.4	44	A3	A3	A5
P1K5	2.7	4.3	2.2	3.5	1.5	2	2	60	A3	A3	A5
P2K2	3.9	6.2	3.2	5.1	2.2	3	2.9	88	A3	A3	A5
P3K0	4.9	7.8	4.5	7.2	3	4	4	120	A3	A3	A5
P4K0	6.1	9.8	5.5	8.8	4	5	4.9	160	A3	A3	A5
P5K5	9	14.4	7.5	12	5.5	7.5	6.7	220	A3	A3	A5
P7K5	11	17.6	10	16	7.5	10	9	300	A3	A3	A5
P11K	19	20.9	18	19.8	15	15	19.5	220	B4	B2	B2
P15K	23	25.3	22	24.2	18.5	20	24	300	B4	B2	B2
P18K	28	30.8	27	29.7	22	25	29	370	B4	B2	B2
P22K	36	39.6	34	37.4	30	30	36	440	B4	B2	B2
P30K	43	47.3	41	45.1	37	40	48	740	B4	C2	C2
P37K	54	59.4	52	57.2	45	50	58	900	C3	C2	C2
P45K	65	71.5	62	68.2	55	60	70	1100	C3	C2	C2
P55K	87	95.7	83	91.3	75	75	86	1500	C4	C2	C2
P75K	105	115.5	100	110	90	100	98	1800	C4	C2	C2

*Note: T7 drives are not UL certified. Select T6 for UL certification.

Dimensions VLT® AutomationDrive enclosure sizes A, B and C

Enclosure size		VLT® AutomationDrive														
		A1	A2		A3		A4	A5	B1	B2	B3	B4	C1	C2	C3	C4
Protection rating [IEC/UL]		IP20 Chassis	IP20 Chassis	IP21 Type 1	IP20 Chassis	IP21 Type 1	IP55/Type 12 IP66/Type 4X		IP21/Type 1 IP55/Type 12 IP66/Type 4X		IP20/Chassis		IP21/Type 1 IP55/Type 12 IP66/Type 4X		IP20/Chassis	
[mm]	Height	200	268	375	268	375	390	420	480	650	399	520	680	770	550	660
	Height with decoupling plate	316	374	–	374	–	–	–	–	–	420	595	–	–	630	800
	Width	75	90	90	130	130	200	242	242	242	165	230	308	370	308	370
	Width with one C option	–	130	130	170	170	–	242	242	242	205	230	308	370	308	370
	Width with two C options	–	150	150	190	190	–	242	242	242	225	230	308	370	308	370
	Depth	207	205	207	205	207	175	200	260	260	249	242	310	335	333	333
	Depth with A, B option	222	220	222	220	222	175	200	260	260	262	242	310	335	333	333
	Depth with mains disconnect	–	–	–	–	–	206	224	289	290	–	–	344	378	–	–
[kg]	Weight	2.7	4.9	5.3	6	7	9.7	14.2	23	27	12	23.5	45	64	35	50
[in]	Height	7.9	10.6	14.8	10.6	14.8	15.4	16.6	18.9	25.6	15.8	20.5	26.8	30.4	21.7	26
	Height with decoupling plate	12.4	14.8	–	14.8	–	–	–	–	–	16.6	23.5	–	–	24.8	31.5
	Width	3.0	3.6	3.6	5.2	5.2	7.9	9.6	9.6	9.6	6.5	9.1	12.2	14.6	12.2	14.6
	Width with one C option	–	5.2	5.2	6.7	6.7	–	9.6	9.6	9.6	8.1	9.1	12.2	14.6	12.2	14.6
	Width with two C options	–	6	6	7.5	7.5	–	9.6	9.6	9.6	8.9	9.1	12.2	14.6	12.2	14.6
	Depth	8.1	8.1	18.2	8.1	8.2	6.9	7.9	10.3	10.3	9.8	9.6	12.3	13.2	13	13
	Depth with A, B option	8.7	8.7	8.8	8.7	8.8	6.9	7.9	10.3	10.3	10.4	9.6	12.3	13.2	13	13
	Depth with mains disconnect	–	–	–	–	–	8.2	8.9	11.4	11.5	–	–	13.6	14.9	–	–
[lb]	Weight	6.0	10.8	11.7	14.6	15.5	21.5	31.5	50.7	59.6	26.5	52	99.3	143.3	77.2	110.2

Examples of different enclosure variants:

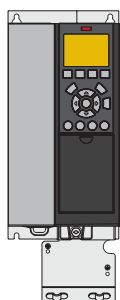

A3 IP20/Chassis with decoupling plate

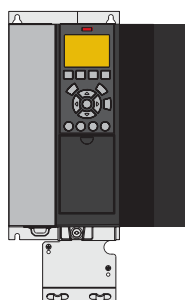

A3 IP20 with option C

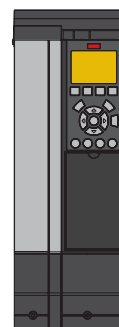

A3 with IP21/Type 12 NEMA 1 Kit



A4 IP55 with mains disconnect

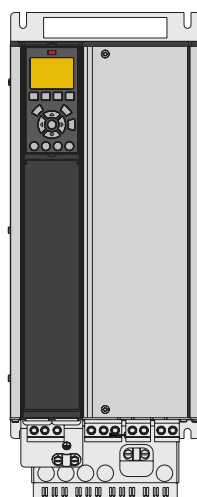

B4 IP20

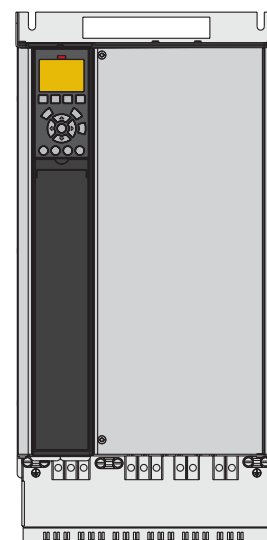

C3 IP20

Ordering type code

VLT® AutomationDrive A, B and C enclosures

[1]	[2]	[3]	[4]	[5]	[6]	[7]	[8]	[9]	[10]	[11]	[12]	[13]	[14]	[15]	[16]	[17]	[18]	[19]
FC-																		

[1] Application (character 4-6)	
301	VLT® AutomationDrive FC 301
302	VLT® AutomationDrive FC 302
[2] Power size (character 7-10)	
PK25	0.25 kW / 0.33 Hp
PK37	0.37 kW / 0.50 Hp
PK55	0.55 kW / 0.75 Hp
PK75	0.75 kW / 1.0 Hp
P1K1	1.1 kW / 1.5 Hp
P1K5	1.5 kW / 2.0 Hp
P2K2	2.2 kW / 3.0 Hp
P3K0	3.0 kW / 4.0 Hp
P3K7	3.7 kW / 5.0 Hp
P4K0	4.0 kW / 5.5 Hp
P5K5	5.5 kW / 7.5 Hp
P7K5	7.5 kW / 10 Hp
P11K	11 kW / 15 Hp
P15K	15 kW / 20 Hp
P18K	18.5 kW / 25 Hp
P22K	22 kW / 30 Hp
P30K	30 kW / 40 Hp
P37K	37 kW / 50 Hp
P45K	45 kW / 60 Hp
P55K	55 kW / 75 Hp
P75K	75 kW / 100 Hp
P90K	90 kW / 125 Hp
[3] AC Line Voltage (character 11-12)	
T2	3 x 200-240 V AC
T4	3 x 380-480 V AC (FC 301 only)
T5	3 x 380-500 V AC
T6	3 x 525-600 V AC
T7	3 x 525-690 V AC ²⁾
[4] IP/UL protection ratings (character 13-15)	
IP20 / Chassis enclosures	
Z20	IP20/Chassis (A1 enclosure, FC 301 only)
E20	IP20/Chassis
P20	IP20/Chassis + backplate
IP21 / UL Type 1 enclosures	
E21	IP21 / Type 1
P21	IP21 / Type 1 + backplate
IP55 / UL Type 12 enclosures	
E55	IP55/Type 12
P55	IP55/Type 12 + backplate
Y55	IP55/ Type 12 + backplate (A4 enclosure, no C-options)
Z55	IP55/Type 12 (A4 enclosure, no C-options)
UL Type 3R enclosures	
E3R	UL Type 3R (North America only)
P3R	UL Type 3R + backplate (North America only)
IP66 / UL Type 4X enclosures	
E66	IP66/Type 4X
Y66	IP66/Type 4X + backplate (A4 enclosure, no C-options)
Z66	IP66/Type 4X (A4 enclosure, no C-options)

[5] RFI filter, terminal and monitoring options – EN/IEC 61800-3 (character 16-17)	
H1	RFI-Filter Class A1/B (C1)
H2	RFI-Filter, Class A2 (C3)
H3	RFI-Filter Class A1/B ¹⁾
H4	RFI-Filter, Class A1 (C2)
H5	RFI-Filter, Class A2 (C3) Marine ruggedized
HX	No RFI-Filter
[6] Braking and safety (character 18)	
X	No Brake IGBT
B	Brake IGBT
T	Safe Torque Off without Brake IGBT
U	Brake IGBT plus Safe Torque Off
[7] LCP Display (character 19)	
X	Blank faceplate, no LCP installed
N	VLT® Control Panel LCP 101 (Numerical)
G	VLT® Control Panel LCP 102 (Graphical)
W	VLT® Wireless Communication Panel LCP 103
[8] PCB Coating – IEC 721-3-3 (character 20)	
X	Standard coated PCB Class 3C2
C	Coated PCB Class 3C3
[9] Mains input (character 21)	
X	No mains option
1	Mains disconnect (A4, A5, B1, B2, C1 and C2 enclosures only)
8	Mains disconnect and load sharing (B1, B2, C1 and C2 enclosures only)
D	Load sharing terminals (B1, B2, B4, C1, C2 enclosures only)
[10] Hardware option A (character 22)	
X	Standard cable entries
O	Metric cable entry (threaded)
S	Imperial cable entry
[11] Hardware option B (character 23)	
X	No adaptation
[12] Special version (character 24-27)	
SXXX	Latest released standard software
S067	Integrated Motion Control
LX1X	Condition monitoring
[13] LCP language (character 28)	
X	Standard language package including English, German, French, Spanish, Danish, Italian, Finnish and others
Contact factory for other language options	
[14] A-options: Fieldbus (character 29-30)	
AX	No option
AL	VLT® PROFINET MCA 120
AN	VLT® EtherNet/IP MCA 121
AQ	VLT® Modbus TCP MCA 122
AY	VLT® POWERLINK MCA 123
A8	VLT® EtherCAT MCA 124
A0	VLT® PROFIBUS DP V1 MCA 101
A4	VLT® DeviceNet MCA 104
A6	VLT® CANopen MCA 105
AT	VLT® 3000 PROFIBUS Converter MCA 113
AU	VLT® 5000 PROFIBUS Converter MCA 114
AV	VLT® 5000 DeviceNet Converter MCA 194

[15] B-options (character 31-32)	
BX	No option
BK	VLT® General Purpose MCB 101
BR	VLT® Encoder Input MCB 102
BU	VLT® Resolver Input MCB 103
BP	VLT® Relay Option MCB 105
BZ	VLT® Safety PLC I/O MCB 108
B2	VLT® PTC Thermistor Card MCB 112
B4	VLT® Sensor Input Card MCB 114
B5	VLT® Programmable I/O MCB 115
B6	VLT® Safety Option MCB 150 TTL
B7	VLT® Safety Option MCB 151 HTL
B8	VLT® Safety Option MCB 152 PROFIsafe STO
[16] C0-option (character 33-34)	
CX	No option
C4	VLT® Motion Control MCO 305
[17] C1-option (character 35)	
X	No option
R	VLT® Extended Relay Card MCB 113
7	VLT® Sensorless Safety MCB 159
[18] C-option software (character 36-37)	
XX	No software option Note: C4 option in [16] selected with no motion software in [18] will require programming by qualified individual
10	VLT® Synchronizing Controller MCO 350 (must select C4 in position [16])
11	VLT® Positioning Controller MCO 351 (must select C4 in position [16])
[19] D-options (character 38-39)	
DX	No option
D0	VLT® 24 V DC Supply Option MCB 107
D1	VLT® Real-time Clock Option MCB 117

1) Reduced motor cable length

2) Note: T7 drives are not UL certified. Select T6 for UL certification.

Please beware that not all combinations are possible. Find help configuring your drive with the online configurator found under: vltconfig.danfoss.com

Electrical data – VLT® Decentral Drive FCD 302

[T4] 3 x 380-480 V AC – high overload

High overload (160% 1 min/10 min)									Enclosure
Type code	Output current				Typical shaft output power		Continuous input current	Estimated power loss	Protection
	(3 x 380-440 V)		(3 x 441-500 V)		kW @ 400 V	Hp @ 460 V			IP66
FCD 302	Con. I _N	Inter. I _{MAX} (60 s)	Con. I _N	Inter. I _{MAX} (60 s)					[A] @ 400 V
PK37	1.3	2.1	1.2	1.9	0.37	0.5	1.2	35	MF1/MF2
PK55	1.8	2.9	1.6	2.6	0.55	0.75	1.6	42	MF1/MF2
PK75	2.4	3.8	2.1	3.4	0.75	1	2.2	46	MF1/MF2
P1K1	3	4.8	3.0	4.3	1.1	1.5	2.7	58	MF1/MF2
P1K5	4.1	6.6	3.4	5.4	1.5	2	3.7	62	MF1/MF2
P2K2	5.2	8.3	4.8	7.7	2.2	3	5	88	MF2
P3K0	7.2	11.5	6.3	10.1	3	4	6.5	116	

Dimensions - VLT® Decentral Drive FCD 302

Enclosure size MF1 (0.37 – 2.2 kW/0.5 – 3.0 HP)

Enclosure size MF2 (0.37 – 3 kW/0.5 – 4.0 HP)

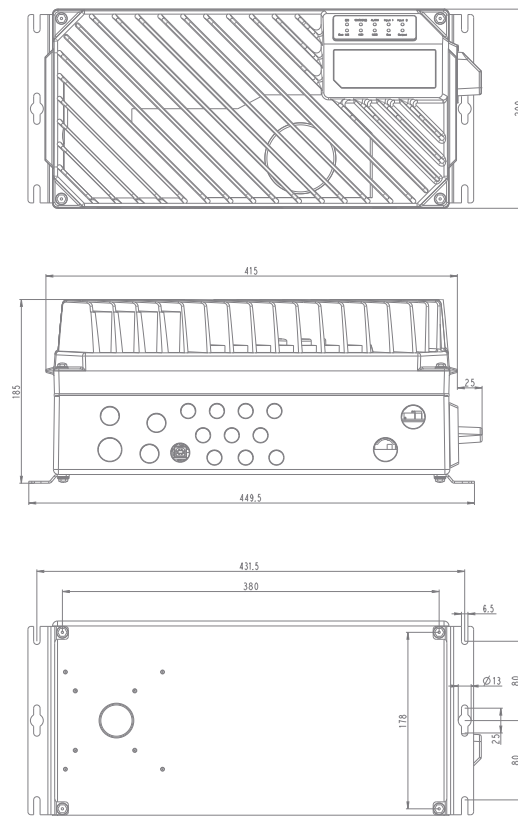
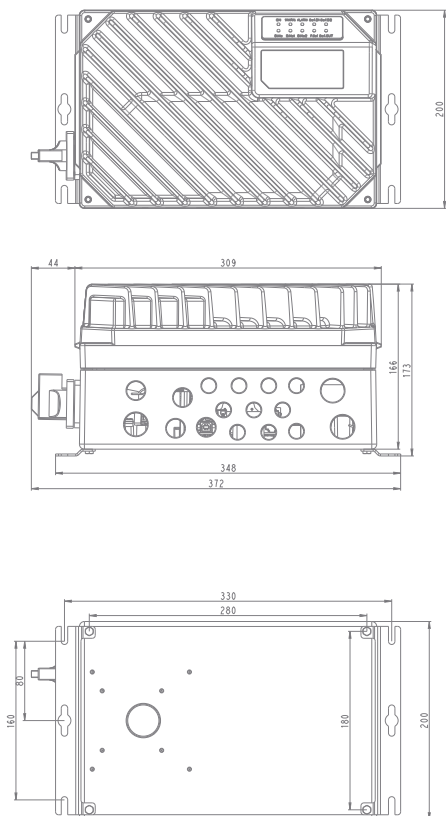

Measures are in [mm]

Ordering type code

VLT® Decentral Drive FCD 302

Position	1	2	3	4	5	6	7	8	9	10	11	12	13	14	15	16	17	18	19	20	21	22	23	24	25	26	27	28	29	30	31	32	33	34	35	36	37	38	39	
Fixed	F	C	D	3	0	2	P				T	4				H	1											X	A		B		X	X	X	X	X	D		
Variants								K	3	7			B	6	6			X	1	X	X	X	C	X	X	X	X			X	X								X	
								K	5	5			W	6	6			S	3	E	M	E		E			E			0		R							0	
								K	7	5			W	6	9				X	F	N	F		F			P			N		U								
								1	K	1									Y			O	S						L		Z									
								1	K	5								R					M						8		8									
								2	K	2								T					L						Y											
								3	K	0													K																	
								X	X	X																														

[01-03] Product group	
FCD	VLT® Decentral Drive FCD 302

[04-06] AC drive series	
302	VLT® Decentral Drive

[07-10] Power size	
PK37	0.37 kW / 0.5 HP
PK55	0.55 kW / 0.75 HP
PK75	0.75 kW / 1.0 HP
P1K1	1.1 kW / 1.5 HP
P1K5	1.5 kW / 2.0 HP
P2K2	2.2 kW / 3.0 HP
P3K0	3.0 kW / 4.0 HP
PXXX	Installation box only (without power section)

[11-12] Phases, mains voltage	
T	Three phase
4	380 – 480 V

[13-15] Enclosure	
B66	Standard Black – IP 66/NEMA 4X
W66	Standard White – IP 66/NEMA 4X
W69	Hygienic White – IP 66/NEMA 4X

[16-17] RFI filter	
H1	RFI filter class A1/C2

[18] Brake	
X	No brake
S	Brake + mechanical brake supply

[19] Hardware configuration	
1	Complete product, small enclosure, stand alone mount
3	Complete product, large enclosure, stand alone mount
X	Drive part, small enclosure (No installation box)
Y	Drive part, large enclosure (No installation box)
R	Installation box, small enclosure, stand alone mount (No drive part)
T	Installation box, large enclosure, stand alone mount (No drive part)

[20] Brackets	
X	No brackets
E	Flat brackets
F	40 mm brackets

[21] Threads type	
X	No installation box
M	Metric threads
N	NPT variant1
O	NPT variant2

[22] Switch option	
X	No switch option
E	Service switch on mains input
F	Service switch on motor output
S	small circuit braker
M	medium circuit braker
L	large circuit braker
K	Service switch on mains input with additional looping terminals (only for MF2 enclosure)

[23] Display	
C	With display connector

[24] Sensor plugs	
X	No sensor plugs
E	Direct mount 4xM12
F	Direct mount 6xM12

[25] Motor plug	
X	No motor plug

[26] Mains plug	
X	No mains plug

[27] Fieldbus plug	
X	No fieldbus plug
E	M12 Ethernet
P	M12 Profibus

[28] Reserved	
X	

[29-30] A-options: Fieldbus	
AX	No option
AL	PROFINET
AN	EtherNet/IP
AY	POWERLINK
A8	EtherCAT
A0	PROFIBUS DP V1
AR	FCD 300 PROFIBUS Converter

[31-32] B-options	
BX	No option
BR	VLT® Encoder Input MCB 102
BU	VLT® Resolver Input MCB 103
BZ	VLT® Safe PLC I/O MCB 108
B8	VLT ProfiSafe MCB 152

[33-37] Software options	
XXXXX	Latest released standard software
S067X	Integrated Motion Control
LX1XX	Condition Monitoring

[38-39] D-option	
DX	No option
D0	VLT® 24 V DC Supply MCB 107

NOTE: For availability of specific options and configurations please refer to drive configurator at <http://driveconfig.danfoss.com>

Electrical data – VLT® Automation Drive D, E and F enclosures

[T2] 3 x 200-240 V AC – high overload

High overload (150% 1 min/10 min)							Enclosure size		
Type code	Output current (3 x 200-240 V)		Typical shaft output power		Continuous input current	Estimated power loss	Protection rating [IEC/UL]		
	Con. I _N	Inter. I _{MAX} (60 s)	kW	Hp			IP20	IP21	IP54
FC 302	Con. I _N	Inter. I _{MAX} (60 s)	kW	Hp	[A]	[W]	Chassis	Type 1	Type 12
N45K	160	240	45	60	154	1482	D3h	D1h	
N55K	190	285	55	75	183	1794	D3h	D1h	
N75K	240	360	75	100	231	1990	D4h	D2h	
N90K	302	453	90	120	291	2613	D4h	D2h	
N110	361	542	110	150	348	3195	D4h	D2h	
N150	443	665	150	200	427	4103	D4h	D2h	

[T2] 3 x 200-240 V AC – normal overload

Normal overload (110% 1 min/10 min)							Enclosure size		
Type code	Output current (3 x 200-240 V)		Typical shaft output power		Continuous input current	Estimated power loss	Protection rating [IEC/UL]		
	Con. I _N	Inter. I _{MAX} (60 s)	kW	Hp			IP20	IP21	IP54
FC 302	Con. I _N	Inter. I _{MAX} (60 s)	kW	Hp	[A]	[W]	Chassis	Type 1	Type 12
N45K	190	209	55	75	183	1505	D3h	D1h	
N55K	240	264	75	100	231	2398	D3h	D1h	
N75K	302	332	90	120	291	2623	D4h	D2h	
N90K	361	397	110	150	348	3284	D4h	D2h	
N110	443	487	150	200	427	4117	D4h	D2h	
N150	535	589	160	215	516	5209	D4h	D2h	

[T5] 3 x 380-500 V AC – high overload

High overload (150% 1 min/10 min)									Enclosure size		
Type code	Output current				Typical shaft output power		Contin-uous input current	Esti-mated power loss	Protection rating [IEC/UL]		
	(3 x 380-440 V)		(3 x 441-500 V)						IP20	IP21	IP54
FC 302	Con. I _N	Inter. I _{MAX} (60 s)	Con. I _N	Inter. I _{MAX} (60 s)	kW @ 400 V	Hp @ 460 V	[A] @ 400 V	[W]	Chassis	Type 1	Type 12
N90K	177	266	160	240	90	125	171	2031	D3h	D1h/D5h/D6h	
N110	212	318	190	285	110	150	204	2289	D3h	D1h/D5h/D6h	
N132	260	390	240	360	132	200	251	2923	D3h	D1h/D5h/D6h	
N160	315	473	302	453	160	250	304	3093	D4h	D2h/D7h/D8h	
N200	395	593	361	542	200	300	381	4039	D4h	D2h/D7h/D8h	
N250	480	720	443	665	250	350	463	5005	D4h	D2h/D7h/D8h	
N315	600	900	540	810	315	450	578	6178	E3h	E1h	E1h
N355	658	987	590	885	355	500	634	6851	E3h	E1h	E1h
N400	695	1043	678	1017	400	550	670	7297	E3h	E1h	E1h
N450	800	1200	730	1095	450	600	771	8352	E4h	E2h	E2h
N500	880	1320	780	1170	500	650	848	9449	E4h	E2h	E2h
P450	800	1200	730	1095	450	600	771	9031	–	F1/F3	F1/F3
P500	880	1320	780	1170	500	650	848	10146	–	F1/F3	F1/F3
P560	990	1485	890	1335	560	750	954	10649	–	F1/F3	F1/F3
P630	1120	1680	1050	1575	630	900	1079	12490	–	F1/F3	F1/F3
P710	1260	1890	1160	1740	710	1000	1214	14244	–	F2/F4	F2/F4
P800	1460	2190	1380	2070	800	1200	1407	15466	–	F2/F4	F2/F4

[T5] 3 x 380-500 V AC – normal overload

Normal overload (110% 1 min/10 min)									Enclosure size		
Type code	Output current				Typical shaft output power		Contin-uous input current	Esti-mated power loss	Protection rating [IEC/UL]		
	(3 x 380-440 V)		(3 x 441-500 V)						IP20	IP21	IP54
FC 302	Con. I _N	Inter. I _{MAX} (60 s)	Con. I _N	Inter. I _{MAX} (60 s)	kW @ 400 V	Hp @ 460 V	[A] @ 400 V	[W]	Chassis	Type 1	Type 12
N90K	212	233	190	209	110	150	204	2559	D3h	D1h/D5h/D6h	
N110	260	286	240	264	132	200	251	2954	D3h	D1h/D5h/D6h	
N132	315	347	302	332	160	250	304	3770	D3h	D1h/D5h/D6h	
N160	395	435	361	397	200	300	381	4116	D4h	D2h/D7h/D8h	
N200	480	528	443	487	250	350	463	5137	D4h	D2h/D7h/D8h	
N250	588	647	535	588	315	450	567	6674	D4h	D2h/D7h/D8h	
N315	658	724	590	649	355	500	634	6928	E3h	E1h	E1h
N355	745	820	678	746	400	600	718	8036	E3h	E1h	E1h
N400	800	880	730	803	450	600	771	8783	E3h	E1h	E1h
N450	880	968	780	858	500	650	848	9473	E4h	E2h	E2h
N500	990	1089	890	979	560	750	771	11102	E4h	E2h	E2h
P450	880	968	780	858	500	650	848	10162	–	F1/F3	F1/F3
P500	990	1089	890	979	560	750	954	11822	–	F1/F3	F1/F3
P560	1120	1232	1050	1155	630	900	1079	12512	–	F1/F3	F1/F3
P630	1260	1386	1160	1276	710	1000	1214	14674	–	F1/F3	F1/F3
P710	1460	1606	1380	1518	800	1200	1407	17293	–	F2/F4	F2/F4
P800	1720	1892	1530	1683	1000	1350	1658	19278	–	F2/F4	F2/F4

[T7] 3 x 525-690 V AC – high overload

High overload (150% 1 min/10 min)									Enclosure size		
Type code	Output current				Typical shaft output power		Continuous input current	Estimated power loss	Protection rating [IEC/UL]		
	(3 x 525-550 V)		(3 x 551-690 V)						IP20	IP21	IP54
FC 302	Con. I _N	Inter. I _{MAX} (60 s)	Con. I _N	Inter. I _{MAX} (60 s)	kW @ 690 V	Hp @ 575 V	[A] @ 690 V	[W]	Chassis	Type 1	Type 12
N55K	76	114	73	110	55	60	70	1056	D3h	D1h/D5h/D6h	
N75K	90	135	86	129	75	75	83	1204	D3h	D1h/D5h/D6h	
N90K	113	170	108	162	90	100	104	1479	D3h	D1h/D5h/D6h	
N110	137	206	131	197	110	125	126	1798	D3h	D1h/D5h/D6h	
N132	162	243	155	233	132	150	149	2157	D3h	D1h/D5h/D6h	
N160	201	302	192	288	160	200	185	2443	D4h	D2h/D7h/D8h	
N200	253	380	242	363	200	250	233	3121	D4h	D2h/D7h/D8h	
N250	303	455	290	435	250	300	279	3768	D4h	D2h/D7h/D8h	
N315	360	540	344	516	315	350	332	4254	D4h	D2h/D7h/D8h	
N355	395	593	380	570	355	400	366	4917	E3h	E1h	E1h
N400	429	644	410	615	400	400	395	5329	E3h	E1h	E1h
N500	523	785	500	750	500	500	482	6673	E3h	E1h	E1h
N560	596	894	570	855	560	600	549	7842	E3h	E1h	E1h
N630	659	989	630	945	630	650	607	8357	E4h	E2h	E2h
N710	763	1145	730	1095	710	750	704	10010	E4h	E2h	E2h
P630	659	989	630	945	630	650	607	7826	–	F1/ F3	F1/ F3
P710	763	1145	730	1095	710	750	704	8983	–	F1/ F3	F1/ F3
P800	889	1334	850	1275	800	950	819	10646	–	F1/ F3	F1/ F3
P900	988	1482	945	1418	900	1050	911	11681	–	F2/ F4	F2/ F4
P1M0	1108	1662	1060	1590	1000	1150	1022	12997	–	F2/ F4	F2/ F4
P1M2	1317	1976	1260	1890	1200	1350	1214	15763	–	F2/ F4	F2/ F4

[T7] 3 x 525-690 V AC – normal overload

Normal overload (110% 1 min/10 min)									Enclosure size		
Type code	Output current				Typical shaft output power		Continuous input current	Estimated power loss	Protection rating [IEC/UL]		
	(3 x 525-550 V)		(3 x 551-690 V)						IP20	IP21	IP54
FC 302	Con. I _N	Inter. I _{MAX} (60 s)	Con. I _N	Inter. I _{MAX} (60 s)	kW @ 690 V	Hp @ 575 V	[A] @ 690 V	[W]	Chassis	Type 1	Type 12
N55K	90	99	86	95	75	75	83	1203	D3h	D1h/D5h/D6h	
N75K	113	124	108	119	90	100	104	1476	D3h	D1h/D5h/D6h	
N90K	137	151	131	144	110	125	126	1796	D3h	D1h/D5h/D6h	
N110	162	178	155	171	132	150	149	2165	D3h	D1h/D5h/D6h	
N132	201	221	192	211	160	200	185	2738	D3h	D1h/D5h/D6h	
N160	253	278	242	266	200	250	233	3172	D4h	D2h/D7h/D8h	
N200	303	333	290	319	250	300	279	3848	D4h	D2h/D7h/D8h	
N250	360	396	344	378	315	350	332	4610	D4h	D2h/D7h/D8h	
N315	418	460	400	440	400	400	385	5150	D4h	D2h/D7h/D8h	
N355	470	517	450	495	450	450	434	5935	E3h	E1h	E1h
N400	523	575	500	550	500	500	482	6711	E3h	E1h	E1h
N500	596	656	570	627	560	600	549	7846	E3h	E1h	E1h
N560	630	693	630	693	630	650	607	8915	E3h	E1h	E1h
N630	763	839	730	803	710	750	704	10059	E4h	E2h	E2h
N710	889	978	850	935	800	950	819	12253	E4h	E2h	E2h
P630	763	839	730	803	710	750	704	9212	–	F1/ F3	F1/ F3
P710	889	978	850	935	800	950	819	10659	–	F1/ F3	F1/ F3
P800	988	1087	945	1040	900	1050	911	12080	–	F1/ F3	F1/ F3
P900	1108	1219	1060	1166	1000	1150	1022	13305	–	F2/ F4	F2/ F4
P1M0	1317	1449	1260	1386	1200	1350	1214	15865	–	F2/ F4	F2/ F4
P1M2	1479	1627	1415	1557	1400	1550	1364	18173	–	F2/ F4	F2/ F4

Dimensions enclosure size D

Enclosure size		VLT® AutomationDrive									
Protection rating [IEC/UL]		IP21 /Type 1 IP54 /Type 12		IP20 /Chassis				IP21 /Type 1 IP54 /Type 12			
[mm]	Height	901.0	1107.0	909.0	1027.0	1122.0	1294.0	1324.0	1663.0	1978.0	2284.0
	Width	325.0	420.0	250.0	250.0	350.0	350.0	325.0	325.0	420.0	420.0
	Depth	378.4	378.4	375.0	375.0	375.0	375.0	381.0	381.0	386.0	406.0
[kg]	Weight	62.0	125.0	62.0	108.0	125.0	179.0	99.0	128.0	185.0	232.0
[in]	Height	35.5	43.6	35.8	39.6	44.2	50.0	52.1	65.5	77.9	89.9
	Width	12.8	12.8	19.8	9.9	14.8	13.8	12.8	12.8	16.5	16.5
	Depth	14.9	14.9	14.8	14.8	14.8	14.8	15.0	15.0	15.2	16.0
[lb]	Weight	136.7	275.6	136.7	238.1	275.6	394.6	218.3	282.2	407.9	511.5

⁽¹⁾ Dimensions with regeneration or load share terminals

⁽²⁾ D5h is used with disconnect and/or brake chopper options

⁽³⁾ D6h is used with contactor and/or circuit breaker options

⁽⁴⁾ D7h is used with disconnect and/or brake chopper options

⁽⁵⁾ D8h is used with contactor and/or circuit breaker options

Dimensions enclosure sizes E and F

Frame		VLT® AutomationDrive							
Protection rating [IEC/UL]		IP21 /Type 1 IP54 /Type 12		IP20 /Chassis *		IP21 /Type 1 IP54 /Type 12			
[mm]	Height	2043.0	2043.0	1578.0	1578.0	2204.0	2204.0	2204.0	2204.0
	Width	602.0	698.0	506.0	604.0	1400.0	1800.0	2000.0	2400.0
	Depth	513.0	513.0	482.0	482.0	606.0	606.0	606.0	606.0
[kg]	Weight	295.0	318.0	272.0	295.0	1017.0	1260.0	1318.0	1561.0
[in]	Height	80.4	80.4	62.1	62.1	86.8	86.8	86.8	86.8
	Width	23.7	27.5	199.9	23.9	55.2	70.9	78.8	94.5
	Depth	20.2	20.2	19.0	19.0	23.9	23.9	23.9	23.9
[lb]	Weight	650.0	700.0	600.0	650.0	2242.1	2777.9	2905.7	3441.5

* IP00 when ordered with loadshare or regen terminals

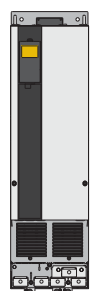

D3h/D4h

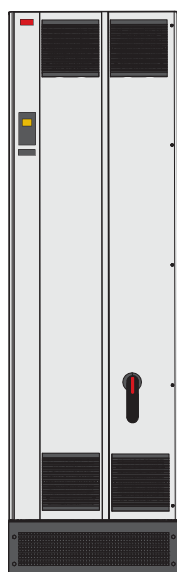

E1h



F

Electrical data and dimensions – VLT® AutomationDrive 12-Pulse

[T5] 6 x 380-500 V AC – high overload

High overload (150% 1 min/10 min)									Enclosure size			
Type code	Output current				Typical shaft output power		Continuous input current	Estimated power loss	Protection rating [IEC/UL]			
	(3 x 380-440 V)		(3 x 441-500 V)						IP21/Type 1		IP54/Type 12	
FC 302	Con. I _N	Inter. I _{MAX} (60 s)	Con. I _N	Inter. I _{MAX} (60 s)	kW @ 400 V	Hp @ 460 V	[A] @ 400 V	[W]	AC drive	+ options	AC drive	+ options
P250	480	720	443	665	250	350	472	5164	F8	F9	F8	F9
P315	600	900	540	810	315	450	590	6960	F8	F9	F8	F9
P355	658	987	590	885	355	500	647	7691	F8	F9	F8	F9
P400	695	1043	678	1017	400	550	684	8178	F8	F9	F8	F9
P450	800	1200	730	1095	450	600	779	9492	F10	F11	F10	F11
P500	880	1320	780	1170	500	650	857	10631	F10	F11	F10	F11
P560	990	1485	890	1335	560	750	964	11263	F10	F11	F10	F11
P630	1120	1680	1050	1575	630	900	1090	13172	F10	F11	F10	F11
P710	1260	1890	1160	1740	710	1000	1227	14967	F12	F13	F12	F13
P800	1460	2190	1380	2070	800	1200	1422	16392	F12	F13	F12	F13

[T5] 6 x 380-500 V AC – normal overload

Normal overload (110% 1 min/10 min)									Enclosure size			
Type code	Output current				Typical shaft output power		Continuous input current	Estimated power loss	Protection rating [IEC/UL]			
	(3 x 380-440 V)		(3 x 441-500 V)						IP21/Type 1		IP54/Type 12	
FC 302	Con. I _N	Inter. I _{MAX} (60 s)	Con. I _N	Inter. I _{MAX} (60 s)	kW @ 400 V	Hp @ 460 V	[A] @ 400 V	[W]	AC drive	+ options	AC drive	+ options
P250	600	660	540	594	315	450	590	6790	F8	F9	F8	F9
P315	658	724	590	649	355	500	647	7701	F8	F9	F8	F9
P355	745	820	678	746	400	600	733	8879	F8	F9	F8	F9
P400	800	880	730	803	450	600	787	9670	F8	F9	F8	F9
P450	880	968	780	858	500	650	857	10647	F10	F11	F10	F11
P500	990	1089	890	979	560	750	964	12338	F10	F11	F10	F11
P560	1120	1232	1050	1155	630	900	1090	13201	F10	F11	F10	F11
P630	1260	1386	1160	1276	710	1000	1227	15436	F10	F11	F10	F11
P710	1460	1606	1380	1518	800	1200	1422	18084	F12	F13	F12	F13
P800	1720	1892	1530	1683	1000	1350	1675	20358	F12	F13	F12	F13

[T7] 6 x 525-690 V AC – high overload

High overload (150% 1 min/10 min)									Enclosure size			
Type code	Output current				Typical shaft output power		Continu-ous input current	Esti-mated power loss	Protection rating [IEC/UL]			
	(3 x 525-550 V)		(3 x 551-690 V)						IP21/Type 1		IP54/Type 12	
FC 302	Con. I _N	Inter. I _{MAX} (60 s)	Con. I _N	Inter. I _{MAX} (60 s)	kW @ 690 V	Hp @ 575 V	[A] @ 690 V	[W]	AC drive	+ options	AC drive	+ options
P355	395	593	380	570	355	400	366	4589	F8	F9	F8	F9
P450	429	644	410	615	400	400	395	4970	F8	F9	F8	F9
P500	523	785	500	750	500	500	482	6707	F8	F9	F8	F9
P560	596	894	570	855	560	600	549	7633	F8	F9	F8	F9
P630	659	989	630	945	630	650	613	8388	F10	F11	F10	F11
P710	763	1145	730	1095	710	750	711	9537	F10	F11	F10	F11
P800	889	1334	850	1275	800	950	828	11291	F10	F11	F10	F11
P900	988	1482	945	1418	900	1050	920	12524	F12	F13	F12	F13
P1M0	1108	1662	1060	1590	1000	1150	1032	13801	F12	F13	F12	F13
P1M2	1317	1976	1260	1890	1200	1350	1227	16719	F12	F13	F12	F13

[T7] 6 x 525-690 V AC – normal overload

Normal overload (110% 1 min/10 min)									Enclosure size			
Type code	Output current				Typical shaft output power		Continu-ous input current	Esti-mated power loss	Protection rating [IEC/UL]			
	(3 x 525-550 V)		(3 x 551-690 V)						IP21/Type 1		IP54/Type 12	
FC 302	Con. I _N	Inter. I _{MAX} (60 s)	Con. I _N	Inter. I _{MAX} (60 s)	kW @ 690 V	Hp @ 575 V	[A] @ 690 V	[W]	AC drive	+ options	AC drive	+ options
P355	470	517	450	495	450	450	434	5529	F8	F9	F8	F9
P450	523	575	500	550	500	500	482	6239	F8	F9	F8	F9
P500	596	656	570	627	560	600	549	7653	F8	F9	F8	F9
P560	630	693	630	693	630	650	607	8495	F8	F9	F8	F9
P630	763	839	730	803	710	750	711	9863	F10	F11	F10	F11
P710	889	978	850	935	800	950	828	11304	F10	F11	F10	F11
P800	988	1087	945	1040	900	1050	920	12798	F10	F11	F10	F11
P900	1108	1219	1060	1166	1000	1150	1032	13801	F12	F13	F12	F13
P1M0	1317	1449	1260	1386	1200	1350	1227	16821	F12	F13	F12	F13
P1M2	1479	1627	1415	1557	1400	1550	1378	19247	F12	F13	F12	F13

Dimensions enclosure size F

		VLT® AutomationDrive					
Enclosure size		F8	F9	F10	F11	F12	F13
Protection rating [IEC/UL]		IP21/Type 1 IP54/Type 12					
[mm]	Height	2204.0	2204.0	2204.0	2204.0	2204.0	2204.0
	Width	800.0	1400.0	1600.0	2400.0	2000.0	2800.0
	Depth	606.0	606.0	606.0	606.0	606.0	606.0
[kg]	Weight	447.0	669.0	893.0	1116.0	1037.0	1259.0
[in]	Height	86.8	86.8	86.8	86.8	86.8	86.8
	Width	31.5	55.2	63.0	94.5	78.8	110.2
	Depth	23.9	23.9	23.9	23.9	23.9	23.9
[lb]	Weight	985.5	1474.9	1968.8	2460.4	2286.4	2775.7

Electrical data and dimensions

VLT® Enclosed Drive

[T5] 3 x 380-500 V AC – high overload

High overload (150% 1 min/10 min)										
Type code	Output current				Typical shaft output power		Continuous input current	Estimated power loss	Protection rating [IEC]	
	(3 x 380-440 V)		(3 x 441-500 V)		kW @ 400 V	Hp @ 460 V			IP21	IP54
FC 302	Con. I _N	Inter. I _{MAX} (60 s)	Con. I _N	Inter. I _{MAX} (60 s)			[A] @ 400 V	[W]		
N90K	177	266	160	240	90	125	171	2031	D9h	D9h
N110	212	318	190	285	110	150	204	2289	D9h	D9h
N132	260	390	240	360	132	200	251	2923	D9h	D9h
N160	315	473	302	453	160	250	304	3093	D10h	D10h
N200	395	593	361	542	200	300	381	4039	D10h	D10h
N250	480	720	443	665	250	350	463	5005	D10h	D10h
N315	600	900	540	810	315	450	578	6178	E5h	E5h
N355	658	987	590	885	355	500	634	6851	E5h	E5h
N400	695	1043	678	1017	400	550	718	7297	E5h	E5h
N450	800	1200	730	1095	450	600	771	8352	E6h	E6h
N500	880	1320	780	1170	500	650	848	9449	E6h	E6h

[T5] 3 x 380-500 V AC – normal overload

Normal overload (110% 1 min/10 min)										
Type code	Output current				Typical shaft output power		Continuous input current	Estimated power loss	Protection rating [IEC]	
	(3 x 380-440 V)		(3 x 441-500 V)		kW @ 400 V	Hp @ 460 V			IP21	IP54
FC 302	Con. I _N	Inter. I _{MAX} (60 s)	Con. I _N	Inter. I _{MAX} (60 s)			[A] @ 400V	[W]		
N90K	212	233	190	209	110	150	204	2559	D9h	D9h
N110	260	286	240	264	132	200	251	2954	D9h	D9h
N132	315	347	302	332	160	250	304	3770	D9h	D9h
N160	395	435	361	397	200	300	381	4116	D10h	D10h
N200	480	528	443	487	250	350	463	5137	D10h	D10h
N250	588	647	535	588	315	450	578	6674	D10h	D10h
N315	658	724	590	649	355	500	634	6928	E5h	E5h
N355	745	820	678	746	400	600	718	8036	E5h	E5h
N400	800	880	730	803	450	600	771	8783	E5h	E5h
N450	880	968	780	858	500	650	848	9473	E6h	E6h
N500	990	1089	890	979	560	750	954	11102	E6h	E6h

[T7] 3 x 525-690 V AC – high overload

High overload (150% 1 min/10 min)										
Type code	Output current				Typical shaft output power		Continuous input current	Estimated power loss	Protection rating [IEC]	
	(3 x 525-550 V)		(3 x 551-690 V)						IP21	IP54
FC 302	Con. I _N	Inter. I _{MAX} (60 s)	Con. I _N	Inter. I _{MAX} (60 s)	kW @ 690 V	Hp @ 575 V	[A] @ 690 V	[W]		
N90K	113	170	108	162	90	100	109	1479	D9h	D9h
N110	137	206	131	197	110	125	132	1798	D9h	D9h
N132	162	243	155	233	132	150	156	2157	D9h	D9h
N160	201	302	192	288	160	200	193	2443	D10h	D10h
N200	253	380	242	363	200	250	244	3121	D10h	D10h
N250	303	455	290	435	250	300	292	3768	D10h	D10h
N315	360	540	344	516	315	350	347	4254	D10h	D10h
N355	395	593	380	570	355	400	381	4989	E5h	E5h
N400	429	644	410	615	400	400	413	5419	E5h	E5h
N500	523	785	500	750	500	500	504	6833	E5h	E5h
N560	596	894	570	855	560	600	574	8069	E5h	E5h
N630	659	989	630	945	630	650	635	8543	E6h	E6h
N710	763	1145	730	1095	710	750	735	10319	E6h	E6h

[T7] 3 x 525-690 V AC – normal overload

Normal overload (110% 1 min/10 min)										
Type code	Output current				Typical shaft output power		Continuous input current	Estimated power loss	Protection rating [IEC]	
	(3 x 525-550 V)		(3 x 551-690 V)						IP21	IP54
FC 302	Con. I _N	Inter. I _{MAX} (60 s)	Con. I _N	Inter. I _{MAX} (60 s)	kW @ 690 V	Hp @ 575 V	[A] @ 690 V	[W]		
N90K	137	151	131	144	110	125	132	1796	D9h	D9h
N110	162	178	155	171	132	150	156	2165	D9h	D9h
N132	201	221	192	211	160	200	193	2738	D9h	D9h
N160	253	278	242	266	200	250	244	3172	D10h	D10h
N200	303	333	290	319	250	300	292	3848	D10h	D10h
N250	360	396	344	378	315	350	347	4610	D10h	D10h
N315	418	460	400	440	400	400	381	5150	D10h	D10h
N355	470	517	450	495	450	450	413	6062	E5h	E5h
N400	523	575	500	550	500	500	504	6879	E5h	E5h
N500	596	656	570	627	560	600	574	8076	E5h	E5h
N560	630	693	630	693	630	650	635	9208	E5h	E5h
N630	763	839	730	803	710	750	735	10346	E6h	E6h
N710	889	978	850	935	800	950	857	12723	E6h	E6h



Dimensions for VLT® AutomationDrive Enclosed Drive

VLT® AutomationDrive				
	D9h	D10h	E5h	E6h
Enclosed Drive				
Rated power at 380–500 V [kW (hp)]	90–132 (125–200)	160–250 (250–350)	315–400 (450–550)	450–500 (600–650)
Rated power at 525–690 V [kW (hp)]	90–132 (100–150)	160–315 (200–350)	355–560 (400–600)	630–710 (650–950)
Protection rating	IP21/Type 1 IP54/Type 12	IP21/Type 1 IP54/Type 12	IP21/Type 1 IP54/Type 12	IP21/Type 1 IP54/Type 12
Drive cabinet				
Height [mm (in)] ¹⁾	2100 (82.7)	2100 (82.7)	2100 (82.7)	2100 (82.7)
Width [mm (in)] ²⁾	400 (15.8)	600 (23.6)	600 (23.6)	800 (31.5)
Depth [mm (in)]	600 (23.6)	600 (23.6)	600 (23.6)	600 (23.6)
Weight [kg (lb)] ²⁾	280 (617)	355 (783)	400 (882)	431 (950)
Input filter cabinet				
Height [mm (in)] ¹⁾	–	2100 (82.7)	2100 (82.7)	2100 (82.7)
Width [mm (in)]	–	600 (23.6)	600 (23.6)	600 (23.6)
Depth [mm (in)]	–	600 (23.6)	600 (23.6)	600 (23.6)
Weight [kg (lb)]	–	380 (838)	380 (838)	380 (838)
Sine-wave filter cabinet				
Height [mm (in)] ¹⁾	2100 (82.7)	2100 (82.7)	2100 (82.7)	2100 (82.7)
Width [mm (in)]	600 (23.6)	600 (23.6)	1200 (47.2)	1200 (47.2)
Depth [mm (in)]	600 (23.6)	600 (23.6)	600 (23.6)	600 (23.6)
Weight [kg (lb)]				
dV/dt filter cabinet				
Height [mm (in)] ¹⁾	–	–	2100 (82.7)	2100 (82.7)
Width [mm (in)] ³⁾	–	–	400 (15.8)	400 (15.8)
Depth [mm (in)]	–	–	600 (23.6)	600 (23.6)
Weight [kg (lb)]	–	–	240 (529)	240 (529)
Top entry/exit cabinet				
Height [mm (in)] ¹⁾	2100 (82.7)	2100 (82.7)	2100 (82.7)	2100 (82.7)
Width [mm (in)] ³⁾	400 (15.8)	400 (15.8)	400 (15.8)	400 (15.8)
Depth [mm (in)]	600 (23.6)	600 (23.6)	600 (23.6)	600 (23.6)
Weight [kg (lb)]	164 (362)	164 (362)	164 (362)	164 (362)

¹⁾ Cabinet height includes standard 100 mm (3.9 in) plinth. A 200 mm (7.9 in) or 400 mm (15.8 in) plinth is optional.

²⁾ Without options.

³⁾ The E5h and E6h enclosures contain 2 sine wave cabinets. The provided width is the total of both cabinets.

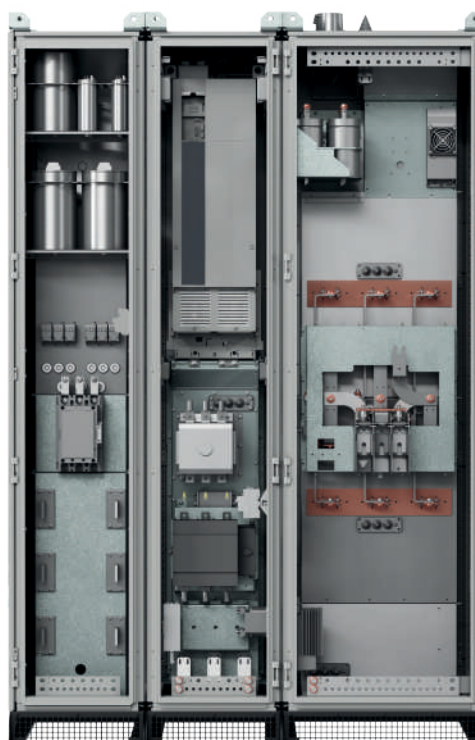

Electrical data – VLT® AutomationDrive Low Harmonic Drive & VLT® Advanced Active Filter

[T5] 3 x 380-480 V AC – VLT® Low Harmonic Drive

High overload (150% 1 min/10 min)									Enclosure size	
Type code	Output current				Typical shaft output power		Continu-ous input current	Estimat-ed power loss	Protection rating [IEC/UL]	
	(3 x 380-440 V)		(3 x 441-480 V)						IP21	IP54
FC 302	Con. I _N	Inter. I _{MAX} (60 s)	Con. I _N	Inter. I _{MAX} (60 s)	kW @ 400 V	Hp @ 460 V	[A]	[W]	Type 1	Type 12
N132	260	390	240	360	132	200	251	7428	D1n	D1n
N160	315	473	302	453	160	250	304	8048	D2n	D2n
N200	395	593	361	542	200	300	381	9753	D2n	D2n
N250	480	720	443	665	250	350	472	11587	E9	E9
P315	600	900	540	810	315	450	590	14140	E9	E9
P355	658	987	590	885	355	500	647	15286	E9	E9
P400	695	1043	678	1017	400	550	684	16063	E9	E9
P450	800	1200	730	1095	450	600	779	20077	F18	F18
P500	880	1320	780	1170	500	650	857	21851	F18	F18
P560	900	1485	890	1335	560	750	964	23320	F18	F18
P630	1120	1680	1050	1575	630	900	1090	26559	F18	F18

[T5] 3 x 380-480 V AC – VLT® Low Harmonic Drive

Normal overload (110% 1 min/10 min)									Enclosure size	
Type code	Output current				Typical shaft output power		Continu-ous input current	Estimat-ed power loss	Protection rating [IEC/UL]	
	(3 x 380-440 V)		(3 x 441-480 V)						IP21	IP54
FC 302	Con. I _N	Inter. I _{MAX} (60 s)	Con. I _N	Inter. I _{MAX} (60 s)	kW @ 400 V	Hp @ 460 V	[A]	[W]	Type 1	Type 12
N132	315	347	302	332	160	250	304	8725	D1n	D1n
N160	395	435	361	397	200	300	381	9831	D2n	D2n
N200	480	528	443	487	250	350	463	11371	D2n	D2n
N250	600	660	540	594	315	450	590	14051	E9	E9
P315	658	724	590	649	355	500	647	15320	E9	E9
P355	745	820	678	746	400	600	733	17180	E9	E9
P400	800	880	730	803	450	600	787	18447	E9	E9
P450	800	968	780	858	500	650	857	21909	F18	F18
P500	990	1089	890	979	560	750	964	24592	F18	F18
P560	1120	1232	1050	1155	630	900	1090	26640	F18	F18
P630	1260	1380	1160	1276	710	1000	1227	30519	F18	F18

[T4] 3 x 380-480 V AC VLT® Advanced Active Filter

Normal overload (110% 1 min/10 min automatically regulated)										Enclosure size		
Type code	Output current								Recom-mended fuse and disconnect rating*	Estimat-ed power loss	Protection rating [IEC/UL]	
	@ 400 V		@ 460 V		@ 480 V		@ 500 V				IP21	IP54
AAF006	Reac-tive	Harmo-nics	Reac-tive	Harmo-nics	Reac-tive	Harmo-nics	Reac-tive	Harmo-nics	[A]	[W]	Type 1	Type 12
A190	190	171	190	171	190	171	190	152	350	5000	D14	D14
A250	250	225	250	225	250	225	250	200	630	7000	E1	E1
A310	310	279	310	279	310	279	310	248	630	9000	E1	E1
A400	400	360	400	360	400	360	400	320	900	11100	E1	E1

* Built-in options for fuses and disconnect recommended

Dimensions – VLT® Low Harmonic Drive and VLT® Advanced Active Filter

		VLT® Low Harmonic Drive				VLT® Advanced Active Filter	
Enclosure size		D1n	D2n	E9	F18	D14	E1
Protection rating [IEC/UL]		IP21 /Type 1 IP54 /Type 12				IP21 /Type 1 IP54 /Type 12	
[mm]	Height	1781.70	1781.7	2000.7	2278.4	1780.0	2000.0
	Width	929.2	1024.2	1200.0	2792.0	600.0	600.0
	Depth	418.4	418.4	538.0	605.8	418.4	538.0
[kg]	Weight	353.0	413.0	676.0	1900.0	238.0	453.0
[in]	Height	70.1	70.1	78.8	89.7	70.0	78.7
	Width	36.6	40.3	47.2	109.9	23.6	23.6
	Depth	16.5	16.5	21.0	23.9	16.5	21.0
[lb]	Weight	777.0	910.0	1490.0	4189.0	524.7	998.7

Specifications VLT® Advanced Active Filter

Filter type	3P/3W, Active Shunt Filter (TN, TT, IT)	Harmonics currents capability in % from the rated current	I5: 63%, I7: 45%, I11: 29%, I13: 25%, I17: 18%, I19: 16%, I23: 14%, I25: 13%
Frequency	50 to 60 Hz, ± 5%	Reactive current compensation	Yes, leading (capacitive) or lagging (inductive) to target power factor
Enclosures	IP21 – NEMA 1, IP54 – NEMA 12	Flicker reduction	Yes
Max. voltage pre-distortion	10% 20% with reduced performance	Compensation priority	Programmable to harmonics or displacement power factor
Operating temperature	0-40 °C +5 °C with reduced performance -10 °C with reduced performance	Paralleling option	Up to 4 units of same power rating in master-follower setup
Altitude	1000 m without derating 3000 m with reduced performance (5%/1000 m)	Current Transformer Support (Customer supply and field mounting)	1 A or 5 A secondary with auto tuning Class 0.5 or better
EMC standards	IEC61000-6-2 IEC61000-6-4	Digital inputs /outputs	4 (2 programmable) Programmable PNP or NPN logic
Circuitry coating	Conformal coated – per ISA S71.04-1985, class G3	Communication interface	RS485, USB1.1
Languages	18 different	Control type	Direct harmonic control (for faster response)
Harmonic compensation modes	Selective or overall (90% RMS for harmonic reduction)	Response time	< 15 ms (including HW)
Harmonic compensation spectrum	2 nd to 40 th in overall mode, including triplens 5 th , 7 th , 11 th , 13 th , 17 th , 19 th , 23 rd , 25 th in selective mode	Harmonic settling time (5-95%)	< 15 ms
		Reactive settling time (5-95%)	< 15 ms
		Maximum overshoot	5%
		Switching frequency	Progressive control in the range of 3 – 18 kHz
		Average switching frequency	3 – 4.5 kHz

Type code VLT® Advanced Active Filter

The different VLT® Active Filters can easily be configured according to customer request at drives.danfoss.com

1	2	3	4	5	6	7	8	9	10	11	12	13	14	15	16	17	18	19	20	21	22	23	24	..	39
A	A	F	0	0	6	A	x	x	x	T	4	E	x	x	H	x	x	G	C	x	x	x	S	.	X
8-10: 190: 190 A correction current 250: 250 A correction current 310: 310 A correction current 400: 400 A correction current			13-15: E21: IP 21/NEMA 1 E2M: IP 21/NEMA 1 w. mains shield C2M: IP 21/NEMA 1 w. stainless steel back-channel and mains shield						E54: IP 54/NEMA 12 E5M: IP 54/NEMA 12 w. mains shield C5M: IP 54/NEMA 12 w. stainless steel back-channel and mains shield						16-17: HX: No RFI Filter H4: RFI class A1			21: X: No mains options 3: Disconnect & Fuse 7: Fuse							

A options: Fieldbuses

Available for the full product range

Fieldbus	FC 301	FC 302	FCD 302
VLT® PROFINET MCA 120	■	■	■
VLT® EtherNet/IP MCA 121	■	■	■
VLT® Modbus TCP MCA 122	■	■	-
VLT® POWERLINK MCA 123	■	■	■
VLT® EtherCAT MCA 124	■	■	■
VLT® PROFIBUS DP MCA 101	■	■	■
VLT® DeviceNet MCA 104	■	■	-
VLT® CANopen MCA 105	■	■	-
VLT® 3000 PROFIBUS Converter MCA 113	-	■	-
VLT® 5000 PROFIBUS Converter MCA 114	-	■	-
VLT® 5000 DeviceNet Converter MCA 194	-	■	-
VLT® FCD 300 PROFIBUS Converter	-	-	■

■ Standard □ Optional

PROFINET

PROFINET uniquely combines the highest performance with the highest degree of openness. The option is designed so that many of the features from the PROFIBUS can be reused, minimizing user effort to migrate PROFINET and securing the investment in a PLC program.

- Same PPO types as PROFIBUS for easy migration to PROFINET
- Support of MRP for line topology
- Support of DP-V1 Diagnostic allows easy, fast and standardized handling of warning and fault information into the PLC, improving bandwidth in the system
- Implementation in accordance with Conformance Class B
- Built-in web server
- E-mail client for service notification
- Support of PROFISAFE

VLT® PROFINET MCA 120

Ordering number*

130B1135 standard, dual-port
130B1235 coated, dual-port

EtherNet/IP

Ethernet is the future standard for communication at the factory floor. EtherNet/IP is based on the newest technology available for industrial use and handles even the most demanding requirements.

EtherNet/IP™ extends commercial off-the-shelf Ethernet to the Common Industrial Protocol (CIP™) – the same upper-layer protocol and object model found in DeviceNet.

The option offers advanced features such as:

- Built-in high performance switch enabling line-topology, and eliminating the need for external switches
- DLR Ring
- Advanced switch and diagnosis functions
- Built-in web server
- E-mail client for service notification
- Unicast and Multicast communication

VLT® EtherNet/IP MCA 121

Ordering number*

130B1119 standard, dual-port
130B1219 coated, dual-port

Modbus TCP

Modbus TCP is the first industrial Ethernet-based protocol for automation. Modbus TCP is able to handle connection intervals down to 5 ms in both directions, positioning it among the fastest performing Modbus TCP devices in the market. For master redundancy, it features hot swapping between two masters.

Other features:

- Dual Master PLC connection for redundancy in dual port options (MCA 122 only)

VLT® Modbus TCP MCA 122

Ordering number*

130B1196 standard, dual-port
130B1296 coated, dual-port

POWERLINK

POWERLINK represents the second generation of fieldbus. The high bit rate of industrial Ethernet can now be used to make the full power of IT technologies used in the automation world available for the factory world.

POWERLINK provides high performance real-time and time synchronization features. Due to its CANopen-based communication models, network management and device description model, it offers much more than just a fast communication network.

The perfect solution for:

- Dynamic motion control applications
- Material handling
- Synchronization and positioning applications
- Built-in web server
- E-mail client for service notification

VLT® POWERLINK MCA 123

Ordering number*

130B1489 standard, dual-port
130B1490 coated, dual-port

EtherCAT

The EtherCAT offers connectivity to EtherCAT®-based networks via the EtherCAT Protocol.

The option handles the EtherCAT line communication in full speed, and connection towards the drive with an interval down to 4 ms in both directions. This allows the option to participate in networks ranging from low performance up to servo applications.

- EoE Ethernet over EtherCAT support
- HTTP (Hypertext Transfer Protocol) for diagnosis via built-in web server
- CoE (CAN Over Ethernet) for access to drive parameters
- SMTP (Simple Mail Transfer Protocol) for e-mail notification
- TCP/IP for easy access to drive configuration data from MCT 10

VLT® EtherCAT MCA 124

Ordering number*

130B5546 standard
130B5646 coated

PROFIBUS DP V1

Operating the AC drive via a fieldbus enables you to reduce the cost of your system, communicate faster and more efficiently and benefit from an easier user interface.

Other features:

- Wide compatibility, a high level of availability, support for all major PLC vendors, and compatibility with future versions
- Fast, efficient communication, transparent installation, advanced diagnosis and parameterization and auto-configuration of process data via GSD-file
- Acyclic parameterization using PROFIBUS DP-V1, PROFIdrive or Danfoss FC (MCA101 only) profile state machines, PROFIBUS DP-V1, Master Class 1 and 2

VLT® PROFIBUS DP MCA 101

Ordering number*

130B1100 standard
130B1200 coated

* Code number for loose option card (to be used only for FC 301 and FC 302)

DeviceNet

DeviceNet offers robust, efficient data handling thanks to advanced Producer/Consumer technology.

- Support of ODVA's AC drive profile supported via I/O instance 20/70 and 21/71 secures compatibility to existing systems
- Benefit from ODVA's strong conformance testing policies, which ensure that products are interoperable
- Built-in web server
- E-mail client for service notification

VLT® DeviceNet MCA 104

Ordering number*

130B1102 standard
130B1202 coated

CANopen

High flexibility and low cost are two of the "cornerstones" for CANopen.

The CANopen option is fully equipped with both high-priority access to control and status of the drive (PDO Communication) and access all parameters through acyclic data (SDO Communication).

For interoperability, the option has implemented the DSP402 AC drive Profile. These features all guarantee standardized handling, interoperability and low cost.

VLT® CANopen MCA 105

Ordering number*

130B1103 standard
130B1205 coated

VLT® 3000 PROFIBUS Converter

The VLT® PROFIBUS Converter MCA 113 is a special version of the PROFIBUS options that emulates the VLT® 3000 commands in the VLT® AutomationDrive.

The VLT® 3000 can be replaced by the VLT® AutomationDrive, or an existing system can be expanded without costly change of the PLC program.

VLT® 3000 PROFIBUS Converter MCA 113

Ordering number*

130B1245 coated

VLT® 5000 PROFIBUS Converter

The VLT® PROFIBUS Converter MCA 114 is a special version of the PROFIBUS options that emulates the VLT® 5000 commands in the VLT® AutomationDrive.

The VLT® 5000 can be replaced by the VLT® AutomationDrive, or an existing system can be expanded without costly change of the PLC program.

The option supports DPV1.

VLT® 5000 PROFIBUS Converter MCA 114

Ordering number*

130B1246 coated

VLT® 5000 DeviceNet Converter

The VLT® DeviceNet Converter MCA 194 emulates VLT® 5000 commands in the VLT® AutomationDrive.

This means that a VLT® 5000 drive can be replaced by the VLT® AutomationDrive, or a system can be expanded without costly change of the PLC program.

The option emulates I/O instances and explicit messages of a VLT® 5000.

VLT® DeviceNet Converter MCA 194

Ordering number*

130B5601 coated

VLT® FCD 300 PB Converter MCA 117

The VLT® FCD 300 PB Converter MCA 117 emulates the FCD300 or FCM 300 commands on the PROFIBUS network. All FCD/FCM300 commands from the PLC are translated in the MCA117 to FCD 302 commands. This eliminates the need to rewrite the PLC program and change the configuration.

VLT® FCD 300 PB Converter MCA 117

Ordering number*

only available as factory option

* Ordering number for loose option card (to be used only for FC 301 and FC 302)

B options: Functional extensions

Available for the full product range

Option	FC 301	FC 302	FCD 302
VLT® General Purpose MCB 101	■	■	-
VLT® Encoder Input MCB 102	■	■	■
VLT® Resolver Input MCB 103	■	■	■
VLT® Relay Option MCB 105	■	■	-
VLT® Safety PLC I/O MCB 108	■	■	■
VLT® Analog I/O Option MCB 109	-	■	-
VLT® PTC Thermistor Card MCB 112	■	■	-
VLT® Sensor Input Card MCB 114	-	■	-
VLT® Programmable I/O MCB 115	■	■	-
VLT® Safety Option MCB 150 TTL	-	■	-
VLT® Safety Option MCB 151 HTL	-	■	-
VLT® Safety Option MCB 152 PROFIsafe STO	-	■	■
VLT® Sensorless Safety MCB 159	-	■	-

■ Standard □ Optional

VLT® General Purpose I/O MCB 101

This I/O option offers an extended number of control inputs and outputs:

- 3 digital inputs 0-24 V: Logic '0' < 5 V; Logic '1' > 10V
- 2 analog inputs 0-10 V: Resolution 10 bit plus sign
- 2 digital outputs NPN/PNP push pull
- 1 analog output 0/4-20 mA
- Spring-loaded connection

Ordering number

130B1125 standard
130B1212 coated (Class 3C3/IEC 60721-3-3)

VLT® Encoder Input MCB 102

This option offers the possibility to connect various types of incremental and absolute encoders. The connected encoder can be used for closed loop speed/position control as well as closed loop flux motor control.

The following encoder types are supported:

- 5V TTL (RS 422)
- 1VPP SinCos
- SSI
- Hiperface
- EnDat 2.1 and 2.2

Ordering number

130B1115 standard
130B1203 coated (Class 3C3/IEC 60721-3-3)

VLT® Resolver Input MCB 103

This option enables connection of a resolver to provide speed feedback from the motor.

- Primary voltage 2-8 Vrms
- Primary frequency 2.0-15 kHz
- Primary current max. 50 mA rms
- Secondary input voltage 4 Vrms
- Spring-loaded connection

Ordering number

130B1127 standard
130B1227 coated (Class 3C3/IEC 60721-3-3)

VLT® Relay Card MCB 105

Makes it possible to extend relay functions with 3 additional relay outputs.

- Max. switch rate at rated load/min. load 6 min⁻¹/20 sec⁻¹
- Protects control cable connection
- Spring-loaded control wire connection

Max. terminal load:

- AC-1 Resistive load 240 V AC 2 A
- AC-15 Inductive load @cos phi 0.4 240 V AC 0.2 A
- DC-1 Resistive load 24 V DC 1 A
- DC-13 Inductive load @cos phi 0.4 24 V DC 0.1 A

Min. terminal load:

- DC 5 V 10 mA

Ordering number

130B1110 standard
130B1210 coated (Class 3C3/IEC 60721-3-3)

VLT® Safe PLC I/O MCB 108

The VLT® AutomationDrive FC 302 provides a safety input based on a single-pole 24 V DC input.

- For the majority of applications, this input enables the user to implement safety in a cost-effective way. For applications that work with more advanced products like Safety PLC and light curtains, the Safe PLC interface enables the connection of a two-wire safety link
- The Safe PLC Interface allows the Safe PLC to interrupt on the plus or the minus link without interfering the sense signal of the Safe PLC

Ordering number

130B1120 standard
130B1220 coated (Class 3C3/IEC 60721-3-3)

VLT® Analog I/O Option MCB 109

This analog input/output option is easily fitted in the AC drive for upgrading to advanced performance and control using the additional I/O. This option also upgrades the AC drive with a battery back-up supply for the AC drive built-in clock. This provides stable use of all AC drive clock functions as timed actions.

- 3 analog inputs, each configurable as both voltage and temperature input
- Connection of 0-10 V analog signals as well as Pt1000 and Ni1000 temperature inputs
- 3 analog outputs each configurable as 0-10 V outputs
- Back-up supply for the standard clock function in the AC drive

The back-up battery typically lasts for 10 years, depending on environment.

Ordering number

130B1143 standard
130B1243 coated (Class 3C3/IEC 60721-3-3)

VLT® PTC Thermistor Card MCB 112

The VLT® PTC Thermistor Card MCB 112 enables improved surveillance of the motor condition compared to the built-in ETR function and thermistor terminal.

- Protects the motor from overheating
- ATEX-approved for use with Ex d and Ex e motors
- Uses Safe Torque Off function, which is approved in accordance with SIL 2 IEC 61508

Ordering number

130B1137 coated (Class 3C3/IEC 60721-3-3)

VLT® Sensor Input Card MCB 114

This option protects the motor from being overheated by monitoring the temperature of bearings and windings in the motor.

- Protects the motor from overheating
- 3 self-detecting sensor inputs for 2 or 3 wire PT100/PT1000 sensors
- 1 additional analog input 4-20 mA

Ordering number

130B1172 standard
130B1272 coated (Class 3C3/IEC 60721-3-3)

VLT® Programmable I/O MCB 115

The option provides 3 programmable analog inputs and 3 analog outputs. Analog inputs can be used for voltage, current and temperature input. Analog outputs can be used as voltage, current and digital output.

Ordering number

130B1266

VLT® Safety Option MCB 150, 151

The VLT® Safety Options MCB 150 and MCB 151 expand the Safe Torque Off (STO) function, which is integrated in a standard VLT® AutomationDrive. Use the Safe Stop 1 (SS1) function to perform a controlled stop before removing torque. Use the Safely-Limited Speed SLS function to monitor whether a specified speed is exceeded.

When the VLT® Safety Option MCB 150 or MCB 151 is combined with the built-in VLT® Sensorless Safety MCB 159 option, an external sensor is no longer required for safe speed monitoring.

The functions can be used up to PLd according to ISO 13849-1 and SIL 2 according to IEC 61508.

- Additional standards-compliant safety functions
- Replacement of external safety equipment
- Reduced space requirements
- 2 safe programmable inputs
- 1 safe output (for T37)
- Easier machine certification
- Drive can be powered continuously
- Safe LCP Copy
- Dynamic commissioning report
- TTL (MCB 150) or HTL (MCB 151) encoder as speed feedback

Ordering number

130B3280 MCB 150, 130B3290 MCB 151

VLT® Safety Option MCB 152

The VLT® Safety Option MCB 152 enables activation of Safe Torque Off (STO) via the PROFIsafe fieldbus in combination with VLT® PROFINET MCA 120 fieldbus option. It improves flexibility by connecting safety devices within a plant.

The safety functions of the MCB 152 are implemented according to EN IEC 61800-5-2. The MCB 152 supports PROFIsafe functionality to activate integrated safety functions of the VLT® AutomationDrive from any PROFIsafe host, up to Safety Integrity Level SIL 2 according to EN IEC 61508 and EN IEC 62061, Performance Level PLd, Category 3 according to EN ISO 13849-1.

- PROFIsafe device (in combination with MCA 120)
- Replacement of external safety equipment
- 2 safe programmable inputs
- Safe LCP copy
- Dynamic commissioning report

Ordering number

130B9860 coated (Class 3C3/IEC 60721-3-3)

VLT® Sensorless Safety MCB 159

The VLT® Safety Option MCB 151 extended with the VLT® Sensorless Safety MCB 159 option provides safe sensorless speed functions (SS1/SLS/SMS) for VLT® AutomationDrive FC 302.

With the MCB 159 option, an external sensor is no longer required for safe speed monitoring. Select VLT® Sensorless Safety MCB 159 as a C1 option in the configurator when ordering a new drive. MCB 159 is not available for retrofit.

MCB 159 is only available as an extension to MCB 151.

Ordering number

Only available as factory option

*Ordering number for loose option card (to be used only for FC 301 and FC 302)

C options: Relay card and Motion control

Available for the full product range

Option	FC 301	FC 302	FCD 302
VLT® Extended Relay Card MCB 113	■	■	–
VLT® Motion Control MCO 305	■	■	–
VLT® Synchronizing Control MCO 350	■	■	–
VLT® Positioning Controller MCO 351	■	■	–

■ Standard

□ Optional

VLT® Extended Relay Card MCB 113

The VLT® Extended Relay Card MCB 113 adds inputs/outputs for increased flexibility.

- 7 digital inputs
- 2 analog outputs
- 4 SPDT relays
- Meets NAMUR recommendations
- Galvanic isolation capability

Ordering number

130B1164 standard
130B1264 coated (Class 3C3/IEC 60721-3-3)

VLT® Motion Control MCO 305

An integrated programmable motion controller adding extra functionality for VLT® AutomationDrive FC 301 and FC 302.

VLT® Motion Control Option MCO 305 offers easy-to-use motion functions combined with programmability – an ideal solution for positioning and synchronizing applications.

- Synchronization (electronic shaft), positioning and electronic cam control
- 2 separate interfaces supporting both incremental and absolute encoders
- 1 encoder output (virtual master function)
- 10 digital inputs
- 8 digital outputs
- Support of CANopen motion bus, encoders and I/O modules
- Sends and receives data via fieldbus interface (requires fieldbus option)
- PC software tools for debugging and commissioning: Program and Cam editor
- Structured programming language with both cyclic and event-driven execution

Ordering number

130B1134 standard
130B1234 coated (Class 3C3/IEC 60721-3-3)

VLT® Synchronizing Controller MCO 350

The VLT® Synchronizing Controller MCO 350 for VLT® AutomationDrive expands the functional properties of the AC drive in synchronizing applications, and replaces traditional mechanical solutions.

- Speed synchronizing
- Position (angle) synchronizing with or without marker correction
- On-line adjustable gear ratio
- On-line adjustable position (angle) offset
- Encoder output with virtual master function for synchronization of multiple followers
- Control via I/Os or fieldbus
- Home function
- Configuration as well as read-out of status and data via the LCP

Ordering number

130B1152 standard
130B1252 coated (Class 3C3/IEC 60721-3-3)

VLT® Positioning Controller MCO 351

The VLT® Positioning Controller MCO 351 offers a host of user-friendly benefits for positioning applications in many industries.

Features:

- Relative positioning
- Absolute positioning
- Touch-probe positioning
- End-limit handling (software and hardware)
- Control via I/Os or fieldbus
- Mechanical brake handling (programmable hold delay)
- Error handling
- Jog speed/manual operation
- Marker related positioning
- Home function
- Configuration as well as read-out of status and data via the LCP

Ordering number

130B1153 standard
130B1253 coated (Class 3C3/IEC 60721-3-3)

D options: 24 V back-up power supply and RTC

Available for the full product range

Option	FC 301	FC 302	FCD 302
VLT® 24 V DC Supply MCB 107	■	■	■
VLT® Real-time Clock MCB 117	■	■	–

■ Standard □ Optional

VLT® 24 V DC Supply MCB 107

Connect an external DC supply to keep the control section and any installed option functioning during power failure.

This enables full operation of the LCP (including the parameter setting) and all installed options without connection to mains.

- Input voltage range.....24 V DC +/- 15%
(max. 37 V for 10 sec.)
- Max. input current2.2 A
- Max. cable length75 m
- Input capacitance load < 10 uF
- Power-up delay< 0.6 s

Ordering number*

130B1108 standard
130B1208 coated (Class 3C3/IEC 60721-3-3)

VLT® Real-time Clock MCB 117

The option provides advanced data-logging functionality. It allows events to be time and date stamped, providing vast amounts of actionable data. The option keeps the drive updated with daily date and real-time data.

- Availability of real time data with reference to run-time data
- Programmable both locally and remotely via option
- Advanced data logging using real-time stamps

Ordering number

134B6544

*Ordering number for loose option card (to be used only for FC 301 and FC 302)

Power options

Power option	FC 301	FC 302	FCD 302
VLT® Advanced Harmonic Filter AHF 005/010	■	■	-
VLT® Line Reactor MCC 103	■	■	-
VLT® Sine-Wave Filter MCC 101	■	■	-
VLT® All-mode Filter MCC 201	■	■	-
VLT® dU/dt Filter MCC 102	■	■	-
VLT® Common Mode Filters MCC 105	■	■	-
VLT® Brake Resistors MCE 101	■	■	-

■ Standard □ Optional

VLT® Advanced Harmonic Filter AHF 005 and AHF 010

- Optimized harmonic performance for VLT® drives rated up to 250 kW
- A patented technique reduces THD levels in the mains network to less than 5-10%
- Perfect match for industrial automation, highly dynamic applications and safety installations
- Intelligent cooling with variable-speed fan

Power range

380-415 V AC (50 and 60 Hz)
440-480 V AC (60 Hz)
600 V AC (60 Hz)
500-690 V AC (50 Hz)

Enclosure ratings

- IP20
(An IP21/NEMA 1 upgrade kit is available)

Ordering number

See relevant Design Guide

VLT® Line Reactor MCC 103

- Ensures current balance in load-sharing applications, where the DC-side of the rectifier of multiple drives is connected together
- UL-recognized for applications using load sharing
- When planning load-sharing applications, pay special attention to different enclosure type combinations and inrush concepts
- For technical advice regarding load-sharing applications, contact Danfoss application support
- Compatible with VLT® AutomationDrive 50 Hz or 60 Hz mains supply

Ordering number

See relevant Design Guide

VLT® Sine-wave Filter MCC 101

- VLT® Sine-wave Filters are positioned between the AC drive and the motor to provide a sinusoidal phase-to-phase motor voltage
- Reduces motor insulation stress
- Reduces acoustic noise from the motor
- Reduces bearing currents (especially in large motors)
- Reduces losses in the motor
- Prolongs service lifetime
- VLT® FC series family look

Power range

3 x 200-500 V, 2.5-800 A
3 x 525-690 V, 4.5-660 A

Enclosure ratings

- IP00 and IP20 wall-mounted enclosures rated up to 75 A (500 V) or 45 A (690 V)
- IP23 floor-mounted enclosures rated 115 A (500 V) or 76 A (690 V) or more
- IP54 both wall-mounted and floor-mounted enclosures rated up to 4.5 A, 10 A, 22 A (690 V)

Ordering number

See relevant Design Guide

VLT® All-mode Filter MCC 201

- Reduces voltage drop for long cable operation
- Enables longer cables than limited by the drive
- Enables use of unshielded motor cables
- Reduces acoustical switching noise from motor
- Improves conducted emissions
- Eliminates motor bearing currents
- Eliminates motor insulation stress
- Extends motor service life

Ordering number

See relevant Design Guide

VLT® dU/dt Filter MCC 102

- Reduces the dU/dt values on the motor terminal phase-to-phase voltage
- Positioned between the AC drive and the motor to eliminate very fast voltage changes
- The motor terminal phase-to-phase voltage is still pulse shaped but its dU/dt values are reduced
- Reduces stress on the motor's insulation and are recommended in applications with older motors, aggressive environments or frequent braking which cause increased DC link voltage
- VLT® FC series family look

Power range

3 x 200-690 V (up to 880 A)

Enclosure ratings

- IP00 and IP20/IP23 enclosure in the entire power range
- IP54 enclosure available up to 177 A

Ordering number

See relevant Design Guide

VLT® Common Mode Filter MCC 105

- Positioned between the AC drive and the motor
- They are nano-crystalline cores that mitigate high-frequency noise in the motor cable (shielded or unshielded) and reduce bearing currents in the motor
- Extends motor bearing lifetime
- Can be combined with dU/dt and sine-wave filters
- Reduces radiated emissions from the motor cable
- Reduces electromagnetic interference
- Easy to install – no adjustments necessary
- Oval shaped – allows mounting inside the AC drive enclosure or motor terminal box

Power range

380-415 V AC (50 and 60 Hz)
440-480 V AC (60 Hz)
600 V AC (60 Hz)
500-690 V AC (50 Hz)

Ordering number

130B3257 Enclosure size A and B
130B7679 Enclosure size C1
130B3258 Enclosure size C2, C3 and C4
130B3259 Enclosure size D
130B3260 Enclosure size E and F

VLT® Brake Resistor MCE 101

- Energy generated during braking is absorbed by the resistors, protecting electrical components from heating up
- Optimized for the FC-series and general versions for horizontal and vertical motion are available
- Built-in thermo switch
- Versions for vertical and horizontal mounting
- A selection of the vertically mounted units are UL-recognized

Power range

Precision electrical match to each individual VLT® drive power size

Enclosure ratings:

- IP20
- IP21
- IP54
- IP65

Ordering number

See relevant Design Guide

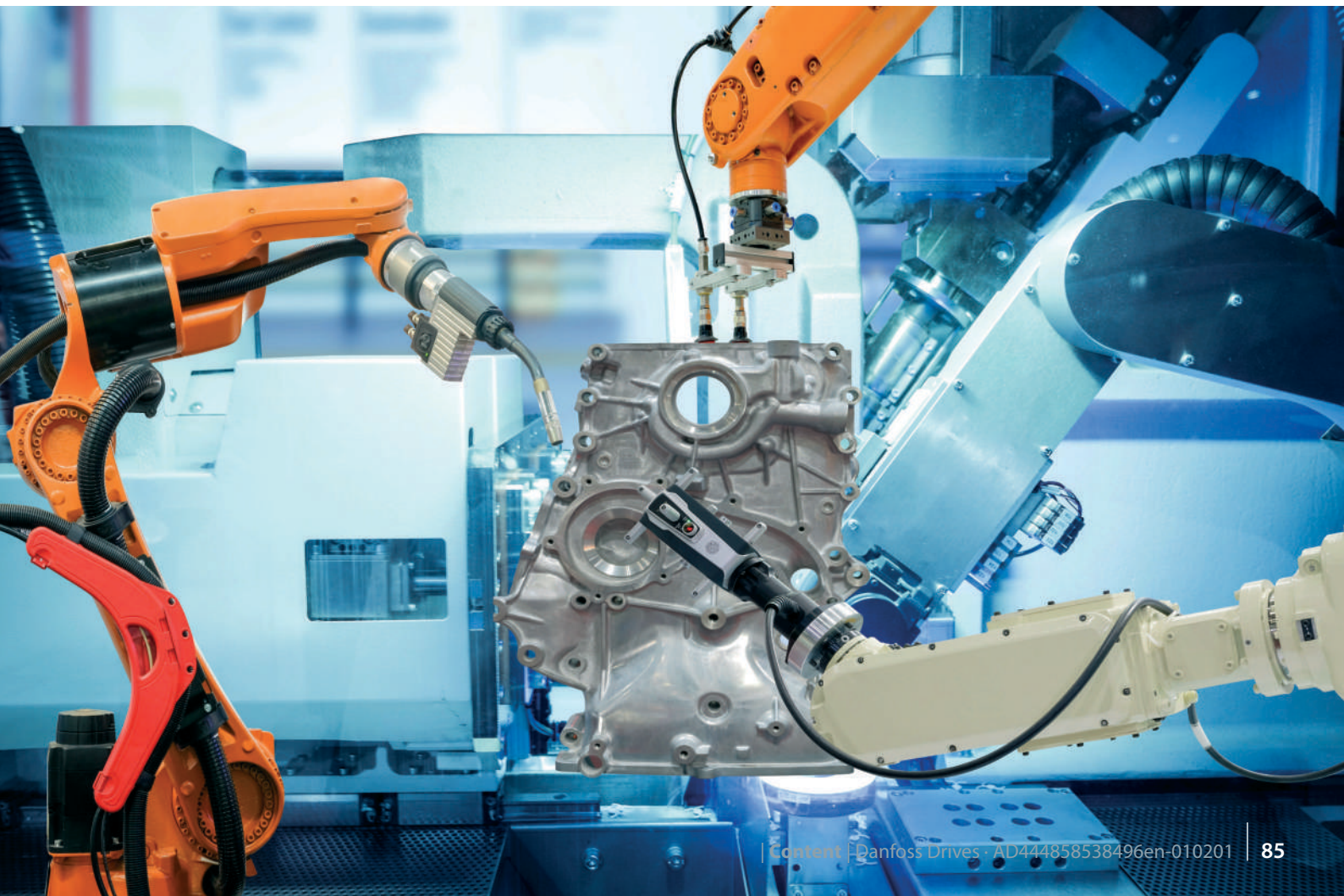

Accessories

Available for VLT® AutomationDrive VLT® Decentral Drive

Local Control Panel (LCP)	FC 301	FC 302	FCD 302
VLT® Control Panel LCP 101 (Numerical) Ordering number: 130B1124	■	■	–
VLT® Control Panel LCP 102 (Graphical) Ordering number: 130B1107	■	■	–
VLT® Control Panel LCP 102 (Graphical) IP66 Ordering number: 130B1078	–	–	■
VLT® Wireless Communication Panel LCP 103 Ordering number: 134B0460	■	■	–
LCP Panel Mounting Kit Ordering number for IP20 enclosure: 130B1113: With fasteners, gasket, graphical LCP and 3 m cable 130B1114: With fasteners, gasket, numerical LCP and 3 m cable 130B1117: With fasteners, gasket and without LCP and with 3 m cable 130B1170: With fasteners, gasket and without LCP Ordering number for IP55 enclosure: 130B1129: With fasteners, gasket, blind cover and 8 m "free end" cable	■	■	–
LCP Remote Mounting Kit Ordering number: 134B5223 – Kit with 3 m cable 134B5224 – Kit with 5 m cable 134B5225 – Kit with 10 m cable	■	■	–
LCP cable Preconfectioned cable to be used between the drive and the and the LCP Ordering number: 130B5776	–	–	■
Mounting Accessories and Adapters	FC 301	FC 302	FCD 302
PROFIBUS SUB-D9 Adapter suitable for IP20, A2 and A3 enclosure Ordering number: 130B1112	■	■	–
Option Adapter Ordering number: 130B1130 standard 130B1230 coated	■	■	–
C option adapter Ordering number: 134B7093	■	■	–
Wall mount adapter-kit FCD300 to FCD302 (small box to small box only) Ordering number: 134B6784	–	–	■
Adapter Plate for VLT® 3000 and VLT® 5000 suitable for IP20/NEMA type 1 units up to 7.5 kW Ordering number: 130B0524	■	■	–
USB Extension Ordering number 350mm cable: 130B1155 Ordering number 650mm cable: 130B1156	■	■	–
IP21/Type 1 (NEMA 1) kit Ordering number: 130B1121: For enclosure size size A1 130B1122: For enclosure size size A2 130B1123: For enclosure size size A3 130B1187: For enclosure size size B3 130B1189: For enclosure size size B4 130B1191: For enclosure size size C3 130B1193: For enclosure size size C4	■	■	–
NEMA 3R outdoor weather shield Ordering number: 176F6302: For enclosure size size D1h 176F6303: For enclosure size size D2h	–	■	–
NEMA 4X outdoor weather shield Ordering number: 130B4598: For enclosure size size A4, A5, B1, B2 130B4597: For enclosure size size C1, C2	■	■	–
Motor connector Ordering number: 130B1065: enclosure size A2 to A5 (10 pieces)	■	■	–
Mains connector Ordering number: 130B1066: 10 pieces mains connectors IP55 130B1067: 10 pieces mains connectors IP20/21	■	■	–
Relay 01 terminal Ordering number: 130B1069 (10 pieces 3 pole connectors for relay 01)	■	■	–
Relay 02 terminal Ordering number: 130B1068 (10 pieces 3 pole connectors for relay 02)	–	■	–

Mounting Accessories and Adapters	FC 301	FC 302	FCD 302
Control card terminals Ordering number: 130B0295	■	■	–
VLT® Leakage Current Monitor Module RCMB20/RCMB35 Ordering number: 130B5645: A2-A3 130B5764: B3 130B5765: B4 130B6226: C3 130B5647: C4	■	■	–
Mounting brackets 5mm Ordering number: 130B5772	–	–	■
Mounting brackets 40mm Ordering number: 130B5771	–	–	■
PE termination M16/M20, stainless steel Ordering number: 175N2703	–	–	■
Goretex Venting membrane Preventing condensation inside enclosure Ordering number: 175N2116	–	–	■
Brake resistor for mounting inside installation box below motor terminals Ordering number: 130B5780: 350 ohm 10 W/100% 130B5778: 1750 ohm 10 W/100%	–	–	■
PC software	FC 301	FC 302	FCD 302
VLT® Motion Control Tool MCT 10	■	■	■
VLT® Motion Control Tool MCT 31	■	■	■
Danfoss HCS Harmonic Calculation Software	■	■	■
VLT® Energy Box	■	■	■
MyDrive® ecoSmart™	■	■	■

□ Optional
■ Standard



Accessory compatibility with enclosure size

Overview for VLT® AutomationDrive enclosure sizes D, E and F only

Enclosure size	Type code position	D1h/ D2h	D3h/ D4h	D5h/ D7h	D6h/ D8h	D1n/ D2n	E1h/ E2h	E3h/ E4h	E9	F1/F2	F3/F4 (w/ options cabinet)	F8	F9 (w/ options cabinet)	F10/ F12	F11/F13 (w/options cabinet)
Enclosure with stainless steel back channel	4	-	□	-	-	-	□	□	-	□	□	-	-	-	-
Mains shielding	4	□	-	□	□	□	□	-	□	■	■	■	■	■	■
Space heaters and thermostat	4	□	-	□	□	-	□	-	-	□	□	-	-	□	□
Cabinet light with power outlet	4	-	-	-	-	-	-	-	-	□	□	-	-	□	□
RFI filters ^(*)	5	□	□	□	□	□	□	□	□	-	□	-	□	-	□
Insulation Resistance Monitor (IRM)	5	-	-	-	-	-	-	-	-	-	□	-	□	-	□
Residual Current Device (RCD)	5	-	-	-	-	-	-	-	-	-	□	-	□	-	□
Brake Chopper (IGBTs)	6	-	□	□	□	□	□	□	□	□	□	□	□	□	□
Safe Torque Off with Pilz Safety Relay	6	□	□	□	□	□	□	□	□	□	□	□	□	□	□
Regeneration terminals	6	-	□	□	□	□	□	□	□	□	□	□	□	□	□
Common Motor Terminals	6	■	■	■	■	■	■	■	■	□	□	■	■	□	□
Emergency Stop with Pilz Safety Relay	6	-	-	-	-	-	-	-	-	-	□	-	-	-	-
Safe Torque Off + Pilz Safety Relay	6	-	-	-	-	-	-	-	-	□	□	□	□	□	□
No LCP	7	□	□	□	□	-	□	□	-	-	-	-	-	-	-
VLT® Control Panel LCP 101 (Numeric)	7	□	□	□	□	-	-	-	-	-	-	-	-	-	-
VLT® Control Panel LCP 102 (Graphical)	7	□	□	□	□	■	■	■	■	■	■	■	■	■	■
Fuses	9	□	□	□	-	□	■	□	□	□	□	□	□	□	□
Load sharing terminals	9	-	□	-	-	-	-	□	-	□	□	-	-	-	-
Fuses + load sharing terminals	9	-	□	-	-	-	-	□	-	□	□	-	-	-	-
Disconnect	9 ⁽¹⁾	-	-	-	□	□	□	□	□	-	□	-	□	-	□
Circuit breakers	9 ⁽¹⁾	-	-	-	□	-	-	-	-	-	□	-	-	-	-
Contactors	9 ⁽¹⁾	-	-	-	□	-	-	-	-	-	□	-	-	-	-
Manual motor starters	10	-	-	-	-	-	-	-	-	□	□	-	-	□	□
30 A, fuse-protected terminals	10	-	-	-	-	-	-	-	-	□	□	-	-	□	□
24V DC supply	11	-	-	-	-	-	-	-	-	□	□	-	-	□	□
External temperature monitoring	11	-	-	-	-	-	-	-	-	□	□	-	-	□	□
Heat sink access panel	11	□	□	□	□	-	□	□	-	-	-	-	-	-	-
NEMA 3R ready drive	11	□	-	-	-	-	-	-	-	-	-	-	-	-	-

⁽¹⁾ Options supplied with fuses

^(*) Not available in 690 V

□ Optional

■ Standard

Enclosure with stainless steel back channel

For additional protection from corrosion in harsh environments, units can be ordered in an enclosure that includes a corrosion resistant back channel.

This option is recommended in salty-air environments, such as those near the ocean.

Mains shielding

Lexan® shielding can be mounted in front of incoming power terminals and the input plate to protect from accidental contact when the enclosure door is open.

Space heaters and thermostat

Mounted in the cabinet interior of drives with enclosure sizes D and F and controlled via an automatic thermostat, space heaters controlled via an automatic thermostat prevent condensation inside the enclosure.

The thermostat default settings turn on the heaters at 10 °C (50 °F) and turn them off at 15.6 °C (60 °F).

Cabinet light with power outlet

A light can be mounted on the cabinet interior of drives with enclosure size F, to increase visibility during servicing and maintenance. The light housing includes a power outlet for temporarily powering laptop computers or other devices. Available in two voltages:

- 230 V, 50 Hz, 2.5 A, CE/ENEC
- 120 V, 60 Hz, 5 A, UL/cUL

RFI filters

VLT® Series drives feature integrated Class A2 RFI filters as standard. If additional levels of RFI/EMC protection are required, they can be obtained using optional Class A1 RFI filters, which provide suppression of radio frequency interference and electromagnetic radiation in accordance with EN 55011.

On drives with enclosure size F, the Class A1 RFI filter requires the addition of the options cabinet.

Marine-use RFI filters are also available.

Insulation Resistance Monitor (IRM)

Monitors the insulation resistance in ungrounded systems (IT systems in IEC terminology) between the system phase conductors and ground. There is an ohmic pre-warning and a main alarm setpoint for the insulation level. Associated with each setpoint is an SPDT alarm relay for external use. Only one insulation resistance monitor can be connected to each ungrounded (IT) system.

- Integrated into the drive's Safe Torque Off circuit
- LCD display of insulation resistance
- Fault memory
- INFO, TEST and RESET key

Residual Current Device (RCD)

Uses the core balance method to monitor ground fault currents in grounded and high-resistance grounded systems (TN and TT systems in IEC terminology). There is a pre-warning (50% of main alarm setpoint) and a main alarm setpoint. Associated with each setpoint is an SPDT alarm relay for external use. Requires an external "window-type" current transformer (supplied and installed by customer).

- Integrated into the drive's Safe Torque Off circuit
- IEC 60755 Type B device monitors, pulsed DC, and pure DC ground fault currents
- LED bar graph indicator of the ground fault current level from 10-100% of the setpoint
- Fault memory
- TEST / RESET key

Safe Torque Off with Pilz Safety Relay

Available for drives with enclosure size F. Enables the Pilz Relay to fit in the enclosure without requiring an options cabinet.

Emergency Stop with Pilz Safety Relay

Includes a redundant 4-wire emergency stop pushbutton mounted on the front of the enclosure, and a Pilz relay that monitors it in conjunction with the drive's Safe Torque Off circuit and contactor position. Requires a contactor and the options cabinet for drives with enclosure size F.

Brake Chopper (IGBTs)

Brake terminals with an IGBT brake chopper circuit allow for the connection of external brake resistors. For detailed data on brake resistors please see the VLT® Brake Resistor MCE 101 Design Guide, MG.90.Ox.yy, available at <http://drivesliterature.danfoss.com/>

Regeneration terminals

Allow connection of regeneration units to the DC bus on the capacitor bank side of the DC-link reactors for regenerative braking. The enclosure size F regeneration terminals are sized for approximately 50% of the power rating of the drive. Consult the factory for regeneration power limits based on the specific drive size and voltage.

Load sharing terminals

These terminals connect to the DC-bus on the rectifier side of the DC-link reactor and allow for the sharing of DC bus power between multiple drives. For drives with enclosure size F, the load sharing terminals are sized for approximately 33% of the power rating of the drive. Consult the factory for load sharing limits based on the specific drive size and voltage.

Disconnect

A door-mounted handle disconnect switch to enable and disable power to the drive, increasing safety during servicing. The disconnect is interlocked with the cabinet doors to prevent them from being opened while power is still applied.

Circuit breakers

A circuit breaker can be remotely tripped, but must be manually reset. Circuit breakers are interlocked with the cabinet doors to prevent them from being opened while power is still applied. When a circuit breaker is ordered as an option, fuses are also included for fast-acting current overload protection of the AC drive.

Contactors

An electrically controlled contactor switch allows for the remote enabling and disabling of power to the drive. An auxiliary contact on the contactor is monitored by the Pilz Safety Module if the IEC Emergency Stop option is ordered.

Manual motor starters

Provide 3-phase power for electric cooling blowers that are often required for larger motors. Power for the starters is provided from the load side of any supplied contactor, circuit breaker or disconnect switch. If a Class 1 RFI filter option is ordered, the input side of the RFI provides the power to the starter. Power is fused before each motor starter and is off when the incoming power to the drive is off. Up to two starters are allowed. If a 30 A, fuse-protected circuit is ordered, then only one starter is allowed. Starters are integrated into the drive's Safe Torque Off circuit.

Unit features include:

- Operation switch (on/off)
- Short circuit and overload protection with test function
- Manual reset function

30 A, fuse-protected terminals

- 3-phase power matching incoming mains voltage for powering auxiliary customer equipment
- Not available if two manual motor starters are selected
- Terminals are off when the incoming power to the drive is off
- Power for the fused-protected terminals will be provided from the load side of any supplied contactor, circuit breaker, or disconnect switch. If a Class 1 RFI filter option is ordered, the input side of the RFI provides the power to the starter.

Common Motor Terminals

The common motor terminal option provides the bus bars and hardware required to connect the motor terminals from the paralleled inverters to a single terminal (per phase) to accommodate the installation of the motor-side top entry kit.

This option is also recommended to connect the output of a drive to an output filter or output contactor. The common motor terminals eliminate the need for equal cable lengths from each inverter to the common point of the output filter (or motor).

24 V DC supply

- 5 A, 120 W, 24 V DC
- Protected against output overcurrent, overload, short circuits, and overtemperature
- For powering customer-supplied accessory devices such as sensors, PLC I/O, contactors, temperature probes, indicator lights and/or other electronic hardware
- Diagnostics include a dry DC-ok contact, a green DC-ok LED and a red overload LED
- Version with RTC available

External temperature monitoring

Designed for monitoring temperatures of external system components, such as the motor windings and/or bearings. Includes eight universal input modules plus two dedicated thermistor input modules. All ten modules are integrated into the drive's Safe Torque Off circuit and can be monitored via a fieldbus

network, which requires the purchase of a separate module/bus coupler. A Safe Torque Off brake option must be ordered when selecting external temperature monitoring.

Universal inputs (5)

Signal types:

RTD inputs (including Pt100), 3-wire or 4-wire Thermocouple

Analog current or analog voltage

Additional features:

- One universal output, configurable for analog voltage or analog current
- Two output relays (N.O.)
- Dual-line LC display and LED diagnostics
- Sensor lead wire break, short circuit and incorrect polarity detection
- Interface set-up software
- If 3 PTC are required, an MCB 112 control card option must be added.

Additional external temperature monitors:

- This option is available in case you need more than the MCB 114 and MCB 112 provides.

VLT® Control Panel LCP 101 (Numeric)

- Status messages
- Quick menu for easy commissioning
- Parameter setting and adjusting
- Hand-operated start/stop function or selection of Automatic mode
- Reset function

Ordering number

130B1124

VLT® Control Panel LCP 102 (Graphical)

- Multi-language display
- Quick menu for easy commissioning
- Full parameter back-up and copy function
- Alarm logging
- Info key explains the function of the selected item on display
- Hand-operated start/stop or selection of Automatic mode
- Reset function
- Trend graphing

Ordering number

130B1107

VLT® Wireless Communication Panel LCP 103

- Full access to the drive
- Real-time error messages
- PUSH notifications for alarms/warnings
- Safe and secure WPA2 encryption
- Intuitive parameter functionalities
- Live graphs for monitoring and fine tuning
- Multi-language support
- Upload or download parameter file to the built-in memory or to your smartphone

Ordering number

134B0460

USB in the door kit

Available for all enclosure sizes, this USB extension cord kit allows access to the drive controls via laptop computer without opening the drive.

The kits can only be applied to drives manufactured after a certain date. Drives built prior to these dates do not have the provisions to accommodate the kits. Reference the following table to determine which drives the kits can be applied to.

Ordering number

Enclosure sizes D.....	176F1784
Enclosure sizes E.....	176F1784
Enclosure sizes F.....	176F1784

Enclosure size F top entry kit motor cables

To use this kit, the drive must be ordered with the common motor terminal option. The kit includes everything to install a top entry cabinet on the motor side (right side) of an F size enclosure.

Ordering number

F1/F3, 400 mm	176F1838
F1/F3, 600 mm	176F1839
F2/F4 400 mm	176F1840
F2/F4, 600 mm	176F1841
F8, F9, F10, F11, F12, F13	Contact factory

Enclosure size F top entry kit mains cables

The kits include everything required to install a top entry section onto the mains side (left side) of an F size enclosure.

Ordering number

F1/F2, 400 mm	176F1832
F1/F2, 600 mm	176F1833
F3/F4 with disconnect, 400 mm	176F1834
F3/F4 with disconnect, 600 mm	176F1835
F3/F4 without disconnect, 400 mm	176F1836
F3/F4 without disconnect, 600 mm	176F1837
F8, F9, F10, F11, F12, F13	Contact factory

Common motor terminal kits

The common motor terminal kits provide the busbars and hardware required to connect the motor terminals from the paralleled inverters to a single terminal (per phase) to accommodate the installation of the motor-side top entry kit. This kit is equivalent to the common motor terminal option of a drive. This kit is not required to install the motor-side top entry kit if the common motor terminal option was specified when the drive was ordered.

This kit is also recommended to connect the output of a drive to an output filter or output contactor. The common motor terminals eliminate the need for equal cable lengths from each inverter to the common point of the output filter (or motor).

Ordering number

F1/F2, 400 mm	176F1832
F1/F2, 600 mm	176F1833

Adapter plate

The adapter plate is used to replace an old enclosure size D drive with the new enclosure size D drive, using the same mounting.

Ordering number

D1h/D3h adapter plate to replace D1/D3 drive.....	176F3409
D2h/D4h adapter plate to replace D2/D4 drive.....	176F3410

Back-channel duct kit

Back-channel duct kits are offered for conversion of enclosure sizes D and E. They are offered in two configurations – in-bottom/out-top venting and top only venting. Available for enclosure sizes D3h and D4h.

Ordering number top and bottom

D3h kit 1800 mm without pedestal.....	176F3627
D4h kit 1800 mm without pedestal.....	176F3628
D3h Kit 2000 mm with pedestal.....	176F3629
D4h Kit 2000 mm with pedestal.....	176F3630

NEMA 3R Rittal and welded enclosures

The kits are designed to be used with the IP00/IP20/Chassis drives to achieve an ingress protection rating of NEMA 3R or NEMA 4. These enclosures are intended for outdoor use to provide a degree of protection against inclement weather.

Ordering number for NEMA 3R (welded enclosures)

D3h back-channel cooling kit (in back out back).....	176F3521
D4h back-channel cooling kit (in back out back).....	176F3526

Ordering number for NEMA 3R (Rittal enclosures)

D3h back-channel cooling kit (in back out back).....	176F3633
D4h back-channel cooling kit (in back out back).....	176F3634
E3h back-channel cooling kit (in back out back).....	176F3924
600mm bottom plate.....	176F3924
E3h back-channel cooling kit (in back out back).....	176F3925
800mm bottom plate.....	176F3925
E4h back-channel cooling kit (in back out back).....	176F3926
800mm bottom plate.....	176F3926

NEMA 3R outdoor weather shield

Designed to be mounted over the VLT® drive to protect from direct sun, snow and falling debris. Drives used with this shield must be ordered from the factory as "NEMA 3R Ready". This is an enclosure option in the type code – ESS.

Ordering number

D1h.....	176F6302
D2h.....	176F6303

Back-channel cooling kits for non-Rittal enclosures

The kits are designed to be used with the IP20/Chassis drives in non-Rittal enclosures for in-back/out-back cooling. Kits do not include plates for mounting in the enclosures.

Ordering number

D3h.....	176F3519
D4h.....	176F3524

Ordering number for stainless steel

D3h.....	176F3520
D4h.....	176F3525

Back-channel cooling kit (in-bottom/out-back)

Kit for directing the back-channel air flow in the bottom of the drive and out the back.

Ordering number

D1h/D3h.....	176F3522
D2h/D4h.....	176F3527

Ordering number stainless steel

D1h/D3h.....	176F3523
D2h/D4h.....	176F3528

Back-channel cooling kit (in-back/out-back)

These kits are designed to be used for redirecting the back-channel air flow. Factory back-channel cooling directs air in the bottom of the drive and out the top. The kit allows the air to be directed in and out the back of the drive.

Ordering number for in-back/out-back cooling kit

D1h.....	176F3648
D2h.....	176F3649
D3h.....	176F3625
D4h.....	176F3626
D5h/D6h.....	176F3530
E1h.....	176F6617
E2h.....	176F6618

Ordering number for stainless steel

D1h.....	176F3656
D2h.....	176F3657
D3h.....	176F3654
D4h.....	176F3655

Ordering number for VLT® Low Harmonic Drives

D1n.....	176F6482
D2n.....	176F6481
E9.....	176F3538
F18.....	176F3534

Ordering number for VLT® Advanced Active Filter AAF006

D14.....	176F3535
----------	----------

Telescopic back-channel cooling kit

Back-channel cooling kits for IP20/Chassis drives allow the heat sink air of the drive to be directed out of the panel in which the drive is installed. The new telescopic provides more flexibility and easier installation to fit inside the panel.

The kits are supplied in almost pre-assembled condition, and include a gland plate that fits standard Rittal enclosures.

Ordering numbers for D-frames:

D3h (in-bottom/out-back).....	176F6760
D4h (in-bottom/out-back).....	176F6761

Ordering numbers for E-frames:

E3h (in bottom/out top).....	176F6606
600 mm bottom plate.....	176F6606
E3h (in bottom/out top).....	176F6607
800 mm bottom plate.....	176F6607
E4h (in bottom/out top).....	176F6608
800 mm bottom plate.....	176F6608
E3h (in back/out back).....	176F6610
E4h (in back/out back).....	176F6611
E3h (in bottom/out back).....	176F6612
600 mm bottom plate.....	176F6612
E3h (in bottom/out back).....	176F6613
800 mm bottom plate.....	176F6613
E4h (in bottom/out back).....	176F6614
800 mm bottom plate.....	176F6614
E3h (in back/out top).....	176F6615
E4h (in back/out top).....	176F6616

Pedestal kit with in-back/ out-back cooling

See additional documents 177R0508 and 177R0509.

Ordering number

D1h 400 mm kit 176F3532
D2h 400 mm kit 176F3533

Pedestal kit

The pedestal kit is a 400 mm high pedestal for enclosure sizes D1h, D2h, E1h and E2h and 200 mm high for enclosure sizes D5h and D6h, that allows the drives to be floor mounted. The front of the pedestal has openings for input air to cool the power components.

Ordering number

D1h 400 mm kit 176F3631
D2h 400 mm kit 176F3632
D5h/D6h 200 mm kit 176F3452
D7h/D8h 200 mm kit 176F3539
E1h 400 mm kit 176F6764
E2h 400 mm kit 176F6763

Input-plate option kit

Input-plate option kits are available for enclosure sizes D and E. The kits can be ordered to add fuses, disconnect/fuses, RFI, RFI/fuses and RFI/disconnect/fuses. Please consult the factory for kit ordering numbers.

Top entry of fieldbus cables

The top entry kit provides the ability to install fieldbus cables through the top of the drive. The kit is IP20 when installed. If an increased rating is desired, a different mating connector can be used.

Ordering number

D1h-D8h 176F3594

Top-entry Sub D9 connector kit for PROFIBUS option

This kit provides a top-entry sub D9 PROFIBUS connection that maintains the IP protection rating of the drive up to IP54.

Ordering number

176F1742

LCP Remote Mounting Kit

The LCP Remote Mounting Kit offers an easy-to-install, IP54 design which you can mount on panels and walls of 1-90 mm thickness. The front cover blocks the sunlight for convenient

programming. The closed cover is lockable to prevent tampering, while keeping the On/Warning/Alarm LEDs visible. It is compatible with all VLT® Local Control Panel options.

Ordering number for IP20 enclosure

3 m cable length 134B5223
5 m cable length 134B5224
10 m cable length 134B5225

Ground bar kit

More grounding points for E1h and E2h drives. The kit includes a pair of ground bars for installation inside the enclosure.

Ordering number

E1h/E2h 176F6609

Multi-wire kit

The kit is designed to connect the drive with multi-wire cable for each motor phase or mains phase.

Ordering number

D1h 176F3817
D2h 176F3818

L-shaped busbar kit

The kit allows multi-wires mounting for each phase of mains or motor. D1h, D3h drives can have 3 connections per phase of 50 mm² and D2h, D4h can accommodate 4 connections per phase of 70 mm².

Ordering number

D1h/D3h L-shaped motor
busbars kit 176F3812
D2h/D4h L-shaped motor
busbars kit 176F3810
D1h/D3h L-shaped mains
busbars kit 176F3854
D2h/D4h L-shaped mains
busbars kit 176F3855

Common mode cores kit

Designed as a subassembly of 2 or 4 common mode cores to reduce bearing currents. Depending on the voltage and length of the cables, the number of cores change.

Ordering number

Common mode filter T5/50 m 176F6770
Common mode filter T5/100 m
or T7 176F3811

Space heater kit

The space heater kit includes a pair of 40 W anti-condensation heaters for installation inside E1h and E2h enclosures.

Ordering number

E1h, E2h 176F6748

Cable clamp kit

The kit includes all parts required to install cable clamps for mains, motor, and control wiring.

Ordering number

E3h 176F6746
E4h 176F6747

Disconnect accessory kit

This kit is to be ordered when you select E3h & E4h drive with disconnect option. E3h & E4h drive with disconnect option. The kit contains disconnect handle & shaft.

Ordering number

E3h, E4h 176F3857





Stronger on the outside, more intelligent on the inside

Providing consistently awesome performance for almost 50 years, VLT® AutomationDrive is built to last. This robust drive operates effectively and reliably even with the most demanding applications and in the most challenging environments.

The modular VLT® AutomationDrive helps save energy, increase flexibility, reduce costs related to spare parts and servicing, and optimize process control on any industrial machine or production line across a wide range of industries.

Powder mixing
productivity triples
with wireless PROFINET
Huijbregts Groep, Holland

[Read the story](#)

Peroni Brewery selects
VLT® FlexConcept®
to **optimize**
operating costs
Peroni Brewery, Rome, Italy

[Read the story](#)

Italcementi enjoys
optimized process
performance in all
conditions
Italcementi Group (GSM Aggregates
limestone quarry, Roussas, France)

[Read the story](#)

[Discover more case stories for the AutomationDrive industry](#)

Follow us and learn more about AC drives

