

Frequency Inverters S1 Series

HITACHI

Inspire the Next





S1 Series

The new Standard in Sensorless Vector Control Drives

Hitachi maintains research and development departments throughout the business. These are continually working on the further improvement of products and technologies and synergy effects are specifically used in product policy.

Hitachi offers a broad range of inverters for many industrial applications. The inverters' modular design and high versatility ensure optimal, cost-efficient technical solutions which can be individually adapted to the respective application. The industrial inverters can be configured easily, and are designed to deliver unprecedented performance, reliability and flexibility.

The new S1 series is perceived as the new standard for general purpose inverter, highly flexible and user friendly for easy commissioning. It is suitable for a wide range of applications, using advanced sensorless vector control. S1 achieves exceptional stability and efficient drive characteristics to save energy and maximize performance.



Full product line-up from 0.4kW up to 500kW



Compact Design Dual Rating

(0.4kW – 2.2kW)

Features

Thanks to the compact design, less installation space is required. Flexible installation with DIN rail and wall mounting possibilities. Available to mount multi-inverter in side-by-side installation to be more effective and space-saving.

- Easy maintenance
- Various installation ways
- Excellent performance
- Multi-function and easy to use
- Potentiometer on the front for easy frequency adjustment

Dual rating to support space and cost savings

LD- Low Duty for Applications with normal load without large temporarily overload or torque.
 ND- Normal Duty for applications with heavy load and constant high torque.



Optional external keypad

- Supports optional external LED keypad
- The external LED keypad supports parameter copy function

Advanced thermal technology



Maintenance friendly thanks to easily removable cooling fan.



For space saving side-by-side mounting it is required to remove the protective film from the top heat releasing grids.



1PH 220V (-15%) – 240V (+10%)
 3PH 380V (-15%) – 440V (+10%)



Mounting Dimensions

Model	W1	W2	H1	H2	H3	H4	D1	D2	Installation hole (d)
S1-00032SFE	80.0	60.0	160.0	150.0	35.4	36.6	123.5	120.3	5
S1-00055SFE	80.0	60.0	160.0	150.0	35.4	36.6	123.5	120.3	5
S1-00100SFE	80.0	60.0	185.0	175.0	35.4	36.6	140.5	137.3	5
S1-00130SFE	80.0	60.0	185.0	175.0	35.4	36.6	140.5	137.3	5
S1-00032HFE	80.0	60.0	185.0	175.0	35.4	36.6	140.5	137.3	5
S1-00055HFE	80.0	60.0	185.0	175.0	35.4	36.6	140.5	137.3	5
S1-00073HFE	80.0	60.0	185.0	175.0	35.4	36.6	140.5	137.3	5

Wall Mounting

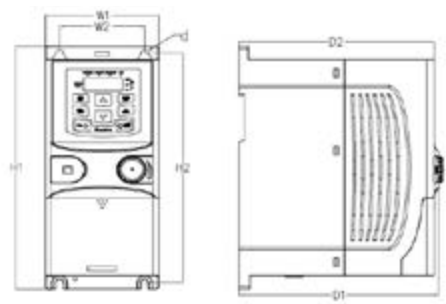

Rail Mounting

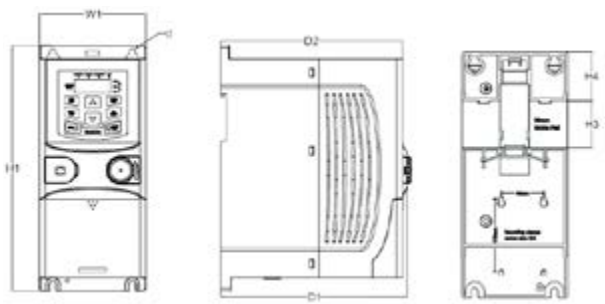



4.0kW – 500kW

Dual Rating

S1 is the new simple and easy to use inverter with top performance. Targeting for OEM equipment markets, mainly covering general applications like packaging, winding, Fan & Pump and many others.

Product Features

- Supports SVC control
- Enables high precision of speed torque control and fast speed response
- Integrates safety function-STO (Safe Torque OFF, SIL2)
- The unique I/F control is very suitable at low speed with high torque requirements
- The transition from rotating state to dc braking is very smooth. The current impact is small, and the current response of dc braking is faster
- Excellent performance at "Catch-on-the-Fly"
- Solid plastic housing 4 – 75kW
- Solid metal housing 90 – 500kW
- ≤37kW Standard built-in DBU
- Internal C3 EMC filter, Optional external C2 EMC filter
- PID control function (with sleep function).
- Automatic voltage regulation (AVR), Torque compensate function
- Optional parameter copy LED external keypad, meeting the requirements of diverse applications

Typical applications

- Pumps & Irrigation
- Fans
- Hoisting / Crane
- Crushers
- Mills
- Conveyors
- Machine Tools
- CNC
- Mixers
- DC Motor replacement
- Slip-ring motor replacement
- Servo drive
- Chemical
- Plastic extruder, granulator
- Variable speed motor control
- Energy Saving





3PH 380V (-15%) - 440V (+10%)



Excellent performance at "Catch-on-the-Fly"

The S1 is very suitable for applications where large flywheel masses continue to run for a very long time after the power supply has been interrupted. These are for example applications with large fans or centrifuges. S1 detects the remaining speed and catches the motor at the correct position to accelerate back to the intended speed.

Output frequency

Output current

Output voltage

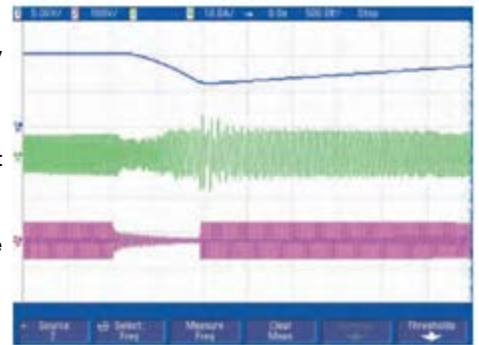

Dimensions (4kW - 500kW)

Voltage	Model	W1	H1	D1	Installation hole (d)	Fixing screw
400V	S1-00125HFEF	126	186	201	5	M4
	S1-00170HFEF; S1-00230HFEF	146	256	192	6	M5
	S1-00320HFEF; S1-00380HFEF	170	320	220	6	M5
	S1-00450HFEF; S1-00600HFEF	200	340.6	208	6	M5
	S1-00750HFEF; S1-00920HFEF	250	400	223	6	M5
	S1-01150HFEF; S1-01500HFEF	282	560	258	9	M8
	S1-02150HFEF; S1-01700HFEF	338	554	330	10	M8
	S1-03050HFEF; S1-03400HFEF; S1-02600HFEF S1-03800HFEF; S1-04250HFEF	500	870	360	11	M10
	S1-04800HFEF; S1-05300HFEF; S1-06000HFEF; S1-06500HFEF	680	926	380	13	M12
	S1-07200HFEF; S1-08600HFEF	620	1700	580	22	M20

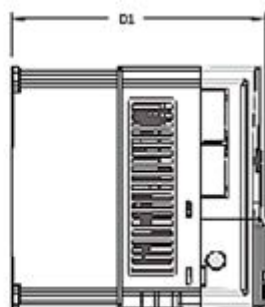



S1 Series IP55 version Dual Rating (4kW – 110kW)



S1-IP55: Well equipped for decentralized drive applications with the robust S1 in high protection class.
 Many applications require that the inverter can be used in close proximity to the motor. A high protection class is therefore essential. In applications such as overhead air vents or agitators in the activated sludge tanks of sewage treatment plants as well as many other applications, it is often a mandatory requirement to be able to install the inverter in a harsh environment threatened by dust or moisture.
 The S1 in IP55 version offers this in an efficient version in a power range from 4kW–110kW with integrated C3 filter.

Features

- Ingress protection rating of IP55 applicable to working environments dust and water vapor conditions (NEMA rating 3S)
- The S1 IP55 inverter is also designed as a dual-rated inverter, to be used cost-effectively in ND or LD mode, depending on the application and load.
- Built-in DC reactors as standard from 18,5kW to 110kW
- Built-in brake chopper (standard from 4 to 37 kW (ND), optional from 45 to 110 kW (ND))

Safe Torque Off function (STO, common feature for IP20 and IP55)

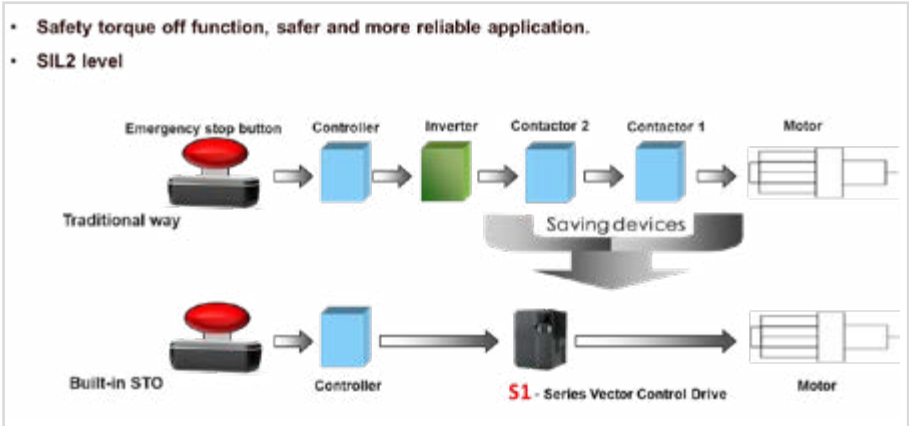
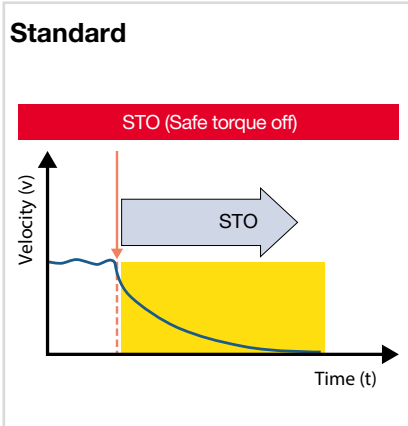

General specifications

Function	(0.4kW – 2.2kW)	(4.0kW – 500kW)
Input voltage (V)	AC 1PH 220V (-15%) – 240V (+10%) AC 3PH 380V (-15%) – 440V (+10%)	AC 3PH 380V (-15%) – 440V (+10%)
Input current (A)	Refer to Rated value ND or LD	
Input frequency (Hz)	50Hz or 60Hz, allowed range: 47–63Hz	
Output voltage (V)	AC 3PH 0 - Input Voltage	
Output current (A)	Refer to Rated value ND or LD	
Output power (kW)	Refer to Rated value ND or LD	
Output frequency (Hz)	0–400Hz	
Speed control precision	±0.2% (SVC)	
Speed fluctuation	±0.3% (SVC)	
Torque response	<20ms (SVC)	
Torque control precision	10% (SVC)	
Starting torque	0.5Hz/150% (SVC)	0.25Hz/150% (SVC)
Overload capacity	150% of rated current: 1min (ND), 120% of rated current: 1min (LD) 180% of rated current: 10s (ND), 150% of rated current: 10s (LD) 200% of rated current: 1s (ND), 180% of rated current: 1s (LD)	
Frequency setup mode	Digital setting, analog setting, pulse frequency setting, multi-step, speed running setting, PID setting, MODBUS communication setting	
Automatic voltage regulation function	Keep the output voltage constant when grid voltage changes.	
Fault protection function	Fault protection function Provide over 30 kinds of fault protection functions: overcurrent, overvoltage, undervoltage, overtemperature, phase loss and overload, etc.	
Speed tracking restart function (Catch-on-the-fly)	-	Realize impact-free starting of the rotating motor
Analog input	2 inputs: 0–10V / 0–20mA and -10–10V	
Analog output	1 output: 0–10V / 0–20mA	
Digital input	4 common inputs, max. frequency: 1kHz; 1 high speed input, max. frequency: 50kHz	4 common inputs; max. frequency: 1kHz; 2 high-speed inputs; max. frequency: 50kHz
Digital output	1 high-speed pulse output; max. frequency: 50kHz 1 Y terminal open collector output	
Relay output	1 programmable relay output R01A NO, R01B NC, R01C common port 3A/AC250V, 1A/DC30V	2 programmable relay outputs R01A NO, R01B NC, R01C common port R02A NO, R02B NC, R02C common port 3A/AC250V, 1A/DC30V
Terminal analog input	Less than 20mV	
Terminal digital input resolution	Less than 2ms	
Degree of Protection	IP20	
Operating ambient temperature	-10–50°C, derating is required if the ambient temperature exceeds 40°C	
Speed regulation ratio	1:100 (SVC)	1:200 (SVC)
EMC filter	- Optional external filter fulfils IEC61800-3 C2	Built-in EMC filter fulfils IEC61800-3 C3 Optional external filter fulfils IEC61800-3 C2
Cooling mode	Air-cooling	
Installation mode	Wall and rail mountable	Support wall-mounting, floor-mounting and flange-mounting
Functional Safety	STO: SIL2	
Pollution level	Level 2	
Altitude	<1000m If the sea level is above 1000m, please derate 1% for every additional 100m.	
Brake unit	Brake unit up to 37kW, Optional brake unit from 45kW	
Certification	CE marking	



Standard specifications

Model name S1-*****		00032SFE	00055SFE	00100SFE	00130SFE	00032HFE	00055HFE	00073HFE	00125HFEF	00170HFEF	00230HFEF
Degree of Protection		IP20									
Applicable motor capacity (4 poles) (kW)	LD	0.75	1.10	2.20	3.00	1.10	2.20	3.00	5.50	7.50	11.0
	ND	0.40	0.75	1.50	2.20	0.75	1.50	2.20	4.00	5.50	7.50
Rated capacity (kVA)	LD	0.74	1.27	2.30	3.00	2.21	3.80	5.05	8.65	12.80	15.92
	ND	0.58	0.97	1.73	2.30	1.70	2.90	3.80	6.60	9.70	12.8
Rated AC input voltage		AC 1PH 220V (-15%) – 230V (+10%)					AC 3PH 380V (-15%) – 440V (+10%)				
Rated output current (A)	LD	3.20	5.50	10.0	13.0	3.20	5.50	7.30	12.5	17.0	23.0
	ND	2.50	4.20	7.50	10.0	2.50	4.20	5.50	9.50	14.0	18.5
Overload current rating	LD	120% 60sec / 150% 10s / 180% 1s									
	ND	150% 60sec / 180% 10s / 200% 1s									
Rated output voltage		AC 3PH: 230 or 400V (proportional to input voltage)									
Starting torque (ND)		0.50Hz/150% (SVC) (ND)							0.25Hz/150% (SVC) (ND)		
Regenerative braking		Brake unit up to 37kW, Optional brake unit from 45kW									
Minimum resistance value (Ω)		42	42	30	21	240	170	130	80	60	47
H (height) (mm)		160	160	185	185	185	185	185	186	256	256
W (width) (mm)		80	80	80	80	80	80	80	126	146	146
D (depth) (mm)		123.5	123.5	140.5	140.5	140.5	140.5	140.5	201	192	192
Weight (kg)		0.9	0.9	1.2	1.2	1.0	1.0	1.0	2.5	2.5	3.0

Model name S1-*****HFEF		00320	00380	00450	00600	00750	00920	01150	01500	01700	02150
Degree of Protection		IP20									
Applicable motor capacity (4 poles) (kW)	LD	15.0	18.5	22.0	30.0	37.0	45.0	55.0	75.0	90.0	110.0
	ND	11.0	15.0	18.5	22.0	30.0	37.0	45.0	55.0	75.0	90.0
Rated capacity (kVA)	LD	22.1	26.3	31.1	41.5	51.9	63.7	79.6	103.8	118.0	148.8
	ND	17.3	22.1	26.3	31.1	41.5	51.9	63.7	79.6	103.8	124.6
Rated AC input voltage		AC 3PH 380V (-15%) – 440V (+10%)									
Rated output current (A)	LD	32.0	38.0	45.0	60.0	75.0	92.0	115.0	150.0	170.0	215.0
	ND	25.0	32.0	38.0	45.0	60.0	75.0	92.0	115.0	150.0	180.0
Overload current rating	LD	120% 60sec / 150% 10s / 180% 1s									
	ND	150% 60sec / 180% 10s / 200% 1s									
Rated output voltage		AC 3PH: 230 or 400V (proportional to input voltage)									
Starting torque		0.25Hz/150% (SVC) (ND)									
Regenerative braking		Brake unit up to 37kW, Optional brake unit from 45kW									
Minimum resistance value (Ω)		31	23	19	17	17	11.7	6.4	6.4	6.4	4.4
H (height) (mm)		320	320	340.6	340.6	400	400	560	560	554	554
W (width) (mm)		170	170	200	200	250	250	282	282	338	338
D (depth) (mm)		220	220	208	208	223	223	258	258	330	330
Weight (kg)		6.0	6.0	8.5	8.5	16.0	16.0	25.0	25.0	25.0	41.0

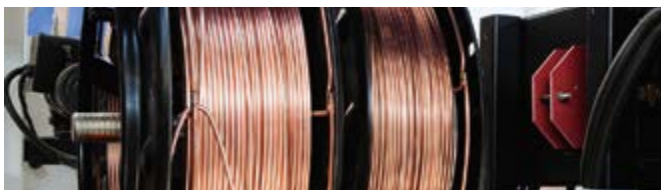

Model name S1-****HFEF		02600	03050	03400	03800	04250	04800	05300	06000	06500	07200	08600
Degree of Protection		IP20										
Applicable motor capacity (4 poles) (kW)	LD	132.0	160.0	185.0	200.0	220.0	250.0	280.0	315.0	350.0	400.0	500.0
	ND	110.0	132.0	160.0	185.0	200.0	220.0	250.0	280.0	315.0	350.0	400.0
Rated capacity (kVA)	LD	179.9	211.1	235.3	263.0	294.1	332.2	366.8	415.2	449.8	498.2	595.1
	ND	148.8	179.9	211.1	235.3	263.0	294.1	332.2	366.8	415.2	449.8	498.2
Rated AC input voltage		AC 3PH 380V (-15%) – 440V (+10%)										
Rated output current (A)	LD	260.0	305.0	340.0	380.0	425.0	480.0	530.0	600.0	650.0	720.0	860.0
	ND	215.0	260.0	305.0	340.0	380.0	425.0	480.0	530.0	600.0	650.0	720.0
Overload current rating	LD	120% 60sec / 150% 10s / 180% 1s										
	ND	150% 60sec / 180% 10s / 200% 1s										
Rated output voltage		AC 3PH: 230 to 400V (proportional to input voltage)										
Starting torque (ND)		0.25Hz/150% (SVC) (ND)										
Regenerative braking		Brake unit up to 37kW, Optional brake unit from 45kW										
H (height) (mm)		554	870	870	870	870	960	960	960	960	1700	1700
W (width) (mm)		338	500	500	500	500	680	680	680	680	620	620
D (depth) (mm)		330	360	360	360	360	380	380	380	380	560	560
Weight (kg)		41.0	85.0	85.0	85.0	85.0	135.0	135.0	135.0	135.0	350.0	350.0

Model S1-****HFEF-55M		00125	00170	00230	00320	00380	00450	00600	00750	00920	01150	01500	01700	02150	02150-55MND
Degree of Protection		IP55													
Mains Switch		Integrated as standard													
Display		Full Graphic LCD													
Applicable motor capacity (4 poles) (kW)	LD	5.50	7.50	11.0	15.0	18.5	22.0	30.0	37.0	45.0	55.0	75.0	90.0	110.0	–
	ND	4.00	5.50	7.50	11.0	15.0	18.5	22.0	30.0	37.0	45.0	55.0	75.0	90.0	110.0
Rated capacity (kVA)	LD	8.65	12.80	15.92	22.1	26.3	31.1	41.5	51.9	63.7	79.6	103.8	118.0	148.8	–
	ND	6.60	9.70	12.8	17.3	22.1	26.3	31.1	41.5	51.9	63.7	79.6	103.8	124.6	148.8
Rated AC input voltage		AC 3PH 380V (-15%) – 440V (+10%)													
Rated output current (A)	LD	12.5	17.0	23.0	32.0	38.0	45.0	60.0	75.0	92.0	115.0	150.0	170.0	215.0	–
	ND	9.50	14.0	18.5	25.0	32.0	38.0	45.0	60.0	75.0	92.0	115.0	150.0	180.0	215.0
Overload current rating	LD	120% 60sec / 150% 10s / 180% 1s													–
	ND	150% 60sec / 180% 10s / 200% 1s													
Rated output voltage		AC 3PH: 400V (proportional to input voltage)													
Starting torque (ND)		150% from 0.25Hz (SVC) (ND)													
Braking Chopper		Standard										Optional			
Minimum resistance value (Ω)		80	60	47	31	23	19	17	17	11.7	6.4	6.4	6.4	4.4	4.4
H (height) (mm)		403	403	475	475	475	522	522	587	587	800	800	788	788	788
W (width) (mm)		260.5	260.5	289.4	289.4	289.4	279.5	279.5	290	290	336.7	336.7	380	380	380
D (depth) (mm)		196	196	223	223	223	274	274	318	318	338	338	370	370	370
Weight (kg)		7.0	7.0	13.0	13.0	13.0	21.0	21.0	26.5	26.5	48.2	48.2	64.0	64.0	64.0



HITACHI

Inspire the Next

Hitachi Europe GmbH, Niederkasseler Lohweg 191, D-40547 Düsseldorf
Phone: +49(0)211-5283-0
www.hitachi-industrial.eu, automation.industrial@hitachi-eu.com

All company and product names in this brochure are the property of the respective companies.