

HITACHI INVERTER

SJ700D-3 SERIES

Quick Reference Guide

Read through this Quick Reference Guide, and keep it handy for future reference.

NT2311X

HITACHI

Introduction

Introduction

Thank you for purchasing Hitachi SJ700D-3 Series Inverter. This Quick Reference Guide describes the contents of planning the installation, installing, commissioning, using and servicing the Hitachi SJ700D-3 Series Inverter. Please read this document and the instruction manual before operation to perfectly understand proper handling and safety precautions for the product to ensure safety and proper usage. Before attempting installation, operation and maintenance work, you should understand the knowledge of equipment, information of safety, caution and how to use and service the inverter. You should also use the inverter by observing specifications described this guide and prevent risks by performing maintenance.

This guide is "Quick Reference Guide". Refer to "SJ700D-3 series Instruction Manual" on CD bundled with the inverter for more information. If you use the inverter with optional products, also you should read the manuals for those products. Note that this guide, the instruction manual and the manual for each optional product to be used should be delivered to the end user of the inverter.

Handling of this Quick Reference Guide and bundled CD (the Instruction Manual)

- The contents of the guide and the CD are subject to change without prior notice.
- Even if you lose the guide and the CD, it will not be resupplied, so please keep it carefully.
- No part of the guide and the CD may be reproduced in any form without the publisher's permission.
- If you find any incorrect description, missing description or have a question concerning the contents of these manuals, please contact the publisher.

Revision History

No.	Revision content	Date of issue	Manual code
1	First edition	April, 2014	NT2311X

Safety Instructions

Safety Instructions

Be sure to read this Quick Reference Guide and appended documents thoroughly before installing, operating, maintaining, or inspecting the inverter. In this Quick Reference Guide, safety instructions are classified into two levels, namely WARNING and CAUTION.

 **WARNING** : Indicates that incorrect handling may cause hazardous situations, which may result in serious personal injury or death.

 **CAUTION** : Indicates that incorrect handling may cause hazardous situations, which may result in moderate or slight personal injury or physical damage alone.

Note that even a  **CAUTION** level situation may lead to a serious consequence according to circumstances. Be sure to follow every safety instruction, which contains important safety information. Also focus on and observe the items and instructions described under "Notes" in the text.

CAUTION

- Many of the drawings in the Quick Reference Guide show the inverter with covers and/or parts blocking your view as removed. Do not operate the inverter in the status shown in those drawings. If you have removed the covers and/or parts, be sure to reinstall them in their original positions before starting operation, and follow all instructions in this Instruction Manual when operating the inverter.

1. Installation

CAUTION

- Install the inverter on a non-flammable surface, e.g., metal. Otherwise, you run the risk of fire.
- Do not place flammable materials near the installed inverter. Otherwise, you run the risk of fire.
- When carrying the inverter, do not hold its top cover. Otherwise, you run the risk of injury by dropping the inverter.
- Prevent foreign matter (e.g., cut pieces of wire, sputtering welding materials, iron chips, wire, and dust) from entering the inverter. Otherwise, you run the risk of fire.
- Install the inverter on a structure able to bear the weight specified in this Instruction Manual. Otherwise, you run the risk of injury due to the inverter falling.
- Install the inverter on a vertical wall that is free of vibrations. Otherwise, you run the risk of injury due to the inverter falling.
- Do not install and operate the inverter if it is damaged or its parts are missing. Otherwise, you run the risk of injury.
- Install the inverter in a well-ventilated indoor site not exposed to direct sunlight. Avoid places where the inverter is exposed to high temperature, high humidity, condensation, dust, explosive gases, corrosive gases, flammable gases, grinding fluid mist, or salt water. Otherwise, you run the risk of fire.
- The inverter is precision equipment. Do not allow it to fall or be subject to high impacts, step on it, or place a heavy load on it. Doing so may cause the inverter to fail.

2. Wiring

WARNING

- Be sure to ground the inverter. Otherwise, you run the risk of electric shock or fire.
- Commit wiring work to a qualified electrician. Otherwise, you run the risk of electric shock or fire.
- Before wiring, make sure that the power supply is off. Otherwise, you run the risk of electric shock or fire.
- Perform wiring only after installing the inverter. Otherwise, you run the risk of electric shock or injury.
- Do not remove rubber bushings from the wiring section. Otherwise, the edges of the wiring cover may damage the wire, resulting in a short circuit or ground fault.

CAUTION

- Make sure that the voltage of AC power supply matches the rated voltage of your inverter. Otherwise, you run the risk of injury or fire.
- Do not input single-phase power into the inverter. Otherwise, you run the risk of fire.
- Do not connect AC power supply to any of the output terminals (U, V, and W). Otherwise, you run the risk of injury or fire.
- Do not connect a resistor directly to any of the DC terminals (PD, P, and N). Otherwise, you run the risk of fire.
- Connect an earth-leakage breaker to the power input circuit. Otherwise, you run the risk of fire.
- Use only the power cables, earth-leakage breaker, and magnetic contactors that have the specified capacity (ratings). Otherwise, you run the risk of fire.
- Do not use the magnetic contactor installed on the primary and secondary sides of the inverter to stop its operation.
- Tighten each screw to the specified torque. No screws must be left loose. Otherwise, you run the risk of fire.
- Before operating, slide switch SW1 in the inverter, be sure to turn off the power supply. Otherwise, you run the risk of electric shock and injury.
- Since the inverter supports two modes of cooling-fan operation, the inverter power is not always off, even when the cooling fan is stopped. Therefore, be sure to confirm that the power supply is off before wiring. Otherwise, you run the risk of electric shock and injury.

Safety Instructions

3. Operation

WARNING

- While power is supplied to the inverter, do not touch any terminal or internal part of the inverter, check signals, or connect or disconnect any wire or connector. Otherwise, you run the risk of electric shock or fire.
- Be sure to close the terminal block cover before turning on the inverter power. Do not open the terminal block cover while power is being supplied to the inverter or voltage remains inside. Otherwise, you run the risk of electric shock.
- Do not operate switches with wet hands. Otherwise, you run the risk of electric shock.
- While power is supplied to the inverter, do not touch the terminal of the inverter, even if it has stopped. Otherwise, you run the risk of injury or fire.
- If the retry mode has been selected, the inverter will restart suddenly after a break in the tripping status. Stay away from the machine controlled by the inverter when the inverter is under such circumstances. (Design the machine so that human safety can be ensured, even when the inverter restarts suddenly.) Otherwise, you run the risk of injury.
- Do not select the retry mode for controlling an elevating or traveling device because output free-running status occurs in retry mode. Otherwise, you run the risk of injury or damage to the machine controlled by the inverter.
- If an operation command has been input to the inverter before a short-term power failure, the inverter may restart operation after the power recovery. If such a restart may put persons in danger, design a control circuit that disables the inverter from restarting after power recovery. Otherwise, you run the risk of injury.
- The [STOP] key is effective only when its function is enabled by setting. Prepare an emergency stop switch separately. Otherwise, you run the risk of injury.
- If an operation command has been input to the inverter before the inverter enters alarm status, the inverter will restart suddenly when the alarm status is reset. Before resetting the alarm status, make sure that no operation command has been input.
- While power is supplied to the inverter, do not touch any internal part of the inverter or insert a bar in it. Otherwise, you run the risk of electric shock or fire.

CAUTION

- Do not touch the heat sink, which heats up during the inverter operation. Otherwise, you run the risk of burn injury.
- The inverter allows you to easily control the speed of motor or machine operations. Before operating the inverter, confirm the capacity and ratings of the motor or machine controlled by the inverter. Otherwise, you run the risk of injury.
- Install an external brake system if needed. Otherwise, you run the risk of injury.
- When using the inverter to operate a standard motor at a frequency of over 60 Hz, check the allowable motor speeds with the manufacturers of the motor and the machine to be driven and obtain their consent before starting inverter operation. Otherwise, you run the risk of damage to the motor and machine.
- During inverter operation, check the motor for the direction of rotation, abnormal sound, and vibrations. Otherwise, you run the risk of damage to the machine driven by the motor.

4. Maintenance, inspection, and parts replacement

WARNING

- Before inspecting the inverter, be sure to turn off the power supply and wait for 10 minutes or more. Otherwise, you run the risk of electric shock. (Before inspection, confirm that the Charge lamp on the inverter is off and the DC voltage between terminals P and N is 45 V or less.)
- Commit only a designated person to maintenance, inspection, and the replacement of parts. (Be sure to remove wristwatches and metal accessories, e.g., bracelets, before maintenance and inspection work and to use insulated tools for the work.) Otherwise, you run the risk of electric shock and injury.

5. Others

WARNING

- Never modify the inverter. Otherwise, you run the risk of electric shock and injury.

CAUTION

- Do not discard the inverter with household waste. Contact an industrial waste management company in your area who can treat industrial waste without polluting the environment.

Safety Instructions**Caution for EMC (Electromagnetic Compatibility) (0.4kW-150kW)**

The SJ700D series inverter conforms to the requirements of Electromagnetic Compatibility (EMC) Directive (2004/108/EC). However, when using the inverter in Europe, you must comply with the following specifications and requirements to meet the EMC Directive and other standards in Europe:



WARNING: This equipment must be installed, adjusted, and maintained by qualified engineers who have expert knowledge of electric work, inverter operation, and the hazardous circumstances that can occur. Otherwise, personal injury may result.

1. Power supply requirements

- a. Voltage fluctuation must be -15% to +10% or less.
- b. Voltage imbalance must be $\pm 3\%$ or less.
- c. Frequency variation must be $\pm 4\%$ or less.
- d. Total harmonic distortion (THD) of voltage must be $\pm 10\%$ or less.

2. Installation requirement

- a. The integrated filter in the SJ700D series inverter must be enabled. (See chapter 2 Installation and Wiring)
* When using the specific external filter for the SJ700D series inverter, please refer to the instruction described in the dedicated guide book for the filter.

3. Wiring requirements

- a. A shielded wire (screened cable) must be used for motor wiring, and the length of the cable must be according to the following table (Table 1).
- b. The carrier frequency must be set according to the following table to meet an EMC requirement (Table 1).
- c. The main circuit wiring must be separated from the control circuit wiring.

4. Environmental requirements (to be met when a filter is used)

- a. Ambient temperature must be within the range -10°C to $+50^{\circ}\text{C}$.
- b. Relative humidity must be within the range 20% to 90% (non-condensing).
- c. Vibrations must be 5.9 m/s^2 (0.6 G) (10 to 55 Hz) or less. (0.4 to 22kW)
 2.94 m/s^2 (0.3 G) (10 to 55Hz) or less. (30 to 150kW)
- d. The inverter must be installed indoors (not exposed to corrosive gases and dust) at an altitude of 1,000 m or less.

Safety Instructions

Table 1

model	cat.	cable length(m)	carrier frequency(kHz)	model	cat.	cable length(m)	carrier frequency(kHz)
SJ700D-004L	C3	5	2.5				
SJ700D-007L	C3	5	2.5	SJ700D-007H	C3	5	2.5
SJ700D-015L	C3	5	2.5	SJ700D-015H	C3	5	2.5
SJ700D-022L	C3	5	2.5	SJ700D-022H	C3	5	2.5
SJ700D-037L	C3	5	2.5	SJ700D-037H SJ700D-040H	C3	5	2.5
SJ700D-055L	C3	1	1	SJ700D-055H	C3	1	2.5
SJ700D-075L	C3	1	1	SJ700D-075H	C3	1	2.5
SJ700D-110L	C3	1	1	SJ700D-110H	C3	1	2.5
SJ700D-150L	C3	1	1	SJ700D-150H	C3	1	2.5
SJ700D-185L	C3	1	1	SJ700D-185H	C3	1	2.5
SJ700D-220L	C3	5	2.5	SJ700D-220H	C3	1	2.5
SJ700D-300L	C3	5	2.5	SJ700D-300H	C3	1	2.5
SJ700D-370L	C3	5	2.5	SJ700D-370H	C3	1	2.5
SJ700D-450L	C3	5	2.5	SJ700D-450H	C3	5	2.5
SJ700D-550L	C3	5	2.5	SJ700D-550H	C3	5	2.5
				SJ700D-750H	C3	10	2.5
				SJ700D-900H	C3	10	2.5
				SJ700D-1100H	C3	10	2.5
				SJ700D-1320H	C3	10	2.5
				SJ700D-1500H	C3	10	2.5

Safety Instructions

Cautions for UL and cUL (0.4kW-150kW)

(Standard to comply with: UL508C, CSA C22.2 No14-5)

Warning Markings

GENERAL:

These devices are open type and/or Enclosed Type 1 (when employing accessory Type 1 Chassis Kit) AC Inverters with three phase input and three phase output. They are intended to be used in an enclosure. They are used to provide both an adjustable voltage and adjustable frequency to the ac motor. The inverter automatically maintains the required volts-Hz ration allowing the capability through the motor speed range.

- (1) "Use 60/75°C CU wire only" or equivalent.
For models SJ700D series except for models SJ700D-055H, SJ700D-075H, SJ700D-110H.
- (2) "Use 75°C CU wire only" or equivalent.
For models SJ700D series except for SJ700D-075H, SJ700D-110H, SJ700D-055H.
- (3) "Suitable for use on a circuit capable of delivering not more than 100,000rms symmetrical amperes, 240V maximum". For models with suffix L.
- (4) "Suitable for use on a circuit capable of delivering not more than 100,000 rms symmetrical amperes, 480V maximum". For models with suffix H.
- (5) "Install device in pollution degree 2 environment"
- (6) "Maximum Surrounding Air Temperature 45 or 50°C"
- (7) "CAUTION - Risk of Electric Shock - Capacitor discharge time is at least 10 min."
- (8) "Integral solid state short circuit protection does not provide branch circuit protection.
Branch circuit protection must be provided in accordance with the NEC and any additional local codes"
- (9) "Solid State motor overload protection reacts with max. 120% of FLA".
- (10) Tightening torque and wire range for field wiring terminals are in the table below:

<u>Model No.</u>	<u>Required Torque (N.m)</u>	<u>Wire Range (AWG)</u>
SJ700D-004L	1.8	14(Stranded only)
SJ700D-007L	1.8	14(Stranded only)
SJ700D-015L	1.8	14(Stranded only)
SJ700D-022L	1.8	14(Stranded only)
SJ700D-037L	1.8	10(Stranded only)
SJ700D-050L	3.0	8
SJ700D-055L	4.0	8
SJ700D-075L	4.0	6
SJ700D-110L	4.0	6-4
SJ700D-150L	4.9	2
SJ700D-185L	4.9	1
SJ700D-220L	8.8	1 or 1/0
SJ700D-300L	8.8	2/0 or Parallel of 1/0
SJ700D-370L	20.0	4/0 (Prepared wire only) or Parallel of 1/0
SJ700D-450L	20.0	4/0 (Prepared wire only) or Parallel of 1/0
SJ700D-550L	19.6	350 kcmil (Prepared wire only) or Parallel of 2/0 (Prepared wire only)

Safety Instructions

<u>Model No.</u>	<u>Required Torque (N.m)</u>	<u>Wire Range (AWG)</u>
SJ700D-007H	1.8	14(Stranded only)
SJ700D-015H	1.8	14(Stranded only)
SJ700D-022H	1.8	14(Stranded only)
SJ700D-037H	1.8	14(Stranded only)
SJ700D-040H	1.8	14(Stranded only)
SJ700D-055H	4.0	12
SJ700D-075H	4.0	10
SJ700D-110H	4.0	8
SJ700D-150H	4.9	6
SJ700D-185H	4.9	6
SJ700D-220H	4.9	6 or 4
SJ700D-300H	4.9	3
SJ700D-370H	20.0	1
SJ700D-450H	20.0	1
SJ700D-550H	20.0	2/0
SJ700D-750H	20.0	Parallel of 1/0
SJ700D-900H	20.0	Parallel of 1/0
SJ700D-1100H	35.0	Parallel of 3/0
SJ700D-1320H	35.0	Parallel of 3/0
SJ700D-1500H	35.0	Parallel of 3/0

- (11) Distribution fuse / circuit breaker size marking is included in the manual to indicate that the unit shall be connected with a listed inverse time circuit breaker, rated 600 V with the current ratings as shown in the table below:

<u>Model No.</u>	<u>Fuse Size (Maximum A)</u>		<u>Circuit Breaker (A)</u>	
	<u>Type</u>	<u>Rating</u>		<u>Type</u>
SJ700D-004L	J	30 A	SJ700D-004L	J
SJ700D-007L	J	30 A	SJ700D-007L	J
SJ700D-015L	J	30 A	SJ700D-015L	J
SJ700D-022L	J	30 A	SJ700D-022L	J
SJ700D-037L	J	30 A	SJ700D-037L	J
SJ700D-050L	J	30 A	SJ700D-050L	J
SJ700D-055L	J	100 A	SJ700D-055L	J
SJ700D-075L	J	100 A	SJ700D-075L	J
SJ700D-110L	J	100 A	SJ700D-110L	J
SJ700D-150L	J	125 A	SJ700D-150L	J
SJ700D-185L	J	125 A	SJ700D-185L	J
SJ700D-220L	J	125 A	SJ700D-220L	J
SJ700D-300L	J	225 A	SJ700D-300L	J
SJ700D-370L	J	225 A	SJ700D-370L	J
SJ700D-450L	J	250 A	SJ700D-450L	J
SJ700D-550L	J	300 A	SJ700D-550L	J

Safety Instructions

Model No.	Fuse Size (Maximum A)		Circuit Breaker (A)	
	Type	Rating	Type	
SJ700D-007H	J	20 A	SJ700D-007H	J
SJ700D-015H	J	20 A	SJ700D-015H	J
SJ700D-022H	J	20 A	SJ700D-022H	J
SJ700D-037H	J	20 A	SJ700D-037H	J
SJ700D-040H	J	20 A	SJ700D-040H	J
SJ700D-055H	J	40 A	SJ700D-055H	J
SJ700D-075H	J	40 A	SJ700D-075H	J
SJ700D-110H	J	40 A	SJ700D-110H	J
SJ700D-150H	J	75 A	SJ700D-150H	J
SJ700D-185H	J	75 A	SJ700D-185H	J
SJ700D-220H	J	75 A	SJ700D-220H	J
SJ700D-300H	J	100 A	SJ700D-300H	J
SJ700D-370H	J	100 A	SJ700D-370H	J
SJ700D-450H	J	150 A	SJ700D-450H	J
SJ700D-550H	J	150 A	SJ700D-550H	J
SJ700D-750H	J	225 A	SJ700D-750H	J
SJ700D-900H	J	225 A	SJ700D-900H	J
SJ700D-1100H	J	300 A	SJ700D-1100H	J
SJ700D-1320H	J	350 A	SJ700D-1320H	J

Note) Please select an appropriate fuse or an appropriate circuit breaker for a system.

- (12) “Field wiring connection must be made by a UL Listed and CN closed-loop terminal connector sized for the wire gauge involved. Connector must be fixed using the crimp tool specified by the connector manufacturer.”
- (13) “Motor over temperature protection is not provided by the drive.”

DANGER! RISQUE DE BLESSURE OU DE CHOC ELECTRIQUE

- Lire attentivement le manuel avant l'installation et suivre les instructions
- Avant d'intervenir dans le variateur, couper le circuit de puissance et attendre 10 minutes avant d'ouvrir le capot

SJ700-2 to SJ700D-3

The Hitachi SJ700D-3 series succeed the SJ700-2 series with the additional and enhanced features.

The table below is a brief summary of the major improved features.

Subject	SJ700-2	SJ700D-3	Point!
Dual rating Constant torque/ Variable torque	N/A	Selectable	If the inverter drives the light load application (e.g. fan pump application), you can choose the one size smaller capacity inverter than the motor capacity, which allows you to reduce the total cost of your system.
Easy sequence (EzSQ) – Drive program function	Process with 1 task.	Supporting 5 tasks processing with improved user friendliness.	The inverter processes 5 tasks at the same time, which allows you to realize 5 times faster EzSQ processing in maximum.
Optional LCD Operator	WOP operator (2-line LCD)	Full compatibility with WOP operator (5-line LCD and multi-language)	WOP, the optional LCD Operator, provides several user friendliness; <ul style="list-style-type: none"> – Multi data monitoring – Parameter configuration as monitoring data – Parameter / Program copy – Multi-language display
RS-485 serial communications	19.2kbps (maximum)	115.2kbps (maximum), and so on.	Approx. 6 times faster communication in comparison with the former model are supported. In addition, some communication commands are newly supported.
Initialization	After setting b084 (initialization selection), press some keys.	In addition to the conventional method, executing initialization by a parameter is possible. (Select b084 and b180=01 : enable the initializing)	You can initialize easily only by setting the parameter and no special procedure is required
Phase loss protection	Phase loss input protection	Phase loss input protection Phase loss output protection	Protection function expands to not only input side but output side, which provides more reliable protection against the phase loss.

Contents

Start-up Commissioning the drive

S.1	Quick installation and commissioning flowchart	S - 2
S.2	Instructing in using the panel.....	S - 3
S.3	Example of I/O connections	S - 4
S.4	Basic Parameter Setting to Drive Motor.....	S - 8
	S.4.1 Setting Frequency command source and Run command source.....	S - 8
	S.4.2 Frequency command source selection	S - 9
	S.4.3 Run command source selection	S - 11
S.5	Selecting the control mode	S - 13

Chapter 1 Overview

1.1	Inspection of the Purchased Product.....	1 - 2
	1.1.1 Inspecting the product.....	1 - 2
	1.1.2 Quick Reference Guide and Instruction Manual.....	1 - 2
1.2	Method of Inquiry and Product Warranty	1 - 3
	1.2.1 Method of inquiry	1 - 3
	1.2.2 Product warranty.....	1 - 3
	1.2.3 Warranty Terms	1 - 3
1.3	Exterior Views and Names of Parts	1 - 4

Chapter 2 Installation and Wiring

2.1	Installation	2 - 2
	2.1.1 Precautions for installation	2 - 3
	2.1.2 Backing plate	2 - 5
2.2	Wiring	2 - 6
	2.2.1 Terminal connection diagram and explanation of terminals and switch settings	2 - 7
	2.2.2 Wiring of the main circuit	2 - 10
	2.2.3 Wiring of the control circuit	2 - 19
	2.2.4 Wiring of the digital operator	2 - 20

Chapter 3 Operation

3.1	Operating Methods.....	3 - 2
3.2	How to operate the Digital Operator (OPE-SBK)	3 - 4
	3.2.1 Names and functions of components	3 - 4
	3.2.2 Code display system and key operations	3 - 5

Chapter 4 List of Data Settings

4.1	Precautions for Data Setting	4 - 2
4.2	Monitoring Mode	4 - 2
4.3	Function Mode	4 - 3
4.4	Extended Function Mode	4 - 4

Chapter 5 Error Codes

5.1	Error Codes and Troubleshooting	5 - 2
	5.1.1 Error codes	5 - 2
	5.1.2 Trip conditions monitoring	5 - 4
5.2	Warning Codes	5 - 5

Chapter 6 Specifications

6.1	Specifications	6 - 2
6.2	External dimensions	6 - 5

Contents

(Memo)

Start-up Commissioning the drive



This chapter contains quick installation and commissioning flowchart to drive the motor.

S.1	Quick installation and commissioning flowchart.....	S - 2
S.2	Instructing in using the panel	S - 3
S.3	Example of I/O connections	S - 4
S.4	Basic Parameter Setting to Drive Motor	S - 8
S.5	Selecting the control mode.....	S - 13

Start-up Commissioning the drive

S.1 Quick installation and commissioning flowchart

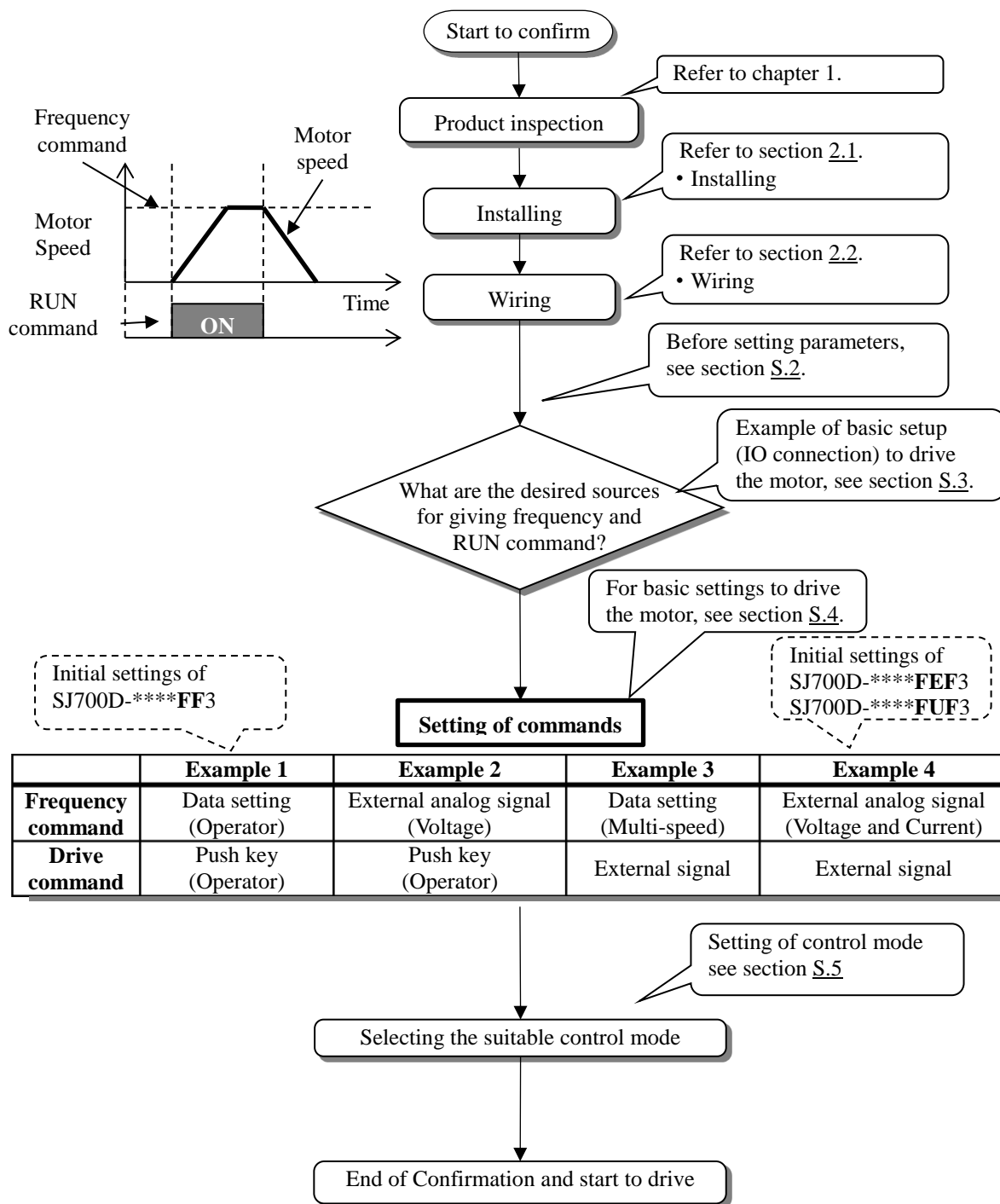

Start-up Commissioning the drive

S.2 Instructing in using the panel

This section describes how to use the operator to change the settings.
 For more information, refer to the SJ700D-3 manual or section 3.2 : How to operate the Digital Operator.

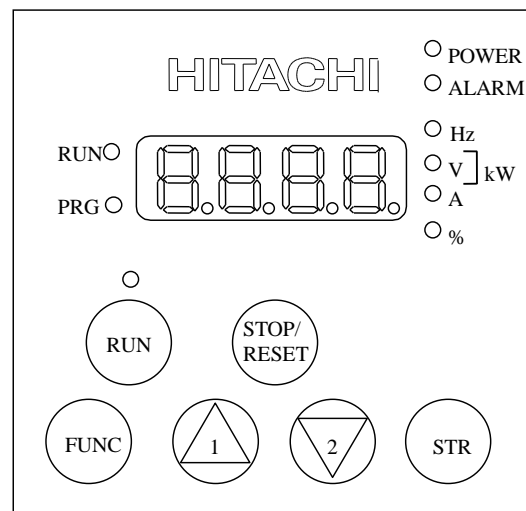

Standard Operator (OPE-SBK)

Indication of using the control panel

Key Operation	Display(Example)	Use examples (** is a three digit number)
FUNC	$\underline{d001} \longleftrightarrow \underline{0.00}$ (Frequency monitor)	In case d*** or F*** display on the panel, indication changes between parameters and data with pushing FUNC key.
	$\begin{matrix} \underline{A---} & \rightarrow & \underline{A044} \\ \uparrow & & \downarrow \\ \underline{A044} & \leftarrow & \underline{00} \end{matrix}$ (Control mode)	In case A***, B***, C***, H***, P*** or U*** display on the panel, indication changes among A--- (head of group), A044 (parameter) and 00 (data) with pushing FUNC key.
STR	$\underline{00} \rightarrow \underline{A044}$ (Control mode)	When the panel indication displays 00 (data), the inverter saves the displayed value as the new setting with pushing the STR key, and panel indication changes to the A044 (parameter). The saved data are held even if the power supply to the inverter is turned off.
1	$\underline{d001} \rightarrow \underline{d002} \rightarrow \dots$ $\rightarrow \underline{F004} \rightarrow \underline{A---} \rightarrow \dots$	Panel Indication scrolls up through d***, F*** and the heads of group (for example A---, B---, C---, H---, P--- and U---).
	$\underline{1.00} \rightarrow \underline{1.01} \rightarrow \dots$ $\underline{A011} \rightarrow \underline{A012} \rightarrow \dots$	The value increases if panel indication displays parameters or data. Holding the key down changes the value faster.
2	$\underline{A---} \rightarrow \underline{F004} \rightarrow \dots \rightarrow$ $\underline{d002} \rightarrow \underline{d001} \rightarrow \dots$	Panel indication scrolls down through d***, F*** and the heads of group (for example A---, B---, C---, H---, P--- and U---).
	$\underline{1.01} \rightarrow \underline{1.00} \rightarrow \dots$ $\underline{A012} \rightarrow \underline{A011} \rightarrow \dots$	The value decreases if panel indication displays parameters or data. Holding the key down changes the value faster.
Simultaneously	$\underline{A044} \rightarrow \text{'A'044}$	Pushing simultaneously enables to change each digit directly.
	$\underline{0.00} \rightarrow \text{'0'.00}$	Operating of the blinking digit is as follows.

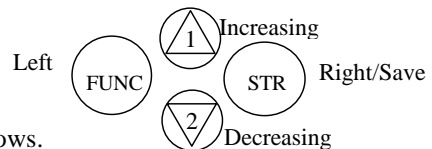

*) In some cases parameters and data are discontinuous.
 (For more information, refer to SJ700D-3 manual.)

Start-up Commissioning the drive

S.3 Example of I/O connections

- Example 1: Frequency command source Setting data in F001 (Digital Operator)
 Run command source RUN/STOP key (Digital Operator)
 *) SJ700D-****FF3 (Initial settings)

(1) I/O connections

(2) Operation

Frequency: By using the digital operator, set the frequency command into parameter F001.

Run/Stop: Push the key **RUN** and **STOP/RESET** on the digital operator to run and stop.

*) Refer to section S.4.2 for changing the frequency command source and section S.4.3 for changing the run command source.

(3) Parameter settings

Parameter	Details	Setting data
A001	Digital Operator	02
A002	Digital Operator	02
F001	Output frequency setting	50.00 <small>Note)</small>

Note) Initial settings are 0.00Hz. You need to set the appropriate data.

Start-up Commissioning the drive

Example 2: : Frequency command source External potentiometer (Control terminal)
 Run command source RUN/STOP key (Control panel)

(1) I/O connections

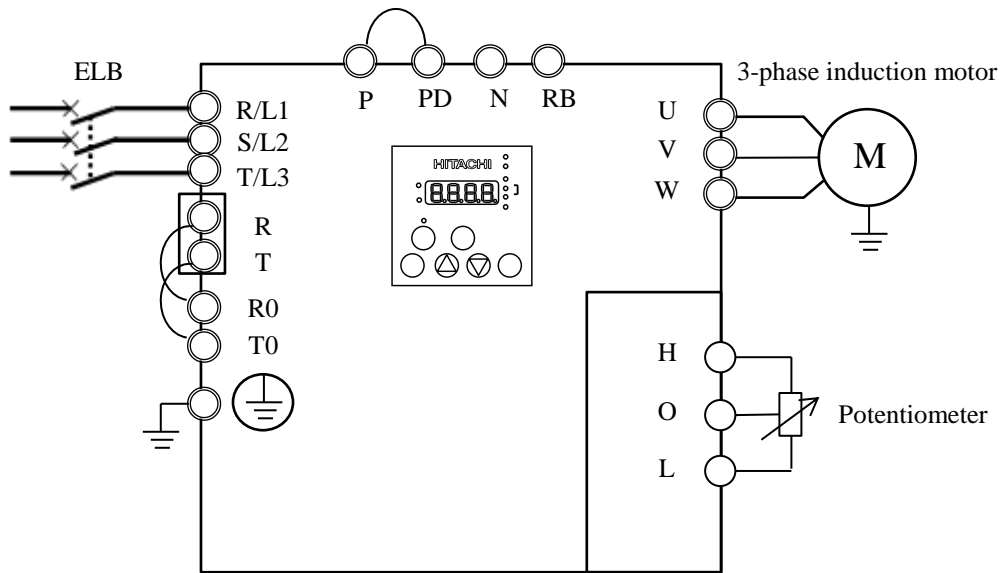

(2) Operation

Frequency: Set the frequency command via a potentiometer connected to H/O/L terminal.

Run/Stop: Push the key **RUN** and **STOP/RESET** to run and stop.

*) Refer to section S.4.2 for changing the frequency command source and section S.4.3 for changing the run command source.

(3) Parameter settings

Parameter	Details	Setting data
A001	Control circuit terminal block	01
A002	Digital Operator	02

Start-up Commissioning the drive

Example 3: Frequency command source Setting data in F001 (Control panel) + multi speed select
 Run command source External signal (Control terminal)

(1) I/O connections

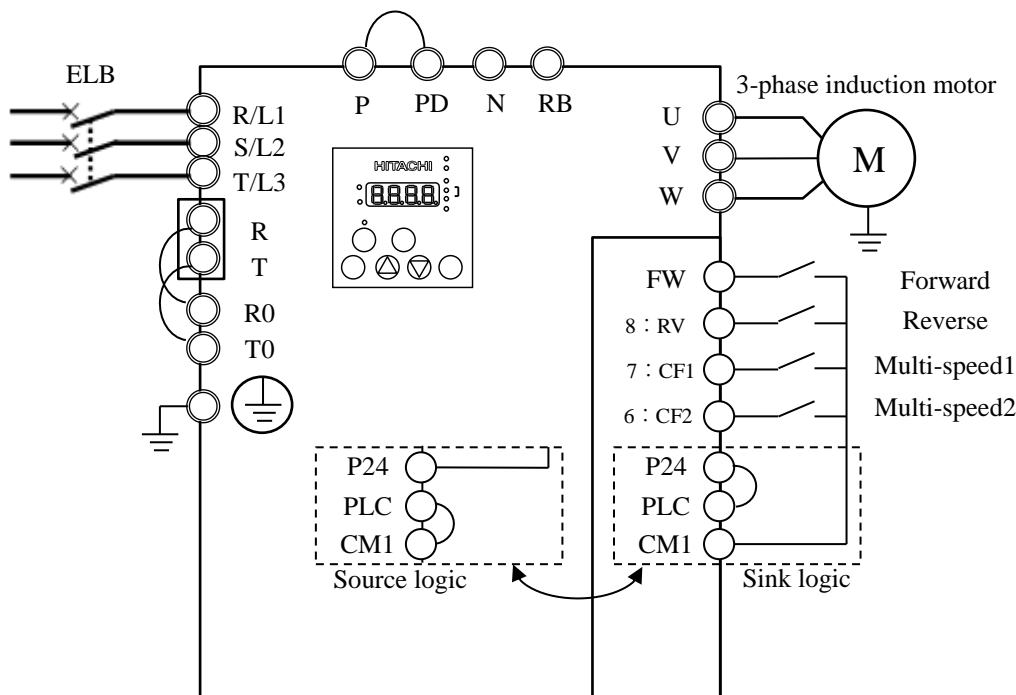

- *) In case of SJ700D-****FUF3, you need to set C006=03 and C016=00.
- *) You need to set multi speed frequency command into parameters (from A020 to A022).
- *) Refer to section [S.4.2](#) for changing the frequency command source and section [S.4.3](#) for changing the run command source.

(2) Operation

Frequency: By using the multi speed terminals, set the frequency command.

Run/Stop: Using the forward / reverse terminal to run and stop.

(3) Parameter settings

Parameter	Details	Setting data
A001	Digital Operator	02
A002	Control circuit terminal block	01
A020	Multi speed 1 and 2 are not active.	0.00 Note)
A021	Multi speed 1is active and multi speed 2 is not active.	0.00 Note)
A022	Multi speed 1is not active and multi speed 2 is active.	0.00 Note)

Note) Initial settings are 0.00Hz. You need to set the appropriate data.

Start-up Commissioning the drive

Example 4: Frequency command source External analog voltage source and current source (Control terminal)

Run command source External signal (Control terminal)

*) SJ700D-****FEF3/FUF3 (Initial settings)

(1) I/O connections

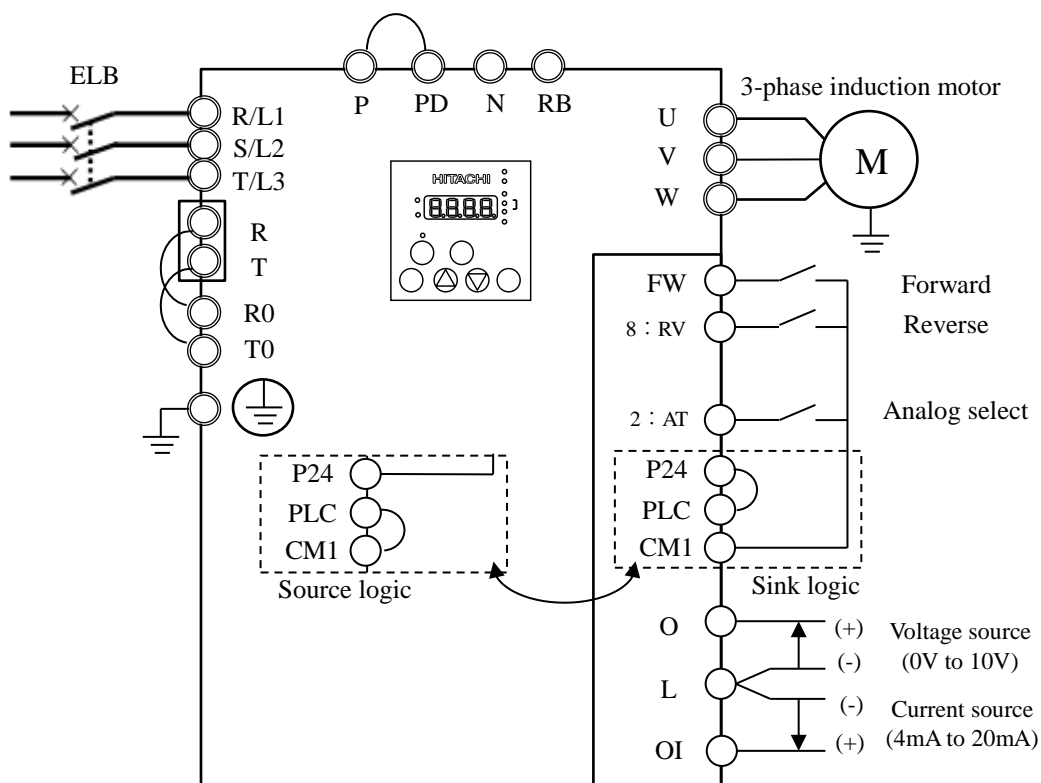

*) Refer to S.4.2 for changing the frequency command source and S.4.3 for changing the run command source.

(2) Operation

Frequency: Using the voltage source and current source to set the frequency command with analog select terminal (AT terminal: OFF: Voltage command / ON: Current command).

* AT terminal is used to switch the analog input O and OI to which the inverter refers as the frequency command. (e.g. When AT terminal is OFF, the inverter outputs the frequency according to the voltage input given to the O terminal)

Run/Stop: Using the forward / reverse terminal to run and stop.

(3) Parameter settings

Parameter	Details	Setting data
A001	Control circuit terminal block	01
A002	Control circuit terminal block	01

Start-up Commissioning the drive

S.4 Basic Parameter Setting to Drive Motor

S.4.1 Setting Frequency command source and Run command source

This section describes how to drive the motor with SJ700D briefly.

The frequency and run command are necessary to drive the motor with the inverter.

In many cases, these sources are set as below;

Setting the frequency : (A) Data settings (Digital operator)
(B) Via external analog signals (Control terminal)

Run and stop : (A) RUN / STOP key (Digital operator)
(B) Via external signal (Control terminal)

The frequency command and Run command sources can be changed by the parameter A001 (Frequency command source) and A002 (Run command source) respectively.

In addition to the basic setting mentioned above, there are several options for A001 and A002 setting.

Parameter	Detail	Data range	Initial settings	
			****FF3	****FEF3 ****FUF3
A001	Frequency source	00(keypad potentiometer) 01(control circuit terminal block) 02(operator) 03(RS485) 04(option 1) 05(option 2) 06(pulse-string input) 07(easy sequence) 10(operation function result)	02	01
A002	Run command source	01(control circuit terminal block) 02(operator) 03(RS485) 04(option 1) 05(option 2)	02	01





*) This chapter explains 01(control circuit terminal block) and 02(operator) mainly.

Start-up Commissioning the drive

S.4.2 Frequency command source selection

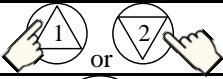

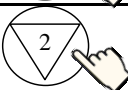
Key operation to set A001

****FF3 : Change A001 from 02 (operator) to 01 (control circuit terminal block).

Procedure	Key operation	Indication	Details
1-1		0.00	After powering up of the inverter, the operator displays 0.00, output frequency monitor (d001)
1-2		d001	Indication changes from data display (0.00) to parameter display (d001).
1-3		A---	Push the key and select the head of Group A.
1-4		A001	Push the key and indication changes from A--- to A001.
1-5		02	Push the key and indication changes to 02(operator).
1-6		01	Push the key and change from 02 to 01 (control circuit terminal block).
1-7		A001	Push the key and indication changes A001 (Data save).
1-8		0.00	By pushing the key for more than three seconds, indication changes to the output frequency data (d001). (It depends on b038 setting)

****FEF3/FUF3 : Change from 01 (control circuit terminal block) to 02 (operator).

*) Replace the procedure 1-5 and 1-6 in the list above with 1-5' and 1-6' in the list below.

Procedure	Key operation	Indication	Details
1-5'		01	Push the key and indication changes to 01(control circuit terminal block).
1-6'		02	Push the key and change the data to 02 (operator).





Start-up Commissioning the drive

Setting frequency command

(A) A001=02: Digital operator

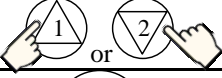
With this setting, the value set in the parameter F001 defines the target frequency of the inverter.

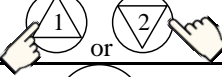
The procedure below shows an example of a procedure to set F001=40Hz.

Procedure	Key operation	Indication	Details
1		0.00	After powering up of the inverter, the operator displays 0.00, output frequency monitor (d001)
2		d001	Indication changes from data (0.00) to parameter (d001).
3		F001	Push the key and select F001 (setting frequency).
4		0.00	Push the key and indication changes setting frequency.
5		40.00	(Example) Set the frequency to 40Hz.
6		F001	Push the key and indication goes back to F001 (Data save). note)
7		0.00	By pushing the key for more than three seconds, the indication changes to the output frequency data. (It depends on b038 setting)

note) In case of the setting A001=02, on displaying the output frequency, the setting frequency can change by the up and down keys.

(B) A001=01: Control terminal

The frequency command can be changed in accordance with the analog input given to the O/OI terminal on the control terminal by using a potentiometer (connected to H/O/L terminal) or an analog voltage / current supply. With this setting, the parameter F001 indicates the frequency command value given via the control terminal. Please refer to the instruction manual for the detailed information about the analog input (e.g. adjustment of the start / end value).

(C) Multi-speed selection – Binary operation

The inverter can store several target frequencies (up to 16), which is useful to define such low / middle / high frequencies and those frequencies are switched by external signals. The actual target frequency is selected from those pre-set frequencies in accordance with the signal status of the multi speed inputs. This part describes an example using 3 frequency sets.

Parameters	Condition	Setting
A001	Operator	02 *1)
A020	Multi speed 1 and 2 are not active.	0.00 *2)
A021	Multi speed 1 is active and multi speed 2 is not active.	0.00 *2)
A022	Multi speed 1 is not active and multi speed 2 is active.	0.00 *2)

*1) In case multi speed 1 and 2 are not active, the setting of A001 defines the frequency command source.

In case of A001=02, and if multi speed 1 and 2 are not active, F001 adopts the A020 value.







*2) Initial settings are 0.00Hz. You should set the appropriate data.

Start-up Commissioning the drive

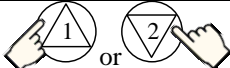
S.4.3 Run command source selection



Key operation to set A002

****FF3 : Change from 02 (operator) to 01 (control circuit terminal block).

Procedure	Key operation	Indication	Details
2-1		0.00	After powering up of the inverter, the operator displays 0.00, output frequency monitor (d001)
2-2		d001	Indication changes from data (0.00) to parameter (d001).
2-3		A---	Push the key and select the head of Group A.
2-4		A001	Push the key and indication changes to A001.
2-5		A002	Push the key and select A002 (Run command source).
2-6		02	Push the key and indication changes to 02(operator).
2-7		01	Push the key and change the data to 01 (control circuit terminal block).
2-8		A002	Push the key and indication changes to A002 (Data save).
2-9		0.00	By pushing the key for more than three seconds, indication changes to the output frequency data. (It depends on b038 setting)

****FEF3/FUF3 : Change 01 (control circuit terminal block) to 02 (operator).

*) Replace the procedure 2-6 and 2-7 on the list above with 2-6' and 2-7' in the list below.

Procedure	Key operation	Indication	Details
2-6'		01	Push the key and indication changes to 01 (control circuit terminal block).
2-7'		02	Push the key and change to 02(operator).

Start-up Commissioning the drive

Operating run command

(A) A001=02: Digital operator

RUN and STOP key on the digital operator allows you to start and stop the motor respectively.



*) Changing the rotatory direction can be done by changing the parameter F004, keypad run key routing or to exchange any two phases of the wiring to the motor. Before wiring, you should confirm that the power supply to the inverter has been cut off.

(B) A001=01: Control terminal

You can start and stop the motor operation via the FW terminal (forward rotation) or RV terminal (Reverse rotation).

In case of terminal FW:

Sink logic (short between P24 and PLC)

FW-CM1 short: The inverter runs the motor in the forward direction --- RUN command is active.

FW-CM1 open: The inverter decelerates and stops the motor --- RUN command is not active.

Source logic (short between CM1 and PLC)

FW-P24 short: The inverter runs the motor in the forward direction --- RUN command is active.

FW-P24 open: The inverter decelerates and stops the motor --- RUN command is not active.

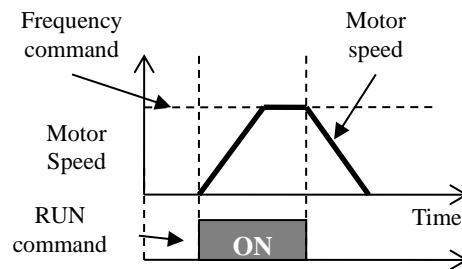

Start-up Commissioning the drive

S.5 Selecting the control mode

The SJ700D-3 inverter series provides several options for motor control to satisfy various application requirements. Please choose a suitable control mode for your application by referring to the table below. Initial setting of A044 is 00 (V/f control mode).

Check	
In case you want to drive fan, pump or light load application :	-Using the reduced torque mode (A044=01) -Use the light load mode (b049=01) to drive the motor with the one size smaller inverter.
In case you want to set the characteristic of voltage/frequency freely :	-Using Free V/f mode (A044=02)
In case you want to drive the application which requires high torque control without the motor feedback :	-Using sensor-less vector mode (A044=03)*
In case you want to drive the application which requires the high torque control at low frequency range without the motor feedback.	-Using 0Hz sensor-less vector mode (A044=04)*
In case you want to - drive the application which requires high torque control - drive the application which requires the position control with the motor feedback :	-Using vector control mode (A044=05)*

*) Depending on the load, applying the one size bigger inverter may be required. For more information, refer to SJ700D-3 manual.

Start-up Commissioning the drive

(Memo)

Chapter 1 Overview

This chapter describes the inspection of the purchased product, the product warranty, and the names of parts.

- 1.1 Inspection of the Purchased Product 1 - 2
- 1.2 Method of Inquiry and Product Warranty · 1 - 3
- 1.3 Exterior Views and Names of Parts 1 - 4

Chapter 1 Overview

1.1 Inspection of the Purchased Product

1.1.1 Inspecting the product

After unpacking, inspect the product as described below.

If you find the product is abnormal or defective, contact your supplier or local Hitachi Distributor.

- (1) Check the product for damage (including falling of parts and dents in the inverter body) caused during transportation.
- (2) Check that the product package contains an inverter set, this Quick Reference Guide and a CD (including the SJ700D-3 Instruction Manual).
- (3) Check the specification label to confirm that the product is the one you have ordered.

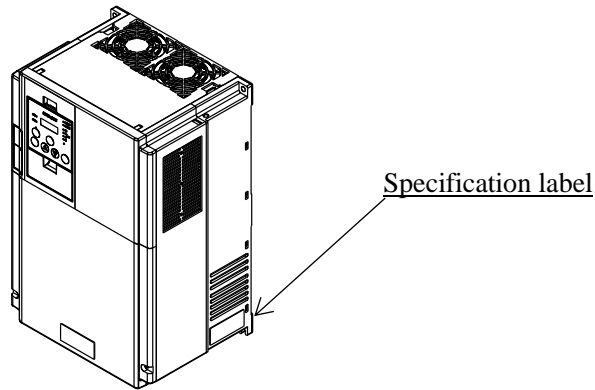

Figure 1 Location of the specifications label

HITACHI		INVERTER
Inverter model	→	Model: SJ700D-150HFF3
Input ratings	→	Input/Entree: 50Hz,60Hz V 1 Ph A
Output ratings	→	50Hz,60Hz 380-480V 3 Ph 35/41A
Serial number	→	Output/Sortie: 0 - 400Hz 380-480V 3 Ph 32/37A
		MEGNo. 44A T12345AA 001 Date: 1404
		Hitachi Industrial Equipment Systems Co.,Ltd. MADE IN JAPAN NE18238-29

Figure 1-2 Contents of the specifications label

1.1.2 Quick Reference Guide and Instruction Manual

This Quick Reference Guide describes how to handle and maintain the Hitachi SJ700D-3 Series Inverter briefly and "SJ700D-3 series Instruction Manual" on CD bundled with inverter describes the more detailed information. Read these manuals carefully before using the inverter, and then keep it handy for those who operate, maintain, and inspect the inverter. When using the inverter together with optional products, also read the manuals for those products.

Note that these manuals and the manual for each optional product to be used should be delivered to the end user of the inverter.

1.2 Method of Inquiry and Product Warranty

1.2.1 Method of inquiry

For an inquiry about product damage or faults or a question about the product, notify your supplier of the following information:

- (1) Model of your inverter
- (2) Serial number (MFG No.)
- (3) Date of purchase
- (4) Content of inquiry
 - Location and condition of damage
 - Content of your question

1.2.2 Product warranty

The product will be warranted under the term described in the next section “1.2.3 Warranty Terms”.

Even within the warranty period, repair of a product fault will not be covered by the warranty (but the repair will be at your own cost) if:

- (1) the fault has resulted from incorrect usage not conforming to the instructions given in this Instruction Manual or the repair or modification of the product carried out by an unqualified person,
- (2) the fault has resulted from a cause not attributable to the delivered product,
- (3) the fault has resulted from use beyond the limits of the product specifications, or
- (4) the fault has resulted from disaster or other unavoidable events.

The warranty will only apply to the delivered inverter and excludes all damage to other equipment and facilities induced by any fault of the inverter.

Repair at the user's charge :

Following the warranty period, any examination and repair of the product will be accepted at your charge. Even during the warranty period, examination and repairs of faults, subject to the above scope of the warranty disclaimer, will be available at charge. To request a repair at your charge, contact your supplier or local Hitachi Distributor.

1.2.3 Warranty Terms

The warranty period under normal installation and handling conditions shall be two (2) years from the date of manufacture (“DATE” on product nameplate), or one (1) year from the date of installation, whichever occurs first. The warranty shall cover the repair or replacement, at Hitachi’s sole discretion, of ONLY the inverter that was installed.

- (1) Service in the following cases, even within the warranty period, shall be charged to the purchaser:
 - a. Malfunction or damage caused by mis-operation or modification or improper repair
 - b. Malfunction or damage caused by a drop after purchase and transportation
 - c. Malfunction or damage caused by fire, earthquake, flood, lightening, abnormal input voltage, contamination, or other natural disasters
- (2) When service is required for the product at your work site, all expenses associated with field repair shall be charged to the purchaser.
- (3) Always keep this manual handy; please do not lose it. Please contact your Hitachi distributor to purchase replacement or additional manuals.

Chapter 1 Overview

1.3 Exterior Views and Names of Parts

The figure below shows an exterior view of the inverter.

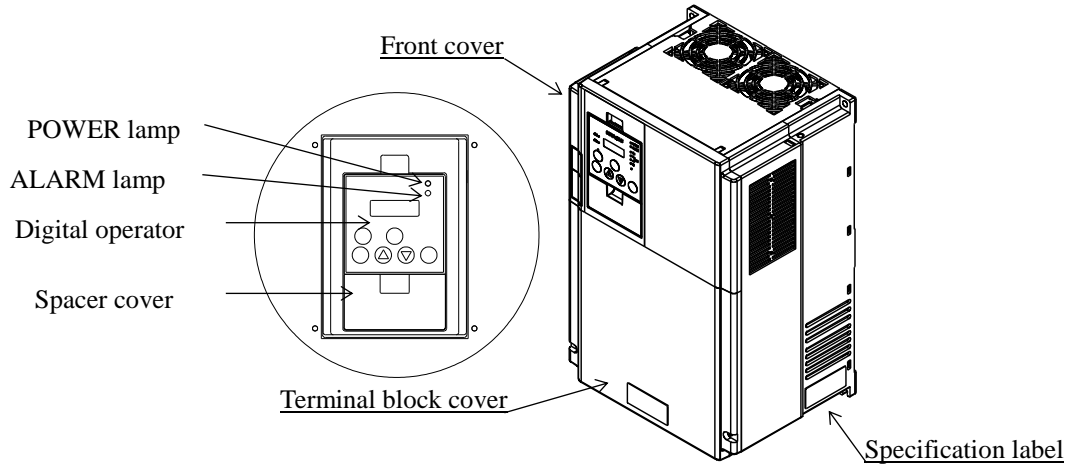

Exterior view of inverter

For the wiring of the main circuit and control circuit terminals, open the terminal block cover.
 For mounting optional circuit boards, open the front cover.

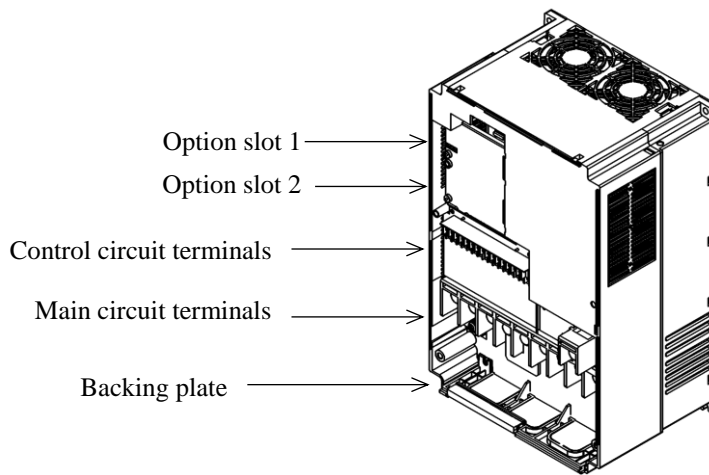

Exterior view of inverter with the removed front and terminal block covers

Chapter 2 Installation and Wiring

This chapter describes how to install the inverter and the wiring of main circuit and control signal terminals with typical examples of wiring.

2.1	Installation	2 - 2
2.2	Wiring.....	2 - 6

Chapter 2 Installation and Wiring

2.1 Installation

CAUTION

- Install the inverter on a non-flammable surface, e.g., metal. Otherwise, you run the risk of fire.
- Do not place flammable materials near the installed inverter. Otherwise, you run the risk of fire.
- When carrying the inverter, do not hold its top cover. Otherwise, you run the risk of injury by dropping the inverter.
- Prevent foreign matter (e.g., cut pieces of wire, sputtering welding materials, iron chips, wire, and dust) from entering the inverter. Otherwise, you run the risk of fire.
- Install the inverter on a structure able to bear the weight specified in this Instruction Manual. Otherwise, you run the risk of injury due to the inverter falling.
- Install the inverter on a vertical wall that is free of vibrations. Otherwise, you run the risk of injury due to the inverter falling.
- Do not install and operate the inverter if it is damaged or its parts are missing. Otherwise, you run the risk of injury.
- Install the inverter in a well-ventilated indoor site not exposed to direct sunlight. Avoid places where the inverter is exposed to high temperature, high humidity, condensation, dust, explosive gases, corrosive gases, flammable gases, grinding fluid mist, or salt water. Otherwise, you run the risk of fire.
- The inverter is precision equipment. Do not allow it to fall or be subject to high impacts, step on it, or place a heavy load on it. Doing so may cause the inverter to fail.

Chapter 2 Installation and Wiring

2.1.1 Precautions for installation

(1) Transportation

The inverter uses plastic parts. When carrying the inverter, handle it carefully to prevent damage to the parts.
Do not carry the inverter by holding the front or terminal block cover. Doing so may cause the inverter to fall.
Do not install and operate the inverter if it is damaged or its parts are missing.

(2) Surface on which to install the inverter

The inverter will reach a high temperature (up to about 150°C) during operation. Install the inverter on a vertical wall surface made of nonflammable material (e.g., metal) to avoid the risk of fire.

Leave sufficient space around the inverter. In particular, keep sufficient distance between the inverter and other heat sources (e.g., braking resistors and reactors) if they are installed in the vicinity.

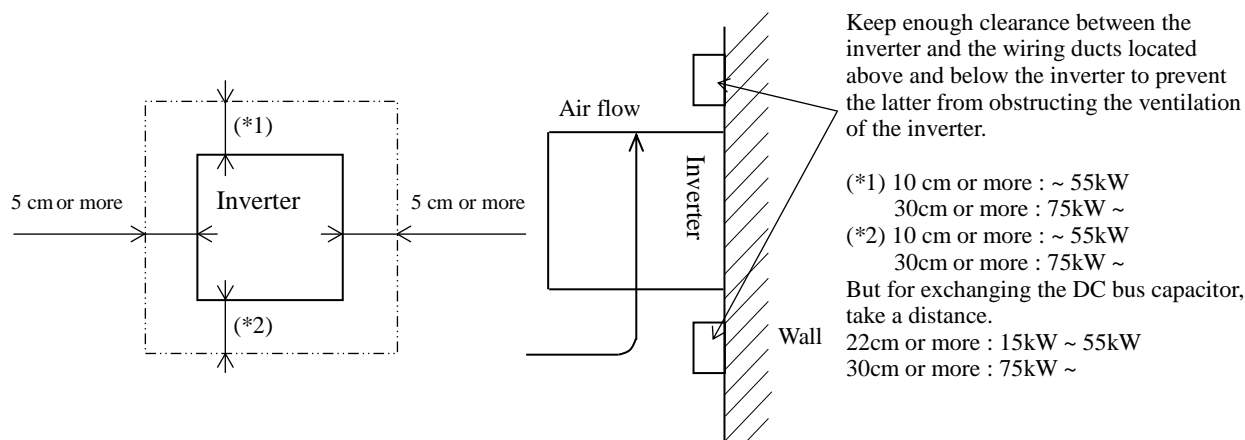

(3) Ambient temperature

Avoid installing the inverter in a place where the ambient temperature goes above or below the allowable range (-10°C to +40°C), as defined by the standard inverter specification.

Measure the temperature in a position about 5 cm distant from the bottom-center point of the inverter, and check that the measured temperature is within the allowable range.

Operating the inverter at a temperature outside this range will shorten the inverter life (especially the capacitor life).

(4) Humidity

Avoid installing the inverter in a place where the relative humidity goes above or below the allowable range (20% to 90% RH), as defined by the standard inverter specification.

Avoid a place where the inverter is subject to condensation.

Condensation inside the inverter will result in short circuits and malfunctioning of electronic parts. Also avoid places where the inverter is exposed to direct sunlight.

(5) Ambient air

Avoid installing the inverter in a place where the inverter is subject to dust, corrosive gases, combustible gases, flammable gases, grinding fluid mist, or salt water.

Foreign particles or dust entering the inverter will cause it to fail. If you use the inverter in a considerably dusty environment, install the inverter inside a totally enclosed panel.

Chapter 2 Installation and Wiring

(6) Installation method and position

Install the inverter vertically and securely with screws or bolts on a surface that is free from vibrations and that can bear the inverter weight. If the inverter is not installed vertically, its cooling performance may be degraded and tripping or inverter damage may result.

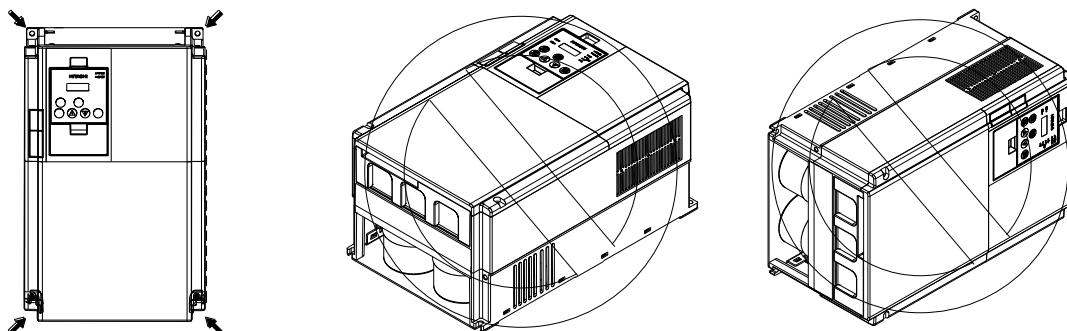

(7) When mounting multiple inverters in an enclosure with a ventilation fan, carefully design the layout of the ventilation fan, air intake port, and inverters. An inappropriate layout will reduce the inverter-cooling effect and raise the ambient temperature. Plan the layout so that the inverter ambient temperature will remain within the allowable range.

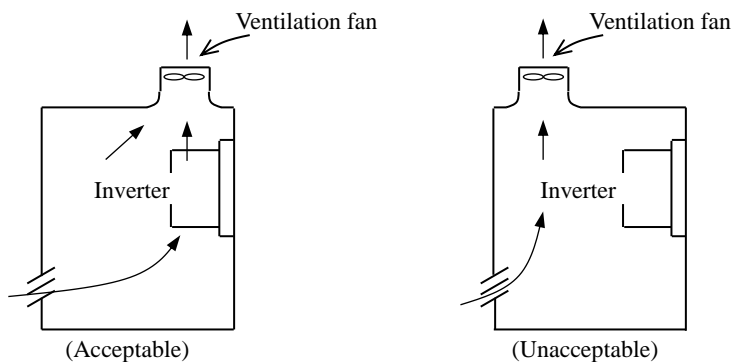

Position of ventilation fan

(8) Mounting in an enclosure

The internal fan releases the heat generated by the inverter from the upper part of the inverter. When it is necessary to install a device above the inverter, please ensure that the device is protected against this heat. When several inverters are mounted in the same cabinet the standard arrangement of the inverters is side-by-side with certain space as shown in the figure on the left below. If the inverters must be mounted one above the other in order to save the cabinet space or similar, the heat from the lower inverter may lead to temperature rise and breakdown of the higher inverter. Please ensure that the heat generated by the lower inverter does not affect the one above by installing a mechanical separation or similar (e.g. guide plate between the inverters as shown in the figure below right).

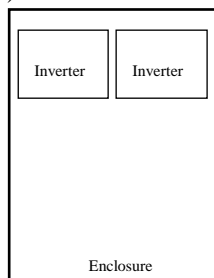

Horizontal mounting

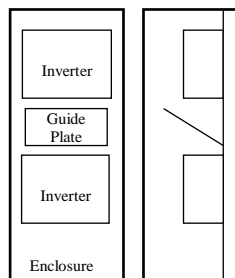

Vertical mounting

When mounting several inverters in the same cabinet, design the cabinet so that the temperature inside the cabinet does not exceed the allowable specific range for the inverter (by using increased ventilation and/or enlarging the size of cabinet etc.)

Chapter 2 Installation and Wiring

(9) Reduction of enclosure size

If you mount the inverter inside an enclosure such that the heat sink of the inverter is positioned outside the enclosure, the amount of heat produced inside the enclosure can be reduced and likewise the size of the enclosure. Mounting the inverter in an enclosure with the heat sink positioned outside requires an optional dedicated special metal fitting. To mount the inverter in an enclosure with the heat sink positioned outside, cut out the enclosure panel according to the specified cutting dimensions. The cooling section (including the heat sink) positioned outside the enclosure has a cooling fan. Therefore, do not place the enclosure in any environment where it is exposed to waterdrops, oil mist, or dust.

(10) Approximate loss by inverter capacity

Inverter capacity (kW)	0.4	0.75	1.5	2.2	3.7/4.0	5.5	7.5	11	15	18.5
Loss with 70% load (W)	64	76	102	127	179	242	312	435	575	698
Loss with 100% load (W)	70	88	125	160	235	325	425	600	800	975
Efficiency at rated output (%)	85.1	89.5	92.3	93.2	94.0	94.4	94.6	94.8	94.9	95.0

Inverter capacity (kW)	22	30	37	45	55	75	90	110	132/150
Loss with 70% load (W)	820	1100	1345	1625	1975	2675	3375	3900	4670
Loss with 100% load (W)	1150	1550	1900	2300	2800	3800	4800	5550	6650
Efficiency at rated output (%)	95.0	95.0	95.1	95.1	95.1	95.2	95.2	95.2	95.2

2.1.2 Backing plate

(1) For models with 30 kW or less capacity

On the backing plate, cut the joints around each section to be cut off with cutting pliers or a cutter, remove them, and then perform the wiring.

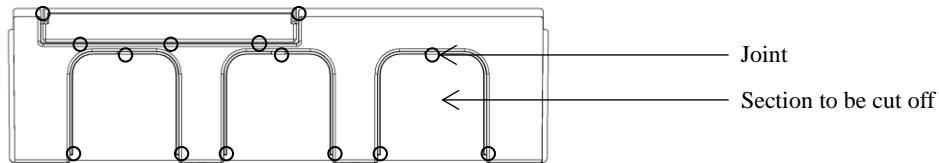

(2) For the models with 37 kW to 75kW

1) For wiring without using conduits

Cut an X in each rubber bushing of the backing plate with cutting pliers or a cutter, and then perform the wiring.

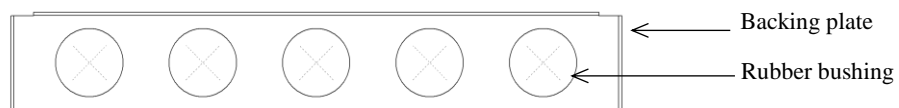

2) For wiring using conduits

Remove the rubber bushings from the holes to be used for wiring with conduits, and then fit conduits into the holes.

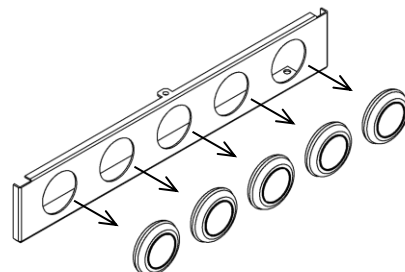

Note: Do not remove the rubber bushing from holes that are not used for wiring with a conduit.

If a cable is connected through the plate hole without a rubber bushing and conduit, the cable insulation may be damaged by the edge of the hole, resulting in a short circuit or ground fault.

Chapter 2 Installation and Wiring

2.2 Wiring



WARNING

- Be sure to ground the inverter. Otherwise, you run the risk of electric shock or fire.
- Commit wiring work to a qualified electrician. Otherwise, you run the risk of electric shock or fire.
- Before wiring, make sure that the power supply is off. Otherwise, you run the risk of electric shock or fire.
- Perform wiring only after installing the inverter. Otherwise, you run the risk of electric shock or injury.
- Do not remove rubber bushings from the wiring section. Otherwise, the edges of the wiring cover may damage the wire, resulting in a short circuit or ground fault.



CAUTION

- Make sure that the voltage of AC power supply matches the rated voltage of your inverter. Otherwise, you run the risk of injury or fire.
- Do not input single-phase power into the inverter. Otherwise, you run the risk of fire.
- Do not connect AC power supply to any of the output terminals (U, V, and W). Otherwise, you run the risk of injury or fire.
- Do not connect a resistor directly to any of the DC terminals (PD, P, and N). Otherwise, you run the risk of fire.
- Connect an earth-leakage breaker to the power input circuit. Otherwise, you run the risk of fire.
- Use only the power cables, earth-leakage breaker, and magnetic contactors that have the specified capacity (ratings). Otherwise, you run the risk of fire.
- Do not use the magnetic contactor installed on the primary and secondary sides of the inverter to stop its operation.
- Tighten each screw to the specified torque. No screws must be left loose. Otherwise, you run the risk of fire.
- Before operating, slide switch SW1 in the inverter, be sure to turn off the power supply. Otherwise, you run the risk of electric shock and injury.
- Since the inverter supports two modes of cooling-fan operation, the inverter power is not always off, even when the cooling fan is stopped. Therefore, be sure to confirm that the power supply is off before wiring. Otherwise, you run the risk of electric shock and injury.

Chapter 2 Installation and Wiring

2.2.1 Terminal connection diagram and explanation of terminals and switch settings

3-phase power supply

200 V class: 200 to 240 V +10%, -15%
(50/60 Hz ±5%)

400 V class: 380 to 480 V +10%, -15%
(50/60 Hz ±5%)

When connecting separate power supplies to main and control circuits, remove J51 connector cables beforehand.

Default jumper position (sinking type : FUF/FF)

Default jumper position (source type : FEF)

Forward rotation command

Intelligent input (8 contacts)

Digital monitor output (PWM output)

Frequency setting circuit
500 to 2,000Ω

Analog monitor output (voltage output)

Analog monitor output (current output)

Jumper

Power supply for control circuit

DC24V

The dotted line indicates the detachable control terminal board.

Intelligent relay output contact (default: alarm output)

Intelligent output (5 terminals)

RS485

Option 1

Option 2

Type-D grounding (for 200 V class model)
Type-C grounding (for 400 V class model)
(See page 2-12.)

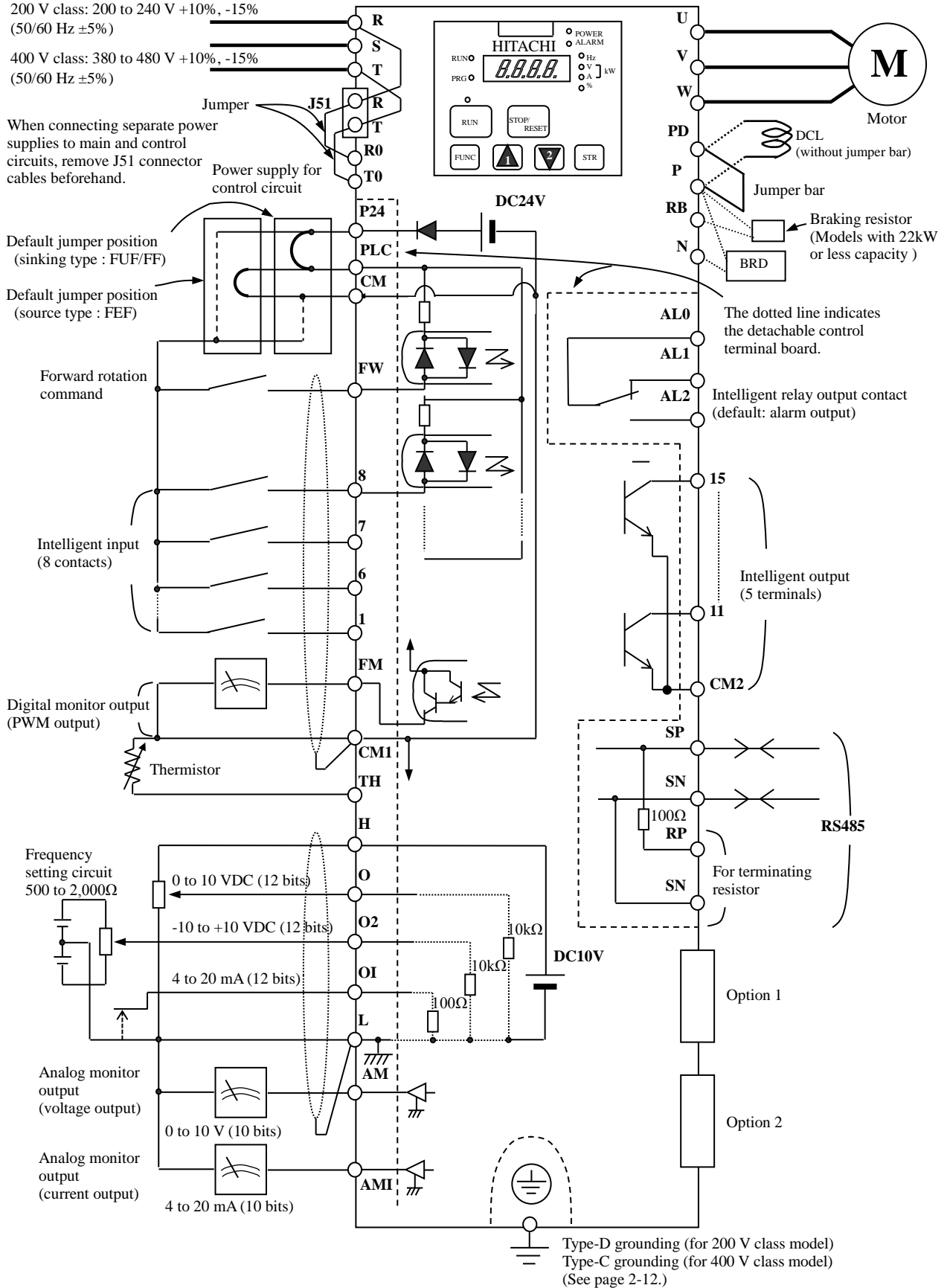

Chapter 2 Installation and Wiring

(1) Explanation of main circuit terminals

Symbol	Terminal name	Description
R, S, T (L1, L2, L3)	Main power input	Connect to the AC power supply. Leave these terminals unconnected when using a regenerative converter (HS900 series).
U, V, W (T1, T2, T3)	Inverter output	Connect a 3-phase motor.
PD, P (+1, +)	DC reactor connection	Remove the jumper from terminals PD and P, and connect the optional power factor reactor (DCL).
P, RB (+, RB)	External braking resistor connection	Connect the optional external braking resistor. (The RB terminal is provided on models with 30 kW or less capacity.)
P, N (+, -)	Regenerative braking unit connection	Connect the optional regenerative braking unit (BRD).
G ⊕	Inverter ground	Connect to ground for grounding the inverter chassis by type-D grounding (for 200 V class models) or type-C grounding (for 400 V class models).

(2) Explanation of control circuit terminals

		Symbol	Terminal name	Description	Electric property	
Analog	Power supply	L	Analog power supply (common)	This common terminal supplies power to frequency command terminals (O, O2, and OI) and analog output terminals (AM and AMI). Do not ground this terminal.		
		H	Frequency setting power supply	This terminal supplies 10 VDC power to the O, O2, OI terminals.		Allowable load current: 20 mA or less
	Frequency setting input	O	Frequency command (voltage)	Input a voltage (0 to 10 VDC) as a frequency command. 10 V specifies the maximum frequency. To specify the maximum frequency with a voltage of 10 V or less, set the voltage using function "A014".	Input impedance: 10kΩ Allowable input voltages: -0.3 to +12 VDC	
		O2	Auxiliary frequency command (voltage)	Input a voltage (0 to ±10 VDC) as a signal to be added to the frequency command input from the O or OI terminal. You can input an independent frequency command from this terminal (O2 terminal) alone by changing the setting.	Input impedance: 10kΩ Allowable input voltages: 0 to ±12 VDC	
		OI	Frequency command (current)	Input a current (4 to 20 mA DC) as a frequency command. 20 mA specifies the maximum frequency. The OI signal is valid only when the AT signal is on. Assign the AT function to an intelligent input terminal.	Input impedance: 10kΩ Maximum allowable current: 24 mA	
	Monitor output	AM	Analog monitor (voltage)	This terminal outputs one of the selected "0 to 10 VDC voltage output" monitoring items. The monitoring items available for selection include output frequency, output current, output torque (signed or unsigned), output voltage, input power, electronic thermal overload, LAD frequency, motor temperature, heat sink temperature, and general output.	Maximum allowable current: 2 mA Output voltage accuracy ±20% (Ta=25±10 degrees C)	
		AMI	Analog monitor (current)	This terminal outputs one of the selected "4 to 20 mA DC current output" monitoring items. The monitoring items available for selection include output frequency, output current, output torque (unsigned), output voltage, input power, electronic thermal overload, LAD frequency, motor temperature, heat sink temperature, and general output.	Allowable load impedance: 250Ω or less Output current accuracy ±20% (Ta=25±10 degrees C)	
	Digital (contact)	Monitor output	FM	Digital monitor (voltage)	This terminal outputs one of the selected "0 to 10 VDC voltage output (PWM output mode)" monitoring items. The monitoring items available for selection include output frequency, output current, output torque (unsigned), output voltage, input power, electronic thermal overload, LAD frequency, motor temperature, heat sink temperature, general output, digital output frequency, and digital current monitor. For the items "digital output frequency" and "digital current monitor," this terminal outputs a digital pulse signal at 0/10 VDC with a duty ratio of 50%.	Maximum allowable current: 1.2 mA Maximum frequency: 3.6 kHz
		Power supply	P24	Interface power supply	This terminal supplies 24 VDC power for contact input signals. If the source logic is selected, this terminal is used as a common contact input terminal.	Maximum allowable output current: 100 mA
			CM1	Interface power supply (common)	This common terminal supplies power to the interface power supply (P24), thermistor input (TH), and digital monitor (FM) terminals. If the sink logic is selected, this terminal is used as a common contact input terminal. Do not ground this terminal.	
Contact input		Operation command	FW	Forward rotation command	Turn on this FW signal to start the forward rotation of the motor; turn it off to stop forward rotation after deceleration.	[Conditions for turning contact input on] Voltage across input and PLC: 18 VDC or more
		Function selection and logic switching	1 2 3 4 5 6 7 8	Intelligent input	Select eight of a total 56 functions, and assign these eight functions to terminals 1 to 8. Note: If the emergency stop function is used, terminals 1 and 3 are used exclusively for the function. For details, refer to the SJ700D-3 instruction manual.	Input impedance between input and PLC: 4.7kΩ Maximum allowable voltage across input and PLC: 27 VDC Load current with 27 VDC power: about 5.6 mA

Chapter 2 Installation and Wiring

		Symbol	Terminal name	Description	Electric property
Digital (contact)	Contact input Function selection and logic switching	PLC	Intelligent input (common)	To switch the control logic between sink logic and source logic, change the jumper connection of this (PLC) terminal to another terminal on the control circuit terminal block. Jumper terminals P24 and PLC for the sink logic; jumper terminals CM1 and PLC for the sink logic. To use an external power supply to drive the contact inputs, remove the jumper, and connect the PLC terminal to the external interface circuit.	
	Open collector output Status and factor	11 12 13 14 15	Intelligent output	Select five of a total 51 functions, and assign these five functions to terminals 11 to 15. If you have selected an alarm code using the function "C062", terminals 11 to 13 or 11 to 14 are used exclusively for the output of cause code for alarm (e.g., inverter trip). The control logic between each of these terminals and the CM2 terminal always follows the sink or source logic.	Voltage drop between each terminal and CM2 when output signal is on: 4 V or less Maximum allowable voltage: 27 VDC
		CM2	Intelligent output (common)	This terminal serves as the common terminal for intelligent output terminals [11] to [15].	Maximum allowable current: 50 mA
Relay contact output Status and alarm	AL0 AL1 AL2	Intelligent relay output	Select functions from the 43 available, and assign the selected functions to these terminals, which serve as C contact output terminals. In the initial setting, these terminals output an alarm indicating that the inverter protection function has operated to stop inverter output.	(Maximum contact capacity) AL1-AL0: 250 VAC, 2 A (resistance) or 0.2 A (inductive load) AL2-AL0: 250 VAC, 1 A (resistance) or 0.2 A (inductive load) (Minimum contact capacity) 100 VAC, 10 mA 5 VDC, 100 mA	
			TH	External thermistor input	Connect to an external thermistor to make the inverter trip if an abnormal temperature is detected. The CM1 terminal serves as the common terminal for this terminal. [Recommended thermistor properties] Allowable rated power: 100 mW or more Impedance at temperature error: 3kΩ The impedance to detect temperature errors can be adjusted within the range 0Ω to 9,999Ω.
Analog	Analog input Sensor	TH	External thermistor input		

(3) Explanation of switch

In case of using the emergency stop function*, you need to set the SW1 to “ON”. Refer to the SJ700D-3 manuals for more information.

* This function does not comply with any functional safety norm.

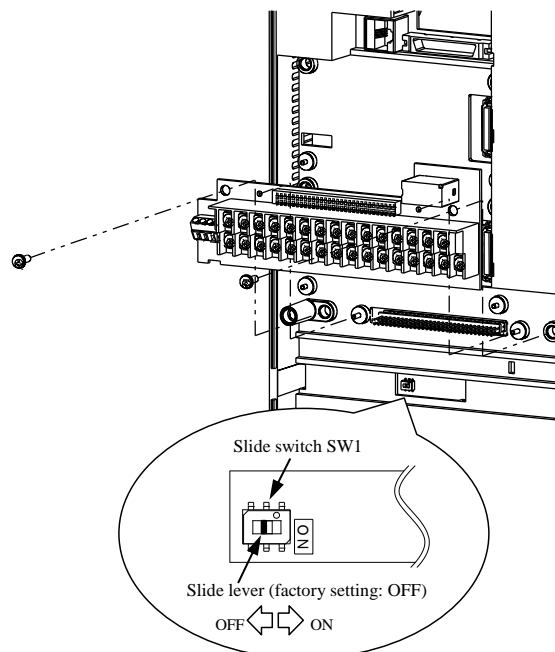

*) Do not change the other switch, which is intended for factory adjustment

Chapter 2 Installation and Wiring

2.2.2 Wiring of the main circuit

(1) Wiring instructions

Before wiring, be sure to confirm that the Charge lamp on the inverter is turned off. When the inverter power has been turned on once, a dangerous high voltage remains in the internal capacitors for some time after power-off, regardless of whether the inverter has been operated. When rewiring after power-off, always wait 10 minutes or more after power-off, and check with a multimeter that the residual voltage across terminals P and N is zero to ensure safety during rewiring work.

(note) As for the 5.5kW and 7.5kW inverters, the washer on the main terminal screw (R, S, T, PD, P, N, U, V, W, RB) has two cutouts. Since those cutouts are to avoid the cable fixing portion of crimp terminal goes under the washer, it should be fixed in direction with those two cutouts in line with cable as described below. Otherwise, you run the risk of loose connection and fire.

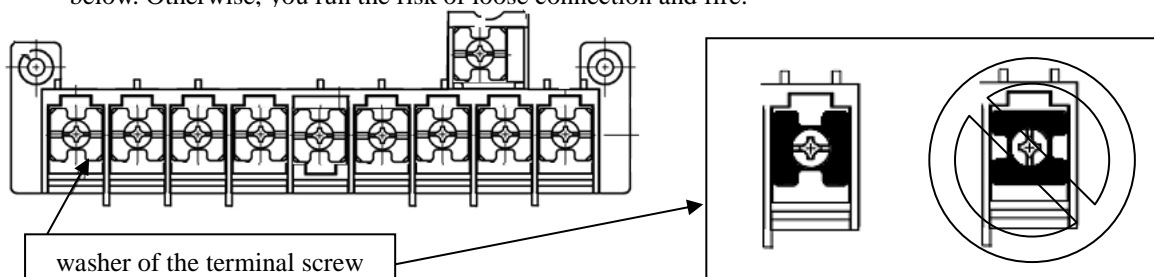

1) Main power input terminals (R, S, and T)

- Install an earth-leakage breaker for circuit (wiring) protection between the power supply and main power input terminals (R, S, and T).
- Use an earth-leakage breaker with a high rating of a high-frequency sensitive current to prevent the breaker from malfunctioning under the influence of high frequency.
- When the protective function of the inverter operates, a fault or accident may have occurred in your system. Therefore, you are recommended to connect a magnetic contactor that interrupts the power supply to the inverter.
- Do not use the magnetic contactor connected to the power input terminal (primary side) or power output terminal (secondary side) of the inverter to start or stop the inverter. To start and stop inverter operation by external signals, use only the operation commands (FW and RV signals) that are input via control circuit terminals.
- This inverter does not support a single-phase input but supports only a three-phase input. If you need to use a single-phase power input, contact your supplier or local Hitachi Distributor.
- Do not operate the inverter when an input phase is lost (input phase loss), otherwise the inverter may be damaged. Since the factory setting of the inverter disables the phase loss input protection, the inverter will go into the following status if a phase of power supply input is interrupted and not supplied to the inverter:
 - R or T phase interrupted: The inverter does not power up.
 - S phase interrupted: The inverter goes into single-phase operation, and may trip because of insufficient voltage or overcurrent, or be damaged.

Internal capacitors remain charged, even when the power input is under a phase loss condition. Therefore, touching an internal part may result in electric shock and injury.

When rewiring the main circuit, follow the instructions given in Item (1), "Wiring instructions."

- Carefully note that the internal converter module of the inverter may be damaged if:
 - The imbalance of power voltage is 3% or more,
 - The power supply capacity is at least 10 times as high as the inverter capacity and 500 kVA or more, or
 - The power voltage changes rapidly.

Example: The above conditions may occur when multiple inverters are connected to each other by a short bus line or your system includes a phase-advanced capacitor that is turned on and off during operation.

- Do not turn the inverter power on and off more often than once every 3 minutes. Otherwise, the inverter may be damaged.

Chapter 2 Installation and Wiring

- 2) Inverter output terminals (U, V, and W)
- Use a cable thicker than the specified applicable cable for the wiring of output terminals to prevent the output voltage between the inverter and motor dropping. Especially at low frequency output, a voltage drop due to cable will cause the motor torque to decrease.
 - Do not connect a phase-advanced capacitor or surge absorber on the output side of the inverter. If connected, the inverter may trip or the phase-advanced capacitor or surge absorber may be damaged.
 - If the cable length between the inverter and motor exceeds 20 m (especially in the case of 400 V class models), the stray capacitance and inductance of the cable may cause a surge voltage at motor terminals, resulting in a motor burnout. A special filter to suppress the surge voltage is available. If you need this filter, contact your supplier or local Hitachi Distributor.
 - When connecting multiple motors to the inverter, connect a thermal relay to the inverter output circuit for each motor.
 - The RC rating of the thermal relay must be 1.1 times as high as the rated current of the motor. The thermal relay may go off too early, depending on the cable length. If this occurs, connect an AC reactor to the output of the inverter.
- 3) DC reactor connection terminals (PD and P)
- Use these terminals to connect the optional DC power factor reactor (DCL). As the factory setting, terminals P and PD are connected by a jumper. Remove this to connect the DCL.
 - The cable length between the inverter and DCL must be 5 m or less.
- Remove the jumper only when connecting the DCL. If the jumper is removed and the DCL is not connected, power is not supplied to the main circuit of the inverter, and the inverter cannot operate.
- 4) External braking resistor connection terminals (P and RB) and regenerative braking unit connection terminals (P and N)
- Inverter models with 22 kW or less capacity have a built-in regenerative braking (BRD) circuit. If you need increased braking performance, connect an optional external braking resistor to terminals P and RB. Do not connect an external braking resistor with resistance less than the specified value. Such a resistor may cause damage to the regenerative braking (BRD) circuit.
 - Inverter models with capacity of 30 kW or more do not have a built-in regenerative braking (BRD) circuit. Increasing the braking performance of these models requires an optional regenerative braking unit and an external braking resistor. Connect the P and N terminals of the optional regenerative braking unit to the P and N terminals of the inverters.
 - The cable length between the inverter and optional regenerative braking unit must be 5 m or less, and the two cables must be twisted for wiring.
 - Do not use these terminals for connecting any devices other than the optional external braking resistor and regenerative braking unit.
- 5) Inverter ground terminal (G \oplus)
- Be sure to ground the inverter and motor to prevent electric shock.
 - According to the Electric Apparatus Engineering Regulations, connect 200 V class models to grounding electrodes constructed in compliance with type-D grounding (conventional type-III grounding with ground resistance of 100 Ω or less) or the 400 V class models to grounding electrodes constructed in compliance with type-C grounding (conventional special type-III grounding with ground resistance of 10 Ω or less).
 - Use a grounding cable thicker than the specified applicable cable, and make the ground wiring as short as possible.
 - When grounding multiple inverters, avoid a multi-drop connection of the grounding route and formation of a ground loop, otherwise the inverter may malfunction.

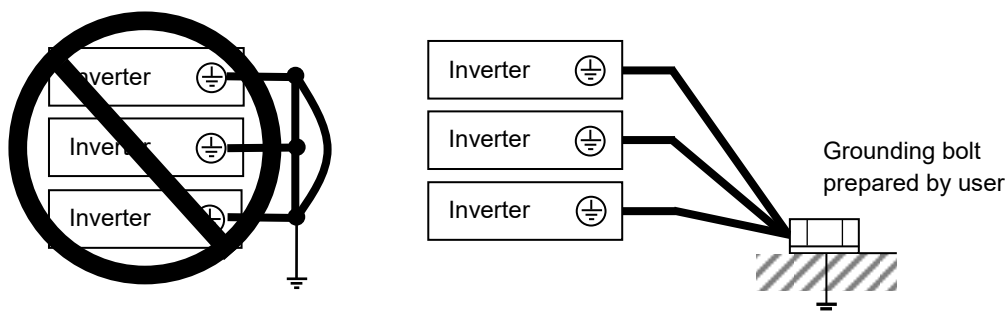







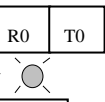

Chapter 2 Installation and Wiring

(2) Layout of main circuit terminals

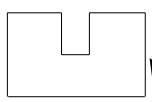
The figures below show the terminal layout on the main circuit terminal block of the inverter.

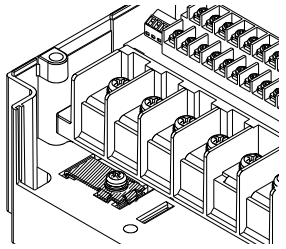
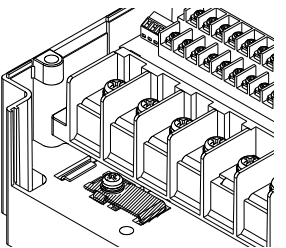
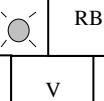
Terminal layout	Inverter model																									
<div style="text-align: center;"> <table border="1" style="margin: 0 auto;"> <tr> <td style="padding: 5px;">R0</td> <td style="padding: 5px;">T0</td> <td style="padding: 5px;">R (L1)</td> <td style="padding: 5px;">S (L2)</td> <td style="padding: 5px;">T (L3)</td> <td style="padding: 5px;">U (T1)</td> <td style="padding: 5px;">V (T2)</td> <td style="padding: 5px;">W (T3)</td> </tr> <tr> <td colspan="2"></td> <td style="padding: 5px;">PD (+1)</td> <td style="padding: 5px;">P (+)</td> <td style="padding: 5px;">N (-)</td> <td style="padding: 5px;">RB</td> <td style="padding: 5px; text-align: center;">⊖ G</td> <td style="padding: 5px; text-align: center;">⊖ G</td> </tr> </table> </div> <div style="margin-top: 20px;"> <p>Charge lamp</p> </div> <div style="margin-top: 20px; text-align: center;"> <p>Jumper connecting terminals PD and P</p> <p>When not using the DCL, do not remove the jumper from terminals PD and P.</p> </div> <div style="margin-top: 20px;"> <p>[Method of enabling/disabling the EMC filter function]</p> <p style="margin-left: 100px;">Dummy plug (green)</p> <p style="margin-left: 100px;">Enabling PIN(J61)</p> <p style="margin-left: 100px;">Short plug</p> <p style="margin-left: 100px;">Disabling PIN(J62)</p> </div> <div style="margin-top: 20px;"> <p>If you need to activate the EMC filter, you need to set the dummy plug and the short plug in reference to below list appropriately.</p> <p>Note: Before setting the plugs, make sure that the power supply is off. Otherwise, you run the risk of electric shock. You need to set the plugs before power supply to the inverter.</p> </div> <div style="margin-top: 20px;"> <table border="1" style="width: 100%; border-collapse: collapse; text-align: center;"> <thead> <tr> <th style="width: 30%;"></th> <th style="width: 35%;">Enabling PIN(J61)</th> <th style="width: 35%;">Disabling PIN(J62)</th> </tr> </thead> <tbody> <tr> <td style="text-align: left;">EMC filter disables (factory setting)</td> <td>Dummy plug (green)</td> <td>Short plug</td> </tr> <tr> <td style="text-align: left;">EMC filter enables</td> <td>Short plug</td> <td>Dummy plug (green)</td> </tr> </tbody> </table> </div>	R0	T0	R (L1)	S (L2)	T (L3)	U (T1)	V (T2)	W (T3)			PD (+1)	P (+)	N (-)	RB	⊖ G	⊖ G		Enabling PIN(J61)	Disabling PIN(J62)	EMC filter disables (factory setting)	Dummy plug (green)	Short plug	EMC filter enables	Short plug	Dummy plug (green)	<p>SJ700D-004-037LFF3 SJ700D-007-037HFF3</p> <p>R0 and T0: M4 Ground terminal: M4 Other terminals: M4</p>
R0	T0	R (L1)	S (L2)	T (L3)	U (T1)	V (T2)	W (T3)																			
		PD (+1)	P (+)	N (-)	RB	⊖ G	⊖ G																			
	Enabling PIN(J61)	Disabling PIN(J62)																								
EMC filter disables (factory setting)	Dummy plug (green)	Short plug																								
EMC filter enables	Short plug	Dummy plug (green)																								

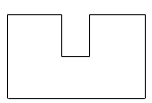
Chapter 2 Installation and Wiring

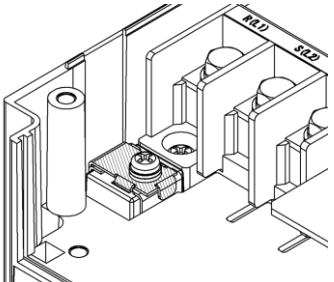
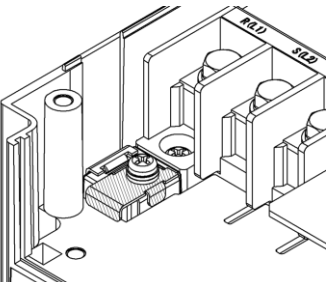
Terminal layout	Inverter model
<p style="text-align: center;">Charge lamp </p> <div style="display: flex; justify-content: center; align-items: center; gap: 10px;"> <div style="border: 1px solid black; padding: 5px; text-align: center;">R (L1)</div> <div style="border: 1px solid black; padding: 5px; text-align: center;">S (L2)</div> <div style="border: 1px solid black; padding: 5px; text-align: center;">T (L3)</div> <div style="border: 1px solid black; padding: 5px; text-align: center;">PD (+1)</div> <div style="border: 1px solid black; padding: 5px; text-align: center;">P (+)</div> <div style="border: 1px solid black; padding: 5px; text-align: center;">N (-)</div> <div style="border: 1px solid black; padding: 5px; text-align: center;">U (T1)</div> <div style="border: 1px solid black; padding: 5px; text-align: center;">V (T2)</div> <div style="border: 1px solid black; padding: 5px; text-align: center;">W (T3)</div> </div> <div style="display: flex; justify-content: space-around; margin-top: 20px;"> <div style="text-align: center;">  <p>Ground terminal with jumper (shaded in the figure) to enable/disable the EMC filter function.</p> </div> <div style="text-align: center;">  <p>Jumper connecting terminals PD and P</p> </div> <div style="text-align: center;">  </div> </div> <p style="text-align: center;">When not using the DCL, do not remove the jumper from terminals PD and P.</p> <p>[Method of enabling/disabling the EMC filter function]</p> <div style="display: flex; justify-content: space-around;"> <div style="text-align: center;">  <p>Enabling the EMC filter</p> </div> <div style="text-align: center;">  <p>Disabling the EMC filter (factory setting)</p> </div> </div>	<p>SJ700D-055, 075LFF3 SJ700D-055, 075HFF3</p> <p>R0 and T0: M4 Ground terminal: M5 Other terminals: M5</p> <hr/> <p>SJ700D-110LFF3 SJ700D-110HFF3</p> <p>R0 and T0: M4 Ground terminal: M5 Other terminals: M6</p>
<p style="text-align: center;">Charge lamp </p> <div style="display: flex; justify-content: center; align-items: center; gap: 10px;"> <div style="border: 1px solid black; padding: 5px; text-align: center;">R (L1)</div> <div style="border: 1px solid black; padding: 5px; text-align: center;">S (L2)</div> <div style="border: 1px solid black; padding: 5px; text-align: center;">T (L3)</div> <div style="border: 1px solid black; padding: 5px; text-align: center;">PD (+1)</div> <div style="border: 1px solid black; padding: 5px; text-align: center;">P (+)</div> <div style="border: 1px solid black; padding: 5px; text-align: center;">N (-)</div> <div style="border: 1px solid black; padding: 5px; text-align: center;">U (T1)</div> <div style="border: 1px solid black; padding: 5px; text-align: center;">V (T2)</div> <div style="border: 1px solid black; padding: 5px; text-align: center;">W (T3)</div> </div> <div style="display: flex; justify-content: space-around; margin-top: 20px;"> <div style="text-align: center;">  <p>Ground terminal with jumper (shaded in the figure) to enable/disable the EMC filter function</p> </div> <div style="text-align: center;">  <p>Jumper connecting terminals PD and P</p> </div> <div style="text-align: center;">  </div> </div> <p style="text-align: center;">When not using the DCL, do not remove the jumper from terminals PD and P.</p> <p>[Method of enabling/disabling the EMC filter function]</p> <div style="display: flex; justify-content: space-around;"> <div style="text-align: center;">  <p>Enabling the EMC filter</p> </div> <div style="text-align: center;">  <p>Disabling the EMC filter (factory setting)</p> </div> </div>	<p>SJ700D-150 to 185 LFF3 SJ700D-150 to 220 HFF3</p> <p>R0 and T0: M4 Ground terminal: M6 Other terminals: M6</p> <hr/> <p>SJ700D-220LFF3</p> <p>R0 and T0: M4 Ground terminal: M6 Other terminals: M8</p>

Chapter 2 Installation and Wiring

Terminal layout	Inverter model
<p style="text-align: center;">Charge lamp R0 T0</p> <p>Ground terminal with jumper (shaded in the figure) to enable/disable the EMC filter function</p> <p>When not using the DCL, do not remove the jumper from terminals PD and P.</p> <p>[Method of enabling/disabling the EMC filter function]</p> <p>Enabling the EMC filter</p> <p>Disabling the EMC filter (factory setting)</p>	<p>SJ700D-300LFF3</p> <p>R0 and T0: M4 Ground terminal: M6 Other terminals: M8</p> <hr/> <p>SJ700D-300HFF3</p> <p>R0 and T0: M4 Ground terminal: M6 Other terminals: M6</p> <hr/> <p>SJ700D-370LFF3 SJ700D-370HFF3</p> <p>R0 and T0: M4 Ground terminal: M8 Other terminals: M8</p>
<p style="text-align: center;">Charge lamp R0 T0</p> <p>Ground terminal with jumper (shaded in the figure) to enable/disable the EMC filter function</p> <p>When not using the DCL, do not remove the jumper from terminals PD and P.</p> <p>[Method of enabling/disabling the EMC filter function]</p> <p>Enabling the EMC filter</p> <p>Disabling the EMC filter (factory setting)</p>	<p>SJ700D-450LFF3 SJ700D-450HFF3 SJ700D-550HFF3</p> <p>R0 and T0: M4 Ground terminal: M8 Other terminals: M8</p>

Chapter 2 Installation and Wiring

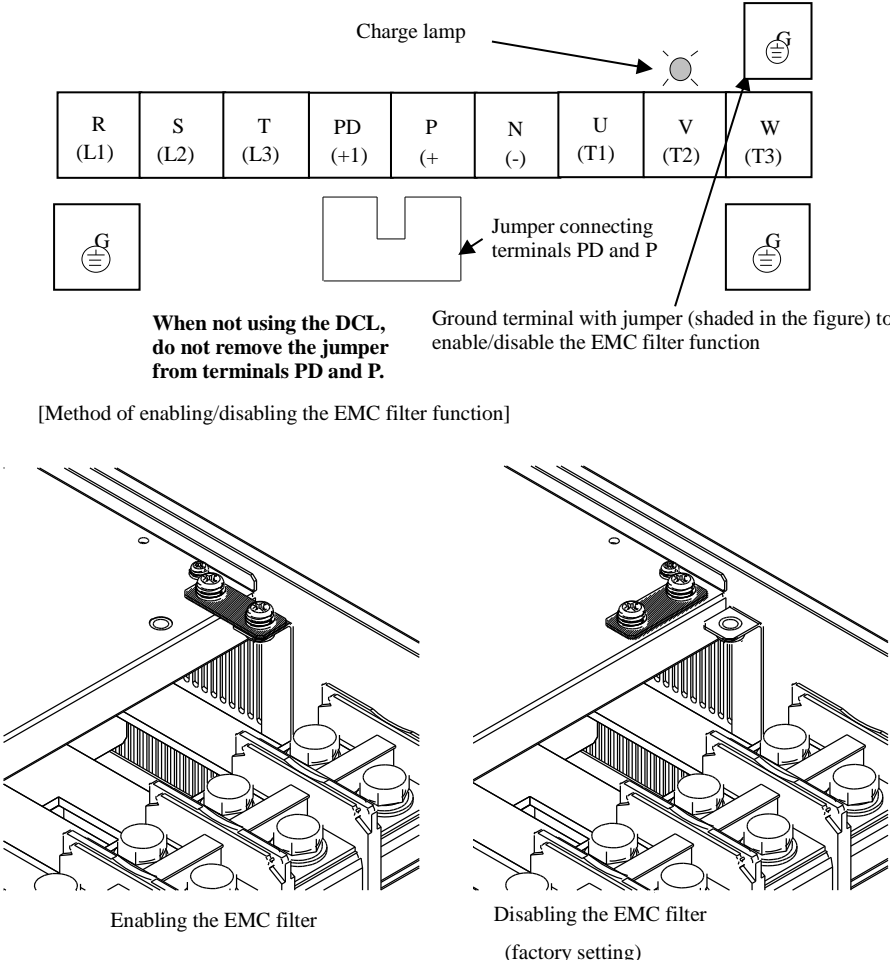
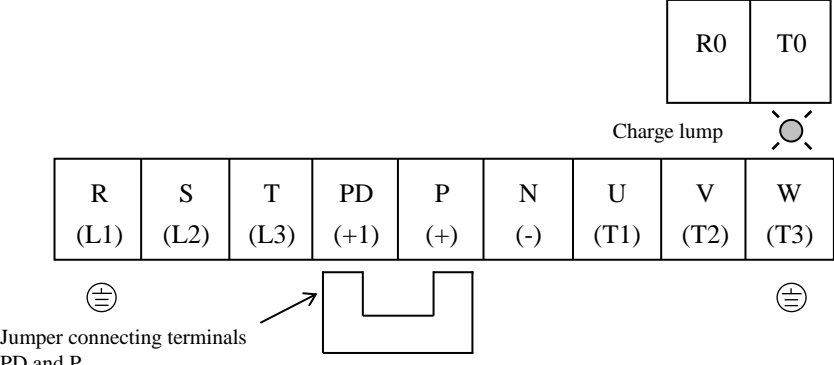
Terminal layout	Inverter model
 <p>Charge lamp</p> <p>R (L1) S (L2) T (L3) PD (+1) P (+) N (-) U (T1) V (T2) W (T3)</p> <p>Jumper connecting terminals PD and P</p> <p>Ground terminal with jumper (shaded in the figure) to enable/disable the EMC filter function</p> <p>When not using the DCL, do not remove the jumper from terminals PD and P.</p> <p>[Method of enabling/disabling the EMC filter function]</p> <p>Enabling the EMC filter</p> <p>Disabling the EMC filter (factory setting)</p>	<p>SJ700D-550LFF3</p> <p>R0 and T0: M4 Ground terminal: M8 Other terminals: M10</p>
 <p>R0 T0</p> <p>Charge lamp</p> <p>R (L1) S (L2) T (L3) PD (+1) P (+) N (-) U (T1) V (T2) W (T3)</p> <p>Jumper connecting terminals PD and P</p>	<p>SJ700D-750 to 1320 HFF3</p> <p>R0 and T0:M4 Ground terminal:M8 Other terminal:M10</p>

Reference: Leakage current by inverter with model EMC filter enabled or disabled (reference data). The table below lists the reference currents that may leak from the inverter when the internal EMC filter is enabled or disabled. (Leakage current is in proportion to the voltage and frequency of input power.) Note that the values listed in the table below indicate the reference currents leaking from the inverter alone. The values exclude current leakage from external devices and equipment (e.g., power cables). The drive in the range from 75kW to 150kW doesn't have the switch to activate and deactivate the internal EMC filter. They complies EMC directive C3 level in standard condition.

	200 V class model (input power: 200 VAC, 50 Hz)				400 V class model (input power: 400 VAC, 50 Hz)				
	0.4kW to 3.7kW	5.5kW to 11kW	15kW to 37kW	45kW to 55kW	0.75kW to 3.7kW	5.5kW to 11kW	15kW to 37kW	45kW to 55kW	75kW to 150kW
Internal EMC filter enabled	Ca. 2.5mA	Ca. 48mA	Ca. 23mA	Ca. 23mA	Ca. 5mA	Ca. 95mA	Ca 56mA	Ca 56mA	-
Internal EMC filter disabled	Ca. 0.1mA	Ca. 0.1mA	Ca. 0.1mA	Ca. 0.1mA	Ca. 0.2mA	Ca. 0.2mA	Ca 0.2mA	Ca. 0.2mA	Ca. 0.2mA

Chapter 2 Installation and Wiring

(3) Applicable peripheral equipment

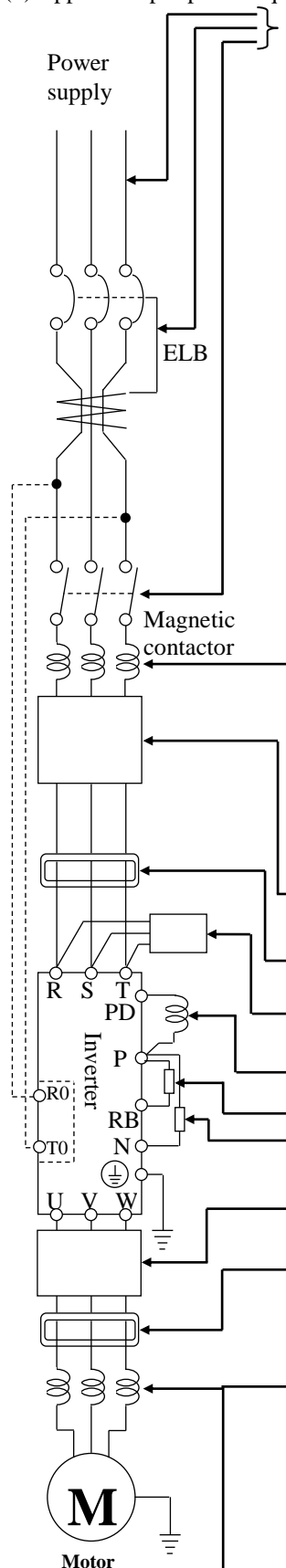

- See Item (4), "Recommended cable gauges, wiring accessories, and crimp terminals."
- Note 1: The peripheral equipment described here is applicable when the inverter connects a standard Hitachi 3-phase, 4-pole squirrel-cage motor.
 - Note 2: Select breakers that have proper capacity. (Use breakers that comply with inverters.)
 - Note 3: Use earth-leakage breakers (ELB) to ensure safety.
 - Note 4: Use copper electric wire (HIV cable) of which the maximum allowable temperature of the insulation is 75°C.
 - Note 5: If the power line exceeds 20 m, cable that is thicker than the specified applicable cable must be used for the power line.
 - Note 6: Use a 0.75 mm² cable to connect the alarm output contact.
 - Note 7: Tighten each terminal screw with the specified tightening torque. Loose terminal screws may cause short circuits and fire. Tightening a terminal screw with excessive torque may cause damage to the terminal block or inverter body.
 - Note 8: Select an earth-leakage breaker (ELB) of which the rated sensitivity current matches the total length of cables connected between the inverter and power supply and between the inverter and motor. Do not use a high-speed type ELB but use a delayed-type ELB because the high-speed type may malfunction.
 - Note 9: When a CV cable is used for wiring through a metal conduit, the average current leakage is 30 mA/km.
 - Note 10: When an IV cable, which has a high relative dielectric constant, is used, the leakage current is about eight times as high as the standard cable. Therefore, when using an IV cable, use the ELB of which the rated sensitivity current is eight times as high as that given in the table below. If the total cable length exceeds 100 m, use a CV cable.

Total cable length	Sensitivity current (mA)
100 m or less	50
300 m or less	100

Name	Description
Reactor on input side (for harmonic control, power supply coordination, and power factor improvement) (ALI-XXX)	Use this reactor to control harmonic waves or when the imbalance of power supply voltage is 3% or more, when the power supply capacity is 500 kVA or more, or when the power voltage may change rapidly. This reactor also improves the power factor.
Noise filter for inverter (NF-XXX)	This noise filter reduces the conductive noise that is generated by the inverter and transmitted in cables. Connect this noise filter to the primary side (input side) of the inverter.
Radio noise filter (Zero-phase reactor) (ZCL-X)	The inverter may generate radio noise through power supply wiring during operation. Use this noise filter to reduce the radio noise (radiant noise).
Radio noise filter on input side (Capacitor filter) (CFI-X)	Use this noise filter to reduce the radiant noise radiated from input cables.
DC reactor (DCL-X-XX)	Use this reactor to control the harmonic waves generated by the inverter.
Braking resistor Regenerative braking unit	Use these devices to increase the braking torque of the inverter for operation in which the inverter turns the connected load on and off very frequently or decelerates the load running with a high moment of inertia.
Noise filter on the output side (ACF-CX)	Connect this noise filter between the inverter and motor to reduce the radiant noise radiated from cables for the purpose of reducing the electromagnetic interference with radio and television reception and preventing malfunctions of measuring equipment and sensors.
Radio noise filter (Zero-phase reactor) (ZCL-XXX)	Use this noise filter to reduce the noise generated on the output side of the inverter. (This noise filter can be used on both the input and output sides.)
AC reactor for the output side For reducing vibrations and preventing thermal relay malfunction (ACL-X-XX)	Using the inverter to drive a general-purpose motor may cause larger vibrations of the motor when compared with driving it directly with the commercial power supply. Connect this AC reactor between the inverter and motor to lessen the pulsation of motor. Also, connect this AC reactor between the inverter and motor, when the cable length between them is long (10 m or more), to prevent thermal relay malfunction due to the harmonic waves that are generated by the switching operation on the inverter. Note that the thermal relay can be replaced with a current sensor to avoid the malfunction.
LCR filter	Connect this noise filter between the inverter and motor to convert the inverter output into a sinusoidal waveform and to reduce the motor vibration, motor noise and the radiant noise radiated from cables.

Chapter 2 Installation and Wiring

(4) Recommended cable gauges, wiring accessories, and crimp terminals

Note: For compliance with CE and UL standards, see the safety precautions concerning EMC and the compliance with UL and cUL standards under Safety Instructions.

The table below lists the specifications of cables, crimp terminals, and terminal screw tightening torques for reference.

	Motor output (kW)	Applicable inverter model	Gauge of power line cable (mm ²) (Terminals: R, S, T, U, V, W, P, PD, and N)	Grounding cable (mm ²)	External braking resistor across terminals P and RB (mm ²)	Size of terminal screw	Crimp terminal	Tightening torque (N·m)	Applicable device	
									Earth-leakage breaker (ELB)	Magnetic contactor (MC)
200 V class	0.4	SJ700D-004L***3	1.25	1.25	1.25	M4	1.25-4	1.2(MAX1.8)	EX50B(5A)	HS10
	0.75	SJ700D-007L***3	1.25	1.25	1.25	M4	1.25-4	1.2(MAX1.8)	EX50B(10A)	HS10
	1.5	SJ700D-015L***3	2	2	2	M4	2-4	1.2(MAX1.8)	EX50B(15A)	HS10
	2.2	SJ700D-022L***3	2	2	2	M4	2-4	1.2(MAX1.8)	EX50B(20A)	HS20
	3.7	SJ700D-037L***3	3.5	3.5	3.5	M4	3.5-4	1.2(MAX1.8)	EX50B(30A)	HS20
	5.5	SJ700D-055L***3	5.5	5.5	5.5	M5	R5.5-5	2.4(MAX4.0)	EX50B(50A)	HS25
	7.5	SJ700D-075L***3	8	8	8	M5	R8-5	2.4(MAX4.0)	EX60(60A)	HS35
	11	SJ700D-110L***3	14	14	14	M6	R14-6	4.0(MAX4.4)	RXX100-H(75A)	HS50
	15	SJ700D-150L***3	22	22	22	M6	22-6	4.5(MAX4.9)	RXX100-H(100A)	H65C
	18.5	SJ700D-185L***3	30	22	30	M6	38-6	4.5(MAX4.9)	RXX100-H(100A)	H80C
	22	SJ700D-220L***3	38	30	38	M8	38-8	8.1(MAX8.8)	RXX225-H(150A)	H100C
	30	SJ700D-300L***3	60(22×2)	30	—	M8	60-8	8.1(MAX8.8)	RXX225-H(200A)	H125C
	37	SJ700D-370L***3	100(38×2)	38	—	M8	100-8	8.1(MAX20)	RXX225-H(225A)	H150C
	45	SJ700D-450L***3	100(38×2)	38	—	M8	100-8	8.1(MAX20)	RXX225-H(225A)	H200C
55	SJ700D-550L***3	150(60×2)	60	—	M10	150-10	19.5(MAX22)	RX400B(350A)	H250C	
400 V class	0.75	SJ700D-007H***3	1.25	1.25	1.25	M4	1.25-4	1.2(MAX1.8)	EX50C(5A)	HS10
	1.5	SJ700D-015H***3	2	2	2	M4	2-4	1.2(MAX1.8)	EX50C(10A)	HS10
	2.2	SJ700D-022H***3	2	2	2	M4	2-4	1.2(MAX1.8)	EX50C(10A)	HS10
	3.7	SJ700D-037H***3	2	2	2	M4	2-4	1.2(MAX1.8)	EX50C(15A)	HS20
	5.5	SJ700D-055H***3	3.5	3.5	3.5	M5	R2-5	2.4(MAX4.0)	EX50C(30A)	HS20
	7.5	SJ700D-075H***3	3.5	3.5	3.5	M5	3.5-5	2.4(MAX4.0)	EX50C(30A)	HS25
	11	SJ700D-110H***3	5.5	5.5	5.5	M6	R5.5-6	4.0(MAX4.4)	EX50C(50A)	HS35
	15	SJ700D-150H***3	8	8	8	M6	8-6	4.5(MAX4.9)	EX60B(60A)	HS35
	18.5	SJ700D-185H***3	14	14	14	M6	14-6	4.5(MAX4.9)	EX60B(60A)	HS50
	22	SJ700D-220H***3	14	14	14	M6	14-6	4.5(MAX4.9)	RXX100-H(75A)	HS50
	30	SJ700D-300H***3	22	22	—	M6	22-6	4.5(MAX4.9)	RXX100-H(100A)	H65C
	37	SJ700D-370H***3	38	22	—	M8	38-8	8.1(MAX20)	RXX100-H(100A)	H80C
	45	SJ700D-450H***3	38	22	—	M8	38-8	8.1(MAX20)	RXX225-H(150A)	H100C
	55	SJ700D-550H***3	60	30	—	M8	R60-8	8.1(MAX20)	RXX225-H(175A)	H125C
	75	SJ700D-750H***3	100(38×2)	38	—	M10	100-10	20.0(MAX22)	RXX225-H(225A)	H150C
	90	SJ700D-900H***3	100(38×2)	38	—	M10	100-10	20.0(MAX22)	RXX225-H(225A)	H200C
110	SJ700D-1100H***3	150(60×2)	60	—	M10	150-10	20.0(MAX35)	RX400B(350A)	H250C	
132	SJ700D-1320HFF3 SJ700D-1320HFEF3	80×2	80	—	M10	80-10	20.0(MAX35)	RX400B(350A)	H300C	
150	SJ700D-1320HFF3	80×2	80	—	M10	80-10	20.0(MAX35)	RX400B(350A)	H300C	

Note: Cable gauges indicate those of HIV cables (maximum heat resistance: 75°C).

Note: *** is described as FF, FEF or FUF.

Note: Please use the round type crimp terminals (for the UL standard) suitable for the use electric wire when you connect the electric wire with the main circuit terminal stand. Please put on pressure to the crimp terminals with a crimp tool that the terminal stand maker recommends.

Chapter 2 Installation and Wiring

(5) Connecting the control circuit to a power supply separately from the main circuit.

If the protective circuit of the inverter operates to open the magnetic contactor in the input power supply circuit, the inverter control circuit power is lost, and the alarm signal cannot be retained. To retain the alarm signal, connect control circuit terminals R0 and T0 to a power supply. In details, connect the control circuit power supply terminals R0 and T0 to the primary side of the magnetic contactor as shown below.

(Connection method)

Power-receiving specifications

200 V class model:

200 to 240 V (+10%, -15%)

(50/60 Hz \pm 5%), (282 to 339 VDC)

400 V class model:

380 to 480 V (+10%, -15%)

(50/60 Hz \pm 5%), (537 to 678 VDC)

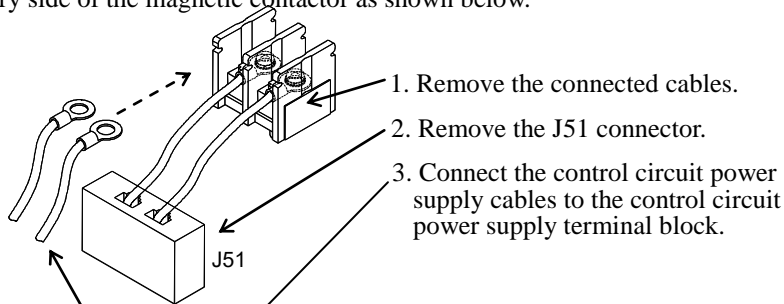

Note the following when connecting separate power supplies to control circuit power supply terminals (R0 and T0) and main circuit power supply terminals (R, S, and T):

- Use a cable thicker than 1.25 mm² to connect the terminals R0 and T0 (terminal screw size: M4).
- Connect a 3A fuse in the control circuit power supply line. (Tightening torque: 1.2Nm,max torque: 1.4Nm)
- If the control circuit power supply (connected to R0 and T0) is turned on earlier than the main circuit power supply (connected to R, S, and T), ground fault is not checked at power-on.
- When supplying DC power to the control circuit power supply terminals (R0 and T0), specify "00" as the "a/b (NO/NC)" selection (function code C031 to C036) for intelligent output terminals ([11] to [15]) and intelligent relay terminals (AL0, AL1, and AL2). If "01" is specified as the "a/b (NO/NC)" selection, output signals may chatter when the DC power supply is shut off.

Chapter 2 Installation and Wiring

2.2.3 Wiring of the control circuit

(1) Wiring instructions

- 1) Terminals L and CM1 are common to I/O signals and isolated from each other.
Do not connect these common terminals to each other or ground them.
Do not ground these terminals via any external devices. (Check that the external devices connected to these terminals are not grounded.)
- 2) Use a shielded, twisted-pair cable (recommended gauge: 0.75 mm²) for connection to control circuit terminals, and connect the cable insulation to the corresponding common terminal. (Tightening torque: 0.7Nm,max torque: 0.8Nm)
- 3) The length of cables connected to control circuit terminals must be 20 m or less. If the cable length exceeds 20 m unavoidably, you should use UP/DOWN function or current signal input with an isolation amplifier.
- 4) Separate the control circuit wiring from the main circuit wiring (power line) and relay control circuit wiring. If these wirings intersect with each other unavoidably, square them with each other. Otherwise, the inverter may malfunction.
- 5) Twist the cables connected from a thermistor to the thermistor input terminal (TH) and terminal CM1, and separate the twisted cables from other cables connected to other common terminals. Since very low current flows through the cables connected to the thermistor, separate the cables from those (power line cables) connected to the main circuit. The length of the cables connected to the thermistor must be 20 m or less.

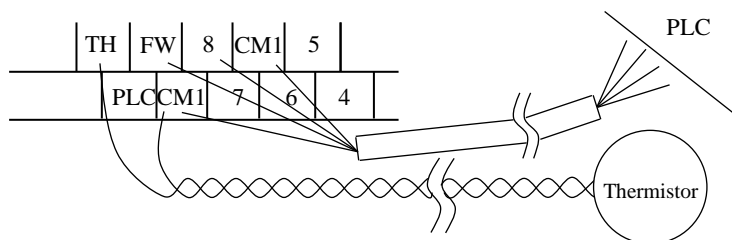

- 6) When connecting a contact to a control circuit terminal (e.g., an intelligent input terminal), use a relay contact (e.g., crossbar twin contact) in which even a very low current or voltage will not trigger any contact fault.
- 7) When connecting a relay to an intelligent output terminal, also connect a surge-absorbing diode in parallel with the relay.
- 8) Do not connect analog power supply terminals H and L or interface power supply terminals P24 and CM1 to each other. Otherwise, the inverter may fail.

(2) Layout of control circuit terminals

H	O2	AM	FM	TH	FW	8	CM1	5	3	1	14	13	11	AL1	
L	O	OI	AMI	P24	PLC	CM1	7	6	4	2	15	CM2	12	AL0	AL2

Terminal screw size: M3 (Tightening torque:0.7Nm,max torque:0.8Nm)

(3) Switching the input control logic

- In the factory setting, the input control logic for terminal FW and intelligent input terminals is the sink logic. To switch the input control logic to the source logic, remove the jumper connecting terminals P24 and PLC on the control circuit block, and then connect terminals PLC and CM1 with the jumper.

Chapter 2 Installation and Wiring

(4) Connecting a programmable controller to intelligent input terminals

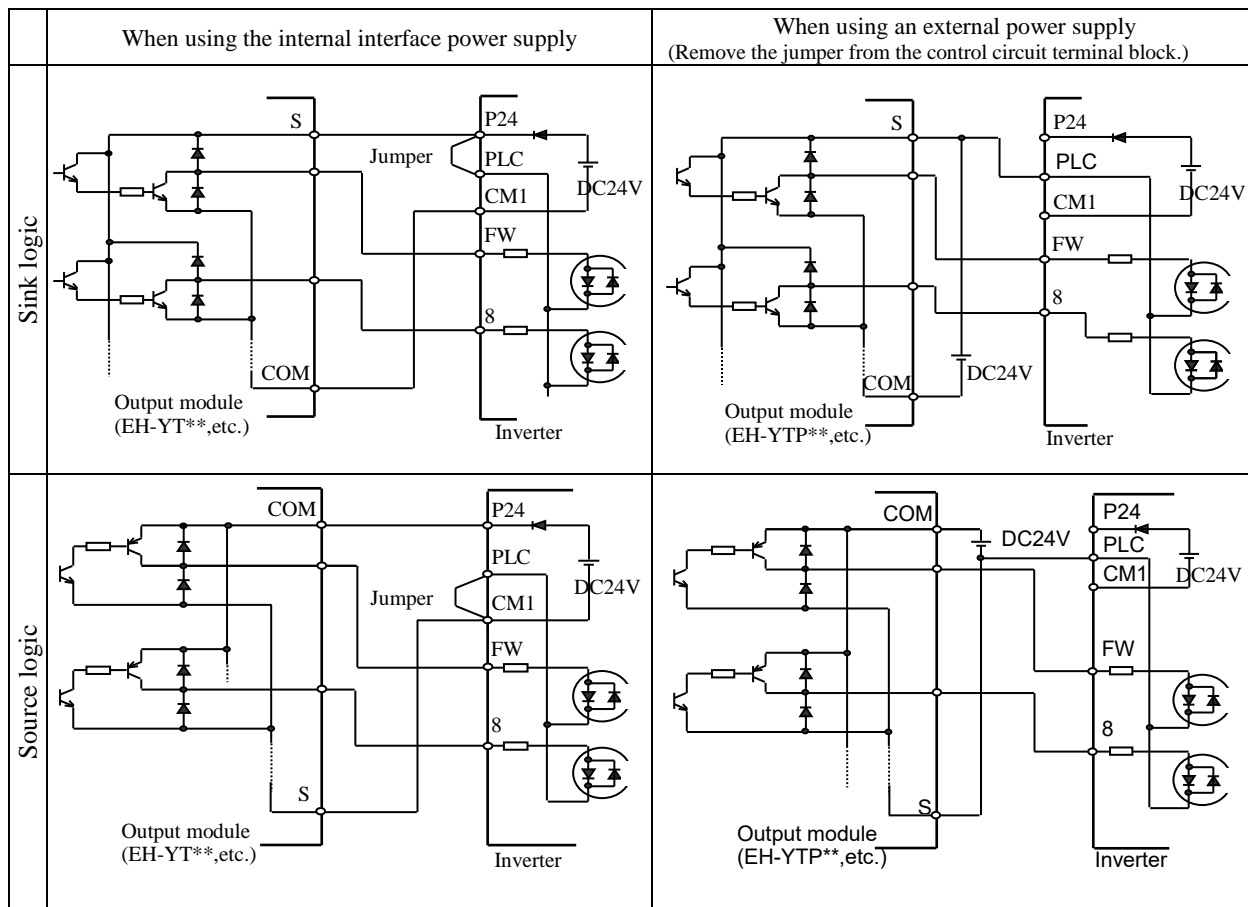

(5) Connecting a programmable controller to intelligent output terminals

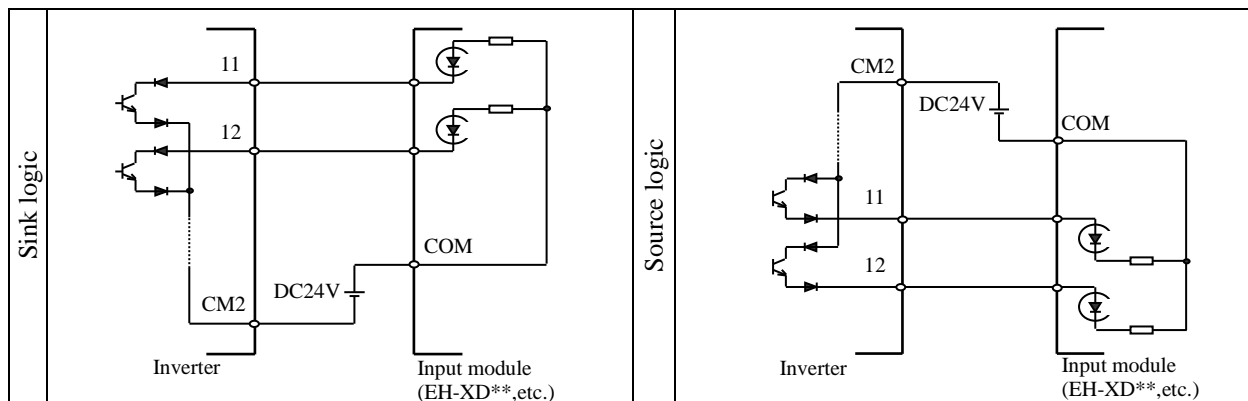

2.2.4 Wiring of the digital operator

- You can operate the inverter with not only the digital operator mounted in the inverter as standard equipment but also an optional digital operator (OPE-S, OPE-SR, WOP).
- When you intend to remove the standard digital operator from the inverter and use it as remote equipment, request your local Hitachi Distributor to supply a connection cable, ICS-1 (1-meter cable) or ICS-3 (3-meter cable). If you prepare the cable by yourself, the following product is recommended: HUTP5 PC 4P -X-X: Straight cable equipped with connector at both ends (made by Hitachi Metal, Ltd.)
- The length of the connection cable must be 3 m or less. If a cable over 3 m is used, the inverter may malfunction.

Chapter 3 Operation

This chapter describes typical methods of operating the inverter, how to operate the digital operator, and how to make a test run of the inverter.

3.1 Operating Methods	3 - 2
3.2 How To Operate the Digital Operator (OPE-SBK).....	3 - 4

Chapter 3 Operation

3.1 Operating Methods



- While power is supplied to the inverter, do not touch any terminal or internal part of the inverter, check signals, or connect or disconnect any wire or connector. Otherwise, you run the risk of electric shock or fire.
- Be sure to close the terminal block cover before turning on the inverter power. Do not open the terminal block cover while power is being supplied to the inverter or voltage remains inside. Otherwise, you run the risk of electric shock.
- Do not operate switches with wet hands. Otherwise, you run the risk of electric shock.
- While power is supplied to the inverter, do not touch the terminal of the inverter, even if it has stopped. Otherwise, you run the risk of injury or fire.
- If the retry mode has been selected, the inverter will restart suddenly after a break in the tripping status. Stay away from the machine controlled by the inverter when the inverter is under such circumstances. (Design the machine so that human safety can be ensured, even when the inverter restarts suddenly.) Otherwise, you run the risk of injury.
- Do not select the retry mode for controlling an elevating or traveling device because output free-running status occurs in retry mode. Otherwise, you run the risk of injury or damage to the machine controlled by the inverter.
- If an operation command has been input to the inverter before a short-term power failure, the inverter may restart operation after the power recovery. If such a restart may put persons in danger, design a control circuit that disables the inverter from restarting after power recovery. Otherwise, you run the risk of injury.
- The [STOP] key is effective only when its function is enabled by setting. Prepare an emergency stop switch separately. Otherwise, you run the risk of injury.
- If an operation command has been input to the inverter before the inverter enters alarm status, the inverter will restart suddenly when the alarm status is reset. Before resetting the alarm status, make sure that no operation command has been input.
- While power is supplied to the inverter, do not touch any internal part of the inverter or insert a bar in it. Otherwise, you run the risk of electric shock or fire.



- Do not touch the heat sink, which heats up during the inverter operation. Otherwise, you run the risk of burn injury.
- The inverter allows you to easily control the speed of motor or machine operations. Before operating the inverter, confirm the capacity and ratings of the motor or machine controlled by the inverter. Otherwise, you run the risk of injury and damage to machine.
- Install an external brake system if needed. Otherwise, you run the risk of injury.
- When using the inverter to operate a standard motor at a frequency of over 60 Hz, check the allowable motor speeds with the manufacturers of the motor and the machine to be driven and obtain their consent before starting inverter operation. Otherwise, you run the risk of damage to the motor and machine and injury.
- During inverter operation, check the motor for the direction of rotation, abnormal sound, and vibrations. Otherwise, you run the risk of damage to the machine driven by the motor.

Chapter 3 Operation

You can operate the inverter in different ways, depending on how to input the operation and frequency-setting commands as described below.

This section describes the features of operating methods and the items required for operation.

(1) Entering operation and frequency-setting commands from the digital operator

This operating method allows you to operate the inverter through key operations on the standard digital operator mounted in the inverter or an optional digital operator.

When operating the inverter with a digital operator alone, you need not wire the control circuit terminals.

(Items required for operation)

*) Optional digital operator (not required when you use the standard digital operator)

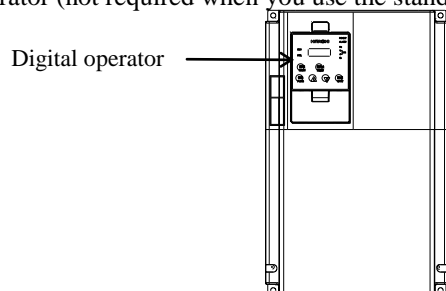

(2) Entering operation and frequency-setting commands via control circuit terminals

This operating method allows you to operate the inverter via the input of operation signals from external devices (e.g., frequency-setting circuit and start switch) to control circuit terminals. The inverter starts operation when the input power supply is turned on and then an operation command signal (FW or RV) is turned on. You can select the frequency-setting method (setting by voltage specification or current specification) through the input to a control circuit terminal according to your system. For details, see Item (2), "Explanation of control circuit terminals," in Section 2.2.1. (Items required for operation)

1) Operation command input device: External switch or relay

2) Frequency-setting command input device: External device to input signals (0 to 10 VDC, -10 to +10 VDC, or 4 to 20 mA)

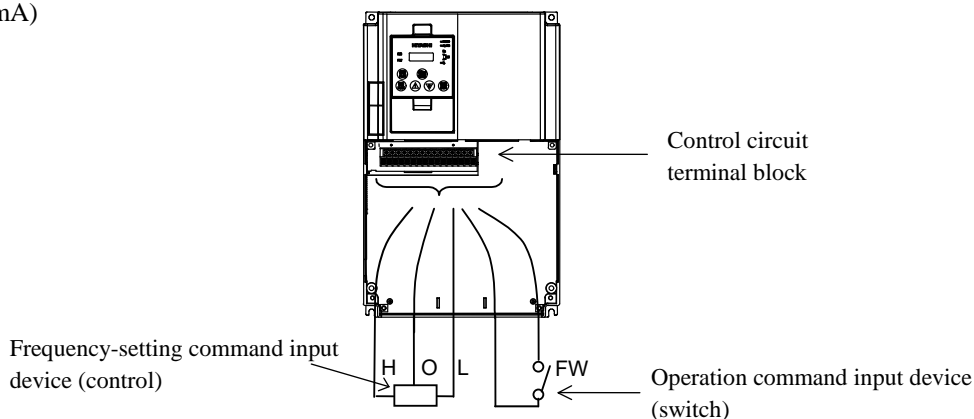

(3) Entering operation and frequency-setting commands; both from a digital operator and via control circuit terminals

This operating method allows you to arbitrarily select the digital operator or control circuit terminals as the means to input operation commands and frequency-setting commands. (Items required for operation)

1) See the items required for the above two operating methods.

(4) Operation by Easy sequence function (Drive programming function)

The inverter can be operated by downloading the user's program made with the dedicated PC software, ProDriveNext. Please refer to "Easy sequence function" for details.

(5) Operation via communication

The inverter can be operated by an external communication device via Modbus-RTU or ASCII protocol (Hitachi protocol) through the TM2 terminal on the control terminal I board. Please refer to "Communication function" for details.

Chapter 3 Operation

3.2 How To Operate the Digital Operator (OPE-SBK)

3.2.1 Names and functions of components

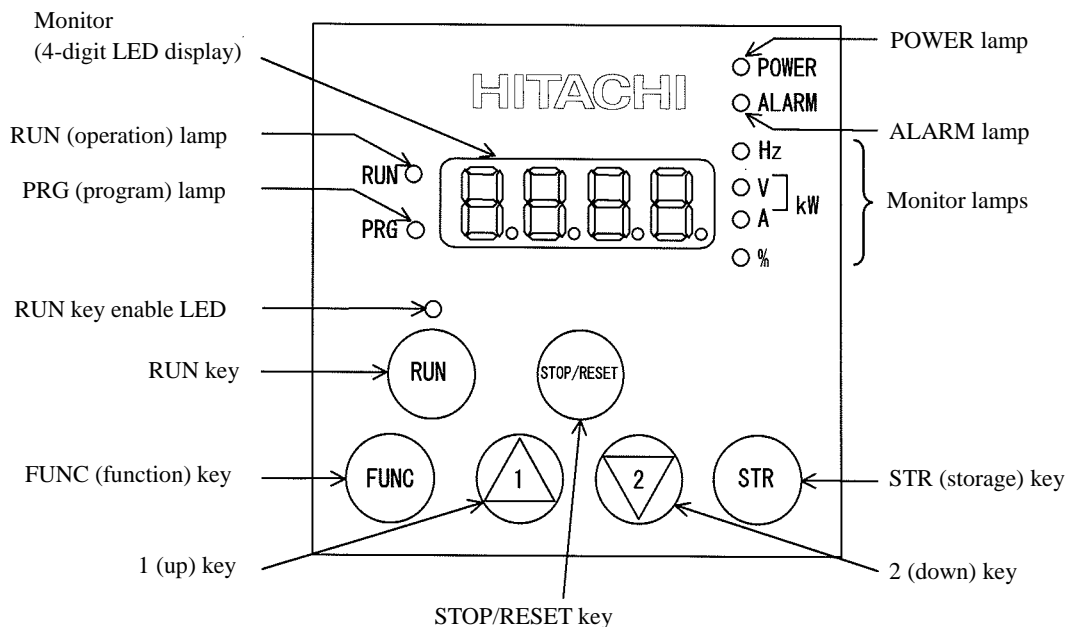



Name	Function
POWER lamp	Lights when the control circuit power is on.
ALARM lamp	Lights to indicate that the inverter has tripped.
RUN (operation) lamp	Lights to indicate that the inverter is operating.
PRG (program) lamp	Lights when the monitor shows a value set for a function. This lamp starts blinking to indicate a warning (when the set value is invalid).
Monitor	Displays a frequency, output current, or set value.
Monitor lamps	Indicates the type of value and units displayed on the monitor. "Hz" (frequency), "V" (voltage), "A" (current), "kW" (electric power), and "%" (percentage)
RUN key enable LED	Lights up when the inverter is ready to respond to the RUN key. (When this lamp is on, you can start the inverter with the RUN key on the digital operator.)
RUN key	Starts the inverter to run the motor. This key is effective only when the RUN command source setting A002 is set to "02": digital operator. (To use this key, confirm that RUN key enable LED is on.)
STOP/RESET key	Decelerates and stops the motor or resets the inverter from alarm status.
FUNC (function) key	Makes the inverter enter the monitor, function, or extended function mode.
STR (storage) key	Stores each set value. (Always press this key after changing a set value.)
1 (up) or 2 (down) key	Switches the inverter operation mode (among monitor, function, and extended function modes) or increases or decreases the value set on the monitor for a function.







3.2.2 Code display system and key operations

This section describes typical examples of digital operator operation (full display mode). Refer to SJ700D-3 Instruction manual for more information.

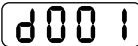
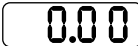
The initial display on the monitor screen after power-on depends on the setting of function "b038". For details, see "Initial-screen selection,"

When the setting of function "b038" is "01" (factory setting), the monitor initially shows  as the setting of function "d001" (output frequency monitoring). Pressing the  key in this status changes the display to .

Note: The display contents on the monitor depend on the settings of functions "b037" (function code display restriction), "b038" (initial-screen selection), and "b039" (automatic setting of user parameters). Refer to SJ700D-3 Instruction manual for more information.

- The following procedure enables you to turn the monitor display back to  or * regardless of the current display mode:
- Hold down the  key for 3 seconds or more. The monitor shows *.
- During this status, press the  key. The monitor will show only  or *, which is shown when the  is pressed.

*) The monitor shows  only when the motor driven by the inverter is stopped. While the motor is running, the monitor shows an output frequency. The displayed monitor is depending on "b038" (initial-screen selection).

Chapter 3 Operation

Example of operation in full display mode ("b037" = "00") [Factory setting]

All parameters can be displayed in full display mode. If you use other display mode, refer to the SJ700D-3 Instruction Manual.

Key operation and transition of codes on display (in monitor or function mode)	Key operation and transition of monitored data on display (in monitor or function mode)	Key operation and transition of codes on display (in extended function mode)	Key operation and transition of monitored data on display (in extended function mode)
--	---	--	---

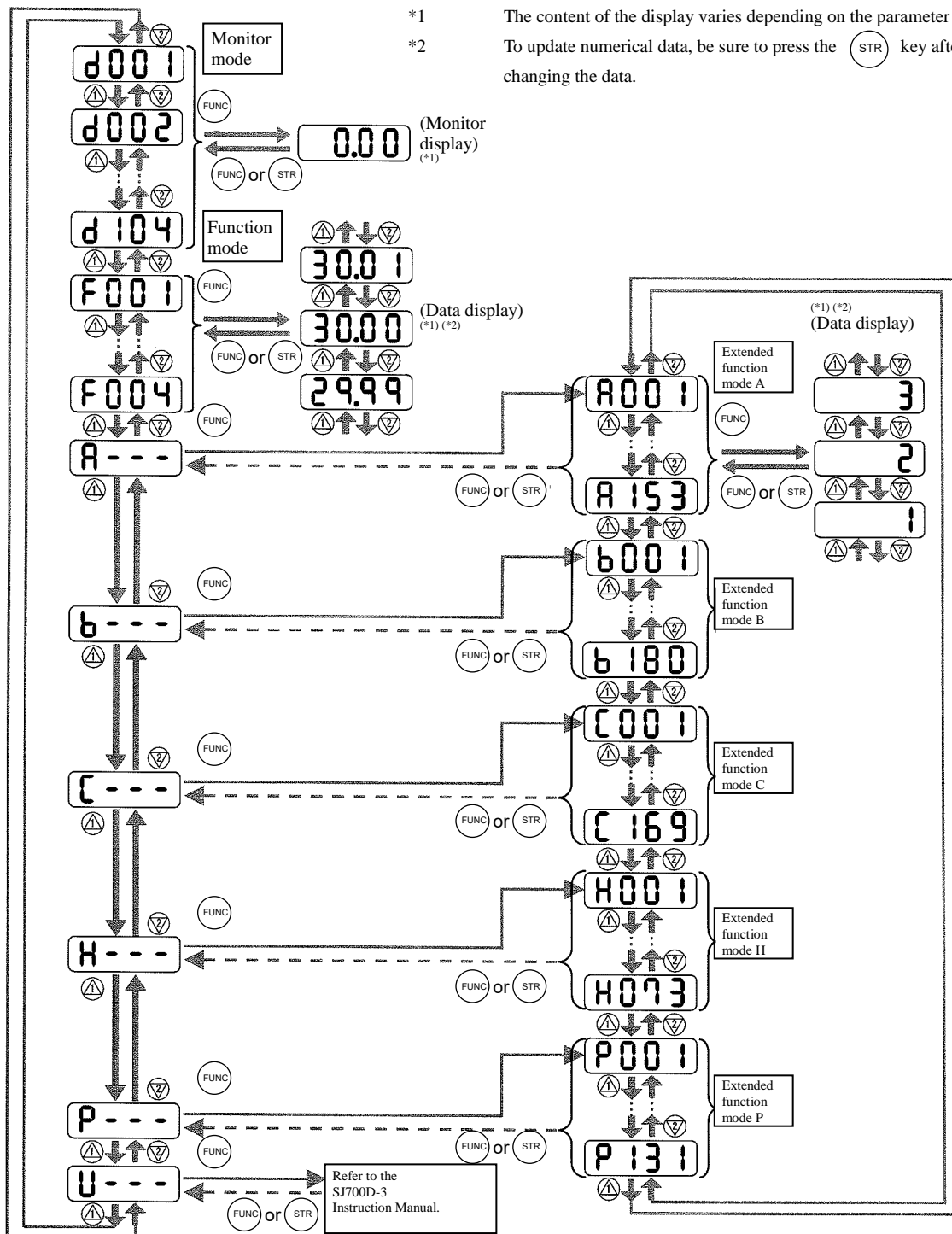

Pressing the **▲** or **▼** key respectively scrolls up or down the code displayed in code display mode or increases or decreases the numerical data displayed in data display mode.

Press the **▲** or **▼** key until the desired code or numerical data is shown. To scroll codes or increase/decrease numerical data fast, press and hold the key.

Chapter 3 Operation

Procedure for directly specifying or selecting a code

- You can specify or select a code or data by entering each digit of the code or data instead of scrolling codes or data in the monitor, function, or extended function mode.
- The following shows an example of the procedure for changing the monitor mode code "d001" displayed to extended function code "A029":

1) Display the monitor mode code.

("d001" is displayed.)

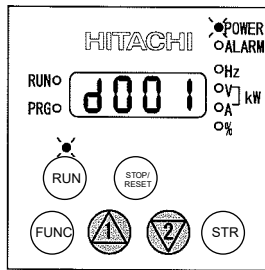

(*2)

(*3)

Press the **FUNC** key together. Press the **1** and **2** keys (*1)

2) Change to the extended function mode.

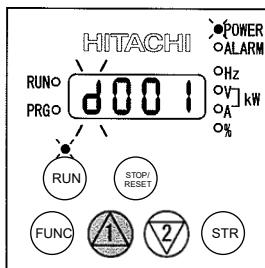

- Character "d" in the leftmost digit (fourth digit from the right) starts blinking.

Press the **1** key twice.
("A001" is displayed.)

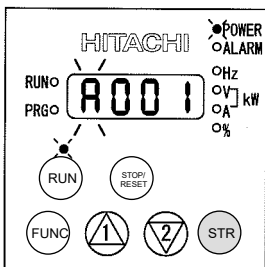

(*3)

- Character "A" is blinking.
- Pressing the [STR] key determines the blinking character.

(*2)

Press the **STR** key (to determine character "A").

3) Change the third digit of the code.

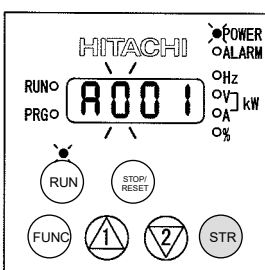

Press the **STR** key.
(Character "0" is determined.)

- Character "0" in the third digit is blinking.
- Since the third digit need not be changed, press the [STR] key to determine the character "0".

("A029" is displayed.)

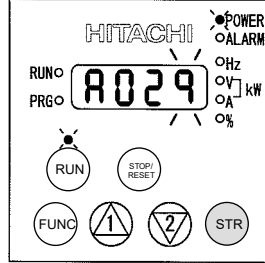

(*2)

- Character "9" in the first digit is blinking.

Press the **1** key eight times or the **2** key twice.

5) Change the first digit of the code.

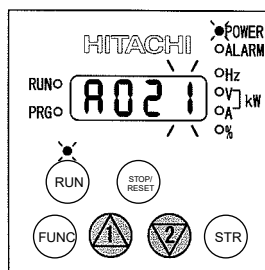

- Character "1" in the first digit is blinking.

Press the **STR** key.

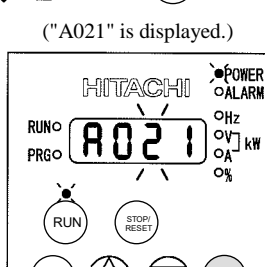

(*2)

- Character "2" in the second digit is blinking.

Press the **1** key twice.

4) Change the second digit of the code.

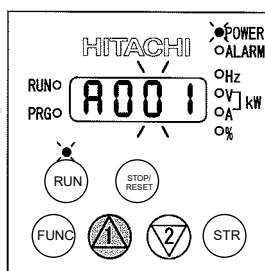

- Character "0" in the second digit is blinking.

6) End the change of the extended function code.

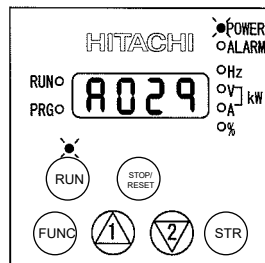

Press the **STR** key.

(Character "9" is determined.)

- Selection of code "A029" is completed.

* If a code that is not defined in the code list or not intended for display is entered, the leftmost digit (fourth digit) (character "A" in this example) will start blinking again.

In such a case, confirm the code to be entered and enter it correctly. For further information, refer to Section 4.2.84, "Function code display restriction," (on page 4-79), Section 4.2.85, "Initial-screen selection," (on page 4-81), Section 4.2.86, "Automatic user-parameter setting," (on page 4-82), and Chapter 8, "List of Data Settings."

7) Press the **FUNC** key to display the data corresponding to the function code, change the data with the **1** and/or **2** key, and then press the **STR** key to store the changed data. (*4)

Note that you can also use the procedure (steps 1) to 6) described here to change the data. (*3)(*4)

*1 This procedure can also be used on screens displaying a code other than "d001".

*2 If the **FUNC** key is pressed while a digit is blinking, the display will revert to the preceding status for entering the digit to the right of the blinking digit.

*3 If the **FUNC** key is pressed while the leftmost (fourth) digit is blinking, the characters having been entered to change the code will be cancelled and the display will revert to the original code shown before the **1** and **2** keys were pressed in step 1).

*4 When changing data, be sure to press the **FUNC** key first.

Chapter 3 Operation

(Memo)

Chapter 4 List of Data Settings

This chapter describes the data settings for the various functions of the inverter.

4.1	Precautions for Data Setting.....	4 - 2
4.2	Monitoring Mode	4 - 2
4.3	Function Mode	4 - 3
4.4	Extended Function Mode	4 - 4

Chapter 4 List of Data Settings

IMPORTANT! Please be sure to set the motor nameplate data into appropriate parameters to ensure proper operation and protection of the motor.

*b012 is the motor overload protection value
 *A003 is the motor base frequency setting
 *H003 is the motor kW capacity

*A082 is the motor voltage selection
 *H004 is the number of motor poles

Please refer to the appropriate pages in this guide and the Instruction Manual for further details.

4.1 Precautions for Data Setting

- FF, FEF and FUF are the parts of inverter model.
 For example, in case of 1.5kW/400V class, SJ700D-015H***3 (***) is described as FF, FEF or FUF.)
- Even though the inverter is driving the motor, you can change some parameters. If you specify "10" for the software lock mode selection (b031), you can change some more parameters. See the table below.
- In case of setting VT mode, some parameters and some data become invisible. Refer to the SJ700D-3 instruction manual for more information.

4.2 Monitoring Mode

With the default settings, the initial display on the operator after powering on is always the output frequency monitor (d001). To change the initial display content, change the setting of the initial-screen selection (b038) as required.

Code	Function name	Monitored data or setting	Default			Change during RUN operation	
			FF	FEF	FUF	b031≠10	b031=10
d001	Output frequency monitoring	0.00 to 99.99, 100.0 to 400.0 (Hz)	-			Allowed	Allowed
d002	Output current monitoring	0.0 to 999.9, 1000 to 9999 (A)	-			-	-
d003	Rotation direction monitoring	F (forward rotation), o (stopped), r (reverse rotation)	-			-	-
d004	Process variable (PV), PID feedback monitoring	0.00 to 99.99, 100.0 to 999.9, 1000. to 9999, 1000 to 9999 (10000 to 99990), 100 to 999 (100000 to 999000)	-			-	-
d005	Intelligent input terminal status	<div style="display: flex; align-items: center;"> <div style="margin-right: 20px;"> <p>FW</p> </div> <div> <p>(Example) Terminals FW, 7, 2, and 1: ON Terminals 8, 6, 5, 4, and 3: OFF</p> </div> </div>	-			-	-
d006	Intelligent output terminal status	<div style="display: flex; align-items: center;"> <div style="margin-right: 20px;"> </div> <div> <p>(Example) Terminals 12 and 11: ON Terminals AL, 15, 14, and 13: OFF</p> </div> </div>	-			-	-
d007	Scaled output frequency monitoring	0.00 to 99.99, 100.0 to 999.9, 1000. to 9999, 1000 to 3996 (10000 to 39960)	-			Allowed	Allowed
d008	Actual-frequency monitoring	-400. to -100., -99.9 to 0.00 to 99.99, 100.0 to 400.0 (Hz)	-			-	-
d009	Torque command monitoring	-200. to +200. (%)	-			-	-
d010	Torque bias monitoring		-			-	-
d012	Torque monitoring		-			-	-
d013	Output voltage monitoring	0.0 to 600.0 (V)	-			-	-
d014	Power monitoring	0.0 to 999.9 (kW)	-			-	-
d015	Cumulative power monitoring	0.0 to 999.9, 1000. to 9999, 1000 to 9999 (10000 to 99990), 100 to 999 (100000 to 999000)	-			-	-
d016	Cumulative operation RUN time monitoring	0. to 9999., 1000 to 9999 (10000 to 99990), 100 to 999 (100000 to 999000) (hr)	-			-	-
d017	Cumulative power-on time monitoring		-			-	-
d018	Heat sink temperature monitoring	-020. to 200.0 (°C)	-			-	-
d019	Motor temperature monitoring		-			-	-

Chapter 4 List of Data Settings

Code	Function name	Monitored data or setting	Default			Change during RUN operation	
			FF	FEF	FUF	b031≠10	b031=10
d022	Life-check monitoring		-	-	-	-	-
d023	Program counter	0 to 1024	-	-	-	-	-
d024	Program number monitoring	0000 to 9999	-	-	-	-	-
d025	User monitor 0	-2147483647 to 2147483647 (upper 4 digits including "--")	-	-	-	-	-
d026	User monitor 1		-	-	-	-	-
d027	User monitor 2		-	-	-	-	-
d028	Pulse counter	0 to 2147483647 (upper 4 digits)	-	-	-	-	-
d029	Position setting monitor	-1073741823 to 1073741823 (upper 4 digits including "--")	-	-	-	-	-
d030	Position feedback monitor		-	-	-	-	-
d031	Clock monitor	* In case you use WOP (option), this monitor is activated.	-	-	-	-	-
d060	Inverter mode monitor	I-C(CT)/ I-v(VT)	-	-	-	-	-
d080	Trip Counter	0. to 9999., 1000 to 6553 (10000 to 65530) (times)	-	-	-	-	-
d081	Trip monitoring 1	Factor, frequency (Hz), current (A), voltage across P-N (V), running time (hours), power-on time (hours)	-	-	-	-	-
d082	Trip monitoring 2		-	-	-	-	-
d083	Trip monitoring 3		-	-	-	-	-
d084	Trip monitoring 4		-	-	-	-	-
d085	Trip monitoring 5		-	-	-	-	-
d086	Trip monitoring 6		-	-	-	-	-
d090	Programming error monitoring	Warning code	-	-	-	-	-
d102	DC voltage monitoring	0.0 to 999.9 (V)	-	-	-	-	-
d103	BRD load factor monitoring	0.0 to 100.0 (%)	-	-	-	-	-
d104	Electronic thermal overload monitoring		-	-	-	-	-

(Note) CT : Constant torque mode, VT : Variable torque mode, you can set CT or VT by b049.

4.3 Function Mode

Code	Function name	Monitored data or setting	Default			Change during RUN operation	
			FF	FEF	FUF	b031≠10	b031=10
F001	Output frequency setting	0.0, "start frequency" to "maximum frequency" (or maximum frequency, 2nd/3rd motors) (Hz) 0.0 to 100.0 (when PID function is enabled)	0.00			Allowed	Allowed
F002	Acceleration time setting	0.01 to 99.99, 100.0 to 999.9, 1000. to 3600. (s)	30.00			Allowed	Allowed
F202	Acceleration time setting, 2nd motor		30.00			Allowed	Allowed
F302	Acceleration time setting, 3rd motor		30.00			Allowed	Allowed
F003	Deceleration time setting	0.01 to 99.99, 100.0 to 999.9, 1000. to 3600. (s)	30.00			Allowed	Allowed
F203	Deceleration time setting, 2nd motor		30.00			Allowed	Allowed
F303	Deceleration time setting, 3rd motor		30.00			Allowed	Allowed
F004	Keypad Run key routing	00 (forward rotation), 01 (reverse rotation)	00			Not	Not

Chapter 4 List of Data Settings

4.4 Extended Function Mode

Code	Function name	Monitored data or setting	Default			Change during RUN operation				
			FF	FEF	FUF	b031≠10	b031=10			
Basic settings	A001	Frequency source setting	00 (keypad potentiometer) (*1), 01 (control circuit terminal block), 02 (digital operator), 03 (RS485), 04 (option 1), 05 (option 2), 06 (pulse-string input), 07 (easy sequence), 10 (operation function result)			02	01	01	Not	Not
	A002	Run command source setting	01 (control circuit terminal block), 02 (digital operator), 03 (RS485), 04 (option 1), 05 (option 2)			02	01	01	Not	Not
	A003	Base frequency setting	30. to "Maximum frequency " (Hz)			60.	50.	60.	Not	Not
	A203	Base frequency setting, 2nd motor	30. to "Maximum frequency, 2nd motor" (Hz)			60.	50.	60.	Not	Not
	A303	Base frequency setting, 3rd motor	30. to "Maximum frequency, 3rd motor" (Hz)			60.	50.	60.	Not	Not
	A004	Maximum frequency setting	"Base frequency" (Hz) to 400. (Hz)			60.	50.	60.	Not	Not
	A204	Maximum frequency setting, 2nd motor	"Base frequency, 2nd motor" (Hz) to 400. (Hz)			60.	50.	60.	Not	Not
	A304	Maximum frequency setting, 3rd motor	"Base frequency, 3rd motor" (Hz) to 400. (Hz)			60.	50.	60.	Not	Not
Analog input and others	A005	[AT] selection	00 (switching between O and OI terminals), 01 (switching between O and O2 terminals), 02 (switching between O terminal and keypad potentiometer) (*1), 03 (switching between OI terminal and keypad potentiometer) (*1), 04 (switching between O2 and keypad potentiometer) (*1)			00			Not	Not
	A006	[O2] selection	00 (single), 01 (auxiliary frequency input via O and OI terminals) nonreversible), 02 (auxiliary frequency input via O and OI terminals) (reversible), 03 (disabling O2 terminal)			03			Not	Not
	A011	[O]-[L] input active range start frequency	0.00 to 99.99, 100.0 to 400.0 (Hz)			0.00			Not	Allowed
	A012	[O]-[L] input active range end frequency	0.00 to 99.99, 100.0 to 400.0 (Hz) (In case of setting 0.00, internal setting is "Maximum frequency ")			0.00			Not	Allowed
	A013	[O]-[L] input active range start voltage	0. to "[O]-[L] input active range end voltage" (%)			0.			Not	Allowed
	A014	[O]-[L] input active range end voltage	"[O]-[L] input active range start voltage" to 100. (%)			100.			Not	Allowed
	A015	[O]-[L] input active range start frequency selection	00 (external start frequency), 01 (0 Hz)			01			Not	Allowed
	A016	External frequency filter time const.	1. to 30. or 31. (500 ms filter ±0.1 Hz with hysteresis)			31.			Not	Allowed
A017	Easy sequence function selection	00 (disabling), 01 (enabling)			00			Not	Not	
Multispeed operation and jogging	A019	Multispeed operation selection	00 (binary: 16 speeds selectable with 4 terminals), 01 (bit: 8 speeds selectable with 7 terminals)			00			Not	Not
	A020	Multispeed frequency setting	0.0 or "start frequency" to "maximum frequency" (Hz)			0.00			Allowed	Allowed
	A220	Multispeed frequency setting, 2nd motor	0.0 or "start frequency" to "maximum frequency, 2nd motor" (Hz)			0.00			Allowed	Allowed
	A320	Multispeed frequency setting, 3rd motor	0.0 or "start frequency" to "maximum frequency, 3rd motor" (Hz)			0.00			Allowed	Allowed
	A021	Multispeed 1 setting	0.0 or "start frequency" to "1st maximum frequency" (Hz)			0.00			Allowed	Allowed
	A022	Multispeed 2 setting	0.0 or "start frequency" to "2nd maximum frequency" (Hz)			0.00			Allowed	Allowed
	A023	Multispeed 3 setting	0.0 or "start frequency" to "3rd maximum frequency" (Hz)			0.00			Allowed	Allowed
	A024	Multispeed 4 setting	0.0 or "start frequency" to "n-th maximum frequency" (Hz) (n=1 to 3)			0.00			Allowed	Allowed
	A025	Multispeed 5 setting	0.0 or "start frequency" to "n-th maximum frequency" (Hz) (n=1 to 3)			0.00			Allowed	Allowed
	A026	Multispeed 6 setting	0.0 or "start frequency" to "n-th maximum frequency" (Hz) (n=1 to 3)			0.00			Allowed	Allowed
	A027	Multispeed 7 setting	0.0 or "start frequency" to "n-th maximum frequency" (Hz) (n=1 to 3)			0.00			Allowed	Allowed
	A028	Multispeed 8 setting	0.0 or "start frequency" to "n-th maximum frequency" (Hz) (n=1 to 3)			0.00			Allowed	Allowed
	A029	Multispeed 9 setting	0.0 or "start frequency" to "n-th maximum frequency" (Hz) (n=1 to 3)			0.00			Allowed	Allowed
	A030	Multispeed 10 setting	0.0 or "start frequency" to "n-th maximum frequency" (Hz) (n=1 to 3)			0.00			Allowed	Allowed
	A031	Multispeed 11 setting	0.0 or "start frequency" to "n-th maximum frequency" (Hz) (n=1 to 3)			0.00			Allowed	Allowed
	A032	Multispeed 12 setting	0.0 or "start frequency" to "n-th maximum frequency" (Hz) (n=1 to 3)			0.00			Allowed	Allowed
	A033	Multispeed 13 setting	0.0 or "start frequency" to "n-th maximum frequency" (Hz) (n=1 to 3)			0.00			Allowed	Allowed
	A034	Multispeed 14 setting	0.0 or "start frequency" to "n-th maximum frequency" (Hz) (n=1 to 3)			0.00			Allowed	Allowed
	A035	Multispeed 15 setting	0.0 or "start frequency" to "n-th maximum frequency" (Hz) (n=1 to 3)			0.00			Allowed	Allowed
	A038	Jog frequency setting	"Start frequency" to 9.99 (Hz)			1.00			Allowed	Allowed
	A039	Jog stop mode	00 (free-running after jogging stops [disabled during operation]), 01 (deceleration and stop after jogging stops [disabled during operation]), 02 (DC braking after jogging stops [disabled during operation]), 03 (free-running after jogging stops [enabled during operation]), 04 (deceleration and stop after jogging stops [enabled during operation]), 05 (DC braking after jogging stops [enabled during operation])			00			Not	Allowed

*1 This setting is valid only when the OPE-SR is connected.

Chapter 4 List of Data Settings

Code	Function name	Monitored data or setting	Default			Change during RUN operation		
			FF	FEE	FUF	b031≠10	b031=10	
V/f characteristic	A041	Torque boost method selection	00 (manual torque boost), 01 (automatic torque boost)			00	Not	Not
	A241	Torque boost method selection, 2nd motor				00	Not	Not
	A042	Manual torque boost value	0.0 to 20.0 (%)			1.0	Allowed	Allowed
	A242	Manual torque boost value, 2nd motor				1.0	Allowed	Allowed
	A342	Manual torque boost value, 3rd motor				1.0	Allowed	Allowed
	A043	Manual torque boost frequency adjustment				0.0 to 50.0 (%)		
	A243	Manual torque boost frequency adjustment, 2nd motor	5.0	Allowed	Allowed			
	A343	Manual torque boost frequency adjustment, 3rd motor	5.0	Allowed	Allowed			
	A044	V/F characteristic curve selection, 1st motor	00 (VC), 01 (VP), 02 (free V/f), 03 (sensorless vector control), 04 (0Hz sensorless vector control)(only CT), 05(vector with sensor)(only CT)			00	Not	Not
	A244	V/F characteristic curve selection, 2nd motor	00 (VC), 01 (VP), 02 (free V/f), 03 (sensorless vector control), 04 (0Hz sensorless vector control)(only CT)			00	Not	Not
	A344	V/F characteristic curve selection, 3rd motor	00(VC), 01(VP)			00	Not	Not
	A045	V/f gain setting	20. to 100. (%)			100.	Allowed	Allowed
	A046	Voltage compensation gain setting for automatic torque boost. 1st motor	0. to 255.			100.	Allowed	Allowed
	A246	Voltage compensation gain setting for automatic torque boost, 2nd motor				100.	Allowed	Allowed
A047	Slippage compensation gain setting for automatic torque boost, 1st motor	0. to 255.			100.	Allowed	Allowed	
A247	Slippage compensation gain setting for automatic torque boost, 2nd motor				100.	Allowed	Allowed	
DC braking	A051	DC braking enable	00 (disabling), 01 (enabling), 02 (set frequency only)			00	Not	Allowed
	A052	DC braking frequency setting	0.00 to 99.99, 100.0 to 400.0 (Hz)			0.50	Not	Allowed
	A053	DC braking wait time	0.0 to 5.0 (s)			0.0	Not	Allowed
	A054	DC braking force during deceleration	0. to 100. (%) <0. to 80. (%)> (In case of CT) 0. to 70. (%) <0. to 50. (%)> (In case of VT)			20.	Not	Allowed
	A055	DC braking time for deceleration	0.0 to 60.0 (s)			0.5	Not	Allowed
	A056	DC braking/edge or level detection for [DB] input	00 (edge operation), 01 (level operation)			01	Not	Allowed
	A057	DC braking force for starting	0. to 100. (%) <0. to 80. (%)> (In case of CT) 0. to 70. (%) <0. to 50. (%)> (In case of VT)			0.	Not	Allowed
	A058	DC braking time for starting	0.0 to 60.0(s)			0.0	Not	Allowed
	A059	DC braking carrier frequency setting	0.5 to 15.0(kHz) <0.5 to 10.0 (kHz) > (In case of CT) 0.5 to 12.0(kHz) <0.5 to 8.0 (kHz) > (In case of VT)			5.0<3.0> (CT) 3.0 (VT)	Not	Not
Frequency upper/lower limit and jump frequency	A061	Frequency upper limit setting	0.00 or "1st minimum frequency limit" to "maximum frequency" (Hz)			0.00	Not	Allowed
	A261	Frequency upper limit setting, 2nd motor	0.00 or "2nd minimum frequency limit" to "maximum frequency, 2nd motor" (Hz)			0.00	Not	Allowed
	A062	Frequency lower limit setting	0.00 or "start frequency" to "maximum frequency limit" (Hz)			0.00	Not	Allowed
	A262	Frequency lower limit setting, 2nd motor	0.00 or "start frequency" to "maximum frequency, 2nd motor limit" (Hz)			0.00	Not	Allowed
	A063	Jump (center) frequency setting 1	0.00 to 99.99, 100.0 to 400.0 (Hz)			0.00	Not	Allowed
	A064	Jump (hysteresis) frequency width setting 1	0.00 to 10.00 (Hz)			0.50	Not	Allowed
	A065	Jump (center) frequency setting 2	0.00 to 99.99, 100.0 to 400.0 (Hz)			0.00	Not	Allowed
	A066	Jump (hysteresis) frequency width setting 2	0.00 to 10.00 (Hz)			0.50	Not	Allowed
	A067	Jump (center) frequency setting 3	0.00 to 99.99, 100.0 to 400.0 (Hz)			0.00	Not	Allowed
	A068	Jump (hysteresis) frequency width setting 3	0.00 to 10.00 (Hz)			0.50	Not	Allowed
PID control	A069	Acceleration stop frequency setting	0.00 to 99.99, 100.0 to 400.0 (Hz)			0.00	Not	Allowed
	A070	Acceleration stop time frequency setting	0.0 to 60.0 (s)			0.0	Not	Allowed
	A071	PID Function Enable	00 (disabling), 01 (enabling), 02 (enabling inverted-data output)			00	Not	Allowed
	A072	PID proportional gain	0.2 to 5.0			1.0	Allowed	Allowed
	A073	PID integral time constant	0.0 to 999.9, 1000. to 3600. (s)			1.0	Allowed	Allowed
	A074	PID derivative gain	0.00 to 99.99, 100.0 (s)			0.00	Allowed	Allowed
	A075	PV scale conversion	0.01 to 99.99			1.00	Not	Allowed
	A076	PV source setting	00 (input via OI), 01 (input via O), 02 (external communication), 03 (pulse-string frequency input), 10 (operation result output)			00	Not	Allowed
	A077	Output of inverted PID deviation	00(OFF), 01 (ON)			00	Not	Allowed
	A078	PID variation range	0.0 to 100.0 (%)			0.00	Not	Allowed
	A079	PID feed forward selection	00 (disabled), 01 (O input), 02 (OI input), 03 (O2 input)			00	Not	Allowed

(Note) < > indicate the setting range of 75 to 150kW

(Note) CT : Constant torque mode, VT : Variable torque mode, you can set CT or VT by b049.

Chapter 4 List of Data Settings

Code	Function name	Monitored data or setting	Default			Change during RUN operation				
			FF	FEF	FUF	b031≠10	b031=10			
AVR	A081	AVR function select	00 (always on), 01 (always off), 02 (off during deceleration)			02	00	00	Not	Not
	A082	AVR voltage select	200 V class: 200, 215, 220, 230, 240 (V) 400 V class: 380, 400, 415, 440, 460, 480 (V)			200/ 400	230/ 400	230/ 460	Not	Not
Operation mode and acceleration/deceleration function	A085	Operation mode selection	00 (normal operation), 01 (energy-saving operation) 02 (fuzzy operation)(only CT)			00			Not	Not
	A086	Energy saving mode tuning	0.0 to 100.0			50.0			Allowed	Allowed
	A092	Acceleration (2) time setting	0.01 to 99.99, 100.0 to 999.9, 1000. to 3600. (s)			15.00			Allowed	Allowed
	A292	Acceleration (2) time setting, 2nd motor				15.00			Allowed	Allowed
	A392	Acceleration (2) time setting, 3rd motor				15.00			Allowed	Allowed
	A093	Deceleration (2) time setting				15.00			Allowed	Allowed
	A293	Deceleration (2) time setting, 2nd motor	0.01 to 99.99, 100.0 to 999.9, 1000. to 3600. (s)			15.00			Allowed	Allowed
	A393	Deceleration (2) time setting, 3rd motor				15.00			Allowed	Allowed
	A094	Select method to switch to Acc2/Dec2 profile	00 (switching by 2CH terminal), 01 (switching by setting), 02 (switching only when rotation is reversed)			00			Not	Not
	A294	Select method to switch to Acc2/Dec2, 2nd motor				00			Not	Not
	A095	Acc1 to Acc2 frequency transition point	0.00 to 99.99, 100.0 to 400.0 (Hz)			0.00			Not	Not
	A295	Acc1 to Acc2 frequency transition point, 2nd motor				0.00			Not	Not
	A096	Dec1 to Dec2 frequency transition point				0.00			Not	Not
	A296	Dec1 to Dec2 frequency transition point, 2nd motor	0.00 to 99.99, 100.0 to 400.0 (Hz)			0.00			Not	Not
A097	Acceleration curve selection	00 (linear), 01 (S curve), 02 (U curve), 03 (inverted-U curve), 04 (EL-S curve)			00			Not	Not	
A098	Deceleration curve setting				00			Not	Not	
External frequency adjustment	A101	[OI]-[L] input active range start frequency	0.00 to 99.99, 100.0 to 400.0 (Hz)			0.00			Not	Allowed
	A102	[OI]-[L] input active range end frequency	0.00 to 99.99, 100.0 to 400.0 (Hz) (In case of setting 0.00, internal setting is "Maximum frequency")			0.00			Not	Allowed
	A103	[OI]-[L] input active range start current	0. to "[OI]-[L] input active range end current" (%)			20.			Not	Allowed
	A104	[OI]-[L] input active range end current	"[OI]-[L] input active range start current" to 100. (%)			100.			Not	Allowed
	A105	[OI]-[L] input start frequency enable	00 (external start frequency), 01 (0 Hz)			00			Not	Allowed
	A111	[O2]-[L] input active range start frequency	-400. to -100., -99.9 to 0.00 to 99.99, 100.0 to 400.0 (Hz)			0.00			Not	Allowed
	A112	[O2]-[L] input active range end frequency	-400. to -100., -99.9 to 0.00 to 99.99, 100.0 to 400.0 (Hz)			0.00			Not	Allowed
	A113	[O2]-[L] input active range start voltage	-100. to 02 end-frequency rate (%)			-100.			Not	Allowed
A114	[O2]-[L] input active range end voltage	"02 start-frequency rate" to 100. (%)			100.			Not	Allowed	
Acceleration and deceleration	A131	Acceleration curve constants setting	01 (smallest swelling) to 10 (largest swelling)			02			Not	Allowed
	A132	Deceleration curve constants setting	01 (smallest swelling) to 10 (largest swelling)			02			Not	Allowed
Operation-target frequency	A141	Operation-target frequency selection 1	00 (digital operator), 01 (keypad potentiometer), 02 (input via O), 03 (input via OI), 04 (external communication), 05 (option 1), 06 (option 2), 07 (pulse-string frequency input)			02			Not	Allowed
	A142	Operation-target frequency selection 2				03			Not	Allowed
	A143	Operator selection	00 (addition: A141 + A142), 01 (subtraction: A141 - A142), 02 (multiplication: A141 x A142)			00			Not	Allowed
	A145	Frequency to be added	0.00 to 99.99, 100.0 to 400.0 (Hz)			0.00			Not	Allowed
	A146	Sign of the frequency to be added	00 (frequency command + A145), 01 (frequency command - A145)			00			Not	Allowed
Acceleration and deceleration	A150	EL-S-curve acceleration ratio 1	0. to 50. (%)			25.			Not	Not
	A151	EL-S-curve acceleration ratio 2				25.			Not	Not
	A152	EL-S-curve deceleration ratio 1	0. to 50. (%)			25.			Not	Not
	A153	EL-S-curve deceleration ratio 2				25.			Not	Not

*1 This setting is valid only when the OPE-SR is connected.

(Note) CT : Constant torque mode, VT : Variable torque mode, you can set CT or VT by b049.

Chapter 4 List of Data Settings

Code	Function name	Monitored data or setting	Default			Change during RUN operation				
			FF	FEF	FUF	b031≠10	b031=10			
Restart after instantaneous power failure or tripping	b001	Selection of restart mode	00 (tripping), 01 (starting with 0 Hz), 02 (starting with matching frequency), 03 (tripping after deceleration and stopping with matching frequency), 04 (restarting with active matching frequency)			00	Not	Allowed		
	b002	Allowable under-voltage power failure time	0.3 to 25.0 (s)			1.0	Not	Allowed		
	b003	Retry wait time before motor restart	0.3 to 100.0 (s)			1.0	Not	Allowed		
	b004	Instantaneous power failure/under-voltage trip alarm enable	00 (disabling), 01 (enabling), 02 (disabling during stopping and decelerating to stop)			00	Not	Allowed		
	b005	Number of restarts on power failure/under-voltage trip events	00 (16 times), 01 (unlimited)			00	Not	Allowed		
	b006	Input phase loss detection enable	00 (disabling), 01 (enabling)			00	Not	Allowed		
	b007	Restart frequency threshold	0.00 to 99.99, 100.0 to 400.0 (Hz)			0.00	Not	Allowed		
	b008	Selection of retry after tripping	00 (tripping), 01 (starting with 0 Hz), 02 (starting with matching frequency), 03 (tripping after deceleration and stopping with matching frequency), 04 (restarting with active matching frequency)			00	Not	Allowed		
	b009	Selection of retry after under voltage	00 (16 times), 01 (unlimited)			00	Not	Allowed		
	b010	Selection of retry count after overvoltage or overcurrent	1 to 3 (times)			3	Not	Allowed		
Electronic thermal function	b011	Retry wait time after tripping	0.3 to 100.0 (s)			1.0	Not	Allowed		
	b012	Electronic thermal setting				Rated current	Not	Allowed		
	b212	Electronic thermal setting, 2nd motor	0.20 x "rated current" to 1.00 x "rated current" (A)			Rated current	Not	Allowed		
	b312	Electronic thermal setting, 3rd motor				Rated current	Not	Allowed		
	b013	Electronic thermal characteristic				00	01	01	Not	Allowed
	b213	Electronic thermal characteristic, 2nd motor	00 (reduced-torque characteristic), 01 (constant-torque characteristic), 02 (free setting)			00	01	01	Not	Allowed
	b313	Electronic thermal characteristic, 3rd motor				00	01	01	Not	Allowed
	b015	Free setting, electronic thermal frequency (1)	0. to 400. (Hz)			0.	Not	Allowed		
	b016	Free setting, electronic thermal current (1)	0.0 to rated current (A)			0.0	Not	Allowed		
	b017	Free setting, electronic thermal frequency (2)	0. to 400. (Hz)			0.	Not	Allowed		
Overload restriction and overcurrent restraint	b018	Free setting, electronic thermal current (2)	0.0 to rated current (A)			0.0	Not	Allowed		
	b019	Free setting, electronic thermal frequency (3)	0. to 400. (Hz)			0.	Not	Allowed		
	b020	Free setting, electronic thermal current (3)	0.0 to rated current (A)			0.0	Not	Allowed		
	b021	Overload restriction operation mode	00 (disabling), 01 (enabling during acceleration and deceleration), 02 (enabling during constant speed), 03 (enabling during acceleration and deceleration (increasing the speed during regeneration))			01	Not	Allowed		
	b022	Overload restriction setting	0.20 x "rated current" to 2.00 x "rated current" (A) <0.20 x "rated current" to 1.80 x "rated current" (A)> (In case of CT) 0.20 x "rated current" to 1.50 x "rated current" (A) (In case of VT)			Rated current x 1.50 (CT) Rated current x 1.20 (VT)	Not	Allowed		
	b023	Deceleration rate at overload restriction	0.10 to 30.00 (s)			1.00	Not	Allowed		
	b024	Overload restriction operation mode (2)	00 (disabling), 01 (enabling during acceleration and deceleration), 02 (enabling during constant speed), 03 (enabling during acceleration and deceleration (increasing the speed during regeneration))			01	Not	Allowed		
	b025	Overload restriction setting (2)	0.20 x "rated current" to 1.50 x "rated current" (A) <0.20 x "rated current" to 1.50 x "rated current" (A)>			Rated current x 1.50 (CT) Rated current x 1.20 (VT)	Not	Allowed		
	b026	Deceleration rate at overload restriction (2)	0.10 to 30.00 (s)			1.00	Not	Allowed		
	b027	Overcurrent suppression enable	00 (disabling), 01 (enabling)			01	Not	Allowed		
Software lock	b028	Active frequency matching, scan start frequency	0.20 x "rated current" to 2.00 x "rated current" (A) <0.20 x "rated current" to 1.80 x "rated current" (A)> (In case of CT) 0.20 x "rated current" to 1.50 x "rated current" (A) (In case of VT)			Rated current	Not	Allowed		
	b029	Active frequency matching, scan-time constant	0.10 to 30.00 (s)			0.50	Not	Allowed		
	b030	Active frequency matching, restart frequency select	00 (frequency at the last shutoff), 01 (maximum frequency), 02 (set frequency)			00	Not	Allowed		
b031	Software lock mode selection	00 (disabling change of data other than "b031" when SFT is on), 01 (disabling change of data other than "b031" and frequency settings when SFT is on), 02 (disabling change of data other than "b031"), 03 (disabling change of data other than "b031" and frequency settings), 10 (enabling data changes during operation)			01	Not	Allowed			

(Note) <> indicate the setting range of 75 to 150kW

(Note) CT : Constant torque mode, VT : Variable torque mode, you can set CT or VT by b049.

Chapter 4 List of Data Settings

Code	Function name	Monitored data or setting	Default			Change during RUN operation		
			FF	FEF	FUF	b031≠10	b031=10	
Others	b034	Run/power-on warning time	0. to 9999. (0 to 99990), 1000 to 6553 (100000 to 655300) (hr)			0.	Not	Allowed
	b035	Rotational direction restriction	00 (enabling both forward and reverse rotations), 01 (enabling only forward rotation), 02 (enabling only reverse rotation)			00	Not	Not
	b036	Reduced voltage start selection	0 (minimum reduced voltage start time) to 255 (maximum reduced voltage start time)			6	Not	Allowed
	b037	Function code display restriction	00 (full display), 01 (function-specific display), 02 (user setting), 03 (data comparison display), 04 (basic display)			00	Not	Allowed
	b038	Initial-screen selection	00 (screen displayed when the STR key was pressed last), 001~060 (d001~d060), 201 (F001) 202 *)			001	Not	Allowed
	b039	Automatic user-parameter setting function enable	00 (disabling), 01 (enabling)			00	Not	Allowed
Torque limitation	b040	Torque limit selection	00 (quadrant-specific setting), 01 (switching by terminal), 02 (analog input), 03 (option 1), 04 (option 2)			00	Not	Allowed
	b041	Torque limit (1) (forward-driving in 4-quadrant mode)	0. to 200. (%), no (disabling torque limitation) <0. to 150. (%), no (disabling torque limitation)> (In case of CT) 0. to 150. (%), no (disabling torque limitation)(In case of VT)	150.(CT) 120.(VT)		Not	Allowed	
	b042	Torque limit (2) (reverse-regenerating in 4-quadrant mode)		150.(CT) 120.(VT)		Not	Allowed	
	b043	Torque limit (3) (reverse-driving in 4-quadrant mode)		150.(CT) 120.(VT)		Not	Allowed	
	b044	Torque limit (4) (forward-regenerating in 4-quadrant mode)		150.(CT) 120.(VT)		Not	Allowed	
	b045	Torque limit LADSTOP enable	00 (disabling), 01 (enabling)			00	Not	Allowed
b046	Reverse Run protection enable	00 (disabling), 01 (enabling)			00	Not	Allowed	
Mode	b049	Dual rating selection	00 (CT : Constant torque) 01 (VT : Variable torque)			00(CT) 01(VT)	Not	Not
Non-stop operation at momentary power failure	b050	Controller deceleration and stop on power loss	00 (disabling), 01 (nonstop deceleration to stop), 02 (DC voltage constant control, with resume), 03 (DC voltage constant control, without resume)			00	Not	Not
	b051	DC bus voltage trigger level during power loss	0.0 to 999.9, 1000. (V)			220.0/440.0	Not	Not
	b052	Over-voltage threshold during power loss	0.0 to 999.9, 1000. (V)			360.0/720.0	Not	Not
	b053	Deceleration time setting during power loss	0.01 to 99.99, 100.0 to 999.9, 1000. to 3600. (s)			1.00	Not	Not
	b054	Initial output frequency decrease during power loss	0.00 to 10.00 (Hz)			0.00	Not	Not
	b055	Proportional gain setting for nonstop operation at power loss	0.00 to 2.55			0.20	Allowed	Allowed
b056	Integral time setting for nonstop operation at power loss	0.000 to 9.999 /10.00 to 65.53 (s)			0.100	Allowed	Allowed	
Window comparator	b060	Maximum-limit level of window comparators O	0. to 100. (lower limit : b061 + b062 x 2) (%)			100	Allowed	Allowed
	b061	Minimum-limit level of window comparators O	0. to 100. (upper limit : b060 - b062 x 2) (%)			0	Allowed	Allowed
	b062	Hysteresis width of window comparators O	0. to 10. (upper limit : b060 - b061 / 2) (%)			0	Allowed	Allowed
	b063	Maximum-limit level of window comparators OI	0. to 100. (lower limit : b064 + b065 x 2) (%)			100	Allowed	Allowed
	b064	Minimum-limit level of window comparators OI	0. to 100. (upper limit : b063 - b064 x 2) (%)			0	Allowed	Allowed
	b065	Hysteresis width of window comparators OI	0. to 10. (upper limit : b063 - b064 / 2) (%)			0	Allowed	Allowed
	b066	Maximum-limit level of window comparators OI	-100. to 100. (lower limit : b067 + b068 x 2) (%)			100	Allowed	Allowed
	b067	Minimum-limit level of window comparators O/OI/O2	-100. to 100. (upper limit : b066 - b068 x 2) (%)			-100	Allowed	Allowed
	b068	Hysteresis width of window comparators O/OI/O2	0. to 10. (upper limit : b066 - b067 / 2) (%)			0	Allowed	Allowed
	b070	Operation level at O disconnection	0. to 100. (%) or "no" (ignore)			no	Not	Allowed
	b071	Operation level at OI disconnection	0. to 100. (%) or "no" (ignore)			no	Not	Allowed
b072	Operation level at O2 disconnection	-100. to 100. (%) or "no" (ignore)			no	Not	Allowed	

(Note) <> indicate the setting range of 75 to 150kW

(Note) CT : Constant torque mode, VT : variable torque mode, you can set CT or VT by b049.

*) In case of connecting OPE-S to the inverter, '201' setting is same as '00' setting. Refer to the SJ700D-3 instruction manual.

Chapter 4 List of Data Settings

Code	Function name	Monitored data or setting	Default			Change during RUN operation			
			FF	FEF	FUF	b031≠10	b031=10		
Others	b078	Cumulative input power data clearance	Clearance by setting "01" and pressing the STR key			00	Allowed	Allowed	
	b079	Cumulative input power display gain setting	1. to 1000.			1.	Allowed	Allowed	
	b082	Start frequency adjustment	0.10 to 9.99 (Hz)			0.50	Not	Allowed	
	b083	Carrier frequency setting	0.5~15.0(kHz) <0.5~10.0(kHz)> (In case of CT) 0.5~12.0(kHz) (In case of VT)			5.0<3.0>(CT) 3.0(VT)	Not	Not	
	b084	Initialization mode (parameters or trip history)	00 (disabled), 01 (clearing the trip history), 02 (initializing the data), 03 (clearing the trip history and initializing the data), 04 (clearing the trip history and initializing the data and EzSQ program)			00	Not	Not	
	b085	Country for initialization	00 (JPN), 01(EU), 02(USA)			00 01 02	Not	Not	
	b086	Frequency scaling conversion factor	0.1 to 99.0			1.0	Allowed	Allowed	
	b087	STOP key enable	00 (enabling), 01 (disabling), 02 (disabling only the function to stop)			00	Not	Allowed	
	b088	Restart mode after FRS	00 (starting with 0 Hz), 01 (starting with matching frequency), 02 (starting with active matching frequency)			00	Not	Allowed	
	b089	Automatic carrier frequency reduction	00: invalid, 01: valid			00	Not	×	
	b090	Dynamic braking usage ratio	0.0 to 100.0 (%)			0.0	Not	Allowed	
	b091	Stop mode selection	00 (deceleration until stop), 01 (free-run stop)			00	Not	Allowed	
	b092	Cooling fan control	00 (always operating the fan), 01 (operating the fan only during inverter operation [including 5 minutes after power-on and power-off])			01	Not	Allowed	
	b095	Dynamic braking control	00 (disabling), 01 (enabling [disabling while the motor is topped]), 02 (enabling [enabling also while the motor is topped])			01	Not	Allowed	
	b096	Dynamic braking activation level	330 to 390 (V) (200 V class model), 660 to 780 (V) (400 V class model)			360/720	Not	Allowed	
	b098	Thermistor for thermal protection control	00 (disabling the thermistor), 01 (enabling the thermistor with PTC), 02 (enabling the thermistor with NTC)			00	Not	Allowed	
	b099	Thermal protection level setting	0. to 9999. (Ω)			3000.	Not	Allowed	
	Free setting of V/f characteristic	b100	Free-setting V/f frequency (1)	0. to "free-setting V/f frequency (2)" (Hz)			0.	Not	Not
		b101	Free-setting V/f voltage (1)	0.0 to 800.0 (V)			0.0	Not	Not
b102		Free-setting V/f frequency (2)	"free-setting V/f frequency (1)" to "free-setting V/f frequency (3)" (Hz)			0.	Not	Not	
b103		Free-setting V/f voltage (2)	0.0 to 800.0 (V)			0.0	Not	Not	
b104		Free-setting V/f frequency (3)	"free-setting V/f frequency (2)" to "free-setting V/f frequency (4)" (Hz)			0.	Not	Not	
b105		Free-setting V/f voltage (3)	0.0 to 800.0 (V)			0.0	Not	Not	
b106		Free-setting V/f frequency (4)	"free-setting V/f frequency (3)" to "free-setting V/f frequency (5)" (Hz)			0.	Not	Not	
b107		Free-setting V/f voltage (4)	0.0 to 800.0 (V)			0.0	Not	Not	
b108		Free-setting V/f frequency (5)	"free-setting V/f frequency (4)" to "free-setting V/f frequency (6)" (Hz)			0.	Not	Not	
b109		Free-setting V/f voltage (5)	0.0 to 800.0 (V)			0.0	Not	Not	
b110		Free-setting V/f frequency (6)	"free-setting V/f frequency (5)" to "free-setting V/f frequency (7)" (Hz)			0.	Not	Not	
b111		Free-setting V/f voltage (6)	0.0 to 800.0 (V)			0.0	Not	Not	
b112		Free-setting V/f frequency (7)	"free-setting V/f frequency (6)" (Hz) to 400. (Hz)			0.	Not	Not	
b113	Free-setting V/f voltage (7)	0.0 to 800.0 (V)			0.0	Not	Not		
Brake control	b120	Brake control enable	00 (disabling), 01 (enabling)			00	Not	Allowed	
	b121	Brake wait time for release	0.00 to 5.00 (s)	0.00			Not	Allowed	
	b122	Brake wait time for acceleration		0.00			Not	Allowed	
	b123	Brake wait time for stopping		0.00			Not	Allowed	
	b124	Brake wait time for confirmation		0.00			Not	Allowed	
	b125	Brake release frequency setting	0.00 to 99.99, 100.0 to 400.0 (Hz)			0.00	Not	Allowed	
	b126	Brake release current setting	0.00 x "rated current" to 2.00 x "rated current" (A)			Rated current	Not	Allowed	
b127	Braking frequency	0.00 to 99.99, 100.0 to 400.0 (Hz)			0.00	Not	Allowed		
Overvoltage suppression	b130	Overvoltage suppression enable	00 (disabling restraint), 01 (controlled deceleration), 02 (enabling acceleration with decelerating), 03 (enabling acceleration)			00	Not	Allowed	
	b131	Overvoltage suppression level	330 to 390 (V) (200 V class), 660 to 780 (V) (400 V class)			380/760	Not	Allowed	
	b132	Acceleration and deceleration rate at overvoltage suppression	0.10 to 30.00 (s)			1.00	Not	Allowed	
	b133	Overvoltage suppression proportional gain	0.00 to 2.55			0.50	Allowed	Allowed	
	b134	Overvoltage suppression Integral time	0.000 to 9.999 / 10.00 to 65.53 (s)			0.060	Allowed	Allowed	
Others	b141	Output loss detection enable	00 (disabling), 01 (enabling)			00	Not	Allowed	
	b142	Output loss detection sensibility	1.~100.(%)			10.	Allowed	Allowed	
	b164	Automatic return to initial display	00 (disabling), 01 (enabling)			00	Allowed	Allowed	
	b166	Data Read/Write select	00 (Read/Write OK), 01 (Protected)			00	Not	Allowed	
	b180	Initialization trigger	00 (Initialization disable), 01 (Perform initialization)			00	Not	Not	

(Note) < > indicate the setting range of 75 to 150kW

(Note) CT : Constant torque mode, VT : variable torque mode, you can set CT or VT by b049.

Chapter 4 List of Data Settings

Code	Function name	Monitored data or setting	Default			Change during RUN operation	
			FF	FEF	FUF	b031≠10	b031=10
Intelligent input terminals	C001	Terminal [1] function (*2)	18 (*)			Not	Allowed
	C002	Terminal [2] function	16			Not	Allowed
	C003	Terminal [3] function (*2)	06 (*)			Not	Allowed
	C004	Terminal [4] function	11			Not	Allowed
	C005	Terminal [5] function	09			Not	Allowed
	C006	Terminal [6] function	03	03	13	Not	Allowed
	C007	Terminal [7] function	02			Not	Allowed
	C008	Terminal [8] function	01			Not	Allowed
	C009	Terminal [9] function	00			Not	Allowed
C010	Terminal [10] function	00			Not	Allowed	
C011	Terminal [1] active state	00 (NO) / 01 (NC)	00			Not	Allowed
C012	Terminal [2] active state	00 (NO) / 01 (NC)	00			Not	Allowed
C013	Terminal [3] active state	00 (NO) / 01 (NC)	00			Not	Allowed
C014	Terminal [4] active state	00 (NO) / 01 (NC)	00			Not	Allowed
C015	Terminal [5] active state	00 (NO) / 01 (NC)	00			Not	Allowed
C016	Terminal [6] active state	00 (NO) / 01 (NC)	00			Not	Allowed
C017	Terminal [7] active state	00 (NO) / 01 (NC)	00			Not	Allowed
C018	Terminal [8] active state	00 (NO) / 01 (NC)	00			Not	Allowed
C019	Terminal [FW] active state	00 (NO) / 01 (NC)	00			Not	Allowed

(*) When the emergency stop function is enabled (SW1 = ON), "18" (RS) and "64" (EMR) are forcibly written to parameters "C001" and "C003", respectively. (You cannot arbitrarily write "64" to "C001".) If the SW1 signal is turned off and then turned on, "no" (no assignment) is set in parameter "C003".

Chapter 4 List of Data Settings

Code	Function name	Monitored data or setting	Default			Change during RUN operation				
			FF	FEF	FUF	b031≠10	b031=10			
Intelligent output terminals	C021	Terminal [11] function	00 (RUN: running), 01 (FA1: constant-speed reached), 02 (FA2: set frequency overreached), 03 (OL: overload notice advance signal (1)), 04 (OD: output deviation for PID control), 05 (AL: alarm signal), 06 (FA3: set frequency reached), 07 (OTQ: over-torque), 08 (IP: instantaneous power failure), 09 (UV: under voltage), 10 (TRQ: torque limited), 11 (RNT: operation time over), 12 (ONT: plug-in time over), 13 (THM: thermal alarm signal), 19(BRK:brakge release), 20(BER:braking error)21 (ZS: 0 Hz detection signal), 22(DSE:speed deviation maximum), 23(POK:positioning completed), 24 (FA4: set frequency overreached 2), 25 (FA5: set frequency reached 2), 26 (OL2: overload notice advance signal (2)), 27 (Odc: Analog O disconnection detection), 28 (OIDc: Analog OI disconnection detection), 29 (O2Dc: Analog O2 disconnection detection), 31 (FBV: PID feedback comparison), 32 (Ndc: communication line disconnection), 33 (LOG1: logical operation result 1), 34 (LOG2: logical operation result 2), 35 (LOG3: logical operation result 3), 36 (LOG4: logical operation result 4), 37 (LOG5: logical operation result 5), 38 (LOG6: logical operation result 6), 39 (WAC: capacitor life warning), 40 (WAF: cooling-fan speed drop), 41 (FR: starting contact signal), 42 (OHF: heat sink overheat warning), 43 (LOC: low-current indication signal), 44 (M01: general-purpose output 1), 45 (M02: general-purpose output 2), 46 (M03: general-purpose output 3), 47 (M04: general-purpose output 4), 48 (M05: general-purpose output 5), 49 (M06: general-purpose output 6), 50 (IRDY: inverter ready), 51 (FWR: forward rotation), 52 (RVR: reverse rotation), 53 (MJA: major failure), 54(WCO: window comparator O), 55(WCOI: window comparator OI), 56 (WCO2: window comparator O2)			01			Not	Not
	C022	Terminal [12] function	20(BER:braking error)21 (ZS: 0 Hz detection signal), 22(DSE:speed deviation maximum), 23(POK:positioning completed), 24 (FA4: set frequency overreached 2), 25 (FA5: set frequency reached 2), 26 (OL2: overload notice advance signal (2)), 27 (Odc: Analog O disconnection detection), 28 (OIDc: Analog OI disconnection detection), 29 (O2Dc: Analog O2 disconnection detection), 31 (FBV: PID feedback comparison), 32 (Ndc: communication line disconnection), 33 (LOG1: logical operation result 1), 34 (LOG2: logical operation result 2), 35 (LOG3: logical operation result 3), 36 (LOG4: logical operation result 4), 37 (LOG5: logical operation result 5), 38 (LOG6: logical operation result 6), 39 (WAC: capacitor life warning), 40 (WAF: cooling-fan speed drop), 41 (FR: starting contact signal), 42 (OHF: heat sink overheat warning), 43 (LOC: low-current indication signal), 44 (M01: general-purpose output 1), 45 (M02: general-purpose output 2), 46 (M03: general-purpose output 3), 47 (M04: general-purpose output 4), 48 (M05: general-purpose output 5), 49 (M06: general-purpose output 6), 50 (IRDY: inverter ready), 51 (FWR: forward rotation), 52 (RVR: reverse rotation), 53 (MJA: major failure), 54(WCO: window comparator O), 55(WCOI: window comparator OI), 56 (WCO2: window comparator O2)			00			Not	Not
	C023	Terminal [13] function	27 (Odc: Analog O disconnection detection), 28 (OIDc: Analog OI disconnection detection), 29 (O2Dc: Analog O2 disconnection detection), 31 (FBV: PID feedback comparison), 32 (Ndc: communication line disconnection), 33 (LOG1: logical operation result 1), 34 (LOG2: logical operation result 2), 35 (LOG3: logical operation result 3), 36 (LOG4: logical operation result 4), 37 (LOG5: logical operation result 5), 38 (LOG6: logical operation result 6), 39 (WAC: capacitor life warning), 40 (WAF: cooling-fan speed drop), 41 (FR: starting contact signal), 42 (OHF: heat sink overheat warning), 43 (LOC: low-current indication signal), 44 (M01: general-purpose output 1), 45 (M02: general-purpose output 2), 46 (M03: general-purpose output 3), 47 (M04: general-purpose output 4), 48 (M05: general-purpose output 5), 49 (M06: general-purpose output 6), 50 (IRDY: inverter ready), 51 (FWR: forward rotation), 52 (RVR: reverse rotation), 53 (MJA: major failure), 54(WCO: window comparator O), 55(WCOI: window comparator OI), 56 (WCO2: window comparator O2)			03			Not	Not
	C024	Terminal [14] function	40 (WAF: cooling-fan speed drop), 41 (FR: starting contact signal), 42 (OHF: heat sink overheat warning), 43 (LOC: low-current indication signal), 44 (M01: general-purpose output 1), 45 (M02: general-purpose output 2), 46 (M03: general-purpose output 3), 47 (M04: general-purpose output 4), 48 (M05: general-purpose output 5), 49 (M06: general-purpose output 6), 50 (IRDY: inverter ready), 51 (FWR: forward rotation), 52 (RVR: reverse rotation), 53 (MJA: major failure), 54(WCO: window comparator O), 55(WCOI: window comparator OI), 56 (WCO2: window comparator O2)			07			Not	Not
	C025	Terminal [15] function	44 (M01: general-purpose output 1), 45 (M02: general-purpose output 2), 46 (M03: general-purpose output 3), 47 (M04: general-purpose output 4), 48 (M05: general-purpose output 5), 49 (M06: general-purpose output 6), 50 (IRDY: inverter ready), 51 (FWR: forward rotation), 52 (RVR: reverse rotation), 53 (MJA: major failure), 54(WCO: window comparator O), 55(WCOI: window comparator OI), 56 (WCO2: window comparator O2)			40			Not	Not
	C026	Alarm relay terminal function	50 (IRDY: inverter ready), 51 (FWR: forward rotation), 52 (RVR: reverse rotation), 53 (MJA: major failure), 54(WCO: window comparator O), 55(WCOI: window comparator OI), 56 (WCO2: window comparator O2) (When alarm code output is selected for "C062", functions "AC0" to "AC2" or "AC0" to "AC3" [ACn: alarm code output] are forcibly assigned to intelligent output terminals 11 to 13 or 11 to 14, respectively.)			05			Not	Not
Analog monitoring	C027	[FM] signal selection	00 (output frequency), 01 (output current), 02 (output torque), 03 (digital output frequency), 04 (output voltage), 05 (input power), 06 (electronic thermal overload), 07 (LAD frequency), 08 (digital current monitoring), 09 (motor temperature), 10 (heat sink temperature), 12 (general-purpose output YA0)			00			Not	Not
	C028	[AM] signal selection	00 (output frequency), 01 (output current), 02 (output torque), 04 (output voltage), 05 (input power), 06 (electronic thermal overload), 07 (LAD frequency), 09 (motor temperature), 10 (heat sink temperature), 11 (output torque [signed value]), 13 (general-purpose output YA1)			00			Not	Not
	C029	[AMI] signal selection	00 (output frequency), 01 (output current), 02 (output torque), 04 (output voltage), 05 (input power), 06 (electronic thermal overload), 07 (LAD frequency), 09 (motor temperature), 10 (heat sink temperature), 14 (general-purpose output YA2)			00			Not	Not
	C030	Digital current monitor reference value	0.20 x "rated current" to 1.50 x "rated current" (A) (Current with digital current monitor output at 1,440 Hz)			Rated current			Allowed	Allowed
Intelligent output terminals	C031	Terminal [11] active state	00 (NO) / 01 (NC)			00			Not	Not
	C032	Terminal [12] active state	00 (NO) / 01 (NC)			00			Not	Not
	C033	Terminal [13] active state	00 (NO) / 01 (NC)			00			Not	Not
	C034	Terminal [14] active state	00 (NO) / 01 (NC)			00			Not	Not
	C035	Terminal [15] active state	00 (NO) / 01 (NC)			00			Not	Not
	C036	Alarm relay active state	00 (NO) / 01 (NC)			01			Not	Not

Chapter 4 List of Data Settings

Code	Function name	Monitored data or setting	Default			Change during RUN operation		
			FF	FE	FUF	b031≠10	b031=10	
Levels and output terminal status	C038	Low-current indication signal output mode selection	00 (output during acceleration/deceleration and constant-speed operation), 01 (output only during constant-speed operation)			01	Not	Allowed
	C039	Low-current indication signal detection level	0.00 to 2.00 x "rated current" (A) <0.00 to 1.80 x "rated current" (A) > (In case of CT) 0.00 to 1.50 x "rated current" (A) (In case of VT)			Rated current	Allowed	Allowed
	C040	Overload signal output mode	00 (output during acceleration/deceleration and constant-speed operation), 01 (output only during constant-speed operation)			01	Not	Allowed
	C041	Overload level setting	0.00 to 2.00 x "rated current" (A) <0.00 to 1.80 x "rated current" (A) > (In case of CT) 0.00 to 1.50 x "rated current" (A) (In case of VT)			Rated current	Allowed	Allowed
	C042	Frequency arrival setting for accel.	0.00 to 99.99, 100.0 to 400.0 (Hz)			0.00	Not	Allowed
	C043	Frequency arrival setting for decel.	0.00 to 99.99, 100.0 to 400.0 (Hz)			0.00	Not	Allowed
	C044	PID deviation level setting	0.0 to 100.0 (%)			3.0	Not	Allowed
	C045	Frequency arrival setting for acceleration (2)	0.00 to 99.99, 100.0 to 400.0 (Hz)			0.00	Not	Allowed
	C046	Frequency arrival setting for deceleration (2)	0.00 to 99.99, 100.0 to 400.0 (Hz)			0.00	Not	Allowed
	C052	Maximum PID feedback data	0.0 to 100.0 (%)			100.0	Not	Allowed
	C053	Minimum PID feedback data	0.0 to 100.0 (%)			0.0	Not	Allowed
	C055	Over-torque (forward-driving) level setting	0. to 200. (%), no (disabling torque limitation) <0. to 150. (%), no (disabling torque limitation)> (In case of CT) 0. to 150. (%), no (disabling torque limitation)(In case of VT)			100.	Not	Allowed
	C056	Over-torque (reverse regenerating) level setting				100.	Not	Allowed
	C057	Over-torque (reverse driving) level setting				100.	Not	Allowed
	C058	Over-torque (forward regenerating) level setting				100.	Not	Allowed
	C061	Electronic thermal warning level setting	0. to 100. (%)			80.	Not	Allowed
C062	Alarm code output	00 (disabling), 01 (3 bits), 02 (4 bits)			00	Not	Allowed	
C063	Zero speed detection level	0.00 to 99.99, 100.0 (Hz)			0.00	Not	Allowed	
C064	Heat sink overheat warning level	0. to 200.0 (°C)			120.	Not	Allowed	
Communication function	C071	Communication speed selection	02 (loopback test), 03(2400bps), 04(4800bps), 05(9600bps), 06(19.2kbps), 07(38.4kbps), 08(57.6kbps), 09(76.8kbps), 10(115.2kbps)			04	Not	Allowed
	C072	Node allocation	1. to 32.			1.	Not	Allowed
	C073	Communication data length selection	7 (7 bits), 8 (8 bits)			7	Not	Allowed
	C074	Communication parity selection	00 (no parity), 01 (even parity), 02 (odd parity)			00	Not	Allowed
	C075	Communication stop bit selection	1 (1 bit), 2 (2 bits)			1	Not	Allowed
	C076	Selection of the operation after communication error	00 (tripping), 01 (tripping after decelerating and stopping the motor), 02 (ignoring errors), 03 (stopping the motor after free-running), 04 (decelerating and stopping the motor)			02	Not	Allowed
	C077	Communication timeout limit before tripping	0.00 to 99.99 (s)			0.00	Not	Allowed
	C078	Communication wait time	0. to 1000. (ms)			0.	Not	Allowed
	C079	Communication mode selection	00(ASCII), 01(Modbus-RTU)			00	Not	Allowed
Adjustment	C081	[O] input span calibration	0. to 9999., 1000 to 6553(10000 to 65530)			Factory setting	Allowed	Allowed
	C082	[OI] input span calibration				Factory setting	Allowed	Allowed
	C083	[O2] input span calibration				Factory setting	Allowed	Allowed
	C085	Thermistor input tuning	0.0 to 999.9, 1000.			Factory setting	Allowed	Allowed
	C091	Debug mode enable	(Do not change this parameter, which is intended for factory adjustment.)			00	Not	Not
Others	C101	Up/Down memory mode selection	00 (not storing the frequency data), 01 (storing the frequency data)			00	Not	Allowed
	C102	Reset mode selection	00 (resetting the trip when RS is on), 01 (resetting the trip when RS is off), 02 (enabling resetting only upon tripping [resetting when RS is on]), 03(resetting only trip)			00	Allowed	Allowed
	C103	Restart mode after reset	00 (starting with 0 Hz), 01 (starting with matching frequency), 02 (restarting with active matching frequency)			00	Not	Allowed
Meter adjustment	C105	FM gain adjustment	50. to 200. (%)			100.	Allowed	Allowed
	C106	AM gain adjustment				100.	Allowed	Allowed
	C107	AMI gain adjustment				100.	Allowed	Allowed
	C109	AM bias adjustment	0. to 100. (%)			0.	Allowed	Allowed
	C110	AMI bias adjustment				20.	Allowed	Allowed

(Note) <>indicate the setting range of 75 to 150kW

(Note) CT : Constant torque mode, VT : variable torque mode, you can set CT or VT by b049.

Chapter 4 List of Data Settings

Code	Function name	Monitored data or setting	Default			Change during RUN operation		
			FF	FEF	FUF	b031≠10	b031=10	
Terminal	C111	Overload setting (2)	0.20 to 2.00 x "rated current" (A) <0.20 to 1.80 x "rated current" (A) > (In case of CT) 0.20 to 1.50 x "rated current" (A) (In case of VT)			Rated current	Allowed	Allowed
	C121	[O] input zero calibration	0. to 9999., 1000 to 6553 (10000 to 65530)			Factory setting	Allowed	Allowed
C122	[OI] input zero calibration	Factory setting				Allowed	Allowed	
C123	[O2] input zero calibration	Factory setting				Allowed	Allowed	
Adjustment	C130	Output 11 on-delay time	0.0 to 100.0 (s)			0.0	Not	Allowed
	C131	Output 11 off-delay time	0.0 to 100.0 (s)			0.0	Not	Allowed
	C132	Output 12 on-delay time				0.0	Not	Allowed
	C133	Output 12 off-delay time	0.0 to 100.0 (s)			0.0	Not	Allowed
	C134	Output 13 on-delay time				0.0	Not	Allowed
	C135	Output 13 off-delay time	0.0 to 100.0 (s)			0.0	Not	Allowed
	C136	Output 14 on-delay time	0.0 to 100.0 (s)			0.0	Not	Allowed
	C137	Output 14 off-delay time	0.0 to 100.0 (s)			0.0	Not	Allowed
	C138	Output 15 on-delay time				0.0	Not	Allowed
	C139	Output 15 off-delay time	0.0 to 100.0 (s)			0.0	Not	Allowed
	C140	Output RY on-delay time	0.0 to 100.0 (s)			0.0	Not	Allowed
	C141	Output RY off-delay time				0.0	Not	Allowed
	C142	Logical output signal 1 selection 1	Same as the settings of C021 to C026 (except those of LOG1 to LOG6)			00	Not	Allowed
	C143	Logical output signal 1 selection 2				00	Not	Allowed
	C144	Logical output signal 1 operator selection	00 (AND), 01 (OR), 02 (XOR)			00	Not	Allowed
	C145	Logical output signal 2 selection 1	Same as the settings of C021 to C026 (except those of LOG1 to LOG6)			00	Not	Allowed
	C146	Logical output signal 2 selection 2				00	Not	Allowed
	C147	Logical output signal 2 operator selection	00 (AND), 01 (OR), 02 (XOR)			00	Not	Allowed
	C148	Logical output signal 3 selection 1	Same as the settings of C021 to C026 (except those of LOG1 to LOG6)			00	Not	Allowed
	C149	Logical output signal 3 selection 2				00	Not	Allowed
C150	Logical output signal 3 operator selection	00 (AND), 01 (OR), 02 (XOR)			00	Not	Allowed	
C151	Logical output signal 4 selection 1	Same as the settings of C021 to C026 (except those of LOG1 to LOG6)			00	Not	Allowed	
C152	Logical output signal 4 selection 2				00	Not	Allowed	
C153	Logical output signal 4 operator selection	00 (AND), 01 (OR), 02 (XOR)			00	Not	Allowed	
C154	Logical output signal 5 selection 1	Same as the settings of C021 to C026 (except those of LOG1 to LOG6)			00	Not	Allowed	
C155	Logical output signal 5 selection 2				00	Not	Allowed	
C156	Logical output signal 5 operator selection	00 (AND), 01 (OR), 02 (XOR)			00	Not	Allowed	
C157	Logical output signal 6 selection 1	Same as the settings of C021 to C026 (except those of LOG1 to LOG6)			00	Not	Allowed	
C158	Logical output signal 6 selection 2				00	Not	Allowed	
C159	Logical output signal 6 operator selection	00 (AND), 01 (OR), 02 (XOR)			00	Not	Allowed	
Input terminal response	C160	Input terminal response time setting 1	0. to 200. (×2ms)			1	Not	Allowed
	C161	Input terminal response time setting 2	0. to 200. (×2ms)			1	Not	Allowed
	C162	Input terminal response time setting 3	0. to 200. (×2ms)			1	Not	Allowed
	C163	Input terminal response time setting 4	0. to 200. (×2ms)			1	Not	Allowed
	C164	Input terminal response time setting 5	0. to 200. (×2ms)			1	Not	Allowed
	C165	Input terminal response time setting 6	0. to 200. (×2ms)			1	Not	Allowed
	C166	Input terminal response time setting 7	0. to 200. (×2ms)			1	Not	Allowed
	C167	Input terminal response time setting 8	0. to 200. (×2ms)			1	Not	Allowed
C168	Input terminal response time setting FW	0. to 200. (×2ms)			1	Not	Allowed	
Other	C169	Multistage speed/position determination time	0. to 200. (×10ms)			0	Not	Allowed

(Note) < > indicate the setting range of 75 to 150kW

Chapter 4 List of Data Settings

Code	Function name	Monitored data or setting	Default			Change during RUN operation		
			FF	FEF	FUF	b031≠10	b031=10	
Control constants	H001	Auto-tuning Setting	00 (disabling auto-tuning), 01 (auto-tuning without rotation), 02 (auto-tuning with rotation)			00	Not	Not
	H002	Motor data selection, 1st motor	00 (Hitachi standard data), 01 (auto-tuned data), 02 (auto-tuned data [with online auto-tuning function])			00	Not	Not
	H202	Motor data selection, 2nd motor				00	Not	Not
	H003	Motor capacity, 1st motor	0.20 to 160. (kW)	Factory setting			Not	Not
	H203	Motor capacity, 2nd motor		Factory setting			Not	Not
	H004	Motor poles setting, 1st motor	2, 4, 6, 8, 10 (poles)	4			Not	Not
	H204	Motor poles setting, 2nd motor		4			Not	Not
	H005	Motor speed constant, 1st motor	0.001 to 9.999, 10.00 to 80.00 (10.000 to 80.000)	1.590			Allowed	Allowed
	H205	Motor speed constant, 2nd motor		1.590			Allowed	Allowed
	H006	Motor stabilization constant, 1st motor	0. to 255.	100.			Allowed	Allowed
	H206	Motor stabilization constant, 2nd motor		100.			Allowed	Allowed
	H306	Motor stabilization constant, 3rd motor		100.			Allowed	Allowed
	H020	Motor constant R1, 1st motor	0.001 to 9.999, 10.00 to 65.53 (Ω)	Factory setting			Not	Not
	H220	Motor constant R1, 2nd motor		Factory setting			Not	Not
	H021	Motor constant R2, 1st motor	0.001 to 9.999, 10.00 to 65.53 (Ω)	Factory setting			Not	Not
	H221	Motor constant R2, 2nd motor		Factory setting			Not	Not
	H022	Motor constant L, 1st motor	0.01 to 99.99, 100.0 to 655.3 (mH)	Factory setting			Not	Not
	H222	Motor constant L, 2nd motor		Factory setting			Not	Not
	H023	Motor constant Io	0.01 to 99.99, 100.0 to 655.3 (A)	Factory setting			Not	Not
	H223	Motor constant Io, 2nd motor		Factory setting			Not	Not
	H024	Motor constant J	0.001 to 9.999, 10.00 to 99.99, 100.0 to 999.9, 1000. to 9999.	Factory setting			Not	Not
	H224	Motor constant J, 2nd motor		Factory setting			Not	Not
	H030	Auto constant R1, 1st motor	0.001 to 9.999, 10.00 to 65.53 (Ω)	Factory setting			Not	Not
	H230	Auto constant R1, 2nd motor		Factory setting			Not	Not
	H031	Auto constant R2, 1st motor	0.001 to 9.999, 10.00 to 65.53 (Ω)	Factory setting			Not	Not
	H231	Auto constant R2, 2nd motor		Factory setting			Not	Not
	H032	Auto constant L, 1st motor	0.01 to 99.99, 100.0 to 655.3 (mH)	Factory setting			Not	Not
	H232	Auto constant L, 2nd motor		Factory setting			Not	Not
	H033	Auto constant Io, 1st motor	0.01 to 99.99, 100.0 to 655.3 (A)	Factory setting			Not	Not
	H233	Auto constant Io, 2nd motor		Factory setting			Not	Not
	H034	Auto constant J, 1st motor	0.001 to 9.999, 10.00 to 99.99, 100.0 to 999.9, 1000. to 9999.	Factory setting			Not	Not
	H234	Auto constant J, 2nd motor		Factory setting			Not	Not
	H050	PI proportional gain for 1st motor	0.0 to 999.9, 1000.	100.0			Allowed	Allowed
	H250	PI proportional gain for 2nd motor		100.0			Allowed	Allowed
	H051	PI integral gain for 1st motor	0.0 to 999.9, 1000.	100.0			Allowed	Allowed
	H251	PI integral gain for 2nd motor		100.0			Allowed	Allowed
	H052	P proportional gain setting for 1st motor	0.01 to 10.00	1.00			Allowed	Allowed
	H252	P proportional gain setting for 2nd motor		1.00			Allowed	Allowed
	H060	Zero level limit for 1st motor	0.0 to 100.0	100.0			Allowed	Allowed
	H260	Zero level limit for 2nd motor		100.0			Allowed	Allowed
	H061	Zero level starting boost current for 1st motor	0. to 50. (%)	50.			Allowed	Allowed
	H261	Zero level starting boost current for 2nd motor		50.			Allowed	Allowed
	H070	Terminal selection PI proportional gain setting	0.0 to 999.9, 1000.	100.0			Allowed	Allowed
	H071	Terminal selection PI integral gain setting		100.0			Allowed	Allowed
	H072	Terminal selection P proportional gain setting	0.00 to 10.00	1.00			Allowed	Allowed
	H073	Gain switching time	0. to 9999. (ms)	100.			Allowed	Allowed

Chapter 4 List of Data Settings

Code	Function name	Monitored data or setting	Default			Change during RUN operation	
			FF	FEF	FUF	b031≠10	b031=10
P001	Operation mode on expansion card 1 error	00 (tripping), 01 (continuing operation)	00			Not	Allowed
P002	Operation mode on expansion card 2 error		00			Not	Allowed
P011	Encoder pulse-per-revolution (PPR) setting	128. to 9999., 1000 to 6500 (10000 to 65000) (pulses)	1024.			Not	Not
P012	Control pulse setting	00 (ASR), 01 (APR), 02 (APR2), 03 (HAPR)	00			Not	Not
P013	Pulse input mode setting	00 (mode 0), 01 (mode 1), 02 (mode 2)	00			Not	Not
P014	Home search stop position setting	0. to 4095.	0.			Not	Allowed
P015	Home search speed setting	"start frequency" to "maximum frequency" (up to 120.0) (Hz)	5.00			Not	Allowed
P016	Home search direction setting	00 (forward), 01 (reverse)	00			Not	Allowed
P017	Home search completion range setting	0. to 9999., 1000 (10000) (pulses)	5.			Not	Allowed
P018	Home search completion delay time setting	0.00 to 9.99 (s)	0.00			Not	Allowed
P019	Electronic gear set position selection	00 (feedback side), 01 (commanding side)	00			Not	Allowed
P020	Electronic gear ratio numerator setting	1. to 9999.	1.			Allowed	Allowed
P021	Electronic gear ratio denominator setting	1. to 9999.	1.			Allowed	Allowed
P022	Feed-forward gain setting	0.00 to 99.99, 100.0 to 655.3	0.00			Allowed	Allowed
P023	Position loop gain setting	0.00 to 99.99, 100.0	0.50			Allowed	Allowed
P024	Position bias setting	-204 (-2048.) / -999. to 2048	0.			Allowed	Allowed
P025	Temperature compensation thermistor enable	00 (no compensation), 01 (compensation)	00			Not	Allowed
P026	Over-speed error detection level setting	0.0 to 150.0 (%)	135.0			Not	Allowed
P027	Speed deviation error detection level setting	0.00 to 99.99, 100.0 to 120.0 (Hz)	7.50			Not	Allowed
P028	Numerator of motor gear ratio	1. to 9999.	1.			Not	Allowed
P029	Denominator of motor gear ratio	1. to 9999.	1.			Not	Allowed
P031	Accel/decel time input selection	00 (digital operator), 01 (option 1), 02 (option 2), 03 (easy sequence)	00			Not	Not
P032	Positioning command input selection	00 (digital operator), 01 (option 1), 02 (option 2)	00			Not	Allowed
P033	Torque command input selection	00 (O terminal), 01 (OI terminal), 02 (O2 terminal), 03 (digital operator)	00			Not	Not
P034	Torque command setting	0. to 200. (%) <0. to 180. (%)>	0.			Allowed	Allowed
P035	Polarity selection at the torque command input via O2 terminal	00 (as indicated by the sign), 01 (depending on the operation direction)	00			Not	Not
P036	Torque bias mode	00 (disabling the mode), 01 (digital operator), 02 (input via O2 terminal)	00			Not	Not
P037	Torque bias value	-200. to +200. (%) <-180. to +180. (%)>	0.			Allowed	Allowed
P038	Torque bias polarity selection	00 (as indicated by the sign), 01 (depending on the operation direction)	00			Not	Not
P039	Speed limit for torque-controlled operation (forward rotation)	0.00 to "maximum frequency" (Hz)	0.00			Allowed	Allowed
P040	Speed limit for torque-controlled operation (reverse rotation)		0.00			Allowed	Allowed
P044	DeviceNet comm watchdog timer	0.00 to 99.99 (s)	1.00			Not	Not
P045	Inverter action on DeviceNet comm error	00 (tripping), 01 (tripping after decelerating and stopping the motor), 02 (ignoring errors), 03 (stopping the motor after free-running), 04 (decelerating and stopping the motor)	01			Not	Not
P046	DeviceNet polled I/O: Output instance number	20, 21, 100	21			Not	Not
P047	DeviceNet polled I/O: Input instance number	70, 71, 101	71			Not	Not
P048	Inverter action on DeviceNet idle mode	00 (tripping), 01 (tripping after decelerating and stopping the motor), 02 (ignoring errors), 03 (stopping the motor after free-running), 04 (decelerating and stopping the motor)	01			Not	Not
P049	DeviceNet motor poles setting for RPM	0, 2, 4, 6, 8, 10, 12, 14, 16, 18, 20, 22, 24, 26, 28, 30, 32, 34, 36, 38 (poles)	0			Not	Not

(Note) <>indicate the setting range of 75 to 150kW

Chapter 4 List of Data Settings

Code	Function name	Monitored data or setting	Default			Change during RUN operation		
			FF	FEF	FUF	b031≠10	b031=10	
Output pulse	P055	Pulse-string frequency scale	1.0 to 50.0 (kHz)			25.0	Not	Allowed
	P056	Time constant of pulse-string frequency filter	0.01 to 2.00 (s)			0.10	Not	Allowed
	P057	Pulse-string frequency bias	-100. to +100. (%)			0.	Not	Allowed
	P058	Pulse-string frequency limit	0. to 100. (%)			100.	Not	Allowed
Absolute position control	P060	Multistage position setting 0	Position setting range reverse side – forward side (upper 4 digits including “-“)			0	Allowed	Allowed
	P061	Multistage position setting 1	Position setting range reverse side – forward side (upper 4 digits including “-“)			0	Allowed	Allowed
	P062	Multistage position setting 2	Position setting range reverse side – forward side (upper 4 digits including “-“)			0	Allowed	Allowed
	P063	Multistage position setting 3	Position setting range reverse side – forward side (upper 4 digits including “-“)			0	Allowed	Allowed
	P064	Multistage position setting 4	Position setting range reverse side – forward side (upper 4 digits including “-“)			0	Allowed	Allowed
	P065	Multistage position setting 5	Position setting range reverse side – forward side (upper 4 digits including “-“)			0	Allowed	Allowed
	P066	Multistage position setting 6	Position setting range reverse side – forward side (upper 4 digits including “-“)			0	Allowed	Allowed
	P067	Multistage position setting 7	Position setting range reverse side – forward side (upper 4 digits including “-“)			0	Allowed	Allowed
	P068	Zero-return mode selection	00(Low)/01 (Hi1)/00 (Hi2)			00	Allowed	Allowed
	P069	Zero-return direction selection	00 (FW)/01 (RV)			00	Allowed	Allowed
	P070	Low-speed zero-return frequency	0.00 to 10.00 (Hz)			0.00	Allowed	Allowed
	P071	High-speed zero-return frequency	0.00 – 99.99 / 100.0 – Maximum frequency setting, 1st motor (Hz)			0.00	Allowed	Allowed
	P072	Position range specification (forward)	0 – 268435455 (when P012 = 02) 0 – 1073741823 (When P012 = 03) (upper 4 digits)			2684 (268435455)	Allowed	Allowed
	P073	Position range specification (reverse)	-268435455 – 0 (when P012 = 02) -1073741823 – 0 (When P012 = 03) (upper 4 digits)			-268 (-268435455)	Allowed	Allowed
	P074	Teaching selection	00 (X00) / 01 (X01) / 02 (X02) / 03 (X03) / 04 (X04) / 05 (X05) / 06 (X06) / 07 (X07)			00	Allowed	Allowed
	Easy sequence function	P100	Easy sequence user parameter U (00)	0. to 9999., 1000 to 6553 (10000 to 65535)			0.	Allowed
P101		Easy sequence user parameter U (01)	0. to 9999., 1000 to 6553 (10000 to 65535)			0.	Allowed	Allowed
P102		Easy sequence user parameter U (02)	0. to 9999., 1000 to 6553 (10000 to 65535)			0.	Allowed	Allowed
P103		Easy sequence user parameter U (03)	0. to 9999., 1000 to 6553 (10000 to 65535)			0.	Allowed	Allowed
P104		Easy sequence user parameter U (04)	0. to 9999., 1000 to 6553 (10000 to 65535)			0.	Allowed	Allowed
P105		Easy sequence user parameter U (05)	0. to 9999., 1000 to 6553 (10000 to 65535)			0.	Allowed	Allowed
P106		Easy sequence user parameter U (06)	0. to 9999., 1000 to 6553 (10000 to 65535)			0.	Allowed	Allowed
P107		Easy sequence user parameter U (07)	0. to 9999., 1000 to 6553 (10000 to 65535)			0.	Allowed	Allowed
P108		Easy sequence user parameter U (08)	0. to 9999., 1000 to 6553 (10000 to 65535)			0.	Allowed	Allowed
P109		Easy sequence user parameter U (09)	0. to 9999., 1000 to 6553 (10000 to 65535)			0.	Allowed	Allowed
P110		Easy sequence user parameter U (10)	0. to 9999., 1000 to 6553 (10000 to 65535)			0.	Allowed	Allowed

Chapter 4 List of Data Settings

Code	Function name	Monitored data or setting	Default			Change during RUN operation		
			FF	FEF	FUF	b031≠10	b031=10	
Easy sequence function	P111	Easy sequence user parameter U (11)	0. to 9999., 1000 to 6553 (10000 to 65535)			0.	Allowed	Allowed
	P112	Easy sequence user parameter U (12)	0. to 9999., 1000 to 6553 (10000 to 65535)			0.	Allowed	Allowed
	P113	Easy sequence user parameter U (13)	0. to 9999., 1000 to 6553 (10000 to 65535)			0.	Allowed	Allowed
	P114	Easy sequence user parameter U (14)	0. to 9999., 1000 to 6553 (10000 to 65535)			0.	Allowed	Allowed
	P115	Easy sequence user parameter U (15)	0. to 9999., 1000 to 6553 (10000 to 65535)			0.	Allowed	Allowed
	P116	Easy sequence user parameter U (16)	0. to 9999., 1000 to 6553 (10000 to 65535)			0.	Allowed	Allowed
	P117	Easy sequence user parameter U (17)	0. to 9999., 1000 to 6553 (10000 to 65535)			0.	Allowed	Allowed
	P118	Easy sequence user parameter U (18)	0. to 9999., 1000 to 6553 (10000 to 65535)			0.	Allowed	Allowed
	P119	Easy sequence user parameter U (19)	0. to 9999., 1000 to 6553 (10000 to 65535)			0.	Allowed	Allowed
	P120	Easy sequence user parameter U (20)	0. to 9999., 1000 to 6553 (10000 to 65535)			0.	Allowed	Allowed
	P121	Easy sequence user parameter U (21)	0. to 9999., 1000 to 6553 (10000 to 65535)			0.	Allowed	Allowed
	P122	Easy sequence user parameter U (22)	0. to 9999., 1000 to 6553 (10000 to 65535)			0.	Allowed	Allowed
	P123	Easy sequence user parameter U (23)	0. to 9999., 1000 to 6553 (10000 to 65535)			0.	Allowed	Allowed
	P124	Easy sequence user parameter U (24)	0. to 9999., 1000 to 6553 (10000 to 65535)			0.	Allowed	Allowed
	P125	Easy sequence user parameter U (25)	0. to 9999., 1000 to 6553 (10000 to 65535)			0.	Allowed	Allowed
	P126	Easy sequence user parameter U (26)	0. to 9999., 1000 to 6553 (10000 to 65535)			0.	Allowed	Allowed
	P127	Easy sequence user parameter U (27)	0. to 9999., 1000 to 6553 (10000 to 65535)			0.	Allowed	Allowed
	P128	Easy sequence user parameter U (28)	0. to 9999., 1000 to 6553 (10000 to 65535)			0.	Allowed	Allowed
P129	Easy sequence user parameter U (29)	0. to 9999., 1000 to 6553 (10000 to 65535)			0.	Allowed	Allowed	
P130	Easy sequence user parameter U (30)	0. to 9999., 1000 to 6553 (10000 to 65535)			0.	Allowed	Allowed	
P131	Easy sequence user parameter U (31)	0. to 9999., 1000 to 6553 (10000 to 65535)			0.	Allowed	Allowed	
User parameters	U001	User-selected function 1	no/d001 to P131			no	Allowed	Allowed
	U002	User-selected function 2	no/d001 to P131			no	Allowed	Allowed
	U003	User-selected function 3	no/d001 to P131			no	Allowed	Allowed
	U004	User-selected function 4	no/d001 to P131			no	Allowed	Allowed
	U005	User-selected function 5	no/d001 to P131			no	Allowed	Allowed
	U006	User-selected function 6	no/d001 to P131			no	Allowed	Allowed
	U007	User-selected function 7	no/d001 to P131			no	Allowed	Allowed
	U008	User-selected function 8	no/d001 to P131			no	Allowed	Allowed
	U009	User-selected function 9	no/d001 to P131			no	Allowed	Allowed
	U010	User-selected function 10	no/d001 to P131			no	Allowed	Allowed
	U011	User-selected function 11	no/d001 to P131			no	Allowed	Allowed
	U012	User-selected function 12	no/d001 to P131			no	Allowed	Allowed

(Note) < > indicate the setting range of 75 to 150kW

Chapter 4 List of Data Settings

(Memo)

Chapter 5 Error Codes

This chapter describes the error and warning codes of the inverter.

5.1	Error Codes and Troubleshooting.....	5 - 2
5.2	Warning Codes	5 - 5

Chapter 5 Error Codes

5.1 Error Codes and Troubleshooting

5.1.1 Error Codes

Name	Description	Display on digital operator
Overcurrent protection	If the motor is constrained or suddenly accelerated or decelerated, a high current will flow in the inverter and the inverter may fail. To avoid this problem, the inverter shuts off its output and displays the error code shown on the right when it detects a current higher than a specified level. This protective function uses a DC current detector to detect overcurrent. When a current as high as about 220% of the inverter's rated output current of constant torque mode is detected, the protective circuit operates and the inverter trips.	During constant-speed operation E01
		During deceleration E02
		During acceleration E03
		Others E04
Overload protection (*1)	This protective function monitors the inverter output current, and shuts off the inverter output and displays the error code shown on the right when the internal electronic thermal protection circuit detects a motor overload. If the error occurs, the inverter will trip according to the setting of the electronic thermal function.	E05
Braking resistor overload protection	When the BRD operation rate exceeds the setting of "b090", this protective function shuts off the inverter output and displays the error code shown on the right.	E06
Overvoltage protection	If the DC voltage across the P and N terminals rises too high, an inverter failure may result. To avoid this problem, this protective function shuts off the inverter output and displays the error code shown on the right when the DC voltage across the P and N terminals exceeds a specified level because of an increase in the energy regenerated by the motor or the input voltage (during operation). The inverter will trip if the DC voltage across the P and N terminals exceeds about 400 VDC (in case of the 200 V class models) or about 800 VDC (in case of the 400 V class models).	E07
EEPROM error (*2) (*3)	When an internal-EEPROM is caused by external noise or an abnormal temperature rise, the inverter shuts off its output and displays the error code shown on the right. Note: An EEPROM error may result in a CPU error.	E08
Under voltage	If the inverter input voltage drops, the control circuit of the inverter cannot function normally. Therefore, the inverter shuts off its output when the input voltage falls below a specified level. The inverter will trip if the DC voltage across the P and N terminals exceeds about 175 VDC (in case of the 200 V class models) or about 345 VDC (in case of the 400 V class models).	E09













Name	Description	Display on digital operator
CT error	If an error occurs in the internal current detector (CT), the inverter will shut off its output and display the error code shown on the right. The inverter will trip when the CT outputs about 0.6 V or more at power-on.	E10
CPU error (*3)	If the internal CPU malfunctions or an error occurs in it, the inverter will shut off its output and display the error code shown on the right. Note: Reading an abnormal data from the EEPROM may result in a CPU error.	E11
External trip	If an error occurs in the external equipment or device connected to the inverter, the inverter will fetch the error signal and shut off its output. (This protective function is enabled when the external trip function is enabled.)	E12
USP error	A USP error is indicated when the inverter power is turned on with an input operation signal remaining in the inverter. (This protective function is enabled when the USP function is enabled.)	E13
Ground-fault protection (*3)	When the inverter power is turned on, this protective function detects the ground fault between the inverter output circuit and the motor to protect the inverter. (This function does not operate when a residual voltage remains in the motor.)	E14
Input overvoltage protection	This protective function determines an error if the input voltage is kept above the specification level for 100 seconds while the inverter is stopped. The inverter will trip if the DC voltage of the main circuit is kept above about 390 VDC (in case of the 200 V class models) or about 780 VDC (in case of the 400 V class models).	E15
Instantaneous power failure protection	If an instantaneous power failure lasts 15 ms or more, the inverter will shut off its output. When the power failure duration is long, the inverter assumes a normal power-off. If a restart mode has been selected and an operation command remains in the inverter, the inverter will restart after the power is recovered.	E16
Temperature error due to low cooling-fan speed	The inverter will display the error code shown on the right if the lowering of cooling-fan speed is detected at the occurrence of the temperature error described below.	E20
Temperature error	If the main circuit temperature rises because of a high ambient temperature or for other reasons, the inverter will shut off its output.	E21













*1 The inverter will not accept any reset command within about 10 seconds after tripping (i.e., after the protective function operates).

*2 The inverter will not accept any reset command after an EEPROM error occurs with error code **E08** displayed. Turn off the inverter power once. If error code "E08" is displayed when the inverter power is turned on subsequently, the internal memory device may have failed or parameters may have not been stored correctly. In such cases, initialize the inverter, and then re-set the parameters.

*3 The inverter will not accept reset commands input via the RS terminal or entered by the STOP/RESET key. Therefore, turn off the inverter power.

Chapter 5 Error Codes

Name	Description	Display on digital operator
Gate array communication error	If an error occurs in the communication between the internal CPU and gate array, the inverter will trip.	
Phase loss input protection	When the phase loss input protection has been enabled (b006 = 01), the inverter will trip to avoid damage if an phase loss input is detected. The inverter trips when the phase loss input continues for about 1 second or more.	
Main circuit error (*4)	The inverter will trip if the gate array cannot confirm the on/off state of IGBT because of a malfunction due to noise, short or damage to the main circuit element.	
IGBT error	If instantaneous overcurrent occurs, the main circuit element temperature is abnormal, or the main circuit element drive power drops, the inverter will shut off its output to protect the main circuit element. (After tripping because of this protective function, the inverter cannot retry the operation.)	
Phase loss output protection	When the phase loss output protection has been enabled (b141 = 01), the inverter will trip to avoid damage if an phase loss output is detected. The inverter can detect an phase loss when the output frequency is from 5 Hz to 100 Hz.	
Thermistor error	The inverter monitors the resistance of the thermistor (in the motor) connected to the inverter's TH terminal, and will shut off the inverter output if the motor temperature rises.	
Emergency stop (*5)	If the EMR signal (on three terminals) is turned on when the slide switch (SW1) on the logic board is set to ON, the inverter hardware will shut off the inverter output and display the error code shown on the right. Malfunction due to incoming noise, in case EMR terminal is not ON.	
Low-speed overload protection	If overload occurs during the motor operation at a very low speed at 0.2 Hz or less, the electronic thermal protection circuit in the inverter will detect the overload and shut off the inverter output. (2nd electronic thermal control) (Note that a high frequency may be recorded as the error history data.)	
Modbus communication error	If timeout occurs because of line disconnection during the communication in Modbus-RTU mode, the inverter will display the error code shown on the right. (The inverter will trip according to the setting of "C076".)	
Invalid instruction	The inverter detects errors in the easy sequence. Refer to SJ700D-3 instruction manual.	
Nesting count error		
Execution error		

Name	Description	Display on digital operator
User Trip	The inverter detects errors in the easy sequence. Refer to SJ700D-3 instruction manual.	 to 
Option 1 error	The inverter detects errors in the option board mounted in the optional slot 1. For details, refer to the instruction manual for the mounted option board.	 to 
Option 2 error	The inverter detects errors in the option board mounted in the optional slot 1. For details, refer to the instruction manual for the mounted option board.	 to 
Waiting in under voltage status	If the input voltage falls, the inverter will shut off its output, display the code shown on the right, and wait for the recovery of the input voltage. The inverter will display the same error code also during an instantaneous power failure. (remark) Inverter trips with under voltage when this status continues for 40 seconds.	
Communication error	If a problem occurs in the communication between the digital operator and inverter, the inverter will display the code shown on the right. For example disconnection.	
Waiting for retry	When the retry after instantaneous power failure or tripping has been enabled, the inverter displays the code shown on the right while awaiting retry after an instantaneous power failure or tripping.	
Power-off	The inverter displays the code shown on the right when the inverter power is turned off.	
Restricted operation command	When an operation direction has been restricted by the setting of "b035", the inverter will display the error code shown on the right if the operation command specifying the restricted operation direction is input.	
Empty trip history	If the inverter has not tripped before, the inverter displays  .	

*4 The inverter will not accept reset commands input via the RS terminal or entered by the STOP/RESET key. Therefore, turn off the inverter power.

*5 The inverter will not accept the reset command entered from the digital operator. Therefore, reset the inverter by turning on the RS terminal.

Chapter 5 Error Codes

5.1.2 Trip conditions monitoring

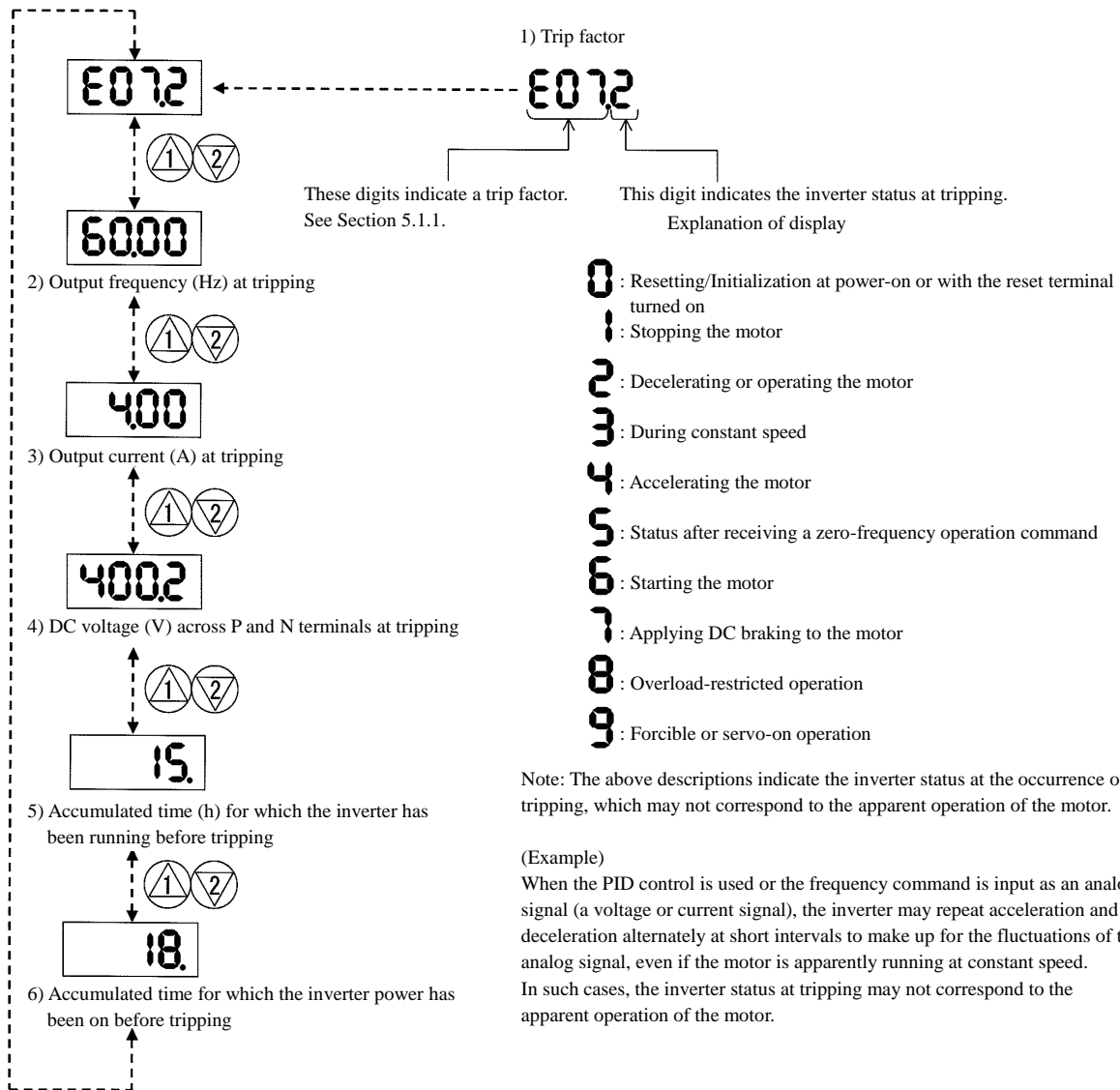

Chapter 5 Error Codes

5.2 Warning Codes

The following table lists the warning codes and the contents of parameter readjustments:

Warning code	Target function code	Condition	Basic function code
$\frac{001}{201}$	Frequency upper limit setting (A061/A261)	>	Maximum frequency setting (A004/A204/A304)
$\frac{002}{202}$	Frequency lower limit setting (A062/A262)	>	
$\frac{005}{205}$ / $\frac{305}{305}$	Output frequency setting (F001) (*)	>	Frequency upper limit setting (A061/A261)
$\frac{015}{215}$	Output frequency setting (F001) (*)	>	
$\frac{019}{019}$	Home search speed setting (P015)	>	Frequency lower limit setting (A062/A262)
$\frac{025}{225}$	Output frequency setting (F001) (*)	<	
$\frac{029}{029}$	Home search speed setting (P015)	<	Start frequency adjustment (b082)
$\frac{031}{231}$	Frequency upper limit setting (A061/A261)	<	
$\frac{032}{232}$	Frequency lower limit setting (A062/A262)	<	
$\frac{035}{235}$ / $\frac{335}{335}$	Output frequency setting (F001) (*)	<	
$\frac{037}{037}$	Jog frequency setting (A038)	<	Jump (center) frequency settings 1/2/3 ± " Jump (hysteresis) frequency width settings 1/2/3"
$\frac{085}{285}$ / $\frac{385}{385}$	Output frequency setting (F001) (*)	<>	
$\frac{086}{086}$	Multispeed 1 to 15 settings (A021 to A035)	<>	A063 ± A064, A065 ± A066, A067 ± A068
$\frac{091}{291}$	Frequency upper limit setting (A061/A261)	>	Free-setting V/f frequency (7) (b112)
$\frac{092}{292}$	Frequency lower limit setting (A062/A262)	>	
$\frac{095}{295}$	Output frequency setting (F001) (*)	>	

- The inverter displays a warning code when the data set as a target function code satisfies the condition (specified in the Condition column) in relation to the data set as the corresponding basic function code.
- When the inverter is warning, it can not run to work the motor. Refer to the above column and modify the parameters to the correct data.
- When the inverter is warning, you can confirm the warning information 'd090'.
- * These parameters are checked, even when the digital operator (02) is not specified for the frequency source setting (A001).

Chapter 5 Error Codes

(Memo)

Chapter 6 Specifications



This chapter describes the specifications and external dimensions of the inverter.

- 6.1 Specifications 6 - 2
- 6.2 External dimensions 6 - 5

Chapter 6 Specifications

6.1 Specifications (CT : Constant torque mode, VT : Variable torque mode)

(1) Specifications of the 200 V class model

Model name (type name) SJ700D-***LFF3/FUF3		004	007	015	022	037	055	075	110	150	185	220	300	370	450	550	
Max. applicable motor capacity (4-pole) (kW)	CT	0.4	0.75	1.5	2.2	3.7	5.5	7.5	11	15	18.5	22	30	37	45	55	
	VT	0.75	1.1	2.2	3.0	5.5	7.5	11	15	18.5	22	30	37	45	55	75	
Rated capacity (kVA)	200V	CT	1.0	1.7	2.5	3.6	5.7	8.3	11.0	15.9	22.1	26.3	32.9	41.9	50.2	63.0	76.2
		VT	1.2	2.1	3.2	4.1	6.7	10.3	15.2	20.0	25.2	29.4	39.1	48.4	58.5	72.7	93.5
	240V	CT	1.2	2.0	3.1	4.3	6.8	9.9	13.3	19.1	26.6	31.5	39.4	50.2	60.2	75.6	91.4
		VT	1.5	2.6	3.9	4.9	8.1	12.4	18.2	24.1	30.3	35.3	46.9	58.1	70.2	87.2	112.2
Rated input AC voltage		Three-phase (3-wire), 200 to 240 V (+10%, -15%), 50/60 Hz (±5%)															
Rated output voltage		Three-phase (3-wire), 200 to 240 V (corresponding to the input voltage)															
Rated output current (A)	CT	3.0	5.0	7.5	10.5	16.5	24	32	46	64	76	95	121	145	182	220	
	VT	3.7	6.3	9.4	12	19.6	30	44	58	73	85	113	140	169	210	270	
Braking	Regenerative braking	Internal BRD circuit (external discharge resistor)											External regenerative braking unit				
	Minimum connectable resistance (Ω)	50	50	35	35	35	16	10	10	7.5	7.5	5	-				
Approx. weight (kg)		3.5	3.5	3.5	3.5	3.5	6	6	6	14	14	14	22	30	30	43	

(2) Specifications of the 400 V class model

Model name (type name) SJ700D-***FF3/FEF3/FUF3		007	015	022	037 040	055	075	110	150	185	220	300	370	450	550	750	900	1100	1320 1500	
Max. applicable motor capacity (4-pole) (kW)	CT	0.75	1.5	2.2	3.7/ 4.0	5.5	7.5	11	15	18.5	22	30	37	45	55	75	90	110	132/ 150	
	VT	1.5	2.2	3.7	5.5	7.5	11	15	18.5	22	30	37	45	55	75	90	110	132	160	
Rated capacity (kVA)	400V	CT	1.7	2.6	3.6	6.2	9.7	13.1	17.3	22.1	26.3	33.2	40.1	51.9	62.3	76.2	103.2	121.9	150.3	180.1
		VT	2.1	3.3	4.6	7.6	11.0	15.2	20.0	25.6	29.7	39.4	48.4	58.8	72.7	93.5	110.8	135	159.3	200.9
	480V	CT	2.0	3.1	4.3	7.4	11.6	15.8	20.7	26.6	31.5	39.9	48.2	62.3	74.8	91.4	123.8	146.3	180.4	216.1
		VT	2.5	3.9	5.5	9.2	13.3	18.2	24.1	30.7	35.7	47.3	58.1	70.6	87.2	112.2	133	162.1	191.2	241.1
Rated input AC voltage		Three-phase (3-wire), 380 to 480 V (+10%, -15%), 50/60 Hz (±5%)																		
Rated output voltage		Three-phase (3-wire), 380 to 480 V (corresponding to the input voltage)																		
Rated output current (A)	CT	2.5	3.8	5.3	9.0	14	19	25	32	38	48	58	75	91	112	149	176	217	260	
	VT	3.1	4.8	6.7	11.1	16	22	29	37	43	57	70	85	105	135	160	195	230	290	
Braking	Regenerative braking	Internal BRD circuit (external discharge resistor)											External regenerative braking unit							
	Minimum connectable resistance (Ω)	100	100	100	70	70	35	35	24	24	20	-								
Approx. weight (kg)		3.5	3.5	3.5	3.5	6	6	6	14	14	14	22	30	30	30	55	55	70	70	

(3) Common specifications of 200 V class and 400 V class models

Model name (type name) SJ700D-***FF3/FEF3/FUF3		004 L	007 L/H	015 L/H	022 L/H	037 040 L/H	055 L/H	075 L/H	110 L/H	150 L/H	185 L/H	220 L/H	300 L/H	370 L/H	450 L/H	550 L/H	750 L/H	900 H	1100 H	1320 1500 H
Protective structure		IP20											IP00							
Control system		Sine-wave PWM control																		
Output frequency range		0.1 to 400 Hz (Note 3)																		
Frequency accuracy		Within ±0.01% of the maximum output frequency for digital input, within ±0.2% of maximum frequency for digital input (at 25±10°C)																		
Frequency setting resolution		Digital input: 0.01 Hz Analog input: Maximum output frequency/4000 (O terminal input: 12 bits/0 to +10 V, O2 terminal input: 12 bits/-10 to +10 V, OI terminal input: 12 bits/0 to +20 mA)																		
Voltage/frequency characteristic		IM : V/f characteristic variable with the base frequency set between 30 to 400 Hz, constant- or reduced-torque V/f control, SLV : sensorless vector control, 0Hz-SLV : 0Hz ranged sensorless vector control (only CT), vector with sensor (only VT)																		
Speed fluctuation		±0.5% (with sensorless vector control) Note8)																		
Rated overload current		CT : 150%/60sec, 200%/3sec VT : 120%/60sec, 150%/5sec													CT : 150%/60sec, 180%/3sec VT : 120%/60sec, 150%/5sec					
Acceleration/deceleration time		0.01 to 3,600.0 seconds (in linear or curved pattern)																		
Starting torque	SLV	CT : 200%/0.3Hz VT : 150%/0.5Hz													CT : 180%/0.3Hz VT : 120%/0.5Hz					
	0Hz-SLV	CT : 150%/0Hz range (with motor less one power level than inverter) VT : Disable.													CT : 130% (same as the left) VT : Disable.					

note) There are only 037HFF3, 037HFUF3 and 040HFEF3 as 037/040 model.

note) There are only 1320HFF3, 1320HFEF3 and 1500HFUF3 as 1320/1500 model.

Chapter 6 Specifications

(3) Common specifications of 200 V class and 400 V class models (continued)

Model name (type name)	004	007	015	022	037	055	075	110	150	185	220	300	370	450	550	750	900	1100	1320		
SJ700D-***FF3/FEF3/FUF3	L	L/H	L/H	L/H	040 L/H	L/H	L/H	L/H	L/H	L/H	L/H	L/H	L/H	L/H	L/H	H	H	H	H	1500 H	
Input	Frequency setting	Standard operator	Setting with and keys																		
		External signal (Note6)	0 to +10 VDC, -10 to +10 VDC (input impedance: 10kΩ), 4 to 20 mA (input impedance: 100Ω)																		
		External port	Setting via RS485 communication																		
	Start/stop command Forward/reverse command	Standard operator	Start/stop commands (forward/reverse switching by parameter setting)																		
		External signal	Forward-operation start/stop commands (reverse-operation start/stop possible when relevant commands are assigned to intelligent input terminals) 3-wire input possible (when relevant commands are assigned to control circuit terminals)																		
		External port	Setting via RS485 communication																		
	Intelligent input terminals	8 terminals, NO/NC switchable, sink logic/source logic switchable [Terminal functions] Select eight of 69 functions. Reverse operation (RV), Multispeed 1 setting (CF1), Multispeed 2 setting (CF2), Multispeed 3 setting (CF3), Multispeed 4 setting (CF4), Jogging (JG), external DC braking (DB), 2nd motor control (SET), 2-stage acceleration/deceleration (2CH), free-run stop (FRS), external trip (EXT), unattended start protection (USP), commercial power supply switching (CS), software lock (SFT), analog input switching (AT), 3rd motor control (SET3), reset (RS), starting by 3-wire input (STA), stopping by 3-wire input (STP), forward/reverse switching by 3-wire input (F/R), PID disable (PID), PID integration reset (PIDC), control gain switching (CAS), acceleration by remote control (UP), deceleration by remote control (DWN), data clearance by remote control (UDC), forcible operation (OPE), multispeed bit 1 (SF1), multispeed bit 2 (SF2), multispeed bit 3 (SF3), multispeed bit 4 (SF4), multispeed bit 5 (SF5), multispeed bit 6 (SF6), multispeed bit 7 (SF7), overload restriction selection (OLR), torque limit selection (enabling/disabling) (TL), torque limit 1 (TRQ1), torque limit 2 (TRQ2), P/PI switching (PPI), LAD cancellation (LAC), trigger for frequency addition (A145) (ADD), forcible-terminal operation (F-TM), cumulative power clearance (KHC), general-purpose input 1 (MI1), general-purpose input 2 (MI2), general-purpose input 3 (MI3), general-purpose input 4 (MI4), general-purpose input 5 (MI5), general-purpose input 6 (MI6), general-purpose input 7 (MI7), general-purpose input 8 (MI8), analog command holding (AHD), emergency stop(EMR)*Note4,no assignment (no)																			
	Thermistor input terminal	1 terminal (positive temperature coefficient/negative temperature coefficient switchable for resistor)																			
	Output	Intelligent output terminals	5 open-collector output terminals, NO/NC switchable, sink logic/source logic switchable 1 relay (1c-contact) output terminal: NO/NC switchable [Terminal functions] Select six of 51 functions. Running (RUN), constant-speed reached (FA1), set frequency overreached (FA2), overload notice advance signal (1) (OL), output deviation for PID control (OD), alarm signal (AL), set frequency reached (FA3), over-torque (OTQ), instantaneous power failure (IP), under voltage (UV), torque limited (TRQ), operation time over (RNT), plug-in time over (ONT), thermal alarm signal (THM), 0 Hz detection signal (ZS), set frequency overreached 2 (FA4), set frequency reached 2 (FA5), overload notice advance signal (2) (OL2), PID feedback comparison (FBV), communication line disconnection (NDc), logical operation result 1 (LOG1), logical operation result 2 (LOG2), logical operation result 3 (LOG3), logical operation result 4 (LOG4), logical operation result 5 (LOG5), logical operation result 6 (LOG6), capacitor life warning (WAC), cooling-fan speed drop (WAF), starting contact signal (FR), heat sink overheat warning (OHF), low-current indication signal (LOC), general-purpose output 1 (M01), general-purpose output 2 (M02), general-purpose output 3 (M03), general-purpose output 4 (M04), general-purpose output 5 (M05), general-purpose output 6 (M06), inverter ready (IRDY), forward rotation (FWR), reverse rotation (RVR), major failure (MJA), alarm code 0 to 3 (AC0 to AC3)																		
		Intelligent monitor output terminals	Analog voltage output(Note7), analog current output(Note7), pulse-string output (e.g., A-F, D-F [n-fold, pulse output only], A, T, V, P)																		
Monitoring on display		Output frequency, output current, output torque, frequency conversion data, trip history, input/output terminal status, electric power, and others																			
DC braking	Triggered at motor start-up, when the actual motor frequency exceeds the acceleration frequency set by a stop command, when the actual motor frequency exceeds the frequency set by a frequency command, or by an externally input command (braking force, time, and frequency are variable).																				
Other functions	Free V/f setting (7 breakpoints), frequency upper/lower limit, jump (center) frequency, acceleration/deceleration according to characteristic curve, manual torque boost level/breakpoint, energy-saving operation, analog meter adjustment, start frequency setting, carrier frequency adjustment, electronic thermal function (available also for free setting), external start/end frequency/frequency rate, analog input selection, retry after trip, restart after instantaneous power failure, output of various signals, starting with reduced voltage, overload restriction, initial-value setting, automatic deceleration at power failure, AVR function, fuzzy acceleration/deceleration, online/offline auto-tuning, high-torque multi-motor operation (sensorless vector control of two motors by one inverter)																				
Carrier frequency variation	CT : 0.5 to 15kHz VT : 0.5 to 12 kHz															CT : 0.5 to 10kHz VT : 0.5 to 8 kHz					
Protective functions	Overcurrent protection, overvoltage protection, under voltage protection, electronic thermal protection, temperature error protection, instantaneous power failure protection, phase loss input protection, braking-resistor overload protection, ground-fault current detection at power-on, USP error, external trip, emergency stop trip, CT error, communication error, option board error, and others																				

Chapter 6 Specifications

(3) Common specifications of 200 V class and 400 V class models (continued)

Model name (type name)		004	007	015	022	037	055	075	110	150	185	220	300	370	450	550	750	900	1100	1320	1500
SJ700D-***FF3/FEF3/FUF3		L	L/H	L/H	L/H	L/H	L/H	L/H	L/H	L/H	L/H	L/H	L/H	L/H	L/H	L/H	H	H	H	H	H
Operating environment	Ambient temperature, storage temperature(Note5), humidity	-10°C to +50°C (ambient), -20°C to +65°C (storage), 20% to 90% RH (no condensation allowed)																			
	Vibration tolerance (See Note 1.)	5.9m/s ² (0.6G),10~55Hz										2.94m/s ² (0.3G),10~55Hz									
	Installation environment	Environment without corrosive gases and dust, at an altitude of 1,000 m or less Note9)																			
Coating color		Grey																			
Optional boards	Feedback option	Vector control with sensor																			
	Digital input option	4-digit BCD input, 16-bit binary input																			
	DeviceNet option	Option to support the open-network DeviceNet function (Same as SJ700-2) note12)																			
	Profibus-DP option	Option to support the open-network Profibus-DP function (Same as SJ700-2) note12)																			
Other optional components		LCD operator WOP, digital operator with potentiometer, Braking resistor, AC reactor, DC reactor, Noise filter, Operator cables, Harmonic-wave suppressor unit, LCR filter, Analog operation panel, Regenerative braking unit, Regenerative energy-saving unit, Harmonics suppression unit, Controllers for various applications, PC tool ProdriveNext																			

Note 1: The vibration tolerance was tested in compliance with JIS C60068-2-6:2010 (IEC 60068-2-6:2007).

Note 2: The insulation distance complies with the UL and CE standards.

Note 3: The applicable motor refers to Hitachi standard 3-phase motor(4-pole).when using other motors, care must be taken to prevent the rated motor current(50/60Hz)from exceeding the rated output current of the inverter.

Note 4: Function “64(EMR)”cannot be assigned to input terminal 3 by an operation from the operator. The function is automatically assigned to the terminal when slide switch SW1 is set to ON.

Note 5: The storage temperature refers to the short-term temperature during transport.

Note 6: The frequency command will equal the maximum frequency at 9.8V for input voltage 0 to 10VDC, or at 19.6mA for input current 4 to 20mA.If this characteristic is not satisfactory for your application, contact your Hitachi sales representative.

Note 7: The analog voltage monitor and the analog current monitor are rough output values for analog meter connection.

The maximum output value might shift a little by the difference of the analog output circuit than 10V or 20mA.

Please inquire when there is a possibility that the inconvenience is caused.

Note8: As for the range of the speed change, the variation range is different according to the installation situation and the characteristic and the usage condition of the motor. Please inquire about details.

Note9: The density of air decreases by 1% whenever rising by 100m when the altitude exceeds 1000m. Therefore, it is necessary to decrease the calorific value. The calorific value of the main circuit semiconductor such as IGBT is proportional to the current and the voltage.

Therefore, please decrease by 1% and use the current rating every time it rises by 100m.

Please inquire about use in the high ground of 2500m or more.

Note10: When Sensor-less vector control is selected (A044=03), you may not obtain an intended starting torque or motor may trip depending on the applied motor.

Note11: The inverter detects IGBT error (E30) as a protection function.

However IGBT error (E30) is not a protection for an output short circuit, therefore there is a possibility that IGBT will get damaged.

Moreover overcurrent error (E01 to E04) may be detected instead of IGBT error depending on the operational condition of an inverter.

Note12: The option cannot access new parameters in SJ700D-3.

Chapter 6 Specifications

6.2 External dimensions

(200V class) SJ700D-004 to 037 LFF3/LFEF3/LFUF3
 (400V class) SJ700D-007 to 037 HFF3/HFEF3/HFUF3

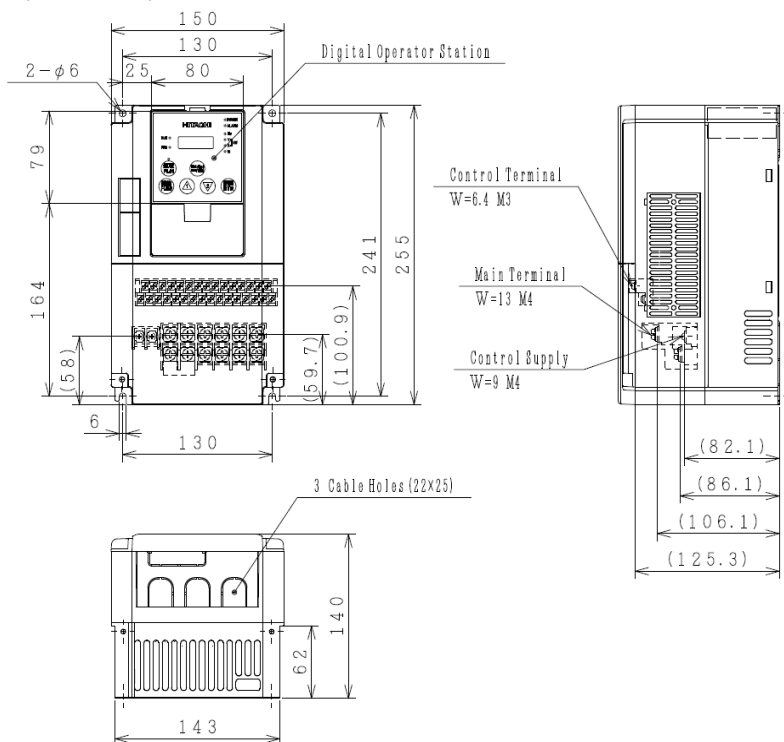

SJ700D-055 to 110 LFF3/LFEF3/LFUF3/HFF3/HFEF3/HFUF3

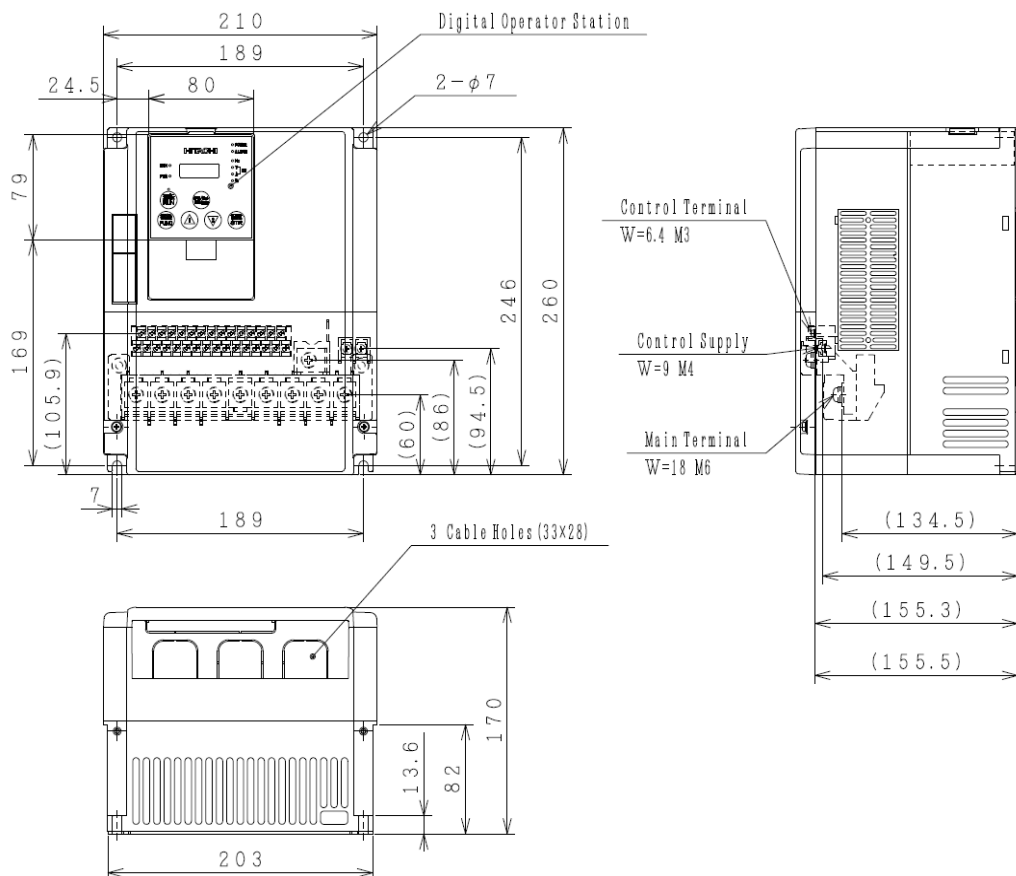

Chapter 6 Specifications

SJ700D-150 to 220 LFF3/LFEF3/LFUF3/HFF3/HFEF3/HFUF3

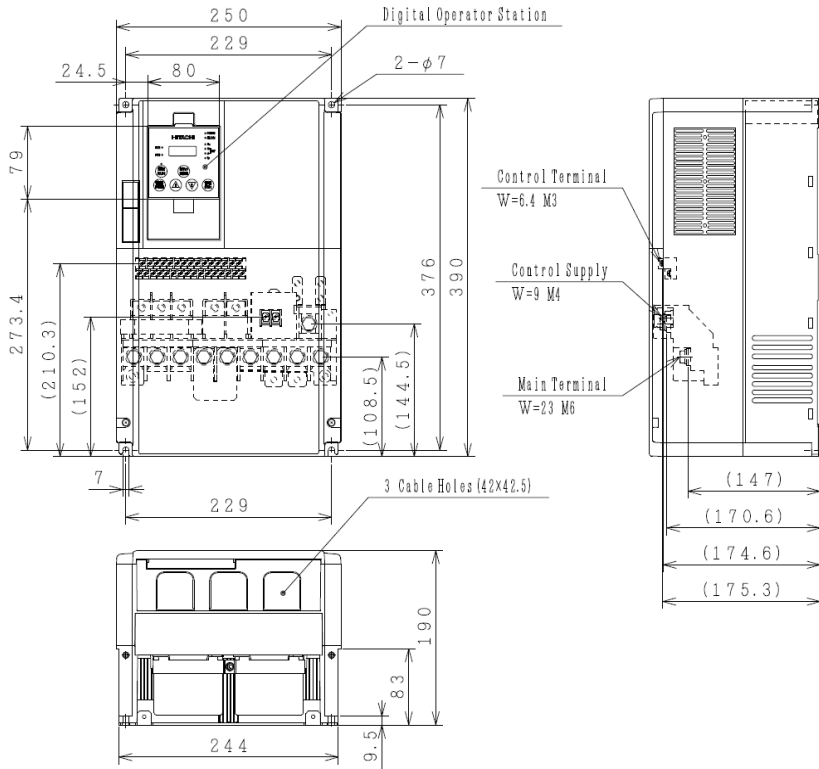

SJ700D-300 LFF3/LFEF3/LFUF3/HFF3/HFEF3/HFUF3

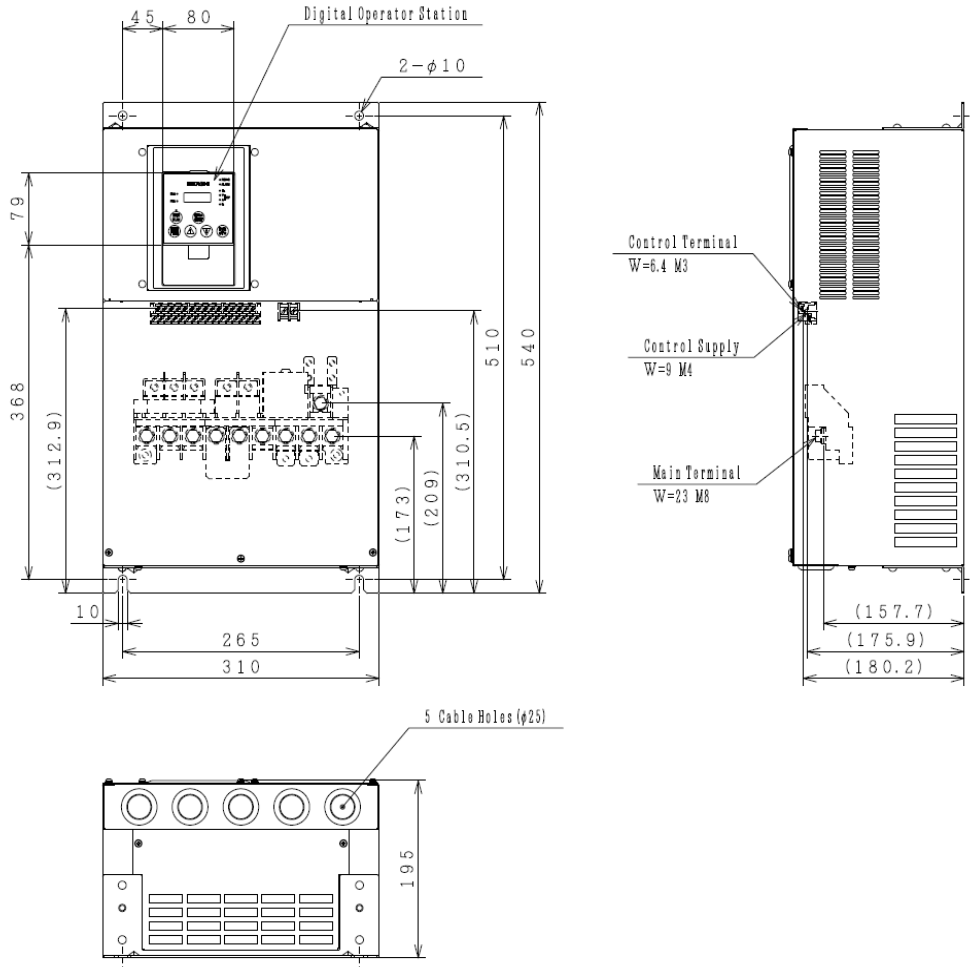

Chapter 6 Specifications

SJ700D-370 to 450 LFF3/LFEF3/LFUF3/HFF3/HFEF3/HFUF3
SJ700D-550HFF3/HFEF3/HFUF3

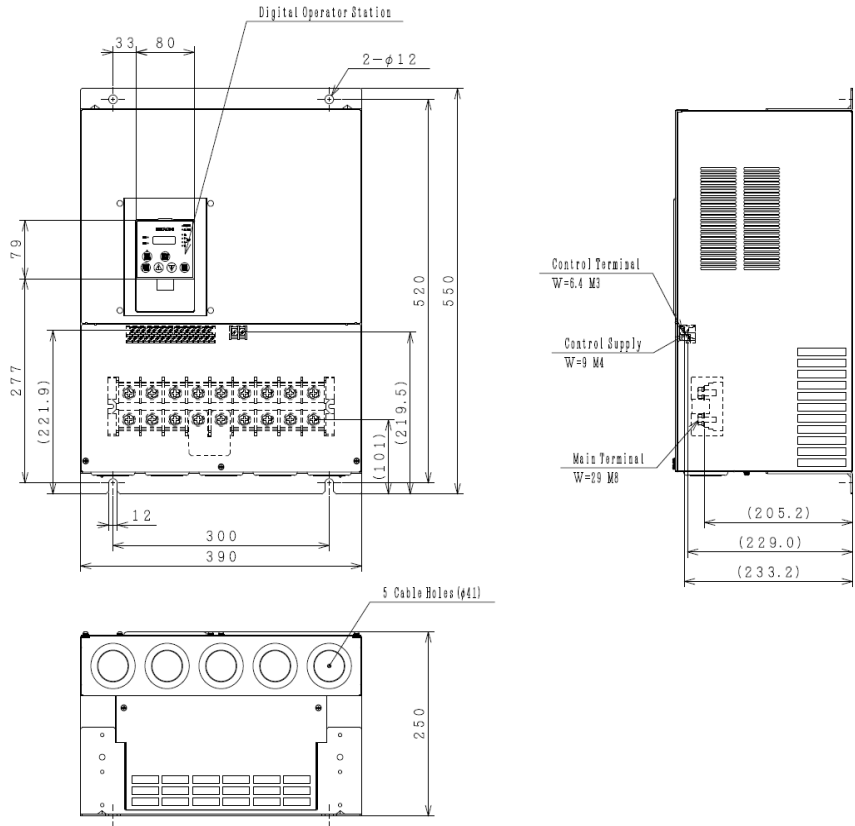

SJ700D-550LFF3/LFEF3/LFUF3

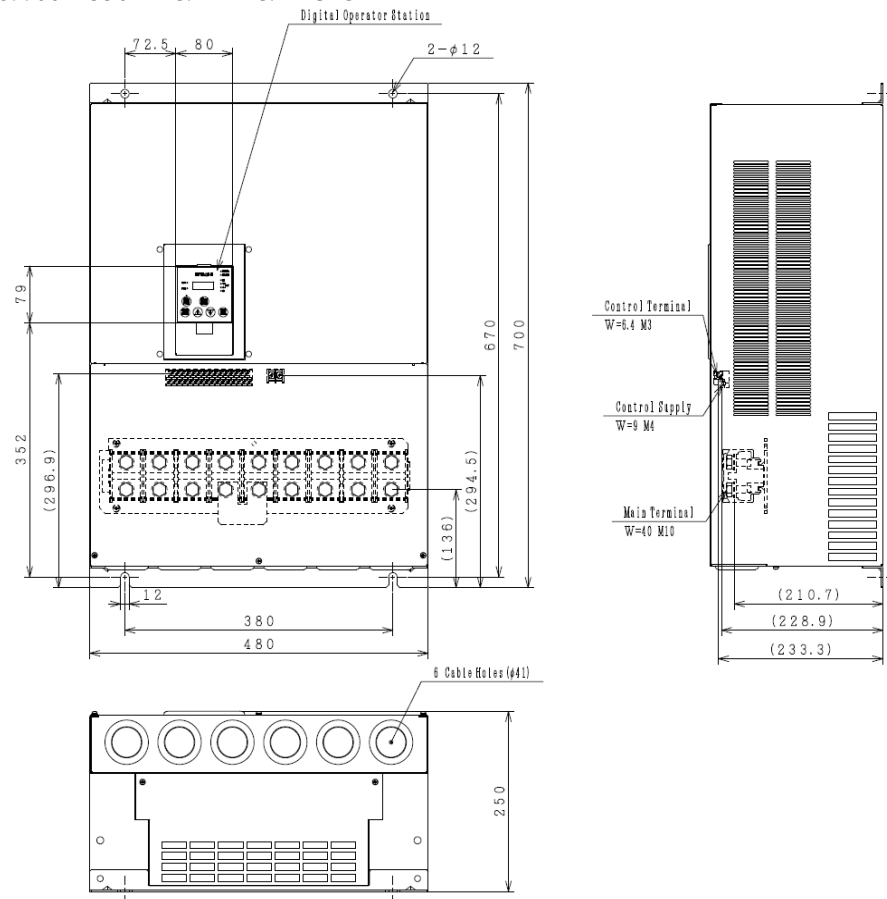

Chapter 6 Specifications

SJ700D-750 to 900 HFF3/HFEF3/HFUF3

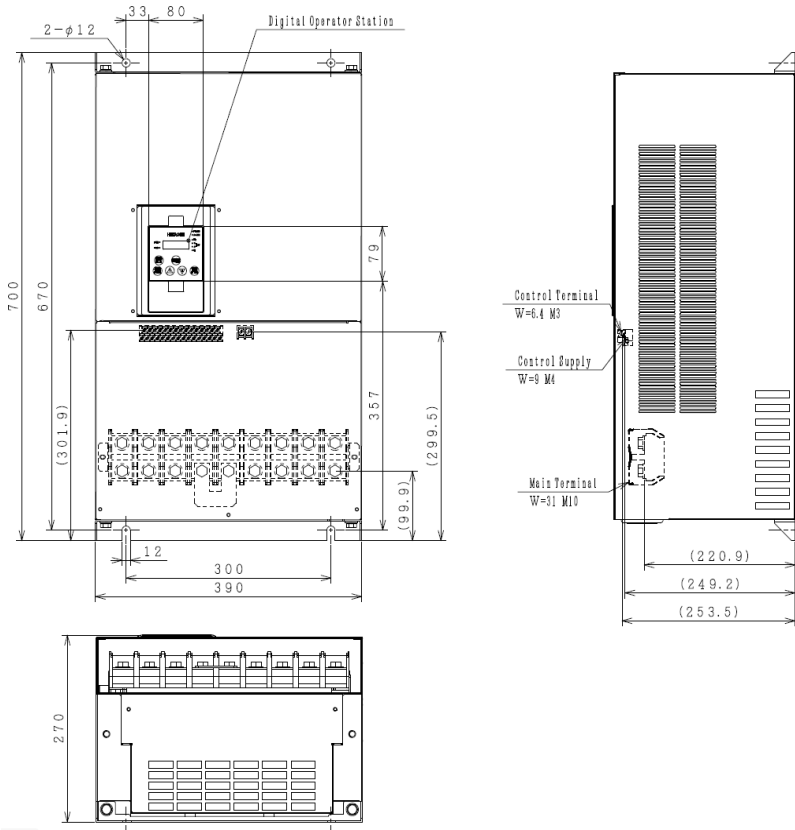

SJ700D-1100HFF3/HFEF3/HFUF3, SJ700D-1320HFF3/HFEF3, SJ700D-1500HFUF3

