

Frequency Inverters
WJ-C1 Series

HITACHI
Inspire the Next



EtherCAT

Ethernet

PROFI
BUS

PROFI
NET

Automation Solutions by Hitachi

WJ-C1 - Compact Frequency Inverter

Hitachi maintains research and development departments throughout the company with experience in a wide range of engineering fields. These products are constantly being worked on to improve and implement far-reaching modern technologies in a simple and innovative way. Many components are used directly from Hitachi's own production.

The Original Sensorless Vector Control Inverter

Hitachi offers an excellent range of high-performance Inverters for a wide range of industrial applications. The modular design and high versatility of the inverters provide optimal and cost-efficient technical solutions which can be individually adapted to the specific application.

Our new industrial inverters of the WJ Series, Type C1, are easily configurable, very efficient and fully compatible to the older series.

They are designed to deliver unprecedented results, reliably support existing applications and offer excellent performance and flexibility.

With our WJ-C1 we present an ingenious enhancement of compact and in very many applications of already known inverters ideally suited for applications such as textile machines, materials handling, roller shutters, pump and fans and much more.



Move forward
to greener &
smarter
Society



Easy to Use

ProDrive Next Software

Easy to use programming software allows user-friendly and intuitive operation.

- Online monitoring of all parameters and I/O terminal status
- Parameter conversion between different series
- Faster parameter download/ upload for RS422 communication

Easy operation

- LED control
- RS422 port
- Mini USB port

WOP LCD operator

- 12 languages available
- 5-line LCD operator
- Real time clock built-in
- Two-color backlight that distinguish trip status

Password function

To ensure parameters remain consistent and to hide some or all parameters.

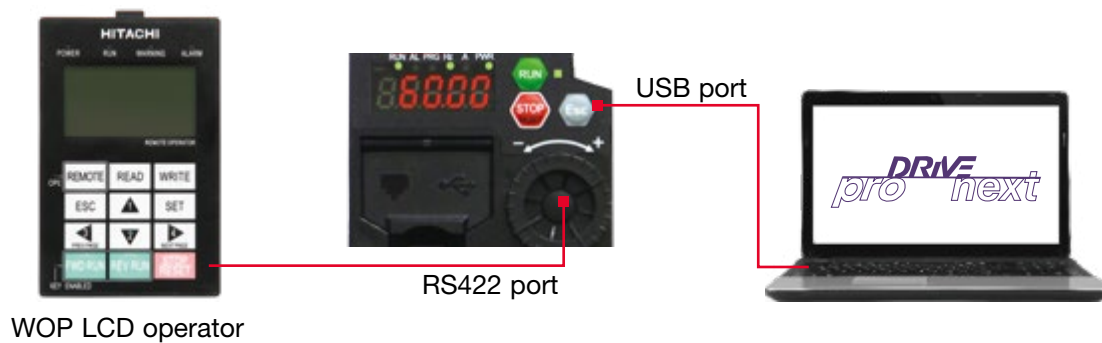

Network compatibility & external ports

The WJ-C1 Series is particularly suitable for easy integration into various networks using optional fieldbus modules known from WJ200.

- RS485-Modbus (Built-in)
- RS422 port (Built-in)
- DeviceNet
- Profibus-DP
- EtherCAT
- PROFINET



Fieldbus communication PLC – WJ-C1

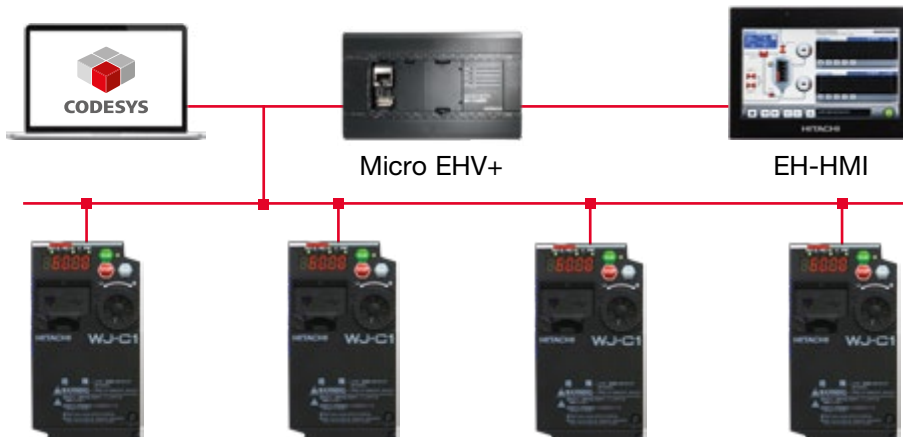

Direct communication HMI – WJ-C1

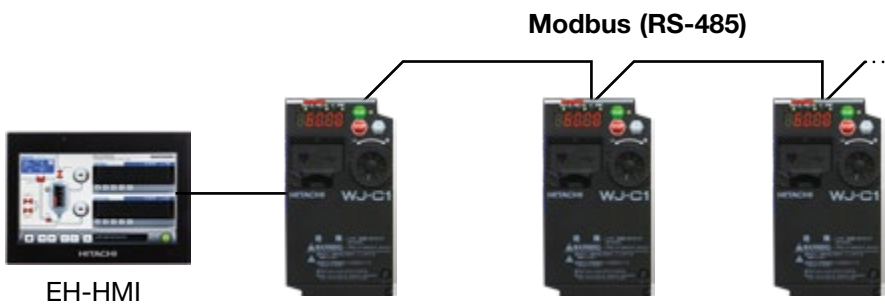

Flexible & User-friendly

Side-by-side installation

Inverters can be installed with no space between them to save space in the panel.*



*Ambient temperature 40°C max., individual mounting.

Ease of wiring

Screw-less terminals (control circuit terminals) spring-type for use with solid or stranded wire with ferrules.



Trip avoidance functions

Minimum time deceleration function, over-current suppression and DC bus AVR functions are included as standard.

These functions increase the robustness of the product and help to avoid unnecessary tripping. Improved torque limiting / current limiting function enables a load restriction to protect machinery and equipment.

Fast connection module

Connection to various field bus systems via an easy to install optional expansion card.



Easy sequence programming function [EzSQ]

Logic operations can be realised within the inverter using Hitachi's EzSQ software without the need for external relays or PLC. User programs are compiled using a PC program which are then down-loaded to the drive. This function turns the inverter, which is already equipped with many internal functions, into a very intelligent control system.

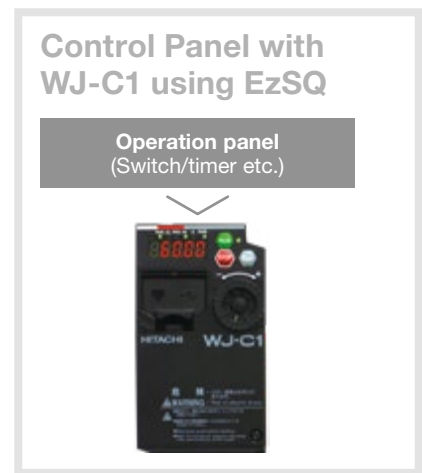
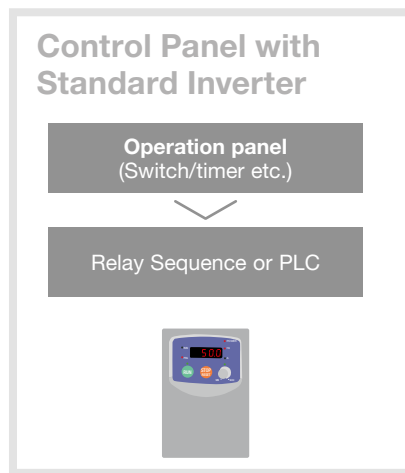

EzSQ Application Example:

Energy saving through speed reduction on a spinning machine.

■ Daytime:

motor speed is auto-magically decreased to reduce demand during peak hours.

■ Night-time:

motor speed is increased to take advantage of off-peak power rates. Average productivity is maintained.

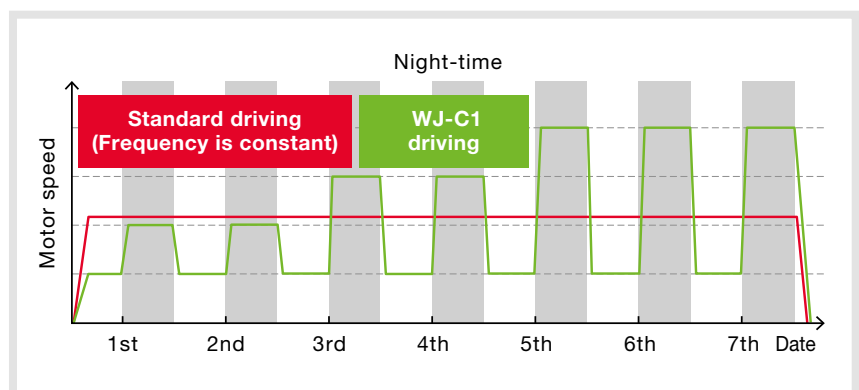

Control Panel with Standard Inverter

Operation panel (Switch/timer etc.)

Control Panel with WJ-C1 using EzSQ

Operation panel (Switch/timer etc.)

Safety & Safe Operation improved

Safety stop function

WJ-C1 Series conform to the applicable safety standards and corresponds to Machinery Directive of Europe. Inverter is shut down via hardware, bypassing the CPU, achieving a reliable safe stop function. Cat.3 PLe, SIL3, STO compliant as standard

(IEC61508; IEC/EN/UL61800-5-2; IEC/EN60204-1; IEC/EN62061; EN ISO13849-1)

Only one MC is enough

- LED control
- RS422 port
- Mini USB port

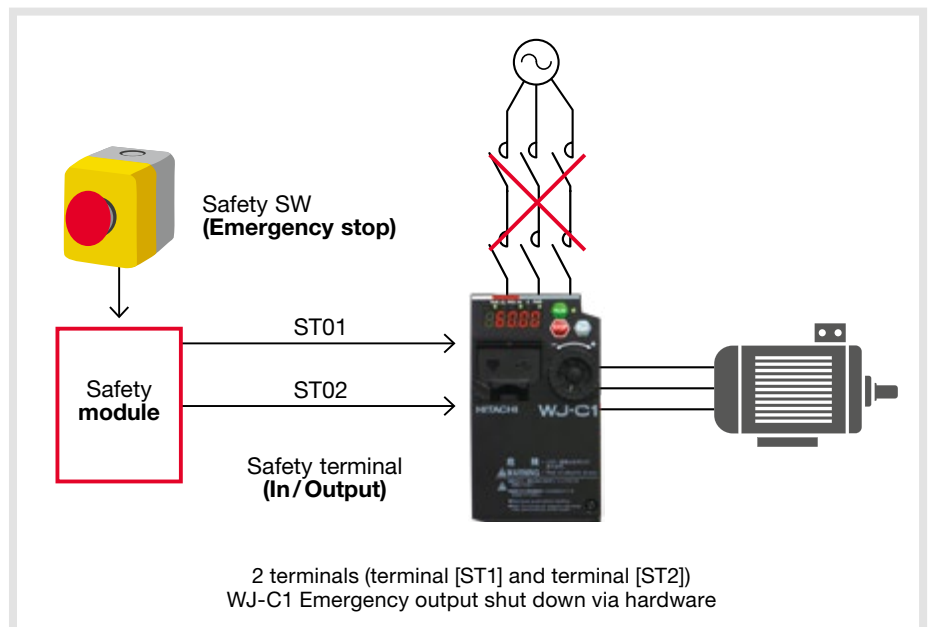

Micro surge voltage suppress function

Hitachi original PWM control method limits motor terminal voltage to less than twice inverter DC bus voltage.

(During regeneration, the motor terminal voltage may exceed the motor maximum insulation voltage.)

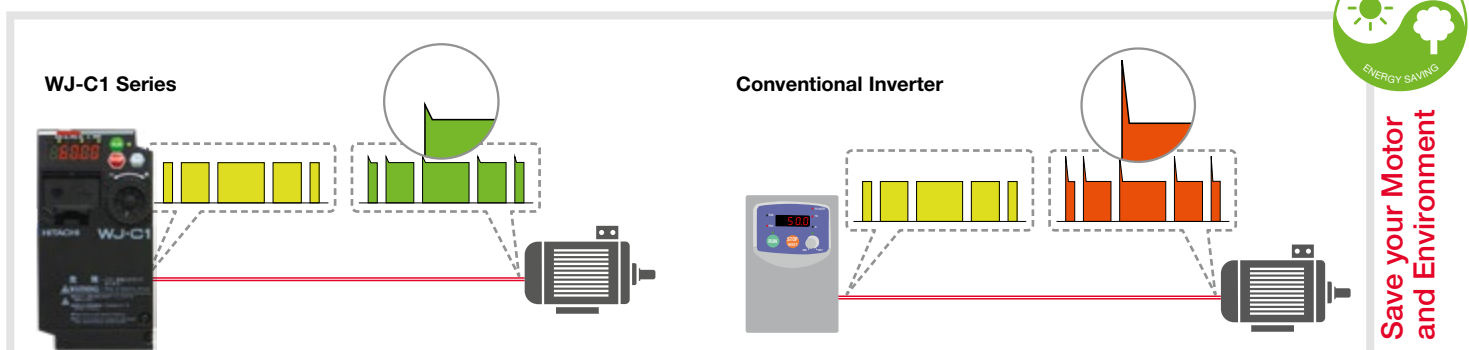

Easy replacement from WJ200

The **WJ-C1 continues** the compact performance of its predecessor, the WJ200, with the latest components available on the market that guarantee higher performance and computing speed, as well as safe and fast running of your Easy Sequence programs with the usual HITACHI durability. Further new and convincing functions are already planned and will be available very soon in the next upgrade level.



Mounting dimensions are the same as those of WJ2002

Parameters are the same as WJ200
ProDriveNext data can be ported. (*1)(*2)

Safety Function Certified
STO function
IEC61508,
IEC61800-5-2:SIL3
ISO13849-1:Cat.3 PLe
IEC60204-1:Stop Cat.0

Conform to New UL Standards
UL61800-5-1

The option board to be used: (*1)

- WJ-CCL
- WJ-PB
- WJ-PN
- WJ-ECT

The option remote to be used: (*1)

- OPE-SRmini
- OPE-SBK
- WOP

(*1) When Basic mode is selected.
(*2) ProDriveNext recognizes it as WJ200 x 3.x model.

Easy parameter setting with JOG dial



UP
(Clock-wise)

DOWN
(Counter clock-wise)

- JOG Dial is attached in standard module
- Easy parameter setting
- Easy to use



LED for unit and status
 MINUS (RED)*
 RUN (GREEN)
 ALM (RED)
 PRG (GREEN)
 Hz (GREEN)
 A (GREEN)
 PWR (GREEN)

RUN key enable LED (GREEN)

Key operation
 RUN
 STOP/RESET
 ESC

SET

7 segments LED display (5 digit)

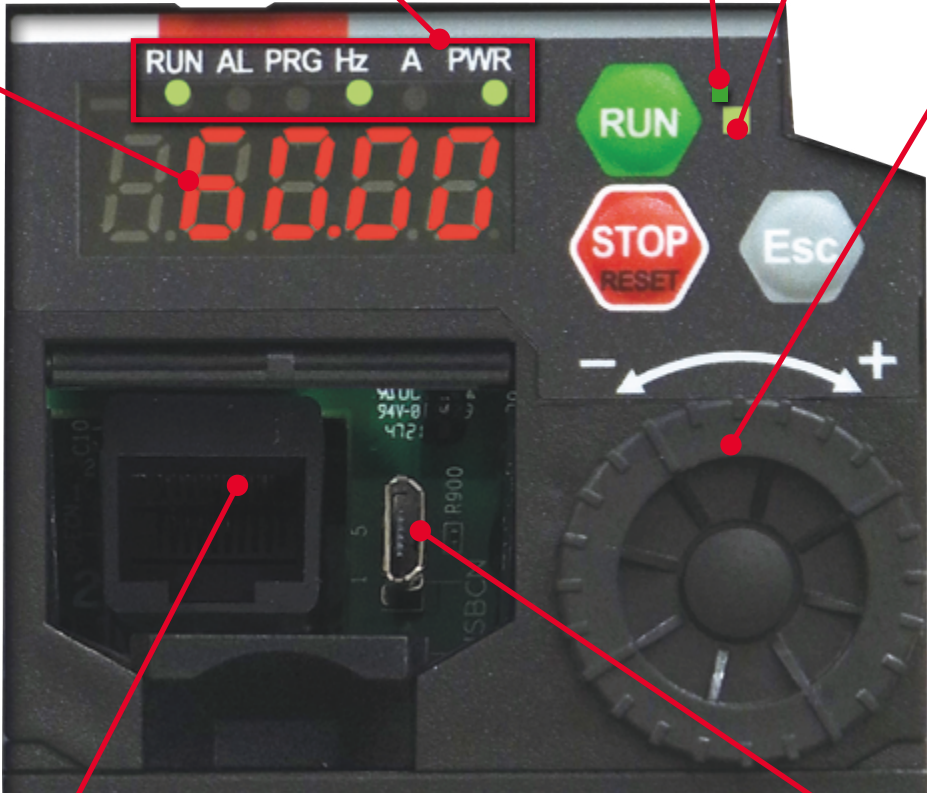

RJ45 Connector for remote operator

USB (Micro B)

*Minus sign is always in connection with 7-segment display



Various Functions

Output monitoring (2 terminals)

Two programmable output terminals* can be used to monitor items such as frequency, motor current and more.

*Analog 0 ~ 10VDC (10-bit), pulse train (0 ~ 10VDC, max. 32kHz)

Watt-hour monitor

Energy consumption is displayed in kWh.



Built-in BRD circuit

Built-in braking resistor control circuit as standard in all models (Resistor optional).

Flexible display functions

- **Automatic return to the initial display**
10 mins after the last key operation, display returns to the initial parameter set.
- **Display limitation**
show only the contents of display parameter.
- **Dual monitor**
two arbitrary monitor items can be set. Parameters are selected via the Jog-Dial.

EzCOM (peer-to-peer communication)

WJ-C1 support peer-to-peer communication between multiple inverters using the built-in RS485 port. One administrator inverter is necessary in the network, and the other inverters act as master or slave.



Eco-friendly

RoHS2 compliant

The WJ-C1 Series meets the EU RoHS2 requirements.

Endurance in severe conditions

Vanish coating of the internal PC board ensures an improved endurance to certain severe conditions (logic PCB and I/F PCB are excluded).

Long life components

The cooling fans and built-in capacitors have an estimated design lifetime of 10 years*. By using the ON/OFF control function the lift time can be extended.

*10 years is a design lifetime based on calculation, not guaranteed



Here the important focus is on the very good durability of the products, which avoids that the environment is burdened more than necessary by constantly replacing components or entire systems. It is the responsibility of mankind not to pollute the environment more than necessary.

WJ-C1 Series Functions

High starting torque of 200% or greater achieved using sensorless vector control (when sized for heavy duty)

Sensorless vector control allows for the realization of high torque required for applications such as cranes, hoist, lifts etc. Auto-tuning function makes the implementation of sensorless vector control easy and effective.

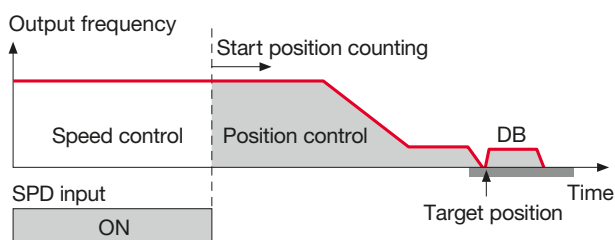

Simple positioning control (in combination with a feedback signal)

When simple positioning function is activated, speed or positioning control operation is selectable via intelligent input. While the [SPD] input is ON, the current position counter is held at 0. When [SPD] is OFF, the inverter enters positioning control operation, and the position counter is active.



Induction motor & permanent magnet motor* control with one inverter series

The WJ-C1 inverter can be used to drive both induction motors (IM) and permanent magnetic motors (PM). PM motors are energy efficient and make effective use of available space.

*The permanent magnet motor control function is only suitable for variable torque applications such as fan and pump

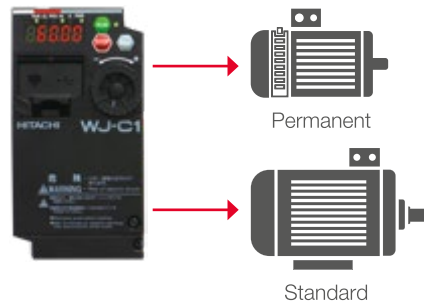

*When using sensorless vector control for permanent magnet motor (PM), please contact your dealer.

Dual rating

WJ-C1 can be used for both heavy and normal duty. One-frame-size smaller WJ-C1 can be applicable to certain applications.

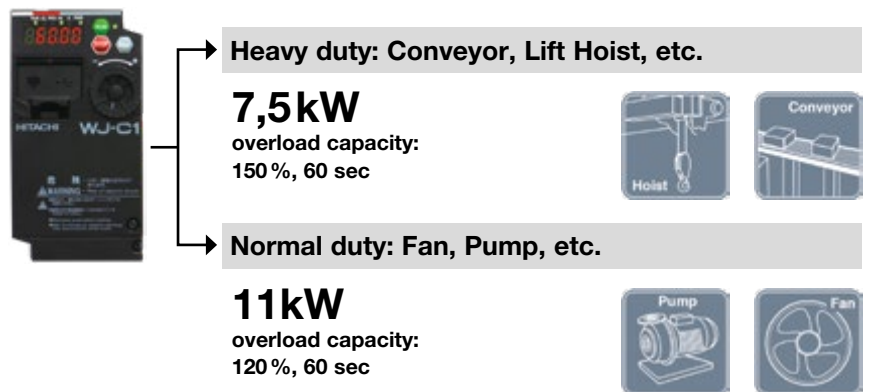

General Specifications

Item		WJ-C1 Series
Control method		PWM control
Output frequency range (*1)		0.01 to 590.00Hz
Frequency accuracy		±0.01% for digital input / ±0.2% for analog input (at 25±10°C) (at the maximum frequency setting)
Frequency setting resolution		Digital input: 0.01 Hz , Analog input: (maximum frequency setting)/1000
Voltage/ Frequency control mode (*2)	IM	V/f control (constant- or reduced-torque, free V/f, Auto-boost mode), V/f control with sensor, IM sensorless vector control
	PM (SM/PMM)	PM sensorless vector control (*3)
Rated overload current		Dual Rating: Normal Duty (ND): 150%/60sec / Light Duty (LD): 120%/60sec
Acceleration/Deceleration time		0.00 to 3600.00 seconds (in linear or curved pattern)
Starting torque (*4)		200%, 0.5Hz (by IM sensorless vector control)
Regenerative braking		Built-in transistor circuit (without resistor)
Carrier frequency range		Normal Duty (ND): 2 to 15kHz, Light Duty (LD): 2 to 10kHz (with derating)
Monitor function (*5)		40 kinds
Protective function (*6)		Over Current, Over Voltage, Under Voltage, Electronic thermal, Over Load and etc.
Other functions		57 kinds
Digital panel		5 digits 7 seg, 1 sign LED, 7 status LED, 4 keys and 1 JOG dial (non-detachable)
Input	Frequency reference	Keypad, Remote operator, Modbus®, Field network option, External analog signal
	RUN/STOP command	Keypad, Remote operator, Modbus®, Field network option
	Input terminals	7 terminals (NO/NC selectable, Sinc(PLC-P24 jumper)/Source(PLC-L jumper) selectable)
	Pulse train input	2 terminals max. 32kHz x 2 (terminal [8] (fix to phase A), terminal [7](when enable phase B))
	Analog input	2 terminals (terminal [Ai1] for DC0 to 10V voltage input, terminal [Ai2] for DC4 to 20mA current input)
	Thermistor input	1 terminal (shared with terminal [5]) (support for PTC type thermistor)
	Safety input	2 terminals (terminal [ST1] and terminal [ST2])
Output	Output terminals	2 terminals with open collector (NO/NC selectable, capable for Sink/Source circuit), 1 terminal for relay output (1c type)
	Safety output	1 terminal (shared with terminal [11], switched to EDM by slide switch)
	Analog output / Pulse train output	2 terminals (terminal [Ao1] for DC0 to 10V voltage output, terminal [Ao2] for pulse train output, max. 32kHz/DC10V output)
External interface	USB	Micro-B (for inverter configuration software ProDriveNext)
	Modbus® (*7)	Support for Modbus-RTU (RS-485 serial communication)
	External operator	RJ45 connector (Exclusive connector for remote operator)
	Field network option	WJ200 series field network options. WJ-ECT: for EtherCAT® communication, WJ-PB: for PROFIBUS® communication, WJ-PN: for PROFINET® communication, WJ-CCL: for CC-Link® communication. (*7) One unit can be mounted.
External control power supply		External 24 VDC can be input from [P24] terminal (installation of reverse-current-prevention diode is mandatory).
EMC noise filter		Not built-in (optional external noise filter can be connected)
Environment	Ambient temperature	ND (normal duty): -10 to 50°C / LD (light duty): -10 to 40°C
	Storage temperature (*8)	-20-65°C
	Humidity	20-90%RH (non-condensing)
	Vibration	0.075 mm amplitude for 10 to 57 Hz 9.8 m/s ² (1.0G) for 57 to 150 Hz
	Installation (*9)	Altitude: 1000m or less, indoors (free from corrosive gases, oil mist, and dust)
Structure	Structure	Protection: IP20 (UL open type), replaceable Fan
Standards (*10)		CE: IEC 61800-3 (EMC-filter option required), IEC 61800-5-1 UL : UL 61800-5-1, -Overvoltage Category 3, -Pollution Degree 2 Others: c-UL Safety function: STO (Safe torque off) function/ IEC 61508, IEC 61800-5-2: SIL3, ISO 13849-1: Cat.3 PL _e , IEC 60204-1: Stop Cat.0
Other optional components		Noise Filter, DC link choke, AC reactor, Braking resistor, Regenerative braking unit, Remote operator (OPE-SR/OPE-SBK/OPE-SRmini/WOP), Inverter configuration software ProDriveNext, etc.



Conformity to global standards

CE, UL, c-UL, c-Tick approvals New UL standards,
EU directive, RoHS2

Sink / source logic is standard

Logic input and output terminals can be configured for sink or source
logic

Wide input power voltage range

Input voltage 240 V for 200 V class and 480 V for 400 V class as standard



*1) The output frequency range depends on the control mode and the motor used. Consult the motor manufacturer for the maximum allowable frequency of the motor when operating beyond base frequency.

*2) Motor constants might need to be adjusted depending on the control mode.

*3) When using sensorless vector control for permanent magnet motor (PM), contact your dealer.

*4) The value is specified for the 4 poles Hitachi standard motor controlled by the IM sensorless vector control at ND rating. Torque characteristics may vary depending on the control mode and the motor used.

*5) Monitor function is for reference only. To obtain more accurate values, apply an external device.

*6) When a driver error (E30) occurs due to the protective function, it may be resulted from the short-circuit protection, as well as damaged IGBT. Depending on the operating conditions of the inverter, an overcurrent error may occur instead of a driver error.

*7) Trademark

- Modbus® is a registered trademark of Schneider Automation Inc.
- EtherCAT® is registered trademark and patented technology, licensed by Beckhoff Automaton GmbH, Germany.
- PROFSBUS® and PROFINET® are registered trademarks of PROFIBUS Nutzerorganisation e.V. (PNO).
- CC-Link® is a registered trademark of Mitsubishi Electric Corporation.

*8) The storage temperature is the temperature during transportation.

*9) For installation at an altitude of 1000m or more, the atmospheric pressure will decrease by approximately 1% for every 100m altitude increase. Apply 1% current derating from the rated current for every 100m altitude increase and conduct an evaluation test. When using at an altitude of 2500m or more, please contact Hitachi Inverter distributor.

*10) The standards information on the common specifications is as of July 2022.

1-phase 200 V class

Model WJC1-		002SFE		004SFE		007SFE		015SFE		022SFE			
Motor (kW) (*2)		LD	0.4	0.55	1.1	2.2	3.0						
		ND	0.2	0.4	0.75	1.5	2.2						
Rated output current (A) (*3)		LD	1.9	3.5	6.0	9.6	12.0						
		ND	1.6	3.0	5.0	8.0	11.0						
Output		Rated output voltage (V) (*4)		Three phases 200 to 240V									
		Rated capacity (kVA)		200V		LD	0.6	1.2	2.0	3.3	4.1		
						ND	0.5	1.0	1.7	2.7	3.8		
				240V		LD	0.7	1.4	2.4	3.9	4.9		
						ND	0.6	1.2	2.0	3.3	4.5		
		Rated output voltage (V)		Single phase 200V to 240V (-15%/+10%), 50/60Hz ± 5%									
Braking		Regenerative braking		Built-in transistor circuit (without resistor)									
		Minimum breaking resistance (Ω)		100				50		35			
Cooling method		Self-cooling						Forced air cooling					
Dimensions		Width		68				108					
		Height		128				128					
		Depth		109		122.5		170.5					
		Depth 1		13.5		27		55.5					
		Depth 2		4.5									
Approx. Weight (kg)		1.0		1.1		1.6		1.8		1.8			

LD normal duty / ND heavy duty

3-phase 200 V class versions are also available

Information in this brochure is subject to change without notice.

3-phase 400 V class

Model WJC1-		004HFE		007HFE		015HFE		022HFE		030HFE		040HFE		055HFE		075HFE		110HFE		150HFE			
Motor (kW) (*2)		LD	0.75	1.5	2.2	3.0	4.0	5.5	7.5	11	15	18.5											
		ND	0.4	0.75	1.5	2.2	3.0	4.0	5.5	7.5	11	15	18.5										
Rated output current (A) (*3)		LD	2.1	4.1	5.4	6.9	8.8	11.1	17.5	23.0	31.0	38.0											
		ND	1.8	3.4	4.8	5.5	7.2	9.2	14.8	18.0	24.0	31.0	38.0										
Output		Rated output voltage (V) (*4)		Three phases 380 to 480V																			
		Rated capacity (kVA)		380V		LD	1.3	2.6	3.5	4.5	5.7	7.3	11.5	15.1	20.4	25.0							
						ND	1.1	2.2	3.1	3.6	4.7	6.0	9.7	11.8	15.7	20.4							
				480V		LD	1.7	3.4	4.4	5.7	7.3	9.2	14.5	19.1	25.7	31.5							
						ND	1.4	2.8	3.9	4.5	5.9	7.6	12.3	14.9	19.9	25.7							
		Rated output voltage (V)		Three phases 380V to 480V (-15%/+10%), 50/60Hz ±5%																			
Braking		Regenerative braking		Built-in transistor circuit (without resistor)																			
		Minimum breaking resistance (Ω)		180				100				70				35							
Cooling method		Self-cooling		Forced air cooling																			
Dimensions		Width		108						140						180							
		Height		128						260						296							
		Depth		143.5		170.5						155						165					
		Depth 1		28.5		55.5						74						84					
		Depth 2		4.5						6.5						5							
Approx. Weight (kg)		1.5		1.8		1.8		1.8		2.0		2.0		3.5		3.5		4.5		4.5			

*1) The model name indicates capacity code and voltage class.

*2) LD: Light Duty, ND: Normal Duty(Dual rating).

Applicable motors are Hitachi's three-phase (4P) standard motors.

If use to other motors, be sure to prevent a rated current of a motor from exceeding the rated output current of the inverter.

*3) When Basic mode is selected.

*4) The inverter cannot output the voltage more than the input voltage (main power supply voltage).



Explanation of dimensions

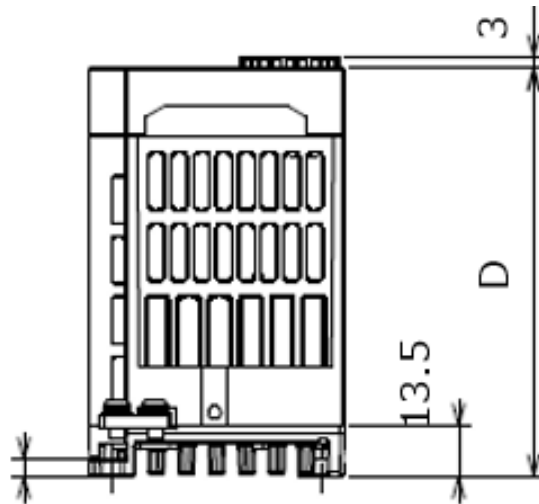
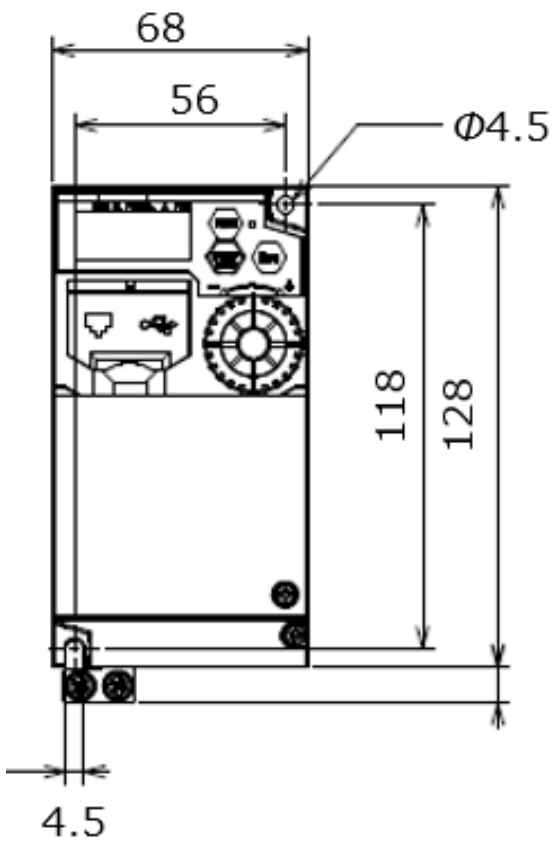

* The symbols in the table are meant the dimensions of W (width), H (height), D (depth), D1 (fin depth), and D2 (thickness of mounting feet).

** H (height) dimensions of 004H ~040H do not include the dimensions of the ground terminal.



HITACHI

Inspire the Next

Hitachi Europe GmbH, Niederkasseler Lohweg 191, D-40547 Düsseldorf
Phone: +49 (0) 211-5283-0
www.hitachi-industrial.eu, automation.industrial@hitachi-eu.com
© Hitachi Industrial Equipment Systems Co., Ltd., Japan

All company and product names in this brochure are the property of the respective companies.

Hitachi Industrial Equipment Systems Co., Ltd. (Hitachi) shall not be liable for any manufacturing loss, or any product damage due to trouble. Hitachi continually improves products. The right, therefore, is reserved to alter the designs and/or specifications without giving prior notice. Information in this brochure is subject to change without notice.