



# Simple, Trip-less and Environment-friendly Compact Inverter!

# X200 Series

## VARIABLE FREQUENCY DRIVE

1

## Environment-friendly Inverter

RoHS compliance for all models.

2

## Integrated EMC Filter

Cost and space reduction compared with external EMC filter. (European version only)

Single-phase input : EN61800-3 cat.C1  
Three-phase input : EN61800-3 cat.C2

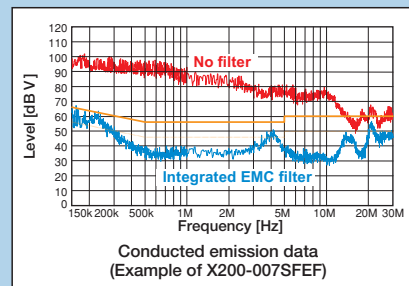

3

## Emergency Stop Function

Shut off INV output by hardware without software(CPU) high quality emergency stop.

4

## Improved Trip Avoidance Function

Over current and over voltage suppressing function is incorporated. This function reduces inverter tripping. The X200 decelerates and stops the motor using regenerative energy from the motor even though the power is not supplied.

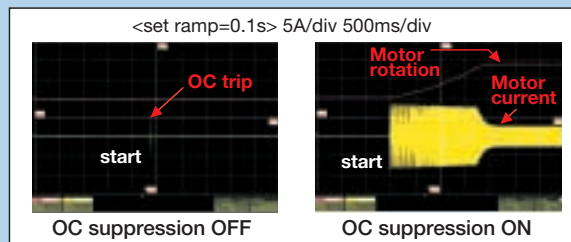

5

## Non-stop operation at IPF

This can achieve smooth retry even when the IPF (Instantaneous Power Failure) occurs. This is useful especially in Fan and pump application.

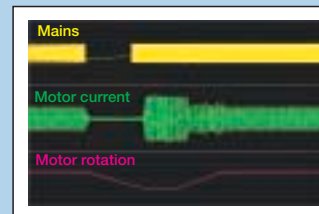

## Model Configuration

Applicable Motor kW (HP)	1-/3-phase 200V class			3-phase 400V class	
	US version	European version	Japanese version	US version	European version
0.2(1/4)	X200-002NFU	X200-002SFEF	X200-002LFRF		
0.4(1/2)	X200-004NFU	X200-004SFEF	X200-004LFRF	X200-004HFU	X200-004HFEF
0.55(3/4)		X200-005SFEF			
0.75(1)	X200-007NFU	X200-007SFEF	X200-007LFRF	X200-007HFU	X200-007HFEF
1.1(1.5)		X200-011SFEF			
1.5(2)	X200-015NFU	X200-015SFEF	X200-015LFRF	X200-015HFU	X200-015HFEF
2.2(3)	X200-022NFU	X200-022SFEF	X200-022LFRF	X200-022HFU	X200-022HFEF
3.0(4)					X200-030HFEF
3.7(5)	X200-037LFU		X200-037LFRF		
4.0(5)				X200-040HFU	X200-040HFEF
5.5(7.5)	X200-055LFU		X200-055LFRF	X200-055HFU	X200-055HFEF
7.5(10)	X200-075LFU		X200-075LFRF	X200-075HFU	X200-075HFEF

# 6

## Automatic Energy-saving Function

The X200 delivers "real-time" energy-saving operation for your fan and pump applications. This function insures that motor operates at minimum current in response to the torque required by the load.

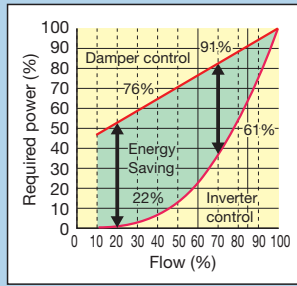

# 7

## Micro Surge Voltage suppress function (Patent registered in Japan,USA & Korea)

Hitachi original PWM control suppressing Motor terminal Voltage less than 2 times of INV DC voltage E.  
Lower than Hitachi motor Max. insulation voltage (1,250V)  
(during regenerating operation increase the DC bus voltage may over motor max. insulation voltage)

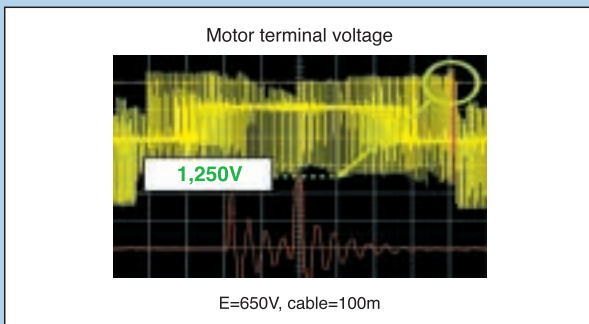

# 8

## Network Compatibility

RS-485 is provided as standard for Modbus-RTU serial communication PROFIBUS, CANopen option modules are available soon.

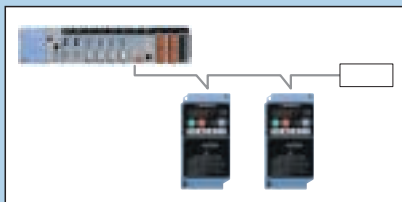

# 9

## Side-by-side installation

Since an inverter can be stuck and installed in a horizontal direction, a space can be used effectively.

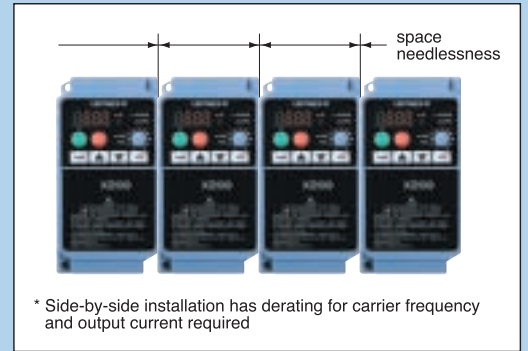

# 10

## Versatile Functions

- Pure analog monitor output(10-bit, 0-10VDC)
- Low load detection
- External thermistor terminal (PTC)
- Cooling-fan on/off
- Instantaneous power failure recovery
- Second motor setting
- 3-wire control
- Analog input selection
- Second acceleration/deceleration setting
- Jogging
- Auto-carrier frequency reduction
- Unattended start protection (USP)
- Analog input wire-break detection

# 11

## Global Performance

- Conformity to global standards CE, UL, c-UL and c-Tick approvals



<p><b>ISO 14001</b> EC97J1095</p>	<p>Hitachi variable frequency drives (inverters) in this brochure are produced at the factory registered under the ISO 14001 standard for environmental management system and the ISO 9001 standard for inverter quality management system.</p>
<p><b>ISO 9001</b> JQA-1153</p>	

## Model Name Indication

### X200-004 H F E F

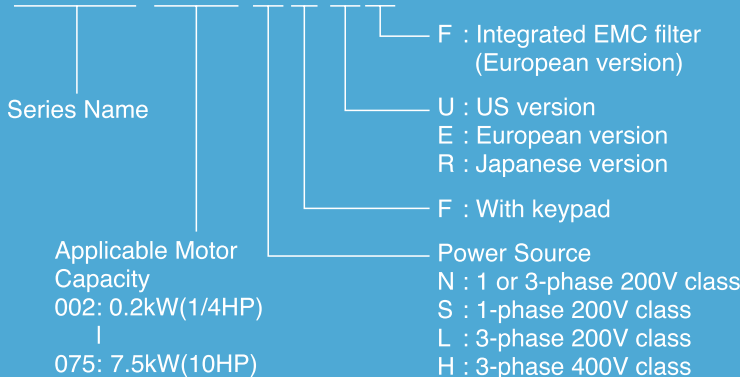

## CONTENTS

Features	1-2
Standard Specifications	3
Dimensions	4
Operation and Programming	5
Operation / Terminal Functions	6
Function List	7-9
Protective Functions	10
Connecting Diagram	11-12
Wiring and Accessories	13
Torque characteristics/Derating Curves	14
For Correct Operation	15-16

# Standard Specifications

## 1-/3-phase 200V class

Model X200-		European Version	002SFEF	004SFEF	005SFEF	007SFEF	011SFEF	015SFEF	022SFEF	-	-	-	
		US Version	002NFU	004NFU	-	007NFU	-	015NFU	022NFU	037LFU	55LFU	075LFU	
Output Ratings	Applicable motor size, 4-pole kW(HP) *1		0.2(1/4)	0.4(1/2)	0.55(3/4)	0.75(1)	1.1(1.5)	1.5 (2)	2.2(3)	3.7(5)	5.5(7.5)	7.5(10)	
	Rated capacity	230V	0.5	1.0	1.1	1.5	1.9	2.8	3.9	6.3	9.6	12.7	
		240V	0.5	1.0	1.2	1.6	2.0	2.9	4.1	6.6	9.9	13.3	
	Rated output current (A) *2		1.4	2.6	3.0	4.0	5.0	7.1	10.0	15.9	24.0	32.0	
	Overload capacity/output current)		150% for 60 sec.										
	Rated output voltage (V)		3-phase (3-wire) 200 to 240V (corresponding to input voltage)										
Input Rating	Rated input voltage (V)		SFEF: 1-phase 200 to 240V+10%, -15%, 50/60Hz±5%										
			NFU: 1-/3-phase 200 to 240V+10%, -15%, 50/60Hz±5%										
			LFU: 3-phase 200 to 240V+10%, -15%, 50/60Hz±5%										
Enclosure *4			Self-cooling					Force ventilation					
Cooling method			Self-cooling					Force ventilation					
Integrated EMC filter	-SFEF		EN61800-3 category C1 filter										
	-NFU/LFU		-										
Weight (kg)	-SFEF		0.8	1.0	1.5	1.5	2.4	2.4	2.5	-	-	-	
	-NFU/LFU		0.8	0.9	-	1.5	-	2.3	2.4	2.3	4.2	4.2	

## 3-phase 400V class

Model X200-		European Version	004HFEF	007HFEF	015HFEF	022HFEF	030HFEF	040HFEF	055HFEF	075HFEF			
		US Version	004HFU	007HFU	015HFU	022HFU	-	040HFU	055HFU	075HFU			
Output Ratings	Applicable motor size, 4-pole kW(HP) *1		0.4(1/2)	0.75(1)	1.5 (2)	2.2(3)	3(4)	4(5)	5.5(7.5)	7.5(10)			
	Rated capacity	400V	1.0	1.7	2.6	3.8	5.4	5.9	9.0	11.1			
		480V	1.2	2.0	3.1	4.5	6.4	7.1	10.8	13.3			
	Rated output current (A) *2		1.5	2.5	3.8	5.5	7.8	8.6	13.0	16.0			
	Overload capacity/output current)		150% for 60 sec.										
	Rated output voltage (V)		3-phase (3-wire) 380 to 480V (corresponding to input voltage)										
Input Rating	Rated input voltage (V)		3-phase 380 to 480V +10%, -15%, 50/60Hz±5%										
			IP20										
Enclosure *4			Self-cooling					Force ventilation					
Cooling method			Self-cooling					Force ventilation					
Integrated EMC filter	-HFEF		EN61800-3 category C2 filter										
	-HFU		-										
Weight (kg)	-HFEF		1.5	2.3	2.4	2.4	2.4	2.4	4.2	4.2	4.2		
	-HFU		1.4	2.2	2.3	2.3	-	2.3	4.2	4.2	4.2		

## General Specifications

Item		General Specifications	
Control	Control method	Line-to-line sine wave pulse-width modulation (PWM) control	
	Output frequency range *5	0.5 to 400Hz	
	Frequency accuracy *6	Digital command ±0.01%, Analog command±0.4% (25±10°C)	
	Frequency setting resolution	Digital: 0.1Hz, Analog: (max frequency)/1000	
	Voltage/Frequency Characteristic	V/f control, V/f variable (constant torque, reduced torque)	
	Acceleration/deceleration time	0.01 to 3000 sec. (linear, sigmoid), two-stage accel./decel.	
	Starting torque *7	100%/6Hz	
	Carrier frequency range	2.0 to 12kHz	
Input terminal	Protective functions	Over-current, over-voltage, under-voltage, overload, overheat, ground fault at power-on, input over-voltage, external trip, EEPROM error, CPU error, USP error, Termistor error, Driver error, Emergency stop	
	Specification	10kohm input impedance, sink/source logic selectable	
Output signal	Intelligent output terminal	Functions	FW(Forward), RV(Reverse), CF1-CF4(Multispeed command), JG(Jogging), DB(External DC braking), SET(Second motor constants setting), 2CH(Second accel./decel.), FRS(Free-run stop), EXT(External trip), USP(Unattended start protection), SFT(Software lock), AT(Analog input selection), RS(Reset), PTC(Thermistor input) *8, STA(3-wire start), STP(3-wire stop), F/R(3-wire fwd./rev.), PID(PID On/Off), PIDC(PID reset), UP/DWN(Remote-controlled accel./decel.), UDC(Remote-controlled data clearing), OPE(Operator control), ADD(ADD frequency enable), F-TM(force terminal mode), RDY(quick start enable), S-ST(Special-Set 2nd Motor Data), EMR(Emergency stop), NO(Not selected)
		Specification	27V DC 50mA max open collector output, 1 terminals 1c output 250V AC/30V DC 2.5A relay (ALO, AL1, AL2 terminals)
Operator	Display	Function	RUN(run signal), FA1(Frequency arrival type 1 - constant speed), FA2(Frequency arrival type 2 - over-frequency), OL(overload advance notice signal), OD(Output deviation for PID control), AL(alarm signal), DC(Wire brake detect on analog input), FBV(PID Second Stage Output), NDC(ModBus Network Detection Signal), LOG(Logic Output Function), ODC(Option Card Detection Signal), LOC(Low load)
		Specification	0 to 10V DC
Operation	Status LED Interface	Function	Analog Frequency monitor, analog current monitor
		Specification	4-digits 7 segment LEDs
	Frequency setting	Operator keypad	Up and Down keys / Value settings or analog setting via potentiometer on operator keypad
		External signal	0 to 10 V DC, 4 to 20 mA
FW/RV Run	Operator Keypad	RS485 interface (Modbus RTU)	
	External signal	Run key / Stop key (change FW/RV by function command)	
Environment	Operating temperature	Serial port	FW Run/Stop (NO contact), RV set by terminal assignment (NC/NO), 3-wire input available
		Serial port	RS485 interface (Modbus RTU)
	Storage temperature	-10 to 50°C(carrier derating required for aambient temperature higher than 40°C), no freezing	
	Humidity	-20 to 65°C	
Other functions	Vibration	20 to 90% RH	
	Location	5.9mm/s² (0.6G) 10 to 55Hz	
Coating color	Altitude	Altitude 1,000 m or less, indoors (no corrosive gasses or dust)	
	Options	AVR (Automatic Voltage Regulation), V/f characteristic selection, accel./decel. curve selection, frequency upper/lower limit, 16 stage multispeed, PID control, frequency jump, external frequency input bias start/end, jogging, cooling fan On/Off, trip history etc.	
Remote operator with copy function (SRW-0EX), input/output reactors, DC reactors, radio noise filters, braking resistors, braking units, LCR filter, communication cables (ICS-1, 3)			

- Note 1: The applicable motor refers to Hitachi standard 3-phase motor (4-pole). When using other motors, care must be taken to prevent the rated motor current (50/60 Hz) from exceeding the rated output current of the inverter.
- Note 2: The output voltage decreases as the main supply voltage decreases (except when using the AVR function). In any case, the output voltage cannot exceed the input power supply voltage.
- Note 3: The braking torque via capacitive feedback is the average deceleration torque at the shortest deceleration (stopping from 50/60 Hz as indicated). It is not continuous regenerative braking torque. The average decel torque varies with motor loss. This value decreases when operating beyond 50 Hz. If a large regenerative torque is required, the optional regenerative braking resistor should be used.
- Note 4: The protection method conforms to JEM 1030.
- Note 5: To operate the motor beyond 50/60 Hz, consult the motor manufacturer for the maximum allowable rotation speed.
- Note 6: The output frequency may exceed the maximum frequency setting (A004 or A204) for automatic stabilization control.
- Note 7: At the rated voltage when using a Hitachi standard 3-phase, 4pole motor.
- Note 8: Only terminal 5 is assignable the PTC (thermistor) function.



# Dimensions

[Unit: mm(inch)]  
Inches for reference only

## • X200-002SFEF, NFU

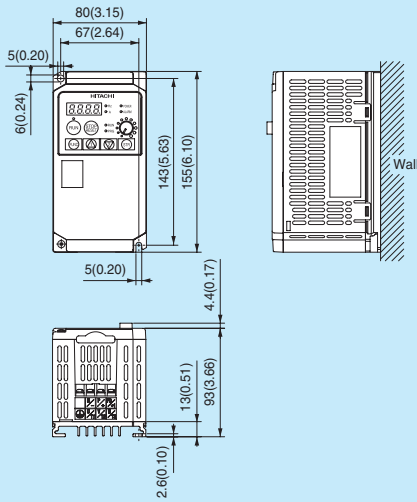

## • X200-004SFEF, NFU

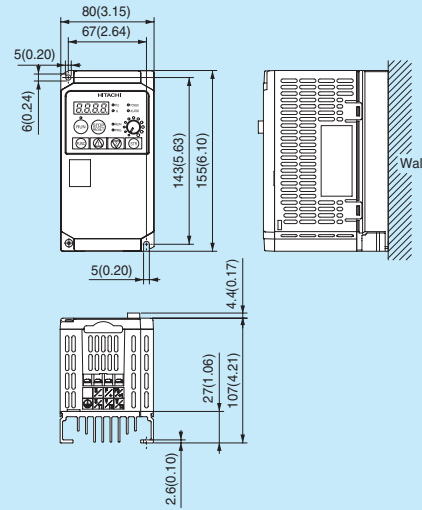

## • X200-005SFEF • X200-004HFEF, HFU

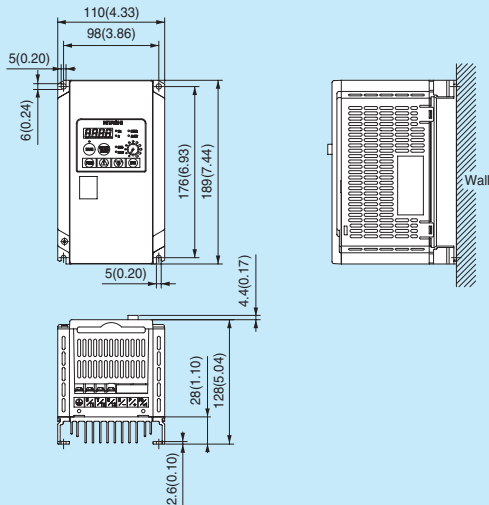

## • X200-007SFEF, NFU

## • X200-011SFEF • X200-015~022SFEF, NFU • X200-037LFU • X200-007~040HFEF, HFU

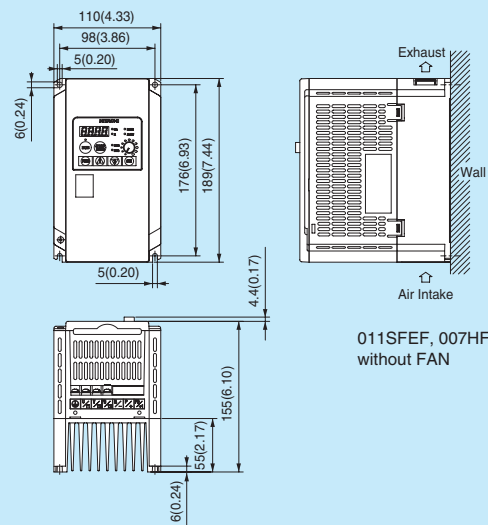

011SFEF, 007HFEF, HFU:  
without FAN

## • X200-055~075LFU, HFU • X200-055~075HFEF

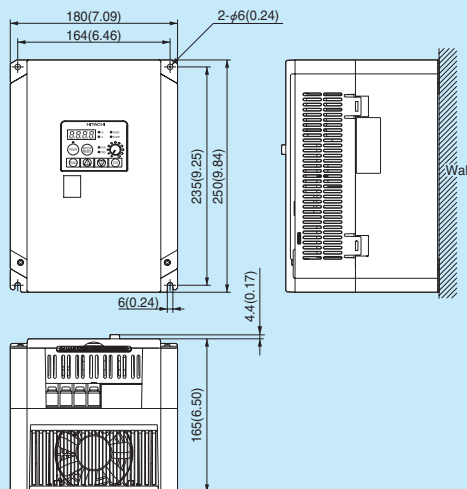

# Operation and Programming

The X200 series can be easily operated with the digital operator provided as standard. The digital operator can also be detached and used for remote-control. An operator with copy function is also available as an option.

## Parameter Display

Displays frequency, motor current, rotational speed of the motor, and an alarm code.

## RUN Key

Press to run the motor.

## STOP/RESET Key

Press to stop the drive or reset an alarm.

## Function Key

Press to set or monitor a parameter value.

## Up/Down Keys

Press up or down to sequence through parameters and functions shown on the display, and increment/decrement values.



## Power LED

Lights when the power input to the drive is ON.

## Display Unit LEDs

Indicates the unit associated with the parameter display.

## Monitor LEDs

Shows drive's status.

## Potentiometer

## Store Key

Press to write the new value to the EEPROM.

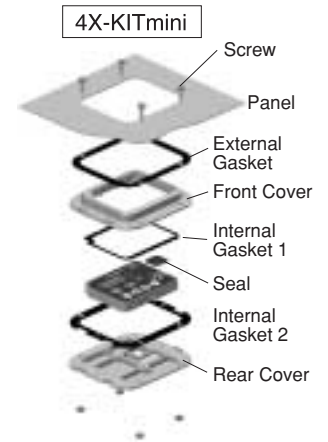

You can mount an optional keypad with the potentiometer part no. OPE-SRmini for a NEMA1 rated installation. The kit also provides for removing the potentiometer knob to meet NEMA 4X requirements, as shown (part no. 4X-KITmini).

## 1. Setting the maximum output frequency

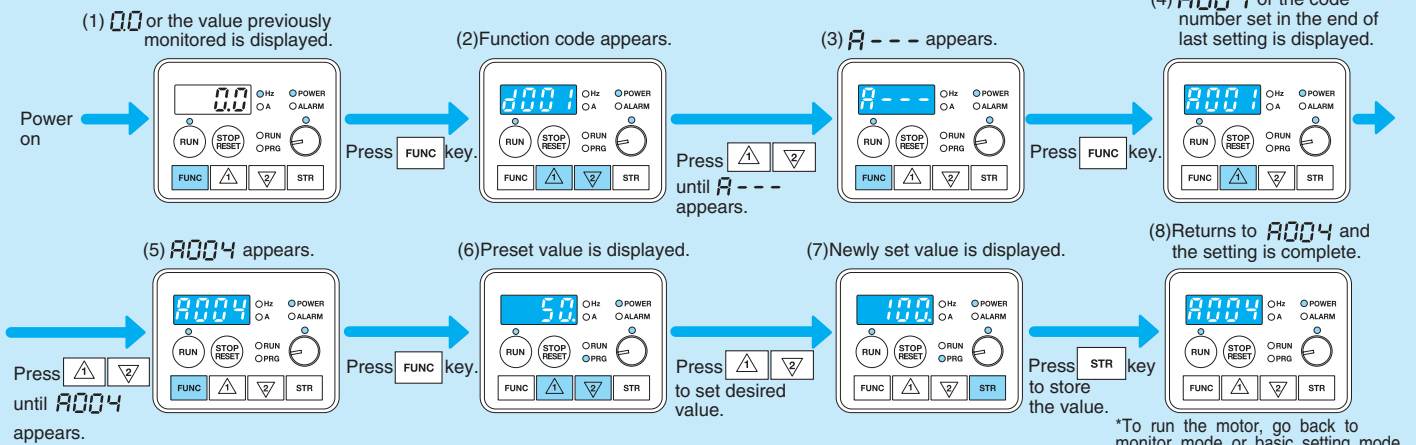

## 2. Running the motor (by potentiometer)

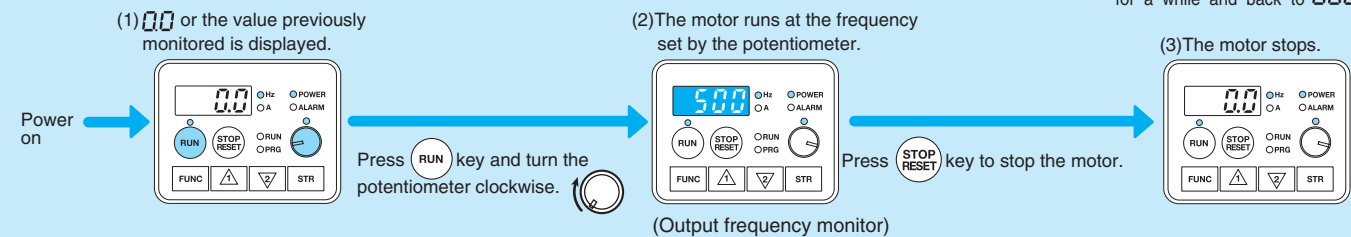

## 3. Monitoring output current value

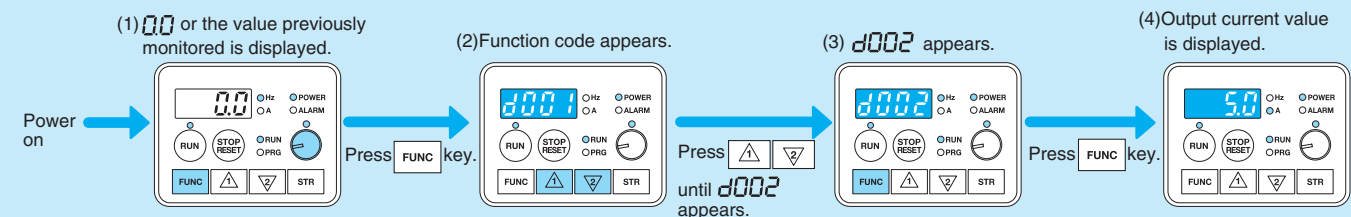

# Operation / Terminal Functions

## Hardware switches

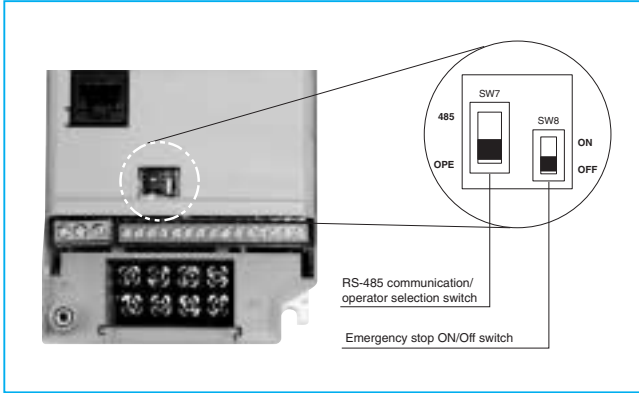

Switch symbol	Switch Name	Switch Name Description
SW7	RS-485 communication/key pad selection switch	Select communication connector destination. *1
		485 RS-485 communication via Modbus protocol
		OPE [default] Keypad (option)
SW8	Emergency stop ON/OFF	Select frequency and run command input source. The SW8 is for the emergency signal input. If you turn this DIP switch ON, the inverter is ready to receive emergency signal from the dedicated terminal #3. Inverter shuts off the output by means of pure hardware when a signal is given to the terminal. Each signals related to this emergency input must be in accordance with the norm. Additionally, the logic input terminal assign will be changed automatically if the SW8 is made ON.

Note 1: The standard keypad OPE (OPE-SRmini) can be used either the switch is set to 485 or OPE.

Note 2: Input terminal selection (EMR) cannot be chosen from an operator. If the slide switch SW8 is turned ON, it divides automatically and is attached.

## Terminal Description

### Terminal Symbol

Terminal Symbol	Terminal Name
L1, L2, N/L3	Main power supply input terminals
U/T1, V/T2, W/T3	Inverter output terminals
+1, +	DC reactor connection terminals
+ -	External braking unit connection terminals
⊕	Ground connection terminal

### Screw Diameter and Terminal Width

Model	Screw diameter (mm)	Terminal width W (mm)
002 - 004NFU/SFEF	M3.5	7.1
007- 022NFU, 037LFU	M4	9.2
005 - 022SFEF		
004- 040HFU/HFEF		
055- 075LFU/HFU/HFEF	M5	12

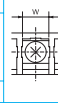

### Terminal arrangement

• X200-002~004SFEF, 002~004NFU

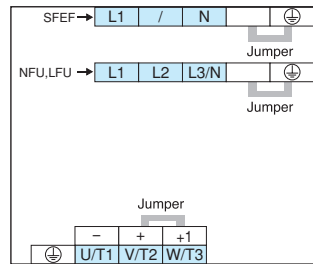

• X200-005~022SFEF, 007~022NFU, 037LFU  
004~040HFEF, 004~040HFU  
055~075LFU, 055~075HFU  
055~075HFEF

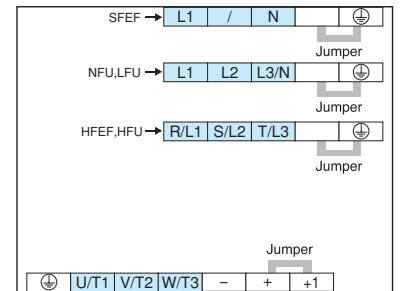

## Control circuit terminals

### Terminal arrangement

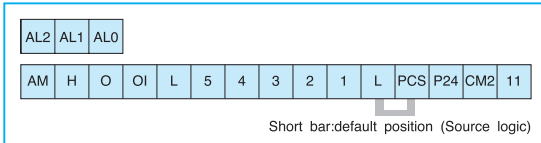

## Terminal function

	Terminal name	Description	Ranges and Notes
Input/monitor signals	AM	Voltage analog output	0 to 10V DC, 1mA max.
	L	Common for inputs	-
	P24	+24V for logic inputs	24V DC, 30mA (do not short to terminal L)
	PCS	Intelligent input common	-
	5	Intelligent (programmable) input terminals, selection from:	
	4	FW(Forward), RV(Reverse), CF1-CF4(Multispeed command), JG(Jogging), DB(External DC braking), SET(Second motor constants setting), 2CH(Second accel./decel.), FRS(Free-run stop), EXT(External trip), USP(Unattended start protection), SFT(software lock), AT(Analog input selection), RS(Reset), PTC(Thermistor input), STA(3-wire start), STP(3-wire stop), F/R(3-wire fwd./rev.), PID(PID On/Off), PIDC(PID reset), UP/DWN(Remote-controlled accel./decel.), UDC(Remote-controlled data clearing), OPE(Operator control), ADD(Frequency setpoint), F-TM(Force terminal enable), RDY(Quick start enable), S-ST(Special-Set 2nd Motor Data), EMR(Emergency stop) or NO(Not selected).	
	3		
2			
Frequency setting	H	+10V analog reference	10V DC, 10mA max
	O	Analog input, voltage	0 to 10V DC, input impedance 10kohm
	OI	Analog input, current	4 to 20mA DC, input impedance 250ohm
	L	Common for inputs	-
Output signals	11	Intelligent (programmable) output terminals, selection from: RUN(run signal), FA1(Frequency arrival type 1 -constant speed), FA2(Frequency arrival type 2 -over-frequency), OL(overload advance notice signal), OD(Output deviation for PID control), AL(alarm signal), DC(Wire brake detect on analog input), FBV(Feedback voltage comparison), NDc(Network Disconnection), LOG(Logic operation result), ODC(Option Card Detection signal), LOC(Low Load Detection).	Open collector output L level at operation (ON) 27V DC, 50mA max.
	CM2	Common for intelligent output terminals	-
Relay output	AL2		AC250V 2.5A (Resistive load) 0.2A (cosφ=0.4) DC30V 3.0A (Resistive load) 0.7A (cosφ=0.4) (minimum) AC100V 10mA DC 5V 100mA
	AL1		
	AL0		

# Function List

The parameter tables in this chapter have a column titled "Run Mode Edit." An Ex mark x means the parameter cannot be edited; a Check mark ✓ means the parameter can be edited. The table example to the right contains two adjacent marks "x ✓". These two marks (that can also be "xx" or "✓ ✓") correspond to low-access or high-access levels to Run Mode edits (note *Lo* and *Hi* in column heading).

## Monitoring and main profile parameters

✓: Allowed  
X: Not allowed

Function Code	Name	Range	Default	Unit	Run mode edit		
					Lo	Hi	
Monitor	d001	Output frequency monitor	0.0 to 400.0	—	Hz	—	—
	d002	Output current monitor	0.0 to 999.9	—	A	—	—
	d003	Rotation direction monitor	F(Forward)/o(Stop)/r(Reverse)	—	—	—	—
	d004	Process variable, PID feedback monitor	0.00 to 99.99/100.0 to 999.9/1000. to 9999.	—	—	—	—
	d005	Intelligent input terminal status	ON e.g. :1,2 : ON OFF 3,4,5 : OFF	—	—	—	—
	d006	Intelligent output terminal status	ON e.g. :11 : ON OFF AL : OFF	—	—	—	—
	d007	Scaled output frequency monitor	0.00 to 99.99/100.0 to 999.9/1000. to 9999./1000 to 9999(10000 to 99999)	—	—	—	—
	d013	Output voltage monitor	0.0 to 600.0	—	V	—	—
	d016	Cumulative operation RUN time monitor	0. to 9999./1000 to 9999/ [100 to ] [999 (10000 to 99900)]	—	hr	—	—
	d017	Cumulative power-on time monitor	0. to 9999./1000 to 9999	—	hr	—	—
	d018	Cooling fin temperature monitor	0.0 to 200.0	—	°C	—	—
	d080	Trip counter	0. to 9999.	—	events	—	—
	d081	Trip monitor 1	—	—	—	—	—
	d082	Trip monitor 2	Displays trip event information	—	—	—	—
d083	Trip monitor 3	—	—	—	—	—	
d102	DC bus voltage monitor	0.0 to 999.9	—	V	—	—	
d104	Electronic thermal monitor	0.0 to 100.0	—	%	—	—	
Main Profile Parameters	F001	Output frequency setting	0.0/start freq. to 400.0	0.0	Hz	✓	✓
	F002	Acceleration time (1) setting	0.01 to 99.99/100.0 to 999.9/1000. to 3000.	10.0	sec	✓	✓
	F202	Acceleration time (2) setting	0.01 to 99.99/100.0 to 999.9/1000. to 3000.	10.0	sec	✓	✓
	F003	Deceleration time (1) setting	0.01 to 99.99/100.0 to 999.9/1000. to 3000.	10.0	sec	✓	✓
	F203	Deceleration time (2) setting	0.01 to 99.99/100.0 to 999.9/1000. to 3000.	10.0	sec	✓	✓
F004	Keypad Run key routing	00(Forward)/01(Reverse)	00	—	X	X	
Expanded functions	A--	A Group: Standard functions	—	—	—	—	—
	b--	b Group: Fine-tuning functions	—	—	—	—	—
	C--	C Group: Intelligent terminal functions	—	—	—	—	—
	H--	H Group: Motor constants functions	—	—	—	—	—
	P--	P Group: Expansion Card Functions	—	—	—	—	—

## A Group: Standard functions

✓: Allowed  
X: Not allowed

Function Code	Name	Range	Default		Unit	Run mode edit	
			-EF(CE)	-U(UL)		Lo	Hi
Basic setting	A001	Frequency source setting	00(Keypad potentiometer)/01(Control terminal)/	01	00	—	X X
	A201	Frequency source setting, 2nd motor	02(Function F001 setting)/03(RS485)/10(Calculation result)	01	00	—	X X
	A002	Run command source setting	01(Control terminal)/02(Run key on keypad)/03(RS485)	01	02	—	X X
	A202	Run command source setting, 2nd motor	01(Control terminal)/02(Run key on keypad)/03(RS485)	01	02	—	X X
	A003	Base frequency setting	30 to maximum freq.	50.	60.	Hz	X X
	A203	Base frequency setting, 2nd motor	30 to maximum freq.	50.	60.	Hz	X X
Analog input setting	A004	Maximum frequency setting	30 to 400	50.	60.	Hz	X X
	A204	Maximum frequency setting, 2nd motor	30 to 400	50.	60.	Hz	X X
	A005	[AT] selection	02(O/VR)/03(OI/VR)/04(O)/05(OI)	02	02	—	X ✓
	A011	[O]-[L] input active range start frequency	0.0 to maximum freq.	0.0	0.0	Hz	X ✓
	A012	[O]-[L] input active range end frequency	0.0 to maximum freq.	0.0	0.0	Hz	X ✓
	A013	[O]-[L] input active range start voltage	0 to 100	0.0	0.0	%	X ✓
Multi-speed and jogging	A014	[O]-[L] input active range end voltage	0 to 100	100.	100.	%	X ✓
	A015	[O]-[L] input start frequency enable	00(use set value)/01(use 0 Hz)	01	01	—	X ✓
	A016	External frequency filter time constant	1 to 17	8.	8.	—	X ✓
	A020 - A035	Multi-speed frequency setting (0-15)	0.0/start freq. to maximum freq.	0.0	0.0	Hz	✓ ✓
	A220	Multi-speed frequency (2nd), setting 2nd motor	0.0/start freq. to maximum freq.	0.0	0.0	Hz	✓ ✓
	A038	Jog frequency setting	0.0/start freq. to 9.99	1.00	1.00	Hz	✓ ✓
V/f Characteristic	A039	Jog stop mode	00(free-run stop)/01(deceleration and stop)/02 (DC braking)	00	00	—	X ✓
	A041	Torque boost select	00(Manual)/01(Automatic)	00	00	—	X X
	A241	Torque boost select 2nd motor	00(Manual)/01(Automatic)	00	00	—	X X
	A042	Manual torque boost value	0.0 to 20.0	1.8	1.8	%	✓ ✓
	A242	Manual torque boost value, 2nd motor	0.0 to 20.0	0.0	0.0	%	✓ ✓
	A043	Manual torque boost frequency adjustment	0.0 to 50.0	10.0	10.0	%	✓ ✓
DC braking	A243	Manual torque boost frequency adjustment, 2nd motor	0.0 to 50.0	0.0	0.0	%	✓ ✓
	A044	V/f characteristic curve selection	00(VC)/01(Reduced torque)/06 (Reduced torque 1)	00	00	—	X X
	A244	V/f characteristic curve selection, 2nd motor	00(VC)/01(Reduced torque)/06 (Reduced torque 1)	00	00	—	X X
	A045	V/f gain setting	20 to 100	100.	100.	%	X ✓
	A245	V/f gain setting, 2nd motor	20 to 100	100.	100.	%	X ✓
	A051	DC braking enable	00(Disable)/01(Enable)/02(Frequency detection)	00	00	—	X ✓
Frequency limit and jump frequency	A052	DC braking frequency setting	0.0 to 60.0	0.5	0.5	Hz	X ✓
	A053	DC braking wait time	0.0 to 5.0	0.0	0.0	sec	X ✓
	A054	DC braking force during deceleration	0. to 100.	0.	0.	%	X ✓
	A055	DC braking time for deceleration	0.0 to 60.0	0.0	0.0	sec	X ✓
	A056	DC braking / edge or level detection for [DB] input	00(Edge)/01(Level)	01	01	—	X ✓
	A061	Frequency upper limit setting	0.0/Freq. lower limit setting to maximum freq.	0.0	0.0	Hz	X ✓
A261	Frequency upper limit setting, 2nd motor	0.0/Freq. lower limit setting (2nd) to maximum freq. (2nd)	0.0	0.0	Hz	X ✓	
A062	Frequency lower limit setting	0.0/Start freq. to freq. upper limit setting	0.0	0.0	Hz	X ✓	
A262	Frequency lower limit setting, 2nd motor	0.0/Start freq. (2nd) to freq. upper limit setting (2nd)	0.0	0.0	Hz	X ✓	
A063	Jump (center) frequency setting 1	0.0 to 400.	0.0	0.0	Hz	X ✓	
A064	Jump (hysteresis) frequency setting 1	0.0 to 10.0	0.5	0.5	Hz	X ✓	
A065	Jump (center) frequency setting 2	0.0 to 400.	0.0	0.0	Hz	X ✓	
A066	Jump (hysteresis) frequency setting 2	0.0 to 10.0	0.5	0.5	Hz	X ✓	
A067	Jump (center) frequency setting 3	0.0 to 400.	0.0	0.0	Hz	X ✓	
A068	Jump (hysteresis) frequency setting 3	0.0 to 10.0	0.5	0.5	Hz	X ✓	



# Function List

## A Group: Standard functions

✓: Allowed  
✗: Not allowed

Function Code	Name	Range	Default		Unit	Run mode edit	
			-EF(CE)	-U(UL)		Lo	Hi
PID Control	A071	PID Enable	00(Disable)/01(Enable)		-	✗	✓
	A072	PID proportional gain	0.2 to 5.0		-	✓	✓
	A073	PID integral time constant	0.0 to 150.0		sec	✓	✓
	A074	PID derivative time constant	0.00 to 100.0		sec	✓	✓
	A075	PV scale conversion	0.01 to 99.99		-	✗	✓
	A076	PV source setting	00([O] terminal)/01([O] terminal)/02(RS485)/10(Calculation result)		-	✗	✓
	A077	Reverse PID action	00(OFF)/01(ON)		-	✗	✓
	A078	PID output limit	0.0 to 100.0		%	✗	✓
AVR function	A081	AVR function select	00(Enable)/01(Disable)/02(Enabled except during deceleration)		-	✗	✗
	A082	AVR voltage select	200V class: 200/215/220/230/240 400V class: 380/400/415/440/460/480		V	✗	✗
Automatic Energy Saving	A085	Operation mode selection	00(Normal)/01(Energy-saver)		-	✗	✗
	A086	Energy saving mode tuning	0.0 to 100.0		sec	✗	✗
Operation mode and acc./dec. function	A092	Acceleration (2) time setting	0.01 to 99.99/100.0 to 999.9/1000. to 3000.		sec	✓	✓
	A292	Acceleration (2) time setting, 2nd motor	0.01 to 99.99/100.0 to 999.9/1000. to 3000.		sec	✓	✓
	A093	Deceleration (2) time setting	0.01 to 99.99/100.0 to 999.9/1000. to 3000.		sec	✓	✓
	A293	Deceleration (2) time setting, 2nd motor	0.01 to 99.99/100.0 to 999.9/1000. to 3000.		sec	✓	✓
	A094	Select method to switch to Acc2/Dec2 profile	00(2CH from input terminal)/01(transition freq.)		-	✗	✗
	A294	Select method to switch to Acc2/Dec2 profile, 2nd motor	00(2CH from input terminal)/01(transition freq.)		-	✗	✗
	A095	Acc1 to Acc2 frequency transition point	0.0 to 400.0		Hz	✗	✗
	A295	Acc1 to Acc2 frequency transition point, 2nd motor	0.0 to 400.0		Hz	✗	✗
	A096	Dec1 to Dec2 frequency transition point	0.0 to 400.0		Hz	✗	✗
	A296	Dec1 to Dec2 frequency transition point, 2nd motor	0.0 to 400.0		Hz	✗	✗
External freq. tuning	A097	Acceleration curve selection	00(Linear)/01(S-curve)		-	✗	✗
	A098	Deceleration curve selection	00(Linear)/01(S-curve)		-	✗	✗
	A101	[O]-[L] input active range start frequency	0.0 to 400.0		Hz	✗	✓
	A102	[O]-[L] input active range end frequency	0.0 to 400.0		Hz	✗	✓
	A103	[O]-[L] input active range start current	0. to 100.		%	✗	✓
Frequency calculation	A104	[O]-[L] input active range end current	0. to 100.		%	✗	✓
	A105	[O]-[L] input start frequency enable	00(Use setting value)/01(0Hz)		-	✗	✓
	A141	A input select for calculate function	00(Digital operator)/01(Keypad potentiometer)		-	✗	✓
	A142	B input select for calculate function	02(O input)/03(OI input)/04(RS485)		-	✗	✓
	A143	Calculation symbol	00(A141+A142)/01(A141-A142)/02(A141*A142)		-	✗	✓
	A145	ADD frequency	0.0 to 400.0		Hz	✓	✓
	A146	ADD direction select	00(Plus)/01(Minus)		-	✗	✓
	A151	Pot. input active range start frequency	0.0 to 400.0		Hz	✗	✓
	A152	Pot. input active range end frequency	0.0 to 400.0		Hz	✗	✓
	A153	Pot. input active range start current	0.0 to 100.0		%	✗	✓
A154	Pot. input active range end current	0.0 to 100.0		%	✗	✓	
A155	Pot.input start frequency enable	00(Use effect (A151 value))/01(Use 0Hz)		-	✗	✓	

## b Group: Fine-tuning functions

✓: Allowed  
✗: Not allowed

Function Code	Name	Range	Default		Unit	Run mode edit	
			-EF(CE)	-U(UL)		Lo	Hi
Restart after instantaneous power failure	b001	Selection of automatic restart mode	00(Alarm output)/01(Restart at 0Hz)/02(Resume after freq. matching)/03(Resume freq. matching then trip)		-	✗	✓
	b002	Allowable under-voltage power failure time	0.3 to 25.0		sec	✗	✓
	b003	Retry wait time before motor restart	0.3 to 100.0		sec	✗	✓
	b004	Instantaneous power failure / under-voltage trip alarm enable	00(Disable)/01(Enable)		-	✗	✓
	b005	Number of restarts on power failure / under-voltage trip events	00(Restart 16 times)/01(Always restart)		-	✗	✓
	b011	Start frequency to be used in case of frequency pull-in restart	00(frequency at previous shutoff)/01(Max. Hz)/02(Set frequency)		-	✗	✗
	b012	Electronic thermal setting	0.2*Rated current to 1.0*Rated current		A	✗	✓
	b212	Electronic thermal setting, 2nd motor	0.2*Rated current to 1.0*Rated current		A	✗	✓
Overload restriction	b013	Electronic thermal characteristic	00(Reduced torque)/01(Constant torque)/02(Reduced torque 2)		-	✗	✓
	b213	Electronic thermal characteristic, 2nd motor	00(Reduced torque)/01(Constant torque)/02(Reduced torque 2)		-	✗	✓
	b021	Overload restriction operation mode	00(Disable)/01(Enable)/02(Enable for during acceleration)		-	✗	✓
	b221	Overload restriction operation mode, 2nd motor	00(Disable)/01(Enable)/02(Enable for during acceleration)		-	✗	✓
	b022	Overload restriction setting	0.2*Rated current to 1.5*Rated current		A	✗	✓
	b222	Overload restriction setting, 2nd motor	0.2*Rated current to 1.5*Rated current		A	✗	✓
	b023	Deceleration rate at overload restriction	1.0 to 3000.0		sec	✗	✓
	b223	Deceleration rate at overload restriction, 2nd motor	1.0 to 3000.0		sec	✗	✓
	b028	Overload restriction source selection	00(b022/b222 setting level)/01([O]-[L] analog input)		-	✗	✓
	b228	Overload restriction source selection, 2nd motor	00(b022/b222 setting level)/01([O]-[L] analog input)		-	✗	✓
Lock	b029	Deceleration rate of frequency pull-in restart	0.1 to 3000.0		sec	✗	✗
	b030	Current level of frequency pull-in restart	0.2*Rated current to 2.0*Rated current		A	✗	✗
Others	b031	Software lock mode selection	00([SFT] input blocks all edits)/01([SFT] input blocks edits except F001 and Multispeed parameters)/02(No access to edits except F001 and Multi-speed parameters)/10(High-level access, including b031)		-	✗	✓
	b050	Selection of the non stop operation	00(Disabled)/01(Enabled stop)/02(Enabled restart)		-	✗	✗
	b051	Non stop operation start voltage setting	0.0 to 1000.0		V	✗	✗
	b052	OV-LAD Stop level of non stop operation setting	0.0 to 1000.0		V	✗	✗
	b053	Deceleration time of non stop operation setting	0.01 to 3000		sec	✗	✗
	b054	Frequency width of quick deceleration setting	0.0 to 10.0		Hz	✗	✗
	b055	DC bus AVR P-gain	0.2 to 5.0		-	✗	✗
	b056	DC bus AVR I-time	0.0 to 150.0		sec	✗	✗
	b057	DC bus AVR D-time	0.0 to 100.0		sec	✗	✗
	b080	[AM] terminal analog meter adjustment	0. to 255.		-	✓	✓
	b082	Start frequency adjustment	0.5 to 9.9		Hz	✗	✓
	b083	Carrier frequency setting	2.0 to 12.0		kHz	✗	✗

# Function List

Function Code	Name	Range	Default		Unit	Run mode edit		
			-EF(CE)	-U(UL)		Lo	Hi	
Others	b084	Initialization mode (parameters or trip history)	00(Trip history clear)/01(Parameter initialization)/02(Trip history clear and parameter initialization)	00	00	–	X	X
	b085	Country code for initialization	00(JP)/01(CE)/02(US)	01	02	–	X	X
	b086	Frequency scaling conversion factor	0.1 to 99.9	1.0	1.0	–	✓	✓
	b087	STOP key enable	00(Enable)/01(Disable)	00	00	–	X	✓
	b088	Restart mode after FRS	00(Restart from 0Hz)/01(Restart with frequency detection)	00	00	–	X	✓
	b089	Monitor display select for networked inverter	01(Output frequency)/02(Output current)/03(Rotation direction)/04(PV, PID feedback)/05(Input terminal status)/06(Output terminal status)/07(Scaled output frequency)	01	01	–	✓	✓
	b091	Stop mode selection	00(Deceleration and stop)/01(Free-run stop)	00	00	–	X	X
	b092	Cooling fan control (see note below)	00(Always ON)/01(ON during RUN, OFF during STOP)/02(Temperature controlled)	00	00	–	X	X
	b130	Over-voltage LADSTOP enable	00(Disable)/01(Enable)	00	00	–	X	✓
	b131	Over-voltage LADSTOP level	330 to 395V/660 to 790V	380/760	380/760	V	✓	✓
	b133	DC bus AVR selection	00(Disabled)/01(Enabled)	00	00	–	X	✓
	b134	Threshold voltage of DC bus AVR setting	330 to 395V/660 to 790V	380/760	380/760	V	X	✓
	b140	Over-current trip suppression	00(Disable)/01(Enable)	01	01	–	X	✓
	b150	Carrier mode	00(Disable)/01(Enable)	00	00	–	X	✓
	b151	Quick start enable	00(Disable)/01(Enable)	00	00	–	✓	✓

## C Group: Intelligent terminal functions

✓: Allowed  
X: Not allowed

Function Code	Name	Range	Default		Unit	Run mode edit		
			-EF(CE)	-U(UL)		Lo	Hi	
Intelligent input terminal	C001	Terminal [1] function	00(FW:Forward, 01(RV:Reverse), 02-05(CF1-CF4:Multispeed command), 06(JG:Jogging), 07(DB:External DC braking), 08(SET:Second motor constants setting), 09(2CH:Second accel./decel.), 11(FRS:Free-run stop), 12(EXT:External trip), 13(USP:Unattended start protection), 15(SFT:Software lock), 16(AT:Analog input selection), 18(RS:Reset), 19(PTC:Thermistor input), 20(STA:3-wire start), 21(STP:3-wire stop), 22(F/R:3-wire fwd./rev.), 23(PID:PID On/Off), 24(PIDC:PID reset), 27(UP:Remote-controlled accel.), 28(DWN:Remote-controlled decel.), 29(UDC:Remote-controlled data clearing), 31(OPE:Operator control), 50(ADD: Frequency setpoint), 51(F-TM: Force terminal enable), 52(RDY: Quick Start Enable), 53(S-ST: Special-Set (select) 2nd Motor Data), 64(EMR:Emergency stop), 255(NO:Not selected)	00	00	–	X	X
	C201	Terminal [1] function, 2nd motor	06(JG:Jogging), 07(DB:External DC braking), 08(SET:Second motor constants setting), 09(2CH:Second accel./decel.), 11(FRS:Free-run stop), 12(EXT:External trip), 13(USP:Unattended start protection), 15(SFT:Software lock), 16(AT:Analog input selection), 18(RS:Reset), 19(PTC:Thermistor input), 20(STA:3-wire start), 21(STP:3-wire stop), 22(F/R:3-wire fwd./rev.), 23(PID:PID On/Off), 24(PIDC:PID reset), 27(UP:Remote-controlled accel.), 28(DWN:Remote-controlled decel.), 29(UDC:Remote-controlled data clearing), 31(OPE:Operator control), 50(ADD: Frequency setpoint), 51(F-TM: Force terminal enable), 52(RDY: Quick Start Enable), 53(S-ST: Special-Set (select) 2nd Motor Data), 64(EMR:Emergency stop), 255(NO:Not selected)	00	00	–	X	X
	C002	Terminal [2] function	00(FW:Forward, 01(RV:Reverse), 02-05(CF1-CF4:Multispeed command), 06(JG:Jogging), 07(DB:External DC braking), 08(SET:Second motor constants setting), 09(2CH:Second accel./decel.), 11(FRS:Free-run stop), 12(EXT:External trip), 13(USP:Unattended start protection), 15(SFT:Software lock), 16(AT:Analog input selection), 18(RS:Reset), 19(PTC:Thermistor input), 20(STA:3-wire start), 21(STP:3-wire stop), 22(F/R:3-wire fwd./rev.), 23(PID:PID On/Off), 24(PIDC:PID reset), 27(UP:Remote-controlled accel.), 28(DWN:Remote-controlled decel.), 29(UDC:Remote-controlled data clearing), 31(OPE:Operator control), 50(ADD: Frequency setpoint), 51(F-TM: Force terminal enable), 52(RDY: Quick Start Enable), 53(S-ST: Special-Set (select) 2nd Motor Data), 64(EMR:Emergency stop), 255(NO:Not selected)	01	01	–	X	X
	C202	Terminal [2] function, 2nd motor	06(JG:Jogging), 07(DB:External DC braking), 08(SET:Second motor constants setting), 09(2CH:Second accel./decel.), 11(FRS:Free-run stop), 12(EXT:External trip), 13(USP:Unattended start protection), 15(SFT:Software lock), 16(AT:Analog input selection), 18(RS:Reset), 19(PTC:Thermistor input), 20(STA:3-wire start), 21(STP:3-wire stop), 22(F/R:3-wire fwd./rev.), 23(PID:PID On/Off), 24(PIDC:PID reset), 27(UP:Remote-controlled accel.), 28(DWN:Remote-controlled decel.), 29(UDC:Remote-controlled data clearing), 31(OPE:Operator control), 50(ADD: Frequency setpoint), 51(F-TM: Force terminal enable), 52(RDY: Quick Start Enable), 53(S-ST: Special-Set (select) 2nd Motor Data), 64(EMR:Emergency stop), 255(NO:Not selected)	01	01	–	X	X
	C003	Terminal [3] function	00(FW:Forward, 01(RV:Reverse), 02-05(CF1-CF4:Multispeed command), 06(JG:Jogging), 07(DB:External DC braking), 08(SET:Second motor constants setting), 09(2CH:Second accel./decel.), 11(FRS:Free-run stop), 12(EXT:External trip), 13(USP:Unattended start protection), 15(SFT:Software lock), 16(AT:Analog input selection), 18(RS:Reset), 19(PTC:Thermistor input), 20(STA:3-wire start), 21(STP:3-wire stop), 22(F/R:3-wire fwd./rev.), 23(PID:PID On/Off), 24(PIDC:PID reset), 27(UP:Remote-controlled accel.), 28(DWN:Remote-controlled decel.), 29(UDC:Remote-controlled data clearing), 31(OPE:Operator control), 50(ADD: Frequency setpoint), 51(F-TM: Force terminal enable), 52(RDY: Quick Start Enable), 53(S-ST: Special-Set (select) 2nd Motor Data), 64(EMR:Emergency stop), 255(NO:Not selected)	02	16	–	X	X
	C203	Terminal [3] function, 2nd motor	06(JG:Jogging), 07(DB:External DC braking), 08(SET:Second motor constants setting), 09(2CH:Second accel./decel.), 11(FRS:Free-run stop), 12(EXT:External trip), 13(USP:Unattended start protection), 15(SFT:Software lock), 16(AT:Analog input selection), 18(RS:Reset), 19(PTC:Thermistor input), 20(STA:3-wire start), 21(STP:3-wire stop), 22(F/R:3-wire fwd./rev.), 23(PID:PID On/Off), 24(PIDC:PID reset), 27(UP:Remote-controlled accel.), 28(DWN:Remote-controlled decel.), 29(UDC:Remote-controlled data clearing), 31(OPE:Operator control), 50(ADD: Frequency setpoint), 51(F-TM: Force terminal enable), 52(RDY: Quick Start Enable), 53(S-ST: Special-Set (select) 2nd Motor Data), 64(EMR:Emergency stop), 255(NO:Not selected)	02	16	–	X	X
	C004	Terminal [4] function	00(FW:Forward, 01(RV:Reverse), 02-05(CF1-CF4:Multispeed command), 06(JG:Jogging), 07(DB:External DC braking), 08(SET:Second motor constants setting), 09(2CH:Second accel./decel.), 11(FRS:Free-run stop), 12(EXT:External trip), 13(USP:Unattended start protection), 15(SFT:Software lock), 16(AT:Analog input selection), 18(RS:Reset), 19(PTC:Thermistor input), 20(STA:3-wire start), 21(STP:3-wire stop), 22(F/R:3-wire fwd./rev.), 23(PID:PID On/Off), 24(PIDC:PID reset), 27(UP:Remote-controlled accel.), 28(DWN:Remote-controlled decel.), 29(UDC:Remote-controlled data clearing), 31(OPE:Operator control), 50(ADD: Frequency setpoint), 51(F-TM: Force terminal enable), 52(RDY: Quick Start Enable), 53(S-ST: Special-Set (select) 2nd Motor Data), 64(EMR:Emergency stop), 255(NO:Not selected)	03	13	–	X	X
	C204	Terminal [4] function, 2nd motor	06(JG:Jogging), 07(DB:External DC braking), 08(SET:Second motor constants setting), 09(2CH:Second accel./decel.), 11(FRS:Free-run stop), 12(EXT:External trip), 13(USP:Unattended start protection), 15(SFT:Software lock), 16(AT:Analog input selection), 18(RS:Reset), 19(PTC:Thermistor input), 20(STA:3-wire start), 21(STP:3-wire stop), 22(F/R:3-wire fwd./rev.), 23(PID:PID On/Off), 24(PIDC:PID reset), 27(UP:Remote-controlled accel.), 28(DWN:Remote-controlled decel.), 29(UDC:Remote-controlled data clearing), 31(OPE:Operator control), 50(ADD: Frequency setpoint), 51(F-TM: Force terminal enable), 52(RDY: Quick Start Enable), 53(S-ST: Special-Set (select) 2nd Motor Data), 64(EMR:Emergency stop), 255(NO:Not selected)	03	13	–	X	X
	C005	Terminal [5] function	00(FW:Forward, 01(RV:Reverse), 02-05(CF1-CF4:Multispeed command), 06(JG:Jogging), 07(DB:External DC braking), 08(SET:Second motor constants setting), 09(2CH:Second accel./decel.), 11(FRS:Free-run stop), 12(EXT:External trip), 13(USP:Unattended start protection), 15(SFT:Software lock), 16(AT:Analog input selection), 18(RS:Reset), 19(PTC:Thermistor input), 20(STA:3-wire start), 21(STP:3-wire stop), 22(F/R:3-wire fwd./rev.), 23(PID:PID On/Off), 24(PIDC:PID reset), 27(UP:Remote-controlled accel.), 28(DWN:Remote-controlled decel.), 29(UDC:Remote-controlled data clearing), 31(OPE:Operator control), 50(ADD: Frequency setpoint), 51(F-TM: Force terminal enable), 52(RDY: Quick Start Enable), 53(S-ST: Special-Set (select) 2nd Motor Data), 64(EMR:Emergency stop), 255(NO:Not selected)	18	18	–	X	X
	C205	Terminal [5] function, 2nd motor	06(JG:Jogging), 07(DB:External DC braking), 08(SET:Second motor constants setting), 09(2CH:Second accel./decel.), 11(FRS:Free-run stop), 12(EXT:External trip), 13(USP:Unattended start protection), 15(SFT:Software lock), 16(AT:Analog input selection), 18(RS:Reset), 19(PTC:Thermistor input), 20(STA:3-wire start), 21(STP:3-wire stop), 22(F/R:3-wire fwd./rev.), 23(PID:PID On/Off), 24(PIDC:PID reset), 27(UP:Remote-controlled accel.), 28(DWN:Remote-controlled decel.), 29(UDC:Remote-controlled data clearing), 31(OPE:Operator control), 50(ADD: Frequency setpoint), 51(F-TM: Force terminal enable), 52(RDY: Quick Start Enable), 53(S-ST: Special-Set (select) 2nd Motor Data), 64(EMR:Emergency stop), 255(NO:Not selected)	18	18	–	X	X
C011-C015	Terminal [1] to [5] active state	00(NO)/01(NC)	00	00*	–	X	X	
Intelligent input terminal	C021	Terminal [11] function	00(RUN:run signal), 01(FA1:Frequency arrival type 1 - constant speed), 02(FA2:Frequency arrival type 2 - over-frequency), 03(OL:overload advance notice signal), 04(OD:Output deviation for PID control), 05(AL:alarm signal), 06(DC:Wire brake detect on analog input), 07(FBV: Feedback voltage comparison), 08(NDC: Network Disconnection), 09(LOG: Logic operation result), 10(ODC: Option Card Detection Signal), 43(LOC:Low load detection)	01	01	–	X	X
	C026	Alarm relay function	00(Output frequency)/01(Output current)	05	05	–	X	X
	C028	[AM] signal selection	00(NO)/01(NC)	00	00	–	X	✓
	C031	Terminal [11] active state	00(NO)/01(NC)	00	00	–	X	X
	C036	Alarm relay active state	00(NO)/01(NC)	01	01	–	X	X
	C038	Output mode of low load detection signal	00(Disabled)/01(During acceleration, deceleration and constant speed)/02(During constant speed only)	01	01	–	X	✓
	C039	Low load detection level	0.0 to 2.0*Rated current	Rated current	Rated current	A	X	✓
	C041	Overload level setting	0.0 to 2.0*Rated current	Rated current	Rated current	A	X	✓
	C241	Overload level setting, 2nd motor	0.0*Rated current to 2.0*Rated current	Rated current	Rated current	A	X	✓
	C042	Frequency arrival setting for acceleration	0.0 to 400.0	0.0	0.0	Hz	X	✓
	C043	Frequency arrival setting for deceleration	0.0 to 400.0	0.0	0.0	Hz	X	✓
	C044	PID deviation level setting	0.0 to 100.0	3.0	3.0	%	X	✓
	C052	Feedback comparison upper level	0.0 to 100.0	100	100	%	X	✓
	C053	Feedback comparison lower level	0.0 to 100.0	0.0	0.0	%	X	✓
Serial communication	C070	SELECTION OF OPE/MODBUS	02(OPE or option)/03(485)	02	02	–	X	✓
	C071	Communication speed selection	04(4800bps)/05(9600bps)/06(19200bps)	06	04	–	X	✓
	C072	Node allocation	1. to 32.	1.	1.	–	X	✓
	C074	Communication parity selection	00(No parity)/01(Even parity)/02(Odd parity)	00	00	–	X	✓
	C075	Communication stop bit selection	1(1-bit)/2(2-bit)	1	1	bit	X	✓
	C076	Communication error mode	00(Trip)/01(Trip after deceleration stop)/02(Disable)/03(FRS)/04(Deceleration stop)	02	02	–	X	✓
	C077	Communication error time	0.00 to 99.99	0.00	0.00	sec	X	✓
Analog meter setting	C078	Communication wait time	0. to 1000.	0.	0.	msec	X	✓
	C081	[O] input span calibration	0. to 200.	100.	100.	%	✓	✓
	C082	[O] input span calibration	0. to 200.	100.	100.	%	✓	✓
Others	C086	[AM] terminal offset tuning	0.0 to 10.0	0.0	0.0	V	✓	✓
	C091	Reserved (for factory adjustment)	00 (must not be changed)	00	00	–	✓	✓
	C101	Up/Down memory mode selection	00(Clear last frequency)/01(Keep last frequency adjusted by UP/DWN)	00	00	–	X	✓
	C102	Reset mode selection	00(Cancel trip state at input signal ON transition)/ 01(Cancel trip state at signal OFF transition)/ 02(Cancel trip state at input signal ON transition)	00	00	–	X	✓
	C141	Input A select for logic output 1	00(RUN)/01(FA1)/02(FA2)/03(OL)/04(OD)	00	00	–	X	X
	C142	Input A select for logic output 2	05(AL)/06(Dc)/07(FBV)/08(NDC)/10(ODC)/43(LOC)	01	01	–	X	X
	C143	Logic function select	00(AND)/01(OR)/02(XOR)	00	00	–	X	X
C144	ON delay time, output terminal 11	0.0 to 100.0	0.0	0.0	sec	X	✓	
C145	OFF delay time, output terminal 11	0.0 to 100.0	0.0	0.0	sec	X	✓	
C148	ON delay time, relay	0.0 to 100.0	0.0	0.0	sec	X	✓	
C149	OFF delay time, relay	0.0 to 100.0	0.0	0.0	sec	X	✓	

Note: C014: 01 for UL version.

## H Group: Motor constants functions

✓: Allowed  
X: Not allowed

Function Code	Name	Range	Default		Unit	Run mode edit		
			-EF(CE)	-U(UL)		Lo	Hi	
Motor constants and gain	H003	Motor capacity, 1st motor	0.2/0.4/0.55/0.75/1.1/1.5/2.2/3.0/4.0/5.5	Factory set	Factory set	kW	X	X
	H203	Motor capacity, 2nd motor		set	set	kW	X	X
	H004	Motor poles setting, 1st motor	2/4/6/8	4	4	poles	X	X
	H204	Motor poles setting, 2nd motor		4	4	poles	X	X
	H006	Motor stabilization constant, 1st motor	0. to 255.	100	100	–	✓	✓
	H206	Motor stabilization constant, 2nd motor		100	100	–	✓	✓

# Function List

## P Group: Expansion Card Functions

✓: Allowed  
✗: Not allowed

Function Code	Name	Range	Default		Unit	Run mode edit		
			-EF(CE)	-U(UL)		Lo	Hi	
Option Setting	P044	Network comm watchdog timer	0.00 to 99.99	1.00	1.00	sec.	✗	✗
	P045	Inverter action on network comm error	00(Trip (Error Code E70)) 01(Decelerate to stop and trip (Error Code E70)) 02(Hold last speed), 03(Free run stop), 04(Decelerate and stop)	01	01	-	✗	✗
	P046	Polled I/O output instance number	20/21/100	21	21	-	✗	✗
	P047	Polled I/O input instance number	70/71/101	71	71	-	✗	✗
	P048	Inverter action on network idle mode	00(Trip (Error Code E70)) 01(Decelerate to stop and trip (Error Code E70)) 02(Hold last speed), 03(Free run stop), 04(Decelerate and stop)	01	01	-	✗	✗
P049	Network motor poles setting for RPM	00 to 38	0	0	-	✗	✗	

Note: The "P" Group parameters do not appear in the parameter list shown on the keypad display unless the expansion card is installed on the inverter.

# Protective Functions

## Error Codes

Name	Cause(s)	Display on digital operator	Display on remote operator/copy unit
Over current	The inverter output was short-circuited, or the motor shaft is locked or has a heavy load. These conditions cause excessive current for the inverter, so the inverter output is turned OFF.	While at constant speed	<input type="text" value="E 01"/> OC.Drive
		During deceleration	<input type="text" value="E 02"/> OC.Decel
		During acceleration	<input type="text" value="E 03"/> OC.Accel
		Others	<input type="text" value="E 04"/> Over.C
Overload protection *1	When a motor overload is detected by the electronic thermal function, the inverter trips and turns OFF its output.	<input type="text" value="E 05"/> Over.L	<input type="text" value="Over.L"/>
Over voltage protection	When the DC bus voltage exceeds a threshold, due to regenerative energy from the motor.	<input type="text" value="E 07"/> Over.V	<input type="text" value="Over.V"/>
EEPROM error *2,3	When the built-in EEPROM memory has problems due to noise or excessive temperature, the inverter trips and turns OFF its output to the motor.	<input type="text" value="E 08"/> EEPROM	<input type="text" value="EEPROM"/>
Under-voltage error	A decrease of internal DC bus voltage below a threshold results in a control circuit fault. This condition can also generate excessive motor heat or cause low torque. The inverter trips and turns OFF its output.	<input type="text" value="E 09"/> Under.V	<input type="text" value="Under.V"/>
CPU error	A malfunction in the built-in CPU has occurred, so the inverter trips and turns OFF its output to the motor.	<input type="text" value="E 11"/> CPU	<input type="text" value="CPU"/>
External trip	A signal on an intelligent input terminal configured as EXT has occurred. The inverter trips and turns OFF the output to the motor.	<input type="text" value="E 12"/> EXTERNAL	<input type="text" value="EXTERNAL"/>
USP *4	When the Unattended Start Protection (USP) is enabled, an error occurred when power is applied while a Run signal is present. The inverter trips and does not go into Run Mode until the error is cleared.	<input type="text" value="E 13"/> USP	<input type="text" value="USP"/>
Ground fault *5	The inverter is protected by the detection of ground faults between the inverter output and the motor during powerup tests. This feature protects the inverter, and does not protect humans.	<input type="text" value="E 14"/> GND.Fit	<input type="text" value="GND.Fit"/>
Input over-voltage	When the input voltage is higher than the specified value, it is detected 100 seconds after powerup and the inverter trips and turns OFF its output.	<input type="text" value="E 15"/> OV.SRC	<input type="text" value="OV.SRC"/>
Inverter thermal trip	When the inverter internal temperature is above the threshold, the thermal sensor in the inverter module detects the excessive temperature of the power devices and trips, turning the inverter output OFF.	<input type="text" value="E 21"/> OH.FIN	<input type="text" value="OH.FIN"/>
Driver error	An internal inverter error has occurred at the safety protection circuit between the CPU and main driver unit. Excessive electrical noise may be the cause. The inverter has turned OFF the IGBT module output.	<input type="text" value="E 30"/> DRIV	<input type="text" value="DRIV"/>
Thermistor	When a thermistor is connected to terminals [PTC] and [CM1] and the inverter has sensed the temperature is too high, the inverter trips and turns OFF the output.	<input type="text" value="E 35"/> TH	<input type="text" value="TH"/>
Emergency Stop	Emergency stop signal given.	<input type="text" value="E 37"/> EMERGENCY	<input type="text" value="EMERGENCY"/>
Communications error	The inverter's watchdog timer for the communications network has timed out.	<input type="text" value="E 60"/> COMM	<input type="text" value="COMM"/>

Note 1: Reset operations acceptable 10 seconds after the trip.

Note 2: If an EEPROM error (E08) occurs, be sure to confirm the parameter data values are still correct.

Note 3: EEPROM error may occur at power-on after shutting down the power while copying data with remote operator or initializing data. Shut down the power after completing copy or initialization.

Note 4: USP error occurs at resetting trip after under-voltage error (E09) if USP is enabled. Reset once more to recover.

Note 5: Ground fault error (E14) cannot be released with resetting. Shut the power and check wiring.

## How to access the details about the present fault

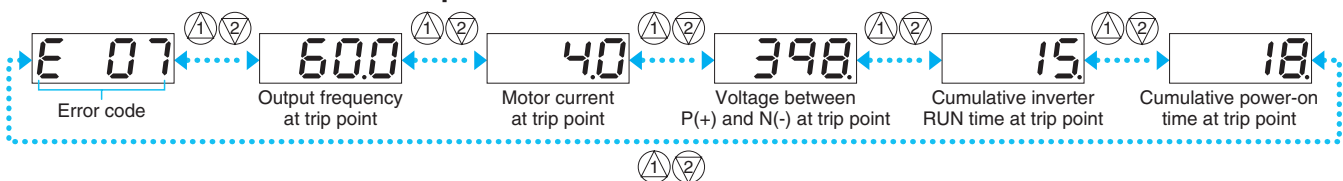

# Connecting Diagram

## Source type logic

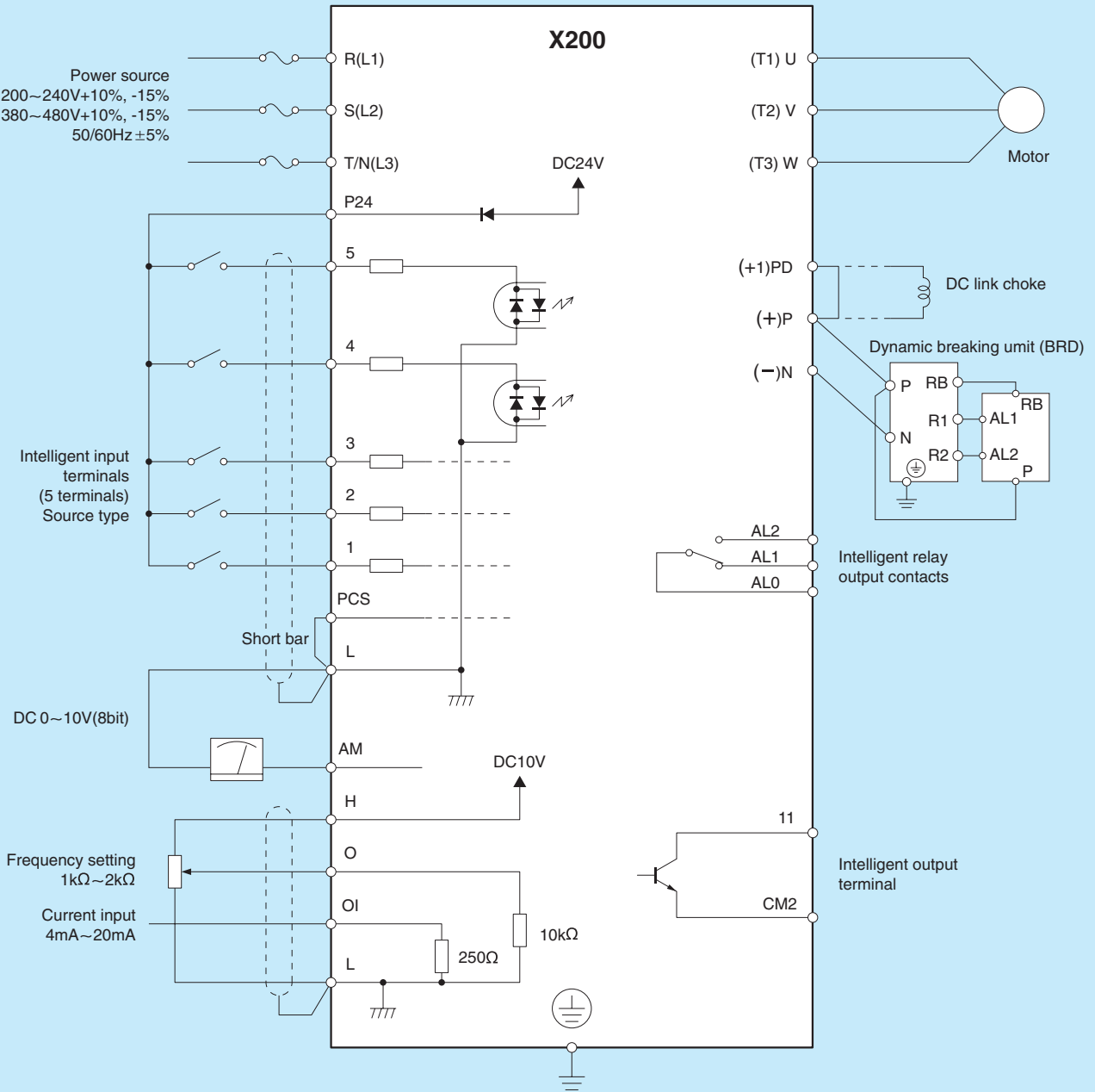

Note 1: Common terminals are depend on logic.

Terminal	1,2,3,4,5	H,O,OI	11
Common	Sink logic : L	L	CM2
	Source logic : PCS		

Note 2: Please choose proper inverter input volotage rating.

# Connecting Diagram

## Sink type logic

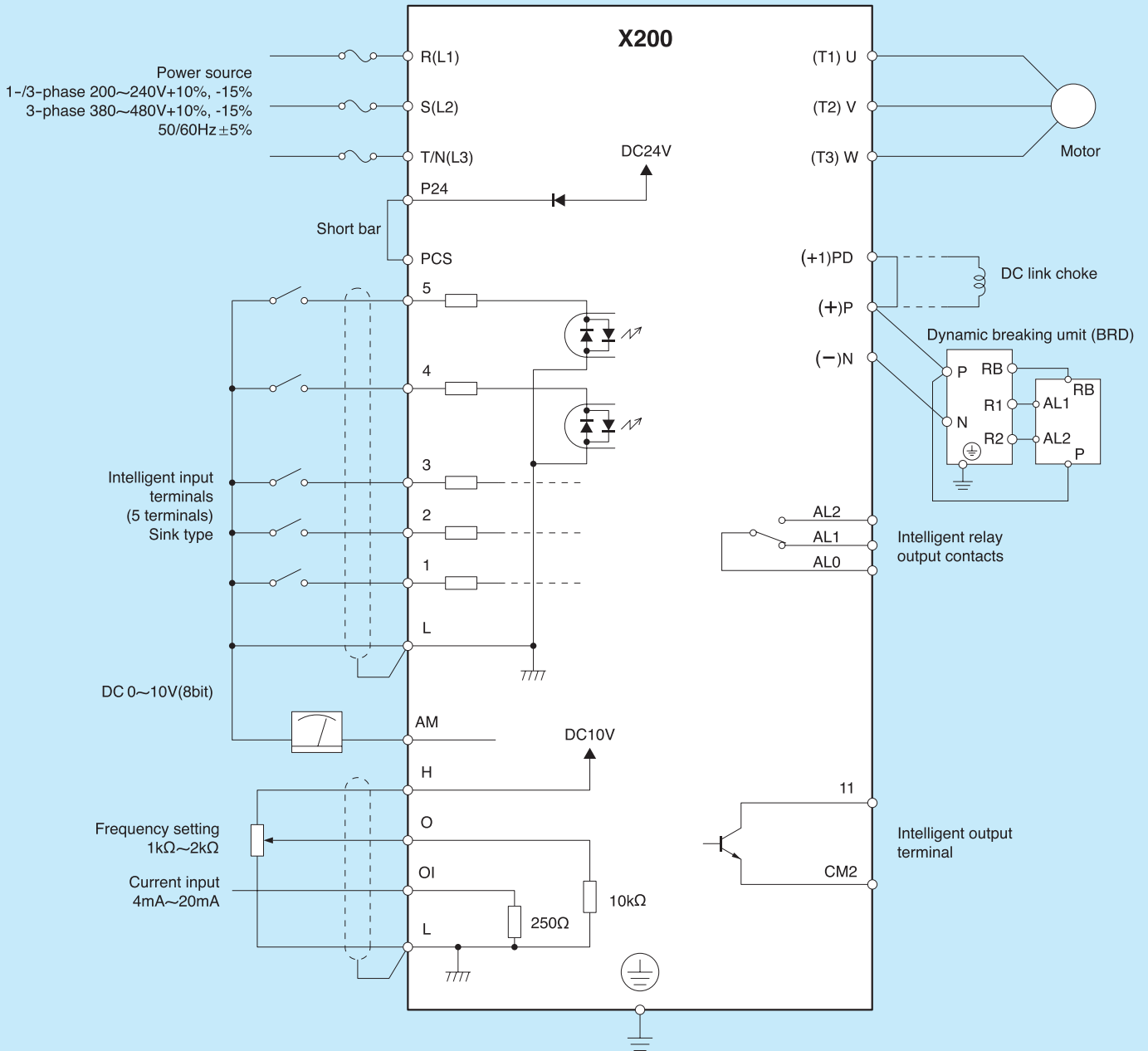

Note 1: Common terminals are depend on logic.

Terminal	1,2,3,4,5	H,O,OI	11
Common	Sink logic : L	L	CM2
	Source logic : PCS		

Note 2: Please choose proper inverter input volotage rating.



# Wiring and Accessories

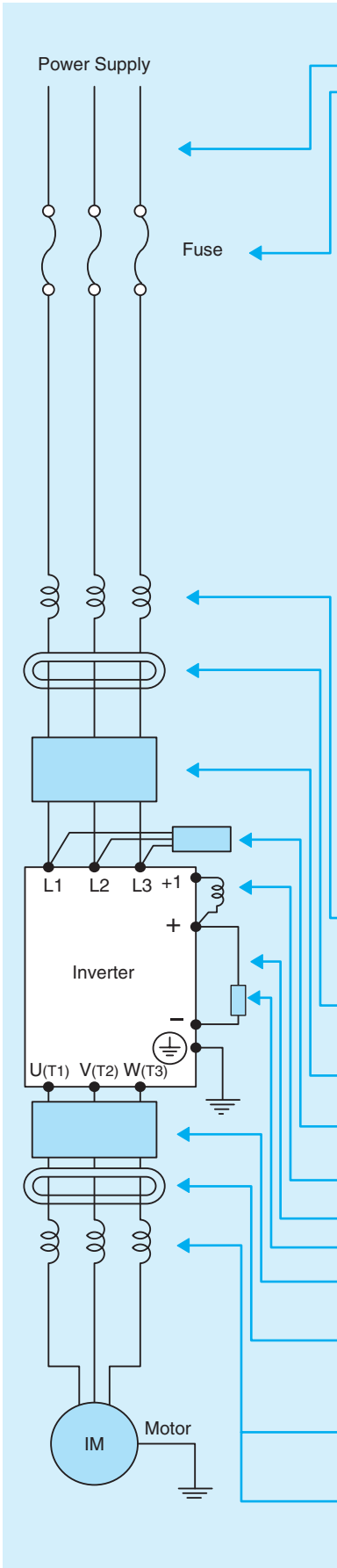

Input Voltage	Applicable Motor (kW(HP))	Model	Wiring		Signal Lines	Fuse (Class J)
			Power Lines			
			AWG	mm <sup>2</sup>		
200V	0.2(1/4)	X200-002NFU/SFEF	14	2.0	18 to 28 AWG 0.14 to 0.75mm <sup>2</sup> shelded wire	No fuse required
	0.4(1/2)	X200-004NFU/SFEF	14	2.0		
	0.55(3/4)	X200-005SFEF	14	2.0		
	0.75(1)	X200-007NFU/SFEF	14	2.0		
	1.1(1.5)	X200-011SFEF	10	5.5		
	1.5(2)	X200-015NFU/SFEF	10	5.5		
	2.2(3)	X200-022NFU/SFEF	10	5.5		
	3.7(5)	X200-037LFU	12	3.5		
	5.5(7.5)	X200-055LFU	10	5.3		
7.5(10)	X200-075LFU	8	8.4			
400V	0.4(1/2)	X200-004HFU/HFEF	16	1.25	18 to 28 AWG 0.14 to 0.75mm <sup>2</sup> shelded wire	3
	0.75(1)	X200-007HFU/HFEF	16	1.25		6
	1.5(2)	X200-015HFU/HFEF	16	1.25		10
	2.2(3)	X200-022HFU/HFEF	14	2.0		10
	3(4)	X200-030HFEF	14	2.0		15
	4.0(5)	X200-040HFU/HFEF	14	2.0		15
	5.5(7.5)	X200-055HFU/HFEF	12	3.3		20
	7.5(10)	X200-075HFU/HFEF	12	3.3		25

Note 1: Field wiring connection must be made by a UL and c-UL listed closed-loop terminal connector sized for the wire gauge involved. Connector must be fixed using the crimping tool specified by the connector manufacturer.

Note 2: Be sure to use large wire gauges for power wiring if the distance exceeds 20m (66ft).

Note 3: Use 0.75mm<sup>2</sup> /18 AWG wire for the relay terminals (AL0, AL1 and AL2) signal wire.

Name	Function
Input side AC reactor	This is useful in suppressing harmonics induced on the power supply lines, or when the main power voltage imbalance exceeds 3% (and power source capacity is more than 500kVA), or to smooth out line fluctuations. It also improves the power factor.
Radio noise filter	Electrical noise interference may occur on nearby equipment such as a radio receiver. This magnetic choke filter helps reduce radiated noise (can also be used on output).
EMC filter	Reduces the conducted noise on the power supply wiring generated by the inverter. Connect to the inverter input side.
Radio noise filter (Capacitor filter)	This capacitor filter reduces radiated noise from the main power wires in the inverter input side.
DC link choke	Suppresses harmonics generated by the inverter.
Braking resistor	This is useful for increasing the inverter's control torque for high duty-cycle (on-off) applications, and improving the decelerating capability.
Braking unit	
Output side noise filter	Reduces radiated noise from wiring in the inverter output side.
Radio noise filter	Electrical noise interference may occur on nearby equipment such as a radio receiver. This magnetic choke filter helps reduce radiated noise (can also be used on input).
AC reactor	This reactor reduces the vibration in the motor caused by the inverter's switching waveforms, by smoothing the waveforms to approximate commercial power quality. It is also useful when wiring from the inverter to the motor is more than 10m in length, to reduce harmonics.
LCR filter	Sine wave shaping filter for the output side.

# Torque characteristics/Derating Curves

## Torque characteristics

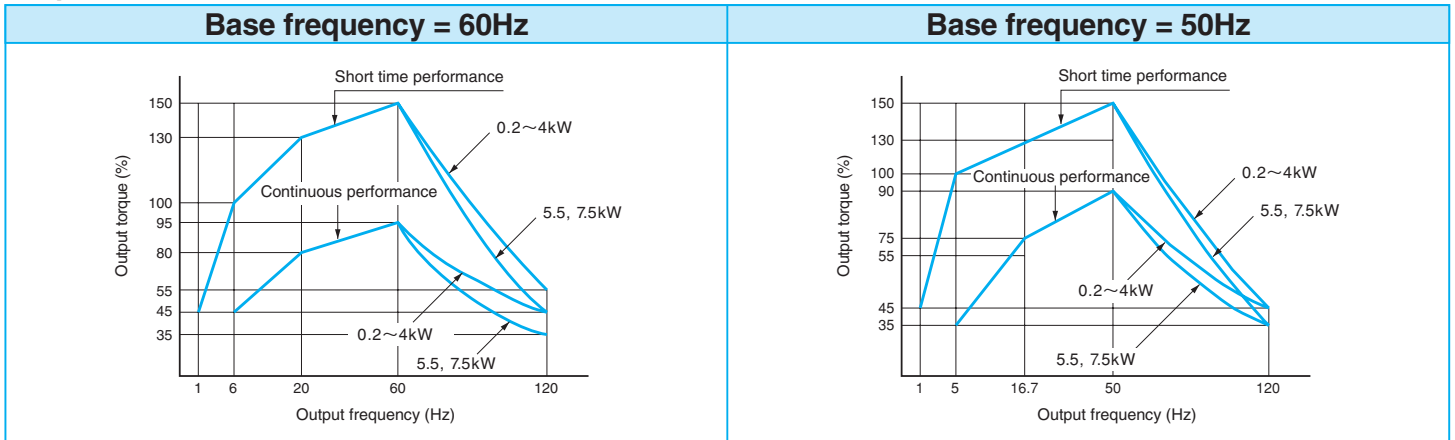

## Derating Curves

Use the following derating curves to help determine the optimal carrier frequency setting for your inverter and find the output current derating. Be sure to use the proper curve for your particular X200 inverter model number.

① Ambient temperature 40°C max., side-by-side mounting

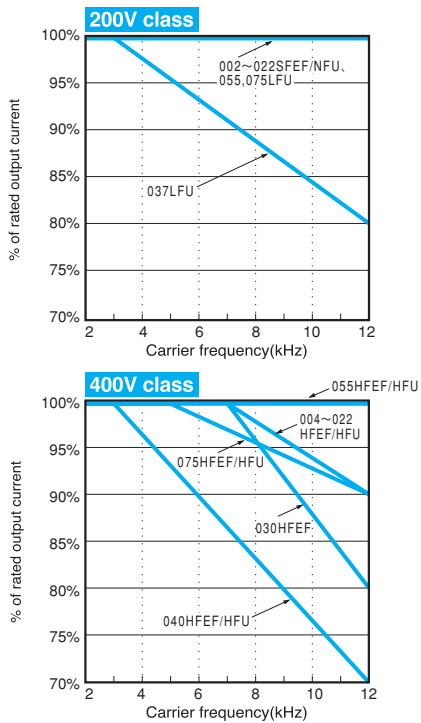

② Ambient temperature 50°C max., individual mounting

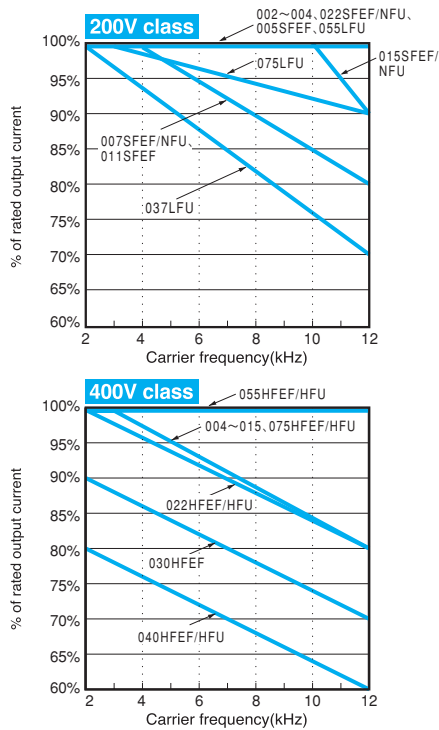

③ Ambient temperature 40°C max., individual mounting

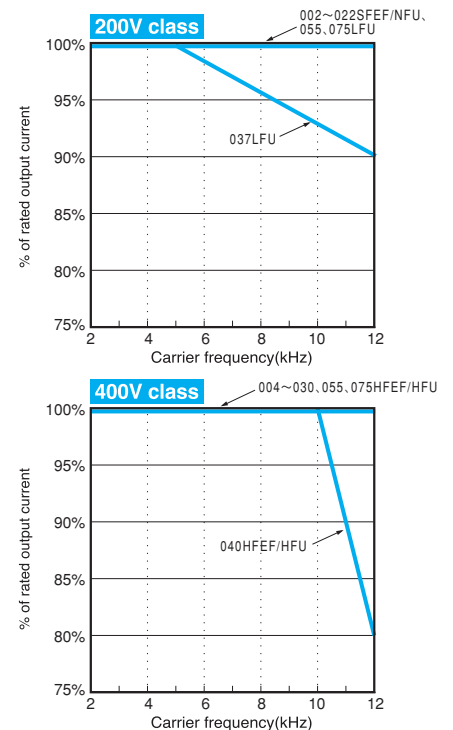

# For Correct Operation

## Application to Motors

### Application to general-purpose motors

Operating frequency	The overspeed endurance of a general-purpose motor is 120% of the rated speed for 2 minutes (JIS C4,004). For operation at higher than 60Hz, it is required to examine the allowable torque of the motor, useful life of bearings, noise, vibration, etc. In this case, be sure to consult the motor manufacturer as the maximum allowable rpm differs depending on the motor capacity, etc.
Torque characteristics	The torque characteristics of driving a general-purpose motor with an inverter differ from those of driving it using commercial power (starting torque decreases in particular). Carefully check the load torque characteristic of a connected machine and the driving torque characteristic of the motor.
Motor loss and temperature increase	The torque characteristics of driving a general-purpose motor with an inverter differ from those of driving it using commercial power
Noise	When run by an inverter, a general-purpose motor generates noise slightly greater than with commercial power.
Vibration	When run by an inverter at variable speeds, the motor may generate vibration, especially because of (a) unbalance of the rotor including a connected machine, or (b) resonance caused by the natural vibration frequency of a mechanical system. Particularly, be careful of (b) when operating at variable speeds a machine previously fitted with a constant speed motor. Vibration can be minimized by (1) avoiding resonance points using the frequency jump function of the inverter, (2) using a tire-shaped coupling, or (3) placing a rubber shock absorber beneath the motor base.
Power transmission mechanism	Under continued, low-speed operation, oil lubrication can deteriorate in a power transmission mechanism with an oil-type gear box (gear motor) or reducer. Check with the motor manufacturer for the permissible range of continuous speed. To operate at more than 60Hz, confirm the machine's ability to withstand the centrifugal force generated.

### Application to special motors

Gear motor	The allowable rotation range of continuous drive varies depending on the lubrication method or motor manufacturer. (Particularly in case of oil lubrication, pay attention to the low frequency range.)
Brake-equipped motor	For use of a brake-equipped motor, be sure to connect the braking power supply from the primary side of the inverter.
Pole-change motor	There are different kinds of pole-change motors (constant output characteristic type, constant torque characteristic type, etc.), with different rated current values. In motor selection, check the maximum allowable current for each motor of a different pole count. At the time of pole changing, be sure to stop the motor. Also see: Application to the 400V-class motor.
Submersible motor	The rated current of a submersible motor is significantly larger than that of the general-purpose motor. In inverter selection, be sure to check the rated current of the motor.
Explosion-proof motor	Inverter drive is not suitable for a safety-enhanced explosion-proof type motor. The inverter should be used in combination with a pressure-proof explosion-proof type of motor. *Explosion-proof verification is not available for X200 Series.
Synchronous (MS) motor High-speed (HFM) motor	In most cases, the synchronous (MS) motor and the high-speed (HFM) motor are designed and manufactured to meet the specifications suitable for a connected machine. As to proper inverter selection, consult the manufacturer.
Single-phase motor	A single-phase motor is not suitable for variable-speed operation by an inverter drive. Therefore, use a three-phase motor.

### Application to the 400V-class motor

A system applying a voltage-type PWM inverter with IGBT may have surge voltage at the motor terminals resulting from the cable constants including the cable length and the cable laying method. Depending on the surge current magnification, the motor coil insulation may be degraded. In particular, when a 400V-class motor is used, a longer cable is used, and critical loss can occur, take the following countermeasures:

- (1) install the LCR filter between the inverter and the motor,
- (2) install the AC reactor between the inverter and the motor, or
- (3) enhance the insulation of the motor coil.

## Notes on Use

### Drive

Run/Stop	Run or stop of the inverter must be done with the keys on the operator panel or through the control circuit terminal. Do not operate by installing an electromagnetic contactor (MC) in the main circuit.
Emergency motor stop	When the protective function is operating or the power supply stops, the motor enters the free run stop state. When an emergency stop is required or when the motor should be kept stopped, use of a mechanical brake should be considered.
High-frequency run	A max. 400Hz can be selected on the X200 Series. However, a two-pole motor can attain up to approx. 24,000 rpm, which is extremely dangerous. Therefore, carefully make selection and settings by checking the mechanical strength of the motor and connected machines. Consult the motor manufacturer when it is necessary to drive a standard (general-purpose) motor above 60Hz. A full line of high-speed motors is available from Hitachi.

### Installation location and operating environment

Avoid installation in areas of high temperature, excessive humidity, or where moisture can easily collect, as well as areas that are dusty, subject to corrosive gasses, mist of liquid for grinding, or salt. Install the inverter away from direct sunlight in a well-ventilated room that is free of vibration. The inverter can be operated in the ambient temperature range from -10 to 50°C. (Carrier frequency and output current must be reduced in the range of 40 to 50°C.)

# For Correct Operation

## Main power supply

<p>Installation of an AC reactor on the input side</p>	<p>In the following examples involving a general-purpose inverter, a large peak current flows on the main power supply side, and is able to destroy the converter module. Where such situations are foreseen or the connected equipment must be highly reliable, install an AC reactor between the power supply and the inverter. Also, where influence of indirect lightning strike is possible, install a lightning conductor.</p> <p>(A) The unbalance factor of the power supply is 3% or higher. (Note)          (B) The power supply capacity is at least 10 times greater than the inverter capacity (the power supply capacity is 500 kVA or more).          (C) Abrupt power supply changes are expected.</p> <p>Examples:          (1) Several inverters are interconnected with a short bus.          (2) A thyristor converter and an inverter are interconnected with a short bus.          (3) An installed phase advance capacitor opens and closes.</p> <p>In cases (A), (B) and (C), it is recommended to install an AC reactor on the main power supply side.          Note: Example calculation with <math>V_{RS} = 205V</math>, <math>V_{ST} = 201V</math>, <math>V_{TR} = 200V</math>  <math>V_{RS}</math> : R-S line voltage, <math>V_{ST}</math> : S-T line voltage, <math>V_{TR}</math> : T-R line voltage</p>
<p>Using a private power generator</p>	<p>An inverter run by a private power generator may overheat the generator or suffer from a deformed output voltage waveform of the generator. Generally, the generator capacity should be five times that of the inverter (kVA) in a PWM control system, or six times greater in a PAM control system.</p>

## Notes on Peripheral Equipment Selection

<p>Wiring connections</p>	<p>(1) Be sure to connect main power wires with R(L1), S(L2), and T(L3) terminals (input) and motor wires to U(T1), V(T2), and W(T3) terminals (output). (Incorrect connection will cause an immediate failure.)          (2) Be sure to provide a grounding connection with the ground terminal (⊕).</p>
<p>Wiring between inverter and motor</p>	<p>Electromagnetic contactor          When an electromagnetic contactor is installed between the inverter and the motor, do not perform on-off switching during running operation.</p>
	<p>Thermal relay          When used with standard applicable output motors (standard three-phase squirrel-cage four-pole motors), the X200 Series does not need a thermal relay for motor protection due to the internal electronic protective circuit. A thermal relay, however, should be used:          • during continuous running outside a range of 30 to 60 Hz.          • for motors exceeding the range of electronic thermal adjustment (rated current).          • when several motors are driven by the same inverter; install a thermal relay for each motor.          • The RC value of the thermal relay should be more than 1.1 times the rated current of the motor. Where the wiring length is 10 m or more, the thermal relay tends to turn off readily. In this case, provide an AC reactor on the output side or use a current sensor.</p>
<p>Installing a circuit breaker</p>	<p>Install a circuit breaker on the main power input side to protect inverter wiring and ensure personal safety. Choose an inverter-compatible circuit breaker. The conventional type may malfunction due to harmonics from the inverter. For more information, consult the circuit breaker manufacturer.</p>
<p>Wiring distance</p>	<p>The wiring distance between the inverter and the remote operator panel should be 20 meters or less. When this distance is exceeded, use CVD-E (current-voltage converter) or RCD-E (remote control device). Shielded cable should be used on the wiring. Beware of voltage drops on main circuit wires. (A large voltage drop reduces torque.)</p>
<p>Earth leakage relay</p>	<p>If the earth leakage relay (or earth leakage breaker) is used, it should have a sensitivity level of 15 mA or more (per inverter).</p>
<p>Phase advance capacitor</p>	<p>Do not use a capacitor for power factor improvement between the inverter and the motor because the high-frequency components of the inverter output may overheat or damage the capacitor.</p>

## High-frequency Noise and Leakage Current

- (1) High-frequency components are included in the input/output of the inverter main circuit, and they may cause interference in a transmitter, radio, or sensor if used near the inverter. The interference can be minimized by attaching noise filters (option) in the inverter circuitry.
- (2) The switching action of an inverter causes an increase in leakage current. Be sure to ground the inverter and the motor.

## Lifetime of Primary Parts

Because a DC bus capacitor deteriorates as it undergoes internal chemical reaction, it should normally be replaced every five years. Be aware, however, that its life expectancy is considerably shorter when the inverter is subjected to such adverse factors as high temperatures or heavy loads exceeding the rated current of the inverter. The approximate lifetime of the capacitor is as shown in the figure at the right when it is used 12 hours daily (according to the "Instructions for Periodic Inspection of General-Purpose Inverter" (JEMA).) Also, such moving parts as a cooling fan should be replaced. Maintenance inspection and parts replacement must be performed by only specified trained personnel.

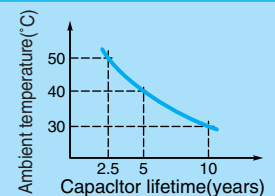

## Precaution for Correct Usage

- Before use, be sure to read through the Instruction Manual to insure proper use of the inverter.
- Note that the inverter requires electrical wiring; a trained specialist should carry out the wiring.
- The inverter in this catalog is designed for general industrial applications. For special applications in fields such as aircraft, outer space, nuclear power, electrical power, transport vehicles, clinics, and underwater equipment, please consult with us in advance.
- For application in a facility where human life is involved or serious losses may occur, make sure to provide safety devices to avoid a serious accident.
- The inverter is intended for use with a three-phase AC motor. For use with a load other than this, please consult with us.







