



Operation **Manual**

Goodrive10 **Series Mini VFD**



Contents

Contents	i
1 Safety precautions	1
1.1 Safety definition	1
1.2 Warning signs	1
1.3 Safety guidelines	2
1.3.1 Delivery and installation	2
1.3.2 Commissioning and running	3
1.3.3 Maintenance and replacement of components	3
1.3.4 Device disposal	4
2 Product overview	5
2.1 Quick start	5
2.1.1 Unpacking inspection	5
2.1.2 Application confirmation	5
2.1.3 Environment	5
2.1.4 Installation confirmation	6
2.1.5 Basic commissioning	6
2.2 Product specifications	7
2.3 Product nameplate	8
2.4 Mode code	9
2.5 Rated specifications	9
2.6 Structure diagram	10
3 Installation guidelines	11
3.1 Mechanical installation	11
3.1.1 Installation environment	11
3.1.2 Installation direction	12
3.1.3 Installation mode	13
3.1.4 Installation space	13
3.2 Electrical installation	14
3.2.1 Wiring of main circuit	14
3.2.2 Main circuit terminals	14
3.2.3 Wiring of main circuit terminals	15
3.2.4 Wiring of control circuit	16
3.2.5 Control circuit terminals	16
3.3 Wiring protection	17
3.3.1 Protect the VFD and input power cable in short-circuit situations	17
3.3.2 Protect the motor and motor cables	18
3.3.3 Establish a bypass connection	18

4 Keypad operation	19
4.1 Keypad introduction	19
4.2 Keypad display	21
4.2.1 Displaying stopped-state parameters	21
4.2.2 Displaying running-state parameters	21
4.2.3 Displaying fault information.....	22
4.2.4 Editing function codes.....	22
4.3 Operations on the keypad	22
4.3.1 Modifying VFD function codes	22
4.3.2 Setting a password for the VFD	23
4.3.3 Viewing VFD status.....	24
5 Function parameters	25
P00 group Basic functions.....	26
P01 group Start and stop control	31
P02 group Motor parameters.....	36
P04 group SVPWM control.....	38
P05 group Input terminals	41
P06 group Output terminals.....	47
P07 group HMI	49
P08 group Enhanced functions	56
P09 group PID control	62
P10 group Multi-step speed control.....	66
P11 group Protection parameters	68
P14 group Serial communication.....	71
P17 group Status viewing	74
6 Fault tracking	76
6.1 Fault prevention.....	76
6.1.1 Maintenance intervals.....	76
6.1.2 Cooling fan.....	79
6.1.3 Capacitors.....	79
6.1.4 Power cable	80
6.2 Fault handling.....	81
6.2.1 Alarm and fault indications.....	81
6.2.2 Fault reset.....	81
6.2.3 Fault instruction and solution	81
6.2.4 Fault instruction and solution	83
7 Communication protocol.....	84
7.1 Modbus protocol introduction	84
7.2 Application mode for the VFD.....	84
7.2.1 2-wire RS485.....	84

7.2.2 RTU mode.....	87
7.3 RTU command code and communication data description	90
7.3.1 Command code: 03H.....	90
7.3.2 Command code: 06H.....	92
7.3.3 Command code 08H, diagnosis.....	93
7.3.4 Data address definition	93
7.3.5 Fieldbus ratio scale	97
7.3.6 Error message response	98
7.3.7 Read/Write operation example	100
7.4 Common communication faults	102
Appendix A Technical data	103
A.1 Derating in application.....	103
A.1.1 Capacity.....	103
A.1.2 Derating.....	103
A.2 CE	104
A.2.1 CE marking.....	104
A.2.2 EMC compliance declaration.....	104
A.3 EMC regulations.....	104
A.3.1 VFDs of category C2	105
A.3.2 VFDs of category C3	105
Appendix B Dimension drawings	106
B.1 Keypad structure	106
B.2 VFD chart	107
Appendix C Optional peripheral accessories	108
C.1 Peripheral wiring	108
C.2 Power supply	109
C.3 Cable.....	110
C.3.1 Power cable	110
C.3.2 Control cable	110
C.4 Breaker and electromagnetic contactor	111
C.5 Reactors.....	112
C.6 Filter	113
C.6.1 C3 filter model description.....	113
C.6.2 C3 filter model selection	114
C.6.3 C2 Filter model description	115
C.6.4 C2 filter model selection	116
C.7 Braking system	116
C.7.1 Braking unit	116
C.7.2 Braking resistor selection	116
C.7.3 Braking resistor installation	118

Appendix D Further information	119
D.1 Product and service inquiries	119
D.2 Feedback on INVT VFD manuals	119
D.3 Documents on the Internet.....	119

1 Safety precautions

Read this manual carefully and follow all safety precautions before moving, installing, operating and servicing the variable-frequency drive (VFD). If ignored, physical injury or death may occur, or damage may occur to the devices.









If any physical injury or death or damage to the devices occurs for ignoring to the safety precautions in the manual, our company will not be responsible for any damages and we are not legally bound in any manner.

1.1 Safety definition

Danger:	Serious physical injury or even death may occur if related requirements are not followed.
Warning:	Physical injury or damage to the devices may occur if related requirements are not followed.
Note:	Physical hurt may occur if related requirements are not followed.
Qualified electricians:	People working on the device should take part in professional electrical and safety training, receive the certification and be familiar with all steps and requirements of installing, commissioning, operating and maintaining the device to avoid any emergency.





1.2 Warning signs

Warnings caution you about conditions which can result in serious injury or death and/or damage to the equipment, and advice on how to avoid the danger. Following warning symbols are used in this manual:

Sign	Name	Instruction	Abbreviation
 Danger	Danger	Serious physical injury or even death may occur if related requirements are not followed	
 Warning	Warning	Physical injury or damage to the devices may occur if related requirements are not followed	
 Do not touch	Electrostatic discharge	Damage to the PCBA board may occur if related requirements are not followed	
 Hot sides	Hot sides	Sides of the device may become hot. Do not touch.	

Sign	Name	Instruction	Abbreviation
Note	Note	Physical hurt may occur if related requirements are not followed	Note

1.3 Safety guidelines

	<ul style="list-style-type: none"> Only qualified electricians are allowed to operate on the VFD. Do not carry out any wiring and inspection or changing components when the power supply is applied. Ensure all input power supply is disconnected before wiring and checking and always wait for at least the time designated on the VFD or until the DC bus voltage is less than 36V. Below is the table of the waiting time: <table border="1" style="margin-left: auto; margin-right: auto;"> <thead> <tr> <th colspan="2">VFD model</th> <th>Minimum waiting time</th> </tr> </thead> <tbody> <tr> <td>1PH 220V</td> <td>0.2kW-2.2kW</td> <td>5 minutes</td> </tr> <tr> <td>3PH 220V</td> <td>0.2kW-2.2kW</td> <td>5 minutes</td> </tr> <tr> <td>3PH 380V</td> <td>0.75kW-2.2kW</td> <td>5 minutes</td> </tr> </tbody> </table>	VFD model		Minimum waiting time	1PH 220V	0.2kW-2.2kW	5 minutes	3PH 220V	0.2kW-2.2kW	5 minutes	3PH 380V	0.75kW-2.2kW	5 minutes
VFD model		Minimum waiting time											
1PH 220V	0.2kW-2.2kW	5 minutes											
3PH 220V	0.2kW-2.2kW	5 minutes											
3PH 380V	0.75kW-2.2kW	5 minutes											
	<ul style="list-style-type: none"> Do not refit the VFD unauthorizedly; otherwise fire, electric shock or other injury may occur. 												
	<ul style="list-style-type: none"> The base of the radiator may become hot during running. Do not touch to avoid hurt. 												
	<ul style="list-style-type: none"> The electrical parts and components inside the VFD are electrostatic. Take measurements to avoid electrostatic discharge during relevant operation. 												

1.3.1 Delivery and installation

	<ul style="list-style-type: none"> Install the VFD on fire-retardant material and keep the VFD away from combustible materials. Connect the braking optional parts according to the wiring diagram. Do not operate on the VFD if there is any damage or components loss to the VFD. Do not touch the VFD with wet items or body, otherwise electric shock may occur.
--	--

Note:

- Select appropriate moving and installing tools to ensure a safe and normal running of the VFD and avoid physical injury or death. For physical safety, the erector should take some mechanical protective measurements, such as wearing exposure shoes and working uniforms.

- Ensure to avoid physical shock or vibration during delivery and installation.
- Do not carry the VFD by its cover. The cover may fall off.
- Install away from children and other public places.
- The pick-up current of the VFD may be above 3.5mA during operation. Ground with proper techniques and ensure the grounding resistor is less than 10Ω. The conductivity of PE grounding conductor is the same as that of the phase conductor (with the same cross sectional area).
- R, S and T are the input terminals of the power supply, while U, V and W are the motor terminals. Please connect the input power cables and motor cables with proper techniques; otherwise the damage to the VFD may occur.

1.3.2 Commissioning and running

	<ul style="list-style-type: none"> ● Disconnect all power supplies applied to the VFD before the terminal wiring and wait for at least the designated time after disconnecting the power supply. ● High voltage is present inside the VFD during running. Do not carry out any operation except for the keypad setting. ● The VFD may start up by itself when P01.21=1. Do not get close to the VFD and motor. ● The VFD can not be used as “Emergency-stop device”. ● The VFD can not be used to break the motor suddenly. A mechanical braking device should be provided.
--	--

Note:

- Do not switch on/off the input power supply of the VFD frequently.
- For VFDs that have been stored for a long time, check and fix the capacitance and try to run it again before utilization (see Maintenance and Hardware Fault Diagnose).
- Cover the front board before running, otherwise electric shock may occur.



1.3.3 Maintenance and replacement of components

	<ul style="list-style-type: none"> ● Only qualified electricians are allowed to perform the maintenance, inspection, and components replacement of the VFD. ● Disconnect all power supplies to the VFD before the terminal wiring. Wait for at least the time designated on the VFD after disconnection. ● Take measures to avoid screws, cables and other conductive matters to fall into the VFD during maintenance and component replacement.
--	---

Note:

- Select proper torque to tighten screws.
- Keep the VFD, parts and components away from combustible materials during maintenance and component replacement.
- Do not carry out any isolation and pressure test on the VFD and do not measure the control circuit of the VFD by megameter.

1.3.4 Device disposal

	<ul style="list-style-type: none">● There are heavy metals in the VFD. Deal with it as industrial effluent.
	<ul style="list-style-type: none">● When the life cycle ends, the product should enter the recycling system. Dispose of it separately at an appropriate collection point instead of placing it in the normal waste stream.

2 Product overview

2.1 Quick start

2.1.1 Unpacking inspection

Check as followings after receiving products:

1. Check that there are no damage and humidification to the package. If not, please contact with local agents or INVT offices.
2. Check the information on the type designation label on the outside of the package to verify that the drive is of the correct type. If not, please contact with local dealers or INVT offices.
3. Check that there are no signs of water in the package and no signs of damage or breach to the VFD. If not, please contact with local dealers or INVT offices.
4. Check the information on the type designation label on the outside of the package to verify that the nameplate is of the correct type. If not, please contact with local dealers or INVT offices.
5. Check to ensure the accessories (including user's manual and control keypad) inside the device is complete. If not, please contact with local dealers or INVT offices.

2.1.2 Application confirmation

Check the machine before beginning to use the VFD:

1. Check the load type to verify that there is no overload of the VFD during work and check that whether the drive needs to modify the power degree.
2. Check that the actual current of the motor is less than the rated current of the VFD.
3. Check that the control accuracy of the load is the same of the VFD.
4. Check that the incoming supply voltage is correspondent to the rated voltage of the VFD.

2.1.3 Environment

Check as followings before the actual installation and usage:

1. Check that the ambient temperature of the VFD is below 40°C. If exceeds, derate 1% for every additional 1°C. Additionally, the VFD can not be used if the ambient temperature is above 50°C. Note: For the cabinet VFD, the ambient temperature means the air temperature inside the cabinet.
2. Check that the ambient temperature of the VFD in actual usage is above -10°C. If not, add heating facilities. Note: For the cabinet VFD, the ambient temperature means the air temperature inside the cabinet.

3. Check that the altitude of the actual usage site is below 1000m. If exceeds, derate 1% for every additional 100m.
4. Check that the humidity of the actual usage site is below 90% and condensation is not allowed. If not, add additional protection VFDs.
5. Check that the actual usage site is away from direct sunlight and foreign objects can not enter the VFD. If not, add additional protective measures.
6. Check that there is no conductive dust or flammable gas in the actual usage site. If not, add additional protection to VFDs.

2.1.4 Installation confirmation

Check as followings after the installation:

1. Check that the load range of the input and output cables meet the need of actual load.
2. Check that the accessories of the VFD are correctly and properly installed. The installation cables should meet the needs of every component (including reactors, input filters, output reactors, output filters, DC reactors and braking resistors).
3. Check that the VFD is installed on non-flammable materials and the calorific accessories (reactors and brake resistors) are away from flammable materials.
4. Check that all control cables and power cables are run separately and the routation complies with EMC requirement.
5. Check that all grounding systems are properly grounded according to the requirements of the VFD.
6. Check that the free space during installation is sufficient according to the instructions in user's manual.
7. Check that the installation conforms to the instructions in user's manual. The drive must be installed in an upright position.
8. Check that the external connection terminals are tightly fastened and the torque is appropriate.
9. Check that there are no screws, cables and other conductive items left in the VFD. If not, get them out.

2.1.5 Basic commissioning

Complete the basic commissioning as followings before actual utilization:

1. Adjust the ACC/DEC time according to the actual running of the load.
2. Commission the device via jogging and check that the rotation direction is as required. If not, change the rotation direction by changing the wiring of motor.
3. Set all control parameters and then operate.

2.2 Product specifications

Function		Specification
Power input	Input voltage (V)	1PH 220(-15%)–240(+10%) 3PH 220(-15%)–240(+10%) 3PH 380(-15%)–440(+10%)
	Input current (A)	Refer to section 2.5 "Rated specifications"
	Input frequency (Hz)	50Hz or 60Hz, allowed range: 47–63Hz
Power output	Output voltage (V)	Equal to input voltage (error < 5%)
	Output current (A)	Refer to section 2.5 "Rated specifications"
	Output power (kW)	Refer to section 2.5 "Rated specifications"
	Output frequency (Hz)	50Hz/60Hz, fluctuation:±5%
Technical control performance	Control mode	SVPWM
	Max. output frequency	400Hz
	Adjustable-speed ratio	1:100
	Overload capability	150% of rated current: 1 minute 180% of rated current: 10 seconds 200% of rated current: 1 second
	Key functions	Stop mode and anti-temperature of the bus
	Temperature measurement accuracy	Overtemperature point ±3°C
	Terminal analog input resolution	≤ 20mV
	Terminal digital input resolution	≤ 2ms
Peripheral interference	Analog input	1 input 0–10V/0–20mA
	Analog output	1 input 0–10V/0–20mA
	Digital input	5 common input
	Digital output	1 Y output (commonly used with digital output) and 1 programmable relay output
	Communication	RS485 communication
Running control performance	Frequency setting mode	Digital setting, analog setting, multi-step speed setting, PID setting, Modbus communication setting and so on. Realizes switchover between the set

	Function	Specification
		combination and the set channel
	Automatic voltage regulation function	Keep the output voltage constant when grid voltage changes
	Fault protection function	Provides more than 10 kinds of fault protection functions: overcurrent, overvoltage, undervoltage, over-temperature, overload, and so on
Others	Installation mode	Wall mounting
	Temperature of running environment	-10~50°C. If temperature is above 40°C, derate 1% for every additional 1°C.
	Cooling mode	Natural air cooling for 1PH/3PH 220V 0.2-0.75kW Forced air cooling for 1PH/3PH 220V 1.5-2.2kW and 3PH 380V 0.75-2.2kW
	Pollution level	Level 2
	Braking unit	Built-in, select optional braking units according to the lot number.
	Braking resistor	Optional and external
	DC reactor	Not optional
	EMC filter	C2 filter is optional. C3 input filter is optional for some models.

2.3 Product nameplate

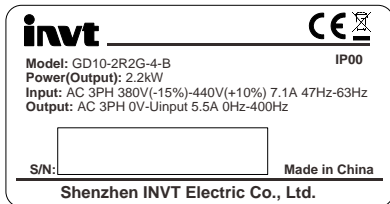

Figure 2-1 Product nameplate

Note: This is a nameplate example of a standard VFD product. The CE/TUV/IP marking on the top right will be marked according to actual certification conditions.

2.4 Mode code

The model code contains product information. You can find the model code on the VFD nameplate or simplified nameplate.

GD10 - 2R2G - 4 - B

① ② ③ ④

Figure 2-2 Product model

Field	Sign	Description	Contents
Abbreviation of product series	①	Abbreviation of product series	GD10: Goodrive10 series mini VFD
Rated power	②	Power range + Load type	2R2: 2.2kW G: Constant torque load
Voltage level	③	Voltage level	4: 380(-15%)–440(+10%) 2: 220(-15%)–240(+10%) S2: 220(-15%)–240(+10%)
Lot No.	④	Lot No.	B: Standard braking unit

2.5 Rated specifications

Model		Output power (kW)	Input current (A)	Output current (A)
1PH 220V	GD10-0R2G-S2-B	0.2	4.9	1.6
	GD10-0R4G-S2-B	0.4	6.5	2.5
	GD10-0R7G-S2-B	0.75	9.3	4.2
	GD10-1R5G-S2-B	1.5	15.7	7.5
	GD10-2R2G-S2-B	2.2	24	10
3PH 220V	GD10-0R2G-2-B	0.2	1.9	1.6
	GD10-0R4G-2-B	0.4	2.7	2.5
	GD10-0R7G-2-B	0.75	4.9	4.2
	GD10-1R5G-2-B	1.5	9.0	7.5
	GD10-2R2G-2-B	2.2	15	10
3PH 380V	GD10-0R7G-4-B	0.75	3.2	2.5
	GD10-1R5G-4-B	1.5	4.3	4.2
	GD10-2R2G-4-B	2.2	7.1	5.5

2.6 Structure diagram

Figure 2-3 shows the structure of the VFD (taking the VFD of 2.2kW as an example).

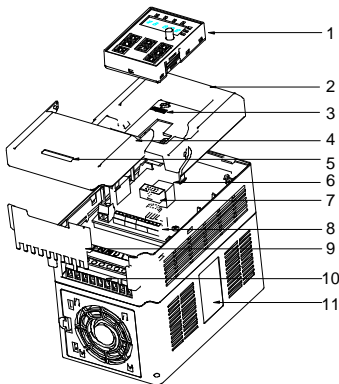



Figure 2-3 Product structure diagram

No.	Name	Description
1	Keypad	See Chapter 4 "Keypad operation" for detailed information.
2	Cover	To protect the internal parts and components.
3	POWER indicator	POWER indicator
4	Flip-open cover	To protect the internal components, turnover for wiring.
5	Simple nameplate	See section 2.4 "Mode code" for detailed information.
6	Keypad port	To connect the keypad.
7		6 is used for external installation.
8	Control circuit terminals	See section 3.2 "Electrical installation" for detailed information.
9	Bobbin winder	To protect the internal parts and components, detachable for wiring.
10	Main circuit terminals	See section 3.2 "Electrical installation" for detailed information.
11	Nameplate	See section 2.3 "Product nameplate" for detailed information.

3 Installation guidelines

The chapter describes the mechanical installation and electrical installation.

	<ul style="list-style-type: none"> ● Only qualified electricians are allowed to carry out what described in this chapter. Please operate as the instructions in chapter 1 "Safety precautions". Ignoring these may cause physical injury or death or damage to the devices. ● Ensure the power supply of the VFD is disconnected during the operation. Wait for at least the time designated until the POWER indicator is off after the disconnection if the power supply is applied. ● The installation and design of the VFD should be complied with the requirement of the local laws and regulations in the installation site. If the installation infringes the requirement, our company will exempt from any responsibility. Additionally, if users do not comply with the suggestion, some damage beyond the assured maintenance range may occur.
--	---

3.1 Mechanical installation

3.1.1 Installation environment

The installation environment is the safeguard for a full performance and long-term stable functions of the VFD. Check the installation environment as followings:

Environment	Conditions
Installation site	Indoor
Environment temperature	<ul style="list-style-type: none"> ● -10°C—$+40^{\circ}\text{C}$, and the temperature changing rate is less than $0.5^{\circ}\text{C}/\text{minute}$. ● If the ambient temperature of the VFD is above 40°C, derate 1% for every additional 1°C. ● It is not recommended to use the VFD if the ambient temperature is above 60°C (empty load). ● In order to improve the reliability of the device, do not use the VFD if the ambient temperature changes frequently. ● Please provide cooling fan or air conditioner to control the internal ambient temperature below the required one if the VFD is used in a close space such as in the control cabinet. ● When the temperature is too low, if the VFD needs to restart to run after a long stop, it is necessary to provide an external heating device to increase the internal temperature, otherwise damage to

Environment	Conditions
	the devices may occur.
Humidity	<ul style="list-style-type: none"> ● RH≤90% ● No condensation is allowed. The maximum relative humidity should be equal to or less than 60% in corrosive air.
Storage temperature	-40°C—+70°C, and the temperature changing rate is less than 1°C/minute.
Running environment condition	<p>The installation site should meet the following requirements.</p> <ul style="list-style-type: none"> ● Keep away from the electromagnetic radiation source; ● Keep away from oil mist, corrosive gases and combustible gases; ● Ensure foreign object like metal powder, dust, oil and water will not fall into the VFD (do not install the VFD onto combustible object like wood); ● Keep away from radioactive substance and combustible objects; ● Keep away from harmful gases and liquids; ● Low salt content; ● No direct sunlight.
Altitude	<ul style="list-style-type: none"> ● When the altitude exceeds 1000m, derate by 1% for every increase of 100m. ● When the altitude exceeds 3000m, consult the local INVT dealer or office for details.
Vibration	Max. vibration acceleration: 5.8m/s^2 (0.6g)
Installation direction	The VFD should be installed on an upright position to ensure sufficient cooling effect.

Note:

- Goodrive10 series VFDs should be installed in a clean and ventilated environment according to enclosure classification.
- Cooling air must be clean, free from corrosive materials and electrically conductive dust.

3.1.2 Installation direction

The VFD may be installed on the wall or in a cabinet.

The VFD must be installed in an upright position. Check the installation site according to the requirements below. See Appendix B "Dimension drawings" for details.

3.1.3 Installation mode

The VFD can be installed in wall mounting (suitable for VFDs of all overall dimensions):

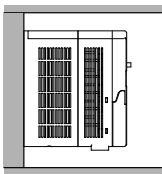

Figure 3-1 Wall mounting

1. Mark the position of the installation hole. See appendix for the position of installation hole.
2. Mount the screws or bolts onto the designated position.
3. Put the VFD on the wall.
4. Tighten the fixing screws on the wall.

3.1.4 Installation space

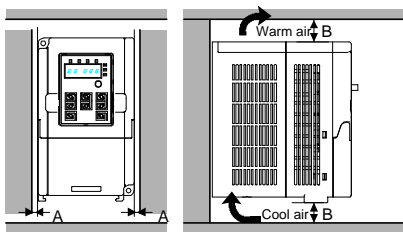

Figure 3-2 Installation space

Note: The minimum space of A and B is 100mm.

3.2 Electrical installation

3.2.1 Wiring of main circuit

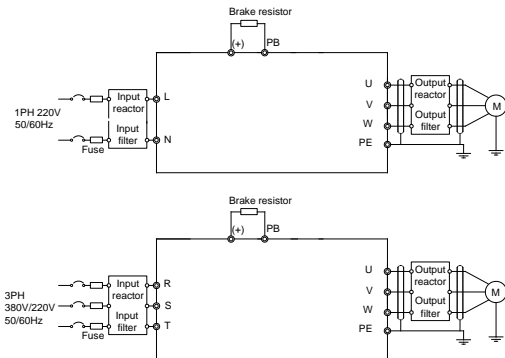

Figure 3-3 Wiring of main circuit

Note:

- The fuse, DC reactor, braking resistor, input reactor, input filter, output reactor, output filter are optional parts. Refer to Appendix C "Optional peripheral accessories" for detailed information.
- Before connecting the braking resistor cable, remove the yellow labels of PB, (+), and (-) from the terminal blocks. Otherwise, poor connection may occur.

3.2.2 Main circuit terminals

R/L	S/N	T	(+)	PB	U	V	W	⊕
-----	-----	---	-----	----	---	---	---	---

Figure 3-4 Main circuit terminal diagram

Terminal sign	Terminal name	Function
R/L	Main circuit power input	3PH/1PH AC input terminals, connected to the grid.
S/N		
T		
U	VFD output	3PH AC output terminals, connected to the motor.
V		
W		

Terminal sign	Terminal name	Function
PB	Braking resistor terminals	PB and (+) are connected to the external resistor.
(+)		
	Grounding terminal	Each machine must carry one PE terminal as standard configuration.

Note:

- Do not use asymmetrical motor cables. If there is a symmetrical grounding conductor in the motor cable besides the conductive shielded layer, ground the grounding conductor on the VFD end and motor end.
- Route the motor cable, input power cable and control cables separately.
- "T" terminal can not be wired in 1PH input.
- If C3 input filter is selected, C3 input filter is connected in parallel to input end of the VFD.
- GD series VFDs cannot share the DC bus with CH series VFDs.
- When sharing the DC bus, the VFDs must be the same in power and must be simultaneously powered on or off.
- In shared DC bus running mode, current balance on the VFD input side must be considered during wiring, and equalizing reactors are recommended to be configured.

3.2.3 Wiring of main circuit terminals

1. Connect the ground wire of the input power cable to the ground terminal (PE) of the VFD, and connect the 3PH input cable to the terminals R, S, and T, and fasten them up.
2. Connect the ground wire of the motor cable to the ground terminal of the VFD, and connect the 3PH motor cable to the terminals U, V, and W, and fasten them up.
3. Connect the brake resistor and other accessories that are equipped with cables to the specified positions.
4. Fasten all the cables outside of the VFD mechanically, if possible.

3.2.4 Wiring of control circuit

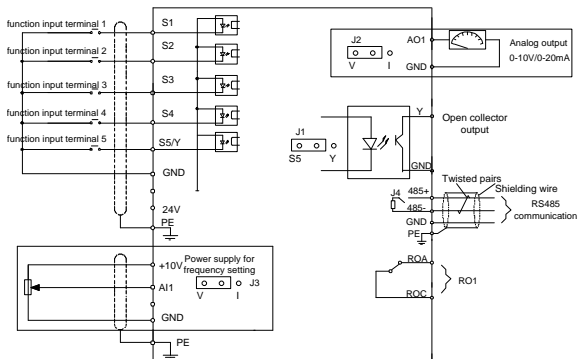

Figure 3-5 Wiring of control circuit

3.2.5 Control circuit terminals

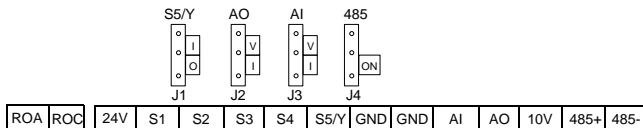

Figure 3-6 Control circuit terminal diagram

Terminal	Description
ROA	RO relay output
ROC	Contactora capability: 3A/AC250V,1A/DC30V
+10V	Local power supply +10V
AI	1. Input range: AI voltage and curren: 0–10V/0–20mA and switch by J3 2. Input impedance:voltage input: 20kΩ; current input: 500Ω 3. Resolution: the minimum one is 5mV when 10V corresponds to 50Hz 4. Deviation ±1%, 25°C Note: Keypad potentiometer set AI1parameters of and AI terminal set AI2 parameters.
24V	Local +24V power supply, 100mA
GND	+10V reference zero potential

Terminal	Description	
AO	1. Output range:0–10V or 0–20mA 2. The voltage or the current output is depended on J2 3. Deviation $\pm 1\%$, 25°C	
S1	Digital input 1	1. Internal impedance:3.3k Ω 2. 0–4V corresponds to low electric level input and 7–30V corresponds to high electric level input 3. Max input frequency:1kHz 4. All terminals are programmable digital input terminals. User can set the terminal function through function codes.
S2	Digital input 2	
S3	Digital input 3	
S4	Digital input 4	
S5	Digital input 5	
Y	Digital output terminal	Common terminal for S5/Y and switch by J1 Note: S5 and Y can not be used at the same time
485+	RS485 communication/differential signal port. The standard RS485 communication interface should use twisted shielded pair	
485-		

3.3 Wiring protection

3.3.1 Protect the VFD and input power cable in short-circuit situations

Protect the VFD and input power cable during short-circuit to avoid thermal overload.

Carry out protective measures according to the following requirements.

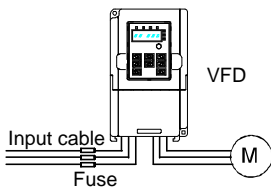

Figure 3-7 Fuse configuration

Note: Select the fuse according to operation manual. During short-circuit, the fuse will protect input power cables to avoid damage to the VFD; when internal short-circuit occurred to the VFD, it can protect neighboring equipment from being damaged.

3.3.2 Protect the motor and motor cables

If the motor cable is selected based on the rated current of the VFD, the VFD can protect the motor cable and motor when a short circuit occurs. The VFD provides the motor thermal overload protection function, which can protect the motor, and lock the output and cut off the current when necessary.



- If the VFD is connected to multiple motors, it is a must to use a separated thermal overload switch or breaker to protect the cable and motor, which may require the fuse to cut off the short circuit current.

3.3.3 Establish a bypass connection

In some critical occasions, industrial frequency conversion circuit is necessary to ensure proper operation of the system when a VFD fault occurs. In some special cases, such as, only soft startup is needed, it will convert to power-frequency operation directly after soft startup, corresponding bypass link is also needed.



- Do not connect any power source to VFD output terminals U, V and W. The voltage applied to motor cable may cause permanent damage to the VFD.

If frequent switch-over is needed, you can use the switch which carries mechanical interlock or a contactor to ensure motor terminals will not be connected to input power cables and VFD output ends simultaneously.

4 Keypad operation

4.1 Keypad introduction

You can use the keypad to control the start and stop, read status data, and set parameters of the VFD. The keypad can be externally connected to the VFD, which requires a network cable with a standard RJ45 crystal head as the connection cable.

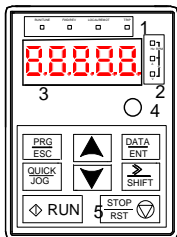
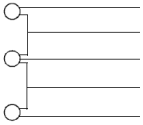









Figure 4-1 Keypad diagram

Note: Fix the external keypad with M3 screws or keypad installation bracket. The installation bracket is optional.

No.	Name	Description	
1	State LED	RUN/TUNE	LED off means that the VFD is in the stopping state; LED blinking means the VFD is in the parameter autotune state; LED on means the VFD is in the running state.
		FWD/REV	FED/REV LED LED off means the VFD is in the forward rotation state; LED on means the VFD is in the reverse rotation state
		LOCAL/REMOT	LED for keypad operation, terminals operation and remote communication control LED off means that the VFD is in the keypad operation state; LED blinking means the VFD is in the terminals operation state; LED on means the VFD is in the remote communication control state.
		TRIP	LED for faults

No.	Name	Description							
			LED on when the VFD is in the fault state; LED off in normal state; LED blinking means the VFD is in the overload pre-alarm state.						
2	Unit LED	Mean the unit displayed currently							
			Hz Frequency unit						
			A Current unit						
			V Voltage unit						
			RPM Rotating speed unit						
		% Percentage							
3	Code displaying zone	5-figure LED display displays various monitoring data and alarm code such as set frequency and output frequency.							
		Display	Means	Display	Means	Display	Means	Display	Means
		0	0	1	1	2	2	3	3
		4	4	5	5	6	6	7	7
		8	8	9	9	A	A	B	B
		C	C	D	D	E	E	F	F
		H	H	I	I	L	L	N	N
		n	n	o	o	P	P	r	r
S	S	t	t	U	U	v	v		
.	.	-	-						
4	Digital potentiometer	Corresponds to AI1.							
5	Buttons		Programming key	Enter or escape from the first level menu and remove the parameter quickly					
			Entry key	Enter the menu step-by-step Confirm parameters					
			UP key	Increase data or function code progressively					
			DOWN key	Decrease data or function code progressively					
			Right-shift key	Move right to select the displaying parameter circularly in stopping and running mode. Select the parameter modifying digit during the parameter modification					

No.	Name	Description	
		Run key	This key is used to operate on the VFD in key operation mode
		Stop/ Reset key	This key is used to stop in running state and it is limited by function code P07.04 This key is used to reset all control modes in the fault alarm state
		Quick key	The function of this key is confirmed by function code P07.02.



4.2 Keypad display

The keypad of Goodrive10 series VFD displays the stopped-state parameters, running-state parameters, function parameter editing status, and fault alarm status.



4.2.1 Displaying stopped-state parameters



When the VFD is in stopped state, the keypad displays stopped-state parameters.

In the stopped state, parameters in various states can be displayed. You can determine which parameters are displayed by setting the binary bits of P07.07. For definitions of the bits, see the description of P07.07.

In stopping state, there are 10 parameters that can be selected for display, including set frequency, bus voltage, input terminal state, output terminal state, PID reference, PID feedback, AI1, AI2, current step of multi-step speed, and pulse counting. P07.07 can select the parameter to be displayed or not by bit, and you can press  to shift selected parameters from left to right or press  to shift selected parameters from right to left.

4.2.2 Displaying running-state parameters

After receiving a valid running command, the VFD enters the running state, and the keypad displays running-state parameters, with the  indicator on. The on/off state of the  indicator is determined by the current running direction.

In running state, there are 20 parameters that can be selected for display, including running frequency, set frequency, bus voltage, output voltage, output current, running speed, output power, output torque, PID reference PID feedback, input terminal state, output terminal state, pulse counting, current step of multi-step speed, AI1, AI2, motor overload percentage, VFD overload percentage, ramp frequency reference, and linear speed. P07.05 and P07.06 can select the parameter to be displayed or not by bit, and you can press  to shift selected parameters from left to right or press  to shift selected parameters from right to left.

4.2.3 Displaying fault information

After detecting a fault signal, the VFD enters the fault alarm state immediately, the fault code blinks on the keypad, and the **TRIP** indicator is on. You can perform fault reset by using the **STOP/RST** key, control terminals, or communication commands.

If the fault persists, the fault code is continuously displayed.

4.2.4 Editing function codes

You can press the **PRG/ESC** key to enter the editing mode in stopped, running, or fault alarm state (if a user password is used, see the description of P07.00). The editing mode contains two levels of menus in the following sequence: Function code group or function code number → Function code setting. You can press the **DATA/ENT** key to enter the function parameter display interface. On the function parameter display interface, you can press the **DATA/ENT** key to save parameter settings or press the **PRG/ESC** key to exit the parameter display interface.



Figure 4-2 Status display

4.3 Operations on the keypad

You can operate the VFD by using the keypad. For details about function code descriptions, see the function code list.

4.3.1 Modifying VFD function codes

The VFD provides three levels of menus, including:

1. Function code group number (level-1 menu)
2. Function code number (level-2 menu)
3. Function code setting (level-3 menu)

Note: When performing operations on the level-3 menu, you can press the **PRG/ESC** or **DATA/ENT** key to return to the level-2 menu. If you press the **DATA/ENT** key, the set value of the parameter is saved to the control board first, and then the level-2 menu is returned, displaying the next function code. If you press the **PRG/ESC** key, the level-2 menu is returned directly, without saving the set value of the parameter, and the current function code is displayed.

If you enter the level-3 menu but the parameter does not have a digit blinking, the parameter

cannot be modified due to either of the following reasons:

- 1) It is read only. Read-only parameters include actual detection parameters and running record parameters.
- 2) It cannot be modified in running state and can be modified only in stopped state.

Example: Change the value of P00.01 from 0 to 1.

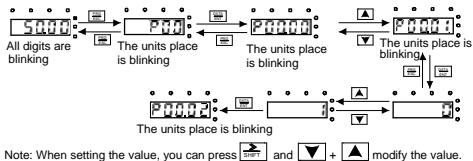

Figure 4-3 Modifying a parameter

4.3.2 Setting a password for the VFD

Goodrive10 series VFDs provide password protection function to users. Set P07.00 to gain the password and the password protection becomes effective 1 minute later after retreating from the function code editing state. Press **[PRG/ESC]** again to the function code editing state, "0.0.0.0.0" will be displayed. Unless using the correct password, you cannot enter it.

To disable the password protection function, you need only to set P07.00 to 0.

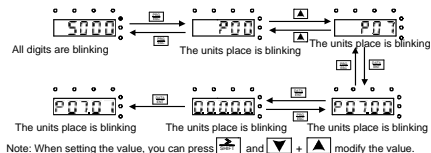

Figure 4-4 Setting a password

4.3.3 Viewing VFD status

The VFD provides group P17 for status viewing. You can enter group P17 for viewing.

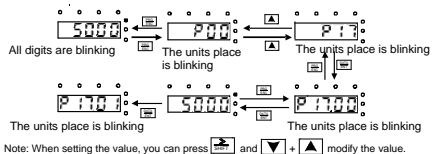

Figure 4-5 Viewing a parameter

5 Function parameters

The function parameters of Goodrive10 series VFDs have been divided into 30 groups (P00–P29) according to the function, of which P18–P28 are reserved. Each function group contains certain function codes. A three-level menu style is applied to function codes. For example, "P08.08" indicates the 8th function code in the P8 group. The P29 group consist of factory function parameters, which are user inaccessible.

The function group numbers correspond to the level-1 menus, the function codes correspond to the level-2 menus, and the function parameters correspond to the level-3 menus.

1. The content of the function code table is as follows:

Column 1 "Function code": Code of the function group and parameter.

Column 2 "Name": Full name of the function parameter.

Column 3 "Description": Detailed description of the function parameter.

Column 4 "Default": Initial value set in factory.

Column 5 "Modify": Whether the function parameter can be modified, and conditions for the modification.

"○" indicates that the value of the parameter can be modified when the VFD is in the stop or running state.

"◎" indicates that the value of the parameter cannot be modified when the VFD is in the running state.

"●" indicates that the value of the parameter is detected and recorded, and cannot be modified.

Note: The VFD automatically checks and constrains the modification of parameters, which helps prevent incorrect modifications.

P00 group Basic functions

Function code	Name	Description	Default	Modify
P00.00	Speed control mode	2:SVPWM control (suitable for asynchronous motor) 2 is suitable in cases where it does not need high control accuracy. Note: AM: asynchronous motor. Carry out motor parameter autotuning before adopting vector mode.	2	⊙
P00.01	Channel of running commands	Select the channel of VFD running commands. The control command of the VFD includes: start-up, stop, forward, reverse, jogging and fault reset. 0:Keypad ("LOCAL/REMOT" light off) Carry out the command control by RUN , STOP/RST on the keypad. Set the multi-function key QUICK/JOG to FWD/REV shifting function (P07.02=3) to change the running direction; press RUN and STOP/RST simultaneously in running state to make the VFD coast to stop. 1:Terminal ("LOCAL/REMOT" flickering) Carry out the running command control by the forward rotation, reverse rotation and forward jogging and reverse jogging of the multi-function terminals 2:Communication ("LOCAL/REMOT" on) The running command is controlled by the upper monitor via communication	0	○
P00.03	Max. output frequency	The parameter is used to set the max. output frequency of the VFD. It is the basis of frequency setup and the acceleration/deceleration. Setting range: P00.04–400.00Hz	50.00Hz	⊙

Function code	Name	Description	Default	Modify
P00.04	Upper limit of the running frequency	The upper limit of the running frequency is the upper limit of the output frequency of the VFD which is lower than or equal to the maximum frequency. Setting range:P00.05–P00.03 (Max. output frequency)	50.00Hz	☉
P00.05	Lower limit of the running frequency	The lower limit of the running frequency is that of the output frequency of the VFD. The VFD runs at the lower limit frequency if the set frequency is lower than the lower limit one. Note: Max. output frequency \geq Upper limit frequency \geq Lower limit frequency Setting range:0.00Hz–P00.04 (Upper limit of the running frequency)	0.00Hz	☉
P00.06	A frequency command selection	Note: Frequency A and frequency B cannot use the same frequency setting mode. The frequency source can be set by P00.09. 0:Keypad data setting (correspond to the keypad potentiometer)	0	○
P00.07	B frequency command selection	Modify the value of function code P00.10 (set the frequency by keypad) to modify the frequency by the keypad. 1: AI1 setting (corresponding to keypad potentiometer) 2: AI2 setting (corresponding to terminal AI) Analog input terminal sets the frequency. There are 2 standard analog input terminal, of which AI1 is adjusted through digital potentiometer, AI2 (0–10V/0–20mA) can be switched by the jumper. Note: when AI2 selects 0–20mA input, 20mA corresponds to 10V. 100.0% of the analog input corresponds to P00.03, -100.0% of the analog input corresponds to the reverse P00.03. 6: Multi-step speed running setting The VFD runs at multi-step speed mode when P00.06=6 or P00.07=6. Set P05 to select the current running step, and set P10 to select the	2	○

Function code	Name	Description	Default	Modify
		<p>current running frequency.</p> <p>The multi-step speed has the priority when P00.06 or P00.07 does not equal to 6, but the setting step can only be the 1–15 steps. The setting step is 1–15 if P00.06 or P00.07 equals to 6.</p> <p>7: PID control setting The running mode of the VFD is process PID control when P00.06=7 or P00.07=7. It is necessary to set P09. The running frequency of the VFD is the value after PID effect. See P09 for the detailed information of the preset source, preset value, feedback source of PID.</p> <p>8: Modbus communication setting The frequency is set by Modbus communication. See P14 for detailed information.</p>		
P00.08	B frequency command reference	<p>0: Max.output frequency, 100% of B frequency setting corresponds to max. output frequency</p> <p>1: A frequency command, 100% of B frequency setting corresponds to the max. output frequency. Select this setting if it needs to adjust on the base of A frequency command</p>	1	○
P00.09	Combination of the setting source	<p>0: A, the current frequency setting is A frequency command</p> <p>1: B, the current frequency setting is B frequency command</p> <p>2: A+B, the current frequency setting is A frequency command + B frequency command</p> <p>3: A-B, the current frequency setting is A frequency command - B frequency command</p> <p>4: Max (A, B): The bigger one between A frequency command and B frequency is the set frequency.</p> <p>5: Min (A, B): The lower one between A frequency command and B frequency is the set frequency.</p> <p>Note: The combination manner can be shifted by P05 (terminal function).</p>	0	○

Function code	Name	Description	Default	Modify
P00.10	Frequency set through keypad	When A and B frequency commands are selected as "keypad setting", this parameter will be the initial value of VFD reference frequency Setting range: 0.00Hz–P00.03 (max. output frequency)	50.00Hz	<input type="radio"/>
P00.11	ACC time 1	ACC time means the time needed if the VFD speeds up from 0Hz to max. output frequency (P00.03). DEC time means the time needed if the VFD speeds down from max. output frequency to 0Hz (P00.03).	Depend on model	<input type="radio"/>
P00.12	DEC time 1	Goodrive10 series VFDs define four groups of ACC/DEC time which can be selected by P05. The factory default ACC/DEC time of the VFD is the first group. Setting range of P00.11 and P00.12: 0.0–3600.0s	Depend on model	<input type="radio"/>
P00.13	Running direction selection	0: Runs at the default direction, the VFD runs in the forward direction. FWD/REV indicator is off. 1: Runs at the opposite direction, the VFD runs in the reverse direction. FWD/REV indicator is on. Modify the function code to shift the rotation direction of the motor. This effect equals to the shifting the rotation direction by adjusting either two of the motor lines (U, V and W). The motor rotation direction can be changed by QUICK/JOG on the keypad. Refer to parameter P07.02. Note: When the function parameter comes back to the default value, the motor's running direction will come back to the factory default state, too. In some cases it should be used with caution after commissioning if the change of rotation direction is disabled. 2: Forbid to run in reverse direction: It can be used in some special cases if the reverse running is disabled.	0	<input type="radio"/>

Function code	Name	Description	Default	Modify																				
P00.14	Carrier frequency setting	<p>The relationship table of the motor type and carrier frequency:</p> <table border="1"> <thead> <tr> <th>Motor type</th> <th>Factory value of carrier frequency</th> </tr> </thead> <tbody> <tr> <td>0.2–2.2kW</td> <td>4kHz</td> </tr> </tbody> </table> <table border="1"> <thead> <tr> <th>Carrier frequency</th> <th>Electro magnetic noise</th> <th>Noise and leakage current</th> <th>Heating eliminating</th> </tr> </thead> <tbody> <tr> <td>1kHz</td> <td>↑ High</td> <td>↑ Low</td> <td>↑ Low</td> </tr> <tr> <td>10kHz</td> <td>↕</td> <td>↕</td> <td>↕</td> </tr> <tr> <td>15kHz</td> <td>↓ Low</td> <td>↓ High</td> <td>↓ High</td> </tr> </tbody> </table> <p>The advantage of high carrier frequency: ideal current waveform, little current harmonic wave and motor noise.</p> <p>The disadvantage of high carrier frequency: increasing the switch loss, increasing VFD temperature and the impact to the output capacity. The VFD needs to derate on high carrier frequency. At the same time, the leakage and electrical magnetic interference will increase.</p> <p>Applying low carrier frequency is contrary to the above, too low carrier frequency will cause unstable running, torque decreasing and surge.</p> <p>The manufacturer has set a reasonable carrier frequency when the VFD is in factory. In general, users do not need to change the parameter.</p> <p>When the frequency used exceeds the default carrier frequency, the VFD needs to derate 10% for each additional 1kHz carrier frequency.</p> <p>Setting range:1.0–15.0kHz</p>	Motor type	Factory value of carrier frequency	0.2–2.2kW	4kHz	Carrier frequency	Electro magnetic noise	Noise and leakage current	Heating eliminating	1kHz	↑ High	↑ Low	↑ Low	10kHz	↕	↕	↕	15kHz	↓ Low	↓ High	↓ High	Depend on model	○
Motor type	Factory value of carrier frequency																							
0.2–2.2kW	4kHz																							
Carrier frequency	Electro magnetic noise	Noise and leakage current	Heating eliminating																					
1kHz	↑ High	↑ Low	↑ Low																					
10kHz	↕	↕	↕																					
15kHz	↓ Low	↓ High	↓ High																					
P00.16	AVR function selection	<p>0: Invalid</p> <p>1: Valid during the whole process</p> <p>The auto-adjusting function of the VFD can cancel the impact on the output voltage of the VFD because of the bus voltage fluctuation.</p>	1	○																				

Function code	Name	Description	Default	Modify
P00.18	Function restore parameter	0:No operation 1:Restore the default value 2:Clear fault records Note: <ul style="list-style-type: none"> The function code will restore to 0 after finishing the operation of the selected function code. Restoring to the default value will cancel the user password, please use this function with caution. 	0	⊙

P01 group Start and stop control

Function code	Name	Description	Default	Modify
P01.00	Start mode	0: Start-up directly:start from the starting frequency P01.01 1:Start-up after DC braking: start the motor from the starting frequency after DC braking (set the parameter P01.03 and P01.04). It is suitable in the cases where reverse rotation may occur to the low inertia load during starting.	0	⊙
P01.01	Starting frequency of direct start	Starting frequency of direct start-up means the original frequency during the VFD starting. See P01.02 for detailed information. Setting range: 0.00–50.00Hz	0.50Hz	⊙
P01.02	Starting frequency hold time	Set a proper starting frequency to increase the torque of the VFD during starting. During the retention time of the starting frequency, the output frequency of the VFD is the starting frequency. And then, the VFD will run from the starting frequency to the set frequency. If the set frequency is lower than the starting frequency, the VFD will stop running and keep in the stand-by state. The starting frequency is not limited in the lower limit frequency.	0.0s	⊙

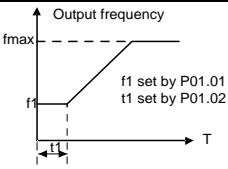
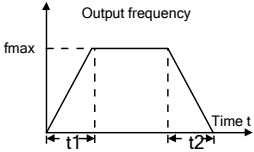
Function code	Name	Description	Default	Modify
		 <p>Setting range: 0.0–50.0s</p>		
P01.03	Braking current before start	The VFD will carry out DC braking at the braking current set before starting and it will speed up after the DC braking time. If the DC braking time is set to 0, the DC braking is invalid.	0.0%	⊙
P01.04	Braking time before start	The stronger the braking current, the bigger the braking power. The DC braking current before starting means the percentage of the rated current of the VFD. Setting range of P01.03: 0.0–100.0% Setting range of P01.04: 0.0–50.0s	0.00s	⊙
P01.05	ACC/DEC mode selection	The changing mode of the frequency during start-up and running. 0: Linear type. The output frequency increases or decreases linearly. 	0	⊙
P01.08	Stop mode	0: Decelerate to stop. After a stop command takes effect, the VFD lowers output frequency based on the DEC mode and the DEC time; after the frequency drop to 0Hz, the VFD stops. 1: Coast to stop. After a stop command takes effect, the VFD stops output immediately; and the load coasts to stop according to mechanical inertia.	0	○

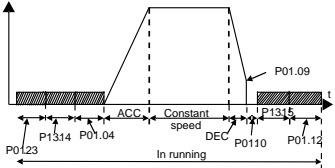
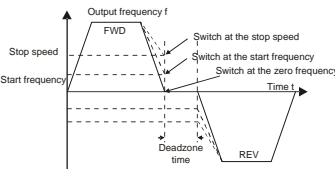
Function code	Name	Description	Default	Modify
P01.09	Starting frequency of DC braking for stop	Starting frequency of DC braking for stop: During the deceleration to stop, the VFD starts DC braking for stop when running frequency reaches the starting frequency determined by P1.09.	0.00Hz	○
P01.10	Waiting time before DC braking	Waiting time before DC braking: The VFD blocks the output before starting DC braking. After this wait time, DC braking is started so as to prevent overcurrent caused by DC braking at high speed.	0.00s	○
P01.11	DC braking current for stop	DC braking current for stop: The value of P01.11 is the percentage of rated current of VFD. Stronger current indicates greater DC braking effect.	0.0%	○
P01.12	DC braking time for stop	DC braking time for stop: It indicates the hold time of DC braking. If the time is 0, DC braking is invalid, and the VFD coasts to stop. 	0.00s	○
P01.13	FWD/REV running deadzone time	This function code indicates the transition time specified in P01.14 during FWD/REV rotation switching. See the following figure. 	0.00s	○

Function code	Name	Description	Default	Modify
		Setting range: 0.0–3600.0s		
P01.14	FWD/REV running switching mode	Set the switching threshold of the VFD: 0: Switch at zero frequency 1: Switch at the starting frequency 2: Switch after the speed reaches the stop speed with a delay.	0	☉
P01.15	Stop speed	0.00–100.00Hz	1.00 Hz	☉
P01.18	Terminal-based running command protection at power-on	When the channel of running commands is terminal control, the system detects the state of the running terminal during power-on. 0: The terminal running command is invalid at power-on. Even the running command is considered as valid during power-on, the VFD does not run and it keeps the protection state until the running command is canceled and enabled again. 1: The terminal running command is valid at power-on. If the running command is considered as valid during power-on, the VFD is started automatically after the initialization. Note: Exercise caution before using this function. Otherwise, serious result may follow.	0	○
P01.19	Action selected when running frequency less than frequency lower limit (valid when frequency lower limit greater than 0)	This function code determines the running state of the VFD when the set frequency is lower than the lower-limit one. 0: Run at the frequency lower limit 1: Stop 2: Sleep The VFD will coast to stop when the set frequency is lower than the lower-limit one. If the set frequency is above the lower limit one again and it lasts for the time set by P01.20, the VFD will come back to the running state automatically.	0	☉

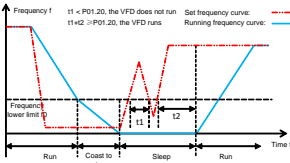
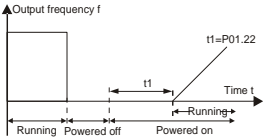
Function code	Name	Description	Default	Modify
P01.20	Wake-up-from-sleep delay	<p>This function code determines the wake-up-from-sleep delay time. When the running frequency of the VFD is lower than the lower limit, the VFD becomes standby. When the set frequency exceeds the lower limit one again and it lasts for the time set by P01.20, the VFD runs automatically.</p>  <p>Setting range: 0.0–3600.0s (valid when P01.19=2)</p>	0.0s	<input type="radio"/>
P01.21	Power-off restart selection	<p>This function can enable the VFD start or not after the power off and then power on.</p> <p>0: Disabled 1: Enabled, if the starting need is met, the VFD will run automatically after waiting for the time defined by P01.22.</p>	0	<input type="radio"/>
P01.22	Wait time for restart after power-off	<p>The function indicates the wait time before the automatic running of the VFD that is re-powered on.</p>  <p>Setting range: 0.0–3600.0s (valid when P01.21=1)</p>	1.0s	<input type="radio"/>
P01.23	Start delay	<p>After a VFD running command is given, the VFD is in standby state and restarts with the delay defined by P01.23 to implement brake release.</p> <p>Setting range: 0.0–60.0s</p>	0.0s	<input type="radio"/>

Function code	Name	Description	Default	Modify
P01.24	Delay of the stopping speed	Setting range: 0.0–100.0 s	0.0s	<input type="radio"/>

P02 group Motor parameters

Function code	Name	Description	Default	Modify	
P02.01	Rated power of AM	0.1–3000.0kW	Parameters of the controlled asynchronous motor. To ensure the control performance, set P02.01–P02.05 correctly according to the information on the nameplate of the asynchronous motor. You need to configure a motor based on the standard motor configuration of the VFD. If the power of the motor is greatly different from that of the standard motor configuration, the control performance of the VFD degrades significantly.	Depend on model	<input checked="" type="radio"/>
P02.02	Rated frequency of AM	0.01Hz–P00.03 (max. output frequency)		50.00Hz	<input checked="" type="radio"/>
P02.03	Rated speed of AM	1–36000rpm		Depend on model	<input checked="" type="radio"/>
P02.04	Rated voltage of AM	0–1200V		Depend on model	<input checked="" type="radio"/>
P02.05	Rated current of AM	0.8–6000.0A		Depend on model	<input checked="" type="radio"/>
P02.06	Stator resistor of AM	0.001–65.535Ω		Depend on model	<input type="radio"/>
P02.07	Rotor resistor of AM	0.001–65.535Ω		Depend on model	<input type="radio"/>
P02.08	Leakage inductance of AM	0.1–6553.5mH		Depend on model	<input type="radio"/>

Function code	Name	Description	Default	Modify
P02.09	Mutual inductance of AM	0.1–6553.5mH	Depend on model	<input type="radio"/>
P02.10	Non-load current of AM	0.1–6553.5A	Depend on model	<input type="radio"/>
P02.26	Motor overload protection	<p>0: No protection</p> <p>1: Common motor protection (with low speed compensation). As the cooling effect of a common motor is degraded at low speed running, the corresponding electronic thermal protection value needs to be adjusted properly. The low speed compensation indicates lowering the overload protection threshold of the motor whose running frequency is lower than 30Hz.</p> <p>2: Variable-frequency motor compensation (without low speed compensation). Because the heat dissipation function for a variable-frequency motor is not impacted by the rotation speed, it is not necessary to adjust the protection value at low speed running.</p>	2	<input checked="" type="radio"/>
P02.27	Motor overload protection coefficient	<p>Motor overload multiples $M = I_{out}/(I_n * K)$</p> <p>I_n is rated motor current, I_{out} is VFD output current, and K is motor overload protection coefficient.</p> <p>A smaller value of K indicates a bigger value of M. When $M=116\%$, protection is performed after motor overload lasts for 1 hour; when $M=150\%$, protection is performed after motor overload lasts for 12 minutes; when $M=180\%$, protection is performed after motor overload lasts for 5 minutes; when $M=200\%$, protection is performed after motor overload lasts for 60 seconds; and when $M \geq 400\%$, protection is performed immediately.</p>	100.0%	<input type="radio"/>

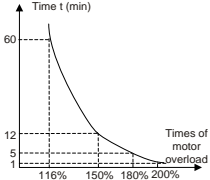
Function code	Name	Description	Default	Modify
		 <p>Setting range: 20.0%–120.0%</p>		

P04 group SVPWM control

Function code	Name	Description	Default	Modify
P04.00	Motor V/F curve setting	This group of function code defines the V/F curve of motor to meet the needs of different loads. 0: Straight-line V/F curve, applicable to the constant torque load 1: Multi-dot V/F curve	0	<input checked="" type="radio"/>
P04.01	Torque boost	In order to compensate for low-frequency torque characteristics, you can make some boost compensation for the output voltage. P04.01 is relative to the maximum output voltage V_b .	0.0%	<input type="radio"/>
P04.02	Torque boost cut-off	P04.02 defines the percentage of cut-off frequency of manual torque boost to the rated motor frequency f_b . Torque boost can improve the low-frequency torque characteristics of SVPWM. You need to select torque boost based on the load. For example, larger load requires larger torque boost, however, if the torque boost is too large, the motor will run at over-excitation, which may cause increased output current and motor overheating, thus decreasing the efficiency. When torque boost is set to 0.0%, the VFD is	20.0%	<input type="radio"/>

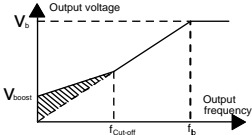
Function code	Name	Description	Default	Modify
		<p>automatic torque boost.</p> <p>Torque boost cut-off threshold: Below this frequency threshold, the torque boost is valid, exceeding this threshold will invalidate torque boost.</p>  <p>Setting range of P04.01: 0.0% (automatic), 0.1%–10.0%</p> <p>Setting range of P04.02: 0.0%–50.0%</p>		
P04.03	Motor V/F frequency point 1	When P04.00 = 1, the user can set V//F curve through P04.03–P04.08.	0.00Hz	<input type="radio"/>
P04.04	Motor V/F voltage point 1	V/F is generally set according to the load of the motor.	00.0%	<input type="radio"/>
P04.05	Motor V/F frequency point 2	Note: $V_1 < V_2 < V_3$, $f_1 < f_2 < f_3$. Too high low frequency voltage will heat the motor excessively or damage. The VFD may occur the overcurrent speed or overcurrent protection.	00.00Hz	<input type="radio"/>
P04.06	Motor V/F voltage point 2		00.0%	<input type="radio"/>
P04.07	Motor V/F frequency point 3		00.00Hz	<input type="radio"/>
P04.08	Motor V/F voltage point 3	<p>Setting range of P04.03: 0.00Hz–P04.05</p> <p>Setting range of P04.04: 0.0%–110.0% (rated voltage of the motor)</p> <p>Setting range of P04.05: P04.03– P04.07</p> <p>Setting range of P04.06: 0.0%–110.0% (rated voltage of the motor)</p>	00.0%	<input type="radio"/>

Function code	Name	Description	Default	Modify
		Setting range of P04.07: P04.05–P02.02 (rated frequency of motor) Setting range of P04.08: 0.0%–110.0% (rated voltage of the motor)		
P04.09	Motor V/F slip compensation gain	This function code is used to compensate the change of the rotation speed caused by load during compensation SVPWM control to improve the rigidity of the motor. It can be set to the rated slip frequency of the motor which is counted as below: $\Delta f = f_b - n \cdot p / 60$ Of which, f_b is the rated frequency of the motor, its function code is P02.02; n is the rated rotating speed of the motor and its function code is P02.03; p is the pole pair of the motor. 100.0% corresponds to the rated slip frequency Δf . Note: No torque compensation for 1PH 220V VFDs. Setting range: 0.0–200.0%	380V: 100.0%	○
			220V: 0%	
P04.10	Low frequency vibration control factor	In the SVPWM control mode, current fluctuation may occur to the motor on some frequency, especially the motor with big power. The motor can not run stably or overcurrent may occur. These phenomena can be canceled by adjusting this parameter. Setting range of P04.10: 0–100 Setting range of P04.11: 0–100 Setting range of P04.12: 0.00Hz–P00.03 (max. output frequency)	10	○
P04.11	High frequency vibration control factor		10	○
P04.12	Vibration control threshold		30.00 Hz	○

Function code	Name	Description	Default	Modify
P04.26	Energy-saving operation	0: No action 1: Automatic energy-saving operation Under light-load state, the motor can adjust the output voltage automatically to achieve energy-saving purpose.	0	⊙

P05 group Input terminals

Function code	Name	Description	Default	Modify
P05.01	S1 terminal function selection	0: No function 1: Forward running 2: Reverse running 3: 3-wire running control	1	⊙
P05.02	S2 terminal function selection	4: Forward jogging 5: Reverse jogging 6: Coast to stop 7: Fault reset	4	⊙
P05.03	S3 terminal function selection	8: Running pause 9: External fault input 10: Frequency increase (UP) 11: Frequency decrease (DOWN)	7	⊙
P05.04	S4 terminal function selection	12: Clear frequency increase/decrease setting 13: Switch-over between setup A and setup B 14: Switch-over between combination setting and setup A	0	⊙
P05.05	S5 terminal function selection	15: Switch-over between combination setting and setup B 16: Multi-step speed terminal 1 17: Multi-step speed terminal 2 18: Multi-step speed terminal 3 19: Multi-step speed terminal 4 20: Multi-step speed pause 21: ACC/DEC time selection 1 25: PID control pause 26: Wobbling frequency pause (stop at the current frequency)	0	⊙

Function code	Name	Description	Default	Modify										
		27: Wobbling frequency reset (return to the center frequency) 28: Counter reset 30: ACC/DEC disabled 31: Counter trigger 33: Clear frequency increase/decrease setting temporarily 34: DC brake 36: Command switches to keypad 37: Command switches to the terminals 38: Command switches to communication												
P05.10	Input terminal polarity	The function code is used to set the polarity of input terminals. When a bit is 0, the input terminal is positive. When a bit is 1, the input terminal is negative. <table border="1" style="margin: 10px auto;"> <tr> <td>BIT4</td> <td>BIT3</td> <td>BIT2</td> <td>BIT1</td> <td>BIT0</td> </tr> <tr> <td>S5</td> <td>S4</td> <td>S3</td> <td>S2</td> <td>S1</td> </tr> </table> Setting range:0x000–0x01F	BIT4	BIT3	BIT2	BIT1	BIT0	S5	S4	S3	S2	S1	0x000	○
BIT4	BIT3	BIT2	BIT1	BIT0										
S5	S4	S3	S2	S1										
P05.11	Digital filter time	The function code is used to set the filter time for S1–S5. In strong interference cases, increase the value to avoid mal-operation. 0.000–1.000s	0.010s	○										
P05.12	Virtual terminals setting	Enable the virtual terminal input function in communication mode. 0:Virtual terminals is invalid 1: Modbus communication virtual terminals are valid Note: After a virtual terminal is enabled, the state of the terminal can be changed only in communication mode. The communication address is 0x200A.	0	◎										
P05.13	Terminal control running mode	The function code is used to set the mode of terminal control. 0: 2-wire control 1, the enabling consistent with the direction. This mode is widely used. The defined FWD/REV terminal command determines the motor rotation direction.	0	◎										

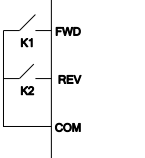
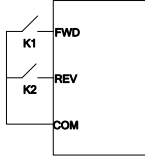
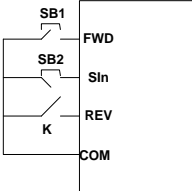
Function code	Name	Description	Default	Modify																														
		 <table border="1" data-bbox="543 189 709 393"> <thead> <tr> <th>FWD</th> <th>REV</th> <th>Running command</th> </tr> </thead> <tbody> <tr> <td>OFF</td> <td>OFF</td> <td>Stopping</td> </tr> <tr> <td>ON</td> <td>OFF</td> <td>Forward running</td> </tr> <tr> <td>OFF</td> <td>ON</td> <td>Reverse running</td> </tr> <tr> <td>ON</td> <td>ON</td> <td>Hold on</td> </tr> </tbody> </table> <p>1: 2-wire control 2, the enabling separated from the direction. In this mode, FWD is the enabling terminal. The direction depends on the defined REV state.</p>  <table border="1" data-bbox="543 531 709 735"> <thead> <tr> <th>FWD</th> <th>REV</th> <th>Running command</th> </tr> </thead> <tbody> <tr> <td>OFF</td> <td>OFF</td> <td>Stopping</td> </tr> <tr> <td>ON</td> <td>OFF</td> <td>Forward running</td> </tr> <tr> <td>OFF</td> <td>ON</td> <td>Stopping</td> </tr> <tr> <td>ON</td> <td>ON</td> <td>Reverse running</td> </tr> </tbody> </table> <p>2: 3-wire control 1; This mode defines Sin as the enabling terminal, and the running command is generated by FWD, while the direction is controlled by REV. During running, the Sin terminal needs to be closed, and terminal FWD generates a rising edge signal, then the VFD starts to run in the direction set by the state of terminal REV; the VFD needs to be stopped by disconnecting terminal Sin.</p> 	FWD	REV	Running command	OFF	OFF	Stopping	ON	OFF	Forward running	OFF	ON	Reverse running	ON	ON	Hold on	FWD	REV	Running command	OFF	OFF	Stopping	ON	OFF	Forward running	OFF	ON	Stopping	ON	ON	Reverse running		
FWD	REV	Running command																																
OFF	OFF	Stopping																																
ON	OFF	Forward running																																
OFF	ON	Reverse running																																
ON	ON	Hold on																																
FWD	REV	Running command																																
OFF	OFF	Stopping																																
ON	OFF	Forward running																																
OFF	ON	Stopping																																
ON	ON	Reverse running																																

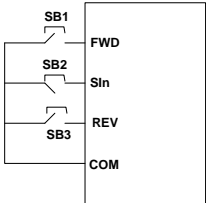
Function code	Name	Description	Default	Modify																																									
		<p>During running, the direction control is as follows:</p> <table border="1"> <thead> <tr> <th>SIn</th> <th>REV</th> <th>Previous direction</th> <th>Present direction</th> </tr> </thead> <tbody> <tr> <td rowspan="2">ON</td> <td rowspan="2">OFF→ON</td> <td>Forward</td> <td>Reverse</td> </tr> <tr> <td>Reverse</td> <td>Forward</td> </tr> <tr> <td rowspan="2">ON</td> <td rowspan="2">ON→OFF</td> <td>Reverse</td> <td>Forward</td> </tr> <tr> <td>Forward</td> <td>Reverse</td> </tr> <tr> <td rowspan="2">ON→OFF</td> <td>ON</td> <td colspan="2" rowspan="2">Decelerate to stop</td> </tr> <tr> <td>OFF</td> </tr> </tbody> </table> <p>SIn: 3-wire control, FWD: Forward running, REV: Reverse running</p> <p>3: 3-wire control 2; This mode defines SIn as the enabling terminal, and the running command is generated by FWD or REV, but the direction is controlled by both FWD and REV. During running, the SIn terminal needs to be closed, and terminal FWD or REV generates a rising edge signal to control the running and direction of VFD; the VFD needs to be stopped by disconnecting terminal SIn.</p>  <table border="1"> <thead> <tr> <th>SIn</th> <th>FWD</th> <th>REV</th> <th>Direction</th> </tr> </thead> <tbody> <tr> <td rowspan="2">ON</td> <td rowspan="2">OFF→ON</td> <td>ON</td> <td>Forward</td> </tr> <tr> <td>OFF</td> <td>Reverse</td> </tr> <tr> <td rowspan="2">ON</td> <td>ON</td> <td rowspan="2">OFF→ON</td> <td>Forward</td> </tr> <tr> <td>OFF</td> <td>Reverse</td> </tr> <tr> <td>ON→OFF</td> <td>/</td> <td>/</td> <td>Decelerate to stop</td> </tr> </tbody> </table>	SIn	REV	Previous direction	Present direction	ON	OFF→ON	Forward	Reverse	Reverse	Forward	ON	ON→OFF	Reverse	Forward	Forward	Reverse	ON→OFF	ON	Decelerate to stop		OFF	SIn	FWD	REV	Direction	ON	OFF→ON	ON	Forward	OFF	Reverse	ON	ON	OFF→ON	Forward	OFF	Reverse	ON→OFF	/	/	Decelerate to stop		
SIn	REV	Previous direction	Present direction																																										
ON	OFF→ON	Forward	Reverse																																										
		Reverse	Forward																																										
ON	ON→OFF	Reverse	Forward																																										
		Forward	Reverse																																										
ON→OFF	ON	Decelerate to stop																																											
	OFF																																												
SIn	FWD	REV	Direction																																										
ON	OFF→ON	ON	Forward																																										
		OFF	Reverse																																										
ON	ON	OFF→ON	Forward																																										
	OFF		Reverse																																										
ON→OFF	/	/	Decelerate to stop																																										

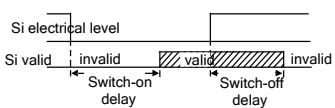
Function code	Name	Description	Default	Modify	
		<p>SIn: 3-wire control, FWD: Forward running, REV: Reverse running</p> <p>Note: For 2-wire controlled running mode, when the FWD/REV terminal is valid, if the VFD stops due to a stop command given by another source, the VFD does not run again after the stop command disappears even if the control terminal FWD/REV is still valid. To make the VFD run, you need to trigger FWD/REV again, for example, PLC single-cycle stop, fixed-length stop, and valid STOP/RST stop during terminal control. (See P07.04).</p>			
P05.14	S1 switch-on delay	<p>The function code defines the corresponding delay time of electrical level of the programmable terminals from switching on to switching off.</p>  <p>Si electrical level</p> <p>Si valid invalid valid invalid</p> <p>Switch-on delay Switch-off delay</p>	0.000s	○	
P05.15	S1 switch-off delay		0.000s	○	
P05.16	S2 switch-on delay		0.000s	○	
P05.17	S2 switch-off delay		0.000s	○	
P05.18	S3 switch-on delay		0.000s	○	
P05.19	S3 switch-off delay		Setting range:0.000–50.000s	0.000s	○
P05.20	S4 switch-on delay		0.000s	○	
P05.21	S4 switch-off delay		0.000s	○	

Function code	Name	Description	Default	Modify
P05.22	S5 switch-on delay		0.000s	<input type="radio"/>
P05.23	S5 switch-off delay		0.000s	<input type="radio"/>
P05.32	Lower limit of AI1	AI1 is set by the keypad potentiometer, AI2 is set by control terminal AI.	0.00V	<input type="radio"/>
P05.33	Corresponding setting of the lower limit of AI1	The function code defines the relationship between the analog input voltage and its corresponding set value. If the analog input voltage beyond the set minimum or maximum input value, the VFD will count at the minimum or maximum one.	0.0%	<input type="radio"/>
P05.34	Upper limit of AI1	When the analog input is the current input, the corresponding voltage of 0–20 mA is 0–10V. In different cases, the corresponding rated value of 100.0% is different. See the application for detailed information.	10.00V	<input type="radio"/>
P05.35	Corresponding setting of the upper limit of AI1		Input filter time: this parameter is used to adjust the sensitivity of the analog input. Increasing the value properly can enhance the anti-interference of the analog, but weaken the sensitivity of the analog input	100.0%
P05.36	AI1 input filter time	The following figure illustrates different applications:	0.100s	<input type="radio"/>
P05.37	Lower limit of AI2	The following figure illustrates different applications:	0.00V	<input type="radio"/>
P05.38	Corresponding setting of the lower limit of AI2		0.0%	<input type="radio"/>
P05.39	Upper limit of AI2		10.00V	<input type="radio"/>
P05.40	Corresponding setting of the upper limit of AI2		100.0%	<input type="radio"/>

Function code	Name	Description	Default	Modify
P05.41	AI2 input filter time	<p>Note: AI2 supports 0–10V or 0–20mA input, when AI2 selects 0–20mA input, the corresponding voltage of 20mA is 10V.</p> <p>Setting range of P05.32: 0.00V–P05.34 Setting range of P05.33: -100.0%–100.0% Setting range of P05.34: P05.32–10.00V Setting range of P05.35: -100.0%–100.0% Setting range of P05.36: 0.000s–10.000s Setting range of P05.37: 0.00V–P05.39 Setting range of P05.38: -100.0%–100.0% Setting range of P05.39: P05.37–10.00V Setting range of P05.40: -100.0%–100.0% Setting range of P05.41: 0.000s–10.000s</p>	0.100s	○

P06 group Output terminals

Function code	Name	Description	Default	Modify
P06.01	Y output selection	0: Invalid 1: In running 2: In forward running 3: In reverse running 4: In jogging 5: VFD fault 6: Frequency level detection FDT1 8: Frequency reached 9: Running in zero speed 10: Reach frequency upper limit 11: Reach frequency lower limit 12: Ready to run 14: Overload pre-alarm 15: Underload pre-alarm 18: Reach set counting value 19: Reach designated counting value 20: External fault is valid 22: Reach running time 23: Virtual terminals output of Modbus communication	0	○
P06.03	Relay RO output selection		1	○

Function code	Name	Description	Default	Modify								
P06.05	Output terminal polarity selection	<p>The function code is used to set the polarity of output terminals.</p> <p>When the bit is set to 0, the input terminal is positive.</p> <p>When the bit is set to 1, the input terminal is negative.</p> <table border="1"> <tr> <td>BIT3</td> <td>BIT2</td> <td>BIT1</td> <td>BIT0</td> </tr> <tr> <td>Reserved</td> <td>RO1</td> <td>Reserved</td> <td>Y</td> </tr> </table> <p>Setting range:00-0F</p>	BIT3	BIT2	BIT1	BIT0	Reserved	RO1	Reserved	Y	00	<input type="radio"/>
BIT3	BIT2	BIT1	BIT0									
Reserved	RO1	Reserved	Y									
P06.06	Y switch-on delay	0.000-50.000s	0.000s	<input type="radio"/>								
P06.07	Y switch-off delay	0.000-50.000s	0.000s	<input type="radio"/>								
P06.10	RO switch-on delay	<p>The function code defines the delay time corresponding to the electrical level changes when the programmable output terminals switch on or switch off.</p> <p>Setting range :0.000-50.000s</p>	0.000s	<input type="radio"/>								
P06.11	RO switch-off delay		0.000s	<input type="radio"/>								
P06.14	AO output	<p>0: Running frequency</p> <p>1: Set frequency</p> <p>2: Ramp reference frequency</p> <p>3: Running rotation speed (relative to twice the rotating speed of the motor)</p> <p>4: Output current (relative to twice the rated current of the VFD)</p> <p>5: Output current (relative to twice the rated current of the motor)</p> <p>6: Output voltage (relative to 1.5 times the rated voltage of the VFD)</p> <p>7: Output power (relative to twice the rated power of the motor)</p> <p>8: Set torque (relative to twice the rated torque of</p>	0	<input type="radio"/>								

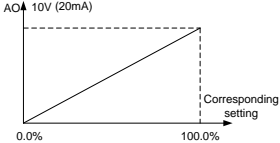
Function code	Name	Description	Default	Modify
		the motor) 9: Output torque 10: AI1 input 11: AI2 input 14: Value 1 set through Modbus communication 15: Value 2 set through Modbus communication		
P06.17	Lower limit of AO output	The function codes define the relationship between the output value and analog output.	0.0%	<input type="radio"/>
P06.18	Corresponding AO output to the lower limit	When the output value exceeds the allowed range, the output uses the lower limit or upper limit.	0.00V	<input type="radio"/>
P06.19	Upper limit of AO output	When the analog output is current output, 1 mA equals to 0.5 V.	100.0%	<input type="radio"/>
P06.20	The corresponding AO output to the upper limit	In different cases, the corresponding analog output of 100% of the output value is different. 	10.00V	<input type="radio"/>
P06.21	AO output filter time	Setting range of P06.17 0.0%–P06.19 Setting range of P06.18 0.00V–10.00V Setting range of P06.19 P06.17–100.0% Setting range of P06.20 0.00V–10.00V Setting range of P06.21 0.000s–10.000s	0.000s	<input type="radio"/>

P07 group HMI

Function code	Name	Description	Default	Modify
P07.00	User password	0–65535 When you set the function code to a non-zero number, password protection is enabled. If you set the function code to 00000, the previous user password is cleared and password protection is disabled. After the user password is set and takes effect,	0	<input type="radio"/>

Function code	Name	Description	Default	Modify
		<p>you cannot enter the parameter menu if you enter an incorrect password. Please remember your password and save it in a secure place.</p> <p>After you exit the function code editing interface, the password protection function is enabled within 1 minute. If password protection is enabled, "0.0.0.0.0" is displayed when you press the PRG/ESC key again to enter the function code editing interface. You need to enter the correct user password to enter the interface.</p> <p>Note: Restoring to the default value may delete the user password. Exercise caution when using this function.</p>		
P07.02	QUICK/JOG key function selection	<p>0: No function</p> <p>1: Jogging running. Press QUICK/JOG to start jogging running.</p> <p>2: Shift the display state by the shifting key. Press QUICK/JOG to shift the displayed function code from right to left.</p> <p>3: Shift between forward rotations and reverse rotations. Press QUICK/JOG to shift the direction of the frequency commands. This function is only valid in the keypad commands channels.</p> <p>4: Clear UP/DOWN settings. Press QUICK/JOG to clear the set value of UP/DOWN.</p> <p>5: Coast to stop. Press QUICK/JOG to coast to stop.</p> <p>6: Shift the running commands source. Press QUICK/JOG to shift the running commands source.</p> <p>7: Quick commission mode(committee according to the non-factory parameter)</p> <p>Note: Press QUICK/JOG to shift between forward rotation and reverse rotation, the VFD does not record the state after shifting during powering off. The VFD will run according to parameter P00.13 during next powering on.</p>	1	©

Function code	Name	Description	Default	Modify
P07.03	Sequence of switching running command channels by pressing QUICK/JOG	When P07.02 =6, set the sequence of switching running command channels by pressing this key. 0: Keypad→Terminal→Communication 1: Keypad←→Terminal 2: Keypad←→Communication 3: Terminal←→Communication	0	<input type="radio"/>
P07.04	Stop function validity of STOP/RST	The function code specifies the stop function validity of STOP/RST . For fault reset, STOP/RST is valid in any conditions. 0: Valid only for keypad control 1: Valid both for keypad and terminal control 2: Valid both for keypad and communication control 3: Valid for all control modes	0	<input type="radio"/>
P07.05	Displayed parameters 1 of running state	0x0000–0xFFFF BIT0: Running frequency (Hz on) BIT1: Set frequency(Hz flickering) BIT2: Bus voltage (Hz on) BIT3: Output voltage (V on) BIT4: Output current (A on) BIT5: Running speed (rpm on) BIT6: Output power (% on) BIT7: Output torque (% on) BIT8: PID reference (% flickering) BIT9: PID feedback (% on) BIT10: Input terminal state BIT11: Output terminal state BIT13: Pulse counting BIT15: Current step of multi-step speed	0x03FF	<input type="radio"/>
P07.06	Displayed parameters 2 of running state	0x0000–0xFFFF BIT0: AI1 (V on) BIT1: AI2 (V on) BIT4: Motor overload percentage (% on) BIT5: VFD overload percentage (% on) BIT6: Ramp frequency reference (Hz on) BIT7: Linear speed	0x0000	<input type="radio"/>

Function code	Name	Description	Default	Modify
P07.07	Parameter selection of stopping state	0x0000–0xFFFF BIT0: Set frequency (Hz on, frequency flickering slowly) BIT1: Bus voltage (V on) BIT2: Input terminal state BIT3: Output terminal state BIT4: PID reference (% flickering) BIT5: PID feedback (% on) BIT7: AI1 (V on) BIT8: AI2 (V on) BIT11: Current step of multi-step speed BIT12: Pulse counting	0x00FF	○
P07.08	Frequency display coefficient	0.01–10.00 Displayed frequency = Running frequency × P07.08	1.00	○
P07.09	Rotation speed coefficient	0.1–999.9% Mechanical rotation speed = 120 × displayed running frequency × P07.09/motor pole pairs	100.0%	○
P07.10	Linear speed displayed coefficient	0.1–999.9% Linear speed = Mechanical rotation speed × P07.10	1.0%	○
P07.11	Reserved			●
P07.12	Inverter module temperature	-20.0–120.0°C		●
P07.13	Control board software version	1.00–655.35		●
P07.14	Local accumulative running time	0–65535h		●
P07.18	Rated power of the VFD	0.4–3000.0kW		●
P07.19	Rated voltage of the VFD	50–1200V		●
P07.20	Rated current of the VFD	0.1–6000.0A		●

Function code	Name	Description	Default	Modify
P07.21	Factory bar code 1	0x0000-0xFFFF		●
P07.22	Factory bar code 2	0x0000-0xFFFF		●
P07.23	Factory bar code 3	0x0000-0xFFFF		●
P07.24	Factory bar code 4	0x0000-0xFFFF		●
P07.25	Factory bar code 5	0x0000-0xFFFF		●
P07.26	Factory bar code 6	0x0000-0xFFFF		●
P07.27	Type of present fault	0: No fault 4: Overcurrent during acceleration (OC1) 5: Overcurrent during deceleration (OC2) 6: Overcurrent during constant speed running (OC3)		●
P07.28	Type of the last fault	7: Overvoltage during acceleration (OV1) 8: Overvoltage during deceleration (OV2) 9: Overvoltage during constant speed running (OV3)		●
P07.29	Type of the 2nd-last fault	10: Bus undervoltage (UV)		●
P07.30	Type of the 3rd-last fault	11: Motor overload (OL1) 12: VFD overload (OL2)		●
P07.31	Type of the 4th-last fault	15: Rectifier module overheat (OH1) 16: Inverter module overheat (OH2) 17: External fault(EF)		●
P07.32	Type of the 5th-last fault	18: RS485 communication fault (CE) 21: EEPROM operation fault (EEP) 22: PID feedback offline fault (PIDE) 24: Running time reached (END) 25: Electronic overload fault (OL3) 36: Electronic underload fault (LL)		●
P07.33	Running frequency of present fault		0.00Hz	●

Function code	Name	Description	Default	Modify
P07.34	Ramp reference frequency of present fault		0.00Hz	●
P07.35	Output voltage of present fault		0V	●
P07.36	Output current of present fault		0.0A	●
P07.37	Bus voltage of present fault		0.0V	●
P07.38	Max. temperature of present fault		0.0°C	●
P07.39	Input terminal state of present fault		0	●
P07.40	Output terminal state of present fault		0	●
P07.41	Running frequency of the last fault		0.00Hz	●
P07.42	Ramp reference frequency of the last fault		0.00Hz	●
P07.43	Output voltage of last fault		0V	●
P07.44	Output current of last fault		0.0A	●

Function code	Name	Description	Default	Modify
P07.45	Bus voltage of last fault		0.0V	●
P07.46	Max. temperature of last fault		0.0° C	●
P07.47	Input terminal state of last fault		0	●
P07.48	Output terminal state of last fault		0	●
P07.49	Running frequency of the 2nd-last fault		0.00Hz	●
P07.50	Ramp reference frequency of the 2nd-last fault		0.00Hz	●
P07.51	Output voltage of the 2nd-last fault		0V	●
P07.52	Output current of the 2nd-last fault		0.0A	●
P07.53	Bus voltage of the 2nd-last fault		0.0V	●
P07.54	Max. temperature of the 2nd-last fault		0.0° C	●
P07.55	Input terminal state of the 2nd-last fault		0	●

Function code	Name	Description	Default	Modify
P07.56	Output terminal state of the 2nd-last fault		0	●

P08 group Enhanced functions

Function code	Name	Description	Default	Modify
P08.00	ACC time 2	Refer to P00.11 and P00.12 for detailed definition.	Depend on model	<input type="radio"/>
P08.01	DEC time 2	Goodrive10 series define four groups of ACC/DEC time which can be selected by P5 group. The first group of ACC/DEC time is the factory default one. Setting range:0.0–3600.0s	Depend on model	<input type="radio"/>
P08.06	Running frequency of jogging	This parameter is used to define the reference frequency during jogging. Setting range: 0.0 0Hz–P00.03 (max. output frequency)	5.00Hz	<input type="radio"/>
P08.07	ACC time of jogging	Jogging ACC time means the time needed for the VFD to accelerate from 0Hz to the max. output frequency (P00.03).	Depend on model	<input type="radio"/>
P08.08	DEC time of jogging	Jogging DEC time means the time needed for the VFD to decelerate from the max. output frequency (P00.03) to 0Hz. Setting range:0.0–3600.0s	Depend on model	<input type="radio"/>
P08.15	Traverse range	This function applies to the industries where traverse and convolution function are required	0.0%	<input type="radio"/>
P08.16	Sudden jumping frequency range	such as textile and chemical fiber. The traverse function means that the output frequency of the VFD is fluctuated with the set frequency as its center. The route of the	0.0%	<input type="radio"/>
P08.17	Traverse boost time	running frequency is illustrated as below, of which the traverse is set by P08.15 and when	5.0s	<input type="radio"/>
P08.18	Traverse declining time	P08.15 is set as 0, the traverse is 0 with no function.	5.0s	<input type="radio"/>

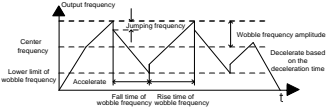
Function code	Name	Description	Default	Modify
		 <p>Traverse range: The traverse running is limited by upper and low frequency.</p> <p>The traverse range relative to the center frequency: $\text{traverse range AW} = \text{center frequency} \times \text{traverse range P08.15}$.</p> <p>Sudden jumping frequency = $\text{traverse range AW} \times \text{sudden jumping frequency range P08.16}$. When run at the traverse frequency, the value which is relative to the sudden jumping frequency.</p> <p>The raising time of the traverse frequency: The time from the lowest point to the highest one.</p> <p>The declining time of the traverse frequency: The time from the highest point to the lowest one.</p> <p>Setting range of P08.15: 0.0–100.0%(relative to the set frequency)</p> <p>Setting range of P08.16: 0.0–50.0%(relative to the traverse range)</p> <p>Setting range of P08.17: 0.1–3600.0s</p> <p>Setting range of P08.18: 0.1–3600.0s</p>		
P08.25	Set count value	The counter works by the input pulse signals of the HDI terminals.	0	○
P08.26	Designated counting value	When the counter achieves a given number, the multi-function output terminals will output the signal of "fixed counting number arrival" and the counter go on working; when the counter achieves a setting number, the multi-function output terminals will output the signal of "setting counting number arrival", the counter will clear all numbers and stop to	0	○

Function code	Name	Description	Default	Modify
		<p>recount before the next pulse.</p> <p>The setting counting value P08.26 should be no more than the setting counting value P08.25.</p> <p>The function is illustrated as below:</p>  <p>Setting range of P08.25:P08.26–65535 Setting range of P08.26:0–P08.25</p>		
P08.27	Set running time	<p>Pre-set running time of the VFD. When the accumulative running time achieves the set time, the multi-function digital output terminals will output the signal of “running time arrival”.</p> <p>Setting range:0–65535min</p>	0m	○
P08.28	Auto fault reset count	<p>Auto fault reset count: When the VFD uses automatic fault reset, it is used to set the number of automatic fault reset times. When the number of continuous reset times exceeds the value, the VFD reports a fault and stops.</p>	0	○
P08.29	Interval time of auto fault reset	<p>Interval time of auto fault reset: Time interval from when a fault occurred to when automatic fault reset takes effect.</p> <p>Setting range of P08.28:0–10 Setting range of P08.29:0.1–3600.0s</p>	1.0s	○
P08.32	FDT electrical level detection value	<p>When the output frequency exceeds the corresponding frequency of FDT electrical level, the multi-function digital output terminals will output the signal of “frequency level detect FDT” until the output frequency decreases to a value lower than (FDT electrical level—FDT lagging detection value) the corresponding frequency, the signal is invalid. Below is the waveform diagram:</p>	50.00Hz	○
P08.33	FDT lagging detection value		5.0%	○

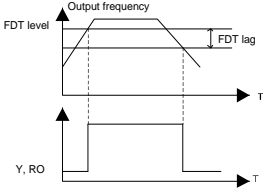
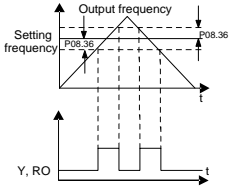
Function code	Name	Description	Default	Modify
		 <p>Setting range of P08.32: 0.00Hz–P00.03 (max. output frequency) Setting range of P08.33: 0.0–100.0%(FDT electrical level)</p>		
P08.36	Detection value for frequency being reached	<p>When the output frequency is within the detection range, the multi-function digital output terminal outputs the signal of "Frequency reached". See the diagram below for detailed information:</p>  <p>Setting range: 0.00Hz–P00.03 (max. output frequency)</p>	0.00Hz	○
P08.37	Energy consumption braking enabling	<p>The function code is used to control enabling of the brake tube action inside the VFD.</p> <p>0: Disable 1: Enable</p> <p>Note: It is only applicable to VFD models that are built in braking tubes.</p>	0	○
P08.38	Energy Braking threshold voltage	<p>The function code is used to set the starting bus voltage of energy consumption braking. Adjust this value properly to achieve effective braking for the load. The default value varies</p>	220V voltage: 380.0V 380V	○

Function code	Name	Description	Default	Modify
		depending on the voltage class. Note: It is only applicable to VFD models that are built in optional braking tubes. Setting range: 200.0–2000.0V	voltage: 700.0V	
P08.39	Cooling fan running mode	0: Common running mode 1: The fan keeps running after being powered on	0	○
P08.40	PWM selection	0x0000–0x0021 LED ones: PWM mode selection 0: PWM mode 1, 3PH modulation and 2PH modulation 1: PWM mode 2, 3PH modulation LED tens: low-speed carrier frequency limit 0: low-speed carrier frequency limit mode 1; when the carrier frequency exceeds 1k at low speed, limit to 1k. 1: low-speed carrier frequency limit mode 2; when the carrier frequency exceeds 2k at low speed, limit to 2k. 2: No limit for the carrier frequency at low speed	0x01	◎
P08.41	Overmodulation	0:Invalid 1:Valid	1	◎
P08.42	Keypad data control setting	0x000–0x1223 LED ones: Frequency enable selection 0: ^/V keys adjustments are valid 1:Reserved 2: ^/V keys adjustments are invalid 3: Reserved LED tens: Frequency control selection 0: Only valid when P00.06=0 or P00.07=0 1: Valid for all frequency setting manner 2: Invalid for multi-step speed when multi-step speed has the priority LED hundreds: Action selection during stopping 0: Setting is valid	0x0000	○

Function code	Name	Description	Default	Modify
		1: Valid during running, cleared after stopping 2: Valid during running, cleared after receiving the stop command LED thousands: \wedge / \vee keys and digital potentiometer Integral function 0: The integral function is valid 1: The integral function is invalid		
P08.44	UP/DOWN terminals control setting	0x00–0x221 LED ones: frequency enabling selection 0: UP/DOWN terminals setting valid 1: UP/DOWN terminals setting invalid LED tens: frequency control selection 0: Only valid when P00.06=0 or P00.07=0 1: All frequency means are valid 2: When the multi-step are priority, it is invalid to the multi-step LED hundreds: action selection when stop 0: Setting valid 1: Valid in the running, clear after stop 2: Valid in the running, clear after receiving the stop commands	0x000	○
P08.45	Frequency increment integral rate of the UP terminal	0.01–50.00s	0.50s	○
P08.46	Frequency increment integral rate of the DOWN terminal	0.01–50.00s	0.50s	○
P08.47	Action selection for frequency settings on power off	0x000–0x111 LED ones: Action for digital adjustable frequency on power off 0: Save on power off 1: Clear on power off LED tens: Action for Modbus frequency setting on power off	0x000	○

Function code	Name	Description	Default	Modify
		0: Save on power off 1: Clear on power off LED hundreds: Action for other-mode frequency setting on power off 0: Save on power off 1: Clear on power off		
P08.50	Magnetic flux braking	This function code is used to enable magnetic flux. 0: Invalid. 100 - 150: The bigger the coefficient, the bigger the braking strength. This VFD can slow down the motor by increasing the magnetic flux. The energy generated by the motor during braking can be transformed into heat energy by increasing the magnetic flux. The VFD monitors the state of the motor continuously even during the magnetic flux period. So the magnetic flux can be used in the motor stop, as well as to change the rotation speed of the motor. Its other advantages are: Brake immediately after the stop command. It does not need to wait the magnetic flux weaken. The cooling is better. The current of the stator other than the rotor increases during magnetic flux braking, while the cooling of the stator is more valid than the rotor.	0	●

P09 group PID control

Function code	Name	Description	Default	Modify
P09.00	PID reference source selection	When the frequency command selection (P00.06, P00.07) is 7, the running mode of the VFD is procedure PID control. The parameter determines the target	0	○

Function code	Name	Description	Default	Modify
		reference channel during the PID procures. 0: P09.01 1: AI1 2: AI2 5: Multi-step speed 6: Modbus communication The set target of process PID is a relative value, for which 100% equals to 100% of the feedback signal of the controlled system. The system always calculates a related value (0–100.0%). Note: Multi-step running reference can be achieved by setting P10 group parameters.		
P09.01	PID value reference	The function code is mandatory when P09.00=0. The base value of the function code is the feedback of the system. Setting range: -100.0%–100.0%	0.0%	<input type="radio"/>
P09.02	PID feedback source selection	Select the PID channel by the parameter. 1: AI2 4: Modbus communication Note: The reference channel and feedback channel cannot be duplicate. Otherwise, effective PID control cannot be achieved.	1	<input type="radio"/>
P09.03	PID output feature selection	0: PID output is positive. When the feedback signal exceeds the PID reference value, the output frequency of the VFD will decrease to balance the PID. For example, the strain PID control during wrapup 1: PID output is negative. When the feedback signal is stronger than the PID reference value, the output frequency of the VFD will increase to balance the PID. For example, the strain PID control during wrapdown	0	<input type="radio"/>
P09.04	Proportional gain (Kp)	The function is applied to the proportional gain P of PID input. P determines the strength of the whole PID adjuster. The parameter of 100 means that when the offset of PID feedback and	1.00	<input type="radio"/>

Function code	Name	Description	Default	Modify
		reference value is 100%, the adjusting range of PID adjustor is the Max. Frequency (ignoring integral function and differential function). Setting range:0.00–100.00		
P09.05	Integral time (Ti)	This parameter determines the speed of PID adjustor to carry out integral adjustment on the deviation of PID feedback and reference. When the deviation of PID feedback and reference is 100%, the integral adjustor works continuously after the time (ignoring the proportional effect and differential effect) to achieve the Max. Frequency (P00.03) or the Max. Voltage (P04.31). Shorter the integral time, stronger is the adjustment Setting range: 0.01–10.00s	0.10s	○
P09.06	Differential time (Td)	This parameter determines the strength of the change ratio when PID adjustor carries out integral adjustment on the deviation of PID feedback and reference. If the PID feedback changes 100% during the time, the adjustment of integral adjustor (ignoring the proportional effect and differential effect) is the Max. Frequency (P00.03). Longer the integral time, stronger is the adjusting. Setting range: 0.00–10.00s	0.00s	○
P09.07	Sampling cycle (T)	This parameter means the sampling cycle of the feedback. The modulator calculates in each sampling cycle. The longer the sapling cycle is, the slower the response is. Setting range: 0.00–100.00s	0.10s	○
P09.08	PID control deviation limit	As shown in the diagram below, PID adjustor stops to work during the deviation limit. Set the function properly to adjust the accuracy and stability of the system.	0.0%	○

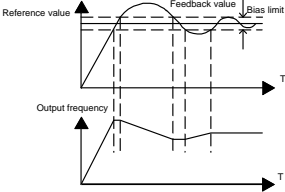
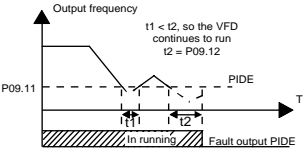
Function code	Name	Description	Default	Modify
		 <p>Setting range:0.0–100.0%</p>		
P09.09	Upper limit of PID output	The two function codes are used to set the upper /lower limit value of PID regulator. 100.0% corresponds to max. output frequency (P00.03).	100.0%	<input type="radio"/>
P09.10	Lower limit of PID output	Setting range of P09.09: P09.10–100.0% Setting range of P09.10: -100.0%–P09.09	0.0%	<input type="radio"/>
P09.11	Feedback offline detection value	Set the PID feedback offline detection value, when the detection value is smaller than or equal to the feedback offline detection value, and the lasting time exceeds the set value in P09.12, the VFD will report "PID feedback offline fault" and the keypad will display PIDE.	0.0%	<input type="radio"/>
P09.12	Feedback offline detection time	 <p>Setting range of P09.11: 0.0–100.0% Setting range of P09.12: 0.0–3600.0s</p>	1.0s	<input type="radio"/>
P09.13	PID adjustment selection	0x00–0x11 LED ones: 0: Keep on integral adjustment when the frequency achieves the upper and low limit; the integration shows the change between the reference and the feedback unless it reaches the internal integral limit. When the trend	0x00	<input type="radio"/>

Function code	Name	Description	Default	Modify
		<p>between the reference and the feedback changes, it needs more time to offset the impact of continuous working and the integration will change with the trend.</p> <p>1: Stop integral adjustment when the frequency reaches the upper and low limit. If the integration keeps stable, and the trend between the reference and the feedback changes, the integration will change with the trend quickly.</p> <p>LED tens:</p> <p>0: The same with the setting direction. If the output of PID adjustment is different from the current running direction, the internal will output 0 forcedly.</p> <p>1: Opposite to the setting direction. If the output of PID adjustment is different from the current running direction, the closed-loop adjustment output opposite to the current running direction is executed.</p>		

P10 group Multi-step speed control

Function code	Name	Description	Default	Modify
P10.02	Multi-step speed 0	<p>Multi-step speeds are within the range of $-f_{max} \sim f_{max}$, and they can be set continuously. The VFD supports the setting of speeds of 16 steps, which are set by combined codes of</p>	0.0%	○
P10.04	Multi-step speed 1		0.0%	○
P10.06	Multi-step speed 2		0.0%	○
P10.08	Multi-step speed 3		0.0%	○
P10.10	Multi-step speed 4		0.0%	○
P10.12	Multi-step speed 5		0.0%	○
P10.14	Multi-step	0.0%	○	

Function code	Name	Description	Default	Modify																																																							
	speed 6																																																										
P10.16	Multi-step speed 7		0.0%	<input type="radio"/>																																																							
P10.18	Multi-step speed 8		0.0%	<input type="radio"/>																																																							
P10.20	Multi-step speed 9		0.0%	<input type="radio"/>																																																							
P10.22	Multi-step speed 10		0.0%	<input type="radio"/>																																																							
P10.24	Multi-step speed 11		0.0%	<input type="radio"/>																																																							
P10.26	Multi-step speed 12		0.0%	<input type="radio"/>																																																							
P10.28	Multi-step speed 13		When terminal1= terminal 2= terminal 3= terminal 4=OFF, the frequency input manner is selected via code P00.06 or P00.07. When not all terminals are off, it runs at multi-step which takes precedence of keypad, analog value, communication frequency input. Select at most 16 steps speed via the combination code of terminals 1, 2, 3, and 4.	0.0%	<input type="radio"/>																																																						
P10.30	Multi-step speed 14		The start-up and stopping of multi-step running is determined by function code P00.06, the relationship between terminals 1, 2, 3, and 4 and multi-step speed is as following:	0.0%	<input type="radio"/>																																																						
P10.32	Multi-step speed 15		<table border="1"> <tbody> <tr> <td>Terminal 1</td> <td>OFF</td> <td>ON</td> <td>OFF</td> <td>ON</td> <td>OF F</td> <td>ON</td> <td>OF F</td> <td>ON</td> </tr> <tr> <td>Terminal 2</td> <td>OFF</td> <td>OFF</td> <td>ON</td> <td>ON</td> <td>OF F</td> <td>OF F</td> <td>ON</td> <td>ON</td> </tr> <tr> <td>Terminal 3</td> <td>OFF</td> <td>OFF</td> <td>OFF</td> <td>OF F</td> <td>ON</td> <td>ON</td> <td>ON</td> <td>ON</td> </tr> <tr> <td>Terminal 4</td> <td>OFF</td> <td>OFF</td> <td>OFF</td> <td>OF F</td> <td>OF F</td> <td>OF F</td> <td>OF F</td> <td>OF F</td> </tr> <tr> <td>Step</td> <td>0</td> <td>1</td> <td>2</td> <td>3</td> <td>4</td> <td>5</td> <td>6</td> <td>7</td> </tr> <tr> <td>Terminal 1</td> <td>OFF</td> <td>ON</td> <td>OFF</td> <td>ON</td> <td>OF F</td> <td>ON</td> <td>OF F</td> <td>ON</td> </tr> </tbody> </table>	Terminal 1	OFF	ON	OFF	ON	OF F	ON	OF F	ON	Terminal 2	OFF	OFF	ON	ON	OF F	OF F	ON	ON	Terminal 3	OFF	OFF	OFF	OF F	ON	ON	ON	ON	Terminal 4	OFF	OFF	OFF	OF F	OF F	OF F	OF F	OF F	Step	0	1	2	3	4	5	6	7	Terminal 1	OFF	ON	OFF	ON	OF F	ON	OF F	ON	0.0%	<input type="radio"/>
Terminal 1	OFF		ON	OFF	ON	OF F	ON	OF F	ON																																																		
Terminal 2	OFF		OFF	ON	ON	OF F	OF F	ON	ON																																																		
Terminal 3	OFF		OFF	OFF	OF F	ON	ON	ON	ON																																																		
Terminal 4	OFF		OFF	OFF	OF F	OF F	OF F	OF F	OF F																																																		
Step	0	1	2	3	4	5	6	7																																																			
Terminal 1	OFF	ON	OFF	ON	OF F	ON	OF F	ON																																																			

Function code	Name	Description	Default	Modify																																				
		<table border="1"> <tr> <td>Terminal 2</td> <td>OFF</td> <td>OFF</td> <td>ON</td> <td>ON</td> <td>OFF</td> <td>OFF</td> <td>ON</td> <td>ON</td> </tr> <tr> <td>Terminal 3</td> <td>OFF</td> <td>OFF</td> <td>OFF</td> <td>OFF</td> <td>ON</td> <td>ON</td> <td>ON</td> <td>ON</td> </tr> <tr> <td>Terminal 4</td> <td>ON</td> <td>ON</td> <td>ON</td> <td>ON</td> <td>ON</td> <td>ON</td> <td>ON</td> <td>ON</td> </tr> <tr> <td>step</td> <td>8</td> <td>9</td> <td>10</td> <td>11</td> <td>12</td> <td>13</td> <td>14</td> <td>15</td> </tr> </table> <p>Setting range of P10.(2n, 1<n<17): -100.0~100.0%</p>	Terminal 2	OFF	OFF	ON	ON	OFF	OFF	ON	ON	Terminal 3	OFF	OFF	OFF	OFF	ON	ON	ON	ON	Terminal 4	ON	ON	ON	ON	ON	ON	ON	ON	step	8	9	10	11	12	13	14	15		
Terminal 2	OFF	OFF	ON	ON	OFF	OFF	ON	ON																																
Terminal 3	OFF	OFF	OFF	OFF	ON	ON	ON	ON																																
Terminal 4	ON	ON	ON	ON	ON	ON	ON	ON																																
step	8	9	10	11	12	13	14	15																																

P11 group Protection parameters

Function code	Name	Description	Default	Modify						
P11.01	Frequency drop at transient power-off	0: Disable 1: Enable	0	<input type="radio"/>						
P11.02	Frequency drop ratio at transient power-off	<p>Setting range: 0.00Hz/s~P00.03 (max. output frequency)</p> <p>After the grid powers off, the bus voltage drops to the frequency drop point at transient power-off, the VFD begins to decrease the running frequency based on P11.02, to make the motor generate power again. The returning power can maintain the bus voltage to ensure a rated running of the VFD until the VFD is powered on again.</p> <table border="1"> <tr> <td>Voltage class</td> <td>220V</td> <td>380V</td> </tr> <tr> <td>Frequency drop point at transient power-off</td> <td>260V</td> <td>460V</td> </tr> </table> <p>Note:</p> <ol style="list-style-type: none"> Adjust the parameter properly to avoid the stopping caused by VFD protection during the switching of the grid. Disable input phase loss protection to enable this function. 	Voltage class	220V	380V	Frequency drop point at transient power-off	260V	460V	10.00Hz/s	<input type="radio"/>
Voltage class	220V	380V								
Frequency drop point at transient power-off	260V	460V								

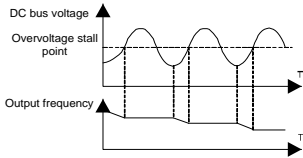
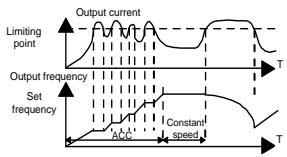
Function code	Name	Description	Default	Modify
P11.03	Overvoltage stall protection	0: Disable 1: Enable 	1	<input type="radio"/>
P11.04	Overvoltage stall protection voltage	120–150% (standard bus voltage) (380V)	136%	<input type="radio"/>
		120–150% (standard bus voltage) (220V)	120%	
P11.05	Current limit action selection	The actual increasing ratio is less than the ratio of output frequency because of the big load during ACC running. It is necessary to take measures to avoid overcurrent fault and the VFD trips.	1	<input checked="" type="radio"/>
P11.06	Automatic current limit level	During the running of the VFD, this function will detect the output current and compare it with the limit level defined in P11.06. If it exceeds the level, the VFD will run at stable frequency in ACC running, or the VFD will derate to run during the constant running. If it exceeds the level continuously, the output frequency will keep on decreasing to the lower limit. If the output current is detected to be lower than the limit level, the VFD will accelerate to run.	160.0%	<input checked="" type="radio"/>
P11.07	The decreasing ratio during current limit		10.00Hz/s	<input checked="" type="radio"/>

Setting range of P11.05:

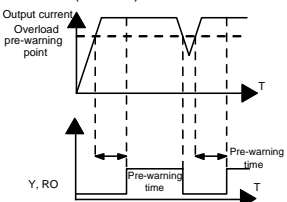
Function code	Name	Description	Default	Modify
		0: Current limit invalid 1: Current limit is always valid Setting range of P11.06: 50.0–200.0% Setting range of P11.07: 0.00–50.00Hz/s		
P11.08	Pre-alarm selection for VFD/motor OL/UL	 <p>Setting range of P11.08: The function code is used to enable and define the overload pre-alarm of the VFD/motor. Setting range: 0x000–0x131 LED ones: 0: Motor overload/underload pre-alarm, relative to rated motor current; 1: VFD overload/underload pre-alarm, relative to rated VFD current. LED tens: 0: The VFD continues running after overload/underload alarm; 1: The VFD continues running after underload alarm, and stops running after overload fault; 2: The VFD continues running after overload alarm, and stops running after underload fault; 3: The VFD stops running after</p>	0x000	○
P11.09	Overload pre-alarm detection level		150%	○
P11.10	Overload pre-alarm detection time		1.0s	○

Function code	Name	Description	Default	Modify
		overload/underload fault. LED hundreds : 0: Always detect 1: Detect during constant-speed running Setting range of P11.09: P11.11–200% Setting range of P11.10: 0.1–60.0s		
P11.11	Underload pre-alarm detection level	Underload pre-alarm signal will be outputted if the output current of the VFD or motor is lower than underload pre-alarm detection level (P11.11), and the duration exceeds underload pre-alarm detection time (P11.12). Setting range of P11.11: 0–P11.09 Setting range of P11.12: 0.1–60.0s	50%	<input type="radio"/>
P11.12	Underload pre-alarm detection time		1.0s	<input type="radio"/>
P11.13	Fault output terminal action upon fault occurring	The function code is used to set the action of fault output terminals at undervoltage and fault reset. 0x00–0x11 LED ones: 0: Act at undervoltage 1: Do not act at undervoltage LED tens: 0: Act at fault reset 1: Do not act at fault reset	0x00	<input type="radio"/>

P14 group Serial communication

Function code	Name	Description	Default	Modify
P14.00	Local communication address	Setting range:1–247 When the master is writing the frame, the communication address of the slave is set to 0; the broadcast address is the communication address. All slaves on the Modbus fieldbus can receive the frame, but the slave doesn't answer. The communication address of the drive is	1	<input type="radio"/>

Function code	Name	Description	Default	Modify
		unique in the communication net. This is the fundamental for the point to point communication between the upper monitor and the drive. Note: The address of the slave cannot set to 0.		
P14.01	Communication baud rate	Set the digital transmission speed between the upper monitor and the VFD. 0: 1200BPS 1: 2400BPS 2: 4800BPS 3: 9600BPS 4: 19200BPS 5: 38400BPS Note: The baud rate set on the VFD must be consistent with that on the upper computer. Otherwise, the communication fails. A greater baud rate indicates faster communication.	4	<input type="radio"/>
P14.02	Data bit check	The data format set on the VFD must be consistent with that on the upper computer. Otherwise, the communication fails. 0: No check (N,8,1) for RTU 1: Even check (E,8,1) for RTU 2: Odd check (O,8,1) for RTU 3: No check (N,8,2) for RTU 4: Even check (E,8,2) for RTU 5: Odd check(O,8,2) for RTU	1	<input type="radio"/>
P14.03	Communication response delay	0–200ms It means the interval time between the interval time when the drive receive the data and sent it to the upper monitor. If the answer delay is shorter than the system processing time, then the answer delay time is the system processing time, if the answer delay is longer than the system processing time, then after the system deal	5	<input type="radio"/>

Function code	Name	Description	Default	Modify
		with the data, waits until achieving the answer delay time to send the data to the upper monitor.		
P14.04	Communication overtime fault time	0.0 (invalid),0.1–60.0s When the function code is set as 0.0, the communication overtime parameter is invalid. When the function code is set as non-zero, if the interval time between two communications exceeds the communication overtime, the system will report "RS485 communication faults" (CE). Generally, set it as invalid; set the parameter in the continuous communication to monitor the communication state.	0.0s	○
P14.05	Transmission fault processing	0: Alarm and stop freely 1: No alarm and continue to run 2: No alarm and stop according to the stop means(only under the communication control) 3: No alarm and stop according to the stop means(under all control modes)	0	○
P14.06	Communication processing action selection	0x00–0x11 LED ones: 0: Operation with response. The drive will respond to all reading and writing commands of the upper monitor. 1: Operation without response. The drive only responds to the reading command other than the writing command of the drive. The communication efficiency can be increased by this method. LED tens: (reserved)	0x00	○

P17 group Status viewing

Function code	Name	Description	Default	Modify
P17.00	Set frequency	Display current set frequency of the VFD. Range: 0.00Hz–P00.03	0.00Hz	●
P17.01	Output frequency	Display current output frequency of the VFD. Range: 0.00Hz–P00.03	0.00Hz	●
P17.02	Ramp reference frequency	Display current ramp reference frequency of the VFD. Range: 0.00Hz–P00.03	0.00Hz	●
P17.03	Output voltage	Display current output voltage of the VFD. Range: 0–1200V	0V	●
P17.04	Output current	Display current output current of the VFD. Range: 0.0–5000.0A	0.0A	●
P17.05	Motor speed	Displays current motor speed. Range: 0–65535RPM	0 RPM	●
P17.08	Motor power	Displays current motor power; 100% relative to rated motor power, positive value is motoring state, negative value is generating state. Setting range: -300.0%–300.0% (relative to rated motor power)	0.0%	●
P17.09	Output torque	Displays current output torque of the VFD; 100% relative to rated motor torque, positive value is motoring state, negative value is generating state. Range: -250.0–250.0%	0.0%	●
P17.11	DC bus voltage	Display current DC bus voltage of the VFD Range: 0.0–2000.0V	0V	●
P17.12	Digital input terminal state	Display current digital input terminals state of the VFD Range: 0000–00FF	0	●
P17.13	Digital output terminal state	Display current digital output terminals state of the VFD Range: 0000–000F	0	●
P17.14	Digital adjustment	Display the adjustment through the keypad of the VFD. Range : 0.00Hz–P00.03	0.00V	●

Function code	Name	Description	Default	Modify
P17.18	Counting value	Display the current counting number of the VFD. Range: 0–65535	0	●
P17.19	AI1 input voltage	Display analog AI1 input signal. Range: 0.00–10.00V	0.00V	●
P17.20	AI2 input voltage	Display analog AI2 input signal. Range: 0.00–10.00V	0.00V	●
P17.23	PID reference value	Display PID reference value. Range: -100.0–100.0%	0.0%	●
P17.24	PID response value	Display PID response value. Range: -100.0–100.0%	0.0%	●
P17.25	Power factor of the motor	Display the current power factor of the motor. Range: -1.00–1.00		●
P17.26	Current running time	Display current running time of the VFD. Range:0–65535min	0m	●
P17.27	Current step of the multi-step speed	Display the current step of the multi-step speed. Range: 0–15	0	●
P17.36	Output torque	Display the output torque. Positive value is in the electromotion state, and negative value is in the power generating state. Range : -3000.0Nm–3000.0Nm	0.0Nm	●
P17.37	Motor overload count value	0–100 (Display the "OL1" fault when the count value is 100.)	0	●

6 Fault tracking

6.1 Fault prevention

This chapter describes how to perform preventive maintenance on the VFD.

6.1.1 Maintenance intervals

Little maintenance is required when the VFD is installed in the environment that meets requirements. The following table describes the routine maintenance periods recommended by INVT.

Subject		Item	Method	Criterion
Ambient environment		Check the temperature, and humidity, and whether there is vibration, dust, gas, oil spray, and water droplets in the environment.	Visual inspection, and use instruments for measurement.	The requirements stated in this manual are met.
		Check whether there are foreign matters, such as tools, or dangerous substances placed nearby.	Visual inspection	There are no tools or dangerous substances placed nearby.
Voltage		Check the voltage of the main circuit and control circuit.	Use multimeters or other instruments for measurement.	The requirements stated in this manual are met.
Keypad		Check the display of information.	Visual inspection	The characters are displayed properly.
		Check whether characters are not completely displayed.	Visual inspection	The requirements stated in this manual are met.
Main circuit	Common	Check whether the bolts loose or come off.	Screw them up.	No exception occurs.
		Check whether the machine is deformed, cracked, or damaged, or their color changes due to overheating and aging.	Visual inspection	No exception occurs.

Subject	Item	Method	Criterion
	Check whether there are stains and dust attached.	Visual inspection	No exception occurs. Note: Discoloration of copper bars does not mean that they cannot work properly.
Conductor and wire	Check whether the conductors are deformed or their color change due to overheat.	Visual inspection	No exception occurs.
	Check whether the wire sheaths are cracked or their color changes.	Visual inspection	No exception occurs.
Terminal block	Check whether there is damage.	Visual inspection	No exception occurs.
Filter capacitor	Check whether there is electrolyte leakage, discoloration, cracks, and chassis expansion.	Visual inspection	No exception occurs.
	Check whether the safety valves are released.	Determine the service life based on the maintenance information, or measure them through electrostatic capacity.	No exception occurs.
	Check whether the electrostatic capacity is measured as required.	Use instruments to measure the capacity.	Electrostatic capacity \geq initial value $\times 0.85$
Resistor	Check whether there is displacement caused due to overheat.	Olfactory and visual inspection	No exception occurs.
	Check whether the resistors are disconnected.	Visual inspection, or remove one end of the connection cable and use a	Resistance range: $\pm 10\%$ (of the standard resistance)

Subject		Item	Method	Criterion
			multimeter for measurement.	
	Transformer and reactor	Check whether there is unusual vibration sounds or smells.	Auditory, olfactory, and visual inspection	No exception occurs.
	Electromagnetic contactor and relay	Check whether there are vibration sounds in the workshop.	Auditory inspection	No exception occurs.
		Check whether the contacts are in good contact.	Visual examination	No exception occurs.
Control circuit	Control PCB, connector	Check whether the screws and connectors loose.	Screw them up.	No exception occurs.
		Check whether there is unusual smell or discoloration.	Olfactory and visual inspection	No exception occurs.
		Check whether there are cracks, damage, deformation, or rust.	Visual inspection	No exception occurs.
		Check whether there is electrolyte leakage or deformation.	Visual inspection, and determine the service life based on the maintenance information.	No exception occurs.
Cooling system	Cooling fan	Check whether there are unusual sounds or vibration.	Auditory and visual inspection, and turn the fan blades with your hand.	The rotation is smooth.
		Check whether the bolts loose.	Screw them up.	No exception occurs.
		Check whether there is discoloration caused due to overheat.	Visual inspection, and determine the service life based on the maintenance information.	No exception occurs.

Subject	Item	Method	Criterion
Ventilation duct	Check whether there are foreign matters blocking or attached to the cooling fan, air inlets, or air outlets.	Visual inspection	No exception occurs.

6.1.2 Cooling fan

The service life of the cooling fan of the VFD is more than 25,000 hours. The actual service life of the cooling fan is related to the use of the VFD and the temperature in the ambient environment. You can view the running duration of the VFD through P07.14 (Accumulated running time).

The increase of the bearing noise indicates a fan fault. If the VFD is applied in a key position, replace the fan once the fan starts to generate unusual noise. You can purchase spare parts of fans from INVT.

	<ul style="list-style-type: none"> Read and follow the instructions in chapter 1 "Safety precautions". Ignoring the instructions would cause physical injury or death, or damage to the equipment.
--	---

1. Stop the VFD and disconnect it from the AC power source and wait for at least the time designated on the VFD.
2. Lever the fan mounting plate from the cabinet with a screwdriver, and lift the fan mounting plate slightly upward.
3. Disconnect the fan cable.
4. Remove the fan cable, and remove the fan mounting plate.
5. Install the new fan mounting plate including the fan back to the VFD in reverse order.
6. Power on the VFD.

6.1.3 Capacitors

Capacitor reforming

If the VFD has been left unused for a long time, you need to follow the instructions to reform the DC bus capacitor before using it. The storage time is calculated from the date the VFD is delivered.

Storage time	Operation principle
Less than 1 year	No charging operation is required.
1 to 2 years	The VFD needs to be powered on for 1 hour before the first running command.

Storage time	Operation principle
2 to 3 years	Use a voltage controlled power supply to charge the VFD: Charge the VFD at 25% of the rated voltage for 30 minutes, and then charge it at 50% of the rated voltage for 30 minutes, at 75% for another 30 minutes, and finally charge it at 100% of the rated voltage for 30 minutes.
More than 3 years	Use a voltage controlled power supply to charge the VFD: Charge the VFD at 25% of the rated voltage for 2 hours, and then charge it at 50% of the rated voltage for 2 hours, at 75% for another 2 hours, and finally charge it at 100% of the rated voltage for 2 hours.

The method for using a voltage controlled power supply to charge the VFD is described as follows:

The selection of a voltage controlled power supply depends on the power supply of the VFD. For VFDs with an incoming voltage of 1PH/3PH 220 V AC, you can use a 220 V AC/2 A voltage regulator. Both 1PH and 3PH VFDs can be charged with a 1PH voltage controlled power supply (connect L+ to R, and N to S or T). All the DC bus capacitors share one rectifier, and therefore they are all charged.

For VFDs of a high voltage class, ensure that the voltage requirement (for example, 380 V) is met during charging. Capacitor charging requires little current, and therefore you can use a small-capacity power supply (2 A is sufficient).

Change electrolytic capacitors

	<ul style="list-style-type: none"> ● Read and follow the instructions in chapter 1 "Safety precautions". Ignoring the instructions may cause physical injury or death, or damage to the equipment.
--	---

The electrolytic capacitor of a VFD must be replaced if it has been used for more than 35,000 hours. For details about the replacement, contact with the local INVT offices or dial our national service hotline (400-700-9997) for detailed operation.

6.1.4 Power cable

	<ul style="list-style-type: none"> ● Read and follow the instructions in chapter 1 "Safety precautions". Ignoring the instructions may cause physical injury or death, or damage to the equipment.
--	---

1. Stop the VFD, disconnect the power supply, and wait for a time no shorter than the waiting time designated on the VFD.

2. Check the connection of the power cables. Ensure that they are firmly connected.
3. Power on the VFD.

6.2 Fault handling



- Only qualified electricians are allowed to maintain the VFD. Read the safety instructions in chapter 1 "Safety precautions" before working on the VFD.

6.2.1 Alarm and fault indications

Fault is indicated by LEDs. See chapter 4 "Keypad". When **TRIP** light is on, an alarm or fault message on the panel display indicates abnormal VFD state. P07.27 - P07.32 record the latest 6 fault type and P07.33 - P07.56 record the operation data of the latest 3 fault type. Using the information reference in this chapter, most alarm and fault cause can be identified and corrected. If not, contact with the INVT office.

6.2.2 Fault reset

The VFD can be reset by pressing the keypad key **STOP/RST**, through digital input, or by switching the power light. When the fault has been removed, the motor can be restarted.

6.2.3 Fault instruction and solution

Do as the following after the VFD fault:

1. Check to ensure there is nothing wrong with the keypad. If not, please contact with the local INVT office.
2. If there is nothing wrong, please check P07 and ensure the corresponding recorded fault parameters to confirm the real state when the current fault occurs by all parameters.
3. See the following table for detailed solution and check the corresponding abnormal state.
4. Eliminate the fault and ask for relative help.
5. Check to eliminate the fault and carry out fault reset to run the VFD.

Note: The numbers enclosed in square brackets such as [4], [5] and [6] in the Fault type column in the following table indicate the VFD fault type codes read through communication.

Fault code	Fault type	Possible cause	Solution
OC1	[4] Overcurrent during acceleration	<ul style="list-style-type: none"> ● Acceleration or deceleration is too fast. 	<ul style="list-style-type: none"> ● Increase acceleration /deceleration time.
OC2	[5] Overcurrent during deceleration	<ul style="list-style-type: none"> ● Grid voltage is too low. ● VFD power is too low. 	<ul style="list-style-type: none"> ● Check the input power. ● Select the VFD with

Fault code	Fault type	Possible cause	Solution
OC3	[6] Overcurrent during constant speed running	<ul style="list-style-type: none"> ● Load transient or exception occurred. ● To-ground short circuit or output phase loss occur. ● There is strong external interference. 	<ul style="list-style-type: none"> ● larger power. ● Check whether the load is short circuited (to-ground short circuit or line-to-line short circuit) or the rotation is not smooth. ● Check the output wiring. ● Check whether there is strong interference.
OV1	[7] Overvoltage during acceleration	<ul style="list-style-type: none"> ● Exception occurred to input voltage. ● There is large energy feedback. 	<ul style="list-style-type: none"> ● Check the input power. ● Check whether load deceleration time is too short, or the motor starts during rotating. ● Install dynamic braking units.
OV2	[8] Overvoltage during deceleration		
OV3	[9] Overvoltage during constant speed running		
UV	[10] Bus undervoltage	<ul style="list-style-type: none"> ● Grid voltage is too low. 	<ul style="list-style-type: none"> ● Check grid input power.
OL1	[11] Motor overload	<ul style="list-style-type: none"> ● Grid voltage is too low. ● Rated motor current is set improperly. ● Motor stall or load jumps violently. 	<ul style="list-style-type: none"> ● Check grid voltage. ● Reset rated motor current. ● Check the load and adjust torque boost.
OL2	[12] VFD overload	<ul style="list-style-type: none"> ● Acceleration is too fast. ● The motor in rotating is restarted. ● Grid voltage is too low. ● Load is too large. ● The motor power is too small. 	<ul style="list-style-type: none"> ● Increase acceleration time. ● Avoid restart after stop. ● Check grid voltage. ● Select the VFD with larger power. ● Select a proper motor.
OH1	[15] Rectifier module overheat	<ul style="list-style-type: none"> ● Air duct is blocked or fan is damaged. ● Ambient temperature is too high. ● Long-time overload running. 	<ul style="list-style-type: none"> ● Ventilate the air duct or replace the fan. ● Lower the ambient temperature.
OH2	[16] Inverter module overheat		

Fault code	Fault type	Possible cause	Solution
EF	[17] External fault	<ul style="list-style-type: none"> SI external fault input terminals acts. 	<ul style="list-style-type: none"> Check the external device input.
CE	[18] RS485 communication fault	<ul style="list-style-type: none"> Baud rate is set improperly. Communication line fault. Communication address error. Communication suffers from strong interference. 	<ul style="list-style-type: none"> Set proper baud rate. Check the wiring of communication interfaces. Set proper communication address. Replace or change the wiring to enhance anti-interference capacity.
EEP	[21] EEPROM operation fault	<ul style="list-style-type: none"> R/W error occurred to the control parameters. EEPROM is damaged. 	<ul style="list-style-type: none"> Press STOP/RST to reset. Replace the main control board.
PIDE	[22] PID feedback offline fault	<ul style="list-style-type: none"> PID feedback offline PID feedback source disappears. 	<ul style="list-style-type: none"> Check PID feedback signal wires. Check PID feedback source.
END	[24] Running time reached	<ul style="list-style-type: none"> The actual running time of the VFD is larger than the set running time. 	<ul style="list-style-type: none"> Ask help from the supplier, and adjust the set running time
OL3	[25] Electronic overload fault	<ul style="list-style-type: none"> The VFD releases overload pre-alarm based on the set value. 	<ul style="list-style-type: none"> Check the load and overload pre-alarm threshold.
LL	[36] Electronic underload fault	<ul style="list-style-type: none"> The VFD releases underload pre-alarm based on the set value. 	<ul style="list-style-type: none"> Check the load and underload pre-alarm threshold.

6.2.4 Fault instruction and solution

Fault code	Fault type	Possible cause	Solution
PoFF	System power failure	<ul style="list-style-type: none"> The system is powered off or the bus voltage is too low. 	<ul style="list-style-type: none"> Check the grid conditions.

7 Communication protocol

7.1 Modbus protocol introduction

Modbus protocol is a software protocol and common language which is applied in the electrical controller. With this protocol, the controller can communicate with other devices via network (the channel of signal transmission or the physical layer, such as RS485). And with this industrial standard, the controlling devices of different manufacturers can be connected to an industrial network for the convenient of being monitored.

There are two transmission modes for Modbus protocol: ASCII mode and RTU (Remote Terminal Units) mode. On one Modbus network, all devices should select same transmission mode and their basic parameters, such as baud rate, digital bit, check bit, and stopping bit should have no difference.

Modbus network is a controlling network with single-master and multiple slaves, which means that there is only one device performs as the master and the others are the slaves on one Modbus network. The master means the device which has active talking right to sent message to Modbus network for the controlling and inquiring to other devices. The slave means the passive device which sends data message to the Modbus network only after receiving the controlling or inquiring message (command) form the master (response). After the master sends message, there is a period of time left for the controlled or inquired slaves to response, which ensure there is only one slave sends message to the master at a time for the avoidance of singles impact.

Generally, the user can set PC, PLC, IPC and HMI as the masters to realize central control. Setting certain device as the master is a promise other than setting by a bottom or a switch or the device has a special message format. For example, when the upper monitor is running, if the operator clicks sending command bottom, the upper monitor can send command message actively even it can not receive the message form other devices. In this case, the upper monitor is the master. And if the designer makes the VFD send the data only after receiving the command, then the VFD is the slave.

The master can communicate with any single slave or with all slaves. For the single-visiting command, the slave should feedback a response message; for the broadcasting message from the master, the slave does not need to feedback the response message.

7.2 Application mode for the VFD

The VFD uses the Modbus RTU mode and the physical layer is 2-wire RS485.

7.2.1 2-wire RS485

2-wire RS485 interfaces works in half-duplex mode and send data signals in the differential transmission way, which is also referred to as balanced transmission. An RS485 interface

uses a twisted pair, in which one wire is defined as A (+), and the other B (-). Generally, if the positive electrical level between the transmission drives A and B ranges from +2 V to +6 V, the logic is "1"; and if it ranges from -2 V to -6 V, the logic is "0".

On the VFD terminal block, the 485+ terminal corresponds to A, and 485- corresponds to B.

The communication baud rate (P14.01) indicates the number of bits sent in a second, and the unit is bit/s (bps). A higher baud rate indicates faster transmission and poorer anti-interference capability. When a twisted pair of 0.56mm (24 AWG) is used, the maximum transmission distance varies according to the baud rate, as described in the following table.

Baud rate	Max. transmission distance	Baud rate	Max. transmission distance	Baud rate	Max. transmission distance	Baud rate	Max. transmission distance
2400 BPS	1800m	4800 BPS	1200m	9600 BPS	800m	19200 BPS	600m

When RS485 interfaces are used for long-distance communication, it is recommended that you use shielded cables, and use the shielding layer as the ground wires.

When there are fewer devices and the transmission distance is short, the whole network works well without terminal load resistors. The performance, however, degrades as the distance increases. Therefore, it is recommended that you use a 120Ω terminal resistor when the transmission distance is long.

7.2.1.1 When one VFD is used

Figure 7-1 is the Modbus wiring diagram for the network with one VFD and PC. Generally, PCs do not provide RS485 interfaces, and therefore you need to convert an RS232 or USB interface of a PC to an RS485 interface through a converter. Then, connect end A of the RS485 interface to the 485+ port on the terminal block of the VFD, and connect end B to the 485- port. It is recommended that you use shielded twisted pairs. When an RS232-RS485 converter is used, the cable used to connect the RS232 interface of the PC and the converter cannot be longer than 15 m. Use a short cable when possible. It is recommended that you insert the converter directly into the PC. Similarly, when a USB-RS485 converter is used, use a short cable when possible.

When the wiring is completed, select the correct port (for example, COM1 to connect to the RS232-RS485 converter) for the upper computer of the PC, and keep the settings of basic parameters such as communication baud rate and data check bit consistent with those of the VFD. Select

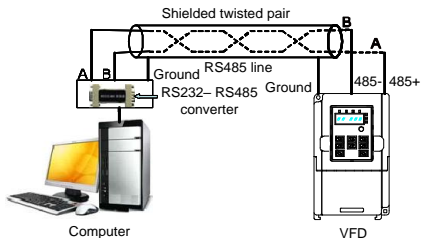

Figure 7-1 RS485 wiring diagram for the network with one VFD

7.2.1.2 When multiple VFDs are used

In the network with multiple VFDs, chrysanthemum connection and star connection are commonly used. According to the requirements of the RS485 industrial bus standards, all the devices need to be connected in chrysanthemum mode with one 120 Ω terminal resistor on each end, as shown in Figure 7-2.

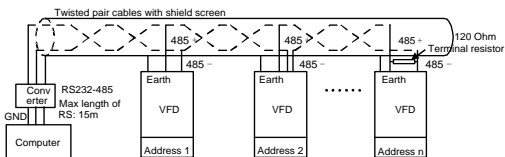

Figure 7-2 Practical application diagram of chrysanthemum connection

Figure 7-3 shows the start connection diagram. When this connection mode is adopted, the two devices that are farthest away from each other on the line must be connected with a terminal resistor (in this figure, the two devices are devices 1# and 15#).

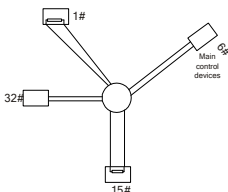

Figure 7-3 Star connection

Use shielded cables, if possible, in multi-VFD connection. The baud rates, data bit check settings, and other basic parameters of all the devices on the RS485 line must be set consistently, and addresses cannot be repeated.

7.2.2 RTU mode

7.2.2.1 RTU communication frame format

If the controller is set to communicate by RTU mode in Modbus network every 8bit byte in the message includes two 4Bit hex characters. Compared with ACSII mode, this mode can send more data at the same baud rate.

Code system

- 1 start bit
- 7 or 8 digital bit, the minimum valid bit can be sent firstly. Every 8 bit frame includes two hex characters (0...9, A...F)
- 1even/odd check bit . If there is no checkout, the even/odd check bit is inexistent.
- 1 stop bit (with checkout), or 2 bits (no checkout)

Error detection domain

- Cyclic redundancy check (CRC)

The following table describes the data format.

11-bit character frame (Bits 1 to 8 are data bits)

Start bit	BIT1	BIT2	BIT3	BIT4	BIT5	BIT6	BIT7	BIT8	Check bit	EStop bit
-----------	------	------	------	------	------	------	------	------	-----------	-----------

10-bit character frame (Bits 1 to 7 are data bits)

Start bit	BIT1	BIT2	BIT3	BIT4	BIT5	BIT6	BIT7	Check bit	EStop bit
-----------	------	------	------	------	------	------	------	-----------	-----------

In a character frame, only the data bits carry information. The start bit, check bit, and stop bit are used to facilitate the transmission of the data bits to the destination device. In practical applications, you must set the data bits, parity check bits, and stop bits consistently.

In RTU mode, the transmission of a new frame always starts from an idle time (the transmission time of 3.5 bytes). On a network where the transmission rate is calculated based on the baud rate, the transmission time of 3.5 bytes can be easily obtained. After the idle time ends, the data domains are transmitted in the following sequence: slave address, operation command code, data, and CRC check character. Each byte transmitted in each domain includes 2 hexadecimal characters (0–9, A–F). The network devices always monitor

the communication bus. After receiving the first domain (address information), each network device identifies the byte. After the last byte is transmitted, a similar transmission interval (the transmission time of 3.5 bytes) is used to indicate that the transmission of the frame ends. Then, the transmission of a new frame starts.

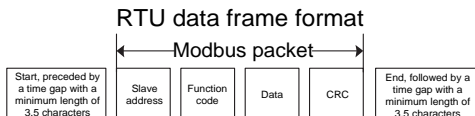

The information of a frame must be transmitted in a continuous data flow. If there is an interval greater than the transmission time of 1.5 bytes before the transmission of the entire frame is complete, the receiving device deletes the incomplete information, and mistakes the subsequent byte for the address domain of a new frame. Similarly, if the transmission interval between two frames is shorter than the transmission time of 3.5 bytes, the receiving device mistakes it for the data of the last frame. The CRC check value is incorrect due to the disorder of the frames, and thus a communication fault occurs.

The following table describes the standard structure of an RTU frame.

START (frame header)	T1-T2-T3-T4 (time gap with a min. length of 3.5 bytes)
ADDR (slave address domain)	Communication address: 0–247 (in decimal system) (0 indicates the broadcast address)
CMD (function domain)	03H:read slave parameters 06H:write slave parameters
Data domain DATA (N-1) ... DATA (0)	TData of 2*N bytes, main content of the communication as well as the core of data exchanging
LSB of CRC CHK	Detection value: CRC (16 bits)
MSB of CRC CHK	
END (frame tail)	T1-T2-T3-T4 (time gap with a min. length of 3.5 bytes)

7.2.2.2 RTU communication frame error check modes

During the transmission of data, errors may occur due to various factors (such as electromagnetic interference). For example, if the sending message is a logic "1", A-B potential difference on RS485 should be 6V, but in reality, it may be -6V because of electromagnetic interference, and then the other devices take the sent message as logic "0". Without error check, the data receiving device cannot identify data errors and may make a wrong response. The wrong response may cause severe problems. Therefore, the data must be checked.

The check is implemented as follows: The transmitter calculates the to-be-transmitted data based on a specific algorithm to obtain a result, adds the result to the rear of the message, and transmits them together. After receiving the message, the receiver calculates the data based on the same algorithm to obtain a result, and compares the result with that transmitted by the transmitter. If the results are the same, the message is correct. Otherwise, the message is considered wrong.

The error check of a frame includes two parts, namely, bit check on individual bytes (that is, odd/even check using the check bit in the character frame), and whole data check (CRC check).

Bit check on individual bytes (odd/even check)

You can select the bit check mode as required, or you can choose not to perform the check, which will affect the check bit setting of each byte.

Definition of even check: Before the data is transmitted, an even check bit is added to indicate whether the number of "1" in the to-be-transmitted data is odd or even. If it is even, the check bit is set to "0"; and if it is odd, the check bit is set to "1".

Definition of odd check: Before the data is transmitted, an odd check bit is added to indicate whether the number of "1" in the to-be-transmitted data is odd or even. If it is odd, the check bit is set to "0"; and if it is even, the check bit is set to "1".

For example, the data bits to be transmitted are "11001110", including five "1". If the even check is applied, the even check bit is set to "1"; and if the odd check is applied, the odd check bit is set to "0". During the transmission of the data, the odd/even check bit is calculated and placed in the check bit of the frame. The receiving device performs the odd/even check after receiving the data. If it finds that the odd/even parity of the data is inconsistent with the preset information, it determines that a communication error occurs.

Cyclical Redundancy Check (CRC) method

A frame in the RTU format includes an error detection domain based on the CRC calculation. The CRC domain checks all the content of the frame. The CRC domain consists of two bytes, including 16 binary bits. It is calculated by the transmitter and added to the frame. The receiver calculates the CRC of the received frame, and compares the result with the value in the received CRC domain. If the two CRC values are not equal to each other, errors occur in the transmission.

During CRC, 0xFFFF is stored first, and then a process is invoked to process a minimum of 6 contiguous bytes in the frame based on the content in the current register. CRC is valid only for the 8-bit data in each character. It is invalid for the start, stop, and check bits.

During the generation of the CRC values, the "exclusive or" (XOR) operation is performed on

the each 8-bit character and the content in the register. The result is placed in the bits from the low-order bit to the high-order bit, and 0 is placed in the high-order bit. Then, the low-order bit is detected. If the low-order bit is 1, the XOR operation is performed on the current value in the register and the preset value. If low-order bit is 0, no operation is performed. This process is repeated 8 times. After the last bit (8th bit) is detected and processed, the XOR operation is performed on the next 8-bit byte and the current content in the register. The final values in the register are the CRC values obtained after operations are performed on all the bytes in the frame.

The calculation adopts the international standard CRC check rule. You can refer to the related standard CRC algorithm to compile the CRC calculation program as required.

Here provided a simple function of CRC calculation for the reference (programmed with C language):

```
unsigned int crc_cal_value(unsigned char *data_value,unsigned char
data_length)
{
int i;
unsigned int crc_value=0xffff;
while(data_length--)
{  crc_value^=*data_value++;
    for(i=0;i<8;i++)
    {
if(crc_value&0x0001)crc_value=(crc_value>>1)^0xa001;
    else crc_value=crc_value>>1;
    }  }
return(crc_value);
}
```

In the ladder logic, CKSM uses the table look-up method to calculate the CRC value according to the content in the frame. The program of this method is simple, and the calculation is fast, but the ROM space occupied is large. Use this program with caution in scenarios where there are space occupation requirements on programs.

7.3 RTU command code and communication data description

7.3.1 Command code: 03H

03H (corresponding to binary 0000 0011), read N words (Word) (N≤16)

Command code 03H means that if the master read data from the VFD, the reading number depends on the "data number" in the command code. The Max. Continuous reading number is 16 and the parameter address should be continuous. The byte length of every data is 2 (one word). The following command format is illustrated by hex (a number with "H" means

hex) and one hex occupies one byte.

The command code is used to read the working stage of the VFD.

For example, read continuous 2 data content from 0004H from the VFD with the address of 01H (read the content of data address of 0004H and 0005H), the frame structure is as follows:

RTU master command (sent from the master to the VFD)		RTU slave response (sent from the VFD to the master)	
START	T1-T2-T3-T4	START	T1-T2-T3-T4
ADDR	01H	ADDR	01H
CMD	03H	CMD	03H
		Byte number	04H
MSB of the start address	00H	MSB of data in 0004H	13H
LSB of the start address	04H	LSB of data in 0004H	88H
MSB of data number	00H	MSB of data in 0005H	00H
LSB of data number	02H	LSB of data in 0005H	00H
LSB of CRC	85H	LSB of CRC CHK	7EH
MSB of CRC	CAH	LSB of CRC CHK	9DH
END	T1-T2-T3-T4	END	T1-T2-T3-T4

T1-T2-T3-T4 between START and END is to provide at least the time of 3.5 bytes as the leisure time and distinguish two messages for the avoidance of taking two messages as one message.

ADDR = 01H means the command message is sent to the VFD with the address of 01H and ADDR occupies one byte.

CMD=03H means the command message is sent to read data from the VFD and CMD occupies one byte.

"Start address" means reading data from the address and it occupies 2 bytes with the fact that the MSB is in the front and the LSB is in the behind.

"Data number" means the reading data number with the unit of word. If the "start address" is 0004H and the "data number" is 0002H, the data of 0004H and 0005H will be read.

CRC occupies 2 bytes with the fact that the LSB is in the front and the MSB is in the behind.

The meaning of the response is that:

ADDR = 01H means the command message is transmitted by the VFD whose address is 01H. The ADDR information occupies one byte.

CMD=03H means the message is received from the VFD to the master for the response of reading command. The CMD information occupies one byte.

"Byte number" means all byte number from the byte (excluding the byte) to CRC byte (excluding the byte). 04 means there are 4 byte of data from the "byte number" to "LSB of CRC CHK", which are "MSB of data in 0004H", "LSB of data in 0004H", "MSB of data in 0005H" and "LSB of data in 0005H".

There are 2 bytes stored in one data with the fact that the MSB is in the front and the LSB is in the behind of the message, the data of data address 0004H is 1388H, and the data of data address 0005H is 0000H.

CRC occupies 2 bytes with the fact that the LSB is in the front and the MSB is in the behind.

7.3.2 Command code: 06H

06H (corresponding to binary 0000 0110), write a word

The command means that the master write data to the VFD and one command can write one data other than multiple dates. The effect is to change the working mode of the VFD.

For example, write 5000 (1388H) to 0004H from the VFD with the address of 02H, the frame structure is as follows.

RTU master command (sent from the master to the VFD)		RTU slave response (sent from the VFD to the master)	
START	T1-T2-T3-T4	START	T1-T2-T3-T4
ADDR	02H	ADDR	02H
CMD	06H	CMD	06H
MSB of data writing address	00H	MSB of data writing address	00H
LSB of data writing address	04H	LSB of data writing address	04H
MSB of to-be-written data	13H	MSB of to-be-written data	13H
LSB of to-be-written data	88H	LSB of to-be-written data	88H
LSB of CRC CHK	C5H	LSB of CRC CHK	C5H
MSB of CRC CHK	6EH	MSB of CRC CHK	6EH
END	T1-T2-T3-T4	END	T1-T2-T3-T4

Note: Section 7.3.1 and 7.3.2 mainly describe the command format.

7.3.3 Command code 08H, diagnosis

Sub-function code description:

Sub-function code	Description
0000	Return data based on query requests

For example, to query about the circuit detection information about the VFD whose address is 01H, the query and return strings are the same, and the formats are described in the following tables.

RTU master command		RTU slave command	
START	T1-T2-T3-T4	START	T1-T2-T3-T4
ADDR	01H	ADDR	01H
CMD	08H	CMD	08H
MSB of sub-function code	00H	MSB of sub-function code	00H
LSB of sub-function code	00H	LSB of sub-function code	00H
MSB of data	12H	MSB of data	12H
LSB of data	ABH	LSB of data	ABH
LSB of CRC CHK	ADH	LSB of CRC CHK	ADH
MSB of CRC CHK	14H	MSB of CRC CHK	14H
END	T1-T2-T3-T4	END	T1-T2-T3-T4

7.3.4 Data address definition

This section describes the address definition of communication data. The addresses are used for controlling the running, obtaining the status information, and setting function parameters of the VFD.

7.3.4.1 Function code address format rules

The parameter address occupies 2 bytes with the fact that the MSB is in the front and the LSB is in the behind. The range of MSB and LSB are: MSB—00~ffH; LSB—00~ffH. The MSB is the group number before the radix point of the function code and the LSB is the number after the radix point. But both the MSB and the LSB should be changed into hex. For example P05.05, the group number before the radix point of the function code is 05, then the MSB of the parameter is 05, the number after the radix point 05, then the LSB of the parameter is 05, then the function code address is 0505H and the parameter address of P10.01 is 0A01H.

Note:

- P29 group is the factory parameter which cannot be read or changed. Some parameters cannot be changed when the VFD is in the running state and some parameters cannot be changed in any state. The setting range, unit and related

instructions should be paid attention to when modifying the function code parameters.

- EEPROM is stocked frequently, which may shorten the usage time of EEPROM. For users, some functions are not necessary to be stocked on the communication mode. The needs can be met on by changing the value in RAM. Changing the MSB of the function code from 0 to 1 can also realize the function. For example, the function code P00.07 is not stocked into EEPROM. Only by changing the value in RAM can set the address to 8007H. This address can only be used in writing RAM other than reading. If it is used to read, it is an invalid address.

7.3.4.2 Description of other function addresses in Modbus

In addition to modifying the parameters of the VFD, the master can also control the VFD, such as start and stop it, and monitor the operation state of the VFD. The following table describes other function parameters.

Function instruction	Address definition	Data meaning instruction	R/W characteristics
Communication-based control command	2000H	0001H: Forward running	R/W
		0002H: Reverse running	
		0003H: Forward jogging	
		0004H: Reverse jogging	
		0005H: Stop	
		0006H: Coast to stop	
		0007H: Fault reset	
		0008H: Jogging stop	
Communication-based value setting	2001H	Communication setting frequency (0–Fmax (unit: 0.01Hz))	R/W
	2002H	PID reference, range (0–1000, 1000 corresponds to 100.0%)	
	2003H	PID feedback, range (0–1000, 1000 corresponds to 100.0%)	R/W
	200AH	Virtual input terminal command , range: 0x000–0x1FF	R/W
	200BH	Virtual input terminal command , range: 0x00–0x0F	R/W
	200DH	AO output setting 1 (-1000–1000, 1000 corresponds to 100.0%)	R/W
VFD state word 1	2100H	0001H: Forward running	R
		0002H: Forward running	
		0003H: Stop	
		0004H: Fault	

Function instruction	Address definition	Data meaning instruction	R/W characteristics
		0005H: POFF state	
VFD state word 2	2101H	Bit0: =0: Bus voltage is not established =1: Bus voltage is established Bit1-2:=00: Motor 1 Bit3: =0: Asynchronous motor =1: Synchronous motor Bit4:=0: Pre-alarm without overload =1: Overload pre-alarm Bit5-Bit6:=00: Keypad control =01: Terminal control =10: Communication control	R
VFD fault code	2102H	See the description of fault types.	R
VFD identification code	2103H	Goodrive10-----0x010d	R
Running frequency	3000H	0-Fmax (unit: 0.01Hz)	Compatible with GD series, CHF100A and CHV100
Set frequency	3001H	0-Fmax (unit: 0.01Hz)	
Bus voltage	3002H	0.0-2000.0V (unit: 0.1V)	
Output voltage	3003H	0-1200V (unit: 1V)	
Output current	3004H	0.0-3000.0A (unit: 0.1A)	
Rotating speed	3005H	0-65535 (unit: 1RPM)	
Output power	3006H	-300.0-300.0% (unit: 0.1%)	
Output torque	3007H	-250.0-250.0% (unit: 0.1%)	
PID setting	3008H	-100.0-100.0% (unit: 0.1%)	
PID feedback	3009H	-100.0-100.0% (unit: 0.1%)	
Input IO state	300AH	000-1FF	
Output IO state	300BH	000-1FF	
Analog input 1	300CH	0.00-10.00V	R

Function instruction	Address definition	Data meaning instruction	R/W characteristics
		(unit: 0.01V)	
Analog input 2	300DH	0.00–10.00V (unit: 0.01V)	R
Reserved	300EH		R
Reserved	300FH		R
Reserved	3011H		R
Current step of the multi-step speed	3012H	0–15	R
Reserved	3013H		R
External count value	3014H	0–65535	R
Torque setting	3015H	-300.0–300.0% (unit: 0.1%)	R
VFD identification code	3016H		R
Fault code	5000H		R

The Read/Write (R/W) characteristics indicate whether a function can be read and written. For example, "Communication-based control command" can be written, and therefore the command code 6H is used to control the VFD. The R characteristic indicates that a function can only be read, and W indicates that a function can only be written.

Note: Some parameters in the preceding table are valid only after they are enabled. Take the running and stop operations as examples, you need to set "Running command channel" (P00.01) to "Communication", and set "Communication running command channel" (P00.02) to the Modbus communication channel. For another example, when modifying "PID setting", you need to set "PID reference source" (P09.00) to Modbus communication.

The following table describes the encoding rules of device codes (corresponding to the identification code 2103H of the VFD).

8 MSBs	Meaning	8 LSBs	Meaning
0x01	GD	0x08	GD35 vector VFD
		0x09	GD35-H1 vector VFD
		0x0a	GD300 vector VFD
		0x0b	GD100 simple vector VFD
		0x0c	GD200 general VFD
		0x0d	GD10 mini VFD

Note: The code is consisted of 16 bit which is 8 MSBs and 8 LSBs. 8 MSBs indicate the motor type series and 8 LSBs indicate the derived motor types of the series.

7.3.5 Fieldbus ratio scale

In practical applications, communication data is represented in the hexadecimal form, but hexadecimal values cannot represent decimals. For example, 50.12Hz cannot be represented in the hexadecimal form. In such cases, we can multiply 50.12 by 100 to obtain an integer 5012, and then 50.12 can be represented as 1394H (5012 in the decimal form) in the hexadecimal form.

In the process of multiplying a non-integer by a multiple to obtain an integer, the multiple is referred to as a fieldbus scale.

The fieldbus scale depends on the number of decimals in the value specified in "Description" or "Default". If there are n decimals in the value, the fieldbus scale m is the n^{th} -power of 10. Take the following table as an example, m is 10.

Function code	Name	Description	Default	Modify
P01.20	Wake-up-from-sleep delay	0.0–3600.0s (valid when P01.19=2)	0.0s	<input type="radio"/>
P01.21	Restart after power off	0: Disable 1: Enable	0	<input type="radio"/>

The value specified in "Setting range" or "Default" contains one decimal, so the fieldbus scale is 10. If the value received by the upper computer is 50, the value of "Wake-up-from-sleep delay" of the VFD is 5.0 ($5.0=50/10$).

To set the "Wake-up-from-sleep delay" to 5.0s through Modbus communication, you need first to multiply 5.0 by 10 according to the scale to obtain an integer 50, that is, 32H in the hexadecimal form, and then transmit the following write command:

01 06 01 14 00 32 49 E7
 VFD Write Parameters Data number CRC check
 address command address

After receiving the command, the VFD converts 50 into 5.0 based on the fieldbus scale, and then sets "Wake-up-from-sleep delay" to 5.0s.

For another example, after the upper computer transmits the "Wake-up-from-sleep delay" parameter command, the master receives the following response from the VFD:

01 03 02 00 32 39 91
 VFD Read 2-byte Parameter CRC check
 address command data data

The parameter data is 0032H, that is, 50, so 5.0 is obtained based on the fieldbus scale (50/10=5.0). In this case, the master identifies that the "Wake-up-from-sleep delay" is 5.0s.

7.3.6 Error message response

Operation errors may occur in communication-based control. For example, some parameters can only be read, but a write command is transmitted. In this case, the VFD returns an error message response. Error message responses are sent from the VFD to the master. The following table describes the codes and definitions of the error message responses.

Code	Name	Meaning
01H	Invalid command	The command code received by the upper computer is not allowed to be executed. The possible causes are as follows: <ul style="list-style-type: none"> • The function code is applicable only on new devices and is not implemented on this device. • The slave is in the faulty state when processing this request.
02H	Invalid data address.	For the VFD, the data address in the request of the upper computer is not allowed. In particular, the combination of the register address and the number of the to-be-transmitted bytes is invalid.
03H	Invalid data value	The received data domain contains a value that is not allowed. The value indicates the error of the remaining structure in the combined request. Note: It does not mean that the data item submitted for storage in the register includes a value unexpected by the program.
04H	Operation failure	The parameter is set to an invalid value in the write operation. For example, a function input terminal cannot be set repeatedly.
05H	Password error	The password entered in the password verification address is different from that set in P07.00.
06H	Data frame error	The length of the data frame transmitted by the upper computer is incorrect, or in the RTU format, the value of the CRC check bit is inconsistent with the CRC value calculated by the lower computer.
07H	Parameter read-only	The parameter to be modified in the write operation of the upper computer is a read-only parameter.

Code	Name	Meaning
08H	Parameter cannot be modified in running	The parameter to be modified in the write operation of the upper computer cannot be modified during the running of the VFD.
09H	Password protection	A user password is set, and the upper computer does not provide the password to unlock the system when performing a read or write operation. The error of "system locked" is reported.

The slave uses functional code fields and fault addresses to indicate it is a normal response or some error occurs (named as objection response). For normal responses, the slave shows corresponding function codes, digital address or sub-function codes as the response. For objection responses, the slave returns a code which equals the normal code, but the first byte is logic 1.

For example: when the master sends a message to the slave, requiring it to read a group of address data of the VFD function codes, there will be following function codes:

0 0 0 0 0 1 1 (Hex 03H)

For normal responses, the slave responds the same codes, while for objection responses, it will return:

1 0 0 0 0 1 1 (Hex 83H)

Besides the function codes modification for the objection fault, the slave will respond a byte of abnormal code which defines the error reason. When the master receives the response for the objection, in a typical processing, it will send the message again or modify the corresponding order.

For example, set the "running command channel" of the VFD (P00.01, parameter address is 0001H) with the address of 01H to 03, the command is as following:

<u>01</u>	<u>06</u>	<u>00 01</u>	<u>00 03</u>	<u>98 0B</u>
VFD address	Write command	Parameter address	Parameter data	CRC check

But the setting range of "running command channel" is 0–2, if it is set to 3, because the number is beyond the range, the VFD will return fault response message as below:

<u>01</u>	<u>86</u>	<u>04</u>	<u>43 A3</u>
VFD address	Exception response code	Fault code	CRC check

Abnormal response code 86H means the abnormal response to writing command 06H; the fault code is 04H. In the table above, its name is operation failed and its meaning is that the parameter setting in parameter writing is invalid.

7.3.7 Read/Write operation example

For details about the formats of the read and write commands, see section 7.3.

7.3.7.1 Examples of reading command 03H

Read the state word 1 of the VFD with the address of 01H (see section 7.3.4.2 "Description of other function addresses in Modbus"). The parameter address of the state word 1 of the VFD is 2100H.

The command sent to the VFD:

<u>01</u>	<u>03</u>	<u>21 00</u>	<u>00 01</u>	<u>8E 36</u>
VFD address	Read command	Parameter address	Data quantity	CRC check

If the response message is as below:

<u>01</u>	<u>03</u>	<u>02</u>	<u>00 03</u>	<u>F8 45</u>
VFD address	Read command	Number of bytes	Data content	CRC check

The data content is 0003H. From the table 1, the VFD stops.

Watch "the current fault type" to "the previous 5 times fault type" of the VFD through commands, the corresponding function code is P07.27-P07.32 and corresponding parameter address is 071BH - 0720H(there are 6 from 071BH).

The command sent to the VFD:

<u>03</u>	<u>03</u>	<u>07 1B</u>	<u>00 06</u>	<u>B5 59</u>
VFD address	Read command	Start address	6 parameters in total	CRC check

If the response message is as below:

<u>03</u>	<u>03</u>	<u>0C</u>	<u>00 23</u>	<u>00 23</u>	<u>00 23</u>	<u>00 23</u>	<u>00 23</u>	<u>00 23</u>	<u>00 23</u>	<u>5F D2</u>
VFD address	Read command	Number of bytes	Type of current fault	Type of last fault	Type of last but one fault	Type of last but two fault	Type of last but three fault	Type of last but four fault		CRC check

See from the returned data, all fault types are 0023H (decimal 35) with the meaning of maladjustment (STo).

7.3.7.2 Examples of writing command 06H

Make the VFD with the address of 03H to run forward. See section 7.3.4.2 “Description of other function addresses in Modbus”, the address of “Communication-based control command” is 2000H and forward running is 0001.

Function	Address	Data description	R/W
Communication-based control command	2000H	0001H: Forward running	R/W
		0002H: Reverse running	
		0003H: Forward jogging	
		0004H: Reverse jogging	
		0005H: Stop	
		0006H: Coast to stop (emergency stop)	
		0007H: Fault reset	
		0008H: Jogging to stop	

The command sent by the master:

<u>03</u>	<u>06</u>	<u>20 00</u>	<u>00 01</u>	<u>42 28</u>
VFD address	Write command	Parameter address	Forward running	CRC check

If the operation is successful, the response may be as below (the same with the command sent by the master):

<u>03</u>	<u>06</u>	<u>20 00</u>	<u>00 01</u>	<u>42 28</u>
VFD address	Write command	Parameter address	Forward running	CRC check

Set max. output frequency of the VFD with the address of 03H as 100Hz.

Function code	Name	Description	Default	Modify
P00.03	Max. output frequency	Used to set max. output frequency of the VFD. It is the basis of frequency setup and the acceleration/deceleration. Setting range: P00.04–400.00Hz	50.00Hz	☉

See the figures behind the radix point, the fieldbus ratio value of max. output frequency (P00.03) is 100. 100Hz timed by 100 is 10000 and the corresponding hex is 2710H.

The command sent by the master:

<u>03</u>	<u>06</u>	<u>00 03</u>	<u>27 10</u>	<u>62 14</u>
VFD address	Write command	Parameter address	Parameter data	CRC check

If the operation is successful, the response may be as below (the same with the command sent by the master):

<u>03</u>	<u>06</u>	<u>00 03</u>	<u>27 10</u>	<u>62 14</u>
VFD address	Write command	Parameter address	Parameter data	CRC check

Note: The blank in the above command is for illustration. The blank cannot be added in the actual application unless the upper monitor can automatically remove the blank.

7.4 Common communication faults

Common communication faults include the following:

- No response is returned.
- The VFD returns an exception response.

Possible causes of no response include the following:

- The serial port is set incorrectly. For example, the converter uses the serial port COM1, but COM2 is selected for the communication.
- The settings of the baud rates, data bits, stop bits, and check bits are inconsistent with those set on the VFD.
- The positive pole (+) and negative pole (-) of the RS485 bus are connected reversely.
- The RS485 wire cap on the terminal board of the VFD is not connected. This wire cap is at the back of the terminal block.

Appendix A Technical data

A.1 Derating in application

A.1.1 Capacity

Choose a VFD based on the rated current and power of the motor. To endure the rated power of the motor, the rated output current of the VFD must be larger or equal to the rated current of the motor. The rated power of the VFD must be higher or equal to that of the motor.

Note:

- The maximum allowable shaft power of the motor is limited to 1.5 times the rated power of the motor. If the limit is exceeded, the VFD automatically restricts the torque and current of the motor. This function effectively protects the input shaft against overload.
- The rated capacity is the capacity at the ambient temperature of 40°C.
- You need to check and ensure that the power flowing through the common DC connection in the common DC system does not exceed the rated power of the motor.

A.1.2 Derating

If the ambient temperature on the site where the VFD is installed exceeds 40°C, the altitude exceeds 1000m, or the carrier frequency is changed from 4 kHz to 8, 12 or 15 kHz, the VFD needs to be derated.

A.1.2.1 Derating due to temperature

When the temperature ranges from +40°C to +50°C, the rated output current is derated by 1% for each increased 1°C.

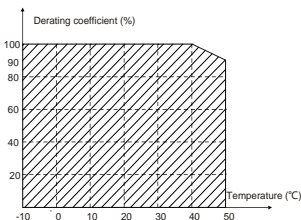

Note: It is not recommended to use the VFD at an environment with the temperature higher than 50°C. If you do, you shall be held accountable for the consequences caused.

A.1.2.2 Derating due to altitude

When the altitude of the site where the VFD is installed is lower than 1000m, the VFD can run at the rated power. When the altitude exceeds 1000m, derate by 1% for every increase of 100m. When the altitude exceeds 3000m, consult the local INVT dealer or office for details.

A.1.2.3 Derating due to carrier frequency

The VFDs in different power classes are different in carrier frequency. The rated power of a VFD is defined based on the carrier frequency set in factory. If the carrier frequency exceeds the factory setting, the power of the VFD is derated by 10% for each increased 1 kHz.

A.2 CE

A.2.1 CE marking

The CE marking on the name plate of a VFD indicates that the VFD is CE-compliant, meeting the regulations of the European low-voltage directive (2014/35/EU) and EMC directive (2014/30/EU).

A.2.2 EMC compliance declaration

European union (EU) stipulates that the electric and electrical devices sold in Europe cannot generate electromagnetic disturbance that exceeds the limits stipulated in related standards, and can work properly in environments with certain electromagnetic interference. The EMC product standard (EN 61800-3) describes the EMC standards and specific test methods for adjustable speed electrical power drive systems. Our products have been compliant with these EMC regulations.

A.3 EMC regulations

The EMC product standard (EN 61800-3) describes the EMC requirements on VFDs.

Application environment categories

Category I: Civilian environments, including application scenarios where VFDs are directly connected to the civil power supply low-voltage grids without intermediate transformers

Category II: All environments except those in Category I.

VFD categories

C1: Rated voltage lower than 1000 V, applied to environments of Category I.

C2: Rated voltage lower than 1000 V, non-plug, socket, or mobile devices; power drive systems that must be installed and operated by specialized personnel when applied to environments of Category I

Note: The EMC standard IEC/EN 61800-3 no longer restricts the power distribution of VFDs,

but it specifies their use, installation, and commissioning. Specialized personnel or organizations must have the necessary skills (including the EMC-related knowledge) for installing and/or performing commissioning on the electrical drive systems.

C3: Rated voltage lower than 1000 V, applied to environments of Category II. They cannot be applied to environments of Category I.

C4: Rated voltage higher than 1000 V, or rated current higher or equal to 400 A, applied to complex systems in environments of Category II.

A.3.1 VFDs of category C2

The induction disturbance limit meets the following stipulations:

1. Select an optional EMC filter according to Appendix D Optional peripheral accessories and install it following the description in the EMC filter manual.
2. Select the motor and control cables according to the description in the manual.
3. Install the VFD according to the description in the manual.



- Currently in environments in China, the VFD may generate radio interference, you need to take measures to reduce the interference.

A.3.2 VFDs of category C3

The anti-interference performance of the VFD meets the requirements of environments Category II in the IEC/EN 61800-3 standard.

The induction disturbance limit meets the following stipulations:

1. Select an optional EMC filter according to Appendix D Optional peripheral accessories and install it following the description in the EMC filter manual.
2. Select the motor and control cables according to the description in the manual.
3. Install the VFD according to the description in the manual.



- VFDs of category C3 cannot be applied to civilian low-voltage common grids. When applied to such grids, the VFDs may generate radio frequency electromagnetic interference.

Appendix B Dimension drawings

This chapter describes the dimension drawings of Goodrive350 series VFDs. The dimension unit used in the drawings is mm.

B.1 Keypad structure

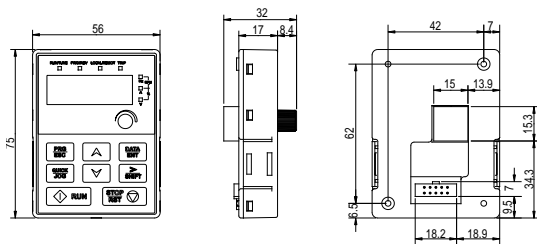

Figure B-1 Keypad structure diagram

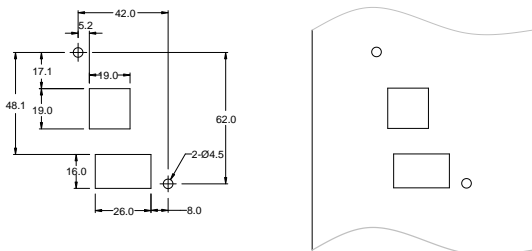
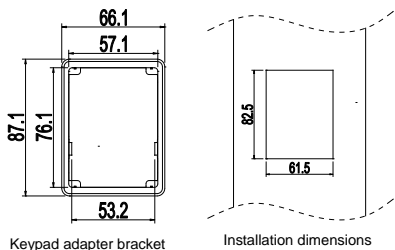

Figure B-2 Hole-cutting diagram for non-bracket keypad

If the keypad is externally installed on an optional keypad adapter bracket, it can be 20 meters away from the VFD at most.



Keypad adapter bracket

Installation dimensions

B.2 VFD chart

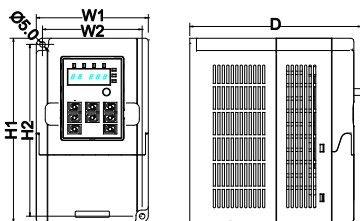

Figure B-3 Wall mounting

Table B-1 Wall-mounting dimensions (unit: mm)

	Model	W1	W2	H1	H2	D
1PH 220V	GD10-0R2G-S2-B	85.0	74.0	145.5	131.5	134.2
	GD10-0R4G-S2-B	85.0	74.0	145.5	131.5	134.2
	GD10-0R7G-S2-B	85.0	74.0	145.5	131.5	153.2
	GD10-1R5G-S2-B	100.0	89.0	170.5	154.0	153.2
	GD10-2R2G-S2-B	100.0	89.0	170.5	154.0	153.2
3PH 220V	GD10-0R2G-2-B	85.0	74.0	145.5	131.5	134.2
	GD10-0R4G-2-B	85.0	74.0	145.5	131.5	134.2
	GD10-0R7G-2-B	85.0	74.0	145.5	131.5	153.2
	GD10-1R5G-2-B	100.0	89.0	170.5	154.0	153.2
	GD10-2R2G-2-B	100.0	89.0	170.5	154.0	153.2
3PH 380V	GD10-0R7G-4-B	100.0	89.0	170.5	154.0	153.2
	GD10-1R5G-4-B	100.0	89.0	170.5	154.0	153.2
	GD10-2R2G-4-B	100.0	89.0	170.5	154.0	153.2

Note: If C3 input filter is selected, the VFD height (H1) increases.

Appendix C Optional peripheral accessories





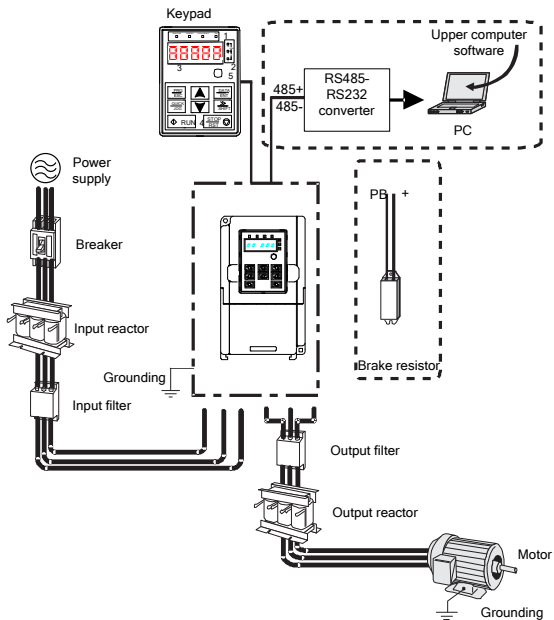

This chapter describes how to select the options and parts of Goodrive10 series VFDs.

C.1 Peripheral wiring

Figure C-1 shows the peripheral wiring of Goodrive10 series VFDs.



Note: If C3 input filter is selected, C3 input filter is connected in parallel to input end of the VFD.

Image	Name	Description
	Cable	Accessory for signal transmission.
	Breaker	Device for electric shock prevention and protection against short-to-ground that may cause current leakage and fire. Select residual-current circuit breakers (RCCBs) that are applicable to VFDs and can restrict high-order harmonics, and of which the rated sensitive current for one VFD is larger than 30 mA.
	Input reactor	Accessories used to improve the current adjustment coefficient on the input side of the VFD, and thus restrict high-order harmonic currents.
	Input filter	Accessory that restricts the electromagnetic interference generated by the VFD and transmitted to the public grid through the power cable. Try to install the input filter near the input terminal side of the VFD.
	Braking resistor	Accessories used to consume the regenerative energy of the motor to reduce the DEC time. The VFD models need only to be configured with braking resistors.
	Output filter	Accessory used to restrict interference generated in the wiring area on the output side of the VFD. Try to install the output filter near the output terminal side of the VFD.
	Output reactor	Accessory used to lengthen the valid transmission distance of the VFD, which effectively restrict the transient high voltage generated during the switch-on and switch-off of the IGBT module of the VFD.

C.2 Power supply

	<ul style="list-style-type: none"> Ensure that the voltage class of the VFD is consistent with that of the grid.
--	---

C.3 Cable

C.3.1 Power cable

The sizes of the input power cables and motor cables must meet the local regulation.

Note: If the conductivity of the shielding layer of the motor cables cannot meet the requirements, separate PE conductors must be used.

C.3.2 Control cable

All analog control cables and cables used for frequency input must be shielded cables.

Relay cables need to be those with metal braided shield layers.

Keypads need to be connected by using network cables. In complicated electromagnetic environments, shielded network cables are recommended.

Note:

- Analog signals and digital signals cannot use the same cables, and their cables must be arranged separately.
- Check the insulation conditions of the input power cable of a VFD according to the local regulations before connecting it.

VFD model	Recommended cable size(mm ²)		Size of connectable cable (mm ²)				Terminal screw	Tightening torque (Nm)
	RST UVW	PE	RST UVW	P1 and (+)	PB (+) and (-)	PE		
GD10-0R2G-S2-B	1.5	1.5	1.5	1.5	1.5	1.5	M3	0.56
GD10-0R4G-S2-B	1.5	1.5	1.5	1.5	1.5	1.5	M3	0.56
GD10-0R7G-S2-B	1.5	1.5	1.5	1.5	1.5	1.5	M3	0.56
GD10-1R5G-S2-B	2.5	2.5	2.5	2.5	2.5	2.5	M3	0.8
GD10-2R2G-S2-B	2.5	2.5	2.5	2.5	2.5	2.5	M3	0.8
GD10-0R2G-2-B	1.5	1.5	1.5	1.5	1.5	1.5	M3	0.56
GD10-0R4G-2-B	1.5	1.5	1.5	1.5	1.5	1.5	M3	0.56
GD10-0R7G-2-B	1.5	1.5	1.5	1.5	1.5	1.5	M3	0.56
GD10-1R5G-2-B	2.5	2.5	2.5	2.5	2.5	2.5	M3	0.8
GD10-2R2G-2-B	2.5	2.5	2.5	2.5	2.5	2.5	M3	0.8
GD10-0R7G-4-B	1.5	1.5	1.5	1.5	1.5	1.5	M3	0.8
GD10-1R5G-4-B	2.5	2.5	2.5	2.5	2.5	2.5	M3	0.8
GD10-2R2G-4-B	2.5	2.5	2.5	2.5	2.5	2.5	M3	0.8

Note:

- Cables of the sizes recommended for the main circuit can be used in scenarios where the ambient temperature is lower than 40°C, the wiring distance is shorter than 100 m, and the current is the rated current.
- Terminals P1, (+), PB and (-) are used to connect to braking resistor.
- If the control cable and power cable need to be crossed, ensure that the angle between the control cable and the power cable is 90 degrees.
- If the inside of the motor is wet, the insulation resistance will decrease. If you think there is moisture inside the motor, dry the motor and re-measure it.

C.4 Breaker and electromagnetic contactor

You need to add a fuse to prevent overload.

You need to configure a manually manipulated molded case circuit breaker (MCCB) between the AC power supply and VFD. The breaker must be locked in the open state to facilitate installation and inspection. The capacity of the breaker needs to be 1.5 to 2 times the rated current of the VFD.



- According to the working principle and structure of breakers, if the manufacturer's regulation is not followed, hot ionized gases may escape from the breaker enclosure when a short-circuit occurs. To ensure safe use, exercise extra caution when installing and placing the breaker. Follow the manufacturer's instructions.

To ensure safety, you can configure an electromagnetic contactor on the input side to control the switch-on and switch-off of the main circuit power, so that the input power supply of the VFD can be effectively cut off when a system fault occurs.

VFD model	Fuse (A)	Breaker (A)	Rated current of the contactor (A)
GD10-0R2G-S2-B	16	10	10
GD10-0R4G-S2-B	16	16	10
GD10-0R7G-S2-B	16	16	16
GD10-1R5G-S2-B	25	25	16
GD10-2R2G-S2-B	50	40	32
GD10-0R2G-2-B	6	6	6
GD10-0R4G-2-B	6	10	10
GD10-0R7G-2-B	10	10	10
GD10-1R5G-2-B	25	16	16

VFD model	Fuse (A)	Breaker (A)	Rated current of the contactor (A)
GD10-2R2G-2-B	32	25	16
GD10-0R7G-4-B	10	6	10
GD10-1R5G-4-B	10	10	10
GD10-2R2G-4-B	16	16	10

C.5 Reactors

When the voltage of the grid is high, the transient large current that flows into the input power circuit may damage rectifier components. You need to configure an AC reactor on the input side, which can also improve the current adjustment coefficient on the input side.

When the distance between the VFD and motor is longer than 50 m, the parasitic capacitance between the long cable and ground may cause large leakage current, and overcurrent protection of the VFD may be frequently triggered. To prevent this from happening and avoid damage to the motor insulator, compensation must be made by adding an output reactor. When a VFD is used to drive multiple motors, take the total length of the motor cables (that is, sum of the lengths of the motor cables) into account. When the total length is longer than 50 m, an output reactor must be added on the output side of the VFD. If the distance between the VFD and motor is 50 m to 100 m, select the reactor according to the following table. If the distance is longer than 100 m, contact INVT's technical support technicians.

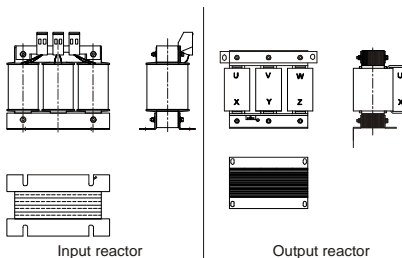

VFD model	Input reactor	Output reactor
GD10-0R2G-S2-B	-	-
GD10-0R4G-S2-B	-	-
GD10-0R7G-S2-B	-	-
GD10-1R5G-S2-B	-	-

VFD model	Input reactor	Output reactor
GD10-2R2G-S2-B	-	-
GD10-0R2G-2-B	ACL2-1R5-4	OCL2-1R5-4
GD10-0R4G-2-B	ACL2-1R5-4	OCL2-1R5-4
GD10-0R7G-2-B	ACL2-2R2-4	OCL2-2R2-4
GD10-1R5G-2-B		
GD10-2R2G-2-B		
GD10-0R7G-4-B	ACL2-1R5-4	OCL2-1R5-4
GD10-1R5G-4-B	ACL2-1R5-4	OCL2-1R5-4
GD10-2R2G-4-B	ACL2-2R2-4	OCL2-2R2-4

Note:

- The rated input voltage drop of input reactors is $2\% \pm 15\%$.
- The current adjustment coefficient on the input side of the VFD is higher than 90% after a DC reactor is configured.
- The rated output voltage drop of output reactors is $1\% \pm 15\%$.
- The preceding table describes external accessories. You need to specify the ones you choose when purchasing accessories.

C.6 Filter

Interference filters on the input side can reduce the VFD interference on the surrounding devices.

Noise filters on the output side can decrease the radio noise caused by the cables between VFDs and motors and the leakage current of conducting wires.

INVT provides some of the filters for you to choose.

C.6.1 C3 filter model description

FLT - P 04 003 L - C - G
A B C D E F G

Field identifier	Field description
A	FLT: Name of the VFD filter series
B	Filter type P: Power input filter

Field identifier	Field description
	L: Output filter
C	Voltage class S2: AC 1PH 220V (-15%)–240V (+10%) 02: AC 3PH 220V (-15%)–240V (+10%) 04: AC 3PH 380V (-15%)–440V (+10%)
D	3-digit development serial number. For example, 003 indicates the serial number of C3 filters in development.
E	Filter performance L: General H: High-performance
F	Filter application environment A: Environment Category I (IEC61800-3), C1 (EN 61800-3) B: Environment Category I (IEC61800-3), C2 (EN 61800-3) C: Environment Category II (IEC61800-3), C3 (EN 61800-3)
G	Lot No. G: Special for external C3 filter

C.6.2 C3 filter model selection

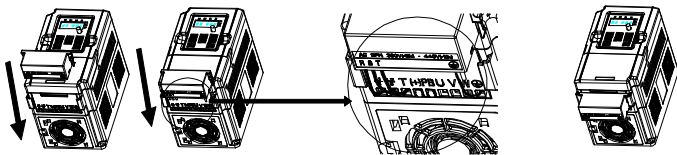

Note: If C3 input filter is selected, C3 input filter is connected in parallel to input end of the VFD.

VFD model	Input filter
GD10-0R2G-S2-B	FLT-PS2005L-C-G
GD10-0R4G-S2-B	FLT-PS2005L-C-G
GD10-0R7G-S2-B	FLT-PS2005L-C-G
GD10-1R5G-S2-B	FLT-PS2010L-C-G
GD10-2R2G-S2-B	FLT-PS2010L-C-G
GD10-0R2G-2-B	FLT-P04008L-C-G

VFD model	Input filter
GD10-0R4G-2-B	FLT-P04008L-C-G
GD10-0R7G-2-B	FLT-P04008L-C-G
GD10-1R5G-2-B	FLT-P04006L-C-G
GD10-2R2G-2-B	FLT-P04006L-C-G
GD10-0R7G-4-B	FLT-P04006L-C-G
GD10-1R5G-4-B	FLT-P04006L-C-G
GD10-2R2G-4-B	FLT-P04006L-C-G

Note:

- The input EMI meets the C3 requirements after an input filter is configured.
- The preceding table describes external accessories. You need to specify the ones you choose when purchasing accessories.

C.6.3 C2 Filter model description

FLT – P 04 016 L – B
A
B
C
D
E
F

Field identifier	Field description
A	FLT: Name of the VFD filter series
B	Filter type P: Power input filter L: Output filter
C	Voltage class S2: AC 1PH 220V (-15%)–240V (+10%) 04: AC 3PH 380V (-15%)–440V (+10%)
D	3-digit code indicating the rated current. For example, 016 indicates 16A.
E	Filter performance L: General H: High-performance
F	Filter application environment A: Environment Category I (IEC61800-3), C1 (EN 61800-3) B: Environment Category I (IEC61800-3), C2 (EN 61800-3)

C.6.4 C2 filter model selection

VFD model	Input filter	Output filter
GD10-0R2G-S2-B	FLT-PS2010H-A	FLT-L02010H-A
GD10-0R4G-S2-B	FLT-PS2010H-A	FLT-L02010H-A
GD10-0R7G-S2-B	FLT-PS2010H-A	FLT-L02010H-A
GD10-1R5G-S2-B	FLT-P04016L-B	FLT-L04016L-B
GD10-2R2G-S2-B	FLT-P04032L-B	FLT-L04032L-B
GD10-0R2G-2-B	FLT-P04006L-B	FLT-L04006L-B
GD10-0R4G-2-B	FLT-P04006L-B	FLT-L04006L-B
GD10-0R7G-2-B	FLT-P04006L-B	FLT-L04006L-B
GD10-1R5G-2-B	FLT-P04016L-B	FLT-L04016L-B
GD10-2R2G-2-B	FLT-P04016L-B	FLT-L04016L-B
GD10-0R7G-4-B	FLT-P04006L-B	FLT-L04006L-B
GD10-1R5G-4-B	FLT-P04006L-B	FLT-L04006L-B
GD10-2R2G-4-B	FLT-P04016L-B	FLT-L04016L-B

Note:

- The input EMI meets the C2 requirements after an input filter is configured.
- The preceding table describes external accessories. You need to specify the ones you choose when purchasing accessories.

C.7 Braking system

C.7.1 Braking unit

The GD10 series VFDs do not provide braking units. If needed, you can select optional braking units according to the lot number.

C.7.2 Braking resistor selection

When the VFD driving a high-inertia load decelerates or needs to decelerate abruptly, the motor runs in the power generation state and transmits the load-carrying energy to the DC circuit of the VFD, causing the bus voltage of the VFD to rise. If the bus voltage exceeds a specific value, the VFD reports an overvoltage fault. To prevent this from happening, you need to configure brake components.





- The design, installation, commissioning, and operation of the device must be performed by trained and qualified professionals.
- Follow all the "Warning" instructions during the operation. Otherwise, major physical injuries or property loss may be caused.

	<ul style="list-style-type: none"> ● Only qualified electricians are allowed to perform the wiring. Otherwise, damage to the VFD or brake components may be caused. ● Read the braking resistor instructions carefully before connecting them to the VFD. ● Connect braking resistors only to the terminals PB and (+). Do not connect them to other terminals. Otherwise, damage to the brake circuit and VFD and fire may be caused.
	<ul style="list-style-type: none"> ● Connect the brake components to the VFD according to the wiring diagram. If the wiring is not properly performed, damage to the VFD or other devices may be caused.

VFD model	Resistance applicable for 100% braking torque (Ω)	Dissipated power of braking resistor (kW)	Dissipated power of braking resistor (kW)	Dissipated power of braking resistor (kW)	Min. allowable braking resistance (Ω)
		10% braking usage	50% braking usage	80% braking usage	
GD10-0R2G-S2-B	722	0.03	0.15	0.24	42
GD10-0R4G-S2-B	361	0.06	0.30	0.48	42
GD10-0R7G-S2-B	192	0.11	0.56	0.90	42
GD10-1R5G-S2-B	96	0.23	1.1	1.8	30
GD10-2R2G-S2-B	65	0.33	1.7	2.6	21
GD10-0R2G-2-B	722	0.03	0.15	0.24	42
GD10-0R4G-2-B	361	0.06	0.30	0.48	42
GD10-0R7G-2-B	192	0.11	0.56	0.90	42
GD10-1R5G-2-B	96	0.23	1.1	1.8	30
GD10-2R2G-2-B	65	0.33	1.7	2.6	21
GD10-0R7G-4-B	653	0.11	0.6	0.9	100
GD10-1R5G-4-B	326	0.23	1.1	1.8	100
GD10-2R2G-4-B	222	0.33	1.7	2.6	54

Note:

- Select braking resistors according to the resistance and power data provided by our company.
- The braking resistor may increase the braking torque of the VFD. The preceding table describes the resistance and power for 100% braking torque, 10% braking usage, 50% braking usage, and 80% braking usage. You can select the braking system based on the actual operation conditions.

	<ul style="list-style-type: none"> Do not use braking resistors whose resistance is lower than the specified minimum resistance. VFDs do not provide protection against overcurrent caused by resistors with low resistance.
	<ul style="list-style-type: none"> In scenarios where braking is frequently implemented, that is, the braking usage is greater than 10%, you need to select a braking resistor with higher power as required by the operation conditions according to the preceding table.

C.7.3 Braking resistor installation

Braking resistor cables shall be shielded cables.

All resistors must be installed in places with good cooling conditions. Braking resistors are connected externally.

	<ul style="list-style-type: none"> The materials near the braking resistor must be non-flammable. The surface temperature of the resistor is high. Air flowing from the resistor is of hundreds of degrees Celsius. Prevent any materials from coming into contact with the resistor.
--	--

Goodrive10 series VFD need only external braking resistors. PB and (+) are the terminals for connecting braking resistors. Installation of braking resistors is shown in the following figure.

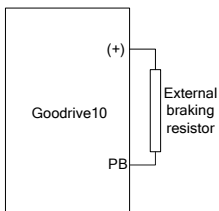

Appendix D Further information

D.1 Product and service inquiries

Should you have any queries about the product, contact the local INVT office. Provide the model and serial number of the product you query about. You can visit www.invt.com to find a list of INVT offices.

D.2 Feedback on INVT VFD manuals

Your comments on our manuals are welcome. Visit www.invt.com, directly contact online service personnel or choose **Contact Us** to obtain contact information.

D.3 Documents on the Internet

You can find manuals and other product documents in the PDF format on the Internet. Visit www.invt.com and choose **Support > Download**.



Service line: 86-755-23535967 E-mail: overseas@invt.com.cn Website: www.invt.com

The products are owned by **Shenzhen INVT Electric Co.,Ltd.**

Two companies are commissioned to manufacture: (For product code, refer to the 2nd/3rd place of S/N on the name plate.)

Shenzhen INVT Electric Co.,Ltd. (origin code: 01)

Address: INVT Guangming Technology Building, Songbai Road,
Matian, Guangming District, Shenzhen, China

INVT Power Electronics (Suzhou) Co.,Ltd. (origin code: 06)

Address: No. 1 Kunlun Mountain Road, Science & Technology
Town, Gaoxin District, Suzhou, Jiangsu, China

- Industrial Automation: HMI PLC VFD Servo System
 Elevator Intelligent Control System Rail Transit Traction System
- Energy & Power: UPS DCIM Solar Inverter SVG
 New Energy Vehicle Powertrain System New Energy Vehicle Charging System
 New Energy Vehicle Motor

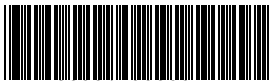

66001-00099