

Goodrive270 Series VFD for Fan and Pump



CONTENTS



About Us	2
Application Scenarios	4
Product Features	5
Technical Specification	10
Model Description	11
Expansion Card Selection	12
Reactor&Filter Selection	12
Accessory Selection	13
Standard Wiring	14
Installation Dimensions	15
Automation Product Family	19
Marketing service network	20

N T S

Good choice for fan and pump

Goodrive270 series VFD is designed for fan and pump driving in wastewater treatment, HVAC, chemical, metallurgical, electric power and other industries, with high energy efficiency and flexibility.

- ◆ Size advantage: Adopts book-type design for easy installation and compact structure
- ◆ Motor compatible: Supports the driving of synchronous motors and asynchronous motors
- ◆ Install and play: Integrated with the fan and pump industrial application functions (HVAC)
- ◆ Energy saving and high efficiency: Uses new ECO algorithm, reducing operating costs
- ◆ Flexible configuration: Optionally configured with built-in DC reactor and output reactor
- ◆ Highly extensible: Supports Profibus-DP, Profinet, CANopen communications, and I/O expansion
- ◆ Enhanced protection: Equipped with thickened protective coating in the core circuit board

Power range: 1.5kW~500kW Voltage level: : AC 3PH 380V~480V



About Us



Corporate Introduction

INVT (Shenzhen INVT Electric Co., Ltd) has been concentrating on industry automation and energy power since its foundation in 2002 and is committed to "Providing the best product and service to allow customers more competitiveness". INVT goes public in 2010 and is the first A-share listed company (002334) in Shenzhen Stock Exchange in the industry. At present, INVT owns 15 subsidiaries and more than 4000 employees, over 40 branches, forming a sales network covering more than 100 overseas countries and regions.

INVT has been awarded as the Key High-tech Enterprise of National Torch Plan based on mastering of key technologies in power electronics, auto control and IT. With business covering industry automation, electric vehicle, network power and rail transit, INVT has established 11 R&D centers nationwide, boasts more than 1300 patents and owns the first lab in the industry awarded ACT qualification from TÜV SÜD, UL-WTDP and CNAS National Lab. The industrial parks in Shenzhen and Suzhou aim to provide customers with advanced integrated product development design management, comprehensive product R&D test and auto informational production. The worldwide INVT branches and warranty service centers are ready to offer customers all-around back-ups including professional solutions, technical trainings and service support.

In the next decade, INVT will continue to take "Honesty and Integrity, Professionalism and Excellence" as our business philosophy, enhance core business sectors including industrial automation, electric vehicle, network power and rail transit based on the three major technologies in industry automation and energy power fields, and strive to become a leading, responsible and harmonic international professional group armed with proper product structure, leading technologies, efficient management, robust profitability and superior competitiveness.



Industrial Park in Suzhou

Group's core industrial base and R&D center in East China



Industrial Park in Guangming Shenzhen

Group headquarters, new product development and new business incubation base



Application Scenarios



HVAC



Municipal water supply



Sewage treatment



Municipal heating system



Delivery pump



Irrigation pump

Product Features Application Scenarios

Energy-efficient

◆ ECO mode: ensures optimal performance and lowest losses at low dynamic loads, optimizing output power

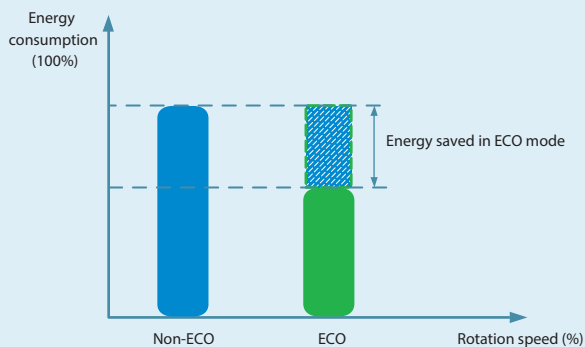

Outcome
Annual power saving: about 8100 kWh
<small>Note: This is an internal measured data. The actual effect differs from motor feature and performance.</small>

Conditions
<ul style="list-style-type: none"> ● Applicable to 4kW IE2 asynchronous motors ● Load rate: 40% Motor count: 10 ● Running times per year: 24 hours, 365 days ● Speed control mode: V/F, VF energy-saving mode: Max. efficiency ● Gain coefficient for energy saving: 100% ● Angle compensation coefficient for energy saving: 80%
<small>Valid only for asynchronous motor control and V/F control. It is recommended to enable this function for fan and pump applications with small load variations.</small>

◆ Bypass function: external contactors can be controlled by relays to achieve industrial frequency switching and reduce energy consumption

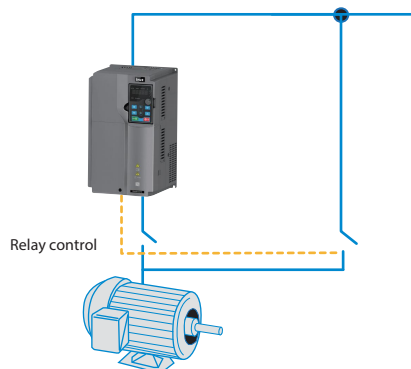

◆ Energy-saving control: enables sleep at night or energy-saving operation under extremely low load conditions by avoiding frequent start and stop

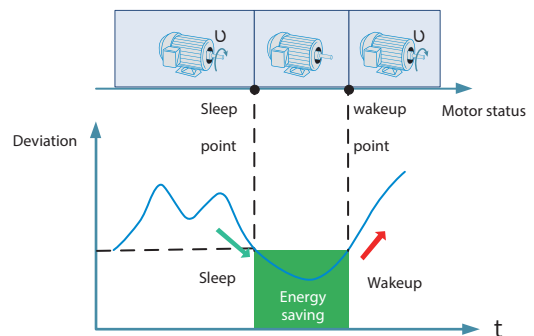

Multifunctional

- ◆ Retention at transient voltage drop: ensures continuous operation of equipments during short-term fluctuations in the power grid.

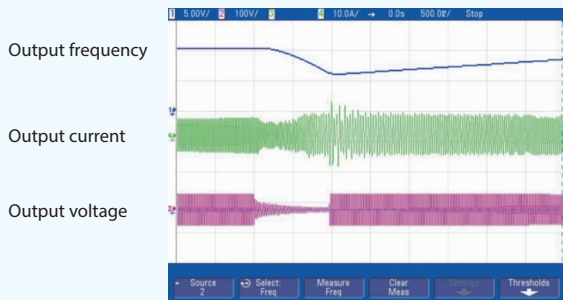

- ◆ Level control

When the water level is lower than the lower level limit and higher than the water shortage level, the system runs with the reserve pressure for abnormal cases. When the water level is lower than the water shortage level, the system stops all operations.

- ◆ Soft filling of water pipes

The VFD prevents the water hammer effect by slowly and smoothly injecting water into the water pipe during power-up.

- ◆ Pipe break detection

Pipe break detection is conducted based on the running frequency of VFD or the upper limit of PID output frequency.

- ◆ Multi-pump switch-over and auxiliary pump start/stop: supports variable-frequency pump water supply in the cyclic mode and the fixed mode, and provides sleep control (Note: An additional relay card is required).

The VFD does not designate a pump as the variable-frequency pump. When the water supply pressure is insufficient, the running variable-frequency pump will switch to the power frequency oper and then the next pump will become the variable-frequency pump (up ation, to 8 variable-frequency pumps can be controlled. Only one variable-frequency pump can be used at the same time)

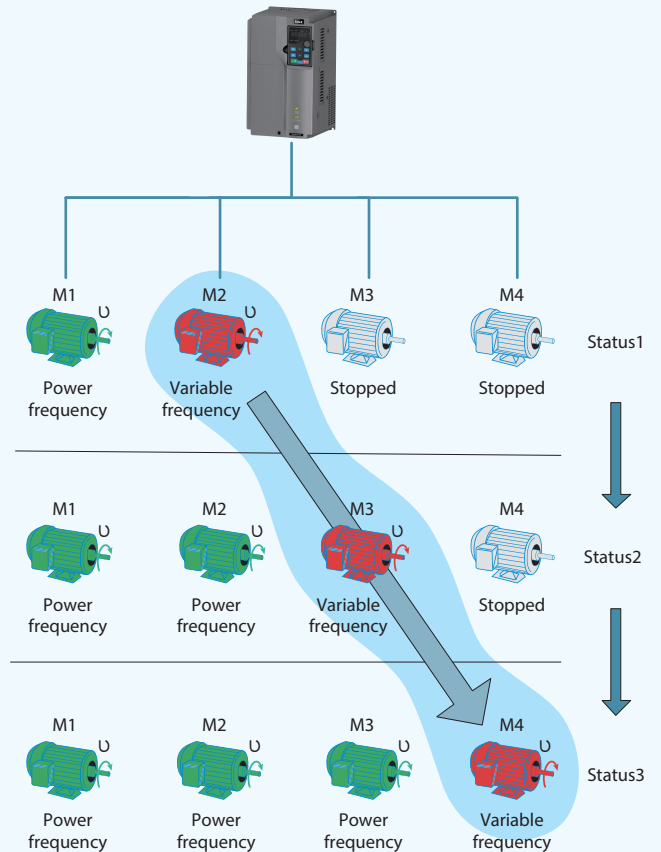

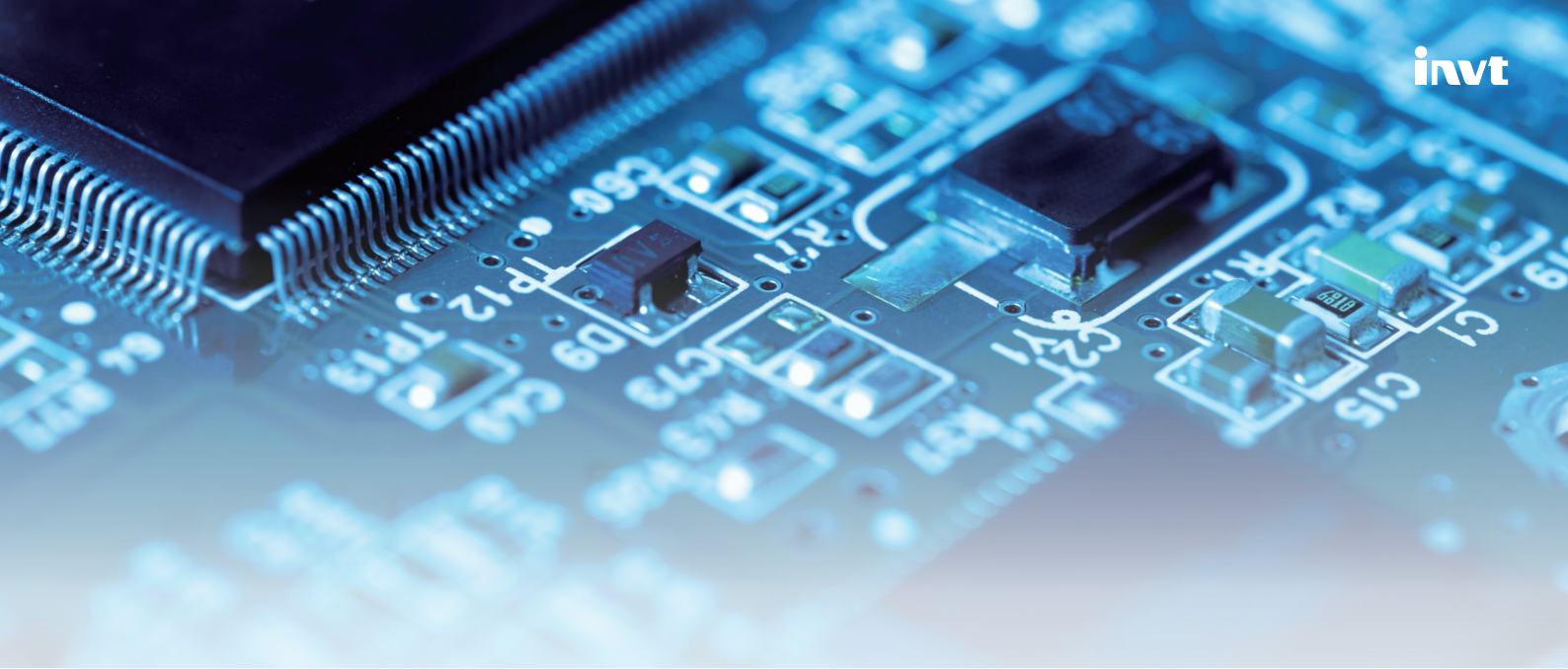

- ◆ Rotating speed tracking (for fan): tracks the rotating speed of fan before start-up to reduce the shock to the devices and improve the restart efficiency.

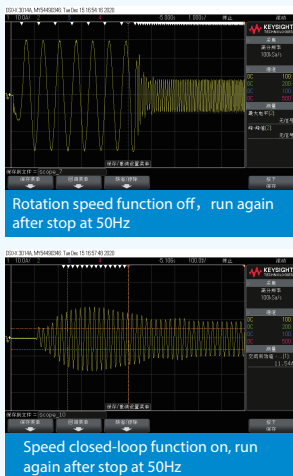

- ◆ Regeneration avoidance (for fan): A fan is in the state of slight regeneration under the influence of other fans that share the same pipe. The VFD will automatically increase the output frequency to prevent over-voltage alarm and ensure the stable operation of the machine.

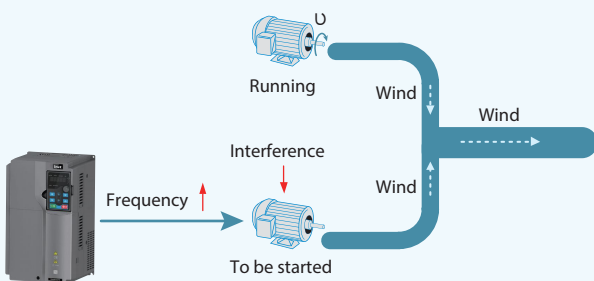

- ◆ Restart after power off: The VFD can automatically start up by itself when power-off restart is enabled.

- ◆ Multi-step speed reference: A total of 16-step speeds can be set by combining digital states of the four terminals, enabling airflow regulation at different time periods or load conditions.

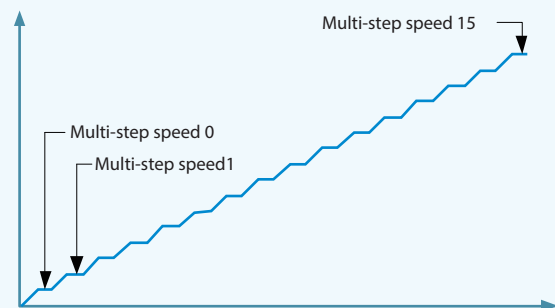

- ◆ Fire ride through (for pump): When a fire breaks out in a tunnel or building, the VFD can quickly disperse smoke and ignore other control commands and internal protection functions to keep working.



Safe and Reliable

- ◆ **Deslitting:** The motor periodic forward rotation, sleep, and reverse rotation enable the pump self-cleaning function, reducing the manual cleaning workload.

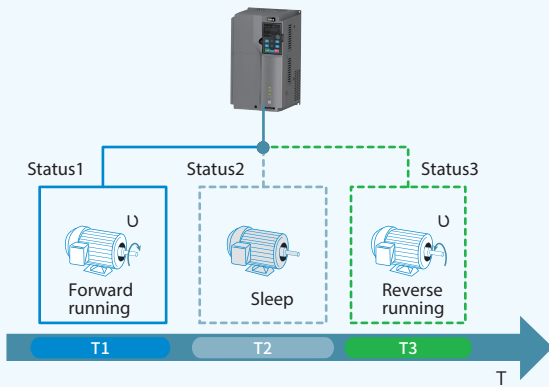

- ◆ **Independent air duct design:** The independent air duct effectively improves the protection effect of the VFD by preventing dust from entering the machine, and brings out the heat from the VFD to improve its reliability and extending its service life.

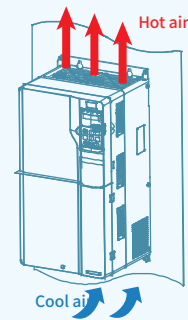

- ◆ **Frost proofing:** When the ambient temperature falls below a set threshold, the motor will automatically rotate to prevent water from freezing and thus protect the pump.

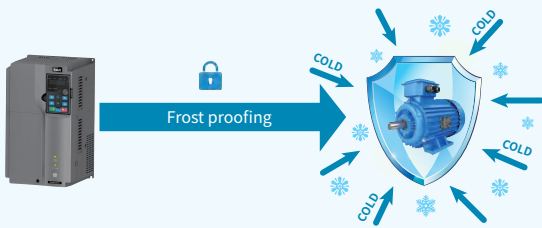

- ◆ **Motor heating:** The VFD outputs DC current to increase the surface temperature of the motor during work interruption, avoiding motor failure caused by condensed water.

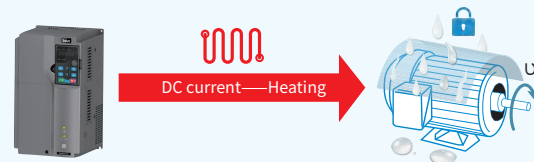

- ◆ **Enhanced PCB coating:** After strengthened in terms of three proofings, the PCB gains a strong protection ability to resist harsh environment, which guarantees the long-term healthy operation of the VFD.



- ◆ **built in Safe Torque Off (STO) function** (only GD270-EU models support)
 Designed according to relevant international standards, meeting SIL3 level (TUV certificate acquisition in progress)
 EN ISO 13849-1:2015 (Cat. 3 PL e)
 EN IEC 62061:2021 (SIL 3)
 EN 61800-5-2:2017

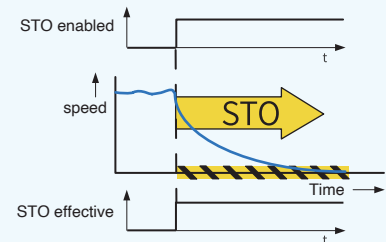



Configurable

Reactor configurations

- ◆ **A** For 11kW~355kW: Built-in DC reactor is optional
For 400kW~500kW: DC reactor is a standard configuration part



- ◆ **B** For 220kW and higher: Output reactor is available as an option (select L3 model)

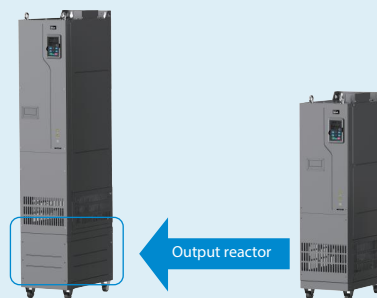

Expansion card configurations

- ◆ Support a variety of application environments, meeting the customization requirements.

1	Optional IO expansion card	Provides digital input, digital output, analog input, analog output, and relay terminals
2	Optional communication expansion card	Supports multiple industrial fieldbus systems such as PROFINET/PROFIBUS-DP/CANopen

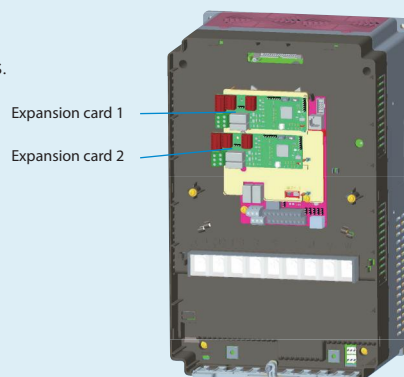

Technical Specifications

	Function	Specifications
Technical control performance	Input voltage (V)	◆ AC 3PH 380~480V Rated voltage: 380V
	Allowed voltage transient fluctuation	◆ -15%~+10%
	Input frequency (Hz)	◆ 50Hz or 60Hz; Allowed range: 47~63Hz
	Output frequency (Hz)	◆ 0~400Hz
	Control mode	◆ Space voltage vector control, and sensorless vector control (SVC)
	Motor type	◆ Asynchronous motor (AM) and synchronous motor (SM)
	Speed ratio	◆ For AMs: 1:200 (SVC), for SMs: 1:20 (SVC)
	Speed control accuracy	◆ $\pm 0.2\%$ (SVC)
	Speed fluctuation	◆ $\pm 0.3\%$ (SVC)
	Torque response	◆ <20ms (SVC)
	Torque control accuracy	◆ $\pm 10\%$ (SVC)
	Overload capacity	◆ Able to run at 110% of rated current for 1min, and an overload allowed for every 5min
Running control performance	Frequency setting method	◆ Settings can be implemented through digital, analog, pulse frequency, multi-step speed run, simple PLC, PID, and communication. ◆ Settings can be combined and the setting channels can be switched.
	Automatic voltage regulation	◆ The output voltage can be kept constant although the grid voltage changes.
	Fault protection	◆ Many protection functions available, such as protection against overcurrent, overvoltage, undervoltage, overtemperature, and phase loss
	Speed tracking restart	◆ Used to implement impact-free smooth startup for rotating motors
Peripheral interface	Analog input	◆ Two inputs. AI1: 0 (2)~10V / 0 (4)~20mA; AI2: -10 ~ +10V
	Analog output	◆ Two outputs. AO0/AO1: 0 (2)~10V/0 (4)~20mA
	Digital input	◆ Five regular inputs. Max. frequency: 1kHz; internal impedance: 3.3k Ω ◆ One high-speed input. Max. frequency: 50kHz
	Digital output	◆ One Y terminal open collector output, sharing the terminal with S4. The function can be selected through a jumper.
	Relay output	◆ Two programmable relay outputs. ◆ RO1A: NO; RO1B: NC; RO1C: common ◆ RO2A: NO; RO2B: NC; RO2C: common ◆ Contact capacity: 3A/AC250V, 1A/DC30V
	H1	◆ Safe torque off (STO) inputs ◆ STO redundant input, connected to the external NC contact. When the contact opens, STO acts and the VFD stops output. ◆ Safety input signal wires use shielded wires whose length is within 25m. ◆ The H1 and H2 terminals are short connected to +24V by default. Remove the jumper from the terminals before using the STO function.
	H2	Note:1. Only the -EU Models support safe-torque-off function. 2. For the 1.5-7.5kW -EU models, the extended interface SLOT1 will be occupied due to the H1/H2 terminals.
	Extended interfaces	◆ Two extended interfaces: SLOT1 and SLOT2 ◆ Supporting communication expansion cards, I/O cards and so on Note:1. For the 1.5-7.5kW -EU models, the extended interface SLOT1 will be occupied due to the H1/H2 terminals. 2. That is, 1.5-7.5kW -EU models only support extended interface SLOT2.
Other	Installation method	◆ Supports wall-mounting (1.5kW~250kW) ◆ Supports floor-mounting (1.5kW~132kW) ◆ Supports flange-mounting (220kW~500kW)
	Keypad	◆ 1.5~22kW: with laminated LED keyboard as a standard configuration ◆ 30~500kW: with a LED keypad that can be used externally
	EMC filter	◆ A built-in C3 filter is optional for 1.5~132kW ◆ A built-in C3 filter is a standard configuration for 160kW and higher
	Temperature of running environment	◆ -10°C ~+50°C; Derating is required when the ambient temperature exceeds 40°C.
	IP rating	◆ IP20 for 200kW and lower ◆ IP00 for 200kW and higher
	Pollution degree	◆ Degree 2
	Cooling method	◆ 1.5kW: Natural cooling ◆ 2.2kW and higher: Forced air cooling

Model description

Product model designation and selection

GD270-160-4-L1-C3-EU

① ② ③ ④ ⑤ ⑥

Field	No.	Field description	Content
Product series abbreviation	①	Product series abbreviation	◆ GD270: Goodrive270 series VFD for fan and pump
Rated power	②	Power range	◆ 160: 160kW
Voltage class	③	Voltage class	◆ 4: AC 3PH 380V-480V ◆ Rated voltage: 380V
Reactor configuration	④	Reactor configuration	◆ Default: Empty ◆ L1: with built-in DC reactor, applicable to 11-500kW models. ◆ L3: with built-in DC reactor and output AC reactor, applicable to 220kW and higher models. Note: DC reactors are standard parts for 400-500kW models.
Built-in filter configuration	⑤	Built-in filter configuration	◆ Empty: with built-in C3 filter applicable to 160kW -500kW without built-in C3/C2 filter applicable to 1.5-132kW ◆ C2: with built-in C2 filter, applicable to 1.5-22kW models ◆ C3: with built-in C3 filter, applicable to 30-132kW models
safe torque off function configuration	⑥	/	◆ EMPTY: without safe torque off function ◆ EU: Built-in safe torque off function

VFD mode	Output power (kW)	Input (A)	Output current (A)
GD270-1R5-4(-C2)(-EU)	1.5	5 (5)	3.7
GD270-2R2-4(-C2)(-EU)	2.2	6 (6)	5
GD270-004-4(-C2)(-EU)	4	15 (15)	9.5
GD270-5R5-4(-C2)(-EU)	5.5	20 (20)	13
GD270-7R5-4(-C2)(-EU)	7.5	27 (27)	17
GD270-011-4(-L1/-C2)(-EU)	11	35 (35)	25
GD270-015-4(-L1/-C2)(-EU)	15	44 (44)	32
GD270-018-4(-L1/-C2)(-EU)	18	46 (46)	38
GD270-022-4(-L1/-C2)(-EU)	22	54 (54)	45
GD270-030-4(-L1)(-C3)(-EU)	30	75 (56)	60
GD270-037-4(-L1)(-C3)(-EU)	37	90 (69)	75
GD270-045-4(-L1)(-C3)(-EU)	45	108 (101)	92
GD270-055-4(-L1)(-C3)(-EU)	55	142 (117)	115
GD270-075-4(-L1)(-C3)(-EU)	75	177 (149)	150
GD270-090-4(-L1)(-C3)(-EU)	90	200 (171)	180
GD270-110-4(-L1)(-C3)(-EU)	110	240 (205)	215
GD270-132-4(-L1)(-C3)(-EU)	132	278 (235)	250
GD270-160-4(-L1)(-EU)	160	310 (296)	305
GD270-185-4(-L1)(-EU)	185	335 (320)	330
GD270-200-4(-L1)(-EU)	200	385 (368)	380
GD270-220-4(-Ln)(-EU)	220	430 (411)	425
GD270-250-4(-Ln)(-EU)	250	465 (444)	460
GD270-280-4(-Ln)(-EU)	280	540 (485)	530
GD270-315-4(-Ln)(-EU)	315	605 (550)	600
GD270-355-4(-Ln)(-EU)	355	655 (600)	650
GD270-400-4-Ln(-EU)	400	660	720
GD270-450-4-Ln(-EU)	450	745	820
GD270-500-4-Ln(-EU)	500	800	860

Note:

$n = 1$ or 3

The parentheses "()" in the "VFD model" column are used to distinguish models when selecting different product configurations. Please note that 11-22kW models can only be configured with one from the built-in DC reactor (L1) and the built-in C2 filter.

The rated output current is the output current when the output voltage is 380V.



The data in the "Input current" column are measured at an input voltage of 380V. The data in "()" are measured when a DC reactor is configured.

Expansion card

Card type	Model	Name	Specifications
IO card	EC-IO501-00	IO expansion card	<ul style="list-style-type: none"> ◆ Four digital inputs ◆ One digital output ◆ One analog input ◆ One analog output ◆ Two relay outputs: one double-contact output, and one single-contact output
	EC-IO503-00	Relay card	<ul style="list-style-type: none"> ◆ Two digital inputs ◆ Six relay outputs
Communication card	EC-TX503D	PROFIBUS-DP communication card	<ul style="list-style-type: none"> ◆ Supports the PROFIBUS-DP protocol
	EC-TX505C	CAN multi-protocol communication card	<ul style="list-style-type: none"> ◆ Supports the CANopen protocol and INVT's master-slave control proprietary protocol
	EC-TX509C	PROFINET communication card	<ul style="list-style-type: none"> ◆ Supports the PROFINET protocol

Note: The expansion cards are optional and need to be purchased separately.

Optional parts

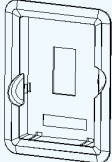
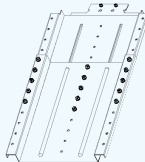
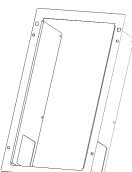
Name	Image	Model/Function/Apply to	Name	Image	Model/Function/Apply to
LCD keypad		<p>Model: SOP-270</p> <p>Function: External LCD display and operation panel</p> <p>Apply to: Full series</p>	LED keypad		<p>Model: BOP-270</p> <p>Function: External LCD display and operation panel</p> <p>Apply to: Any models in the power range 1.5~22kW (Standard configuration for models in the power range 30~500kW)</p>
Keypad bracket		<p>Model: GD350-JPZJ</p> <p>Function: For fixing LED/LCD keypad outside the electrical cabinet</p> <p>Apply to: Full series</p>	Cabinet rail component		<p>Model: GD270-DGZJ</p> <p>Function: To assist cabinet installation to improve installation efficiency and safety</p> <p>Apply to: Any models in the power range 220~500kW</p>
Flange mounting bracket		<p>Model: Conatct us</p> <p>Functions: For flange mounting</p> <p>Apply to: Any models in the power range 1.5~200kW</p>			

Reactor & filter

VFD model	Reactor		Filter	
	Input reactor	Output reactor	Input filter	Output filter
GD270-1R5-4(-C2)(-EU)	GDL-ACL0005-4CU	GDL-OCL0005-4CU	FLT-P04006L-B	FLT-L04006L-B
GD270-2R2-4(-C2)(-EU)	GDL-ACL0006-4CU	GDL-OCL0006-4CU		
GD270-004-4(-C2)(-EU)	GDL-ACL0014-4CU	GDL-OCL0010-4CU	FLT-P04016L-B	FLT-L04016L-B
GD270-5R5-4(-C2)(-EU)	GDL-ACL0020-4CU	GDL-OCL0014-4CU	FLT-P04032L-B	FLT-L04032L-B
GD270-7R5-4(-C2)(-EU)	GDL-ACL0025-4CU	GDL-OCL0020-4CU		
GD270-011-4(-L1)(-C2)(-EU)	GDL-ACL0035-4AL	GDL-OCL0025-4CU	FLT-P04045L-B	FLT-L04045L-B
GD270-015-4(-L1)(-C2)(-EU)	GDL-ACL0040-4AL	GDL-OCL0035-4AL	FLT-P04065L-B	FLT-L04065L-B
GD270-018-4(-L1)(-C2)(-EU)	GDL-ACL0051-4AL	GDL-OCL0040-4AL		
GD270-022-4(-L1)(-C2)(-EU)	GDL-ACL0051-4AL	GDL-OCL0050-4AL	FLT-P04100L-B (FLT-P04065L-B)	FLT-L04065L-B
GD270-030-4(-L1)(-C3)(-EU)	GDL-ACL0070-4AL	GDL-OCL0060-4AL		
GD270-037-4(-L1)(-C3)(-EU)	GDL-ACL0090-4AL	GDL-OCL0075-4AL	FLT-P04100L-B	FLT-L04100L-B
GD270-045-4(-L1)(-C3)(-EU)	GDL-ACL0110-4AL	GDL-OCL0092-4AL		
GD270-055-4(-L1)(-C3)(-EU)	GDL-ACL0150-4AL	GDL-OCL0115-4AL	FLT-P04150L-B	FLT-L04150L-B
GD270-075-4(-L1)(-C3)(-EU)	GDL-ACL0150-4AL	GDL-OCL0150-4AL	FLT-P04240L-B (FLT-P04150L-B)	FLT-L04150L-B
GD270-090-4(-L1)(-C3)(-EU)	GDL-ACL0220-4AL	GDL-OCL0220-4AL	FLT-P04240L-B	FLT-L04240L-B
GD270-110-4(-L1)(-C3)(-EU)	GDL-ACL0220-4AL	GDL-OCL0220-4AL		
GD270-132-4(-L1)(-C3)(-EU)	GDL-ACL0265-4AL	GDL-OCL0265-4AL	FLT-P04400L-B	FLT-L04400L-B
GD270-160-4(-L1)(-EU)	GDL-ACL0330-4AL	GDL-OCL0330-4AL		
GD270-185-4(-L1)(-EU)	GDL-ACL0390-4AL	GDL-OCL0400-4AL		
GD270-200-4(-L1)(-EU)	GDL-ACL0390-4AL	GDL-OCL0400-4AL		
GD270-220-4(-Ln)(-EU)	GDL-ACL0450-4AL	/	FLT-P04600L-B	FLT-L04600L-B
GD270-250-4(-Ln)(-EU)	GDL-ACL0500-4AL	/		
GD270-280-4(-Ln)(-EU)	GDL-ACL0500-4AL	/		
GD270-315-4(-Ln)(-EU)	GDL-ACL0580-4AL	/	FLT-P04800L-B	FLT-L04800L-B
GD270-355-4(-Ln)(-EU)	GDL-ACL0660-4AL	/		
GD270-400-4(-Ln)(-EU)	GDL-ACL0715-4AL	/		
GD270-450-4(-Ln)(-EU)	GDL-ACL0840-4AL	/		
GD270-500-4(-Ln)(-EU)	GDL-ACL1000-4AL	/	FLT-P041000L-B	FLT-L041000L-B

Note:

Above options are external installation, customer need to specify them when choosing and purchasing, and it can be flexibly adjusted according to the rated working current value.

For reactors selection with different material requirements from the above recommended table, please refer to, «Low Voltage VFD GDL Series Filter Option Brochure» .

Wiring diagram

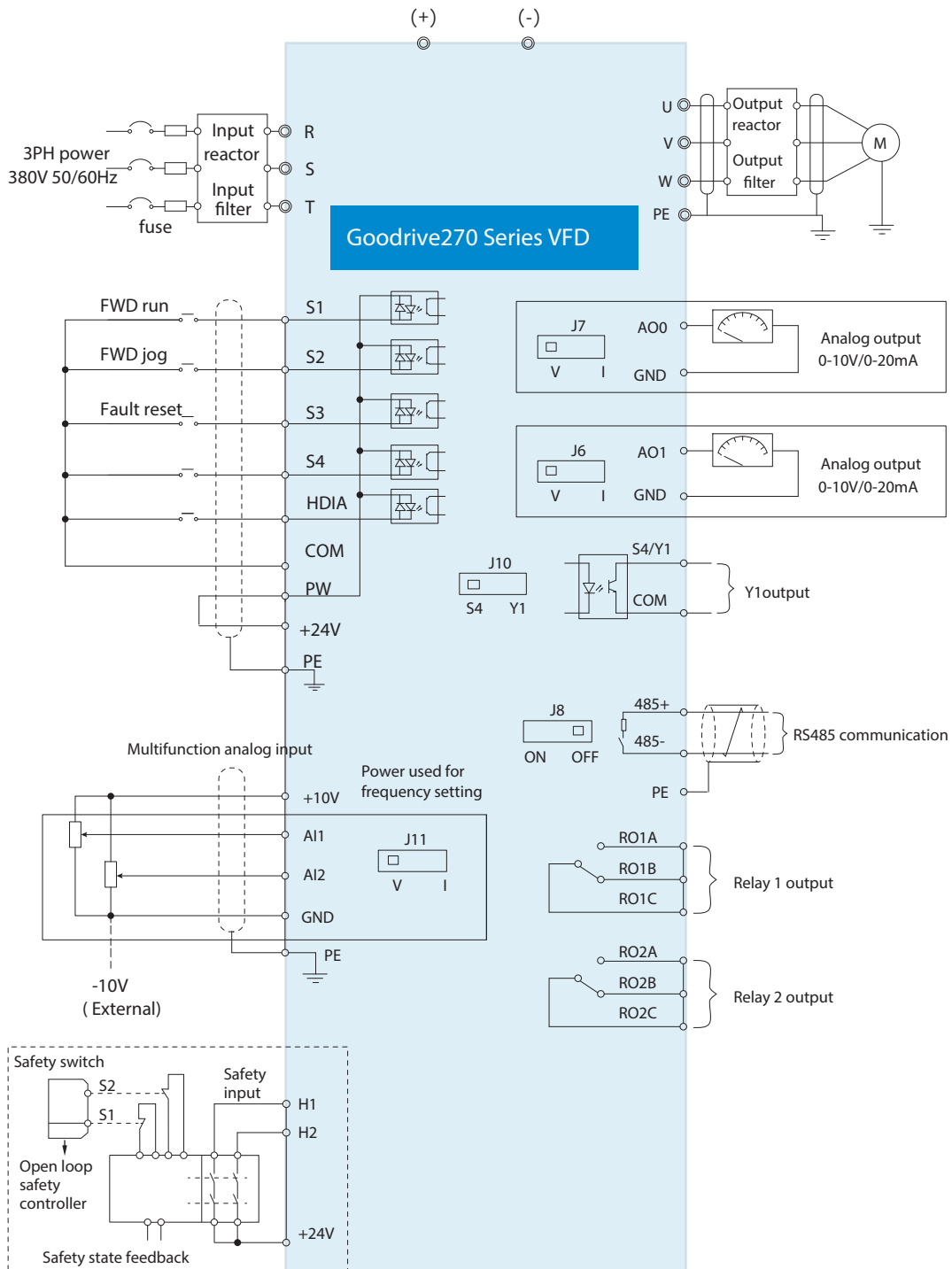

Installation method

Wall mounting

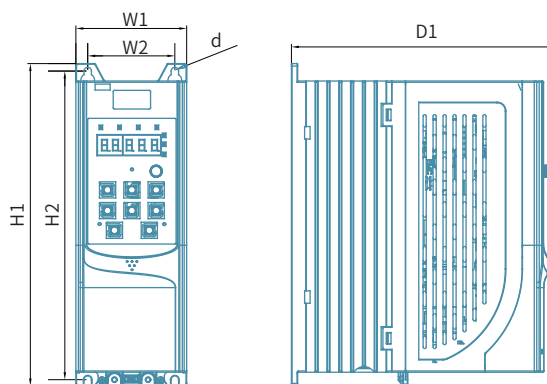

AC 3PH 380V
1.5~7.5kW mounting diagram

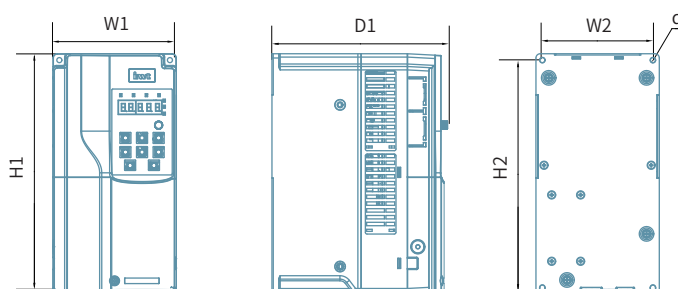

AC 3PH 380V
11~45kW mounting diagram

Dimensions (unit: mm)

VFD model	Outline dimensions (mm)			Mounting hole distance (mm)			Mounting hole diameter (mm)	Fixing screw
	W1	H1	D1	H2	W2	D2		
1.5~4kW	89	231	193	221	70	/	5	M4
5.5~7.5kW	89	259	212	248	70	/	6	M5
11~15kW	145	280	207	268	130	/	6	M5
18.5~22kW	169	320	214	308	154	/	6	M5
30~37kW	200	341	213	328.5	185	/	6	M5
45kW	250	400	228	380	230	/	6	M5

Wall mounting

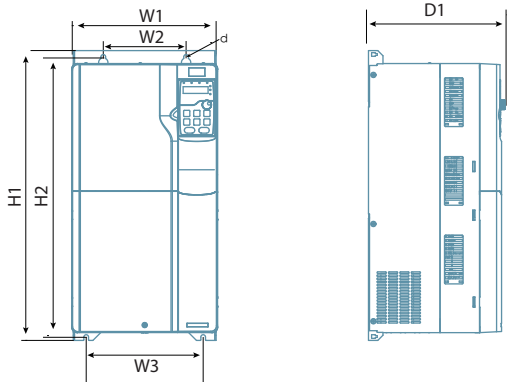

AC 3PH 380V
55~90kW mounting diagram

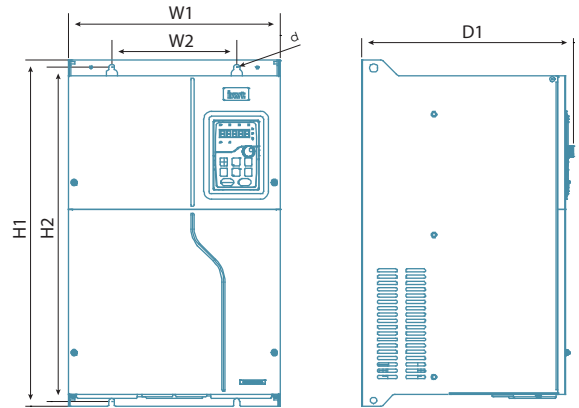

AC 3PH 380V
110~132kW mounting diagram

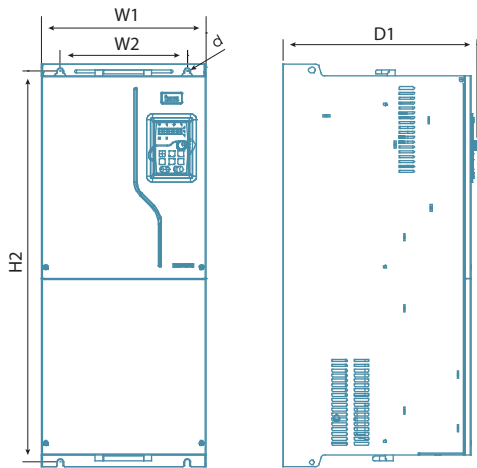

AC 3PH 380V
160~200kW mounting diagram

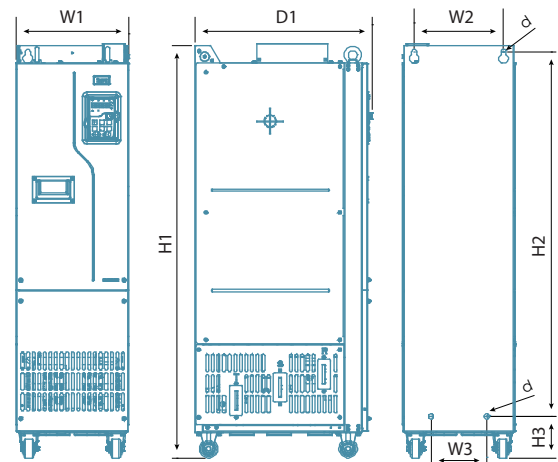

AC 3PH 380V
220~250kW mounting diagram

Dimensions (unit: mm)

VFD model	Outline dimensions (mm)			Mounting hole distance (mm)			Mounting hole diameter (mm)	Fixing screw
	W1	H1	D1	H2	W2	W3		
55~90kW	282	560	264	542	160	226	9	M8
110~132kW	338	554	338	534	200	/	9.5	M8
160~200kW	338	825	398	800	260	/	11	M10
220~250kW	303	1108	477	980	240	150	14	M12

Floor mounting

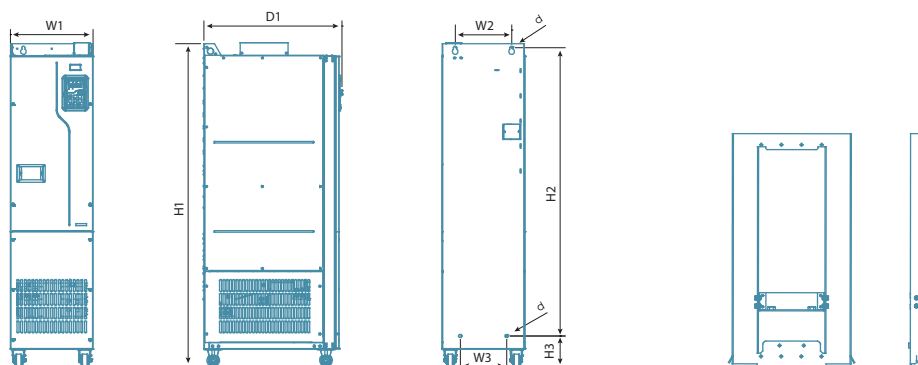

AC 3PH 380V

220-500kW mounting diagram of models without output reactor

Floor mounting bracket

Dimensions (unit: mm)

VFD model	Outline dimensions(mm)			Mounting hole distance(mm)				Mounting hole diameter(mm)	Fixing screw
	W1	H1	D1	H2	H3	W2	W3		
220~250kW	303	1108	477	980	111	240	150	14	M12
280~355kW	330	1288	552	1150	122	225	185	13	M10
400~500kW	330	1398	552	1280	101	240	200	13	M10

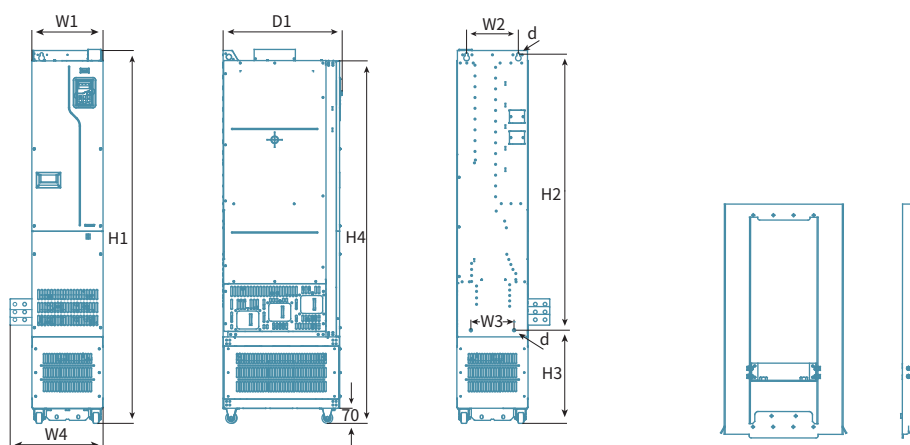

AC 3PH 380V

220-500kW mounting diagram of L3 models without output reactor

Floor mounting bracket

Dimensions (unit: mm)

VFD model	Outline dimensions (mm)				Mounting hole distance (mm)					Mounting hole diameter(mm)	Fixing screw
	W1	W4	H1	D1	H2	H3	H4	W2	W3		
220~250kW	303	350	1470	477	980	471	1420	240	150	14	M12
280~355kW	330	428	1619	552	1150	453	1571	225	185	13	M10
400~500kW	330	430	1729	552	1280	432	1681	240	200	13	M10

Note: Please refer to the product manual for more information about the size of the installation base.

Flange mounting

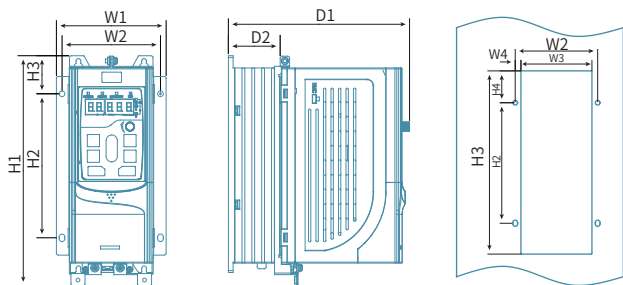

AC 3PH 380V
1.5~7.5kW mounting diagram

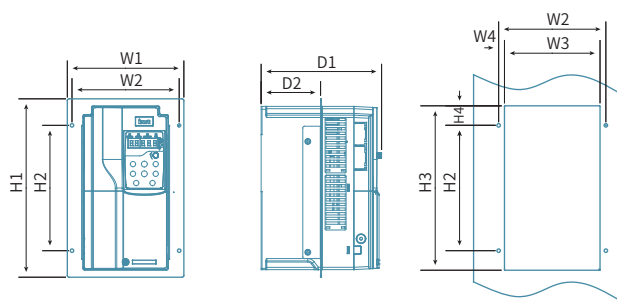

AC 3PH 380V
11~22kW mounting diagram

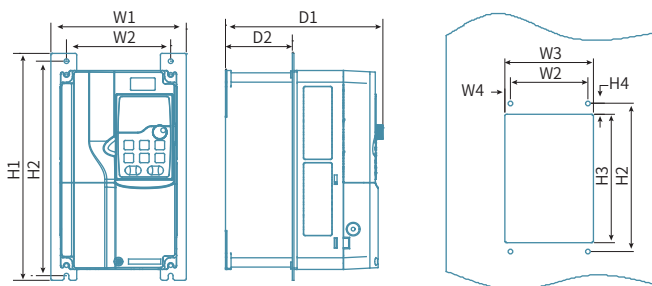

AC 3PH 380V
30~90kW mounting diagram

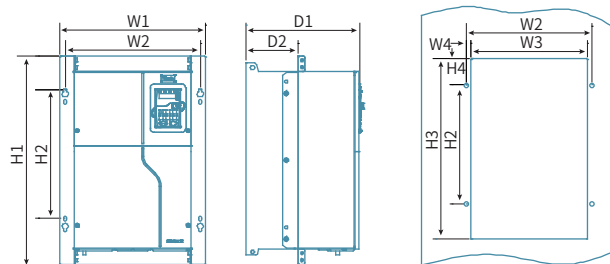

AC 3PH 380V
110~200kW mounting diagram

Dimensions (unit: mm)

VFD model	Outline dimensions (mm)			Mounting hole distance (mm)							Mounting hole diameter (mm)	Fixing screw
	W1	H1	D1	H2	H3	H4	W2	W3	W4	D2		
1.5~4kW	117	234	193	153.5	225	30	105	92.5	6.5	55	6	M5
5.5~7.5kW	117	261	212	180	250	30	105	92.5	6.5	75	6	M5
11~15kW	200	306	207	215	282	33.5	184	164	10	102	6	M5
18.5~22kW	224	346	214	255	322	33.5	208	189	9.5	108	6	M5
30~37kW	266	371	213	250	350.5	50.5	250	224	13	104	6	M5
45kW	316	430	228	300	410	55	300	274	13	118.5	6	M5
55~90kW	352	580	264	400	570	90	332	306	13	134	9	M8
110~132kW	419	600	338	370	559	80.5	389.5	361	14	149.5	10	M8
160~200kW	428	868	398.5	625	830	80	394	345	24.5	183	11	M10

Automation Product Family



■ HMI

- VK Series
- VT Series
- VS Series
- VA Series
- TC Series



■ Controller

- IVC1S Series Programmable Controller
- IVC1L Series Programmable Controller
- INV2 Series Programmable Controller
- IVC3 Series Programmable Controller
- AX Series High-performance Programmable Controller



■ Servo System

- General servo drive System
- Industry specific servo system
- Industry specific electronic control system



■ VFD

- Low-voltage general VFD
- Midum-voltage VFD
- Industry specific VFD

Marketing service network

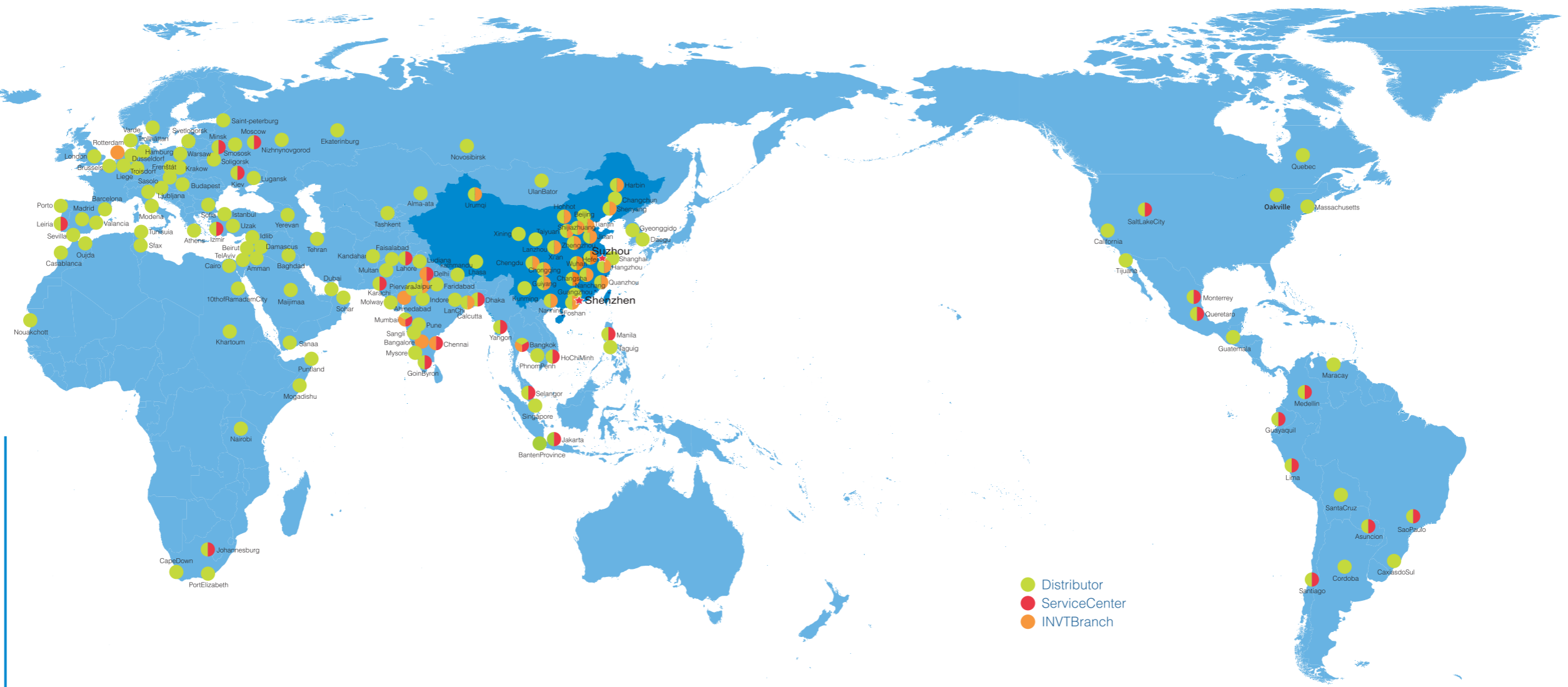

Factories* **3**
 Headquarter in Shenzhen
 Overseas subsidiaries and offices***8**
 More than **100** overseas partners

Your trusted industry automation solution provider



E-mail: overseas@invt.com.cn Website: www.invt.com

SHENZHEN INVT ELECTRIC CO.,LTD. INVT Guangming Technology Building, Songbai Road, Matian, Guangming District, Shenzhen, China

- Industrial Automation:**
- HMI
 - PLC
 - VFD
 - Servo System
 - Elevator Intelligent Control System
 - Rail Transit Traction System
- Electric Power:**
- UPS
 - DCIM
 - Solar Inverter
 - New Energy Vehicle Powertrain System
 - New Energy Vehicle Charging System
 - New Energy Vehicle Motor

INVT Copyright.
Information may be subject to change without notice during product improving.

66003-00257 20240731(V2.6)