



Operation **Manual**

Goodrive300-21 Series Dual-inverter
Integrated Machine for Air Compressor



SHENZHEN INVT ELECTRIC CO., LTD.

Preface

Goodrive300-21 series dual inverter integrated machine for air compressor (hereafter referred to as GD300-21 air compressor integrated machine) is especially developed for synchronous/asynchronous twin screw air compressor. It can be used in combination with HMI touch screen to drive and control the twin screw air compressor.

GD300-21 air compressor integrated machine is capable of providing dual inverter output of master and fan for the air compressor as well as offering +24V power to the touch screen. It supports control of solenoid valve and receiving of temperature and pressure signal. In respect of function, it is a perfect replacement for the original dual inverter electrical control cabinet of air compressor but with a much smaller size and simpler installation and commissioning procedures.

Given the application scenarios and actual demands of air compressor, GD300-21 air compressor integrated machine can realize fast start-up and stable operation of air compressor through dual PID and unique weak magnetic design. It adopts independent air duct, heavy load and high power factor design to effectively cope with challenging grid conditions and application environment. In addition, it can realize IOT application by installing optional parts and accessories.

Read through this manual carefully before installation to ensure correct installation and operation of GD300-21 air compressor integrated machine, thus giving full play to its excellent functions and performance.

If the end user is a military unit or the product is used for weapon manufacturing, please comply with relevant export control regulations in the Foreign Trade Law of the People's Republic of China, and complete necessary formalities.

The manual is subject to change without prior notice.

Contents

Preface	i
Contents	ii
1 Product overview	1
1.1 Product specifications	1
1.2 Product nameplate	2
1.3 Model instruction	3
1.4 Product ratings	3
2 Installation guidance	5
2.1 Wiring and terminal instruction of main circuit	5
2.1.1 Wiring diagram of the main circuit	5
2.1.2 Terminal diagram of the main circuit	5
2.2 Wiring and terminal instruction of control circuit	7
2.2.1 Control circuit layout diagram	7
2.2.2 Wiring diagram of control circuit	9
2.2.3 User terminal instruction of control circuit	9
3 Instruction for panel display	11
4 Commissioning guidelines	12
4.1 Wiring diagram of integrated machine system	12
4.2 Recommended wiring process	12
4.3 Function commissioning procedure	16
5 Function description	24
5.1 Function code instruction	24
Group P00 Basic functions	24
Group P01 Start and stop control	26
Group P02 Parameters of motor 1	26
Group P03 Vector control	29
Group P04 V/F control	31
Group P05 Input terminals	32
Group P06 Output terminals	35
Group P07 Human-machine interface	36
Group P08 Enhanced functions	40
Group P09 PID control	41
Group P11 Protection parameters	44
Group P13 SM control parameters	45
Group P14 Serial communication function	46
Group P15 Customized functions	47
Group P17 State viewing function	49
Group P18 Functions special for air compressors	51

Group P19 Air compressor status viewing function	59
5.2 Air compressor control logic	64
5.3 PID commissioning.....	66
5.3.1 General procedures for PID parameter setup	67
5.3.2 How to fine-tune PID	68
5.4 Running logic of blower oil pump.....	72
6 Troubleshooting	73
6.1 Faults and countermeasures for integrated machine	73
6.2 Faults and countermeasures for air compressor device.....	77
Appendix A Product dimension	80
A.1 Wall-mounting dimensions	80
A.2 Floor-mounting dimensions (with top cover)	81
A.3 Floor-mounting dimension (without top cover)	82
A.4 Product weight and packaging dimension.....	83
Appendix B Optional parts	84
B.1 Contactor component.....	84
B.1.1 Unpacking inspection.....	84
B.1.2 Breakers and electromagnetic contactors.....	84
B.1.3 Electrical wiring.....	85
B.1.4 Fuse pedestal installation	86
B.1.5 Dimension of contactor component	87
B.2 Drip-proof top cover	87
B.2.1 Installation of drip-proof top cover.....	88
B.3 Floor installation pedestal	89
B.3.1 Package list	89
B.3.2 Installation diagram of the pedestal	89
B.3.3 Installation diagram of optional pedestal.....	90
B.3.4 Floor wiring process.....	91
B.4 TC070A touch screen	91
B.4.1 Product specifications	91
B.4.2 Connection terminals	93
B.4.3 Wiring description	94
B.4.4 Cable description	95
B.4.5 Installation dimensions and description	96
Appendix C Communication protocol	98
C.1 Application of Modbus.....	98
C.1.1 RS485.....	98
C.2 RTU command codes and communication data	98
C.2.1 Command code 03H, reading N words (continuously up to 16 words)	98
C.2.2 Command code 06H, writing a word.....	98

C.2.3 Command code 10H, continuous writing	99
C.2.4 Data address definition	99
C.2.5 Error messages	103
Appendix D Common EMC problems and solutions	105
D.1 Interference problems of meter switch and sensors	105
D.2 Interference on RS485 communication.....	105
D.3 Failure to stop and indicator shimmering due to motor cable coupling	106
D.4 Leakage current and interference on RCD	107
D.5 Live device chassis.....	108

1 Product overview

GD300-21 air compressor integrated machine is capable of providing dual inverter output of master and fan for the air compressor as well as offering +24V power to the touch screen. It supports control of solenoid valve and receiving of temperature and pressure signal. In respect of function, it is a perfect replacement for the original dual inverter electrical control cabinet of air compressor but with a much smaller size and simpler installation and debugging procedures.

1.1 Product specifications

Category	Function	Specifications
Power input	Input voltage of inverter (V)	3PH 220V(-15%)–240V(+10%) 3PH 380V(-15%)–440V(+10%)
	Rated input current (A)	See section 1.4 Product ratings.
	Rated input frequency (Hz)	50Hz or 60Hz; Allowed range: 47–63Hz
	Efficiency	> 97%
	Power factor	0.9
Power output of main inverter	Output voltage (V)	Equal to the input voltage, with the deviation less than 5%.
	Rated output current (A)	See section 1.4 Product ratings.
	Rating output power (kW)	See section 1.4 Product ratings.
	Output frequency (Hz)	0–400Hz
Power output of fan inverter	Output voltage (V)	Equal to the input voltage, with the deviation less than 5%.
	Rated output current (A)	See section 1.4 Product ratings.
	Rating output power (kW)	See section 1.4 Product ratings.
	Output frequency (Hz)	0–50Hz
Other power output	+24VDC power	24W
	220VAC/110VAC	30W
Running control performance	Control mode	Open loop vector, space voltage vector
	Speed ratio	Asynchronous motor (AM): 1:200 (SVC), synchronous motor (SM): 1:20 (SVC)
	Speed control accuracy	±0.2% (SVC)
	Speed fluctuation	±0.3% (SVC)
	Torque response	<20ms (SVC)
	Starting torque	For AMs: 0.25Hz150% (SVC) For SMs: 2.5Hz150% (SVC)
	Overload capacity	Master inverter: Overload of 120% can last for a long time, 150% for 1 minute

Category	Function	Specifications
		Fan inverter: 120% for 1 minute
	Specialized function	Sleep and wake-up function, constant pressure control, constant temperature control, accessory maintenance and phase sequence inspection
	Analog input of pressure	Two 4–20mA/0–1.6MPa inputs
	Analog input of temperature	Two temperature analog inputs; resolution rate: 1°C, range: -20°C→+150°C
	Digital input	Three regular inputs; max. frequency: 1kHz
	Digital output	One Y terminal output, two relay outputs (NO) 250VAC/3A
	Fault protection	More than 30 protection functions, such as protection against overcurrent, overvoltage, undervoltage, overtemperature, phase loss, and overload
	Communication 485	One 485 communication (two terminal interfaces)
Other	Installation method	Supports wall-mounting and floor-mounting
	Temperature of running environment	-10°C→+50°C; Derating is required if the ambient temperature exceeds 40°C. Derate 1% for each additional 1°C.
	Ingress protection (IP) rating	IP20
	Cooling method	Forced air cooling
	DC reactor	Standard
	EMC filter	Optional external filters can be used to meet the IEC61800-3 C2 requirements.

Note: When the voltage of the integrated machine is above 440VAC, the power frequency transformer inside the integrated machine needs to be customized as needed.

1.2 Product nameplate

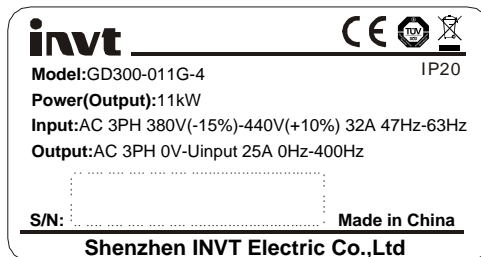

Figure 1-1 Product nameplate

Model	Rated input current of the integrated machine (A)	Main motor inverter		Fan inverter	
		Rating output power (kW)	Rated output current (A)	Rating output power (kW)	Rated output current (A)
GD300-21-075G-4	146	75	150	3	6.8
GD300-21-090G-4	175	90	180	4	9.5

Note:

- The rated input current of 15–90kW integrated machine is the actual result gained under 380V input voltage.
- The rated output current is the output current when the output voltage is 380V.

2 Installation guidance

2.1 Wiring and terminal instruction of main circuit

2.1.1 Wiring diagram of the main circuit

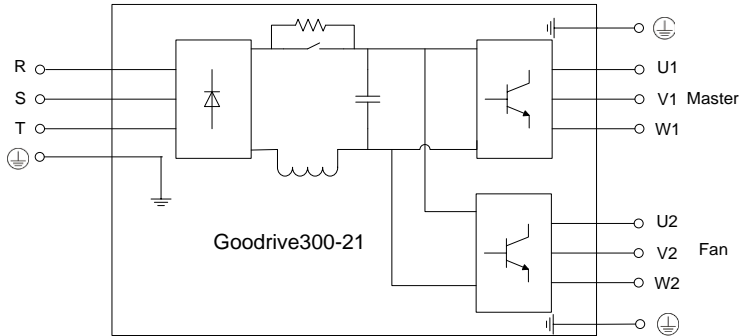

Figure 2-1 Wiring diagram of the main circuit

2.1.2 Terminal diagram of the main circuit

The terminal layout of 15–22kW, 30kW–37kW and 45–90kW main circuit slightly differs from each other. In below figure, 15–22kW and 45–90kW models are taken as examples for terminal layout.

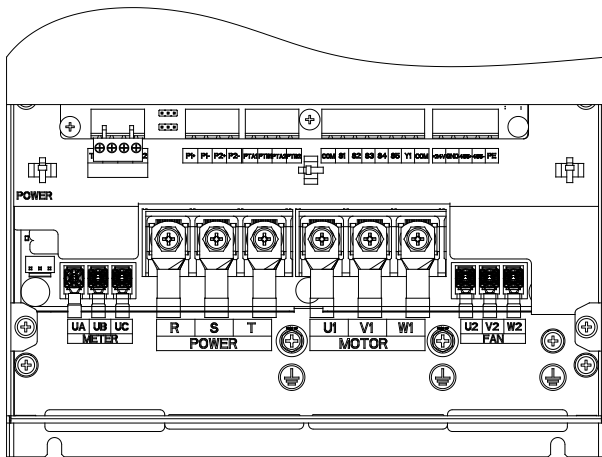

Figure 2-2 AC380V 15–22kW

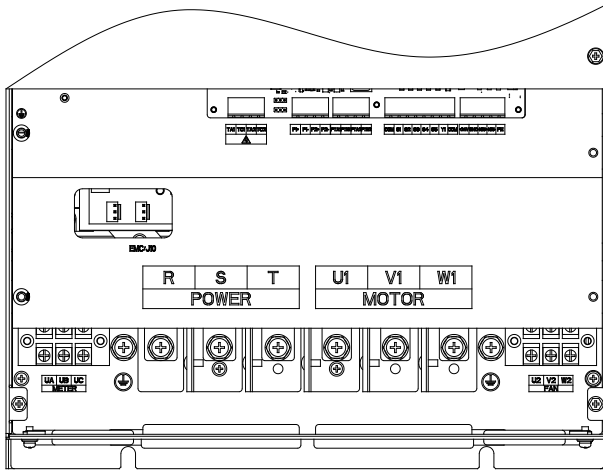



Figure 2-3 AC380V 45–90kW

Table 2-1 Terminal instruction

Symbol	Description
UA, UB, UC	Used for input connection of optional contactor components.
R, S, T	3PH AC input terminals, connecting to the grid
U1, V1, W1	3PH AC output terminal, connected to main motor of air compressor
U2, V2, W2	3PH AC output terminal, connected to the fan
	Grounding terminal of safety protection, each machine must be grounded.

Note:

1. It is not recommended to use asymmetrical motor cables. Do not use asymmetrically constructed motor cable. If there is a symmetrically constructed ground conductor in the motor cable in addition to the conductive shielding layer, ground the ground conductor at the inverter end and motor end.
2. Route the motor cable, input power cable and control cable separately.
3. Before powering on the system, ensure that U1/V1/W1 or U2/V2/W2 are not short-circuited to PE on the output side. Otherwise, tripping may occur on the power distribution cabinet when the system is being powered on.

2.2 Wiring and terminal instruction of control circuit

2.2.1 Control circuit layout diagram

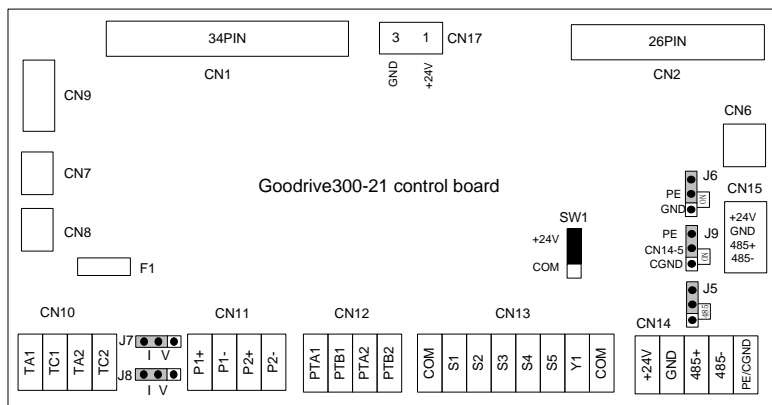

Figure 2-4 Control circuit layout diagram

Table 2-2 Terminal instruction

Symbol	Name	Remarks
CN1	Flat cable interface	Connected to drive board, master control signal wire
CN17	Power interface	Outputs +24V power, can be used to power up external GPRS.
CN2	Flat cable interface	Connected to drive board, fan control signal wire
CN6	Keypad interface	Reserved interface, connected with keypad Note: It is a host keypad interface (not for fan connection).
CN14	Touch screen interface	Connected to touch screen, provide +24V power and 485 communication interface
CN13	Digital input/output terminal	Multi-function input/output terminal
CN12	Temperature detection terminal	Connected to PT100 temperature sensor
CN11	Pressure detection terminal	Connected to pressure sensor
CN10	Relay output terminal	Connected to solenoid valve or contactor coil
F1	Fuse (0.6A/250VAC)	Protection against short circuit of solenoid valve/contactor coil terminal or overcurrent
CN9	220V/110V voltage input terminal	Connected to internal power frequency transformer
CN7	220V voltage selection	Select this terminal with jumpers when users select the

Symbol	Name	Remarks
	terminal	solenoid valve with 220V coil or the contactor. Note: The default selection is 220V voltage terminal.
CN8	110V voltage selection terminal	Select this terminal with jumpers when users select the solenoid valve with 110V coil or the contactor.
J5	Access terminal for 485 communication terminal resistor	485 corresponds to access terminal resistor. Does not connect terminal resistor by default.
J6	Short-circuit terminal of PE and GND	ON corresponds to short-circuit. No short circuit by default
J7	Jumper terminal	Corresponds to P1+, P1- pressure analog signal selection. "I" corresponds to current signal, "V" to voltage signal. The default is current input signal.
J8	Jumper terminal	Corresponds to P2+, P2- pressure analog signal selection. "I" corresponds to current signal, "V" to voltage signal. The default is current input signal.
J9	PE/CGND selection terminal	485 communication is non-isolation mode. CN14-5 is short circuited with PE by default.
SW1	DIP switch	Set to +24V terminal by default. See details at Figure 2-5 and Figure 2-6.

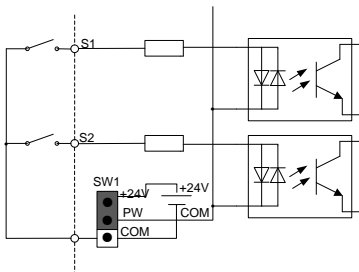

Figure 2-5 Internal power (NPN mode)

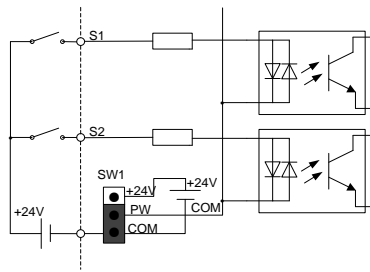

Figure 2-6 External power (PNP mode)

When digital input adopts internal +24V, set the toggle switch according to Figure 2-5 and short circuit +24V with PW. When digital input adopts external +24V, set the toggle switch according to Figure 2-6 and short circuit COM with PW.

2.2.2 Wiring diagram of control circuit

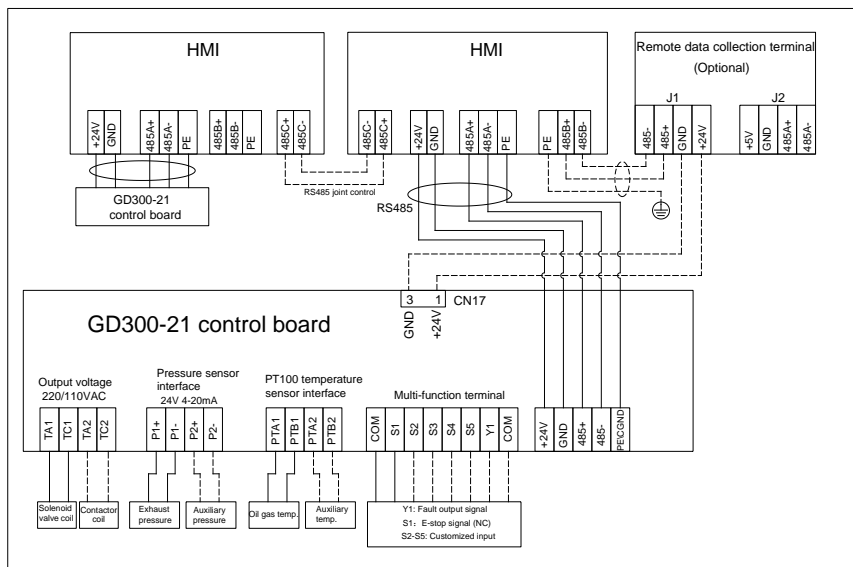

Figure 2-7 Wiring diagram of control circuit

Note: The solid line represents the recommended wiring diagram which carries the least wiring for ensuring system operation. The dotted line represents the wiring diagram used when discrepancy occurred to the configuration of integrated machine.

2.2.3 User terminal instruction of control circuit

Table 2-1 User terminal instruction of control circuit

Category	Symbol	Terminal name	Description
Power supply	+24V	+24V power supply	Used to externally provide +24V±5% power supply, max. output current: 1A Used for powering up GPRS, touch screen module
	GND	+24V power GND	Reference ground of the +24V power supply
PT100 signal input	PTA1	Temperature analog signal 1	1. Resolution rate: 1°C 2. Range: -20°C—+150°C 3. Detection precision: 3°C
	PTB1		
	PTA2	Temperature analog signal 2	
	PTB2		

Category	Symbol	Terminal name	Description
Pressure signal input	P1+	Pressure analog signal 1	<ol style="list-style-type: none"> Input range: Current and voltage is optional, 4–20mA/2–10V corresponds to 0–1.6MPa; P1 is switched by jumper J7 while P2 by J8 Input impedance: 20kΩ for voltage input; 500Ω for current input Resolution rate: min. 5mV Error: ±1%, 25°C
	P1-		
	P2+	Pressure analog signal 2	
	P2-		
Digital input	S1	Digital input 1	<ol style="list-style-type: none"> Internal impedance: 3.3kΩ 12–30V voltage input is acceptable Max. input frequency: 1kHz
	S2	Digital input 2	
	S3	Digital input 3	
	S4	Digital input 4	
	S5	Digital input 5	
	COM	Digital reference GND	
Digital output	Y1	Digital output	<ol style="list-style-type: none"> Switch capacity: 50mA/30V Output frequency range: 0–1kHz
Communication	485+, 485-	RS485 communication	RS485 communication terminals, using the Modbus RTU protocol
PE/CGND	PE/CGND		<p>PE: When select PE by J9, it can be used in connection terminal of 485 communication shielded cable;</p> <p>CGND: When select CGND by J10, it can be used in connection terminal of 485 communication reference GND or shielded cable.</p>
Solenoid valve	TA1	Solenoid valve coil	<ol style="list-style-type: none"> Contact capacity: 3A/250VAC, 1A/30VDC Cannot used as high frequency switch output Voltage of power supply: 220V/110V, select via CN7/CN8 Max. output power of internal power frequency transformer: 30W
	TC1		
	TA2	Contactor coil	
	TC2		

Note: The connection terminal of solenoid valve/contacter cannot be connected to other load. When the power of solenoid valve and contactor coil exceeds 30W, the power frequency transformer inside the integrated machine needs to be customized or connected with external 220V power independently.

3 Instruction for panel display

The panel of GD300-21 series air compressor integrated machine carries three LED indicators (fault, running, power). The position and display state of the indicators are illustrated as below:

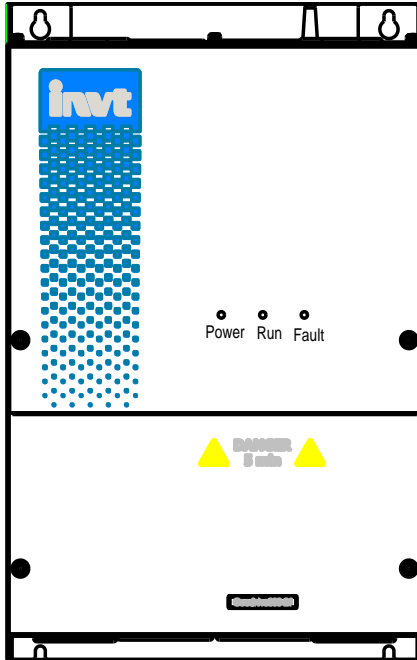

Figure 3-1 Diagram of indicator position

Display state of indicators		State instruction
Power indicator (green)	ON	Bus voltage is normal
	Blinking	Bus voltage is abnormal
Running indicator (green)	ON	Run
	OFF	Stop
Fault indicator (read)	ON	Fault
	OFF	Normal running

4 Commissioning guidelines

4.1 Wiring diagram of integrated machine system

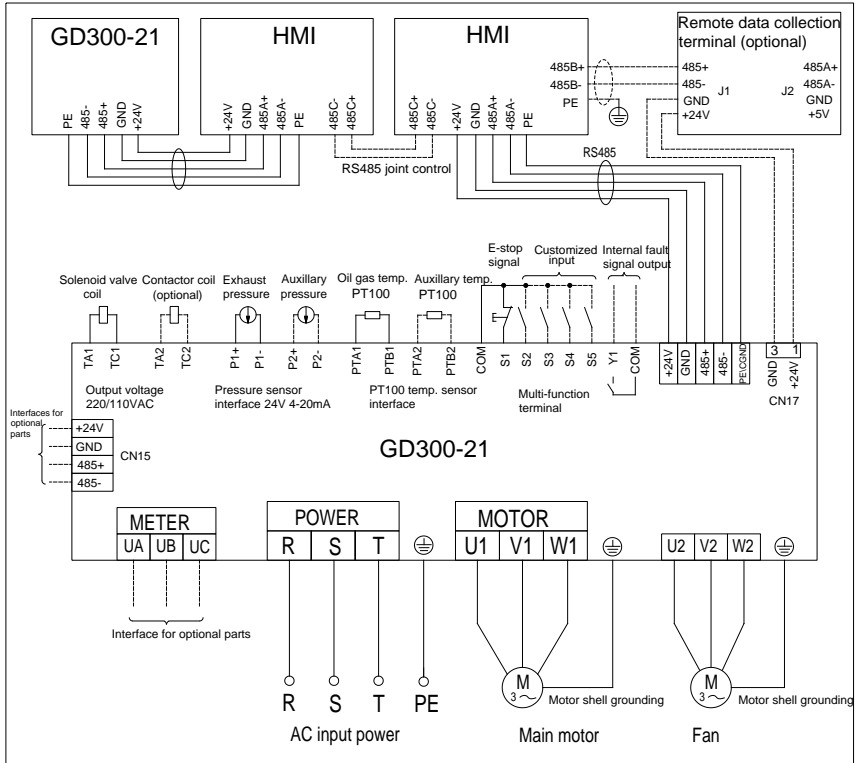

Figure 4-1 Wiring diagram of integrated machine system

Note: The solid line represents the recommended wiring diagram which carries the least wiring for ensuring system operation. The dotted line represents the wiring diagram used when discrepancy occurred to the configuration of integrated machine.

4.2 Recommended wiring process

The terminal layout of 15–22kW, 30kW–37kW and 45–90kW slightly differs from each other. The following figure shows the wall-mounting wiring.

Note: Take 22kW and 37kW as examples for 15–22kW and 30kW–37kW wiring diagrams respectively. The difference is that the control board for 22kW/37kW model is equipped with a fan (to dissipate heat for underlying devices).

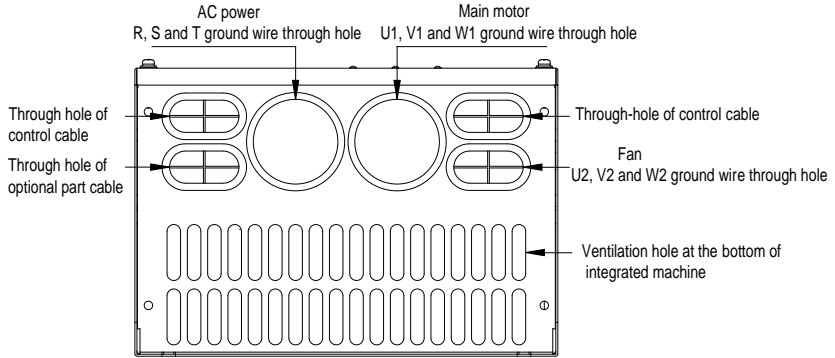

Figure 4-2 Bottom view for AC380V 15–22kW models

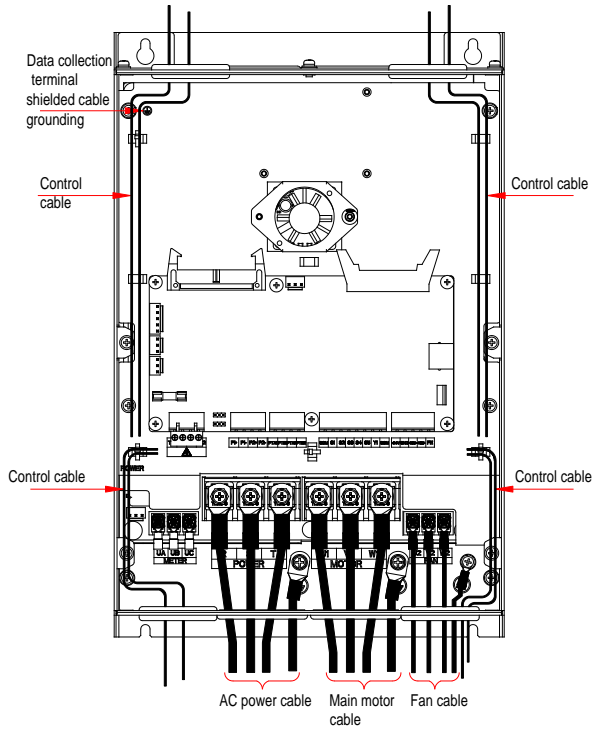

Figure 4-3 Front wiring diagram for AC380V 15–22kW models

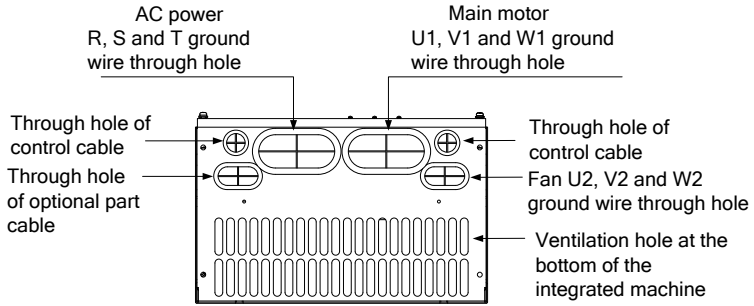

Figure 4-4 Bottom view for AC380V 30–37kW models

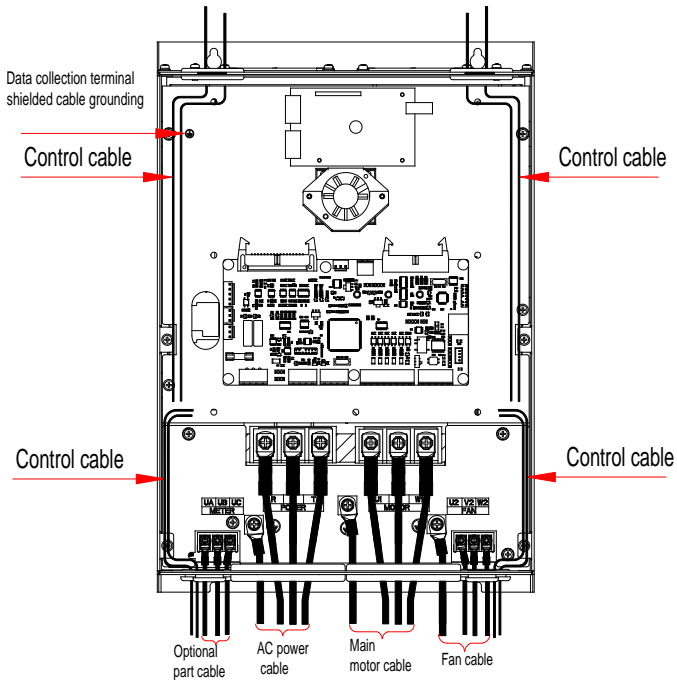

Figure 4-5 Front wiring diagram for AC380V 30–37kW models

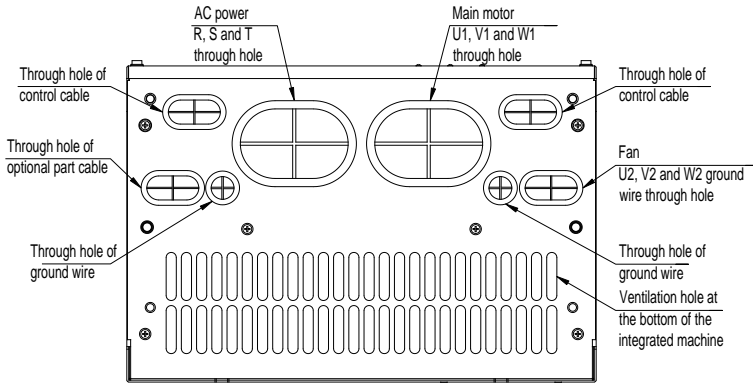

Figure 4-6 Bottom view for AC380V 45-90kW models

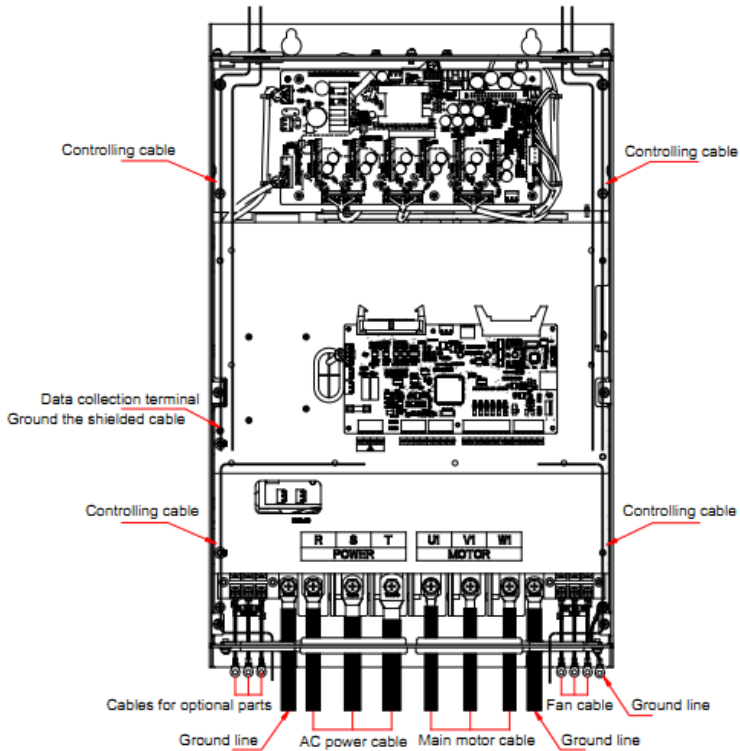

Figure 4-7 Front wiring diagram for AC380V 45-90kW models

Note:

1. There are two controlling cable through holes on the top and at the bottom of the integrated machine cabinet, users can select which through-hole to use based on wiring condition. It is recommended that the controlling cable is routed via top through-hole to realize separation between controlling cable and motor cable and reduce interference. The motor temperature detection or temperature protection cable which follows the motor power cable can be routed via bottom through-hole.
2. Refer to B.3.3 Installation diagram of optional pedestal for floor installation layout.

4.3 Function commissioning procedure

It is recommended that GD300-21 air compressor integrated machine adopt touch screen for displaying and commissioning. The concrete procedures are listed as follows: (if other controllers are used, contact our technician)

1. Conduct wiring and routing according to "4.1 Wiring diagram of integrated machine system" and "4.2 Recommended wiring process"; check carefully if the wiring is correct and ensure the integrated machine and its shell GND is properly connected.
2. After power on, the touch screen HMI interface is shown as follows:



Figure 4-8 Login interface

- Click "Enter" to enter the working environment interface, as shown in the following figure:

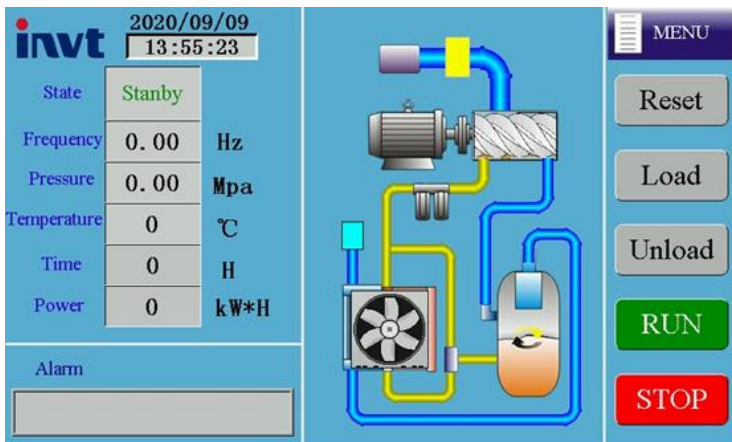

Figure 4-9 Working interface

- Click "MENU" in above interface and the interface is as follows:

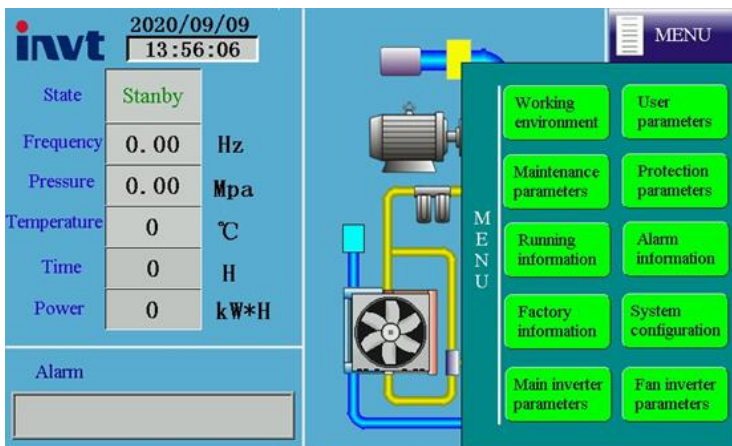

Figure 4-10 Menu interface

- Click "System configuration" in touch screen menu to enter the system configuration page, as shown in the following figure:

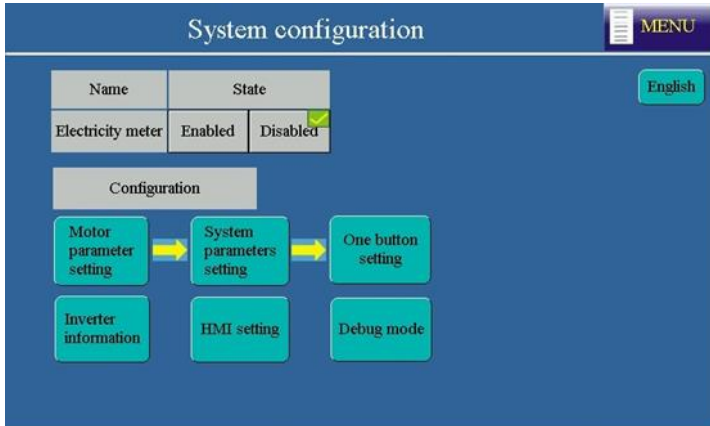

Figure 4-11 System configuration interface

The fan inverter is enabled by default. Debug according to the debugging procedures.

Step 1 Click "Motor parameter setting" in system configuration interface and the interface is shown as follows:

- ✧ If the Motor type is set to "Synchronous", the max. frequency, Rated power, Rated frequency, Rated voltage, Rated current, Pole pairs, and Carrier frequency are required.
- ✧ If the Motor type is set to "Asynchronous", the max. frequency, Rated power, Rated frequency, Rated voltage, Rated current, Rated speed, and Carrier frequency are required.

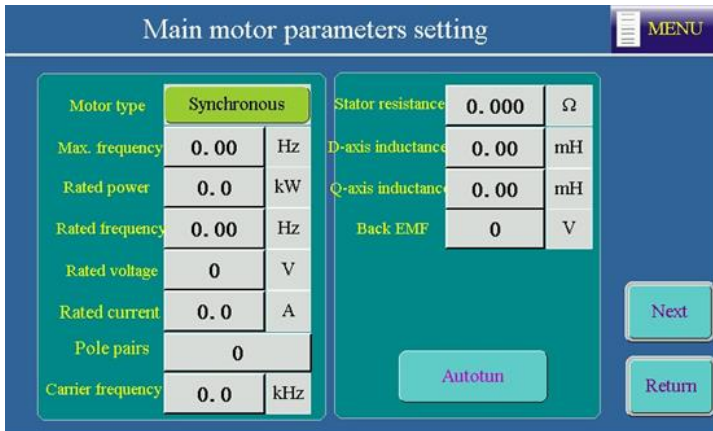

Figure 4-12 Main (synchronous) motor parameters setting interface

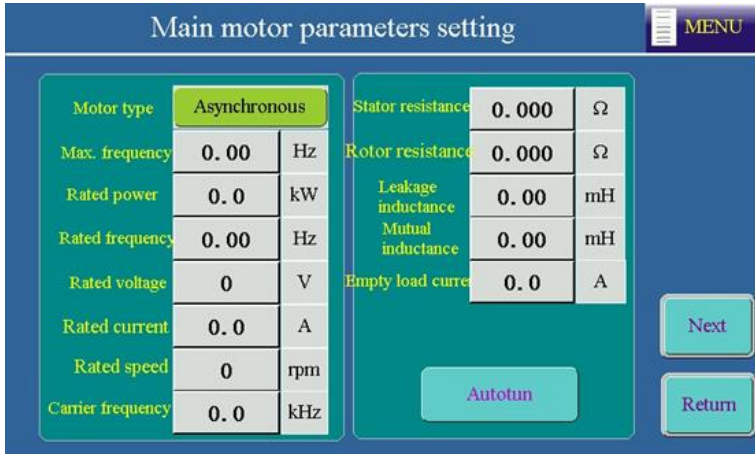

Figure 4-13 Main (asynchronous) motor parameters setting interface

Step 2 After setting motor parameters according to actual motor nameplate parameters, click "Autotun" and after recognition completes, click "Next" and set fan motor parameter (Max. frequency, Rated power, Rated frequency, Rated voltage, Rated current and Rated rotation speed are required.)

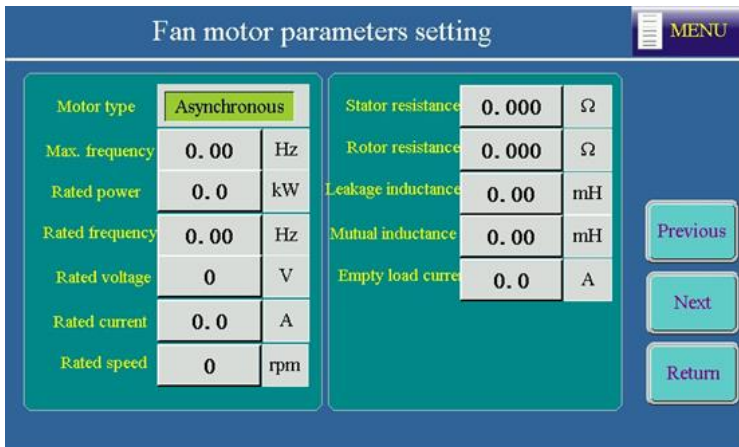

Figure 4-14 Fan motor parameters setting interface

Step 3 In system configuration interface, click "One button setting" button and the system will complete relevant parameter configuration automatically.

For details about parameter configuration, see the following table:

Function code	Configuration value	Description
P00.00	0 or 2	0: Vector control (SM) 2: VF control (AM) Select according to the motor type.
P00.01	2	2: Communication
P00.06	7	Main frequency PID control setting
P01.15	35.00	Stop frequency: 35Hz
P03.27	1	Vector control speed displayed by set value
P09.00	10	Pressure setting for air compressor
P09.02	8	Pressure feedback for air compressor
P11.15	0	No speed deviation protection
P05.01	6	Coast to stop
P05.10	3	Reverse S1, S2 terminal polarities
P05.02	46	External fault (motor over-temperature)
P06.03	28	Solenoid valve control output
P06.04	29	Fan start/stop control
P05.32	2.04	P1 lower limit corresponds to voltage 2.04V

Step 4 In system configuration interface, click "System parameters setting". When S1 functions as emergency-stop switch, select **NO** or **NC** based on the polarity of the emergency-stop switch. When S2 functions as motor overtemperature switch, select **NC** based on the polarity.

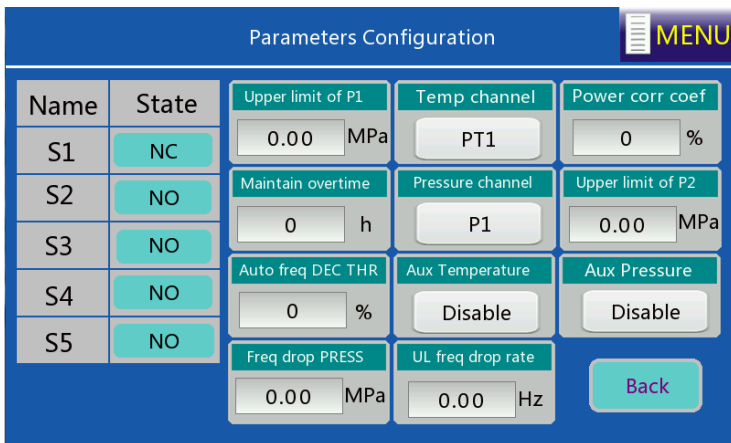

Figure 4-15 System parameter configuration interface

Set pressure sensor parameter, temperature sensor parameter and specialized function parameter according to system sensor configuration condition. Then, click "Return" to enter system configuration page.

Step 5 In system configuration interface, click "Debug mode" and the interface is shown as follows:

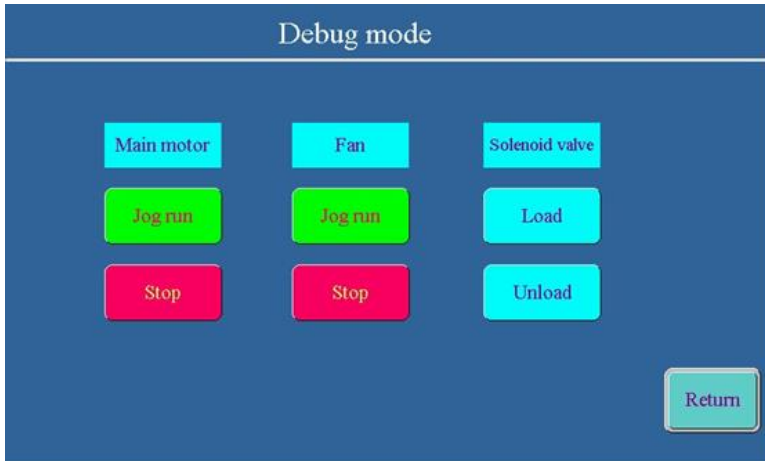

Figure 4-16 Debugging mode interface

Click "Jog run" for motor and fan to determine motor rotation direction; click "Load" or "Unload" to test the action of solenoid valve. Click "Return" to enter system configuration, then, click "MENU" to return menu interface.

Note: If the motor runs reversely, please adjust the motor wiring sequence.

6. Tap "User parameters" in touch screen menu and the interface is shown as follows:

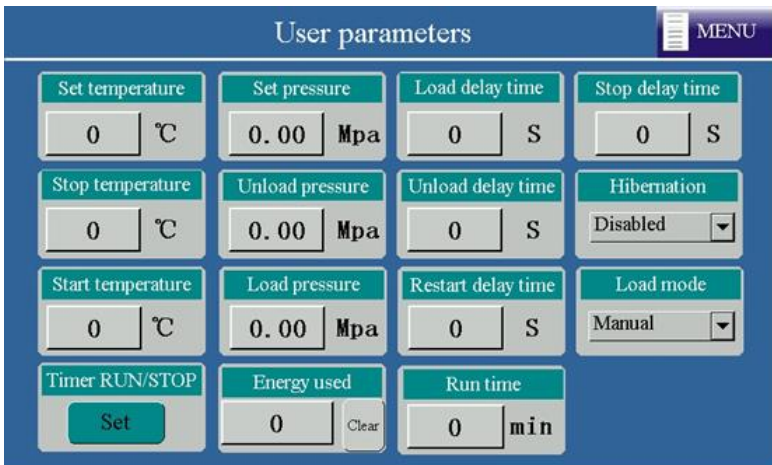

Figure 4-17 User parameter interface

- Click "Maintenance parameters" in touch screen menu and the interface is shown as follows:

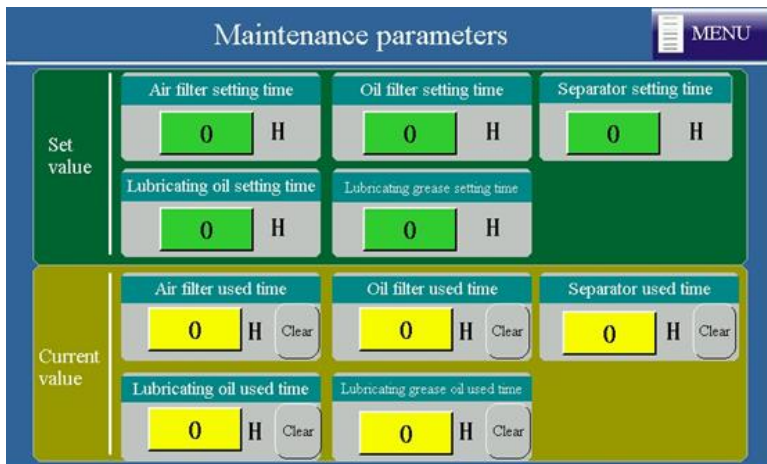

Figure 4-18 Maintenance parameter interface

- Click "Protection parameters" in the menu and the interface is shown as follows:

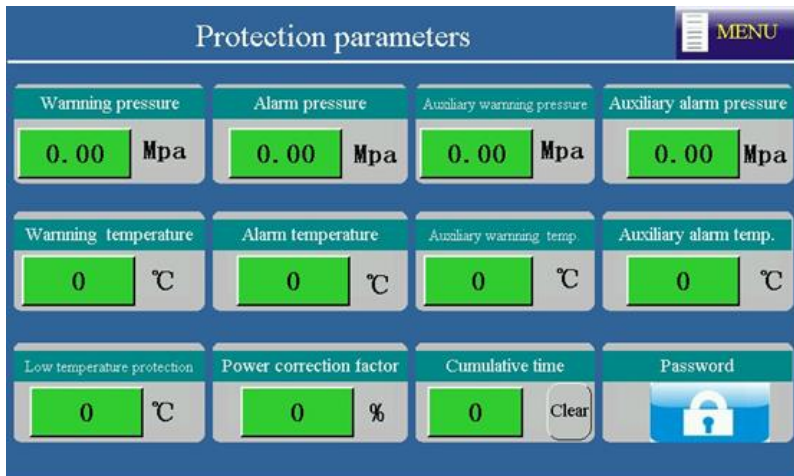

Figure 4-19 Protection parameter interface

9. Click "Running information" in the menu and the interface is shown as follows:

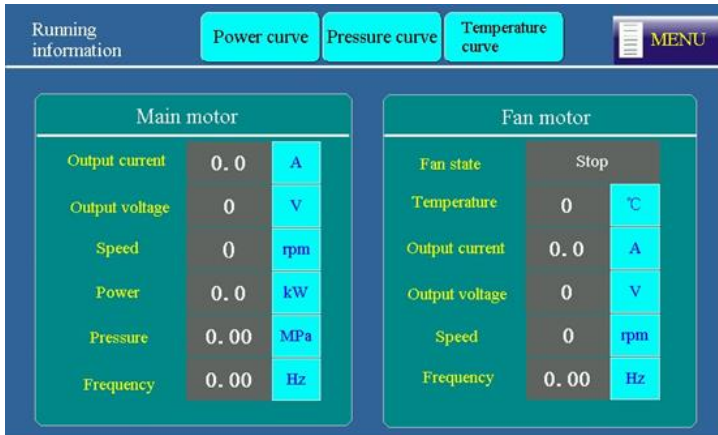

Figure 4-20 Running information interface

10. After adjusting user parameter, factory parameter, maintenance parameter according to touch screen manual, return to the working interface and click "RUN" to run.

Note: All the parameters displayed in 4.3 Function commissioning procedure are for reference only and subject to actual displayed content.

5 Function description

5.1 Function code instruction

The symbols in the table are described as follows:

"○" indicates that the value of the parameter can be modified when the inverter is in stopped or running state.

"⊙" indicates that the value of the parameter cannot be modified when the inverter is in running state.

"●" indicates that the value of the parameter is detected and recorded, and cannot be modified.

(The inverter automatically checks and constrains the modification of parameters, which helps prevent incorrect modifications.)

Group P00 Basic functions

Function code	Name	Description	Default	Modify
P00.00	Speed control mode	0: Sensorless vector control (SVC) mode 0 (for AM, SM) 1: SVC mode 1 (for AM) 2: V/F control Note: AM: asynchronous motor; SM: synchronous motor	0	⊙
P00.01	Channel of running commands	0: Keypad (the indicator is off) 1: Terminal (the indicator blinks) 2: Communication (the indicator is on)	0	○
P00.02	Communication mode of running commands	0: Modbus communication channel 1–3: Reserved	0	○
P00.03	Max. output frequency	P00.04–600.00Hz (400.00Hz)	50.00Hz	⊙
P00.04	Upper limit of running frequency	P00.03–P00.05 (Max. frequency) Setting range: P00.03–P00.06	50.00Hz	○
P00.05	Lower limit of running frequency	0.00Hz–P00.04 (Upper limit of running frequency)	0.00Hz	○
P00.06	Setting channel of A frequency command	0: Keypad 1: Analog P1-setting	0	○
P00.07	Setting channel of B frequency command	2: Reserved 3: Analog P2-setting 4: Reserved 5: Reserved	2	○

Function code	Name	Description	Default	Modify
		6: Multi-step speed running 7: PID control 8: Modbus communication 9–11: Reserved Note: A frequency and B frequency cannot be set to the same frequency reference mode. Frequency source can be set by P00.09.		
P00.08	Reference object of B frequency command	0: Max. output frequency 1: A frequency command	0	<input type="radio"/>
P00.09	Combination mode of setting source	0: A 1: B 2: (A+B) 3: (A- B) 4: Max.(A, B) 5: Min.(A, B)	0	<input type="radio"/>
P00.10	Frequency set through keypad	0.00 Hz–P00.03 (Max. output frequency)	50.00Hz	<input type="radio"/>
P00.11	ACC time 1	0.0–3600.0s	Model depended	<input type="radio"/>
P00.12	DEC time 1	0.0–3600.0s	Model depended	<input type="radio"/>
P00.13	Running direction	0: Run at the default direction. 1: Run at the opposite direction. 2: Disable reverse running	2	<input type="radio"/>
P00.14	Carrier frequency	1.0–15.0kHz	Model depended	<input type="radio"/>
P00.15	Motor parameter autotuning	0: No operation 1: Rotary autotuning 2: Static autotuning 1 (all-around autotuning) 3: Static autotuning 2 (partial autotuning)	0	<input checked="" type="radio"/>
P00.16	AVR function selection	0: Disable 1: Valid during the whole procedure	1	<input type="radio"/>
P00.17	Inverter type	0: G type 1: P type	0	<input checked="" type="radio"/>
P00.18	Function parameter restore	0: No operation 1: Restore default values	0	<input checked="" type="radio"/>

Function code	Name	Description	Default	Modify
		2: Clear fault records 3–6: Reserved 7: Parameter 1 for customer 1 8: Parameter 2 for customer 1 9: Parameter for customer 2 10: Parameter for customer 3 Note: When the factory setting is restored, the motor parameters in group P02 keep the current value unchanged. In addition, the values of P05.38, P05.40, P05.48, P05.50 in group P05, and P18.04, P18.28, P18.29, P18.32, P18.33, P18.38 in group P18 remain unchanged.		

Group P01 Start and stop control

Function code	Name	Description	Default	Modify
P01.01	Starting frequency of direct start	0.00–50.00Hz	0.50Hz	☉
P01.08	Stop mode	0: Decelerate to stop 1: Coast to stop	0	○
P01.15	Stop speed	0.00–100.00Hz	0.50Hz	☉
P01.16	Stop speed detection mode	0: Detect by the setting value of the speed (determine the ramps frequency) 1: Detect by the feedback value of the speed (valid only for vector control)	1	☉
P01.17	Feedback speed detection time	0.00–100.00 s (valid when P01.16=1)	0.50s	☉

Group P02 Parameters of motor 1

Function code	Name	Description	Default	Modify
P02.00	Type of motor 1	0: Asynchronous motor (AM) 1: Synchronous motor (SM)	0	☉
P02.01	Rated power of AM 1	0.1–3000.0kW	Model depended	☉

Function code	Name	Description	Default	Modify
P02.02	Rated frequency of AM 1	0.01Hz–P00.03 (Max. output frequency)	50.00Hz	☉
P02.03	Rated speed of AM 1	1–36000rpm	Model depended	☉
P02.04	Rated voltage of AM 1	0–1200V	Model depended	☉
P02.05	Rated current of AM 1	0.8–6000.0A	Model depended	☉
P02.06	Stator resistance of AM 1	0.001–65.535Ω	Model depended	○
P02.07	Rotor resistance of AM 1	0.001–65.535Ω	Model depended	○
P02.08	Leakage inductance of AM 1	0.1–6553.5mH	Model depended	○
P02.09	Mutual inductance of AM 1	0.1–6553.5mH	Model depended	○
P02.10	No-load current of AM 1	0.1–6553.5A	Model depended	○
P02.11	Magnetic saturation coefficient 1 of iron core of AM 1	0.0–100.0%	80.0%	☉
P02.12	Magnetic saturation coefficient 2 of iron core of AM 1	0.0–100.0%	68.0%	☉
P02.13	Magnetic saturation coefficient 3 of iron core of AM 1	0.0–100.0%	57.0%	☉
P02.14	Magnetic saturation coefficient 4 of iron core of AM 1	0.0–100.0%	40.0%	☉
P02.15	Rated power of SM 1	0.1–3000.0kW	Model depended	☉
P02.16	Rated frequency of SM 1	0.01Hz–P00.03 (Max. output frequency)	50.00Hz	☉
P02.17	Number of pole pairs of SM 1	1–50	2	☉

Function code	Name	Description	Default	Modify								
P02.18	Rated voltage of SM 1	0-1200V	Model depended	☉								
P02.19	Rated current of SM 1	0.8-6000.0A	Model depended	☉								
P02.20	Stator resistance of SM 1	0.001-65.535Ω	Model depended	○								
P02.21	Direct-axis inductance of SM 1	0.01-655.35mH	Model depended	○								
P02.22	Quadrature-axis inductance of SM 1	0.01-655.35mH	Model depended	○								
P02.23	Counter-emf constant of SM 1	0-10000	350	○								
P02.26	Overload protection of motor 1	0: No protection 1: Common motor (with low-speed compensation) 2: Frequency-variable motor (without low-speed compensation)	2	☉								
P02.27	Overload protection coefficient of motor 1	<p>Motor overload multiples $M = I_{out} / (I_n * K)$</p> <p>"I_n" is rated motor current, "I_{out}" is inverter output current, "K" is motor overload protection coefficient.</p> <p>A smaller value of "K" indicates a bigger value of "M".</p> <p>When $M=116\%$, protection is performed after motor overload lasts for 1 hour; when $M=150\%$, protection is performed after motor overload lasts for 12 minutes; when $M=200\%$, protection is performed after motor overload lasts for 60 seconds; and when $M \geq 400\%$, protection is performed immediately.</p> <table border="1"> <caption>Data points from the graph</caption> <thead> <tr> <th>Motor overload multiple</th> <th>Time (min)</th> </tr> </thead> <tbody> <tr> <td>116%</td> <td>60</td> </tr> <tr> <td>150%</td> <td>12</td> </tr> <tr> <td>200%</td> <td>5</td> </tr> </tbody> </table>	Motor overload multiple	Time (min)	116%	60	150%	12	200%	5	100.0%	○
Motor overload multiple	Time (min)											
116%	60											
150%	12											
200%	5											

Function code	Name	Description	Default	Modify
		Setting range: 20.0%–120.0%		
P02.28	Power calibration coefficient of motor 1	0.00–3.00	1.00	<input type="radio"/>
P02.29	Parameter display of motor 1	0: Display based on motor type 1: Display all	0	<input type="radio"/>

Group P03 Vector control

Function code	Name	Description	Default	Modify
P03.00	Speed-loop proportional gain 1	0–200.0	20.0	<input type="radio"/>
P03.01	Speed-loop integral time 1	0.000–10.000s	0.200s	<input type="radio"/>
P03.02	Low-point frequency for switching	0.00Hz–P03.05	5.00Hz	<input type="radio"/>
P03.03	Speed-loop proportional gain 2	0–200.0	20.0	<input type="radio"/>
P03.04	Speed-loop integral time 2	0.000–10.000s	0.200s	<input type="radio"/>
P03.05	High-point frequency for switching	P03.02–P00.03 (Max. frequency)	10.00Hz	<input type="radio"/>
P03.06	Speed-loop output filter	0–8 (corresponding to $0-2^8/10\text{ms}$)	0	<input type="radio"/>
P03.07	Electromotive slip compensation coefficient of vector control	50%–200.0%	100%	<input type="radio"/>
P03.08	Vector control power generation slip compensation coefficient	50%–200.0%	100%	<input type="radio"/>
P03.09	Current-loop proportional coefficient P	0–65535 In differing power ranges, the default values of P03.09 and P03.10 are different. Set power	Model depended	<input type="radio"/>
P03.10	Current-loop integral coefficient I	ranges by touch screen and they will be set to the following empirical parameters after	Model depended	<input type="radio"/>

Function code	Name	Description	Default	Modify																								
		autotuning. <table border="1"> <thead> <tr> <th>Empirical value of P03.09 (for reference only)</th> <th>Empirical value of P03.10 (for reference only)</th> <th>Motor power</th> </tr> </thead> <tbody> <tr> <td>2000</td> <td>1000</td> <td>15kW</td> </tr> <tr> <td>2000</td> <td>1000</td> <td>18.5kW</td> </tr> <tr> <td>2000</td> <td>1000</td> <td>22kW</td> </tr> <tr> <td>2500</td> <td>1500</td> <td>37kW</td> </tr> <tr> <td>3000</td> <td>1500</td> <td>55kW</td> </tr> <tr> <td>3000</td> <td>1500</td> <td>75kW</td> </tr> <tr> <td>3000</td> <td>1500</td> <td>90kW</td> </tr> </tbody> </table>	Empirical value of P03.09 (for reference only)	Empirical value of P03.10 (for reference only)	Motor power	2000	1000	15kW	2000	1000	18.5kW	2000	1000	22kW	2500	1500	37kW	3000	1500	55kW	3000	1500	75kW	3000	1500	90kW		
Empirical value of P03.09 (for reference only)	Empirical value of P03.10 (for reference only)	Motor power																										
2000	1000	15kW																										
2000	1000	18.5kW																										
2000	1000	22kW																										
2500	1500	37kW																										
3000	1500	55kW																										
3000	1500	75kW																										
3000	1500	90kW																										
P03.20	Electromotive torque upper limit set through keypad	0.0–300.0% (of the motor rated current)	180.0%	<input type="radio"/>																								
P03.21	Braking torque upper limit set through keypad	0.0–300.0% (of the motor rated current)	180.0%	<input type="radio"/>																								
P03.22	Weakening coefficient in constant power zone	0.1–2.0	0.3	<input type="radio"/>																								
P03.23	Lowest weakening point in constant power zone	10%–100.0%	20%	<input type="radio"/>																								
P03.24	Max. voltage limit	0.0–120.0%	100.0%	<input type="radio"/>																								
P03.25	Pre-exciting time	0.000–10.000s	0.300s	<input type="radio"/>																								
P03.26	Flux-weakening proportional gain	0–8000	300	<input type="radio"/>																								
P03.27	Speed display selection in vector control	0: Display the actual value 1: Display the set value	0	<input type="radio"/>																								
P03.28	Injected current at start	0.0–100.0%	60.0%	<input type="radio"/>																								
P03.29	Inductance coefficient	0.2–4.0	1.0	<input type="radio"/>																								

Group P04 V/F control

Function code	Name	Description	Default	Modify
P04.00	V/F curve setting of motor 1	0: Straight-line V/F curve 1: Multi-point V/F curve 2: Torque-down V/F curve (power of 1.3) 3: Torque-down V/F curve (power of 1.7) 4: Torque-down V/F curve (power of 2.0) 5: Reserved	0	☉
P04.01	Torque boost of motor 1	0.0%: (automatic) 0.1%–10.0%	0.0%	○
P04.02	Torque boost cut-off of motor 1	0.0%–50.0% (of the rated frequency of motor 1)	20.0%	○
P04.03	V/F frequency point 1 of motor 1	0.00Hz–P04.05	0.00Hz	○
P04.04	V/F voltage point 1 of motor 1	0.0%–110.0% (of the rated voltage of motor 1)	00.0%	○
P04.05	V/F frequency point 2 of motor 1	P04.03–P04.07	00.00Hz	○
P04.06	V/F voltage point 2 of motor 1	0.0%–110.0% (of the rated voltage of motor 1)	00.0%	○
P04.07	V/F frequency point 3 of motor 1	P04.05–P02.02 (Rated frequency of motor 1) / P04.05–P02.16 (Rated frequency of motor 1)	00.00Hz	○
P04.08	V/F voltage point 3 of motor 1	0.0%–110.0% (of the rated voltage of motor 1)	00.0%	○
P04.09	V/F slip compensation gain of motor 1	0.0–200.0%	100.0%	○
P04.10	Low-frequency oscillation control factor of motor 1	0–100	10	○
P04.11	High-frequency oscillation control factor of motor 1	0–100	10	○
P04.12	Oscillation control threshold of motor 1	0.00Hz–P00.03 (Max. output frequency)	30.00Hz	○
P04.26	Energy-saving run	0: Disable 1: Automatic energy-saving run	0	☉

Function code	Name	Description	Default	Modify
P04.33	Weakening coefficient in constant power zone	1.00–1.30	1.00	<input type="radio"/>
P04.34	Reactive closed-loop proportional coefficient	0–3000	100	<input type="radio"/>
P04.35	Reactive closed-loop integral coefficient	0–3000	20	<input type="radio"/>

Group P05 Input terminals

Function code	Name	Description	Default	Modify
P05.00	Reserved	Reserved	0	<input type="radio"/>
P05.01	Function of S1	0: No function	0	<input type="radio"/>
P05.02	Function of S2	1: Run forward	0	<input type="radio"/>
P05.03	Function of S3	2: Run reversely	0	<input type="radio"/>
P05.04	Function of S4	3: Three-wire running control	0	<input type="radio"/>
P05.05	Function of S5	4: Jog forward	0	<input type="radio"/>
P05.06	Reserved	5: Jog reversely 6: Coast to stop 7: Reset faults 8: Pause running 9: External fault input 10–24: Reserved 25: Pause PID control 26–39: Reserved 40: Clear electricity consumption 41: Keep electricity consumption 42: Air filter block signal 43: Oil filter block signal 44: Separator block signal 45: Splitter block signal 46: External fault 1 47: External fault 2		

Function code	Name	Description	Default	Modify																				
		48: Fan running control signal 49: Solenoid valve control signal 50: Cooling fan control signal of main motor 51–63: Reserved																						
P05.10	Input terminal polarity	<p>The function code is used to set the polarity of input terminals.</p> <p>When a bit is 0, the input terminal is positive; when a bit is 1, the input terminal is negative.</p> <table border="1" style="margin-left: auto; margin-right: auto;"> <tr> <td></td> <td>Bit8</td> <td>Bit7</td> <td>Bit6</td> <td>Bit5</td> </tr> <tr> <td></td> <td>Reserved</td> <td>Reserved</td> <td>Reserved</td> <td>Reserved</td> </tr> <tr> <td>Bit4</td> <td>Bit3</td> <td>Bit2</td> <td>Bit1</td> <td>Bit0</td> </tr> <tr> <td>S5</td> <td>S4</td> <td>S3</td> <td>S2</td> <td>S1</td> </tr> </table> <p>Setting range: 0x000–0x1FF</p>		Bit8	Bit7	Bit6	Bit5		Reserved	Reserved	Reserved	Reserved	Bit4	Bit3	Bit2	Bit1	Bit0	S5	S4	S3	S2	S1	0x000	○
	Bit8	Bit7	Bit6	Bit5																				
	Reserved	Reserved	Reserved	Reserved																				
Bit4	Bit3	Bit2	Bit1	Bit0																				
S5	S4	S3	S2	S1																				
P05.11	Digital input filter time	0.000–1.000s	0.200s	○																				
P05.14	S1 switch-on delay	0.000–50.000s	0.000s	○																				
P05.15	S1 switch-off delay	0.000–50.000s	0.000s	○																				
P05.16	S2 switch-on delay	0.000–50.000s	0.000s	○																				
P05.17	S2 switch-off delay	0.000–50.000s	0.000s	○																				
P05.18	S3 switch-on delay	0.000–50.000s	0.000s	○																				
P05.19	S3 switch-off delay	0.000–50.000s	0.000s	○																				
P05.20	S4 switch-on delay	0.000–50.000s	0.000s	○																				
P05.21	S4 switch-off delay	0.000–50.000s	0.000s	○																				
P05.22	S5 switch-on delay	0.000–50.000s	0.000s	○																				
P05.23	S5 switch-off delay	0.000–50.000s	0.000s	○																				
P05.32	P1 lower limit	<p>P05.32 setting range: 0.00V–P05.34</p>	2.00V	○																				
P05.33	Corresponding setting of P1 lower limit		0.0%	○																				
P05.34	P1 upper limit		10.00V	○																				
P05.35	Corresponding setting of P1 upper limit		100.0%	○																				

Function code	Name	Description	Default	Modify
		P05.33 setting range: -100.0% -100.0% P05.34 setting range: P05.32-10.00V P05.35 setting range: -100.0% -100.0%		
P05.36	P1 input filter time	0.000s-10.000s	0.200s	<input type="radio"/>
P05.37	PT1 lower limit	Corresponding setting of the upper and lower limits are the percentage of temperature calibration point within the total range. The percentage of analog input voltage can be derived from the linear relationship between the limits and their corresponding settings.	0.00V	<input type="radio"/>
P05.38	Corresponding setting of PT1 lower limit	Current temperature = Corresponding percentage × 160°C Note: When the factory setting is restored, the value of P05.38/P05.40/P05.48/P05.50 remains unchanged.	12.5%	<input type="radio"/>
P05.39	PT1 upper limit		10.00V	<input type="radio"/>
P05.40	Corresponding setting of PT1 upper limit	<p>Current temperature = Corresponding percentage × 160°C</p> <p>Note: When the factory setting is restored, the value of P05.38/P05.40/P05.48/P05.50 remains unchanged.</p> <p>P05.37 setting range: 0.00V-P05.39 P05.38 setting range: -100.0% -100.0% P05.39 setting range: P05.37-10.00V P05.40 setting range: -100.0% -100.0%</p>	75.0%	<input type="radio"/>
P05.41	PT1 input filter time	0.000s-10.000s	0.300s	<input type="radio"/>
P05.42	P2 lower limit	0.00V-P05.44	2.00V	<input type="radio"/>
P05.43	Corresponding setting of P2 lower limit	-100.0%-100.0%	0.0%	<input type="radio"/>
P05.44	P2 upper limit	P05.42-10.00V	10.00V	<input type="radio"/>
P05.45	Corresponding setting of P2 upper	-100.0%-100.0%	100.0%	<input type="radio"/>

Function code	Name	Description	Default	Modify
	limit			
P05.46	P2 input filter time	0.000s–10.000s	0.200s	<input type="radio"/>
P05.47	PT2 lower limit	0.00V–P05.49	0.00V	<input type="radio"/>
P05.48	Corresponding setting of PT2 lower limit	-100.0%–100.0%	12.5%	<input type="radio"/>
P05.49	PT2 upper limit	P05.47–10.00V	10.00V	<input type="radio"/>
P05.50	Corresponding setting of PT2 upper limit	-100.0%–100.0%	75.0%	<input type="radio"/>
P05.51	PT2 input filter time	0.000s–10.000s	0.300s	<input type="radio"/>

Group P06 Output terminals

Function code	Name	Description	Default	Modify
P06.01	Y1 output	0: Disable	5	<input type="radio"/>
P06.02	Reserved	1: Running	0	<input type="radio"/>
P06.03	TAC1 output	2: Running forward	0	<input type="radio"/>
P06.04	TAC2 output	3: Running reversely 4: Jogging 5: Inverter in fault 6–11: Reserved 12: Ready for running 13: Pre-exciting 14–19: Reserved 20: External fault is valid 21–22: Reserved 23: Modbus communication virtual terminal output 24–25: Reserved 26: Special for oil pump (for blower) 27: Auxiliary motor start/stop control (for air compressor) 28: Solenoid valve control output (for air compressor) 29: Cooling fan control of main motor (for air	0	<input type="radio"/>

Function code	Name	Description	Default	Modify								
		compressor) 30: Internal fault and alarm										
P06.05	Output terminal polarity selection	<p>The function code is used to set the polarity of output terminals. When a bit is 0, the output terminal is positive. When a bit is 1, the output terminal is negative.</p> <table border="1" style="margin-left: auto; margin-right: auto;"> <tr> <td style="text-align: center;">Bit3</td> <td style="text-align: center;">Bit2</td> <td style="text-align: center;">Bit1</td> <td style="text-align: center;">Bit0</td> </tr> <tr> <td style="text-align: center;">TAC2</td> <td style="text-align: center;">TAC1</td> <td style="text-align: center;">Reserved</td> <td style="text-align: center;">Y</td> </tr> </table> <p>Setting range: 0–0xF</p>	Bit3	Bit2	Bit1	Bit0	TAC2	TAC1	Reserved	Y	0	○
Bit3	Bit2	Bit1	Bit0									
TAC2	TAC1	Reserved	Y									
P06.06	Y switch-on delay	0.000–50.000s	0.000s	○								
P06.07	Y switch-off delay	0.000–50.000s	0.000s	○								
P06.08	Reserved	0.000–50.000s	0.000s	○								
P06.09	Reserved	0.000–50.000s	0.000s	○								
P06.10	TAC1 switch-on delay	0.000–50.000s	0.000s	○								
P06.11	TAC1 switch-off delay	0.000–50.000s	0.000s	○								
P06.12	TAC2 switch-on delay	0.000–50.000s	0.000s	○								
P06.13	TAC2 switch-off delay	0.000–50.000s	0.000s	○								

Group P07 Human-machine interface

Function code	Name	Description	Default	Modify
P07.00	User password	0–65535	0	○
P07.01	Parameter copy	<p>0: No operation 1: Upload parameters from the local address to the keypad 2: Download parameters (including motor parameters) from the keypad to the local address 3: Download parameters (excluding groups P02 and P12) from the keypad to the local</p>	0x00	◎

Function code	Name	Description	Default	Modify
		address 4: Download parameters (only including groups P02 and P12) from the keypad to the local address Note: After any operation among 1–4 is complete, the parameter restores to 0. The upload and download functions are not applicable to group P29. Tens place: Parameter group setting 0–4: Group 1–group 5 Setting range: 0x00–0x44		
P07.11	Rectifier bridge temperature	0–100.0°C		●
P07.12	Inverter temperature	0–100.0°C		●
P07.13	Control board software version	1.00–655.35		●
P07.14	Local accumulative running time	0–65535h		●
P07.15	Inverter electricity consumption high-order bits	0–65535 kWh (*1000)		●
P07.16	Inverter electricity consumption low-order bits	0.0–999.9 kWh		●
P07.17	Inverter model	0: G type 1: P type		●
P07.18	Inverter rated power	0.4–3000.0kW		●
P07.19	Inverter rated voltage	50–1200V		●
P07.20	Inverter rated current	0.1–6000.0A		●
P07.21	Factory bar code 1	0x0000–0xFFFF		●
P07.22	Factory bar code 2	0x0000–0xFFFF		●
P07.23	Factory bar code 3	0x0000–0xFFFF		●
P07.24	Factory bar code 4	0x0000–0xFFFF		●
P07.25	Factory bar code 5	0x0000–0xFFFF		●
P07.26	Factory bar code 6	0x0000–0xFFFF		●

Function code	Name	Description	Default	Modify
P07.27	Present fault type	0: No fault		●
P07.28	Last fault type	1: Inverter unit U-phase protection (OUt1)		●
P07.29	2nd-last fault type	2: Inverter unit V-phase protection (OUt2)		●
P07.30	3rd-last fault type	3: Inverter unit W-phase protection (OUt3)		●
P07.31	4th-last fault type	4: Overcurrent during acceleration (OC1)		●
P07.32	5th-last fault type	5: Overcurrent during deceleration (OC2)		●
		6: Overcurrent during constant speed running (OC3)		
		7: Overvoltage during acceleration (OV1)		
		8: Overvoltage during deceleration (OV2)		
		9: Overvoltage during constant speed running (OV3)		
		10: Bus undervoltage fault (UV)		
		11: Motor overload (OL1)		
		12: Inverter overload (OL2)		
		13: Phase loss on input side (SPI)		
		14: Phase loss on output side (SPO)		
		15: Rectifier module overheat (OH1)		
		16: Inverter module overheat (OH2)		
		17: External fault (EF)		
		18: RS485 communication fault (CE)		
		19: Current detection fault (ItE)		
		20: Motor autotuning fault (tE)		
		21: EEPROM operation error (EEP)		
		22: PID feedback offline fault (PIDE)		
		23: Reserved		
		24: Running time reached (END)		
		25: Electronic overload (OL3)		
		26: Keypad communication error (PCE)		
		27: Parameter upload error (UPE)		
		28: Parameter download error (DNE)		
		29–31: Reserved		
		32: To-ground short-circuit fault 1 (ETH1)		
		33: To-ground short-circuit fault 2 (ETH2)		
34: Speed deviation fault (dEu)				
35: Mal-adjustment fault (STo)				
36: Underload fault (LL)				
37: Auxiliary fan fault (E_FAN)				

Function code	Name	Description	Default	Modify
		38: Phase lock failure (PSF) 39–43: Reserved 44: Low auxiliary pressure fault (L-AUP) 45: Handshake failure (HAnd)		
P07.33	Running frequency at present fault		0.00Hz	●
P07.34	Ramp reference frequency at present fault		0.00Hz	●
P07.35	Output current at present fault		0V	●
P07.36	Output current at present fault		0.0A	●
P07.37	Bus voltage at present fault		0.0V	●
P07.38	Max. temperature at present fault		0.0°C	●
P07.39	Input terminal status at present fault		0	●
P07.40	Output terminal status at present fault		0	●
P07.41	Running frequency at last fault		0.00Hz	●
P07.42	Ramp reference frequency at last fault		0.00Hz	●
P07.43	Output voltage at last fault		0V	●
P07.44	Output current at last fault		0.0A	●
P07.45	Bus voltage at last fault		0.0V	●
P07.46	Max. temperature at last fault		0.0°C	●
P07.47	Input terminal status at last fault		0	●

Function code	Name	Description	Default	Modify
P07.48	Output terminal status at last fault		0	●
P07.49	Running frequency at 2 nd -last fault		0.00Hz	●
P07.50	Ramp reference frequency at 2 nd -last fault		0.00Hz	●
P07.51	Output voltage at 2 nd -last fault		0V	●
P07.52	Output current at 2 nd -last fault		0.0A	●
P07.53	Bus voltage at 2 nd -last fault		0.0V	●
P07.54	Max. temperature at 2 nd -last fault		0.0°C	●
P07.55	Input terminal status at 2 nd -last fault		0	●
P07.56	Output terminal status at 2 nd -last fault		0	●

Group P08 Enhanced functions

Function code	Name	Description	Default	Modify
P08.15	Bus voltage pre-protection function	0-1	0	○
P08.16	Low voltage protection threshold	0.0V-2000.0V	300.0V	○
P08.17	Overvoltage pre-protection threshold	0.0V-2000.0V	780.0V	○
P08.18	Delay time of automatic start-up	0.0-6000.0s	60.0s	○
P08.19	Low voltage frequency-limit running time	0.0-6000.0s	60.0s	○

Function code	Name	Description	Default	Modify
P08.26	Counting mode of maintenance time	0–1 0: Counting during motor running 1: Counting during motor running and sleeping	0	<input type="radio"/>

Group P09 PID control

Function code	Name	Description	Default	Modify
P09.00	PID reference source	0: Keypad (P09.01) 1: Analog P1-reference 2: Reserved 3: Analog P2-setting 4: Reserved 5: Multi-step running 6: Modbus communication 7–9: Reserved 10: Pressure setting for air compressor-specific function	0	<input type="radio"/>
P09.01	PID reference preset through keypad	-100.0%–100.0%	0.0%	<input type="radio"/>
P09.02	PID feedback source	0: Analog P1-feedback 1: Reserved 2: Analog P2-feedback 3: Reserved 4: Modbus communication feedback 5–7: Reserved 8: Pressure feedback for air compressor-specific function	0	<input type="radio"/>
P09.03	PID output characteristics selection	0: PID output is positive. When the feedback signal is greater than the PID reference value, the output frequency of the inverter will decrease to balance the PID. Example: PID control on strain during unwinding. 1: PID output is negative. When the feedback signal is greater than the PID reference value, the output frequency of the inverter will increase to balance the PID. Example: PID	0	<input type="radio"/>

Function code	Name	Description	Default	Modify
		control on strain during unwinding.		
P09.04	Proportional gain (Kp)	P determines the strength of the whole PID adjuster. The larger the value of P, the stronger the adjustment intensity. The value 100 indicates that when the difference between the PID feedback value and given value is 100%, the range within which the proportional regulator (ignoring integral function and differential function) can regulate the output frequency command is the max. frequency (P00.03). Setting range: 0.00–100.00	10.00	<input type="radio"/>
P09.05	Integral time (Ti)	Used to determine the speed of the integral adjustment on the deviation of PID feedback and reference from the PID regulator. When the deviation of PID feedback and reference is 100%, the integral adjuster works continuously during the time (ignoring proportional and differential function) to achieve the max. output frequency (P00.03). Shorter integral time indicates stronger adjustment. Setting range: 0.00–10.00s	2.00s	<input type="radio"/>
P09.06	Differential time (Td)	Used to determine the strength of the change ratio adjustment on the deviation of PID feedback and reference from the PID regulator. If feedback quantity changes 100% during this time period, the range within which the differential regulator (ignoring integral function and differential function) can regulate is the max. frequency (P00.03). Longer differential time indicates stronger adjustment. Setting range: 0.00–10.00s	1.00s	<input type="radio"/>
P09.07	Sampling cycle (T)	Used to indicate the sampling cycle of feedback. The regulator calculates in each sampling cycle. A longer sampling cycle indicates slower response.	0.100s	<input type="radio"/>

Function code	Name	Description	Default	Modify
		Setting range: 0.001–10.000s		
P09.08	PID control deviation limit	The feedback value of the PID system is relative to the max. deviation of the closed loop reference. The PID regulator stops regulating in the range of deviation limit. Set the function parameter properly to adjust the accuracy and stability of the PID system. Setting range: 0.0–100.0%	0.1%	○
P09.09	PID output upper limit	P09.10–100.0% (Max. frequency)	100.0%	○
P09.10	PID output lower limit	-100.0%–P09.09 (Max. frequency)	0.0%	○
P09.11	Feedback offline detection value	0.0–100.0%	0.0%	○
P09.12	Feedback offline detection time	0.0–3600.0s	1.0s	○
P09.13	PID control selection	0x00–0x11 LED ones place: 0: Continue integral control after the frequency reaches upper/lower limit 1: Stop integral control after the frequency reaches upper/lower limit LED hundreds place: 0: Consistent with the set direction 1: Contrary to the set direction	0x01	○
P09.14	Differential filter times	0–60	2	○
P09.15	Dynamic password	0–9999 Note: This value is automatically refreshed every time the device is powered on/every 8 hours/every time a new P09.15 value is entered.		●
P09.16	Handshake password	0–9999 Note: This is used to turn on or turn off the handshake protocol.		◎

Group P11 Protection parameters

Function code	Name	Description	Default	Modify
P11.00	Protection against phase loss	0x0000–0x1111 LED ones place: 0: Software protection against input phase loss disabled 1: Software protection against input phase loss enabled Note: The ones place of the LED detects input phase loss by phase sequence detection circuit. LED tens place: 0: Output phase loss protection disabled 1: Output phase loss protection enabled LED hundreds place: 0: Hardware protection against input phase loss disabled 1: Hardware protection against input phase loss enabled Note: The hundreds place of the LED detects input phase loss by hardware detection circuit. LED thousands place: 0: Phase sequence protection disabled 1: Phase sequence protection enabled	0x0110	○
P11.01	Frequency drop at transient power-off	0: Disable 1: Enable	0	○
P11.02	Frequency drop rate at transient power-off	0.00Hz/s–P00.03/s (Max. output frequency)	10.00Hz/s	○
P11.03	Overvoltage stalling protection	0: Disable 1: Enable	1	○
P11.04	Overvoltage stalling protection voltage	120–150% (standard bus voltage) (380V)	140%	○
P11.05	Current limit mode	0x00–0x11 Ones place: Current limit action selection 0: Invalid 1: Always valid Tens place: Hardware current limit overload alarm 0: Valid	01	◎

Function code	Name	Description	Default	Modify
		1: Invalid		
P11.06	Automatic current limit threshold	50.0–200.0%	160.0%	☉
P11.07	Frequency drop rate during current limit	0.00–50.00Hz/s	10.00Hz/s	☉
P11.13	Fault output terminal action upon fault occurring	0x00–0x11 LED ones place: 0: Act upon an undervoltage fault 1: Do not act upon an undervoltage fault LED tens place: 0: Act during automatic reset 1: Do not act during the automatic reset period	0x00	○
P11.14	Speed deviation detection value	0.0–50.0%	10.0%	○
P11.15	Speed deviation detection time	0.0–10.0s (No speed deviation protection for the value=0.0)	0.5s	○
P11.16	Automatic frequency-reduction during voltage drop	0: Disable 1: Enable	1	○

Group P13 SM control parameters

Function code	Name	Description	Default	Modify
P13.00	Reduction coefficient of pull-in current	0.0–100.0%	50.0%	○
P13.01	Detection mode of initial pole	0: No detection 1: High frequency superimposition (reserved) 2: Pulse superimposition (reserved)	0	☉
P13.02	Pull-in current 1	0.0%–100.0% (of the motor rated current)	20.0%	○
P13.03	Pull-in current 2	0.0%–100.0% (of the motor rated current)	10.0%	○
P13.04	Source-current switchover frequency	0.00Hz–P00.03 (Max. output frequency)	30.00Hz	○
P13.05	High frequency overlay frequency	200Hz–1000Hz	500Hz	☉

Function code	Name	Description	Default	Modify
	(reserved)			
P13.06	High frequency superimposed voltage	0.0–300.0% (of the motor rated voltage)	40.0%	☉
P13.08	Control parameter 1	0x0000–0xFFFF	0x0120	○
P13.09	Control parameter 2	0–300.00	5.00	○
P13.11	Maladjustment detection time	Used to adjust the responsiveness of anti-maladjustment function. If the load inertia is large, increase the value of this parameter properly, however, the responsiveness may slow down accordingly. Setting range: 0.0–10.0s	0.5s	○
P13.12	High frequency compensation coefficient	Valid when the motor speed exceeds the rated speed. If oscillation occurred to the motor, adjust this parameter properly. Setting range: 0.0–100.0%	50.0%	○

Group P14 Serial communication function

Function code	Name	Description	Default	Modify
P14.00	Local communication address	1–247; 0 indicates a broadcast address	2	○
P14.01	Communication baud rate	0: 1200BPS 1: 2400BPS 2: 4800BPS 3: 9600BPS 4: 19200BPS 5: 38400BPS	4	○
P14.02	Data bit check	0: No check (N, 8, 1) for RTU 1: Even check (E, 8, 1) for RTU 2: Odd check (O, 8, 1) for RTU 3: No check (N, 8, 2) for RTU 4: Even check (E, 8, 2) for RTU 5: Odd check (O, 8, 2) for RTU	1	○

Function code	Name	Description	Default	Modify
P14.03	Communication response delay	0–200ms	5	<input type="radio"/>
P14.04	Communication timeout time	0.0 (invalid), 0.1–60.0s	0.0s	<input type="radio"/>
P14.05	Transmission error processing	0: Report an alarm and coast to stop 1: Keep running without reporting an alarm 2: Stop in enabled stop mode without reporting an alarm (applicable only to communication mode) 3: Stop in enabled stop mode without reporting an alarm (applicable to any mode)	0	<input type="radio"/>
P14.06	Communication processing action	0x00–0x11 LED ones: Writing operation 0: Respond to write operations 1: Not respond to write operations LED tens: Communication encryption 0: Disabled 1: Enabled	0x00	<input type="radio"/>
P14.07	Communication address of auxiliary fan	1–247; 0 indicates a broadcast address	1	<input type="radio"/>
P14.08	Handshake timeout time	0–65535s Note: If the handshake fails after the time set in P14.08, a HAnd fault is reported, and no fault is reported when it is set to 0.	20s	<input type="radio"/>

Group P15 Customized functions

Function code	Name	Description	Default	Modify
P15.00	Auxiliary pressure start-up protection	0: Disable 1: Enable	0	<input checked="" type="radio"/>
P15.01	Auxiliary pressure start-up protection setting value	0.00–20.00MPa The inverter cannot start if current auxiliary pressure (P19.20) is greater than auxiliary pressure start-up protection value (P15.01).	0.30MPa	<input type="radio"/>
P15.02	Stop delay time of auxiliary pressure start-up protection	0–300s When the auxiliary pressure start-up protection (P15.00=1) is turned on, if the current auxiliary pressure is still greater than	30s	<input type="radio"/>

Function code	Name	Description	Default	Modify
		<p>the set value of P15.01 after the stop time delay (P18.14), the inverter will keep running at idle frequency and stop running after the delay time of P15.02.</p>		
P15.03	Pressure limit after the time threshold reached	<p>0.00–P18.04MPa</p> <p>When the accumulated running time of the device (P19.16) reaches the set value of P15.04, the pressure cannot exceed the value of P15.03.</p>	0.50MPa	<input type="radio"/>
P15.04	Upper limit of accumulated device running time	<p>0–65535h</p> <p>Note: P15.03 is invalid when P15.04 is set to 0.</p>	0	<input type="radio"/>
P15.05	Device status flag	<p>Bit0: High auxiliary pressure flag</p> <p>0: None</p> <p>1: Auxiliary pressure is high. The device is not allowed to start.</p> <p>Bit1: Limited max. set pressure flag</p> <p>0: None</p> <p>1: Function limited. Please contact the manufacturer.</p>	0	<input checked="" type="radio"/>
P15.06	Delay time of auxiliary pressure detection	<p>0–65535s</p> <p>Note: The value 0 indicates that the low auxiliary pressure fault will not be detected.</p>	0	<input type="radio"/>
P15.07	Auxiliary pressure low protection point	<p>0.00–20.00MPa</p> <p>When the auxiliary pressure protection is enabled (P18.39=1) and the auxiliary pressure is less than the P15.11 set value, an auxiliary pressure low fault is reported.</p> <p>Note: Auxiliary pressure low fault detection is disabled when the air compressor is asleep.</p>	0.00	<input type="radio"/>
P15.11	Handshake protocol open count	0–65535	0	<input checked="" type="radio"/>

Function code	Name	Description	Default	Modify
P15.12	Number of decimal points of pressure	0–1 0: 2 bits 1: 3 bits	0	<input type="radio"/>

Group P17 State viewing function

Function code	Name	Description	Default	Modify
P17.00	Set frequency	0.00Hz–P00.03	0.00Hz	●
P17.01	Output frequency	0.00Hz–P00.03	0.00Hz	●
P17.02	Ramp reference frequency	0.00Hz–P00.03	0.00Hz	●
P17.03	Output voltage	0–1200V	0V	●
P17.04	Output current	0.0–3000.0A	0.0A	●
P17.05	Motor rotation speed	0–65535rpm	0rpm	●
P17.06	Torque current	-3000.0–3000.0A	0.0A	●
P17.07	Exciting current	-3000.0–3000.0A	0.0A	●
P17.08	Motor power	-300.0% –300.0% (of the motor rated power)	0.0%	●
P17.09	Output torque	-250.0–250.0%	0.0%	●
P17.10	Estimated motor frequency	0.00–P00.03	0.00Hz	●
P17.11	DC bus voltage	0.0–2000.0V	0V	●
P17.12	Digital input terminal status	0000–00FF	0	●
P17.13	Digital output terminal status	0000–00FF	0	●
P17.16	Master fault code	0–45 (See P07.27–P07.32 for details)	0	●
P17.17	Fan fault code	0–38 (See P07.27–P07.32 for details)	0	●
P17.18	Handshake status	0–1 0: Disabled 1: Enabled	0	●
P17.19	P1–input voltage	Displays analog input voltage value of P1-channel. 2.00V–10.00V corresponds to 4–50mA. P05.32-P05.34 corresponds to pressure 0.0-P18.04. When P1-input voltage is detected to be above 9.8V or below 1V, it is	0.00V	●

Function code	Name	Description	Default	Modify
		deemed as pressure signal fault. Range: 0.00–10.00V		
P17.20	PT1 input voltage	Displays the analog input voltage value of PT1 channel. Connect PT100 thermal resistor temperature sensor in air compressor mode, and different resistance value will be generated under different temperature. Different resistance value corresponds to different input voltage. Therefore, the input voltage value can correspond to the corresponding detection temperature. The input voltage P18.28–P18.29 corresponds to -20°C–+150°C. Range: 0.00–10.00V	0.00V	●
P17.21	P2-input voltage	Displays analog input voltage value of P2-channel. 2.00V–10.00V corresponds to 4–50mA. P05.42-P05.44 corresponds to pressure 0.0-P18.38. When P2-input voltage is detected to be above 9.8V or below 1V, it is deemed as pressure signal fault. Range: 0.00–10.00V	0.00V	●
P17.22	PT2 input voltage	Displays the analog input voltage value of PT2 channel. Connect PT100 thermal resistor temperature sensor in air compressor mode, and different resistance value will be generated under different temperature. Different resistance value corresponds to different input voltage. Therefore, the input voltage value can correspond to the corresponding detection temperature. The input voltage P18.32–P18.33 corresponds to -20°C–+150°C. Range: 0.00–10.00V	0.00V	●
P17.23	PID reference value	Displays the set value of exhaust pressure signal. 100.0% corresponds to the upper limit value of exhaust pressure sensor P18.04 (If P18.37=1, 100% corresponds to P18.38). Range: -100.0–100.0%	0.0%	●

Function code	Name	Description	Default	Modify
P17.24	PID feedback value	Displays detection value of exhaust pressure signal. Range: -100.0–100.0%	0.0%	●
P17.25	Motor power factor	-1.00–1.00	0.0	●
P17.26	Duration of this run	0–65535m	0m	●
P17.28	ASR controller output	-300.0%–300.0% (of the motor rated current)	0.0%	●
P17.29	Magnetic pole angle of SM	0.0–360.0	0.0	●
P17.30	Phase compensation of SM	-180.0–180.0	0.0	●
P17.36	Output torque	-3000.0Nm–3000.0Nm	0.0Nm	●
P17.38	PID output	Displays PID control adjustment output value of exhaust pressure signal. 100.0% corresponds to maximum output frequency P00.03. Setting range: -100.00–100.00%	0.00%	●

Group P18 Functions special for air compressors

Function code	Name	Description	Default	Modify
P18.00	Air compressor control mode	0: Disable 1: Air compressor control mode Note: When P18.00=1, P19 group air compressor state check group is valid.	0	◎
P18.01	Sleep function selection		1	◎

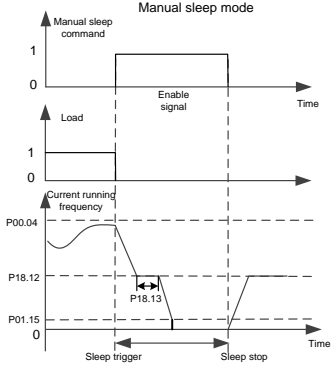
Function code	Name	Description	Default	Modify
		 <p>The diagram illustrates the 'Manual sleep mode' operation. It consists of three vertically aligned graphs sharing a common 'Time' axis. <ul style="list-style-type: none"> Top Graph: 'Manual sleep command' is a step function that transitions from 0 to 1 at the 'Sleep trigger' event and returns to 0 at the 'Sleep stop' event. An 'Enable signal' is shown as a horizontal line at level 1 during the active period. Middle Graph: 'Load' is a step function that transitions from 0 to 1 at the 'Sleep trigger' event and returns to 0 at the 'Sleep stop' event. Bottom Graph: 'Current running frequency' starts at a value above P00.04, decelerates to P18.12 at the 'Sleep trigger' event. It then remains at P18.12 for a duration P18.13. After this period, it decelerates to P01.15 and then to 0. At the 'Sleep stop' event, it ramps back up to a value above P00.04. </p> <p>0: Disable 1: Automatic 2: Manual Note: When sleep function is valid and unloading condition is met, the inverter running frequency decelerates to P18.12, after that, if the duration time P18.13 of exhaust pressure is larger than loading pressure P18.06, the inverter will decelerate to stop speed P01.15 and then coast to stop to enter sleep stage. If the exhaust pressure is lower than loading pressure within P18.13, the inverter will carry out loading operation again and pressure PID will regulate accordingly. Manual: set through touch screen or other communication methods</p>		
P18.02	Loading/unloading mode	<p>0: Automatic 1: Manual</p> <p>In manual mode, loading/unloading is conducted manually via touch screen or other communication methods after air compressor starts; In automatic mode, load/unloading will be conducted automatically according to the pressure after air compressor starts. For details, see section 5.2 Air compressor control logic.</p>	0	○

Function code	Name	Description	Default	Modify
P18.03	Temperature sensor channel	0: head temperature PT1, auxiliary temperature PT2 1: head temperature PT2, auxiliary temperature PT1 2: Temperature display in regular inverter mode (P18.00=0) (head temperature (P19.12) PT1, auxiliary temperature (P19.21) PT2)	0	☉
P18.04	Upper limit of pressure sensor P1	0.00–20.00Mpa It is related to actual range of pressure sensor. The voltage corresponds to P18.04 is P05.34. Note: This value stays in current set value during restoring to factory value.	1.60Mpa	☉
P18.05	Unloading pressure	In automatic loading/unloading mode, when air compressor control is valid and air supply of the compressor becomes normal after it starts, if exhaust pressure is detected to be above P18.05, automatic unloading will be applied. If sleep function is valid (P18.01=1), the inverter enters sleep state; when exhaust pressure is detected to be below P18.06, automatic loading will be applied. P18.07 is used to set the air supply pressure when air compressor operation is stable. During loading operation, the rotation speed of the master is controlled by pressure PID. The system keeps exhaust pressure constant by adjusting the rotation speed of the master. Refer to section 5.2 Air compressor control logic for process logic of pressure control. Setting range: 0.00–P18.04	0.80Mpa	○
P18.06	Loading pressure		0.60Mpa	○
P18.07	Set pressure		0.70Mpa	○
P18.08	Starting temperature of the fan	When the head temperature exceeds P18.08, the fan starts.	75℃	○
P18.09	Stop temperature of the fan	When the head temperature is below P18.09, the fan stops.	65℃	○
P18.10	Set temperature	P18.10 is used to set the target head temperature during stable running of the air compressor. The rotation speed of fan is	75℃	○

Function code	Name	Description	Default	Modify
		controlled by constant temperature PID (P18.42=0). Constant temperature control is realized by PID calculation based on P18.10 and the head temperature. Setting range: -20~150		
P18.11	Lower limit of loaded running frequency	P18.12~P00.04 (Upper limit of running frequency) Indicates the min. running frequency that the inverter is allowed to output during the loading process.	40.00Hz	○
P18.12	No-load running frequency	P01.15~P18.11 (lower limit of loaded running frequency) It is the working frequency allowed to be output during no-load of air compressor.	38.00Hz	○
P18.13	No-load delay time	When sleep function is valid, the inverter, after unloading, runs at the no-load running frequency until passing the time set by P18.13, then it enters sleep state. Sleep function can be enabled when the gas consumption is relatively small. If sleep function is valid, decrease P18.13 to make the device enter sleep state at faster speed. Setting range: 0~3600s	300s	○
P18.14	Stop delay time	After stop command is valid, the inverter runs at no-load running frequency until passing the time set by P18.14 and then it stops. Setting range: 0~3600s	0s	○
P18.15	Delay time of loading	Loading operation can only be available after the master runs at no-load frequency by the time set by P18.15. Setting range: 0~3600s	10s	○
P18.16	Delay time of restart	After system stops, wait for the time set by P18.16 before determining whether to start again. Setting range: 0~3600s	30s	○
P18.17	Pre-alarm pressure	When the current exhaust pressure is	0.90Mpa	○
P18.18	Alarm pressure	detected to be above P18.17, the system	1.00Mpa	○

Function code	Name	Description	Default	Modify
		releases pressure pre-alarm by changing bit8 of P19.13 to 1. When the current exhaust pressure is detected to be above P18.18, the system releases pressure alarm by changing bit10 of P19.13 to 1 and emergency stop will be applied. Setting range: 0.00–P18.04		
P18.19	Pre-alarm temperature	When head temperature is detected to be above P18.19, system releases temperature pre-alarm by changing bit9 of P19.13 to 1.	105℃	<input type="radio"/>
P18.20	Alarm temperature	When head temperature is detected to be above P18.20, system releases temperature alarm by changing bit11 of P19.13 to 1 and emergency stop will be applied.	110℃	<input type="radio"/>
P18.21	Low temperature protection threshold	When head temperature is detected to be below P18.21, system releases low temperature pre-alarm by changing bit14 of P19.13 to 1 and the air compressor will be prohibited from starting. Setting range: -20–150	-10℃	<input type="radio"/>
P18.22	Power correction coefficient	It is used to correct P19.10. Setting range: 0%–200%	100%	<input type="radio"/>
P18.23	Temperature PID calculation cycle (Ts)	Used to set the sampling cycle of temperature PID Setting range: 0.0–10.0s	2.0s	<input type="radio"/>
P18.24	Gain coefficient (kp)	Setting range: 0.0–100.0 It determines the adjustment intensity of temperature PID regulator. The larger the kp, the stronger the intensity, however, too strong the intensity may cause temperature oscillation. It is viable to make adjustment based on factory value according to actual conditions.	18.0	<input type="radio"/>
P18.25	Convergence coefficient (K)	It determines the convergence speed of temperature, PID regulator. The larger the value of K, the stronger the intensity, however, too strong the intensity may cause	0.12	<input type="radio"/>

Function code	Name	Description	Default	Modify
		temperature oscillation. It is viable to make adjustment based on factory value according to actual conditions. Setting range: 0.00–1.00		
P18.26	Upper limit of temperature PID	It is used to limit the output value of temperature PID adjustment. 100.00%	100.00%	<input type="radio"/>
P18.27	Lower limit of temperature PID	corresponds to the maximum output frequency P00.03 of the fan. Setting range: 0.00–100.00%	10.00%	<input type="radio"/>
P18.28	Lower limit voltage of PT1 (20°C)	It is used for calibration of temperature detection circuit in the factory:	3.10V	<input type="radio"/>
P18.29	Upper limit voltage of PT1 (120°C)	Connect the resistor whose resistance corresponds to PT100 at -20°C, read the voltage value of P17.20 and input it to P18.28. Connect the resistor whose resistance corresponds to PT100 at 120°C, read the voltage value of P17.20 and input it to P18.29. Setting range: 0.00–10.00V Note: This value stays in current set value during restoring to factory value.	8.10V	<input type="radio"/>
P18.30	Pressure value of descending of upper limit frequency	0.00–P18.04 When current pressure is larger than this pressure value, decrease the upper limit frequency according to P18.31.	0.70Mpa	<input type="radio"/>
P18.31	Reduction rate of upper limit frequency	0.00Hz–10.00Hz It is the reduction quantity of the corresponding upper limit frequency for each additional 0.01Mpa when current pressure is larger than P18.30.	0.00Hz	<input type="radio"/>
P18.32	Lower limit voltage of PT2 (20°C)	It is used for calibration of temperature detection circuit in the factory:	3.10V	<input type="radio"/>
P18.33	Upper limit voltage of PT2 (120°C)	Connect the resistor whose resistance corresponds to PT100 at 20°C, read the voltage value of P17.22 and input it to P18.32. Connect the resistor whose resistance corresponds to PT100 at 120°C, read the	8.10V	<input type="radio"/>

Function code	Name	Description	Default	Modify
		voltage value of P17.22 and input it to P18.33 Setting range: 0.00–10.00V Note: This value stays in current set value during restoring to factory value.		
P18.34	Auxiliary temperature protection enable	0: Disable 1: Enable	0	☉
P18.35	Auxiliary temperature pre-alarm	-20–150°C When P18.34 is enabled and the auxiliary temperature exceeds P18.35, the system releases auxiliary temperature pre-alarm by changing bit8 of P19.14 to 1.	105° C	○
P18.36	Auxiliary temperature alarm	-20–150°C When P18.34 is enabled and the auxiliary temperature exceeds P18.36, system releases auxiliary temperature alarm by changing bit10 of P19.14 to 1 and emergency stop will be applied.	110°C	○
P18.37	Pressure sensor channel	0: Exhaust pressure P1, auxiliary pressure P2 1: Exhaust pressure P2, auxiliary pressure P1 2: Pressure display in regular inverter mode (P18.00=0) (main pressure (P19.21) P1, auxiliary pressure (P19.20) P2)	0	☉
P18.38	Upper limit of pressure sensor P2	0.00–20.00Mpa It is related to actual range of pressure sensor. The voltage corresponds to P18.04 is P05.44. Note: This value stays in current set value during restoring to factory value.	1.60Mpa	☉
P18.39	Auxiliary pressure protection enable	0: Disable 1: Enable	0	☉
P18.40	Auxiliary pressure pre-alarm	0.00–20.00 When auxiliary pressure protection function P19.39 is enabled, and auxiliary pressure is larger than P18.40, system releases auxiliary pressure pre-alarm by changing bit7 of P19.14 to 1.	0.90Mpa	○

Function code	Name	Description	Default	Modify
P18.41	Auxiliary pressure alarm	0.00–20.00 When auxiliary pressure protection function P19.39 is enabled and auxiliary pressure is larger than P18.41, system releases auxiliary pressure alarm by changing bit9 of P19.14 to 1 and emergency stop will be applied.	1.00Mpa	<input type="radio"/>
P18.42	Reference mode of fan frequency	0: Temperature PID 1: Analog P2 2: 485 communication (address 0X201C, writing of 1000 corresponds to 100.0%, 100.0% corresponds to the max. output frequency of the fan)	0	<input checked="" type="radio"/>
P18.43	Fan control mode	0: Air compressor mode, the fan inverter starts and stops automatically based on the temperature 1: Terminal, the fan inverter starts and stops by enabling terminals. 2: 485 communication (address 0X201B, write 1 to start, write 3 to stop)	0	<input checked="" type="radio"/>
P18.44	Automatic frequency-reduction threshold	0–120% Add automatic frequency reduction function. When output current is larger than automatic frequency reduction threshold, output frequency will be adjusted by the regulator to ensure the running current of the master will not exceed automatic frequency reduction threshold.	120%	<input type="radio"/>
P18.45	Time-out time of maintenance	0–8000h When this parameter is set to "0", the maintenance time-out function is invalid. If it is set to non-zero value, then the system will release maintenance time-out pre-alarm by changing bit11 of P19.14 to 1 in cases where the working time, after part maintenance pre-alarm, exceeds the value set by P18.45.	0	<input type="radio"/>

Group P19 Air compressor status viewing function

Function code	Name	Description	Default	Modify
P19.00	Maintenance set time of part 1	P19.00–P19.04 displays the set value of maintenance time on five kinds of parts. When the accumulated working time of the part exceeds the corresponding set value, the system will release pre-alarm by changing the bit of P19.14 to 1. If set to "0", working time pre-alarm of the parts will be invalid. P19.05–P19.09 displays the working hours of corresponding parts. Range: 0–65535h	0	●
P19.01	Maintenance set time of part 2		0	●
P19.02	Maintenance set time of part 3		0	●
P19.03	Maintenance set time of part 4		0	●
P19.04	Maintenance set time of part 5		0	●
P19.05	Working hours of part 1		0	●
P19.06	Runtime of part 2		0	●
P19.07	Runtime of part 3		0	●
P19.08	Working hours of part 4		0	●
P19.09	Runtime of part 5		0	●
P19.10	Actual output power of motor	It displays the output frequency of the motor and can be calibrated by setting P18.22. Range: 0.0–6553.5kW	0.0kW	●
P19.11	Current pressure	Displays the exhaust pressure value detected currently. <p>Range: 0.00–655.35Mpa</p>	0.00Mpa	●

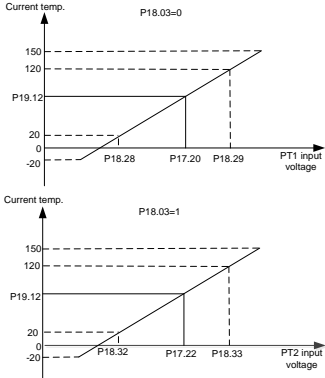
Function code	Name	Description	Default	Modify
P19.12	Current temperature	<p>Displays the head temperature currently detected.</p>  <p>Range: -20–150°C</p>	0 ° C	●
P19.13	Signal state 1	<p>0000–0xFFFF</p> <p>Bit0: Air filter block signal 1: Fault; 0: normal</p> <p>Bit1: Oil filter block signal 1: Fault; 0: normal</p> <p>Bit2: Separator block signal 1: Fault; 0: normal</p> <p>Bit3: Splitter block signal 1: Fault; 0: normal</p> <p>Bit4: External fault signal 1 1: Fault; 0: normal</p> <p>Bit5: External fault signal 2 1: Fault; 0: normal</p> <p>Bit6: Solenoid valve signal state 1: Load; 0: unload</p> <p>Bit7: Auxiliary motor state 1: Run; 0: Stop</p> <p>Bit8: Pressure pre-alarm signal 1: Pressure pre-alarm; 0: normal</p> <p>Bit9: Temperature pre-alarm signal 1: Temperature pre-alarm; 0: normal</p> <p>Bit10: Pressure alarm signal 1: Pressure alarm; 0: normal</p> <p>Bit11: Temperature alarm signal</p>	0	●

Function code	Name	Description	Default	Modify
		1: Temperature pre-alarm; 0: normal Bit12: Pressure signal 1: Pressure signal fault; 0: normal Bit13: Temperature signal 1: Temperature signal fault; 0: normal Bit14: Low temperature protection 1: Low temperature alarm; 0: normal Bit15: Master state 1: Run; 0: Stop		
P19.14	Signal state 2	0-0xFFFF Bit0: Maintenance reminder of part 1 1: maintenance required; 0: normal Bit1: Maintenance reminder of part 2 1: maintenance required; 0: normal Bit2: Maintenance reminder of part 3 1: maintenance required; 0: normal Bit3: Maintenance reminder of part 4 1: maintenance required; 0: normal Bit4: Maintenance reminder of part 5 1: maintenance required; 0: normal Bit5: Auxiliary pressure signal 1: auxiliary pressure signal fault; 0: normal Bit6: Auxiliary temperature signal 1: auxiliary temperature signal fault; 0: normal Bit7: Auxiliary pressure pre-alarm signal 1: Pressure pre-alarm; 0: normal Bit8: Auxiliary temperature pre-alarm signal 1: Temperature pre-alarm; 0: normal Bit9: Auxiliary pressure alarm signal 1: Pressure alarm; 0: normal Bit10: Auxiliary temperature alarm signal 1: Temperature pre-alarm; 0: normal Bit11: Maintenance time-out reminder 1: maintenance time-out reminder; 0: normal Bit12: Phase sequence reminder 1: Fault; 0: normal	0	●
P19.15	Device state	0: Stand-by 1: Run 2: Faulty 3: Emergency-stop 4: Under-voltage	0	●

Function code	Name	Description	Default	Modify
		5: Alarm 6: Sleep 7: Stop 8: Restart delay		
P19.16	Accumulated running time of the device	Range: 0–65535h	0	●
P19.17	Accumulated loading running time		0	●
P19.18	Restart count down	It displays the residue time of restart delay. The system enters restart delay state and restart count down after stop to prevent restart immediately. After restart delay time is passed, the system enters stand-by state and it can receive starting command in stand-by state. Range: 0–3600s	0s	●
P19.19	Temperature PID output value	It displays the output value of head temperature PID control adjustment. 100.00% corresponds to the maximum output frequency P00.03 of the fan. Range: 0.00–100.00%	0.00%	●
P19.20	Current auxiliary pressure	It displays the auxiliary pressure value detected currently. Range: 0.00–655.35Mpa	0.00Mpa	●

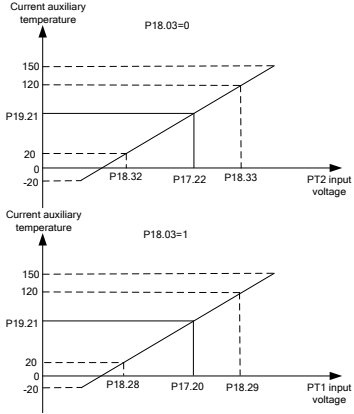
Function code	Name	Description	Default	Modify
P19.21	Current auxiliary temperature	<p>It displays the auxiliary temperature value detected currently.</p>  <p>Range: -20–150°C</p>	0°C	●
P19.22	Phase sequence state of input power	<p>If phase sequence detection and input phase loss hardware protection are enabled, the inverter will report fault when negative sequence and any phase loss occurred. If they are not enabled, the inverter will not report the fault.</p> <p>0: Positive sequence 1: Negative sequence 2: R-phase loss 3: S-phase loss 4: T-phase loss</p>	0	●

5.2 Air compressor control logic

(1) The control logic of the air compressor is shown as follows.

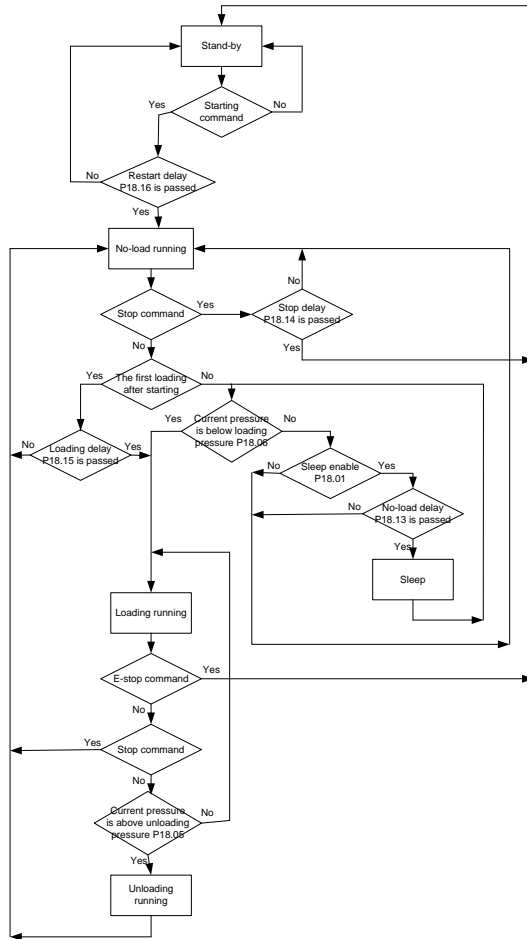

(2) The pressure and running frequency control of the air compressor during running is shown as follows.

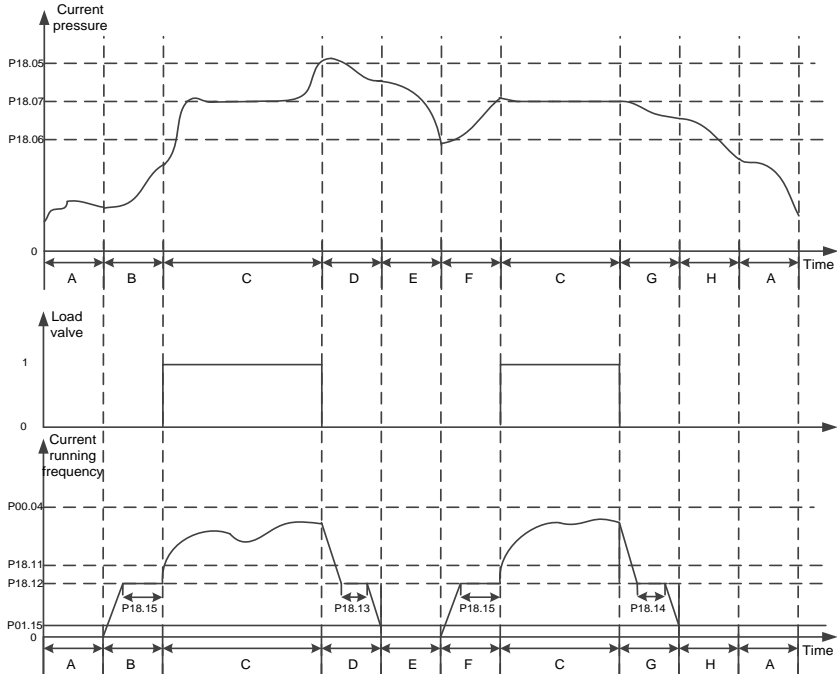

In above figure, P18.05 is unloading pressure, P18.06 is loading pressure and P18.07 is the set pressure.

P00.04 is upper limit frequency, P18.11 is lower limit value of loading running frequency, P18.12 is no-load frequency and P01.15 is stop speed. In the figure, the process instructions for A–H stages are listed as below:

A: Stand-by state

B: Beginning stage of starting, the duration time is P18.15 (including part of ACC time P00.11)

C: Constant pressure exhaust stage of loading, pressure PID adjustment is valid

D: Unloading stage, the duration time includes part of DEC time P00.12 and P18.13

E: Sleep stage, the inverter does not run

F: Wake-up and starting stage, the duration time is P18.15 (including part of ACC time P00.11)

G: Beginning of stop, the duration time includes part of DEC time P00.12 and P18.14

H: Restart delay stage after stop, the duration time is P18.16

In automatic loading/unloading mode, when air compressor control is valid and air supply of the compressor becomes normal after it starts, if exhaust pressure is detected to be above P18.05, automatic unloading will be applied.

If sleep function is valid, the inverter will enter sleep state. While if sleep function is invalid, the inverter will run continuously at no-load frequency P18.12. When exhaust pressure is detected to be below P18.06, automatic loading will be applied. During loading operation, the rotation speed of the master is controlled by pressure PID. P18.07 is the air supply pressure when setting stable running of air compressor, the inverter keeps exhaust pressure constant by regulating the rotation speed of the master. Constant pressure control adopts PID algorithm, and the frequency reference source of the master is set by P00.06=7, the reference source of PID is P09.00=10, the reference pressure is set by P18.07. The feedback source of PID is P09.02=8, which is gained by detecting pressure signal. P09.04, P09.05 and P09.06 adopts system default values.

Note: In above figure, the stop mode of the inverter is operated by P01.08, the default setting is decelerating to stop. The inverter is in deceleration process under normal stop command and unloading stage; it changes to coast to stop mode when emergency stop or fault occur.

5.3 PID commissioning

PID control, a common mode for process control, is mainly used to adjust the inverter output frequency or output voltage by performing scale-division, integral and differential operations on the difference between feedback signal of controlled variables and signal of the target, thus forming a negative feedback system to keep the controlled variables above the target. It is applicable to flow control, pressure control, temperature control, and so on. The following is the basic schematic block diagram for output frequency regulation.

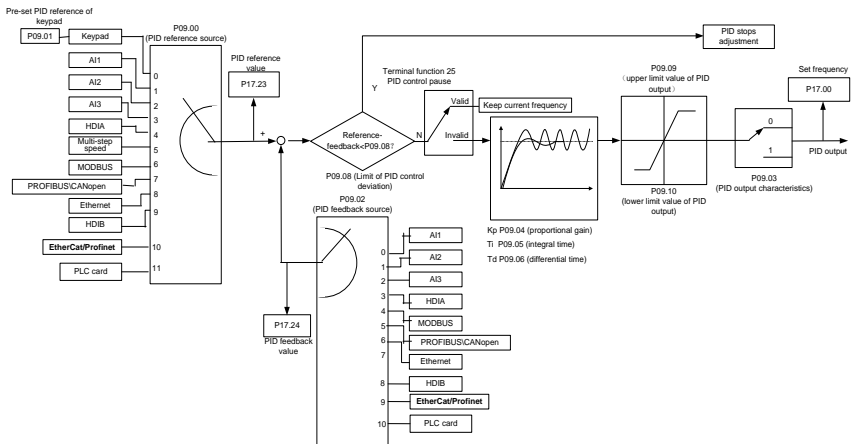

Introduction to the working principles and control methods for PID control:

Proportional control (Kp):

When the feedback is different from the reference, the output will be proportional to the difference. If such a difference is constant, the regulating variable will also be constant. Proportional control can respond to feedback changes rapidly, however, it cannot eliminate the difference by itself. A larger proportional gain indicates a faster regulating speed, but a too large gain will result in oscillation. To solve this problem, set the integral time to a large value and the differential time to 0, run the system only with proportional control, and then change the reference to observe the difference (that is, static difference) between the feedback signal and reference. If the static difference occurs in the direction of reference change (such as reference increase, where the feedback is always less than the reference after system stabilizes), continue increasing the proportional gain; otherwise, decrease the proportional gain. Repeat this process until the static difference becomes small.

Integral time (Ti):

When feedback is different from reference, the output regulating variable accumulates continuously, if the difference persists, the regulating variable will increase continuously until difference disappears. The integral regulator can be used to eliminate static difference. However, too large regulation may lead to repetitive overshoot, which will cause system instability and oscillation. The feature of oscillation caused by strong integral effect is that the feedback signal fluctuates up and down based on the reference variable, and fluctuation range increases gradually until oscillation occurs. The integral time parameter is generally regulated gradually from large to small until the stabilized system speed fulfills the requirement.

Differential time (Td):

When the difference between feedback and reference changes, there is output of the regulating variable that is proportional to the difference variation rate, and this regulating variable is only related to the direction and magnitude of the difference change rather than the direction and magnitude of the difference itself. Differential control is used to control the feedback signal variation based on the change trend. Exercise caution before using the differential regulator since it may enlarge the system interferences, especially those with high change frequency.

5.3.1 General procedures for PID parameter setup**a. Determining proportional gain P**

When determining proportional gain P, first, remove the integral term and derivative term of PID by making $T_i=0$ and $T_d=0$ (see PID parameter setup for details), thus turning PID into pure proportional control. Set the input to 60%–70% of the max. allowable value, and increase proportional gain P gradually from 0 until system oscillation occurred, and then in turn, decrease proportional gain P gradually from current value until system oscillation disappears, record the proportional gain P at this point and set the proportional gain P of PID to 60%–70% of current value. This is the entire commissioning procedure of proportional gain P.

b. Determine integral time Ti

After proportional gain P is determined, set the initial value of integral time T_i to a large value, and decrease T_i gradually until system oscillation occurs. Then in reverse, increase T_i until system oscillation disappears. Record the value of T_i at this point. Set the integral time constant T_i of PID to 150%–180% of this value. This is the commissioning procedure of integral time constant T_i .

c. Determining derivative time T_d

The differential time T_d is generally set to 0.

If you need to set T_d to another value, the setting method is similar to that for P and T_i , namely, set T_d to 30% of the value when there is no oscillation.

d. Empty system load, perform load-carrying joint debugging, and then fine-tune PID parameter until fulfilling the requirement.

5.3.2 How to fine-tune PID

After setting the parameters controlled by PID, you can adjust these parameters by the following means.

Control overshoot: When overshoot occurred, shorten the derivative time (T_d) and prolong integral time (T_i).

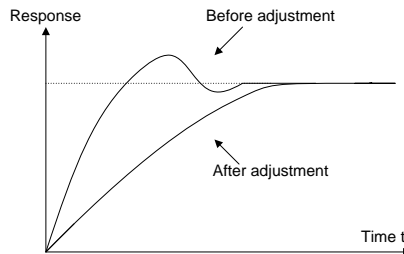

Stabilize the feedback value as fast as possible: When overshoot occurred, shorten integral time (T_i) and prolong derivative time (T_d) to stabilize control as fast as possible.

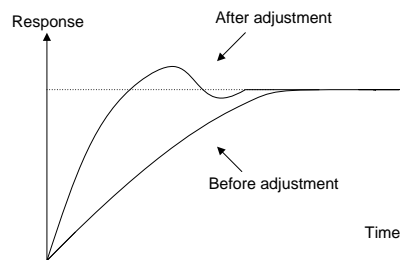

Control long-term vibration: If the cycle of periodic vibration is longer than the set value of integral

time (Ti), it indicates the integral action is too strong, prolong the integral time (Ti) to control vibration.

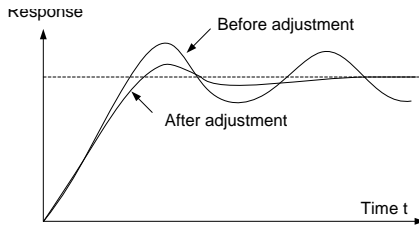

Control short-term vibration: If the vibration cycle is as short almost the same as the set value of differential time (Td), it indicates the differential action is too strong. Shorten the differential time (Td) to control vibration. When the differential time (Td) is set to 0.00 (namely no differential control), and there is no way to control vibration, decrease the proportional gain.

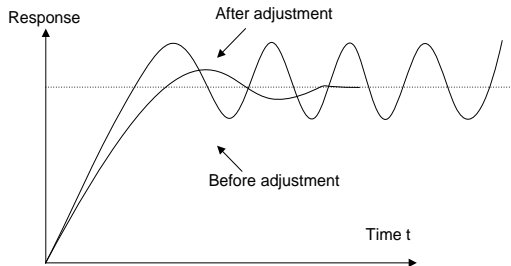

Related parameter list:

Function code	Name	Description	Default
P09.00	PID reference source	0: Keypad (P09.01) 1: Analog P1-reference 2: Reserved 3: Analog P2-setting 4: Reserved 5: Reserved 6: Modbus communication 7-9: Reserved 10: Pressure setting for air compressor-specific function	0
P09.01	PID reference preset through keypad	-100.0%~100.0%	0.0%
P09.02	PID feedback source	0: Analog P1-feedback 1: Reserved	0

Function code	Name	Description	Default
		2: Analog P2-feedback 3: Reserved 4: Modbus communication 5–7: Reserved 8: Pressure feedback for air compressor-specific function	
P09.03	PID output characteristics selection	0: PID output is positive. When the feedback signal is greater than the PID reference value, the output frequency of the inverter will decrease to balance the PID. Example: PID control on strain during unwinding. 1: PID output is negative. When the feedback signal is greater than the PID reference value, the output frequency of the inverter will increase to balance the PID. Example: PID control on strain during unwinding.	0
P09.04	Proportional gain (Kp)	P determines the strength of the whole PID adjuster. The value 100 indicates that when the difference between the PID feedback value and given value is 100%, the range within which the proportional regulator (ignoring integral function and differential function) can regulate the output frequency command is the max. frequency (P00.03). Setting range: 0.00–100.00	10.00
P09.05	Integral time (Ti)	Used to determine the speed of the integral adjustment on the deviation of PID feedback and reference from the PID regulator. When the deviation of PID feedback and reference is 100%, the integral adjuster works continuously during the time (ignoring proportional and differential function) to achieve the max. output frequency (P00.03). Shorter integral time indicates stronger adjustment. 0.01–10.00s	2.00s
P09.06	Differential time (Td)	Used to determine the strength of the change ratio adjustment on the deviation of PID feedback	1.00s

Function code	Name	Description	Default
		and reference from the PID regulator. If feedback quantity changes 100% during this time period, the range within which the differential regulator (ignoring integral function and differential function) can regulate is the max. frequency (P00.03). Longer differential time indicates stronger adjustment. 0.00–10.00s	
P09.07	Sampling cycle (T)	0.000–10.000s	0.100s
P09.08	PID control deviation limit	The feedback value of the PID system is relative to the max. deviation of the closed loop reference. The PID regulator stops regulating in the range of deviation limit. Set the function parameter properly to adjust the accuracy and stability of the PID system. 0.0–100.0%	0.1%
P09.09	PID output upper limit	P09.10–100.0% (Max. frequency or voltage)	100.0%
P09.10	PID output lower limit	-100.0%–P09.09 (Max. frequency or voltage)	0.0%
P09.11	Feedback offline detection value	0.0–100.0%	0.0%
P09.12	Feedback offline detection time	0.0–3600.0s	1.0s
P09.13	PID control selection	0x0000–0x1111 Ones place: 0: Continue integral control after the frequency reaches upper/lower limit 1: Stop integral control after the frequency reaches upper/lower limit Tens place: 0: Same as the main reference direction 1: Contrary to the main reference direction Hundreds place: 0: Limit as per the max. frequency 1: Limit as per A frequency	0x0001

Function code	Name	Description	Default
		Thousands place: 0: A+B frequency. Acceleration /deceleration of main reference A frequency source buffering is invalid. 1: A+B frequency. Acceleration/ deceleration of main reference A frequency source buffering is valid. The acceleration/deceleration is determined by P08.04 (acceleration time 4).	
P17.00	Set frequency	0.00Hz–P00.03 (Max. output frequency)	0.00Hz
P17.23	PID reference value	-100.0–100.0%	0.0%
P17.24	PID feedback value	-100.0–100.0%	0.0%

5.4 Running logic of blower oil pump

Special function: the RO terminal is enabled when receiving the inverter start command. After the start-up delay time (P01.23), the inverter starts. The inverter stops when receiving the inverter stop command and the RO terminal turns off the output after the corresponding switch-off delay. For details, see the following figure. Please see group P06 for "RO switch-off delay" and set the corresponding RO switch-off delay function code.

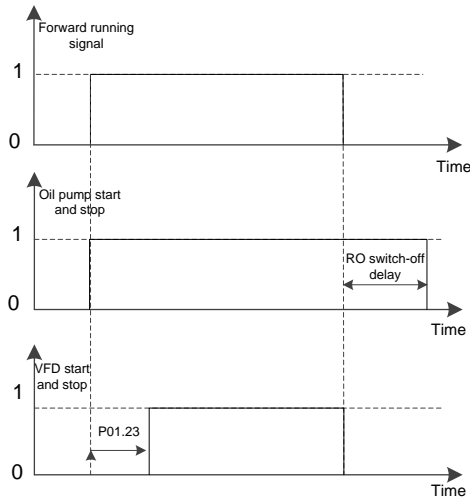

6 Troubleshooting

6.1 Faults and countermeasures for integrated machine

Note: The numbers enclosed in square brackets such as [1], [2] and [3] in the **Fault type** column in the following table indicate the VFD fault type codes read through communication.

Fault code	Fault type	Possible cause	Solution
OUt1	[1] Inverter unit U-phase protection	ACC is too fast. IGBT module is damaged.	Increase ACC time. Replace the power unit.
OUt2	[2] Inverter unit V-phase protection	Misacts caused by interference.	Check drive wires. Check whether there is strong interference surrounding the peripheral device.
OUt3	[3] Inverter unit W-phase protection	Drive wires are poorly connected. To-ground short circuit occurs.	
OV1	[7] Overvoltage during acceleration		Check the input power. Check whether load DEC time is too short;
OV2	[8] Overvoltage during deceleration	Exception occurred to input voltage.	or the motor starts during rotating;
OV3	[9] Overvoltage during constant speed running	Large energy feedback.	or additional dynamic brake components is required.
OC1	[4] Overcurrent during acceleration	ACC/DEC is too fast. The voltage of the grid is too low.	Increase ACC/DEC time. Check the input power. Select the inverter with larger power.
OC2	[5] Overcurrent during deceleration	Inverter power is too small. Load transient or exception occurred.	Check if the load is short circuited (to-ground short circuit or line-to-line short circuit) or the rotation is not smooth.
OC3	[6] Overcurrent during constant speed running	To-ground short circuit or output phase loss occurred. Strong external interference sources.	Check the output wiring. Check if there is strong interference.
UV	[10] Bus undervoltage fault	The voltage of the grid is too low.	Check the grid input power.
OL1	[11] Motor overload	The grid voltage is too low. The motor rated current is set incorrectly. The motor stall occurs or the load transient is too large.	Check the grid voltage. Reset the motor rated current. Check the load and adjust the torque boost quantity.

Fault code	Fault type	Possible cause	Solution
OL2	[12] Inverter overload	ACC is too fast. The motor in rotating is restarted. The voltage of the grid is too low. Load is too large.	Increase ACC time. Avoid restart after stop. Check the grid voltage. Select the inverter with larger power. Select a proper motor.
SPI	[13] Phase loss on input side	Phase loss or violent fluctuation occurred on input R, S, T.	Check the input power. Check the installation wiring.
SPO	[14] Phase loss on output side	Phase loss occurred to U, V, W output (or the three phases of motor is asymmetrical).	Check the output wiring. Check the motor and cables.
OH1	[15] Rectifier module overheating	Air duct is blocked or fan is damaged.	Ventilate the air duct or replace the fan. Lower the ambient temperature.
OH2	[16] Inverter module overheat	Ambient temperature is too high. Long-time overload running.	
EF	[17] External fault	S external faulty input terminal action.	Check external device input.
CE	[18] RS485 communication fault	Baud rate is set improperly. Communication line fault. Incorrect communication address. Communication suffers from strong interference.	Set proper baud rate. Check the wiring of communication interfaces. Set the communication address correctly. Replace or change the wiring to enhance the anti-interference capacity.
ItE	[19] Current detection fault	Poor contact of the connector of control board. Hall component is damaged. Exception occurred to amplification circuit.	Check the connector and re-plug. Replace the hall component. Replace the main control board.
tE	[20] Motor autotuning fault	The motor capacity does not match the inverter capacity. Motor parameter is set improperly. The parameters gained from autotuning deviate sharply from the standard parameters.	Change the inverter model. Set proper motor type and nameplate parameters. Empty the motor load and carry out autotuning again. Check the motor wiring and parameter setup. Check whether the upper limit

Fault code	Fault type	Possible cause	Solution
		Autotuning timeout.	frequency is larger than 2/3 of the rated frequency.
EEP	[21] EEPROM operation fault	Error in reading or writing control parameters. The EEPROM is damaged.	Press STOP/RST to reset. Replace the main control board.
PIDE	[22] PID feedback offline fault	PID feedback offline. PID feedback source disappears.	Check PID feedback signal wires. Check PID feedback source.
END	[24] Running time reached	The actual running time of the inverter is longer than the internal set running time.	Ask for the supplier and adjust the set running time.
OL3	[25] Electronic overload fault	The inverter reports overload pre-alarm according to the setting.	Check the load and the overload pre-alarm points.
PCE	[26] Keypad communication fault	Keypad cable connected improperly or disconnected Keypad cable too long, causing strong interference Keypad or mainboard communication circuit error.	Check the keypad cable to determine whether a fault occurs. Check for and remove the external interference source. Replace the hardware and seek maintenance services.
UPE	[27] Parameter upload error	Keypad cable connected improperly or disconnected Keypad cable too long, causing strong interference Keypad or mainboard communication circuit error.	Check for and remove the external interference source. Replace the hardware and seek maintenance services. Replace the hardware and seek maintenance services.
DNE	[28] Parameter download error	Keypad cable connected improperly or disconnected Keypad cable too long, causing strong interference Data storage error occurred to the keypad.	Check for and remove the external interference source. Replace the hardware and seek maintenance services. Re-back up the data on the keypad.
ETH1	[32] To-ground short-circuit fault 1	inverter output is short connected to the ground. There is a fault in the current detection circuit.	Check whether the motor wiring is normal/the motor is short circuited to the ground. Replace the hall component. Replace the main control panel/drive board.

Fault code	Fault type	Possible cause	Solution
ETH2	[33] To-ground short-circuit fault 2	Inverter output is short connected to the ground. There is a fault in the current detection circuit.	Check whether the motor wiring is normal/the motor is short circuited to the ground. Replace the hall component. Replace the main control panel/drive board.
dEu	[34] Speed deviation fault	The load is too heavy or stalled.	Check the load to ensure it is proper, and increase the detection time. Check whether the control parameters are set properly.
STo	[35] Mal-adjustment fault	SM control parameters are set incorrectly. Autotuned parameters are not accurate. The inverter is not connected to the motor.	Check the load and ensure the load is normal. Check whether control parameters are set correctly. Increase the mal-adjustment detection time.
LL	[36] Electronic underload fault	The inverter reports underload pre-alarm according to the setting.	Check the load and the underload pre-alarm points.
E_FAN	[37] Auxiliary fan fault	The fan inverter is in fault.	Check the fault code on the touch screen.
PSF	[38] Phase sequence fault	The phase sequence on the input side of the power is negative.	Swap any two power input cables
	Communication interruption	RS485 communication port is disconnected.	Check whether the communication cable is loose or dropped.
L-AUP	[44] Low auxiliary pressure fault	Auxiliary pressure is too low at start-up.	Check whether P15.06 and P15.07 are set properly.
HAnd	[45] Handshake failure	The handshake process timeout.	Check whether the handshake between the Plott controller and inverter is performed according to the handshake protocol. Check whether P15.10 is set properly.

6.2 Faults and countermeasures for air compressor device

Fault and countermeasures for air compressor device are listed as below:

P19.13	Status type	Possible cause	Solution
Bit0=1	Air filter is blocked	Air filter is abnormal.	Stop and check the air filter
Bit1=1	Oil filter is blocked	Oil filter is abnormal.	Stop and check the oil filter
Bit2=1	Separator is blocked	Separator is abnormal.	Stop and check the separator
Bit3=1	Splitter is blocked	Splitter is abnormal.	Stop and check the splitter
Bit8=1	Pressure pre-alarm	The actual pressure detected by P1 is larger than the pre-alarm pressure set by P18.17.	Check if solenoid valve is normal. Check if pressure control parameters are set correctly.
Bit9=1	Temperature pre-alarm	The actual temperature detected by PT1 is larger than the pre-alarm temperature set by P18.19.	Check if control parameters of the fan are set correctly. Check if the fan operates normally. The fan power is too small for effective cooling. Check if there is lubricating oil.
Bit10=1	Pressure alarm	The actual pressure detected by P1 is larger than the alarm pressure set by P18.18.	Check if solenoid valve is normal. Check if pressure control parameters are set correctly.
Bit11=1	Temperature alarm	The actual temperature detected by PT1 is larger than the alarm temperature set by P18.20.	Check if control parameters of the fan are set correctly. Check if the fan operates normally. The fan power is too small for effective cooling. Check if there is lubricating oil.
Bit12=1	Pressure signal fault	The actual pressure detected by P1 is less than 1V.	Check if pressure detection sensor is abnormal. The input P1 signal wire of pressure detection is dropped. The pressure signal interface does not select current signal.
Bit13=1	Temperature signal fault	PT100 sensor is disconnected.	Check if the wiring of PT100 is normal. Temperature detection sensor is abnormal.

P19.13	Status type	Possible cause	Solution
			Temperature detection circuit is abnormal.
Bit14=1	Low temperature protection pre-alarm	The actual temperature detected by PT1 is less than the low temperature protection threshold set by P18.21.	Temperature detection sensor is abnormal. Temperature detection input circuit is abnormal. The actual temperature is too low. So low temperature pre-alarm is released as normal to prevent air compressor from starting.

P19.14	Status type	Possible cause	Solution
Bit0=1	Part 1 needs maintenance	The part 1 working hours exceeds the set time in P19.00.	Stop and carry out maintenance.
Bit1=1	Part 2 needs maintenance	The part 2 working hours exceeds the set time in P19.01.	Stop and carry out maintenance.
Bit2=1	Part 3 needs maintenance	The part 3 working hours exceeds the set time in P19.02.	Stop and carry out maintenance.
Bit3=1	Part 4 needs maintenance	The part 4 working hours exceeds the set time in P19.03.	Stop and carry out maintenance.
Bit4=1	Part 5 needs maintenance	The part 5 working hours exceeds the set time in P19.04.	Stop and carry out maintenance.
Bit5=1	Auxiliary pressure signal fault	The actual pressure detected by P2 is less than 1V.	Check if pressure detection sensor is abnormal. The input P2 signal wire of pressure detection is dropped.
Bit6=1	Auxiliary temperature signal fault	PT100 sensor is disconnected.	Detect if PT100 wiring is normal. Temperature detection sensor is abnormal. Temperature detection circuit is abnormal.

P19.14	Status type	Possible cause	Solution
Bit7=1	Auxiliary pressure pre-alarm	The actual pressure detected by P2 is larger than the pre-alarm pressure set by P18.17.	Check if pressure detection sensor is abnormal. The set value of pressure is too large. Adjust pressure PID regulator
Bit8=1	Auxiliary temperature pre-alarm	The actual temperature detected by PT2 is larger than the pre-alarm temperature set by P18.19.	Temperature detection sensor is abnormal. Temperature detection input circuit is abnormal. The starting temperature of the fan is set to high. The set temperature of the fan is too high. The fan power is too low for effective cooling.
Bit9=1	Auxiliary pressure alarm	The actual pressure detected by P2 is larger than the alarm pressure set by P18.18.	Check if pressure detection sensor is abnormal. The set value of pressure is too large. Adjust pressure PID regulator
Bit10=1	Auxiliary temperature alarm	The actual temperature detected by PT2 is larger than the alarm temperature set by P18.20.	Temperature detection sensor is abnormal. Temperature detection input circuit is abnormal. The starting temperature of the fan is set to high. The set temperature of the fan is too high. The fan power is too low for effective cooling.
Bit11=1	Maintenance time-out alarm	Any part whose working time exceeds the set time will enter time-out maintenance stage. Then if its working time exceeds the time set by P18.45, system will release alarm.	Conduct maintenance on time-out parts after stop.

Appendix A Product dimension

A.1 Wall-mounting dimensions

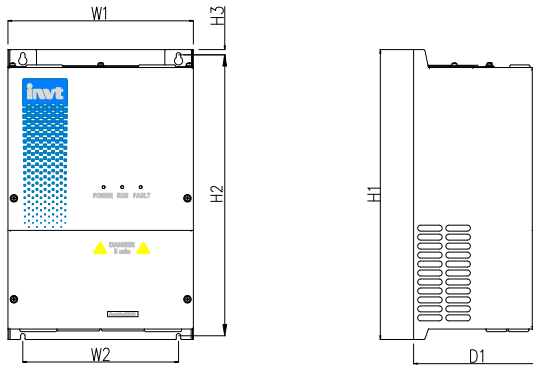

Figure A-1 Diagram for 220V 7.5–18.5kW/380V 15–37kW

Table A-1 Dimensions for 220V 7.5–18.5kW/380V 15–37kW (unit: mm)

Model	W1	W2	H1	H2	H3	D1	Installation hole diameter	Screw specification
220V 7.5–11kW	250	210	388	377	7	170	Ø6	M5
380V 15–22kW								
220V 15–18.5kW	300	210	438	426	8	190	Ø6	M5
380V 30–37kW								

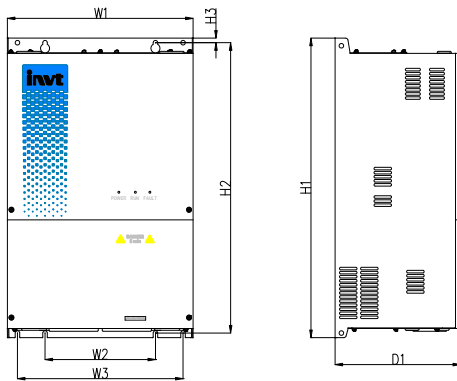

Figure A-2 Diagram for 220V 22–45kW/380V 45–90kW

Table A-2 Dimensions for 220V 22–45kW/380V 45–90kW (unit: mm)

Model	W1	W2	W3	H1	H2	H3	D1	Installation hole diameter	Screw specification
220V 22–45kW 380V 45–90kW	370	220	330	590	572	9	250	Ø9	M8

A.2 Floor-mounting dimensions (with top cover)

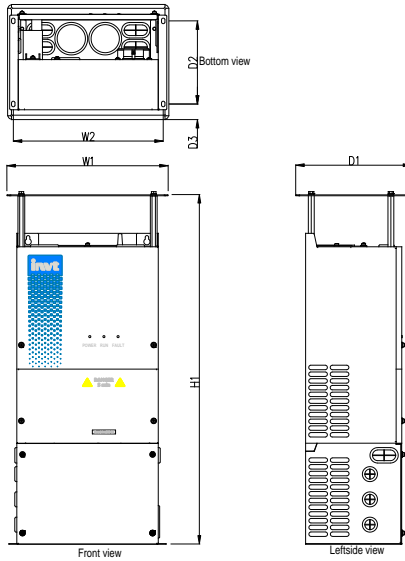

Figure A-3 Diagram for 220V 7.5–45kW/380V 15–90kW

Table A-3 Dimensions for 220V 7.5–45kW/380V 15–90kW (unit: mm)

Model	W1	W2	H1	D1	D2	D3	Installation hole diameter	Screw specification
220V 7.5–11kW 380V 15–22kW	285	265	623	205	148	28	Ø6	M5
220V 15–18.5kW 380V 30–37kW	335	315	682	225	158	33	Ø6	M5
220V 22–45kW 380V 45–90kW	405	388	884	285	160	65	Ø9	M8

Note: Top cover must be selected together with the pedestal, namely floor mounting (with top cover). Wall mounting will be unavailable when installing with the top cover.

A.3 Floor-mounting dimension (without top cover)

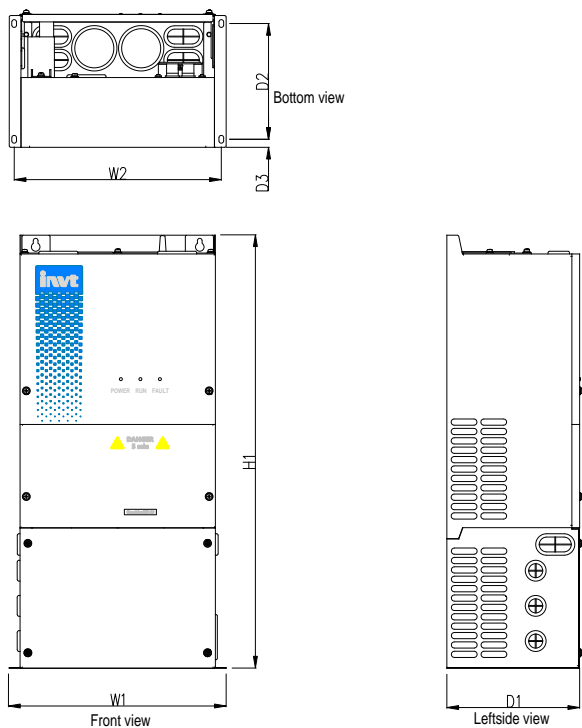

Figure A-4 Diagram for 220V 7.5–45kW/380V 15–90kW

Table A-4 Dimension for 220V 7.5–45kW/380V 15–90kW (unit: mm)

Model	W1	W2	H1	D1	D2	D3	Installation hole diameter	Screw specification
220V 7.5–11kW	278	265	555	180	148	10	Ø6	M5
380V 15–22kW								
220V 15–18.5kW	328	315	604	190	158	15	Ø6	M5
380V 30–37kW								
220V 22–45kW	404	388	812	250	160	44	Ø9	M8
380V 45–90kW								

A.4 Product weight and packaging dimension

Product weight	N.W(kg)	G.W (kg)	Packaging dimension (mm)
220V 7.5–11kW/380V 15–22kW (integrated machine)	15	18	515×385×320
220V 15–18.5kW/380V 30–37kW (integrated machine)	22	24	585×435×340
220V 22–37kW/380V 45–75kW (integrated machine)	38	42	725×490×410
220V 45kW/380V 90kW (integrated machine)	42	45	725×490×410
220V 7.5–11kW/380V 15–22kW (top cover)	0.7	1	310×220×35
220V 15–18.5kW/380V 30–37kW (top cover)	1	2	360×240×40
220V 22–45kW/380V 45–90kW (top cover)	1.5	2.5	430×295×35
220V 7.5–11kW/380V 15kW–22kW (Pedestal)	1.8	3	370×245×290
220V 15–18.5kW/380V 30–37kW (Pedestal)	2	3	420×265×270
220V 22–45kW/380V 45–90kW (Pedestal)	4	5.5	520×360×370

Appendix B Optional parts

Accessories	Installation manner
Contacting component	Externally installed during wall installation, and built-in installation can be available if the optional floor stand is installed.
Remote data collection terminal	Built in
Drip-proof top cover	External
Floor installation pedestal	External
Touch screen	On the air compressor panel

B.1 Contactor component

When the main motor and its cooling fan is connected in non-coaxial way, it is recommended to install the optional contactor component to control the operation of main motor cooling fan. The optional contactor component is available from INVT.

B.1.1 Unpacking inspection

Please carefully check if the product package is intact before open-package inspection. If any question, please contact the supplier immediately.

Name	Model	Qty.	Remark
Contactor	CJX2-0910M380V 9A; Coil voltage 220VAC	1	/
	CJX2-0910F 380V 9A; Coil voltage 110VAC		
3-pin conversion terminal	TB-2503L	1	/
Fuse	RO15 690V 2A	2	/
Fuse pedestal	RT14-20/690V	2	/
Fixing parts	/	2	/
Connection cable of contactor component	/	1	/
Pan head screws	M4×10	4	Fixing the conversion terminal and fuse pedestal
Ribbon	/	10	Fixing cables

Note: Users should select contactor coil voltage based on actual usage condition. When 110V coil is selected, it is required to adjust CN7 short-circuit terminal of the control board to CN8.

B.1.2 Breakers and electromagnetic contactors

The breaker is mainly used to prevent electric shock accidents and short circuits to the ground that may cause leakage current fire. The electromagnetic contactor is mainly used to control the main circuit power on and off, which can effectively cut off the input power of the VFD in case of system

failure to ensure safety.

	<p>◇ According to the working principle and structure of breakers, if the manufacturer's regulation is not followed, hot ionized gases may escape from the breaker enclosure when a short-circuit occurs. To ensure safe use, exercise caution when installing and placing the breaker, and follow the manufacturer's instructions for operation.</p>
---	---

Table B-1 3PH AC 380V(-15%)~440V(+10%)

VFD model	Breaker rated current (A)	Fast-acting fuse rated current (A)	Contactors rated current (A)
GD300-21-015G-4	63	60	50
GD300-21-018G-4	63	70	65
GD300-21-022G-4	80	90	80
GD300-21-030G-4	100	125	80
GD300-21-037G-4	125	125	115
GD300-21-045G-4	140	150	115
GD300-21-055G-4	180	200	150
GD300-21-075G-4	225	250	185
GD300-21-090G-4	250	300	225

Note: The accessory specifications described in the preceding table are ideal values. You can select accessories based on the site conditions, but try not to use those with lower values.

B.1.3 Electrical wiring

Contactors component is comprised of contactor and fuse. Its electrical wiring diagram is shown as below:

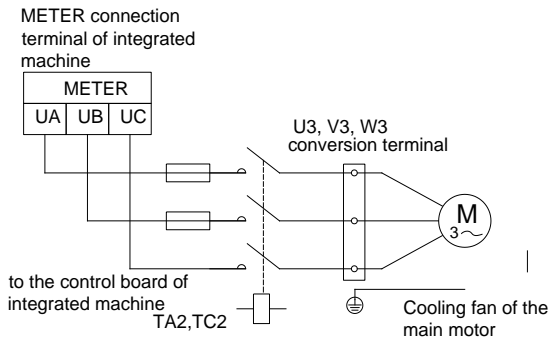

Figure B-1 Electrical diagram of contactor component

B.1.4 Fuse pedestal installation

The fuse pedestal must be installed according to the following procedures, otherwise any wiring attempt would fail.

Step 1: Connect the cable to the bottom of the two pedestals respectively. The yellow cable (cable mark is FU-2) should be connected to the left side while the green cable (cable mark is FU-4) should be connected to the right side.

Step 2: Yellow cable goes through the through-hole on the left side and green cable goes through the through-hole on the right side.

Step 3: Put the fuse pedestal into the installation stand and fix the fuse pedestal with M4 pan head screw.

Step 4: Mount the fuse into the fuse pedestal.

Step 5: Fuse pedestal installation is completed.

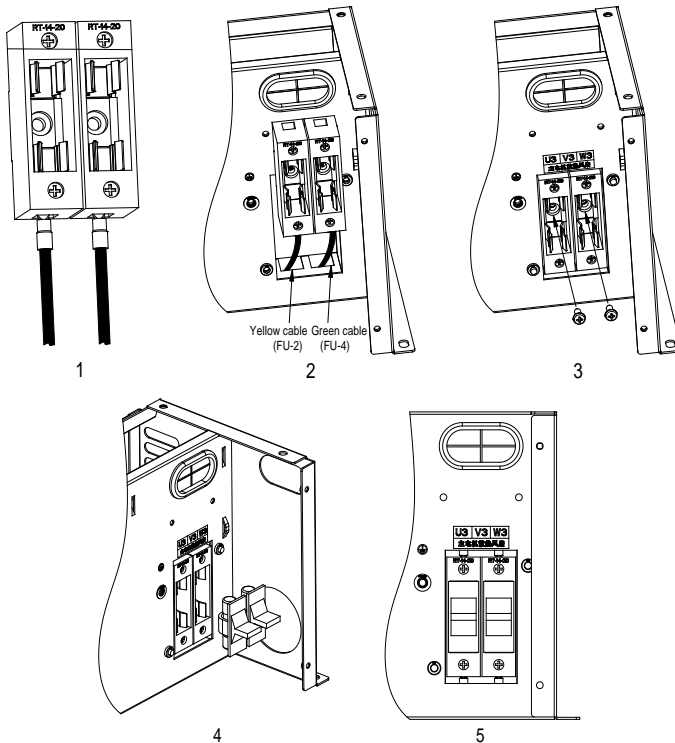

Figure B-2 Installation diagram of fuse pedestal

B.1.5 Dimension of contactor component

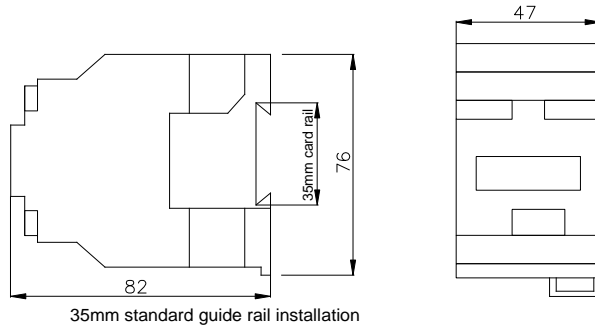

Figure B-3 Contactor dimension (unit: mm)

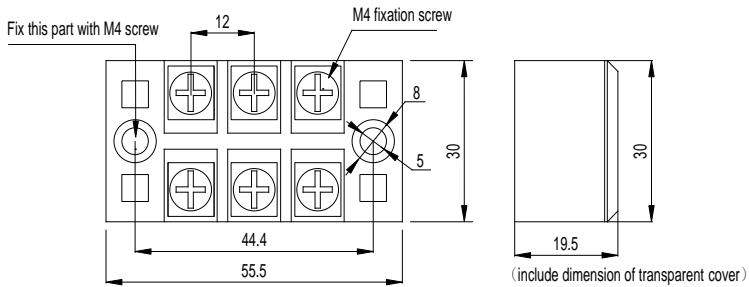

Figure B-4 Dimension of conversion terminals (unit: mm)

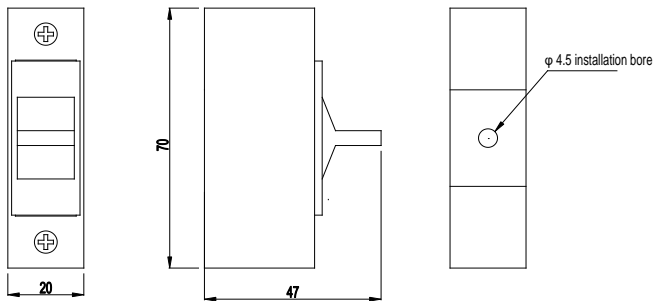

Figure B-5 Dimension of fuse pedestal (unit: mm)

B.2 Drip-proof top cover

To meet the requirements of IP21 protection level, it is recommended to install optional drip-proof top cover on GD300-21. The detailed package list is shown as follows:

Name	Model	Qty.	Remark
Hex-head stud	M5×101	4	220V 7.5–11kW, 380V 15–22kW
	M5×110	4	220V 15–18.5kW 380V 30–37kW
	M5×110	4	220V 22–45kW 380V 45–90kW
Combination screw	M5×10	4	220V 7.5–11kW 380V 15–22kW
	M4×10	4	220V 15–18.5kW 380V 30–37kW
	M4×10	4	220V 22–45kW 380V 45–90kW
Top cover	285×205	1	220V 7.5–11kW 380V 15–22kW
	335×225	1	220V 15–18.5kW 380V 30–37kW
	405×285	1	220V 22–45kW 380V 45–90kW

Note:

1. For detailed dimension drawings, see A.2 Floor-mounting dimensions (with top cover).
2. If users select top cover by themselves, please note that the distance between top cover and the fan should be no less than 110mm, otherwise cooling performance may be impacted.

B.2.1 Installation of drip-proof top cover

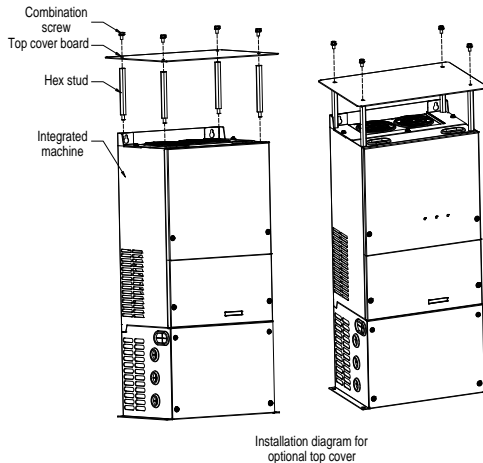

Figure B-6 Installation diagram of drip-proof top cover

B.3 Floor installation pedestal

B.3.1 Package list

The default installation mode is wall mounting. If floor mounting is needed, users can install the pedestal for floor mounting. The package list is shown as below:

Name	Model	Qty.	Remark
Combination screw	M5×10	4	220V 7.5–18.5kW 380V 15–37kW
	M8×16		220V 22–45kW 380V 45–90kW
Pedestal	278×170×180	1	220V 7.5–11kW 380V 15–22kW
	328×190×180		220V 15–18.5kW 380V 30–37kW
	404×250×240		220V 22–45kW 380V 45–90kW

Note:

- For detailed dimension drawings, see A.2 Floor-mounting dimensions (with top cover) and A.3 Floor-mounting dimension (without top cover).
- If users select pedestal by themselves, please note that the ventilation hole size of the pedestal should be no less than 1.2 times of the ventilation hole size at the bottom of integrated machine.

B.3.2 Installation diagram of the pedestal

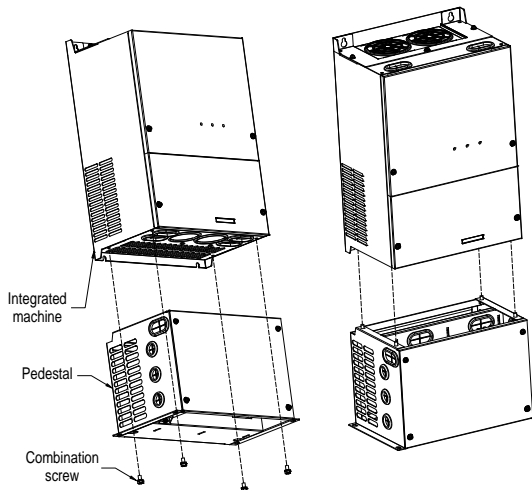

Figure B-7 Installation diagram of the pedestal

Note: If users need to install a contactor component, it is recommended to install the components onto the pedestal first, then, install the pedestal onto the integrated machine.

B.3.3 Installation diagram of optional pedestal

Please refer to the following diagram if it is needed to install optional fan contactor component on the installation pedestal.

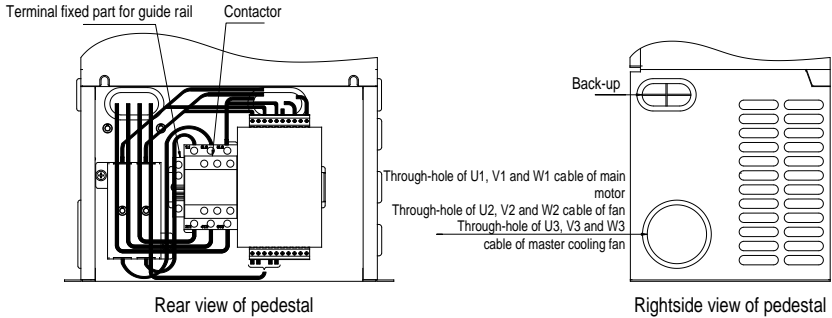

Figure B-8 Wiring diagram of the back of optional pedestal

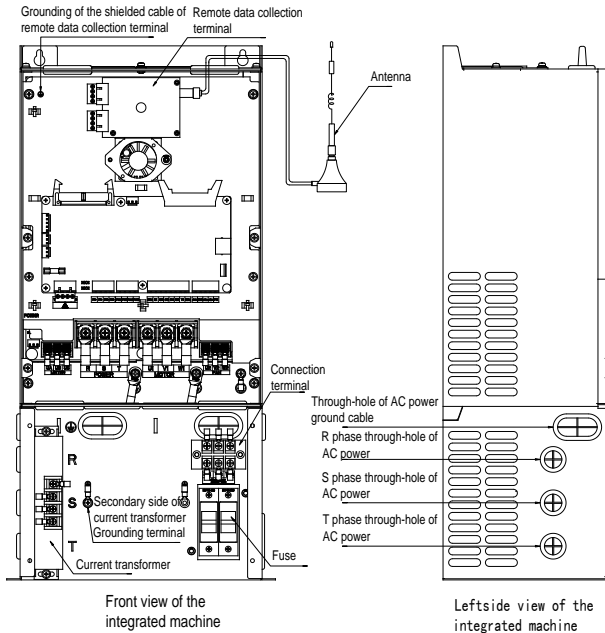

Figure B-9 Installation diagram of optional pedestal

B.3.4 Floor wiring process

With an optional pedestal added at the bottom, the device can be mounted on the floor instead of a wall.

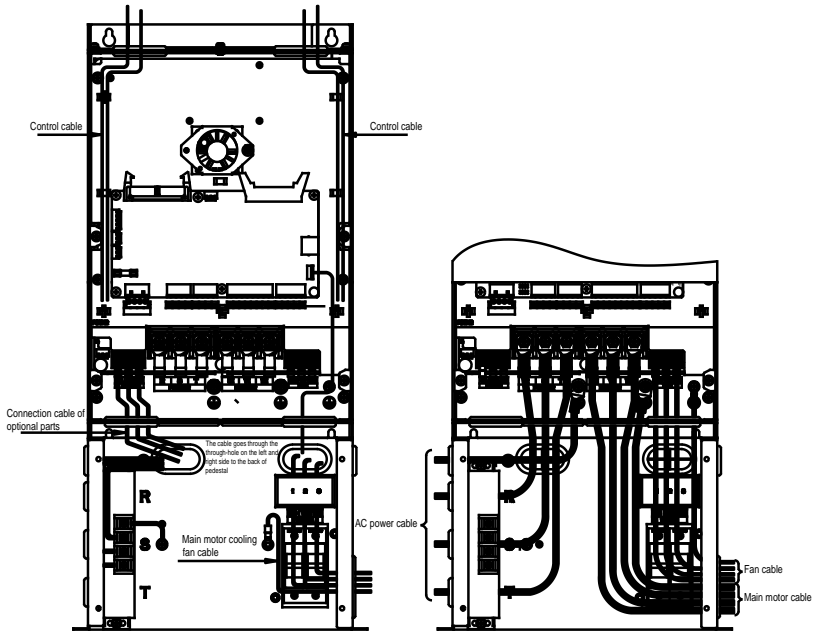

Figure B-10 Wiring diagram of control circuit and main circuit

Note: If the optional parts are not installed on the pedestal, the cable length may be inappropriate. Users can make cables based on actual conditions.

B.4 TC070A touch screen

B.4.1 Product specifications

Table B-2 Product specifications

Category	Item	Specifications
Hardware category	Display screen	7" 16:9 TFT LCD screen
	Resolution	800x480
	Color	24 bits
	Brightness	360 cd/m ²
	Backlight	LED
	LCD lifetime	50000 hours
	Touch screen	4-wire industrial resistance touch screen



Category	Item	Specifications
	CPU	600MHz ARM Cortex-A8
	Memory	128M Flash + 128M DDR3
	RTC	Real-time clock (embedded)
	Ethernet	None
	USB port	1 USB Slave 2.0 port; 1 USB Host 2.0 port
	Program download method	USB Slave/U disk
	Serial communication port	COM1: RS232/RS485/RS422; COM2: RS485 COM3: RS232
	Viewing angle of LCD (T/B/L/R)	50°/70°/70°/70°
Electrical performance	Rated power	< 10W
	Rated voltage	DC24V, allowable working range DC 9V–28V
	Power supply protection	Surge protection capability
	Allowed power outage	< 5mS
	CE&RoHS	Compliant with EN61000-6-2 and EN61000-6-4 Compliant with RoHS lightning surge ±1kV, group pulse ±2kV Static contact 4kV, air discharge 8kV
Environment requirement	Working temperature	0–+50°C
	Storage temperature	-20–+60°C
	UV resistance	Disallowed to work under strong UV (such as direct sunlight)
	Humidity	10–90%RH (no condensation)
	Shock resistance	10–25Hz (X, Y, Z direction 2G/30 minutes)
	Cooling method	Natural air cooling
Mechanical performance	IP rating	The front panel reaches IP65 (installed with a flat panel cabinet), and the rear shell of the device reaches IP20.
	Mechanical structure	Engineering plastic
	Cut-out dimensions	192mm×138mm
	Overall dimensions	204mm×145mm×33.8mm
	Overall weight	About 560g

Table B-3 Touch screen ordering description

Item	Description	Order No.
TC070A touch screen	Includes the RS485 communication cable, 24V power cable, and emergency stop cable, each of which is 2.5-meter long.	11026-00011
Communication function module	Communication mode GPRS, plug directly	34008-00097

B.4.2 Connection terminals

Power supply terminals (Pins 1–3, from left to right)		
	Pin1	FG
	Pin2	0V
	Pin3	DC24V
DB9 serial port terminals		
	Pin1	Rx-(B)
	Pin2	RxD (COM1 RS232)
	Pin3	TxD (COM1 RS232)
	Pin4	Tx-
	Pin5	GND
	Pin6	Rx+(A)
	Pin7	RxD (COM3 RS232)
	Pin8	TxD (COM3 RS232)
	Pin9	Tx+
RS485 terminals (Pins 1–2, from left to right)		
	Pin1	A+ (COM2 RS485)
	Pin2	B- (COM2 RS485)
USB Host		

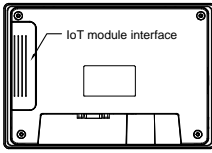
	USB Type A	Used to connect external peripherals such as the USB disk and barcode scanning device
USB Slave		
	MicroUSB	Used for program download and debugging
FLink expansion module		
	Expansion module slot	Supported modules: FLink, FLink-2G, FLink-4G, and FLink-WiFi

B.4.3 Wiring description

In order to drive and manage the air compressor better, use the provided RS485 communication cable, of which one end is connected to the touch screen power supply port and DB9 serial port and the other is connected to the inverter control board terminal (CN 7).

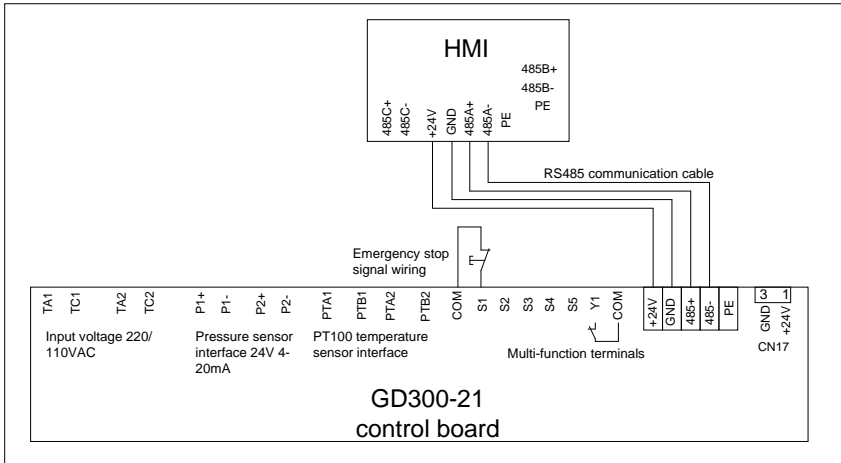

Figure B-11 Standard touch screen wiring diagram

Note:

- The touch screen is provided with a non-shielded RS485 communication cable. If a shielded cable is required, please order separately.
- For details about the touch screen use, please see *Touch Screen HMI User Manual*.

B.4.4 Cable description

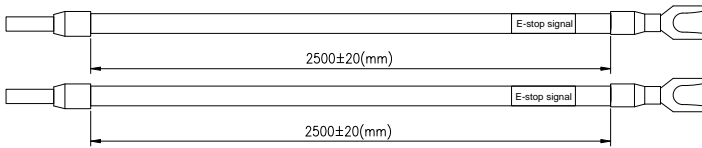

Figure B-12 Emergency stop cable diagram

Note: The emergency stop cable is used for emergency stop control when a device fault occurs and it is often connected to the S1 terminal and COM terminal.

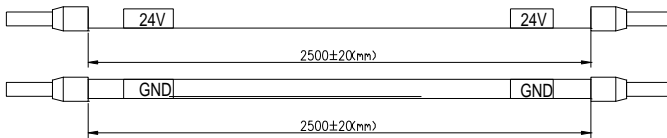

Figure B-13 Touch screen power supply cable diagram

Note: As shown in Figure B-11, the touch screen power supply interface is connected to the CN17 of inverter control board.

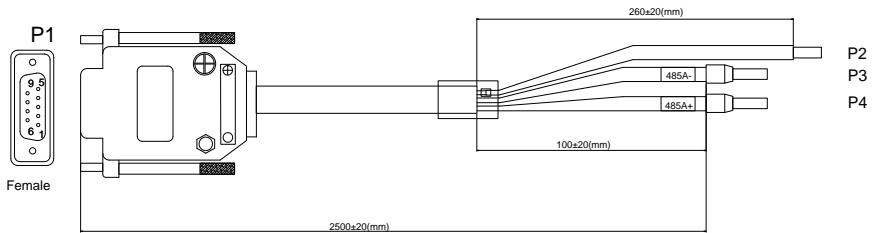

Figure B-14 Touch screen communication cable diagram

Terminal diagram	Terminal		Cable	
<p>P1</p> <p>Female</p>	P1 (1PIN)	RX-(B)	P3	485-
	P1 (6PIN)	RX+(A)	P4	485+
	Iron shell		P2	Shield layer grounding cable

B.4.5 Installation dimensions and description

B.4.5.1 Touch screen installation dimensions

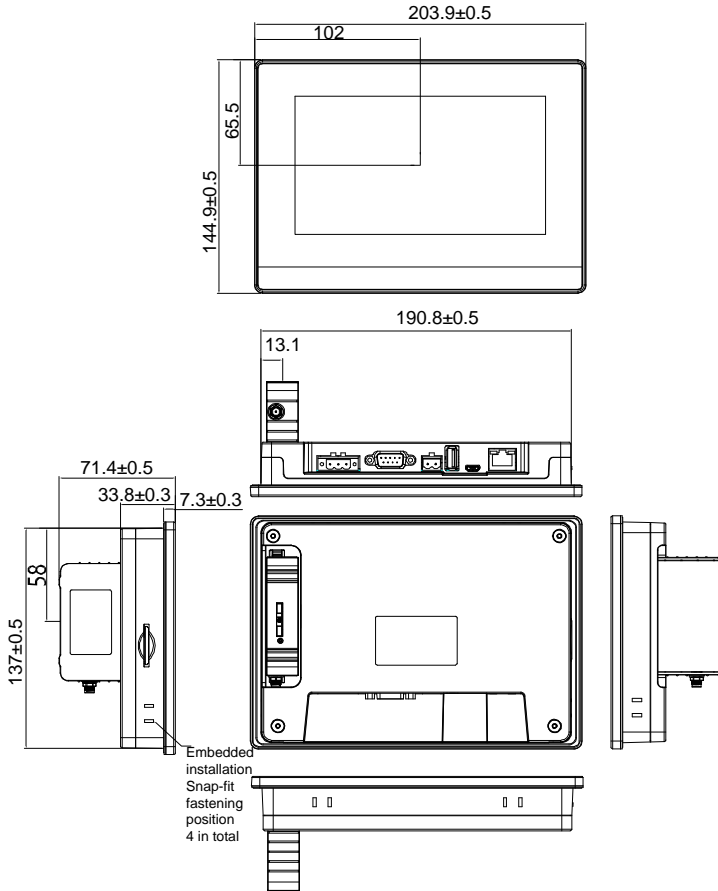
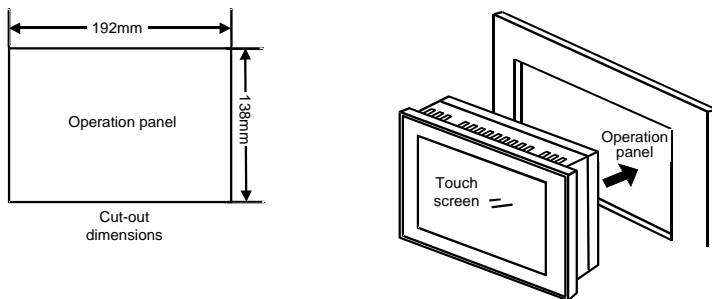

Figure B-15 Touch screen installation dimensions (unit: mm)

B.4.5.2 Cut-out installation description

When you want to mount the touch screen into the operation panel of the control cabinet, use the cross screwdriver and metal installation snap-fit. The installation procedure is as follows:

- Step 1 Cut a rectangular installation groove on the operation panel of the control cabinet according to the cut-out dimensions, and then insert the touch screen from the front of the operation panel.



Step 2 Insert the metal snap-fits into the back, top and bottom mounting jacks of the touch screen, insert the fastening screws (attached), and then tighten the screws with the cross screwdriver.

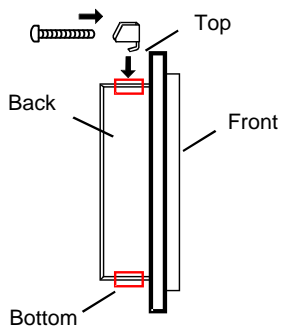

Appendix C Communication protocol

C.1 Application of Modbus

The inverter uses Modbus RTU mode and communicates through RS485 interfaces.

C.1.1 RS485

RS485 interfaces work in half-duplex mode and transmit data signals in the differential transmission way, which is also referred to as balanced transmission. The two-wire RS485 interface uses a twisted pair, in which one wire is defined as A (+), and the other B (-). Generally, if the positive electrical level between the transmission drives A and B ranges from +2V to +6V, the logic is "1"; and if it ranges from -2V to -6V, the logic is "0".

On the inverter terminal block, the 485+ terminal corresponds to A, and 485- corresponds to B.

The communication baud rate (P14.01) indicates the number of bits sent in a second, and the unit is bit/s (bps). A higher baud rate indicates faster transmission and poorer anti-interference capability. When a twisted pair of 0.56mm (24 AWG) is used, the maximum transmission distance varies according to the baud rate, as described in the following table.

Baud rate	Max. transmission distance	Baud rate	Max. transmission distance
2400bps	1800m	9600bps	800m
4800bps	1200m	19200bps	600m

In long-distance RS485 communication, it is recommended that you use shielded cables, and use the shielding layer as the ground wire.

When there are fewer devices and the transmission distance is short, the whole network works well without terminal load resistors. The performance, however, degrades as the distance increases. Therefore, it is recommended that you use a 120 Ω terminal resistor when the transmission distance is long.

C.2 RTU command codes and communication data

C.2.1 Command code 03H, reading N words (continuously up to 16 words)

The command code 03H is used by the master to read data from the inverter. The count of data to be read depends on the "data count" in the command. A maximum of 16 pieces of data can be read. The addresses of the read parameters must be contiguous. Each piece of data occupies 2 bytes, that is, one word. The command format is presented using the hexadecimal system (a number followed by "H" indicates a hexadecimal value). One hexadecimal value occupies one byte.

The 03H command is used to read information including the parameters and running status of the inverter.

C.2.2 Command code 06H, writing a word

This command is used by the master to write data to the inverter. One command can be used to write only one piece of data. It is used to modify the parameters and running mode of the inverter.

C.2.3 Command code 10H, continuous writing

The command code 10H is used by the master to write data to the inverter. The quantity of data to be written is determined by "Data quantity", and a maximum of 16 pieces of data can be written.

C.2.4 Data address definition

This section describes the address definition of communication data. The addresses are used for controlling the running, obtaining the state information, and setting related function parameters of the inverter.

C.2.4.1 Function code address format rules

The address of a function code consists of two bytes, with the MSB on the left and LSB on the right. The MSB ranges from 00 to ffH, and the LSB also ranges from 00 to ffH. The MSB is the hexadecimal form of the group number before the dot mark, and LSB is that of the number behind the dot mark. Take P05.06 as an example: The group number is 05, that is, the MSB of the parameter address is the hexadecimal form of 05; and the number behind the dot mark is 06, that is, the LSB is the hexadecimal form of 05. Therefore, the function code address is 0506H in the hexadecimal form. For P10.01, the parameter address is 0A01H.

C.2.4.2 Address description of other Modbus functions

This section describes the address definition of communication data. The addresses are used for controlling the running, obtaining the status information, and setting function parameters of the inverter.

Table C-1 Other function parameters

Function	Address	Data description	R/W
Communication-based control command	2000H	0001H: Run forward	R/W
		0002H: Run reversely	
		0003H: Jog forward	
		0004H: Jog reversely	
		0005H: Stop	
		0006H: Coast to stop	
		0007H: Fault reset	
		0008H: Jogging stop	
Communication-based setting address	2001H	Communication-based frequency setting (0–Fmax; unit: 0.01 Hz)	R/W
	2002H	PID reference (0–1000, in which 1000 corresponds to 100.0%)	
	2003H	PID feedback (0–1000, in which 1000 corresponds to 100.0%)	R/W
	2004H	Torque setting (-3000–3000, in which 1000	R/W

Function	Address	Data description	R/W
		corresponds to 100.0% of the motor rated current)	
	2005H	Upper limit setting of forward running frequency (0–Fmax; unit: 0.01 Hz)	R/W
	2006H	Upper limit setting of reverse running frequency (0–Fmax; unit: 0.01Hz)	R/W
	2007H	Upper limit of the electromotive torque (0–3000, in which 1000 corresponds to 100.0% of the motor rated current)	R/W
	2008H	Braking torque upper limit. (0–3000, in which 1000 corresponds to 100.0% of the inverter rated current)	R/W
	2009H	Special CW Bit0–1: = 00: Motor1 =01: Motor2 =10: Motor 3 =11: motor 4 Bit2: =1: Torque control =0: Speed control Bit3=1 Clear electricity consumption data =0: Keep electricity consumption data Bit4=1 Enable pre-excitation =0: Disable pre-excitation Bit5=1 Enable DC braking =0: Disable DC braking	R/W
	200AH	Virtual input terminal command (0x000–0x1FF)	R/W
	200BH	Virtual output terminal command (0x00–0x0F)	R/W
	200CH	Voltage setting (used when V/F separation is implemented) (0–1000, 1000 corresponding to 100.0% of the motor rated voltage)	R/W
	200DH	AO setting 1 (-1000–+1000, in which 1000 corresponding to 100.0%)	R/W
	200EH	AO setting 2 (-1000–+1000, in which 1000 corresponding to 100.0%)	R/W
	200FH	Bit0:=1 Clear the working time of part 1 =0 invalid Bit1:=1 Clear the working time of part 2 =0 invalid Bit2:=1 Clear the working time of part 3 =0 invalid Bit3:=1 Clear the working time of part 4	R/W

Function	Address	Data description	R/W
		=0 invalid Bit4:=1 Clear the working time of part 5 =0 invalid Bit5:=1 Clear the working time of the device =0 invalid Bit6:=1 Solenoid valve loading =0 Solenoid valve unloading	
	2010H	Maintenance set time of part 1, range: 0–65535	W
	2011H	Maintenance set time of part 2, range: 0–65535	W
	2012H	Maintenance set time of part 3, range: 0–65535	W
	2013H	Maintenance set time of part 4, range: 0–65535	W
	2014H	Maintenance set time of part 5, range: 0–65535	W
	2015H	Working time of part 1; 0–65535	W
	2016H	Working time of part 2; 0–65535	W
	2017H	Working time of part 3; 0–65535	W
	2018H	Working time of part 4; 0–65535	W
	2019H	Working time of part 5; 0–65535	W
	201AH	Running time of the device; 0–65535	W
	201BH	Command reference during fan debugging mode 0: No action 1: Run 2: Jogging 3: Stop 4: Coast to stop 5: Reset faults	R/W
	201CH	Frequency reference during fan debugging mode; range (0–1000, 1000 corresponds to 100.0%)	R/W
Inverter status word 1	2100H	0001H: Forward running 0002H: Reverse running 0003H: Stopped 0004H: Fault 0005H: POFF	R

Function	Address	Data description	R/W
		0006H: Pre-exciting	
Inverter status word 2	2101H	Bit0: =0: Not ready to run =1: Ready to run Bit1-2: = 00: Motor1 =01: Motor2 =10: Motor 3 =11: motor 4 Bit3: =0: AM =1: SM Bit4: = 0: No pre-alarm upon overload =1: overload pre-alarm Bit5-Bit6: =00: Keypad control =01: terminal control =10: Communication control	R
Inverter fault code	2102H	See the description of fault types.	R
Inverter identification code	2103H	GD300-21-----0x0129	R
Running frequency	3000H	Compatible with the communication addresses of CHF100A and CHV100 series	R
Set frequency	3001H		R
Bus voltage	3002H		R
Output voltage	3003H		R
Output current	3004H		R
Rotational speed	3005H		R
Output power	3006H		R
Output torque	3007H		R
Closed-loop setting	3008H		R
Closed-loop feedback	3009H		R
Input IO status	300AH		R
Output IO status	300BH		R
Analog input 1	300CH		R
Analog input 2	300DH		R
Analog input 3	300EH		R
Analog input 4	300FH		R
Read high speed pulse 1 input	3010H		R
Read high speed pulse 2 input	3011H		R
Read the actual step of multi-step speed	3012H		R
External length value	3013H		R
External counting value	3014H	R	
Torque setting	3015H	R	

Function	Address	Data description	R/W
Inverter identification code	3016H		R
Fault code	5000H		R

C.2.5 Error messages

Table C-2 Code and definition for fault message response

Code	Name	Definition
01H	Invalid command	The command code received by the upper computer is not allowed to be executed. The possible causes are as follows: The function code is applicable only on new devices and is not implemented on this device. The slave is in faulty state when processing this request.
02H	Invalid data address	For the inverter, the data address in the request of the upper computer is not allowed. In particular, the combination of the register address and the number of the to-be-sent bytes is invalid.
03H	Invalid data value	The received data domain contains a value that is not allowed. The value indicates the error of the remaining structure in the combined request. Note: It does not mean that the data item submitted for storage in the register includes a value unexpected by the program.
04H	Operation failure	The parameter is set to an invalid value in the write operation. For example, a function input terminal cannot be set repeatedly.
05H	Incorrect password	The password entered in the password verification address is different from that is specified by P07.00.
06H	Incorrect data frame	The data frame sent from the upper computer is incorrect in the length, or in the RTU format, the value of the CRC check bit is inconsistent with the CRC value calculated by the lower computer.
07H	Parameter read-only	The parameter to be modified in the write operation of the upper computer is a read-only parameter.
08H	Parameter cannot be modified in running	The parameter to be modified in the write operation of the upper computer cannot be modified during the running of the inverter.
09H	Password protection	If the upper computer does not provide the correct password to unlock the system to perform a read or write operation, the error of "system being locked" is reported.

When returning a response, the slave uses a function code domain and fault address to indicate whether it is a normal response (no error) or exception response (an error occurs). In a normal

response, the slave returns the corresponding function code and data address or sub-function code. In an exception response, the slave returns a code that is equal to a normal code, but the first bit is logic 1.

For example, if the master sends a request message to a slave for reading a group of function code address data, the following code is generated:

0 0 0 0 0 1 1 (03H in the hexadecimal form)

In a normal response, the slave returns the same code. In an exception response, the slave returns the following code:

1 0 0 0 0 1 1 (83H in the hexadecimal form)

In addition to the modification of the code, the slave returns a byte of exception code that describes the cause of the exception. After receiving the exception response, the typical processing of the master is to send the request message again or modify the command based on the fault information.

Appendix D Common EMC problems and solutions

D.1 Interference problems of meter switch and sensors

Interference phenomenon

Pressure, temperature, displacement, and other signals of a sensor are collected and displayed by a human-machine interaction device. The values are incorrectly displayed as follows after the inverter is started:

- The upper or lower limit is wrongly displayed, for example, 999 or -999.
- The displayed value changes randomly (often occurred to pressure transmitter).
- The display of values is stable, but there is a large deviation, for example, the temperature is dozens of degrees higher than the common temperature (usually occurring on thermocouples).
- A signal collected by a sensor is not displayed but functions as a drive system running feedback signal. For example, the inverter is expected to decelerate when the upper pressure limit of the compressor is reached, but in actual running, it starts to decelerate before the upper pressure limit is reached.
- After the inverter is started, the display of all kinds of meters (such as frequency meter and current meter) that are connected to the analog output (AO) terminal of the inverter is severely affected, displaying the values incorrectly.
- Proximity switches are used in the system. After the inverter is started, the indicator of a proximity switch flickers, and the output level flips.

Solution

- Check and ensure that the feedback cable of the sensor is 20 cm or farther away from the motor cable.
- Check and ensure that the ground wire of the motor is connected to the PE terminal of the inverter (if the ground wire of the motor has been connected to the ground block, you need to use a multimeter to measure and ensure that the resistance between the ground block and PE terminal is lower than 1.5 Ω).
- If a large number of meters or sensors are disturbed, it is recommended that you configure an external C2 filter on the inverter input power end.

D.2 Interference on RS485 communication

The interference described in this section on RS485 communication mainly includes communication delay, out of synchronization, occasional power-off, or complete power-off that occurs after the inverter is started.

If the communication cannot be implemented properly, regardless of whether the inverter is running, the exception is not necessarily caused by interference. You can find out the causes as follows:

- Check whether the RS485 communication bus is disconnected or in poor contact.
- Check whether the two ends of line A or B are connected reversely.
- Check whether the communication protocol (such as the baud rate, data bits, and check bit) of the inverter is consistent with that of the upper computer.

If you are sure that communication exceptions are caused by interference, you can resolve the problem through the following measures:

- Arrange the communication cables and motor cables in different cable trays.
- In multi-inverter application scenarios, adopt the chrysanthemum connection mode to connect the communication cables between inverters, which can improve the anti-interference capability.
- In multi-inverter application scenarios, check and ensure that the driving capacity of the master is sufficient.
- In the connection of multiple inverters, you need to configure one 120 Ω terminal resistor on each end.

Solution:

- Check and ensure that the ground wire of the motor is connected to the PE terminal of the inverter (if the ground wire of the motor has been connected to the ground block, you need to use a multimeter to measure and ensure that the resistance between the ground block and PE terminal is lower than 1.5 Ω).
- Do not connect the inverter and motor to the same ground terminal as the upper computer (PLC, HMI, and touch screen). It is recommended that you connect the inverter and motor to the power ground, and connect the upper computer separately to a ground stud.
- Try to short the signal reference ground terminal (GND) of the inverter with that of the upper computer controller to ensure that ground potential of the communication chip on the control board of the inverter is consistent with that of the communication chip of the upper computer.
- Try to short GND of the inverter to its ground terminal (PE).

D.3 Failure to stop and indicator shimmering due to motor cable coupling

Interference phenomenon

- Unable to stop

In an inverter system where an S terminal is used to control the start and stop, the motor cable and control cable are arranged in the same cable tray. After the system is started properly, the S terminal cannot be used to stop the inverter.

- Indicator shimmering

After the inverter is started, shimmering, flickering or abnormal noise occurred to below devices:

- a) Relay indicator
- b) Indicator of distribution box
- c) PLC indicator
- d) Indicating buzzer

Solution:

- Check and ensure that the exception signal cable is arranged 20 cm or farther away from the motor cable.
- Connect the digital input terminal (S) that controls the start and stop to other idle digital input terminals in parallel. For example, if S1 is used to control the start and stop and S4 is idle, you can try to short connect S1 to S4 in parallel.

D.4 Leakage current and interference on RCD

Inverters output high-frequency PWM voltage to drive motors. In this process, the distributed capacitance between the internal IGBT of an inverter and the heat sink and that between the stator and rotor of a motor may inevitably cause the inverter to generate high-frequency leakage current to the ground. A residual current operated protective device (RCD) is used to detect the power-frequency leakage current when a grounding fault occurs on a circuit. The application of a inverter may cause misoperation of a RCD.

Rules for selecting RCDs

Inverter systems are special. In these systems, it is required that the rated residual current of common RCDs at all levels is larger than 200 mA, and the inverters are grounded reliably.

For RCDs, the time limit of an action needs to be longer than that of a next action, and the time difference between two actions need to be longer than 20ms. For example, 1s, 0.5s, and 0.2s.

For circuits in inverter systems, electromagnetic RCDs are recommended. Electromagnetic RCDs have strong anti-interference capability, and thus can prevent the impact of high-frequency leakage current.

Electronic RCD	Electromagnetic RCD
Low cost, high sensitivity, small in volume, susceptible to voltage fluctuation of the grid and ambient temperature, and weak anti-interference capability.	Requiring highly sensitive, accurate, and stable zero-phase sequence current transformer, using permalloy high-permeability materials, complex process, high cost, not susceptible to voltage fluctuation of the power supply and ambient temperature, strong anti- interference capability.

Solution to mal-operation of RCD (on the part of inverter)

- a) Try to disassemble the jumper cap in "EMC/J10" (see chapter 2.1.2 Terminal diagram of the main circuit for the position of J10 jumper)
- b) Try to decrease the carrier frequency to 1.5kHz (P00.14=1.5).
- c) Try to modify the modulation mode to "3PH modulation and 2PH modulation" (P08.40=00).

Solution to mal-operation of RCD (on the part of system distribution)

- a) Check and ensure that the power cable is not soaking in water.
- b) Check and ensure that the cables are not damaged or spliced.
- c) Check and ensure that no secondary grounding is performed on the neutral wire.
- d) Check and ensure that the main power cable terminal is in good contact with the air switch or contactor (all screws are tightened).
- e) Check 1PH powered devices, and ensure that no earth lines are used as neutral wires by these devices.
- f) Do not use shielded cables as inverter power cables and motor cables.

Leakage protection of motor autotuning

During motor autotuning, the measurement on differing motor parameters is conducted step by step, in which the first two steps is to measure the resistance of motor stator/rotor while the inverter will output square wave to motor stator winding at 4kHz (default carrier frequency), as leakage current generated by 4kHz carrier frequency against distributed capacitance between motor rotor and stator during charging/discharging is quite obvious, which may cause mal-operation of RCD. If such problem occurred, bypass RCD first and restore after parameter autotuning is completed.

D.5 Live device chassis

After the inverter is started, there is sensible voltage on the chassis, and you may feel an electric shock when touching the chassis. The chassis, however, is not live (or the voltage is far lower than the human safety voltage) when the inverter is powered on but not running.

Solution:

- a) If there is power distribution grounding or ground stud on the site, ground the cabinet chassis of the inverter through the power ground or stud.
- b) If there is no grounding on the site, you need to connect the motor chassis to the ground terminal PE of the inverter, and ensure that the jumper at "EMC/J10" on the middle casing of the inverter is shorted. For the position of EMC/J10 jumper, see chapter 2.1.2 Terminal diagram of the main circuit.



E-mail: overseas@invt.com.cn Website: www.invt.com

The products are owned by **Shenzhen INVT Electric Co.,Ltd.**

Two companies are commissioned to manufacture: (For product code, refer to the 2nd/3rd place of S/N on the name plate.)

Shenzhen INVT Electric Co., Ltd. (origin code: 01)

Address: INVT Guangming Technology Building, Songbai Road,
Matian, Guangming District, Shenzhen, China

INVT Power Electronics (Suzhou) Co., Ltd. (origin code: 06)

Address: 1# Kunlun Mountain Road, Science&Technology Town,
Gaixin District, Suzhou, Jiangsu, China

- Industrial Automation:** ■ HMI ■ PLC ■ VFD ■ Servo System
- Elevator Intelligent Control System ■ Rail Transit Traction System
- Energy & Power:** ■ UPS ■ DCIM ■ Solar Inverter ■ SVG
- New Energy Vehicle Powertrain System ■ New Energy Vehicle Charging System
- New Energy Vehicle Motor

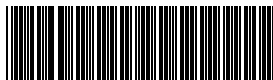

66001-00485

Copyright© INVT.

Manual information may be subject to change without prior notice.

202406 (V1.9)