



Operation **Manual**

Goodrive350 Series **High-performance** **Multifunction VFD**



SHENZHEN INVT ELECTRIC CO., LTD.

Preface

Thank you for choosing Goodrive350 series variable-frequency drive (VFD).

If not otherwise specified in this manual, the VFD always indicates Goodrive350 series VFD, which is a high-performance and multi-function VFD aiming to integrate the capability to drive both synchronous motors and asynchronous motors, and support torque control, speed control, and position control. The VFD is armed with advanced vector control technology and the latest digital processor dedicated for motor control, thus enhancing product reliability and adaptability to the environment. The VFD adopts customized and industrialized design to realize excellent control performance through optimized functions and flexible applications.

In order to meet diversified customer demands, the VFD provides abundant expansion cards including programmable card, PG card, communication card and I/O card to achieve various functions as needed.

The programmable card adopts the mainstream development environment for customers to carry out secondary development easily, fulfilling varied customized needs and reducing customer cost.

The PG card supports a variety of encoders like incremental encoders and resolver-type encoders, in addition, it also supports pulse reference and frequency-division output. The PG card adopts digital filter technology to improve EMC performance and to realize stable transmission of the encoder signal over a long distance. It is equipped with encoder offline detection function to contain the impact of system faults.

The VFD supports multiple types of popular communication modes to realize complicated system solutions. It can be connected to the internet with the optional wireless communication card, by which you can monitor the VFD state anywhere any time through mobile APP.

The VFD uses high power density design. Some power ranges carry built-in DC reactors and braking units to save installation space. Through overall EMC design, it can satisfy the low noise and low electromagnetic interference requirements to cope with challenging grid, temperature, humidity and dust conditions, thus greatly improving product reliability.

This operation manual presents installation wiring, parameter setup, fault diagnosis and trouble shooting, and precautions related to daily maintenance. Read through this manual carefully before installation to ensure the VFD is installed and operated in a proper manner to give full play to its excellent performance and powerful functions.

If the end user is a military unit or the product is used for weapon manufacturing, please comply with relevant export control regulations in the Foreign Trade Law of the People's Republic of China, and complete necessary formalities.

We reserve the right to update the manual information without prior notice and have the final interpretation for the manual content.

Contents

Preface	i
Contents	ii
1 Safety precautions	1
1.1 What this chapter contains	1
1.2 Safety definition	1
1.3 Warning symbols	1
1.4 Safety guidelines	2
1.4.1 Delivery and installation	2
1.4.2 Commissioning and running	3
1.4.3 Maintenance and component replacement	4
1.4.4 What to do after scrapping	4
2 Quick startup	5
2.1 What this chapter contains	5
2.2 Unpack inspection	5
2.3 Application confirmation	5
2.4 Environment confirmation	5
2.5 Installation confirmation	6
2.6 Basic commissioning	6
2.7 Safety standard related data	7
3 Product overview	8
3.1 What this chapter contains	8
3.2 Basic principle	8
3.3 Product specifications	10
3.4 Product nameplate	12
3.5 Type designation key	12
3.6 Ratings of a single product	13
3.7 Parallel products	15
3.8 Ratings of parallel products	15
3.9 Structure diagram	16
4 Installation guidelines	17
4.1 What this chapter contains	17
4.2 Mechanical installation	17
4.2.1 Installation environment	17
4.2.2 Installation direction	18
4.2.3 Installation mode	19
4.2.4 Single-product installation	19
4.2.5 Multiple-product installation	20
4.2.6 Vertical installation	21
4.2.7 Tilted installation	22
4.3 Standard wiring of main circuit	23

4.3.1	Wiring diagram of main circuit for a single product	23
4.3.2	Wiring diagram of main circuit for parallel products	24
4.3.3	Main circuit terminal diagram	25
4.3.4	Wiring procedure of the main circuit terminals	28
4.4	Standard wiring of control circuit.....	29
4.4.1	Wiring diagram of basic control circuit.....	29
4.4.2	Wiring diagram of control circuit for parallel products.....	31
4.4.3	Input/output signal connection diagram	32
4.5	Wiring protection	33
4.5.1	Protect the VFD and input power cable in short-circuit	33
4.5.2	Protect the motor and motor cable in short circuit.....	33
4.5.3	Protect motor and prevent thermal overload.....	33
4.5.4	Bypass connection.....	33
5	Basic operation guidelines	34
5.1	What this chapter contains	34
5.2	Keypad introduction.....	34
5.3	Keypad display.....	37
5.3.1	Displaying stopped-state parameters	37
5.3.2	Displaying running-state parameters	38
5.3.3	Displaying fault information	39
5.4	Operating the VFD through the keypad.....	39
5.4.1	Entering/exiting menus	39
5.4.2	Editing a parameter list	44
5.4.3	Adding parameters to the parameter list displayed in stopped/running state	45
5.4.4	Adding parameters to the user defined parameter list.....	45
5.4.5	Editing user defined parameters	46
5.4.6	Editing parameters in parameter groups	47
5.4.7	Monitoring states	47
5.4.8	Autotuning motor parameters	48
5.4.9	Backing up parameters	48
5.4.10	System settings	49
5.4.11	Power-on setup wizard.....	49
5.5	Basic operations.....	50
5.5.1	What this section contains	50
5.5.2	Common commissioning procedures	51
5.5.3	Vector control	54
5.5.4	SVPWM control mode.....	59
5.5.5	Torque control.....	68
5.5.6	Motor parameter.....	73
5.5.7	Start/stop control	78
5.5.8	Frequency setup.....	83

5.5.9 Analog input.....	87
5.5.10 Analog output.....	90
5.5.11 Digital input.....	95
5.5.12 Digital output	104
5.5.13 Simple PLC	109
5.5.14 Multi-step speed running.....	112
5.5.15 PID control.....	113
5.5.16 Run at wobbling frequency.....	119
5.5.17 Local encoder input	120
5.5.18 Commissioning procedures for closed-loop control, position control and spindle positioning.....	121
5.5.19 Fault handling.....	126
5.5.20 Tension control solutions.....	131
6 Function parameter list.....	136
6.1 What this chapter contains	136
6.2 Function parameter list.....	136
P00—Basic functions	137
P01—Start/stop control	141
P02—Parameters of motor 1.....	147
P03—Vector control of motor 1	151
P04—V/F control.....	158
P05—Input terminals.....	166
P06—Output terminals.....	175
P07—HMI	179
P08—Enhanced functions.....	186
P09—PID control	193
P10—Simple PLC and multi-step speed control	198
P11—Protection parameters	201
P12—Parameters of motor 2.....	209
P13—Control parameters of synchronous motor	212
P14—Serial communication function.....	214
P15—Functions of communication expansion card 1.....	219
P16—Functions of communication expansion card 2.....	222
P17—Status viewing.....	227
P18—Closed-loop control state check	232
P19—Expansion card state check.....	235
P20—Encoder of motor 1	237
P21—Position control.....	241
P22—Spindle positioning	247
P23—Vector control of motor 2	250
P24—Encoder of motor 2.....	252

P25—Expansion I/O card input functions	256
P26—Output functions of expansion I/O card	259
P27—Programmable expansion card functions	262
P28—Master/slave control functions	265
P90—Tension control in speed mode	268
P91—Tension control in torque mode	272
P92—Customized tension control functions.....	275
P93—Tension control status viewing	277
7 Troubleshooting	280
7.1 What this chapter contains	280
7.2 Indications of alarms and faults	280
7.3 Fault reset.....	280
7.4 Fault history	280
7.5 VFD faults and solutions.....	280
7.5.1 Details of faults and solutions.....	280
7.5.2 Other state	289
7.6 Analysis on common faults	289
7.6.1 Motor fails to work	289
7.6.2 Motor vibrates.....	290
7.6.3 Overvoltage	291
7.6.4 Undervoltage	291
7.6.5 Unusual heating of motor.....	292
7.6.6 VFD overheating.....	293
7.6.7 Motor stalls during ACC	294
7.6.8 Overcurrent	295
7.7 Countermeasures on common interference	296
7.7.1 Interference on meter switches and sensors	296
7.7.2 Interference on communication	297
7.7.3 Failure to stop and indicator shimmering due to motor cable coupling	298
7.7.4 Leakage current and interference on RCD	298
7.7.5 Live device chassis.....	299
8 Maintenance and hardware fault diagnosis.....	300
8.1 What this chapter contains	300
8.2 Periodical inspection	300
8.3 Cooling fan.....	302
8.4 Capacitor	303
8.4.1 Capacitor reforming	303
8.4.2 Electrolytic capacitor replacement.....	304
8.5 Power cable	304
9 Communication.....	306
9.1 What this chapter contains	306

9.2 Modbus protocol introduction.....	306
9.3 Application of Modbus	306
9.3.1 RS485	306
9.3.2 RTU mode	309
9.4 RTU command code and communication data.....	312
9.4.1 Command code 03H, reading N words (continuously up to 16 words)	312
9.4.2 Command code 06H, writing a word.....	314
9.4.3 Command code 08H, diagnosis	314
9.4.4 Command code 10H, continuous writing	315
9.4.5 Data address definition	316
9.4.6 Fieldbus scale	320
9.4.7 Error message response.....	321
9.4.8 Read/Write operation example.....	323
9.5 Common communication faults.....	328
Appendix A Expansion cards.....	329
A.1 Model definition.....	329
A.2 Dimensions and installation.....	337
A.3 Wiring.....	339
A.4 IO expansion cards.....	340
A.4.1 IO expansion card 1 (EC-IO501-00)	340
A.4.2 IO expansion card 2 (EC-IO502-00)	342
A.5 Programmable expansion card (EC-PC502-00).....	344
A.6 Communication cards	347
A.6.1 Bluetooth communication card (EC-TX501) and WIFI communication card (EC-TX502).....	347
A.6.2 PROFIBUS-DP communication card (EC-TX503)	349
A.6.3 Ethernet communication card (EC-TX504).....	350
A.6.4 CANopen communication card (EC-TX505) and CAN master/slave control communication card (EC-TX511)	351
A.6.5 PROFINET communication card (EC-TX509)	352
A.6.6 EtherNet/IP communication card (EC-TX510) and Modbus TCP communication card (EC-TX515)	354
A.7 PG cards	356
A.7.1 Sin/Cos PG card (EC-PG502)	356
A.7.2 UVW incremental PG card (EC-PG503-05)	359
A.7.3 Resolver PG card (EC-PG504-00).....	361
A.7.4 Multifunction incremental PG card (EC-PG505-12)	363
A.7.5 24V incremental PG card (EC-PG505-24)	367
A.7.6 Simplified incremental PG card (EC-PG507-12).....	370
A.7.7 24V simplified incremental PG card (EC-PG507-24).....	371
A.8 GPRS card (EC-IC501-2).....	375

Appendix B Technical data	376
B.1 What this chapter contains	376
B.2 Derated application	376
B.2.1 Capacity	376
B.2.2 Derating	376
B.3 Grid specifications	377
B.4 Motor connection data	377
B.4.1 EMC compatibility and motor cable length	377
B.5 Application standards	378
B.5.1 CE marking	378
B.5.2 EMC compliance declaration	378
B.6 EMC regulations	378
B.6.1 VFD category C2	379
B.6.2 VFD category C3	379
Appendix C Dimension drawings	380
C.1 What this chapter contains	380
C.2 Keypad structure	380
C.2.1 Structure diagram	380
C.2.2 Keypad installation bracket	380
C.3 VFD structure	381
C.4 Dimensions of AC 3PH 380V (-15%)–440V (+10%)	381
C.4.1 Wall mounting dimensions	381
C.4.2 Flange mounting dimensions	383
C.4.3 Floor mounting dimensions	385
C.5 Dimensions of AC 3PH 520V (-15%)–690V (+10%)	386
C.5.1 Wall mounting dimensions	386
C.5.2 Flange installation dimensions	387
C.5.3 Floor mounting dimensions	388
C.6 Dimensions for parallel VFDs	389
C.6.1 Dimensions with the recommended mounting method	389
C.6.2 Dimensions with the close mounting method	391
Appendix D Optional peripheral accessories	393
D.1 What this chapter contains	393
D.2 Wiring of peripheral accessories	393
D.3 Power supply	395
D.4 Cables	395
D.4.1 Power cables	395
D.4.2 Control cables	396
D.4.3 Recommended cable sizes	396
D.4.4 Cable sizes for parallel VFDs	398
D.4.5 Cable configuration for parallel VFDs	400

D.4.6 Cable arrangement	400
D.4.7 Insulation inspection.....	401
D.5 Breaker and electromagnetic contactor	401
D.6 Reactors.....	403
D.6.1 For a single VFD	404
D.6.2 For parallel VFDs	406
D.7 Filters	407
D.7.1 Filter model description	408
D.7.2 Filter model selection	408
D.8 Braking system.....	410
D.8.1 Braking component selection.....	410
D.8.2 Braking resistor cable selection	414
D.8.3 Braking resistor installation.....	414
Appendix E STO function description	415
E.1 STO function logic table	415
E.2 STO channel delay description.....	415
E.3 STO function installation checklist	416
Appendix F Energy efficiency data	417
Appendix G Further information	419
G.1 Product and service queries	419
G.2 Feedback on INVT VFD manuals.....	419
G.3 Documents on the Internet.....	419

1 Safety precautions

1.1 What this chapter contains

Read this manual carefully and follow all safety precautions before moving, installing, operating and servicing the VFD. If these safety precautions are ignored, physical injury or death may occur, or damage may occur to the equipment.

If any physical injury or death or damage to the equipment occurred due to neglect of the safety precautions in the manual, we will not be responsible for any damages and we are not legally bound in any manner.

1.2 Safety definition

Danger: Serious physical injury or even death may occur if related requirements are not followed.











Warning: Physical injury or damage to the equipment may occur if related requirements are not followed.



Note: Actions taken to ensure proper operation.

Qualified electricians: People working on the device should take part in professional electrical and safety training, receive the certification and be familiar with all steps and requirements of installing, commissioning, operating and maintaining the device to prevent any emergencies.

1.3 Warning symbols

Warnings caution you about conditions which can result in serious injury or death and/or damage to the equipment, and advice on how to avoid the danger. The following warning symbols are used in this manual.

Symbol	Name	Instruction	Abbreviation
 Danger	Danger	Serious physical injury or even death may occur if related requirements are not followed.	
 Warning	Warning	Physical injury or damage to the equipment may occur if related requirements are not followed.	
 Forbid	Electrostatic discharge	The PCBA may be damaged if related requirements are not followed	
 Hot	Hot sides	The VFD base may become hot. Do not touch.	
 5 min	Electric shock	As high voltage still presents in the bus capacitor after power off, wait for at least five minutes (or 15 min / 25 min, depending on the warning symbols on the machine) after power off to prevent electric shock.	 5 min

Symbol	Name	Instruction	Abbreviation
	Read manual	Read the operation manual before operating on the equipment.	
Note	Note	Actions taken to ensure proper operation.	Note

1.4 Safety guidelines

	<ul style="list-style-type: none"> ◇ Only trained and qualified electricians are allowed to carry out related operations. ◇ Do not perform wiring, inspection or component replacement when power supply is applied. Ensure all the input power supplies are disconnected before wiring and inspection, and wait for at least the time designated on the VFD or until the DC bus voltage is less than 36V. The minimum waiting time is listed in the table below. 																					
	<table border="1"> <thead> <tr> <th colspan="2">VFD model</th> <th>Minimum waiting time</th> </tr> </thead> <tbody> <tr> <td>380V</td> <td>1.5kW–110kW</td> <td>5 min</td> </tr> <tr> <td>380V</td> <td>132kW–315kW</td> <td>15 min</td> </tr> <tr> <td>380V</td> <td>Above 355kW</td> <td>25 min</td> </tr> <tr> <td>660V</td> <td>22kW–132kW</td> <td>5 min</td> </tr> <tr> <td>660V</td> <td>160kW–355kW</td> <td>15 min</td> </tr> <tr> <td>660V</td> <td>Above 400kW</td> <td>25 min</td> </tr> </tbody> </table>	VFD model		Minimum waiting time	380V	1.5kW–110kW	5 min	380V	132kW–315kW	15 min	380V	Above 355kW	25 min	660V	22kW–132kW	5 min	660V	160kW–355kW	15 min	660V	Above 400kW	25 min
	VFD model		Minimum waiting time																			
	380V	1.5kW–110kW	5 min																			
	380V	132kW–315kW	15 min																			
	380V	Above 355kW	25 min																			
	660V	22kW–132kW	5 min																			
660V	160kW–355kW	15 min																				
660V	Above 400kW	25 min																				
<ul style="list-style-type: none"> ◇ Do not refit the VFD unless authorized; otherwise, fire, electric shock or other injuries may occur. 																						
<ul style="list-style-type: none"> ◇ The base of the radiator may become hot during running. Do not touch to avoid hurt. 																						
<ul style="list-style-type: none"> ◇ The electrical parts and components inside the VFD are electrostatic. Take measures to prevent electrostatic discharge during related operation. 																						

1.4.1 Delivery and installation

	<ul style="list-style-type: none"> ◇ Install the VFD on fire-retardant material and keep the VFD away from combustible materials. ◇ Connect the optional braking parts (such as braking resistors, braking units or feedback units) according to the wiring diagram. ◇ Do not operate on a damaged or incomplete VFD. ◇ Do not touch the VFD with wet items or body parts; otherwise, electric shock may occur.
---	---

Note:

- ◇ Select appropriate tools for delivery and installation to ensure a safe and proper running of the VFD and avoid physical injury or death. To ensure physical safety, the installation staff should take mechanical protective measures like wearing safety shoes and working uniforms.
- ◇ Protect the VFD against physical shock or vibration during delivery and installation.

- ✧ Do not carry the VFD by its front cover only as the cover may fall off.
- ✧ Installation site should be away from children and other public places.
- ✧ The VFD should be used in proper environment (see section 4.2.1 Installation environment for details).
- ✧ Prevent the screws, cables and other conductive parts from falling into the VFD.
- ✧ As leakage current of the VFD during running may exceed 3.5mA, ground properly and ensure the grounding resistance is less than 10Ω. The conductivity of PE grounding conductor is the same with that of the phase conductor (with the same cross sectional area).
- ✧ R, S and T are the power input terminals, while U, V and W are output motor terminals. Connect the input power cables and motor cables properly; otherwise, damage to the VFD may occur.

1.4.2 Commissioning and running

	<ul style="list-style-type: none"> ✧ Disconnect all power sources applied to the VFD before terminal wiring, and wait for at least the time designated on the VFD after disconnecting the power sources. ✧ High voltage presents inside the VFD during running. Do not carry out any operation on the VFD during running except for keypad setup. For products at voltage class 4 or 6, the control terminals form extra-low voltage circuits. Therefore, you need to prevent the control terminals from connecting to accessible terminals of other devices. ✧ The VFD may start up by itself when P01.21 (restart after power outage) is set to 1. Do not get close to the VFD and motor. ✧ The VFD cannot be used as "Emergency-stop device". ✧ The VFD cannot act as an emergency brake for the motor; it is a must to install mechanical brake device. ✧ During driving permanent magnet synchronous motor, besides above-mentioned items, the following work must be done before installation and maintenance. <ul style="list-style-type: none"> • Disconnect all the input power sources including main power and control power. • Ensure the permanent-magnet synchronous motor has been stopped, and the voltage on output end of the VFD is lower than 36V. • After the permanent-magnet synchronous motor is stopped, wait for at least the time designated on the VFD, and ensure the voltage between "+" and "-" is lower than 36V. • During operation, it is a must to ensure the permanent-magnet synchronous motor cannot run again by the action of external load; it is recommended to install effective external brake device or disconnect the direct electrical connection between permanent-magnet synchronous motor and the VFD.
---	---

Note:

- ◇ Do not switch on or switch off input power sources of the VFD frequently;
- ◇ If the VFD has been stored for a long time without use, set the capacitance and carry out inspection and pilot run on the VFD before use. For details about capacitor reforming, see chapter 8 Maintenance and hardware fault diagnosis.
- ◇ Close the front cover before running; otherwise, electric shock may occur.



1.4.3 Maintenance and component replacement

	<ul style="list-style-type: none"> ◇ Only well-trained and qualified professionals are allowed to perform maintenance, inspection, and component replacement on the VFD. ◇ Disconnect all the power sources applied to the VFD before terminal wiring, and wait for at least the time designated on the VFD after disconnecting the power sources. ◇ Take measures to prevent screws, cables and other conductive matters from falling into the VFD during maintenance and component replacement.
---	--

Note:

- ◇ Use proper torque to tighten the screws.
- ◇ Keep the VFD and its parts and components away from combustible materials during maintenance and component replacement.
- ◇ Do not carry out insulation voltage-endurance test on the VFD, or measure the control circuits of the VFD with megameter.
- ◇ Take proper anti-static measures on the VFD and its internal parts during maintenance and component replacement.

1.4.4 What to do after scrapping

	<ul style="list-style-type: none"> ◇ The heavy metals inside the VFD should be treated as industrial effluent.
	<ul style="list-style-type: none"> ◇ When the life cycle ends, the product should enter the recycling system. Dispose of it separately at an appropriate collection point instead of placing it in the normal waste stream.

2 Quick startup

2.1 What this chapter contains

This chapter introduces the basic principles required during installation commissioning. You can realize quick installation commissioning by following these principles.

2.2 Unpack inspection

Check as follows after receiving products.

1. Check whether the packing box is damaged or dampened.
2. Check the model identifier on the exterior surface of the packing box is consistent with the purchased model.
3. Check whether the interior surface of packing box is improper, for example, in wet condition, or whether the enclosure of the VFD is damaged or cracked.
4. Check whether the nameplate of the VFD is consistent with the model identifier on the exterior surface of the packing box.
5. Check whether the accessories (including user's manual, control keypad and expansion card units) inside the packing box are complete.

If any problems are found, contact the local INVT dealer or office.

2.3 Application confirmation

Check the following items before operating on the VFD.

1. Check the load mechanical type to be driven by the VFD, and check whether the VFD will be overloaded during actual use and whether the VFD power class needs to be enlarged?
2. Check whether the actual running current of load motor is less than rated VFD current.
3. Check whether the control precision required by actual load is the same with the control precision provided by the VFD.
4. Check whether the grid voltage is consistent with rated VFD voltage.
5. Check whether the functions required need an optional expansion card to be realized.

2.4 Environment confirmation

Check the following items before use.

1. Check whether the ambient temperature of the VFD during actual application exceeds 40°C. If yes, derate 1% for every additional 1°C. In addition, do not use the VFD when the ambient temperature exceeds 50°C.
2. Check whether ambient temperature of the VFD during actual application is below -10°C. If yes, install heating facility.
3. Check whether the altitude of the application site exceeds 1000m. If yes, derate 1% for every increase of 100m; when the installation site altitude exceeds 3000m, consult the local INVT dealer or office.
4. Check whether the humidity of application site exceeds 90%, if yes, check whether

condensation occurred, if condensation does exist, take additional protective measures.
5. Check whether there is direct sunlight or animal intrusion in the application site, if yes, take additional protective measures.
6. Check whether there is dust, explosive or combustible gases in the application site, if yes, take additional protective measures.

Note: For a cabinet-installed VFD, its ambient temperature is the air temperature inside the cabinet.

2.5 Installation confirmation

After the VFD is installed properly, check the installation condition of the VFD.

1. Check whether the input power cable and current-carrying capacity of the motor cable fulfill actual load requirements.
2. Check whether peripheral accessories (including input reactors, input filters, output reactors, output filters, DC reactors, braking units and braking resistors) of the VFD are of correct type and installed properly; check whether the installation cables fulfill requirements on current-carrying capacity.
3. Check whether the VFD is installed on fire-retardant materials; check whether the hot parts (reactors, braking resistors, and so on) are kept away from combustible materials.
4. Check whether all control cables are routed separately from power cables based on EMC requirements.
5. Check whether all grounding systems are properly grounded according to requirements.
6. Check whether VFD installation clearances meet the requirements in the operation manual.
7. Check whether the VFD installation mode complies with the requirements in the operation manual. Vertical installation should be adopted whenever possible.
8. Check whether VFD external connection terminals are securely wired with proper moment.
9. Check whether there are redundant screws, cables or other conductive objects inside the VFD. If yes, take them out.

2.6 Basic commissioning

Carry out basic commissioning according to the following procedures before operating on the VFD.

1. Select motor type, set motor parameters and select VFD control mode according to actual motor parameters.
2. Check whether autotuning is needed? If possible, disconnect the motor load to perform dynamic parameter autotuning. If the load cannot be disconnected, perform static autotuning.
3. Adjust the acceleration and deceleration time based on actual load working conditions.
4. Perform device commissioning by means of jogging. Check whether the motor runs in the direction required. If no, it is recommended to change the motor running direction by exchanging the motor wiring of any two phases.
5. Set all the control parameters, and carry out actual operation.

2.7 Safety standard related data

IEC/EN 61508 (Class A system)							ISO 13849**				
SIL	PFH	HFT	SFF	λ_{du}	λ_{dd}	PTI*	PL	CCF	MTTFd	DC	Category
2	8.73×10^{-10}	1	71.23%	1.79×10^{-9}	0	1 year	d	57	343.76 years	60%	3

* PTI: Proof test interval

** Depends on the the classification defined on the EN ISO 13849-1.

3 Product overview

3.1 What this chapter contains

This chapter mainly introduces the operation principles, product features, layouts, nameplates and model instructions.

3.2 Basic principle

The VFD is used to control asynchronous AC induction motor and permanent-magnet synchronous motor. The figure below shows the main circuit diagram of the VFD. The rectifier converts 3PH AC voltage into DC voltage, and the capacitor bank of intermediate circuit stabilizes the DC voltage. The inverter converts DC voltage into the AC voltage used by AC motor. When the circuit voltage exceeds the maximum limit value, external braking resistor will be connected to intermediate DC circuit to consume the feedback energy.

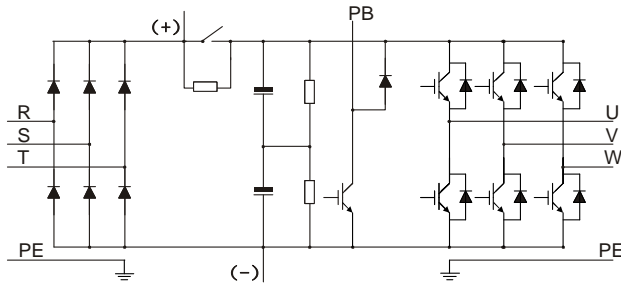

Figure 3-1 380V (15kW and lower) main circuit diagram

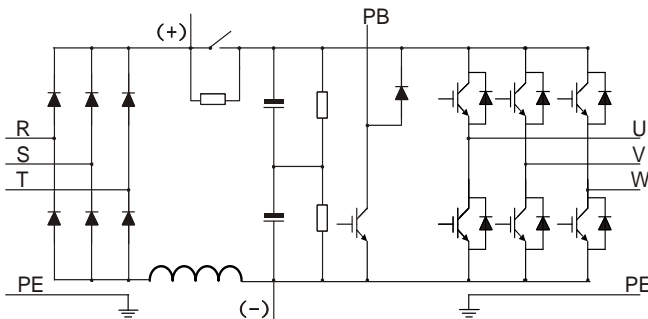

Figure 3-2 380V (18.5kW–110kW, 110kW included) main circuit diagram

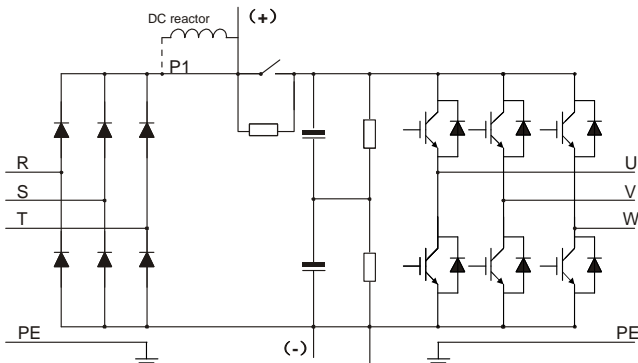

Figure 3-3 380V (132kW and higher) main circuit diagram

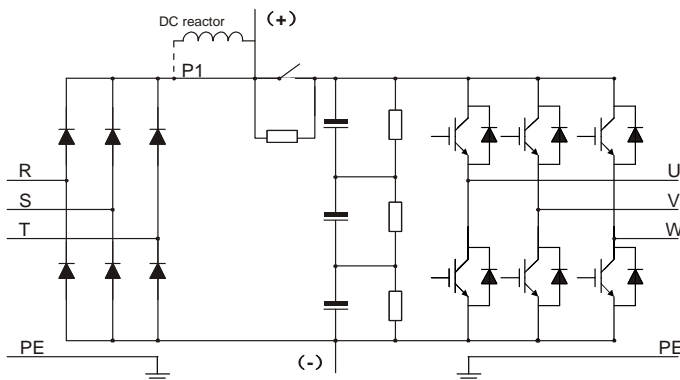

Figure 3-4 660V main circuit diagram

Note:

- The 380V 132kW and higher VFD models can be connected to external DC reactors. Before connection, remove the copper bar between P1 and (+). The 380V 132kW and higher VFD models can be connected to external braking units. DC reactors and braking units are optional parts.
- The 380V 18.5kW–110kW (inclusive) VFD models are equipped with built-in DC reactors, while the 380V 355kW and higher are equipped with built-in AC input reactors.
- The 380V 37kW and lower VFD models are equipped with built-in braking units, which are optional for the 45kW–110kW (inclusive) models. The models with built-in braking units can be connected to external braking resistors. Braking resistors are optional parts.
- The 660V VFD models can be connected to external DC reactors. Before connection, remove the copper bar between P1 and (+). These models can be connected to external braking units. DC reactors and braking units are optional parts. The 660V 400kW and higher VFD models are equipped with built-in AC input reactors.

3.3 Product specifications

Function description		Specification
Power input	Input voltage (V)	AC 3PH 380V (-15%)–440V (+10%) Rated voltage: 380V AC 3PH 520V (-15%)–690V (+10%) Rated voltage: 660V
	Input current (A)	Refer to section 3.6 Ratings of a single product.
	Input frequency (Hz)	50Hz or 60Hz, allowable range: 47–63Hz
Power output	Output voltage (V)	0–input voltage
	Output current (A)	Refer to section 3.6 Ratings of a single product.
	Output power (kW)	Refer to section 3.6 Ratings of a single product.
	Output frequency (Hz)	0–400Hz
Technical control performance	Control mode	Space voltage vector control, sensorless vector control (SVC), and feedback vector control (FVC)
	Motor type	Asynchronous motor, permanent-magnet synchronous motor
	Speed regulation ratio	Asynchronous motor 1: 200 (SVC); Synchronous motor 1: 20 (SVC), 1:1000 (FVC)
	Speed control precision	±0.2% (SVC), ±0.02% (FVC)
	Speed fluctuation	± 0.3% (SVC)
	Torque response	< 20ms (SVC); <10ms (FVC)
	Torque control precision	10% (SVC); 5% (FVC)
	Starting torque	Asynchronous motor: 0.25Hz/150% (SVC) Synchronous motor: 2.5 Hz/150% (SVC) 0Hz/200% (FVC)
Overload capacity	150% of rated current: 1min 180% of rated current: 10s 200% of rated current: 1s	
Running control performance	Frequency setup mode	Digital, analog, pulse frequency, multi-step speed running, simple PLC, PID, Modbus/Modbus TCP communication, PROFIBUS communication, and so on; Setting combinations and setting channels can be switched.
	Automatic voltage regulation function	Keeps the output voltage constant when grid voltage changes.
	Fault protection function	Fault protection function Provides over 30 fault protection functions: overcurrent, overvoltage, undervoltage, over-temperature, phase loss and overload, and so on
	Speed tracking restart function	Realizes impact-free starting of the motor in rotating. Note: Only available for the 4kW and higher VFD models.
	Retention at transient	Keeps running with regenerative energy when the grid

Function description		Specification
	voltage drop	transiently drops.
	Motor switchover	Supports two groups of motor parameters to control motor switchover.
Peripheral interface	Terminal analog input resolution	No more than 20mV
	Terminal digital input resolution	No more than 2ms
	Analog input	Two inputs. AI1: 0–10V/0–20mA; AI2: -10–10V
	Analog output	One output. AO1: 0–10V/0–20mA
	Digital input	Four regular inputs; max. frequency: 1kHz; internal impedance: 3.3kΩ Two high-speed inputs; max. frequency: 50kHz; supports quadrature encoder input; with speed measurement function
	Digital output	One high-speed pulse output; max. frequency: 50kHz One Y terminal open collector output
	Relay output	Two programmable relay outputs RO1A: NO, RO1B NC, RO1C: common RO2A: NO, RO2B: NC, RO2C: common Contact capacity: 3A/AC250V, 1A/DC30V
	Extension interface	Three extension interfaces: SLOT1, SLOT2, and SLOT3 (only on the control boards of 7.5kW and higher VFD models) Expandable PG card, programmable expansion card, communication card, I/O card, and so on
Others	Installation mode	Supports wall mounting, floor mounting and flange mounting.
	Temperature of running environment	-10–50°C; Derating is required when the ambient temperature exceeds 40°C.
	IP rating	IP20
	Pollution degree	Degree 2
	Cooling mode	Forced air cooling
	Braking unit	For 380V 37kW and lower: standard part, already built in For 380V 45kW–110kW (inclusive): optional part, built-in only For all 660V models: optional part, externally connected only
	EMC filter	The conductivity and transmission of all 380V VFD models can meet the IEC61800-3 C3 requirements.

Function description		Specification
		Optional external filters can be used to meet the IEC61800-3 C2 requirements. Note: Comply with the EMC regulations in the appendix in the manual, and select the motor and motor cables according to the technical requirements in the appendix in the manual.

3.4 Product nameplate

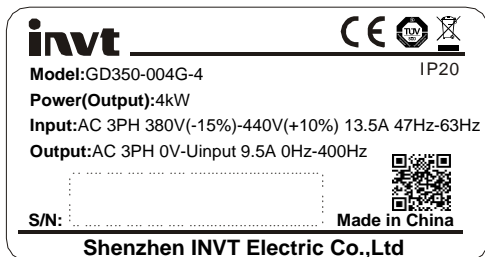

Figure 3-5 Product nameplate

Note:

- The preceding nameplate is a standard product nameplate example. The marking such as CE, TUV, and IP20 on the nameplate is marked according to the actual certificate result.
- You can scan the QR code on the nameplate to download the product App and manual.

3.5 Type designation key

The type designation key contains product information. You can find the type designation key on the nameplate and simple nameplate of the VFD.

GD350-5R5G-4

① ② ③

Figure 3-6 Type designation key

Field	Sign	Description	Contents
Abbreviation of product series	①	Abbreviation of product series	GD350: Goodrive350 series high-performance multi-function VFD
Rated power	②	Power range + load type	5R5: 5.5kW G: Constant torque load
Voltage class	③	Voltage class	4: AC 3PH 380V (-15%)–440V (+10%) Rated voltage: 380V 6: AC 3PH 520V (-15%)–690V (+10%) Rated voltage: 660V

Field	Sign	Description	Contents
Note:			
The braking unit has been built in the 380V 37kW and lower VFD models as a standard configuration.			
The braking unit is not a standard configuration for the 380V 45–110kW VFD models (but you can choose to purchase the built-in braking unit, and then the VFD model has a suffix "B", for example, GD350-045G-4-B).			

3.6 Ratings of a single product

Table 3–1 AC 3PH 380V(-15%)–440V(+10%)

Product model	Output power (kW)	Input current (A)	Output current (A)
GD350-1R5G-4	1.5	5.0	3.7
GD350-2R2G-4	2.2	5.8	5
GD350-004G-4	4	13.5	9.5
GD350-5R5G-4	5.5	19.5	14
GD350-7R5G-4	7.5	25	18.5
GD350-011G-4	11	32	25
GD350-015G-4	15	40	32
GD350-018G-4	18.5	47	38
GD350-022G-4	22	51	45
GD350-030G-4	30	70	60
GD350-037G-4	37	80	75
GD350-045G-4	45	98	92
GD350-055G-4	55	128	115
GD350-075G-4	75	139	150
GD350-090G-4	90	168	180
GD350-110G-4	110	201	215
GD350-132G-4	132	265	260
GD350-160G-4	160	310	305
GD350-185G-4	185	345	340
GD350-200G-4	200	385	380
GD350-220G-4	220	430	425
GD350-250G-4	250	460	480
GD350-280G-4	280	500	530
GD350-315G-4	315	580	600
GD350-355G-4	355	625	650
GD350-400G-4	400	715	720
GD350-450G-4	450	840	820
GD350-500G-4	500	890	860

Note:

- The input current of the 1.5–500kW VFD models is measured in cases where the input voltage is 380V without additional reactors.
- The rated output current is the output current when the output voltage is 380V.
- Within allowable input voltage range, the output current/power cannot exceed the rated output current/power.

Table 3–2 AC 3PH 520V (-15%)–690V (+10%)

Product model	Output power (kW)	Input current (A)	Output current (A)
GD350-022G-6	22	35	27
GD350-030G-6	30	40	35
GD350-037G-6	37	47	45
GD350-045G-6	45	52	52
GD350-055G-6	55	65	62
GD350-075G-6	75	85	86
GD350-090G-6	90	95	98
GD350-110G-6	110	118	120
GD350-132G-6	132	145	150
GD350-160G-6	160	165	175
GD350-185G-6	185	190	200
GD350-200G-6	200	210	220
GD350-220G-6	220	230	240
GD350-250G-6	250	255	270
GD350-280G-6	280	286	300
GD350-315G-6	315	334	350
GD350-355G-6	355	360	380
GD350-400G-6	400	411	430
GD350-450G-6	450	445	465
GD350-500G-6	500	518	540
GD350-560G-6	560	578	600
GD350-630G-6	630	655	680

Note:

- The input current of the 22–350kW VFD models is measured in cases where the input voltage is 660V without DC reactors or input/output reactors.
- The input current of the 400–630kW VFD models is measured in cases where the input voltage is 660V and there are input reactors.
- Rated output current is the output current when the output voltage is 660V.
- Within allowable input voltage range, the output current/power cannot exceed the rated output current/power.

3.7 Parallel products

Total power (kW)	380V parallel VFD requirement		660V parallel VFD requirement	
	Power (kW)	Quantity	Power (kW)	Quantity
560	280	2	-	-
630	315	2	-	-
710	350	2	350	2
800	400	2	400	2
1000	500	2	500	2
1200	400	3	630	2
1500	500	3	500	3
2000	500	4	500	4
2500	500	5	630	4
3000	500	6	630	5

3.8 Ratings of parallel products

Table 3–3 AC 3PH 380V(-15%)–440V(+10%)

Rated output power (kW)	Rated input current (A)	Rated output current (A)
560	1090	1060
630	1220	1200
710	1250	1300
800	1430	1440
1000	1780	1720
1200	2145	2160
1500	2670	2580
2000	3560	3440
2500	4450	4300
3000	5340	5160

Table 3–4 AC 3PH 520V(-15%)–690V(+10%)

Rated output power (kW)	Rated input current (A)	Rated output current (A)
710	720	760
800	822	860
1000	1036	1080
1200	1310	1360
1500	1554	1620
2000	2072	2160
2500	2620	2720
3000	3275	3400

3.9 Structure diagram

The VFD structure is shown in the following figure (taking the 380V 30kW VFD model as an example).

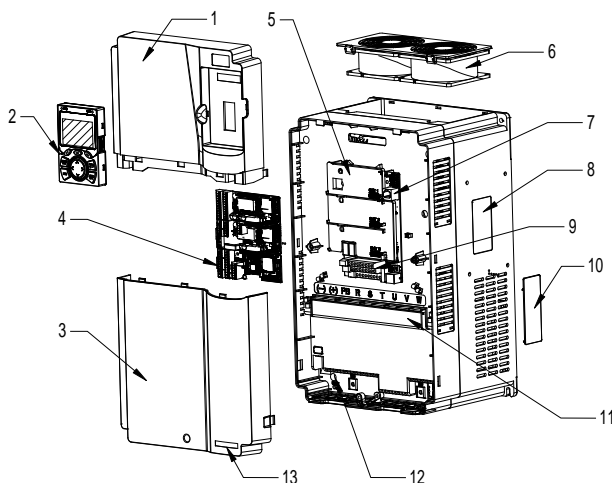



Figure 3-7 Structure diagram

No.	Item	Description
1	Upper cover	Protects internal components and parts.
2	Keypad	For details, see section 5.4 Operating the VFD through the keypad.
3	Lower cover	Protects internal components and parts.
4	Expansion card	Optional. For details, see Appendix A Expansion cards.
5	Baffle of control board	Protects the control board and install expansion card.
6	Cooling fan	For details, see chapter 8 Maintenance and hardware fault diagnosis.
7	Keypad interface	Connects the keypad.
8	Nameplate	For details, see section 3.4 Product nameplate.
9	Control terminals	For details, see chapter 4 Installation guidelines.
10	Cover plate of heat emission hole	Optional. Cover plate can upgrade protection level, however, as it will also increase internal temperature, derated use is required.
11	Main circuit terminal	For details, see chapter 4 Installation guidelines.
12	POWER indicator	Power indicator.
13	GD350 product series label	For details, see section 3.5 Type designation key.

4 Installation guidelines

4.1 What this chapter contains

This chapter introduces the mechanical and electrical installations of the VFD.

	<ul style="list-style-type: none"> ✧ Only well trained and qualified professionals are allowed to carry out the operations mentioned in this chapter. Please carry out operations according to instructions presented in Safety precautions. Ignoring these safety precautions may lead to physical injury or death, or device damage. ✧ Ensure the VFD power is disconnected before installation. If the VFD has been powered on, disconnect the VFD and wait for at least the time designated on the VFD, and ensure the POWER indicator is off. You are recommended to use a multimeter to check and ensure the VFD DC bus voltage is below 36V. ✧ Installation must be designed and done according to applicable local laws and regulations. INVT does not assume any liability whatsoever for any installation which breaches local laws and regulations. If recommendations given by INVT are not followed, the VFD may experience problems that the warranty does not cover.
---	--

4.2 Mechanical installation

4.2.1 Installation environment

Installation environment is essential for the VFD to operate at its best in the long run. The installation environment of the VFD should meet the following requirements.

Environment	Condition
Installation site	Indoors
Ambient temperature	<ul style="list-style-type: none"> ✧ -10—+50° ✧ When the ambient temperature exceeds 40°C, derate 1% for every additional 1°C. ✧ It is not recommended to use the VFD when the ambient temperature is above 50°C. ✧ In order to improve reliability, do not use the VFD in cases where the temperature changes rapidly. ✧ When the VFD is used in a closed space such as control cabinet, use cooling fan or air conditioner to prevent internal temperature from exceeding the temperature required. ✧ When the temperature is too low, if restart a VFD which has been idled for a long time, it is required to install external heating device before use to eliminate the freeze inside the VFD, failing to do so may cause damage to the VFD.
Humidity	✧ The relative humidity (RH) of the air is less than 90%.

Environment	Condition
	<ul style="list-style-type: none"> ◇ Condensation is not allowed. ◇ The max RH cannot exceed 60% in the environment where there are corrosive gases.
Storage temperature	-30—+60°C
Running environment	<p>The installation site should meet the following requirements.</p> <ul style="list-style-type: none"> ◇ Away from electromagnetic radiation sources. ◇ Away from oil mist, corrosive gases and combustible gases. ◇ Ensure foreign object like metal powder, dust, oil and water will not fall into the VFD (do not install the VFD onto combustible object like wood). ◇ Away from radioactive substance and combustible objects ◇ Away from harmful gases and liquids ◇ Low salt content ◇ No direct sunlight
Altitude	<ul style="list-style-type: none"> ◇ Below 1000m. ◇ When the altitude exceeds 1000m, derate 1% for every additional 100m. ◇ When the installation site altitude exceeds 3000m, consult the local INVT dealer or office.
Vibration	Max. vibration acceleration: 5.8m/s ² (0.6g)
Installation direction	You are recommended to install the VFD vertically to ensure good heat dissipation effect.

Note:

- The VFD must be installed in a clean and well-ventilated environment based on the IP rating.
- The cooling air must be clean enough and free from corrosive gases and conductive dust.

4.2.2 Installation direction

The VFD can be installed on the wall or in a cabinet.

The VFD must be installed vertically. Check the installation position according to following requirements. See Appendix C Dimension drawings.

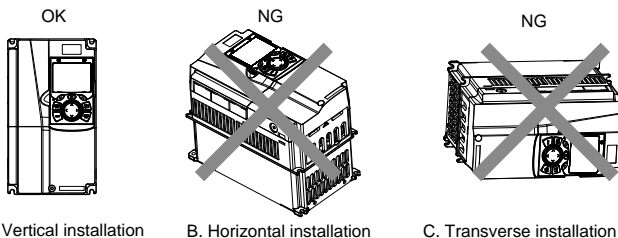

Figure 4-1 Installation direction of the VFD

4.2.3 Installation mode

There are three kinds of installation modes based on different VFD dimensions.

1. Wall-mounting: applicable to 380V 315kW and lower, and 660V 355kW and lower
2. Flange-mounting: applicable to 380V 200kW and lower, and 660V 220kW and lower
3. Floor-mounting: applicable to 380V 220–3000kW, and 660V 250–3000kW

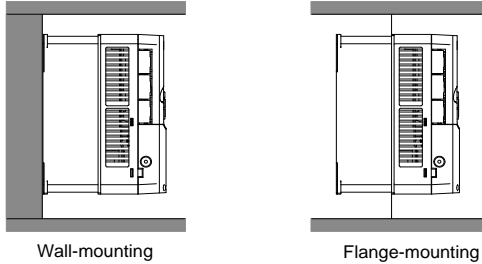

Figure 4-2 Installation mode

- (1) Mark the position of the Mounting hole. See appendix for the position of Mounting hole.
- (2) Mount the screws or bolts onto the designated position.
- (3) Put the VFD on the wall.
- (4) Tighten the fixing screws on the wall.

Note:

- In flange-mounting mode, the flange-mounting plate is a must for the 380V 1.5–110kW VFD models, while the 380V 132–200kW and 660V 22–220kW models need no flange-mounting plate.
- The optional installation base is available for the 380V 220–315kW and 660V 250–355kW VFD models. The base can hold an input AC (or DC) reactor or an output AC reactor.

4.2.4 Single-product installation

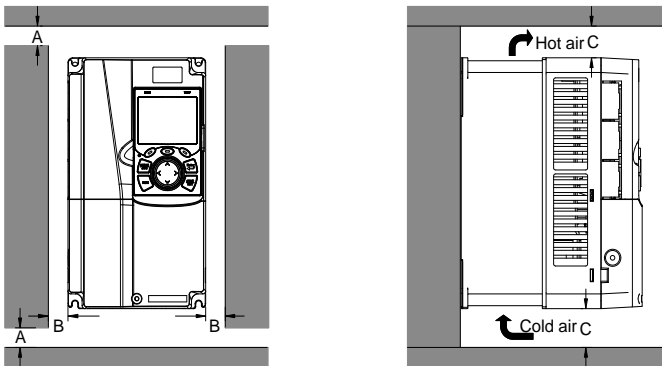

Figure 4-3 Single-product installation

Note: The min. dimension of B and C is 100mm.

4.2.5 Multiple-product installation

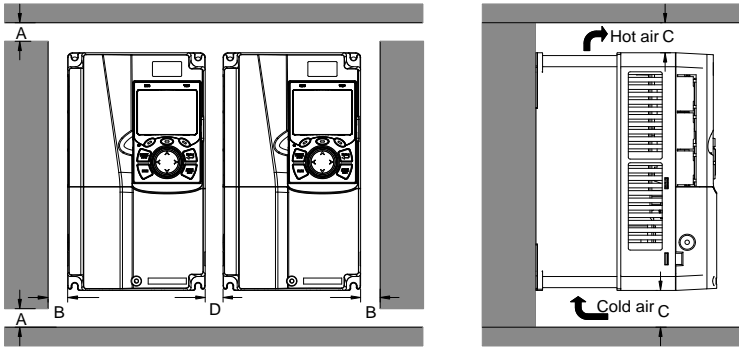

Figure 4-4 Parallel installation

Note:

- When you install VFDs in different sizes, align the top of each VFD before installation for the convenience of future maintenance.
- For clearances B, D and C, each must be at least 100mm.

4.2.6 Vertical installation

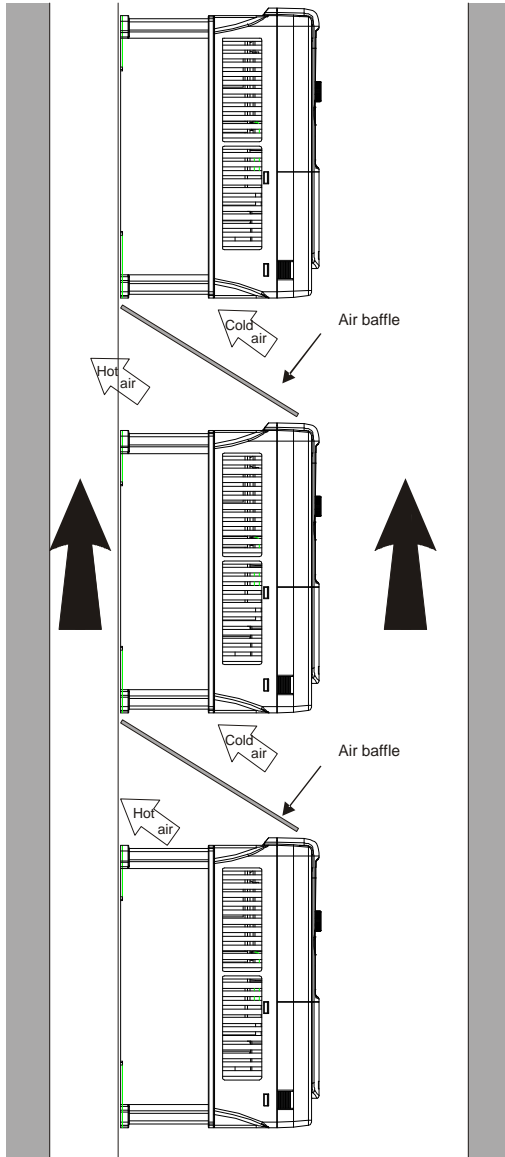

Figure 4-5 Vertical installation

Note: During vertical installation, you must install windshield, otherwise, the VFD will experience mutual interference, and the heat dissipation effect will be degraded.

4.2.7 Tilted installation

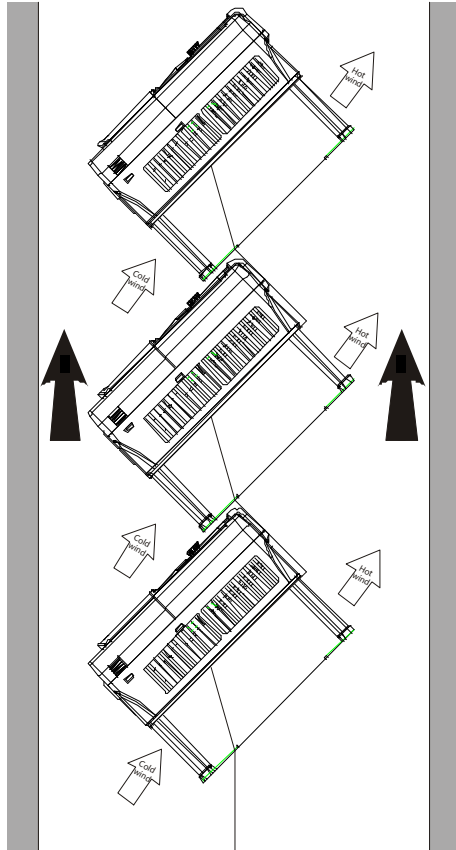

Figure 4-6 Tilted installation

Note: During tilted installation, it is a must to ensure the air inlet duct and air outlet duct are separated from each other to avoid mutual interference.

4.3 Standard wiring of main circuit

4.3.1 Wiring diagram of main circuit for a single product

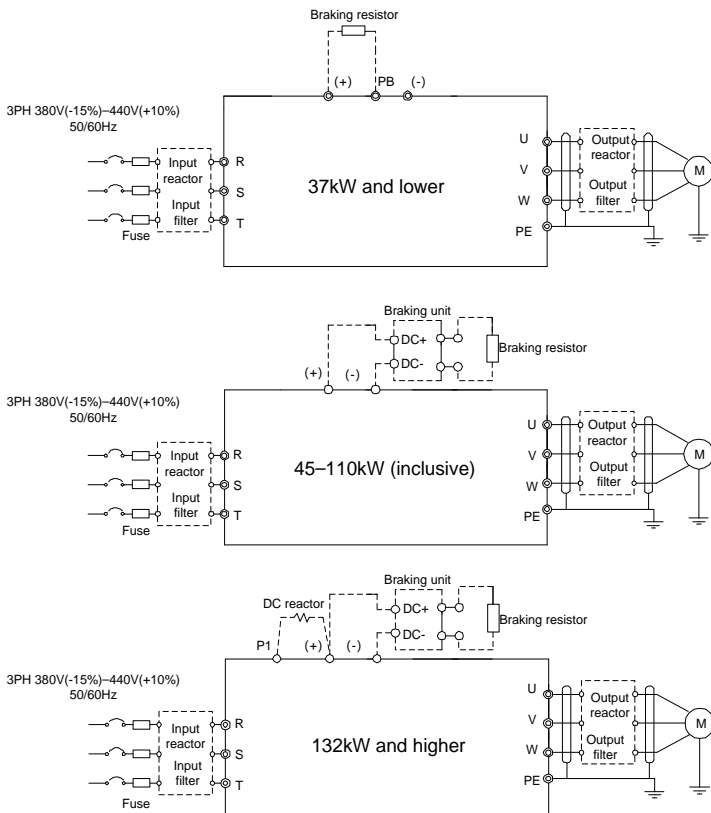

Figure 4-7 Main circuit wiring diagram for AC 3PH 380V(-15%)–440V(+10%)

Note:

- The fuse, DC reactor, braking unit, braking resistor, input reactor, input filter, output reactor and output filter are optional parts. See Appendix D Optional peripheral accessories.
- P1 and (+) have been short connected by default for the 380V 132kW and higher VFD models. If you need to connect to an external DC reactor, remove the jumper between P1 and (+).
- Before connecting the braking resistor, remove the yellow warning sign marked with PB, (+) and (-) on the terminal block before connecting the braking resistor wire; otherwise, poor contact may occur.
- Built-in braking units are optional for the 380V 45kW–110kW VFD models.

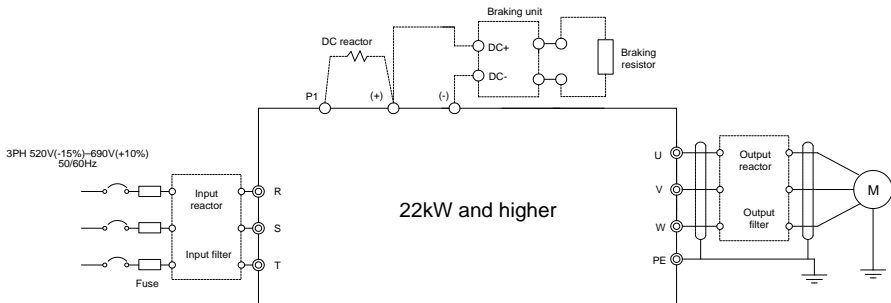
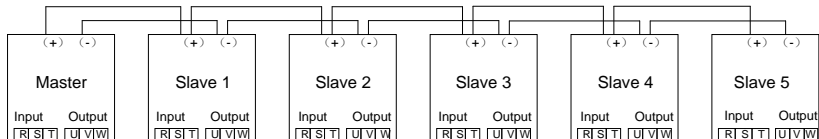

Figure 4-8 Main circuit wiring diagram for AC 3PH 520V(-15%)–690V(+10%)

Note:

- The fuse, DC reactor, braking resistor, input reactor, input filter, output reactor and output filter are optional parts. See Appendix D Optional peripheral accessories.
- P1 and (+) have been short connected by default. If you need to connect to an external DC reactor, remove the jumper between P1 and (+).
- Before connecting a braking resistor, remove the yellow warning label with (+) and (-) from the terminal block; otherwise, poor contact may occur.

4.3.2 Wiring diagram of main circuit for parallel products



	Master	Master-Slave 1	Slave 1-Slave 2	Slave 2-Slave 3	Slave 3-Slave 4	Slave 4-Slave 5
(+) bus length	About 1700mm	About 1700mm	About 1700mm	About 1700mm	About 1700mm	About 1700mm
(-) bus length	About 1700mm	About 1700mm	About 1700mm	About 1700mm	About 1700mm	About 1700mm

Note:

- The number of VFDs that can be paralleled depends on the actual power. A maximum of six VFDs can be paralleled together.
- Both the input side and output side of the master and slave need to be connected with parallel connection cables of the same length.

4.3.3 Main circuit terminal diagram

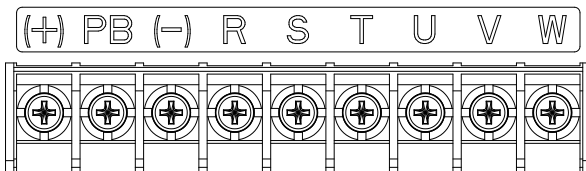

Figure 4-9 3PH 380V 22kW and lower

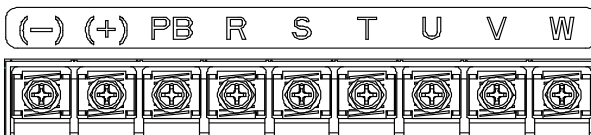

Figure 4-10 3PH 380V 30-37kW

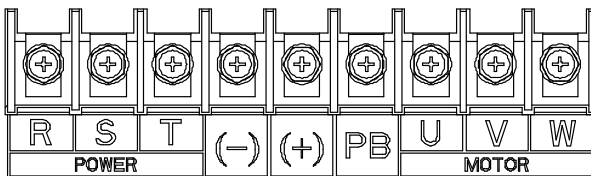

Figure 4-11 3PH 380V 45-110kW (Enabling PB when a braking unit is embedded)

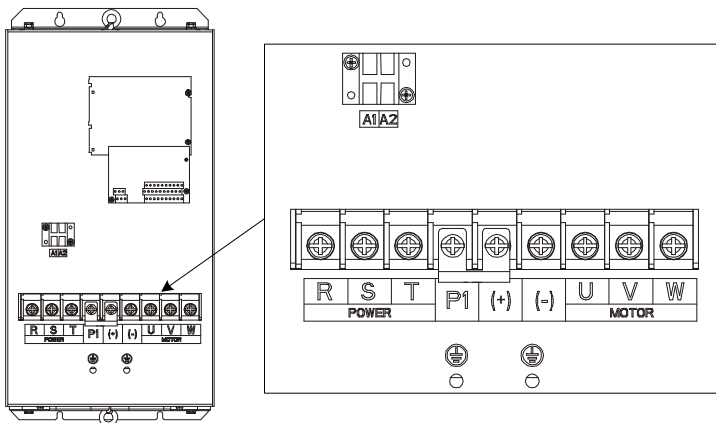

Figure 4-12 660V 22-45kW

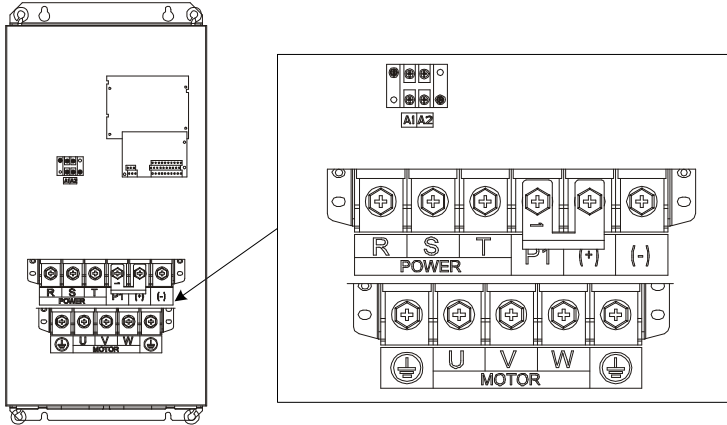

Figure 4-13 660V 55–132kW

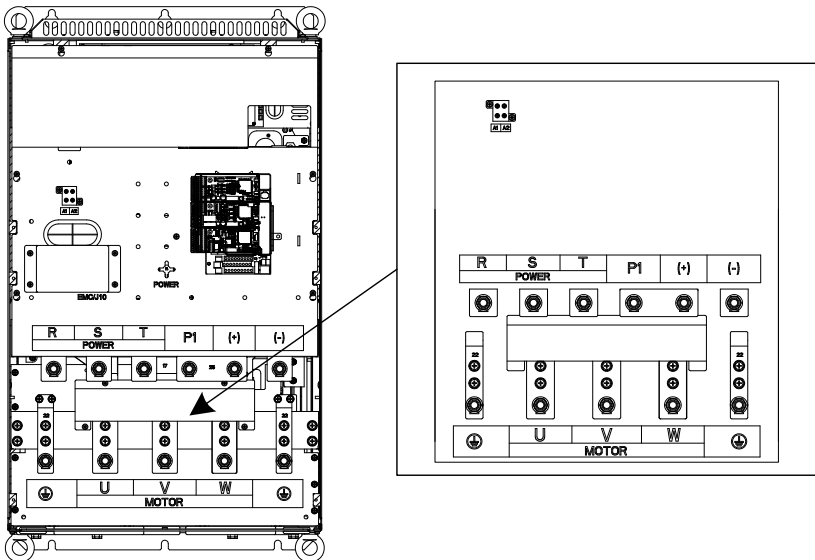

Figure 4-14 380V 132–200kW (without AI1 or AI2) and 660V 160–220kW

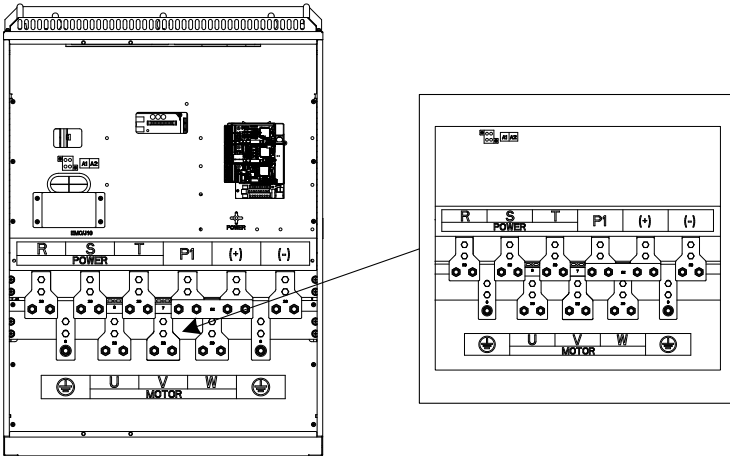

Figure 4-15 380V 220–315kW (without AI1 or AI2) and 660V 250–355kW

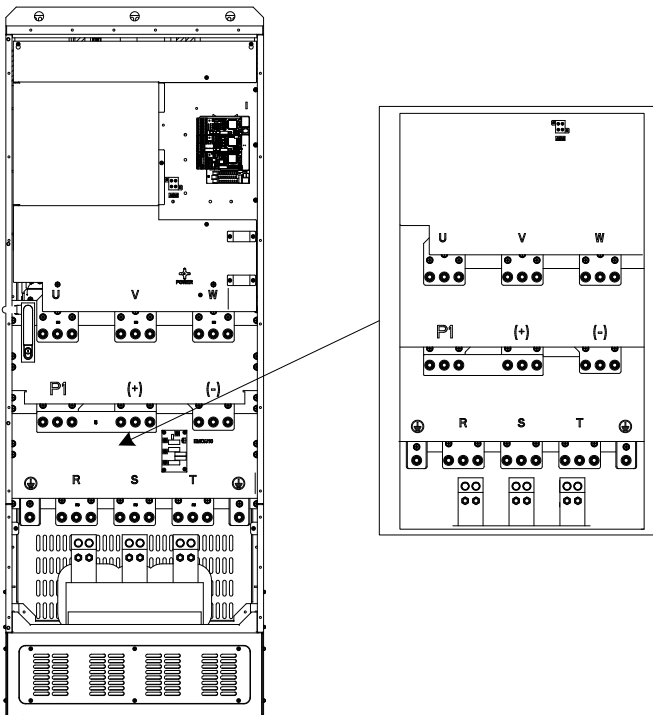

Figure 4-16 380V 355–500kW (without AI1 or AI2) and 660V 400–630kW

Terminal	Terminal name			Function description
	380V 37kW and lower	380V 45–110kW (inclusive)	380V 132kW and higher 660V	
R, S, T	Main circuit power input			3PH AC input terminals, connected to the grid
U, V, W	VFD output			3PH AC output terminals, connected to the motor
P1	Not available	Not available	DC reactor terminal 1	P1 and (+) connect to the external DC reactor. (+) and (-) connect to the external braking unit.
(+)	Braking resistor terminal 1	Braking unit terminal 1	DC reactor terminal 2, Braking unit terminal 1	
(-)	/	Braking unit terminal 2		
PB	Braking resistor terminal 2	Not available		PB and (+) connect to external braking resistor terminal
PE	Safety protection grounding terminal			Grounding terminal for safety protection. Each VFD carries two PE terminals and proper grounding is required.
A1, A2	Not available		For 660V models: 220V control power supply terminals	Terminals for connection to external 220V power supply.

Note:

- Do not use asymmetrical motor cables. If there is a symmetrical grounding conductor in the motor cable besides the conductive shielded layer, ground the grounding conductor on the VFD end and motor end.
- Braking resistor, braking unit and DC reactor are optional parts.
- Route the motor cable, input power cable and control cables separately.
- "Not available" means this terminal is not provided for external connection.
- GD series VFDs cannot share the DC bus with CH series VFDs.
- When sharing the DC bus, the VFDs must be the same in power and must be simultaneously powered on or off.
- In shared DC bus running mode, current balance on the VFD input side must be considered during wiring, and equalizing reactors are recommended to be configured.

4.3.4 Wiring procedure of the main circuit terminals

1. Connect the grounding line of the input power cable to the grounding terminal (PE) of the VFD, and connect the 3PH input cable to R, S and T terminals and tighten up.
2. Connect the grounding line of the motor cable to the grounding terminal of the VFD, and connect 3PH motor cable to U, V and W terminals and tighten up.
3. Connect the braking resistor which carries cables to the designated position.

- Fix all the cables outside the VFD mechanically if allowed.

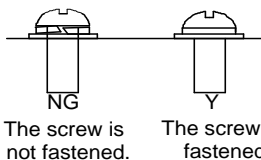

Figure 4-17 Screw installation diagram

4.4 Standard wiring of control circuit

4.4.1 Wiring diagram of basic control circuit

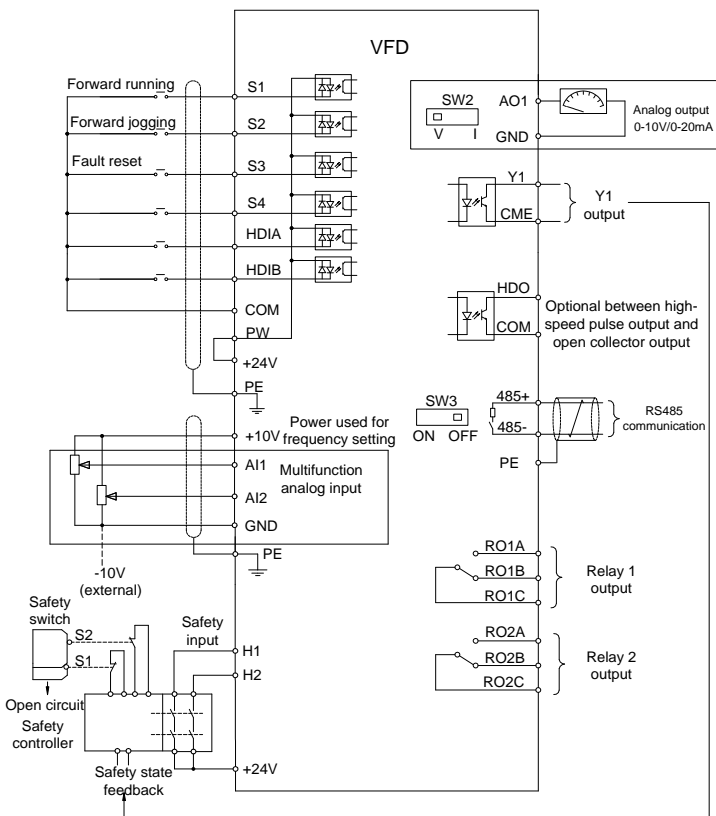

Figure 4-18 Wiring diagram of control circuit

Note: If wire-passing board outlet space is insufficient when all terminals on the control board are wired, cut the knock-out hole on the lower cover for wire outlet. If a dangerous situation occurs when the knock-out hole is cut for a purpose but not wire outlet, we will not bear any responsibility.

Terminal	Description	
+10V	Locally provided +10.5V power	
A11	✧ Input range: A11: 0–10V/0–20mA; A12: -10V→+10V	
A12	✧ Input impedance: 20kΩ during voltage input; 250Ω during current input ✧ A11 voltage or current input is set by P05.50. ✧ Resolution ratio: When 10V corresponds to 50Hz, min. resolution ratio is 5mV ✧ Error: ±0.5% at 25°C, when input is above 5V/10mA	
GND	+10.5V reference zero potential	
AO1	✧ Output range: 0–10V/0–20mA ✧ Whether the output type is voltage or current can be set through DIP switch SW2 ✧ Error: ±0.5% at 25°C, when input is above 5V/10mA	
RO1A	RO1 relay output; RO1A is NO, RO1B is NC, RO1C is common Contact capacity: 3A/AC250V, 1A/DC30V	
RO1B		
RO1C		
RO2A	RO2 relay output; RO2A is NO, RO2B is NC, RO2C is common Contact capacity: 3A/AC250V, 1A/DC30V	
RO2B		
RO2C		
HDO	✧ Switch capacity: 50mA/30V ✧ Range of output frequency: 0–50kHz ✧ Duty ratio: 50%	
CME	Common port of open collector output; short connected to COM by default	
Y1	Switch capacity:50mA/30V; Range of output frequency: 0–1kHz	
485+	RS485 communication/differential signal port. The standard 485 communication interface should use twisted shielded pair; the 120ohm terminal matching resistor of RS485 communication can be connected through DIP switch SW3.	
485-		
PE	Grounding terminal	
PW	Provides input digital working power from external to internal Voltage range: 12–30V	
24V	User power provided by the VFD. Max. output current: 200mA	
COM	Common terminal of +24V	
S1	Digital input 1	✧ Internal impedance: 3.3kΩ ✧ Accept 12–30V voltage input ✧ Bi-directional input terminals, supporting NPN/PNP modes ✧ Max. input frequency: 1kHz ✧ All are programmable digital input terminals. You can set the terminal function via function codes.
S2	Digital input 2	
S3	Digital input 3	
S4	Digital input 4	
HDIA	Besides S1–S4 functions, it can also act as high frequency pulse input channel Max. input frequency: 50kHz. Duty ratio: 30%–70%	
HDIB	Supports the input of a quadrature encoder with 24V power supply; equipped with speed-measurement function	
+24V—H1	STO input 1	✧ Safe torque off (STO) redundant inputs, connected to external NC contacts. When the contacts open, STO acts and VFD output stops. ✧ Safety input signal cable: shielded, with length within 25m ✧ H1 and H2 terminals are short connected to +24V by default. Remove the jumper on the terminal before using STO function.
+24V—H2	STO input 2	

4.4.2 Wiring diagram of control circuit for parallel products

	Master	Master-Slave 1	Master-Slave 2	Master-Slave 3	Master-Slave 4	Master-Slave 5
15-core serial port cable length	About 960mm	About 1910mm	About 3220mm	About 3220mm	About 4740mm	About 4740mm
Optical fiber cable length	About 1000mm	About 1500mm	About 2600mm	About 3700mm	About 4800mm	About 5900mm

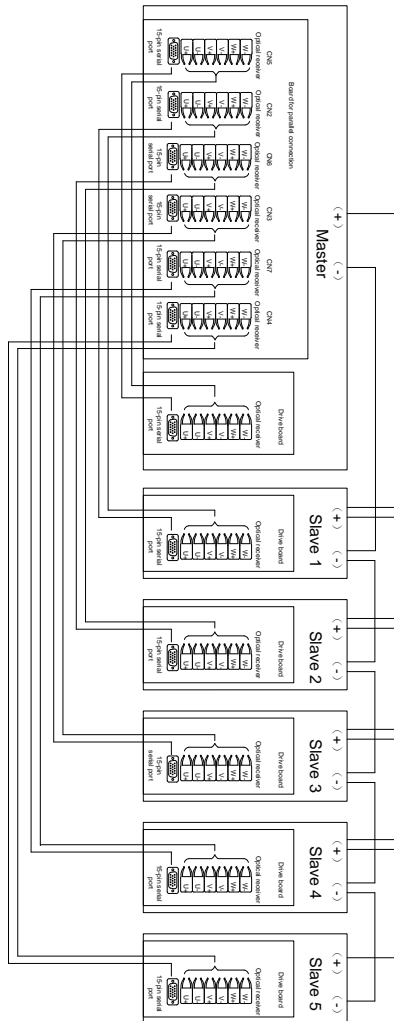

4.4.3 Input/output signal connection diagram

Set NPN /PNP mode and internal/external power via U-shaped jumper. The NPN internal mode is adopted by default.

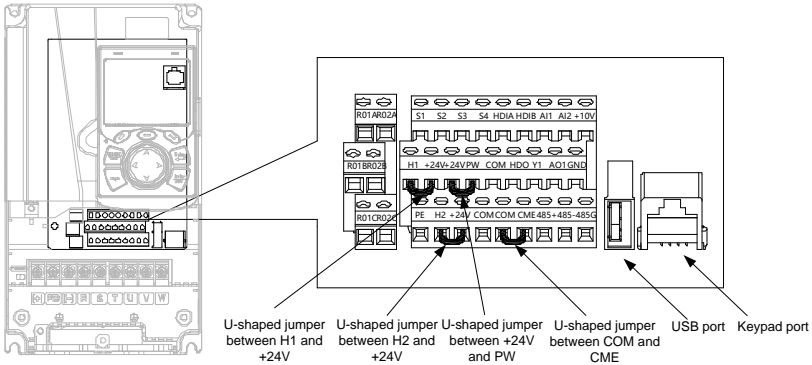

Figure 4-19 Position of U-shaped jumper

Note: As shown in Figure 4-19, the USB port can be used to upgrade the software, and the keypad port can be used to connect an external keypad. The external keypad cannot be used when the local VFD keypad is used.

If input signal comes from NPN transistors, set the U-shaped jumper between +24V and PW based on the power used according to the figure below.

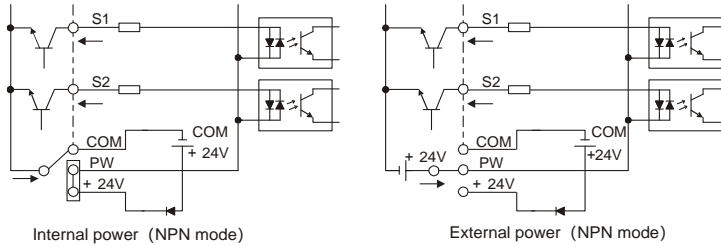

Figure 4-20 NPN mode

If input signal comes from PNP transistor, set the U-shaped jumper based on the power used according to the figure below.

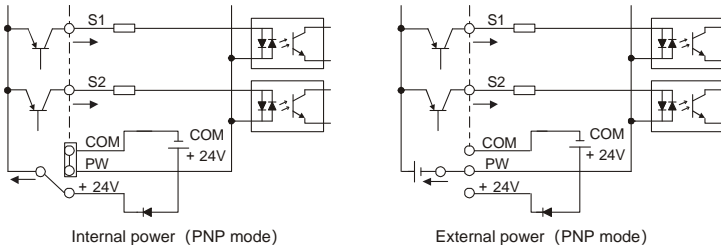

Figure 4-21 PNP mode

4.5 Wiring protection

4.5.1 Protect the VFD and input power cable in short-circuit

Protect the VFD and input power cable during short-circuit to avoid thermal overload.

Carry out protective measures according to the following requirements.

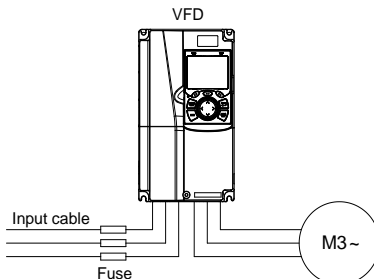



Figure 4-22 Fuse configuration

Note: Select the fuse according to operation manual. During short-circuit, the fuse will protect input power cables to avoid damage to the VFD; when internal short-circuit occurred to the VFD, it can protect neighboring equipment from being damaged.

4.5.2 Protect the motor and motor cable in short circuit

If the motor cable is selected based on rated VFD current, the VFD will be able to protect the motor cable and motor during short circuit without other protective devices.

	<p>⚡ If the VFD is connected to multiple motors, it is a must to use a separated thermal overload switch or breaker to protect the cable and motor, which may require the fuse to cut off the short circuit current.</p>
---	--

4.5.3 Protect motor and prevent thermal overload

According to the requirements, the motor must be protected to prevent thermal overload. Once overload is detected, you must cut off the current. The VFD is equipped with motor thermal overload protection function, which will block output and cut off the current (if necessary) to protect the motor.

4.5.4 Bypass connection

In some critical occasions, industrial frequency conversion circuit is necessary to ensure proper operation of the system when a VFD fault occurs.

In some special cases, such as, only soft startup is needed, it will convert to power-frequency operation directly after soft startup, corresponding bypass link is also needed.

	<p>⚡ Do not connect any power source to VFD output terminals U, V and W. The voltage applied to motor cable may cause permanent damage to the VFD.</p>
---	--

If frequent switchover is needed, you can use the switch which carries mechanical interlock or a contactor to ensure motor terminals will not be connected to input power cables and VFD output ends simultaneously.

5 Basic operation guidelines

5.1 What this chapter contains

This chapter tells you how to use the VFD keypad and the commissioning procedures for common functions of the VFD.

5.2 Keypad introduction

The VFD has been equipped with a LCD keypad as a standard configuration part. You can use the keypad to control the start and stop, read status data, and set parameters of the VFD.

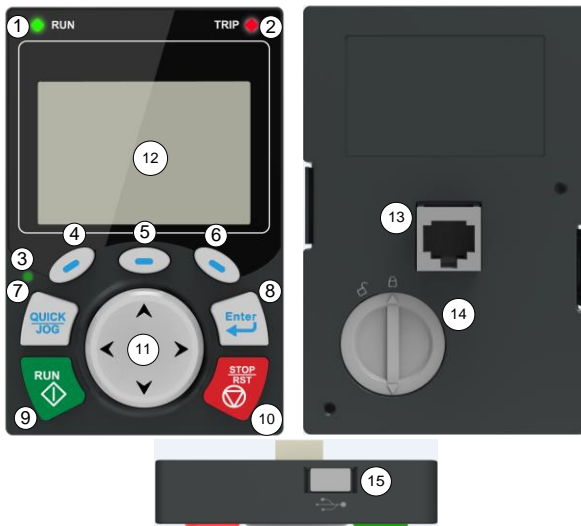













Figure 5-1 Keypad diagram

Note:

- The LCD keypad is equipped with a real-time clock, which can run properly after being installed with batteries even if the power line is disconnected. The clock battery (type: CR2032) is user purchased.
- The LCD keypad has the parameter copying function.
- If you need install the keypad externally (that is, on another position rather than on the VFD), you can use M3 screws to fix the keypad, or you can use the keypad installation bracket to install the keypad. When installing the keypad externally, use an extension cable with a standard RJ45 crystal head for connection.

Item	Instruction		
State indicator	(1)	RUN	Running indicator; LED off – the VFD is stopped; LED blinking – the VFD is in parameter autotune LED on – the VFD is running

Item	Instruction			
	2)		Fault indicator; LED on – in fault state LED off – in normal state LED blinking – in pre-alarm state	
	(3)		Short-cut key indicator, which displays different state under different functions, see definition of QUICK/JOG key for details	
Key area	(4)		Function key	The function of function key varies with the menu;
	(5)			The function of function key is displayed in the footer
	(6)			
	(7)		Short-cut key	Re-definable. It is defined as JOG function by default, namely jogging. The function of short-cut key can be set by the ones of P07.02, as shown below. 0: No function 1: Jogging (linkage indicator (3); logic : NO); 2: Reserved 3: FWD/REV switchover (linkage indicator (3); logic: NC) 4: Clear UP/DOWN setting (linkage indicator (3) logic: NC) 5: Coast to stop (linkage indicator (3); logic: NC) 6: Switching running command reference mode in order (linkage indicator (3); logic: NC) 7: Reserved Note: After restoring to the default value, the default function of short-cut key (7) is 1.
	(8)		Confirmation key	The function of confirmation key varies with menus, such as confirming parameter setup, confirming parameter selection, and entering the next menu.
	(9)		Running key	Under keypad operation mode, the running key is used for running operation or autotuning operation.

Item	Instruction			
	(10)		Stop/ Reset key	During running state, press the Stop/Reset key can stop running or autotuning; this key is limited by P07.04. During fault alarm state, all the control modes can be reset by this key.
	(11)		Direction key UP:  DOWN:  LEFT:  RIGHT: 	UP: The function of UP key varies with interfaces, such as shifting up the displayed item, shifting up the selected item, and changing digits; DOWN: The function of DOWN key varies with interfaces, such as shifting down the displayed item, shifting down the selected item, changing digits; LEFT: The function of LEFT key varies with interfaces, such as switch over the monitoring interface, such as shifting the cursor leftward, exiting current menu and returning to previous menu; RIGHT: The function of RIGHT key varies with interfaces, such as switch over the monitoring interface, shifting the cursor rightward, enter the next menu etc.
Display area	(12)	LCD	Display screen	240x160 dot-matrix LCD; display three monitoring parameters or six sub-menu items simultaneously
Others	(13)	RJ45 interface	RJ45 interface	RJ45 interface is used to connect to the VFD.
	(14)	Battery cover	Clock battery cover	Remove this cover when replacing or installing clock battery, and close the cover after battery is installed
	(15)	USB terminal	Mini USB terminal	Mini USB terminal is used to connect to the USB flash drive through an adapter.

The LCD has different display areas, which displays different contents under different interfaces. The figure below is the main interface of stop state.

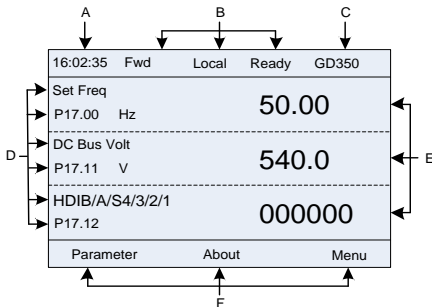

Figure 5-2 Main interface of LCD



Area	Name	Used to
Header A	Real-time display area	Display the real-time; clock battery is not included; the time needs to be reset when powering on the VFD
Header B	VFD running state display area	Display the running state of the VFD: 1. Display motor rotating direction: "Fwd" – Run forward during operation; Rev – Run reversely during operation; "Disrev" – Reverse running is forbidden; 2. Display VFD running command channel: "Local" – Keypad; "Trml" – Terminal; "Remote" - Communication 3. Display current running state of the VFD : "Ready" – The VFD is in stop state (no fault); "Run" – The VFD is in running state; "Jog" – The VFD is in jogging state; "Pre-alarm" – the VFD is under pre-alarm state during running; "Fault" – VFD fault occurred.
Header C	VFD model display area	VFD model display: "GD350" – current VFD is GD350 series VFD
Display D	Parameter names and function codes on the VFD homepage	Display a maximum of three parameter names and function codes on the homepage. The parameters displayed on the homepage can be managed.
Display E	Values of parameters on the VFD homepage	Display the values of parameters on the VFD homepage, which are updated in real time.
Footer F	Corresponding menus of function keys (4), (5) and (6)	Indicate the menus corresponding to function keys (4), (5) and (6). The corresponding menus of function keys (4), (5) and (6) vary with interfaces, and the content displayed in this area varies also.

5.3 Keypad display

The VFD keypad can display the stopped-state parameters, running-state parameters, function parameter editing status, and fault alarm status.

5.3.1 Displaying stopped-state parameters

When the VFD is in stopped state, the keypad displays stopped-state parameters, and this interface

is the main interface during power-up by default. In stopped state, parameters in various states can be displayed. Press  or  to shift the displayed parameter up or down.

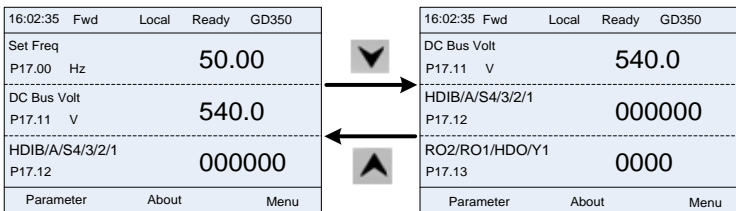



Figure 5-3 Stopped-state parameter display 1

Press  or  to switch between different display styles, including list display style and progress bar display style.

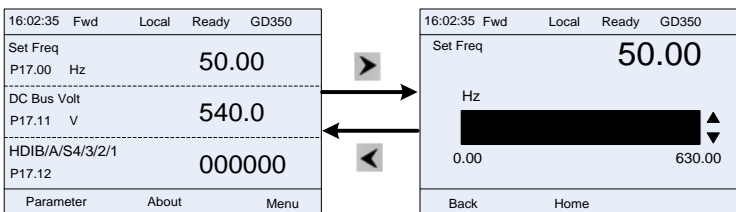



Figure 5-4 Stopped-state parameter display 2

The stopped-state parameter display list is user defined, and each state variable function code can be added to the stopped-state parameter display list as needed. A function code which has been added to the stopped-state parameter display list can also be deleted or shifted.

5.3.2 Displaying running-state parameters

After receiving a valid running command, the VFD will enter running state, and the keypad displays running state parameter with **RUN** indicator on the keypad turning on. In running state, multiple kinds of state parameters can be displayed. Press  or  to shift up or down.

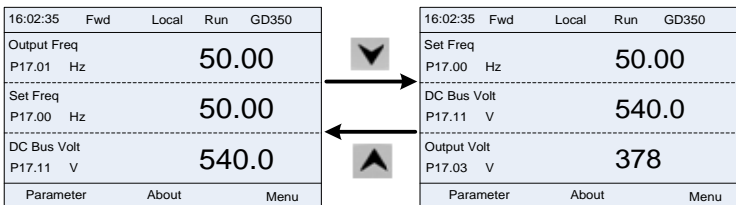

Figure 5-5 Running parameter display state

Press  or  to switch between different display styles, including list display style and progress bar display style.

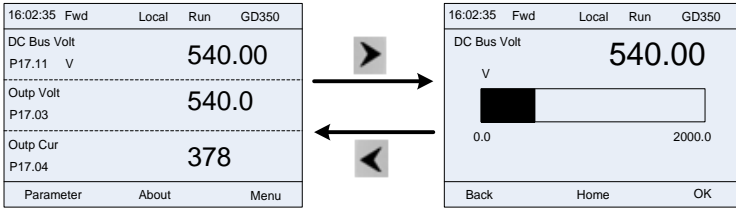

Figure 5-6 Running parameter display state

In running state, multiple kinds of state parameters can be displayed. The running display parameter list is user defined, and each state variable function code can be added to the running display parameter list as needed. A function code which has been added to the running display parameter list can also be deleted or shifted.

5.3.3 Displaying fault information

The VFD enters fault alarm display state once fault signal is detected, and the keypad displays fault code and fault information with **TRIP** indicator on the keypad turning on. Fault reset operation can be carried out via **STOP/RST** key, control terminal or communication command.

The fault code will be kept displaying until fault is removed.

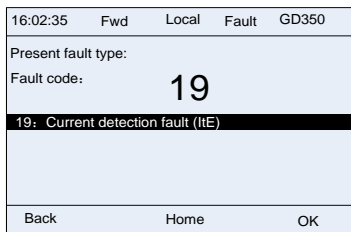

Figure 5-7 Fault alarm display state

5.4 Operating the VFD through the keypad

You can perform various operations on the VFD by using the keypad, including entering/exiting menu, parameter selection, list modification and parameter addition.

5.4.1 Entering/exiting menus

The keypad displays three main menus at the home interface by default: **Parameter**, **About**, and **Menu**. The following figure shows how to enter the **Parameter** main menu and how to operate under this main menu.

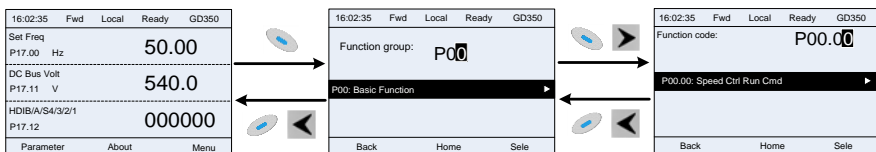

Figure 5-8 Enter/exit menu diagram 1

The following figure shows how to enter the **Menu** main menu and operate under this main menu.

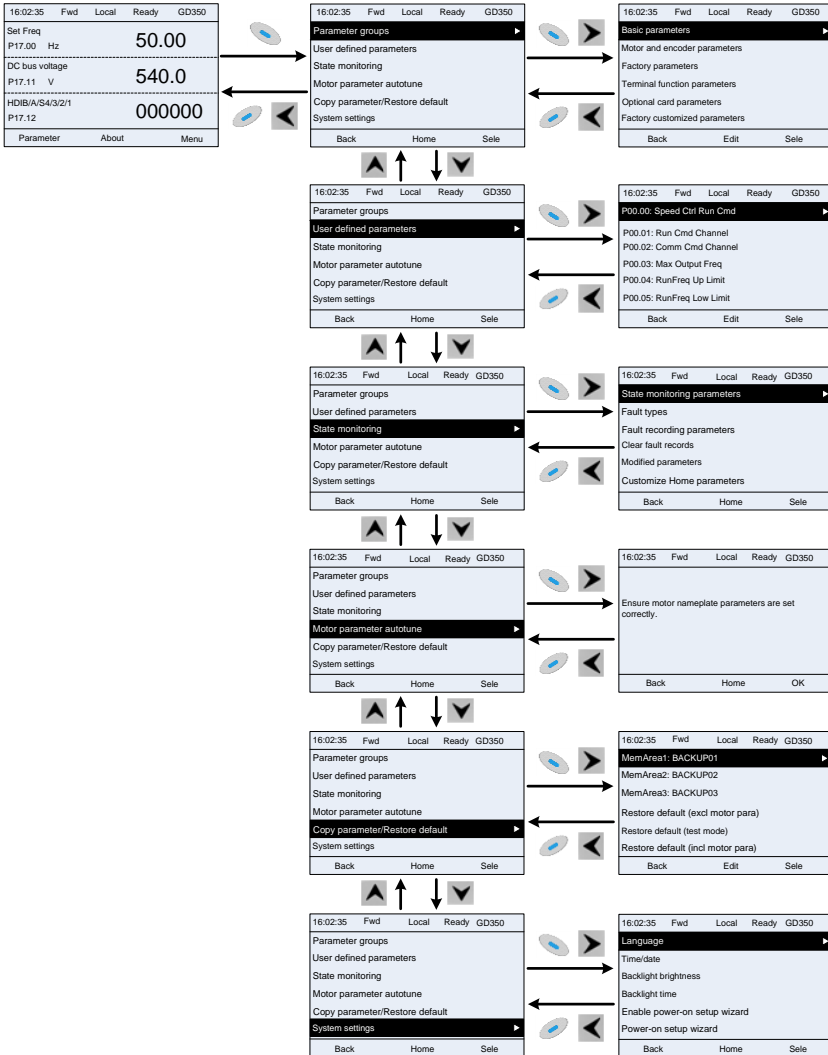

Figure 5-9 Enter/exit menu diagram 2

The keypad menu setup is shown as follows.

Level 1	Level 2	Level 3	Level 4
Parameter groups	Basic parameters	P00: Basic Function	P00.xx
		P01: Start/stop control	P01.xx
		P03: Motor1 Vector Ctrol	P03.xx
		P04: V/F Control	P04.xx
		P07: HMI	P07.xx

Level 1	Level 2	Level 3	Level 4	
		P08: Enhanced Function	P08.xx	
		P09: PID Control	P09.xx	
		P10: PLC&Mul-stepSpCtrl	P10.xx	
		P11: Protection Param	P11.xx	
		P13: SM Ctrl Param	P13.xx	
		P14: Serial Comm Func	P14.xx	
		P21: Position Ctrl	P21.xx	
		P22: Spdl Positioning	P22.xx	
		P23: Motor 2 Vector Ctrl	P23.xx	
	Motor and encoder parameters	P02: Motor 1 Param	P02.xx	
		P12: Motor 2 Param	P12.xx	
		P20: Motor 1 EEncoder	P20.xx	
		P24: Motor 2 Encoder	P24.xx	
	Factory parameters	P99: Factory Func	P99.xx	
	Terminal function parameters	P05: Input Terminals	P05.xx	
		P06: Output Terminals	P06.xx	
		P98: AIAO Calibration	P98.xx	
	Optional card parameters	P15: Comm Ex-card 1	P15.xx	
		P16: Comm Ex-card 2	P16.xx	
		P25: Ex I/OCard InpFunc	P25.xx	
		P26: Ex I/OCard OutpFunc	P26.xx	
		P27: PLC Func	P27.xx	
		P28: Master/slave Ctrl	P28.xx	
	Factory customized parameters	P90: Tension control speed mode	P90.xx	
		P91: Tension control torque	P91.xx	
		P92: Tension control optimization	P92.xx	
	User defined parameters	/	/	Pxx.xx ...
	State monitoring	State monitoring parameters	P07: HMI	P07.xx

Level 1	Level 2	Level 3	Level 4	
		P17: State Viewing Func	P17.xx	
		P18: Cl-IpCtrlStateView	P18.xx	
		P19: Ex-card StateView	P19.xx	
		P93: Tension control state viewing func	P93.xx	
	Fault types	/		P07.27: TypeofLatelyFault
				P07.28: Typeof1stLastFault
				P07.29: Typeof2ndLastFault
				P07.30: Typeof3rdLastFault
				P07.31: Typeof4thLastFault
				P07.32: Typeof5thLastFault
	Fault recording parameters	/		P07.33: RunFreq atLatelyFault ... P07.xx: xx state of fault xx
	Clear fault records	/		Sure to clear fault records?
Modified parameters	/		Pxx.xx: Modified parameter 1	
			Pxx.xx: Modified parameter 2	
			Pxx.xx: Modified parameter xx	
Customize Home parameters		Stopped-state parameters	/	
		Running-state parameters	/	
Motor parameter autotune	/	Ensure motor nameplate parameters are set correctly.	Complete para rotary autotune	
			Complete para static autotune	
			Partial para static autotune	
			Complete para rotary autotune 2 (for AM)	
			Partial para static autotune 2 (for AM)	
Copy parameter/Restore	/	MemArea1: BACKUP01	Upload local func para to keypad	

Level 1	Level 2	Level 3	Level 4
default			Download all func para from keypad
		Download NonMotor func para from keypad	
		Download motor func para from keypad	
		MemArea2: BACKUP012	Upload local func para to keypad
			Download all func para from keypad
			Download NonMotor func para from keypad
			Download motor func para from keypad
		MemArea3: BACKUP03	Upload local func para to keypad
			Download all func para from keypad
			Download NonMotor func para from keypad
			Download motor func para from keypad
		Restore default (excl motor para)	Sure to restore defaults (excl motor para)?
		Restore default (test mode)	Sure to restore default (test mode)?
Restore default (incl motor para)	Sure to restore default (incl motor para)?		
System settings	/	/	Language
			Time/date
			Backlight brightness
			Backlight time
			Enable power-on setup wizard
			Power-on setup wizard
			Keypad programming
			Fault time setting
			Control board programming
Up/Down key sensitivity			

5.4.2 Editing a parameter list

The parameters in the parameter list in stopped state can be added as needed (through the menu of user defined home parameters), and the list can also be edited such as "Move up", "Move down", "Delete from the list", and "Restore default". The edit function is shown in the following.

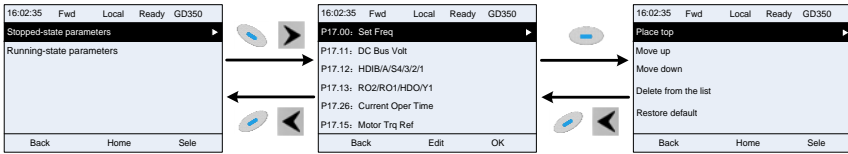

Figure 5-10 List edit diagram 1

Press key to enter edit interface, select the operation needed, and press the key, key or key to confirm the edit operation and return to the previous menu (parameter list), the returned list is the list edited. If the key or key is pressed in edit interface without selecting an edit operation, it will return to the previous menu (parameter list remain unchanged).

Note: For the parameter objects in the list header, move-up operation will be invalid, and the same principle can be applied to the parameter objects in the list footer; after deleting a certain parameter, the parameter objects under it will be moved up automatically.

The items in the parameter list in running state can be added as needed (through the menu of user defined home parameters), and the list can also be edited such as "Place top", "Move up", "Move down", "Delete from the list", and "Restore default parameters". The edit function is shown in the interface below.

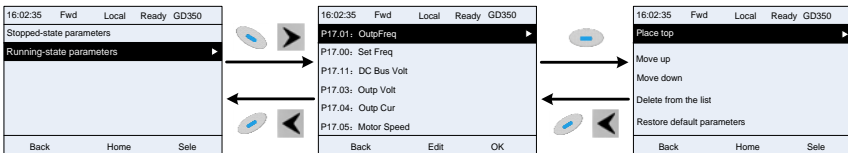

Figure 5-11 List edit diagram 2

The parameters of user defined parameter setting can be added, deleted or adjusted as needed, such as "Place top", "Move up", "Move down", "Delete from the list", and "Restore default parameters"; the adding function can be set in a certain function code in a function group. The edit function is shown in the figure below.

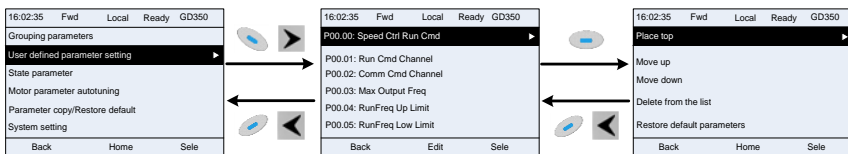

Figure 5-12 List edit diagram 3

5.4.3 Adding parameters to the parameter list displayed in stopped/running state

You can choose **Menu > State monitoring**, choose a submenu, and enter a specific function group and then a specific function code to add the parameter to the list of parameters displayed in stopped state or parameters displayed in running state.

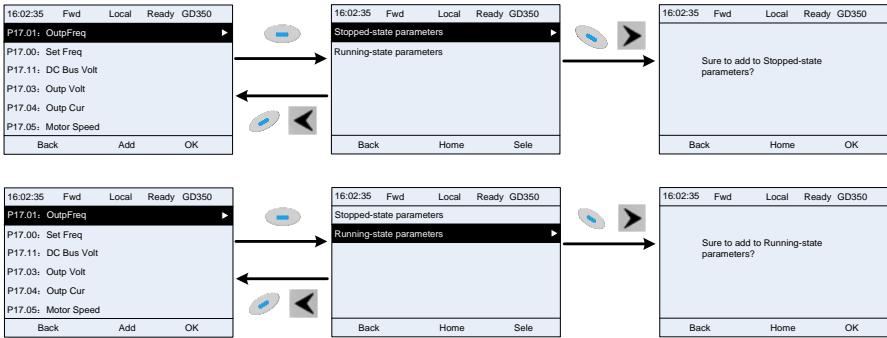







Figure 5-13 Adding parameter diagram 1

After selecting a specific function code, press  key to enter parameter addition interface, and press  key,  key or  key to confirm the addition operation. If this parameter is not included in the list of parameters displayed in stopped state or list of parameters displayed in running state, the parameter added will be at the end of the list; if the parameter is already in the list of parameters displayed in stopped state or list of parameters displayed in running state, the addition operation will be invalid. If  key or  key is pressed without selecting addition operation in "Addition" interface, it will return to monitoring parameter list menu.

Part of the monitoring parameters in P07 HMI group can be added to the "parameter displayed in stop state" list or "parameter displayed in running state" list; all the parameters in P17, P18 and P19 group can be added to the "parameter displayed in stop state" list or "parameter displayed in running state" list.

Up to 16 monitoring parameters can be added to the list of parameters displayed in stopped state; and up to 32 monitoring parameters can be added to the list of parameters displayed in running state.

5.4.4 Adding parameters to the user defined parameter list

You can choose **Menu > Parameter groups**, choose a submenu, and enter a specific function group and then a specific function code to add the parameter to the user defined parameter list.

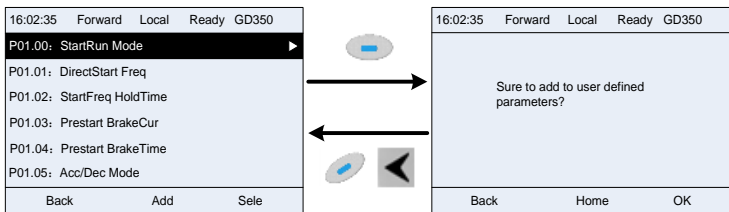

Figure 5-14 Add parameter diagram 2

Press key to enter addition interface, and press key, key or key to confirm the addition operation. If this parameter is not included in the original user defined parameter list, the newly-added parameter will be at the end of the list; if this parameter is already in the user defined parameter list, the addition operation will be invalid. If key or key is pressed without selecting addition operation, it will return to parameter setup list menu.

All the function code groups under the submenu can be added to user defined parameter list. Up to 64 function codes can be added to the user defined parameter list.

5.4.5 Editing user defined parameters

After accessing a specific function code under the **User defined parameters** menu, you can press the key, key or key to enter the parameter edit interface. After entering the edit interface, the present value is highlighted. Press the key and key to edit the parameter value, and the corresponding parameter item of current value will be highlighted automatically. After the edit operation is completed, press or key to save the selected parameter and return to the previous menu; or press key to maintain the value and return to the previous menu.

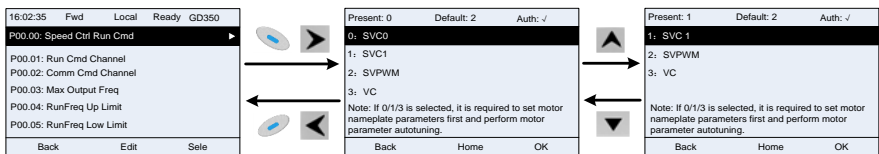

Figure 5-15 Editing user defined parameters

In parameter selection edit interface, the "Auth" field on the top right indicates whether this parameter is editable or not.











" ✓ " indicates the set value of this parameter can be modified under the present state.

" x " indicates the set value of this parameter cannot be modified under the present state.

"Present" indicates the present value.

"Default" indicates the default value of this parameter.

5.4.6 Editing parameters in parameter groups

You can choose **Menu > Parameter groups**, enter a specific function group and then a specific function code, and then press  key,  key or  key to edit the parameter setting interface. After entering edit interface, set the parameter from low bit to high bit, and the bit under setting will be highlighted. Press  key or  key to increase or decrease the parameter value (this operation is valid until the parameter value exceeds the max. value or min. value); press  or  to shift the editing bit. After parameters are set, press  or  key to save the set parameters and return to the previous menu; press  to maintain the original parameter value and return to the previous menu.

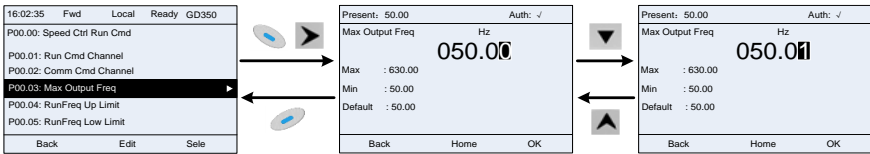

Figure 5-16 Editing parameters in parameter groups

In the parameter edit interface, the "Auth" field on the top right indicates whether this parameter can be modified or not.



" ✓ " indicates the set value of this parameter can be modified under the present state.

" x " indicates the set value of this parameter cannot be modified under the present state.

"Present" indicates the present value.

"Default" indicates the default value of this parameter.

5.4.7 Monitoring states

You can choose **Menu > State monitoring > State monitoring parameter**, enter a specific function group and then a specific function code, and press  key,  key or  key to enter the state monitoring interface. After entering the state monitoring interface, the actual parameter value will be displayed in real time, this value is the actually detected value which cannot be modified.

In the state monitoring interface, you can press  key or  key to return to the previous menu.

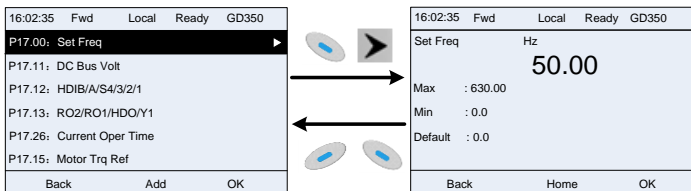

Figure 5-17 State monitoring interface

5.4.8 Autotuning motor parameters

You can choose **Menu > Motor parameter autotune** and press key, key or key to enter motor parameter autotuning interface. However, before entering the motor parameter autotuning interface, you must set the motor nameplate parameters correctly. After entering the interface, select a motor autotuning type to carry out motor parameter autotuning. In motor parameter autotuning interface, you can press key or key to return to the previous menu.

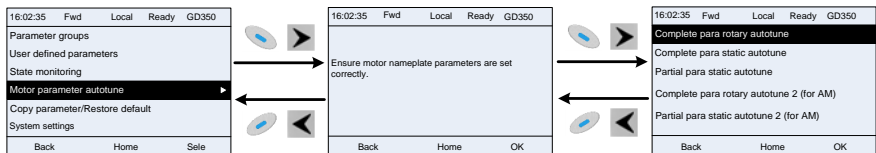

Figure 5-18 Selecting a parameter autotuning type

After selecting a motor autotuning type, enter motor parameter autotuning interface, and press **RUN** key to start motor parameter autotuning. After autotuning is done, a message will pop up indicating autotuning is succeeded, and then it will return to the main interface of stop. During autotuning, you can press **STOP/RST** key to terminate autotuning; if any fault occur during autotuning, the keypad will display a fault interface.

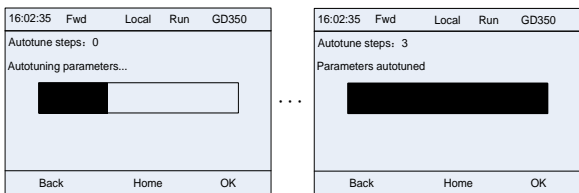

Figure 5-19 Parameter autotuning

5.4.9 Backing up parameters

You can choose **Menu > Copy parameter/Restore default**, and press key, key or key to enter the function parameter backup interface and function parameter restoration interface to upload/download VFD parameters, or restore VFD parameters to default values. The keypad has three different storage areas for parameter backup, and each storage area can save the parameters of one VFD, which means the keypad can save parameters of three VFDs in total.

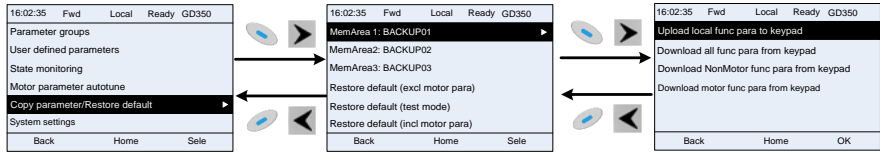

Figure 5-20 Parameter backup

5.4.10 System settings

You can choose **Menu > System settings**, and press key, key or key to enter system setting interface to set the keypad language, time/date, backlight brightness, backlight time and restore parameters.

Note: Clock battery is not included, and the keypad time/date needs to be reset after power off. If time-keeping after power off is needed, you should purchase the clock batteries separately.

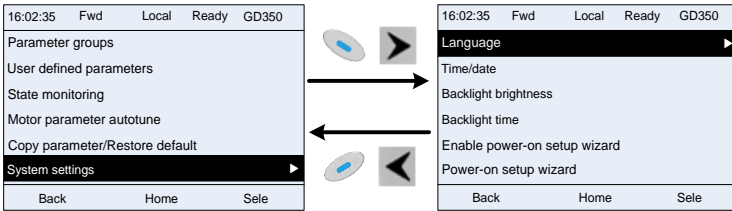

Figure 5-21 System setting diagram

5.4.11 Power-on setup wizard

The keypad supports the power-on setup wizard function, mainly for the first power-on situation, instructing you to enter the setting menu, and gradually implementing basic functions such as basic parameter setting, direction judgment, mode setting and autotuning.

For first power-on, the keypad automatically enters the setup wizard interface. See the following.

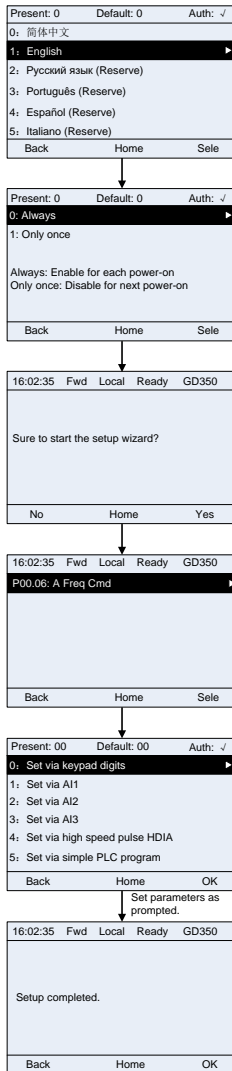

Figure 5-22 Power-up setup wizard

If you want to change the guiding settings, you can choose **Menu > System settings**, and then choose **Enable power-on setup wizard** or **Power-on setup wizard**, and then make changes.

5.5 Basic operations

5.5.1 What this section contains

This section introduces the function modules inside the VFD.



- ◇ Ensure all the terminals are fixed and tightened firmly.
- ◇ Ensure the motor matches with the VFD power.

5.5.2 Common commissioning procedures

The common operation procedures are shown below (taking motor 1 as an example).

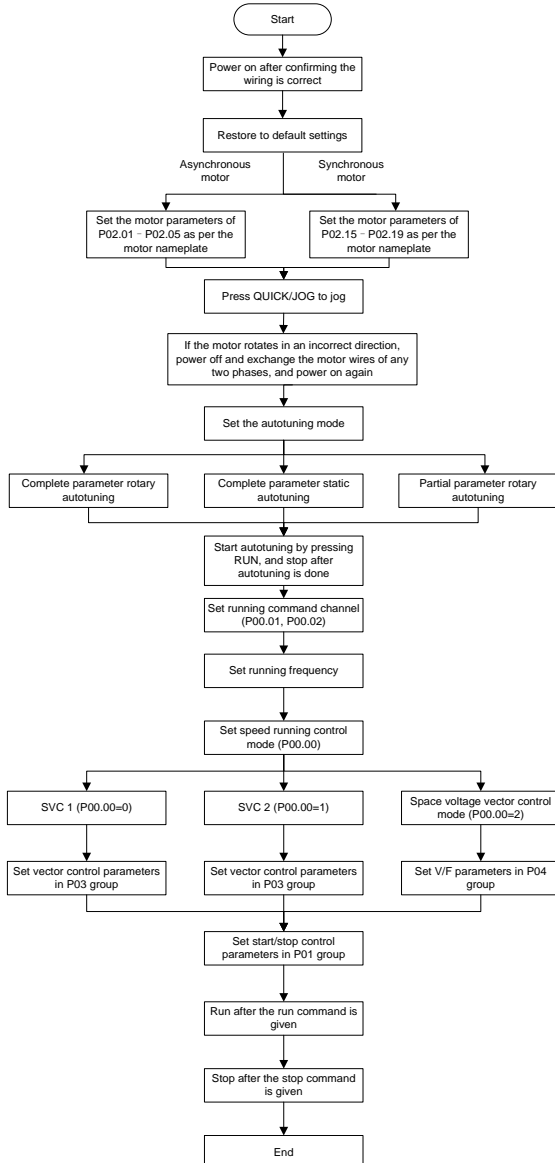

Note: If a fault occurs, find out the fault cause according to chapter 7 Troubleshooting.

The running command channel can be set by terminal commands besides P00.01 and P00.02.

Current running command channel P00.01	Multi-function terminal function (36) Command switched to keypad	Multi-function terminal function (37) Command switched to terminal	Multi-function terminal function (38) Command switched to communication
Keypad	/	Terminal	Communication
Terminal	Keypad	/	Communication
Communication	Keypad	Terminal	/

Note: "/" means this multi-function terminal is invalid under current reference channel.

Related parameter list:

Function code	Name	Description	Default value
P00.00	Speed control mode	0: Sensorless vector control (SVC) mode 0 1: SVC 1 2: SVPWM 3: FVC Note: To select 0, 1, or 3 as the control mode, enable the VFD to perform motor parameter autotuning first.	2
P00.01	Channel of running commands	0: Keypad 1: Terminal 2: Communication	0
P00.02	Communication mode of running commands	0: Modbus/Modbus TCP 1: PROFIBUS/CANopen/DeviceNet 2: Ethernet 3: EtherCAT/PROFINET/EtherNet IP 4: Programmable card 5: Bluetooth card 6: Reserved	0
P00.15	Motor parameter autotuning	0: No operation 1: Rotary autotuning 1; carry out comprehensive motor parameter autotuning; rotary autotuning is used in cases where high control precision is required; 2: Static autotuning 1 (comprehensive autotuning); static autotuning 1 is used in cases where the motor cannot be disconnected from load;	0

Function code	Name	Description	Default value
		<p>3: Static autotuning 2 (partial autotuning) ; when current motor is motor 1, only P02.06, P02.07 and P02.08 will be autotuned; when current motor is motor 2, only P12.06, P12.07 and P12.08 will be autotuned.</p> <p>4: Rotary autotuning 2, which is similar to rotary autotuning 1 but is only applicable to asynchronous motors.</p> <p>5: Rotary autotuning 3 (partial autotuning), which is only applicable to asynchronous motors.</p>	
P00.18	Function parameter restoration	<p>0: No operation</p> <p>1: Restore default values (excluding motor parameters)</p> <p>2: Clear fault records</p> <p>3: Reserved</p> <p>4: Reserved</p> <p>5: Restore default values (for factory test mode)</p> <p>6: Restore default values (including motor parameters)</p> <p>Note: After the selected operation is done, this parameter is automatically restored to 0. Restoring the default values may delete the user password. Exercise caution when using this function. The option 5 can be used only for factory testing.</p>	0
P02.00	Type of motor 1	<p>0: Asynchronous motor</p> <p>1: Synchronous motor</p>	0
P02.01	Rated power of asynchronous motor 1	0.1–3000.0kW	Depends on model
P02.02	Rated frequency of asynchronous motor 1	0.01Hz–P00.03 (Max. output frequency)	50.00Hz
P02.03	Rated speed of asynchronous motor 1	1–60000rpm	Depends on model
P02.04	Rated voltage of asynchronous motor 1	0–1200V	Depends on model
P02.05	Rated current of asynchronous motor 1	0.8–6000.0A	Depends on model

Function code	Name	Description	Default value
P02.15	Rated power of synchronous motor 1	0.1–3000.0kW	Depends on model
P02.16	Rated frequency of synchronous motor 1	0.01Hz–P00.03 (Max. output frequency)	50.00Hz
P02.17	Number of pole pairs of synchronous motor 1	1–50	2
P02.18	Rated voltage of synchronous motor 1	0–1200V	Depends on model
P02.19	Rated current of synchronous motor 1	0.8–6000.0A	Depends on model
P05.01–P05.06	Function of multi-function digital input terminal (S1–S4, HDIA, HDIB)	36: Command switches to keypad 37: Command switches to terminal 38: Command switches to communication	/
P07.01	Reserved	/	/
P07.02	QUICK/JOG key function	Range: 0x00–0x27 Ones: QUICK/JOG key function selection 0: No function 1: Jogging 2: Reserved 3: Switching between forward/reverse rotation 4: Clear UP/DOWN setting 5: Coast to stop 6: Switch running command reference mode by sequence 7: Reserved Tens: Reserved	0x01

5.5.3 Vector control

Asynchronous motors are featured with high order, non-linear, strong coupling and multi-variables, which makes it very difficult to control asynchronous motors during actual application. The vector control theory aims to solve this problem through measuring and controlling the stator current vector of asynchronous motor, and decomposing the stator current vector into exciting current (current component which generates internal magnet field) and torque current (current component which generates torque) based on field orientation principle, and then controlling the amplitude value and phase position of these two components (namely, control the stator current vector of motor) to realize decoupling control of exciting current and torque current, thus achieving high-performance speed regulation of asynchronous motor.

The VFD carries built-in speed sensor-less vector control algorithm, which can be used to drive the

asynchronous motor and permanent-magnet synchronous motor simultaneously. As the core algorithm of vector control is based on accurate motor parameter model, the accuracy of motor parameters will impact the control performance of vector control. It is recommended to input accurate motor parameters and carry out motor parameter autotuning before vector operation.

As vector control algorithm is complicated, you should be cautious of regulation on dedicated function parameters of vector control.

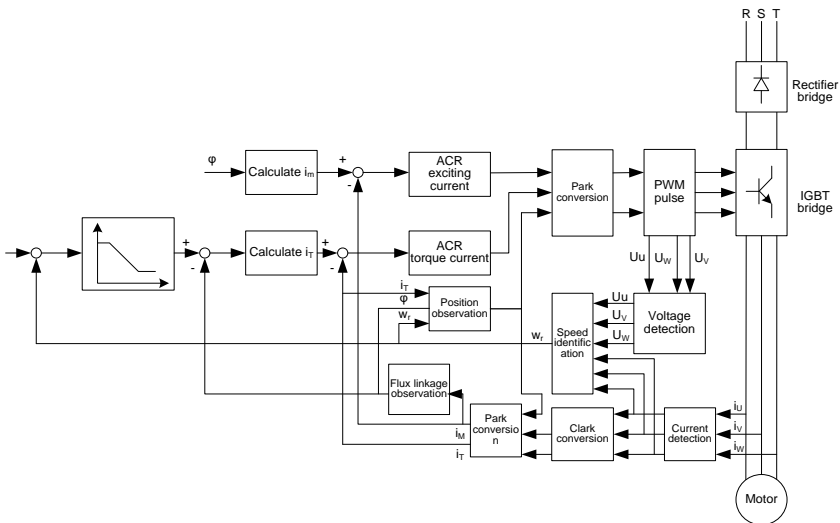

Function code	Name	Description	Default value
P00.00	Speed control mode	0: Sensorless vector control (SVC) mode 0 1: SVC 1 2: SVPWM 3: FVC Note: To select 0, 1, or 3 as the control mode, enable the VFD to perform motor parameter autotuning first.	2
P00.15	Motor parameter autotuning	0: No operation 1: Rotary autotuning 1; carry out comprehensive motor parameter autotuning; rotary autotuning is used in cases where high control precision is required; 2: Static autotuning 1 (comprehensive autotuning); static autotuning 1 is used in	0

Function code	Name	Description	Default value
		cases where the motor cannot be disconnected from load; 3: Static autotuning 2 (partial autotuning); when current motor is motor 1, only P02.06, P02.07 and P02.08 will be autotuned; when current motor is motor 2, only P12.06, P12.07 and P12.08 will be autotuned. 4: Rotary autotuning 2, which is similar to rotary autotuning 1 but is only applicable to asynchronous motors. 5: Rotary autotuning 3 (partial autotuning), which is only applicable to asynchronous motors.	
P02.00	Type of motor 1	0: Asynchronous motor 1: Synchronous motor	0
P03.00	Speed loop proportional gain 1	0–200.0	20.0
P03.01	Speed loop integral time 1	0.000–10.000s	0.200s
P03.02	Switching low point frequency	0.00Hz–P03.05	5.00Hz
P03.03	Speed loop proportional gain 2	0–200.0	20.0
P03.04	Speed loop integral time 2	0.000–10.000s	0.200s
P03.05	Switching high point frequency	P03.02–P00.03 (Max. output frequency)	10.00Hz
P03.06	Speed loop output filter	0–8 (corresponds to $0-2^8/10\text{ms}$)	0
P03.07	Electromotion slip compensation coefficient of vector control	50%–200%	100%
P03.08	Brake slip compensation coefficient of vector control	50%–200%	100%
P03.09	Current loop proportional coefficient P	0–65535	1000
P03.10	Current loop integral coefficient I	0–65535	1000
P03.11	Torque setting method	1: Keypad (P03.12) 2: AI1	1

Function code	Name	Description	Default value
		3: AI2 4: AI3 5: Pulse frequency HDIA 6: Multi-step torque 7: Modbus/Modbus TCP communication 8: PROFIBUS/CANopen/DeviceNet communication 9: Ethernet communication 10: Pulse frequency HDIB 11: EtherCAT/PROFINET/EtherNet IP communication 12: Programmable card Note: For these settings, 100% corresponds to the motor rated current.	
P03.12	Torque set through keypad	-300.0%–300.0% (of the motor rated current)	50.0%
P03.13	Torque reference filter time	0.000–10.000s	0.010s
P03.14	Setting source of FWD rotation frequency upper limit in torque control	0: Keypad (P03.16) 1: AI1 2: AI2 3: AI3 4: Pulse frequency HDIA 5: Multi-step setting 6: Modbus/Modbus TCP communication 7: PROFIBUS/CANopen/DeviceNet communication 8: Ethernet communication 9: Pulse frequency HDIB 10: EtherCAT/PROFINET/EtherNet IP communication 11: Programmable card 12: Reserved Note: For these settings, 100% corresponds to the max. frequency.	0
P03.15	Setting source of REV rotation frequency upper limit in torque control	0: Keypad (P03.17) 1–11: Same as those of P03.14	0
P03.16	FWD rotation frequency upper limit set through	Value range: 0.00 Hz–P00.03 (Max. output frequency)	50.00Hz

Function code	Name	Description	Default value
	keypad in torque control		
P03.17	REV rotation frequency upper limit set through keypad in torque control		50.00Hz
P03.18	Setting source of electromotive torque upper limit	0: Keypad (P03.20) 1: AI1 2: AI2 3: AI3 4: Pulse frequency HDIA 5: Modbus/Modbus TCP communication 6: PROFIBUS/CANopen/DeviceNet communication 7: Ethernet communication 8: Pulse frequency HDIB 9: EtherCAT/PROFINET/EtherNet IP communication 10: Programmable card 11: Reserved Note: For these settings, 100% corresponds to the motor rated current.	0
P03.19	Setting source of braking torque upper limit	0: Keypad (P03.21) 1–10: Same as those for P03.18	0
P03.20	Electromotive torque upper limit set through keypad	0.0–300.0% (of the motor rated current)	180.0%
P03.21	Braking torque upper limit set through keypad		180.0%
P03.22	Flux-weakening coefficient in constant power area	0.1–2.0	0.3
P03.23	Min. flux-weakening point in constant power area	10%–100%	20%
P03.24	Max. voltage limit	0.0–120.0%	100.0%
P03.25	Pre-exciting time	0.000–10.000s	0.300s
P03.32	Enabling torque control	0:Disable 1:Enable	0
P03.33	Flux weakening integral gain	0–8000	1200
P03.35	Control optimization setting	0x0000–0x1111 Ones place: Torque command selection	0x0000

Function code	Name	Description	Default value
		0: Torque reference 1: Torque current reference Tens place: Reserved 0: Reserved 1: Reserved Hundreds place: Whether to enable ASR integral separation 0: Disable 1: Enable Thousands place: Reserved 0: Reserved 1: Reserved	
P03.36	ASR differential gain	0.00–10.00s	0.00s
P03.37	High-frequency ACR proportional coefficient	In the FVC (P00.00=3), when the frequency is lower than the ACR high-frequency switching threshold (P03.39), the ACR PI parameters are P03.09 and P03.10; and when the frequency is higher than the ACR high-frequency switching threshold (P03.39), the ACR PI parameters are P03.37 and P03.38. Setting range of P03.37: 0–65535 Setting range of P03.38: 0–65535 Setting range of P03.39: 0.0–100.0% (in relative to the maximum frequency)	1000
P03.38	High-frequency ACR integral coefficient		1000
P03.39	ACR high-frequency switching threshold		100.0%
P17.32	Flux linkage	0.0–200.0%	0.0%

5.5.4 SVPWM control mode

The VFD also carries built-in SVPWM control function. SVPWM mode can be used in cases where mediocre control precision is enough. In cases where a VFD needs to drive multiple motors, it is also recommended to adopt SVPWM control mode.

The VFD provides multiple kinds of V/F curve modes to meet different field needs. You can select corresponding V/F curve or set the V/F curve as needed.

Suggestions:

- For the load featuring constant moment, such as conveyor belt which runs in straight line, as the moment should be constant during the whole running process, it is recommended to adopt straight-type V/F curve.
- For the load featuring decreasing moment, such as fan and water pump, as the relation

between its actual torque and speed is squared or cubed, it is recommended to adopt the V/F curve corresponds to power 1.3, 1.7 or 2.0.

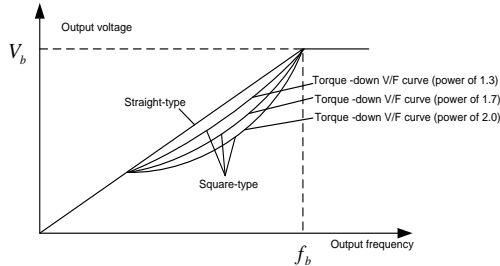

The VFD also provides multi-point V/F curve. You can alter the V/F curve outputted by VFD through setting the voltage and frequency of the three points in the middle. The whole curve consists of five points starting from (0Hz, 0V) and ending in (fundamental motor frequency, rated motor voltage). During setting, follow the rule: $0 \leq f_1 \leq f_2 \leq f_3 \leq$ Motor fundamental frequency, and, $0 \leq V_1 \leq V_2 \leq V_3 \leq$ Motor rated voltage

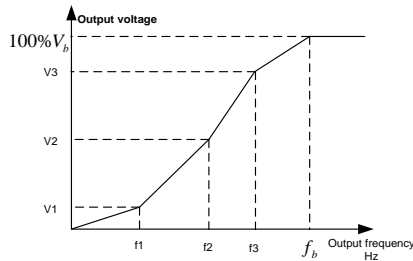

The VFD provides dedicated function codes for SVPWM control mode. You can improve the performance of SVPWM through settings.

1. Torque boost

Torque boost function can effectively compensate for the low-speed torque performance during SVPWM control. Automatic torque boost has been set by default to enable the VFD to adjust the torque boost value based on actual load conditions.

Note:

- (1) Torque boost is effective only under torque boost cut-off frequency;
- (2) If the torque boost is too large, low-frequency vibration or overcurrent may occur to the motor, if such situation occurs, lower the torque boost value.

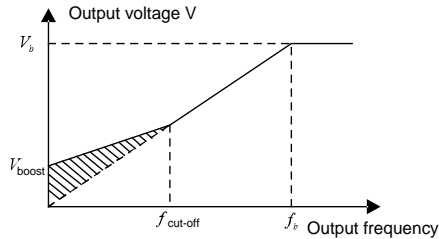

2. Energy-saving run

During actual running, the VFD can search for the max. efficiency point to keep running in the most efficient state to save energy.

Note:

- This function is generally used in light load or no-load cases.
- This function does for fit in cases where load transient is required.

3. V/F slip compensation gain

SVPWM control belongs to open-loop mode, which will cause motor speed to fluctuate when motor load transients. In cases where strict speed requirement is needed, you can set the slip compensation gain to compensate for the speed variation caused by load fluctuation through VFD internal output adjustment.

The setting range of slip compensation gain is 0–200%, in which 100% corresponds to the rated slip frequency.

Note: Rated slip frequency = (Rated synchronous rotation speed of motor – Rated rotation speed of motor) x (Number of motor pole pairs)/60

4. Oscillation control

Motor oscillation often occurs in space voltage vector control in large-power driving applications. To solve this problem, the VFD provides two oscillation factor function codes. You can set the function codes based on the oscillation occurrence frequency.

Note: A greater value indicates better control effect. However, if the value is too large, the VFD output current may be too large.

5. Asynchronous motor IF control

Generally, the IF control mode is valid for asynchronous motors. It can be used for a synchronous motor only when the frequency of the synchronous motor is extremely low. Therefore, the IF control described in this manual is only involved with asynchronous motors. IF control is implemented by performing closed-loop control on the total output current of the VFD. The output voltage adapts to the current reference, and open-loop control is separately performed over the frequency of the voltage and current.

Customized V/F curve (V/F separation) function:

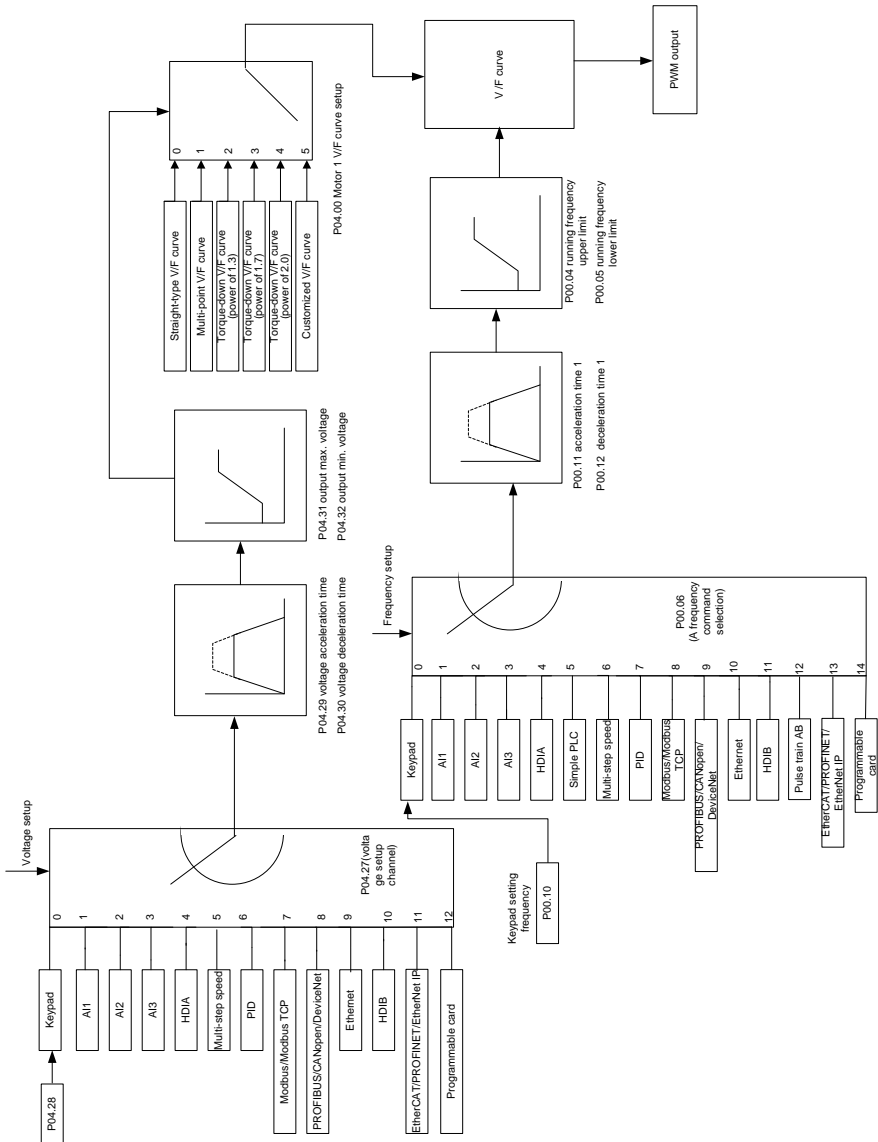

When selecting customized V/F curve function, you can set the reference channels and acceleration/deceleration time of voltage and frequency respectively, which will form a real-time V/F curve through combination.

Note: This kind of V/F curve separation can be applied in various frequency-conversion power sources, however, you should be cautious of parameter setup as improper setup may damage the machine.

Function code	Name	Description	Default value
P00.00	Speed control mode	0: Sensorless vector control (SVC) mode 0 1: SVC 1 2: SVPWM 3: FVC Note: To select 0, 1, or 3 as the control mode, enable the VFD to perform motor parameter autotuning first	2
P00.03	Max. output frequency	P00.04–400.00Hz	50.00Hz
P00.04	Upper limit of running frequency	P00.05–P00.03	50.00Hz
P00.05	Lower limit of running frequency	0.00Hz–P00.04	0.00Hz
P00.11	Acceleration time 1	0.0–3600.0s	Depends on model
P00.12	Deceleration time 1	0.0–3600.0s	Depends on model
P02.00	Type of motor 1	0: Asynchronous motor 1: Synchronous motor	0
P02.02	Rated power of asynchronous motor 1	0.01Hz–P00.03 (Max. output frequency)	50.00Hz
P02.04	Rated voltage of asynchronous motor 1	0–1200V	Depends on model
P04.00	V/F curve setting of motor 1	0: Straight-type V/F curve 1: Multi-point V/F curve 2: Torque-down V/F curve (power of 1.3) 3: Torque-down V/F curve (power of 1.7) 4: Torque-down V/F curve (power of 2.0) 5: Customized V/F (V/F separation)	0
P04.01	Torque boost of motor 1	0.0%: (automatic) 0.1%–10.0%	0.0%
P04.02	Motor 1 torque boost cut-off	0.0%–50.0% (rated frequency of motor 1)	20.0%
P04.03	V/F frequency point 1 of motor 1	0.00Hz–P04.05	0.00Hz
P04.04	V/F voltage point 1 of	0.0%–110.0%	0.0%

Function code	Name	Description	Default value
	motor 1		
P04.05	V/F frequency point 2 of motor 1	P04.03– P04.07	0.00Hz
P04.06	V/F voltage point 2 of motor 1	0.0%–110.0%	0.0%
P04.07	V/F frequency point 3 of motor 1	P04.05– P02.02 or P04.05– P02.16	0.00Hz
P04.08	V/F voltage point 3 of motor 1	0.0%–110.0%	0.0%
P04.09	V/F slip compensation gain of motor 1	0.0–200.0%	100.0%
P04.10	Low-frequency oscillation control factor of motor 1	0–100	10
P04.11	High-frequency oscillation control factor of motor 1	0–100	10
P04.12	Oscillation control threshold of motor 1	0.00Hz–P00.03 (Max. output frequency)	30.00Hz
P04.13	V/F curve setup of motor 2	0: Straight V/F curve 1: Multi-point V/F curve 2: Torque-down V/F curve (power of 1.3) 3: Torque-down V/F curve (power of 1.7) 4: Torque-down V/F curve (power of 2.0) 5: Customize V/F (V/F separation)	0
P04.14	Torque boost of motor 2	0.0%: (automatic) 0.1%–10.0%	0.0%
P04.15	Motor 2 torque boost cut-off	0.0%–50.0% (rated frequency of motor 1)	20.0%
P04.16	V/F frequency point 1 of motor 2	0.00Hz–P04.18	0.00Hz
P04.17	V/F voltage point 1 of motor 2	0.0%–110.0%	0.0%
P04.18	V/F frequency point 2 of motor 2	P04.16– P04.20	0.00Hz
P04.19	V/F voltage point 2 of motor 2	0.0%–110.0%	0.0%
P04.20	V/F frequency point 3	P04.18–P02.02 or P04.18–P02.16	0.00Hz

Function code	Name	Description	Default value
	of motor 2		
P04.21	V/F voltage point 3 of motor 2	0.0%–110.0%	0.0%
P04.22	V/F slip compensation gain of motor 2	0.0–200.0%	100.0%
P04.23	Low-frequency oscillation control factor of motor 2	0–100	10
P04.24	High-frequency oscillation control factor of motor 2	0–100	10
P04.25	Oscillation control threshold of motor 2	0.00Hz–P00.03 (Max. output frequency)	30.00Hz
P04.26	Energy-saving run	0: No 1: Automatic energy-saving run	0
P04.27	Voltage setting channel	0: Keypad; output voltage is determined by P04.28 1: AI1 2: AI2 3: AI3 4: HDIA 5: Multi-step 6: PID 7: Modbus/Modbus TCP communication 8: PROFIBUS/CANopen/DeviceNet communication 9: Ethernet communication 10: HDIB 11: EtherCAT/PROFINET/EtherNet IP communication 12: Programmable card 13: Reserved	0
P04.28	Set voltage value via keypad	0.0%–100.0% (rated motor voltage)	100.0%
P04.29	Voltage increase time	0.0–3600.0s	5.0s
P04.30	Voltage decrease time	0.0–3600.0s	5.0s
P04.31	Output max. voltage	P04.32–100.0% (rated motor voltage)	100.0%
P04.32	Output min. voltage	0.0%–P04.31 (rated motor voltage)	0.0%
P04.33	Flux-weakening	1.00–1.30	1.00

Function code	Name	Description	Default value
	coefficient in the constant power zone		
P04.34	Pull-in current 1 in synchronous motor VF control	When the synchronous motor VF control mode is enabled, this parameter is used to set the reactive current of the motor when the output frequency is lower than the frequency set in P04.36. Setting range: -100.0%→+100.0% (of the motor rated current)	20.0%
P04.35	Pull-in current 2 in synchronous motor VF control	When the synchronous motor VF control mode is enabled, this parameter is used to set the reactive current of the motor when the output frequency is higher than the frequency set in P04.36. Setting range: -100.0%→+100.0% (of the motor rated current)	10.0%
P04.36	Frequency threshold for pull-in current switching in synchronous motor VF control	When the synchronous motor VF control mode is enabled, this parameter is used to set the frequency threshold for the switching between input current 1 and pull-in current 2. Setting range: 0.0%–200.0% (of the motor rated frequency)	20.0%
P04.37	Reactive current closed-loop proportional coefficient in synchronous motor VF control	When the synchronous motor VF control mode is enabled, this parameter is used to set the proportional coefficient of the reactive current closed-loop control. Setting range: 0–3000	50
P04.38	Reactive current closed-loop integral time in synchronous motor VF control	When the synchronous motor VF control mode is enabled, this parameter is used to set the integral coefficient of the reactive current closed-loop control. Setting range: 0–3000	30
P04.39	Reactive current closed-loop output limit in synchronous motor VF control	When the synchronous motor VF control mode is enabled, this parameter is used to set the output limit of the reactive current closed-loop control. A greater value indicates a higher reactive closed-loop compensation voltage and higher output power of the motor. In general, you do not need to modify this parameter. Setting range: 0–16000	8000

Function code	Name	Description	Default value
P04.40	Enable/disable IF mode for asynchronous motor 1	0: Disabled 1: Enabled	0
P04.41	Current setting in IF mode for asynchronous motor 1	When IF control is adopted for asynchronous motor 1, this parameter is used to set the output current. The value is a percentage in relative to the rated current of the motor. Setting range: 0.0–200.0%	120.0%
P04.42	Proportional coefficient in IF mode for asynchronous motor 1	When IF control is adopted for asynchronous motor 1, this parameter is used to set the proportional coefficient of the output current closed-loop control. Setting range: 0–5000	650
P04.43	Integral coefficient in IF mode for asynchronous motor 1	When IF control is adopted for asynchronous motor 1, this parameter is used to set the integral coefficient of the output current closed-loop control. Setting range: 0–5000	350
P04.44	Starting frequency point for switching off IF mode for asynchronous motor 1	0.00Hz–P04.50	10.00Hz
P04.45	Enable/disable IF mode for asynchronous motor 2	0: Disable 1: Enable	0
P04.46	Current setting in IF mode for asynchronous motor 2	When IF control is adopted for asynchronous motor 2, this parameter is used to set the output current. The value is a percentage in relative to the rated current of the motor. Setting range: 0.0–200.0%	120.0%
P04.47	Proportional coefficient in IF mode for asynchronous motor 2	When IF control is adopted for asynchronous motor 2, this parameter is used to set the proportional coefficient of the output current closed-loop control. Setting range: 0–5000	650
P04.48	Integral coefficient in IF mode for asynchronous motor 2	When IF control is adopted for asynchronous motor 2, this parameter is used to set the integral coefficient of the output current closed-loop control. Setting range: 0–5000	350
P04.49	Starting frequency point for switching off IF mode for	0.00Hz–P04.51	10.00Hz

Function code	Name	Description	Default value
	asynchronous motor 2		
P04.50	End frequency point for switching off IF mode for asynchronous motor 1	P04.44–P00.03	25.00Hz
P04.51	End frequency point for switching off IF mode for asynchronous motor 2	P04.49–P00.03	25.00Hz

5.5.5 Torque control

The VFD supports torque control and speed control. Speed control mode aims to stabilize the speed to keep the set speed consistent with the actual running speed, meanwhile, the max. load-carrying capacity is restricted by torque limit. Torque control mode aims to stabilize the torque to keep the set torque consistent with the actual output torque, meanwhile, the output frequency is restricted by upper/lower limit.

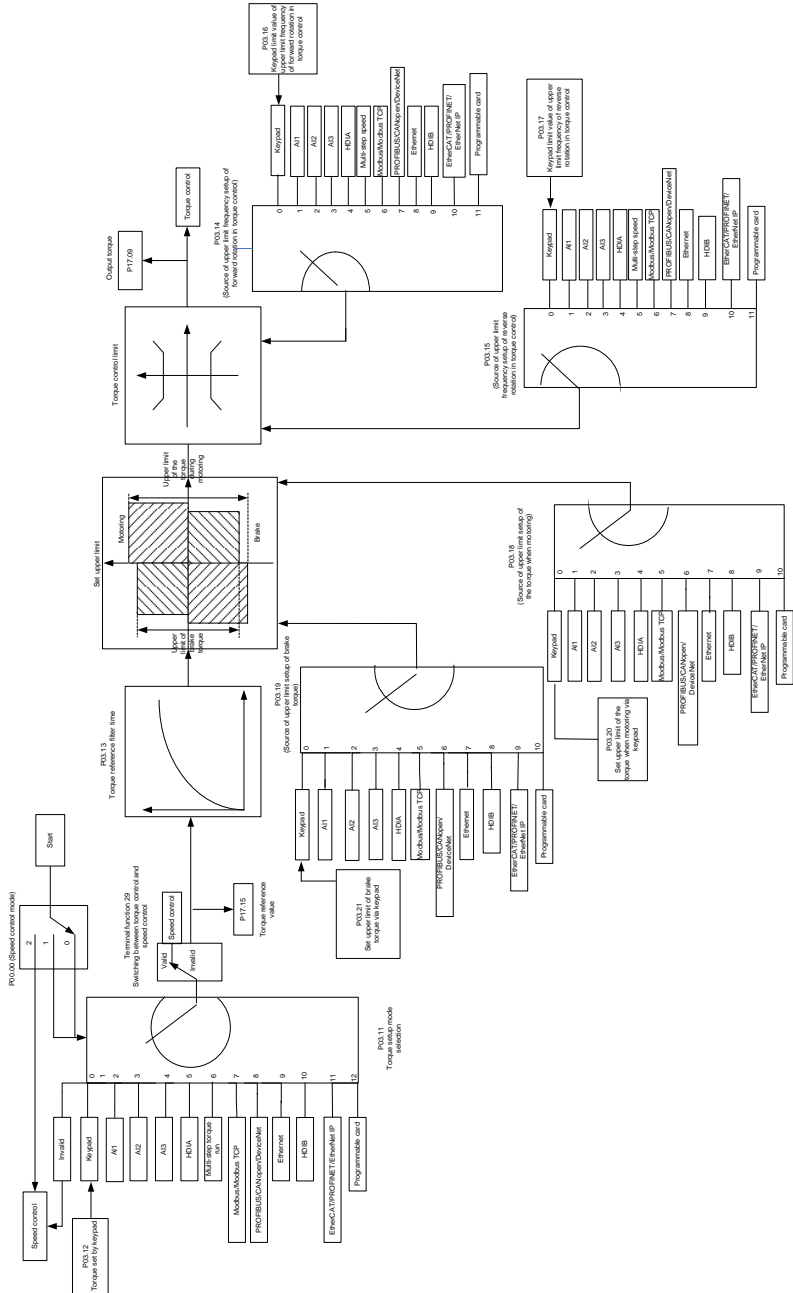



Function code	Name	Description	Default value
P00.00	Speed control mode	0: Sensorless vector control (SVC) mode 0 1: SVC 1 2: SVPWM 3: FVC Note: To select 0, 1, or 3 as the control mode, enable the VFD to perform motor parameter autotuning first	2
P03.32	Enabling torque control	0: Disable 1: Enable	0
P03.11	Torque setting method	0–1: Keypad (P03.12) 2: AI1 3: AI2 4: AI3 5: Pulse frequency HDIA 6: Multi-step torque 7: Modbus/Modbus TCP communication 8: PROFIBUS/CANopen/DeviceNet communication 9: Ethernet communication 10: Pulse frequency HDIB 11: EtherCAT/PROFINET/EtherNet IP communication 12: Programmable card Note: For these settings, 100% corresponds to the motor rated current.	0
P03.12	Torque set through keypad	-300.0%–300.0% (of the motor rated current)	50.0%
P03.13	Torque reference filter time	0.000–10.000s	0.010s
P03.14	Setting source of FWD rotation frequency upper limit in torque control	0: Keypad (P03.16) 1: AI1 2: AI2 3: AI3 4: Pulse frequency HDIA 5: Multi-step setting 6: Modbus/Modbus TCP communication 7: PROFIBUS/CANopen/DeviceNet communication 8: Ethernet communication	0

Function code	Name	Description	Default value
		9: Pulse frequency HDIB 10: EtherCAT/PROFINET/EtherNet IP communication 11: Programmable card 12: Reserved Note: For these settings, 100% corresponds to the max. frequency.	
P03.15	Setting source of REV rotation frequency upper limit in torque control	0: Keypad (P03.17) 1: AI1 2: AI2 3: AI3 4: Pulse frequency HDIA 5: Multi-step setting 6: Modbus/Modbus TCP communication 7: PROFIBUS/CANopen/DeviceNet communication 8: Ethernet communication 9: Pulse frequency HDIB 10: EtherCAT/PROFINET/EtherNet IP communication 11: Programmable card 12: Reserved Note: For these settings, 100% corresponds to the max. frequency.	0
P03.16	FWD rotation frequency upper limit set through keypad in torque control	0.00Hz–P00.03 (Max. output frequency)	50.00 Hz
P03.17	REV rotation frequency upper limit set through keypad in torque control	0.00Hz–P00.03 (Max. output frequency)	50.00 Hz
P03.18	Setting source of electromotive torque upper limit	0: Keypad (P03.20) 1: AI1 2: AI2 3: AI3 4: Pulse frequency HDIA	0

Function code	Name	Description	Default value
		5: Modbus/Modbus TCP communication 6: PROFIBUS/CANopen/DeviceNet communication 7: Ethernet communication 8: Pulse frequency HDIB 9: EtherCAT/PROFINET/EtherNet IP communication 10: Programmable card 11: Reserved Note: For these settings, 100% corresponds to the motor rated current.	
P03.19	Setting source of braking torque upper limit	0: Keypad (P03.21) 1: AI1 2: AI2 3: AI3 4: Pulse frequency HDIA 5: Modbus/Modbus TCP communication 6: PROFIBUS/CANopen/DeviceNet communication 7: Ethernet communication 8: Pulse frequency HDIB 9: EtherCAT/PROFINET/EtherNet IP communication 10: Programmable card 11: Reserved Note: For these settings, 100% corresponds to the motor rated current.	0
P03.20	Electromotive torque upper limit set through keypad	0.0–300.0% (of the motor rated current)	180.0%
P03.21	Braking torque upper limit set through keypad	0.0–300.0% (of the motor rated current)	180.0%
P17.09	Motor output torque	-250.0–250.0%	0.0%
P17.15	Torque reference value	-300.0–300.0% (of the motor rated current)	0.0%

5.5.6 Motor parameter

	<ul style="list-style-type: none"> ◇ Check the safety conditions surrounding the motor and load machineries before autotuning as physical injury may occur due to sudden start of motor during autotuning. ◇ Although the motor does not run during static autotuning, the motor is stilled supplied with power, do not touch the motor during autotuning; otherwise, electric shock may occur.
	<ul style="list-style-type: none"> ◇ If the motor has been connected to load, do not carry out rotary autotuning; otherwise, misact or damage may occur to the VFD. If rotary autotuning is carried out on a motor which has been connected to load, wrong motor parameters and motor misacts may occur. Disconnect the load to carry out autotuning if necessary.

The VFD can drive asynchronous motors and synchronous motors, and it supports two sets of motor parameters, which can be switched over by multi-function digital input terminals or communication modes.

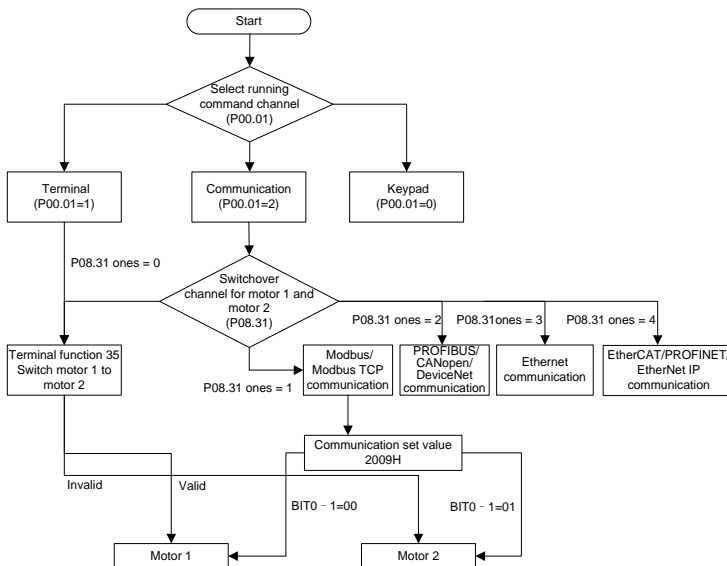

The control performance of the VFD is based on the accurate motor model, therefore, you need to carry out motor parameter autotuning before running the motor for the first time (taking motor 1 as an example).

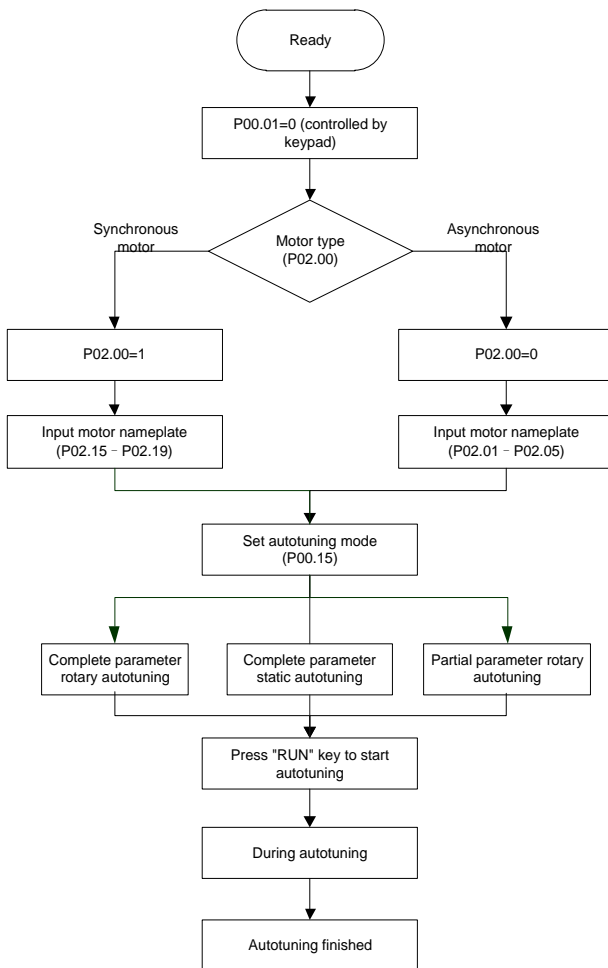

Note:

1. Motor parameters must be set correctly according to motor nameplate;
2. If rotary autotuning is selected during motor autotuning, it is a must to disconnect the motor from load to put the motor in static and no-load state, failed to do so may lead to inaccurate autotuned results. At this time, the asynchronous motor can autotune P02.06–P02.10, and synchronous motor can autotune P02.20–P02.23.
3. If static autotuning is selected during motor autotuning, there is no need to disconnect the motor from load, as only part of the motor parameters have been autotuned, the control performance may be impacted, under such situation, the asynchronous motor can autotune P02.06–P02.10, while synchronous motor can autotune P02.20–P02.22, P02.23 (counter-emf constant of

synchronous motor 1) can be obtained via calculation.

4. Motor autotuning can be carried out on current motor only, if you need to perform autotuning on the other motor, switch over the motor through selecting the switchover channel of motor 1 and motor 2 by setting the ones of P08.31.

Related parameter list:

Function code	Name	Description	Default value
P00.01	Channel of running commands	0: Keypad 1: Terminal 2: Communication	0
P00.15	Motor parameter autotuning	0: No operation 1: Rotary autotuning 1; carry out comprehensive motor parameter autotuning; rotary autotuning is used in cases where high control precision is required; 2: Static autotuning 1 (comprehensive autotuning); static autotuning 1 is used in cases where the motor cannot be disconnected from load; 3: Static autotuning 2 (partial autotuning) ; when current motor is motor 1, only P02.06, P02.07 and P02.08 will be autotuned; when current motor is motor 2, only P12.06, P12.07 and P12.08 will be autotuned. 4: Rotary autotuning 2, which is similar to rotary autotuning 1 but is only applicable to asynchronous motors. 5: Rotary autotuning 3 (partial autotuning), which is only applicable to asynchronous motors.	0
P02.00	Type of motor 1	0: Asynchronous motor 1: Synchronous motor	0
P02.01	Rated power of asynchronous motor 1	0.1–3000.0kW	Depends on model
P02.02	Rated frequency of asynchronous motor 1	0.01Hz–P00.03 (Max. output frequency)	50.00Hz
P02.03	Rated speed of asynchronous motor 1	1–60000rpm	Depends on model

Function code	Name	Description	Default value
P02.04	Rated voltage of asynchronous motor 1	0–1200V	Depends on model
P02.05	Rated current of asynchronous motor 1	0.8–6000.0A	Depends on model
P02.06	Stator resistance of asynchronous motor 1	0.001–65.535Ω	Depends on model
P02.07	Rotor resistance of asynchronous motor 1	0.001–65.535Ω	Depends on model
P02.08	Leakage inductance of asynchronous motor 1	0.1–6553.5mH	Depends on model
P02.09	Mutual inductance of asynchronous motor 1	0.1–6553.5mH	Depends on model
P02.10	No-load current of asynchronous motor 1	0.1–6553.5A	Depends on model
P02.15	Rated power of synchronous motor 1	0.1–3000.0kW	Depends on model
P02.16	Rated frequency of synchronous motor 1	0.01Hz–P00.03 (Max. output frequency)	50.00Hz
P02.17	Number of pole pairs of synchronous motor 1	1–50	2
P02.18	Rated voltage of synchronous motor 1	0–1200V	Depends on model
P02.19	Rated current of synchronous motor 1	0.8–6000.0A	Depends on model
P02.20	Stator resistance of synchronous motor 1	0.001–65.535Ω	Depends on model
P02.21	Direct-axis inductance of synchronous motor 1	0.01–655.35mH	Depends on model
P02.22	Quadrature-axis inductance of synchronous motor 1	0.01–655.35mH	Depends on model
P02.23	Counter-emf constant of synchronous motor 1	0–10000	300
P05.01– P05.06	Function of multi-function digital input terminal (S1–S4, HDIA, HDIB)	35: Switch from motor 1 to motor 2	/
P08.31	Switching between motor 1 and motor 2	0x00–0x14 Ones: Switchover channel 0: Switch over by	0x00

Function code	Name	Description	Default value
		terminal 1: Switch over by Modbus/Modbus TCP communication 2: Switch over by PROFIBUS/CANopen/DeviceNet 3: Switch over by Ethernet communication 4: Switch over by EtherCAT/PROFINET/EtherNet IP communication Tens: Motor switchover during running 0: Disable switchover during running 1: Enable switchover during running	
P12.00	Type of motor 2	0: Asynchronous motor 1: Synchronous motor	0
P12.01	Rated power of asynchronous motor 2	0.1–3000.0kW	Depends on model
P12.02	Rated frequency of asynchronous motor 2	0.01Hz–P00.03 (Max. output frequency)	50.00Hz
P12.03	Rated speed of asynchronous motor 2	1–60000rpm	Depends on model
P12.04	Rated voltage of asynchronous motor 2	0–1200V	
P12.05	Rated current of asynchronous motor 2	0.8–6000.0A	
P12.06	Stator resistance of asynchronous motor 2	0.001–65.535Ω	
P12.07	Rotor resistance of asynchronous motor 2	0.001–65.535Ω	
P12.08	Leakage inductance of asynchronous motor 2	0.1–6553.5mH	
P12.09	Mutual inductance of asynchronous motor 2	0.1–6553.5mH	
P12.10	No-load current of asynchronous motor 2	0.1–6553.5A	
P12.15	Rated power of synchronous motor 2	0.1–3000.0kW	
P12.16	Rated frequency of	0.01Hz–P00.03 (Max. output frequency)	

Function code	Name	Description	Default value
	synchronous motor 2		
P12.17	Number of pole pairs of synchronous motor 2	1–50	2
P12.18	Rated voltage of synchronous motor 2	0–1200V	Depends on model
P12.19	Rated current of synchronous motor 2	0.8–6000.0A	Depends on model
P12.20	Stator resistance of synchronous motor 2	0.001–65.535Ω	Depends on model
P12.21	Direct-axis inductance of synchronous motor 2	0.01–655.35mH	Depends on model
P12.22	Quadrature-axis inductance of synchronous motor 2	0.01–655.35mH	Depends on model
P12.23	Counter-emf constant of synchronous motor 2	0–10000	300

5.5.7 Start/stop control

The start/stop control of the VFD is divided into three states: start after running command at power-on; start after restart-at-power-cut function is effective; start after automatic fault reset. Descriptions for these three start/stop control states are presented below.

There are three start modes for the VFD, which are start at starting frequency, start after DC brake, and start after speed-tracking. You can select the proper start mode based on field conditions.

For large-inertia load, especially in cases where reversal may occur, you can choose to start after DC braking or start after speed-racking.

Note: It is recommended to drive synchronous motors in direct start mode.

1. Logic diagram for running command after power-on

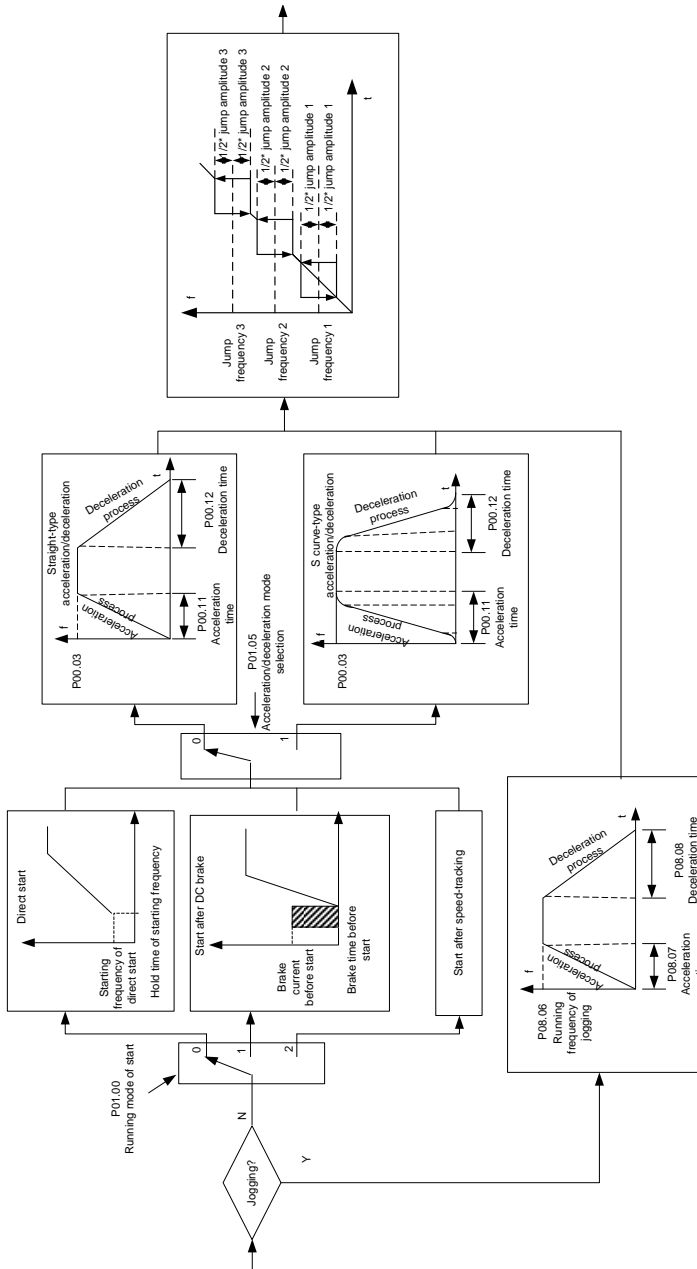

2. Logic diagram for restart after power-off

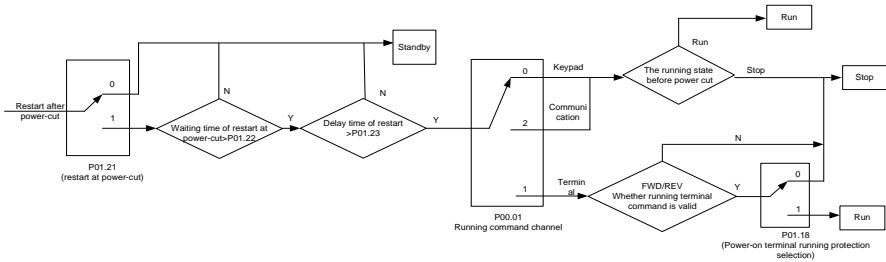

3. Logic diagram for restart after automatic fault reset

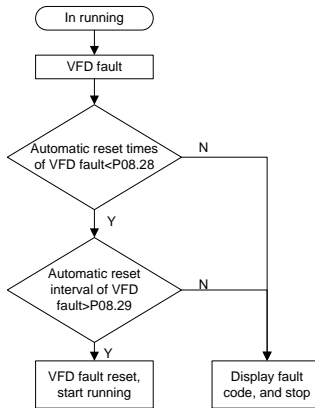

Related parameter list:

Function code	Name	Description	Default value
P00.01	Channel of running commands	0: Keypad 1: Terminal 2: Communication	0
P00.11	Acceleration time 1	0.0–3600.0s	Depends on model
P00.12	Deceleration time 1	0.0–3600.0s	Depends on model
P01.00	Running mode of start	0: Direct start 1: Start after DC brake 2: Start after speed tracking	0
P01.01	Starting frequency of direct start	0.00–50.00Hz	0.50Hz
P01.02	Hold time of starting frequency	0.0–50.0s	0.0s

Function code	Name	Description	Default value
P01.03	DC braking current before start	0.0–100.0%	0.0%
P01.04	DC braking time before start	0.00–50.00s	0.00s
P01.05	Acceleration/deceleration mode	0: Straight line 1: S curve Note: If mode 1 is selected, it is required to set P01.07, P01.27 and P01.08 accordingly	0
P01.08	Stop mode	0: Decelerate to stop 1: Coast to stop	0
P01.09	Starting frequency of DC braking after stop	0.00Hz–P00.03 (Max. output frequency)	0.00Hz
P01.10	Waiting time of DC braking after stop	0.00–50.00s	0.00s
P01.11	DC braking current of stop	0.0–100.0%	0.0%
P01.12	DC braking time of stop	0.00–50.00s	0.00s
P01.13	Deadzone time of forward/reverse rotation	0.0–3600.0s	0.0s
P01.14	Forward/reverse rotation switchover mode	0: switch over after zero frequency 1: switch over after starting frequency 2: switch over after passing stop speed and delay	1
P01.15	Stop speed	0.00–100.00Hz	0.50Hz
P01.16	Stop speed detection mode	0: Set value of speed (the only detection mode valid in SVPWM mode) 1: Detection value of speed	1
P01.18	Power-on terminal running protection selection	0: Terminal running command is invalid at power-on 1: Terminal running command is valid at power-on	0
P01.19	Action selected when running frequency less than frequency lower limit (valid when frequency lower limit greater than 0)	Ones place: Action selection 0: Run at the frequency lower limit 1: Stop 2: Sleep Tens place: Stop mode 0: Coast to stop 1: Decelerate to stop	0x00
P01.20	Wake-up-from-sleep delay	0.0–3600.0s (valid when P01.19 is 2)	0.0s

Function code	Name	Description	Default value
P01.21	Restart after power outage	0: Restart is disabled 1: Restart is enabled	0
P01.22	Waiting time of restart after power outage	0.0–3600.0s (valid when P01.21 is 1)	1.0s
P01.23	Start delay	0.0–60.0s	0.0s
P01.24	Stop speed delay	0.0–100.0s	0.0s
P01.25	Open-loop 0Hz output selection	0: No voltage output 1: With voltage output 2: Output as per DC braking current of stop	0
P01.26	Deceleration time of emergency-stop	0.0–60.0s	2.0s
P01.27	Time of starting section of deceleration S curve	0.0–50.0s	0.1s
P01.28	Time of ending section of deceleration S curve	0.0–50.0s	0.1s
P01.29	Short-circuit braking current	0.0–150.0% (of rated VFD output current)	0.0%
P01.30	Hold time of short-circuit braking at startup	0.00–50.00s	0.00s
P01.31	Hold time of short-circuit braking at stop	0.00–50.00s	0.00s
P01.32	Pre-exciting time of jogging	0–10.000s	0.000s
P01.33	Starting frequency of braking for jogging to stop	0–P00.03	0.00Hz
P01.34	Delay to enter sleep	0–3600.0s	0.0s
P05.01–P05.06	Digital input function selection	1: Forward running 2: Reverse running 4: Forward jogging 5: Reverse jogging 6: Coast to stop 7: Fault reset 8: Running pause 21: Acceleration/deceleration time selection 1 22: Acceleration/deceleration time selection 2 30: Acceleration/deceleration disabled	/

Function code	Name	Description	Default value
P08.06	Running frequency of jog	0.00Hz–P00.03 (Max. output frequency)	5.00Hz
P08.07	Acceleration time at jogging	0.0–3600.0s	Depends on model
P08.08	Deceleration time at jogging	0.0–3600.0s	Depends on model
P08.00	Acceleration time 2	0.0–3600.0s	Depends on model
P08.01	Declaration time 2	0.0–3600.0s	Depends on model
P08.02	Acceleration time 3	0.0–3600.0s	Depends on model
P08.03	Declaration time 3	0.0–3600.0s	Depends on model
P08.04	Acceleration time 4	0.0–3600.0s	Depends on model
P08.05	Declaration time 4	0.0–3600.0s	Depends on model
P08.19	Switching frequency of acceleration/deceleration time	0.00–P00.03 (Max. output frequency) 0.00Hz: No switch over If the running frequency is larger than P08.19, switch to acceleration /deceleration time 2	0
P08.21	Reference frequency of acceleration/deceleration time	0: Max. output frequency 1: Set frequency 2: 100Hz Note: Valid for straight-line acceleration/deceleration only	0
P08.28	Automatic fault reset times	0–10	0
P08.29	Automatic fault reset time interval	0.1–3600.0s	1.0s

5.5.8 Frequency setup

The VFD supports multiple kinds of frequency reference modes, which can be categorized into two types: main reference channel and auxiliary reference channel.

There are two main reference channels, namely A frequency reference channel and B frequency reference channel. These two channels support simple arithmetical operation between each other, and they can be switched dynamically by setting multi-function terminals.

There is one input mode for auxiliary reference channel, namely terminal UP/DOWN switch input. By setting function codes, you can enable the corresponding reference mode and the impact made on

the VFD frequency reference by this reference mode.

The VFD actual reference is comprised of the main reference channel and auxiliary reference channel.

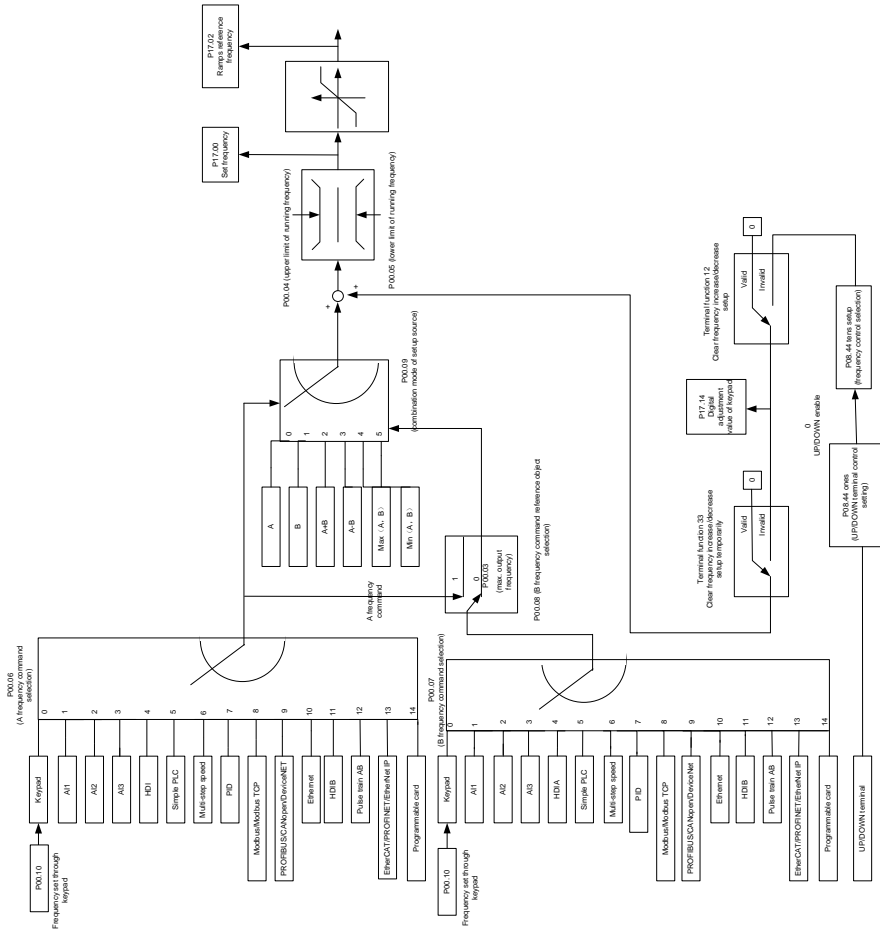

The VFD supports switchover between different reference channels, and the rules for channel switchover are shown below.

Present reference channel P00.09	Multi-function terminal function 13 Channel A switches to channel B	Multi-function terminal function 14 Combination setup switches to channel A	Multi-function terminal function 15 Combination setup switches to channel B
A	B	/	/

Present reference channel P00.09	Multi-function terminal function 13 Channel A switches to channel B	Multi-function terminal function 14 Combination setup switches to channel A	Multi-function terminal function 15 Combination setup switches to channel B
B	A	/	/
A+B	/	A	B
A-B	/	A	B
Max (A, B)	/	A	B
Min (A, B)	/	A	B

Note: "/" indicates this multi-function terminal is invalid under present reference channel.

When setting the auxiliary frequency inside the VFD via multi-function terminal UP (10) and DOWN (11), you can increase/decrease the frequency quickly by setting P08.45 (UP terminal frequency incremental change rate) and P08.46 (DOWN terminal frequency decremental change rate).

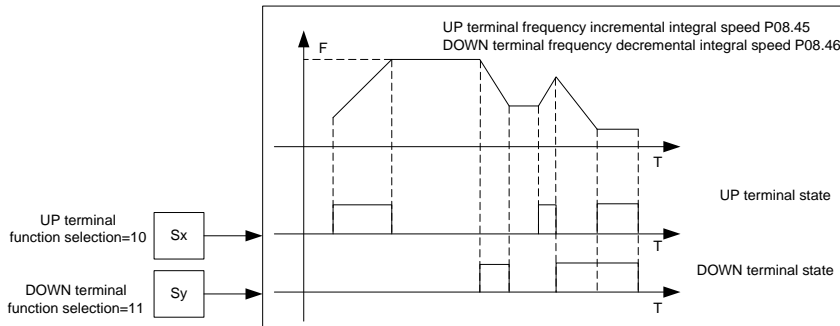

Related parameter list:

Function code	Name	Description	Default value
P00.03	Max. output frequency	P00.04–400.00Hz	50.00Hz
P00.04	Upper limit of running frequency	P00.05–P00.03	50.00Hz
P00.05	Lower limit of running frequency	0.00Hz–P00.04	0.00Hz
P00.06	A frequency command selection	0: Keypad 1: AI1 2: AI2 3: AI3	0
P00.07	B frequency command selection	4: High speed pulse HDIA 5: Simple PLC program 6: Multi-step speed running	15

Function code	Name	Description	Default value
		7: PID control 8: Modbus/Modbus TCP communication 9: PROFIBUS/CANopen/DeviceNet communication 10: Ethernet communication 11: High speed pulse HDIB 12: Pulse train AB 13: EtherCAT/PROFINET/EtherNet IP communication 14: Programmable card 15: Reserved	
P00.08	Reference object of B frequency command	0: Max. output frequency 1: A frequency command	0
P00.09	Combination mode of setup source	0: A 1: B 2: (A+B) 3: (A-B) 4: Max (A, B) 5: Min (A, B)	0
P05.01– P05.06	Function of multi-function digital input terminal (S1–S4, HDIA, HDIB)	10: Frequency increase (UP) 11: Frequency decrease (DOWN) 12: Clear frequency increase/decrease setting 13: Switchover between setup A and setup B 14: Switchover between combination setup and setup A 15: Switchover between combination setup and setup B	/
P08.42	Reserved	/	/
P08.43	Reserved	/	/
P08.44	UP/DOWN terminal control	0x000–0x221 Ones: Frequency enabling selection 0: UP/DOWN terminal setting is valid 1: UP/DOWN terminal setting is invalid Tens: Frequency control selection 0: Valid only when P00.06=0 or P00.07=0 1: Valid for all frequency modes	0x000

Function code	Name	Description	Default value
		2: Invalid for multi-step speed when multi-step speed takes priority Hundreds: Action selection at stop 0: Valid 1: Valid during running, clear after stop 2: Valid during running, clear after receiving stop command	
P08.45	UP terminal frequency incremental change rate	0.01–50.00 Hz/s	0.50 Hz/s
P08.46	DOWN terminal frequency decremental change rate	0.01–50.00 Hz/s	0.50 Hz/s
P17.00	Set frequency	0.00Hz–P00.03 (Max. output frequency)	0.00Hz
P17.02	Ramp reference frequency	0.00Hz–P00.03 (Max. output frequency)	0.00Hz
P17.14	Digital adjustment value	0.00Hz–P00.03	0.00Hz

5.5.9 Analog input

The VFD carries two analog input terminals (AI1 is 0–10V/0–20mA (voltage input or current input can be set by P05.50); AI2 is -10–10V) and two high-speed pulse input terminals. Each input can be filtered separately, and the corresponding reference curve can be set by adjusting the reference corresponds to the max. value and min. value.

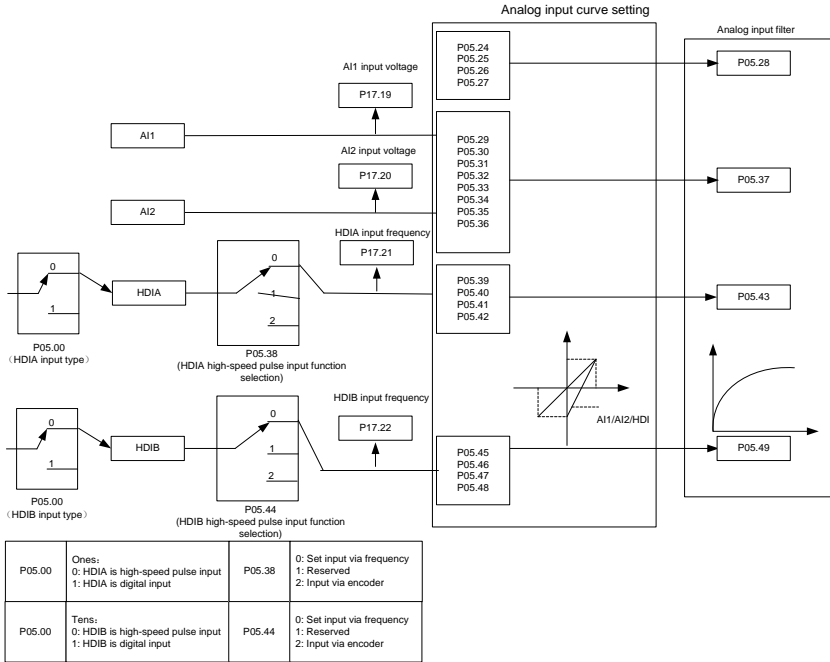

Related parameter list:

Function code	Name	Description	Default value
P05.00	HDI input type	0x00–0x11 Ones: HDIA input type 0: HDIA is high-speed pulse input 1: HDIA is digital input Tens: HDIB input type 0: HDIB is high-speed pulse input 1: HDIB is digital input	0x00
P05.24	Lower limit value of AI1	0.00V–P05.26	0.00V
P05.25	Corresponding setting of lower limit of AI1	-300.0%–300.0%	0.0%
P05.26	Upper limit value of AI1	P05.24–10.00V	10.00V
P05.27	Corresponding setting of upper limit of AI1	-300.0%–300.0%	100.0%
P05.28	Input filter time of AI1	0.000s–10.000s	0.100s
P05.29	Lower limit value of AI2	-10.00V–P05.31	-10.00V

Function code	Name	Description	Default value
P05.30	Corresponding setting of lower limit of AI2	-300.0%~300.0%	-100.0%
P05.31	Intermediate value 1 of AI2	P05.29~P05.33	0.00V
P05.32	Corresponding setting of intermediate value 1 of AI2	-300.0%~300.0%	0.0%
P05.33	Intermediate value 2 of AI2	P05.31~P05.35	0.00V
P05.34	Corresponding setting of intermediate value 2 of AI2	-300.0%~300.0%	0.0%
P05.35	Upper limit value of AI2	P05.33~10.00V	10.00V
P05.36	Corresponding setting of upper limit of AI2	-300.0%~300.0%	100.0%
P05.37	Input filter time of AI2	0.000s~10.000s	0.100s
P05.38	HDIA high-speed pulse input function	0: Set input via frequency 1: Reserved 2: Input via encoder, used in combination with HDIB	0
P05.39	Lower limit frequency of HDIA	0.000 kHz – P05.41	0.000kHz
P05.40	Corresponding setting of lower limit frequency of HDIA	-300.0%~300.0%	0.0%
P05.41	Upper limit frequency of HDIA	P05.39 –50.000kHz	50.000kHz
P05.42	Corresponding setting of upper limit frequency of HDIA	-300.0%~300.0%	100.0%
P05.43	HDIA frequency input filter time	0.000s~10.000s	0.030s
P05.44	HDIB high-speed pulse input function selection	0: Set input via frequency 1: Reserved 2: Input via encoder, used in combination with HDIA	0
P05.45	Lower limit frequency of HDIB	0.000 kHz – P05.47	0.000kHz
P05.46	Corresponding setting of lower limit frequency of HDIB	-300.0%~300.0%	0.0%
P05.47	Upper limit frequency of HDIB	P05.45 –50.000kHz	50.000kHz

Function code	Name	Description	Default value
P05.48	Corresponding setting of upper limit frequency of HDIB	-300.0%–300.0%	100.0%
P05.49	HDIB frequency input filter time	0.000s–10.000s	0.030s
P05.50	AI1 input signal type	0–1 0: Voltage type 1: Current type	0

5.5.10 Analog output

The VFD carries one analog output terminal (0–10V/0–20mA) and one high-speed pulse output terminal. Analog output signals can be filtered separately, and the proportional relation can be adjusted by setting the max. value, min. value, and the percentage of their corresponding output. Analog output signal can output motor speed, output frequency, output current, motor torque and motor power at a certain proportion.

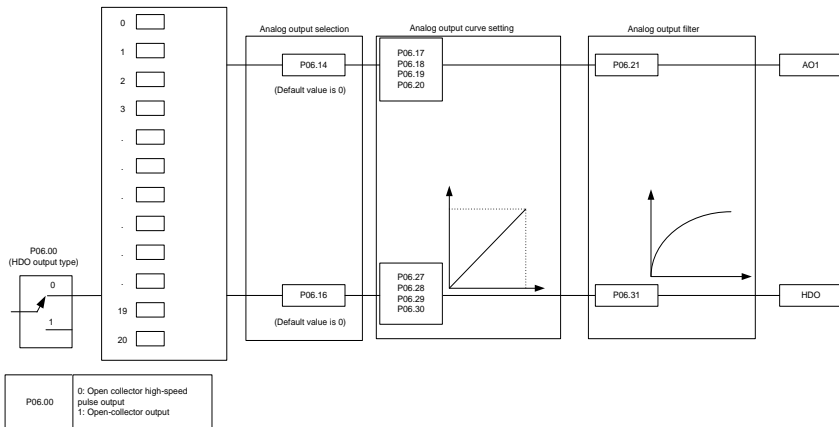

AO output relationship description:

(The min. value and max. value of the output correspond to 0.% and 100.00% of the pulse or analog default output. The actual output voltage or pulse frequency corresponds to the actual percentage, which can be through function codes.)

Setting	Function	Description
0	Running frequency	0–Max. output frequency
1	Set frequency	0–Max. output frequency
2	Ramp reference frequency	0–Max. output frequency
3	Running speed	0–Synchronous speed corresponding to max. output frequency

Setting	Function	Description
4	Output current (relative to VFD)	0–Twice the VFD rated current
5	Output current (relative to motor)	0–Twice the motor rated current
6	Output voltage	0–1.5 times the VFD rated voltage
7	Output power	0–Twice the motor rated power
8	Set torque value (bipolar)	0–Twice the motor rated current. A negative value corresponds to 0.0% by default.
9	Output torque (absolute value)	0 – +/- (Twice the motor rated torque)
10	AI1 input value	0–10V/0–20mA
11	AI2 input value	0V–10V. A negative value corresponds to 0.0% by default.
12	AI3 input value	0–10V/0–20mA
13	High-speed pulse HDIA input	0.00–50.00kHz
14	Value 1 set through Modbus/Modbus TCP communication	0–1000
15	Value 2 set through Modbus/Modbus TCP communication	0–1000
16	Value 1 set through PROFIBUS/CANopen/Device Net communication	0–1000
17	Value 2 set through PROFIBUS/CANopen/Device Net communication	0–1000
18	Value 1 set through Ethernet communication	0–1000
19	Value 2 set through Ethernet communication	0–1000
20	High-speed pulse HDIB input	0.00–50.00kHz
21	Value 1 set through EtherCAT/PROFINET/EtherNET IP communication	0–1000. A negative value corresponds to 0.0% by default.
22	Torque current (bipolar)	0–Triple the motor rated current. A negative value corresponds to 0.0% by default.
23	Exciting current	0–Triple the motor rated current. A negative value

Setting	Function	Description
		corresponds to 0.0% by default.
24	Set frequency (bipolar)	0–Max. output frequency. A negative value corresponds to 0.0% by default.
25	Ramp reference frequency (bipolar)	0–Max. output frequency. A negative value corresponds to 0.0% by default.
26	Running speed (bipolar)	0–Synchronous speed corresponding to max. output frequency. A negative value corresponds to 0.0% by default.
27	Value 2 set through EtherCAT/PROFINET/EtherNet IP communication	0–1000
28	AO1 from the programmable card	0–1000
29	AO2 from the programmable card	0–1000
30	Running speed	0–Twice the motor rated synchronous speed.
31	Output torque (bipolar)	0–Twice the motor rated torque. A negative value corresponds to 0.0% by default.
32	AI/AO temperature detection output	AO value of AI/AO temperature detection
33–63	Reserved	

Related parameter list:

Function code	Name	Description	Default value
P06.00	HDO output type	0: Open collector high-speed pulse output 1: Open collector output	0
P06.14	AO1 output selection	0: Running frequency	0
P06.15	Reserved	1: Set frequency	0
P06.16	HDO high-speed pulse output	2: Ramp reference frequency 3: Rotational speed (100% corresponds to the speed corresponding to max. output frequency) 4: Output current (100% corresponds to twice the VFD rated current) 5: Output current (100% corresponds to twice the motor rated current) 6: Output voltage (100% corresponds to	0

Function code	Name	Description	Default value
		1.5 times the VFD rated voltage) 7: Output power (100% corresponds to twice the motor rated power) 8: Set torque (100% corresponds to twice the motor rated torque) 9: Output torque (Absolute value, 100% corresponds to twice the motor rated torque) 10: AI1 input 11: AI2 input 12: AI3 input 13: HDIA input 14: Value 1 set through Modbus/Modbus TCP communication 15: Value 2 set through Modbus/Modbus TCP communication 16: Value 1 set through PROFIBUS/CANopen/DeviceNet communication 17: Value 2 set through PROFIBUS/CANopen/DeviceNet communication 18: Value 1 set through Ethernet communication 19: Value 2 set through Ethernet communication 20: HDIB input 21: Value 1 set through EtherCAT/PROFINET/EtherNet IP communication 22: Torque current (bipolar, 0–Triple the motor rated current) 23: Exciting current (bipolar, 0–Triple the motor rated current) 24: Set frequency (bipolar) 25: Ramp reference frequency (bipolar) 26: Rotational speed (bipolar) 27: Value 2 set through EtherCAT/PROFINET/EtherNet IP	

Function code	Name	Description	Default value
		<p>communication</p> <p>28: AO1 from the programmable card</p> <p>29: AO2 from the programmable card</p> <p>30: Rotational speed (100% corresponds to twice the motor rated synchronous speed)</p> <p>31: Output torque (Actual value, 100% corresponds to twice the motor rated torque)</p> <p>32: AI/AO temperature detection output</p> <p>33–63: Reserved</p> <p>Note:</p> <p>When the output comes from the programmable card (28–29), if the card is a Codesys programmable card, P27.00 must be set to 1.</p> <p>When AO1 is of the current output type, 100% corresponds to 20mA; when AO1 is of the voltage output type, 100% corresponds to 10V; 100% of HDO corresponds to the output of P06.30.</p>	
P06.17	Lower limit of AO1 output	-300.0%–P06.19	0.0%
P06.18	Corresponding AO1 output of lower limit	0.00V–10.00V	0.00V
P06.19	Upper limit of AO1 output	P06.17–300.0%	100.0%
P06.20	Corresponding AO1 output of upper limit	0.00V–10.00V	10.00V
P06.21	AO1 output filter time	0.000s–10.000s	0.000s
P06.22–P06.26	Reserved	/	/
P06.27	Lower limit of HDO output	-300.0%–P06.29	0.0%
P06.28	Corresponding HDO output of lower limit	0.00–50.00kHz	0.0kHz
P06.29	Upper limit of HDO output	P06.27–300.0%	100.0%
P06.30	Corresponding HDO output of upper limit	0.00–50.00kHz	50.00kHz
P06.31	HDO output filter time	0.000s–10.000s	0.000s

5.5.11 Digital input

The VFD carries four programmable digital input terminals and two HDI input terminals. The function of all the digital input terminals can be programmed by function codes. HDI input terminal can be set to act as high-speed pulse input terminal or common digital input terminal; if it is set to act as high-speed pulse input terminal, you can also set HDIA or HDIB high-speed pulse input to serve as the frequency reference and encoder signal input.

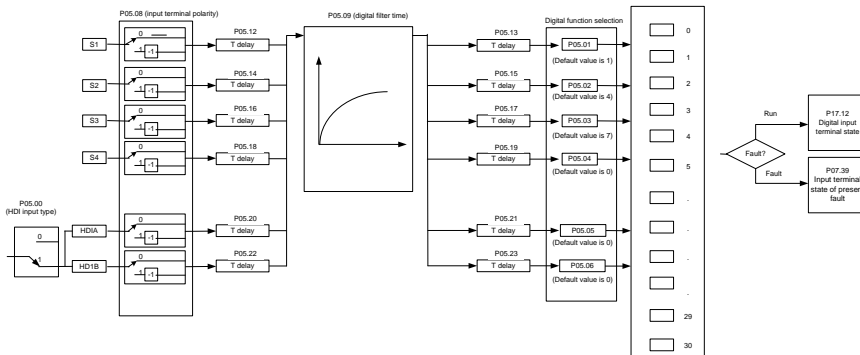

The parameters are used to set the corresponding function of digital multi-function input terminals.

Note: Two different multi-function input terminals cannot be set to the same function.

Setting	Function	Description
0	No function	The VFD does not act even if there is signal input; you can set the unused terminals to "no function" to avoid misacts.
1	Forward running (FWD)	Control the forward/reverse running of the VFD by external terminals.
2	Reverse running (REV)	
3	3-wire control/Sin	Set the VFD running mode to 3-wire control mode by this terminal. See P05.13 for details.
4	Forward jogging	Frequency when jogging, see P08.06, P08.07 and P08.08 for jogging acceleration/deceleration time.
5	Reverse jogging	
6	Coast to stop	The VFD blocks output, and the stop process of motor is uncontrolled by the VFD. This mode is applied in cases of large-inertia load and free stop time; its definition is the same with P01.08, and it is mainly used in remote control.
7	Fault reset	External fault reset function, its function is the same with the STOP/RST key on the keypad. This function can be used in remote fault reset.
8	Running pause	The VFD decelerates to stop, however, all the running parameters are in memory state, such as PLC

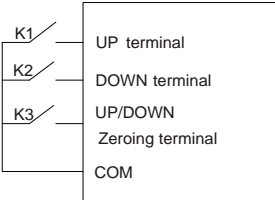
Setting	Function	Description								
		parameter, wobbling frequency, and PID parameter. After this signal disappears, the VFD will revert to the state before stop.								
9	External fault input	When external fault signal is transmitted to the VFD, the VFD releases fault alarm and stops.								
10	Frequency increase (UP)	Used to change the frequency-increase/decrease command when the frequency is given by external terminals.								
11	Frequency decrease (DOWN)									
12	Clear frequency increase/decrease setting	 <p>The terminal used to clear frequency-increase/decrease setting can clear the frequency value of auxiliary channel set by UP/DOWN, thus restoring the reference frequency to the frequency given by main reference frequency command channel.</p>								
13	Switching between A setting and B setting	This function is used to switch between the frequency setting channels.								
14	Switching between combination setting and A setting	A frequency reference channel and B frequency reference channel can be switched by no. 13 function; the combination channel set by P00.09 and the A								
15	Switching between combination setting and B setting	frequency reference channel can be switched by no. 14 function; the combination channel set by P00.09 and the B frequency reference channel can be switched by no. 15 function.								
16	Multi-step speed terminal 1	16-step speeds can be set by combining digital states of these four terminals. Note: Multi-step speed 1 is low bit, multi-step speed 4 is high bit.								
17	Multi-step speed terminal 2									
18	Multi-step speed terminal 3									
19	Multi-step speed terminal 4									
		<table border="1" data-bbox="498 1236 980 1340"> <tr> <td>Multi-step speed 4</td> <td>Multi-step speed 3</td> <td>Multi-step speed 2</td> <td>Multi-step speed 1</td> </tr> <tr> <td>BIT3</td> <td>BIT2</td> <td>BIT1</td> <td>BIT0</td> </tr> </table>	Multi-step speed 4	Multi-step speed 3	Multi-step speed 2	Multi-step speed 1	BIT3	BIT2	BIT1	BIT0
Multi-step speed 4	Multi-step speed 3	Multi-step speed 2	Multi-step speed 1							
BIT3	BIT2	BIT1	BIT0							
20	Multi-step speed pause	Pause multi-step speed selection function to keep the set value in present state.								
21	Acceleration/deceleration time selection 1	Use these two terminals to select four groups of acceleration/decoration time.								

Setting	Function	Description			
		Terminal 1	Terminal 2	Acceleration or deceleration time selection	Corresponding parameter
22	Acceleration/deceleration time selection 2	OFF	OFF	Acceleration/ deceleration time 1	P00.11/P00.12
		ON	OFF	Acceleration/ deceleration time 2	P08.00/P08.01
		OFF	ON	Acceleration/ deceleration time 3	P08.02/P08.03
		ON	ON	Acceleration/ deceleration time 4	P08.04/P08.05
23	Simple PLC stop reset	Restart simple PLC process and clear previous PLC state information.			
24	Simple PLC pause	The program pauses during PLC execution, and keeps running in current speed step. After this function is cancelled, simple PLC keeps running.			
25	PID control pause	PID is ineffective temporarily, and the VFD maintains current frequency output.			
26	Wobbling frequency pause (stop at current frequency)	The VFD pauses at current output. After this function is canceled, it continues wobbling-frequency operation at current frequency.			
27	Wobbling frequency reset (revert to center frequency)	The set frequency of VFD reverts to center frequency.			
28	Counter reset	Zero out the counter state.			
29	Switching between speed control and torque control	The VFD switches from torque control mode to speed control mode, or vice versa.			
30	Acceleration/deceleration disabled	Ensure the VFD will not be impacted by external signals (except for stop command), and maintains current output frequency.			
31	Counter trigger	Enable pulse counting of the counter.			
33	Clear frequency increase/decrease setting temporarily	When the terminal is closed, the frequency value set by UP/DOWN can be cleared to restore to the frequency given by frequency command channel; when the terminal is disconnected, it will revert to the frequency value after frequency increase/decrease setting.			
34	DC brake	The VFD starts DC braking immediately after the command becomes valid.			
35	Switching between motor 1 and motor 2	When this terminal is valid, you can realize switchover control of two motors.			

Setting	Function	Description
36	Command switches to keypad	When this terminal is valid, the running command channel will switch to keypad compulsorily. If this function becomes invalid, the running command channel will revert to the original state.
37	Command switches to terminal	When this terminal is valid, the running command channel will switch to terminal compulsorily. If this function becomes invalid, the running command channel will revert to the original state.
38	Command switches to communication	When this terminal is valid, the running command channel will switch to communication compulsorily. If this function becomes invalid, the running command channel will revert to the original state.
39	Pre-exciting command	When this terminal is valid, motor pre-exciting will be started until this terminal becomes invalid.
40	Zero out power consumption quantity	After this command becomes valid, the power consumption quantity of the VFD will be zeroed out.
41	Maintain power consumption quantity	When this command is valid, current operation of the VFD will not impact the power consumption quantity.
42	Source of upper torque limit switches to keypad	When this command is valid, the upper limit of the torque will be set by keypad.
43	Position reference point input	Valid only for S1, S2, and S3.
44	Disable spindle orientation	Spindle orientation is invalid.
45	Spindle zeroing/local position zeroing	Spindle positioning is triggered.
46	Spindle zero position selection 1	Spindle zero position selection 1.
47	Spindle zero position selection 2	Spindle zero position selection 2.
48	Spindle scale division selection 1	Spindle scale division selection 1.
49	Spindle scale division selection 2	Spindle scale division selection 2.
50	Spindle scale division selection 3	Spindle scale division selection 3.
51	Position/speed control switchover terminal	Terminal for switching between position control and speed control.
52	Disable pulse input	Pulse input is invalid when the terminal is valid.
53	Clear position deviation	Used to clear the input deviation of position loop.

Setting	Function	Description
54	Switch position proportional gains	Used to switch position proportional gains.
55	Enable cyclic digital positioning	Cyclic positioning can be enabled when digital positioning is valid.
56	Emergency stop	When this command is valid, the motor decelerate to emergency stop as per the time set by P01.26.
57	Motor overtemperature fault input	Motor stops at motor over-temperature fault input.
59	Switch from FVC to SVPWM control	When this terminal is valid in stop state, switch to SVPWM control.
60	Switch to FVC control	When this terminal is valid in stop state, switch to FVC (closed-loop vector) control.
61	PID polarity switchover	Switching the output polarity of PID, this terminal should be used in conjunction with P09.03
62	Reserved	
63	Enable servo	When the thousands place of P21.00 is set to enable the servo, the servo enabling terminal is valid, which controls the VFD to enter zero servo control. At this situation, no startup command is needed.
64	FWD max. limit	Max frequency limit on forward rotation
65	REV max limit	Max frequency limit on reverse rotation
66	Zero out the counter	Zero out the position counting value
67	Pulse increase	When the terminal function is valid, the pulse input is increased according to the P21.27 pulse speed.
68	Enable pulse superimposition	When the pulse superimposition is enabled, pulse increase and pulse decrease are effective.
69	Pulse decrease	When the terminal function is valid, the pulse input is decreased according to the P21.27 pulse speed.
70	Electronic gear selection	If the terminal is valid, the proportional numerator is switched to the P21.30 numerator of the 2 nd command ratio.
71	Switch to mater	In stopped state, if the terminal is valid, the master is used.
72	Switch to slave	In stopped state, if the terminal is valid, the slave is used.
73	Reset roll diameter	Used to reset the roll diameter when the tension control function is enabled.
74	Switch winding/unwinding	Used to switch winding/unwinding modes when the tension control function is enabled.

Setting	Function	Description
75	Tension control pre-drive	If the terminal is valid when the tension control function is enabled, tension control pre-drive is performed.
76	Disable roll diameter calculation	If the terminal is valid when the tension control function is enabled, roll diameter calculation is disabled.
77	Clear alarm display	Used to clear the alarm display when the tension control function is enabled.
78	Manual braking of tension control	If the terminal is valid when the tension control function is enabled, manual braking is activated.
79	Trigger forced feeding interrupt	If the terminal is valid when the tension control function is enabled, a feeding interrupt signal is triggered forcibly.
80	Initial roll diameter 1	Used to select different initial roll diameters by combining with the initial roll diameter 2 when the tension control function is enabled.
81	Initial roll diameter 2	Used to select different initial roll diameters by combining with the initial roll diameter 1 when the tension control function is enabled.
82	Trigger fire mode control	In fire mode, if the terminal is valid, the fire mode control signal is triggered.
83	Switch tension PID parameters	Used to switch two PID parameter groups when the tension control function is enabled. The first group is used by default. If the terminal is valid, the second group is used.
84–95	Reserved	/

Related parameter list:

Function code	Name	Description	Default value
P05.00	HDI input type	0x00–0x11 Ones: HDIA input type 0: HDIA is high-speed pulse input 1: HDIA is digital input Tens: HDIB input type 0: HDIB is high-speed pulse input 1: HDIB is digital input	0x00
P05.01	Function of S1 terminal	0: No function	1
P05.02	Function of S2 terminal	1: Forward running	4
P05.03	Function of S3 terminal	2: Reverse running	7
P05.04	Function of S4 terminal	3: 3-wire control/Sin	0
P05.05	Function of HDIA terminal	4: Forward jogging 5: Reverse jogging	0

Function code	Name	Description	Default value
P05.06	Function of HDIB terminal	6: Coast to stop	0
		7: Fault reset	
		8: Running pause	
		9: External fault input	
		10: Frequency increase (UP)	
		11: Frequency decrease (DOWN)	
		12: Clear frequency	
		increase/decrease setting	
		13: Switchover between setup A and	
		setup B	
		14: Switchover between combination	
		setting and A setting	
		15: Switchover between combination	
		setting and setup B	
		16: Multi-step speed terminal 1	
		17: Multi-step speed terminal 2	
		18: Multi-step speed terminal 3	
		19: Multi-step speed terminal 4	
		20: Multi-step speed pause	
		21: Acceleration/deceleration time	
		selection 1	0
		22: Acceleration/deceleration time	
		selection 2	
		23: Simple PLC stop reset	
		24: Simple PLC pause	
		25: PID control pause	
		26: Wobbling frequency pause	
		27: Wobbling frequency reset	
		28: Counter reset	
		29: Switching between speed control	
		and torque control	
		30: Acceleration/deceleration	
		disabled	
		31: Counter trigger	
32: Reserved			
33: Clear frequency			
increase/decrease setting			
temporarily			
34: DC brake			

Function code	Name	Description	Default value
		35: Switch from motor 1 to motor 2 36: Command switches to keypad 37: Command switches to terminal 38: Command switches to communication 39: Pre-exciting command 40: Zero out power consumption quantity 41: Maintain power consumption quantity 42: Source of upper torque limit switches to keypad 43: Position reference point input (only valid for S1, S2 and S3) 44: Disable spindle orientation 45: Spindle zeroing/local positioning zeroing 46: Spindle zero position selection 1 47: Spindle zero position selection 2 48: Spindle scale division selection 1 49: Spindle scale division selection 2 50: Spindle scale division selection 3 51: Position/speed control switchover terminal 52: Disable pulse input 53: Clear position deviation 54: Switch position proportional gains 55: Enable cyclic digital positioning 56: Emergency stop 57: Motor overtemperature fault input 59: Switch to V/F control 60: Switch to FVC control 61: PID polarity switchover 62: Reserved 63: Enable servo 64: FWD max. limit 65: REV max limit 66: Zero out the counter 67: Pulse increase	

Function code	Name	Description	Default value
		68: Enable pulse superimposition 69: Pulse decrease 70: Electronic gear selection 71: Switch to master 72: Switch to slave 73: Reset the roll diameter 74: Switch winding/unwinding 75: Pre-drive 76: Disable roll diameter calculation 77: Clear alarm display 78: Manual braking 79: Trigger forced feeding interrupt 80: Initial roll diameter 1 81: Initial roll diameter 2 82: Trigger fire mode control 83: Switch tension PID parameters 84–95: Reserved	
P05.07	Reserved	/	/
P05.08	Polarity of input terminal	0x00–0x3F	0x00
P05.09	Digital filter time	0.000–1.000s	0.010s
P05.10	Virtual terminal setting	0x00–0x3F (0: disable, 1: enable) BIT0: S1 virtual terminal BIT1: S2 virtual terminal BIT2: S3 virtual terminal BIT3: S4 virtual terminal BIT4: HDIA virtual terminal BIT8: HDIB virtual terminal	0x00
P05.11	2/3-wire control mode	0: 2-wire control 1 1: 2-wire control 2 2: 3-wire control 1 3: 3-wire control 2	0
P05.12	S1 terminal switch-on delay	0.000–50.000s	0.000s
P05.13	S1 terminal switch-off delay	0.000–50.000s	0.000s
P05.14	S2 terminal switch-on delay	0.000–50.000s	0.000s
P05.15	S2 terminal switch-off delay	0.000–50.000s	0.000s
P05.16	S3 terminal switch-on delay	0.000–50.000s	0.000s
P05.17	S3 terminal switch-off delay	0.000–50.000s	0.000s

Function code	Name	Description	Default value
P05.18	S4 terminal switch-on delay	0.000–50.000s	0.000s
P05.19	S4 terminal switch-off delay	0.000–50.000s	0.000s
P05.20	HDIA terminal switch-on delay	0.000–50.000s	0.000s
P05.21	HDIA terminal switch-off delay	0.000–50.000s	0.000s
P05.22	HDIB terminal switch-on delay	0.000–50.000s	0.000s
P05.23	HDIB terminal switch-off delay	0.000–50.000s	0.000s
P07.39	Input terminal status at present fault	/	0x0000
P17.12	Digital input terminal state	/	0x00

5.5.12 Digital output

The VFD carries two groups of relay output terminals, one open collector Y output terminal and one high-speed pulse output (HDO) terminal. The function of all the digital output terminals can be programmed by function codes, of which the high-speed pulse output terminal HDO can also be set to high-speed pulse output or digital output by function code.

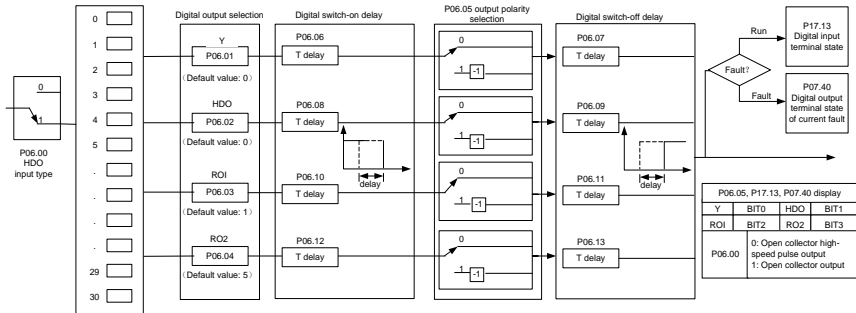

The table below lists the options for the above four function parameters, and you are allowed to select the same output terminal functions repetitively.

Set value	Function	Description
0	Invalid	Output terminal has no function
1	In running	Output ON signal when there is frequency output during running
2	In forward running	Output ON signal when there is frequency output during forward running
3	In reverse running	Output ON signal when there is frequency output during reverse running

Set value	Function	Description
4	In jogging	Output ON signal when there is frequency output during jogging
5	VFD fault	Output ON signal when VFD fault occurred
6	Frequency level detection FDT1	Refer to P08.32 and P08.33
7	Frequency level detection FDT2	Refer to P08.34 and P08.35
8	Frequency reached	Refer to P08.36
9	Running in zero speed	Output ON signal when the VFD output frequency and reference frequency are both zero.
10	Reach upper limit frequency	Output ON signal when the running frequency reaches upper limit frequency
11	Reach lower limit frequency	Output ON signal when the running frequency reached lower limit frequency
12	Ready to run	Main circuit and control circuit powers are established, the protection functions do not act; when the VFD is ready to run, output ON signal.
13	In pre-exciting	Output ON signal during pre-exciting of the VFD
14	Overload pre-alarm	Output ON signal after the pre-alarm time elapsed based on the pre-alarm threshold; see P11.08–P11.10 for details.
15	Underload pre-alarm	Output ON signal after the pre-alarm time elapsed based on the pre-alarm threshold; see P11.11–P11.12 for details.
16	Simple PLC state completed	Output signal when current stage of simple PLC is completed
17	Simple PLC cycle completed	Output signal when a single cycle of simple PLC operation is completed
23	Virtual terminal output of Modbus/Modbus TCP communication	Output corresponding signal based on the set value of Modbus/Modbus TCP; output ON signal when it is set to 1, output OFF signal when it is set to 0
24	Virtual terminal output of PROFIBUS/CANopen/DeviceNet communication	Output corresponding signal based on the set value of PROFIBUS/CANopen/DeviceNet; output ON signal when it is set to 1, output OFF signal when it is set to 0
25	Virtual terminal output of Ethernet communication	Output corresponding signal based on the set value of Ethernet; output ON signal when it is set to 1, output OFF signal when it is set to 0.
26	DC bus voltage established	Output is valid when the bus voltage is above the

Set value	Function	Description
		undervoltage threshold of the inverter
27	Z pulse output	Output is valid when the encoder Z pulse is arrived, and is invalid after 10 ms.
28	During pulse superposition	Output is valid when the pulse superposition terminal input function is valid
29	STO action	Output when STO fault occurred
30	Positioning completed	Output is valid when position control positioning is completed
31	Spindle zeroing completed	Output is valid when spindle zeroing is completed
32	Spindle scale-division completed	Output is valid when spindle scale-division is completed
33	In speed limit	Output is valid when the frequency is limited
34	Virtual terminal output of EtherCAT/PROFINET/EtherNet IP communication	The corresponding signal is output according to the set value of PROFINET communication. When it is set to 1, the ON signal is output, and when it is set to 0, the OFF signal is output.
35	Reserved	/
36	Speed/position control switchover completed	Output is valid when the mode switchover is completed
37	Any frequency reached	The frequency reached signal is output when the present ramp reference frequency is greater than the detection value for frequency being reached.
38–40	Reserved	/
41	Y1	Y1 from the programmable card
42	Y2	Y2 from the programmable card
43	HDO	HDO from the programmable card
44	RO1	RO1 from the programmable card
45	RO2	RO2 from the programmable card
46	RO3	RO3 from the programmable card
47	RO4	RO4 from the programmable card
48	EC PT100 detected OH pre-alarm	Pre-alarm of overheating (OH) detected by the expansion card (EC) with PT100.
49	EC PT1000 detected OH pre-alarm	Pre-alarm of OH detected by the EC with PT1000.
50	AI/AO detected OH pre-alarm	Pre-alarm of OH detected by AI/AO.
51	Stopped or running at zero speed	The VFD is in stopped state or running at zero speed.
52	Disconnection detected in tension	Disconnection is detected when the disconnection

Set value	Function	Description
	control	detection is enabled in tension control.
53	Roll diameter setting reached	The set roll diameter is reached during running in tension control.
54	Max. roll diameter reached	The max. roll diameter is reached during running in tension control.
55	Min. roll diameter reached	The min. roll diameter is reached during running in tension control.
56	Fire control mode enabled	The fire mode is turned on.
57-63	Reserved	

Related parameter list:

Function code	Name	Description	Default value
P06.00	HDO output type	0: Open collector high-speed pulse output 1: Open collector output	0
P06.01	Y1 output selection	0: Invalid	0
P06.02	HDO output selection	1: In running	0
P06.03	Relay RO1 output selection	2: In forward running 3: In reverse running	1
P06.04	Relay RO2 output selection	4: In jogging 5: VFD fault 6: Frequency level detection FDT1 7: Frequency level detection FDT2 8: Frequency reached 9: Running in zero speed 10: Reach upper limit frequency 11: Reach lower limit frequency 12: Ready to run 13: In pre-exciting 14: Overload pre-alarm 15: Underload pre-alarm 16: Simple PLC stage completed 17: Simple PLC cycle completed 18: Reach set counting value 19: Reach designated counting value 20: External fault is valid 21: Reserved 22: Reach running time 23: Virtual terminal output of	5

Function code	Name	Description	Default value
		Modbus/Modbus TCP communication 24: Virtual terminal output of POROFIBUS/CANopen/DeviceNet communication 25: Virtual terminal output of Ethernet communication 26: DC bus voltage established 27: Z pulse output 28: During pulse superposition 29: STO action 30: Positioning completed 31: Spindle zeroing completed 32: Spindle scale-division completed 33: Speed limit reached in torque control 34: Virtual terminal output of EtherCAT/PROFINET/EtherNet IP communication 35: Reserved 36: Speed/position control switchover completed 37: Any frequency reached 38–40: Reserved 41: Y1 from the programmable card 42: Y2 from the programmable card 43: HDO from the programmable card 44: RO1 from the programmable card 45: RO2 from the programmable card 46: RO3 from the programmable card 47: RO4 from the programmable card 48: EC PT100 detected OH pre-alarm 49: EC PT1000 detected OH pre-alarm 50: AI/AO detected OH pre-alarm 51: Stopped or running at zero speed 52: Disconnection detected in tension control 53: Roll diameter setting reached 54: Max. roll diameter reached 55: Min. roll diameter reached 56: Fire control mode enabled	

Function code	Name	Description	Default value
		57–63: Reserved	
P06.05	Output terminal polarity selection	0x00–0x0F	0x00
P06.06	Y switch-on delay	0.000–50.000s	0.000s
P06.07	Y switch-off delay	0.000–50.000s	0.000s
P06.08	HDO switch-on delay	0.000–50.000s (valid only when P06.00=1)	0.000s
P06.09	HDO switch-off delay	0.000–50.000s (valid only when P06.00=1)	0.000s
P06.10	Relay RO1 switch-on delay	0.000–50.000s	0.000s
P06.11	Relay RO1 switch-off delay	0.000–50.000s	0.000s
P06.12	Relay RO2 switch-on delay	0.000–50.000s	0.000s
P06.13	Relay RO2 switch-off delay	0.000–50.000s	0.000s
P07.40	Output terminal status at present fault	/	0x0000
P17.13	Digital output terminal state	/	0x00

5.5.13 Simple PLC

Simple PLC is a multi-step speed generator, and the VFD can change the running frequency and direction automatically based on the running time to fulfill process requirements. Previously, such function was realized with external PLC, while now, the VFD itself can achieve this function.

The VFD can realize 16-step speeds control, and provide four groups of acceleration/deceleration time for choose.

After the configured PLC completes a cycle (or stage), an ON signal can be output by the multi-function relay.

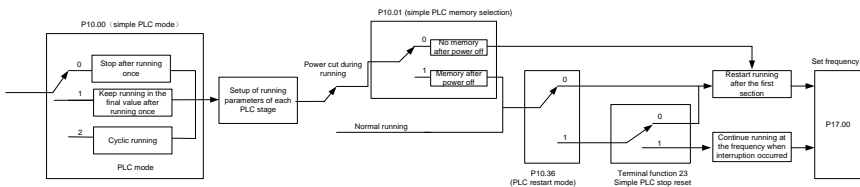

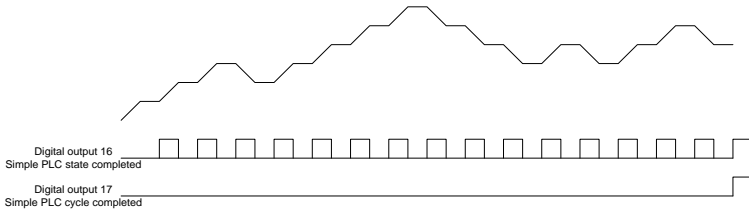

Related parameter list:

Function code	Name	Description	Default value
P05.01–P05.06	Digital input function selection	23: Simple PLC stop reset 24: Pause simple PLC 25: Pause PID control	
P06.01–P06.04	Digital output function selection	16: Simple PLC stage reached 17: Simple PLC cycle reached	
P10.00	Simple PLC mode	0: Stop after running once 1: Keep running in the final value after running once 2: Cyclic running	0
P10.01	Simple PLC memory selection	0: No memory after power down 1: Memory after power down	0
P10.02	Multi-step speed 0	-300.0–300.0%	0.0%
P10.03	Running time of step 0	0.0–6553.5s (min)	0.0s
P10.04	Multi-step speed 1	-300.0–300.0%	0.0%
P10.05	Running time of step 1	0.0–6553.5s (min)	0.0s
P10.06	Multi-step speed 2	-300.0–300.0%	0.0%
P10.07	Running time of step 2	0.0–6553.5s (min)	0.0s
P10.08	Multi-step speed 3	-300.0–300.0%	0.0%
P10.09	Running time of step 3	0.0–6553.5s (min)	0.0s
P10.10	Multi-step speed 4	-300.0–300.0%	0.0%
P10.11	Running time of step 4	0.0–6553.5s (min)	0.0s
P10.12	Multi-step speed 5	-300.0–300.0%	0.0%
P10.13	Running time of step 5	0.0–6553.5s (min)	0.0s
P10.14	Multi-step speed 6	-300.0–300.0%	0.0%
P10.15	Running time of step 6	0.0–6553.5s (min)	0.0s
P10.16	Multi-step speed 7	-300.0–300.0%	0.0%

Function code	Name	Description	Default value
P10.17	Running time of step 7	0.0–6553.5s (min)	0.0s
P10.18	Multi-step speed 8	-300.0–300.0%	0.0%
P10.19	Running time of step 8	0.0–6553.5s (min)	0.0s
P10.20	Multi-step speed 9	-300.0–300.0%	0.0%
P10.21	Running time of step 9	0.0–6553.5s (min)	0.0s
P10.22	Multi-step speed 10	-300.0–300.0%	0.0%
P10.23	Running time of step 10	0.0–6553.5s (min)	0.0s
P10.24	Multi-step speed 11	-300.0–300.0%	0.0%
P10.25	Running time of step 11	0.0–6553.5s (min)	0.0s
P10.26	Multi-step speed 12	-300.0–300.0%	0.0%
P10.27	Running time of step 12	0.0–6553.5s (min)	0.0s
P10.28	Multi-step speed 13	-300.0–300.0%	0.0%
P10.29	Running time of step 13	0.0–6553.5s (min)	0.0s
P10.30	Multi-step speed 14	-300.0–300.0%	0.0%
P10.31	Running time of step 14	0.0–6553.5s (min)	0.0s
P10.32	Multi-step speed 15	-300.0–300.0%	0.0%
P10.33	Running time of step 15	0.0–6553.5s (min)	0.0s
P10.36	PLC restart mode	0: Restart from the first section 1: Continue running at the frequency when interruption occurred	0
P10.34	Acceleration/deceleration time of steps 0–7 of simple PLC	0x0000–0xFFFF	0x0000
P10.35	Acceleration/deceleration time of steps 8–15 of simple PLC	0x0000–0xFFFF	0x0000
P05.01–P05.09	Digital input function	23: Simple PLC stop reset 24: Simple PLC pause 25: PID control pause	
P06.01–P06.04	Digital output function	16: Simple PLC stage reached 17: Simple PLC cycle reached	
P17.00	Set frequency	0.00Hz–P00.03 (Max. output frequency)	0.00Hz
P17.27	Actual stage of simple PLC	Displays the actual stage of the simple PLC function.	0

5.5.14 Multi-step speed running

Set the parameters used in multi-step speed running. The VFD can set 16-step speeds, which are selectable by multi-step speed terminals 1–4, corresponding to multi-step speed 0 to multi-step speed 15.

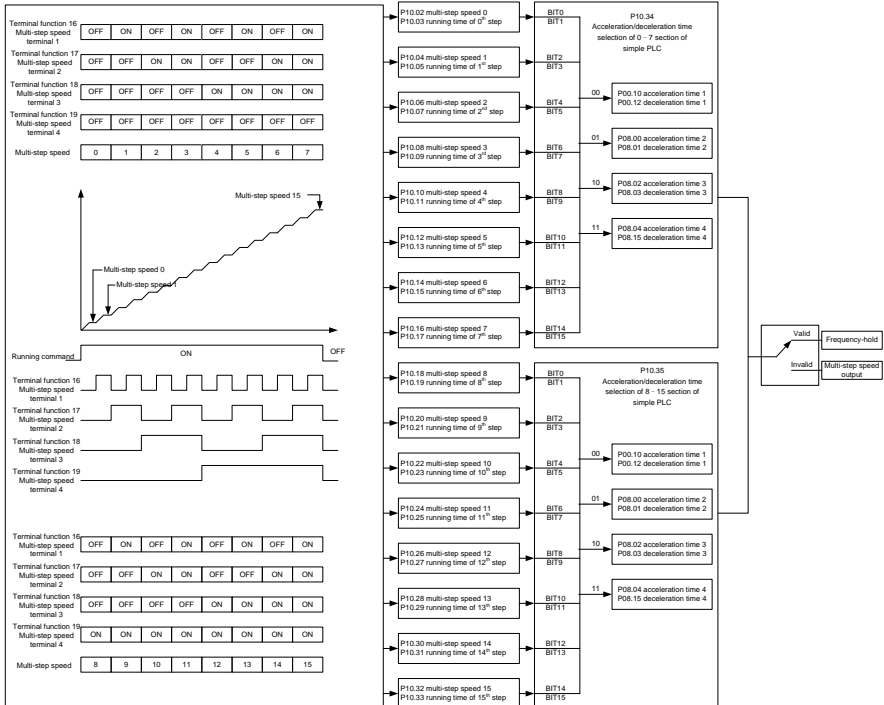

Related parameter list:

Function code	Name	Description	Default value
P05.01–P05.06	Digital input function selection	16: Multi-step speed terminal 1 17: Multi-step speed terminal 2 18: Multi-step speed terminal 3 19: Multi-step speed terminal 4 20: Pause multi-step speed running	
P10.02	Multi-step speed 0	-300.0–300.0%	0.0%
P10.03	Running time of step 0	0.0–6553.5s (min)	0.0s
P10.04	Multi-step speed 1	-300.0–300.0%	0.0%
P10.05	Running time of step 1	0.0–6553.5s (min)	0.0s
P10.06	Multi-step speed 2	-300.0–300.0%	0.0%
P10.07	Running time of step 2	0.0–6553.5s (min)	0.0s

Function code	Name	Description	Default value
P10.08	Multi-step speed 3	-300.0–300.0%	0.0%
P10.09	Running time of step 3	0.0–6553.5s (min)	0.0s
P10.10	Multi-step speed 4	-300.0–300.0%	0.0%
P10.11	Running time of step 4	0.0–6553.5s (min)	0.0s
P10.12	Multi-step speed 5	-300.0–300.0%	0.0%
P10.13	Running time of step 5	0.0–6553.5s (min)	0.0s
P10.14	Multi-step speed 6	-300.0–300.0%	0.0%
P10.15	Running time of step 6	0.0–6553.5s (min)	0.0s
P10.16	Multi-step speed 7	-300.0–300.0%	0.0%
P10.17	Running time of step 7	0.0–6553.5s (min)	0.0s
P10.18	Multi-step speed 8	-300.0–300.0%	0.0%
P10.19	Running time of step 8	0.0–6553.5s (min)	0.0s
P10.20	Multi-step speed 9	-300.0–300.0%	0.0%
P10.21	Running time of step 9	0.0–6553.5s (min)	0.0s
P10.22	Multi-step speed 10	-300.0–300.0%	0.0%
P10.23	Running time of step 10	0.0–6553.5s (min)	0.0s
P10.24	Multi-step speed 11	-300.0–300.0%	0.0%
P10.25	Running time of step 11	0.0–6553.5s (min)	0.0s
P10.26	Multi-step speed 12	-300.0–300.0%	0.0%
P10.27	Running time of step 12	0.0–6553.5s (min)	0.0s
P10.28	Multi-step speed 13	-300.0–300.0%	0.0%
P10.29	Running time of step 13	0.0–6553.5s (min)	0.0s
P10.30	Multi-step speed 14	-300.0–300.0%	0.0%
P10.31	Running time of step 14	0.0–6553.5s (min)	0.0s
P10.32	Multi-step speed 15	-300.0–300.0%	0.0%
P10.33	Running time of step 15	0.0–6553.5s (min)	0.0s
P10.34	Acceleration/decoration time of steps 0–7 of simple PLC	0x0000–0XFFFF	0000
P10.35	Acceleration/decoration time of steps 8–15 of simple PLC	0x0000–0XFFFF	0000
P17.27	Actual stage of simple PLC	Displays the present stage of the simple PLC function.	0

5.5.15 PID control

PID control, a common mode for process control, is mainly used to adjust the VFD output frequency or output voltage by performing scale-division, integral and differential operations on the difference between feedback signal of controlled variables and signal of the target, thus forming a negative

feedback system to keep the controlled variables above the target. It is applicable to flow control, pressure control, temperature control, and so on. The following is the basic schematic block diagram for output frequency regulation.

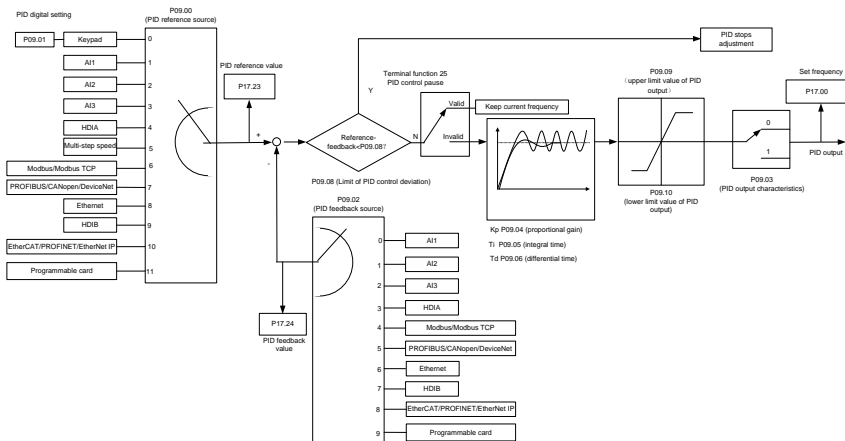

Introduction to the working principles and control methods for PID control

Proportional control (Kp): When the feedback is different from the reference, the output will be proportional to the difference. If such a difference is constant, the regulating variable will also be constant. Proportional control can respond to feedback changes rapidly, however, it cannot eliminate the difference by itself. A larger proportional gain indicates a faster regulating speed, but a too large gain will result in oscillation. To solve this problem, set the integral time to a large value and the differential time to 0, run the system only with proportional control, and then change the reference to observe the difference (that is, static difference) between the feedback signal and reference. If the static difference occurs in the direction of reference change (such as reference increase, where the feedback is always less than the reference after system stabilizes), continue increasing the proportional gain; otherwise, decrease the proportional gain. Repeat this process until the static difference becomes small.

Integral time (Ti): When feedback deviates from reference, the output regulating variable accumulates continuously, if the deviation persists, the regulating variable will increase continuously until deviation disappears. Integral regulator can be used to eliminate static difference; however, too large regulation may lead to repetitive overshoot, which will cause system instability and oscillation. The feature of oscillation caused by strong integral effect is that the feedback signal fluctuates up and down based on the reference variable, and fluctuation range increases gradually until oscillation occurred. Integral time parameter is generally regulated gradually from large to small until the stabilized system speed fulfills the requirement.

Derivative time (Td): When the deviation between feedback and reference changes, output the regulating variable which is proportional to the deviation variation rate, and this regulating variable is only related to the direction and magnitude of the deviation variation rather than the direction and

magnitude of the deviation itself. Differential control is used to control the feedback signal variation based on the variation trend. Differential regulator should be used with caution as it may easily enlarge the system interferences, especially those with high variation frequency.

When frequency command selection (P00.06, P00.07) is 7, or the voltage setting channel (P04.27) is 6, the running mode of VFD is process PID control.

5.5.15.1 General procedures for PID parameter setup

a. Determining proportional gain P

When determining proportional gain P, first, remove the integral term and derivative term of PID by making $T_i=0$ and $T_d=0$ (see PID parameter setup for details), thus turning PID into pure proportional control. Set the input to 60%–70% of the max. allowable value, and increase proportional gain P gradually from 0 until system oscillation occurred, and then in turn, decrease proportional gain P gradually from current value until system oscillation disappears, record the proportional gain P at this point and set the proportional gain P of PID to 60%–70% of current value. This is whole commissioning process of proportional gain P.

b. Determine integral time T_i

After proportional gain P is determined, set the initial value of a larger integral time T_i , and decrease T_i gradually until system oscillation occurred, and then in turn, increase T_i until system oscillation disappears, record the T_i at this point, and set the integral time constant T_i of PID to 150%–180% of current value. This is the commissioning process of integral time constant T_i .

c. Determining derivative time T_d

The derivative time T_d is generally set to 0.

If you need to set T_d to another value, set in the same way with P and T_i , namely set T_d to 30% of the value when there is no oscillation.

d. Empty system load, perform load-carrying joint debugging, and then fine-tune PID parameter until fulfilling the requirement.

5.5.15.2 PID adjusting method

After setting the parameters controlled by PID, you can fine-tune these parameters by the following means.

Control overmodulation: When overmodulation occurred, shorten the derivative time (T_d) and prolong integral time (T_i).

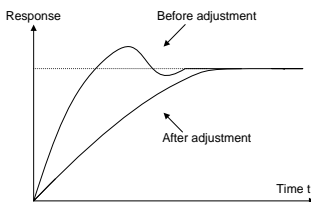

Stabilize the feedback value as fast as possible: when overmodulation occurred, shorten integral

time (T_i) and prolong derivative time (T_d) to stabilize control as fast as possible.

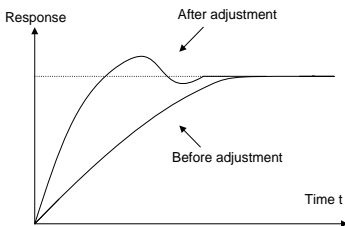

Control long-term vibration: If the cycle of periodic vibration is longer than the set value of integral time (T_i), it indicates the integral action is too strong, prolong the integral time (T_i) to control vibration.

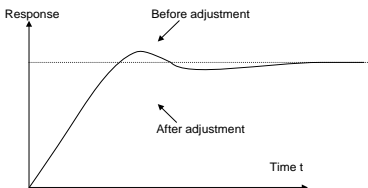

Control short-term vibration: If the vibration cycle is short is almost the same with the set value of derivative time (T_d), it indicates derivative action is too strong, shorten the derivative time (T_d) to control vibration. When derivative time (T_d) is set to 0.00 (namely no derivative control), and there is no way to control vibration, decrease the proportional gain.

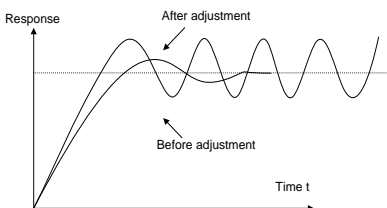

Related parameter list:

Function code	Name	Description	Default value
P09.00	PID reference source	0: Set by P09.01 1: AI1 2: AI2 3: AI3 4: High-speed pulse HDIA 5: Multi-step 6: Modbus/Modbus TCP communication 7: PROFIBUS/CANopen/DeviceNet communication	0

Function code	Name	Description	Default value
		8: Ethernet communication 9: High-speed pulse HDIB 10: EtherCAT/PROFINET/EtherNet IP communication 11: Programmable expansion card 12: Reserved	
P09.01	PID digital setting	-100.0%–100.0%	0.0%
P09.02	PID feedback source	0: AI1 1: AI2 2: AI3 3: High-speed pulse HDIA 4: Modbus/Modbus TCP communication 5: PROFIBUS/CANopen/DeviceNet communication 6: Ethernet communication 7: High-speed pulse HDIB 8: EtherCAT/PROFINET/EtherNet IP communication 9: Programmable expansion card 10: Reserved	0
P09.03	PID output characteristics	0: PID output is positive characteristic 1: PID output is negative characteristic	0
P09.04	Proportional gain (Kp)	0.00–100.00	1.80
P09.05	Integral time (Ti)	0.01–10.00s	0.90s
P09.06	Derivative time (Td)	0.00–10.00s	0.00s
P09.07	Sampling cycle (T)	0.000–10.000s	0.100s
P09.08	Limit of PID control deviation	0.0–100.0%	0.0%
P09.09	Upper limit value of PID output	P09.10–100.0% (max. frequency or voltage)	100.0%
P09.10	Lower limit value of PID output	-100.0%–P09.09 (max. frequency or voltage)	0.0%
P09.11	Feedback offline detection value	0.0–100.0%	0.0%
P09.12	Feedback offline detection time	0.0–3600.0s	1.0s
P09.13	PID control selection	0x0000–0x1111 Ones:	0x0001

Function code	Name	Description	Default value
		0: Continue integral control after the frequency reaches upper/lower limit 1: Stop integral control after the frequency reaches upper/lower limit Tens: 0: The same with the main reference direction 1: Contrary to the main reference direction Hundreds: 0: Limit as per the max. frequency 1: Limit as per A frequency Thousands: 0: A+B frequency, acceleration /deceleration of main reference A frequency source buffering is invalid 1: A+B frequency, acceleration/ deceleration of main reference A frequency source buffering is valid, acceleration/deceleration is determined by P08.04 (acceleration time 4).	
P09.14	Low frequency proportional gain (Kp)	0.00–100.00	1.00
P09.15	ACC/DEC time of PID command	0.0–1000.0s	0.0s
P09.16	PID output filter time	0.000–10.000s	0.000s
P09.17	Reserved		
P09.18	Low frequency integral time (Ti)	0.00–10.00s	0.90s
P09.19	Low frequency differential time (Td)	0.00–10.00s	0.00s
P09.20	Low frequency point for PID parameter switching	0.00–P09.21	5.00Hz
P09.21	High frequency point for PID parameter switching	P09.20–P00.04	10.00Hz
P17.00	Set frequency	0.00Hz–P00.03 (Max. output frequency)	0.00Hz
P17.23	PID reference value	-100.0–100.0%	0.0%
P17.24	PID feedback value	-100.0–100.0%	0.0%

5.5.16 Run at wobbling frequency

Wobbling frequency is applied in cases where transverse movement and winding functions are needed like textile and chemical fiber industries. The typical working process is shown as below.

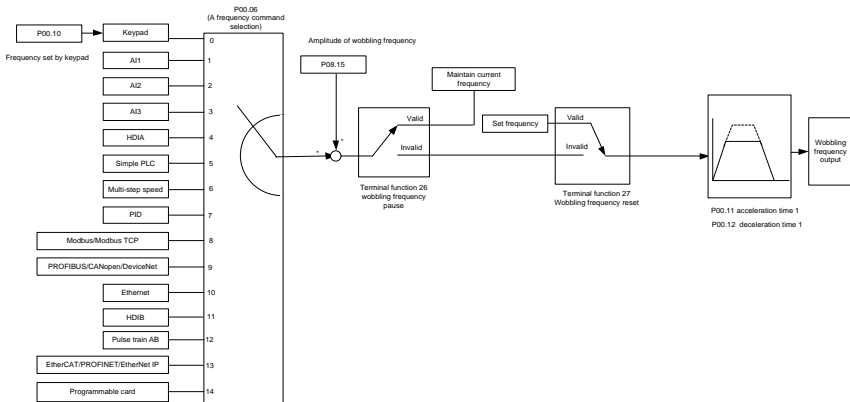

Function code	Name	Description	Default value
P00.03	Max. output frequency	P00.03–400.00Hz	50.00Hz
P00.06	A frequency command selection	0: Keypad 1: AI1 2: AI2 3: AI3 4: High speed pulse HDIA 5: Simple PLC program 6: Multi-step speed running 7: PID control 8: Modbus/Modbus TCP communication 9: PROFIBUS/CANopen/DeviceNet communication 10: Ethernet communication 11: High speed pulse HDIB 12: Pulse train AB 13: EtherCAT/PROFINET/EtherNet IP communication 14: Programmable card	0
P00.11	Acceleration time 1	0.0–3600.0s	Depends on model
P00.12	Deceleration time 1	0.0–3600.0s	Depends on model

Function code	Name	Description	Default value
P05.01– P05.06	Digital input function selection	26: Wobbling frequency pause (stop at current frequency) 27: Wobbling frequency reset (revert to center frequency)	/
P08.15	Amplitude of wobbling frequency	0.0–100.0% (relative to set frequency)	0.0%
P08.16	Amplitude of jump frequency	0.0–50.0% (relative to amplitude of wobbling frequency)	0.0%
P08.17	Wobbling frequency rise time	0.1–3600.0s	5.0s
P08.18	Wobbling frequency fall time	0.1–3600.0s	5.0s

5.5.17 Local encoder input

The VFD supports pulse count function by inputting the count pulse from HDI high-speed pulse port. When the actual count value is no less than the set value, digital output terminal will output count-value-reached pulse signal, and the corresponding count value will be zeroed out.

Function code	Name	Description	Default value
P05.00	HDI input type	0x00–0x11 Ones: HDIA input type 0: HDIA is high-speed pulse input 1: HDIA is digital input Tens: HDIB input type 0: HDIB is high-speed pulse input 1: HDIB is digital input	0x00
P05.38	HDIA high-speed pulse input function	0: Set input via frequency 1: Reserved 2: Input via encoder, used in combination with HDIB	0
P05.44	HDIB high-speed pulse input function selection	0: Set input via frequency 1: Reserved 2: Input via encoder, used in combination with HDIA	0
P18.00	Actual frequency of encoder	-999.9–3276.7Hz	0.0Hz
P20.15	Speed measurement mode	0: PG card 1: local; realized by HDIA and HDIB; supports incremental 24V encoder only	0

5.5.18 Commissioning procedures for closed-loop control, position control and spindle positioning

1. Commissioning procedure for closed-loop vector control of asynchronous motor

Step 1: Restore to default value via keypad

Step 2: Set P00.03, P00.04 and P02 group motor nameplate parameters

Step 3: Motor parameter autotuning

Carry out rotary parameter autotuning or static parameter autotuning via keypad. If the motor can be disconnected from load, then you can carry out rotary parameter autotuning; otherwise, carry out static parameter autotuning, the parameter obtained from autotuning will be saved in P02 motor parameter group automatically.

Step 4: Verify whether the encoder is installed and set properly

- a) Confirm the encoder direction and parameter setup

Set P20.01 (encoder pulse-per-revolution), set P00.00=2 and P00.10=20Hz, and run the VFD, at this point, the motor rotates at 20Hz, observe whether the speed measurement value of P18.00 is correct, if the value is negative, it indicates the encoder direction is reversed, under such situation, set P20.02 to 1; if the speed measurement value deviates greatly, it indicates P20.01 is set improperly. Observe whether P18.02 (encoder Z pulse count value) fluctuates, if yes, it indicates the encoder suffers interference or P20.01 is set improperly, requiring the check of the wiring and the shielding layer.

- b) Determine Z pulse direction

Set P00.10=20Hz, and set P00.13 (running direction) to forward and reverse direction respectively to observe whether the difference value of P18.02 is less than 5, if the difference value remains to be larger than 5 after setting Z pulse reversal function of P20.02, power off and exchange phase A and phase B of the encoder, and then observe the difference between the value of P18.02 during forward and reverse rotation. Z pulse direction only affects the forward/reverse positioning precision of the spindle positioning carried out with Z pulse.

Step 5: Closed-loop vector pilot-run

Set P00.00=3, and carry out closed-loop vector control, adjust P00.10 and speed loop and current loop PI parameter in P03 group to make it run stably in the whole range.

Step 6: Flux-weakening control

Set flux-weakening regulator gain P03.26=0–8000, and observe the flux-weakening control effect. P03.22–P03.24 can be adjusted as needed.

2. Commissioning procedure for closed-loop vector control of synchronous motor

Step 1: Set P00.18=1, restore to default value

Step 2: Set P00.00=3 (closed-loop vector control), set P00.03, P00.04, and motor nameplate parameters in P02 group.

Step 3: Set P20.01.

When the encoder is resolver-type encoder, set the encoder pulse count value to (resolver pole pair number \times 1024), eg, if pole pair number is 4, set P20.01 to 4096.

Step 4: Ensure the encoder is installed and set correctly

When motor stops, observe whether P18.21 (resolver angle) fluctuates, if it fluctuates sharply, check the wiring and grounding. Rotates the motor slowly, observe whether P18.21 changes accordingly. If yes, it indicates motor is connected correctly; if the value of P18.02 keeps constant at a non-zero value after rotating for multiple circles, it indicates encoder Z signal is correct.

Step 5: Autotuning of initial position of magnetic pole

Set P20.11=2 or 3 (3: rotary autotuning; 2: static autotuning), press RUN key to run the VFD.

a) Rotary autotuning (P20.11 = 3)

Detect the position of current magnetic pole when autotuning starts, and then accelerates to 10.00Hz, autotuning corresponding magnetic pole position of encoder Z pulse, and decelerate to stop.

During running, if ENC1o or ENC1d fault occurred, set P20.02=1 and carry out autotuning again.

After autotuning is done, the angle obtained from autotuning will be saved in P20.09 and P20.10 automatically.

b) Static autotuning

In cases where the load can be disconnected, it is recommended to adopt rotary autotuning (P20.11=3) as it has high angle precision. If the load cannot be disconnected, you can adopt static autotuning (P20.11=2). The magnetic pole position obtained from autotuning will be saved in P20.09 and P20.10.

Step 6: Closed-loop vector pilot-run

Adjust P00.10 and speed loop and current loop PI parameter in P03 group to make it run stably in the whole range. If oscillation occurred, reduce the value of P03.00, P03.03, P03.09 and P03.10. If current oscillation noise occurred during low speed, adjust P20.05.

Note: It is necessary to re-determine P20.02 (encoder direction) and carry out magnetic pole position autotuning again if the wiring of motor or encoder is changed.

3. Commissioning procedure for pulse train control

Pulse input is operated based on closed-loop vector control; speed detection is needed in the subsequent spindle positioning, zeroing operation and division operation.

Step 1: Restore to default value by keypad

Step 2: Set P00.03, P00.04 and motor nameplate parameters in P02 group

Step 3: Motor parameter autotuning: rotary parameter autotuning or static parameter autotuning

Step 4: Verify the installation and settings of encoder. Set P00.00=3 and P00.10=20.00Hz to run the

system, and check the control effect and performance of the system.

Step 5: Set P21.00=0001 to set positioning mode to position control, namely pulse-string control. There are four kinds of pulse command modes, which can be set by P21.01 (pulse command mode).

In position control mode, you can check the high bit and low bit of position reference and feedback, P18.02 (count value of Z pulse), P18.00 (actual frequency of encoder), P18.17 (pulse command frequency), and P18.19 (position regulator output), through which you can figure out the relation between P18.08 (position of position reference point) and P18.02 (count value of Z pulse), and between P18.17 (pulse command frequency), P18.18 (pulse command feedforward) and P18.19 (position regulator output).

Step 6: The position regulator has two gains, namely P21.02 and P21.03, and they can be switched by speed command, torque command and terminals.

Step 7: When P21.08 (output limit of position controller) is set to 0, the position control will be invalid, and at this point, the pulse train acts as frequency source, P21.13 (position feedforward gain) should be set to 100%, and the speed acceleration/deceleration time is determined by the acceleration /deceleration time of pulse train, the pulse train acceleration/deceleration time of the system can be adjusted. If the pulse train acts as the frequency source in speed control, you can also set P21.00 to 0000, and set the frequency source reference P00.06 or P00.07 to 12 (set by Pulse train AB), at this point, the acceleration/deceleration time is determined by the acceleration/deceleration time of the VFD, meanwhile, the parameters of Pulse train AB is still set by P21 group. In speed mode, the filter time of Pulse train AB is determined by P21.29.

Step 8: The input frequency of pulse train is the same with the feedback frequency of encoder pulse, the relation between them can be changed by altering P21.11 (numerator of position command ratio) and P21.12 (denominator of position command ratio)

Step 9: When running command or servo enabling is valid (by setting P21.00 or terminal function 63), it will enter pulse train servo running mode.

4. Commissioning procedure for spindle positioning

Spindle orientation is to realize orientation functions like zeroing and division based on closed-loop vector control

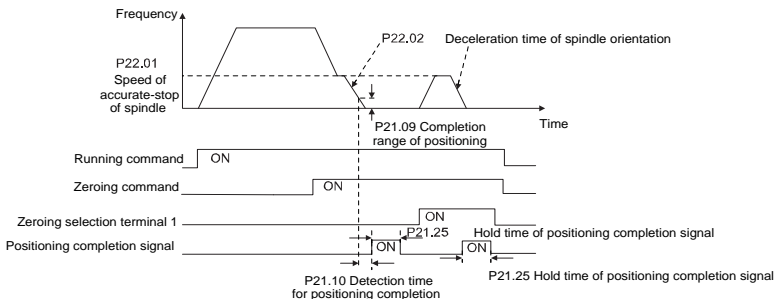

Step 1–4: These four steps are the same with the first four steps of the commissioning procedures for closed-loop vector control, which aim to fulfill the control requirements of closed-loop vector control, thus realizing spindle positioning function in either position control or speed control mode.

Step 5: Set P22.00.bit0=1 to enable spindle positioning, set P22.00.bit1 to select spindle zero input. If the system adopts encoder for speed measurement, set P22.00.bit1 to 0 to select Z pulse input; if the system adopts photoelectric switch for speed measurement, set P22.00.bit1 to 1 to select photoelectric switch as zero input; set P22.00.bit2 to select zero search mode, set P22.00.bit3 to enable or disable zero calibration, and select zero calibration mode by setting P22.00.bit7.

Step 6: Spindle zeroing operation

a) Select the positioning direction by setting P22.00.bit4;

b) There are four zero positions in P22 group, you can choose one out of four zeroing positions by setting zeroing input terminal selection (46, 47) in P05 group. When executing zeroing function, the motor will stop accurately at corresponding zeroing position according to the set positioning direction, which can be viewed via P18.10;

c) The positioning length of spindle zeroing is determined by the deceleration time of accurate-stop and the speed of accurate-stop;

Step 7: Spindle division operation

There are seven scale-division positions in P22 group, you can choose one out of seven scale-division positions by setting scale-division input terminal selection (48, 49, 50) in P05 group. Enable corresponding scale-division terminal after the motor stops accurately, and the motor will check the scale-division position state and switch to corresponding position incrementally, at this point, you can check P18.09.

Step 8: Priority level of speed control, position control and zeroing

The priority level of speed running is higher than that of the scale division, when the system runs in scale-division mode, if spindle orientation is prohibited, the motor will turn to speed mode or position mode.

The priority level of zeroing is higher than that of the scale division.

Scale-division command is valid when the scale-division terminal is from 000 state to non-000 state, eg, in 000–011, the spindle executes scale division 3. The transition time during terminal switchover needs to be less than 10ms; otherwise, wrong scale division command may be executed.

Step 9: Hold positioning

The position loop gain during positioning is P21.03; while the position loop gain in positioning-completion-hold state is P21.02. In order to keep sufficient position-hold force and ensure no system oscillation occurred, adjust P03.00, P03.01, P20.05 and P21.02.

Step 10: Positioning command selection (bit6 of P22.00)

Electric level signal: Positioning command (zeroing and scale division) can be executed only when there is running command or the servo is enabled.

Step 11: Spindle reference point selection (bit0 of P22.00)

Encoder Z pulse positioning supports the following spindle positioning modes:

- a) the encoder is installed on the motor shaft, the motor shaft and spindle is 1:1 rigid connection;
- b) the encoder is installed on the motor shaft, the motor shaft and spindle is 1:1 belt connection;

At this point, the belt may slip during high-speed running and cause inaccurate positioning, it is recommended to install proximity switch on the spindle.

- c) The encoder is installed on the spindle, and the motor shaft is connected to the spindle with belt, the drive ratio is not necessarily 1:1;

At this point, set P20.06 (speed ratio of the mounting shaft between motor and encoder), and set P22.14 (spindle drive ratio) to 1. As the encoder is not installed on the motor, the control performance of closed-loop vector will be affected.

Proximity switch positioning supports the following spindle positioning modes:

- a) The encoder is installed on the motor shaft, the drive ratio between motor shaft and spindle is not necessarily 1:1;

At this point, it is required to set P22.14 (spindle drive ratio).

5. Commissioning procedure for digital positioning

The diagram for digital positioning is shown below.

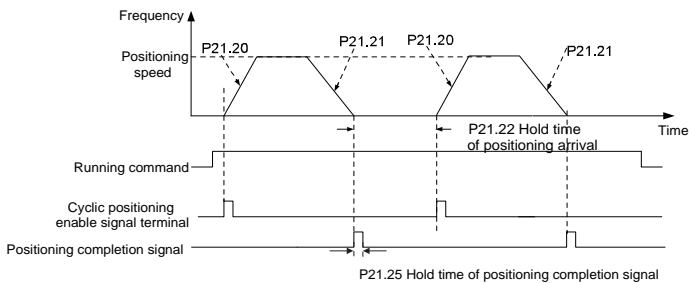

Step 1–4: These four steps are the same with the first four steps of the commissioning procedures for closed-loop vector control, which aim to fulfill the control requirements of closed-loop vector control.

Step 5: Set P21.00=0011 to enable digital positioning. Set P21.17, P21.11 and P21.12 (set positioning displacement) according to actual needs ; set P21.18 and P21.19 (set positioning speed); set P21.20 and P21.21 (set acceleration/deceleration time of positioning).

Step 6: Single positioning operation

Set P21.16.bit1=0, and the motor will carry out single positioning action and stay in the positioning position according to the setup in step 5.

Step 7: Cyclic positioning operation

Set P21.16.bit1=1 to enable cyclic positioning. The cyclic positioning is divided into continuous mode and repetitive mode; you can also carry out cyclic positioning through terminal function (no. 55, enable digital positioning cycle)

6. Commissioning procedure for positioning of photoelectric switch

Photoelectric switch positioning is to realize positioning function based on closed-loop vector control.

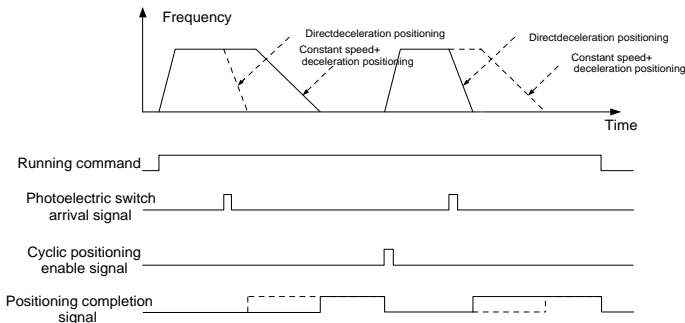

Step 1–4: These four steps are the same with the first four steps of the commissioning procedures for closed-loop vector control, which aim to fulfill the control requirements of closed-loop vector control.

Step 5: Set P21.00=0021 to enable photoelectric switch positioning, the photoelectric switch signal can be connected to S8 terminal only, and set P05.08=43, meanwhile, set P21.17, P21.11 and P21.12 (set positioning displacement) based on actual needs; set P21.21 (deceleration time of positioning), however, when present running speed is too fast or the set positioning displacement is too small, the deceleration time of positioning will be invalid, and it will enter direct deceleration positioning mode.

Step 6: Cyclic positioning

After positioning is done, the motor will stay in current position. You can set cyclic positioning through input terminal function selection (55: enable cyclic digital positioning) in P05 group; when the terminal receives cyclic positioning enable signal (pulse signal), the motor will continue running in the set speed as per the speed mode and re-enter positioning state after encountering photoelectric switch.

7 Hold positioning

The position loop gain during positioning is P21.03; while the position loop gain in positioning-completion-hold state is P21.02. In order to keep sufficient position-hold force and ensure no system oscillation occurred, adjust P03.00, P03.01, P20.05 and P21.02.

5.5.19 Fault handling

The following provides fault handling information.

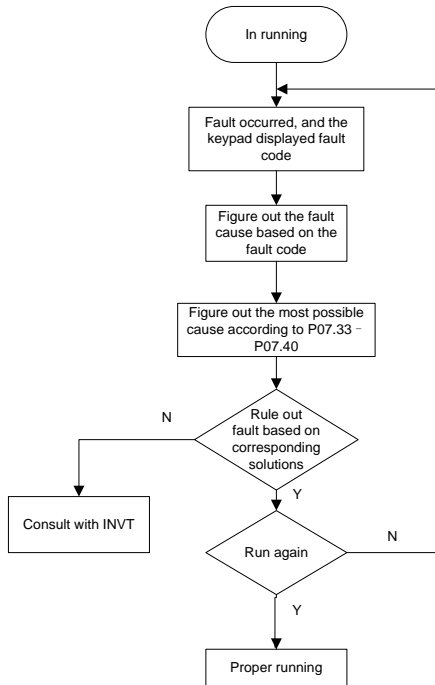

Related parameter list:

Function code	Name	Description	Default value
P07.27	Present fault type	0: No fault	0
P07.28	Last fault type	1: Inverter unit U phase protection (OUt1)	0
P07.29	2nd-last fault type	2: Inverter unit V phase protection (OUt2)	0
P07.30	3rd-last fault type	3: Inverter unit W phase protection (OUt3)	0
P07.31	4th-last fault type	4: Overcurrent during acceleration (OC1)	0
P07.32	5th-last fault type	5: Overcurrent during deceleration (OC2)	0
		6: Overcurrent during constant speed (OC3)	
		7: Overvoltage during acceleration (OV1)	
		8: Overvoltage during deceleration (OV2)	
		9: Overvoltage during constant speed (OV3)	
		10: Bus undervoltage fault (UV)	
		11: Motor overload (OL1)	
		12: VFD overload (OL2)	
		13: Phase loss on input side (SPI)	
		14: Phase loss on output side (SPO)	

Function code	Name	Description	Default value
		15: Rectifier module overheat (OH1) 16: Inverter module overheat (OH2) 17: External fault (EF) 18: Modbus/Modbus TCP communication fault (CE) 19: Current detection fault (ItE) 20: Motor autotuning fault (tE) 21: EEPROM operation fault (EEP) 22: PID feedback offline fault (PIDE) 23: Braking unit fault (bCE) 24: Running time reached (END) 25: Electronic overload (OL3) 26: Keypad communication error (PCE) 27: Parameter upload error (UPE) 28: Parameter download error (DNE) 29: PROFIBUS communication fault (E-DP) 30: Ethernet communication fault (E-NET) 31: CANopen communication fault (E-CAN) 32: To-ground short-circuit fault 1 (ETH1) 33: To-ground short-circuit fault 2 (ETH2) 34: Speed deviation fault (dEu) 35: Maladjustment fault (STo) 36: Underload fault (LL) 37: Encoder offline fault (ENC1o) 38: Encoder reversal fault (ENC1d) 39: Encoder Z pulse offline fault (ENC1Z) 40: Safe torque off (STO) 41: Channel H1 safety circuit exception (STL1) 42: Channel H2 safety circuit exception (STL2) 43: Channel H1 and H2 exception (STL3) 44: Safety code FLASH CRC fault (CrCE) 45: Programmable card customized fault 1 (P-E1) 46: Programmable card customized fault 2 (P-E2) 47: Programmable card customized fault 3 (P-E3) 48: Programmable card customized fault 4 (P-E4)	

Function code	Name	Description	Default value
		49: Programmable card customized fault 5 (P-E5) 50: Programmable card customized fault 6 (P-E6) 51: Programmable card customized fault 7 (P-E7) 52: Programmable card customized fault 8 (P-E8) 53: Programmable card customized fault 9 (P-E9) 54: Programmable card customized fault 10 (P-E10) 55: Duplicate card type(E-Err) 56: Encoder UVW loss fault (ENCUV) 57: PROFIBUS communication fault (E-PN) 58: CANopen communication fault (SECAN) 59: Motor over-temperature fault (OT) 60: Failure to identify the card at slot 1 (F1-Er) 61: Failure to identify the card at slot 2 (F2-Er) 62: Failure to identify the card at slot 3 (F3-Er) 63: Communication timeout of the card at slot 1 (C1-Er) 64: Communication timeout of the card at slot 2 (C2-Er) 65: Communication timeout of the card at slot 3 (C3-Er) 66: EtherCAT communication fault (E-CAT) 67: Bacnet communication fault (E-BAC) 68: DeviceNet communication fault (E-DEV) 69: CAN slave fault in master/slave synchronization (S-Err) 70: EC PT100 detected overheating (OtE1) 71: EC PT1000 detected overheating (OtE2) 72: EtherNet/IP communication timeout (E-EIP) 73: No upgrade bootload (E-PAO) 74: AI1 disconnected (E-AI1) 75: AI2 disconnected (E-AI2) 76: AI3 disconnected (E-AI3)	
P07.33	Running frequency at	0.00Hz~P00.03	0.00Hz

Function code	Name	Description	Default value
	present fault		
P07.34	Ramp reference frequency at present fault	0.00Hz–P00.03	0.00Hz
P07.35	Output voltage at present fault	0–1200V	0V
P07.36	Output current at present fault	0.0–6300.0A	0.0A
P07.37	Bus voltage at present fault	0.0–2000.0V	0.0V
P07.38	Max. temperature at present fault	-20.0–120.0°C	0.0°C
P07.39	Input terminal status at present fault	0x0000–0xFFFF	0x0000
P07.40	Output terminal status at present fault	0x0000–0xFFFF	0x0000
P07.41	Running frequency at last fault	0.00Hz–P00.03	0.00Hz
P07.42	Ramp reference frequency at last fault	0.00Hz–P00.03	0.00Hz
P07.43	Output voltage at last fault	0–1200V	0V
P07.44	Output current at last fault	0.0–6300.0A	0.0A
P07.45	Bus voltage at last fault	0.0–2000.0V	0.0V
P07.46	Max. temperature at last fault	-20.0–120.0°C	0.0°C
P07.47	Input terminal status at last fault	0x0000–0xFFFF	0x0000
P07.48	Output terminal state at last fault	0x0000–0xFFFF	0x0000
P07.49	Running frequency at 2nd-last fault	0.00Hz–P00.03	0.00Hz
P07.50	Ramp reference frequency at 2nd-last fault	0.00Hz–P00.03	0.00Hz
P07.51	Output voltage at	0–1200V	0V

Function code	Name	Description	Default value
	2nd-last fault		
P07.52	Output current at 2nd-last fault	0.0–6300.0A	0.0A
P07.53	Bus voltage at 2nd-last fault	0.0–2000.0V	0.0V
P07.54	Max. temperature at 2nd-last fault	-20.0–120.0°C	0.0°C
P07.55	Input terminal status at 2nd-last fault	0x0000–0xFFFF	0x0000
P07.56	Output terminal status at 2nd-last fault	0x0000–0xFFFF	0x0000

5.5.20 Tension control solutions

In many fields of industrial production, precise tension control is needed to maintain a constant output tension of the drive equipment, in order to improve the quality of the products. In the winding and unwinding of some industries such as paper processing, printing and dyeing, packing, wire and cable manufacturing, textile, fiber, optic cable, leather, metal foil material processing and so on, tension needs to keep constant.

The VFD controls the tension by regulating the motor output torque or speed. There are three modes to control the tension: speed mode, open-loop torque mode and closed-loop torque mode.

5.5.20.1 Typical tension control applications for winding/unwinding

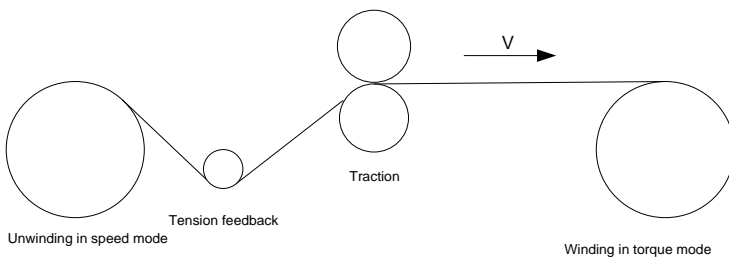

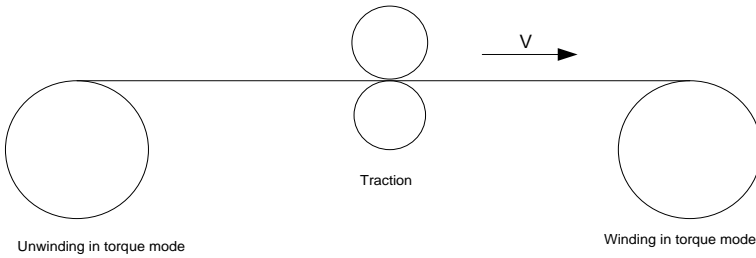
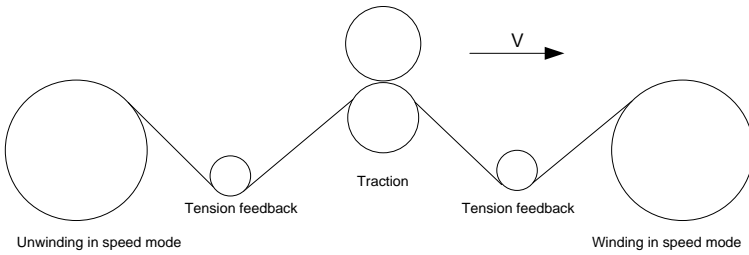
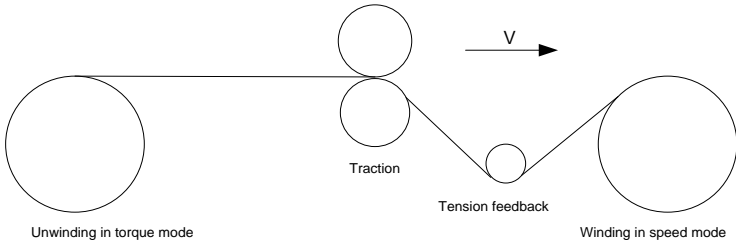

In some special situations, if the roll diameter can be counted through thickness, the following applications can be implemented:

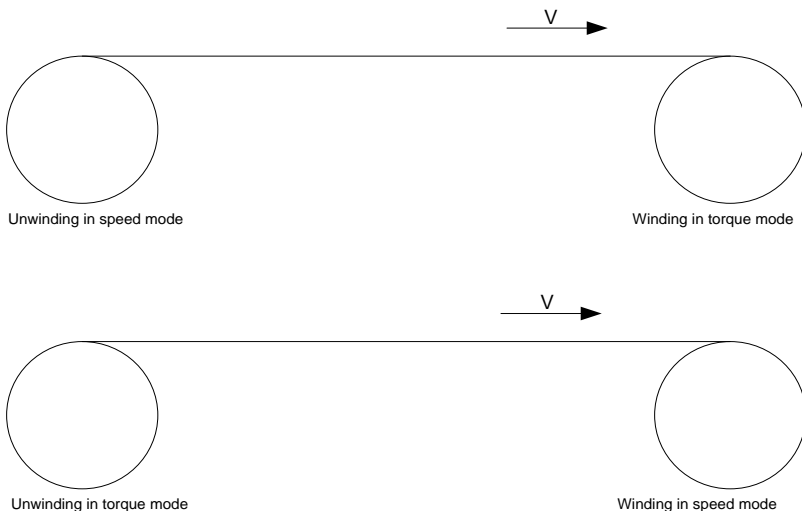

5.5.20.2 Speed control

The detection feedback signal is needed in the closed-loop adjustment. PID calculation is carried out according to the feedback signal for the motor speed regulation, linear speed and stable tension control. If the tension rocker or floating roller is used for feedback, changing the set value (PID reference) may change the actual tension, and at the same time, changing the mechanical configuration such as the tension rocker or floating roller weight can also change the tension.

The control principle is as follows.

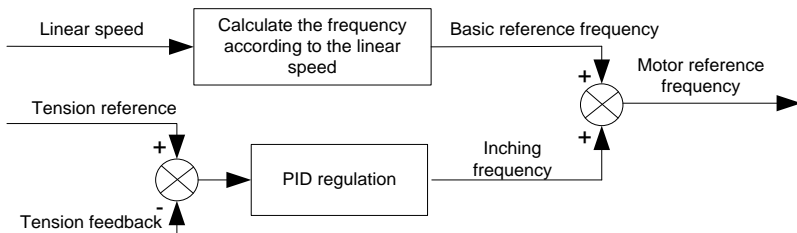

Related modules:

- (1) Linear speed input module: It is important for the calculation of the basic setting frequency according to the linear speed and the calculation of roll diameter according to the linear speed.
- (2) Real-time roll diameter calculation module: The calculation accuracy of roll diameter determines the control performance. The roll diameter can be calculated according to the VFD output frequency and the linear speed. In addition, it can also be calculated through the thickness or sensor. The linear

speed is widely used for the calculation. If the set linear speed is used for the calculation, you choose whether to enable the function of roll diameter change limiting.

(3) PID regulation module: There are two groups of PID parameters in P09. The linear speed synchronization and stable tension can be kept through PID regulation. PID parameters can be modified based on site commissioning. The two groups of PID parameters can be switched for PID regulation improvement.

(4) Material feeding interrupt detection and processing module: The function is valid when material feeding interrupt detection has been enabled.

(5) Pre-drive: This function is applied to automatic reel change. After the VFD is started if the pre-drive function terminal is valid, the roller runs at the set linear speed. If the terminal is invalid, the VFD will automatically switch to the corresponding control mode after a period of time.

5.5.20.3 Open-loop torque mode

Open loop means there is no tension feedback signal. In this mode, stable tension can be achieved by means of motor torque control. The rotation speed automatically changes with the linear speed of material. The control basis is as follows: For a reel control system, the relationship between the tension F of the roller with materials, present roll diameter D and output torque of the shaft is: $T = F \times D / 2$. If the output torque can be adjusted according to the variation of roll diameter, the tension can be controlled. In order to ensure the constant tension in the process of acceleration and deceleration, the internal friction compensation module and inertia compensation module have been built in the VFD to calculate the real time rotation inertia, and compensate the torque according to the actual speed change rate. The control principle is shown in the following figure.

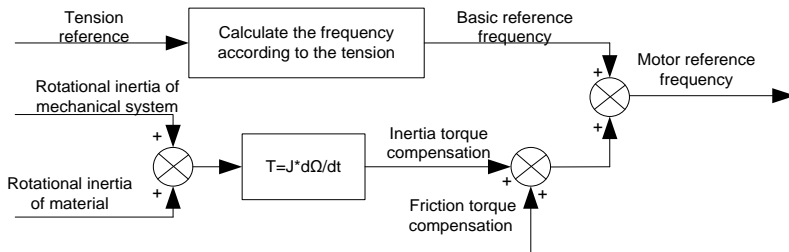

Relevant modes:

(1) Linear speed input module: It has two functions: calculating the synchronous frequency in torque control according to the linear speed, and calculating the roll diameter according to the linear speed.

(2) Tension setting module: Used to set the tension adapting to the control system. It needs to be adjusted according to the actual situation. After confirmation, the value remains the same. In some scenarios where the forming effect after winding needs to be improved, the tension taper function can be used so that the tension decreases as the roll diameter increases.

(3) Real-time roll diameter calculation module: The calculation accuracy of roll diameter determines the control performance. The roll diameter can be calculated according to the VFD output frequency

and the linear speed. In addition, it can also be calculated through the thickness or sensor. The linear speed is widely used for the calculation. If the set linear speed is used for the calculation, you choose whether to enable the function of roll diameter change limiting.

(4) Torque compensation module: Torque compensation includes friction torque compensation and inertia torque compensation. Friction torque compensation is used to eliminate the impact of friction on tension, and it needs to be adjusted according to actual requirements. rRotation inertia includes inertial of mechanical systems and that of materials. In order to keep the tension stable in ACC/DEC, compensation torque is required. In some cases without strict tension control requirements, disabling rotation inertia torque compensation can also achieve the control.

(5) Material feeding interrupt detection and processing module: The function is valid when material feeding interrupt detection has been enabled.

(6) This function is applied to automatic reel change. After the VFD is started if the pre-drive function terminal is valid, the roller runs at the set linear speed. If the terminal is invalid, the VFD will automatically switch to the corresponding control mode after a period of time.

5.5.20.4 Closed-loop torque mode

Similar to the open-loop torque mode, the closed-loop torque mode has only the difference that tension detection sensors are installed on the winding/unwinding side. In addition to all the function modules supported in open-loop torque mode, this mode supports an additional tension feedback PID closed-loop regulation module. The control principle is shown in the following figure.

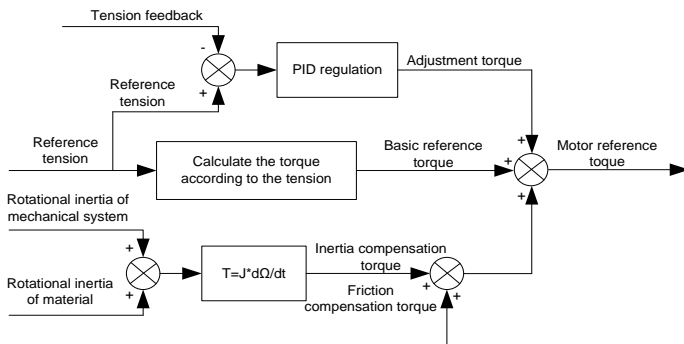

6 Function parameter list

6.1 What this chapter contains

This chapter lists all the function codes and corresponding descriptions.

6.2 Function parameter list

The function parameters of the VFD are divided into groups by function. Among the function parameter groups, the P98 group is the analog input and output calibration group, while the P99 group contains the factory function parameters, which are user inaccessible. Each group includes several function codes (each function code identifies a function parameter). A three-level menu style is applied to present the function groups, function codes, and function parameters. For example, "P08.08" indicates the 8th function code in the P08 group.

The function group numbers correspond to the level-1 menus, the function codes correspond to the level-2 menus, and the function parameters correspond to the level-3 menus.

1. The function list is divided into the following columns.

Column 1 "Function code ": Code of the function group and parameter

Column 2 "Name": Full name of the function parameter

Column 3 "Description": Detailed description of the function parameter

Column 4 "Default value": Initial value set in factory

Column 5 "Modify": Whether the function parameter can be modified, and conditions for the modification

"○": indicates that the value of the parameter can be modified when the VFD is in stopped or running state.

"◎": indicates that the value of the parameter cannot be modified when the VFD is in running state.

"●": indicates that the value of the parameter is detected and recorded, and cannot be modified.

(The VFD automatically checks and constrains the modification of parameters, which helps prevent incorrect modifications.)

2. The parameters adopt the decimal system (DEC). If the hexadecimal system is adopted, all bits are mutually independent on data during parameter editing, and the setting ranges at some bits can be hexadecimal (0–F).
3. "Default value" indicates the factory setting of the function parameter. If the value of the parameter is detected or recorded, the value cannot be restored to the factory setting.
4. In order to enhance parameter protection, the VFD provides the password protection function. After a user password is set (that is, P07.00 is set to a non-zero value), "0.0.0.0" is displayed when you press the **PRG/ESC** key to enter the function code editing interface, and

you can enter the interface only with the correct user password. For the factory parameters, you need to enter the correct factory password to enter the interface. (You are not advised to modify the factory parameters. Incorrect parameter setting may cause operation exceptions or even damage to the VFD.) If password protection is not in locked state, you can change the password any time. You can set P07.00 to 0 to cancel the user password. When P07.00 is set to a non-zero value during power-on, parameters are prevented from being modified by using the user password function. When you modify function parameters through serial communication, the user password protection function is also applicable and compliant with the same rule.

P00—Basic functions

Function code	Name	Description	Default value	Modify
P00.00	Speed control mode	0: Sensorless vector control (SVC) mode 0 1: SVC 1 2: SVPWM 3: FVC Note: To select 0, 1, or 3 as the control mode, enable the VFD to perform motor parameter autotuning first	2	☉
P00.01	Channel of running commands	0: Keypad 1: Terminal 2: Communication	0	○
P00.02	Communication mode of running commands	0: Modbus/Modbus TCP 1: PROFIBUS/CANopen/DeviceNet 2: Ethernet 3: EtherCAT/PROFINET/EtherNet IP 4: Programmable card 5: Wireless communication card 6: Reserved Note: The Modbus TCP communication mode of option 0, and options 1, 2, 3, 4 and 5 are extended functions which are applicable with corresponding cards.	0	○
P00.03	Max. output frequency	Used to set the maximum output frequency of the VFD. It is the basis of frequency setting and the acceleration/deceleration. Setting range: Max. (P00.04, 10.00)–630.00Hz	50.00Hz	☉
P00.04	Upper limit of running frequency	Used to set the upper limit of VFD output frequency. This value cannot be more than the maximum output frequency.	50.00Hz	☉

Function code	Name	Description	Default value	Modify
		When the set frequency is higher than the upper limit, the VFD runs at the upper limit frequency. Setting range: P00.05–P00.03 (Max. output frequency)		
P00.05	Lower limit of running frequency	The lower limit of running frequency is the lower limit value of VFD output frequency. When the set frequency is lower than the lower limit, the VFD runs at the lower limit frequency. Note: Max. output frequency ≥ upper limit frequency ≥ lower limit frequency. Setting range: 0.00Hz–P00.04 (upper limit of running frequency)	0.00Hz	☉
P00.06	A frequency command selection	0: Keypad 1: AI1 2: AI2	0	○
P00.07	B frequency command selection	3: AI3 4: High speed pulse HDIA 5: Simple PLC program 6: Multi-step speed running 7: PID control 8: Modbus/Modbus TCP communication 9: PROFIBUS/CANopen/DeviceNet communication 10: Ethernet communication 11: High speed pulse HDIB 12: Pulse train AB 13: EtherCAT/PROFINET/EtherNet IP communication 14: Programmable card 15: Reserved	15	○
P00.08	Reference object of B frequency command	0: Max. output frequency 1: A frequency command	0	○
P00.09	Combination mode of setting source	0: A 1: B 2: (A+B) 3: (A-B) 4: Max. (A, B) 5: Min. (A, B)	0	○

Function code	Name	Description	Default value	Modify																									
P00.10	Set frequency via keypad	When A and B frequency commands are set by keypad, the value is the initial digital set value of the VFD frequency. Setting range: 0.00 Hz–P00.03 (Max. output frequency)	50.00Hz	<input type="radio"/>																									
P00.11	Acceleration time 1	Acceleration time is the time needed for accelerating from 0Hz to Max. output frequency (P00.03).	Depends on model	<input type="radio"/>																									
P00.12	Deceleration time 1	Deceleration time is the time needed from decelerating from Max. output frequency (P00.03) to 0Hz. The VFD defines four groups of acceleration and deceleration time, which can be selected via multi-function digital input terminals (P05 group). The acceleration/deceleration time of the VFD is the first group by default. Setting range of P00.11 and P00.12: 0.0–3600.0s	Depends on model	<input type="radio"/>																									
P00.13	Running direction	0: Run in default direction 1: Run in reverse direction 2: Reverse running is prohibited	0	<input type="radio"/>																									
P00.14	Carrier frequency setting	<table border="1"> <thead> <tr> <th>Carrier frequency</th> <th>Electro magnetic noise</th> <th>Noise and leakage current</th> <th>Cooling level</th> </tr> </thead> <tbody> <tr> <td>1kHz</td> <td rowspan="3">↑ High ↓ Low</td> <td rowspan="3">↑ Low ↓ High</td> <td rowspan="3">↑ Low ↓ High</td> </tr> <tr> <td>10kHz</td> </tr> <tr> <td>15kHz</td> </tr> </tbody> </table> <p>The relation between the model and carrier frequency is shown below.</p> <table border="1"> <thead> <tr> <th colspan="2">Model</th> <th>Default carrier frequency</th> </tr> </thead> <tbody> <tr> <td rowspan="3">380V</td> <td>1.5–11kW</td> <td>8kHz</td> </tr> <tr> <td>15–55kW</td> <td>4kHz</td> </tr> <tr> <td>Above 75kW</td> <td>2kHz</td> </tr> <tr> <td rowspan="2">660V</td> <td>22–55kW</td> <td>4kHz</td> </tr> <tr> <td>Above 75kW</td> <td>2kHz</td> </tr> </tbody> </table> <p>Advantages of high carrier frequency are as follows: ideal current waveform, few current</p>	Carrier frequency	Electro magnetic noise	Noise and leakage current	Cooling level	1kHz	↑ High ↓ Low	↑ Low ↓ High	↑ Low ↓ High	10kHz	15kHz	Model		Default carrier frequency	380V	1.5–11kW	8kHz	15–55kW	4kHz	Above 75kW	2kHz	660V	22–55kW	4kHz	Above 75kW	2kHz	Depends on model	<input type="radio"/>
Carrier frequency	Electro magnetic noise	Noise and leakage current	Cooling level																										
1kHz	↑ High ↓ Low	↑ Low ↓ High	↑ Low ↓ High																										
10kHz																													
15kHz																													
Model		Default carrier frequency																											
380V	1.5–11kW	8kHz																											
	15–55kW	4kHz																											
	Above 75kW	2kHz																											
660V	22–55kW	4kHz																											
	Above 75kW	2kHz																											

Function code	Name	Description	Default value	Modify
		<p>harmonics and small motor noise.</p> <p>Disadvantages of high carrier frequency are as follows: growing switch consumption, enlarged temperature rise, impacted output capacity; under high carrier frequency, the VFD needs to be derated for use, meanwhile, the leakage current will increase, which increases electromagnetic interference to the surroundings.</p> <p>While low carrier frequency is the contrary. Low carrier frequency will cause unstable operation at low frequency, decrease the torque, or even lead to oscillation.</p> <p>The carrier frequency of VFD is set properly by default, and it should not be changed at will.</p> <p>If the default carrier frequency is exceeded during use, derating is required, derate by 10% for every additional 1k carrier frequency.</p> <p>Setting range: 1.0–15.0kHz</p>		
P00.15	Motor parameter autotuning	<p>0: No operation</p> <p>1: Rotary autotuning 1; carry out comprehensive motor parameter autotuning; rotary autotuning is used in cases where high control precision is required;</p> <p>2: Static autotuning 1 (comprehensive autotuning); static autotuning 1 is used in cases where the motor cannot be disconnected from load;</p> <p>3: Static autotuning 2 (partial autotuning) ; when current motor is motor 1, only P02.06, P02.07 and P02.08 will be autotuned; when current motor is motor 2, only P12.06, P12.07 and P12.08 will be autotuned.</p> <p>4: Rotary autotuning 2, which is similar to rotary autotuning 1 but is only applicable to asynchronous motors.</p> <p>5: Rotary autotuning 3 (partial autotuning), which is only applicable to asynchronous motors.</p>	0	☉
P00.16	AVR function	<p>0: Invalid</p> <p>1: Valid during the whole process</p> <p>Automatic voltage regulation function is used to</p>	1	○

Function code	Name	Description	Default value	Modify
		eliminate the impact on the output voltage of VFD when bus voltage fluctuates.		
P00.17	Reserved			
P00.18	Function parameter restoration	0: No operation 1: Restore default values (excluding motor parameters) 2: Clear fault records 3: Reserved 4: Reserved 5: Restore default values (for factory test mode) 6: Restore default values (including motor parameters) Note: After the selected operation is performed, this parameter is automatically restored to 0. Restoring the default values may delete the user password. Exercise caution when using this function. The option 5 can be used only for factory testing.	0	⊙

P01—Start/stop control

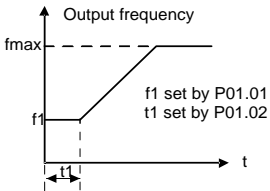
Function code	Name	Description	Default value	Modify
P01.00	Running mode of start	0: Direct start 1: Start after DC brake 2: Start after speed tracking	0	⊙
P01.01	Starting frequency of direct start	Starting frequency of direct startup is the initial frequency when the VFD starts. See P01.02 (hold time of starting frequency) for details. Setting range: 0.00–50.00Hz	0.50Hz	⊙
P01.02	Hold time of starting frequency	 <p>A proper starting frequency can increase the torque during startup. Within the hold time of starting frequency, the output frequency of VFD is the starting frequency, and then it runs from the starting frequency to the target frequency, if the target frequency (frequency command) is below</p>	0.0s	⊙

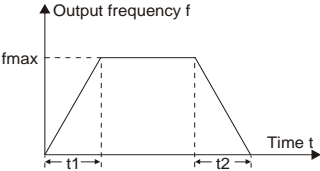
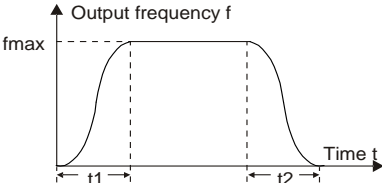
Function code	Name	Description	Default value	Modify
		the starting frequency, the VFD will be standby rather than running. The starting frequency value is unlimited by the lower limit frequency. Setting range: 0.0–50.0s		
P01.03	DC braking current before start	During starting, the VFD will first perform DC braking based on the set DC braking current before startup, and then it will accelerate after the set DC braking time before startup elapses. If the set DC braking time is 0, DC braking will be invalid. The larger the DC braking current, the stronger the braking force. The DC braking current before startup refers to the percentage relative to rated VFD output current.	0.0%	⊙
P01.04	DC braking time before start	Setting range of P01.03: 0.0–100.0% Setting range of P01.04: 0.00–50.00s	0.00s	⊙
P01.05	Acceleration/deceleration mode	This function code is used to select the frequency variation mode during starting and running. 0: Straight line; the output frequency increases or decreases in straight line;  1: S curve; the output frequency increases or decreases in S curve; S curve is generally used in cases where smooth start/stop is required, such as elevator, conveyer belt, and so on.  Note: When set to 1, it is required to set P01.06, P01.07, P01.27 and P01.28 accordingly.	0	⊙
P01.06	Time of starting	The curvature of S curve is determined by	0.1s	⊙

Function code	Name	Description	Default value	Modify
	section of acceleration S curve	acceleration range and acceleration and deceleration time.		
P01.07	Time of ending section of acceleration S curve	<p>t1=P01.06 t2=P01.07 t3=P01.27 t4=P01.28</p> <p>Setting range: 0.0–50.0s</p>	0.1s	☉
P01.08	Stop mode	<p>0: Decelerate to stop; after stop command is valid, the VFD lowers output frequency based on the deceleration mode and the defined deceleration time, after the frequency drops to the stop speed (P01.15), the VFD stops.</p> <p>1: Coast to stop; after stop command is valid, the VFD stops output immediately, and the load coasts to stop as per mechanical inertia.</p>	0	○
P01.09	Starting frequency of DC braking after stop	Starting frequency of DC braking after stop; during decelerating to stop, when this frequency is reached, DC braking will be performed after stop.	0.00Hz	○
P01.10	Waiting time of DC braking after stop	Demagnetization time (waiting time of DC braking after stop): Before the DC brake, the VFD will block output, and after the demagnetization time elapses, DC braking will start. This function is used to prevent overcurrent fault caused by DC braking	0.00s	○
P01.11	DC braking current of stop	during high speed.	0.0%	○
P01.12	DC braking time of stop	<p>DC braking current after stop: it means the DC braking force applied, the larger the current, the stronger the DC braking effect.</p> <p>Setting range of P01.09: 0.00Hz–P00.03 (Max. output frequency)</p> <p>Setting range of P01.10: 0.00–30.00s</p> <p>Setting range of P01.11: 0.0–100.0% (of the rated</p>	0.00s	○

Function code	Name	Description	Default value	Modify
		VFD output current) Setting range of P01.12: 0.0–50.0s		
P01.13	Deadzone time of forward/reverse rotation	<p>This function code refers to the transition time of the threshold set by P01.14 during setting forward/reverse rotation of the VFD, as shown below.</p> <p>Setting range: 0.0–3600.0s</p>	0.0s	○
P01.14	Forward/reverse rotation switchover mode	0: Switch over after zero frequency 1: Switch over after starting frequency 2: Switch over after passing stop speed and delay	1	◎
P01.15	Stop speed	0.00–100.00Hz	0.50Hz	◎
P01.16	Stop speed detection mode	0: Set value of speed (the only detection mode valid in SVPWM mode) 1: Detection value of speed	0	◎
P01.17	Stop speed detection time	0.00–100.00s	0.50s	◎
P01.18	Terminal running protection at power-on	<p>When the running command channel is controlled by terminals, the system will detect running terminal state automatically during power-on.</p> <p>0: Terminal running command is invalid during power-on. The VFD will not run during power-on even if the running command terminal is detected to be valid, and the system is in running protection state. The VFD will run only after this terminal is cancelled and enabled again.</p> <p>1: Terminal running command is valid during power-on. The system will start the VFD automatically after initialization is done if the running command terminal is detected to be valid during power-on.</p> <p>Note: This function must be set with caution, otherwise, serious consequences may occur.</p>	0	○

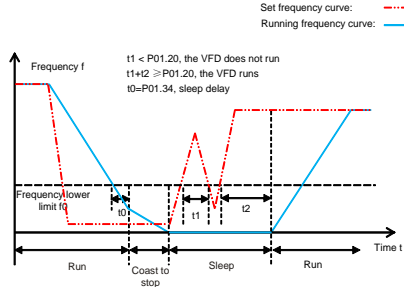
Function code	Name	Description	Default value	Modify
P01.19	Action selected when running frequency less than frequency lower limit (valid when frequency lower limit greater than 0)	<p>This parameter specifies the running status of VFD when the set frequency is below the lower limit.</p> <p>Ones place: Action selection 0: Run in lower limit of the frequency 1: Stop 2: Sleep</p> <p>Tens place: Stop mode 0: Coast to stop 1: Decelerate to stop</p> <p>The VFD stops as set in the tens place if the action selection is stop or sleep when the set frequency is below the lower limit. The VFD resumes the running state automatically when the set frequency is above the lower limit again and this situation lasts for the time set by P01.20.</p>	0x00	☉
P01.20	Wake-up-from-sleep delay	<p>This parameter specifies the sleep delay. When the running frequency of VFD is below the lower limit frequency, the VFD enters sleep state; when the set frequency is above the lower limit again and continues to be so after the time set by P01.20 elapses, the VFD will run automatically.</p>  <p>Setting range: 0.0–3600.0s (valid when the ones place of P01.19 is 2)</p>	0.0s	○
P01.21	Restart after power down	<p>This parameter specifies the automatic running of the VFD at next power-on after power down.</p> <p>0: Disabled restart 1: Enable restart, namely the VFD will run automatically after the time set by P01.22 elapses if the starting conditions are met.</p>	0	○

Function code	Name	Description	Default value	Modify
P01.22	Waiting time of restart after power down	<p>This parameter specifies the waiting time before automatically running at next power-on after power down.</p> <p>Setting range: 0.0–3600.0s (valid when P01.21=1)</p>	1.0s	<input type="radio"/>
P01.23	Start delay	<p>This parameter specifies the delay of the VFD's wake-up-from-sleep after running command is given, the VFD will start to run and output after the time set by P01.23 elapses to realize brake release.</p> <p>Setting range: 0.0–600.0s</p>	0.0s	<input type="radio"/>
P01.24	Stop speed delay	0.0–600.0s	0.0s	<input type="radio"/>
P01.25	Open-loop 0Hz output selection	0: No voltage output 1: With voltage output 2: Output as per DC braking current of stop	0	<input type="radio"/>
P01.26	Deceleration time of emergency-stop	0.0–60.0s	2.0s	<input type="radio"/>
P01.27	Time of starting section of deceleration S curve	0.0–50.0s	0.1s	<input checked="" type="radio"/>
P01.28	Time of ending section of deceleration S curve	0.0–50.0s	0.1s	<input checked="" type="radio"/>
P01.29	Short-circuit braking current	When the VFD starts in direct start mode (P01.00=0), set P01.30 to a non-zero value to enter short-circuit brake.	0.0%	<input type="radio"/>
P01.30	Hold time of short-circuit braking at startup	During stop, if the running frequency of VFD is below the starting frequency of braking after stop, set P01.31 to a non-zero value to enter short-circuit braking after stop, and then carry out DC braking in the time set by P01.12 (refer to	0.00s	<input type="radio"/>
P01.31	Hold time of short-circuit braking at stop		0.00s	<input type="radio"/>

Function code	Name	Description	Default value	Modify
		P01.09–P01.12). Setting range of P01.29: 0.0–150.0% (of the rated VFD output current) Setting range of P01.30: 0.0–50.0s Setting range of P01.31: 0.0–50.0s		
P01.32	Pre-exciting time of jogging	0–10.000s	0.000s	<input type="radio"/>
P01.33	Starting frequency of braking for jogging to stop	0.00Hz–P00.03	0.00Hz	<input type="radio"/>
P01.34	Delay to enter sleep	0–3600.0s	0.0s	<input type="radio"/>

P02—Parameters of motor 1

Function code	Name	Description	Default value	Modify
P02.00	Type of motor 1	0: Asynchronous motor 1: Synchronous motor	0	<input checked="" type="radio"/>
P02.01	Rated power of asynchronous motor 1	0.1–3000.0kW	Depends on model	<input checked="" type="radio"/>
P02.02	Rated frequency of asynchronous motor 1	0.01Hz–P00.03 (Max. output frequency)	50.00Hz	<input checked="" type="radio"/>
P02.03	Rated speed of asynchronous motor 1	1–60000rpm	Depends on model	<input checked="" type="radio"/>
P02.04	Rated voltage of asynchronous motor 1	0–1200V	Depends on model	<input checked="" type="radio"/>
P02.05	Rated current of asynchronous motor 1	0.8–6000.0A	Depends on model	<input checked="" type="radio"/>
P02.06	Stator resistance of asynchronous motor 1	0.001–65.535Ω	Depends on model	<input type="radio"/>
P02.07	Rotor resistance of asynchronous	0.001–65.535Ω	Depends on model	<input type="radio"/>

Function code	Name	Description	Default value	Modify
	motor 1			
P02.08	Leakage inductance of asynchronous motor 1	0.1–6553.5mH	Depends on model	<input type="radio"/>
P02.09	Mutual inductance of asynchronous motor 1	0.1–6553.5mH	Depends on model	<input type="radio"/>
P02.10	No-load current of asynchronous motor 1	0.1–6553.5A	Depends on model	<input type="radio"/>
P02.11	Magnetic saturation coefficient 1 of iron core of asynchronous motor 1	0.0–100.0%	80.0%	<input type="radio"/>
P02.12	Magnetic saturation coefficient 2 of iron core of asynchronous motor 1	0.0–100.0%	68.0%	<input type="radio"/>
P02.13	Magnetic saturation coefficient 3 of iron core of asynchronous motor 1	0.0–100.0%	57.0%	<input type="radio"/>
P02.14	Magnetic saturation coefficient 4 of iron core of asynchronous motor 1	0.0–100.0%	40.0%	<input type="radio"/>
P02.15	Rated power of synchronous	0.1–3000.0kW	Depends on model	<input checked="" type="radio"/>

Function code	Name	Description	Default value	Modify
	motor 1			
P02.16	Rated frequency of synchronous motor 1	0.01Hz~P00.03 (Max. output frequency)	50.00Hz	☉
P02.17	Number of pole pairs of synchronous motor 1	1~128	2	☉
P02.18	Rated voltage of synchronous motor 1	0~1200V	Depends on model	☉
P02.19	Rated current of synchronous motor 1	0.8~6000.0A	Depends on model	☉
P02.20	Stator resistance of synchronous motor 1	0.001~65.535Ω	Depends on model	○
P02.21	Direct-axis inductance of synchronous motor 1	0.01~655.35mH	Depends on model	○
P02.22	Quadrature-axis inductance of synchronous motor 1	0.01~655.35mH	Depends on model	○
P02.23	Counter-emf constant of synchronous motor 1	0~10000	300	○
P02.24	Reserved	/	/	/
P02.25	Reserved	/	/	/
P02.26	Overload protection of motor 1	0: No protection 1: Common motor (with low-speed compensation). As the cooling effect of common motor will be degraded in low speed, the corresponding electronic thermal protection value should also be adjusted properly, the low compensation here means to lower the overload protection threshold	2	☉

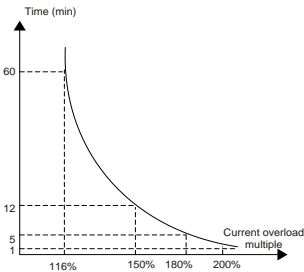
Function code	Name	Description	Default value	Modify
		of the motor whose running frequency is below 30Hz. 2: Frequency-variable motor (without low speed compensation). As the cooling effect of frequency-variable motor is not affected by the rotating speed, there is no need to adjust the protection value during low speed running.		
P02.27	Overload protection coefficient of motor 1	<p>Motor overload multiples $M = I_{out} / (I_n \times K)$ I_n is rated motor current, I_{out} is VFD output current, K is motor overload protection coefficient. The smaller the K, the larger the value of M, and the easier the protection. When $M=116\%$, protection is performed after motor overload last for 1 hour; when $M=150\%$, protection is performed after motor overload lasts for 12 minutes; when $M=180\%$, protection is performed after motor overload lasts for 5 minutes; when $M=200\%$, protection is performed after motor overload lasts for 60 seconds; and when $M \geq 400\%$, protection is performed immediately.</p>  <p>Setting range: 20.0%–120.0%</p>	100.0%	<input type="radio"/>
P02.28	Power display calibration coefficient of motor 1	This function adjusts the power display value of motor 1 only, and it does not affect the control performance of the VFD. Setting range: 0.00–3.00	1.00	<input type="radio"/>
P02.29	Parameter display of motor 1	0: Display as per motor type; under this mode, only parameters related to current motor type will be displayed. 1: Display all; under this mode, all the motor parameters will be displayed.	0	<input type="radio"/>

Function code	Name	Description	Default value	Modify
P02.30	System inertia of motor 1	0~30.000kgm ²	0 kgm ²	<input type="radio"/>
P02.31~P02.32	Reserved	/	/	/

P03—Vector control of motor 1

Function code	Name	Description	Default value	Modify
P03.00	Speed loop proportional gain 1	<p>Parameters of P03.00–P03.05 fit for vector control mode only. Below P03.02, speed loop PI parameter is P03.00 and P03.01; above P03.06, speed loop PI parameter is P03.03 and P03.04; in between, PI parameter is obtained by linear variation between two groups of parameters, as shown below.</p>	20.0	<input type="radio"/>
P03.01	Speed loop integral time 1		0.200s	<input type="radio"/>
P03.02	Switch low point frequency		5.00Hz	<input type="radio"/>
P03.03	Speed loop proportional gain 2		20.0	<input type="radio"/>
P03.04	Speed loop integral time 2		0.200s	<input type="radio"/>
P03.05	Switch over high point frequency	<p>The speed loop dynamic response characteristics of vector control can be adjusted by setting the proportional coefficient and integral time of speed regulator. Increase proportional gain or decrease integral time can accelerate dynamic response of speed loop, however, if the proportional gain is too large or integral time is too small, system oscillation and overshoot may occur; if proportional gain is too small, stable oscillation or speed offset may occur.</p> <p>Speed loop PI parameter is closely related to the system inertial, you should make adjustment based on default PI parameter according to different load characteristics to fulfill different needs.</p> <p>Setting range of P03.00:0.0–200.0; Setting range of P03.01: 0.000–10.000s</p>	10.00Hz	<input type="radio"/>

Function code	Name	Description	Default value	Modify
		Setting range of P03.02: 0.00Hz–P03.05 Setting range of P03.03: 0.0–200.0 Setting range of P03.04: 0.000–10.000s Setting range of P03.05: P03.02–P00.03 (Max. output frequency)		
P03.06	Speed loop output filter	0–8 (corresponds to 0–2 ⁸ /10ms)	0	<input type="radio"/>
P03.07	Vector control slip compensation coefficient (motoring)	Slip compensation coefficient is used to adjust the slip frequency of vector control to improve speed control precision. This parameter can be used to control speed offset. Setting range: 50–200%	100%	<input type="radio"/>
P03.08	Vector control slip compensation coefficient (generating)		100%	<input type="radio"/>
P03.09	Current loop proportional coefficient P	Note: 1. These two parameters are used to adjust PI parameters of current loop; it affects dynamic response speed and control precision of the system directly. The default value needs no adjustment under common conditions; 2. Applicable to SVC mode 0 (P00.00=0), SVC mode 1 (P00.00=1), and FVC (P00.00=3) Setting range: 0–65535	1000	<input type="radio"/>
P03.10	Current loop integral coefficient I		1000	<input type="radio"/>
P03.11	Torque setting method	0–1: Keypad (P03.12) 2: AI1 3: AI2 4: AI3 5: Pulse frequency HDIA 6: Multi-step torque 7: Modbus/Modbus TCP communication 8: PROFIBUS/CANopen/DeviceNet communication 9: Ethernet communication 10: Pulse frequency HDIB 11: EtherCAT/PROFINET/EtherNet IP communication	0	<input type="radio"/>

Function code	Name	Description	Default value	Modify
		12: Programmable card Note: For these settings, 100% corresponds to the motor rated current.		
P03.12	Torque set through keypad	-300.0%~300.0% (of the motor rated current)	20.0%	<input type="radio"/>
P03.13	Torque reference filter time	0.000~10.000s	0.010s	<input type="radio"/>
P03.14	Setting source of FWD rotation frequency upper limit in torque control	0: Keypad (P03.16) 1: AI1 2: AI2 3: AI3 4: Pulse frequency HDIA 5: Multi-step setting 6: Modbus/Modbus TCP communication 7: PROFIBUS/CANopen/DeviceNet communication 8: Ethernet communication 9: Pulse frequency HDIB 10: EtherCAT/PROFINET/EtherNet IP communication 11: Programmable card 12: Reserved Note: For these settings, 100% corresponds to the max. frequency.	0	<input type="radio"/>
P03.15	Setting source of REV rotation frequency upper limit in torque control	0: Keypad (P03.17) 1: AI1 2: AI2 3: AI3 4: Pulse frequency HDIA 5: Multi-step setting 6: Modbus/Modbus TCP communication 7: PROFIBUS/CANopen/DeviceNet communication 8: Ethernet communication 9: Pulse frequency HDIB 10: EtherCAT/PROFINET/EtherNet IP communication 11: Programmable card 12: Reserved	0	<input type="radio"/>

Function code	Name	Description	Default value	Modify
		Note: For these settings, 100% corresponds to the max. frequency.		
P03.16	FWD rotation frequency upper limit set through keypad in torque control	Used to specify frequency limits. 100% corresponds to the max. frequency. P03.16 specifies the upper-limit frequency when P03.14=1; P03.17 specifies the upper-limit frequency when P03.15=1. Setting range: 0.00Hz–P00.03 (Max. output frequency)	50.00Hz	<input type="radio"/>
P03.17	REV rotation frequency upper limit set through keypad in torque control		50.00Hz	<input type="radio"/>
P03.18	Setting source of electromotive torque upper limit	0: Keypad (P03.20) 1: AI1 2: AI2 3: AI3 4: Pulse frequency HDIA 5: Modbus/Modbus TCP communication 6: PROFIBUS/CANopen/DeviceNet communication 7: Ethernet communication 8: Pulse frequency HDIB 9: EtherCAT/PROFINET/EtherNet IP communication 10: Programmable card 11: Reserved Note: For these settings, 100% corresponds to the motor rated current.	0	<input type="radio"/>
P03.19	Setting source of braking torque upper limit	0: Keypad (P03.21) 1: AI1 2: AI2 3: AI3 4: Pulse frequency HDIA 5: Modbus/Modbus TCP communication 6: PROFIBUS/CANopen/DeviceNet communication 7: Ethernet communication 8: Pulse frequency HDIB 9: EtherCAT/PROFINET/EtherNet IP	0	<input type="radio"/>

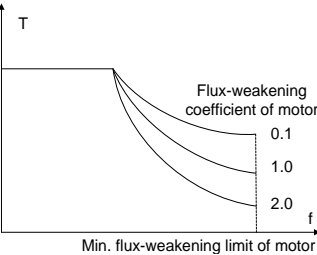
Function code	Name	Description	Default value	Modify
		communication 10: Programmable card 11: Reserved Note: For these settings, 100% corresponds to the motor rated current.		
P03.20	Electromotive torque upper limit set through keypad	Used to set torque limits. Setting range: 0.0–300.0% (of the motor rated current)	180.0%	<input type="radio"/>
P03.21	Braking torque upper limit set through keypad		180.0%	<input type="radio"/>
P03.22	Flux-weakening coefficient of constant-power zone	Used when asynchronous motor is in flux-weakening control.	0.3	<input type="radio"/>
P03.23	Min. flux-weakening point of constant-power zone	 <p>P03.22 and P03.23 are valid during constant power. When motor speed is above rated speed, motor enters flux-weakening running state. The flux-weakening control coefficient can change the flux-weakening curvature, the larger the coefficient, the steeper the curve, the smaller the coefficient, the smoother the curve. Setting range of P03.22: 0.1–2.0 Setting range of P03.23: 10%–100%</p>	20%	<input type="radio"/>
P03.24	Max. voltage limit	P03.24 sets the maximum output voltage of the VFD, which is the percentage of rated motor voltage. Set the value according to onsite conditions. Setting range:0.0–120.0%	100.0%	<input type="radio"/>
P03.25	Pre-exciting time	Carry out motor pre-exciting during starting to build a magnetic field inside the motor to improve the torque characteristics of motor during starting.	0.300s	<input type="radio"/>

Function code	Name	Description	Default value	Modify
		Setting range: 0.000–10.000s		
P03.26	Flux-weakening proportional gain	0–8000	1000	<input type="radio"/>
P03.27	Vector control speed display	0: Display as per the actual value 1: Display as per the set value	0	<input type="radio"/>
P03.28	Static friction compensation coefficient	0.0–100.0%	0.0%	<input type="radio"/>
P03.29	Corresponding frequency point of static friction	0.50Hz–P03.31	1.00Hz	<input type="radio"/>
P03.30	High speed friction compensation coefficient	0.0–100.0%	0.0%	<input type="radio"/>
P03.31	Corresponding frequency of high speed friction torque	P03.29–400.00Hz	50.00Hz	<input type="radio"/>
P03.32	Enabling torque control	0: Disable 1: Enable	0	<input checked="" type="radio"/>
P03.33	Flux weakening integral gain	0–8000	1200	<input type="radio"/>
P03.34	Flux-weakening control mode	0x000–0x112 Ones place: Control mode 0: Mode 0 1: Mode 1 2: Mode 2 Tens place: Compensation of inductance saturation coefficient 0: Enable 1: Disable Hundreds place: Reserved 0: Reserved 1: Reserved	0x000	<input type="radio"/>
P03.35	Control optimization setting	0x0000–0x1111 Ones place: Torque command selection 0: Torque reference	0x0000	<input type="radio"/>

Function code	Name	Description	Default value	Modify
		1: Torque current reference Tens place: Reserved 0: Reserved 1: Reserved Hundreds place: Whether to enable ASR integral separation 0: Disable 1: Enable Thousands place: Reserved 0: Reserved 1: Reserved		
P03.36	Speed loop differential gain	0.00–10.00s	0.00s	<input type="radio"/>
P03.37	High-frequency current loop proportional coefficient	Under FVC (P00.00=3) and P03.39, the current loop PI parameters are P03.09 and P03.10; above P03.39, the PI parameters are P03.37 and P03.38. Setting range of P03.37: 0–65535 Setting range of P03.38: 0–65535 Setting range of P03.39: 0.0–100.0% (relative to max. frequency)	1000	<input type="radio"/>
P03.38	High-frequency current loop integral coefficient		1000	<input type="radio"/>
P03.39	Current loop high-frequency switchover point		100.0%	<input type="radio"/>
P03.40	Enabling inertia compensation	0: Disable 1: Enable	0	<input type="radio"/>
P03.41	Upper limit of inertia compensation torque	Limit the max. inertia compensation torque to prevent inertia compensation torque from being too large. Setting range: 0.0–150.0% (rated motor torque)	10.0%	<input type="radio"/>
P03.42	Inertia compensation filter times	Filter times of inertia compensation torque, used to smooth inertia compensation torque. Setting range: 0–10	7	<input type="radio"/>
P03.43	Inertia identification torque value	Due to friction force, it is required to set certain identification torque for the inertia identification to be performed properly. 0.0–100.0% (rated motor torque)	10.0%	<input type="radio"/>
P03.44	Enable inertia identification	0: No operation 1: Start identification	0	<input checked="" type="radio"/>

Function code	Name	Description	Default value	Modify
P03.45	Current loop proportional coefficient after autotuning	Automatic update will be performed after motor parameter autotuning. In the closed-loop vector control mode for synchronous motors, you can set the value of this function code to P03.09. Range: 0–65535 Note: Set the value to 0 if motor parameter autotuning is not performed.	0	●
P03.46	Current integral proportional coefficient after autotuning	Automatic update will be performed after motor parameter autotuning. In the closed-loop vector control mode for synchronous motors, you can set the value of this function code to P03.10. Range: 0–65535 Note: Set the value to 0 if motor parameter autotuning is not performed.	0	●

P04—V/F control

Function code	Name	Description	Default value	Modify
P04.00	V/F curve setting of motor 1	This group of function code defines the V/F curve of motor 1 to satisfy different load characteristics needs. 0: Straight V/F curve; fit for constant-torque load 1: Multi-point V/F curve 2: Torque down V/F curve (power of 1.3) 3: Torque down V/F curve (power of 1.7) 4: Torque down V/F curve (power of 2.0) Curves 2–4 are suitable for torque-variable load of fan pump and similar equipment. You can make adjustment based on load characteristics to achieve optimal energy-saving effect. 5: Customized V/F (V/F separation); under this mode, V is separated from f. You can adjust f through the frequency reference channel set by P00.06 to change the curve characteristic, or adjust V through the voltage reference channel set by P04.27 to change the curve characteristics. Note: The V_b in the figure below corresponds to rated motor voltage, and f_b corresponds to rated motor frequency.	0	◎

Function code	Name	Description	Default value	Modify
P04.01	Torque boost of motor 1	In order to compensate for low-frequency torque characteristics, you can make some boost compensation to the output voltage. P04.01 is relative to the maximum output voltage V_b .	0.0%	<input type="radio"/>
P04.02	Motor 1 torque boost cut-off	<p>P04.02 defines the percentage of cut-off frequency of manual torque boost to the rated motor frequency f_b. Torque boost can improve the low-frequency torque characteristics of V/F.</p> <p>You should select torque boost based on the load, for example, larger load requires larger torque boost, however, if the torque boost is too large, the motor will run at over-excitation, which will cause increased output current and motor heat-up, thus degrading the efficiency.</p> <p>When torque boost is set to 0.0%, the VFD is automatic torque boost.</p> <p>Torque boost cut-off threshold: Below this frequency threshold, the torque boost is valid, exceeding this threshold will nullify torque boost.</p> <p>Setting range of P04.01: 0.0%: (automatic) 0.1%–10.0%</p> <p>Setting range of P04.02: 0.0%–50.0%</p>	20.0%	<input type="radio"/>
P04.03	V/F frequency point 1 of motor 1	When P04.00 =1 (multi-point V/F curve), you can set V/F curve via P04.03–P04.08.	0.00Hz	<input type="radio"/>
P04.04	V/F voltage point 1 of motor 1	V/F curve is usually set according to the characteristics of motor load.	0.0%	<input type="radio"/>
P04.05	V/F frequency	Note: $V1 < V2 < V3$, $f1 < f2 < f3$. If low-frequency	0.00Hz	<input type="radio"/>

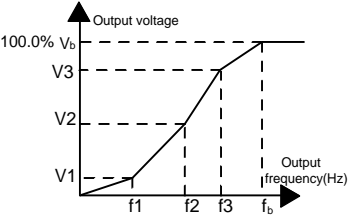
Function code	Name	Description	Default value	Modify
	point 2 of motor 1	voltage is set too high, motor overheat or burnt-down may occur, and overcurrent stall or overcurrent protection may occur to the VFD.		
P04.06	V/F voltage point 2 of motor 1		0.0%	<input type="radio"/>
P04.07	V/F frequency point 3 of motor 1		0.00Hz	<input type="radio"/>
P04.08	V/F voltage point 3 of motor 1	 <p>Setting range of P04.03: 0.00Hz–P04.05 Setting range of P04.04: 0.0%–110.0% (rated voltage of motor 1) Setting range of P04.05: P04.03–P04.07 Setting range of P04.06: 0.0%–110.0% (rated voltage of motor 1) Setting range of P04.07: P04.05–P02.02 (rated frequency of asynchronous motor 1) or P04.05–P02.16 (rated frequency of synchronous motor 1) Setting range of P04.08: 0.0%–110.0% (rated voltage of motor 1)</p>	0.0%	<input type="radio"/>
P04.09	V/F slip compensation gain of motor 1	This parameter is used to compensate for the motor rotating speed change caused by load change in the SVPWM mode, and thus improve the rigidity of the mechanical characteristics of the motor. You need to calculate the rated slip frequency of the motor as follows: $\Delta f = f_b - n \times p / 60$ where f_b is the rated frequency of motor 1, corresponding to P02.02; n is the rated speed of motor 1, corresponding to P02.03; p is the number of pole pairs of motor 1. 100% corresponds to the rated slip frequency Δf of motor 1. Setting range: 0.0–200.0%	100.0%	<input type="radio"/>
P04.10	Low-frequency oscillation control factor of motor 1	In SVPWM mode, the motor, especially the large-power motor may experience current oscillation during certain frequencies, which may lead to unstable motor operation, or even VFD overcurrent, you can adjust these two parameters	10	<input type="radio"/>
P04.11	High-frequency oscillation control		10	<input type="radio"/>

Function code	Name	Description	Default value	Modify
	factor of motor 1	properly to eliminate such phenomenon.		
P04.12	Oscillation control threshold of motor 1	Setting range of P04.10: 0–100 Setting range of P04.11: 0–100 Setting range of P04.12: 0.00Hz–P00.03 (Max. output frequency)	30.00Hz	○
P04.13	V/F curve setting of motor 2	This parameter defines the V/F curve of motor 2 of the VFD to meet various load characteristic requirements. 0: Straight V/F curve 1: Multi-point V/F curve 2: Torque-down V/F curve (power of 1.3) 3: Torque-down V/F curve (power of 1.7) 4: Torque-down V/F curve (power of 2.0) 5: Customize V/F (V/F separation)	0	◎
P04.14	Torque boost of motor 2	Note: Refer to the parameter description of P04.01 and P04.02.	0.0%	○
P04.15	Torque boost cut-off of motor 2	Setting range of P04.14: 0.0%: (automatic) 0.1%–10.0% Setting range of 0.0%–50.0% (relative to rated frequency of motor 2)	20.0%	○
P04.16	V/F frequency point 1 of motor 2	Note: Refer to the parameter description of P04.03–P04.08	0.00Hz	○
P04.17	V/F voltage point 1 of motor 2	Setting range of P04.16: 0.00Hz–P04.18 Setting range of P04.17: 0.0%–110.0% (rated voltage of motor 2)	00.0%	○
P04.18	V/F frequency point 2 of motor 2	Setting range of P04.18: P04.16–P04.20	0.00Hz	○
P04.19	V/F voltage point 2 of motor 2	Setting range of P04.19: 0.0%–110.0% (rated voltage of motor 2)	0.0%	○
P04.20	V/F frequency point 3 of motor 2	Setting range of P04.20: P04.18–P12.02 (rated frequency of asynchronous motor 2) or P04.18–P12.16 (rated frequency of synchronous motor 2)	0.00Hz	○
P04.21	V/F voltage point 3 of motor 2	Setting range of P04.21: 0.0%–110.0% (of the rated voltage of motor 2)	0.0%	○
P04.22	V/F slip compensation gain of motor 2	This parameter is used to compensate for the motor rotating speed change caused by load change in the SVPWM mode, and thus improve the rigidity of the mechanical characteristics of the motor. You need to calculate the rated slip frequency of the motor as follows:	0.0%	○

Function code	Name	Description	Default value	Modify
		$\Delta f = f_b - n * p / 60$ where f_b is the rated frequency of motor 2, corresponding to P12.02; n is the rated speed of motor 2, corresponding to P12.03; p is the number of pole pairs of motor 2. 100% corresponds to the rated slip frequency Δf of motor 2. Setting range: 0.0–200.0%		
P04.23	Low-frequency oscillation control factor of motor 2	In the SVPWM mode, current oscillation may easily occur on motors, especially large-power motors, at some frequency, which may cause	10	<input type="radio"/>
P04.24	High-frequency oscillation control factor of motor 2	unstable running of motors or even overcurrent of VFDs. You can modify this parameter to prevent current oscillation.	10	<input type="radio"/>
P04.25	Oscillation control threshold of motor 2	Setting range of P04.23: 0–100 Setting range of P04.24: 0–100 Setting range of P04.25: 0.00 Hz–P00.03 (Max. output frequency)	30.00Hz	<input type="radio"/>
P04.26	Energy-saving run	0: No action 1: Automatic energy-saving operation Under light-load state, the motor can adjust the output voltage automatically to achieve energy-saving purpose	0	<input checked="" type="radio"/>
P04.27	Voltage setting channel	0: Keypad; output voltage is determined by P04.28 1: AI1 2: AI2 3: AI3 4: HDIA 5: Multi-step (the set value is determined by P10 group) 6: PID 7: Modbus/Modbus TCP communication 8: PROFIBUS/CANopen/DeviceNet communication 9: Ethernet communication 10: HDIB 11: EtherCAT/PROFINET/EtherNet IP communication 12: Programmable card 13: Reserved	0	<input type="radio"/>

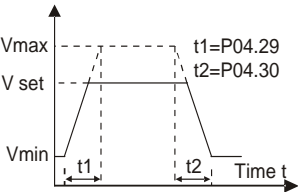
Function code	Name	Description	Default value	Modify
P04.28	Voltage value set through keypad	When the keypad is set as the voltage setting channel, the value of this parameter is used as the voltage value. Setting range: 0.0%–100.0%	100.0%	<input type="radio"/>
P04.29	Voltage increase time	Voltage increase time means the time needed from outputting the min. voltage to accelerating to output the max. voltage. Voltage decrease time means the time needed from outputting max. voltage to outputting the min. voltage Setting range: 0.0–3600.0s	5.0s	<input type="radio"/>
P04.30	Voltage decrease time		5.0s	<input type="radio"/>
P04.31	Output max. voltage	 <p>Set the upper/lower limit value of output voltage.</p> <p>Setting range of P04.31: P04.32–100.0% (rated motor voltage) Setting range of P04.32: 0.0%–P04.31</p>	100.0%	<input checked="" type="radio"/>
P04.32	Output min. voltage		0.0%	<input checked="" type="radio"/>
P04.33	Flux-weakening coefficient in the constant power zone	1.00–1.30	1.00	<input type="radio"/>
P04.34	Pull-in current 1 in synchronous motor VF control	When the synchronous motor VF control mode is enabled, this parameter is used to set the reactive current of the motor when the output frequency is lower than the frequency set in P04.36. Setting range: -100.0%–+100.0% (of the motor rated current)	20.0%	<input type="radio"/>
P04.35	Pull-in current 2 in synchronous motor VF control	When the synchronous motor VF control mode is enabled, this parameter is used to set the reactive current of the motor when the output frequency is higher than the frequency set in P04.36. Setting range: -100.0%–+100.0% (of the motor rated current)	10.0%	<input type="radio"/>
P04.36	Frequency	When the synchronous motor VF control mode is	20.0%	<input type="radio"/>

Function code	Name	Description	Default value	Modify
	threshold for pull-in current switching in synchronous motor VF control	enabled, this parameter is used to set the frequency threshold for the switching between pull-in current 1 and pull-in current 2. Setting range: 0.0%–200.0% (of the motor rated frequency)		
P04.37	Reactive current closed-loop proportional coefficient in synchronous motor VF	When the synchronous motor VF control mode is enabled, this parameter is used to set the proportional coefficient of the reactive current closed-loop control. Setting range: 0–3000	50	○
P04.38	Reactive current closed-loop integral time in synchronous motor VF control	When the synchronous motor VF control mode is enabled, this parameter is used to set the integral coefficient of the reactive current closed-loop control. Setting range: 0–3000	30	○
P04.39	Reactive current closed-loop output limit in synchronous motor VF control	When the synchronous motor VF control mode is enabled, this parameter is used to set the output limit of the reactive current in the closed-loop control. A greater value indicates a higher reactive closed-loop compensation voltage and higher output power of the motor. In general, you do not need to modify this parameter. Setting range: 0–16000	8000	○
P04.40	Enable/disable IF mode for asynchronous motor 1	0: Disabled 1: Enabled	0	◎
P04.41	Current setting in IF mode for asynchronous motor 1	When IF control is adopted for asynchronous motor 1, this parameter is used to set the output current. The value is a percentage in relative to the rated current of the motor. Setting range: 0.0–200.0%	120.0%	○
P04.42	Proportional coefficient in IF mode for asynchronous motor 1	When IF control is adopted for asynchronous motor 1, this parameter is used to set the proportional coefficient of the output current closed-loop control. Setting range: 0–5000	650	○

Function code	Name	Description	Default value	Modify
P04.43	Integral coefficient in IF mode for asynchronous motor 1	When IF control is adopted for asynchronous motor 1, this parameter is used to set the integral coefficient of the output current closed-loop control. Setting range: 0–5000	350	<input type="radio"/>
P04.44	Starting frequency point for switching off IF mode for asynchronous motor 1	0.00Hz–P04.50	10.00Hz	<input type="radio"/>
P04.45	Enable/disable IF mode for asynchronous motor 2	0: Disable 1: Enable	0	<input checked="" type="radio"/>
P04.46	Current setting in IF mode for asynchronous motor 2	When IF control is adopted for asynchronous motor 2, this parameter is used to set the output current. The value is a percentage in relative to the rated current of the motor. Setting range: 0.0–200.0%	120.0%	<input type="radio"/>
P04.47	Proportional coefficient in IF mode for asynchronous motor 2	When IF control is adopted for asynchronous motor 2, this parameter is used to set the proportional coefficient of the output current closed-loop control. Setting range: 0–5000	650	<input type="radio"/>
P04.48	Integral coefficient in IF mode for asynchronous motor 2	When IF control is adopted for asynchronous motor 2, this parameter is used to set the integral coefficient of the output current closed-loop control. Setting range: 0–5000	350	<input type="radio"/>
P04.49	Starting frequency point for switching off IF mode for asynchronous motor 2	0.00Hz–P04.51	10.00Hz	<input type="radio"/>
P04.50	End frequency point for switching off IF	P04.44–P00.03	25.00Hz	<input type="radio"/>

Function code	Name	Description	Default value	Modify
	mode for asynchronous motor 1			
P04.51	End frequency point for switching off IF mode for asynchronous motor 2	P04.49–P00.03	25.00Hz	○

P05—Input terminals

Function code	Name	Description	Default value	Modify
P05.00	HDI input type	0x00–0x11 Ones: HDIA input type 0: HDIA is high-speed pulse input 1: HDIA is digital input Tens: HDIB input type 0: HDIB is high-speed pulse input 1: HDIB is digital input	0x00	◎
P05.01	Function of S1 terminal	0: No function 1: Forward running	1	◎
P05.02	Function of S2 terminal	2: Reverse running 3: 3-wire control/Sin	4	◎
P05.03	Function of S3 terminal	4: Forward jogging 5: Reverse jogging	7	◎
P05.04	Function of S4 terminal	6: Coast to stop 7: Fault reset	0	◎
P05.05	Function of HDIA terminal	8: Running pause 9: External fault input	0	◎
P05.06	Function of HDIB terminal	10: Frequency increase (UP) 11: Frequency decrease (DOWN) 12: Clear frequency increase/decrease setting 13: Switchover between setup A and setup B 14: Switchover between combination setup and setup A 15: Switchover between combination setup and setup B 16: Multi-step speed terminal 1	0	◎

Function code	Name	Description	Default value	Modify
		17: Multi-step speed terminal 2 18: Multi-step speed terminal 3 19: Multi-step speed terminal 4 20: Multi-step speed pause 21: Acceleration/deceleration time selection 1 22: Acceleration/deceleration time selection 2 23: Simple PLC stop reset 24: Simple PLC pause 25: PID control pause 26: Wobbling frequency pause 27: Wobbling frequency reset 28: Counter reset 29: Switchover between speed control and torque control 30: Acceleration/deceleration disabled 31: Counter trigger 32: Reserved 33: Clear frequency increase/decrease setting temporarily 34: DC brake 35: Switch from motor 1 to motor 2 36: Command switches to keypad 37: Command switches to terminal 38: Command switches to communication 39: Pre-exciting command 40: Zero out power consumption quantity 41: Maintain power consumption quantity 42: Switching the upper torque limit setting mode to keypad 43: Position reference point input (valid only for S1, S2 and S3 are valid) 44: Spindle orientation disabled 45: Spindle zeroing/local positioning zeroing 46: Spindle zero position selection 1 47: Spindle zero position selection 2 48: Spindle scale division selection 1 49: Spindle scale division selection 2 50: Spindle scale division selection 3 51: Terminal for switching between position control		

Function code	Name	Description	Default value	Modify
		and speed control 52: Pulse input disabled 53: Clear position deviation cleared 54: Switch over position proportional gain 55: Enable cyclic positioning of digital position positioning 56: Emergency stop 57: Motor over-temperature fault input 58: Enable rigid tapping 59: Switch to V/F control 60: Switch to FVC control 61: PID polarity switchover 62: Reserved 63: Enable servo 64: Limit of forward run 65: Limit of reverse run 66: Zero out encoder counting 67: Pulse increase 68: Enable pulse superimposition 69: Pulse decrease 70: Electronic gear selection 71: Switch to master 72: Switch to slave 73: Reset the roll diameter 74: Switch winding/unwinding 75: Pre-drive 76: Disable roll diameter calculation 77: Clear alarm display 78: Manual braking 79: Trigger forced feeding interrupt 80: Initial roll diameter 1 81: Initial roll diameter 2 82: Trigger fire mode control 83: Switch tension PID parameters 84-95: Reserved		
P05.07	Reserved	/	/	/
P05.08	Polarity of input terminal	This parameter specifies the polarity of input terminals. When the bit is set to 0, the input terminal polarity	0x00	○

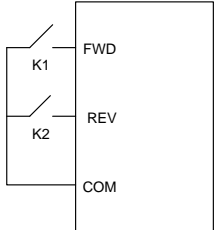
Function code	Name	Description	Default value	Modify															
		is positive. When the bit is set to 1, the input terminal polarity is negative. 0x000–0x3F																	
P05.09	Digital filter time	Set the sampling filtering time of the S1–S4, HDIA, and HDIB terminals. In cases where interference is strong, increase the value of this parameter to avoid mal-operation. 0.000–1.000s	0.010s	○															
P05.10	Virtual terminal setting	0x00–0x3F (0: disable, 1: enable) BIT0: S1 virtual terminal BIT1: S2 virtual terminal BIT2: S3 virtual terminal BIT3: S4 virtual terminal BIT4: HDIA virtual terminal BIT5: HDIB virtual terminal	0x00	◎															
P05.11	2/3 Wire control mode	<p>This parameter specifies the 2/3 Wire control mode.</p> <p>0: 2-Wire control 1; integrate enabling function with direction. This mode is the most popular dual-line mode. Direction of motor rotation is determined by the defined FWD/REV terminal command.</p>  <table border="1" data-bbox="624 922 809 1153"> <thead> <tr> <th>FWD</th> <th>REV</th> <th>Running command</th> </tr> </thead> <tbody> <tr> <td>OFF</td> <td>OFF</td> <td>Stop</td> </tr> <tr> <td>ON</td> <td>OFF</td> <td>Forward running</td> </tr> <tr> <td>OFF</td> <td>ON</td> <td>Reverse running</td> </tr> <tr> <td>ON</td> <td>ON</td> <td>Hold</td> </tr> </tbody> </table> <p>1: 2-wire control 2; separate enabling function with direction. In this mode, the defined FWD is enabling terminal, and the direction is determined by the state of REV.</p>	FWD	REV	Running command	OFF	OFF	Stop	ON	OFF	Forward running	OFF	ON	Reverse running	ON	ON	Hold	0	◎
FWD	REV	Running command																	
OFF	OFF	Stop																	
ON	OFF	Forward running																	
OFF	ON	Reverse running																	
ON	ON	Hold																	

Function code	Name	Description	Default value	Modify																																					
		<div data-bbox="389 212 813 448"> <table border="1" data-bbox="624 212 813 448"> <tr> <td>FWD</td> <td>REV</td> <td>Running command</td> </tr> <tr> <td>OFF</td> <td>OFF</td> <td>Stop</td> </tr> <tr> <td>ON</td> <td>OFF</td> <td>Forward running</td> </tr> <tr> <td>OFF</td> <td>ON</td> <td>Stop</td> </tr> <tr> <td>ON</td> <td>ON</td> <td>Reverse running</td> </tr> </table> </div> <p data-bbox="378 459 833 708">2: 3-wire control 1; This mode defines Sin as enabling terminal, and the running command is generated by FWD, the direction is controlled by REV. During running, the Sin terminal should be closed, and terminal FWD generates a rising edge signal, then the VFD starts to run in the direction set by the state of terminal REV; the VFD should be stopped by disconnecting terminal Sin.</p> <div data-bbox="456 711 748 1002"> </div> <p data-bbox="378 1015 784 1070">The direction control during running is shown below.</p> <table border="1" data-bbox="385 1074 824 1390"> <thead> <tr> <th>Sin</th> <th>REV</th> <th>Previous running direction</th> <th>Current running direction</th> </tr> </thead> <tbody> <tr> <td rowspan="2">ON</td> <td rowspan="2">OFF→ON</td> <td>Forward</td> <td>Reverse</td> </tr> <tr> <td>Reverse</td> <td>Forward</td> </tr> <tr> <td rowspan="2">ON</td> <td rowspan="2">ON→OFF</td> <td>Reverse</td> <td>Forward</td> </tr> <tr> <td>Forward</td> <td>Reverse</td> </tr> <tr> <td>ON→OF</td> <td>ON</td> <td colspan="2" rowspan="2">Decelerate to stop</td> </tr> <tr> <td>F</td> <td>OFF</td> </tr> </tbody> </table> <p data-bbox="378 1398 799 1453">Sin: 3-wire control/Sin, FWD: Forward running, REV: Reverse running</p>	FWD	REV	Running command	OFF	OFF	Stop	ON	OFF	Forward running	OFF	ON	Stop	ON	ON	Reverse running	Sin	REV	Previous running direction	Current running direction	ON	OFF→ON	Forward	Reverse	Reverse	Forward	ON	ON→OFF	Reverse	Forward	Forward	Reverse	ON→OF	ON	Decelerate to stop		F	OFF		
FWD	REV	Running command																																							
OFF	OFF	Stop																																							
ON	OFF	Forward running																																							
OFF	ON	Stop																																							
ON	ON	Reverse running																																							
Sin	REV	Previous running direction	Current running direction																																						
ON	OFF→ON	Forward	Reverse																																						
		Reverse	Forward																																						
ON	ON→OFF	Reverse	Forward																																						
		Forward	Reverse																																						
ON→OF	ON	Decelerate to stop																																							
F	OFF																																								

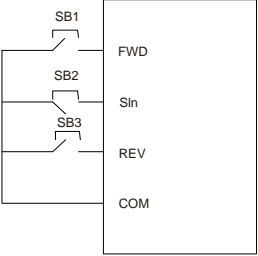
Function code	Name	Description	Default value	Modify																					
		<p>3: 3-wire control 2; This mode defines Sin as enabling terminal. The running command is generated by FWD or REV, and they control the running direction. During running, the terminal Sin should be closed, and terminal FWD or REV generates a rising edge signal to control the running and direction of VFD; the VFD should be stopped by disconnecting terminal Sin.</p>  <table border="1" data-bbox="386 730 826 1034"> <thead> <tr> <th>SIn</th> <th>FWD</th> <th>REV</th> <th>Running direction</th> </tr> </thead> <tbody> <tr> <td rowspan="2">ON</td> <td>OFF→ON</td> <td>ON</td> <td>Forward</td> </tr> <tr> <td></td> <td>OFF</td> <td>Forward</td> </tr> <tr> <td rowspan="2">ON</td> <td>ON</td> <td rowspan="2">OFF→ON</td> <td>Reverse</td> </tr> <tr> <td>OFF</td> <td>Reverse</td> </tr> <tr> <td>ON→OFF</td> <td></td> <td></td> <td>Decelerate to stop</td> </tr> </tbody> </table> <p>SIn: 3-wire control/Sin, FWD: Forward running, REV: Reverse running</p> <p>Note: For dual-line running mode, when FWD/REV terminal is valid, if the VFD stops due to stop command given by other sources, it will not run again after the stop command disappears even if the control terminals FWD/REV are still valid. To make the VFD run again, you need to trigger FWD/REV again, such as PLC single-cycle stop, fixed-length stop, and valid STOP/RST stop during terminal control. (See P07.04)</p>	SIn	FWD	REV	Running direction	ON	OFF→ON	ON	Forward		OFF	Forward	ON	ON	OFF→ON	Reverse	OFF	Reverse	ON→OFF			Decelerate to stop		
SIn	FWD	REV	Running direction																						
ON	OFF→ON	ON	Forward																						
		OFF	Forward																						
ON	ON	OFF→ON	Reverse																						
	OFF		Reverse																						
ON→OFF			Decelerate to stop																						
P05.12	S1 terminal	These function codes define corresponding delay	0.000s	○																					

Function code	Name	Description	Default value	Modify	
	switch-on delay	of the programmable input terminals during level variation from switch-on to switch-off .			
P05.13	S1 terminal switch-off delay	<p>Si electrical level</p> <p>Si valid invalid valid invalid</p> <p>Switch-on delay Switch-off delay</p>	0.000s	<input type="radio"/>	
P05.14	S2 terminal switch-on delay		0.000s	<input type="radio"/>	
P05.15	S2 terminal switch-off delay		Setting range: 0.000–50.000s	0.000s	<input type="radio"/>
P05.16	S3 terminal switch-on delay		Note: After a virtual terminal is enabled, the state of the terminal can be changed only in communication mode. The communication address is 0x200A.	0.000s	<input type="radio"/>
P05.17	S3 terminal switch-off delay		0.000s	<input type="radio"/>	
P05.18	S4 terminal switch-on delay		0.000s	<input type="radio"/>	
P05.19	S4 terminal switch-off delay		0.000s	<input type="radio"/>	
P05.20	HDIA terminal switch-on delay		0.000s	<input type="radio"/>	
P05.21	HDIA terminal switch-off delay		0.000s	<input type="radio"/>	
P05.22	HDIB terminal switch-on delay		0.000s	<input type="radio"/>	
P05.23	HDIB terminal switch-off delay	0.000s	<input type="radio"/>		
P05.24	Lower limit value of AI1	<p>These function codes define the relation between analog input voltage and corresponding set value of analog input. When the analog input voltage exceeds the range of max./min. input, the max. input or min. input will be adopted during calculation.</p> <p>When analog input is current input, 0–20mA current corresponds to 0–10V voltage.</p> <p>In different applications, 100% of analog setting corresponds to different nominal values.</p> <p>The figure below illustrates several settings.</p>	0.00V	<input type="radio"/>	
P05.25	Corresponding setting of lower limit of AI1		0.0%	<input type="radio"/>	
P05.26	Upper limit value of AI1		10.00V	<input type="radio"/>	
P05.27	Corresponding setting of upper limit of AI1		100.0%	<input type="radio"/>	
P05.28	Input filter time of AI1		0.030s	<input type="radio"/>	
P05.29	Lower limit value of AI2		-10.00V	<input type="radio"/>	
P05.30	Corresponding		-100.0%	<input type="radio"/>	

Function code	Name	Description	Default value	Modify
	setting of lower limit of AI2			
P05.31	Intermediate value 1 of AI2		0.00V	<input type="radio"/>
P05.32	Corresponding setting of intermediate value 1 of AI2		0.0%	<input type="radio"/>
P05.33	Intermediate value 2 of AI2		0.00V	<input type="radio"/>
P05.34	Corresponding setting of intermediate value 2 of AI2	Input filter time: Adjust the sensitivity of analog input, increase this value properly can enhance the anti-interference capacity of analog variables; however, it will also degrade the sensitivity of analog input. Note: AI1 can support 0–10V/0–20mA input, when AI1 selects 0–20mA input; the corresponding voltage of 20mA is 10V; AI2 supports -10V+10V input.	0.0%	<input type="radio"/>
P05.35	Upper limit value of AI2		10.00V	<input type="radio"/>
P05.36	Corresponding setting of upper limit of AI2		100.0%	<input type="radio"/>
P05.37	Input filter time of AI2	Setting range of P05.24: 0.00V–P05.26 Setting range of P05.25: -300.0%–300.0% Setting range of P05.26: P05.24–10.00V Setting range of P05.27: -300.0%–300.0% Setting range of P05.28: 0.000s–10.000s Setting range of P05.29: -10.00V–P05.31 Setting range of P05.30: -300.0%–300.0% Setting range of P05.31: P05.29–P05.33 Setting range of P05.32: -300.0%–300.0% Setting range of P05.33: P05.31–P05.35 Setting range of P05.34: -300.0%–300.0% Setting range of P05.35: P05.33–10.00V Setting range of P05.36: -300.0%–300.0% Setting range of P05.37: 0.000s–10.000s	0.030s	<input type="radio"/>
P05.38	HDIA high-speed pulse input function	0: Set input via frequency 1: Reserved 2: Input via encoder, used in combination with HDIB	0	<input checked="" type="radio"/>
P05.39	Lower limit frequency of HDIA	0.000 kHz – P05.41	0.000 kHz	<input type="radio"/>

Function code	Name	Description	Default value	Modify
P05.40	Corresponding setting of lower limit frequency of HDIA	-300.0%~300.0%	0.0%	<input type="radio"/>
P05.41	Upper limit frequency of HDIA	P05.39 ~50.000kHz	50.000 kHz	<input type="radio"/>
P05.42	Corresponding setting of upper limit frequency of HDIA	-300.0%~300.0%	100.0%	<input type="radio"/>
P05.43	HDIA frequency input filter time	0.000s~10.000s	0.030s	<input type="radio"/>
P05.44	HDIB high-speed pulse input function selection	0: Set input via frequency 1: Reserved 2: Encoder input, used in combination with HDIA	0	<input checked="" type="radio"/>
P05.45	Lower limit frequency of HDIB	0.000 kHz – P05.47	0.000 kHz	<input type="radio"/>
P05.46	Corresponding setting of lower limit frequency of HDIB	-300.0%~300.0%	0.0%	<input type="radio"/>
P05.47	Upper limit frequency of HDIB	P05.45~50.000kHz	50.000 kHz	<input type="radio"/>
P05.48	Corresponding setting of upper limit frequency of HDIB	-300.0%~300.0%	100.0%	<input type="radio"/>
P05.49	HDIB frequency input filter time	0.000s~10.000s	0.030s	<input type="radio"/>
P05.50	AI1 input signal type	0: Voltage type 1: Current type Note: You can set the AI1 input signal type through the corresponding function code.	0	<input checked="" type="radio"/>
P05.51~ P05.52	Reserved	/	/	/

P06—Output terminals

Function code	Name	Description	Default value	Modify
P06.00	HDO output type	0: Open collector high-speed pulse output: Max. frequency of the pulse is 50.00kHz. For details about the related functions, see P06.27–P06.31. 1: Open collector output: For details about the related functions, see P06.02.	0	☉
P06.01	Y1 output selection	0: Invalid 1: In running	0	○
P06.02	HDO output selection	2: In forward running 3: In reverse running	0	○
P06.03	Relay RO1 output selection	4: In jogging 5: VFD fault	1	○
P06.04	Relay RO2 output selection	6: Frequency level detection FDT1 7: Frequency level detection FDT2 8: Frequency reached 9: Running in zero speed 10: Reach upper limit frequency 11: Reach lower limit frequency 12: Ready to run 13: In pre-exciting 14: Overload pre-alarm 15: Underload pre-alarm 16: Simple PLC stage completed 17: Simple PLC cycle completed 18: Reach set counting value 19: Reach designated counting value 20: External fault is valid 21: Reserved 22: Reach running time 23: Virtual terminal output of Modbus/Modbus TCP communication 24: Virtual terminal output of PROFIBUS/CANopen/DeviceNet communication 25: Virtual terminal output of Ethernet communication 26: DC bus voltage established 27: Z pulse output 28: During pulse superposition	5	○

Function code	Name	Description	Default value	Modify								
		29: STO action 30: Positioning completed 31: Spindle zeroing completed 32: Spindle scale-division completed 33: In speed limit 34: Virtual terminal output of EtherCAT/PROFINET/EtherNet IP communication 35: Reserved 36: Speed/position control switchover completed 37: Any frequency reached 38–40: Reserved 41: Y1 from the programmable card 42: Y2 from the programmable card 43: HDO from the programmable card 44: RO1 from the programmable card 45: RO2 from the programmable card 46: RO3 from the programmable card 47: RO4 from the programmable card 48: EC PT100 detected OH pre-alarm 49: EC PT1000 detected OH pre-alarm 50: AI/AO detected OH pre-alarm 51: Stopped or running at zero speed 52: Disconnection detected in tension control 53: Roll diameter setting reached 54: Max. roll diameter reached 55: Min. roll diameter reached 56: Fire control mode enabled 57–63: Reserved										
P06.05	Output terminal polarity selection	This parameter specifies the polarity of output terminals. When the bit is set to 0, input terminal polarity is positive; When the bit is set to 1 input terminal polarity is negative. <table border="1" style="margin-left: auto; margin-right: auto;"> <tr> <td>BIT3</td> <td>BIT2</td> <td>BIT1</td> <td>BIT0</td> </tr> <tr> <td>RO2</td> <td>RO1</td> <td>HDO</td> <td>Y1</td> </tr> </table> Setting range: 0x00–0xF	BIT3	BIT2	BIT1	BIT0	RO2	RO1	HDO	Y1	0x00	○
BIT3	BIT2	BIT1	BIT0									
RO2	RO1	HDO	Y1									
P06.06	Y switch-on delay	This function code defines the corresponding	0.000s	○								

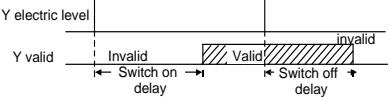
Function code	Name	Description	Default value	Modify
P06.07	Y switch-off delay	delay of the level variation from switch-on to switch-off.	0.000s	<input type="radio"/>
P06.08	HDO switch-on delay	 <p>Setting range: 0.000–50.000s Note: P06.08 and P06.09 are valid only when P06.00=1.</p>	0.000s	<input type="radio"/>
P06.09	HDO switch-off delay		0.000s	<input type="radio"/>
P06.10	Relay RO1 switch-on delay		0.000s	<input type="radio"/>
P06.11	Relay RO1 switch-off delay		0.000s	<input type="radio"/>
P06.12	Relay RO2 switch-on delay		0.000s	<input type="radio"/>
P06.13	Relay RO2 switch-off delay		0.000s	<input type="radio"/>
P06.14	AO1 output selection		0: Running frequency 1: Set frequency	0
P06.15	Reserved	2: Ramp reference frequency	/	/
P06.16	HDO high-speed pulse output	3: Rotational speed (100% corresponds to the speed corresponding to max. output frequency) 4: Output current (100% corresponds to twice the VFD rated current) 5: Output current (100% corresponds to twice the motor rated current) 6: Output voltage (100% corresponds to 1.5 times the VFD rated voltage) 7: Output power (100% corresponds to twice the motor rated power) 8: Set torque (100% corresponds to twice the motor rated torque) 9: Output torque (Absolute value, 100% corresponds to twice the motor rated torque) 10: AI1 input 11: AI2 input 12: AI3 input 13: HDIA input 14: Value 1 set through Modbus/Modbus TCP communication 15: Value 2 set through Modbus/Modbus TCP communication	0	<input type="radio"/>

Function code	Name	Description	Default value	Modify
		16: Value 1 set through PROFIBUS/CANopen/DeviceNet communication 17: Value 2 set through PROFIBUS/CANopen/DeviceNet communication 18: Value 1 set through Ethernet communication 19: Value 2 set through Ethernet communication 20: HDIB input 21: Value 1 set through EtherCAT/PROFINET/EtherNet IP communication 22: Torque current (bipolar, 0–Triple the motor rated current) 23: Exciting current (bipolar, 0–Triple the motor rated current) 24: Set frequency (bipolar) 25: Ramp reference frequency (bipolar) 26: Rotational speed (bipolar) 27: Value 2 set through EtherCAT/PROFINET/EtherNet IP communication 28: AO1 from the programmable card 29: AO2 from the programmable card 30: Rotational speed (100% corresponds to twice the motor rated synchronous speed) 31: Output torque (Actual value, 100% corresponds to twice the motor rated torque) 32: AI/AO temperature detection output 33–63: Reserved Note: When the output comes from the programmable card (28–29), if the card is a Codesys programmable card, P27.00 must be set to 1. When AO1 is of the current output type, 100% corresponds to 20mA; when AO1 is of the voltage output type, 100% corresponds to 10V; 100% of HDO corresponds to the output of P06.30.		
P06.17	Lower limit of AO1 output	Above function codes define the relation between output value and analog output. When the output value exceeds the set max./min. output range, the upper/low limit of output will be adopted during calculation.	0.0%	○
P06.18	Corresponding AO1 output of lower limit		0.00V	○

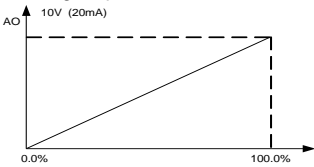
Function code	Name	Description	Default value	Modify
P06.19	Upper limit of AO1 output	When analog output is current output, 1mA corresponds to 0.5V voltage. In different applications, 100% of output value corresponds to different analog outputs. 	100.0%	<input type="radio"/>
P06.20	Corresponding AO1 output of upper limit		10.00V	<input type="radio"/>
P06.21	AO1 output filter time		Setting range of P06.17: -300.0%–P06.19 Setting range of P06.18: 0.00V–10.00V Setting range of P06.19: P06.17–300.0% Setting range of P06.20: 0.00V–10.00V Setting range of P06.21: 0.000s–10.000s	0.000s
P06.22–P06.26	Reserved	/	/	/
P06.27	Lower limit of HDO output	-300.0%–P06.29	0.00%	<input type="radio"/>
P06.28	Corresponding HDO output of lower limit	0.00–50.00kHz	0.00kHz	<input type="radio"/>
P06.29	Upper limit of HDO output	P06.27–300.0%	100.0%	<input type="radio"/>
P06.30	Corresponding HDO output of upper limit	0.00–50.00kHz	50.00 kHz	<input type="radio"/>
P06.31	HDO output filter time	0.000s–10.000s	0.000s	<input type="radio"/>
P06.32	Reserved	/	/	/
P06.33	Frequency reach detection value	0–P00.03	1.00Hz	<input type="radio"/>
P06.34	Frequency reach detection time	0–3600.0s	0.5s	<input type="radio"/>

P07—HMI

Function code	Name	Description	Default value	Modify
P07.00	User password	0–65535 Set it to any non-zero value to enable password	0	<input type="radio"/>

Function code	Name	Description	Default value	Modify
		<p>protection.</p> <p>00000: Clear the previous user password and disable password protection.</p> <p>After the user password is set and takes effect, you cannot enter the parameter menu if you enter an incorrect password. Please remember your password and save it in a secure place.</p> <p>After you exit the function code editing interface, the password protection function is enabled within 1 minute. If password protection is enabled, "0.0.0.0" is displayed when you press the PRG/ESC key again to enter the function code editing interface. You need to enter the correct user password to enter the interface.</p> <p>Note: Restoring the default values may delete the user password. Exercise caution when using this function.</p>		
P07.01	Reserved	/	/	/
P07.02	Function of keys	<p>Range: 0x00–0x27</p> <p>Ones: Function selection of QUICK/JOG key</p> <p>0: No function</p> <p>1: Jogging</p> <p>2: Reserved</p> <p>3: Forward/reverse rotation switchover</p> <p>4: Clear UP/DOWN setting</p> <p>5: Coast to stop</p> <p>6: Switch over the running command reference mode in sequence</p> <p>7: Reserved</p> <p>Tens: Reserved</p>	0x01	☉
P07.03	Running command channel switchover sequence of QUICK key	<p>When P07.02=6, set the switchover sequence of running command channel.</p> <p>0: keypad control→terminal control→communication control</p> <p>1: keypad control←→terminal control</p> <p>2: keypad control←→communication control</p> <p>3: terminal control←→communication control</p>	0	○
P07.04	Stop function selection of	<p>Validness selection of stop function of STOP/RST.</p> <p>For fault reset, STOP/RST is valid under any</p>	0	○

Function code	Name	Description	Default value	Modify
	STOP/RST key	situation. 0: valid only for panel control only 1: valid for both panel and terminal control 2: valid for both panel and communication control 3: valid for all control modes		
P07.05– P07.07	Reserved	/	/	/
P07.08	Frequency display coefficient	0.01–10.00 Display frequency=running frequency× P07.08	1.00	○
P07.09	Speed display coefficient	0.1–999.9% Mechanical speed=120×display running frequency×P07.09/number of motor pole pairs	100.0%	○
P07.10	Linear speed display coefficient	0.1–999.9% Linear speed=mechanical speed×P07.10	1.0%	○
P07.11	Temperature of rectifier bridge module	-20.0–120.0°C	0.0°C	●
P07.12	Temperature of inverter module	-20.0–120.0°C	0.0°C	●
P07.13	Software version of control board	1.00–655.35	Depends on version	●
P07.14	Accumulated running time	0–65535h	0h	●
P07.15	High bit of VFD power consumption	Display the power consumption of the VFD. VFD power consumption=P07.15×1000+P07.16	0kWh	●
P07.16	Low bit of VFD power consumption	Setting range of P07.15: 0–65535 kWh (×1000) Setting range of P07.16: 0.0–999.9 kWh	0.0kWh	●
P07.17	Reserved	/	/	/
P07.18	Rated power of VFD	0.4–3000.0kW	Depends on model	●
P07.19	Rated voltage of VFD	50–1200V	Depends on model	●
P07.20	Rated current of	0.1–6000.0A	Depends	●

Function code	Name	Description	Default value	Modify
	VFD		on model	
P07.21	Factory barcode 1	0x0000-0xFFFF	Depends on model	●
P07.22	Factory barcode 2	0x0000-0xFFFF	Depends on model	●
P07.23	Factory barcode 3	0x0000-0xFFFF	Depends on model	●
P07.24	Factory barcode 4	0x0000-0xFFFF	Depends on model	●
P07.25	Factory barcode 5	0x0000-0xFFFF	Depends on model	●
P07.26	Factory barcode 6	0x0000-0xFFFF	Depends on model	●
P07.27	Present fault type	0: No fault	0	●
P07.28	Last fault type	1: Inverter unit U phase protection (OUt1)	0	●
P07.29	2nd-last fault type	2: Inverter unit V phase protection (OUt2)	0	●
		3: Inverter unit W phase protection (OUt3)		
P07.30	3rd-last fault type	4: Overcurrent during acceleration (OC1)	0	●
P07.31	4th-last fault type	5: Overcurrent during deceleration (OC2)	0	●
P07.32	5th-last fault type	6: Overcurrent during constant speed (OC3)	0	●
		7: Overvoltage during acceleration (OV1)		
		8: Overvoltage during deceleration (OV2)		
		9: Overvoltage during constant speed (OV3)		
		10: Bus undervoltage fault (UV)		
		11: Motor overload (OL1)		
		12: VFD overload (OL2)		
		13: Phase loss on input side (SPI)		
		14: Phase loss on output side (SPO)		
		15: Rectifier module overheat (OH1)		
		16: Inverter module overheat (OH2)		
		17: External fault (EF)		
		18: Modbus/Modbus TCP communication fault (CE)		
		19: Current detection fault (ItE)		
20: Motor autotuning fault (tE)				
21: EEPROM operation fault (EEP)				
22: PID feedback offline fault (PIDE)				
23: Braking unit fault (bCE)				
24: Running time reached (END)				
25: Electronic overload (OL3)				
26: Keypad communication error (PCE)				
27: Parameter upload error (UPE)				

Function code	Name	Description	Default value	Modify
		28: Parameter download error (DNE) 29: PROFIBUS communication fault (E-DP) 30: Ethernet communication fault (E-NET) 31: CANopen communication fault (E-CAN) 32: To-ground short-circuit fault 1 (ETH1) 33: To-ground short-circuit fault 2 (ETH2) 34: Speed deviation fault (dEu) 35: Maladjustment fault (STo) 36: Underload fault (LL) 37: Encoder offline fault (ENC1o) 38: Encoder reversal fault (ENC1d) 39: Encoder Z pulse offline fault (ENC1Z) 40: Safe torque off (STO) 41: Channel H1 safety circuit exception (STL1) 42: Channel H2 safety circuit exception (STL2) 43: Channel H1 and H2 exception (STL3) 44: Safety code FLASH CRC fault (CrCE) 45: Programmable card customized fault 1 (P-E1) 46: Programmable card customized fault 2 (P-E2) 47: Programmable card customized fault 3 (P-E3) 48: Programmable card customized fault 4 (P-E4) 49: Programmable card customized fault 5 (P-E5) 50: Programmable card customized fault 6 (P-E6) 51: Programmable card customized fault 7 (P-E7) 52: Programmable card customized fault 8 (P-E8) 53: Programmable card customized fault 9 (P-E9) 54: Programmable card customized fault 10 (P-E10) 55: Duplicate card type (E-Err) 56: Encoder UVW loss fault (ENCUV) 57: PROFIBUS communication fault (E-PN) 58: CANopen communication fault (SECAN) 59: Motor over-temperature fault (OT) 60: Failure to identify the card at slot 1 (F1-Er) 61: Failure to identify the card at slot 2 (F2-Er) 62: Failure to identify the card at slot 3 (F3-Er) 63: Communication timeout of the card at slot 1 (C1-Er) 64: Communication timeout of the card at slot 2		

Function code	Name	Description	Default value	Modify
		(C2-Er) 65: Communication timeout of the card at slot 3 (C3-Er) 66: EtherCAT communication fault (E-CAT) 67: Bacnet communication fault (E-BAC) 68: DeviceNet communication fault (E-DEV) 69: CAN slave fault in master/slave synchronization (S-Err) 70: EC PT100 detected overheating (OtE1) 71: EC PT1000 detected overheating (OtE2) 72: EtherNet/IP communication timeout (E-EIP) 73: No upgrade bootloader (E-PAO) 74: AI1 disconnected (E-AI1) 75: AI2 disconnected (E-AI2) 76: AI3 disconnected (E-AI3)		
P07.33	Running frequency at present fault	0.00Hz~P00.03	0.00Hz	●
P07.34	Ramp reference frequency at present fault	0.00Hz~P00.03	0.00Hz	●
P07.35	Output voltage at present fault	0~1200V	0V	●
P07.36	Output current at present fault	0.0~6300.0A	0.0A	●
P07.37	Bus voltage at present fault	0.0~2000.0V	0.0V	●
P07.38	Max. temperature at present fault	-20.0~120.0°C	0.0°C	●
P07.39	Input terminal status at present fault	0x0000~0xFFFF	0x0000	●
P07.40	Output terminal status at present fault	0x0000~0xFFFF	0x0000	●
P07.41	Running frequency at last fault	0.00Hz~P00.03	0.00Hz	●

Function code	Name	Description	Default value	Modify
P07.42	Ramp reference frequency at last fault	0.00Hz~P00.03	0.00Hz	●
P07.43	Output voltage at last fault	0~1200V	0V	●
P07.44	Output current at last fault	0.0~6300.0A	0.0A	●
P07.45	Bus voltage at last fault	0.0~2000.0V	0.0V	●
P07.46	Max. temperature at last fault	-20.0~120.0°C	0.0°C	●
P07.47	Input terminal status at last fault	0x0000~0xFFFF	0x0000	●
P07.48	Output terminal state at last fault	0x0000~0xFFFF	0x0000	●
P07.49	Running frequency at 2nd-last fault	0.00Hz~P00.03	0.00Hz	●
P07.50	Ramp reference frequency at 2nd-last fault	0.00Hz~P00.03	0.00Hz	●
P07.51	Output voltage at 2nd-last fault	0~1200V	0V	●
P07.52	Output current at 2nd-last fault	0.0~6300.0A	0.0A	●
P07.53	Bus voltage at 2nd-last fault	0.0~2000.0V	0.0V	●
P07.54	Max. temperature at 2nd-last fault	-20.0~120.0°C	0.0°C	●
P07.55	Input terminal status at 2nd-last fault	0x0000~0xFFFF	0x0000	●
P07.56	Output terminal status at 2nd-last fault	0x0000~0xFFFF	0x0000	●

P08—Enhanced functions

Function code	Name	Description	Default value	Modify
P08.00	Acceleration time 2	See P00.11 and P00.12 for detailed definitions. Goodrive350 series VFD defines four groups of acceleration/deceleration time, which can be selected by multi-function digital input terminal (P05 group). The acceleration/deceleration time of the VFD is the first group by default. Setting range: 0.0–3600.0s	Depends on model	<input type="radio"/>
P08.01	Deceleration time 2		Depends on model	<input type="radio"/>
P08.02	Acceleration time 3		Depends on model	<input type="radio"/>
P08.03	Deceleration time 3		Depends on model	<input type="radio"/>
P08.04	Acceleration time 4		Depends on model	<input type="radio"/>
P08.05	Deceleration time 4		Depends on model	<input type="radio"/>
P08.06	Running frequency of jogging	This function code is used to define the reference frequency of the VFD during jogging. Setting range: 0.00Hz–P00.03 (Max. output frequency)	5.00Hz	<input type="radio"/>
P08.07	Acceleration time of jogging	Jogging acceleration time is the time needed for the VFD to accelerate from 0Hz to Max. output frequency (P00.03).	Depends on model	<input type="radio"/>
P08.08	Deceleration time of jogging	Jogging deceleration time is the time needed from decelerating from Max. output frequency (P00.03) to 0Hz. Setting range: 0.0–3600.0s		<input type="radio"/>
P08.09	Jump frequency 1	When the set frequency is within the range of jump frequency, the VFD will run at the boundary of jump frequency. The VFD can avoid mechanical resonance point by setting the jump frequency, and three jump frequency points can be set. If the jump frequency points are set to 0, this function will be invalid.	0.00Hz	<input type="radio"/>
P08.10	Jump frequency amplitude 1		0.00Hz	<input type="radio"/>
P08.11	Jump frequency 2		0.00Hz	<input type="radio"/>
P08.12	Jump frequency amplitude 2		0.00Hz	<input type="radio"/>
P08.13	Jump frequency 3		0.00Hz	<input type="radio"/>
P08.14	Jump frequency amplitude 3		0.00Hz	<input type="radio"/>

Function code	Name	Description	Default value	Modify
		Setting range: 0.00Hz–P00.03 (Max. output frequency)		
P08.15	Amplitude of wobbling frequency	0.0–100.0% (relative to set frequency)	0.0%	<input type="radio"/>
P08.16	Amplitude of jump frequency	0.0–50.0% (relative to amplitude of wobbling frequency)	0.0%	<input type="radio"/>
P08.17	Rise time of wobbling frequency	0.1–3600.0s	5.0s	<input type="radio"/>
P08.18	Descend time of wobbling frequency	0.1–3600.0s	5.0s	<input type="radio"/>
P08.19	Switching frequency of acceleration/deceleration time	0.00–P00.03 (Max. output frequency) 0.00Hz: no switchover Switch to acceleration/deceleration time 2 if the running frequency is larger than P08.19	0.00Hz	<input type="radio"/>
P08.20	Frequency threshold of the start of droop control	0.00–50.00Hz	2.00Hz	<input type="radio"/>
P08.21	Reference frequency of acceleration/deceleration time	0: Max. output frequency 1: Set frequency 2: 100Hz Note: Valid for straight acceleration/deceleration only	0	<input checked="" type="radio"/>
P08.22	Output torque calculation mode	0: Calculated based on torque current 1: Calculated based on output power	0	<input type="radio"/>
P08.23	Number of decimal points of frequency	0: Two decimal points 1: One decimal point	0	<input type="radio"/>
P08.24	Number of decimal points of linear speed	0: No decimal point 1: One 2: Two 3: Three	0	<input type="radio"/>
P08.25	Set count value	P08.26–65535	0	<input type="radio"/>
P08.26	Designated count value	0–P08.25	0	<input type="radio"/>

Function code	Name	Description	Default value	Modify
P08.27	Set running time	0–65535min	0min	<input type="radio"/>
P08.28	Automatic fault reset times	Automatic fault reset times: When the VFD selects automatic fault reset, it is used to set the times of automatic reset, if the continuous reset times exceeds the value set by P08.29, the VFD will report fault and stop to wait for repair.	0	<input type="radio"/>
P08.29	Automatic fault reset time interval	Interval of automatic fault reset: select the interval time from when fault occurred to automatic fault reset actions. After VFD starts, if no fault occurred during 60s, the fault reset times will be zeroed out. Setting range of P08.28: 0–10 Setting range of P08.29: 0.1–3600.0s	1.0s	<input type="radio"/>
P08.30	Reduction ratio of droop control	This parameter specifies the variation rate of the VFD output frequency based on the load; it is mainly used in balancing the power when multiple motors drive the same load. Setting range: 0.00–50.00Hz	0.00Hz	<input type="radio"/>
P08.31	Switchover selection for motor 1 and motor 2	0x00–0x14 Ones: Switchover channel 0: Terminal 1: Modbus/Modbus TCP communication 2: PROFIBUS/CANopen/DeviceNet communication 3: Ethernet communication 4: EtherCAT/PROFINET/EtherNet IP communication Tens: indicates whether to enable switchover during running 0: Disable 1: Enable	0x00	<input checked="" type="radio"/>
P08.32	FDT1 level detection value	When the output frequency exceeds the corresponding frequency of FDT level,	50.00Hz	<input type="radio"/>
P08.33	FDT1 lag detection value	multi-function digital output terminal outputs "frequency level detection FDT" signal, this signal	5.0%	<input type="radio"/>
P08.34	FDT2 level detection value	will be valid until the output frequency lowers to below the corresponding frequency (FDT	50.00Hz	<input type="radio"/>
P08.35	FDT2 lag	level-FDT lag detection value), the waveform is shown in the figure below.	5.0%	<input type="radio"/>

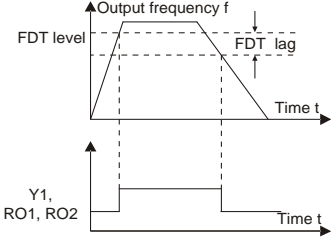
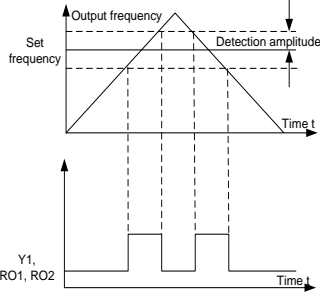
Function code	Name	Description	Default value	Modify
	detection value	 <p>Setting range of P08.32: 0.00Hz~P00.03 (Max. output frequency) Setting range of P08.33: 0.0~100.0% (FDT1 level) Setting range of P08.34: 0.00Hz~P00.03 (Max. output frequency) Setting range of P08.35: 0.0~100.0% (FDT2 level)</p>		
P08.36	Detection value for frequency arrival	<p>When the output frequency is within the positive /negative detection range of the set frequency, the multi-function digital output terminal outputs "frequency arrival" signal as shown below.</p>  <p>Setting range: 0.00Hz~P00.03 (Max. output frequency)</p>	0.00Hz	○
P08.37	Enable/disable energy-consumption brake	<p>0: Disable energy-consumption 1: Enable energy-consumption</p>	1	○
P08.38	Energy-consumption braking threshold voltage	<p>Set the starting bus voltage of energy-consumption brake, adjust this value properly can brake the load effectively. The default value will change with the change of voltage class. Setting range: 200.0~2000.0V</p>	220V voltage: 380.0V; 380V voltage:	○

Function code	Name	Description	Default value	Modify
			700.0V; 660V voltage: 1120.0V	
P08.39	Running mode of cooling fan	0: Common running mode 1: The fan keeps running after power-on 2: Running mode 2	0	○
P08.40	PWM selection	0x0000–0x1121 Ones place: PWM mode selection 0: PWM mode 1, 3PH modulation and 2PH modulation 1: PWM mode 2, 3PH modulation Tens place: PWM low-speed carrier limit 0: Low-speed carrier limit mode 1 1: Low-speed carrier limit mode 2 2: No limit Hundreds place: Deadzone compensation method 0: Compensation method 1 1: Compensation method 2 Thousands place: PWM loading mode selection 0: Interruptive loading 1: Normal loading	0x1101	◎
P08.41	Overmodulation selection	0x0000–0x1111 Ones place: Whether to enable overmodulation 0: Disable overmodulation 1: Enable overmodulation Tens place: Overmodulation mode 0: Mild overmodulation 1: Deepened overmodulation Hundreds: Carrier frequency limit 0: Yes 1: No Thousands: Output voltage compensation 0: No 1: Yes	0x1001	◎
P08.42	Reserved	/	/	/
P08.43	Reserved	/	/	/
P08.44	UP/DOWN	0x000–0x221	0x000	○

Function code	Name	Description	Default value	Modify
	terminal control setup	Ones: Frequency control selection 0: <input type="checkbox"/> UP/DOWN terminal setup is valid 1: <input type="checkbox"/> UP/DOWN terminal setup is invalid Tens: Frequency control selection 0: Valid only when P00.06=0 or P00.07=0 1: All frequency modes are valid 2: Invalid for multi-step speed when multi-step speed takes priority Hundreds: Action selection during stop 0: Valid 1: Valid during running, clear after stop 2: Valid during running, clear after receiving stop command		
P08.45	UP terminal frequency incremental integral rate	0.01–50.00Hz/s	0.50Hz/s	<input type="radio"/>
P08.46	DOWN terminal frequency decremental change rate	0.01–50.00Hz/s	0.50Hz/s	<input type="radio"/>
P08.47	Action selection for frequency setup during power down	0x000–0x111 Ones place: Action selection at power-off during frequency adjusting through digitals. 0: Save the setting at power-off. 1: Clear the setting at power-off. Action selection at power-off during frequency adjusting through Modbus/Modbus TCP communication 0: Save the setting at power-off. 1: Clear the setting at power-off. Hundreds place: Action selection at power-off during frequency adjusting through DP communication 0: Save the setting at power-off. 1: Clear the setting at power-off.	0x000	<input type="radio"/>
P08.48	High bit of initial value of power consumption	Set the initial value of power consumption. Initial value of power consumption=P08.48×1000+ P08.49	0kWh	<input type="radio"/>

Function code	Name	Description	Default value	Modify
P08.49	Low bit of initial value of power consumption	Setting range of P08.48: 0–59999 kWh (k) Setting range of P08.49: 0.0–999.9 kWh	0.0kWh	<input type="radio"/>
P08.50	Flux braking	This function code is used to enable flux braking function. 0: Invalid 100–150: The larger the coefficient, the stronger the braking intensity The VFD enables motor to decelerate quickly by increasing the motor flux which converts energy generated during braking into thermal energy. The VFD monitors motor state continuously even during flux braking, thus flux braking can be applied in motor stop or used to change motor speed. The flux braking also carries the following advantages. 1) Brake immediately after sending stop command, removing the need to wait for flux to attenuate. 2) Better cooling effect. During flux braking, the stator current of the motor increases, while the rotor current does not change, while the cooling effect of stator is much more effective than that of the rotor.	0	<input type="radio"/>
P08.51	Current regulation coefficient on input side	This function code is used to adjust the current display value on the AC input side. 0.00–1.00	0.56	<input type="radio"/>
P08.52	STO lock	0: STO alarm lock Alarm-lock means STO alarm must be reset after state restoration when STO occurs. 1: STO alarm unlock Alarm-unlock means when STO occurs, after state restoration, STO alarm will disappear automatically.	0	<input type="radio"/>
P08.53	Bias value of upper limit frequency of torque control	0.00 Hz–P00.03 (Max. output frequency) Note: This parameter is valid only for the torque control mode.	0.00Hz	<input type="radio"/>

Function code	Name	Description	Default value	Modify
P08.54	Acceleration/ deceleration selection of upper limit frequency of torque control	0: No limit on acceleration or deceleration 1: Acceleration/deceleration time 1 2: Acceleration/deceleration time 2 3: Acceleration/deceleration time 3 4: Acceleration/deceleration time 4	0	<input type="radio"/>
P08.55	Enabling auto carrier frequency reduction	0: Disable 1: Enable Note: Automatic carrier frequency reduction indicates that the VFD automatically reduces the carrier frequency when detecting the heat sink temperature exceeds the rated temperature. When the temperature decreases to a certain degree, the carrier frequency recovers. This function reduces the chance of VFD overheat alarm.	0	<input type="radio"/>
P08.56	Min. carrier frequency	0.0–15.0kHz	Depends on model	<input checked="" type="radio"/>
P08.57	Temperature point of auto carrier frequency reduction	40.0–85.0°C	70.0°C	<input type="radio"/>
P08.58	Interval of carrier frequency reduction	0–30min	10min	<input type="radio"/>
P08.59	A11 disconnection detection threshold	0–100%	0	<input type="radio"/>
P08.60	A12 disconnection detection threshold	0–100%	0	<input type="radio"/>
P08.61	A13 disconnection detection threshold	0–100%	0	<input type="radio"/>
P08.62	Output current filter time	0.000–10.000s	0.000s	<input type="radio"/>
P08.63	Output torque filter times	0–8	8	<input type="radio"/>

P09—PID control

Function code	Name	Description	Default value	Modify
P09.00	PID reference source	When frequency command (P00.06, P00.07) is set to 7, or voltage setting channel (P04.27) is set to 6, the VFD running mode is process PID control. This parameter determines the target reference	0	<input type="radio"/>

Function code	Name	Description	Default value	Modify
		channel of process PID. 0: Set by P09.01 1: AI1 2: AI2 3: AI3 4: High-speed pulse HDIA 5: Multi-step 6: Modbus/Modbus TCP communication 7: PROFIBUS/CANopen/DeviceNet communication 8: Ethernet communication 9: High-speed pulse HDIB 10: EtherCAT/PROFINET/EtherNet IP communication 11: Programmable card 12: Reserved The set target of process PID is a relative value, for which 100% equals 100% of the feedback signal of the controlled system. The system always calculates a relative value (0–100.0%).		
P09.01	PID digital setting	This parameter is mandatory when P09.00 is set to 0. The reference value of this parameter is the feedback of the system. Setting range: -100.0%–100.0%	0.0%	○
P09.02	PID feedback source	This parameter is used to select PID feedback channel. 0: AI1 1: AI2 2: AI3 3: High-speed pulse HDIA 4: Modbus/Modbus TCP communication 5: PROFIBUS/CANopen/DeviceNet communication 6: Ethernet communication 7: High-speed pulse HDIB 8: EtherCAT/PROFINET/EtherNet IP communication 9: Programmable expansion card	0	○

Function code	Name	Description	Default value	Modify
		10: Reserved Note: The reference channel and feedback channel cannot overlap. Otherwise, effective PID control cannot be achieved.		
P09.03	PID output characteristics	0: PID output is positive characteristic: namely, the feedback signal is larger than the PID reference, which requires the VFD output frequency to decrease for PID to reach balance, eg, tension PID control of winding 1: PID output is negative characteristics: namely the feedback signal is less than PID reference, which requires VFD output frequency to increase for PID to reach balance, eg, tension PID control of unwinding.	0	<input type="radio"/>
P09.04	Proportional gain (Kp)	This function code is suitable for proportional gain P of PID input. It determines the regulation intensity of the whole PID regulator, the larger the value of P, the stronger the regulation intensity. If this parameter is 100, it means when the deviation between PID feedback and reference is 100%, the regulation amplitude of PID regulator (ignoring integral and differential effect) on output frequency command is the max. frequency (ignoring integral and differential actions). Setting range: 0.00–100.00	1.80	<input type="radio"/>
P09.05	Integral time (Ti)	It determines the speed of integral regulation made on the deviation between PID feedback and reference by PID regulator. When the deviation between PID feedback and reference is 100%, the regulation of integral regulator (ignoring integral and differential actions), after undergoing continuous regulation during this time period, can reach Max. output frequency (P00.03) The shorter the integral time, the stronger the regulation intensity. Setting range: 0.00–10.00s	0.90s	<input type="radio"/>
P09.06	Derivative time (Td)	It determines the intensity of the regulation made on the change rate of deviation between PID	0.00s	<input type="radio"/>

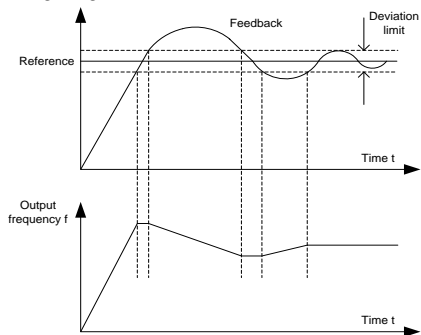
Function code	Name	Description	Default value	Modify
		feedback and reference by PID regulator. If feedback changes by 100% during this period, the regulation of differential regulator (ignoring integral and differential actions) is Max. output frequency (P00.03) The longer the derivative time, the stronger the regulation intensity. Setting range: 0.00–10.00s		
P09.07	Sampling cycle (T)	It means the sampling cycle of feedback. The regulator operates once during each sampling cycle. The larger the sampling cycle, the slower the response. Setting range: 0.001–10.000s	0.001s	<input type="radio"/>
P09.08	Limit of PID control deviation	It is the max. allowable deviation of PID system output value relative to closed-loop reference value. Within this limit, PID regulator stops regulation. Set this function code properly to regulate the precision and stability of PID system. Setting range: 0.0–100.0% 	0.0%	<input type="radio"/>
P09.09	Upper limit value of PID output	These two function codes are used to set the upper/lower limit value of PID regulator. 100.0% corresponds to Max. output frequency (P00.03) or max. voltage (P04.31) Setting range of P09.09: P09.10–100.0% Setting range of P09.10: -100.0%–P09.09	100.0%	<input type="radio"/>
P09.10	Lower limit value of PID output		0.0%	<input type="radio"/>
P09.11	Feedback offline detection value	Set PID feedback offline detection value, when the detection value is no more than the feedback offline detection value, and the duration exceeds	0.0%	<input type="radio"/>
P09.12	Feedback offline		1.0s	<input type="radio"/>

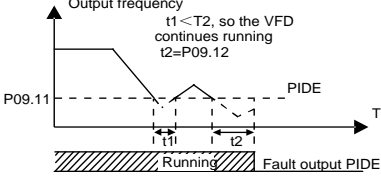
Function code	Name	Description	Default value	Modify
	detection time	<p>the value set in P09.12, the VFD will report "PID feedback offline fault", and keypad displays PIDE.</p>  <p>Setting range of P09.11: 0.0–100.0% Setting range of P09.12: 0.0–3600.0s</p>		
P09.13	PID control selection	<p>0x0000–0x1111 Ones: 0: Continue integral control after the frequency reaches upper/lower limit 1: Stop integral control after the frequency reaches upper/lower limit Tens: 0: The same with the main reference direction 1: Contrary to the main reference direction Hundreds: 0: Limit based on the max. frequency 1: Limit based on A frequency Thousands: 0: A+B frequency, acceleration /deceleration of main reference A frequency source buffering is invalid 1: A+B frequency, acceleration/ deceleration of main reference A frequency source buffering is valid, acceleration and deceleration are determined by P08.04 (acceleration time 4).</p>	0x0001	○
P09.14	Low-frequency proportional gain (Kp)	<p>0.00–100.00 Low-frequency switching point: 5.00Hz, high-frequency switching point: 10.00Hz (P09.04 corresponds to high-frequency parameter), and the middle is the linear interpolation between these two points</p>	1.00	○
P09.15	Acceleration/ deceleration time of PID command	0.0–1000.0s	0.0s	○

Function code	Name	Description	Default value	Modify
P09.16	Filter time of PID output	0.000–10.000s	0.000s	<input type="radio"/>
P09.17	Reserved	/	/	/
P09.18	Low-frequency integral time (Ti)	0.00–10.00s	0.90s	<input type="radio"/>
P09.19	Low-frequency differential time (Td)	0.00–10.00s	0.00s	<input type="radio"/>
P09.20	Low-frequency point of PID parameter switching	0.00Hz–P09.21	5.00Hz	<input type="radio"/>
P09.21	High-frequency point of PID parameter switching	P09.20–P00.04	10.00Hz	<input type="radio"/>
P09.22–P09.28	Reserved	/	/	/

P10—Simple PLC and multi-step speed control

Function code	Name	Description	Default value	Modify
P10.00	Simple PLC mode	0: Stop after running once; the VFD stops automatically after running for one cycle, and it can be started only after receiving running command. 1: Keep running in the final value after running once; The VFD keeps the running frequency and direction of the last section after a single cycle. 2: Cyclic running; the VFD enters the next cycle after completing one cycle until receiving stop command and stops.	0	<input type="radio"/>
P10.01	Simple PLC memory selection	0: No memory after power down 1: Memory after power down; PLC memories its running stage and running frequency before power down.	0	<input type="radio"/>
P10.02	Multi-step speed 0	Frequency setting range for steps from step 0 to step 15: -300.0–300.0%, 100% corresponds to Max. output frequency (P00.03).	0.0%	<input type="radio"/>
P10.03	Running time of step 0		0.0s(min)	<input type="radio"/>
P10.04	Multi-step speed 1		Running time setting range for steps from step 0 to	0.0%

Function code	Name	Description	Default value	Modify
P10.05	Running time of step 1	step 15: 0.0–6553.5s (min). The time unit is specified by P10.37.	0.0s(min)	<input type="radio"/>
P10.06	Multi-step speed 2	When simple PLC operation is selected, you must set P10.02–P10.33 to determine the running frequency and running time of each step.	0.0%	<input type="radio"/>
P10.07	Running time of step 2	Note: The symbol of multi-step speed determines the running direction of simple PLC, and the negative value means reverse running.	0.0s(min)	<input type="radio"/>
P10.08	Multi-step speed 3		0.0%	<input type="radio"/>
P10.09	Running time of step 3		0.0s(min)	<input type="radio"/>
P10.10	Multi-step speed 4		0.0%	<input type="radio"/>
P10.11	Running time of step 4		0.0s(min)	<input type="radio"/>
P10.12	Multi-step speed 5		0.0%	<input type="radio"/>
P10.13	Running time of step 5	When selecting multi-step speed running, the multi-step speed is within the range of -fmax–fmax, and it can be set continuously. The start/stop of multi-step running is also determined by P00.01.	0.0s(min)	<input type="radio"/>
P10.14	Multi-step speed 6		0.0%	<input type="radio"/>
P10.15	Running time of step 6	The VFD supports the setting of speeds of 16 steps, which are set by combined codes of multi-step terminals 1–4 (set by S terminals, corresponding to function codes P05.01–P05.06) and correspond to multi-step speeds 0–15.	0.0s(min)	<input type="radio"/>
P10.16	Multi-step speed 7		0.0%	<input type="radio"/>
P10.17	Running time of step 7		0.0s(min)	<input type="radio"/>
P10.18	Multi-step speed 8		0.0%	<input type="radio"/>
P10.19	Running time of step 8	When terminals 1–4 are OFF, the frequency input mode is set by P00.06 or P00.07. When terminals 1–4 are not all OFF, the frequency set by multi-step speed will prevail, and the priority of multi-step setting is higher than that of the keypad,	0.0s(min)	<input type="radio"/>
P10.20	Multi-step speed 9		0.0%	<input type="radio"/>
P10.21	Running time of step 9		0.0s(min)	<input type="radio"/>
P10.22	Multi-step speed 10		0.0%	<input type="radio"/>
P10.23	Running time of step 10		0.0s(min)	<input type="radio"/>
P10.24	Multi-step speed 11		0.0%	<input type="radio"/>
P10.25	Running time of step 11		0.0s(min)	<input type="radio"/>
P10.26	Multi-step speed 12		0.0%	<input type="radio"/>

Function code	Name	Description	Default value	Modify																																																																																																							
P10.27	Running time of step 12	analog, high-speed pulse, PID, and communication settings.	0.0s(min)	<input type="radio"/>																																																																																																							
P10.28	Multi-step speed 13	The relationship between terminals 1–4 are shown in the table below.	0.0%	<input type="radio"/>																																																																																																							
P10.29	Running time of step 13	Terminal 1	OFF ON OFF ON OFF ON OFF ON	0.0s(min)	<input type="radio"/>																																																																																																						
		Terminal 2	OFF OFF ON ON OFF OFF ON ON																																																																																																								
P10.30	Multi-step speed 14	Terminal 3	OFF OFF OFF OFF ON ON ON ON	0.0%	<input type="radio"/>																																																																																																						
		Terminal 4	OFF OFF OFF OFF OFF OFF OFF OFF																																																																																																								
P10.31	Running time of step 14	Step	0 1 2 3 4 5 6 7	0.0s(min)	<input type="radio"/>																																																																																																						
		Terminal 1	OFF ON OFF ON OFF ON OFF ON																																																																																																								
P10.32	Multi-step speed 15	Terminal 2	OFF OFF ON ON OFF OFF ON ON	0.0%	<input type="radio"/>																																																																																																						
		Terminal 3	OFF OFF OFF OFF ON ON ON ON																																																																																																								
P10.33	Running time of step 15	Terminal 4	ON ON ON ON ON ON ON ON	0.0s(min)	<input type="radio"/>																																																																																																						
		Step	8 9 10 11 12 13 14 15																																																																																																								
P10.34	Acceleration/ deceleration time of steps 0–7 of simple PLC	Detailed illustration is shown in the table below.	0x0000	<input type="radio"/>																																																																																																							
		<table border="1"> <thead> <tr> <th>Function code</th> <th>Binary</th> <th>Step no.</th> <th>ACC/ DEC time 1</th> <th>ACC/ DEC time 2</th> <th>ACC/ DEC time 3</th> <th>ACC/ DEC time 4</th> </tr> </thead> <tbody> <tr> <td rowspan="8">P10.34</td> <td>BIT1 BIT0</td> <td>0</td> <td>00</td> <td>01</td> <td>10</td> <td>11</td> </tr> <tr> <td>BIT3 BIT2</td> <td>1</td> <td>00</td> <td>01</td> <td>10</td> <td>11</td> </tr> <tr> <td>BIT5 BIT4</td> <td>2</td> <td>00</td> <td>01</td> <td>10</td> <td>11</td> </tr> <tr> <td>BIT7 BIT6</td> <td>3</td> <td>00</td> <td>01</td> <td>10</td> <td>11</td> </tr> <tr> <td>BIT9 BIT8</td> <td>4</td> <td>00</td> <td>01</td> <td>10</td> <td>11</td> </tr> <tr> <td>BIT11 BIT10</td> <td>5</td> <td>00</td> <td>01</td> <td>10</td> <td>11</td> </tr> <tr> <td>BIT13 BIT12</td> <td>6</td> <td>00</td> <td>01</td> <td>10</td> <td>11</td> </tr> <tr> <td>BIT15 BIT14</td> <td>7</td> <td>00</td> <td>01</td> <td>10</td> <td>11</td> </tr> <tr> <td rowspan="8">P10.35</td> <td>BIT1 BIT0</td> <td>8</td> <td>00</td> <td>01</td> <td>10</td> <td>11</td> </tr> <tr> <td>BIT3 BIT2</td> <td>9</td> <td>00</td> <td>01</td> <td>10</td> <td>11</td> </tr> <tr> <td>BIT5 BIT4</td> <td>10</td> <td>00</td> <td>01</td> <td>10</td> <td>11</td> </tr> <tr> <td>BIT7 BIT6</td> <td>11</td> <td>00</td> <td>01</td> <td>10</td> <td>11</td> </tr> <tr> <td>BIT9 BIT8</td> <td>12</td> <td>00</td> <td>01</td> <td>10</td> <td>11</td> </tr> <tr> <td>BIT11 BIT10</td> <td>13</td> <td>00</td> <td>01</td> <td>10</td> <td>11</td> </tr> <tr> <td>BIT13 BIT12</td> <td>14</td> <td>00</td> <td>01</td> <td>10</td> <td>11</td> </tr> <tr> <td>BIT15 BIT14</td> <td>15</td> <td>00</td> <td>01</td> <td>10</td> <td>11</td> </tr> </tbody> </table>			Function code	Binary	Step no.	ACC/ DEC time 1	ACC/ DEC time 2	ACC/ DEC time 3	ACC/ DEC time 4	P10.34	BIT1 BIT0	0	00	01	10	11	BIT3 BIT2	1	00	01	10	11	BIT5 BIT4	2	00	01	10	11	BIT7 BIT6	3	00	01	10	11	BIT9 BIT8	4	00	01	10	11	BIT11 BIT10	5	00	01	10	11	BIT13 BIT12	6	00	01	10	11	BIT15 BIT14	7	00	01	10	11	P10.35	BIT1 BIT0	8	00	01	10	11	BIT3 BIT2	9	00	01	10	11	BIT5 BIT4	10	00	01	10	11	BIT7 BIT6	11	00	01	10	11	BIT9 BIT8	12	00	01	10	11	BIT11 BIT10	13	00	01	10	11	BIT13 BIT12	14	00	01	10	11	BIT15 BIT14	15	00	01
Function code	Binary	Step no.	ACC/ DEC time 1	ACC/ DEC time 2	ACC/ DEC time 3	ACC/ DEC time 4																																																																																																					
P10.34	BIT1 BIT0	0	00	01	10	11																																																																																																					
	BIT3 BIT2	1	00	01	10	11																																																																																																					
	BIT5 BIT4	2	00	01	10	11																																																																																																					
	BIT7 BIT6	3	00	01	10	11																																																																																																					
	BIT9 BIT8	4	00	01	10	11																																																																																																					
	BIT11 BIT10	5	00	01	10	11																																																																																																					
	BIT13 BIT12	6	00	01	10	11																																																																																																					
	BIT15 BIT14	7	00	01	10	11																																																																																																					
P10.35	BIT1 BIT0	8	00	01	10	11																																																																																																					
	BIT3 BIT2	9	00	01	10	11																																																																																																					
	BIT5 BIT4	10	00	01	10	11																																																																																																					
	BIT7 BIT6	11	00	01	10	11																																																																																																					
	BIT9 BIT8	12	00	01	10	11																																																																																																					
	BIT11 BIT10	13	00	01	10	11																																																																																																					
	BIT13 BIT12	14	00	01	10	11																																																																																																					
	BIT15 BIT14	15	00	01	10	11																																																																																																					
P10.35	Acceleration/ deceleration time of steps 8–15 of simple PLC	Select corresponding acceleration/deceleration time, and then convert 16-bit binary number into hexadecimal number, finally, set corresponding function code.	0x0000	<input type="radio"/>																																																																																																							

Function code	Name	Description	Default value	Modify
		Acceleration/deceleration time 1 is set by P00.11 and P00.12; Acceleration/deceleration time 2 is set by P08.00 and P08.01; Acceleration/deceleration time 3 is set by P08.02 and P08.03; Acceleration /deceleration time 4 is set by P08.04 and P08.05. Setting range: 0x0000–0xFFFF		
P10.36	PLC restart mode	0: Restart from the first step, namely if the VFD stops during running (caused by stop command, fault or power down), it will run from the first step after restart. 1: Continue running from the step frequency when interruption occurred, namely if the VFD stops during running (caused by stop command or fault), it will record the running time of current step, and enters this step automatically after restart, then continue running at the frequency defined by this step in the remaining time.	0	☉
P10.37	Multi-step time unit	0: second (s). The running time of each step is counted in seconds. 1: minute (min). The running time of each step is counted in minutes.	0	☉

P11—Protection parameters

Function code	Name	Description	Default value	Modify
P11.00	Phase-loss protection	0x000–0x111 Ones: 0: Disable software input phase loss protection 1: Enable software input phase loss protection Tens: 0: Disable output phase loss protection 1: Enable output phase loss protection Hundreds: 0: Disable hardware input phase loss protection 1: Enable hardware input phase loss protection	0x110	○
P11.01	Frequency-drop at transient power down	0: Disable 1: Enable	0	○
P11.02	Energy braking in	0: Enable	0	☉

Function code	Name	Description	Default value	Modify
	standby state	1: Disable		
P11.03	Overvoltage stall protection	0: Disable 1: Enable 	1	○
P11.04	Overvoltage stall protection voltage	120–150% (standard bus voltage) (380V)	136%	○
		120–150% (standard bus voltage) (220V)	120%	
P11.05	Current-limit selection	During accelerated running, as the load is too large, the actual acceleration rate of motor is lower than that of output frequency, if no measures are taken, the VFD may trip due to overcurrent during acceleration. 0x00–0x11 Ones: Current-limit action selection 0: Invalid 1: Always valid Tens: Hardware current-limit overload alarm selection 0: Valid 1: Invalid	0x01	◎
P11.06	Automatic current-limit level	Current-limit protection function detects output current during running, and compares it with the current-limit level defined by P11.06, if it exceeds the current-limit level, the VFD will run at stable frequency during accelerated running, or run in decreased frequency during constant-speed running; if it exceeds the current-limit level continuously, the VFD output frequency will drop continuously until reaching lower limit frequency. When the output current is detected to be lower than the current-limit level again, it will continue	G type: 160.0% P type: 120.0%	◎
P11.07	Frequency-drop rate during current limit	When the output current is detected to be lower than the current-limit level again, it will continue	10.00 Hz/s	◎

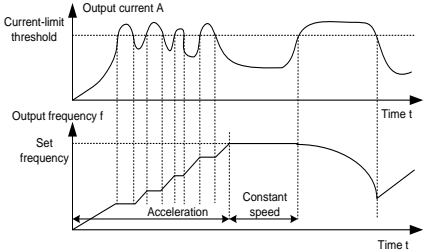
Function code	Name	Description	Default value	Modify
		<p>accelerated running.</p>  <p>Setting range of P11.06: 50.0–200.0% (of the rated VFD output current) Setting range of P11.07: 0.00–50.00Hz/s</p>		
P11.08	VFD or motor overload/underload pre-alarm	<p>0x000–0x1132</p> <p>Ones place:</p> <ul style="list-style-type: none"> 0: Motor overload/underload pre-alarm, relative to rated motor current 1: VFD overload/underload pre-alarm, relative to rated VFD output current 2: VFD output torque overload/underload pre-alarm, relative to rated motor torque <p>Tens place:</p> <ul style="list-style-type: none"> 0: The VFD continues running after overload/underload alarm. 1: The VFD continues running after underload alarm, and stops running after overload fault. 2: The VFD continues running after overload alarm, and stops running after underload fault. 3: The VFD stops running after overload/underload fault. <p>Hundreds place:</p> <ul style="list-style-type: none"> 0: Always detect 1: Detect during constant-speed running <p>Thousands place: VFD overload current reference selection</p> <ul style="list-style-type: none"> 0: Related to current calibration coefficient 1: Irrelated to current calibration coefficient 	0x000	○

Function code	Name	Description	Default value	Modify
P11.09	Overload pre-alarm detection level	If the VFD or motor output current is larger than the overload pre-alarm detection level (P11.09), and the duration exceeds the overload pre-alarm detection time (P11.10), overload pre-alarm signal will be outputted.	G type: 150% P type: 120%	<input type="radio"/>
P11.10	Overload pre-alarm detection time	<p>Setting range of P11.09: P11.11–200% (relative value determined by the ones place of P11.08) Setting range of P11.10: 0.1–3600.0s</p>	1.0s	<input type="radio"/>
P11.11	Underload pre-alarm detection level	Underload pre-alarm signal will be outputted if the output current of the VFD or motor is lower than underload pre-alarm detection level (P11.11), and the duration exceeds underload pre-alarm detection time (P11.12).	50%	<input type="radio"/>
P11.12	Underload pre-alarm detection time	Setting range of P11.11: 0–P11.09 (relative value determined by the ones place of P11.08) Setting range of P11.12: 0.1–3600.0s	1.0s	<input type="radio"/>
P11.13	Fault output terminal action during fault	Used to set the action of fault output terminals during undervoltage and fault reset. 0x00–0x11 Ones: 0: Act during undervoltage fault 1: Do not act during undervoltage fault Tens: 0: Act during fault reset 1: Do not act during fault reset	0x00	<input type="radio"/>
P11.14	Speed deviation detection value	0.0–50.0% This parameter is used to set the speed deviation detection value.	10.0%	<input type="radio"/>

Function code	Name	Description	Default value	Modify
P11.15	Speed deviation detection time	<p>Used to set the speed deviation detection time. Note: Speed deviation protection is invalid when P11.15 is set to 0.0.</p> <p>Setting range: 0.0–10.0s</p>	2.0s	<input type="radio"/>
P11.16	Automatic frequency-reduction during voltage drop	<p>0–1 0: Invalid 1: Valid</p>	0	<input type="radio"/>
P11.17	Proportional coefficient of voltage regulator during undervoltage stall	<p>This parameter is used to set the proportional coefficient of the bus voltage regulator during undervoltage stall. Setting range: 0–1000</p>	100	<input type="radio"/>
P11.18	Integral coefficient of voltage regulator during undervoltage stall	<p>This parameter is used to set the integral coefficient of the bus voltage regulator during undervoltage stall. Setting range: 0–1000</p>	40	<input type="radio"/>
P11.19	Proportional coefficient of current regulator during undervoltage stall	<p>This parameter is used to set the proportional coefficient of the active current regulator during undervoltage stall. Setting range: 0–1000</p>	25	<input type="radio"/>
P11.20	Integral coefficient of current regulator during undervoltage stall	<p>This parameter is used to set the integral coefficient of the active current regulator during undervoltage stall. Setting range: 0–2000</p>	150	<input type="radio"/>
P11.21	Proportional coefficient of voltage regulator	<p>This parameter is used to set the proportional coefficient of the bus voltage regulator during overvoltage stall.</p>	60	<input type="radio"/>

Function code	Name	Description	Default value	Modify
	during overvoltage stall	Setting range: 0–1000		
P11.22	Integral coefficient of voltage regulator during overvoltage stall	This parameter is used to set the integral coefficient of the bus voltage regulator during overvoltage stall. Setting range: 0–1000	10	<input type="radio"/>
P11.23	Proportional coefficient of current regulator during overvoltage stall	This parameter is used to set the proportional coefficient of the active current regulator during overvoltage stall. Setting range: 0–1000	60	<input type="radio"/>
P11.24	Integral coefficient of current regulator during overvoltage stall	This parameter is used to set the integral coefficient of the active current regulator during overvoltage stall. Setting range: 0–2000	250	<input type="radio"/>
P11.25	Enable VFD overload integral	0: Disabled 1: Enabled When this parameter is set to 0, the overload timing value is reset to zero after the VFD is stopped. In this case, the determination of VFD overload takes more time, and therefore the effective protection over the VFD is weakened. When this parameter is set to 1, the overload timing value is not reset, and the overload timing value is accumulative. In this case, the determination of VFD overload takes less time, and therefore the protection over the VFD can be performed more quickly.	0	<input checked="" type="radio"/>
P11.26	Reserved	/	/	/
P11.27	VF vibration control method	0x00–0x11 Ones place: 0: Method 1 1: Method 2 Tens place: 0–1: Reserved	0x00	<input checked="" type="radio"/>
P11.28	SPO detection	0.0–60.0s	5.0s	<input type="radio"/>

Function code	Name	Description	Default value	Modify
	start delay time	Note: The SPO detection is started only after the VFD runs for the delay time specified by P11.28 to avoid false alarms caused by the unstable frequency.		
P11.29	SPO unbalance factor	0–10	6	○
P11.30	Reserved	/	/	/
P11.31	Fault severity group 1	0x0000–0x3333 Thousands place/Hundreds place/Tens	0x0000	○
P11.32	Fault severity group 2	place/Ones place: 0: Report the fault	0x0000	○
P11.33	Fault severity group 3	1: Report the fault after deceleration to stop	0x0000	○
P11.34	Fault severity group 4	2: Pre-alarm, with the action executed according to P11.51 3: Screen out the fault	0x0000	○
P11.35	Fault severity group 5	Note: Different fault actions are taken for different fault severities. The first 10 faults are not grouped by severity, but each four of the subsequent faults are grouped by severity in ascending order from right to left in hexadecimal format, that is, from the ones place to the thousands place (for example, the ones place of fault severity group 1 corresponds to fault 11).	0x0000	○
P11.36	Fault severity group 6		0x0000	○
P11.37	Fault severity group 7		0x0000	○
P11.38	Fault severity group 8		0x0000	○
P11.39	Fault severity group 9	Group 1: Faults 11–14 (OL1, OL2, SPI, SPO) Group 2: Faults 15–18 (OH1, OH2, EF, CE)	0x0000	○
P11.40	Fault severity group 10	Group 3: Faults 19–22 (ItE, tE, EEP, PIDE) Group 4: Faults 23–26 (bCE, END, OL3, PCE)	0x0000	○
P11.41	Fault severity group 11	Group 5: Faults 27–30 (UPE, DNE, E-DP, E-NET) Group 6: Faults 31–34 (E-CAN, ETH1, ETH2,	0x0000	○
P11.42	Fault severity group 12	dEu) Group 7: Faults 35–38 (STo, LL, ENC1o, ENC1d)	0x0000	○
P11.43	Fault severity group 13	Group 8: Faults 39–42 (ENC1Z, STO, STL1, STL2)	0x0000	○
P11.44	Fault severity group 14	Group 9: Faults 43–46 (STL3, CrCE, P-E1, P-E2) Group 10: Faults 47–50 (P-E3, P-E4, P-E5, P-E6)	0x0000	○
P11.45	Fault severity group 15	Group 11: Faults 51–54 (P-E7, P-E8, P-E9, P-E10) Group 12: Faults 55–58 (E-Err, ENCU, E-PN,	0x0000	○
P11.46	Fault severity	SECAN)	0x0000	○

Function code	Name	Description	Default value	Modify
	group 16	Group 13: Faults 59–62 (OT, F1-Er, F2-Er, F3-Er)		
P11.47	Fault severity group 17	Group 14: Faults 63–66 (C1-Er, C2-Er, C3-Er, E-CAT)	0x0000	○
P11.48	Fault severity group 18	Group 15: Faults 67–70 (E-BAC, E-DEV, S-Err, OtE1)	0x0000	○
P11.49	Fault severity group 19	Group 16: Faults 71–75 (OtE2, E-EIP, E-PAO, E-AI1)	0x0000	○
P11.50	Fault severity group 20	Group 17: Faults 75–78 (E-AI2, E-AI3, Reserved, Reserved) Group 18: Faults 79–82 (Reserved, Reserved, Reserved, Reserved) Group 19: Faults 83–86 (Reserved, Reserved, Reserved, Reserved) Group 20: Faults 87–90 (Reserved, Reserved, Reserved, Reserved)	0x0000	○
P11.51	Action for fault pre-alarm	0–4 0: Run at the set frequency 1: Run at the output frequency at the time of fault 2: Run at the frequency upper limit 3: Run at the frequency lower limit 4: Run at the frequency reserved for exception	0	○
P11.52	Frequency reserved for exception	0.00–630.00Hz	0.00Hz	○
P11.53	Fire mode function	0–2 0: Invalid 1: Fire mode 1 2: Fire mode 2 When P11.53=0, the fire mode is invalid, and the normal running mode is used. In this case, the VFD stops when encountering a fault. When the fire mode function is valid, the VFD runs at the speed specified by P11.54. When fire mode 1 is selected, the VFD always runs except when the VFD has been damaged. When fire mode 2 is selected, the VFD always runs, but the VFD stops when encountering OUT1, OUT2, OUT3, OC1, OC2, OC3, OV1, OV2, OV3, or SPO. Note: Terminal control must be used for a fire	0	◎

Function code	Name	Description	Default value	Modify
		mode. When the fire mode has lasted 5 minutes, it is reset, and no warranty of repair is processed.		
P11.54	Running frequency in fire mode	0.00Hz–P00.03 (Max. output frequency)	50.00Hz	○
P11.55	Fire mode flag	0–1 Note: When the fire mode has lasted 5 minutes, it is reset, and no warranty of repair is processed.	0	●
P11.56– P11.69	Reserved	/	/	/

P12—Parameters of motor 2

Function code	Name	Description	Default value	Modify
P12.00	Type of motor 2	0: Asynchronous motor 1: Synchronous motor	0	◎
P12.01	Rated power of asynchronous motor 2	0.1–3000.0kW	Depends on model	◎
P12.02	Rated frequency of asynchronous motor 2	0.01Hz–P00.03 (Max. output frequency)	50.00Hz	◎
P12.03	Rated speed of asynchronous motor 2	1–60000rpm	Depends on model	◎
P12.04	Rated voltage of asynchronous motor 2	0–1200V	Depends on model	◎
P12.05	Rated current of asynchronous motor 2	0.8–6000.0A	Depends on model	◎
P12.06	Stator resistance of asynchronous motor 2	0.001–65.535Ω	Depends on model	○
P12.07	Rotor resistance of asynchronous motor 2	0.001–65.535Ω	Depends on model	○
P12.08	Leakage inductance of	0.1–6553.5mH	Depends on model	○

Function code	Name	Description	Default value	Modify
	asynchronous motor 2			
P12.09	Mutual inductance of asynchronous motor 2	0.1–6553.5mH	Depends on model	○
P12.10	No-load current of asynchronous motor 2	0.1–6553.5A	Depends on model	○
P12.11	Magnetic saturation coefficient 1 of iron core of asynchronous motor 2	0.0–100.0%	80%	○
P12.12	Magnetic saturation coefficient 2 of iron core of asynchronous motor 2	0.0–100.0%	68%	○
P12.13	Magnetic saturation coefficient 3 of iron core of asynchronous motor 2	0.0–100.0%	57%	○
P12.14	Magnetic saturation coefficient 4 of iron core of asynchronous motor 2	0.0–100.0%	40%	○
P12.15	Rated power of synchronous motor 2	0.1–3000.0kW	Depends on model	◎
P12.16	Rated frequency of synchronous motor 2	0.01Hz–P00.03 (Max. output frequency)	50.00Hz	◎

Function code	Name	Description	Default value	Modify
P12.17	Number of pole pairs of synchronous motor 2	1–128	2	☉
P12.18	Rated voltage of synchronous motor 2	0–1200V	Depends on model	☉
P12.19	Rated voltage of synchronous motor 2	0.8–6000.0A	Depends on model	☉
P12.20	Stator resistance of synchronous motor 2	0.001–65.535Ω	Depends on model	○
P12.21	Direct-axis inductance of synchronous motor 2	0.01–655.35mH	Depends on model	○
P12.22	Quadrature-axis inductance of synchronous motor 2	0.01–655.35mH	Depends on model	○
P12.23	Counter-emf constant of synchronous motor 2	0–10000V	300	○
P12.24	Reserved	/	/	/
P12.25	Reserved	/	/	/
P12.26	Overload protection of motor 2	0: No protection 1: Common motor (with low-speed compensation) 2: Frequency-variable motor (without low-speed compensation)	2	☉
P12.27	Overload protection coefficient of motor 2	Motor overload multiples $M = I_{out}/(I_n \times K)$ I_n is rated motor current, I_{out} is VFD output current, K is motor overload protection coefficient. The smaller the K , the larger the value of M , the easier the protection. When $M=116\%$, protection is performed after motor overload last for 1 hour; when $M=150\%$,	100.0%	○

Function code	Name	Description	Default value	Modify
		protection is performed after motor overload lasts for 12 minutes; when M=180%, protection is performed after motor overload lasts for 5 minutes; when M=200%, protection is performed after motor overload lasts for 60 seconds; and when M≥400%, protection is performed immediately. Setting range: 20.0%–120.0%		
P12.28	Power display calibration coefficient of motor 2	0.00–3.00	1.00	<input type="radio"/>
P12.29	Parameter display of motor 2	0: Display based on the motor type; under this mode, only parameters related to current motor type will be displayed. 1: Display all; under this mode, all the parameters will be displayed.	0	<input type="radio"/>
P12.30	System inertia of motor 2	0–30.000kgm ²	0.000 kgm ²	<input type="radio"/>
P12.31–P12.32	Reserved	/	/	/

P13—Control parameters of synchronous motor

Function code	Name	Description	Default value	Modify
P13.00	Reduction rate of the pull-in current of synchronous motor	This parameter is used to set the reduction rate of the input reactive current. When the active current of the synchronous motor increases to some extent, the input reactive current can be reduced to improve the power factor of the motor. Setting range: 0.0%–100.0% (of the motor rated	80.0%	<input type="radio"/>

Function code	Name	Description	Default value	Modify
		current)		
P13.01	Initial pole detection mode	0: No detection 1: High-frequency current injection 2: Pulse superimposition	0	☉
P13.02	Pull-in current 1	Pull-in current is the pole position orientation current; pull-in current 1 is valid within the lower limit of pull-in current switchover frequency threshold. If you need to increase the starting torque, increase the value of this function code properly. Setting range: 0.0%–100.0% (of the motor rated current)	20.0%	○
P13.03	Pull-in current 2	Pull-in current is the pole position orientation current; pull-in current 2 is valid within the upper limit of pull-in current switchover frequency threshold, and you do not need to change pull-in current 2 under common situations. Setting range: 0.0%–100.0% (of the motor rated current)	10.0%	○
P13.04	Pull-in current switchover frequency	0.0%–200.0% (of the motor rated current)	20.0%	○
P13.05	High-frequency superposition frequency (reserved)	/	/	/
P13.06	Pulse current setting	This parameter is used to set the pulse current threshold when the initial magnetic pole position is detected in the pulse mode. The value is a percentage in relative to the rated current of the motor. Setting range: 0.0–300.0% (of the motor rated voltage)	100.0%	☉
P13.07	Reserved	/	/	/
P13.08	Control parameter 1	0x0000–0xFFFF	0x0000	○
P13.09	Frequency threshold of	This parameter is used to set the frequency threshold for enabling the counter-electromotive	50.00	○

Function code	Name	Description	Default value	Modify
	phase-lock loop switch-in	force phase-locked loop in SVC 0. When the running frequency is lower than the value of this parameter, the phase-locked loop is disabled; and when the running frequency is higher than that, the phase-locked loop is enabled. Setting range: 0.00–655.35		
P13.10	Reserved	/	/	/
P13.11	Maladjustment detection time	This parameter is used to adjust the responsiveness of anti-maladjustment function. If the load inertia is large, increase the value of this parameter properly, however, the responsiveness may slow down accordingly. Setting range: 0.0–10.0s	0.5s	○
P13.12	High-frequency compensation coefficient of synchronous motor	This parameter is valid when the motor speed exceeds the rated speed. If motor oscillation occurred, adjust this parameter properly. Setting range: 0.0–100.0%	0.0	○
P13.13	High-frequency pull-in current	0–300.0% (of the rated VFD output current)	20.0%	◎
P13.14–P13.19	Reserved	/	/	/

P14—Serial communication function

Function code	Name	Description	Default value	Modify
P14.00	Local communication address	Setting range: 1–247 When the master is writing frames, and the slave communication address is set to 0, it is the broadcast communication address, and all the slaves on the Modbus bus will accept this frame, but the slave never responds. Local communication address is unique in the communication network, which is the basis for point-to-point communication between the upper computer and the VFD. Note: The slave address cannot be set to 0.	1	○
P14.01	Communication baud rate setup	This parameter is used to set the data transmission speed between upper computer and	4	○

Function code	Name	Description	Default value	Modify
		the VFD. 0: 1200BPS 1: 2400BPS 2: 4800BPS 3: 9600BPS 4: 19200BPS 5: 38400BPS 6: 57600BPS 7: 115200BPS Note: Baud rate of the upper computer must be the same with the VFD; otherwise, communication cannot be performed. The larger the baud rate, the faster the communication speed.		
P14.02	Data bit check setup	The data format of upper computer must be the same with the VFD; otherwise, communication cannot be performed. 0: No parity check (N, 8, 1) for RTU 1: Even parity (E, 8, 1) for RTU 2: Odd parity (O, 8, 1) for RTU 3: No parity check (N, 8, 2) for RTU 4: Even parity (E, 8, 2) for RTU 5: Odd parity (O, 8, 2) for RTU	1	<input type="radio"/>
P14.03	Communication response delay	0–200ms It refers to the time interval from when the data is received by the VFD to the moment when the data is sent to the upper computer. If the response delay is less than the system processing time, the response delay will be subject to system processing time; if the response delay is longer than the system processing time, data will be sent to the upper computer at a delay after data process is done by system.	5ms	<input type="radio"/>
P14.04	RS485 communication timeout period	0.0 (invalid)–60.0s When this parameter is set to 0.0, the communication timeout time is invalid. When it is set a non-zero value, the VFD reports the "Modbus/Modbus TCP communication fault" (CE) if the communication interval exceeds the	0.0s	<input type="radio"/>

Function code	Name	Description	Default value	Modify
		value. In general, this parameter is set to 0.0. When continuous communication is required, you can set the function code to monitor communication status.		
P14.05	Transmission error processing	0: Alarm and coast to stop 1: Do not alarm and continue running 2: Do not alarm and stop as per the stop mode (under communication control mode only) 3: Do not alarm and stop as per the stop mode (under all control modes)	0	○
P14.06	Modbus communication processing action	0x000–0x111 Ones: 0: Write operation has response 1: Write operation has no response Tens: 0: Communication password protection is invalid 1: Communication password protection is valid Hundreds place: Valid only for RS485 communication 0: User-defined addresses specified by P14.07 and P14.08 are invalid 1: User-defined addresses specified by P14.07 and P14.08 are valid	0x000	○
P14.07	User-defined running command address	0x0000–0xFFFF	0x2000	○
P14.08	User-defined frequency setting address	0x0000–0xFFFF	0x2001	○
P14.09	Modbus TCP communication timeout time	0.0–60.0s	5.0s	○
P14.10	Enabling program upgrade through RS485	0–1 0: Disable 1: Enable	0	⊙
P14.11	Bootloader software version	0.00–655.35	0.00	●
P14.12	Displaying no	0–1	0	○

Function code	Name	Description	Default value	Modify
	upgrade bootloader fault	0: Display 1: Do not display		
P14.13– P14.47	Reserved	/	/	/
P14.48	Channel selection for mapping between PZDs and function codes	0x00–0x12 Ones place: Channel for mapping function codes to PZDs 0: Reserved 1: Group P15 2: Group P16 Tens place: Save function at power failure 0: Disable 1: Enable	0x12	○
P14.49	Mapped function code of received PZD2	0x0000–0xFFFF	0x0000	○
P14.50	Mapped function code of received PZD3	0x0000–0xFFFF	0x0000	○
P14.51	Mapped function code of received PZD4	0x0000–0xFFFF	0x0000	○
P14.52	Mapped function code of received PZD5	0x0000–0xFFFF	0x0000	○
P14.53	Mapped function code of received PZD6	0x0000–0xFFFF	0x0000	○
P14.54	Mapped function code of received PZD7	0x0000–0xFFFF	0x0000	○
P14.55	Mapped function code of received PZD8	0x0000–0xFFFF	0x0000	○
P14.56	Mapped function code of received PZD9	0x0000–0xFFFF	0x0000	○
P14.57	Mapped function	0x0000–0xFFFF	0x0000	○

Function code	Name	Description	Default value	Modify
	code of received PZD10			
P14.58	Mapped function code of received PZD11	0x0000-0xFFFF	0x0000	○
P14.59	Mapped function code of received PZD12	0x0000-0xFFFF	0x0000	○
P14.60	Mapped function code of sent PZD2	0x0000-0xFFFF	0x0000	○
P14.61	Mapped function code of sent PZD3	0x0000-0xFFFF	0x0000	○
P14.62	Mapped function code of sent PZD4	0x0000-0xFFFF	0x0000	○
P14.63	Mapped function code of sent PZD5	0x0000-0xFFFF	0x0000	○
P14.64	Mapped function code of sent PZD6	0x0000-0xFFFF	0x0000	○
P14.65	Mapped function code of sent PZD7	0x0000-0xFFFF	0x0000	○
P14.66	Mapped function code of sent PZD8	0x0000-0xFFFF	0x0000	○
P14.67	Mapped function code of sent PZD9	0x0000-0xFFFF	0x0000	○
P14.68	Mapped function code of sent PZD10	0x0000-0xFFFF	0x0000	○
P14.69	Mapped function code of sent PZD11	0x0000-0xFFFF	0x0000	○

Function code	Name	Description	Default value	Modify
P14.70	Mapped function code of sent PZD12	0x0000–0xFFFF	0x0000	<input type="radio"/>

P15—Functions of communication expansion card 1

Function code	Name	Description	Default value	Modify
P15.00	Reserved	/	/	/
P15.01	Module address	0–127	2	<input checked="" type="radio"/>
P15.02	Received PZD2	0–31	0	<input type="radio"/>
P15.03	Received PZD3	0: Invalid	0	<input type="radio"/>
P15.04	Received PZD4	1: Set frequency (0–Fmax. Unit: 0.01Hz)	0	<input type="radio"/>
P15.05	Received PZD5	2: PID reference (-1000–1000, in which 1000 corresponds to 100.0%)	0	<input type="radio"/>
P15.06	Received PZD6	3: PID feedback (-1000–1000, in which 1000 corresponds to 100.0%)	0	<input type="radio"/>
P15.07	Received PZD7	4: Torque setting (-3000–+3000, in which 1000 corresponds to 100.0% of the motor rated current)	0	<input type="radio"/>
P15.08	Received PZD8	5: Setting of the upper limit of forward running frequency (0–Fmax. Unit: 0.01 Hz)	0	<input type="radio"/>
P15.09	Received PZD9	6: Setting of the upper limit of reverse running frequency (0–Fmax. Unit: 0.01 Hz)	0	<input type="radio"/>
P15.10	Received PZD10	7: Upper limit of electromotive torque (0–3000, in which 1000 corresponds to 100.0% of the motor rated current)		
P15.11	Received PZD11	8: Upper limit of braking torque (0–3000, in which 1000 corresponds to 100% of the motor rated current)		
P15.12	Received PZD12	9: Virtual input terminal command (Range: 0x000–0x3FF, corresponding to S8/S7/S6/S5/HDIB/HDIA/S4/S3/S2/S1)	0	<input type="radio"/>
		10: Virtual output terminal command (Range: 0x00–0x0F, corresponding to RO2/RO1/HDO/Y1)		
		11: Voltage setting (special for V/F separation) (0–1000, in which 1000 corresponds to 100% of the motor rated voltage)		
		12: AO1 output setting 1 (-1000–+1000, in which 1000 corresponds to 100.0%)		
		13: AO2 output setting 2 (-1000–1000, in which		

Function code	Name	Description	Default value	Modify
		1000 corresponds to 100.0%) 14: High-order bit of position reference (signed) 15: Low-order bit of position reference (unsigned) 16: High-order bit of position feedback (signed) 17: Low-order bit of position feedback (unsigned) 18: Position feedback setting flag (position feedback can be set only after this flag is set to 1 and then to 0) 19: Function parameter mapping (PZD2–PZD12 correspond to P14.49–P14.59) 20–31: Reserved		
P15.13	Sent PZD2	0–31	0	<input type="radio"/>
P15.14	Sent PZD3	0: Invalid	0	<input type="radio"/>
P15.15	Sent PZD4	1: Running frequency (x100, Hz)	0	<input type="radio"/>
P15.16	Sent PZD5	2: Set frequency (x100, Hz)	0	<input type="radio"/>
P15.17	Sent PZD6	3: Bus voltage (x10, V)	0	<input type="radio"/>
P15.18	Sent PZD7	4: Output voltage (x1, V)	0	<input type="radio"/>
P15.19	Sent PZD8	5: Output current (x10, A)	0	<input type="radio"/>
P15.20	Sent PZD9	6: Actual output torque (x10, %)	0	<input type="radio"/>
P15.21	Sent PZD10	7: Actual output power (x10, %)	0	<input type="radio"/>
P15.22	Sent PZD11	8: Rotation speed of running (x1, RPM)	0	<input type="radio"/>
		9: Linear speed of running (x1, m/s)	0	<input type="radio"/>
		10: Ramp reference frequency	0	<input type="radio"/>
P15.23	Sent PZD12	11: Fault code 12: AI1 input (x100, V) 13: AI2 input (x100, V) 14: AI3 input (x100, V) 15: HDIA frequency value (x100, kHz) 16: Terminal input status 17: Terminal output status 18: PID reference (x100, %) 19: PID feedback (x100, %) 20: Motor rated torque 21: High-order bit of position reference (signed) 22: Low-order bit of position reference (unsigned) 23: High-order bit of position feedback (signed) 24: Low-order bit of position feedback (unsigned) 25: Status word 26: HDIB frequency value (x100, kHz)	0	<input type="radio"/>

Function code	Name	Description	Default value	Modify
		27: High-order bit of PG card pulse feedback 28: Low-order bit of PG card pulse feedback 29: High-order bit of PG card pulse reference 30: Low-order bit of PG card pulse reference 31: Function parameter mapping (PZD2–PZD12 correspond to P14.60–P14.70)		
P15.24	Reserved	/	/	/
P15.25	DP communication timeout time	0.0 (invalid)–60.0s	5.0s	○
P15.26	CANopen communication timeout time	0.0 (invalid)–60.0s	5.0s	○
P15.27	CANopen communication baud rate	0–7 0: 1000kbps 1: 800kbps 2: 500kbps 3: 250kbps 4: 125kbps 5: 100kbps 6: 50kbps 7: 20kbps	3	◎
P15.28	Master/slave CAN communication address	0–127	1	◎
P15.29	Master/slave CAN communication baud rate selection	0: 50Kbps 1: 100 Kbps 2: 125Kbps 3: 250Kbps 4: 500Kbps 5: 1M bps	2	◎
P15.30	Master/slave CAN communication timeout time	0.0 (invalid)–300.0s	0.0s	○
P15.31–P15.42	Reserved	/	/	/

Function code	Name	Description	Default value	Modify
P15.43	Communication control word expression format	0–1 0: Decimal format 1: Binary format	0	⊙

P16—Functions of communication expansion card 2

Function code	Name	Description	Default value	Modify
P16.00– P16.01	Reserved	/	/	/
P16.02	Ethernet monitoring card IP address 1	0–255	192	⊙
P16.03	Ethernet monitoring card IP address 2	0–255	168	⊙
P16.04	Ethernet monitoring card IP address 3	0–255	0	⊙
P16.05	Ethernet monitoring card IP address 4	0–255	1	⊙
P16.06	Ethernet monitoring card subnet mask 1	0–255	255	⊙
P16.07	Ethernet monitoring card subnet mask 2	0–255	255	⊙
P16.08	Ethernet monitoring card subnet mask 3	0–255	255	⊙
P16.09	Ethernet monitoring card subnet mask 4	0–255	0	⊙
P16.10	Ethernet monitoring card gateway 1	0–255	192	⊙
P16.11	Ethernet monitoring card	0–255	168	⊙

Function code	Name	Description	Default value	Modify
	gateway 2			
P16.12	Ethernet monitoring card gateway 3	0–255	0	☉
P16.13	Ethernet monitoring card gateway 4	0–255	1	☉
P16.14	Ethernet monitoring variable address 1	0x0000–0xFFFF	0x0000	○
P16.15	Ethernet monitoring variable address 2	0x0000–0xFFFF	0x0000	○
P16.16	Ethernet monitoring variable address 3	0x0000–0xFFFF	0x0000	○
P16.17	Ethernet monitoring variable address 4	0x0000–0xFFFF	0x0000	○
P16.18– P16.23	Reserved	/	/	/
P16.24	Identification time for the expansion card in card slot 1	0.0–600.0s If it is set to 0.0, identification fault will not be detected.	0.0s	○
P16.25	Identification time for the expansion card in card slot 2	0.0–600.0s If it is set to 0.0, offline fault will not be detected.	0.0s	○
P16.26	Identification time for the expansion card in card slot 3	0.0–600.0s If it is set to 0.0, offline fault will not be detected.	0.0s	○
P16.27	Communication timeout period of expansion card in card slot 1	0.0–600.0s If it is set to 0.0, offline fault will not be detected.	0.0s	○

Function code	Name	Description	Default value	Modify
P16.28	Communication timeout period of expansion card in card slot 2	0.0–600.0s If it is set to 0.0, offline fault will not be detected.	0.0s	○
P16.29	Communication timeout period of expansion card in card slot 3	0.0–600.0s If it is set to 0.0, offline fault will not be detected.	0.0s	○
P16.30	Reserved	/	/	/
P16.31	PROFINET communication timeout time	0.0–60.0s	5.0s	○
P16.32	Received PZD2	0–31	0	○
P16.33	Received PZD3	0: Invalid	0	○
P16.34	Received PZD4	1: Set frequency (0–Fmax. Unit: 0.01Hz)	0	○
P16.35	Received PZD5	2: PID reference (-1000–1000, in which 1000 corresponds to 100.0%)	0	○
P16.36	Received PZD6	3: PID feedback (-1000–1000, in which 1000 corresponds to 100.0%)	0	○
P16.37	Received PZD7		0	○
P16.38	Received PZD8	4: Torque setting (-3000–+3000, in which 1000 corresponds to 100.0% of the motor rated current)	0	○
P16.39	Received PZD9	5: Setting of the upper limit of forward running frequency (0–Fmax. Unit: 0.01 Hz)	0	○
P16.40	Received PZD10		0	○
P16.41	Received PZD11	6: Setting of the upper limit of reverse running frequency (0–Fmax. Unit: 0.01 Hz)	0	○
P16.42	Received PZD12	7: Upper limit of electromotive torque (0–3000, in which 1000 corresponds to 100.0% of the motor rated current) 8: Upper limit of braking torque (0–3000, in which 1000 corresponds to 100% of the motor rated current) 9: Virtual input terminal command (Range: 0x000–0x3FF, corresponding to S8/S7/S6/S5/HDIB/HDIA/S4/S3/S2/S1) 10: Virtual output terminal command (Range: 0x00–0x0F, corresponding to RO2/RO1/HDO/Y1) 11: Voltage setting (special for V/F separation) (0–1000, in which 1000 corresponds to 100% of the motor rated voltage)	0	○

Function code	Name	Description	Default value	Modify
		12: AO1 output setting 1 (-1000→+1000, in which 1000 corresponds to 100.0%) 13: AO2 output setting 2 (-1000→1000, in which 1000 corresponds to 100.0%) 14: High-order bit of position reference (signed) 15: Low-order bit of position reference (unsigned) 16: High-order bit of position feedback (signed) 17: Low-order bit of position feedback (unsigned) 18: Position feedback setting flag (position feedback can be set only after this flag is set to 1 and then to 0) 19: Function parameter mapping (PZD2–PZD12 correspond to P14.49–P14.59) 20–31: Reserved		
P16.43	Sent PZD2	0–31	0	<input type="radio"/>
P16.44	Sent PZD3	0: Invalid	0	<input type="radio"/>
P16.45	Sent PZD4	1: Running frequency (x100, Hz)	0	<input type="radio"/>
P16.46	Sent PZD5	2: Set frequency (x100, Hz)	0	<input type="radio"/>
P16.47	Sent PZD6	3: Bus voltage (x10, V)	0	<input type="radio"/>
P16.48	Sent PZD7	4: Output voltage (x1, V)	0	<input type="radio"/>
P16.49	Sent PZD8	5: Output current (x10, A)	0	<input type="radio"/>
P16.50	Sent PZD9	6: Actual output torque (x10, %)	0	<input type="radio"/>
P16.51	Sent PZD10	7: Actual output power (x10, %)	0	<input type="radio"/>
P16.52	Sent PZD11	8: Rotation speed of running (x1, RPM)	0	<input type="radio"/>
P16.53	Sent PZD12	9: Linear speed of running (x1, m/s) 10: Ramp reference frequency 11: Fault code 12: AI1 input (x100, V) 13: AI2 input (x100, V) 14: AI3 input (x100, V) 15: HDIA frequency value (x100, kHz) 16: Terminal input status 17: Terminal output status 18: PID reference (x100, %) 19: PID feedback (x100, %) 20: Motor rated torque 21: High-order bit of position reference (signed) 22: Low-order bit of position reference (unsigned) 23: High-order bit of position feedback (signed)	0	<input type="radio"/>

Function code	Name	Description	Default value	Modify
		24: Low-order bit of position feedback (unsigned) 25: Status word 26: HDIB frequency value (x100, kHz) 27: High-order bit of PG card pulse feedback 28: Low-order bit of PG card pulse feedback 29: High-order bit of PG card pulse reference 30: Low-order bit of PG card pulse reference 31: Function parameter mapping (PZD2–PZD12 correspond to P14.60–P14.70)		
P16.54	Ethernet IP communication timeout time	0.0–60.0s	5.0s	○
P16.55	Ethernet IP communication rate	0–4 0: Self-adaptive 1: 100M full-duplex 2: 100M half-duplex 3: 10M full-duplex 4: 10M half-duplex	0	◎
P16.56	Bluetooth pairing code	0–65535	0	●
P16.57	Bluetooth host type	0–65535 0: No host connection 1: Mobile APP 2: Bluetooth box 3–65535: Reserved	0	●
P16.58	Industrial Ethernet communication card IP address 1	0–255	192	◎
P16.59	Industrial Ethernet communication card IP address 2	0–255	168	◎
P16.60	Industrial Ethernet communication card IP address 3	0–255	0	◎
P16.61	Industrial Ethernet communication card IP address 4	0–255	20	◎
P16.62	Industrial Ethernet communication card subnet mask 1	0–255	255	◎

Function code	Name	Description	Default value	Modify
P16.63	Industrial Ethernet communication card subnet mask 2	0–255	255	☉
P16.64	Industrial Ethernet communication card subnet mask 3	0–255	255	☉
P16.65	Industrial Ethernet communication card subnet mask 4	0–255	0	☉
P16.66	Industrial Ethernet communication card gateway 1	0–255	192	☉
P16.67	Industrial Ethernet communication card gateway 2	0–255	168	☉
P16.68	Industrial Ethernet communication card gateway 3	0–255	0	☉
P16.69	Industrial Ethernet communication card gateway 4	0–255	1	☉

P17—Status viewing

Function code	Name	Description	Default value	Modify
P17.00	Set frequency	Display current set frequency of the VFD. Range: 0.00Hz–P00.03	50.00Hz	●
P17.01	Output frequency	Display current output frequency of the VFD. Range: 0.00Hz–P00.03	0.00Hz	●
P17.02	Ramp reference frequency	Display current ramp reference frequency of the VFD. Range: 0.00Hz–P00.03	0.00Hz	●
P17.03	Output voltage	Display current output voltage of the VFD. Range: 0–1200V	0V	●
P17.04	Output current	Display the valid value of current output current of the VFD. Range: 0.0–5000.0A	0.0A	●
P17.05	Motor speed	Display current motor speed.	0 RPM	●

Function code	Name	Description	Default value	Modify
		Range: 0–65535RPM		
P17.06	Torque current	Display current torque current of the VFD. Range: -3000.0–3000.0A	0.0A	●
P17.07	Exciting current	Display current exciting current of the VFD. Range: -3000.0–3000.0A	0.0A	●
P17.08	Motor power	Display current motor power; 100% relative to rated motor power, positive value is motoring state, negative value is generating state. Range: -300.0–300.0% (relative to rated motor power)	0.0%	●
P17.09	Motor output torque	Display current output torque of the VFD; 100% relative to rated motor torque, during forward running, positive value is motoring state, negative value is generating state, during reverse running, positive value is generating state, negative value is motoring state. Range: -250.0–250.0%	0.0%	●
P17.10	Estimated motor frequency	The estimated motor rotor frequency under open-loop vector condition. Range: 0.00– P00.03	0.00Hz	●
P17.11	DC bus voltage	Display current DC bus voltage of the VFD. Range: 0.0–2000.0V	0V	●
P17.12	Digital input terminal state	Display current digital input terminal state of the VFD. 0x00–0x3F Bit0: S1 Bit1: S2 Bit2: S3 Bit3: S4 Bit4: HDIA Bit5: HDIB	0x00	●
P17.13	Digital output terminal state	Display current digital output terminal state of the VFD. 0x00–0x0F Bit0: Y1 Bit1: HDO Bit2: RO1 Bit3: RO2	0x00	●
P17.14	Digital	Display the regulating variable by <u>UP/DOWN</u>	0.00Hz	●

Function code	Name	Description	Default value	Modify
	adjustment variable	terminals of the VFD. Range: 0.00Hz–P00.03		
P17.15	Torque reference value	Relative to percentage of the rated torque of current motor, display torque reference. Range: -300.0%–300.0% (of the motor rated current)	0.0%	●
P17.16	Linear speed	0–65535	0	●
P17.17	Reserved	/	/	/
P17.18	Count value	0–65535	0	●
P17.19	AI1 input voltage	Display input signal of AI 1 Range: 0.00–10.00V	0.00V	●
P17.20	AI2 input voltage	Display input signal of AI2 Range: -10.00V–10.00V	0.00V	●
P17.21	HDIA input frequency	Display input frequency of HDIA Range: 0.000–50.000kHz	0.000 kHz	●
P17.22	HDIB input frequency	Display input frequency of HDIB Range: 0.000–50.000kHz	0.000 kHz	●
P17.23	PID reference value	Display PID reference value Range: -100.0–100.0%	0.0%	●
P17.24	PID feedback value	Display PID feedback value Range: -100.0–100.0%	0.0%	●
P17.25	Motor power factor	Display the power factor of current motor. Range: -1.00–1.00	1.00	●
P17.26	Current running time	Display current running time of the VFD. Range: 0–65535min	0min	●
P17.27	Actual stage of simple PLC	Displays the present stage of the simple PLC function. Range: 0–15	0	●
P17.28	Motor ASR controller output	Display the speed loop ASR controller output value under vector control mode, relative to the percentage of rated torque of the motor. Range: -300.0%–300.0% (of the motor rated current)	0.0%	●
P17.29	Pole angle of open-loop synchronous motor	Display initial identification angle of synchronous motor Range: 0.0–360.0	0.0	●
P17.30	Phase	Display phase compensation of synchronous	0.0	●

Function code	Name	Description	Default value	Modify
	compensation of synchronous motor	motor Range: -180.0~180.0		
P17.31	High-frequency superposition current of synchronous motor	0.0%~200.0% (of the motor rated current)	0.0%	●
P17.32	Motor flux linkage	0.0%~200.0%	0.0%	●
P17.33	Exciting current reference	Display the exciting current reference value under vector control mode Range: -3000.0~3000.0A	0.0A	●
P17.34	Torque current reference	Display torque current reference value under vector control mode Range: -3000.0~3000.0A	0.0A	●
P17.35	AC incoming current	Display the valid value of incoming current on AC side Range: 0.0~5000.0A	0.0A	●
P17.36	Output torque	Display output torque value, during forward running, positive value is motoring state, negative value is generating state; during reverse running, positive value is generating state, negative value is motoring state. Range: -3000.0Nm~3000.0Nm	0.0Nm	●
P17.37	Motor overload count value	0~65535	0	●
P17.38	Process PID output	-100.0%~100.0%	0.00%	●
P17.39	Parameter download wrong function code	0.00~99.00	0.00	●
P17.40	Motor control mode	0x000~0x123 Ones: Control mode 0: Vector 0 1: Vector 1 2: VF control 3: Closed-loop vector control Tens: Control state	0x000	●

Function code	Name	Description	Default value	Modify
		0: Speed control 1: Torque control 2: Position control Hundreds: Motor number 0: Motor 1 1: Motor 2		
P17.41	Upper limit of the torque when motoring	0.0%–300.0% (of the motor rated current)	180.0%	●
P17.42	Upper limit of braking torque	0.0%–300.0% (of the motor rated current)	180.0%	●
P17.43	Upper limit frequency of forward running of torque control	0.00–P00.03	50.00Hz	●
P17.44	Upper limit frequency of reverse running of torque control	0.00–P00.03	50.00Hz	●
P17.45	Inertia compensation torque	-100.0%–100.0%	0.0%	●
P17.46	Friction compensation torque	-100.0%–100.0%	0.0%	●
P17.47	Motor pole pairs	0–65535	0	●
P17.48	VFD overload count value	0–65535	0	●
P17.49	Frequency set by A source	0.00–P00.03	0.00Hz	●
P17.50	Frequency set by B source	0.00–P00.03	0.00Hz	●
P17.51	PID proportional output	-100.0%–100.0%	0.0%	●
P17.52	PID integral output	-100.0%–100.0%	0.0%	●
P17.53	PID differential output	-100.0%–100.0%	0.0%	●

Function code	Name	Description	Default value	Modify
P17.54	Actual PID proportional gain	0.00–100.00	0.00	●
P17.55	Actual PID integral time	0.00–10.00s	0.00s	●
P17.56	Actual PID differential time	0.00–10.00s	0.00s	●
P17.57	Peak value at 100Hz frequency component (square-wave orthogonal function detected)	0.0–300.0V Peak value of bus voltage fluctuation at 100Hz frequency component, which is detected by using a square-wave orthogonal function	0.0V	●
P17.58	Peak value at 100Hz frequency component (sine-wave orthogonal function detected)	0.0–300.0V Peak value of bus voltage fluctuation at 100Hz frequency component, which is detected by using a sine-wave orthogonal function	0.0V	●
P17.59– P17.63	Reserved	0–65535	0	●

P18—Closed-loop control state check

Function code	Name	Description	Default value	Modify
P18.00	Actual frequency of encoder	The actual-measured encoder frequency; the value of forward running is positive; the value of reverse running is negative. Range: -999.9–3276.7Hz	0.0Hz	●
P18.01	Encoder position count value	Encoder count value, quadruple frequency, Range: 0–65535	0	●
P18.02	Encoder Z pulse count value	Corresponding count value of encoder Z pulse. Range: 0–65535	0	●
P18.03	High bit of position reference value	High bit of position reference value, zero out after stop. Range: 0–30000	0	●
P18.04	Low bit of position	Low bit of position reference value, zero out after stop.	0	●

Function code	Name	Description	Default value	Modify
	reference value	Range: 0–65535		
P18.05	High bit of position feedback value	High bit of position feedback value, zero out after stop. Range: 0–30000	0	●
P18.06	Low bit of position feedback value	Low bit of position feedback value, zero out after stop. Range: 0–65535	0	●
P18.07	Position deviation	Deviation between current reference position and actual running position. Range: -32768–32767	0	●
P18.08	Position of position reference point	Position of reference point of Z pulse when the spindle stops accurately. Range: 0–65535	0	●
P18.09	Current position setup of spindle	Current position setup when the spindle stops accurately. Range: 0–359.99	0.00	●
P18.10	Current position when spindle stops accurately	Current position when spindle stops accurately. Range: 0–65535	0	●
P18.11	Encoder Z pulse direction	Z pulse direction display. When the spindle stops accurately, there may be a couple of pulses' error between the position of forward and reverse orientation, which can be eliminated by adjusting Z pulse direction of P20.02 or exchanging phase AB of encoder. 0: Forward 1: Reverse	0	●
P18.12	Encoder Z pulse angle	Reserved. Range: 0.00–359.99	0.00	●
P18.13	Encoder Z pulse error times	Reserved. Range: 0–65535	0	●
P18.14	High bit of encoder pulse count value	0–65535	0	●
P18.15	Low bit of encoder pulse count value	0–65535	0	●
P18.16	Main control	-3276.8–3276.7Hz	0.0Hz	●

Function code	Name	Description	Default value	Modify
	board measured speed value			
P18.17	Pulse command frequency	Pulse command (A2, B2 terminal) is converted to the set frequency, and it is valid under pulse position mode and pulse speed mode. Range: -3276.8–3276.7Hz	0.00Hz	●
P18.18	Pulse command feedforward	Pulse command (A2, B2 terminal) is converted to the set frequency, and it is valid under pulse position mode and pulse speed mode. Range: -3276.8–3276.7Hz	0.00Hz	●
P18.19	Position regulator output	-327.68–327.67Hz	0.00Hz	●
P18.20	Count value of resolver	Count value of resolver. Range: 0–65535	0	●
P18.21	Resolver angle	The pole position angle read according to the resolver-type encoder. Range: 0.00–359.99	0.00	●
P18.22	Pole angle of closed-loop synchronous motor	Current pole position. Range: 0.00–359.99	0.00	●
P18.23	State control word 3	0–65535	0	●
P18.24	High bit of count value of pulse reference	0–65535	0	●
P18.25	Low bit of count value of pulse reference	0–65535	0	●
P18.26	PG card measured speed value	-3276.8–3276.7Hz	0.0Hz	●
P18.27	Encoder UVW sector	0–7	0	●
P18.28	Encoder PPR (pulse-per-revolution) display	0–65535	0	●

Function code	Name	Description	Default value	Modify
P18.29	Angle compensation value of synchronous motor	-180.0–180.0	0.00	●
P18.30	Reserved	0–65535	0	●
P18.31	Pulse reference Z pulse value	0–65535	0	●
P18.32	Pulse-given main control board measured speed value	-3276.8–3276.7Hz	0.0Hz	●
P18.33	Pulse-given PG card measured speed value	-3276.8–3276.7Hz	0.0Hz	●
P18.34	Present encoder filter width	0–63	0	●
P18.35	8k test duration	0–65535	0	●

P19—Expansion card state check

Function code	Name	Description	Default value	Modify
P19.00	Type of card at slot 1	0–65535 0: No card	0	●
P19.01	Type of card at slot 2	1: Programmable card 2: I/O card	0	●
P19.02	Type of card at slot 3	3: Incremental PG card 4: Incremental PG card with UWW 5: Ethernet communication card 6: DP communication card 7: Bluetooth card 8: Resolver PG card 9: CANopen communication card 10: WIFI card 11: PROFINET communication card 12: Sine/Cosine PG card without CD signal 13: Sine/Cosine PG card with CD signal 14: Absolute encoder PG card 15: CAN master/slave communication card	0	●

Function code	Name	Description	Default value	Modify
		16: Modbus/Modbus TCP communication card 17: EtherCAT communication card 18: BacNet communication card 19: DeviceNet communication card 20: PT100/PT1000 temperature detection card 21: EtherNet IP communication card 22: MECHATROLINK communication card 23-65535: Reserved		
P19.03	Software version of expansion card at slot 1	0.00-655.35	0.00	●
P19.04	Software version of expansion card at slot 2	0.00-655.35	0.00	●
P19.05	Software version of expansion card at slot 3	0.00-655.35	0.00	●
P19.06	Input state of expansion I/O card terminals	0x0000-0xFFFF	0x0000	●
P19.07	Output state of expansion I/O card terminals	0x0000-0xFFFF	0x0000	●
P19.08	Reserved	/	/	/
P19.09	AI3 input voltage of expansion I/O card	0.00-10.00V	0.00V	●
P19.10	EC PT100 detected temperature	-50.0-150.0°C	0.0°C	●
P19.11	EC PT100 detected digital	0-4096	0	●
P19.12	EC PT1000 detected temperature	-50.0-150.0°C	0.0°C	●
P19.13	EC PT1000 detected digital	0-4096	0	●
P19.14	Alarm display	0-4	0	●

Function code	Name	Description	Default value	Modify
		0: No alarm 1: PT100 detected OH alarm (A-Ot1) 2: PT1000 detected OH alarm (A-Ot2) 3: PT100 disconnection alarm (A-Pt1) 4: PT1000 disconnection alarm (A-Pt2)		
P19.15	VFD control word	0–65535	0	●
P19.16	VFD status word	0–65535	0	●
P19.17	Ethernet monitoring variable 1	0–65535	0	●
P19.18	Ethernet monitoring variable 2	0–65535	0	●
P19.19	Ethernet monitoring variable 3	0–65535	0	●
P19.20	Ethernet monitoring variable 4	0–65535	0	●
P19.21	AI/AO detected temperature	-20.0–200.0°C	0.0°C	●
P19.22–P19.39	Reserved	0–65535	0	●

P20—Encoder of motor 1

Function code	Name	Description	Default value	Modify
P20.00	Encoder type display	0: Incremental encoder 1: Resolver-type encoder 2: Sin/Cos encoder 3: Endat absolute encoder	0	●
P20.01	Encoder pulse number	Number of pulses generated when the encoder revolves for one circle. Setting range: 0–60000	1024	◎
P20.02	Encoder direction	0x000–0x111 Ones: AB direction 0: Forward 1: Reverse Tens: Z pulse direction (reserved)	0x000	◎

Function code	Name	Description	Default value	Modify
		0: Forward 1: Reverse Hundreds: CD/UVW pole signal direction 0: Forward 1: Reverse		
P20.03	Detection time of encoder offline fault	The detection time of encoder offline fault. Setting range: 0.0–10.0s Note: When the value is 0.0s, the fault will not be detected.	2.0s	<input type="radio"/>
P20.04	Detection time of encoder reversal fault	Detection time of encoder reversal fault. Setting range: 0.0–100.0s	0.8s	<input type="radio"/>
P20.05	Filter times of encoder detection	Setting range: 0x00–0x99 Ones: Low-speed filter time, corresponds to $2^{\wedge}(0-9) \times 125\mu\text{s}$. Tens: High-speed filter times, corresponds to $2^{\wedge}(0-9) \times 125\mu\text{s}$.	0x33	<input type="radio"/>
P20.06	Speed ratio between encoder mounting shaft and motor	You need to set this parameter when the encoder is not installed on the motor shaft and the drive ratio is not 1. Setting range: 0.001–65.535	1.000	<input type="radio"/>
P20.07	Control parameters of synchronous motor	0x0000–0xFFFF Bit0: Enable Z pulse calibration Bit1: Enable encoder angle calibration Bit2: Enable SVC speed measurement Bit3: Reserved Bit4: Reserved Bit5: Reserved Bit6: Enable CD signal calibration Bit7: Reserved Bit8: Do not detect encoder fault during autotuning Bit9: Enable Z pulse detection optimization Bit10: Enable initial Z pulse calibration optimization Bit11: Reserved Bit12: Clear Z pulse arrival signal after stop Bit13: Reserved Bit14: Detect Z pulse after one rotation Bit15: Reserved	0x0003	<input type="radio"/>

Function code	Name	Description	Default value	Modify
P20.08	Enable Z pulse offline detection	0x00–0x11 Ones: Z pulse 0: Do not detect 1: Enable Tens: UVW pulse (for synchronous motor) 0: Do not detect 1: Enable	0x10	<input type="radio"/>
P20.09	Initial angle of Z pulse	Relative electric angle of encoder Z pulse and motor pole position. Setting range: 0.00–359.99	0.00	<input type="radio"/>
P20.10	Initial angle of the pole	Relative electric angle of encoder position and motor pole position. Setting range: 0.00–359.99	0.00	<input type="radio"/>
P20.11	Autotuning of initial angle of pole	0–3 0: No operation 1: Rotary autotuning (DC braking) 2: Static autotuning (suitable for resolver-type encoder, sin/cos with CD signal feedback) 3: Rotary autotuning (initial angle identification)	0	<input checked="" type="radio"/>
P20.12	Speed measurement optimization selection	0–2 0: No optimization 1: Optimization mode 1 2: Optimization mode 2	1	<input checked="" type="radio"/>
P20.13	CD signal zero offset gain	0–65535	0	<input type="radio"/>
P20.14	Encoder type selection	0x00–0x11 Ones: Incremental encoder 0: without UVW 1: with UVW Tens: Sin/Cos encoder 0: without CD signal 1: with CD signal	0x00	<input checked="" type="radio"/>
P20.15	Speed measurement mode	0: PG card 1: local; realized by HDIA and HDIB; supports incremental 24V encoder only	0	<input checked="" type="radio"/>
P20.16	Frequency-division coefficient	0–255 When this parameter is set to 0 or 1, frequency division of 1:1 is implemented.	0	<input type="radio"/>

Function code	Name	Description	Default value	Modify
P20.17	Pulse filter processing	0x0000–0xFFFF Bit0: Enable/disable encoder input filter 0: No filter 1: Filter Bit1: Encoder signal filter mode (set Bit0 or Bit2 to 1) 0: Self-adaptive filter 1: Use P20.18 filter parameters Bit2: Enable/disable encoder frequency-division output filter 0: No filter 1: Filter Bit3: Enable/disable filter for frequency-division output of pulse reference 0: No filter 1: Filter Bit4: Enable/disable pulse reference filter 0: No filter 1: Filter Bit5: Pulse reference filter mode (valid when Bit4 is set to 1) 0: Self-adaptive filter 1: Use P20.19 filter parameters Bit6: Frequency-divided output source setting (valid only for incremental encoders) 0: Encoder signals 1: Pulse reference signals Bits7–15: Reserved	0x0033	○
P20.18	Encoder pulse filter width	0–63 The filtering time is $P20.18 \times 0.25 \mu s$. The value 0 or 1 indicates $0.25 \mu s$.	2	○
P20.19	Pulse reference filter width	0–63 The filtering time is $P20.19 \times 0.25 \mu s$. The value 0 or 1 indicates $0.25 \mu s$.	2	○
P20.20	Pulse number of pulse reference	0–16000	1024	◎
P20.21	Enable angle compensation of synchronous	0–1	0	○

Function code	Name	Description	Default value	Modify
	motor			
P20.22	Switchover frequency threshold of speed measurement mode	0–630.00Hz Note: This parameter is valid only when P20.12 is set to 0.	1.00Hz	<input type="radio"/>
P20.23	Synchronous motor angle compensation coefficient	-200.0–200.0%	100.0%	<input type="radio"/>
P20.24	Number of pole pairs in initial magnetic pole angle autotuning	1–128	2	<input checked="" type="radio"/>

P21—Position control

Function code	Name	Description	Default value	Modify
P21.00	Positioning mode	0x0000–0x7121 Ones: Control mode selection 0: Speed control 1: Position control Tens: Position command source 0: Pulse train 1: Digital position 2: Positioning of photoelectric switch during stop Hundreds: Position feedback source (reserved, fixed to channel P) 0: PG1 1: PG2 Thousands: Servo mode (Reserved) 0: Servo disabled, without position deviation 1: Servo disabled, with position deviation 2: Servo enabled, without position deviation 3: Servo enabled, with position deviation 4–7: Reserved Note: In pulse train positioning mode or spindle positioning mode, when the servo enabling signal	0x0000	<input type="radio"/>

Function code	Name	Description	Default value	Modify
		is valid, the VFD enters the servo running mode; when there is no servo enabling signal, the VFD can use the servo running mode only after receiving the FWD or REV running mode.		
P21.01	Pulse command mode	0x0000–0x3133 Ones: Pulse mode 0: A/B quadrature pulse; A precedes B 1: A: PULSE; B: SIGN If channel B is of low electric level, the edge counts up; if channel B is of high electric level, the edge counts down. 2: A: Positive pulse Channel A is positive pulse; channel B needs no wiring 3: A/B dual-channel pulse; channel A pulse edge counts up, channel B pulse edge counts down Tens: Pulse direction Bit0: Set pulse direction 0: Forward 1: Reverse Bit1: Set pulse direction by running direction 0: Disable, and BIT0 is valid; 1: Enable Hundreds: Frequency-multiplication selection for pulse + direction (reserved) 0: No frequency-multiplication 1: Frequency-multiplication Thousands: Pulse control selection Bit0: Pulse filter selection 0: Inertia filter 1: Average moving filter Bit1: Overspeed control 0: No control 1: Control	0x0000	☉
P21.02	APR gain 1	The two automatic position regulator (APR) gains are switched based on the switching mode set in P21.04. When the spindle orientation function is used, the gains are switched automatically, regardless of the setting of P21.04. P21.03 is used	20.0	○
P21.03	APR gain 2		30.0	○

Function code	Name	Description	Default value	Modify
		for dynamic running, and P21.02 is used for maintaining the locked state. Setting range: 0.0–400.0		
P21.04	Switching mode of position loop gain	This parameter is used to set the APR gain switching mode. To use torque command-based switching, you need to set P21.05; and to use speed command-based switching, you need to set P21.06. 0: No switching 1: Torque command 2: Speed command 3–5: Reserved	0	<input type="radio"/>
P21.05	Torque command level during position gain switchover	0.0–100.0% (of the rated motor torque)	10.0%	<input type="radio"/>
P21.06	Speed command level during position gain switchover	0.0–100.0% (of the rated motor speed)	10.0%	<input type="radio"/>
P21.07	Smooth filter coefficient during gain switchover	The smooth filter coefficient during position gain switchover. Setting range: 0–15	5	<input type="radio"/>
P21.08	Output limit of position controller	The output limit of position regulator, if the limit value is 0, position regulator will be invalid, and no position control can be performed, however, speed control is available. Setting range: 0.0–100.0% (Max. output frequency P00.03)	20.0%	<input type="radio"/>
P21.09	Completion range of positioning	When the position deviation is less than P21.09, and the duration is larger than P21.10, positioning completion signal will be outputted. Setting range: 0–1000	10	<input type="radio"/>
P21.10	Detection time for positioning completion	0.0–1000.0ms	10.0ms	<input type="radio"/>
P21.11	Numerator of position command ratio	Electronic gear ratio, used to adjust the corresponding relation between position command and actual running displacement.	1000	<input type="radio"/>

Function code	Name	Description	Default value	Modify
		Setting range: 1–65535		
P21.12	Denominator of position command ratio	Setting range: 1–65535	1000	<input type="radio"/>
P21.13	Position feedforward gain	0.00–120.00% For pulse train reference only (position control)	100.00%	<input type="radio"/>
P21.14	Position feedforward filter time constant	0.0–3200.0ms For pulse train reference only (position control)	3.0ms	<input type="radio"/>
P21.15	Position command filter time constant	The position feedforward filter time constant during pulse train positioning. 0.0–3200.0ms	0.0ms	<input checked="" type="radio"/>
P21.16	Digital positioning mode	0x0000–0xFFFF Bit0: Positioning mode selection 0: Relative position 1: Absolute position (home) (reserved) Bit1: Positioning cycle selection 0: Cyclic positioning by terminals 1: Automatic cyclic positioning Bit2: Cycle mode 0: Continuous 1: Repetitive (supported by automatic cyclic positioning only) Bit3: P21.17 digital setting mode 0: Incremental 1: Position type (do not support continuous mode) Bit4: Home searching mode 0: Search for the home just once 1: Search for the home during each run Bit5: Home calibration mode 0: Calibrate in real time 1: Single calibration Bit6: Positioning completion signal selection 0: Valid during the time set by P21.25 (Hold time of positioning completion signal) 1: Always valid Bit7: Initial positioning selection (for cyclic positioning by terminals) 0: Invalid (do not rotate)	0x0000	<input type="radio"/>

Function code	Name	Description	Default value	Modify
		1: Valid Bit8: Positioning enable signal selection (for cyclic positioning by terminals only; positioning function is always enabled for automatic cyclic positioning) 0: Pulse signal 1: Level signal Bit9: Position source 0: P21.17 setting 1: PROFIBUS/CANopen setting Bit10: Whether to save the encoder pulse counting value at power failure 0: Do not save 1: Save Bit 11: Reserved Bit12: Positioning curve selection (reserved) 0: Straight line 1: S curve		
P21.17	Position digital reference	Set digital positioning position; Actual position=P21.17×P21.11/P21.12 0–65535	0	<input type="radio"/>
P21.18	Positioning speed setup selection	0: Set by P21.19 1: Set by AI1 2: Set by AI2 3: Set by AI3 4: Set by high speed pulse HDIA 5: Set by high speed pulse HDIB	0	<input type="radio"/>
P21.19	Positioning speed digits	0–100.0% max. frequency	20.0%	<input type="radio"/>
P21.20	Acceleration time of positioning	Set the acceleration/deceleration time of positioning process.	3.00s	<input type="radio"/>
P21.21	Deceleration time of positioning	Acceleration time of positioning means the time needed for the VFD to accelerate from 0Hz to Max. output frequency (P00.03). Deceleration time of positioning means the time needed for the VFD to decelerate from Max. output frequency (P00.03) to 0hz. Setting range of P21.20: 0.01–300.00s Setting range of P21.21: 0.01–300.00s	3.00s	<input type="radio"/>
P21.22	Hold time of	Set the hold time of waiting when target positioning	0.100s	<input type="radio"/>

Function code	Name	Description	Default value	Modify
	positioning arrival	position is reached. Setting range: 0.000–60.000s		
P21.23	Home search speed	0.00–50.00Hz	2.00Hz	○
P21.24	Home position offset	0–65535	0	○
P21.25	Hold time of positioning completion signal	The hold time of positioning completion signal, this parameter is also valid for positioning completion signal of spindle orientation. Setting range: 0.000–60.000s	0.200s	○
P21.26	Pulse superposition value	P21.26: -9999–32767 P21.27: 0–3000.0/ms This function is enabled in the pulse speed reference (P00.06=12) or pulse position mode (P21.00=1):	0	○
P21.27	Pulse superposition speed	(P21.00=1): 1. Input terminal function #68 (enable pulse superposition) When the rising edge of the terminal is detected, the pulse setting is increased to the value of P21.26, and the pulse reference channel is compensated by the pulse superposition rate set in P21.27. 2. Input terminal function #67 (progressive increase of pulses) When this terminal is enabled, the pulse reference channel is compensated by the pulse superposition rate set in P21.27.	8.0/ms	○
P21.28	Acceleration/ deceleration time after disabling pulse	Note: Terminal filtering set in P05.09 may slightly affect the actual superposition. Example: P21.27 = 1.0/ms; P05.05 = 67 If the input signal of terminal S5 is 0.5s, the actual number of superposed pulses is 500. 3. Input terminal function #69 (progressive decrease of pulses) The sequence of this function is the same as those described above. The difference lies in that this terminal indicates that negative pulses are superposed. Note: All the pulses described here are	5.0s	○

Function code	Name	Description	Default value	Modify
		superposed on the pulse reference channel (A2, B2). Pulse filtering, electronic gear, and other functions are valid for superposed pulses. 4. Output terminal function #28 (pulse superposing) When pulses are superposed, the output terminal operates. After pulses are superposed, the terminal does not operate.		
P21.29	Speed feedforward filter time constant (Pulse train speed mode)	It is the filter time constant detected by pulse train when the speed reference source is set to pulse train (P0.06=12 or P0.07=12). Setting range: 0–3200.0ms	10.0ms	<input type="radio"/>
P21.30	Numerator of the 2nd command ratio	1–65535	1000	<input type="radio"/>
P21.31	Pulse reference speed measuring method	0–2 0: Main control board 1: PG card 2: Hybrid	0	<input type="radio"/>
P21.32	Pulse reference feedforward source	0x0–0x1	0x0	<input checked="" type="radio"/>
P21.33	Set value of clearing encoder count	0–65535	0	<input checked="" type="radio"/>

P22—Spindle positioning

Function code	Name	Description	Default value	Modify
P22.00	Spindle positioning mode selection	0x0000–0xFFFF Bit0: Enable spindle positioning 0: Disable 1: Enable Bit1: Select spindle positioning reference point 0: Z pulse input 1: S2/S3/S4 terminal input Bit2: Search for reference point 0: Search the reference point only once	0x0000	<input type="radio"/>

Function code	Name	Description	Default value	Modify
		1: Search the reference point every time Bit3: Enable reference point calibration 0: Disable 1: Enable Bit4: Positioning mode selection 1 0: Set direction positioning 1: Near-by direction positioning Bit5: Positioning mode selection 2 0: Forward positioning 1: Reverse positioning Bit6: Zeroing command selection 0: Electric level mode 1: Pulse mode Bit7: Reference point calibration mode 0: Calibrate at the first time 1: Calibrate in real time Bit8: Action selection after zeroing signal cancellation (electric level type) 0: Switch to speed mode 1: Position lock mode Bit9: Positioning completion signal selection 0: Electric level signal 1: Pulse signal Bit10: Z pulse signal source 0: Motor 1: Spindle Bits 11–15: Reserved		
P22.01	Speed of spindle orientation	During spindle orientation, the speed of the position point of orientation will be searched, and then it will switch over to position control orientation. Setting range: 0.00–100.00Hz	10.00Hz	<input type="radio"/>
P22.02	Deceleration time of spindle orientation	Deceleration time of spindle orientation. Spindle orientation deceleration time means the time needed for the VFD to decelerate from Max. output frequency (P00.03) to 0Hz. Setting range: 0.0–100.0s	3.0s	<input type="radio"/>
P22.03	Spindle zeroing position 0	You can select the zeroing positions of four spindles by terminals (functions 46 and 47).	0	<input type="radio"/>

Function code	Name	Description	Default value	Modify
		Setting range: 0–65535		
P22.04	Spindle zeroing position 1	Setting range: 0–65535	0	<input type="radio"/>
P22.05	Spindle zeroing position 2	Setting range: 0–65535	0	<input type="radio"/>
P22.06	Spindle zeroing position 3	Setting range: 0–65535	0	<input type="radio"/>
P22.07	Spindle scale-division angle 1	You can select seven spindle scale-division values by terminals (functions 48, 49 and 50). Setting range: 0.00–359.99	15.00	<input type="radio"/>
P22.08	Spindle scale-division angle 2	Setting range: 0.00–359.99	30.00	<input type="radio"/>
P22.09	Spindle scale-division angle 3	Setting range: 0.00–359.99	45.00	<input type="radio"/>
P22.10	Spindle scale-division angle 4	Setting range: 0.00–359.99	60.00	<input type="radio"/>
P22.11	Spindle scale-division angle 5	Setting range: 0.00–359.99	90.00	<input type="radio"/>
P22.12	Spindle scale-division angle 6	Setting range: 0.00–359.99	120.00	<input type="radio"/>
P22.13	Spindle scale-division angle 7	Setting range: 0.00–359.99	180.00	<input type="radio"/>
P22.14	Spindle drive ratio	This parameter specifies the reduction ratio of the spindle and the mounting shaft of the encoder. Setting range: 0.000–30.000	1.000	<input type="radio"/>
P22.15	Zero-point communication setup of spindle	P22.15 sets spindle zero-point offset, if the selected spindle zero point is P22.03, the final spindle zero point will be the sum of P22.03 and P22.15. Setting range: 0–39999	0	<input type="radio"/>
P22.16	Reserved	/	/	/
P22.17	Reserved	/	/	/

Function code	Name	Description	Default value	Modify
P22.18	Rigid tapping selection	Ones: Enable/disable 0: Disable 1: Enable Tens: Analog input port selection 0: Invalid 1: AI1 2: AI2 3: AI3	0x00	☉
P22.19	Analog filter time of rigid tapping	0.0ms–1000.0ms	1.0ms	○
P22.20	Max. frequency of rigid tapping	0.00–400.00Hz	50.00Hz	○
P22.21	Corresponding frequency of analog zero drift of rigid tapping	0.00–10.00Hz	0.00Hz	○
P22.22–P22.24	Reserved	/	/	/

P23—Vector control of motor 2

Function code	Name	Description	Default value	Modify
P23.00	Speed loop proportional gain 1	P23.00–P23.05 fit for vector control mode only. Below switchover frequency 1 (P23.02), the speed loop PI parameters are P23.00 and P23.01. Above switchover frequency 2 (P23.05), the speed loop PI parameters are P23.03 and P23.04; in between them, the PI parameters are obtained by linear variation between two groups of parameters, as shown in the figure below. <div style="text-align: center;"> </div>	20.0	○
P23.01	Speed loop integral time 1		0.200s	○
P23.02	Switch over low point frequency		5.00Hz	○
P23.03	Speed loop proportional gain 2		20.0	○
P23.04	Speed loop integral time 2		0.200s	○
P23.05	Switch over high point frequency		10.00Hz	○

Function code	Name	Description	Default value	Modify
		<p>regulator. Increase proportional gain or decrease integral time can accelerate dynamic response of speed loop, however, if the proportional gain is too large or integral time is too small, system oscillation and large overshoot may occur; if proportional gain is too small, stable oscillation or speed offset may occur.</p> <p>Speed loop PI parameter is closely related to the system inertia, you should make adjustment according to different load characteristics based on the default PI parameter to fulfill different needs.</p> <p>Setting range of P23.00: 0.0–200.0 Setting range of P23.01: 0.000–10.000s Setting range of P23.02: 0.00Hz–P23.05 Setting range of P23.03: 0.0–200.0 Setting range of P23.04: 0.000–10.000s Setting range of P23.05: P23.02–P00.03 (Max. output frequency)</p>		
P23.06	Speed loop output filter	0–8 (corresponds to 0–2 ⁸ /10ms)	0	<input type="radio"/>
P23.07	Slip compensation coefficient of vector control (motoring)	<p>Slip compensation coefficient is used to adjust the slip frequency of vector control to improve system speed control precision. You can effectively control the static error of speed by adjusting this parameter properly.</p> <p>Setting range: 50–200%</p>	100%	<input type="radio"/>
P23.08	Slip compensation coefficient of vector control (generating)		100%	<input type="radio"/>
P23.09	Current loop proportional coefficient P	<p>Note:</p> <p>1. These two parameters are used to adjust PI parameters of current loop; it affects dynamic response speed and control precision of the system directly. The default value needs no adjustment under common conditions;</p> <p>2. Applicable to SVC mode 0 (P00.00=0), SVC mode 1 (P00.00=1), and FVC (P00.00=3)</p>	1000	<input type="radio"/>
P23.10	Current loop integral coefficient I		1000	<input type="radio"/>

Function code	Name	Description	Default value	Modify
		Setting range: 0–65535		
P23.11	Speed loop differential gain	0.00–10.00s	0.00s	<input type="radio"/>
P23.12	Proportional coefficient of high-frequency current loop	In the FVC (P00.00=3), when the frequency is lower than the current-loop high-frequency switching threshold (P23.14), the current-loop PI parameters are P23.09 and P23.10; and when the	1000	<input type="radio"/>
P23.13	Integral coefficient of high-frequency current loop	frequency is higher than the current-loop high-frequency switching threshold, the current-loop PI parameters are P23.12 and P23.13.	1000	<input type="radio"/>
P23.14	High-frequency switchover threshold of current loop	Setting range of P23.12: 0–65535 Setting range of P23.13: 0–65535 Setting range of P23.14: 0.0–100.0% (relative to max. frequency)	100.0%	<input type="radio"/>
P23.15–P23.19	Reserved	/	/	/

P24—Encoder of motor 2

Function code	Name	Description	Default value	Modify
P24.00	Encoder type display	0: Incremental encoder 1: Resolver-type encoder 2: Sin/Cos encoder 3: Endat absolute encoder	0	<input checked="" type="radio"/>
P24.01	Encoder pulse number	Number of pulses generated when the encoder revolves for one circle. Setting range: 0–60000	1024	<input type="radio"/>
P24.02	Encoder direction	0x000–0x111 Ones: AB direction 0: Forward 1: Reverse Tens: Z pulse direction (reserved) 0: Forward 1: Reverse Hundreds: CD/UVW pole signal direction 0: Forward 1: Reverse	0x000	<input type="radio"/>
P24.03	Detection time of	0.0–10.0s	2.0s	<input type="radio"/>

Function code	Name	Description	Default value	Modify
	encoder offline fault			
P24.04	Detection time of encoder reversal fault	0.0–100.0s	0.8s	○
P24.05	Filter times of encoder detection	Setting range: 0x00–0x99 Ones: Low-speed filter times, corresponds to $2^{(0-9)} \times 125\mu\text{s}$. Tens: High-speed filter times; corresponds to $2^{(0-9)} \times 125\mu\text{s}$.	0x33	○
P24.06	Speed ratio between encoder mounting shaft and motor	You need to set this parameter when the encoder is not installed on the motor shaft and the drive ratio is not 1. Setting range: 0.001–65.535	1.000	○
P24.07	Control parameters of synchronous motor	0x0000–0xFFFF Bit0: Enable Z pulse calibration Bit1: Enable encoder angle calibration Bit2: Enable SVC speed measurement Bit3: Reserved Bit4: Reserved Bit5: Reserved Bit6: Enable CD signal calibration Bit7: Reserved Bit8: Do not detect encoder fault during autotuning Bit9: Enable Z pulse detection optimization Bit10: Enable initial Z pulse calibration optimization Bit11: Reserved Bit12: Clear Z pulse arrival signal after stop Bit13: Reserved Bit14: Detect Z pulse after one rotation Bit15: Reserved	0x0003	○
P24.08	Enable Z pulse offline detection	0x00–0x11 Ones: Z pulse Reserved Tens: UVW pulse 0: Do not detect 1: Enable	0x10	○
P24.09	Initial angle of Z pulse	Relative electric angle of encoder Z pulse and motor pole position.	0.00	○

Function code	Name	Description	Default value	Modify
		Setting range: 0.00–359.99		
P24.10	Initial angle of the pole	Relative electric angle of encoder position and motor pole position. Setting range: 0.00–359.99	0.00	<input type="radio"/>
P24.11	Autotuning of initial angle of pole	0–3 0: No operation 1: Rotary autotuning (DC braking) 2: Static autotuning (suitable for resolver-type encoder, sin/cos with CD signal feedback) 3: Rotary autotuning (initial angle identification)	0	<input checked="" type="radio"/>
P24.12	Speed measurement optimization selection	0: No optimization 1: Optimization mode 1 2: Optimization mode 2	1	<input checked="" type="radio"/>
P24.13	CD signal zero offset gain	0–65535	0	<input type="radio"/>
P24.14	Encoder type selection	0x00–0x11 Ones: Incremental encoder 0: without UVW 1: with UVW Tens: Sin/Cos encoder 0: without CD signal 1: with CD signal	0x00	<input checked="" type="radio"/>
P24.15	Speed measurement mode	0: PG card 1: local; realized by HDIA and HDIB; supports incremental 24V encoder only	0	<input checked="" type="radio"/>
P24.16	Frequency-division coefficient	0–255 When this parameter is set to 0 or 1, frequency division of 1:1 is implemented.	0	<input type="radio"/>
P24.17	Pulse filter processing	0x0000–0xFFFF Bit0: Enable/disable encoder input filter 0: No filter 1: Filter Bit1: Encoder signal filter mode 0: Self-adaptive filter 1: Use P24.18 filter parameters Bit2: Enable/disable encoder frequency-division output filter	0x0033	<input type="radio"/>

Function code	Name	Description	Default value	Modify
		0: No filter 1: Filter Bit3: Enable/disable pulse reference frequency-division output filter 0: No filter 1: Filter Bit4: Enable/disable pulse reference filter 0: No filter 1: Filter Bit5: Pulse reference filter mode 0: Self-adaptive filter 1: Use P24.19 filter parameters Bit6: Frequency- division output source setting (valid only for incremental encoders) 0: Encoder signals 1: Pulse reference signals Bits 7–15: Reserved		
P24.18	Encoder pulse filter width	0–63 The filtering time is $P24.18 \times 0.25 \mu s$. The value 0 or 1 indicates $0.25 \mu s$.	2	<input type="radio"/>
P24.19	Pulse reference filter width	0–63 The filtering time is $P24.19 \times 0.25 \mu s$. The value 0 or 1 indicates $0.25 \mu s$.	2	<input type="radio"/>
P24.20	Pulse number of pulse reference	0–16000	1024	<input checked="" type="radio"/>
P24.21	Enable angle compensation of synchronous motor	0–1	0	<input type="radio"/>
P24.22	Switchover frequency threshold of speed measurement mode	0–630.00Hz	1.00Hz	<input type="radio"/>
P24.23	Synchronous motor angle compensation coefficient	-200.0–200.0%	100.0%	<input type="radio"/>

Function code	Name	Description	Default value	Modify
P24.24	Number of pole pairs in initial magnetic pole angle autotuning	1–128	2	☉

P25—Expansion I/O card input functions

Function code	Name	Description	Default value	Modify
P25.00	HDI3 input type selection	0: HDI3 is high-speed pulse input 1: HDI3 is digital input	0	☉
P25.01	S5 terminal function	The same with P05 group	0	☉
P25.02	S6 terminal function		0	☉
P25.03	S7 terminal function		0	☉
P25.04	S8 terminal function		0	☉
P25.05	S9 terminal function		0	☉
P25.06	S10 terminal function		0	☉
P25.07	HDI3 terminal function		0	☉
P25.08	Input terminal polarity of expansion card		0x00–0x7F	0x00
P25.09	Virtual terminal setup of expansion card	0x00–0x7F (0: disable, 1: enable) BIT0: S5 virtual terminal BIT1: S6 virtual terminal BIT2: S7 virtual terminal BIT3: S8 virtual terminal BIT4: S9 virtual terminal BIT5: S10 virtual terminal BIT6: HDI3 virtual terminal	0x00	☉
P25.10	HDI3 terminal switch-on delay	These function codes define corresponding delay of the programmable input terminals during level variation from switch-on to switch-off .	0.000s	○
P25.11	HDI3 terminal switch-off delay		0.000s	○

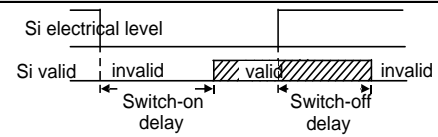
Function code	Name	Description	Default value	Modify
P25.12	S5 terminal switch-on delay	 <p>Setting range: 0.000–50.000s</p>	0.000s	<input type="radio"/>
P25.13	S5 switch-off delay		0.000s	<input type="radio"/>
P25.14	S6 terminal switch-on delay		0.000s	<input type="radio"/>
P25.15	S6 switch-off delay		0.000s	<input type="radio"/>
P25.16	S7 terminal switch-on delay		0.000s	<input type="radio"/>
P25.17	S7 switch-off delay		0.000s	<input type="radio"/>
P25.18	S8 terminal switch-on delay		0.000s	<input type="radio"/>
P25.19	S8 switch-off delay		0.000s	<input type="radio"/>
P25.20	S9 terminal switch-on delay		0.000s	<input type="radio"/>
P25.21	S9 switch-off delay		0.000s	<input type="radio"/>
P25.22	S10 terminal switch-on delay		0.000s	<input type="radio"/>
P25.23	S10 switch-off delay		0.000s	<input type="radio"/>
P25.24	Lower limit value of AI3		<p>These function codes define the relation between analog input voltage and corresponding set value of analog input. When the analog input voltage exceeds the range of max./min. input, the max. input or min. input will be adopted during calculation.</p> <p>When analog input is current input, 0–20mA current corresponds to 0–10V voltage.</p> <p>In different application cases, 100% of the analog setting corresponds to different nominal values.</p> <p>The figure below illustrates several settings.</p>	0.00V
P25.25	Corresponding setting of lower limit of AI3	0.0%		<input type="radio"/>
P25.26	Upper limit value of AI3	10.00V		<input type="radio"/>
P25.27	Corresponding setting of upper limit of AI3	100.0%		<input type="radio"/>
P25.28	Input filter time of AI3	0.030s		<input type="radio"/>
P25.29	Lower limit value of AI4	0.00V		<input type="radio"/>

Function code	Name	Description	Default value	Modify
P25.30	Corresponding setting of lower limit of AI4		0.0%	<input type="radio"/>
P25.31	Upper limit value of AI4		10.00V	<input type="radio"/>
P25.32	Corresponding setting of upper limit of AI4		100.0%	<input type="radio"/>
P25.33	Input filter time of AI4	<p>Input filter time: Adjust the sensitivity of analog input, increase this value properly can enhance the anti-interference capacity of analog variables; however, it will also degrade the sensitivity of analog input.</p> <p>Note: AI3 and AI4 can support 0–10V/0–20mA input, when AI3 and AI4 select 0–20mA input, the corresponding voltage of 20mA is 10V.</p> <p>Setting range of P25.24: 0.00V–P25.26 Setting range of P25.25: -300.0%–300.0% Setting range of P25.26: P25.24–10.00V Setting range of P25.27: -300.0%–300.0% Setting range of P25.28: 0.000s–10.000s Setting range of P25.29: 0.00V–P25.31 Setting range of P25.30: -300.0%–300.0% Setting range of P25.31: P25.29–10.00V Setting range of P25.32: -300.0%–300.0% Setting range of P25.33: 0.000s–10.000s</p>	0.030s	<input type="radio"/>
P25.34	HDI3 high-speed pulse input function	0: Set input via frequency 1: Count	0	<input checked="" type="radio"/>
P25.35	Lower limit frequency of HDI3	0.000 kHz – P25.37	0.000 kHz	<input type="radio"/>
P25.36	Corresponding setting of lower limit frequency of HDI3	-300.0%–300.0%	0.0%	<input type="radio"/>
P25.37	Upper limit frequency of HDI3	P25.35 –50.000kHz	50.000 kHz	<input type="radio"/>

Function code	Name	Description	Default value	Modify
P25.38	Corresponding setting of upper limit frequency of HDI3	-300.0%~300.0%	100.0%	<input type="radio"/>
P25.39	HDI3 frequency input filter time	0.000s~10.000s	0.030s	<input type="radio"/>
P25.40	AI3 input signal type	Range: 0~1 0: Voltage type 1: Current type	0	<input type="radio"/>
P25.41	AI4 input signal type	Range: 0~1 0: Voltage type 1: Current type	0	<input type="radio"/>
P25.42~P25.45	Reserved	/	/	/

P26—Output functions of expansion I/O card

Function code	Name	Description	Default value	Modify
P26.00	HDO2 output type	0: Open collector high-speed pulse output 1: Open collector output	0	<input checked="" type="radio"/>
P26.01	HDO2 output selection	The same with P06.01	0	<input type="radio"/>
P26.02	Y2 output selection		0	<input type="radio"/>
P26.03	Y3 output selection		0	<input type="radio"/>
P26.04	Relay RO3 output selection		0	<input type="radio"/>
P26.05	Relay RO4 output selection		0	<input type="radio"/>
P26.06	Relay RO5 output selection		0	<input type="radio"/>
P26.07	Relay RO6 output selection		0	<input type="radio"/>
P26.08	Relay RO7 output selection		0	<input type="radio"/>
P26.09	Relay RO8 output selection		0	<input type="radio"/>

Function code	Name	Description	Default value	Modify	
P26.10	Relay RO9 output selection		0	<input type="radio"/>	
P26.11	Relay RO10 output selection		0	<input type="radio"/>	
P26.12	Output terminal polarity of expansion card	0x0000–0x1FFF Bit0: Y2 Bit1: Y3 Bit2: HDO2 Bit3: RO3 Bit4: RO4 Bit5: RO5 Bit6: RO6 Bit7: RO7 Bit8: RO8 Bit9: RO9 Bit10: RO10 Bit11: RO11 Bit12: RO12	0x0000	<input type="radio"/>	
P26.13	HDO2 switch-on delay	<p>Used to define the corresponding delay of the level variation from switch-on to switch-off.</p>	0.000s	<input type="radio"/>	
P26.14	HDO2 switch-off delay		0.000s	<input type="radio"/>	
P26.15	Y2 switch-on delay		0.000s	<input type="radio"/>	
P26.16	Y2 switch-off delay		0.000s	<input type="radio"/>	
P26.17	Y3 switch-on delay		0.000s	<input type="radio"/>	
P26.18	Y3 switch-off delay		0.000s	<input type="radio"/>	
P26.19	Relay RO3 switch-on delay		Setting range: 0.000–50.000s Note: P26.13 and P26.14 are valid only when P26.00 is set to 1.	0.000s	<input type="radio"/>
P26.20	Relay RO3 switch-off delay		0.000s	<input type="radio"/>	
P26.21	Relay RO4 switch-on delay		0.000s	<input type="radio"/>	
P26.22	Relay RO4 switch-off delay		0.000s	<input type="radio"/>	

Function code	Name	Description	Default value	Modify	
P26.23	Relay RO5 switch-on delay		0.000s	<input type="radio"/>	
P26.24	Relay RO5 switch-off delay		0.000s	<input type="radio"/>	
P26.25	Relay RO6 switch-on delay		0.000s	<input type="radio"/>	
P26.26	Relay RO6 switch-off delay		0.000s	<input type="radio"/>	
P26.27	Relay RO7 switch-on delay		0.000s	<input type="radio"/>	
P26.28	Relay RO7 switch-off delay		0.000s	<input type="radio"/>	
P26.29	Relay RO8 switch-on delay		0.000s	<input type="radio"/>	
P26.30	Relay RO8 switch-off delay		0.000s	<input type="radio"/>	
P26.31	Relay RO9 switch-on delay		0.000s	<input type="radio"/>	
P26.32	Relay RO9 switch-off delay		0.000s	<input type="radio"/>	
P26.33	Relay RO10 switch-on delay		0.000s	<input type="radio"/>	
P26.34	Relay RO10 switch-off delay		0.000s	<input type="radio"/>	
P26.35	AO2 output selection		The same with P06.14	0	<input type="radio"/>
P26.36	AO3 output selection			0	<input type="radio"/>
P26.38	Lower limit of AO2 output	Above function codes define the relation between output value and analog output. When the output value exceeds the set max./min. output range, the upper/low limit of output will be adopted during calculation. When analog output is current output, 1mA corresponds to 0.5V voltage. In different applications, 100% of output value corresponds to different analog outputs.	0.0%	<input type="radio"/>	
P26.39	Corresponding AO2 output of lower limit		0.00V	<input type="radio"/>	
P26.40	Upper limit of AO2 output		100.0%	<input type="radio"/>	
P26.41	Corresponding AO2 output of upper limit		10.00V	<input type="radio"/>	

Function code	Name	Description	Default value	Modify	
P26.42	AO2 output filter time		0.000s	<input type="radio"/>	
P26.43	Lower limit of AO3 output		0.0%	<input type="radio"/>	
P26.44	Corresponding AO3 output of lower limit		0.00V	<input type="radio"/>	
P26.45	Upper limit of AO3 output		100.0%	<input type="radio"/>	
P26.46	Corresponding AO3 output of upper limit		10.00V	<input type="radio"/>	
P26.47	AO3 output filter time		Setting range of P26.38: -300.0%–P26.40	0.000s	<input type="radio"/>
			Setting range of P26.39: 0.00V–10.00V		
P26.48–P26.52	Reserved	Setting range of P26.40: P26.38–100.0%	/	/	
		Setting range of P26.41: 0.00V–10.00V			
		Setting range of P26.42: 0.000s–10.000s			
		Setting range of P26.43: -300.0%–P26.45			
		Setting range of P26.44: 0.00V–10.00V			
		Setting range of P26.45: P26.43–300.0%			
		Setting range of P26.46: 0.00V–10.00V			
		Setting range of P26.47: 0.000s–10.000s			

P27—Programmable expansion card functions

Function code	Name	Description	Default value	Modify
P27.00	Enabling programmable card	0–1 This function is reserved.	0	<input checked="" type="radio"/>
P27.01	I_WrP1	0–65535 Used to write a value to WrP1 of the programmable card.	0	<input type="radio"/>
P27.02	I_WrP2	0–65535 Used to write a value to WrP2 of the programmable card.	0	<input type="radio"/>
P27.03	I_WrP3	0–65535 Used to write a value to WrP3 of the programmable card.	0	<input type="radio"/>
P27.04	I_WrP4	0–65535 Used to write a value to WrP4 of the programmable card.	0	<input type="radio"/>

Function code	Name	Description	Default value	Modify
P27.05	I_WrP5	0-65535 Used to write a value to WrP5 of the programmable card.	0	<input type="radio"/>
P27.06	I_WrP6	0-65535 Used to write a value to WrP6 of the programmable card.	0	<input type="radio"/>
P27.07	I_WrP7	0-65535 Used to write a value to WrP7 of the programmable card.	0	<input type="radio"/>
P27.08	I_WrP8	0-65535 Used to write a value to WrP8 of the programmable card.	0	<input type="radio"/>
P27.09	I_WrP9	0-65535 Used to write a value to WrP9 of the programmable card.	0	<input type="radio"/>
P27.10	I_WrP10	0-65535 Used to write a value to WrP10 of the programmable card.	0	<input type="radio"/>
P27.11	Programmable card status	0-1 Used to display the status of the programmable card. 0: Stopped 1: Running	0	<input checked="" type="radio"/>
P27.12	C_MoP1	0-65535 Used to monitor/view the MoP1 value of the programmable card.	0	<input checked="" type="radio"/>
P27.13	C_MoP2	0-65535 Used to monitor/view the MoP2 value of the programmable card.	0	<input checked="" type="radio"/>
P27.14	C_MoP3	0-65535 Used to monitor/view the MoP3 value of the programmable card.	0	<input checked="" type="radio"/>
P27.15	C_MoP4	0-65535 Used to monitor/view the MoP4 value of the programmable card.	0	<input checked="" type="radio"/>
P27.16	C_MoP5	0-65535 Used to monitor/view the MoP5 value of the programmable card.	0	<input checked="" type="radio"/>

Function code	Name	Description	Default value	Modify
P27.17	C_MoP6	0-65535 Used to monitor/view the MoP6 value of the programmable card.	0	●
P27.18	C_MoP7	0-65535 Used to monitor/view the MoP7 value of the programmable card.	0	●
P27.19	C_MoP8	0-65535 Used to monitor/view the MoP8 value of the programmable card.	0	●
P27.20	C_MoP9	0-65535 Used to monitor/view the MoP9 value of the programmable card.	0	●
P27.21	C_MoP10	0-65535 Used to monitor/view the MoP10 value of the programmable card.	0	●
P27.22	Digital input terminal status of programmable card	0x00-0x3F Bit5-Bit0 indicate PS6-PS1 respectively.	0x00	●
P27.23	Digital output terminal status of programmable card	0x0-0x3 Bit0 indicates PRO1, and Bit1 indicates PRO2.	0x0	●
P27.24	AI1 of the programmable card	0-10.00V/0.00-20.00mA AI1 value from the programmable card.	0	●
P27.25	AO1 of programmable card	0-10.00V/0.00-20.00mA AO1 value from the programmable card.	0	●
P27.26	Length of data sent by programmable card and PZD communication object	0x00-0x28 Ones place: Quantity of data sent from the programmable card and VFD (that is, quantity of data sent from the programmable card + from VFD sending table 1 + from VFD sending table 2) 0: 0+24+60 1: 12+24+60 2: 24+24+60 3: 36+24+60	0x03	○

Function code	Name	Description	Default value	Modify
		4: 48+24+60 5: 60+48+60 6: 72+24+60 7: 84+24+60 8: 96+96+96 Tens place: Card that communicates with the programmable card through PZD (valid only when the ones place of P27.26 is 5) 0: DP card 1: CANopen card 2: PN card Note: P27.26 can be changed at any time, but the change will only take effect after the re-power on.		
P27.27	Programmable card save function at power failure	0-1 0: Disable 1: Enable	1	⊙

P28—Master/slave control functions

Function code	Name	Description	Default	Modify
P28.00	Master/slave mode	0: Master/slave control is invalid 1: The local machine is a master 2: The local machine is a slave	0	⊙
P28.01	Master/slave communication data selection	0: CAN 1: Reserved	0	⊙
P28.02	Master/slave control mode	0x000-0x112 Ones place: Master/slave running mode selection 0: Master/slave mode 0 (The master and slave adopt speed control and maintain the power balance by droop control) 1: Master/slave mode 1 (The master and slave must be in the same type of vector control mode. The master is speed control, and the slave will be forced to be in the torque control mode. 2: Master/slave mode 2 Start in the slave first speed mode (master/slave mode 0) and then switch to torque mode at a certain frequency point (master/slave mode 1)	0x001	⊙

Function code	Name	Description	Default	Modify
		Tens place: Slave start command source selection 0: Follow the master to start 1: Determined by <u>P00.01</u> Hundreds place: Slave transmitting/master receiving data enable 0: Enable 1: Disable		
P28.03	Slave speed gain	0.0–500.0%	100.0%	○
P28.04	Slave torque gain	0.0–500.0%	100.0%	○
P28.05	Speed/torque mode switching frequency point in master/slave mode 2	0.00–10.00Hz	5.00Hz	○
P28.06	Slave count	1–15	1	◎
P28.07–P28.08	Reserved	/	/	/
P28.09	CAN slave torque offset	-100.0–100.0%	0.0%	○
P28.10	Enabling EC PT100/PT1000 to detect temperature	0x00–0x11 Ones place: PT100 temperature detection 0: Disable 1: Enable Tens place: PT1000 temperature detection 0: Disable 1: Enable	0x00	◎
P28.11	EC PT100 detected OH protection threshold	Protection threshold of overheating (OH) detected by the expansion card (EC) with PT100. 0.0–150.0°C	120.0°C	○
P28.12	EC PT100 detected OH pre-alarm threshold	Pre-alarm threshold of OH detected by the EC with PT100. 0.0–150.0°C	100.0°C	○
P28.13	EC PT100 detected temperature calibration upper limit	Calibration upper limit of temperature detected by the EC with PT100. 50.0–150.0°C	120.0°C	○

Function code	Name	Description	Default	Modify
P28.14	EC PT100 detected temperature calibration lower limit	Calibration lower limit of temperature detected by the EC with PT100. -20.0~50.0°C	10.0°C	○
P28.15	EC PT100 calibration upper limit digital	0~4096	2950	○
P28.16	EC PT100 calibration lower limit digital	0~4096	1270	○
P28.17	EC PT1000 detected OH protection threshold	0.0~150.0°C	120.0°C	○
P28.18	EC PT1000 detected OH pre-alarm threshold	0.0~150.0°C	100.0°C	○
P28.19	PT1000 detected temperature calibration upper limit	50.0~150.0°C	120.0°C	○
P28.20	EC PT1000 detected temperature calibration lower limit	-20.0~50.0°C	10.0°C	○
P28.21	EC PT1000 calibration upper limit digital	0~4096	3100	○
P28.22	EC PT1000 calibration lower limit digital	0~4096	1100	○
P28.23	Detecting for PT100/PT1000 disconnection from EC	0x00~0x11 Ones place: PT100 disconnection detection 0: Disable 1: Enable Tens place: PT1000 disconnection detection	0x00	◎

Function code	Name	Description	Default	Modify
		0: Disable 1: Enable		
P28.24	Enabling digital calibration in EC PT100/PT1000 temperature detection	0–4 0: Disable 1: Enable PT100 lower limit digital calibration. 2: Enable PT100 upper limit digital calibration. 3: Enable PT1000 lower limit digital calibration. 4: Enable PT1000 upper limit digital calibration.	0	○
P28.25	Type of sensor for AI/AO card to detect motor temperature	0–3 0: No temperature sensor 1: PT100 2: PT1000 3: KTY84 4: PTC (Measuring resistance only) Note: Temperature is displayed through P19.11. To measure temperature, switch the output of AO1 to current, and connect one end of the temperature resistor to AI1 and AO1, and the other end to GND.	0	◎
P28.26	AI/AO detected motor OH protection threshold	0.0–200.0°C Note: When the motor temperature exceeds the threshold, the VFD releases the OT alarm.	110.0°C	○
P28.27	AI/AO detected motor OH pre-alarm threshold	0.0–200.0°C Note: When the motor temperature exceeds the value, the DO terminal with function 48 (AI detected motor OH pre-alarm) outputs a valid signal.	90.0°C	○

P90—Tension control in speed mode

Function code	Name	Description	Default	Modify
P90.00	Tension control mode	0: Invalid 1: Speed mode 2: Open-loop torque mode 3: Closed-loop torque mode Note: The value 0 indicates tension control is invalid. Select a non-0 value to enable the tension control function.	0	◎

Function code	Name	Description	Default	Modify
P90.01	Winding/ unwinding mode	0: Winding 1: Unwinding Note: The motor forward rotation direction is the winding direction. When using the tension control mode, check whether the motor rotation direction is correct in the winding mode; if not, change the rotation direction by swapping two phase wires of the motor. After the rotation direction is corrected, the winding mode can be switched to the unwinding mode by setting P90.01 to 1 or changing the winding/unwinding switchover terminals.	0	○
P90.02	Reel mechanical transmission rate	0.01–600.00 =Motor rotation speed/Reel rotation speed=Reel diameter/Motor shaft diameter	1.00	○
P90.03	Max. linear speed	0.0–6000.0 m/min	1000.0 m/min	○
P90.04	Input source of linear speed	0: Keypad 1: AI1 2: AI2 3: AI3 4: High-speed pulse HDI 5: Main traction encoder frequency-division input	0	◎
P90.05	Linear speed set through keypad	0.0–100.0%	20.0%	○
P90.06	Diameter of main traction	0.0–6000.0mm	99.0mm	○
P90.07	Main traction drive ratio	0.000–60.000	1.000	○
P90.08	Linear speed ACC time	0.00–600.00s	0.00s	○
P90.09	Linear speed DEC time	0.00–600.00s	0.00s	○
P90.10	Tension setting	0x00–0x14 Ones place: Tension setting source 0: Keypad 1: AI1 2: AI2 3: AI3	0x00	◎

Function code	Name	Description	Default	Modify
		4: High-speed pulse HDI Tens place: Multiplier of max. tension (P90.12) 0: 1 1: 10		
P90.11	Tension set through keypad	0.0–100.0%	10.0%	○
P90.12	Max. tension	When the tens place of P90.10 is 0, the setting range is 0–60000N. When the tens place of P90.10 is 1, the setting range is (0–60000)*10N.	1000N	○
P90.13	Roll diameter calculation mode	0: Not calculated 1: AI1 2: AI2 3: AI3 4: High-speed pulse HDI 5: Linear speed 6: Thickness (of wire) 7: Thickness (of strip)	0	◎
P90.14	Roll diameter calculation delay time	0.0–100.0s	1.0s	○
P90.15	Min. roll diameter	0.0mm–P90.16	50.0mm	○
P90.16	Max. roll diameter	P90.15–5000.0mm	1000.0 mm	○
P90.17	Initial roll diameter 1	P90.15–P90.16 (mm)	100.0 mm	○
P90.18	Initial roll diameter 2	P90.15–P90.16 (mm)	100.0 mm	○
P90.19	Initial roll diameter 3	P90.15–P90.16 (mm)	100.0 mm	○
P90.20	Linear speed roll diameter calculation filter time	0.000–60.000s	2.000s	○
P90.21	Linear speed roll diameter calculation restriction	0x00–0x11 Ones place: 0:No 1: Restrict changes in reverse direction	0x00	○

Function code	Name	Description	Default	Modify
		Tens place: 0: No 1: Automatic restriction according to running frequency and material thickness		
P90.22	Material thickness	0.001–65.535mm	0.010 mm	<input type="radio"/>
P90.23	Number of coils per layer	1–10000	1	<input checked="" type="radio"/>
P90.24	Revolution counting function selection	0–2 0: Digital terminal input 1: PG card input (Applicable to thickness calculation method) 2: Running frequency (No input automatic revolution counting)	0	<input checked="" type="radio"/>
P90.25	Number of pulses per revolution	1–60	1	<input checked="" type="radio"/>
P90.26	Roll diameter set value	0.0–100.0%	80.0%	<input type="radio"/>
P90.27	Roll diameter reset setting	0x0000–0x1111 Ones place: At stop 0: Remain current roll diameter 1: Restore to initial roll diameter Tens place: Power off at running 0: Remain current roll diameter 1: Restore to initial roll diameter Hundreds place: Reach the roll diameter set value 0: Remain current roll diameter 1: Restore to initial roll diameter Thousands place: Terminal reset limitation 0: Reset allowed at running 1: Reset only allowed at stop	0x1000	<input type="radio"/>
P90.28	Tension PID output reference	0–1 0: Max. value 1: Given value	0	<input type="radio"/>
P90.29	Tension PID parameter source	0–5 0: First group of P90 1: Roll diameter (max. roll diameter) 2: Main reference frequency (max. Frequency) 3: Running linear speed (max. linear speed)	0	<input type="radio"/>

Function code	Name	Description	Default	Modify
		4: Deviation (Reference 100%) 5: Terminal		
P90.30	Group 1 proportional gain	0.000–30.000	0.030	○
P90.31	Group 1 integral time	0.00–30.00s	5.00s	○
P90.32	Group 1 differential time	0.00–10.00s	0.00s	○
P90.33	Group 2 proportional gain	0.000–30.000	0.030	○
P90.34	Group 2 integral time	0.00–30.00s	5.00s	○
P90.35	Group 2 differential time	0.00–10.00s	0.00s	○
P90.36	PID parameter adjustment reference point 1	0.0%–P90.37	10.0%	○
P90.37	PID parameter adjustment reference point 2	P90.36–100.0%	50.0%	○
P90.38	Min. frequency for roll diameter calculation	0.00–50.00Hz	0.30Hz	○
P90.39	Min. linear speed for roll diameter calculation	0.0–100.0%	3.0%	○

P91—Tension control in torque mode

Function code	Name	Description	Default	Modify
P91.00	Tension control zero speed reference	0–1 0: Max. linear speed 1: Max. frequency	0	◎
P91.01	Tension control zero speed threshold	0.0–50.0%	3.0%	○
P91.02	Zero speed offset	0.0–50.0%	2.0%	○
P91.03	Upper-limit frequency source	0–3 0: P03.14, P03.15	3	◎

Function code	Name	Description	Default	Modify
	of torque control	1: Forward rotation limit set by line speed 2: Reverse rotation limit set by line speed 3: Forward and reverse rotations limit set by line speed		
P91.04	Running frequency upper limit offset of tension control	0.0–100.0%	5.0%	<input type="radio"/>
P91.05	Differential separation threshold	0.0–100.0%	5.0%	<input type="radio"/>
P91.06	PID restricts reverse limit at zero speed	0–1 0: Enable 1: Disable	0	<input checked="" type="radio"/>
P91.07	Torque compensation selection	0x000–0x111 Ones place: Frictional torque compensation 0: No 1: Yes Tens place: Inertia compensation 0: No 1: Yes Hundreds place: Compensation direction 0: In line with torque direction 1: Different from torque direction	0x000	<input checked="" type="radio"/>
P91.08	System mechanical parameters identification	0–2 0: No operation 1: Enable system mechanical inertia identification 2: Enable mechanical friction torque identification	0	<input checked="" type="radio"/>
P91.09	Static friction torque compensation coefficient	0.0–100.0%	0.0%	<input type="radio"/>
P91.10	Sliding friction torque compensation coefficient 1	0.0–100.0%	0.0%	<input type="radio"/>
P91.11	Sliding friction torque compensation	0.0–100.0%	0.0%	<input type="radio"/>

Function code	Name	Description	Default	Modify
	coefficient 2			
P91.12	Sliding friction torque compensation coefficient 3	0.0–100.0%	0.0%	○
P91.13	High speed torque compensation coefficient	0.0–100.0%	0.0%	○
P91.14	Compensation frequency point of static friction torque	0.0%–P91.15	1.0%	○
P91.15	Compensation frequency point of sliding friction torque 1	P91.14–P91.16 (%)	20.0%	○
P91.16	Compensation frequency point of sliding friction torque 2	P91.15–P91.17 (%)	50.0%	○
P91.17	Compensation frequency point of sliding friction torque 3	P91.16–P91.18 (%)	80.0%	○
P91.18	High-speed friction torque compensation frequency point	P91.17–100.0%	100.0%	○
P91.19	ACC/DEC frequency source	0–1 0: Linear speed 1: Running frequency	0	◎
P91.20	Material density	0–30000 kg/m ³	0 kg/m ³	○
P91.21	Reel width	0.000–60.000m	0.000m	○
P91.22	ACC inertia compensation coefficient	0.0–100.0%	10.0%	○
P91.23	DEC inertia	0.0–100.0%	10.0%	○

Function code	Name	Description	Default	Modify
	compensation coefficient			
P91.24	Tension taper coefficient source	0–4 0: Keypad 1: AI1 2: AI2 3: AI3 4: High-speed pulse HDI	0	☉
P91.25	Tension taper set through keypad	0.0–100.0%	30.0%	○
P91.26	Tension taper compensation correction	0.0–5000.0mm	0.0mm	○
P91.27	Tension taper curve selection	0–1 0: Inverse proportional curve 1: Multi-point curve	0	☉
P91.28	Roll diameter value 1	0.0–5000.0mm	200.0 mm	○
P91.29	Tension taper coefficient for roll diameter value 1	0.0–50.0%	3.0%	○
P91.30	Roll diameter value 2	0.0–5000.0mm	500.0 mm	○
P91.31	Tension taper coefficient for roll diameter value 2	0.0–50.0%	7.0%	○
P91.32	Tension offset value at zero speed	0.0–300.0%	0.0%	○
P91.33	Present roll diameter setting	0.0–5000.0mm	0.0mm	☉

P92—Customized tension control functions

Function code	Name	Description	Default	Modify
P92.00	Pre-drive speed gain	0.0–100.0%	100.0%	○
P92.01	Pre-drive torque limit	0–2 0: Set based on P03.20, P03.21	2	○

Function code	Name	Description	Default	Modify
		1: Set based on P93.02 2: Set based on the set tension		
P92.02	Pre-drive torque limit setting	0.0–200.0%	100.0%	○
P92.03	Zero bit conversion enabling	0–1 0: Disable 1: Enable	0	◎
P92.04	Initial zero bit	0.0–100.0%	10.0%	○
P92.05	Final zero bit	0.0–100.0%	50.0%	○
P92.06	Conversion time from initial zero bit to final zero bit	0.00–60.00s	5.00s	○
P92.07	Conversion time from final zero bit to initial zero bit	0.00–60.00s	5.00s	○
P92.08	Feeding interrupt detection mode	0–3 0: Not detect 1: Detect based on digital value 2: Detect based on roll diameter calculation value 3: Detect based on feedback position	0	○
P92.09	Feeding interrupt detection start delay time	0.0–200.0s	20.0s	○
P92.10	Frequency lower limit of feeding interrupt detection	0.00–300.00Hz	10.00 Hz	○
P92.11	Error range of feeding interrupt detection	0.1–50.0%	10.0%	○
P92.12	Determination delay time of feeding interrupt detection	0.1–60.0s	1.0s	○
P92.13	Handling mode of feeding interrupt	0x000–0x111 Ones place: Stop mode 0: Decelerate to stop in emergency manner 1: Coast to stop	0x000	◎

Function code	Name	Description	Default	Modify
		Tens place: Alarm mode 0: Stop in enabled stop mode without reporting an alarm 1: Report an alarm and coast to stop Hundreds place: Roll diameter memory function of feeding interrupt 0: Disable 1: Enable		
P92.14	Stop braking frequency	0.00–300.00Hz	1.50Hz	<input type="radio"/>
P92.15	Stop braking time	0.0–600.0s	0.0s	<input type="radio"/>

P93—Tension control status viewing

Function code	Name	Description	Default	Modify
P93.00	Actual control mode	0–3 0: Invalid tension control 1: Close-loop tension speed control 2: Open loop tension torque control 3: Close-loop tension torque control	0	<input checked="" type="radio"/>
P93.01	Actual winding/unwinding mode	0–1 0: Winding 1: Unwinding	0	<input checked="" type="radio"/>
P93.02	Initial roll diameter	0.0–5000.0mm	0.0mm	<input checked="" type="radio"/>
P93.03	Reset roll diameter	0.0–5000.0mm	0.0mm	<input checked="" type="radio"/>
P93.04	Roll diameter change rate	0.00–655.35 mm/s	0.00 mm/s	<input checked="" type="radio"/>
P93.05	Present roll diameter	0.0–5000.0mm	0.0mm	<input checked="" type="radio"/>
P93.06	Roll diameter for linear speed calculation	0.0–5000.0mm	0.0mm	<input checked="" type="radio"/>
P93.07	Set linear speed	0.0–6000.0 m/min	0.0 m/min	<input checked="" type="radio"/>
P93.08	Present linear speed	0.0–6000.0 m/min	0.0 m/min	<input checked="" type="radio"/>
P93.09	Main reference	0.00–600.00Hz	0.00 Hz	<input checked="" type="radio"/>

Function code	Name	Description	Default	Modify
	frequency			
P93.10	Actual proportional gain	0.00–30.00	0.00	●
P93.11	Actual integral time	0.00–30.00s	0.00s	●
P93.12	Proportional output value	0–65535	0	●
P93.13	Integral output value	0–65535	0	●
P93.14	PID upper limit	-100.0–100.0%	0.0%	●
P93.15	PID lower limit	-100.0–100.0%	0.0%	●
P93.16	PID output frequency	-99.99–99.99Hz	0.00Hz	●
P93.17	Main traction running frequency	-300.0–300.0Hz	0.0Hz	●
P93.18	Set tension	0–30000N	0N	●
P93.19	Tension taper coefficient	0.0–100.0%	0.0%	●
P93.20	Actual tension	0–30000N	0N	●
P93.21	Basic torque reference value	-300.0–300.0%	0.0%	●
P93.22	Friction compensation torque value	-300.0–300.0%	0.0%	●
P93.23	System rotational inertia	0.00–655.35 kg.m ²	0.00 kg.m ²	●
P93.24	Frequency change rate	-99.99–327.67 Hz/s	0.00 Hz/s	●
P93.25	Torque compensation value of system rotational inertia	-300.0–300.0%	0.0%	●
P93.26	Reference value after torque compensation	-300.0–300.0%	0.0%	●
P93.27	PID output torque	-300.0–300.0%	0.0%	●
P93.28	Final output	-300.0–300.0%	0.0%	●

Function code	Name	Description	Default	Modify
	torque			
P93.29	Measured tension	0–30000N	0N	●
P93.30	Number of material turns on the reel	-100–32767	0	●
P93.31	Length of material on the reel	0–65535m	0m	●
P93.32	Length increment	0.0–6553.5m	0.0m	●

7 Troubleshooting

7.1 What this chapter contains

The chapter tells you how to reset faults and check faults history. A complete list of alarms and fault information as well as possible causes and corrective measures are presented in this chapter.

	✧ Only well-trained and qualified professionals are allowed to carry out the work described in this chapter. Operations should be carried out according to the instructions presented in Safety precautions.
---	--

7.2 Indications of alarms and faults

Faults are indicated by indicators (you can refer to 5.4 Operating the VFD through the keypad). When the **TRIP** indicator is on, the alarm or fault code displayed in the keypad indicates the VFD is in exception state. This chapter covers most of the alarms and faults, and their possible causes and corrective measures, if you cannot figure out the alarm or fault causes, contact local INVT office.

7.3 Fault reset

You can reset the VFD through the **STOP/RST** key on the keypad, digital inputs, or by cutting off the VFD power. After faults are removed, the motor can be started again.

7.4 Fault history

P07.27–P07.32 record the types of last six faults; P07.33–P07.40, P07.41–P07.48, and P07.49–P07.56 record the running data of the VFD when the latest three faults occurred.

7.5 VFD faults and solutions

When fault occurred, process the fault as shown below.

1. When VFD fault occurred, confirm whether keypad display is improper? If yes, contact INVT.
2. If keypad works properly, check the function codes in P07 group to confirm the corresponding fault record parameters, and determine the real state when current fault occurred through parameters.
3. Check the table below to see whether corresponding exception states exist based on the corresponding corrective measures.
4. Rule out the faults or ask for help from professionals.
5. After confirming faults are removed, reset the fault and start running.

7.5.1 Details of faults and solutions

Note: The numbers enclosed in square brackets such as [1], [2] and [3] in the **Fault type** column in the following table indicate the VFD fault type codes read through communication.

Fault code	Fault type	Possible cause	Corrective measures
OUt1	[1] Inverter unit phase-U protection	Acceleration is too fast; IGBT module is damaged;	Increase acceleration time; Replace the power unit;
OUt2	[2] Inverter unit phase-V protection	Misacts caused by interference; drive wires are	Check drive wires; Check whether there is strong
OUt3	[3] Inverter unit	poorly connected;	interference surrounds the

Fault code	Fault type	Possible cause	Corrective measures
	phase-W protection	Shorted to ground.	peripheral equipment
OV1	[7] Over-voltage during acceleration	Deceleration time is too short;	Check input power; Check whether load deceleration time is too short;
OV2	[8] Over-voltage during deceleration	Exception occurred to input voltage;	or the motor starts during rotating;
OV3	[9] Over-voltage during constant speed running	Large energy feedback; Lack of braking units; Dynamic braking is not enabled	Install dynamic braking units; Check the setup of related function codes
OC1	[4] Over-current during acceleration	Acceleration is too fast; Grid voltage is too low; VFD power is too small; Load transient or exception occurred; To-ground short circuit or output phase loss occur; Strong external interference sources; Overcurrent stall protection is not enabled	Increase acceleration /deceleration time;
OC2	[5] Over-current during deceleration		Check input power; Select the VFD with larger power;
OC3	[6] Over-current during constant speed running		Check if the load is short circuited (to-ground short circuit or line-to-line short circuit) or the rotation is not smooth; Check the output wiring; Check if there is strong interference; Check the setup of related function codes.
UV	[10] Bus undervoltage fault	Grid voltage is too low; Overvoltage stall protection is not enabled	Check grid input power; Check the setup of related function codes
OL1	[11] Motor overload	Grid voltage is too low; Rated motor current is set improperly; Motor stall or load jumps violently	Check grid voltage; Reset rated motor current; Check the load and adjust torque boost
OL2	[12] VFD overload	Acceleration is too fast; The motor in rotating is restarted; Grid voltage is too low; Load is too large; Power is too small;	Increase acceleration time; Avoid restart after stop; Check grid voltage; Select the VFD with larger power; Select proper motor
SPI	[13] Phase loss on	Phase loss or violent	Check the input power;

Fault code	Fault type	Possible cause	Corrective measures
	input side	fluctuation occurred to R, S and T input	Check installation wiring
SPO	[14] Phase loss on output side	Phase loss occurred to U, V, W output (or the three phases of motor is asymmetrical)	Check the output wiring; Check the motor and cable
OH1	[15] Overheat of rectifier module	Air duct is blocked or fan is damaged;	Ventilate the air duct or replace the fan; Lower the ambient temperature
OH2	[16] Overheat of inverter module	Ambient temperature is too high; Long-time overload running	
EF	[17] External fault	SI external fault input terminal acts	Check external device input
CE	[18] Modbus/Modbus TCP communication fault	Baud rate is set improperly; Communication line fault; Communication address error; Communication suffers from strong interference	Set proper baud rate; Check the wiring of communication interfaces; Set proper communication address; Replace or change the wiring to enhance anti-interference capacity
ItE	[19] Current detection fault	Poor contact of the connector of control board; Hall component is damaged; Exception occurred to amplification circuit	Check the connector and re-plug; Replace the hall component; Replace the main control board
tE	[20] Motor autotuning fault	Motor capacity does not match with the VFD capacity, this fault may occur easily if the difference between them is exceeds five power classes; Motor parameter is set improperly; The parameters gained from autotuning deviate sharply from the standard parameters; Autotuning timeout	Change the VFD model, or adopt V/F mode for control; Set proper motor type and nameplate parameters; Empty the motor load and carry out autotuning again; Check motor wiring and parameter setup; Check whether upper limit frequency is larger than 2/3 of the rated frequency

Fault code	Fault type	Possible cause	Corrective measures
EEP	[21] EEPROM fault	R/W error occurred to the control parameters; EEPROM is damaged	Press STOP/RST to reset; Replace the main control board
PIDE	[22] PID feedback offline fault	PID feedback offline; PID feedback source disappears;	Check PID feedback signal wires; Check PID feedback source
bCE	[23] Braking unit fault	Braking circuit fault or braking tube is damaged; The resistance of external braking resistor is too small	Check the braking unit, replace with new braking tubes; Increase braking resistance
END	[24] Running time is up	The actual running time of the VFD is larger than the set running time	Ask help from the supplier, adjust the set running time
OL3	[25] Electronic overload fault	The VFD releases overload pre-alarm based on the set value	Check the load and overload pre-alarm threshold
PCE	[26] Keypad communication fault	The keypad wire is poorly contacted or disconnected; The keypad wire is too long and suffers strong interference; Circuit fault occurred to the keypad or communication part of the main board	Check the keypad wires to confirm whether fault exists; Check the surroundings to rule out interference source; Replace the hardware and ask for maintenance service
UPE	[27] Parameter upload error	The keypad wire is poorly contacted or disconnected; The keypad wire is too long and suffers strong interference; Circuit fault occurred to the keypad or communication part of the main board	Check the surroundings to rule out interference source; Replace the hardware and ask for maintenance service; Replace the hardware and ask for maintenance service
DNE	[28] Parameter download error	The keypad wire is poorly contacted or disconnected; The keypad wire is too long and suffers strong interference; Data storage error occurred to the keypad	Check the surroundings to rule out interference source; Replace the hardware and ask for maintenance service; Re-backup keypad data

Fault code	Fault type	Possible cause	Corrective measures
ETH1	[32] To-ground short circuit fault 1	VFD output is short connected to the ground; Current detection circuit is faulty; Actual motor power setup deviates sharply from the VFD power	Check whether motor wiring is proper; Replace the hall component; Replace the main control board; Reset the motor parameters properly
ETH2	[33] To-ground short circuit fault 1	VFD output is short connected to ground; Current detection circuit is faulty; Actual motor power setup deviates sharply from the VFD power	Check whether motor wiring is proper; Replace the hall component; Replace the main control board; Reset the motor parameters properly
dEu	[34] Speed deviation fault	Load is too heavy, or stall occurred	Check the load to ensure it is proper, increase the detection time; Check whether control parameters are set properly
STo	[35] Maladjustment fault	Control parameters of synchronous motor is set improperly; The parameter gained from autotuning is inaccurate; The VFD is not connected to motor	Check the load to ensure it is proper; Check whether load is proper; Check whether control parameters are set correctly; Increase maladjustment detection time
LL	[36] Electronic underload fault	The VFD performs underload pre-alarm based on the set value	Check the load and overload pre-alarm threshold
ENC1o	[37] Encoder offline fault	Encoder line sequence is wrong, or signal wires are poorly connected	Check the encoder wiring
ENC1d	[38] Encoder reversal fault	The encoder speed signal is contrary to the motor running direction	Reset encoder direction
ENC1Z	[39] Encoder Z pulse offline fault	Z signal wires are disconnected	Check the wiring of Z signal
OT	[59] Motor over-temperature	Motor over-temperature input terminal is valid;	Check the wiring of motor over-temperature input terminal

Fault code	Fault type	Possible cause	Corrective measures
	fault	Exception occurred to t temperature detection Exception occurred to resistor; Long-time overload running or exception occurred	(terminal function 57); Check whether temperature sensor is proper; Check the motor and perform maintenance on the motor
STO	[40] Safe torque off	Safe torque off function is enabled by external forces	/
STL1	[41] Exception occurred to safe circuit of channel H1	The wiring of STO is improper; Fault occurred to external switch of STO; Hardware fault occurred to safety circuit of channel H1	Check whether terminal wiring of STO is proper and firm enough; Check whether external switch of STO can work properly and restart it; Replace the control board
STL2	[42] Exception occurred to channel H2 safe circuit	The wiring of STO is improper; Fault occurred to external switch of STO; Hardware fault occurred to safety circuit of channel H2	Check whether terminal wiring of STO is proper and firm enough; Check whether external switch of STO can work properly and restart it; Replace the control board
STL3	[43] Exception occurred to channel H1 and channel H2	Hardware fault occurred to STO circuit	Replace the control board
CrCE	[44] Safety code FLASH CRC check fault	Control board is faulty	Replace the control board
E-Err	[55] Repetitive expansion card type	The two inserted expansion cards are of the same type	You should not insert two cards with the same type; check the type of expansion card, and remove one card after power down
ENCUV	[56] Encoder UVW loss fault	No electric level variation occurred to UVW signal	Check the wiring of UVW; Encoder is damaged
F1-Er	[60] Failed to identify the expansion card in card slot 1	There is data transmission in interfaces of card slot 1, however, it cannot read the card type	Confirm whether the expansion card inserted can be supported; Stabilize the expansion card

Fault code	Fault type	Possible cause	Corrective measures
			interfaces after power down, and confirm whether fault still occurs at next power-on; Check whether the insertion port is damaged, if yes, replace the insertion port after power down
F2-Er	[61] Failed to identify the expansion card in card slot 2	There is data transmission in interfaces of card slot 2, however, it cannot read the card type	Confirm whether the expansion card inserted can be supported; Stabilize the expansion card interfaces after power down, and confirm whether fault still occurs at next power-on; Check whether the insertion port is damaged, if yes, replace the insertion port after power down
F3-Er	[62] Failed to identify the expansion card in card slot 3	There is data transmission in interfaces of card slot 3, however, it cannot read the card type	Confirm whether the expansion card inserted can be supported; Stabilize the expansion card interfaces after power down, and confirm whether fault still occurs at next power-on; Check whether the insertion port is damaged, if yes, replace the insertion port after power down
C1-Er	[63] Communication timeout occurred to the expansion card in card slot 1	There is no data transmission in interfaces of card slot 1	Confirm whether the expansion card inserted can be supported; Stabilize the expansion card interfaces after power down, and confirm whether fault still occurs at next power-on; Check whether the insertion port is damaged, if yes, replace the insertion port after power down
C2-Er	[64] Communication timeout occurred to	There is no data transmission in interfaces of	Confirm whether the expansion card inserted can be supported;

Fault code	Fault type	Possible cause	Corrective measures
	the expansion card in card slot 2	card slot 2	Stabilize the expansion card interfaces after power down, and confirm whether fault still occurs at next power-on; Check whether the insertion port is damaged, if yes, replace the insertion port after power down
C3-Er	[65] Communication timeout occurred to the expansion card in card slot 3	There is no data transmission in interfaces of card slot 3	Confirm whether the expansion card inserted can be supported; Stabilize the expansion card interfaces after power down, and confirm whether fault still occurs at next power-on; Check whether the insertion port is damaged, if yes, replace the insertion port after power down
E-DP	[29] PROFIBUS card communication timeout fault	There is no data transmission between the communication card and the host controller (or PLC).	Check whether the communication card wiring is loose or dropped.
E-NET	[30] Ethernet card communication timeout fault	There is no data transmission between the communication card and the host controller.	Check whether the communication card wiring is loose or dropped.
E-CAN	[31] CANopen card communication timeout fault	There is no data transmission between the communication card and the host controller (or PLC)	Check whether the communication card wiring is loose or dropped.
E-PN	[57] PROFINET card communication timeout fault	There is no data transmission between the communication card and the host controller (or PLC)	Check whether the communication card wiring is loose or dropped.
E-CAT	[66] EtherCAT card communication timeout fault	There is no data transmission between the communication card and the host controller (or PLC)	Check whether the communication card wiring is loose or dropped

Fault code	Fault type	Possible cause	Corrective measures
E-BAC	[67] BACNet card communication timeout fault	There is no data transmission between the communication card and the host controller (or PLC).	Check whether the communication card wiring is loose or dropped
E-DEV	[68] DeviceNet card communication timeout fault	There is no data transmission between the communication card and the host controller (or PLC).	Check whether the communication card wiring is loose or dropped
SECAN	[58] CAN master/slave communication card communication timeout fault	There is no data transmission between the CAN master and slave communication cards	Check whether the communication card wiring is loose or dropped
S-Err	[69] CAN slave fault in master/slave synchronization	Fault occurred to one of the CAN slave VFDs	Detect the CAN slave VFD and analyze the corresponding fault cause of the VFD
P-E1– P-E10	[45]–[54] Programmable card customized faults 1–10	User program logic error in the programmable card. A fault occurred on the customized position.	Check the user program logic. Perform troubleshooting based on actual customized faults.
OtE1	[70] EC PT100 detected OH	The PT100 temperature sensor is inaccurate or not calibrated. Device or ambient temperature is too high.	Calibrate the sensor through parameter settings. Lower the device or ambient temperature.
OtE2	[71] EC PT1000 detected OH	The PT1000 temperature sensor is inaccurate or not calibrated. Device or ambient temperature is too high.	Calibrate the sensor through parameter settings. Lower the device or ambient temperature.
E-EIP	[72] EtherNet IP communication timeout	There is no data transmission between the communication card and the host controller (or PLC).	Check whether the communication card wiring is loose or dropped.
E-PAO	[73] No upgrade bootloader	The upgrade bootloader is missing.	Contact us.
E-AI1	[74] AI1 disconnection	Input voltage of AI1 is too low; AI1 wiring is disconnected.	Connect a 5V or 10mA power source to check whether the input is normal; Check the wiring or replace the cables.

Fault code	Fault type	Possible cause	Corrective measures
E-AI2	[75] AI2 disconnection	Input voltage of AI2 is too low; AI2 wiring is disconnected.	Connect a 5V or 10mA power source to check whether the input is normal; Check the wiring or replace the cables.
E-AI3	[76] AI3 disconnection	Input voltage of AI3 is too low; AI4 wiring is disconnected.	Connect a 5V or 10mA power source to check whether the input is normal; Check the wiring or replace the cables.

7.5.2 Other state

Displayed code	State type	Possible cause	Solution
PoFF	System power failure	The system is powered off or the bus voltage is too low.	Check the grid conditions.

7.6 Analysis on common faults

7.6.1 Motor fails to work

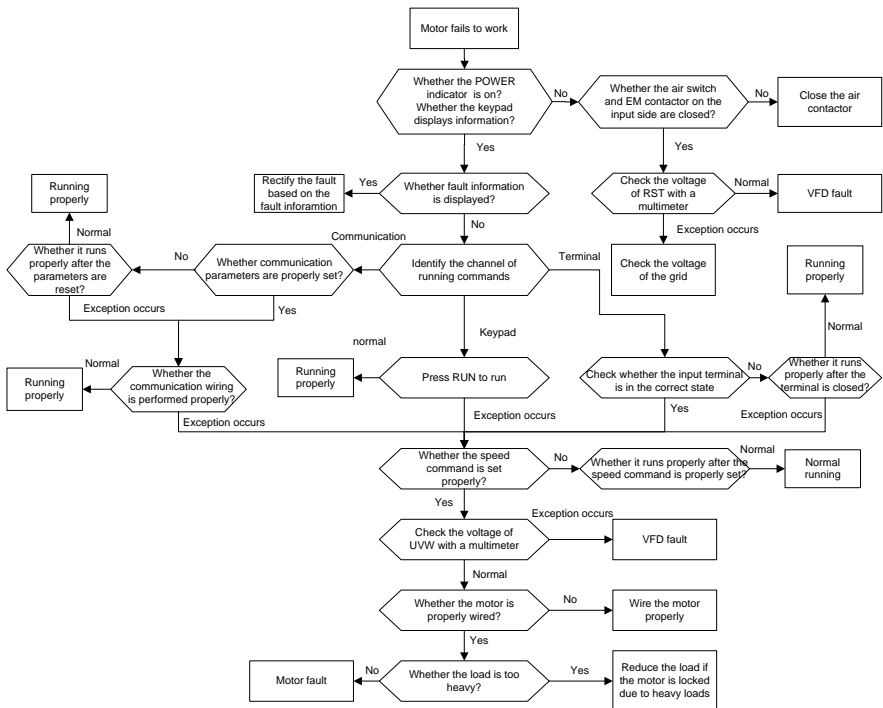

7.6.2 Motor vibrates

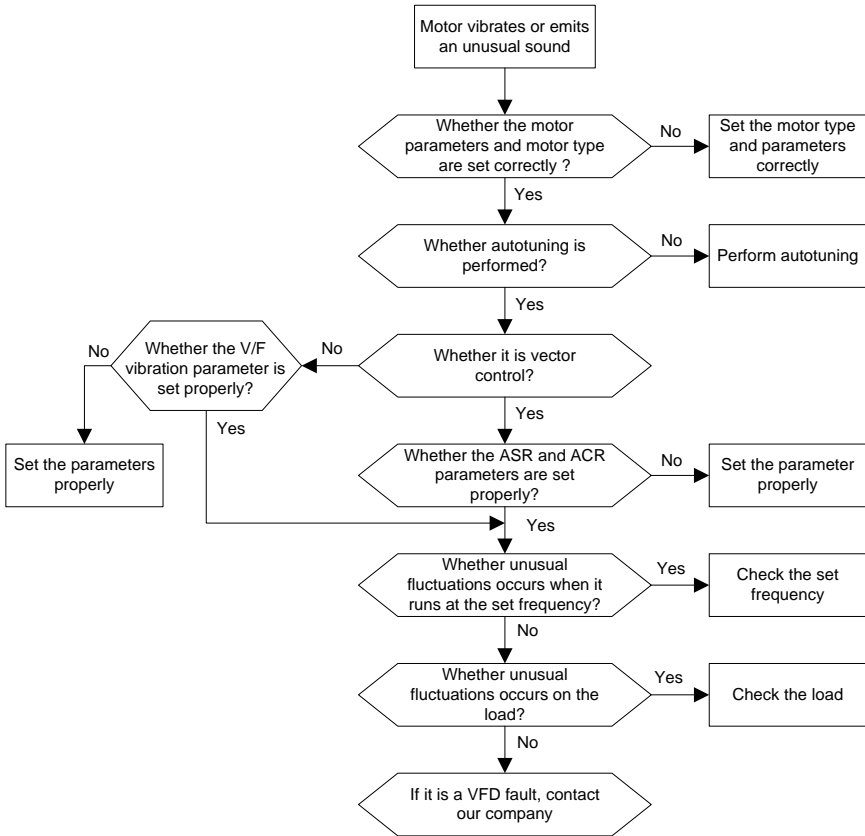

7.6.3 Overvoltage

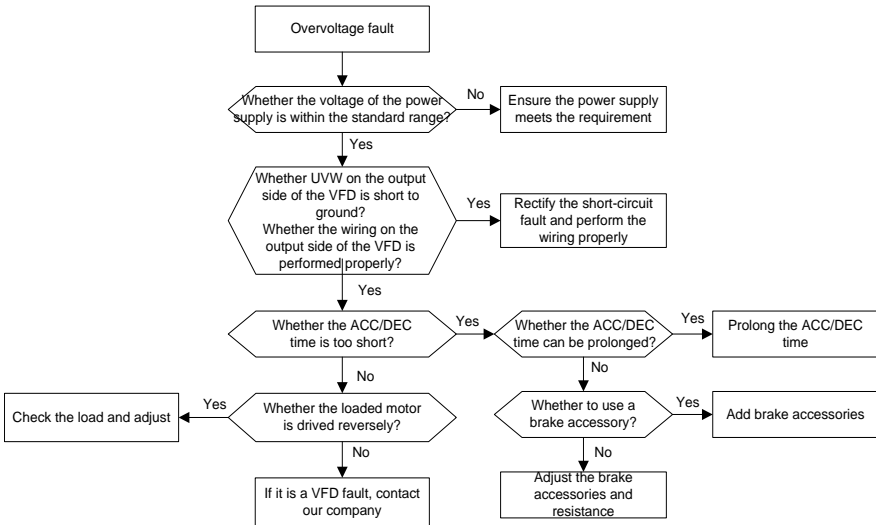

7.6.4 Undervoltage

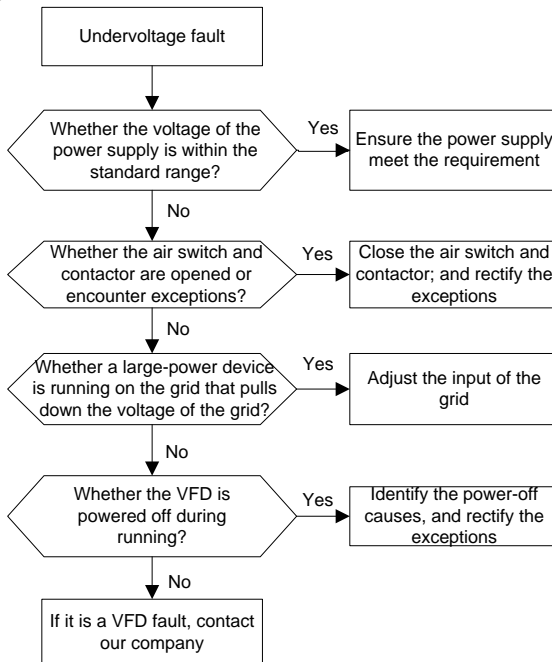

7.6.5 Unusual heating of motor

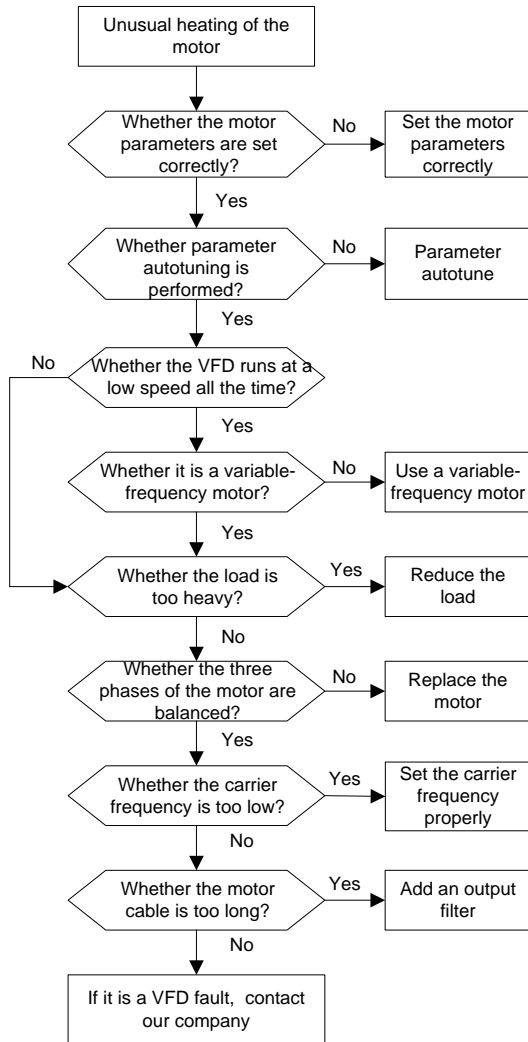

7.6.6 VFD overheating

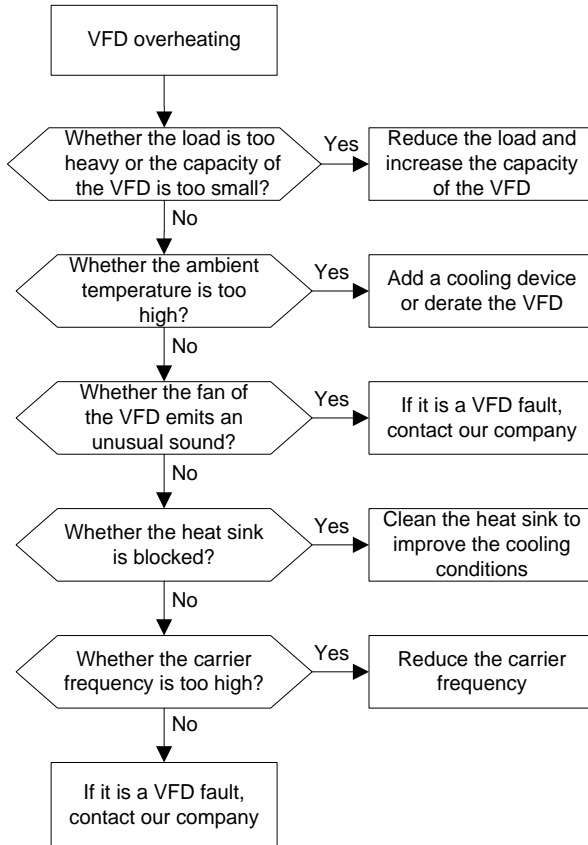

7.6.7 Motor stalls during ACC

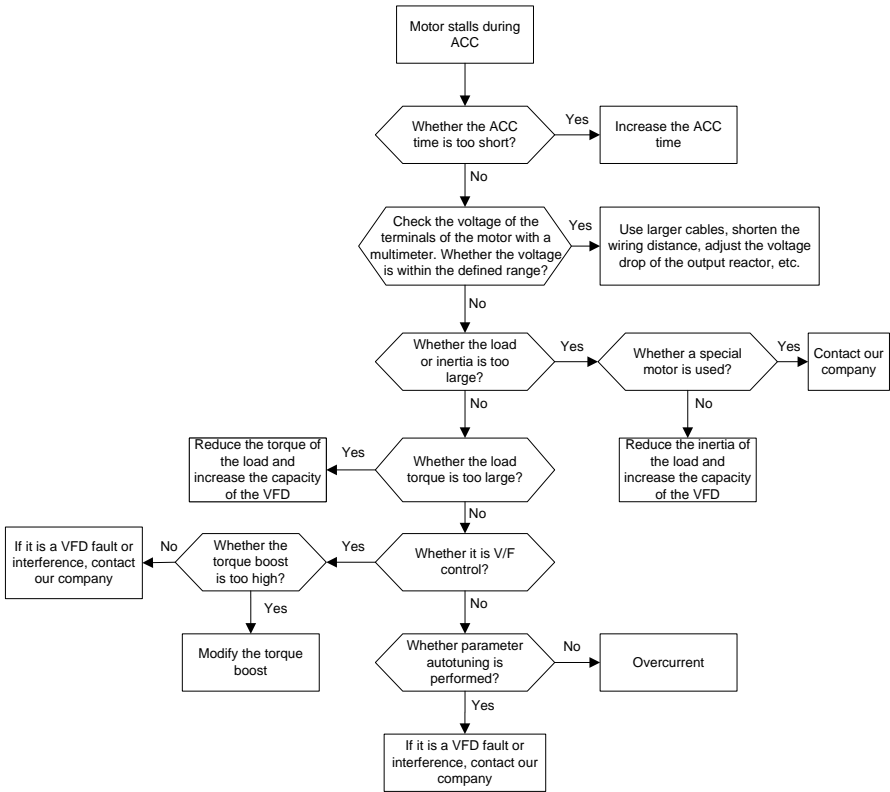

7.6.8 Overcurrent

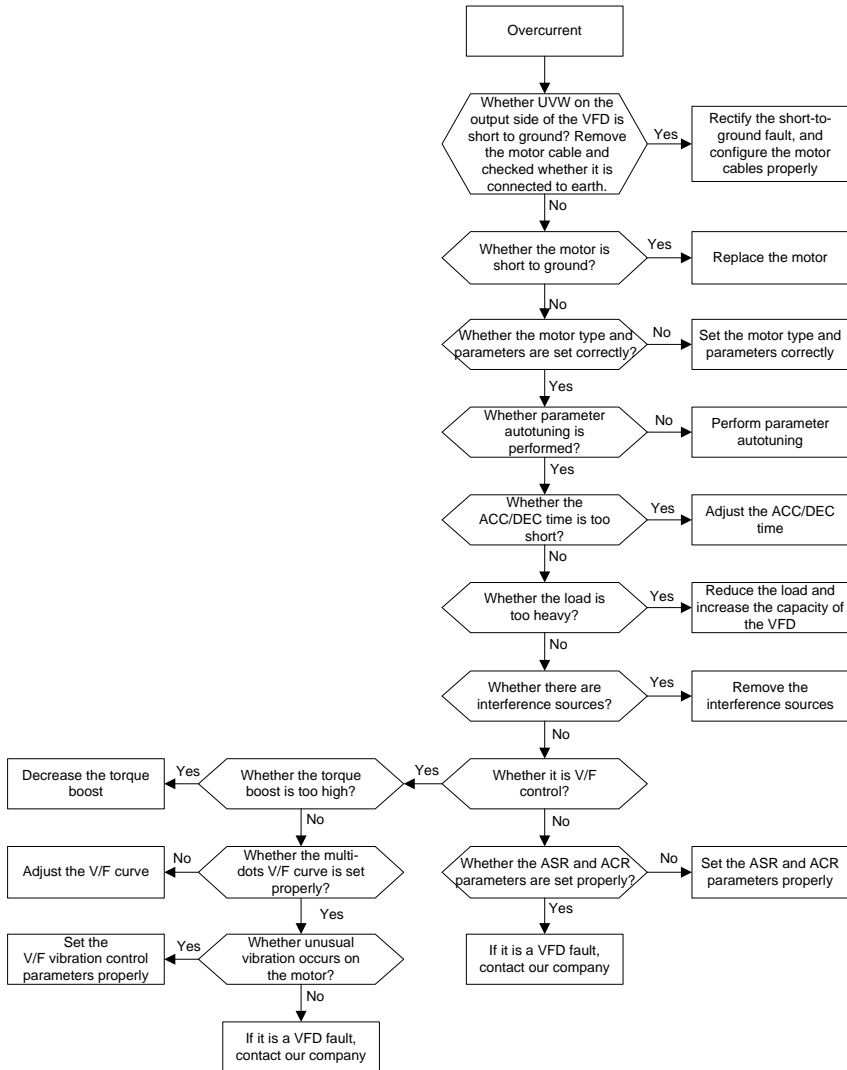

7.7 Countermeasures on common interference

7.7.1 Interference on meter switches and sensors

Interference phenomenon

Pressure, temperature, displacement, and other signals of a sensor are collected and displayed by a human-machine interaction device. The values are incorrectly displayed as follows after the VFD is started:

1. The upper or lower limit is wrongly displayed, for example, 999 or -999.
2. The display of values jumps (usually occurring on pressure transmitters).
3. The display of values is stable, but there is a large deviation, for example, the temperature is dozens of degrees higher than the common temperature (usually occurring on thermocouples).
4. A signal collected by a sensor is not displayed but functions as a drive system running feedback signal. For example, a VFD is expected to decelerate when the upper pressure limit of the compressor is reached, but in actual running, it starts to decelerate before the upper pressure limit is reached.
5. After a VFD is started, the display of all kinds of meters (such as frequency meter and current meter) that are connected to the analog output (AO) terminal of the VFD is severely affected, displaying the values incorrectly.
6. Proximity switches are used in the system. After a VFD is started, the indicator of a proximity switch flickers, and the output level flips.

Solution

1. Check and ensure that the feedback cable of the sensor is 20 cm or farther away from the motor cable.
2. Check and ensure that the ground wire of the motor is connected to the PE terminal of the VFD (if the ground wire of the motor has been connected to the ground block, you need to use a multimeter to measure and ensure that the resistance between the ground block and PE terminal is lower than 1.5 Ω).
3. Try to add a safety capacitor of 0.1 μF to the signal end of the feedback signal terminal of the sensor.
4. Try to add a safety capacitor of 0.1 μF to the power end of the sensor meter (pay attention to the voltage of the power supply and the voltage endurance of the capacitor).
5. For interference on meters connected to the AO terminal of a VFD, if AO uses current signals of 0 to 20 mA, add a capacitor of 0.47 μF between the AO and GND terminals; and if AO uses voltage signals of 0 to 10 V, add a capacitor of 0.1 μF between the AO and GND terminals.

Note:

1. When a decoupling capacitor is required, add it to the terminal of the device connected to the sensor. For example, if a thermocouple is to transmit signals of 0 to 20 mA to a temperature meter,

the capacitor needs to be added on the terminal of the temperature meter.; if an electronic ruler is to transmit signals of 0 to 30 V to a PLC signal terminal, the capacitor needs to be added on the terminal of the PLC.

2. If a large number of meters or sensors are disturbed. It is recommended that you configure an external C2 filter on the input power end of the VFD. For models of filters, see section D.7 Filters.

7.7.2 Interference on communication

Interference phenomenon

The interference described in this section on 485 communication mainly includes communication delay, out of sync, occasional power-off, or complete power-off that occurs after a VFD is started.

If the communication cannot be implemented properly, regardless of whether the VFD is running, the exception is not necessarily caused by interference. You can find out the causes as follows:

1. Check whether the 485 communication bus is disconnected or in poor contact.
2. Check whether the two ends of line A or B are connected reversely.
3. Check whether the communication protocol (such as the baud rate, data bits, and check bit) of the VFD is consistent with that of the upper computer.

If you are sure that communication exceptions are caused by interference, you can resolve the problem through the following measures:

1. Simple inspection.
2. Arrange the communication cables and motor cables in different cable trays.
3. In multi-VFD application scenarios, adopt the chrysanthemum connection mode to connect the communication cables between VFDs, which can improve the anti-interference capability.
4. In multi-VFD application scenarios, check and ensure that the driving capacity of the master is sufficient.
5. In the connection of multiple VFDs, you need to configure one 120 Ω terminal resistor on each end.

Solution

1. Check and ensure that the ground wire of the motor is connected to the PE terminal of the VFD (if the ground wire of the motor has been connected to the ground block, you need to use a multimeter to measure and ensure that the resistance between the ground block and PE terminal is lower than 1.5 Ω).
2. Do not connect the VFD and motor to the same ground terminal as the upper computer. It is recommended that you connect the VFD and motor to the power ground, and connect the upper computer separately to a ground stud.
3. Try to short the signal reference ground terminal (GND) of the VFD with that of the upper computer controller to ensure that ground potential of the communication chip on the control board of the VFD is consistent with that of the communication chip of the upper computer.

4. Try to short GND of the VFD to its ground terminal (PE).
5. Try to add a safety capacitor of 0.1 μF on the power terminal of the upper computer (PLC, HMI, and touch screen). During this process, pay attention to the voltage of the power supply and the voltage endurance capability of the capacitor. Alternatively, you can use a magnet ring (Fe-based nanocrystalline magnet rings are recommended). Put the power L/N line or +/- line of the upper computer through the magnet ring in the same direction and wind 8 coils around the magnet ring.

7.7.3 Failure to stop and indicator shimmering due to motor cable coupling

Interference phenomenon

1. Failure to stop

In a VFD system where an S terminal is used to control the start and stop, the motor cable and control cable are arranged in the same cable tray. After the system is started properly, the S terminal cannot be used to stop the VFD.

2. Indicator shimmering

After a VFD is started, the relay indicator, power distribution box indicator, PLC indicator, and indication buzzer shimmers, blinks, or emits unusual sounds unexpectedly.

Solution

1. Check and ensure that the exception signal cable is arranged 20 cm or farther away from the motor cable.
2. Add a safety capacitor of 0.1 μF between the digital input terminal (S) and the COM terminal.
3. Connect the digital input terminal (S) that controls the start and stop to other idle digital input terminals in parallel. For example, if S1 is used to control the start and stop and S4 is idle, you can try to connect S1 to S4 in parallel.

Note: If the controller (such as PLC) in the system controls more than 5 VFDs at the same time through digital input terminals (S), this scheme is not available.

7.7.4 Leakage current and interference on RCD

VFDs output high-frequency PWM voltage to drive motors. In this process, the distributed capacitance between the internal IGBT of a VFD and the heat sink and that between the stator and rotor of a motor may inevitably cause the VFD to generate high-frequency leakage current to the ground. A residual current operated protective device (RCD) is used to detect the power-frequency leakage current when a grounding fault occurs on a circuit. The application of a VFD may cause misoperation of a RCD.

1. Rules for selecting RCDs

- (1) VFD systems are special. In these systems, it is required that the rated residual current of common RCDs at all levels is larger than 200 mA, and the VFDs are grounded reliably.
- (2) For RCDs, the time limit of an action needs to be longer than that of a next action, and the time difference between two actions need to be longer than 20 ms. For example, 1s, 0.5s, and 0.2s.
- (3) For circuits in VFD systems, electromagnetic RCDs are recommended. Electromagnetic RCDs

have strong anti-interference capability, and thus can prevent the impact of high-frequency leakage current.

Electronic RCD	Electromagnetic RCD
Low cost, high sensitivity, small in volume, susceptible to voltage fluctuation of the grid and ambient temperature, weak anti-interference capability	Requiring highly sensitive, accurate, and stable zero-phase sequence current transformer, using permalloy high-permeability materials, complex process, high cost, not susceptible to voltage fluctuation of the power supply and ambient temperature, strong anti-interference capability

2. Solution to RCD misoperation (handling the VFD)
 - (1) Try to remove the jumper cap at "EMC/J10" on the middle casing of the VFD.
 - (2) Try to reduce the carrier frequency to 1.5 kHz (P00.14=1.5).
 - (3) Try to modify the modulation mode to "3PH modulation and 2PH modulation" (P8.40=0).
3. Solution to RCD misoperation (handling the system power distribution)
 - (1) Check and ensure that the power cable is not soaking in water.
 - (2) Check and ensure that the cables are not damaged or spliced.
 - (3) Check and ensure that no secondary grounding is performed on the neutral wire.
 - (4) Check and ensure that the main power cable terminal is in good contact with the air switch or contactor (all screws are tightened).
 - (5) Check 1PH powered devices, and ensure that no earth lines are used as neutral wires by these devices.
 - (6) Do not use shielded cables as VFD power cables and motor cables.

7.7.5 Live device chassis

Phenomenon

After a VFD is started, there is sensible voltage on the chassis, and you may feel an electric shock when touching the chassis. The chassis, however, is not live (or the voltage is far lower than the human safety voltage) when the VFD is powered on but not running.

Solution

1. If there is power distribution grounding or ground stud on the site, ground the cabinet chassis of the drive system through the power ground or stud.
2. If there is no grounding on the site, you need to connect the motor chassis to the ground terminal PE of the VFD, and ensure that the jumper at "EMC/J10" on the middle casing of the VFD is shorted.

8 Maintenance and hardware fault diagnosis

8.1 What this chapter contains

This chapter describes how to carry out preventive maintenance on the VFD.

8.2 Periodical inspection

Little maintenance is required when the VFD is installed in the environment that meets requirements.

The following table describes the routine maintenance periods recommended by INVT.

Subject		Item	Method	Criterion
Ambient environment		Check the temperature, and humidity, and whether there is vibration, dust, gas, oil spray, and water droplets in the environment.	Visual inspection, and use instruments for measurement.	The requirements stated in this manual are met.
		Check whether there are foreign matters, such as tools, or dangerous substances placed nearby.	Visual inspection	There are no tools or dangerous substances placed nearby.
Voltage		Check the voltage of the main circuit and control circuit.	Use multimeters or other instruments for measurement.	The requirements stated in this manual are met.
Keypad		Check the display of information.	Visual inspection	The characters are displayed properly.
		Check whether characters are not completely displayed.	Visual inspection	The requirements stated in this manual are met.
Main circuit	Common	Check whether the bolts loose or come off.	Screw them up.	No exception occurs.
		Check whether the machine is deformed, cracked, or damaged, or their color changes due to overheating and aging.	Visual inspection	No exception occurs.
		Check whether there are stains and dust attached.	Visual inspection	No exception occurs. Note: Discoloration of copper bars does not mean that they cannot work properly.

Subject	Item	Method	Criterion
Conductor and wire	Check whether the conductors are deformed or their color change due to overheat.	Visual inspection	No exception occurs.
	Check whether the wire sheaths are cracked or their color changes.	Visual inspection	No exception occurs.
Terminal block	Check whether there is damage.	Visual inspection	No exception occurs.
Filter capacitor	Check whether there is electrolyte leakage, discoloration, cracks, and chassis expansion.	Visual inspection	No exception occurs.
	Check whether the safety valves are released.	Determine the service life based on the maintenance information, or measure them through electrostatic capacity.	No exception occurs.
	Check whether the electrostatic capacity is measured as required.	Use instruments to measure the capacity.	Electrostatic capacity \geq initial value \times 0.85
Resistor	Check whether there is displacement caused due to overheat.	Olfactory and visual inspection	No exception occurs.
	Check whether the resistors are disconnected.	Visual inspection, or remove one end of the connection cable and use a multimeter for measurement.	Resistance range: $\pm 10\%$ (of the standard resistance)
Transformer and reactor	Check whether there is unusual vibration sounds or smells.	Auditory, olfactory, and visual inspection	No exception occurs.
Electromagnetic contactor and relay	Check whether there are vibration sounds in the workshop.	Auditory inspection	No exception occurs.
	Check whether the contacts	Visual inspection	No exception

Subject		Item	Method	Criterion
		are in good contact.		occurs.
Control circuit	Control PCB, connector	Check whether the screws and connectors loose.	Screw them up.	No exception occurs.
		Check whether there is unusual smell or discoloration.	Olfactory and visual inspection	No exception occurs.
		Check whether there are cracks, damage, deformation, or rust.	Visual inspection	No exception occurs.
		Check whether there is electrolyte leakage or deformation.	Visual inspection, and determine the service life based on the maintenance information.	No exception occurs.
Cooling system	Cooling fan	Check whether there are unusual sounds or vibration.	Auditory and visual inspection, and turn the fan blades with your hand.	The rotation is smooth.
		Check whether the bolts loose.	Screw them up.	No exception occurs.
		Check whether there is discoloration caused due to overheat.	Visual inspection, and determine the service life based on the maintenance information.	No exception occurs.
	Ventilation duct	Check whether there are foreign matters blocking or attached to the cooling fan, air inlets, or air outlets.	Visual inspection	No exception occurs.

For more details about maintenance, contact the local INVT office, or visit our website <http://www.invt.com>, and choose **Support > Services**.

8.3 Cooling fan

The service life of the cooling fan of the VFD is more than 25,000 hours. The actual service life of the cooling fan is related to the use of the VFD and the temperature in the ambient environment.

You can view the running duration of the VFD through P07.14 (Accumulated running time).

The increase of the bearing noise indicates a fan fault. If the VFD is applied in a key position, replace the fan once the fan starts to generate unusual noise. You can purchase spare parts of fans from INVT.

Cooling fan replacement:

	<p>⚠ Read the safety precautions carefully and follow the instructions to perform operations. Otherwise, physical injuries or damage to the device may be caused.</p>
---	---

1. Stop the device, disconnect the AC power supply, and wait for a time no shorter than the waiting time designated on the VFD.
2. Open the cable clamp to loose the fan cable (for the 380V 1.5–30 kW VFD models, the middle casing needs to be removed).
3. Remove the fan cable.
4. Remove the fan with a screwdriver.
5. Install a new fan in the VFD in the reverse steps. Assemble the VFD. Ensure that the air direction of the fan is consistent with that of the VFD, as shown in the following figure.

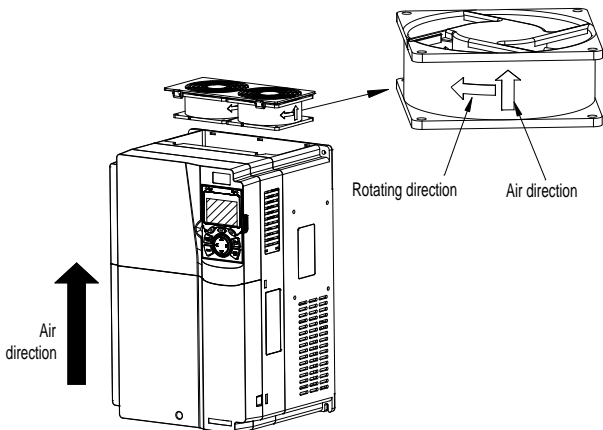

Figure 8-1 Fan maintenance for 7.5 kW and higher VFD models

6. Power on the VFD.

8.4 Capacitor

8.4.1 Capacitor reforming

If the VFD has been left unused for a long time, you need to follow the instructions to reform the DC bus capacitor before using it. The storage time is calculated from the date the VFD is delivered.

Storage time	Operation principle
Less than 1 year	No charging operation is required.
1 to 2 years	The VFD needs to be powered on for 1 hour before the first running command.
2 to 3 years	Use a voltage controlled power supply to charge the VFD: Charge the VFD at 25% of the rated voltage for 30 minutes, and then

Storage time	Operation principle
	charge it at 50% of the rated voltage for 30 minutes, at 75% for another 30 minutes, and finally charge it at 100% of the rated voltage for 30 minutes.
More than 3 years	Use a voltage controlled power supply to charge the VFD: Charge the VFD at 25% of the rated voltage for 2 hours, and then charge it at 50% of the rated voltage for 2 hours, at 75% for another 2 hours, and finally charge it at 100% of the rated voltage for 2 hours.

The method for using a voltage controlled power supply to charge the VFD is described as follows:

The selection of a voltage controlled power supply depends on the power supply of the VFD. For VFDs with an incoming voltage of 1PH/3PH 220 V AC, you can use a 220 V AC/2 A voltage regulator. Both 1PH and 3PH VFDs can be charged with a 1PH voltage controlled power supply (connect L+ to R, and N to S or T). All the DC bus capacitors share one rectifier, and therefore they are all charged. For VFDs of a high voltage class, ensure that the voltage requirement (for example, 380 V) is met during charging. Capacitor charging requires little current, and therefore you can use a small-capacity power supply (2 A is sufficient).

The method for using a resistor (incandescent lamp) to charge the drive is described as follows:

If you directly connect the drive device to a power supply to charge the DC bus capacitor, it needs to be charged for a minimum of 60 minutes. The charging operation must be performed at a normal indoor temperature without load, and you must connect a resistor in series mode in the 3PH circuit of the power supply.

For a 380 V drive device, use a resistor of 1 kΩ/100W. If the voltage of the power supply is no higher than 380 V, you can also use an incandescent lamp of 100W. If an incandescent lamp is used, it may go off or the light may become very weak.

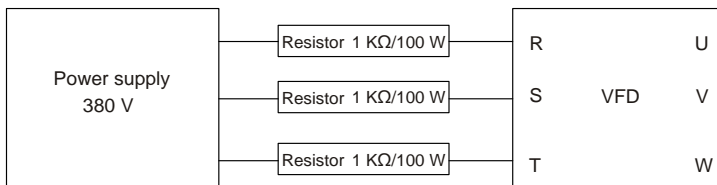

Figure 8-2 380V driving-device charging circuit example

8.4.2 Electrolytic capacitor replacement

	⚡ Read the safety precautions carefully and follow the instructions to perform operations. Otherwise, physical injuries or damage to the device may be caused.
--	--

The electrolytic capacitor of a VFD must be replaced if it has been used for more than 35,000 hours. For details about the replacement, contact the local INVT office.

8.5 Power cable

	⚡ Read the safety precautions carefully and follow the instructions to perform
--	--

	operations. Otherwise, physical injuries or damage to the device may be caused.
--	---

1. Stop the VFD, disconnect the power supply, and wait for a time no shorter than the waiting time designated on the VFD.
2. Check the connection of the power cables. Ensure that they are firmly connected.
3. Power on the VFD.

9 Communication

9.1 What this chapter contains

This chapter describes the communication of the VFD.

The VFD provides RS485 communication interfaces and adopts the master-slave communication based on the international standard Modbus communication protocol. You can implement centralized control (setting commands for controlling the VFD, modifying the running frequency and related function code parameters, and monitoring the working state and fault information of the VFD) through PC/PLC, upper control computer, or other devices to meet specific application requirements.

9.2 Modbus protocol introduction

Modbus is a software protocol, a common language used in electronic controllers. By using this protocol, a controller can communicate with other devices through transmission lines. It is a general industrial standard. With this standard, control devices produced by different manufacturers can be connected to form an industrial network and be monitored in a centralized way.

The Modbus protocol provides two transmission modes, namely American Standard Code for Information Interchange (ASCII) and remote terminal units (RTU). On one Modbus network, all the device transmission modes, baud rates, data bits, check bits, end bits, and other basic parameters must be set consistently.

A Modbus network is a control network with one master and multiple slaves, that is, on one Modbus network, there is only one device serving as the master, and other devices are the slaves. The master can communicate with one slave or broadcast messages to all the slaves. For separate access commands, a slave needs to return a response. For broadcasted information, slaves do not need to return responses.

9.3 Application of Modbus

The VFD uses the Modbus RTU mode and communicates through RS485 interfaces.

9.3.1 RS485

RS485 interfaces work in half-duplex mode and transmit data signals in the differential transmission way, which is also referred to as balanced transmission. An RS485 interface uses a twisted pair, where one wire is defined as A (+), and the other B (-). Generally, if the positive electrical level between the transmission drives A and B ranges from +2 V to +6 V, the logic is "1"; and if it ranges from -2 V to -6 V, the logic is "0".

The 485+ terminal on the terminal block of the VFD corresponds to A, and 485- corresponds to B.

The communication baud rate (P14.01) indicates the number of bits transmitted in a second, and the unit is bit/s (bps). A higher baud rate indicates faster transmission and poorer anti-interference capability. When a twisted pair of 0.56 mm (24 AWG) is used, the maximum transmission distance varies according to the baud rate, as described in the following table.

Baud rate (bps)	Max. transmission distance	Baud rate (bps)	Max. transmission distance
2400	1800 m	9600	800 m
4800	1200 m	19200	600 m

When RS485 interfaces are used for long-distance communication, it is recommended that you use shielded cables, and use the shield layer as the ground wires.

When there are fewer devices and the transmission distance is short, the whole network works well without terminal load resistors. The performance, however, degrades as the distance increases. Therefore, it is recommended that you use a 120 Ω terminal resistor when the transmission distance is long.

9.3.1.1 Application to one VFD

Figure 9-1 is the Modbus wiring diagram of one VFD and a PC. Generally, PCs do not provide RS485 interfaces, so you need to convert an RS232 interface or USB port of a PC to an RS485 interface. Connect end A of the RS485 interface to the 485+ port on the terminal block of the VFD, and connect end B to the 485- port. It is recommended that you use shielded twisted pairs. When an RS232-RS485 converter is used, the cable used to connect the RS232 interface of the PC and the converter cannot be longer than 15 m. Use a short cable when possible. It is recommended that you insert the converter directly into the PC. Similarly, when a USB-RS485 converter is used, use a short cable when possible.

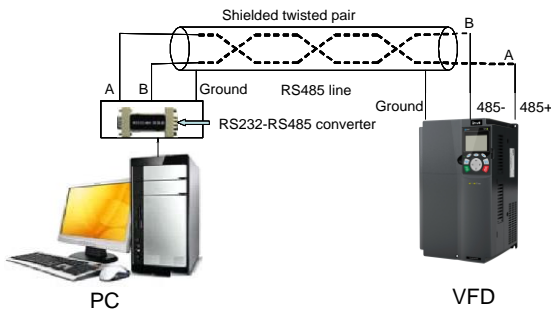

Figure 9-1 Wiring of RS485 applied to one VFD

9.3.1.2 Application to multiple VFDs

In practical application to multiple VFDs, chrysanthemum connection and star connection are commonly used.

According to the requirements of the RS485 industrial bus standards, all the devices need to be connected in chrysanthemum mode with one 120 Ω terminal resistor on each end, as shown in Figure 9-2. Figure 9-3 is the simplified wiring diagram, and Figure 9-4 is the practical application diagram.

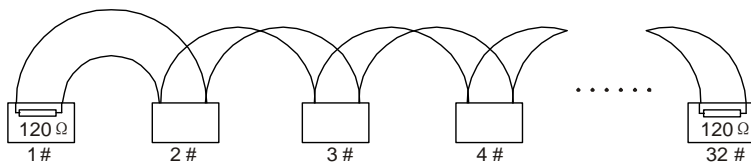

Figure 9-2 On-site chrysanthemum connection diagram

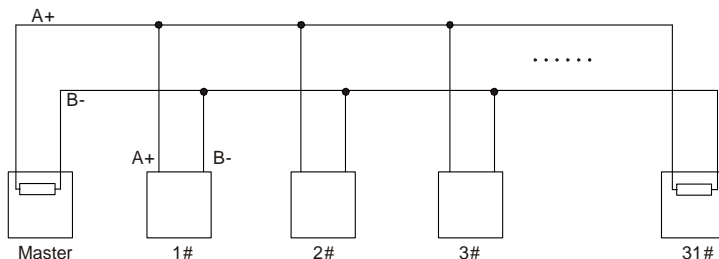

Figure 9-3 Simplified chrysanthemum connection diagram

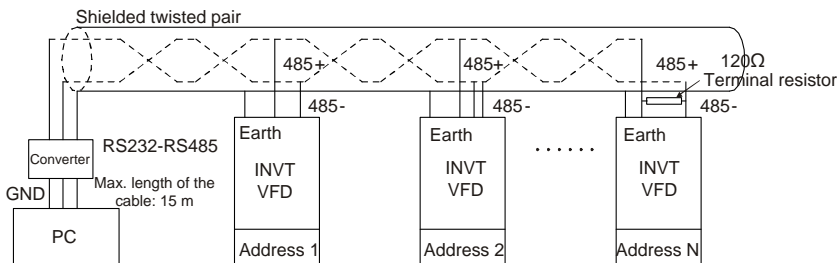

Figure 9-4 Practical application diagram of chrysanthemum connection

Figure 9-5 shows the star connection diagram. When this connection mode is adopted, the two devices that are farthest away from each other on the line must be connected with a terminal resistor (in Figure 9-5, the two devices are devices 1# and 15#).

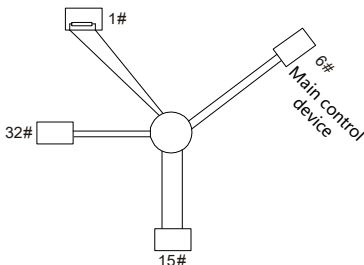

Figure 9-5 Star connection

Use shielded cable, if possible, in multi-device connection. The baud rates, data bit check settings, and other basic parameters of all the devices on the RS485 line must be set consistently, and

addresses cannot be repeated.

9.3.2 RTU mode

9.3.2.1 RTU communication frame structure

When a controller is set to use the RTU communication mode on a Modbus network, every byte (8 bits) in the message includes 2 hexadecimal characters (each includes 4 bits). Compared with the ASCII mode, the RTU mode can transmit more data with the same baud rate.

Code system

- 1 start bit
- 7 or 8 data bits; the minimum valid bit is transmitted first. Each frame domain of 8 bits includes 2 hexadecimal characters (0–9, A–F).
- 1 odd/even check bit; this bit is not provided if no check is needed.
- 1 end bit (with check performed), 2 bits (without check)

Error detection domain

- Cyclic redundancy check (CRC)

The following table describes the data format.

11-bit character frame (Bits 1 to 8 are data bits)

Start bit	BIT1	BIT2	BIT3	BIT4	BIT5	BIT6	BIT7	BIT8	Check bit	End bit
-----------	------	------	------	------	------	------	------	------	-----------	---------

10-bit character frame (Bits 1 to 7 are data bits)

Start bit	BIT1	BIT2	BIT3	BIT4	BIT5	BIT6	BIT7	Check bit	End bit
-----------	------	------	------	------	------	------	------	-----------	---------

In a character frame, only the data bits carry information. The start bit, check bit, and end bit are used to facilitate the transmission of the data bits to the destination device. In practical applications, you must set the data bits, parity check bits, and end bits consistently.

In RTU mode, the transmission of a new frame always starts from an idle time (the transmission time of 3.5 bytes). On a network where the transmission rate is calculated based on the baud rate, the transmission time of 3.5 bytes can be easily obtained. After the idle time ends, the data domains are transmitted in the following sequence: slave address, operation command code, data, and CRC check character. Each byte transmitted in each domain includes 2 hexadecimal characters (0–9, A–F). The network devices always monitor the communication bus. After receiving the first domain (address information), each network device identifies the byte. After the last byte is transmitted, a similar transmission interval (the transmission time of 3.5 bytes) is used to indicate that the transmission of the frame ends. Then, the transmission of a new frame starts.

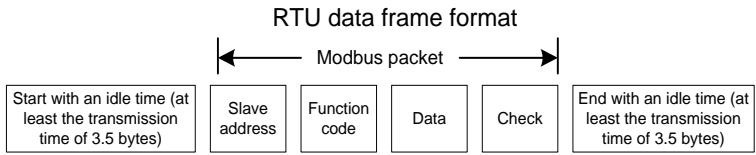

The information of a frame must be transmitted in a continuous data flow. If there is an interval greater than the transmission time of 1.5 bytes before the transmission of the entire frame is complete, the receiving device deletes the incomplete information, and mistakes the subsequent byte for the address domain of a new frame. Similarly, if the transmission interval between two frames is shorter than the transmission time of 3.5 bytes, the receiving device mistakes it for the data of the last frame. The CRC check value is incorrect due to the disorder of the frames, and thus a communication fault occurs.

The following table describes the standard structure of an RTU frame.

START (frame header)	T1-T2-T3-T4 (transmission time of 3.5 bytes)
ADDR (slave address domain)	Communication address: 0–247 (decimal system) (0 is the broadcast address)
CMD (function domain)	03H: read slave parameters 06H: write slave parameters
DATA (N-1) ... DATA (0) (data domain)	Data of 2×N bytes, main content of the communication as well as the core of data exchanging
CRC CHK LSBs	Detection value: CRC (16 bits)
CRC CHK MSBs	
END (frame tail)	T1-T2-T3-T4 (transmission time of 3.5 bytes)

9.3.2.2 RTU communication frame error check modes

During the transmission of data, errors may occur due to various factors. Without check, the data receiving device cannot identify data errors and may make a wrong response. The wrong response may cause severe problems. Therefore, the data must be checked.

The check is implemented as follows: The transmitter calculates the to-be-transmitted data based on a specific algorithm to obtain a result, adds the result to the rear of the message, and transmits them together. After receiving the message, the receiver calculates the data based on the same algorithm to obtain a result, and compares the result with that transmitted by the transmitter. If the results are the same, the message is correct. Otherwise, the message is considered wrong.

The error check of a frame includes two parts, namely, bit check on individual bytes (that is, odd/even check using the check bit in the character frame), and whole data check (CRC check).

Bit check on individual bytes (odd/even check)

You can select the bit check mode as required, or you can choose not to perform the check, which will affect the check bit setting of each byte.

Definition of even check: Before the data is transmitted, an even check bit is added to indicate whether the number of "1" in the to-be-transmitted data is odd or even. If it is even, the check bit is set to "0"; and if it is odd, the check bit is set to "1".

Definition of odd check: Before the data is transmitted, an odd check bit is added to indicate whether the number of "1" in the to-be-transmitted data is odd or even. If it is odd, the check bit is set to "0"; and if it is even, the check bit is set to "1".

For example, the data bits to be transmitted are "11001110", including five "1". If the even check is applied, the even check bit is set to "1"; and if the odd check is applied, the odd check bit is set to "0". During the transmission of the data, the odd/even check bit is calculated and placed in the check bit of the frame. The receiving device performs the odd/even check after receiving the data. If it finds that the odd/even parity of the data is inconsistent with the preset information, it determines that a communication error occurs.

CRC check mode

A frame in the RTU format includes an error detection domain based on the CRC calculation. The CRC domain checks all the content of the frame. The CRC domain consists of two bytes, including 16 binary bits. It is calculated by the transmitter and added to the frame. The receiver calculates the CRC of the received frame, and compares the result with the value in the received CRC domain. If the two CRC values are not equal to each other, errors occur in the transmission.

During CRC, 0xFFFF is stored first, and then a process is invoked to process a minimum of 6 contiguous bytes in the frame based on the content in the current register. CRC is valid only for the 8-bit data in each character. It is invalid for the start, end, and check bits.

During the generation of the CRC values, the "exclusive or" (XOR) operation is performed on the each 8-bit character and the content in the register. The result is placed in the bits from the least significant bit (LSB) to the most significant bit (MSB), and 0 is placed in the MSB. Then, LSB is detected. If LSB is 1, the XOR operation is performed on the current value in the register and the preset value. If LSB is 0, no operation is performed. This process is repeated 8 times. After the last bit (8th bit) is detected and processed, the XOR operation is performed on the next 8-bit byte and the current content in the register. The final values in the register are the CRC values obtained after operations are performed on all the bytes in the frame.

The calculation adopts the international standard CRC check rule. You can refer to the related standard CRC algorithm to compile the CRC calculation program as required.

The following is a simple CRC calculation function for your reference (using the C programming language):

```
unsigned int    crc_cal_value(unsigned char*data_value,unsigned char
data_length)
{
    int i;
    unsigned int crc_value=0xffff;
```



```

while (data_length--)
{
    crc_value^=*data_value++;
    for (i=0;i<8;i++)
    {
        if (crc_value&0x0001)
            crc_value=(crc_value>>1)^0xa001;
        else
            crc_value=crc_value>>1;
    }
}
return (crc_value);
}

```

In the ladder logic, CKSM uses the table look-up method to calculate the CRC value according to the content in the frame. The program of this method is simple, and the calculation is fast, but the ROM space occupied is large. Use this program with caution in scenarios where there are space occupation limits on programs.

9.4 RTU command code and communication data

9.4.1 Command code 03H, reading N words (continuously up to 16 words)

The command code 03H is used by the master to read data from the VFD. The quantity of data to be read depends on the "data quantity" in the command. A maximum of 16 pieces of data can be read. The addresses of the read parameters must be contiguous. Each piece of data occupies 2 bytes, that is, one word. The command format is presented using the hexadecimal system (a number followed by "H" indicates a hexadecimal value). One hexadecimal value occupies one byte.

The 03H command is used to read information including the parameters and operation state of the VFD.

For example, starting from the data address of 0004H, to read two contiguous pieces of data (that is, to read content from the data addresses 0004H and 0005H), the structure of the frame is described in the following table.

RTU master command (transmitted by the master to the VFD)

START	T1-T2-T3-T4 (transmission time of 3.5 bytes)
ADDR (address)	01H
CMD (command code)	03H
Most significant byte (MSB) of the start address	00H
Least significant byte (LSB) of	04H

the start address	
MSB of data quantity	00H
LSB of data quantity	02H
LSB of CRC	85H
MSB of CRC	CAH
END	T1-T2-T3-T4 (transmission time of 3.5 bytes)

The value in START and END is "T1-T2-T3-T4 (transmission time of 3.5 bytes)", indicating that the RS485 needs to stay idle for at least the transmission time of 3.5 bytes. An idle time is required to distinguish on message from another to ensure that the two messages are not regarded as one.

The value of ADDR is 01H, indicating that the command is transmitted to the VFD whose address is 01H. The ADDR information occupies one byte.

The value of CMD is 03H, indicating that the command is used to read data from the VFD. The CMD information occupies one byte.

"Start address" indicates that data reading is started from this address. It occupies two bytes, with the MSB on the left and LSB on the right.

"Data quantity" indicates the quantity of data to be read (unit: word).

The value of "Start address" is 0004H, and that of "Data quantity" is 0002H, indicating that data is to be read from the data addresses of 0004H and 0005H.

CRC check occupies two bytes, with the LSB on the left, and MSB on the right.

RTU slave response (transmitted by the VFD to the master)

START	T1-T2-T3-T4 (transmission time of 3.5 bytes)
ADDR	01H
CMD	03H
Number of bytes	04H
MSB of data in 0004H	13H
LSB of data in 0004H	88H
MSB of data in 0005H	00H
LSB of data in 0005H	00H
LSB of CRC	7EH
MSB of CRC	9DH
END	T1-T2-T3-T4 (transmission time of 3.5 bytes)

The definition of the response information is described as follows:

The value of ADDR is 01H, indicating that the message is transmitted by the VFD whose address is 01H. The ADDR information occupies one byte.

The value of CMD is 03H, indicating that the message is a response of the VFD to the 03H command of the master for reading data. The CMD information occupies one byte.

"Number of bytes" indicates the number of bytes between a byte (not included) and the CRC byte (not included). The value 04 indicates that there are four bytes of data between "Number of bytes" and "LSB of CRC", that is, "MSB of data in 0004H", "LSB of data in 0004H", "MSB of data in 0005H", and "LSB of data in 0005H".

A piece of data is two bytes, with the MSB on the left and LSB on the right. From the response, we can see that the data in 0004H is 1388H, and that in 0005H is 0000H.

CRC check occupies two bytes, with the LSB on the left, and MSB on the right.

9.4.2 Command code 06H, writing a word

This command is used by the master to write data to the VFD. One command can be used to write only one piece of data. It is used to modify the parameters and operation mode of the VFD.

For example, to write 5000 (1388H) to 0004H of the VFD whose address is 02H, the structure of the frame is described in the following table.

RTU master command (transmitted by the master to the VFD)

START	T1-T2-T3-T4 (transmission time of 3.5 bytes)
ADDR	02H
CMD	06H
MSB of data writing address	00H
LSB of data writing address	04H
MSB of to-be-written data	13H
LSB of to-be-written data	88H
LSB of CRC	C5H
MSB of CRC	6EH
END	T1-T2-T3-T4 (transmission time of 3.5 bytes)

RTU slave response (transmitted by the VFD to the master)

START	T1-T2-T3-T4 (transmission time of 3.5 bytes)
ADDR	02H
CMD	06H
MSB of data writing address	00H
LSB of data writing address	04H
MSB of to-be-written data	13H
LSB of to-be-written data	88H
LSB of CRC	C5H
MSB of CRC	6EH
END	T1-T2-T3-T4 (transmission time of 3.5 bytes)

Note: The sections 9.4.1 and 9.4.2 mainly describe the command formats. For the detailed application, see the examples in section 9.4.8 Read/Write operation example.

9.4.3 Command code 08H, diagnosis

Sub-function code description:

Sub-function code	Description
0000	Return data based on query requests

For example, to query about the circuit detection information about the VFD whose address is 01H, the query and return strings are the same, and the format is described in the following tables.

RTU master command:

START	T1-T2-T3-T4 (transmission time of 3.5 bytes)
ADDR	01H
CMD	08H
MSB of the sub-function code	00H
LSB of the sub-function code	00H
MSB of data	12H
LSB of data	ABH
LSB of CRC CHK	ADH
MSB of CRC CHK	14H
END	T1-T2-T3-T4 (transmission time of 3.5 bytes)

RTU slave response:

START	T1-T2-T3-T4 (transmission time of 3.5 bytes)
ADDR	01H
CMD	08H
MSB of the sub-function code	00H
LSB of the sub-function code	00H
MSB of data	12H
LSB of data	ABH
LSB of CRC CHK	ADH
MSB of CRC CHK	14H
END	T1-T2-T3-T4 (transmission time of 3.5 bytes)

9.4.4 Command code 10H, continuous writing

The command code 10H is used by the master to write data to the VFD. The quantity of data to be written is determined by "Data quantity", and a maximum of 16 pieces of data can be written.

For example, to write 5000 (1388H) and 50 (0032H) respectively to 0004H and 0005H of the VFD whose slave address is 02H, the structure of the frame is described in the following table.

RTU master command (transmitted by the master to the VFD):

START	T1-T2-T3-T4 (transmission time of 3.5 bytes)
ADDR	02H
CMD	10H
MSB of data writing address	00H
LSB of data writing address	04H
MSB of data quantity	00H

LSB of data quantity	02H
Number of bytes	04H
MSB of data to be written to 0004H	13H
LSB of data to be written to 0004H	88H
MSB of data to be written to 0005H	00H
LSB of data to be written to 0005H	32H
LSB of CRC	C5H
MSB of CRC	6EH
END	T1-T2-T3-T4 (transmission time of 3.5 bytes)

RTU slave response (transmitted by the VFD to the master):

START	T1-T2-T3-T4 (transmission time of 3.5 bytes)
ADDR	02H
CMD	10H
MSB of data writing address	00H
LSB of data writing address	04H
MSB of data quantity	00H
LSB of data quantity	02H
LSB of CRC	C5H
MSB of CRC	6EH
END	T1-T2-T3-T4 (transmission time of 3.5 bytes)

9.4.5 Data address definition

This section describes the address definition of communication data. The addresses are used for controlling the running, obtaining the state information, and setting related function parameters of the VFD.

9.4.5.1 Function code address representation rules

The address of a function code consists of two bytes, with the MSB on the left and LSB on the right. The MSB ranges from 00 to ffH, and the LSB also ranges from 00 to ffH. The MSB is the hexadecimal form of the group number before the dot mark, and LSB is that of the number behind the dot mark. Take P05.06 as an example, the group number is 05, that is, the MSB of the parameter address is the hexadecimal form of 05; and the number behind the dot mark is 06, that is, the LSB is the hexadecimal form of 06. Therefore, the function code address is 0506H in the hexadecimal form. For P10.01, the parameter address is 0A01H.

Function code	Name	Description	Setting range	Default value	Modify
P10.00	Simple PLC mode	0: Stop after running once 1: Keep running in the final value after running once 2: Cyclic running	0-2	0	<input type="radio"/>
P10.01	Simple PLC memory selection	0: No memory after power down 1: Memory after power down	0-1	0	<input type="radio"/>

Note:

- The parameters in the P99 group are set by the manufacturer. They cannot be read or modified. Some parameters cannot be modified when the VFD is running; some cannot be modified regardless of the state of the VFD. Pay attention to the setting range, unit, and related description of a parameter when modifying it.
- The service life of the Electrically Erasable Programmable Read-Only Memory (EEPROM) may be reduced if it is frequently used for storage. Some function codes do not need to be stored during communication. The application requirements can be met by modifying the value of the on-chip RAM, that is, modifying the MSB of the corresponding function code address from 0 to 1. For example, if P00.07 is not to be stored in the EEPROM, you need only to modify the value of the RAM, that is, set the address to 8007H. The address can be used only for writing data to the on-chip RAM, and it is invalid when used for reading data.

9.4.5.2 Description of other Modbus function addresses

In addition to modifying the parameters of the VFD, the master can also control the VFD, such as start and stop it, and monitor the operation state of the VFD. The following table describes other function parameters.

Function	Address	Data description	R/W
Communication-based control command	2000H	0001H: Forward running	R/W
		0002H: Reverse running	
		0003H: Forward jogging	
		0004H: Reverse jogging	
		0005H: Stop	
		0006H: Coast to stop	
		0007H: Fault reset	
		0008H: Jogging to stop	
Communication-based value setting	2001H	Communication-based frequency setting (0–Fmax, unit: 0.01 Hz)	R/W
	2002H	PID setting, range (0–1000, 1000 corresponding to 100.0%)	
	2003H	PID feedback, range (0–1000, 1000 corresponding to 100.0%)	R/W
	2004H	Torque setting (-3000+3000, 1000 corresponding to 100.0% of the rated current of the motor)	R/W
	2005H	Setting of the upper limit of the forward running frequency (0–Fmax, unit: 0.01 Hz)	R/W
	2006H	Setting of the upper limit of the reverse running frequency (0–Fmax, unit: 0.01 Hz)	R/W
	2007H	Upper limit of the electromotion torque (0–3000,	R/W

Function	Address	Data description	R/W
		1000 corresponding to 100.0% of the rated current of the VFD)	
	2008H	Upper limit of the braking torque (0–3000, 1000 corresponding to 100.0% of the rated current of the motor)	R/W
	2009H	Special control command word: Bit0–1: =00: Motor 1 =01: Motor 2 =10: Motor 3 =11: Motor 4 Bit2: =1 Torque control disabled =0: Torque control cannot be disabled Bit3: =1 Power consumption reset to 0 =0: Power consumption not reset Bit4: =1 Pre-excitation =0: Pre-excitation disabled Bit5: =1 DC braking =0: DC braking disabled	R/W
	200AH	Virtual input terminal command, range: 0x000–0x3FF Corresponding to S8/S7/S6/S5/HDIB/HDIA/S4/S3/ S2/S1	R/W
	200BH	Virtual output terminal command, range: 0x00–0x0F Corresponding to local RO2/RO1/HDO/Y1	R/W
	200CH	Voltage setting (used when V/F separation is implemented) (0–1000, 1000 corresponding to 100.0% of the rated voltage of the motor)	R/W
	200DH	AO output setting 1 (-1000→+1000, 1000 corresponding to 100.0%)	R/W
	200EH	AO output setting 2 (-1000→+1000, 1000 corresponding to 100.0%)	R/W
VFD state word 1	2100H	0001H: Forward running	R
		0002H: Reverse running	
		0003H: Stopped	
		0004H: Faulty	
		0005H: POFF	
		0006H: Pre-excited	
VFD state word 2	2101H	Bit0: =0: Not ready to run =1: Ready to run Bit1–2: =00: Motor 1 =01: Motor 2 =10: Motor 3 =11: Motor 4	R

Function	Address	Data description	R/W
		Bit3: =0: Asynchronous machine =1: Synchronous machine Bit4: =0: No overload alarm =1: Overload alarm Bit5–Bit6: =00: Keypad-based control =01: Terminal-based control =10: Communication-based control Bit7: Reserved Bit8: =0: Speed control =1: Torque control Bit9: =0: Non-position control =1: Position control Bit10–bit11: =0: Vector 0 =1: Vector 1 =2: Closed-loop vector =3: Space voltage vector	
VFD fault code	2102H	See the description of fault types.	R
VFD identification code	2103H	GD350-----0x01A0	R
Running frequency	3000H	0–Fmax (unit: 0.01Hz)	R
Set frequency	3001H	0–Fmax (unit: 0.01Hz)	R
Bus voltage	3002H	0.0–2000.0 V (unit: 0.1V)	R
Output voltage	3003H	0–1200V (unit: 1V)	R
Output current	3004H	0.0–3000.0A (unit: 0.1A)	R
Rotating speed	3005H	0–65535 (unit: 1RPM)	R
Output power	3006H	-300.0–+300.0% (unit: 0.1%)	R
Output torque	3007H	-250.0–+250.0% (unit: 0.1%)	R
Closed-loop setting	3008H	-100.0–+100.0% (unit: 0.1%)	R
Closed-loop feedback	3009H	-100.0–+100.0% (unit: 0.1%)	R
Input state	300AH	000–3F Corresponding to the local HDIB/ HDIA/S4/S3/S2/S1	R
Output state	300BH	000–0F Corresponding to the local RO2/RO1/HDO/Y1	R
Analog input 1	300CH	0.00–10.00V (unit: 0.01V)	R
Analog input 2	300DH	0.00–10.00V (unit: 0.01V)	R
Analog input 3	300EH	-10.00–10.00V (unit: 0.01V)	R
Analog input 4	300FH		R
Read input of high-speed pulse 1	3010H	0.00–50.00kHz (unit: 0.01Hz)	R
Read input of high-speed pulse 2	3011H		R

Function	Address	Data description		R/W
Read current step of multi-step speed	3012H	0-15		R
External length	3013H	0-65535		R
External count value	3014H	0-65535		R
Torque setting	3015H	-300.0-+300.0% (unit: 0.1%)		R
Identification code	3016H			R
Fault code	5000H			R

The Read/Write (R/W) characteristics indicate whether a function can be read and written. For example, "Communication-based control command" can be written, and therefore the command code 6H is used to control the VFD. The R characteristic indicates that a function can only be read, and W indicates that a function can only be written.

Note: Some parameters in the preceding table are valid only after they are enabled. Take the running and stop operations as examples, you need to set "Channel of running commands" (P00.01) to "Communication", and set "Communication mode of running commands" (P00.02) to the Modbus/Modbus TCP communication channel. For another example, when modifying "PID setting", you need to set "PID reference source" (P09.00) to Modbus/Modbus TCP communication.

The following table describes the encoding rules of device codes (corresponding to the identification code 2103H of the VFD).

8 MSBs	Meaning	8 LSBs	Meaning
0x01	GD	0x08	GD35 vector VFD
		0x09	GD35-H1 vector VFD
		0x0a	GD300 vector VFD
		0xa0	GD350 vector VFD
		0xa1	GD350-UL vector VFD
		0xa2	GD350A vector VFD

9.4.6 Fieldbus scale

In practical applications, communication data is represented in the hexadecimal form, but hexadecimal values cannot represent decimals. For example, 50.12 Hz cannot be represented in the hexadecimal form. In such cases, we can multiply 50.12 by 100 to obtain an integer 5012, and then 50.12 can be represented as 1394H (5012 in the decimal form) in the hexadecimal form.

In the process of multiplying a non-integer by a multiple to obtain an integer, the multiple is referred to as a fieldbus scale.

The fieldbus scale depends on the number of decimals in the value specified in "Description" or "Default value". If there are n decimals in the value, the fieldbus scale m is the n^{th} -power of 10. Take the following table as an example, m is 10.

Function code	Name	Description	Default value
P01.20	Wake-up-from-sleep delay	0.0-3600.0s (valid when P01.19 is 2)	0.0s

Function code	Name	Description	Default value
P01.21	Restart after power outage	0: Restart is disabled 1: Restart is enabled	0

The value specified in "Description" or "Default value" contains one decimal, so the fieldbus scale is 10. If the value received by the upper computer is 50, the value of "Wake-up-from-sleep delay" of the VFD is 5.0 (5.0=50/10).

To set the "Wake-up-from-sleep delay" to 5.0s through Modbus/Modbus TCP communication, you need first to multiply 5.0 by 10 according to the scale to obtain an integer 50, that is, 32H in the hexadecimal form, and then transmit the following write command:

01 **06** **01 14** **00 32** **49 E7**
 VFD Write Parameter Parameter CRC
 address command address data

After receiving the command, the VFD converts 50 into 5.0 based on the fieldbus scale, and then sets "Wake-up-from-sleep delay" to 5.0s.

For another example, after the upper computer transmits the "Wake-up-from-sleep delay" parameter read command, the master receives the following response from the VFD:

01 **03** **02** **00 32** **39 91**
 VFD Read 2-byte Parameter CRC
 address command data data

The parameter data is 0032H, that is, 50, so 5.0 is obtained based on the fieldbus scale (50/10=5.0). In this case, the master identifies that the "Wake-up-from-sleep delay" is 5.0s.

9.4.7 Error message response

Operation errors may occur in communication-based control. For example, some parameters can only be read, but a write command is transmitted. In this case, the VFD returns an error message response.

Error message responses are transmitted by the VFD to the master. The following table describes the codes and definitions of the error message responses.

Code	Name	Definition
01H	Invalid command	The command code received by the upper computer is not allowed to be executed. The possible causes are as follows: • The function code is applicable only on new devices and is not implemented on this device. • The slave is in the faulty state when processing this request.
02H	Invalid data	For the VFD, the data address in the request of the upper

Code	Name	Definition
	address	computer is not allowed. In particular, the combination of the register address and the number of the to-be-transmitted bytes is invalid.
03H	Invalid data bit	The received data domain contains a value that is not allowed. The value indicates the error of the remaining structure in the combined request. Note: It does not mean that the data item submitted for storage in the register includes a value unexpected by the program.
04H	Operation failure	The parameter is set to an invalid value in the write operation. For example, a function input terminal cannot be set repeatedly.
05H	Password error	The password entered in the password verification address is different from that set in P07.00.
06H	Data frame error	The length of the data frame transmitted by the upper computer is incorrect, or in the RTU format, the value of the CRC check bit is inconsistent with the CRC value calculated by the lower computer
07H	Parameter read-only	The parameter to be modified in the write operation of the upper computer is a read-only parameter.
08H	Parameter cannot be modified in running	The parameter to be modified in the write operation of the upper computer cannot be modified during the running of the VFD.
09H	Password protection	A user password is set, and the upper computer does not provide the password to unlock the system when performing a read or write operation. The error of "system locked" is reported.

When returning a response, the device uses a function code domain and fault address to indicate whether it is a normal response (no error) or exception response (some errors occur). In a normal response, the device returns the corresponding function code and data address or sub-function code. In an exception response, the device returns a code that is equal to a normal code, but the first bit is logic 1.

For example, if the master device transmits a request message to a slave device for reading a group of function code address data, the code is generated as follows:

0 0 0 0 0 1 1 (03H in the hexadecimal form)

For a normal response, the same code is returned.

For an exception response, the following code is returned:

1 0 0 0 0 1 1 (83H in the hexadecimal form)

In addition to the modification of the code, the slave returns a byte of exception code that describes the cause of the exception. After receiving the exception response, the typical processing of the

master device is to transmit the request message again or modify the command based on the fault information.

For example, to set the "Channel of running commands" (P00.01, the parameter address is 0001H) of the VFD whose address is 01H to 03, the command is as follows:

<u>01</u>	<u>06</u>	<u>00 01</u>	<u>00 03</u>	<u>98 0B</u>
VFD address	Write command	Parameter address	Parameter data	CRC

But the setting range of the "Channel of running commands" is 0 to 2. The value 3 exceeds the setting range. In this case, the VFD returns an error message response as shown in the following:

<u>01</u>	<u>86</u>	<u>04</u>	<u>43 A3</u>
VFD address	Exception response code	Error code	CRC

The exception response code 86H (generated based on the MSB "1" of the write command 06H) indicates that it is an exception response to the write command (06H). The error code is 04H. From the preceding table, we can see that it indicates the error "Operation failure", which means "The parameter is set to an invalid value in the write operation".

9.4.8 Read/Write operation example

For the formats of the read and write commands, see sections 9.4.1 and 9.4.2.

9.4.8.1 Read command 03H examples

Example 1: Read state word 1 of the VFD whose address is 01H. According to the table of other Modbus function addresses in section 9.4.5 Data address definition, the parameter address of state word 1 of the VFD is 2100H.

The read command transmitted to the VFD is as follows:

<u>01</u>	<u>03</u>	<u>21 00</u>	<u>00 01</u>	<u>8E 36</u>
VFD address	Read command	Parameter address	Data quantity	CRC

Assume that the following response is returned:

<u>01</u>	<u>03</u>	<u>02</u>	<u>00 03</u>	<u>F8 45</u>
VFD address	Read command	Number of bytes	Data content	CRC

The data content returned by the VFD is 0003H, which indicates that the VFD is in the stopped state.

Example 2: View information about the VFD whose address is 03H, including "Type of current fault" (P07.27) to "Type of 5th-last fault" (P07.32) of which the parameter addresses are 071BH to 0720H (contiguous 6 parameter addresses starting from 071BH).

The command transmitted to the VFD is as follows:

03 **03** **07 1B** **00 06** **B5 59**
 VFD Read Start 6 parameters in total CRC
 address command address

Assume that the following response is returned:

03 **03** **0C** **00 23** **00 23** **00 23** **00 23** **00 23** **00 23** **00 23** **5F D2**
 VFD Read Number of Most recent Last fault 2nd-last fault 3rd-last fault 4th-last fault 5th-last fault CRC
 address command bytes fault type type type type type type

From the returned data, we can see that all the fault types are 0023H, that is, 35 in the decimal form, which means the maladjustment fault (STo).

9.4.8.2 Write command 06H examples

Example 1: Set the VFD whose address is 03H to be forward running. Refer to the table of other function parameters, the address of "Communication-based control command" is 2000H, and 0001H indicates forward running, as shown in the following table.

Function	Address	Data description	R/W
Communication-based control command	2000H	0001H: Forward running	R/W
		0002H: Reverse running	
		0003H: Forward jogging	
		0004H: Reverse jogging	
		0005H: Stop	
		0006H: Coast to stop	
		0007H: Fault reset	
		0008H: Jogging to stop	

The command transmitted by the master is as follows:

03 **06** **20 00** **00 01** **42 28**
 VFD Write Parameter Forward CRC
 address command address running

If the operation is successful, the following response is returned (same as the command transmitted by the master):

03 **06** **20 00** **00 01** **42 28**
 VFD Write Parameter Forward CRC
 address command address running

Example 2: Set the "Max. output frequency" of the VFD whose address is 03H to 100 Hz.

Function code	Name	Description	Default value	Modify
P00.03	Max. output frequency	Used to set the maximum output frequency of the VFD. It is the basis of frequency setting and the acceleration/deceleration.	50.00Hz	☉

Function code	Name	Description	Default value	Modify
		Setting range: Max (P00.04, 10.00) –630.00Hz		

From the number of decimals, we can see that the fieldbus scale of the "Max. output frequency" (P00.03) is 100. Multiply 100 Hz by 100. The value 10000 is obtained, and it is 2710H in the hexadecimal form.

The command transmitted by the master is as follows:

03
VFD address
06
Write command
00 03
Parameter address
27 10
Parameter data
62 14
CRC

If the operation is successful, the following response is returned (same as the command transmitted by the master):

03
VFD address
06
Write command
00 03
Parameter address
27 10
Parameter data
62 14
CRC

Note: In the preceding command description, spaces are added to a command just for explanatory purposes. In practical applications, no space is required in the commands.

9.4.8.3 Continuously write command 10H examples

Example 1: Set the VFD whose address is 01H to be forward running at the frequency of 10 Hz. Refer to the table of other function parameters, the address of "Communication-based control command" is 2000H, 0001H indicates forward running, and the address of "Communication-based value setting" is 2001H, as shown in the following figure. 10 Hz is 03E8H in the hexadecimal form.

Function	Address	Data description	R/W
Communication-based control command	2000H	0001H: Forward running	R/W
		0002H: Reverse running	
		0003H: Forward jogging	
		0004H: Reverse jogging	
		0005H: Stop	
		0006H: Coast to stop	
		0007H: Fault reset	
		0008H: Jogging to stop	
Communication-based value setting	2001H	Communication-based frequency setting (0–Fmax, unit: 0.01 Hz)	R/W
	2002H	PID setting, range (0–1000, 1000 corresponding to 100.0%)	

In the actual operation, set P00.01 to 2 and P00.06 to 8.

The command transmitted by the master is as follows:

01 **10** **20 00** **00 02** **04** **00 01** **03 E8** **3B 10**
 VFD Continuous Parameter Parameter Number of Forward 10 Hz CRC
 address write address quantity bytes running

If the operation is successful, the following response is returned:

01 **10** **20 00** **00 02** **4A 08**
 VFD Continuous Parameter Parameter CRC
 address write address quantity

Example 2: Set "Acceleration time" of the VFD whose address is 01H to 10s, and "Deceleration time" to 20s.

Function code	Name	Description	Default value	Modify
P00.11	Acceleration time 1	Acceleration time is the time needed for accelerating from 0Hz to Max. output frequency (P00.03).	Depends on model	<input type="radio"/>
P00.12	Deceleration time 1	Deceleration time is the time needed from decelerating from Max. output frequency (P00.03) to 0Hz. Goodrive350 series VFD defines four groups of acceleration and deceleration time, which can be selected via multi-function digital input terminals (P05 group). The acceleration/deceleration time of the VFD is the first group by default. Setting range of P00.11 and P00.12: 0.0–3600.0s	Depends on model	<input type="radio"/>

The address of P00.11 is 000B, 10s is 0064H in the hexadecimal form, and 20s is 00C8H in the hexadecimal form.

The command transmitted by the master is as follows:

01 **10** **00 0B** **00 02** **04** **00 64** **00 C8** **F2 55**
 VFD Continuous Parameter Parameter Number of 10s 20s CRC
 address write address quantity bytes

If the operation is successful, the following response is returned:

01 **10** **00 0B** **00 02** **30 0A**
 VFD Continuous Parameter Parameter CRC
 address write address quantity

Note: In the preceding command description, spaces are added to a command just for explanatory purposes. In practical applications, no space is required in the commands.

9.4.8.4 Modbus communication commissioning example

A PC is used as the host, an RS232-RS485 converter is used for signal conversion, and the PC serial port used by the converter is COM1 (an RS232 port). The upper computer commissioning software is the serial port commissioning assistant Commix, which can be downloaded from the Internet. Download a version that can automatically execute the CRC check function. The following figure shows the interface of Commix.



First, set the serial port to **COM1**. Then, set the baud rate consistently with P14.01. The data bits, check bits, and end bits must be set consistently with P14.02. If the RTU mode is selected, you need to select the hexadecimal form **Input HEX**. To set the software to automatically execute the CRC function, you need to select **ModbusRTU**, select **CRC16 (MODBU SRTU)**, and set the start byte to 1. After the auto CRC check function is enabled, do not enter CRC information in commands. Otherwise, command errors may occur due to repeated CRC check.

The commissioning command to set the VFD whose address is 03H to be forward running is as follows:

<u>03</u>	<u>06</u>	<u>20 00</u>	<u>00 01</u>	<u>42 28</u>
VFD address	Write command	Parameter address	Forward running	CRC

Note:

1. Set the address (P14.00) of the VFD to 03.
2. Set "Channel of running commands" (P00.01) to "Communication", and set "Communication channel of running commands" (P00.02) to the Modbus/Modbus TCP communication channel.
3. Click **Send**. If the line configuration and settings are correct, a response transmitted by the VFD is received as follows:

<u>03</u>	<u>06</u>	<u>20 00</u>	<u>00 01</u>	<u>42 28</u>
VFD address	Write command	Parameter address	Forward running	CRC

9.5 Common communication faults

Common communication faults include the following:

- No response is returned.
- The VFD returns an exception response.

Possible causes of no response include the following:

- The serial port is set incorrectly. For example, the converter uses the serial port COM1, but COM2 is selected for the communication.
- The settings of the baud rates, data bits, end bits, and check bits are inconsistent with those set on the VFD.
- The positive pole (+) and negative pole (-) of the RS485 bus are connected reversely.
- The resistor connected to 485 terminals on the terminal block of the VFD is set incorrectly.

Appendix A Expansion cards

A.1 Model definition

EC-PG 5 01-05 B

① ② ③ ④ ⑤ ⑥

Field	Field description	Naming example
①	Product category	EC: Expansion card
②	Card category	IC: IoT card IO: IO card PC: Programmable card PG: PG card PS: Power supply card TX: Communication card
③	Technical version	Indicates the generation of technical version by using an odd number. For example, 1, 3, 5, and 7 indicate the 1st, 2nd, 3rd and 4th generations of technical version.
④	Distinguishing code	01: Incremental PG card + frequency-divided output
		02: Sine/Cosine PG card + pulse direction setting + frequency-divided output
		03: UVW PG interface + pulse direction setting + frequency-divided output
		04: Resolver PG interface + pulse direction setting + frequency-divided output
		05: Incremental PG card + pulse direction setting + frequency-divided output
		06: Absolute PG interface + pulse direction setting + frequency-divided output
		07: Simple incremental PG card
⑤	Working power	00: Passive
		05: 5V
		12: 12–15 V
		24: 24 V
⑥	Expansion card version	Empty: Version A B: Version B C: Version C

EC-PC 5 02-00

① ② ③ ④ ⑤

Field	Field description	Naming example
①	Product category	EC: Expansion card
②	Card category	IC: IoT card IO: IO card PC: Programmable card PG: PG card PS: Power supply card TX: Communication card
③	Technical version	Indicates the generation of technical version by using an odd number. For example, 1, 3, 5, and 7 indicate the 1st, 2nd, 3rd and 4th generations of technical version.
④	Distinguishing code	01: 10 points, with 6 inputs and 4 outputs (2 transistor outputs + 2 relay outputs) 02: 8 points of IO, 1 point of AI, 1 point of AO, and 1 point of RS485 communication 03: Reserved
⑤	Special requirement	Reserved. The default value is 00.

EC-TX 5 01 B

① ② ③ ④ ⑤

Field	Field description	Naming example
①	Product category	EC: Expansion card
②	Card category	IC: IoT card IO: IO card PC: Programmable card PG: PG card PS: Power supply card TX: Communication card
③	Technical version	Indicates the generation of technical version by using an odd number. For example, 1, 3, 5, and 7 indicate the 1st, 2nd, 3rd and 4th generations of technical version.
④	Distinguishing code	01: Bluetooth communication card

Field	Field description	Naming example
		02: WIFI communication card
		03: PROFIBUS communication card
		04: Ethernet communication card
		05: CANopen communication card
		06: DeviceNet communication card
		07: BACnet communication card
		08: EtherCAT communication card
		09: PROFINET communication card
		10: EtherNet/IP communication card
		11: CAN master/slave control communication card
		15: Modbus TCP communication card
⑤	Expansion card version	Empty: Version A B: Version B C: Version C

EC-IO 5 01-00

- ① ② ③ ④ ⑤

Field	Field description	Naming example
①	Product category	EC: Expansion card
②	Card category	IC: IoT card IO: IO card PC: Programmable card PG: PG card PS: Power supply card TX: Communication card
③	Technical version	Indicates the generation of technical version by using an odd number. For example, 1, 3, 5, and 7 indicate the 1st, 2nd, 3rd and 4th generations of technical version.
④	Distinguishing code	01: Multiple-function I/O expansion card (4 digital inputs, 1 digital output, 1 analog input, 1 analog output, and 2 relay outputs)
		02: Digital I/O card
		03: Analog I/O card
		04: Reserved
		05: Reserved

Field	Field description	Naming example
⑤	Special requirement	

EC - IC 5 01 - 2 1 G
 ① ② ③ ④ ⑤ ⑥ ⑦

Field	Field description	Naming example
①	Product category	EC: Expansion card
②	Card category	IC: IoT card IO: IO card PC: Programmable card PG: PG card PS: Power supply card TX: Communication card
③	Technical version	Indicates the generation of technical version by using an odd number. For example, 1, 3, 5, and 7 indicate the 1st, 2nd, 3rd and 4th generations of technical version.
④	Distinguishing code	01: GPRS card 02: 4G card 03: Reserved
⑤	Antenna type	1: Internal 2: External
⑥	SIM card type	0: Plug-in (standard) 1: Surface mounted
⑦	Special requirement	G: With GPS S: Surface mounted SIM card This field is blank for a standard model since it does not have special functions.

The following table describes expansion cards that the VFD supports. The expansion cards are optional and need to be purchased separately.

Name	Model	Specification
IO expansion card	EC-IO501-00	<ul style="list-style-type: none"> ✧ 4 digital inputs ✧ 1 digital output ✧ 1 analog input ✧ 1 analog output ✧ 2 relay outputs: 1 double-contact output, and 1 single-contact output
IO expansion card 2	EC-IO502-00	<ul style="list-style-type: none"> ✧ 4 digital inputs ✧ 1 PT100

Name	Model	Specification
		<ul style="list-style-type: none"> ◇ 1 PT1000 ◇ 2 relay outputs: single-contact output
Programmable expansion card	EC-PC502-00	<ul style="list-style-type: none"> ◇ Adopting the global mainstream development environment PLC, supporting multiple types of programming languages, such as the instruction language, structural text, function block diagram, ladder diagram, continuous function chart, and sequential function chart ◇ Supporting breakpoint commissioning and periodic task run mode selection ◇ Providing user program storage space of 16K steps, and data storage space of 8K words ◇ 6 digital inputs ◇ 2 relay outputs ◇ 1 AI and 1 AO ◇ 1 RS485 communication channel, supporting the host controller to switch the master/slave ◇ Saving data of 1K words at power down
Bluetooth communication card	EC-TX501-1 EC-TX501-2	<ul style="list-style-type: none"> ◇ Supporting Bluetooth 4.0 ◇ With INVT's mobile phone APP, you can set the parameters and monitor the states of the VFD through Bluetooth ◇ The maximum communication distance in open environments is 30 m. ◇ EC-TX501-1 is equipped with a built-in antenna and applicable to molded case machines. ◇ EC-TX501-2 is configured with an external sucker antenna and applicable to sheet metal machines.
WIFI communication card	EC-TX501-1 EC-TX502-2	<ul style="list-style-type: none"> ◇ Meeting IEEE802.11b/g/n ◇ With INVT's mobile phone APP, you can monitor the VFD locally or remotely through WIFI communication ◇ The maximum communication distance in open environments is 30 m. ◇ EC-TX501-1 is equipped with a built-in antenna and applicable to molded case machines. ◇ EC-TX501-2 is configured with an external sucker antenna and applicable to sheetmetal machines.
PROFIBUS-DP communication card	EC-TX503	<ul style="list-style-type: none"> ◇ Supporting the PROFIBUS-DP protocol
Ethernet	EC-TX504	<ul style="list-style-type: none"> ◇ Supporting Ethernet communication with INVT's

Name	Model	Specification
communication card		internal protocol ✧ Can be used in combination with INVT's upper computer monitoring software INVT Workshop
CANopen communication card	EC-TX505	✧ Based on the CAN2.0A physical layer ✧ Supporting the CANopen protocol
PROFINET communication card	EC-TX509	✧ Supporting the PROFINET protocol
Ethernet/IP communication card	EC-TX510	✧ Supporting the Ethernet IP protocol and ODVA protocol ✧ With two Ethernet IP ports, supporting 10/100M half/full duplex operating ✧ Supporting star, line, and ring network topologies (but not supporting ring network monitoring)
CAN master/slave control communication card	EC-TX511	✧ Based on the CAN2.0B physical layer ✧ Adopting INVT's master-slave control proprietary protocol
Modbus TCP communication card	EC-TX515	✧ With two Modbus TCP IO ports, supporting 100M full duplex operating, and supporting line and star network topologies, with the nodes up to 32 ✧ Able to function as a Modbus TCP slave
Sin/Cos PG card	EC-PG502	✧ Applicable to Sin/Cos encoders with or without CD signals ✧ Supporting A, B, Z frequency-divided output ✧ Supporting input of pulse train reference
UVW incremental PG card	EC-PG503-05	✧ Applicable to 5V differential encoders ✧ Supporting A, B, Z orthogonal input ✧ Supporting U, V, W 3PH pulse input ✧ Supporting A, B, Z frequency-divided output ✧ Supporting input of pulse train reference
Resolver PG card	EC-PG504-00	✧ Applicable to resolver encoders ✧ Supporting simulated A, B, Z frequency-divided output of resolvers ✧ Supporting input of pulse train reference
Multi-function incremental PG card	EC-PG505-12	✧ Applicable to OC encoders of 5 V or 12 V ✧ Applicable to push-pull encoders of 5 V or 12 V ✧ Applicable to differential encoders of 5 V ✧ Supporting the orthogonal input of A, B, and Z ✧ Supporting the frequency-divided output of A, B, and Z ✧ Supporting pulse train setting

Name	Model	Specification
24V incremental PG card	EC-PG505-24	<ul style="list-style-type: none"> ✧ Applicable to 24V OC encoders ✧ Applicable to 24 V push-pull encoders ✧ Applicable to 5 V differential encoders ✧ Supporting A, B, Z orthogonal input ✧ Supporting A, B, Z frequency-divided output ✧ Supporting pulse train reference input
Simple incremental PG card	EC-PG507-12	<ul style="list-style-type: none"> ✧ Applicable to 5 V or 12 V OC encoders ✧ Applicable to 5 V or 12 V push-pull encoders ✧ Applicable to 5 V differential encoders
24V simplified incremental PG card	EC-PG507-24	<ul style="list-style-type: none"> ✧ Applicable to 24 V OC encoders ✧ Applicable to 24 V push-pull encoders ✧ Applicable to 24 V differential encoders
GPRS card	EC-IC501-2	<ul style="list-style-type: none"> ✧ Supporting IoT monitoring ✧ Supporting remote VFD upgrade

Remarks: Contact us for details about the EtherCAT communication card, 24V power supply card, and the shockproof GPRS card with high-precision GPS positioning.



IO expansion card
EC-IO501-00



IO expansion card 2
EC-IO502-00



Programmable
expansion card
EC-PC502-00



Bluetooth/WIFI
communication card
EC-TX501/502



PROFIBUS-DP
communication card
EC-TX503



Ethernet
communication card
EC-TX504



CANopen/CAN
master/slave control
communication card
EC-TX505/511



PROFINET
communication card
EC-TX509



Ethernet/IP
communication card
EC-TX510/
EC-TX515



Sin/Cos PG card
EC-PG502



UVW incremental
PG card
EC-PG503-05



Resolver PG card
EC-PG504-00



Multifunction
incremental PG card
EC-PG505-12



24V incremental PG
card
EC-PG505-24



Simplified
incremental PG card
EC-PG507-12



24V simplified
incremental PG card
EC-PG507-24



GPRS card
EC-IC501-2

A.2 Dimensions and installation

All expansion cards are of the same dimensions (108 mm × 39 mm) and can be installed in the same way.

Comply with the following operation principles when installing or removing an expansion card:

1. Ensure that no power is applied before installing an expansion card.
2. An expansion card can be inserted into a respective card slot among SLOT1, SLOT2, and SLOT3.
3. VFDs of 5.5 kW or lower can be configured with two expansion cards at the same time, and those of 7.5 kW or higher can be configured with three expansion cards.
4. If interference occurs on the external wires after expansion cards are installed, change their installation card slots flexibly to facilitate the wiring. For example, the connector of the connection cable of the DP card is large, so it is recommended to be installed in the SLOT1 card slot.
5. To ensure high anti-interference capability in closed-loop control, you need to use a shielding wire in the encoder cable and ground the two ends of the shielding wire, that is, connect the shielding layer to the housing of the motor on the motor side, and connect the shielding layer to the PE terminal on the PG card side.

Note: For 2.2–5.5kW models, the 24V power supply card can be inserted into SLOT1; for 7.5kW and higher models, the 24V power supply card can be inserted into SLOT1 or SLOT3; for 11kW and higher models, the 24V power supply card can be inserted into any of the three slots.

Figure A-1 shows the installation diagram and a VFD with expansion cards installed.

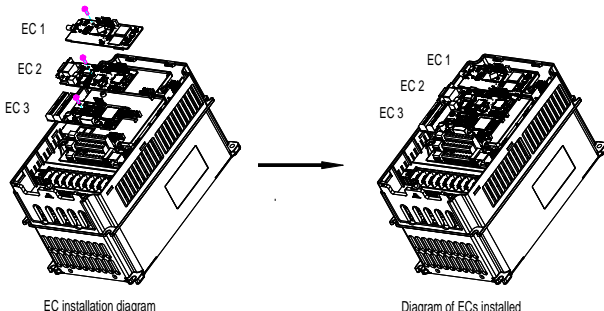

Figure A-1 VFD of 7.5 kW or higher with expansion cards installed

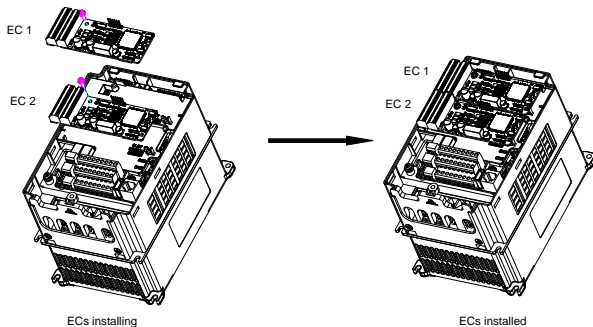

Figure A-2 VFD of 5.5 kW or lower with expansion cards installed

Expansion card installation process:

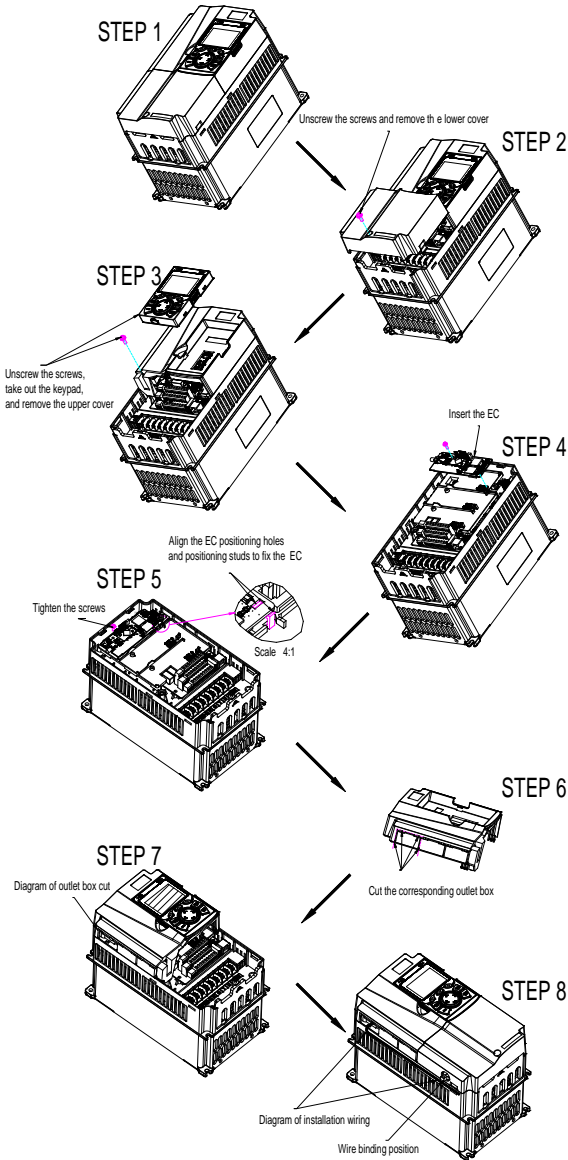

Figure A-3 Expansion card installation process diagram

A.3 Wiring

1. Ground a shielded cable as follows:

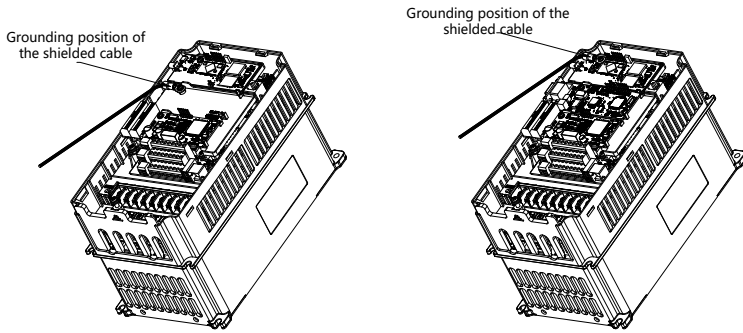

Figure A-4 Expansion card grounding diagram

2. Wire an expansion card as follows:

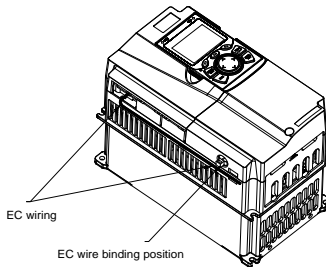
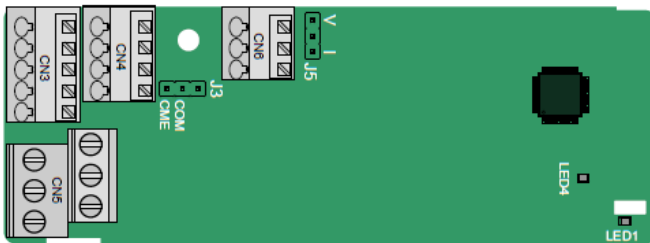

Figure A-5 Expansion card wiring

A.4 IO expansion cards

A.4.1 IO expansion card 1 (EC-IO501-00)



CME and COM are shorted through J3 before delivery, and J5 is the jumper for selecting the output type (voltage or current) of AO2.

The terminals are arranged as follows:

AI3	AO2	GND
-----	-----	-----

COM	CME	Y2	S5	
PW	+24V	S6	S7	S8

RO3A	RO3B	RO3C	
	RO4A		RO4C

Indicator definition

Indicator	Name	Description
LED1	State indicator	On: The expansion card is establishing a connection with the control board. Blinking periodically: The expansion card is properly connected to the control board (the period is 1s, on for 0.5s, and off for the other 0.5s). Off: The expansion card is disconnected from the control board.
LED4	Power indicator	On: The control board feeds power to the expansion card.

The EC-IO501-00 expansion card can be used in scenarios where the I/O interfaces of a Goodrive350-UL VFD cannot meet the application requirements. It can provide 4 digital inputs, 1 digital output, 1 analog input, 1 analog output, and two relay outputs. It is user-friendly, providing relay outputs through European-style screw terminals and other inputs and outputs through spring terminals.

EC-IO501-00 terminal function description

Category	Symbol	Name	Description
Power	PW	External power supply	The working power of digital input is provided by an external power supply. Voltage range: 12–30 V The terminals PW and +24V are shorted before delivery.
Analog input/output	AI3—GND	Analog input 1	1. Input range: 0–10 V, 0–20 mA 2. Input impedance: 20 kΩ for voltage input; 250 Ω for current input 3. Set it to be voltage or current input through the corresponding function code. 4. Resolution: When 10 V corresponds to 50 Hz, the minimum resolution is 5 mV. 5. Deviation: ±0.5%; input of 5 V or 10 mA or higher at the temperature of 25°C
	AO2—GND	Analog output 1	1. Output range: 0–10 V, 0–20 mA 2. Whether it is voltage or current output is determined by J5.

Category	Symbol	Name	Description
			3. Deviation $\pm 0.5\%$; output of 5 V or 10 mA or higher at the temperature of 25°C
Digital input/output	S5—COM	Digital input 1	1. Internal impedance: 3.3 k Ω 2. Power input range: 12–30 V 3. Bidirectional input terminal 4. Max. input frequency: 1 kHz
	S6—COM	Digital input 2	
	S7—COM	Digital input 3	
	S8—COM	Digital input 4	
	Y2—CME	Digital output	1. Switch capacity: 50 mA/30 V 2. Output frequency range: 0–1 kHz 3. The terminals CME and COM are shorted through J3 before delivery.
Relay output	RO3A	NO contact of relay 3	1. Contact capacity: 3A/AC 250 V, 1A/DC 30 V 2. Do not use them as high-frequency digital outputs.
	RO3B	NC contact of relay 3	
	RO3C	Common contact of relay 3	
	RO4A	NO contact of relay 4	
	RO4C	Common contact of relay 4	

A.4.2 IO expansion card 2 (EC-IO502-00)

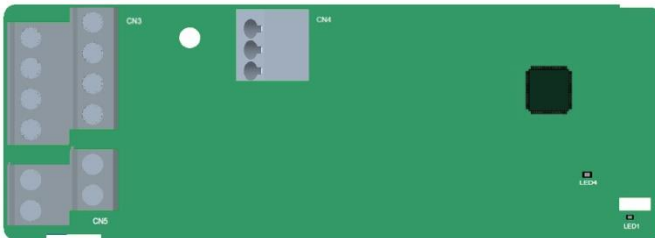

The terminals are arranged as follows.

PT1+	PT-	PT2+
------	-----	------

S5	S6	S7	S8
+24V	PW	COM	COM

RO4A	RO4C
RO3A	RO3C

Indicator definition

Indicator	Definition	Function
LED1	State indicator	This indicator is on when the expansion card is establishing a connection with the control board; it

Indicator	Definition	Function
		blinks periodically after the expansion card is properly connected to the control board (the period is 1s, on for 0.5s, and off for the other 0.5s); and it is off when the expansion card is disconnected from the control board.
LED4	Power indicator	This indicator is on after the IO expansion card is powered on by the control board.

The EC-IO502-00 expansion card can be used in scenarios where the IO interfaces of the VFD cannot meet the application requirements. It can provide four digital inputs, one PT100 temperature measurement input (PT1+), one PT1000 temperature measurement input (PT2+), and two relay outputs. It is user-friendly, providing relay outputs and digital inputs through European-style screw terminals and temperature measurement inputs through spring terminals.

EC-IO502-00 terminal function description

Category	Symbol	Name	Function
Power	PW	External power supply	The working power of digital input is provided by an external power supply. Voltage range: 24(-20%)–48VDC(+10%), 24(-10%)–48VAC(+10%)
	+24V	Internal power	User power provided by the VFD. Max. output current: 200mA
	COM	Power reference	Common terminal of +24V
Digital input	S5—COM	Digital input 5	Internal impedance: 6.6kΩ Supported external power: 24(-20%)–48VDC(+10%), 24(-10%)–48VAC(+10%) Supporting internal power 24V Bi-directional input terminals, supporting NPN/PNP modes Max. input frequency: 1kHz All are programmable digital input terminals. You can set the terminal function via function codes.
	S6—COM	Digital input 6	
	S7—COM	Digital input 7	
	S8—COM	Digital input 8	
Temperature detection input	PT1+	PT100 input	Independent PT100 and PT1000 inputs. PT1+ connects to PT100, and PT2+ connects to PT1000. 1. Resolution: 1°C 2. Range: -20°C–150°C 3. Detection accuracy: 3°C 4. Supporting offline protection
	PT2+	PT1000 input	
	PT-	Reference input of PT100/PT1000	Zero potential reference of PT100/PT1000

Category	Symbol	Name	Function
Relay output	RO3A	Contact A of NO relay 3	RO3 relay output. RO3A: NO; RO3C: common terminal Contact capacity: 3A/AC250V, 1A/DC30V
	RO3C	Contact C of NO relay 3	
	RO4A	Contact A of NO relay 4	RO4 relay output. RO4A: NO; RO4C: common terminal Contact capacity: 3A/AC250V, 1A/DC30V
	RO4C	Contact C of NO relay 4	

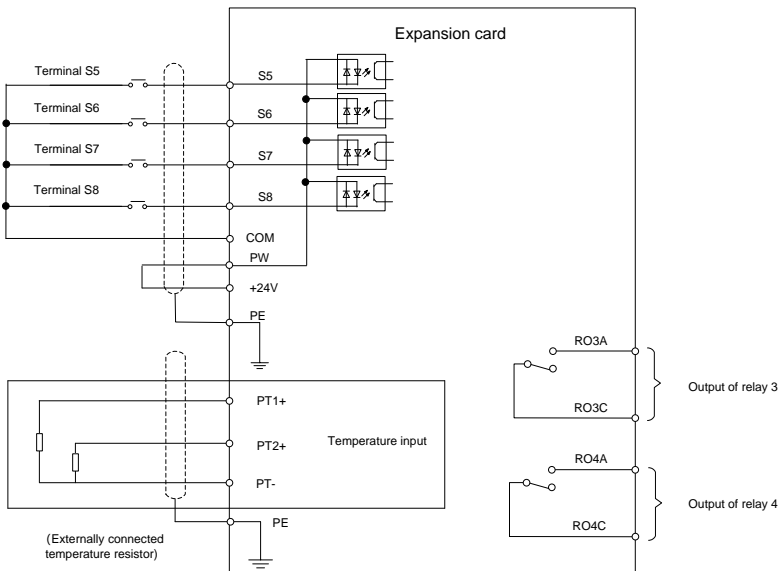
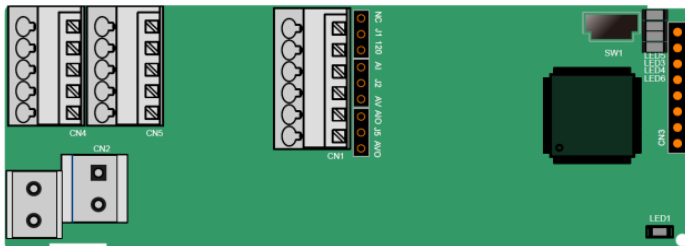

Figure A-6 Control circuit wiring of IO expansion card 2

A.5 Programmable expansion card (EC-PC502-00)



SW1 is the start/stop switch of the programmable expansion card. CN1 contains terminals PE, 485-

485+, GND, AI1, and AO1, and a selection jumper resides on the next. "AI" and "AV" are the current type input selection and voltage type input selection of AI1, and they can be selected through J2. "AIO" and "AVO" are the current type output selection and voltage type output selection of AO1, and they can be selected through J5. "120" indicates 120Ω terminal resistor, and it can connect to J1. By default, J1 connects to NC, J2 to AV, and J5 to AVO.

The terminals are arranged as follows.

PE	485-	485+	GND	AI1	AO1
----	------	------	-----	-----	-----

COM	COM	PS1	PS2	PS3
PW	24V	PS4	PS5	PS6

PRO1A	PRO1C
PRO2A	PRO2C

Indicator definition

Indicator	Name	Description
LED1	PWR power indicator (green)	The indicator is on when the expansion card is powered on.
LED3	COMM communication indicator (green)	This indicator is on when the expansion card is establishing a connection with the control board; it blinks periodically after the expansion card is properly connected to the control board (the period is 1s, on for 0.5s, and off for the other 0.5s); and it is off when the expansion card is disconnected from the control board.
LED4	ERR fault indicator (red)	Blinks: an error occurs (the period is 1s, on for 0.5s, and off for the other 0.5s), and the error type can be queried through the upper computer Auto Station; Off: no fault.
LED5	PWR power indicator (green)	The indicator is on when the expansion card is powered on.
LED6	RUN status indicator (green)	On: PLC program is running Off: PLC program stops

The EC-PC502-00 programmable expansion card can replace some micro PLC applications. It adopts the global mainstream development environment PLC, supporting the instruction language (IL), ladder diagram (LD), and sequential function chart (SFC). It provides a user program storage space of 16K steps and data storage space of 8K words, and supports saving data of 1K words at power failure, which facilitate customers' secondary development and meets the customization requirements.

The EC-PC502-00 programmable expansion card provides six digital inputs, 2 relay outputs, 1 analog input, 1 analog output, 1 RS485 communication channel (supports master/slave switchover). It is user-friendly, providing relay outputs through European-style screw terminals and other inputs and outputs through spring terminals.

EC-PC502-00 terminal function description

Category	Symbol	Name	Function
Power supply	PW	External power supply	To provide input digital working power from external to internal. Voltage range: 12–24V PW and +24V are short connected by default.
	24V	Internal power supply	Internal output power supply, 100mA
Common terminal/ground	COM	Common terminal of +24V	Common terminal of +24V. If PS1 is connected, COM indicates PS1 is connected.
	GND	Analog ground	Reference zero potential of +10V
	PE	Protective earthing terminal	Protective earthing terminal
Digital input	PS1—COM	Digital input 1	<ol style="list-style-type: none"> 1. Internal impedance: 4kΩ 2. Accept 12–30V voltage input 3. Bi-directional input terminal 4. Max. input frequency: 1kHz 5. Both source and sink inputs are allowed, but the input types must be the same
	PS2—COM	Digital input 2	
	PS3—COM	Digital input 3	
	PS4—COM	Digital input 4	
	PS5—COM	Digital input 5	
	PS6—COM	Digital input 6	
Analog input and output	AI1	Analog input 1	<ol style="list-style-type: none"> 1. Input range: AI1 voltage and current range: 0–10V, 0–20mA 2. Input impedance: 20kΩ during voltage input; 250Ω during current input 3. Voltage or current input is set through the jumper. 4. Resolution ratio: When 10V corresponds to 50Hz, the min. resolution ratio is 5mV 5. Deviation: $\pm 1\%$ when the input reaches full the measurement range at 25$^{\circ}$C
	AO1	Analog output 1	<ol style="list-style-type: none"> 1. Output range: 0–10V voltage or 0–20mA current 2. Voltage or current output is set through the jumper. 3. Deviation: $\pm 1\%$ when the input reaches full the measurement range at 25$^{\circ}$C.
Relay output	PRO1A	NO contact of relay 1	<ol style="list-style-type: none"> 1. Contact capacity: 2A/AC250V, 1A/DC30V 2. Unable to function as high frequency switch output
	PRO1C	Common contact of relay 1	
	PRO2A	NO contact of relay 2	

Category	Symbol	Name	Function
	PRO2C	Common contact of relay 2	
Communication	485+	RS485 communication terminal	RS485 communication port, which can be set as the master or slave through the Auto Station. It is differential signal output. Whether to connect the 120Ω resistor of RS485 is set through the jumper.
	485-		

For details about how to use the programmable card, see the Goodrive350 series AutoStation programmable card manual.

A.6 Communication cards

A.6.1 Bluetooth communication card (EC-TX501) and WIFI communication card (EC-TX502)

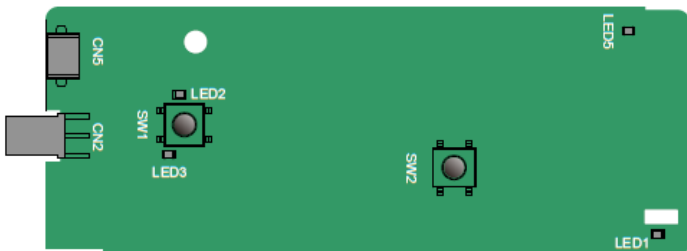

Definitions of indicators and function buttons

Indicator	Name	Description
LED1/LED3	Bluetooth/WIFI state indicator	On: The expansion card is establishing a connection with the control board. Blinking periodically: The expansion card is properly connected to the control board (the period is 1s, on for 0.5s, and off for the other 0.5s). Off: The expansion card is disconnected from the control board.
LED2	Bluetooth communication state indicator	On: Bluetooth communication is online and data exchange can be performed. Off: Bluetooth communication is not in the online state.
LED5	Power indicator	On: The control board feeds power to the Bluetooth card.
SW1	WIFI factory reset button	It is used to restore the expansion card to default values and return to the local monitoring mode.
SW2	WIFI hardware reset button	It is used to restart the expansion card.

The wireless communication card is especially useful for scenarios where you cannot directly use the keypad to operate the VFD due to the restriction of the installation space. With a mobile phone APP, you can operate the VFD in a maximum distance of 30 m. You can choose a PCB antenna or an

external sucker antenna. If the VFD is located in an open space and is a molded case machine, you can use a built-in PCB antenna; and if it is a sheetmetal machine and located in a metal cabinet, you need to use an external sucker antenna.

When installing a sucker antenna, install a wireless communication card on the VFD first, and then lead the SMA connector of the sucker antenna into the VFD and screw it to CN2, as shown in the following figure. Place the antenna base on the chassis and expose the upper part. Try to keep it unblocked.

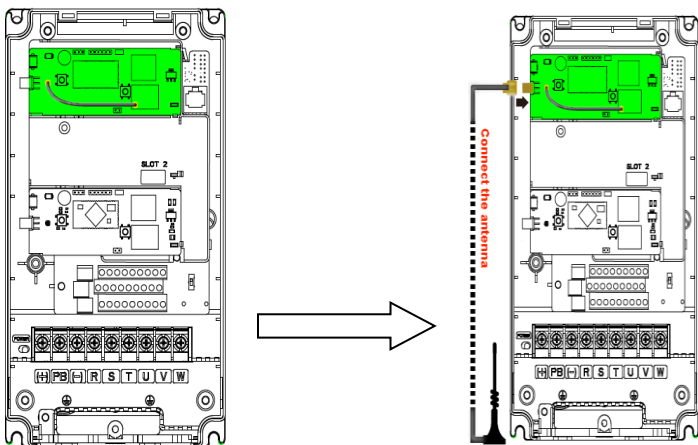

The wireless communication card must be used with the INVT VFD APP. Scan the QR code of the VFD nameplate to download it. For details, refer to the wireless communication card manual provided with the expansion card. The main interface is shown as follows.

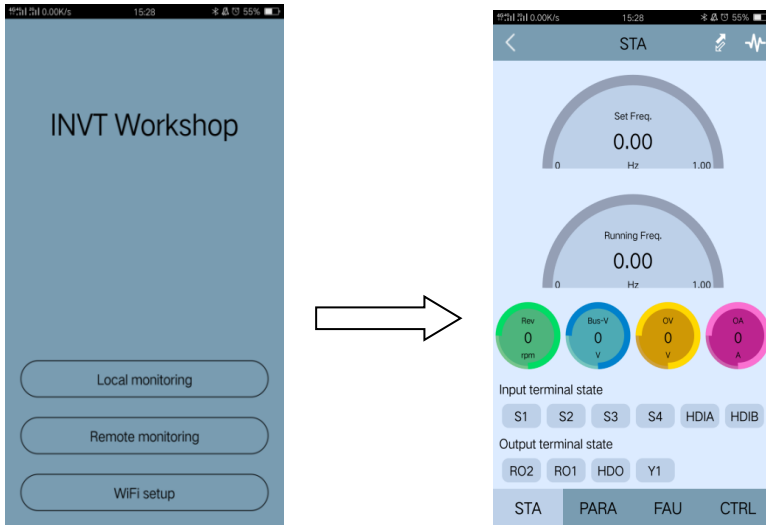

A.6.2 PROFIBUS-DP communication card (EC-TX503)

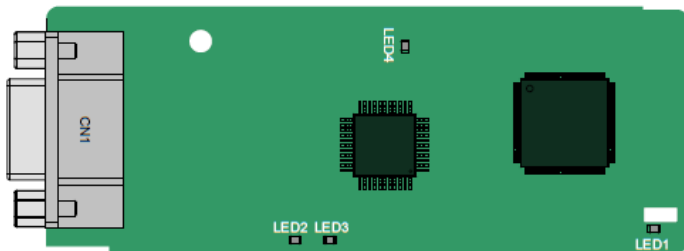

CN1 is a 9-pin D-type connector, as shown in the following figure.

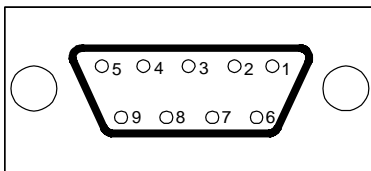

Connector pin		Description
1	-	Unused
2	-	Unused
3	B-Line	Data+ (twisted pair 1)
4	RTS	Request transmission
5	GND_BUS	Isolation ground
6	+5V BUS	Isolated power supply of 5 V DC
7	-	Unused
8	A-Line	Data- (twisted pair 2)
9	-	Unused
Housing	SHLD	PROFIBUS cable shielding line

+5V and GND_BUS are bus terminators. Some devices, such as the optical transceiver (RS485), may need to obtain power through these pins.

On some devices, the transmission and receiving directions are determined by RTS. In normal applications, only A-Line, B-Line, and the shield layer need to be used.

Indicator definition

Indicator	Name	Description
LED1	State indicator	<p>On: The expansion card is establishing a connection with the control board.</p> <p>Blinking periodically: The expansion card is properly connected to the control board (the period is 1s, on for 0.5s, and off for the other 0.5s).</p> <p>Off: The expansion card is disconnected from the control</p>

Indicator	Name	Description
		board.
LED2	Online indicator	On: The communication card is online and data exchange can be performed. Off: The communication card is not in the online state.
LED3	Offline/Fault indicator	On: The communication card is offline and data exchange cannot be performed. Blinks: The communication card is not in the offline state. Blinks at the frequency of 1 Hz: A configuration error occurs: The length of the user parameter data set during the initialization of the communication card is different from that during the network configuration. Blinks at the frequency of 2 Hz: User parameter data is incorrect. The length or content of the user parameter data set during the initialization of the communication card is different from that during the network configuration. Blinks at the frequency of 4 Hz: An error occurs in the ASIC initialization of PROFIBUS communication. Off: The diagnosis function is disabled.
LED4	Power indicator	On: The control board feeds power to the communication card.

For details about the operation, see the *Goodrive350 Series VFD Communication Expansion Card Operation Manual*.

A.6.3 Ethernet communication card (EC-TX504)

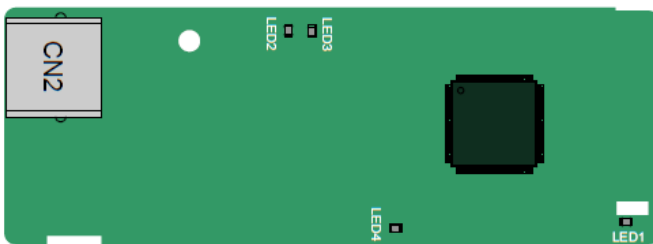

The EC-TX504 communication card adopts standard RJ45 terminals. It is used only on the upper computer that supports INVT Workshop. If you want to support the standard EtherNet/IP protocol, select the card EC-TX510.

Indicator definition

Indicator	Definition	Function
LED1	State indicator	On: The expansion card is establishing a connection with the control board. Blinking periodically: The expansion card is

Indicator	Definition	Function
		properly connected to the control board (the period is 1s, on for 0.5s, and off for the other 0.5s). Off: The expansion card is disconnected from the control board.
LED2	Network connection status indicator	On: The physical connection to the upper computer is normal. Off: The upper computer is disconnected.
LED3	Network communication status indicator	On: There is data exchange with the upper computer. Off: There is no data exchange with the upper computer.
LED4	Power indicator	On: The control board feeds power to the communication card.

A.6.4 CANopen communication card (EC-TX505) and CAN master/slave control communication card (EC-TX511)

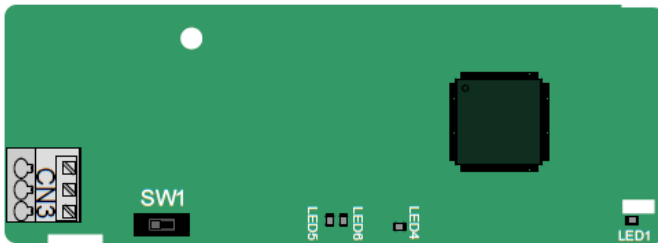

The EC-TX505/511 communication card is user-friendly, adopting spring terminals.

3-pin spring terminal	Pin	Function	Description
	1	CANH	CANopen bus high level signal
	2	CANG	CANopen bus shielding
	3	CANL	CANopen bus low level signal

Terminal resistor switch function description

Terminal resistor switch	Position	Function	Description
	Left	OFF	CAN_H and CAN_L are not connected to a terminal resistor.
	Right	ON	CAN_H and CAN_L are connected to a terminal resistor of 120 Ω.

Indicator definition

Indicator	Definition	Function
LED1	State indicator	On: The communication card is establishing a connection with the control board. Blinking periodically: The communication card is properly connected to the control board (the period is 1s, on for 0.5s, and off for the other 0.5s). Off: The communication card is disconnected from the control board.
LED4	Power indicator	On: The control board feeds power to the communication card.
LED5	Running indicator	On: The communication card is running. Off: A fault occurs. Check whether the reset pin of the communication card and the power supply are properly connected. Blinks: The communication card is in the pre-operation state. Blinks once: The communication card is in the stopped state.
LED6	Error indicator	On: The CAN controller bus is off or a fault occurs on the VFD. Off: The communication card is in the working state. Blinks: The address setting is incorrect. Blinks once: A received frame is missed or an error occurs during frame receiving.

For details about the operation, see the *Goodrive350 Series VFD Communication Expansion Card Operation Manual*.

A.6.5 PROFINET communication card (EC-TX509)

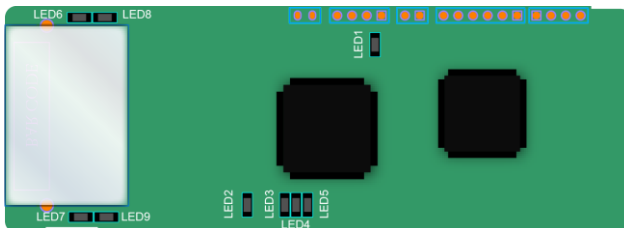

The terminal CN2 adopts a standard RJ45 interface, where CN2 is the dual RJ45 interface, and these two RJ45 interfaces are not distinguished from each other and can be interchangeably inserted. They are arranged as follows:

Pin	Name	Description
1	TX+	Transmit Data+
2	TX-	Transmit Data-

Pin	Name	Description
3	RX+	Receive Data+
4	n/c	Not connected
5	n/c	Not connected
6	RX-	Receive Data-
7	n/c	Not connected
8	n/c	Not connected

Definition of the state indicator

The PROFINET communication card has 9 indicators, of which LED1 is the power indicator, LEDs 2–5 are the communication state indicators of the communication card, and LEDs 6–9 are the state indicators of the network port.

Indicator	Color	State	Description
LED1	Green		3.3V power indicator
LED2 (Bus state indicator)	Red	On	No network connection
		Blinking	The connection to the PROFINET controller through a network cable is OK, but the communication is not established.
		Off	Communication with the PROFINET controller has been established
LED3 (System fault indicator)	Green	On	PROFINET diagnosis is enabled
		Off	PROFINET diagnosis is not enabled
LED4 (Slave ready indicator)	Green	On	TPS-1 protocol stack has started
		Blinking	TPS-1 waits for MCU initialization
		Off	TPS-1 protocol stack does not start
LED5 (Maintenance state indicator)	Green		Manufacturer-specific—depending on the characteristics of the device
LED6/7 (Network port state indicator)	Green	On	PROFINET communication card and PC/PLC have been connected through a network cable.
		Off	PROFINET communication card and PC/PLC have not been connected.
LED8/9 (Network port communication indicator)	Green	On	PROFINET communication card and PC/PLC are communicating.
		Off	PROFINET communication card and PC/PLC are not communicating.

Electrical connection

The PROFINET communication card adopts a standard RJ45 interface and can adopt the linear

network topology or star network topology. The electrical connection in linear network topology mode is shown in the following.

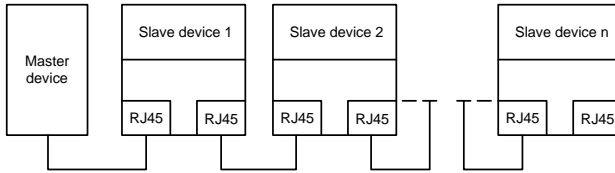

Note: For the star network topology, you need to prepare PROFINET switches.

The electrical connection in start network topology mode is shown in the following.

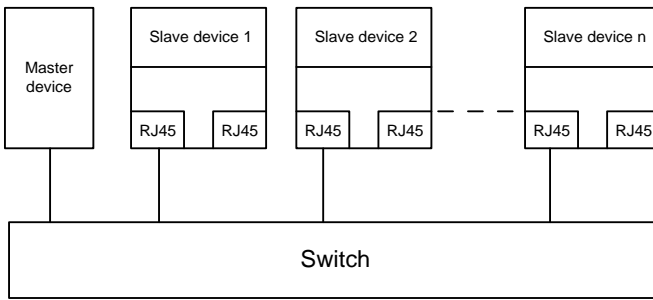

A.6.6 EtherNet/IP communication card (EC-TX510) and Modbus TCP communication card (EC-TX515)

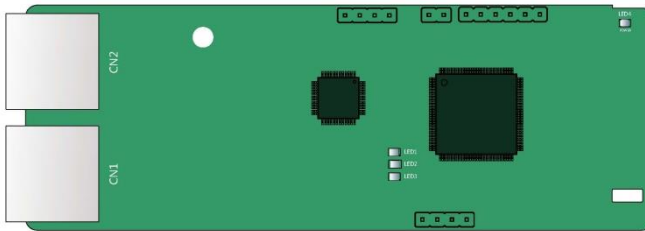

The communication port adopts standard dual RJ45 interfaces, and the two RJ45 interfaces are not distinguished from each other and can be interchangeably inserted.



Figure A-7 Standard RJ45 interface

Standard RJ45 interface functions

Pin	Name	Description
1	TX+	Transmit Data+
2	TX-	Transmit Data-

Pin	Name	Description
3	RX+	Receive Data+
4	n/c	Not connected
5	n/c	Not connected
6	RX-	Receive Data-
7	n/c	Not connected
8	n/c	Not connected

Indicator definition

The EtherNet/IP communication card provides four LED indicators and four net port indicators to indicate its states.

Indicator	Color	State	Description
LED1	Green	On	The card is shaking hands with the VFD.
		Blinking (1Hz)	The card and VFD communicate normally.
		Off	The card and VFD communicate improperly.
LED2	Green	On	The communication between the card and PLC is online and data interchange is allowed.
		Blinking (1Hz)	IP address conflict between the card and PLC.
		Off	The communication between the card and PLC is offline.
LED3	Red	On	Failed to set up I/O between the card and PLC.
		Blinking (1Hz)	Incorrect PLC configuration.
		Blinking (2Hz)	The card failed to send data to the PLC.
		Blinking (4Hz)	The connection between the card and PLC timed out.
		Off	No fault.
LED4	Red	On	3.3V power indicator.
Net port indicator	Yellow	On	Link indicator, indicating successful Ethernet connection.
		Off	Link indicator, indicating Ethernet connection not established.
Net port indicator	Green	On	ACK indicator, indicating data interchange being performed.
		Off	ACK indicator, indicating data interchange not be performed.

Electrical wiring

The EtherNet/IP communication card provides standard RJ45 ports and supports the linear, star, and ring topologies. The following three figures show the electrical wiring diagrams.

Use CAT5, CAT5e, and CAT6 network cables for electrical wiring. When the communication distance is greater than 50 meters, use high-quality network cables that meet the high-quality standards.

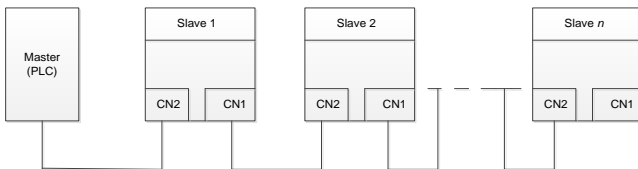

Figure A-8 Electrical wiring diagram for a linear topology

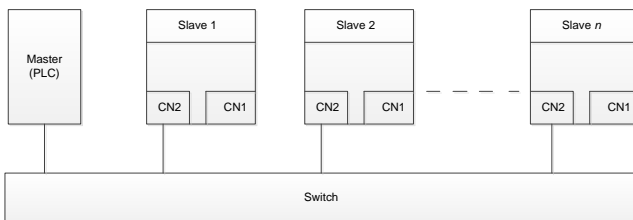

Figure A-9 Electrical wiring diagram for a star topology

Note: Ethernet switches must be available when the star topology is used.

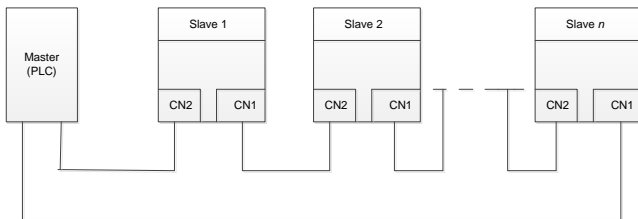
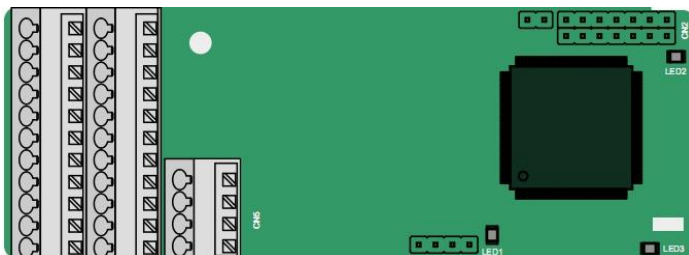

Figure A-10 Electrical wiring diagram for a ring network

A.7 PG cards

A.7.1 Sin/Cos PG card (EC-PG502)



The terminals are arranged as follows:

							C1+	C1-	D1+	D1-
PE	AO+	BO+	ZO+	A1+	B1+	R1+	A2+	B2+	Z2+	PWR
GND	AO-	BO-	ZO-	A1-	B1-	R1-	A2-	B2-	Z2-	GND

Indicator definition

Indicator	Name	Description
LED1	Disconnection indicator	Off: A1 and B1 of the encoder are disconnected. Blinking: C1 and D1 of the encoder are disconnected. On: The encoder signals are normal.
LED2	Power indicator	On: The control board feeds power to the PG card.
LED3	State indicator	On: The expansion card is establishing a connection with the control board. Blinking periodically: The expansion card is properly connected to the control board (the period is 1s, on for 0.5s, and off for the other 0.5s). Off: The expansion card is disconnected from the control board.

EC-PG502 terminal function description

Signal	Port	Function
PWR	Encoder power	Voltage: 5 V ± 5% Max. output current: 150 mA
GND		
A1+	Encoder interface	1. Supporting Sin/Cos encoders 2. SINA/SINB/SINC/SIND 0.6–1.2Vpp; SINR 0.2–0.85Vpp 3. Max. frequency response of A/B signals: 200 kHz Max. frequency response of C/D signals: 1 kHz
A1-		
B1+		
B1-		
R1+		
R1-		
C1+		
C1-		
D1+		
D1-		
A2+	Pulse reference	1. Supporting 5V differential signal 2. Frequency response: 200 kHz
A2-		
B2+		
B2-		
Z2+		
Z2-		

Signal	Port	Function
AO+	Frequency-divided output	1. Differential output of 5 V 2. Supporting frequency division of 2^N , which can be set through P20.16 or P24.16; Max. output frequency: 200 kHz
AO-		
BO+		
BO-		
ZO+		
ZO-		

The following figure shows the external wiring of the PG card when it is used in combination with an encoder without CD signals.

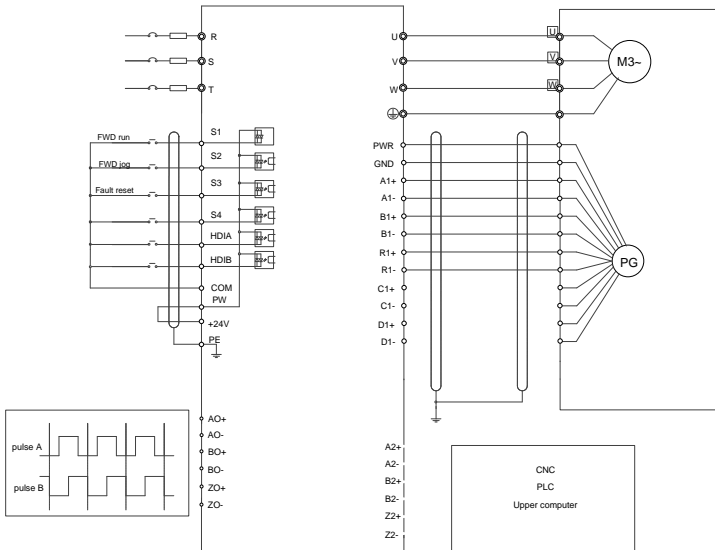

The following figure shows the external wiring of the PG card when it is used in combination with an encoder with CD signals.

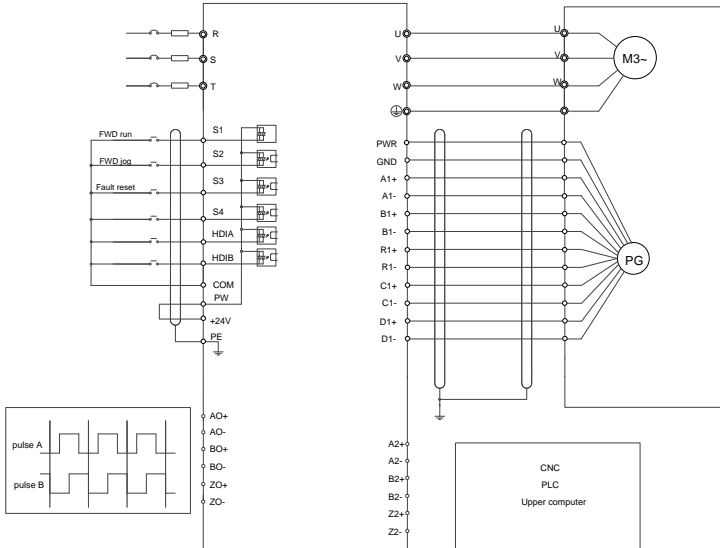

A.7.2 UVW incremental PG card (EC-PG503-05)

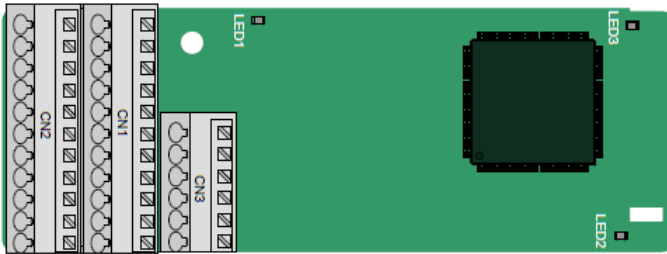

The terminals are arranged as follows:

					A2+	A2-	B2+	B2-	Z2+	Z2-
PE	AO+	BO+	ZO+	A1+	B1+	Z1+	U+	V+	W+	PWR
GND	AO-	BO-	ZO-	A1-	B1-	Z1-	U-	V-	W-	PGND

Indicator definition

Indicator	Name	Description
LED1	Disconnection indicator	This indicator blinks only if A1 or B1 signal is disconnected during encoder rotating; and it is on in other cases.
LED2	State indicator	On: The expansion card is establishing a connection with the control board. Blinking periodically: The expansion card is properly connected to the control board (the period is 1s, on for 0.5s, and off for the

		other 0.5s). Off: The expansion card is disconnected from the control board.
LED3	Power indicator	On: The control board feeds power to the PG card.

The EC-PG503-05 expansion card supports the input of absolute position signals and integrates the advantages of absolute and incremental encoders. It is user-friendly, adopting spring terminals.

EC-PG503-05 terminal function description

Signal	Port	Description
PWR	Encoder power	Voltage: 5 V±5% Max. current: 200 mA
PGND		
A1+	Encoder interface	1. Differential incremental PG interface of 5 V 2. Response frequency: 400 kHz
A1-		
B1+		
B1-		
Z1+		
Z1-		
A2+	Pulse setting	1. Differential input of 5 V 2. Response frequency: 200 kHz
A2-		
B2+		
B2-		
Z2+		
Z2-		
AO+	Frequency-divided output	1. Differential output of 5 V 2. Supporting frequency division of 1–255, which can be set through P20.16 or P24.16
AO-		
BO+		
BO-		
ZO+		
ZO-		
U+	UVW encoder interface	1. Absolute position (UVW information) of the hybrid encoder, differential input of 5 V 2. Response frequency: 40 kHz
U-		
V+		
V-		
W+		
W-		

The following figure shows the external wiring of the EC-PG503-05 expansion card.

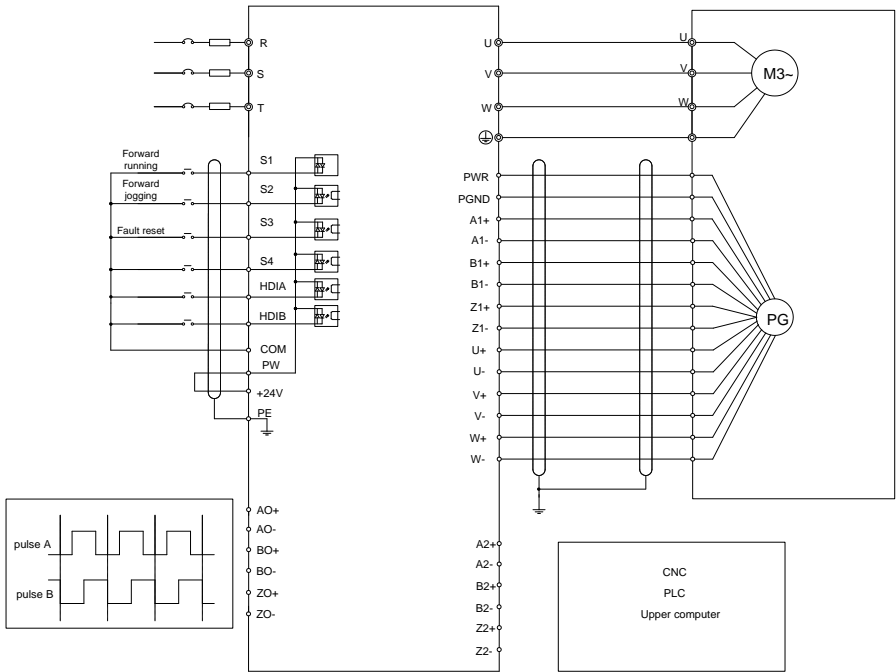

A.7.3 Resolver PG card (EC-PG504-00)

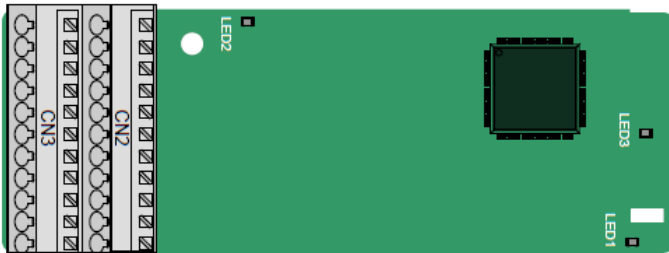

PE	AO+	BO+	ZO+	EX+	SI+	CO+	A2+	B2+	Z2+	PWR
GND	AO-	BO-	ZO-	EX-	SI-	CO-	A2-	B2-	Z2-	GND

Indicator definition

Indicator	Name	Description
LED1	State indicator	On: The expansion card is establishing a connection with the control board. Blinking periodically: The expansion card is properly connected to the control board (the

Indicator	Name	Description
		period is 1s, on for 0.5s, and off for the other 0.5s). Off: The expansion card is disconnected from the control board.
LED2	Disconnection indicator	Off: The encoder is disconnected. On: The encoder signals are normal. Blinks: The encoder signals are not stable.
LED3	Power indicator	On: The control board feeds power to the PG card.

The EC-PG504-00 expansion card can be used in combination with a resolver of excitation voltage 7 Vrms. It is user-friendly, adopting spring terminals.

EC-PG504-00 terminal function description

Signal	Port	Description
SI+	Encoder signal input	Recommended resolver transformation ratio: 0.5
SI-		
CO+		
CO-		
EX+	Encoder excitation signal	1. Factory setting of excitation: 10 kHz 2. Supporting resolvers with an excitation voltage of 7 Vrms
EX-		
A2+	Pulse setting	1. Differential input of 5 V 2. Response frequency: 200 kHz
A2-		
B2+		
B2-		
Z2+		
Z2-		
AO+	Frequency-divided output	1. Differential output of 5 V 2. Frequency-divided output of resolver simulated A1, B1, and Z1, which is equal to an incremental PG card of 1024 pps. 3. Supporting frequency division of 2^N , which can be set through P20.16 or P24.16 4. Max. output frequency: 200 kHz
AO-		
BO+		
BO-		
ZO+		
ZO-		

The following figure shows the external wiring of the EC-PG504-00 expansion card.

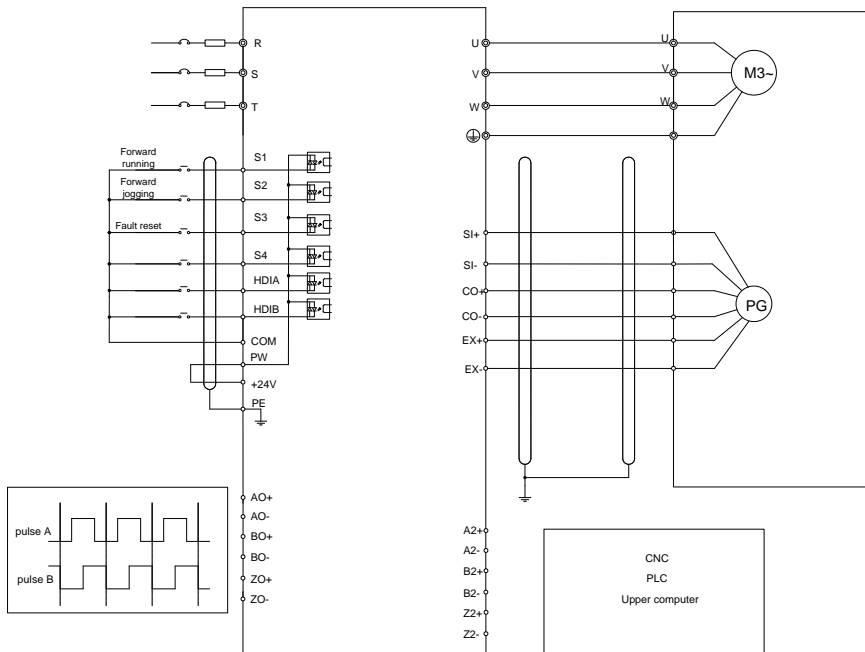

A.7.4 Multifunction incremental PG card (EC-PG505-12)



The terminals are arranged as follows:

The dual in-line package (DIP) switch SW1 is used to set the voltage class (5 V or 12 V) of the power supply of the encoder. The DIP switch can be operated with an auxiliary tool.

PE	AO+	BO+	ZO+	A1+	B1+	Z1+	A2+	B2+	Z2+	PWR
GND	AO-	BO-	ZO-	A1-	B1-	Z1-	A2-	B2-	Z2-	PGND

Indicator definition

Indicator	Name	Description
LED1	State indicator	On: The expansion card is establishing a connection with the control board. Blinking periodically: The expansion card is properly connected

Indicator	Name	Description
		to the control board (the period is 1s, on for 0.5s, and off for the other 0.5s). Off: The expansion card is disconnected from the control board.
LED2	Disconnection indicator	This indicator blinks only if A1 or B1 signal is disconnected during encoder rotating; and it is on in other cases.
LED3	Power indicator	On: The control board feeds power to the PG card.

The EC-PG505-12 expansion card can be used in combination with multiple types of incremental encoders through different modes of wiring. It is user-friendly, adopting spring terminals.

EC-PG505-12 terminal function description

Signal	Port	Description
PWR	Encoder power	Voltage: 5 V/12 V \pm 5% Max. output: 150 mA Select the voltage class through the DIP switch SW1 based on the voltage class of the used encoder.
PGND		
A1+	Encoder interface	<ol style="list-style-type: none"> Supporting push-pull interfaces of 5 V/12 V Supporting open collector interfaces of 5 V/12 V Supporting differential interfaces of 5 V Response frequency: 200 kHz
A1-		
B1+		
B1-		
Z1+		
Z1-		
A2+	Pulse setting	<ol style="list-style-type: none"> Supporting the same signal types as the encoder signal types Response frequency: 200 kHz
A2-		
B2+		
B2-		
Z2+		
Z2-		
AO+	Frequency-divided output	<ol style="list-style-type: none"> Differential output of 5 V Supporting frequency division of 1–255, which can be set through P20.16 or P24.16
AO-		
BO+		
BO-		
ZO+		
ZO-		

The following figure shows the external wiring of the expansion card used in combination with an open collector encoder. A pull-up resistor is configured inside the PG card.

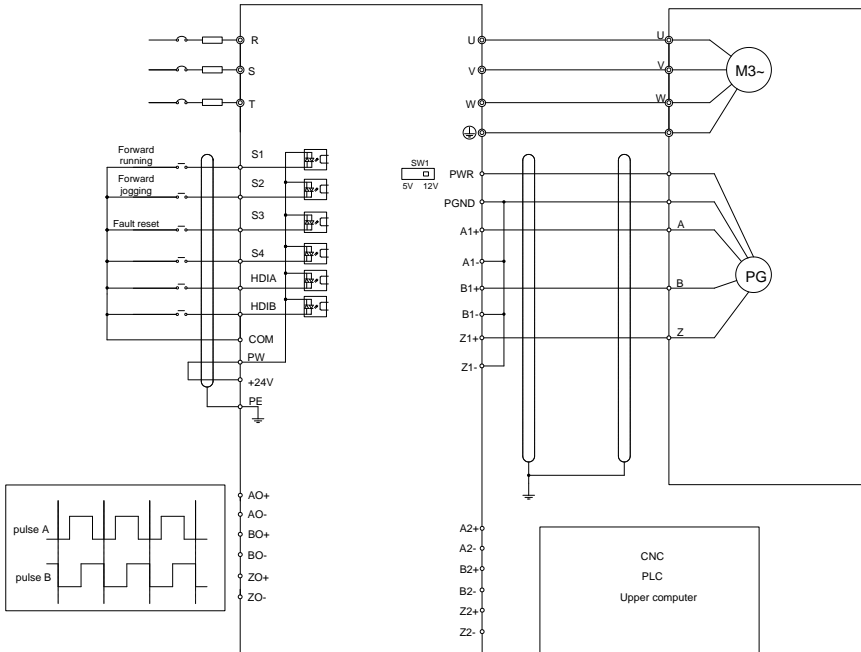

The following figure shows the external wiring of the expansion card used in combination with a push-pull encoder.

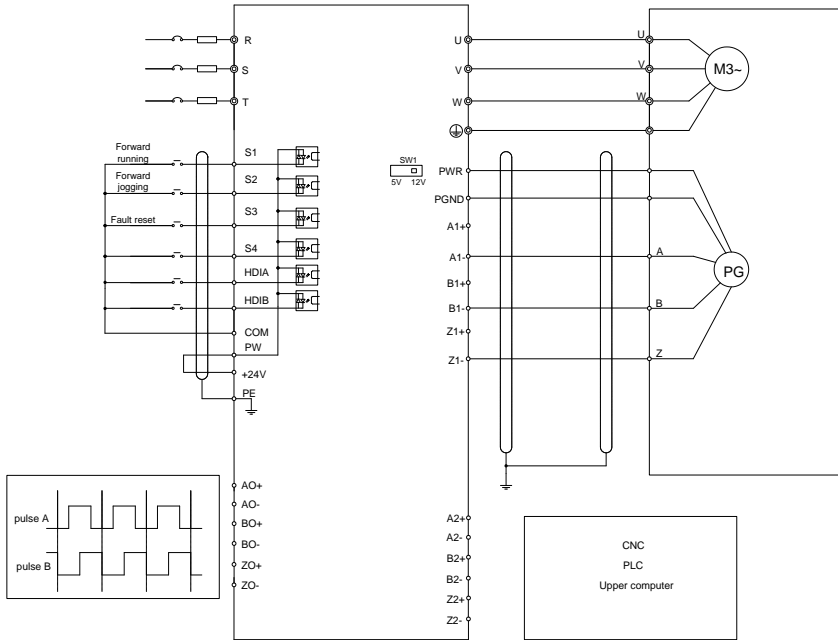

The following figure shows the external wiring of the expansion card used in combination with a differential encoder.

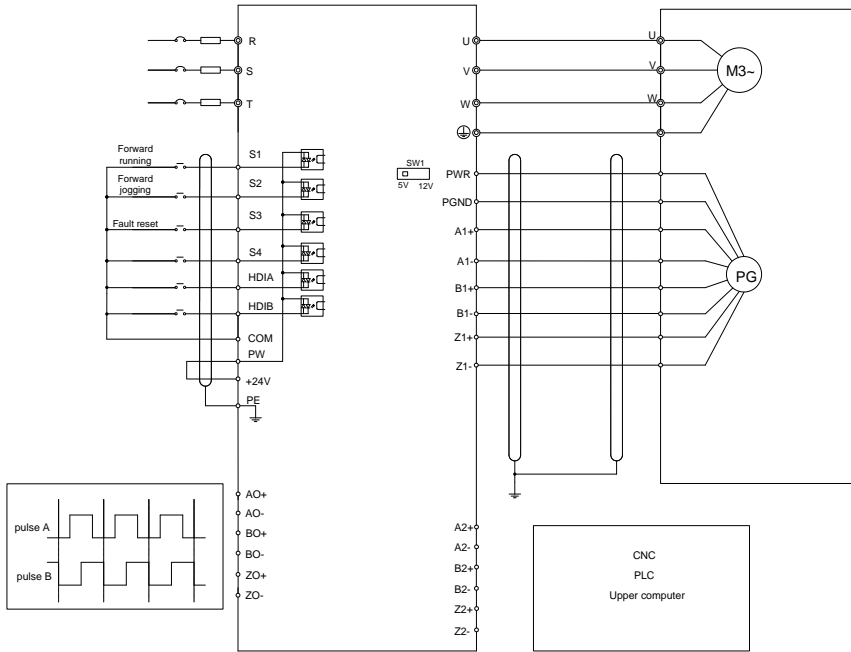

A.7.5 24V incremental PG card (EC-PG505-24)

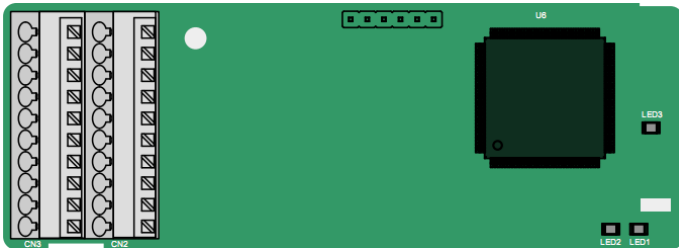

The terminals are arranged as follows:

PE	AO	BO	A1+	B1+	Z1+	A2+	B2+	Z2+	PWR
GND	PGND	ZO	A1-	B1-	Z1-	A2-	B2-	Z2-	PGND

Indicator definition

Indicator	Name	Description
LED1	State indicator	On: The expansion card is establishing a connection with the control board. Blinking periodically: The expansion card is properly connected to the control board (the period is 1s, on for 0.5s, and off for the other 0.5s). Off: The expansion card is disconnected from the control board.
LED2	Disconnection indicator	This indicator blinks only if A1 or B1 signal is disconnected during encoder rotating; and it is on in other cases.
LED3	Power indicator	On: The control board feeds power to the PG card.

EC-PG505-24 can work in combination with multiple types of incremental encoders through various external wiring modes. It is user-friendly, adopting spring terminals.

EC-PG505-24 terminal function description

Signal	Port	Description
PWR	Encoder power supply	Voltage: 24 V \pm 5% Max. output current: 150 mA
PGND		
A1+	Encoder interface	1. Supporting 24 V push-pull interfaces 2. Supporting 24 V open collector interfaces 3. Frequency response: 200 kHz
A1-		
B1+		
B1-		
Z1+		
Z1-		
A2+	Pulse reference	1. Supporting interfaces whose signal type is the same as the encoder 2. Frequency response: 200 kHz
A2-		
B2+		
B2-		
Z2+		
Z2-		
AO	Frequency-divided output	1. Open collector output 2. Supporting frequency division of 1–255, which can be set through P20.16 or P24.16
BO		
ZO		

The following figure shows the external wiring of the PG card when it is used in combination with an open collector encoder. A pull-up resistor is configured in the PG card.

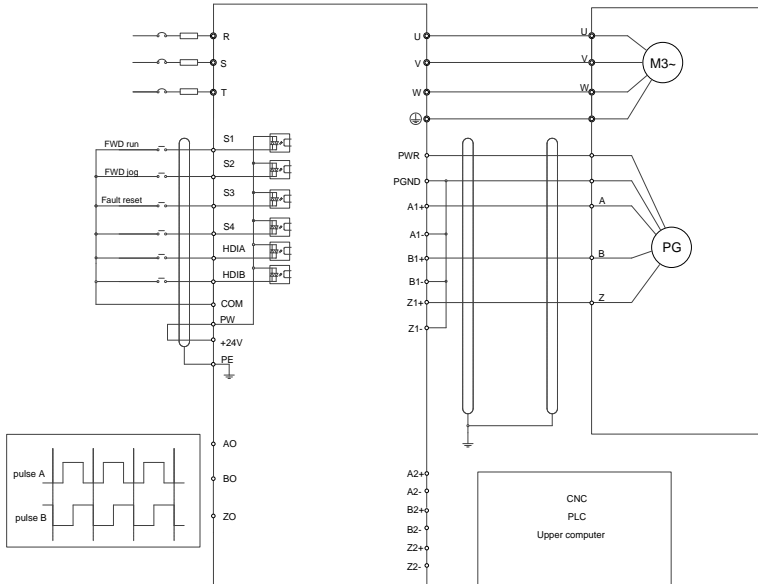

The following figure shows the external wiring of the PG card when it is used in combination with a push-pull encoder.

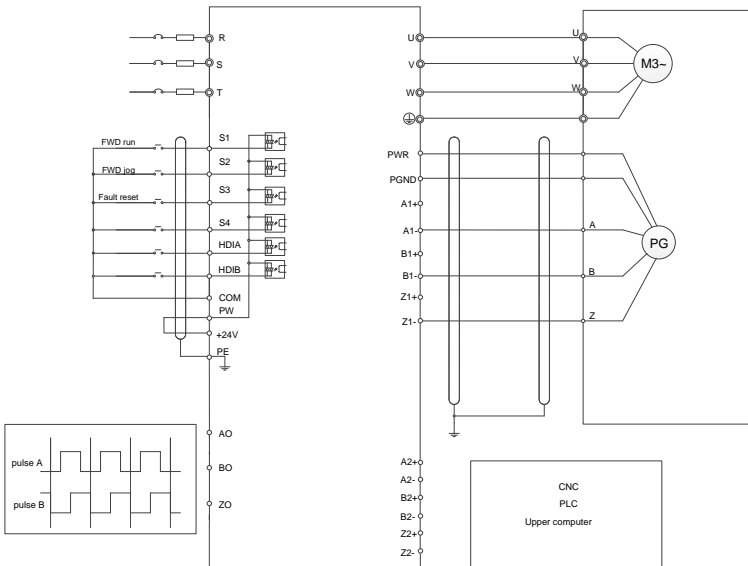

A.7.6 Simplified incremental PG card (EC-PG507-12)

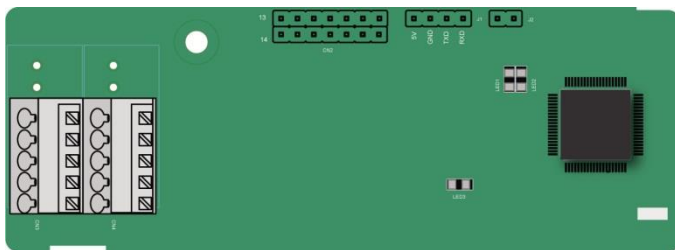

The DIP switch SW1 is used to set the voltage class (5 V or 12 V) of the power supply of the encoder. The DIP switch can be operated with an auxiliary tool.

The terminals are arranged as follows:

PE	A1+	B1+	Z1+	PWR
PGND	A1-	B1-	Z1-	PGND

Indicator definition

Indicator	Name	Description
LED1	State indicator	On: The expansion card is establishing a connection with the control board. Blinking periodically: The expansion card is properly connected to the control board (1s duration, on for 0.5s, and off for the other 0.5s). Off: The expansion card is disconnected from the control board.
LED2	Disconnection indicator	Off: A1 or B1 of the encoder is disconnected. On: The encoder pulses are normal.
LED3	Power indicator	On: The control board feeds power to the PG card.

The EC-PG507-12 expansion card can be used in combination with multiple types of incremental encoders through different modes of wiring. The wiring modes are similar with EC-PG505-12.

EC-PG507-12 terminal function description

Signal	Port	Description
PWR	Encoder power	Voltage: 5V/12V ± 5%; Max. current: 150 mA
PGND		The voltage class can be selected through SW1, depending on the encoder voltage class.
A1+	Encoder interface	1. Supporting push-pull interfaces of 5 V/12 V 2. Supporting open collector interfaces of 5 V/12 V 3. Supporting differential interfaces of 5 V 4. Response frequency: 400 kHz 5. Supporting the encoder cable length of up to 50 m
A1-		
B1+		
B1-		
Z1+		
Z1-		

A.7.7 24V simplified incremental PG card (EC-PG507-24)

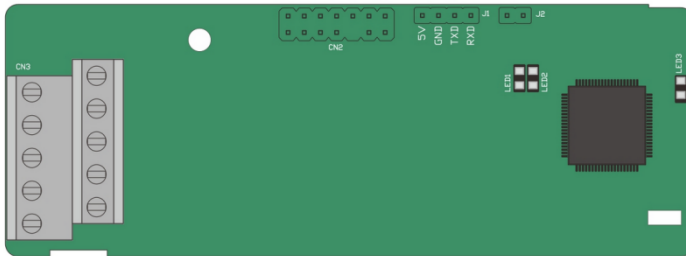

The terminals are arranged as follows:

PE	A1+	B1+	Z1+	PWR
PGND	A1-	B1-	Z1-	PGND

Indicator definition

Indicator	Name	Description
LED1	State indicator	This indicator is on when the expansion card is establishing a connection with the control board; it blinks periodically after the expansion card is properly connected to the control board (the period is 1s, on for 0.5s, and off for the other 0.5s); and it is off when the expansion card is disconnected from the control board.
LED2	Disconnection indicator	Off: A1 or B1 of the encoder is disconnected. On: The encoder pulses are normal.
LED3	Power indicator	This indicator is on after the control board feeds power to the PG card.

EC-PG507-24 can work in combination with multiple types of incremental encoders through various external wiring modes. It is easy to use for the use of 5.08mm pitch terminal.

EC-PG507-24 terminal function description

Signal	Port	Description
PE	Grounding terminal	Connected to the ground to enhance anti-interference performance.
PWR	Encoder power	Voltage: 24V±5%; Max. output current: 150mA (PGND is the ground for power isolation)
PGND		
A1+	Encoder interface	1. Supporting push-pull interfaces of 24 V 2. Supporting open collector interfaces of 24 V 3. Supporting differential interfaces of 24 V 4. Frequency response: 200 kHz 5. Supporting upporting the encoder cable length of up to 100 m
A1-		
B1+		
B1-		
Z1+		
Z1-		

The following figure shows the external wiring of the PG card when it is used in combination with an open collector encoder. A pull-up resistor is configured in the PG card.

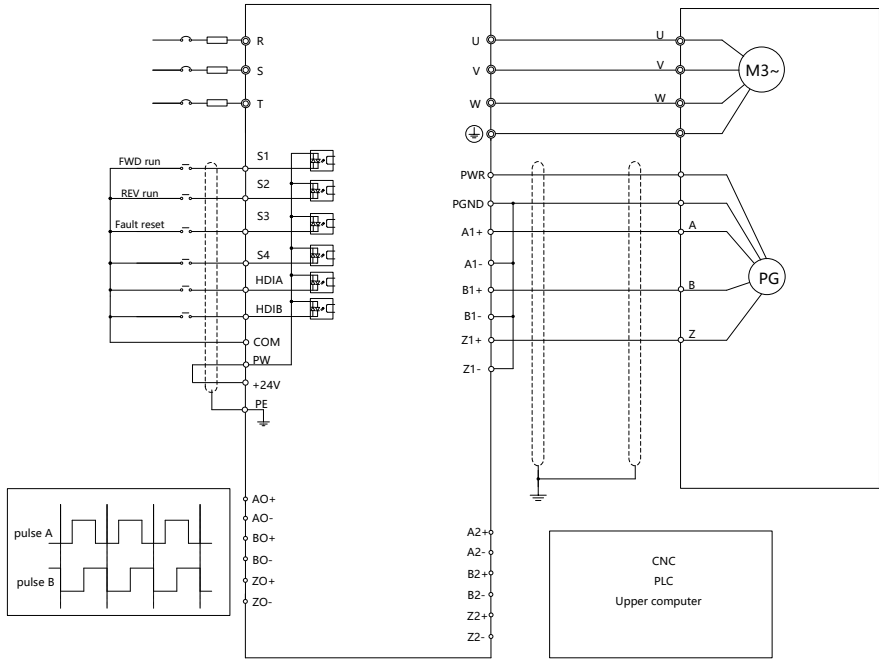

Using a shield cable

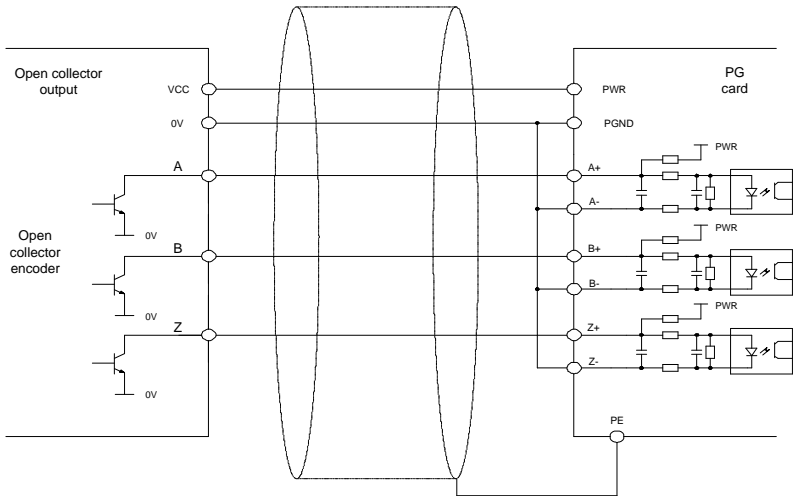

The following figure shows the external wiring of the PG card when it is used in combination with a push-pull encoder.

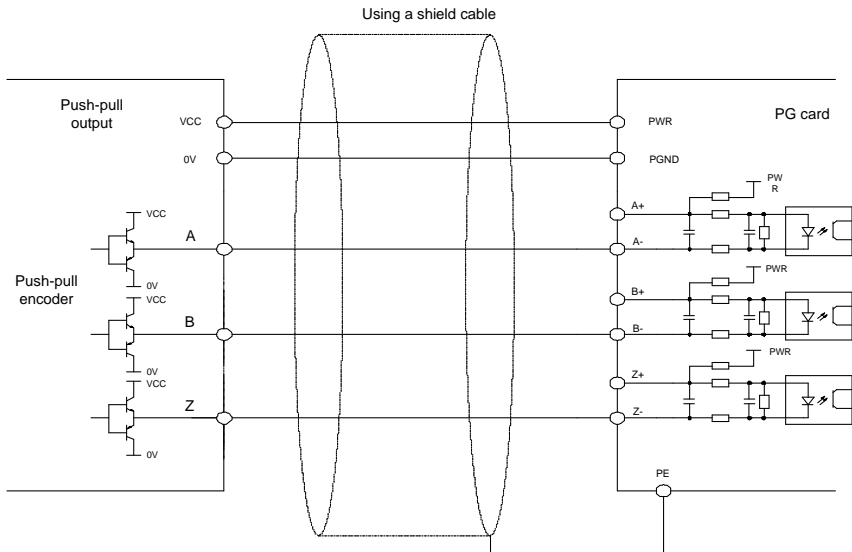
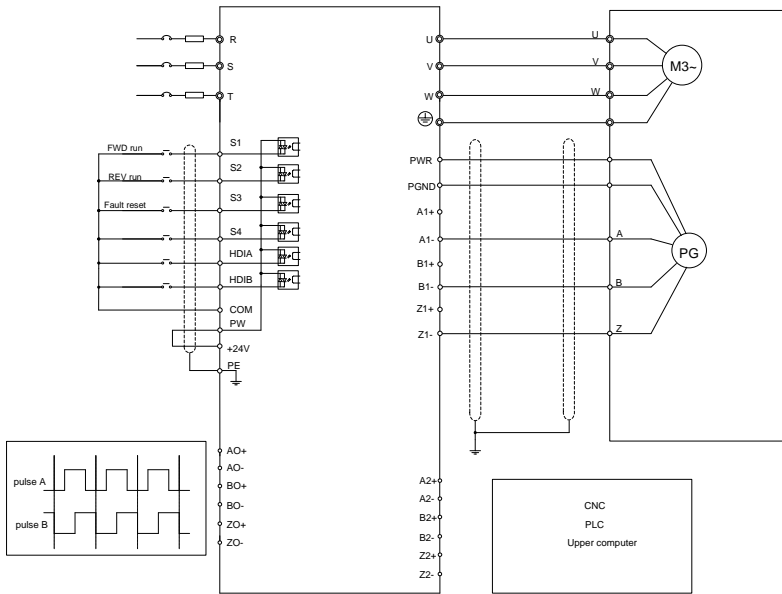

The following figure shows the external wiring of the PG card when it is used in combination with a differential encoder.

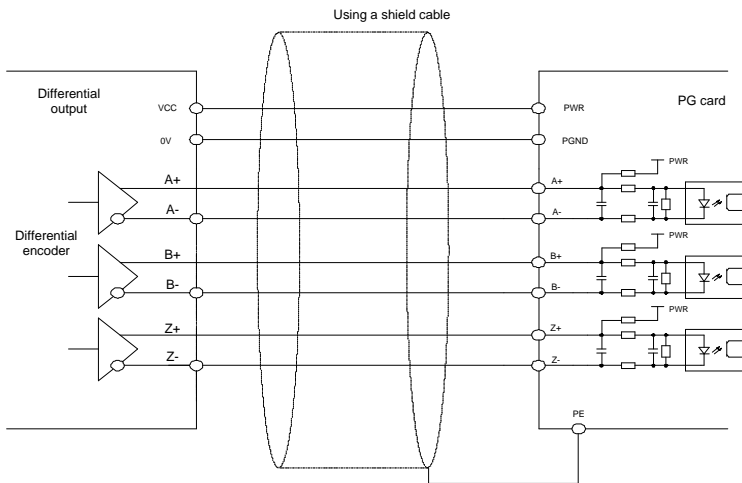
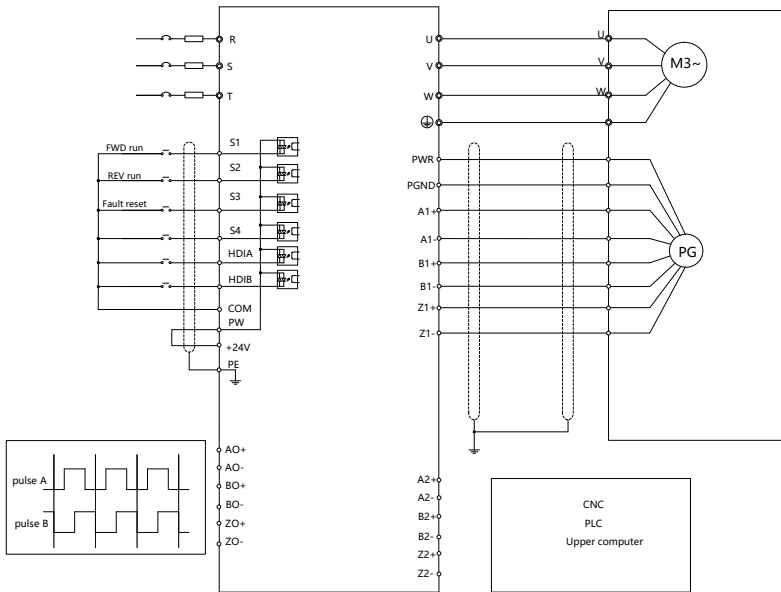

A.8 GPRS card (EC-IC501-2)

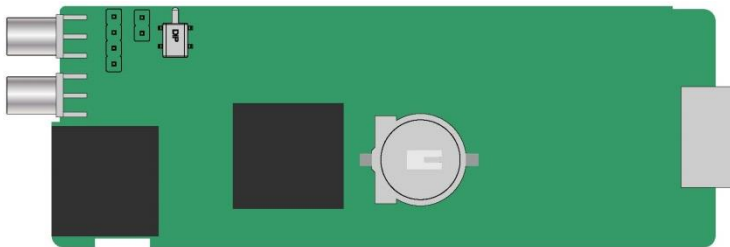

CN6 pin definition

Pin	Name	Description
1	485-	485B
2	485+	485A
3	GND	Power ground
4	24V	24V power

State indicator definition

The GPRS IoT card has five state indicators.

Indicator	Name	Function
LED1	Handshaking indicator	It blinks at a frequency of 1s when the card normally connects to the control board.
LED2	Power indicator	It is on upon power on.
LED3	Run indicator	The card communicates normally.
LED4	GPRS state indicator	When GPRS connects to the network, it blinks fast at a specific interval (with 64ms on and 300ms off); when GPRS does not connect to the network, it blinks slowly at a specific interval (with 64ms on and 800ms off).
LED5	State indicator	It is always on when the GPRS module is powered on.

For details, see the EC series GPRS expansion card manual.

Appendix B Technical data

B.1 What this chapter contains

This chapter describes the technical data of the VFD and its compliance to CE and other quality certification systems.

B.2 Derated application

B.2.1 Capacity

Choose a VFD model based on the rated current and power of the motor. To withstand the rated power of the motor, the rated output current of the VFD must be larger or equal to the rated current of the motor. The rated power of the VFD must be higher or equal to that of the motor.

Note:

- The maximum allowable shaft power of the motor is limited to 1.5 times the rated power of the motor. If the limit is exceeded, the VFD automatically restricts the torque and current of the motor. This function effectively protects the input shaft against overload.
- The rated capacity is the capacity at the ambient temperature of 40°C.
- You need to check and ensure that the power flowing through the common DC connection in the common DC system does not exceed the rated power of the motor.

B.2.2 Derating

If the ambient temperature at the VFD installation site exceeds 40°C, the VFD installation site altitude exceeds 1000m, a cover with heat dissipation vents is used, or the carrier frequency is higher than the recommended, the VFD needs to be derated.

B.2.2.1 Derating due to temperature

When the temperature ranges from +40°C to +50°C, the rated output current is derated by 1% for each increased 1°C. For the actual derating, see the following figure.

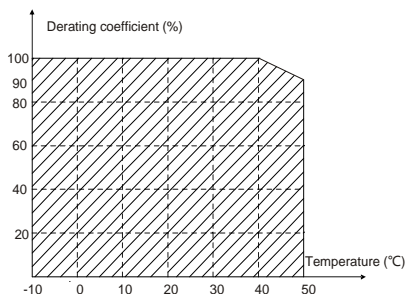

Note: It is not recommended to use the VFD at an environment with the temperature higher than 50°C. If you do, you shall be held accountable for the consequences caused.

B.2.2.2 Derating due to altitude

When the altitude of the site where the VFD is installed is lower than 1000 m, the VFD can run at the rated power. When the altitude exceeds 1000 m, derate 1% for every additional 100 m. When the installation site altitude exceeds 3000 m, consult the local INVT dealer or office.

B.2.2.3 Derating due to carrier frequency

The VFDs in different power classes are different in carrier frequency. The rated power of a VFD is defined based on the carrier frequency set in factory. If the carrier frequency exceeds the factory setting, the power of the VFD is derated by 10% for each increased 1 kHz.

B.3 Grid specifications

Grid voltage	AC 3PH 380V (-15%)–440V (+10%) AC 3PH 520V (-15%)–690V (+10%)
Short-circuit capacity	According to the definition in IEC 61439-1, the maximum allowable short-circuit current at the incoming end is 100 kA. Therefore, the VFD is applicable to scenarios where the transmitted current in the circuit is no larger than 100 kA when the VFD runs at the maximum rated voltage.
Frequency	50/60 Hz±5%, with a maximum change rate of 20%/s

B.4 Motor connection data

Motor type	Asynchronous induction motor or permanent-magnet synchronous motor
Voltage	0–U1 (Motor rated voltage), 3PH symmetrical, Umax (VFD rated voltage) at the field-weakening point
Short-circuit protection	The short-circuit protection for the motor output meets the requirements of IEC 61800-5-1.
Frequency	0–400 Hz
Frequency resolution	0.01 Hz
Current	See section 3.6 Ratings.
Power limit	1.5 times the motor rated power
Field-weakening point	10–400 Hz
Carrier frequency	4, 8, 12, or 15 kHz

B.4.1 EMC compatibility and motor cable length

The following table describes the maximum motor cable lengths that meet the requirements of the EU EMC directive (2014/30/EU).

All models (with external EMC filters)	Maximum motor cable length (m)
Second environment (C3)	30

You can learn the maximum length of the motor cable through the running parameters of the VFD. To understand the accurate maximum cable length for using an external EMC filter, contact the local INVT office.

For description about the environments category II (C3), see section B.6 EMC regulations.

B.5 Application standards

The following table describes the standards that the VFDs comply with.

EN/ISO 13849-1	Safety of machinery—Safety-related parts of control systems—Part 1: General principles for design
IEC/EN 60204-1	Safety of machinery—Electrical equipment of machines. Part 1: General requirements
IEC/EN 62061	Safety of machinery—Safety-related functional safety of electrical, electronic, and programmable electronic control systems
IEC/EN 61800-3	Adjustable speed electrical power drive systems—Part 3: EMC requirements and specific test methods
IEC/EN 61800-5-1	Adjustable speed electrical power drive systems—Part 5-1: Safety requirements—Electrical, thermal and energy
IEC/EN 61800-5-2	Adjustable speed electrical power drive systems—Part 5-2: Safety requirements—Function
GB/T 30844.1	General-purpose variable-frequency adjustable-speed equipment of 1 kV and lower—Part 1: Technical conditions
GB/T 30844.2	General-purpose variable-frequency adjustable-speed equipment of 1 kV and lower—Part 2: Test methods
GB/T 30844.3	General-purpose variable-frequency adjustable-speed equipment of 1 kV and lower—Part 3: Safety regulations

B.5.1 CE marking

The CE marking on the name plate of a VFD indicates that the VFD is CE-compliant, meeting the regulations of the European low-voltage directive (2014/35/EU) and EMC directive (2014/30/EU).

B.5.2 EMC compliance declaration

European union (EU) stipulates that the electric and electrical devices sold in Europe cannot generate electromagnetic disturbance that exceeds the limits stipulated in related standards, and can work properly in environments with certain electromagnetic interference. The EMC product standard (EN 61800-3) describes the EMC standards and specific test methods for adjustable speed electrical power drive systems. Our products have been compliant with these EMC regulations.

B.6 EMC regulations

The EMC product standard (EN 61800-3) describes the EMC requirements on VFDs.

Application environment categories:

First environment: Any residential area where the VFD is directly connected to a public low-voltage supply without an intermediate transformer.

Second environment: All locations outside residential areas.

VFD categories:

C1: Rated voltage lower than 1000 V, applied to the first environment.

C2: Rated voltage lower than 1000 V, non-plug, socket, or mobile devices; power drive systems that

must be installed and operated by specialized personnel when applied to the first environment

Note: The EMC standard IEC/EN 61800-3 no longer restricts the power distribution of VFDs, but it specifies their use, installation, and commissioning. Specialized personnel or organizations must have the necessary skills (including the EMC-related knowledge) for installing and/or performing commissioning on the electrical drive systems.

C3: Rated voltage lower than 1000 V, applied to the second environment. They cannot be applied to the first environment.

C4: Rated voltage higher than 1000 V, or rated current higher or equal to 400 A, applied to complex systems in the second environment.

B.6.1 VFD category C2

The induction disturbance limit meets the following stipulations:

1. Select an optional EMC filter according to Appendix D Optional peripheral accessories and install it following the description in the EMC filter manual.
2. Select the motor and control cables according to the description in the manual.
3. Install the VFD according to the description in the manual.
4. For the maximum length of the motor cable, see section "EMC compatibility and motor cable length".

B.6.2 VFD category C3

The anti-interference performance of the VFD meets the requirements of the second environment in the IEC/EN 61800-3 standard.

The induction disturbance limit meets the following stipulations:

1. Select an optional EMC filter according to Appendix D Optional peripheral accessories and install it following the description in the EMC filter manual.
2. Select the motor and control cables according to the description in the manual.
3. Install the VFD according to the description in the manual.
4. For the maximum length of the motor cable, see section "EMC compatibility and motor cable length".



⚡ VFDs of C3 category cannot be applied to civilian low-voltage common grids. When applied to such grids, the VFDs may generate radio frequency electromagnetic interference.

Appendix C Dimension drawings

C.1 What this chapter contains

This chapter describes the VFD dimension drawings. The dimension unit used in the drawings is millimeter (mm).

C.2 Keypad structure

C.2.1 Structure diagram

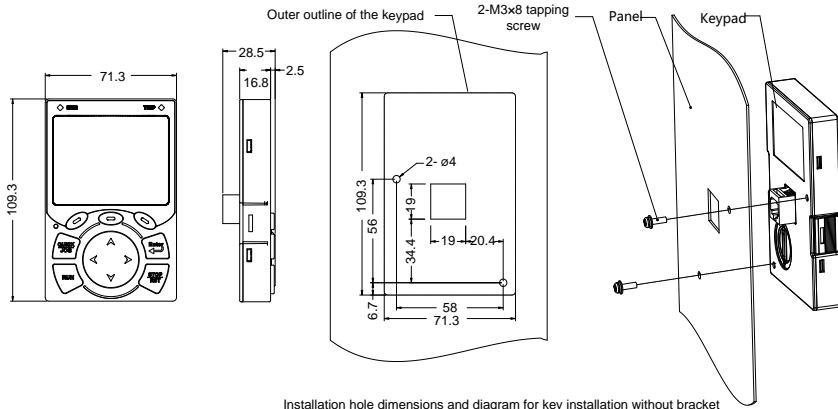

Installation hole dimensions and diagram for key installation without bracket

Figure C-1 Keypad structure diagram

C.2.2 Keypad installation bracket

Note: You can directly use M3 threaded screws or a keypad bracket to install the keypad externally. For the 380V 1.5–75kW VFD models, you need to use optional keypad installation brackets. For the 380V 90–500kW and the 660V 22–630kW VFD models, you can either use optional brackets or install the standard keypad brackets externally.

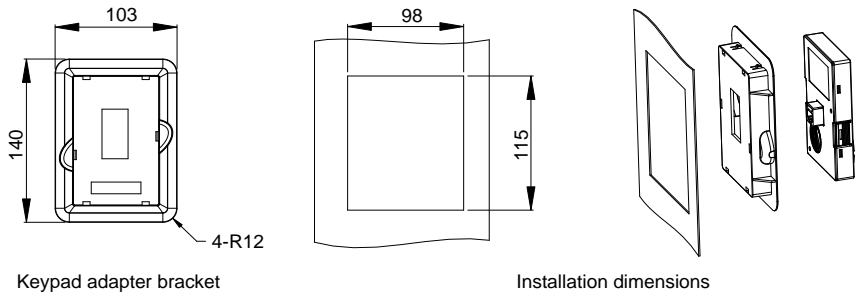

Keypad adapter bracket

Installation dimensions

Figure C-2 Keypad installation bracket (optional) for 380V 1.5–500kW and 660V 22–630kW models

C.3 VFD structure

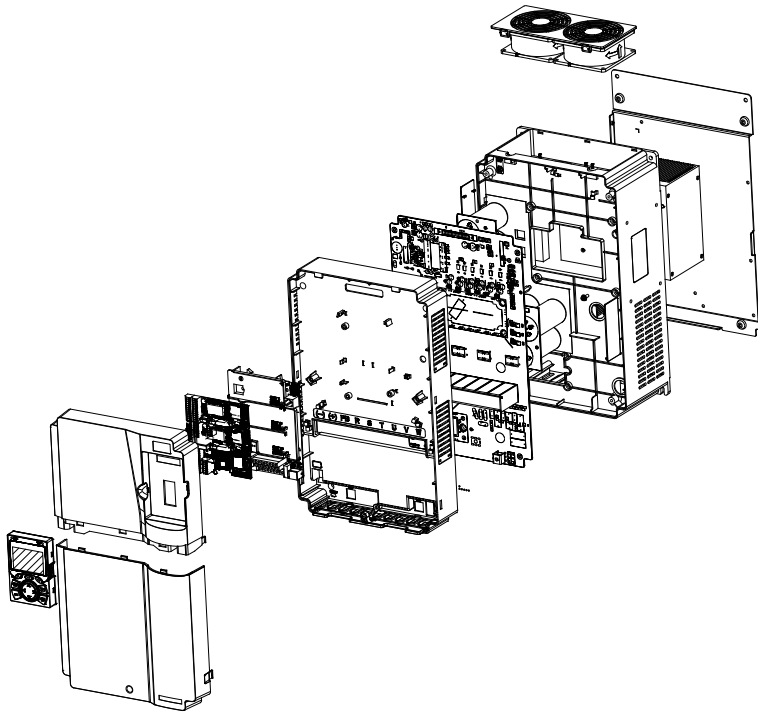

Figure C-3 VFD structure diagram

C.4 Dimensions of AC 3PH 380V (-15%)–440V (+10%)

C.4.1 Wall mounting dimensions

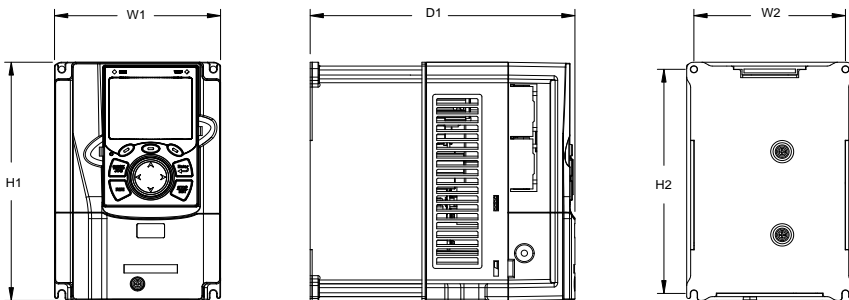

Figure C-4 Wall mounting diagram for 380V 1.5–37kW models

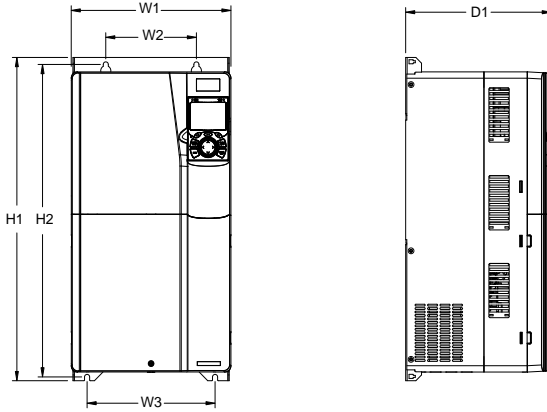

Figure C-5 Wall mounting diagram for 380V 45-75kW models

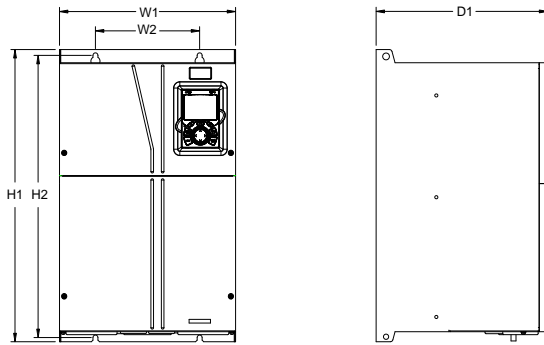

Figure C-6 Wall mounting diagram for 380V 90-110kW models

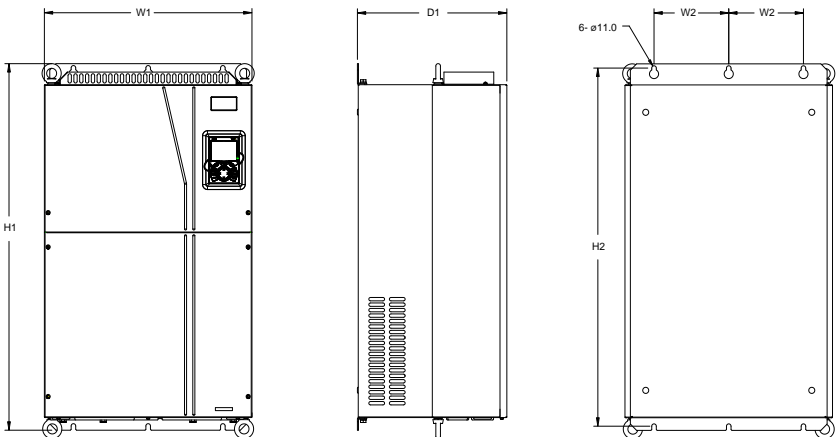

Figure C-7 Wall mounting diagram for 380V 132-200kW models

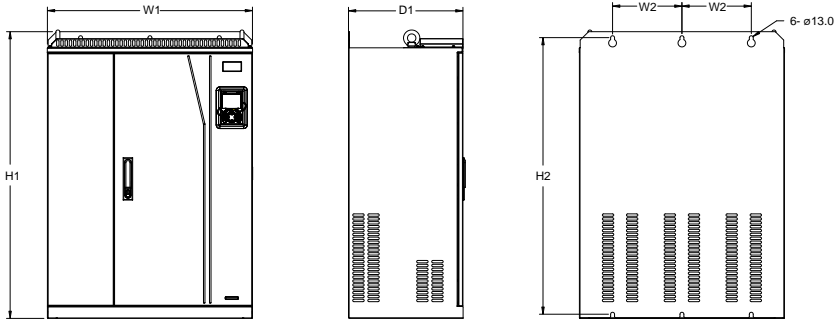

Figure C-8 Wall mounting diagram for 380V 220–315kW models
 Table C-1 Wall mounting dimensions of 380V VFD models (unit: mm)

VFD model	W1	W2	W3	H1	H2	D1	Mounting hole	Fixing screw
1.5kW–2.2kW	126	115	-	186	175	185	Ø 5	M4
4kW–5.5kW	126	115	-	186	175	201	Ø 5	M4
7.5kW	146	131	-	256	243.5	192	Ø 6	M5
11kW–15kW	170	151	-	320	303.5	220	Ø 6	M5
18.5kW–22kW	200	185	-	340.6	328.6	208	Ø 6	M5
30kW–37kW	250	230	-	400	380	223	Ø 6	M5
45kW–75kW	282	160	226	560	542	258	Ø 9	M8
90kW–110kW	338	200	-	554	535	330	Ø 10	M8
132kW–200kW	500	180	-	870	850	360	Ø 11	M10
220kW–315kW	680	230	-	960	926	380	Ø 13	M12

C.4.2 Flange mounting dimensions

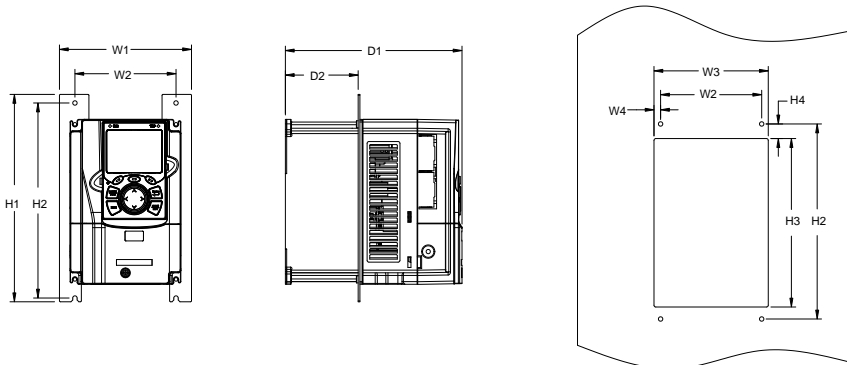

Figure C-9 Flange mounting diagram for 380V 1.5–75kW models

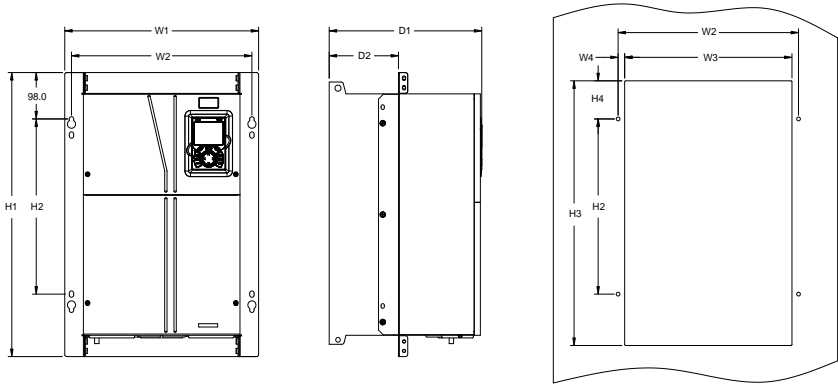

Figure C-10 Flange mounting diagram for 380V 90–110kW models

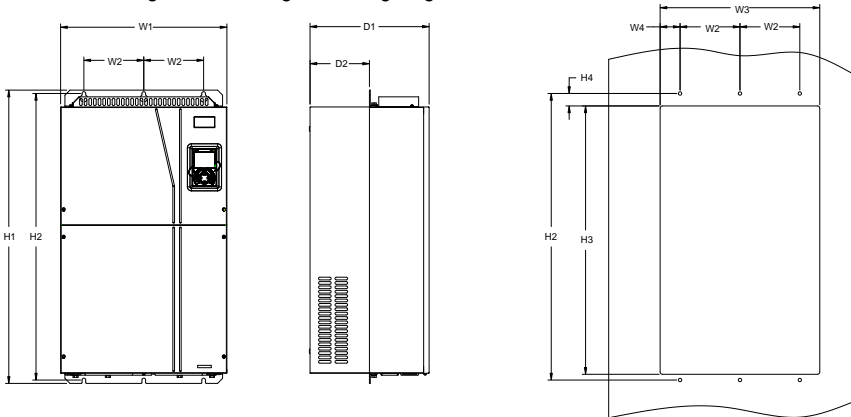

Figure C-11 Flange mounting diagram for 380V 132–200kW models

Table C-2 Flange mounting dimensions of 380V VFDs (unit: mm)

VFD model	W1	W2	W3	W4	H1	H2	H3	H4	D1	D2	Mounting hole	Fixing screw
1.5kW–2.2kW	150.2	115	130	7.5	234	220	190	13.5	185	65.5	Ø 5	M4
4kW–5.5kW	150.2	115	130	7.5	234	220	190	13.5	201	83	Ø 5	M4
7.5kW	170.2	131	150	9.5	292	276	260	6	192	84.5	Ø 6	M5
11kW–15kW	191.2	151	174	11.5	370	351	324	12	220	113	Ø 6	M5
18.5kW–22kW	266	250	224	13	371	250	350.6	20.3	208	104	Ø 6	M5
30kW–37kW	316	300	274	13	430	300	410	55	223	118.3	Ø 6	M5
45kW–75kW	352	332	306	12	580	400	570	80	258	133.8	Ø 9	M8
90kW–110kW	418.5	389.5	361	14.2	600	370	559	108.5	330	149.5	Ø 10	M8
132kW–200kW	500	180	480	60	870	850	796	37	360	178.5	Ø 11	M10

C.4.3 Floor mounting dimensions

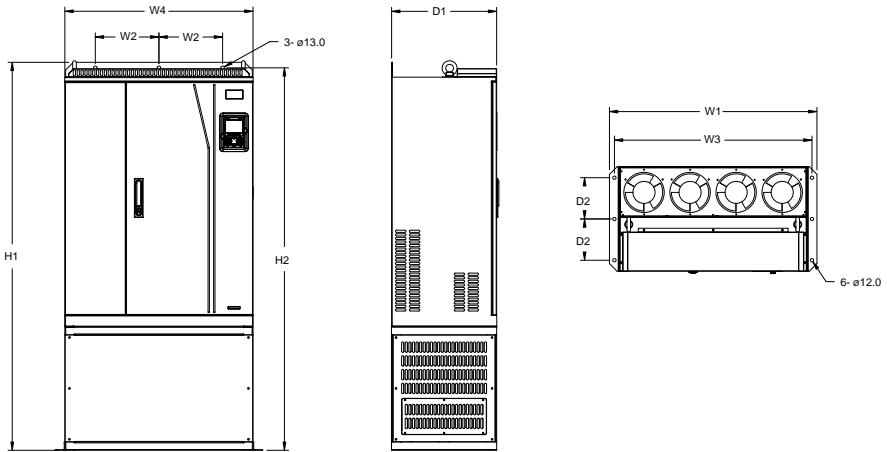

Figure C-12 Floor mounting diagram for 380V 220–315kW models

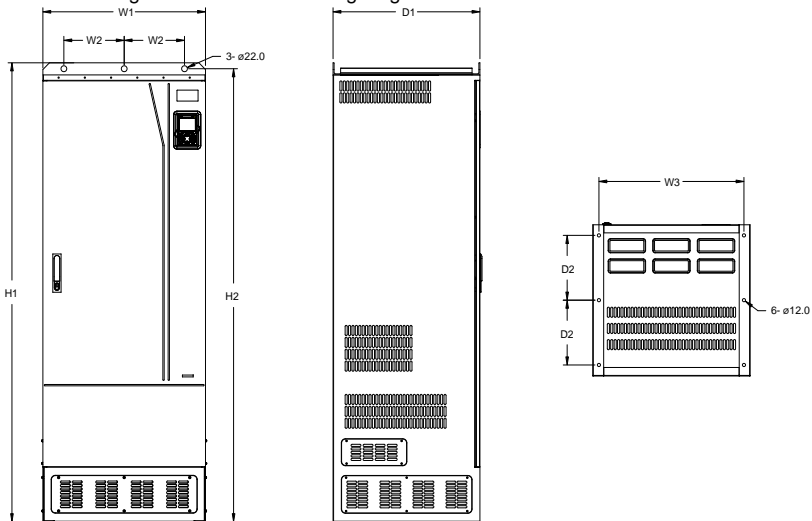

Figure C-13 Floor mounting diagram for 380V 355–500kW models

Table C-3 Floor mounting dimensions of 380V VFD models (unit: mm)

VFD model	W1	W2	W3	W4	H1	H2	D1	D2	Mounting hole	Fixing screw
220kW–315kW	750	230	714	680	1410	1390	380	150	Ø 13/12	M12/M10
355kW–500kW	620	230	572	-	1700	1678	560	240	Ø 22/12	M20/M10

C.5 Dimensions of AC 3PH 520V (-15%)–690V (+10%)

C.5.1 Wall mounting dimensions

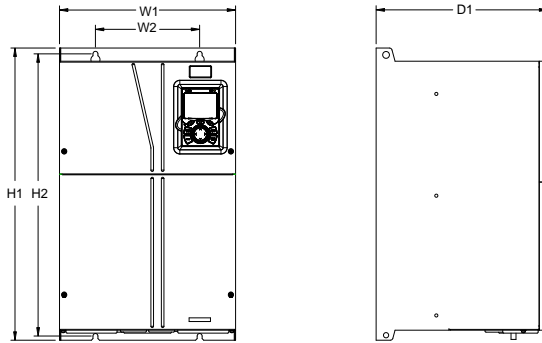

Figure C-14 Wall mounting diagram for 660V 22–132kW models

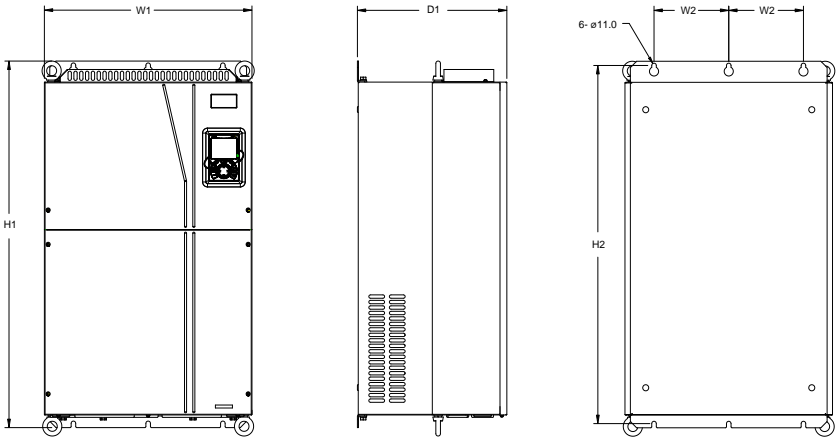

Figure C-15 Wall mounting diagram for 660V 160–220kW models

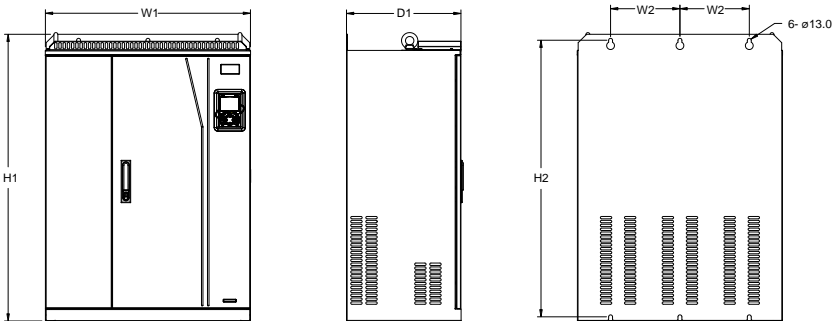

Figure C-16 Wall mounting diagram for 660V 250–355kW models

Table C-4 Wall mounting dimensions of 660V VFD models (unit: mm)

VFD model	W1	W2	H1	H2	D1	Mounting hole	Fixing screw
22kW-45kW	270	130	555	540	325	Ø 7	M6
55kW-132kW	325	200	680	661	365	Ø 9.5	M8
160kW-220kW	500	180	870	850	360	Ø 11	M10
250kW-355kW	680	230	960	926	380	Ø 13	M12

C.5.2 Flange installation dimensions

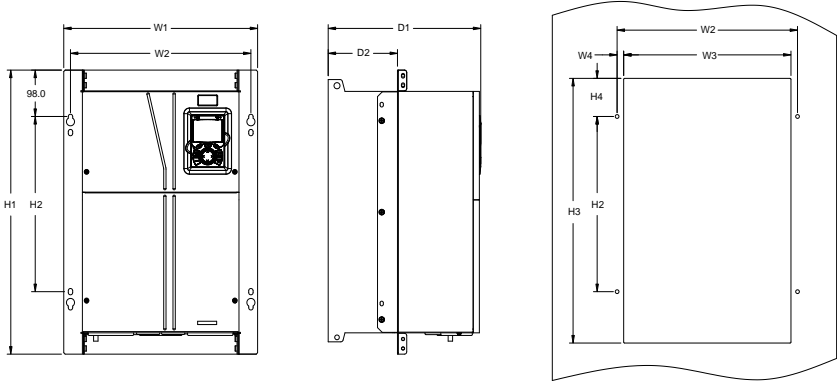

Figure C-17 Flange mounting diagram for 660V 22-132kW models

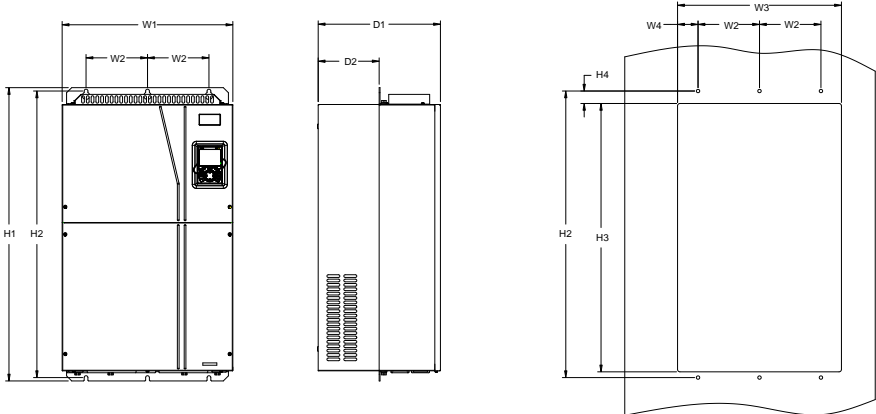

Figure C-18 Flange mounting diagram for 660V 160-220kW models

Table C-5 Flange mounting dimensions of 660V VFD models (unit: mm)

VFD model	W1	W2	W3	W4	H1	H2	H3	H4	D1	D2	Mounting hole	Fixing screw
22kW-45kW	270	130	261	65.5	555	540	516	17	325	167	Ø 7	M6
55kW-132kW	325	200	317	58.5	680	661	626	23	363	182	Ø 9.5	M8
160kW-220kW	500	180	480	60	870	850	796	37	358	178.5	Ø 11	M10

C.5.3 Floor mounting dimensions

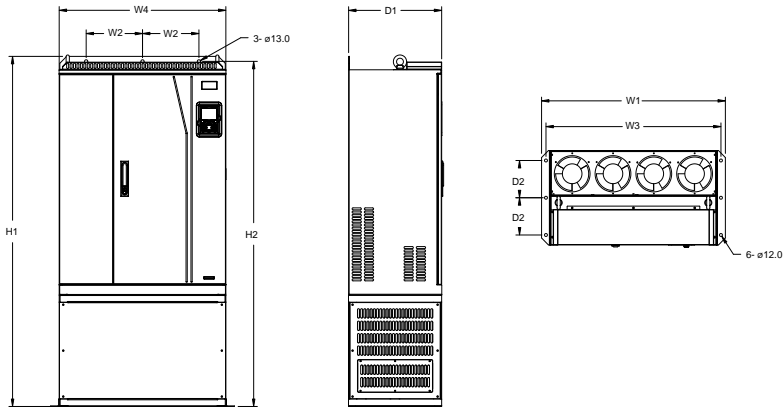

Figure C-19 Floor mounting diagram for 660V 250–355kW models

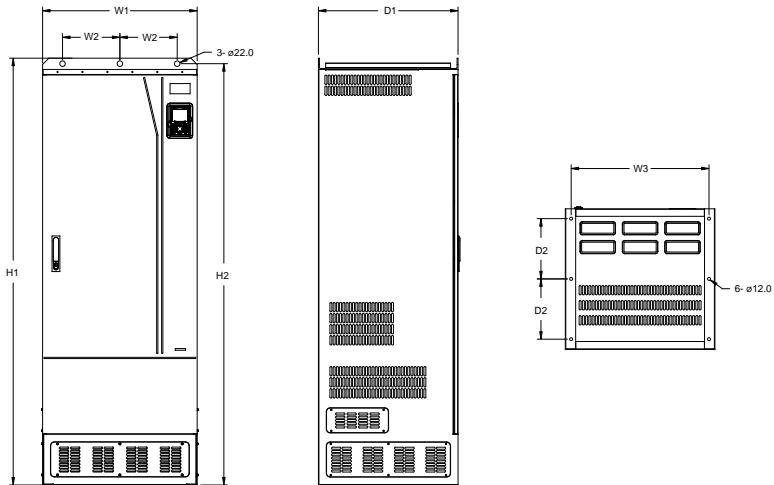

Figure C-20 Floor mounting diagram for 660V 400–630kW models

Table C-6 Floor mounting dimensions of 660V VFD models (unit: mm)

VFD model	W1	W2	W3	W4	H1	H2	D1	D2	Mounting hole	Fixing screw
250kW–355kW	750	230	714	680	1410	1390	380	150	Ø 13/12	M12/M10
400kW–630kW	620	230	572	/	1700	1678	560	240	Ø 22/12	M20/M10

C.6 Dimensions for parallel VFDs

C.6.1 Dimensions with the recommended mounting method

Note: The recommended mounting method for parallel VFDs facilitates internal air intake and better heat dissipation, but the installation size is larger.

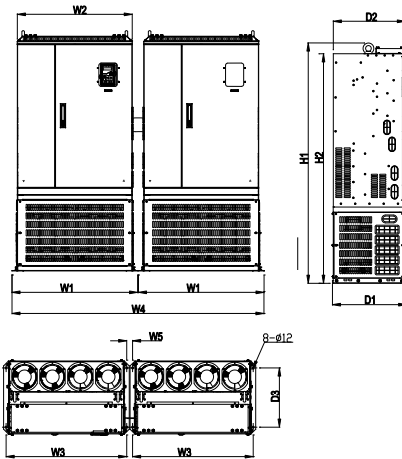

Figure C-21 Parallel mounting diagram for 380V 560–630kW and for 660V 710kW

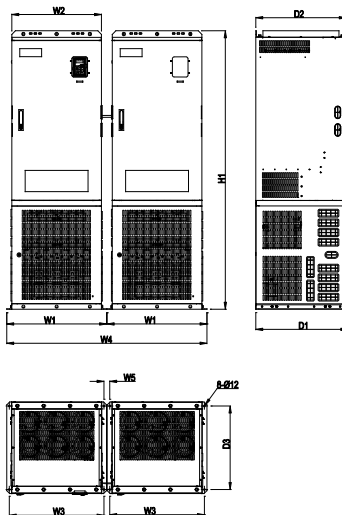

Figure C-22 Parallel mounting diagram for 380V 710–3000kW and for 660V 800–3000kW

Table C-7 Dimensions of mounting parallel 380V VFDs with recommended method (Unit: mm)

VFD model	W1	W2	W3	W4	W5	H1	H2	D1	D2	D3	Mounting hole
560–630kW	749	685	719	1503	35	1419.9	1356	442.5	429.5	350	Ø 12
710–1000kW	690	620	655	1385	40	1900	-	636.3	625.5	570	Ø 12
1200–1500kW	690	620	655	2080	40	1900	-	636.3	625.5	570	Ø 12
2000kW	690	620	655	2775	40	1900	-	636.3	625.5	570	Ø 12
2500kW	690	620	655	3470	40	1900	-	636.3	625.5	570	Ø 12
3000kW	690	620	655	4165	40	1900	-	636.3	625.5	570	Ø 12

Table C-8 Dimensions of mounting parallel 660V VFDs with recommended method (Unit: mm)

VFD model	W1	W2	W3	W4	W5	H1	H2	D1	D2	D3	Mounting hole
710kW	749	685	719	1503	35	1419.9	1356	442.5	429.5	350	Ø 12
800–1200kW	690	620	655	1385	40	1900	-	636.3	625.5	570	Ø 12
1500kW	690	620	655	2080	40	1900	-	636.3	625.5	570	Ø 12
2000–2500kW	690	620	655	2775	40	1900	-	636.3	625.5	570	Ø 12
3000kW	690	620	655	3470	40	1900	-	636.3	625.5	570	Ø 12

C.6.2 Dimensions with the close mounting method

Note: Using the close mounting method for parallel VFDs will have a smaller size, which affects the internal air intake of the product, but meets the product cooling effect.

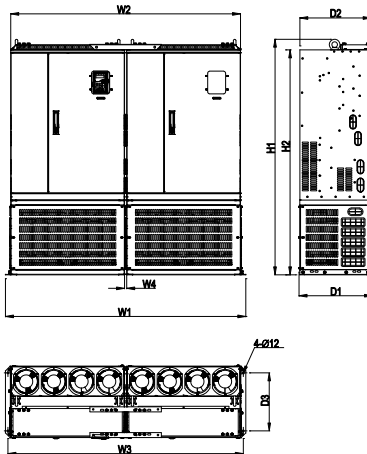

Figure C-23 Parallel mounting diagram for 380V 560–630kW and 660V 710kW

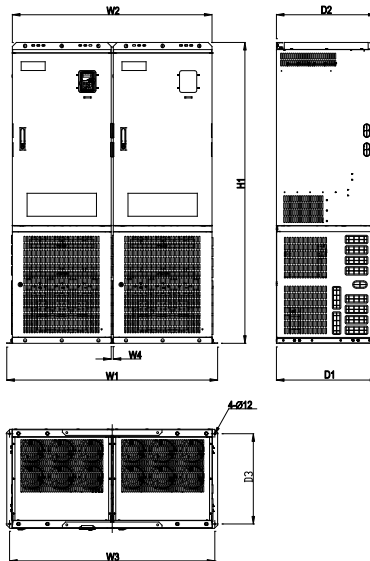

Figure C-24 Parallel mounting diagram for 380V 710–3000kW and 660V 800–3000kW

Table C-9 Dimensions of closely mounting parallel 380V VFDs (Unit: mm)

VFD model	W1	W2	W3	W4	H1	H2	D1	D2	D3	Mounting hole
560-630kW	1447	1383	1417	13	1419.9	1356	442.5	429.5	350	Ø12
710-1000kW	1323	1253	1288	13	1900	-	636.3	625.5	570	Ø12
1200-1500kW	1956	1886	1921	13	1900	-	636.3	625.5	570	Ø12
2000kW	2589	2519	2554	13	1900	-	636.3	625.5	570	Ø12
2500kW	3222	3152	3187	13	1900	-	636.3	625.5	570	Ø12
3000kW	3855	3785	3820	13	1900	-	636.3	625.5	570	Ø12

Table C-10 Dimensions of closely mounting parallel 660V VFDs (Unit: mm)

VFD model	W1	W2	W3	W4	H1	H2	D1	D2	D3	Mounting hole
710kW	1447	1383	1417	13	1419.9	1356	442.5	429.5	350	Ø 12
800-1200kW	1323	1253	1288	13	1900	-	636.3	625.5	570	Ø 12
1500kW	1956	1886	1921	13	1900	-	636.3	625.5	570	Ø 12
2000-2500kW	2589	2519	2554	13	1900	-	636.3	625.5	570	Ø 12
3000kW	3222	3152	3187	13	1900	-	636.3	625.5	570	Ø 12

Appendix D Optional peripheral accessories

D.1 What this chapter contains

This chapter describes how to select optional accessories of the VFD.





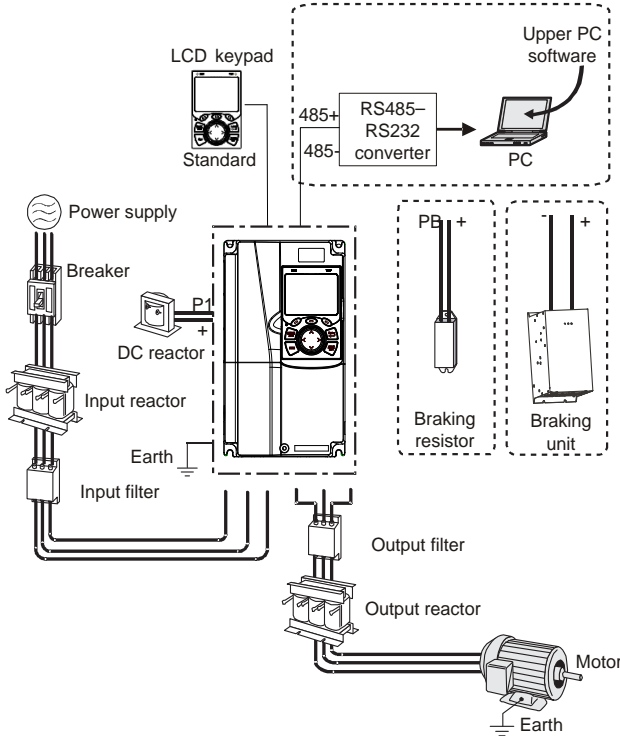

D.2 Wiring of peripheral accessories

The following figure shows the external wiring of the VFD.

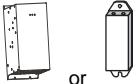

Note:

- The 380V 37kW and lower models are equipped with built-in braking units, and the 380V 45–110kW models can be configured with optional built-in braking units.
- The 380V 18.5–110kW models are equipped with built-in DC reactors.
- The P1 terminal is equipped only for the 380V 132kW and higher models and all 660V models, enabling the VFDs to be directly connected to external DC reactors.
- The braking units are INVT DBU series standard braking units. For details, see the DBU operation manual.

Image	Name	Description
	Cable	Accessory for signal transmission
	Breaker	Device for electric shock prevention and protection against short-to-ground that may cause current leakage and fire. Select residual-current circuit breakers (RCCBs) that are applicable to VFDs and can restrict high-order harmonics, and of which the rated sensitive current for one VFD is larger than 30mA.
	Input reactor	Accessories used to improve the current adjustment coefficient on the input side of the VFD, and thus restrict high-order harmonic currents.
	DC reactor	
	Input filter	Accessory that restricts the electromagnetic interference generated by the VFD and transmitted to the public grid through the power cable. Try to install the input filter near the input terminal side of the VFD.
	Braking unit or braking resistor	Accessories used to consume the regenerative energy of the motor to reduce the deceleration time. The 380V 37kW and lower VFD models only need external braking resistors. The 380V 132kW and higher and all 660V VFD models also need braking units. The 380V 45kW–110kW VFD models can be configured with built-in braking units.
	Output filter	Accessory used to restrict interference generated in the wiring area on the output side of the VFD. Try to install the output filter near the output terminal side of the VFD.
	Output reactor	Accessory used to lengthen the valid transmission distance of the VFD, which effectively restrict the transient high voltage generated during the switch-on and switch-off of the IGBT module of the VFD.

D.3 Power supply

Refer to chapter 4 Installation guide.

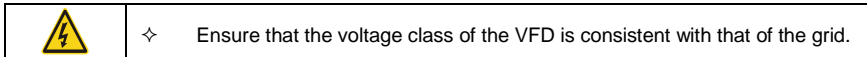

D.4 Cables

D.4.1 Power cables

The sizes of the input power cables and motor cables must meet the local regulation.

- The input power cables and motor cables must be able to carry the corresponding load currents.
- The maximum temperature margin of the motor cables in continuous operation cannot be lower than 70°C.
- The conductivity of the PE grounding conductor is the same as that of the phase conductor, that is, the cross-sectional areas are the same.
- For details about the EMC requirements, see Appendix B Technical data.

To meet the EMC requirements stipulated in the CE standards, you must use symmetrical shielded cables as motor cables (as shown in the following figure).

Four-core cables can be used as input cables, but symmetrical shielded cables are recommended. Compared with four-core cables, symmetrical shielded cables can reduce electromagnetic radiation as well as the current and loss of the motor cables.

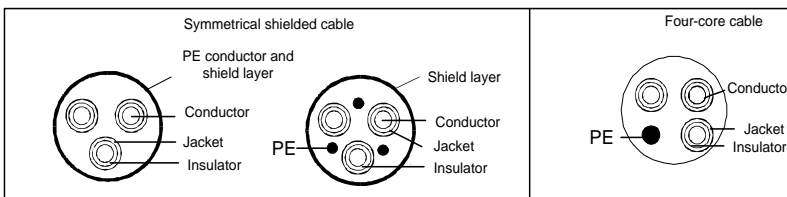

Note: If the conductivity of the shield layer of the motor cables cannot meet the requirements, separate PE conductors must be used.

To protect the conductors, the cross-sectional area of the shielded cables must be the same as that of the phase conductors if the cable and conductor are made of materials of the same type. This reduces grounding resistance, and thus improves impedance continuity.

To effectively restrict the emission and conduction of radio frequency (RF) interference, the conductivity of the shielded cable must at least be 1/10 of the conductivity of the phase conductor. This requirement can be well met by a copper or aluminum shield layer. The following figure shows the minimum requirement on motor cables of a VFD. The cable must consist of a layer of spiral-shaped copper strips. The denser the shield layer is, the more effectively the electromagnetic interference is restricted.

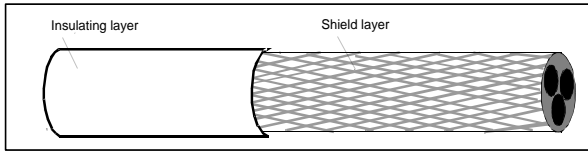

Cross-section of the cable

D.4.2 Control cables

All analog control cables and cables used for frequency input must be shielded cables. Analog signal cables need to be double-shielded twisted-pair cables (as shown in figure a). Use one separate shielded twisted pair for each signal. Do not use the same ground wire for different analog signals.

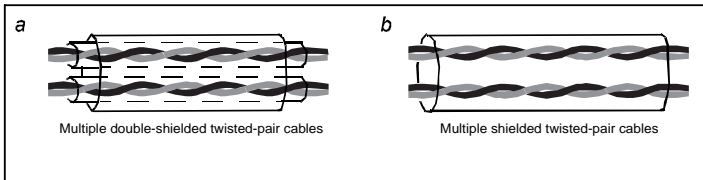

Power cable arrangement

For low-voltage digital signals, double-shielded cables are recommended, but shielded or unshielded twisted pairs (as shown in figure b) also can be used. For frequency signals, however, only shielded cables can be used.

Relay cables need to be those with metal braided shield layers.

Keypads need to be connected by using network cables. In complicated electromagnetic environments, shielded network cables are recommended.

Note: Analog signals and digital signals cannot use the same cables, and their cables must be arranged separately.

Do not perform any voltage endurance or insulation resistance tests, such as high-voltage insulation tests or using a megameter to measure the insulation resistance, on the VFD or its components. Insulation and voltage endurance tests have been performed between the main circuit and chassis of each VFD before delivery. In addition, voltage limiting circuits that can automatically cut off the test voltage are configured inside the VFDs.

Note: Check the insulation conditions of the input power cable of a VFD according to the local regulations before connecting it.

D.4.3 Recommended cable sizes

Table D-1 AC 3PH 380V(-15%)–440V(+10%)

VFD model	Recommended cable size (mm ²)				Screw	
	R, S, T U, V, W	PE	P1, (+)	PB, (+), (-)	Terminal screw	Fastening torque (Nm)
GD350-1R5G-4	1.0	1.0	1.0	1.0	M4	1.2–1.5

VFD model	Recommended cable size (mm ²)				Screw	
	R, S, T U, V, W	PE	P1, (+)	PB, (+), (-)	Terminal screw	Fastening torque (Nm)
GD350-2R2G-4	1.0	1.0	1.0	1.0	M4	1.2–1.5
GD350-004G-4	1.5	1.5	1.5	1.5	M4	1.2–1.5
GD350-5R5G-4	1.5	1.5	1.5	1.5	M5	2–2.5
GD350-7R5G-4	2.5	2.5	2.5	2.5	M5	2–2.5
GD350-011G-4	4	4	4	4	M5	2–2.5
GD350-015G-4	6	6	6	6	M5	2–2.5
GD350-018G-4	10	10	10	10	M6	4–6
GD350-022G-4	10	10	10	10	M6	4–6
GD350-030G-4	16	16	16	16	M8	9–11
GD350-037G-4	25	16	25	25	M8	9–11
GD350-045G-4	25	16	25	25	M8	9–11
GD350-055G-4	35	16	35	35	M10	18–23
GD350-075G-4	50	25	50	50	M10	18–23
GD350-090G-4	70	35	70	70	M10	18–23
GD350-110GP-4	95	50	95	95	M12	31–40
GD350-132G-4	95	50	95	95	M12	31–40
GD350-160G-4	150	70	150	150	M12	31–40
GD350-185G-4	185	95	185	185	M12	31–40
GD350-200G-4	185	95	185	185	M12	31–40
GD350-220G-4	2×95	95	2×95	2×95	M12	31–40
GD350-250G-4	2×95	95	2×95	2×95	M12	31–40
GD350-280G-4	2×150	150	2×150	2×150	M12	31–40
GD350-315G-4	2×150	150	2×150	2×150	M12	31–40
GD350-355G-4	2×185	185	2×185	2×185	M12	31–40
GD350-400G-4	3×150	2×120	3×150	3×150	M12	31–40
GD350-450G-4	3×185	2×150	3×185	3×185	M12	31–40
GD350-500G-4	3×185	2×150	3×185	3×185	M12	31–40

Note:

- Cables of the sizes recommended for the main circuit can be used in scenarios where the ambient temperature is lower than 40°C, the wiring distance is shorter than 100m, and the current is the rated current.
- The terminals P1, (+), PB, and (-) are used to connect to DC reactors and braking accessories.

Table D-2 AC 3PH 520V(-15%)–690V(+10%)

VFD model	Recommended cable size (mm ²)				Screw	
	R, S, T U, V, W	PE	P1, (+)	PB, (+), (-)	Terminal screw	Fastening torque (Nm)
GD350-022G-6	4	4	4	4	M8	9–11
GD350-030G-6	6	6	6	6	M8	9–11
GD350-037G-6	6	6	6	6	M8	9–11
GD350-045G-6	10	10	10	10	M8	9–11
GD350-055G-6	16	16	16	16	M10	18–23
GD350-075G-6	16	16	16	16	M10	18–23
GD350-090G-6	16	16	16	16	M10	18–23
GD350-110G-6	25	16	25	25	M10	18–23
GD350-132G-6	35	16	35	35	M10	18–23
GD350-160G-6	50	25	50	50	M12	31–40
GD350-185G-6	70	35	70	70	M12	31–40
GD350-200G-6	70	35	70	70	M12	31–40
GD350-220G-6	95	50	95	95	M12	31–40
GD350-250G-6	95	50	95	95	M12	31–40
GD350-280G-6	120	70	120	120	M12	31–40
GD350-315G-6	150	70	150	150	M12	31–40
GD350-355G-6	185	95	185	185	M12	31–40
GD350-400G-6	2×70	70	2×70	2×70	M12	31–40
GD350-450G-6	2×95	95	2×95	2×95	M12	31–40
GD350-500G-6	2×120	120	2×120	2×120	M12	31–40
GD350-560G-6	2×150	150	2×150	2×150	M12	31–40
GD350-630G-6	2×150	150	2×150	2×150	M12	31–40

Note:

- Cables of the sizes recommended for the main circuit can be used in scenarios where the ambient temperature is lower than 40°C, the wiring distance is shorter than 100m, and the current is the rated current.
- The terminals P1, (+), PB and (-) are used to connect to DC reactors and braking accessories.

D.4.4 Cable sizes for parallel VFDs

Table D-3 AC 3PH 380V(-15%)–440V(+10%)

Total power (kW)	380V parallel VFD requirement		Recommended copper-core cable size for a single VFD (mm ²)		
	Power (kW)	Quantity	RST UVW	PE	(+)(-)
560	280	2	95*4P	95*2P	120*2P
630	315	2	95*4P	95*2P	150*2P

Total power (kW)	380V parallel VFD requirement		Recommended copper-core cable size for a single VFD (mm ²)		
	Power (kW)	Quantity	RST UVW	PE	(+)(-)
560kW	280	2	2×150	150	2×150
630 kW	315	2	2×150	150	2×150
710 kW	355	2	2×185	185	2×185
800 kW	400	2	3×150	2×120	3×150
1000 kW	500	2	3×185	2×150	3×185
1200 kW	400	3	3×150	2×120	3×150
1500 kW	500	3	3×185	2×150	3×185
2000 kW	500	4	3×185	2×150	3×185
2500 kW	500	5	3×185	2×150	3×185
3000 kW	500	6	3×185	2×150	3×185

Table D-4 AC 3PH 520V(-15%)–690V(+10%)

Total power (kW)	660V parallel VFD requirement		Recommended copper-core cable size for a single VFD (mm ²)		
	Power (kW)	Quantity	RST UVW	PE	(+)(-)
710 kW	355	2	185	95	185
800 kW	400	2	2×70	70	2×70
1000 kW	500	2	2×120	120	2×120
1200 kW	630	2	2×150	150	2×150
1500 kW	500	3	2×120	120	2×120
2000 kW	500	4	2×120	120	2×120
2500 kW	630	4	2×150	150	2×150
3000 kW	630	5	2×150	150	2×150

Note:

- Cables of the sizes recommended for the main circuit can be used in scenarios where the ambient temperature is lower than 40°C, the wiring distance is shorter than 100m, and the current is the rated current.
- The terminals P1, (+), PB and (-) are used to connect to DC reactors and braking accessories.

D.4.5 Cable configuration for parallel VFDs

	Master	Slave 1	Slave 2	Slave 3	Slave 4	Slave 5
RST input cable	User provided	User provided	User provided	User provided	User provided	User provided
UVW output cable	User provided	User provided	User provided	User provided	User provided	User provided

	Master	Master–Slave 1	Slave 1–Slave 2	Slave 2–Slave 3	Slave 3–Slave 4	Slave 4–Slave 5
Bus cable of (+) and (-)	-	Standard	Standard	Standard	Standard	Standard

	Master	Master–Slave 1	Master–Slave 2	Master–Slave 3	Master–Slave 4	Master–Slave 5
Optical fiber cable	Standard	Standard	Standard	Standard	Standard	Standard
15-core serial port cable	Standard	Standard	Standard	Standard	Standard	Standard

D.4.6 Cable arrangement

Motor cables must be arranged away from other cables. The motor cables of several VFDs can be arranged in parallel. It is recommended that you arrange the motor cables, input power cables, and control cables separately in different trays. The output dU/dt of the VFDs may increase electromagnetic interference on other cables. Do not arrange other cables and the motor cables in parallel.

If a control cable and power cable must cross each other, ensure that the angle between them is 90 degrees.

The cable trays must be connected properly and well grounded. Aluminum trays can implement local equipotential.

The following figure shows the cable arrangement distance requirements.

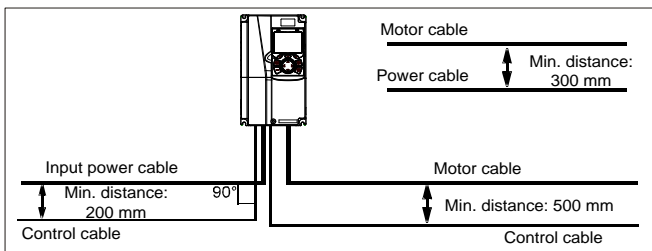

Cable arrangement distances

D.4.7 Insulation inspection

Check the motor and the insulation conditions of the motor cable before running the motor.

1. Ensure that the motor cable is connected to the motor, and then remove the motor cable from the U, V, and W output terminals of the VFD.
2. Use a megameter of 500 V DC to measure the insulation resistance between each phase conductor and the protection grounding conductor. For details about the insulation resistance of the motor, see the description provided by the manufacturer.

Note: The insulation resistance is reduced if it is damp inside the motor. If it may be damp, you need to dry the motor and then measure the insulation resistance again.

D.5 Breaker and electromagnetic contactor

You need to add a fuse to prevent overload.

You need to configure a manually manipulated molded case circuit breaker (MCCB) between the AC power supply and VFD. The breaker must be locked in the open state to facilitate installation and inspection. The capacity of the breaker needs to be 1.5 to 2 times the VFD rated input current.

The fuse/breaker model selection for a VFD in a parallel product is consistent with that for a single VFD, and the capacity of the fuse/breaker for a parallel product is twice the rated current of the parallel product. (For details about the rated current of each parallel product, see 3.8 Ratings of parallel products.

	<p>◇ According to the working principle and structure of breakers, if the manufacturer's regulation is not followed, hot ionized gases may escape from the breaker enclosure when a short-circuit occurs. To ensure safe use, exercise extra caution when installing and placing the breaker. Follow the manufacturer's instructions.</p>
---	---

To ensure safety, you can configure an electromagnetic contactor on the input side to control the switch-on and switch-off of the main circuit power, so that the input power supply of the VFD can be effectively cut off when a system fault occurs.

Table D-5 AC 3PH 380V(-15%)–440V(+10%)

VFD model	Breaker rated current (A)	Fast-acting fuse rated current (A)	Contactor rated current (A)
GD350-1R5G-4	6	10	9
GD350-2R2G-4	10	10	9

VFD model	Breaker rated current (A)	Fast-acting fuse rated current (A)	Contactora rated current (A)
GD350-004G-4	20	20	18
GD350-5R5G-4	25	35	25
GD350-7R5G-4	32	40	32
GD350-011G-4	50	50	38
GD350-015G-4	63	60	50
GD350-018G-4	63	70	65
GD350-022G-4	80	90	80
GD350-030G-4	100	125	80
GD350-037G-4	125	125	115
GD350-045G-4	140	150	115
GD350-055G-4	180	200	150
GD350-075G-4	225	250	185
GD350-090G-4	250	300	225
GD350-110G-4	315	350	265
GD350-132G-4	400	400	330
GD350-160G-4	500	500	400
GD350-185G-4	500	600	400
GD350-200G-4	630	600	500
GD350-220G-4	630	700	500
GD350-250G-4	700	800	630
GD350-280G-4	800	1000	630
GD350-315G-4	1000	1000	800
GD350-355G-4	1000	1000	800
GD350-400G-4	1000	1200	1000
GD350-450G-4	1250	1200	1000
GD350-500G-4	1250	1400	1000

Note: The accessory specifications described in the preceding table are ideal values. You can select accessories based on the actual market conditions, but try not to use those with lower values.

Table D-6 AC 3PH 520V(-15%)–690V(+10%)

VFD model	Breaker rated current (A)	Fast-acting fuse rated current (A)	Contactora rated current (A)
GD350-022G-6	50	50	50
GD350-030G-6	63	60	50
GD350-037G-6	63	70	65
GD350-045G-6	80	80	65
GD350-055G-6	100	100	80
GD350-075G-6	125	125	115

VFD model	Breaker rated current (A)	Fast-acting fuse rated current (A)	Contactora rated current (A)
GD350-090G-6	140	150	115
GD350-110G-6	180	200	150
GD350-132G-6	225	250	185
GD350-160G-6	225	250	225
GD350-185G-6	250	300	225
GD350-200G-6	315	350	265
GD350-220G-6	315	350	265
GD350-250G-6	350	400	330
GD350-280G-6	400	500	330
GD350-315G-6	500	600	400
GD350-355G-6	500	600	500
GD350-400G-6	630	700	500
GD350-450G-6	700	800	630
GD350-500G-6	800	900	630
GD350-560G-6	800	900	800
GD350-630G-6	1000	1000	800

Note: The accessory specifications described in the preceding table are ideal values. You can select accessories based on the actual market conditions, but try not to use those with lower values.

D.6 Reactors

When the voltage of the grid is high, the transient large current that flows into the input power circuit may damage rectifier components. You need to configure an AC reactor on the input side, which can also improve the current adjustment coefficient on the input side.

When the distance between the VFD and motor is longer than 50m, the parasitic capacitance between the long cable and ground may cause large leakage current, and overcurrent protection of the VFD may be frequently triggered. To prevent this from happening and avoid damage to the motor insulator, compensation must be made by adding an output reactor. When a VFD is used to drive multiple motors, take the total length of the motor cables (that is, sum of the lengths of the motor cables) into account. When the total length is longer than 50 m, an output reactor must be added on the output side of the VFD. If the distance between the VFD and motor is 50 m to 100 m, select the reactor according to the following table. If the distance is longer than 100m, contact INVT's technical support technicians.

DC reactors can be directly connected to the 380V 132kW and higher and all 660V VFD models. DC reactors can improve the power factor, avoid damage to bridge rectifiers caused due to large input current of the VFD when large-capacity transformers are connected, and also avoid damage to the rectification circuit caused due to harmonics generated by grid voltage transients or phase-control loads.

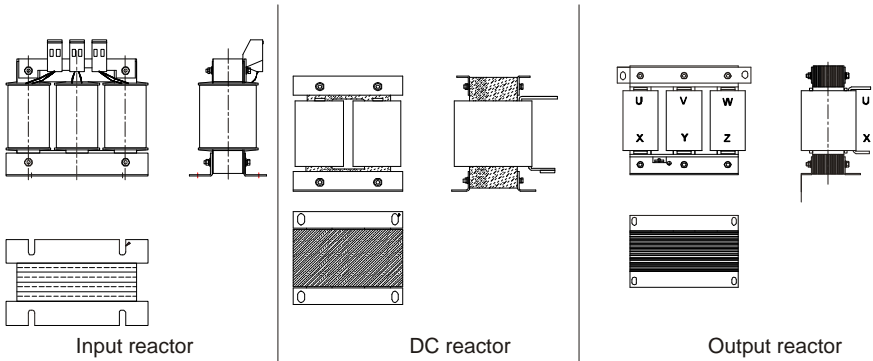

Figure D-1 Vertical reactor diagram for 380V 315kW and lower and 660V 350kW and lower

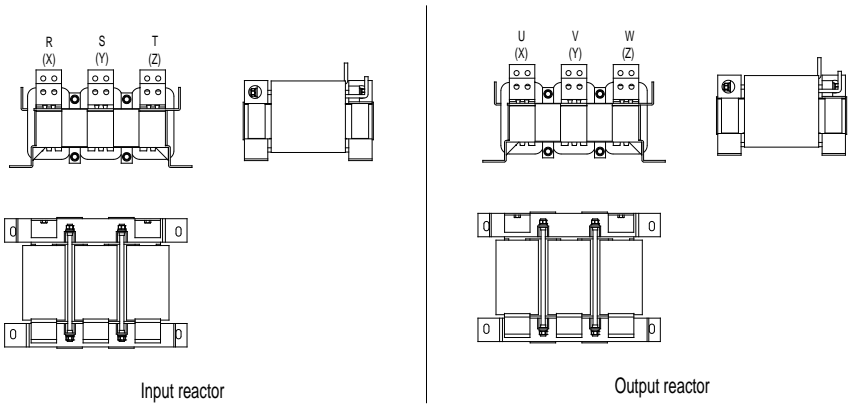

Figure D-2 Horizontal reactor diagram for 380V 350–500kW and 660V 400–630kW

D.6.1 For a single VFD

Table D–7 Reactors for AC 3PH 380V (-15%)–440V (+10%)

VFD model	Input reactor	DC reactor	Output reactor
GD350-1R5G-4	ACL2-1R5-4	/	OCL2-1R5-4
GD350-2R2G-4	ACL2-2R2-4	/	OCL2-2R2-4
GD350-004G-4	ACL2-004-4	/	OCL2-004-4
GD350-5R5G-4	ACL2-5R5-4	/	OCL2-5R5-4
GD350-7R5G-4	ACL2-7R5-4	/	OCL2-7R5-4
GD350-011G-4	ACL2-011-4	/	OCL2-011-4
GD350-015G-4	ACL2-015-4	/	OCL2-015-4
GD350-018G-4	ACL2-018-4	Standard	OCL2-018-4

VFD model	Input reactor	DC reactor	Output reactor
GD350-022G-4	ACL2-022-4	Standard	OCL2-022-4
GD350-030G-4	ACL2-037-4	Standard	OCL2-037-4
GD350-037G-4	ACL2-037-4	Standard	OCL2-037-4
GD350-045G-4	ACL2-045-4	Standard	OCL2-045-4
GD350-055G-4	ACL2-055-4	Standard	OCL2-055-4
GD350-075G-4	ACL2-075-4	Standard	OCL2-075-4
GD350-090G-4	ACL2-110-4	Standard	OCL2-110-4
GD350-110G-4	ACL2-110-4	Standard	OCL2-110-4
GD350-132G-4	ACL2-160-4	DCL2-132-4	OCL2-200-4
GD350-160G-4	ACL2-160-4	DCL2-160-4	OCL2-200-4
GD350-185G-4	ACL2-200-4	DCL2-200-4	OCL2-200-4
GD350-200G-4	ACL2-200-4	DCL2-220-4	OCL2-200-4
GD350-220G-4	ACL2-280-4	DCL2-280-4	OCL2-280-4
GD350-250G-4	ACL2-280-4	DCL2-280-4	OCL2-280-4
GD350-280G-4	ACL2-280-4	DCL2-280-4	OCL2-280-4
GD350-315G-4	ACL2-350-4	DCL2-315-4	OCL2-350-4
GD350-350G-4	Standard	DCL2-400-4	OCL2-350-4
GD350-400G-4	Standard	DCL2-400-4	OCL2-400-4
GD350-450G-4	Standard	DCL2-500-4	OCL2-500-4
GD350-500G-4	Standard	DCL2-500-4	OCL2-500-4

Note:

- The rated input voltage drop of input reactors is 2%.
- The current adjustment coefficient on the input side of the VFD is higher than 90% after a DC reactor is configured.
- The rated output voltage drop of output reactors is 1%.
- The preceding table describes external accessories. You need to specify whether external or built-in accessories are needed in your purchase order.

Table D-8 Reactors for AC 3PH 520V (-15%)–690V (+10%)

VFD model	Input reactor	DC reactor	Output reactor
GD350-022G-6	ACL2-030-6	DCL2-030-6	OCL2-030-6
GD350-030G-6	ACL2-030-6	DCL2-030-6	OCL2-030-6
GD350-037G-6	ACL2-055-6	DCL2-055-6	OCL2-055-6
GD350-045G-6	ACL2-055-6	DCL2-055-6	OCL2-055-6
GD350-055G-6	ACL2-055-6	DCL2-055-6	OCL2-055-6
GD350-075G-6	ACL2-110-6	DCL2110-6	OCL2-110-6
GD350-090G-6	ACL2-110-6	DCL2-110-6	OCL2-110-6
GD350-110G-6	ACL2-110-6	DCL2-110-6	OCL2-110-6

VFD model	Input reactor	DC reactor	Output reactor
GD350-132G-6	ACL2-185-6	DCL2-185-6	OCL2-185-6
GD350-160G-6	ACL2-185-6	DCL2-185-6	OCL2-185-6
GD350-185G-6	ACL2-185-6	DCL2-185-6	OCL2-185-6
GD350-200G-6	ACL2-250-6	DCL2-250-6	OCL2-250-6
GD350-220G-6	ACL2-250-6	DCL2-250-6	OCL2-250-6
GD350-250G-6	ACL2-250-6	DCL2-250-6	OCL2-250-6
GD350-280G-6	ACL2-350-6	DCL2-350-6	OCL2-350-6
GD350-315G-6	ACL2-350-6	DCL2-350-6	OCL2-350-6
GD350-355G-6	ACL2-350-6	DCL2-350-6	OCL2-350-6
GD350-400G-6	Standard	DCL2-400-6	OCL2-400-6
GD350-450G-6	Standard	DCL2-560-6	OCL2-560-6
GD350-500G-6	Standard	DCL2-560-6	OCL2-560-6
GD350-560G-6	Standard	DCL2-560-6	OCL2-560-6
GD350-630G-6	Standard	DCL2-630-6	OCL2-630-6

Note:

- The rated input voltage drop of input reactors is 2%.
- The current adjustment coefficient on the input side of the VFD is higher than 90% after a DC reactor is configured.
- The rated output voltage drop of output reactors is 1%.
- The preceding table describes external accessories. You need to specify whether external or built-in accessories are needed in your purchase order.

D.6.2 For parallel VFDs

The following tables lists the reactor model selection for the VFDs to be paralleled.

Table D-9 Reactor model selection for AC 3PH 380V(-15%)–440V(+10%)

VFD model	Input reactor model	DC reactor model	Output reactor model
280kW	ACL2-280-4 (Standard)	DCL2-280-4 (Optional)	OCL2-280-4 (Standard)
315 kW	ACL2-315-4 (Standard)	DCL2-315-4 (Optional)	OCL2-315-4 (Standard)
350 kW	ACL2-350-4 (Standard)	DCL2-400-4 (Optional)	OCL2-350-4 (Standard)
400 kW	ACL2-400-4 (Standard)	DCL2-400-4 (Optional)	OCL2-400-4 (Standard)
500 kW	ACL2-500-4 (Standard)	DCL2-500-4 (Optional)	OCL2-500-4 (Standard)

Note:

- The rated input voltage drop of input reactors is 2%.
- The current adjustment coefficient on the input side of the VFD is higher than 90% after a DC reactor is configured.
- The rated output voltage drop of output reactors is 1%.
- DC reactors are externally connected. You need to specify whether external or built-in reactors

are needed in your purchase order.

Table D-10 Reactor model selection for AC 3PH 520V(-15%)–690V(+10%)

VFD model	Input reactor model	DC reactor model	Output reactor model
350 kW	ACL2-350G-6 (Standard)	DCL2-350G-6 (Optional)	OCL2-350G-6 (Standard)
400 kW	ACL2-400G-6 (Standard)	DCL2-400G-6 (Optional)	OCL2-400G-6 (Standard)
500 kW	ACL2-560G-6 (Standard)	DCL2-560G-6 (Optional)	OCL2-560G-6 (Standard)
630 kW	ACL2-630G-6 (Standard)	DCL2-630G-6 (Optional)	OCL2-630G-6 (Standard)

Note:

- The rated input voltage drop of input reactors is 2%.
- The current adjustment coefficient on the input side of the VFD is higher than 90% after a DC reactor is configured.
- The rated output voltage drop of output reactors is 1%.
- DC reactors are externally connected. You need to specify whether external or built-in reactors are needed in your purchase order.

D.7 Filters

J10 is not connected in factory for the 380V 110kW and lower VFD models. Connect the J10 packaged with the manual if IEC/EN 61800-3 C3 requirements need to be met.

J10 is connected in factory for the 380V 132kW and higher VFD models, all of which meet IEC/EN 61800-3 C3 requirements.

Note:

Disconnect J10 in the following situations:

- The EMC filter is applicable to the neutral-grounded grid system. If it is used for the IT grid system (that is, non-neutral grounded grid system), disconnect J10.
- If leakage protection occurs during configuration of a residual-current circuit breaker, disconnect J10.

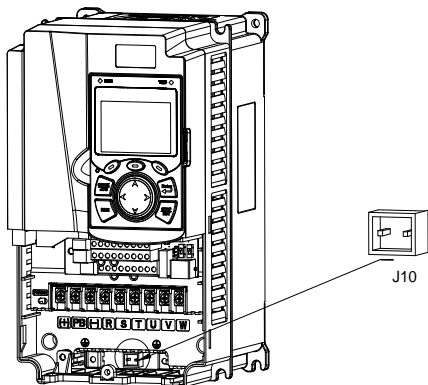

Note: Do not connect C3 filters in IT power systems.

Interference filters on the input side can reduce the VFD interference on the surrounding devices.

Noise filters on the output side can decrease the radio noise caused by the cables between VFDs and motors and the leakage current of conducting wires.

INVT provides some of the filters for you to choose.

D.7.1 Filter model description

FLT - P 04 045 L - B
A B C D E F

Field identifier	Field description
A	FLT: Name of the VFD filter series
B	Filter type P: Power input filter L: Output filter
C	Voltage class 04: AC 3PH 380V (-15%)–440V (+10%) 06: AC 3PH 520V (-15%)–690V (+10%)
D	3-digit code indicating the rated current. For example, 015 indicates 15A.
E	Filter performance L: General H: High-performance
F	Filter application environment A: First environment (IEC61800-3), category C1 (EN 61800-3) B: First environment (IEC61800-3), category C2 (EN 61800-3) C: Second environment (IEC61800-3), category C3 (EN 61800-3)

D.7.2 Filter model selection

Table D–11 AC 3PH 380V(-15%)–440V(+10%)

VFD model	Input filter	Output filter
GD350-1R5G-4	FLT-P04006L-B	FLT-L04006L-B
GD350-2R2G-4		FLT-L04016L-B
GD350-004G-4	FLT-P04032L-B	FLT-L04032L-B
GD350-5R5G-4		FLT-L04045L-B
GD350-7R5G-4	FLT-P04065L-B	FLT-L04065L-B
GD350-011G-4		FLT-L04065L-B
GD350-015G-4	FLT-P04065L-B	FLT-L04065L-B
GD350-018G-4		FLT-L04065L-B
GD350-022G-4	FLT-P04065L-B	FLT-L04065L-B
GD350-030G-4		FLT-L04065L-B

VFD model	Input filter	Output filter
GD350-037G-4	FLT-P04100L-B	FLT-L04100L-B
GD350-045G-4		
GD350-055G-4	FLT-P04150L-B	FLT-L04150L-B
GD350-075G-4		
GD350-090G-4	FLT-P04240L-B	FLT-L04240L-B
GD350-110G-4		
GD350-132G-4		
GD350-160G-4	FLT-P04400L-B	FLT-L04400L-B
GD350-185G-4		
GD350-200G-4		
GD350-220G-4	FLT-P04600L-B	FLT-L04600L-B
GD350-250G-4		
GD350-280G-4		
GD350-315G-4	FLT-P04800L-B	FLT-L04800L-B
GD350-355G-4		
GD350-400G-4		
GD350-450G-4	FLT-P041000L-B	FLT-L041000L-B
GD350-500G-4		

Refer to the preceding table for the filter model selection for a parallel VFD system.

Note:

- The input EMI meets the C2 requirements after an input filter is configured.
- The preceding table describes external accessories. You need to specify whether external or built-in accessories are needed in your purchase order.

Table D–12 AC 3PH 520V(-15%)–690V(+10%)

VFD model	Input filter	Output filter
GD350-022G-6	FLT-P06050H-B	FLT-L06050H-B
GD350-030G-6		
GD350-037G-6		
GD350-045G-6	FLT-P06100H-B	FLT-L06100H-B
GD350-055G-6		
GD350-075G-6		
GD350-090G-6		
GD350-110G-6	FLT-P06200H-B	FLT-L06200H-B
GD350-132G-6		
GD350-160G-6		
GD350-185G-6		
GD350-200G-6	FLT-P06300H-B	FLT-L06300H-B
GD350-220G-6		

VFD model	Input filter	Output filter
GD350-250G-6	FLT-P06400H-B	FLT-L06400H-B
GD350-280G-6		
GD350-315G-6		
GD350-355G-6		
GD350-400G-6	FLT-P061000H-B	FLT-L061000H
GD350-450G-6		
GD350-500G-6		
GD350-560G-6		
GD350-630G-6		
GD350-630G-6		

Refer to the preceding table for the filter model selection for a paralel VFD system.



Note:

- The input EMI meets the C2 requirements after an input filter is configured.
- The preceding table describes external accessories. You need to specify whether external or built-in accessories are needed in your purchase order.

D.8 Braking system

D.8.1 Braking component selection

When the VFD driving a high-inertia load decelerates or needs to decelerate abruptly, the motor runs in the power generation state and transmits the load-carrying energy to the DC circuit of the VFD, causing the bus voltage of the VFD to rise. If the bus voltage exceeds a specific value, the VFD reports an overvoltage fault. To prevent this from happening, you need to configure braking components.

	<ul style="list-style-type: none"> ✧ The design, installation, commissioning, and operation of the device must be performed by trained and qualified professionals. ✧ Follow all the "Warning" instructions during the operation. Otherwise, major physical injuries or property loss may be caused. ✧ Only qualified electricians are allowed to perform the wiring. Otherwise, damage to the VFD or braking components may be caused. ✧ Read the braking resistor or unit instructions carefully before connecting them to the VFD. ✧ Connect braking resistors only to the terminals PB and (+), and braking units only to the terminals (+) and (-). Do not connect them to other terminals. Otherwise, damage to the braking circuit and VFD and fire may be caused.
	<ul style="list-style-type: none"> ✧ Connect the braking components to the VFD according to the wiring diagram. If the wiring is not properly performed, damage to the VFD or other devices may be caused.

The 380V 37kW and lower VFD models are equipped with built-in braking units, and the 380V 45kW and higher VFD models need to be configured with external braking units. The 380V 45kW–110kW

VFD models can be configured with optional built-in braking units. After a built-in braking unit is configured for the VFD, the VFD model is added with a suffix "-B", for example, GD350-045G-4-B. For a parallel 380V large-power VFD system, you need to configure the external braking unit that is an optional part. Select braking resistors according to the specific requirements (such as the braking torque and braking usage requirements) on site.

Table D-13 Braking units for AC 3PH 380V(-15%)–440V(+10%)



VFD model	Braking unit model	Resistance applicable for 100% braking torque (Ω)	Dissipated power of braking resistor (kW)			Min. allowable braking resistance (Ω)
			10% braking usage	50% braking usage	80% braking usage	
GD350-1R5G-4	Built-in braking unit	326	0.23	1.1	1.8	170
GD350-2R2G-4		222	0.33	1.7	2.6	130
GD350-004G-4		122	0.6	3	4.8	80
GD350-5R5G-4		89	0.75	4.1	6.6	60
GD350-7R5G-4		65	1.1	5.6	9	47
GD350-011G-4		44	1.7	8.3	13.2	31
GD350-015G-4		32	2	11	18	23
GD350-018G-4		27	3	14	22	19
GD350-022G-4		22	3	17	26	17
GD350-030G-4		17	5	23	36	17
GD350-037G-4		13	6	28	44	11.7
GD350-045G-4		DBU100H-110-4	10	7	34	54
GD350-055G-4	8		8	41	66	
GD350-075G-4	6.5		11	56	90	
GD350-090G-4	DBU100H-160-4	5.4	14	68	108	4.4
GD350-110G-4		4.5	17	83	132	
GD350-132G-4	DBU100H-220-4	3.7	20	99	158	3.2
GD350-160G-4	DBU100H-320-4	3.1	24	120	192	2.2
GD350-185G-4		2.8	28	139	222	
GD350-200G-4		2.5	30	150	240	
GD350-220G-4	DBU100H-400-4	2.2	33	165	264	1.8
GD350-250G-4		2.0	38	188	300	
GD350-280G-4	DBU100H-320-4 Quantity: Two	3.6×2	21×2	105×2	168×2	2.2×2
GD350-315G-4		3.2×2	24×2	118×2	189×2	
GD350-355G-4		2.8×2	27×2	132×2	210×2	

VFD model	Braking unit model	Resistance applicable for 100% braking torque (Ω)	Dissipated power of braking resistor (kW)			Min. allowable braking resistance (Ω)
			10% braking usage	50% braking usage	80% braking usage	
GD350-400G-4		2.4x2	30x2	150x2	240x2	
GD350-450G-4	DBU100H-400-4	2.2x2	34x2	168x2	270x2	1.8x2
GD350-500G-4	Quantity: Two	2.0x2	38x2	186x2	300x2	

Refer to the preceding table for the braking unit model selection for a paralel VFD system.

Note:

- Select braking resistors according to the resistance and power data provided by our company.
- The braking resistor may increase the braking torque of the VFD. The preceding table describes the resistance and power for 100% braking torque, 10% braking usage, 50% braking usage, and 80% braking usage. You can select the braking system based on the actual operation conditions.
- When using an external braking unit, set the braking voltage class of the braking unit properly by referring to the manual of the dynamic braking unit. If the voltage class is set incorrectly, the VFD may not run properly.

	◇ Do not use braking resistors whose resistance is lower than the specified minimum resistance. VFDs do not provide protection against overcurrent caused by resistors with low resistance.
	◇ In scenarios where braking is frequently implemented, that is, the braking usage is greater than 10%, you need to select a braking resistor with higher power as required by the operation conditions according to the preceding table.

External braking units need to be configured for the 660V models and a parallel 660V large-power VFD system. Select braking resistors according to the specific requirements (such as the braking torque and braking usage requirements) on site.

Table D–14 Braking units for AC 3PH 520V(-15%)–690V(+10%)

VFD model	Braking unit model	Resistance applicable for 100% braking torque (Ω)	Braking resistor dissipated power (kW)			Min. allowable braking resistance (Ω)
			10% braking usage	50% braking usage	80% braking usage	
GD350-022G-6	DBU100H-110-6	55	4	17	27	10.0
GD350-030G-6		40.3	5	23	36	
GD350-037G-6		32.7	6	28	44	
GD350-045G-6		26.9	7	34	54	
GD350-055G-6		22.0	8	41	66	
GD350-075G-6		16.1	11	56	90	
GD350-090G-6		13.4	14	68	108	
GD350-110G-6		11.0	17	83	132	
GD350-132G-6	DBU100H-160-6	9.2	20	99	158	6.9
GD350-160G-6		7.6	24	120	192	
GD350-185G-6	DBU100H-220-6	6.5	28	139	222	5.0
GD350-200G-6		6.1	30	150	240	
GD350-220G-6		5.5	33	165	264	
GD350-250G-6		4.8	38	188	300	
GD350-280G-6	DBU100H-320-6	4.3	42	210	336	3.4
GD350-315G-6		3.8	47	236	378	
GD350-355G-6		3.5	53	263	420	
GD350-400G-6	DBU100H-400-6	3.0	60	300	480	2.8
GD350-450G-6	DBU100H-320-6 Quantity: Two	5.5×2	34×2	168×2	270×2	3.4×2
GD350-500G-6		4.8×2	38×2	188×2	300×2	
GD350-560G-6		4.3×2	42×2	210×2	336×2	
GD350-630G-6		3.8×2	47×2	236×2	378×2	

Refer to the preceding table for the braking unit model selection for a paralel VFD system.

Note:

- Select braking resistors according to the resistance and power data provided by our company.
- The braking resistor may increase the braking torque of the VFD. The preceding table describes the resistance and power for 100% braking torque, 10% braking usage, 50% braking usage, and 80% braking usage. You can select the braking system based on the actual operation conditions.
- When using an external braking unit, set the braking voltage class of the braking unit properly by referring to the manual of the dynamic braking unit. If the voltage class is set incorrectly, the VFD may not run properly.

	⚡ Do not use braking resistors whose resistance is lower than the specified minimum resistance. The VFD does not provide protection against overcurrent caused by resistors with low resistance.
---	--

	<ul style="list-style-type: none"> ◇ In scenarios where braking is frequently implemented, that is, the braking usage exceeds 10%, you need to select a braking resistor with higher power as required by the operation conditions according to the preceding table.
---	---

D.8.2 Braking resistor cable selection

Braking resistor cables should be shielded cables.

D.8.3 Braking resistor installation

All resistors must be installed in places with good cooling conditions.

	<p>The materials near the braking resistor or unit must be non-flammable. The resistor surface temperature is high. Air flowing from the resistor is of hundreds of degrees Celsius. Prevent any materials from contacting the resistor.</p>
---	--

Installation of braking resistors

	<ul style="list-style-type: none"> ◇ The 380V 37kW and lower VFD models need only external braking resistors. ◇ PB and (+) are the terminals for connecting braking resistors.
---	--

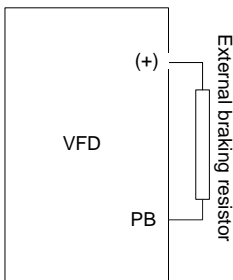

Installation of braking units

	<ul style="list-style-type: none"> ◇ All 660V VFD models need external braking units. ◇ (+) and (-) are the terminals for connecting braking units. ◇ The connection cables between the (+) and (-) terminals of a VFD and those of a braking unit must be shorter than 5m, and the connection cables between the BR1 and BR2 terminals of a braking unit and the terminals of a braking resistor must be shorter than 10 m.
--	---

The following figure shows the connection of one VFD to a dynamic braking unit.

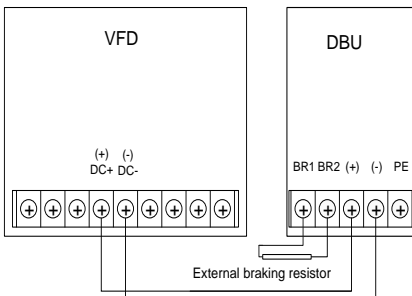

Appendix E STO function description

Reference standards: IEC 61508-1, IEC 61508-2, IEC 61508-3, IEC 61508-4, IEC 62061, ISO 13849-1, and IEC 61800-5-2

You can enable the safe torque off (STO) function to prevent unexpected startups when the main power supply of the drive is not switched off. The STO function switches off the drive output by turning off the drive signals to prevent unexpected startups of the motor (see the following figure). After the STO function is enabled, you can perform some-time operations (such as non-electrical cleaning in the lathe industry) and maintain the non-electrical components of the device without switching off the drive.

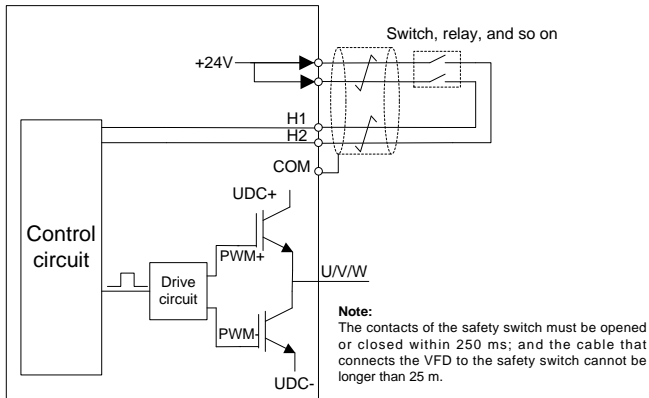

E.1 STO function logic table

The following table describes the input states and corresponding faults of the STO function.

STO input state	Corresponding fault
H1 and H2 opened simultaneously	The STO function is triggered, and the drive stops running. Fault code: 40: Safe torque off (STO)
H1 and H2 closed simultaneously	The STOP function is not triggered, and the drive runs properly.
Either of H1 and H2 opened, and the other closed	The STL1, STL2, or STL3 fault occurs. Fault code: 41: Channel H1 exception (STL1) 42: Channel H2 exception (STL2) 43: Both channels H1 and H2 are abnormal (STL3)

E.2 STO channel delay description

The following table describes the trigger and indication delay of the STO channels.

STO mode	STO trigger delay ¹ and STO indication delay ²
STO fault: STL1	Trigger delay < 10 ms Indication delay < 280 ms
STO fault: STL2	Trigger delay < 10 ms Indication delay < 280 ms
STO fault: STL3	Trigger delay < 10 ms Indication delay < 280 ms
STO fault: STO	Trigger delay < 10 ms Indication delay < 100 ms

1. STO trigger delay: Time interval between triggering the STO function and switching off the drive output
2. STO instruction delay: Time interval between triggering the STO function and indicating STO output status

E.3 STO function installation checklist

Before installing the STO, check the items described in the following table to ensure that the STO function can be properly used.

	Item
<input type="checkbox"/>	Ensure that the drive can be run or stopped randomly during commissioning.
<input type="checkbox"/>	Stop the drive (if it is running), disconnect the input power supply, and isolate the drive from the power cable through the switch.
<input type="checkbox"/>	Check the STO circuit connection according to the circuit diagram.
<input type="checkbox"/>	Check whether the shielding layer of the STO input cable is connected to the +24 V reference ground COM.
<input type="checkbox"/>	Connect the power supply.
<input type="checkbox"/>	Test the STO function as follows after the motor stops running: <ul style="list-style-type: none"> ✧ If the drive is running, send a stop command to it and wait until the shaft of the motor stops rotating. ✧ Activate the STO circuit and send a start command to the drive. Ensure that the motor does not start. ✧ Deactivate the STO circuit.
<input type="checkbox"/>	Restart the drive, and check whether the motor is running properly.
<input type="checkbox"/>	Test the STO function as follows when the motor is running: <ul style="list-style-type: none"> ✧ Start the drive. Ensure that the motor is running properly. ✧ Activate the STO circuit. ✧ The drive reports an STO fault (for details, see section 5.5.19 Fault handling). Ensure that the motor coasts to stop rotating. ✧ Deactivate the STO circuit.
<input type="checkbox"/>	Restart the drive, and check whether the motor is running properly.

Appendix F Energy efficiency data

Table F-1 Power loss and IE class

Model	Relative loss (%)								Standby loss (W)	IE class
	(0;25)	(0;50)	(0;100)	(50;25)	(50;50)	(50;100)	(90;50)	(90;100)		
GD350-1R5G-4	1.54	1.50	1.67	1.12	1.04	1.45	0.91	1.45	3	IE2
GD350-2R2G-4	1.21	1.96	2.43	0.80	1.00	1.50	0.83	1.43	5	IE2
GD350-004G-4	1.13	1.40	2.05	1.14	1.43	2.14	1.41	2.28	6	IE2
GD350-5R5G-4	0.94	1.27	2.07	1.01	1.38	2.33	1.53	2.60	8	IE2
GD350-7R5G-4	0.76	0.96	1.53	0.85	1.04	2.25	1.17	1.86	7	IE2
GD350-011G-4	0.61	0.84	1.55	0.61	1.04	1.97	0.99	2.16	9	IE2
GD350-015G-4	0.42	0.52	1.27	0.55	0.73	1.46	0.78	1.66	9	IE2
GD350-018G-4	0.54	0.74	1.2	0.77	1.03	1.70	0.96	1.65	11	IE2
GD350-022G-4	0.47	0.67	1.21	0.67	0.90	1.54	0.87	1.38	11	IE2
GD350-030G-4	0.53	0.72	0.71	0.71	0.9	0.85	1.45	1.5	13	IE2
GD350-037G-4	0.47	0.69	1.39	0.63	0.88	1.60	0.99	1.72	14	IE2
GD350-045G-4	0.49	0.69	1.39	0.78	1.00	1.64	0.97	1.66	21	IE2
GD350-045G-4-B(F)	0.49	0.69	1.39	0.78	1.00	1.64	0.97	1.66	21	IE2
GD350-055G-4	0.51	0.69	1.26	0.71	0.89	1.47	0.88	1.40	22	IE2
GD350-055G-4-B(F)	0.51	0.69	1.26	0.71	0.89	1.47	0.88	1.40	22	IE2
GD350-075G-4	0.44	0.61	1.12	0.51	0.69	1.29	0.76	1.42	22	IE2
GD350-075G-4-B(F)	0.44	0.61	1.12	0.51	0.69	1.29	0.76	1.42	22	IE2
GD350-090G-4	0.42	0.59	1.15	0.47	0.65	1.29	0.90	1.48	25	IE2
GD350-090G-4-B(F)	0.42	0.59	1.15	0.47	0.65	1.29	0.90	1.48	25	IE2
GD350-110G-4	0.43	0.63	1.30	0.48	0.75	1.64	0.80	1.78	28	IE2
GD350-110G-4-B(F)	0.43	0.63	1.30	0.48	0.75	1.64	0.80	1.78	28	IE2
GD350-132G-4	0.47	0.59	1.06	0.61	0.71	1.28	0.85	1.43	55	IE2
GD350-160G-4	0.59	0.71	1.36	1.22	0.97	1.87	1.00	1.84	55	IE2
GD350-185G-4	0.62	0.76	1.21	1.17	1.12	1.70	1.08	1.61	55	IE2
GD350-200G-4	0.53	0.71	1.42	0.74	0.94	1.81	1.00	1.84	55	IE2
GD350-220G-4	0.33	0.42	0.69	0.85	0.95	1.33	1.10	1.18	80	IE2
GD350-250G-4	0.38	0.59	1.22	0.65	0.92	1.67	0.93	1.74	80	IE2
GD350-280G-4	0.40	0.59	1.10	0.64	0.89	1.58	1.12	1.35	80	IE2
GD350-315G-4	0.56	0.35	0.79	0.94	0.94	1.63	1.36	2.22	80	IE2
GD350-355G-4	0.37	0.47	0.98	0.91	1.11	1.95	1.41	2.44	80	IE2
GD350-400G-4	0.17	0.26	0.42	0.28	0.41	0.74	0.47	0.92	80	IE2
GD350-450G-4	0.31	0.54	0.98	0.46	0.62	1.02	0.67	0.85	80	IE2
GD350-500G-4	0.32	0.55	0.98	0.45	0.61	1.02	0.66	0.83	80	IE2

Table F-2 Rated specifications

Model	Apparent power (kVA)	Rated output power (kW)	Rated output current (A)	Max. working temperature (°C)	Rated power frequency (Hz)	Rated power voltage (V)
GD350-1R5G-4	2.4	1.5	3.7	50°C Derate by 1% for every increase of 1°C when the temperature exceeds 40°C.	50Hz/60Hz Allowed range: 47-63Hz	3PH 380V
GD350-2R2G-4	3.3	2.2	5			
GD350-004G-4	6.2	4	9.5			
GD350-5R5G-4	9.2	5.5	14			
GD350-7R5G-4	12.2	7.5	18.5			
GD350-011G-4	16.4	11	25			
GD350-015G-4	21.0	15	32			
GD350-018G-4	25.0	18.5	38			
GD350-022G-4	29.6	22	45			
GD350-030G-4	39.4	30	60			
GD350-037G-4	49.3	37	75			
GD350-045G-4	60.5	45	92			
GD350-045G-4-B(F)	60.5	45	92			
GD350-055G-4	75.7	55	115			
GD350-055G-4-B(F)	75.7	55	115			
GD350-075G-4	98.7	75	150			
GD350-075G-4-B(F)	98.7	75	150			
GD350-090G-4	118.5	90	180			
GD350-090G-4-B(F)	118.5	90	180			
GD350-110G-4	141.5	110	215			
GD350-110G-4-B(F)	141.5	110	215			
GD350-132G-4	171.1	132	260			
GD350-160G-4	200.7	160	305			
GD350-185G-4	223.7	185	340			
GD350-200G-4	250.1	200	380			
GD350-220G-4	279.7	220	425			
GD350-250G-4	315.9	250	480			
GD350-280G-4	348.8	280	530			
GD350-315G-4	394.9	315	600			
GD350-355G-4	427.8	355	650			
GD350-400G-4	473.8	400	720			
GD350-450G-4	539.7	450	820			
GD350-500G-4	566.0	500	860			

Appendix G Further information

G.1 Product and service queries

Should you have any queries about the product, contact the local INVT office. Provide the model and serial number of the product you query about. You can visit www.invt.com to find a list of INVT offices.

G.2 Feedback on INVT VFD manuals

Your comments on our manuals are welcome. Visit www.invt.com, directly contact online service personnel or choose **Contact Us** to obtain contact information.

G.3 Documents on the Internet

You can find manuals and other product documents in the PDF format on the Internet. Visit www.invt.com and choose **Support > Download**.



Service line: 86-755-23535967 E-mail: overseas@invt.com.cn Website: www.invt.com

The products are owned by **Shenzhen INVT Electric Co.,Ltd.**

Two companies are commissioned to manufacture: (For product code, refer to the 2nd/3rd place of S/N on the name plate.)

Shenzhen INVT Electric Co., Ltd. (origin code: 01)

Address: INVT Guangming Technology Building, Songbai Road,
Matian, Guangming District, Shenzhen, China

INVT Power Electronics (Suzhou) Co., Ltd. (origin code: 06)

Address: 1# Kunlun Mountain Road, Science&Technology Town,
Gaixin District, Suzhou, Jiangsu, China

- Industrial Automation:** ■ HMI ■ PLC ■ VFD ■ Servo System
- Elevator Intelligent Control System ■ Rail Transit Traction System
- Energy & Power:** ■ UPS ■ DCIM ■ Solar Inverter ■ SVG
- New Energy Vehicle Powertrain System ■ New Energy Vehicle Charging System
- New Energy Vehicle Motor



Copyright© INVT.

Manual information may be subject to change without prior notice.

202203 (V1.3)