

IVC1L Series PLC Quick Start User Manual

This quick start manual is to offer you a quick guide to the design, installation, connection and maintenance of IVC1L series PLC, convenient for on-site reference. Briefly introduced in this booklet are the hardware specs, features, and usage of IVC1L series PLC, plus the optional parts and FAQ for your reference. For ordering the above user manuals, contact your INVT distributor or sales office.

1 Introduction

1.1 Model Designation

The model designation is shown in the following figure.

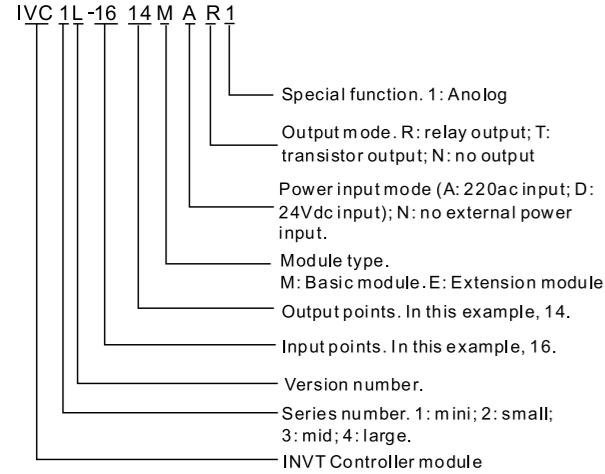

To Customers:

Thank you for choosing our products. To improve the product and provide better service for you, could you please fill in the form after the product has been operated for 1 month, and mail or fax it to our Customer Service Center? We will send you an exquisite souvenir upon receiving the complete Product Quality Feedback Form. Furthermore, if you can give us some advices on improving the product and service quality, you will be awarded a special gift. Thank you very much!

Shenzhen INVT Electric Co., Ltd.

Product Quality Feedback Form

Customer name	Tele
Address	Zip code
Model	Date of use
Machine SN	
Appearance or structure	
Performance	
Package	
Material	
Quality problem during usage	
Suggestion about improvement	

Address: INVT Guangming Technology Building, Songbai Road, Matian, Guangming District, Shenzhen, China Tel: +86 23535967

1.2 Outline

The outline of the basic module is shown in the following figure by taking the example of IVC1L-1614MAR.

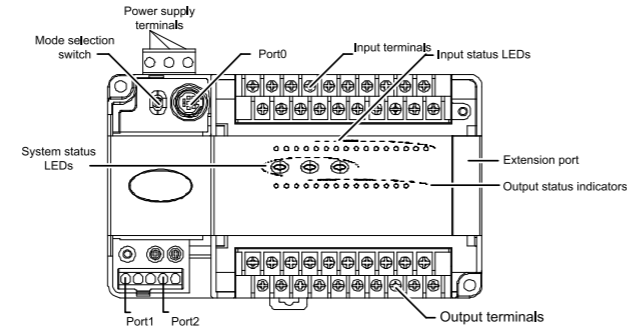

PORT0 and PORT1, PORT2 are communication terminals. PORT0 uses RS232 mode with Mini DIN8 socket. PORT1 and PORT2 Have Double RS485. The busbar socket is for connecting the extension module. The mode selection switch has three positions: ON, TM and OFF.

1.3 Terminal Introduction

The layouts of terminals of different I/O points are shown below:

1. 14-point, 16-point, 24-point

Input terminal:

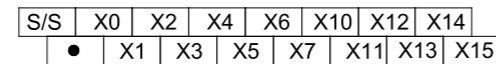

Output terminal:

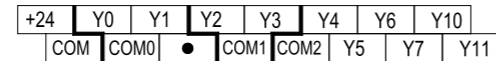

2. 30-point

Input terminal:

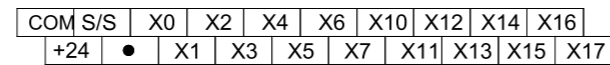

Output terminal:

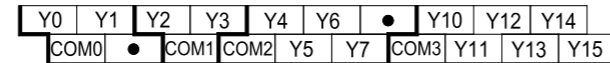

3. 40-point

Input terminal:

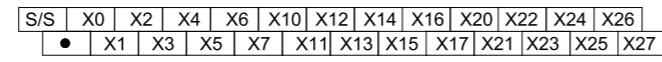

Output terminal:

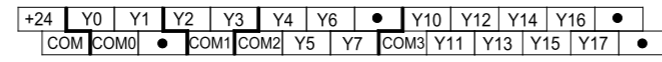

4. 60-point

Input terminal:

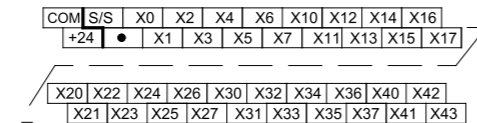

Output terminal:

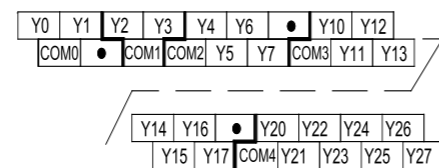

5. 30-point with analog

Input terminal:

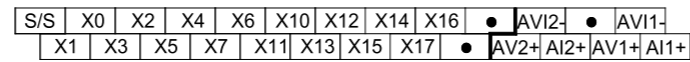

Output terminal:

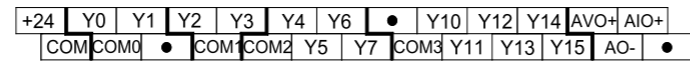

2 Power Supply

The specification of PLC built-in power and power for extension modules is listed in the following table.

Item	Unit	Min.	Rated	Max.	Note
Power supply voltage	Vac	85	220	264	Normal startup and operation
Input current	A	/	/	1.5	Input: 90Vac, 100% output
Output current	5V/GND	mA	/	900	The total power of outputs 5V/GND and 24V/GND ≤ 10.4W. Max. output power: 24.8W (sum of all branches)
	24V/GND	mA	/	300	
	24V/COM	mA	/	600	

3 Digital Inputs & Outputs

3.1 Input Characteristic And Specification

The input characteristic and specs are shown as follows:

Item	High-speed input terminals X0-X7	General input terminal
Input mode	Source mode or sink mode, set through s/s terminal	
Electric parameters	Input voltage	24Vdc
	Input impedance	3.3kΩ / 4.3kΩ
	Input ON	External circuit resistance < 400Ω
	Input OFF	External circuit resistance > 24kΩ
Filtering function	Digital filter	X0-X7 have digital filtering function. Filtering time: 0, 8, 16, 32 or 64ms (selected through user programme)
	Hardware filter	Input terminals other than X0-X7 are of hardware filtering. Filtering time: about 10ms
High-speed function	X0-X7: high-speed counting, interrupt, and pulse catching X0 and X1: up to 50kHz counting frequency X2-X5: up to 10kHz counting frequency The sum of input frequency should be less than 60kHz	
Common terminal	Only one common terminal: COM	

The input terminal act as a counter has a limit over the maximum frequency. Any frequency higher than that may result in incorrect counting or abnormal system operation. Make sure that the input terminal arrangement is reasonable and external sensors used are proper.

Input connection example

The following diagram shows an example of IVC1L-1614MAR in connection with an IVC1-0808ENR, which realizes simple positioning control. The positioning signals from the PG are input through high speed counting terminals X0 and X1, the limit switch signals that require high-speed response can be input through high-speed terminals X2-X7. Other user signals can be input through any other input terminals.

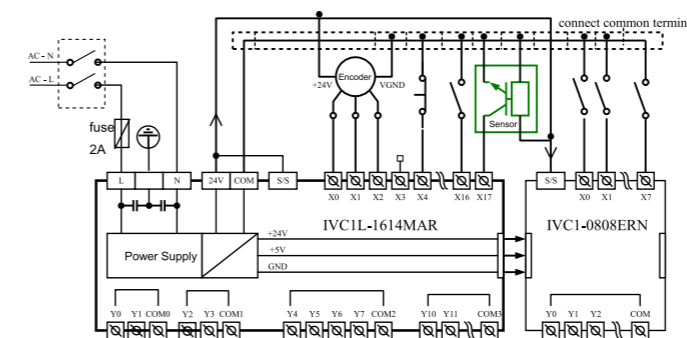

3.2 Output Characteristic And Specification

The following table shows the relay output and transistor output.

Item	Relay output	Transistor output
Output mode	When output state is ON, the circuit is closed; OFF, open	
Common terminal	Divided into multiple groups, each with a common terminal COMn, suitable for control circuits with different potentials. All common terminals are isolated from each other	

Item	Relay output	Transistor output
Voltage	220Vac; 24Vdc, no polarity requirement	24Vdc, correct polarity required
Current	Accord with output electric specs (see following Table)	
Difference	High driving voltage, large current	Small driving current, high frequency, long lifespan
Application	Loads with low action frequency such as intermediate relay, contactor coil, and LEDs	Loads with high frequency and long life, such as control servoamplifier and electromagnet that action frequently

The electric specs of outputs is shown in the following table.

Item	Relay output terminal	Transistor output terminal	
Switched voltage	Below 250Vac, 30Vdc	5-24Vdc	
Circuit isolation	By Relay	PhotoCoupler	
Operation indication	Relay output contacts closed, LED on	LED is on when optical coupler is driven	
Leakage current of open circuit	/	Less than 0.1mA/30Vdc	
Minimum load	2mA/5Vdc	5mA (5-24Vdc)	
Max. output current	Resistive load 2A/1 point; 8A/4 points, using a COM 8A/8 points, using a COM	Y0/Y1/ Y2/Y3: 0.3A/1 point. Others: 0.3A/1 point, 0.8A/4 point, 1.2A/6 point, 1.6A/8 point. Above 8 points, total current increases 0.1A at each point increase	
		Inductive load 220Vac, 80VA	Y0/Y1/ Y2/Y3: 7.2W/24Vdc Others: 12W/24Vdc
		Illumination load 220Vac, 100W	Y0/Y1/ Y2/Y3: 0.9W/24Vdc Others: 1.5W/24Vdc
Response time	OFF→ON	20ms Max	
	ON→OFF	20ms Max	
Y0, Y1 max. output frequency	/	Each channel: 100kHz	
Y2, Y3 max. output frequency	/	Each channel: 10kHz	
Output common terminal	Y0/ Y1-COM0; Y2/Y3-COM1. After Y4, Max 8 terminals use one isolated common terminal		
Fuse protection	No		

Output connection example

The following diagram shows an example of IVC1L-1614MAR in connection with an IVC1-0808ENR. Different output groups can be connected to different signal circuits with different voltages. Some (like Y0-COM0) are connected to the 24Vdc circuit powered by local 24V-COM, some (like Y2-COM1) are connected to the 5Vdc low voltage signal circuit, and others (like Y4-Y7) are connected to the 220Vac voltage signal circuit.

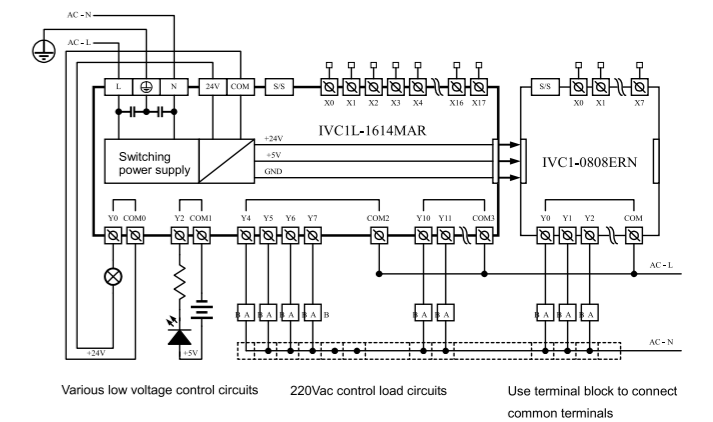

4 Communication Port

IVC1L series PLC basic module has three serial asynchronous communication ports: PORT0, PORT1, and PORT2. Supported baud rates:

115200 bps	57600 bps	38400 bps	19200 bps
9600 bps	4800 bps	2400 bps	1200 bps

The mode selection switch determines the communication protocol.

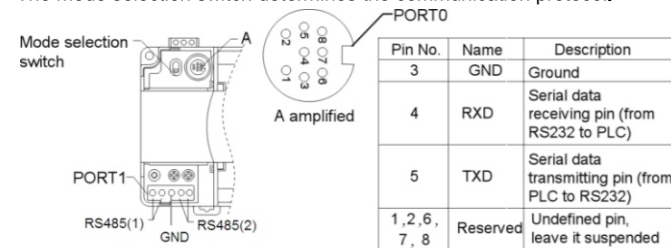

As a terminal dedicated to user programming, PORT0 can be converted to programming protocol through the mode selection switch. The relationship between PLC operation status and the protocol used by PORT0 is shown in the following table.

Mode selection switch position	status	PORT0 operation protocol
ON	Running	Programming protocol, or Modbus protocol, or free-port protocol, or N: N network protocol, as determined by user program and system configuration
ON->TM	Running	Converted to programming protocol
OFF->TM	Stop	
OFF	Stop	If the system configuration of user program is free-port protocol, it converts to programming protocol automatically after stop; or system protocol keeps unchanged

PORT1, PORT2 are ideal for connection with equipment that can communicate (such as inverters). With Modbus protocol or RS485 terminal free protocol, it can control multiple devices through the network. Its terminals are fixed with screws. You can use a shielded twisted-pair as the signal cable to connect communication ports by yourself.

5 Installation

PLC is applicable to Installation category II, Pollution degree 2.

5.1 Installation Dimensions

Model	Length	Width	Height	Weight
IVC1L-0806MAR, IVC1L-0806MAT	135mm	90mm	71.2mm	440g
IVC1L-1208MAR, IVC1L-1208MAT				440g
IVC1L-1410MAR, IVC1L-1410MAT				470g
IVC1L-1614MAR, IVC1L-1614MAT	150mm	90mm	71.2mm	650g
IVC1L-2416MAR, IVC1L-2416MAT, IVC1L-1614MAR1, IVC1L-1614MAT1	182mm	90mm	71.2mm	750g
IVC1L-3624MAR, IVC1L-3624MAT	224.5mm	90mm	71.2mm	950g

5.2 Installation Method

DIN rail mounting

Generally you can mount the PLC onto a 35mm-wide rail (DIN), as shown in the following figure.

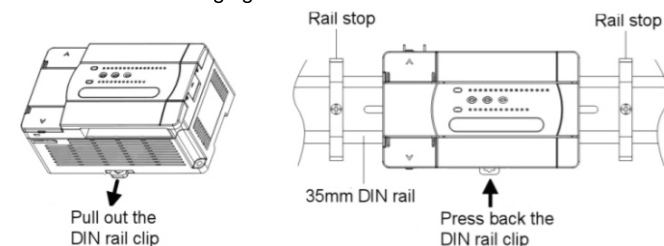

Screw fixing

Fixing the PLC with screws can stand greater shock than DIN rail mounting. Use M3 screws through the mounting holes on PLC enclosure to fix the PLC onto the backboard of the electric cabinet, as shown in the following figure.

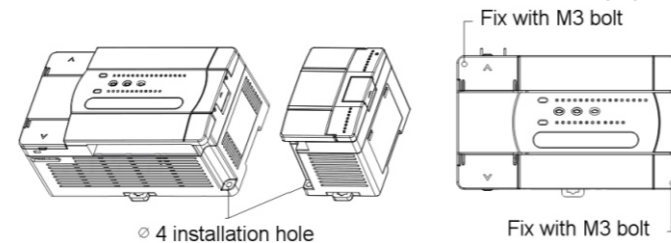

5.3 Cable Connection And Specification

Connecting power cable and grounding cable

The connection of AC power and auxiliary power is demonstrated in the following figure.

We suggest you wire a protection circuit at the power supply input terminal. See the figure below.

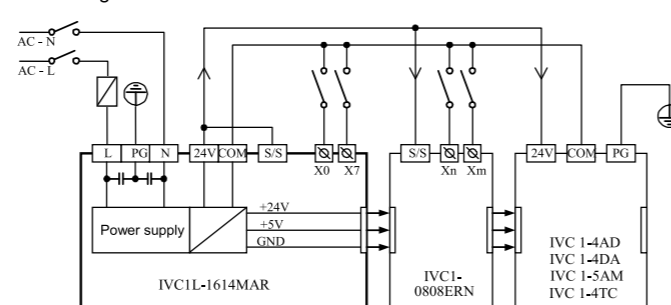

Connect the PLC terminal to the grounding electrode. To ensure reliable grounding cable connection, which makes the equipment safer and protects it from EMI, use AWG12-16 cable, and make the cable as short as possible. Use independent grounding. Avoid sharing route with the grounding cable of other equipment (particularly those with strong EMI). See the following figure.

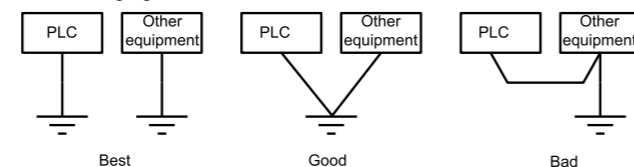

Cable specification

When wiring a PLC, use multi-strand copper wire and ready-made insulated terminals to ensure the quality. The recommended model and the cross-sectional area of the cable are shown in the following table.

Cable	Cross-sectional area	Recommended model	Cable lug and heat-shrink tube
AC power cable (L, N)	1.0-2.0mm ²	AWG12, 18	H1.5/14 round insulated lug, or tinned cable lug
Earth cable (⊕)	2.0mm ²	AWG12	H2.0/14 round insulated lug, or tinned cable end
Input signal cable (X)	0.8-1.0mm ²	AWG18, 20	UT1-3 or OT1-3 solderless lug
Output signal cable (Y)	0.8-1.0mm ²	AWG18, 20	Φ3 or Φ4 heat shrinkable tube

Fix the prepared cable head onto the PLC terminals with screws. Fastening torque: 0.5-0.8Nm.

The recommended cable processing-method is shown in the following figure.

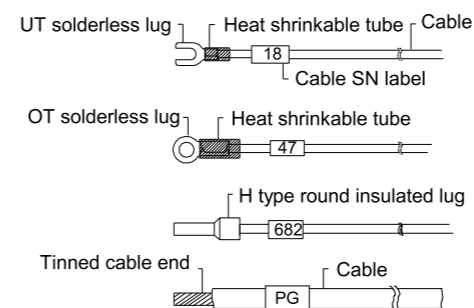
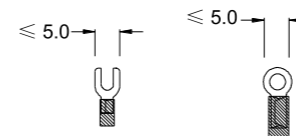

6 Power-on Operation And Maintenance

6.1 Startup

Check the cable connection carefully. Make sure that the PLC is clear of alien objects and the heat dissipation channel is clear.

1. Power on the PLC, the PLC POWER indicator should be on.
2. Start the AutoStation software on the host and download the compiled user program to the PLC.
3. After checking the download program, switch the mode selection switch to the ON position, the RUN indicator should be on. If the ERR indicator is on, the user program or the system is faulty. Loop up in the *IV2/IVC1L series PLC Programming Manual* and remove the fault.
4. Power on the PLC external system to start system debugging.

6.2 Routine Maintenance

Do the following:

1. Ensure the PLC a clean environment. Protect it from aliens and dust.
2. Keep the ventilation and heat dissipation of PLC in good condition.
3. Ensure that the cable connections are reliable and in good condition.



Warning

1. Never connect the transistor output to an AC circuit (like 220Vac). The design of the output circuit must abide by the requirements of electric parameters, and no over-voltage or over-current is allowed.
2. Use the relay contacts only when necessary, because the life span of relay contacts depends largely on its action times.
3. The relay contacts can support loads smaller than 2A. To support larger loads, use external contacts or mid-relay.
4. Note that the relay contact may fail to close when the current is smaller than 5mA.

Notice

1. The warranty range is confined to the PLC only.
2. **Warranty period is 18 months**, within which period INVT conducts free maintenance and repairing to the PLC that has any fault or damage under the normal operation conditions.
3. **The start time of warranty period is the delivery date of the product**, of which the product SN is the sole basis of judgment. PLC without a product SN shall be regarded as out of warranty.
4. Even within 18 months, maintenance will also be charged in the following situations:
 - Damages incurred to the PLC due to mis-operations, which are not in compliance with the User Manual;
 - Damages incurred to the PLC due to fire, flood, abnormal voltage, etc;
 - Damages incurred to the PLC due to the improper use of PLC functions.
5. The service fee will be charged according to the actual costs. If there is any contract, the contract prevails.
6. Please keep this paper and show this paper to the maintenance unit when the product needs to be repaired.
7. If you have any question, please contact the distributor or our company directly.

Shenzhen INVT Electric Co., Ltd.

Address: INVT Guangming Technology Building, Songbai Road, Matian, Guangming District, Shenzhen, China

Website: www.invt.com

All rights reserved. The contents in this document are subject to change without notice.