

**MITSUBISHI
ELECTRIC
INVERTER
FR-D700**

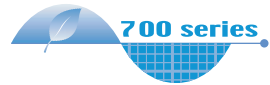

INSTRUCTION MANUAL (BASIC)

FR-D720-0.1K to 15K
FR-D740-0.4K to 15K
FR-D720S-0.1K to 2.2K
FR-D710W-0.1K to 0.75K

Thank you for choosing this Mitsubishi Electric Inverter.
This Instruction Manual (Basic) provides handling information and precautions for use of the equipment.
Please forward this Instruction Manual (Basic) to the end user.

CONTENTS

[1] OUTLINE	1
[2] INSTALLATION AND WIRING	5
[3] PRECAUTIONS FOR USE OF THE INVERTER.....	19
[4] FAILSAFE OF THE SYSTEM WHICH USES THE INVERTER ...	22
[5] DRIVING THE MOTOR.....	23
[6] ENERGY SAVING OPERATION FOR FANS AND PUMPS	31
[7] PARAMETERS	32
[8] TROUBLESHOOTING	36
[9] PRECAUTIONS FOR MAINTENANCE AND INSPECTION	41
[10] SPECIFICATIONS.....	43



To obtain the Instruction Manual (Applied) and the Safety stop function instruction manual

Contact where you purchased the inverter, your Mitsubishi Electric sales representative, or the nearest Mitsubishi Electric FA Center for the following manuals:

- *Instruction Manual (Applied) [IB(NA)-0600366ENG]*
- *Safety stop function instruction manual [BCN-A211508-000]*

These manuals are required if you are going to utilize functions and performance.

The PDF manuals are also available for download at the Mitsubishi Electric FA Global Website (URL: <http://www.MitsubishiElectric.co.jp/fa/>).

1

2

3

4

5

6

7

8

9

10

This Instruction Manual (Basic) provides handling information and precautions for use of this product. Please forward this Instruction Manual (Basic) to the end user.

This section is specifically about safety matters

Do not attempt to install, operate, maintain or inspect this product until you have read through the Instruction Manual (Basic) and supplementary documents carefully and can use the equipment correctly. Do not use this product until you have a full knowledge of this product mechanism, safety information and instructions. In this Instruction Manual (Basic), the safety instruction levels are classified into "WARNING" and "CAUTION".

⚠ WARNING

Incorrect handling may cause hazardous conditions, resulting in death or severe injury.

⚠ CAUTION

Incorrect handling may cause hazardous conditions, resulting in medium or slight injury, or may cause only material damage.

The **⚠ CAUTION** level may even lead to a serious consequence according to conditions. Both instruction levels must be followed because these are important to personal safety.

1. Electric Shock Prevention

⚠ WARNING

- While the power of this product is ON, do not remove the front cover or the wiring cover. Do not run this product with the front cover or the wiring cover removed. Otherwise you may access the exposed high voltage terminals or the charging part of the circuitry and get an electric shock.
- Even if power is OFF, do not remove the front cover except for wiring or periodic inspection. You may accidentally touch the charged inverter circuits and get an electric shock.
- Before wiring or inspection, power must be switched OFF. To confirm that, LED indication of the operation panel must be checked. (It must be OFF.) Any person who is involved in wiring or inspection shall wait for at least 10 minutes after the power supply has been switched OFF and check that there are no residual voltage using a tester or the like. The capacitor is charged with high voltage for some time after power OFF, and it is dangerous.
- This product must be earthed (grounded). Earthing (grounding) must conform to the requirements of national and local safety regulations and electrical code (NEC section 250, IEC 61140 class 1 and other applicable standards). A neutral-point earthed (grounded) power supply for 400V class of this product in compliance with EN standard must be used.
- Any person who is involved in wiring or inspection of this product shall be fully competent to do the work.
- This product body must be installed before wiring. Otherwise you may get an electric shock or be injured.
- Do not touch the setting dial or keys with wet hands. Doing so may cause an electric shock.
- Do not subject the cables to scratches, excessive stress, heavy loads or pinching. Doing so may cause an electric shock.
- Do not change the cooling fan while power is ON, as it is dangerous.
- Do not touch the printed circuit board or handle the cables with wet hands. Doing so may cause an electric shock.
- Never touch the motor terminals, etc. right after powering OFF as the DC voltage is applied to the motor for 1 second at powering OFF if the main circuit capacitor capacity is measured. Doing so may cause an electric shock.

2. Fire Prevention

⚠ CAUTION

- This product must be installed on a nonflammable wall without holes (so that nobody touches the inverter heatsink on the rear side, etc.). Mounting it to or near flammable material can cause a fire.
- If this product becomes faulty, the product power must be switched OFF. A continuous flow of large current could cause a fire.
- When using a brake resistor, a sequence that will turn OFF power when a fault signal is output must be configured. Otherwise the brake resistor may overheat due to damage of the brake transistor and possibly cause a fire.
- Do not connect a resistor directly to the DC terminals P/+ and N/-. Doing so could cause a fire.
- Be sure to perform daily and periodic inspections as specified in the Instruction Manual. If this product is used without inspection, an explosion, failure, or fire may occur.

3. Injury Prevention

⚠ CAUTION

- The voltage applied to each terminal must be the ones specified in the Instruction Manual. Otherwise an explosion or damage may occur.
- The cables must be connected to the correct terminals. Otherwise an explosion or damage may occur.
- Polarity must be correct. Otherwise an explosion or damage may occur.
- While power is ON or for some time after power-OFF, do not touch this product since the inverter will be extremely hot. Doing so can cause burns.

4. Additional Instructions

Also the following points must be noted to prevent an accidental failure, injury, electric shock, etc.

(1) Transportation and Mounting

⚠ CAUTION

- Use proper lifting techniques or a trolley when carrying products. Failure to do so may lead to injuries.
- Do not stack the boxes containing this product higher than the number recommended.
- This product must be installed to the position where withstands the weight of the product according to the information in the Instruction Manual.
- Do not install or operate this product if it is damaged or has parts missing.
- When carrying this product, do not hold it by the front cover or setting dial; it may fall off or fail.
- Do not stand or rest heavy objects on the product.
- Ensure the mounting orientation of this product is correct.
- Foreign conductive objects must be prevented from entering this product. That includes screws and metal fragments or other flammable substance such as oil.
- As this product is a precision instrument, do not drop or subject it to impact.
- This product must be used under the following environment: Otherwise the product may be damaged.

Environment	Surrounding air temperature	-10°C to +50°C (non-freezing)
	Ambient humidity	90%RH or less (non-condensing)
	Storage temperature	-20°C to +65°C ±1
	Atmosphere	Indoors (free from corrosive gas, flammable gas, oil mist, dust and dirt)
	Altitude/vibration	Maximum 1000m 5.9m/s ² or less at 10 to 55Hz (directions of X, Y, Z axes)

- *1 Temperature applicable for a short time, e.g. in transit.
- If halogens (including fluorine, chlorine, bromine, and iodine) contained in fumigants for wood packages enter this product, the product may be damaged. Prevent the entry of fumigant residuals or use an alternative method such as heat disinfection. Note that sterilization or disinfection of wood packages should be performed before packing the product.

(2) Wiring

CAUTION

- Do not install a power factor correction capacitor, surge absorber, or radio noise filter on the output side of this product. These devices may overheat or burn out.
- The connection orientation of the output cables U, V, W to the motor affects the rotation direction of the motor.

(3) Trial run

CAUTION

- Before starting operation, each parameter must be confirmed and adjusted. Failure to do so may cause some machines to make unexpected motions.

(4) Usage

WARNING

- Stay away from the equipment when the retry function is set as it will restart suddenly after trip.
- Since pressing  key may not stop output depending on the function setting status, separate circuit and switch that make an emergency stop (power OFF, mechanical brake operation for emergency stop, etc.) must be provided.
- OFF status of the start signal must be confirmed before resetting the inverter fault. Resetting inverter alarm with the start signal ON restarts the motor suddenly.
- The inverter must be used for three-phase induction motors. Connection of any other electrical equipment to the product output may damage the equipment.
- Do not modify the equipment.
- Do not perform parts removal which is not instructed in this manual. Doing so may lead to fault or damage of the product.

CAUTION

- The electronic thermal relay function does not guarantee protection of the motor from overheating. It is recommended to install both an external thermal and PTC thermistor for overheat protection.
- Do not use a magnetic contactor on the inverter input for frequent starting/stopping of the inverter. Otherwise, the life of the inverter decreases.
- The effect of electromagnetic interference must be reduced by using an EMC filter or by other means. Otherwise nearby electronic equipment may be affected.
- Appropriate precautions must be taken to suppress harmonics. Otherwise power supply harmonics from the inverter may heat/damage the power factor correction capacitor and generator.
- When driving a 400V class motor with the inverter, the motor must be an insulation-enhanced motor or measures must be taken to suppress surge voltage. Otherwise surge voltage, which is attributed to the length and thickness of wire, may occur at the motor terminals, causing the motor insulation to deteriorate.
- When parameter clear or all parameter clear is performed, the required parameters must be set again before starting operations because all parameters return to the initial value.
- The inverter can be easily set for high-speed operation. Before changing its setting, the performances of the motor and machine must be fully examined.
- This product's brake function cannot be used as a mechanical brake. Use a separate device instead.
- Perform an inspection and test operation of this product if it has been stored for a long period of time.
- Static electricity in your body must be discharged before you touch the product. Otherwise the product may be damaged.
- If you are installing the inverter to drive a three-phase device while you are contracted for lighting and power service, consult your electric power supplier.

(5) Emergency stop

CAUTION

- A safety backup such as an emergency brake must be provided for devices or equipment in a system to prevent hazardous conditions in case of failure of this product or an external device controlling this product.
- If the breaker installed on the input side of this product trips, check for wiring faults (short circuits etc.) and damage to internal parts of this product. The cause of the trip must be identified and removed before turning ON the power of the breaker.
- When any protective function is activated, appropriate corrective action must be taken, and this product must be reset before resuming operation.

(6) Maintenance, inspection and parts replacement

CAUTION

- Do not carry out a megger (insulation resistance) test on the control circuit of this product. It will cause a failure.

(7) Disposal

CAUTION

- This product must be treated as industrial waste.

(8) Application of caution labels

CAUTION

Caution labels are used to ensure safety during use of Mitsubishi Electric inverters.
Apply the following labels to the inverter if the "retry function" and/or "automatic restart after instantaneous power failure" have been enabled.

- For the retry function

 **CAUTION**
(Retry Function Has Been Selected)

 Stay away from the motor and machine. They will start suddenly (after given time has elapsed) when alarm occurs.

- For automatic restart after instantaneous power failure

 **CAUTION**
(Automatic Restart after Instantaneous Power Failure Has Been Selected)

 Stay away from the motor and machine. They will start suddenly (after reset time has elapsed) when instantaneous power failure occurs.

General instruction

Many of the diagrams and drawings in this Instruction Manual (Basic) show the inverter without a cover or partially open for explanation. Never operate the inverter in this manner. The cover must be always reinstalled and the instruction in this Instruction Manual (Basic) must be followed when operating the inverter.

<Abbreviation>

- PU: Operation panel and parameter unit (FR-PU04/FR-PU07)
- Inverter: Mitsubishi Electric inverter FR-D700 series
- FR-D700: Mitsubishi Electric inverter FR-D700 series
- Pr.: Parameter number (Number assigned to function)
- PU operation: Operation using the PU (operation panel/FR-PU04/FR-PU07)
- External operation: Operation using the control circuit signals
- Combined operation: Operation using both the PU (operation panel/FR-PU04/FR-PU07) and External operation
- Standard motor: SF-JR
- Constant torque motor: SF-HRCA

<Trademark>

- Company and product names herein are the trademarks and registered trademarks of their respective owners.

<Mark>



REMARKS: Additional helpful contents and relations with other functions are stated.



Note: Contents requiring caution or cases when set functions are not activated are stated.



POINT: Useful contents and points are stated.

<Notes on descriptions in this Instruction Manual>

- Connection diagrams in this Instruction Manual appear with the control logic of the input terminals as sink logic, unless otherwise specified. (For the control logic, refer to *page 1*.)

<Related document>



Refer to the *Instruction Manual (Applied)* for further information on the following points.

- Removal and reinstallation of the cover
- Connection of stand-alone option unit
- EMC and leakage currents
- Detailed explanation on parameters
- Troubleshooting
- Check first when you have a trouble
- Inspection items (life diagnosis, cooling fan replacement)
- Measurement of main circuit voltages, currents and powers
- For customers who are replacing the conventional model with this inverter

Harmonic suppression guideline (when inverters are used in Japan)

All models of general-purpose inverters used by specific consumers are covered by "Harmonic Suppression Guidelines for Consumers Who Receive High Voltage or Special High Voltage". (For further details,  refer to *Chapter 3 of the Instruction Manual (Applied)*.)

1 OUTLINE

1.1 Product checking and parts identification

Unpack the inverter and check the capacity plate on the front cover and the rating plate on the inverter side face to ensure that the product agrees with your order and the inverter is intact.

● Inverter model

FR - D740 - 1.5 K

Symbol	Voltage class
D720	Three-phase 200V class
D740	Three-phase 400V class
D720S	Single-phase 200V class
D710W	Single-phase 100V class

Represents the inverter capacity [kW]

Cooling fan
The cooling fan is removable.

Operation panel
(Refer to page 2)

Voltage/current input switch
(Refer to page 8)

PU connector
(Refer to page 8)

Front cover
Refer to the Instruction Manual (Applied) for installation/removal.

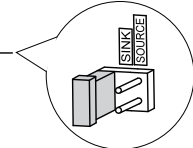

Control logic switchover jumper connector

The jumper connector is in the sink logic (SINK) when shipped from the factory. Move the jumper connector to change to the source logic (SOURCE). Always fit the jumper connector to the either position. (Refer to the Instruction Manual (Applied))

Control circuit terminal block
(Refer to page 9)

Main circuit terminal block
(Refer to page 9)

Combed shaped wiring cover
Refer to the Instruction Manual (Applied) for installation/removal.

Capacity plate

FR-D740-1.5K SERIAL: XXXXXX

Inverter model Serial number

Rating plate

Inverter model	MODEL FR-D740-1.5K	PASSED	INVERTER
Input rating	INPUT : XXXXXX		
Output rating	OUTPUT : XXXXXX		
Serial number	SERIAL :		SAMPLE
Country of origin	MITSUBISHI ELECTRIC CORPORATION		MADE IN JAPAN

● Accessory

- Fan cover fixing screws (M3 × 35mm)
These screws are necessary for compliance with the EU Directive. (Refer to page 46)

Capacity	Quantity
1.5K to 3.7K	1
5.5K to 15K	2

REMARKS

- For how to find the SERIAL number, refer to page 50.

1.2 Operation panel

1.2.1 Names and functions of the operation panel

The operation panel cannot be removed from the inverter.

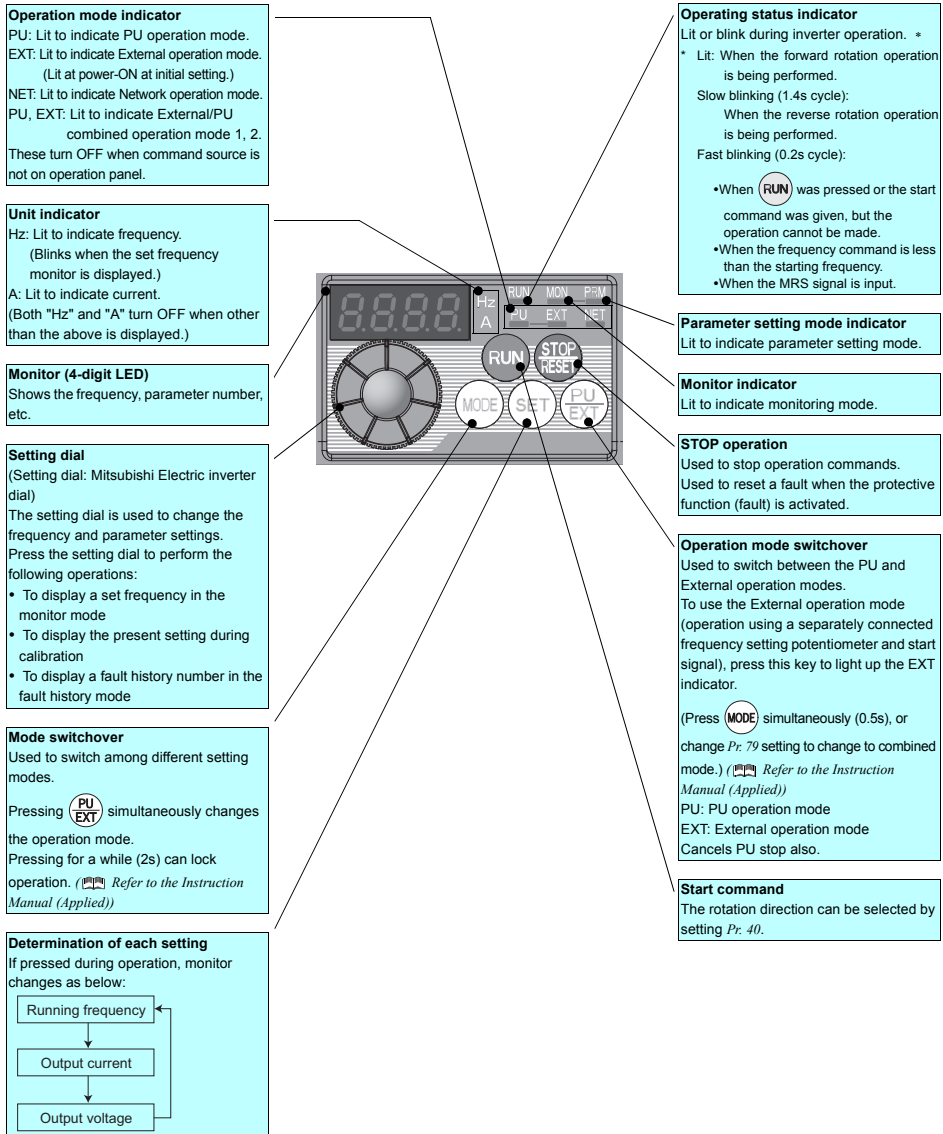

1.2.2 Basic operation (factory setting)

1

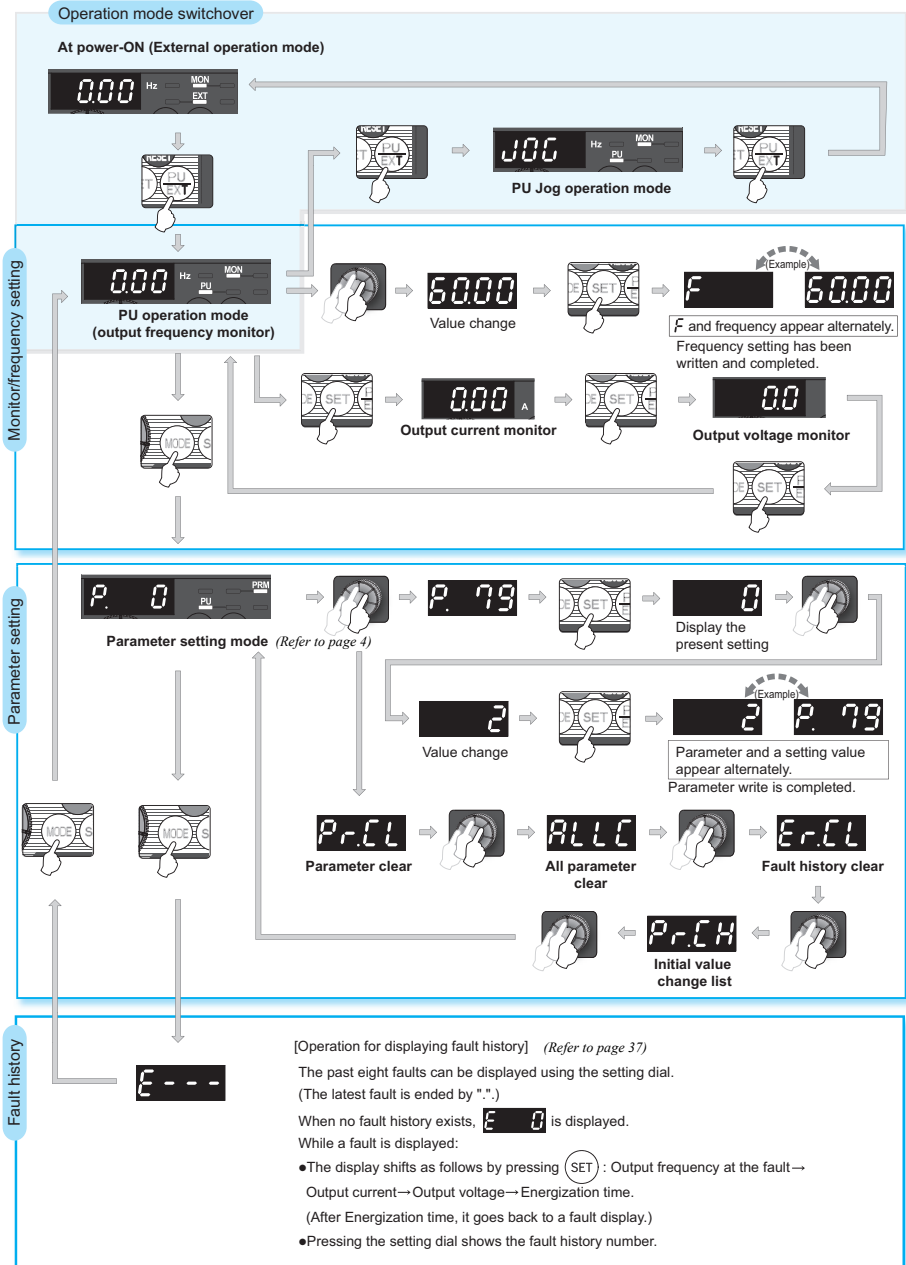

1.2.3 Changing the parameter setting value

Operation example Change the Pr. 1 Maximum frequency setting.

Operation

1. Screen at power-ON
The monitor display appears.
2. Operation mode change
Press **PU EXT** to choose the PU operation mode. PU indicator is lit.
3. Parameter setting mode
Press **MODE** to choose the parameter setting mode.
4. Selecting the parameter number
Turn **▲** until "P. 1" (Pr. 1) appears.
5. Reading the setting value
Press **SET** to read the present set value.
"120.0"(120.0Hz (initial value)) appears.
6. Changing the setting value
Turn **▲** to change the set value to "60.00" (60.00Hz).
7. Setting the parameter
Press **SET** to set.
The parameter number and the setting value blink alternately.

REMARKS

? **Er 1** to **Er 4** is displayed...Why?

- Er 1** appearsWrite disable error
- Er 2** appearsWrite error during operation
- Er 3** appearsCalibration error
- Er 4** appearsMode designation error

(For details, refer to the Instruction Manual (Applied).)

- The number of digits displayed on the operation panel is four. Only the upper four digits of values can be displayed and set. If the values to be displayed have five digits or more including decimal places, the fifth or later numerals cannot be displayed nor set. (Example) For Pr. 1

When 60Hz is set, 60.00 is displayed.

When 120Hz is set, 120.0 is displayed and second decimal place is not displayed nor set.

1.2.4 Parameter clear/all parameter clear



POINT

- Set "1" in Pr.CL Parameter clear or ALLC All parameter clear to initialize parameters. (Parameters are not cleared when "1" is set in Pr. 77 Parameter write selection.)
- Refer to the extended parameter list of the Instruction Manual (Applied) for parameters cleared with this operation.

Operation

1. Screen at power-ON
The monitor display appears.
2. Operation mode change
Press **PU EXT** to choose the PU operation mode. PU indicator is lit.
3. Parameter setting mode
Press **MODE** to choose the parameter setting mode.
4. Selecting Parameter Clear (All Parameter Clear)
Turn **▲** until "Pr. CL" ("ALLC") appears.
5. Selecting the setting value
Press **SET** to read the present set value.
"0"(initial value) appears.
Turn **▲** to change it to the set value "1".
6. Executing Parameter Clear
Press **SET** to set.
"1" and Pr. CL (ALLC) indications blink alternately.

REMARKS

? **1** and **Er 4** are displayed alternately ... Why?

The inverter is not in the PU operation mode. (Refer to the step 2.)

PU connector is used (when a parameter unit (FR-PU04/FR-PU07) is used).

- Stop the inverter. Parameter clear is unavailable when the inverter is running, and will cause the write disable error.

Setting	Description
0	Clear is not executed.
1	Sets parameters back to the initial values. (Parameter clear sets back all parameters except calibration parameters, terminal function selection parameters to the initial values.) Refer to the parameter list of the Instruction Manual (Applied) for availability of parameter clear and all parameter clear.

2 INSTALLATION AND WIRING



AC power supply
Use within the permissible power supply specifications of the inverter. To ensure safety, use a molded case circuit breaker, earth leakage circuit breaker or magnetic contactor to switch power ON/OFF. (Refer to page 43)

Molded case circuit breaker (MCCB) or earth leakage circuit breaker (ELB), fuse

The breaker must be selected carefully since an in-rush current flows in the inverter at power on.

(Refer to page 6.)

Magnetic contactor (MC)
Install the magnetic contactor to ensure safety. Do not use this magnetic contactor to start and stop the inverter. Doing so will cause the inverter life to be shortened.

(Refer to page 6.)

Reactor (FR-HAL, FR-HEL option)
Reactors (option) must be used when power harmonics measures are taken, the power factor is to be improved or the inverter is installed near a large power supply system (500kVA or more). The inverter may be damaged if you do not use reactors. Select the reactor according to the model. Remove the jumpers across terminals P/+ and P1 to connect the DC reactor.



AC reactor (FR-HAL)



DC reactor (FR-HEL) *



Noise filter (ferrite core) * (FR-BSF01, FR-BLF)



Install a noise filter (ferrite core) to reduce the electromagnetic noise generated from the inverter. Effective in the range from about 1MHz to 10MHz. When more wires are passed through, a more effective result can be obtained. A wire should be wound four turns or more.



Parameter unit (FR-PU07)

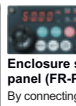

Enclosure surface operation panel (FR-PA07)

By connecting the connection cable (FR-CB2) to the PU connector, operation can be performed from FR-PU07, FR-PA07.



RS-232C - RS-485 converter is required when connecting to PC with RS-232C interface. (Refer to the Instruction Manual (Applied))

RS-485 ↔ RS-232C Converter



Approved safety relay module
Required for compliance with safety standard.

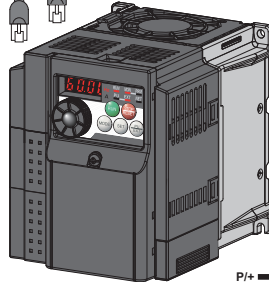

Inverter (FR-D700)



Brake resistor (FR-ABR, MRS type, MYS type)
Braking capability can be improved. (0.4K or higher)
Always install a thermal relay when using a brake resistor whose capacity is 11K or higher. (Refer to page 18.)

Noise filter (capacitor) * (FR-BIF)



Reduces the radio noise.

Noise filter (ferrite core) (FR-BSF01, FR-BLF)



Install a noise filter (ferrite core) to reduce the electromagnetic noise generated from the inverter. Effective in the range from about 1MHz to 10MHz. A wire should be wound four turns at a maximum.

* Filterpack (FR-BFP2), which contains DC reactor and noise filter in one package, is also available.



High power factor converter (FR-HC2)

Power supply harmonics can be greatly suppressed.



Power regeneration common converter (FR-CV)

Great braking capability is obtained.



Resistor unit (FR-BR)
Discharging resistor (GZG, GRZG)

The regenerative braking capability of the inverter can be exhibited fully.



Brake unit (FR-BU2)



Earth (Ground)

Devices connected to the output

Do not install a power factor correction capacitor, surge suppressor or noise filter (capacitor) on the output side of the inverter. When installing a molded case circuit breaker on the output side of the inverter, contact each manufacturer for selection of the molded case circuit breaker.

Earth (Ground)

To prevent an electric shock, always earth (ground) the motor and inverter. For reduction of induction noise from the power line of the inverter, it is recommended to wire the earth (ground) cable by returning it to the earth (ground) terminal of the inverter.

■: Install these options as required.



NOTE

- The life of the inverter is influenced by surrounding air temperature. The surrounding air temperature should be as low as possible within the permissible range. This must be noted especially when the inverter is installed in an enclosure. (Refer to page 7)
- Wrong wiring might lead to damage of the inverter. The control signal lines must be kept fully away from the main circuit to protect them from noise. (Refer to page 8.)
- Do not install a power factor correction capacitor, surge suppressor or noise filter (capacitor) on the inverter output side. This will cause the inverter to trip or the capacitor and surge suppressor to be damaged. If any of the above devices are connected, immediately remove them.
- Electromagnetic wave interference
The input/output (main circuit) of the inverter includes high frequency components, which may interfere with the communication devices (such as AM radios) used near the inverter. In this case, install the FR-BIF optional noise filter (capacitor) (for use in the input side only) or FR-BSF01 or FR-BLF noise filter (ferrite core) to minimize interference. (Refer to Chapter 3 of the Instruction Manual (Applied))
- Refer to the Instruction Manual of each option and peripheral devices for details of peripheral devices.

2.1 Peripheral devices

Check the inverter model of the inverter you purchased. Appropriate peripheral devices must be selected according to the capacity. Refer to the following list and prepare appropriate peripheral devices.

Voltage	Applicable Inverter Model	Motor Output (kW)	Molded Case Circuit Breaker (MCCB) *1 or Earth Leakage Circuit Breaker (ELB) (NF or NV type)		Input Side Magnetic Contactor (MC) *2		Reactor	
			Reactor or Filterpack connection		Reactor or Filterpack connection		FR-HAL	FR-HEL
			without	with	without	with		
Three-Phase 200V class	FR-D720-0.1K	0.1	5A	5A	S-T10	S-T10	0.4K *4	0.4K *4
	FR-D720-0.2K	0.2	5A	5A	S-T10	S-T10	0.4K *4	0.4K *4
	FR-D720-0.4K	0.4	5A	5A	S-T10	S-T10	0.4K	0.4K
	FR-D720-0.75K	0.75	10A	5A	S-T10	S-T10	0.75K	0.75K
	FR-D720-1.5K	1.5	15A	10A	S-T10	S-T10	1.5K	1.5K
	FR-D720-2.2K	2.2	20A	15A	S-T10	S-T10	2.2K	2.2K
	FR-D720-3.7K	3.7	30A	30A	S-T21	S-T10	3.7K	3.7K
	FR-D720-5.5K	5.5	50A	40A	S-T35	S-T21	5.5K	5.5K
	FR-D720-7.5K	7.5	60A	50A	S-T35	S-T35	7.5K	7.5K
	FR-D720-11K	11	75A	75A	S-T35	S-T35	11K	11K
FR-D720-15K	15	125A	100A	S-T50	S-T50	15K	15K	
Three-Phase 400V class	FR-D740-0.4K	0.4	5A	5A	S-T10	S-T10	H0.4K	H0.4K
	FR-D740-0.75K	0.75	5A	5A	S-T10	S-T10	H0.75K	H0.75K
	FR-D740-1.5K	1.5	10A	10A	S-T10	S-T10	H1.5K	H1.5K
	FR-D740-2.2K	2.2	15A	10A	S-T10	S-T10	H2.2K	H2.2K
	FR-D740-3.7K	3.7	20A	15A	S-T10	S-T10	H3.7K	H3.7K
	FR-D740-5.5K	5.5	30A	20A	S-T21	S-T12	H5.5K	H5.5K
	FR-D740-7.5K	7.5	30A	30A	S-T21	S-T21	H7.5K	H7.5K
	FR-D740-11K	11	50A	40A	S-T21	S-T21	H11K	H11K
	FR-D740-15K	15	60A	50A	S-T35	S-T21	H15K	H15K
	Single-Phase 200V class	FR-D720S-0.1K	0.1	5A	5A	S-T10	S-T10	0.4K *4
FR-D720S-0.2K		0.2	5A	5A	S-T10	S-T10	0.4K *4	0.4K *4
FR-D720S-0.4K		0.4	10A	10A	S-T10	S-T10	0.75K *4	0.75K *4
FR-D720S-0.75K		0.75	15A	10A	S-T10	S-T10	1.5K *4	1.5K *4
FR-D720S-1.5K		1.5	20A	20A	S-T10	S-T10	2.2K *4	2.2K *4
FR-D720S-2.2K		2.2	40A	30A	S-T21	S-T10	3.7K *4	3.7K *4
Single-Phase 100V class	FR-D710W-0.1K	0.1	10A	5A	S-T10	S-T10	0.75K *3, *4	— *5
	FR-D710W-0.2K	0.2	10A	10A	S-T10	S-T10	1.5K *3, *4	— *5
	FR-D710W-0.4K	0.4	15A	15A	S-T10	S-T10	2.2K *3, *4	— *5
	FR-D710W-0.75K	0.75	30A	20A	S-T10	S-T10	3.7K *3, *4	— *5

*1 Select a MCCB according to the power supply capacity.

Install one MCCB per inverter.

For the use in the United States or Canada, refer to "Instructions for UL and cUL" in, and select an appropriate fuse or molded case circuit breaker (MCCB).

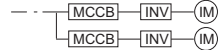

*2 Magnetic contactor is selected based on the AC-1 class. The electrical durability of magnetic contactor is 500,000 times. When the magnetic contactor is used for emergency stop during motor driving, the electrical durability is 25 times.

If using an MC for emergency stop during motor driving, select an MC regarding the inverter input side current as JEM1038-AC-3 class rated current. When using an MC on the inverter output side for commercial-power supply operation switching using a general-purpose motor, select an MC regarding the motor rated current as JEM1038-AC-3 class rated current.

*3 When connecting a single-phase 100V power input model to a power transformer (50kVA or more), install an AC reactor (FR-HAL) so that the performance is more reliable. (Refer to Chapter 3 of the Instruction Manual (Applied))

*4 The power factor may be slightly lower.

*5 Single-phase 100V power input model is not compatible with DC reactor.



NOTE

- When the inverter capacity is larger than the motor capacity, select an MCCB and a magnetic contactor according to the inverter model, and cable and reactor according to the motor output.
- When the breaker on the inverter input side trips, check for the wiring fault (short circuit), damage to internal parts of the inverter, etc. Identify the cause of the trip, then remove the cause and power ON the breaker.

2.2 Installation of the inverters and precautions

(1) Installation of the inverter

Enclosure surface mounting

Remove the front cover and wiring cover to mount the inverter to the surface. (Remove the covers in the directions of the arrows.)

- FR-D720-0.1K to 0.75K
- FR-D720S-0.1K to 0.75K
- FR-D710W-0.1K to 0.4K

- FR-D720-1.5K to 3.7K
- FR-D740-0.4K to 3.7K
- FR-D720S-1.5K, 2.2K
- FR-D710W-0.75K

- FR-D720-5.5K to 15K
- FR-D740-5.5K to 15K

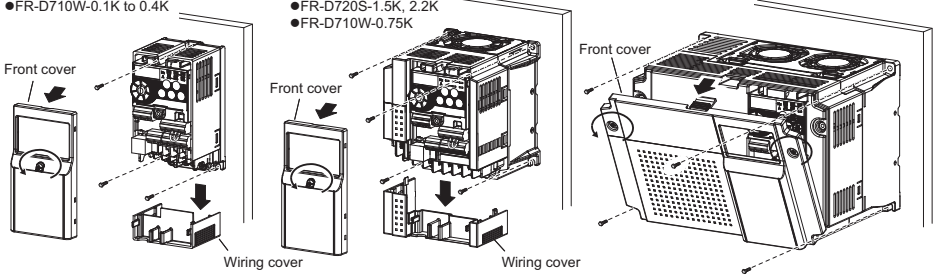

NOTE

- When encasing multiple inverters, install them in parallel as a cooling measure.
- Install the inverter vertically.
- For heat dissipation and maintenance, allow minimum clearance shown in the figures below from the inverter to the other devices and to the inner surface of the enclosure.

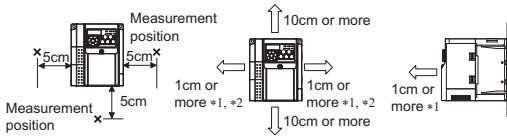

-10°C to +50°C
(non-freezing)

*1 Allow 5cm or more clearance for 5.5K or higher.

*2 When using the inverters at the surrounding air temperature of 40°C or less, the inverters can be installed without any clearance between them (0cm clearance).

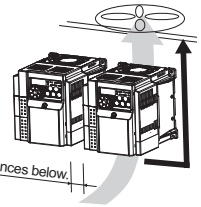

(2) Environment

Before installation, check that the environment meets the specifications on *page 44*.



Note

- Install the inverter on a strong surface securely and vertically with bolts.
- Leave enough clearances and take cooling measures.
- Avoid places where the inverter is subjected to direct sunlight, high temperature and high humidity.
- Install the inverter on a nonflammable wall surface.
- When designing or building an enclosure for the inverter, carefully consider influencing factors such as heat generation of the contained devices and the operating environment.

2.3 Wiring

2.3.1 Terminal connection diagram

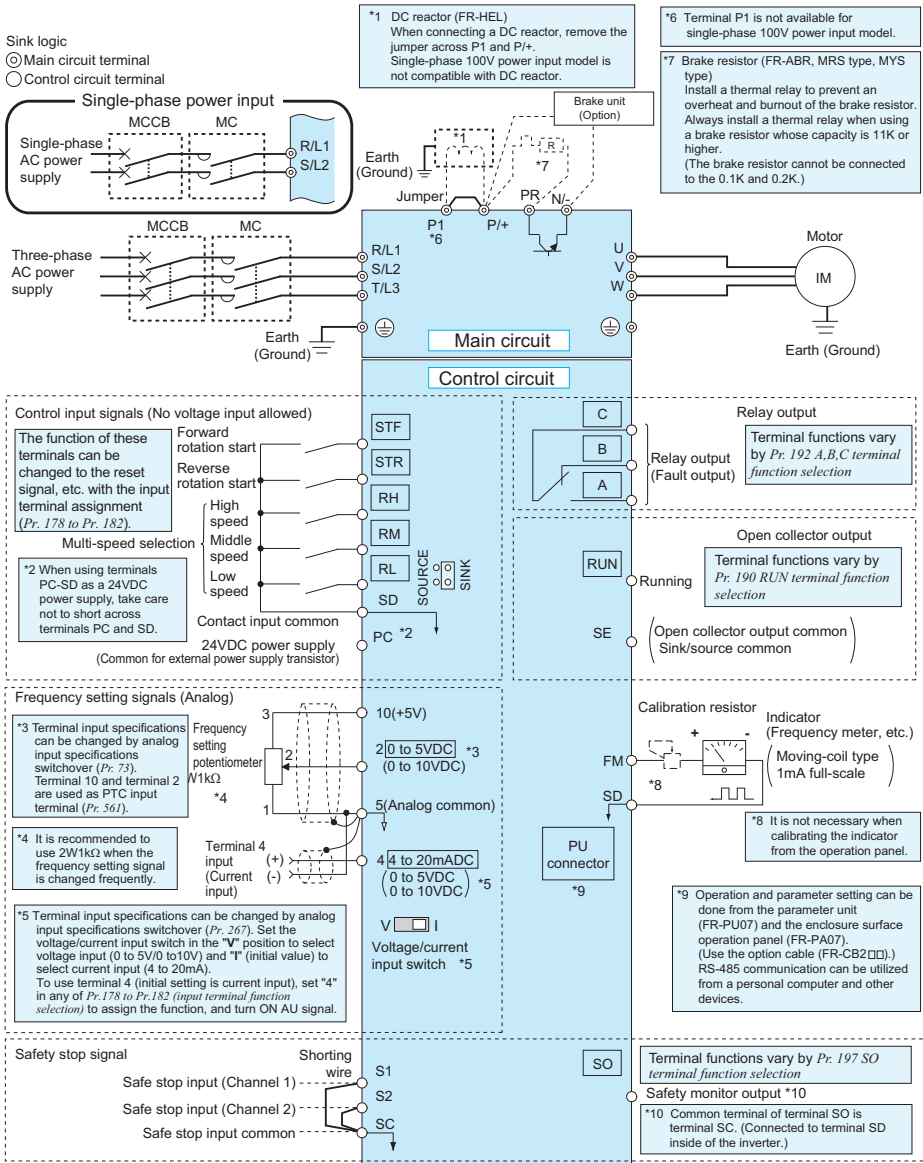

NOTE

- To prevent a malfunction caused by noise, separate the signal cables more than 10cm from the power cables. Also separate the main circuit wire of the input side and the output side.
- After wiring, wire offsets must not be left in the inverter. Wire offsets can cause an alarm, failure or malfunction. Always keep the inverter clean. When drilling mounting holes in an enclosure etc., take care not to allow chips and other foreign matter to enter the inverter.
- The output of the single-phase power input model is three-phase 200V.

2.3.2 Terminal specifications

Type	Terminal Symbol	Terminal Name	Terminal Specification		
Main circuit terminal	R/L1, S/L2, T/L3 *	AC power input	Connect to the commercial power supply. Do not connect anything to these terminals when using the high power factor converter (FR-HC2) or power regeneration common converter (FR-CV). * When using single-phase power input, terminals are R/L1 and S/L2.		
	U, V, W	Inverter output	Connect a three-phase squirrel-cage motor.		
	P/+, PR	Brake resistor connection	Connect a brake resistor (FR-ABR, MRS type, MYS type) across terminals P/+ and PR. (The brake resistor cannot be connected to the 0.1K and 0.2K.)		
	P/+, N/-	Brake unit connection	Connect the brake unit (FR-BU2), power regeneration common converter (FR-CV) or high power factor converter (FR-HC2).		
	P/+, P1 *	DC reactor connection	Remove the jumper across terminals P/+ and P1 and connect a DC reactor. (Single-phase 100V power input model is not compatible with the DC reactor.) * Terminal P1 is not available for single-phase 100V power input model.		
		Earth (Ground)	For earthing (grounding) the inverter chassis. Must be earthed (grounded).		
Control circuit terminal/input signal	Contact input	STF	Forward rotation start	Turn ON the STF signal to start forward rotation and turn it OFF to stop.	When the STF and STR signals are turned ON simultaneously, the stop command is given.
		STR	Reverse rotation start	Turn ON the STR signal to start reverse rotation and turn it OFF to stop.	
		RH, RM, RL	Multi-speed selection	Multi-speed can be selected according to the combination of RH, RM and RL signals.	
		SD	Contact input common (sink) (initial setting)	Common terminal for contact input terminal (sink logic) and terminal FM.	
			External transistor common (source)	Connect this terminal to the power supply common terminal of a transistor output (open collector output) device, such as a programmable controller, in the source logic to avoid malfunction by undesirable current.	
			24VDC power supply common	Common output terminal for 24VDC 0.1A power supply (PC terminal). Isolated from terminals 5 and SE.	
	PC	External transistor common (sink) (initial setting)	Connect this terminal to the power supply common terminal of a transistor output (open collector output) device, such as a programmable controller, in the sink logic to avoid malfunction by undesirable current.		
		Contact input common (source)	Common terminal for contact input terminal (source logic).		
		24VDC power supply	Can be used as 24VDC 0.1A power supply.		
	Frequency setting	10	Frequency setting power supply	Used as power supply when connecting potentiometer for frequency setting (speed setting) from outside of the inverter.	5.0V ± 0.2VDC permissible load current 10mA
			Frequency setting (voltage)	Inputting 0 to 5VDC (or 0 to 10V) provides the maximum output frequency at 5V (10V) and makes input and output proportional. Use Pr. 73 to switch between input 0 to 5VDC input (initial setting) and 0 to 10VDC.	Input resistance 10kΩ ± 1kΩ Permissible maximum voltage 20VDC
		4	Frequency setting (current)	Inputting 4 to 20mADC (or 0 to 5V, 0 to 10V) provides the maximum output frequency at 20mA and makes input and output proportional. This input signal is valid only when the AU signal is ON (terminal 2 input is invalid). To use terminal 4 (initial setting is current input), set "4" in any of Pr.178 to Pr.182 (input terminal function selection) to assign the function, and turn ON AU signal. Use Pr. 267 to switch among input 4 to 20mA (initial setting), 0 to 5VDC and 0 to 10VDC. Set the voltage/current input switch in the "V" position to select voltage input (0 to 5V/0 to 10V).	Current input: Input resistance 249Ω ± 5Ω Maximum permissible current 30mA Voltage input: Input resistance 10kΩ ± 1kΩ Permissible maximum voltage 20VDC
Frequency setting common			Frequency setting signal (terminal 2, 4) common terminal. Do not earth (ground).		
Thermistor	10	PTC thermistor input	For connecting PTC thermistor output.	Adaptive PTC thermistor specification Heat detection resistance : 500Ω to 30kΩ (Set by Pr. 361)	
	2		When PTC thermistor protection is valid (Pr. 361 ≠ "9999"), terminal 2 is not available for frequency setting.		

2

Type	Terminal Symbol	Terminal Name	Terminal Specification		
Control circuit terminal/Output signal	Relay	A, B, C	Relay output (fault output)	1 changeover contact output indicates that the inverter protective function has activated and the output stopped. Fault: discontinuity across B-C (continuity across A-C). Normal: continuity across B-C (discontinuity across A-C)	Contact capacity:230VAC 0.3A (power factor =0.4) 30VDC 0.3A
	Open collector	RUN	Inverter running	Switched Low when the inverter output frequency is equal to or higher than the starting frequency (initial value 0.5Hz). Switched High during stop or DC injection brake operation. (Low is when the open collector output transistor is ON (conducts). High is when the transistor is OFF (does not conduct).)	Permissible load 24VDC (maximum 27VDC) 0.1A (a voltage drop is 3.4V maximum when the signal is ON)
		SE	Open collector output common	Common terminal of terminal RUN.	
	Pulse	FM	For meter	Used to output a selected monitored item (such as Output frequency) among several monitored items. (Not output during inverter reset.) The output signal is proportional to the magnitude of the corresponding monitored item.	Permissible load current 1mA 1440 pulses/s at 60Hz
Communication	—	PU connector	With the PU connector, communication can be established through RS-485. •Conforming standard: EIA-485 (RS-485) •Transmission format: Multidrop link •Communication speed: 4800 to 38400bps •Overall length: 500m		
Safety stop function *	S1	Safety stop input (Channel 1)	Terminals S1 and S2 are for safety stop input signals used with the safety relay module. Terminals S1 and S2 are used simultaneously (dual channel). Inverter output is shut off by shortening/opening across terminals S1 and SC and across S2 and SC. In the initial status, terminals S1 and S2 are shorted with terminal SC by shortening wire. Remove the shortening wire and connect the safety relay module when using the safety stop function.	Input resistance 4.7kΩ Voltage when contacts are open 21 to 26VDC When contacts are short-circuited 4 to 6mADC	
	S2	Safety stop input (Channel 2)			
	SC	Safety stop input terminal common	Common terminal for terminals S1, S2 and SO. Connected to terminal SD inside of the inverter.		
	SO	Safety monitor output (open collector output)	The signal indicates the status of safety stop input. Low indicates safe state, and High indicates drive enabled or fault detected. (Low is when the open collector output transistor is ON (conducts). High is when the transistor is OFF (does not conduct).)	Permissible load 24VDC (maximum 27VDC) 0.1A (a voltage drop is 3.4V maximum when the signal is ON)	

* For more details, refer to the Safety stop function instruction manual (BCN-A211508-000). (Please contact your sales representative for the manual.)



NOTE

- To change the input specification for terminal 4, set Pr. 267 and the voltage/current input switch correctly, then input the analog signal relevant to the setting. Applying a voltage with voltage/current input switch in "I" position (current input is selected) or a current with switch in "V" position (voltage input is selected) could cause component damage to the inverter or analog circuit of output devices.
- Connecting the power supply to the inverter output terminals (U, V, W) will damage the inverter. Do not perform such wiring.
- indicates that terminal functions can be selected using Pr. 178 to Pr. 182, Pr. 190, Pr. 192, Pr. 197 (I/O terminal function selection).
- The terminal names and functions shown here are the initial settings.

2.3.3 Terminal arrangement of the main circuit terminal, power supply and the motor wiring

●Three-phase 200V/400V class

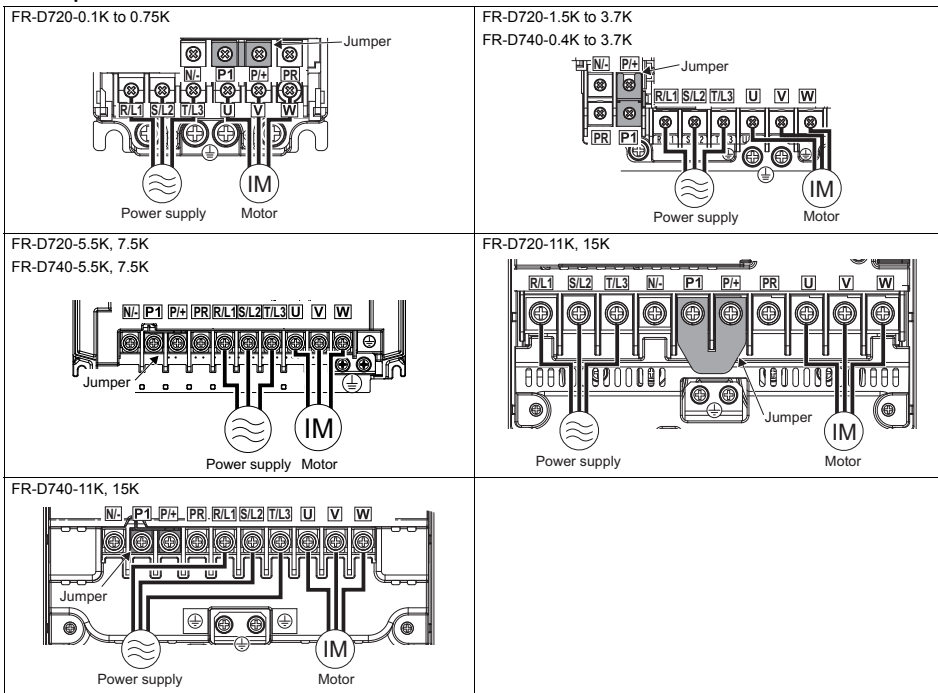

●Single-phase 200V class

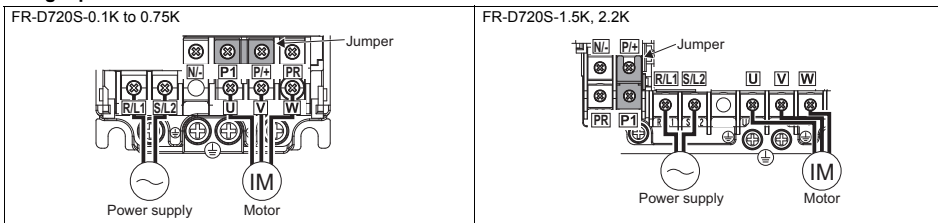

●Single-phase 100V class

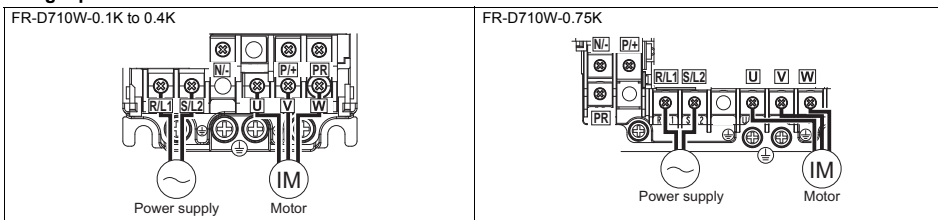

NOTE

- Make sure the power cables are connected to the R/L1, S/L2, T/L3. (Phase need not be matched.) Never connect the power cable to the U, V, W of the inverter. Doing so will damage the inverter.
- Connect the motor to U, V, W. Turning ON the forward rotation switch (signal) at this time rotates the motor counterclockwise when viewed from the load shaft.

2

(1) Cable sizes etc., of the main control circuit terminals and earth (ground) terminals

Select the recommended cable size to ensure that a voltage drop will be 2% or less.

If the wiring distance is long between the inverter and motor, a main circuit cable voltage drop will cause the motor torque to decrease especially at the output of a low frequency.

The following table indicates a selection example for the wiring length of 20m.

Three-phase 200V class (when input power supply is 220V)

Applicable Inverter Model	Terminal Screw Size ^{*4}	Tightening Torque N·m	Crimp Terminal		Cable Size							
					HIV Cables, etc. (mm ²) ^{*1}			AWG ^{*2}		PVC Cables, etc. (mm ²) ^{*3}		
			R/L1 S/L2 T/L3	U, V, W	R/L1 S/L2 T/L3	U, V, W	Earthing (grounding) cable	R/L1 S/L2 T/L3	U, V, W	R/L1 S/L2 T/L3	U, V, W	Earthing (grounding) cable
FR-D720-0.1K to 0.75K	M3.5	1.2	2-3.5	2-3.5	2	2	2	14	14	2.5	2.5	2.5
FR-D720-1.5K, 2.2K	M4	1.5	2-4	2-4	2	2	2	14	14	2.5	2.5	2.5
FR-D720-3.7K	M4	1.5	3.5-4	3.5-4	3.5	3.5	3.5	12	12	4	4	4
FR-D720-5.5K	M5	2.5	5.5-5	5.5-5	5.5	5.5	5.5	10	10	6	6	6
FR-D720-7.5K	M5	2.5	14-5	8-5	14	8	5.5	6	8	16	10	6
FR-D720-11K	M5	2.5	14-5	14-5	14	14	8	6	6	16	16	16
FR-D720-15K	M6 (M5)	4.4	22-6	22-6	22	22	14	4	4	25	25	16

Three-phase 400V class (when input power supply is 440V)

Applicable Inverter Model	Terminal Screw Size ^{*4}	Tightening Torque N·m	Crimp Terminal		Cable Size							
					HIV Cables, etc. (mm ²) ^{*1}			AWG ^{*2}		PVC Cables, etc. (mm ²) ^{*3}		
			R/L1 S/L2 T/L3	U, V, W	R/L1 S/L2 T/L3	U, V, W	Earthing (grounding) cable	R/L1 S/L2 T/L3	U, V, W	R/L1 S/L2 T/L3	U, V, W	Earthing (grounding) cable
FR-D740-0.4K to 3.7K	M4	1.5	2-4	2-4	2	2	2	14	14	2.5	2.5	2.5
FR-D740-5.5K	M4	1.5	3.5-4	2-4	3.5	2	3.5	12	14	4	2.5	4
FR-D740-7.5K	M4	1.5	3.5-4	3.5-4	3.5	3.5	3.5	12	12	4	4	4
FR-D740-11K	M4	1.5	5.5-4	5.5-4	5.5	5.5	5.5	10	10	6	6	10
FR-D740-15K	M5	2.5	8-5	5.5-5	8	5.5	5.5	8	8	10	10	10

Single-phase 200V class (when input power supply is 220V)

Applicable Inverter Model	Terminal Screw Size ^{*4}	Tightening Torque N·m	Crimp Terminal		Cable Size							
					HIV Cables, etc. (mm ²) ^{*1}			AWG ^{*2}		PVC Cables, etc. (mm ²) ^{*3}		
			R/L1 S/L2	U, V, W	R/L1 S/L2	U, V, W	Earthing (grounding) cable	R/L1 S/L2	U, V, W	R/L1 S/L2	U, V, W	Earthing (grounding) cable
FR-D720S-0.1K to 0.75K	M3.5	1.2	2-3.5	2-3.5	2	2	2	14	14	2.5	2.5	2.5
FR-D720S-1.5K	M4	1.5	2-4	2-4	2	2	2	14	14	2.5	2.5	2.5
FR-D720S-2.2K	M4	1.5	3.5-4	2-4	3.5	2	3.5	12	14	4	2.5	4

Single-phase 100V class (when input power supply is 100V)

Applicable Inverter Model	Terminal Screw Size ^{*4}	Tightening Torque N·m	Crimp Terminal		Cable Size							
					HIV Cables, etc. (mm ²) ^{*1}			AWG ^{*2}		PVC Cables, etc. (mm ²) ^{*3}		
			R/L1 S/L2	U, V, W	R/L1 S/L2	U, V, W	Earthing (grounding) cable	R/L1 S/L2	U, V, W	R/L1 S/L2	U, V, W	Earthing (grounding) cable
FR-D710W-0.1K to 0.4K	M3.5	1.2	2-3.5	2-3.5	2	2	2	14	14	2.5	2.5	2.5
FR-D710W-0.75K	M4	1.5	3.5-4	2-4	3.5	2	2	12	14	4	2.5	2.5

*1 The cable size is that of the cable (HIV cable (600V class 2 vinyl-insulated cable) etc.) with continuous maximum permissible temperature of 75°C. Assumes that the surrounding air temperature is 50°C or less and the wiring distance is 20m or less.

*2 The recommended cable size is that of the cable (THHW cable) with continuous maximum permissible temperature of 75°C. Assumes that the surrounding air temperature is 40°C or less and the wiring distance is 20m or less. (For the use in the United States or Canada, refer to page 49.)

*3 The recommended cable size is that of the cable (PVC cable) with continuous maximum permissible temperature of 70°C. Assumes that the surrounding air temperature is 40°C or less and the wiring distance is 20m or less. (Selection example for use mainly in Europe.)

*4 The terminal screw size indicates the terminal size for R/L1, S/L2, T/L3, U, V, W, PR, P/+, N/-, P1 and a screw for earthing (grounding).

Screw size for earthing (grounding) the FR-D720-15K is indicated in parentheses.
For single-phase power input, the terminal screw size indicates the size of terminal screw for R/L1, S/L2, U, V, W, PR, P/+, N/-, P1 and a screw for earthing (grounding).



NOTE

- Tighten the terminal screw to the specified torque. A screw that has been tightened too loosely can cause a short circuit or malfunction. A screw that has been tightened too tightly can cause a short circuit or malfunction due to the unit breakage.
- Use crimp terminals with insulation sleeve to wire the power supply and motor.

The line voltage drop can be calculated by the following formula:

$$\text{Line voltage drop [V]} = \frac{\sqrt{3} \times \text{wire resistance [m}\Omega\text{/m]} \times \text{wiring distance [m]} \times \text{current [A]}}{1000}$$

Use a larger diameter cable when the wiring distance is long or when it is desired to decrease the voltage drop (torque reduction) in the low speed range.

(2) Total wiring length

The overall wiring length for connection of a single motor or multiple motors should be within the value in the table below.

Cable Type	Pr. 72 Setting (carrier frequency)	Voltage Class	0.1K	0.2K	0.4K	0.75K	1.5K	2.2K	3.7K or Higher
Unshielded cable	1 (1kHz) or lower	100V/200V	200m	200m	300m	500m	500m	500m	500m
		400V	-	-	200m	200m	300m	500m	500m
	2 (2kHz) or higher	100V/200V	30m	100m	200m	300m	500m	500m	500m
		400V	-	-	30m	100m	200m	300m	500m
Shielded cable	1 (1kHz) or lower	100V/200V	50m	50m	75m	100m	100m	100m	100m
		400V	-	-	50m	50m	75m	100m	100m
	2 (2kHz) or higher	100V/200V	10m	25m	50m	75m	100m	100m	100m
		400V	-	-	10m	25m	50m	75m	100m

When driving a 400V class motor by the inverter, surge voltages attributable to the wiring constants may occur at the motor terminals, deteriorating the insulation of the motor. Take the following measures 1) or 2) in this case.

- 1) Use a "400V class inverter-driven insulation-enhanced motor" and set frequency in *Pr. 72 PWM frequency selection* according to wiring length

Carrier frequency	Wiring Length		
	50m or less	50m to 100m	Exceeding 100m
	14.5kHz or less	8kHz or less	2kHz or less

- 2) Connect the surge voltage suppression filter (FR-ASF-H/FR-BMF-H) on the inverter output side.



NOTE

- Especially for long-distance wiring, the inverter may be affected by a charging current caused by the stray capacitances of the wiring, leading to a malfunction of the overcurrent protective function, fast response current limit function, or stall prevention function or a malfunction or fault of the equipment connected on the inverter output side. If malfunction of fast-response current limit function occurs, disable this function. If malfunction of stall prevention function occurs, increase the stall level. (Refer to *Pr. 22 Stall prevention operation level* and *Pr. 156 Stall prevention operation selection* in the chapter 4 of the Instruction Manual (applied))
- When using the automatic restart after instantaneous power failure function with wiring length exceeding below, select without frequency search (*Pr. 162 = "1, 11"*). (Refer to Chapter 4 of the Instruction Manual (Applied))

Motor capacity	0.1kW	0.2kW	0.4kW or higher
Wiring length	20m	50m	100m

2.3.4 Wiring of control circuit

(1) Control circuit terminal layout

Recommend wire size:
0.3mm² to 0.75mm²

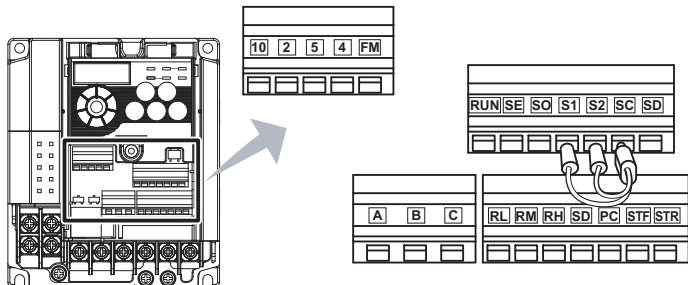

2

(2) Wiring method

●Wiring

Use a blade terminal and a wire with a sheath stripped off for the control circuit wiring. For a single wire, strip off the sheath of the wire and apply directly.

Insert the blade terminal or the single wire into a socket of the terminal.

- Strip off the sheath about the length below. If the length of the sheath peeled is too long, a short circuit may occur among neighboring wires. If the length is too short, wires might come off.
Wire the stripped wire after twisting it to prevent it from becoming loose. In addition, do not solder it.

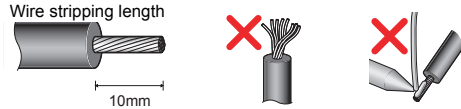

- Crimp the blade terminal.
Insert wires to a blade terminal, and check that the wires come out for about 0 to 0.5 mm from a sleeve. Check the condition of the blade terminal after crimping. Do not use a blade terminal of which the crimping is inappropriate, or the face is damaged.

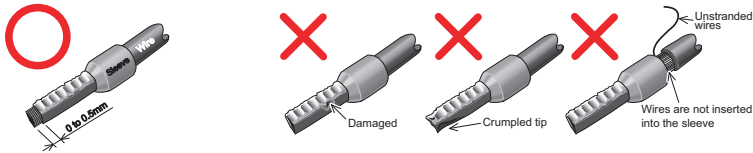

Blade Terminals available on the market: (as of January 2017)

●Phoenix Contact Co., Ltd.

Wire Size (mm ²)	Ferrule Terminal Model			Crimping Tool Name
	With Insulation Sleeve	Without Insulation Sleeve	For UL Wire *1	
0.3	AI 0,34-10TQ	—	—	CRIMPFOX 6
0.5	AI 0,5-10WH	—	AI 0,5-10WH-GB	
0.75	AI 0,75-10GY	A 0,75-10	AI 0,75-10GY-GB	
1	AI 1-10RD	A1-10	AI 1-10RD/1000GB	
1.25, 1.5	AI 1,5-10BK	A1,5-10	AI 1,5-10BK/1000GB *2	
0.75 (for two wires)	AI-TWIN 2 x 0,75-10GY	—	—	

*1 A ferrule terminal with an insulation sleeve compatible with MTW wire which has a thick wire insulation
*2 Applicable for terminal ABC.

●NICHIFU Co., Ltd.

Wire Size (mm ²)	Blade Terminal Product Number	Insulation Cap Product Number	Crimping Tool Product Number
0.3 to 0.75	BT 0.75-11	VC 0.75	NH 69

- Insert the wire into a socket.

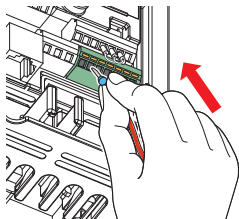

When using a single wire or a stranded wire without a blade terminal, push an open/close button all the way down with a flathead screwdriver, and insert the wire.

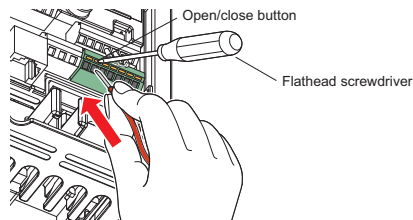

NOTE

- When using a stranded wire without a blade terminal, twist enough to avoid short circuit with a nearby terminals or wires.
- Place the flathead screwdriver vertical to the open/close button. In case the blade tip slips, it may cause damage to inverter or injury.

●Wire removal

Pull the wire with pushing the open/close button all the way down firmly with a flathead screwdriver.

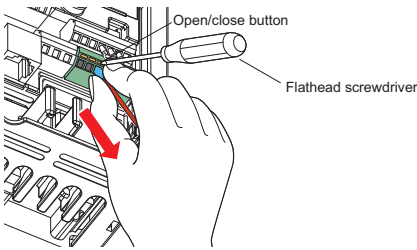

NOTE

- Pulling out the terminal block forcefully without pushing the open/close button all the way down may damage the terminal block.
- Use a small flathead screwdriver (Tip thickness: 0.4mm/ tip width: 2.5mm). If a flathead screwdriver with a narrow tip is used, terminal block may be damaged.

Products available on the market :(as of Feb. 2016)

Product	Type	Manufacturer
Flathead screwdriver	SZF 0- 0,4 x 2,5	Phoenix Contact Co., Ltd.

- Place the flathead screwdriver vertical to the open/close button. In case the blade tip slips, it may cause damage to inverter or injury.

(3) Control circuit common terminals (SD, 5, SE)

- Terminals SD, SE and 5 are common terminals for I/O signals. (All common terminals are isolated from each other.) Do not earth them. Avoid connecting the terminals SD and 5 and the terminals SE and 5.
- Terminal SD is a common terminal for the contact input terminals (STF, STR, RH, RM, RL) and the pulse train output terminal (FM). The open collector circuit is isolated from the internal control circuit by photocoupler.
- Terminal 5 is a common terminal for the frequency setting signals (terminals 2 or 4). It should be protected from external noise using a shielded or twisted cable.
- Terminal SE is a common terminal for the open collector output terminal (RUN). The contact input circuit is isolated from the internal control circuit by photocoupler.

(4) Wiring instructions

- It is recommended to use the cables of 0.3mm² to 0.75mm² gauge for connection to the control circuit terminals.
- The maximum wiring length should be 30m (200m for terminal FM).
- Do not short across terminals PC and SD. Inverter may be damaged.
- When using contact inputs, use two or more parallel micro-signal contacts or twin contacts to prevent contact faults since the control circuit input signals are micro-currents.
- To suppress EMI, use shielded or twisted cables for the control circuit terminals and run them away from the main and power circuits (including the 200V relay sequence circuit). For the cables connected to the control circuit terminals, connect their shields to the common terminal of the connected control circuit terminal. When connecting an external power supply to the terminal PC, however, connect the shield of the power supply cable to the negative side of the external power supply. Do not directly earth (ground) the shield to the enclosure, etc.
- Always apply a voltage to the fault output terminals (A, B, C) via a relay coil, lamp, etc.
- When using an external power supply for transistor output, note the following points to prevent a malfunction caused by undesirable current.

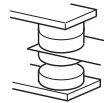

Micro signal contacts

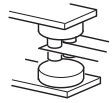

Twin contacts

Do not connect any terminal SD on the inverter and the 0V terminal of the external power supply (when the sink logic is selected).

Do not connect terminal PC on the inverter and the +24V terminal of the external power supply (when the source logic is selected).

Do not install an external power source in parallel with the internal 24VDC power source (connected to terminals PC and SD) to use them together.

 Refer to Chapter 2 of the Instruction Manual (Applied) for the detail.

2.3.5 Assigning signals (output stop signal (MRS), reset signal (RES), etc.) to contact input terminals



POINT

- Use *Pr.178 to Pr.182 (input terminal function selection)* to select and change the functions assigned to input terminals.
To assign the output stop signal (MRS) to the terminal RH, for example, assign "24" to *Pr.182 RH terminal function selection*. (Refer to page 4 to change a parameter setting value.)

Pr.	Name	Initial Value	Range	
178	STF terminal function selection	60	0: Low-speed operation command (RL) 1: Middle-speed operation command (RM) 2: High-speed operation command (RH)	18: V/F switchover (X18) 24: Output stop (MRS)
179	STR terminal function selection	61	3: Second function selection (RT) 4: Terminal 4 input selection (AU) 5: JOG operation selection (JOG)	25: Start self-holding selection (STOP) 60: Forward rotation (STF) *1 61: Reverse rotation (STR) *2
180	RL terminal function selection	0	6: Jog operation selection (JOG) 7: External thermal relay input (OH) 8: Fifteen speed selection (REX)	62: Inverter reset (RES) 65: PU-NET operation switchover (X65) 66: External-NET operation switchover (X66)
181	RM terminal function selection	1	9: Inverter operation enable signal (X10) (FR-HC2/FR-CV connection) 10: Inverter operation enable signal (X10) (FR-HC2/FR-CV connection)	67: Command source switchover (X67)
182	RH terminal function selection	2	11: PU operation external interlock (X12) 12: PU operation external interlock (X12) 14: PID control valid terminal (X14) 16: PU-External operation switchover (X16)	9999: No function *1 Assigned to STF terminal (<i>Pr. 178</i>) only *2 Assigned to STR terminal (<i>Pr. 179</i>) only



NOTE

- Changing the terminal assignment using *Pr.178 to Pr.182 (input terminal function selection)* may affect the other functions. Set parameters after confirming the function of each terminal.

2.3.6 Safety stop function

(1) Description of the function

The terminals related to the safety stop function are shown below.

Terminal Symbol	Description	
S1 *1	For input of safety stop channel 1.	
S2 *1	For input of safety stop channel 2.	
SO *2	SAFE signal	For output of safety stop function. The signal is output when inverter output is shut off due to the safety stop function.
SC	Common terminal for S1,S2,SO signals. (SC is connected terminal SD internally.)	
RUN *3	SAFE2 signal	Outputs when an alarm or failure is detected Outputs when there is no internal safety circuit fault *4
SE	Common terminal for open collector outputs (terminal RUN)	

- *1 In the initial status, terminal S1 and S2 are shorted with terminal SC by shortening wire. Remove the shortening wire and connect the safety relay module when using the safety stop function.
- *2 In the initial setting, safety monitor output signal (SAFE signal) is assigned to terminal SO. The function can be assigned to other terminals by setting "80 (positive logic) or 180 (negative logic)" to any of Pr. 190, Pr. 192 or Pr. 197 (Output terminal function selection). (Refer to Chapter 4 of the Instruction Manual (Applied))
- *3 In the initial setting, inverter running (RUN signal) is assigned to terminal RUN. Set "81" to Pr. 190 RUN terminal function selection to assign SAFE2 signal. The function can be assigned to other terminals by setting "81 (positive logic) or 181 (negative logic)" to any of Pr. 190, Pr. 192 or Pr. 197 (Output terminal function selection). (Refer to Chapter 4 of the Instruction Manual (Applied))
- *4 At an internal safety circuit fault, E.SAF or E.CPU is displayed on the operation panel.

NOTE



- Use SAFE signal for the purpose to monitor safety stop status. SAFE signal cannot be used as safety stop input signal to other devices (other than the safety relay module.)
- SAFE2 signal can only be used to output an alarm or to prevent restart of an inverter. The signal cannot be used as safety stop input signal to other devices.

(2) Wiring connection diagram

To prevent restart at fault occurrence, connect terminals RUN (SAFE2 signal) and SE to terminals XS0 and XS1, which are the feedback input terminals of the safety relay module.

By setting Pr.190 RUN terminal function selection = "81 (SAFE2 signal)", terminal RUN is turned OFF at fault occurrence.

- Pr. 178 = "60 (initial value)"
- Pr. 179 = "25"
- Pr. 190 = "81"
- Pr. 197 = "80 (initial value)"

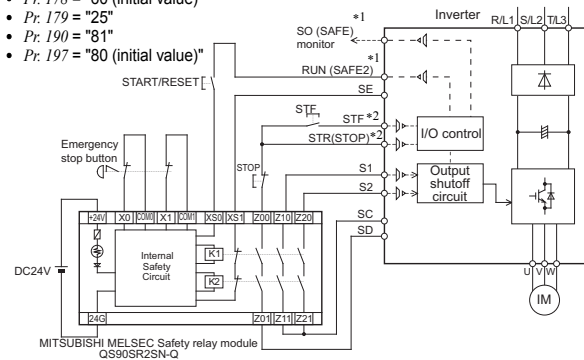

- *1 Output signals differ by the setting of Pr. 190, Pr. 192 and Pr. 197 (Output terminal function selection).
- *2 Input signals differ by the setting of Pr. 178 to Pr. 182 (Input terminal function selection).



NOTE

- Changing the terminal assignment using Pr. 190, Pr. 192, and Pr. 197 (output terminal function selection) may affect the other functions. Set parameters after confirming the function of each terminal.

(3) Safety stop function operation

"N/A" denotes a condition where circuit fault does not apply.

Input Power	Input Signal		Internal Safety Circuit*1	Output Signal		Inverter Operation State
	S1-SC	S2-SC		SAFE*2	SAFE2*2	
OFF	—	—	—	OFF	OFF	Output shutoff (Safe state)
ON	Short	Short	No Failure	OFF	ON	Drive enabled
			Failure	OFF	OFF	Output shutoff (Safe state)
	Open	Open	No Failure	ON	ON	Output shutoff (Safe state)
			Failure	OFF	OFF	Output shutoff (Safe state)
	Short	Open	N/A	OFF	OFF	Output shutoff (Safe state)
Open	Short	N/A	OFF	OFF	Output shutoff (Safe state)	

- *1 At an internal safety circuit fault, E.SAF or E.CPU is displayed on the operation panel. SA is displayed on the operation panel when both the S1 and S2 signals are in the open state without any internal safety circuit fault (E.SAF, E.CPU).
- *2 ON: Transistor used for an open collector output is conducted.
OFF: Transistor used for an open collector output is not conducted.

For more details, refer to the Safety stop function instruction manual (BCN-A211508-000). (Please contact your sales representative for the manual.)

2.4 Connection of a dedicated external brake resistor (MRS type, MYS type, FR-ABR)

Install a dedicated brake resistor (MRS type, MYS type, FR-ABR) outside when the motor driven by the inverter is made to run by the load, quick deceleration is required, etc. Connect a dedicated brake resistor (MRS type, MYS type, FR-ABR) to terminal P/+ and PR. (For the locations of terminal P/+ and PR, refer to the terminal block layout (page 11).)

Set parameters below. (Refer to the Instruction Manual (Applied) for the parameter details.)

Connected Brake Resistor	Pr. 30 Regenerative function selection Setting	Pr. 70 Special regenerative brake duty Setting	
MRS type, MYS type	0 (initial value)	—	
MYS type (used at 100% torque/6%ED)	1	6%	
FR-ABR	1	7.5K or lower	10%
		11K or higher	6%

- It is recommended to configure a sequence, which shuts off power in the input side of the inverter by the external thermal relay as shown below, to prevent overheating and burnout of the brake resistor (MRS type, MYS type) and high duty brake resistor (FR-ABR) in case the regenerative brake transistor is damaged. (The brake resistor cannot be connected to the 0.1K and 0.2K.)

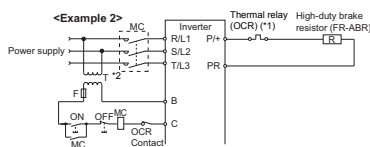
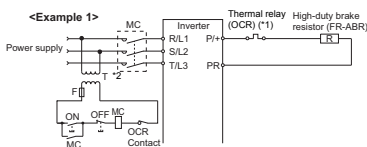

- *1 Refer to the table below for the type number of each capacity of thermal relay and the diagram below for the connection. (Always install a thermal relay when using a brake resistor whose capacity is 11K or higher.)
- *2 When the power supply is 400V class, install a step-down transformer.

Power Supply Voltage	Brake Resistor	Thermal Relay Type (Mitsubishi Electric product)	Rated Operating Current
100V, 200V	MRS120W200	TH-T25-0.7A	120VAC: 2A (NO contact) / 3A (NC contact),
	MRS120W100	TH-T25-1.3A	240VAC: 1A (NO contact) / 2A (NC contact) (AC15 class)
	MRS120W60	TH-T25-2.1A	110VDC: 0.2A,
	MRS120W40	TH-T25-3.6A	220VDC: 0.1A (DC13 class)
	MYS220W50 (two units in parallel)	TH-T25-5A	

Power Supply Voltage	High-duty Brake Resistor	Thermal Relay Type (Mitsubishi Electric product)	Rated Operating Current
100V, 200V	FR-ABR-0.4K	TH-T25-0.7A	120VAC: 2A (NO contact) / 3A (NC contact), 240VAC: 1A (NO contact) / 2A (NC contact) (AC15 class) 110VDC: 0.2A, 220VDC: 0.1A (DC13 class)
	FR-ABR-0.75K	TH-T25-1.3A	
	FR-ABR-2.2K	TH-T25-2.1A	
	FR-ABR-3.7K	TH-T25-3.6A	
	FR-ABR-5.5K	TH-T25-5A	
	FR-ABR-7.5K	TH-T25-6.6A	
	FR-ABR-11K	TH-T25-11A	
	FR-ABR-15K	TH-T25-11A	
400V	FR-ABR-H0.4K	TH-T25-0.24A	
	FR-ABR-H0.75K	TH-T25-0.35A	
	FR-ABR-H1.5K	TH-T25-0.9A	
	FR-ABR-H2.2K	TH-T25-1.3A	
	FR-ABR-H3.7K	TH-T25-2.1A	
	FR-ABR-H5.5K	TH-T25-2.5A	
	FR-ABR-H7.5K	TH-T25-3.6A	
	FR-ABR-H11K	TH-T25-6.6A	
FR-ABR-H15K	TH-T25-6.6A		

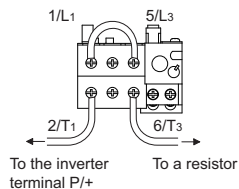

NOTE

- The brake resistor connected should only be the dedicated brake resistor.
- Perform wiring and operation according to the Instruction Manual of each option unit.
- Brake resistor cannot be used with the brake unit, high power factor converter, power supply regeneration converter, etc.
- Do not use the brake resistor (MRS type, MYS type) with a lead wire extended.
- Do not connect a resistor directly to terminals P/+ and N/-. This could cause a fire.

3 PRECAUTIONS FOR USE OF THE INVERTER

The FR-D700 series is a highly reliable product, but using incorrect peripheral circuits or incorrect operation/handling methods may shorten the product life or damage the product.

Before starting operation, always recheck the following items.

- (1) **Use crimp terminals with insulation sleeve to wire the power supply and motor.**
- (2) **Application of power to the output terminals (U, V, W) of the inverter will damage the inverter. Never perform such wiring.**

- (3) **After wiring, wire offcuts must not be left in the inverter.**

Wire offcuts can cause an alarm, failure or malfunction. Always keep the inverter clean.

When drilling mounting holes in an enclosure etc., take care not to allow chips and other foreign matter to enter the inverter.

- (4) **Use cables of the appropriate size to make a voltage drop of 2% or less.**

If the wiring distance is long between the inverter and motor, a main circuit cable voltage drop will cause the motor torque to decrease especially at the output of a low frequency. Refer to *page 12* for the recommended wire sizes.

- (5) **The total wiring length should be within the prescribed length.**

Especially for long distance wiring, the fast-response current limit function may decrease, or the equipment connected to the output side may malfunction. This is caused by a charging current due to the stray capacity of the wiring. Therefore, note the overall wiring length. (*Refer to page 13*)

- (6) **Electrical corrosion of the bearing**

When a motor is driven by the inverter, axial voltage is generated on the motor shaft, which may cause electrical corrosion of the bearing in rare cases depending on the wiring, load, operating conditions of the motor or specific inverter settings (high carrier frequency, use of a capacitive filter*1).

The following shows examples of countermeasures for the inverter.

- Decrease the carrier frequency.
- Remove the capacitive filter.
- Provide a common mode choke*2 on the output side of the inverter. (This is effective regardless of the use of the capacitive filter.)

*1 Mitsubishi Electric capacitive filter: FR-BIF, SF[], FR-E5NF-[], FR-S5NFA[], FR-BFP2-[]

*2 Recommended common mode choke: FT-3KM F series FINEMET® common mode choke cores manufactured by Hitachi Metals, Ltd. FINEMET is a registered trademark of Hitachi Metals, Ltd.

- (7) **Electromagnetic wave interference**

The input/output (main circuit) of the inverter includes high frequency components, which may interfere with the communication devices (such as AM radios) used near the inverter. In this case, install the FR-BIF optional capacitor type filter (for use in the input side only) or FR-BSF01 or FR-BLF line noise filter to minimize interference.

- (8) **Do not install a power factor correction capacitor, surge suppressor or capacitor type filter on the inverter output side.**

This will cause the inverter to trip or the capacitor and surge suppressor to be damaged. If any of the above devices are connected, immediately remove them. (When using capacitor type filter (FR-BIF) for a single-phase power input model, make sure of secure insulation of T/L3-phase, and connect to the input side of the inverter.)

- (9) **For some short time after the power is switched OFF, a high voltage remains in the smoothing capacitor.**

When accessing the inverter for inspection, wait for at least 10 minutes after the power supply has been switched OFF, and then make sure that the voltage across the main circuit terminals P/+ and N/- of the inverter is no more than 30VDC using a tester.

(10) A short circuit or earth (ground) fault on the inverter output side may damage the inverter modules.

- Fully check the insulation resistance of the circuit prior to inverter operation since repeated short circuits may damage the inverter modules. These short circuits may be caused by peripheral circuit inadequacy, an earth (ground) fault caused by wiring inadequacy, or reduced motor insulation resistance.
- Fully check the to-earth (ground) insulation and phase to phase insulation of the inverter output side before power-on. Especially for an old motor or use in a hostile atmosphere, securely check the motor insulation resistance etc.

(11) Do not use the inverter input side magnetic contactor to start/stop the inverter.

Since repeated inrush currents at power ON will shorten the life of the converter circuit (switching life is about 1,000,000 times), frequent starts and stops of the MC must be avoided. Turn ON/OFF the inverter start controlling terminals (STF, STR) to run/stop the inverter. (Refer to the Instruction Manual (Applied))

(12) Across terminals P/+ and PR, connect only an external brake resistor.

Do not connect a mechanical brake.

The brake resistor cannot be connected to the 0.1K and 0.2K. Do not connect anything to terminals P/+ and PR. Also, never short between these terminals.

(13) Do not apply a voltage higher than the permissible voltage to the inverter I/O signal circuits.

Application of a voltage higher than the permissible voltage to the inverter I/O signal circuits or opposite polarity may damage the I/O devices. Especially check the wiring to prevent the speed setting potentiometer from being connected incorrectly to short terminals 10 and 5.

(14) To use the commercial power supply, be sure to provide electrical and mechanical interlocks between the electronic bypass contactors MC1 and MC2.

When using a switching circuit as shown right, chattering due to misconfigured sequence or arc generated at switching may allow undesirable current to flow in and damage the inverter. Miswiring may also damage the inverter.

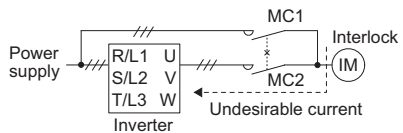

(15) If the machine must not be restarted when power is restored after a power failure, provide a magnetic contactor in the inverter's input side and also make up a sequence which will not switch ON the start signal.

If the start signal (start switch) remains ON after a power failure, the inverter will automatically restart as soon as the power is restored.

(16) Inverter input side magnetic contactor (MC)

On the inverter input side, connect a MC for the following purposes. (Refer to page 6 for selection.)

- 1) To release the inverter from the power supply when a fault occurs or when the drive is not functioning (e.g. emergency stop operation). For example, MC avoids overheat or burnout of the brake resistor when heat capacity of the resistor is insufficient or brake regenerative transistor is damaged with short while connecting an optional brake resistor.
- 2) To prevent any accident due to an automatic restart at restoration of power after an inverter stop made by a power failure
- 3) To separate the inverter from the power supply to ensure safe maintenance and inspection work.

Use the inverter input current as a reference for selection of an MC to perform an emergency stop during operation, and select the MC conforming to JEM1038-AC-3 class rated operational current.

(17) Handling of inverter output side magnetic contactor

Switch the magnetic contactor between the inverter and motor only when both the inverter and motor are at a stop. When the magnetic contactor is turned ON while the inverter is operating, overcurrent protection of the inverter and such will activate. When MC is provided for switching to the commercial power supply, for example, switch it ON/OFF after the inverter and motor have stopped.

(18) Countermeasures against inverter-generated EMI

If electromagnetic noise generated from the inverter causes frequency setting signal to fluctuate and motor rotation speed to be unstable when changing motor speed with analog signal, the following countermeasures are effective.

- Do not run the signal cables and power cables (inverter I/O cables) in parallel with each other and do not bundle them.
- Run signal cables as far away as possible from power cables (inverter I/O cables).
- Use shield cables as signal cables.
- Install a ferrite core on the signal cable (Example: ZCAT3035-1330 TDK).

(19) Instructions for overload operation

When performing operation of frequent start/stop of the inverter, rise/fall in the temperature of the transistor element of the inverter will repeat due to a repeated flow of large current, shortening the life from thermal fatigue. Since thermal fatigue is related to the amount of current, the life can be increased by reducing current at locked condition, starting current, etc. Decreasing current may increase the life. However, decreasing current will result in insufficient torque and the inverter may not start. Therefore, choose the inverter which has enough allowance for current (up to 2 rank larger in capacity).

(20) Make sure that the specifications and rating match the system requirements.

4 FAILSAFE OF THE SYSTEM WHICH USES THE INVERTER

When a fault occurs, the inverter output is shut off to output a fault signal. However, a fault output signal may not be output at an inverter fault occurrence when the detection circuit or output circuit fails, etc. Although Mitsubishi Electric assures best quality products, provide an interlock which uses inverter status output signals to prevent accidents such as damage to machine when the inverter fails for some reason and at the same time consider the system configuration where failsafe from outside the inverter, without using the inverter, is enabled even if the inverter fails.

(1) Interlock method which uses the inverter status output signals

By combining the inverter status output signals to provide an interlock as shown below, an inverter alarm can be detected.

No.	Interlock Method	Check Method	Used Signals	Refer to Page
1)	Inverter protective function operation	Operation check of an alarm contact Circuit error detection by negative logic	Fault (ALM) signal	Refer to Chapter 4 of the Instruction Manual (Applied).
2)	Inverter operating status	Operation ready signal check	Inverter operation ready (RY) signal	Refer to Chapter 4 of the Instruction Manual (Applied).
3)	Inverter running status	Logic check of the start signal and running signal	Start (STF/STR) signal Inverter running (RUN) signal	Refer to Chapter 4 of the Instruction Manual (Applied).
4)	Inverter running status	Logic check of the start signal and output current	Start (STF/STR) signal Output current detection (Y12) signal	Refer to Chapter 4 of the Instruction Manual (Applied).

(2) Backup method outside the inverter

Even if the interlock is provided by the inverter status signal, enough failsafe is not ensured depending on the failure status of the inverter itself. For example, when the inverter CPU fails, even if the interlock is provided using the inverter fault signal, start signal and RUN signal, there is a case where a fault signal is not output and RUN signal is kept output even if an inverter fault occurs.

Provide a speed detector to detect the motor speed and current detector to detect the motor current and consider the backup system such as checking up as below according to the level of importance of the system.

1) Start signal and actual operation check

Check the motor running and motor current while the start signal is input to the inverter by comparing the start signal to the inverter and detected speed of the speed detector or detected current of the current detector. Note that the motor current runs as the motor is running for the period until the motor stops since the inverter starts decelerating even if the start signal turns OFF. For the logic check, configure a sequence considering the inverter deceleration time. In addition, it is recommended to check the three-phase current when using the current detector.

2) Command speed and actual operation check

Check if there is no gap between the actual speed and commanded speed by comparing the inverter speed command and detected speed of the speed detector.

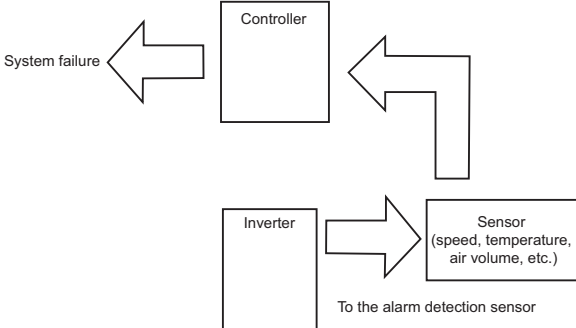

5 DRIVING THE MOTOR

The inverter needs frequency command and start command.
 Frequency command (set frequency) determines the rotation speed of the motor.
 Turning ON the start command starts the motor to rotate.

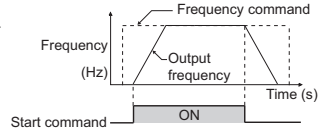

REMARKS

- Set the required parameters according to the load and operating conditions. (Refer to page 32.)

5.1 Start/stop from the operation panel (PU operation)



POINT

From where is the frequency command given?

- Operation at the frequency set in the frequency setting mode of the operation panel Refer to 5.1.1 (Refer to page 23)
- Operation using the setting dial as the potentiometer Refer to 5.1.2 (Refer to page 24)
- Change of frequency with ON/OFF switches connected to terminals Refer to 5.1.3 (Refer to page 25)
- Perform frequency setting using voltage input signal Refer to 5.1.4 (Refer to page 26)
- Perform frequency setting using current input signal Refer to 5.1.4 (Refer to page 26)

5.1.1 Setting the frequency by the operation panel

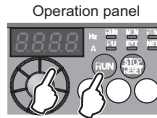

Operation example Operate at 30Hz.

Operation

1. Screen at power-ON
The monitor display appears.
2. Operation mode change
Press to choose the PU operation mode. PU indicator is lit.
Frequency setting
Turn to show the frequency "30.00" (30.00Hz) you want to set. The frequency blinks for about 5s. While the value is blinking, press to set the frequency. "F" and "30.00" appear alternately. After about 3s, the indication of the value goes back to "0.00" (0.00Hz) (monitor display). (If is not pressed, the indication of the value goes back to "0.00" (0.00Hz) after about 5s of blinking. In that case, turn again, and set the frequency.)
Start → acceleration → constant speed
4. Press to start operation.
The frequency value on the display increases in Pr. 7 Acceleration time, and "30.00" (30.00Hz) appears. (To change the set frequency, perform the operation in above step 3. Starting from the previously set frequency.)
Deceleration → stop
5. Press to stop. The frequency value on the display decreases in Pr. 8 Deceleration time, and the motor stops rotating with "0.00" displayed.



REMARKS

- can also be used like a potentiometer to perform operation. Refer to 5.1.2 (Refer to page 24.)
- When you always operate in the PU operation mode at power-ON, set Pr. 79 Operation mode selection = "1" to choose the PU operation mode always.

5.1.2 Using the setting dial like a potentiometer to perform operation







POINT

- Set "0" (extended parameter valid) in *Pr. 160 Extended function display selection*.
- Set "1" (setting dial potentiometer mode) in *Pr. 161 Frequency setting/key lock operation selection*.



Operation example Change the frequency from 0Hz to 60Hz during operation

Operation

1. Screen at power-ON
The monitor display appears.
2. Operation mode change
Press  to choose the PU operation mode. PU indicator is lit.
3. Selecting the setting dial mode
Change the *Pr. 160* setting to "0" and the *Pr. 161* setting to "1".
(Refer to page 4 for change of the setting.)
4. Start
Press  to start the inverter.
5. Frequency setting
Turn  until "60.00" (60.00Hz) appears. The blinking frequency is the set frequency.
You need not press .



REMARKS

- If blinking "60.00" turns to "0.00", the *Pr. 161 Frequency setting/key lock operation selection* setting may not be "1".
 - Independently of whether the inverter is running or at a stop, the frequency can be set by merely turning the .
- (Use *Pr. 295 Magnitude of frequency change setting* to change the frequency setting increments of .)



NOTE

- When setting frequency by turning setting dial, the frequency goes up to the set value of *Pr. 1 Maximum frequency* (initial value: 120Hz).
Adjust *Pr. 1 Maximum frequency setting* according to the application.

5.1.3 Setting the frequency by switches (three-speed setting) (Pr. 4 to Pr. 6)



POINT

- Use the operation panel () to give a start command.
- Switch ON the RH, RM, or RL signal to give a frequency command.
- Set "4" (External/PU combined operation mode 2) in Pr. 79 Operation mode selection.
[Connection diagram]

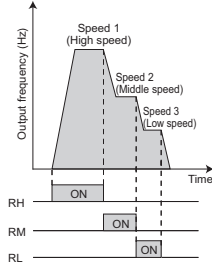
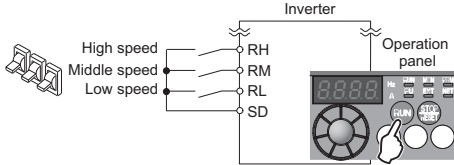

Operation example Operation at low speed (10Hz)

Operation

- Screen at power-ON
The monitor display appears.
- Easy operation mode setting
Press and for 0.5s. " - - " appears, and the [PRM] indicator blinks.
- Operation mode selection
Turn until " - 4 " appears. [PU] and [PRM] indicators blink.
- Operation mode setting
Press to enter the setting. (Set "4" in Pr. 79.)
" - 4 " and " - - " appear alternately. [PU] and [EXT] indicators are lit.
- Start
Turn ON the low-speed switch (RL).
- Acceleration → constant speed
Press to start running.
The frequency value on the display increases in Pr. 7 Acceleration time, and " " (10.00Hz) appears.
[RUN] indicator is lit during forward rotation operation and blinks slowly during reverse rotation operation.
- Deceleration
Press to stop.
The frequency value on the display decreases in Pr. 8 Deceleration time, and the motor stops rotating with " " (0.00Hz) displayed.
- Stop
Turn OFF the low-speed switch (RL).



REMARKS

- The initial values of the terminals RH, RM, RL are 60Hz, 30Hz, and 10Hz. (Use Pr. 4, Pr. 5 and Pr. 6 to change.)
- In the initial setting, when two or three of multi-speed settings are simultaneously selected, priority is given to the set frequency of the lower signal.
For example, when the RH and RM signals turn ON, the RM signal (Pr. 5) has a higher priority.
- Maximum of 15-speed operation can be performed. (Refer to Chapter 4 of the Instruction Manual (Applied).)

5.1.4 Setting the frequency by analog input (voltage input/current input)



POINT

- Use the operation panel (RUN) to give a start command.
- Use the potentiometer (frequency setting potentiometer) (voltage input) or 4-to-20mA input (current input) to give a frequency command.
- Set "4" (External/PU combined operation mode 2) in Pr. 79 Operation mode selection.

[Connection example for voltage input]
(The inverter supplies 5V power to the frequency setting potentiometer. (terminal 10))

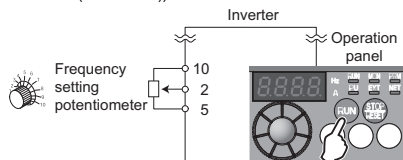

[Connection example for current input]
Assign the AU signal in one of Pr. 178 to Pr. 182.

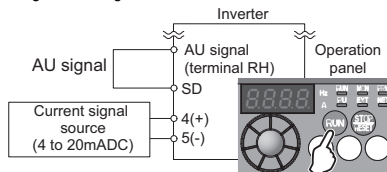

Operation example Operate at 60Hz.

Operation

- Screen at power-ON**
The monitor display appears.
- Assignment of the AU signal (current input) (Refer to the step 3 for voltage input.)**
Set Pr. 160 to "0" to activate extended parameters.
To assign the AU signal, set "4" in one of Pr. 178 to Pr. 182. (Refer to page 4 to change the setting.)
Turn ON the AU signal.
- Easy operation mode setting**
Press **PU/EXT** and **MODE** for 0.5s. "7.9 - -" appears, and the [PRM] indicator blinks.
- Operation mode selection**
Turn **▲** until "7.9 - 4" appears. [PU] and [PRM] indicators blink.
- Operation mode setting**
Press **SET** to enter the setting. (Set "4" in Pr.79.)
"7.9 - 4" and "7.9 - -" appear alternately. [PU] and [EXT] indicators are lit.
- Start**
Press **RUN**. [RUN] blinks fast as no frequency command is given.
- Acceleration → constant speed**
For voltage input, turn the potentiometer (frequency setting potentiometer) clockwise slowly to full.
For current input, input 20mA.
The frequency value on the display increases in Pr. 7 Acceleration time, and "6.0000" (60.00Hz) appears.
[RUN] indicator is lit during forward rotation operation and blinks slowly during reverse rotation operation.
- Deceleration**
For voltage input, turn the potentiometer (frequency setting potentiometer) counterclockwise slowly to full.
For current input, input 4mA.
The frequency value on the display decreases in Pr. 8 Deceleration time, and the motor stops rotating with "0.0000" (0.00Hz) displayed.
[RUN] blinks fast.
- Stop**
Press **STOP/RESET**. [RUN] indicator turns OFF.



REMARKS





- For voltage input, the frequency (maximum potentiometer setting) at the full right turn of the (frequency setting) potentiometer is 60Hz in the initial setting. (To change the setting, use Pr. 125.) (Refer to page 30.)
- To input 10VDC to terminal 2, set Pr. 73 Analog input selection = "0". The initial value is "1 (0 to 5V input)" (Refer to Chapter 4 of the Instruction Manual (Applied)).
- For current input, the frequency at 20mA input is 60Hz in the initial setting. (To change the setting, use Pr. 126.) (Refer to Chapter 4 of the Instruction Manual (Applied)).
- When terminal 10 is used, the maximum output frequency may fluctuate in a range of ± 2 to 3Hz due to fluctuations in the output voltage ($5V \pm 0.2VDC$). Use Pr. 125 or C4 to adjust the output frequency at the maximum analog input as required. (Refer to Chapter 4 of the Instruction Manual (Applied)).

5.2 Start and stop using terminals (External operation)



POINT

From where is the frequency command given?

- Operation at the frequency set in the frequency setting mode of the operation panel  Refer to 5.2.1 (Refer to page 27)
- Give a frequency command by switch (multi-speed setting)  Refer to 5.2.2 (Refer to page 28)
- Perform frequency setting by a voltage input signal  Refer to 5.2.3 (Refer to page 29)
- Perform frequency setting by a current input signal  Refer to 5.2.3 (Refer to page 29)

5.2.1 Setting the frequency by the operation panel (Pr. 79 = 3)



POINT





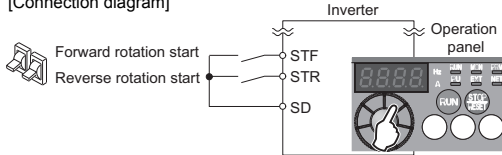



- Switch ON the STF (STR) signal to give a start command.
- Use the operation panel  to give a frequency command.
- Set "3" (External/PU combined operation mode 1) in Pr. 79.

[Connection diagram]



Operation example Operate at 30Hz.

Operation

- Screen at power-ON
The monitor display appears.
- Easy operation mode setting
Press  and  for 0.5s. "79 - -" appears, and the [PRM] indicator blinks.
- Operation mode selection
Turn  until "79 - 3" appears. [EXT] and [PRM] indicators blink.
- Operation mode setting
Press  to enter the setting. (Set "3" in Pr. 79.)
"79 - 3" and "79 - -" appear alternately. [PU] and [EXT] indicators are lit.
- Frequency setting
Turn  to show the frequency "3000" you want to set. The frequency blinks for about 5s. While the value is blinking, press  to set the frequency. "F" and "3000" appear alternately. After about 3s, the indication of the value goes back to "000" (monitor display). (If  is not pressed, the indication of the value goes back to "000" (0.00Hz) after about 5s of blinking. In that case, turn  again, and set the frequency.)
- Start → acceleration → constant speed
Turn the start switch (STF or STR) ON.
The frequency value on the display increases in Pr. 7 Acceleration time, and "3000" (30.00Hz) appears. [RUN] indicator is lit during forward rotation operation and blinks during reverse rotation operation. (To change the set frequency, perform the operation in above step 5. Starting from the previously set frequency.)
- Deceleration → stop
Turn OFF the start switch (STF or STR). The frequency value on the display decreases in Pr. 8 Deceleration time, and the motor stops rotating with "000" (0.00Hz) displayed. [RUN] turns OFF.

5.2.2 Setting the frequency by switches (three-speed setting) (Pr. 4 to Pr. 6)



POINT

- Switch ON the STF (STR) signal to give a start command.
- Switch ON the RH, RM, or RL signal to give a frequency command.

[Connection diagram]

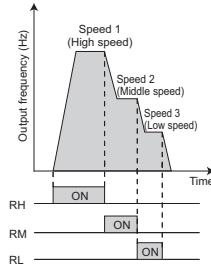
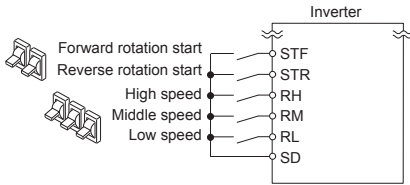

Operation example Operation at high speed (60Hz)

Operation

1. Screen at power-ON
The monitor display appears.
2. Start
Turn ON the high-speed switch (RH).
Acceleration → constant speed
Turn ON the start switch (STF or STR). The frequency value on the display increases in *Pr. 7 Acceleration time*, and "60.00" (60.00Hz) appears.
[RUN] indicator is lit during forward rotation operation and blinks during reverse rotation operation.
 - When RM is turned ON, 30Hz is displayed. When RL is turned ON, 10Hz is displayed.
3. Deceleration
Turn OFF the start switch (STF or STR). The frequency value on the display decreases in *Pr. 8 Deceleration time*, and the motor stops rotating with "0.00" (0.00Hz) displayed. [RUN] turns OFF.
4. Stop
Turn OFF the high-speed switch (RH)



REMARKS

- To always select the External operation mode, set *Pr. 79 Operation mode selection* = "2 (External operation mode)".
- Initial values of terminals RH, RM, RL are 60Hz, 30Hz, and 10Hz. (To change, set *Pr. 4, Pr. 5* and *Pr. 6*.)
- In the initial setting, when two or three of multi-speed settings are simultaneously selected, priority is given to the set frequency of the lower signal.
For example, when the RH and RM signals turn ON, the RM signal (*Pr. 5*) has a higher priority.
- Maximum of 15-speed operation can be performed. (Refer to Chapter 4 of the Instruction Manual (Applied).)

5.2.3 Setting the frequency by analog input (voltage input/current input)



POINT

- Switch ON the STF (STR) signal to give a start command.
- Use the potentiometer (frequency setting potentiometer) (voltage input) or 4-to-20mA input (current input) to give a frequency command.

[Connection example for voltage input]

(The inverter supplies 5V power to the frequency setting potentiometer. (terminal 10))

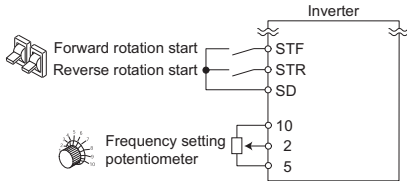

[Connection example for current input]

Assign the AU signal in one of Pr. 178 to Pr. 182.

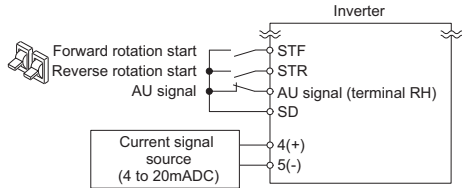

Operation example Operate at 60Hz.

Operation

1. Screen at power-ON

The monitor display appears.

Assignment of the AU signal (current input) (Refer to the step 3 for voltage input.)

2.

Set Pr. 160 to "0" to activate extended parameters.

To assign the AU signal, set "4" in one of Pr. 178 to Pr. 182. (Refer to page 4 to change the setting.)

Turn ON the AU signal.

Start

3.

Turn the start switch (STF or STR) ON.

[RUN] blinks fast because the frequency command is not given.

Acceleration → constant speed

For voltage input, turn the potentiometer (frequency setting potentiometer) clockwise slowly to full.

For current input, input 20mA.

4.

The frequency value on the display increases in Pr. 7 Acceleration time, and "60.00" (60.00Hz) appears.

[RUN] indicator is lit during forward rotation operation and blinks slowly during reverse rotation operation.

Deceleration

For voltage input, turn the potentiometer (frequency setting potentiometer) counterclockwise slowly to full.

For current input, input 4mA.

5.

The frequency value on the display decreases in Pr. 8 Deceleration time, and the motor stops rotating with "0.00" (0.00Hz) displayed.

[RUN] blinks fast.

Stop



6.

Turn the start switch (STF or STR) OFF.

[RUN] turns OFF.



REMARKS

- For voltage input, the frequency (maximum potentiometer setting) at the full right turn of the (frequency setting) potentiometer is 60Hz in the initial setting. (To change the setting, use Pr.125.) (Refer to page 30.)
- To input 10VDC to the terminal 2, set Pr.73 Analog input selection = "0". The initial value is "1 (0 to 5V input)".
( Refer to Chapter 4 of the Instruction Manual (Applied).)
- For current input, the frequency at 20mA input is 60Hz in the initial setting. (To change the setting, use Pr. 126.) ( Refer to Chapter 4 of the Instruction Manual (Applied).)
- To always select the External operation mode, set Pr. 79 Operation mode selection = "2 (External operation mode)".
- When terminal 10 is used, the maximum output frequency may fluctuate in a range of ± 2 to 3Hz due to fluctuations in the output voltage ($5V \pm 0.2VDC$). Use Pr. 125 or C4 to adjust the output frequency at the maximum analog input as required. ( Refer to Chapter 4 of the Instruction Manual (Applied).)

5.2.4 Operating at 60Hz or higher using the external potentiometer

< How to change the maximum frequency >

Changing example

When you want to use 0 to 5VDC input frequency setting potentiometer to change the frequency at 5V from 60Hz (initial value) to 70Hz, make adjustment to output "70Hz" at 5V voltage input. Set "70Hz" in Pr. 125.

Operation

Parameter selection	
1.	Turn until "P. 125" (Pr. 125) appears. Press to show the present set value "60.00" (60.00Hz).
Changing the maximum frequency	
2.	Turn to change the set value to "70.00"(70.00Hz). Press to enter. "70.00" and "P. 125" appear alternately.
Mode/monitor check	
3.	Press twice to choose the monitor/frequency monitor.
Start	
4.	Turn the start switch (STF or STR) ON. [RUN] blinks fast because the frequency command is not given.
Acceleration → constant speed	
5.	Turn the potentiometer (frequency setting potentiometer) clockwise slowly to full. The frequency value on the display increases in Pr. 7 Acceleration time, and "70.00" (70.00Hz) appears. [RUN] indicator is lit during forward rotation operation and blinks slowly during reverse rotation operation.
Deceleration	
6.	Turn the potentiometer (frequency setting potentiometer) counterclockwise slowly to full. The frequency value on the display decreases in Pr. 8 Deceleration time, and the motor stops rotating with "0.00" (0.00Hz) displayed. [RUN] blinks fast.
Stop	
7.	Turn the start switch (STF or STR) OFF. [RUN] turns OFF.

REMARKS

- To change the value to 120Hz or more, the maximum frequency must be set to 120Hz or more.
- Use calibration parameter C2 to set frequency at 0V and calibration parameter C0 to adjust the meter.

(Refer to Chapter 4 of the Instruction Manual (Applied)).

- To input 10VDC to the terminal 2, set Pr.73 Analog input selection = "0". The initial value is "1 (0 to 5V input)".

(Refer to Chapter 4 of the Instruction Manual (Applied)).

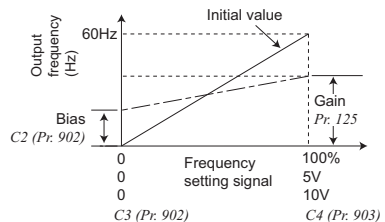

- As other adjustment methods of frequency setting voltage gain, there are methods to adjust with a voltage applied across terminals 2 and 5 or a method to adjust at any point without a voltage applied. (Refer to Chapter 4 of the Instruction Manual (Applied) for the setting method of calibration parameter C4.)

? Change the frequency (60Hz) at the maximum current input (20mA in the initial setting)

Adjust it with Pr.126 Terminal 4 frequency setting gain frequency. (Refer to Chapter 4 of the Instruction Manual (Applied)).

? Change the frequency (0Hz) at the minimum current input (4mA in the initial setting)

Adjust with the calibration parameter C5 Terminal 4 frequency setting bias frequency. (Refer to Chapter 4 of the Instruction Manual (Applied)).

- When terminal 10 is used, the maximum output frequency may fluctuate in a range of ± 2 to 3Hz due to fluctuations in the output voltage ($5V \pm 0.2VDC$). Use Pr. 125 or C4 to adjust the output frequency at the maximum analog input as required. (Refer to Chapter 4 of the Instruction Manual (Applied)).

6 ENERGY SAVING OPERATION FOR FANS AND PUMPS

Set the following functions to perform energy saving operation for fans and pumps.

(1) Load pattern selection (Pr. 14)

Select the optimum output characteristic (V/F characteristic) that is suitable for the application and load characteristics.

- Set Pr.14 Load pattern selection = "1 (for variable-torque load)."
- When the output frequency is equal to or less than the base frequency, the output voltage changes by its square in proportion to the output frequency.

Use this setting to drive a load whose load torque changes in proportion to the square of the speed, such as a fan and a pump.

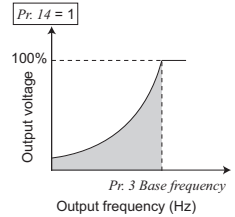

NOTE

- Load pattern selection is available only under V/F control. Load pattern selection is not available under General-purpose magnetic flux vector control. (Refer to Chapter 4 of the Instruction Manual (Applied).)

(2) Optimum excitation control (Pr. 60)

Without a detailed parameter setting, the inverter automatically performs energy saving operation.

- Set Pr.60 Energy saving control selection = "9 (Optimum excitation control mode)."
- The Optimum excitation control mode is a control system which controls excitation current to improve the motor efficiency to the maximum and determines output voltage as an energy saving method.



REMARKS

- When the motor capacity is too small as compared to the inverter capacity or two or more motors are connected to one inverter, the energy saving effect is not expected.



NOTE

- When the Optimum excitation control mode is selected, deceleration time may be longer than the setting value. Since overvoltage alarm tends to occur as compared to the constant-torque load characteristics, set a longer deceleration time.
- Optimum excitation control is available only under V/F control. Optimum excitation control is not available under General-purpose magnetic flux vector control. (Refer to Chapter 4 of the Instruction Manual (Applied).)
- Optimum excitation control will not be performed during an automatic restart after instantaneous power failure.
- Since output voltage is controlled by Optimum excitation control, output current may slightly increase.

7 PARAMETERS

Simple variable-speed operation can be performed with the inverter in the initial settings. Set the required parameters according to the load and operating conditions. Use the operation panel to set or change a parameter. (Refer to  Chapter 4 of the Instruction Manual (Applied) for the detailed description of parameters.)

7.1 Simple mode parameters



POINT

In the initial setting, only the simple mode parameters are displayed by the Pr.160 Extended function display selection setting. Change the Pr.160 Extended function display selection setting as required. (Refer to page 4 to change the parameter.)

Parameter Number	Name	Unit	Initial Value	Range	Application
0	Torque boost	0.1%	6%/4%/3%/2%*	0 to 30%	Use this parameter to increase starting torque under V/F control. Use this when a loaded motor cannot be driven and the warning [OL] occurs, then the inverter trips with [OC1] under V/F control. * Initial value depends on the inverter capacity. (0.75K or lower/1.5K to 3.7K/5.5K, 7.5K/11K, 15K)
1	Maximum frequency	0.01Hz	120Hz	0 to 120Hz	Use this parameter to set the upper limit for the output frequency.
2	Minimum frequency	0.01Hz	0Hz	0 to 120Hz	Use this parameter to set the lower limit for the output frequency.
3	Base frequency	0.01Hz	60Hz	0 to 400Hz	Use this parameter when the rated motor frequency is 50Hz. Check the rating plate of the motor.
4	Multi-speed setting (high speed)	0.01Hz	60Hz	0 to 400Hz	Use these parameters to change among pre-set operation speeds with the terminals. The speeds are pre-set with parameters.
5	Multi-speed setting (middle speed)	0.01Hz	30Hz	0 to 400Hz	
6	Multi-speed setting (low speed)	0.01Hz	10Hz	0 to 400Hz	
7	Acceleration time	0.1s	5s/10s/15s*	0 to 3600s	Use these parameters to set the acceleration/deceleration time. * Initial value depends on the inverter capacity. (3.7K or lower/5.5K, 7.5K/11K, 15K)
8	Deceleration time	0.1s	5s/10s/15s*	0 to 3600s	
9	Electronic thermal O/L relay	0.01A	Inverter rated current	0 to 500A	With this parameter, the inverter protects the motor from heat. Set the rated motor current.
79	Operation mode selection	1	0	0	External/PU switchover mode
				1	Fixed to PU operation mode
				2	Fixed to External operation mode
				3	External/PU combined operation mode 1 (Start command from External, frequency command from PU)
				4	External/PU combined operation mode 2 (Frequency command from External, start command from PU)
				6	Switchover mode
				7	External operation mode (PU operation interlock)
125	Terminal 2 frequency setting gain frequency	0.01Hz	60Hz	0 to 400Hz	Use this parameter to change the frequency at the maximum potentiometer setting (5V in the initial setting)
126	Terminal 4 frequency setting gain frequency	0.01Hz	60Hz	0 to 400Hz	Use this parameter to change the frequency at the maximum current input (20mA in the initial setting)
160	Extended function display selection	1	9999	0	Simple mode + extended mode parameters are displayed.
				9999	Only the simple mode parameters are displayed.
Pr.CL	Parameter clear	1	0	0, 1	Setting "1" returns all parameters except calibration parameters to the initial values.
ALLC	All parameter clear	1	0	0, 1	Setting "1" returns all parameters to the initial values.
Er.CL	Fault history clear	1	0	0, 1	Setting "1" clears eight past faults.
Pr.CH	Initial value change list	—	—	—	Displays and sets the parameters changed from the initial value.

7.2 Parameter list



REMARKS

- ● indicates simple mode parameters.
- The parameters surrounded by a black border in the table allow its setting to be changed during operation even if "0" (initial value) is set in Pr. 77 Parameter write selection.

Pr.	Name	Setting Range	Initial Value
● 0	Torque boost	0 to 30%	6/4/3/2% ^{*1}
● 1	Maximum frequency	0 to 120Hz	120Hz
● 2	Minimum frequency	0 to 120Hz	0Hz
● 3	Base frequency	0 to 400Hz	60Hz
● 4	Multi-speed setting (high speed)	0 to 400Hz	60Hz
● 5	Multi-speed setting (middle speed)	0 to 400Hz	30Hz
● 6	Multi-speed setting (low speed)	0 to 400Hz	10Hz
● 7	Acceleration time	0 to 3600s	5/10/15s ^{*2}
● 8	Deceleration time	0 to 3600s	5/10/15s ^{*2}
● 9	Electronic thermal O/L relay	0 to 500A	Inverter rated current
10	DC injection brake operation frequency	0 to 120Hz	3Hz
11	DC injection brake operation time	0 to 10s	0.5s
12	DC injection brake operation voltage	0 to 30%	6/4/2% ^{*3}
13	Starting frequency	0 to 60Hz	0.5Hz
14	Load pattern selection	0 to 3	0
15	Jog frequency	0 to 400Hz	5Hz
16	Jog acceleration/ deceleration time	0 to 3600s	0.5s
17	MRS input selection	0, 2, 4	0
18	High speed maximum frequency	120 to 400Hz	120Hz
19	Base frequency voltage	0 to 1000V, 8888, 9999	9999
20	Acceleration/deceleration reference frequency	1 to 400Hz	60Hz
22	Stall prevention operation level	0 to 200%	150%
23	Stall prevention operation level compensation factor at double speed	0 to 200%, 9999	9999
24	Multi-speed setting (speed 4)	0 to 400Hz, 9999	9999
25	Multi-speed setting (speed 5)	0 to 400Hz, 9999	9999
26	Multi-speed setting (speed 6)	0 to 400Hz, 9999	9999
27	Multi-speed setting (speed 7)	0 to 400Hz, 9999	9999
29	Acceleration/deceleration pattern selection	0, 1, 2	0
30	Regenerative function selection	0, 1, 2	0
31	Frequency jump 1A	0 to 400Hz, 9999	9999
32	Frequency jump 1B	0 to 400Hz, 9999	9999
33	Frequency jump 2A	0 to 400Hz, 9999	9999
34	Frequency jump 2B	0 to 400Hz, 9999	9999
35	Frequency jump 3A	0 to 400Hz, 9999	9999
36	Frequency jump 3B	0 to 400Hz, 9999	9999
37	Speed display	0, 0.01 to 9998	0

Pr.	Name	Setting Range	Initial Value
40	RUN key rotation direction selection	0, 1	0
41	Up-to-frequency sensitivity	0 to 100%	10%
42	Output frequency detection	0 to 400Hz	6Hz
43	Output frequency detection for reverse rotation	0 to 400Hz, 9999	9999
44	Second acceleration/ deceleration time	0 to 3600s	5/10/15s ^{*2}
45	Second deceleration time	0 to 3600s, 9999	9999
46	Second torque boost	0 to 30%, 9999	9999
47	Second V/F (base frequency)	0 to 400Hz, 9999	9999
48	Second stall prevention operation current	0 to 200%, 9999	9999
51	Second electronic thermal O/L relay	0 to 500A, 9999	9999
52	DU/PU main display data selection	0, 5, 8 to 12, 14, 20, 23 to 25, 52 to 55, 61, 62, 64, 100	0
54	FM terminal function selection	1 to 3, 5, 8 to 12, 14, 21, 24, 52, 53, 61, 62	1
55	Frequency monitoring reference	0 to 400Hz	60Hz
56	Current monitoring reference	0 to 500A	Inverter rated current
57	Restart coasting time	0, 0.1 to 5s, 9999	9999
58	Restart cushion time	0 to 60s	1s
59	Remote function selection	0, 1, 2, 3	0
60	Energy saving control selection	0, 9	0
65	Retry selection	0 to 5	0
66	Stall prevention operation reduction starting frequency	0 to 400Hz	60Hz
67	Number of retries at fault occurrence	0 to 10, 101 to 110	0
68	Retry waiting time	0.1 to 600s	1s
69	Retry count display erase	0	0
70	Special regenerative brake duty	0 to 30%	0%
71	Applied motor	0, 1, 3, 13, 23, 40, 43, 50, 53	0
72	PWM frequency selection	0 to 15	1
73	Analog input selection	0, 1, 10, 11	1
74	Input filter time constant	0 to 8	1
75	Reset selection/ disconnected PU detection/ PU stop selection	0 to 3, 14 to 17	14
77	Parameter write selection	0, 1, 2	0
78	Reverse rotation prevention selection	0, 1, 2	0
● 79	Operation mode selection	0, 1, 2, 3, 4, 6, 7	0
80	Motor capacity	0.1 to 15kW, 9999	9999
82	Motor excitation current	0 to 500A, 9999	9999
83	Rated motor voltage	0 to 1000V	200V/400V ^{*4}

Pr.	Name	Setting Range	Initial Value
84	Rated motor frequency	10 to 120Hz	60Hz
90	Motor constant (R1)	0 to 50 Ω , 9999	9999
96	Auto tuning setting/status	0, 11, 21	0
117	PU communication station number	0 to 31 (0 to 247)	0
118	PU communication speed	48, 96, 192, 384	192
119	PU communication stop bit length	0, 1, 10, 11	1
120	PU communication parity check	0, 1, 2	2
121	Number of PU communication retries	0 to 10, 9999	1
122	PU communication check time interval	0, 0.1 to 999.8s, 9999	0
123	PU communication waiting time setting	0 to 150ms, 9999	9999
124	PU communication CR/LF selection	0, 1, 2	1
⊙ 125	Terminal 2 frequency setting gain frequency	0 to 400Hz	60Hz
⊙ 126	Terminal 4 frequency setting gain frequency	0 to 400Hz	60Hz
127	PID control automatic switchover frequency	0 to 400Hz, 9999	9999
128	PID action selection	0, 20, 21, 40 to 43	0
129	PID proportional band	0.1 to 1000%, 9999	100%
130	PID integral time	0.1 to 3600s, 9999	1s
131	PID upper limit	0 to 100%, 9999	9999
132	PID lower limit	0 to 100%, 9999	9999
133	PID action set point	0 to 100%, 9999	9999
134	PID differential time	0.01 to 10s, 9999	9999
145	PU display language selection	0 to 7	0
146 ^{-s}	Built-in potentiometer switching	0, 1	1
150	Output current detection level	0 to 200%	150%
151	Output current detection signal delay time	0 to 10s	0s
152	Zero current detection level	0 to 200%	5%
153	Zero current detection time	0 to 1s	0.5s
154	Voltage reduction selection during stall prevention operation	1, 11	1
156	Stall prevention operation selection	0 to 31, 100, 101	0
157	OL signal output timer	0 to 25s, 9999	0s
⊙ 160	Extended function display selection	0, 9999	9999
161	Frequency setting/key lock operation selection	0, 1, 10, 11	0
162	Automatic restart after instantaneous power failure selection	0, 1, 10, 11	1
165	Stall prevention operation level for restart	0 to 200%	150%
166	Output current detection signal retention time	0 to 10s, 9999	0.1s
167	Output current detection operation selection	0, 1	0
168	Parameter for manufacturer setting. Do not set.		
169			
170	Watt-hour meter clear	0, 10, 9999	9999
171	Operation hour meter clear	0, 9999	9999

Pr.	Name	Setting Range	Initial Value
178	STF terminal function selection	0 to 5, 7, 8, 10, 12, 14, 16, 18, 24, 25, 60 ^{-s} , 61 ^{-r} , 62, 65 to 67, 9999	60
179	STR terminal function selection		61
180	RL terminal function selection		0
181	RM terminal function selection		1
182	RH terminal function selection		2
190	RUN terminal function selection	0, 1, 3, 4, 7, 8, 11 to 16, 25, 26, 46, 47, 64, 70, 80, 81, 90, 91, 93 ^{-s} , 95, 96, 98, 99, 100, 101, 103, 104, 107, 108, 111 to 116, 125, 126, 146, 147, 164, 170, 180, 181, 190, 191, 193 ^{-s} , 195, 196, 198, 199, 9999 ^{-r}	0
192	A,B,C terminal function selection	0 to 100%, 9999	99
197	SO terminal function selection		80
232	Multi-speed setting (speed 8)	0 to 400Hz, 9999	9999
233	Multi-speed setting (speed 9)	0 to 400Hz, 9999	9999
234	Multi-speed setting (speed 10)	0 to 400Hz, 9999	9999
235	Multi-speed setting (speed 11)	0 to 400Hz, 9999	9999
236	Multi-speed setting (speed 12)	0 to 400Hz, 9999	9999
237	Multi-speed setting (speed 13)	0 to 400Hz, 9999	9999
238	Multi-speed setting (speed 14)	0 to 400Hz, 9999	9999
239	Multi-speed setting (speed 15)	0 to 400Hz, 9999	9999
240	Soft-PWM operation selection	0, 1	1
241	Analog input display unit switchover	0, 1	0
244	Cooling fan operation selection	0, 1	1
245	Rated slip	0 to 50%, 9999	9999
246	Slip compensation time constant	0.01 to 10s	0.5s
247	Constant-power range slip compensation selection	0, 9999	9999
249	Earth (ground) fault detection at start	0, 1	0
250	Stop selection	0 to 100s, 1000 to 1100s, 8888, 9999	9999
251	Output phase loss protection selection	0, 1	1
255	Life alarm status display	(0 to 15)	0
256	Inrush current limit circuit life display	(0 to 100%)	100%
257	Control circuit capacitor life display	(0 to 100%)	100%
258	Main circuit capacitor life display	(0 to 100%)	100%
259	Main circuit capacitor life measuring	0, 1 (2, 3, 8, 9)	0
260	PWM frequency automatic switchover	0, 1	0
261	Power failure stop selection	0, 1, 2	0
267	Terminal 4 input selection	0, 1, 2	0
268	Monitor decimal digits selection	0, 1, 9999	9999

Pr.	Name	Setting Range	Initial Value
269	Parameter for manufacturer setting. Do not set.		
295	Magnitude of frequency change setting	0, 0.01, 0.10, 1.00, 10.00	0
296	Password lock level	1 to 6, 101 to 106, 9999	9999
297	Password lock/unlock	1000 to 9998 (0 to 5, 9999)	9999
298	Frequency search gain	0 to 32767, 9999	9999
299	Rotation direction detection selection at restarting	0, 1, 9999	0
338	Communication operation command source	0, 1	0
339	Communication speed command source	0, 1, 2	0
340	Communication startup mode selection	0, 1, 10	0
342	Communication EEPROM write selection	0, 1	0
343	Communication error count	—	0
450	Second applied motor	0, 1, 9999	9999
495	Remote output selection	0, 1, 10, 11	0
496	Remote output data 1	0 to 4095	0
502	Stop mode selection at communication error	0, 1, 2	0
503	Maintenance timer	0 (1 to 9998)	0
504	Maintenance timer alarm output set time	0 to 9998, 9999	9999
549	Protocol selection	0, 1	0
551	PU mode operation command source selection	2, 4, 9999	9999
552	Frequency jump range	0 to 30Hz, 9999	9999
555	Current average time	0.1 to 1s	1s
556	Data output mask time	0 to 20s	0s
557	Current average value monitor signal output reference current	0 to 500A	Inverter rated current
561	PTC thermistor protection level	0.5 to 30k Ω , 9999	9999
563	Energyzation time carrying-over times	(0 to 65535)	0
564	Operating time carrying-over times	(0 to 65535)	0
571	Holding time at a start	0 to 10s, 9999	9999
575	Output interruption detection time	0 to 3600s, 9999	1s
576	Output interruption detection level	0 to 400Hz	0Hz
577	Output interruption cancel level	900 to 1100%	1000%
611	Acceleration time at a restart	0 to 3600s, 9999	9999
653	Speed smoothing control	0 to 200%	0%
665	Regeneration avoidance frequency gain	0 to 200%	100%
872 ^{*10}	Input phase loss protection selection	0, 1	0
882	Regeneration avoidance operation selection	0, 1, 2	0
883	Regeneration avoidance operation level	300 to 800V	400VDC/ 780VDC ⁺
885	Regeneration avoidance compensation frequency limit value	0 to 10Hz, 9999	6Hz
886	Regeneration avoidance voltage gain	0 to 200%	100%
888	Free parameter 1	0 to 9999	9999
889	Free parameter 2	0 to 9999	9999
891	Cumulative power monitor digit shifted times	0 to 4, 9999	9999

Pr.	Name	Setting Range	Initial Value
C0 (900) ^{*11}	FM terminal calibration	—	—
C2 (902) ^{*11}	Terminal 2 frequency setting bias frequency	0 to 400Hz	0Hz
C3 (902) ^{*11}	Terminal 2 frequency setting bias	0 to 300%	0%
125 (903) ^{*11}	Terminal 2 frequency setting gain frequency	0 to 400Hz	60Hz
C4 (903) ^{*11}	Terminal 2 frequency setting gain	0 to 300%	100%
C5 (904) ^{*11}	Terminal 4 frequency setting bias frequency	0 to 400Hz	0Hz
C6 (904) ^{*11}	Terminal 4 frequency setting bias	0 to 300%	20%
126 (905) ^{*11}	Terminal 4 frequency setting gain frequency	0 to 400Hz	60Hz
C7 (905) ^{*11}	Terminal 4 frequency setting gain	0 to 300%	100%
C22 (922) ^{*5+11}	Frequency setting voltage bias frequency (built-in potentiometer)	0 to 400Hz	0Hz
C23 (922) ^{*5+11}	Frequency setting voltage bias (built-in potentiometer)	0 to 300%	0%
C24 (923) ^{*5+11}	Frequency setting voltage gain frequency (built-in potentiometer)	0 to 400Hz	60Hz
C25 (923) ^{*5+11}	Frequency setting voltage gain (built-in potentiometer)	0 to 300%	100%
990	PU buzzer control	0, 1	1
991	PU contrast adjustment	0 to 63	58
ⓄPr.CL	Parameter clear	0, 1	0
ⓄALLC	All parameter clear	0, 1	0
ⓄEr.CL	Fault history clear	0, 1	0
ⓄPr.CH	Initial value change list	—	—

- *1 Differ according to capacities.
6%: 0.75K or lower
4%: 1.5K to 3.7K
3%: 5.5K, 7.5K
2%: 11K, 15K
- *2 Differ according to capacities.
5s: 3.7K or lower
10s: 5.5K, 7.5K
15s: 11K, 15K
- *3 Differ according to capacities.
6%: 0.1K, 0.2K
4%: 0.4K to 7.5K
2%: 11K, 15K
- *4 The initial value differs according to the voltage class. (100V class, 200V class / 400V class)
- *5 Set this parameter when calibrating the operation panel built-in potentiometer for the FR-E500 series operation panel (PA02) connected with cable.
- *6 The setting value "60" is only available for Pr. 178.
- *7 The setting value "61" is only available for Pr. 179.
- *8 The setting value "93" and "193" are only available for Pr. 190 and Pr. 197.
- *9 The setting value "9999" is only available for Pr. 190 and Pr. 192.
- *10 Available only for the three-phase power input model.
- *11 The parameter number in parentheses is the one for use with the operation panel (PA02) for the FR-E500 series or parameter unit (FR-PU04/FR-PU07).

8 TROUBLESHOOTING

When a fault occurs in the inverter, the inverter output is shut off and the PU display automatically changes to one of the following fault or alarm indications.

If the fault does not correspond to any of the following faults or if you have any other problem, please contact your sales representative.

- Retention of fault output signal...When the magnetic contactor (MC) provided on the input side of the inverter is opened at a fault occurrence, the inverter's control power will be lost and the fault output will not be held.
- Fault or alarm indicationWhen a fault or alarm occurs, the operation panel display automatically switches to the fault or alarm indication.
- Resetting methodWhen a fault occurs, the inverter output is kept stopped. Unless reset, therefore, the inverter cannot restart. (Refer to page 36)
- When any fault occurs, take the appropriate corrective action, then reset the inverter, and resume operation. Not doing so may lead to the inverter fault and damage.

Inverter fault or alarm indications are roughly categorized as below.

- (1) Error message
A message regarding operational fault and setting fault by the operation panel and parameter unit (FR-PU04 /FR-PU07) is displayed. The inverter output is not shut off.
- (2) Warning
The inverter output is not shut off even when a warning is displayed. However, failure to take appropriate measures will lead to a fault.
- (3) Alarm
The inverter output is not shut off. You can also output an alarm signal by making parameter setting.
- (4) Fault
When a fault occurs, the inverter output is shut off and a fault signal is output.

REMARKS

- For the details of fault displays and other malfunctions, also  refer to the Instruction Manual (Applied).
- Past eight faults can be displayed using the setting dial. (Refer to page 3 for the operation.)

8.1 Reset method of protective function

The inverter can be reset by performing any of the following operations. Note that the internal thermal integrated value of the electronic thermal relay function and the number of retries are cleared (erased) by resetting the inverter.

Inverter recovers about 1s after the reset is released.

Operation 1Using the operation panel, press  to reset the inverter.

(This may only be performed when a fault occurs (Refer to page 37 for fault.))

Operation 2Switch power OFF once. After the indicator of the operation panel turns OFF, switch it ON again.

Operation 3Turn ON the reset signal (RES) for more than 0.1s. (If the RES signal is kept ON, "Err." appears (blinks) to indicate that the inverter is in a reset status.)

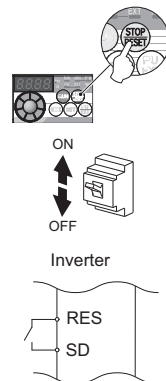

NOTE

- OFF status of the start signal must be confirmed before resetting the inverter fault. Resetting inverter fault with the start signal ON restarts the motor suddenly.

8.2 List of fault displays



When a fault occurs in the inverter, the inverter trips and the PU display automatically changes to one of the following fault or alarm indications.

The error message shows an operational error. The inverter output is not shut off.

Warnings are messages given before faults occur. The inverter output is not shut off.

Alarms warn the operator of failures with output signals. The inverter output is not shut off.

When faults occur, the protective functions are activated to the inverter trip and output the fault signals.

Function Name	Description	Corrective action	Display	
Error message	Operation panel lock	Operation has been attempted during the operation panel lock. Press  for 2s to release the lock.	$HOL\ \delta$	
	Password locked	Reading/writing of a password-restricted parameter has been attempted. Enter the password in Pr. 297 Password lock/unlock to unlock the password function before operating.	$L\ O\ \delta$	
	Write disable error	<ul style="list-style-type: none"> Parameter setting has been attempted although parameter writing is set to be disabled. Overlapping range has been set for the frequency jump. PU and the inverter cannot make normal communication. 	<ul style="list-style-type: none"> Check the setting of Pr. 77 Parameter write selection Check the settings of Pr. 31 to Pr. 36 (frequency jump). Check the connection of PU and the inverter. 	$E\ r\ 1$
	Write error during operation	Parameter writing has been attempted while a value other than "2" is set in Pr. 77 Parameter write selection and the STF (STR) is ON.	<ul style="list-style-type: none"> Set "2" in Pr. 77 Parameter write selection. After stopping the operation, set parameters. 	$E\ r\ 2$
	Calibration error	Analog input bias and gain calibration values have been set too close.	Check the settings of calibration parameters C3, C4, C6 and C7 (calibration functions).	$E\ r\ 3$
	Mode designation error	<ul style="list-style-type: none"> Parameter setting has been attempted in the External or NET operation mode when Pr. 77 Parameter write selection is not "2." Parameter writing has been attempted when the command source is not at the operation panel. 	<ul style="list-style-type: none"> After setting the operation mode to the "PU operation mode," set parameters. Set "2" in Pr. 77 Parameter write selection Disconnect the parameter unit (FR-PU04/FR-PU07), then set Pr. 551 PU mode operation command source selection = "9999 (initial setting)." Set Pr. 551 PU mode operation command source selection = "4." 	$E\ r\ 4$
	Inverter reset	The reset signal (RES signal) is ON. (Inverter output is shutdown.)	Turn OFF the reset command	$E\ r\ r$
Warning	Stall prevention (overcurrent)	The overcurrent stall prevention has been activated.	<ul style="list-style-type: none"> Increase or decrease the Pr. 0 Torque boost setting by 1% and check the motor status. Set a larger value in Pr. 7 Acceleration time and Pr. 8 Deceleration time. Reduce the load weight. Try General-purpose magnetic flux vector control. Adjust the Pr. 13 Starting frequency setting. Change the Pr. 14 Load pattern selection setting. Set the stall prevention operation current in Pr. 22 Stall prevention operation level. (The acceleration/deceleration time may change.) Increase the stall prevention operation level with Pr. 22 Stall prevention operation level, or disable stall prevention with Pr. 156 Stall prevention operation selection. (Operation at OL occurrence can be selected using Pr. 156 Stall prevention operation selection.) 	OL
	Stall prevention (overvoltage)	The overvoltage stall prevention function has been activated. (This warning is also output during the regeneration avoidance operation.)	Set the deceleration time longer.	oL
	Regenerative brake pre-alarm *2	The regenerative brake duty has reached 85% of the Pr. 70 Special regenerative brake duty setting or higher.	<ul style="list-style-type: none"> Set the deceleration time longer. Check that the Pr. 30 Regenerative function selection and Pr. 70 Special regenerative brake duty settings. 	$r\ b$
	Electronic thermal relay function pre-alarm	The cumulative value of the electronic thermal O/L relay has reached 85% of the Pr. 9 Electronic thermal O/L relay setting or higher.	<ul style="list-style-type: none"> Reduce the load and frequency of operation. Set an appropriate value in Pr. 9 Electronic thermal O/L relay. 	$f\ H$
	PU stop	 on the operation panel has been pressed during the External operation.	Turn the start signal OFF and release with  .	$P\ S$
	Maintenance signal output *2	The cumulative energization time has exceeded the maintenance output timer set value.	Setting "0" in Pr. 503 Maintenance timer erases the signal.	$M\ f$
	Undervoltage	The voltage at the main circuit power has been lowered.	Investigate the devices on the power supply line such as the power supply itself.	$U\ u$
Alarm	Safety stop	Safety stop function activating (Outputs are being shut off.)	<ul style="list-style-type: none"> When not using the safety stop function, short across terminals S1 and SC and across S2 and SC with shorting wire for the inverter to run. If $S\ \bar{R}$ is indicated when across S1 and SC and across S2 and SC are both shorted while using the safety stop function (drive enabled), internal failure might be the cause. Check the wiring of terminals S1, S2 and SC and contact your sales representative if the wiring has no fault. 	$S\ \bar{R}$
	Fan alarm	The cooling fan is at a standstill although it is required to be operated. The cooling fan speed has decelerated.	Check for fan failure. Please contact your sales representative.	$F\ r$

Function Name	Description	Corrective action	Display	
Fault	Overcurrent trip during acceleration	Overcurrent has occurred during acceleration.	<ul style="list-style-type: none"> Set the acceleration time longer. (Shorten the downward acceleration time in vertical lift application.) If "E.OC1" always appears at start, disconnect the motor once and restart the inverter. If "E.OC1" still appears, the inverter may be faulty. Contact your sales representative. Check the wiring for output short circuit and ground fault. When the rated motor frequency is 50Hz, set the <i>Pr. 3 Base frequency</i> to 50Hz. Lower the stall prevention operation level. Activate the stall prevention operation and the fast-response current limit operation. (<i>Pr.156</i>) For the operation with frequent regenerative driving, set the base voltage (rated motor voltage, etc.) in <i>Pr. 19 Base/frequency voltage</i>. 	E.OC1
	Overcurrent trip during constant speed	Overcurrent has occurred during constant speed operation.	<ul style="list-style-type: none"> Keep the load stable. Check the wiring to avoid output short circuit or ground fault. Lower the stall prevention operation level. Activate the stall prevention operation and the fast-response current limit operation. (<i>Pr.156</i>) 	E.OC2
	Overcurrent trip during deceleration or stop	Overcurrent has occurred during deceleration or at a stop.	<ul style="list-style-type: none"> Set the deceleration time longer. Check the wiring to avoid output short circuit or ground fault. Check if the mechanical brake is set to be activated too early. Lower the stall prevention operation level. Activate the stall prevention operation and the fast-response current limit operation. (<i>Pr.156</i>) 	E.OC3
	Regenerative overvoltage trip during acceleration	Overvoltage has occurred during acceleration.	<ul style="list-style-type: none"> Set the acceleration time shorter. Use the regeneration avoidance function (<i>Pr. 882, Pr. 883, Pr. 885, Pr. 886</i>). Set the <i>Pr.22 Stall prevention operation level</i> correctly. Set <i>Pr.154 Voltage reduction selection during stall prevention operation</i> = "11". 	E.Ov1
	Regenerative overvoltage trip during constant speed	Overvoltage has occurred during constant speed operation.	<ul style="list-style-type: none"> Keep the load stable. Use the regeneration avoidance function (<i>Pr. 882, Pr. 883, Pr. 885, Pr. 886</i>). Use the brake resistor, brake unit or power regeneration common converter (FR-CV) as required. Set the <i>Pr.22 Stall prevention operation level</i> correctly. Set <i>Pr.154 Voltage reduction selection during stall prevention operation</i> = "11". 	E.Ov2
	Regenerative overvoltage trip during deceleration or stop	Overvoltage has occurred during deceleration or at a stop.	<ul style="list-style-type: none"> Set the deceleration time longer. (Set the deceleration time which matches the moment of inertia of the load) Make the brake cycle longer. Use the regeneration avoidance function (<i>Pr. 882, Pr. 883, Pr. 885, Pr. 886</i>). Use the brake resistor, brake unit or power regeneration common converter (FR-CV) as required. Set <i>Pr.154 Voltage reduction selection during stall prevention operation</i> = "11". 	E.Ov3
	Inverter overload trip (electronic thermal O/L relay function) *1	The electronic thermal relay function for inverter element protection has been activated.	<ul style="list-style-type: none"> Set the acceleration/deceleration time longer. Adjust the <i>Pr. 0 Torque boost</i> setting. Set the <i>Pr. 14 Load pattern selection</i> setting according to the load pattern of the using machine. Reduce the load. Set the surrounding air temperature to within the specifications. 	E.FHr
	Motor overload trip (electronic thermal O/L relay function) *1	The electronic thermal relay function for motor protection has been activated.	<ul style="list-style-type: none"> Reduce the load. For a constant-torque motor, set the constant-torque motor in <i>Pr. 71 Applied motor</i>. Set the stall prevention operation level accordingly. 	E.FHn
	Heatsink overheat	The heatsink has overheated.	<ul style="list-style-type: none"> Set the surrounding air temperature to within the specifications. Clean the heatsink. Replace the cooling fan. 	E.FI n
	Input phase loss *3	One of the three phases on the inverter input side has been lost. It may also appear if phase-to-phase voltage of the three-phase power input has become largely unbalanced.	<ul style="list-style-type: none"> Wire the cables properly. Repair a break portion in the cable. Check the <i>Pr. 872 Input phase loss protection selection</i> setting. Set <i>Pr. 872</i> = "0" (without input phase loss protection) when three-phase input voltage is largely unbalanced. 	E.I L F
Stall prevention stop	The output frequency has dropped to 1Hz as a result of deceleration due to the excess motor load.	Reduce the load. (Check the <i>Pr. 22 Stall prevention operation level</i> setting.)	E.O.L r	
Brake transistor alarm detection	A fault has occurred in the brake circuit, such as a brake transistor breakage. (In this case, the inverter must be powered off immediately.)	Replace the inverter.	E. bE	
Output side earth (ground) fault overcurrent at start *2	An earth (ground) fault has occurred on the inverter's output side (detected only at a start).	Remedy the ground fault portion.	E. GF	
Output phase loss	One of the three phases (U, V, W) on the inverter's output side (load side) has been lost during inverter operation.	<ul style="list-style-type: none"> Wire the cables properly. If the motor capacity is smaller than the inverter capacity, choose the inverter and motor capacities that match. 	E. L F	

Function Name	Description	Corrective action	Display
External thermal relay operation *2	The external thermal relay connected to the OH signal has been activated.	<ul style="list-style-type: none"> Reduce the load and operate less frequently. Even if the relay contacts are reset automatically, the inverter will not restart unless it is reset. 	εOHF
PTC thermistor operation *2	Resistance of the PTC thermistor connected between the terminal 2 and terminal 10 has reached the Pr. 561 PTC thermistor protection level setting value or higher.	Reduce the load.	εPFC
Parameter storage device fault	Operation of the component where parameters are stored (control circuit board) has become abnormal.	Please contact your sales representative. When performing parameter write frequently for communication purposes, set "1" in Pr. 342 to enable RAM write. Note that powering OFF returns the inverter to the status before RAM write.	ε. PE
PU disconnection	<ul style="list-style-type: none"> A communication error has occurred between the PU and the inverter. The communication interval has exceeded the permissible time period during RS-485 communication via the PU connector. The number of communication errors has exceeded the number of retries. 	<ul style="list-style-type: none"> Connect the parameter unit cable securely. Check the communication data and communication settings. Increase the Pr. 122 PU communication check time interval setting. Or set "9999" (no communication check). 	εPUE
Retry count excess *2	Operation restart within the set number of retries has failed.	Eliminate the cause of the error preceding this error indication.	εrEr
CPU fault	An error has occurred in the CPU and in the peripheral circuits.	<ul style="list-style-type: none"> Take measures against noises if there are devices producing excess electrical noises around the inverter. If the situation does not improve after taking the above measure, please contact your sales representative. 	ε. S / εCPU
Output current detection value exceeded *2	Output current has exceeded the output current detection level, which was set in a parameter.	Check the settings of Pr. 150 Output current detection level, Pr. 151 Output current detection signal delay time, Pr. 166 Output current detection signal retention time, Pr. 167 Output current detection operation selection.	εεdO
Inrush current limit circuit fault	The resistor of the inrush current limit circuit has overheated.	Configure a circuit where frequent power ON/OFF is not repeated. If the situation does not improve after taking the above measure, please contact your sales representative.	εI OH
Analog input fault	A voltage (current) has been input to terminal 4 when the setting in Pr. 267 Terminal 4 input selection and the setting of voltage/current input switch are different.	Give a frequency command by a current input or set Pr.267 Terminal 4 input selection, and set the voltage/current input switch to voltage input.	εR; E
Safety circuit fault	While a safety circuit fault is occurring, the terminals across S1 and PC, or across S2 and PC are opened.	<ul style="list-style-type: none"> When not using the safety stop function, short across terminals S1 and SC and across S2 and SC with shorting wire. When using the safety stop function, check that wiring of terminal S1, S2 and SC is correct and the safety stop input signal source such as safety relay module is operating properly. Refer to the Safety stop function instruction manual (BCN-A211508-000) for causes and countermeasures. (Please contact your sales representative for the manual.) 	εSRF

If faults other than the above appear, contact your sales representative.

- *1 Resetting the inverter initializes the internal cumulative heat value of the electronic thermal relay function.
- *2 This protective function does not function in the initial status.
- *3 This protective function is available with the three-phase power input specification model only.

8.3 Check first when you have a trouble

Description	Countermeasure
Motor does not start.	Check start and frequency command sources and enter a start command (STF, etc.) and a frequency command.
Motor or machine is making abnormal acoustic noise.	Take EMC measures if a steady operation cannot be performed due to EMI. Alternatively, set the <i>Pr.74 Input filter time constant</i> setting higher.
Inverter generates abnormal noise.	Install the fan cover correctly.
Motor generates heat abnormally.	Clean the motor fan. Improve the environment.
Motor rotates in the opposite direction.	Connect phase sequence of the output cables (terminal U, V, W) to the motor correctly. Alternatively, check the connection of the start signal. (STF: forward rotation, STR: reverse rotation)
Speed greatly differs from the setting.	Check the settings of <i>Pr.1 Maximum frequency</i> , <i>Pr.2 Minimum frequency</i> , <i>Pr.18 High speed maximum frequency</i> , and <i>calibration parameters C2 to C7</i> .
Acceleration/deceleration is not smooth.	Reduce the load. Alternatively, increase the acceleration/deceleration time.
Speed varies during operation.	Check the frequency setting signals. If the load fluctuates, select General-purpose magnetic flux vector control.
Operation mode is not changed properly.	Turn OFF the start signal (STF or STR). Check if <i>Pr.79 Operation mode selection</i> is set appropriately.
Operation panel display is not operating.	Check the wiring and the installation.
Motor current is large.	Increase/decrease the <i>Pr.0 Torque boost</i> setting value by 0.5% increments so that stall prevention does not occur. Set the rated motor frequency to <i>Pr.3 Base frequency</i> .
Speed does not accelerate.	Check the settings of <i>Pr.1 Maximum frequency</i> , <i>Pr.2 Minimum frequency</i> , and <i>calibration parameters C2 to C7</i> . To operate at 120Hz or higher, set <i>Pr.18 High speed maximum frequency</i> .
Unable to write parameter setting.	Check <i>Pr.77 Parameter write selection</i> setting.

* For further information on troubleshooting,  refer to the *Instruction Manual (Applied)*.

9 PRECAUTIONS FOR MAINTENANCE AND INSPECTION

The inverter is a static unit mainly consisting of semiconductor devices. Daily inspection must be performed to prevent any fault from occurring due to the adverse effects of the operating environment, such as temperature, humidity, dust, dirt and vibration, changes in the parts with time, service life, and other factors.



REMARKS

For maintenance/inspection and parts life, also refer to the Instruction Manual (Applied).

Precautions for maintenance and inspection

For some short time after the power is switched OFF, a high voltage remains in the smoothing capacitor. When accessing the inverter for inspection, wait for at least 10 minutes after the power supply has been switched OFF, and then make sure that the voltage across the main circuit terminals P/+ and N/- of the inverter is not more than 30VDC using a tester, etc.

9.1 Inspection items

Area of Inspection	Inspection Item	Description	Interval		Corrective Action at Alarm Occurrence	Customer's Check	
			Daily	Periodic *3			
General	Surrounding environment	Check the surrounding air temperature, humidity, dirt, corrosive gas, oil mist, etc.	○		Improve environment.		
	Overall unit	Check for unusual vibration and noise.	○		Check alarm location and retighten.		
		Check for dirt, oil, and other foreign material.*1	○		Clean.		
	Power supply voltage	Check that the main circuit voltages are normal.*2	○		Inspect the power supply.		
Main circuit	General	(1) Check with megger (across main circuit terminals and earth (ground) terminal).		○	Contact the manufacturer.		
		(2) Check for loose screws and bolts.		○	Retighten.		
		(3) Check for overheat traces on parts.		○	Contact the manufacturer.		
		(4) Check for stains.		○	Clean.		
	Conductors, cables	(1) Check conductors for distortion. (2) Check cable sheaths for breakage and deterioration (crack, discoloration, etc.)		○	Contact the manufacturer. Contact the manufacturer.		
	Terminal block	Check for damage.		○	Stop the device and contact the manufacturer.		
Smoothing aluminum electrolytic capacitor	(1) Check for liquid leakage. (2) Check for safety valve projection and bulge. (3) Visual check and judge by the life check of the main circuit capacitor (Refer to Chapter 4 of the Instruction Manual (Applied).)		○	Contact the manufacturer. Contact the manufacturer.			
	Relay	Check that the operation is normal and no chatter is heard.		○	Contact the manufacturer.		
Control circuit, Protective circuit	Operation check	(1) Check that the output voltages across phases with the inverter operated alone is balanced (2) Check that no fault is found in protective and display circuits in a sequence protective operation test.		○	Contact the manufacturer. Contact the manufacturer.		
		Overall	(1) Check for unusual odors and discoloration. (2) Check for serious rust development		○	Stop the device and contact the manufacturer. Contact the manufacturer.	
	Aluminum electrolytic capacitor		(1) Check for liquid leakage in a capacitor and deformation trace (2) Visual check and judge by the life check of the main circuit capacitor (Refer to Chapter 4 of the Instruction Manual (Applied).)		○	Contact the manufacturer.	
		Cooling system	Cooling fan	(1) Check for unusual vibration and noise. (2) Check for loose screws and bolts (3) Check for stains.	○		Replace the fan. Fix with the fan cover fixing screws. Clean.
Heatsink	(1) Check for clogging (2) Check for stains.				○	Clean. Clean.	
	Indication			(1) Check that display is normal. (2) Check for stains.	○	○	Contact the manufacturer. Clean.
Meter			Check that reading is normal	○		Stop the device and contact the manufacturer.	

Area of Inspection	Inspection Item	Description	Interval		Corrective Action at Alarm Occurrence	Customer's Check
			Daily	Periodic *3		
Load motor	Operation check	Check for vibration and abnormal increase in operation noise	○		Stop the device and contact the manufacturer.	

- *1 Oil component of the heat dissipation grease used inside the inverter may leak out. The oil component, however, is not flammable, corrosive, nor conductive and is not harmful to humans. Wipe off such oil component.
- *2 It is recommended to install a device to monitor voltage for checking the power supply voltage to the inverter.
- *3 One to two years of periodic inspection cycle is recommended. However, it differs according to the installation environment. Consult us for periodic inspection.



NOTE

- Continuous use of a leaked, deformed, or degraded smoothing aluminum electrolytic capacitor (as shown in the table above) may lead to a burst, breakage or fire. Replace such capacitor without delay.
 - When using the safety stop function, periodic inspection is required to confirm that safety function of the safety system operates correctly.
- For more details, refer to the *Safety stop function instruction manual (BCN-A211508-000)*. (Please contact your sales representative for the manual.)

9.2 Replacement of parts

The inverter consists of many electronic parts such as semiconductor devices.

The following parts may deteriorate with age because of their structures or physical characteristics, leading to reduced performance or fault of the inverter. For preventive maintenance, the parts must be replaced periodically.

Use the life check function as a guidance of parts replacement.

Part Name	Estimated Lifespan *1	Description
Cooling fan	10 years	Replace (as required)
Main circuit smoothing capacitor	10 years *2	Replace (as required)
On-board smoothing capacitor	10 years *2	Replace the board (as required)
Relay output terminals	—	As required

- *1 Estimated lifespan for when the yearly average surrounding air temperature is 40°C (without corrosive gas, flammable gas, oil mist, dust and dirt etc.)
- *2 Output current: 80% of the inverter rated current



NOTE

- For parts replacement, contact the nearest Mitsubishi Electric FA Center.

10 SPECIFICATIONS

10.1 Rating

● Three-phase 200V power supply

Model FR-D720-□K		0.1	0.2	0.4	0.75	1.5	2.2	3.7	5.5	7.5	11	15	
Applicable motor capacity (kW) ⁺¹		0.1	0.2	0.4	0.75	1.5	2.2	3.7	5.5	7.5	11	15	
Output	Rated capacity (kVA) ⁺²	0.3	0.6	1.0	1.7	2.8	4.0	6.6	9.5	12.7	17.9	23.1	
	Rated current (A)	0.8	1.4	2.5	4.2	7.0	10.0	16.5	23.8	31.8	45.0	58.0	
	Overload current rating ⁺³	150% 60s, 200% 0.5s (inverse-time characteristics)											
Rated voltage ⁺⁴		Three-phase 200 to 240V											
Regenerative braking torque ⁺⁵		150%			100%			50%			20%		
Power supply	Rated input AC voltage/frequency	Three-phase 200 to 240V 50Hz/60Hz											
	Permissible AC voltage fluctuation	170 to 264V 50Hz/60Hz											
	Permissible frequency fluctuation	±5%											
	Power supply capacity (kVA) ⁺⁶	0.4	0.7	1.2	2.1	4.0	5.5	9.0	12.0	17.0	20.0	27.0	
Protective structure (JEM1030)		Enclosed type (IP20)											
Cooling system		Natural					Forced air						
Approximate mass (kg)		0.5	0.5	0.8	1.0	1.4	1.4	1.8	3.6	3.6	6.5	6.5	

● Three-phase 400V power supply

Model FR-D740-□K		0.4	0.75	1.5	2.2	3.7	5.5	7.5	11	15	
Applicable motor capacity (kW) ⁺¹		0.4	0.75	1.5	2.2	3.7	5.5	7.5	11	15	
Output	Rated capacity (kVA) ⁺²	0.9	1.7	2.7	3.8	6.1	9.1	12.2	17.5	22.5	
	Rated current (A)	1.2	2.2	3.6	5.0	8.0	12.0	16.0	23.0	29.5	
	Overload current rating ⁺³	150% 60s, 200% 0.5s (inverse-time characteristics)									
Rated voltage ⁺⁴		Three-phase 380 to 480V									
Regenerative braking torque ⁺⁵		100%			50%			20%			
Power supply	Rated input AC voltage/frequency	Three-phase 380 to 480V 50Hz/60Hz									
	Permissible AC voltage fluctuation	325 to 528V 50Hz/60Hz									
	Permissible frequency fluctuation	±5%									
	Power supply capacity (kVA) ⁺⁶	1.5	2.5	4.5	5.5	9.5	12.0	17.0	20.0	28.0	
Protective structure (JEM1030)		Enclosed type (IP20)									
Cooling system		Natural				Forced air					
Approximate mass (kg)		1.3	1.3	1.4	1.5	1.5	3.3	3.3	6.0	6.0	

● Single-phase 200V power supply

Model FR-D720S-□K		0.1	0.2	0.4	0.75	1.5	2.2
Applicable motor capacity (kW) ⁺¹		0.1	0.2	0.4	0.75	1.5	2.2
Output	Rated capacity (kVA) ⁺²	0.3	0.6	1.0	1.7	2.8	4.0
	Rated current (A)	0.8	1.4	2.5	4.2	7.0	10.0
	Overload current rating ⁺³	150% 60s, 200% 0.5s (inverse-time characteristics)					
Rated voltage ⁺⁴		Three-phase 200 to 240V					
Regenerative braking torque ⁺⁵		150%		100%		50%	
Power supply	Rated input AC voltage/frequency	Single-phase 200 to 240V 50Hz/60Hz					
	Permissible AC voltage fluctuation	170 to 264V 50Hz/60Hz					
	Permissible frequency fluctuation	±5%					
	Power supply capacity (kVA) ⁺⁶	0.5	0.9	1.5	2.3	4.0	5.2
Protective structure (JEM1030)		Enclosed type (IP20)					
Cooling system		Natural			Forced air		
Approximate mass (kg)		0.5	0.5	0.9	1.1	1.5	2.0

● Single-phase 100V power supply

Model FR-D710W-□K		0.1	0.2	0.4	0.75
Applicable motor capacity (kW) ^{*1}		0.1	0.2	0.4	0.75
Rated capacity (kVA) ^{*2}		0.3	0.6	1.0	1.7
Rated current (A)		0.8	1.4	2.5	4.2
Output	Overload current rating ^{*3}	150% 60s, 200% 0.5s (inverse-time characteristics)			
	Rated voltage	Three-phase 200 to 230V ^{*7, *8}			
	Regenerative braking torque ^{*5}	150%	100%		
Power supply	Rated input AC voltage/frequency	Single-phase 100 to 115V 50Hz/60Hz			
	Permissible AC voltage fluctuation	90 to 132V 50Hz/60Hz			
	Permissible frequency fluctuation	±5%			
	Power supply capacity (kVA) ^{*6}	0.5	0.9	1.5	2.5
Protective structure (JEM1030)		Enclosed type (IP20)			
Cooling system		Natural			
Approximate mass (kg)		0.6	0.7	0.9	1.4

- *1 The applicable motor capacity indicated is the maximum capacity applicable for use of the Mitsubishi Electric 4-pole standard motor.
- *2 The rated output capacity assumes the following output voltages: 230V for three-phase 200V/single-phase 200V/single-phase 100V, and 440V for three-phase 400V.
- *3 The % value of the overload current rating indicated is the ratio of the overload current to the inverter's rated output current. For repeated duty, allow time for the inverter and motor to return to or below the temperatures under 100% load. If the automatic restart after instantaneous power failure function (*Pr 57*) or power failure stop function (*Pr 261*) is set and power supply voltage is low while load becomes bigger, the bus voltage decreases to power failure detection level and load of 100% or more may not be available.
- *4 The maximum output voltage does not exceed the power supply voltage. The maximum output voltage can be changed within the setting range. However, the pulse voltage value of the inverter output side voltage remains unchanged at about $\sqrt{2}$ that of the power supply.
- *5 The braking torque indicated is a short-duration average torque (which varies with motor loss) when the motor alone is decelerated from 60Hz in the shortest time and is not a continuous regenerative torque. When the motor is decelerated from the frequency higher than the base frequency, the average deceleration torque will reduce. Since the inverter does not contain a brake resistor, use the optional brake resistor when regenerative energy is large. (Option brake resistor cannot be used for 0.1K and 0.2K.) A brake unit (FR-BU2) may also be used.
- *6 The power supply capacity varies with the value of the power supply side inverter impedance (including those of the input reactor and cables).
- *7 For single-phase 100V power input model, the maximum output voltage is twice the amount of the power supply voltage and cannot be exceeded.
- *8 In a single-phase 100V power input model, the output voltage may fall down when the load is heavy, and larger output current may flow compared to a three-phase input model. Use the motor with less load so that the output current is within the rated motor current range.

10.2 Common specifications

Control specifications	Control method		Soft-PWM control/high carrier frequency PWM control (V/F control, General-purpose magnetic flux vector control, and Optimum excitation control are available)
	Output frequency range		0.2 to 400Hz
	Frequency setting resolution	Analog input	0.06Hz/60Hz (terminal 2, 4: 0 to 10V/10bit) 0.12Hz/60Hz (terminal 2, 4: 0 to 5V/9bit) 0.06Hz/60Hz (terminal 4: 0 to 20mA/10bit)
		Digital input	0.01Hz
	Frequency accuracy	Analog input	Within ±1% of the maximum output frequency (25°C ±10°C)
		Digital input	Within 0.01% of the set output frequency
	Voltage/frequency characteristics		Base frequency can be set from 0 to 400Hz. Constant-torque/variable torque pattern can be selected
	Starting torque		150% or more (at 1Hz)...when General-purpose magnetic flux vector control and slip compensation is set
	Torque boost		Manual torque boost
	Acceleration/deceleration time setting		0.1 to 3600s (acceleration and deceleration can be set individually), Linear and S-pattern acceleration/deceleration modes are available.
DC injection brake		Operation frequency (0 to 120Hz), operation time (0 to 10s), and operation voltage (0 to 30%) can be changed	
Stall prevention operation level		Operation current level (0 to 200%), and whether to use the function or not can be selected	
Environment	Surrounding air temperature		-10°C to +50°C maximum (non-freezing) *1
	Ambient humidity		90%RH or less (non-condensing)
	Storage temperature*2		-20°C to +65°C
	Atmosphere		Indoors (without corrosive gas, flammable gas, oil mist, dust and dirt etc.)
Altitude/vibration		Maximum 1000m, 5.9m/s ² or less at 10 to 55Hz (directions of X, Y, Z axes)	

- *1 When using the inverters at the surrounding air temperature of 40°C or less, the inverters can be installed closely attached (0cm clearance).
- *2 Temperatures applicable for a short time, e.g. in transit.

10.3 Outline dimension drawings

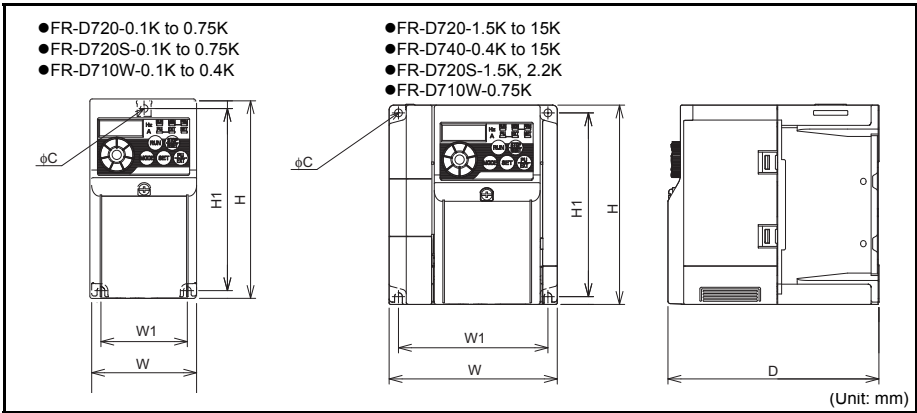

• Three-phase 200V class

Inverter Model	W	W1	H	H1	D	C
FR-D720-0.1K	68	56	128	118	80.5	5
FR-D720-0.2K					112.5	
FR-D720-0.4K					132.5	
FR-D720-0.75K					135.5	
FR-D720-1.5K	108	96	150	138	142.5	
FR-D720-2.2K	170	158	150	138	155	6
FR-D720-3.7K						
FR-D720-5.5K						
FR-D720-7.5K	220	208	260	244	190	6
FR-D720-11K						
FR-D720-15K						

• Three-phase 400V class

Inverter Model	W	W1	H	H1	D	C
FR-D740-0.4K	108	96	128	118	129.5	5
FR-D740-0.75K					135.5	
FR-D740-1.5K					155.5	
FR-D740-2.2K					165.5	
FR-D740-3.7K	220	208	150	138	155	
FR-D740-5.5K						
FR-D740-7.5K						
FR-D740-11K	220	195	260	244	190	6
FR-D740-15K						

• Single-phase 200V class

Inverter Model	W	W1	H	H1	D	C
FR-D720S-0.1K	68	56	128	118	80.5	5
FR-D720S-0.2K					142.5	
FR-D720S-0.4K					162.5	
FR-D720S-0.75K					155.5	
FR-D720S-1.5K	108	96	150	138	145	
FR-D720S-2.2K	140	128	150	138	145	

• Single-phase 100V class

Inverter Model	W	W1	H	H1	D	C
FR-D710W-0.1K	68	56	128	118	80.5	5
FR-D710W-0.2K					110.5	
FR-D710W-0.4K					142.5	
FR-D710W-0.75K					149.5	
FR-D710W-0.75K	108	96	150	138	145	

Appendix 1 Instructions for Compliance with the EU Directives

The EU Directives are issued to standardize different national regulations of the EU Member States and to facilitate free movement of the equipment, whose safety is ensured, in the EU territory.

Since 1996, compliance with the EMC Directive that is one of the EU Directives has been legally required. Since 1997, compliance with the Low Voltage Directive, another EU Directive, has been also legally required. When a manufacturer confirms its equipment to be compliant with the EMC Directive and the Low Voltage Directive, the manufacturer must declare the conformity and affix the CE marking.

● The authorized representative in the EU

The authorized representative in the EU is shown below.

Name: Mitsubishi Electric Europe B.V.

Address: Mitsubishi-Electric-Platz 1, 40882 Ratingen, Germany

(1) EMC Directive

We declare that this inverter, when equipped with the EMC Directive compliant EMC filter, conforms with the EMC Directive and affix the CE marking on the inverter.

- EMC Directive: 2014/30/EU
- Standard(s): EN61800-3:2004+A1:2012 (Second environment / PDS Category "C3")

Note: First environment

Environment including buildings/facilities which are directly connected to a low voltage main supply which also supplies residential buildings.

Directly connected means that there is no intermediate transformer between these buildings.

Second environment

Environment including all buildings/facilities which are not directly connected to a low voltage main supply which also supplies residential buildings.

● Note

- * Set the EMC Directive compliant EMC filter to the inverter. Insert line noise filters and ferrite cores to the power and control cables as required.
- * Connect the inverter to an earthed power supply.
- * Install a motor, the EMC Directive compliant EMC filter, and a control cable according to the instructions written in the EMC Installation Guidelines (BCN-A21041-204). (Please contact your sales representative for the EMC Installation Guidelines.)
- * The cable length to the motor should be 20m at maximum so that the EMC Directive compliant noise filter functions sufficiently.
- * Confirm that the final integrated system with the inverter conforms with the EMC Directive.

(2) Low Voltage Directive

We have self-confirmed our inverters as products compliant to the Low Voltage Directive and affix the CE marking on the inverters.

- Low Voltage Directive: 2014/35/EU
- Standard: EN61800-5-1:2007

Outline of instructions

- * Do not use an earth leakage circuit breaker as an electric shock protector without connecting the equipment to the earth. Connect the equipment to the earth securely.
- * Wire the earth (ground) terminal independently. (Do not connect two or more cables to one terminal.)
- * Use the cable sizes on *page 12* under the following conditions.
 - Surrounding air temperature: 40°C maximum
 - If conditions are different from above, select appropriate wire according to EN 60204.
- * Use a tinned (plating should not include zinc) crimp terminal to connect the earth cable. When tightening the screw, be careful not to damage the threads.

For use as a product compliant with the Low Voltage Directive, use PVC cable on *page 12*.

- * Use the molded case circuit breaker and magnetic contactor which conform to the EN or IEC Standard.
- * When using an earth leakage circuit breaker, use a residual current operated protective device (RCD) of type B (breaker which can detect both AC and DC). If not, provide double or reinforced insulation between the inverter and other equipment, or put a transformer between the main power supply and inverter.
- * Use the inverter under the conditions of overvoltage category II (usable regardless of the earth (ground) condition of the power supply) specified in IEC 60664.
 - To use the inverter under the conditions of pollution degree 3, install it in the enclosure of IP54 or higher.
 - To use the inverter outside of an enclosure in the environment of pollution degree 2, fix the fan cover with fan cover fixing screws enclosed.

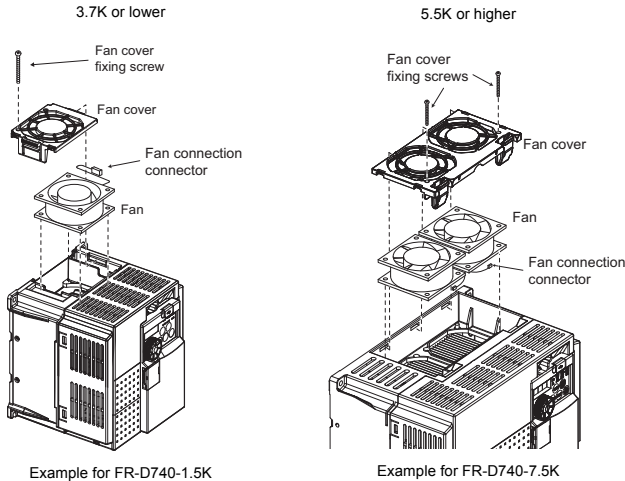

Note, the protection structure of the Inverter units is considered to be an IP00.

- * On the input and output of the inverter, use cables of the type and size set forth in EN 60204.
- * The operating capacity of the relay outputs (terminal symbols A, B, C) should be 30VDC, 0.3A. (Relay output has basic isolation from the inverter internal circuit.)
- * Control circuit terminals on *page 8* are safely isolated from the main circuit.
- * Environment

	Running	In Storage	During Transportation
Surrounding air temperature	-10°C to +50°C	-20°C to +65°C	-20°C to +65°C
Humidity	90% RH or less	90% RH or less	90% RH or less
Maximum Altitude	1000m	1000m	10000m

* For branch circuit protection, select an appropriate UL and cUL listed fuse with a cut-off speed of Class T, Class J, Class CC, or faster, or a UL 489 molded case circuit breaker (MCCB) in accordance with the following table.

FR-D720-□□□K		0.1	0.2	0.4	0.75	1.5	2.2	3.7	5.5	7.5	11	15
Rated fuse voltage(V)		240V or more										
Fuse allowable rating (A)	Without power factor improving reactor	15	15	15	20	30	40	60	70	80	150	175
	With power factor improving reactor	15	15	15	20	20	30	50	60	70	125	150
Molded case circuit breaker (MCCB) Maximum allowable rating (A)*1, *2		15	15	15	15	20	25	40	60	80	110	150

FR-D740-□□□K		0.4	0.75	1.5	2.2	3.7	5.5	7.5	11	15	
Rated fuse voltage(V)		480V or more									
Fuse allowable rating (A)	Without power factor improving reactor	6	10	15	20	30	40	70	80	90	
	With power factor improving reactor	6	10	10	15	25	35	60	70	90	
Molded case circuit breaker (MCCB) Maximum allowable rating (A)*1, *2		15	15	15	15	20	30	40	50	70	

FR-D720S-□□□K		0.1	0.2	0.4	0.75	1.5	2.2	
Rated fuse voltage(V)		240V or more						
Fuse allowable rating (A)	Without power factor improving reactor	15	20	20	30	40	60	
	With power factor improving reactor	15	20	20	20	30	50	
Molded case circuit breaker (MCCB) Maximum allowable rating (A)*1, *2		15	15	15	20	25	40	

FR-D710W-□□□K		0.1	0.2	0.4	0.75	
Rated fuse voltage(V)		115V or more				
Fuse allowable rating (A)	Without power factor improving reactor	20	20	40	60	
	With power factor improving reactor	20	20	30	50	
Molded case circuit breaker (MCCB) Maximum allowable rating (A)*1, *2		15	15	25	40	

*1 Maximum allowable rating by US National Electrical Code. Exact size must be chosen for each installation.

*2 Select an appropriate molded case circuit breaker with a rating that is suitable for the size of the cable.

* When using the electronic thermal relay function as motor overload protection, set the rated motor current in Pr. 9 Electronic thermal O/L relay.

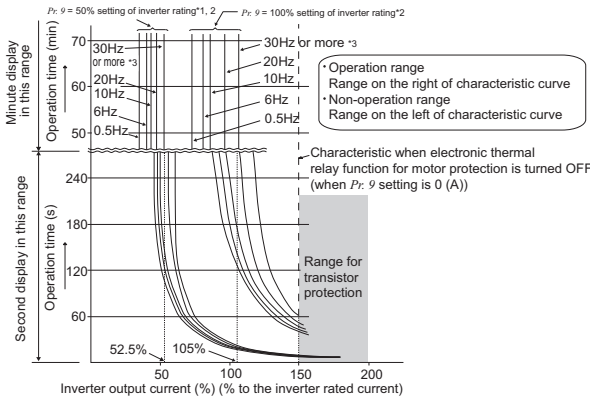

This function detects the overload (overheat) of the motor, stops the operation of the inverter's output transistor, and stops the output.

(The operation characteristic is shown on the left)

• When using the Mitsubishi Electric constant-torque motor

- 1) Set "1" or any of "13", "50", "53" in Pr. 71.
(This provides a 100% continuous torque characteristic in the low-speed range.)
- 2) Set the rated current of the motor in Pr. 9.

*1 When 50% of the inverter rated output current (current value) is set in Pr. 9

*2 The % value denotes the percentage to the inverter rated output current. It is not the percentage to the motor rated current.

*3 When you set the electronic thermal relay function dedicated to the Mitsubishi Electric constant-torque motor, this characteristic curve applies to operation at 6Hz or higher.

(For selection of the operation characteristic,

refer to Chapter 4 of the Instruction Manual.)



NOTE

• The electronic thermal memory retention function is not provided by the drive.

* Short circuit current ratings

- 100V class
Suitable for use in a circuit capable of delivering not more than 5kA rms symmetrical amperes, 132V maximum.
- 200V class
Suitable for use in a circuit capable of delivering not more than 5kA rms symmetrical amperes, 264V maximum.
- 400V class
Suitable for use in a circuit capable of delivering not more than 5kA rms symmetrical amperes, 528V maximum.

Appendix 2 Instructions for UL and cUL

(Standard to comply with: UL 508C, CSA C22.2 No. 274)

1. General precaution

CAUTION - Risk of Electric Shock -

The bus capacitor discharge time is 10 minutes. Before starting wiring or inspection, switch power off, wait for more than 10 minutes, and check for residual voltage between terminal P/+ and N/- with a meter etc., to avoid a hazard of electrical shock.

ATTENTION - Risque de choc électrique -

La durée de décharge du condensateur de bus est de 10 minutes. Avant de commencer le câblage ou l'inspection, mettez l'appareil hors tension et attendez plus de 10 minutes.

2. Environment

Before installation, check that the environment meets following specifications.

Surrounding Air Temperature*	-10°C to + 50°C (non-freezing)	
	Ambient humidity	
Storage temperature	-20°C to + 65°C	
Ambience	Indoors (No corrosive and flammable gases, oil mist, dust and dirt.)	
Altitude, vibration	Below 1000m, 5.9m/s ² or less at 10 to 55Hz (directions of X, Y, Z axes)	

* Surrounding Air Temperature is a temperature measured at a measurement position in an enclosure. Ambient Temperature is a temperature outside an enclosure.

3. Installation

The below types of inverter have been approved as products for use in enclosure and approval tests were conducted under the following conditions. Design the enclosure so that the surrounding air temperature, humidity and ambience of the inverter will satisfy the above specifications. (Refer to page 44)

Branch Circuit Protection

Integral solid state short circuit protection does not provide branch circuit protection. Branch circuit protection must be provided in accordance with the National Electrical Code for the U.S. or the Canadian Electrical Code for Canada and any additional codes. As specified, UL Class T, Class J, Class CC fuses or any faster acting fuse with the appropriate rating or Listed UL 489 Molded Case Circuit Breaker (MCCB), or Type E combination motor controller must be employed.

FR-D720-□□K		0.1	0.2	0.4	0.75	1.5	2.2	3.7	5.5	7.5	11	15
Rated fuse voltage(V)		240V or more										
Fuse allowable rating (A)	Without power factor improving reactor	15	15	15	20	30	40	60	70	80	150	175
	With power factor improving reactor	15	15	15	20	20	30	50	60	70	125	150
Molded case circuit breaker (MCCB) Maximum allowable rating (A)*1, *2		15	15	15	15	20	25	40	60	80	110	150
Type E combination motor controller*3	Maximum current rating (A)	1.6	4	6.3	8	13	18	25				
	Maximum SCCR (kA)*4	50	50	50	50	50	50	25				

FR-D740-□□K		0.4	0.75	1.5	2.2	3.7	5.5	7.5	11	15	
Rated fuse voltage(V)		480V or more									
Fuse allowable rating (A)	Without power factor improving reactor	6	10	15	20	30	40	70	80	90	
	With power factor improving reactor	6	10	10	15	25	35	60	70	90	
Molded case circuit breaker (MCCB) Maximum allowable rating (A)*1, *2		15	15	15	15	20	30	40	50	70	
Type E combination motor controller*3	Maximum current rating (A)	2.5	4	6.3	10	18	25	32			
	Maximum SCCR (kA)*4	50	50	50	50	50	25	25			

FR-D720S-□□K		0.1	0.2	0.4	0.75	1.5	2.2
Rated fuse voltage(V)		240V or more					
Fuse allowable rating (A)	Without power factor improving reactor	15	20	20	30	40	60
	With power factor improving reactor	15	20	20	30	30	50
Molded case circuit breaker (MCCB) Maximum allowable rating (A)*1, *2		15	15	15	20	25	40

FR-D710W-□□K		0.1	0.2	0.4	0.75	
Rated fuse voltage(V)		115V or more				
Fuse allowable rating (A)	Without power factor improving reactor	20	20	40	60	
	With power factor improving reactor	20	20	30	50	
Molded case circuit breaker (MCCB) Maximum allowable rating (A)*1, *2		15	15	25	40	

*1 Maximum allowable rating by US National Electrical Code. Exact size must be chosen for each installation.

*2 Select an appropriate fuse or molded case circuit breaker with a rating that is suitable for the size of the cable.

*3 For UL/cUL certification, use the following product.

Model	Manufacturer	Rated Voltage, Vac
MMP-T32	Mitsubishi Electric Corp.	480Y/277

*4 Suitable for use in a circuit capable of delivering not more than 50 or 25 kA rms symmetrical amperes, 480Y/277 volts maximum when protected by the Type E combination motor controllers indicated in the above table.

4. Short circuit ratings

- 100V class
Suitable for use in a circuit capable of delivering not more than 100kA rms symmetrical amperes, 132V maximum.
- 200V class
Suitable for use in a circuit capable of delivering not more than 100kA rms symmetrical amperes, 264V maximum.
- 400V class
Suitable for use in a circuit capable of delivering not more than 100kA rms symmetrical amperes, 528V maximum.

5. Wiring

Refer to the National Electrical Code (Article 310) regarding the allowable current of the cable. Select the cable size for 125% of the rated current according to the National Electrical Code (Article 430).

For wiring the input (R/L1, S/L2, T/L3) and output (U, V, W) terminals of the inverter, use the UL Listed copper, stranded wires (rated at 75°C) and round crimping terminals. Crimp the terminals with the crimping tool recommended by the terminal maker.

6. Motor overload protection

When using the electronic thermal relay function as motor overload protection, set the rated motor current to *Pr. 9 Electronic thermal O/L relay*. (Refer to page 48.)



NOTE

- Motor over temperature sensing is not provided by the drive.

Appendix 3 SERIAL number check

The SERIAL number can be checked on the inverter rating plate or package. (Refer to page 1)

Rating plate example

□	○	○	○○○○○○
Symbol	Year	Month	Control number
SERIAL (Serial No.)			

The SERIAL consists of one symbol, two characters indicating production year and month, and six characters indicating control number.

The last digit of the production year is indicated as the Year, and the Month is indicated by 1 to 9, X (October), Y (November), or Z (December).

Appendix 4 Instructions for EAC



The product certified in compliance with the Eurasian Conformity has the EAC marking.

Note: EAC marking

In 2010, three countries (Russia, Belarus, and Kazakhstan) established a Customs Union for the purposes of revitalizing the economy by forming a large economic bloc by abolishing or reducing tariffs and unifying regulatory procedures for the handling of articles.

Products to be distributed over these three countries of the Customs Union must comply with the Customs Union Technical Regulations (CU-TR), and the EAC marking must be affixed to the products.

For information on the country of origin, manufacture year and month, and authorized sales representative (importer) in the CU area of this product, refer to the following:

- Country of origin indication
Check the rating plate of the product. (Refer to page 1.)
Example: MADE IN JAPAN
- Manufactured year and month
The SERIAL number (refer to Appendix 3) can be checked on the rating plate (refer to page 1) of the product.
- Authorized sales representative (importer) in the CU area
The authorized sales representative (importer) in the CU area is shown below.
Name: Mitsubishi Electric (Russia) LLC
Address: 52, bld 1 Kosmodamianskaya Nab 115054, Moscow, Russia
Phone: +7 (495) 721-2070
Fax: +7 (495) 721-2071

Appendix 5 Restricted Use of Hazardous Substances in Electronic and Electrical Products

The mark of restricted use of hazardous substances in electronic and electrical products is applied to the product as follows based on the "Management Methods for the Restriction of the Use of Hazardous Substances in Electrical and Electronic Products" of the People's Republic of China.

电器电子产品有害物质限制使用标识要求

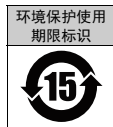

本产品中所含有的有害物质的名称、含量、含有部件如下表所示。

• 产品中所含有害物质的名称及含量

部件名称 *2	有害物质 *1					
	铅 (Pb)	汞 (Hg)	镉 (Cd)	六价铬 (Cr (VI))	多溴联苯 (PBB)	多溴二苯醚 (PBDE)
电路板组件 (包括印刷电路板及其构成的零部件, 如电阻、电容、集成电路、连接器等)、电子部件	×	○	×	○	○	○
金属壳体、金属部件	×	○	○	○	○	○
树脂壳体、树脂部件	○	○	○	○	○	○
螺丝、电线	○	○	○	○	○	○

上表依据 SJ/T11364 的规定编制。

○: 表示该有害物质在该部件所有均质材料中的含量均在 GB/T26572 规定的限量要求以下。

×: 表示该有害物质在该部件的至少一种均质材料中的含量超出 GB/T26572 规定的限量要求。

*1 即使表中记载为 ×, 根据产品型号, 也可能会有有害物质的含量为限制值以下的情况。

*2 根据产品型号, 一部分部件可能不包含在产品中。

Appendix 6 Referenced Standard (Requirement of Chinese standardized law)

This Product is designed and manufactured accordance with following Chinese standards.

Machinery safety : GB/T 16855.1
 GB/T 12668.502
 GB 28526
 GB/T 12668.3

Electrical safety : GB/T 12668.501

EMC : GB/T 12668.3

Warranty

When using this product, make sure to understand the warranty described below.

1. Warranty period and coverage

We will repair any failure or defect (hereinafter referred to as "failure") in our FA equipment (hereinafter referred to as the "Product") arisen during warranty period at no charge due to causes for which we are responsible through the distributor from which you purchased the Product or our service provider. However, we will charge the actual cost of dispatching our engineer for an on-site repair work on request by customer in Japan or overseas countries. We are not responsible for any on-site readjustment and/or trial run that may be required after a defective unit are repaired or replaced.

[Term]

The term of warranty for Product is twelve months after your purchase or delivery of the Product to a place designated by you or eighteen months from the date of manufacture whichever comes first ("Warranty Period"). Warranty period for repaired Product cannot exceed beyond the original warranty period before any repair work.

[Limitations]

- (1) You are requested to conduct an initial failure diagnosis by yourself, as a general rule. It can also be carried out by us or our service company upon your request and the actual cost will be charged.
However, it will not be charged if we are responsible for the cause of the failure.
- (2) This limited warranty applies only when the condition, method, environment, etc. of use are in compliance with the terms and conditions and instructions that are set forth in the instruction manual and user manual for the Product and the caution label affixed to the Product.
- (3) Even during the term of warranty, the repair cost will be charged on you in the following cases;
 - 1) a failure caused by your improper storing or handling, carelessness or negligence, etc., and a failure caused by your hardware or software problem
 - 2) a failure caused by any alteration, etc. to the Product made on your side without our approval
 - 3) a failure which may be regarded as avoidable, if your equipment in which the Product is incorporated is equipped with a safety device required by applicable laws and has any function or structure considered to be indispensable according to a common sense in the industry
 - 4) a failure which may be regarded as avoidable if consumable parts designated in the instruction manual, etc. are duly maintained and replaced
 - 5) any replacement of consumable parts (condenser, cooling fan, etc.)
 - 6) a failure caused by external factors such as inevitable accidents, including without limitation fire and abnormal fluctuation of voltage, and acts of God, including without limitation earthquake, lightning and natural disasters
 - 7) a failure generated by an unforeseeable cause with a scientific technology that was not available at the time of the shipment of the Product from our company
 - 8) any other failures which we are not responsible for or which you acknowledge we are not responsible for

2. Term of warranty after the stop of production

- (1) We may accept the repair at charge for another seven (7) years after the production of the product is discontinued. The announcement of the stop of production for each model can be seen in our Sales and Service, etc.
- (2) Please note that the Product (including its spare parts) cannot be ordered after its stop of production.

3. Service in overseas

Our regional FA Center in overseas countries will accept the repair work of the Product; however, the terms and conditions of the repair work may differ depending on each FA Center. Please ask your local FA center for details.

4. Exclusion of loss in opportunity and secondary loss from warranty liability

Regardless of the gratis warranty term, Mitsubishi Electric shall not be liable for compensation to:

- (1) Damages caused by any cause found not to be the responsibility of Mitsubishi Electric.
- (2) Loss in opportunity, lost profits incurred to the user by Failures of Mitsubishi Electric products.
- (3) Special damages and secondary damages whether foreseeable or not, compensation for accidents, and compensation for damages to products other than Mitsubishi Electric products.
- (4) Replacement by the user, maintenance of on-site equipment, start-up test run and other tasks.

5. Change of Product specifications

Specifications listed in our catalogs, manuals or technical documents may be changed without notice.

6. Application and use of the Product

- (1) For the use of our product, its applications should be those that may not result in a serious damage even if any failure or malfunction occurs in product, and a backup or fail-safe function should operate on an external system to product when any failure or malfunction occurs.
- (2) Our product is designed and manufactured as a general purpose product for use at general industries.
Therefore, applications substantially influential on the public interest for such as atomic power plants and other power plants of electric power companies, and also which require a special quality assurance system, including applications for railway companies and government or public offices are not recommended, and we assume no responsibility for any failure caused by these applications when used.
In addition, applications which may be substantially influential to human lives or properties for such as airlines, medical treatments, railway service, incineration and fuel systems, man-operated material handling equipment, entertainment machines, safety machines, etc. are not recommended, and we assume no responsibility for any failure caused by these applications when used.
We will review the acceptability of the abovementioned applications, if you agree not to require a specific quality for a specific application. Please contact us for consultation.

MEMO

REVISIONS

*The manual number is given on the bottom left of the back cover.

Revision Date	*Manual Number	Revision
Aug. 2010	IB(NA)-0600438ENG-A	First edition
Apr. 2012	IB(NA)-0600438ENG-B	<p data-bbox="445 220 527 240"><u>Addition</u></p> <ul data-bbox="445 244 796 292" style="list-style-type: none"> <li data-bbox="445 244 611 264">• Safety stop function <li data-bbox="445 268 796 292">• Energy saving operation for fans and pumps
Jun. 2018	IB(NA)-0600438ENG-C	<p data-bbox="445 300 527 320"><u>Addition</u></p> <ul data-bbox="445 323 1010 499" style="list-style-type: none"> <li data-bbox="445 323 925 344">• <i>Pr.154 Voltage reduction selection during stall prevention operation</i> <li data-bbox="445 347 665 368">• <i>Pr.552 Frequency jump range</i> <li data-bbox="445 371 701 392">• Appendix 4 Instructions for EAC <li data-bbox="445 395 1010 443">• Appendix 5 Restricted Use of Hazardous Substances in Electronic and Electrical Products <li data-bbox="445 446 1010 499">• Appendix 6 Referenced Standard (Requirement of Chinese standardized law) <p data-bbox="445 502 558 523"><u>Modification</u></p> <ul data-bbox="445 526 754 547" style="list-style-type: none"> <li data-bbox="445 526 754 547">• Appendix 2 Instructions for UL and cUL
Jan. 2019	IB(NA)-0600438ENG-D	<p data-bbox="445 560 527 580"><u>Addition</u></p> <ul data-bbox="445 584 673 604" style="list-style-type: none"> <li data-bbox="445 584 673 604">• Application of caution labels

International FA Center

●Shanghai FA Center

MITSUBISHI ELECTRIC AUTOMATION (CHINA) LTD. Shanghai FA Center
Mitsubishi Electric Automation Center,
No.1386 Hongqiao Road, Shanghai, China
TEL. 86-21-2322-3030
FAX. 86-21-2322-3000 (9611#)

●Beijing FA Center

MITSUBISHI ELECTRIC AUTOMATION (CHINA) LTD. Beijing FA Center
5/F, ONE INDIGO, 20 Jiuxianqiao Road
Chaoyang District, Beijing, China
TEL. 86-10-6518-8830
FAX. 86-10-6518-2938

●Tianjin FA Center

MITSUBISHI ELECTRIC AUTOMATION (CHINA) LTD. Tianjin FA Center
Room 2003 City Tower, No.35, Youyi Road,
Hexi District, Tianjin, China
TEL. 86-22-2813-1015
FAX. 86-22-2813-1017

●Guangzhou FA Center

MITSUBISHI ELECTRIC AUTOMATION (CHINA) LTD. Guangzhou FA Center
Room 1609, North Tower, The Hub Center,
No.1068, Xingang East Road, Haizhu District,
Guangzhou, China
TEL. 86-20-8923-6730
FAX. 86-20-8923-6715

●Korea FA Center

MITSUBISHI ELECTRIC AUTOMATION
KOREA CO., LTD.
8F, Gangseo Hangang Xi-tower A, 401,
Yangcheon-ro , Gangseo-Gu, Seoul 07528,
Korea
TEL. 82-2-3660-9630
FAX. 82-2-3664-0475

●Taipei FA Center

SETSUYO ENTERPRISE CO., LTD.
3F, No.105, Wugong 3rd Road, Wugu District,
New Taipei City 24889, Taiwan
TEL. 886-2-2299-9917
FAX. 886-2-2299-9963

●Taichung FA Center

MITSUBISHI ELECTRIC TAIWAN CO.,LTD.
No.8-1, Industrial 16th Road, Taichung
Industrial Park, Taichung City 40768 Taiwan
TEL. 886-4-2359-0688
FAX. 886-4-2359-0689

●Thai FA Center

MITSUBISHI ELECTRIC FACTORY
AUTOMATION (THAILAND) CO., LTD.
12th Floor, SV.City Building, Office Tower 1,
No. 896/19 and 20 Rama 3 Road, Kwaeng
Bangpompang, Khet Yannawa, Bangkok
10120, Thailand
TEL. 66-2682-6522 to 31
FAX. 66-2682-6020

●ASEAN FA Center

MITSUBISHI ELECTRIC ASIA PTE. LTD.
307, Alexandra Road, Mitsubishi Electric
Building, Singapore 159943
TEL. 65-6470-2480
FAX. 65-6476-7439

●Indonesia FA Center

PT. MITSUBISHI ELECTRIC INDONESIA
Cikarang Office
Jl. Kenari Raya Blok G2-07A Delta Silicon 5,
Lippo Cikarang - Bekasi 17550, Indonesia
TEL. 62-21-2961-7797
FAX. 62-21-2961-7794

●Hanoi FA Center

MITSUBISHI ELECTRIC VIETNAM
COMPANY LIMITED Hanoi Branch Office
6th Floor, Detech Tower, 8 Ton Thach Thuyet
Street, My Dinh 2 Ward, Nam Tu Liem
District, Hanoi, Vietnam
TEL. 84-4-3937-8075
FAX. 84-4-3937-8076

●Ho Chi Minh FA Center

MITSUBISHI ELECTRIC VIETNAM
COMPANY LIMITED
Unit 01-04, 10th Floor, Vincom Center, 72 Le
Thanh Ton Street, District 1, Ho Chi Minh
City, Vietnam
TEL. 84-8-3910-5945
FAX. 84-8-3910-5947

●India Pune FA Center

MITSUBISHI ELECTRIC INDIA PVT. LTD.
Pune Branch
Emerald House, EL -3, J Block, M.I.D.C
Bhosari, Pune - 411026, Maharashtra, India
TEL. 91-20-2710-2000
FAX. 91-20-2710-2100

●India Gurgaon FA Center

MITSUBISHI ELECTRIC INDIA PVT. LTD.
Gurgaon Head Office
2nd Floor, Tower A & B, Cyber Greens, DLF
Cyber City, DLF Phase - III, Gurgaon -
122002 Haryana, India
TEL. 91-124-463-0300
FAX. 91-124-463-0399

●India Bangalore FA Center

MITSUBISHI ELECTRIC INDIA PVT. LTD.
Bangalore Branch
Prestige Emerald, 6th Floor, Municipal No. 2,
Madras Bank Road, Bangalore - 560001,
Karnataka, India
TEL. 91-80-4020-1600
FAX. 91-80-4020-1699

●India Chennai FA Center

MITSUBISHI ELECTRIC INDIA PVT. LTD.
Chennai Branch
Citilights Corporate Centre No.1,
Vivekananda Road, Srinivasa Nagar,
Chetpet, Chennai - 600031, Tamil Nadu,
India
TEL. 91-44-4554-8772
FAX. 91-44-4554-8773

●India Ahmedabad FA Center

MITSUBISHI ELECTRIC INDIA PVT. LTD.
Ahmedabad Branch
B/4, 3rd Floor, SAFAL Profitaire, Corporate
Road, Prahaladnagar, Satellite, Ahmedabad
- 380015, Gujarat, India
TEL. 91-79-6512-0063
FAX. 91-79-6512-0063

●North America FA Center

MITSUBISHI ELECTRIC AUTOMATION,
INC.
500 Corporate Woods Parkway, Vernon
Hills, IL 60061, U.S.A.
TEL. 1-847-478-2334
FAX. 1-847-478-2253

●Mexico FA Center

MITSUBISHI ELECTRIC AUTOMATION,
INC. Queretaro Office
Parque Tecnológico Innovacion Queretaro
Lateral Carretera Estatal 431, Km 2 200,
Lote 91 Modulos 1 y 2
Hacienda la Machorra, CP 76246, El
Marques, Queretaro, Mexico
TEL. 52-442-153-6014

●Mexico Monterrey FA Center

MITSUBISHI ELECTRIC AUTOMATION,
INC. Monterrey Office
Plaza Mirage, Av. Gonzalitos 460 Sur, Local
28, Col. San Jeronimo,
Monterrey, Nuevo Leon, C.P. 64640, Mexico
TEL. 52-55-3067-7521

●Mexico City FA Center

MITSUBISHI ELECTRIC AUTOMATION,
INC. Mexico Branch
Mariano Escobedo #69, Col.Zona Industrial,
Tlalnepanitla Edo. Mexico, C.P.54030
TEL. 52-55-3067-7511

●Brazil FA Center

MITSUBISHI ELECTRIC DO BRASIL
COMERCIO E SERVICOS LTDA.
Avenida Adelino Cardana, 293, 21 andar,
Bethaville, Barueri SP, Brazil
TEL. 55-11-4689-3000
FAX. 55-11-4689-3016

●Brazil Votorantim FA Center

MELCO CNC DO BRASIL COMERCIO E
SERVICOS S.A.
Avenida Gisele Constantino,1578, Parque
Bela Vista - Votorantim-SP, Brazil
TEL. 55-15-3023-9000

●Europe FA Center

MITSUBISHI ELECTRIC EUROPE B.V.
Polish Branch
ul. Krakowska 50, 32-083 Balice, Poland
TEL. 48-12-347-65-81
FAX. 48-12-630-47-01

●Germany FA Center

MITSUBISHI ELECTRIC EUROPE B.V.
German Branch
Mitsubishi-Electric-Platz 1, 40882 Ratingen,
Germany
TEL. 49-2102-486-0
FAX. 49-2102-486-1120

●UK FA Center

MITSUBISHI ELECTRIC EUROPE B.V. UK
Branch
Travellers Lane, Hatfield, Hertfordshire,
AL10 8XB, UK.
TEL. 44-1707-28-8780
FAX. 44-1707-27-8695

●Czech Republic FA Center

MITSUBISHI ELECTRIC EUROPE B.V.
Czech Branch
Pekarska 621/7, 155 00 Praha 5, Czech
Republic
TEL. 420-255-719-200
FAX. 420-251-551-471

●Italy FA Center

MITSUBISHI ELECTRIC EUROPE B.V.
Italian Branch
Centro Direzionale Colleoni - Palazzo Sirio,
Viale Colleoni 7, 20864 Agrate Brianza (MB),
Italy
TEL. 39-039-60531
FAX. 39-039-6053-12

●Russia FA Center

MITSUBISHI ELECTRIC (Russia) LLC St.
Petersburg Branch
Piskarevsky pr. 2, bld 2, lit "Sch", BC
"Benua", office 720; 195027, St. Petersburg,
Russia
TEL. 7-812-633-3497
FAX. 7-812-633-3499

●Turkey FA Center

MITSUBISHI ELECTRIC TURKEY A.S.
Umraniye Branch
Serfali Mahallesi Nutuk Sokak No.5, TR-
34775 Umraniye / Istanbul, Turkey
TEL. 90-216-526-3990
FAX. 90-216-526-3995

MITSUBISHI ELECTRIC CORPORATION

HEAD OFFICE: TOKYO BUILDING 2-7-3, MARUNOUCHI, CHIYODA-KU, TOKYO 100-8310, JAPAN

MODEL	FR-D700 TORISETSU KISO EIBUN
MODEL CODE	1AJ017