

INVERTER

FR-E800

Instruction Manual (Maintenance)

Compact, high functionality inverters

FR-E820-0008(0.1K) to 0900(22K)
FR-E840-0016(0.4K) to 0440(22K)
FR-E860-0017(0.75K) to 0120(7.5K)
FR-E820S-0008(0.1K) to 0110(2.2K)
FR-E810W-0008(0.1K) to 0050(0.75K)
FR-E820-0008(0.1K) to 0900(22K)E
FR-E840-0016(0.4K) to 0440(22K)E
FR-E860-0017(0.75K) to 0120(7.5K)E
FR-E820S-0008(0.1K) to 0110(2.2K)E
FR-E810W-0008(0.1K) to 0050(0.75K)E
FR-E820-0008(0.1K) to 0900(22K)SCE
FR-E840-0016(0.4K) to 0440(22K)SCE
FR-E860-0017(0.75K) to 0120(7.5K)SCE
FR-E820S-0008(0.1K) to 0110(2.2K)SCE
FR-E810W-0008(0.1K) to 0050(0.75K)SCE
FR-E846-0026(0.75K) to 0095(3.7K)SCE

Chapter 1 Introduction	4
1.1 Product checking	6
1.2 Related manuals	8
Chapter 2 Protective Functions	10
2.1 Inverter fault and alarm indications	10
2.2 Reset method for the protective functions	11
2.3 Check and clear of the fault history	12
2.4 List of fault displays	14
2.5 Causes and corrective actions	17
2.6 Check first when you have a trouble	37
2.6.1 Motor does not start	37
2.6.2 Motor or machine is making abnormal acoustic noise	40
2.6.3 Inverter generates abnormal noise	40
2.6.4 Motor generates heat abnormally	40
2.6.5 Motor rotates in the opposite direction	41
2.6.6 Speed greatly differs from the setting	41
2.6.7 Acceleration/deceleration is not smooth	41
2.6.8 Speed varies during operation	42
2.6.9 Operation mode is not changed properly	42
2.6.10 Operation panel display is not operating	43
2.6.11 The motor current is too large	43
2.6.12 Speed does not accelerate	44
2.6.13 Unable to write parameter setting	44
2.6.14 Unable to establish Ethernet communication	45
Chapter 3 Precautions for Maintenance and Inspection	48
3.1 Inspection item	48
3.1.1 Daily inspection	48
3.1.2 Periodic inspection	48
3.1.3 Daily and periodic inspection	49
3.1.4 Checking the inverter and converter modules	50
3.1.5 Cleaning	52
3.1.6 Replacement of parts	53
3.1.7 Inverter replacement	57
3.2 Measurement of main circuit voltages, currents, and powers	59
3.2.1 Measurement of powers	61
3.2.2 Measurement of voltages and use of PT	61
3.2.3 Measurement of currents	61
3.2.4 Measurement of inverter input power factor	61
3.2.5 Measurement of converter output voltage (between terminals P and N)	61
3.2.6 Measurement of inverter output frequency	62
3.2.7 Insulation resistance test using megger	62

3.2.8 Withstand voltage test 62

Chapter 4 Appendix 64

4.1 How to check specification changes64

4.1.1 Details of specification changes 64

CHAPTER 1 Introduction

1.1	Product checking	6
1.2	Related manuals	8

1 Introduction

The contents described in this chapter must be read before using this product.







Always read the instructions before use.

◆ Abbreviations

Item	Description
PU	Operation panel, parameter unit (FR-PU07), LCD operation panel (FR-LU08), and enclosure surface operation panel (FR-PA07)
Parameter unit	Parameter unit (FR-PU07), LCD operation panel (FR-LU08), and enclosure surface operation panel (FR-PA07)
Inverter	Mitsubishi Electric inverter FR-E800 series
E800	Standard model (RS-485 + SIL2/PLd functional safety)
E800-E	Ethernet model (Ethernet + SIL2/PLd functional safety)
E800-SCE	Safety communication model (Ethernet + SIL3/PLe functional safety)
E806	IP67 model (Ethernet + SIL3/PLe functional safety + IP67)
FM type inverter	Standard model with terminal FM (pulse output)
AM type inverter	Standard model with terminal AM (voltage output)
Vector control compatible option	FR-A8AP E kit
Pr.	Parameter number (Number assigned to function)
PU operation	Operation using the PU (operation panel / parameter unit)
External operation	Operation using the control circuit signals
Combined operation	Combined operation using the PU (operation panel / parameter unit) and External operation
Mitsubishi Electric standard efficiency motor	SF-JR
Mitsubishi Electric constant-torque motor	SF-HRCA
Mitsubishi Electric high-performance energy-saving motor	SF-PR
Mitsubishi Electric high-performance energy-saving motor with encoder	SF-PR-SC
Mitsubishi Electric Vector control dedicated motor	SF-V5RU
Mitsubishi Electric geared motor	GM-[]
Mitsubishi Electric inverter-driven geared motor for encoder feedback control	GM-DZ, GM-DP
Mitsubishi Electric PM motor	MM-GKR, EM-A

◆ Names of the parts on the operation panel

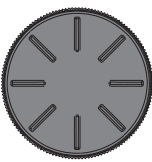
The following table shows the names of the keys and the dial on the operation panel in this document. (For details of the operation panel, refer to the FR-E800 Instruction Manual (Function).) For the IP67 model, the operation panel does not have the keys and the dial.

Appearance	Name
	PU/EXT key
	MODE key
	SET key
	RUN key
	STOP/RESET key
	Setting dial ^{*1}
	UP/DOWN key ^{*2}

*1 The dial is provided for the standard model.

*2 The keys are provided for the Ethernet model and the safety communication model.

◆ Digital characters and their corresponding printed equivalents

0	1	2	3	4	5	6	7	8	9	A	B	C
0	1	2	3	4	5	6	7	8	9	A	b	C
D	E	F	G	H	I	J	K	L	M	N	O	P
d	E	F	G	H	I	J	K	L	N	n	o	P
Q	R	S	T	U	V	W	X	Y	Z	-	-	
q	r	s	t	u	v	w	x	y	z	-	-	

◆ Trademarks

- MODBUS is a registered trademark of SCHNEIDER ELECTRIC USA, INC.
- BACnet is a registered trademark of the American Society of Heating, Refrigerating and Air-Conditioning Engineers (ASHRAE).
- DeviceNet and EtherNet/IP are registered trademarks of ODVA (Open DeviceNet Vendor Association, INC).
- PROFIBUS and PROFINET are either trademarks or registered trademarks of PROFIBUS & PROFINET International.
- CC-Link IE TSN and CC-Link IE Field Network Basic are registered trademarks of CC-Link Partner Association.
- EtherCAT® is registered trademark and patented technology, licensed by Beckhoff Automation GmbH, Germany.
- Other company and product names herein are the trademarks and registered trademarks of their respective owners.

◆ Notes on descriptions in this Instruction Manual

- Connection diagrams in this Instruction Manual appear with the control logic of the input terminals as sink logic, unless otherwise specified. (Refer to the FR-E800 Instruction Manual (Connection) for the switching of the control logic of the inverter.)

1.1 Product checking

◆ Inverter model

FR-E8 2 0 - 0008 -1

A B C D E F G H

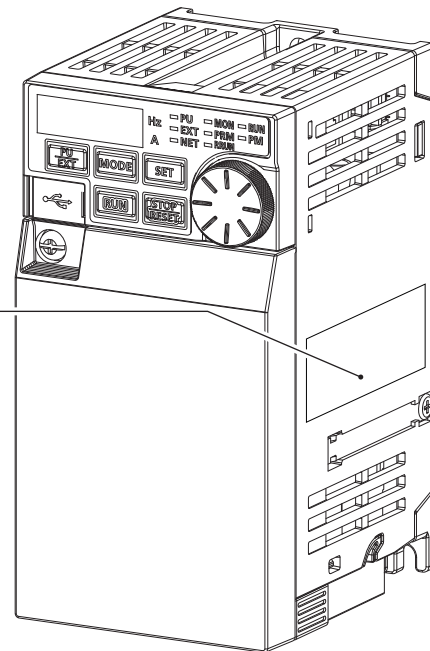
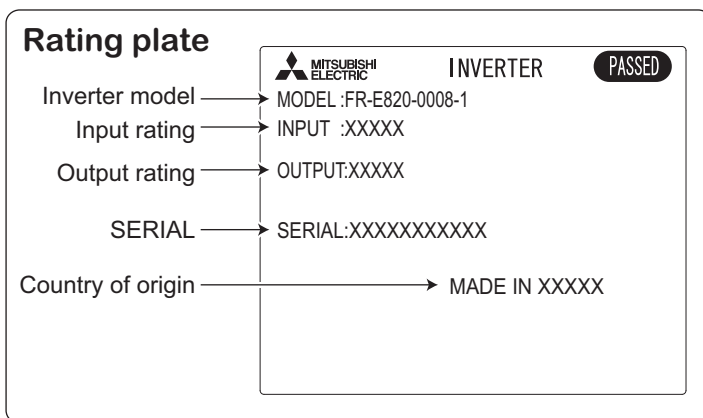

- A: The voltage class is shown.

Symbol	Voltage class
1	100 V class
2	200 V class
4	400 V class
6	575 V class

- B: The protective structure is shown.

Symbol	Protective structure
0	Open type (IP20)
6	Enclosed type (IP66/IP67, UL Type 4X, indoor use only)

- C: The number of phases of the power source is shown.

Symbol	Description
None	Three-phase input
S	Single-phase input
W	Single-phase input (double voltage output)

- D: The applicable motor capacity or the inverter rated current is shown.

Symbol	Description
0.1K to 22K	Applicable motor capacity (ND) (kW)
0008 to 0900	Inverter rated current (ND) (A)

- E: The communication type and the functional safety specification are shown.

Symbol	Communication / functional safety
None	RS-485 + SIL2/PLd
E	Ethernet + SIL2/PLd
SCE	Ethernet + SIL3/PLe

- F: The output specification for monitoring and the rated frequency are shown for the standard model, and the communication protocol group is shown for the Ethernet model, safety communication model, and IP67 model. The control logic is fixed to the source logic for the safety communication model and IP67 model.

Symbol	Monitoring/protocol specification	Rated frequency (initial setting)	Control logic	
			Input signal (initial status)	Safety stop signal
-1	Pulse (terminal FM)	60 Hz	Sink logic	Source logic (fixed)
-4	Voltage (terminal AM)	50 Hz	Source logic	
-5	Voltage (terminal AM)	60 Hz	Sink logic	
PA	Protocol group A (CC-Link IE TSN, CC-Link IE Field Network Basic, MODBUS/TCP, EtherNet/IP, and BACnet/IP)	60 Hz	Sink logic	
PB	Protocol group B (CC-Link IE TSN, CC-Link IE Field Network Basic, MODBUS/TCP, PROFINET)	50 Hz	Sink logic / source logic ^{*1}	
PC ^{*2}	Protocol group C (EtherCAT)	50 Hz	Sink logic / source logic ^{*1}	

*1 The initial status of the control logic differs depending on the inverter model.
Sink logic for the models indicated with the applicable motor capacity (kW)
Source logic for the models indicated with the rated current (A)

*2 Available for the Ethernet model only.

- G: Availability of circuit board coating / plated conductors / power ON/OFF switch is shown.

Symbol	Circuit board coating ^{*1}	Plated conductors	Power ON/OFF switch
None	Without coating	Without plated conductors	Without switch
-60	With coating	Without plated conductors	Without switch
-06 ^{*2}	With coating	With plated conductors	Without switch
-S6 ^{*3}	With coating	Without plated conductors	With switch

*1 Conforming to IEC 60721-3-3:1994 3C2

*2 Applicable for the FR-E820-0470(11K) or higher, and the FR-E840-0380(18.5K) or higher.

*3 IP67 model only.

- H: Availability of an EMC filter is shown.

Symbol	EMC filter
None	Without filter
C2 ^{*1}	With filter (Class C2)

*1 IP67 model only.

NOTE

- In this Instruction Manual, the inverter model name consists of the inverter rated current and the applicable motor capacity. (Example) FR-E820-0008(0.1K)

◆ How to read the SERIAL number

Rating plate example

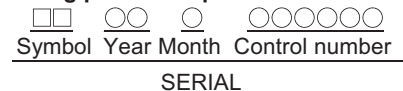

The SERIAL consists of two symbols, three characters indicating the production year and month, and six characters indicating the control number.

The last two digits of the production year are indicated as the Year, and the Month is indicated by 1 to 9, X (October), Y (November), or Z (December).

1.2 Related manuals

When using this inverter for the first time, prepare the following manuals as required and use the inverter safely. The latest version of e-Manual Viewer and the latest PDF manuals can be downloaded from the Mitsubishi Electric FA Global Website. <https://www.mitsubishielectric.com/app/fa/download/search.do?kisyu=/inv&mode=manual>

Point

- e-Manual refers to the Mitsubishi FA electronic book manuals that can be browsed using a dedicated tool.
- e-Manual has the following features:
 - Required information can be cross-searched in multiple manuals.
 - Pages that users often browse can be bookmarked.

Manuals related to the FR-E800 inverter are shown in the following table.

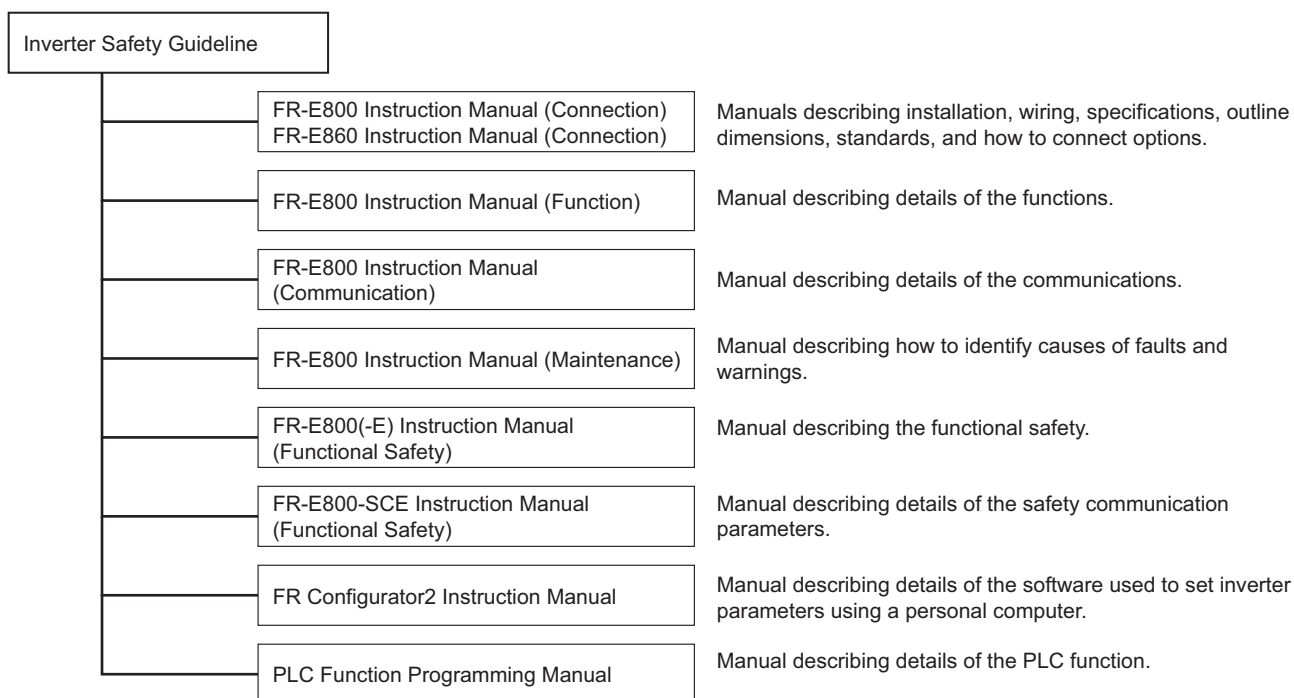

Name	Manual number
FR-E800 Inverter Safety Guideline	IB-0600857ENG
FR-E800-E Inverter Safety Guideline	IB-0600860ENG
FR-E800-SCE Inverter Safety Guideline	IB-0600921ENG
FR-E860 Inverter Safety Guideline	IB-0600862ENG
FR-E860-E Inverter Safety Guideline	IB-0600863ENG
FR-E860-SCE Inverter Safety Guideline	IB-0600924ENG
FR-E806-SCE Inverter Safety Guideline	IB-0600984ENG
FR-E800 Instruction Manual (Connection)	IB-0600865ENG
FR-E860 Instruction Manual (Connection)	IB-0600906ENG
FR-E800 Instruction Manual (Function)	IB-0600868ENG
FR-E800 Instruction Manual (Communication)	IB-0600871ENG
FR-E800(-E) Instruction Manual (Functional Safety)	BCN-A23488-000(E)
FR-E800-SCE Instruction Manual (Functional Safety)	BCN-A23488-004(E)
FR Configurator2 Instruction Manual	IB-0600516ENG
PLC Function Programming Manual	IB-0600492ENG

CHAPTER 2 Protective Functions

2.1	Inverter fault and alarm indications.....	10
2.2	Reset method for the protective functions	11
2.3	Check and clear of the fault history	12
2.4	List of fault displays	14
2.5	Causes and corrective actions.....	17
2.6	Check first when you have a trouble.....	37

2 Protective Functions

This chapter explains the "PROTECTIVE FUNCTIONS" that operate in this product.
Always read the instructions before use.

2.1 Inverter fault and alarm indications

- When the inverter detects a fault, depending on the nature of the fault, the operation panel displays an error message or warning, or a protective function is activated to shut off the inverter output.
- When any fault occurs, take an appropriate corrective action, then reset the inverter, and resume the operation. Restarting the operation without a reset may break or damage the inverter.
- When a protective function is activated, note the following points.

Item	Description
Fault output signal	Opening the magnetic contactor (MC) provided on the input side of the inverter at a fault occurrence shuts off the control circuit power to the inverter, therefore, the fault output will not be retained.
Fault or alarm indication	When a protective function is activated, the operation panel displays a fault indication.
Operation restart method	While a protective function is activated, the inverter output is kept shutoff. Reset the inverter to restart the operation.

- Inverter fault or alarm indications are categorized as follows.

Displayed item	Description
Error message	A message regarding operational fault or setting fault on the operation panel is displayed. The inverter output is not shut off.
Warning	The inverter output is not shut off even when a warning is displayed. However, failure to take appropriate measures will lead to a fault.
Alarm	The inverter output is not shut off. An Alarm (LF) signal can also be output with a parameter setting.
Fault	When a protective function is activated, the inverter output is shut off and a Fault (ALM) signal is output.

NOTE

- The last 10 faults can be displayed on the operation panel. (Fault history) (For operation, refer to [page 12.](#))

2.2 Reset method for the protective functions

Reset the inverter by performing any of the following operations. Note that the accumulated heat value of the electronic thermal relay function and the number of retries are cleared (erased) by resetting the inverter.

The inverter recovers about 1 second after the reset is released.

- On the operation panel, press the STOP/RESET key to reset the inverter. (This may only be performed when a fault occurs. (Refer to [page 22](#) of the Instruction Manual for faults.))

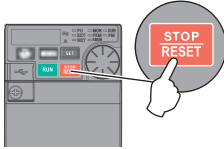

- Switch the power OFF once, then switch it ON again.

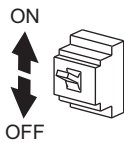

- Turn ON the Reset (RES) signal for 0.1 s or more. (If the RES signal is kept ON, "Err" appears (blinks) to indicate that the inverter is in a reset status.)

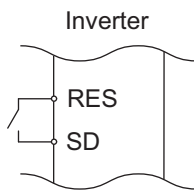

NOTE

- OFF status of the start signal must be confirmed before resetting the inverter fault. Resetting an inverter fault with the start signal ON restarts the motor suddenly.
- For the IP67 model, the operation panel does not have the STOP/RESET key.

2.3 Check and clear of the fault history

The operation panel stores the fault indications which appear when a protective function is activated to display the fault record for the past 10 faults. (Fault history)

◆ Check for the fault history

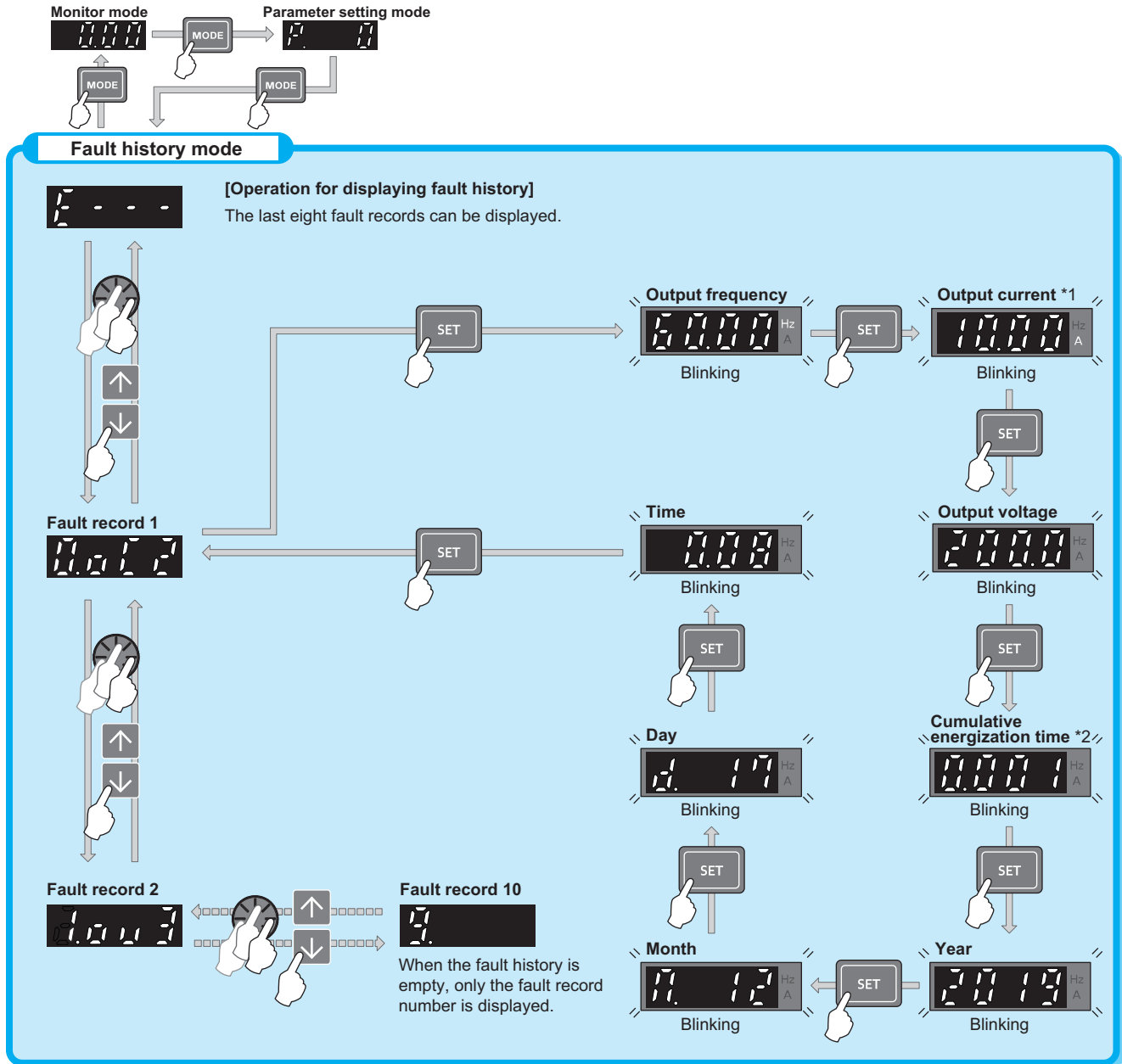

*1 When an overcurrent trip occurs by an instantaneous overcurrent, the monitored current value saved in the fault history may be lower than the actual current that has flowed.

*2 The cumulative energization time is accumulated from 0 to 65535 hours, then cleared, and accumulated again from 0.

NOTE

- For the IP67 model, the fault history cannot be checked using the operation panel.

◆ Fault history clearing procedure

Point

- Set Er.CL Fault history clear = "1" to clear the fault history.

Operating procedure

- 1.** Turning ON the power of the inverter
The operation panel is in the monitor mode.
- 2.** Selecting the parameter setting mode
Press the MODE key to choose the parameter setting mode. (The parameter number read previously appears.)
- 3.** Selecting the parameter number
Turn the setting dial or press the UP/DOWN key until "ER.CL" (Fault history clear) appears. Press the SET key to read the present set value. "0" (initial value) appears.
- 4.** Fault history clear
Turn the setting dial or press the UP/DOWN key to change the value to "1". Press the SET key to start clearing. "1" and "ER.CL" are displayed alternately after the fault history is cleared.
 - Turn the setting dial or press the UP/DOWN key to read another parameter.
 - Press the SET key to show the setting again.
 - Press the SET key twice to show the next parameter.

2.4 List of fault displays

If the displayed message does not correspond to any of the following or if you have any other problem, contact your sales representative.

◆ Error message

- A message regarding operational fault or setting fault on the operation panel is displayed. The inverter output is not shut off.

Operation panel indication	Name	Refer to page
HoLD	HOLD	Operation panel lock 17
LoCd	LOCD	Password locked 17
Er 1 to Er 4	Er1 to Er4	Parameter write error 17
Err.	Err.	Error 18

◆ Warning

- The inverter output is not shut off even when a warning is displayed. However, failure to take appropriate measures will lead to a fault.

Operation panel indication	Name	Data code	Refer to page
oLc	OLC	Stall prevention (overcurrent) 1 (H01)	18
oLv	OLV	Stall prevention (overvoltage) 2 (H02)	18
rb	RB	Regenerative brake pre-alarm 3 (H03)	19
rH	TH	Electronic thermal relay function pre-alarm 4 (H04)	19
ps	PS	PU stop 6 (H06)	19
nr	MT	Maintenance timer 8 (H08)	20
sl	SL	Speed limit indication 9 (H09)	19
cf	CF	Continuous operation during communication 10 (H0A)	20
sa	SA	Safety stop 12 (H0C)	19
LdF	LDF	Load fault warning 26 (H1A)	20
Ehr	EHR	Ethernet communication fault 28 (H1C)	20
dIP	DIP	Duplicate IP address 32 (H20)	20
IP	IP	IP address fault 38 (H26)	20
SE	SE	Incorrect parameter setting 48 (H30)	21

Operation panel indication	Name	Data code	Refer to page
Cor	Cor	Corrosion warning 50 (H32)	21
Uv	UV	Undervoltage —	21
LP	LP	Stroke limit warning 20 (H14)	21
HP1	HP1	Home position return setting error 21 (H15)	21
HP2	HP2	Home position return uncompleted 22 (H16)	21
Ed	ED	Emergency drive in operation 24 (H18)	21

◆ Alarm

- The inverter output is not shut off. An Alarm (LF) signal can also be output with a parameter setting.

Operation panel indication	Name	Refer to page
Fn	FN	Fan alarm 22

◆ Fault

- When a protective function is activated, the inverter output is shut off and a Fault (ALM) signal is output.
- The data code is used for checking the fault detail via communication or with **Pr.997 Fault initiation**.

■ Data code 16 to 199

Operation panel indication	Name	Data code	Refer to page
E.oC1	E.OC1	Overcurrent trip during acceleration 16 (H10)	22
E.oC2	E.OC2	Overcurrent trip during constant speed 17 (H11)	23
E.oC3	E.OC3	Overcurrent trip during deceleration or stop 18 (H12)	23
E.ov1	E.OV1	Regenerative overvoltage trip during acceleration 32 (H20)	24
E.ov2	E.OV2	Regenerative overvoltage trip during constant speed 33 (H21)	24
E.ov3	E.OV3	Regenerative overvoltage trip during deceleration or stop 34 (H22)	24
E.rHr	E.THT	Inverter overload trip (electronic thermal relay function) 48 (H30)	25
E.rHn	E.THM	Motor overload trip (electronic thermal relay function) 49 (H31)	25

Operation panel indication		Name	Data code	Refer to page
<i>E.Fin</i>	E.FIN	Heat sink overheat	64 (H40)	25
<i>E.UvF</i>	E.UVT	Undervoltage	81 (H51)	26
<i>E.lLF</i>	E.ILF	Input phase loss	82 (H52)	26
<i>E.oLr</i>	E.OLT	Stall prevention stop	96 (H60)	26
<i>E.Sof</i>	E.SOT	Loss of synchronism detection	97 (H61)	26
<i>E.LUP</i>	E.LUP	Upper limit fault detection	98 (H62)	27
<i>E.Ldn</i>	E.LDN	Lower limit fault detection	99 (H63)	27
<i>E.bE</i>	E.BE	Brake transistor alarm detection	112 (H70)	27
<i>E.GF</i>	E.GF	Output side earth (ground) fault overcurrent	128 (H80)	27
<i>E.LF</i>	E.LF	Output phase loss	129 (H81)	27
<i>E.oHT</i>	E.OHT	External thermal relay operation	144 (H90)	28
<i>E.PTC</i>	E.PTC	PTC thermistor operation	145 (H91)	28
<i>E.oPr</i>	E.OPT	Option fault	160 (HA0)	28
<i>E.oP1</i>	E.OP1	Communication option fault	161 (HA1)	28
<i>E. 16</i>	E.16	User definition error by the PLC function	164 (HA4)	29
<i>E. 17</i>	E.17		165 (HA5)	
<i>E. 18</i>	E.18		166 (HA6)	
<i>E. 19</i>	E.19		167 (HA7)	
<i>E. 20</i>	E.20		168 (HA8)	
<i>E.PE6</i>	E.PE6	Internal storage device fault	172 (HAC)	29
<i>E.PE</i>	E.PE	Parameter storage device fault (control circuit board)	176 (HB0)	29
<i>E.PUE</i>	E.PUE	PU disconnection	177 (HB1)	29
<i>E.rEr</i>	E.RET	Retry count excess	178 (HB2)	30
<i>E.PE2</i>	E.PE2	Parameter storage device fault (main circuit board)	179 (HB3)	30
<i>E.CPU</i>	E.CPU	CPU fault	192 (HC0)	30
<i>E.Cdo</i>	E.CDO	Abnormal output current detection	196 (HC4)	30
<i>E.ioH</i>	E.IOH	Inrush current limit circuit fault	197 (HC5)	30
<i>E.AiE</i>	E.AIE	Analog input fault	199 (HC7)	31

■ Data code 200 or more

Operation panel indication		Name	Data code	Refer to page
<i>E.USb</i>	E.USB	USB communication fault	200 (HC8)	31
<i>E.SAF</i>	E.SAF	Safety circuit fault	201 (HC9)	31
<i>E.oS</i>	E.OS	Overspeed occurrence	208 (HD0)	31
<i>E.oSd</i>	E.OSD	Speed deviation excess detection	209 (HD1)	32
<i>E.ECr</i>	E.ECT	Signal loss detection	210 (HD2)	32
<i>E.od</i>	E.OD	Excessive position fault	211 (HD3)	33
<i>E.Mb1</i>	E.MB1	Brake sequence fault	213 (HD5)	33
<i>E.Mb2</i>	E.MB2		214 (HD6)	
<i>E.Mb3</i>	E.MB3		215 (HD7)	
<i>E.Mb4</i>	E.MB4		216 (HD8)	
<i>E.Mb5</i>	E.MB5		217 (HD9)	
<i>E.Mb6</i>	E.MB6		218 (HDA)	
<i>E.Mb7</i>	E.MB7		219 (HDB)	
<i>E.oA</i>	E.OA	Acceleration error	221 (HDD)	33
<i>E.IAH</i>	E.IAH	Abnormal internal temperature	225 (HE1)	33
<i>E.Pid</i>	E.PID	PID signal fault	230 (HE6)	34
<i>E.EHr</i>	E.EHR	Ethernet communication fault	231 (HE7)	34
<i>E.CMb</i>	E.CMB	Board combination fault	232 (HE8)	34
<i>E. 1</i>	E.1	Option fault	241 (HF1)	35
<i>E. 5</i>	E.5	CPU fault	245 (HF5)	30
<i>E. 6</i>	E.6		246 (HF6)	
<i>E. 7</i>	E.7		247 (HF7)	
<i>E. 10</i>	E.10	Inverter output fault	250 (HFA)	35
<i>E. 11</i>	E.11	Opposite rotation deceleration fault	251 (HFB)	35
<i>E. 13</i>	E.13	Internal circuit fault	253 (HFD)	35

◆ Others

- The fault history and the operation status of the inverter are displayed. It is not a fault indication.

Operation panel indication	Name	Refer to page
<i>E - - -</i>	Fault history	12

Operation panel indication	Name	Refer to page
E. 0	No fault history	36
Eu	24 V external power supply operation	36
rd	Backup in progress	36
br	Restoration in progress	36

2.5 Causes and corrective actions

◆ Error message

A message regarding operational troubles is displayed. Output is not shut off.

■ Operation panel lock

Operation panel indication	HOLD	Hold
Description	Operation lock is set. Operation other than pressing the STOP/RESET key is disabled.	
Check point	-----	
Corrective action	Press the MODE key for 2 seconds to release the lock.	
Reference manual	FR-E800 Instruction Manual (Function)	

■ Password locked

Operation panel indication	LOCD	LoCd
Description	Password function is active. Display and setting of parameters are restricted.	
Check point	-----	
Corrective action	Enter the password in Pr.297 Password lock/unlock to unlock the password function before operating.	
Reference manual	FR-E800 Instruction Manual (Function)	

■ Write disable error

Operation panel indication	Er1	Er1
Description	<ul style="list-style-type: none"> Parameter setting was attempted while Pr.77 Parameter write selection is set to disable parameter write. Overlapping range has been set for the frequency jump. The PU and inverter cannot make normal communication. 	
Check point	<ul style="list-style-type: none"> Check the Pr.77 setting. Check the settings of Pr.31 to Pr.36 (frequency jump). Check the connection of PU and the inverter. 	
Reference manual	FR-E800 Instruction Manual (Function)	

■ Write error during operation

Operation panel indication	Er2	Er2
Description	Parameter write was attempted while Pr.77 Parameter write selection = "0".	
Check point	<ul style="list-style-type: none"> Check that the inverter is stopped. 	
Corrective action	<ul style="list-style-type: none"> After stopping the operation, make parameter setting. When setting Pr.77 = "2", parameter write is enabled during operation. 	
Reference manual	FR-E800 Instruction Manual (Function)	

■ Calibration error

Operation panel indication	Er3	Er3
Description	Analog input bias and gain calibration values have been set too close.	
Check point	Check the settings of the calibration parameters C3, C4, C6, and C7 (calibration functions).	
Reference manual	FR-E800 Instruction Manual (Function)	

■ Mode designation error

Operation panel indication	Er4	Er4
Description	<ul style="list-style-type: none"> Parameter setting was attempted in the External or NET operation mode while Pr.77 Parameter write selection = "1". Parameter write was attempted when the command source is not at the operation panel. 	
Check point	<ul style="list-style-type: none"> Check that the operation mode is the PU operation mode. Check that the Pr.551 PU mode operation command source selection setting is correct. 	
Corrective action	<ul style="list-style-type: none"> After setting the operation mode to the "PU operation mode", make parameter setting. When Pr.77 = "2", parameter write is enabled regardless of the operation mode. Set Pr.551 = "4". 	
Reference manual	FR-E800 Instruction Manual (Function)	

■ Error

Operation panel indication	Err.	<i>Err.</i>
Description	<ul style="list-style-type: none"> The RES signal is turned ON. This error may occur when the voltage at the input side of the inverter drops. 	
Corrective action	<ul style="list-style-type: none"> Turn OFF the RES signal. 	

◆ Warning

Output is not shut off when a protective function is activated.

■ Stall prevention (overcurrent)

Operation panel indication	OLC	<i>olc</i>	FR-LU08 indication	OL
Description	<ul style="list-style-type: none"> When the output current of the inverter increases, the stall prevention (overcurrent) function is activated. The following section explains about the stall prevention (overcurrent) function. 			
	During acceleration	When the output current (output torque under Real sensorless vector control or Vector control) of the inverter exceeds the stall prevention level (Pr.22 Stall prevention operation level , etc.), this function stops the increase in frequency until the overload current decreases to prevent the inverter from resulting in overcurrent trip. When the overload current is reduced below stall prevention operation level, this function increases the frequency again.		
	During constant-speed operation	When the output current (output torque under Real sensorless vector control or Vector control) of the inverter exceeds the stall prevention level (Pr.22 Stall prevention operation level , etc.), this function reduces frequency until the overload current decreases to prevent the inverter from resulting in overcurrent trip. When the overload current is reduced below stall prevention operation level, this function increases the frequency up to the set value.		
	During deceleration	When the output current (output torque under Real sensorless vector control or Vector control) of the inverter exceeds the stall prevention level (Pr.22 Stall prevention operation level , etc.), this function stops the decrease in frequency until the overload current decreases to prevent the inverter from resulting in overcurrent trip. When the overload current is reduced below stall prevention operation level, this function decreases the frequency again.		
Check point	<ul style="list-style-type: none"> Check that the Pr.0 Torque boost setting is not too large. The Pr.7 Acceleration time and Pr.8 Deceleration time settings may be too short. Check that the load is not too heavy. Check for any failures in peripheral devices. Check that the Pr.13 Starting frequency is not too large. Check that Pr.22 Stall prevention operation level is appropriate. 			
Corrective action	<ul style="list-style-type: none"> Gradually increase or decrease the Pr.0 setting by 1% at a time and check the motor status. Set a larger value in Pr.7 and Pr.8. Reduce the load. Try Advanced magnetic flux vector control, Real sensorless vector control, or Vector control. Change the Pr.14 Load pattern selection setting. The stall prevention operation current can be set in Pr.22 Stall prevention operation level. (The initial value is 150% for the ND rating.) Acceleration/deceleration time may change. Increase the stall prevention operation level with Pr.22 Stall prevention operation level, or disable stall prevention with Pr.156 Stall prevention operation selection. (Use Pr.156 to set either operation continued or not at OLC operation.) 			
Reference manual	FR-E800 Instruction Manual (Function)			

■ Stall prevention (overvoltage)

Operation panel indication	OLV	<i>olv</i>	FR-LU08 indication	oL
Description	<ul style="list-style-type: none"> When the output voltage of the inverter increases, the stall prevention (overvoltage) function is activated. The regeneration avoidance function is activated due to excessive regenerative power of the motor. The following section explains the stall prevention (overvoltage) function. 			
	During deceleration	If the regenerative power of the motor becomes excessive to exceed the regenerative power consumption capability, this function stops decreasing the frequency to prevent overvoltage trip. As soon as the regenerative power has reduced, deceleration resumes.		
Check point	<ul style="list-style-type: none"> Check for sudden speed reduction. Check if the regeneration avoidance function (Pr.882, Pr.883, Pr.885, and Pr.886) is being used. 			
Corrective action	The deceleration time may change. Increase the deceleration time using Pr.8 Deceleration time .			
Reference manual	FR-E800 Instruction Manual (Function)			

■ Regenerative brake pre-alarm

Operation panel indication	RB		FR-LU08 indication	RB
Description	Appears if the actual regenerative brake duty reaches or exceeds 85% of the reference regenerative brake duty (100%) determined by the settings of Pr.30 Regenerative function selection and Pr.70 Special regenerative brake duty . If the regenerative brake duty reaches 100%, a regenerative overvoltage (E. OV[]) occurs.			
Check point	<ul style="list-style-type: none"> • Check if the brake resistor duty is not too high. • Check that the Pr.30 Regenerative function selection and Pr.70 settings are correct. 			
Corrective action	<ul style="list-style-type: none"> • Set the deceleration time longer. • Check the Pr.30 and Pr.70 settings. 			
Reference manual	FR-E800 Instruction Manual (Function)			

■ Electronic thermal relay function pre-alarm

Operation panel indication	TH		FR-LU08 indication	TH
Description	Appears if the cumulative value of the electronic thermal O/L relay reaches or exceeds 85% of the preset level of Pr.9 Electronic thermal O/L relay . If the specified value is reached, the protection circuit is activated to shut off the inverter output.			
Check point	<ul style="list-style-type: none"> • Check for large load or sudden acceleration. • Check that the Pr.9 setting is appropriate. 			
Corrective action	<ul style="list-style-type: none"> • Reduce the load and frequency of operation. • Set an appropriate value in Pr.9. 			
Reference manual	FR-E800 Instruction Manual (Function)			

■ PU stop

Operation panel indication	PS		FR-LU08 indication	PS
Description	<ul style="list-style-type: none"> • The motor is stopped using the STOP/RESET key under the mode other than the PU operation mode. (To enable the STOP/RESET key under the mode other than the PU operation mode, set Pr.75 Reset selection/disconnected PU detection/PU stop selection.) • The motor is stopped by the emergency stop function. 			
Check point	<ul style="list-style-type: none"> • Check for a stop made by pressing the STOP/RESET key on the operation panel. • Check for whether the X92 signal is OFF. 			
Corrective action	<ul style="list-style-type: none"> • Turn OFF the start signal and press the PU/EXT key for release. • Turn ON the X92 signal and OFF the start signal for release. 			
Reference manual	FR-E800 Instruction Manual (Function)			

■ Speed limit indication (output during speed limit)

Operation panel indication	SL		FR-LU08 indication	SL
Description	Output if the speed limit level is exceeded during torque control.			
Check point	<ul style="list-style-type: none"> • Check that the torque command is not larger than required. • Check if the speed limit level is set too low. 			
Corrective action	<ul style="list-style-type: none"> • Decrease the torque command value. • Increase the speed limit level. 			
Reference manual	FR-E800 Instruction Manual (Function)			

■ Safety stop

Operation panel indication	SA		FR-LU08 indication	SA
Description	Appears when safety stop function is activated (during output shutoff).			
Check point	<ul style="list-style-type: none"> • Check if an emergency stop device is activated. • Check if the shorting wire between S1 and PC or between S2 and PC is disconnected when not using the safety stop function. 			
Corrective action	<ul style="list-style-type: none"> • An emergency stop device is active when using the safety stop function. Identify the cause of emergency stop, ensure the safety and restart the system. • When not using the safety stop function, short across terminals S1 and PC and across S2 and PC with shorting wire for the inverter to run. • If "SA" is indicated when wires across S1 and PC and across S2 and PC are both conducted while using the safety stop function (drive enabled), internal failure might be the cause. Check the wiring of terminals S1, S2, and SIC and contact your sales representative if the wiring has no fault. 			
Reference manual	FR-E800 Instruction Manual (Functional Safety)			

■ Maintenance timer

Operation panel indication	MT		FR-LU08 indication	MT
Description	Appears when the inverter's cumulative energization time reaches or exceeds the parameter set value. Set the time until the MT is displayed using Pr.504 Maintenance timer warning output set time (MT) . "MT" does not appear when the setting of Pr.504 is the initial value ("9999").			
Check point	The set time of maintenance timer has been exceeded.			
Corrective action	Take appropriate countermeasures according to the purpose of the maintenance timer setting. Setting "0" in Pr.503 Maintenance timer clears the indication.			
Reference manual	FR-E800 Instruction Manual (Function)			

■ Continuous operation during communication fault

Operation panel indication	CF		FR-LU08 indication	CF
Description	Appears when the operation continues while an error is occurring in the communication line or communication option (when Pr.502 = "6").			
Check point	<ul style="list-style-type: none"> • Check for a break in the communication cable. • Check for communication option faults. 			
Corrective action	<ul style="list-style-type: none"> • Check the connection of communication cable. • Replace the communication option. 			
Reference manual	FR-E800 Instruction Manual (Function)			

■ Load fault warning

Operation panel indication	LDF		FR-LU08 indication	LDF
Description	Appears when the load is deviated from the detection width set in Pr.1488 Upper limit warning detection width or Pr.1489 Lower limit warning detection width .			
Check point	<ul style="list-style-type: none"> • Check if too much load is applied to the equipment, or if the load is too light. • Check that the load characteristics settings are correct. 			
Corrective action	<ul style="list-style-type: none"> • Inspect the equipment. • Set the load characteristics (Pr.1481 to Pr.1487) correctly. 			
Reference manual	FR-E800 Instruction Manual (Function)			

■ Ethernet communication fault

Operation panel indication	EHR		FR-LU08 indication	EHR
Description	Appears when Ethernet communication is interrupted by physical factors while Pr.1431 Ethernet signal loss detection function selection = "1 to 3".			
Check point	<ul style="list-style-type: none"> • Check for a break in the communication cable. • Check for a break in the Ethernet cable. 			
Corrective action	<ul style="list-style-type: none"> • Connect the Ethernet board securely. • Check that the Ethernet cable is connected to the Ethernet connector properly and the Ethernet cable is not damaged. 			
Reference manual	FR-E800 Instruction Manual (Communication)			

■ Duplicate IP address

Operation panel indication	DIP		FR-LU08 indication	DIP
Description	Appears when duplicate IP address is detected.			
Check point	Check that the specified IP address is not overlapping with the IP address of any other device on the network.			
Corrective action	Enter a unique IP address.			
Reference manual	FR-E800 Instruction Manual (Communication)			

■ IP address fault

Operation panel indication	IP		FR-LU08 indication	IP
Description	Appears when the IP address or the subnet mask is out of the specified range.			
Check point	<ul style="list-style-type: none"> • Check that "0 or 255" is not set in the third or fourth octet of the IP address. • Check that the subnet mask setting is appropriate. • Check that the IP address settings are correct. 			
Corrective action	<ul style="list-style-type: none"> • Set "1 to 254" in the third or fourth octet of the IP address. • Set the subnet mask (Pr.1438 to Pr.1441) correctly. • Set the IP address (Pr.1434 to Pr.1447) correctly. 			
Reference manual	FR-E800 Instruction Manual (Communication)			

■ Incorrect parameter setting

Operation panel indication	SE		FR-LU08 indication	SE
Description	Appears when a start command is input while the condition to start operation is not satisfied in the motor setting (Pr.71, Pr.450, Pr.80, Pr.453, Pr.81, or Pr.454) for the control method selected in Pr.800 or Pr.451.			
Check point	Check that the motor setting is appropriate for the control method.			
Corrective action	Change the control method setting or the motor setting as appropriate.			
Reference manual	FR-E800 Instruction Manual (Function)			

■ Corrosion warning

Operation panel indication	Cor		FR-LU08 indication	Cor
Description	Appears when the corrosion level of the control circuit board becomes "3" (Pr.198 = "3"). (Available only for the FR-E800-□-□-60 (with coating).)			
Check point	Check that the operating environment of the inverter is appropriate.			
Corrective action	<ul style="list-style-type: none"> • Improve the operating environment of the inverter (by a filter or ventilation). • Consider replacing the inverter early. 			
Reference manual	FR-E800 Instruction Manual (Function)			

■ Undervoltage

Operation panel indication	UV		FR-LU08 indication	—
Description	If the power supply voltage of the inverter decreases, the control circuit will not perform normal functions. In addition, the motor torque will be insufficient and/or heat generation will increase. To prevent this, if the power supply voltage decreases to about 115 VAC (230 VAC for the 400 V class, 330 VAC for the 575 V class, 58 VAC for the 100 V class) or below (when the PM sensorless vector control is selected: about 156 VAC (311 VAC for the 400 V class, 448 VAC for the 575 V class, 78 VAC for the 100 V class) or below), this function shuts off the inverter output and "UV" is displayed. The warning is removed when the voltage returns to normal.			
Check point	Check that the power supply voltage is normal.			
Corrective action	Check the devices on the power system such as the power supply itself.			

■ Stroke limit warning

Operation panel indication	LP		FR-LU08 indication	LP
Description	Appears when the Forward stroke end (LSP) signal or the Reverse stroke end (LSN) signal is assigned to the input terminal and the signal is turned OFF (normally closed input). The indication remains displayed while the signal is OFF.			
Check point	Check if the LSP/LSN signal is turned OFF (normally closed input).			
Corrective action	Turn ON the LSP/LSN signal (normally closed input).			
Reference manual	FR-E800 Instruction Manual (Function)			

■ Home position return error

Operation panel indication	HP1, HP2		FR-LU08 indication	HP1, HP2
Description	Appears when an error occurs during the home position return operation under position control.			
Check point	Identify the cause of the error occurrence.			
Corrective action	Check the parameter setting, and check that the input signal is correct.			
Reference manual	FR-E800 Instruction Manual (Function)			

■ Emergency drive in operation (Standard model / Ethernet model)

Operation panel indication	ED		FR-LU08 indication	ED
Description	Appears during emergency drive operation.			
Check point	Emergency drive operation is performed by turning ON the X84 signal.			
Corrective action	The display is cleared when the emergency drive operation ends.			
Reference manual	FR-E800 Instruction Manual (Function)			

◆ Alarm

Output is not shut off when a protective function is activated. The Alarm (LF) signal can be output depending on the parameter setting. (Set "98" in **Pr.190 to Pr.197 (Output terminal function selection)**). Refer to the FR-E800 Instruction Manual (Function).)

■ Fan alarm

Operation panel indication	FN	<i>F_n</i>	FR-LU08 indication	FN
Description	For the inverter that contains a cooling fan, FN appears on the operation panel when the cooling fan stops due to a fault, low rotation speed, or different operation from the setting of Pr.244 Cooling fan operation selection .			
Check point	When the cooling fan is replaced, check that the fan is not installed upside down. Check the cooling fan for a failure.			
Corrective action	Install the fan correctly. (Refer to page 53 .) If the fan alarm still occurs after the fan is installed correctly, the fan may be faulty. Contact your sales representative.			

◆ Fault

When a protective function is activated, the inverter output is shut off and a fault signal is output.

■ Overcurrent trip during acceleration

Operation panel indication	E.OC1	<i>E.oC1</i>	FR-LU08 indication	OC During Acc
Description	When the inverter output current reaches or exceeds approximately 230% ^{*1} of the rated current during acceleration, the protection circuit is activated and the inverter output is shut off.			
Check point	<ul style="list-style-type: none"> • Check for sudden speed acceleration. • Check if the downward acceleration time is too long in a lift application. • Check for output short-circuit. • Check that the Pr.3 Base frequency setting is not 60 Hz when the motor rated frequency is 50 Hz. • Check if the stall prevention operation level is set too high. Check if the fast-response current limit operation is disabled. • Check that the regenerative driving is not performed frequently. (Check if the output voltage becomes larger than the V/F reference voltage at regenerative driving and overcurrent occurs due to increase in the motor current.) • Check that the encoder wiring and the specifications (encoder power supply, resolution, differential/complementary) are correct. Check also that the motor wiring (U, V, W) is correct (under Vector control). • Check that the rotation direction is not switched from forward to reverse rotation (or from reverse to forward) during torque control under Real sensorless vector control. • Check that the inverter capacity matches with the motor capacity. (PM sensorless vector control) • Check if a start command is given to the inverter while the motor is coasting. (PM sensorless vector control) 			
Corrective action	<ul style="list-style-type: none"> • Set the acceleration time longer. (Shorten the downward acceleration time of the lift.) • If "E.OC1" always appears at start, disconnect the motor once and restart the inverter. If "E.OC1" still appears, contact your sales representative. • Check the wiring to make sure that output short circuit does not occur. • Set 50 Hz in Pr.3 Base frequency. • Lower the stall prevention operation level. Activate the fast-response current limit operation. • Set the base voltage (rated voltage of the motor, etc.) in Pr.19 Base frequency voltage. • Check the wiring and specifications of the encoder and the motor. Perform the setting according to the specifications of the encoder and the motor (under Vector control). • Prevent the motor from switching the rotation direction from forward to reverse (or from reverse to forward) during torque control under Real sensorless vector control. • Choose inverter and motor capacities that match. (PM sensorless vector control) • Input a start command after the motor stops. Alternatively, use the automatic restart after instantaneous power failure / flying start function. (PM sensorless vector control) 			
Reference manual	<ul style="list-style-type: none"> • FR-E800 Instruction Manual (Connection) • FR-E860 Instruction Manual (Connection) • FR-E800 Instruction Manual (Function) 			

*1 Differs according to ratings and the inverter capacity. The rating can be changed using **Pr.570 Multiple rating setting**.

Three-phase input:

170% for LD rating, 230% for ND rating (initial setting) (FR-E820-0175(3.7K) or lower, FR-E820-0760(18.5K), FR-E820-0900(22K), FR-E840-0095(3.7K) or lower, FR-E840-0380(18.5K), FR-E840-0440(22K), FR-E860-0061(3.7K) or lower, FR-E846-0095(3.7K) or lower), and 235% for ND rating (FR-E820-0240(5.5K) to FR-E820-0600(15K), FR-E840-0120(5.5K) to FR-E840-0300(15K), FR-E860-0090(5.5K) or higher)

Single-phase input (ND rating only):

280% (FR-E820S-0015(0.2K) or lower, or lower) and 230% (FR-E820S-0030(0.4K) or higher, or higher)

■ Overcurrent trip during constant speed

Operation panel indication	E.OC2		FR-LU08 indication	OC During Cnst Spd
Description	When the inverter output current reaches or exceeds approximately 230% ^{*2} of the rated current during constant-speed operation, the protection circuit is activated and the inverter output is shut off.			
Check point	<ul style="list-style-type: none"> • Check for sudden load change. • Check for a short-circuit in the output circuit. • Check if the stall prevention operation level is set too high. Check if the fast-response current limit operation is disabled. • Check that the rotation direction is not switched from forward to reverse rotation (or from reverse to forward) during torque control under Real sensorless vector control. • Check that the inverter capacity matches with the motor capacity. (PM sensorless vector control) • Check if a start command is given to the inverter while the motor is coasting. (PM sensorless vector control) 			
Corrective action	<ul style="list-style-type: none"> • Keep the load stable. • Check the wiring to make sure that output short circuit does not occur. • Lower the stall prevention operation level. Activate the fast-response current limit operation. • Prevent the motor from switching the rotation direction from forward to reverse (or from reverse to forward) during torque control under Real sensorless vector control. • Choose inverter and motor capacities that match. (PM sensorless vector control) • Input a start command after the motor stops. Alternatively, use the automatic restart after instantaneous power failure / flying start function. (PM sensorless vector control) 			
Reference manual	FR-E800 Instruction Manual (Function)			

*2 Differs according to ratings and the inverter capacity. The rating can be changed using **Pr.570 Multiple rating setting**.

Three-phase input:

170% for LD rating, 230% for ND rating (initial setting) (FR-E820-0175(3.7K) or lower, FR-E820-0760(18.5K), FR-E820-0900(22K), FR-E840-0095(3.7K) or lower, FR-E840-0380(18.5K), FR-E840-0440(22K), FR-E860-0061(3.7K) or lower, FR-E846-0095(3.7K) or lower), and 235% for ND rating (FR-E820-0240(5.5K) to FR-E820-0600(15K), FR-E840-0120(5.5K) to FR-E840-0300(15K), FR-E860-0090(5.5K) or higher)

Single-phase input (ND rating only):

280% (FR-E820S-0015(0.2K) or lower, or lower) and 230% (FR-E820S-0030(0.4K) or higher, or higher)

■ Overcurrent trip during deceleration or stop

Operation panel indication	E.OC3		FR-LU08 indication	OC During Dec
Description	When the inverter output current reaches or exceeds approximately 230% ^{*3} of the rated current during deceleration (other than acceleration or constant speed), the protection circuit is activated and the inverter output is shut off.			
Check point	<ul style="list-style-type: none"> • Check for sudden speed reduction. • Check for a short-circuit in the output circuit. • Check for too fast operation of the motor's mechanical brake. • Check if the stall prevention operation level is set too high. Check if the fast-response current limit operation is disabled. • Check that the rotation direction is not switched from forward to reverse rotation (or from reverse to forward) during torque control under Real sensorless vector control. • Check that the inverter capacity matches with the motor capacity. (PM sensorless vector control) • Check if a start command is given to the inverter while the motor is coasting. (PM sensorless vector control) 			
Corrective action	<ul style="list-style-type: none"> • Set the deceleration time longer. • Check the wiring to make sure that output short circuit does not occur. • Check the mechanical brake operation. • Lower the stall prevention operation level. Activate the fast-response current limit operation. • Prevent the motor from switching the rotation direction from forward to reverse (or from reverse to forward) during torque control under Real sensorless vector control. • Choose inverter and motor capacities that match. (PM sensorless vector control) • Input a start command after the motor stops. Alternatively, use the automatic restart after instantaneous power failure / flying start function. (PM sensorless vector control) 			
Reference manual	FR-E800 Instruction Manual (Function)			

*3 Differs according to ratings and the inverter capacity. The rating can be changed using **Pr.570 Multiple rating setting**.

Three-phase input:

170% for LD rating, 230% for ND rating (initial setting) (FR-E820-0175(3.7K) or lower, FR-E820-0760(18.5K), FR-E820-0900(22K), FR-E840-0095(3.7K) or lower, FR-E840-0380(18.5K), FR-E840-0440(22K), FR-E860-0061(3.7K) or lower, FR-E846-0095(3.7K) or lower), and 235% for ND rating (FR-E820-0240(5.5K) to FR-E820-0600(15K), FR-E840-0120(5.5K) to FR-E840-0300(15K), FR-E860-0090(5.5K) or higher)

Single-phase input (ND rating only):

280% (FR-E820S-0015(0.2K) or lower, or lower) and 230% (FR-E820S-0030(0.4K) or higher, or higher)

■ Regenerative overvoltage trip during acceleration

Operation panel indication	E.OV1	<i>E.ov1</i>	FR-LU08 indication	OV During Acc
Description	If regenerative power causes the inverter's internal main circuit DC voltage to reach or exceed the specified value, the protection circuit is activated to stop the inverter output. The circuit may also be activated by a surge voltage produced in the power supply system.			
Check point	<ul style="list-style-type: none"> • Check for too slow acceleration. (e.g. during downward acceleration in vertical lift load) • Check that the Pr.22 Stall prevention operation level is not set to the no load current or lower. • Check if the stall prevention operation is frequently activated in an application with a large load inertia. 			
Corrective action	<ul style="list-style-type: none"> • Set the acceleration time shorter. • Use the regeneration avoidance function (Pr.882, Pr.883, Pr.885, and Pr.886). • Set a value larger than the no load current in Pr.22. • Set Pr.154 Voltage reduction selection during stall prevention operation = "11". 			
Reference manual	FR-E800 Instruction Manual (Function)			

■ Regenerative overvoltage trip during constant speed

Operation panel indication	E.OV2	<i>E.ov2</i>	FR-LU08 indication	OV During Cnst Spd
Description	If regenerative power causes the inverter's internal main circuit DC voltage to reach or exceed the specified value, the protection circuit is activated to stop the inverter output. The circuit may also be activated by a surge voltage produced in the power supply system.			
Check point	<ul style="list-style-type: none"> • Check for sudden load change. • Check that the Pr.22 Stall prevention operation level is not set to the no load current or lower. • Check if the stall prevention operation is frequently activated in an application with a large load inertia. • Check that acceleration/deceleration time is not too short. 			
Corrective action	<ul style="list-style-type: none"> • Keep the load stable. • Use the regeneration avoidance function (Pr.882, Pr.883, Pr.885, and Pr.886). • Use a brake resistor or brake unit, or the multifunction regeneration converter (FR-XC) as required. • Set a value larger than the no load current in Pr.22. • Set Pr.154 Voltage reduction selection during stall prevention operation = "11". • Set the acceleration/deceleration time longer. (Under Vector control or Advanced magnetic flux vector control, the output torque can be increased. However, sudden acceleration may cause an overshoot in speed, resulting in an occurrence of overvoltage.) 			
Reference manual	FR-E800 Instruction Manual (Function)			

■ Regenerative overvoltage trip during deceleration or stop

Operation panel indication	E.OV3	<i>E.ov3</i>	FR-LU08 indication	OV During Dec
Description	If regenerative power causes the inverter's internal main circuit DC voltage to reach or exceed the specified value, the protection circuit is activated to stop the inverter output. The circuit may also be activated by a surge voltage produced in the power supply system.			
Check point	<ul style="list-style-type: none"> • Check for sudden speed reduction. • Check if the stall prevention operation is frequently activated in an application with a large load inertia. 			
Corrective action	<ul style="list-style-type: none"> • Set the deceleration time longer. (Set the deceleration time which matches the moment of inertia of the load.) • Make the brake cycle longer. • Use the regeneration avoidance function (Pr.882, Pr.883, Pr.885, and Pr.886). • Use a brake resistor or brake unit, or the multifunction regeneration converter (FR-XC) as required. • Set Pr.154 Voltage reduction selection during stall prevention operation = "11". 			
Reference manual	FR-E800 Instruction Manual (Function)			

■ Inverter overload trip (electronic thermal relay function)

Resetting the inverter initializes the internal cumulative heat value of the electronic thermal relay function.

Operation panel indication	E.THT		FR-LU08 indication	Inv. overload trip
Description	If the temperature of the output transistor elements exceeds the protection level with a rated output current or higher flowing without the overcurrent trip (E.OC[]), the inverter output is stopped. (Overload capacity 150% 60 s)			
Check point	<ul style="list-style-type: none"> • Check that acceleration/deceleration time is not too short. • Check that torque boost setting is not too large (small). • Check that load pattern selection setting is appropriate for the load pattern of the using machine. • Check the motor for the use under overload. • Check that the encoder wiring and the specifications (encoder power supply, resolution, differential/complementary) are correct. Check also that the motor wiring (U, V, W) is correct (under Vector control). 			
Corrective action	<ul style="list-style-type: none"> • Set the acceleration/deceleration time longer. • Adjust the torque boost setting. • Set the load pattern selection setting according to the load pattern of the using machine. • Reduce the load. • Check the wiring and specifications of the encoder and the motor. Perform the setting according to the specifications of the encoder and the motor (under Vector control). 			
Reference manual	<ul style="list-style-type: none"> • FR-E800 Instruction Manual (Connection) • FR-E860 Instruction Manual (Connection) • FR-E800 Instruction Manual (Function) 			

■ Motor overload trip (electronic thermal relay function)

Resetting the inverter initializes the internal cumulative heat value of the electronic thermal relay function.

Operation panel indication	E.THM		FR-LU08 indication	Motor overload trip
Description	The electronic thermal O/L relay function in the inverter detects motor overheat, which is caused by overload or reduced cooling capability during low-speed operation. When the cumulative heat value reaches 85% of the Pr.9 Electronic thermal O/L relay setting, pre-alarm (TH) is output. When the accumulated value reaches the specified value, the protection circuit is activated to stop the inverter output. When the inverter is used to drive a dedicated motor, such as a multiple-pole motor, or several motors, the motor cannot be protected by the electronic thermal O/L relay. Install an external thermal relay on the inverter output side.			
Check point	<ul style="list-style-type: none"> • Check the motor for the use under overload. • Check that the setting of Pr.71 Applied motor for motor selection is correct. • Check that the stall prevention operation setting is correct. 			
Corrective action	<ul style="list-style-type: none"> • Reduce the load. • For a constant-torque motor, set the constant-torque motor in Pr.71. • Set the stall prevention operation level accordingly. 			
Reference manual	FR-E800 Instruction Manual (Function)			

■ Heat sink overheat

Operation panel indication	E.FIN		FR-LU08 indication	Heatsink overheat
Description	When the heat sink overheats, the temperature sensor is activated, and the inverter output is stopped. The FIN signal can be output when the temperature becomes approximately 85% of the heat sink overheat protection operation temperature. For the terminal used for the FIN signal output, assign the function by setting "26" (positive logic) or "126" (negative logic) in any parameter from Pr.190 to Pr.197 (Output terminal function selection) .			
Check point	<ul style="list-style-type: none"> • Check for too high surrounding air temperature. • Check for heat sink clogging. • Check that the cooling system is not stopped. (Check that FN is not displayed on the operation panel.) • Check that the cooling fan is installed in correct orientation. 			
Corrective action	<ul style="list-style-type: none"> • Set the surrounding air temperature to within the specifications. • Clean the heat sink. • Replace the cooling fan. • Install the cooling fan in correct orientation. 			
Reference manual	FR-E800 Instruction Manual (Function)			

■ Undervoltage

Operation panel indication	E.UVT	<i>E.UVT</i>	FR-LU08 indication	Under Voltage
Description	When a PM motor is used, the protective function is activated in the following case: a fault such as power failure or voltage drop occurs, the converter voltage drops to cause the motor to coast, and restarting and coasting are repeated by the automatic restart after instantaneous power failure function.			
Check point	Check that no fault is found in the power supply.			
Corrective action	Supply appropriate power.			
Reference manual	FR-E800 Instruction Manual (Function)			

■ Input phase loss

Operation panel indication	E.ILF	<i>E.ILF</i>	FR-LU08 indication	Input phase loss
Description	When Pr.872 Input phase loss protection selection = "1" (function enabled) and one of the three-phase power input is lost, the inverter output is shut off. This protective function is not available when "0" is set in Pr.872 . (Available only for the three-phase power input model.)			
Check point	Check for a break in the cable for the three-phase power supply input.			
Corrective action	<ul style="list-style-type: none"> • Wire the cables properly. • Repair a break portion in the cable. 			
Reference manual	FR-E800 Instruction Manual (Function)			

■ Stall prevention stop

Operation panel indication	E.OLT	<i>E.OLT</i>	FR-LU08 indication	Stall prevention STP
Description	<p>V/F Magnetic flux</p> <p>If the output frequency has fallen to 1.0 Hz by stall prevention operation and remains for 3 seconds, a fault (E.OLT) appears and the inverter is shut off. OLC or OLV appears while stall prevention is being activated.</p> <p>Sensorless Vector PM</p> <p>When speed control is performed, a fault (E.OLT) appears and the inverter output is shut off if frequency drops to the Pr.865 Low speed detection (initial value is 1.5 Hz) setting by torque limit operation and the output torque exceeds the Pr.874 OLT level setting (initial value is 150%) setting and remains 3 seconds.</p>			
Check point	<ul style="list-style-type: none"> • Check the motor for the use under overload. • Check that the Pr.865 and Pr.874 values are correct. (Check the Pr.22 Stall prevention operation level setting under V/F control and Advanced magnetic flux vector control.) • Check if a motor is connected under PM sensorless vector control. 			
Corrective action	<ul style="list-style-type: none"> • Reduce the load. • Change the Pr.22, Pr.865, and Pr.874 values. (Check the Pr.22 setting under V/F control and Advanced magnetic flux vector control.) • For the test operation without connecting a motor, select the PM sensorless vector control test operation. • Also check that the stall prevention (overcurrent) warning (OLC) or the stall prevention (overvoltage) warning (OLV) countermeasure is taken. 			
Reference manual	FR-E800 Instruction Manual (Function)			

■ Loss of synchronism detection

Operation panel indication	E.SOT PM	<i>E.SOT</i>	FR-LU08 indication	Motor Step Out
Description	The inverter output is shut off when the motor operation is not synchronized. (This function is only available under PM sensorless vector control.)			
Check point	<ul style="list-style-type: none"> • Check that the PM motor is not driven overloaded. • Check if a start command is given to the inverter while the PM motor is coasting. • Check if a motor is connected under PM sensorless vector control. • Check if a motor other than PM motors is driven. 			
Corrective action	<ul style="list-style-type: none"> • Set the acceleration time longer. • Reduce the load. • If the inverter restarts during coasting, set Pr.57 Restart coasting time ≠ "9999", and select the automatic restart after instantaneous power failure. • Check the connection of the IPM motor. • For the test operation without connecting a motor, select the PM sensorless vector control test operation. • When driving a PM motor, offline auto tuning must be performed. 			
Reference manual	FR-E800 Instruction Manual (Function)			

■ Upper limit fault detection

Operation panel indication	E.LUP	<i>E.LUP</i>	FR-LU08 indication	Upper limit fault
Description	The inverter output is shut off when the load exceeds the upper limit fault detection range. This protective function is not available in the initial setting of Pr.1490 (Pr.1490 = "9999").			
Check point	<ul style="list-style-type: none"> • Check if too much load is applied to the equipment. • Check that the load characteristics settings are correct. 			
Corrective action	<ul style="list-style-type: none"> • Inspect the equipment. • Set the load characteristics (Pr.1481 to Pr.1487) correctly. 			
Reference manual	FR-E800 Instruction Manual (Function)			

■ Lower limit fault detection

Operation panel indication	E.LDN	<i>E.Ldn</i>	FR-LU08 indication	Lower limit fault
Description	The inverter output is shut off when the load falls below the lower limit fault detection range. This protective function is not available in the initial setting of Pr.1491 (Pr.1491 = "9999").			
Check point	<ul style="list-style-type: none"> • Check if the equipment load is too light. • Check that the load characteristics settings are correct. 			
Corrective action	<ul style="list-style-type: none"> • Inspect the equipment. • Set the load characteristics (Pr.1481 to Pr.1487) correctly. 			
Reference manual	FR-E800 Instruction Manual (Function)			

■ Brake transistor alarm detection

Operation panel indication	E.BE	<i>E.bE</i>	ER-LU08 indication	Brake transistor err
Description	<ul style="list-style-type: none"> • The inverter output is shut off if a fault due to damage of the brake transistor and such occurs in the brake circuit. In such a case, the power supply to the inverter must be shut off immediately.			
Check point	<ul style="list-style-type: none"> • Reduce the load inertia. • Check that the brake duty is proper. 			
Corrective action	Replace the inverter.			

■ Output side earth (ground) fault overcurrent

Operation panel indication	E.GF	<i>E.GF</i>	FR-LU08 indication	Ground Fault
Description	The inverter output is shut off if an earth (ground) fault overcurrent flows due to an earth (ground) fault that occurred on the inverter's output side (load side).			
Check point	Check for a ground fault in the motor and connection cable.			
Corrective action	Remedy the earth (ground) fault portion.			
Reference manual	FR-E800 Instruction Manual (Function)			

■ Output phase loss

Operation panel indication	E.LF	<i>E.LF</i>	FR-LU08 indication	Output phase loss
Description	The inverter output is shut off if one of the three phases (U, V, W) on the inverter's output side (load side) is lost.			
Check point	<ul style="list-style-type: none"> • Check the wiring. (Check that the motor is normally operating.) • Check that the capacity of the motor used is not smaller than that of the inverter. • Check if a start command is given to the inverter while the motor is coasting. (PM sensorless vector control) 			
Corrective action	<ul style="list-style-type: none"> • Wire the cables properly. • Input a start command after the motor stops. Alternatively, use the automatic restart after instantaneous power failure / flying start function. (PM sensorless vector control) 			
Reference manual	FR-E800 Instruction Manual (Function)			

■ External thermal relay operation

Operation panel indication	E.OHT	<i>E.OHT</i>	FR-LU08 indication	Ext TH relay oper
Description	The inverter output is shut off if the external thermal relay provided for motor overheat protection or the internally mounted thermal relay in the motor, etc. switches ON (contacts open). This function is available when "7" (OH signal) is set in any of Pr.178 to Pr.184 (Input terminal function selection) . This protective function is not available in the initial status. (OH signal is not assigned.) (This protective function is available for the standard model and the Ethernet model.)			
Check point	<ul style="list-style-type: none"> • Check for motor overheating. • Check that the value "7" (OH signal) is set correctly to any of Pr.178 to Pr.184 (Input terminal function selection). 			
Corrective action	<ul style="list-style-type: none"> • Reduce the load and operation duty. • Even if the relay contacts are reset automatically, the inverter will not restart unless it is reset. 			

■ PTC thermistor operation

Operation panel indication	E.PTC	<i>E.PTC</i>	FR-LU08 indication	PTC thermistor oper
Description	The inverter output is shut off if resistance of the PTC thermistor connected between terminal 2 and terminal 10 is equal to or higher than the Pr.561 PTC thermistor protection level setting for a continuous time equal to or longer than the setting value in Pr.1016 PTC thermistor protection detection time . This protective function is not available in the initial setting of Pr.561 (Pr.561 = "9999") .			
Check point	<ul style="list-style-type: none"> • Check the connection with the PTC thermistor. • Check the Pr.561 and Pr.1016 settings. • Check the motor for operation under overload. 			
Corrective action	Reduce the load.			
Reference manual	FR-E800 Instruction Manual (Function)			

■ Option fault

Operation panel indication	E.OPT	<i>E.OPT</i>	FR-LU08 indication	Option Fault
Description	<ul style="list-style-type: none"> • Appears when torque command by the plug-in option is selected using Pr.804 Torque command source selection and no plug-in option is mounted. This function is available under torque control. • Appears when the switch for manufacturer setting of the plug-in option is changed. • Appears when a communication option is connected while Pr.296 Password lock level = "0 or 100". 			
Check point	<ul style="list-style-type: none"> • Check that the plug-in option for torque command setting is connected. • Check for the password lock with a setting of Pr.296 = "0, 100". 			
Corrective action	<ul style="list-style-type: none"> • Check for connection of the plug-in option. Check the Pr.804 setting. • Set the switch on the plug-in option, which is for manufacturer setting, back to the initial setting. • To apply the password lock when installing a communication option, set Pr.296 ≠ "0, 100". 			
Reference manual	<ul style="list-style-type: none"> • FR-E800 Instruction Manual (Function) • Instruction Manual of each option 			

■ Communication option fault

Operation panel indication	E.OP1	<i>E.OP1</i>	FR-LU08 indication	Option1 Fault
Description	The inverter output is shut off if a communication line error occurs in the communication option.			
Check point	<ul style="list-style-type: none"> • Check for an incorrect option function setting and operation. • Check that the plug-in option is plugged into the connector securely. • Check for a break in the communication cable. • Check that the terminating resistor is fitted properly. 			
Corrective action	<ul style="list-style-type: none"> • Check the option function setting, etc. • Connect the plug-in option securely. • Check the connection of communication cable. • If the fault occurs again when the inverter is reset, contact your sales representative. 			

■ User definition error by the PLC function

Operation panel indication	E.16 to E.20	<i>E. 16</i> to <i>E. 20</i>	FR-LU08 indication	Fault 16 to Fault 20
Description	The protective function is activated by setting "16 to 20" in the special register SD1214 for the PLC function. The inverter output is shut off when the protective function is activated. The protective function is activated when the PLC function is enabled. This protective function is not available in the initial setting (Pr.414 = "0").			
Check point	• Check if "16 to 20" is set in the special register SD1214.			
Corrective action	• Set a value other than "16 to 20" in the special register SD1214.			
Reference manual	FR-E800 Instruction Manual (Function)			

■ Internal storage device fault

Operation panel indication	E.PE6	<i>E.PE6</i>	FR-LU08 indication	Fault
Description	This protective function is activated by an inverter reset if writing data fails due to power-OFF or a data fault occurs in the storage device during parameter operations ^{*1} .			
Check point	Check if the power was turned OFF during parameter operations.			
Corrective action	Check the power supply or the devices on the power system to check that the devices have no fault. • When E.PE6 occurs due to power-OFF during parameter operations: Check the read value of Pr.890 . When the value is "7" or smaller, perform All parameter clear and then an inverter reset. The parameters that had been changed before All parameter clear must be set again. • When E.PE6 occurs due to other reason (such as turning OFF/ON the power or an inverter reset) or when the read value of Pr.890 is "8" or more: Contact your sales representative.			
Reference manual	FR-E800 Instruction Manual (Function)			

*1 For example, when parameter clear, All parameter clear, Parameter copy, or offline auto tuning is performed in the inverter, or when parameter batch write is performed in FR Configurator2.

■ Parameter storage device fault (control circuit board)

Operation panel indication	E.PE	<i>E.PE</i>	FR-LU08 indication	Corrupt Memory
Description	The inverter output is shut off if a fault occurs in the parameter stored. (EEPROM failure)			
Check point	Check for too many number of parameter write times.			
Corrective action	Contact your sales representative. Set "1" in Pr.342 Communication EEPROM write selection (write to RAM) for the operation which requires frequent parameter writing via communication, etc. Note that writing to RAM goes back to the initial status at power OFF.			
Reference manual	FR-E800 Instruction Manual (Function)			

■ PU disconnection

Operation panel indication	E.PUE	<i>E.PUE</i>	FR-LU08 indication	PU disconnection
Description	<ul style="list-style-type: none"> • The inverter output is shut off if communication between the inverter and PU is suspended, e.g. the cable is disconnected from the PU connector, when the disconnected PU detection function is valid in Pr.75 Reset selection/disconnected PU detection/PU stop selection. • The inverter output is shut off if communication errors occurred consecutively for more than permissible number of retries when Pr.121 PU communication retry count ≠ "9999" during the RS-485 communication via the PU connector. • The inverter output is shut off if communication is broken within the period of time set in Pr.122 PU communication check time interval during the RS-485 communication via the PU connector. (This protective function is available for the standard model.) 			
Check point	Check the Pr.75 setting.			
Corrective action	Change the Pr.75 setting.			
Reference manual	FR-E800 Instruction Manual (Function)			

■ Retry count excess

Operation panel indication	E.RET	<i>E.r ET</i>	FR-LU08 indication	Retry count excess
Description	The inverter output is shut off if the operation cannot be resumed properly within the number of retries set in Pr.67 Number of retries at fault occurrence . This function is available when Pr.67 is set. This protective function is not available in the initial setting (Pr.67 = "0").			
Check point	Find the cause of the fault occurrence.			
Corrective action	Eliminate the cause of the fault preceding this fault indication.			
Reference manual	FR-E800 Instruction Manual (Function)			

■ Parameter storage device fault (main circuit board)

Operation panel indication	E.PE2	<i>E.PE2</i>	FR-LU08 indication	PR storage alarm
Description	The inverter output is shut off if a fault occurs in the inverter model information.			
Check point	-----			
Corrective action	Contact your sales representative.			

■ CPU fault

Operation panel indication	E.CPU	<i>E.CPU</i>	FR-LU08 indication	CPU fault
	E. 5	<i>E. 5</i>		Fault 5
	E. 6	<i>E. 6</i>		Fault 6
	E. 7	<i>E. 7</i>		Fault 7
Description	The inverter output is shut off if the communication fault of the built-in CPU occurs.			
Check point	<ul style="list-style-type: none"> • Check for devices producing excess electrical noises around the inverter. • When Ethernet communication is used, check that the communication cable is connected properly. 			
Corrective action	<ul style="list-style-type: none"> • Take measures against noises if there are devices producing excess electrical noises around the inverter. • When Ethernet communication is used, connect the communication cable properly. • Contact your sales representative. 			
Reference manual	<ul style="list-style-type: none"> • FR-E800 Instruction Manual (Function) • FR-E800 Instruction Manual (Communication) 			

■ Abnormal output current detection

Operation panel indication	E.CDO	<i>E.Cdo</i>	FR-LU08 indication	OC detect level
Description	The inverter output is shut off if the output current exceeds the Pr.150 Output current detection level setting. This functions is available when "1" is set in Pr.167 Output current detection operation selection . When the initial value (Pr.167 = "0") is set, this protective function is not available.			
Check point	Check the settings of Pr.150 , Pr.151 Output current detection signal delay time , Pr.166 Output current detection signal retention time , and Pr.167 .			
Reference manual	FR-E800 Instruction Manual (Function)			

■ Inrush current limit circuit fault

Operation panel indication	E.IOH	<i>E, oH</i>	FR-LU08 indication	Inrush overheat
Description	The inverter output is shut off when the resistor of the inrush current limit circuit is overheated. The inrush current limit circuit is faulty.			
Check point	<ul style="list-style-type: none"> • Check that frequent power ON/OFF is not repeated. • Check if the input side fuse (5A) in the power supply circuit of the inrush current limit circuit contactor is blown. • Check that the power supply circuit of inrush current limit circuit contactor is not damaged. 			
Corrective action	Configure a circuit where frequent power ON/OFF is not repeated. If the problem still persists after taking the above measure, contact your sales representative.			
Reference manual	FR-E800 Instruction Manual (Function)			

■ Analog input fault

Operation panel indication	E.AIE	<i>E.A. E</i>	FR-LU08 indication	Analog input fault
Description	The inverter output is shut off when a 30 mA or higher current or a 7.5 V or higher voltage is input to terminal 2 while the current input is selected by Pr.73 Analog input selection , or to terminal 4 while the current input is selected by Pr.267 Terminal 4 input selection .			
Check point	Check the Pr.73, Pr.267 , and the voltage/current input switch settings.			
Corrective action	Either give a current less than 30 mA, or set Pr.73, Pr.267 , and the voltage/current input switch to the voltage input and input a voltage.			
Reference manual	FR-E800 Instruction Manual (Function)			

■ USB communication fault

Operation panel indication	E.USB	<i>E.USB</i>	FR-LU08 indication	USB comm error
Description	The inverter output is shut off when the communication is cut off for the time set in Pr.548 USB communication check time interval .			
Check point	<ul style="list-style-type: none"> Check that the USB communication cable is connected securely. 			
Corrective action	<ul style="list-style-type: none"> Check the Pr.548 setting. Connect the USB communication cable securely. Increase the Pr.548 setting or set "9999." 			
Reference manual	FR-E800 Instruction Manual (Function)			

■ Safety circuit fault (Standard model / Ethernet model)

Operation panel indication	E.SAF	<i>E.SAF</i>	FR-LU08 indication	Safety circuit fault
Description	<ul style="list-style-type: none"> The inverter output is shut off when a safety circuit fault occurs. The inverter output is shut off if the either of the wire between S1 and PC or S2 and PC becomes non-conductive while using the safety stop function. When the safety stop function is not used, the inverter output is shut off when the shorting wire between terminals S1 and PC or across S2 and PC is disconnected. 			
Check point	<ul style="list-style-type: none"> Check that the safety relay module or the connection has no fault when using the safety stop function. Check if the shorting wire between S1 and PC or between S2 and PC is disconnected when not using the safety stop function. 			
Corrective action	<ul style="list-style-type: none"> When using the safety stop function, check that the wiring of terminals S1, S2 and PC is correct and the safety stop input signal source such as a safety relay module is operating properly. When the safety stop function is not used, short across terminals S1 and PC and across S2 and PC with shorting wires. 			
Reference manual	<ul style="list-style-type: none"> FR-E800 Instruction Manual (Function) FR-E800 Instruction Manual (Functional Safety) 			

■ Safety circuit fault (Safety communication model)

Operation panel indication	E.SAF	<i>E.SAF</i>	FR-LU08 indication	Safety circuit fault
Description	When a fault related to functional safety occurs, the inverter output is shut off by the protective function. For details, refer to the FR-E800-SCE Instruction Manual (Functional Safety).			
Reference manual	FR-E800-SCE Instruction Manual (Functional Safety)			

■ Overspeed occurrence

Operation panel indication	E.OS	<i>E.OS</i>	FR-LU08 indication	Overspeed occurrence
Description	The inverter output is shut off when the motor speed exceeds the Pr.374 Overspeed detection level under encoder feedback control, Real sensorless vector control, Vector control, and PM sensorless vector control. When Pr.374 = "9999 (initial value)", the inverter output is shut off when the motor speed exceeds the "maximum frequency + 20 Hz" for the induction motor (up to 420 Hz under Vector control or Real sensorless vector control), or when the motor speed exceeds the "maximum motor frequency + 10 Hz" for the PM motor.			
Check point	<ul style="list-style-type: none"> Check that the Pr.374 setting is correct. Check that the setting of Pr.369 Number of encoder pulses does not differ from the actual number of encoder pulses. (Under encoder feedback control or Vector control) Check that the motor temperature is not increased under Real sensorless vector control. (The motor constant may vary due to increase in the motor temperature.) 			
Corrective action	<ul style="list-style-type: none"> Set Pr.374 correctly. Set Pr.369 correctly. (Under encoder feedback control or Vector control) When the motor temperature increases, enable the online auto tuning at startup (set Pr.95 (Pr.574) = "1") (under Real sensorless vector control). 			
Reference manual	FR-E800 Instruction Manual (Function)			

■ Speed deviation excess detection

Operation panel indication	E.OSD		FR-LU08 indication	Spd deviation fault
Description	<ul style="list-style-type: none"> When Pr.285 Speed deviation excess detection frequency is set during Vector control or PM sensorless vector control, if the motor speed is increased or decreased by factors such as influence of the load and cannot be controlled in accordance with the speed command value, the deceleration check function (Pr.690) is activated to stop the inverter output. 			
Check point	<ul style="list-style-type: none"> Check that the settings of Pr.285 and Pr.853 Speed deviation time are correct. Check for sudden load change. Check that the setting of Pr.369 Number of encoder pulses does not differ from the actual number of encoder pulses. 			
Corrective action	<ul style="list-style-type: none"> Set Pr.285 and Pr.853 correctly. Keep the load stable. Set Pr.369 correctly. 			
Reference manual	FR-E800 Instruction Manual (Function)			

■ Signal loss detection

Operation panel indication	E.ECT		FR-LU08 indication	Encoder signal loss
Description	The inverter output is shut off when the encoder signal is shut off under orientation control, encoder feedback control, or Vector control. This protective function is not available in the initial status.			
Check point	<ul style="list-style-type: none"> Check for the encoder signal loss. Check that the encoder specifications are correct. Check for a loose connector. Check that the switch setting of a Vector control compatible option is correct. Check that the power is supplied to the encoder. Alternatively, check that the power is not supplied to the encoder later than the inverter. Check that the voltage of the power supplied to the encoder is the same as the encoder output voltage. 			
Corrective action	<ul style="list-style-type: none"> Remedy the signal loss. Use an encoder that meets the specifications. Make connection securely. Make a switch setting of a Vector control compatible option correctly. Supply the power to the encoder. Or supply the power to the encoder at the same time when the power is supplied to the inverter. If the power is supplied to the encoder after sent to the inverter, check that the encoder signal is properly sent and set "0 (initial value)" in Pr.376 Encoder signal loss detection enable/disable selection to disable signal loss detection. Make the voltage of the power supplied to the encoder the same as the encoder output voltage. 			
Reference manual	<ul style="list-style-type: none"> FR-E800 Instruction Manual (Connection) FR-E860 Instruction Manual (Connection) 			

■ Excessive position fault

Operation panel indication	E.OD Vector	E.od	FR-LU08 indication	Position fault
Description	The inverter output is shut off when the difference between the position command and position feedback exceeds Pr.427 Excessive level error during position control. This protective function is not available in the initial status.			
Check point	<ul style="list-style-type: none"> • Check that the position detecting encoder mounting orientation matches the parameter. • Check that the load is not large. • Check that correct values are set in Pr.427 and Pr.369 Number of encoder pulses. • When "11 or 12" is set in Pr.538 Current position retention selection, check that the power was not turned OFF or the inverter was not reset before completion of the position data writing to the EEPROM. 			
Corrective action	<ul style="list-style-type: none"> • Check the parameters. • Reduce the load. • Set Pr.427 and Pr.369 correctly. • While "11 or 12" is set in Pr.538, to turn OFF the power or reset the inverter after the output shutoff, wait at least one second. 			
Reference manual	FR-E800 Instruction Manual (Function)			

■ Brake sequence fault

Operation panel indication	E.MB1 to 7	E.MB1 to E.MB7	FR-LU08 indication	E.MB1 Fault to E.MB7 Fault
Description	The inverter output is shut off when a sequence error occurs during use of the brake sequence function (Pr.278 to Pr.285). This protective function is not available in the initial status. (The brake sequence function is invalid.)			
Check point	Find the cause of the fault occurrence.			
Corrective action	Check the set parameters and perform wiring properly.			
Reference manual	FR-E800 Instruction Manual (Function)			

■ Acceleration error

Operation panel indication	E.OA	E.oA	FR-LU08	Acceleration Error
Description	The acceleration error (E.OA) occurs and the inverter output is shut off when the acceleration rate of the motor rotation speed has exceeded the faulty acceleration rate detection level (Pr.375). This protective function is not available in the initial status.			
Check point	<ul style="list-style-type: none"> • Check for sudden load change. • Check that the Pr.375 Faulty acceleration rate detection level setting is correct. • Check if the acceleration/deceleration rate setting is high. 			
Corrective action	<ul style="list-style-type: none"> • Reduce the load. • Set Pr.375 Faulty acceleration rate detection level correctly. • If the acceleration/deceleration rate is great and an error occurs during normal operation, set Pr.375 to "9999 (no error detection)". 			
Reference manual	FR-E800 Instruction Manual (Function)			

■ Abnormal internal temperature (IP67 model)

Operation panel indication	E.IAH	E. AH	FR-LU08	Abnormal Intl Temp
Description	The inverter output is shut off when the inverter internal temperature reaches the specified value or higher.			
Check point	<ul style="list-style-type: none"> • Check for too high surrounding air temperature. • Check if the cooling fan stops due to a fault. 			
Corrective action	<ul style="list-style-type: none"> • Install an inverter suitable for the installation environment. • Replace the cooling fan. 			
Reference manual	FR-E800 Instruction Manual (Connection)			

■ Ethernet communication fault

Operation panel indication	E.EHR		FR-LU08 indication	Ethernet communication fault
Description	<ul style="list-style-type: none"> • Appears when Ethernet communication is interrupted by physical factors while Pr.1431 Ethernet signal loss detection function selection = "3" or Pr.1457 Extended setting for Ethernet signal loss detection function selection = "3". • The inverter output is shut off if Ethernet communication is broken for the time set in Pr.1432 Ethernet communication check time interval or longer for all devices with IP addresses in the range specified for Ethernet command source selection (Pr.1449 to Pr.1454). • When the CC-Link IE Field Network Basic is used, the inverter output is shut off in the following cases: the data addressed to the own station is not received for the predetermined timeout period or longer, or the status bit of the cyclic transmission addressed to the own station turns OFF (when the master inverter gives a command to stop the cyclic transmission). (For details on the timeout period, status bit of the cyclic transmission, and command to stop the cyclic transmission, refer to the User's Manual of the master device which supports the CC-Link IE Field Network Basic.) • When BACnet/IP is used, the inverter output will be shut off after the time period set in Pr.1432 after power is supplied to the inverter if an IP address of any other inverter falls within the Ethernet IP address range set for command source selection. (This protective function is available for the Ethernet model and the safety communication model.) • When PROFINET is used, the inverter output will be shut off regardless of the Pr.502 setting in the following 			
Check point	<ul style="list-style-type: none"> • Check for a break in the Ethernet cable. • Check that the Pr.1432 setting is not too short. • Check for excessive noise around the inverter. • When the CC-Link IE Field Network Basic is used, check that the timeout period set in the master is not shorter than the period during which the inverter does not receive the data addressed to the own station. • When the CC-Link IE Field Network Basic is used, check that the status bit of the cyclic transmission addressed to the own station is not OFF. • When BACnet/IP is used, check that IP addresses of other inverters are not included in the Ethernet IP address range set for command source selection. • Check that the master is not in the stop state while the inverter is running during PROFINET communication. 			
Corrective action	<ul style="list-style-type: none"> • Check that the Ethernet cable is connected to the Ethernet connector properly and the Ethernet cable is not damaged. • Set a larger value in Pr.1432. • When excessive noise occurs around the inverter, change the communication setting of the master. (The noise may be reduced by setting a shorter timeout period or increasing the number of retries in the communication setting of the master.) • When the CC-Link IE Field Network Basic is used, set a timeout period longer than the period during which the inverter does not receive the data addressed to the own station. When the CC-Link IE Field Network Basic is used, turn ON the status bit of the cyclic transmission addressed to the own station. • When BACnet/IP is used, do not include IP addresses of other inverters in the Ethernet IP address range set for command source selection. • Check the status of the master. 			
Reference manual	<ul style="list-style-type: none"> • FR-E800 Instruction Manual (Function) • FR-E800 Instruction Manual (Communication) 			

■ Board combination fault

Operation panel indication	E.CMB		FR-LU08 indication	Board mismatch
Description	Appears when the combination of the inverter and its circuit board is not appropriate, or when the circuit board with the control circuit terminal block is not connected to the inverter.			
Check point	Check that the circuit board with the control circuit terminal block is connected to the inverter.			
Corrective action	<ul style="list-style-type: none"> • Connect the circuit board with the control circuit terminal block to the inverter. (Tightening torque when the circuit board is connected to the inverter: 0.7 N·m) • Contact your sales representative. 			

■ PID signal fault

Operation panel indication	E.PID		FR-LU08 indication	PID signal fault
Description	The inverter output is shut off if the measured value exceeds the PID upper limit or PID lower limit parameter setting, or the absolute deviation value exceeds the PID deviation parameter setting during PID control. Set this function in Pr.131 PID upper limit , Pr.132 PID lower limit , Pr.553 PID deviation limit and Pr.554 PID signal operation selection . This protective function is not available in the initial status.			
Check point	<ul style="list-style-type: none"> • Check the meter for a failure or break. • Check that the parameter settings are correct. 			
Corrective action	<ul style="list-style-type: none"> • Check that the meter has no failure or break. • Set the parameters correctly. 			
Reference manual	FR-E800 Instruction Manual (Function)			

■ Option fault

Operation panel indication	E.1	<i>E. 1</i>	FR-LU08 indication	Fault 1
Description	<ul style="list-style-type: none"> The inverter output is shut off when a contact failure occurs between the inverter and the plug-in option. Appears when the switch for manufacturer setting of the plug-in option is changed. 			
Check point	<ul style="list-style-type: none"> Check that the plug-in option is plugged into the connector securely. Check for excessive noise around the inverter. 			
Corrective action	<ul style="list-style-type: none"> Connect the plug-in option securely. Take measures against noises if there are devices producing excessive electrical noises around the inverter. If the problem still persists after taking the above measure, contact your sales representative. Set the switch on the plug-in option, which is for manufacturer setting, back to the initial setting. 			
Reference manual	<ul style="list-style-type: none"> FR-E800 Instruction Manual (Function) Instruction Manual of each option 			

■ Inverter output fault

Operation panel indication	E.10	<i>E. 10</i>	FR-LU08 indication	Fault 10
Description	The inverter output is shut off if the inverter detects an output current fault such as an earth (ground) fault that occurred on the inverter's output side (load side).			
Check point	Check for an earth (ground) fault in the motor and connection cable.			
Corrective action	Remedy the earth (ground) fault or other fault.			

■ Opposite rotation deceleration fault

Operation panel indication	E.11 <u>Sensorless</u>	<i>E. 11</i>	FR-LU08 indication	Opst rot dtct fault
Description	The speed may not decelerate during low speed operation if the rotation direction of the speed command and the estimated speed differ when the rotation is changing from forward to reverse or from reverse to forward during torque control under Real sensorless vector control. The inverter output is shut off when overload occurs due to the un-switched rotation direction. This protective function is not available in the initial status (V/F control). (This function is only available under Real sensorless vector control.)			
Check point	<ul style="list-style-type: none"> Check that the rotation direction is not switched from forward to reverse rotation (or from reverse to forward) during torque control under Real sensorless vector control. 			
Corrective action	<ul style="list-style-type: none"> Prevent the motor from switching the rotation direction from forward to reverse (or from reverse to forward) during torque control under Real sensorless vector control. Contact your sales representative. 			
Reference manual	FR-E800 Instruction Manual (Function)			

■ Internal circuit fault

Operation panel indication	E.13	<i>E. 13</i>	FR-LU08 indication	Intrnl circuit fault
Description	Appears when the internal circuit is faulty.			
Check point	————			
Corrective action	Contact your sales representative.			

◆ Others

Indicate the status of the inverter. It is not a fault.

■ No fault history

Operation panel indication	E.0		FR-LU08 indication	No faults
Description	Appears when no fault records are stored. (Appears when the fault history is cleared after the protective function has been activated.)			

■ 24 V external power supply operation

Operation panel indication	EV		FR-LU08 indication	—
Description	Blinks when the main circuit power supply is OFF and the 24 V external power supply is being input in either of the following conditions: <ul style="list-style-type: none"> • When the FR-E8DS is installed • IP67 model 			
Check point	• Power is supplied from a 24 V external power supply.			
Corrective action	• Turning ON the power supply (main circuit) of the inverter clears the indication. • If the indication is still displayed after turning ON of the power supply (main circuit) of the inverter, the power supply voltage may be low, or the jumper between terminals P/+ and P1 may be disconnected.			
Reference manual	FR-E8DS E Kit Instruction Manual			

■ Backup in progress

Operation panel indication	RD		FR-LU08 indication	Rd
Description	Backup operation is in progress to back up inverter parameters and the data used in the PLC function to a computer.			
Reference manual	FR-E800 Instruction Manual (Communication)			

■ Restoration in progress

Operation panel indication	WR		FR-LU08 indication	WR
Description	Restore operation is in progress to restore the backup data stored in the computer in the inverter.			
Reference manual	FR-E800 Instruction Manual (Communication)			

NOTE

- If protective functions with indication of "Fault" on the FR-LU08 are activated, "ERR" appears in the fault history of the FR-LU08.
- If faults other than the above appear, contact your sales representative.

2.6 Check first when you have a trouble

For Real sensorless vector control and Vector control, also refer to the troubleshooting on speed control, torque control, and position control in the FR-E800 Instruction Manual (Function).

Point 

- If the cause is still unknown after every check, it is recommended to initialize the parameters, set the required parameter values and check again.

2.6.1 Motor does not start

Check point	Possible cause	Countermeasure
Main circuit	An appropriate power supply voltage is not applied. (The operation panel display is not operating.)	Power on a molded case circuit breaker (MCCB), an earth leakage circuit breaker (ELB), or a magnetic contactor (MC). Check for the decreased input voltage, input phase loss, and wiring. If only the control circuit power is ON when using a separate power source for the control circuit, turn ON the main circuit power.
	The motor is not connected properly.	Check the wiring between the inverter and the motor. If the electronic bypass function is active, check the wiring of the magnetic contactor (MC) between the inverter and the motor.
	The jumper across P/+ to P1 is disconnected. A DC reactor (FR-HEL) is not connected.	Securely fit a jumper across P/+ and P1. When using a DC reactor (FR-HEL), remove the jumper across P/+ to P1, and then connect the DC reactor.

Check point	Possible cause	Countermeasure
Input signal	A start signal is not input.	Check the start command source, and input a start signal.
	Both the forward and reverse rotation start signals (STF and STR) are input simultaneously.	Turn ON either one of the signals. When the STF and STR signals are turned ON simultaneously in the initial setting, a stop command is given.
	Frequency command is zero. (The [RUN] LED indicator on the operation panel is blinking.)	Check the frequency command source and input a frequency command.
	The Terminal 4 input selection (AU) signal is not ON when terminal 4 is used for frequency setting. (The [RUN] indicator on the operation panel is blinking.)	Turn ON the AU signal. Turning ON the AU signal activates terminal 4 input.
	The Output stop (MRS) signal or Inverter reset (RES) signal is ON. (The [RUN] LED indicator on the operation panel is blinking.)	Turn the MRS or RES signal OFF. The inverter starts the operation with a given start command and a frequency command after turning OFF the MRS or RES signal. Before turning OFF, ensure the safety.
	The switch setting for selecting sink logic or source logic is incorrect. (The [FWD] or [REV] LED indicator on the operation panel is blinking.)	Check that the control logic switch is set correctly. If it is not set correctly, the input signal is not recognized.
	The wiring of the encoder is incorrect. (Under encoder feedback control or Vector control)	Check the wiring of the encoder.
	The voltage/current input switch is not correctly set for the analog input signal (0 to 5 V, 0 to 10 V, or 4 to 20 mA). (The [RUN] LED indicator on the operation panel is blinking.)	Set Pr.73 Analog input selection , Pr.267 Terminal 4 input selection , and a voltage/current input switch correctly, then input an analog signal in accordance with the setting.
	The STOP/RESET key was pressed. (The operation panel indication is "PS".)	During the External operation mode, check the method of restarting after the operation is stopped using the STOP/RESET key on the PU.
	During position control, the Pre-excitation (LX) signal is not input.	Assign the LX signal to an input terminal and turn ON the signal.
	During position control, the Position control sudden stop (X87) signal is input.	Turn OFF the X87 signal. Check the Pr.1292 Position control terminal input selection setting.
	During position control, the Forward stroke end (LSP) signal or the Reverse stroke end (LSN) signal is assigned to the input terminal, but the signal is not input.	Turn ON the LSP/LSN signal. Check the Pr.1292 Position control terminal input selection setting.
	Two-wire or three-wire type connection is incorrect.	Check the connection. Use the Start self-holding selection (STP (STOP)) signal when the three-wire type is used.

Check point	Possible cause	Countermeasure
Parameter setting	Under V/F control, Pr.0 Torque boost setting is not appropriate.	Increase the Pr.0 setting by 0.5% increments while observing the rotation of a motor. If that makes no difference, decrease the setting.
	Pr.78 Reverse rotation prevention selection is set.	Check the Pr.78 setting. Set Pr.78 when you want to limit the motor rotation to only one direction.
	The Pr.79 Operation mode selection setting is incorrect.	Select the operation mode suitable for the input methods of the start command and frequency command.
	The bias and gain (the calibration parameter C2 to C7) settings are not appropriate.	Check the bias and gain (the calibration parameter C2 to C7) settings.
	The Pr.13 Starting frequency setting is greater than the set frequency.	Set the frequency higher than the one set in Pr.13 . The inverter does not start if the frequency setting signal has a value lower than that of Pr.13 .
	Zero is set in frequency settings (such as for multi-speed operation). Especially, Pr.1 Maximum frequency is zero.	Set the frequency command according to the application. Set Pr.1 equal to or higher than the actual frequency used.
	Pr.15 Jog frequency is lower than Pr.13 Starting frequency for JOG operation.	The Pr.15 setting should be equal to or higher than the Pr.13 setting.
	The Pr.359 Encoder rotation direction setting is incorrect under encoder feedback control or Vector control.	When the [RUN] indicator on the operation panel is blinking slowly (1.4-second cycle) while the forward rotation command is given, set Pr.359 = "1".
	Operation mode and a writing device do not correspond.	Check Pr.79 Operation mode selection , Pr.338 Communication operation command source , Pr.339 Communication speed command source , Pr.550 NET mode operation command source selection and Pr.551 PU mode operation command source selection , and select an operation mode suitable for the purpose.
	The start signal operation selection is set by Pr.250 Stop selection .	Check the Pr.250 setting and the connection of the STF and STR signals.
	The motor has decelerated to a stop when the power failure time deceleration-to-stop function is selected.	When power is restored, ensure the safety, and turn OFF the start signal once, then turn ON again to restart. When Pr.261 Power failure stop selection = "2", the motor automatically restarts after the power is restored.
	Auto tuning is being performed.	When offline auto tuning ends, press the STOP/RESET key on the operation panel during PU operation. For the External operation, turn OFF the start signal (STF or STR). This operation resets the offline auto tuning, and the PU's monitor display returns to the normal indication. (Without this operation, next operation cannot be started.)
	The automatic restart after instantaneous power failure function or power failure stop function has been activated. (Performing overload operation by the single-phase power input model or during input phase loss may cause voltage insufficiency, and that may result in detection of power failure.)	Set Pr.872 Input phase loss protection selection = "1" (input phase failure protection active). Disable the automatic restart after instantaneous power failure function and power failure stop function. Reduce the load. Increase the acceleration time if the function was activated during acceleration.
	The motor test operation is selected under Vector control or PM sensorless vector control.	Check the Pr.800 Control method selection setting.
Load	Load is too heavy.	Reduce the load.
	The shaft is locked.	Inspect the machine (motor).
Others	During position control, point table position control based on the absolute position does not operate.	Perform home position return.

2.6.2 Motor or machine is making abnormal acoustic noise

Check point	Possible cause	Countermeasure
Input signal	Disturbance due to EMI when the frequency or torque command is given through analog input terminal 2 or 4.	Take countermeasures against EMI.
Parameter setting		Increase the Pr.74 Input filter time constant setting if steady operation cannot be performed due to EMI.
Parameter setting	No carrier frequency noises (metallic noises) are generated.	In the initial setting, Pr.240 Soft-PWM operation selection is enabled to change motor noise to an unoffending complex tone. Therefore, no carrier frequency noises (metallic noises) are generated. Set Pr.240 = "0" to disable this function.
	The motor noise increases due to activation of the carrier frequency automatic reduction function when the motor is driven overloaded.	Reduce the load. Disable the automatic reduction function by setting Pr.260 PWM frequency automatic switchover = "0". (As the load remains excessive, overload may cause a protective function E.THT.)
	Resonance occurs. (Output frequency)	Set Pr.31 to Pr.36 , and Pr.552 (frequency jump). When it is desired to avoid resonance attributable to the natural frequency of a mechanical system, these parameters allow resonant frequencies to be jumped.
	Resonance occurs. (Carrier frequency)	Change the Pr.72 PWM frequency selection setting. Changing the PWM carrier frequency produces an effect on avoiding the resonance frequency of a mechanical system or a motor.
	Auto tuning is not performed under Advanced magnetic flux vector control, Real sensorless vector control, or Vector control.	Perform offline auto tuning.
	Gain adjustment during PID control is insufficient.	To stabilize the measured value, change the proportional band (Pr.129) to a larger value, the integral time (Pr.130) to a slightly longer time, and the differential time (Pr.134) to a slightly shorter time. Check the calibration of set point and measured value.
	The gain is too high under Real sensorless vector control, Vector control, or PM sensorless vector control.	During speed control, check the setting of Pr.820 Speed control P gain . During torque control, check the setting of Pr.824 Torque control P gain .
	During position control, the position control gain is too high.	Check the Pr.422 Position control gain setting.
Others	Mechanical looseness	Adjust machine/equipment so that there is no mechanical looseness.
	Contact the motor manufacturer.	
Motor	Operating with output phase loss	Check the motor wiring.

2.6.3 Inverter generates abnormal noise

Check point	Possible cause	Countermeasure
Fan	The fan cover was not correctly installed when a cooling fan was replaced.	Install the fan cover correctly.

2.6.4 Motor generates heat abnormally

Check point	Possible cause	Countermeasure
Motor	The motor fan is not working. (Dust is accumulated.)	Clean the motor fan. Improve the environment.
	Phase to phase insulation of the motor is insufficient.	Check the insulation of the motor.
Main circuit	The inverter output voltage (U, V, W) are unbalanced.	Check the output voltage of the inverter. Check the insulation of the motor.
Parameter setting	The Pr.71 Applied motor setting is incorrect.	Check the Pr.71 Applied motor setting.
—	Motor current is too large	Refer to "Motor current is too large" (page 43).

2.6.5 Motor rotates in the opposite direction

Check point	Possible cause	Countermeasure
Main circuit	The phase sequence of output terminals U, V and W is incorrect.	Connect the output side terminals (terminals U, V, and W) correctly.
Input signal	The start signals (STF and STR signals) are connected improperly.	Check the connection. (STF: forward rotation, STR: reverse rotation)
	The polarity of the frequency command is negative during the polarity reversible operation set by Pr.73 Analog input selection .	Check the polarity of the frequency command.
Input signal, parameter setting	The torque command is negative during torque control under Vector control.	Check the torque command value.
	During position control, the sign of the position command is incorrect.	Check the sign settings in Pr.1225 to Pr.1249 for positioning sub-functions.

2

2.6.6 Speed greatly differs from the setting

Check point	Possible cause	Countermeasure
Input signal	The frequency setting signal is incorrect.	Measure the input signal level.
	The input signal lines are affected by external EMI.	Take countermeasures against EMI, such as using shielded wires for input signal lines.
Parameter setting	Pr.1 Maximum frequency, Pr.2 Minimum frequency, Pr.18 High speed maximum frequency , and the calibration parameter C2 to C7 settings are not appropriate.	Check the settings of Pr.1, Pr.2, and Pr.18 . Check the calibration parameter C2 to C7 settings.
	Pr.31 to Pr.36 (frequency jump) settings are not appropriate.	Narrow down the range of frequency jump.
	During position control, the maximum speed setting in any of Pr.4 to Pr.6 and Pr.24 to Pr.27 is incorrect.	Check the maximum speed settings of Pr.4 to Pr.6 and Pr.24 to Pr.27 .
Load		Reduce the load weight.
Parameter setting	The stall prevention (torque limit) function is activated due to a heavy load.	Set Pr.22 Stall prevention operation level (Torque limit level) higher according to the load. (If Pr.22 is set too high, an overcurrent trip (E.OC[]) is likely to occur.)
Motor		Check the capacities of the inverter and the motor.

2.6.7 Acceleration/deceleration is not smooth

Check point	Possible cause	Countermeasure
Parameter setting	The acceleration/deceleration time is too short.	Increase the acceleration/deceleration time.
	The torque boost (Pr.0, Pr.46) setting is not appropriate under V/F control, so the stall prevention function is activated.	Increase/decrease the Pr.0 Torque boost setting value by 0.5% increments so that stall prevention does not occur.
	The base frequency does not match the motor characteristics.	Under V/F control, set Pr.3 Base frequency and Pr.47 Second V/F (base frequency) . Under Vector control, set Pr.84 Rated motor frequency .
	Regeneration avoidance operation is performed.	If the frequency becomes unstable during regeneration avoidance operation, decrease the setting of Pr.886 Regeneration avoidance voltage gain .
Load		Reduce the load.
Parameter setting	The stall prevention (torque limit) function is activated due to a heavy load.	Set Pr.22 Stall prevention operation level (Torque limit level) higher according to the load. (If Pr.22 is set too high, an overcurrent trip (E.OC[]) is likely to occur.)
Motor		Check the capacities of the inverter and the motor.

2.6.8 Speed varies during operation

Under Advanced magnetic flux vector control, Real sensorless vector control, Vector control, and encoder feedback control, the output frequency varies between 0 and 2 Hz as the load fluctuates. This is a normal operation and not a fault.

Check point	Possible cause	Countermeasure
Load	The load varies during an operation.	Select Advanced magnetic flux vector control, Real sensorless vector control, Vector control, or encoder feedback control.
Input signal	The frequency setting signal is varying.	Check the frequency setting signal.
	The frequency setting signal is affected by EMI.	Set filter to the analog input terminal using Pr.74 Input filter time constant , Pr.822 Speed setting filter 1 .
		Take countermeasures against EMI, such as using shielded wires for input signal lines.
	A malfunction is occurring due to the undesirable current generated when the transistor output unit is connected.	Use terminal PC (terminal SD when source logic) as a common terminal to prevent a malfunction caused by undesirable current.
	An input signal is chattering.	Take countermeasures to suppress chattering. Use relay contacts with high contact reliability. When the chattering is caused by noises, take measures against noises. Design a ladder program to prevent chattering.
The feedback signal from the encoder is affected by EMI.	Run the encoder cable away from any EMI source such as the main circuit and power supply voltage. Earth (ground) the shield of the encoder cable to the enclosure using a metal P-clip or U-clip.	
Parameter setting	Fluctuation of power supply voltage is too large.	Under V/F control, change the Pr.19 Base frequency voltage setting (approximately by 3%).
	The Pr.80 Motor capacity and Pr.81 Number of motor poles settings are not appropriate for the motor capacity under Advanced magnetic flux vector control, Real sensorless vector control, Vector control, or PM sensorless vector control.	Check the settings of Pr.80 and Pr.81 .
	The wiring length exceeds 30 m when Advanced magnetic flux vector control, Real sensorless vector control, Vector control, or PM sensorless vector control is selected.	Perform offline auto tuning.
	Under V/F control, wiring is too long and a voltage drop occurs.	In the low-speed range, adjust the Pr.0 Torque boost setting by 0.5% increments. Change the control method to Advanced magnetic flux vector control or Real sensorless vector control.
	Hunting occurs by the generated vibration, for example, when structural rigidity of the load is insufficient.	Disable automatic control functions, such as the energy saving operation, fast-response current limit operation, torque limit, regeneration avoidance function, Advanced magnetic flux vector control, Real sensorless vector control, Vector control, encoder feedback control, droop control, stall prevention, online auto tuning, and orientation control. For PID control, set smaller values to Pr.129 PID proportional band and Pr.130 PID integral time . Lower the control gain to increase the stability.
		Change the Pr.72 PWM frequency selection setting.

2.6.9 Operation mode is not changed properly

Check point	Possible cause	Countermeasure
Input signal	The start signal (STF or STR) is ON.	Check that the STF and STR signals are OFF. When either is ON, the operation mode cannot be changed.
Parameter setting	The Pr.79 Operation mode selection setting is not appropriate.	When the Pr.79 is set to "0 (initial value)", the operation mode is the External operation mode at power ON. To switch to the PU operation mode, press the PU/EXT key on the operation panel. At other settings (1 to 4, 6, 7), the operation mode is limited accordingly.
	Operation mode and a writing device do not correspond.	Check Pr.79 Operation mode selection , Pr.338 Communication operation command source , Pr.339 Communication speed command source , Pr.550 NET mode operation command source selection and Pr.551 PU mode operation command source selection , and select an operation mode suitable for the purpose.

2.6.10 Operation panel display is not operating.

Check point	Possible cause	Countermeasure
Main circuit, control circuit	The power is not input.	Input the power.
Front cover	The operation panel is not properly connected to the inverter.	Check if the inverter front cover is installed securely.

2

2.6.11 The motor current is too large

Check point	Possible cause	Countermeasure
Parameter setting	The torque boost (Pr.0 , Pr.46) setting is not appropriate under V/F control, so the stall prevention function is activated.	Increase/decrease the Pr.0 Torque boost setting value by 0.5% increments so that stall prevention does not occur.
	The V/F pattern is not appropriate when V/F control is performed. (Pr.3 , Pr.14 , Pr.19)	Set the rated frequency of the motor to Pr.3 Base frequency . Use Pr.19 Base frequency voltage to set the base voltage (for example, rated motor voltage).
		Change the Pr.14 Load pattern selection setting according to the load characteristic.
	The stall prevention (torque limit) function is activated due to a heavy load.	Reduce the load weight.
		Set Pr.22 Stall prevention operation level (Torque limit level) higher according to the load. (If Pr.22 is set too high, an overcurrent trip (E.OC[]) is likely to occur.)
	Offline auto tuning is not performed under Advanced magnetic flux vector control, Real sensorless vector control, or Vector control.	Check the capacities of the inverter and the motor.
When PM sensorless vector control is selected for an IPM motor other than the MM-GKR or E-MA, offline auto tuning is not performed.	Perform offline auto tuning.	
	Performing the offline auto tuning for a PM motor	

2.6.12 Speed does not accelerate

Check point	Possible cause	Countermeasure
Input signal	The start command or frequency command is chattering.	Check if the start command and the frequency command are correct.
	The wiring length is too long for the analog frequency command, causing a voltage (current) drop.	Perform the bias and gain calibration for the analog input.
	The input signal lines are affected by external EMI.	Take countermeasures against EMI, such as using shielded wires for input signal lines.
Parameter setting	Pr.1 Maximum frequency, Pr.2 Minimum frequency, Pr.18 High speed maximum frequency, and the calibration parameter C2 to C7 settings are not appropriate.	Check the settings of Pr.1 and Pr.2 . To operate at 120 Hz or higher, set Pr.18 High speed maximum frequency . Check the calibration parameter C2 to C7 settings.
	The maximum voltage (current) input value is not set during the External operation. (Pr.125, Pr.126, Pr.18)	Check the settings of Pr.125 Terminal 2 frequency setting gain frequency and Pr.126 Terminal 4 frequency setting gain frequency . To operate at 120 Hz or higher, set Pr.18 .
	The torque boost (Pr.0, Pr.46) setting is not appropriate under V/F control, so the stall prevention function is activated.	Increase/decrease the Pr.0 Torque boost setting value by 0.5% increments so that stall prevention does not occur.
	The V/F pattern is not appropriate when V/F control is performed. (Pr.3, Pr.14, Pr.19)	Set the rated frequency of the motor to Pr.3 Base frequency . Use Pr.19 Base frequency voltage to set the base voltage (for example, rated motor voltage). Change the Pr.14 Load pattern selection setting according to the load characteristic.
	The stall prevention (torque limit) function is activated due to a heavy load.	Reduce the load weight.
		Set Pr.22 Stall prevention operation level (Torque limit level) higher according to the load. (If Pr.22 is set too high, an overcurrent trip (E.OC[]) is likely to occur.) Check the capacities of the inverter and the motor.
	Auto tuning is not performed under Advanced magnetic flux vector control, Real sensorless vector control, or Vector control.	Perform offline auto tuning.
	During PID control, the output frequency is automatically controlled so that the measured value equals the set point.	
Main circuit	A brake resistor is connected across terminals P/+ and P1 or across P1 and PR by mistake.	Connect an optional brake resistor across terminals P/+ and PR.

2.6.13 Unable to write parameter setting

Check point	Possible cause	Countermeasure
Input signal	Operation is being performed (the STF or STR signal is ON).	Stop the operation. When Pr.77 Parameter write selection = "0 (initial value)", writing is enabled only during a stop.
Parameter setting	Parameter setting was attempted in External operation mode.	Choose the PU operation mode. Or, set Pr.77 Parameter write selection = "2" to enable parameter writing regardless of the operation mode.
	Parameter write is disabled by the Pr.77 Parameter write selection setting.	Check the Pr.77 setting.
	The key lock mode is enabled by the Pr.161 Frequency setting/key lock operation selection setting.	Check the Pr.161 setting.
	Operation mode and a writing device do not correspond.	Check Pr.79, Pr.338, Pr.339, Pr.550 and Pr.551 , and select an operation mode suitable for the purpose.

2.6.14 Unable to establish Ethernet communication

Check point	Possible cause	Countermeasure
Wiring	The Ethernet cable has a break.	Check that the Ethernet cable is connected to the Ethernet connector properly and the Ethernet cable is not damaged.
	Excessive electrical noise is present around the inverter.	When excessive noise occurs around the inverter, change the communication setting of the master. (The noise may be reduced by setting a shorter timeout period or increasing the number of retries in the communication setting of the master.)
	The FR-A8NC is installed when CC-Link IE TSN or CC-Link IE Field Network Basic is used for communication.	Remove the FR-A8NC.
Parameter setting	Communication protocols that cannot be used together are selected.	Check the settings of Pr.1427 to Pr.1430 . (Refer to the FR-E800 Instruction Manual (Communication).)
	The Pr.1432 setting is too small when CC-Link IE Field Network Basic, MODBUS/TCP, BACnet/IP, or EtherNet/IP is selected.	Set a larger value in Pr.1432 .
	When the CC-Link IE Field Network Basic is used, the timeout period set in the master is shorter than the period during which the inverter does not receive the data addressed to the own station.	When the CC-Link IE Field Network Basic is used, set a timeout period longer than the period during which the inverter does not receive the data addressed to the own station.
	When the CC-Link IE Field Network Basic is used, the status bit of the cyclic transmission addressed to the own station is OFF.	When the CC-Link IE Field Network Basic is used, turn ON the status bit of the cyclic transmission addressed to the own station.
	When CC-Link IE Field Network Basic, MODBUS/TCP, BACnet/IP, or EtherNet/IP is used, IP addresses of other inverters are included in the Ethernet IP address range set for command source selection.	When CC-Link IE Field Network Basic, MODBUS/TCP, BACnet/IP, or EtherNet/IP is used, do not include IP addresses of other inverters in the Ethernet IP address range set for command source selection.

MEMO

CHAPTER 3 Precautions for Maintenance and Inspection

3.1	Inspection item.....	48
3.2	Measurement of main circuit voltages, currents, and powers.....	59

3 Precautions for Maintenance and Inspection

This chapter explains the precautions for maintenance and inspection of this product.
Always read the instructions before use.

3.1 Inspection item

The inverter is a static unit mainly consisting of semiconductor devices. Daily inspection must be performed to prevent any fault from occurring due to the adverse effects of the operating environment, such as temperature, humidity, dust, dirt and vibration, changes in the parts with time, service life, and other factors.

◆ Precautions for maintenance and inspection

When accessing the inverter for inspection, wait for at least 10 minutes after the power supply has been switched OFF. Then, make sure that the voltage across the main circuit terminals P/+ and N/- on the inverter is not more than 30 VDC using a digital multimeter, etc.

If "EV" is displayed on the operation panel when the FR-E8DS is installed, turn OFF the 24 V external power supply before an inspection.

3.1.1 Daily inspection

Basically, check for the following faults during operation.

- Motor operation fault
- Improper installation environment
- Cooling system fault
- Abnormal vibration, abnormal noise
- Abnormal overheat, discoloration

3.1.2 Periodic inspection

Check the areas inaccessible during operation and requiring periodic inspection. Consult us for periodic inspection.

Check and clean the cooling system:

Clean the air filter, etc.

Check the tightening and retighten:

The screws and bolts may become loose due to vibration, temperature changes, etc. Check and tighten them. Tighten them according to the specified tightening torque. (Refer to the FR-E800 Instruction Manual (Connection) or the FR-E860 Instruction Manual (Connection).)

Check the conductors and insulating materials for corrosion and damage.

Measure the insulation resistance.

Check and change the cooling fan and relay.

NOTE

- When using the safety stop function, periodic inspection is required to confirm that safety function of the safety system operates correctly. For details, refer to the FR-E800 Instruction Manual (Functional Safety).
-

3.1.3 Daily and periodic inspection

Area of inspection	Inspection item	Description	Inspection interval		Corrective action at fault occurrence	Check by user
			Daily	Periodic ^{*3}		
General	Surrounding environment	Check the surrounding air temperature, humidity, dirt, corrosive gas, oil mist, etc.	○		Improve the environment.	
	Overall unit	Check for unusual vibration and noise.	○		Check fault location and retighten.	
		Check for dirt, oil, and other foreign material. ^{*1}	○		Clean.	
Power supply voltage	Check that the main circuit voltage and control circuit voltage are normal. ^{*2}	○		Inspect the power supply.		
Main circuit	General	<ul style="list-style-type: none"> • Check with megger (between main circuit terminals and earth (ground) terminal). • Check for loose screws and bolts. • Check for overheat traces on the parts. • Check for stains. 		○	Contact the manufacturer. Retighten. Contact the manufacturer. Clean.	
	Conductors and cables	<ul style="list-style-type: none"> • Check conductors for distortion. • Check cable sheaths for breakage and deterioration (crack, discoloration, etc.). 		○	Contact the manufacturer. Contact the manufacturer.	
	Transformer/reactor	Check for unusual odor and abnormal increase of whining sound.	○		Stop the equipment and contact the manufacturer.	
	Terminal block	Check for a damage.		○	Stop the equipment and contact the manufacturer.	
	Smoothing aluminum electrolytic capacitor	<ul style="list-style-type: none"> • Check for liquid leakage. • Check for safety valve projection and bulge. • Visual check and judge by the life check of the main circuit capacitor. (Refer to page 53.) 		○	Contact the manufacturer. Contact the manufacturer.	
	Relay/contactor	Check that the operation is normal and no chattering sound is heard.		○	Contact the manufacturer.	
	Resistor	<ul style="list-style-type: none"> • Check for cracks in the resistor insulator. • Check for a break in the cable. 		○	Contact the manufacturer. Contact the manufacturer.	
	Operation check	<ul style="list-style-type: none"> • Check for an output voltage imbalance between phases while operating the inverter alone. • Check that no fault is found in protective and display circuits in a sequence protective operation test. 		○	Contact the manufacturer. Locate the fault and check the wiring.	
Control circuit, protection circuit	Components check	Overall		○	Stop the equipment and contact the manufacturer. Contact the manufacturer.	
		Aluminum electrolytic capacitor	<ul style="list-style-type: none"> • Check for liquid leakage in a capacitor and deformation trace. • Visual check and judge by the life check of the control circuit capacitor. (Refer to page 53.) 	○	Contact the manufacturer.	
Cooling system	Cooling fan	<ul style="list-style-type: none"> • Check for unusual vibration and noise. • Check for loose screws and bolts. • Check for stains. 	○		Replace the fan. Fix with the fan cover fixing screws. Clean.	
	Heat sink	<ul style="list-style-type: none"> • Check for clogging. • Check for stains. 		○	Clean. Clean.	

Area of inspection	Inspection item	Description	Inspection interval		Corrective action at fault occurrence	Check by user
			Daily	Periodic ^{*3}		
Display	Indication	<ul style="list-style-type: none"> Check that indications are correct. Check for stains. 	○	○	Contact the manufacturer. Clean.	
	Meter/counter	Check that readouts are correct.	○		Stop the equipment and contact the manufacturer.	
Load motor	Operation check	Check for vibration and abnormal increase in operation noise.	○		Stop the equipment and contact the manufacturer.	
Waterproof performance Dustproof performance ^{*4}	Resin cap	<ul style="list-style-type: none"> Check for damage. 		○	Stop the equipment and contact the manufacturer.	
		<ul style="list-style-type: none"> Check parts such as the gasket for degradation (crack, discoloration, or deformation). 		○	Stop the equipment and contact the manufacturer.	
	Connector	<ul style="list-style-type: none"> Check for improper connection. Check if the cap of an unused connector is removed. 		○	Connect the cable properly. Install the caps to the unused connectors.	

*1 Oil component of the heat dissipation grease used inside the inverter may leak out. The oil component, however, is not flammable, corrosive, nor conductive and is not harmful to humans. Wipe off such oil component.

*2 It is recommended to install a voltage monitoring device for checking the voltage of the power supplied to the inverter.

*3 One to two years of periodic inspection cycle is recommended. However, it differs according to the installation environment. Consult us for periodic inspection.

*4 Inspections for the IP67 model.

NOTE

- Continuous use of a leaked, deformed, or degraded smoothing aluminum electrolytic capacitor (as shown in the table above) may lead to a burst, breakage, or fire. Replace such capacitor without delay.

3.1.4 Checking the inverter and converter modules

◆ Preparation

- Disconnect the external power supply cables (R/L1, S/L2, T/L3) and motor cables (U, V, W).
- Prepare a continuity tester. (For the resistance measurement, use the 100 Ω range.)

◆ Checking method

Change the polarity of the tester alternately at the inverter terminals R/L1, S/L2, T/L3, U, V, W, P/+, and N/- and check the electric continuity.

NOTE

- Before measurement, check that the smoothing capacitor is discharged.
- At the time of electric discontinuity, the measured value is almost ∞. When there is an instantaneous electric continuity, due to the smoothing capacitor, the tester may not indicate ∞. At the time of electric continuity, the measured value is several Ω to several tens of Ω. When all measured values are almost the same (although values may not be constant depending on the tester type), it shows that there are no electrical paths with problems.

◆ Module device numbers and terminals to be checked

■ Three-phase 200 V class, three-phase 400 V class, single-phase 200 V class

		Tester polarity		Continuity			Tester polarity		Continuity
		⊕	⊖				⊕	⊖	
Converter module	D1	R/L1	P/+	No	D4	R/L1	N/-	Yes	
		P/+	R/L1	Yes		N/-	R/L1	No	
	D2	S/L2	P/+	No	D5	S/L2	N/-	Yes	
		P/+	S/L2	Yes		N/-	S/L2	No	
	D3	T/L3 ^{*1}	P/+	No	D6	T/L3 ^{*1}	N/-	Yes	
		P/+	T/L3 ^{*1}	Yes		N/-	T/L3 ^{*1}	No	
Inverter module	TR1	U	P/+	No	TR4	U	N/-	Yes	
		P/+	U	Yes		N/-	U	No	
	TR3	V	P/+	No	TR6	V	N/-	Yes	
		P/+	V	Yes		N/-	V	No	
	TR5	W	P/+	No	TR2	W	N/-	Yes	
		P/+	W	Yes		N/-	W	No	

(Assuming that an analog meter is used.)

*1 Terminals T/L3, D3, and D6 are provided only on the three-phase power input model.

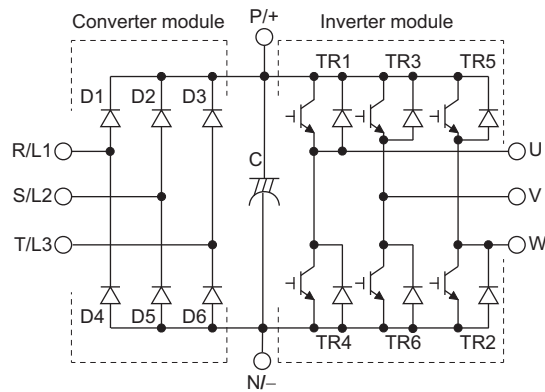

■ Single-phase 100 V class

		Tester polarity		Continuity		Tester polarity		Continuity
		⊕	⊖			⊕	⊖	
Converter module	D1	S/L2	P/+	No	—	R/L1	P/+	No
		P/+	S/L2	Yes		P/+	R/L1	No
	D2	S/L2	N/-	Yes		R/L1	N/-	No
		N/-	S/L2	No		N/-	R/L1	No
Inverter module	TR1	U	P/+	No	TR4	U	N/-	Yes
		P/+	U	Yes		N/-	U	No
	TR3	V	P/+	No	TR6	V	N/-	Yes
		P/+	V	Yes		N/-	V	No
	TR5	W	P/+	No	TR2	W	N/-	Yes
		P/+	W	Yes		N/-	W	No

(Assuming that an analog meter is used.)

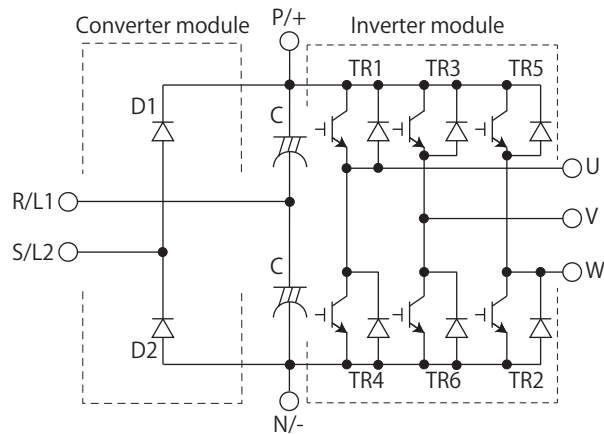

3.1.5 Cleaning

Always run the inverter in a clean status.

When cleaning the inverter, gently wipe dirty areas with a soft cloth immersed in neutral detergent or ethanol.

NOTE

- Do not use solvent, such as acetone, benzene, toluene and alcohol, as these will cause the inverter surface paint to peel off.
- The display, etc. of the operation panel are vulnerable to detergent and alcohol. Therefore, avoid using them for cleaning.

3.1.6 Replacement of parts

The inverter consists of many electronic parts such as semiconductor devices.

The following parts may deteriorate with age because of their structures or physical characteristics, leading to reduced performance or fault of the inverter. For preventive maintenance, the parts must be replaced periodically. Use the life check function as a guidance of parts replacement.

Part name	Estimated lifespan ^{*1}	Description
Cooling fan	10 years	Replace (as required)
Main circuit smoothing capacitor	10 years ^{*2}	Replace (as required)
On-board smoothing capacitor	10 years ^{*2}	Replace the board (as required).
ABC/ABC2 ^{*3} relay contact	—	As required
Large resin cap (with gasket) ^{*3*4}	5 years	Replace (as required)
Small resin cap (with gasket) ^{*3*4}	5 years	Replace (as required)
Resin cap (male) (with gasket) ^{*3*4}	10 years	Replace (as required)
Resin cap (female) ^{*3*4}	10 years	Replace (as required)
Gasket of the front cover ^{*4}	10 years	Replace (as required)
Power ON/OFF switch ^{*4}	10 years	Replace (as required)

*1 Estimated lifespan for when the yearly average surrounding air temperature is 30°C (without corrosive gas, flammable gas, oil mist, dust and dirt etc.)

*2 Output current: 80% of the inverter ND rating

*3 For IP67 model only.

*4 The life check function is not available for this part. Replace the part when the estimated lifespan has elapsed, or check whether the part needs to be replaced during periodic inspection.

NOTE

- For parts replacement, contact the nearest Mitsubishi FA center.

◆ Inverter parts life display

The inverter diagnoses the main circuit capacitor, control circuit capacitor, cooling fan, inrush current limit circuit, inverter module, and relay contacts of terminals A, B, and C, and estimates their lives.

The self-diagnostic warning is output when the life span of each part is near its end. It gives an indication of replacement time.

Guideline for life judgment using the life warning output

Part name	Judgment level
Main circuit capacitor	85% of the initial capacity
Control circuit capacitor	Estimated remaining life 10%
Inrush current limit circuit	Estimated remaining life 10% (Power ON: 100,000 times left)
Cooling fan	Less than the specified speed
Inverter module	Estimated remaining life 15%
ABC/ABC2 relay contact ^{*1}	Estimated remaining life 10%

*1 Life check of ABC2 relay contact is applicable only for the IP67 model.

NOTE

- Refer to the FR-E800 Instruction Manual (Function) to perform the life check of the inverter parts.

◆ Replacement procedure of the cooling fan

The replacement interval of the cooling fan used for cooling the parts generating heat such as the main circuit semiconductor is greatly affected by the surrounding air temperature. When unusual noise and/or vibration are noticed during inspection, the cooling fan must be replaced immediately.

■ **Removal of the fan (standard model, Ethernet model, and safety communication model)**

1. Push the hooks from above and remove the fan cover.

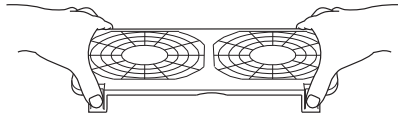
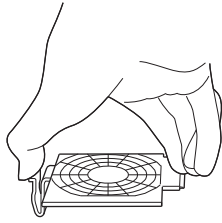

FR-E820-0080(1.5K) to 0330(7.5K)
 FR-E840-0040(1.5K) to 0170(7.5K)
 FR-E860-0027(1.5K) to 0120(7.5K)
 FR-E820S-0080(1.5K), 0110(2.2K)

FR-E820-0470(11K) to 0900(22K)
 FR-E840-0230(11K) to 0440(22K)

2. Disconnect the fan connectors.

3. Remove the fan.

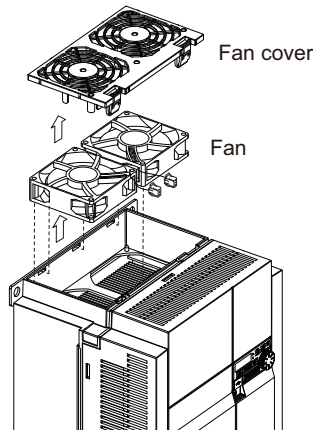
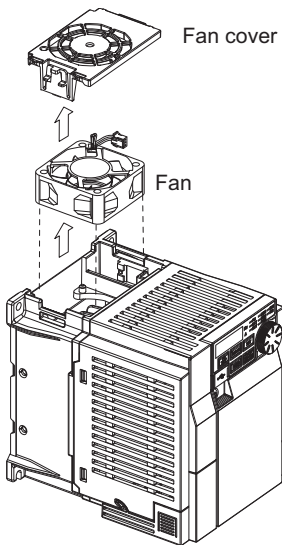

FR-E820-0080(1.5K) to 0330(7.5K)
 FR-E840-0040(1.5K) to 0170(7.5K)
 FR-E860-0027(1.5K) to 0120(7.5K)
 FR-E820S-0080(1.5K) to 0110(2.2K)

FR-E820-0470(11K) to 0900(22K)
 FR-E840-0230(11K) to 0440(22K)

■ **Reinstallation of the fan (standard model, Ethernet model, and safety communication model)**

1. Install the fan so that the air outlet side with the rating plate attached faces up. (The manufacturer name, model, and specifications of the fan are described on the rating plate.) Incorrect installation will shorten the life of the inverter or cause a fault. Disconnect the fan connector, and remove the fan itself.

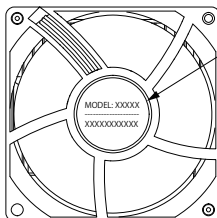

Rating plate (description includes the manufacturer name, model, and specifications)

2. Connect the fan connectors.

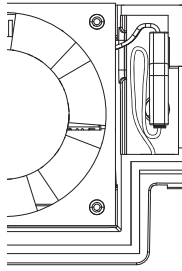

FR-E820-0080(1.5K) to 0330(7.5K)
 FR-E840-0040(1.5K) to 0170(7.5K)
 FR-E860-0027(1.5K) to 0120(7.5K)
 FR-E820S-0080(1.5K), 0110(2.2K)

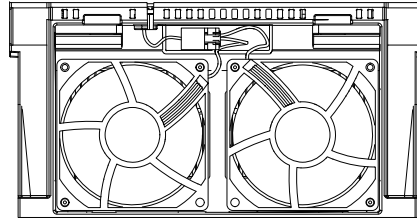

FR-E820-0470(11K) to 0900(22K)
 FR-E840-0230(11K) to 0440(22K)

3. Install the fan cover.

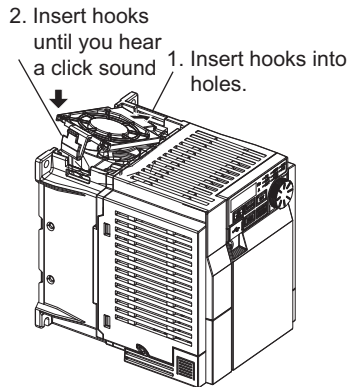

FR-E820-0080(1.5K) to 0330(7.5K)
 FR-E840-0040(1.5K) to 0170(7.5K)
 FR-E860-0027(1.5K) to 0120(7.5K)
 FR-E820S-0080(1.5K), 0110(2.2K)

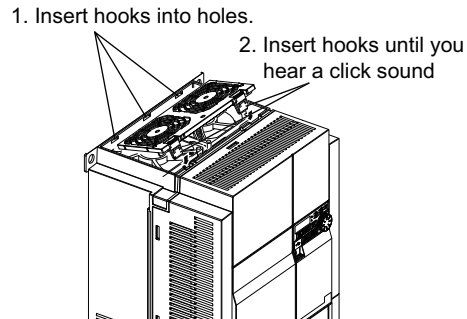

FR-E820-0470(11K) to 0900(22K)
 FR-E840-0230(11K) to 0440(22K)

■ **Removal of the fan (IP67 model)**

1. Remove the screws to disconnect the fan cover, then disconnect the fan connector and remove the fan itself.

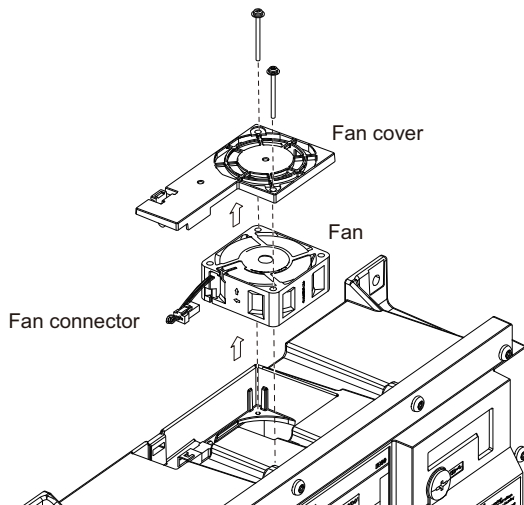

FR-E846-0026(0.75K) to 0095(3.7K)SCE

■ Reinstallation of the fan (IP67 model)

1. Install the fan so that the air outlet side with the rating plate attached faces up. (The manufacturer name, model, and specifications of the fan are described on the rating plate.) Incorrect installation will shorten the life of the inverter or cause a fault.

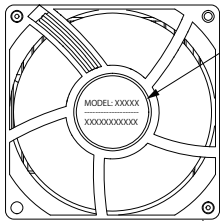

Rating plate (description includes the manufacturer name, model, and specifications)

2. Connect the fan connector, and reinstall the fan itself.

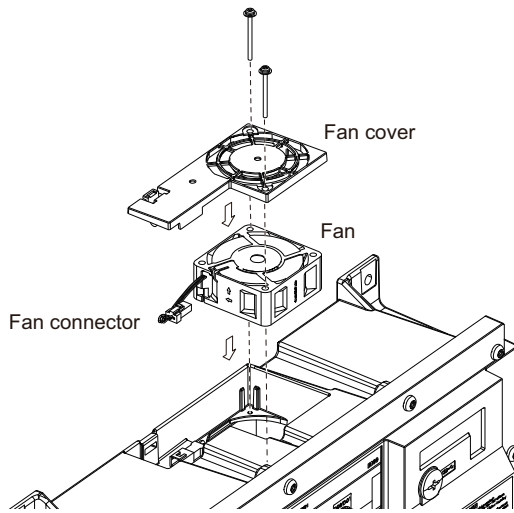

FR-E846-0026(0.75K) to 0095(3.7K)SCE

NOTE

Installing the fan in the opposite direction of air flow may shorten the inverter life.

Ensure that the cables are not caught when the fan is installed.

Switch OFF the power before starting the fan replacement work. To prevent an electric shock accident, power off the inverter and wait for at least 10 minutes as the inverter circuits are charged with voltage even after power OFF.

◆ Smoothing capacitors

A large-capacity aluminum electrolytic capacitor is used for smoothing in the DC section of the main circuit, and an aluminum electrolytic capacitor is used for stabilizing the control circuit power in the control circuit. Adverse effects from ripple currents deteriorate capacitors. Replacement intervals of capacitors vary greatly with surrounding temperatures and operating conditions. Replace them roughly every 10 years when used in normal air-conditioned environments.

Inspecting the product visually:

- Case: Check that the sides and bottom of the capacitor have not ruptured.
- Rubber seal: Check for any noticeable bulging or severe cracks.
- Check for external cracks, discoloration, leakage, etc. It is assumed that the capacitor has reached the end of its life when its capacity has dropped below 80% of its rated capacity.

NOTE

- The inverter diagnoses the main circuit capacitor and control circuit capacitor by itself and estimates its remaining life. (Refer to the FR-E800 Instruction Manual (Function).)

◆ Relay output terminals

- The contacts of relays deteriorate over time. To prevent faults from occurring, relays must be replaced when they have reached the maximum of switching operations (switching life).
- The control circuit terminal block must be replaced in case of failure of the relay connected to the relay output terminals A, B, and C. (Refer to [page 57](#).) (After replacing the control circuit terminal block, set the switch to the correct position in accordance with the control logic of input signals.) (Refer to the FR-E800 Instruction Manual (Connection) or FR-E860 Instruction Manual (Connection).) For the IP67 model, two sets of relay output terminals are provided. If the relay becomes faulty, contact your sales representative.

◆ Resin cap (IP67 model)

- When the resin cap or resin gasket deteriorates with age, IP67 requirements cannot be met. Replace the large/small resin cap after five years of use, and the resin cap (male/female) after 10 years of use.

Part	Model name	Manufacturer	Tightening torque
Large resin cap (with gasket)	A-INSP-M25-65N-P-BK - 1415207	Phoenix Contact Co., Ltd.	1.5 N·m
Small resin cap (with gasket)	A-INSP-M16-68N-P-BK - 1045817		1 N·m
Resin cap (male) (with gasket)	P5407601200-000	TE Connectivity	0.7 N·m
Resin cap (female)	T4104000000-00		0.7 N·m

- Appearance of resin cap

Large resin cap
(A-INSP-M25-65N-P-BK-1415207)



Small resin cap
(A-IN-P-M16-68N-P-BK-1045817)

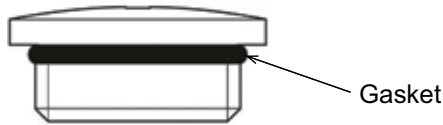

Resin cap (male)
(P5407601200-000)

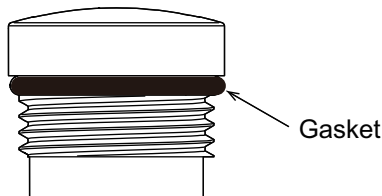

Resin cap (female)
(T4104000000-00)

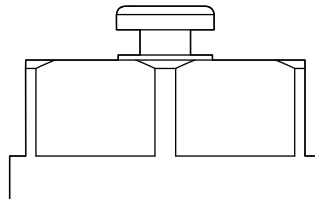

3.1.7 Inverter replacement

This product has a removable control circuit terminal block, which can be replaced with a new one (except for the IP67 model).

◆ Removal and reinstallation

1. Loosen the fixing screw of the control circuit terminal block.
Slide down the control circuit terminal block to remove it.

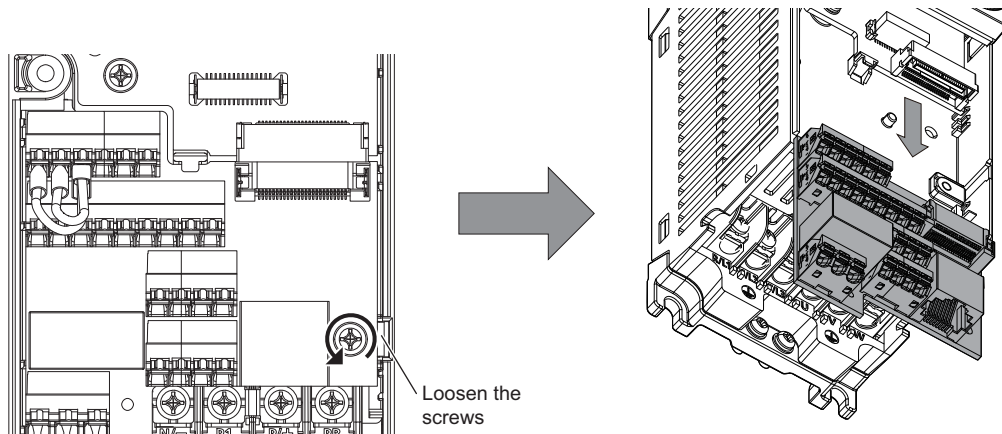

2. Be careful not to bend the pins of the inverter's control circuit connector, reinstall the control circuit terminal block and fix it with the mounting screws.

NOTE

- Before starting the replacement, power OFF the inverter and wait for at least 10 minutes to ensure safety.

◆ Removal and reinstallation precautions

The following are the precautions to remove or reinstall the control circuit terminal block. Observe the following precautions and handle the inverter properly to avoid malfunctions or failures.

- To remove or reinstall the control circuit terminal block, keep it upright so that it is parallel with the inverter.
- Check that the terminal block is parallel to the inverter and the pins on the inverter control circuit connector are not bent. After checking proper connection, tighten the screw to fix the terminal block.

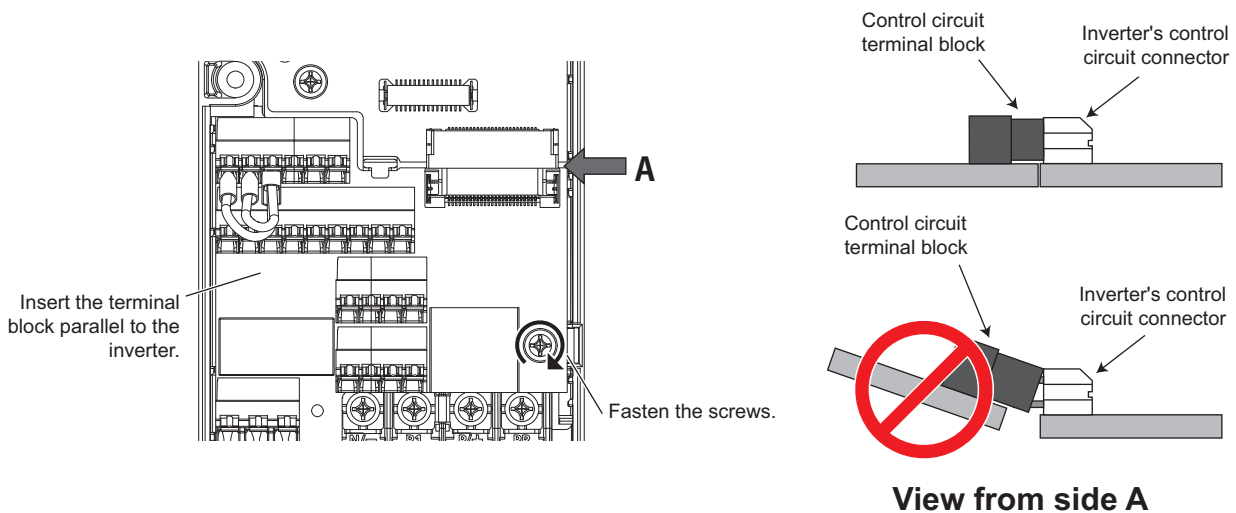

NOTE

- Do not tilt the terminal block while tightening the screws or removing it from the inverter. (Otherwise, a stress applied to the control circuit terminal block or the control circuit connector may cause damage to them.)
- After replacing the control circuit terminal block, set the switch to the correct position in accordance with the control logic of input signals. (Refer to the FR-E800 Instruction Manual (Connection) or FR-E860 Instruction Manual (Connection).)
- When the control circuit terminal block is not connected to the inverter properly, a board combination fault (E.CMB) occurs.

3.2 Measurement of main circuit voltages, currents, and powers

Since the voltages and currents on the inverter power supply and output sides include harmonics, measurement data depends on the instruments used and circuits measured. When instruments for commercial frequency are used for measurement, measure the following circuits with the instruments given on the next page.

NOTE

- When installing meters etc. on the inverter output side
When the inverter-to-motor wiring length is long, especially in the 400/575 V class, small-capacity models, the meters and CTs may generate heat due to line-to-line leakage current. Therefore, choose the equipment which has enough allowance for the current rating.
To measure and display the output voltage and output current of the inverter, it is recommended that the terminal AM and FM output functions of the inverter are used.

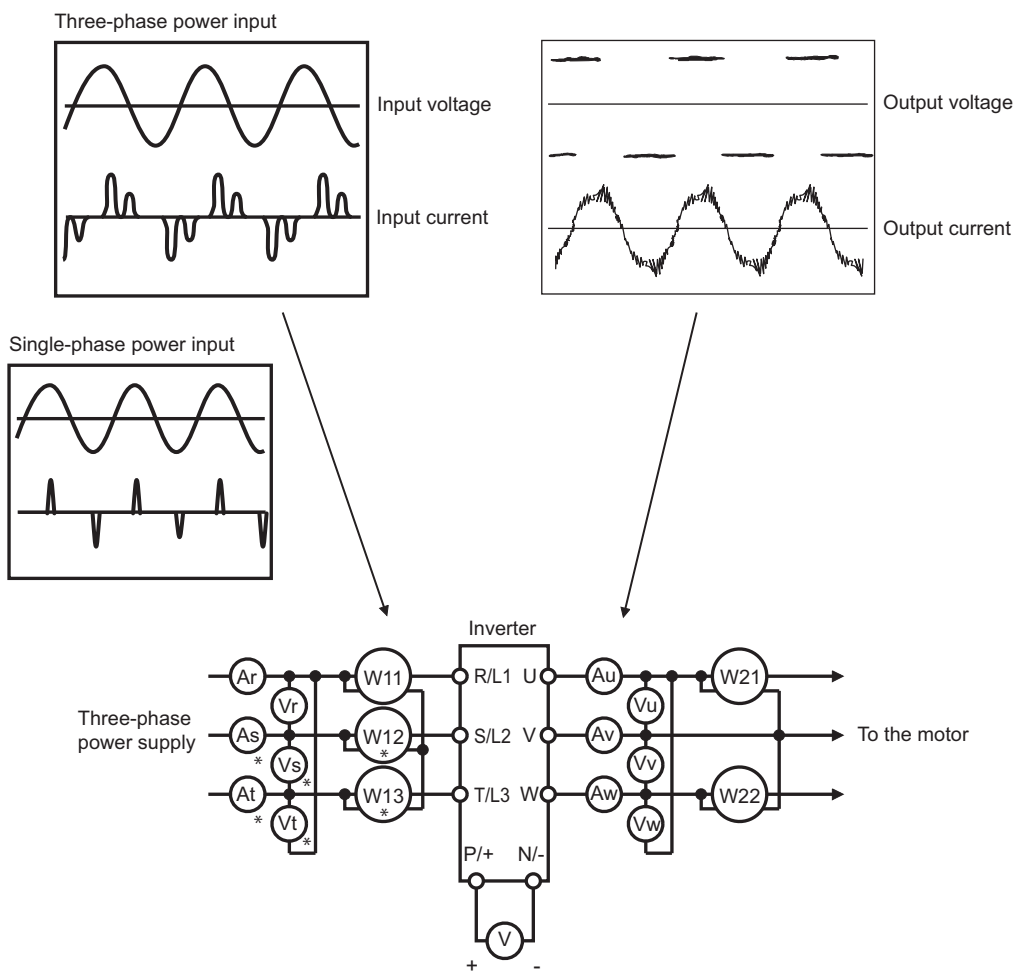

* At, As, Vt, Vs, W12, W13 are only for the three-phase power input specification models.

◆ Measuring points and instruments

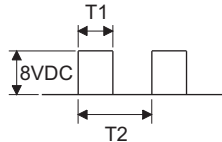
Item	Measuring point	Measuring instrument	Remarks (reference measured value)
Input voltage V1	Between R/L1 and S/L2, S/L2 and T/L3, and T/L3 and R/L1 ^{*3}	Digital power meter (designed for inverter)	Commercial power Within permissible AC voltage fluctuation. (Refer to the FR-E800 Instruction Manual (Connection) or FR-E860 Instruction Manual (Connection).)
Input current I1	R/L1, S/L2, T/L3 line current ^{*3}		
Input power P1	At R/L1, S/L2, and T/L3, and between R/L1 and S/L2, S/L2 and T/L3, and T/L3 and R/L1 ^{*3}		P1 = W11 + W12 + W13 (3-wattmeter method)
Input power factor Pf1	Calculate after measuring input voltage, input current and input power. [Three-phase power supply] [Single-phase power supply] $Pf_1 = \frac{P_1}{\sqrt{3}V_1 \times I_1} \times 100\% \quad Pf_1 = \frac{P_1}{V_1 \times I_1} \times 100\%$		
Output voltage V2	Between U and V, V and W, and W and U	Digital power meter (designed for inverter) ^{*1}	Difference between the phases must be within 1% of the maximum output voltage.
Output current I2	Line current at U, V, and W		Difference between the phases must be within 10%.
Output power P2	At U, V, and W, and between U and V, and V and W	Digital power meter (designed for inverter)	P2 = W21 + W22 2-wattmeter method (or 3-wattmeter method)
Output power factor Pf2	Calculate in similar manner to the input power factor. $Pf_2 = \frac{P_2}{\sqrt{3}V_2 \times I_2} \times 100\%$		
Converter output	Between P/+ and N/-	Digital multimeter or other tester	1.35 × V1
Frequency setting signal	2, and between 4(+) and 5	Digital multimeter or other tester, or moving-coil type instrument (internal resistance 50 kΩ or more)	0 to 10 VDC, 4 to 20 mA
Power supply for a frequency setting potentiometer	Between 10(+) and 5		5.2 VDC
Frequency meter signal	[E800] Between AM(+) and 5		Approximately 10 VDC at maximum frequency (without frequency meter)
	[E800] Between FM(+) and SD	Approximately 5 VDC at maximum frequency (without frequency meter)  Pulse width T1: Adjust with C0 (Pr.900) . Pulse cycle T2: Set with Pr.55 (for frequency monitor only).	Terminal SD is a common terminal.
Start terminal Multi-speed selection terminal Reset terminal Output stop terminal	[E800] Between terminal SD and each of terminal STF, STR, RH, RM, RL, RES, and MRS(+) (for sink logic) [E800-E] Between DI0 and SD, and DI1 and SD (for sink logic)		Voltage when terminal is open: 20 to 30 VDC. Voltage when signal is ON: 1 V or less.
Relay output (fault output) terminal	Between A and C Between B and C	Digital multimeter or other tester	Continuity check ^{*2} Fault: discontinuity across B and C (continuity across A and C), normal: continuity across B and C (discontinuity across A and C)
Relay output 2 terminal ^{*4}	Between A2 and C2 Between B2 and C2		Continuity check ^{*2} Being output: discontinuity across B2 and C2 (continuity across A2 and C2), not being output: continuity across B2 and C2 (discontinuity across A2 and C2)

- *1 Use an FFT to measure the output voltage accurately. A digital multimeter or general measuring instrument cannot measure accurately.
- *2 When the setting of **Pr.192 ABC terminal function selection** or **Pr.197 ABC2 terminal function selection** is the positive logic.
- *3 Terminal T/L3 is provided only on the three-phase power input model.
- *4 IP67 model only.

3.2.1 Measurement of powers

Use digital power meters (for inverter) both on the inverter's input and output sides.

3.2.2 Measurement of voltages and use of PT

◆ Inverter input side

Use a digital power meter (for inverter) on the inverter's input side.

◆ Inverter output side

When using a measuring instrument, use a digital power meter for inverters as the inverter outputs PWM-controlled square wave voltage. The value monitored on the operation panel is the inverter-controlled voltage itself. Monitoring values via the operation panel or by outputting the analog signal is recommended as these values are accurate.

3.2.3 Measurement of currents

Use a digital power meter (for inverter) both on the inverter's input and output sides.

Since the inverter input current tends to be unbalanced, measurement of three phases is recommended. The correct value cannot be obtained by measuring only one or two phases. On the other hand, the unbalanced ratio of each phase of the output current should be within 10%.

The inverter output current can be monitored on the operation panel. The value displayed on the operation panel is accurate even if the output frequency varies. Hence, it is recommended to monitor values on the operation panel or by outputting the analog signal.

3.2.4 Measurement of inverter input power factor

Calculate the factor from the effective power and the apparent power. A power-factor meter cannot indicate an exact value.

[Three-phase power supply]

$$\begin{aligned} \text{Total power factor of the inverter} &= \frac{\text{Effective power}}{\text{Apparent power}} \\ &= \frac{\text{Three-phase input power found by the 3-wattmeter method}}{\sqrt{3} \times V (\text{power supply voltage}) \times I (\text{input current effective value})} \end{aligned}$$

[Single-phase power supply]

$$\begin{aligned} \text{Total power factor of the inverter} &= \frac{\text{Effective power}}{\text{Apparent power}} \\ &= \frac{\text{Three-phase input power found by the 3-wattmeter method}}{V (\text{power supply voltage}) \times I (\text{input current effective value})} \end{aligned}$$

3.2.5 Measurement of converter output voltage (between terminals P and N)

The output voltage of the converter can be measured with a voltmeter (such as a digital multimeter) between terminals P and N. The voltage varies according to the power supply voltage. Approximately 270 to 300 V for the 100/200 V class, approximately 540 to 600 V for the 400 V class, and approximately 800 to 900 V for the 575 V class is output when no load is connected. The voltage decreases when a load is applied.

When energy is regenerated from the motor during deceleration, for example, the converter output voltage rises to nearly 400 to 450 V for the 100/200 V class, nearly 800 to 900 V for the 400 V class, and nearly 1100 to 1300 V for the 575 V class maximum.

3.2.6 Measurement of inverter output frequency

In the initial setting of the FM type inverter, a pulse train proportional to the output frequency is output across the pulse train output terminals FM and SD on the inverter. This pulse train output can be counted by a frequency counter, or a digital multimeter can be used to read the mean value of the pulse train output voltage. When a digital multimeter is used to measure the output frequency, approximately 5 VDC is indicated at the maximum frequency. In the initial setting of the AM type inverter, a voltage proportional to the output frequency is output across the analog voltage output terminals AM and 5 on the inverter. Measure the voltage using a digital multimeter.

The output frequency can be checked using the operation panel for all models including Ethernet models.

For detailed specifications of the pulse train output terminal FM and analog voltage output terminal AM, refer to the FR-E800 Instruction Manual (Function), FR-E800 Instruction Manual (Connection), and FR-E860 Instruction Manual (Connection).

3.2.7 Insulation resistance test using megger

- For the inverter, conduct the insulation resistance test on the main circuit only as follows and do not perform the test on the control circuit.

(Use a 500 VDC megger.)

NOTE

- Before performing the insulation resistance test on the external circuit, disconnect the cables from all terminals of the inverter so that the test voltage is not applied to the inverter.
- For the continuity test of the control circuit, use a tester for high resistance range and do not use the megger or buzzer.

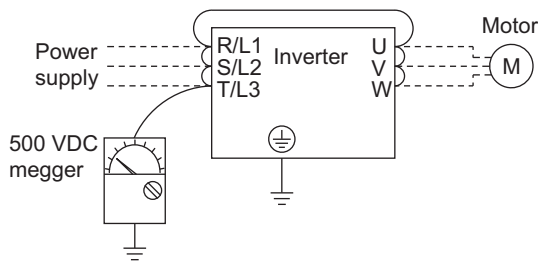

3.2.8 Withstand voltage test

Do not conduct a withstand voltage test. Deterioration may occur.

CHAPTER 4 Appendix

4.1	How to check specification changes	64
-----	--	----

4 Appendix

4.1 How to check specification changes

Check the SERIAL number indicated on the inverter rating plate or packaging. For how to read the SERIAL number, refer to [page 7](#).

The inverter firmware can be updated by using Firmware Update Tool of FR Configurator2. The functions added due to specification changes are available. For details on firmware update, refer to the FR Configurator2 Instruction Manual.

4.1.1 Details of specification changes

◆ Number of connectable units on the CC-Link IE Field Network Basic

Number of connectable units	SERIAL
Master: 1 Remote: up to 16 stations (16 stations × 1 group)	□□ 204 ○○○○○○ or earlier
Master: 1 Remote: up to 64 stations (16 stations × 4 groups)	□□ 205 ○○○○○○ or later

◆ Functions available for the inverters manufactured in May 2020 or later

- Firmware version: 1 or later

Item	Details
Mitsubishi Electric geared motor	GM-□
Plug-in option	FR-A8ND E kit, FR-A8NP E-kit
Stand-alone option	Parameter unit (FR-PU07), LCD operation panel (FR-LU08)
Added parameters	Pr.1499, P.E107 (Pr.75)
Changed parameter setting range	<ul style="list-style-type: none"> • Setting value "13" added for Pr.52, Pr.54, Pr.158, Pr.774 to Pr.776, Pr.992, Pr.1027 to Pr.1034 • Setting values "1800 and 1803" added for Pr.71 and Pr.450 (for 200/400 V class only) • Setting values "10000 to 10003, and 10014 to 10017" added for Pr.75 (for the safety communication model only)

◆ Functions available for the inverters manufactured in August 2020 or later

- Firmware version: 2 or later

Item	Details
Mitsubishi Electric Vector control dedicated motor (SF-V5RU (1500 r/min series))	The SF-V5RU 1.5 to 5.5 kW motors can be driven by the FR-E820-0110(2.2K) to 0330(7.5K) inverters. The SF-V5RUH 1.5 to 5.5 kW motors can be driven by the FR-E840-0060(2.2K) to 0170(7.5K) inverters.
Mitsubishi Electric high-performance energy-saving motor with encoder	SF-PR-SC
Mitsubishi Electric inverter-driven geared motor for encoder feedback control	GM-DZ, GM-DP
Plug-in option	FR-A8AP E kit
EtherNet/IP communication specifications	Access to the parameters, monitor data, and terminals is available. Inverter Configuration Object (64h) <ul style="list-style-type: none"> • Inverter Parameters (12288 to 16383) • Monitor Data (16384 to 20479) • Inverter Control Parameters (20480 to 24575)
PROFINET communication specifications	Access to the parameters, monitor data, and terminals is available. <ul style="list-style-type: none"> • Inverter Parameters (12288 to 16383) • Monitor Data (16384 to 20479) • Inverter Control Parameters (20480 to 24575)
Added parameters	Pr.284, Pr.359, Pr.367, Pr.368, Pr.369, Pr.376, Pr.422, Pr.552, Pr.600 to Pr.604, Pr.607, Pr.608, Pr.690, Pr.692 to Pr.696, Pr.802, Pr.823, Pr.828, Pr.833, Pr.840 to Pr.848, Pr.854, Pr.873, Pr.877 to Pr.881, P.A107 (Pr.285)
Changed parameter setting range	<ul style="list-style-type: none"> • Setting value "8888" added for Pr.11 • Setting values "19 and 35" added for Pr.52, Pr.774 to Pr.776, Pr.992, and Pr.1027 to Pr.1034 • Setting values "30 and 33" added for Pr.71 and Pr.450 • Setting values "13, 23, 42, 43, and 74" added for Pr.178 to Pr.189 • Setting values "30 to 33, and 130 to 133" added for Pr.190 to Pr.196, and Pr.313 to Pr.319 • Setting values "30 to 33" added for Pr.320 to Pr.322 • Setting values "0 to 2, and 9" added for Pr.800 • Setting value "2" added for Pr.850 • Setting value "6" added for Pr.858
Added faults	<ul style="list-style-type: none"> • Signal loss detection (E.ECT) • Brake sequence fault (E.MB1 to E.MB3)

◆ Functions available for the inverters manufactured in January 2021 or later

- Firmware version: 3 or later

Item	Details	Related manuals
Position control (Vector control)	Position control (Vector control) is supported for induction motors. • Pr.420, Pr.421, Pr.423, Pr.425 to Pr.427, Pr.430, Pr.446, Pr.464 to Pr.478, Pr.510, Pr.511, Pr.538, Pr.698, Pr.1222, Pr.1223, Pr.1225 to Pr.1227, Pr.1229 to Pr.1231, Pr.1233 to Pr.1235, Pr.1237 to Pr.1239, Pr.1241 to Pr.1243, Pr.1245 to Pr.1247, Pr.1249, Pr.1282, Pr.1283, Pr.1285, Pr.1286, Pr.1289, Pr.1290, Pr.1292 to Pr.1297	Connection/ Function/ Communication/ Maintenance
	Position control is available. • Setting values "3 to 5" added for Pr.800	
	Signals for position control can be assigned to I/O terminals. • Setting values "76, and 87 to 89" added for Pr.178 to Pr.189 • Setting values "24, 36, 38, 56, 60 to 63, 84, 124, 136, 138, 156, 160 to 163, and 184" added for Pr.190 to Pr.196 and Pr.313 to Pr.319 • Setting values "24, 36, 38, 56, 60 to 63, and 84" added for Pr.320 to Pr.322	
	Monitoring during position control is available (multifunction monitor). • Setting values "26 to 31, and 65" added for Pr.52, Pr.774 to Pr.776, and Pr.992 • Setting value "65" added for Pr.54 and Pr.158 • Setting values "65, 222 to 227, and 229" added for Pr.1027 to Pr.1034	
	The following warnings are added: LP (Stroke limit warning), HP1 (Home position return setting error), and HP2 (Home position return uncompleted)	
	The following faults are added: E.OD (Excessive position fault) and E.OA (acceleration error).	
CC-Link IE TSN communication specifications	User defined cyclic communication is supported. • Setting values "38 and 138" of Pr.544 are available for remote registers.	Function/ Communication
EtherNet/IP communication specifications	User defined cyclic communication is supported. • "Configurable" is added for the connections of Class 1 communication (I/O Message communication) (Instances 100 and 150).	Communication
PROFINET communication specifications	User defined cyclic communication is supported. • Telegram 102 is added for Process Data (Cyclic Data Exchange).	Communication
MODBUS/TCP communication specifications	CiA402 drive profile (24642 to 24644, 24646, 24648, 24649, and 26623) is added for MODBUS registers.	Communication
PTC thermistor	Motor overheat protection by the motor's built-in PTC thermistor is supported. • Pr.561 and Pr.1016 are added. • Setting value "64" of Pr.52, Pr.774 to Pr.776, Pr.992, Pr.1027 to Pr.1034 is available (multifunction monitor). • E.PTC (PTC thermistor operation) is added.	Connection/ Function/ Maintenance
Backup/restore function	Inverter parameters and the data used in the PLC function of inverter can be backed up and restored. • RD (Backup in progress) and WR (Restoration in progress) indications are added.	Communication/ Maintenance
Increased magnetic excitation deceleration	Added functions • Pr.660 to Pr.662 are added.	Function
Optimum excitation control	The control can be enabled under Advanced magnetic flux vector control.	Function
PLC function	The structured text (ST) language is supported, and jump commands are supported.	PLC Function Programming Manual
Capacity	200 V class: 11K to 22K are added. 400 V class: 11K to 22K are added.	Connection/ Function/ Communication/ Maintenance
Parameters	Pr.375 added User Defined Cyclic Communication Input/Output Mapping parameters (Pr.1318 to Pr.1343) added	Function/ Communication

◆ Functions available for the inverters manufactured in May 2021 or later

- Firmware version: 5 or later

Item	Details	Related manuals
PM motor (MM-GKR 0.4kW and 0.75kW, and EM-A 5.5kW and 7.5kW)	Applied motor setting • Setting values "540 and 1140" (200 V class) added for Pr.71 and Pr.450	Connection/ Function/ Communication/ Maintenance
	Parameter initial setting • Setting values "3024, 3044, 3124, and 3144" (200 V class) added for Pr.998	
	Position control (Vector control) is supported for PM motors (MM-GKR and EM-A). Control mode setting • Setting values "13 and 14" added for Pr.451 and Pr.800	
Orientation control	Added parameters • Pr.350 to Pr.358, Pr.361 to Pr.366, Pr.393, Pr.396 to Pr.399	Function/ Communication/ Maintenance
	Setting values • Setting value "22" added for Pr.52 • Setting value "22" added for Pr.178 to Pr.189 • Setting values "27, 28, 127, and 128" added for Pr.190 to Pr.196 • Setting values "27, 28, 127, and 128" added for Pr.313 to Pr.319 • Setting values "27 and 28" added for Pr.320 to Pr.322 • Setting value "22" added for Pr.774 to Pr.776 • Setting value "22" added for Pr.992 • Setting value "22" added for Pr.1027 to Pr.1034	
EtherCAT communication specifications	The FR-E800-EPC models are added.	Connection/ Function/ Communication/ Maintenance
	Added parameters • Pr.1305	
Emergency drive (except for the E800-SCE inverters)	Added parameters • Pr.136, Pr.139, Pr.514, Pr.515, Pr.523, Pr.524, and Pr.1013	Connection/ Function/ Maintenance
	Setting values • Setting value "68" added for Pr.52 • Setting value "84" added for Pr.178 to Pr.189 • Setting values "18, 19, 65, 66, 165, and 166" added for Pr.190 to Pr.196 • Setting values "18, 19, 65, 66, 165, and 166" added for Pr.313 to Pr.319 • Setting values "18, 19, 65, and 66" added for Pr.320 to Pr.322 • Setting value "68" added for Pr.774 to Pr.776 • Setting value "68" added for Pr.992 • Setting value "68" added for Pr.1027 to Pr.1034	
	ED (Emergency drive) warning added	
Ethernet communication specifications	Simple positioning using CiA402 drive profile Added parameters • Pr.1220 added Setting values • Setting values added for Pr.1320 to Pr.1329 [E800-(SC)EPA][E800-(SC)EPB] "24672, 24689, 24698, 24703, 24705, 24707, 24708, 24719, 24721, and 24728 to 24730" [E800-EPC] "12288 to 13787, 20488, 20489, 24642, 24646, 24648 to 24650, 24672, 24677 to 24680, 24689, 24698, 24702, 24703, 24705, 24707 to 24709, 24719, 24721, 24728 to 24730, 24831, and 9999" • Setting values added for Pr.1330 to Pr.1343 [E800-(SC)EPA][E800-(SC)EPB] "20992, 24639, 24643, 24644, 24673 to 24676, 24692, 24695, 24820, 24826, 24828, and 25858" [E800-EPC] "12288 to 13787, 16384 to 16483, 20488, 20489, 20981 to 20990, 20992, 24639, 24643, 24644, 24673 to 24676, 24692, 24695, 24820, 24826, 24828, 25858, and 9999"	Communication
	User defined cyclic communication specifications Added parameters • Pr.1389 to Pr.1398	
	Ethernet relay operation at reset selection Added parameter • Pr.1386	
Parameters	Parameters added for the second functions • Pr.1298 and Pr.1299	Function

◆ Functions available for the inverters manufactured in September 2021 or later

- Firmware version: 6 or later

Item	Details	Related manuals
BACnet MS/TP communication specifications	Added parameters • Pr.726 and Pr.727	Function/ Communication
	Setting values • Setting values "81, 82, and 84 to 86" added for Pr.52, Pr.774 to Pr.776, and Pr.1027 to Pr.1034 • Setting values "81 to 86" added for Pr.992 • Setting value "85" added for Pr.54 • Setting value "86" added for Pr.158 • Setting values "82 and 182" added for Pr.190 and Pr.191 • Setting value "2" added for Pr.549	

◆ Functions available for the inverters manufactured in December 2021 or later

- Firmware version: 7 or later

Item	Details	Related manuals
Cumulative pulse monitoring	Added parameters • Pr.635, Pr.636, and Pr.638	Function
	Setting values • Setting values "71 and 72" added for Pr.52, Pr.774 to Pr.776, Pr.992, and Pr.1027 to Pr.1034 • Setting value "52" added for Pr.178 to Pr.189	
24 V external power supply operation	Plug-in option FR-E8DS E kit is available.	Function/ Maintenance/ FR-E8DS E Kit Instruction Manual
	Setting values • Setting values "68 and 168" added for Pr.190 to Pr.196, and Pr.313 to Pr.319 • Setting value "68" added for Pr.320 to Pr.322	
	Operation panel indication "EV" (24 V external power supply operation) is added.	
Internal storage device status indication	Added parameters • Pr.890	Function/ Maintenance
	E.PE6 (Internal storage device fault) fault added	
MM-GKR motor capacity	0.1 kW and 0.2 kW are added.	Connection/ Function
Environmental impact diagnosis function	Cor (Corrosion warning) warning added	Maintenance

◆ Functions available for the inverters manufactured in May 2022 or later

- Firmware version: 9 or later

Item	Details	Related manuals
EM-A motor capacity	200 V class: 0.75 kW to 3.7 kW are added. 400 V class: 3.7 kW and 5.5 kW are added.	Connection/ Function
Anti-sway control	Added parameters • Pr.1072 to Pr.1079	Function
CC-Link IE TSN communication specifications	Added parameters • Pr.1210	Function/ Communication
EtherNet/IP communication specifications	Instance 21216 (Speed scale (numerator)) and instance 21217 (Speed scale (denominator)) are added for Inverter Configuration Object (64h)	Communication

◆ Functions available for the inverters manufactured in October 2022 or later

- Firmware version: 11 or later

Item	Details	Related manuals
Inverter capacity	100 V class: 0.1K to 0.75K are added.	Connection/ Function/ Communication/ Maintenance

◆ Functions available for the inverters manufactured in November 2022 or later

- Firmware version: 11 or later

Item	Details	Related manuals
EM-A motor capacity	200 V class: 0.1 kW to 0.4 kW are added. 400 V class: 2.2 kW is added.	Connection/ Function
Position accuracy compensation gain tuning	Added parameters • Pr.979 to Pr.981	Function
	Setting values • Setting value "301" added for Pr.96	
Anti-sway control function	Setting values • Setting value "54" added for Pr.178 to Pr.189	Function
BACnet/IP and BACnet MS/TP communication specifications	Network Port Object is added.	Communication
PROFINET communication specifications	E.SAF can be reset by bit 7 of Control word 1 (STW1).	Communication

4

◆ Functions available for the inverters manufactured in July 2023 or later

- Firmware version: 12 or later

Item	Details	Related manuals
SF-PR motor capacity	200 V class: 0.2 kW and 0.4 kW are added. 400 V class: 0.2 kW and 0.4 kW are added.	Function
EM-A motor capacity	400 V class: 0.4 kW to 1.5 kW, and 7.5 kW are added.	Connection/ Function
Position control function	Added parameters • Pr.1095 to Pr.1097	Function
	Setting values • Setting values "21 and 22" added for Pr.538	
SLMP communication specifications	Added link registers • W5807 and W5808 (inverter status) • W5900 to W5969 (fault history)	Communication
Plug-in option	FR-E8AXY E kit	FR-E8AXY E Kit Instruction Manual
Control terminal option	FR-E8TR and FR-E8TE7	FR-E8TR Instruction Manual FR-E8TE7 Instruction Manual

◆ Functions available for the inverters manufactured in October 2023 or later

- Firmware version: 12 or later

Item	Details	Related manuals
IP67 model	400 V class: 0.75 kW to 3.7 kW	Connection/ Function/ Communication/ Maintenance
	Added parameters • Pr.508	
	BACnet/IP communication specifications • Binary input: object identifiers 100, 104, and 106 added. • Binary output: object identifiers 0, 4, and 6 added.	
	E.IAH (Abnormal internal temperature) fault added	
Parameters	Pr.197 added	Function

◆ Functions available for firmware version 13 or later

Item	Details	Related manuals
Selection between resetting or not resetting during power supply to main circuit	Setting values • Setting values "100 to 102" added for Pr.30	Function

MEMO

Warranty

When using this product, make sure to understand the warranty described below.

1. Warranty period and coverage

We will repair any failure or defect (hereinafter referred to as "failure") in our FA equipment (hereinafter referred to as the "Product") arisen during warranty period at no charge due to causes for which we are responsible through the distributor from which you purchased the Product or our service provider. However, we will charge the actual cost of dispatching our engineer for an on-site repair work on request by customer in Japan or overseas countries. We are not responsible for any on-site readjustment and/or trial run that may be required after a defective unit are repaired or replaced.

[Term]

The term of warranty for Product is twelve months after your purchase or delivery of the Product to a place designated by you or eighteen months from the date of manufacture whichever comes first ("Warranty Period"). Warranty period for repaired Product cannot exceed beyond the original warranty period before any repair work.

[Limitations]

- (1) You are requested to conduct an initial failure diagnosis by yourself, as a general rule. It can also be carried out by us or our service company upon your request and the actual cost will be charged.
However, it will not be charged if we are responsible for the cause of the failure.
- (2) This limited warranty applies only when the condition, method, environment, etc. of use are in compliance with the terms and conditions and instructions that are set forth in the instruction manual and user manual for the Product and the caution label affixed to the Product.
- (3) Even during the term of warranty, the repair cost will be charged on you in the following cases;
 - a failure caused by your improper storing or handling, carelessness or negligence, etc., and a failure caused by your hardware or software problem
 - a failure caused by any alteration, etc. to the Product made on your side without our approval
 - a failure which may be regarded as avoidable, if your equipment in which the Product is incorporated is equipped with a safety device required by applicable laws and has any function or structure considered to be indispensable according to a common sense in the industry
 - a failure which may be regarded as avoidable if consumable parts designated in the instruction manual, etc. are duly maintained and replaced
 - any replacement of consumable parts (condenser, cooling fan, etc.)
 - a failure caused by external factors such as inevitable accidents, including without limitation fire and abnormal fluctuation of voltage, and acts of God, including without limitation earthquake, lightning and natural disasters
 - a failure caused by using the emergency drive function
 - a failure generated by an unforeseeable cause with a scientific technology that was not available at the time of the shipment of the Product from our company
 - any other failures which we are not responsible for or which you acknowledge we are not responsible for

2. Term of warranty after the stop of production

- (1) We may accept the repair at charge for another seven (7) years after the production of the product is discontinued. The announcement of the stop of production for each model can be seen in our Sales and Service, etc.
- (2) Please note that the Product (including its spare parts) cannot be ordered after its stop of production.

3. Service in overseas

Our regional FA Center in overseas countries will accept the repair work of the Product; however, the terms and conditions of the repair work may differ depending on each FA Center. Please ask your local FA center for details.

4. Exclusion of loss in opportunity and secondary loss from warranty liability

Regardless of the gratis warranty term, Mitsubishi Electric shall not be liable for compensation to:

- (1) Damages caused by any cause found not to be the responsibility of Mitsubishi Electric.
- (2) Loss in opportunity, lost profits incurred to the user by Failures of Mitsubishi Electric products.
- (3) Special damages and secondary damages whether foreseeable or not, compensation for accidents, and compensation for damages to products other than Mitsubishi Electric products.
- (4) Replacement by the user, maintenance of on-site equipment, start-up test run and other tasks.

5. Change of Product specifications

Specifications listed in our catalogs, manuals or technical documents may be changed without notice.

6. Application and use of the Product

- (1) For the use of our product, its applications should be those that may not result in a serious damage even if any failure or malfunction occurs in product, and a backup or fail-safe function should operate on an external system to product when any failure or malfunction occurs.
- (2) Our product is designed and manufactured as a general purpose product for use at general industries.
Therefore, applications substantially influential on the public interest for such as atomic power plants and other power plants of electric power companies, and also which require a special quality assurance system, including applications for railway companies and government or public offices are not recommended, and we assume no responsibility for any failure caused by these applications when used.
In addition, applications which may be substantially influential to human lives or properties for such as airlines, medical treatments, railway service, incineration and fuel systems, man-operated material handling equipment, entertainment machines, safety machines, etc. are not recommended, and we assume no responsibility for any failure caused by these applications when used. We will review the acceptability of the abovementioned applications, if you agree not to require a specific quality for a specific application. Please contact us for consultation.

Revisions

*The manual number is given on the bottom left of the back cover

Revision date	*Manual number	Revision
Dec. 2019	IB(NA)-0600874ENG-A	First edition
Apr. 2020	IB(NA)-0600874ENG-B	Added <ul style="list-style-type: none"> FR-E820S-0008(0.1K) to 0110(2.2K)(E)(SCE) FR-E800-SCE (safety communication model)
Jun. 2020	IB(NA)-0600874ENG-C	Added <ul style="list-style-type: none"> Vector control
Nov. 2020	IB(NA)-0600874ENG-D	Added <ul style="list-style-type: none"> FR-E820-0470(11K) to 0900(22K)(E)(SCE) FR-E840-0230(11K) to 0440(22K)(E)(SCE) Position control PTC thermistor
Jan. 2021	IB(NA)-0600874ENG-E	Edited <ul style="list-style-type: none"> Models listed on the front cover
Apr. 2021	IB(NA)-0600874ENG-F	Added <ul style="list-style-type: none"> Compatibility with the MM-GKR and E-MA motors Orientation function Emergency drive
Oct. 2021	IB(NA)-0600874ENG-G	Added <ul style="list-style-type: none"> 24 V external power supply operation Internal storage device status indication Environmental impact diagnosis function
Aug. 2022	IB(NA)-0600874ENG-H	Added <ul style="list-style-type: none"> FR-E810W-0008(0.1K) to 0050(0.75K)(E)(SCE)
Jul. 2023	IB(NA)-0600874ENG-J	Added <ul style="list-style-type: none"> Pr.197 FR-E806 (IP67 model)

Model	FR-E800 Instruction Manual (Maintenance)
Model code	1A2P95

MITSUBISHI ELECTRIC CORPORATION

HEAD OFFICE: TOKYO BUILDING 2-7-3, MARUNOUCHI, CHIYODA-KU, TOKYO 100-8310, JAPAN