

INVERTER

FR-E800

Instruction Manual (Function)

Compact, high functionality inverters

FR-E820-0008(0.1K) to 0900(22K)
FR-E840-0016(0.4K) to 0440(22K)
FR-E860-0017(0.75K) to 0120(7.5K)
FR-E820S-0008(0.1K) to 0110(2.2K)
FR-E810W-0008(0.1K) to 0050(0.75K)
FR-E820-0008(0.1K) to 0900(22K)E
FR-E840-0016(0.4K) to 0440(22K)E
FR-E860-0017(0.75K) to 0120(7.5K)E
FR-E820S-0008(0.1K) to 0110(2.2K)E
FR-E810W-0008(0.1K) to 0050(0.75K)E
FR-E820-0008(0.1K) to 0900(22K)SCE
FR-E840-0016(0.4K) to 0440(22K)SCE
FR-E860-0017(0.75K) to 0120(7.5K)SCE
FR-E820S-0008(0.1K) to 0110(2.2K)SCE
FR-E810W-0008(0.1K) to 0050(0.75K)SCE
FR-E846-0026(0.75K) to 0095(3.7K)SCE

Chapter 1 Introduction	12
1.1 Inverter model	13
1.2 Operation steps	15
1.3 Related manuals	18
Chapter 2 Basic Operation	20
2.1 Operation panel	20
2.1.1 Components of the operation panel	20
2.1.2 Basic operation of the operation panel	25
2.1.3 Digital characters and their corresponding printed equivalents	27
2.1.4 Changing the parameter setting value	27
2.2 Monitoring the inverter	29
2.2.1 Monitoring of output current and output voltage	29
2.2.2 First priority monitor screen	29
2.2.3 Displaying the set frequency	29
2.3 Easy setting of the inverter operation mode	30
2.4 Frequently-used parameters (simple mode parameters)	31
2.4.1 Simple mode parameter list	31
2.5 Basic operation procedure (PU operation)	35
2.5.1 Setting the frequency on the operation panel (example: operating at 30 Hz)	35
2.5.2 Setting the frequency with switches (multi-speed setting)	37
2.5.3 Setting the frequency using an analog signal (voltage input)	38
2.5.4 Setting the frequency using an analog signal (current input)	39
2.6 Basic operation procedure (External operation)	41
2.6.1 Setting the frequency on the operation panel	41
2.6.2 Setting the frequency and giving a start command with switches (multi-speed setting) (Pr.4 to Pr.6)	43
2.6.3 Setting the frequency using an analog signal (voltage input)	44
2.6.4 Changing the frequency (initial value: 60 Hz) at the maximum voltage input (initial value: 5 V)	45
2.6.5 Setting the frequency using an analog signal (current input)	46
2.6.6 Changing the frequency (initial value: 60 Hz) at the maximum current input (initial value: 20 mA)	47
2.7 Basic operation procedure (JOG operation)	48
2.7.1 Giving a start command by using external signals for JOG operation	48
2.7.2 Giving a start command from the operation panel for JOG operation	49
2.8 I/O terminal function assignment	50
Chapter 3 Parameters	54
3.1 Parameter initial value groups	54

3.2	Parameter list (by parameter number)	55
3.3	Use of a function group number for the identification of parameters	94
3.4	Parameter list (by function group number)	95
Chapter 4 Control Method		108
4.1	Vector control and Real sensorless vector control	112
4.2	Changing the control method and mode	115
4.3	Selecting the Advanced magnetic flux vector control	121
4.4	Selecting the PM sensorless vector control	123
Chapter 5 Speed Control		132
5.1	Setting procedure of Real sensorless vector control (speed control)	135
5.2	Setting procedure of Vector control (speed control)	136
5.3	Setting procedure of PM sensorless vector control (speed control)	137
5.4	Setting the torque limit level	139
5.5	Performing high-accuracy, fast-response control (gain adjustment)	146
5.6	Speed feed forward control, model adaptive speed control	148
5.7	Torque bias	150
5.8	Avoiding motor overrunning	154
5.9	Troubleshooting in the speed control	156
Chapter 6 Torque Control		160
6.1	Torque control	160
6.2	Setting procedure of Real sensorless vector control (torque control)	165
6.3	Setting procedure for Vector control (torque control)	166

6.4	Torque command	167
6.5	Speed limit	171
6.6	Torque control gain adjustment	173
6.7	Troubleshooting in torque control	175

Chapter 7 Position Control 178

7.1	About position control	178
7.2	Setting procedure of Vector control (position control)	181
7.3	Setting procedure of PM sensorless vector control (position control)	182
7.4	Simple positioning function by point tables	184
7.5	Simple positioning function by direct commands (Ethernet model / safety communication model / IP67 model)	197
7.6	Pulse monitor	207
7.7	Electronic gear settings	210
7.8	Position adjustment parameter settings	212
7.9	Current position retention function	215
7.10	Position control gain adjustment	217
7.11	Troubleshooting in position control	219

Chapter 8 (E) Environment Setting Parameters 222

8.1	Clock	222
8.2	Reset selection / disconnected PU detection / PU stop selection	225
8.3	PU display language selection (Standard model)	228
8.4	Buzzer control (Standard model)	229

8.5	PU contrast adjustment (Standard model)	230
8.6	Automatic frequency setting / key lock operation selection	231
8.7	Frequency change increment amount setting (Standard model)	233
8.8	RUN key rotation direction selection	234
8.9	Multiple rating setting	235
8.10	Parameter write selection	237
8.11	Password	240
8.12	Free parameter	243
8.13	Setting multiple parameters by batch	244
8.14	Extended parameter display and user group function	246
8.15	PWM carrier frequency and Soft-PWM control	249
8.16	Inverter parts life display	251
8.17	Maintenance timer alarm	256
8.18	Current average value monitor signal	257

Chapter 9 (F) Settings for Acceleration/Deceleration 262

9.1	Setting the acceleration and deceleration time	262
9.2	Acceleration/deceleration pattern	267
9.3	Remote setting function	269
9.4	Starting frequency and start-time hold function	274
9.5	Minimum motor speed frequency at the motor start up	275
9.6	Shortest acceleration/deceleration (automatic acceleration/deceleration)	276

Chapter 10 (D) Operation Command and Frequency Command 280

10.1	Operation mode selection	280
10.2	Startup of the inverter in Network operation mode at power-ON	290
10.3	Start command source and frequency command source during communication operation ..	291
10.4	Reverse rotation prevention selection	300
10.5	JOG operation	301
10.6	Operation by multi-speed setting	303

Chapter 11 (H) Protective Function Parameters 306

11.1	Motor overheat protection (electronic thermal O/L relay)	306
11.2	Cooling fan operation selection	314
11.3	Earth (ground) fault detection at start	315
11.4	Inverter output fault detection enable/disable selection	316
11.5	Initiating a protective function	317
11.6	I/O phase loss protection selection	318
11.7	Retry function	319
11.8	Emergency drive (Fire mode) (Standard model / Ethernet model)	322
11.9	Checking faulty area in the internal storage device	330
11.10	Limiting the output frequency (maximum/minimum frequency)	331
11.11	Avoiding machine resonance points (frequency jump)	332
11.12	Stall prevention operation	334
11.13	Load characteristics fault detection	339

11.14	Motor overspeeding detection	344
-------	------------------------------	-----

Chapter 12 (M) Item and Output Signal for Monitoring. 346

12.1	Speed indication and its setting change to rotations per minute	346
12.2	Monitor item selection on operation panel or via communication.	348
12.3	Monitor display selection for terminals FM and AM	358
12.4	Adjustment of terminal FM and terminal AM	362
12.5	Energy saving monitoring.	365
12.6	Output terminal function selection	371
12.7	Output frequency detection	382
12.8	Output current detection function	385
12.9	Output torque detection function	387
12.10	Remote output function	388

Chapter 13 (T) Multi-Function Input Terminal Parameters 392

13.1	Analog input selection	392
13.2	Analog input terminal (terminal 4) function assignment	397
13.3	Response level of analog input and noise elimination	398
13.4	Frequency setting voltage (current) bias and gain	400
13.5	Torque setting current (voltage) bias and gain.	405
13.6	Input terminal function selection.	410
13.7	Inverter output shutoff	416
13.8	Selecting the condition to activate the Second function selection (RT) signal	418
13.9	Start signal operation selection	420

Chapter 14 (C) Motor Constant Parameters 424

14.1	Applied motor.	424
14.2	Offline auto tuning	430
14.3	Offline auto tuning for a PM motor.	441
14.4	Online auto tuning	449
14.5	Parameter settings for a motor with encoder.	452
14.6	Signal loss detection of encoder signals	454

Chapter 15 (A) Application Parameters 456

15.1	Brake sequence function	456
15.2	Stop-on-contact control	461
15.3	Traverse function	464
15.4	Anti-sway control	466
15.5	Orientation control	468
15.6	PID control	479
15.7	Calibration of PID display	492
15.8	Dancer control	495
15.9	Automatic restart after instantaneous power failure / flying start with an induction motor.	502
15.10	Automatic restart after instantaneous power failure / flying start with a PM motor	508
15.11	Offline auto tuning for a frequency search.	510
15.12	Power failure time deceleration-to-stop function	514
15.13	PLC function	516
15.14	Trace function	518

Chapter 16 (G) Control Parameters 528

16.1	Manual torque boost.	528
16.2	Base frequency voltage	530
16.3	Load pattern selection	532
16.4	Energy saving control.	534
16.5	SF-PR slip amount adjustment mode.	535
16.6	DC injection brake, zero speed control, servo lock, and magnetic flux decay output shutoff.	536
16.7	Stop selection.	543
16.8	Regenerative brake selection.	545
16.9	Regeneration avoidance function.	551
16.10	Increased magnetic excitation deceleration	554
16.11	Slip compensation	556
16.12	Speed detection filter	557
16.13	Excitation ratio	558
16.14	Encoder feedback control.	559
16.15	Droop control	561
16.16	Speed smoothing control	562

Chapter 17 Checking and Clearing of Settings 564

17.1	Parameter clear / All parameter clear.	564
17.2	List of parameters changed from the initial values.	565
17.3	Fault history clear	566

Chapter 18 Appendix 568

18.1 For customers replacing the conventional model with this inverter 568

18.1.1 Replacement of the FR-E700 series 568

18.1.2 Replacement of the FR-E500 series 570

18.2 Specification comparison between PM sensorless vector control and induction motor control
. 571

18.3 Major differences between the FR-E840 and the FR-E846 572

18.4 Parameters (functions) and instruction codes under different control methods. 574

18.5 How to check specification changes 599

18.5.1 Details of specification changes 599

CHAPTER 1 Introduction

1.1	Inverter model	13
1.2	Operation steps	15
1.3	Related manuals	18

1 Introduction

The contents described in this chapter must be read before using this product.

Always read the instructions before use.

◆ Abbreviations

Item	Description
PU	Operation panel, parameter unit (FR-PU07), LCD operation panel (FR-LU08), and enclosure surface operation panel (FR-PA07)
Parameter unit	Parameter unit (FR-PU07), LCD operation panel (FR-LU08), and enclosure surface operation panel (FR-PA07)
Inverter	Mitsubishi Electric inverter FR-E800 series
E800	Standard model (RS-485 + SIL2/PLd functional safety)
E800-E	Ethernet model (Ethernet + SIL2/PLd functional safety)
E800-SCE	Safety communication model (Ethernet + SIL3/PLe functional safety)
E806	IP67 model (Ethernet + SIL3/PLe functional safety + IP67)
FM type inverter	Standard model with terminal FM (pulse output)
AM type inverter	Standard model with terminal AM (voltage output)
Vector control compatible option	FR-A8AP E kit
Pr.	Parameter number (Number assigned to function)
PU operation	Operation using the PU (operation panel / parameter unit)
External operation	Operation using the control circuit signals
Combined operation	Combined operation using the PU (operation panel / parameter unit) and External operation
Mitsubishi Electric standard efficiency motor	SF-JR
Mitsubishi Electric constant-torque motor	SF-HRCA
Mitsubishi Electric high-performance energy-saving motor	SF-PR
Mitsubishi Electric high-performance energy-saving motor with encoder	SF-PR-SC
Mitsubishi Electric Vector control dedicated motor	SF-V5RU
Mitsubishi Electric geared motor	GM-[]
Mitsubishi Electric inverter-driven geared motor for encoder feedback control	GM-DZ, GM-DP
Mitsubishi Electric PM motor	MM-GKR, EM-A

◆ Trademarks

- MODBUS is a registered trademark of SCHNEIDER ELECTRIC USA, INC.
- BACnet is a registered trademark of the American Society of Heating, Refrigerating and Air-Conditioning Engineers (ASHRAE).
- DeviceNet and EtherNet/IP are registered trademarks of ODVA (Open DeviceNet Vendor Association, INC).
- PROFIBUS and PROFINET are either trademarks or registered trademarks of PROFIBUS & PROFINET International.
- CC-Link IE TSN and CC-Link IE Field Network Basic are registered trademarks of CC-Link Partner Association.
- EtherCAT® is registered trademark and patented technology, licensed by Beckhoff Automation GmbH, Germany.
- Other company and product names herein are the trademarks and registered trademarks of their respective owners.

◆ Notes on descriptions in this Instruction Manual

- Connection diagrams in this Instruction Manual appear with the control logic of the input terminals as sink logic, unless otherwise specified. (Refer to the FR-E800 Instruction Manual (Connection) for the switching of the control logic of the inverter.)

1.1 Inverter model

Check the rating plate on the side of the product. Some characters in the model name indicate the specification as follows.

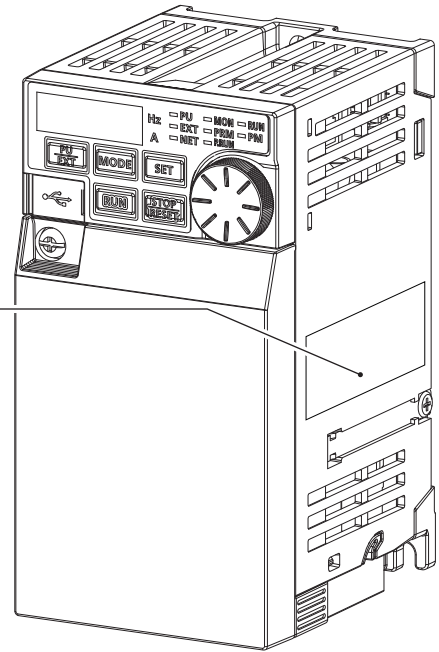
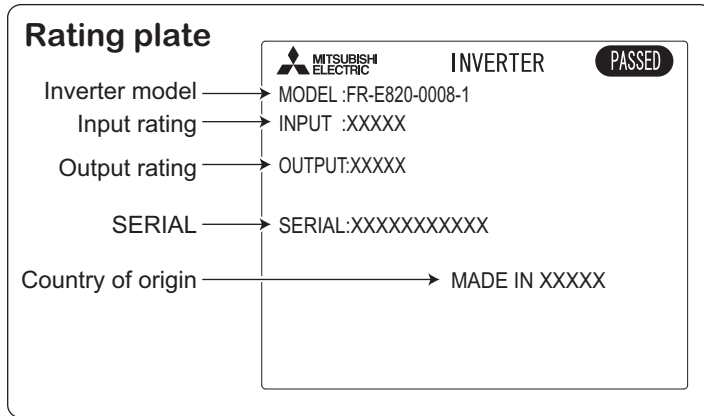
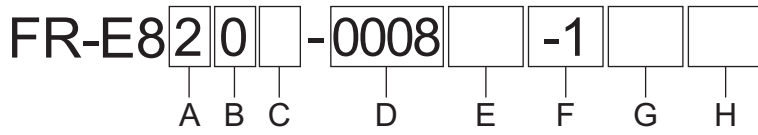

- A: The voltage class is shown.

Symbol	Voltage class
1	100 V class
2	200 V class
4	400 V class
6	575 V class

- B: The protective structure is shown.

Symbol	Protective structure
0	Open type (IP20)
6	Enclosed type (IP66/IP67, UL Type 4X, indoor use only)

- C: The number of phases of the power source is shown.

Symbol	Description
None	Three-phase input
S	Single-phase input
W	Single-phase input (double voltage output)

- D: The applicable motor capacity or the inverter rated current is shown.

Symbol	Description
0.1K to 22K	Applicable motor capacity (ND) (kW)
0008 to 0900	Inverter rated current (ND) (A)

- E: The communication type and the functional safety specification are shown.

Symbol	Communication / functional safety
None	RS-485 + SIL2/PLd
E	Ethernet + SIL2/PLd
SCE	Ethernet + SIL3/PLe

- F: The output specification for monitoring and the rated frequency are shown for the standard model, and the communication protocol group is shown for the Ethernet model, safety communication model, and IP67 model. The control logic is fixed to the source logic for the safety communication model and IP67 model.

Symbol	Monitoring/protocol specification	Rated frequency (initial setting)	Control logic	
			Input signal (initial status)	Safety stop signal
-1	Pulse (terminal FM)	60 Hz	Sink logic	Source logic (fixed)
-4	Voltage (terminal AM)	50 Hz	Source logic	
-5	Voltage (terminal AM)	60 Hz	Sink logic	
PA	Protocol group A (CC-Link IE TSN, CC-Link IE Field Network Basic, MODBUS/TCP, Ethernet/IP, and BACnet/IP)	60 Hz	Sink logic	
PB	Protocol group B (CC-Link IE TSN, CC-Link IE Field Network Basic, MODBUS/TCP, and PROFINET)	50 Hz	Sink logic / source logic ^{*1}	
PC ^{*2}	Protocol group C (EtherCAT)	50 Hz	Sink logic / source logic ^{*1}	

*1 The initial status of the control logic differs depending on the inverter model.

Sink logic for the models indicated with the applicable motor capacity (kW)

Source logic for the models indicated with the rated current (A)

*2 Available for the Ethernet model only.

- G: Availability of circuit board coating / plated conductors / power ON/OFF switch is shown.

Symbol	Circuit board coating ^{*1}	Plated conductor	Power ON/OFF switch
None	Without coating	Without plated conductors	Without switch
-60	With coating	Without plated conductors	Without switch
-06 ^{*2}	With coating	With plated conductors	Without switch
-S6 ^{*3}	With coating	Without plated conductors	With switch

*1 Conforming to IEC 60721-3-3:1994 3C2

*2 Applicable for the FR-E820-0470(11K) or higher, and the FR-E840-0380(18.5K) or higher.

*3 IP67 model only.

- H: Availability of an EMC filter is shown.

Symbol	EMC filter
None	Without filter
C2 ^{*1}	With filter (Class C2)

*1 IP67 model only.

NOTE

- In this Instruction Manual, the inverter model name consists of the applicable motor capacity and the rated current. (Example) FR-E820-0008(0.1K)

◆ How to read the SERIAL number

Rating plate example

Symbol Year Month Control number

SERIAL

The SERIAL consists of two symbols, three characters indicating the production year and month, and six characters indicating the control number.

The last two digits of the production year are indicated as the Year, and the Month is indicated by 1 to 9, X (October), Y (November), or Z (December).

1.2 Operation steps

◆ Standard model, Ethernet model, and safety communication model

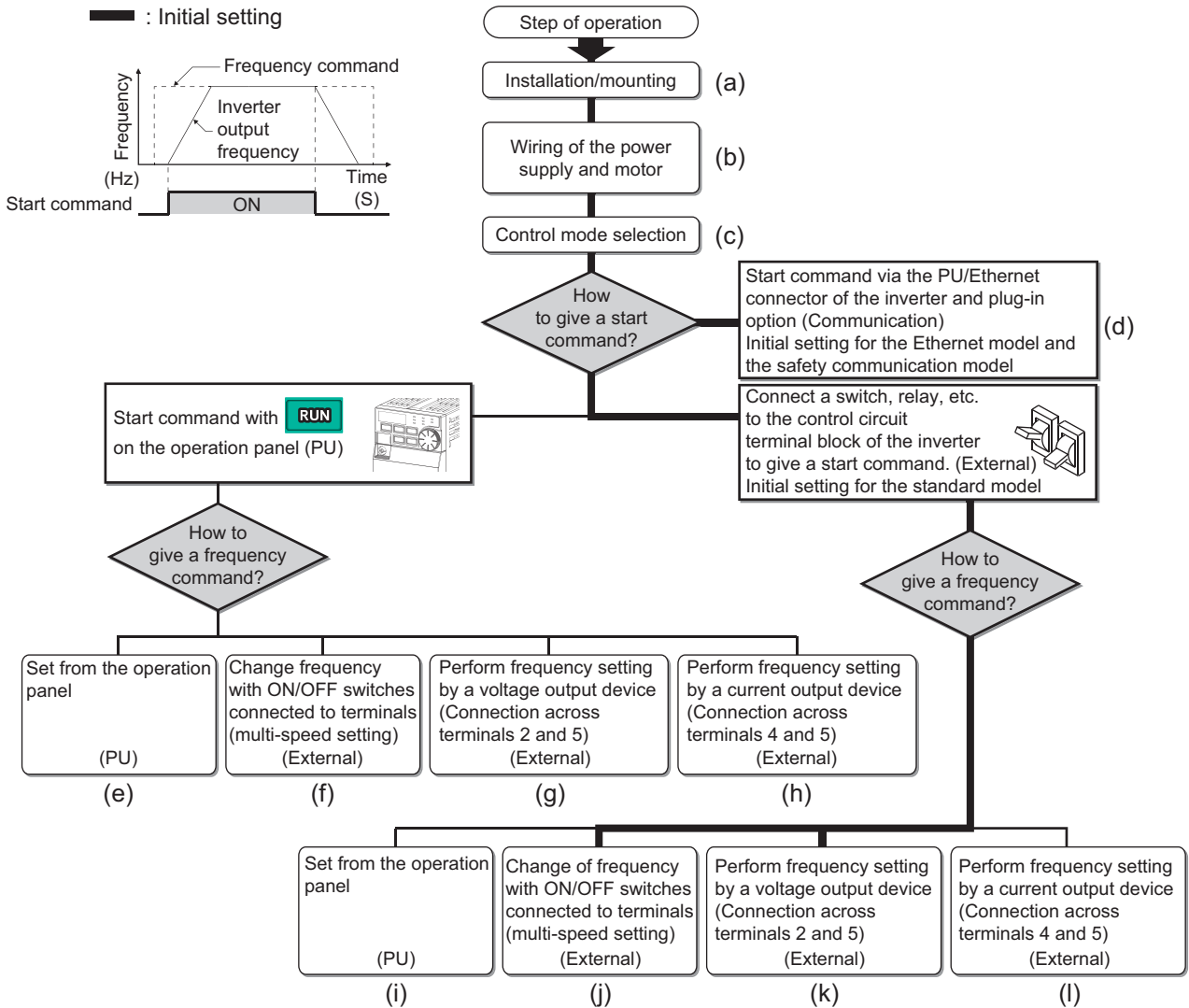

Symbol	Overview	Refer to page
(a)	Install the inverter.	Instruction Manual (Connection)
(b)	Perform wiring for the power supply and the motor.	Instruction Manual (Connection)
(c)	Select the control method (V/F control, Advanced magnetic flux vector control, Real sensorless vector control, Vector control, and PM sensorless vector control).	108
(d)	Give the start command via communication.	Instruction Manual (Communication)
(e)	Give both the start and frequency commands from the PU. (PU operation mode)	35
(f)	Give the start command from the PU and the frequency command via terminals RH, RM, and RL. (External/PU combined operation mode 2)	37
(g)	Give the start command from the PU and the frequency command by voltage input via terminal 2. (External/PU combined operation mode 2)	38
(h)	Give the start command from the PU and the frequency command by current input via terminal 4. (External/PU combined operation mode 2)	39
(i)	Give the start command via terminal STF/DI0 or STR/DI1 and the frequency command from the PU. (External/PU combined operation mode 1)	41
(j)	Give the start command via terminal STF/DI0 or STR/DI1 and the frequency command via terminals RH, RM, and RL. (External operation mode)	43
(k)	Give the start command via terminal STF/DI0 or STR/DI1 and the frequency command by voltage input via terminal 2. (External operation mode)	44
(l)	Give the start command via terminal STF/DI0 or STR/DI1 and the frequency command by current input via terminal 4. (External operation mode)	46

◆ IP67 model

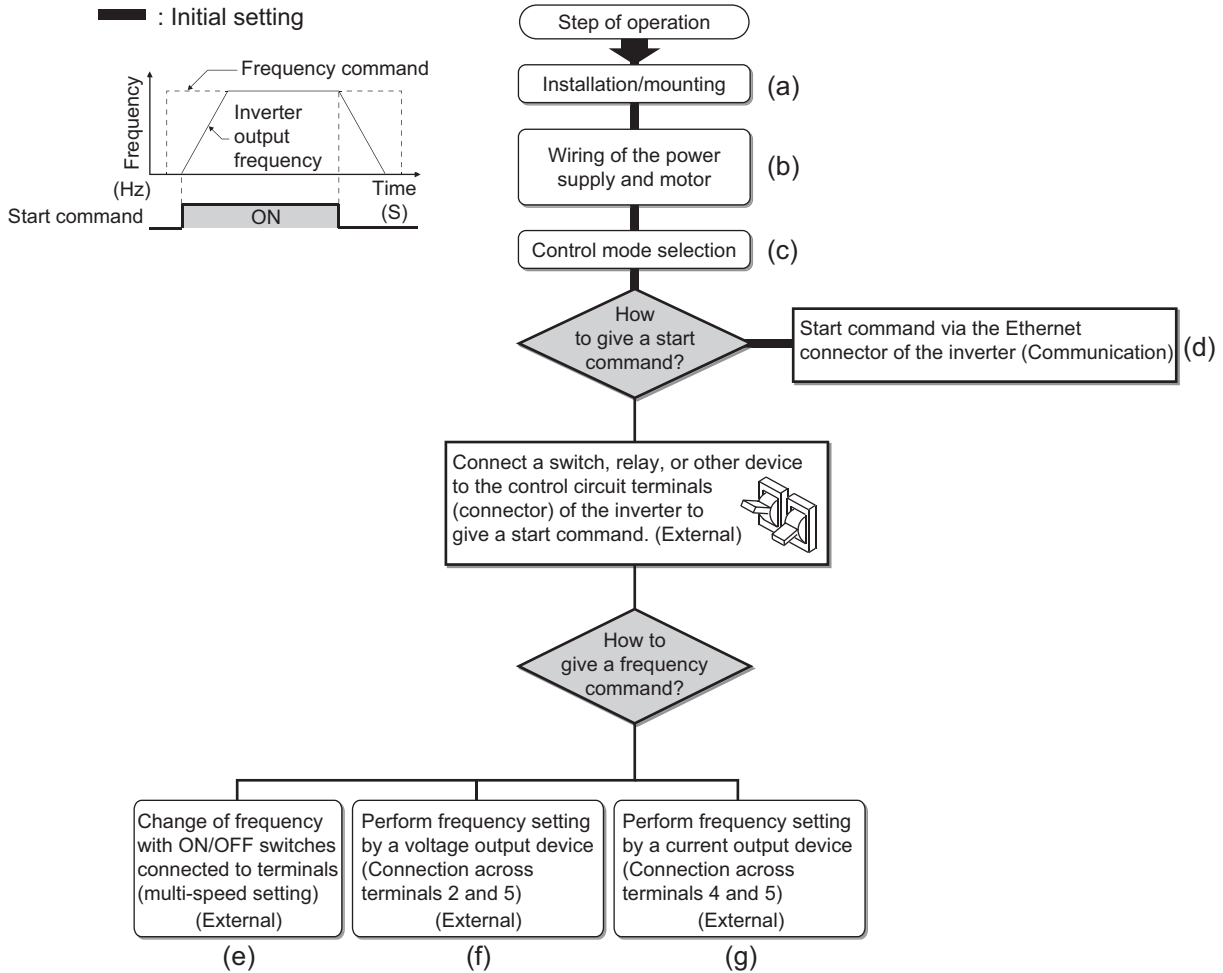

Symbol	Overview	Refer to page
(a)	Install the inverter.	Instruction Manual (Connection)
(b)	Perform wiring for the power supply and the motor.	Instruction Manual (Connection)
(c)	Select the control method (V/F control, Advanced magnetic flux vector control, Real sensorless vector control, and PM sensorless vector control).	108
(d)	Give the start command via communication.	Instruction Manual (Communication)
(e)	Give both the start and frequency commands via terminals DI0 and DI1. (External operation mode)	43
(f)	Give the start command via terminal DI0 or DI1 and the frequency command by voltage input via terminal 2. (External operation mode)	44
(g)	Give the start command via terminal DI0 or DI1 and the frequency command by current input via terminal 4. (External operation mode)	46

1.3 Related manuals

When using this inverter for the first time, prepare the following manuals as required and use the inverter safely. The latest version of e-Manual Viewer and the latest PDF manuals can be downloaded from the Mitsubishi Electric FA Global Website. <https://www.mitsubishielectric.com/app/fa/download/search.do?kisyu=/inv&mode=manual>

Point 

- e-Manual refers to the Mitsubishi FA electronic book manuals that can be browsed using a dedicated tool.
- e-Manual has the following features:
 - Required information can be cross-searched in multiple manuals.
 - Pages that users often browse can be bookmarked.

Manuals related to the FR-E800 inverter are shown in the following table.

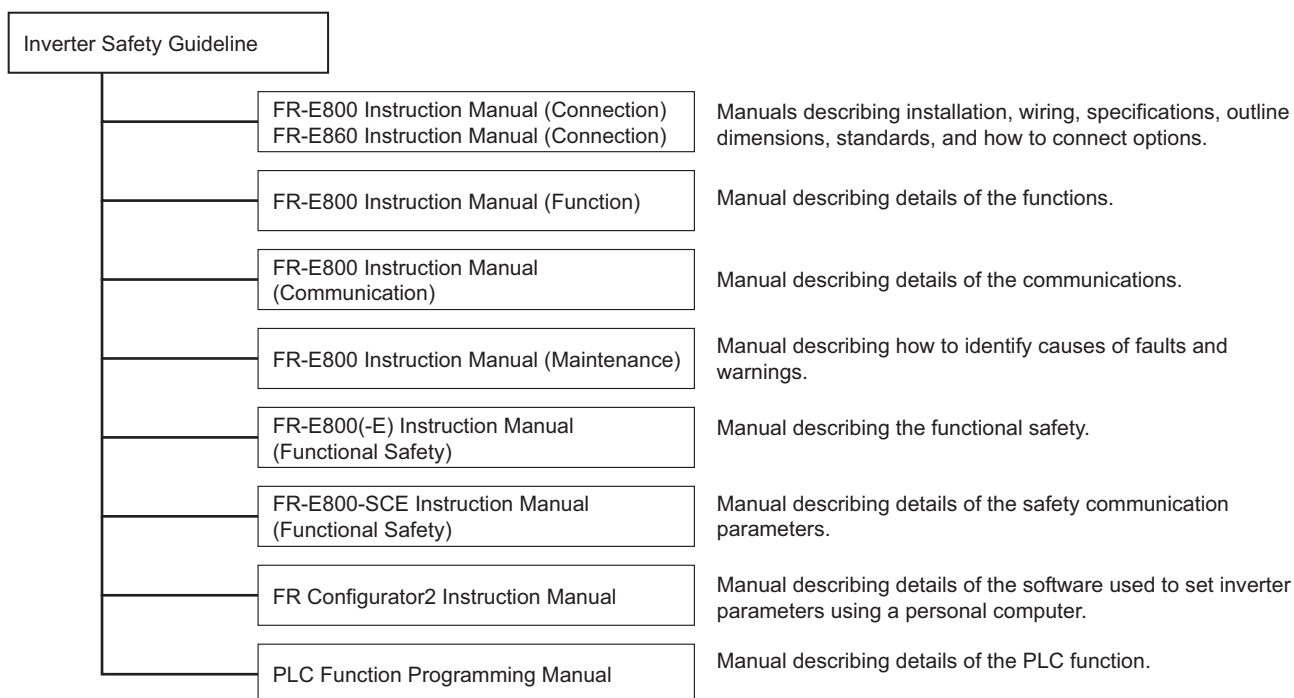

Name	Manual number
FR-E800 Inverter Safety Guideline	IB-0600857ENG
FR-E860 Inverter Safety Guideline	IB-0600862ENG
FR-E800-E Inverter Safety Guideline	IB-0600860ENG
FR-E860-E Inverter Safety Guideline	IB-0600863ENG
FR-E800-SCE Inverter Safety Guideline	IB-0600921ENG
FR-E860-SCE Inverter Safety Guideline	IB-0600924ENG
FR-E806-SCE Inverter Safety Guideline	IB-0600984ENG
FR-E800 Instruction Manual (Connection)	IB-0600865ENG
FR-E860 Instruction Manual (Connection)	IB-0600906ENG
FR-E800 Instruction Manual (Communication)	IB-0600871ENG
FR-E800 Instruction Manual (Maintenance)	IB-0600874ENG
FR-E800(-E) Instruction Manual (Functional Safety)	BCN-A23488-000(E)
FR-E800-SCE Instruction Manual (Functional Safety)	BCN-A23488-004(E)
FR Configurator2 Instruction Manual	IB-0600516ENG
PLC Function Programming Manual	IB-0600492ENG

CHAPTER 2 Basic Operation

2.1	Operation panel	20
2.2	Monitoring the inverter	29
2.3	Easy setting of the inverter operation mode	30
2.4	Frequently-used parameters (simple mode parameters).....	31
2.5	Basic operation procedure (PU operation)	35
2.6	Basic operation procedure (External operation)	41
2.7	Basic operation procedure (JOG operation)	48
2.8	I/O terminal function assignment	50

2 Basic Operation

This chapter explains the basic operation of this product.
Always read the instructions before use.

2.1 Operation panel



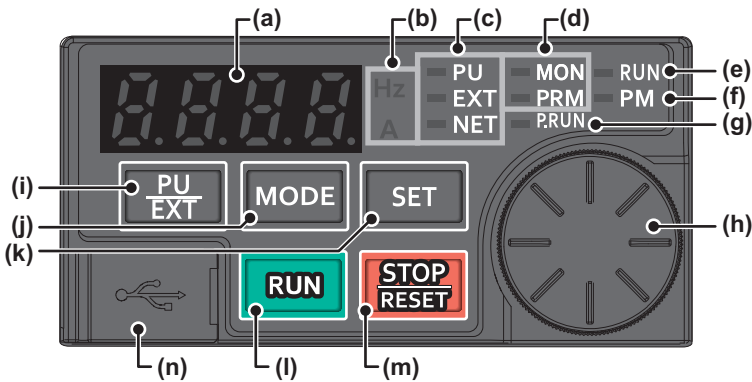

2.1.1 Components of the operation panel

◆ Standard model

The operation panel cannot be removed from the inverter.



No.	Appearance	Name	Description
(a)		Monitor (4-digit LED)	Shows a numeric value (readout) of a monitor item such as the frequency or a parameter number. (The monitor item can be changed according to the settings of Pr.52 , Pr.774 to Pr.776 .)
(b)		Unit indication	Hz: ON when the actual frequency is monitored. (Blinks when the set frequency is monitored.) A: ON when the current is monitored. (Both "Hz" and "A" are OFF to indicate a value other than the frequency or the current.)
(c)		Inverter operation mode LED indicator	PU: ON when the inverter is in the PU operation mode. EXT: ON when the inverter is in the External operation mode. (ON when the inverter in the initial setting is powered ON.) NET: ON when the inverter is in the Network operation mode. PU and EXT: ON when the inverter is in the External/PU combined operation mode 1 or 2.
(d)		Operation panel mode LED indicator	MON: ON or blinks only when the first, second, or third monitor is displayed. PRM: ON when the operation panel is in the parameter setting mode. The indicator blinks when the inverter is in the easy setting mode.
(e)		Operating status indicator	ON or blinks during inverter running. ON: During forward rotation operation. Blinks slowly (1.4-second cycle): During reverse rotation operation. Blinks quickly (0.2-second cycle): Operation is disabled although the start command is given.*1
(f)		Controlled motor type LED indicator	ON when the inverter is set to control the PM motor. The indicator blinks during test operation. The indicator is OFF when the inverter controls the induction motor.
(g)		PLC function LED indicator	ON when the PLC function of the inverter is valid. (The indicator blinks when a fault occurs while the PLC function is valid.)
(h)		Setting dial	The setting dial of the Mitsubishi Electric inverters. Turn the setting dial to change the setting of frequency or parameter, etc. Press the setting dial to perform the following operations: <ul style="list-style-type: none"> To display a set frequency on the LED display in the monitor mode. (The monitor item shown on the display can be changed by using Pr.992.) To display the present setting during calibration.
(i)		PU/EXT key	Switches between the PU operation mode, the PUJOG operation mode, and the External operation mode. The easy setting of the inverter operation mode is enabled by pressing this key simultaneously with the MODE key. Also cancels the PU stop warning.

No.	Appearance	Name	Description
(j)		MODE key	Switches the operation panel to a different mode. The easy setting of the inverter operation mode is enabled by pressing this key simultaneously with the PU/EXT key. Every key on the operation panel becomes inoperable by holding this key for 2 seconds. The key lock function is disabled when Pr.161 = "0 (initial setting)". (Refer to page 231 .)
(k)		SET key	Confirms each selection. When this key is pressed during inverter operation, the monitor item changes. (The monitor item on each screen can be changed according to the settings of Pr.52, Pr.774 to Pr.776 .) Initial setting in the monitor mode <div style="display: flex; align-items: center; margin-left: 20px;"> <div style="border: 1px solid black; padding: 2px; margin-right: 5px;">Output frequency</div> <div style="margin: 0 5px;">→</div> <div style="border: 1px solid black; padding: 2px; margin-right: 5px;">Output current</div> <div style="margin: 0 5px;">→</div> <div style="border: 1px solid black; padding: 2px;">Output voltage</div> </div>
(l)		RUN key	Start command The direction of motor rotation depends on the Pr.40 setting.
(m)		STOP/RESET key	Stops the operation commands. Used to reset the inverter when the protective function is activated.
(n)		USB connector	FR Configurator2 is available by USB connection.

*1 Situations such as when the MRS/X10 signal is input, during the automatic restart after instantaneous power failure, after auto tuning is complete, when "SE" (incorrect parameter setting) alarm occurs.

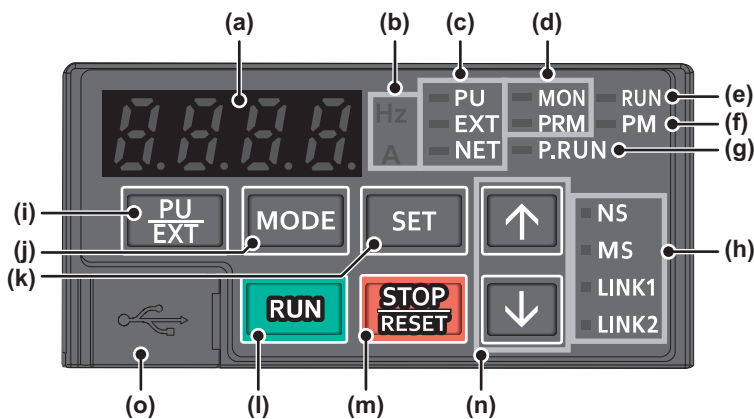

◆ Ethernet model and safety communication model

The operation panel cannot be removed from the inverter.

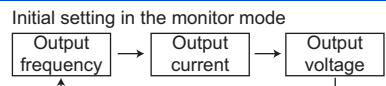

No.	Appearance	Name	Description
(a)		Monitor (4-digit LED)	Shows a numeric value (readout) of a monitor item such as the frequency or a parameter number. (The monitor item can be changed according to the settings of Pr.52 , Pr.774 to Pr.776 .)
(b)		Unit indication	Hz: ON when the actual frequency is monitored. (Blinks when the set frequency is monitored.) A: ON when the current is monitored. (Both "Hz" and "A" are OFF to indicate a value other than the frequency or the current.)
(c)		Inverter operation mode LED indicator	PU: ON when the inverter is in the PU operation mode. EXT: ON when the inverter is in the External operation mode. NET: ON when the inverter is in the Network operation mode. (ON when the inverter in the initial setting is powered ON.) PU and EXT: ON when the inverter is in the External/PU combined operation mode 1 or 2.
(d)		Operation panel mode LED indicator	MON: ON or blinks only when the first, second, or third monitor is displayed. PRM: ON when the operation panel is in the parameter setting mode. The indicator blinks when the inverter is in the easy setting mode.
(e)		Operating status indicator	ON or blinks during inverter running. ON: During forward rotation operation. Blinks slowly (1.4-second cycle): During reverse rotation operation. Blinks quickly (0.2-second cycle): Operation is disabled although the start command is given.*1
(f)		Controlled motor type LED indicator	ON when the inverter is set to control the PM motor. The indicator blinks during test operation. The indicator is OFF when the inverter controls the induction motor.
(g)		PLC function LED indicator	ON when the PLC function of the inverter is valid. (The indicator blinks when a fault occurs while the PLC function is valid.)
(h)		Ethernet communication status	Indicates the Ethernet communication status. For details, refer to the Instruction Manual (Communication).
(i)		PU/EXT key	Switches between the PU operation mode, the PUJOG operation mode, and the Network operation mode. The easy setting of the inverter operation mode is enabled by pressing this key simultaneously with the MODE key. Also cancels the PU stop warning.
(j)		MODE key	Switches the operation panel to a different mode. The easy setting of the inverter operation mode is enabled by pressing this key simultaneously with the PU/EXT key. Every key on the operation panel becomes inoperable by holding this key for 2 seconds. The key lock function is disabled when Pr.161 = "0 (initial setting)". (Refer to page 231 .)
(k)		SET key	Confirms each selection. When this key is pressed during inverter operation, the monitor item changes. (The monitor item on each screen can be changed according to the settings of Pr.52 , Pr.774 to Pr.776 .)
(l)		RUN key	Start command The direction of motor rotation depends on the Pr.40 setting.
(m)		STOP/RESET key	Stops the operation commands. Used to reset the inverter when the protective function is activated.



No.	Appearance	Name	Description
(n)		UP/DOWN key	Used to change the setting of frequency or parameter.
(o)		USB connector	FR Configurator2 is available by USB connection.

*1 Situations such as when the MRS/X10 signal is input, during the automatic restart after instantaneous power failure, after auto tuning is complete, when "SE" (incorrect parameter setting) alarm occurs.

◆ IP67 model

The operation panel cannot be removed from the inverter. Operation using the setting dial and keys is not available for the IP67 model.

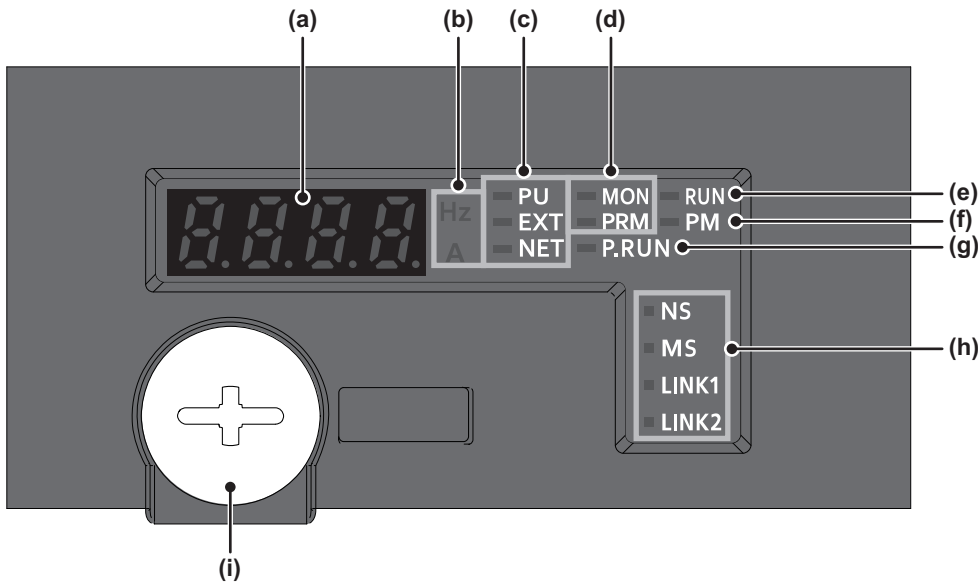

No.	Appearance	Name	Description
(a)		Monitor (4-digit LED)	Shows a numeric value (readout) of a monitor item such as the frequency. (The monitor item can be changed according to the Pr.774 setting.)
(b)		Unit indication	Hz: ON when the actual frequency is monitored. (Blinks when the set frequency is monitored.) A: ON when the current is monitored. (Both "Hz" and "A" are OFF to indicate a value other than the frequency or the current.)
(c)		Inverter operation mode LED indicator	PU: ON when the inverter is in the PU operation mode. EXT: ON when the inverter is in the External operation mode. NET: ON when the inverter is in the Network operation mode. (ON when the inverter in the initial setting is powered ON.) PU and EXT: ON when the inverter is in the External/PU combined operation mode 1 or 2.
(d)		Operation panel mode LED indicator	MON: ON or blinks only when the monitor is displayed. PRM: Not used.
(e)		Operating status indicator	ON or blinks during inverter running. ON: During forward rotation operation. Blinks slowly (1.4-second cycle): During reverse rotation operation. Blinks quickly (0.2-second cycle): Operation is disabled although the start command is given. ^{*1}
(f)		Controlled motor type LED indicator	ON when the inverter is set to control the PM motor. The indicator blinks during test operation. The indicator is OFF when the inverter controls the induction motor.
(g)		PLC function LED indicator	ON when the PLC function of the inverter is valid. (The indicator blinks when a fault occurs while the PLC function is valid.)
(h)		Ethernet communication status	Indicates the Ethernet communication status. For details, refer to the Instruction Manual (Communication).
(i)		USB connector	When the small resin cap is removed, FR Configurator2 is available by USB connection. The protective structure is IP00 when the cap is removed. After using the USB connector, always install the cap. (Tightening torque: 1 N·m)

*1 Situations such as when the MRS/X10 signal is input, during the automatic restart after instantaneous power failure, after auto tuning is complete, when "SE" (incorrect parameter setting) alarm occurs.

2.1.2 Basic operation of the operation panel

◆ Basic operation (Standard model)

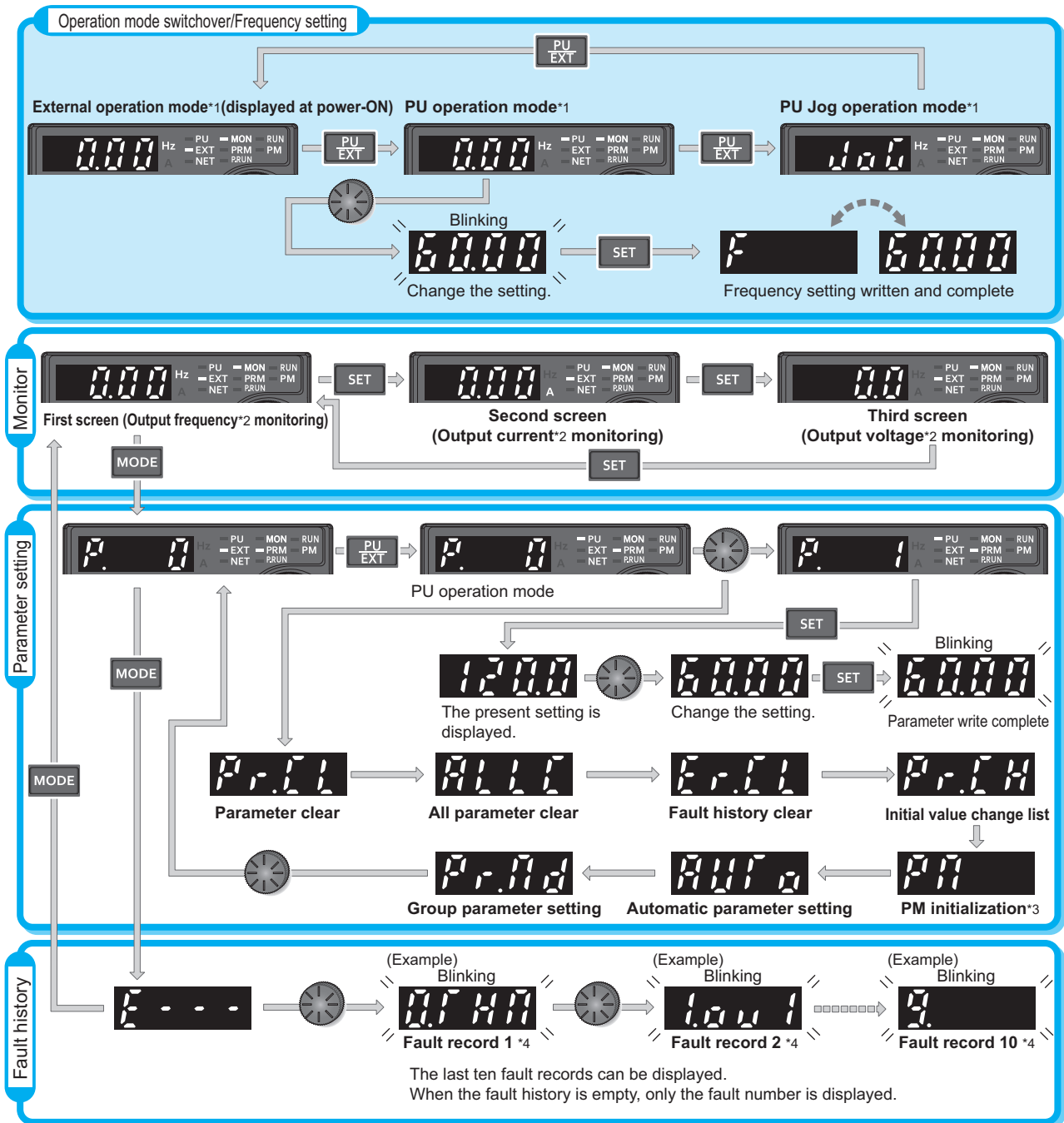

*1 For details on operation modes, refer to page 280.
 *2 The monitor item can be changed. (Refer to page 348.)
 *3 Not displayed for the 575 V class.
 *4 For details on the fault history, refer to the Instruction Manual (Maintenance).

◆ Basic operation (Ethernet model / safety communication model)

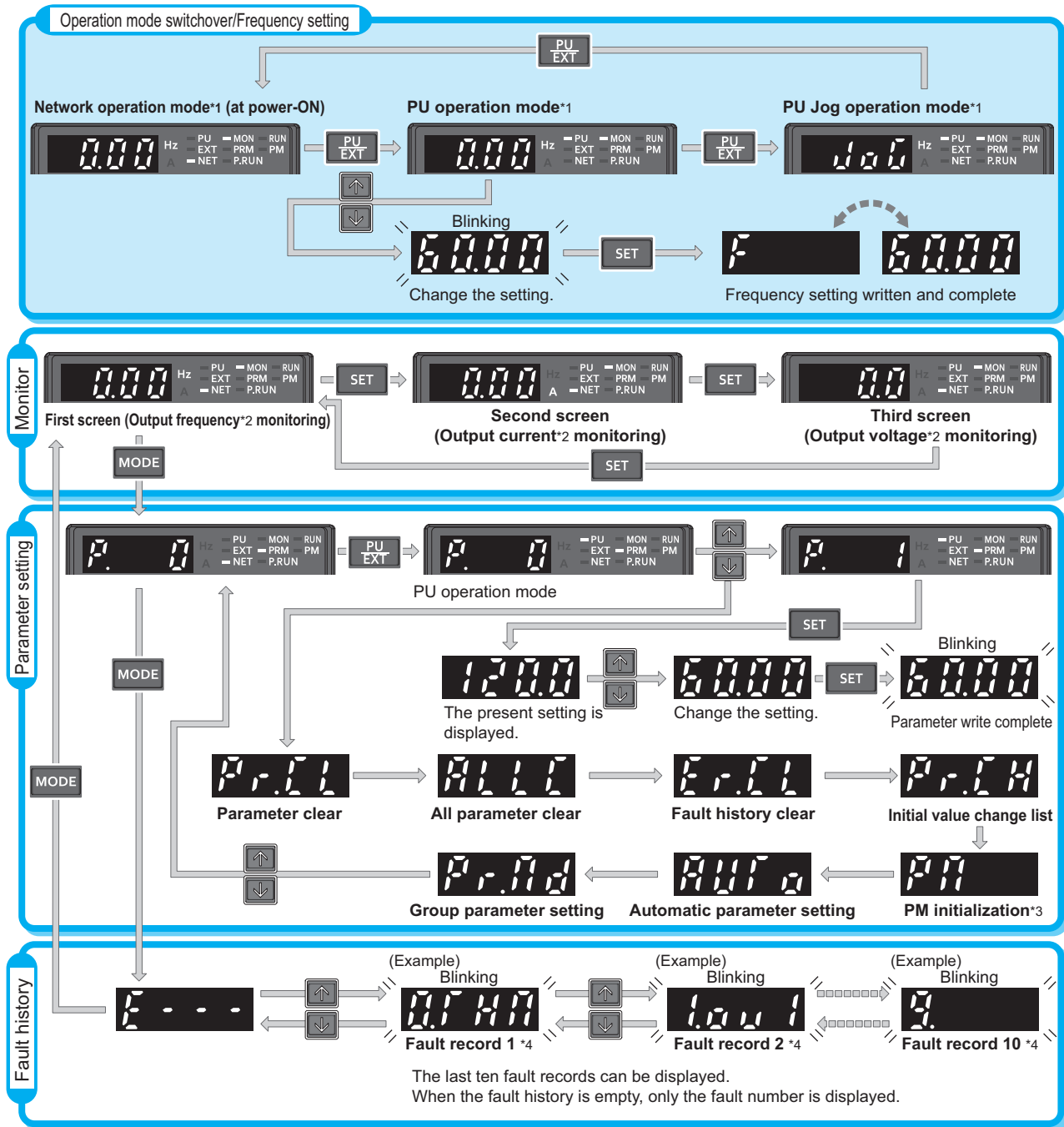

*1 For details on operation modes, refer to [page 280](#).

*2 The monitor item can be changed. (Refer to [page 346](#).)

*3 Not displayed for the 575 V class.

*4 For details on the fault history, refer to the Instruction Manual (Maintenance).

◆ Parameter setting mode

In the parameter setting mode, inverter functions (parameters) are set.

The following table explains the indications in the parameter setting mode.

Operation panel indication	Function name	Description	Refer to page
<i>Pr.</i>	Parameter setting mode	Under this mode, the set value of the displayed parameter number is read or changed. If the setting is changed using a different interface while the value is displayed, the new setting may not be applied. In such a case, read the set value again.	27
<i>Pr.CL</i>	Parameter clear	Clears and resets parameter settings to the initial values. Calibration parameters and offline auto tuning parameters are not cleared. For details on the uncleared parameters, refer to page 574 .	564
<i>ALLC</i>	All parameter clear	Clears and resets parameter settings to the initial values. Calibration parameters and the offline auto tuning parameters are also cleared. For details on the uncleared parameters, refer to page 574 .	564
<i>Er.CL</i>	Fault history clear	Deletes the fault history.	566
<i>Pr.LH</i>	Initial value change list	Identifies the parameters that have been changed from their initial settings.	565
<i>Pr.II</i>	PM parameter initialization	Changes the parameter settings required to drive a PM motor to the settings for V/F control as a batch. (Not displayed for the 575 V class.)	123
<i>Auto</i>	Automatic parameter setting	Changes parameter settings as a batch. The target parameters include communication parameters for the Mitsubishi Electric human machine interface (GOT) connection and the parameters for the rated frequency settings of 50/60 Hz.	244
<i>Pr.Gd</i>	Group parameter setting	Displays parameter numbers by function groups.	94

2.1.3 Digital characters and their corresponding printed equivalents

Digital characters displayed on the operation panel display are as follows.

0	1	2	3	4	5	6	7	8	9	A	B	C
<i>0</i>	<i>1</i>	<i>2</i>	<i>3</i>	<i>4</i>	<i>5</i>	<i>6</i>	<i>7</i>	<i>8</i>	<i>9</i>	<i>A</i>	<i>B</i>	<i>C</i>
D	E	F	G	H	I	J	K	L	M	N	O	P
<i>d</i>	<i>E</i>	<i>F</i>	<i>G</i>	<i>H</i>	<i>I</i>	<i>J</i>	<i>K</i>	<i>L</i>	<i>M</i>	<i>N</i>	<i>O</i>	<i>P</i>
Q	R	S	T	U	V	W	X	Y	Z	-	-	
<i>q</i>	<i>r</i>	<i>S</i>	<i>T</i>	<i>U</i>	<i>V</i>	<i>W</i>	<i>X</i>	<i>Y</i>	<i>Z</i>	<i>-</i>	<i>-</i>	

2.1.4 Changing the parameter setting value

- Select the parameter number in the parameter setting mode and press the SET key to change the parameter setting value.
- After changing the parameter setting value, press the SET key to write the setting value to the inverter.
- When the parameter number is 4-digit, "Pr." and the parameter number are displayed alternately.
- When the parameter number is 5-digit, the upper 1 digit and the lower 4 digits of the parameter number are displayed alternately.

◆ Parameter setting screen

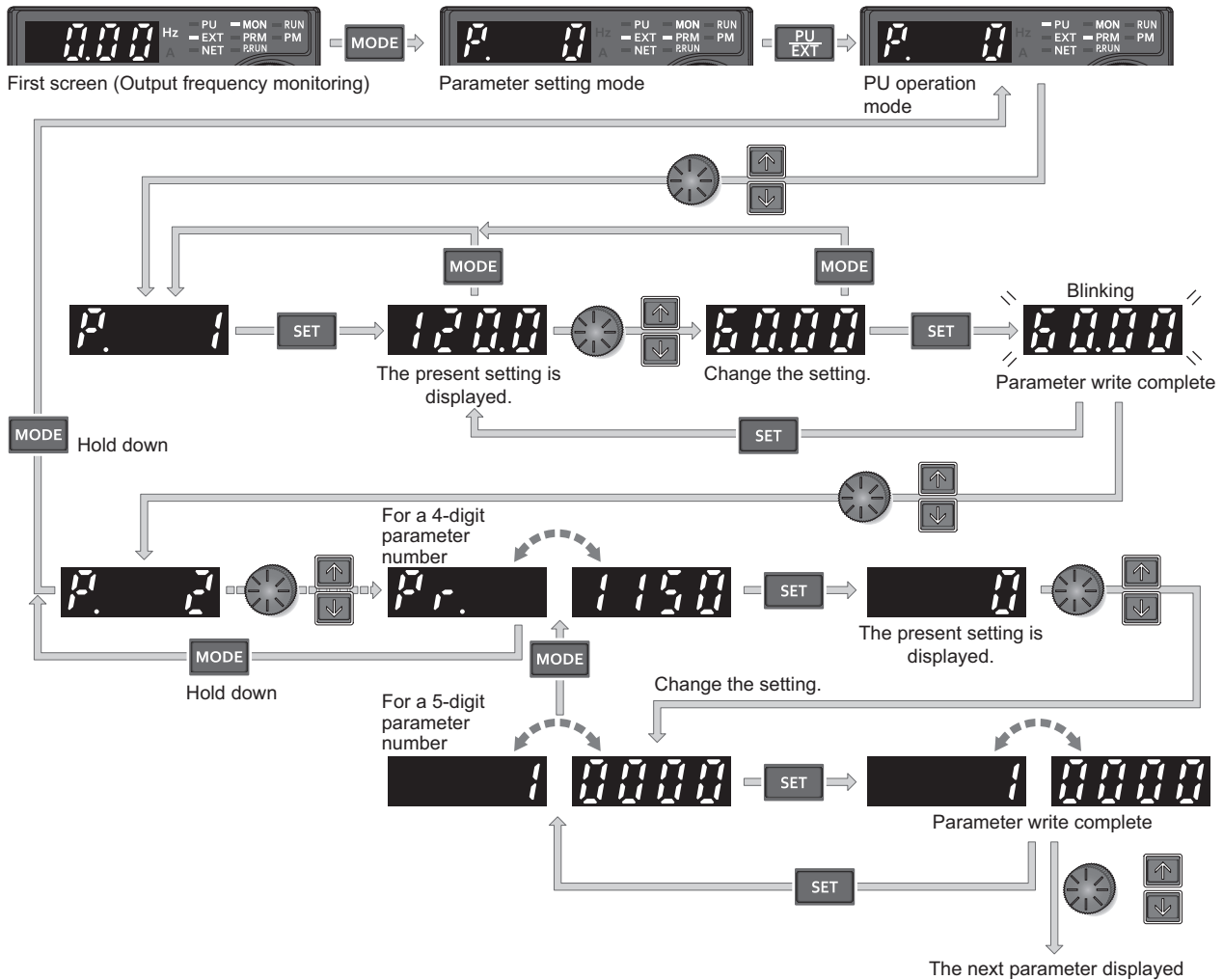

NOTE

- If a parameter write condition is not satisfied, a parameter write error appears. (For details of the errors, refer to the Instruction Manual (Maintenance).)

Error indication	Description
Er 1	Parameter write error
Er 2	Write error during operation
Er 3	Calibration error
Er 4	Mode designation error

- When **Pr.77 Parameter write selection** = "0 (initial setting)", the parameter setting change is only available while the inverter is stopped and under the PU operation mode. To enable the parameter setting change while the inverter is running or under the operation mode other than PU operation mode, change the **Pr.77** setting. (Refer to [page 237](#).)

2.2 Monitoring the inverter

2.2.1 Monitoring of output current and output voltage

Point

- Press the SET key on the operation panel in the monitor mode to switch the monitor item between output frequency, output current, and output voltage.

Operating procedure

1. Press the MODE key during inverter operation to monitor the output frequency. The [Hz] LED turns ON.
2. Press the SET key to monitor the output current. This operation is valid during running or stopping under any operation mode. The [A] LED turns ON.
3. Press the SET key to monitor the output voltage. Unit LEDs are both OFF.

NOTE

- Other monitor item, such as output power or set frequency, is also available. Use **Pr.52 Operation panel main monitor selection** or **Pr.774 Operation panel monitor selection 1 to Pr.776 Operation panel monitor selection 3** to change the setting. (Refer to [page 348](#).)

2.2.2 First priority monitor screen

The first priority monitor screen, which is displayed first when the operation panel switches to the monitor mode, is selectable. To set it, press the SET key for a while when the desired monitor item is displayed on a monitor screen.

The following show the procedure to set the monitor screen displaying the output current as the first priority monitor screen.

Operating procedure

1. Change the mode of the operation panel to the monitor mode, and switch the monitor screen to the one on which the output current can be monitored.
2. Press the SET key for a while (1 second). The output current monitor screen is set as the first priority monitor screen.
3. When the operation panel is in the monitor mode next time, the output current monitored value is displayed first.

NOTE

- Use **Pr.52 Operation panel main monitor selection** or **Pr.774 Operation panel monitor selection 1 to Pr.776 Operation panel monitor selection 3** to change the monitor item. (Refer to [page 348](#).)

2.2.3 Displaying the set frequency

To display the present set frequency in the standard model, change the mode of the operation panel to the monitor mode and

press the setting dial () while the inverter runs in the PU operation mode or in the External/PU combined operation mode 1 (**Pr.79 Operation mode selection = "3"**).

NOTE

- Use **Pr.992 Operation panel setting dial push monitor selection** to change the item to be displayed. (Refer to [page 348](#).)

2.3 Easy setting of the inverter operation mode

The operation mode suitable for start and speed command combinations can be set easily using **Pr.79 Operation mode selection**.

The following shows the procedure to operate with the external start command (STF/STR) and the frequency command by using the operation panel.

Operating procedure





1. Press the PU/EXT key and MODE key for 0.5 second at the same time.



2. Turn the setting dial or press the UP/DOWN key until "79-3" (External/PU combined operation mode 1) appears. (For other settings, refer to the following table.)



3. Press the SET key to confirm the setting. External/PU combined operation mode 1 (**Pr.79** = "3") is set.

Operation panel indication	Operation method		Operation mode
	Start command	Frequency command	
Blinking 	RUN key	Setting dial or UP/DOWN key	PU operation mode
Blinking 	External (STF/STR signal)	Analog voltage input	External operation mode
Blinking 	External (STF/STR signal)	Setting dial or UP/DOWN key	External/PU combined operation mode 1
Blinking 	RUN key	Analog voltage input	External/PU combined operation mode 2

NOTE

- When the user group function is used (**Pr.160** = "1") or the password function is enabled (with **Pr.296** and **Pr.297**), the easy setting is disabled (**Pr.79** is not displayed).
- "ER2" appears if a setting change is attempted during inverter operation. Turn OFF the start command (the RUN key or STF/STR signal).
- If the MODE key is pressed before pressing the SET key, the easy setting mode is terminated and the operation panel returns to the monitor mode. If the easy setting is terminated while **Pr.79** = "0 (initial value)", check the inverter operation mode because the inverter may switch its operation mode between the PU operation mode and the External operation mode.
- Reset by pressing the STOP/RESET key is enabled.
- The following is the frequency commands listed in descending order of priority when "3" is set in **Pr.79**: Multi-speed setting function (RL/RM/RH/REX signal) > PID control (X14 signal) > terminal 4 analog input (AU signal) > set frequency (digital input from the PU).

2.4 Frequently-used parameters (simple mode parameters)

Parameters that are frequently used for the FR-E800 series are grouped as simple mode parameters.

When **Pr.160 User group read selection** = "9999", only the simple mode parameters are displayed on the operation panel. This section explains the simple mode parameters.

2.4.1 Simple mode parameter list

For simple variable-speed operation of the inverter, the initial values of the parameters may be used as they are. Set the necessary parameters to meet the load and operational specifications. Parameter's setting, change and check can be made on the operation panel.

Point

- **Pr.160 User group read selection** can narrow down the displayed parameters to only the simple mode parameters. (In the initial setting, all parameters are displayed.) Set **Pr.160 User group read selection** as required. (To change the parameter setting, refer to [page 27](#).)

Pr.160 setting	Description
9999	Only simple mode parameters are displayed.
0 (initial value)	All parameters (simple mode parameters and extended parameters) are displayed.
1	Only parameters registered in user groups are displayed.

◆ Simple mode parameters (Standard model)

Pr.	Pr. group	Name	Increment	Initial value ^{*10}		Range	Application	Refer to page
				Gr.1	Gr.2			
0	G000	Torque boost	0.1%	6% ^{*1}		0% to 30%	Set this parameter to obtain a higher starting torque under V/F control. Also set this when a loaded motor cannot be driven, the warning "OL" occurs, and the inverter output is shut off with the fault indication "E.OC1".	528
				5% ^{*2}				
				4% ^{*3}				
				3% ^{*4}				
				2% ^{*5}				
1	H400	Maximum frequency	0.01 Hz	120 Hz		0 to 120 Hz	Set the upper limit for the output frequency.	331
2	H401	Minimum frequency	0.01 Hz	0 Hz		0 to 120 Hz	Set the lower limit for the output frequency.	
3	G001	Base frequency	0.01 Hz	60 Hz	50 Hz	0 to 590 Hz	Set this parameter when the rated motor frequency is 50 Hz. Check the rating plate of the motor.	530
4	D301	Multi-speed setting (high speed)	0.01 Hz	60 Hz	50 Hz	0 to 590 Hz	Pre-set the speeds that will be switched among by terminals.	37, 43, 303
5	D302	Multi-speed setting (middle speed)	0.01 Hz	30 Hz		0 to 590 Hz		
6	D303	Multi-speed setting (low speed)	0.01 Hz	10 Hz		0 to 590 Hz		
7	F010	Acceleration time	0.1 s	5 s ^{*6}		0 to 3600 s	Set the acceleration time.	262
				10 s ^{*7}				
				15 s ^{*8}				
8	F011	Deceleration time	0.1 s	5 s ^{*6}		0 to 3600 s	Set the deceleration time.	
				10 s ^{*7}				
				15 s ^{*8}				
9	H000 C103	Electronic thermal O/L relay	0.01 A	Inverter rated current ^{*9}		0 to 500 A	Protects the motor from heat. Set the rated motor current.	306

Pr.	Pr. group	Name	Increment	Initial value ^{*10}		Range	Application	Refer to page
				Gr.1	Gr.2			
79	D000	Operation mode selection	1	0		0 to 4, 6, 7	Select the start and frequency command sources.	280
125	T022	Terminal 2 frequency setting gain frequency	0.01 Hz	60 Hz	50 Hz	0 to 590 Hz	Change the frequency at the maximum potentiometer setting (5 V in the initial setting).	45, 400
126	T042	Terminal 4 frequency setting gain frequency	0.01 Hz	60 Hz	50 Hz	0 to 590 Hz	Change the frequency at the maximum current input (20 mA in the initial setting).	47, 400
160	E440	User group read selection	1	0		0, 1, 9999	This function restricts the parameters that are read by the operation panel and parameter unit.	246
998	E430	PM parameter initialization	1	0		0, 3024, 3044, 3124, 3144, 8009, 8109, 9009, 9109	Select the PM sensorless vector control and set the parameters that are required to drive a PM motor.	123
999	E431	Automatic parameter setting	1	9999		10, 12, 20, 21, 9999	Changes parameter settings as a batch. The target parameters include communication parameters for the Mitsubishi Electric human machine interface (GOT) connection and the parameters for the rated frequency settings of 50/60 Hz.	244

*1 Initial value for the FR-E820-0050(0.75K) or lower, FR-E840-0026(0.75K) or lower, FR-E820S-0050(0.75K) or lower, and FR-E810W-0050(0.75K) or lower.

*2 Initial value for the FR-E860-0017(0.75K).

*3 Initial value for the FR-E820-0080(1.5K) to FR-E820-0175(3.7K), FR-E840-0040(1.5K) to FR-E840-0095(3.7K), and FR-E820S-0080(1.5K) or higher.

*4 Initial value for the FR-E820-0240(5.5K), FR-E820-0330(7.5K), FR-E840-0120(5.5K), FR-E840-0170(7.5K), FR-E860-0027(1.5K), and FR-E860-0040(2.2K).

*5 Initial value for the FR-E820-0470(11K) or higher, FR-E840-0230(11K) or higher, and FR-E860-0061(3.7K) or higher.

*6 Initial value for the FR-E820-0175(3.7K) or lower, FR-E840-0095(3.7K) or lower, FR-E860-0061(3.7K) or lower, FR-E820S-0110(2.2K) or lower, and FR-E810W-0050(0.75K) or lower.

*7 Initial value for the FR-E820-0240(5.5K), FR-E820-0330(7.5K), FR-E840-0120(5.5K), FR-E840-0170(7.5K), and FR-E860-0090(5.5K) or higher.

*8 Initial value for the FR-E820-0470(11K) or higher and FR-E840-0230(11K) or higher.

*9 The initial value for the FR-E820-0050(0.75K) or lower, FR-E840-0026(0.75K) or lower, FR-E860-0017(0.75K), FR-E820S-0050(0.75K) or lower, and FR-E810W-0050(0.75K) or lower is set to the 85% of the inverter rated current.

*10 Gr.1 and Gr.2 are the parameter initial value groups. (Refer to [page 54](#).)

◆ Simple mode parameters (Ethernet model / safety communication model)

Pr.	Pr. group	Name	Increment	Initial value ^{*10}		Range	Application	Refer to page
				Gr.1	Gr.2			
0	G000	Torque boost	0.1%	6% ^{*1}		0% to 30%	Set this parameter to obtain a higher starting torque under V/F control. Also set this when a loaded motor cannot be driven, the warning "OL" occurs, and the inverter output is shut off with the fault indication "E.OC1".	528
				5% ^{*2}				
				4% ^{*3}				
				3% ^{*4}				
				2% ^{*5}				
1	H400	Maximum frequency	0.01 Hz	120 Hz		0 to 120 Hz	Set the upper limit for the output frequency.	331
2	H401	Minimum frequency	0.01 Hz	0 Hz		0 to 120 Hz	Set the lower limit for the output frequency.	
3	G001	Base frequency	0.01 Hz	60 Hz	50 Hz	0 to 590 Hz	Set this parameter when the rated motor frequency is 50 Hz. Check the rating plate of the motor.	530
4	D301	Multi-speed setting (high speed)	0.01 Hz	60 Hz	50 Hz	0 to 590 Hz	Pre-set the speeds that will be switched among by terminals.	37, 43, 303
5	D302	Multi-speed setting (middle speed)	0.01 Hz	30 Hz		0 to 590 Hz		
6	D303	Multi-speed setting (low speed)	0.01 Hz	10 Hz		0 to 590 Hz		
7	F010	Acceleration time	0.1 s	5 s ^{*6}		0 to 3600 s	Set the acceleration time.	262
				10 s ^{*7}				
				15 s ^{*8}				
8	F011	Deceleration time	0.1 s	5 s ^{*6}		0 to 3600 s	Set the deceleration time.	
				10 s ^{*7}				
				15 s ^{*8}				
9	H000 C103	Electronic thermal O/L relay	0.01 A	Inverter rated current ^{*9}		0 to 500 A	Protects the motor from heat. Set the rated motor current.	306
79	D000	Operation mode selection	1	0		0 to 4, 6, 7	Select the start and frequency command sources.	280
125	T022	Terminal 2 frequency setting gain frequency	0.01 Hz	60 Hz	50 Hz	0 to 590 Hz	Change the frequency at the maximum potentiometer setting (5 V in the initial setting).	45, 400
126	T042	Terminal 4 frequency setting gain frequency	0.01 Hz	60 Hz	50 Hz	0 to 590 Hz	Change the frequency at the maximum current input (20 mA in the initial setting).	47, 400
160	E440	User group read selection	1	0		0, 1, 9999	This function restricts the parameters that are read by the operation panel and parameter unit.	246
313	M410	DO0 output selection	1	9999		Refer to page 371.	Set this parameter to assign the functions to the devices RX9 to RXB for the CC-Link IE TSN and CC-Link IE Field Network Basic.	*11
314	M411	DO1 output selection	1	9999				
315	M412	DO2 output selection	1	9999				
349	N010	Communication reset selection	1	0		0, 1	Disable an error reset command given via communication in the External operation mode or the PU operation mode.	*11
541	N100	Frequency command sign selection	1	0		0, 1	Set this parameter to make the start command (forward/reverse rotation) inverted by adding a plus or minus sign to the value of the frequency command sent through the CC-Link IE TSN or the CC-Link IE Field Network Basic.	*11
544	N103	CC-Link extended setting	1	0		0, 1, 12, 14, 18, 38, 100, 112, 114, 118, 138	Set this parameter to extend the function of the remote registers for the CC-Link IE TSN or the CC-Link IE Field Network Basic.	*11

Pr.	Pr. group	Name	Increment	Initial value ^{*10}		Range	Application	Refer to page
				Gr.1	Gr.2			
998	E430	PM parameter initialization	1	0		0, 3024, 3044, 3124, 3144, 8009, 8109, 9009, 9109	Select the PM sensorless vector control and set the parameters that are required to drive a PM motor.	123
999	E431	Automatic parameter setting	1	9999		10, 12, 20, 21, 9999	Changes parameter settings as a batch. The target parameters include communication parameters for the Mitsubishi Electric human machine interface (GOT) connection and the parameters for the rated frequency settings of 50/60 Hz.	244

*1 Initial value for the FR-E820-0050(0.75K) or lower, FR-E840-0026(0.75K) or lower, FR-E820S-0050(0.75K) or lower, and FR-E810W-0050(0.75K) or lower.

*2 Initial value for the FR-E860-0017(0.75K).

*3 Initial value for the FR-E820-0080(1.5K) to FR-E820-0175(3.7K), FR-E840-0040(1.5K) to FR-E840-0095(3.7K), and FR-E820S-0080(1.5K) or higher.

*4 Initial value for the FR-E820-0240(5.5K), FR-E820-0330(7.5K), FR-E840-0120(5.5K), FR-E840-0170(7.5K), FR-E860-0027(1.5K), and FR-E860-0040(2.2K).

*5 Initial value for the FR-E820-0470(11K) or higher, FR-E840-0230(11K) or higher, and FR-E860-0061(3.7K) or higher.

*6 Initial value for the FR-E820-0175(3.7K) or lower, FR-E840-0095(3.7K) or lower, FR-E860-0061(3.7K) or lower, FR-E820S-0110(2.2K) or lower, and FR-E810W-0050(0.75K) or lower.

*7 Initial value for the FR-E820-0240(5.5K), FR-E820-0330(7.5K), FR-E840-0120(5.5K), FR-E840-0170(7.5K), and FR-E860-0090(5.5K) or higher.

*8 Initial value for the FR-E820-0470(11K) or higher and FR-E840-0230(11K) or higher.

*9 The initial value for the FR-E820-0050(0.75K) or lower, FR-E840-0026(0.75K) or lower, FR-E860-0017(0.75K), FR-E820S-0050(0.75K) or lower, and FR-E810W-0050(0.75K) or lower is set to the 85% of the inverter rated current.

*10 Gr.1 and Gr.2 are the parameter initial value groups. (Refer to [page 54](#).)

*11 For details, refer to the Instruction Manual (Communication).

2.5 Basic operation procedure (PU operation)

Select a method to give the frequency command from the list below, and refer to the specified page for its procedure. The PU operation and External/PU combined operation using keys are not available for the IP67 model as neither the operation panel keys or the parameter unit can be used.

Method to give the frequency command	Refer to page
Setting the frequency on the operation panel in the frequency setting mode	35
Give commands by turning ON/OFF switches wired to inverter's terminals (multi-speed setting)	37
Setting the frequency by inputting voltage signals	38
Setting the frequency by inputting current signals	39

2.5.1 Setting the frequency on the operation panel (example: operating at 30 Hz)

Point

- Use the operation panel to give a start command and a frequency command. (PU operation)

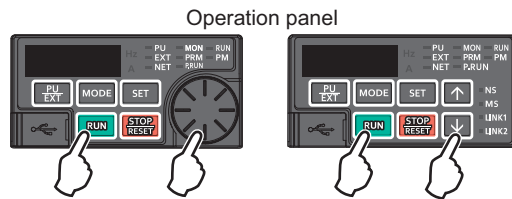

The following shows the procedure to operate at 30 Hz.

Operating procedure

- 1.** Turning ON the power of the inverter
The operation panel is in the monitor mode.
- 2.** Changing the operation mode
Press the PU/EXT key to choose the PU operation mode. The PU LED turns ON.
- 3.** Setting the frequency
Turn the setting dial or press the UP/DOWN key until the target frequency "30.00" (30.00 Hz) appears. The indication blinks for about 5 seconds.
While the value is blinking, press the SET key to enter the frequency. "F" and "30.00" are displayed alternately. After about 3 seconds of alternate display, the indication returns to "0.00" (the indication of a monitored value). (If the SET key is not pressed, the indication of the value returns to "0.00" (0.00 Hz) after about 5 seconds of blinking. In that case, turn the setting dial or press the UP/DOWN key and set the frequency again.)
- 4.** Start → acceleration → constant speed
Press the RUN key to start running. The frequency value on the monitor increases according to the setting of **Pr.7 Acceleration time**, and "30.00" (30.00 Hz) appears on the monitor. (To change the set frequency, return to step 3. The previously set frequency appears.)
- 5.** Deceleration → stop
Press the STOP/RESET key to stop. The frequency value on the monitor decreases according to the setting of **Pr.8 Deceleration time**, "0.00" (0.00 Hz) appears on the monitor, and the motor stops rotating.

 **NOTE**

- To display the set frequency in the standard model, press the setting dial while the inverter runs in the PU operation mode or in the External/PU combined operation mode 1 (**Pr.79** = "3"). (Refer to [page 348](#).)
- The frequency can be set without pressing the SET key when **Pr.161 Frequency setting/key lock operation selection** = "1 or 11". (Refer to [page 231](#).)

« **Parameters referred to** »

Pr.7 Acceleration time, Pr.8 Deceleration time  [page 262](#)

Pr.79 Operation mode selection  [page 280](#)

2.5.2 Setting the frequency with switches (multi-speed setting)

Point

- Use the RUN key on the operation panel to give a start command.
- Turn ON the RH, RM, or RL signal to give a frequency command (multi-speed setting).
- Set **Pr.79 Operation mode selection** = "4" (External/PU combination operation mode 2).

[Connection diagram]

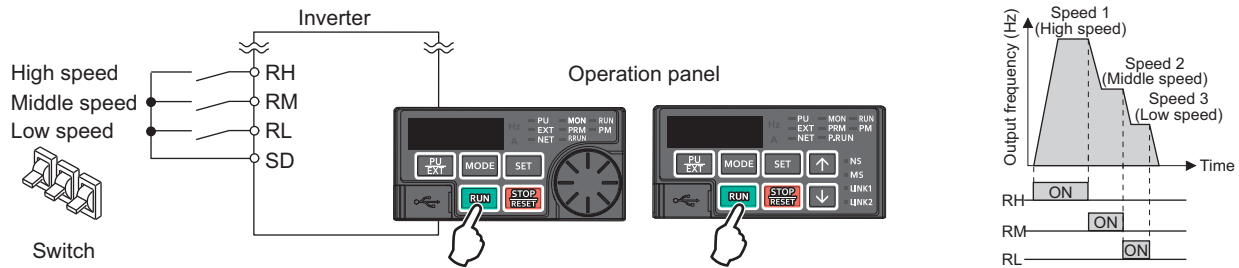

The following shows the procedure to operate at a low speed (10 Hz).

Operating procedure

1. Turning ON the power of the inverter
The operation panel is in the monitor mode.
2. Changing the operation mode
Set "4" in **Pr.79**. The PU LED and EXT LED turn ON. (To change the setting, refer to [page 30](#).)
3. Setting the frequency
Turn ON the low-speed switch (RL signal).
4. Start → acceleration → constant speed
Press the RUN key to start running. The frequency value on the monitor increases according to the setting of **Pr.7 Acceleration time**, and "10.00" (10.00 Hz) appears on the monitor.
5. Deceleration → stop
Press the STOP/RESET key to stop. The frequency value on the monitor decreases according to the setting of **Pr.8 Deceleration time**, "0.00" (0.00 Hz) appears on the monitor, and the motor stops rotating. Turn OFF the low-speed switch (RL signal).

NOTE

- The initial value is 60 Hz for terminal RH in Group 1 (50 Hz in Group 2), 30 Hz for terminal RM, and 10 Hz for terminal RL. (To change the settings, use **Pr.4**, **Pr.5**, and **Pr.6**, respectively.)
- In the initial setting, if two or more speed switches (signals) are simultaneously turned ON, priority is given to the switch (signal) for the lower speed. For example, when both RH and RM signals turn ON, the RM signal (**Pr.5**) has the higher priority.
- Up to 15-speed switching operation can be performed.
- Up to two external input terminals are available for the Ethernet model. Use **Pr.178 STF/DI0 terminal function selection** and **Pr.179 STR/DI1 terminal function selection** to assign the functions to terminals DI0 and DI1.

Parameters referred to

Pr.4 to Pr.6 (Multi-speed setting) [page 303](#)
Pr.7 Acceleration time, Pr.8 Deceleration time [page 262](#)
Pr.79 Operation mode selection [page 280](#)
Pr.178 STF/DI0 terminal function selection [page 410](#)

2.5.3 Setting the frequency using an analog signal (voltage input)

Point

- Use the RUN key on the operation panel to give a start command.
- Use the frequency setting potentiometer to give a frequency command (by connecting it to terminals 2 and 5 (voltage input)).
- Set **Pr.79 Operation mode selection** = "4" (External/PU combination operation mode 2).

[Connection diagram] (The inverter supplies 5 V power to the frequency setting potentiometer via terminal 10.)

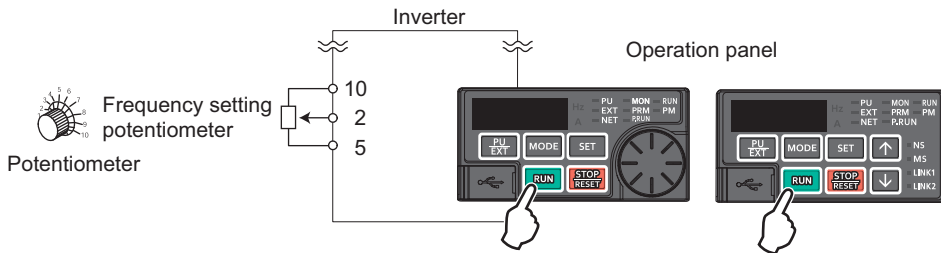

The following shows the procedure to operate at 60 Hz.

Operating procedure

1. Turning ON the power of the inverter
The operation panel is in the monitor mode.
2. Changing the operation mode
Set "4" in **Pr.79**. The PU LED and EXT LED turn ON. (To change the setting, refer to [page 30](#).)
3. Start
Press the RUN key. The RUN LED blinks as no frequency command is given.
4. Acceleration → constant speed
Turn the frequency setting potentiometer clockwise slowly to full. The frequency value on the monitor increases according to the setting of **Pr.7 Acceleration time**, and "60.00" (60.00 Hz) appears on the monitor.
5. Deceleration
Turn the frequency setting potentiometer counterclockwise slowly to full. The frequency value on the monitor decreases according to the setting of **Pr.8 Deceleration time**, "0.00" (0.00 Hz) appears on the monitor, and the motor stops rotating. The RUN LED blinks.
6. Stop
Press the STOP/RESET key. The RUN LED turns OFF.

NOTE

- To change the frequency (60 Hz) at the maximum voltage input (initial value: 5 V), adjust **Pr.125 Terminal 2 frequency setting gain frequency**.
- To change the frequency (0 Hz) at the minimum voltage input (initial value: 0 V), adjust the calibration parameter **C2 (Pr.902) Terminal 2 frequency setting bias frequency**.
- When terminal 10 is used, the maximum output frequency may fluctuate in a range of ± 6 Hz due to fluctuations in the output voltage (5 ± 0.5 VDC). Use **Pr.125** or **C4 (Pr.903)** to adjust the output frequency at the maximum analog input as required. (Refer to [page 400](#).)

Parameters referred to

- Pr.7 Acceleration time, Pr.8 Deceleration time [page 262](#)
 Pr.79 Operation mode selection [page 280](#)
 Pr.125 Terminal 2 frequency setting gain frequency [page 400](#)
 C2(Pr.902) Terminal 2 frequency setting bias frequency [page 400](#)

2.5.4 Setting the frequency using an analog signal (current input)

Point

- Use the RUN key on the operation panel to give a start command.
- Use the current regulator which outputs 4 to 20 mA to give a frequency command (by connecting it across terminals 4 and 5 (current input)).
- Turn ON the AU signal.
- Set **Pr.79 Operation mode selection** = "4" (External/PU combination operation mode 2).

[Connection diagram]

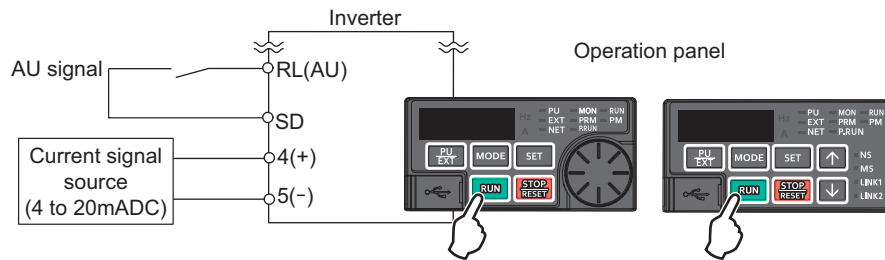

The following shows the procedure to operate at 60 Hz.





Operating procedure

1. Turning ON the power of the inverter
The operation panel is in the monitor mode.
2. Changing the operation mode
Set "4" in **Pr.79**. The PU LED and EXT LED turn ON. (To change the setting, refer to [page 30.](#))
3. Assignment of AU signal
Set **Pr.180 RL terminal function selection** = "4" to assign the AU signal to terminal RL.
4. Selecting the input via terminal 4
Turn ON the Terminal 4 input selection (AU) signal. Input via terminal 4 to the inverter is enabled.
5. Start
Press the RUN key. The RUN LED blinks as no frequency command is given.
6. Acceleration → constant speed
Input a current of 20 mA to the inverter from the regulator. The frequency value on the monitor increases according to the setting of **Pr.7 Acceleration time**, and "60.00" (60.00 Hz) appears on the monitor.
7. Deceleration
Input a current of 4 mA or less. The frequency value on the monitor decreases according to the setting of **Pr.8 Deceleration time**, "0.00" (0.00 Hz) appears on the monitor, and the motor stops rotating. The RUN LED blinks.
8. Stop
Press the STOP/RESET key. The RUN LED turns OFF.

NOTE

- The AU signal can be assigned to another terminal. Set "4" in any parameter from **Pr.178 to Pr.184 (Input terminal function selection)** to assign the function to an input terminal. (For the Ethernet model, assign the signal to terminal DI0 or DI1 using **Pr.178 or Pr.179.**)
- To change the frequency (60 Hz) at the maximum current input (initial value: 20 mA), adjust **Pr.126 Terminal 4 frequency setting gain frequency**.
- To change the frequency (0 Hz) at the minimum current input (initial value: 4 mA), adjust the calibration parameter **C5 (Pr.904) Terminal 4 frequency setting bias frequency**.

« Parameters referred to »

Pr.7 Acceleration time, Pr.8 Deceleration time  [page 262](#)
Pr.79 Operation mode selection  [page 280](#)
Pr.126 Terminal 4 frequency setting gain frequency  [page 400](#)
Pr.178 to Pr.184 (Input terminal function selection)  [page 410](#)
C5(Pr.904) Terminal 4 frequency setting bias frequency  [page 400](#)

2.6 Basic operation procedure (External operation)

Select a method to give the frequency command from the list below, and refer to the specified page for its procedure.

Method to give the frequency command	Refer to page
Setting the frequency on the operation panel in the frequency setting mode	41
Turning ON/OFF switches wired to inverter's terminals (multi-speed setting)	43
Setting the frequency by inputting voltage signals	44
Setting the frequency by inputting current signals	46

2.6.1 Setting the frequency on the operation panel

Point

- Turn ON the STF/STR signal to give a start command.
- Use operation panel (setting dial or UP/DOWN key) to give a frequency command.
- Set **Pr.79** = "3" (External/PU combined operation mode 1).

[Connection diagram]

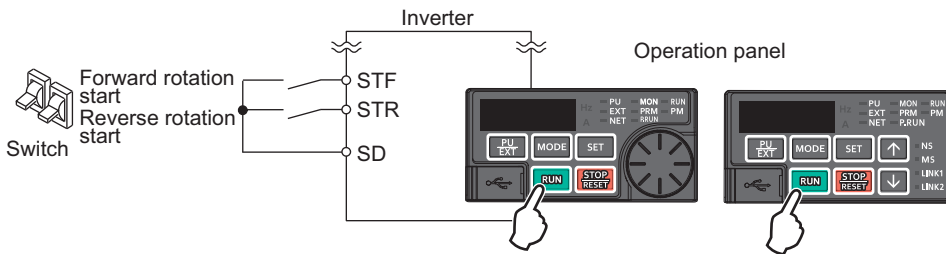

The following shows the procedure to operate at 30 Hz.

Operating procedure

- 1. Changing the operation mode**
 Set "3" in **Pr.79**. The PU LED and EXT LED turn ON. (To change the setting, refer to [page 30](#).)
- 2. Setting the frequency**
 Turn the setting dial or press the UP/DOWN key until the target frequency "30.00" (30.00 Hz) appears. The indication blinks for about 5 seconds.
 While the value is blinking, press the SET key to enter the frequency. "F" and "30.00" are displayed alternately. After about 3 seconds of alternate display, the indication returns to "0.00" (the indication of a monitored value). (If the SET key is not pressed, the indication of the value returns to "0.00" (0.00 Hz) after about 5 seconds of blinking. In that case, turn the setting dial or press the UP/DOWN key and set the frequency again.)
- 3. Start → acceleration → constant speed**
 Turn ON the start switch (STF/STR signal). The frequency value on the monitor increases according to the setting of **Pr.7 Acceleration time**, and "30.00" (30.00 Hz) appears on the monitor. The RUN LED is ON during forward rotation and blinks slowly during reverse rotation. (To change the set frequency, return to step 2. The previously set frequency appears.)
- 4. Deceleration → stop**
 Turn OFF the start switch (STF/STR signal). The frequency value on the monitor decreases according to the setting of **Pr.8 Deceleration time**, "0.00" (0.00 Hz) appears on the monitor, and the motor stops rotating.

NOTE

- When both the forward rotation start switch (STF signal) and the reverse rotation start switch (STR signal) are turned ON, the motor cannot be started. If both are turned ON while the inverter is running, the inverter decelerates to a stop.
- **Pr.178 STF/DI0 terminal function selection** must be set to "60" (or **Pr.179 STR/DI1 terminal function selection** must be set to "61") (initial value).
- Setting **Pr.79 Operation mode selection** = "3" enables multi-speed operation.
- If the STOP/RESET key on the operation panel is pressed during the External operation, the inverter stops and the PU stop warning is activated ("PS" appears on the LCD display of the operation panel.) To reset the PU stop warning, turn OFF the start switch (STF or STR signal), and then press the PU/EXT key. (Refer to [page 227](#).)
- The External/PU combined operation using keys is not available for the IP67 model as neither the operation panel keys or the parameter unit can be used.

Parameters referred to

Pr.4 to Pr.6 (Multi-speed setting) [page 303](#), **Pr.7 Acceleration time, Pr.8 Deceleration time** [page 262](#)
Pr.178 STF/DI0 terminal function selection, Pr.179 STR/DI1 terminal function selection [page 410](#)
Pr.79 Operation mode selection [page 280](#)

2.6.2 Setting the frequency and giving a start command with switches (multi-speed setting) (Pr.4 to Pr.6)

Point

- Turn ON the STF/STR signal to give a start command.
- Turn ON the RH, RM, or RL signal to give a frequency command (multi-speed setting).

[Connection diagram]

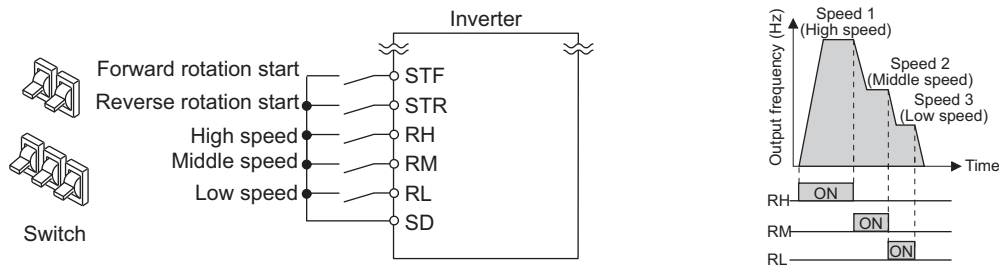

The following shows the procedure to operate at a high speed (60 Hz).

Operating procedure

1. Turning ON the power of the inverter
The operation panel is in the monitor mode.
2. Setting the frequency
Turn ON the high-speed switch (RH signal).
3. Start → acceleration → constant speed
Turn ON the start switch (STF/STR signal). The frequency value on the monitor increases according to the setting of **Pr.7 Acceleration time**, and "60.00" (60.00 Hz) appears on the monitor. The RUN LED is ON during forward rotation and blinks slowly during reverse rotation. When the RM signal is turned ON, 30 Hz is displayed. When the RL signal is turned ON, 10 Hz is displayed.
4. Deceleration → stop
Turn OFF the start switch (STF/STR signal). The frequency value on the monitor decreases according to the setting of **Pr.8 Deceleration time**, "0.00" (0.00 Hz) appears on the monitor, and the motor stops rotating. The RUN LED turns OFF. Turn OFF the high-speed switch (RH signal).

NOTE

- When both the forward rotation start switch (STF signal) and the reverse rotation start switch (STR signal) are turned ON, the motor cannot be started. If both are turned ON while the inverter is running, the inverter decelerates to a stop.
- The initial value is 60 Hz for terminal RH in Group 1 (50 Hz in Group 2), 30 Hz for terminal RM, and 10 Hz for terminal RL. (To change the settings, use **Pr.4**, **Pr.5**, and **Pr.6**, respectively.)
- In the initial setting, if two or more speed switches (signals) are simultaneously turned ON, priority is given to the switch (signal) for the lower speed. For example, when both RH and RM signals turn ON, the RM signal (**Pr.5**) has the higher priority.
- Up to 15-speed switching operation can be performed.
- Up to two external input terminals are available for the Ethernet model and the IP67 model. Use **Pr.178 STF/DI0 terminal function selection** and **Pr.179 STR/DI1 terminal function selection** to assign the functions to terminals DI0 and DI1.

Parameters referred to

Pr.4 to Pr.6 (Multi-speed setting) [page 303](#)

Pr.7 Acceleration time, Pr.8 Deceleration time [page 262](#)

Pr.178 STF/DI0 terminal function selection, Pr.179 STR/DI1 terminal function selection [page 410](#)

2.6.3 Setting the frequency using an analog signal (voltage input)

Point

- Turn ON the STF/STR signal to give a start command.
- Use the frequency setting potentiometer to give a frequency command (by connecting it to terminals 2 and 5 (voltage input)).

[Connection diagram]

(The inverter supplies 5 V power to the frequency setting potentiometer via terminal 10.)

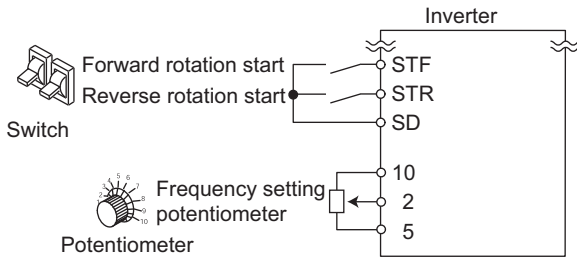

The following shows the procedure to operate at 60 Hz.

Operating procedure

- 1.** Turning ON the power of the inverter
The operation panel is in the monitor mode.
- 2.** Start
Turn ON the start switch (STF/STR signal). The RUN LED on the operation panel blinks as no frequency command is given.
- 3.** Acceleration → constant speed
Turn the frequency setting potentiometer clockwise slowly to full. The frequency value on the monitor increases according to the setting of **Pr.7 Acceleration time**, and "60.00" (60.00 Hz) appears on the monitor. The RUN LED is ON during forward rotation and blinks slowly during reverse rotation.
- 4.** Deceleration
Turn the frequency setting potentiometer counterclockwise slowly to full. The frequency value on the monitor decreases according to the setting of **Pr.8 Deceleration time**, "0.00" (0.00 Hz) appears on the monitor, and the motor stops rotating. The RUN LED blinks.
- 5.** Stop
Turn OFF the start switch (STF/STR signal). The RUN LED turns OFF.

NOTE

- When both the forward rotation start switch (STF signal) and the reverse rotation start switch (STR signal) are turned ON, the motor cannot be started. If both are turned ON while the inverter is running, the inverter decelerates to a stop.
- **Pr.178 STF/DI0 terminal function selection** must be set to "60" (or **Pr.179 STR/DI1 terminal function selection** must be set to "61") (initial value).
- When terminal 10 is used, the maximum output frequency may fluctuate in a range of ± 6 Hz due to fluctuations in the output voltage (5 ± 0.5 VDC). Use **Pr.125** or **C4 (Pr.903)** to adjust the output frequency at the maximum analog input as required. (Refer to [page 400](#).)

Parameters referred to

Pr.7 Acceleration time, **Pr.8 Deceleration time** [page 262](#)

Pr.178 STF/DI0 terminal function selection, **Pr.179 STR/DI1 terminal function selection** [page 410](#)

2.6.4 Changing the frequency (initial value: 60 Hz) at the maximum voltage input (initial value: 5 V)

Point

- Change the maximum frequency.

The following shows the procedure to change the frequency at 5 V from 60 Hz (initial value) to 50 Hz using a frequency setting potentiometer for 0 to 5 VDC input. Set 50 Hz in **Pr.125** so that the inverter outputs 50 Hz at 5 V input.

Operating procedure

1. Selecting the parameter
Turn the setting dial or press the UP/DOWN key until "P.125" (**Pr.125**) appears.
Press the SET key to show the present set value (60.00 Hz).
2. Changing the maximum frequency
Turn the setting dial or press the UP/DOWN key to change the value to "50.00" (50.00 Hz).
Press the SET key to confirm the setting. "50.00" blinks.
3. Selecting the mode and the monitor item
Press the MODE key twice to select the monitor mode and to monitor a frequency.
4. Start
Turn ON the start switch (STF/STR signal), and turn the frequency setting potentiometer clockwise slowly to full.
(Refer to steps 2 and 3 in 2.6.3.)
The motor is operated at 50 Hz.

NOTE

- To set the frequency at 0 V, use the calibration parameter **C2 (Pr.902)**.

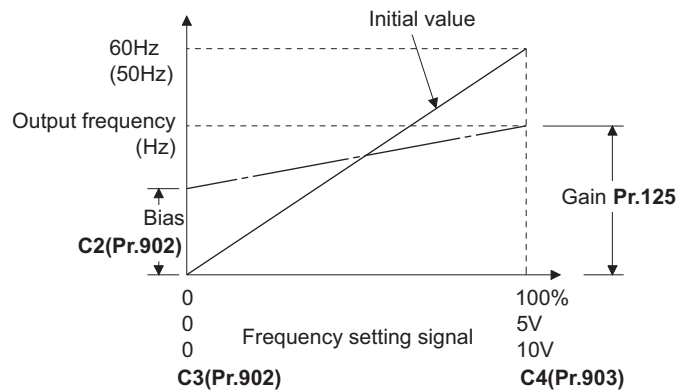

- Other adjustment methods for the frequency setting voltage gain are the following: adjustment by applying a voltage directly across terminals 2 and 5, and adjustment using a specified point without applying a voltage across terminals 2 and 5. (Refer to [page 400](#).)

Parameters referred to

- Pr.125** Terminal 2 frequency setting gain frequency [page 400](#)
C2(Pr.902) Terminal 2 frequency setting bias frequency [page 400](#)
C4(Pr.903) Terminal 2 frequency setting gain [page 400](#)

2.6.5 Setting the frequency using an analog signal (current input)

Point

- Turn ON the STF/STR signal to give a start command.
- Turn ON the AU signal.
- Set **Pr.79 Operation mode selection** = "2" (External operation mode).

[Connection diagram]

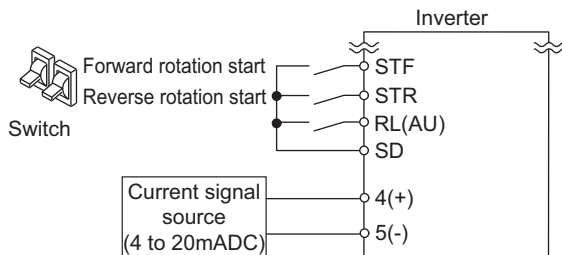

The following shows the procedure to operate at 60 Hz.

Operating procedure

- 1.** Turning ON the power of the inverter
The operation panel is in the monitor mode.
- 2.** Assignment of AU signal
Set **Pr.180 RL terminal function selection** = "4" to assign the AU signal to terminal RL.
- 3.** Selecting the input via terminal 4
Turn ON the Terminal 4 input selection (AU) signal. Input via terminal 4 to the inverter is enabled.
- 4.** Start
Turn ON the start switch (STF/STR signal). The RUN LED blinks as no frequency command is given.
- 5.** Acceleration → constant speed
Input a current of 20 mA to the inverter from the regulator. The frequency value on the monitor increases according to the setting of **Pr.7 Acceleration time**, and "60.00" (60.00 Hz) appears on the monitor. The RUN LED is ON during forward rotation and blinks slowly during reverse rotation.
- 6.** Deceleration
Input a current of 4 mA or less. The frequency value on the monitor decreases according to the setting of **Pr.8 Deceleration time**, "0.00" (0.00 Hz) appears on the monitor, and the motor stops rotating. The RUN LED blinks.
- 7.** Stop
Turn OFF the start switch (STF/STR signal). The RUN LED turns OFF.

NOTE

- When both the forward rotation start switch (STF signal) and the reverse rotation start switch (STR signal) are turned ON, the motor cannot be started. If both are turned ON while the inverter is running, the inverter decelerates to a stop.
- The AU signal can be assigned to another terminal. Set "4" in any parameter from **Pr.178 to Pr.184 (Input terminal function selection)** to assign the function to an input terminal. (For the Ethernet model and the IP67 model, assign the signal to terminal DI0 or DI1 using **Pr.178 or Pr.179**.)

Parameters referred to

Pr.7 Acceleration time, **Pr.8 Deceleration time** page 262
Pr.178 to Pr.184 (Input terminal function selection) page 410

2.6.6 Changing the frequency (initial value: 60 Hz) at the maximum current input (initial value: 20 mA)

Point

- Change the maximum frequency.

The following shows the procedure to change the frequency at 20 mA from 60 Hz (initial value) to 50 Hz using a frequency setting potentiometer for 4 to 20 mA input. Set 50 Hz in **Pr.126** so that the inverter outputs 50 Hz at 20 mA input.

Operating procedure

1. Selecting the parameter
Turn the setting dial or press the UP/DOWN key until "P.126" (**Pr.126**) appears.
Press the SET key to show the present set value (60.00 Hz).
2. Changing the maximum frequency
Turn the setting dial or press the UP/DOWN key to change the value to "50.00" (50.00 Hz).
Press the SET key to confirm the setting. "50.00" blinks.
3. Selecting the mode and the monitor item
Press the MODE key twice to select the monitor mode and to monitor a frequency.
4. Start
Turn ON the start switch (STF or STR) to apply a 20 mA current (refer to steps 3 and 4 in 2.6.5).
Operate at 50 Hz.

NOTE

- To set the frequency at 4 mA, use the calibration parameter **C5 (Pr.904)**.

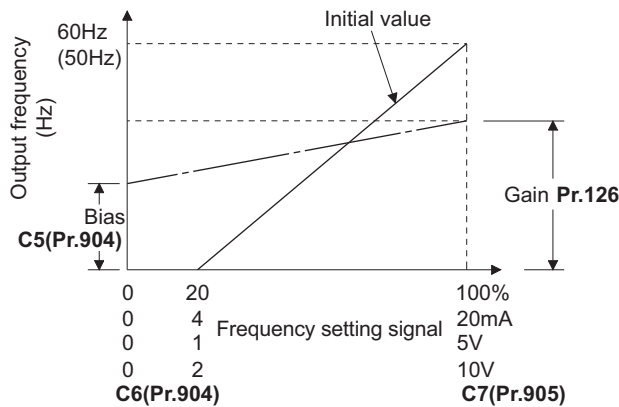

- Other adjustment methods for the frequency setting current gain are the following: adjustment by applying a current through terminals 4 and 5, and adjustment using a specified point without applying a current through terminals 4 and 5. (Refer to [page 400](#).)

Parameters referred to

- Pr.126** Terminal 4 frequency setting gain frequency [page 400](#)
C5(Pr.904) Terminal 4 frequency setting bias frequency [page 400](#)
C7(Pr.905) Terminal 4 frequency setting gain [page 400](#)

2.7 Basic operation procedure (JOG operation)

2.7.1 Giving a start command by using external signals for JOG operation

Point

- The JOG signal can be input only via a control circuit terminal.
- JOG operation is performed while the JOG signal is ON.
- Use **Pr.15 Jog frequency** to set a frequency, and set **Pr.16 Jog acceleration/deceleration time** to set the acceleration/deceleration time for JOG operation.
- Set **Pr.79 Operation mode selection** = "2" (External operation mode).

[Connection diagram]

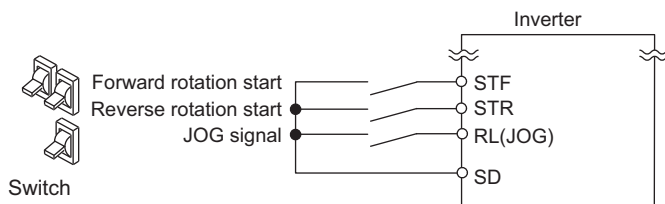

The following shows the procedure to operate at 5 Hz.

Operating procedure

- 1.** Turning ON the power of the inverter
The operation panel is in the monitor mode.
- 2.** Assignment of JOG signal
Set **Pr.180 RL terminal function selection** = "5" to assign the JOG signal to terminal RL.
- 3.** Turning ON the JOG signal
Turn ON the JOG switch (JOG signal). The inverter is set ready for the JOG operation.
- 4.** Start → acceleration → constant speed
Turn ON the start switch (STF/STR signal). The frequency value on the monitor increases according to the setting of **Pr.16 Jog acceleration/deceleration time**, and "5.00" (5.00 Hz) appears on the monitor. The RUN LED is ON during forward rotation and blinks slowly during reverse rotation.
- 5.** Deceleration → stop
Turn OFF the start switch (STF/STR signal). The frequency value on the monitor decreases according to the setting of **Pr.16 Jog acceleration/deceleration time**, "0.00" (0.00 Hz) appears on the monitor, and the motor stops rotating. The RUN LED turns OFF. Turn OFF the JOG switch (JOG signal).

NOTE

- To change the frequency, change the setting of **Pr.15 Jog frequency** (initial value: 5 Hz).
- To change the acceleration/deceleration time, change the setting of **Pr.16 Jog acceleration/deceleration time** (initial value: 0.5 seconds).
- The JOG signal can be assigned to another terminal. Set "5" in any parameter from **Pr.178 to Pr.184 (Input terminal function selection)** to assign the function to an input terminal. (For the Ethernet model and the IP67 model, assign the signal to terminal DI0 or DI1 using **Pr.178 or Pr.179**.)
- The JOG2 signal enables the JOG operation via communication. (Refer to [page 301](#).)

Parameters referred to

Pr.15 Jog frequency, **Pr.16 Jog acceleration/deceleration time** [page 301](#)
Pr.79 Operation mode selection [page 280](#)
Pr.178 to Pr.184 (Input terminal function selection) [page 410](#)

2.7.2 Giving a start command from the operation panel for JOG operation

Point

- JOG operation is performed while the RUN key on the operation panel is pressed.

2

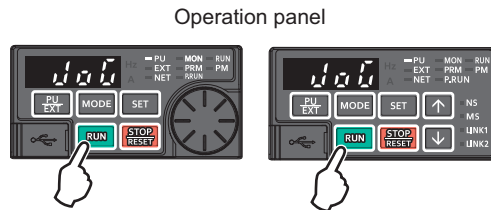

The following shows the procedure to operate at 5 Hz.

Operating procedure

- 1.** Turning ON the power of the inverter
The operation panel is in the monitor mode.
- 2.** Changing the operation mode
Press the PU/EXT key twice to choose the PUJOG operation mode. The display shows "JOG", and the PU LED is ON.
- 3.** Start → acceleration → constant speed
Hold down the RUN key. The frequency value on the monitor increases according to the setting of **Pr.16 Jog acceleration/deceleration time**, and "5.00" (5.00 Hz) appears on the monitor.
- 4.** Deceleration → stop
Release the RUN key. The frequency value on the monitor decreases according to the setting of **Pr.16 Jog acceleration/deceleration time**, "0.00" (0.00 Hz) appears on the monitor, and the motor stops rotating.

NOTE

- To change the frequency, change the setting of **Pr.15 Jog frequency** (initial value: 5 Hz).
- To change the acceleration/deceleration time, change the setting of **Pr.16 Jog acceleration/deceleration time** (initial value: 0.5 second).
- The PU JOG operation is not available for the IP67 model as neither the operation panel keys or the parameter unit can be used.

Parameters referred to

Pr.15 Jog frequency, Pr.16 Jog acceleration/deceleration time [page 301](#)

2.8 I/O terminal function assignment

- Functions can be assigned to the external I/O terminals (physical terminals) or communication (virtual terminals) by setting parameters.

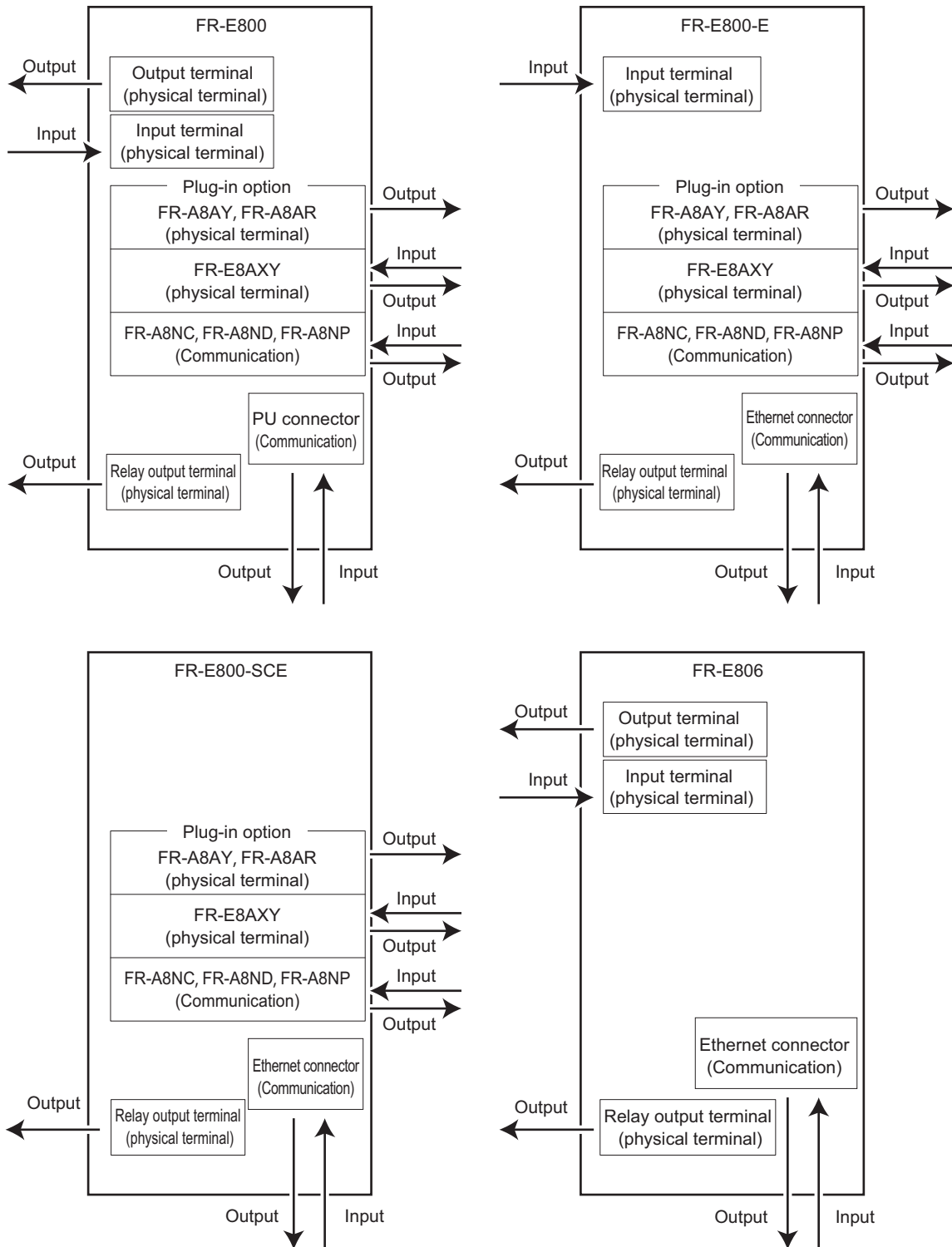

NOTE

- Two or more plug-in options cannot be installed at the same time.

◆ Input terminal function assignment

- Signals can be input to the inverter by using physical terminals (except for the FR-E800-SCE) or via communication, or assigned to the extension terminals of the plug-in option (FR-E8AXY). Option input terminals are not available for the IP67 model as plug-in options are not available.
- Use parameters to assign functions to input terminals. Check the terminal available for each parameter.

Pr.	Terminal name	External input terminal (physical terminal)				Input via communication ^{*1}	Option input terminal (physical terminal) ^{*2} FR-E8AXY
		FR-E800	FR-E800-E	FR-E800-SCE	FR-E806		
178	STF/DI0	○ (STF)	○ (DI0)	—	○ (DI0)	Forward rotation command only	—
179	STR/DI1	○ (STR)	○ (DI1)	—	○ (DI1)	Reverse rotation command only	—
180	RL	○	—	—	—	○	—
181	RM	○	—	—	—	○	—
182	RH	○	—	—	—	○	—
183	MRS	○	—	—	—	○	—
184	RES	○	—	—	—	○	—
185	NET X1	—	—	—	—	○	—
186	NET X2	—	—	—	—	○	—
187	NET X3	—	—	—	—	○	—
188	NET X4	—	—	—	—	○	—
189	NET X5	—	—	—	—	○	—
525	X1	—	—	—	—	—	○
526	X2	—	—	—	—	—	○
527	X3	—	—	—	—	—	○
528	X4	—	—	—	—	—	○
529	X5	—	—	—	—	—	○
530	X6	—	—	—	—	—	○
531	X7	—	—	—	—	—	○

○: Assignment/input available, —: Assignment/input unavailable (no function)

*1 The communication protocol affects which terminals can be used. For details, refer to the Instruction Manual (Communication) or the Instruction Manual of each communication option.

*2 Refer to the Instruction Manual of the option for details on the option input terminals.

NOTE

- For the available signals, refer to [page 410](#).

◆ Output terminal function assignment

- Signals can be output to the inverter by using physical terminals or via communication or assigned to the extension terminals of the plug-in option (FR-A8AY, FR-E8AXY, or FR-A8AR). Option output terminals are not available for the IP67 model as plug-in options are not available.
- Use parameters to assign functions to output terminals. Check the terminal available for each parameter.

Pr.	Terminal name	External output terminal (physical terminal)				Output via communication ^{*1}	Option output terminal (physical terminal) ^{*2}		
		FR-E800	FR-E800-E	FR-E800-SCE	FR-E806		FR-A8AY	FR-E8AXY	FR-A8AR
190	RUN	○	—	—	○	○	—	—	—
191	FU	○	—	—	○	○	—	—	—
192	A,B,C	○	○	○	○	○	—	—	—
193	NET Y1	—	—	—	—	○	—	—	—
194	NET Y2	—	—	—	—	○	—	—	—
195	NET Y3	—	—	—	—	○	—	—	—
196	NET Y4	—	—	—	—	○	—	—	—
197	A2,B2,C2	—	—	—	○	○	—	—	—
313	DO0	—	—	—	—	○	○	—	—
314	DO1	—	—	—	—	○	○	○	—
315	DO2	—	—	—	—	○	○	○	—
316	DO3	—	—	—	—	—	○	—	—
317	DO4	—	—	—	—	—	○	—	—
318	DO5	—	—	—	—	—	○	—	—
319	DO6	—	—	—	—	—	○	—	—
320	RA1	—	—	—	—	—	—	—	○
321	RA2	—	—	—	—	—	—	—	○
322	RA3	—	—	—	—	—	—	—	○

○: Assignment/output available, —: Assignment/output unavailable (no function)

*1 The communication protocol affects which terminals can be used. For details, refer to the Instruction Manual (Communication) or the Instruction Manual of each communication option.

*2 Refer to the Instruction Manual of the option for details on the option output terminals.

NOTE

- For the available signals, refer to [page 371](#).

CHAPTER 3 Parameters





3.1	Parameter initial value groups	54
3.2	Parameter list (by parameter number).....	55
3.3	Use of a function group number for the identification of parameters	94
3.4	Parameter list (by function group number)	95

3 Parameters

This chapter explains the function setting for use of this product.

Always read the instructions before use.

The following marks are used to indicate the controls. (Parameters without any mark are valid for all the controls.)

Mark	Control method	Applied motor
	V/F control	Three-phase induction motor
	Advanced magnetic flux vector control	
	Real sensorless vector control	
	Vector control	
	PM sensorless vector control	PM motor

3.1 Parameter initial value groups

- Initial values of parameters of the FR-E800 differ depending on the parameter initial value group. In this Instruction Manual, Gr.1 indicates the parameter initial value group 1, and Gr.2 indicates the parameter initial value group 2.
- FR-E800 inverters are divided into two groups as shown in the following table.

Parameter initial value groups	Model	Specification
Group 1 (Gr.1)	FR-E800-1	RS-485 communication, terminal FM
	FR-E800-5	RS-485 communication, terminal AM
	FR-E800-(SC)EPA FR-E806-SCEPA	Ethernet communication (Protocol group A)
	FR-E800-4	RS-485 communication, terminal AM
Group 2 (Gr.2)	FR-E800-(SC)EPB FR-E806-SCEPB	Ethernet communication (Protocol group B)
	FR-E800-EPC	Ethernet communication (Protocol group C)

- The initial values of the following parameters differ depending on the parameter initial value group.

Pr.	Name	Initial value		Refer to page
		Gr.1	Gr.2	
3	Base frequency	60 Hz	50 Hz	530
4	Multi-speed setting (high speed)	60 Hz	50 Hz	303
19	Base frequency voltage	9999	8888	530
20	Acceleration/deceleration reference frequency	60 Hz	50 Hz	262
55	Frequency monitoring reference	60 Hz	50 Hz	348
66	Stall prevention operation reduction starting frequency	60 Hz	50 Hz	334
125 (903)	Terminal 2 frequency setting gain frequency	60 Hz	50 Hz	400
126 (905)	Terminal 4 frequency setting gain frequency	60 Hz	50 Hz	400
249	Earth (ground) fault detection at start	0	1	315
301	BCD input gain	60 Hz	50 Hz	*1
303	BIN input gain	60 Hz	50 Hz	*1
386	Frequency for maximum input pulse	60 Hz	50 Hz	*2
390	% setting reference frequency	60 Hz	50 Hz	*3
505	Speed setting reference	60 Hz	50 Hz	346
808	Speed limit	60 Hz	50 Hz	171
C14 (918)	Terminal 1 gain frequency (speed)	60 Hz	50 Hz	*2
1013	Running speed after emergency drive retry reset	60 Hz	50 Hz	322
1486	Load characteristics maximum frequency	60 Hz	50 Hz	339

*1 The parameter is available when the plug-in option (FR-A8AX) is installed. For details, refer to the FR-A8AX E kit Instruction Manual. For the IP67 model, the parameter is not available as plug-in options are not available.

*2 The parameter is available when the plug-in option (FR-E8AXY) is installed. For details, refer to the FR-E8AXY E kit Instruction Manual. For the IP67 model, the parameter is not available as plug-in options are not available.

*3 For details, refer to the Instruction Manual (Communication).

3.2 Parameter list (by parameter number)

For simple variable-speed operation of the inverter, the initial values of the parameters may be used as they are. Set the necessary parameters to meet the load and operational specifications. Parameter's setting, change and check can be made on the operation panel.

NOTE

- **Simple** indicates simple mode parameters. Use **Pr.160 User group read selection** to indicate the simple mode parameters only (initial setting is to indicate the extended mode parameters).
- The changing of the parameter settings may be restricted in some operating status. Use **Pr.77 Parameter write selection** to change the setting of the restriction.
- Refer to [page 574](#) for instruction codes for communication, parameters under different control methods, and availability of Parameter copy, Parameter clear, and All parameter clear.

Notation

Mark	Description
[E800]	Available for the standard model.
[E800-1]	Available for the FM type inverter (standard model).
[E800-4]	Available for the AM (50 Hz) type inverter (standard model).
[E800-5]	Available for the AM (60 Hz) type inverter (standard model).
[E800-E]	Available for the Ethernet model.
[E800-SCE]	Available for the safety communication model.
[E800(-E)]	Available for the standard model and the Ethernet model.
[E800-(SC)E]	Available for the Ethernet model and the safety communication model.
[E800-(SC)EPA]	Available for the Protocol group A (Ethernet model / safety communication model).
[E800-(SC)EPB]	Available for the Protocol group B (Ethernet model / safety communication model).
[E800-EPC]	Available for the Protocol group C (Ethernet model).
[E806]	Available for the IP67 model.
[E806-SCEPA]	Available for the Protocol group A (IP67 model).
[E806-SCEPB]	Available for the Protocol group B (IP67 model).
[100/200/400 V class]	Available for the 100/200/400 V class.
[575 V class]	Available for the 575 V class.
[3-phase]	Available for the three-phase power input model.

◆ Pr.0 to Pr.99

Function	Pr.	Pr. group	Name	Setting range	Minimum setting increments	Initial value ^{*1}		Refer to page	Customer setting
						Gr.1	Gr.2		
Basic function	0	G000	Torque boost <i>Simple</i>	0% to 30%	0.1%	6% ^{*2}		528	
						5% ^{*2}			
						4% ^{*2}			
						3% ^{*2}			
						2% ^{*2}			
	1	H400	Maximum frequency <i>Simple</i>	0 to 120 Hz	0.01 Hz	120 Hz		331	
	2	H401	Minimum frequency <i>Simple</i>	0 to 120 Hz	0.01 Hz	0 Hz		331	
	3	G001	Base frequency <i>Simple</i>	0 to 590 Hz	0.01 Hz	60 Hz	50 Hz	530	
	4	D301	Multi-speed setting (high speed) <i>Simple</i>	0 to 590 Hz	0.01 Hz	60 Hz	50 Hz	303	
	5	D302	Multi-speed setting (middle speed) <i>Simple</i>	0 to 590 Hz	0.01 Hz	30 Hz		303	
6	D303	Multi-speed setting (low speed) <i>Simple</i>	0 to 590 Hz	0.01 Hz	10 Hz		303		
7 ^{*5}	F010	Acceleration time <i>Simple</i>	0 to 3600 s	0.1 s	5 s ^{*3}		262		
					10 s ^{*3}				
					15 s ^{*3}				
8 ^{*5}	F011	Deceleration time <i>Simple</i>	0 to 3600 s	0.1 s	5 s ^{*3}		262		
					10 s ^{*3}				
					15 s ^{*3}				
9	H000 C103	Electronic thermal O/L relay <i>Simple</i> Rated motor current <i>Simple</i>	0 to 500 A	0.01 A	Inverter rated current		306, 430, 441		
DC injection brake	10	G100	DC injection brake operation frequency	0 to 120 Hz	0.01 Hz	3 Hz		536	
	11	G101	DC injection brake operation time	0 to 10 s, 8888	0.1 s	0.5 s		536	
	12	G110	DC injection brake operation voltage	0% to 30%	0.1%	6% ^{*4} 4% ^{*4} 2% ^{*4} 1% ^{*4}		536	
—	13	F102	Starting frequency	0 to 60 Hz	0.01 Hz	0.5 Hz		274, 275	
—	14	G003	Load pattern selection	0 to 3	1	0		532	
JOG operation	15	D200	Jog frequency	0 to 590 Hz	0.01 Hz	5 Hz		301	
	16 ^{*5}	F002	Jog acceleration/ deceleration time	0 to 3600 s	0.1 s	0.5 s		301	
—	17	T720	MRS/X10 terminal input selection	0 to 5	1	0		416	
—	18	H402	High speed maximum frequency	0 to 590 Hz	0.01 Hz	120 Hz		331	
—	19	G002	Base frequency voltage	0 to 1000 V, 8888, 9999	0.1 V	9999	8888	530	

Function	Pr.	Pr. group	Name	Setting range	Minimum setting increments	Initial value ^{*1}		Refer to page	Customer setting
						Gr.1	Gr.2		
Acceleration/deceleration time	20	F000	Acceleration/ deceleration reference frequency	1 to 590 Hz	0.01 Hz	60 Hz	50 Hz	262	
	21	F001	Acceleration/ deceleration time increments	0, 1	1	0		262	
Stall prevention	22	H500	Stall prevention operation level (Torque limit level)	0% to 400%	0.1%	150%		139, 334	
	23	H610	Stall prevention operation level compensation factor at double speed	0% to 200%, 9999	0.1%	9999		334	
Multi-speed setting	24 to 27	D304 to D307	Multi-speed setting (speed 4 to speed 7)	0 to 590 Hz, 9999	0.01 Hz	9999		303	
I	29	F100	Acceleration/ deceleration pattern selection	0 to 2	1	0		267	
I	30	E300	Regenerative function selection	[E800(-E)] 0 to 2, 100 to 102 [E800-SCE] [E806] 0, 1	1	0		545	
Frequency jump	31	H420	Frequency jump 1A	0 to 590 Hz, 9999	0.01 Hz	9999		332	
	32	H421	Frequency jump 1B	0 to 590 Hz, 9999	0.01 Hz	9999		332	
	33	H422	Frequency jump 2A	0 to 590 Hz, 9999	0.01 Hz	9999		332	
	34	H423	Frequency jump 2B	0 to 590 Hz, 9999	0.01 Hz	9999		332	
	35	H424	Frequency jump 3A	0 to 590 Hz, 9999	0.01 Hz	9999		332	
	36	H425	Frequency jump 3B	0 to 590 Hz, 9999	0.01 Hz	9999		332	
I	37 ^{*5}	M000	Speed display	0.01 to 9998	0.001	1800		346	
I	40	E202	RUN key rotation direction selection	0, 1	1	0		234	
Frequency detection	41	M441	Up-to-frequency sensitivity	0% to 100%	0.1%	10%		382	
	42	M442	Output frequency detection	0 to 590 Hz	0.01 Hz	6 Hz		382	
	43	M443	Output frequency detection for reverse rotation	0 to 590 Hz, 9999	0.01 Hz	9999		382	

Function	Pr.	Pr. group	Name	Setting range	Minimum setting increments	Initial value*1		Refer to page	Customer setting
						Gr.1	Gr.2		
Second function	44*5	F020	Second acceleration/ deceleration time	0 to 3600 s	0.1 s	5 s*3 10 s*3 15 s*3		262, 495	
	45*5	F021	Second deceleration time	0 to 3600 s, 9999	0.1 s	9999		262, 495	
	46	G010	Second torque boost	0% to 30%, 9999	0.1%	9999		528	
	47	G011	Second V/F (base frequency)	0 to 590 Hz, 9999	0.01 Hz	9999		530	
	48	H600	Second stall prevention operation level	0% to 400%, 9999	0.1%	9999		334	
	51	H010 C203	Second electronic thermal O/L relay Rated second motor current	0 to 500 A, 9999	0.01 A	9999		306, 430, 441	
Monitoring	52	M100	Operation panel main monitor selection [E800] [E800-(SC)E]	[E800] 0, 5 to 14, 17 to 20, 22 to 33, 35, 38, 40 to 42, 44, 45, 50 to 57, 61, 62, 64, 65, 67, 68, 71, 72, 81 to 84, 85 [E800-1], 86 [E800-4] [E800-5], 91, 97, 100 [E800-(SC)E] 0, 5 to 14, 17 to 20, 22 to 33, 35, 38, 40 to 42, 44, 45, 50 to 57, 61, 62, 64, 65, 67, 68 [E800-E], 71, 72, 83 [E800-(SC)EPA], 91, 97, 100	1	0		348	
	53	M003	Frequency / rotation speed unit switchover	0, 1, 4	1	0		346	
	54	M300	FM terminal function selection [E800-1]	1 to 3, 5 to 14, 17, 18, 21, 24, 32, 33, 50, 52, 53, 61, 62, 65, 67, 70, 85, 97	1	1		358	
	55*8	M040	Frequency monitoring reference	0 to 590 Hz	0.01 Hz	60 Hz	50 Hz	358	
	56*8	M041	Current monitoring reference	0 to 500 A	0.01 A	Inverter rated current		358	
Automatic restart	57	A702	Restart coasting time	0, 0.1 to 30 s, 9999	0.1 s	9999		502, 508	
	58	A703	Restart cushion time	0 to 60 s	0.1 s	1 s		502	
—	59	F101	Remote function selection	0 to 3, 11 to 13	1	0		269	
—	60	G030	Energy saving control selection	0, 9	1	0		534	
Automatic acceleration/deceleration	61	F510	Reference current	0 to 500 A, 9999	0.01 A	9999		276	
	62	F511	Reference value at acceleration	0% to 400%, 9999	1%	9999		276	
	63	F512	Reference value at deceleration	0% to 400%, 9999	1%	9999		276	
—	65	H300	Retry selection	0 to 5	1	0		319	

Function	Pr.	Pr. group	Name	Setting range	Minimum setting increments	Initial value ^{*1}		Refer to page	Customer setting
						Gr.1	Gr.2		
—	66	H611	Stall prevention operation reduction starting frequency	0 to 590 Hz	0.01 Hz	60 Hz	50 Hz	334	
Retry	67	H301	Number of retries at fault occurrence	0 to 10, 101 to 110	1	0		319	
	68	H302	Retry waiting time	0.1 to 600 s	0.1 s	1 s		319	
	69	H303	Retry count display erase	0	1	0		319	
—	70	G107	Special regenerative brake duty	0% to 100%	0.1%	0%		545	
—	71	C100	Applied motor	[100/200/400 V class] 0, 3, 5, 6, 10, 13, 15, 16, 20, 23, 30, 33, 40, 43, 50, 53, 70, 73, 540, 1140, 1800, 1803, 8090, 8093, 9090, 9093 [575 V class] 0, 3, 5, 6, 10, 13, 15, 16, 30, 33, 8090, 8093, 9090, 9093	1	0		424, 430, 441	
—	72	E600	PWM frequency selection	0 to 15	1	1		249	
—	73	T000	Analog input selection	0, 1, 6, 10, 11, 16	1	1		392	
—	74	T002	Input filter time constant	0 to 8	1	1		398	
—	75	—	Reset selection/ disconnected PU detection/PU stop selection	[E800(-E)] 0 to 3, 14 to 17 [E800-SCE] [E806] 0 to 3, 14 to 17, 10000 to 10003, 10014 to 10017	1	[E800(-E)] 14 [E800-SCE] [E806] 10014		225	
		E100	Reset selection	0, 1		0			
		E101	Disconnected PU detection			1			
		E102	PU stop selection			[E800(-E)] 0 [E800-SCE] [E806] 10			
E107	Reset limit	[E800(-E)] 0 [E800-SCE] [E806] 0, 10							
—	77	E400	Parameter write selection	0 to 2	1	0		237	
—	78	D020	Reverse rotation prevention selection	0 to 2	1	0		300	
—	79	D000	Operation mode selection <i>Simple</i>	0 to 4, 6, 7	1	0		280, 290	

Function	Pr.	Pr. group	Name	Setting range	Minimum setting increments	Initial value*1		Refer to page	Customer setting
						Gr.1	Gr.2		
Motor constant	80	C101	Motor capacity	0.1 to 30 kW, 9999	0.01 kW	9999		115, 430, 441	
	81	C102	Number of motor poles	2, 4, 6, 8, 10, 12, 9999	1	9999		115, 430, 441	
	82	C125	Motor excitation current	0 to 500 A, 9999	0.01 A	9999		430	
	83	C104	Rated motor voltage	0 to 1000 V	0.1 V	[100/200 V class] 200 V [400 V class] 400 V [575 V class] 575 V		115, 430, 441	
	84	C105	Rated motor frequency	10 to 400 Hz, 9999	0.01 Hz	9999		115, 430, 441	
	89	G932	Speed control gain (Advanced magnetic flux vector)	0% to 200%, 9999	0.1%	9999		121	
	90	C120	Motor constant (R1)	0 to 50 Ω, 9999	0.001 Ω	9999		430, 441, 510	
	91	C121	Motor constant (R2)	0 to 50 Ω, 9999	0.001 Ω	9999		430	
	92	C122	Motor constant (L1)/d-axis inductance (Ld)	0 to 6000 mH, 9999	0.1 mH	9999		430, 441	
	93	C123	Motor constant (L2)/q-axis inductance (Lq)	0 to 6000 mH, 9999	0.1 mH	9999		430, 441	
	94	C124	Motor constant (X)	0% to 100%, 9999	0.1%	9999		430	
	95	C111	Online auto tuning selection	0, 1	1	0		449	
	96	C110	Auto tuning setting/status	0, 1, 11, 301	1	0		430, 441, 510	

◆ Pr.100 to Pr.199

Function	Pr.	Pr. group	Name	Setting range	Minimum setting increments	Initial value*1		Refer to page	Customer setting
						Gr.1	Gr.2		
PU connector communication	117	N020	PU communication station number [E800]	0 to 31 (0 to 247) (0 to 127)	1	0		*9	
	118	N021	PU communication speed [E800]	48, 96, 192, 384, 576, 768, 1152	1	192		*9	
	119	—	PU communication stop bit length / data length [E800]	0, 1, 10, 11	1	1		*9	
		N022	PU communication data length [E800]	0, 1		0			
		N023	PU communication stop bit length [E800]	0, 1		1			
	120	N024	PU communication parity check [E800]	0 to 2	1	2		*9	
	121	N025	PU communication retry count [E800]	0 to 10, 9999	1	1		*9	
	122	N026	PU communication check time interval [E800]	0, 0.1 to 999.8 s, 9999	0.1 s	0		*9	
	123	N027	PU communication waiting time setting [E800]	0 to 150 ms, 9999	1 ms	9999		*9	
	124	N028	PU communication CR/LF selection [E800]	0 to 2	1	1		*9	
—	125	T022	Terminal 2 frequency setting gain frequency <i>Simple</i>	0 to 590 Hz	0.01 Hz	60 Hz	50 Hz	400	
—	126	T042	Terminal 4 frequency setting gain frequency <i>Simple</i>	0 to 590 Hz	0.01 Hz	60 Hz	50 Hz	400	
PID operation	127	A612	PID control automatic switchover frequency	0 to 590 Hz, 9999	0.01 Hz	9999		479	
	128	A610	PID action selection	0, 20, 21, 40 to 43, 50, 51, 60, 61, 1000, 1001, 1010, 1011, 2000, 2001, 2010, 2011	1	0		479, 495	
	129	A613	PID proportional band	0.1% to 1000%, 9999	0.1%	100%		479, 495	
	130	A614	PID integral time	0.1 to 3600 s, 9999	0.1 s	1 s		479, 495	
	131	A601	PID upper limit	0% to 100%, 9999	0.1%	9999		479, 495	
	132	A602	PID lower limit	0% to 100%, 9999	0.1%	9999		479, 495	
	133	A611	PID action set point	0% to 100%, 9999	0.01%	9999		479, 495	
	134	A615	PID differential time	0.01 to 10 s, 9999	0.01 s	9999		479, 495	
—	136	A001	MC switchover interlock time [E800(-E)]	0 to 100 s	0.1 s	1 s		322	
—	139	A004	Automatic switchover frequency from inverter to bypass operation [E800(-E)]	0 to 60 Hz, 9999	0.01 Hz	9999		322	
PU	145	E103	PU display language selection [E800]	0 to 7	1	—		228	
—	147	F022	Acceleration/deceleration time switching frequency	0 to 590 Hz, 9999	0.01 Hz	9999		262	
Current detection	150	M460	Output current detection level	0% to 400%	0.1%	150%		385	
	151	M461	Output current detection signal delay time	0 to 10 s	0.1 s	0 s		385	
	152	M462	Zero current detection level	0% to 400%	0.1%	5%		385	
	153	M463	Zero current detection time	0 to 10 s	0.01 s	0.5 s		385	

Function	Pr.	Pr. group	Name	Setting range	Minimum setting increments	Initial value ^{*1}		Refer to page	Customer setting	
						Gr.1	Gr.2			
—	154	H631	Voltage reduction selection during stall prevention operation	1, 11	1	1		334		
—	156	H501	Stall prevention operation selection	0 to 31, 100, 101	1	0		334		
—	157	M430	OL signal output timer	0 to 25 s, 9999	0.1 s	0 s		139, 334		
—	158	M301	AM terminal function selection [E800-4] [E800-5]	1 to 3, 5 to 14, 17, 18, 21, 24, 32, 33, 50, 52 to 54, 61, 62, 65, 67, 70, 86, 91, 97	1	1		358		
—	160	E440	User group read selection <i>Simple</i>	0, 1, 9999	1	0		246		
—	161	E200	Frequency setting/key lock operation selection	0, 1, 10, 11	1	0		231		
Automatic restart	162	A700	Automatic restart after instantaneous power failure selection	0, 1, 10, 11	1	0		502, 508, 510		
	165	A710	Stall prevention operation level for restart	0% to 400%	0.1%	150%		502		
Current detection	166	M433	Output current detection signal retention time	0 to 10 s, 9999	0.1 s	0.1 s		385		
	167	M464	Output current detection operation selection	0, 1, 10, 11	1	0		385		
—	168	E000 E080	Parameter for manufacturer setting. Do not set.							
—	169	E001 E081								
Cumulative monitor	170	M020		Watt-hour meter clear	0, 10, 9999	1	9999		348	
	171	M030		Operation hour meter clear	0, 9999	1	9999		348	
User group	172	E441	User group registered display/batch clear	9999, (0 to 16)	1	0		246		
	173	E442	User group registration	0 to 1999, 9999	1	9999		246		
	174	E443	User group clear	0 to 1999, 9999	1	9999		246		

Function	Pr.	Pr. group	Name	Setting range	Minimum setting increments	Initial value*1		Refer to page	Customer setting
						Gr.1	Gr.2		
Input terminal function assignment	178	T700	STF/DI0 terminal function selection [E800(-E)] [E806]	0 to 5, 7, 8, 10, 12 to 16, 18, 22 to 27, 30, 37, 42, 43, 46, 47, 50 to 52, 54, 60, 62, 65 to 67, 72, 74, 76, 84, 87 to 89, 92, 9999	1	60		410	
	179	T701	STR/DI1 terminal function selection [E800(-E)] [E806]	0 to 5, 7, 8, 10, 12 to 16, 18, 22 to 27, 30, 37, 42, 43, 46, 47, 50 to 52, 54, 61, 62, 65 to 67, 72, 74, 76, 84, 87 to 89, 92, 9999	1	61		410	
	180	T702	RL terminal function selection	[E800]	1	0		410	
	181	T703	RM terminal function selection	0 to 5, 7, 8, 10, 12 to 16, 18, 22 to 27, 30, 37, 42, 43, 46, 47, 50 to 52, 54, 62, 65 to 67, 72, 74, 76, 84, 87 to 89, 92, 9999	1	1		410	
	182	T704	RH terminal function selection	[E800-(SC)E] [E806]	1	24		410	
	183	T709	MRS terminal function selection	0 to 4, 8, 13 to 15, 18, 22 to 24, 26, 27, 30, 37, 42, 43, 46, 47, 50 to 52, 54, 72, 74, 76, 84	1	24		410	
	184	T711	RES terminal function selection	[E800-E], 87 to 89, 92, 9999	1		[E800] 62 [E800-(SC)E] [E806] 9999	410	
	185	T751	NET X1 input selection	0 to 4, 8, 13 to 15, 18, 22 to 24, 26, 27, 30, 37, 42, 43, 46, 47, 50 to 52, 54, 72, 74, 76, 84	1	9999		410	
	186	T752	NET X2 input selection	[E800(-E)], 87 to 89, 92, 9999	1			410	
	187	T753	NET X3 input selection		1			410	
	188	T754	NET X4 input selection		1			410	
189	T755	NET X5 input selection		1			410		

Function	Pr.	Pr. group	Name	Setting range	Minimum setting increments	Initial value ^{*1}		Refer to page	Customer setting
						Gr.1	Gr.2		
Output terminal function assignment	190	M400	RUN terminal function selection	0, 1, 3, 4, 7, 8, 11 to 16, 18 [E800(-E)], 19 [E800(-E)], 20, 24 to 28, 30 to 36, 38 to 41, 44 to 48, 56, 57, 60 to 64, 65 [E800(-E)], 66 [E800(-E)], 68, 70, 80, 81, 82 [E800] [E806-SCEPA], 84, 90 to 93, 95, 96, 98 to 101, 103, 104, 107, 108, 111 to 116, 120, 124 to 128, 130 to 136, 138 to 141, 144 to 148, 156, 157, 160 to 164, 165 [E800(-E)], 166 [E800(-E)], 168, 170, 180, 181, 182 [E800] [E806-SCEPA], 184, 190 to 193, 195, 196, 198, 199, 206, 211 to 213, 242 [E800-(SC)E] [E806], 306, 311 to 313, 342 [E800-(SC)E] [E806], 9999	1	0		371	
	191	M404	FU terminal function selection	[E800] 0, 1, 3, 4, 7, 8, 11 to 16, 18 to 20, 24 to 28, 30 to 36, 38 to 41, 44 to 48, 56, 57, 60 to 66, 68, 70, 80 to 82, 84, 90, 91, 95, 96, 98 to 101, 103, 104, 107, 108, 111 to 116, 120, 124 to 128, 130 to 136, 138 to 141, 144 to 148, 156, 157, 160 to 166, 168, 170, 180 to 182, 184, 190, 191, 195, 196, 198, 199, 206, 211 to 213, 306, 311 to 313, 9999	1	4		371	
	192	M405	ABC terminal function selection	[E800] 0, 1, 3, 4, 7, 8, 11 to 16, 18 to 20, 24 to 28, 30 to 36, 38 to 41, 44 to 48, 56, 57, 60 to 66, 68, 70, 80 to 82, 84, 90, 91, 95, 96, 98 to 101, 103, 104, 107, 108, 111 to 116, 120, 124 to 128, 130 to 136, 138 to 141, 144 to 148, 156, 157, 160 to 166, 168, 170, 180 to 182, 184, 190, 191, 195, 196, 198, 199, 206, 211 to 213, 306, 311 to 313, 9999	1	99		371	

Function	Pr.	Pr. group	Name	Setting range	Minimum setting increments	Initial value*1		Refer to page	Customer setting
						Gr.1	Gr.2		
Output terminal function assignment	192	M405	ABC terminal function selection	[E800-(SC)E] [E806] 0, 1, 3, 4, 7, 8, 11 to 16, 18 [E800-E], 19 [E800-E], 20, 24 to 28, 30 to 36, 38 to 41, 44 to 48, 56, 57, 60 to 64, 65 [E800-E], 66 [E800-E], 68, 70, 80, 81, 82 [E800-(SC)EPA] [E806-SCEPA], 84, 90, 91, 95, 96, 98 to 101, 103, 104, 107, 108, 111 to 116, 120, 124 to 128, 130 to 136, 138 to 141, 144 to 148, 156, 157, 160 to 164, 165 [E800-E], 166 [E800-E], 168, 170, 180, 181, 182 [E800-(SC)EPA] [E806-SCEPA], 184, 190, 191, 195, 196, 198, 199, 206, 211 to 213, 242, 306, 311 to 313, 342, 9999	1		99	371	
	193	M451	NET Y1 output selection	0, 1, 3, 4, 7, 8, 11 to 16, 18 [E800(-E)], 19 [E800(-E)], 20, 24 to 28, 30 to 36, 38 to 41, 44 to 48, 56, 57, 60 to 64, 65 [E800(-E)], 66 [E800(-E)], 68, 70, 80, 81, 84, 90 to 93, 95, 98 to 101, 103, 104, 107, 108, 111 to 116, 120, 124 to 128, 130 to 136, 138 to 141, 144 to 148, 156, 157, 160 to 164, 165 [E800(-E)], 166 [E800(-E)], 168, 170, 180, 181, 184, 190 to 193, 195, 198, 199, 206, 211 to 213, 242 [E800-(SC)E] [E806], 306, 311 to 313, 342 [E800-(SC)E] [E806], 9999	1		9999	371	
	194	M452	NET Y2 output selection	0, 1, 3, 4, 7, 8, 11 to 16, 18 [E800(-E)], 19 [E800(-E)], 20, 24 to 28, 30 to 36, 38 to 41, 44 to 48, 56, 57, 60 to 64, 65 [E800(-E)], 66 [E800(-E)], 68, 70, 80, 81, 84, 90 to 93, 95, 98 to 101, 103, 104, 107, 108, 111 to 116, 120, 124 to 128, 130 to 136, 138 to 141, 144 to 148, 156, 157, 160 to 164, 165 [E800(-E)], 166 [E800(-E)], 168, 170, 180, 181, 184, 190 to 193, 195, 198, 199, 206, 211 to 213, 242 [E800-(SC)E] [E806], 306, 311 to 313, 342 [E800-(SC)E] [E806], 9999	1		9999	371	
	195	M453	NET Y3 output selection	0, 1, 3, 4, 7, 8, 11 to 16, 18 [E800(-E)], 19 [E800(-E)], 20, 24 to 28, 30 to 36, 38 to 41, 44 to 48, 56, 57, 60 to 64, 65 [E800(-E)], 66 [E800(-E)], 68, 70, 80, 81, 84, 90 to 93, 95, 98 to 101, 103, 104, 107, 108, 111 to 116, 120, 124 to 128, 130 to 136, 138 to 141, 144 to 148, 156, 157, 160 to 164, 165 [E800(-E)], 166 [E800(-E)], 168, 170, 180, 181, 184, 190 to 193, 195, 198, 199, 206, 211 to 213, 242 [E800-(SC)E] [E806], 306, 311 to 313, 342 [E800-(SC)E] [E806], 9999	1		9999	371	
	196	M454	NET Y4 output selection	0, 1, 3, 4, 7, 8, 11 to 16, 18 [E800(-E)], 19 [E800(-E)], 20, 24 to 28, 30 to 36, 38 to 41, 44 to 48, 56, 57, 60 to 64, 65 [E800(-E)], 66 [E800(-E)], 68, 70, 80, 81, 84, 90 to 93, 95, 98 to 101, 103, 104, 107, 108, 111 to 116, 120, 124 to 128, 130 to 136, 138 to 141, 144 to 148, 156, 157, 160 to 164, 165 [E800(-E)], 166 [E800(-E)], 168, 170, 180, 181, 184, 190 to 193, 195, 198, 199, 206, 211 to 213, 242 [E800-(SC)E] [E806], 306, 311 to 313, 342 [E800-(SC)E] [E806], 9999	1		9999	371	

Function	Pr.	Pr. group	Name	Setting range	Minimum setting increments	Initial value*1		Refer to page	Customer setting
						Gr.1	Gr.2		
Output terminal function assignment	197	M406	ABC2 terminal function selection	<p>[E800] 0, 1, 3, 4, 7, 8, 11 to 16, 18 to 20, 24 to 28, 30 to 36, 38 to 41, 44 to 48, 56, 57, 60 to 66, 68, 70, 80, 81, 84, 90, 91, 95, 96, 98 to 101, 103, 104, 107, 108, 111 to 116, 120, 124 to 128, 130 to 136, 138 to 141, 144 to 148, 156, 157, 160 to 166, 168, 170, 180, 181, 184, 190, 191, 195, 196, 198, 199, 206, 211 to 213, 306, 311 to 313, 9999</p> <p>[E800-(SC)E] [E806] 0, 1, 3, 4, 7, 8, 11 to 16, 18 [E800-E], 19 [E800-E], 20, 24 to 28, 30 to 36, 38 to 41, 44 to 48, 56, 57, 60 to 64, 65 [E800-E], 66 [E800-E], 68, 70, 80, 81, 82 [E806-SCEPA], 84, 90, 91, 95, 96, 98 to 101, 103, 104, 107, 108, 111 to 116, 120, 124 to 128, 130 to 136, 138 to 141, 144 to 148, 156, 157, 160 to 164, 165 [E800-E], 166 [E800-E], 168, 170, 180, 181, 182 [E806-SCEPA], 184, 190, 191, 195, 196, 198, 199, 206, 211 to 213, 242, 306, 311 to 313, 342, 9999</p>	1	9999	371		
	—	198	E709	Display corrosion level	(1 to 3)	1	1	251	

◆ Pr.200 to Pr.299

Function	Pr.	Pr. group	Name	Setting range	Minimum setting increments	Initial value*1		Refer to page	Customer setting
						Gr.1	Gr.2		
Multi-speed setting	232 to 239	D308 to D315	Multi-speed setting (speed 8 to speed 15)	0 to 590 Hz, 9999	0.01 Hz	9999		303	
—	240	E601	Soft-PWM operation selection	0, 1	1	1		249	
—	241	M043	Analog input display unit switchover	0, 1	1	0		400	
—	244	H100	Cooling fan operation selection	0, 1	1	1		314	
Slip compensation	245	G203	Rated slip	0% to 50%, 9999	0.01%	9999		556	
	246	G204	Slip compensation time constant	0.01 to 10 s	0.01 s	0.5 s		556	
	247	G205	Constant output range slip compensation selection	0, 9999	1	9999		556	

Function	Pr.	Pr. group	Name	Setting range	Minimum setting increments	Initial value*1		Refer to page	Customer setting
						Gr.1	Gr.2		
—	249	H101	Earth (ground) fault detection at start	0, 1	1	0	1	315	
—	250	G106	Stop selection	0 to 100 s, 1000 to 1100 s, 8888, 9999	0.1 s	9999		420, 543	
—	251	H200	Output phase loss protection selection	0, 1	1	1		318	
Life check	255	E700	Life alarm status display	(0 to 1007)	1	0		251	
	256	E701	Inrush current limit circuit life display	(0% to 100%)	1%	100%		251	
	257	E702	Control circuit capacitor life display	(0% to 100%)	1%	100%		251	
	258	E703	Main circuit capacitor life display	(0% to 100%)	1%	100%		251	
	259	E704	Main circuit capacitor life measuring	0, 1 (2, 3, 8, 9)	1	0		251	
—	260	E602	PWM frequency automatic switchover	0, 10	1	10		249	
Power failure stop	261	A730	Power failure stop selection	0 to 2	1	0		514	
—	267	T001	Terminal 4 input selection	0 to 2	1	0		392	
—	268	M022	Monitor decimal digits selection	0, 1, 9999	1	9999		348	
—	269	E023	Parameter for manufacturer setting. Do not set.						
Stop-on-contact control	270	A200	Stop-on-contact control selection	0, 1, 11	1	0		461	
	275	A205	Stop-on contact excitation current low-speed scaling factor	0% to 300%, 9999	0.1%	9999		461	
	276	A206	PWM carrier frequency at stop-on contact	0 to 9, 9999	1	9999		461	
	277	H630	Stall prevention operation current switchover	0, 1	1	0		334	
Brake sequence	278	A100	Brake opening frequency	0 to 30 Hz	0.01 Hz	3 Hz		456	
	279	A101	Brake opening current	0% to 400%	0.1%	130%		456	
	280	A102	Brake opening current detection time	0 to 2 s	0.1 s	0.3 s		456	
	281	A103	Brake operation time at start	0 to 5 s	0.1 s	0.3 s		456	
	282	A104	Brake operation frequency	0 to 30 Hz	0.01 Hz	6 Hz		456	
	283	A105	Brake operation time at stop	0 to 5 s	0.1 s	0.3 s		456	
	284	A106	Deceleration detection function selection	0, 1	1	0		456	
	285	A107 H416	Overspeed detection frequency Speed deviation excess detection frequency	0 to 30 Hz, 9999	0.01 Hz	9999		154, 456, 559	
Droop control	286	G400	Droop gain	0% to 100%	0.1%	0%		561	
	287	G401	Droop filter time constant	0 to 1 s	0.01 s	0.3 s		561	
—	289	M431	Inverter output terminal filter	5 to 50 ms, 9999	1 ms	9999		371	
—	290	M044	Monitor negative output selection	0, 1, 4, 5, 8, 9, 12, 13	1	0		348, 358	
—	292	A110 F500	Automatic acceleration/ deceleration	0, 1, 7, 8, 11	1	0		276, 456	

Function	Pr.	Pr. group	Name	Setting range	Minimum setting increments	Initial value*1		Refer to page	Customer setting
						Gr.1	Gr.2		
—	293	F513	Acceleration/deceleration separate selection	0 to 2	1	0		276	
—	295	E201	Frequency change increment amount setting [E800]	0, 0.01, 0.1, 1, 10	0.01	0		233	
Password	296	E410	Password lock level	0 to 6, 99, 100 to 106, 199, 9999	1	9999		240	
	297	E411	Password lock/unlock	(0 to 5), 1000 to 9998, 9999	1	9999		240	
—	298	A711	Frequency search gain	0 to 32767, 9999	1	9999		430, 510	
—	299	A701	Rotation direction detection selection at restarting	0, 1, 9999	1	0		502	

◆ Pr.300 to Pr.399

Function	Pr.	Pr. group	Name	Setting range	Minimum setting increments	Initial value*1		Refer to page	Customer setting
						Gr.1	Gr.2		
Output terminal function assignment	313*10	M410	DO0 output selection	0, 1, 3, 4, 7, 8, 11 to 16, 18 [E800(-E)], 19 [E800(-E)], 20, 24 to 28, 30 to 36, 38 to 41, 44 to 48, 56, 57, 60 to 64, 65 [E800(-E)], 66 [E800(-E)], 68, 70, 80, 81, 84, 90 to 93, 95, 96, 98 to 101, 103, 104, 107, 108, 111 to 116, 120, 124 to 128, 130 to 136, 138 to 141, 144 to 148, 156, 157, 160 to 164, 165 [E800(-E)], 166 [E800(-E)], 168, 170, 180, 181, 184, 190 to 193, 195, 196, 198, 199, 206, 211 to 213, 242 [E800-(SC)E] [E806], 306, 311 to 313, 342 [E800-(SC)E] [E806], 9999	1	9999		371	
	314*10	M411	DO1 output selection	0, 1, 3, 4, 7, 8, 11 to 16, 18 [E800(-E)], 19 [E800(-E)], 20, 24 to 28, 30 to 36, 38 to 41, 44 to 48, 56, 57, 60 to 64, 65 [E800(-E)], 66 [E800(-E)], 68, 70, 80, 81, 84, 90 to 93, 95, 96, 98 to 101, 103, 104, 107, 108, 111 to 116, 120, 124 to 128, 130 to 136, 138 to 141, 144 to 148, 156, 157, 160 to 164, 165 [E800(-E)], 166 [E800(-E)], 168, 170, 180, 181, 184, 190 to 193, 195, 196, 198, 199, 206, 211 to 213, 242 [E800-(SC)E] [E806], 306, 311 to 313, 342 [E800-(SC)E] [E806], 9999	1	9999		371	
	315*10	M412	DO2 output selection	0, 1, 3, 4, 7, 8, 11 to 16, 18 [E800(-E)], 19 [E800(-E)], 20, 24 to 28, 30 to 36, 38 to 41, 44 to 48, 56, 57, 60 to 64, 65 [E800(-E)], 66 [E800(-E)], 68, 70, 80, 81, 84, 90 to 93, 95, 96, 98 to 101, 103, 104, 107, 108, 111 to 116, 120, 124 to 128, 130 to 136, 138 to 141, 144 to 148, 156, 157, 160 to 164, 165 [E800(-E)], 166 [E800(-E)], 168, 170, 180, 181, 184, 190 to 193, 195, 196, 198, 199, 206, 211 to 213, 242 [E800-(SC)E] [E806], 306, 311 to 313, 342 [E800-(SC)E] [E806], 9999	1	9999		371	
	316*10	M413	DO3 output selection	0, 1, 3, 4, 7, 8, 11 to 16, 18 [E800(-E)], 19 [E800(-E)], 20, 24 to 28, 30 to 36, 38 to 41, 44 to 48, 56, 57, 60 to 64, 65 [E800(-E)], 66 [E800(-E)], 68, 70, 80, 81, 84, 90 to 93, 95, 96, 98 to 101, 103, 104, 107, 108, 111 to 116, 120, 124 to 128, 130 to 136, 138 to 141, 144 to 148, 156, 157, 160 to 164, 165 [E800(-E)], 166 [E800(-E)], 168, 170, 180, 181, 184, 190 to 193, 195, 196, 198, 199, 206, 211 to 213, 242 [E800-(SC)E] [E806], 306, 311 to 313, 342 [E800-(SC)E] [E806], 9999	1	9999		371	
	317*10	M414	DO4 output selection	0, 1, 3, 4, 7, 8, 11 to 16, 18 [E800(-E)], 19 [E800(-E)], 20, 24 to 28, 30 to 36, 38 to 41, 44 to 48, 56, 57, 60 to 64, 65 [E800(-E)], 66 [E800(-E)], 68, 70, 80, 81, 84, 90 to 93, 95, 96, 98 to 101, 103, 104, 107, 108, 111 to 116, 120, 124 to 128, 130 to 136, 138 to 141, 144 to 148, 156, 157, 160 to 164, 165 [E800(-E)], 166 [E800(-E)], 168, 170, 180, 181, 184, 190 to 193, 195, 196, 198, 199, 206, 211 to 213, 242 [E800-(SC)E] [E806], 306, 311 to 313, 342 [E800-(SC)E] [E806], 9999	1	9999		371	
	318*10	M415	DO5 output selection	0, 1, 3, 4, 7, 8, 11 to 16, 18 [E800(-E)], 19 [E800(-E)], 20, 24 to 28, 30 to 36, 38 to 41, 44 to 48, 56, 57, 60 to 64, 65 [E800(-E)], 66 [E800(-E)], 68, 70, 80, 81, 84, 90 to 93, 95, 96, 98 to 101, 103, 104, 107, 108, 111 to 116, 120, 124 to 128, 130 to 136, 138 to 141, 144 to 148, 156, 157, 160 to 164, 165 [E800(-E)], 166 [E800(-E)], 168, 170, 180, 181, 184, 190 to 193, 195, 196, 198, 199, 206, 211 to 213, 242 [E800-(SC)E] [E806], 306, 311 to 313, 342 [E800-(SC)E] [E806], 9999	1	9999		371	
	319*10	M416	DO6 output selection	0, 1, 3, 4, 7, 8, 11 to 16, 18 [E800(-E)], 19 [E800(-E)], 20, 24 to 28, 30 to 36, 38 to 41, 44 to 48, 56, 57, 60 to 64, 65 [E800(-E)], 66 [E800(-E)], 68, 70, 80, 81, 84, 90 to 93, 95, 96, 98 to 101, 103, 104, 107, 108, 111 to 116, 120, 124 to 128, 130 to 136, 138 to 141, 144 to 148, 156, 157, 160 to 164, 165 [E800(-E)], 166 [E800(-E)], 168, 170, 180, 181, 184, 190 to 193, 195, 196, 198, 199, 206, 211 to 213, 242 [E800-(SC)E] [E806], 306, 311 to 313, 342 [E800-(SC)E] [E806], 9999	1	9999		371	
	320*10	M420	RA1 output selection	0, 1, 3, 4, 7, 8, 11 to 16, 18 [E800(-E)], 19 [E800(-E)], 20, 24 to 28, 30 to 36, 38 to 41, 44 to 48, 56, 57, 60 to 64, 65 [E800(-E)], 66 [E800(-E)], 68, 70, 80, 81, 84, 90, 91, 95, 96, 98, 99, 206, 211 to 213, 242 [E800-(SC)E] [E806], 9999	1	0		371	
	321*10	M421	RA2 output selection	0, 1, 3, 4, 7, 8, 11 to 16, 18 [E800(-E)], 19 [E800(-E)], 20, 24 to 28, 30 to 36, 38 to 41, 44 to 48, 56, 57, 60 to 64, 65 [E800(-E)], 66 [E800(-E)], 68, 70, 80, 81, 84, 90, 91, 95, 96, 98, 99, 206, 211 to 213, 242 [E800-(SC)E] [E806], 9999	1	1		371	
	322*10	M422	RA3 output selection	0, 1, 3, 4, 7, 8, 11 to 16, 18 [E800(-E)], 19 [E800(-E)], 20, 24 to 28, 30 to 36, 38 to 41, 44 to 48, 56, 57, 60 to 64, 65 [E800(-E)], 66 [E800(-E)], 68, 70, 80, 81, 84, 90, 91, 95, 96, 98, 99, 206, 211 to 213, 242 [E800-(SC)E] [E806], 9999	1	4		371	
RS-485 communication	338	D010	Communication operation command source	0, 1	1	0		291	
	339	D011	Communication speed command source	0 to 2	1	0		291	
	340	D001	Communication startup mode selection	0, 1, 10	1	[E800] 0 [E800-(SC)E] [E806] 10		290	
	342	N001	Communication EEPROM write selection	0, 1	1	0		*9	
	343	N080	Communication error count [E800]	(0 to 999)	1	0		*9	
—	349*11	N010	Communication reset selection	0, 1	1	0		*9	

Function	Pr.	Pr. group	Name	Setting range	Minimum setting increments	Initial value*1		Refer to page	Customer setting
						Gr.1	Gr.2		
Orientation control	350 ^{*6}	A510	Stop position command selection	0, 9999	1	9999		468	
	351 ^{*6}	A526	Orientation speed	0 to 30 Hz	0.01 Hz	2 Hz		468	
	352 ^{*6}	A527	Creep speed	0 to 10 Hz	0.01 Hz	0.5 Hz		468	
	353 ^{*6}	A528	Creep switchover position	0 to 16383	1	511		468	
	354 ^{*6}	A529	Position loop switchover position	0 to 8191	1	96		468	
	355 ^{*6}	A530	DC injection brake start position	0 to 255	1	5		468	
	356 ^{*6}	A531	Internal stop position command	0 to 16383	1	0		468	
	357 ^{*6}	A532	Orientation in-position zone	0 to 255	1	5		468	
	358 ^{*6}	A533	Servo torque selection	0 to 13	1	1		468	
	359 ^{*6}	C141	Encoder rotation direction	100, 101	1	101		452, 468, 559	
	361 ^{*6}	A512	Position shift	0 to 16383	1	0		468	
	362 ^{*6}	A520	Orientation position loop gain	0.1 to 100	0.1	1.0		468	
	363 ^{*6}	A521	Completion signal output delay time	0 to 5 s	0.1 s	0.5 s		468	
	364 ^{*6}	A522	Encoder stop check time	0 to 5 s	0.1 s	0.5 s		468	
	365 ^{*6}	A523	Orientation limit	0 to 60 s, 9999	1 s	9999		468	
	366 ^{*6}	A524	Recheck time	0 to 5 s, 9999	0.1 s	9999		468	
Encoder feedback	367 ^{*6}	G240	Speed feedback range	0 to 590 Hz, 9999	0.01 Hz	9999		559	
	368 ^{*6}	G241	Feedback gain	0 to 100	0.1	1		559	
	369 ^{*6}	C140	Number of encoder pulses	2 to 4096	1	1024		452, 468, 559	
	374	H800	Overspeed detection level	0 to 590 Hz, 9999	0.01 Hz	9999		344	
	375	H801	Faulty acceleration rate detection level	0 to 400 Hz, 9999	0.01 Hz	9999		262	
	376 ^{*6}	C148	Encoder signal loss detection enable/disable selection	0, 1	1	0		454, 559	
I	390	N054	% setting reference frequency [E800] [E800-(SC)EPA] [E806-SCEPA]	1 to 590 Hz	0.01 Hz	60 Hz	50 Hz	*9	
Orientation control	393 ^{*6}	A525	Orientation selection	0 to 2	1	0		468	
	396 ^{*6}	A542	Orientation speed gain (P term)	0 to 1000	1	60		468	
	397 ^{*6}	A543	Orientation speed integral time	0 to 20 s	0.001 s	0.333 s		468	
	398 ^{*6}	A544	Orientation speed gain (D term)	0 to 100	0.1	1		468	
	399 ^{*6}	A545	Orientation deceleration ratio	0 to 1000	1	20		468	

◆ Pr.400 to Pr.499

Function	Pr.	Pr. group	Name	Setting range	Minimum setting increments	Initial value*1		Refer to page	Customer setting
						Gr.1	Gr.2		
PLC	414	A800	PLC function operation selection	0 to 2, 11, 12	1	0		516	
	415	A801	Inverter operation lock mode setting	0, 1	1	0		516	

Function	Pr.	Pr. group	Name	Setting range	Minimum setting increments	Initial value*1		Refer to page	Customer setting
						Gr.1	Gr.2		
Position control	420	B001	Command pulse scaling factor numerator (electronic gear numerator)	1 to 32767	1	1		210	
	421	B002	Command pulse multiplication denominator (electronic gear denominator)	1 to 32767	1	1		210	
	422	B003	Position control gain	0 to 150 s ⁻¹	1 s ⁻¹	10 s ⁻¹		217, 536	
	423	B004	Position feed forward gain	0% to 100%	1%	0%		217	
	425	B006	Position feed forward command filter	0 to 5 s	0.001 s	0 s		217	
	426	B007	In-position width	0 to 32767 pulses	1 pulse	100 pulses		212	
	427	B008	Excessive level error	0 to 400k pulses, 9999	1k pulses	40k pulses		212	
	430	B011	Pulse monitor selection	0 to 5, 100 to 105, 1000 to 1005, 1100 to 1105, 8888, 9999	1	9999		207	
Ethernet	442	N620	Default gateway address 1 [E800-(SC)EPA] [E800-(SC)EPB] [E806]	0 to 255	1	0		*9	
	443	N621	Default gateway address 2 [E800-(SC)EPA] [E800-(SC)EPB] [E806]					*9	
	444	N622	Default gateway address 3 [E800-(SC)EPA] [E800-(SC)EPB] [E806]					*9	
	445	N623	Default gateway address 4 [E800-(SC)EPA] [E800-(SC)EPB] [E806]					*9	
—	446	B012	Model position control gain	0 to 150 s ⁻¹	1 s ⁻¹	25 s ⁻¹		217	

Function	Pr.	Pr. group	Name	Setting range	Minimum setting increments	Initial value*1		Refer to page	Customer setting
						Gr.1	Gr.2		
Second motor constant	450	C200	Second applied motor	[100/200/400 V class] 0, 3, 5, 6, 10, 13, 15, 16, 20, 23, 30, 33, 40, 43, 50, 53, 70, 73, 540, 1140, 1800, 1803, 8090, 8093, 9090, 9093, 9999 [575 V class] 0, 3, 5, 6, 10, 13, 15, 16, 30, 33, 8090, 8093, 9090, 9093, 9999	1		9999	424	
	451	G300	Second motor control method selection	10 to 14, 20, 40, 9999	1		9999	115	
	453	C201	Second motor capacity	0.1 to 30 kW, 9999	0.01 kW		9999	430, 441	
	454	C202	Number of second motor poles	2, 4, 6, 8, 10, 12, 9999	1		9999	430, 441	
	455	C225	Second motor excitation current	0 to 500 A, 9999	0.01 A		9999	430	
	456	C204	Rated second motor voltage	0 to 1000 V	0.1 V		[100/200 V class] 200 V [400 V class] 400 V [575 V class] 575 V	430, 441	
	457	C205	Rated second motor frequency	10 to 400 Hz, 9999	0.01 Hz		9999	430, 441	
	458	C220	Second motor constant (R1)	0 to 50 Ω, 9999	0.001 Ω		9999	430, 441, 510	
	459	C221	Second motor constant (R2)	0 to 50 Ω, 9999	0.001 Ω		9999	430	
	460	C222	Second motor constant (L1) / d-axis inductance (Ld)	0 to 6000 mH, 9999	0.1 mH		9999	430, 441	
	461	C223	Second motor constant (L2) / q-axis inductance (Lq)	0 to 6000 mH, 9999	0.1 mH		9999	430, 441	
	462	C224	Second motor constant (X)	0% to 100%, 9999	0.1%		9999	430	
	463	C210	Second motor auto tuning setting/status	0, 1, 11	1		0	430, 441, 510	

Function	Pr.	Pr. group	Name	Setting range	Minimum setting increments	Initial value *1		Refer to page	Customer setting
						Gr.1	Gr.2		
Position control	464	B020	Digital position control sudden stop deceleration time	0.01 to 360 s	0.01 s	0.01 s		184, 197	
	465	B021	First target position lower 4 digits	0 to 9999	1	0		184	
	466	B022	First target position upper 4 digits	0 to 9999	1	0		184	
	467	B023	Second target position lower 4 digits	0 to 9999	1	0		184	
	468	B024	Second target position upper 4 digits	0 to 9999	1	0		184	
	469	B025	Third target position lower 4 digits	0 to 9999	1	0		184	
	470	B026	Third target position upper 4 digits	0 to 9999	1	0		184	
	471	B027	Fourth target position lower 4 digits	0 to 9999	1	0		184	
	472	B028	Fourth target position upper 4 digits	0 to 9999	1	0		184	
	473	B029	Fifth target position lower 4 digits	0 to 9999	1	0		184	
	474	B030	Fifth target position upper 4 digits	0 to 9999	1	0		184	
	475	B031	Sixth target position lower 4 digits	0 to 9999	1	0		184	
	476	B032	Sixth target position upper 4 digits	0 to 9999	1	0		184	
	477	B033	Seventh target position lower 4 digits	0 to 9999	1	0		184	
478	B034	Seventh target position upper 4 digits	0 to 9999	1	0		184		
Remote output	495	M500	Remote output selection	0, 1, 10, 11	1	0		388	
	496	M501	Remote output data 1	0 to 4095	1	0		388	
	497	M502	Remote output data 2	0 to 4095	1	0		388	
—	498	A804	PLC function flash memory clear	0, 9696 (0 to 9999)	1	0		516	

◆ Pr.500 to Pr.599

Function	Pr.	Pr. group	Name	Setting range	Minimum setting increments	Initial value *1		Refer to page	Customer setting
						Gr.1	Gr.2		
—	502	N013	Stop mode selection at communication error	0 to 2, 6	1	0		*9	
Maintenance	503	E710	Maintenance timer	0 (1 to 9998)	1	0		256	
	504	E711	Maintenance timer warning output set time	0 to 9998, 9999	1	9999		256	
—	505	M001	Speed setting reference	1 to 590 Hz	0.01 Hz	60 Hz	50 Hz	346	
Life check	506	E705	Display estimated main circuit capacitor residual life	(0% to 100%)	1%	100%		251	
	507	E706	Display/reset ABC relay contact life	0% to 100%	1%	100%		251	
	508	E707	Display/reset ABC2 relay contact life [E806]	0% to 100%	1%	100%		251	
	509	E708	Display power cycle life	(0% to 100%)	0.01%	100%		251	
Position control	510	B196	Rough match output range	0 to 32767	1	0		212	
	511	B197	Home position return shifting speed	0 to 400 Hz	0.01 Hz	0.5 Hz		184, 197	

Function	Pr.	Pr. group	Name	Setting range	Minimum setting increments	Initial value*1		Refer to page	Customer setting
						Gr.1	Gr.2		
Emergency drive	514	H324	Emergency drive dedicated retry waiting time [E800(-E)]	0.1 to 600 s, 9999	0.1 s	9999		322	
	515	H322	Emergency drive dedicated retry count [E800(-E)]	1 to 200, 9999	1	1		322	
	523	H320	Emergency drive mode selection [E800(-E)]	100, 111, 112, 121, 122, 200, 211, 212, 221, 222, 300, 311, 312, 321, 322, 400, 411, 412, 421, 422, 9999	1	9999		322	
	524	H321	Emergency drive running speed [E800(-E)]	0 to 590 Hz, 9999	0.01 Hz	9999		322	
—	538	B015	Current position retention selection	1, 2, 11, 12, 21, 22, 9999	1	9999		215	
Communication	541*11	N100	Frequency command sign selection	0, 1	1	0		*9	
	544*11	N103	CC-Link extended setting	0, 1, 12, 14, 18, 38, 100, 112, 114, 118, 138	1	0		*9	
USB	547	N040	USB communication station number	0 to 31	1	0		*9	
	548	N041	USB communication check time interval	0 to 999.8 s, 9999	0.1 s	9999		*9	
Communication	549	N000	Protocol selection [E800]	0 to 2	1	0		*9	
	550	D012	NET mode operation command source selection	[E800] 0, 2, 9999 [E800-(SC)E] [E806] 0, 5, 9999	1	9999		291	
	551	D013	PU mode operation command source selection	[E800] 2 to 4, 9999 [E800-(SC)E] [E806] 3, 4, 9999	1	9999		291	
—	552	H429	Frequency jump range	0 to 30 Hz, 9999	0.01 Hz	9999		332	
PID control	553	A603	PID deviation limit	0% to 100%, 9999	0.1%	9999		479	
	554	A604	PID signal operation selection	0 to 3, 10 to 13	1	0		479	
Average current monitoring	555	E720	Current average time	0.1 to 1 s	0.1 s	1 s		257	
	556	E721	Data output mask time	0 to 20 s	0.1 s	0 s		257	
	557	E722	Current average value monitor signal output reference current	0 to 500 A	0.01 A	Inverter rated current		257	
—	560	A712	Second frequency search gain	0 to 32767, 9999	1	9999		430, 510	
—	561	H020	PTC thermistor protection level	0.5 to 30 kΩ, 9999	0.01 kΩ	9999		306	
—	563	M021	Energization time carrying-over times	(0 to 65535)	1	0		348	
—	564	M031	Operating time carrying-over times	(0 to 65535)	1	0		348	

Function	Pr.	Pr. group	Name	Setting range	Minimum setting increments	Initial value*1		Refer to page	Customer setting
						Gr.1	Gr.2		
Second motor constant	569	G942	Second motor speed control gain	0% to 200%, 9999	0.1%	9999		121	
Multiple rating	570	E301	Multiple rating setting [3-phase]	1, 2	1	2		235	
—	571	F103	Holding time at a start	0 to 10 s, 9999	0.1 s	9999		274	
—	574	C211	Second motor online auto tuning	0, 1	1	0		449	
PID control	575	A621	Output interruption detection time	0 to 3600 s, 9999	0.1 s	1 s		479	
	576	A622	Output interruption detection level	0 to 590 Hz	0.01 Hz	0 Hz		479	
	577	A623	Output interruption cancel level	900% to 1100%	0.1%	1000%		479	
Traverse	592	A300	Traverse function selection	0 to 2	1	0		464	
	593	A301	Maximum amplitude amount	0% to 25%	0.1%	10%		464	
	594	A302	Amplitude compensation amount during deceleration	0% to 50%	0.1%	10%		464	
	595	A303	Amplitude compensation amount during acceleration	0% to 50%	0.1%	10%		464	
	596	A304	Amplitude acceleration time	0.1 to 3600 s	0.1 s	5 s		464	
597	A305	Amplitude deceleration time	0.1 to 3600 s	0.1 s	5 s		464		

◆ Pr.600 to Pr.699

Function	Pr.	Pr. group	Name	Setting range	Minimum setting increments	Initial value*1		Refer to page	Customer setting
						Gr.1	Gr.2		
Electronic thermal O/L relay	600	H001	First free thermal reduction frequency 1	0 to 590 Hz, 9999	0.01 Hz	9999		306	
	601	H002	First free thermal reduction ratio 1	1% to 100%	1%	100%		306	
	602	H003	First free thermal reduction frequency 2	0 to 590 Hz, 9999	0.01 Hz	9999		306	
	603	H004	First free thermal reduction ratio 2	1% to 100%	1%	100%		306	
	604	H005	First free thermal reduction frequency 3	0 to 590 Hz, 9999	0.01 Hz	9999		306	
—	607	H006	Motor permissible load level	110% to 250%	1%	150%		306	
—	608	H016	Second motor permissible load level	110% to 250%, 9999	1%	9999		306	
PID control	609	A624	PID set point/deviation input selection	2 to 5	1	2		479, 495	
	610	A625	PID measured value input selection	2 to 5	1	3		479, 495	
—	611	F003	Acceleration time at a restart	0 to 3600 s, 9999	0.1 s	9999		502, 508	
—	631	H182	Inverter output fault detection enable/disable selection	0, 1	1	0		316	

Function	Pr.	Pr. group	Name	Setting range	Minimum setting increments	Initial value*1		Refer to page	Customer setting
						Gr.1	Gr.2		
Cumulative pulse monitoring	635*6	M610	Cumulative pulse clear signal selection	0, 1	1	0		207	
	636*6	M611	Cumulative pulse division scaling factor	1 to 16384	1	1		207	
	638*6	M613	Cumulative pulse storage	0, 1	1	0		207	
Brake sequence	639	A108	Brake opening current selection	0, 1	1	0		456	
	640	A109	Brake operation frequency selection	0, 1	1	0		456	
Speed smoothing control	653	G410	Speed smoothing control	0% to 200%	0.1%	0%		562	
	654	G411	Speed smoothing cutoff frequency	0 to 120 Hz	0.01 Hz	20 Hz		562	
Increased magnetic excitation deceleration	660	G130	Increased magnetic excitation deceleration operation selection	0, 1	1	0		554	
	661	G131	Magnetic excitation increase rate	0% to 40%, 9999	0.1%	9999		554	
	662	G132	Increased magnetic excitation current level	0% to 200%	0.1%	100%		554	
—	665	G125	Regeneration avoidance frequency gain	0% to 200%	0.1%	100%		551	
—	673	G060	SF-PR slip amount adjustment operation selection [100/200/400 V class]	2, 4, 6, 9999	1	9999		535	
—	674	G061	SF-PR slip amount adjustment gain [100/200/400 V class]	0% to 500%	0.1%	100%		535	
—	675	A805	User parameter auto storage function selection	1, 9999	1	9999		516	
—	690	H881	Deceleration check time	0 to 3600 s, 9999	0.1 s	1 s		154	
Electronic thermal O/L relay	692	H011	Second free thermal reduction frequency 1	0 to 590 Hz, 9999	0.01 Hz	9999		306	
	693	H012	Second free thermal reduction ratio 1	1% to 100%	1%	100%		306	
	694	H013	Second free thermal reduction frequency 2	0 to 590 Hz, 9999	0.01 Hz	9999		306	
	695	H014	Second free thermal reduction ratio 2	1% to 100%	1%	100%		306	
	696	H015	Second free thermal reduction frequency 3	0 to 590 Hz, 9999	0.01 Hz	9999		306	
—	698	G219	Speed control D gain	0% to 100%	0.1%	0%		217	
—	699	T740	Input terminal filter [E800(-E)] [E806]	5 to 50 ms, 9999	1 ms	9999		410	

◆ Pr.700 to Pr.799

Function	Pr.	Pr. group	Name	Setting range	Minimum setting increments	Initial value*1		Refer to page	Customer setting
						Gr.1	Gr.2		
Motor constant	702	C106	Maximum motor frequency	0 to 400 Hz, 9999	0.01 Hz	9999		441	
	706	C130	Induced voltage constant (phi f)	0 to 5000 mV (rad/s), 9999	0.1 mV (rad/s)	9999		441	
	707	C107	Motor inertia (integer)	10 to 999, 9999	1	9999		441	
	711	C131	Motor Ld decay ratio	0% to 100%, 9999	0.1%	9999		441	
	712	C132	Motor Lq decay ratio	0% to 100%, 9999	0.1%	9999		441	
	717	C182	Starting resistance tuning compensation coefficient 1	0% to 200%, 9999	0.1%	9999		441	
	720	C188	Starting resistance tuning compensation coefficient 2	0% to 200%, 9999	0.1%	9999		430	
	721	C185	Starting magnetic pole position detection pulse width	0 to 6000 μs, 9999	1 μs	9999		441	
	724	C108	Motor inertia (exponent)	0 to 7, 9999	1	9999		441	
	725	C133	Motor protection current level	100% to 500%, 9999	0.1%	9999		441	
BACnet	726	N050	Auto Baudrate/Max Master [E800]	0 to 255	1	255	*9		
	727	N051	Max Info Frames [E800]	1 to 255	1	1	*9		
	728	N052	Device instance number (Upper 3 digits) [E800] [E800-(SC)EPA] [E806-SCEPA]	0 to 419	1	0	*9		
	729	N053	Device instance number (Lower 4 digits) [E800] [E800-(SC)EPA] [E806-SCEPA]	0 to 9999	1	0	*9		
Motor constant	737	C288	Second motor starting resistance tuning compensation coefficient 2	0% to 200%, 9999	0.1%	9999		441	
	738	C230	Second motor induced voltage constant (phi f)	0 to 5000 mV (rad/s), 9999	0.1 mV (rad/s)	9999		441	
	739	C231	Second motor Ld decay ratio	0% to 100%, 9999	0.1%	9999		441	
	740	C232	Second motor Lq decay ratio	0% to 100%, 9999	0.1%	9999		441	
	741	C282	Second motor starting resistance tuning compensation coefficient 1	0% to 200%, 9999	0.1%	9999		441	
	742	C285	Second motor magnetic pole detection pulse width	0 to 6000 μs, 9999	1 μs	9999		441	
	743	C206	Second motor maximum frequency	0 to 400 Hz, 9999	0.01 Hz	9999		441	
	744	C207	Second motor inertia (integer)	10 to 999, 9999	1	9999		441	
	745	C208	Second motor inertia (exponent)	0 to 7, 9999	1	9999		441	
	746	C233	Second motor protection current level	100% to 500%, 9999	0.1%	9999		441	
—	759	A600	PID unit selection	0 to 43, 9999	1	9999		492	

Function	Pr.	Pr. group	Name	Setting range	Minimum setting increments	Initial value*1		Refer to page	Customer setting
						Gr.1	Gr.2		
Monitoring	774	M101	Operation panel monitor selection 1	[E800] 1 to 3, 5 to 14, 17 to 20, 22 to 33, 35, 38, 40 to 42, 44, 45, 50 to 57, 61, 62, 64, 65, 67, 68, 71, 72, 81 to 84, 85	1	9999		348	
	775	M102	Operation panel monitor selection 2 [E800] [E800-(SC)E]	[E800-1], 86 [E800-4] [E800-5], 91, 97, 100, 9999	1	9999		348	
	776	M103	Operation panel monitor selection 3 [E800] [E800-(SC)E]	[E800-(SC)E] [E806] 1 to 3, 5 to 14, 17 to 20, 22 to 33, 35, 38, 40 to 42, 44, 45, 50 to 57, 61, 62, 64, 65, 67, 68 [E800-E], 71, 72, 83 [E800-(SC)EPA] [E806-SCEPA], 91, 97, 100, 9999	1	9999		348	
—	779	N014	Operation frequency during communication error	0 to 590 Hz, 9999	0.01 Hz	9999		*9	
—	791*5	F070	Acceleration time in low-speed range	0 to 3600 s, 9999	0.1 s	9999		262	
—	792*5	F071	Deceleration time in low-speed range	0 to 3600 s, 9999	0.1 s	9999		262	

◆ Pr.800 to Pr.999

Function	Pr.	Pr. group	Name	Setting range	Minimum setting increments	Initial value*1		Refer to page	Customer setting
						Gr.1	Gr.2		
—	800	G200	Control method selection	0 to 5, 9, 10 to 14, 19, 20, 40	1	40		115	
—	801	H704	Output limit level	0% to 400%, 9999	0.1%	9999		139, 167	
—	802	G102	Pre-excitation selection	0, 1	1	0		536	
Torque command	803	G210	Constant output range torque characteristic selection	0 to 2, 10	1	0		139, 167	
	804	D400	Torque command source selection	0, 1, 3 to 6	1	0		167	
	805	D401	Torque command value (RAM)	600% to 1400%	1%	1000%		139, 167	
	806	D402	Torque command value (RAM, EEPROM)	600% to 1400%	1%	1000%		139, 167	
Speed limit	807	H410	Speed limit selection	0, 1	1	0		171	
	808	H411	Speed limit	0 to 400 Hz	0.01 Hz	60 Hz	50 Hz	171	
	809	H412	Reverse-side speed limit	0 to 400 Hz, 9999	0.01 Hz	9999		171	
Torque limit	810	H700	Torque limit input method selection	0 to 2	1	0		139	
	811	D030	Set resolution switchover	0, 10	1	0		139	
	812	H701	Torque limit level (regeneration)	0% to 400%, 9999	0.1%	9999		139	
	813	H702	Torque limit level (3rd quadrant)	0% to 400%, 9999	0.1%	9999		139	
	814	H703	Torque limit level (4th quadrant)	0% to 400%, 9999	0.1%	9999		139	
	815	H710	Torque limit level 2	0% to 400%, 9999	0.1%	9999		139	
	816	H720	Torque limit level during acceleration	0% to 400%, 9999	0.1%	9999		139	
	817	H721	Torque limit level during deceleration	0% to 400%, 9999	0.1%	9999		139	

Function	Pr.	Pr. group	Name	Setting range	Minimum setting increments	Initial value*1		Refer to page	Customer setting
						Gr.1	Gr.2		
Adjustment	820	G211	Speed control P gain 1	0% to 1000%	1%	60%		146	
	821	G212	Speed control integral time 1	0 to 20 s	0.001 s	0.333 s		146	
	822	T003	Speed setting filter 1	0 to 5 s, 9999	0.001 s	9999		398	
	823 ^{*6}	G215	Speed detection filter 1	0 to 0.01 s	0.001 s	0.001 s		557	
	824	G213	Torque control P gain 1 (current loop proportional gain)	0% to 500%	1%	100%		173	
	825	G214	Torque control integral time 1 (current loop integral time)	0 to 500 ms	0.1 ms	5 ms		173	
	826	T004	Torque setting filter 1	0 to 5 s, 9999	0.001 s	9999		398	
	828	G224	Model speed control gain	0 to 1000 rad/s	1 rad/s	100 rad/s		148, 217	
	830	G311	Speed control P gain 2	0% to 1000%, 9999	1%	9999		146	
	831	G312	Speed control integral time 2	0 to 20 s, 9999	0.001 s	9999		146	
	832	T005	Speed setting filter 2	0 to 5 s, 9999	0.001 s	9999		398	
	833 ^{*6}	G315	Speed detection filter 2	0 to 0.01 s, 9999	0.001 s	9999		557	
	834	G313	Torque control P gain 2 (current loop proportional gain)	0% to 500%, 9999	1%	9999		173	
	835	G314	Torque control integral time 2 (current loop integral time)	0 to 500 ms, 9999	0.1 ms	9999		173	
	836	T006	Torque setting filter 2	0 to 5 s, 9999	0.001 s	9999		398	
Torque bias	840	G230	Torque bias selection	0 to 3, 9999	1	9999		150	
	841	G231	Torque bias 1	600% to 1400%, 9999	1%	9999		150	
	842	G232	Torque bias 2	600% to 1400%, 9999	1%	9999		150	
	843	G233	Torque bias 3	600% to 1400%, 9999	1%	9999		150	
	844	G234	Torque bias filter	0 to 5 s, 9999	0.001 s	9999		150	
	845	G235	Torque bias operation time	0 to 5 s, 9999	0.01 s	9999		150	
	846	G236	Torque bias balance compensation	0% to 100%, 9999	0.1%	9999		150	
	847	G237	Fall-time torque bias terminal 4 bias	0% to 400%, 9999	1%	9999		150	
	848	G238	Fall-time torque bias terminal 4 gain	0% to 400%, 9999	1%	9999		150	
Additional function	849	T007	Analog input offset adjustment	0% to 200%	0.1%	100%		398	
	850	G103	Brake operation selection	0 to 2	1	0		536	
	853	H417	Speed deviation time	0 to 100 s	0.1 s	1 s		154	
	854	G217	Excitation ratio	0% to 100%	1%	100%		558	
	858	T040	Terminal 4 function assignment	0, 4, 6, 9999	1	0		139, 397	
	859	C126	Torque current/Rated PM motor current	0 to 500 A, 9999	0.01 A	9999		430, 441	
	860	C226	Second motor torque current/Rated PM motor current	0 to 500 A, 9999	0.01 A	9999		430, 441	
	864	M470	Torque detection	0% to 400%	0.1%	150%		387	
	865	M446	Low speed detection	0 to 590 Hz	0.01 Hz	1.5 Hz		382	
Indication	866	M042	Torque monitoring reference	0% to 400%	0.1%	150%		358	
—	867	M321	AM output filter [E800-4] [E800-5]	0 to 5 s	0.01 s	0.01 s		362	
—	870	M440	Speed detection hysteresis	0 to 15 Hz	0.01 Hz	0 Hz		382	
Protective function	872	H201	Input phase loss protection selection [3-phase]	0, 1	1	1		318	
	873 ^{*6}	H415	Speed limit	0 to 400 Hz	0.01 Hz	20 Hz		154	
	874	H730	OLT level setting	0% to 400%	0.1%	150%		139	

Function	Pr.	Pr. group	Name	Setting range	Minimum setting increments	Initial value*1		Refer to page	Customer setting
						Gr.1	Gr.2		
Control system	877	G220	Speed feed forward control/ model adaptive speed control selection	0 to 2	1	0		148, 217	
	878	G221	Speed feed forward filter	0.01 to 1 s	0.01 s	0.01 s		148	
	879	G222	Speed feed forward torque limit	0% to 400%	0.1%	150%		148	
	880	C114	Load inertia ratio	0 to 200 times	0.1 time	7 times		146, 148, 217	
	881	G223	Speed feed forward gain	0% to 1000%	1%	0%		148	
Regeneration avoidance	882	G120	Regeneration avoidance operation selection	0 to 2	1	0		551	
	883	G121	Regeneration avoidance operation level	300 to 1200 V	0.1 V	[100/200 V class] 400 V [400 V class] 780 V [575 V class] 944 V		551	
	885	G123	Regeneration avoidance compensation frequency limit value	0 to 45 Hz, 9999	0.01 Hz	6 Hz		551	
	886	G124	Regeneration avoidance voltage gain	0% to 200%	0.1%	100%		551	
Free parameter	888	E420	Free parameter 1	0 to 9999	1	9999		243	
	889	E421	Free parameter 2	0 to 9999	1	9999		243	
I	890	H325	Internal storage device status indication	(0 to 255)	1	0		330	
Energy saving monitoring	891	M023	Cumulative power monitor digit shifted times	0 to 4, 9999	1	9999		348, 365	
	892	M200	Load factor	30% to 150%	0.1%	100%		365	
	893	M201	Energy saving monitor reference (motor capacity)	0.1 to 30 kW	0.01 kW	Applicable motor capacity		365	
	894	M202	Control selection during commercial power-supply operation	0 to 3	1	0		365	
	895	M203	Power saving rate reference value	0, 1, 9999	1	9999		365	
	896	M204	Power unit cost	0 to 500, 9999	0.01	9999		365	
	897	M205	Power saving monitor average time	0 to 1000 h, 9999	1 h	9999		365	
	898	M206	Power saving cumulative monitor clear	0, 1, 10, 9999	1	9999		365	
	899	M207	Operation time rate (estimated value)	0% to 100%, 9999	0.1%	9999		365	
Position control	979	C194	Position accuracy compensation gain 1	90% to 110%, 9999	0.01%	9999		441	
	980	C195	Position accuracy compensation gain 2	90% to 110%, 9999	0.01%	9999		441	
	981	C196	Position accuracy compensation gain 3	90% to 110%, 9999	0.01%	9999		441	
I	986	H110	Display safety fault code [E800-SCE] [E806]	0 to 127	1	0		*12	
PU	990	E104	PU buzzer control [E800]	0, 1	1	1		229	
	991	E105	PU contrast adjustment [E800]	0 to 63	1	58		230	

Function	Pr.	Pr. group	Name	Setting range	Minimum setting increments	Initial value ^{*1}		Refer to page	Customer setting
						Gr.1	Gr.2		
Monitoring	992	M104	Operation panel setting dial push monitor selection [E800]	0 to 3, 5 to 14, 17 to 20, 22 to 33, 35, 38, 40 to 42, 44, 45, 50 to 57, 61, 62, 64, 65, 67, 68, 71, 72, 81 to 84, 85 [E800-1], 86 [E800-4] [E800-5], 91, 97, 100	1	0		348	
—	997	H103	Fault initiation	0 to 255, 9999	1	9999		317	
—	998	E430	PM parameter initialization <i>Simple</i>	0, 3024, 3044, 3124, 3144, 8009, 8109, 9009, 9109	1	0		123	
—	999	E431	Automatic parameter setting <i>Simple</i>	10, 12, 20, 21, 9999	1	9999		244	

◆ Pr.1000 to Pr.1099

Function	Pr.	Pr. group	Name	Setting range	Minimum setting increments	Initial value ^{*1}		Refer to page	Customer setting
						Gr.1	Gr.2		
—	1002	C150	Lq tuning target current adjustment coefficient	50% to 150%, 9999	0.1%	9999		441	
Clock	1006	E020	Clock (year)	2000 to 2099	1	2000		222	
	1007	E021	Clock (month, day)	Jan. 1 to Dec. 31	1	101		222	
	1008	E022	Clock (hour, minute)	0:00 to 23:59	1	0		222	
—	1013	H323	Running speed after emergency drive retry reset [E800(-E)]	0 to 590 Hz	0.01 Hz	60 Hz	50 Hz	322	
—	1015	A607	Integral stop selection at limited frequency	0 to 2	1	0		479	
—	1016	H021	PTC thermistor protection detection time	0 to 60 s	1 s	0 s		306	

Function	Pr.	Pr. group	Name	Setting range	Minimum setting increments	Initial value*1		Refer to page	Customer setting
						Gr.1	Gr.2		
Trace	1020	A900	Trace operation selection	0 to 3	1	0		518	
	1022	A902	Sampling cycle	1, 2, 5, 10, 50, 100, 500, 1000	1	1		518	
	1023	A903	Number of analog channels	1 to 8	1	4		518	
	1024	A904	Sampling auto start	0, 1	1	0		518	
	1025	A905	Trigger mode selection	0 to 4	1	0		518	
	1026	A906	Number of sampling before trigger	0% to 100%	1%	90%		518	
	1027	A910	Analog source selection (1ch)	[E800] 1 to 3, 5 to 14, 17 to 20, 22 to 24, 32, 33, 35, 40 to 42, 52 to 54, 61, 62, 64, 65, 67, 68, 71, 72, 81 to 84, 85 [E800-1], 86 [E800-4] [E800-5], 91, 97, 201 to 210, 212, 213, 222 to 227, 229 to 232, 235 to 238	1	201		518	
	1028	A911	Analog source selection (2ch)			202		518	
	1029	A912	Analog source selection (3ch)			203		518	
	1030	A913	Analog source selection (4ch)			204		518	
	1031	A914	Analog source selection (5ch)	[E800-(SC)E] [E806] 1 to 3, 5 to 14, 17 to 20, 22 to 24, 32, 33, 35, 40 to 42, 52 to 54, 61, 62, 64, 65, 67, 68 [E800-E], 71, 72, 83 [E800-(SC)EPA] [E806-SCEPA], 91, 97, 201 to 210, 212, 213, 222 to 227, 229 to 232, 235 to 238		205		518	
	1032	A915	Analog source selection (6ch)			206		518	
	1033	A916	Analog source selection (7ch)			207		518	
	1034	A917	Analog source selection (8ch)			208		518	
	1035	A918	Analog trigger channel	1 to 8	1	1		518	
	1036	A919	Analog trigger operation selection	0, 1	1	0		518	
	1037	A920	Analog trigger level	600 to 1400	1	1000		518	
	1038	A930	Digital source selection (1ch)	0 to 255	1	0		518	
	1039	A931	Digital source selection (2ch)			0		518	
	1040	A932	Digital source selection (3ch)			0		518	
1041	A933	Digital source selection (4ch)	0				518		
1042	A934	Digital source selection (5ch)	0				518		
1043	A935	Digital source selection (6ch)	0				518		
1044	A936	Digital source selection (7ch)	0				518		
1045	A937	Digital source selection (8ch)	0				518		
1046	A938	Digital trigger channel	1 to 8	1	1		518		
1047	A939	Digital trigger operation selection	0, 1	1	0		518		
Anti-sway control	1072	A310	DC brake judgment time for anti-sway control operation	0 to 10 s	0.1 s	3 s		466	
	1073	A311	Anti-sway control operation selection	0, 1	1	0		466	
	1074	A312	Anti-sway control frequency	0.05 to 3 Hz, 9999	0.001 Hz	9999		466	
	1075	A313	Anti-sway control depth	0 to 3	1	0		466	
	1076	A314	Anti-sway control width	0 to 3	1	0		466	
	1077	A315	Rope length	0.1 to 100 m	0.1 m	1 m		466	
	1078	A316	Trolley weight	0 to 50000 kg	1 kg	0 kg		466	
	1079	A317	Load weight	0 to 50000 kg	1 kg	0 kg		466	

Function	Pr.	Pr. group	Name	Setting range	Minimum setting increments	Initial value *1		Refer to page	Customer setting
						Gr.1	Gr.2		
Home position return	1095	B110	Home position return function selection	1000, 9999	1	9999		184, 197	
	1096	B111	Home position return position data lower 4 digits	0 to 9999	1	0		184, 197	
	1097	B112	Home position return position data upper 4 digits	0 to 9999	1	0		184, 197	

◆ Pr.1100 to Pr.1399

Function	Pr.	Pr. group	Name	Setting range	Minimum setting increments	Initial value ^{*1}		Refer to page	Customer setting
						Gr.1	Gr.2		
—	1103 ^{*5}	F040	Deceleration time at emergency stop	0 to 3600 s	0.1 s	5 s		262	
Monitoring	1106	M050	Torque monitor filter	0 to 5 s, 9999	0.01 s	9999		348	
	1107	M051	Running speed monitor filter	0 to 5 s, 9999	0.01 s	9999		348	
	1108	M052	Excitation current monitor filter	0 to 5 s, 9999	0.01 s	9999		348	
—	1124	N681	Station number in inverter-to-inverter link [E800-(SC)EPA] [E800-(SC)EPB] [E806]	0 to 5, 9999	1	9999		*9	
—	1125	N682	Number of inverters in inverter-to-inverter link system [E800-(SC)EPA] [E800-(SC)EPB] [E806]	2 to 6	1	2		*9	
PLC function	1150 to 1199	A810 to A859	PLC function user parameters 1 to 50	0 to 65535	1	0		516	
—	1200	M390	AM output offset calibration [E800-4] [E800-5]	2700 to 3300	1	3000		362	
—	1210	N120	CC-Link IE TSN protocol version selection [E800-(SC)EPA] [E800-(SC)EPB] [E806]	0, 9999	1	0		*9	
—	1220	B100	Direct command mode selection [E800-(SC)E] [E806]	[E800-(SC)EPA] [E800-(SC)EPB] [E806] 0, 3 [E800-EPC] 0, 4	1	0		197	

Function	Pr.	Pr. group	Name	Setting range	Minimum setting increments	Initial value ^{*1}		Refer to page	Customer setting
						Gr.1	Gr.2		
Position control	1222	B120	First positioning acceleration time	0.01 to 360 s	0.01 s	5 s		184, 197	
	1223	B121	First positioning deceleration time	0.01 to 360 s	0.01 s	5 s		184, 197	
	1225	B123	First positioning sub-function	0, 1, 10, 11, 100, 101, 110, 111	1	10		184, 197	
	1226	B124	Second positioning acceleration time	0.01 to 360 s	0.01 s	5 s		184	
	1227	B125	Second positioning deceleration time	0.01 to 360 s	0.01 s	5 s		184	
	1229	B127	Second positioning sub-function	0, 1, 10, 11, 100, 101, 110, 111	1	10		184	
	1230	B128	Third positioning acceleration time	0.01 to 360 s	0.01 s	5 s		184	
	1231	B129	Third positioning deceleration time	0.01 to 360 s	0.01 s	5 s		184	
	1233	B131	Third positioning sub-function	0, 1, 10, 11, 100, 101, 110, 111	1	10		184	
	1234	B132	Fourth positioning acceleration time	0.01 to 360 s	0.01 s	5 s		184	
	1235	B133	Fourth positioning deceleration time	0.01 to 360 s	0.01 s	5 s		184	
	1237	B135	Fourth positioning sub-function	0, 1, 10, 11, 100, 101, 110, 111	1	10		184	
	1238	B136	Fifth positioning acceleration time	0.01 to 360 s	0.01 s	5 s		184	
	1239	B137	Fifth positioning deceleration time	0.01 to 360 s	0.01 s	5 s		184	
	1241	B139	Fifth positioning sub-function	0, 1, 10, 11, 100, 101, 110, 111	1	10		184	
	1242	B140	Sixth positioning acceleration time	0.01 to 360 s	0.01 s	5 s		184	
	1243	B141	Sixth positioning deceleration time	0.01 to 360 s	0.01 s	5 s		184	
	1245	B143	Sixth positioning sub-function	0, 1, 10, 11, 100, 101, 110, 111	1	10		184	
	1246	B144	Seventh positioning acceleration time	0.01 to 360 s	0.01 s	5 s		184	
	1247	B145	Seventh positioning deceleration time	0.01 to 360 s	0.01 s	5 s		184	
1249	B147	Seventh positioning sub-function	0, 10, 100, 110	1	10		184		
Home position return	1282	B180	Home position return method selection	2, 3, 4, 6, 103, 106, 203, 206	1	4		184	
	1283	B181	Home position return speed	0 to 400 Hz	0.01 Hz	2 Hz		184	
	1285	B183	Home position shift amount lower 4 digits	0 to 9999	1	0		184, 197	
	1286	B184	Home position shift amount upper 4 digits	0 to 9999	1	0		184, 197	
	1289	B187	Home position return stopper torque	0% to 200%	0.1%	40%		184, 197	
	1290	B188	Home position return stopper waiting time	0 to 10 s	0.1 s	0.5 s		184, 197	
	1292	B190	Position control terminal input selection	0, 1, 10, 11, 100, 101, 110, 111	1	0		184, 197	
	1293	B191	Roll feeding mode selection	0 to 2	1	0		184, 197	

Function	Pr.	Pr. group	Name	Setting range	Minimum setting increments	Initial value ^{*1}		Refer to page	Customer setting
						Gr.1	Gr.2		
Position detection	1294	B192	Position detection lower 4 digits	0 to 9999	1	0		212	
	1295	B193	Position detection upper 4 digits	0 to 9999	1	0		212	
	1296	B194	Position detection selection	0 to 2	1	0		212	
	1297	B195	Position detection hysteresis width	0 to 32767	1	0		212	
—	1298	B013	Second position control gain	0 to 150 s ⁻¹	1 s ⁻¹	10 s ⁻¹		536	
—	1299	G108	Second pre-excitation selection	0, 1	1	0		536	
—	1305	N690	EtherCAT node address setting [E800-EPC]	0 to 65535	1	0		*9	

Function	Pr.	Pr. group	Name	Setting range	Minimum setting increments	Initial value*1		Refer to page	Customer setting
						Gr.1	Gr.2		
User defined cyclic communication	1318	N800	User Defined Cyclic Communication Input fixing format selection [E800-(SC)EPA] [E806-SCEPA]	20 to 23, 9999	1	9999		*9	
	1319	N801	User Defined Cyclic Communication Output fixing format selection [E800-(SC)EPA] [E806-SCEPA]	70 to 73, 9999	1	9999		*9	
	1320	N810	User Defined Cyclic Communication Input 1 Mapping [E800-(SC)E] [E806]	[E800-(SC)EPA] [E806-SCEPA] 12288 to 13787, 20488, 20489, 24672, 24689, 24698, 24703, 24705, 24707, 24708, 24719, 24721, 24728 to 24730, 9999 [E800-(SC)EPB] [E806-SCEPB] 5, 100, 12288 to 13787, 20488, 20489, 24672, 24689, 24698, 24703, 24705, 24707, 24708, 24719, 24721, 24728 to 24730, 9999 [E800-EPC]	1	[E800-(SC)EPA] [E800-(SC)EPB] [E806] 9999 [E800-EPC] 24642	*9		
	1321 to 1329	N811 to N819	User Defined Cyclic Communication Input 2 to 10 Mapping [E800-(SC)E] [E806]	12288 to 13787, 20488, 20489, 24642, 24646, 24648 to 24650, 24672, 24677 to 24680, 24689, 24698, 24702, 24703, 24705, 24707 to 24709, 24719, 24721, 24728 to 24730, 24831, 9999	1	9999		*9	
	1330	N850	User Defined Cyclic Communication Output 1 Mapping [E800-(SC)E] [E806]	[E800-(SC)EPA] [E800-EPC] [E806-SCEPA] 12288 to 13787, 16384 to 16483, 20488, 20489, 20981 to 20990, 20992 [E800-E], 24639, 24643, 24644, 24673 to 24676, 24692, 24695, 24820, 24826, 24828, 25858, 9999	1	[E800-(SC)EPA] [E800-(SC)EPB] [E806] 9999 [E800-EPC] 24643	*9		
	1331 to 1343	N851 to N863	User Defined Cyclic Communication Output 2 to 14 Mapping [E800-(SC)E] [E806]	[E800-(SC)EPB] [E806-SCEPB] 6, 101, 12288 to 13787, 16384 to 16483, 20488, 20489, 20981 to 20990, 20992 [E800-E], 24639, 24643, 24644, 24673 to 24676, 24692, 24695, 24820, 24826, 24828, 25858, 9999	1	9999		*9	

Function	Pr.	Pr. group	Name	Setting range	Minimum setting increments	Initial value ^{*1}		Refer to page	Customer setting
						Gr.1	Gr.2		
—	1386	N652	Ethernet relay operation at reset selection [E800-(SC)EPA] [E800-(SC)EPB] [E806]	0, 9999	1	0		*g	
User defined cyclic communication	1389 to 1393	—	User Defined Cyclic Communication Input Sub 1 and 2 Mapping to User Defined Cyclic Communication Input Sub 9 and 10 Mapping [E800-(SC)E] [E806]	0 to 2, 256 to 258, 512 to 514	1	0		*g	
		N830 to N839	User Defined Cyclic Communication Input Sub 1 to 10 Mapping [E800-(SC)E] [E806]	0 to 2	1	0		*g	
	1394 to 1398	—	User Defined Cyclic Communication Output Sub 1 and 2 Mapping to User Defined Cyclic Communication Output Sub 9 and 10 Mapping [E800-(SC)E] [E806]	0 to 2, 256 to 258, 512 to 514	1	0		*g	
		N870 to N879	User Defined Cyclic Communication Output Sub 1 to 10 Mapping [E800-(SC)E] [E806]	0 to 2	1	0		*g	
—	1399	N649	Inverter identification enable/disable selection [E800-(SC)EPA] [E800-(SC)EPB] [E806]	0, 1	1	1		*g	

◆ Pr.1400 to Pr.1499

Function	Pr.	Pr. group	Name	Setting range	Minimum setting increments	Initial value ^{*1}		Refer to page	Customer setting
						Gr.1	Gr.2		
—	1412	C135	Motor induced voltage constant (phi f) exponent	0 to 2, 9999	1	9999		441	
—	1413	C235	Second motor induced voltage constant (phi f) exponent	0 to 2, 9999	1	9999		441	

Function	Pr.	Pr. group	Name	Setting range	Minimum setting increments	Initial value *1		Refer to page	Customer setting
						Gr.1	Gr.2		
Ethernet communication	1424	N650	Ethernet communication network number [E800-(SC)EPA] [E800-(SC)EPB] [E806]	1 to 239	1	1		*9	
	1425	N651	Ethernet communication station number [E800-(SC)EPA] [E800-(SC)EPB] [E806]	1 to 120	1	1		*9	
	1426	N641	Link speed and duplex mode selection [E800-(SC)EPA] [E800-(SC)EPB] [E806]	0 to 4	1	0		*9	
	1427	N630	Ethernet function selection 1 [E800-(SC)EPA] [E800-(SC)EPB] [E806]	[E800-(SC)EPA] [E806-SCEPA] 502, 5000 to 5002, 5006 to 5008, 5010 to 5013, 44818, 45237, 45238, 47808, 61450, 9999	1	5001		*9	
	1428	N631	Ethernet function selection 2 [E800-(SC)EPA] [E800-(SC)EPB] [E806]	[E800-(SC)EPA] [E806-SCEPA] 502, 5000 to 5002, 5006 to 5008, 5010 to 5013, 34962, 45237, 45238, 61450, 9999	1	45237		*9	
	1429	N632	Ethernet function selection 3 [E800-(SC)EPA] [E800-(SC)EPB] [E806]	[E800-(SC)EPA] [E806-SCEPA] 502, 5000 to 5002, 5006 to 5008, 5010 to 5013, 34962, 45237, 45238, 61450, 9999	1	45238		*9	
	1430	N633	Ethernet function selection 4 [E800-(SC)EPA] [E800-(SC)EPB] [E806]	[E800-(SC)EPA] [E806-SCEPA] 502, 5000 to 5002, 5006 to 5008, 5010 to 5013, 34962, 45237, 45238, 61450, 9999	1	9999		*9	
	1431	N643	Ethernet signal loss detection function selection [E800-(SC)E] [E806]	0 to 3	1	3		*9	
	1432	N644	Ethernet communication check time interval [E800-(SC)EPA] [E800-(SC)EPB] [E806]	0 to 999.8 s, 9999	0.1 s	1.5		*9	
	1434	N600	IP address 1 (Ethernet) [E800-(SC)EPA] [E800-(SC)EPB] [E806]	0 to 255	1	192		*9	
	1435	N601	IP address 2 (Ethernet) [E800-(SC)EPA] [E800-(SC)EPB] [E806]	0 to 255	1	168		*9	
	1436	N602	IP address 3 (Ethernet) [E800-(SC)EPA] [E800-(SC)EPB] [E806]	0 to 255	1	50		*9	
	1437	N603	IP address 4 (Ethernet) [E800-(SC)EPA] [E800-(SC)EPB] [E806]	0 to 255	1	1		*9	
	1438	N610	Subnet mask 1 [E800-(SC)EPA] [E800-(SC)EPB] [E806]	0 to 255	1	255		*9	
	1439	N611	Subnet mask 2 [E800-(SC)EPA] [E800-(SC)EPB] [E806]	0 to 255	1	255		*9	
	1440	N612	Subnet mask 3 [E800-(SC)EPA] [E800-(SC)EPB] [E806]	0 to 255	1	255		*9	
1441	N613	Subnet mask 4 [E800-(SC)EPA] [E800-(SC)EPB] [E806]	0 to 255	1	0		*9		

Function	Pr.	Pr. group	Name	Setting range	Minimum setting increments	Initial value*1		Refer to page	Customer setting
						Gr.1	Gr.2		
Ethernet communication	1442	N660	IP filter address 1 (Ethernet) [E800-(SC)EPA] [E800-(SC)EPB] [E806]	0 to 255	1	0		*9	
	1443	N661	IP filter address 2 (Ethernet) [E800-(SC)EPA] [E800-(SC)EPB] [E806]	0 to 255	1	0		*9	
	1444	N662	IP filter address 3 (Ethernet) [E800-(SC)EPA] [E800-(SC)EPB] [E806]	0 to 255	1	0		*9	
	1445	N663	IP filter address 4 (Ethernet) [E800-(SC)EPA] [E800-(SC)EPB] [E806]	0 to 255	1	0		*9	
	1446	N664	IP filter address 2 range specification (Ethernet) [E800-(SC)EPA] [E800-(SC)EPB] [E806]	0 to 255, 9999	1	9999		*9	
	1447	N665	IP filter address 3 range specification (Ethernet) [E800-(SC)EPA] [E800-(SC)EPB] [E806]	0 to 255, 9999	1	9999		*9	
	1448	N666	IP filter address 4 range specification (Ethernet) [E800-(SC)EPA] [E800-(SC)EPB] [E806]	0 to 255, 9999	1	9999		*9	
	1449	N670	Ethernet command source selection IP address 1 [E800-(SC)EPA] [E800-(SC)EPB] [E806]	0 to 255	1	0		*9	
	1450	N671	Ethernet command source selection IP address 2 [E800-(SC)EPA] [E800-(SC)EPB] [E806]	0 to 255	1	0		*9	
	1451	N672	Ethernet command source selection IP address 3 [E800-(SC)EPA] [E800-(SC)EPB] [E806]	0 to 255	1	0		*9	
	1452	N673	Ethernet command source selection IP address 4 [E800-(SC)EPA] [E800-(SC)EPB] [E806]	0 to 255	1	0		*9	
	1453	N674	Ethernet command source selection IP address 3 range specification [E800-(SC)EPA] [E800-(SC)EPB] [E806]	0 to 255, 9999	1	9999		*9	
	1454	N675	Ethernet command source selection IP address 4 range specification [E800-(SC)EPA] [E800-(SC)EPB] [E806]	0 to 255, 9999	1	9999		*9	
	1455	N642	Keepalive time [E800-(SC)EPA] [E800-(SC)EPB] [E806]	1 to 7200 s	1	60 s		*9	
	1456	N647	Network diagnosis selection [E800-(SC)EPA] [E800-(SC)EPB] [E806]	0 to 2, 9999	1	9999		*9	
	1457	N648	Extended setting for Ethernet signal loss detection function selection [E800-(SC)EPA] [E800-(SC)EPB] [E806]	0 to 3, 8888, 9999	1	9999		*9	

Function	Pr.	Pr. group	Name	Setting range	Minimum setting increments	Initial value *1		Refer to page	Customer setting
						Gr.1	Gr.2		
Load characteristics fault detection	1480	H520	Load characteristics measurement mode	0, 1 (2 to 5, 81 to 85)	1	0		339	
	1481	H521	Load characteristics load reference 1	0% to 400%, 8888, 9999	0.1%	9999		339	
	1482	H522	Load characteristics load reference 2	0% to 400%, 8888, 9999	0.1%	9999		339	
	1483	H523	Load characteristics load reference 3	0% to 400%, 8888, 9999	0.1%	9999		339	
	1484	H524	Load characteristics load reference 4	0% to 400%, 8888, 9999	0.1%	9999		339	
	1485	H525	Load characteristics load reference 5	0% to 400%, 8888, 9999	0.1%	9999		339	
	1486	H526	Load characteristics maximum frequency	0 to 590 Hz	0.01 Hz	60 Hz	50 Hz	339	
	1487	H527	Load characteristics minimum frequency	0 to 590 Hz	0.01 Hz	6 Hz		339	
	1488	H531	Upper limit warning detection width	0% to 400%, 9999	0.1%	20%		339	
	1489	H532	Lower limit warning detection width	0% to 400%, 9999	0.1%	20%		339	
	1490	H533	Upper limit fault detection width	0% to 400%, 9999	0.1%	9999		339	
	1491	H534	Lower limit fault detection width	0% to 400%, 9999	0.1%	9999		339	
	1492	H535	Load status detection signal delay time / load reference measurement waiting time	0 to 60 s	0.1 s	1 s		339	
—	1499	E415	Parameter for manufacturer setting. Do not set.						

◆ Alphabet (calibration parameters, etc.)

Function	Pr.	Pr. group	Name	Setting range	Minimum setting increments	Initial value ^{*1}		Refer to page	Customer setting
						Gr.1	Gr.2		
Calibration parameter	C0 (900) ^{*7}	M310	FM terminal calibration [E800-1]	—	—	—		362	
	C1 (901) ^{*7}	M320	AM terminal calibration [E800-4] [E800-5]	—	—	—		362	
	C2 (902) ^{*7}	T200	Terminal 2 frequency setting bias frequency	0 to 590 Hz	0.01 Hz	0 Hz		400	
	C3 (902) ^{*7}	T201	Terminal 2 frequency setting bias	0% to 300%	0.1%	0%		400	
	125 (903) ^{*7}	T202	Terminal 2 frequency setting gain frequency	0 to 590 Hz	0.01 Hz	60 Hz	50 Hz	400	
	C4 (903) ^{*7}	T203	Terminal 2 frequency setting gain	0% to 300%	0.1%	100%		400	
	C5 (904) ^{*7}	T400	Terminal 4 frequency setting bias frequency	0 to 590 Hz	0.01 Hz	0 Hz		400	
	C6 (904) ^{*7}	T401	Terminal 4 frequency setting bias	0% to 300%	0.1%	20%		400	
	126 (905) ^{*7}	T402	Terminal 4 frequency setting gain frequency	0 to 590 Hz	0.01 Hz	60 Hz	50 Hz	400	
	C7 (905) ^{*7}	T403	Terminal 4 frequency setting gain	0% to 300%	0.1%	100%		400	
	C38 (932) ^{*7}	T410	Terminal 4 bias command (torque)	0% to 400%	0.1%	0%		405	
	C39 (932) ^{*7}	T411	Terminal 4 bias (torque)	0% to 300%	0.1%	0%		405	
	C40 (933) ^{*7}	T412	Terminal 4 gain command (torque)	0% to 400%	0.1%	150%		405	
	C41 (933) ^{*7}	T413	Terminal 4 gain (torque)	0% to 300%	0.1%	100%		405	
	PID display	C42 (934) ^{*7}	A630	PID display bias coefficient	0 to 500, 9999	0.01	9999		492
C43 (934) ^{*7}		A631	PID display bias analog value	0% to 300%	0.1%	20%		492	
C44 (935) ^{*7}		A632	PID display gain coefficient	0 to 500, 9999	0.01	9999		492	
C45 (935) ^{*7}		A633	PID display gain analog value	0% to 300%	0.1%	100%		492	
Clear parameters	PR.CL		Parameter clear	(0), 1	1	0		564	
	ALLC		All parameter clear	(0), 1	1	0		564	
	ER.CL		Fault history clear	(0), 1	1	0		566	
—	PR.CH		Initial value change list	—	1	0		54	
—	PM		PM parameter initialization	0	1	0		123	
—	AUTO		Automatic parameter setting	—	—	—		244	
—	PR.MD		Group parameter setting	(0), 1, 2	1	0		94	

*1 Gr.1 and Gr.2 are the parameter initial value groups. (Refer to page 54).

*2 Differs depending on the capacity.

6%: FR-E820-0050(0.75K) or lower, FR-E840-0026(0.75K) or lower, FR-E820S-0050(0.75K) or lower, FR-E810W-0050(0.75K) or lower, and FR-E846-0026(0.75K)

5%: FR-E860-0017(0.75K)

4%: FR-E820-0080(1.5K) to FR-E820-0175(3.7K), FR-E840-0040(1.5K) to FR-E840-0095(3.7K), FR-E820S-0080(1.5K) or higher, and FR-E846-0040(1.5K) or higher

3%: FR-E820-0240(5.5K), FR-E820-0330(7.5K), FR-E840-0120(5.5K), FR-E840-0170(7.5K), FR-E860-0027(1.5K), and FR-E860-0040(2.2K)

2%: FR-E820-0470(11K) or higher, FR-E840-0230(11K) or higher, and FR-E860-0061(3.7K) or higher

- *3 Differs depending on the capacity.
 5 s: FR-E820-0175(3.7K) or lower, FR-E840-0095(3.7K) or lower, FR-E860-0061(3.7K) or lower, FR-E820S-0110(2.2K) or lower, FR-E810W-0050(0.75K) or lower, and FR-E846-0095(3.7K) or lower
 10 s: FR-E820-0240(5.5K), FR-E820-0330(7.5K), FR-E840-0120(5.5K), FR-E840-0170(7.5K), and FR-E860-0090(5.5K) or higher
 15 s: FR-E820-0470(11K) or higher and FR-E840-0230(11K) or higher
- *4 Differs depending on the capacity.
 6%: FR-E820-0015(0.2K) or lower, FR-E820S-0015(0.2K) or lower, and FR-E810W-0015(0.2K) or lower
 4%: FR-E820-0030(0.4K) to FR-E820-0330(7.5K), FR-E840-0016(0.4K) to FR-E840-0170(7.5K), FR-E820S-0030(0.4K) or higher, FR-E810W-0030(0.4K) or higher, and FR-E846-0026(0.75K) or higher
 2%: FR-E820-0470(11K) or higher and FR-E840-0230(11K) or higher
 1%: FR-E860-0017(0.75K) or higher
- *5 The set value is read/written in 2-word (32-bit) units when the PLC function is used for parameter reading/writing.
- *6 The setting is available only when a Vector control compatible option is installed. For the IP67 model, the setting is not available as plug-in options are not available. (The parameter can be read or written using communication protocols regardless of whether the option is installed.)
- *7 On the LCD operation panel or the parameter unit used as the command source, the parameter number in parentheses appears instead of that starting with the letter C.
- *8 For the Ethernet model and the safety communication model, the setting is available only when the FR-A8AY or the FR-E8AXY is installed. For the IP67 model, the setting is not available as plug-in options are not available.
- *9 For details, refer to the Instruction Manual (Communication).
- *10 The setting is available when a compatible plug-in option is installed or when the PLC function is enabled. (Pr.313 to Pr.315 are always available for settings in the FR-E800-(SC)EPA, the FR-E800-(SC)EPB, and the FR-E806.)
- *11 For the standard model, the setting is available only when a communication option is installed.
- *12 For details, refer to the FR-E800-SCE Instruction Manual (Functional Safety).

3.3 Use of a function group number for the identification of parameters

A parameter identification number shown on the PU can be switched from a parameter number to a function group number. As parameters are grouped by function and displayed by the group, the related parameters can be set continually at a time.

◆ Changing a parameter identification number to a function group number

Pr.MD setting	Description
0	The setting of parameter identification number remains the same as the last setting.
1	The parameter number is used for the identification of parameters, and displayed in numerical order.
2	The function group number is used for the identification of parameters, and displayed in alphanumeric order.

Operating procedure

1. Turning ON the power of the inverter
The operation panel is in the monitor mode.
2. Selecting the parameter setting mode
Press the MODE key to choose the parameter setting mode. (The parameter number read previously appears on the 12-segment LCD display.)
3. Selecting a parameter
Turn the setting dial or press the UP/DOWN key until "Pr.MD" (Group parameter setting) appears. Press the SET key to confirm the selection. "0" (initial value) will appear.
4. Selecting the use of the function group number
Turn the setting dial or press the UP/DOWN key to change the value to "2" (function group number). Press the SET key to confirm the Group parameter setting. "2" blinks after the setting is completed.

◆ Selecting a parameter by function group number to change its setting

The following shows the procedure to change the setting of **P.H400 (Pr.1) Maximum frequency**.

Operating procedure

1. Turning ON the power of the inverter
The operation panel is in the monitor mode.
2. Changing the operation mode
Press the PU/EXT key to choose the PU operation mode. [PU] indicator turns ON.
3. Selecting the parameter setting mode
Press the MODE key to choose the parameter setting mode. (The parameter group number read previously appears.)
4. Enabling the function group selection
Turn the setting dial or press the UP/DOWN key until "H4.." (Protective function parameter 4) appears. Press the SET key to confirm the selection. "H4--" will appear, which shows that the operation panel is ready for selection of a number in the group of monitor parameter 4.
5. Selecting a parameter
Turn the setting dial or press the UP/DOWN key until "H400" (**P.H400 Maximum frequency**) appears. Press the SET key to display the present set value. "120.0" (initial value) appears.
6. Changing the setting value
Turn the setting dial or press the UP/DOWN key to change the value to "60.00". Press the SET key to confirm the setting. "60.00" blinks after the setting is completed.

3.4 Parameter list (by function group number)

◆ E: Environment setting parameters

Parameters for the inverter operating environment.

Pr. group	Pr.	Name	Refer to page
E000	168	Parameter for manufacturer setting. Do not set.	
E001	169	Parameter for manufacturer setting. Do not set.	
E020	1006	Clock (year)	222
E021	1007	Clock (month, day)	222
E022	1008	Clock (hour, minute)	222
E023	269	Parameter for manufacturer setting. Do not set.	
E080	168	Parameter for manufacturer setting. Do not set.	
E081	169	Parameter for manufacturer setting. Do not set.	
E100	75	Reset selection	225
E101		Disconnected PU detection	
E102		PU stop selection	
E103	145	PU display language selection [E800]	228
E104	990	PU buzzer control [E800]	229
E105	991	PU contrast adjustment [E800]	230
E107	75	Reset limit	225
E200	161	Frequency setting/key lock operation selection	231
E201	295	Frequency change increment amount setting [E800]	233
E202	40	RUN key rotation direction selection	234
E300	30	Regenerative function selection	545
E301	570	Multiple rating setting	235
E400	77	Parameter write selection	237
E410	296	Password lock level	240
E411	297	Password lock/unlock	240
E415	1499	Parameter for manufacturer setting. Do not set.	
E420	888	Free parameter 1	243
E421	889	Free parameter 2	243
E430	998	PM parameter initialization <i>Simple</i>	123
E431	999	Automatic parameter setting <i>Simple</i>	244
E440	160	User group read selection <i>Simple</i>	246
E441	172	User group registered display/batch clear	246
E442	173	User group registration	246
E443	174	User group clear	246
E600	72	PWM frequency selection	249
E601	240	Soft-PWM operation selection	249
E602	260	PWM frequency automatic switchover	249
E700	255	Life alarm status display	251

Pr. group	Pr.	Name	Refer to page
E701	256	Inrush current limit circuit life display	251
E702	257	Control circuit capacitor life display	251
E703	258	Main circuit capacitor life display	251
E704	259	Main circuit capacitor life measuring	251
E705	506	Display estimated main circuit capacitor residual life	251
E706	507	Display/reset ABC relay contact life	251
E707	508	Display/reset ABC2 relay contact life [E806]	251
E708	509	Display power cycle life	251
E709	198	Display corrosion level	251
E710	503	Maintenance timer	256
E711	504	Maintenance timer warning output set time	256
E720	555	Current average time	257
E721	556	Data output mask time	257
E722	557	Current average value monitor signal output reference current	257

◆ F: Settings for acceleration/ deceleration

Parameters for the motor acceleration/deceleration characteristics.

Pr. group	Pr.	Name	Refer to page
F000	20	Acceleration/deceleration reference frequency	262
F001	21	Acceleration/deceleration time increments	262
F002	16 ^{*1}	Jog acceleration/deceleration time	301
F003	611	Acceleration time at a restart	502, 508
F010	7 ^{*1}	Acceleration time <i>Simple</i>	262
F011	8 ^{*1}	Deceleration time <i>Simple</i>	262
F020	44 ^{*1}	Second acceleration/ deceleration time	262, 495
F021	45 ^{*1}	Second deceleration time	262, 495
F022	147	Acceleration/deceleration time switching frequency	262
F040	1103 ^{*1}	Deceleration time at emergency stop	262
F070	791 ^{*1}	Acceleration time in low-speed range	262
F071	792 ^{*1}	Deceleration time in low-speed range	262
F100	29	Acceleration/deceleration pattern selection	267
F101	59	Remote function selection	269

Pr. group	Pr.	Name	Refer to page
F102	13	Starting frequency	274, 275
F103	571	Holding time at a start	274
F500	292	Automatic acceleration/ deceleration	276, 456
F510	61	Reference current	276
F511	62	Reference value at acceleration	276
F512	63	Reference value at deceleration	276
F513	293	Acceleration/deceleration separate selection	276

◆ D: Parameters for the setting of operation command and frequency command

Parameters for setting the command source to the inverter, and the motor driving frequency and torque.

Pr. group	Pr.	Name	Refer to page
D000	79	Operation mode selection <i>Simple</i>	280, 290
D001	340	Communication startup mode selection	290
D010	338	Communication operation command source	291
D011	339	Communication speed command source	291
D012	550	NET mode operation command source selection	291
D013	551	PU mode operation command source selection	291
D020	78	Reverse rotation prevention selection	300
D030	811	Set resolution switchover	139, 346
D200	15	Jog frequency	301
D301	4	Multi-speed setting (high speed) <i>Simple</i>	303
D302	5	Multi-speed setting (middle speed) <i>Simple</i>	303
D303	6	Multi-speed setting (low speed) <i>Simple</i>	303
D304 to D307	24 to 27	Multi-speed setting (speed 4 to speed 7)	303
D308 to D315	232 to 239	Multi-speed setting (speed 8 to speed 15)	303
D400	804	Torque command source selection	167
D401	805	Torque command value (RAM)	139, 167
D402	806	Torque command value (RAM, EEPROM)	139, 167

◆ H: Protective function parameter

Parameters to protect the motor and the inverter.

Pr. group	Pr.	Name	Refer to page
H000	9	Electronic thermal O/L relay <i>Simple</i>	306, 430, 441
H001	600	First free thermal reduction frequency 1	306
H002	601	First free thermal reduction ratio 1	306
H003	602	First free thermal reduction frequency 2	306
H004	603	First free thermal reduction ratio 2	306
H005	604	First free thermal reduction frequency 3	306
H006	607	Motor permissible load level	306
H010	51	Second electronic thermal O/L relay	306, 430, 441
H011	692	Second free thermal reduction frequency 1	306
H012	693	Second free thermal reduction ratio 1	306
H013	694	Second free thermal reduction frequency 2	306
H014	695	Second free thermal reduction ratio 2	306
H015	696	Second free thermal reduction frequency 3	306
H016	608	Second motor permissible load level	306
H020	561	PTC thermistor protection level	306
H021	1016	PTC thermistor protection detection time	306
H100	244	Cooling fan operation selection	314
H101	249	Earth (ground) fault detection at start	315
H110	986	Display safety fault code [E800-SCE] [E806]	*8
H182	631	Inverter output fault detection enable/disable selection	316
H200	251	Output phase loss protection selection	318
H300	65	Retry selection	319
H301	67	Number of retries at fault occurrence	319
H302	68	Retry waiting time	319
H303	69	Retry count display erase	319
H320	523	Emergency drive mode selection [E800(-E)]	322
H321	524	Emergency drive running speed [E800(-E)]	322
H322	515	Emergency drive dedicated retry count [E800(-E)]	322
H323	1013	Running speed after emergency drive retry reset [E800(-E)]	322
H324	514	Emergency drive dedicated retry waiting time [E800(-E)]	322
H325	890	Internal storage device status indication	330

Pr. group	Pr.	Name	Refer to page
H400	1	Maximum frequency <i>Simple</i>	331
H401	2	Minimum frequency <i>Simple</i>	331
H402	18	High speed maximum frequency	331
H415	873 ^{*2}	Speed limit	154
H416	285	Speed deviation excess detection frequency	154, 456
H420	31	Frequency jump 1A	332
H421	32	Frequency jump 1B	332
H422	33	Frequency jump 2A	332
H423	34	Frequency jump 2B	332
H424	35	Frequency jump 3A	332
H425	36	Frequency jump 3B	332
H429	552	Frequency jump range	332
H500	22	Stall prevention operation level (Torque limit level)	139, 334
H501	156	Stall prevention operation selection	334
H600	48	Second stall prevention operation level	334
H610	23	Stall prevention operation level compensation factor at double speed	334
H611	66	Stall prevention operation reduction starting frequency	334
H630	277	Stall prevention operation current switchover	334
H631	154	Voltage reduction selection during stall prevention operation	334
H103	997	Fault initiation	317
H800	374	Overspeed detection level	344
H520	1480	Load characteristics measurement mode	339
H521	1481	Load characteristics load reference 1	339
H522	1482	Load characteristics load reference 2	339
H523	1483	Load characteristics load reference 3	339
H524	1484	Load characteristics load reference 4	339
H525	1485	Load characteristics load reference 5	339
H526	1486	Load characteristics maximum frequency	339
H527	1487	Load characteristics minimum frequency	339
H531	1488	Upper limit warning detection width	339
H532	1489	Lower limit warning detection width	339
H533	1490	Upper limit fault detection width	339
H534	1491	Lower limit fault detection width	339
H535	1492	Load status detection signal delay time / load reference measurement waiting time	339
H801	375	Faulty acceleration rate detection level	262
H881	690	Deceleration check time	154

◆ M: Item and output signal for monitoring

Parameters for the settings regarding the monitoring to check the inverter's operating status and the output signals for the monitoring.

Pr. group	Pr.	Name	Refer to page
M000	37 ^{*1}	Speed display	346
M001	505	Speed setting reference	346
M003	53	Frequency / rotation speed unit switchover	346
M020	170	Watt-hour meter clear	348
M021	563	Energization time carrying-over times	348
M022	268	Monitor decimal digits selection	348
M023	891	Cumulative power monitor digit shifted times	348, 365
M030	171	Operation hour meter clear	348
M031	564	Operating time carrying-over times	348
M040	55 ^{*4}	Frequency monitoring reference	358
M041	56 ^{*4}	Current monitoring reference	358
M042	866	Torque monitoring reference	358
M043	241	Analog input display unit switchover	400
M044	290	Monitor negative output selection	348, 358
M050	1106	Torque monitor filter	348
M051	1107	Running speed monitor filter	348
M052	1108	Excitation current monitor filter	348
M100	52	Operation panel main monitor selection [E800] [E800-(SC)E]	348
M101	774	Operation panel monitor selection 1	348
M102	775	Operation panel monitor selection 2 [E800] [E800-(SC)E]	348
M103	776	Operation panel monitor selection 3 [E800] [E800-(SC)E]	348
M104	992	Operation panel setting dial push monitor selection [E800]	348
M200	892	Load factor	365
M201	893	Energy saving monitor reference (motor capacity)	365
M202	894	Control selection during commercial power-supply operation	365
M203	895	Power saving rate reference value	365
M204	896	Power unit cost	365
M205	897	Power saving monitor average time	365
M206	898	Power saving cumulative monitor clear	365
M207	899	Operation time rate (estimated value)	365
M300	54	FM terminal function selection [E800-1]	358
M301	158	AM terminal function selection [E800-4] [E800-5]	358

Pr. group	Pr.	Name	Refer to page
M310	C0 (900) ^{*3}	FM terminal calibration [E800-1]	362
M320	C1 (901) ^{*3}	AM terminal calibration [E800-4] [E800-5]	362
M321	867	AM output filter [E800-4] [E800-5]	362
M390	1200	AM output offset calibration [E800-4] [E800-5]	362
M400	190	RUN terminal function selection	371
M404	191	FU terminal function selection	371
M405	192	ABC terminal function selection	371
M406	197	ABC2 terminal function selection	371
M410	313 ^{*6}	DO0 output selection	371
M411	314 ^{*6}	DO1 output selection	371
M412	315 ^{*6}	DO2 output selection	371
M413	316 ^{*6}	DO3 output selection	371
M414	317 ^{*6}	DO4 output selection	371
M415	318 ^{*6}	DO5 output selection	371
M416	319 ^{*6}	DO6 output selection	371
M420	320 ^{*6}	RA1 output selection	371
M421	321 ^{*6}	RA2 output selection	371
M422	322 ^{*6}	RA3 output selection	371
M430	157	OL signal output timer	139, 334
M431	289	Inverter output terminal filter	371
M433	166	Output current detection signal retention time	385
M440	870	Speed detection hysteresis	382
M441	41	Up-to-frequency sensitivity	382
M442	42	Output frequency detection	382
M443	43	Output frequency detection for reverse rotation	382
M446	865	Low speed detection	382
M451	193	NET Y1 output selection	371
M452	194	NET Y2 output selection	371
M453	195	NET Y3 output selection	371
M454	196	NET Y4 output selection	371
M460	150	Output current detection level	385
M461	151	Output current detection signal delay time	385
M462	152	Zero current detection level	385
M463	153	Zero current detection time	385
M464	167	Output current detection operation selection	385
M470	864	Torque detection	387
M610	635 ^{*2}	Cumulative pulse clear signal selection	207
M611	636 ^{*2}	Cumulative pulse division scaling factor	207
M613	638 ^{*2}	Cumulative pulse storage	207

◆ T: Multi-function input terminal parameters

Parameters for the setting of the input terminals via which commands are given to the inverter.

Pr. group	Pr.	Name	Refer to page
T000	73	Analog input selection	392
T001	267	Terminal 4 input selection	392
T002	74	Input filter time constant	398
T003	822	Speed setting filter 1	398
T004	826	Torque setting filter 1	398
T005	832	Speed setting filter 2	398
T006	836	Torque setting filter 2	398
T007	849	Analog input offset adjustment	398
T022	125	Terminal 2 frequency setting gain frequency Simple	400
T040	858	Terminal 4 function assignment	139, 397
T042	126	Terminal 4 frequency setting gain frequency Simple	400
T200	C2 (902) ^{*3}	Terminal 2 frequency setting bias frequency	400
T201	C3 (902) ^{*3}	Terminal 2 frequency setting bias	400
T202	125 (903) ^{*3}	Terminal 2 frequency setting gain frequency	400
T203	C4 (903) ^{*3}	Terminal 2 frequency setting gain	400
T400	C5 (904) ^{*3}	Terminal 4 frequency setting bias frequency	400
T401	C6 (904) ^{*3}	Terminal 4 frequency setting bias	400
T402	126 (905) ^{*3}	Terminal 4 frequency setting gain frequency	400
T403	C7 (905) ^{*3}	Terminal 4 frequency setting gain	400
T410	C38 (932) ^{*3}	Terminal 4 bias command (torque)	405
T411	C39 (932) ^{*3}	Terminal 4 bias (torque)	405
T412	C40 (933) ^{*3}	Terminal 4 gain command (torque)	405
T413	C41 (933) ^{*3}	Terminal 4 gain (torque)	405
T700	178	STF/DI0 terminal function selection [E800(-E)] [E806]	410
T701	179	STR/DI1 terminal function selection [E800(-E)] [E806]	410
T702	180	RL terminal function selection	410
T703	181	RM terminal function selection	410
T704	182	RH terminal function selection	410
T709	183	MRS terminal function selection	410
T711	184	RES terminal function selection	410
T720	17	MRS/X10 terminal input selection	416
T740	699	Input terminal filter [E800(-E)] [E806]	410

Pr. group	Pr.	Name	Refer to page
T751	185	NET X1 input selection	410
T752	186	NET X2 input selection	410
T753	187	NET X3 input selection	410
T754	188	NET X4 input selection	410
T755	189	NET X5 input selection	410

◆ C: Motor constant parameters

Parameters for the applied motor setting.

Pr. group	Pr.	Name	Refer to page
C100	71	Applied motor	424, 430, 441
C101	80	Motor capacity	115, 430, 441
C102	81	Number of motor poles	115, 430, 441
C103	9	Rated motor current <i>Simple</i>	306, 430, 441
C104	83	Rated motor voltage	115, 430, 441
C105	84	Rated motor frequency	115, 430, 441
C106	702	Maximum motor frequency	441
C107	707	Motor inertia (integer)	441
C108	724	Motor inertia (exponent)	441
C110	96	Auto tuning setting/status	430, 441, 510
C111	95	Online auto tuning selection	449
C114	880	Load inertia ratio	146, 148
C120	90	Motor constant (R1)	430, 441, 510
C121	91	Motor constant (R2)	430
C122	92	Motor constant (L1)/d-axis inductance (Ld)	430, 441
C123	93	Motor constant (L2)/q-axis inductance (Lq)	430, 441
C124	94	Motor constant (X)	430
C125	82	Motor excitation current	430
C126	859	Torque current/Rated PM motor current	430, 441
C130	706	Induced voltage constant (phi f)	441
C131	711	Motor Ld decay ratio	441
C132	712	Motor Lq decay ratio	441
C133	725	Motor protection current level	441
C135	1412	Motor induced voltage constant (phi f) exponent	441
C140	369 ^{*2}	Number of encoder pulses	452, 468, 559
C141	359 ^{*2}	Encoder rotation direction	452, 468, 559

Pr. group	Pr.	Name	Refer to page
C148	376 ^{*2}	Encoder signal loss detection enable/disable selection	454, 559
C150	1002	Lq tuning target current adjustment coefficient	441
C182	717	Starting resistance tuning compensation coefficient 1	441
C185	721	Starting magnetic pole position detection pulse width	441
C188	720	Starting resistance tuning compensation coefficient 2	430
C194	979	Position accuracy compensation gain 1	441
C195	980	Position accuracy compensation gain 2	441
C196	981	Position accuracy compensation gain 3	441
C200	450	Second applied motor	424
C201	453	Second motor capacity	430, 441
C202	454	Number of second motor poles	430, 441
C203	51	Rated second motor current	306, 430, 441
C204	456	Rated second motor voltage	430, 441
C205	457	Rated second motor frequency	430, 441
C206	743	Second motor maximum frequency	441
C207	744	Second motor inertia (integer)	441
C208	745	Second motor inertia (exponent)	441
C210	463	Second motor auto tuning setting/status	430, 441, 510
C211	574	Second motor online auto tuning	449
C220	458	Second motor constant (R1)	430, 441, 510
C221	459	Second motor constant (R2)	430
C222	460	Second motor constant (L1) / d-axis inductance (Ld)	430, 441
C223	461	Second motor constant (L2) / q-axis inductance (Lq)	430, 441
C224	462	Second motor constant (X)	430
C225	455	Second motor excitation current	430
C226	860	Second motor torque current/ Rated PM motor current	430, 441
C230	738	Second motor induced voltage constant (phi f)	441
C231	739	Second motor Ld decay ratio	441
C232	740	Second motor Lq decay ratio	441
C233	746	Second motor protection current level	441
C235	1413	Second motor induced voltage constant (phi f) exponent	441
C282	741	Second motor starting resistance tuning compensation coefficient 1	441
C285	742	Second motor magnetic pole detection pulse width	441

Pr. group	Pr.	Name	Refer to page
C288	737	Second motor starting resistance tuning compensation coefficient 2	441

◆ A: Application parameters

Parameters for the setting of a specific application.

Pr. group	Pr.	Name	Refer to page
A001	136	MC switchover interlock time [E800(-E)]	322
A004	139	Automatic switchover frequency from inverter to bypass operation [E800(-E)]	322
A100	278	Brake opening frequency	456
A101	279	Brake opening current	456
A102	280	Brake opening current detection time	456
A103	281	Brake operation time at start	456
A104	282	Brake operation frequency	456
A105	283	Brake operation time at stop	456
A106	284	Deceleration detection function selection	456
A107	285	Overspeed detection frequency	456, 559
A108	639	Brake opening current selection	456
A109	640	Brake operation frequency selection	456
A110	292	Automatic acceleration/ deceleration	276, 456
A200	270	Stop-on-contact control selection	461
A205	275	Stop-on contact excitation current low-speed scaling factor	461
A206	276	PWM carrier frequency at stop-on contact	461
A300	592	Traverse function selection	464
A301	593	Maximum amplitude amount	464
A302	594	Amplitude compensation amount during deceleration	464
A303	595	Amplitude compensation amount during acceleration	464
A304	596	Amplitude acceleration time	464
A305	597	Amplitude deceleration time	464
A310	1072	DC brake judgment time for anti-sway control operation	466
A311	1073	Anti-sway control operation selection	466
A312	1074	Anti-sway control frequency	466
A313	1075	Anti-sway control depth	466
A314	1076	Anti-sway control width	466
A315	1077	Rope length	466
A316	1078	Trolley weight	466
A317	1079	Load weight	466
A510	350 ⁺²	Stop position command selection	468
A512	361 ⁺²	Position shift	468
A520	362 ⁺²	Orientation position loop gain	468
A521	363 ⁺²	Completion signal output delay time	468

Pr. group	Pr.	Name	Refer to page
A522	364 ⁺²	Encoder stop check time	468
A523	365 ⁺²	Orientation limit	468
A524	366 ⁺²	Recheck time	468
A525	393 ⁺²	Orientation selection	468
A526	351 ⁺²	Orientation speed	468
A527	352 ⁺²	Creep speed	468
A528	353 ⁺²	Creep switchover position	468
A529	354 ⁺²	Position loop switchover position	468
A530	355 ⁺²	DC injection brake start position	468
A531	356 ⁺²	Internal stop position command	468
A532	357 ⁺²	Orientation in-position zone	468
A533	358 ⁺²	Servo torque selection	468
A542	396 ⁺²	Orientation speed gain (P term)	468
A543	397 ⁺²	Orientation speed integral time	468
A544	398 ⁺²	Orientation speed gain (D term)	468
A545	399 ⁺²	Orientation deceleration ratio	468
A600	759	PID unit selection	492
A601	131	PID upper limit	479, 495
A602	132	PID lower limit	479, 495
A603	553	PID deviation limit	479
A604	554	PID signal operation selection	479
A607	1015	Integral stop selection at limited frequency	479
A610	128	PID action selection	479, 495
A611	133	PID action set point	479, 495
A612	127	PID control automatic switchover frequency	479
A613	129	PID proportional band	479, 495
A614	130	PID integral time	479, 495
A615	134	PID differential time	479, 495
A621	575	Output interruption detection time	479
A622	576	Output interruption detection level	479
A623	577	Output interruption cancel level	479
A624	609	PID set point/deviation input selection	479, 495
A625	610	PID measured value input selection	479, 495
A630	C42 (934) ⁺³	PID display bias coefficient	492
A631	C43 (934) ⁺³	PID display bias analog value	492
A632	C44 (935) ⁺³	PID display gain coefficient	492
A633	C45 (935) ⁺³	PID display gain analog value	492

Pr. group	Pr.	Name	Refer to page
A700	162	Automatic restart after instantaneous power failure selection	502, 508, 510
A701	299	Rotation direction detection selection at restarting	502
A702	57	Restart coasting time	502, 508
A703	58	Restart cushion time	502
A710	165	Stall prevention operation level for restart	502
A711	298	Frequency search gain	430, 510
A712	560	Second frequency search gain	430, 510
A730	261	Power failure stop selection	514
A800	414	PLC function operation selection	516
A801	415	Inverter operation lock mode setting	516
A804	498	PLC function flash memory clear	516
A805	675	User parameter auto storage function selection	516
A810 to A859	1150 to 1199	PLC function user parameters 1 to 50	516
A900	1020	Trace operation selection	518
A902	1022	Sampling cycle	518
A903	1023	Number of analog channels	518
A904	1024	Sampling auto start	518
A905	1025	Trigger mode selection	518
A906	1026	Number of sampling before trigger	518
A910	1027	Analog source selection (1ch)	518
A911	1028	Analog source selection (2ch)	518
A912	1029	Analog source selection (3ch)	518
A913	1030	Analog source selection (4ch)	518
A914	1031	Analog source selection (5ch)	518
A915	1032	Analog source selection (6ch)	518
A916	1033	Analog source selection (7ch)	518
A917	1034	Analog source selection (8ch)	518
A918	1035	Analog trigger channel	518
A919	1036	Analog trigger operation selection	518
A920	1037	Analog trigger level	518
A930	1038	Digital source selection (1ch)	518
A931	1039	Digital source selection (2ch)	518
A932	1040	Digital source selection (3ch)	518
A933	1041	Digital source selection (4ch)	518
A934	1042	Digital source selection (5ch)	518
A935	1043	Digital source selection (6ch)	518
A936	1044	Digital source selection (7ch)	518
A937	1045	Digital source selection (8ch)	518
A938	1046	Digital trigger channel	518
A939	1047	Digital trigger operation selection	518

◆ B: Position control parameters

Parameters for the position control setting.

Pr. group	Pr.	Name	Refer to page
B001	420	Command pulse scaling factor numerator (electronic gear numerator)	210
B002	421	Command pulse multiplication denominator (electronic gear denominator)	210
B003	422	Position control gain	217, 536
B004	423	Position feed forward gain	217
B006	425	Position feed forward command filter	217
B007	426	In-position width	212
B008	427	Excessive level error	212
B011	430	Pulse monitor selection	207
B012	446	Model position control gain	217
B013	1298	Second position control gain	536
B015	538	Current position retention selection	215
B020	464	Digital position control sudden stop deceleration time	184, 197
B021	465	First target position lower 4 digits	184
B022	466	First target position upper 4 digits	184
B023	467	Second target position lower 4 digits	184
B024	468	Second target position upper 4 digits	184
B025	469	Third target position lower 4 digits	184
B026	470	Third target position upper 4 digits	184
B027	471	Fourth target position lower 4 digits	184
B028	472	Fourth target position upper 4 digits	184
B029	473	Fifth target position lower 4 digits	184
B030	474	Fifth target position upper 4 digits	184
B031	475	Sixth target position lower 4 digits	184
B032	476	Sixth target position upper 4 digits	184
B033	477	Seventh target position lower 4 digits	184
B034	478	Seventh target position upper 4 digits	184
B100	1220	Direct command mode selection [E800-(SC)E] [E806]	197
B110	1095	Home position return function selection	184, 197
B111	1096	Home position return position data lower 4 digits	184, 197
B112	1097	Home position return position data upper 4 digits	184, 197
B120	1222	First positioning acceleration time	184, 197
B121	1223	First positioning deceleration time	184, 197

Pr. group	Pr.	Name	Refer to page
B123	1225	First positioning sub-function	184, 197
B124	1226	Second positioning acceleration time	184
B125	1227	Second positioning deceleration time	184
B127	1229	Second positioning sub-function	184
B128	1230	Third positioning acceleration time	184
B129	1231	Third positioning deceleration time	184
B131	1233	Third positioning sub-function	184
B132	1234	Fourth positioning acceleration time	184
B133	1235	Fourth positioning deceleration time	184
B135	1237	Fourth positioning sub-function	184
B136	1238	Fifth positioning acceleration time	184
B137	1239	Fifth positioning deceleration time	184
B139	1241	Fifth positioning sub-function	184
B140	1242	Sixth positioning acceleration time	184
B141	1243	Sixth positioning deceleration time	184
B143	1245	Sixth positioning sub-function	184
B144	1246	Seventh positioning acceleration time	184
B145	1247	Seventh positioning deceleration time	184
B147	1249	Seventh positioning sub-function	184
B180	1282	Home position return method selection	184
B181	1283	Home position return speed	184
B183	1285	Home position shift amount lower 4 digits	184, 197
B184	1286	Home position shift amount upper 4 digits	184, 197
B187	1289	Home position return stopper torque	184, 197
B188	1290	Home position return stopper waiting time	184, 197
B190	1292	Position control terminal input selection	184, 197
B191	1293	Roll feeding mode selection	184, 197
B192	1294	Position detection lower 4 digits	212
B193	1295	Position detection upper 4 digits	212
B194	1296	Position detection selection	212
B195	1297	Position detection hysteresis width	212
B196	510	Rough match output range	212
B197	511	Home position return shifting speed	184, 197

◆ N: Communication operation parameters

Parameters for the setting of communication operation such as the communication specifications or operating characteristics.

Pr. group	Pr.	Name	Refer to page
N000	549	Protocol selection [E800]	*5
N001	342	Communication EEPROM write selection	*5
N010	349 ^{*7}	Communication reset selection	*5
N013	502	Stop mode selection at communication error	*5
N014	779	Operation frequency during communication error	*5
N020	117	PU communication station number [E800]	*5
N021	118	PU communication speed [E800]	*5
N022	119	PU communication data length [E800]	*5
N023	119	PU communication stop bit length [E800]	*5
N024	120	PU communication parity check [E800]	*5
N025	121	PU communication retry count [E800]	*5
N026	122	PU communication check time interval [E800]	*5
N027	123	PU communication waiting time setting [E800]	*5
N028	124	PU communication CR/LF selection [E800]	*5
N040	547	USB communication station number	*5
N041	548	USB communication check time interval	*5
N050	726	Auto Baudrate/Max Master [E800]	*5
N051	727	Max Info Frames [E800]	*5
N052	728	Device instance number (Upper 3 digits) [E800] [E800-(SC)EPA] [E806-SCEPA]	*5
N053	729	Device instance number (Lower 4 digits) [E800] [E800-(SC)EPA] [E806-SCEPA]	*5
N054	390	% setting reference frequency [E800] [E800-(SC)EPA] [E806-SCEPA]	*5
N080	343	Communication error count [E800]	*5
N100	541 ^{*7}	Frequency command sign selection	*5
N103	544 ^{*7}	CC-Link extended setting	*5
N120	1210	CC-Link IE TSN protocol version selection [E800-(SC)EPA] [E800-(SC)EPB] [E806]	*5
N600	1434	IP address 1 (Ethernet) [E800-(SC)EPA] [E800-(SC)EPB] [E806]	*5

Pr. group	Pr.	Name	Refer to page
N601	1435	IP address 2 (Ethernet) [E800-(SC)EPA] [E800-(SC)EPB] [E806]	*5
N602	1436	IP address 3 (Ethernet) [E800-(SC)EPA] [E800-(SC)EPB] [E806]	*5
N603	1437	IP address 4 (Ethernet) [E800-(SC)EPA] [E800-(SC)EPB] [E806]	*5
N610	1438	Subnet mask 1 [E800-(SC)EPA] [E800-(SC)EPB] [E806]	*5
N611	1439	Subnet mask 2 [E800-(SC)EPA] [E800-(SC)EPB] [E806]	*5
N612	1440	Subnet mask 3 [E800-(SC)EPA] [E800-(SC)EPB] [E806]	*5
N613	1441	Subnet mask 4 [E800-(SC)EPA] [E800-(SC)EPB] [E806]	*5
N620	442	Default gateway address 1 [E800-(SC)EPA] [E800-(SC)EPB] [E806]	*5
N621	443	Default gateway address 2 [E800-(SC)EPA] [E800-(SC)EPB] [E806]	*5
N622	444	Default gateway address 3 [E800-(SC)EPA] [E800-(SC)EPB] [E806]	*5
N623	445	Default gateway address 4 [E800-(SC)EPA] [E800-(SC)EPB] [E806]	*5
N630	1427	Ethernet function selection 1 [E800-(SC)EPA] [E800-(SC)EPB] [E806]	*5
N631	1428	Ethernet function selection 2 [E800-(SC)EPA] [E800-(SC)EPB] [E806]	*5
N632	1429	Ethernet function selection 3 [E800-(SC)EPA] [E800-(SC)EPB] [E806]	*5
N633	1430	Ethernet function selection 4 [E800-(SC)EPA] [E800-(SC)EPB] [E806]	*5
N641	1426	Link speed and duplex mode selection [E800-(SC)EPA] [E800-(SC)EPB] [E806]	*5
N642	1455	Keepalive time [E800-(SC)EPA] [E800-(SC)EPB] [E806]	*5
N643	1431	Ethernet signal loss detection function selection [E800-(SC)E] [E806]	*5
N644	1432	Ethernet communication check time interval [E800-(SC)EPA] [E800-(SC)EPB] [E806]	*5
N647	1456	Network diagnosis selection [E800-(SC)EPA] [E800-(SC)EPB] [E806]	*5
N648	1457	Extended setting for Ethernet signal loss detection function selection [E800-(SC)EPA] [E800-(SC)EPB] [E806]	*5
N649	1399	Inverter identification enable/disable selection [E800-(SC)EPA] [E800-(SC)EPB] [E806]	*5

Pr. group	Pr.	Name	Refer to page
N650	1424	Ethernet communication network number [E800-(SC)EPA] [E800-(SC)EPB] [E806]	*5
N651	1425	Ethernet communication station number [E800-(SC)EPA] [E800-(SC)EPB] [E806]	*5
N652	1386	Ethernet relay operation at reset selection [E800-(SC)EPA] [E800-(SC)EPB] [E806]	*5
N660	1442	IP filter address 1 (Ethernet) [E800-(SC)EPA] [E800-(SC)EPB] [E806]	*5
N661	1443	IP filter address 2 (Ethernet) [E800-(SC)EPA] [E800-(SC)EPB] [E806]	*5
N662	1444	IP filter address 3 (Ethernet) [E800-(SC)EPA] [E800-(SC)EPB] [E806]	*5
N663	1445	IP filter address 4 (Ethernet) [E800-(SC)EPA] [E800-(SC)EPB] [E806]	*5
N664	1446	IP filter address 2 range specification (Ethernet) [E800-(SC)EPA] [E800-(SC)EPB] [E806]	*5
N665	1447	IP filter address 3 range specification (Ethernet) [E800-(SC)EPA] [E800-(SC)EPB] [E806]	*5
N666	1448	IP filter address 4 range specification (Ethernet) [E800-(SC)EPA] [E800-(SC)EPB] [E806]	*5
N670	1449	Ethernet command source selection IP address 1 [E800-(SC)EPA] [E800-(SC)EPB] [E806]	*5
N671	1450	Ethernet command source selection IP address 2 [E800-(SC)EPA] [E800-(SC)EPB] [E806]	*5
N672	1451	Ethernet command source selection IP address 3 [E800-(SC)EPA] [E800-(SC)EPB] [E806]	*5
N673	1452	Ethernet command source selection IP address 4 [E800-(SC)EPA] [E800-(SC)EPB] [E806]	*5
N674	1453	Ethernet command source selection IP address 3 range specification [E800-(SC)EPA] [E800-(SC)EPB] [E806]	*5
N675	1454	Ethernet command source selection IP address 4 range specification [E800-(SC)EPA] [E800-(SC)EPB] [E806]	*5
N681	1124	Station number in inverter-to-inverter link [E800-(SC)EPA] [E800-(SC)EPB] [E806]	*5
N682	1125	Number of inverters in inverter-to-inverter link system [E800-(SC)EPA] [E800-(SC)EPB] [E806]	*5

Pr. group	Pr.	Name	Refer to page
N690	1305	EtherCAT node address setting [E800-EPC]	*5
N800	1318	User Defined Cyclic Communication Input fixing format selection [E800-(SC)EPA] [E806-SCEPA]	*5
N801	1319	User Defined Cyclic Communication Output fixing format selection [E800-(SC)EPA] [E806-SCEPA]	*5
N810 to N819	1320 to 1329	User Defined Cyclic Communication Input 1 to 10 Mapping [E800-(SC)E] [E806]	*5
N830 to N839	1389 to 1393	User Defined Cyclic Communication Input Sub 1 to 10 Mapping [E800-(SC)E] [E806]	*5
N850 to N863	1330 to 1343	User Defined Cyclic Communication Output 1 to 14 Mapping [E800-(SC)E] [E806]	*5
N870 to N879	1394 to 1398	User Defined Cyclic Communication Output Sub 1 to 10 Mapping [E800-(SC)E] [E806]	*5

◆ (G) Control parameters

Parameters for motor control.

Pr. group	Pr.	Name	Refer to page
G000	0	Torque boost <i>Simple</i>	528
G001	3	Base frequency <i>Simple</i>	530
G002	19	Base frequency voltage	530
G003	14	Load pattern selection	532
G010	46	Second torque boost	528
G011	47	Second V/F (base frequency)	530
G030	60	Energy saving control selection	534
G060	673	SF-PR slip amount adjustment operation selection [100/200/400 V class]	535
G061	674	SF-PR slip amount adjustment gain [100/200/400 V class]	535
G100	10	DC injection brake operation frequency	536
G101	11	DC injection brake operation time	536
G102	802	Pre-excitation selection	536
G103	850	Brake operation selection	536
G106	250	Stop selection	420, 543
G107	70	Special regenerative brake duty	545
G108	1299	Second pre-excitation selection	536
G110	12	DC injection brake operation voltage	536
G120	882	Regeneration avoidance operation selection	551
G121	883	Regeneration avoidance operation level	551

Pr. group	Pr.	Name	Refer to page
G123	885	Regeneration avoidance compensation frequency limit value	551
G124	886	Regeneration avoidance voltage gain	551
G125	665	Regeneration avoidance frequency gain	551
G130	660	Increased magnetic excitation deceleration operation selection	554
G131	661	Magnetic excitation increase rate	554
G132	662	Increased magnetic excitation current level	554
G200	800	Control method selection	115
G203	245	Rated slip	556
G204	246	Slip compensation time constant	556
G205	247	Constant output range slip compensation selection	556
G210	803	Constant output range torque characteristic selection	139, 167
G211	820	Speed control P gain 1	146
G212	821	Speed control integral time 1	146
G213	824	Torque control P gain 1 (current loop proportional gain)	173
G214	825	Torque control integral time 1 (current loop integral time)	173
G215	823 ^{*2}	Speed detection filter 1	557
G217	854	Excitation ratio	558
G219	698	Speed control D gain	217
G220	877	Speed feed forward control/ model adaptive speed control selection	148
G221	878	Speed feed forward filter	148
G222	879	Speed feed forward torque limit	148
G223	881	Speed feed forward gain	148
G224	828	Model speed control gain	148
G230	840	Torque bias selection	150
G231	841	Torque bias 1	150
G232	842	Torque bias 2	150
G233	843	Torque bias 3	150
G234	844	Torque bias filter	150
G235	845	Torque bias operation time	150
G236	846	Torque bias balance compensation	150
G237	847	Fall-time torque bias terminal 4 bias	150
G238	848	Fall-time torque bias terminal 4 gain	150
G240	367 ^{*2}	Speed feedback range	559
G241	368 ^{*2}	Feedback gain	559
G300	451	Second motor control method selection	115
G311	830	Speed control P gain 2	146
G312	831	Speed control integral time 2	146
G313	834	Torque control P gain 2 (current loop proportional gain)	173

Pr. group	Pr.	Name	Refer to page
G314	835	Torque control integral time 2 (current loop integral time)	173
G315	833 ^{*2}	Speed detection filter 2	557
G400	286	Droop gain	561
G401	287	Droop filter time constant	561
G410	653	Speed smoothing control	562
G411	654	Speed smoothing cutoff frequency	562
G932	89	Speed control gain (Advanced magnetic flux vector)	121
G942	569	Second motor speed control gain	121

- *1 The set value is read/written in 2-word (32-bit) units when the PLC function is used for parameter reading/writing.
- *2 The setting is available only when a Vector control compatible option is installed. For the IP67 model, the setting is not available as plug-in options are not available. (The parameter can be read or written using communication protocols regardless of whether the option is installed.)
- *3 On the LCD operation panel or the parameter unit used as the command source, the parameter number in parentheses appears instead of that starting with the letter C.
- *4 For the Ethernet model and the safety communication model, the setting is available only when the FR-A8AY or the FR-E8AXY is installed. For the IP67 model, the setting is not available as plug-in options are not available.
- *5 For details, refer to the Instruction Manual (Communication).
- *6 The setting is available when a compatible plug-in option is installed or when the PLC function is enabled. (**Pr.313 to Pr.315** are always available for settings in the FR-E800-(SC)EPA, the FR-E800-(SC)EPB, and the FR-E806.)
- *7 For the standard model, the setting is available only when a communication option is installed.
- *8 For details, refer to the FR-E800-SCE Instruction Manual (Functional Safety).

MEMO

CHAPTER 4 Control Method

4.1	Vector control and Real sensorless vector control	112
4.2	Changing the control method and mode.....	115
4.3	Selecting the Advanced magnetic flux vector control	121
4.4	Selecting the PM sensorless vector control.....	123

4 Control Method

V/F control (initial setting), Advanced magnetic flux vector control, Real sensorless vector control, Vector control, and PM sensorless vector control are available with this inverter.

◆ V/F control

The inverter controls the output frequency (F) and the output voltage (V) so that the ratio of frequency to voltage (V/F) is kept constant when the frequency is changed.

◆ Advanced magnetic flux vector control

The inverter performs vector calculation and divide its output current into the excitation current and the torque current. The inverter compensates the frequency and the voltage to output a current that meets the load torque to the motor, which improves the motor torque at low speed. The output frequency is further compensated (slip compensation) to bring the actual motor speed closer to the commanded speed. This control method is useful when the load fluctuates are severe.

NOTE

- Advanced magnetic flux vector control requires the following conditions.
If these conditions are not satisfied, select V/F control. Otherwise, malfunctions such as insufficient torque, uneven rotation may occur.
- The motor capacity must be the same or one rank lower than the inverter capacity.
If a motor with substantially low rated current compared with the inverter rated current is used, speed and torque accuracies may deteriorate due to torque ripples, etc. Set the rated motor current to about 40% or higher of the inverter rated current. (For details on the inverter rated current, refer to the inverter rated specifications in the Instruction Manual (Connection).)
- The motor described in the following table is used.

Motor	Condition
Mitsubishi Electric standard efficiency motor (SF-JR)	Offline auto tuning is not required.
Mitsubishi Electric high-efficiency motor (SF-HR)	
Mitsubishi Electric constant-torque motor (SF-JRCA 4P, SF-HRCA)	
Mitsubishi Electric high-performance energy-saving motor (SF-PR)	
Mitsubishi Electric geared motor (constant-torque) (GM-[])	
Other motors (other manufactures' motors)	Offline auto tuning is required.

- Single-motor operation (one motor to one inverter) is performed.
- The wiring length from the inverter to the motor is 30 m or less. (When the wiring length exceeds 30 m, perform offline auto tuning with the wiring in place.)

◆ Real sensorless vector control

- As the inverter estimates the motor speed and controls the output current more accurately, a high-level control of the speed and the torque is enabled. Select Real sensorless vector control for a high-accuracy, fast-response control. The offline auto tuning is required initially.
- This control method is useful for the following purposes:
 - To minimize the speed fluctuation even at a severe load fluctuation
 - To generate a low speed torque
 - To prevent machine from damage due to a too large torque (To set the torque limit)
 - To control the torque

NOTE

- Real sensorless vector control requires the following conditions.
If these conditions are not satisfied, select V/F control. Otherwise, malfunctions such as insufficient torque, uneven rotation may occur.
- The rated motor current should be equal to or less than the inverter rated current.
If a motor with substantially low rated current compared with the inverter rated current is used, speed and torque accuracies may deteriorate due to torque ripples, etc. Set the rated motor current to about 40% or higher of the inverter rated current. (For details on the inverter rated current, refer to the inverter rated specifications in the Instruction Manual (Connection).)
- Offline auto tuning is performed.
Offline auto tuning is required under Real sensorless vector control even when the Mitsubishi Electric motor is used since the wiring length affects the operation.
- Single-motor operation (one motor to one inverter) is performed.
- A surge voltage suppression filter (FR-ASF/FR-BMF) is not used.

◆ Vector control

- With a vector control option (FR-A8AP E kit) installed, full-scale vector control operation of a motor with an encoder can be performed. Speed control (zero speed control, servo lock), torque control, and position control can be performed with fast response and high accuracy. Vector control is not available for the IP67 model as plug-in options are not available.
- Vector control has excellent control characteristic compared to other control methods such as V/F control. Its control characteristic is equal to those of DC machines.
- This control method is useful for the following purposes:
 - To minimize the speed fluctuation even at a severe load fluctuation
 - To generate a low speed torque
 - To prevent machine from damage due to a too large torque (To set the torque limit)
 - To control the torque or position
 - To control a torque generated in a motor in a servo-lock state (the motor with its shaft stopped)

NOTE

- A vector control option (FR-A8AP E kit) needs to be installed to perform Vector control. The FR-A8AP E kit cannot be used with another plug-in option, as two or more plug-in options cannot be installed to the FR-E800 inverter at the same time.
- Vector control requires the following conditions.
When the conditions are not satisfied, malfunctions such as insufficient torque, uneven rotation may occur.
- The rated motor current should be equal to or less than the inverter rated current.
If a motor with substantially low rated current compared with the inverter rated current is used, speed and torque accuracies may deteriorate due to torque ripples, etc. Set the rated motor current to about 40% or higher of the inverter rated current. (For details on the inverter rated current, refer to the inverter rated specifications in the Instruction Manual (Connection).)
- An induction motor is used. (Vector control is not available for a PM (IPM/SPM) motor.)
- The motor described in the following table is used.

Motor	Condition
Mitsubishi Electric high-performance energy-saving motor with encoder (SF-PR-SC)	The offline auto tuning is not required.
Mitsubishi Electric Vector control dedicated motor (SF-V5RU (1500 r/min series))	
Mitsubishi Electric inverter-driven geared motor for encoder feedback control (GM-DP)	
Mitsubishi Electric standard efficiency motor with encoder (SF-JR)	
Mitsubishi Electric high-efficiency motor with encoder (SF-HR)	
Mitsubishi Electric constant-torque motor with encoder (SF-JRCA 4P, SF-HRCA)	
Mitsubishi Electric inverter-driven geared motor for encoder feedback control (GM-DZ)	The offline auto tuning is required.
Other motors (motors other than SF-V5RU 1500 r/min series, other manufactures' motors, etc.)	

- Single-motor operation (one motor to one inverter) is performed.
- The wiring length from the inverter to the motor is 30 m or less. (When the wiring length exceeds 30 m, perform offline auto tuning with the wiring in place.)
- A surge voltage suppression filter (FR-ASF/FR-BMF) is not used.

◆ PM sensorless vector control

- The inverter enables highly efficient motor control and highly accurate motor speed control of a PM (permanent magnet embedded) motor, which is more efficient than an induction motor.
- A speed detector such as an encoder is not required as the inverter estimates the motor speed by the calculation from the inverter output voltage and current. The inverter drives the PM motor with the least required current for a load in order to achieve the highest motor efficiency.
- When a PM motor (MM-GKR or EM-A) is used, just performing PM parameter initialization enables PM sensorless vector control.

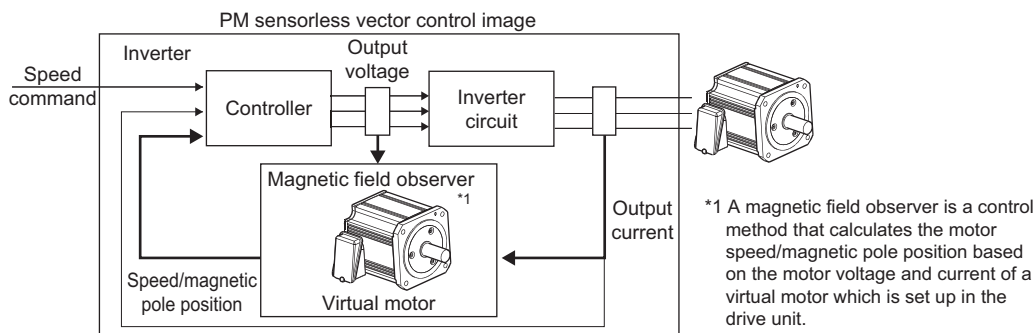

NOTE

- The PM sensorless vector control requires the following conditions.
- The motor described in the following table is used.

Motor	Condition
Mitsubishi Electric PM motor (MM-GKR) Mitsubishi Electric PM motor (EM-A)	The offline auto tuning is not required.
IPM motor other than the above or SPM motor	The offline auto tuning is required.

- The rated motor current should be equal to or less than the inverter rated current.
If a motor with substantially low rated current compared with the inverter rated current is used, speed and torque accuracies may deteriorate due to torque ripples, etc. Set the rated motor current to about 40% or higher of the inverter rated current. (For details on the inverter rated current, refer to the inverter rated specifications in the Instruction Manual (Connection).)
- Single-motor operation (one motor to one inverter) is performed.
- Except for the cases shown in the following table, the wiring length from the inverter to the motor should be 100 m or less. (Offline auto tuning is required for the MM-GKR or EM-A motor when the wiring length is long (exceeding 30 m as a reference), when the wiring length is changed, or when positioning accuracy for the EM-A motor need to be improved.)

Motor		Condition
100 V class	MM-GKR	0.1 kW 30 m or less
200 V class	MM-GKR, EM-A	
400 V class	EM-A	0.4 kW 50 m or less
		Other than the above For carrier frequency of 8 kHz or higher: 50 m or less
	IPM motor or SPM motor	

- A surge voltage suppression filter (FR-ASF/FR-BMF) is not used.

4.1 Vector control and Real sensorless vector control

Vector control is one of the control techniques for driving an induction motor. To help explain Vector control, the fundamental equivalent circuit of an induction motor is shown below.

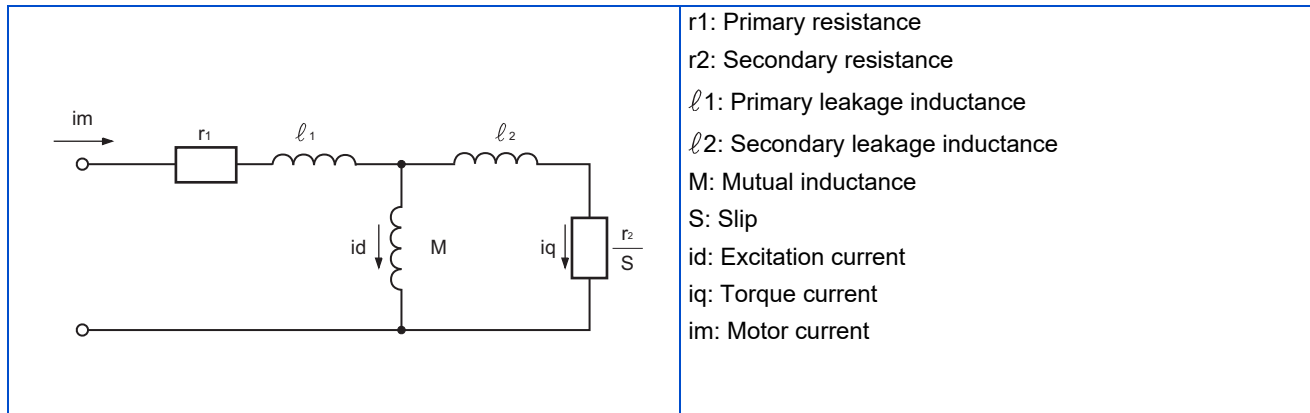

In the above diagram, currents flowing in the induction motor can be classified into a current i_d (excitation current) for making a magnetic flux in the motor and a current i_q (torque current) for causing the motor to develop torque.

In Vector control, the voltage and output frequency are calculated to control the motor so that the excitation current and torque current flow to the optimum as described below:

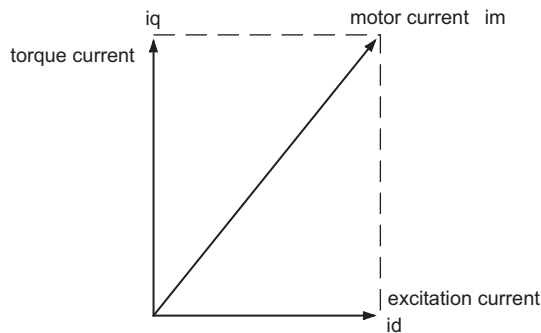

- The excitation current is controlled to place the internal magnetic flux of the motor in the optimum status.
- The torque command value is derived so that the difference between the motor speed command and the actual speed (speed estimated value for Real sensorless vector control) obtained from the encoder connected to the motor shaft is zero. Torque current is controlled so that torque as set in the torque command is developed.

Motor-generated torque (T_M), slip angular velocity (ω_s) and the motor's secondary magnetic flux (Φ_2) can be found by the following calculation:

$$T_M \propto \Phi_2 \cdot i_q$$

$$\Phi_2 = M \cdot i_d$$

$$\omega_s = \frac{r_2}{L_2} \cdot \frac{i_q}{i_d}$$

where, L_2 : secondary inductance

$$L_2 = l_2 + M$$

Vector control provides the following advantages:

- Vector control has excellent control characteristic compared to V/F control and other controls. The control characteristic of the Vector control is equal to those of DC machines.

- It is applicable to fast response applications with which induction motors were previously regarded as difficult to use. Applications requiring a wide variable-speed range from extremely low speed to high speed, frequent acceleration/ deceleration operations, continuous four-quadrant operations, etc.
- Torque control is enabled
- It allows servo-lock torque control which generates a torque in the motor shaft while stopped. (Not available under Real sensorless vector control.)

Block diagram of Real sensorless vector control

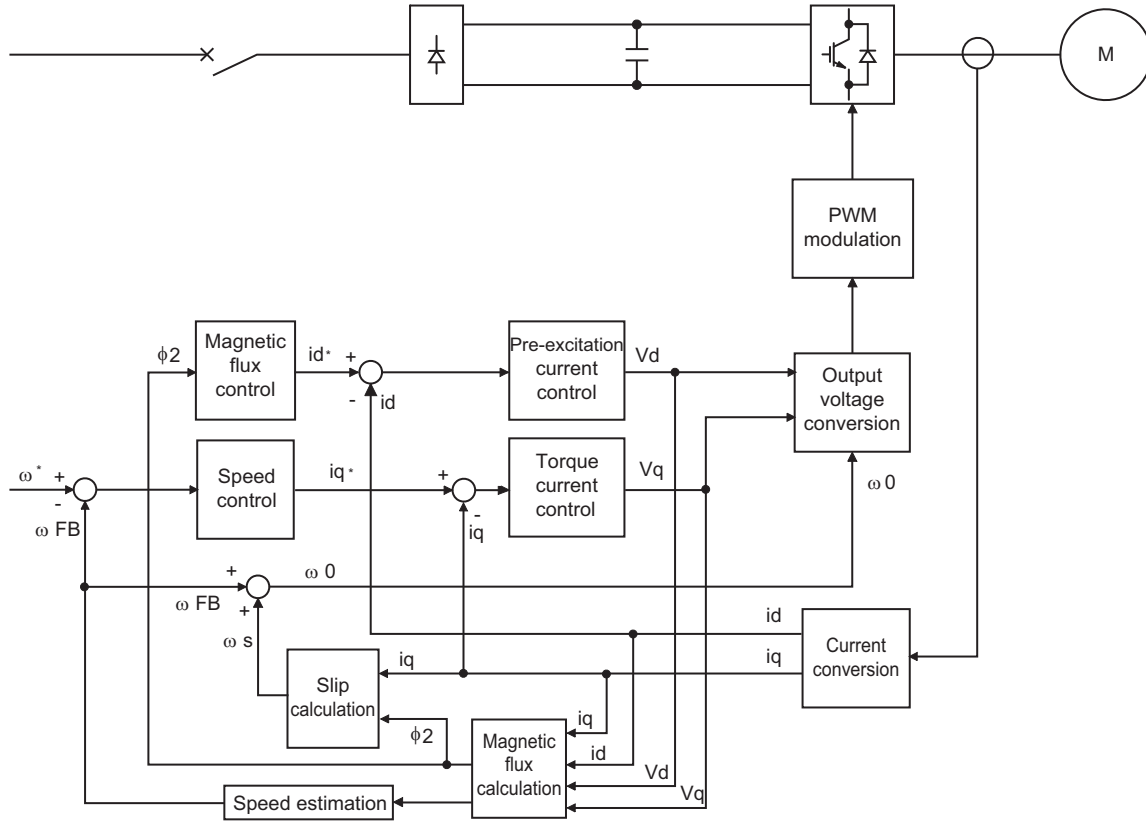

Block diagram of Vector control

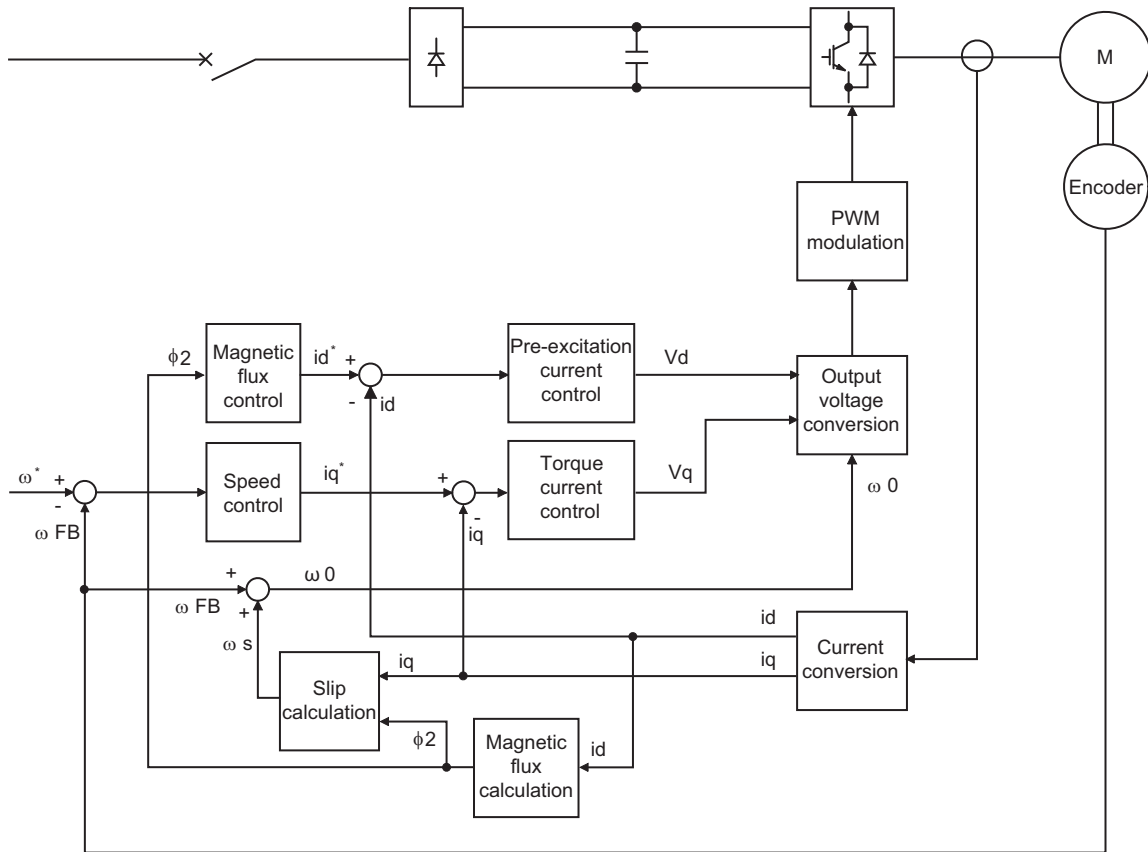

Speed control	Speed control operation is performed to zero the difference between the speed command (ω^*) and actual rotation value detected by encoder (ω_{FB}). At this time, the motor load is found and its result is transferred to the torque current controller as a torque current command (i_q^*).
Torque current control	A voltage (V_q) is calculated to flow a current (i_q) which is identical to the torque current command (i_q^*) found by the speed controller.
Magnetic flux control	The magnetic flux (Φ_2) of the motor is derived from the excitation current (i_d). The excitation current command (i_d^*) is calculated to use that motor magnetic flux (Φ_2) as a predetermined magnetic flux.
Excitation current control	A voltage (V_d) is calculated to flow a current (i_d) which is identical to the excitation current command (i_d^*).
Output frequency calculation	Motor slip (ω_s) is calculated on the basis of the torque current value (i_q) and magnetic flux (Φ_2). The output frequency (ω_0) is found by adding that slip (ω_s) to the feedback (ω_{FB}) found by a feedback from the encoder.

The above results are used to make PWM modulation and run the motor.

4.2 Changing the control method and mode

Set the control method and the control mode.

V/F control, Advanced magnetic flux vector control, Real sensorless vector control, Vector control, and PM sensorless vector control are available.

The available control modes are speed control, torque control, and position control modes.

- Select a control method and a control mode by setting **Pr.800 (Pr.451) Control method selection**.
- The control mode can be switched using a mode switching signal (MC).

Pr.	Name	Initial value	Setting range	Description
71 C100	Applied motor	0	0, 3, 5, 6, 10, 13, 15, 16, 20, 23, 30, 33, 40, 43, 50, 53, 70, 73, 540 ^{*4} , 1140 ^{*5} , 1800, 1803, 8090, 8093, 9090, 9093 ^{*1}	By selecting a standard motor or constant-torque motor, the thermal characteristic and motor constant of each motor are set.
80 C101	Motor capacity	9999	0.1 to 30 kW 9999	Set the applied motor capacity. No motor capacity setting
81 C102	Number of motor poles	9999	2, 4, 6, 8, 10, 12 9999	Set the number of motor poles. No number of motor poles setting
83 C104	Rated motor voltage	200/400/575 V ^{*2}	0 to 1000 V	Set the rated motor voltage (V).
84 C105	Rated motor frequency	9999	10 to 400 Hz 9999	Set the rated motor frequency (Hz). The setting value of Pr.3 Base frequency is used. ^{*3}
800 G200	Control method selection	40	0 to 5	Vector control
			9	Vector control test operation
			10	Real sensorless vector control / PM sensorless vector control
			11, 12	Real sensorless vector control
			13, 14	PM sensorless vector control
			19	PM sensorless vector control test operation
			20	Advanced magnetic flux vector control
451 G300	Second motor control method selection	9999	10	Real sensorless vector control / PM sensorless vector control
			11, 12	Real sensorless vector control
			13, 14	PM sensorless vector control
			20	Advanced magnetic flux vector control
			40	V/F control
			9999	Control selected in Pr.800

*1 The setting range for the 575 V class is "0, 3, 5, 6, 10, 13, 15, 16, 30, 33, 8090, 8093, 9090, and 9093".

*2 The initial value differs according to the inverter's voltage class (100/200 V, 400 V, or 575 V).

*3 The inverter internal data is used under PM sensorless vector control.

*4 The value is valid only when the FR-E820-0080(1.5K) or lower, the FR-E820S-0080(1.5K) or lower, or FR-E810W-0050(0.75K) or lower is used and **Pr.80 (Pr.453) ≤ 0.75 kW**. Under other conditions, "SE" (Incorrect parameter setting) is displayed when the start command is turned ON.

*5 The value is valid in any of the following conditions. Under other conditions, "SE" (Incorrect parameter setting) is displayed when the start command is turned ON.

The FR-E820-0470(11K) or lower is used and **Pr.80 (Pr.453) ≤ 7.5 kW**.

The FR-E840-0230(11K) or lower is used and **Pr.80 (Pr.453) = 0.4 to 7.5 kW**.

The FR-E820S-0110(2.2K) or lower is used and **Pr.80 (Pr.453) ≤ 2.2 kW**.

The FR-E810W-0050(0.75K) or lower is used and **Pr.80 (Pr.453) ≤ 0.75 kW**.

The FR-E846-0095(3.7K) or lower is used and **Pr.80 (Pr.453) = 2.2 or 3.7 kW**.

◆ Setting the motor capacity and the number of motor poles (Pr.80, Pr.81)

- Motor specifications (the motor capacity and the number of motor poles) must be set to select Advanced magnetic flux vector control, Real sensorless vector control, Vector control, or PM sensorless vector control.
- Set the motor capacity (kW) in **Pr.80 Motor capacity** and set the number of motor poles in **Pr.81 Number of motor poles**.

◆ Selection of the control method and the control mode

- Select a control method (and a control mode) from V/F control, Advanced magnetic flux vector control (speed control), Real sensorless vector control (speed control, torque control), Vector control (speed control, torque control, position control), and PM sensorless vector control (speed control, position control).
- To enable the control method and the control mode selected in **Pr.800 (Pr.451)**, the condition to start operation must be satisfied as shown in the following table. Otherwise the operation does not start due to the setting error (SE) alarm when the start signal is input.

Pr.800 setting	Pr.451 setting	Control method	Control mode	Condition to start operation		MC signal
				Pr.80 (Pr.453), Pr.81 (Pr.454) setting	Pr.71 (Pr.450)	
0	—	Vector control ^{*3}	Speed control	Other than 9999	Induction motor	—
1	—		Torque control			—
2	—		Speed control / torque control switchover			ON: Torque control OFF: Speed control
3	—		Position control			—
4	—		Speed control / position control switchover			ON: Position control OFF: Speed control
5	—		Position control / torque control switchover			ON: Torque control OFF: Position control
9	—	Vector control test operation		—	—	
10	—	Real sensorless vector control / PM sensorless vector control	Speed control	— ^{*1}	—	
11	—	Real sensorless vector control	Torque control	Induction motor	—	
12	—		Speed control / torque control switchover		ON: Torque control OFF: Speed control	
13	—	PM sensorless vector control	Position control	PM motor (MM-GKR, EM-A)	—	
14	—		Speed control / position control switchover		ON: Position control OFF: Speed control	
19	—	PM sensorless vector control test operation		PM motor	—	
20	—	Advanced magnetic flux vector control	Speed control	Induction motor	—	
40 (initial value)	40	V/F control	—		— ^{*2}	—
—	9999 (initial value)	Control method and control mode selected in Pr.800 (provided that they are selectable with Pr.451)				

*1 The control method depends on the motor selected in **Pr.71 (Pr.450)**: Real sensorless vector control for the induction motor, and PM sensorless vector control for the PM motor.

*2 Operation can start regardless of the setting.

*3 A Vector control compatible option is required. Vector control is not available for the IP67 model as plug-in options are not available.

◆ Automatic parameter setting by changing the Pr.800 setting

- The **Pr.10** and **Pr.22** settings are automatically changed when the control method is changed.
- When the control method is changed from V/F control or Advanced magnetic flux vector control to Vector control, the **Pr.10** setting is automatically changed as follows.

Pr.	Setting value before change	Setting value after change
10	3 Hz (initial value)	0.5 Hz

- When the control method is changed from Vector control to V/F control or Advanced magnetic flux vector control, the **Pr.10** setting is automatically changed as follows.

Pr.	Setting value before change	Setting value after change
10	0.5 Hz	3 Hz (initial value)

- When the control method is changed from V/F control or Advanced magnetic flux vector control to Real sensorless vector control or Vector control, the **Pr.22** setting is automatically changed for the ND rating as follows (in the FR-E820-0175(3.7K) or lower, FR-E840-0095(3.7K) or lower, FR-E860-0061(3.7K) or lower, FR-E820S-0110(2.2K) or lower, FR-E810W-0050(0.75K) or lower, and FR-E846-0095(3.7K) or lower).

Pr.	Setting value before change	Setting value after change
22	150% (initial setting)	200%

- When the control method is changed from Real sensorless vector control or Vector control to V/F control or Advanced magnetic flux vector control, the **Pr.22** setting is automatically changed for the ND rating as follows (in the FR-E820-0175(3.7K) or lower, FR-E840-0095(3.7K) or lower, FR-E860-0061(3.7K) or lower, FR-E820S-0110(2.2K) or lower, FR-E810W-0050(0.75K) or lower, and FR-E846-0095(3.7K) or lower).

Pr.	Setting value before change	Setting value after change
22	200%	150% (initial setting)

◆ Vector control test operation, PM sensorless vector control test operation (Pr.800 = "9 or 19")

- A test operation for speed control is available without connecting a motor to the inverter. The speed calculation changes to track the speed command, and such speed changes can be checked on the operation panel or by outputting it as analog signals to terminal FM or AM.

NOTE

- Since current is not detected and voltage is not output, monitors related to current and voltage such as output current and output voltage, etc. and output signals do not function.
- For speed calculation, speed is calculated in consideration of **Pr.880 Load inertia ratio**.

◆ I/O signal status during the test operation

- During the test operation, the following signals are disabled.

Input terminal function selection (Pr.178 to Pr.189)	Output terminal function selection (Pr.190 to Pr.197)
<ul style="list-style-type: none"> Brake opening completion (BRI) V/F switchover (X18) Control mode switchover (MC) Torque bias selection 1, Torque bias selection 2 (X42, X43) Sudden stop (X87) 	<ul style="list-style-type: none"> Electronic thermal O/L relay pre-alarm (THP) Brake opening request (BOF) Orientation complete (ORA) Orientation fault (ORM) In-position (Y36) Travel completed (MEND) Start time tuning completion (Y39) Home position return failure (ZA) Position detection level (FP) During position command operation (PBSY) Rough match (CPO) Home position return completed (ZP) Position control preparation ready (RDY)

NOTE

- Do not use the Orientation command (X22) signal. The function may not operate normally.

Parameters referred to

Pr.178 to Pr.189 (Input terminal function selection)  page 410
Pr.190 to Pr.197 (Output terminal function selection)  page 371

◆ Status of the monitoring during the test operation

○: Enabled

×: Disabled (0 is displayed at any time.)

Δ: A cumulative total before the test operation is displayed.

—: Not available

Monitor item	Monitoring on the operation panel	Output via FM/AM	Monitor item	Monitoring on the operation panel	Output via FM/AM
Output frequency	○	○	Feedback pulse	×	—
Output current	×	×	Trace status	○	—
Output voltage	×	×	User monitor 1	○	—
Fault indication	○	—	User monitor 2	○	—
Frequency setting value	○	○	User monitor 3	○	—
Motor speed	○	○	Communication station number (PU port)	○	—
Motor torque	○	○	Station number (CC-Link)	○	—
Converter output voltage	○	○	Energy saving effect	Δ ^{*3}	Δ ^{*3}
Brake duty	○	○	Cumulative energy saving	Δ	—
Electronic thermal O/L relay load factor	× ^{*1}	× ^{*1}	PID set point	○	○
Output current peak value	× ^{*1}	× ^{*1}	PID measured value	○	○
Converter output voltage peak value	○	○	PID deviation	○	○ ^{*4}
Input power	×	×	Inverter I/O terminal monitor	○	—
Output power	×	×	Option input terminal monitor	○	—
Load meter	×	×	Option output terminal monitor	○	—
Motor excitation current	×	×	Option input terminal monitor 1 (for communication)	○	—
Position pulse	×	—	Option input terminal monitor 2 (for communication)	○	—
Cumulative energization time	○	—	Option output terminal monitor (for communication)	○	—
Reference voltage output	—	○	Motor thermal load factor	× ^{*1}	× ^{*1}
Actual operation time	○	—	Inverter thermal load factor	○ ^{*2}	○ ^{*2}
Motor load factor	×	×	PTC thermistor value	○	—
Cumulative energy	Δ	—	Ideal speed command	×	—
Position command	×	—	PID measured value 2	○	○
Current position	×	—	PLC function analog output	—	○
Droop pulse	×	—	PID manipulated variable	○	○ ^{*4}
Commanded torque	○	○	Dancer main speed setting	○	○
Torque current command	○	○			

*1 When the inverter operation is switched to the test operation, the indication is changed to 0. When Vector control or PM sensorless vector control is selected again after a test operation, the following monitor items from the last operation are displayed: output current peak value, electronic thermal relay load factor, and motor thermal load factor.

*2 When the inverter operation is switched to the test operation, the accumulated thermal value is reduced because the output current is considered as 0.

*3 During the test operation, only the average power saving, average power saving rate, and average power cost savings can be monitored.

*4 The output is enabled via terminal AM only.

« Parameters referred to »

Operation panel main monitor selection  page 348

Pr.158 AM terminal function selection  page 358

◆ Changing the control method with external terminals (RT signal, X18 signal)

- Control method (V/F control, Advanced magnetic flux vector control, Real sensorless vector control, Vector control) can be switched using external terminals.

The control method can be switched using either the Second function selection (RT) signal or the V/F switchover (X18) signal.

- Set the second motor in **Pr.450 Second applied motor** and set the second motor's control method in **Pr.451 Second motor control method selection**. Turning ON the RT signal or X18 signal enables the second function, enabling the switchover of the control method.
- To input the RT signal, set "3" in any parameter from **Pr.178 to Pr.189 (Input terminal function selection)** to assign the function.

To input the X18 signal, set "18" in any parameter from **Pr.178 to Pr.189 (Input terminal function selection)** to assign the function.

First motor control method	Second motor control method (RT/X18 signal-ON)	Pr.450 setting	Pr.453 to Pr.454 settings	Pr.451 setting
V/F control	V/F control	9999	—	—
		—	—	9999
		Induction motor	—	40
	Advanced magnetic flux vector control	Induction motor	Other than 9999	20
	Real sensorless vector control			10 to 12
PM sensorless vector control	PM motor			10, 13, 14
Advanced magnetic flux vector control ^{*1} Real sensorless vector control ^{*1} Vector control ^{*1} PM sensorless vector control	Same control as the first motor ^{*1}	9999	—	—
		Same as Pr.71 setting	Other than 9999	Same as Pr.800 setting
	V/F control	Induction motor	—	40
	Advanced magnetic flux vector control	Induction motor	Other than 9999	20
	Real sensorless vector control			10 to 12
PM sensorless vector control	PM motor			10, 13, 14

*1 V/F control is set by turning ON the X18 signal.

NOTE

- The RT signal is a second function selection signal. The RT signal also enables other second functions. (Refer to [page 418](#).)
- When V/F control is set using the V/F switchover (X18) signal, the second functions are selected at the same time.
- The control method could be changed by external terminals (RT signal, X18 signal) while the inverter is stopped. If a signal is switched during the operation, the control method changes after the inverter stops.

◆ Changing the control mode with external terminals (MC signal)

- The setting of **Pr.800** or **Pr.451** can be used to switch the control mode by turning ON/OFF the MC signal. Refer to [page 116](#) to set **Pr.800** or **Pr.451**.

To input the MC signal, set "26" in any parameter from **Pr.178 to Pr.189 (Input terminal function selection)** to assign the function.

- When using an analog input terminal (terminal 4) for torque limit and torque command, switching of the control mode changes the terminal function as follows:

Pr.858 setting	Speed control / torque control switchover ^{*1}		Speed control / position control switchover ^{*2}		Position control / torque control switchover ^{*3}	
	Speed control (MC signal-OFF)	Torque control (MC signal-ON)	Speed control (MC signal-OFF)	Position control (MC signal-ON)	Position control (MC signal-OFF)	Torque control (MC signal-ON)
0 (initial value)	Speed command (AU signal-ON)	Speed limit (AU signal-ON)	Speed command (AU signal-ON)	—	—	Speed limit (AU signal-ON)
4	Torque limit (Pr.810 = "1")	Torque command (Pr.804 = "0")	Torque limit (Pr.810 = "1")	Torque limit (Pr.810 = "1")	Torque limit (Pr.810 = "1")	Torque command (Pr.804 = "0")
6	Torque bias input (Pr.840 = "1 to 3")	—	Torque bias input (Pr.840 = "1 to 3")	—	—	—
9999	—	—	—	—	—	—

—: No function

*1 Real sensorless vector control (Pr.800 = "12"), Vector control (Pr.800 = "2")

*2 Vector control (Pr.800 = "4"), PM sensorless vector control (Pr.800 = "14")

*3 Vector control (Pr.800 = "5")

NOTE

- Switching between the speed control and the torque control is always enabled regardless of the motor status: in a stop, in running, or in DC injection brake (during pre-excitation).
- During operation, the control mode is switched between speed control and position control or between torque control and position control when the output frequency reaches **Pr.865 Low speed detection** or lower with no position command given. Switching is disabled when either of the following signals is ON: Sudden stop (X87) signal (normally open input), Forward stroke end (LSP) signal (normally open input), or Reverse stroke end (LSN) signal (normally open input).
- Changing the terminal assignment using **Pr.178 to Pr.189 (Input terminal function selection)** may affect the other functions. Set parameters after confirming the function of each terminal.

Parameters referred to

Pr.178 to Pr.189 (Input terminal function selection) [page 410](#)

Pr.450 Second applied motor [page 424](#)

Pr.804 Torque command source selection [page 167](#)

Pr.807 Speed limit selection [page 171](#)

Pr.810 Torque limit input method selection [page 139](#)

Pr.858 Terminal 4 function assignment [page 397](#)

4.3 Selecting the Advanced magnetic flux vector control

Magnetic flux

Point

- To use the Advanced magnetic flux vector control, select the control method using **Pr.800**, and the motor type and specification using **Pr.71**, **Pr.80**, and **Pr.81**.

◆ Advanced magnetic flux vector control

Operating procedure

1. Perform wiring properly. (Refer to the Instruction Manual (Connection).)
2. Change the control method to Advanced magnetic flux vector control (**Pr.800** = "20").
3. Make the motor setting (**Pr.71**).
 - 100/200/400 V class

Motor	Pr.71 setting ^{*1}	Remarks	
Mitsubishi Electric standard efficiency motor Mitsubishi Electric high-efficiency motor	SF-JR	0 (initial value) (3)	
	SF-JR 4P 1.5 kW or lower	20	
	SF-HR	40	
	Others	0 (3)	Offline auto tuning is required. ^{*2}
Mitsubishi Electric constant-torque motor	SF-JRCA 4P	10	
	SF-HRCA	50	
	Other (SF-JRC, etc.)	10 (13)	Offline auto tuning is required. ^{*2}
Mitsubishi Electric high-performance energy-saving motor	SF-PR	70 (73)	
Mitsubishi Electric geared motor (constant-torque)	GM-[]	1800 (1803)	
Other manufacturer's standard motor	—	0 (3)	Offline auto tuning is required. ^{*2}
Other manufacturer's constant-torque motor	—	10 (13)	Offline auto tuning is required. ^{*2}

- 575 V class

Motor	Pr.71 setting ^{*1}	Remarks
Standard motor	0 (initial value) (3)	
Constant-torque motor	10	Offline auto tuning is required. ^{*2}
Other manufacturer's standard motor	0 (3)	Offline auto tuning is required. ^{*2}
Other manufacturer's constant-torque motor	10 (13)	Offline auto tuning is required. ^{*2}

*1 For the other setting values of **Pr.71**, refer to [page 424](#).

*2 For offline auto tuning, refer to [page 430](#).

4. Set the motor overheat protection (**Pr.9**). (Refer to [page 306](#).)
5. Set the motor capacity and number of motor poles (**Pr.80**, **Pr.81**). (Refer to [page 115](#).)
Operation does not start when the setting value is "9999" (initial value).
6. Set the rated motor voltage and frequency (**Pr.83**, **Pr.84**). (Refer to [page 430](#).)
7. Set the operation command. (Refer to [page 280](#).)
Select the start command and speed command.
8. Perform the test operation.

As required

- Perform the offline auto tuning (**Pr.96**). (Refer to [page 430](#).)
- Select the online auto tuning (**Pr.95**). (Refer to [page 449](#).)

NOTE

- To perform driving in a better accuracy, perform offline auto tuning, then set the online auto tuning, and select Real sensorless vector control.
- Under this control, rotations are more likely to be uneven than under V/F control. (This control method is not suitable for grinder, wrapping machine, etc., which require even rotation at a low speed.)
- When the inverter is operated with a surge voltage suppression filter (FR-ASF-H/FR-BMF-H) installed between the inverter and the motor, the output torque may decrease.

◆ Keeping the motor speed constant when the load fluctuates (speed control gain)

Pr.	Name	Initial value	Setting range	Description
89 G932	Speed control gain (Advanced magnetic flux vector)	9999	0% to 200%	Makes adjustments to keep the motor speed constant during variable load operation under Advanced magnetic flux vector control. The reference value is 100%.
			9999	The gain set by Pr.71 . (The gain set in accordance with the motor.)
569 G942	Second motor speed control gain	9999	0% to 200%	Makes adjustments to keep the second motor speed constant during variable load operation under Advanced magnetic flux vector control. The reference value is 100%.
			9999	The gain set by Pr.450 . (The gain set in accordance with the motor.)

- Use **Pr.89** to keep the motor speed constant during variable load operation. (This parameter is useful to make adjustments on the motor speed after replacing a conventional model with an FR-E800 series model.)

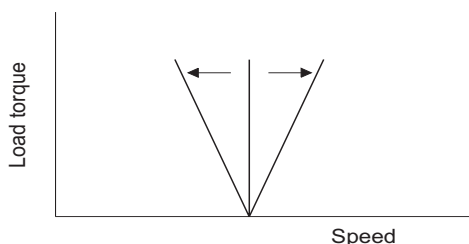

◆ Driving two motors under Advanced magnetic flux vector control

- Turning ON the Second function selection (RT) signal enables the second motor operation.
- Set a second motor in **Pr.450 Second applied motor**. (In the initial setting, "9999" (no second applied motor) is selected. Refer to [page 424](#).)

Function	RT signal-ON (second motor)	RT signal-OFF (first motor)
Applied motor	Pr.450	Pr.71
Motor capacity	Pr.453	Pr.80
Number of motor poles	Pr.454	Pr.81
Speed control gain (Advanced magnetic flux vector)	Pr.569	Pr.89
Control method selection	Pr.451	Pr.800

NOTE

- The RT signal is a Second function selection signal. The RT signal also enables other second functions. (Refer to [page 418](#).) To input the RT signal, set "3" in any parameter from **Pr.178 to Pr.189 (Input terminal function selection)** to assign the function.
- Changing the terminal assignment using **Pr.178 to Pr.189 (Input terminal function selection)** may affect the other functions. Set parameters after confirming the function of each terminal.

Parameters referred to

Pr.71, Pr.450 Applied motor [page 424](#)
Pr.800, Pr.451 Control method selection [page 115](#)

4.4 Selecting the PM sensorless vector control

PM

Two methods of the motor parameter initialization are available for the use of MM-GKR or EM-A motor: using **Pr.998 PM parameter initialization**, and using PM parameter initialization ("PM").

◆ Initializing the parameters required for the PM sensorless vector control (Pr.998)

- Use PM parameter initialization to set the parameters required for driving a PM motor.
- The offline auto tuning enables the operation with a PM motor other than the MM-GKR or EM-A. (Refer to [page 430](#).)
- All the parameters required for PM motor control are automatically set by setting **Pr.998** ≠ "0".

Pr.	Name	Initial value	Setting range	Description	
998 E430	PM parameter initialization	0	0	Parameter setting (in frequencies) for an induction motor	The setting of the motor parameters is changed to the setting required to drive an induction motor.
			3024* ¹	Parameter setting (in rotations per minute) for an MM-GKR motor	The setting of the motor parameters is changed to the setting required to drive a PM motor.
			3044* ²	Parameter setting (in rotations per minute) for an EM-A motor	
			3124* ¹	Parameter setting (in frequencies) for an MM-GKR motor	
			3144* ²	Parameter setting (in frequencies) for an EM-A motor	
			8009	Parameter setting (in rotations per minute) for an IPM motor (after tuning)	The setting of the motor parameters is changed to the setting required to drive an IPM motor. (Set Pr.71 Applied motor and perform offline auto tuning in advance. (Refer to page 441 .)
			8109	Parameter setting (in frequencies) for an IPM motor (after tuning)	
			9009	Parameter setting (in rotations per minute) for an SPM motor (after tuning)	The setting of the motor parameters is changed to the setting required to drive an SPM motor. (Set Pr.71 Applied motor and perform offline auto tuning in advance. (Refer to page 441 .)
			9109	Parameter setting (in frequencies) for an SPM motor (after tuning)	

*1 The value can be set in either of the following conditions.
 The FR-E820-0080(1.5K) or lower, the FR-E820S-0080(1.5K) or lower, or FR-E810W-0050(0.75K) or lower is used and **Pr.80** ≤ 0.75 kW.
 The FR-E820-0050(0.75K) or lower, the FR-E820S-0050(0.75K) or lower, or FR-E810W-0050(0.75K) or lower is used and **Pr.80** = "9999".

*2 The value can be set in any of the following conditions.
 The FR-E820-0470(11K) or lower is used and **Pr.80** ≤ 7.5 kW.
 The FR-E820-0330(7.5K) or lower is used and **Pr.80** = "9999".
 The FR-E840-0230(11K) or lower is used and **Pr.80** = 0.4 to 7.5 kW.
 The FR-E840-0170(7.5K) or lower is used and **Pr.80** = "9999".
 The FR-E820S-0110(2.2K) or lower is used and **Pr.80** ≤ 2.2 kW.
 The FR-E820S-0110(2.2K) or lower is used and **Pr.80** = "9999".
 The FR-E810W-0050(0.75K) or lower is used and **Pr.80** ≤ 0.75 kW.
 The FR-E810W-0050(0.75K) or lower is used and **Pr.80** = "9999".
 The FR-E846-0095(3.7K) or lower is used and **Pr.80** = 2.2 or 3.7 kW.
 The FR-E846-0060(2.2K) or FR-E846-0095(3.7K) is used and **Pr.80** = "9999".

- To use a motor capacity that is one rank lower than the inverter capacity, set **Pr.80 Motor capacity** before performing PM parameter initialization.
- When "3024, 3044, 8009, or 9009" is set in **Pr.998**, the motor speed which was set/monitored in frequencies is set/monitored in motor rotations per minute. To set/monitor in frequencies, set "3124, 3144, 8109, or 9109" in **Pr.998**.
- Set **Pr.998** = "0" to change the PM sensorless vector control parameter settings to the parameter settings required to drive an induction motor.
- When using a PM motor other than the MM-GKR or EM-A, set "8009, 8109, 9009, or 9109" in **Pr.998**.

NOTE

- Make sure to set **Pr.998** before setting other parameters. If the **Pr.998** setting is changed after setting other parameters, some of those parameters are initialized too. (Refer to the "List of the target parameters for the motor parameter initialization".)
- To change back to the parameter settings required to drive an induction motor, perform Parameter clear or All parameter clear.
- Whenever the setting of **Pr.998 PM parameter initialization** is changed from "3024, 3044, 8009, or 9009 (rotations per minute)" to "3124, 3144, 8109, or 9109 (frequency)", and vice versa, all the relevant parameters are initialized.
The purpose of Pr.998 is not to change the display units. Use **Pr.53 Frequency / rotation speed unit switchover** to change the display units between rotations per minute and frequency. Using **Pr.53** enables switching the unit between rotations per minute and frequencies without initializing the setting of the motor parameters.
- The PM parameter initialization (**Pr.998**) changes parameter settings for the first motor. When a PM motor is used as the second motor, parameters for the second motor must be set individually.

◆ List of the target parameters for the motor parameter initialization

- The settings of the parameters in the following table are changed to the settings for PM sensorless vector control by performing the motor parameter initialization using **Pr.998 PM parameter initialization**. The changed settings differ according to the specification (capacity) of the PM motor used.
- Performing Parameter clear or All parameter clear resets these parameter settings to the settings required to drive an induction motor.
- PM motor (MM-GKR, EM-A)

Pr.	Name	Setting						Setting increments	
		Induction motor		PM motor (rotations per minute)		PM motor (frequency)		3024, 3044	0, 3124, 3144
		0 (initial value) ^{*1}		3024 (MM-GKR)	3044 (EM-A)	3124 (MM-GKR)	3144 (EM-A)		
Gr.1	Gr.2								
1	Maximum frequency	120 Hz		Maximum motor rotations per minute ^{*2}		Maximum motor frequency ^{*2}		1 r/min	0.01 Hz
4	Multi-speed setting (high speed)	60 Hz	50 Hz	Rated motor rotations per minute ^{*2}		Rated motor frequency ^{*2}		1 r/min	0.01 Hz
9	Electronic thermal O/L relay	Inverter rated current		Rated motor current ^{*2}				0.01 A	
10	DC injection brake operation frequency	3 Hz		Rated motor rotations per minute ^{*2} × 3%		Rated motor frequency ^{*2} × 3%		1 r/min	0.01 Hz
13	Starting frequency	0.5 Hz		Rated motor rotations per minute ^{*2} × 0.5%		Rated motor frequency ^{*2} × 0.5%		1 r/min	0.01 Hz
15	Jog frequency	5 Hz		Rated motor rotations per minute ^{*2} × 10%		Rated motor frequency ^{*2} × 10%		1 r/min	0.01 Hz
18	High speed maximum frequency	120 Hz		Maximum motor rotations per minute ^{*2}		Maximum motor frequency ^{*2}		1 r/min	0.01 Hz
20	Acceleration/deceleration reference frequency	60 Hz	50 Hz	Rated motor rotations per minute ^{*2}		Rated motor frequency ^{*2}		1 r/min	0.01 Hz
22	Stall prevention operation level	150% ^{*4}		200%				0.1%	
42	Output frequency detection	6 Hz		Rated motor rotations per minute ^{*2} × 6%		Rated motor frequency ^{*2} × 6%		1 r/min	0.01 Hz
53	Frequency / rotation speed unit switchover	0		1		0		1	
55	Frequency monitoring reference	60 Hz	50 Hz	Rated motor rotations per minute ^{*2}		Rated motor frequency ^{*2}		1 r/min	0.01 Hz
56	Current monitoring reference	Inverter rated current		Rated motor current ^{*2}				0.01 A	
71	Applied motor	0		540	1140	540	1140	1	
72	PWM frequency selection	1		8				1	
80	Motor capacity	9999		Applicable motor capacity (ND) ^{*5}				0.01 kW	
81	Number of motor poles	9999		Number of motor poles ^{*2}				1	
84	Rated motor frequency	9999		Rated motor rotations per minute ^{*2}		Rated motor frequency ^{*2}		1 r/min	0.01 Hz
125 (903)	Terminal 2 frequency setting gain frequency	60 Hz	50 Hz	Rated motor rotations per minute ^{*2}		Rated motor frequency ^{*2}		1 r/min	0.01 Hz

Pr.	Name	Setting						Setting increments	
		Induction motor		PM motor (rotations per minute)		PM motor (frequency)		3024, 3044	0, 3124, 3144
		0 (initial value) ^{*1}		3024 (MM-GKR)	3044 (EM-A)	3124 (MM-GKR)	3144 (EM-A)		
Gr.1	Gr.2								
126 (905)	Terminal 4 frequency setting gain frequency	60 Hz	50 Hz	Rated motor rotations per minute ^{*2}		Rated motor frequency ^{*2}		1 r/min	0.01 Hz
240	Soft-PWM operation selection	1		0				1	
374	Overspeed detection level	9999		Maximum motor rotations per minute ^{*2} × 115%		Maximum motor frequency ^{*2} × 115%		1 r/min	0.01 Hz
386 ^{*6}	Frequency for maximum input pulse	60 Hz	50 Hz	Rated motor rotations per minute ^{*2}		Rated motor frequency ^{*2}		1 r/min	0.01 Hz
390	% setting reference frequency	60 Hz	50 Hz	Rated motor rotations per minute ^{*2}		Rated motor frequency ^{*2}		1 r/min	0.01 Hz
422	Position control gain	10		20				1 s ⁻¹	
505	Speed setting reference	60 Hz	50 Hz	—				0.01 Hz	
511	Home position return shifting speed	0.5 Hz		Rated motor rotations per minute ^{*2} × 50%		Rated motor frequency ^{*2} × 50%		1 r/min	0.01 Hz
557	Current average value monitor signal output reference current	Inverter rated current		Rated motor current ^{*2}				0.01 A	
665	Regeneration avoidance frequency gain	100.0%		100.0%	80.0%	100.0%	80.0%	0.1%	
800	Control method selection	40		10				1	
820	Speed control P gain 1	60%		100%	30%	100%	30%	1%	
821	Speed control integral time 1	0.333 s		0.200 s	0.333 s	0.200 s	0.333 s	0.001 s	
824	Torque control P gain 1 (current loop proportional gain)	100%		200% / 150% ^{*3}	150%	200% / 150% ^{*3}	150%	1%	
825	Torque control integral time 1 (current loop integral time)	5 ms		2.5 ms / 6.7 ms ^{*3}	6.7 ms	2.5 ms / 6.7 ms ^{*3}	6.7 ms	0.1 ms	
865	Low speed detection	1.5 Hz		Rated motor rotations per minute ^{*2} × 2.5%		Rated motor frequency ^{*2} × 2.5%		1 r/min	0.01 Hz
870	Speed detection hysteresis	0 Hz		Rated motor rotations per minute ^{*2} × 0.5%		Rated motor frequency ^{*2} × 0.5%		1 r/min	0.01 Hz
885	Regeneration avoidance compensation frequency limit value	6 Hz		Rated motor rotations per minute ^{*2} × 6%		Rated motor frequency ^{*2} × 6%		1 r/min	0.01 Hz
893	Energy saving monitor reference (motor capacity)	Applicable motor capacity		Motor capacity (Pr.80)				0.01 kW	
C14 (918) ^{*6}	Terminal 1 gain frequency (speed)	60 Hz	50 Hz	Rated motor rotations per minute ^{*2}		Rated motor frequency ^{*2}		1 r/min	0.01 Hz
1283	Home position return speed	2 Hz		Rated motor rotations per minute ^{*2} × 10%		Rated motor frequency ^{*2} × 10%		1 r/min	0.01 Hz

—: Not changed

*1 Gr.1 and Gr.2 are the parameter initial value groups. (Refer to page 54.)

*2 When "9999" is set in the corresponding parameter, the value shown in the following table is used. When a value other than "9999" is set, the set value is used without change.

	MM-GKR	EM-A		Corresponding parameter
		0.75 kW or lower	1.5 kW or higher	
Rated motor rotations per minute (frequency)	3000 r/min (250 Hz)	3000 r/min (100 Hz)	3000 r/min (150 Hz)	Pr.84
Maximum motor rotations per minute (frequency)	3000 r/min (250 Hz)	4000 r/min (133.33 Hz)	4000 r/min (200 Hz)	Pr.702
Number of motor poles	10	4	6	Pr.81
Rated motor current	Refer to the Instruction Manual (Connection).			Pr.859

*3 The value differs depending on the motor capacity (0.1 kW / others).

*4 120% for LD rating and 150% for ND rating (Refer to Pr.570 Multiple rating setting on page 235.)

*5 When a value other than "9999" is set in Pr.80, the set value is used without change.

*6 The setting is available only when the FR-E8AXY is installed.

- PM motor other than the MM-GKR or EM-A

Pr.	Name	Setting				Setting increments	
		Induction motor		PM motor (rotations per minute)	PM motor (frequency)		
		0 (initial value) ^{*1}		8009, 9009	8109, 9109	8009, 9009	0, 8109, 9109
Gr.1	Gr.2						
1	Maximum frequency	120 Hz		Maximum motor rotations per minute ^{*3}	Maximum motor frequency ^{*3}	1 r/min	0.01 Hz
4	Multi-speed setting (high speed)	60 Hz	50 Hz	Pr.84	Pr.84	1 r/min	0.01 Hz
9	Electronic thermal O/L relay	Inverter rated current		—	—	0.01 A	0.01 A
10	DC injection brake operation frequency	3 Hz		3 Hz ^{*4}	3 Hz	1 r/min	0.01 Hz
13	Starting frequency	0.5 Hz		Pr.84 × 10%	Pr.84 × 10%	1 r/min	0.01 Hz
15	Jog frequency	5 Hz		Pr.84 × 10%	Pr.84 × 10%	1 r/min	0.01 Hz
18	High speed maximum frequency	120 Hz		Maximum motor rotations per minute ^{*3}	Maximum motor frequency ^{*3}	1 r/min	0.01 Hz
20	Acceleration/deceleration reference frequency	60 Hz	50 Hz	Pr.84	Pr.84	1 r/min	0.01 Hz
22	Stall prevention operation level	150% ^{*2}		150% ^{*2}	150% ^{*2}	0.1%	0.1%
42	Output frequency detection	6 Hz		6 Hz ^{*4}	6 Hz	1 r/min	0.01 Hz
53	Frequency / rotation speed unit switchover	0		1	0	1	1
55	Frequency monitoring reference	60 Hz	50 Hz	Pr.84	Pr.84	1 r/min	0.01 Hz
56	Current monitoring reference	Inverter rated current		Pr.859	Pr.859	0.01 A	0.01 A
71	Applied motor	0		—	—	1	1
72	PWM frequency selection	1		2	2	1	1
80	Motor capacity	9999		—	—	0.01 kW	0.01 kW
81	Number of motor poles	9999		—	—	1	1
84	Rated motor frequency	9999		—	—	1 r/min	0.01 Hz
125 (903)	Terminal 2 frequency setting gain frequency	60 Hz	50 Hz	Pr.84	Pr.84	1 r/min	0.01 Hz
126 (905)	Terminal 4 frequency setting gain frequency	60 Hz	50 Hz	Pr.84	Pr.84	1 r/min	0.01 Hz
240	Soft-PWM operation selection	1		0	0	1	1
374	Overspeed detection level	9999		Maximum motor rotations per minute + 10 Hz ^{*3*4}	Maximum motor frequency + 10 Hz ^{*3}	1 r/min	0.01 Hz
386 ^{*5}	Frequency for maximum input pulse	60 Hz	50 Hz	Pr.84	Pr.84	1 r/min	0.01 Hz
390	% setting reference frequency	60 Hz	50 Hz	Pr.84	Pr.84	1 r/min	0.01 Hz
422	Position control gain	10		10	10	1 s ⁻¹	1 s ⁻¹
505	Speed setting reference	60 Hz	50 Hz	—	—	0.01 Hz	0.01 Hz
511	Home position return shifting speed	0.5 Hz		0.5 Hz ^{*4}	0.5 Hz	1 r/min	0.01 Hz
557	Current average value monitor signal output reference current	Inverter rated current		Pr.859	Pr.859	0.01 A	0.01 A
665	Regeneration avoidance frequency gain	100.0%		100.0%	100.0%	0.1%	0.1%
800	Control method selection	40		10	10	1	1
820	Speed control P gain 1	60%		30%	30%	1%	1%
821	Speed control integral time 1	0.333 s		0.333 s	0.333 s	0.001 s	0.001 s
824	Torque control P gain 1 (current loop proportional gain)	100%		100%	100%	1%	1%
825	Torque control integral time 1 (current loop integral time)	5 ms		20 ms	20 ms	0.1 ms	0.1 ms
865	Low speed detection	1.5 Hz		1.5 Hz ^{*4}	1.5 Hz	1 r/min	0.01 Hz
870	Speed detection hysteresis	0 Hz		0.5 Hz ^{*4}	0.5 Hz	1 r/min	0.01 Hz
885	Regeneration avoidance compensation frequency limit value	6 Hz		Pr.84 × 10%	Pr.84 × 10%	1 r/min	0.01 Hz

Pr.	Name	Setting			Setting increments		
		Induction motor		PM motor (rotations per minute)			PM motor (frequency)
		0 (initial value) ^{*1}		8009, 9009	8109, 9109	8009, 9009	0, 8109, 9109
Gr.1	Gr.2						
893	Energy saving monitor reference (motor capacity)	Applicable motor capacity		Motor capacity (Pr.80)	Motor capacity (Pr.80)	0.01 kW	0.01 kW
C14 (918) ^{*5}	Terminal 1 gain frequency (speed)	60 Hz	50 Hz	Pr.84	Pr.84	1 r/min	0.01 Hz
1283	Home position return speed	2 Hz		2 Hz ^{*4}	2 Hz	1 r/min	0.01 Hz

—: Not changed

*1 Gr.1 and Gr.2 are the parameter initial value groups. (Refer to [page 54](#).)

*2 120% for LD rating and 150% for ND rating (Refer to **Pr.570 Multiple rating setting** on [page 235](#).)

*3 The **Pr.702 Maximum motor frequency** is used as the maximum motor frequency (rotations per minute). When **Pr.702** = "9999" (initial value), the **Pr.84 Rated motor frequency** is used as the maximum motor frequency (rotations per minute).

*4 The setting value is converted from frequency to rotations per minute. (It differs according to the number of motor poles.)

*5 The setting is available only when the FR-E8AXY is installed.

NOTE

- When the motor parameter initialization is performed with the setting in units of rotations per minute (**Pr.998** = "3024, 3044, 8009, or 9009"), the parameters not listed in the table and the monitor items are also set and displayed in rotations per minute.

◆ Setting for the PM sensorless vector control by selecting PM parameter initialization on the operation panel ("PM")

Point

- The parameters required to drive a PM motor (MM-GKR or EM-A) are automatically set by batch. (Refer to [page 124](#).)
- The PM LED on the operation panel turns ON when the PM sensorless vector control is set.

The following shows the procedure to initialize the parameter settings for an MM-GKR motor by selecting PM parameter initialization on the operation panel.

Operating procedure

- 1.** Turning ON the power of the inverter
The operation panel is in the monitor mode.
- 2.** Changing the operation mode
Press the PU/EXT key to choose the PU operation mode.
The PU LED turns ON.
- 3.** Selecting the parameter setting mode
Press the MODE key to choose the parameter setting mode.
The PRM LED is ON.
- 4.** PM parameter initialization
Turn the setting dial or press the UP/DOWN key until "PM" (PM parameter initialization) appears.
- 5.** Displaying the set value
Press the SET key to read the present set value.
The value set in **Pr.998** is displayed.
- 6.** Changing the setting value
Turn the setting dial or press the UP/DOWN key to change the value to "3024", and the SET key to confirm it.
"3024" and "PM" are displayed alternately. The setting is completed.

Setting	Description
0 (initial value)	Parameter setting (in frequencies) for an induction motor
3024	Parameter setting (in rotations per minute) for an MM-GKR motor
3044	Parameter setting (in rotations per minute) for an EM-A motor

NOTE

- If the motor parameter initialization is performed by using PM parameter initialization for the use of a PM motor, the setting of **Pr.998 PM parameter initialization** is also changed automatically.
- In the initial parameter setting, the capacity same as the inverter capacity is set in **Pr.80 Motor capacity**. To use a motor capacity that is one rank lower than the inverter capacity, set **Pr.80** before performing PM parameter initialization.
- Use **Pr.998** to set a speed by adjusting frequencies or to monitor it, or to drive a PM motor other than the MM-GKR or EM-A. (Refer to [page 123](#).)

◆ Setting for the V/F control by selecting PM parameter initialization on the operation panel ("PM")

Point

- When the control method is changed from PM sensorless vector control to V/F control, all the parameter settings required to drive an induction motor are automatically set. (Refer to [page 124](#).)

The following shows the procedure to change the control method from PM sensorless vector control to V/F control by selecting PM parameter initialization on the operation panel.

Operating procedure

- 1.** Turning ON the power of the inverter
The operation panel is in the monitor mode.
- 2.** Changing the operation mode
Press the PU/EXT key to choose the PU operation mode.
The PU LED turns ON.
- 3.** Selecting the parameter setting mode
Press the MODE key to choose the parameter setting mode.
The PRM LED is ON.
- 4.** PM parameter initialization
Turn the setting dial or press the UP/DOWN key until "PM" (PM parameter initialization) appears.
- 5.** Displaying the set value
Press the SET key to read the present set value.
The value set in **Pr.998** is displayed.
- 6.** Changing the setting value
Turn the setting dial or press the UP/DOWN key to change the value to "0", and the SET key to confirm it.
"0" blinks. The setting is completed.

NOTE

- If PM parameter initialization is selected on the operation panel to set V/F control, the setting of **Pr.998 PM parameter initialization** is also changed automatically.
- The changed parameter settings are the same as those when **Pr.998 = "0"**.

MEMO

CHAPTER 5 Speed Control

5.1	Setting procedure of Real sensorless vector control (speed control)	135
5.2	Setting procedure of Vector control (speed control)	136
5.3	Setting procedure of PM sensorless vector control (speed control)	137
5.4	Setting the torque limit level.....	139
5.5	Performing high-accuracy, fast-response control (gain adjustment)	146
5.6	Speed feed forward control, model adaptive speed control.....	148
5.7	Torque bias.....	150
5.8	Avoiding motor overrunning.....	154
5.9	Troubleshooting in the speed control.....	156

5 Speed Control

Purpose	Parameter to set			Refer to page
To limit the torque during speed control	Torque limit	P.H500, P.H700 to P.H704, P.H710, P.H720, P.H721, P.H730, P.D030, P.T040, P.G210	Pr.22, Pr.801, Pr.803, Pr.810 to Pr.817, Pr.858, Pr.874	139
To adjust the speed control gain	Speed control P gain, speed control integral time	P.G211, P.G212, P.G311, P.G312	Pr.820, Pr.821, Pr.830, Pr.831	146
To improve the motor trackability for the speed command changes	Speed feed forward control, model adaptive speed control	P.G220 to P.G224, P.C114	Pr.828, Pr.877 to Pr.881	148
To stabilize the speed detection signal	Speed detection filter	P.G215, P.G315	Pr.823, Pr.833	557
To make starting torque start-up faster	Torque bias	P.G230 to P.G238	Pr.840 to Pr.848	150
To avoid motor overrunning	Speed deviation excess	P.H415 to P.H417, P.H881	Pr.285, Pr.690, Pr.853, Pr.873	154

This chapter explains the speed control under Real sensorless vector control, Vector control, and PM sensorless vector control. Speed control performs control so that the speed command and the actual motor rotation speed match.

◆ Control block diagram

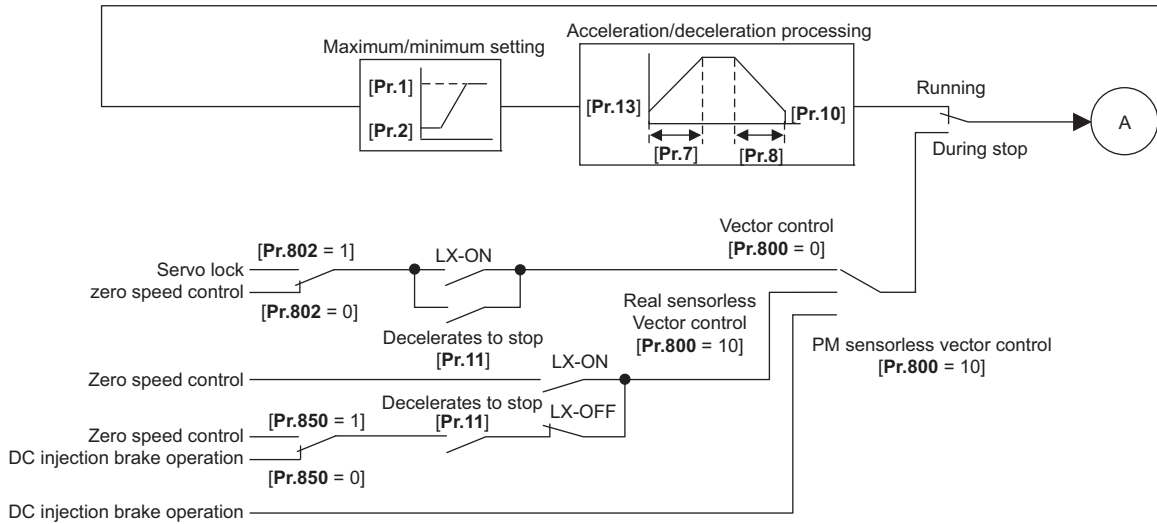
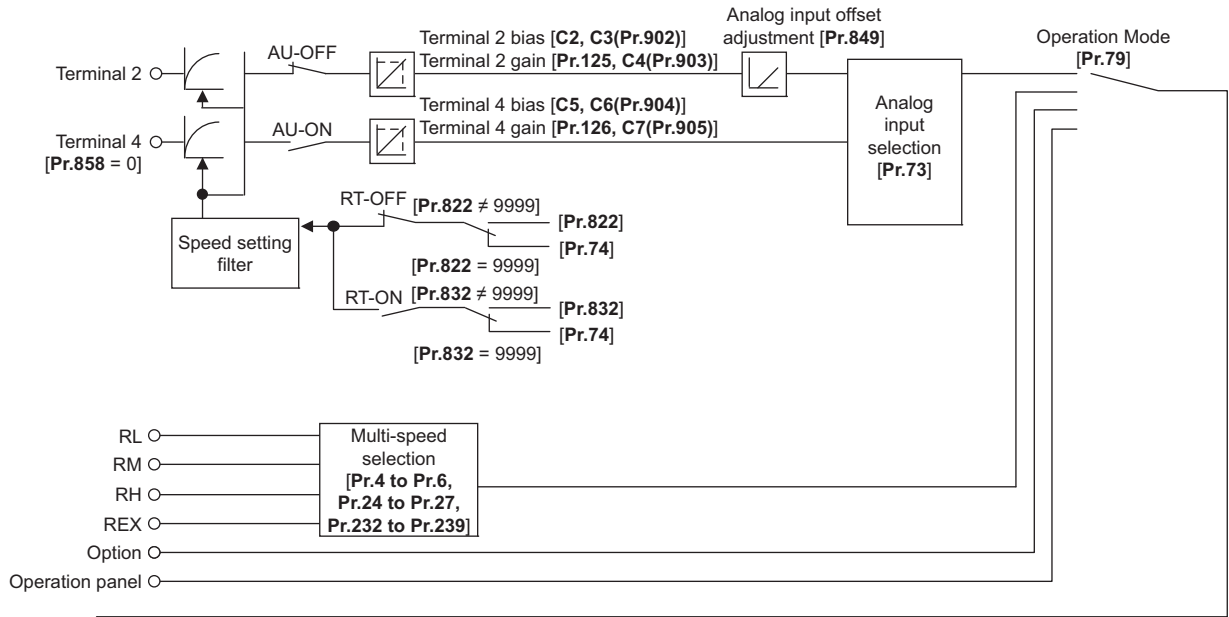

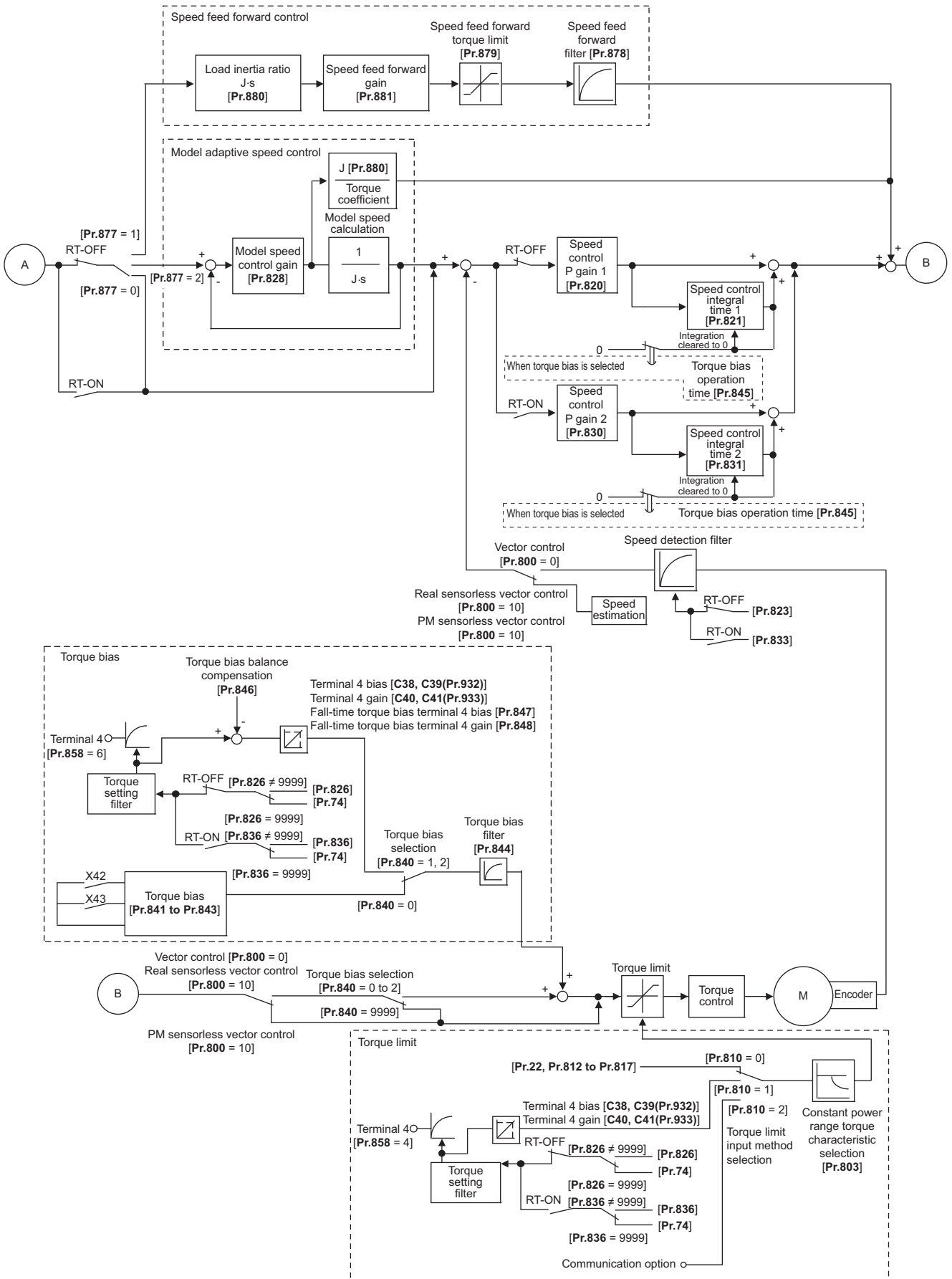

5.1 Setting procedure of Real sensorless vector control (speed control)

Sensorless

Operating procedure

1. Perform wiring properly. (Refer to the Instruction Manual (Connection).)
2. Set the applied motor (**Pr.71**). (Refer to [page 424](#).)
Set **Pr.71 Applied motor** to "0" (standard motor) or "10" (constant-torque motor).
3. Set the overheat protection of the motor (**Pr.9**). (Refer to [page 306](#).)
4. Set the motor capacity and number of motor poles (**Pr.80, Pr.81**). (Refer to [page 115](#).)
Operation does not start when the setting value is "9999" (initial value).
5. Set the rated motor voltage and the rated motor frequency (**Pr.83, Pr.84**). (Refer to [page 430](#).)
6. Select the control method (**Pr.800**). (Refer to [page 115](#).)
Select **Pr.800** = "10" (speed control) or "12" (speed/torque switchover) to enable speed control.
7. Set the operation command. (Refer to [page 280](#).)
Select the start command and speed command.
8. Set the torque limit (**Pr.810**). (Refer to [page 139](#).)
9. Perform the offline auto tuning (**Pr.96**). (Refer to [page 430](#).)
10. Perform the test operation.

As required

- Select online auto tuning (**Pr.95**). (Refer to [page 449](#).)
- Adjust the speed control gain manually. (Refer to [page 146](#).)

NOTE

- During Real sensorless vector control, offline auto tuning must be performed properly before starting operations.
- The speed command setting range under Real sensorless vector control is 0 to 400 Hz.
- The carrier frequency is limited during Real sensorless vector control. (Refer to [page 249](#).)
- Torque control is not available in a low-speed (about 10 Hz or lower) regenerative range, or with a low speed and light load (about 5 Hz or lower and rated torque about 20% or lower). Vector control must be selected.
- Performing pre-excitation (LX signal and X13 signal) under torque control may start the motor running at a low speed even when the start signal (STF or STR) is not input. This product with the start command ON may also rotate the motor at a low speed when the speed limit value is set to zero. Confirm that the motor running does not cause any safety problems before performing pre-excitation.
- Switching between the forward rotation command (STF) and reverse rotation command (STR) must not be performed during operations under torque control. An overcurrent trip (E.OCII) or opposite rotation deceleration fault (E.11) will occur.
- In case of starting the motor while the motor is coasting under Real sensorless vector control, the frequency search must be set for the automatic restart after instantaneous power failure function (**Pr.57** ≠ "9999", **Pr.162** = "10"). (Refer to [page 502](#).)
- When Real sensorless vector control is applied, there may not be enough torque provided in the ultra low-speed range of about 2 Hz or lower.

Generally, the speed control range is as follows.

For power driving, 1:200 (2, 4 or 6 poles) (available at 0.3 Hz or higher when the rating is 60 Hz), 1:30 (8 or 10 poles) (available at 2 Hz or higher when the rating is 60 Hz).

For regenerative driving, 1:12 (2 to 10 poles) (available at 5 Hz or higher when the rating is 60 Hz).

5.2 Setting procedure of Vector control (speed control)

Vector

Operating procedure

- 1.** Perform wiring properly. (Refer to the Instruction Manual (Connection).)
Install a Vector control compatible option.
- 2.** Set the applied motor and encoder (**Pr.71, Pr.359, Pr.369**). (Refer to [page 424](#), [page 452](#).)
- 3.** Set the overheat protection of the motor (**Pr.9**). (Refer to [page 306](#).)
When using the SF-V5RU or a motor equipped with a thermal sensor, set **Pr.9** = 0 A. For details on connecting a motor equipped with a thermal sensor, refer to the Instruction Manual (Connection).
- 4.** Set the motor capacity and number of motor poles (**Pr.80, Pr.81**). (Refer to [page 115](#).)
V/F control is performed when the setting is "9999" (initial value).
- 5.** Set the rated motor voltage and the rated motor frequency (**Pr.83, Pr.84**). (Refer to [page 430](#).)
- 6.** Select the control method (**Pr.800**). (Refer to [page 115](#).)
Select **Pr.800** = "0" (speed control), "2" (speed/torque switchover), or "4" (speed/position switchover) to enable speed control.
- 7.** Set the operation command. (Refer to [page 280](#).)
Select the start command and speed command.
- 8.** Set the torque limit (**Pr.810**). (Refer to [page 139](#).)
- 9.** Perform the test operation.

As required

- Perform offline auto tuning (**Pr.96**). (Refer to [page 430](#).)
- Select online auto tuning (**Pr.95**). (Refer to [page 449](#).)

NOTE

- Under Vector control, the magnetic flux observer is enabled to estimate or measure the flux within the motor using the current running through the motor and the inverter output voltage. This improves the torque accuracy since the flux of a motor can be accurately estimated and optimum characteristics can be obtained without being affected by temperature change in the second resistor.
 - The speed command setting range under Vector control is 0 to 400 Hz.
 - The carrier frequency is limited during Vector control. (Refer to [page 249](#).)
 - Vector control is not available for the IP67 model as plug-in options are not available.
-

5.3 Setting procedure of PM sensorless vector control (speed control)

PM

This inverter is set for an induction motor in the initial setting. Follow the following procedure to change the setting for the PM sensorless vector control.

◆ When using a PM motor (MM-GKR, EM-A)

Operating procedure

1. Perform wiring properly. (Refer to the Instruction Manual (Connection).)
2. Perform PM parameter initialization. (Refer to [page 123](#).)
Set "3024, 3044, 3124, or 3144" in **Pr.998 PM parameter initialization**, or select "PM" (PM parameter initialization) and set "3024 or 3044" on the operation panel.
To use a motor capacity that is one rank lower than the inverter capacity, set **Pr.80 Motor capacity** before performing PM parameter initialization.

Setting	Description
3024	Parameter setting (in rotations per minute) for an MM-GKR motor
3044	Parameter setting (in rotations per minute) for an EM-A motor
3124	Parameter setting (in frequencies) for an MM-GKR motor
3144	Parameter setting (in frequencies) for an EM-A motor

3. Set parameters such as the acceleration/deceleration time and multi-speed setting.
Set parameters such as the acceleration/deceleration time and multi-speed setting as required.
4. Set the operation command. (Refer to [page 280](#).)
Select the start command and speed command.
5. Perform the test operation.

NOTE

- To change to the PM sensorless vector control, perform PM parameter initialization first. If parameter initialization is performed after setting other parameters, some of those parameters are initialized too. (Refer to [page 124](#) for the parameters that are initialized.)
- The carrier frequency is limited during PM sensorless vector control. (Refer to [page 249](#).)
- During PM sensorless vector control, the RUN signal is output about 100 ms after turning ON the start command (STF, STR). The delay is due to the magnetic pole detection.
- When the wiring length from the inverter to the motor exceeds 30 m, perform offline auto tuning. (Refer to [page 441](#).)

◆ When using a PM motor (other than the MM-GKR or EM-A)

Operating procedure

1. Set the applied motor (**Pr.9**, **Pr.71**, **Pr.80**, **Pr.81**, **Pr.83**, and **Pr.84**). (Refer to [page 424](#), [page 441](#).)
Set "8093" (IPM motor) or "9093" (SPM motor) in **Pr.71 Applied motor**. Set **Pr.9 Rated motor current**, **Pr.80 Motor capacity**, **Pr.81 Number of motor poles**, **Pr.83 Rated motor voltage**, and **Pr.84 Rated motor frequency** according to the motor specifications. (Operation does not start when the setting values of **Pr.80** and **Pr.81** are "9999" (initial value).)
2. Select the PM sensorless vector control (**Pr.800**). (Refer to [page 115](#).)
The PM LED on the operation panel turns ON when the PM sensorless vector control is set by setting **Pr.800** = "10".
3. Perform the offline auto tuning for a PM motor (**Pr.96**). (Refer to [page 441](#).)
Set "1" (offline auto tuning without rotating motor) in **Pr.96**, and perform tuning.
4. Configure the initial setting for the PM sensorless vector control using **Pr.998**. (Refer to [page 123](#).)
When the setting for the PM motor is selected in **Pr.998 PM parameter initialization**, all the parameters required for PM sensorless vector control are automatically set.

Setting	Description
8009	Parameter settings (in rotations per minute) for an IPM motor
8109	Parameter settings (in frequencies) for an IPM motor
9009	Parameter settings (in rotations per minute) for an SPM motor
9109	Parameter settings (in frequencies) for an SPM motor

5. Set parameters such as the acceleration/deceleration time and multi-speed setting.
Set parameters such as the acceleration/deceleration time and multi-speed setting as required.
6. Set the operation command. (Refer to [page 280](#).)
Select the start command and speed command.
7. Perform the test operation.

NOTE

- To change to the PM sensorless vector control, perform PM parameter initialization after offline auto tuning. If parameter initialization is performed after setting other parameters, some of those parameters are initialized too. (Refer to [page 124](#) for the parameters that are initialized.)
- To use a motor capacity that is one rank lower than the inverter capacity, set **Pr.80 Motor capacity** before performing PM parameter initialization.
- The carrier frequency is limited during PM sensorless vector control. (Refer to [page 249](#).)
- The protective function may be activated due to insufficient torque in the low-speed range of 10% of the rated motor frequency or lower. The torque limit is not activated.
- During PM sensorless vector control, the RUN signal is output about 100 ms after turning ON the start command (STF, STR). The delay is due to the magnetic pole detection.

5.4 Setting the torque limit level

Sensorless Vector PM

Limit the output torque not to exceed the specified value.

The torque limit level can be set in a range of 0% to 400%. The TL signal can be used to switch between two types of torque limit.

The torque limit level can be selected by setting it with a parameter, or by using the analog input terminal (terminal 4). Also, the torque limit levels of forward rotation (power driving/regenerative driving) and reverse rotation (power driving/regenerative driving) can be set individually.

Pr.	Name	Initial value	Setting range	Description
22 H500	Stall prevention operation level (Torque limit level)	150% / 200% *1	0% to 400%	Set the torque limit level as a percentage with regards to the rated torque as 100%.
157 M430	OL signal output timer	0 s	0 to 25 s	Set the OL signal output start time at the activation of torque limit operation.
			9999	No OL signal output.
801 H704	Output limit level	9999	0% to 400%	Set the torque current limit level.
			9999	The torque limit setting value is used for limiting the torque current level.
803 G210	Constant output range torque characteristic selection	0	0	The torque rises in the low-speed range. The motor power output is limited to be constant in the constant power range.
			1	The torque is kept constant in the low-speed range. The torque is limited to be constant in the constant power range.
			2	The torque is kept constant in the low-speed range. (The torque current is limited.) The torque is limited to be constant in the constant power range unless the output limit of the torque current is reached. (The torque current is limited.)
			10	The torque is kept constant in the low-speed range. The motor power output is limited to be constant in the constant power range.
804 D400	Torque command source selection	0	0	Torque command given by analog input via terminal 4
			1	Torque limit by the parameter setting (Pr.805 or Pr.806) (-400% to 400%)
			3	Torque limit via communication *2
			4	The internal torque limit 2 cannot be used
			5	
			6	Torque limit via communication *2
805 D401	Torque command value (RAM)	1000%	600% to 1400%	Writes the torque limit value in RAM. Regards 1000% as 0%, and set torque command by an offset of 1000%.
806 D402	Torque command value (RAM, EEPROM)	1000%	600% to 1400%	Writes the torque limit value in RAM and EEPROM. Regards 1000% as 0%, and set torque command by an offset of 1000%.
810 H700	Torque limit input method selection	0	0	Internal torque limit 1 (torque limited by parameter settings)
			1	External torque limit (torque limited by terminal 4)
			2	Internal torque limit 2 (torque limited via communication) *2
811 D030	Set resolution switchover	0	0	Torque limit setting increments 0.1%
			10	Torque limit setting increments 0.01%
812 H701	Torque limit level (regeneration)	9999	0% to 400%	Set the torque limit level for forward rotation regenerative driving.
			9999	Limit using Pr.22 or the analog terminal values.
813 H702	Torque limit level (3rd quadrant)	9999	0% to 400%	Set the torque limit level for reverse rotation power driving.
			9999	Limit using Pr.22 or the analog terminal values.
814 H703	Torque limit level (4th quadrant)	9999	0% to 400%	Set the torque limit level for reverse rotation regenerative driving.
			9999	Limit using Pr.22 or the analog terminal values.
815 H710	Torque limit level 2	9999	0% to 400%	When the torque limit selection (TL) signal is ON, Pr.815 is the torque limit value regardless of Pr.810.
			9999	The torque limit set to Pr.810 is valid.

Pr.	Name	Initial value	Setting range	Description
816 H720	Torque limit level during acceleration	9999	0% to 400%	Set the torque limit value during acceleration.
			9999	The same torque limit as constant speed.
817 H721	Torque limit level during deceleration	9999	0% to 400%	Set the torque limit value during deceleration.
			9999	The same torque limit as constant speed.
858 T040	Terminal 4 function assignment	0	0, 4, 6, 9999	The torque limit level can be changed with setting value "4" and the signal to terminal 4.
874 H730	OLT level setting	150%	0% to 400%	The inverter can be set to be shut off at activation of torque limit and stalling of the motor. Set the output to be shut off.

*1 The initial value changes from 150% to 200% when the control method is changed from V/F control or Advanced magnetic flux vector control to Real sensorless vector control or Vector control in the FR-E820-0175(3.7K) or lower, FR-E840-0095(3.7K) or lower, FR-E860-0061(3.7K) or lower, FR-E820S-0110(2.2K) or lower, FR-E810W-0050(0.75K) or lower, and FR-E846-0095(3.7K) or lower.

*2 CC-Link communication is unavailable when the Vector control compatible option is installed or when the IP67 model is used. (For the details of the CC-Link communication, refer to the FR-A8NC E kit Instruction Manual. For details on communication protocols, refer to the Instruction Manual (Communication).)

NOTE

- The lower limit for the torque limit level under Real sensorless vector control is set to 30% even if a value lower than 30% is set.
- Under PM sensorless vector control, the torque limit is not activated in a low-speed range with a rated frequency of less than 10%.
- Under PM sensorless vector control, the torque limit level is reduced inversely proportional to the output frequency in the constant output range of the rated motor frequency or higher.

◆ Block diagram of torque limit

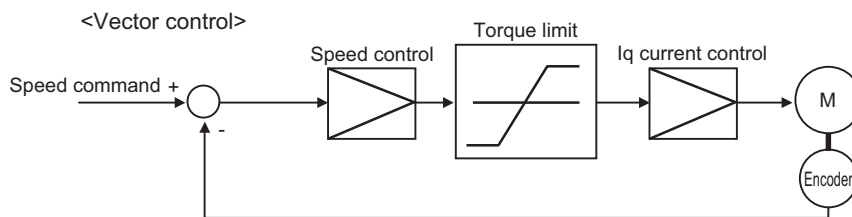

◆ Selecting the torque limit input method (Pr.810)

- Use **Pr.810 Torque limit input method selection** to select the method to limit the output torque for speed control. The method in the initial setting is use of the parameter settings.

Pr.810 setting	Torque limit input method	Operation
0 (initial value)	Internal torque limit 1	Perform the torque limit operation using the parameter (Pr.22, Pr.812 to Pr.814) settings. If changing the torque limit parameters via communication is enabled, the torque limit input can be performed via communication.
1	External torque limit	Torque limit using analog voltage (current) to terminal 4 is valid.
2	(Internal torque limit 2)	<ul style="list-style-type: none"> • The setting value of Pr.805 or Pr.806 is used as the torque limit value. • The torque limit via communication is enabled.

◆ Internal torque limit 1 (Pr.810 = "0", Pr.812 to Pr.814)

- The torque is limited by parameter setting
- In the initial value, a limit is applied to all quadrants by **Pr.22 Stall prevention operation level (Torque limit level)**.

- To set individually for each quadrant, use **Pr.812 Torque limit level (regeneration)**, **Pr.813 Torque limit level (3rd quadrant)**, **Pr.814 Torque limit level (4th quadrant)**. When "9999" is set, **Pr.22** setting is regarded as torque limit level in all the quadrants.

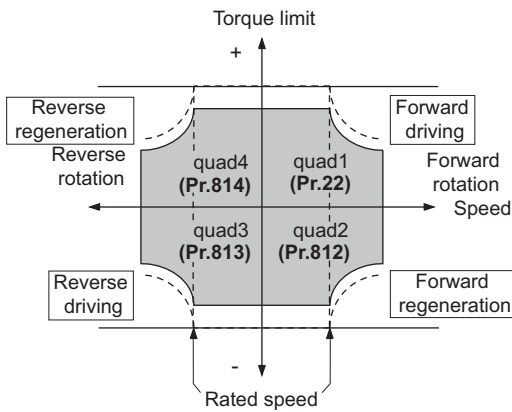

◆ Torque limit level using analog input (terminal 4) (Pr.810 = "1", Pr.858)

- The torque is limited with the analog input of terminal 4. (External torque limit)
- Torque limit using analog input is valid with a limit value lower than the internal torque limit (**Pr.22, Pr.812 to Pr.814**). (If the torque limit using analog input exceeds the internal torque limit, the internal torque limit is valid.)
- For inputting from terminal 4, set **Pr.858 Terminal 4 function assignment** = "4".
- The torque limit using analog input can be calibrated by the calibration parameters **C38 (Pr.932) to C41 (Pr.933)**. (Refer to [page 405](#).)

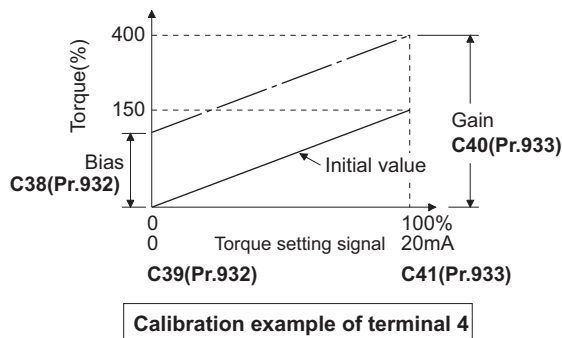

◆ Internal torque limit 2 (Pr.810 = "2", Pr.805, Pr.806)

- The setting value of **Pr.805** or **Pr.806** is used as the torque limit value.
- When the CC-Link, CC-Link IE TSN, or CC-Link IE Field Network Basic is used, the torque limit value can be input using a remote register (RWwC).

Pr.804 setting	Torque limit input	Setting range ^{*1}	Setting increments	Required condition
1	Torque limit by Pr.805, Pr.806 ^{*2}	600 to 1400	1%	FR-A8NC is installed, or CC-Link IE TSN or CC-Link IE Field Network Basic is used.
3	Torque limit by remote register (RWwC) ^{*3}	(-400% to 400%)		
5	Torque limit by remote register (RWwC) ^{*3}	-32768 to 32767 (two's complement)	0.01% ^{*4}	
6	Torque limit by Pr.805, Pr.806 ^{*2}	(-327.68% to 327.67%) ^{*4}		

*1 The torque limit setting is defined as an absolute value.
 *2 The torque limit value can also be set using the operation panel or parameter unit.
 *3 The torque can also be limited by setting a value in **Pr.805** or **Pr.806**.
 *4 On the operation panel or parameter unit, the setting range is "673 to 1327 (-327% to 327%)" and the setting increment is 1%.

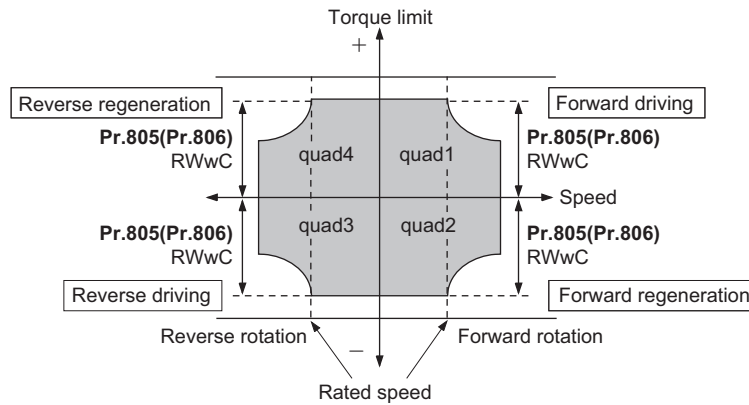

NOTE

- For the details of the CC-Link communication, refer to the FR-A8NC E kit Instruction Manual. For details on communication protocols, refer to the Instruction Manual (Communication).
- CC-Link communication is unavailable when the Vector control compatible option is installed or when the IP67 model is used.

◆ Second torque limit level (TL signal, Pr.815)

- For **Pr.815 Torque limit level 2**, when the Torque limit selection (TL) signal is ON, the setting value of **Pr.815** is the limit value regardless of the setting of **Pr.810 Torque limit input method selection**.
- To assign the TL signal, set "27" in any parameter from **Pr.178 to Pr.189 (Input terminal function selection)**.

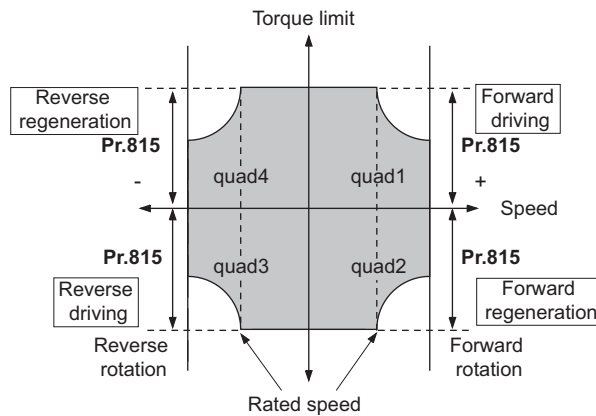

NOTE

- Changing the terminal assignment using **Pr.178 to Pr.189 (Input terminal function selection)** may affect the other functions. Set parameters after confirming the function of each terminal.

◆ Setting the torque limit values during acceleration/deceleration individually (Pr.816, Pr.817)

- The torque limit during acceleration and deceleration can be set individually. Torque limit using the setting values of **Pr.816 Torque limit level during acceleration** and **Pr.817 Torque limit level during deceleration** is as follows.
- If 1 second elapses while the difference between the set speed and rotation speed is within ± 2 Hz, the torque limit level during acceleration/deceleration (**Pr.816** or **Pr.817**) changes to the torque control level during constant speed (**Pr.22**).

- When the difference between the set speed and rotation speed is -2 Hz or less, the torque limit level during deceleration Torque limit level during deceleration (**Pr.817**) activates.

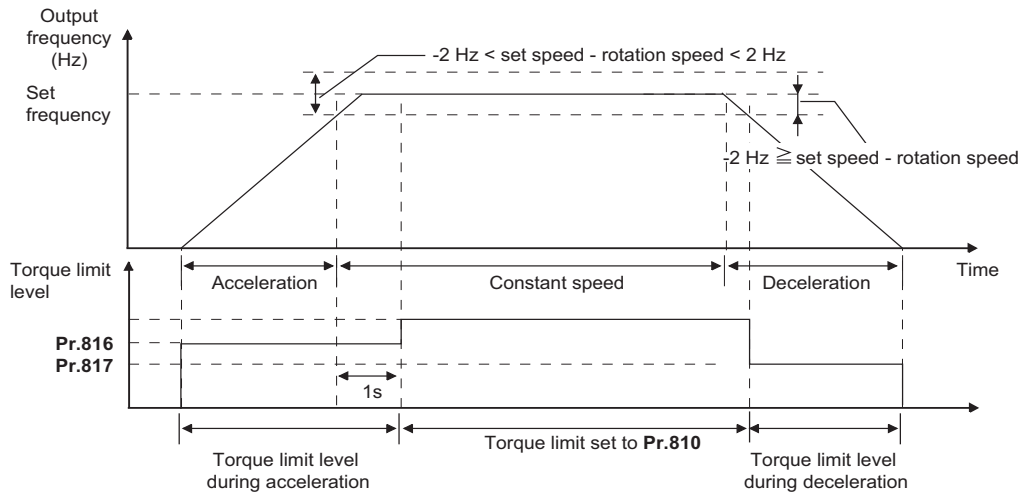

NOTE

- The **Pr.816** and **Pr.817** settings are invalid under position control.

◆ Changing the setting increments of the torque limit level (Pr.811)

- The setting increments of **Pr.22 Torque limit level**, **Pr.801 Output limit level**, and **Pr.812 to Pr.817 Torque limit level** can be changed to 0.01% by setting **Pr.811 Set resolution switchover** = "10".

Pr.811 setting	Torque limit setting increments
0 (initial value)	0.1%
10	0.01%

NOTE

- The internal resolution of the torque limit is 0.024% ($100/2^{12}$), and fractions below this resolution are rounded off.
- When Real sensorless vector control is selected, fractions below a resolution equivalent to 0.1% are rounded off even if **Pr.811** = "10" is set.

◆ Changing the torque characteristic of the constant-power range (Pr.801, Pr.803)

- For the torque limit operation, the torque characteristic can be changed between in the low-speed range and in the constant power range.

Pr.803 setting	Torque characteristic in low-speed range	Torque characteristic in constant-power range	
		Torque characteristic	Output limit
0 (initial value)	Torque rise	Constant motor output	—
1	Constant torque	Constant torque	Disabled
2	Constant torque	Constant torque	Enabled
10	Constant torque	Constant motor output	—

- To avoid overload or overcurrent of the inverter or motor, use **Pr.801 Output limit level** to limit the torque current.

Pr.801 setting	Description
0% to 400%	Set the torque current limit level.
9999	The torque limit setting value (Pr.22, Pr.812 to Pr.817, etc.) is used for limiting the torque current.

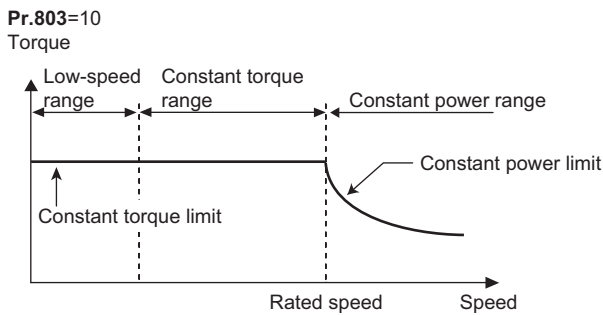
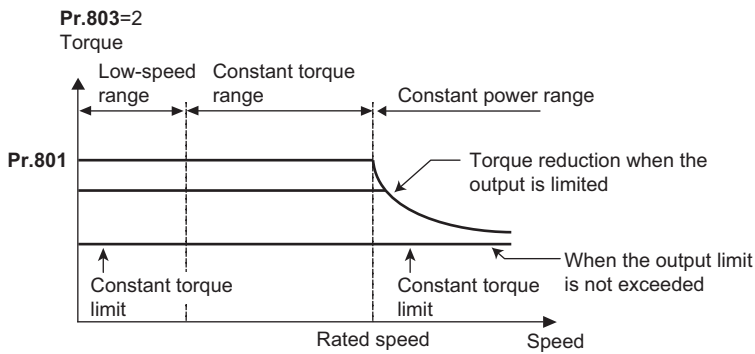
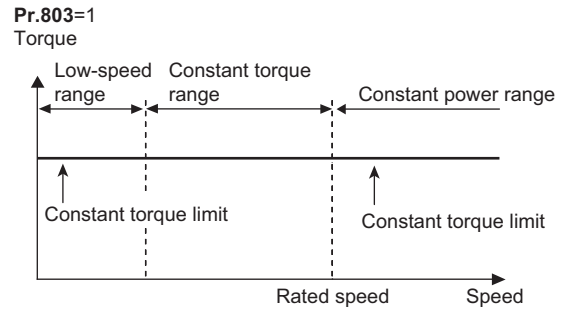
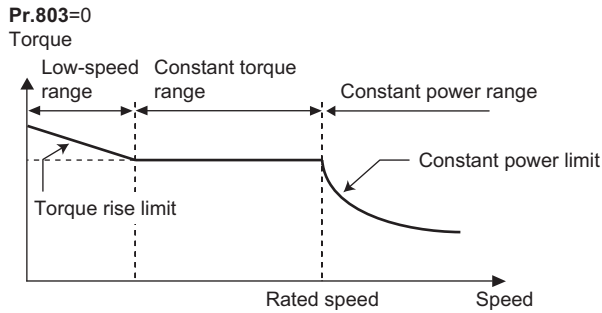

NOTE

- When the **Pr.801** setting value is less than the torque limit setting value (**Pr.22, Pr.812 to Pr.817, etc.**), the **Pr.801** setting is used for limiting the torque current.

◆ Trip during torque limit operation (Pr.874)

- The inverter can be set to be shut off at activation of torque limit and stalling of the motor.

- When a high load is applied and the torque limit is activated under speed control or position control, the motor stalls. At this time, if the rotation speed is lower than the value set in **Pr.865 Low speed detection** and the output torque exceeds the level set in **Pr.874 OLT level setting**, and this state continues for 3 seconds, Stall prevention stop (E.OLT) is activated and the inverter output is shut off.

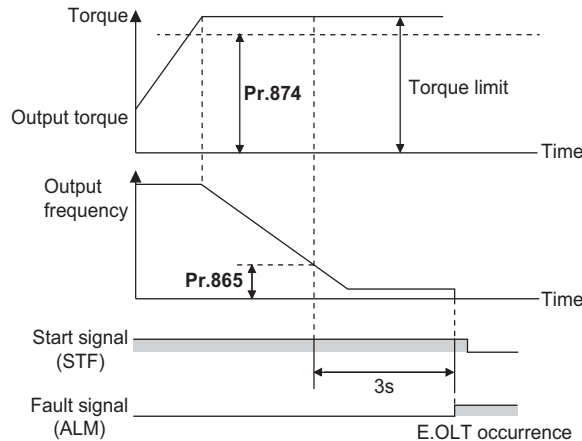

NOTE

- Under V/F control or Advanced magnetic flux vector control, if the output frequency drops to 1 Hz due to the stall prevention operation and this state continues for 3 seconds, a fault indication (E.OLT) appears, and the inverter output is shut off. This operation is activated regardless of the **Pr.874** setting.
- This fault does not occur under torque control.

◆ Adjusting the signal output under torque limit operation and output timing (OL signal, Pr.157)

- If the output torque exceeds the torque limit level and the torque limit is activated, the overload warning (OL signal) is turned ON for 100 ms or longer. When the output torque drops to the torque limit level or lower, the output signal also turns OFF.
- Pr.157 OL signal output timer** can be used to set whether to output the OL signal immediately, or whether to output it after a certain time period has elapsed.
- For the OL signal, set "3" (positive logic) or "103" (negative logic) in any parameter from **Pr.190 to Pr.197 (Output terminal function selection)** to assign the function to an output terminal.

Pr.157 setting value	Description
0 (initial value)	Output immediately.
0.1 to 25	Output after the set time (s).
9999	Not output.

- The OL signal is also output during the regeneration avoidance operation ("OLV" display (overvoltage stall)).

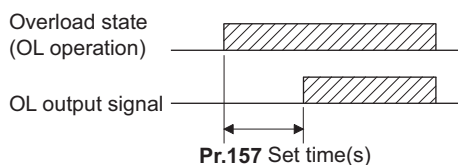

NOTE

- Changing the terminal assignment using **Pr.190 to Pr.197 (Output terminal function selection)** may affect the other functions. Set parameters after confirming the function of each terminal.

Parameters referred to

Pr.22 Stall prevention operation level [page 334](#)
 Pr.178 to Pr.189 (Input terminal function selection) [page 410](#)
 Pr.190 to Pr.197 (Output terminal function selection) [page 371](#)
 Pr.865 Low speed detection [page 382](#)

5.5 Performing high-accuracy, fast-response control (gain adjustment)

Sensorless Vector PM

Gain adjustment is useful for achieving optimum machine performance or improving unfavorable conditions, such as vibration and acoustic noise during operation with high load inertia or gear backlash.

Pr.	Name	Initial value	Setting range	Description
820 G211	Speed control P gain 1	60%	0% to 1000%	The proportional gain during speed control is set. (Setting this parameter higher improves the trackability for speed command changes. It also reduces the speed fluctuation caused by external disturbance.)
821 G212	Speed control integral time 1	0.333 s	0 to 20 s	The integral time during speed control is set. (Setting this parameter lower shortens the return time to the original speed when the speed fluctuates due to external disturbance.)
830 G311	Speed control P gain 2	9999	0% to 1000% 9999	Second function of Pr.820 (valid when RT signal is ON) The Pr.820 setting is applied to the operation.
831 G312	Speed control integral time 2	9999	0 to 20 s 9999	Second function of Pr.821 (enabled when the RT signal is ON) The Pr.821 setting is applied to the operation.
880 C114	Load inertia ratio	7 times	0 to 200 times	The load inertia ratio for the motor is set.

◆ Speed control gain adjustment

- The speed control gain can be adjusted for the conditions such as abnormal machine vibration, acoustic noise, slow response, and overshoot.
- Setting 60% (initial value) in **Pr.820 Speed control P gain 1** is equivalent to 120 rad/s (speed response of a single motor). (Equivalent to the half the rad/s value during Real sensorless vector control.) Setting this parameter higher speeds up the response, but setting this too high causes vibration and acoustic noise.
- Setting **Pr.821 Speed control integral time 1** lower shortens the return time to the original speed during speed fluctuation, but setting it too low causes overshoot.

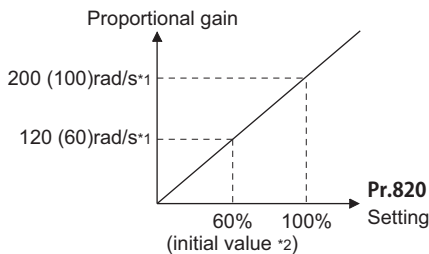

- *1 The value in the parentheses is applicable under Real sensorless vector control.
- *2 Performing PM parameter initialization changes the settings. (Refer to [page 123](#).)

- Actual speed gain is calculated as follows when load inertia is applied.

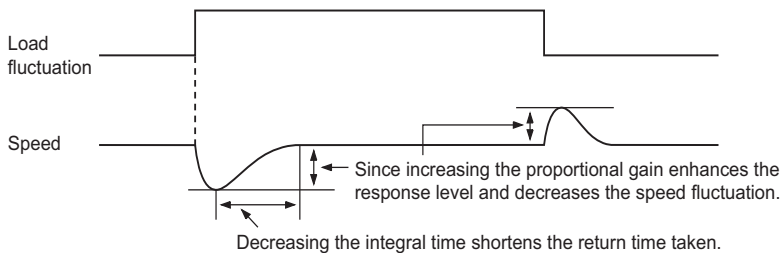

$$\text{Actual speed gain} = \text{Speed gain of a single motor} \times \frac{JM}{JM+JL}$$

JM: Motor inertia
JL: Load inertia converted as the motor axis inertia

◆ Adjustment procedure

1. Change the **Pr.820** setting while checking the conditions.
2. If it cannot be adjusted well, change **Pr.821** setting, and perform step 1 again.

No.	Movement / condition	Adjustment method
1	Load inertia is too high.	Set Pr.820 and Pr.821 higher.
		Pr.820 If acceleration is slow, raise the setting by 10% and then set the value to 80% to 90% of the setting immediately before vibration/noise starts occurring.
		Pr.821 If overshoots occur, set about 80% to 90% of the maximum value without overshooting while increasing the setting value by twice.
2	Vibration or acoustic noise are generated from machines.	Set Pr.820 lower and Pr.821 higher.
		Pr.820 Set about 80% to 90% of the maximum value without any vibration/noise while decreasing the setting value by 10%.
		Pr.821 If overshoots occur, set about 80% to 90% of the maximum value without overshooting while increasing the setting value by twice.
3	Response is slow.	Set Pr.820 higher.
		Pr.820 If acceleration is slow, set about 80% to 90% of the maximum value without any vibration/ acoustic noise while increasing the setting value by 5%.
4	Return time (response time) is long.	Set Pr.821 lower.
		Set about 80% to 90% of the maximum value without overshooting or unstable movements while decreasing the setting value of Pr.821 by half.
5	Overshoots or unstable movements occur.	Set Pr.821 higher.
		Set about 80% to 90% of the maximum value without overshooting or unstable movements while increasing the setting value of Pr.821 by twice.

NOTE

- **Pr.830 Speed control P gain 2** and **Pr.831 Speed control integral time 2** are valid when terminal RT is ON. In this case, replace them for **Pr.820** and **Pr.821** in the description above.

◆ When using a multi-pole motor (8 poles or more)

- If the motor inertia is known, set **Pr.707 Motor inertia (integer)** and **Pr.724 Motor inertia (exponent)**. (Refer to [page 430](#).)
- Under Real sensorless vector control or Vector control, adjust **Pr.820 Speed control P gain 1** and **Pr.824 Torque control P gain 1 (current loop proportional gain)** to suit the motor, by referring to the following methods.
- Setting the parameter of **Pr.820 Speed control P gain 1** higher speeds up the response, but setting this too high causes vibration and acoustic noise.
- Setting the parameter of **Pr.824 Torque control P gain 1 (current loop proportional gain)** too low causes current ripple, and a noise synchronous with this will be emitted from the motor.
- Adjustment method:

No.	Movement / condition	Adjustment method
1	Motor rotation speed in the low-speed range is unstable.	Pr.820 Speed control P gain 1 must be set higher according to the motor inertia. For multi-pole motors, because the inertia of the motor itself tends to be large, first perform broad adjustment to improve the unstable movements, and then perform fine adjustment by referring to the response level based on this setting.
2	Rotation speed trackability is poor.	Set Pr.820 Speed control P gain 1 higher. Raise the setting by 10% and set a value that approximately 80% to 90% of the setting right before vibration/noise starts occurring. If it cannot be adjusted well, double Pr.821 Speed control integral time 1 and perform the adjustment of Pr.820 again.
3	Large fluctuation of the rotation speed relative to load fluctuation.	Set the speed control gain higher. (The same as No.1.) If this cannot be prevented through gain adjustment, raise Pr.13 Starting frequency for a fault that occurs when starting, or shorten the acceleration time and avoid continuous operation in a low-speed range.
4	Torque shortage or motor backlash occurs when starting or passing a low-speed range under Real sensorless vector control.	Set the speed control gain higher. (The same as No.1.) If this cannot be prevented through gain adjustment, raise Pr.13 Starting frequency for a fault that occurs when starting, or shorten the acceleration time and avoid continuous operation in a low-speed range.
5	Unusual vibration, noise and overcurrent of the motor or machine occurs.	Set Pr.824 Torque control P gain 1 (current loop proportional gain) lower.
6	Overcurrent or overspeed (E.OS) occurs when starting under Real sensorless vector control.	Lower the setting by 10% and set a value that is approximately 80% to 90% of the setting immediately before the condition improves.

5.6 Speed feed forward control, model adaptive speed control

Sensorless Vector PM

- Speed feed forward control or model adaptive speed control can be selected using parameter settings. Under speed feed forward control, the motor trackability for speed command changes can be improved. Under model adaptive speed control, the speed trackability and the response level to motor external disturbance torque can be adjusted individually.
- Under PM sensorless vector control, speed feed forward control or model adaptive speed control is enabled only when the MM-GKR or EM-A motor is used.

Pr.	Name	Initial value	Setting range	Description
828 G224	Model speed control gain	100 rad/s	0 to 1000 rad/s	Set the gain for the model speed controller.
877 G220	Speed feed forward control/model adaptive speed control selection	0	0	Perform normal speed control.
			1	Perform speed feed forward control.
			2	Model adaptive speed control becomes valid.
878 G221	Speed feed forward filter	0.01 s	0.01 to 1 s	Set the primary delay filter for the result of the speed feed forward calculated from the speed command and load inertia ratio.
879 G222	Speed feed forward torque limit	150%	0% to 400%	Set a maximum limit for the speed feed forward torque.
880 C114	Load inertia ratio	7 times	0 to 200 times	Set the load inertia ratio for the motor.
881 G223	Speed feed forward gain	0%	0% to 1000%	Set the calculation result for speed feed forward as the gain.

◆ Speed feed forward control (Pr.877 = "1")

- When the load inertia ratio is set in **Pr.880**, the required torque for the set inertia is calculated according to the acceleration and deceleration commands, and the torque is generated quickly.
- When the speed feed forward gain is 100%, the calculation result for speed feed forward is applied as is.
- If the speed command changes suddenly, the torque is increased by the speed feed forward calculation. The maximum limit for the speed feed forward torque is set in **Pr.879**.
- The speed feed forward result can also be lessened with a primary delay filter in **Pr.878**.

[Block diagram]

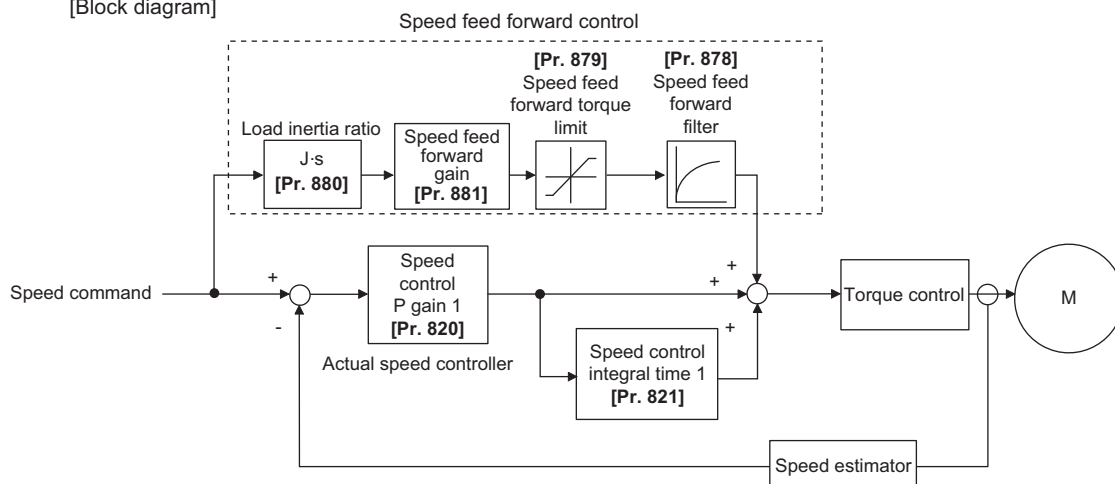

NOTE

- The speed feed forward control is enabled for the first motor.
- Even if the driven motor is switched to the second motor while **Pr.877 = "1"**, the second motor is operated as **Pr.877 = "0"**.

◆ Model adaptive speed control (Pr.877 = "2", Pr.828)

- The model speed of the motor is calculated, and the feedback is applied to the speed controller on the model side. Also, this model speed is set as the command of the actual speed controller.
- The inertia ratio of **Pr.880** is used when the speed controller on the model side calculates the torque current command value.
- The torque current command of the speed controller on the model side is added to the output of the actual speed controller, and set as the input of the i_q current control.

Pr.828 is used for the speed control on the model side (P control), and first gain **Pr.820** is used for the actual speed controller.

[Block diagram]

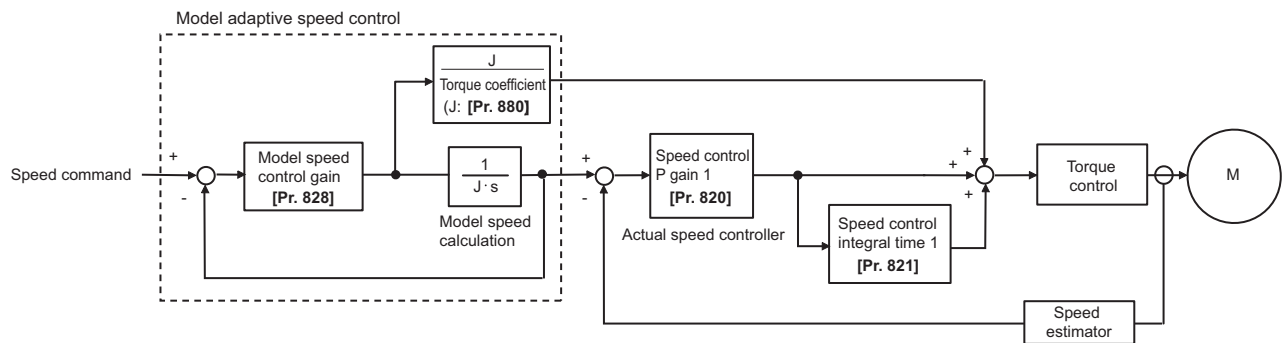

NOTE

- The model adaptive speed control is enabled for the first motor.
- Even if the driven motor is switched to the second motor while **Pr.877** = "2", the second motor is operated as **Pr.877** = "0".

5.7 Torque bias

Sensorless Vector

The torque bias function can be used to make the starting torque start-up faster. At this time, the motor starting torque can be adjusted with a contact signal or analog signal.

Pr.	Name	Initial value	Setting range	Description
840 G230	Torque bias selection	9999	0	Set the torque bias amount using contact signals (X42, X43) in Pr.841 to Pr.843 .
			1	Set the torque bias amount using terminal 4 in any of C38 to C41 . (When the squirrel cage rises during forward motor rotation.)
			2	Set the torque bias amount using terminal 4 in any of C38 to C41 . (When the squirrel cage rises during reverse motor rotation.)
			3	The torque bias amount using terminal 4 can be set automatically in C38 to C41 and Pr.846 according to the load.
			9999	No torque bias, rated torque 100%
841 G231	Torque bias 1	9999	600% to 999%	Negative torque bias amount (-400% to -1%)
842 G232	Torque bias 2		1000% to 1400%	Positive torque bias amount (0% to 400%)
843 G233	Torque bias 3		9999	No torque bias setting
844 G234	Torque bias filter	9999	0 to 5 s	The time until the torque starts up.
			9999	The same operation as 0 s.
845 G235	Torque bias operation time	9999	0 to 5 s	The time for retaining the torque of the torque bias amount.
			9999	The same operation as 0 s.
846 G236	Torque bias balance compensation	9999	0% to 100%	Set the input voltage/current at a balanced load in %, considering the full-scale value of the voltage input via terminal 4 as 100%.
			9999	The same operation as 0 V. (Fixed to 0 V/0%.)
847 G237	Fall-time torque bias terminal 4 bias	9999	0% to 400%	The bias value setting in the torque command.
			9999	The same as (C38, C39 (Pr.932)) when ascending
848 G238	Fall-time torque bias terminal 4 gain	9999	0% to 400%	The gain value setting in the torque command.
			9999	The same as (C40, C41 (Pr.933)) when ascending

◆ Block diagram

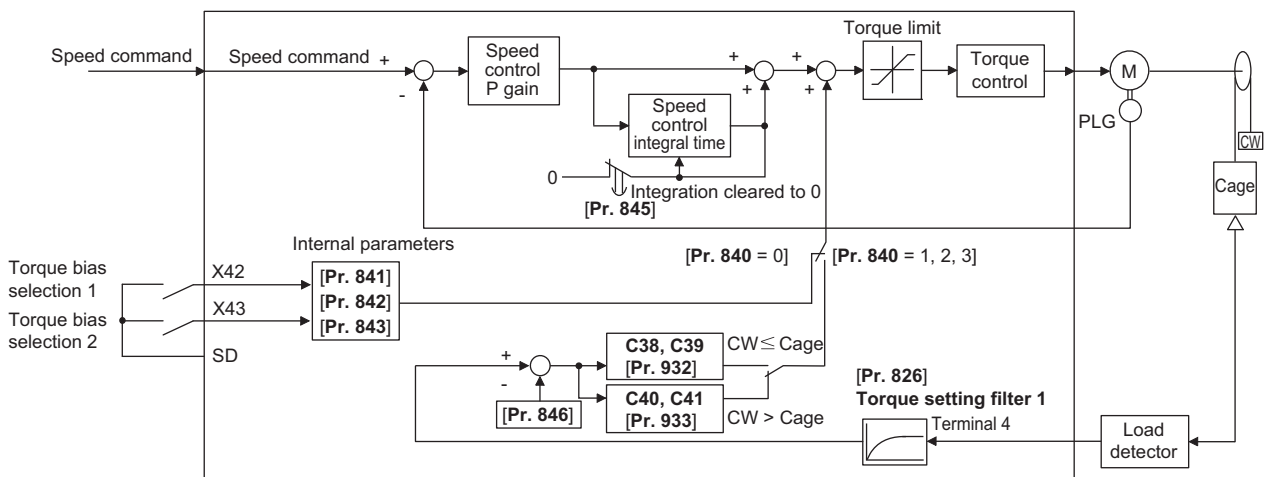

◆ Setting the torque bias amount using contact input (Pr.840 = "0", Pr.841 to Pr.843)

- Select the torque bias amount shown in the following table using the corresponding contact signal combination.

- To input the X42 signal, set "42" in any parameter from **Pr.178 to Pr.189 (Input terminal function selection)** to assign the function to a terminal, and to input the X43 signal, set "43".

Torque bias selection 1 (X42)	Torque bias selection 2 (X43)	Torque bias amount
OFF	OFF	0%
ON	OFF	Pr.841 -400% to +400% (Setting value: 600% to 1400%)
OFF	ON	Pr.842 -400% to +400% (Setting value: 600% to 1400%)
ON	ON	Pr.843 -400% to +400% (Setting value: 600% to 1400%)

Example) When **Pr.841** = "1025", the torque bias is 25%. When **Pr.842** = "975", the torque bias is -25%. When **Pr.843** = "925", the torque bias is -75%.

NOTE

- Changing the terminal assignment using **Pr.178 to Pr.189 (Input terminal function selection)** may affect the other functions. Set parameters after confirming the function of each terminal.

◆ Setting the torque bias amount using terminal 4 (Pr.840 = "1 or 2", Pr.847, Pr.848)

- Calculate the torque bias from the load input to terminal 4 as shown in the following diagram, and then apply the torque bias.
- To set the torque bias amount with a voltage input to terminal 4, set **Pr.858 Terminal 4 function assignment** = "6".
- The torque bias amount (**Pr.847**) and gain amount (**Pr.848**) when descending (reverse motor rotation when the **Pr.840** setting is "1", forward motor rotation when the setting is "2") can be set in a range of 0% to 400%. When **Pr.847** or **Pr.848** = "9999", the setting is the same for both descending and ascending (**C38 to C41**).

Pr.840 setting	When ascending	When descending
1	<p>(Forward motor rotation)</p>	<p>(Reverse motor rotation)</p>
2	<p>(Reverse motor rotation)</p>	<p>(Forward motor rotation)</p>

*1 When the LX signal is ON, the torque bias amount when ascending is applied regardless of the motor rotation direction.

*2 In **Pr.846**, set the input voltage/current at a balanced load in %, considering the full-scale value of the voltage input via terminal 4 as 100%.

Pr.267 setting	Terminal 4 input	Input voltage/current for the balanced load (Pr.846 = "50")
0	4 to 20 mA	20 mA × 50% = 10 mA
1	0 to 5 V	5 V × 50% = 2.5 V
2	0 to 10 V	10 V × 50% = 5 V

◆ Setting the torque bias amount automatically using terminal 4 (Pr.840 = "3", Pr.846)

- The settings of **C38 Terminal 4 bias command (torque)**, **C39 Terminal 4 bias (torque)**, **C40 Terminal 4 gain command (torque)**, **C41 Terminal 4 gain (torque)** and **Pr.846 Torque bias balance compensation** can be set automatically according to the load.
- To set the torque bias amount with a voltage input to terminal 4, set **Pr.858 Terminal 4 function assignment** = "6".
- Set the terminal 4 to accept input of load detection voltage, set "3" in **Pr.840 Torque bias selection**, and adjust the parameter settings according to the following procedures.

Setting C38, C39 (Pr.932)

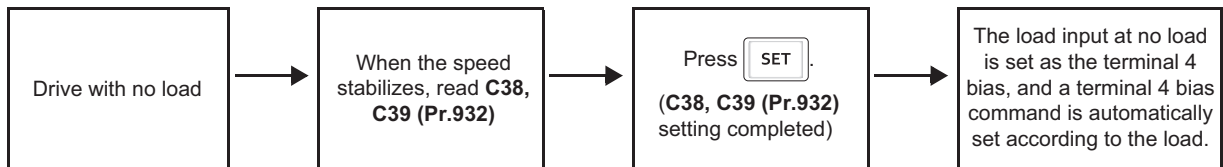

Setting C40, C41 (Pr.933)

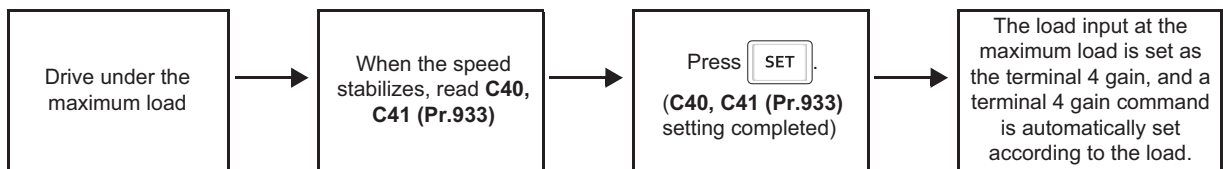

Setting Pr.846

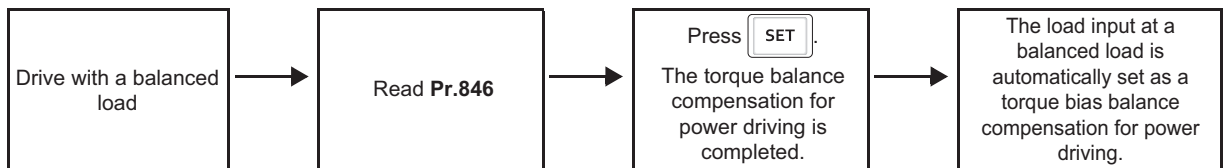

NOTE

- To perform a torque bias operation after the automatic setting is completed, set **Pr.840** to "1" or "2".

◆ Torque bias operation (Pr.844, Pr.845)

- The torque start-up can be made slower by setting **Pr.844 Torque bias filter** ≠ "9999". The torque start-up operation at this time is the time constant of the primary delay filter.
- Set the time for continuing the output torque simply by using the command value for the torque bias in **Pr.845 Torque bias operation time**.

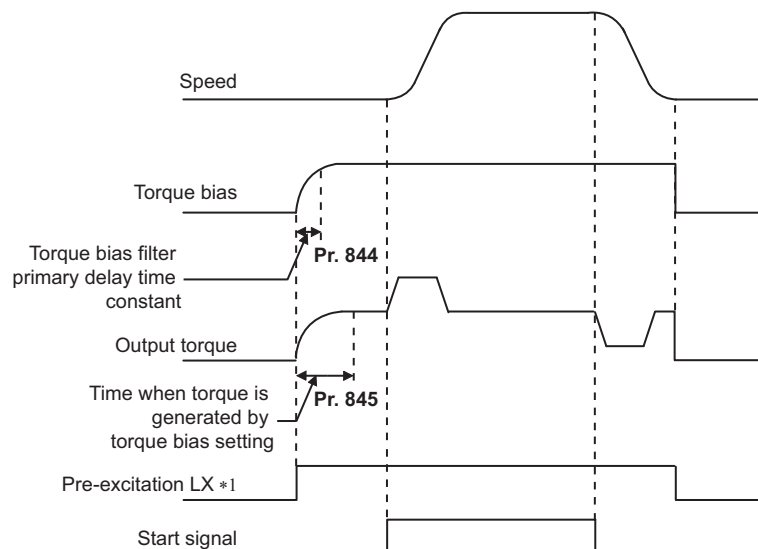

*1 When pre-excitation is not performed, the torque bias functions at the same time as the start signal.

NOTE

- When torque bias is enabled and **Pr.858** = "6", terminal 4 operates as a torque command.
- Changing the terminal assignment using **Pr.178 to Pr.189 (Input terminal function selection)** may affect the other functions. Set parameters after confirming the function of each terminal.
- When the X13 signal is ON, the torque bias function is disabled.
- During emergency drive operation, the torque bias function is disabled.

« Parameters referred to »

Pr.73 Analog input selection  [page 392](#)

Pr.178 to Pr.189 (Input terminal function selection)  [page 410](#)

C38 to C41 (Pr.932, Pr.933) (torque setting voltage (current) bias/gain)  [page 405](#)

5.8 Avoiding motor overrunning



Motor overrunning due to excessive load torque or an error in the setting of the number of encoder pulses can be avoided.

Pr.	Name	Initial value	Setting range	Description
285 H416	Speed deviation excess detection frequency ^{*1}	9999	0 to 30 Hz	Set the speed deviation excess detection frequency (difference between the rotation speed (estimated value) and the speed command value) at which the protective function (E.OSD) activates.
			9999	No speed deviation excess
853 H417	Speed deviation time	1.0 s	0 to 100 s	Set the time from when the speed deviation excess state is entered to when the protective function (E.OSD) activates.
873 ^{*2} H415	Speed limit	20 Hz	0 to 400 Hz	Set the frequency limit with the set frequency + Pr.873 value.
690 H881	Deceleration check time	1.0 s	0 to 3600 s	Set the time required to shut off output due to deceleration check.
			9999	No deceleration check

*1 This is the overspeed detection frequency under encoder feedback control. (Refer to [page 559](#)).

*2 The setting is available when a Vector control compatible option is installed. For the IP67 model, the setting is not available as plug-in options are not available.

◆ Speed deviation excess detection (Pr.285, Pr.853)

- A shutoff can be set for when the deviation between the set frequency and the rotation speed (estimated value under PM sensorless vector control) is large, such as when the load torque is excessive.
- When the difference (absolute value) between the speed command value and the rotation speed (estimated value under PM sensorless vector control) is equal to or higher than the setting value in **Pr.285 Speed deviation excess detection frequency** for a continuous time equal to or longer than the setting value in **Pr.853 Speed deviation time**, the speed deviation excess detection (E.OSD) is activated to shut off the inverter output.

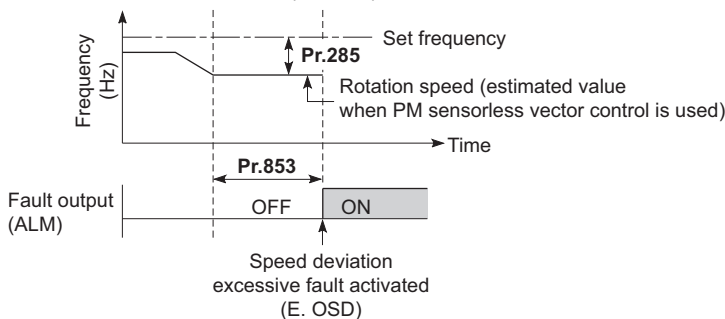

NOTE

- This function is enabled at a frequency equal to or higher than 10% of the rated motor frequency when a PM motor other than the MM-GKR or EM-A is driven under PM sensorless vector control.

◆ Speed limit (Pr.873)

- This function prevents overrunning even when the setting value for and the value of the actual number of pulses are different. When the setting value for the number of encoder pulses is lower than the actual number of pulses, because the motor may increase speed, the output frequency is limited with the frequency of (set frequency + **Pr.873**).

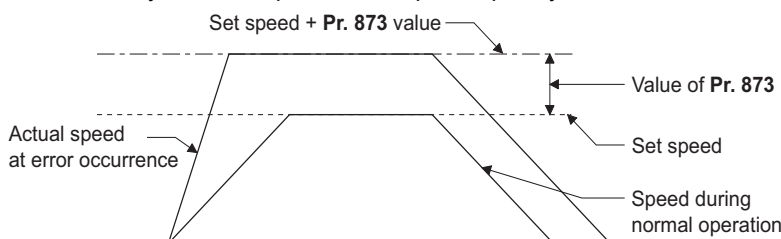

NOTE

- When the automatic restart after instantaneous power failure function is selected (**Pr.57 Restart coasting time** ≠ "9999") and the setting value for the number of encoder pulses is lower than the actual number of pulses, the output speed is limited with the synchronous speed of the value of **Pr.1 Maximum frequency** + **Pr.873**.
- When a regenerative driving torque limit is applied and the speed limit function activates, the output torque may drop suddenly. Also, when the speed limit function activates during pre-excitation operation, output phase loss (E.LF) may occur. If the setting for the number of encoder pulses is confirmed as correct, it is recommended that **Pr.873** be set to the maximum value (400 Hz).
- Even if the set frequency is lowered after inverter operation, the speed limit value is not lowered. During deceleration, the speed is limited at frequency command value + **Pr.873**.

◆ Deceleration check (Pr.690)

- This function can stop the inverter output when the motor is accelerated accidentally during rotation. This prevents a malfunction due to incorrect encoder pulse settings.
- When the difference between the actual motor speed and the speed command value exceeds 2 Hz, the deceleration check starts.
- If the motor does not decelerate within the time period set in **Pr.690**, the speed deviation excess detection (E.OSD) is activated to shut off the inverter output.

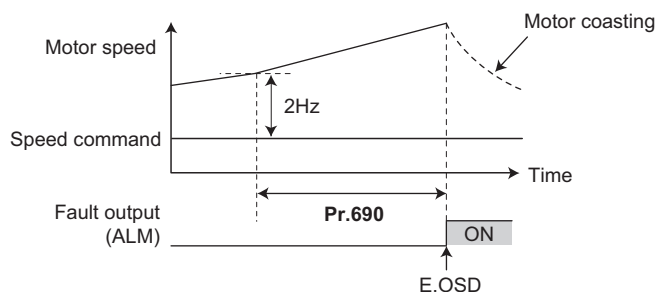

NOTE

- The deceleration check is enabled in the speed control of the Vector control.
- If the protective function (E.OSD) is activated due to deceleration check, check whether the **Pr.369 Number of encoder pulses** setting is correct.
- When the motor accelerates slowly (as a reference, when the frequency increment is less than 2 Hz/s), the protective function may not be activated even when the motor does not decelerate.

Parameters referred to

Pr.285 Overspeed detection frequency [page 559](#)

Pr.369 Number of encoder pulses [page 452](#)

5.9 Troubleshooting in the speed control

Sensorless Vector PM

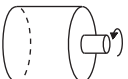
No.	Condition	Possible cause	Countermeasure
1	The motor does not rotate. (Vector control)	Motor wiring is incorrect.	<ul style="list-style-type: none"> Check the wiring. Select V/F control (set "9999" in Pr.80 Motor capacity or Pr.81 Number of motor poles, and "40" in Pr.800 Control method selection) and check the motor rotation direction. <p>When the SF-V5RU (1500 r/min series) motor is used, set Pr.19 Base frequency voltage to 170 V (340 V) for the 3.7 kW motor or lower, and to 160 V (320 V) for the motor whose capacity is higher than 3.7 kW, and set Pr.3 Base frequency to 50 Hz.</p> <ul style="list-style-type: none"> When a forward signal is input, rotation in the counterclockwise direction as viewed from the motor shaft direction is correct. (If the motor rotates clockwise, the phase sequence of the inverter secondary side wiring is incorrect.) 
		Encoder type selection switch (Vector control compatible option) is incorrect.	<ul style="list-style-type: none"> Check the encoder specifications. Check the encoder type selection switch of differential/complementary (Vector control compatible option).
		The wiring of the encoder is incorrect.	<ul style="list-style-type: none"> When using the system where the motor shaft can be rotated by an external force other than the motor without any safety troubles at Vector control setting, rotate the motor counterclockwise and check if FWD is indicated. If REV is indicated, the phase sequence of the encoder is incorrect. Check the wiring, and set Pr.359 Encoder rotation direction in accordance with the motor specification. (Refer to page 452.) If the clockwise direction is forward as viewed from the motor shaft side, set Pr.359 = "100". If the counterclockwise direction is forward as viewed from the motor shaft side, set Pr.359 = "101".
		The parameter setting and the number of encoder pulses used are different.	<ul style="list-style-type: none"> If the parameter setting value is lower than the number of encoder pulses used, the motor does not rotate. Set Pr.369 Number of encoder pulses correctly. (Refer to page 452.)
2	Motor does not run at the correct speed. (Command speed and actual speed differ.)	Encoder power specifications are incorrect. Alternatively, power is not input.	<ul style="list-style-type: none"> Check the encoder power specifications (5 V/12 V/15 V/24 V), and input the external power supply. When the encoder output is the differential line driver type, only 5 V can be input. Make the voltage of the external power supply the same as the encoder output voltage, and connect the external power supply between PG and SD.
		Speed command from the controller is different from the actual speed. The speed command is affected by noise.	<ul style="list-style-type: none"> Check that the speed command sent from the controller is correct. (Take EMC measures.) Lower the setting of Pr.72 PWM frequency selection.
		The setting for the number of encoder pulses is incorrect.	<ul style="list-style-type: none"> Check the Pr.369 setting (under Vector control). (Refer to page 452.)
		The command speed and the speed recognized by the inverter are different.	<ul style="list-style-type: none"> Adjust the bias and gain (Pr.125, Pr.126, C2 (Pr.902) to C7 (Pr.905)) of the speed command again.
3	The speed does not accelerate to the command speed.	The motor constant varies due to increase in the motor temperature.	<ul style="list-style-type: none"> Enable the online auto tuning at startup (set Pr.95 (Pr.574) = "1") (under Real sensorless vector control). (Refer to page 449.) To perform the online auto tuning at startup for a lift, use a brake sequence function for the brake opening timing at a start.
		Torque shortage. The torque limit is operating.	<ul style="list-style-type: none"> Raise the torque limit. (Refer to the torque limit for speed control on page 139.) Increase the capacity.
		Only P (proportional) control is performed.	<ul style="list-style-type: none"> Speed deviation occurs under P (proportional) control when the load is heavy. Select PI control.

No.	Condition	Possible cause	Countermeasure
4	Motor speed fluctuates.	Speed command varies.	<ul style="list-style-type: none"> • Check that the speed command sent from the controller is correct. (Take EMC measures.) • Set Pr.72 lower. • Set Pr.822 Speed setting filter 1 higher. (Refer to page 398.)
		Torque shortage.	<ul style="list-style-type: none"> • Raise the torque limit. (Refer to the torque limit for speed control on page 139.)
		Speed control gain is not suitable for the machine. (Resonance occurs.)	<ul style="list-style-type: none"> • Adjust Pr.820 Speed control P gain 1 and Pr.821 Speed control integral time 1.
5	Hunting (vibration or acoustic noise) occurs in the motor or the machine.	Speed control gain is too high.	<ul style="list-style-type: none"> • Set Pr.820 lower and Pr.821 higher.
		Torque control gain is too high.	<ul style="list-style-type: none"> • Set Pr.824 Torque control P gain 1 (current loop proportional gain) lower.
		Motor wiring is incorrect.	<ul style="list-style-type: none"> • Check the wiring.
6	Acceleration/ deceleration time is different from the setting.	Torque shortage.	<ul style="list-style-type: none"> • Raise the torque limit. (Refer to the torque limit for speed control on page 139.)
		Load inertia is too high.	<ul style="list-style-type: none"> • Set acceleration/deceleration time suitable for the load.
7	Machine movement is unstable.	Speed control gain is not suitable for the machine.	<ul style="list-style-type: none"> • Adjust Pr.820 and Pr.821.
		Response is slow because of the inverter's acceleration/ deceleration time setting.	<ul style="list-style-type: none"> • Set the optimum acceleration/deceleration time.
8	Rotation ripple occurs during the low-speed operation.	High carrier frequency is affecting the motor rotation.	<ul style="list-style-type: none"> • Set Pr.72 lower.
		Speed control gain is too low.	<ul style="list-style-type: none"> • Set Pr.820 higher.

«Parameters referred to»

Pr.72 PWM frequency selection [page 249](#)

Pr.80 Motor capacity, Pr.81 Number of motor poles [page 115](#)

Pr.125 Terminal 2 frequency setting gain frequency, Pr.126 Terminal 4 frequency setting gain frequency [page 400](#)

Pr.359 Encoder rotation direction, Pr.369 Number of encoder pulses [page 452](#)

Pr.822 Speed setting filter 1 [page 398](#)

Pr.824 Torque control P gain 1 (current loop proportional gain) [page 173](#)

MEMO

CHAPTER 6 Torque Control

- 6.1 Torque control..... 160
- 6.2 Setting procedure of Real sensorless vector control (torque control)..... 165
- 6.3 Setting procedure for Vector control (torque control)..... 166
- 6.4 Torque command..... 167
- 6.5 Speed limit..... 171
- 6.6 Torque control gain adjustment 173
- 6.7 Troubleshooting in torque control 175

6 Torque Control

Purpose	Parameter to set			Refer to page
Torque command source selection or torque command value setting	Torque command	P.D400 to P.D402, P.G210, P.H704	Pr.801, Pr.803 to Pr.806	167
To prevent the motor from overspeeding	Speed limit	P.H410 to P.H412	Pr.807 to Pr.809	171
To raise precision of torque control	Torque control gain adjustment	P.G213, P.G214, P.G313, P.G314	Pr.824, Pr.825, Pr.834, Pr.835	173

6.1 Torque control

This chapter explains the torque control under Real sensorless vector control or Vector control.

- Under torque control, output torque is controlled to output the torque as commanded.
- Motor rotation speed is steady when the motor output torque and load torque are balanced.
Thus, motor speed during torque control is determined by the load.
- Under torque control, motor speed accelerates so motor output torque does not exceed motor load.
In order to prevent the motor from overspeeding, set a speed limit.
(Speed control is performed instead of torque control during speed limit.)
- If speed limit is not set, speed limit value setting is regarded as 0 Hz and torque control is not enabled.

◆ Block diagram

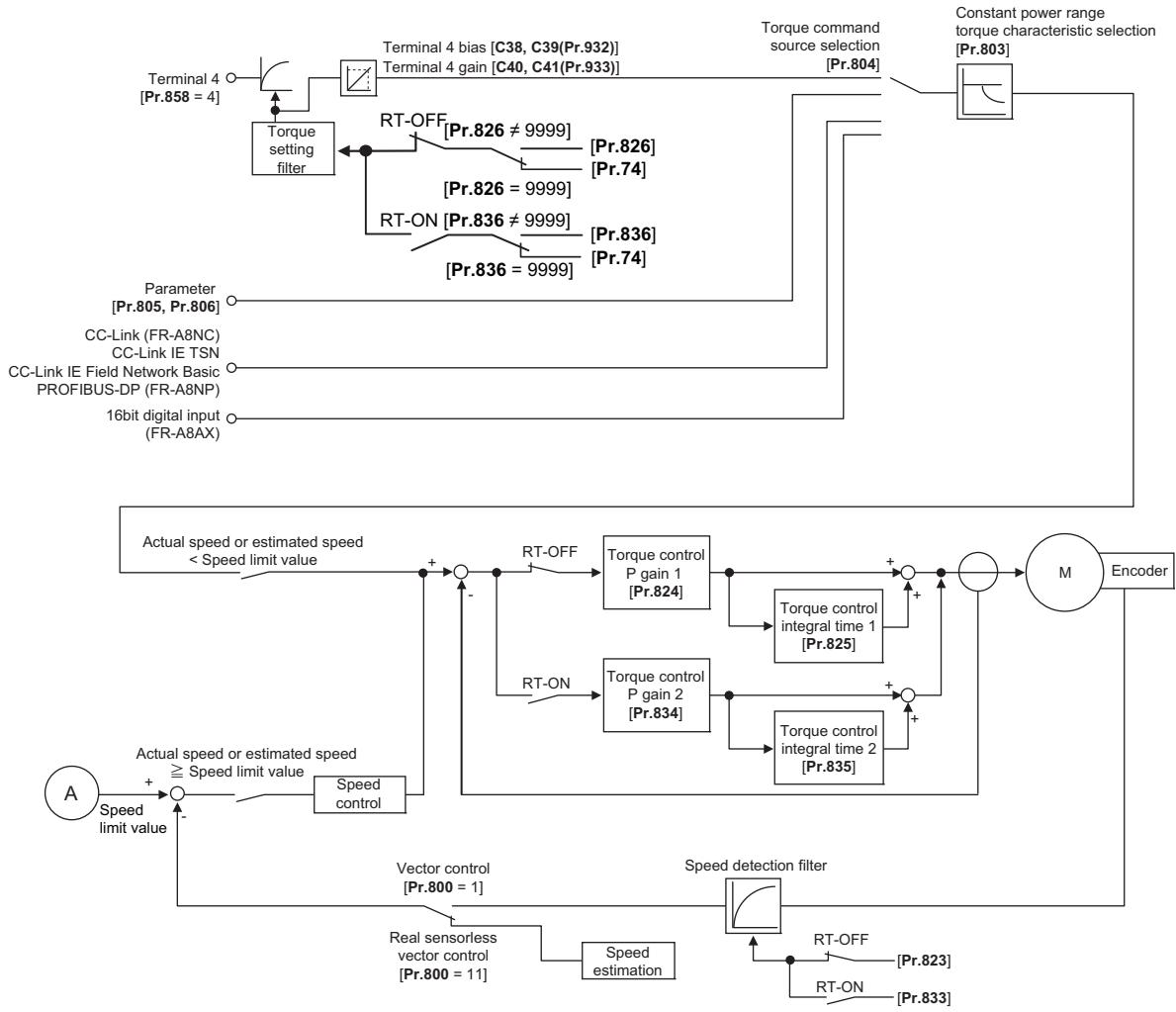

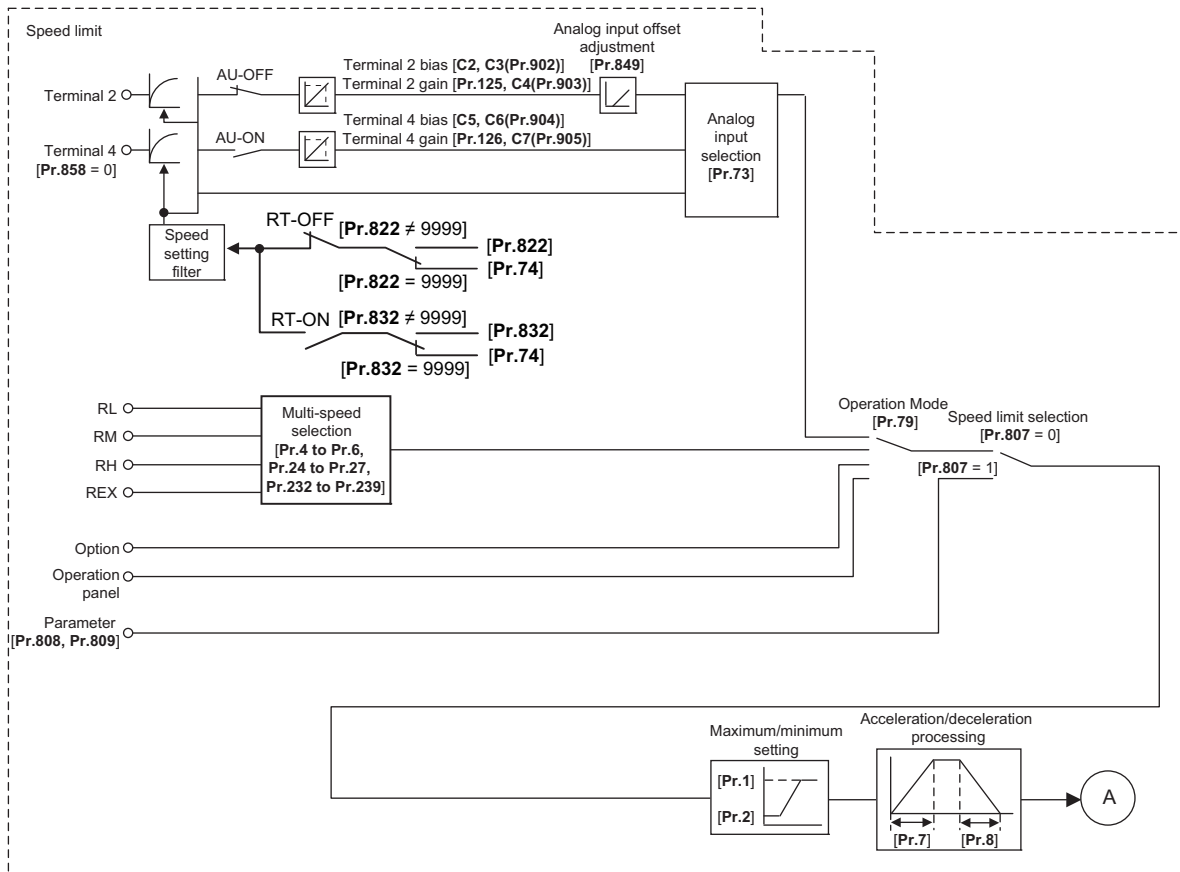

◆ Operation transition

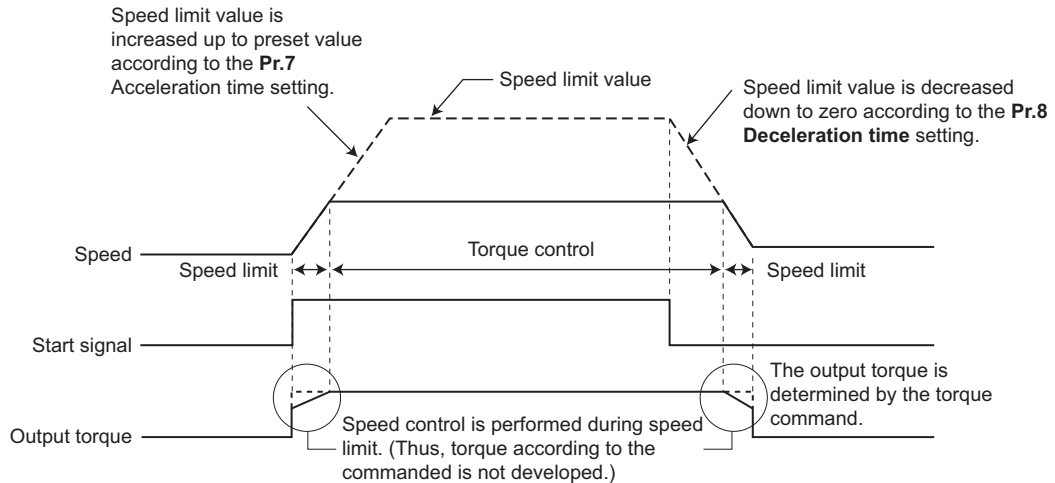

- If the setting value of **Pr.7** and **Pr.8** is "0", turning OFF the start signal enables speed control, and the output torque is controlled by the torque limit value.

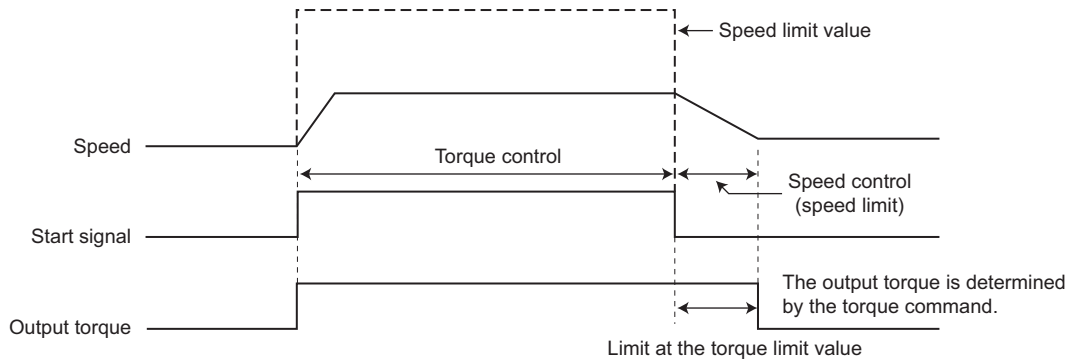

Item	Description	
Start signal	External operation	STF, STR signal
	PU operation	RUN key of the operation panel, or FWD/REV key of the parameter unit
Torque command	Select the method to give the torque command, and give the torque command.	
Speed limit	Select the method to give the speed limit command, and input the speed limit value.	

◆ Operation example

Torque control is possible when actual rotation speed does not exceed the speed limit value.

When the speed reaches or exceeds the speed limit value, speed limit is activated, torque control is stopped, and speed control is performed.

The operation is as follows.

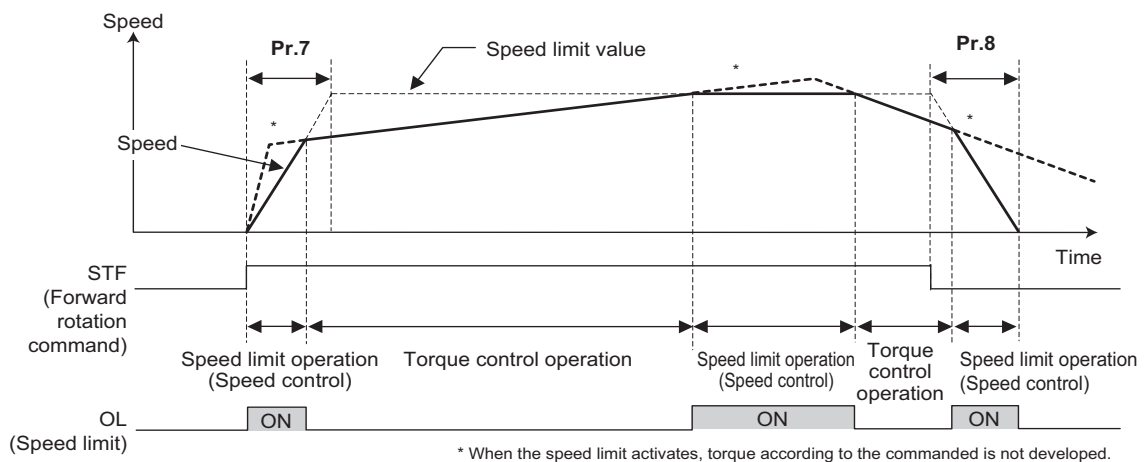

- At the STF signal ON, the speed limit value is raised in accordance with the setting of **Pr.7**.

- Speed control is performed when the actual speed exceeds the speed limit value.
- At the STF signal OFF, the speed limit value is lowered in accordance with the setting of **Pr.8**.
- Under torque control, the actual operation speed is a constant speed when the torque command and load torque are balanced.
- The direction of motor torque generation is determined by a combination of the input torque command polarity and the start signal, as given in the following table.

Polarity of torque command	Torque generation direction	
	STF signal ON	STR signal ON
+ torque command	Forward direction (forward power driving / reverse regenerative driving)	Reverse direction (forward regenerative driving / reverse power driving)
- torque command	Reverse direction (forward regenerative driving / reverse power driving)	Forward direction (forward power driving / reverse regenerative driving)

 **NOTE**

- Once the speed limit is activated, speed control is performed and internal torque limit (**Pr.22 Torque limit level**) is enabled. (Initial value) In this case, it may not be possible to return to torque control. Torque limit should be external torque limit (terminal 4). (Refer to [page 139](#).)
- Under torque control, perform linear acceleration/deceleration (**Pr.29** = "0" (initial value)). When acceleration/deceleration patterns other than the linear acceleration/deceleration are selected, the protective function of the inverter may be activated. (Refer to [page 267](#).)
- Performing pre-excitation (LX signal and X13 signal) under torque control may start the motor running at a low speed even when the start signal (STF or STR) is not input. This product with the start command ON may also rotate the motor at a low speed when the speed limit value is set to zero. Confirm that the motor running does not cause any safety problems before performing pre-excitation.
- Under Real sensorless vector control, torque control is not available for regenerative driving in a low-speed range (about 10 Hz or lower) or light-load operation in a low-speed range (about 5 Hz or lower and about 20% or lower of the rated torque).

6.2 Setting procedure of Real sensorless vector control (torque control)

Sensorless

Operating procedure

1. Perform wiring properly. (Refer to the Instruction Manual (Connection).)
2. Make the motor setting (**Pr.71**). (Refer to [page 424](#).)
Set **Pr.71 Applied motor** to "0" (standard motor) or "10" (constant-torque motor).
3. Set the motor overheat protection (**Pr.9**). (Refer to [page 306](#).)
4. Set the motor capacity and number of motor poles (**Pr.80, Pr.81**). (Refer to [page 115](#).)
Operation does not start when the setting value is "9999" (initial value).
5. Set the rated motor voltage and frequency (**Pr.83, Pr.84**). (Refer to [page 430](#).)
6. Select the control method (**Pr.800**). (Refer to [page 115](#).)
Select **Pr.800 Control method selection** = "11" (torque control) or "12" (speed/torque switchover) to enable torque control.
7. Set the torque command (**Pr.804**). (Refer to [page 167](#).)
8. Set the speed limit (**Pr.807**). (Refer to [page 171](#).)
9. Perform the offline auto tuning (**Pr.96**). (Refer to [page 430](#).)
10. Set the acceleration time to "0" (**Pr.7**). (Refer to [page 262](#).)
11. Perform the test operation.

As required

- Select online auto tuning (**Pr.95**). (Refer to [page 449](#).)
- Adjust the torque control gain manually. (Refer to [page 173](#).)

NOTE

- During Real sensorless vector control, offline auto tuning must be performed properly before starting operations.
- The carrier frequency is limited during Real sensorless vector control. (Refer to [page 249](#).)
- Torque control is not available in a low-speed (about 10 Hz or lower) regenerative range, or with a low speed and light load (about 5 Hz or lower and rated torque about 20% or lower).
- Performing pre-excitation (LX signal and X13 signal) under torque control may start the motor running at a low speed even when the start signal (STF or STR) is not input. This product with the start command ON may also rotate the motor at a low speed when the speed limit value is set to zero. Confirm that the motor running does not cause any safety problems before performing pre-excitation.
- Switching between the forward rotation command (STF) and reverse rotation command (STR) must not be performed during operations under torque control. An overcurrent trip (E.OC[]) or opposite rotation deceleration fault (E.11) will occur.
- If starting may occur while the motor is coasting under Real sensorless vector control, the frequency search must be set for the automatic restart after instantaneous power failure function (**Pr.57** ≠ "9999", **Pr.162** = "10").
- When Real sensorless vector control is applied, there may not be enough torque provided in the ultra low-speed range of about 2 Hz or lower.
Generally, the speed control range is as follows.
For power driving, 1:200 (2, 4 or 6 poles) (available at 0.3 Hz or higher when the rating is 60 Hz), 1:30 (8 or 10 poles) (available at 2 Hz or higher when the rating is 60 Hz).
For regenerative driving, 1:12 (2 to 10 poles) (available at 5 Hz or higher when the rating is 60 Hz).
- To give the constant torque command in the constant output range, set "1" in **Pr.803 Constant output range torque characteristic selection**. (Refer to [page 167](#).)
- For the settings for the SF-V5RU, refer to [page 452](#).

6.3 Setting procedure for Vector control (torque control)

Vector

Operating procedure

1. Perform wiring properly. (Refer to the Instruction Manual (Connection).)
Install a Vector control compatible option.
2. Set the motor and the encoder (**Pr.71, Pr.359, Pr.369**). (Refer to [page 424](#), [page 452](#).)
3. Set the overheat protection of the motor (**Pr.9**). (Refer to [page 306](#).)
When using the SF-V5RU or a motor equipped with a thermal sensor, set **Pr.9** = 0 A. For details on connecting a motor equipped with a thermal sensor, refer to the Instruction Manual (Connection).
4. Set the motor capacity and the number of motor poles (**Pr.80, Pr.81**). (Refer to [page 115](#).)
V/F control is performed when the setting is "9999" (initial value).
5. Set the rated motor voltage and frequency (**Pr.83, Pr.84**). (Refer to [page 430](#).)
6. Select the control method (**Pr.800**). (Refer to [page 115](#).)
Select **Pr.800 Control method selection** = "1" (torque control), "2" (speed/torque switchover), or "5" (position/torque switchover) to enable torque control.
7. Set the torque command (**Pr.804**). (Refer to [page 167](#).)
8. Set the speed limit (**Pr.807**). (Refer to [page 171](#).)
9. Set the acceleration time to "0" (**Pr.7**). (Refer to [page 262](#).)
10. Perform the test operation.

As required

- Perform offline auto tuning (**Pr.96**). (Refer to [page 430](#).)
- Select online auto tuning (**Pr.95**). (Refer to [page 449](#).)
- Adjust the torque control gain manually. (Refer to [page 173](#).)

NOTE

- Under Vector control, the magnetic flux observer is enabled to estimate or measure the flux within the motor using the current running through the motor and the inverter output voltage. This improves the torque accuracy since the flux of a motor can be accurately estimated and optimum characteristics can be obtained without being affected by temperature change in the second resistor.
- Performing pre-excitation (LX signal and X13 signal) under torque control may start the motor running at a low speed even when the start signal (STF or STR) is not input. This product with the start command ON may also rotate the motor at a low speed when the speed limit value is set to zero. Confirm that the motor running does not cause any safety problems before performing pre-excitation.
- The carrier frequency is limited during Vector control. (Refer to [page 249](#).)
- Torque control is not available under the Vector control with PM motors.
- To give the constant torque command in the constant output range, set "1" in **Pr.803 Constant output range torque characteristic selection**. (Refer to [page 167](#).)
- For the settings for the SF-V5RU, refer to [page 452](#).
- Vector control is not available for the IP67 model as plug-in options are not available.

6.4 Torque command

Sensorless Vector

For torque control selection, the torque command source can be selected.

Pr.	Name	Initial value	Setting range	Description
801 H704	Output limit level	9999	0% to 400% 9999	Set the torque current limit level. The torque limit setting value is used for limiting the torque current level.
803 G210	Constant output range torque characteristic selection	0	0, 10 1 2	Constant motor output command Constant torque command The torque is constant unless the output limit of the torque current is reached. (The torque current is limited.)
804 D400	Torque command source selection	0	0 1 3 4 5 6	Torque command given by analog input via terminal 4 Torque command (-400% to 400%) given by the parameter setting (Pr.805 or Pr.806) Torque command via communication*1 12/16-bit digital input (FR-A8AX)*2 Torque command via communication*1
805 D401	Torque command value (RAM)	1000%	600% to 1400%	Writes the torque command value in RAM. Regards 1000% as 0%, and set torque command by an offset of 1000%.
806 D402	Torque command value (RAM, EEPROM)	1000%	600% to 1400%	Writes the torque command value in RAM and EEPROM. Regards 1000% as 0%, and set torque command by an offset of 1000%.

*1 Torque commands can be input via CC-Link, CC-Link IE TSN, CC-Link IE Field Network Basic, and PROFIBUS-DP communication. CC-Link and PROFIBUS-DP communication are unavailable when the Vector control compatible option is installed or when the IP67 model is used.
*2 For the IP67 model, the function is invalid as plug-in options are not available.

◆ Control block diagram

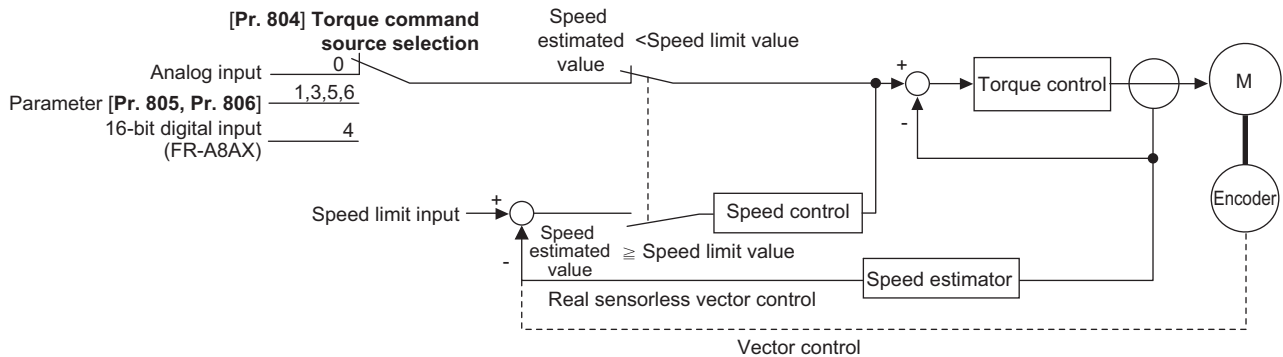

NOTE

- When the torque command exceeding the torque limit value (Pr.22, Pr.810, Pr.812 to Pr.817) is given, the output torque is within the torque limit value. (Refer to page 160.)

◆ Torque command given by analog input (terminal 4) (Pr.804 = "0" (initial value))

- Torque commands are given by voltage (current) input via terminal 4.
- Set Pr.858 Terminal 4 function assignment = "4" to give the torque command via terminal 4.

- Torque commands given by analog inputs can be calibrated by the calibration parameters **C38 (Pr.932) to C41 (Pr.933)** (Refer to [page 405.](#))

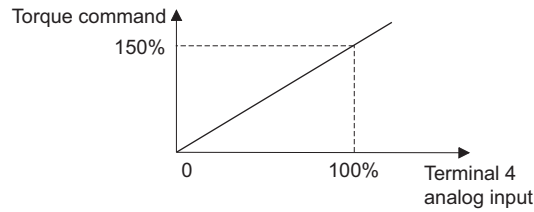

◆ Torque command given by parameter (Pr.804 = "1")

- Set **Pr.805 Torque command value (RAM)** or **Pr.806 Torque command value (RAM, EEPROM)** to set the torque command value.

For **Pr.805** or **Pr.806**, regard 1000% as 0%, and set torque command by offset from 1000%.

The following diagram shows relation between the **Pr.805** or **Pr.806** setting and the actual torque command value.

- To change the torque command value frequently, write it in **Pr.805**. Writing values in **Pr.806** frequently will shorten the life of the EEPROM.

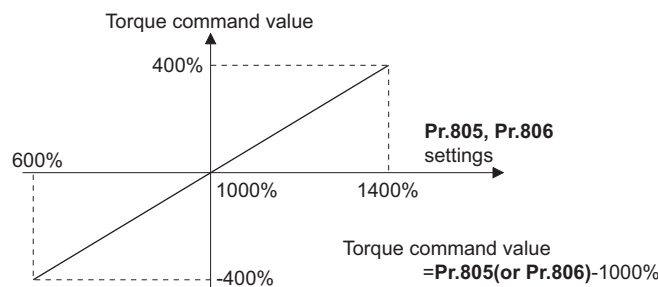

NOTE

- When the torque command is set by **Pr.805** (RAM), powering OFF the inverter erases the changed parameter value. Therefore, the parameter set value is the one saved by **Pr.806** (EEPROM) when the power is turned back on.
- If giving torque command by parameter setting, set the speed limit value properly to prevent overspeeding. (Refer to [page 171.](#))

◆ Torque command via communication (Pr.804 = "3, 5, or 6")

- Set the torque command value via CC-Link (FR-A8NC / PLC function), CC-Link IE TSN, CC-Link IE Field Network Basic, and PROFIBUS-DP (FR-A8NP) communication.
- For speed limit when "3 or 5" is set in **Pr.804**, **Pr.807 Speed limit selection** becomes invalid and **Pr.808 Speed limit** and **Pr.809 Reverse-side speed limit** become valid for speed limit. (When **Pr.544 CC-Link extended setting** = "0, 1, 12, 100, or 112")
- **Pr.807** is valid when the extended cyclic setting of CC-Link communication is quadruple or octuple.

Pr.804 setting	Torque command input	Setting range	Setting increments	Required condition
1	Torque command by Pr.805 or Pr.806 ^{*1}			—
3	• Torque command by remote register (RWw1 or RWwC) • Torque command by Pr.805 or Pr.806 ^{*2}	600 to 1400 (-400% to 400%)	1%	FR-A8NC is installed, CC-Link IE TSN or CC-Link IE Field Network Basic is used, or FR-A8NP is installed.
5	• Torque command by remote register (RWw1 or RWwC) • Torque command by Pr.805 or Pr.806 ^{*2}	-32768 to 32767 (complement of 2) (-327.68% to 327.67%) ^{*3}	0.01% ^{*3}	
6	Torque command by Pr.805 or Pr.806 ^{*1}			

*1 They can also be set using the operation panel or parameter unit.

*2 When the FR-A8NP is installed, the torque command can be set only by **Pr.805** or **Pr.806**.

*3 On the operation panel or parameter unit, the setting range is "673 to 1327 (-327% to 327%)" and the setting increment is 1%.

NOTE

- For the details of the CC-Link communication, refer to the FR-A8NC E kit Instruction Manual. For the details of the CC-Link IE TSN or CC-Link IE Field Network Basic, refer to the Instruction Manual (Communication). For the details of the PROFIBUS-DP communication, refer to the FR-A8NP E kit Instruction Manual.
- For details of the setting using the PLC function, refer to the PLC Function Programming Manual.
- CC-Link and PROFIBUS-DP communication are unavailable when the Vector control compatible option is installed or when the IP67 model is used.

◆ Torque command given by 16-bit digital input (Pr.804 = "4")

- Give the torque command by 12-bit or 16-bit digital input using FR-A8AX (plug-in option) under Real sensorless vector control. For the IP67 model, the function is invalid as plug-in options are not available.

NOTE

- For details of the setting using the FR-A8AX, refer to the FR-A8AX E kit Instruction Manual.

◆ Changing the torque characteristic of the constant-power range (Pr.801, Pr.803)

- According to the motor's characteristics, the torque decreases at the frequency equal to or higher than the base frequency. To give the constant torque command at the speed equal to or higher than the base frequency, set "1" in **Pr.803 Constant output range torque characteristic selection**.
- Torque in a low-speed range is constant during torque control regardless of the setting of **Pr.803**. However, when "2" is set in **Pr.803** under Real sensorless vector control, the torque may not be kept constant in the low-speed range due to a condition such as the **Pr.801** setting.

Pr.803 setting	Torque characteristic in constant-power range	
	Torque characteristic	Output limit
0 (initial value), 10	Constant motor output	—
1	Constant torque	Unlimited
2	Constant torque	Limited

- To avoid overload or overcurrent of the inverter or motor, use **Pr.801 Output limit level** to limit the torque current in the constant power range.

Pr.801 setting	Description
0% to 400%	Set the torque current limit level.
9999	The torque limit setting value (Pr.22, Pr.812 to Pr.817, etc.) is used for limiting the torque current.

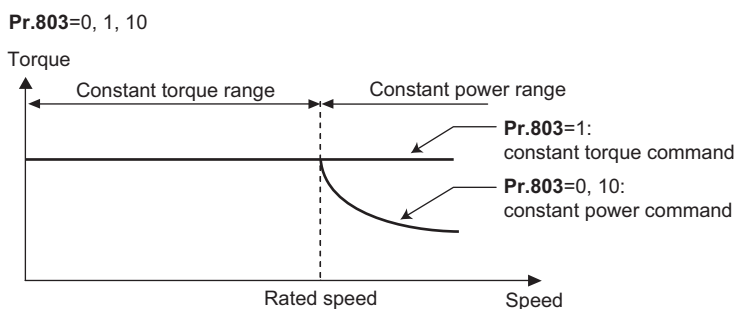

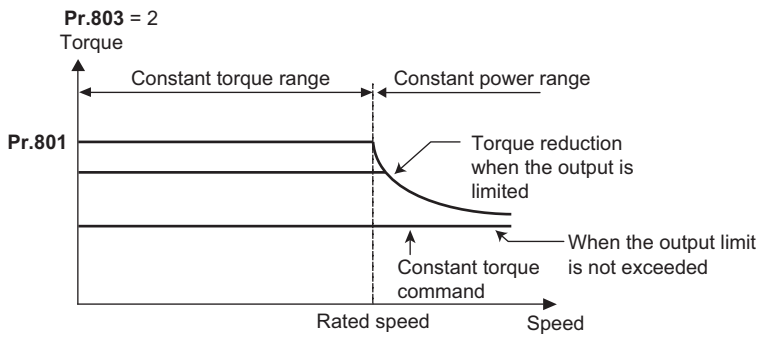

« Parameters referred to »

Pr.858 Terminal 4 function assignment [page 397](#)

Calibration parameter C38 (Pr.932) to C41 (Pr.933) (terminal 4 bias, gain torque) [page 405](#)

6.5 Speed limit

Sensorless Vector

When operating under torque control, motor overspeeding may occur if the load torque drops to a value less than the torque command value, etc. Set the speed limit value to prevent overspeeding.

If the actual speed reaches or exceeds the speed limit value, the control method switches from torque control to speed control, preventing overspeeding.

Pr.	Name	Initial value ^{*1}		Setting range	Description
		Gr.1	Gr.2		
807 H410	Speed limit selection	0		0	Uses the speed command during speed control as the speed limit.
				1	Sets the speed limits for forward and reverse directions individually by using Pr.808 and Pr.809.
808 H411	Speed limit	60 Hz	50 Hz	0 to 400 Hz	Sets speed limit.
809 H412	Reverse-side speed limit	9999		0 to 400 Hz	Sets the speed limit when the load has reversed the motor rotation opposite to the torque polarity.
				9999	Pr.808 setting value is effective.

*1 Gr.1 and Gr.2 are the parameter initial value groups. (Refer to page 54).

◆ Control block diagram

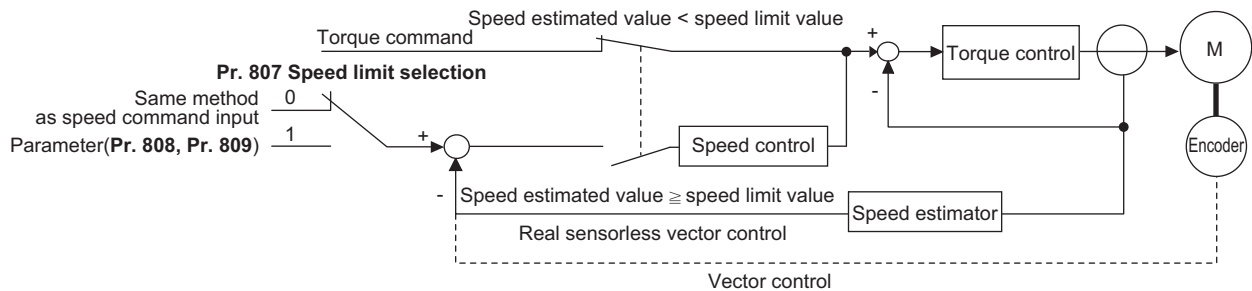

◆ Using the speed command during speed control (Pr.807 = "0")

- Speed limit is set by the same method as speed setting during speed control (speed setting by PU (operation panel / parameter unit), multi-speed setting, plug-in option, etc.)
- When the start signal turns ON, the limit level increases from 0 Hz to the set speed by taking the time set in Pr.7 Acceleration time. When the start signal turns OFF, the limit level at the time decreases to the operation start level of Pr.10 DC injection brake operation frequency, by taking the time set in Pr.8 Deceleration time.
- When the load has reversed the rotation opposite to the torque polarity, the setting of Pr.809 Reverse-side speed limit is applied for the speed limit.

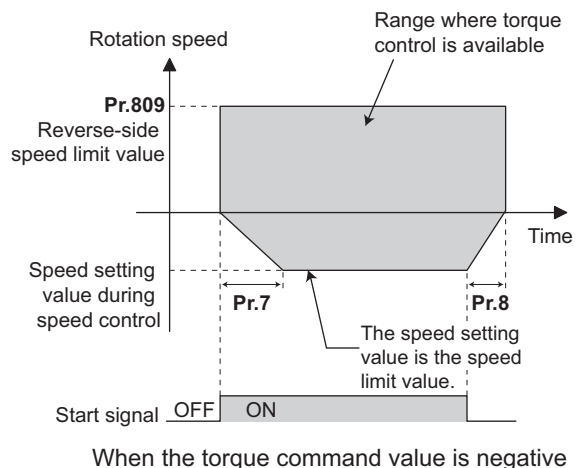
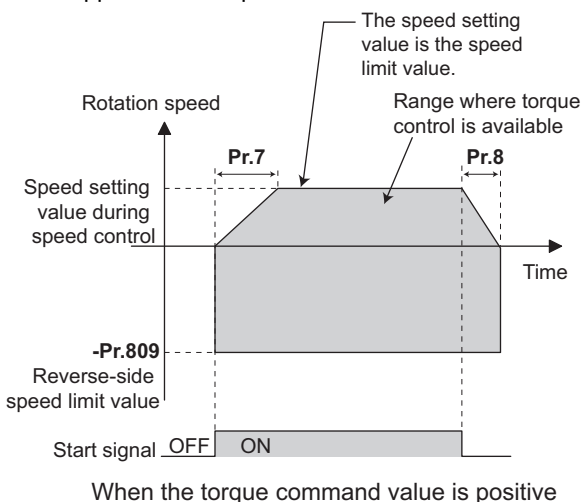

NOTE

- The second acceleration/deceleration time can be set.
- When speed limit command exceeds **Pr.1 Maximum frequency** setting, the speed limit value becomes **Pr.1** setting. When speed limit command falls below **Pr.2 Minimum frequency** setting, the speed limit value becomes **Pr.2** setting. Also, the speed limit command is smaller than **Pr.13 Starting frequency**, the speed limit value becomes 0 Hz.
- To use analog inputs to perform speed limit, calibrate analog input terminals 2 and 4. (Refer to [page 400](#).)
- To use analog inputs to perform speed limit, turn OFF the external signals (RH, RM, RL). If any of the external signals (RH, RM, RL) is ON, speed limit by multi-speed are enabled.

◆ Speed limit by parameters (Pr.807 = "1")

- Following the polarity change in the torque command, the polarity of the speed limit value changes. This prevents the speed from increasing in the torque polarity direction. (When the torque command value is 0, the polarity of the speed limit value is positive.)
- When **Pr.807 Speed limit selection** = "0", the setting during speed control is applied for the speed limit. When **Pr.807 Speed limit selection** = "1", **Pr.808 Speed limit** is applied for the speed limit.
- When the load has reversed the rotation opposite to the torque polarity, the setting of **Pr.809 Reverse-side speed limit** is applied for the speed limit. (The speed limit value and reverse-side speed limit value are limited at **Pr.1 Maximum frequency**.)

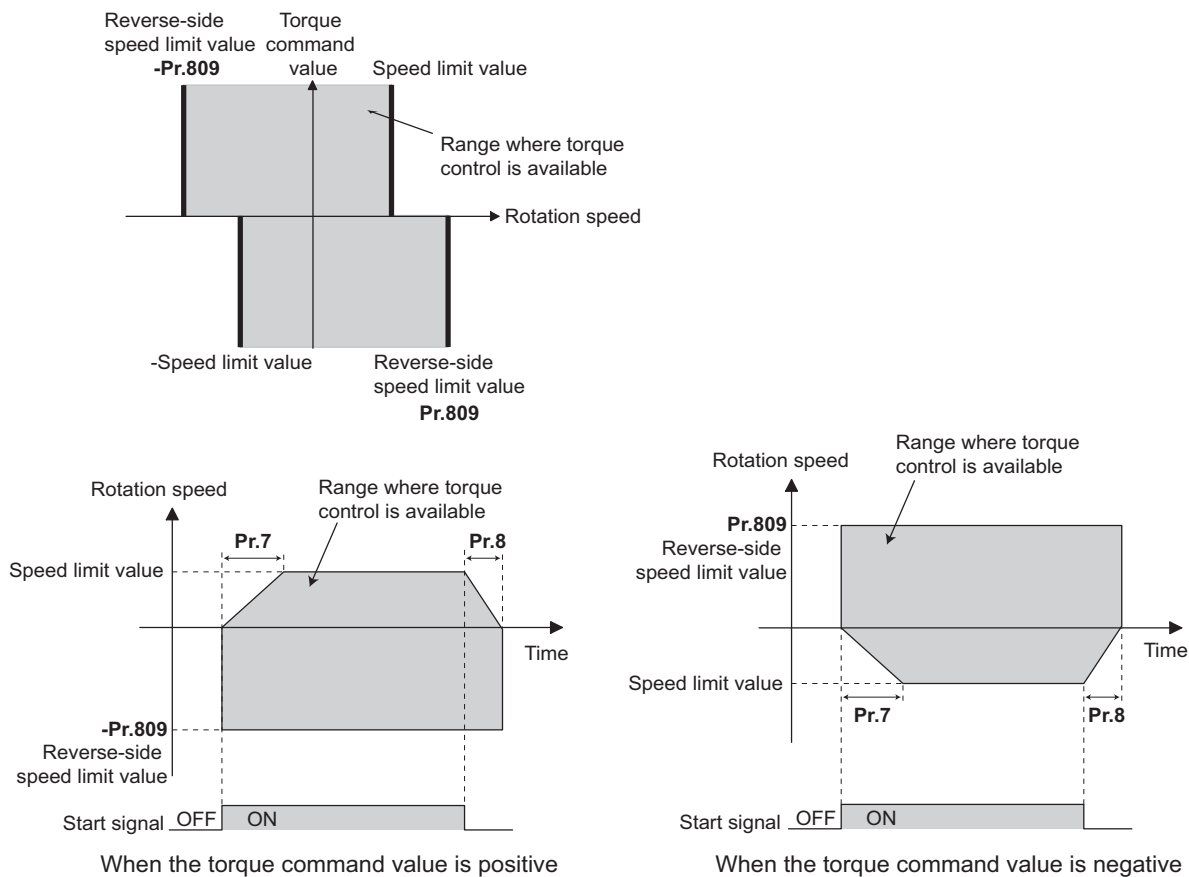

NOTE

- During the speed limit operation, "SL" is displayed on the operation panel and the OL signal is output.
- For the OL signal, set "3" (positive logic) or "103" (negative logic) in any parameter from **Pr.190 to Pr.197 (Output terminal function selection)** to assign the function to an output terminal. Changing the terminal assignment using **Pr.190 to Pr.197** may affect the other functions. Set parameters after confirming the function of each terminal.

Parameters referred to

- Pr.1 Maximum frequency, Pr.2 Minimum frequency [page 331](#)
- Pr.4 to Pr.6, Pr.24 to Pr.27, Pr.232 to Pr.239 (multi-speed operation) [page 303](#)
- Pr.7 Acceleration time, Pr.8 Deceleration time [page 262](#)
- Pr.13 Starting frequency [page 274](#)
- Pr.190 to Pr.197 (Output terminal function selection) [page 371](#)

6.6 Torque control gain adjustment

Sensorless Vector PM

Operation is normally stable enough in the initial setting, but some adjustments can be made if abnormal vibration, noise or overcurrent occur for the motor or machinery.

Pr.	Name	Initial value	Setting range	Description
824 G213	Torque control P gain 1 (current loop proportional gain)	100%	0% to 500%	Set the current loop proportional gain.
825 G214	Torque control integral time 1 (current loop integral time)	5 ms	0 to 500 ms	Set current loop integral compensation time.
834 G313	Torque control P gain 2 (current loop proportional gain)	9999	0% to 500%	Set the current loop proportional gain when RT signal is ON.
			9999	The Pr.824 setting is applied to the operation.
835 G314	Torque control integral time 2 (current loop integral time)	9999	0 to 500 ms	Set the current loop integral compensation time when RT signal is ON.
			9999	The Pr.825 setting is applied to the operation.

◆ Current loop proportional (P) gain adjustment (Pr.824)

- The 100% current loop proportional gain is equivalent to 1000 rad/s during Real sensorless vector control or PM sensorless vector control, and to 1400 rad/s during Vector control.
- For ordinary adjustment, try to set within the range of 50% to 500%.
- Set the proportional gain for during torque control.
- If setting value is large, changes in current command can be followed well and current fluctuation relative to external disturbance is smaller. If the setting value is however too large, it becomes unstable and high frequency torque pulse is produced.

◆ Current control integral time adjustment (Pr.825)

- Set the integral time of current control during torque control.
- Torque response increases if set small; current however becomes unstable if set too small.
- If the setting value is small, it produces current fluctuation toward disturbance, decreasing time until it returns to original current value.

◆ Using two types of gain (Pr.834, Pr.835)

- Use Pr.834 Torque control P gain 2 (current loop proportional gain) and Pr.835 Torque control integral time 2 (current loop integral time) if the gain setting needs to be switched according to application or if multiple motors are switched by a single inverter.
- Pr.834 and Pr.835 is enabled when the second function selection (RT) signal is turned ON.

NOTE

- The RT signal is a second function selection signal which also enables other second functions. (Refer to [page 418](#).)
- To assign the RT signal, set "3" in any parameter from Pr.178 to Pr.189 (Input terminal function selection).

◆ Adjustment procedure

Adjust if any of phenomena such as unusual vibration, noise, current or overcurrent is produced by the motor or machinery.

1. Change the **Pr.824** setting while checking the conditions.
2. If it cannot be adjusted well, change the **Pr.825** setting, and perform step 1 again.

Adjustment method	
Set Pr.824 lower and Pr.825 longer. First, lower Pr.824 and then check if there is still any abnormal vibration, noise or current from the motor. If it still requires improvement, make Pr.825 longer.	
Pr.824	Lower the setting by 10% each time and set a value that is approximately 80% to 90% of the setting immediately before the abnormal noise or current improves. If set too low, current ripple is produced and produces a sound from the motor that synchronizes with it.
Pr.825	Lengthen the current setting by doubling it each time and set a value that is approximately 80% to 90% of the setting value, immediately before abnormal noise or current is improved. If set too long, current ripple is produced and produces a sound from the motor that synchronizes with it.

6.7 Troubleshooting in torque control

Sensorless Vector

No.	Condition	Possible cause	Countermeasure
1	Torque control does not operate properly.	<ul style="list-style-type: none"> There is incorrect phase sequence between the motor wiring and encoder wiring. 	<ul style="list-style-type: none"> Check the wiring. (Refer to the Instruction Manual (Connection).)
		<ul style="list-style-type: none"> Pr.800 Control method selection is not appropriate. 	<ul style="list-style-type: none"> Check the Pr.800 setting. (Refer to page 115.)
		<ul style="list-style-type: none"> The speed limit value has not been input. 	<ul style="list-style-type: none"> Set the speed limit value. (If the speed limit value is not input, it becomes 0 Hz by default and the motor does not run.)
		<ul style="list-style-type: none"> Torque command varies. 	<ul style="list-style-type: none"> Check that the torque command sent from the controller is correct. Set Pr.72 PWM frequency selection lower. Set Pr.826 Torque setting filter 1 higher.
		<ul style="list-style-type: none"> The torque command and the torque recognized by the inverter are different. 	<ul style="list-style-type: none"> Re-calibrate C38 (Pr.932) Terminal 4 bias command (torque), C39 (Pr.932) Terminal 4 bias (torque), C40 (Pr.933) Terminal 4 gain command (torque), and C41 (Pr.933) Terminal 4 gain (torque). (Refer to page 405.)
2	When a small torque command is given, the motor rotates in a direction opposite to the start signal.	<ul style="list-style-type: none"> Torque offset calibration is inaccurate. 	<ul style="list-style-type: none"> Re-calibrate C38 (Pr.932) and C39 (Pr.932). (Refer to page 405.)
3	Torque control cannot operate normally during acceleration/ deceleration. The motor vibrates.	<ul style="list-style-type: none"> The speed limit is operating. (The speed limit may operate because the speed limit value will increase or decrease according to acceleration/deceleration time setting of Pr.7 and Pr.8 when Pr.807 = "0".) 	<ul style="list-style-type: none"> Set the acceleration/deceleration time shorter. Alternatively, set "0" for the acceleration/deceleration time. (The speed limit during acceleration/deceleration is determined by the speed limit for constant speed.)
4	Output torque is nonlinear for the torque command.	<ul style="list-style-type: none"> Torque shortage. 	<ul style="list-style-type: none"> Reset Pr.854 Excitation ratio to the initial value.

Parameters referred to

Pr.72 PWM frequency selection [page 249](#)

Pr.178 to Pr.189 (Input terminal function selection) [page 410](#)

Pr.800 Control method selection [page 115](#)

Pr.807 Speed limit selection [page 171](#)

C38 (Pr.932) to C41 (Pr.933) (torque setting voltage (current) bias/gain) [page 405](#)

MEMO

CHAPTER 7 Position Control

7.1	About position control	178
7.2	Setting procedure of Vector control (position control).....	181
7.3	Setting procedure of PM sensorless vector control (position control).....	182
7.4	Simple positioning function by point tables.....	184
7.5	Simple positioning function by direct commands (Ethernet model / safety communication model / IP67 model)	197
7.6	Pulse monitor.....	207
7.7	Electronic gear settings	210
7.8	Position adjustment parameter settings.....	212
7.9	Current position retention function.....	215
7.10	Position control gain adjustment.....	217
7.11	Troubleshooting in position control	219

7 Position Control

Purpose	Parameter to set			Refer to page
To perform simple position control using parameters	Simple positioning function by point tables	P.B020 to P.B034, P.B110 to P.B112, P.B120, P.B121, P.B123 to P.B125, P.B127 to P.B129, P.B131 to P.B133, P.B135 to P.B137, P.B139 to P.B141, P.B143 to P.B145, P.B147, P.B180, P.B181, P.B183, P.B184, P.B187, P.B188, P.B190, P.B191, P.B197	Pr.464 to Pr.478, Pr.511, Pr.1095 to Pr.1097, Pr.1222, Pr.1223, Pr.1225 to Pr.1227, Pr.1229 to Pr.1231, Pr.1233 to Pr.1235, Pr.1237 to Pr.1239, Pr.1241 to Pr.1243, Pr.1245 to Pr.1247, Pr.1249, Pr.1282, Pr.1283, Pr.1285, Pr.1286, Pr.1289, Pr.1290, Pr.1292, Pr.1293	184
To perform simple position control using CiA402 drive profile (communication)	Simple positioning function by direct commands	P.B020, P.B100, P.B110 to P.B112, P.B120, P.B121, P.B123, P.B183, P.B184, P.B187, P.B188, P.B190, P.B191, P.B197	Pr.464, Pr.511, Pr.1095 to Pr.1097, Pr.1220, Pr.1222, Pr.1223, Pr.1225, Pr.1285, Pr.1286, Pr.1289, Pr.1290, Pr.1292, Pr.1293	197
To adjust the gear ratio of the motor and machine	Electronic gear settings	P.B001 and P.B002	Pr.420 and Pr.421	210
To improve the precision of the position control	Position adjustment parameter settings	P.B007, P.B008, P.B192 to P.B196	Pr.426, Pr.427, Pr.510, Pr.1294 to Pr.1297	212
	Position control gain adjustment	P.B003, P.B004, P.B006, P.B012, P.B013, P.G219, P.G220, P.G224, P.C114	Pr.422, Pr.423, Pr.425, Pr.446, Pr.698, Pr.828, Pr.877, Pr.880, Pr.1298	217
To hold the position data at a stop	Current position retention function	P.B015	Pr.538	215
To monitor pulses	Pulse monitor selection	P.B011	Pr.430	207
	Cumulative pulse monitoring	P.M610, P.M611, P.M613	Pr.635, Pr.636, Pr.638	207

7.1 About position control

This chapter explains the position control under Vector control and PM sensorless vector control.

- A speed command, which is calculated to eliminate the difference between position command and current position, is output to rotate the motor.
- This inverter can perform simple positioning by point tables or direct commands. (Only the point table method is available for the standard model.)
- When performing position control, always perform the home position return. Position commands cannot be received until the completion of the home position return. The home position return is not required when the roll feed mode (**Pr.1293** = "1 or 2") is selected.

◆ Position control specifications

Item		Specification	
Position command input method		Point table method	Direct command method
Input method		Parameters	CiA402 drive profile
Command method	Number of points	7	—
	Command data setting range	-999999999 to +999999999	32-bit data with sign (-2147483647 to 2147483647)
	Command setting method	Absolute position command with sign, incremental position command with sign	
	Continuous operation	Available	Not available
	Electronic gear ratio	1/900 to 900	
Home position return method		Data set type, stopper type, ignoring the home position (servo-ON position as home position), count type with front end reference	
PM motor internal command resolution		MM-GKR: 5120 pulses/rev EM-A: 4096 pulses/rev	
Positioning accuracy		Induction motor: $\pm 1.5^\circ$ (Motor shaft end) MM-GKR: $\pm 1.44^\circ$ (Mechanical angle: Equivalent to the resolution of 250 pulses/rev) EM-A: $\pm 1.8^{*1}$ (Mechanical angle: Equivalent to the resolution of 200 pulses/rev)	
Other positioning functions		Sudden stop function ^{*2} , stroke end detection function ^{*2} , roll feed mode, JOG operation, pulse monitor selection function, current position retention function	
Input signal		Pre-excitation/servo ON (LX) ^{*3*4} , Forward stroke end (LSP) ^{*2} , Reverse stroke end (LSN) ^{*2} , Sudden stop (X87) ^{*2} , Point table selection (RH, RM, and RL) ^{*4} , Forward rotation command (STF) ^{*3*4} , Reverse rotation command (STR) ^{*3*4} , Proximity dog (X76)	
Output signal		Operation ready 2 (RY2), In-position (Y36), Travel completed (MEND), Stroke limit warning (LP), Position control preparation ready (RDY), During position command operation (PBSY), Rough match (CPO), Position detection level (FP), Home position return completed (ZP), Home position return failure (ZA)	
Monitor item		Position command, current position, droop pulse, position pulse (position within one revolution), ideal speed command	
Protective function		Excessive position fault (E.OD), acceleration error (E.OA)	

*1 Accuracy when the position accuracy compensation gain tuning is performed. (Refer to [page 441](#)).

*2 Enabled only during position control.

*3 Disabled for PROFINET communication.

*4 Disabled for EtherCAT communication.

◆ Control block diagram

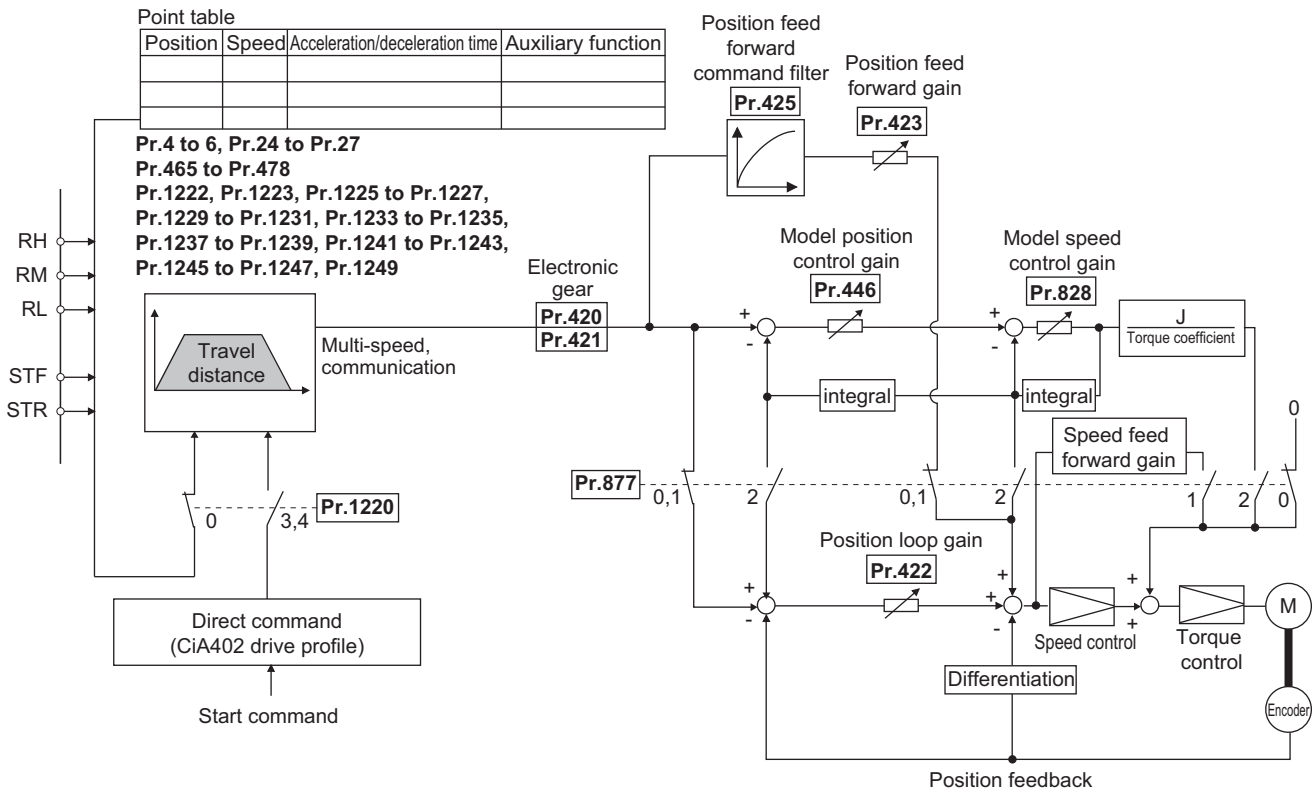

7.2 Setting procedure of Vector control (position control)

Vector

◆ Using an induction motor

Operating procedure

1. Perform wiring properly. (Refer to the Instruction Manual (Connection).)
Install a Vector control compatible option.
2. Set the motor and the encoder (**Pr.71, Pr.359, Pr.369**). (Refer to [page 424](#), [page 452](#).)
3. Set the overheat protection of the motor (**Pr.9**). (Refer to [page 306](#).)
When using the SF-V5RU or other motor equipped with a thermal sensor for overheat protection, set **Pr.9** = 0 A. For details on connecting a motor equipped with a thermal sensor, refer to the Instruction Manual (Connection).
4. Set the motor capacity and number of motor poles (**Pr.80, Pr.81**). (Refer to [page 115](#).)
V/F control is performed when the setting is "9999" (initial value).
5. Set the rated motor voltage and frequency (**Pr.83, Pr.84**). (Refer to [page 430](#).)
6. Select the control method (**Pr.800**). (Refer to [page 115](#).)
Select **Pr.800** = "3" (position control), "4" (speed/position switchover), or "5" (position/torque switchover) to enable position control.
7. Setting of position command
 - Point table method: Set the positioning parameters (**Pr.465 to Pr.478, Pr.1222, Pr.1223, Pr.1225 to Pr.1227, Pr.1229 to Pr.1231, Pr.1233 to Pr.1235, Pr.1237 to Pr.1239, Pr.1241 to Pr.1243, Pr.1245 to Pr.1247, Pr.1249**). (Refer to [page 184](#).)
 - Direct command method: Set the positioning parameters (**Pr.464, Pr.1220, Pr.1225**). (Refer to [page 197](#).)
8. Set parameters related to home position return.
 - Point table method: Set the parameters related to home position return (**Pr.511, Pr.1095 to Pr.1097, Pr.1282, Pr.1283, Pr.1285, Pr.1286**). (Refer to [page 188](#).)
 - Direct command method: Set the parameters related to home position return (**Pr.511, Pr.1095 to Pr.1097, Pr.1222, Pr.1223, Pr.1285, Pr.1286**) and set the indices of the CiA402 drive profile. (Refer to [page 199](#).)
9. Perform the test operation.

As required

- Set the electronic gear. (Refer to [page 210](#).)
- Set the position adjustment parameters. (Refer to [page 212](#).)
- Adjust the position control gain. (Refer to [page 217](#).)
- Set the torque limit. (Refer to [page 139](#).)
- Set the functions of output terminals. (Refer to [page 371](#).)

NOTE

- The carrier frequency is limited during Vector control. (Refer to [page 249](#).)
- To perform operation in position control mode, the Pre-excitation/servo ON (LX) signal needs to be turned ON. To assign the LX signal, set "23" in any parameter from **Pr.178 to Pr.189 (Input terminal function selection)** (not required during PROFINET or EtherCAT communication).
- Ignoring the home position (servo ON position as the home position) is initially selected for the home position return method.
- Vector control is not available for the IP67 model as plug-in options are not available.

7.3 Setting procedure of PM sensorless vector control (position control)

PM

This inverter is set for an induction motor in the initial setting. Follow the following procedure to change the setting for the PM sensorless vector control.

◆ When using a PM motor (MM-GKR, EM-A)

Operating procedure

1. Perform wiring properly. (Refer to the Instruction Manual (Connection).)
2. Perform PM parameter initialization. (Refer to [page 123](#).)
Set "3024, 3044, 3124, or 3144" in **Pr.998 PM parameter initialization**, or select "PM" (PM parameter initialization) and set "3024 or 3044" on the operation panel.
To use a motor capacity that is one rank lower than the inverter capacity, set **Pr.80 Motor capacity** before performing PM parameter initialization.

Setting	Description
3024	Parameter setting (in rotations per minute) for the MM-GKR motor
3044	Parameter setting (in rotations per minute) for the EM-A motor
3124	Parameter setting (in frequencies) for the MM-GKR motor
3144	Parameter setting (in frequencies) for the EM-A motor

3. Select the control method (**Pr.800**). (Refer to [page 115](#).)
Select **Pr.800** = "13" (position control) or "14" (speed/position switchover) to enable position control.
4. Setting of position command
 - Point table method: Set the positioning parameters (**Pr.465 to Pr.478, Pr.1222, Pr.1223, Pr.1225 to Pr.1227, Pr.1229 to Pr.1231, Pr.1233 to Pr.1235, Pr.1237 to Pr.1239, Pr.1241 to Pr.1243, Pr.1245 to Pr.1247, Pr.1249**). (Refer to [page 184](#).)
 - Direct command method: Set the positioning parameters (**Pr.464, Pr.1220, Pr.1225**). (Refer to [page 197](#).)
5. Set parameters related to home position return.
 - Point table method: Set the parameters related to home position return (**Pr.511, Pr.1095 to Pr.1097, Pr.1282, Pr.1283, Pr.1285, Pr.1286**). (Refer to [page 188](#).)
 - Direct command method: Set the parameters related to home position return (**Pr.511, Pr.1095 to Pr.1097, Pr.1222, Pr.1223, Pr.1285, Pr.1286**) and set the indices of the CiA402 drive profile. (Refer to [page 199](#).)
6. Perform the test operation.

As required

- Set the electronic gear. (Refer to [page 210](#).)
- Set the position adjustment parameters. (Refer to [page 212](#).)
- Adjust the position control gain. (Refer to [page 217](#).)
- Set the torque limit. (Refer to [page 139](#).)
- Set the functions of output terminals. (Refer to [page 371](#).)

NOTE

- To change to the PM sensorless vector control, perform PM parameter initialization first. If parameter initialization is performed after setting other parameters, some of those parameters are initialized too. (Refer to [page 124](#) for the parameters that are initialized.)
- The carrier frequency is limited during PM sensorless vector control. (Refer to [page 249](#).)
- During PM sensorless vector control, the RUN signal is output about 100 ms after turning ON the start command (STF, STR). The delay is due to the magnetic pole detection.
- To perform operation in position control mode, the Pre-excitation/servo ON (LX) signal needs to be turned ON. To assign the LX signal, set "23" in any parameter from **Pr.178 to Pr.189 (Input terminal function selection)** (not required during PROFINET or EtherCAT communication).
- Ignoring the home position (servo ON position as the home position) is initially selected for the home position return method.

7.4 Simple positioning function by point tables



Set positioning parameters such as the number of pulses (position) and acceleration/deceleration time in advance to create a point table (point table method). Positioning operation is performed by selecting the point table.

Pr.	Name	Initial value ^{*1}		Setting range	Description
		Gr.1	Gr.2		
4 D301	Multi-speed setting (high speed)	60 Hz	50 Hz	0 to 590 Hz	Maximum speed at the first positioning
5 D302	Multi-speed setting (middle speed)	30 Hz		0 to 590 Hz	Maximum speed at the second positioning
6 D303	Multi-speed setting (low speed)	10 Hz		0 to 590 Hz	Maximum speed at the third positioning
24 D304	Multi-speed setting (speed 4)	9999		0 to 590 Hz, 9999	Maximum speed at the fourth positioning (When Pr.24 = "9999", the Pr.6 setting is used.)
25 D305	Multi-speed setting (speed 5)	9999		0 to 590 Hz, 9999	Maximum speed at the fifth positioning (When Pr.25 = "9999", the Pr.6 setting is used.)
26 D306	Multi-speed setting (speed 6)	9999		0 to 590 Hz, 9999	Maximum speed at the sixth positioning (When Pr.26 = "9999", the Pr.5 setting is used.)
27 D307	Multi-speed setting (speed 7)	9999		0 to 590 Hz, 9999	Maximum speed at the seventh positioning (When Pr.27 = "9999", the Pr.6 setting is used.)
464 B020	Digital position control sudden stop deceleration time	0.01 s		0.01 to 360 s	Set the deceleration time when the operation is stopped by inputting the Sudden stop signal, Forward stroke end signal, or Reverse stroke end signal. Set the basis of deceleration time in Pr.20 Acceleration/deceleration reference frequency. Set the speed change time from the frequency set in Pr.20 to a stop status as the deceleration time.
465 B021	First target position lower 4 digits	0		0 to 9999	Set the target position of the point table 1.
466 B022	First target position upper 4 digits	0		0 to 9999	
467 B023	Second target position lower 4 digits	0		0 to 9999	Set the target position of the point table 2.
468 B024	Second target position upper 4 digits	0		0 to 9999	
469 B025	Third target position lower 4 digits	0		0 to 9999	Set the target position of the point table 3.
470 B026	Third target position upper 4 digits	0		0 to 9999	
471 B027	Fourth target position lower 4 digits	0		0 to 9999	Set the target position of the point table 4.
472 B028	Fourth target position upper 4 digits	0		0 to 9999	
473 B029	Fifth target position lower 4 digits	0		0 to 9999	Set the target position of the point table 5.
474 B030	Fifth target position upper 4 digits	0		0 to 9999	
475 B031	Sixth target position lower 4 digits	0		0 to 9999	Set the target position of the point table 6.
476 B032	Sixth target position upper 4 digits	0		0 to 9999	
477 B033	Seventh target position lower 4 digits	0		0 to 9999	Set the target position of the point table 7.
478 B034	Seventh target position upper 4 digits	0		0 to 9999	
511 B197	Home position return shifting speed	0.5 Hz		0 to 400 Hz	Set the speed for shifting the home position.
1095 B110	Home position return function selection	9999		1000, 9999	Select whether to use a positive or negative value for the position data for home position return (Pr.1096 and Pr.1097).

Pr.	Name	Initial value*1		Setting range	Description
		Gr.1	Gr.2		
1096 B111	Home position return position data lower 4 digits	0		0 to 9999	Set the position data for home position return. Position data for home position return = Pr.1097 × 10000 + Pr.1096
1097 B112	Home position return position data upper 4 digits	0		0 to 9999	
1222 B120	First positioning acceleration time	5 s		0.01 to 360 s	Set the characteristics of the point table 1.
1223 B121	First positioning deceleration time	5 s		0.01 to 360 s	
1225 B123	First positioning sub-function	10		0, 1, 10, 11, 100, 101, 110, 111	
1226 B124	Second positioning acceleration time	5 s		0.01 to 360 s	Set the characteristics of the point table 2.
1227 B125	Second positioning deceleration time	5 s		0.01 to 360 s	
1229 B127	Second positioning sub-function	10		0, 1, 10, 11, 100, 101, 110, 111	
1230 B128	Third positioning acceleration time	5 s		0.01 to 360 s	Set the characteristics of the point table 3.
1231 B129	Third positioning deceleration time	5 s		0.01 to 360 s	
1233 B131	Third positioning sub-function	10		0, 1, 10, 11, 100, 101, 110, 111	
1234 B132	Fourth positioning acceleration time	5 s		0.01 to 360 s	Set the characteristics of the point table 4.
1235 B133	Fourth positioning deceleration time	5 s		0.01 to 360 s	
1237 B135	Fourth positioning sub-function	10		0, 1, 10, 11, 100, 101, 110, 111	
1238 B136	Fifth positioning acceleration time	5 s		0.01 to 360 s	Set the characteristics of the point table 5.
1239 B137	Fifth positioning deceleration time	5 s		0.01 to 360 s	
1241 B139	Fifth positioning sub-function	10		0, 1, 10, 11, 100, 101, 110, 111	
1242 B140	Sixth positioning acceleration time	5 s		0.01 to 360 s	Set the characteristics of the point table 6.
1243 B141	Sixth positioning deceleration time	5 s		0.01 to 360 s	
1245 B143	Sixth positioning sub-function	10		0, 1, 10, 11, 100, 101, 110, 111	
1246 B144	Seventh positioning acceleration time	5 s		0.01 to 360 s	Set the characteristics of the point table 7.
1247 B145	Seventh positioning deceleration time	5 s		0.01 to 360 s	
1249 B147	Seventh positioning sub-function	10		0, 10, 100, 110	
1282 B180	Home position return method selection	4		2	Data set type
				3, 103, 203	Stopper type
				4	Ignoring the home position (servo ON position as the home position)
				6, 106, 206	Count type with front end reference
1283 B181	Home position return speed	2 Hz		0 to 400 Hz	Set the speed for the home position return operation.
1285 B183	Home position shift amount lower 4 digits	0		0 to 9999	Set the home position shift distance. Home position shift amount = Pr.1286 × 10000 digits + Pr.1285
1286 B184	Home position shift amount upper 4 digits	0		0 to 9999	
1289 B187	Home position return stopper torque	40%		0% to 200%	Set the activation level of torque limit operation for the stopper-type home position return.
1290 B188	Home position return stopper waiting time	0.5 s		0 to 10 s	Set the waiting time until home position return is started after the inverter detects the pressing status.

Pr.	Name	Initial value*1		Setting range	Description		
		Gr.1	Gr.2				
1292 B190	Position control terminal input selection	0			The input logic can be selected for X87, LSP, and LSN. Normally open: The operation is stopped when the contact between SD and each signal is closed. Normally closed: The operation is stopped when the contact between SD and each signal is opened.		
					LSN	LSP	X87
				0	Normally open	Normally open	Normally open
				1		Normally closed	Normally closed
				10		Normally open	Normally open
				11	Normally closed	Normally closed	Normally closed
				100		Normally open	Normally open
				101		Normally closed	Normally closed
				110		Normally open	Normally open
111	Normally closed	Normally closed					
1293 B191	Roll feeding mode selection	0		0	Point table position control based on the absolute position		
				1	Point table position control in the roll feed mode 1		
				2	Point table position control in the roll feed mode 2		

*1 Gr.1 and Gr.2 are the parameter initial value groups. (Refer to page 54.)

◆ Positioning by point tables (Pr.4 to Pr.6, Pr.24 to Pr.27, Pr.465 to Pr.478, Pr.1222, Pr.1223, Pr.1225 to Pr.1227, Pr.1229 to Pr.1231, Pr.1233 to Pr.1235, Pr.1237 to Pr.1239, Pr.1241 to Pr.1243, Pr.1245 to Pr.1247, Pr.1249)

- Assign the target position, speed, and acceleration/deceleration time to point tables and select a table using the RH, RM, and RL signals.
- Select the External operation mode or Network operation mode (the Ethernet connector or communication option is the command source). (Point table selection signals are fixed to OFF in the Network operation mode while the PU connector is the command source, or in the PU operation mode.)

Point table	Position data [Command side]*1		Maximum speed*2	Acceleration time	Deceleration time	Auxiliary function	Point table selection signal		
	Upper	Lower					RH	RM	RL
1	Pr.466	Pr.465	Pr.4	Pr.1222	Pr.1223	Pr.1225	ON	OFF	OFF
2	Pr.468	Pr.467	Pr.5	Pr.1226	Pr.1227	Pr.1229	OFF	ON	OFF
3	Pr.470	Pr.469	Pr.6	Pr.1230	Pr.1231	Pr.1233	OFF	OFF	ON
4	Pr.472	Pr.471	Pr.24	Pr.1234	Pr.1235	Pr.1237	OFF	ON	ON
5	Pr.474	Pr.473	Pr.25	Pr.1238	Pr.1239	Pr.1241	ON	OFF	ON
6	Pr.476	Pr.475	Pr.26	Pr.1242	Pr.1243	Pr.1245	ON	ON	OFF
7	Pr.478	Pr.477	Pr.27	Pr.1246	Pr.1247	Pr.1249	ON	ON	ON

*1 Position commands are accepted after the home position return operation is completed. New position data are not accepted during home position return operation.

*2 A frequency higher than Pr.1 Maximum frequency cannot be set for the speed command. The Pr.2 Minimum frequency setting is disabled.

◆ Position data settings

- Set the position feed length in Pr.465 to Pr.478.
- The feed length set to each point table is selected by multi-speed terminals (RH, RM, and RL).
- Under Vector control with encoder, set the value calculated with the following formula as the position feed length: (encoder resolution × rotations per minute × 4).
- For example, to stop the SF-PR-SC motor after 100 times of rotations, the value is calculated as follows:
2048 (pulses/rev) × 100 (rotations per minute) × 4 (multiplier) = 819200 (feed length)
To set 819200 as the first feed length, separate the number into the upper and lower four digits as follows:
Pr.466 (upper digits) = 81 (decimal), Pr.465 (lower digits) = 9200 (decimal)

◆ Acceleration/deceleration time setting

- Set the acceleration/deceleration time for parameters corresponding to each point table.

- The frequency which is the basis of acceleration/deceleration time is **Pr.20 Acceleration/deceleration reference frequency**. However, 1 Hz/s is the minimum acceleration/deceleration rate (acceleration/deceleration frequency divided by acceleration/deceleration time). If the acceleration/deceleration rate is smaller than 1, the motor runs at 1 Hz/s or in the deceleration time.
- The maximum acceleration/deceleration time is limited at 360 seconds.
- During position control, acceleration/deceleration pattern is always the liner acceleration/deceleration. The settings of **Pr.29 Acceleration/deceleration pattern selection**, **Pr.791 Acceleration time in low-speed range**, and **Pr.792 Deceleration time in low-speed range** are ignored.
- This setting is applied to the operation also when the RT signal input or the motor speed is equal to or higher than the **Pr.147 Acceleration/deceleration time switching frequency**. (The second deceleration time is ignored.)

◆ Auxiliary function setting

- Set the handling and operation methods of the position data in each point table, using **Pr.1225**, **Pr.1229**, **Pr.1233**, **Pr.1237**, **Pr.1241**, **Pr.1245**, and **Pr.1249**.
- Set the auxiliary function for parameters corresponding to each point table.

Auxiliary function parameter setting	Sign (hundreds place)	Command method (tens place)	Operation method (ones place)
0	Plus (0)	Absolute position command (0)	Individual (0)
1			Continuous (1)
10 (initial value)		Incremental position command (1)	Individual (0)
11			Continuous (1)
100	Minus (1)	Absolute position command (0)	Individual (0)
101			Continuous (1)
110		Incremental position command (1)	Individual (0)
111			Continuous (1)

- For the sign, select the sign of position data.
- For the command method, select the absolute position command or incremental position command. For the absolute position command, specify the distance from the home position. For the incremental position command, specify the distance from the current position command.
- For the operation method, select individual or continuous. When continuous operation is selected, next point table is executed after a command has been executed.
- Continuous operation cannot be selected for the point table 7. ("10, 100, or 110" can be set in **Pr.1249**).
- Individual operation is only executed in the selected point table.
- When the incremental position command is selected and the reverse rotation command is given, the sign of position data is reversed. When the absolute position command is selected, the sign of position data is not reversed even when the reverse rotation command is given.

Auxiliary function setting	Command method	Incremental position command		Absolute position command	
	Sign	Plus	Minus	Plus	Minus
Forward rotation command		Plus	Minus	Plus	Minus
Reverse rotation command		Minus	Plus	Plus	Minus

◆ Example of positioning operation by point tables (automatic continuous positioning operation)

The following figure shows an operation example using the following point table.

Point table	Target position		Maximum speed (Hz)	Acceleration time (s)	Deceleration time (s)	Auxiliary function
	Upper	Lower				
1	2	0	100.00	0.05	0.05	1 (absolute position, continuous)
2	1	0	50.00	0.10	0.10	11 (incremental position, continuous)
3	0	5000	25.00	0.20	0.20	10 (incremental position, individual)

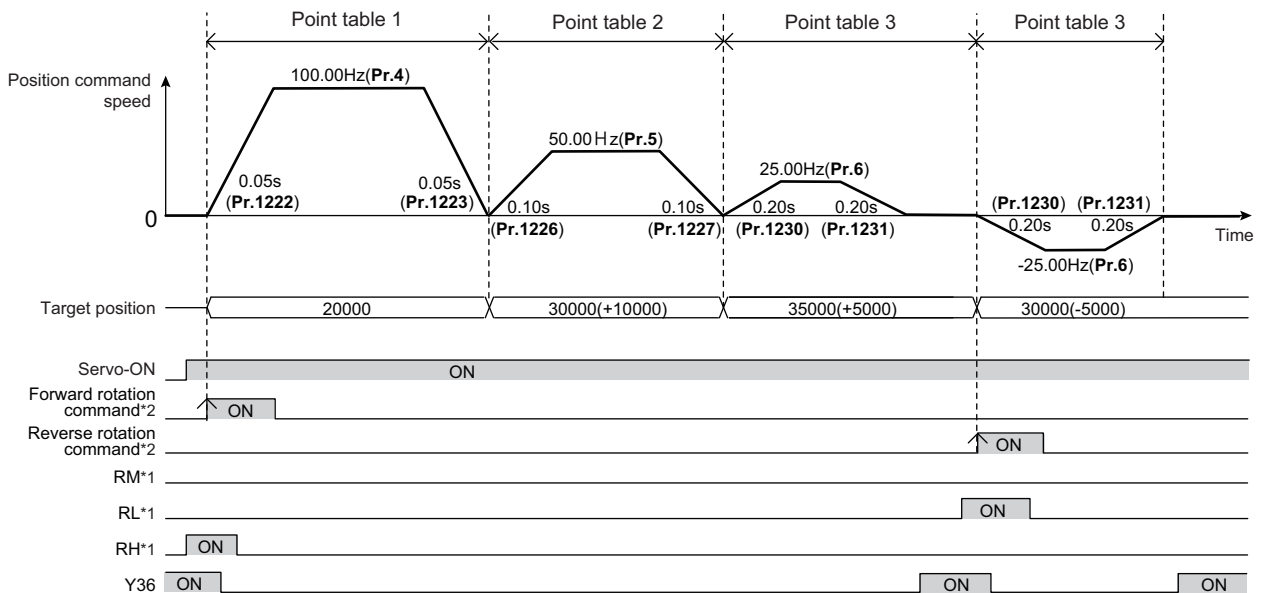

- *1 Turn ON the start signal 5 ms or more after the point table selection signal is turned ON.
 *2 After the start signal is turned ON, the ON state should be retained for 20 ms or longer.

NOTE

- During continuous operation, the position command speed drops to 0 in each point table operation before starting the next point table operation.
- During continuous operation, no point table selection signal is received. Select the position feed length using point table before turning ON the start command.

◆ Return to home position during point table positioning

- Home position return is performed to match the command coordinates with the machine coordinates. Position control with an absolute position cannot be performed until the home position is set.
- The returned home position can be set as point 0, and positioning operation is available using this point.

■ Home position return procedure

1. Set parameters related to home position return.
 - Set the home position return method. (Pr.1282)
 - Set the home position return speed. (Pr.1283)
 - Set the home position return shifting speed. (Pr.511)
 - Set the home position return shift amount if necessary. (Pr.1286 × 10000 + Pr.1285)
 - Select whether to use a positive or negative value for the position data for home position return. (Pr.1095)
 - Set the position data for home position return. (Pr.1097 × 10000 + Pr.1096)
2. Turn OFF the JOG signal and all point table selection signals.
 - Turn OFF all RH, RM, RL and JOG signals. (Not required for EtherCAT communication.)
3. Enable the servo-lock function.
 - Turn ON the Pre-excitation/servo ON (LX) signal. (Not required for PROFINET or EtherCAT communication.)
 - The servo ON/OFF status is switched to ON state along with state transition (for PROFINET or EtherCAT communication).
4. Turn ON the start command.
 - Turn ON the start signal (STF or STR). (Not required for PROFINET or EtherCAT communication.)
 - Turn ON bit 13 of Control word 1 (STW1) (for PROFINET communication only).
 - Turn ON bit 4 of Index H6040 (Controlword) (for EtherCAT communication only).

NOTE

- The setting values of Pr.7 and Pr.8 are used as acceleration/deceleration time.
- For details on communication protocols, refer to the Instruction Manual (Communication).

◆ Selecting the home position return method (Pr.511, Pr.1282, Pr.1283, Pr.1285, Pr.1286)

Pr.1282 setting	Home position return method	Description
2	Data set type	<p>After home position return is started, the In-position (Y36) signal is turned ON when the droop pulses (after electronic gear) are equal to or less than the setting value of Pr.426^{*1} (In-position width)). The position command value when the Y36 signal is turned ON is set as the home position. The settings of the direction for home position return and home position shift distance are ignored. HP1 (Home position return setting error) will be displayed if the Y36 signal remains OFF for 10 seconds after the home position return is started.</p>
3, 103, 203	Stopper type	<p>A workpiece is pressed to a mechanical stopper, and the position where it is stopped is set as the home position. Pressing is confirmed when the speed remains equal to or lower than the value set in Pr.865 Low speed detection for 0.5 second during the torque limit operation. (While the stopper-type home position is performed, Pr.1289 Home position return stopper torque is applied.) After Pr.1290 Home position return stopper waiting time has passed after pressing is confirmed, the home position is shifted by the home position shift distance (Pr.1285 and Pr.1286). After a position command is created and the absolute value of the droop pulse (after electronic gear) reaches the in-position width set in Pr.426^{*1} or less, the home position return is completed.</p> <p>Home position return direction</p> <ul style="list-style-type: none"> • Position pulse increasing direction: when Pr.1282 = "3" and the forward rotation command is given, or when Pr.1282 = "103" • Position pulse decreasing direction: when Pr.1282 = "3" and the reverse rotation command is given, or when Pr.1282 = "203" <p>HP1 (Home position return setting error) will be displayed in any of the following cases:</p> <ul style="list-style-type: none"> • Pressing does not last for the time period set in Pr.1290 Home position return stopper waiting time. • After a position command is created, the Y36 signal remains OFF for 10 seconds. • The home position return is started while the stroke end signal in the direction of travel is detected. • The operation suddenly stops as the stroke end signal in the direction of travel is detected while the position command is being created.

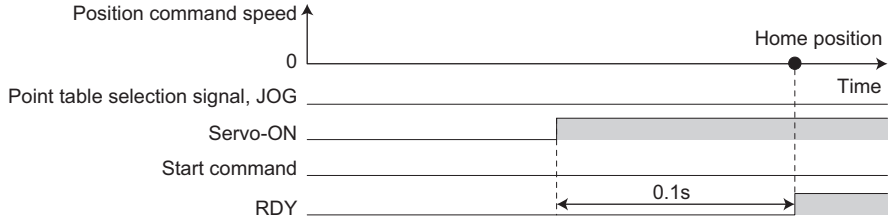
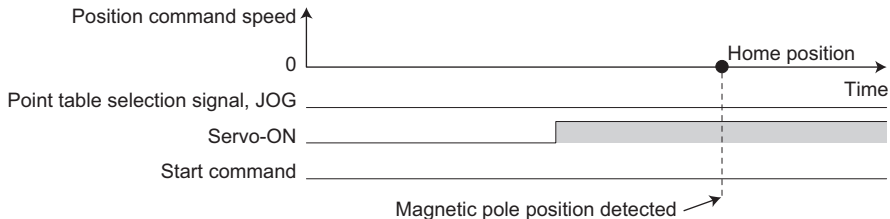
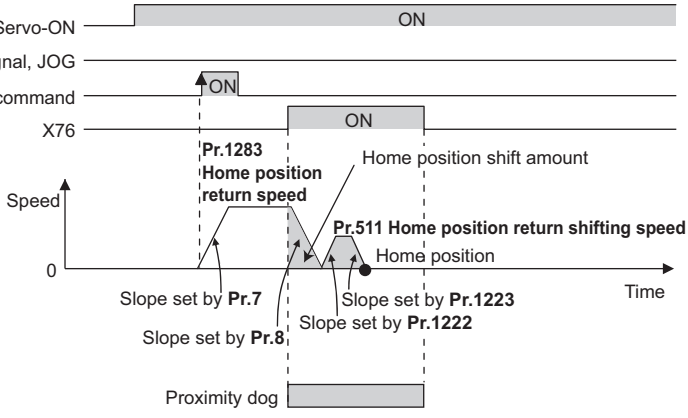
Pr.1282 setting	Home position return method	Description
4 (initial value)	Ignoring the home position (servo ON position as the home position)	<p>The servo ON position is used as the home position. The settings of the direction for home position return and home position shift distance are ignored.</p> <p>Under Vector control: If the servo-lock function is enabled, output shutoff is canceled and the Position control preparation ready (RDY) signal is turned ON after 0.1 second.</p>  <p>Under PM sensorless vector control: If the servo-lock function is enabled, the home position is set after magnetic pole position detection.</p> 
6, 106, 206	Count type with front end reference ^{*2}	<p>The home position is determined based on the detection position of the front end of the proximity dog. Deceleration starts at the front end of the proximity dog, and the position after the shift by the home position shift distance is set as the home position.</p> <p>Home position return direction</p> <ul style="list-style-type: none"> • Position pulse increasing direction: when Pr.1282 = "6" and the forward rotation command is given, or when Pr.1282 = "106" • Position pulse decreasing direction: when Pr.1282 = "6" and the reverse rotation command is given, or when Pr.1282 = "206" <p>To input the X76 signal, set "76" in any parameter from Pr.178 to Pr.189 (Input terminal function selection) to assign the function to a terminal.</p>  <p>HP1 (Home position return setting error) will be displayed in any of the following cases:</p> <ul style="list-style-type: none"> • The operation suddenly stops as the stroke end signal in the direction of travel is detected while the position command is being created. • After a position command is created, the Y36 signal remains OFF for 10 seconds.

*1 For EtherCAT communication, the value set in Index H6067 (Position window) is used.

*2 Change of the speed at which the proximity dog is detected may cause fluctuations of the average home position. Consider fluctuations of the home position to set **Pr.1283**.

NOTE

- Home position return automatic back-off function
 The home position return starts after the transfer device goes back to the point from which the home position return is possible. This function is enabled when a proximity dog is used for the home position return and when the current position at that start is detected on the following places:
 On the proximity dog
 On the place between the proximity dog and the stroke end in the direction of travel
 On the stroke end

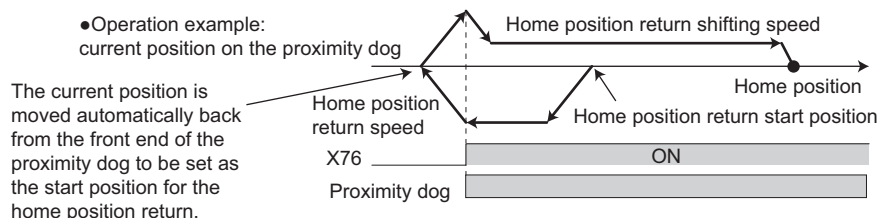

◆ Home position return function selection (Pr.1095), Home position return position data (Pr.1096, Pr.1097)

- Use **Pr.1095 Home position return function selection** to select whether to use a positive or negative value for the position data for home position return (**Pr.1096 and Pr.1097**).

Pr.1095 setting	Position data for home position return (Pr.1096 and Pr.1097)
9999 (initial value)	Positive value
1000	Negative value

- Position data for home position return
 Set the final position for the home position return. Set the upper 4-digit data in **Pr.1097** and the lower 4-digit data in **Pr.1096**.
 Position command (before electronic gear) = Position data for home position return (**Pr.1096 and Pr.1097**)
 Current position (before electronic gear) = Position data for home position return - Droop pulse (converted before electronic gear)
 The droop pulses are not cleared.

NOTE

- If parameters are copied from an inverter without functions of **Pr.1096 and Pr.1097** to a new inverter, "----" is displayed for the settings of **Pr.1096 and Pr.1097** on the operation panel. The operation for the setting of "0 (initial value)" is performed. (Refer to [page 599](#).)

◆ Home position return error

- If home position return is not normally completed, the following warnings appear on the operation panel.

Operation panel indication	Name	Possible cause
HP1	Home position return setting error	• The home position setting has failed.
HP2	Home position return uncompleted	• Start signal for the point table positioning has turned ON without completing the home position return. (Except in the roll feed mode)

- Unless the home position return is completed (the ZP signal is turned ON), position control cannot be performed (except when JOG operation during position control or the roll feed mode is enabled).
- The Home position return failure (ZA) signal is output while the home position return warning is activated. To use the ZA signal, set "56" (positive logic) or "156" (negative logic) in any parameter from **Pr.190 to Pr.197 (Output terminal function selection)** to assign the function.

◆ Sudden stop (Pr.464, Pr.1292, and X87 signal)

- When the Sudden stop (X87) signal is assigned to an input terminal, turning ON the X87 signal (normally open input) stops the operation according to the deceleration time slope set by **Pr.464 Digital position control sudden stop deceleration time**. (For EtherCAT communication, the value set in Index H6085 (Quick stop deceleration) can be also used.) When the deceleration time set in **Pr.464** is longer than that set by the current position control command, the deceleration time slope set by the current position control command is applied. After the operation is stopped, turning OFF the X87 signal (normally open input) starts position control again. To input the X87 signal, set "87" in any parameter from **Pr.178 to Pr.189 (Input terminal function selection)** to assign the function to a terminal.
- When the ones place of the set value in **Pr.1292 Position control terminal input selection** is "0", the normally open input is applied and the operation is stopped by turning ON the X87 signal. When the ones place is "1", the normally closed input is applied and the operation is stopped by turning OFF the X87 signal.

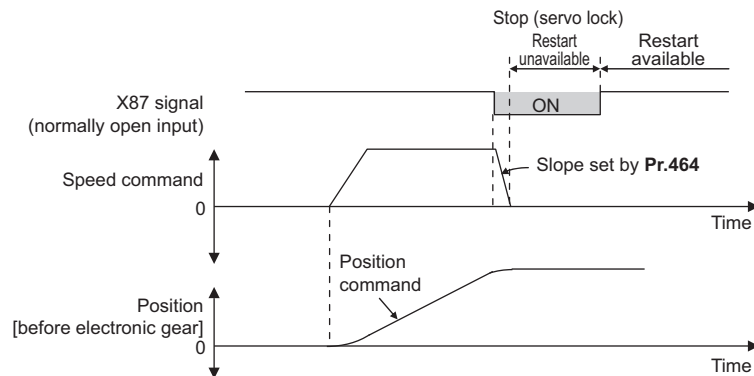

◆ Stroke end settings (Pr.464, Pr.1292, LSP signal, LSN signal, and LP signal)

- The normally open input is applied when **Pr.1292** = "0, 1, 100, or 101" for the LSP signal or "0, 1, 10, or 11" for the LSN signal, and turning ON the signal stops the operation. The normally closed input is applied when **Pr.1292** = "10, 11, 110, or 111" for the LSP signal or "100, 101, 110, or 111" for the LSN signal, and turning OFF the signal stops the operation.
- When the Forward stroke end (LSP) signal or Reverse stroke end (LSN) signal is assigned to an input terminal, turning OFF the LSP/LSN signal (normally closed input) stops the operation according to the deceleration time slope set by **Pr.464 Digital position control sudden stop deceleration time**. (For EtherCAT communication, the value set in Index H6085 (Quick stop deceleration) can be also used.) When the deceleration time set in **Pr.464** is longer than that set by the current position control command, the deceleration time slope set by the current position control command is applied. After stopped, the motor cannot be rotated in the counterclockwise (CCW) direction while the LSP signal is OFF, or in the clockwise (CW) direction while the LSN signal is OFF (normally closed input in both cases).
- The setting of **Pr.359 Encoder rotation direction** determines the motor rotation direction restricted by the LSP/LSN signal.
 LSP signal: After stopped, the motor cannot be rotated in the CCW (CW) direction when **Pr.359** = "101 (100)" while the signal is OFF (normally closed input).
 LSN signal: After stopped, the motor cannot be rotated in the CW (CCW) direction when **Pr.359** = "101 (100)" while the signal is OFF (normally closed input).
- To input the LSP signal, set "88" in any parameter from **Pr.178 to Pr.189 (Input terminal function selection)** to assign the function.
- To input the LSN signal, set "89" in any parameter from **Pr.178 to Pr.189 (Input terminal function selection)** to assign the function.
- When the LSP signal or LSN signal is OFF (normally closed input), the Stroke limit warning (LP) signal is turned ON and "LP" is displayed on the operation panel. To use the Stroke limit warning (LP) signal, set "24" (positive logic) or "124" (negative logic) in any parameter from **Pr.190 to Pr.197 (Output terminal function selection)** to assign the function.

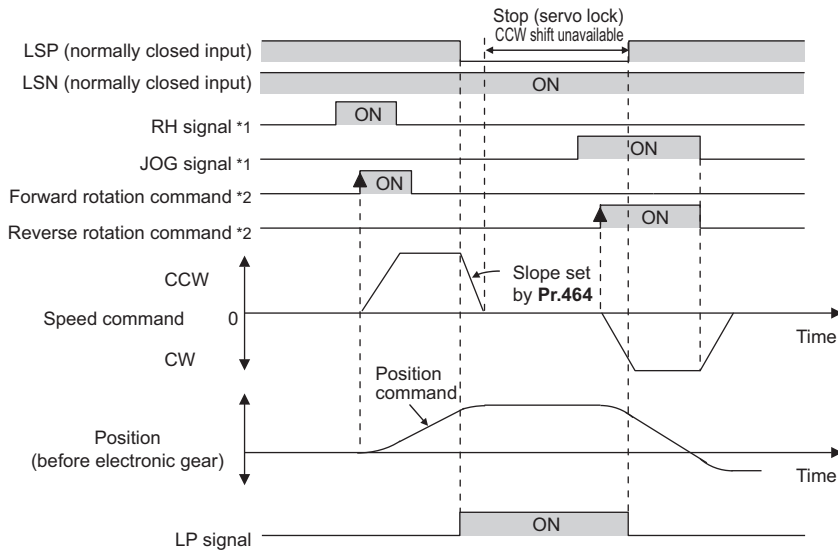

- *1 Turn ON the start signal 5 ms or more after the point table selection signal or JOG signal is turned ON.
- *2 After the start signal is turned ON, the ON state should be retained for 20 ms or longer.

Stroke end input (normally closed input)		Operation availability	
LSP (Forward stroke end)	LSN (Reverse stroke end)	CCW rotation	CW rotation
ON	ON	Available	Available
OFF	ON	Unavailable	Available
ON	OFF	Available	Unavailable
OFF	OFF	Unavailable	Unavailable

NOTE

- The control method cannot be changed while the LSP or LSN signal is OFF (normally closed input).
- When position control is not selected, the LP signal and warning (LP) are available but the sudden stop using stroke end signals is disabled.

◆ Roll feed mode 1 and 2 (Pr.1293)

- These modes are used in an application that needs repeated positioning in the same direction, such as a conveyor.
- When the roll feed mode 1 is selected (**Pr.1293 = "1"**), positioning operation is performed with the current position and position command set to 0 at start. Position commands are not overflowed and the repeated feed by the increment is available.
- When the roll feed mode 2 is selected (**Pr.1293 = "2"**), positioning operation is performed with the position command set to 0 and the current position set to the value of the previous current position data decremented by the droop pulse at start. The difference between the position command and the current position at each start is not accumulated.

• Pr.1293 = "1"

• Pr.1293 = "2"

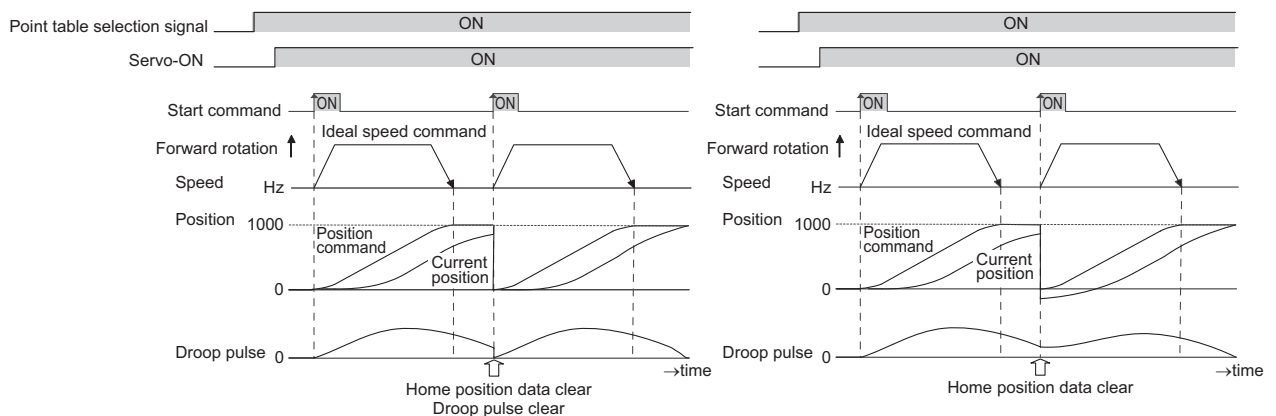

- When the roll feed is enabled, the home position return operation is not required.

- The following shows the operation example during positioning by point tables with **Pr.1293 = "1"** (roll feed mode 1).

Point table	Target position (before electronic gear)	Maximum speed (Hz)	Acceleration time (s)	Deceleration time (s)	Auxiliary function
1	Pr.465 = "1000", Pr.466 = "0"	Pr.4 = "60"	Pr.1222 = "1"	Pr.1223 = "1"	Pr.1225 = "1"
2	Pr.467 = "1000", Pr.468 = "0"	Pr.5 = "40"	Pr.1226 = "2"	Pr.1227 = "2"	Pr.1229 = "10"
3	Pr.469 = "500", Pr.470 = "0"	Pr.6 = "60"	Pr.1230 = "1"	Pr.1231 = "1"	Pr.1233 = "100"

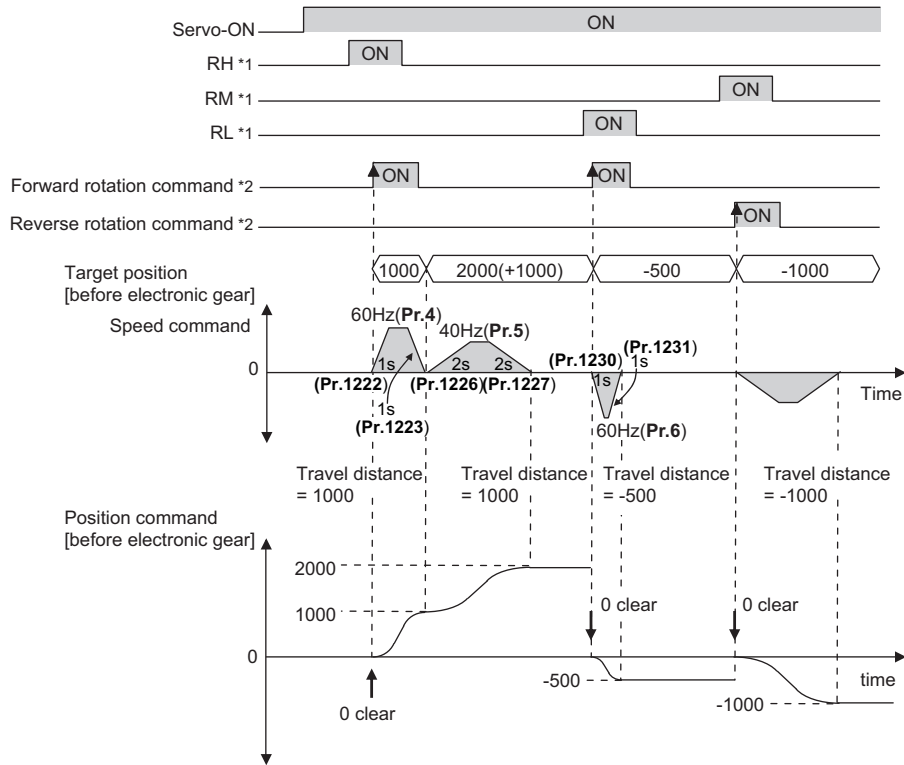

- *1 Turn ON the start signal 5 ms or more after the point table selection signal is turned ON.
- *2 After the start signal is turned ON, the ON state should be retained for 20 ms or longer.

◆ Input/output signals for point table positioning

Input/output	Signal name		Function	Pr.178 to Pr.189 setting	Pr.190 to Pr.197 setting	
					Positive logic	Negative logic
Input	X76	Proximity dog	ON: dog ON, OFF: dog OFF	76	—	
	X87	Sudden stop	Turning ON this signal starts deceleration stop according to Pr.464 ^{*1} (normally open input).	87	—	
	LSP	Forward stroke end	Turning ON this signal starts deceleration stop according to Pr.464 ^{*1} (normally open input).	88	—	
	LSN	Reverse stroke end	Turning ON this signal starts deceleration stop according to Pr.464 ^{*1} (normally open input).	89	—	
Output	MEND	Travel completed	Turns ON when the position command operation has completed while the number of droop pulses is within the positioning completion width.	—	38	138
	LP	Stroke limit warning	Turns ON when the LSP or LSN signal turns ON (normally open input).	—	24	124
	Y36	In-position	Turns ON when the number of droop pulses is equal to or smaller than the Pr.426 ^{*2} setting value.	—	36	136
	ZA	Home position return failure	Turns ON while the home position return warning is activated.	—	56	156
	PBSY	During position command operation	Turns ON during position command operation.	—	61	161
	ZP	Home position return completed	Turns ON after home position return operation is complete.	—	63	163
	RDY	Position control preparation ready	Turns ON when the servo-lock function is working and the inverter is ready to operate.	—	84	184

*1 For EtherCAT communication, the value set in Index H6085 (Quick stop deceleration) can be also used.

*2 For EtherCAT communication, the value set in Index H6067 (Position window) is used.

- Output signal operation during positioning by point tables

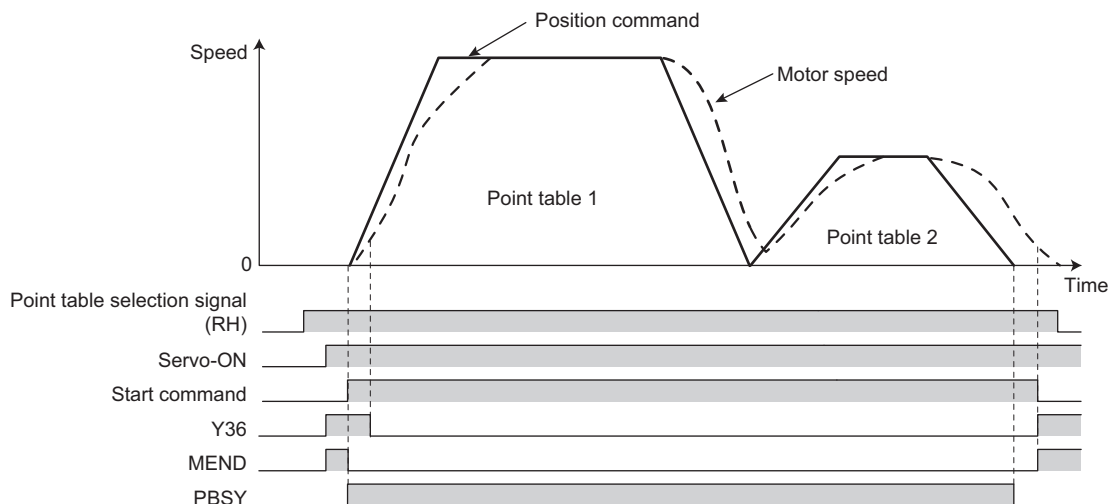

- Output signal operation during positioning with home position return

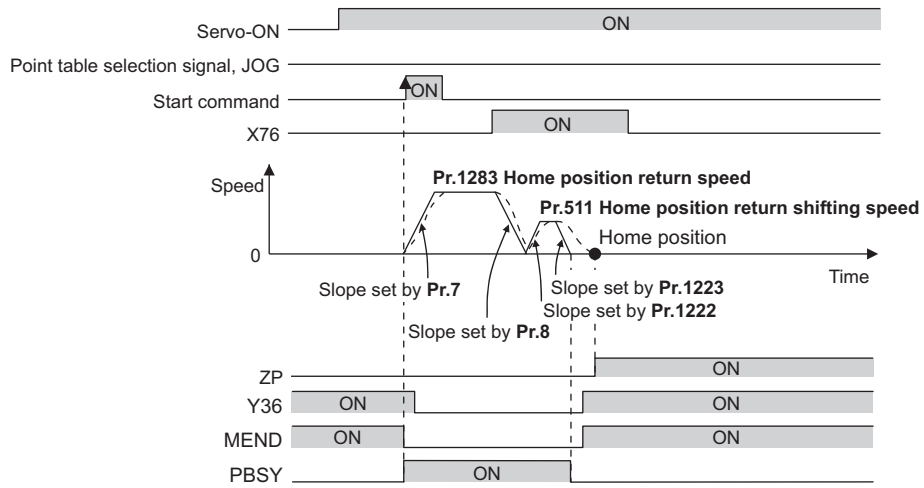

NOTE

- When the servo-lock function is disabled, the home position return completed (ZP) signal is turned OFF. If "9999" is not set in **Pr.538 Current position retention selection**, the ZP signal remains ON even when the servo-lock function is disabled. (For details on the current position retention function, refer to [page 215](#).)

7.5 Simple positioning function by direct commands (Ethernet model / safety communication model / IP67 model)



Position data (target position, maximum speed, and acceleration/deceleration time) and settings for the home position return operation are directly input from the CiA402 drive profile. (For details on the CiA402 drive profile, refer to the Instruction Manual (Communication).)

Pr.	Name	Initial value	Setting range	Description		
464 B020	Digital position control sudden stop deceleration time	0.01 s	0.01 to 360 s	Set the deceleration time when the operation is stopped by inputting the Sudden stop signal, Forward stroke end signal, or Reverse stroke end signal. Set the basis of deceleration time in Pr.20 Acceleration/deceleration reference frequency . Set the speed change time from the frequency set in Pr.20 to a stop status as the deceleration time.		
511 B197	Home position return shifting speed	0.5 Hz	0 to 400 Hz	Set the speed for shifting the home position.		
1095 B110	Home position return function selection	9999	1000, 9999	Select whether to use a positive or negative value for the position data for home position return (Pr.1096 and Pr.1097).		
1096 B111	Home position return position data lower 4 digits	0	0 to 9999	Set the position data for home position return. Position data for home position return = Pr.1097 × 10000 + Pr.1096		
1097 B112	Home position return position data upper 4 digits	0	0 to 9999			
1220 B100	Direct command mode selection	0	[E800-(SC)EPA] [E800-(SC)EPB] [E806] 0, 3 [E800-EPC] 0, 4	Select the position command input method.		
1222 B120	First positioning acceleration time	5 s	0.01 to 360 s	Set the characteristics for positioning.		
1223 B121	First positioning deceleration time	5 s	0.01 to 360 s			
1225 B123	First positioning sub-function	10	0, 1, 10, 11, 100, 101, 110, 111			
1285 B183	Home position shift amount lower 4 digits	0	0 to 9999	Set the home position shift distance. Home position shift amount = Pr.1286 × 10000 digits + Pr.1285		
1286 B184	Home position shift amount upper 4 digits	0	0 to 9999			
1289 B187	Home position return stopper torque	40%	0% to 200%	Set the activation level of torque limit operation for the stopper-type home position return.		
1290 B188	Home position return stopper waiting time	0.5 s	0 to 10 s	Set the waiting time until home position return is started after the inverter detects the pressing status.		
1292 B190	Position control terminal input selection	0		The input logic can be selected for X87, LSP, and LSN. Normally open: The operation is stopped when the contact between SD and each signal is closed. Normally closed: The operation is stopped when the contact between SD and each signal is opened.		
				LSN	LSP	X87
			0	Normally open	Normally open	Normally open
			1			Normally closed
			10	Normally closed	Normally open	Normally open
			11			Normally closed
			100	Normally closed	Normally open	Normally open
			101			Normally closed
110	Normally closed	Normally open				
111		Normally closed				

Pr.	Name	Initial value	Setting range	Description
1293 B191	Roll feeding mode selection	0	0	Direct command position control based on the absolute position
			1	Direct command position control in the roll feed mode 1
			2	Direct command position control in the roll feed mode 2

◆ Positioning by direct commands (Pr.1220, Pr.1225)

- Positioning is performed using the target position, speed, and acceleration/deceleration time determined by the CiA402 drive profile.
- Select the Network operation mode (the Ethernet connector or communication option is the command source).
- To enable the direct command mode, set "3 or 4" in **Pr.1220 Direct command mode selection**. (The change of **Pr.1220** setting is applied when position control is started (home position return or positioning).)

Pr.1220 setting	Position command input method	Target position	Maximum speed	Acceleration time	Deceleration time	Auxiliary function		
						Sign	Command method	Operation method
0 (initial value)	Point table	Parameters						
3 ^{*1}	Direct command	Index H607A (Target position)	Index H6081 (Profile velocity)	Index H6083 (Profile acceleration)	Index H6084 (Profile deceleration)	*3	Pr.1225	*4
4 ^{*2}	Direct command	Index H607A (Target position)	Index H6081 (Profile velocity)	Index H6083 (Profile acceleration)	Index H6084 (Profile deceleration)	*3	Index H6040 (Bit6) (Controlword)	*4

*1 The setting is available only for the FR-E800-(SC)EPA, the FR-E800-(SC)EPB, and the FR-E806.

*2 The setting is available only for the FR-E800-EPC.

*3 Plus when the setting value in the Index H607A ≥ "0" and minus when the setting value in the Index H607A < "0".

*4 Fixed to individual operation

◆ Auxiliary function setting (Pr.1225)

- When **Pr.1220** = "3", the command method can be set using **Pr.1225**.

Pr.1225 setting	Sign (hundreds place)	Command method (tens place)	Operation method (ones place)
0	Plus (0)	Absolute position command (0)	Individual (0)
10 (initial value)		Incremental position command (1)	
100	Minus (1)	Absolute position command (0)	
110		Incremental position command (1)	
1, 11, 101, 111	Setting not available		

- The sign is plus (0) when the setting value in the Index H607A ≥ "0" or minus (1) when the setting value in the Index H607A < "0".
- For the command method, select the absolute position command or incremental position command. For the absolute position command, specify the distance from the home position. For the incremental position command, specify the distance from the current position command.
- The operation method is fixed to individual operation (0).

◆ Return to home position during direct command positioning

- Home position return is performed to match the command coordinates with the machine coordinates. Position control with an absolute position cannot be performed until the home position is set.
- The returned home position can be set as point 0, and positioning operation is available using this point.

■ Home position return procedure

1. Set parameters related to home position return.
 - Set the home position return method (Index H6098 (Homing method)).
 - Set the home position return speed (Index H6099, Sub index H01 (Speed during search for switch)).
 - Set the home position return acceleration/deceleration time (Index H609A (Homing acceleration)).
 - Set the direction of rotation during position control (Index H607E (Polarity)) (for EtherCAT communication only).
 - Set the home position return shifting speed. (**Pr.511**)
 - Set the first positioning acceleration/deceleration time. (**Pr.1222, Pr.1223**)
 - Set the home position return shift amount if necessary. (**Pr.1286** × 10000 + **Pr.1285**)
 - Select whether to use a positive or negative value for the position data for home position return. (**Pr.1095**)
 - Set the position data for home position return. (**Pr.1097** × 10000 + **Pr.1096**)
2. Turn OFF all RH, RM, RL and JOG signals. (Not required for EtherCAT communication.)
3. Enable the servo-lock function.
 - Turn ON the Pre-excitation/servo ON (LX) signal. (Not required for PROFINET or EtherCAT communication.)
 - The servo ON/OFF status is switched to ON state along with state transition (for PROFINET or EtherCAT communication).
4. Turn ON the start command.
 - Turn ON the start signal (STF or STR). (Not required for PROFINET or EtherCAT communication.)
 - Turn ON bit 13 of Control word 1 (STW1) (for PROFINET communication only).
 - Turn ON bit 4 of Index H6040 (Controlword) (for EtherCAT communication only).

NOTE

- For details on communication protocols, refer to the Instruction Manual (Communication).

◆ Selecting the home position return method (Pr.511, Pr.1222, Pr.1223, Pr.1285, Pr.1286)

Index H6098 setting	Home position return method	Description
-3	Data set type	<p>After home position return is started, the In-position (Y36) signal is turned ON when the droop pulses (after electronic gear) are equal to or less than the setting value of Pr.426^{*1} (In-position width). The position command value when the Y36 signal is turned ON is set as the home position. The settings of the direction for home position return and home position shift distance are ignored.</p> <p>HP1 (Home position return setting error) will be displayed if the Y36 signal remains OFF for 10 seconds after the home position return is started.</p>

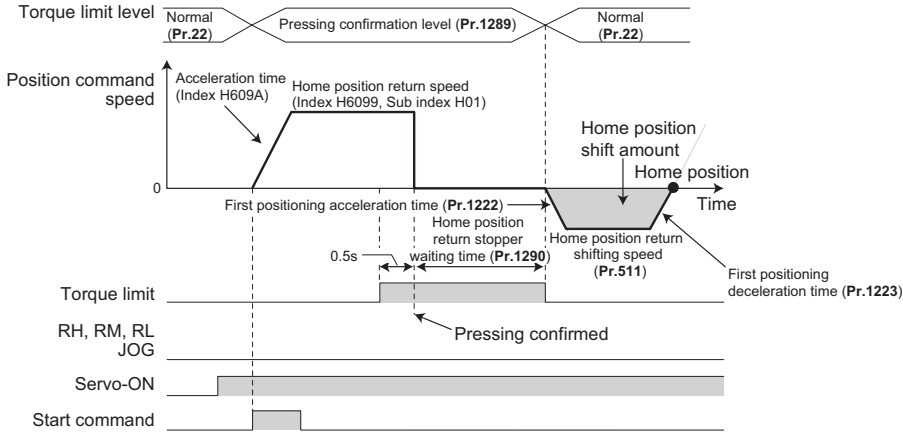
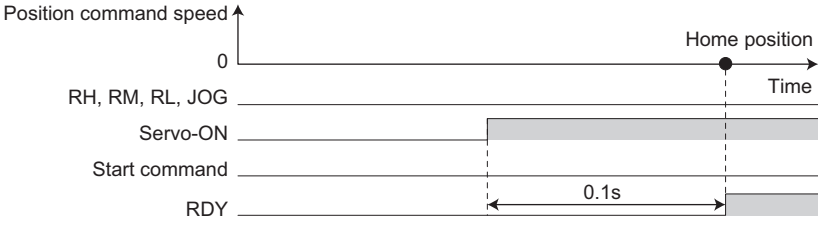
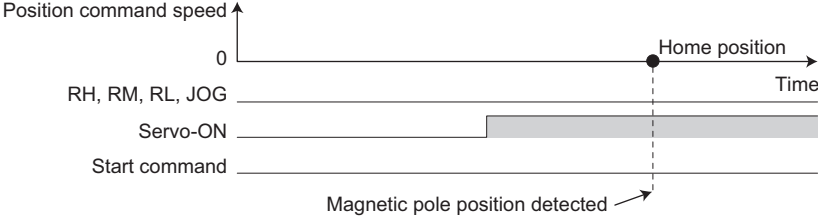
Index H6098 setting	Home position return method	Description
-65, -4, -36	Stopper type	<p>A workpiece is pressed to a mechanical stopper, and the position where it is stopped is set as the home position.</p> <p>Pressing is confirmed when the speed remains equal to or lower than the value set in Pr.865 Low speed detection for 0.5 second during the torque limit operation. (While the stopper-type home position is performed, Pr.1289 Home position return stopper torque is applied.) After Pr.1290 Home position return stopper waiting time has passed after pressing is confirmed, the home position is shifted by the home position shift distance (Pr.1285 and Pr.1286). After a position command is created and the absolute value of the droop pulse (after electronic gear) reaches the in-position width set in Pr.426^{*1} or less, the home position return is completed.</p> <p>Home position return direction</p> <ul style="list-style-type: none"> • Position pulse increasing direction: when Index H6098 = "-65" and the forward rotation command is given, or when Index H6098 = "-4" • Position pulse decreasing direction: when Index H6098 = "-65" and the reverse rotation command is given, or when Index H6098 = "-36" <p>HP1 (Home position return setting error) will be displayed in any of the following cases:</p> <ul style="list-style-type: none"> • Pressing does not last for the time period set in Pr.1290 Home position return stopper waiting time. • After a position command is created, the Y36 signal remains OFF for 10 seconds. • The home position return is started while the stroke end signal in the direction of travel is detected. • The operation suddenly stops as the stroke end signal in the direction of travel is detected while the position command is being created. 
-5 (initial value)	Ignoring the home position (servo ON position as the home position)	<p>The servo ON position is used as the home position. The settings of the direction for home position return and home position shift distance are ignored.</p> <p>Under Vector control: If the servo-lock function is enabled, output shutoff is canceled and the Position control preparation ready (RDY) signal is turned ON after 0.1 second.</p>  <p>Under PM sensorless vector control: If the servo-lock function is enabled, the home position is set after magnetic pole position detection.</p> 

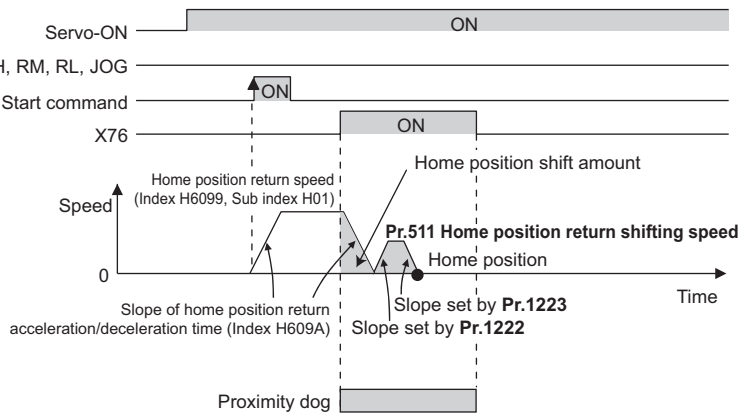
Index H6098 setting	Home position return method	Description
-66, -7, -39	Count type with front end reference ^{*2}	<p>The home position is determined based on the detection position of the front end of the proximity dog. Deceleration starts at the front end of the proximity dog, and the position after the shift by the home position shift distance is set as the home position.</p> <p>Home position return direction</p> <ul style="list-style-type: none"> Position pulse increasing direction: when Index H6098 = "-66" and the forward rotation command is given, or when Index H6098 = "-7" Position pulse decreasing direction: when Index H6098 = "-66" and the reverse rotation command is given, or when Index H6098 = "-39" <p>To input the X76 signal, set "76" in any parameter from Pr.178 to Pr.189 (Input terminal function selection) to assign the function to a terminal.</p>  <p>HP1 (Home position return setting error) will be displayed in any of the following cases:</p> <ul style="list-style-type: none"> The operation suddenly stops as the stroke end signal in the direction of travel is detected while the position command is being created. After a position command is created, the Y36 signal remains OFF for 10 seconds.

*1 For EtherCAT communication, the value set in Index H6067 (Position window) is used.

*2 Change of the speed at which the proximity dog is detected may cause fluctuations of the average home position. Consider fluctuations of the home position to set Index H6099.

NOTE

- Home position return automatic back-off function

The home position return starts after the transfer device goes back to the point from which the home position return is possible. This function is enabled when a proximity dog is used for the home position return and when the current position at that start is detected on the following places:

On the proximity dog

On the place between the proximity dog and the stroke end in the direction of travel

On the stroke end

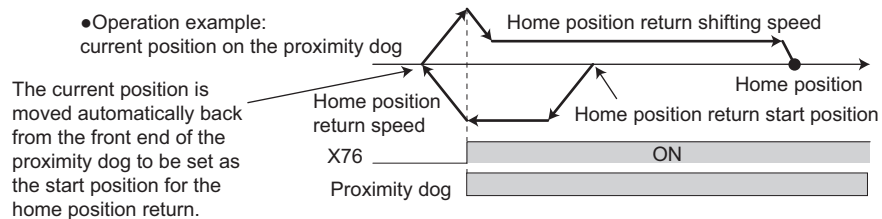

◆ Home position return function selection (Pr.1095), Home position return position data (Pr.1096, Pr.1097)

- Use **Pr.1095 Home position return function selection** to select whether to use a positive or negative value for the position data for home position return (**Pr.1096 and Pr.1097**).

Pr.1095 setting	Position data for home position return (Pr.1096 and Pr.1097)
9999 (initial value)	Positive value
1000	Negative value

- Position data for home position return
Set the final position for the home position return. Set the upper 4-digit data in **Pr.1097** and the lower 4-digit data in **Pr.1096**.
Position command (before electronic gear) = Position data for home position return (**Pr.1096 and Pr.1097**)
Current position (before electronic gear) = Position data for home position return - Droop pulse (converted before electronic gear)
The droop pulses are not cleared.

NOTE

- If parameters are copied from an inverter without functions of **Pr.1096 and Pr.1097** to a new inverter, "----" is displayed for the settings of **Pr.1096 and Pr.1097** on the operation panel. The operation for the setting of "0 (initial value)" is performed. (Refer to [page 599](#).)

◆ Home position return error

- If home position return is not normally completed, the following warnings appear on the operation panel.

Operation panel indication	Name	Possible cause
HP1	Home position return setting error	• The home position setting has failed.
HP2	Home position return uncompleted	• Start signal for the direct command positioning has turned ON without completing the home position return. (Except in the roll feed mode)

- Unless the home position return is completed (the ZP signal is turned ON), position control cannot be performed (except when JOG operation during position control or the roll feed mode is enabled).
- The Home position return failure (ZA) signal is output while the home position return warning is activated. To use the ZA signal, set "56" (positive logic) or "156" (negative logic) in any parameter from **Pr.190 to Pr.197 (Output terminal function selection)** to assign the function.

◆ Sudden stop (Pr.464, Pr.1292, and X87 signal)

- When the Sudden stop (X87) signal is assigned to an input terminal, turning ON the X87 signal (normally open input) stops the operation according to the deceleration time slope set by **Pr.464 Digital position control sudden stop deceleration time**. (For EtherCAT communication, the value set in Index H6085 (Quick stop deceleration) can be also used.) When the deceleration time set in **Pr.464** is longer than that set by the current position control command, the deceleration time slope set by the current position control command is applied. After the operation is stopped, turning OFF the X87 signal (normally open input) starts position control again. To input the X87 signal, set "87" in any parameter from **Pr.178 to Pr.189 (Input terminal function selection)** to assign the function to a terminal.
- When the ones place of the set value in **Pr.1292 Position control terminal input selection** is "0", the normally open input is applied and the operation is stopped by turning ON the X87 signal. When the ones place is "1", the normally closed input is applied and the operation is stopped by turning OFF the X87 signal.

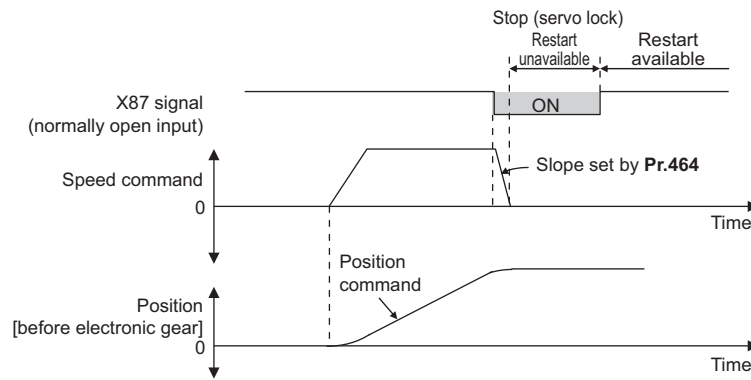

◆ Stroke end settings (Pr.464, Pr.1292, LSP signal, LSN signal, and LP signal)

- The normally open input is applied when **Pr.1292** = "0, 1, 100, or 101" for the LSP signal or "0, 1, 10, or 11" for the LSN signal, and turning ON the signal stops the operation. The normally closed input is applied when **Pr.1292** = "10, 11, 110, or 111" for the LSP signal or "100, 101, 110, or 111" for the LSN signal, and turning OFF the signal stops the operation.
- When the Forward stroke end (LSP) signal or Reverse stroke end (LSN) signal is assigned to an input terminal, turning OFF the LSP/LSN signal (normally closed input) stops the operation according to the deceleration time slope set by **Pr.464 Digital position control sudden stop deceleration time**. (For EtherCAT communication, the value set in Index H6085 (Quick stop deceleration) can be also used.) When the deceleration time set in **Pr.464** is longer than that set by the current position control command, the deceleration time slope set by the current position control command is applied. After stopped, the motor cannot be rotated in the counterclockwise (CCW) direction while the LSP signal is OFF, or in the clockwise (CW) direction while the LSN signal is OFF (normally closed input in both cases).
- The setting of **Pr.359 Encoder rotation direction** determines the motor rotation direction restricted by the LSP/LSN signal.
 LSP signal: After stopped, the motor cannot be rotated in the CCW (CW) direction when **Pr.359** = "101 (100)" while the signal is OFF (normally closed input).
 LSN signal: After stopped, the motor cannot be rotated in the CW (CCW) direction when **Pr.359** = "101 (100)" while the signal is OFF (normally closed input).
- To input the LSP signal, set "88" in any parameter from **Pr.178 to Pr.189 (Input terminal function selection)** to assign the function.
- To input the LSN signal, set "89" in any parameter from **Pr.178 to Pr.189 (Input terminal function selection)** to assign the function.
- When the LSP signal or LSN signal is OFF (normally closed input), the Stroke limit warning (LP) signal is turned ON and "LP" is displayed on the operation panel. To use the Stroke limit warning (LP) signal, set "24" (positive logic) or "124" (negative logic) in any parameter from **Pr.190 to Pr.197 (Output terminal function selection)** to assign the function.

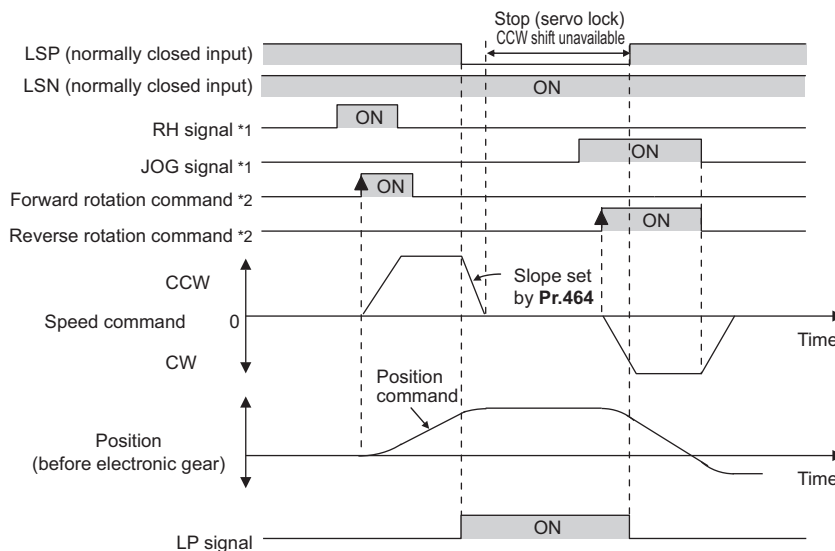

- *1 Turn ON the start signal 5 ms or more after the RH/RM/RL/JOG signal is turned ON.
- *2 After the start signal is turned ON, the ON state should be retained for 20 ms or longer.

Stroke end input (normally closed input)		Operation availability	
LSP (Forward stroke end)	LSN (Reverse stroke end)	CCW rotation	CW rotation
ON	ON	Available	Available
OFF	ON	Unavailable	Available
ON	OFF	Available	Unavailable
OFF	OFF	Unavailable	Unavailable

NOTE

- The control method cannot be changed while the LSP or LSN signal is OFF (normally closed input).
- When position control is not selected, the LP signal and warning (LP) are available but the sudden stop using stroke end signals is disabled.

◆ Roll feed mode 1 and 2 (Pr.1293)

- These modes are used in an application that needs repeated positioning in the same direction, such as a conveyor.
- When the roll feed mode 1 is selected (**Pr.1293 = "1"**), positioning operation is performed with the current position and position command set to 0 at start. Position commands are not overflowed and the repeated feed by the increment is available.
- When the roll feed mode 2 is selected (**Pr.1293 = "2"**), positioning operation is performed with the position command set to 0 and the current position set to the value of the previous current position data decremented by the droop pulse at start. The difference between the position command and the current position at each start is not accumulated.

• Pr.1293 = "1"

• Pr.1293 = "2"

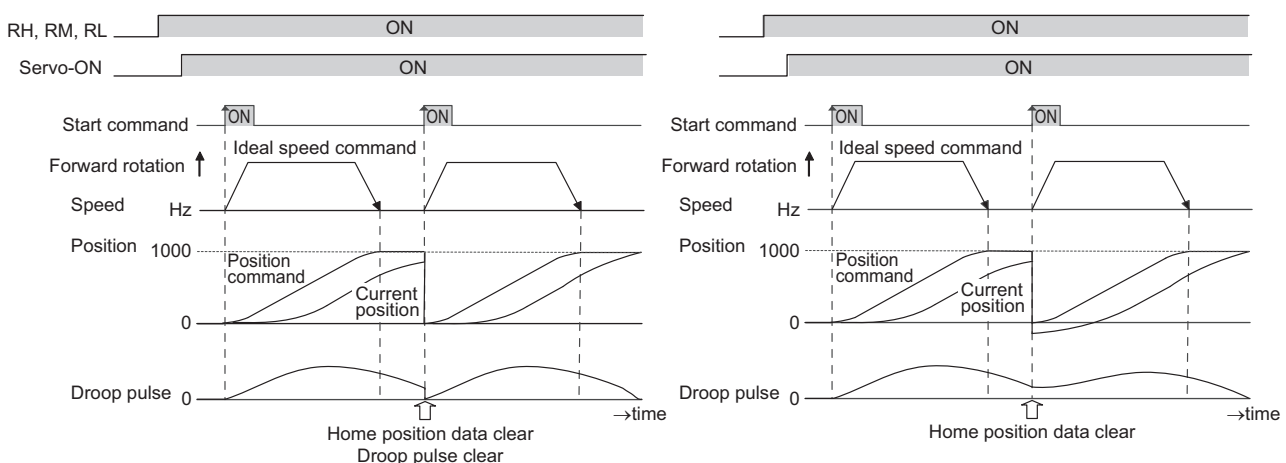

- When the roll feed is enabled, the home position return operation is not required.

◆ Input/output signals for direct command positioning

Input/output	Signal name		Function	Pr.178 to Pr.189 setting	Pr.190 to Pr.197 setting	
					Positive logic	Negative logic
Input	X76	Proximity dog	ON: dog ON, OFF: dog OFF	76	—	
	X87	Sudden stop	Turning ON this signal starts deceleration stop according to Pr.464 ^{*1} (normally open input).	87	—	
	LSP	Forward stroke end	Turning ON this signal starts deceleration stop according to Pr.464 ^{*1} (normally open input).	88	—	
	LSN	Reverse stroke end	Turning ON this signal starts deceleration stop according to Pr.464 ^{*1} (normally open input).	89	—	
Output	MEND	Travel completed	Turns ON when the position command operation has completed while the number of droop pulses is within the positioning completion width.	—	38	138
	LP	Stroke limit warning	Turns ON when the LSP or LSN signal turns ON (normally open input).	—	24	124
	Y36	In-position	Turns ON when the number of droop pulses is equal to or smaller than the Pr.426 ^{*2} setting value.	—	36	136
	ZA	Home position return failure	Turns ON while the home position return warning is activated.	—	56	156
	PBSY	During position command operation	Turns ON during position command operation.	—	61	161
	ZP	Home position return completed	Turns ON after home position return operation is complete.	—	63	163
	RDY	Position control preparation ready	Turns ON when the servo-lock function is working and the inverter is ready to operate.	—	84	184

*1 For EtherCAT communication, the value set in Index H6085 (Quick stop deceleration) can be also used.

*2 For EtherCAT communication, the value set in Index H6067 (Position window) is used.

- Output signal operation during positioning by direct commands

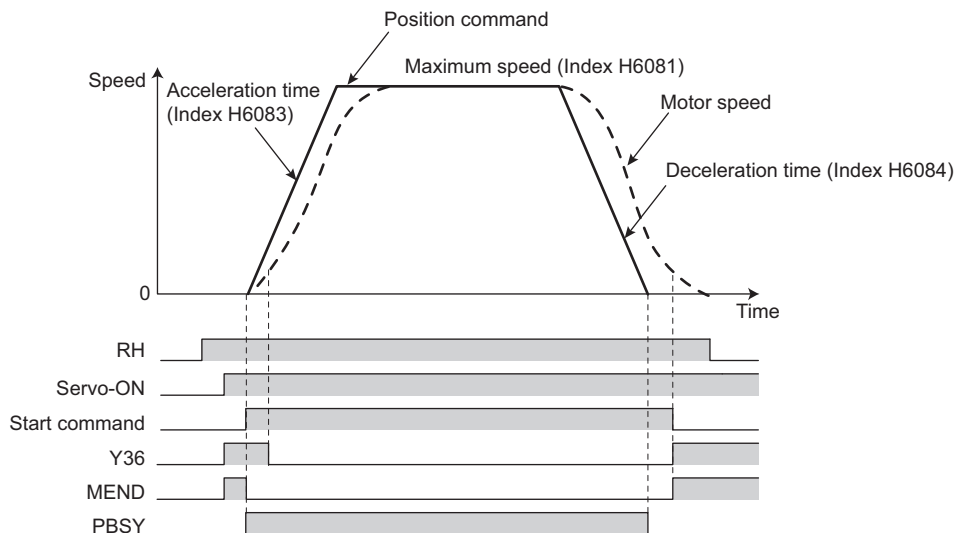

- Output signal operation during positioning with home position return

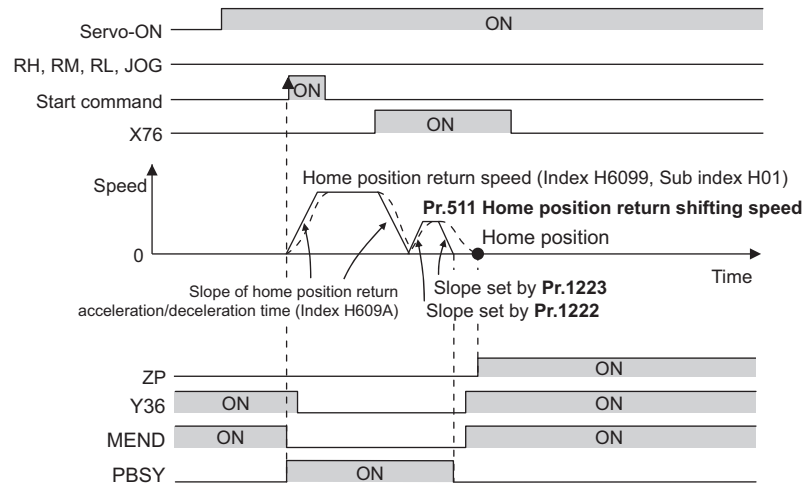

NOTE

- When the servo-lock function is disabled, the home position return completed (ZP) signal is turned OFF. If "9999" is not set in **Pr.538 Current position retention selection**, the ZP signal remains ON even when the servo-lock function is disabled. (For details on the current position retention function, refer to [page 215](#).)

7.6 Pulse monitor



Various pulses can be monitored.

Pr.	Name	Initial value	Setting range	Description
430 B011	Pulse monitor selection	9999	0 to 5, 100 to 105, 1000 to 1005, 1100 to 1105	Shows the various pulse conditions during operation as the number of pulses.
			8888, 9999	Shows the frequency value.
635 ^{*1} M610	Cumulative pulse clear signal selection	0	0, 1	Select the clearing method for the cumulative pulse monitor.
636 ^{*1} M611	Cumulative pulse division scaling factor	1	1 to 16384	Set the division scaling factor on the cumulative pulse for the Vector control compatible option.
638 ^{*1} M613	Cumulative pulse storage	0	0, 1	Select the processing method for the cumulative pulse monitor value when the power is turned OFF or the inverter is reset.

*1 The setting is available when a Vector control compatible option is installed. For the IP67 model, the setting is not available as plug-in options are not available.

◆ Pulse monitor selection (Pr.430)

- To show any of pulse conditions as the number of pulses during operation, set "0" in **Pr.52 Operation panel main monitor selection**. The output frequency will be displayed.
- Setting "26 to 31" in **Pr.52, Pr.774 to Pr.776, Pr.992** (multifunction monitor) changes the electronic gear operation setting in the case of monitoring pulses. (Refer to [page 348.](#))

Pr.430 setting	Description	
0000	Pulse monitor selection	Displays the lower of the position command (accumulated value of command pulses).
0001		Displays the upper of the position command (accumulated value of command pulses).
0002		Displays the lower of the current position (accumulated value of feedback pulses).
0003		Displays the upper of the current position (accumulated value of feedback pulses).
0004		Displays the lower of the accumulated value of droop pulses.
0005	Displays the upper of the accumulated value of droop pulses.	
0000	For pulse monitor selection	Displays the value after electronic gear for position command, current position, or droop pulses to be monitored (pulse monitor).
0100		Displays the value before electronic gear for position command, current position, or droop pulses to be monitored (pulse monitor).
0000	For the multifunction monitor / PLC function special register	Displays the value before electronic gear for position command, current position, or droop pulses to be monitored (multifunction monitor).
		Displays the value before electronic gear for position command, current position, or droop pulses to be monitored (PLC function special register).
1000		Displays the value after electronic gear for position command, current position, or droop pulses to be monitored (multifunction monitor).
	Output frequency display	Displays the value after electronic gear for position command, current position, or droop pulses to be monitored (PLC function special register).
8888		Displays the value after electronic gear for position command, current position, or droop pulses to be monitored (PLC function special register).
9999 (initial value)		Displays the value before electronic gear for position command, current position, or droop pulses to be monitored (multifunction monitor).
		Displays the value before electronic gear for position command, current position, or droop pulses to be monitored (PLC function special register).

◆ Pulse monitor display on the operation panel

- The position command, current position, and the status of droop pulses can be displayed on the operation panel.

Display data		Multifunction monitor display	Pulse monitor display (output frequency displayed)
10000	Lower monitor	0000	0
	Upper monitor	1	1
100	Lower monitor	100	100
	Upper monitor	0	0
100000000 (9-digit) ^{*1}	Lower monitor	0000	0
	Upper monitor	0000	0

*1 The count continues even after 99999999 is exceeded on the pulse monitor.

NOTE

- The pulse count starts at servo on.
- When **Pr.538 Current position retention selection** = "21 or 22" under Vector control, the pulse is counted even at servo off. (Refer to [page 215](#).)

◆ Cumulative pulse monitoring

- The accumulated value of the encoder pulses can be monitored.
- The cumulative pulse monitor is available when "71 or 72" is set in the monitor selection parameters (**Pr.52, Pr.774 to Pr.776, and Pr.992**).

Monitor item	Pr.52, Pr.774 to Pr.776, Pr.992	Display with minus sign	Description
Cumulative pulse ^{*1}	71	○ ^{*2}	The cumulative number of pulses is displayed. (Monitor range: 0 to 32767 when the value is positive or -32767 to 0 when the value is negative)
Cumulative pulse overflow times ^{*1}	72	○ ^{*2}	The number of the cumulative pulse overflow times is displayed. (Monitor range: 0 to 32767 when the value is positive or -32767 to 0 when the value is negative)

*1 Since the panel display of the operation panel or enclosure surface operation panel (FR-PA07) is in 4 digits, the monitor value of more than "9999" is displayed as "----".

*2 The output is always negative regardless of the **Pr.290** setting when a negative value is monitored. Negative values are not displayed on the operation panel or parameter unit. The values "-1 to -32767" are displayed as "65535 to 32769" on the LCD operation panel (FR-LU08) or parameter unit (FR-PU07).

◆ Cumulative pulse division scaling factor (Pr.636)

- Set the division scaling factor on the cumulative pulse in **Pr.636**.
- Cumulative pulse count value calculation method

$$\text{Cumulative pulse count value} = \text{Cumulative pulse division scaling factor} \times (\text{Cumulative pulse overflow times} \times 32768 + \text{Cumulative pulse monitor value})$$
- Cumulative pulse count value: Number of pulses multiplied by 4
- Cumulative pulse division scaling factor: **Pr.636**

◆ Cumulative pulse monitor value clear (Pr.635)

- The cumulative pulse monitor and the cumulative pulse overflow times can be cleared using the X52 signal.
- To input the X52 signal, set "52" (X52) in any parameter from **Pr.178 to Pr.189 (Input terminal function selection)** to assign the function.
- Use **Pr.635 Cumulative pulse clear signal selection** to select the clearance method for the cumulative pulse monitor and the cumulative pulse overflow times.

Pr.635 setting	X52 signal Cumulative pulse monitor value clear
0	Cleared at the edge when the signal is switched to ON.
1	Cleared while the signal is ON.

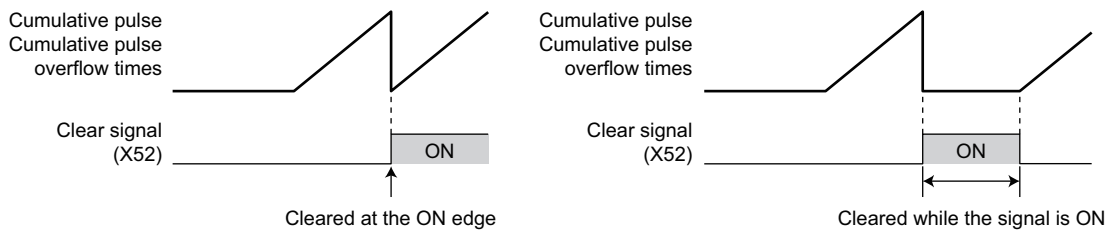

◆ Cumulative pulse storage

- The cumulative pulse monitor value and cumulative pulse overflow times can be retained when the power is turned OFF or the inverter is reset.
- To read the cumulative pulse monitor value and cumulative pulse overflow times stored in the EEPROM, turn ON the main circuit power supply while **Pr.638** = "1" and a Vector control compatible option is installed.

Pr.638 setting	Cumulative pulse monitor / Cumulative pulse overflow times	
	At power-OFF	At reset
0	Not stored in the EEPROM	Cleared
1	Stored in the EEPROM	Retained

NOTE

- When the power is turned OFF during the reset process, the cumulative pulse monitor value and the cumulative pulse overflow times are not stored in the EEPROM.
- When a Vector control compatible option is not installed, the cumulative pulse monitor value and the cumulative pulse overflow times are not stored in the EEPROM.

Parameters referred to

Pr.52 Operation panel main monitor selection [page 348](#)

7.7 Electronic gear settings

Vector **PM**

Set the gear ratio between the machine gear and motor gear.

Pr.	Name	Initial value	Setting range	Description
420 B001	Command pulse scaling factor numerator (electronic gear numerator)	1	1 to 32767	Set the electronic gear. The gear ratio range is from 1/900 to 900. Pr.420 is the numerator and Pr.421 is the denominator.
421 B002	Command pulse multiplication denominator (electronic gear denominator)	1	1 to 32767	

◆ Gear ratio calculation (Pr.420, Pr.421)

The position resolution (travel distance per pulse $\Delta\ell$ [mm]) is the travel distance per motor rotation Δs [mm] and the feedback pulse Pf [pulses/rev] of the detector.

$$\Delta\ell = \frac{\Delta s}{Pf}$$

$\Delta\ell$: Travel distance per pulse [mm]
 Δs : Travel distance in one motor rotation [mm]
 pf: Number of feedback pulses [pulse/rev] (the number of pulses after the number encoder pulses is quadruplicated)

The travel distance in 1 command pulse can be separately specified with a parameter and so an integer can be set as the travel distance in 1 command pulse.

$$\Delta\ell = \frac{\Delta s}{Pf} \times \frac{\text{Pr.420}}{\text{Pr.421}}$$

The following formula shows the relationship between the motor speed and internal command pulse frequency.

$$f_o \times \frac{\text{Pr.420}}{\text{Pr.421}} = Pf \times \frac{N_o}{60}$$

f_o : internal command pulse frequency [pulses/s]
 N_o : motor rotation speed [r/min]

NOTE

- The setting of 1/900 or lower is limited at 1/900, and 900 or higher at 900.

Setting example

To set the travel distance per pulse to 0.01 mm in a machine with $\Delta s = 10$ mm while a motor with a 1024 pulse encoder is used.

$\Delta\ell$: 0.01 [mm]
 Δs : 10 [mm]
 Pf: 4096 [pulse/rev]

$$\frac{\text{Pr.420}}{\text{Pr.421}} = 0.01 \text{ mm} \times \frac{4096 \text{ pulse/rev}}{10} = \frac{512}{125}$$

Thus, set the parameters as follows: Pr.420 = "512", Pr.421 = "125".

■ Relationship between the position resolution and system accuracy

The system accuracy (the positioning accuracy of the machine) is the sum of electric deviation and mechanical deviation. Normally try to prevent the total deviation from being affected by the electronic deviation. Refer to the following relationship as a reference.

$$\Delta\ell < \left(\frac{1}{5} \text{ to } \frac{1}{10}\right) \times \Delta\epsilon$$

$\Delta\epsilon$: positioning accuracy

■ Motor stop characteristics

When running the motor by the parameter settings, pulses as much as the motor speed delay to the internal command pulse frequency are accumulated in the deviation counter. These pulses are called droop pulses (ε). The relationship between the command frequency (f_0) and position loop gain (K_p : **Pr.422**) is shown in the following formula.

$$\varepsilon = \frac{f_0}{K_p} \text{ [pulse]} \quad \varepsilon = \frac{204800}{10} \text{ [pulse] (with the rated motor speed)}$$

The number of droop pulses (ε) is 20480 with the initial value $K_p = 10 \text{ s}^{-1}$.

Since the inverter has droop pulses during operation, a stop settling time (t_s), which is the time between the zero command output and the motor stop, is required. Set the operation pattern taking into the account the stop setting time.

$$t_s = 3 \times \frac{1}{K_p} \text{ [s]}$$

The stop settling time (t_s) is 0.3 second for the initial value $K_p = 10 \text{ s}^{-1}$.

The accuracy of positioning $\Delta\varepsilon$ is $(5 \text{ to } 10) \times \Delta\ell = \Delta\varepsilon \text{ [mm]}$

7.8 Position adjustment parameter settings

Vector **PM**

Pr.	Name	Initial value	Setting range	Description
426 B007	In-position width	100 pulses	0 to 32767 pulses	Set the number of droop pulses that triggers the In-position (Y36) signal.
427 B008	Excessive level error	40K	0 to 400K	Set the number of droop pulses that activates Excessive position fault (E.OD).
			9999	Function disabled
510 B196	Rough match output range	0	0 to 32767	Set the remaining command distance at which the Rough match (CPO) signal is output.
1294 B192	Position detection lower 4 digits	0	0 to 9999	Set the lower four digits of the position detection value.
1295 B193	Position detection upper 4 digits	0	0 to 9999	Set the upper four digits of the position detection value.
1296 B194	Position detection selection	0	0	The position is detected on both the plus and minus sides.
			1	The position is detected on the plus side only.
			2	The position is detected on the minus side only.
1297 B195	Position detection hysteresis width	0	0 to 32767	Set the hysteresis width for the detected position where the Position detection level (FP) signal turns ON.

◆ In-position width (Pr.426, Y36 signal)

- The Y36 signal is used as the In-position signal.
- If the number of droop pulses (after electronic gear) reaches the **Pr.426** setting value or smaller, the In-position (Y36) signal turns ON. (The number of droop pulses (after electronic gear) is calculated by subtracting the current position (after electronic gear) from the position command (after electronic gear).)
- To use the Y36 signal, set "36" (positive logic) or "136" (negative logic) in any parameter from **Pr.190 to Pr.197 (Output terminal function selection)** to assign the function.

◆ Excessive level error (Pr.427)

- If the number of droop pulses (after electronic gear) reaches the **Pr.427** setting value or larger, E.OD (Excessive position fault) is activated and the inverter output is shutoff. (The number of droop pulses (after electronic gear) is calculated by subtracting the current position (after electronic gear) from the position command (after electronic gear).) Increase the error threshold level when a small value is set as the **Pr.422 Position control gain** setting value. Set a small value for early detection even when the load is heavy.
- If **Pr.427** = "9999", E.OD is not activated regardless of the amount of droop pulses.

◆ During position command operation signal (PBSY signal)

- The During position command operation (PBSY) signal turns ON during position command operation. To use the PBSY signal, set "61" (positive logic) or "161" (negative logic) in any parameter from **Pr.190 to Pr.197 (Output terminal function selection)** to assign the function.

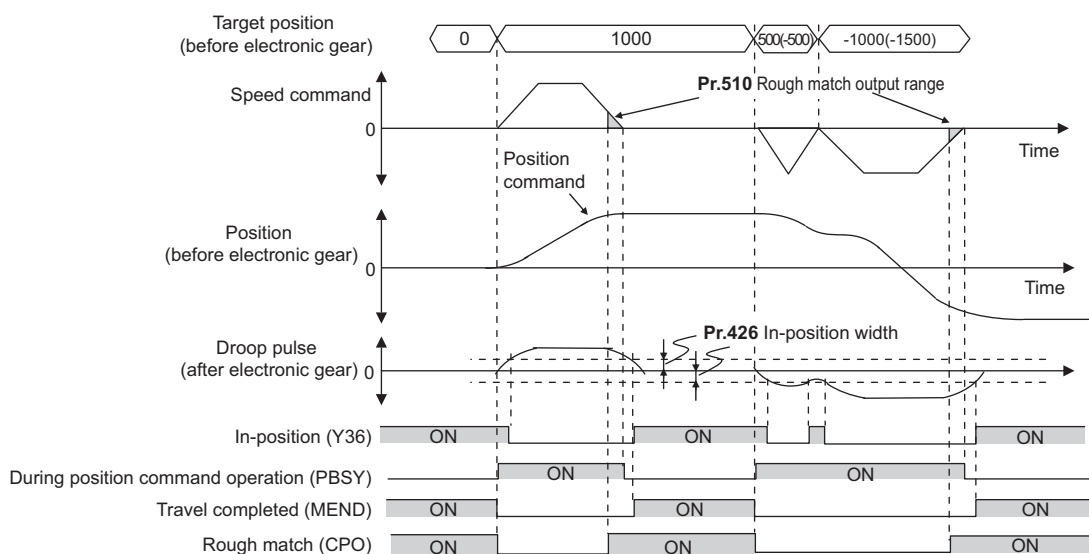

◆ Travel completed signal (MEND signal)

- The Travel completed (MEND) signal turns ON when the In-position (Y36) signal is ON and the During position command operation (PBSY) signal is OFF. To use the MEND signal, set "38" (positive logic) or "138" (negative logic) in any parameter from **Pr.190 to Pr.197 (Output terminal function selection)** to assign the function.

◆ Rough match signal (Pr.510, CPO signal)

- The Rough match (CPO) signal turns ON when the remaining command distance (before electronic gear) reaches the **Pr.510** setting value or less. (The remaining distance can be calculated by subtracting the position command (before electronic gear) from the target position (before electronic gear).) To use the Rough match (CPO) signal, set "62" (positive logic) or "162" (negative logic) in any parameter from **Pr.190 to Pr.197 (Output terminal function selection)** to assign the function.

◆ Position detection signal (Pr.1294 to Pr.1297, FP signal)

- The Position detection level (FP) signal turns ON when the current position (before electronic gear) exceeds the position detection judgment value ($\text{Pr.1295} \times 10000 + \text{Pr.1294}$). To use the FP signal, set "60" (positive logic) or "160" (negative logic) in any parameter from **Pr.190 to Pr.197 (Output terminal function selection)** to assign the function.
- Pr.1296 Position detection selection** can be set to select whether the position detection is determined on the plus side or minus side. When "0" is set, the position is detected on both the plus and minus sides. When "1" is set, the position is detected on the plus side only. When "2" is set, the position is detected on the minus side only.

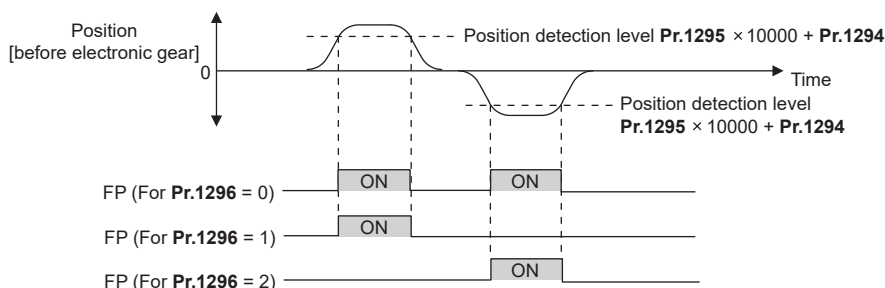

- When a current position varies, the Position detection level (FP) signal may repeat ON/OFF (chatter). Setting hysteresis to the detected position prevents chattering of the signal. Use **Pr.1297 Position detection hysteresis width** to set a hysteresis width.

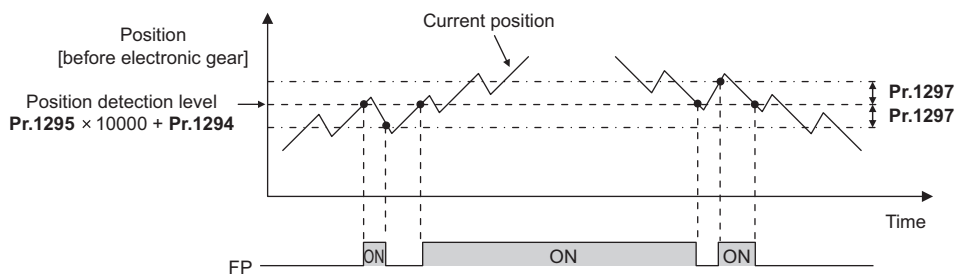

7.9 Current position retention function

Vector PM

If the operation stops with the motor shaft fixed by the electromagnetic brake or the like under position control, holding the current position data at the output shutoff enables the operation without performing the home position return at restart.

Pr.	Name	Initial value	Setting range	Description
538 B015	Current position retention selection	9999	1, 2, 11, 12, 21, 22	Select the combination of the position data to be held.
			9999	Function disabled

- Set **Pr.538 Current position retention selection** to select the combination of the position data (position command, current position, and droop pulse) to be held. Set **Pr.538** while the inverter is stopped.
- When the Pre-excitation/servo ON (LX) signal is turned OFF, the position data selected by **Pr.538** and the Home position return completed (ZP) signal are held.
- When **Pr.538** = "11 or 12", the position data and the ZP signal are held also after power-OFF or inverter reset after turning OFF the LX signal.
- When **Pr.538** = "21 or 22" under Vector control, the position data and the ZP signal are held also when the control mode is changed after turning OFF the LX signal.

Pr.538 setting	Position data			ZP signal	Storing data in EEPROM
	Position command	Current position	Droop pulse		
9999 (initial value)	Cleared	Cleared	Cleared	Turned OFF	Disabled
1	Aligned with current position ^{*1}	Held ^{*1}	Cleared	Held ^{*1}	Disabled
2	Held ^{*1}	Held ^{*1}	Held ^{*1}	Held ^{*1}	Disabled
11	Aligned with current position	Held	Cleared	Held	Enabled
12	Held	Held	Held	Held	Enabled
21 ^{*2}	Aligned with current position ^{*1}	Always updated ^{*1}	Cleared	Held ^{*1}	Disabled
22 ^{*3}	Held ^{*1}	Always updated ^{*1}	Always updated ^{*1}	Held ^{*1}	Disabled

*1 Cleared at power-OFF or inverter reset.

*2 Valid under Vector control only. Under PM sensorless vector control, the operation is the same as the one when "1" is set.

*3 Valid under Vector control only. Under PM sensorless vector control, the operation is the same as the one when "2" is set.

NOTE

- Do not use the current position retention function if the motor shaft is not fixed by the electromagnetic brake or the like while the inverter output is shut off. Motor shaft rotation causes a position fault.
- Even when the motor shaft is fixed, do not use the function if the motor shaft is rotated by an external force. Motor shaft rotation causes a position fault.
- Turn the LX signal OFF after the motor stops and servo lock is activated.
- When the FR-E8DS is installed or when the IP67 model is used, the current position retention function is disabled during the 24 V external power supply operation. Even if **Pr.538** = "11 or 12", the position data remains cleared while the external 24 V power is supplied. When the power source is switched to the main circuit power, the position data last stored in EEPROM before the external power is supplied is used.
- The held position data and the Home position return completed (ZP) signal are cleared in any of the following cases:
 - The **Pr.538** setting is changed.
 - The setting of electronic gear (settings of **Pr.420** and **Pr.421**) is changed.
 - The main circuit capacitor life is measured.
 - Operation is switched between the first and second motors.
 - The control mode is changed while a value other than "21 or 22" is set in **Pr.538**.
 - An inverter protective function has been activated.
 - Offline auto tuning is performed.
 - The current position retention function is not available.
 - The power is turned OFF or the inverter is reset while **Pr.538** = "1, 2, 21, or 22".
 - The motor setting is changed from the EM-A motor (**Pr.71** = "1140") to a different motor. Alternatively, the motor setting is changed from a different motor to the EM-A motor.
 - While **Pr.71** = "1140" (EM-A motor setting), the setting in **Pr.80 Motor capacity** is changed from 0.75K or lower to 1.5K or higher. Alternatively, the setting is changed from 1.5K or higher to 0.75K or lower.
- When **Pr.538** = "11 or 12", about one second is required to complete writing position data after the LX signal is turned OFF. Do not turn OFF the power and do not perform the inverter reset during the writing of position data. If the writing is failed due to power-OFF or inverter reset, the protective function E.OD is activated when the power is turned ON.
- If the inverter output is frequently shut off during the position control operation, do not set "11 or 12" in **Pr.538**. The frequent shutoff while **Pr.538** = "11 or 12" will shorten the life of the EEPROM.
- When **Pr.538** = "11 or 12", position data from -2147483648 to 2147483647 can be stored in EEPROM. When a position data is out of the range, the data is not stored in EEPROM, and the previous data is cleared.
- To give a command to the inverter via communication, use the current position retention function with **Pr.800** = "3". When **Pr.800** = "4" (speed/position switchover) or "5" (position/torque switchover), the held position data and ZP signal may be cleared since the same control mode as when the MC signal is OFF is performed regardless of the actual signal state until the inverter power is turned ON and the communication is established.

7.10 Position control gain adjustment



Adjust gain using the following parameters to achieve optimum machine performance or improve unfavorable conditions, such as vibration and acoustic noise during operation with high load inertia or gear backlash.

Pr.	Name	Initial value	Setting range	Description
422 B003	Position control gain	10 s ⁻¹	0 to 150 s ⁻¹	Set the gain for the position loop.
423 B004	Position feed forward gain	0%	0% to 100%	Enable the function to cancel a delay caused by the droop pulses in the deviation counter.
425 B006	Position feed forward command filter	0 s	0 to 5 s	Input the primary delay filter for the feed forward command.
446 B012	Model position control gain	25 s ⁻¹	0 to 150 s ⁻¹	Set the gain for the model position controller.
1298 B013	Second position control gain	10 s ⁻¹	0 to 150 s ⁻¹	Set the position loop gain for the second motor.
698 G219	Speed control D gain	0%	0% to 100%	Set the differential gain of speed control.
877 G220	Speed feed forward control/ model adaptive speed control selection	0	0 1 2	Normal position control is performed. Perform position feed forward control. Enable Model adaptive position control.
828 G224	Model speed control gain	100 rad/s	0 to 1000 rad/s	Set the gain for the model speed controller.
880 C114	Load inertia ratio	7-fold	0 to 200-fold	Set the load inertia ratio for the motor.

◆ Position loop gain (Pr.422, Pr.1298)

- Adjust the gain when a phenomena such as unusual vibration, noise and overcurrent of the motor/machine occurs.
- Increasing the setting value improves traceability for the position command and also improves servo rigidity at a stop, but oppositely may cause an overshoot and vibration.
- The setting range is normally 5 to 50.

Movement/ condition	How to adjust Pr.422
Response is slow.	Increase the setting value. Increase the setting value by 3 s ⁻¹ until immediately before occurrence of an overshoot, stop-time vibration or other instable phenomenon, and set about 80% to 90% of that value.
Overshoot, stop-time vibration or other instable phenomenon occurs.	Lower the setting value. Lower the setting value by 3 s ⁻¹ until immediately before occurrence of an overshoot, stop-time vibration or other instable phenomenon, and set about 80% to 90% of that value.

◆ Position feed forward gain (Pr.423)

- This function is designed to cancel a delay caused by the droop pulses in the deviation counter. Set this parameter when a sufficient position response cannot be obtained after setting **Pr.422**.
- When a tracking delay for command pulses poses a problem, increase the setting value gradually within the range where an overshoot or vibration will not occur.
- This function has no effects on servo rigidity at a stop.
- Normally set this parameter to 0.
- To set **Pr.423**, set **Pr.877** = "1" to enable position feed forward control.

◆ Model adaptive position control (Pr.446)

- Set each response for position commands and for load and external disturbances individually.
- Set this parameter when a sufficient position response cannot be obtained after setting **Pr.422**.
- When setting **Pr.446**, set **Pr.877** = "2" to enable the model adaptive position control, and set a value other than "0" in **Pr.828 Model speed control gain**, and a load inertia ratio in **Pr.880 Load inertia ratio**.

- Set a small value in **Pr.446** first, and then increase the setting value gradually within the range where an overshoot or vibration will not occur.

◆ **Speed control D gain (Pr.698)**

- When Travel completed (MEND) signal is ON during position control, a vibration may occur around the target position. Adjusting the setting of **Pr.698 Speed control D gain** suppresses this phenomenon.
- Setting **Pr.698** = 100% makes the corner frequency ω_f 10 rad/s and reduces the response level to the frequency equal to or lower than that. (Corner frequency is calculated as follows: $\omega_f = 10 \text{ rad/s} \times \text{Pr.698}[\%]$.) Position deviation, however, increases as a higher value is set to **Pr.698**.
- This suppression is available also for the servo lock function during speed control (**Pr.802 Pre-excitation selection** = "1").

7.11 Troubleshooting in position control



Condition	Possible cause	Countermeasure
The motor does not rotate.	There is incorrect phase sequence between the motor wiring and encoder wiring.	Check the wiring. (Refer to the Instruction Manual (Connection).)
	The setting of Pr.800 Control method selection is not appropriate.	Check the Pr.800 setting. (Refer to page 115 .)
	The LX signal or the STF/STR signal is not input.	Check that the signals are properly input.
	The X87 signal, LSP signal, or LSN signal is input (normally open input), or the PU stop signal is input.	Check if the signals are input.
	When simple position control by point tables is used, the position feed length set by Pr.465 to Pr.478 is not correct.	Check the position feed length in Pr.465 to Pr.478 .
The position is unfavorably shifted.	The command is affected by noise. Noise is superpositioned on the encoder feedback signals.	Set a smaller value in Pr.72 PWM frequency selection . Change the earthing (grounding) position of the shielded cable. Alternatively, do not connect it.
	The electronic gear settings in Pr.420 and Pr.421 are incorrect.	Check the settings of Pr.420 and Pr.421 .
Hunting occurs in the motor or the machine.	Position loop gain is too high.	Set a smaller value in Pr.422 Position control gain .
	Speed loop gain is too high.	Set a smaller value in Pr.820 Speed control P gain 1 and a larger value in Pr.821 Speed control integral time 1 .
Machine movement is unstable.	Acceleration/deceleration time settings are affecting adversely.	Shorten the acceleration/deceleration time (setting values in Pr.7, Pr.8, Pr.1222, Pr.1223, Pr.1225 to Pr.1227, Pr.1229 to Pr.1231, Pr.1233 to Pr.1235, Pr.1237 to Pr.1239, Pr.1241 to Pr.1243, Pr.1245 to Pr.1247, Pr.1249).
The control method/mode cannot be changed.	The LSP/LSN signal is input (normally open input).	Check if the signal is input.

◆ Flowchart

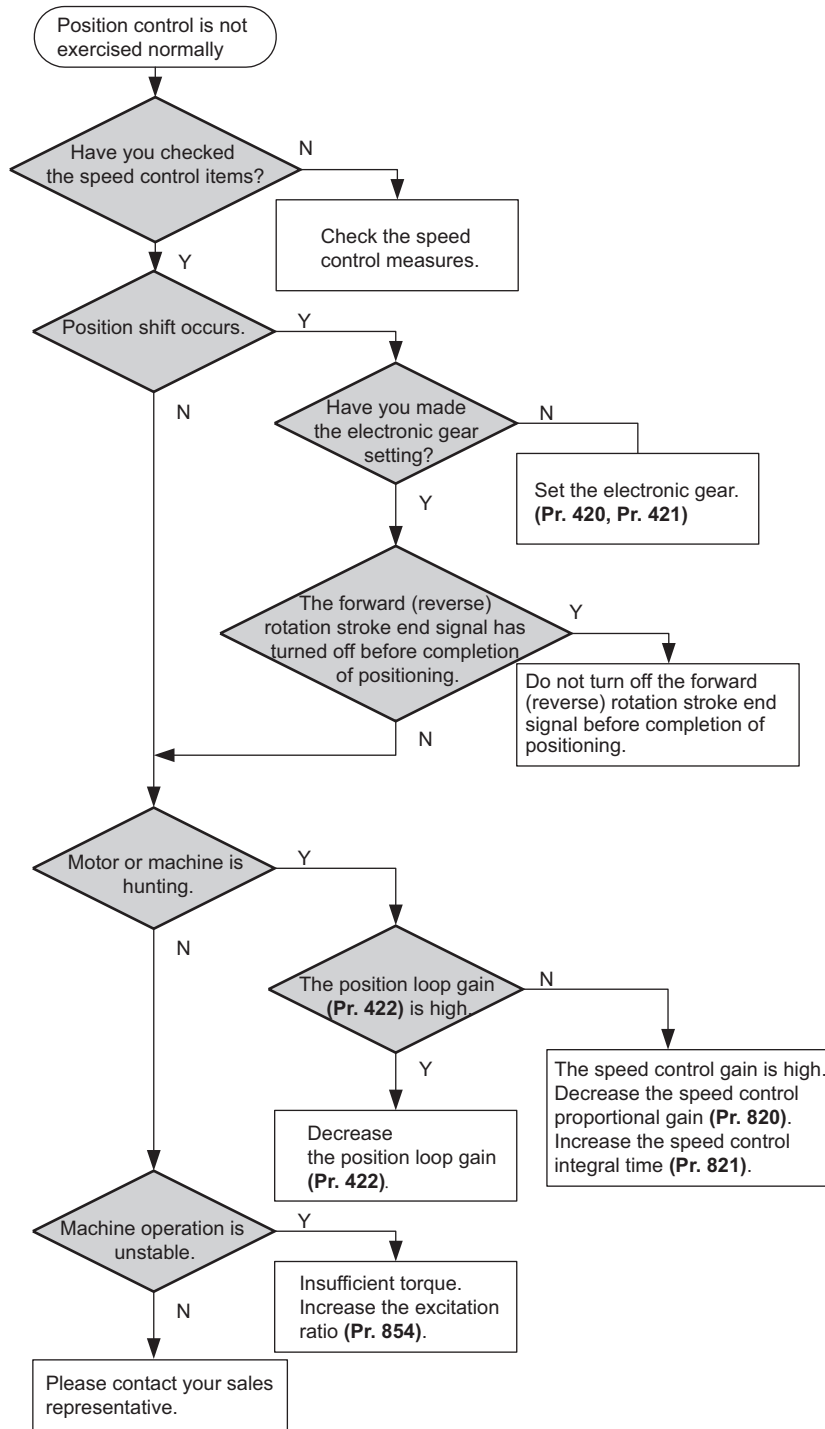

NOTE

- The speed command of position control is related to speed control. (Refer to [page 132](#).)

Parameters referred to

Pr.7 Acceleration time [page 262](#)

Pr.8 Deceleration time [page 262](#)

Pr.72 PWM frequency selection [page 249](#)

Pr.800 Control method selection [page 115](#)

Pr.802 Pre-excitation selection [page 536](#)

Pr.820 Speed control P gain 1 [page 146](#)

Pr.821 Speed control integral time 1 [page 146](#)

CHAPTER 8 (E) Environment Setting Parameters

8.1	Clock.....	222
8.2	Reset selection / disconnected PU detection / PU stop selection	225
8.3	PU display language selection (Standard model).....	228
8.4	Buzzer control (Standard model).....	229
8.5	PU contrast adjustment (Standard model).....	230
8.6	Automatic frequency setting / key lock operation selection	231
8.7	Frequency change increment amount setting (Standard model).....	233
8.8	RUN key rotation direction selection.....	234
8.9	Multiple rating setting.....	235
8.10	Parameter write selection	237
8.11	Password	240
8.12	Free parameter	243
8.13	Setting multiple parameters by batch	244
8.14	Extended parameter display and user group function	246
8.15	PWM carrier frequency and Soft-PWM control.....	249
8.16	Inverter parts life display.....	251
8.17	Maintenance timer alarm	256
8.18	Current average value monitor signal.....	257

8 (E) Environment Setting Parameters

Purpose	Parameter to set			Refer to page
To set the time	Clock	P.E020 to P.E022	Pr.1006 to Pr.1008	222
To set a limit for the reset function. To shut off output if the operation panel disconnects. To force deceleration to stop on the operation panel.	Reset selection/ disconnected PU detection/PU stop selection/reset limit	P.E100 to P.E102, P.E107	Pr.75	225
To select the display language of the parameter unit	PU display language selection	P.E103	Pr.145	228
To control the buzzer of the parameter unit or LCD operation panel	PU buzzer control	P.E104	Pr.990	229
To adjust the LCD contrast of the parameter unit or LCD operation panel	PU contrast adjustment	P.E105	Pr.991	230
To set the frequency automatically. To disable the operation panel.	Operation panel operation selection	P.E200	Pr.161	231
To change the frequency change increments which changes when using the setting dial of the operation panel	Frequency change increment amount setting	P.E201	Pr.295	233
To determine which direction the motor rotates when the RUN key on the operation panel is pressed.	RUN key rotation direction selection	P.E202	Pr.40	234
To use the regeneration unit to increase the motor braking torque	Regenerative brake selection	P.E300, P.G107	Pr.30, Pr.70	545
To change the overload current rating specification	Multiple rating setting	P.E301	Pr.570	235
To prevent parameter rewriting	Parameter write disable selection	P.E400	Pr.77	237
To restrict parameters with a password	Password	P.E410, P.E411	Pr.296, Pr.297	240
To use parameters freely	Free parameter	P.E420, P.E421	Pr.888, Pr.889	243
To change parameter settings for a PM motor by batch	PM parameter initialization	P.E430	Pr.998	123
To set multiple parameters by batch	Automatic parameter setting	P.E431	Pr.999	244
To display the required parameters	Applicable parameter display and user group function	P.E440 to P.E443	Pr.160, Pr.172 to Pr.174	246
To reduce the motor noise and EMI	PWM carrier frequency changing	P.E600 to P.E602	Pr.72, Pr.240, Pr.260	249
To understand the maintenance time of inverter parts and peripheral devices	Inverter parts life display	P.E700 to P.E708	Pr.255 to Pr.259, Pr.506 to Pr.509	251
	Environmental impact diagnosis function	P.E709	Pr.198	251
	Maintenance output function	P.E710, P.E711	Pr.503, Pr.504	256
	Current average monitor	P.E720 to P.E722	Pr.555 to Pr.557	257

8.1 Clock

The time can be set. The time can only be updated while the inverter power is ON.

The real time clock function is enabled using an optional LCD operation panel (FR-LU08).

Pr.	Name	Initial value	Setting range	Description
1006 E020	Clock (year)	2000 (year)	2000 to 2099*1	Set the year.
1007 E021	Clock (month, day)	101 (January 1)	101 to 131, 201 to 228, (229), 301 to 331, 401 to 430, 501 to 531, 601 to 630, 701 to 731, 801 to 831, 901 to 930, 1001 to 1031, 1101 to 1130, 1201 to 1231	Set the month and day. 1000's and 100's digits: Month (1 (January) to 12 (December)). 10's and 1's digits: Day (1 to the last day of the month (28, 29, 30, or 31)). For December 31, set "1231".
1008 E022	Clock (hour, minute)	0 (00:00)	0 to 59, 100 to 159, 200 to 259, 300 to 359, 400 to 459, 500 to 559, 600 to 659, 700 to 759, 800 to 859, 900 to 959, 1000 to 1059, 1100 to 1159, 1200 to 1259, 1300 to 1359, 1400 to 1459, 1500 to 1559, 1600 to 1659, 1700 to 1759, 1800 to 1859, 1900 to 1959, 2000 to 2059, 2100 to 2159, 2200 to 2259, 2300 to 2359	Set the hour and minute using the 24-hour clock. 1000's and 100's digits: 0 to 23 hours, 10's and 1's digits: 0 to 59 minutes. For 23:59, set "2359".

*1 The setting range is "2010 to 2099" when the CC-Link IE TSN communication is used for time synchronization.

◆ Simple clock function

- When the current year, month, day, hour and minute are set in the parameters above, the inverter internal clock starts ticking. The set date and time can be checked by reading the parameters.

NOTE

- The time data of the internal clock is saved in the inverter's EEPROM every 10 minutes.
- The clock does not run while the control circuit power is OFF. The clock needs to be set every time after turning ON the inverter power.
- When the FR-E8DS is installed and power to the main circuit is turned ON while power is supplied to the inverter from the 24 V external power supply, the clock data is reset to the data stored in EEPROM because an inverter reset is to be performed in the initial setting. To prevent the clock from resetting, set **Pr.30 Regenerative function selection**. (Refer to [page 545](#).) (Standard model and Ethernet model)

◆ Real time clock function

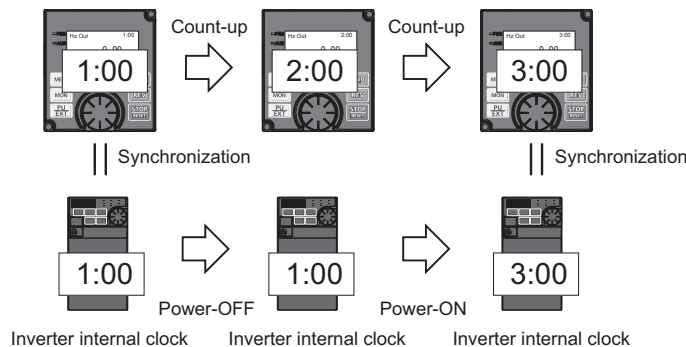

- When the FR-LU08 is connected to the inverter, the internal clock of the inverter can be synchronized with the clock in the FR-LU08 (Real time clock function). The FR-LU08 with battery (CR1216) backup can keep its clock function running even if the main power of the inverter is turned OFF. (The inverter internal clock stops running when the inverter power is turned OFF.)
- To adjust the clock in the FR-LU08, set **Pr.1006 to Pr.1008** on the FR-LU08.

NOTE

- Time synchronization between the inverter internal clock and the clock in the FR-LU08 is performed every one minute.
- If the FR-LU08 clock is reset due to dead battery for example, the data in the inverter internal clock is used.

◆ Time synchronization via CC-Link IE TSN communication (Ethernet model / safety communication model / IP67 model)

- The internal clocks of connected devices on the CC-Link IE TSN Network can be synchronized.

NOTE

- The clock of the inverter is adjusted every minute according to the received clock data. (The clock of the inverter is not synchronized when the received clock data is out of range.)
 - For information about sending clock data, refer to the Instruction Manual of the CC-Link IE TSN master module.
-

8.2 Reset selection / disconnected PU detection / PU stop selection

The reset input acceptance, disconnected PU connector detection function, and PU stop function can be selected.

Pr.	Name	Initial value	Setting range	Description
75	Reset selection/ disconnected PU detection/PU stop selection	[E800(-E)] 14	[E800(-E)] 0 to 3, 14 to 17	In the initial setting, the reset command input is always enabled, the inverter operation continues even when PU is disconnected, the operation can be stopped on the PU, and the reset limit function is disabled.
		[E800-SCE] [E806] 10014	[E800-SCE] [E806] 0 to 3, 14 to 17, 10000 to 10003, 10014 to 10017	In the initial setting, the reset command input is always enabled, the inverter operation continues even when PU is disconnected, the operation can be stopped on the PU, and the reset limit function is enabled.
E100	Reset selection	0	0	Reset input is always enabled.
			1	Reset input is enabled only when the protective function is activated.
E101	Disconnected PU detection	0	0	Operation continues even when the PU is disconnected.
			1	The inverter output is shut off when the PU is disconnected.
E102	PU stop selection	1	0	The inverter decelerates to stop when the STOP key on the PU is pressed in PU operation mode. (The PU stop function is disabled.)
			1	The inverter decelerates to stop when the STOP key on the PU is pressed in any operation mode of the PU, external, or Network. (The PU stop function is enabled.)
E107	Reset limit	[E800(-E)] 0	[E800(-E)] 0	Reset limit is fixed to disabled.
		[E800-SCE] [E806] 10	[E800-SCE] [E806] 0, 10	Reset limit is initially enabled.

8

The parameters above do not return to their initial values even if Parameter clear/All parameter clear is executed.

Pr.75 setting	Reset input	Operation after PU disconnection is detected	PU stop function	Reset limit
0	Always enabled.	Operation continues.	Disabled	Disabled
1	When the protective function is activated.	Operation continues.	Disabled	
2	Always enabled.	Inverter output shutoff	Disabled	
3	When the protective function is activated.	Inverter output shutoff	Disabled	
14	Always enabled.	Operation continues.	Enabled	
15	When the protective function is activated.	Operation continues.	Enabled	
16	Always enabled.	Inverter output shutoff	Enabled	
17	When the protective function is activated.	Inverter output shutoff	Enabled	
10000	Always enabled.	Operation continues.	Disabled	Enabled
10001	When the protective function is activated.	Operation continues.	Disabled	
10002	Always enabled.	Inverter output shutoff	Disabled	
10003	When the protective function is activated.	Inverter output shutoff	Disabled	
10014	Always enabled.	Operation continues.	Enabled	
10015	When the protective function is activated.	Operation continues.	Enabled	
10016	Always enabled.	Inverter output shutoff	Enabled	
10017	When the protective function is activated.	Inverter output shutoff	Enabled	

◆ Reset selection (P.E100)

- While **P.E100** = "1", or **Pr.75** = "1, 3, 15, 17, 10001, 10003, 10015, or 10017", the reset command input is enabled (using the RES signal or through communication) only when the protective function is activated.

NOTE

- When the RES signal is input during operation, the motor coasts since the inverter being reset shuts off the output. Also, the cumulative values of electronic thermal O/L relay and regenerative brake duty are cleared.
- When "reset input always enabled" is selected, the reset key on the PU is enabled only when the protective function is activated.
- During emergency drive operation, reset input is always enabled regardless of the reset selection setting.

◆ Disconnected PU detection (P.E101) (Standard model only)

- When the inverter detects that the PU connector is disconnected from the inverter for 1 second or more while **P.E101** = "1" or **Pr.75** = "2, 3, 16, 17, 10002, 10003, 10016, or 10017", the PU disconnection ("E.PUE") indication is displayed and the inverter output is shut off.

NOTE

- When the PU has been disconnected before power-ON, the output is not shut off.
- To restart the inverter operation, confirm that the PU is connected before reset.
- When the inverter detects that the PU is disconnected during PU JOG operation while **P.E101** or **Pr.75** is set to continue the inverter operation even when the PU is disconnected, the inverter decelerates the motor to stop.
- During RS-485 communication operation via the PU connector, the Reset selection function and the PU stop selection function are enabled but the Disconnected PU detection function is disabled. (The communication is checked according to **Pr.122 PU communication check time interval**.)
- PU disconnection detection function is unavailable for the Ethernet model, the safety communication model, and the IP67 model.

◆ PU stop selection (P.E102)

- The inverter operation can be stopped in any operation mode (PU, External, or Network) by pressing the STOP/RESET key on the PU (operation panel / parameter unit).
- When the inverter is stopped by the PU stop function, "PS" is displayed on the operation panel. However, the Fault signal is not output.
- When **P.E102** = "0", or **Pr.75** = "0 to 3 or 10000 to 10003", only the inverter in the PU operation mode decelerates to stop by pressing the STOP/RESET key.

NOTE

- The inverter decelerates to stop (PU stop function) also when the start command is input using a device which has the command source (set in **Pr.551**) and then the STOP/RESET key is pressed on a PU which does not have the command source.
(Example) When the operation panel has the command source and the stop command is input using a USB (FR Configurator2), the PU stop function is activated.

◆ How to restart the inverter which has been stopped in the External operation mode by using the STOP/RESET key on the PU ("PS" (PU stop) warning reset method)

- PU stop release method for operation panel

1. After completion of deceleration stop, turn OFF the STF and STR signals.
2. Press the PU/EXT key three times (the PS warning is reset) when **Pr.79 Operation mode selection** = "0" (initial value) or "6".
When **Pr.79** = "2, 3, or 7", the PU stop warning can be cleared with one keystroke.

- PU stop release method for parameter unit (FR-PU07)

1. After completion of deceleration stop, turn OFF the STF or STR signal.
2. Press the EXT key (the PS warning is reset).

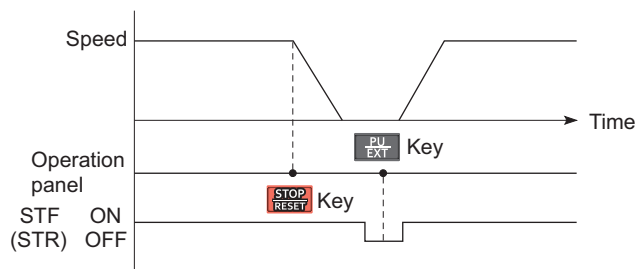

Stop/restart example for External operation

- The inverter can be restarted by performing the reset operation (by turning OFF and ON the power or inputting the RES signal). When **Pr.30 Regenerative function selection** = "100 to 102" (no reset when power is supplied to the main circuit), the inverter can be restarted also when the power is supplied to the main circuit while the FR-E8DS is installed and 24 V external power is supplied to the inverter (refer to [page 545](#)).

NOTE

- Even when **Pr.250 Stop selection** ≠ "9999" is set and coasting stop is selected, using the PU stop function in the External operation mode does not provide coasting stop but deceleration stop.

◆ Reset limit (P.E107) (Safety communication model / IP67 model)

- When "10" is set in **P.E107** or any value from "10000 to 10003, 10014 to 10017" is set in **Pr.75**, the reset command input (using the STOP/RESET key or the RES signal) is disabled when the protective function (E.SAF, E.6, E.7, or E.CPU) is activated. Turn ON the power supply of the inverter again to reset the inverter.

NOTE

- When a communication option is installed, reset is enabled when the protective function (E.SAF, E.6, E.7, or E.CPU) is activated regardless of **P.E107** or **Pr.75** setting.
- For the standard model and the Ethernet model, reset limit is fixed to disabled.

CAUTION

- Do not perform a reset while a start signal is being input. Doing so will cause a sudden start of the motor, which is dangerous.

Parameters referred to

Pr.79 Operation mode selection [page 280](#)

Pr.250 Stop selection [page 543](#)

Pr.551 PU mode operation command source selection [page 291](#)

8.3 PU display language selection (Standard model)

The display language of the parameter unit (FR-PU07) can be selected.

Pr.	Name	Initial value	Setting range	Description
145 E103	PU display language selection	—	0	Japanese
			1	English
			2	German
			3	French
			4	Spanish
			5	Italian
			6	Swedish
			7	Finnish

8.4 Buzzer control (Standard model)

The key sound and buzzer of the LCD operation panel (FR-LU08) or parameter unit (FR-PU07) can be turned ON/OFF.

Pr.	Name	Initial value	Setting range	Description
990 E104	PU buzzer control	1	0	Turns the key sound and buzzer OFF.
			1	Turns the key sound and buzzer ON.

NOTE

- When the buzzer is set to ON, a warning sound will be audible when a fault occurs.

8.5 PU contrast adjustment (Standard model)

Contrast of the LCD display on the LCD operation panel (FR-LU08) or the parameter unit (FR-PU07) can be adjusted. Decreasing the setting value lowers the contrast.

Pr.	Name	Initial value	Setting range	Description
991 E105	PU contrast adjustment	58	0 to 63	0: Low → 63: High

This parameter can be selected from among simple mode parameters only when the LCD operation panel (FR-LU08) or the parameter unit (FR-PU07) is connected to the inverter.

8.6 Automatic frequency setting / key lock operation selection

Turning the setting dial or pressing the UP/DOWN key on the operation panel enables frequency setting without pressing the SET key.

The key operation of the operation panel can be disabled.

Pr.	Name	Initial value	Setting range	Description	
161 E200	Frequency setting/key lock operation selection	0	0	Automatic frequency setting disabled	Key lock function disabled.
			1	Automatic frequency setting enabled	
			10	Automatic frequency setting disabled	Key lock function enabled.
			11	Automatic frequency setting enabled	

◆ Automatic frequency setting (Pr.161 = "1 or 11")

- To set the frequency using the operation panel when Pr.161 = "0" (initial value) or "10", change the frequency value using the setting dial or the UP/DOWN key, and press the SET key to confirm the setting (the value is stored in the RAM and EEPROM).
- When Pr.161 = "1 or 11", the automatic frequency setting is enabled. After the frequency value is changed using the setting dial or the UP/DOWN key, the value indicated is stored in the RAM. If the frequency value has not been changed for 10 seconds, the value is stored in the EEPROM.

When the automatic frequency setting is disabled (Pr.161 = "0 (initial value) or 10")

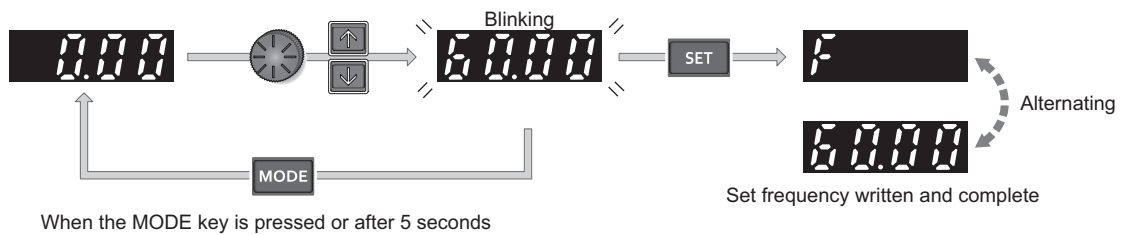

When the automatic frequency setting is enabled (Pr.161 = "1 or 11")

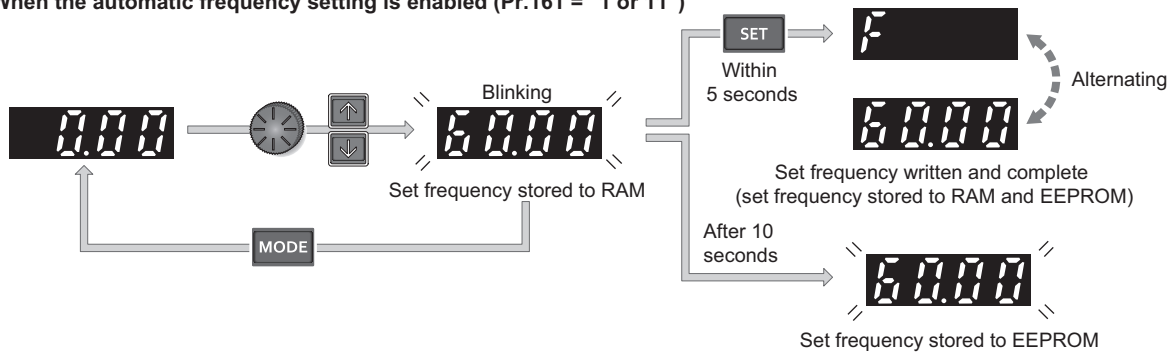

NOTE

- If the operation panel does not have the operation command source (Pr.551 = "2, 3, or 9999" (with USB and/or PU connection)), the frequency cannot be set using the operation panel.
- If the operation mode is changed to one in which the inverter does not operate according to the frequency set on the operation panel after the frequency value is stored in the RAM but before it is stored in the EEPROM, the value is not stored in the EEPROM.
- If the power is OFF or the inverter is reset after the frequency value is stored in the RAM but before it is stored in the EEPROM, the value is not stored in the EEPROM.
- When setting the frequency by turning the setting dial, the frequency goes up to the set value of Pr.1 Maximum frequency. Be aware of what frequency Pr.1 is set to, and adjust the setting of Pr.1 according to the application.

◆ Disabling the setting dial and keys on the operation panel (by holding down the MODE key for 2 seconds)

- Operation using the setting dial and keys of the operation panel can be disabled to prevent parameter changes, unexpected starts or frequency changes.
- Set **Pr.161** to "10 or 11" and then press the MODE key for 2 seconds to disable setting dial or key operations.
- When the setting dial and key operation are disabled, "HOLD" appears on the operation panel. If setting dial or key operation is attempted while dial and key operations are disabled, "HOLD" appears. (After no setting dial or key operation for 2 seconds, the display returns to the monitoring screen.)
- To enable the setting dial and key operation again, press the MODE key for 2 seconds.

NOTE

- Even if setting dial and key operations are disabled, the monitor indicator and STOP/RESET key are enabled.
- The PU stop warning cannot be reset by using keys while the key lock function is enabled.

◀ Parameters referred to ▶

Pr.1 Maximum frequency  page 331

8.7 Frequency change increment amount setting (Standard model)

When setting the set frequency with the setting dial of the operation panel, the frequency changes in 0.01 Hz increments in the initial status. Setting this parameter to increase the frequency increment amount that changes when the setting dial is rotated can improve usability.

Pr.	Name	Initial value	Setting range	Description
295 E201	Frequency change increment amount setting	0	0	Function disabled
			0.01	The minimum change width when the set frequency is changed with the setting dial can be set.
			0.10	
			1.00	
			10.00	

◆ Basic operation

- When Pr.295 ≠ "0", the minimum increment when the set frequency is changed with the setting dial can be set. For example, when Pr.295 = 1.00 Hz, one click (one dial gauge) of the setting dial changes the frequency in increments of 1.00 Hz, such as 1.00 Hz → 2.00 Hz → 3.00 Hz.

When Pr.295="1.00"



8

NOTE

- When machine speed display is selected in Pr.53 Frequency / rotation speed unit switchover, the minimum increments of change are determined by Pr.295 as well. Note that the setting value may differ as speed setting changes the set machine speed and converts it to the speed display again.
- For Pr.295, the increments are not displayed.
- The Pr.295 setting is enabled only for the changes to the set frequency. It does not apply to the settings of other parameters related to frequency.
- When 10 is set, the frequency setting changes in 10 Hz increments. Be cautious of excessive speed (when Automatic frequency setting enabled).

Parameters referred to

Pr.53 Frequency / rotation speed unit switchover [page 346](#)

8.8 RUN key rotation direction selection

The rotation direction of the motor when the RUN key on the operation panel is pressed can be selected.

Pr.	Name	Initial value	Setting range	Description
40 E202	RUN key rotation direction selection	0	0	Forward rotation
			1	Reverse rotation

8.9 Multiple rating setting

Two rating types of different rated current and permissible load can be selected. The optimal inverter rating can be selected according to the application, enabling equipment to be downsized.

Pr.	Name	Initial value	Setting range	Description (overload current rating, surrounding air temperature)
570 E301 ^{*1}	Multiple rating setting	2	1	LD rating. 120% for 60 seconds, 150% for 3 seconds (inverse-time characteristics) at surrounding air temperature of 50°C.
			2	ND rating. 150% for 60 seconds, 200% for 3 seconds (inverse-time characteristics) at surrounding air temperature of 50°C.

*1 Available for the three-phase power input model only.

◆ Changing the parameter initial values and setting ranges

- When the Pr.570 setting is changed, initial values of the following parameters will be changed according to each rating by performing an inverter reset and all parameter clear.

Pr.	Name	Pr.570 setting		Refer to page
		1	2 (initial value)	
0	Torque boost	*1	*1	528
7	Acceleration time	*1	*1	262
8	Deceleration time	*1	*1	262
9	Electronic thermal O/L relay	LD rated current ^{*2}	ND rated current ^{*2*3}	306
12	DC injection brake operation voltage	*1	*1	536
22	Stall prevention operation level	120%	150%	139, 334
44	Second acceleration/deceleration time	*1	*1	262
56	Current monitoring reference	LD rated current ^{*2}	ND rated current ^{*2}	358
150	Output current detection level	120%	150%	385
165	Stall prevention operation level for restart	120%	150%	502
557	Current average value monitor signal output reference current	LD rated current ^{*2}	ND rated current ^{*2}	257
874	OLT level setting	120%	150%	139
893	Energy saving monitor reference (motor capacity)	Applicable motor capacity (LD) ^{*2}	Applicable motor capacity (ND) ^{*2}	365

*1 Initial values differ depending on the rating as follows.

FR-E820-[]	FR-E840-[]	FR-E846-[]	Pr.0 (%)		Pr.7, Pr.8, Pr.44 (s)		Pr.12 (%)	
			ND	LD	ND	LD	ND	LD
0008(0.1K)	—	—	6	6	5	5	6	6
0015(0.2K)	—	—	6	6	5	5	6	4
0030(0.4K)	0016(0.4K)	—	6	6	5	5	4	4
0050(0.75K)	0026(0.75K)	0026(0.75K)	6	4	5	5	4	4
0080(1.5K)	0040(1.5K)	0040(1.5K)	4	4	5	5	4	4
0110(2.2K)	0060(2.2K)	0060(2.2K)	4	4	5	5	4	4
0175(3.7K)	0095(3.7K)	0095(3.7K)	4	3	5	10	4	4
0240(5.5K)	0120(5.5K)	—	3	3	10	10	4	4
0330(7.5K)	0170(7.5K)	—	3	2	10	15	4	2
0470(11K)	0230(11K)	—	2	2	15	15	2	2
0600(15K)	0300(15K)	—	2	2	15	15	2	2
0760(18.5K)	0380(18.5K)	—	2	2	15	15	2	2
0900(22K)	0440(22K)	—	2	2	15	15	2	2

FR-E860-□	Pr.0 (%)		Pr.7, Pr.8, Pr.44 (s)		Pr.12 (%)	
	ND	LD	ND	LD	ND	LD
0017(0.75K)	5	3	5	5	1	1
0027(1.5K)	3	3	5	5	1	1
0040(2.2K)	3	2	5	5	1	1
0061(3.7K)	2	2	5	10	1	1
0090(5.5K)	2	2	10	10	1	1
0120(7.5K)	2	1	10	15	1	1

*2 The rated current and applicable motor capacity values differ depending on the inverter capacity. Refer to the inverter rated specifications in the Instruction Manual (Connection).

*3 The initial value for the FR-E820-0050(0.75K) or lower, the FR-E840-0026(0.75K) or lower, the FR-E860-0017(0.75K), and FR-E846-0026(0.75K) is set to the 85% of the inverter rated current.

8.10 Parameter write selection

Whether or not to enable the writing to various parameters can be selected. Use this function to prevent parameter values from being rewritten by misoperation.

Pr.	Name	Initial value	Setting range	Description
77 E400	Parameter write selection	0	0	Writing is enabled only during stop.
			1	Writing is disabled.
			2	Writing is enabled in any operation mode regardless of the operation status.

- Pr.77 can be set at any time regardless of the operation mode or operation status. (Setting through communication is unavailable except for the Ethernet communication between the inverter and FR Configurator2.)

◆ Parameter write enabled only during stop (Pr.77 = "0" (initial value))

- Parameters can be written only during a stop in the PU operation mode.
- The following parameters can always be written regardless of the operation mode or operation status.

Pr.	Name
4 to 6	(Multi-speed setting high-speed, middle-speed, low-speed)
22	Stall prevention operation level
24 to 27	(Multi-speed setting speed 4 to speed 7)
52	Operation panel main monitor selection
54	FM terminal function selection
55	Frequency monitoring reference
56	Current monitoring reference
72 ^{*1}	PWM frequency selection
75	Reset selection/Disconnected PU detection/PU stop selection
77	Parameter write selection
79 ^{*2}	Operation mode selection
129	PID proportional band
130	PID integral time
133	PID action set point
134	PID differential time
158	AM terminal function selection
160	User group read selection
232 to 239	(Multi-speed setting speed 8 to speed 15)
240 ^{*1}	Soft-PWM operation selection
241	Analog input display unit switchover
268	Monitor decimal digits selection
275 ^{*1}	Stop-on contact excitation current low-speed scaling factor
290	Monitor negative output selection
295	Frequency change increment amount setting
296, 297	(Password setting)
306	Analog output signal selection
310	Analog meter voltage output selection
340 ^{*2}	Communication startup mode selection
345, 346	(DeviceNet communication)
414	PLC function operation selection
442 to 445	(Ethernet communication)
496, 497	(Remote output)
498	PLC function flash memory clear

Pr.	Name
511	Home position return shifting speed
550 ^{*2}	NET mode operation command source selection
551 ^{*2}	PU mode operation command source selection
555 to 557	(Current average value monitoring)
675	User parameter auto storage function selection
759	PID unit selection
774 to 776	(Operation panel monitor item selection)
805	Torque command value (RAM)
806	Torque command value (RAM, EEPROM)
866	Torque monitoring reference
888, 889	(Free parameter)
891 to 899	(Energy saving monitoring)
C0 (900)	FM terminal calibration
C1 (901)	AM terminal calibration
990	PU buzzer control
991	PU contrast adjustment
992	Operation panel setting dial push monitor selection
997	Fault initiation
998 ^{*2}	PM parameter initialization
999 ^{*2}	Automatic parameter setting
1006	Clock (year)
1007	Clock (month, day)
1008	Clock (hour, minute)
1020	Trace operation selection
1124	Station number in inverter-to-inverter link
1125	Number of inverters in inverter-to-inverter link system
1150 to 1199	(PLC function user parameters)
1200	AM output offset calibration
1283	Home position return speed
1318 to 1343	(User defined cyclic communication)
1399, 1424 to 1432, 1434 to 1457	(Ethernet communication)
1480 to 1485	(Load characteristics fault)

*1 Writing during operation is enabled in PU operation mode, but disabled in External operation mode.

*2 Writing during operation is disabled. To change the parameter setting value, stop the operation.

◆ Parameter write disabled (Pr.77 = "1")

- Parameter write, Parameter clear, and All parameter clear are disabled. (Parameter read is enabled.)
- The following parameters can be written even if Pr.77 = "1".

Pr.	Name
22	Stall prevention operation level
75	Reset selection/Disconnected PU detection/PU stop selection
77	Parameter write selection
79 ^{*1}	Operation mode selection
160	User group read selection
296	Password lock level
297	Password lock/unlock

Pr.	Name
345, 346	(DeviceNet communication)
496, 497	(Remote output)
805	Torque command value (RAM)
806	Torque command value (RAM, EEPROM)
997	Fault initiation
1020	Trace operation selection

*1 Writing during operation is disabled. To change the parameter setting value, stop the operation.

◆ Parameter write enabled during operation (Pr.77 = "2")

- Parameters can always be written.
- The following parameters cannot be written during operation if Pr.77 = "2". To change the parameter setting value, stop the operation.

Pr.	Name
23	Stall prevention operation level compensation factor at double speed
40	RUN key rotation direction selection
48	Second stall prevention operation level
60	Energy saving control selection
61	Reference current
66	Stall prevention operation reduction starting frequency
71	Applied motor
79	Operation mode selection
80	Motor capacity
81	Number of motor poles
82	Motor excitation current
83	Rated motor voltage
84	Rated motor frequency
90 to 94	(Motor constant)
95	Online auto tuning selection
96	Auto tuning setting/status
178 to 197	(Input/output terminal function selection)
261	Power failure stop selection
277	Stall prevention operation current switchover
289	Inverter output terminal filter
291	Pulse train input selection
292	Automatic acceleration/deceleration
293	Acceleration/deceleration separate selection
298	Frequency search gain
313 to 322	(Extension output terminal function selection)
329	Digital input unit selection
415	Inverter operation lock mode setting
418	Extension output terminal filter
420, 421	(Electronic gear)
450	Second applied motor
451	Second motor control method selection
453	Second motor capacity
454	Number of second motor poles
455	Second motor excitation current

Pr.	Name
456	Rated second motor voltage
457	Rated second motor frequency
458 to 462	(Second motor constant)
463	Second motor auto tuning setting/status
507	Display/reset ABC relay contact life
508	Display/reset ABC2 relay contact life
525 to 531	(Extension input terminal function selection)
538	Current position retention selection
541	Frequency command sign selection
560	Second frequency search gain
561	PTC thermistor protection level
570	Multiple rating setting
574	Second motor online auto tuning
631	Inverter output fault detection enable/disable selection
639, 640	(Brake sequence)
660 to 662	(Increased magnetic excitation deceleration)
673	SF-PR slip amount adjustment operation selection
699	Input terminal filter
702	Maximum motor frequency
706, 707, 711, 712, 717, 721, 724, 725, 1412	(PM motor tuning)
720, 737	(Motor starting resistance tuning compensation coefficient 2)
738 to 746, 1413	(Second PM motor tuning)
800	Control method selection
858	Terminal 4 function assignment
859	Torque current/Rated PM motor current
860	Second motor torque current/Rated PM motor current
868	Terminal 1 function assignment
979 to 981	(Position accuracy compensation gain 1 to 3)
998	PM parameter initialization
999	Automatic parameter setting
1002	Lq tuning target current adjustment coefficient
1292	Position control terminal input selection
1293	Roll feeding mode selection

8.11 Password

Registering a 4-digit password can restrict access to parameters (reading/writing).

Pr.	Name	Initial value	Setting range	Description
296 E410	Password lock level	9999	0 to 6, 99, 100 to 106, 199	Password protection enabled. Setting the access (reading/writing) restriction level to parameters locked with a password enables writing to Pr.297.
			9999	No password protection
297 E411	Password lock/unlock	9999	1000 to 9998	Input a 4-digit password to lock parameters, or input the valid password to unlock the locked parameters.
			(0 to 5) ^{*1}	Number of failed password attempts (read only, displayed after any of "100 to 106, or 199" is set in Pr.296 and a password to lock parameters is input).
			9999 ^{*1}	No password protection

These parameters can be set when Pr.160 User group read selection = "0". However, when Pr.296 ≠ 9999 (password lock is set), Pr.297 can always be set, regardless of the setting in Pr.160.

*1 Although "0 or 9999" can be input in Pr.297, the value is invalid. (The display cannot be changed.)

◆ Parameter reading/writing restriction level (Pr.296)

- The access (reading/writing) restriction level to parameters in the PU operation mode or NET operation mode can be selected with Pr.296.

Pr.296 setting	PU operation mode operation command ^{*3}		NET operation mode operation command ^{*4}			
			RS-485 communication / PLC function ^{*7}		via communication option	
	Read ^{*1}	Write ^{*2}	Read	Write ^{*2}	Read	Write ^{*2}
9999	○	○	○	○	○	○
0, 100 ^{*6}	×	×	×	×	×	×
1, 101	○	×	○	×	○	×
2, 102	○	×	○	○	○	○
3, 103	○	○	○	×	○	×
4, 104	×	×	×	×	○	×
5, 105	×	×	○	○	○	○
6, 106	○	○	×	×	○	×
99, 199	Only the parameters registered in the user group can be read/written. (For the parameters not registered in the user group, the restriction level when "4 or 104" is set applies.) ^{*5}					

○: Enabled, ×: Disabled

- *1 If the parameter reading is restricted by the setting of Pr.160 User group read selection, those parameters cannot be read even when "○" is indicated.
- *2 If the parameter writing is restricted by the setting of Pr.77 Parameter write selection, those parameters cannot be written even when "○" is indicated.
- *3 Access from the command source in the PU operation mode (the operation panel or the USB connector in the initial setting) is restricted. (For the PU operation mode command source selection, refer to page 291.)
- *4 Access from the command source in the Network operation mode (the PU connector, the Ethernet connector, or a communication option in the initial setting) is restricted. (For the NET operation mode command source selection, refer to page 291.)
- *5 Read/write is enabled only for the simple mode parameters registered in the user group when Pr.160 = "9999". Pr.296 and Pr.297 are always read/write enabled whether registered to a user group or not.
- *6 If a communication option is installed, the Option fault (E.OPT) occurs, and the inverter output shuts off.
- *7 The PLC function user parameters (Pr.1150 to Pr.1199) can be written and read by the PLC function regardless of the Pr.296 setting.

◆ Locking parameters with a password (Pr.296, Pr.297)

- The procedure of locking parameters with a password is as follows.

1. Set the parameter reading/writing restriction level to enable the password protection. (Set a value other than "9999" in Pr.296.)

Pr.296 setting	Allowable number of failed password attempts	Pr.297 readout
0 to 6, or 99	Unlimited	Always 0
100 to 106, 199 ^{*1}	Limited to 5 times	Number of failed password attempts (0 to 5)

*1 If an invalid password is input 5 times while any of "100 to 106, or 199" is set in Pr.296, the password is locked up afterward (the locked parameters cannot be unlocked even with the valid password). All parameter clear is required to reset the password. (After All parameter clear is performed, the parameters are returned to their initial values.)

2. Write a 4-digit number (1000 to 9998) to Pr.297 as a password (writing is disabled when Pr.296 = "9999"). After a password is set, parameters are locked and access (reading/writing) to the parameters is limited at the level set in Pr.296 until the valid password is input to unlock the locked parameters.

NOTE

- After a password is set, the Pr.297 readout is always any of "0 to 5".
- "LOCD" appears when a password-protected parameter is attempted to be read/written.
- Even if a password is set, the parameters which are written by the inverter, such as parameters related to the life check of inverter parts, are overwritten as needed.
- Even if a password is registered, reading/writing is enabled for Pr.991 PU contrast adjustment when the parameter unit (FR-PU07) is connected.

◆ Unlocking the locked parameters (Pr.296, Pr.297)

- There are two ways to unlock the locked parameters.
- Enter the password in Pr.297. When a valid password is input, the locked parameters can be unlocked. When an invalid password is input, an error indication appears and the parameters cannot be unlocked. If an invalid password is input 5 times while any of "100 to 106, or 199" is set in Pr.296, the locked parameters cannot be unlocked afterward even with the valid password (the password is locked up).
- Perform All parameter clear.

NOTE

- If the password is forgotten, it can be reset by performing All parameter clear, but the other parameters are also reset.
- All parameter clear cannot be performed during the inverter operation.
- When using FR Configurator2 in the PU operation mode, do not set "0, 4, 5, 99, 100, 104, 105, or 199" (parameter read is disabled) in Pr.296. Doing so may cause abnormal operation.
- The means to reset the password varies according to how the reset command is sent (from the PU, through RS-485 communication, or via a communication option).

	PU (operation panel or parameter unit)	RS-485 communication	Communication option
All parameter clear	○	○	○
Parameter clear	×	×	○

○: Password reset enabled, ×: Password reset disabled

- To perform Parameter clear or All parameter clear with the parameter unit or via a communication option, refer to the Instruction Manual of each option. (For details of the operation panel, refer to page 20. For details of RS-485 communication, refer to the Instruction Manual (Communication).)

◆ Access to parameters according to the password status

Parameter		Password protection disabled / Parameters unlocked		Parameters locked	Password locked up
		Pr.296 = "9999", Pr.297 = "9999"	Pr.296 ≠ "9999", Pr.297 = "9999"	Pr.296 ≠ "9999", Pr.297 = "0 to 4" (read value)	Pr.296 = "100 to 106, 199" Pr.297 = "5" (read value)
Pr.296	Read	○ ^{*1}	○	○	○
	Write	○ ^{*1}	○ ^{*1}	×	×
Pr.297	Read	○ ^{*1}	○	○	○
	Write	×	○	○	○ ^{*3}
Parameter clear		○	○	×	×
All parameter clear		○	○	○ ^{*2}	○ ^{*2}
Parameter copy		○	○	×	×

○: Enabled, ×: Disabled

- *1 Reading/writing is disabled if reading is restricted by the **Pr.160** setting. (Reading is available in the Network operation mode regardless of the **Pr.160** setting.)
- *2 All parameter clear cannot be performed during the operation.
- *3 Inputting a password is possible but the locked-up password cannot be unlocked or reset even with the valid password.
- *4 Parameter clear can be performed only via a communication option.

NOTE

- When "4, 5, 104, or 105" is set in **Pr.296** and a password is set, PU JOG frequency is not listed on the parameter unit (FR-PU07).
- When a password has been set and parameters are locked, parameter copy cannot be performed using the operation panel, parameter unit, or a USB memory device.

Parameters referred to

Pr.77 Parameter write selection [page 237](#)

Pr.160 User group read selection [page 246](#)

Pr.550 NET mode operation command source selection [page 291](#)

Pr.551 PU mode operation command source selection [page 291](#)

8.12 Free parameter

Any number within the setting range of 0 to 9999 can be input.

For example, these numbers can be used:

- As a unit number when multiple units are used.
- As a pattern number for each operation application when multiple units are used.
- As the year and month of introduction or inspection.

Pr.	Name	Initial value	Setting range	Description
888 E420	Free parameter 1	9999	0 to 9999	Any value can be input. The settings are retained even if the inverter power is turned OFF.
889 E421	Free parameter 2	9999	0 to 9999	

NOTE

- Pr.888 and Pr.889 do not influence the operation of the inverter.
-

8.13 Setting multiple parameters by batch

The setting of particular parameters is changed by batch, such as communication parameters for connection with the Mitsubishi Electric human machine interface (GOT), the parameters for the rated frequency (50/60 Hz) setting, or the parameters for acceleration/deceleration time increment.

Multiple parameters are changed automatically. Users do not have to consider each parameter number (automatic parameter setting).

Pr.	Name	Initial value	Setting range	Description
999 E431	Automatic parameter setting	9999*1	10	GOT initial setting (PU connector) "Controller Type" in GOT: FREQROL 500/700/800, SENSORLESS SERVO
			12	GOT initial setting (PU connector) "Controller Type" in GOT: FREQROL 800 (Automatic Negotiation)
			20	50 Hz rated frequency
			21	60 Hz rated frequency
			9999	No action

*1 The read value is always "9999".

◆ Automatic parameter setting (Pr.999)

- Select which parameters to automatically set from the following table, and set them in **Pr.999**. Multiple parameter settings are changed automatically. Refer to [page 244](#) for the list of parameters that are changed automatically.

Pr.999 setting	Description	Operation in the automatic parameter setting mode
10	Automatically sets the communication parameters for the GOT connection with a PU connector ("Controller Type" in GOT: FREQROL 500/700/800, SENSORLESS SERVO)	"AUTO"→"GOT"→Write "1".
12	Automatically sets the communication parameters for the GOT connection with a PU connector ("Controller Type" in GOT: FREQROL 800 (Automatic Negotiation))	"AUTO"→"GOT"→Write "2".
20	50 Hz rated frequency Sets the related parameters of the rated frequency according to the power supply frequency	"AUTO"→"F50"→Write "1".
21	60 Hz rated frequency	—

NOTE

- If the automatic setting is performed with **Pr.999** or the automatic parameter setting mode, the settings including the changed parameter settings (changed from the initial setting) will be automatically changed. Before performing the automatic setting, confirm that changing the parameters will not cause any problem.
- "AUTO" is displayed on the operation panel also when the user group function is used (**Pr.160** = "1"). However, if **Pr.999** is not registered in the group, the automatic setting cannot be performed (write error (Er1) occurs).

◆ GOT initial setting (PU connector) (Pr.999 = "10, 12") (Standard model)

Pr.	Name	Initial value	Pr.999 = "10"	Pr.999 = "12"	Refer to page
79	Operation mode selection	0	1	1	280
118	PU communication speed	192	192	1152	Instruction Manual (Communication)
119	PU communication stop bit length / data length	1	10	0	
120	PU communication parity check	2	1	1	
121	PU communication retry count	1	9999	9999	
122	PU communication check time interval	9999	9999	9999	
123	PU communication waiting time setting	9999	0 ms	0 ms	
124	PU communication CR/LF selection	1	1	1	
340	Communication startup mode selection	0	0	0	290
414	PLC function operation selection	0	—	2*1	516
549	Protocol selection	0	0	0	Instruction Manual (Communication)

*1 The setting is changed when **Pr.414** = "0" (initial setting).

■ Initial setting with the GOT2000 series

- When "FREQROL 500/700/800, SENSORLESS SERVO" is selected for "Controller Type" in the GOT setting, set **Pr.999** = "10" to configure the GOT initial setting.
- When "FREQROL 800 (Automatic Negotiation)" is selected for "Controller Type" in the GOT setting, the GOT automatic connection can be used. When "FREQROL 800 (Automatic Negotiation)" is selected for "Controller Type" in the GOT setting and the GOT automatic connection is not used, set **Pr.999** = "12" to configure the GOT initial setting. (Refer to the Instruction Manual (Communication).)

■ Initial setting with the GOT1000 series

- Set **Pr.999** = "10" to configure the GOT initial setting.

NOTE

- Always perform an inverter reset after the initial setting.
- For the details of connection with GOT, refer to the Instruction Manual of GOT.

◆ Rated frequency (Pr.999 = "20" (50 Hz) or "21" (60 Hz))

Pr.	Name	Initial value ^{*1}		Pr.999 = "21"	Pr.999 = "20"	Refer to page
		Gr.1	Gr.2			
3	Base frequency	60 Hz	50 Hz	60 Hz	50 Hz	530
4	Multi-speed setting (high speed)	60 Hz	50 Hz	60 Hz	50 Hz	303
20	Acceleration/deceleration reference frequency	60 Hz	50 Hz	60 Hz	50 Hz	262
53	Frequency / rotation speed unit switchover	0		0		346
55	Frequency monitoring reference	60 Hz	50 Hz	60 Hz	50 Hz	358
66	Stall prevention operation reduction starting frequency	60 Hz	50 Hz	60 Hz	50 Hz	334
125 (903)	Terminal 2 frequency setting gain frequency	60 Hz	50 Hz	60 Hz	50 Hz	400
126 (905)	Terminal 4 frequency setting gain frequency	60 Hz	50 Hz	60 Hz	50 Hz	
386	Frequency for maximum input pulse	60 Hz	50 Hz	60 Hz	50 Hz	*3
390	% setting reference frequency	60 Hz	50 Hz	60 Hz	50 Hz	*2
505	Speed setting reference	60 Hz	50 Hz	60 Hz	50 Hz	346
808	Speed limit	60 Hz	50 Hz	60 Hz	50 Hz	171
C14 (918)	Terminal 1 gain frequency (speed)	60 Hz	50 Hz	60 Hz	50 Hz	*3
1013	Running speed after emergency drive retry reset	60 Hz	50 Hz	60 Hz	50 Hz	322

*1 Gr.1 and Gr.2 are the parameter initial value groups. (Refer to [page 54](#)).

*2 Refer to the Instruction Manual (Communication).

*3 Refer to the FR-E8AXY E Kit Instruction Manual.

NOTE

- When the plug-in option FR-A8AX is used, **Pr.301 BCD input gain** and **Pr.303 BIN input gain** are not set automatically.

8.14 Extended parameter display and user group function

Use this parameter to select a group of parameters to be displayed on the operation panel or parameter unit.

Pr.	Name	Initial value	Setting range	Description
160 E440	User group read selection	0	9999	Only simple mode parameters are displayed.
			0	Displays simple mode and extended parameters.
			1	Only parameters registered in user groups are displayed.
172 E441	User group registered display/batch clear	0	(0 to 16)	Displays the number of parameters that are registered in the user groups. (Read-only)
			9999	Batch clear of user group registrations
173 E442	User group registration	9999*1	0 to 1999, 9999	Sets the parameter number to register for the user group.
174 E443	User group clear	9999*1	0 to 1999, 9999	Sets the parameter number to clear from the user group.

*1 The read value is always "9999".

◆ Display of simple mode parameters and extended parameters (Pr.160)

- When **Pr.160** = "9999", only the simple mode parameters are displayed on the operation panel and parameter unit. (For the simple mode parameters, refer to the parameter list on [page 55](#).)
- With the initial value (**Pr.160** = "0"), simple mode parameters and extended parameters can be displayed.

NOTE

- When a plug-in option is installed on the inverter, the option parameters can also be read.
- Every parameter can be read regardless of the **Pr.160** setting when reading parameters via communication.
- When the LCD operation panel (FR-LU08) or parameter unit (FR-PU07) is installed, **Pr.15 Jog frequency**, **Pr.16 Jog acceleration/deceleration time**, **C42 (Pr.934) PID display bias coefficient**, **C43 (Pr.934) PID display bias analog value**, **C44 (Pr.935) PID display gain coefficient**, **C45 (Pr.935) PID display gain analog value**, and **Pr.991 PU contrast adjustment** are displayed as simple mode parameters.

◆ User group function (Pr.160, Pr.172 to Pr.174)

- The user group function is a function for displaying only the parameters required for a setting.
- A maximum of 16 parameters from any of the parameters can be registered in a user group. When **Pr.160** = "1", reading/writing is enabled only for the parameters registered in user groups. (Parameters not registered in user groups can no longer be read.)
- To register a parameter in a user group, set the parameter number in **Pr.173**.
- To clear a parameter from a user group, set the parameter number in **Pr.174**. To batch clear all the registered parameters, set **Pr.172** = "9999".

◆ Registering a parameter in a user group (Pr.173)

- To register **Pr.3** in a user group

Operating procedure

- 1.** Power ON
Make sure the motor is stopped.
- 2.** Changing the operation mode
Press the PU/EXT key to choose the PU operation mode. The PU LED turns ON.
- 3.** Selecting the parameter setting mode
Press the MODE key to choose the parameter setting mode. (The parameter number read previously appears.)
- 4.** Selecting a parameter
Turn the setting dial or press the UP/DOWN key until "P.173" (**Pr.173**) appears.
- 5.** Parameter read
Press the SET key. "9999" appears.
- 6.** Parameter registration
Turn the setting dial or press the UP/DOWN key until "3" (**Pr.3**) appears. Press the SET key to register the parameter.
"3" blinks.
To continue adding parameters, repeat steps 5 and 6.

◆ Clearing a parameter from a user group (Pr.174)

- To delete **Pr.3** from a user group.

Operating procedure

- 1.** Power ON
Make sure the motor is stopped.
- 2.** Changing the operation mode
Press the PU/EXT key to choose the PU operation mode. The PU LED turns ON.
- 3.** Selecting the parameter setting mode
Press the MODE key to choose the parameter setting mode. (The parameter number read previously appears.)
- 4.** Selecting a parameter
Turn the setting dial or press the UP/DOWN key until "P.174" (**Pr.174**) appears.
- 5.** Parameter read
Press the SET key. "9999" appears.
- 6.** Clearing the parameter
Turn the setting dial or press the UP/DOWN key until "3" (**Pr.3**) appears. Press the SET key to delete the parameter. "3" blinks.
To continue deleting parameters, repeat steps 5 and 6.

NOTE

- **Pr.77 Parameter write selection, Pr.160, Pr.296 Password lock level, Pr.297 Password lock/unlock, and Pr.991 PU contrast adjustment** can always be read regardless of the user group setting. (For **Pr.991**, only when the FR-LU08 or the FR-PU07 is connected.)
- **Pr.77, Pr.160, Pr.172 to Pr.174, Pr.296, and Pr.297** cannot be registered in a user group.
- When **Pr.174** is read, "9999" is always displayed. "9999" can be written, but it does not function.
- **Pr.172** is disabled if set to a value other than "9999".

Parameters referred to

Pr.77 Parameter write selection  page 237

Pr.296 Password lock level, Pr.297 Password lock/unlock  page 240

Pr.991 PU contrast adjustment  page 230

8.15 PWM carrier frequency and Soft-PWM control

The motor sound can be changed.

Pr.	Name	Initial value	Setting range	Description
72 E600	PWM frequency selection	1	0 to 15	The PWM carrier frequency can be changed. The setting value represents the frequency in kHz. Note that "0" indicates 0.7 kHz, "15" indicates 14.5 kHz.
240 E601	Soft-PWM operation selection	1	0	Soft-PWM control disabled.
			1	Soft-PWM control enabled.
260 E602	PWM frequency automatic switchover	10	0	PWM carrier frequency automatic reduction function disabled
			10	PWM carrier frequency automatic reduction function enabled

◆ Changing the PWM carrier frequency (Pr.72)

- The PWM carrier frequency of the inverter can be changed.
- Changing the PWM carrier frequency can be effective for avoiding the resonance frequency of the mechanical system or motor, as a countermeasure against EMI generated from the inverter, or for reducing leakage current caused by PWM switching.
- Under Real sensorless vector control, Vector control, and PM sensorless vector control, the following carrier frequencies are used.

Pr.72 setting	Carrier frequency (kHz)	
	Real sensorless vector control / Vector control / PM sensorless vector control (when driving a PM motor other than the MM-GKR or EM-A)	PM sensorless vector control (when driving the MM-GKR or EM-A motor)
0 to 5	2	4
6, 7	6 ^{*1}	
8, 9		10 ^{*1}
10 to 13		
14, 15	14 ^{*1}	

*1 The carrier frequency is automatically changed to 2 kHz in the low-speed range (less than 3 Hz) under Real sensorless vector control, or in the low-speed range (lower than 10% of the rated motor frequency) under PM sensorless vector control.

NOTE

- The carrier frequency may be automatically lowered in the low-speed range (less than about 10 Hz) for the ND rating, and over the entire speed range for the LD rating. Motor noise increases, but not to the point of failure.

◆ Soft-PWM control (Pr.240)

- Soft-PWM control is a function that changes the motor noise from a metallic sound into an inoffensive, complex tone.
- Setting Pr.240 = "1" will enable the Soft-PWM control.
- To enable the Soft-PWM control, set Pr.72 to 5 kHz or less.

◆ PWM carrier frequency automatic reduction function (Pr.260)

- Setting Pr.260 = "10" (initial value) will enable the PWM carrier frequency auto-reduction function. If a heavy load is continuously applied while the inverter carrier frequency is set to 3 kHz or higher (Pr.72 ≥ "3"), the carrier frequency is automatically reduced to prevent occurrence of the inverter overload trip (electronic thermal O/L relay function) (E.THT). Motor noise increases, but not to the point of failure.

- When the carrier frequency automatic reduction function is used, operation with the carrier frequency set to 3 kHz or higher (**Pr.72** ≥ 3) automatically reduces the carrier frequency for heavy-load operation as shown below.

Pr.260 setting	Pr.570 setting	Carrier frequency automatic reduction operation
10	1 (LD)	The carrier frequency will reduce automatically with continuous operation of 85% of the inverter rated current or higher.
	2 (ND)	For the FR-E820-0330(7.5K) or lower, FR-E840-0170(7.5K) or lower, FR-E860-0120(7.5K) or lower, FR-E820S-0110(2.2K) or lower, FR-E810W-0050(0.75K) or lower, and FR-E846-0095(3.7K) or lower, the carrier frequency will reduce automatically with operation of 170% of the inverter rated current or higher (only in a low-speed range). For the FR-E820-0470(11K) or higher and FR-E840-0230(11K) or higher, the carrier frequency will reduce automatically with operation of 120% of the inverter rated current or higher.
0	1 (LD)	Without carrier frequency automatic reduction (Perform continuous operation with the carrier frequency set to 2 kHz or lower or with less than 85% of the inverter rated current for the ND rating.)
	2 (ND)	Without carrier frequency automatic reduction

NOTE

- Reducing the PWM carrier frequency is effective as a countermeasure against EMI from the inverter or for reducing leakage current, but doing so increases the motor noise.
- When the PWM carrier frequency is set to 1 kHz or lower (**Pr.72** ≤ 1), the increase in the harmonic current causes the fast-response current limit to activate before the stall prevention operation, which may result in torque shortage. In this case, disable the fast-response current limit in **Pr.156 Stall prevention operation selection**.
- The carrier frequency is reduced to as low as 4 kHz under PM sensorless vector control (when driving the MM-GKR or EM-A motor).

Parameters referred to

- Pr.156 Stall prevention operation selection [page 334](#)
Pr.570 Multiple rating setting [page 235](#)
Pr.800 Control method selection [page 115](#)

8.16 Inverter parts life display

The degree of deterioration of the control circuit capacitor, main circuit capacitor, cooling fan, inrush current limit circuit, relay contacts of terminals A, B, and C, inverter module, and control circuit board can be diagnosed on the monitor. When a part approaches the end of its life, an alarm can be output by self diagnosis to prevent a fault. (Note that the life diagnosis of this function should be used as a guideline only, the life values are theoretical calculations.)

Pr.	Name	Initial value	Setting range	Description
198 E709	Display corrosion level	1	(1 to 3)	Displays the corrosion level of the control circuit board. Read-only. (Available only for coated models (-60/-06).)
255 E700	Life alarm status display	0	(0 to 1007) ^{*1}	Displays whether or not the life alarm output level is reached for the following parts: the control circuit capacitor, main circuit capacitor, cooling fan, inrush current limit circuit, relay contacts of terminals A, B, and C, inverter module, and control circuit board. Read-only.
256 E701	Inrush current limit circuit life display	100%	(0% to 100%)	Displays the deterioration degree of the inrush current limit circuit. Read-only.
257 E702	Control circuit capacitor life display	100%	(0% to 100%)	Displays the deterioration degree of the control circuit capacitor. Read-only.
258 E703	Main circuit capacitor life display	100%	(0% to 100%)	Displays the deterioration degree of the main circuit capacitor. Read-only. The value measured by Pr.259 is displayed.
259 E704	Main circuit capacitor life measuring	0	0, 1 (2, 3, 8, 9)	Setting "1" and turning the power supply OFF starts the measurement of the main circuit capacitor life. If the setting value of Pr.259 becomes "3" after turning the power supply ON again, it means that the measurement is completed. The degree of deterioration is read to Pr.258 .
506 E705	Display estimated main circuit capacitor residual life	100%	(0% to 100%)	Displays the estimated residual life of the main circuit capacitor. Read-only.
507 E706	Display/reset ABC relay contact life	100%	0% to 100%	Displays the degree of deterioration of the relay contacts of terminals A, B, and C.
508 E707 ^{*2}	Display/reset ABC2 relay contact life	100%	0% to 100%	Displays the degree of deterioration of the relay contacts of terminals A2, B2, and C2.
509 E708	Display power cycle life	100%	(0% to 100%)	Displays the degree of deterioration of the inverter module. Read-only.

*1 The setting range (read-only) depends on the inverter.

*2 The setting is available for the IP67 model only.

◆ Life alarm display and signal output (Y90 signal, Pr.255)

Point

- In the life diagnosis of the main circuit capacitor, the Life alarm (Y90) signal is not output unless measurement by turning OFF the power supply is performed.

- **Pr.255 Life alarm status display** and the Life alarm (Y90) signal can be used to check whether or not the life alarm output level is reached for the following parts: the control circuit capacitor, main circuit capacitor, cooling fan, inrush current limit circuit, relay contacts of terminals A, B, and C, inverter module, or control circuit board.

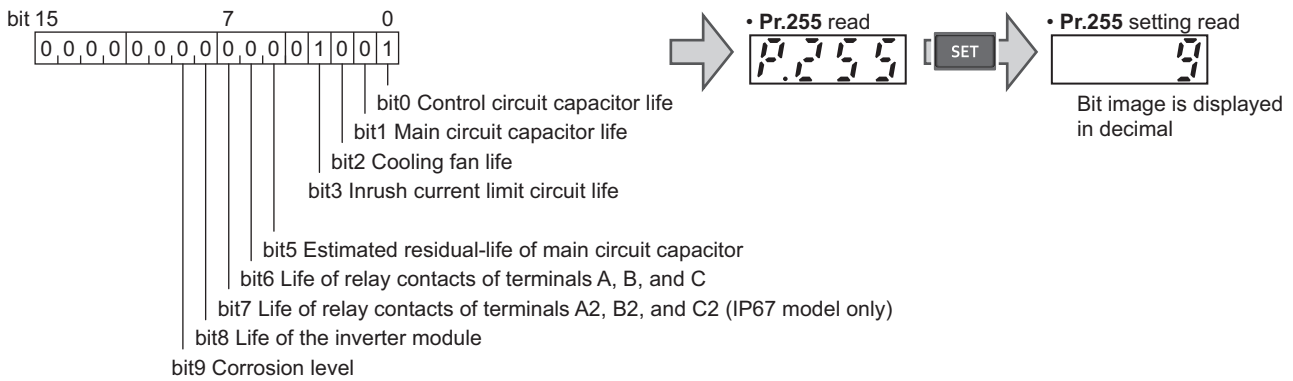

- When the parts have reached the life alarm output level, the corresponding bits of **Pr.255** turns ON. The ON/OFF state of the bits can be checked with **Pr.255**. The following table shows examples.

Pr.255		bit 9	bit 8	bit 7	bit 6	bit 5	bit 4	bit 3	bit 2	bit 1	bit 0	Remarks
Decimal	Binary											
879	1101101111	○	○	×	○	○	×	○	○	○	○	All parts have reached alarm output level for standard model.
5	101	×	×	×	×	×	×	×	○	×	○	Control circuit capacitor and cooling fan have reached alarm output level.
0	0	×	×	×	×	×	×	×	×	×	×	No parts have reached alarm output level.

○: Parts reaching alarm output level ×: Parts not reaching alarm output level

- The Life alarm (Y90) signal turns ON when the warning level is reached for either of the following: the control circuit capacitor life, main circuit capacitor life, cooling fan life, inrush current limit circuit life, the estimated residual-life of the main circuit capacitor, life of relay contacts of terminals A, B, and C, life of relay contacts of terminals A2, B2, and C2 (only for the IP67 model), life of the inverter module, or life of the control circuit board.
- For the terminal used for the Y90 signal, set "90" (positive logic) or "190" (negative logic) in any parameter from **Pr.190 to Pr.197 (Output terminal function selection)**.

NOTE

- Changing the terminal assignment using **Pr.190 to Pr.197 (Output terminal function selection)** may affect the other functions. Set parameters after confirming the function of each terminal.
- For replacement of each part, contact the nearest Mitsubishi FA center.

◆ Life display of the inrush current limit circuit (Pr.256)

- The life of the inrush current limit circuit (relay, contactor and inrush resistor) is displayed in **Pr.256**.
- The number of contact (relay, contactor, thyristor) ON times is counted, and it is counted down from 100% (0 time) every 1%/10,000 times. When the counter reaches 10% (900,000 times), bit 3 of **Pr.255** is turned ON (set to 1) and the Y90 signal is also output as an alert.

◆ Life display of the control circuit capacitor (Pr.257)

- The deterioration degree of the control circuit capacitor is displayed in **Pr.257**.
- In the operating status, the control circuit capacitor life is calculated from the energization time and temperature, and is counted down from 100%. When the counter goes down from 10%, bit 0 of **Pr.255** is turned ON (set to 1) and the Y90 signal is also output as an alert.

◆ Life display of the main circuit capacitor (Pr.258, Pr.259)

Point

- For accurate life measurement of the main circuit capacitor, wait three hours or longer after turning OFF. The temperature left in the main circuit capacitor affects measurement.
-
- The deterioration degree of the main circuit capacitor is displayed in **Pr.258**.
 - With the main circuit capacitor capacity at factory shipment as 100%, the capacitor life is displayed in **Pr.258** every time measurement is made. When the measured value falls to 85% or lower, bit 1 of **Pr.255** turns ON and the Y90 signal is also output as an alert.
 - Measure the capacitor capacity according to the following procedure and check the deterioration degree of the capacitor capacity.
 - 1.** Check that the motor is connected and at a stop.
 - 2.** Set "1" (measuring start) in **Pr.259**.
 - 3.** Switch the power OFF. The inverter applies DC voltage to the motor to measure the capacitor capacity while the inverter is OFF.
 - 4.** After confirming that the LED of the operation panel is OFF, power ON again.
 - 5.** Check that "3" (measurement complete) is set in **Pr.259**, read **Pr.258**, and check the deterioration degree of the main circuit capacitor.

Pr.259	Description	Remarks
0	No measurement	Initial value
1	Start measurement	Measurement starts when the power supply is switched OFF.
2	During measurement	Only displayed and cannot be set.
3	Measurement complete	
8	Forced end	
9	Measurement error	

NOTE

- When the main circuit capacitor life is measured under the following conditions, "forced end" (**Pr.259** = "8"), or "measurement error" (**Pr.259** = "9") may occur, or the status may remain in "measurement start" (**Pr.259** = "1"). To perform measurement, first eliminate the following conditions. Under the following conditions, even if "measurement complete" (**Pr.259** = "3") is reached, measurement cannot be performed correctly.

Condition in which measurement cannot be performed	Condition in which the measured value may fluctuate
<ul style="list-style-type: none"> • FR-HC2 or FR-XC is connected. • The power supply is switched ON during measurement. • The motor is not connected to the inverter. • The inverter output is shut off or a fault occurred while the power was OFF. • The inverter output is shut off with the MRS signal. • The start command is given while measuring. • The EtherCAT communication is used or the control using the controlword is enabled. 	<ul style="list-style-type: none"> • DC power supply is connected to terminals P/+ and N/-. • The motor is running (coasting). • The motor capacity is smaller than the inverter capacity by two ranks or more. • The applied motor setting is incorrect. • The parameter unit (FR-PU07) is connected. • Terminal PC is used for power supply. • An I/O terminal of the control circuit terminal block or the plug-in option is ON (continuity). • A plug-in option is installed (only for 0.75K or lower). • "EV" is displayed on the operation panel (main circuit power supply is OFF, during 24 V external power supply operation).

- Operation environment: Surrounding air temperature (annual average of 40°C (free from corrosive gas, flammable gas, oil mist, dust and dirt)).
Output current: 80% of the inverter rating
- Since repeated inrush currents at power ON will shorten the life of the converter circuit, frequent starts and stops of the magnetic contactor must be avoided.

WARNING

- When measuring the main circuit capacitor capacity (**Pr.259** = "1"), the DC voltage is applied to the motor for about 1 second at power OFF. Never touch the motor terminal, etc. right after powering OFF to prevent an electric shock.

◆ Life display of the cooling fan

- If a cooling fan speed of less than the specified speed is detected, Fan alarm "FN" is displayed on the operation panel or the parameter unit. As an alert output, bit 2 of **Pr.255** turns ON (set to 1), and the Y90 signal and Alarm (LF) signal are also output.
- For the terminal used for the LF signal, set "98" (positive logic) or "198" (negative logic) in any parameter from **Pr.190 to Pr.197 (Output terminal function selection)**.

NOTE

- When the inverter is mounted with two or more cooling fans, "FN" is displayed even only one of the fans is detected.
- Changing the terminal assignment using **Pr.190 to Pr.197 (Output terminal function selection)** may affect the other functions. Set parameters after confirming the function of each terminal.

◆ Display estimated main circuit capacitor residual life (Pr.506)

- Even when the power supply cannot be turned OFF, the remaining life of the main circuit capacitor can be estimated without stopping the operation. Note that the remaining life of the main circuit capacitor estimated by this function is theoretical, and should be used as a guideline only.
- The estimated residual life of the main circuit capacitor is displayed in **Pr.506**.
- The remaining life of the main circuit capacitor is calculated from the energization time and the inverter output power (100% = Start of service life). When the remaining life of the main circuit capacitor falls below 10%, bit 5 of **Pr.255** turns ON and a warning is output by the Y90 signal.

◆ Life display of the relay contacts of terminals A, B, and C (Pr.507, Pr.508)

- The degree of deterioration of the relay contacts of terminals A, B, and C is displayed in **Pr.507**, and that for terminals A2, B2, and C2 is displayed in **Pr.508** (only for the IP67 model).
- The number of times the contacts of relay turn ON is counted down from 100% (0 time) by 1% (500 times). When the counter reaches 10% (45,000 times), bit 6 or bit 7 (IP67 model only) of **Pr.255** turns ON and a warning is output by the Y90 signal.
- Any value can be set in **Pr.507** and **Pr.508** (IP67 model only).

◆ Life display of the inverter module (Pr.509)

- The degree of deterioration of the inverter module is displayed in **Pr.509**.
- The degree of deterioration of the inverter module is determined by the change in the surrounding air temperature of the module. (The degree is counted down from 100% (no deterioration).) When the remaining life of the inverter module reaches 15%, bit 8 of **Pr.255** turns ON and a warning is output by the Y90 signal.

◆ Environmental impact diagnosis function (corrosion level display) (Pr.198)

- The risk of the inverter's corrosive damage (degree of corrosion) can be checked by using a metal corrosion sensor.
- The degree of corrosion is monitored using the metal corrosion sensor (the degree is counted up from level 1). Use **Pr.198** to check the corrosion level. When level 3 is reached, bit 9 of **Pr.255** turns ON, a warning is output by the Y90 signal, and "Cor" appears on the LCD display of the operation panel.

- The following table shows the details of the corrosion level.

Level	Possibility of danger	Definition	Remaining design life (estimation) ^{*1}	Warning output
1	0% to 5%	Corrosion that may affect the inverter is very unlikely to occur.	—	Not output
2	6% to 24%	Corrosion that may affect the inverter is likely to occur. Users should improve the environment (by a filter or ventilation).	Corrosive damage may cause faults of the inverter in a period 16 times as long as the service life so far.	Not output
3	25% to 100%	Corrosion that may affect the inverter is very likely to occur. Users should improve the environment (by a filter or ventilation). Consider replacing the inverter early as required.	Corrosive damage may cause faults of the inverter in a period 4 times as long as the service life so far.	Output

^{*1} Means the remaining service life from when the level is reached. For example, a fault may occur after 4 months if level 3 is reached in a month, and after 12 years if level 3 is reached in 3 years.

8.17 Maintenance timer alarm

The Maintenance timer (Y95) signal is output when the inverter's cumulative energization time reaches the time period set with the parameter. "MT" is displayed on the operation panel. This can be used as a guideline for the maintenance time of peripheral devices.

Pr.	Name	Initial value	Setting range	Description
503 E710	Maintenance timer	0	0 (1 to 9998)	Displays the inverter's cumulative energization time in increments of 100 hours (read-only). Writing the setting of "0" clears the cumulative energization time while Pr.503 = "1 to 9998". (Writing is disabled when Pr.503 = "0".)
504 E711	Maintenance timer warning output set time	9999	0 to 9998	Set the cumulative energization time in 100 hours which triggers the Maintenance timer (Y95) signal output.
			9999	Without the function

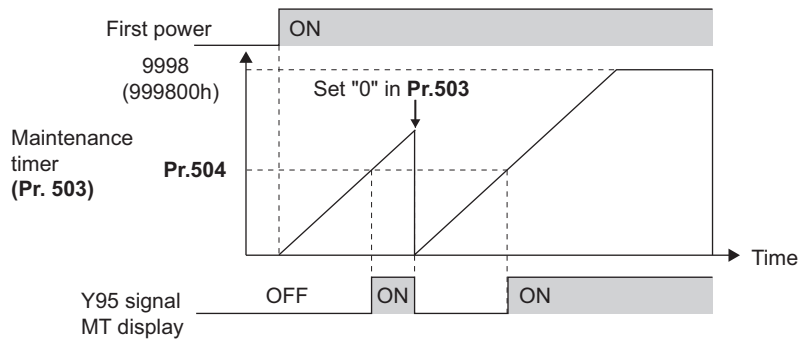

Operation example of the maintenance timer

- The cumulative energization time of the inverter is stored in the EEPROM every hour and displayed in **Pr.503** in 100 h increments. The number indication on **Pr.503** stopped at 9998 (999800h).
- When the value in **Pr.503** reaches the time (100 h increments) set in **Pr.504**, the Maintenance timer (Y95) signal is output, and also "MT" is displayed on the operation panel.
- For the Y95 signal output, set "95" (positive logic) or "195" (negative logic) in any parameter from **Pr.190 to Pr.197 (Output terminal function selection)** to assign the function.

NOTE

- The cumulative energization time is counted every hour. Energization time of less than 1 h is not counted.
- Changing the terminal assignment using **Pr.190 to Pr.197 (Output terminal function selection)** may affect the other functions. Set parameters after confirming the function of each terminal.

Parameters referred to

Pr.190 to Pr.197 (Output terminal function selection) [page 371](#)

8.18 Current average value monitor signal

The output current average value during constant-speed operation and the maintenance timer value are output to the Current average monitor (Y93) signal as a pulse. The output pulse width can be used in a device such as the I/O unit of a programmable controller as a guideline for the maintenance time for mechanical wear, belt stretching, or deterioration of devices with age. The pulse is repeatedly output during constant-speed operation in cycles of 20 seconds to the Current average monitor (Y93) signal.

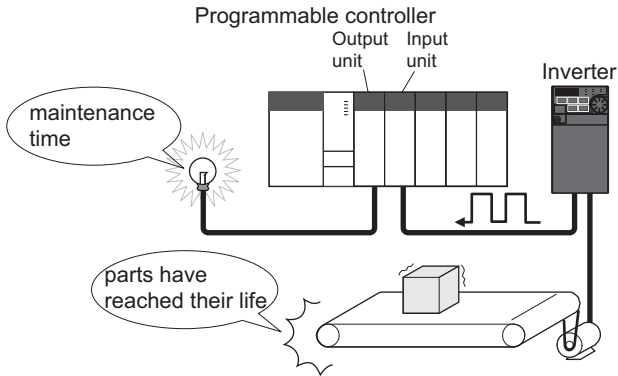

Pr.	Name	Initial value	Setting range	Description
555 E720	Current average time	1 s	0.1 to 1 s	Set the time for calculating the average current during start pulse output (1 second).
556 E721	Data output mask time	0 s	0 to 20 s	Set the time for not obtaining (masking) transitional state data.
557 E722	Current average value monitor signal output reference current	Inverter rated current	0 to 500 A	Set the reference (100%) for outputting the output current average value signal.

◆ Operation example

- The pulse output of the Current average monitor (Y93) signal is indicated below.
- For the Y93 signal output, set "93" (positive logic) or "193" (negative logic) in any parameter of **Pr.190**, **Pr.191**, **Pr.193** to **Pr.196 (Output terminal function selection)** to assign the function. (The function cannot be assigned by using **Pr.192** and **Pr.197**.)

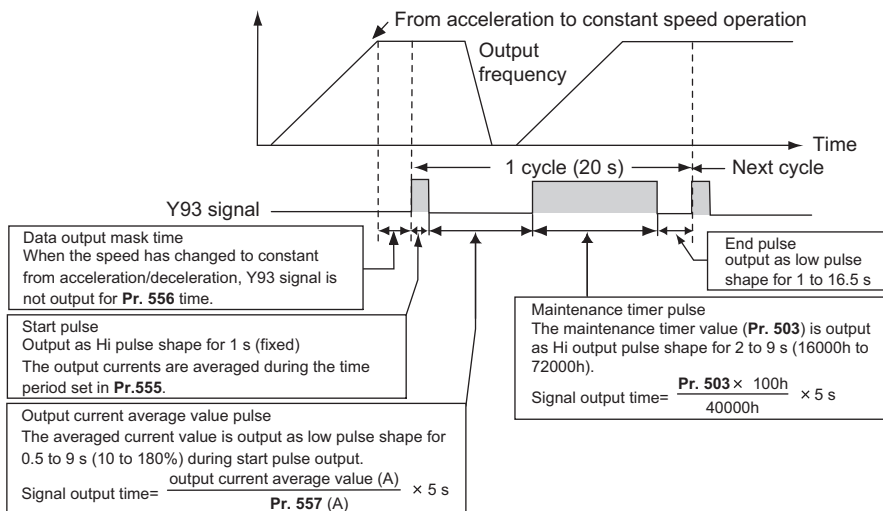

◆ Pr.556 Data output mask time setting

- Immediately after acceleration/deceleration is shifted to constant-speed operation, the output current is unstable (transitional state). Set the time for not obtaining (masking) transitional state data in **Pr.556**.

◆ Pr.555 Current average time setting

- The output current average is calculated during start pulse (1 second) HIGH output. Set the time for calculating the average current during start pulse output in **Pr.555**.

◆ Pr.557 Current average value monitor signal output reference current setting

Set the reference (100%) for outputting the output current average value signal. The signal output time is calculated with the following formula.

$$\frac{\text{Output current average value}}{\text{Pr.557 setting value}} \times 5 \text{ s} \quad (\text{Output current average value } 100\%/5 \text{ s})$$

The output time range is 0.5 to 9 seconds. When the output current average value is less than 10% of the setting value in **Pr.557**, the output time is 0.5 second, and when it is more than 180%, the output time is 9 seconds.

For example, when **Pr.557** = 10 A and the output current average value is 15 A:

15 A / 10 A × 5 s = 7.5 s, thus the Current average monitor signal maintains LOW output for 7.5 seconds.

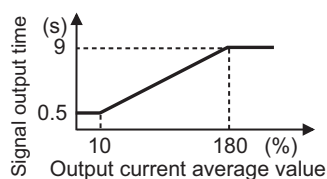

◆ Pr.503 Maintenance timer output

After LOW output of the output current value is performed, HIGH output of the maintenance timer value is performed. The maintenance timer value output time is calculated with the following formula.

$$\frac{\text{Pr.503} \times 100}{40000\text{h}} \times 5 \text{ s} \quad (\text{Maintenance timer value } 100\%/5 \text{ s})$$

The output time range is 2 to 9 seconds. When **Pr.503** is less than 16000 hours, the output time is 2 seconds. When it is more than 72000 hours, the output time is 9 seconds.

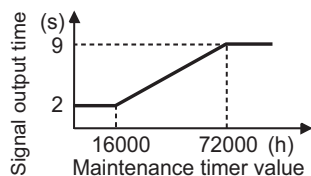

NOTE

- Masking of the data output and sampling of the output current are not performed during acceleration/deceleration.
- If constant speed changes to acceleration or deceleration during start pulse output, it is judged as invalid data, and the signal maintains HIGH start pulse output for 3.5 seconds and LOW end pulse output for 16.5 seconds. After the start pulse output is completed, minimum 1-cycle signal output is performed even if acceleration/deceleration is performed.

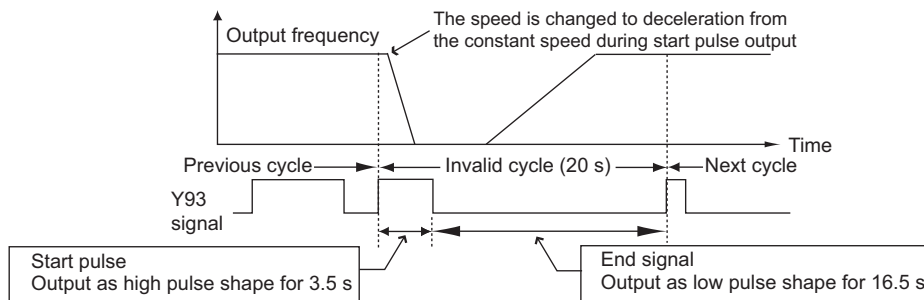

- If the output current value (inverter output current monitor) is 0 A at the completion of the 1-cycle signal output, no signal is output until the next constant-speed state.
- Under the following conditions, the Y93 signal maintains LOW output for 20 seconds (no data output).
 - When acceleration or deceleration is operating at the completion of the 1-cycle signal output
 - When automatic restart after instantaneous power failure (**Pr.57 Restart coasting time** ≠ "9999") is set, and the 1-cycle signal output is completed during the restart operation.
 - When automatic restart after instantaneous power failure (**Pr.57** ≠ "9999") is set, and the restart operation was being performed at the completion of data output masking.
- Changing the terminal assignment using **Pr.190 to Pr.197 (Output terminal function selection)** may affect the other functions. Set parameters after confirming the function of each terminal.

Parameters referred to

Pr.57 Restart coasting time [↗ page 502](#), [page 508](#)

Pr.190 to Pr.197 (Output terminal function selection) [↗ page 371](#)

Pr.503 Maintenance timer [↗ page 256](#)

MEMO

CHAPTER 9 (F) Settings for Acceleration/ Deceleration

9.1	Setting the acceleration and deceleration time	262
9.2	Acceleration/deceleration pattern	267
9.3	Remote setting function	269
9.4	Starting frequency and start-time hold function	274
9.5	Minimum motor speed frequency at the motor start up	275
9.6	Shortest acceleration/deceleration (automatic acceleration/deceleration)	276

9 (F) Settings for Acceleration/Deceleration

Purpose	Parameter to set			Refer to page
To set the motor acceleration/ deceleration time	Acceleration/deceleration time	P.F000 to P.F003, P.F010, P.F011, P.F020 to P.F022, P.F040, P.F070, P.F071, P.H801	Pr.7, Pr.8, Pr.16, Pr.20, Pr.21, Pr.44, Pr.45, Pr.147, Pr.375, Pr.611, Pr.791, Pr.792, Pr.1103	262
To set the acceleration/deceleration pattern suitable for an application	Acceleration/deceleration pattern	P.F100	Pr.29	267
To command smooth speed transition with terminals	Remote setting function	P.F101	Pr.59	269
To set the starting frequency	Starting frequency and start-time hold	P.F102, P.F103	Pr.13, Pr.571	274, 275
To set optimum acceleration/ deceleration time automatically	Automatic acceleration/ deceleration	P.F500, P.F510 to P.F513, P.A110	Pr.61 to Pr.63, Pr.292, Pr.293	276

9.1 Setting the acceleration and deceleration time

The following parameters are used to set motor acceleration/deceleration time.

Set a larger value for a slower acceleration/deceleration, or a smaller value for a faster acceleration/deceleration.

For the acceleration time at automatic restart after instantaneous power failure, refer to **Pr.611 Acceleration time at a restart** (page 502, page 508).

Pr.	Name	Initial value ^{*1}		Setting range	Description
		Gr.1	Gr.2		
20 F000	Acceleration/deceleration reference frequency	60 Hz	50 Hz	1 to 590 Hz	Set the frequency that is the basis of acceleration/ deceleration time. As acceleration/deceleration time, set the time required to change the frequency from stop status (0 Hz) to the frequency set in Pr.20 and vice versa.
21 F001	Acceleration/deceleration time increments	0		0 1	Increment: 0.1 s Increment: 0.01 s
16 F002	Jog acceleration/deceleration time	0.5 s		0 to 3600 s	Set the acceleration/deceleration time for JOG operation (from stop status to Pr.20). Refer to page 301.
611 F003	Acceleration time at a restart	9999		0 to 3600 s 9999	Set the acceleration time (time required to change the frequency from stop status (0 Hz) to the frequency set in Pr.20) for restart. Standard acceleration time (for example, Pr.7) is applied as the acceleration time at restart. Refer to page 502, page 508.
7 F010	Acceleration time	5 s ^{*2} 10 s ^{*3} 15 s ^{*4}		0 to 3600 s	Set the motor acceleration time (time required to change the frequency from stop status (0 Hz) to the frequency set in Pr.20).
8 F011	Deceleration time	5 s ^{*2} 10 s ^{*3} 15 s ^{*4}		0 to 3600 s	Set the motor deceleration time (time required to change the frequency from the frequency set in Pr.20 to stop status (0 Hz)).
44 F020	Second acceleration/ deceleration time	5 s ^{*2} 10 s ^{*3} 15 s ^{*4}		0 to 3600 s	Set the acceleration/deceleration time used while the RT signal is ON.
45 F021	Second deceleration time	9999		0 to 3600 s 9999	Set the deceleration time used while the RT signal is ON. The acceleration time applies to the deceleration time.
147 F022	Acceleration/deceleration time switching frequency	9999		0 to 590 Hz 9999	Set the frequency where the acceleration/deceleration time switches to the time set in Pr.44 and/or Pr.45 . Function disabled.
1103 F040	Deceleration time at emergency stop	5 s		0 to 3600 s	Set the motor deceleration time at a deceleration by turning OFF the X92 signal.

Pr.	Name	Initial value ^{*1}		Setting range	Description
		Gr.1	Gr.2		
791 F070	Acceleration time in low-speed range	9999		0 to 3600 s	Set the acceleration time in a low-speed range.
				9999	The acceleration time set in Pr.7 is applied. (While the RT signal is ON, the second function is enabled.)
792 F071	Deceleration time in low-speed range	9999		0 to 3600 s	Set the deceleration time in a low-speed range.
				9999	The deceleration time set in Pr.8 is applied. (While the RT signal is ON, the second function is enabled.)
375 H801	Faulty acceleration rate detection level	9999		0 to 400 Hz/ms	If the motor rotation speed exceeds the speed set in Pr.375 , E.OA (Acceleration error) is activated, and the inverter output is shut off.

*1 Gr.1 and Gr.2 are the parameter initial value groups. (Refer to page 54.)

*2 Initial value for the FR-E820-0175(3.7K) or lower, FR-E840-0095(3.7K) or lower, FR-E860-0061(3.7K) or lower, FR-E820S-0110(2.2K) or lower, FR-E810W-0050(0.75K) or lower, and FR-E846-0095(3.7K) or lower.

*3 Initial value for the FR-E820-0240(5.5K), FR-E820-0330(7.5K), FR-E840-0120(5.5K), FR-E840-0170(7.5K), and FR-E860-0090(5.5K) or higher.

*4 Initial value for the FR-E820-0470(11K) or higher and FR-E840-0230(11K) or higher.

◆ Control block diagram

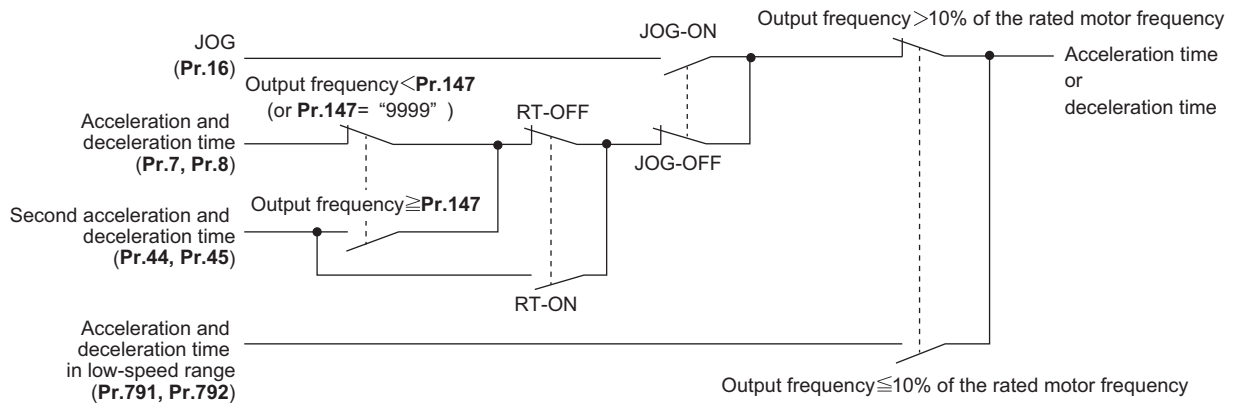

◆ Acceleration time setting (Pr.7, Pr.20)

- Use **Pr.7 Acceleration time** to set the acceleration time required to change the frequency to the frequency set in **Pr.20 Acceleration/deceleration reference frequency** from stop status.
- Set the acceleration time according to the following formula.

$$\text{Acceleration time setting} = \text{Pr.20} \times \text{Acceleration time from stop status to maximum frequency} / (\text{Maximum frequency} - \text{Pr.13})$$

- For example, the following calculation is performed to find the setting value for **Pr.7** when increasing the output frequency to the maximum frequency of 50 Hz in 10 seconds with **Pr.20** = "60 Hz (initial value)" and **Pr.13** = "0.5 Hz".

$$\text{Pr.7 setting} = 60 \text{ Hz} \times 10 \text{ s} / (50 \text{ Hz} - 0.5 \text{ Hz}) \approx 12.1 \text{ s}$$

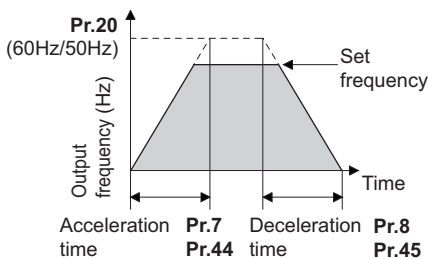

◆ Deceleration time setting (Pr.8, Pr.20)

- Use **Pr.8 Deceleration time** to set the deceleration time required to change the frequency to a stop status from the frequency set in **Pr.20 Acceleration/deceleration reference frequency**.
- Set the deceleration time according to the following formula.

$$\text{Deceleration time setting} = \text{Pr.20} \times \text{deceleration time from maximum frequency to stop} / (\text{maximum frequency} - \text{Pr.10})$$

- For example, the following calculation is used to find the setting value for **Pr.8** when decreasing the output frequency from the maximum frequency of 50 Hz in 10 seconds with **Pr.20** = 120 Hz and **Pr.10** = 3 Hz.

$$\text{Pr.8 setting} = 120 \text{ Hz} \times 10 \text{ s} / (50 \text{ Hz} - 3 \text{ Hz}) \approx 25.5 \text{ s}$$

NOTE

- If the acceleration/deceleration time is set, the actual motor acceleration/deceleration time cannot be made shorter than the shortest acceleration/deceleration time determined by the mechanical system J (moment of inertia) and motor torque.
- If the **Pr.20** setting is changed, the settings of **Pr.125 and Pr.126** (frequency setting signal gain frequency) do not change. Set **Pr.125 and Pr.126** to adjust the gains.
- Under PM sensorless vector control, if the protective function (E.OLT) is activated due to insufficient torque in the low-speed range, set longer acceleration/deceleration times only in the low-speed range in **Pr.791 Acceleration time in low-speed range** and **Pr.792 Deceleration time in low-speed range**.

◆ Changing the minimum increment of the acceleration/deceleration time (Pr.21)

- Use **Pr.21** to set the minimum increment of the acceleration/deceleration time.
Setting value "0" (initial value): minimum increment 0.1 s
Setting value "1": minimum increment 0.01 s
- **Pr.21** setting allows the minimum increment of the following parameters to be changed.
Pr.7, Pr.8, Pr.16, Pr.44, Pr.45, Pr.791, Pr.792, Pr.1103

NOTE

- **Pr.21** setting does not affect the minimum increment setting of **Pr.611 Acceleration time at a restart**.
- The operation panel provides a 4-digit readout (including the number of decimal places) on a value of parameters. Therefore, a value of "100" or larger is set/displayed only in increments of 0.1 second even if **Pr.21** = "1".
- When **Pr.21** is set to "0" after the time is set in 0.01 s increments while **Pr.21** is set to "1", the value is displayed in increments of 0.1 second (rounded down to one decimal place). However, the value for the acceleration/deceleration time setting can be set in increments of 0.01 second.

◆ Setting multiple acceleration/deceleration times (RT signal, Pr.44, Pr.45, Pr.147)

- **Pr.44 and Pr.45** are applied when the RT signal is ON or when the output frequency is equal to or higher than the frequency set in **Pr.147 Acceleration/deceleration time switching frequency**.
- Even at the frequency lower than the **Pr.147** setting, turning ON the RT signal switches the acceleration/deceleration time to the second acceleration/deceleration time. The priority of the signals and settings is as follows: RT signal > **Pr.147** setting.
- When "9999" is set in **Pr.45**, the deceleration time becomes equal to the acceleration time (time set in **Pr.44**).
- While the **Pr.147** setting is equal to or less than the setting of **Pr.10 DC injection brake operation frequency** or **Pr.13 Starting frequency**, the time used as the acceleration/deceleration time switches to the time set in **Pr.44 (Pr.45)** when the output frequency reaches or exceeds the **Pr.10** or **Pr.13** setting.

Pr.147 setting	Acceleration/deceleration time	Description
9999 (initial value)	Pr.7, Pr.8	Acceleration/deceleration time is not automatically changed.
0.00 Hz	Pr.44, Pr.45	Second acceleration/deceleration time is applied from the start.
0.01 Hz ≤ Pr.147 ≤ Set frequency	Output frequency < Pr.147 : Pr.7, Pr.8 Pr.147 ≤ Output frequency: Pr.44, Pr.45	Acceleration/deceleration time is automatically changed.
Set frequency < Pr.147	Pr.7, Pr.8	Not changed as the frequency has not reached the switchover frequency.

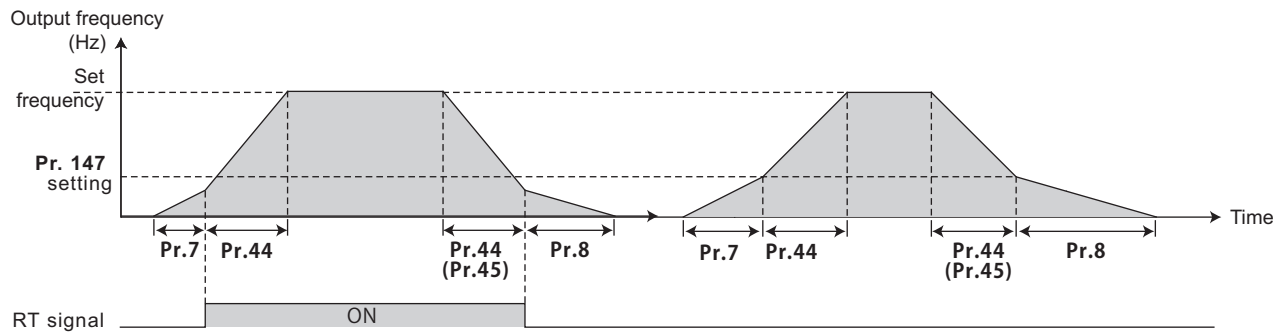

NOTE

- The reference frequency during acceleration/deceleration depends on the **Pr.29 Acceleration/deceleration pattern selection** setting. (Refer to [page 267](#).)
- The RT signal can be assigned to an input terminal by setting **Pr.178 to Pr.189 (Input terminal function selection)**. Changing the terminal assignment may affect other functions. Set parameters after confirming the function of each terminal.
- The RT signal is the Second function selection signal which also enables other second functions. (Refer to [page 418](#).)

◆ Setting the acceleration/deceleration time in the low-speed range (Pr.791, Pr.792)

- If torque is required in the low-speed range^{*1} under PM sensorless vector control, set the **Pr.791 Acceleration time in low-speed range** and **Pr.792 Deceleration time in low-speed range** settings higher than the **Pr.7 Acceleration time** and **Pr.8 Deceleration time** settings so that the mild acceleration/deceleration is performed in the low-speed range. (When the RT signal is turned ON, the second acceleration/deceleration time is prioritized.)

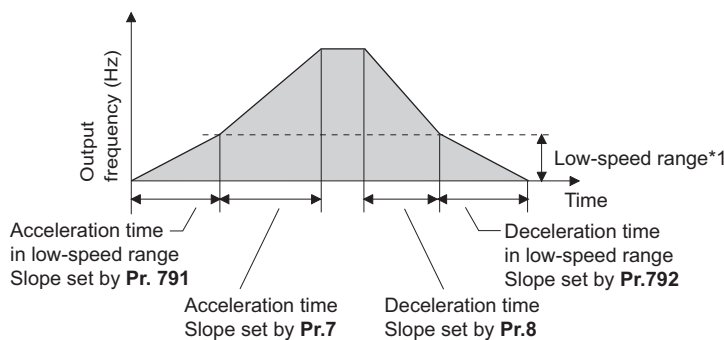

*1 Differs depending on the applied motor.

Applied motor (Pr.71, Pr.450)	Motor capacity (Pr.80, Pr.453)	Low-speed range
MM-GKR	0.1 kW	Less than 20% of the rated motor frequency (600 r/min)
	0.2 kW or higher	Less than 10% of the rated motor frequency (300 r/min)
EM-A	200 V: 7.5 kW or lower 400 V: 0.4 to 7.5 kW	Less than 10% of the rated motor frequency (300 r/min)
Others	All capacities	Less than 10% of the rated motor frequency

NOTE

- Set **Pr.791 (Pr.792)** to a value larger than the **Pr.7 (Pr.8)** setting. If set as **Pr.791 < Pr.7**, the operation is performed as **Pr.791 = Pr.7**. If set as **Pr.792 < Pr.8**, the operation is performed as **Pr.792 = Pr.8**.
- For the rated current of the MM-GKR and EM-A motors, refer to the Instruction Manual (Connection).

◆ Faulty acceleration rate detection level (Pr.375)

- Under PM sensorless vector control, if the motor rotation speed exceeds the speed set in **Pr.375**, E.OA (Acceleration error) is activated, and the inverter output is shut off.
- The **Pr.375** setting value must be much larger than the acceleration/deceleration slope. If the **Pr.375** setting value is smaller than the acceleration/deceleration slope, E.OA (Acceleration error) is activated even during normal operation.

- If rapid acceleration/deceleration is set for normal operation and E.OA (Acceleration error) is activated, set **Pr.375** = "9999" to disable the acceleration rate error detection.

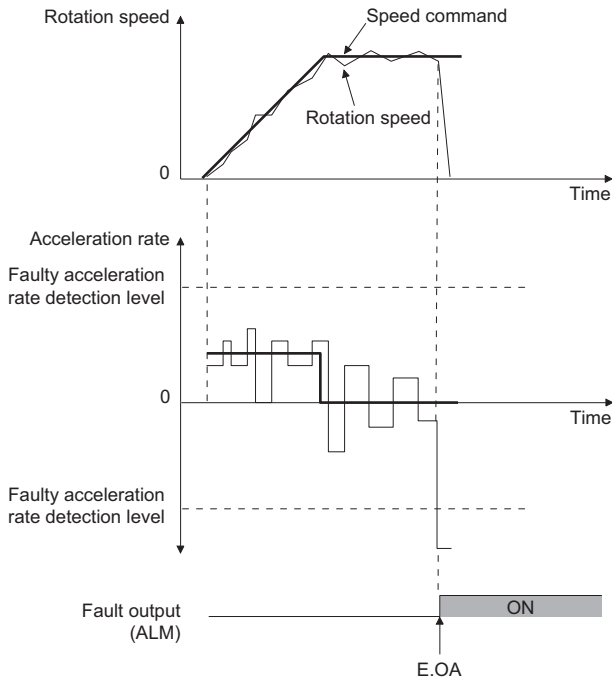

◆ Emergency stop function (Pr.1103)

- When the Emergency stop (X92) signal is OFF (when the contact is opened), the deceleration stop is performed according to the settings in the **Pr.1103 Deceleration time at emergency stop** and **Pr.815 Torque limit level 2**.
- To input the X92 signal, set "92" in any parameter from **Pr.178 to Pr.189 (Input terminal function selection)** to assign the function to a terminal.
- The X92 signal is a normally closed input (NC contact input) when it is input via an external input terminal, and a normally open input (NO contact input) when it is input via communication.
- "PS" is displayed on the operation panel during activation of the emergency stop function.
- The following diagram shows the operation when the signal is input via an external input terminal.

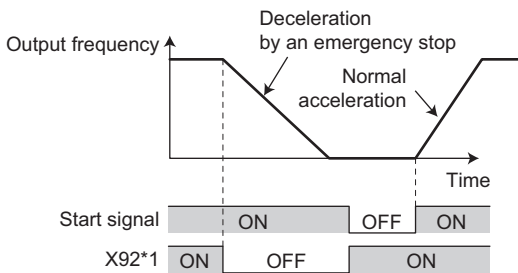

*1 ON/OFF indicates the input status of the physical terminal.

NOTE

- The X92 signal can be assigned to an input terminal by setting **Pr.178 to Pr.189 (Input terminal function selection)**. Changing the terminal assignment may affect other functions. Set parameters after confirming the function of each terminal.

Parameters referred to

Pr.3 Base frequency [page 530](#)
 Pr.10 DC injection brake operation frequency [page 536](#)
 Pr.29 Acceleration/deceleration pattern selection [page 267](#)
 Pr.125, Pr.126 (Frequency setting gain frequency) [page 400](#)
 Pr.178 to Pr.189 (Input terminal function selection) [page 410](#)

9.2 Acceleration/deceleration pattern

The acceleration/deceleration pattern can be set according to the application.

Pr.	Name	Initial value	Setting range	Description
29 F100	Acceleration/deceleration pattern selection	0	0	Linear acceleration/deceleration
			1	S-pattern acceleration/deceleration A
			2	S-pattern acceleration/deceleration B

◆ Linear acceleration/deceleration (Pr.29 = "0" (initial value))

- When the frequency is changed for acceleration, deceleration, etc. during inverter operation, the output frequency is changed linearly (linear acceleration/deceleration) to reach the set frequency without straining the motor and inverter. Linear acceleration/deceleration has a uniform frequency/time slope.

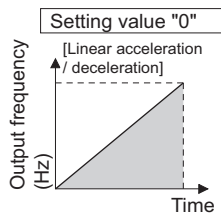

◆ S-pattern acceleration/deceleration A (Pr.29 = "1")

- Use this when acceleration/deceleration is required for a short time until a high-speed area equal to or higher than the base frequency, such as for the main shaft of the machine.
- The acceleration/deceleration pattern has the **Pr.3 Base frequency (Pr.84 Rated motor frequency** under PM motor control) (fb) as the point of inflection in an S-pattern curve, and the acceleration/deceleration time can be set to be suitable for the motor torque reduction in the constant-power operation range at the base frequency (fb) or more.

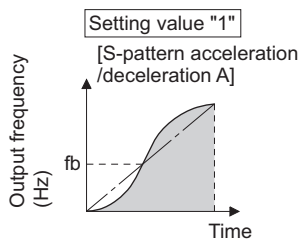

- Acceleration/deceleration time calculation method when the set frequency is equal to or higher than the base frequency

$$\text{Acceleration time } t = (4/9) \times (T/fb^2) \times f^2 + (5/9) \times T$$

Where T is the acceleration/deceleration time (s), f is the set frequency (Hz), and fb is the base frequency (rated motor frequency)

- Reference (0 Hz to set frequency) of acceleration/deceleration time when **Pr.3 = 60 Hz**

Acceleration/deceleration time (s)	Set frequency (Hz)			
	60	120	200	400
5	5	12	27	102
15	15	35	82	305

NOTE

- For the acceleration/deceleration time setting of the S-pattern acceleration/deceleration A, set the time to **Pr.3 (Pr.84** under PM sensorless vector control) instead of **Pr.20 Acceleration/deceleration reference frequency**.

◆ S-pattern acceleration/deceleration B (Pr.29 = "2")

- This is useful for preventing collapsing stacks such as on a conveyor. S-pattern acceleration/deceleration B can reduce the impact during acceleration/deceleration by accelerating/decelerating while maintaining an S-pattern from the present frequency (f2) to the target frequency (f1).

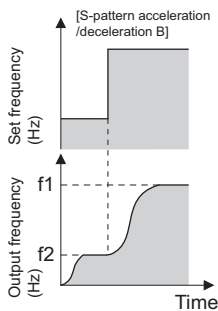

NOTE

- When the RT signal turns ON during acceleration or deceleration with the S-pattern acceleration/deceleration B enabled, a pattern of acceleration or deceleration changes to linear at the moment.
- When acceleration/deceleration time (such as **Pr.7** and **Pr.8**) is set to "0 s" under Real sensorless vector control, linear acceleration and deceleration are performed for the S-pattern acceleration/deceleration (**Pr.29** = "1 or 2").
- Set linear acceleration/deceleration (**Pr.29** = "0" (initial setting)) when torque control is performed under Real sensorless vector control. When acceleration/deceleration patterns other than the linear acceleration/deceleration are selected, the protective function of the inverter may be activated.

Parameters referred to

Pr.3 Base frequency  page 530

Pr.7 Acceleration time, **Pr.8** Deceleration time, **Pr.20** Acceleration/deceleration reference frequency  page 262

9.3 Remote setting function

Even if the operation panel is located away from the enclosure, contact signals can be used to perform continuous variable-speed operation, without using analog signals.

Pr.	Name	Initial value	Setting range	Description		
				RH, RM, RL signal function	Frequency setting storage	Deceleration to the main speed or lower
59 F101	Remote function selection	0	0	Multi-speed setting	—	Not available
			1	Remote setting	Enabled	
			2	Remote setting	Disabled	
			3	Remote setting	Disabled (Turning OFF the STF/STR signal clears the remotely-set frequency.)	Available
			11	Remote setting	Enabled	
			12	Remote setting	Disabled	
			13	Remote setting	Disabled (Turning OFF the STF/STR signal clears the remotely-set frequency.)	

◆ Remote setting function

- When Pr.59 ≠ "0" (remote setting enabled), the functions of the signals are as shown in the following table.

Signal name	Function	Description
STF/STR	Forward/Reverse	The inverter accelerates the motor in the forward or reverse direction up to the main speed or to the set frequency.
RH	Acceleration	The set frequency increases according to the Pr.44 setting.
RM	Deceleration	The set frequency decreases according to the Pr.45 setting.
RL	Clear	The set frequency is cleared and the main speed is applied.
Terminal 2 (analog signal)	Main speed	The setting of the main speed is used as a base. The main speed is increased by the RH signal and decreased by the RM signal.

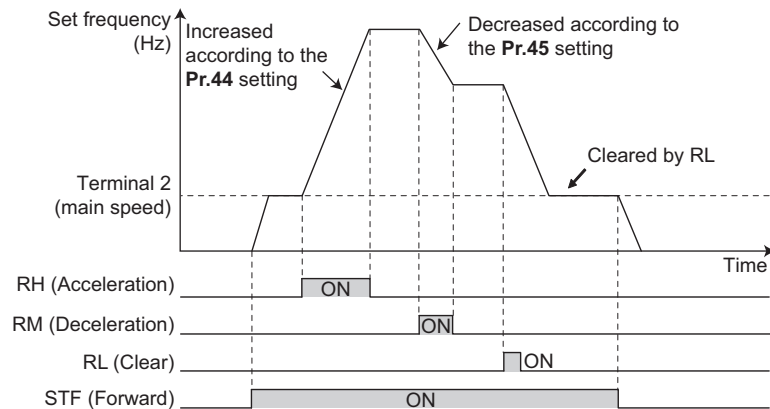
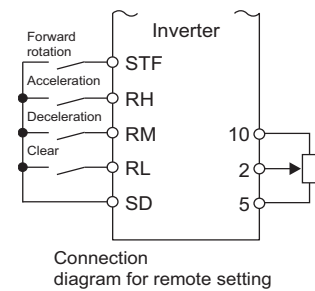

◆ Main speed

- The main speed used in the remote setting corresponds with each of the following operation modes.

Operation mode	Main speed
PU operation mode / NET operation mode	Digital setting
External operation mode / PU/External combined operation mode 2 (Pr.79 = "4")	Analog input
PU/External combined operation mode 1 (Pr.79 = "3")	Analog input via terminal 4 (AU signal ON)

◆ Acceleration/deceleration operation

- The output frequency changes as follows when the set frequency is changed by the remote setting function.

Frequency	Time setting	Description
Set frequency	Pr.44/Pr.45	The set frequency increases/decreases by remote setting according to the Pr.44/Pr.45 setting.
Output frequency	Pr.7/Pr.8	The output frequency increases/decreases by the set frequency according to the Pr.7/Pr.8 setting.

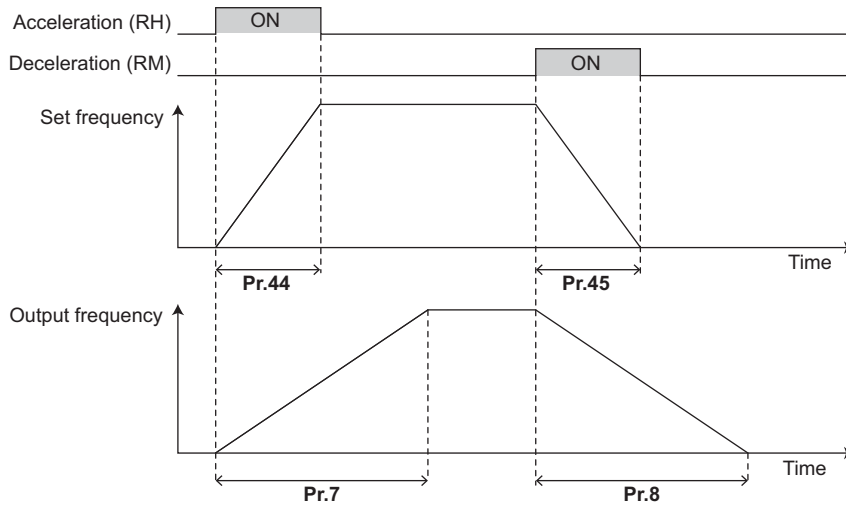

NOTE

- If the time setting of the output frequency is longer than the time setting of the set frequency, the motor accelerates/decelerates according to the time setting of the output frequency.

- Deceleration to the main speed or lower

By setting Pr.59 = "11 to 13", the speed can be decelerated to the frequency lower than the main speed (set by the External operation frequency (except multi-speed setting) or PU operation frequency).

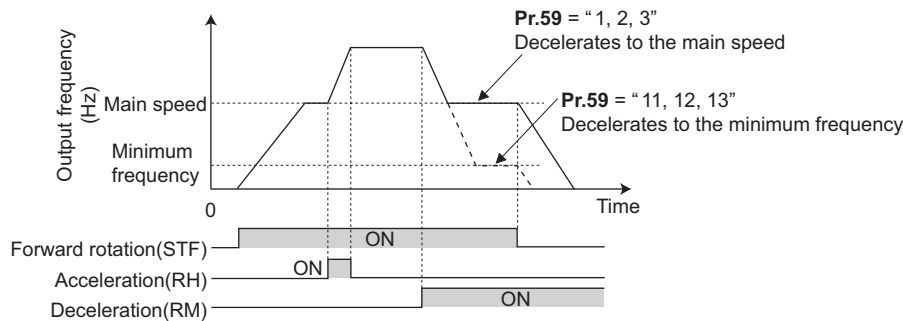

- Regardless of whether the remote setting is enabled or disabled, the acceleration/deceleration time set for the output frequency can be changed to the second acceleration/deceleration time by turning ON the RT signal.
- The acceleration/deceleration time setting of the set frequency is fixed at the Pr.44/Pr.45 setting.

◆ Frequency setting storage

- The remotely set frequency is stored, held, or cleared according to the Pr.59 setting. When the inverter is turned ON again and the operation is resumed, the setting shown in the parentheses will be applied.

Pr.59 setting	Power OFF	STF/STR signal OFF
1, 11	Stored (stored frequency)	Held (stored frequency)
2, 12	Cleared (main speed)	Held (stored frequency)
3, 13	Cleared (main speed)	Cleared (main speed)

- Storage conditions

The remotely-set frequency is stored at the point when the start signal (STF or STR) turns OFF. The remotely-set frequency is stored every minute after turning OFF (ON) the RH and RM signals together. Every minute, the frequency is overwritten in the EEPROM if the latest frequency is different from the previous one when comparing the two. This cannot be written using the RL signal.

When the 24 V external power is supplied, the remotely-set frequency is stored at the point when the operation is switched over to the 24 V external power supply operation ("EV" blinks on the operation panel), even while the start signal (STF/STR) is ON. (The 24 V external power supply operation can be performed when the FR-E8DS is installed or when the IP67 model is used.)

NOTE

- When switching the start signal from ON to OFF, or changing frequency by the RH or RM signal frequently, set the frequency setting value storage function (write to EEPROM) invalid (**Pr.59** = "2, 3, 12, 13"). If the frequency setting value storage function is valid (**Pr.59** = "1, 11"), the frequency is written to EEPROM frequently, and this will shorten the life of the EEPROM.
- The range of frequency changeable by acceleration (RH) signal and deceleration (RM) signal is 0 to maximum frequency (**Pr.1** or **Pr.18** setting). Note that the maximum value of set frequency is equal to the total of the main speed and the maximum frequency.

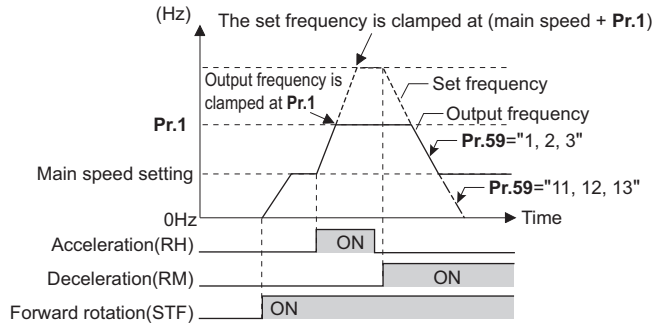

- Even if the start signal (STF or STR) is OFF, turning ON the RH or RM signal varies the preset frequency.
- The RH, RM, or RL signal can be assigned to an input terminal by setting **Pr.178 to Pr.189 (Input terminal function selection)**. Changing the terminal assignment may affect other functions. Set parameters after confirming the function of each terminal.
- The inverter can be used in the Network operation mode.
- The remote setting function is invalid during JOG operation and PID control operation.
- The multi-speed operation function is invalid when remote setting function is selected.

When the setting frequency is "0"

- Even when the remotely-set frequency is cleared by turning ON the RL (clear) signal after turning OFF (ON) both the RH and RM signals, the inverter operates at the remotely-set frequency stored in the last operation if power is reapplied before one minute has elapsed since turning OFF (ON) both the RH and RM signals.

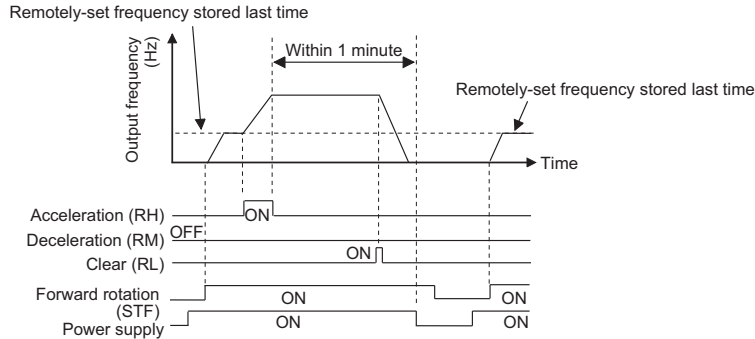

- When the remotely-set frequency is cleared by turning ON the RL (clear) signal after turning OFF (ON) both the RH and RM signals, the inverter operates at the frequency in the remotely-set frequency cleared state if power is reapplied before one minute has elapsed since turning OFF (ON) both the RH and RM signals.

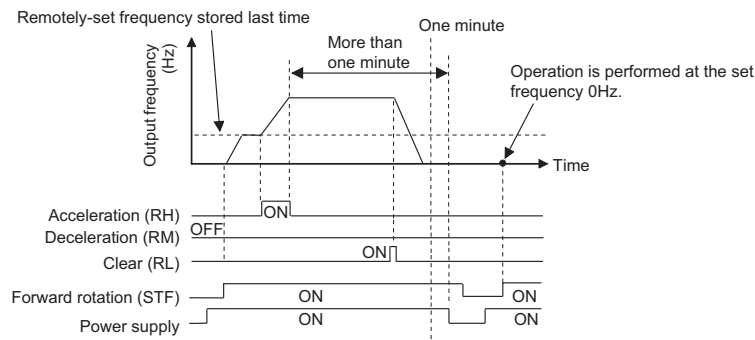



CAUTION

- When using the remote setting function, set the maximum frequency again according to the machine.

« Parameters referred to »

Pr.1 Maximum frequency, Pr.18 High speed maximum frequency  [page 331](#)

Pr.7 Acceleration time, Pr.8 Deceleration time, Pr.44 Second acceleration/deceleration time, Pr.45 Second deceleration time  [page 262](#)

Pr.178 to Pr.189 (Input terminal function selection)  [page 410](#)

9.4 Starting frequency and start-time hold function

V/F Magnetic flux Sensorless Vector

It is possible to set the starting frequency and hold the set starting frequency for a certain period of time.

Set these functions when a starting torque is needed or the motor drive at start needs smoothing.

Pr.	Name	Initial value	Setting range	Description
13 F102	Starting frequency	0.5 Hz	0 to 60 Hz	Set the starting frequency at which the start signal is turned ON.
571 F103	Holding time at a start	9999	0 to 10 s	Set the holding time of the frequency set in Pr.13.
		9999		The holding function at start is disabled.

◆ Starting frequency setting (Pr.13)

- The frequency at start can be set in the range of 0 to 60 Hz.
- Set the starting frequency at which the start signal is turned ON.

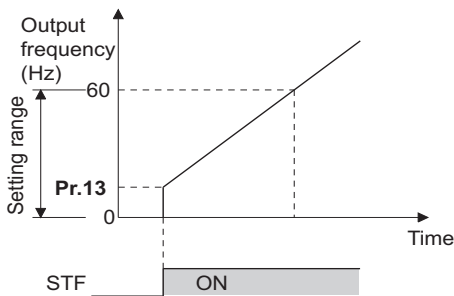

NOTE

- The inverter does not start if the frequency setting signal has a value lower than that of Pr.13. For example, while Pr.13 = 5 Hz, the inverter output starts when the frequency setting signal reaches 5 Hz.

◆ Start-time hold function (Pr.571)

- This function holds during the period set in Pr.571 and the output frequency set in Pr.13 Starting frequency.
- This function performs initial excitation to smooth the motor drive at a start.

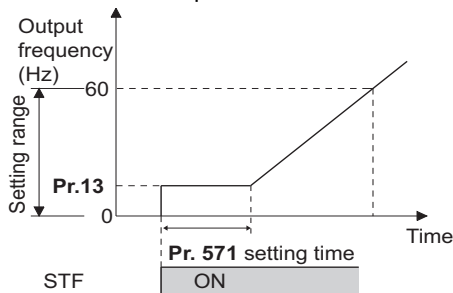

NOTE

- When Pr.13 = 0 Hz, the starting frequency is held at 0.01 Hz.
- When the start signal was turned OFF during start-time hold, deceleration is started at that point.
- At switching between forward rotation and reverse rotation, the starting frequency is valid but the start-time hold function is disabled.

CAUTION

- Note that when Pr.13 is set to a value equal to or lower than the setting of Pr.2 Minimum frequency, simply turning ON the start signal runs the motor at the frequency set in Pr.2 even if the command frequency is not given.

Parameters referred to

Pr.2 Minimum frequency page 331

9.5 Minimum motor speed frequency at the motor start up

PM

Set the frequency where the PM motor starts running.

Set the deadband in the low-speed range to eliminate noise and offset deviation when setting a frequency with analog input.

Pr.	Name	Initial value	Setting range	Description
13 F102	Starting frequency	Minimum frequency / minimum rotations per minute	0 to 60 Hz	Set the frequency where the motor starts running.

◆ Starting frequency setting (Pr.13)

- The frequency where the PM motor starts running can be set in the range of 0 to 60 Hz.
- When the frequency command specifies the frequency less than the one set in **Pr.13 Starting frequency**, the PM motor is stopped.

When the frequency command specifies the frequency equal to the set frequency or higher, the PM motor accelerates according to the setting of **Pr.7 Acceleration time**.

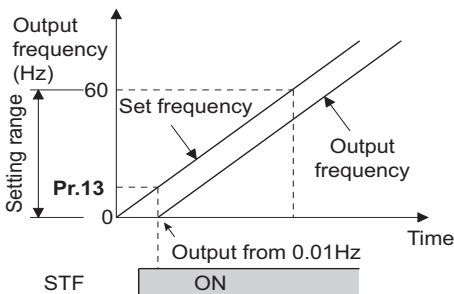

NOTE

- Under induction motor control (under V/F control, Advanced magnetic flux vector control, Real sensorless vector control, and Vector control), the output starts at the frequency set in **Pr.13**. Under PM sensorless vector control, the output always starts at 0.01 Hz.
- The inverter does not start if the frequency setting signal has a value lower than that of **Pr.13**. For example, while **Pr.13** = 20 Hz, the inverter output starts when the frequency setting signal reaches 20 Hz.

⚠ CAUTION

- Note that when **Pr.13** is set to a value equal to or lower than **Pr.2 Minimum frequency**, simply turning ON the start signal runs the motor at the frequency set in **Pr.2** even if the command frequency is not given.

Parameters referred to

Pr.2 Minimum frequency [page 331](#)

Pr.7 Acceleration time [page 262](#)

9.6 Shortest acceleration/deceleration (automatic acceleration/deceleration)

V/F Magnetic flux Sensorless Vector

The inverter can be operated with the same conditions as when the appropriate value is set to each parameter even when acceleration/deceleration time and V/F pattern are not set. This function is useful for operating the inverter without setting detailed parameters.

Pr.	Name	Initial value	Setting range	Description
292 F500 A110	Automatic acceleration/ deceleration	0	0	Normal operation
			1	Shortest acceleration/deceleration (without brakes)
			11	Shortest acceleration/deceleration (with brakes)
			7, 8	Brake sequence 1, 2 (Refer to page 456.)
61 F510	Reference current	9999	0 to 500 A	Set the reference current during shortest acceleration/ deceleration.
			9999	Rated output current value reference of the inverter
62 F511	Reference value at acceleration	9999	0% to 400%	Set the speed limit value during shortest acceleration.
			9999	The limit value is 150% (120% for the LD rating).
63 F512	Reference value at deceleration	9999	0% to 400%	Set the speed limit value during shortest deceleration.
			9999	The limit value is 150% (120% for the LD rating).
293 F513	Acceleration/deceleration separate selection	0	0	Shortest acceleration/deceleration for both acceleration and deceleration
			1	Shortest acceleration/deceleration for acceleration only
			2	Shortest acceleration/deceleration for deceleration only

◆ Shortest acceleration/deceleration (Pr.292 = "1, 11", Pr.293)

- Set this parameter to accelerate/decelerate the motor at the shortest time. This function is useful when the motor needs to be accelerated/decelerated at a shorter time, such as for a machine, but the designed value of the machine constant is not known.
- At acceleration/deceleration, this function adjusts the motor to accelerate/decelerate with the maximum inverter output torque using the **Pr.7 Acceleration time** and **Pr.8 Deceleration time** setting as reference. (**Pr.7** and **Pr.8** settings are not changed.)
- Use **Pr.293 Acceleration/deceleration separate selection** to apply the shortest acceleration/deceleration to one of acceleration and deceleration only.
When "0" (initial value) is set, the shortest acceleration/deceleration is performed for both acceleration and deceleration.
- Set "11" in **Pr.292** when a brake resistor or brake unit is connected. The deceleration time can further be shortened.
- When the shortest acceleration/deceleration is selected under V/F control and Advanced magnetic flux vector control, the stall prevention operation level during acceleration/deceleration becomes 150% (adjustable using **Pr.61 to Pr.63**). The setting of **Pr.22 Stall prevention operation level** and stall level by analog input are used only during a constant speed operation.
Under Real sensorless vector control and Vector control, the torque limit level (**Pr.22**, etc.) is applied during acceleration/deceleration. The adjustments by **Pr.61 to Pr.63** are disabled.
- It is inappropriate to use for the following applications.
 - Machines with large inertia (10 times or more), such as a fan. Since stall prevention operation is activated for a long time, this type of machine may be shut off due to motor overloading, etc.
 - When the inverter is always operated at a specified acceleration/deceleration time.

NOTE

- Even if automatic acceleration/deceleration has been selected, inputting the JOG signal (JOG operation) or RT signal (Second function selection) during an inverter stop switches to the normal operation and give priority to JOG operation or second function selection. Note that during operation, an input of JOG and RT signal does not have any influence even when the automatic acceleration/deceleration is enabled.
- Since acceleration/deceleration is made with the stall prevention operation being activated, the acceleration/deceleration speed always varies according to the load conditions.
- By setting **Pr.7 and Pr.8** appropriately, it is possible to accelerate/decelerate with a shorter time than when selecting the shortest acceleration/deceleration.
- The shortest acceleration/deceleration is enabled when the operation starts with the RT signal OFF while this function and the stop-on-contact control are both enabled. (Stop-on-contact control is not enabled when the RT and RL signals are turned ON during operation.)
- The shortest acceleration/deceleration is disabled when the operation starts after the RT signal is turned ON during a stop while this function and the stop-on-contact control are both enabled. (Stop-on-contact control is enabled by turning ON the RL signal.)
- When the automatic acceleration/deceleration function is enabled (**Pr.292** ≠ "0"), orientation control is disabled.

◆ Shortest and optimum acceleration/deceleration mode adjustment (Pr.61 to Pr.63)

- The application range can be expanded by setting the parameters for adjustment of **Pr.61 to Pr.63**.

Pr.	Name	Setting range	Description
61	Reference current	0 to 500 A	Set the rated motor current value such as when the motor capacity and inverter capacity differ. Set the reference current (A) of the stall prevention operation level during acceleration/deceleration.
		9999 (initial value)	The rated inverter current value is the reference.
62 63	Reference value at acceleration	0% to 400%	Used to change the reference level of acceleration and deceleration. Set the stall prevention operation level (percentage of current value of Pr.61) during acceleration/deceleration.
	Reference value at deceleration	9999 (initial value)	Stall prevention operation level is 150% for the shortest acceleration/deceleration.

NOTE

- When Real sensorless vector control or Vector control is selected with the shortest acceleration/deceleration, **Pr.61 to Pr.63** are invalid.
- Even if **Pr.61 to Pr.63** are set once, changing the setting to other than the shortest acceleration/deceleration (**Pr.292** ≠ "1 or 11") automatically resets to the initial setting (9999). Set **Pr.61 to Pr.63** after setting **Pr.292**.

◀ Parameters referred to ▶

Pr.7 Acceleration time, Pr.8 Deceleration time [page 262](#)
 Pr.22 Stall prevention operation level [page 334](#)
 Pr.22 Torque limit level [page 139](#)

MEMO

CHAPTER 10 (D) Operation Command and Frequency Command

10.1	Operation mode selection	280
10.2	Startup of the inverter in Network operation mode at power-ON	290
10.3	Start command source and frequency command source during communication operation	291
10.4	Reverse rotation prevention selection	300
10.5	JOG operation	301
10.6	Operation by multi-speed setting	303

10 (D) Operation Command and Frequency Command

Purpose	Parameter to set			Refer to page
To select the operation mode	Operation mode selection	P.D000	Pr.79	280
To start up the inverter in Network operation mode at power-ON	Communication startup mode selection	P.D000, P.D001	Pr.79, Pr.340	290
To select the command source during communication operation	Operation and speed command sources during communication operation, command source selection	P.D010 to P.D013	Pr.338, Pr.339, Pr.550, Pr.551	291
To prevent the motor from rotating reversely	Reverse rotation prevention selection	P.D020	Pr.78	300
To change the setting resolution of the torque limit	Set resolution switchover	P.D030	Pr.811	346
To perform JOG (inching) operation	JOG operation	P.D200, P.F002	Pr.15, Pr.16	301
To control the frequency with combinations of terminals	Multi-speed operation	P.D301 to P.D315	Pr.4 to Pr.6, Pr.24 to Pr.27, Pr.232 to Pr.239	303
To select the torque command method during torque control	Torque command source selection	P.D400 to P.D402	Pr.804 to Pr.806	167













10.1 Operation mode selection

Select the operation mode of the inverter.

The mode can be changed among operation using external signals (External operation), operation by the operation panel or parameter unit (PU operation), combined operation of PU operation and External operation (External/PU combined operation), and Network operation (via RS-485 communication or Ethernet communication, or when a communication option is used). The PU operation and External/PU combined operation using keys are not available for the IP67 model as neither the operation panel keys or the parameter unit can be used.

Pr.	Name	Initial value	Setting range	Description
79 D000	Operation mode selection	0	0 to 4, 6, 7	Selects the operation mode.

The following table lists valid and invalid commands in each operation mode.

Pr.79 setting	Description			LED indicator ■: OFF □: ON	Refer to page
0 (initial value)	PU/EXT key selection of the operation mode. The inverter operation mode can be selected by pressing the PU/EXT key. At power ON, the inverter is in the External operation mode.			PU operation mode  External operation mode  NET operation mode 	284
1	Operation mode	Frequency command	Start command	PU operation mode 	285
	Fixed at PU operation mode.	Sent from the operation panel or parameter unit.	Input using the RUN key on the operation panel or the FWD/REV key on the parameter unit		
2	Fixed at External operation mode. However, the inverter operation mode can also be changed to the Network operation mode.	Frequency command	Start command	External operation mode  NET operation mode 	284
		Sent using external signals (input via terminal 2 or 4, using the JOG signal, using the multi-speed setting function, etc.).	Sent using external signals (via terminal STF or STR).		
3	External/PU combined operation mode 1	Frequency command	Start command	External/PU combined operation mode 	285
		Sent from the operation panel or parameter unit, or sent using external signals (input using the multi-speed setting function or via terminal 4). ^{*1}	Sent using external signals (via terminal STF or STR).		
4	External/PU combined operation mode 2	Frequency command	Start command	External/PU combined operation mode 	285
		Sent using external signals (input via terminal 2 or 4, using the JOG signal, using the multi-speed setting function, etc.).	Input using the RUN key on the operation panel or the FWD/REV key on the parameter unit		
6	Operation mode switchover during operation. Switching from among the PU, External, and NET operation modes can be performed during operation.			PU operation mode  External operation mode 	286
7	External operation mode (PU operation interlock). X12 signal ON: Switchover to PU operation mode enabled (signal is OFF during External operation). X12 signal OFF: Switchover to PU operation mode disabled.			External operation mode  NET operation mode 	286
				NET operation mode 	

*1 The following is the frequency commands listed in descending order of priority when "3" is set in Pr.79: Multi-speed setting function (RL/RM/RH/REX signal) > PID control (X14 signal) > terminal 4 analog input (AU signal) > set frequency (digital input from the PU).

◆ Operation mode basics

- The operation mode specifies the source of the start command and the frequency command for the inverter.
- Basic operation modes are as follows.

External operation mode: For giving a start command and a frequency command with an external potentiometer or switches which are connected to the control circuit terminal.

PU operation mode : For giving a start command and a frequency command with the operation panel or parameter unit.

Network operation mode (NET operation mode): For giving a start command and a frequency command via RS-485 communication or Ethernet communication, or using a communication option.

- The operation mode can be selected from the operation panel or with the communication instruction code.

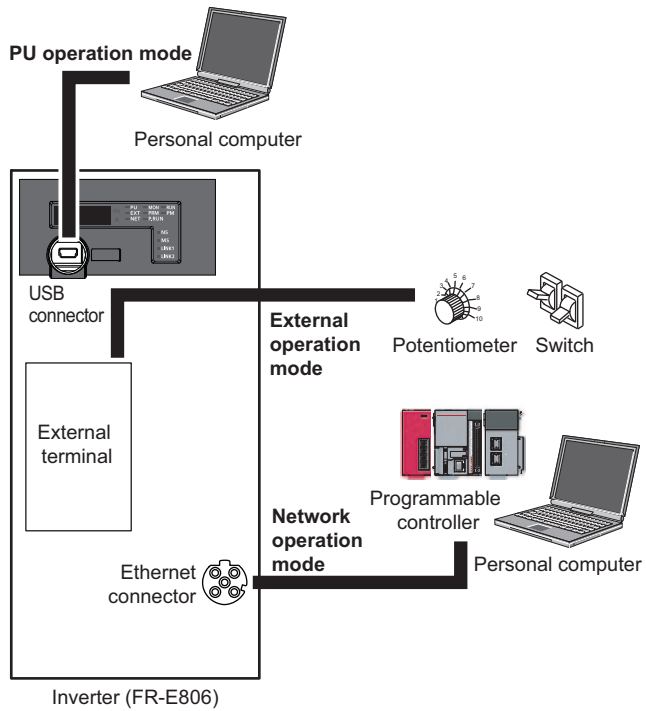
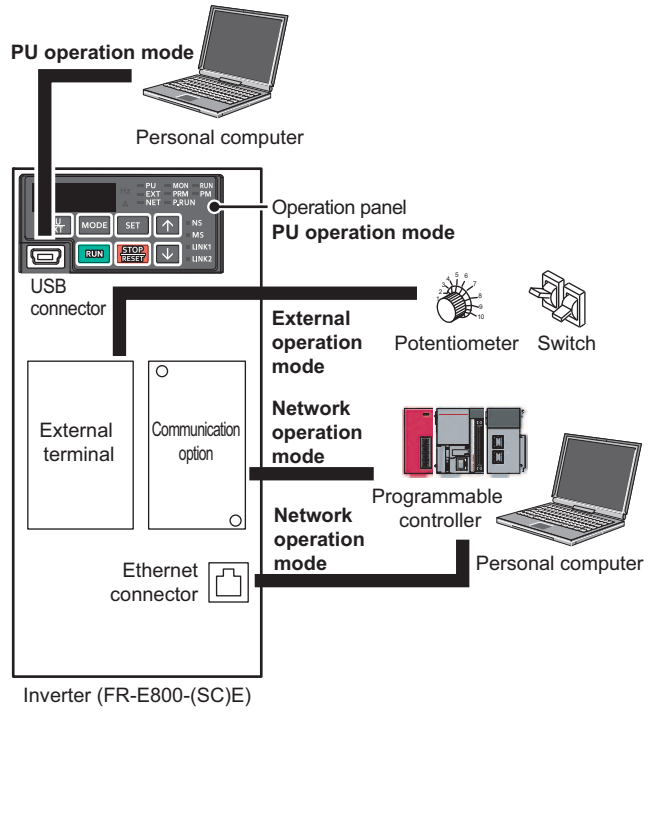
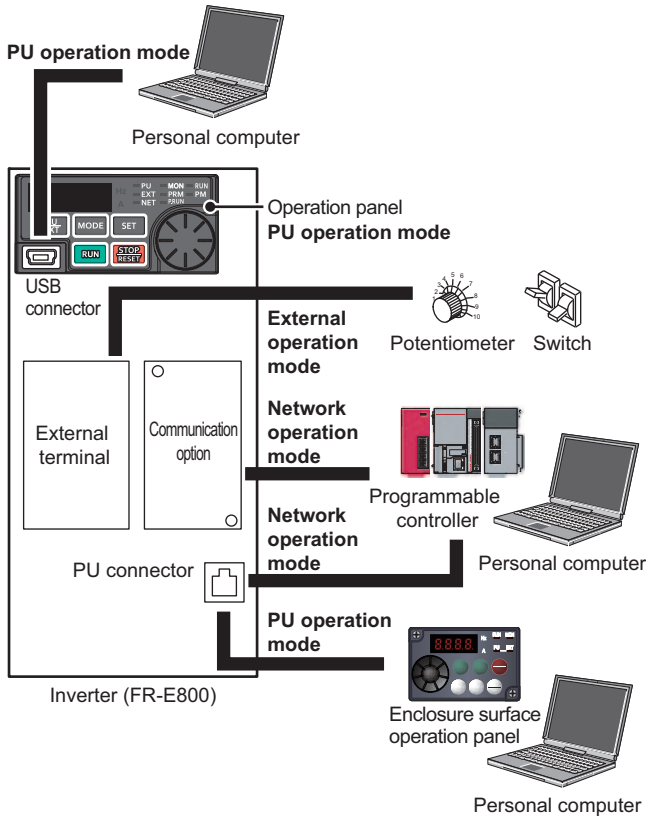

NOTE

- There is a choice of two settings, "3" and "4", for the External/PU combined operation mode. The startup method differs according to the setting value.
- In the initial setting, the PU stop selection (function to stop the inverter operation by pressing the STOP/RESET key on the operation panel or the parameter unit) is enabled even in the operation mode other than the PU operation mode. (Refer to **Pr.75** on [page 225](#).)

◆ Operation mode switching method

When "0 or 1" is set in Pr. 340

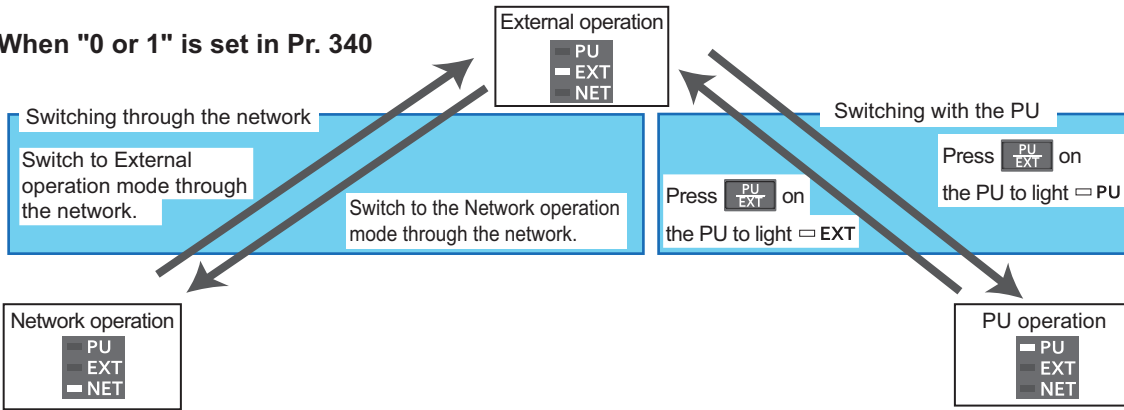

When "10" is set in Pr. 340

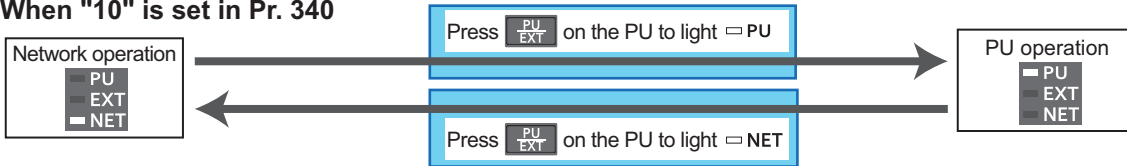

NOTE

- For details on switching by external terminals, refer to the following pages.

PU operation external interlock (X12 signal) [page 286](#)

PU/External operation switchover (X16 signal) [page 287](#)

PU/NET operation switchover (X65 signal), External/NET operation switchover (X66 signal) [page 288](#)

Pr.340 Communication startup mode selection [page 290](#)

◆ Operation mode selection flow

Referring to the following table, select the basic parameter settings or terminal wiring related to the operation mode.

Method to give start command	Method to give frequency setting command	Parameter setting	Operation method	
			Start command	Frequency setting
External signals (via terminal STF/STR)	External signals (input via terminal 2 or 4, using the JOG signal, using the multi-speed setting function, etc.)	Pr.79 = "2" (Fixed at External operation mode)	Turn ON terminal STF/STR.	Turn ON a terminal used for frequency setting.
	Operation panel or parameter unit	Pr.79 = "3" (External/PU combined operation mode 1)	Turn ON terminal STF/STR.	Digital setting
	USB connector	Pr.79 = "3" (External/PU combined operation mode 1)	Turn ON terminal STF/STR.	Digital setting
	Communication (PU connector / Ethernet connector)	Pr.338 = "1" Pr.340 = "1"	Turn ON terminal STF/STR.	Transmit a frequency command via communication.
	Communication (via communication option)	Pr.338 = "1" Pr.340 = "1"	Turn ON terminal STF/STR.	Transmit a frequency command via communication.
Operation panel (RUN key) or parameter unit (FWD/REV key)	External signals (input via terminal 2 or 4, using the JOG signal, using the multi-speed setting function, etc.)	Pr.79 = "4" (External/PU combined operation mode 2)	Press the RUN key. Press the FWD/REV key.	Turn ON a terminal used for frequency setting.
	Operation panel or parameter unit	Pr.79 = "1" (Fixed at PU operation mode)	Press the RUN key. Press the FWD/REV key.	Digital setting
	• USB connector • Communication (PU connector / Ethernet connector / communication option)	Not available		
Communication (PU connector / Ethernet connector)	External signals (input via terminal 2 or 4, using the JOG signal, using the multi-speed setting function, etc.)	Pr.339 = "1" Pr.340 = "1"	Transmit a start command via communication	Turn ON a terminal used for frequency setting.
	• USB connector • Communication (via communication option)	Not available		
	Communication (PU connector / Ethernet connector)	Pr.340 = "1"	Transmit a start command via communication	Transmit a frequency command via communication.
Communication (via communication option)	External signals (input via terminal 2 or 4, using the JOG signal, using the multi-speed setting function, etc.)	Pr.339 = "1" Pr.340 = "1"	Transmit a start command via communication	Turn ON a terminal used for frequency setting.
	• USB connector • Communication (PU connector / Ethernet connector)	Not available		
	Through communication (via communication option)	Pr.340 = "1"	Transmit a start command via communication	Transmit a frequency command via communication.

◆ External operation mode (Pr.79 = "0 (initial value) or 2")

- Select the External operation mode when the start command and the frequency command are applied from a frequency setting potentiometer, start switch, etc. which are provided externally and connected to the control circuit terminals of the inverter.
- Generally, parameter change cannot be performed in the External operation mode. (Some parameters can be changed. Refer to [page 237](#).)

- When **Pr.79** = "0 or 2", the inverter starts up in the External operation mode at power-ON. (When using the Network operation mode, refer to [page 290](#).)
- When parameter changing is seldom necessary, setting "2" fixes the operation mode to the External operation mode. When frequent parameter changing is necessary, setting "0" (initial value) allows the operation mode to be changed easily to the PU operation mode by pressing the PU/EXT key on the operation panel. After switching to the PU operation mode, always return to the External operation mode.
- The STF or STR signal is used as a start command. The input voltage or current via terminal 2 or 4, multi-speed setting signal, or JOG signal is used as a frequency command.

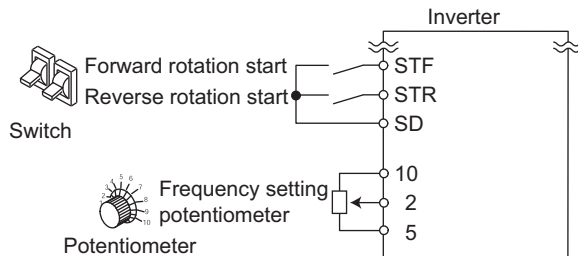

◆ PU operation mode (Pr.79 = "1")

- Select the PU operation mode when giving start and frequency commands by only the key operation of the operation panel or the parameter unit.
- When **Pr.79** = "1", the inverter starts up in the PU operation mode at power-ON. The mode cannot be changed to other operation modes.

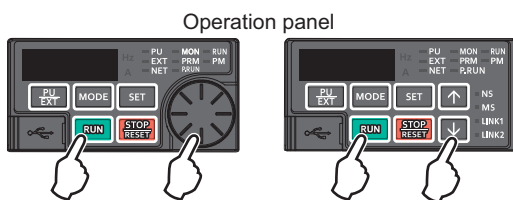

◆ PU/External combined operation mode 1 (Pr.79 = "3")

- Select the PU/External combined operation mode 1 when giving a frequency command from the operation panel or the parameter unit and giving a start command with the external start switches.
- Set "3" in **Pr.79**. The mode cannot be changed to other operation modes.
- When the frequency commands are given using the multi-speed setting signals (external signals), they have a higher priority than the frequency commands given from the PU. When the AU signal is ON, inputting the command signals via terminal 4 is enabled.

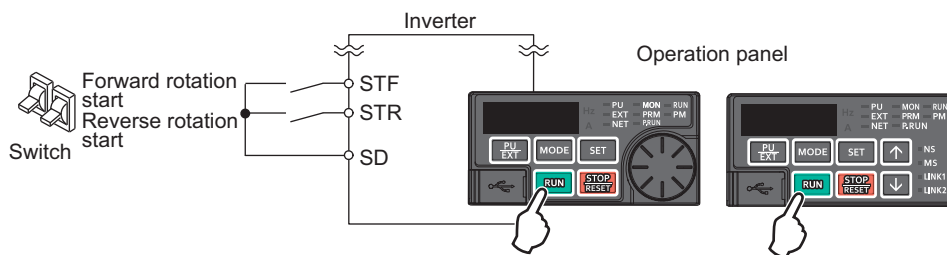

◆ PU/External combined operation mode 2 (Pr.79 = "4")

- Select the PU/External combined operation mode 2 when giving a frequency command from the external potentiometer, or multi-speed and JOG signals, and giving a start command by key operation of the operation panel or the parameter unit.

- Set "4" in **Pr.79**. The mode cannot be changed to other operation modes.

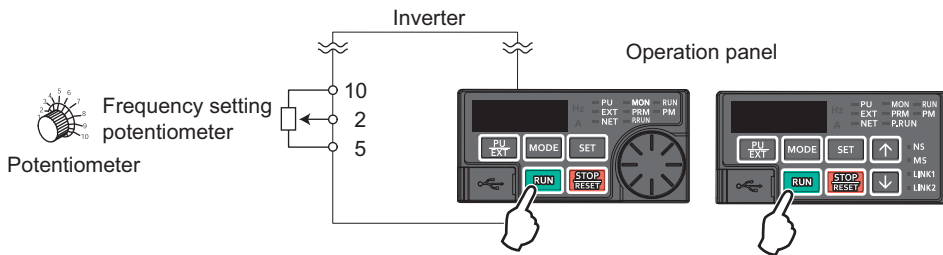

◆ Operation mode switchover during operation (Pr.79 = "6")

- During operation, the inverter operation mode can be switched from among the PU, External, and Network (Network operation mode is selectable via RS-485 communication or Ethernet communication, or when a communication option is used).

Operation mode switchover	Operation/operating status
External operation→PU operation	Use the operation panel or parameter unit to change the operation mode to the PU operation mode. <ul style="list-style-type: none"> • The direction of motor rotation does not change due to the operation mode change from the External operation mode. • The previous setting of frequency which has been set using a potentiometer (frequency command) is taken over. (However, note that the setting disappears when the power is turned OFF or when the inverter is reset.)
External operation→NET operation	Give the command through communication to change the operation mode to the Network operation mode. <ul style="list-style-type: none"> • The direction of motor rotation does not change due to the operation mode change from the External operation mode. • The previous setting of frequency which has been set using a potentiometer (frequency command) is taken over. (However, note that the setting disappears when the power is turned OFF or when the inverter is reset.)
PU operation→External operation	Press the key on the operation panel or parameter unit to change the operation mode to the External operation mode. <ul style="list-style-type: none"> • The direction of operation is determined by external input signals used in the External operation mode. • The setting frequency is determined by the external frequency command signal.
PU operation→NET operation	Give the command through communication to change the operation mode to the Network operation mode. <ul style="list-style-type: none"> • The direction of motor rotation and the frequency setting does not change due to the operation mode change from the PU operation mode.
NET operation→External operation	Give the command through communication to change the operation mode to the External operation mode. <ul style="list-style-type: none"> • The direction of operation is determined by external input signals used in the External operation mode. • The setting frequency is determined by the external frequency command signal.
NET operation→PU operation	Use the operation panel or parameter unit to change the operation mode to the PU operation mode. <ul style="list-style-type: none"> • The direction of motor rotation and the frequency setting do not change due to the operation mode change from the Network operation mode.

◆ PU operation interlock (Pr.79 = "7")

- The operation mode can be forcibly switched to the External operation mode by turning OFF the PU operation external interlock (X12) signal. This function will be usable in a case where the inverter does not reply to external command signals during operation due to the operation mode accidentally unswitched from the PU operation mode to the External operation mode.
- To input the X12 signal, set "12" in any parameter from **Pr.178 to Pr.184 (Input terminal function selection)** to assign the function. (For details on **Pr.178 to Pr.184**, refer to [page 410](#).)
- Set **Pr.79 = "7"** (PU operation interlock).
- If the X12 signal is not assigned, the function of the MRS signal is switched to the PU operation interlock signal from MRS (output stop).

X12 (MRS) signal	Function/Operation	
	Operation mode	Parameter writing ^{*1}
ON	Switching of the operation mode (External, PU, and NET) is enabled. The signal is OFF during External operation.	Enabled.
OFF	Operation mode is forcefully changed to the External operation mode. External operation is enabled. Switching to the PU or NET operation mode from the External operation mode is disabled.	Disabled except for Pr.79 .

*1 Depends on the **Pr.77 Parameter write selection** setting and other parameter write conditions. (Refer to [page 237](#).)

- Functions/operations by X12 (MRS) signal ON/OFF

Operating status		X12 (MRS) signal	Operation mode	Operating status	Switching to PU or NET operation mode
Operation mode	Status				
PU/NET	During stop	ON→OFF ^{*1}	External ^{*2}	If frequency and start commands are given from external source, the inverter runs by those commands.	Disabled
	During running	ON→OFF ^{*1}			Disabled
External	During stop	OFF→ON	External ^{*2}	During stop	Enabled
		ON→OFF			Disabled
	During running	OFF→ON		Running→Output stop	Disabled
		ON→OFF		Output stop→Running	Disabled

*1 The mode is switched to the External operation mode regardless of the ON/OFF state of the start signal (STF/STR). Thus, the motor runs under the External operation mode when the X12 (MRS) signal turns OFF while the STF or STR signal is ON.

*2 When a fault occurs, the inverter can be reset by pressing the STOP/RESET key on the operation panel.

NOTE

- The operation mode cannot be switched to the PU operation mode with the start signal (STF/STR) ON state even if the X12 (MRS) signal turns ON.
- If the MRS signal is ON and **Pr.79** is written to a value other than "7" when the MRS signal is used as the PU interlock signal, the MRS signal will act as a regular MRS function (output stop). Also, when **Pr.79** = "7", the MRS signal becomes the PU interlock signal.
- The logic of the signal follows the **Pr.17 MRS/X10 terminal input selection** setting also when the MRS signal is used as the PU operation interlock signal. When **Pr.17** = "2 to 5", ON and OFF in the table above are reversed.
- Changing the terminal assignment using **Pr.178 to Pr.184 (Input terminal function selection)** may affect the other functions. Set parameters after confirming the function of each terminal.

◆ Switching operation mode by external signal (X16 signal)

- When External operation and the operation from the operation panel are used together, the PU operation mode and External operation mode can be switched during a stop (during motor stop, start command OFF) by using the PU/External operation switchover (X16) signal.
- When **Pr.79** = "0, 6, or 7", switching between the PU operation mode and External operation mode is possible. (When **Pr.79** = "6", switchover is enabled during operation.)
- To input the X16 signal, set "16" in any parameter from **Pr.178 to Pr.184 (Input terminal function selection)** to assign the function to a terminal.

10

Pr.79 setting	X16 signal status and operation mode		Remarks
	ON (External)	OFF (PU)	
0 (initial value)	External operation mode	PU operation mode	Switching among the External, PU, and NET operation modes is enabled.
1	PU operation mode		Fixed at PU operation mode.
2	External operation mode		Fixed at External operation mode (Switching to NET operation mode enabled).
3, 4	External/PU combined operation mode		Fixed at External/PU combined operation mode.
6	External operation mode	PU operation mode	Switching among the External, PU, and NET operation mode is enabled during operation.
7	X12 (MRS) ON	External operation mode	Switching among the External, PU, and NET operation mode is enabled (signal is OFF in the External operation mode).
	X12 (MRS) OFF	External operation mode (forcibly switched to External operation mode).	

NOTE

- The operation mode is determined by the setting of **Pr.340 Communication startup mode selection** and the ON/OFF state of the X65 and X66 signals. (For the details, refer to [page 288](#).)
- The priority of **Pr.79** and **Pr.340** and signals is **Pr.79** > X12 > X66 > X65 > X16 > **Pr.340**.
- Changing the terminal assignment using **Pr.178 to Pr.189 (Input terminal function selection)** may affect the other functions. Set parameters after confirming the function of each terminal.

◆ Switching the operation mode by external signals (X65, X66 signals)

- When **Pr.79** = "0, 2 or 6", the PU operation mode and External operation modes can be changed to the Network operation mode during a stop (during motor stop, start command OFF) by the PU/NET operation switchover (X65) signal, or the External/NET operation switchover (X66) signal. (When **Pr.79** = "6", switchover is enabled during operation.)
- To switch between the Network operation mode and the PU operation mode

1. Set **Pr.79** = "0 (initial value) or 6".
2. Set **Pr.340 Communication startup mode selection** = "10".
3. Set "65" in any parameter from **Pr.178 to Pr.184** to assign the PU/NET operation switchover (X65) signal to a terminal.
4. When the X65 signal is ON, the PU operation mode is selected. When the X65 signal is OFF, the NET operation mode is selected.

Pr.340 setting	Pr.79 setting	X65 signal state		Remarks	
		ON (PU)	OFF (NET)		
10	0 (initial value)	PU operation mode	NET operation mode	—	
	1	PU operation mode		Fixed at PU operation mode.	
	2	NET operation mode		Fixed at NET operation mode.	
	3, 4	External/PU combined operation mode		Fixed at External/PU combined operation mode.	
	6	PU operation mode	NET operation mode	The operation mode can be changed during operation.	
	7	X12 (MRS) ON	Switching between the External operation mode and PU operation mode is enabled.		The signal is OFF during operation in the External operation mode.
		X12 (MRS) OFF	External operation mode		The operation mode is forcibly switched to the External operation mode.

- To switch between the Network operation mode and the External operation mode
1. Set **Pr.79** = "0 (initial value), 2, 6, or 7". (When **Pr.79** = "7" and the X12 (MRS) signal is ON, the operation mode can be switched.)
 2. Set **Pr.340 Communication startup mode selection** = "0" (initial value) or "1".
 3. Set "66" in any parameter from **Pr.178 to Pr.184** to assign the NET-External operation switching signal (X66) to a terminal.
 4. When the X66 signal is ON, the NET operation mode is selected. When the X66 signal is OFF, the External operation mode is selected.

Pr.340 setting	Pr.79 setting	X66 signal state		Remarks	
		ON (NET)	OFF (External)		
0 (initial value), 1	0 (initial value)	NET operation mode	External operation mode	—	
	1	PU operation mode		Fixed at PU operation mode.	
	2	NET operation mode	External operation mode	Switching to PU operation mode is disabled.	
	3, 4	External/PU combined operation mode		Fixed at External/PU combined operation mode.	
	6	NET operation mode	External operation mode	The operation mode can be changed during operation.	
	7	X12 (MRS) ON	NET operation mode	External operation mode	The signal is OFF during operation in the External operation mode.
		X12 (MRS) OFF	External operation mode		The operation mode is forcibly switched to the External operation mode.

NOTE

- The priority of **Pr.79** and **Pr.340** and signals is as follows: **Pr.79** > X12 > X66 > X65 > X16 > **Pr.340**.
- Changing the terminal assignment using **Pr.178 to Pr.184 (Input terminal function selection)** may affect the other functions. Set parameters after confirming the function of each terminal.

« Parameters referred to »

Pr.15 Jog frequency [page 301](#)

Pr.4 to Pr.6, Pr.24 to Pr.27, Pr.232 to Pr.239 multi-speed operation [page 303](#)

Pr.75 Reset selection/disconnected PU detection/PU stop selection [page 225](#)

Pr.161 Frequency setting/key lock operation selection [page 231](#)

Pr.178 to Pr.189 (Input terminal function selection) [page 410](#)

Pr.190 to Pr.197 (Output terminal function selection) [page 371](#)

Pr.340 Communication startup mode selection [page 290](#)

Pr.550 NET mode operation command source selection [page 291](#)

10.2 Startup of the inverter in Network operation mode at power-ON

The operation mode at power ON and at restoration from instantaneous power failure can be selected.

After the inverter starts up in the Network operation mode, parameter writing and operation can be commanded from programs. Set this mode when performing communication operation using the PU connector, Ethernet connector, or a communication option.

Pr.	Name	Initial value	Setting range	Description
79 D000	Operation mode selection	0	0 to 4, 6, 7	Selects the operation mode. (Refer to page 280 .)
340 D001	Communication startup mode selection	[E800]	0	The inverter starts up in an operation mode selected in Pr.79 .
		0	1	The inverter starts up in the Network operation mode.
		[E800-(SC)E][E806]	10	The inverter starts up in the Network operation mode. The operation mode can be changed on the operation panel between the PU operation mode and Network operation mode.

◆ Selecting the operation mode for power-ON (Pr.340)

- Depending on the **Pr.79** and **Pr.340** settings, the operation mode at power-ON (reset) changes as described below.

Pr.340 setting	Pr.79 setting	Operation mode at power-ON, at power restoration, or after a reset	Operation mode switching
0	0 (initial value)	External operation mode	Switching among the External, PU, and NET operation modes is enabled ^{*1}
	1	PU operation mode	Fixed at PU operation mode.
	2	External operation mode	Switching between the External and NET operation modes is enabled. Switching to PU operation mode is disabled.
	3, 4	External/PU combined operation mode	Operation mode switching is disabled.
	6 ^{*3}	External operation mode	Switching among the External, PU, and NET operation mode is enabled during operation.
	7	X12 (MRS) signal ON: External operation mode	Switching among the External, PU, and NET operation modes is enabled ^{*1}
X12 (MRS) signal OFF: External operation mode		Fixed at External operation mode (forcibly switched to External operation mode).	
1	0	NET operation mode	Same as Pr.340 = "0".
	1	PU operation mode	
	2	NET operation mode	
	3, 4	External/PU combined operation mode	
	6 ^{*3}	NET operation mode	
	7	X12 (MRS) signal ON: NET operation mode	
X12 (MRS) signal OFF: External operation mode			
10	0	NET operation mode	Switching between the PU and NET operation mode is enabled. ^{*2}
	1	PU operation mode	Same as Pr.340 = "0".
	2	NET operation mode	Fixed at NET operation mode.
	3, 4	External/PU combined operation mode	Same as Pr.340 = "0".
	6 ^{*3}	NET operation mode	Switching between the PU and NET operation mode is enabled during operation. ^{*2}
	7	External operation mode	Same as Pr.340 = "0".

*1 The operation mode cannot be directly changed between the PU operation mode and Network operation mode.

*2 Switching between the PU and NET operation modes is available with the PU/EXT key on the operation panel and the X65 signal.

*3 When **Pr.128** = "50, 51, 60, or 61", the same operation mode as when **Pr.79** = "0" is selected.

◀ Parameters referred to ▶

Pr.57 Restart coasting time  [page 502](#), [page 508](#)

Pr.79 Operation mode selection  [page 280](#)

10.3 Start command source and frequency command source during communication operation

The start and frequency commands can be given via communication using the external signals. The command source in the PU operation mode can also be selected.

Pr.	Name	Initial value	Setting range	Description
338 D010	Communication operation command source	0	0	Start command source is communication.
			1	Start command source is external.
339 D011	Communication speed command source	0	0	Frequency command source is communication.
			1	Frequency command source is external.
			2	Frequency command source is external. (When there is no external input, the frequency command given via communication is valid, and the frequency command given via terminal 2 is invalid.)
550 D012	NET mode operation command source selection	9999	0	The communication option is the command source in the NET operation mode.
			2* ¹	The PU connector is the command source in the NET operation mode.
			5* ²	The Ethernet connector is the command source in the NET operation mode.
			9999	The communication option is recognized automatically. Normally, the PU connector or Ethernet connector is the command source. When the communication option is installed, the communication option is the command source.
551 D013	PU mode operation command source selection	9999	2* ¹	The PU connector is the command source in the PU operation mode.
			3	The USB connector is the command source in the PU operation mode.
			4	The operation panel is the command source in the PU operation mode.
			9999	The USB is recognized automatically. Normally, the operation panel is the command source. When the USB is connected, the USB connector is the command source.

*1 Available for the standard model only.

*2 Available for the Ethernet model, the safety communication model, and the IP67 model.

◆ Selection of command source in the network (NET) operation mode (Pr.550)

- Any of the PU connector, the Ethernet connector, or the communication option can be specified for the command source in the NET operation mode.
- For example, whether or not the communication option is installed, set **Pr.550** = "2" to write parameters or give the start and frequency commands using the PU connector through communication in the NET operation mode.

NOTE

- In the initial setting, "9999" (communication option automatic recognition) is set for **Pr.550**. Thus, if the communication option is installed, parameters cannot be written or the start and frequency commands cannot be sent by communications through the PU connector or the Ethernet connector. (Monitoring or parameter reading can be performed.)

◆ Selection of the command source of the PU operation mode (Pr.551)

- Any of the PU connector, operation panel, or USB connector can be specified for the command source in the PU operation mode.
- Set **Pr.551** to write parameters or execute the start and frequency commands through communication in the PU operation mode: **Pr.551** = "2" when using the PU connector, and **Pr.551** = "3" or "9999" when using the USB connector.

NOTE

- The PU operation mode has a higher priority when **Pr.550** = "2" (NET mode using the PU connector) and **Pr.551** = "2" (PU mode using the PU connector). For this reason, if the communication option is not mounted, switching to the Network operation mode is no longer possible.
- The changed value is applied after the next power-ON or inverter reset.

- Standard model

Pr.550 setting	Pr.551 setting	Command source					Remarks
		Operation panel	USB connector	PU connector		Communication option	
				Operation option ^{*1}	RS-485 communication		
0	2	x	x	PU	PU ^{*2}	NET ^{*3}	
	3	x	PU	x	x	NET ^{*3}	
	4	PU	x	x	x	NET ^{*3}	
	9999 (initial value)	PU ^{*4}	PU ^{*4}	PU ^{*4}	x	NET ^{*3}	
2	2	x	x	PU	PU ^{*2}	x	Switching to NET operation mode is disabled.
	3	x	PU	x	NET	x	
	4	PU	x	x	NET	x	
	9999 (initial value)	PU ^{*4}	PU ^{*4}	PU ^{*4}	NET	x	
9999 (initial value)	2	x	x	PU	PU ^{*2}	NET ^{*3}	
	3	x	PU	x	x	NET ^{*3}	With communication option
					NET	x	Without communication option
	4	PU	x	x	x	NET ^{*3}	With communication option
					NET	x	Without communication option
	9999 (initial value)	PU ^{*4}	PU ^{*4}	PU ^{*4}	x	NET ^{*3}	With communication option
NET					x	Without communication option	

- Ethernet model / Safety communication model

Pr.550 setting	Pr.551 setting	Command source				Remarks
		Operation panel	USB connector	Ethernet connector	Communication option	
0	3	x	PU	x	NET ^{*3}	
	4	PU	x	x	NET ^{*3}	
	9999 (initial value)	PU ^{*4}	PU ^{*4}	x	NET ^{*3}	
5	3	x	PU	NET	x	
	4	PU	x	NET	x	
	9999 (initial value)	PU ^{*4}	PU ^{*4}	NET	x	
9999 (initial value)	3	x	PU	x	NET ^{*3}	With communication option
				NET	x	Without communication option
	4	PU	x	x	NET ^{*3}	With communication option
				NET	x	Without communication option
	9999 (initial value)	PU ^{*4}	PU ^{*4}	x	NET ^{*3}	With communication option
				NET	x	Without communication option

- IP67 model

Pr.550 setting	Pr.551 setting	Command source			Remarks
		Operation panel	USB connector	Ethernet connector	
0	3	x	PU	x	
	4	PU	x	x	Operation panel is unavailable.
	9999 (initial value)	PU ^{*4}	PU ^{*4}	x	Operation panel is unavailable.
5, 9999 (initial value)	3	x	PU	NET	
	4	PU	x	NET	Operation panel is unavailable.
	9999 (initial value)	PU ^{*4}	PU ^{*4}	NET	Operation panel is unavailable.

PU: Enabled in PU operation mode, NET: Enabled in Network operation mode, x: Not available

*1 When the enclosure surface operation panel (FR-PA07) is used.

*2 The MODBUS RTU protocol cannot be used in the PU operation mode.

*3 If the communication option is not installed, switching to the NET operation mode is not possible.

*4 When Pr.551 = "9999", the priority of the PU control source is defined as follows: USB connector > PU connector / Ethernet connector > operation panel.

◆ Controllability through communication

Command interface	Condition	Item	Controllability in each operation mode					
			PU operation	External operation	Combined operation mode 1 (Pr.79 = "3")	Combined operation mode 2 (Pr.79 = "4")	NET operation (when the PU/Ethernet connector is used)	NET operation (via option)
Operation panel	Pr.551 = "4" or Pr.551 = "9999" (USB / PU connector is not connected)	Operation command (start, stop)	○	Δ ^{*3}	Δ ^{*3}	○	Δ ^{*3}	Δ ^{*3}
		Frequency setting	○	×	○	×	×	×
		Monitor	○	○	○	○	○	○
		Parameter write	○	×	○	○	×	×
		Parameter read	○	○	○	○	○	○
		Inverter reset	× ^{*8}	× ^{*8}	× ^{*8}	× ^{*8}	× ^{*8}	× ^{*8}
	Other than the above	Operation command (start, stop)	Δ ^{*3}	Δ ^{*3}	Δ ^{*3}	Δ ^{*3}	Δ ^{*3}	Δ ^{*3}
		Frequency setting	×	×	×	×	×	×
		Monitor	○	○	○	○	○	○
		Parameter write	×	×	×	×	×	×
		Parameter read	○	○	○	○	○	○
		Inverter reset	× ^{*8}	× ^{*8}	× ^{*8}	× ^{*8}	× ^{*8}	× ^{*8}
PU connector (operation option) ^{*1}	Pr.551 = "2" or Pr.551 = "9999" (USB is not connected)	Operation command (start, stop)	○	Δ ^{*3}	Δ ^{*3}	○	—	Δ ^{*3}
		Frequency setting	○	×	○	○	—	×
		Monitor	○	○	○	○	○	○
		Parameter write	○	×	○	○	—	×
		Parameter read	○	○	○	○	○	○
		Inverter reset	○	○	○	○	—	○
	Other than the above	Operation command (start, stop)	Δ ^{*3}	Δ ^{*3}	Δ ^{*3}	Δ ^{*3}	Δ ^{*3}	Δ ^{*3}
		Frequency setting	×	×	×	×	×	×
		Monitor	○	○	○	○	○	○
		Parameter write	×	×	×	×	×	×
		Parameter read	○	○	○	○	○	○
		Inverter reset	○	○	○	○	○	○
PU connector (RS-485) ^{*2}	Pr.551 = "2" (PU)	Operation command (start, stop)	○	Δ ^{*3}	Δ ^{*3}	○	—	Δ ^{*3}
		Frequency setting	○	×	○	○	—	×
		Monitor	○	○	○	○	○	○
		Parameter write	○ ^{*5}	× ^{*6}	○ ^{*5}	○ ^{*5}	—	×
		Parameter read	○	○	○	○	○	○
		Inverter reset	○	○	○	○	—	○
	Pr.551 ≠ "2" and either of the following: • Pr.550 = "2" • Pr.550 = "9999" (communication option is not installed)	Operation command (start, stop)	×	×	×	×	○ ^{*4}	—
		Frequency setting	×	×	×	×	○	—
		Monitor	○	○	○	○	○	○
		Parameter write	× ^{*6}	× ^{*6}	× ^{*6}	× ^{*6}	○	—
		Parameter read	○	○	○	○	○	○
		Inverter reset	×	×	×	×	○	—
	Other than the above	Operation (start) command	×	×	×	×	—	×
		Operation (stop) command	×	×	×	×	—	×
		Frequency setting	×	×	×	×	—	×
		Monitor	○	○	○	○	○	○
		Parameter write	×	×	×	×	—	×
		Parameter read	○	○	○	○	○	○
Inverter reset	×	×	×	×	—	×		

Command interface	Condition	Item	Controllability in each operation mode					
			PU operation	External operation	Combined operation mode 1 (Pr.79 = "3")	Combined operation mode 2 (Pr.79 = "4")	NET operation (when the PU/Ethernet connector is used)	NET operation (via option)
USB connector	Pr.551 = "3, 9999"	Operation command (start, stop)	○	×	×	○	×	×
		Frequency setting	○	×	○	×	×	×
		Monitor	○	○	○	○	○	○
		Parameter write	○ ^{*5}	×	○	○	×	×
		Parameter read	○	○	○	○	○	○
		Inverter reset	○	○	○	○	○	○
	Other than the above	Operation command (start, stop)	×	×	×	×	×	×
		Frequency setting	×	×	×	×	×	×
		Monitor	○	○	○	○	○	○
		Parameter write	×	×	×	×	×	
		Parameter read	○	○	○	○	○	○
		Inverter reset	○	○	○	○	○	○
Option	Pr.550 = "0, 9999"	Operation command (start, stop)	×	×	×	×	—	○ ^{*4}
		Frequency setting	×	×	×	×	—	○ ^{*4}
		Monitor	○	○	○	○	○	○
		Parameter write	×	×	×	×	—	○ ^{*5}
		Parameter read	○	○	○	○	○	○
		Inverter reset	×	×	×	×	×	○
	Other than the above	Operation command (start, stop)	×	×	×	×	×	—
		Frequency setting	×	×	×	×	×	—
		Monitor	○	○	○	○	○	○
		Parameter write	×	×	×	×	—	○
		Parameter read	○	○	○	○	○	○
		Inverter reset	×	×	×	×	×	—
Ethernet connector	Pr.550 = "5" or Pr.550 = "9999" (communication option is not installed)	Operation command (start, stop)	×	×	×	×	○	—
		Frequency setting	×	×	×	×	○	—
		Monitor	○	○	○	○	○	○
		Parameter write	×	×	×	×	○ ^{*5}	—
		Parameter read	○	○	○	○	○	○
		Inverter reset	×	×	×	×	○ ^{*7}	—
	Other than the above	Operation command (start, stop)	×	×	×	×	—	×
		Frequency setting	×	×	×	×	—	×
		Monitor	○	○	○	○	○	○
		Parameter write	×	×	×	×	—	×
		Parameter read	○	○	○	○	○	○
		Inverter reset	×	×	×	×	—	×
External control circuit terminal	—	Operation command (start, stop)	×	○	○	×	×	×
		Frequency setting	×	○	△ ^{*8}	○	×	×
		Inverter reset	○	○	○	○	○	○

○: Controllable, ×: Uncontrollable, △: Partially controllable, —: No function

*1 Operation when the enclosure surface operation panel (FR-PA07) is used.

*2 RS-485 communication via PU connector

*3 Only the PU stop function is enabled. "PS" is displayed on the operation panel during PU stop. The operation follows the **Pr.75 Reset selection/disconnected PU detection/PU stop selection** setting. (Refer to [page 225](#).)

*4 The operation follows the **Pr.338 Communication operation command source** and **Pr.339 Communication speed command source** settings. (Refer to [page 291](#).)

*5 Writing of some parameters may be disabled by the **Pr.77 Parameter write selection** setting and the operating condition. (Refer to [page 237](#).)

*6 Some parameters are write-enabled regardless of the operation mode or the command source. Writing is also enabled when Pr.77 = "2". (Refer to page 237.) Parameter clear is disabled.

*7 At occurrence of communication error, the inverter cannot be reset.

*8 The inverter can be reset by using the multi-speed operation function and analog input (terminal 4).

◆ Operation when a communication error occurs

- Standard model

Fault type	Condition	Operation in each operation mode at error occurrences					
		PU operation	External operation	Combined operation mode 1 (Pr.79 = "3")	Combined operation mode 2 (Pr.79 = "4")	NET operation (via PU connector) ^{*4}	NET operation (via option) ^{*4}
Inverter fault	—	Stop					
PU connector disconnection	Pr.551 = "2" or Pr.551 = "9999" (USB is not connected / PU connector is connected)	Stop/continued ^{*1*3}					
	Other than the above	Stop/continued ^{*1}					
Communication error at PU connector	Pr.551 = "2"	Stop/continued ^{*2}	Continued		Stop/continued ^{*2}	—	Continued
	Pr.551 ≠ "2" and either of the following: • Pr.550 = "2" • Pr.550 = "9999" (communication option is not installed)	Continued				Stop/continued ^{*2}	—
	Other than the above	Continued				—	Continued
Communication error at USB connector	Pr.551 = "3" or Pr.551 = "9999" (USB is connected)	Stop/continued ^{*2}	Continued		Stop/continued ^{*2}	Continued	
	Other than the above	Continued					
Communication error at communication option	Pr.550 = "0" or Pr.550 = "9999" (communication option is installed)	Continued				—	Stop/continued ^{*4}
	Other than the above	Continued					

- Ethernet model / safety communication model / IP67 model

Fault type	Condition	Operation in each operation mode at error occurrences					
		PU operation	External operation	Combined operation mode 1 (Pr.79 = "3")	Combined operation mode 2 (Pr.79 = "4")	NET operation (via Ethernet connector) ^{*4}	NET operation (via option) ^{*4}
Inverter fault	—	Stop					
Communication error at USB connector	Pr.551 = "3" or Pr.551 = "9999" (USB is connected)	Stop/continued ^{*2}	Continued		Stop/continued ^{*2}	Continued	
	Other than the above	Continued					
Communication error at Ethernet connector	Pr.550 = "5" or Pr.550 = "9999" (communication option is not installed)	Continued				Stop/continued ^{*2}	—
	Other than the above	Continued				—	Continued
Communication error at communication option	Pr.550 = "0" or Pr.550 = "9999" (communication option is installed)	Continued				—	Stop/continued ^{*4}
	Other than the above	Continued					

*1 Selectable with Pr.75 Reset selection/disconnected PU detection/PU stop selection.

*2 Selectable with Pr.122 PU communication check time interval, Pr.548 USB communication check time interval, Pr.1431 Ethernet signal loss detection function selection, Pr.1432 Ethernet communication check time interval, and Pr.1457 Extended setting for Ethernet signal loss detection function selection.

*3 In the PU JOG operation mode, operation always stops when the PU is disconnected. The operation at a PU disconnection fault (E.PUE) occurrence is as set in **Pr.75 Reset selection/disconnected PU detection/PU stop selection**.

*4 The operation depends on the communication option setting.

◆ Selecting the command interface in the Network operation mode (Pr.338, Pr.339)

- Selecting a command interface is required for the following two types of commands: the operation command using the start signals and the signals related to the inverter function selection, and the speed command using signals related to the frequency setting.
- The following table shows the command interface for each function in the Network operation mode, determined by the parameter settings: an external terminal or a communication interface (PU connector, Ethernet connector, or communication option).

[Explanation of Terms in Table]

EXT: External terminal only

NET: Communication interface only

Combined: Either external terminal or communication interface

—: Neither external terminal nor communication interface

Pr.338 Communication operation command source		0: NET			1: EXT			Remarks
Pr.339 Communication speed command source		0: NET	1: EXT	2: EXT	0: NET	1: EXT	2: EXT	
Frequency setting through communication		NET	—	NET	NET	—	NET	
Terminal 2		—	EXT	—	—	EXT	—	
Terminal 4		—	EXT	—	—	EXT	—	
RL*1	Low-speed operation command/Remote setting (setting clear)/Stop-on-contact selection 0	NET	EXT	—	NET	EXT	—	Pr.59 = "0" (multi-speed) Pr.59 ≠ "0" (remote) Pr.270 = "1" (stop-on-contact)
RM*1	Middle-speed operation command/Remote setting (deceleration)	NET	EXT	—	NET	EXT	—	
RH*1	High-speed operation command/ Remote setting (acceleration)	NET	EXT	—	NET	EXT	—	
RT*1	Second function selection/ Stop-on-contact selection 1	NET	—	—	EXT	—	—	Pr.270 = "1" (stop-on-contact)
AU*1	Terminal 4 input selection	—	Combined	—	—	Combined	—	
JOG*1	Jog operation selection	—	—	—	EXT	—	—	
OH*1	External thermal relay input	EXT	—	—	—	—	—	
REX*1	15-speed selection	NET	EXT	—	NET	EXT	—	Pr.59 = "0" (multi-speed)
X10*1	Inverter run enable	EXT	—	—	—	—	—	
X12*1	PU operation external interlock	EXT	—	—	—	—	—	
X13*1	External DC injection brake operation start	NET	—	—	EXT	—	—	
X14*1	PID control valid	NET	EXT	—	NET	EXT	—	
BRI*1	Brake opening completion	NET	—	—	EXT	—	—	
X16*1	PU/External operation switchover	EXT	—	—	—	—	—	
X18*1	V/F switchover	NET	—	—	EXT	—	—	
X22*1	Orientation command	NET	—	—	EXT	—	—	
LX*1	Pre-excitation/servo ON	NET	—	—	EXT	—	—	
MRS*1	Output stop	Combined	—	—	EXT	—	—	Pr.79 ≠ "7"
	PU operation interlock	EXT	—	—	—	—	—	Pr.79 = "7" When X12 signal is not assigned.
STP (STOP)*1	Start self-holding selection	—	—	—	EXT	—	—	
MC*1	Control mode switchover	NET	—	—	EXT	—	—	
TL*1	Torque limit selection	NET	—	—	EXT	—	—	
JOG2*1	Jog operation selection 2	NET	—	—	EXT	—	—	
X37*1	Traverse function selection	NET	—	—	EXT	—	—	
X42*1	Torque bias selection 1	NET	—	—	EXT	—	—	

Pr.338 Communication operation command source		0: NET			1: EXT			Remarks
Pr.339 Communication speed command source		0: NET	1: EXT	2: EXT	0: NET	1: EXT	2: EXT	
X43 ^{*1}	Torque bias selection 2	NET			EXT			
TRG ^{*1}	Trace trigger input	Combined			EXT			
TRC ^{*1}	Trace sampling start/end	Combined			EXT			
SQ ^{*1}	Sequence start	EXT or NET			EXT			Pr.414 = "1": Valid when there is external or network input. Pr.414 = "2": External.
X51 ^{*1}	Fault clear	Combined			EXT			
X52 ^{*1}	Cumulative pulse monitor clear	NET			EXT			
X54 ^{*1}	Anti-sway control disabled	NET			EXT			
STF ^{*1}	Forward rotation command	NET			EXT			
STR ^{*1}	Reverse rotation command	NET			EXT			
RES ^{*1}	Inverter reset	EXT						
X65 ^{*1}	PU/NET operation switchover	EXT						
X66 ^{*1}	External/NET operation switchover	EXT						
X67 ^{*1}	Command source switchover	EXT						
X72 ^{*1}	PID P control switchover	NET	EXT		NET	EXT		
X74 ^{*1}	Magnetic flux decay output shutoff	NET			EXT			
X76 ^{*1}	Proximity dog	Combined			EXT			
X84 ^{*1}	Emergency drive execution command	Combined						
X87 ^{*1}	Sudden stop	Combined ^{*2}			EXT			
LSP ^{*1}	Forward stroke end	Combined ^{*2}			EXT			
LSN ^{*1}	Reverse stroke end	Combined ^{*2}			EXT			
X92 ^{*1}	Emergency stop	Combined			EXT			

*1 Use Pr.178 to Pr.189 (Input terminal function selection) to assign the function to an input terminal. (Refer to page 410.)

*2 When the same signals are input via external input terminal and via communication, the operation is as follows.

Logic	Input via external input terminal	Input via communication	Actual signal state
Normally open input	OFF	OFF	OFF
	OFF	ON (short-circuited)	ON
	ON (short-circuited)	OFF	ON
	ON (short-circuited)	ON (short-circuited)	ON
Normally closed input	OFF (open)	OFF (open)	OFF
	OFF (open)	ON	OFF
	ON	OFF (open)	OFF
	ON	ON	ON

NOTE

- The communication interface selection is determined by the settings of Pr.550 and Pr.551.
- The settings of Pr.338 and Pr.339 can be changed during operation when Pr.77 = "2". Note that the changed setting is applied after the inverter has stopped. Until the inverter has stopped, the previous setting of the interface for the operation command and the speed command in the Network operation mode is valid.

◆ Changing the command interface using a signal input via external terminal (X67 signal)

- In the Network operation mode, the command interface for the operation command and the speed command can be changed using the Command source switchover (X67) signal. This method may be useful to use both external terminal and communication interface by using a different interface according to the command type.
- For the X67 signal, set "67" to any parameter from Pr.178 to Pr.184 (Input terminal function selection) to assign the function to a control circuit terminal.

- When the X67 signal is OFF, the command interface for the operation command and the speed command is the control circuit terminal.

X67 signal state	Interface for the operation command	Interface for the speed command
Signal not assigned	Determined by Pr.338 setting	Determined by Pr.339 setting
ON		
OFF	Control circuit terminal only	

NOTE

- The ON/OFF state of the X67 signal is applied only during a stop. When the terminals are switched during operation, the ON/OFF state is reflected after a stop.
- When the X67 is OFF, a reset via communication is disabled.
- Changing the terminal assignment using **Pr.178 to Pr.184 (Input terminal function selection)** may affect the other functions. Set parameters after confirming the function of each terminal.

«Parameters referred to»

Pr.59 Remote function selection  page 269

Pr.79 Operation mode selection  page 280

10.4 Reverse rotation prevention selection

This function can prevent reverse rotation fault resulting from the incorrect input of the start signal.

Pr.	Name	Initial value	Setting range	Description
78 D020	Reverse rotation prevention selection	0	0	Both forward and reverse rotations allowed
			1	Reverse rotation disabled
			2	Forward rotation disabled

- Set this parameter to limit the motor rotation to only one direction.
- This parameter is valid for all of the RUN key on the operation panel, FWD/REV key on the parameter unit, the start signals (STF, STR signals) via external terminals, and the forward and reverse rotation commands through communication.

10.5 JOG operation

The frequency and acceleration/deceleration time for JOG operation can be set. JOG operation can be used for conveyor positioning, test operation, etc.

Pr.	Name	Initial value	Setting range	Description
15 D200	Jog frequency	5 Hz	0 to 590 Hz	Set the frequency for JOG operation.
16 F002	Jog acceleration/ deceleration time	0.5 s	0 to 3600 s	Set the motor acceleration/deceleration time during JOG operation. The acceleration/deceleration time is a period of time that the inverter takes to increase/decrease the output frequency to the frequency set in Pr.20 Acceleration/deceleration reference frequency ^{*1} . The acceleration/deceleration times cannot be set separately.

These parameters can be selected from among simple mode parameters when the LCD operation panel (FR-LU08) or the parameter unit (FR-PU07) is connected to the inverter.

*1 60 Hz is initially set in **Pr.20** in Group 1, and 50 Hz in Group 2. (Refer to [page 54](#)).

◆ JOG operation by inputting signals (JOG signal and JOG2 signal)

- Operation can be started and stopped by the start signals (STF and STR signals) when the Jog operation selection (JOG) signal or Jog operation selection 2 (JOG2) signal is ON. (For the operation method, refer to [page 48](#).)
- The JOG signal can be input only via a control circuit terminal. For the JOG signal, set "5" to any parameter from **Pr.178 to Pr.184 (Input terminal function selection)** to assign the function to a control circuit terminal.
- The JOG2 signal can be input via a control circuit terminal or via communication. For the JOG2 signal, set "30" to any parameter from **Pr.178 to Pr.189 (Input terminal function selection)** to assign the function to a control circuit terminal.
- Use the JOG acceleration/deceleration time function (**Pr.16**) to set the acceleration/deceleration time for JOG operation.

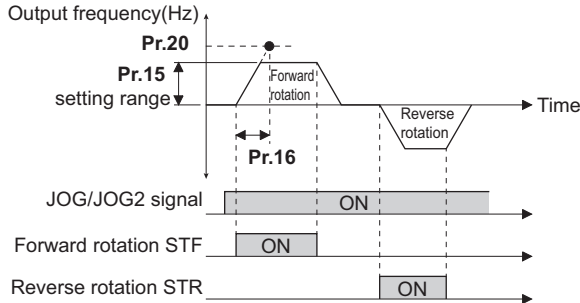

◆ JOG operation using the PU

- When the operation panel or parameter unit is in the JOG operation mode, the motor jogs only while a key for start command is pressed. (For the operation method, refer to [page 49](#).)

NOTE

- The priority of the frequency command given by the external signals is as follows: JOG operation (JOG/JOG2 signal) > stop-on-contact control (RL/RT signal) > multi-speed operation (RL/RM/RH/REX signal) > PID control (X14 signal) > terminal 4 analog input (AU signal) > pulse train input (option FR-E8AXY) > 16-bit digital input (option FR-A8AX) > terminal 2 analog input. Note that stop-on-contact control is disabled when PID control is enabled.
- The reference frequency during acceleration/deceleration depends on the **Pr.29 Acceleration/deceleration pattern selection** setting. (Refer to [page 267](#).)
- The **Pr.15** setting should be equal to or higher than the **Pr.13 Starting frequency** setting.
- Changing the terminal assignment using **Pr.178 to Pr.189 (Input terminal function selection)** may affect the other functions. Set parameters after confirming the function of each terminal.
- During JOG operation, the second acceleration/deceleration function using the RT signal is disabled. (Other second functions are enabled (refer to [page 418](#)).)
- When **Pr.79 Operation mode selection** = "4", JOG operation is started by one push of the RUN key on the operation panel or the FWD/REV key on the parameter unit, and stopped by the STOP/RESET key.
- This function is invalid when **Pr.79** = "3".

Parameters referred to

Pr.13 Starting frequency [page 274](#)

Pr.20 Acceleration/deceleration reference frequency, Pr.21 Acceleration/deceleration time increments [page 262](#)

Pr.29 Acceleration/deceleration pattern selection [page 267](#)

Pr.79 Operation mode selection [page 280](#)

Pr.178 to Pr.189 (Input terminal function selection) [page 410](#)

10.6 Operation by multi-speed setting

Use these parameters to change among pre-set operation speeds with the terminals. The speeds are pre-set with parameters. Any speed can be selected by simply turning ON/OFF the contact signals (RH, RM, RL, and REX signals).

Pr.	Name	Initial value ^{*1}		Setting range	Description
		Gr.1	Gr.2		
4 D301	Multi-speed setting (high speed)	60 Hz	50 Hz	0 to 590 Hz	Sets the frequency when RH is ON.
5 D302	Multi-speed setting (middle speed)	30 Hz		0 to 590 Hz	Sets the frequency when RM is ON.
6 D303	Multi-speed setting (low speed)	10 Hz		0 to 590 Hz	Sets the frequency when RL is ON.
24 D304	Multi-speed setting (speed 4)	9999		0 to 590 Hz, 9999	Frequency from 4th speed to 15th speed can be set according to the combination of the RH, RM, RL and REX signals. 9999: Not selected
25 D305	Multi-speed setting (speed 5)				
26 D306	Multi-speed setting (speed 6)				
27 D307	Multi-speed setting (speed 7)				
232 D308	Multi-speed setting (speed 8)				
233 D309	Multi-speed setting (speed 9)				
234 D310	Multi-speed setting (speed 10)				
235 D311	Multi-speed setting (speed 11)				
236 D312	Multi-speed setting (speed 12)				
237 D313	Multi-speed setting (speed 13)				
238 D314	Multi-speed setting (speed 14)				
239 D315	Multi-speed setting (speed 15)				

*1 Gr.1 and Gr.2 are the parameter initial value groups. (Refer to page 54).

◆ Multi-speed setting (Pr.4 to Pr.6)

- The inverter operates at frequencies set in **Pr.4** when the RH signal is ON, **Pr.5** when the RM signal is ON, or **Pr.6** when the RL signal is ON.

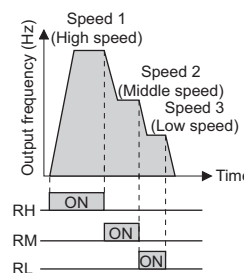
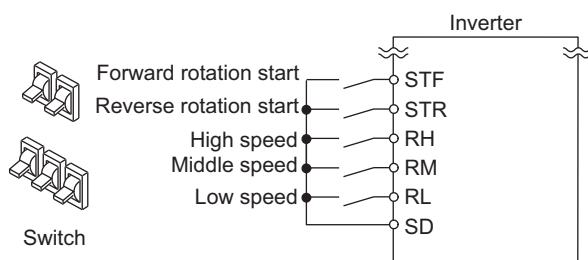

NOTE

- In the initial setting, if two or more speed switches (signals) are simultaneously turned ON, priority is given to the switch (signal) for the lower speed. For example, when both RH and RM signals turn ON, the RM signal (**Pr.5**) has the higher priority.
- The RH, RM and RL signals are assigned to the terminals RH, RM and RL, respectively, in the initial status. To assign each signal to a different terminal, set "0" (RL signal), "1" (RM signal), or "2" (RH signal) in any parameter from **Pr.178 to Pr.189** (Input terminal function selection).

◆ Multi-speed setting for 4th speed or more (Pr.24 to Pr.27, Pr.232 to Pr.239)

- The frequency from 4th speed to 15th speed can be set according to the combination of the RH, RM, RL, and REX signals. Set the frequencies in **Pr.24 to Pr.27, Pr.232 to Pr.239**. (In the initial status, 4th to 15th speeds are invalid.)
- To input the REX signal, set "8" in any parameter from **Pr.178 to Pr.189 (Input terminal function selection)** to assign the function.

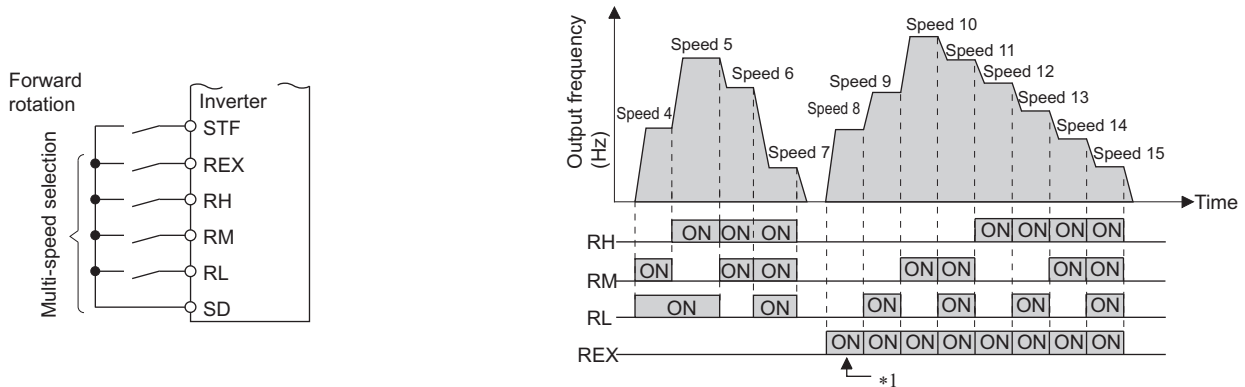

*1 When the RH, RM and RL signals are OFF and the REX signal is ON while "9999" is set to **Pr.232 Multi-speed setting (speed 8)**, the inverter operates at the frequency set in **Pr.6**.

NOTE

- The priority of the frequency command given by the external signals is as follows: JOG operation (JOG/JOG2 signal) > stop-on-contact control (RL/RT signal) > multi-speed operation (RL/RM/RH/REX signal) > PID control (X14 signal) > terminal 4 analog input (AU signal) > pulse train input (option FR-E8AXY) > 16-bit digital input (option FR-A8AX) > terminal 2 analog input. Note that stop-on-contact control is disabled when PID control is enabled. (For details on frequency commands given by analog input, refer to [page 400](#).)
- The input compensation of multi-speed setting is enabled when the inverter is in the External operation mode or PU/External combined operation mode (**Pr.79** = "3 or 4").
- Multi-speed parameters can also be set during PU operation or External operation.
- The **Pr.24 to Pr.27 and Pr.232 to Pr.239** settings have no priority among them.
- When **Pr.59 Remote function selection** ≠ "0", the multi-speed setting is invalid since the RH, RM, and RL signals are for remote setting.
- Changing the terminal assignment using **Pr.178 to Pr.189 (Input terminal function selection)** may affect the other functions. Set parameters after confirming the function of each terminal.

Parameters referred to

- Pr.15 Jog frequency [page 301](#)
- Pr.59 Remote function selection [page 269](#)
- Pr.79 Operation mode selection [page 280](#)
- Pr.178 to Pr.189 (Input terminal function selection) [page 410](#)

CHAPTER 11 (H) Protective Function Parameters

11.1	Motor overheat protection (electronic thermal O/L relay)	306
11.2	Cooling fan operation selection	314
11.3	Earth (ground) fault detection at start	315
11.4	Inverter output fault detection enable/disable selection	316
11.5	Initiating a protective function	317
11.6	I/O phase loss protection selection	318
11.7	Retry function.....	319
11.8	Emergency drive (Fire mode) (Standard model / Ethernet model)	322
11.9	Checking faulty area in the internal storage device	330
11.10	Limiting the output frequency (maximum/minimum frequency)	331
11.11	Avoiding machine resonance points (frequency jump)	332
11.12	Stall prevention operation	334
11.13	Load characteristics fault detection	339
11.14	Motor overspeeding detection	344

11 (H) Protective Function Parameters

Purpose	Parameter to set		Refer to page	
To protect the motor from overheating	Electronic thermal O/L relay	P.H000, P.H006, P.H010, P.H016, P.H020, P.H021	Pr.9, Pr.51, Pr.561, Pr.607, Pr.608, Pr.1016	306
To set the overheat protection characteristics for the motor	Free thermal O/L relay	P.H001 to P.H005, P.H011 to P.H015	Pr.600 to Pr.604, Pr.692 to Pr.696	306
To extend the life of the cooling fan	Cooling fan operation selection	P.H100	Pr.244	314
To detect an earth (ground) fault at start	Earth (ground) fault detection at start	P.H101	Pr.249	315
To detect a fault on the output side of the inverter	Inverter output fault detection enable/disable selection	P.H182	Pr.631	316
To initiate an inverter protective function	Fault initiation	P.H103	Pr.997	317
To disable the I/O phase loss protective function	I/O phase loss	P.H200, P.H201	Pr.251, Pr.872	318
To restart using the retry function when the protective function is activated	Retry operation	P.H300 to P.H303	Pr.65, Pr.67 to Pr.69	319
To operate without activating protective functions in case of emergency	Emergency drive	P.H320 to P.H324, P.A001, P.A004	Pr.136, Pr.139, Pr.514, Pr.515, Pr.523, Pr.524, Pr.1013	322
To check faulty area in the internal storage device	Internal storage device status indication	P.H325	Pr.890	330
To set the upper and lower limits of the output frequency	Maximum/minimum frequency	P.H400 to P.H402	Pr.1, Pr.2, Pr.18	331
To prevent the motor from overspeeding under torque control	Speed limit	P.H410 to P.H412	Pr.807 to Pr.809	171
To avoid overdriving the motor during speed control	Overdriving prevention	P.H415 to P.H417	Pr.285, Pr.853, Pr.873	154
To operate avoiding resonance points	Frequency jump	P.H420 to P.H425, P.H429	Pr.31 to Pr.36, Pr.552	332
To limit the output current so that the inverter protective function does not activate	Stall prevention	P.H500, P.H501, P.H600, P.H610, P.H611, P.H630, P.H631, P.M430	Pr.22, Pr.23, Pr.48, Pr.66, Pr.154, Pr.156, Pr.157, Pr.277	334
To limit the torque during speed control	Torque limit	P.H500, P.H700 to P.H704, P.H710, P.H720, P.H721, P.H730, P.T040, P.G210	Pr.22, Pr.801, Pr.803, Pr.810, Pr.812 to Pr.817, Pr.858, Pr.874	139
To monitor for load faults	Load characteristics fault detection	P.H520 to P.H527, P.H531 to P.H535	Pr.1480 to Pr.1492	339
To shut off output if the operation panel disconnects	Overspeed detection level	P.H800	Pr.374	344
To shut off output if the operation panel disconnects	Deceleration check	P.H880	Pr.690	155

11.1 Motor overheat protection (electronic thermal O/L relay)

Set the current of the electronic thermal relay function to protect the motor from overheating. Such settings provide the optimum protective characteristic considering the low cooling capability of the motor during low-speed operation.

Pr.	Name	Initial value	Setting range	Description
9 H000	Electronic thermal O/L relay	Inverter rated current* ¹	0 to 500 A	Set the rated motor current.
600 H001	First free thermal reduction frequency 1	9999	0 to 590 Hz 9999	The electronic thermal O/L relay operation level can be changed to match the motor temperature characteristics with the combination of these three points (Pr.600, Pr.601), (Pr.602, Pr.603), (Pr.604, Pr.9). 9999: Free thermal O/L relay invalid
601 H002	First free thermal reduction ratio 1	100%	1% to 100% 9999	
602 H003	First free thermal reduction frequency 2	9999	0 to 590 Hz 9999	
603 H004	First free thermal reduction ratio 2	100%	1% to 100% 9999	
604 H005	First free thermal reduction frequency 3	9999	0 to 590 Hz 9999	
607 H006	Motor permissible load level	150%	110% to 250%	
51 H010	Second electronic thermal O/L relay	9999	0 to 500 A 9999	Enabled when the RT signal is ON. Set the rated motor current. Second electronic thermal O/L relay invalid
692 H011	Second free thermal reduction frequency 1	9999	0 to 590 Hz 9999	The electronic thermal O/L relay operation level can be changed to match the motor temperature characteristics with the combination of these three points (Pr.692, Pr.693), (Pr.694, Pr.695), (Pr.696, Pr.51) when the RT signal is ON. 9999: Second free thermal O/L relay invalid
693 H012	Second free thermal reduction ratio 1	100%	1% to 100% 9999	
694 H013	Second free thermal reduction frequency 2	9999	0 to 590 Hz 9999	
695 H014	Second free thermal reduction ratio 2	100%	1% to 100% 9999	
696 H015	Second free thermal reduction frequency 3	9999	0 to 590 Hz 9999	
608 H016	Second motor permissible load level	9999	110% to 250% 9999	Set the permissible frequency when the RT signal is ON. The Pr.607 setting is applied even when the RT signal is ON.
561 H020	PTC thermistor protection level	9999	0.5 to 30 kΩ 9999	Set the PTC thermistor protection level (resistance). PTC thermistor protection disabled
1016 H021	PTC thermistor protection detection time	0 s	0 to 60 s	Set the time from when the resistance of the PTC thermistor reaches the protection level until the protective function is activated.

*1 The initial value for the FR-E820-0050(0.75K) or lower, FR-E840-0026(0.75K) or lower, FR-E860-0017(0.75K), FR-E820S-0050(0.75K) or lower, FR-E810W-0050(0.75K) or lower, and FR-E846-0026(0.75K) is set to the 85% of the inverter rated current.

◆ Electronic thermal O/L relay operation characteristic for induction motor (Pr.9)

- This function detects the overload (overheat) of the motor and shut off the inverter output by stopping the operation of the transistor at the inverter output side.
- Set the rated current (A) of the motor in **Pr.9 Electronic thermal O/L relay**. (If the motor has both 50 Hz and 60 Hz ratings and the **Pr.3 Base frequency** is set to 60 Hz, set to 1.1 times the 60 Hz rated motor current.)
- Set "0" in **Pr.9** to avoid activating the electronic thermal relay function; for example, when using an external thermal relay for the motor.

(Note that the output transistor protection of the inverter is activated. (E.THT))

- When using the Mitsubishi Electric constant-torque motor, set the constant-torque motor in **Pr.71 Applied motor** referring to [page 424](#). (This setting enables the 100% constant-torque characteristic in the low-speed range.)

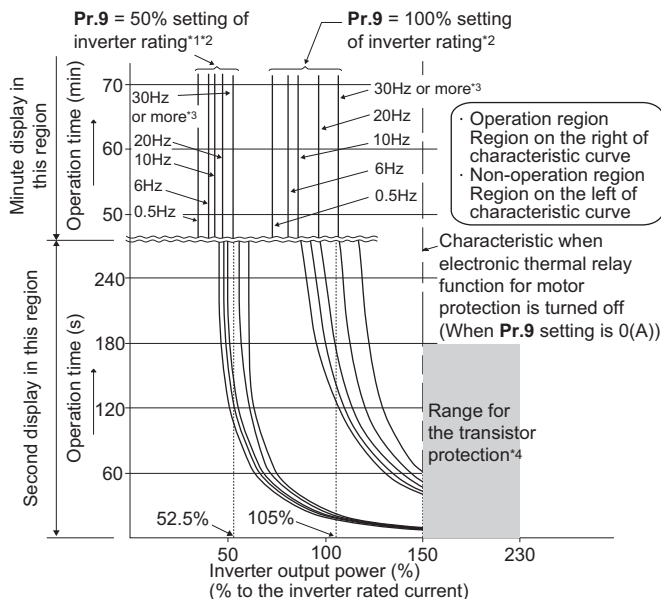

- *1 When setting **Pr.9** to a value (current value) of 50% of the inverter rated current
- *2 The % value denotes the percentage to the rated inverter current. It is not the percentage to the rated motor current.
- *3 When the electronic thermal relay function dedicated to the Mitsubishi Electric constant-torque motor is set, this characteristic curve applies to operation. (For selection of the operation characteristic, refer to [page 424](#).)
- *4 Transistor protection is activated depending on the temperature of the heat sink. The protection may be activated even with less than 150% depending on the operating conditions.

NOTE

- The internal accumulated heat value of the electronic thermal relay function is reset to the initial value by the inverter's power reset or reset signal input. Avoid unnecessary reset and power-OFF.
- Install an external thermal relay (OCR) between the inverter and motors to operate several motors, a multi-pole motor or a dedicated motor with one inverter. When setting an external thermal relay, note that the current indicated on the motor rating plate is affected by the line-to-line leakage current. The cooling effect of the motor drops during low-speed operation. Use a motor with built-in thermal protector. (For details of the line-to-line leakage current, refer to the Instruction Manual (Connection).)
- When the difference between the inverter and motor capacities is large and the set value is small, the protective characteristics of the electronic thermal relay function will be deteriorated. Use an external thermal relay in such cases.
- A dedicated motor cannot be protected by an electronic thermal O/L relay. Use an external thermal relay.
- The transistor protection thermal O/L relay is activated early when the **Pr.72 PWM frequency selection** setting is increased.

◆ Electronic thermal O/L relay when using PM motor (Pr.9)

- This function detects the overload (overheat) of the motor and shut off the inverter output by stopping the operation of the transistor at the inverter output side.
- Set the rated current (A) of the motor in **Pr.9 Electronic thermal O/L relay**.
- Set "0" in **Pr.9** to avoid activating the electronic thermal relay function; for example, when using an external thermal relay for the motor.
(Note that the output transistor protection of the inverter is activated. (E.THT))
- When the MM-GKR or EM-A motor is used, the rated motor current is automatically set by PM parameter initialization.
(Refer to [page 123](#).)

- Operational characteristic of the electronic thermal relay function

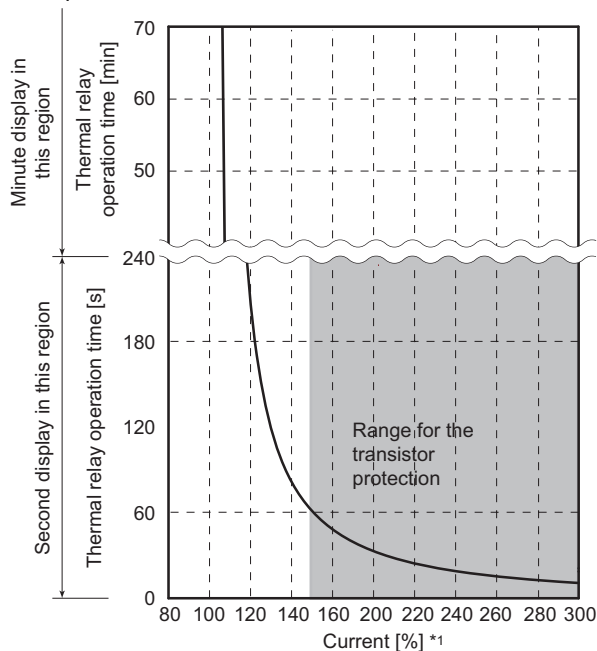

Protective function activated area: the area right of the characteristic curve

Normal operation area: the area left of the characteristic curve

*1 The % value denotes the percentage to the rated motor current.

NOTE

- The internal accumulated heat value of the electronic thermal O/L relay is reset to the initial value by the inverter's power reset or reset signal input. Avoid unnecessary reset and power-OFF.
- When using a PM motor, set the free thermal parameters (**Pr.600 to Pr.604**) in accordance with the motor characteristic.
- The transistor protection thermal O/L relay is activated early when the **Pr.72 PWM frequency selection** setting is increased.

◆ Set two types of electronic thermal O/L relays (Pr.51)

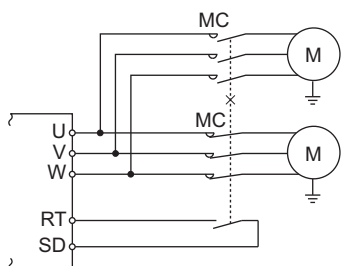

- These settings are used when rotating two motors with different rated current separately by a single inverter. (When rotating two motors together, use an external thermal relay.)
- Set the rated motor current for the second motor in **Pr.51 Second electronic thermal O/L relay**.

- While the RT signal is ON, the setting values of **Pr.51** is referred to provide thermal protection.

Pr.450 Second applied motor	Pr.9 Electronic thermal O/L relay	Pr.51 Second electronic thermal O/L relay	RT signal OFF		RT signal ON	
			First motor	Second monitor	First motor	Second monitor
9999	0	9999	x	x	x	x
		0	x	x	x	x
		0.01 to 500 (0.1 to 3600)	x	Δ	x	○
9999	Other than 0	9999	○	x	○	x
		0	○	x	Δ	x
		0.01 to 500 (0.1 to 3600)	○	Δ	Δ	○
Other than 9999	0	9999	x	x	x	x
		0	x	x	x	x
		0.01 to 500 (0.1 to 3600)	x	Δ	x	○
Other than 9999	Other than 0	9999	○	Δ	Δ	○
		0	○	x	Δ	x
		0.01 to 500 (0.1 to 3600)	○	Δ	Δ	○

○: Values are accumulated by using the output current.
 Δ: Values are accumulated by assuming the output current is 0 A (cooling processing).
 x: Electronic thermal O/L relay does not operate.

NOTE

- The RT signal is the Second function selection signal. The RT signal also enables other second functions. (Refer to [page 418](#).)
- For the RT signal, set "3" in any parameter from **Pr.178 to Pr.189 (Input terminal function selection)** to assign the function.

◆ Motor permissible load level (Pr.607, Pr.608)

The electronic thermal O/L relay operation characteristic can be changed by setting the permissible load level according to the motor characteristics.

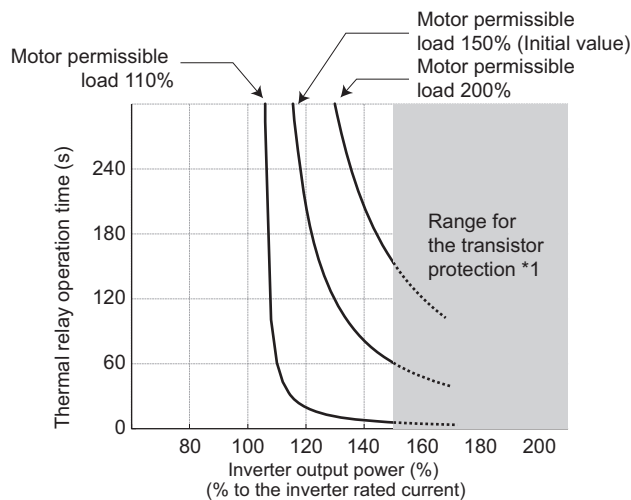

Example of motor permissible load setting (when Pr.9="100% of the inverter rating")

*1 Depending on the settings of **Pr.607** and **Pr.608**, this thermal protection may not be provided as set, as an inverter overload trip (electronic thermal relay function) (E.THT) may be activated before the thermal protection.

◆ Electronic thermal O/L relay pre-alarm (TH) and warning signal (THP signal)

- If the accumulated electronic thermal value reaches 85% of the **Pr.9** or **Pr.51** setting, electronic thermal O/L relay function pre-alarm (TH) is displayed and the electronic thermal O/L relay pre-alarm (THP) signal is output. If the value reaches 100% of the **Pr.9** setting, the motor thermal protection (E.THM/E.THT) is activated to shut off the inverter output. The inverter output is not shut off with the TH display.

- For the THP signal output, set "8" (positive logic) or "108" (negative logic) in any parameter from **Pr.190 to Pr.197 (Output terminal function selection)** to assign the function.

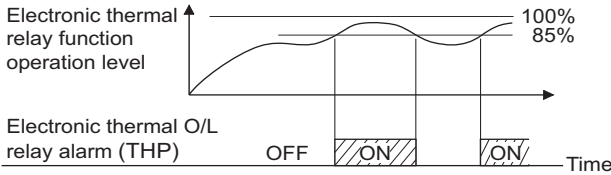

NOTE

- Changing the terminal assignment using **Pr.190 to Pr.197 (Output terminal function selection)** may affect the other functions. Set parameters after confirming the function of each terminal.

◆ External thermal relay input (OH signal, E.OHT)

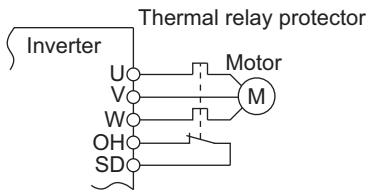

External thermal relay input connection diagram

- The External thermal relay input (OH) signal is used when using the external thermal relay or the thermal protector built into the motor to protect the motor from overheating.
- When the thermal relay is activated, the inverter output is shut off by the external thermal relay (E.OHT).
- To input the OH signal, set "7" in any parameter from **Pr.178 to Pr.189 (Input terminal function selection)** to assign the function.
- Vector-control-dedicated motors (SF-V5RU) are equipped with thermal protectors.

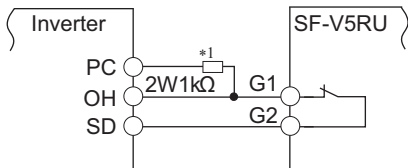

Connecting the SF-V5RU thermal protector

*1 Connect the recommended 2 W 1 kΩ resistor between terminals PC and OH. (Refer to the Instruction Manual (Connection).)

NOTE

- Changing the terminal assignment using **Pr.178 to Pr.189 (Input terminal function selection)** may affect the other functions. Set parameters after confirming the function of each terminal.

◆ PTC thermistor input (Pr.561, Pr.1016, E.PTC)

This function is used to protect the motor from overheating by inputting outputs from the motor's built-in PTC thermistor to the inverter. It is recommended that a PTC thermistor whose resistance increases most rapidly around the rated activating temperature ($TN \pm DT$) is used.

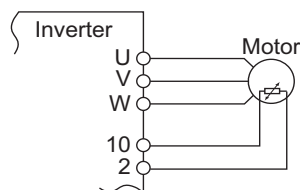

PTC thermistor input connection diagram

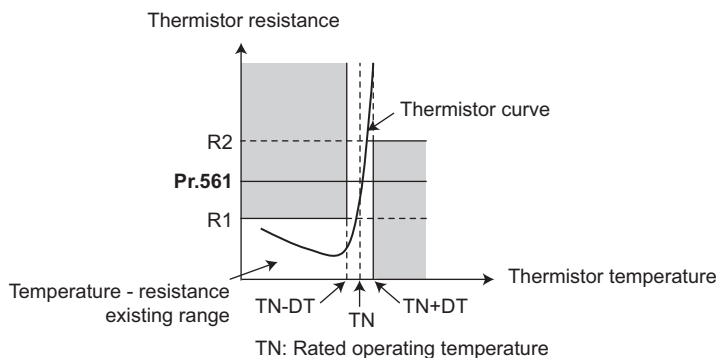

Example of PTC thermistor characteristics

- Outputs from the motor's built-in PTC thermistor can be input to terminals 2 and 10. If the input from the PTC thermistor reaches the resistor value set in **Pr.561 PTC thermistor protection level**, E.PTC (PTC thermistor operation) shuts off the inverter output.
- Confirm the characteristic of the PTC thermistor to be used, and set the resistance for **Pr.561** around the center of the R1 and R2 values shown on the figure above so that it does not deviate from the protective function activating temperature TN. If the **Pr.561** setting becomes too close to R1 or R2, the protective function activating temperature may be too hot (protection is delayed), or too cold (too much protection).
- When the PTC thermistor protection is enabled (**Pr.561** ≠ "9999"), the resistance value for the PTC thermistor can be displayed on the operation panel or via RS-485 communication. (Refer to [page 348](#).)
- When the PTC thermistor protection level setting is used, use **Pr.1016 PTC thermistor protection detection time** to set the time from when the resistance of the PTC thermistor reaches the protection level until the protective function (E.PTC) is activated.
- If the resistance of the PTC thermistor falls below the protection level within the protection detection time, the elapsed time count is cleared.

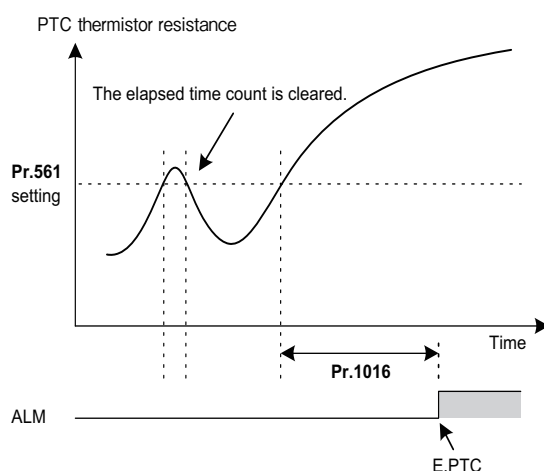

NOTE

- When using terminal 2 for PTC thermistor input (**Pr.561** ≠ "9999"), terminal 2 does not operate as an analog frequency command terminal. When a function for the PID control or dancer control is assigned to terminal 2, the function is disabled. Use **Pr.133 PID action set point** to set the set point for the PID control. When the PID control and dancer control are disabled (**Pr.128 PID action selection** = "0") and **Pr.858** = "0", terminal 4 operates as follows.
 - Pr.79** = "4" or External operation mode is selected: Terminal 4 input is valid regardless of ON/OFF state of the AU signal.
 - Pr.79** = "3": Frequency command given via terminal 4 is valid only when the AU signal is ON.
- To input power to the PTC thermistor power supply, always use the terminal 10 and do not use any other terminals or an external power supply. Otherwise, E.PTC (PTC thermistor protection) does not operate properly.
- When E.PTC is activated, the alarm display, "External protection (AU terminal)", may appear on the parameter unit (FR-PU07), but it is not a fault.

◆ Overheat protection to match the characteristic of the motor (Pr.600 to Pr.604, Pr.692 to Pr.696)

- The activation level of the electronic thermal O/L relay can be varied to match the motor temperature characteristic.
- The electronic thermal O/L relay operation level can be set with the combination of three points (**Pr.600, Pr.601**), (**Pr.602, Pr.603**), (**Pr.604, Pr.9**). Two or more points are required for setting.

- The electronic thermal O/L relay operation level can be set with the combination of three points (**Pr.692, Pr.693**), (**Pr.694, Pr.695**), (**Pr.696, Pr.51**) when the RT signal is ON.

Continuous operation characteristic

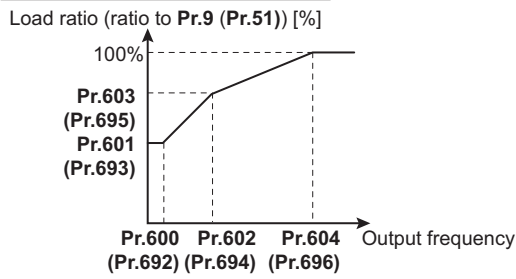

Setting example 1

Pr.9=100% of the rated motor current
Pr.600=6Hz
Pr.601=50%
Pr.602=30Hz
Pr.603=70%
Pr.604=60Hz

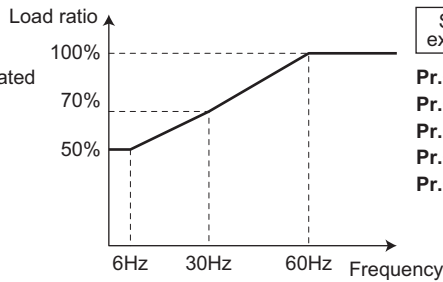

Setting example 2

Pr.600=120Hz
Pr.601=60%
Pr.602=3Hz
Pr.603=50%
Pr.604=60Hz

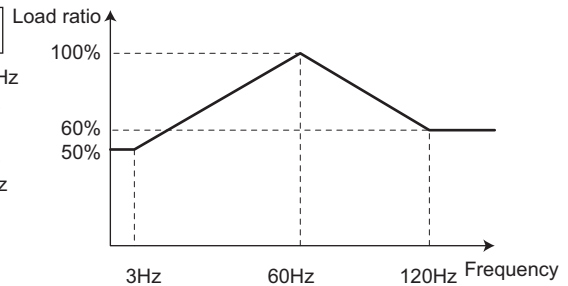

- When setting **Pr.600, Pr.602, Pr.604 (Pr.692, Pr.694, Pr.696)** to the same frequency, the following graph's upper level is applied.

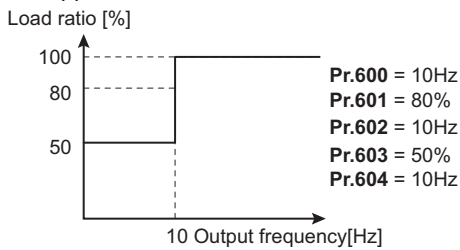

NOTE

- Make sure to set the parameters according to the temperature characteristic of the motor used.

Parameters referred to

Pr.71 Applied motor [page 424](#)
Pr.72 PWM frequency selection [page 249](#)
Pr.178 to Pr.189 (Input terminal function selection) [page 410](#)
Pr.190 to Pr.197 (Output terminal function selection) [page 371](#)

11.2 Cooling fan operation selection

A cooling fan is built into the inverter can be controlled.

Pr.	Name	Initial value	Setting range	Description
244 H100	Cooling fan operation selection	1	0	Cooling fan ON/OFF control disabled. (The cooling fan is always ON at power ON.) A cooling fan operates at power ON.
			1	Cooling fan ON/OFF control enabled. The fan is always ON while the inverter is running. During a stop, the inverter status is monitored and the fan switches ON/OFF according to the temperature.

◆ Cooling fan always ON (Pr.244 = "0")

- When Pr.244 = "0", the cooling fan operates at power ON. If the fan stops at this time, the inverter finds that the fan operation is faulty and the indication of the "FN" (Fan alarm) is displayed on the operation panel. The Fan fault output (FAN) signal and the Alarm (LF) signal are output.
- For the FAN signal output, set "25" (positive logic) or "125" (negative logic) in any parameter from Pr.190 to Pr.197 (Output terminal function selection). For the LF signal, set "98" (positive logic) or "198" (negative logic).

◆ Cooling fan operation control (Pr.244 = "1" (initial value))

- The cooling fan operation is controlled when Pr.244 = "1". When the inverter is running, the cooling fan operates constantly. When the inverter is stopped, the cooling fan operates depending on the temperature of the inverter heat sink. If the fan stops although it meets the conditions for running, fan operation is regarded as faulty, "FN" is displayed on the operation panel, and the FAN signal and LF signals are output.

◆ Cooling fan operation command (Y206) signal

- The Cooling fan operation command (Y206) signal can be output when the inverter cooling fan meets the conditions for running. The function can be used when the fan installed on the enclosure is synchronized with the inverter cooling fan.
- The Y206 signal indicates the operating command condition of the inverter cooling fan depending on the power supply ON/OFF or the Pr.244 settings. The signal does not indicate the actual operation of the cooling fan. (The signal is output even if the cooling fan is stopped due to a fault.)
- To use the Y206 signal, set "206" (positive logic) or "306" (negative logic) in any parameter from Pr.190 to Pr.197 (Output terminal function selection) to assign function to an output terminal.

NOTE

- The cooling fan is installed on the FR-E820-0080(1.5K) or higher, FR-E840-0040(1.5K) or higher, FR-E860-0027(1.5K) or higher, FR-E820S-0080(1.5K) or higher, and FR-E846-0026(0.75K) or higher.
- If the safety stop function is activated to shut off the inverter output in the FR-E820-0080(1.5K), FR-E820-0110(2.2K), FR-E820S-0080(1.5K), or FR-E820S-0110(2.2K), the cooling fan operates at the next power-ON.
- Changing the terminal assignment using Pr.190 to Pr.197 (Output terminal function selection) may affect the other functions. Set parameters after confirming the function of each terminal.

Parameters referred to

Pr.190 to Pr.197 (Output terminal function selection)  page 371

11.3 Earth (ground) fault detection at start

Select whether to make earth (ground) fault detection at start. When enabled, earth (ground) fault detection is performed immediately after a start signal input to the inverter.

Pr.	Name	Initial value ^{*1}		Setting range	Description
		Gr.1	Gr.2		
249 H101	Earth (ground) fault detection at start	0	1	0	Earth (ground) fault detection at start disabled
				1	Earth (ground) fault detection at start enabled

*1 Gr.1 and Gr.2 are the parameter initial value groups. (Refer to [page 54](#)).

- If a ground fault is detected at start while **Pr.249** = "1", the output-side earth (ground) fault overcurrent (E.GF) is displayed and the outputs are shut off.
- When the **Pr.72 PWM frequency selection** setting is high, enable the ground fault detection at start.

NOTE

- Because the detection is performed at start, output is delayed for approx. 20 ms every start.
- Use **Pr.249** to enable/disable ground fault detection at operation start.

11.4 Inverter output fault detection enable/disable selection

Faults occurred on the output side (load side) of the inverter (inverter output fault (E.10)) can be detected during operation.

Pr.	Name	Initial value	Setting range	Description
631 H182	Inverter output fault detection enable/disable selection	0	0	Output fault detection disabled
			1	Output fault detection enabled

11.5 Initiating a protective function

A fault (protective function) is initiated by setting the parameter.

This function can be used to check how the system operates at activation of a protective function.

Pr.	Name	Initial value	Setting range	Description
997 H103	Fault initiation	9999	16 to 253	The setting range is the same with the one for fault data codes of the inverter (which can be read through communication). Written data is not stored in EEPROM.
			9999	The read value is always "9999". The protective function is not activated with this setting.

- To initiate a fault (protective function), set the assigned number of the protective function to be initiated in **Pr.997**.
- The value set in **Pr.997** is not stored in EEPROM.
- When the protective function is activated, the inverter output is shut off and the inverter displays the fault indication and outputs a Fault (ALM) signal.
- The latest fault in the fault history is displayed while the fault initiation function is in operation. After a reset, the fault history goes back to the previous status. (The protective function generated by the fault is not saved in the fault history.)
- Perform inverter reset to cancel the protective function.
- For the selectable parameter by **Pr.997** and the corresponding protective functions, refer to the Instruction Manual (Maintenance).

NOTE

- If a protective function is already operating, no fault can be activated by **Pr.997**.
- The retry function is disabled when a protective function has been initiated by the fault initiation function.
- If a fault occurs after a protective function has been activated, the protective function indication does not change. The fault is not saved in the fault history either.
- When the FR-E8TR or the FR-E8TE7 is installed, **Pr.997** cannot be set to "201" (safety circuit fault).

11.6 I/O phase loss protection selection

The output phase loss protection function, which stops the inverter output if one of the three phases (U, V, W) on the inverter's output side (load side) is lost, can be disabled.

The input phase loss protective function on the inverter input side (R/L1, S/L2, T/L3) can be disabled.

Pr.	Name	Initial value	Setting range	Description
251 H200	Output phase loss protection selection	1	0	Output phase loss protection disabled
			1	Output phase loss protection enabled
872 H201 ^{*1}	Input phase loss protection selection	1	0	Input phase loss protection disabled
			1	Input phase loss protection enabled

*1 Available for the three-phase power input model only.

◆ Output phase loss protection selection (Pr.251)

- When Pr.251 is set to "0", output phase loss protection (E.LF) becomes invalid.

◆ Input phase loss protection selection (Pr.872)

- When Pr.872 = "1", Input phase loss (E.ILF) protection is activated if one of three phases is continuously lost for 1 second.

NOTE

- When several motors are connected, output phase loss cannot be detected even if the wiring to one motor loses phase.
- In the case of R/L1, S/L2 phase loss, the input phase loss protection does not operate, and the inverter output is shut off.
- If an input phase loss continues for a long time, the lives of converter section and capacitor of the inverter become shorter.
- If the load is light or during a stop, lost phase cannot be detected because detection is performed based on the fluctuation of bus voltage. Large unbalanced phase-to-phase voltage of the three-phase power supply may also cause input phase loss protection (E.ILF).
- Phase loss cannot be detected during regeneration load operation.

Parameters referred to

Pr.261 Power failure stop selection  page 514

11.7 Retry function

This function allows the inverter to reset itself and restart at activation of the protective function (fault indication). The retry generating protective functions can also be selected.

When the automatic restart after instantaneous power failure function is selected (**Pr.57 Restart coasting time** ≠ "9999"), the restart operation is also performed after a retry operation as well as after an instantaneous power failure. (For restart operation, refer to [page 502](#) and [page 508](#) for selection.)

Pr.	Name	Initial value	Setting range	Description
65 H300	Retry selection	0	0 to 5	Faults which trigger the retry operation can be selected.
67 H301	Number of retries at fault occurrence	0	0	The retry function disabled.
			1 to 10	Set the number of retries at a fault occurrence. A fault output is not provided during the retry operation.
			101 to 110	Set the number of retries at a fault occurrence. (The setting value minus 100 is the number of retries.) A fault output is provided during the retry operation.
68 H302	Retry waiting time	1 s	0.1 to 600 s	Set the time delay from when an inverter fault occurs until the retry operation starts.
69 H303	Retry count display erase	0	0	Setting "0" clears the retry success counter ("retry success" means that the inverter successfully restarts).

◆ Setting the retry function (Pr.67, Pr.68)

- When the inverter protective function is operating (fault indication), the retry function automatically cancels (resets) the protective function after the time set in **Pr.68**. The retry function then restarts the operation from the starting frequency.
- The retry function is enabled when the **Pr.67** setting is other than "0". Set the number of retries at activation of the protective function in **Pr.67**.

Pr.67 setting	Fault output during retry operation	Retry count
0	—	No retry function
1 to 10	Not available	1 to 10 times
101 to 110	Available	1 to 10 times

- When retries fail consecutively the number of times set in **Pr.67**, a retry count excess (E.RET) occurs, resulting in an inverter retries. (Refer to the Retry failure example.)
- Use **Pr.68** to set the waiting time from a protective function activation to a retry in the range of 0.1 to 600 s.
- During retry operation, the During retry (Y64) signal is ON. For the Y64 signal, set "64" (positive logic) or "164" (negative logic) in any parameter from **Pr.190 to Pr.197 (Output terminal function selection)** to assign the function.

◆ Retry count check (Pr.69)

- Reading the **Pr.69** value provides the cumulative number of successful restart times made by retries. The cumulative count in **Pr.69** increases by 1 when a retry is successful. Retry is regarded as successful when normal operation continues without a fault for the **Pr.68** setting multiplied by four or longer (3.1 seconds at the shortest). (When retry is successful, the cumulative number of retry failures is cleared.)

- Writing "0" in Pr.69 clears the cumulative count.

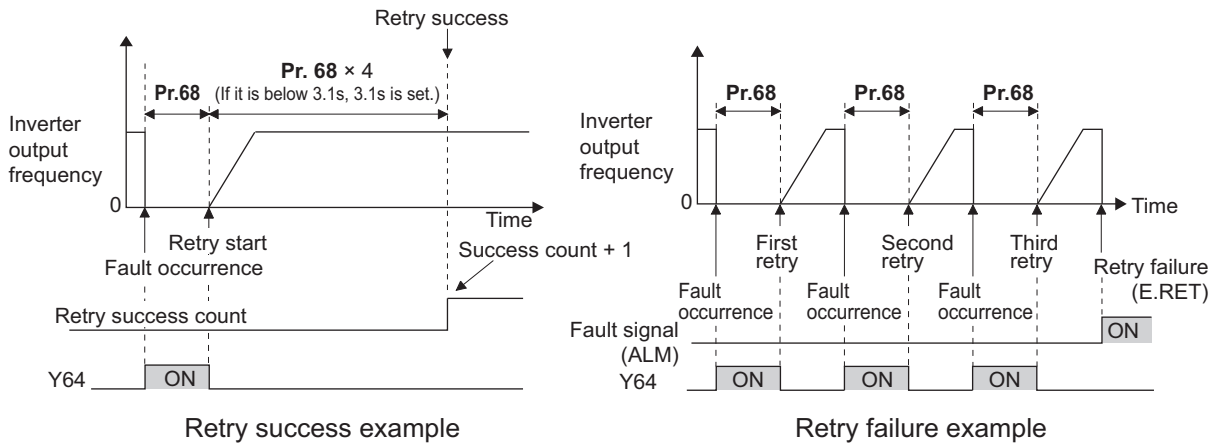

◆ Selecting retry generating faults (Pr.65)

- Using Pr.65, the fault that causes a retry is selectable. The faults not described in the following table do not enable the retry function. (For details on faults, refer to the Instruction Manual (Maintenance).) • indicates the faults selected for retry.

Retry-triggering fault	Pr.65 setting					
	0	1	2	3	4	5
E.OC1	•	•		•	•	•
E.OC2	•	•		•	•	
E.OC3	•	•		•	•	•
E.OV1	•		•	•	•	
E.OV2	•		•	•	•	
E.OV3	•		•	•	•	
E.THM	•					
E.THT	•					
E.UVT	•				•	
E.BE	•				•	
E.GF	•				•	
E.OHT	•					
E.OLT	•				•	
E.OPT	•				•	
E.OP1	•				•	
E.PE	•				•	
E.MB1	•				•	
E.MB2	•				•	

Retry-triggering fault	Pr.65 setting					
	0	1	2	3	4	5
E.MB3	•				•	
E.MB4	•				•	
E.MB5	•				•	
E.MB6	•				•	
E.MB7	•				•	
E.OA	•				•	
E.OS	•				•	
E.OSD	•				•	
E.PTC	•					
E.CDO	•				•	
E.USB	•				•	
E.ILF	•				•	
E.PID	•				•	
E.SOT	•	•		•	•	•
E.LUP	•				•	
E.LDN	•				•	
E.EHR	•				•	
E.10	•				•	

NOTE

- Use the retry function only when the operation can be resumed after resetting a protective function activation. Making a retry against the protective function, which is activated by an unknown condition, will lead the inverter and motor to be faulty. Identify and remove the cause of the protective function activation before restarting the operation.
- If the retry function operates during PU operations, the operating conditions (forward/reverse rotation) are stored; and operations resume after retry reset.
- Only the fault details for the first fault that occurred during retry are stored in the fault history.
- The reset by the retry function does not clear the accumulated data of the electronic thermal O/L relay, regenerative brake duty, etc. (This is different from power supply reset or reset by RES signal.)
- When the parameter storage device fault (control circuit board) (E.PE) is occurring and reading of the retry-function-related parameters is not possible, retry cannot be operated.
- Changing the terminal assignment using Pr.190 to Pr.197 (Output terminal function selection) may affect the other functions. Set parameters after confirming the function of each terminal.

⚠ CAUTION

- When the retry function is set enabled, stay away from the motor and machine in the case of an output shutoff. The motor and machine will start suddenly (after the reset time has elapsed) after the shutoff. When the retry function has been selected, apply the CAUTION sticker(s), which are found in the Inverter Safety Guideline enclosed with the inverter, to easily visible places.

« Parameters referred to »

Pr.57 Restart coasting time  [page 502](#), [page 508](#)

11.8 Emergency drive (Fire mode) (Standard model / Ethernet model)

V/F Magnetic flux Sensorless PM

The inverter can continue driving the motor in case of emergency such as a fire, since protective functions are not activated even if the inverter detects a fault. Using this function may damage the motor or inverter because driving the motor is given the highest priority. Use this function for emergency operation only. The operation can be switched to the commercial power supply operation at the occurrence of a fault which may cause damage of the inverter.

Pr.	Name	Initial value		Setting range	Description
		Gr.1	Gr.2		
523 H320	Emergency drive mode selection	9999		100, 111, 112, 121, 122, 200, 211, 212, 221, 222, 300, 311, 312, 321, 322, 400, 411, 412, 421, 422	Select the operation mode of the emergency drive.
				9999	Emergency drive disabled.
524 H321 ^{*1}	Emergency drive running speed	9999		0 to 590 Hz ^{*2}	Set the running frequency in the fixed frequency mode of the emergency drive (when the fixed frequency mode is selected in Pr.523).
				0% to 100% ^{*2}	Set the PID set point in the PID control mode of the emergency drive (when the PID control mode is selected in Pr.523).
				9999 ^{*2}	Emergency drive disabled.
515 H322	Emergency drive dedicated retry count	1		1 to 200	Set the retry count during emergency drive operation.
				9999 ^{*2}	Without retry count excess (no restriction on the number of retries).
1013 H323	Running speed after emergency drive retry reset	60 Hz	50 Hz	0 to 590 Hz	Set the frequency for operation after a retry when E.1 occurs during emergency drive operation.
514 H324	Emergency drive dedicated retry waiting time	9999		0.1 to 600 s	Set the retry waiting time during emergency drive operation.
				9999	The Pr.68 setting is applied to the operation.
136 A001	MC switchover interlock time	1 s		0 to 100 s	Set the operation interlock time for MC2 and MC3.
139 A004	Automatic switchover frequency from inverter to bypass operation	9999		0 to 60 Hz	Set the frequency at which the inverter-driven operation is switched over to the commercial power supply operation when the condition for the electronic bypass is established during emergency drive operation.
				8888, 9999	Electronic bypass during emergency drive is disabled.

*1 Set **Pr.523** before setting **Pr.524**.

*2 When **Pr.523** = "100, 200, 300, or 400", the emergency drive is activated regardless of the **Pr.524** setting.

NOTE

- The PLC function is available when emergency drive is enabled.
- Emergency drive is enabled when **Pr.800 Control method selection** = "10, 19, 20, or 40" and **Pr.451 Second motor control method selection** = "10, 20, 40, or 9999".

◆ Connection diagram

- The following diagram shows a connection example for emergency drive operation (in the commercial mode).

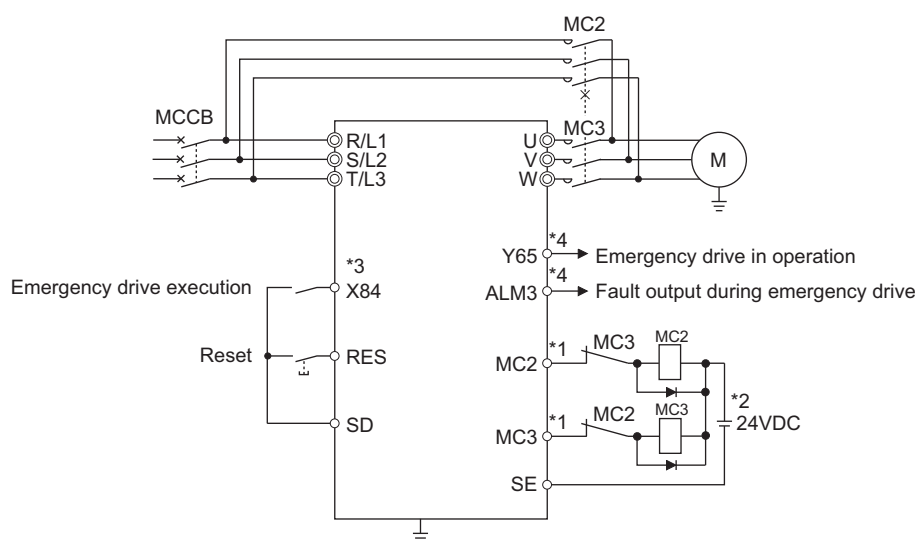

- *1 Be careful of the capacity of the sequence output terminals.
The applied terminals differ by the settings of **Pr.190 to Pr.192, and Pr.197 (Output terminal function selection)**.

Output terminal capacity	Output terminal permissible load
Open collector output of inverter (RUN, FU)	24 VDC 0.1 A
Inverter relay output (A-C, B-C)	240 VAC 2 A 30 VDC 1 A
Relay output option (FR-A8AR)	230 VAC 0.3 A 30 VDC 0.3 A

- *2 When connecting a DC power supply, insert a protective diode.
When connecting an AC power supply, use relay output terminals of the inverter or contact output terminals of the relay output option (FR-A8AR).
- *3 The applied terminals differ by the settings of **Pr.180 to Pr.184 (Input terminal function selection)**
- *4 The applied terminals differ by the settings of **Pr.190 to Pr.192, and Pr.197 (Output terminal function selection)**.

NOTE

- Be sure to provide a mechanical interlock for MC2 and MC3.
- The emergency drive function is disabled when the Inverter run enable (X10) signal is assigned.

◆ Emergency drive execution sequence

Point

- When the X84 signal is ON for 3 seconds, the emergency drive is activated.
- The Y65 signal is ON during emergency drive operation.
- "ED" is displayed on the operation panel during emergency drive operation.
- The ALM3 signal is ON when a fault occurs during emergency drive operation.
- For protective functions (faults) valid during emergency drive operation, refer to [page 327](#).

- The following diagram shows the operation of the emergency drive function (in the retry / output shutoff mode or in the fixed frequency mode (**Pr.523** = "211")).

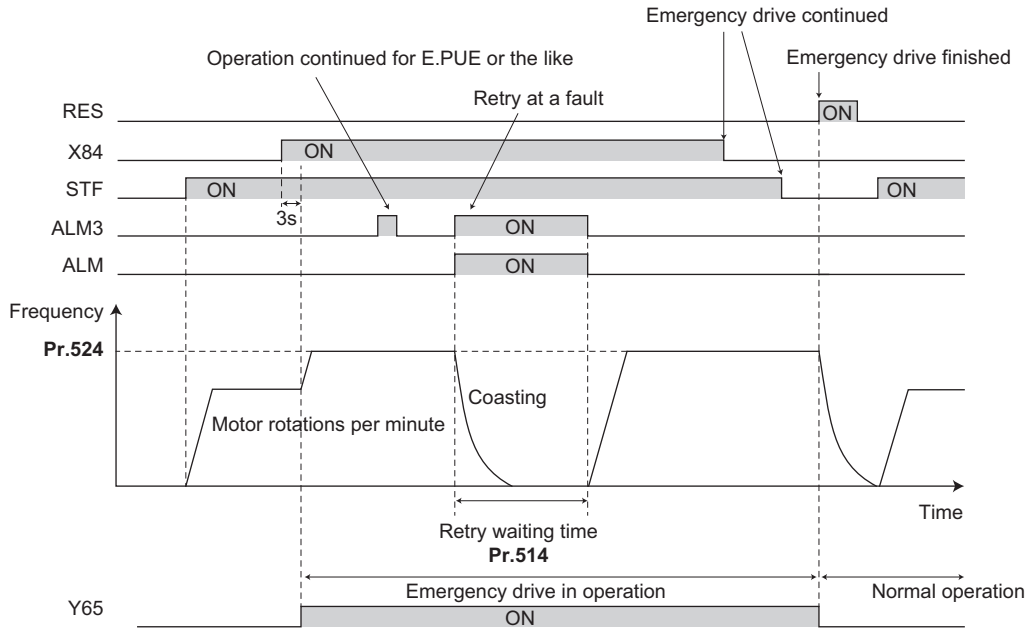

- The following diagram shows the operation of switching over to the commercial power supply operation during emergency drive operation at a fault occurrence (in the commercial mode or in the fixed frequency mode (**Pr.523** = "411")).

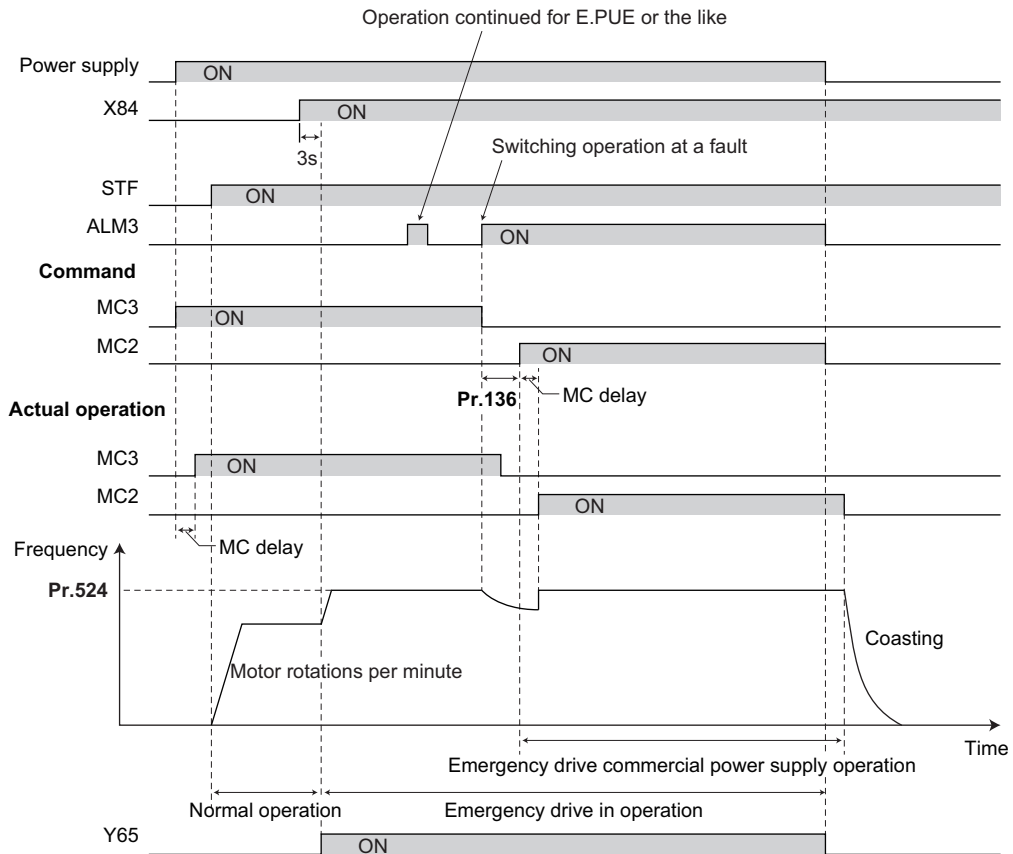

- The following diagram shows the operation when the commercial power supply operation during emergency drive is switched OFF using the X51 signal (in the commercial mode or in the fixed frequency mode (**Pr.523** = "411")).

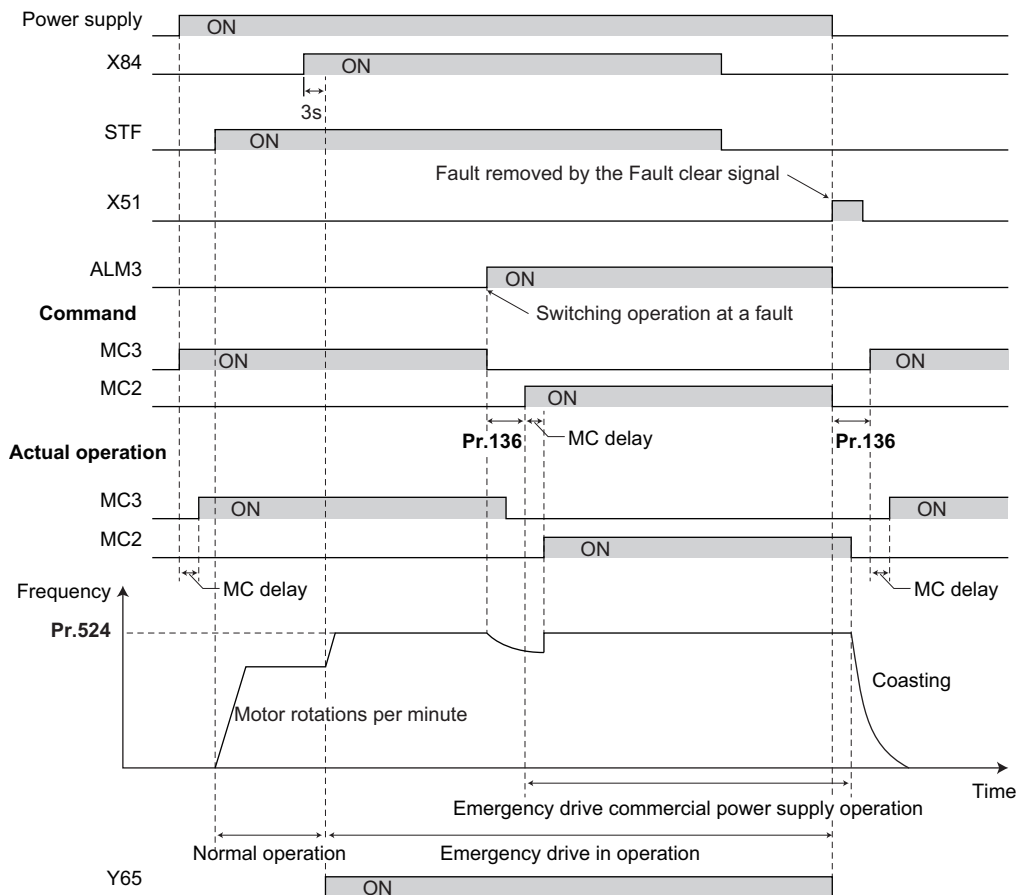

◆ Emergency drive operation selection (Pr.523, Pr.524)

- Use **Pr.523 Emergency drive mode selection** to select the emergency drive operation. Set a value in the hundreds place to select the operation when a valid protective function is activated (fault) during emergency drive operation. Set values in the ones and tens places to select the operation method.
- For protective functions (faults) valid during emergency drive operation, refer to [page 327](#).

Pr.523 setting	Emergency drive operation mode		Description
1□□	Output shutoff mode		Output shutoff when a fault occurs.
2□□	Retry / output shutoff mode		Retry operation when a fault occurs. Output shutoff when a fault for which retry is not permitted occurs or when the retry count is exceeded.
3□□ ^{*1}	Retry / commercial mode		Retry operation when a fault occurs. The operation is switched over to the commercial power supply operation when a fault for which retry is not permitted occurs or when the retry count is exceeded. While Pr.515 = "9999", the operation is switched over to the commercial power supply operation when the retry count reaches 200.
4□□ ^{*1}	Commercial mode		The operation is switched over to the commercial power supply operation when a fault occurs.
□00	Normal operation		The operation is performed with the same set frequency and by the same start command as those in the normal operation. Use this mode to avoid output shutoff due to a fault.
□11	Fixed frequency mode	Forward rotation	The operation is forcibly performed with the frequency set in Pr.524 . Even when the motor is stopped, the operation is started by the emergency drive operation.
□12		Reverse rotation	
□21	PID control mode	Forward rotation	The operation is performed under PID control using the Pr.524 setting as a set point. The measured values are input in the method set in Pr.128 .
□22		Reverse rotation	
9999	Emergency drive disabled.		

*1 Under PM sensorless vector control, the operation is not switched over to the commercial power supply operation and the output is shut off.

◆ Retry operation during emergency drive operation (Pr.515, Pr.514)

- Set the retry operation during emergency drive operation. Use **Pr.515 Emergency drive dedicated retry count** to set the retry count, and use **Pr.514 Emergency drive dedicated retry waiting time** to set the retry waiting time.
- The ALM signal output conditions depend on the **Pr.67 Number of retries at fault occurrence** setting. The signal is not output when **Pr.67** = "0". (Refer to [page 319](#).)
- For the protective functions (faults) for which retry is permitted during emergency drive operation, refer to [page 327](#).

NOTE

- The **Pr.65 Retry selection** is disabled during emergency drive operation.

◆ Electronic bypass during emergency drive (Pr.136, Pr.139)

- For selecting the commercial mode (**Pr.523** = "3□□, 4□□"), setting is required as follows.
Set **Pr.136 MC switchover interlock time** and **Pr.139 Automatic switchover frequency from inverter to bypass operation** and assign the MC2 and MC3 signals to output terminals.
Select V/F control, Advanced magnetic flux vector control, or Real sensorless vector control. (Under PM sensorless vector control, the operation is not switched over to the commercial power supply operation and the output is shut off.)
- During emergency drive operation, the operation is switched over to the commercial power supply operation when any of the following conditions is satisfied.
A fault for which retry is not permitted occurs while **Pr.523** = "3□□".
A fault occurs while **Pr.523** = "4□□".
- While the motor is driven by the inverter during emergency drive operation, if a condition for electronic bypass is satisfied, the output frequency is accelerated/decelerated to the **Pr.139** setting. When the frequency reaches the set frequency, the operation is switched over to the commercial power supply operation. (The operation is immediately switched over to the commercial power supply operation during output shutoff due to a fault occurrence.)
- If the parameter for electronic bypass is not set while the commercial mode is set (**Pr.523** = "3□□, 4□□"), the operation is not switched over to the commercial power supply operation even when a condition for switchover is satisfied, and the output is shut off.
- To assign the MC2 and MC3 signals to output terminals, use any two parameters from **Pr.190 to Pr.192, and Pr.197 (Output terminal function selection)** and set "18" (positive logic) for the MC2 signal and set "19" (positive logic) for the MC3 signal.
- Operation of magnetic contactor (MC2, MC3)

Magnetic contactor	Installation location	Operation	
		During commercial power supply operation	During inverter operation
MC2	Between power supply and motor	Shorted	Open
MC3	Between inverter output side and motor	Open	Shorted

- The input signals are as follows.

Signal	Function	Operation	MC operation ^{*2}	
			MC2	MC3
X84	Emergency drive operation	ON: Emergency drive operation	—	—
		OFF: Normal operation ^{*1}	×	○
RES	Operation status reset	ON: Reset	×	Unchanged
		OFF: Normal operation	—	—

*1 The operation is not switched over to the normal operation even when the signal is turned OFF during emergency drive operation.

*2 MC operation is as follows.

Mark	MC operation
○	ON
×	OFF
—	During inverter operation: MC2-OFF, MC3-ON During commercial power supply operation: MC2-ON, MC3-OFF
Unchanged	The status of the MC remains the same after turning ON or OFF the signal.

◆ PID control during emergency drive operation

- The **Pr.524** setting is used as a set point for operation during emergency drive operation in the PID control mode. Input the measured values in the method set in **Pr.128**.
- While the retry is selected (**Pr.523** = "22[], 32[]") in the PID control mode, if a retry occurs at the occurrence of E.1 during emergency drive operation, the operation is performed not under PID control but with the fixed frequency. Use **Pr.1013 Running speed after emergency drive retry reset** to set the fixed frequency.

NOTE

- Refer to [page 479](#) for details of PID control.

◆ Protective functions during emergency drive operation

- Protective functions during emergency drive operation are as follows.

Protective functions	Operation during emergency drive
E.OC1	Retry
E.OC2	Retry
E.OC3	Retry
E.OV1	Retry
E.OV2	Retry
E.OV3	Retry
E.THT	Retry
E.THM	Retry
E.FIN	Retry
E.UVT	The function is disabled.*1
E.ILF	The function is disabled.*1
E.OLT	Retry
E.SOT	Retry
E.LUP	The function is disabled.
E.LDN	The function is disabled.
E.BE	Retry*2
E.GF	Retry
E.LF	The function is disabled.*1
E.OHT	Retry

Protective functions	Operation during emergency drive
E.PTC	Retry
E.OPT	The function is disabled.
E.OP1	The function is disabled.
E.16	The function is disabled.
E.17	The function is disabled.
E.18	The function is disabled.
E.19	The function is disabled.
E.20	The function is disabled.
E.PE6	The function is disabled.
E.PE	Output shutoff
E.PUE	The function is disabled.
E.RET	Output shutoff
E.PE2	Output shutoff
E.CPU	Output shutoff
E.CDO	Retry
E.IOH	Output shutoff
E.AIE	The function is disabled.
E.USB	The function is disabled.
E.SAF	Retry*2

Protective functions	Operation during emergency drive
E.OS	The function is disabled.
E.OSD	The function is disabled.
E.ECT	The function is disabled.
E.OD	The function is disabled.
E.MB1 to E.MB7	The function is disabled.
E.OA	The function is disabled.
E.PID	The function is disabled.
E.EHR	The function is disabled.
E.CMB	Output shutoff
E.1	Retry*3
E.5	Output shutoff
E.6	Output shutoff
E.7	Output shutoff
E.10	Retry
E.11	The function is disabled.
E.13	Retry*2

*1 If the total number of activations of a certain protective function (E.UVT, E.ILF, or E.LF) reaches the number of retries while the electronic bypass during emergency drive operation is enabled, the operation is switched over to the commercial power supply operation when the output frequency is increased/decreased to the **Pr.139** setting.

*2 If the same protective function is activated continuously while the electronic bypass during emergency drive operation is enabled, retry is performed up to twice and then operation is switched over to the commercial power supply operation.

*3 In normal operation (**Pr.523** = "200 or 300"), the start signal is turned OFF at the same time the retry function resets the protective function. Input the start signal again to resume the operation.

- Fault output during emergency drive operation is as follows.

Signal	Setting of Pr.190 to Pr.192, or Pr.197		Description
	Positive logic	Negative logic	
Y65	65	165	The signal is ON during emergency drive operation.
ALM3	66	166	The signal is output when a fault occurs during emergency drive operation. When a fault which does not activate protective functions occurs during emergency drive operation, the signal is ON for three seconds and then turned OFF.

◆ Input signal operation

- During emergency drive operation in the fixed frequency mode or in the PID control mode, input signals unrelated to the emergency drive become invalid with some exceptions.

- The following table shows functions of the signals that do not become invalid during emergency drive operation in the fixed frequency mode or in the PID control mode.

Input signal status	Fixed frequency mode	PID control mode
Valid	OH, TRG, TRC, X51, RES	OH, TRG, TRC, X51, RES
Held	RT, X18, MC, SQ, X84	RT, X16, X18, MC, SQ, X65, X66, X67, X84
Always-ON	—	X14

◆ Emergency drive status monitor

- Set "68" in **Pr.52, Pr.774 to Pr.776, Pr.992** to monitor the status of the emergency drive on the operation panel.
- Description of the status monitor

Operation panel indication	Description		
	Emergency drive setting	Emergency drive operating status	
0	Emergency drive function setting is not available.	—	
1	Electronic bypass during emergency drive operation is disabled.	During normal operation	
2		Operating properly	
3		A certain alarm is occurring. ^{*2}	
4		A fault is occurring. The operation is being continued by the retry.	
5		A fault is occurring. The continuous operation is not allowed due to output shutoff.	
10	Parameter settings for electronic bypass during emergency drive operation are enabled.	During normal operation	
11	Electronic bypass during emergency drive operation is enabled.	Emergency drive in operation	
12			Operating properly
13			A certain alarm is occurring. ^{*2}
14			A fault is occurring. The operation is being continued by the retry.
15			A fault is occurring. The continuous operation is not allowed due to output shutoff.
2□ ^{*1}		Electronic bypass is started during emergency drive (during acceleration/deceleration to the switchover frequency).	
3□ ^{*1}	During electronic bypass during emergency drive (waiting during the interlock time).		
4□ ^{*1}	During commercial power supply operation during emergency drive		

*1 The value in the ones place indicates the previous displayed value (the setting at a fault occurrence).

*2 "A certain alarm" means a protective function disabled during emergency drive shown in the tables on [page 327](#).

NOTE

- When the retry is selected (**Pr.523** = "2[] [], 3[] []"), it is recommended to use the automatic restart after instantaneous power failure function at the same time.
- During emergency drive operation, parameter setting, Parameter clear, All parameter clear, and Parameter copy are disabled.
- When the emergency drive function is canceled while the X84 signal is ON, "0 or 10" is displayed on the emergency drive status monitor.
- To return to the normal operation during emergency drive operation, turn OFF the start command and the X84 signal, and then do the following. (The operation will not be returned to normal only by turning OFF the X84 signal.)
Reset the inverter, or turn OFF the power.
Clear a fault by turning ON the X51 signal while the sequence function is enabled (when the protective function is activated).
- When the operation is switched from an emergency drive mode (other than normal operation mode) to normal using the X51 signal, the "Emergency drive in operation" status is retained.
- The operation is switched over to the commercial power supply operation in case of the following during emergency drive operation while the commercial mode or the retry / commercial mode is selected. Note that the MC2 signal is OFF at an undervoltage even when the operation is switched over to the commercial power supply operation.
During 24 V external power supply operation (when the FR-E8DS is installed), at a power failure, at an undervoltage (E.UVT)
- The emergency drive function is disabled when **Pr.30** = "2 or 102" to enable the automatic restart after instantaneous power failure function when using the multifunction regeneration converter (FR-XC), power regeneration common converter (FR-CV), and high power factor converter (FR-HC2).
- The emergency drive function is disabled under the following conditions.
Under Vector control, during auto tuning, when the brake sequence function is enabled, or when the X10 signal is assigned

 CAUTION

- When the emergency drive function is enabled, the operation is continued or the retry operation (automatic reset and restart) is repeated even if a fault occurs, which may damage or burn this product and the motor. Before restarting the normal operation after emergency drive operation, make sure that this product and the motor have no fault. Any damage of the inverter or the motor caused by using the emergency drive function is not covered by the warranty even within the guarantee period.

 Parameters referred to

Pr.68 Retry waiting time  page 319

Pr.128 PID action selection  page 479

Pr.800, Pr.451 Control method selection  page 115

C42 (Pr.934) to C45 (Pr.935) (PID display bias/gain)  page 492

11.9 Checking faulty area in the internal storage device

When E.PE6 (Internal storage device fault) occurs, faulty area in the internal storage device can be checked by reading **Pr.890**. When the read value of **Pr.890** is "7" or smaller, an inverter reset after All parameter clear can return the operation to normal. (The parameters that had been changed before All parameter clear must be set again.)

Pr.	Name	Initial value	Setting range	Description
890 H325	Internal storage device status indication	0	(0 to 255)	A detected faulty area can be indicated in the internal storage device. (Read-only)



- Use the read value of **Pr.890** to check the faulty area.

The following table shows faulty areas indicated by the read value of **Pr.890**. Some read values indicate that there are multiple faulty areas. (For example, the read value "7" indicates that all the areas described in No. 1 to No. 3 are faulty.)

No.	Read value	Description
1	1, 3, 5, 7	Storage area other than the area for parameter settings is faulty (such as area for the set frequency). (When All parameter clear is performed, the set frequency, remotely-set frequency, host name for Ethernet communication, and offline auto tuning data are cleared.)
2	2, 3, 6, 7	Storage area for standard parameter settings is faulty.
3	4, 5, 6, 7	Storage area for communication parameter settings is faulty.
4	8 to 255	Area for manufacturer setting

11.10 Limiting the output frequency (maximum/minimum frequency)

Motor speed can be limited. Clamp the upper and lower limits of the output frequency.

Pr.	Name	Initial value	Setting range	Description
1 H400	Maximum frequency	120 Hz	0 to 120 Hz	Set the upper limit of the output frequency.
2 H401	Minimum frequency	0 Hz	0 to 120 Hz	Set the lower limit of the output frequency.
18 H402	High speed maximum frequency	120 Hz	0 to 590 Hz	Set when operating at a frequency higher than 120 Hz.

◆ Setting the maximum frequency (Pr.1, Pr.18)

- Set **Pr.1 Maximum frequency** to the upper limit of the output frequency. If the value of the frequency command given is higher than the setting, the output frequency is clamped at the maximum frequency.
- To operate at a frequency higher than the 120 Hz, adjust the upper output frequency limit with **Pr.18 High speed maximum frequency**. (When setting a frequency in **Pr.18**, the **Pr.1** setting automatically changes to the frequency set in **Pr.18**. Also, when a frequency is set in **Pr.1**, the **Pr.18** setting automatically changes to the frequency set in **Pr.1**.)

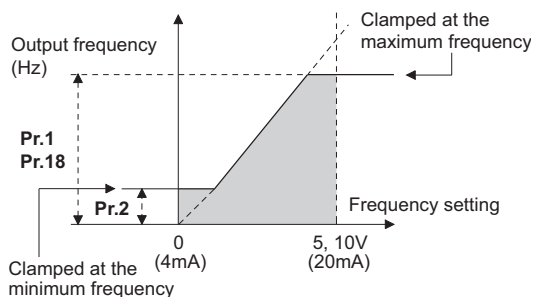

◆ Setting the minimum frequency (Pr.2)

- Set **Pr.2 Minimum frequency** to the lower limit of the output frequency.
- If the set frequency is less than the **Pr.2** setting, the output frequency is clamped at the **Pr.2** setting (does not fall below the **Pr.2** setting).

NOTE

- To operate with a frequency higher than 60 Hz using frequency-setting analog signals, change the **Pr.125 (Pr.126) (frequency setting gain)** setting. Simply changing the **Pr.1** and **Pr.18** settings does not enable the operation at a frequency higher than 60 Hz.
- Under Real sensorless vector control and PM sensorless vector control, the upper and lower limits are for the commanded frequency. The final output frequency that is decided by each control may exceed the lower or upper limits.
- When **Pr.15 Jog frequency** is less than the **Pr.2** setting, the **Pr.15** setting takes precedence.
- If a jump frequency that exceeds the setting of **Pr.1 (Pr.18)** is set, the maximum frequency setting is the set frequency. If the jump frequency is less than the setting of **Pr.2**, the jump frequency is the set frequency. (The set frequency can be less than the minimum frequency.) When stall prevention is activated to decrease the output frequency, the output frequency may drop below the setting of **Pr.2**.

CAUTION

- Note that when **Pr.2** is set to any value equal to or higher than **Pr.13 Starting frequency**, simply turning ON the start signal runs the motor at the frequency set in **Pr.2** even if the command frequency is not given.

Parameters referred to

Pr.13 Starting frequency [page 274](#), [page 275](#)

Pr.15 Jog frequency [page 301](#)

Pr.125 Terminal 2 frequency setting gain frequency, Pr.126 Terminal 4 frequency setting gain frequency [page 400](#)

11.11 Avoiding machine resonance points (frequency jump)

When it is desired to avoid resonance attributable to the natural frequency of a mechanical system, these parameters allow resonant frequencies to be jumped.

Pr.	Name	Initial value	Setting range	Description
31 H420	Frequency jump 1A	9999	0 to 590 Hz, 9999	1A to 1B, 2A to 2B, 3A to 3B are frequency jumps 9999: Function disabled
32 H421	Frequency jump 1B			
33 H422	Frequency jump 2A			
34 H423	Frequency jump 2B			
35 H424	Frequency jump 3A			
36 H425	Frequency jump 3B			
552 H429	Frequency jump range	9999	0 to 30 Hz 9999	Set the jump range for the frequency jumps (6-point jump). 3-point jump

◆ 3-point frequency jump (Pr.31 to Pr.36)

- Up to three areas may be set, with the jump frequencies set to either the top or bottom point of each area.
- The settings of frequency jumps 1A, 2A, 3A are jump points, and operation is performed at these frequencies in the jump areas.

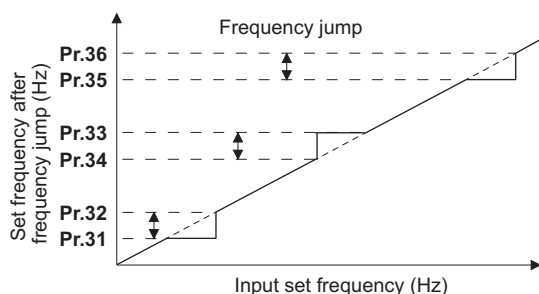

Example 1) To fix the frequency to 30 Hz in the range of 30 Hz to 35 Hz, set 35 Hz in **Pr.34** and 30 Hz in **Pr.33**.

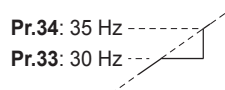

Example 2) To jump the frequency to 35 Hz in the range of 30 Hz to 35 Hz, set 35 Hz in **Pr.33** and 30 Hz in **Pr.34**.

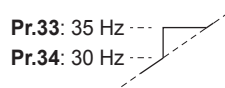

◆ 6-point frequency jump (Pr.552)

- A total of six jump areas can be set by setting the common jump range for the frequencies set in **Pr.31 to Pr.36**.
- When frequency jump ranges overlap, the lower limit of the lower jump range and the upper limit of the upper jump range are used.

- When the set frequency decreases and falls within the jump range, the upper limit of the jump range is the set frequency. When the set frequency increases and falls within the jump range, the lower limit of the jump range is the set frequency.

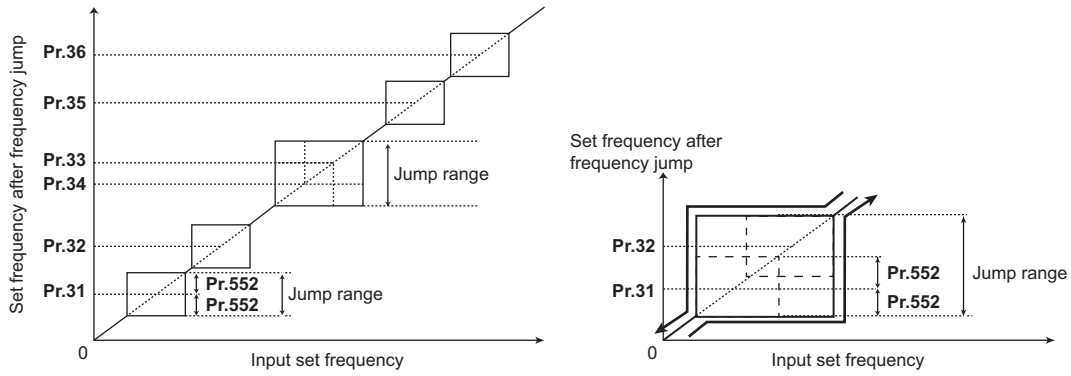

NOTE

- During acceleration/deceleration, the frequency within the set area is valid.
- If the setting ranges of individual groups (1A and 1B, 2A and 2B, 3A and 3B) overlap, Parameter write error (Er1) occurs.
- Setting **Pr.552** = "0" disables frequency jumps.
- If a jump frequency that exceeds the setting of **Pr.1 (Pr.18) Maximum frequency** is set for the 3-point frequency jump, the maximum frequency setting is the set frequency. If the jump frequency is less than the setting of **Pr.2 Minimum frequency**, the jump frequency is the set frequency. (The set frequency can be less than the minimum frequency.)

Example with 6-point frequency jump

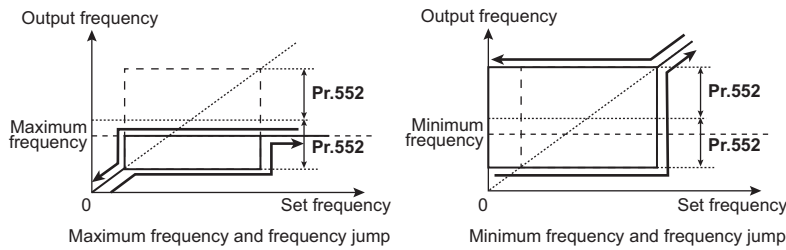

Parameters referred to

Pr.1 Maximum frequency, Pr.2 Minimum frequency, Pr.18 High speed maximum frequency [page 331](#)

11.12 Stall prevention operation



This function monitors the output current and automatically changes the output frequency to prevent the inverter from shutting off due to overcurrent, overvoltage, etc. It can also limit the stall prevention and fast-response current limit operation during acceleration/deceleration and power/regenerative driving.

This function is disabled under Real sensorless vector control, Vector control, and PM sensorless vector control.

- Stall prevention:
If the output current exceeds the stall prevention operation level, the output frequency of the inverter is automatically changed to reduce the output current. Also, the second stall prevention function can limit the output frequency range in which the stall prevention function is enabled.
- Fast-response current limit:
If the current exceeds the limit value, the output of the inverter is shut off to prevent an overcurrent.

Pr.	Name	Initial value ^{*1}		Setting range	Description	
		Gr.1	Gr.2			
22 H500	Stall prevention operation level	150%		0	Stall prevention operation disabled.	
				0.1% to 400% ^{*2}		Set the current limit at which the stall prevention operation starts.
156 H501	Stall prevention operation selection	0		0 to 31, 100, 101	Enable/disable the stall prevention operation and the fast-response current limit operation.	
48 H600	Second stall prevention operation level	9999		0	Second stall prevention operation disabled.	
				0.1% to 400% ^{*2}		The stall prevention operation level can be changed using the RT signal.
				9999		Same as Pr.22 .
23 H610	Stall prevention operation level compensation factor at double speed	9999		0% to 200%	The stall operation level when running at high speeds above the rated frequency can be reduced.	
				9999		Stall prevention operation disabled at double speed.
66 H611	Stall prevention operation reduction starting frequency	60 Hz	50 Hz	0 to 590 Hz	Set the frequency at which the stall operation level reduction starts.	
154 H631	Voltage reduction selection during stall prevention operation	1		1	Does not suppress the overvoltage protective function	
				11		Suppresses the overvoltage protective function
157 M430	OL signal output timer	0 s		0 to 25 s	Set the OL signal output start time when stall prevention is activated.	
				9999		No OL signal output.
277 H630	Stall prevention operation current switchover	0		0	Stall prevention is activated when the output current exceeds the stall prevention operation level.	
				1		Stall prevention is activated when the output torque (current equivalent to the torque) exceeds the stall prevention operation level.

*1 Gr.1 and Gr.2 are the parameter initial value groups. (Refer to page 54).

*2 The upper limit of stall prevention operation is limited internally to the following.
150% (LD rating), 200% (ND rating)

◆ Setting of stall prevention operation level (Pr.22)

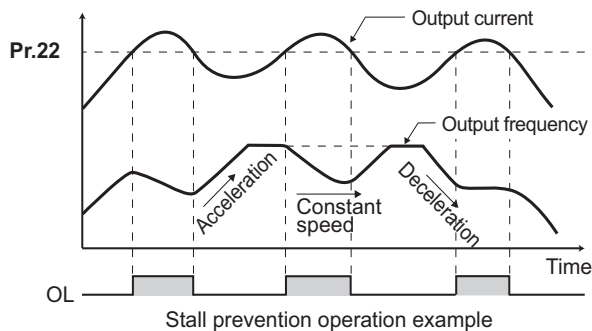

- For **Pr.22 Stall prevention operation level**, set the ratio of the output current to the inverter's rated current at which the stall prevention operation is activated. Normally, use this parameter in the initial setting.
- Stall prevention operation stops acceleration (makes deceleration) during acceleration, makes deceleration during constant speed, and stops deceleration during deceleration.
- When the stall prevention operation is performed, the Overload warning (OL) signal is output.

NOTE

- A continuous overloaded condition may activate a protective function such as motor overload trip (electronic thermal O/L relay function) (E.THM).
- When **Pr.156** has been set to activate the fast response current limit (initial value), the **Pr.22** setting should not be equal to or higher than 170%. Such setting prevents torque generation.
- When Real sensorless vector control or Vector control is selected using **Pr.800 Control method selection**, **Pr.22** serves as the torque limit level.

◆ Disabling the stall prevention operation and fast-response current limit according to operating conditions (Pr.156)

- Referring to the following table, enable/disable the stall prevention operation and the fast-response current limit operation, and also set the operation at OL signal output.

Pr.156 setting	Fast-response current limit ○: enabled ●: disabled	Stall prevention operation selection ○: enabled ●: disabled			Operation during stall prevention ○: continued ●: stopped ^{*1}
		Acceleration	Constant speed	Deceleration	
0 (initial value)	○	○	○	○	○
1	●	○	○	○	○
2	○	●	○	○	○
3	●	●	○	○	○
4	○	○	●	○	○
5	●	○	●	○	○
6	○	●	●	○	○
7	●	●	●	○	○
8	○	○	○	●	○
9	●	○	○	●	○
10	○	●	○	●	○
11	●	●	○	●	○
12	○	○	●	●	○
13	●	○	●	●	○
14	○	●	●	●	○
15	●	●	●	●	— ^{*2}
16	○	○	○	○	●
17	●	○	○	○	●
18	○	●	○	○	●
19	●	●	○	○	●
20	○	○	●	○	●
21	●	○	●	○	●
22	○	●	●	○	●
23	●	●	●	○	●
24	○	○	○	●	●
25	●	○	○	●	●
26	○	●	○	●	●
27	●	●	○	●	●
28	○	○	●	●	●
29	●	○	●	●	●
30	○	●	●	●	●
31	●	●	●	●	— ^{*2}
100 ^{*3}	Power driving	○	○	○	○
	Regenerative driving	●	●	●	— ^{*2}
101 ^{*3}	Power driving	●	○	○	○
	Regenerative driving	●	●	●	— ^{*2}

*1 When "operation stop at OL signal output" is selected, the fault output "E.OLT" (stop due to stall prevention) is displayed, and operation stops.

*2 The OL signal and E.OLT are not output because fast-response current limit and stall prevention are not operating.

*3 Setting values "100, 101" can be individually set for power driving and regenerative driving. The setting value "101" disables the fast-response current limit during power driving.

NOTE

- When the load is heavy or the acceleration/deceleration time is short, stall prevention operates and acceleration/deceleration may not be performed according to the time set. Set **Pr.156** and stall prevention operation level to the optimum values.
- For lift applications, make settings to disable the fast-response current limit. Otherwise, the torque may be insufficient, causing the load to drop.

◆ Adjusting the stall prevention operation signal and output timing (OL signal, Pr.157)

- If the output current exceeds the stall prevention operation level and stall prevention is activated, or the fast-response current limit is enabled, Overload warning (OL) signal turns ON for 100 ms or more. The output signal turns OFF when the output current falls to the stall prevention operation level or less.
- **Pr.157 OL signal output timer** can be used to set whether to output the OL signal immediately, or whether to output it after a certain time period has elapsed.
- This function also operates during regeneration avoidance operation ("OLV" (overvoltage stall)).
- For the OL signal, set "3" (positive logic) or "103" (negative logic) in any parameter from **Pr.190 to Pr.197 (Output terminal function selection)** to assign the function to an output terminal.

Pr.157 setting	Description
0 (initial value)	Output immediately.
0.1 to 25	Output after the set time (s).
9999	Not output.

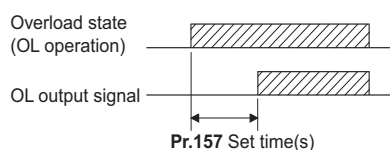

NOTE

- If the stall prevention operation has lowered the output frequency to 1 Hz and kept the level for 3 seconds, the stall prevention stop (E.OLT) is activated to shut off the inverter output.
- Changing the terminal assignment using **Pr.190 to Pr.197 (Output terminal function selection)** may affect the other functions. Set parameters after confirming the function of each terminal.

◆ Setting for stall prevention operation in the high-frequency range (Pr.22, Pr.23, Pr.66)

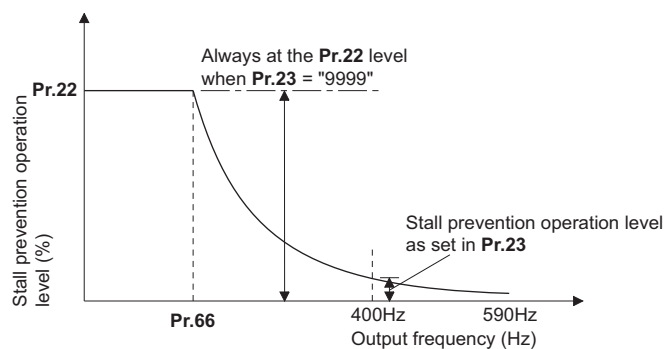

Setting example (Pr.22 = 120%, Pr.23 = 100%, Pr.66 = 60Hz)

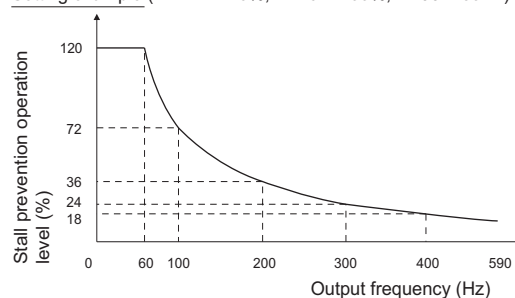

- When operating at high speeds above the rated motor frequency, acceleration may not be made as the motor current does not increase. Also, when operating in the high-frequency range, the current flowing to the locked motor becomes less than the rated output current of the inverter. Even if the motor is stopped, the protective function does not operate (OL). In a case like this, the stall prevention level can be reduced in the high-frequency range to improve the motor's operating characteristics. This is useful when operating up to the high speed range, such as when using a centrifuge. Normally, set **Pr.66 Stall prevention operation reduction starting frequency** to 60 Hz, and **Pr.23 Stall prevention operation level compensation factor at double speed** to 100%.

- Calculation formula for stall prevention operation level

$$\text{Stall prevention operation level (\% in the high-frequency range)} = A + B \times \left[\frac{\text{Pr.22} - A}{\text{Pr.22} - B} \right] \times \left[\frac{\text{Pr.23} - 100}{100} \right]$$

$$\text{Where, } A = \frac{\text{Pr.66 (Hz)} \times \text{Pr.22 (\%)}}{\text{Output frequency (Hz)}}, B = \frac{\text{Pr.66 (Hz)} \times \text{Pr.22 (\%)}}{400 \text{ Hz}}$$

- When **Pr.23 = "9999"** (initial value), the stall prevention operation level is constant at the **Pr.22** level up to 590 Hz.

◆ Protecting equipment and limiting the load by the torque limit (Pr.277)

- Set **Pr.277 Stall prevention operation current switchover** = "1" to enable the torque limit.
- If the output torque (current equivalent to the torque) exceeds the stall prevention operation level, the output torque is limited by adjusting the output frequency. The stall prevention operation level in such a case is based on the rating torque of the motor.

NOTE

- The torque limit cannot work properly when two or more motors are driven by one inverter.
- In the constant power range (**Pr.3 Base frequency**), the torque limit is activated at the torque less than the stall prevention operation level, since the magnetic flux decreases.
- When the torque limit is activated during regenerative driving, the output frequency is increased up to the maximum frequency.
- The torque limit is not activated at the frequency of 5 Hz or less during deceleration.
- When using the torque limit under V/F control, note the following points:
 - Use the inverter whose capacity is the same as that of the motor.
 - The stall prevention operation level (torque limit level) is based on the rating torque of the motor whose capacity is the same as that of the inverter.
 - When a large value is set in **Pr.0 Torque boost**, the torque limit may be activated in the low-speed range.
 - If more accurate torque limit is required, select Advanced magnetic flux vector control.

◆ Setting two stall prevention operation levels (Pr.48)

- Turning ON the RT signal enables **Pr.48 Second stall prevention operation level**.
- To input the RT signal, set "3" in any parameter from **Pr.178 to Pr.189 (Input terminal function selection)** to assign the function.

NOTE

- Changing the terminal assignment using **Pr.178 to Pr.189 (Input terminal function selection)** may affect the other functions. Set parameters after confirming the function of each terminal.
- The RT signal is the Second function selection signal which also enables other second functions. (Refer to [page 418](#)).

◆ Further prevention of a trip (Pr.154)

- Set **Pr.154** = "11" when the overvoltage protective function (E.OV[]) is activated during stall prevention operation in an application with large load inertia. Note that turning OFF the start signal (STF/STR) or varying the frequency command during stall prevention operation may delay the acceleration/deceleration start.

⚠ CAUTION

- Do not set the stall prevention operation current too low.
Doing so will reduce the generated torque.
- Be sure to perform the test operation.
Stall prevention operation during acceleration may extend the acceleration time.
Stall prevention operation during constant-speed operation may cause sudden speed changes.
Stall prevention operation during deceleration may extend the deceleration time.

« Parameters referred to »»

Pr.22 Torque limit level  [page 139](#)

Pr.178 to Pr.189 (Input terminal function selection)  [page 410](#)

Pr.190 to Pr.197 (Output terminal function selection)  [page 371](#)

11.13 Load characteristics fault detection

This function is used to monitor whether the load is operating in normal condition by storing the speed/torque relationship in the inverter to detect mechanical faults or for maintenance. When the load operating condition deviates from the normal range, the protective function is activated or the warning is output to protect the inverter or the motor.

Pr.	Name	Initial value ^{*1}		Setting range	Description
		Gr.1	Gr.2		
1480 H520	Load characteristics measurement mode	0		0	Load characteristics measurement mode does not start. (Measurement of load characteristics complete without fault.)
				1	Load characteristics measurement mode is started.
				(2 to 5, 81 to 85)	The load characteristics measurement status is displayed. (Read-only)
1481 H521	Load characteristics load reference 1	9999		0% to 400%	Used to set the reference value of normal load characteristics. 8888: The present load status is written as reference status. 9999: The load reference is invalid.
1482 H522	Load characteristics load reference 2	9999			
1483 H523	Load characteristics load reference 3	9999			
1484 H524	Load characteristics load reference 4	9999			
1485 H525	Load characteristics load reference 5	9999			
1486 H526	Load characteristics maximum frequency	60 Hz	50 Hz	0 to 590 Hz	Used to set the upper frequency limit of the load characteristics fault detection range.
1487 H527	Load characteristics minimum frequency	6 Hz		0 to 590 Hz	Used to set the lower frequency limit of the load characteristics fault detection range.
1488 H531	Upper limit warning detection width	20%		0% to 400%	Used to set the detection range of when the upper limit load fault warning is output.
				9999	Function disabled
1489 H532	Lower limit warning detection width	20%		0% to 400%	Used to set the detection range of when the lower limit load fault warning is output.
				9999	Function disabled
1490 H533	Upper limit fault detection width	9999		0% to 400%	Used to set the detection range of when output is shut-off when the upper limit load fault occurs.
				9999	Function disabled
1491 H534	Lower limit fault detection width	9999		0% to 400%	Used to set the detection range of when output is shut-off when the lower limit load fault occurs.
				9999	Function disabled
1492 H535	Load status detection signal delay time / load reference measurement waiting time	1 s		0 to 60 s	Used to set the waiting time after the load fault is detected until warning output or output shutoff. In the load characteristics measurement mode, set the waiting time after the load measurement frequency is reached until the load reference is set.

*1 Gr.1 and Gr.2 are the parameter initial value groups. (Refer to [page 54](#)).

◆ Load characteristics reference setting (Pr.1481 to Pr.1487)

- Use Pr.1481 to Pr.1485 to set the reference value of load characteristics.

- Use **Pr.1486 Load characteristics maximum frequency** and **Pr.1487 Load characteristics minimum frequency** to set the output frequency range for load fault detection.

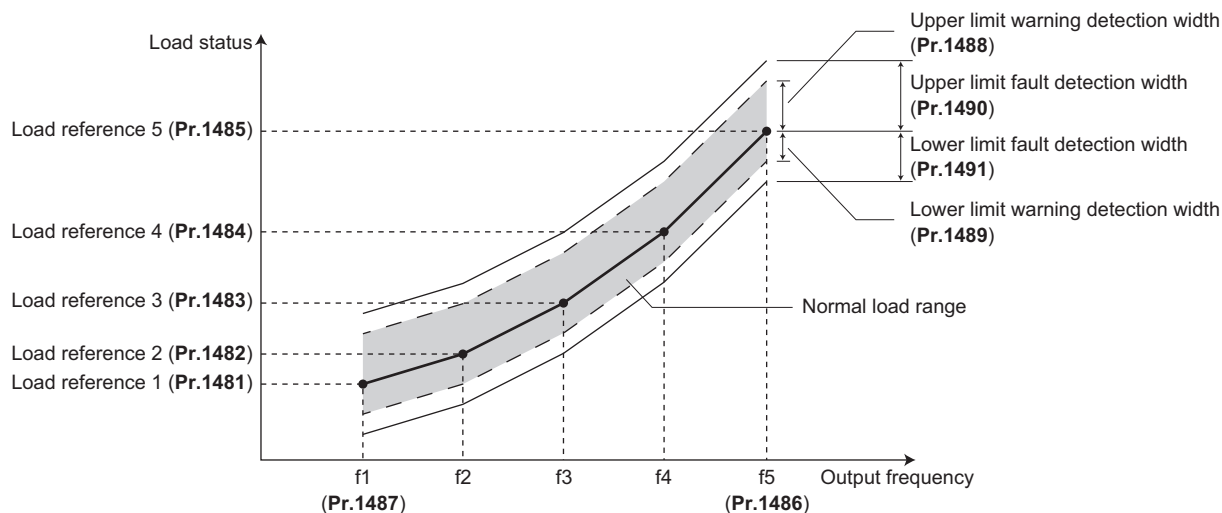

◆ Automatic measurement of the load characteristics reference (Load characteristics measurement mode) (Pr.1480)

Point

- Perform measurement under actual environment with the motor connected.
- Set **Pr.1487 Load characteristics minimum frequency** to a value higher than the **Pr.13 Starting frequency** setting.

- Setting **Pr.1480 Load characteristics measurement mode** = "1" enables automatic measurement of the load characteristics reference. (Load characteristics measurement mode)
- Use **Pr.1486 and Pr.1487** to set the frequency band for the measurement, and set **Pr.1480** = "1". After setting, when the inverter is started, the measurement starts. (When the value set in **Pr.1486** is equal to or smaller than the value set in **Pr.1487**, the measurement does not start.)
- The automatically measured load characteristics reference is written in **Pr.1481 to Pr.1485**.
- After the measurement is started, read **Pr.1480** to display the status of the measurement. If "8" appears in the tens place, the measurement has not properly completed.

Read value of Pr.1480		Status
Tens place	Ones place	
—	1	During measurement from the starting point to Point 1
—	2	During measurement from Point 1 to Point 2
—	3	During measurement from Point 2 to Point 3
—	4	During measurement from Point 3 to Point 4
—	5	During measurement from Point 4 to Point 5
—	0	Normal completion
8	1 to 5	Termination of measurement by an activation of a protective function, Inverter reset, turning ON of MRS signal, turning OFF of the start command, or timeout. (The value in the ones place represents the above-mentioned measurement point.)

- While measuring automatically, the During load characteristics measurement (Y213) signal is output. For the Y213 signal, set "213" (positive logic) or "313" (negative logic) in any parameter from **Pr.190 to Pr.197 (Output terminal function selection)** to assign the function.

- Setting "8888" in **Pr.1481 to Pr.1485** enables fine adjustment of load characteristics. When setting **Pr.1481 to Pr.1485** = "8888" during operation, the load status at that point is set in the parameter (only when the set frequency is within ± 2 Hz of the frequency of the measurement point, and the SU signal is ON).

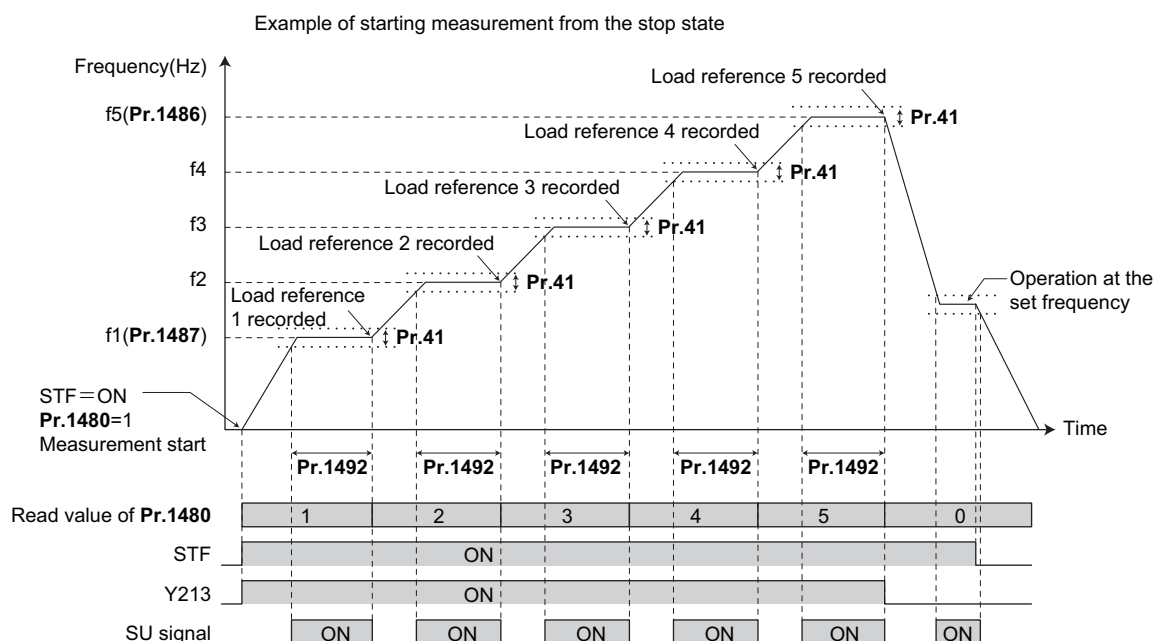

NOTE

- Even if the load measurement is not properly completed, the load characteristics fault is detected based on the load characteristics found by the already-completed portion of the measurement.
- During the load characteristics measurement, the load characteristics fault detection is not performed.
- During the load characteristics measurement, linear acceleration/deceleration is performed even if the S-pattern acceleration/deceleration is set.
- Changing the terminal assignment using **Pr.190 to Pr.197 (Output terminal function selection)** may affect the other functions. Set parameters after confirming the function of each terminal.

◆ Setting the load characteristics reference manually (Pr.1481 to Pr.1485)

- Set **Pr.1480 Load characteristics measurement mode** = "0" (initial value).
- Set **Pr.1486 and Pr.1487** to specify the frequency band for the measurement, and calculate the frequency as the load characteristics reference (f_2 to f_4) using the following table.
- Start the inverter operation, and set **Pr.1481** = "8888" during operation at the frequency of the load characteristics reference 1 (f_1). The load status at that point is set in **Pr.1481** (only when the set frequency is within ± 2 Hz of the frequency of the measurement point, and the SU signal is ON).
- Set load references in **Pr.1482 to Pr.1485** in the same way as **Pr.1481**.

Reference	Frequency	Load reference
Load characteristics reference 1	f_1 : load characteristics minimum frequency (Pr.1487)	Pr.1481
Load characteristics reference 2	$f_2 = (f_5 - f_1)/4 + f_1$	Pr.1482
Load characteristics reference 3	$f_3 = (f_5 - f_1)/2 + f_1$	Pr.1483
Load characteristics reference 4	$f_4 = (f_5 - f_1) \times 3/4 + f_1$	Pr.1484
Load characteristics reference 5	f_5 : load characteristics maximum frequency (Pr.1486)	Pr.1485

NOTE

- When inputting values directly in **Pr.1481 to Pr.1485** under V/F control, input the load meter monitored values at the frequency of each load characteristics reference.
- When inputting values directly in **Pr.1481 to Pr.1485** under Advanced magnetic flux vector control, Real sensorless vector control, Vector control, or PM sensorless vector control, input the motor torque value monitored at the frequency of each load characteristics reference.

◆ Setting example

- The load characteristics are calculated from the parameter setting and the output frequency.
- A setting example is as follows. The reference value is linearly interpolated from the parameter settings. For example, the reference when the output frequency is 30 Hz is 26%, which is linearly interpolated from values of the reference 2 and the reference 3.

Reference	Frequency	Load reference
Load characteristics reference 1	f1: Load characteristics minimum frequency (Pr.1487) = 10 Hz	Pr.1481 = 15%
Load characteristics reference 2	$f2 = (f5 - f1)/4 + f1 = 22.5$ Hz	Pr.1482 = 20%
Load characteristics reference 3	$f3 = (f5 - f1)/2 + f1 = 35$ Hz	Pr.1483 = 30%
Load characteristics reference 4	$f4 = (f5 - f1) \times 3/4 + f1 = 47.5$ Hz	Pr.1484 = 60%
Load characteristics reference 5	f5: Load characteristics maximum frequency (Pr.1486) = 60 Hz	Pr.1485 = 100%

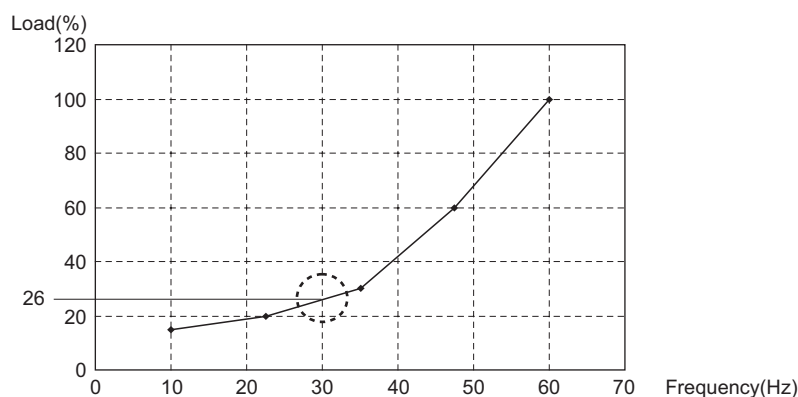

NOTE

- When the load reference is not set for five points, the load characteristics value is determined by linear interpolation of the set load reference values only. If there is only one load reference setting, the set load reference is used as the load reference all through the range.

◆ Load fault detection setting (Pr.1488 to Pr.1491)

- When the load is deviated from the detection width set in **Pr.1488 Upper limit warning detection width**, the Upper limit warning detection (LUP) signal is output. When the load is deviated from the detection width set in **Pr.1489 Lower limit warning detection width**, the Lower limit warning detection (LDN) signal is output. At the same time, the Load fault warning (LDF) appears on the operation panel.
- For the LUP signal, assign the function by setting "211" (positive logic) or "311" (negative logic) in any parameter from **Pr.190 to Pr.197 (Output terminal function selection)**. For the LDN signal, assign the function by setting "212" (positive logic) or "312" (negative logic) in any parameter from **Pr.190 to Pr.197 (Output terminal function selection)**.
- When the load is deviated from the detection width set in **Pr.1490 Upper limit fault detection width**, the protective function (E.LUP) is activated and the inverter output is shut off. When the load is deviated from the detection width set in **Pr.1491 Lower limit fault detection width**, the protective function (E.LDN) is activated and the inverter output is shut off.

- To prevent the repetitive on/off operation of the signal due to load fluctuation near the detection range, **Pr.1492 Load status detection signal delay time / load reference measurement waiting time** can be used to set the delay time. Even when a fault is detected out of the detection range once, the warning is not output if the characteristics value returns to the normal range from a fault state within the output delay time.

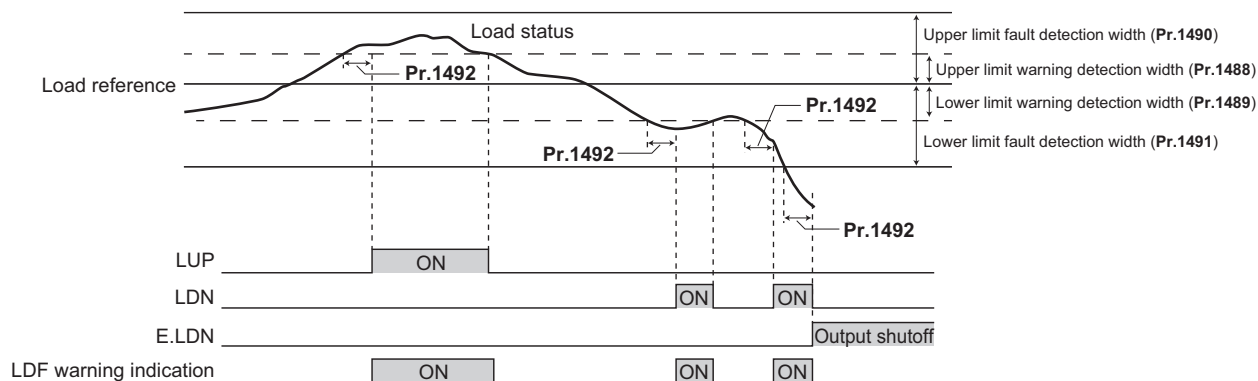

NOTE

- Changing the terminal assignment using **Pr.190 to Pr.197 (Output terminal function selection)** may affect the other functions. Set parameters after confirming the function of each terminal.

Parameters referred to

Pr.41 Up-to-frequency sensitivity [page 382](#)

Pr.190 to Pr.197 (Output terminal function selection) [page 371](#)

11.14 Motor overspeeding detection

Sensorless Vector PM

The Overspeed occurrence (E.OS) is activated when the motor speed exceeds the overspeed detection level. This function prevents the motor from accidentally speeding over the specified value, due to an error in parameter setting, etc.

Pr.	Name	Initial value	Setting range	Description
374 H800	Overspeed detection level	9999	0 to 590 Hz	If the motor rotation speed exceeds the speed set in Pr.374 , overspeed (E.OS) occurs, and the inverter output is shut off.
			9999	If the speed exceeds the speed calculated by adding 20 Hz to the maximum frequency (Pr.1 , Pr.18) during encoder feedback control, Real sensorless vector control, or Vector control, E.OS occurs. During PM sensorless vector control, E.OS occurs when the speed exceeds the speed calculated by adding 10 Hz to the maximum motor frequency ^{*1} .

*1 The motor maximum frequency is set in **Pr.702 Maximum motor frequency**. When **Pr.702** = "9999" (initial value), the value set in **Pr.84 Rated motor frequency** is used as the maximum motor frequency.

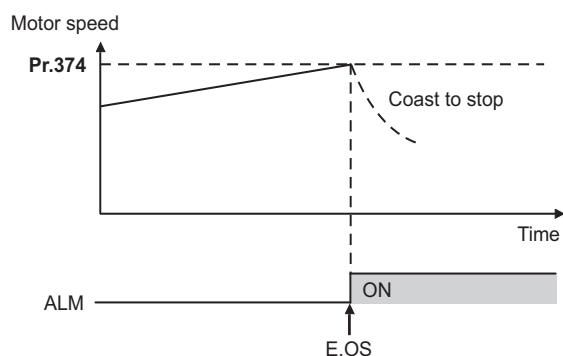

NOTE

- During the encoder feedback control operation or under Vector control, the motor speed is compared against **Pr.374**. Under Real sensorless vector control or PM sensorless vector control, the output frequency is compared against **Pr.374**.

CHAPTER 12 (M) Item and Output Signal for Monitoring

12.1	Speed indication and its setting change to rotations per minute	346
12.2	Monitor item selection on operation panel or via communication	348
12.3	Monitor display selection for terminals FM and AM	358
12.4	Adjustment of terminal FM and terminal AM.....	362
12.5	Energy saving monitoring	365
12.6	Output terminal function selection	371
12.7	Output frequency detection.....	382
12.8	Output current detection function.....	385
12.9	Output torque detection function.....	387
12.10	Remote output function.....	388

12 (M) Item and Output Signal for Monitoring

Purpose	Parameter to set			Refer to page
To display the motor speed (the number of rotations per minute). To switch the unit of measure to set the operation speed from frequency to motor speed.	Speed indication and its setting change to rotations per minute	P.M000, P.M001, P.M003	Pr.37, Pr.53, Pr.505	346
To change the item monitored on the operation panel and parameter unit	Operation panel monitor item selection, clearing the cumulative value during monitoring	P.M020 to P.M023, P.M030, P.M031, P.M044, P.M050 to P.M052, P.M100 to P.M104	Pr.52, Pr.170, Pr.171, Pr.268, Pr.290, Pr.563, Pr.564, Pr.774 to Pr.776, Pr.891, Pr.992, Pr.1106 to Pr.1108	348
To change the monitor item whose data is output via terminal FM or AM	Terminal FM/AM function selection	P.M040 to P.M042, P.M044, P.M300, P.M301	Pr.54, Pr.55, Pr.56, Pr.158, Pr.290, Pr.866	358
To adjust the output via terminal FM or AM	Terminal FM/AM calibration	P.M310, P.M320, P.M321, P.M390	Pr.867, C0 (Pr.900), C1 (Pr.901), Pr.1200	362
To check the effects of energy saving	Energy saving monitoring	P.M023, P.M100, P.M200 to P.M207, P.M300, P.M301	Pr.52, Pr.54, Pr.158, Pr.891 to Pr.899	365
To assign functions to the output terminals	Output terminal function assignment	P.M400, P.M404 to P.M406, P.M410 to P.M416, P.M420 to P.M422, P.M431, P.M451 to P.M454	Pr.190 to Pr.197, Pr.289, Pr.313 to Pr.322	371
To detect the output frequency	Up-to-frequency sensitivity Output frequency detection Low speed detection	P.M440 to P.M443, P.M446	Pr.41 to Pr.43, Pr.865 to Pr.870	382
To detect the output current	Output current detection Zero current detection	P.M433, P.M460 to P.M464	Pr.150 to Pr.153, Pr.166, Pr.167	385
To detect the output torque	Output torque detection	P.M470	Pr.864	387
To use the remote output function	Remote output	P.M500 to P.M502	Pr.495 to Pr.497	388
To monitor pulses	Cumulative pulse monitoring	P.M610, P.M611, P.M613	Pr.635, Pr.636, Pr.638	207

12.1 Speed indication and its setting change to rotations per minute

The frequency monitored or set on the operation panel can be changed to the motor speed or the machine speed.

Pr.	Name	Initial value ^{*1}		Setting range	Description
		Gr.1	Gr.2		
37 M000	Speed display	1800		0.01 to 9998 ^{*2}	Set a number for the speed of machine operated at the speed (frequency) set in Pr.505.
53 M003	Frequency / rotation speed unit switchover	0		0	Frequency displayed
				1	Rotation speed displayed
				4	Machine speed displayed
505 M001	Speed setting reference	60 Hz	50 Hz	1 to 590 Hz ^{*2}	Set the reference speed (frequency) for Pr.37.

*1 Gr.1 and Gr.2 are the parameter initial value groups. (Refer to page 54).

*2 The setting ranges of Pr.1 (Pr.18), Pr.37, and Pr.505 are limited so that the following formula is satisfied.

$$\text{Pr.1 (Pr.18)} \times \text{Pr.37} / \text{Pr.505} < 8388.607$$

The setting range of Pr.1 (Pr.18) is not limited when the machine speed display is not selected. To display the machine speed, set values which satisfy the formula.

◆ Displayed unit switchover (Pr.37, Pr.53, and Pr.505)

- The rotation speed or machine speed can be displayed for monitoring or used for parameter setting instead of the frequency by using **Pr.53**.
- To display the machine speed, set **Pr.37** to the value which corresponds to the speed of machine operated at the frequency set in **Pr.505**.

For example, when **Pr.505** is set to 60 Hz and **Pr.37** is set to "1000", the operation panel indicates "1000" as the monitor value of machine speed while the output frequency is 60 Hz. "500" is displayed while the output frequency is 30 Hz.

- The operation panel indicates the upper 4 digits when the rotation speed or machine speed is displayed. For example, when the internal value "1770.950" is monitored, the operation panel indicates "1770".

Pr.53 setting	Output frequency indication	Set frequency indication Dancer main speed setting indication Ideal speed command indication	Running speed indication	Frequency setting	Parameter setting
0 (initial value)	0.01 Hz	0.01 Hz	1 r/min ^{*1}	0.01 Hz	0.01 Hz
1	1 r/min ^{*1}	1 r/min ^{*1}	1 r/min ^{*1}	1 r/min ^{*1}	1 r/min ^{*1}
4	0.001 (machine speed ^{*1})	0.001 (machine speed ^{*1})	1 (machine speed ^{*1})	0.001 (machine speed ^{*1})	0.01 Hz

*1 Motor speed r/min conversion formula: frequency × 120 / number of motor poles (**Pr.81** or **Pr.454**)

Machine speed conversion formula: **Pr.37** × Frequency / **Pr.505**

The item set in **Pr.505** is consistently a frequency (Hz).

When **Pr.81 (Pr.454)** = "9999", the number of motor poles is regarded as 4.

NOTE

- The inverter's output frequency is displayed as synchronous speed under V/F control. The displayed value is "actual motor speed" + "motor slip". When Advanced magnetic flux vector control, Real sensorless vector control, or PM sensorless vector control is selected, the actual motor speed (estimated value by motor slip calculation) is used. When the encoder feedback control or Vector control is selected, the actual motor speed from the encoder is used.
- To change the main monitor of the operation panel (operation panel main display), refer to **Pr.52**.
- Since the panel display of the operation panel or enclosure surface operation panel (FR-PA07) is in 4 digits, the monitor value of more than "9999" is displayed as "----". Display the frequency on the operation panel when a value equal to or more than 10000 r/min needs to be monitored or set.
- The displayed machine speed is the value converted from the frequency. Therefore, the setting value and read value may fluctuate due to rounding during the conversion.
- When using the machine speed display for the parameter unit (FR-PU07), do not change the speed with the up/down key if a set speed above 65535 is displayed. The set speed may become an undetermined value.
- For details on the displayed unit switchover when a communication protocol or a communication option is used, refer to the Instruction Manual (Communication) or the Instruction Manual of the communication option.

⚠ CAUTION

- Make sure to set the running speed and the number of motor poles.
Otherwise, the motor might run at extremely high speed, damaging the machine.

◀ Parameters referred to ▶

Pr.1 Maximum frequency [page 331](#)

Pr.52 Operation panel main monitor selection [page 348](#)

Pr.81 Number of motor poles [page 115](#)

Pr.800 Control method selection [page 115](#)

12.2 Monitor item selection on operation panel or via communication

The monitor item to be displayed on the operation panel or the parameter unit can be selected.

Pr.	Name	Initial value	Setting range	Description
52 M100*1	Operation panel main monitor selection	0 (output frequency)	0, 5 to 14, 17 to 20, 22 to 33, 35, 38, 40 to 42, 44, 45, 50 to 57, 61, 62, 64, 65, 67, 68, 71, 72, 81 to 86, 91, 97, 100*2	Select the monitor item to be displayed on the operation panel or parameter unit. Refer to page 349 for the monitor item selection.
774 M101*1	Operation panel monitor selection 1	9999	1 to 3, 5 to 14, 17 to 20, 22 to 33, 35, 38, 40 to 42, 44, 45, 50 to 57, 61, 62, 64, 65, 67, 68, 71, 72, 81 to 86, 91, 97, 100, 9999*2	Each of the initial monitor items displayed on the operation panel or parameter unit in the monitor mode (output frequency, output current, and output voltage) can be switched to a user-designated item. 9999: Follows the Pr.52 setting.
775 M102*1	Operation panel monitor selection 2			
776 M103*1	Operation panel monitor selection 3			
992 M104	Operation panel setting dial push monitor selection	0 (set frequency)	0 to 3, 5 to 14, 17 to 20, 22 to 33, 35, 38, 40 to 42, 44, 45, 50 to 57, 61, 62, 64, 65, 67, 68, 71, 72, 81 to 86, 91, 97, 100	Select the monitor item displayed on the operation panel at the time when the setting dial is pressed. (Available for the standard model only.)
170 M020	Watt-hour meter clear	9999	0	Set "0" to clear the watt-hour meter.
			10	Set "10" to monitor the cumulative power in the range of 0 to 9999 kWh via communication.
			9999	Set "9999" to monitor the cumulative power in the range of 0 to 65535 kWh via communication.
563 M021	Energization time carrying-over times	0	(0 to 65535)	The number of times that the cumulative energization time exceeded 65535 hours is displayed (read-only).
268 M022	Monitor decimal digits selection	9999	0	Value is displayed in 1 increments (an integer).
			1	Value is displayed in 0.1 increments.
			9999	No function
891 M023	Cumulative power monitor digit shifted times	9999	0 to 4	Set the number of digits to move the decimal point of the cumulative energy monitored value to the left. The readout peaks out at the upper limit of readout.
			9999	The function of moving the decimal point is not available. The readout is reset to 0 when it exceeds the upper limit.
171 M030	Operation hour meter clear	9999	0	Set "0" to clear the operation hour meter.
			9999	The read value is always "9999". Nothing changes when "9999" is set.
564 M031	Operating time carrying-over times	0	(0 to 65535)	The number of times that the operating time reaches 65535 hours is displayed. Read-only.
290 M044	Monitor negative output selection	0	0, 1, 4, 5, 8, 9, 12, 13	Set the availability of negative signal output via terminal AM, through communication, and to the FR-A8AY or FR-E8AXY. (Refer to page 357 .)
1106 M050	Torque monitor filter	9999	0 to 5 s	The filter time constant is selectable for monitoring of the torque. A larger setting results in slower response.
			9999	0.3 s filter
1107 M051	Running speed monitor filter	9999	0 to 5 s	The filter time constant is selectable for monitoring of the running speed. A larger setting results in slower response.
			9999	0.08 s filter
1108 M052	Excitation current monitor filter	9999	0 to 5 s	The filter time constant is selectable for monitoring of the motor excitation current. A larger setting results in slower response.
			9999	0.3 s filter

*1 Only the first monitor (**Pr.774**) is available for the IP67 model.

*2 The setting range differs depending on the model. For more information, refer to Monitor item list.

◆ Monitor item list (Pr.52, Pr.774 to Pr.776, Pr.992)

- Use **Pr.52, Pr.774 to Pr.776**, or **Pr.992** to select the monitor item to be displayed on the operation panel or the parameter unit.
- Refer to the following table to find the setting value for each monitoring. The value in the Pr. setting column is set in each of the parameters for monitoring (**Pr.52, Pr.774 to Pr.776**, and **Pr.992**) to determine the monitored item. The value in the Communication column is the monitor code for communication. (The items marked with "—" cannot be selected. The circle (○) in the Negative indication (-) column denotes that the monitored item can be indicated with minus sign during monitoring via terminal AM, through communication, and to the FR-A8AY or FR-E8AXY. (Refer to [page 357](#).)

Monitor item	Increment and unit	Pr. setting	Communication		Negative indication (-) ^{*3}	Description
			Monitor code 1 ^{*1}	Monitor code 2 ^{*2}		
Output frequency (speed) ^{*18}	0.01 Hz ^{*17}	1/0/100	H01	40201	○	The inverter output frequency is displayed.
Output current ^{*8*9*18}	0.01 A	2/0/100	H02	40202		The inverter output current effective value is displayed.
Output voltage ^{*8*18}	0.1 V	3/0/100	H03	40203		The inverter output voltage is displayed.
Fault indication	—	0/100	—	—		Each of the last 10 faults is displayed individually.
Set frequency / motor speed setting ^{*22}	0.01 Hz ^{*17}	5 ^{*4}	H05	40205		The set frequency is displayed. (0 Hz is displayed during position control.)
Operation speed	1 r/min ^{*17}	6 ^{*4}	H06	40206	○	The motor speed (number of rotations per minute) is displayed.
Motor torque	0.1%	7 ^{*4}	H07	40207	○	The motor torque is displayed as a percentage (0% under V/F control), considering the rated torque as 100%.
Converter output voltage ^{*8}	0.1 V	8 ^{*4}	H08	40208		The DC bus voltage value is displayed.
Regenerative brake duty	0.1%	9 ^{*4}	H09	40209		The brake duty is displayed as a percentage, considering Pr.70 setting value as 100%. (When Pr.30 = "0 or 100", Pr.70 is disabled.)
Electronic thermal O/L relay load factor	0.1%	10 ^{*4}	H0A	40210		The motor thermal load factor or inverter thermal load factor, whichever is larger, is displayed, considering the thermal operation level as 100%.
Output current peak value ^{*8}	0.01 A	11 ^{*4}	H0B	40211		The peak value of output current, which is constantly stored, is displayed. (It is reset with every startup of the inverter.)
Converter output voltage peak value ^{*8}	0.1 V	12 ^{*4}	H0C	40212		The DC bus voltage peak value, which is constantly stored, is displayed. (It is reset with every startup of the inverter.)
Input power	0.01 kW	13 ^{*4}	H0D	40213		The power at the inverter input side is displayed.
Output power ^{*9}	0.01 kW	14 ^{*4}	H0E	40214		The power at the inverter output side is displayed.
Load meter	0.1%	17	H11	40217		Torque current is displayed as a percentage, considering Pr.56 setting value as 100%. (0% is displayed under the control mode other than V/F control.)
Motor excitation current ^{*8}	0.01 A	18	H12	40218		The motor excitation current is displayed.
Position pulse ^{*8*11}	—	19	H13	40219		The number of pulses per motor rotation during orientation control operation or in the position control mode is displayed. ^{*20} (The output voltage is displayed when a Vector control option is not installed.)
Cumulative energization time ^{*5*22}	1 h	20	H14	40220		The cumulative energization time since the inverter shipment is displayed. The number of times an integrated value has reached the maximum value of 65535 hours can be checked in Pr.563 .
Orientation status ^{*11}	1	22	H16	40222		Monitoring is enabled only during orientation control operation. (The output voltage is displayed when a Vector control option is not installed.) (Refer to page 468 .)
Actual operation time ^{*5*6}	1 h	23	H17	40223		The cumulative operation time is displayed. The number of times an integrated value has reached the maximum value of 65535 hours can be checked in Pr.564 . Use Pr.171 to reset the cumulative operation time. (Refer to page 356 .)

Monitor item	Increment and unit	Pr. setting	Communication		Negative indication (-) ^{*3}	Description
			Monitor code 1 ^{*1}	Monitor code 2 ^{*2}		
Motor load factor	0.1%	24	H18	40224		The output current value is displayed as a percentage, considering the inverter rated current value as 100%. Readout (%) = present output current value / inverter rated current value × 100
Cumulative energy ^{*8}	0.01 kWh ^{*7}	25	H19	40225		The cumulative energy based on the monitored output power is displayed. Use Pr.170 to reset it. (Refer to page 355.)
Position command (lower digits)	1	26	H1A	40226	○	The position command (after multiplied by four) (decimal) before the electronic gear is set is displayed. ^{*10}
Position command (upper digits)	1	27	H1B	40227	○	
Current position (lower digits)	1	28	H1C	40228	○	The converted number of the position feedback pulse into the number of pulses before the electronic gear is set (after multiplied by four) is displayed. ^{*10}
Current position (upper digits)	1	29	H1D	40229	○	
Droop pulse (lower digits)	1	30	H1E	40230	○	The droop pulse before the electronic gear is set (after multiplied by four) is displayed. ^{*10}
Droop pulse (upper digits)	1	31	H1F	40231	○	
Torque command	0.1%	32	H20	40232	○	The torque command value adjusted with Vector control is displayed.
Torque current command	0.1%	33	H21	40233	○	The command value of the current for torque is displayed.
Feedback pulse ^{*8*11}	—	35	H23	40235		The number of pulses fed back from the encoder in one cycle of the sampling (before multiplied by four) is displayed (kept displayed during a stop). (The output voltage is displayed when a Vector control option is not installed.) The sampling time period varies depending on the Pr.369 Number of encoder pulses setting. 1050 or less: 1 s, 1051 to 2100: 0.5 s, 2101 to 4096: 0.25 s
Trace status	1	38	H26	40238		The trace status is displayed. (Refer to page 518.)
PLC function user monitor 1 ^{*22}	Increment set in the register SD1215	40	H28	40240		The user-designated monitor item is displayed using the PLC function.
PLC function user monitor 2 ^{*22}		41	H29	40241		Each value of the following special registers is displayed. SD1216: displayed with the setting value "40", SD1217: displayed with the setting value "41", SD1218: displayed with the setting value "42" (Refer to the PLC Function Programming Manual.)
PLC function user monitor 3 ^{*22}		42	H2A	40242		
Station number (PU) ^{*22}	1	44	H2C	40244		The station number of the inverter enabling communication via the PU connector is displayed. (Available only for the FR-E800.)
Station number (CC-Link) ^{*22}	1	45	H2D	40245		The station number of the inverter enabling CC-Link communication is displayed. ("0" is displayed when the FR-A8NC is not installed.)
Energy saving effect	Increment and unit vary depending on the parameter settings.	50	H32	40250		The energy saving effect monitoring is enabled.
Cumulative saved energy		51	H33	40251		The item to monitor is selectable from among the saved power, the average energy saving, and the energy cost savings. Some of them can be displayed as a percentage according to the parameter settings. (Refer to page 365.)
PID set point ^{*22}	0.1%	52	H34	40252		The set point, measured value, and deviation during PID control operation is displayed. (Refer to page 488.)
PID measured value ^{*22}	0.1%	53	H35	40253		
PID deviation ^{*22}	0.1%	54	H36	40254	○	
Input terminal status ^{*22}	—	55 ^{*19}	H0F ^{*12}	40215 ^{*12}		The ON/OFF state of the input terminals on the inverter is displayed. (Refer to page 354 for details of indication on the operation panel.)
Output terminal status ^{*22}	—		H10 ^{*13}	40216 ^{*13}		The ON/OFF state of the output terminals on the inverter is displayed. (Refer to page 354 for details of indication on the operation panel.)

Monitor item	Increment and unit	Pr. setting	Communication		Negative indication (-) ^{*3}	Description
			Monitor code 1 ^{*1}	Monitor code 2 ^{*2}		
Option input terminal status ^{*11}	—	56	—	—		The ON/OFF state of the digital input terminals on the FR-A8AX or FR-E8AXY is displayed on the operation panel. (Refer to page 354 for details.)
Option output terminal status ^{*11}	—	57	—	—		The ON/OFF state of the digital output terminals on the FR-A8AY or FR-E8AXY or the relay output terminals on the FR-A8AR is displayed on the operation panel. (Refer to page 354 for details.)
Option input terminal status 1 (for communication) ^{*11}	—	—	H3A ^{*14}	40258 ^{*14}		The ON/OFF state of the digital input terminals X0 to X15 on the FR-A8AX is monitored via communication.
Option input terminal status 2 (for communication) ^{*11}	—	—	H3B ^{*15}	40259 ^{*15}		The ON/OFF state of the digital input terminal DY on the FR-A8AX or the digital input terminals X1 to X7 on the FR-E8AXY is monitored via communication.
Option output terminal status (for communication) ^{*11}	—	—	H3C ^{*16}	40260 ^{*16}		The ON/OFF state of the digital output terminals Y0 to Y6 on the FR-A8AY, the digital output terminals Y1 and Y2 on the FR-E8AXY, or the relay output terminals RA1 to RA3 on the FR-A8AR is monitored via communication.
Motor thermal load factor	0.1%	61	H3D	40261		The accumulated heat value of the motor thermal O/L relay is displayed. The Motor overload trip (electronic thermal relay function) (E.THM) occurs at 100%.
Inverter thermal load factor	0.1%	62	H3E	40262		The accumulated heat value of the inverter thermal O/L relay is displayed. The Inverter overload trip (electronic thermal relay function) (E.THT) occurs at 100%.
PTC thermistor resistance	0.01 kΩ	64	H40	40264		The PTC thermistor resistance is displayed when Pr.561 PTC thermistor protection level ≠ "9999". (The output voltage is displayed when Pr.561 = "9999".)
Ideal speed command	0.01 Hz ^{*17}	65	H41	40265	○	The speed command ideal to create a position command.
PID measured value ^{*22}	0.1%	67	H43	40267		The PID measured value is displayed while the PID control is enabled (Pr.128 ≠ "0"), even if PID control operating conditions are not satisfied. (Refer to page 488 .)
Emergency drive status	1	68	H44	40268		Emergency drive status is displayed. (Available for the FR-E800 and FR-E800-E.) (Refer to page 322 .)
Cumulative pulse ^{*8*11}	—	71	H47	40271	○ ^{*21}	The cumulative number of pulses (after multiplied by four) is displayed.
Cumulative pulse overflow times ^{*8*11}	—	72	H48	40272	○ ^{*21}	The number of the cumulative pulse overflow times is displayed.
32-bit cumulative energy (lower 16 bits)	1 kWh	—	H4D	40277		The upper or lower 16 bits of the 32-bit cumulative energy is displayed on each indication. Monitoring via communication is available.
32-bit cumulative energy (upper 16 bits)	1 kWh	—	H4E	40278		
32-bit cumulative energy (lower 16 bits)	0.01 kWh	—	H4F	40279		
32-bit cumulative energy (upper 16 bits)	0.01 kWh	—	H50	40280		
BACnet reception status ^{*22}	1	81	H51	40281		The BACnet reception status is displayed. (Available only for the FR-E800.)
BACnet token pass counter ^{*22}	1	82	H52	40282		The count of received token is displayed. (Available only for the FR-E800.)
BACnet valid APDU counter ^{*22}	1	83	H53	40283		The count of valid APDU detection is displayed. (Available only for the FR-E800, FR-E800-(SC)EPA, and FR-E806-SCEPA.)
BACnet communication error counter ^{*22}	1	84	H54	40284		The count of communication error detection is displayed. (Available only for the FR-E800.)
BACnet terminal FM output level ^{*22}	0.1%	85	H55	40285		The value set in the Analog Output object (ID = 0: Terminal FM) for BACnet communication is displayed. (Available only for the FR-E800-1.)

Monitor item	Increment and unit	Pr. setting	Communication		Negative indication (-) ^{*3}	Description
			Monitor code 1 ^{*1}	Monitor code 2 ^{*2}		
BACnet terminal AM output level ^{*22}	0.1%	86	H56	40286	○	The value set in the Analog Output object (ID = 1: Terminal AM) for BACnet communication is displayed. (When the indication with a minus sign is not possible, the absolute value is displayed.) (Available only for the FR-E800-4 and FR-E800-5.)
PID manipulated amount	0.1%	91	H5B	40291	○	The PID control manipulated amount is displayed. (Refer to page 488.)
Dancer main set speed ^{*22}	0.01 Hz ^{*17}	97	H61	40297		The set speed for main speed during the dancer control operation is displayed.

- *1 The monitor code is used for the Mitsubishi inverter protocol, CC-Link, CC-Link IE TSN, CC-Link IE Field Network Basic, EtherNet/IP, PROFINET, and EtherCAT.
- *2 The monitor code is used for the MODBUS RTU, MODBUS/TCP, BACnet/IP, and BACnet MS/TP.
- *3 Indication with a minus sign is not possible via RS-485 communication (Mitsubishi inverter protocol, MODBUS RTU, or BACnet MS/TP) or when the Monitor Data field is accessed via Ethernet communication (CC-Link IE TSN, EtherNet/IP, PROFINET, or EtherCAT).
- *4 To monitor the item on the LCD operation panel (FR-LU08) or the parameter unit (FR-PU07) in the monitor mode, use **Pr.774 to Pr.776** or the monitor function of the FR-LU08 or the FR-PU07 for setting.
- *5 The cumulative energization time and actual operation time are accumulated from 0 to 65535 hours, then cleared, and accumulated again from 0.
- *6 The actual operation time does not increase if the cumulative running time before power OFF is less than an hour.
- *7 On the parameter unit (FR-PU07), the unit "kW" is displayed.
- *8 Since the panel display of the operation panel or enclosure surface operation panel (FR-PA07) is in 4 digits, the monitor value of more than "9999" is displayed as "----".
- *9 The inverter regards the output current which is less than the specified current level (5% of the rated inverter current) as 0 A. Therefore, each readout of an output current and output power may show "0" if a too small-capacity motor is used as contrasted with the inverter capacity and the output current falls below the specified value.
- *10 The displayed item can be changed to the pulse after the electronic gear is set by using **Pr.430 Pulse monitor selection**. (Refer to [page 207.](#)) **Pr.538 Current position retention selection** can be used to select the position data to be held when the motor is stopped or when the control mode is changed. (Refer to [page 215.](#))
- *11 Available when the plug-in option is connected. For the IP67 model, the function is invalid as plug-in options are not available.
- *12 The details of bits for the input terminal status are as follows. (1: ON state, 0: OFF state of a terminal on the inverter. "—" denotes an indefinite (null) value.)

b15 Standard model b0

-	-	-	-	-	RES	-	MRS	-	RH	RM	RL	-	-	STR	STF
---	---	---	---	---	-----	---	-----	---	----	----	----	---	---	-----	-----

b15 Ethernet model, IP67 model b0

-	-	-	-	-	-	-	-	-	-	-	-	-	-	DI1	DIO
---	---	---	---	---	---	---	---	---	---	---	---	---	---	-----	-----

b15 Safety communication model b0

-	-	-	-	-	-	-	-	-	-	-	-	-	-	-	-
---	---	---	---	---	---	---	---	---	---	---	---	---	---	---	---

- *13 The details of bits for the output terminal status are as follows. (1: ON state, 0: OFF state of a terminal on the inverter. "—" denotes an indefinite (null) value.) When the FR-E8TR or the FR-E8TE7 is installed, terminal SO is fixed to OFF.

b15 Standard model b0

-	-	-	-	-	-	-	-	SO	-	ABC	FU	-	-	-	RUN
---	---	---	---	---	---	---	---	----	---	-----	----	---	---	---	-----

b15 Ethernet model b0

-	-	-	-	-	-	-	-	SO	-	ABC	-	-	-	-	-
---	---	---	---	---	---	---	---	----	---	-----	---	---	---	---	---

b15 Safety communication model b0

-	-	-	-	-	-	-	-	-	-	ABC	-	-	-	-	-
---	---	---	---	---	---	---	---	---	---	-----	---	---	---	---	---

b15 IP67 model b0

-	-	-	-	-	-	-	-	-	ABC2	ABC	FU	-	-	-	RUN
---	---	---	---	---	---	---	---	---	------	-----	----	---	---	---	-----

- *14 The details of bits for the option input terminal status 1 are as follows. (1: ON state, 0: OFF state of a terminal on the FR-A8AX.) Every bit is 0 (OFF) when the option is not installed.

b15 b0

X15	X14	X13	X12	X11	X10	X9	X8	X7	X6	X5	X4	X3	X2	X1	X0
-----	-----	-----	-----	-----	-----	----	----	----	----	----	----	----	----	----	----

- *15 The details of bits for the option input terminal status 2 are as follows. (1: ON state, 0: OFF state of a terminal on the FR-A8AX/FR-E8AXY. "—" denotes an indefinite (null) value.) Every bit is 0 (OFF) when the option is not installed.

b15 b0

-	-	-	-	-	-	-	-	X7	X6	X5	X4	X3	X2	X1	DY
---	---	---	---	---	---	---	---	----	----	----	----	----	----	----	----

- *16 The details of bits for the option output terminal status are as follows. (1: ON state, 0: OFF state of a terminal on the FR-A8AY/FR-E8AXY/FR-A8AR. "—" denotes an indefinite (null) value.) Every bit is 0 (OFF) when the option is not installed.

b15 b0

-	-	-	-	-	-	RA3	RA2	RA1	Y6	Y5	Y4	Y3	Y2	Y1	Y0
---	---	---	---	---	---	-----	-----	-----	----	----	----	----	----	----	----

- *17 The increment varies depending on the **Pr.53** setting. (Refer to [page 346.](#))

- *18 The monitored values are retained even if an inverter fault occurs. Resetting clears the retained values.
- *19 Parameter setting is not available for setting the item as the main monitor item on the LCD operation panel (FR-LU08) or the parameter unit (FR-PU07). Use the monitor function of the FR-LU08 or the FR-PU07 for setting.
- *20 During position control under PM sensorless vector control, the indication of one motor rotation differs depending on the motor type (MM-GKR: 5120, EM-A: 4096).
- *21 The output is always negative regardless of the Pr.290 setting when a negative value is monitored. Negative values are not displayed on the operation panel or parameter unit. The values "-1 to -32767" are displayed as "65535 to 32769" on the LCD operation panel (FR-LU08) or parameter unit (FR-PU07).
- *22 When the FR-E8DS is installed or when the IP67 model is used, the signal is enabled even during the 24 V external power supply operation.

◆ Monitor display for operation panel (Pr.52, Pr.774 to Pr.776)

- When Pr.52 = "0" (initial value), the monitoring of output frequency, output current, output voltage, and fault display can be selected in sequence by pressing the SET key.
- Among the items set in Pr.52, the load meter, motor excitation current, and motor load factor are displayed in the second screen (initially set to monitor the output current). Other items are displayed in the third screen (initially set to monitor the output voltage).
- The first screen (initially set to monitor the output frequency) is displayed at power-ON in the initial setting. To change the screen displayed at power-ON, display the screen you want to display at power-ON, and hold down the SET key for one second. To monitor the output frequency again, display the screen of output frequency, and hold down the SET key for one second.

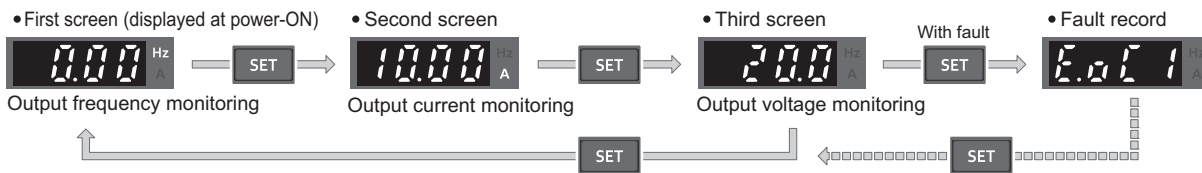

The following is the screen flow diagram when Pr.52 = "20" (cumulative energization time).

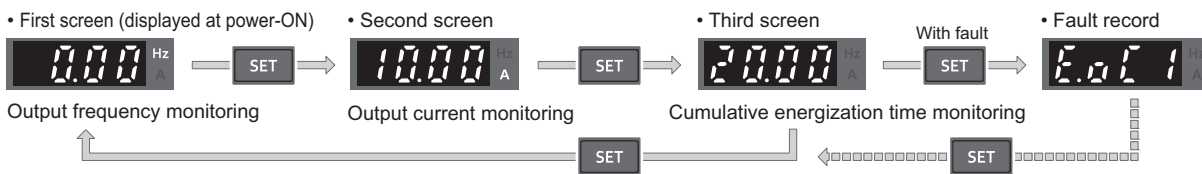

- The monitor item to be displayed is set using Pr.774 for the first screen, Pr.775 for the second screen, and Pr.776 for the third screen. When Pr.774 to Pr.776 = "9999" (initial value), the Pr.52 setting value is used.

NOTE

- On the operation panel, the Hz LED is lit while displaying the output frequency, the Hz LED blinks when displaying the set frequency.
- When the operation panel is used, the displayed units are Hz and A only, and the others are not displayed.

◆ Displaying the set frequency during stop (Pr.52)

- When Pr.52 = "100", the set frequency is displayed during stop, and output frequency is displayed during running. (The Hz LED blinks during stop and is lit during operation.)

Pr.52 setting	Status	Output frequency	Output current	Output voltage	Fault monitor
0	During running/stop	Output frequency	Output current	Output voltage	Fault monitor
100	During stop	Set frequency ^{*1}			
	During running	Output frequency			

*1 Displays the frequency that is output when the start command is ON. The value considers the maximum/minimum frequency and frequency jumps. It is different from the frequency setting displayed when Pr.52 = "5".

NOTE

- During an error, the output frequency at error occurrence appears.
- During output shutoff by the MRS signal, the values displayed are the same as during a stop.
- During offline auto tuning, the tuning state monitor takes priority.

◆ Operation panel setting dial push display (Pr.992) (only for the standard model)

- Use **Pr.992** to select the monitor that appears when the setting dial on the operation panel is pushed.
- When **Pr.992** = "0 (initial value)", keep pressing the setting dial when in PU operation mode or External/PU combined operation mode 1 (**Pr.79 Operation mode selection** = "3") to show the presently set frequency.
- When **Pr.992** = "100", the set frequency is displayed during stop, and output frequency is displayed during running.

Pr.992 setting	Status	Monitor displayed by the setting dial push
0	During running/stop	Set frequency
100	During stop	Set frequency ^{*1}
	During running	Output frequency

*1 Displays the frequency that is output when the start command is ON. The value considers the maximum/minimum frequency and frequency jumps. It is different from the frequency setting displayed when **Pr.992** = "5".

◆ Monitoring I/O terminals on the operation panel (Pr.52, Pr.774 to Pr.776, Pr.992)

- When **Pr.52 (Pr.774 to Pr.776, Pr.992)** = "55 to 57", the I/O terminal state can be monitored on the operation panel.
- When a terminal is ON, the corresponding LED segment is ON. The center LED segments are always ON.

Pr.52, Pr.774 to Pr.776, Pr.992 setting	Monitor item	Monitor description
55	I/O terminal status	Displays the I/O terminal ON/OFF state of the inverter.
56 ^{*1}	Option input terminal status	Displays the input state of the digital input terminals on the FR-A8AX or FR-E8AXY.
57 ^{*1}	Option output terminal status	Displays the output state of the digital output terminals on the FR-A8AY or FR-E8AXY or the relay output terminals on the FR-A8AR.

*1 The setting value "56 or 57" can be set even if the option is not installed. All are OFF when the option is not connected.

- On the I/O terminal monitor, the upper LEDs indicate the input terminal status, and the lower LEDs indicate the output terminal status.

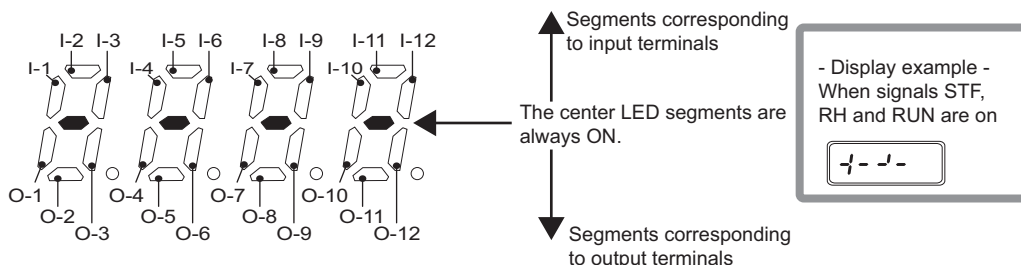

Symbol	Input terminal			
	FR-E800	FR-E800-E	FR-E800-SCE	FR-E806
I-1	RL	—	—	—
I-2	RM	—	—	—
I-3	RH	—	—	—
I-4	—	—	—	—
I-5	—	—	—	—
I-6	—	—	—	—
I-7	MRS	—	—	—
I-8	RES	—	—	—
I-9	STF	DI0	—	DI0
I-10	STR	DI1	—	DI1
I-11	—	—	—	—
I-12	—	—	—	—

Symbol	Output terminal			
	FR-E800	FR-E800-E	FR-E800-SCE	FR-E806
O-1	A,B,C	A,B,C	A,B,C	A,B,C
O-2	—	—	—	A2,B2,C2
O-3	RUN	—	—	RUN
O-4	—	—	—	—
O-5	—	—	—	—
O-6	—	—	—	—
O-7	FU	—	—	FU
O-8	SO ^{*1}	SO	—	—
O-9	—	—	—	—
O-10	—	—	—	—
O-11	—	—	—	—
O-12	—	—	—	—

*1 Fixed to OFF when the FR-E8TR or the FR-E8TE7 is installed.

- The decimal point of the last digit on the LED is lit for the input option terminal monitor.

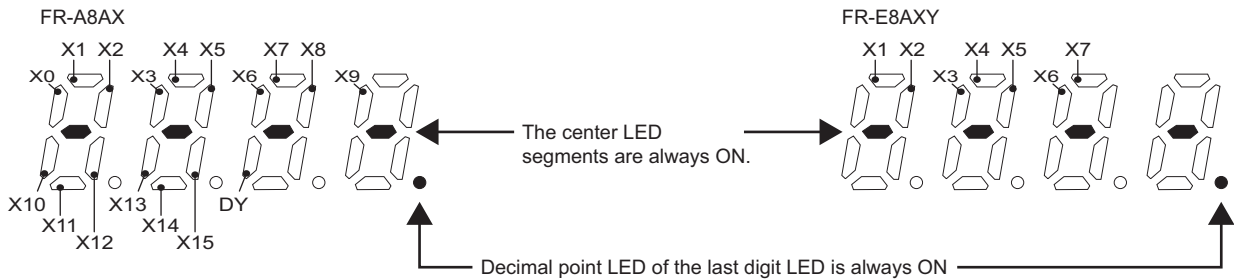

- The decimal point of the second last digit on the LED is lit for the output option terminal monitor.

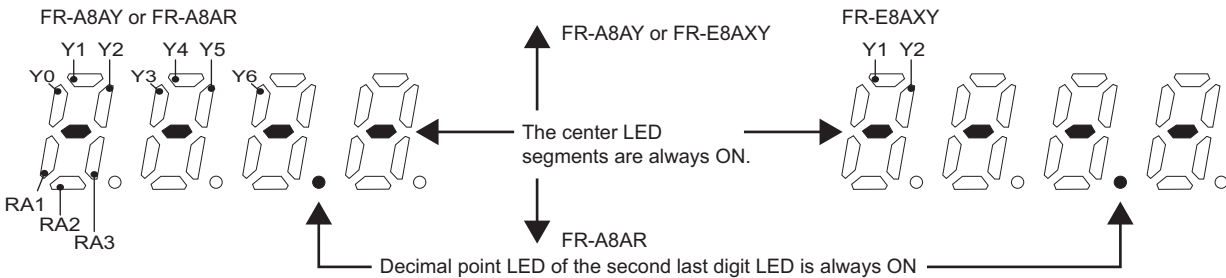

◆ Monitoring and resetting cumulative power (Pr.170, Pr.891)

- When the cumulative power is monitored (Pr.52 = "25"), the output power monitor value is added up and is updated in 100 ms increments.
- The values are stored in EEPROM every 10 minutes. The values are also stored in EEPROM at power OFF (when the FR-E8DS is not installed) or inverter reset.
- Increments and ranges of monitoring on the PU or via communication are as follows (when Pr.891 = "0 or 9999").

PU			Via communication		
Range		Increment	Range		Increment
Operation panel ^{*1}	Parameter unit ^{*2}		Pr.170 = "10"	Pr.170 = "9999"	
0 to 99.99 kWh	0 to 999.99 kWh	0.01 kWh	0 to 9999 kWh	0 to 65535 kWh (initial value)	1 kWh
100.0 to 999.9 kWh	1000.0 to 9999.9 kWh	0.1 kWh			
1000 to 9999 kWh	10000 to 99999 kWh	1 kWh			

*1 Power is measured in the range of 0 to 99999.99 kWh, and displayed in 4 digits. After the watt-hour meter (cumulative power counter) reaches "99.99" (999.99 kWh), the meter displays values in 0.1 increments such as "100.0" (1000.0 kWh). Use Pr.891 to shift the decimal point position when the monitored value becomes equal to or higher than 10000 kWh.

*2 Power is measured in the range of 0 to 99999.99 kWh, and displayed in 5 digits. After the watt-hour meter (cumulative power counter) reaches "999.99" (999.99 kWh), the meter displays values in 0.1 increments such as "1000.0" (1000.0 kWh). Use Pr.891 to shift the decimal point position when the monitored value becomes equal to or higher than 100000 kWh.

- The decimal point position on the watt-hour meter can be shifted to left. The number of digits to be shifted is equal to the setting of Pr.891 Cumulative power monitor digit shifted times. For example, when Pr.891 = "2", the cumulative power value 1278.56 kWh is displayed as 12.78 (in 100 kWh increments) on the operation panel, or displayed as 12 on a display used for monitoring via communication.
- When Pr.891 = "0 to 4", the meter stops at the maximum number. When Pr.891 = "9999", the meter returns to 0 and the counting starts again.
- The cumulative power can be monitored as 32-bit data via communication by setting Pr.52 = "77 to 80". The maximum monitored value is 42949672 kWh in 1 kWh increments or 42949672.94 kWh in 0.01 kWh increments. Pr.891 setting is invalid while 32-bit cumulative power is monitored. (For details on communication for 32-bit cumulative power monitor, refer to the Instruction Manual (Communication) or the Instruction Manual of the communication option.)
- Writing "0" in Pr.170 clears the cumulative power monitor.

NOTE

- When Pr.170 is read just after "0" has been written in Pr.170, the setting "9999" or "10" is displayed.

◆ Monitoring cumulative energization time (Pr.563)

- When the cumulative energization time is selected as a monitor item (Pr.52 = "20"), the counter of cumulative energization time since the inverter shipment accumulated every hour is displayed.
- One hour is displayed as "0.001", and the value is counted up to "65.53".
- The EEPROM is updated every minute until the cumulative energization time reaches one hour, and then the EEPROM is updated every 10 minutes. The EEPROM is also updated at power OFF (when the FR-E8DS is not installed).
- When the cumulative energization time counter reaches 65535, it starts from 0 again. The number of times the cumulative energization time counter reaches 65535 can be checked with Pr.563.

NOTE

- The cumulative energization time does not increase if the power is turned OFF after less than an hour.

◆ Actual operation time monitoring (Pr.171, Pr.564)

- On the actual operation time monitoring (Pr.52 = "23"), the inverter running time is added up every minute. (Time is not added up during a stop.)
- One hour is displayed as "0.001", and the value is counted up to "65.53".
- The values are stored in EEPROM every 10 minutes. The EEPROM is also updated at power OFF (when the FR-E8DS is not installed).
- When the cumulative energization time counter reaches 65535, it starts from 0 again. The number of times the actual operation time counter reaches 65535 can be checked with Pr.564.
- Setting "0" in Pr.171 clears the actual operation time meter.

NOTE

- The actual operation time does not increase if the cumulative running time before power OFF is less than an hour.
- Once "0" is set in Pr.171, the setting of Pr.171 is always turned to "9999" afterwards. Setting "9999" does not clear the actual operation time meter.

◆ Hiding the decimal places for the monitors (Pr.268)

- The numerical figures after a decimal point displayed on the operation panel may fluctuate during analog input, etc. The decimal places can be hidden by selecting the decimal digits with Pr.268.

Pr.268 setting	Description
9999 (initial value)	No function
0	For the first or second decimal places (0.1 increments or 0.01 increments) of the monitor, numbers in the first decimal place and smaller are rounded to display an integral value (1 increments). The monitor value equal to or smaller than 0.99 is displayed as 0.
1	When monitoring with the second decimal place (0.01 increments), the 0.01 decimal place is dropped and the monitor displays the first decimal place (0.1 increments). When monitoring with the first decimal place, the display will not change.

NOTE

- The number of readout digits of the cumulative energization time (Pr.52 = "20"), actual operation time (Pr.52 = "23"), cumulative energy (Pr.52 = "25"), and cumulative energy saving (Pr.52 = "51") does not change.

◆ Enabling display of negative numbers during monitoring (Pr.290)

- Negative values can be used for indication via terminal AM (analog voltage output), communication, terminal AM0 (of the FR-A8AY), and terminal AM1 (of the FR-E8AXY). To check which items can be monitored with indication of negative numbers, refer to Monitor description list (on [page 349](#)).

Pr.290 setting	Negative numbers indication (via terminal AM)	Negative numbers indication via communication ^{*1}	Negative numbers indication (via terminal AM0) (with the FR-A8AY)	Negative numbers indication (via terminal AM1) (with the FR-E8AXY)
0 (initial value)	—	—	—	—
1	Enabled	—	—	—
4	—	Enabled	—	—
5	Enabled	Enabled	—	—
8	—	—	Enabled	Enabled
9	Enabled	—	Enabled	Enabled
12	—	Enabled	Enabled	Enabled
13	Enabled	Enabled	Enabled	Enabled

—: Negative numbers indication disabled (positive only)

*1 Indication with a minus sign is not possible via RS-485 communication (Mitsubishi inverter protocol, MODBUS RTU, or BACnet MS/TP) or when the Monitor Data field is accessed via Ethernet communication (CC-Link IE TSN, EtherNet/IP, PROFINET, or EtherCAT).

NOTE

- When indication with negative numbers is enabled for the output via terminal AM/AM0/AM1 (analog voltage output), the output is within the range of -10 to +10 VDC. Connect the meter with which output level is matched.
- The operation panel or parameter unit displays only unsigned numbers.

◆ Monitor filter (Pr.1106 to Pr.1108)

- The response level (filter time constant) of the following monitor indicators can be adjusted. Increase the setting when a monitor indicator is unstable, for example.

Pr.	Monitor number	Monitor indicator name
1106	7	Motor torque
	17	Load meter
	32	Torque command
	33	Torque current command
1107	6	Motor speed
1108	18	Motor excitation current

Parameters referred to

Pr.53 Frequency / rotation speed unit switchover [page 346](#)

Pr.55 Frequency monitoring reference, Pr.56 Current monitoring reference, Pr.866 Torque monitoring reference [page 358](#)

12.3 Monitor display selection for terminals FM and AM

For the standard model, monitored values are output in either of the following: analog voltage (terminal AM) in the AM type inverters (FR-E800-4 and FR-E800-5) or pulse train (terminal FM) in the FM type inverter (FR-E800-1).

The signal (monitor item) to be output to terminal FM and terminal AM can be selected.

Pr.	Name	Initial value ^{*1}		Setting range	Description
		Gr.1	Gr.2		
54 M300 ^{*2}	FM terminal function selection	1 (output frequency)		1 to 3, 5 to 14, 17, 18, 21, 24, 32, 33, 50, 52, 53, 61, 62, 65, 67, 70, 85, 97	Select the item monitored via terminal FM.
158 M301 ^{*3}	AM terminal function selection			1 to 3, 5 to 14, 17, 18, 21, 24, 32, 33, 50, 52 to 54, 61, 62, 65, 67, 70, 86, 91, 97	Select the item monitored via terminal AM.
55 M040 ^{*4}	Frequency monitoring reference	60 Hz	50 Hz	0 to 590 Hz	Set the full-scale value when the output frequency monitor value is output via terminal FM or AM.
56 M041 ^{*4}	Current monitoring reference	Inverter rated current		0 to 500 A	Set the full-scale value when the output current monitor value is output via terminal FM or AM.
866 M042	Torque monitoring reference	150%		0% to 400%	Set the full-scale value when the torque monitor value is output via terminal FM or AM.
290 M044	Monitor negative output selection	0		0, 1, 4, 5, 8, 9, 12, 13	Set the availability of negative signal output via terminal AM, through communication, and to the FR-A8AY or FR-E8AXY. (Refer to page 357.)

*1 Gr.1 and Gr.2 are the parameter initial value groups. (Refer to [page 54](#)).

*2 The setting is available only for the FR-E800-1.

*3 The setting is available only for the FR-E800-4 and FR-E800-5.

*4 For the Ethernet model and the safety communication model, the setting is available only when the plug-in option (FR-A8AY or FR-E8AXY) is installed. For the IP67 model, the setting is not available as plug-in options are not available.

◆ Monitor description list (Pr.54, Pr.158)

- Set the type of monitor to be output through terminal FM (pulse train output) in **Pr.54 FM terminal function selection**. Terminal FM is provided in the FM type inverter.
- Set **Pr.158 AM terminal function selection** for monitoring via terminal AM (analog voltage output). Negative signals can be output via terminal AM (in the range of -10 to +10 VDC). The circle in the Negative output column indicates that the output of negative signals is available via terminal AM. (To enable the negative output, refer to [page 357.](#)) Terminal AM is provided in the AM type inverter.
- Refer to the following table and select the item to be monitored. (Refer to [page 349](#) for the list of monitor items.)

Monitor item	Increment and unit	Pr.54 (FM), Pr.158 (AM) setting	Terminal FM/AM full-scale value	Negative output	Remarks
Output frequency	0.01 Hz ^{*4}	1	Pr.55 or the value converted with the Pr.37 or Pr.81 (Pr.454) value from Pr.55.	○	
Output current ^{*1}	0.01 A	2	Pr.56		
Output voltage	0.1 V	3	100/200 V class: 400 V, 400 V class: 800 V, 575 V class: 1000 V		
Frequency setting value	0.01 Hz ^{*4}	5	Pr.55 or the value converted with the Pr.37 or Pr.81 (Pr.454) value from Pr.55.		
Motor speed	1 r/min ^{*4}	6	Pr.55 or the value converted with the Pr.37 or Pr.81 (Pr.454) value from Pr.55.	○	

Monitor item	Increment and unit	Pr.54 (FM), Pr.158 (AM) setting	Terminal FM/AM full-scale value	Negative output	Remarks
Motor torque	0.1%	7	Pr.866	○	
Converter output voltage ^{*1}	0.1 V	8	100/200 V class: 400 V, 400 V class: 800 V, 575 V class: 1000 V		
Regenerative brake duty	0.1%	9	Brake duty decided by Pr.30, Pr.70.		
Electronic thermal O/L relay load factor	0.1%	10	Electronic thermal O/L relay (100%)		
Output current peak value	0.01 A	11	Pr.56		
Converter output voltage peak value	0.1 V	12	100/200 V class: 400 V, 400 V class: 800 V, 575 V class: 1000 V		
Input power	0.01 kW	13	Inverter rated power × 2		
Output power ^{*1}	0.01 kW	14	Inverter rated power × 2		
Load meter	0.1%	17	Pr.866		
Motor excitation current	0.01 A	18	Pr.56		
Reference voltage output	—	21	—		Terminal FM: 1440 pulse/s is output. Terminal AM: Output is 10 V.
Motor load factor	0.1%	24	200%		
Torque command	0.1%	32	Pr.866	○	
Torque current command	0.1%	33	Pr.866	○	
Energy saving effect	Increment and unit vary depending on the parameter settings.	50	Inverter capacity		For the information of the power saving effect monitoring, refer to page 365 .
PID set point	0.1%	52	100%		Refer to page 488 for the PID control.
PID measured value	0.1%	53	100%		
PID deviation	0.1%	54 ^{*2}	100%	○	
Motor thermal load factor	0.1%	61	Motor thermal activation level (100%)		
Ideal speed command	0.01 Hz ^{*4}	65	Pr.55 or the value converted with the Pr.37 or Pr.81 (Pr.454) value from Pr.55.	○	
Inverter thermal load factor	0.1%	62	Inverter thermal activation level (100%)		
PID measured value 2	0.1%	67	100%		Refer to page 488 for the PID control.
PLC function analog output	0.1%	70	100%	○	Enabled when Pr.414 ≠ "0". Refer to page 516 for the PLC function.
BACnet terminal FM output level	0.1%	85 ^{*3}	100%		The value set in the Analog Output object (ID = 0: Terminal FM) for BACnet communication is output.
BACnet terminal AM output level	0.1%	86 ^{*2}	100%	○ ^{*5}	The value set in the Analog Output object (ID = 1: Terminal AM) for BACnet communication is output.
PID manipulated amount	0.1%	91 ^{*2}	100%	○	Refer to page 488 for the PID control.
Dancer main speed setting	0.01 Hz ^{*4}	97	Pr.55 or the value converted with the Pr.37 or Pr.81 (Pr.454) value from Pr.55.		For details on dancer control, refer to page 495 .

*1 The inverter regards the output current which is less than the specified current level (5% of the rated inverter current) as 0 A. Therefore, each readout of an output current and output power may show "0" if a too small-capacity motor is used as contrasted with the inverter capacity and the output current falls below the specified value.

*2 The setting is available only in **Pr.158** (terminal AM).

*3 The setting is available only in **Pr.54** (terminal FM).

*4 The increment varies depending on the **Pr.53** setting. (Refer to [page 346](#).)

*5 The output is always negative regardless of the **Pr.290** setting when a negative value is monitored.

◆ Frequency monitor reference (Pr.55)

- Enter the full scale value of the meter used to monitor the output frequency, the frequency setting value, or the dancer main speed setting via terminal FM/AM or terminal AM1 (when the FR-E8AXY is used).
- For the FM type inverter, enter the full-scale value of the meter corresponding to a pulse train of 1440 pulses/s output via terminal FM. Enter the frequency value (for example, 60 Hz or 120 Hz) at full scale of the meter (1 mA analog meter) installed between terminal FM and terminal SD. Pulse speed is proportional to the output frequency of the inverter. (The maximum pulse train output is 2400 pulses/s.)

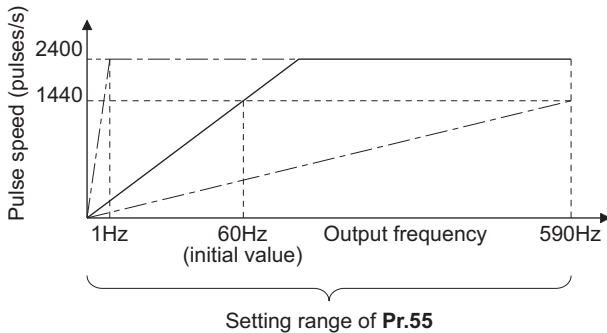

- Enter the full scale value of the meter corresponding to a voltage of 10 VDC output via terminal AM (terminal AM1). Enter the frequency value (for example, 60 Hz or 120 Hz) at full scale of the meter (10 VDC voltmeter) installed between terminals AM and 5 (between terminals AM1 and 5). Output voltage is proportional to the frequency. (The maximum output voltage is 10 VDC.)

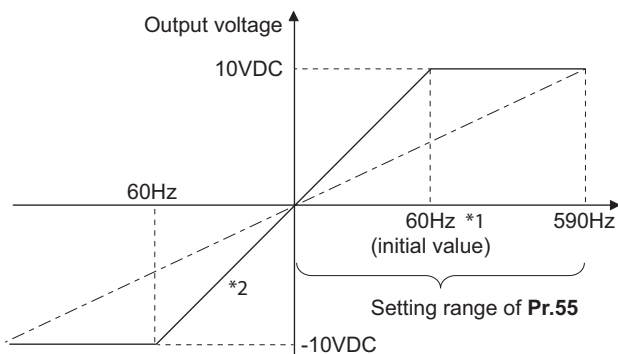

*1 Differs depending on the parameter initial value group. (60/50 Hz)

*2 Output of negative signals enabled when Pr.290 Monitor negative output selection = "1, 5, 9, or 13".

◆ Current monitor reference (Pr.56)

- Enter the full scale value of the meter used to monitor the output current, the output current peak value, or the motor excitation current via terminal FM/AM, or terminal AM1 (when the FR-E8AXY is used).
- For the FM type inverter, enter the full-scale value of the meter corresponding to a pulse train of 1440 pulses/s output via terminal FM. Enter the current value at full scale of the meter (1 mA analog meter) installed between terminal FM and terminal SD. Pulse speed is proportional to the output current monitored. (The maximum pulse train output is 2400 pulses/s.)
- Enter the full scale value of the current meter corresponding to a voltage of 10 VDC output via terminal AM (terminal AM1). Enter the current value at full scale of the meter (10 VDC voltmeter) installed between terminals AM and 5 (between terminals AM1 and 5). Output voltage is proportional to the output current monitored. (The maximum output voltage is 10 VDC.)

◆ Torque monitor reference (Pr.866)

- Enter the full scale value of the meter used to monitor the output torque via terminal FM/AM, or terminal AM1 (when the FR-E8AXY is used).
- For the FM type inverter, enter the full-scale value of the torque meter corresponding to a pulse train of 1440 pulses/s output via terminal FM. Enter the torque value at full scale of the meter (1 mA analog meter) installed between terminal FM and terminal SD. Pulse speed is proportional to the torque monitored. (The maximum pulse train output is 2400 pulses/s.)

- Enter the full scale value of the torque meter corresponding to a voltage of 10 VDC output via terminal AM (terminal AM1). Enter the torque value at full scale of the meter (10 VDC voltmeter) installed between terminals AM and 5 (between terminals AM1 and 5). Output voltage is proportional to the torque monitored. (The maximum output voltage is 10 VDC.)

◆ Terminal FM pulse train output

- The maximum pulse train output of terminal FM is 8 VDC 2400 pulses/s.
The pulse width can be adjusted on the operation panel or the parameter unit by using the calibration parameter **C0** (**Pr.900**) **FM terminal calibration**.
- A 1 mA full-scale DC ammeter or a digital meter can be used to give commands (such as inverter output frequency command).

FM output circuit

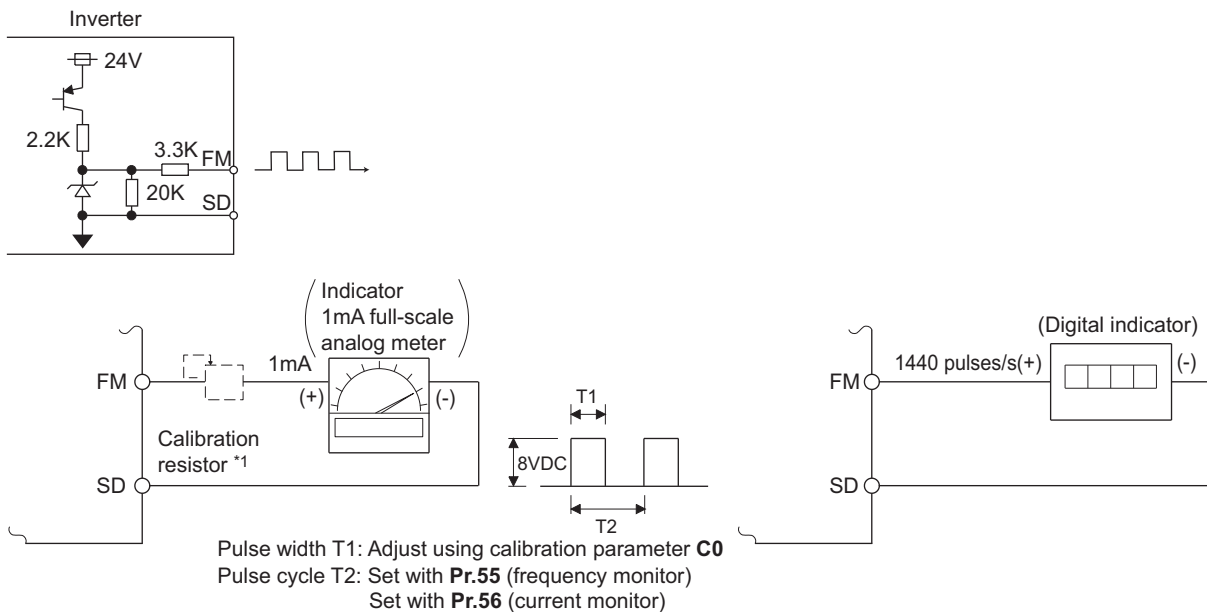

*1 Not required when calibrating with operation panel or the parameter unit.

Use a calibration resistor when the indicator (frequency meter) needs to be calibrated by a neighboring device because the indicator is located far from the inverter.

However, the frequency meter needle may not deflect to full-scale if the calibration resistor is connected. In this case, use the resistor and operation panel or parameter unit together.

*2 In the initial setting, 1 mA full-scale and 1440 pulses/s terminal FM are used at 60 Hz.

12.4 Adjustment of terminal FM and terminal AM

By using the operation panel or the parameter unit, you can adjust (calibrate) terminal FM and terminal AM to full-scale deflection.

Pr.	Name	Initial value	Setting range	Description
C0 (900) M310 ^{*1*2}	FM terminal calibration	—	—	Calibrates the scale of the meter connected to terminal FM.
C1 (901) M320 ^{*1*3}	AM terminal calibration	—	—	Calibrates the scale of the analog meter connected to terminal AM.
867 M321 ^{*3}	AM output filter	0.01 s	0 to 5 s	Set a filter for output via terminal AM.
1200 M390 ^{*3}	AM output offset calibration	3000	2700 to 3300	Calibrates the scale of the meter when the analog output is 0.

*1 On the LCD operation panel or the parameter unit used as the command source, the parameter number in parentheses appears instead of that starting with the letter C.

*2 The setting is available only for the FR-E800-1.

*3 The setting is available only for the FR-E800-4 and FR-E800-5.

◆ Terminal FM calibration (C0 (Pr.900)) (FM type only)

- The output via terminal FM is set to the pulse output. By setting **C0 (Pr.900)**, the meter connected to the inverter can be calibrated by parameter setting without use of a calibration resistor.
- The pulse train output via terminal FM can be used for digital display on a digital counter. The output is 1440 pulses/s at full scale. (Refer to [page 358](#) for the full-scale value of each monitor item.)

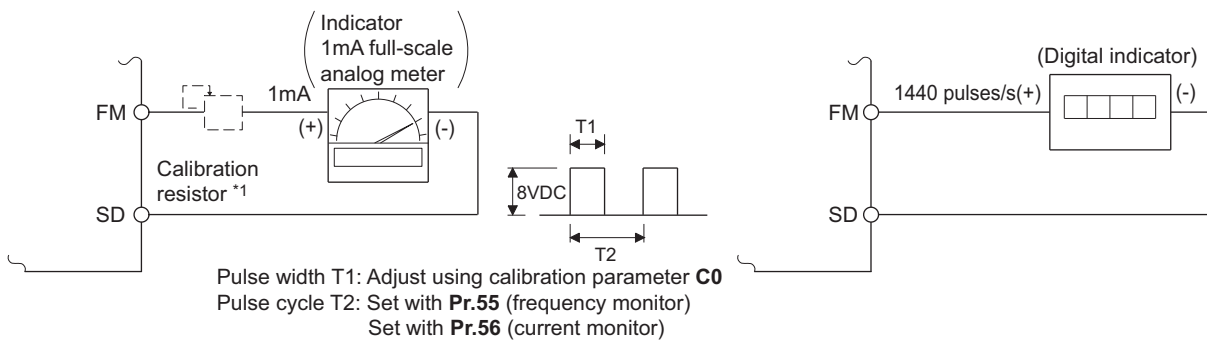

*1 Not required when calibrating with operation panel or the parameter unit.

Use a calibration resistor when the indicator (frequency meter) needs to be calibrated by a neighboring device because the indicator is located far from the inverter.

However, the frequency meter needle may not deflect to full-scale if the calibration resistor is connected. In this case, perform calibration using the operation panel or parameter unit.

*2 In the initial setting, 1 mA full-scale and 1440 pulses/s terminal FM are used at 60 Hz.

- Calibrate the output via terminal FM in the following procedure.

1. Connect an indicator (frequency meter) across terminals FM and SD on the inverter. (Note the polarity. Terminal FM is positive.)
2. When a calibration resistor has already been connected, adjust the resistance to "0" or remove the resistor.
3. Set a monitor item in **Pr.54 FM terminal function selection**. (Refer to [page 358](#).)
When the output frequency or inverter output current is selected on the monitor, set the output frequency or current value at which the output signal will be 1440 pulses/s, using **Pr.55 Frequency monitoring reference** or **Pr.56 Current monitoring reference** beforehand. Normally, at 1440 pulses/s the meter deflects to full-scale.
4. If the meter needle does not point to maximum even at maximum output, calibrate it with **C0 (Pr.900)**.

NOTE

- When outputting an item such as the output current, which cannot reach a 100% value easily by operation, set **Pr.54** to "21" (reference voltage output) and calibrate. A pulse train of 1440 pulses/s are output via terminal FM.
- When **Pr.310 Analog meter voltage output selection** = "21", the output via terminal FM cannot be calibrated. For details of **Pr.310**, refer to the FR-A8AY E kit Instruction Manual.
- The wiring length to terminal FM should be 200 m at maximum.
- The initial value of the calibration parameter **C0 (Pr.900)** is set to 1 mA full-scale and 1440 pulses/s terminal FM pulse train output at 60 Hz. The maximum pulse train output of terminal FM is 2400 pulses/s.
- When connecting a frequency meter between terminals FM and SD and monitoring the output frequency, it is necessary to change **Pr.55** to the maximum frequency, since the FM terminal output will be saturated at the initial value when the maximum frequency reaches 100 Hz or greater.

◆ Calibration procedure for terminal FM when using the operation panel

Operating procedure

1. Turning ON the power of the inverter
The operation panel is in the monitor mode.
2. Changing the operation mode
Press the PU/EXT key to choose the PU operation mode. The PU LED turns ON.
Calibration is also possible in the External operation mode.
3. Selecting the parameter setting mode
Press the MODE key to choose the parameter setting mode. (The parameter number read previously appears.)
4. Calibration parameter selection
Turn the setting dial until "C..." appears. Press the SET key to display "C---".
5. Selecting a parameter
Turn the setting dial until "C0" (**C0 (Pr.900) FM terminal calibration**) appears. Press the SET key to enable the parameter setting.
The monitored value of the item (initially the output frequency) selected by **Pr.54 FM terminal function selection** will appear.
6. Pulse output via terminal FM
If stopped, press the RUN key to start the inverter operation. (To monitor the output frequency, motor connection is not required.)
When a monitor that does not require inverter operation is set in **Pr.54**, calibration is also possible during a stop status.
7. Scale adjustment
Turn the setting dial to move the meter needle to a desired position.
8. Setting completed
Press the SET key to confirm the setting. The monitor indicator blinks.
 - Turn the setting dial to read another parameter.
 - Press the SET key to return to the "C---" display.
 - Press the SET key twice to show the next parameter.

NOTE

- Calibration can also be made for External operation. Set the frequency in the External operation mode, and make calibration in the above procedure.
- Calibration can be performed during operation.
- For operation outline of the parameter unit (FR-PU07), refer to the FR-PU07 Instruction Manual.

◆ Terminal AM calibration (C1 (Pr.901)) (AM type only)

- Terminal AM is initially set to provide a 10 VDC output in the full-scale state of the corresponding monitor item. The calibration parameter **C1 (Pr.901) AM terminal calibration** allows the output voltage ratio (gains) to be adjusted according to the meter scale. Note that the maximum output voltage is 10 VDC.

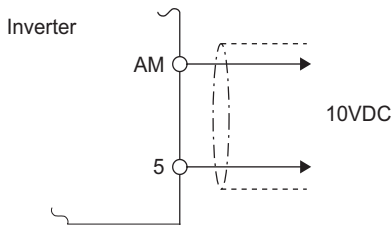

- Calibrate the output via terminal AM in the following procedure.
 - 1.** Connect a 0-10 VDC indicator (frequency meter) across terminal AM and terminal 5 on the inverter. (Note the polarity. Terminal AM is positive.)
 - 2.** Set a monitor item in **Pr.158 AM terminal function selection**. (Refer to [page 358](#).)
When the output frequency or inverter output current is selected on the monitor, set the output frequency or current value at which the output signal is 10 V, using **Pr.55** or **Pr.56** beforehand.
 - 3.** If the meter needle does not point to maximum even at maximum output, calibrate it with **C1 (Pr.901)**.

NOTE

- When outputting an item such as the output current, which cannot reach a 100% value easily by operation, set **Pr.158** to "21" (reference voltage output) and calibrate. A voltage of 10 VDC is output via terminal AM.
- When **Pr.306 Analog output signal selection** = "21", the output via terminal AM cannot be calibrated. For details on **Pr.306**, refer to the FR-A8AY E kit Instruction Manual or the FR-E8AXY E Kit Instruction Manual.
- Use **Pr.290 Monitor negative output selection** to enable negative signal output via terminal AM. The output voltage range is -10 to +10 VDC. Calibrate the maximum positive value output via terminal AM.

◆ Calibration when 0 V is output via terminal AM (Pr.1200) (AM type only)

- When 0 is output via terminal AM, use **Pr.1200 AM output offset calibration** to calibrate the meter. If the meter needle does not point to 0 while 0 is output via terminal AM, set a value in **Pr.1200** so that the needle points to 0.
- Set a larger value in **Pr.1200** when the needle points a minus output voltage while the 0 is output via terminal AM. Set a smaller value in **Pr.1200** when the needle points a plus output voltage while the 0 is output via terminal AM.

◆ Adjusting the response of terminal AM (Pr.867) (AM type only)

- Use **Pr.867** to adjust the output voltage response of the terminal AM in the range of 0 to 5 seconds.
- Increasing the setting stabilizes the output via terminal AM more but reduces the response level. (Setting "0" sets the response level to 6 ms.)

Parameters referred to

- Pr.54 FM terminal function selection [page 348](#)
- Pr.55 Frequency monitoring reference [page 348](#)
- Pr.56 Current monitoring reference [page 348](#)
- Pr.158 AM terminal function selection [page 348](#)
- Pr.290 Monitor negative output selection [page 348](#)

12.5 Energy saving monitoring

From the power consumption estimated value during commercial power supply operation, the energy saving effect by use of the inverter can be monitored and output.

Pr.	Name	Initial value	Setting range	Description
52 M100	Operation panel main monitor selection	0 (output frequency)	Refer to page 348.	50: Energy saving effect 51: Cumulative saved energy
774 M101	Operation panel monitor selection 1	9999		
775 M102	Operation panel monitor selection 2			
776 M103	Operation panel monitor selection 3			
992 M104	Operation panel setting dial push monitor selection	0 (set frequency)		
54 M300 ^{*1}	FM terminal function selection	1 (output frequency)	Refer to page 358.	50: Energy saving effect
158 M301 ^{*2}	AM terminal function selection			
891 M023	Cumulative power monitor digit shifted times	9999	0 to 4	Set the number of times to move the digit of cumulative power monitored value. The readout peaks out at the upper limit of readout.
			9999	The function of moving the decimal point is not available. The readout is reset to 0 when it exceeds the upper limit.
892 M200	Load factor	100%	30% to 150%	Set the load factor for the commercial power supply operation. The setting is used for calculation of the estimated power consumption during commercial power supply operation by being multiplied by the power consumption rate (page 369).
893 M201	Energy saving monitor reference (motor capacity)	Applicable motor capacity	0.1 to 30 kW	Set the motor capacity (pump capacity). Setting this parameter is required for calculating the rate of saved power, the rate of average energy saving, and the commercial power.
894 M202	Control selection during commercial power-supply operation	0	0	Discharge damper control (fan)
			1	Inlet damper control (fan)
			2	Valve control (pump)
			3	Commercial power supply drive (fixed value)
895 M203	Power saving rate reference value	9999	0	Consider the commercial power as 100%.
			1	Consider the power set in Pr.893 as 100%
			9999	No function
896 M204	Power unit cost	9999	0 to 500	Set the power unit cost. Setting this parameter is required for displaying the energy cost savings in the energy saving monitoring.
			9999	No function
897 M205	Power saving monitor average time	9999	0	The time period for averaging is 30 minutes.
			1 to 1000 h	Set the number of hours for averaging.
			9999	No function
898 M206	Power saving cumulative monitor clear	9999	0	Clear the cumulative monitor value
			1	Hold the cumulative monitor value
			10	Continue accumulation (upper limit communication data is 9999)
			9999	Continue accumulation (upper limit communication data is 65535)
899 M207	Operation time rate (estimated value)	9999	0% to 100%	Setting this parameter is required for calculating the annual energy saving. Set an annual operating rate (considering a 24-hours-a-day and 365-days-a-year operation as 100%).
			9999	No function

*1 The setting is available only for the FR-E800-1.

*2 The setting is available only for the FR-E800-4 and FR-E800-5.

◆ Energy saving monitoring list

- The items in the energy saving effect monitoring (items which can be monitored when "50" is set in **Pr.52, Pr.54, Pr.158, Pr.774 to Pr.776, and Pr.992**) are listed below.

(The items which can be monitored via terminal FM (**Pr.54** setting) and via terminal AM (**Pr.158** setting) are limited to [1 Power saving] and [3 Average power saving].)

	Energy saving monitor item	Description and formula	Unit and increment	Parameter setting			
				Pr.895	Pr.896	Pr.897	Pr.899
1	Power saving	It is defined as the difference between the estimated value of the required power during commercial power supply operation and the input power calculated with the inverter. [Power required for commercial power supply operation] - [Input power]	0.01 kW	9999			
2	Power saving rate	It is defined as the power saving expressed as a percentage. The rate of the power saving with respect to the estimated input power for the commercial power supply operation is determined using the following formula. $\frac{[1 \text{ Power saving}]}{\text{Power during commercial power supply operation}} \times 100$	0.1%	0	—	9999	
		The rate of the power saving with respect to the Pr.893 setting is determined using the following formula. $\frac{[1 \text{ Power saving}]}{\text{Pr.893}} \times 100$		1			
3	Average power saving	It is defined as the average hourly energy saving during a monitoring time (set in Pr.897). $\frac{\sum ([1 \text{ Power saving}] \times \Delta t)}{\text{Pr.897}}$	0.01 kWh	9999			—
4	Average power saving rate	It is defined as the average hourly energy saving expressed as a percentage. The rate of the average hourly energy saving with respect to the estimated input power for the commercial power supply operation is determined using the following formula. $\frac{\sum ([2 \text{ Power saving rate}] \times \Delta t)}{\text{Pr.897}} \times 100$	0.1%	0	9999	0 to 1000 h	
		The rate of the average hourly energy saving with respect to the Pr.893 setting is determined using the following formula. $\frac{[3 \text{ Average power saving}]}{\text{Pr.893}} \times 100$		1			
5	Average power cost savings	It is defined as a monetary value of the average hourly energy saving, determined using the following formula. [3 Average power saving] × Pr.896 setting	0.01/0.1	—	0 to 500		

- The items in the cumulative energy saving monitoring (items which can be monitored when "51" is set in **Pr.52**, **Pr.774 to Pr.776**, and **Pr.992**) are listed below.

(The digit of the cumulative energy saving monitored value can be moved to the right according to the setting of **Pr.891 Cumulative power monitor digit shifted times**.)

	Energy saving monitor item	Description and formula	Unit and increment	Parameter setting			
				Pr.895	Pr.896	Pr.897	Pr.899
6	Power saving amount	It is defined as a cumulative energy saving during monitoring, determined by multiplying the saved power by the number of inverter operating hours. $\Sigma ([1 \text{ Power saving}] \times \Delta t)$	0.01 kWh ^{*1*2}	—	9999	—	9999
7	Power cost savings	It is defined as a monetary value of the cumulative energy saving. [6 Power saving amount] × Pr.896 setting	0.01 ^{*1}	—	0 to 500		
8	Annual power saving amount	It is defined as an estimated annual energy saving. $\frac{[6 \text{ Power saving amount}]}{\text{Operation time during power saving accumulation}} \times 24 \times 365 \times \frac{\text{Pr.899}}{100}$	0.01 kWh ^{*1*2}	—	9999	—	0% to 100%
9	Annual power cost savings	It is defined as a monetary value of annual energy saving. [8 Annual power saving amount] × Pr.896 setting	0.01 ^{*1}	—	0 to 500		

*1 For monitoring via communication, the increments are 1 in no units. For example, a value "10.00 kWh" is converted into "10" for communication data.

*2 On the LCD operation panel or the parameter unit, a readout is displayed in units of kilowatt-hours (kW).

NOTE

- The operation panel have a 4-digit display. This means, for example, that a monitored value up to "99.99" is displayed in 0.01 increments and a monitor value of 100 or more is displayed in 0.1 increments as "100.0". The maximum monitored value displayed is "9999".
- The parameter unit have a 5-digit display. This means, for example, that a monitored value up to 999.99 is displayed in 0.01 increments and a monitor value of 1000 or more is displayed in 0.1 increments as "1000.0". The maximum monitored value displayed is "99999".
- The maximum monitored value via communication is 65535 when **Pr.898 Power saving cumulative monitor clear** = "9999". The maximum monitored value on monitoring in 0.01 increments is "655.35", and that on monitoring in 0.1 increments is "6553.5".

◆ Power saving real-time monitoring ([1 Power saving], [2 Power saving rate])

- During **[1 Power saving]** monitoring, an energy saving effect (power difference) of using the inverter as compared to the commercial power supply operation is calculated and displayed on the main monitor.
- In the following cases, the monitored value of **[1 Power saving]** is "0".
The result of calculating the saved power is negative value.
DC injection brake works.
The motor is not connected with the inverter (monitored value of output current is 0 A).
- On **[2 Power saving rate]** monitoring, the rate of the saved power considering the consumed power (estimate) during the power supply operation as 100% is displayed when **Pr.895 Power saving rate reference value** is set to "0". When **Pr.895** is set to "1", the rate of the saved power with respect to the setting of **Pr.893 Energy saving monitor reference (motor capacity)** that is referenced as 100% is displayed.

◆ Average power saving monitoring ([3 Average power saving], [4 Average power saving rate], [5 Average power cost savings])

- The average power saving monitors are displayed by setting a value other than 9999 in **Pr.897 Power saving monitor average time**.
- On **[3 Average power saving]** monitoring, the average hourly energy saving every preset time period is displayed.

- When the setting of **Pr.897** is changed, when the inverter is powered ON, or when the inverter is reset, the averaging is restarted. The Energy saving average value updated timing (Y92) signal is inverted every time the averaging is restarted.

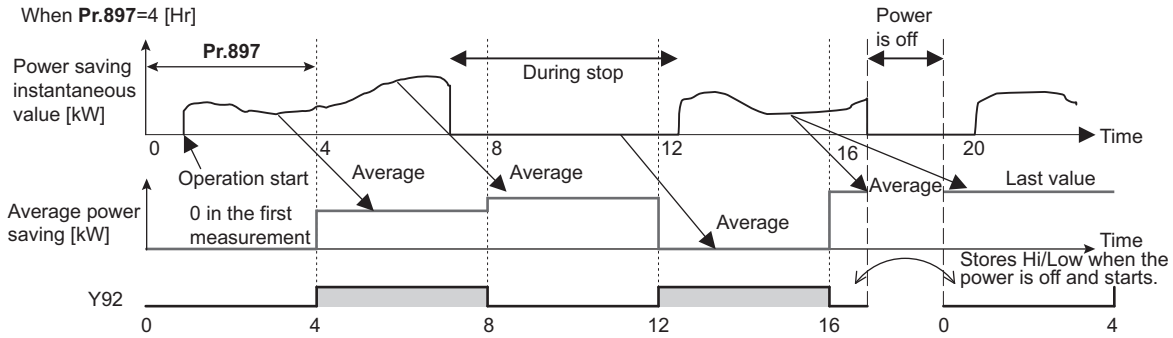

- On **[4 Average power saving rate]** monitoring, the average hourly monitored value of **[2 Power saving rate]** is displayed when **Pr.895 Power saving rate reference value** is set to "0 or 1".
- On **[5 Average power cost savings]** monitoring, a monetary value of the average hourly energy saving (**[3 Average power saving]** × **Pr.896** setting) is displayed when the unit price, power cost per kilowatt (hour), is set in **Pr.896 Power unit cost**.

◆ Cumulative energy saving monitoring (**[6 Power saving amount]**, **[7 Power cost saving]**, **[8 Annual power saving amount]**, **[9 Annual power cost savings]**)

- The digit of the cumulative energy monitored value can be moved to the right by the number set in **Pr.891 Cumulative power monitor digit shifted times**. For example, when **Pr.891** = "2", the cumulative power value 1278.56 kWh is displayed as 12.78 (in 100 kWh increments) on the operation panel, or displayed as 13 on a display used for monitoring via communication. When **Pr.891** = "0 to 4" and the cumulative energy reaches more than the upper limit of readout, the readout peaks out at the upper limit, which indicates that moving digit is necessary. When **Pr.891** = "9999" and the cumulative energy reaches more than the upper limit of readout, cumulative value is reset to 0 and the metering restarts. The readout of other items in the cumulative energy saving monitoring peaks out at the upper limit of readout.
- With the monitored value of **[6 Power saving amount]**, a cumulative energy saving during a desired time period can be measured. Follow this procedure.

- Set "10" or "9999" in **Pr.898 Power saving cumulative monitor clear**.
- Change the setting of **Pr.898** to "0" when you want to start measuring the energy saving. The cumulative value is cleared and the cumulative energy saving meter restarts.
- Change the setting of **Pr.898** to "1" when you want to stop measuring the energy saving. The meter stops and the cumulative value is fixed.

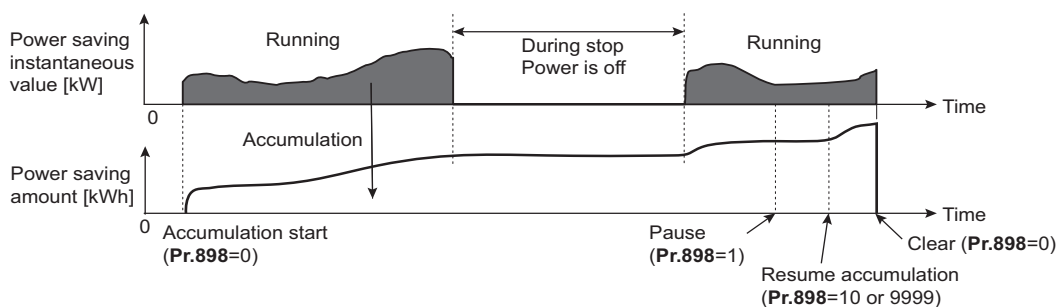

NOTE

- The cumulative value of energy saving is refreshed every hour. This means that the last cumulative value is displayed at a restart of the inverter and the cumulative meter restarts if the time elapsed between turning OFF and re-turning ON of the inverter is shorter than an hour. (In some cases, the cumulative energy value may decrease.)

◆ Estimated input power for the commercial power supply operation (Pr.892, Pr.893, Pr.894)

- Select the pattern of the commercial power supply operation from among four patterns (discharge damper control (fan), suction damper control (fan), valve control (pump) and commercial power drive), and set it in **Pr.894 Control selection during commercial power-supply operation**.
- Set the motor capacity (pump capacity) in **Pr.893 Energy saving monitor reference (motor capacity)**.
- Refer to the following graph to find the rate of power consumption (%) during commercial power supply operation based on the selected pattern and the rate of motor rotations per minute with respect to the rated speed (the result of dividing the present output frequency by **Pr.3 Base frequency** setting).

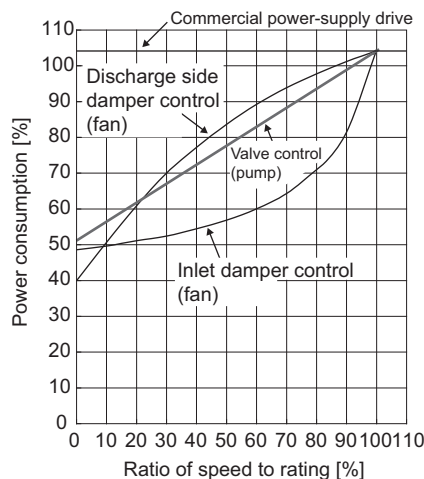

- The estimated input power (kW) for the commercial power supply operation is calculated from the motor capacity set in **Pr.893**, the setting of **Pr.892 Load factor**, and the rate of power consumption using the following formula.

$$\text{Estimated consumed power during commercial power supply operation (kW)} = \text{Pr.893 (kW)} \times \frac{\text{Consumed power (\%)}}{100} \times \frac{\text{Pr.892 (\%)}}{100}$$

NOTE

- If the output frequency rises to the setting of **Pr.3 Base frequency** or higher, it stays at a constant value because the rotations per minute cannot rise higher than the power supply frequency during commercial power supply operation.

◆ Annual energy saving and its monetary value (Pr.899)

- When the operation time rate (ratio of the time period in year when the inverter drives the motor) [%] is set in **Pr.899**, the annual energy saving effect can be estimated.
- When the inverter is operated in specific patterns, the estimate annual energy saving can be calculated by measuring the energy saving in a certain period.
- Refer to the following procedure to set the operation time rate.

1. Estimate the average operation time per day (h/day).
2. Calculate the operation days per year (days/year) using the following formula: Average operation days per month × 12 (months).
3. Calculate the annual operation time (h/year) from values determined in Step 1 and Step 2, using the following formula.

$$\text{Annual operation time (h/year)} = \text{average time (h/day)} \times \text{number of operation days (days/year)}$$

4. Calculate the operation time rate using the following formula, and set it in **Pr.899**.

$$\text{Operation time rate (\%)} = \frac{\text{Annual operation time (h/year)}}{24 \text{ (h/day)} \times 365 \text{ (days/year)}} \times 100(\%)$$

NOTE

- Setting example for operation time rate: In the case where the average operation time per day is about 21 hours and the average operation days per month is 16 days.

$$\text{Annual operation time} = 21 \text{ (h/day)} \times 16 \text{ (days/month)} \times 12 \text{ (months)} = \underline{4032 \text{ (h/year)}}$$

$$\text{Operation time rate (\%)} = \frac{4032 \text{ (h/year)}}{24 \text{ (h/day)} \times 365 \text{ (days/year)}} \times 100(\%) = \underline{46.03\%}$$

Therefore, set 46.03% in **Pr.899**.

- Calculate the annual energy saving from the value of [3 Average power saving] cumulated according to the setting of **Pr.899 Operation time rate (estimated value)**.

$$\text{Annual power saving amount (kWh/year)} = \frac{\text{With Pr.898} = 10 \text{ or } 9999, \text{ average power saving (kW) during cumulative period}}{\times 24\text{h} \times 365 \text{ days} \times \frac{\text{Pr.899}}{100}}$$

- When the power cost per hour is set in **Pr.896 Power unit cost**, the annual energy cost savings can be monitored. The annual energy cost savings is determined by calculation using the following formula.

$$\text{Annual power cost saving} = \text{annual power saving amount (kWh/year)} \times \text{Pr.896}$$

NOTE

- During regenerative driving, substitute the output power during the commercial power supply operation for the saved power (therefore, input power = 0).

Parameters referred to

Pr.3 Base frequency  page 530

Pr.52 Operation panel main monitor selection  page 348

Pr.54 FM terminal function selection  page 358

Pr.158 AM terminal function selection  page 358

12.6 Output terminal function selection

Use the following parameters to change the functions of the open collector output terminals and relay output terminals.

Pr.	Name		Initial value	Signal name	Setting range
190 M400	RUN terminal function selection	For open collector output terminal	0	RUN (Inverter running)	0, 1, 3, 4, 7, 8, 11 to 16, 18 to 20, 24 to 28, 30 to 36, 38 to 41, 44 to 48, 56, 57, 60 to 66, 68, 70, 80 to 82, 84, 90 to 93, 95, 96, 98 to 101, 103, 104, 107, 108, 111 to 116, 120, 124 to 128, 130 to 136, 138 to 141, 144 to 148, 156, 157, 160 to 166, 168, 170, 180 to 182, 184, 190 to 193, 195, 196, 198, 199, 206, 211 to 213, 242, 306, 311 to 313, 342, 9999 ^{*1}
191 M404	FU terminal function selection		4	FU (Output frequency detection)	
192 M405	A,B,C terminal function selection	For relay output terminal	99	ALM (Fault)	0, 1, 3, 4, 7, 8, 11 to 16, 18 to 20, 24 to 28, 30 to 36, 38 to 41, 44 to 48, 56, 57, 60 to 66, 68, 70, 80 to 82, 84, 90, 91, 95, 96, 98 to 101, 103, 104, 107, 108, 111 to 116, 120, 124 to 128, 130 to 136, 138 to 141, 144 to 148, 156, 157, 160 to 166, 168, 170, 180 to 182, 184, 190, 191, 195, 196, 198, 199, 206, 211 to 213, 242, 306, 311 to 313, 342, 9999 ^{*1}
193 M451	NET Y1 output selection	Virtual output terminal for communication operation	9999	No function	0, 1, 3, 4, 7, 8, 11 to 16, 18 to 20, 24 to 28, 30 to 36, 38 to 41, 44 to 48, 56, 57, 60 to 66, 68, 70, 80, 81, 84, 90 to 93, 95, 98 to 101, 103, 104, 107, 108, 111 to 116, 120, 124 to 128, 130 to 136, 138 to 141, 144 to 148, 156, 157, 160 to 166, 168, 170, 180, 181, 184, 190 to 193, 195, 198, 199, 206, 211 to 213, 242, 306, 311 to 313, 342, 9999 ^{*1}
194 M452	NET Y2 output selection				
195 M453	NET Y3 output selection				
196 M454	NET Y4 output selection				
197 M406	ABC2 terminal function selection	For relay output terminal	9999	No function	0, 1, 3, 4, 7, 8, 11 to 16, 18 to 20, 24 to 28, 30 to 36, 38 to 41, 44 to 48, 56, 57, 60 to 66, 68, 70, 80 to 82, 84, 90, 91, 95, 96, 98 to 101, 103, 104, 107, 108, 111 to 116, 120, 124 to 128, 130 to 136, 138 to 141, 144 to 148, 156, 157, 160 to 166, 168, 170, 180 to 182, 184, 190, 191, 195, 196, 198, 199, 206, 211 to 213, 242, 306, 311 to 313, 342, 9999 ^{*1}
313 M410 ^{*2}	DO0 output selection	For terminal on the option	9999	No function	0, 1, 3, 4, 7, 8, 11 to 16, 18 to 20, 24 to 28, 30 to 36, 38 to 41, 44 to 48, 56, 57, 60 to 66, 68, 70, 80, 81, 84, 90 to 93, 95, 96, 98 to 101, 103, 104, 107, 108, 111 to 116, 120, 124 to 128, 130 to 136, 138 to 141, 144 to 148, 156, 157, 160 to 166, 168, 170, 180, 181, 184, 190 to 193, 195, 196, 198, 199, 206, 211 to 213, 242, 306, 311 to 313, 342, 9999 ^{*1}
314 M411 ^{*2}	DO1 output selection		9999	No function	
315 M412 ^{*2}	DO2 output selection		9999	No function	
316 M413 ^{*2}	DO3 output selection		9999	No function	
317 M414 ^{*2}	DO4 output selection		9999	No function	
318 M415 ^{*2}	DO5 output selection		9999	No function	
319 M416 ^{*2}	DO6 output selection		9999	No function	
320 M420 ^{*2}	RA1 output selection		0	RUN (Inverter running)	
321 M421 ^{*2}	RA2 output selection	1	SU (Up to frequency)	0, 1, 3, 4, 7, 8, 11 to 16, 18 to 20, 24 to 28, 30 to 36, 38 to 41, 44 to 48, 56, 57, 60 to 66, 68, 70, 80, 81, 84, 90, 91, 95, 96, 98, 99, 206, 211 to 213, 242, 9999 ^{*1}	
322 M422 ^{*2}	RA3 output selection	4	FU (Output frequency detection)		

Pr.	Name	Initial value	Setting range	Description
289 M431	Inverter output terminal filter	9999	5 to 50 ms	Set the time delay for the output terminal response.
			9999	No filtering of the output terminal.

*1 The setting range differs depending on the model. For the details, refer to Output signal list.

*2 The setting is available when a compatible plug-in option is installed or when the PLC function is enabled. (Pr.313 to Pr.315 are always available for settings in the FR-E800-(SC)EPA, the FR-E800-(SC)EPB, and the FR-E806.)

◆ Output terminal function assignment

- Signals can be output to the inverter by using physical terminals or via communication, or assigned to the extension terminals of the plug-in option (FR-A8AY, FR-E8AXY, or FR-A8AR). Option output terminals are not available for the IP67 model as plug-in options are not available.
- Use parameters to assign functions to output terminals. Check the terminal available for each parameter.

Pr.	Terminal name	External output terminal (physical terminal)				Output via communication ^{*1}	Option output terminal (physical terminal) ^{*2}		
		FR-E800	FR-E800-E	FR-E800-SCE	FR-E806		FR-A8AY	FR-E8AXY	FR-A8AR
190	RUN	○	—	—	○	○	—	—	—
191	FU	○	—	—	○	○	—	—	—
192	A,B,C	○	○	○	○	○	—	—	—
193	NET Y1	—	—	—	—	○	—	—	—
194	NET Y2	—	—	—	—	○	—	—	—
195	NET Y3	—	—	—	—	○	—	—	—
196	NET Y4	—	—	—	—	○	—	—	—
197	A2,B2,C2	—	—	—	○	○	—	—	—
313	DO0	—	—	—	—	○	○	—	—
314	DO1	—	—	—	—	○	○	○	—
315	DO2	—	—	—	—	○	○	○	—
316	DO3	—	—	—	—	—	○	—	—
317	DO4	—	—	—	—	—	○	—	—
318	DO5	—	—	—	—	—	○	—	—
319	DO6	—	—	—	—	—	○	—	—
320	RA1	—	—	—	—	—	—	—	○
321	RA2	—	—	—	—	—	—	—	○
322	RA3	—	—	—	—	—	—	—	○

○: Assignment/output available, —: Assignment/output unavailable (no function)

*1 The communication protocol affects which terminal can be used. For details, refer to the Instruction Manual (Communication) or the Instruction Manual of the communication option.

*2 Refer to the Instruction Manual of the option for details on the option output terminals.

◆ Output signal list

- A function listed below can be set to each output terminal.
- Refer to the following table and set the parameters. (0 to 99, 200 to 299: Positive logic, 100 to 199, 300 to 399: Negative logic)

Setting		Signal name	Function	Operation	Related parameter	Refer to page
Positive logic	Negative logic					
0	100	RUN	Inverter running	Output during operation when the inverter output frequency reaches Pr.13 Starting frequency or higher.	—	377
1	101	SU	Up to frequency ^{*1}	Output when the output frequency reaches the set frequency.	Pr.41	382
3	103	OL	Overload warning	Output while the stall prevention function works.	Pr.22, Pr.23, Pr.66, Pr.154	334
4	104	FU	Output frequency detection	Output when the output frequency reaches the frequency set in Pr.42 (Pr.43 during reverse rotation) or higher.	Pr.42, Pr.43	382
7	107	RBP	Regenerative brake prealarm	Output when the regenerative brake duty reaches 85% of the setting of Pr.70 .	Pr.70	545
8	108	THP	Electronic thermal O/L relay pre-alarm	Output when the cumulative electronic thermal O/L relay value reaches 85% of the trip level. (The electronic thermal O/L relay function (E.THT/E.THM) is activated when the value reaches 100%.)	Pr.9	306
11	111	RY	Inverter operation ready	Output when the reset process is completed after powering ON the inverter or when the inverter is ready to start operation with the start signal ON or during operation.	—	377
12	112	Y12	Output current detection	Output when the output current is higher than the Pr.150 setting for the time set in Pr.151 or longer.	Pr.150, Pr.151	385
13	113	Y13	Zero current detection	Output when the output current is lower than the Pr.152 setting for the time set in Pr.153 or longer.	Pr.152, Pr.153	385
14	114	FDN	PID lower limit	Output when the input value is lower than the lower limit set for the PID control operation.	Pr.127 to Pr.134, Pr.575 to Pr.577	479
15	115	FUP	PID upper limit	Output when the input value is higher than the upper limit set for the PID control operation.		
16	116	RL	PID forward/reverse rotation output	Output during forward rotation operation in the PID control operation.		
18	—	MC2	Electronic bypass MC2 ^{*3}	Used to enable the electronic bypass during emergency drive operation. (Available for the FR-E800 and FR-E800-E.)	Pr.136, Pr.139	322
19	—	MC3	Electronic bypass MC3 ^{*3}			
20	120	BOF	Brake opening request	Output to release the brake while the brake sequence function is enabled.	Pr.278 to Pr.285, Pr.292	456
24	124	LP	Stroke limit warning	Output when the LSP or LSN signal is ON (normally open input).	Pr.1292	192
25	125	FAN	Fan fault output	Output when a fan fault occurs.	Pr.244	314
26	126	FIN	Heat sink overheat pre-alarm	Output when the heat sink temperature rises to 85% of temperature at which the protective function of the Heat sink overheat is activated.	—	Instruction Manual (Maintenance)
27	127	ORA	Orientation complete (output for a Vector control compatible option) ^{*2}	Output while the orientation control operation is enabled.	Pr.350 to Pr.359, Pr.361 to Pr.366, Pr.369, Pr.393, Pr.396 to Pr.399	468
28	128	ORM	Orientation fault (output for a Vector control compatible option) ^{*2}			

Setting		Signal name	Function	Operation	Related parameter	Refer to page
Positive logic	Negative logic					
30	130	Y30	Forward rotation output (output for a Vector control compatible option) ^{*2}	Output while a motor rotates in forward direction.		379
31	131	Y31	Reverse rotation output (output for a Vector control compatible option) ^{*2}	Output while a motor rotates in reverse direction.	—	379
32	132	Y32	Regenerative status output (output for a Vector control compatible option) ^{*2}	Output while a motor is in a regenerative braking state under Vector control.		380
33	133	RY2	Operation ready 2	Output while pre-excitation is enabled or during normal operation under Real sensorless vector control, Vector control, or PM sensorless vector control.	—	377
34	134	LS	Low speed detection	Output when the output frequency drops to the Pr.865 setting or lower.	Pr.865	382
35	135	TU	Torque detection	Output when the motor torque is higher than the Pr.864 setting.	Pr.864	387
36	136	Y36	In-position	Output when the number of droop pulses is equal to or smaller than the Pr.426 setting value.	Pr.426	212
38	138	MEND	Travel completed	Output when the position command operation has completed while the number of droop pulses is within the positioning completion width.	Pr.426	213
39	139	Y39	Start time tuning completion	Output when the start-time tuning complete.	Pr.95, Pr.574	449
40	140	Y40	Trace status	Output during trace operation.	Pr.1020, Pr.1022 to Pr.1047	518
41	141	FB	Speed detection	Output when the actual motor rotations per minute (estimate) reaches the setting of Pr.42 .	Pr.42	382
44	144	RUN2	Inverter running 2	Output while the Forward rotation command signal or Reverse rotation command signal is ON. Output during deceleration even while the Forward rotation command signal or Reverse rotation command signal is OFF. (The signal is not output while pre-excitation is enabled (the LX signal is ON), but output while the servo-lock function is ON (the LX signal is ON) in the position control mode. Under Vector control, the signal is output while the Orientation command (X22) signal is ON.)	—	377
45	145	RUN3	Inverter running and start command ON	Output while the inverter is running or while the start command signal is ON.	—	377
46	146	Y46	During deceleration at occurrence of power failure	Output when the power-failure deceleration function is activated. (The signal output is retained until the function stops.)	Pr.261	514
47	147	PID	During PID control activated	Output during the PID control operation.	Pr.127 to Pr.134, Pr.575 to Pr.577	479
48	148	Y48	PID deviation limit	Output when the absolute deviation value exceeds the limit value.	Pr.127 to Pr.134, Pr.553, Pr.554	479
56	156	ZA	Home position return failure	Output while the home position return error warning occurs.	—	188
57	157	IPM	During PM sensorless vector control ^{*3}	Output while the operation is performed under PM sensorless vector control.	Pr.71 to Pr.80, Pr.998	123

Setting		Signal name	Function	Operation	Related parameter	Refer to page
Positive logic	Negative logic					
60	160	FP	Position detection level	Output when the current position exceeds the position detection judgment value (set in Pr.1294 and Pr.1295).	Pr.1294 to Pr.1297	213
61	161	PBSY	During position command operation	Output while the position command operation is performed.	—	213
62	162	CPO	Rough match	Output when the remaining command distance (before electronic gear) reaches the Pr.510 setting value or less. (The remaining distance can be calculated by subtracting the position command (before electronic gear) from the target position (before electronic gear).)	Pr.510	213
63	163	ZP	Home position return completed	Output when the home position return is completed.	—	188
64	164	Y64	During retry	Output during retry operation.	Pr.65 to Pr.69	319
65	165	Y65	Emergency drive in operation ^{*3}	Output during emergency drive operation. (Available for the FR-E800 and FR-E800-E.)	Pr.514, Pr.515, Pr.523, Pr.524, Pr.1013	322
66	166	ALM3	Fault output during emergency drive	Output when a fault occurs during emergency drive operation. (Available for the FR-E800 and FR-E800-E.)		
68	168	EV	24 V external power supply operation ^{*3}	Output while the inverter is operated with a 24 V power supplied from an external source.	—	FR-E8DS E Kit Instruction Manual, Instruction Manual (Connection)
70	170	SLEEP	PID output interruption	Output while PID output suspension function is activated.	Pr.127 to Pr.134, Pr.575 to Pr.577	479
80	180	SAFE	Safety monitor output ^{*4}	Output while the safety stop function is activated.	—	Instruction Manual (Functional Safety)
81	181	SAFE2	Safety monitor output 2 ^{*4}	Output when no internal safety circuit failure exists.		
82	182	Y82	BACnet binary output ^{*3}	Enables output from the Binary Output object for BACnet communication. (Available for the FR-E800, FR-E800-(SC)EPA, and FR-E806-SCEPA.) The setting is available in the Pr.190 to Pr.192 for the FR-E800. The setting is available only in the Pr.192 for the FR-E800-(SC)EPA. The setting is available in the Pr.190 to Pr.192, or Pr.197 for the FR-E806-SCEPA.	Pr.549	Instruction Manual (Communication)
84	184	RDY	Position control preparation ready	Output when the servo-lock function is working (the LX signal turns ON) and the inverter is ready to operate.	—	189
90	190	Y90	Life alarm ^{*3}	Output when the life check function detects the part approaching the end of its life.	Pr.198, Pr.255 to Pr.259, Pr.506 to Pr.509	251
91	191	Y91	Fault output 3 (Power-OFF signal) ^{*3}	Output when the Fault occurs due to an inverter circuit fault or connection fault.	—	381
92	192	Y92	Energy saving average value updated timing ^{*3}	Switches between ON and OFF every time the average energy saving is updated during the energy saving monitoring. This signal cannot be assigned to any of the relay output terminal (Pr.192, Pr.197, Pr.320 to Pr.322).	Pr.52, Pr.54, Pr.158, Pr.891 to Pr.899	365
93	193	Y93	Current average monitor	Output in pulses for transmission of the average current value and the maintenance timer value. This signal cannot be assigned to any of the relay output terminal (Pr.192, Pr.197, Pr.320 to Pr.322).	Pr.555 to Pr.557	257
95	195	Y95	Maintenance timer ^{*3}	Output when the value of Pr.503 reaches the Pr.504 setting or higher.	Pr.503, Pr.504	256

Setting		Signal name	Function	Operation	Related parameter	Refer to page
Positive logic	Negative logic					
96	196	REM	Remote output ^{*3}	Output via a terminal by setting a proper number in a relative parameter.	Pr.495 to Pr.497	388
98	198	LF	Alarm ^{*3}	Output when an Alarm fault (fan fault or a communication error) occurs.	Pr.121, Pr.244	Instruction Manual (Communication), 314
99	199	ALM	Fault ^{*3}	Output when the inverter's protective function is activated to stop the power output (when the Fault occurs). The signal output stops when the inverter reset starts.	—	380
206	306	Y206	Cooling fan operation command	Output when the cooling fan operation is commanded.	Pr.244	314
211	311	LUP	Upper limit warning detection	Output when the load fault upper limit warning is detected.	Pr.1480 to Pr.1492	339
212	312	LDN	Lower limit warning detection	Output when the load fault lower limit warning is detected.		
213	313	Y213	During load characteristics measurement	Output during measurement of the load characteristics.		
242	342	LNK	Inverter-to-inverter linkup ^{*3}	Output when the inverter receives a response from all the slave inverters during initial communication, or when the inverter returns a response to the master. (Available for the FR-E800-(SC)E and FR-E806.)	Pr.1124, Pr.1125	Instruction Manual (Communication)
9999		—	No function	—	—	—

*1 Note that changing the frequency setting with an analog signal or the setting dial on the operation panel may cause the turning ON and OFF of Up to frequency (SU) signal depending on its changing speed and the timing of the speed change determined by the acceleration/deceleration time setting. (The signal state changing does not occur when the acceleration/deceleration time is set to 0 second.)

*2 Available when the plug-in option is connected. For the IP67 model, the function is invalid as plug-in options are not available.

*3 When the FR-E8DS is installed or when the IP67 model is used, the signal is enabled even during the 24 V external power supply operation. However, the Y90 and LF signals are not output for fan faults.

*4 The setting is not available when the FR-E8TR or the FR-E8TE7 is installed.

NOTE

- One function can be assigned to more than one terminal.
- The function works during the terminal conducts when the parameter setting is any of "0 to 99, 200 to 299", and the function works during the terminal does not conduct when the setting is "100 to 199, 300 to 399".
- Changing the terminal assignment using **Pr.190 to Pr.197 (Output terminal function selection)** may affect the other functions. Set parameters after confirming the function of each terminal.
- Do not assign the signal to terminals A, B, and C which frequently changes its state between ON and OFF. Otherwise, the life of the relay contact may be shortened.

◆ Adjusting the output terminal response level (Pr.289)

- The responsivity of the output terminals can be delayed in a range between 5 to 50 ms. (The following is the operation example of the RUN signal.)

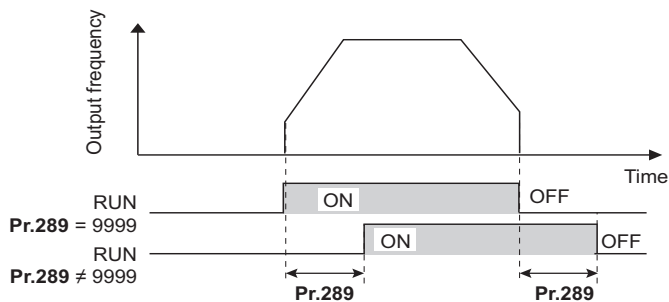

NOTE

- When **Pr.157 OL signal output timer** is set for the Overload warning (OL) signal output, the OL signal is output after the time period calculated by adding the **Pr.289** setting to the **Pr.157** setting elapsed.
- The signal output for the PLC function (see [page 516](#)) and the remote output signal via BACnet communication are not affected by the **Pr.289** setting (not filtered for responsivity).

◆ Inverter operation ready signals (RY, RY2 signals) and inverter running signals (RUN, RUN2, RUN3 signals)

■ Operation under V/F control and Advanced magnetic flux vector control

- When the inverter is ready for operation, the Inverter operation ready (RY) signal turns ON (and stays ON during operation).
- When the inverter output frequency reaches the setting of **Pr.13 Starting frequency** or higher, the inverter running signals (RUN, RUN2 signals) turn ON. The signals are OFF while the inverter is stopped or during the DC injection brake operation.
- The Inverter running and start command ON (RUN3) signal is ON while the inverter is running or while the start command signal is ON. (When the start command signal is ON, the RUN3 signal is ON even while the inverter's protective function is activated or while the MRS signal is ON.) The RUN3 signal is ON even during the DC injection brake operation, and the signal is OFF when the inverter stops.

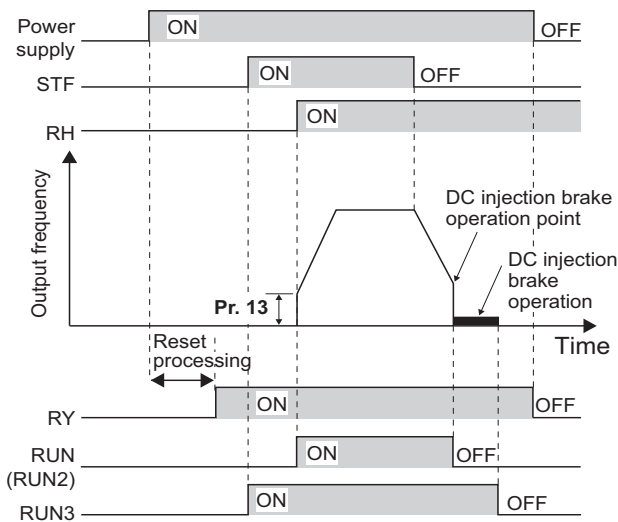

- The ON/OFF state of each signal according to the inverter operating status is shown in the matrix below.

Output signal	During 24 V external power supply operation ^{*1}	Start signal OFF (inverter stopped)	Start signal ON (inverter stopped)	Start signal ON (inverter running)	During DC injection brake operation	Inverter output shutoff ^{*3}		Automatic restart after instantaneous power failure		
						Start signal ON	Start signal OFF	During coasting		Inverter running after restart
								Start signal ON	Start signal OFF	
RY ^{*4}	OFF	ON	ON	ON	ON	OFF	OFF	ON ^{*2}	OFF	ON
RY2	OFF	OFF	OFF	OFF	OFF	OFF	OFF	OFF	OFF	OFF
RUN	OFF	OFF	OFF	ON	OFF	OFF	OFF	OFF	OFF	ON
RUN2	OFF	OFF	OFF	ON	OFF	OFF	OFF	OFF	OFF	ON
RUN3	OFF	OFF	ON	ON	ON	ON	OFF	ON	OFF	ON

^{*1} The operation can be performed when the FR-E8DS is installed or when the IP67 model is used.
^{*2} The signal is OFF during power failure or undervoltage.
^{*3} This means the state during a fault occurrence or while the MRS signal is ON, etc.
^{*4} The signal is OFF while power is not supplied to the main circuit.

■ Operation under Real sensorless vector control, Vector control, and PM sensorless vector control

- When the inverter is ready for operation, the Inverter operation ready (RY) signal turns ON (and stays ON during operation).

- When the inverter output frequency reaches the setting of **Pr.13 Starting frequency** or higher, the Inverter running (RUN) turns ON. The signal is OFF during an inverter stop, during the DC injection brake operation, during tuning at start-up, or during pre-excitation.
- The Inverter running 2 (RUN2) signal is ON while the inverter is running or while the start command signal is ON. (When the inverter's protective function is activated or the MRS signal is ON, the RUN2 signal turns OFF.)
- The Inverter running and start command ON (RUN3) signal is ON while the inverter is running or while the start command signal is ON.
- The RUN2 and RUN3 signals are also ON when the start command signal is ON or during pre-excitation with the speed command value 0. (However, the RUN2 signal is OFF during pre-excitation with the LX signal ON.)
- The Operation ready 2 (RY2) signal turns ON when the pre-excitation starts. The signal is ON during pre-excitation even while the inverter is stopped. The signal is OFF during the inverter output shutoff.

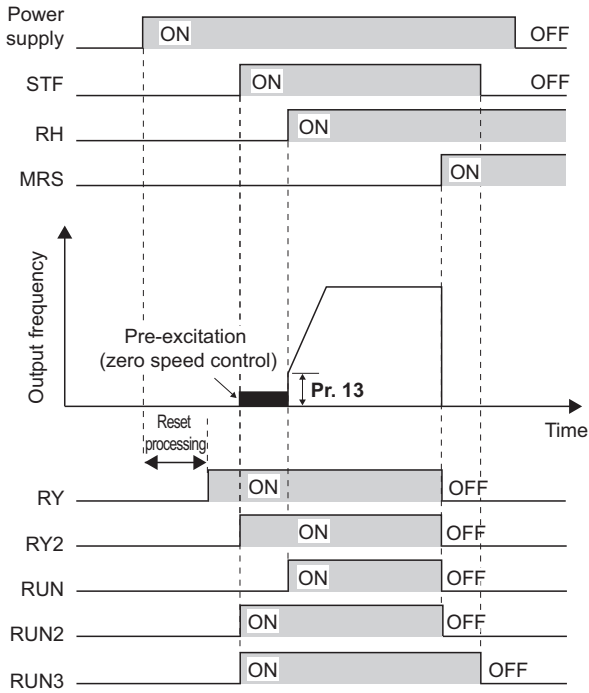

NOTE

- When pre-excitation works with the Pre-excitation (LX) signal ON, the RY2 signal turns ON after 100 ms from the time the LX signal turns ON. (When online auto tuning at start-up is selected (**Pr.95** = "1"), the time the signal turns ON is delayed by the tuning time.)

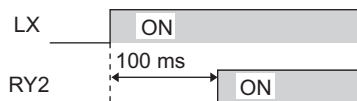

- The ON/OFF state of each signal according to the inverter operating status is shown in the matrix below.

Output signal	During 24 V external power supply operation ^{*1}	Start signal OFF (inverter stopped)	Start signal ON ^{*2} (during pre-excitation)	Start signal ON (inverter running)	LX signal ON (during pre-excitation)	During DC injection brake operation (during pre-excitation)	Inverter output shutoff ^{*6}		Automatic restart after instantaneous power failure		
							Start signal ON	Start signal OFF	During coasting		Inverter running after restart
								Start signal ON	Start signal OFF		
RY ^{*7}	OFF	ON	ON	ON	ON	ON	OFF	OFF	ON ^{*3}	OFF	ON
RY2	OFF	OFF	ON	ON	ON ^{*4}	ON	OFF	OFF	OFF	OFF	ON
RUN	OFF	OFF	OFF	ON	OFF ^{*5}	OFF	OFF	OFF	OFF	OFF	ON
RUN2	OFF	OFF	ON	ON	OFF ^{*5}	OFF	OFF	OFF	OFF	OFF	ON
RUN3	OFF	OFF	ON	ON	ON	ON	ON	OFF	ON	OFF	ON

^{*1} The operation can be performed when the FR-E8DS is installed or when the IP67 model is used.
^{*2} When the start signal is ON and the frequency command is 0 Hz, such state is designated as "during zero speed control".
^{*3} The signal is OFF during power failure or undervoltage.

- *4 The signal turns ON after 100 ms from the time the LX signal turns ON.
- *5 The signal is ON while the servo-lock function is ON (the LX signal is ON) in the position control mode.
- *6 This means the state during a fault occurrence or while the MRS signal is ON, etc.
- *7 The signal is OFF while power is not supplied to the main circuit.

- To use the RY, RY2, RUN, RUN2, or RUN3 signal, set the corresponding number selected from the following table in any parameter from **Pr.190 to Pr.197 (Output terminal function selection)** to assign the function to an output terminal.

Output signal	Pr.190 to Pr.197 settings	
	Positive logic	Negative logic
RY	11	111
RY2	33	133
RUN	0	100
RUN2	44	144
RUN3	45	145

NOTE

- The RUN signal (positive logic) is initially assigned to the terminal RUN (standard models only).

◆ Forward rotation output (Y30) signal and Reverse rotation output (Y31) signal

- Under Vector control, the Forward rotation output (Y30) signal or the Reverse rotation output (Y31) signal is output according to the actual rotation direction of the motor.
- During pre-excitation (zero-speed or servo-lock function ON) in the speed or torque control mode, the Y30 and Y31 signals are OFF.
- To use the Y30 signal, set "30" (positive logic) or "130" (negative logic) in any parameter from **Pr.190 to Pr.197 (Output terminal function selection)** to assign the function to an output terminal.
- To use the Y31 signal, set "31" (positive logic) or "131" (negative logic) in any parameter from **Pr.190 to Pr.197 (Output terminal function selection)** to assign the function to an output terminal.

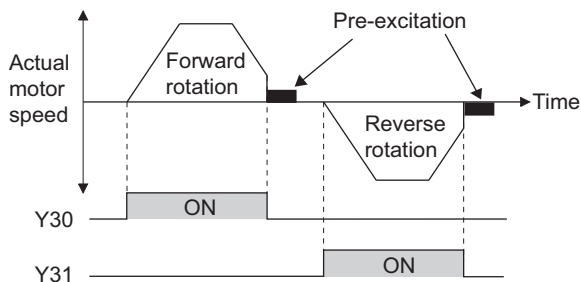

NOTE

- The Y30 and Y31 signals are always OFF under V/F control, Advanced magnetic flux vector control, Real sensorless vector control, and PM sensorless vector control.
- If the motor is rotated by an external force while the inverter is stopped, the Y30 and Y31 signals remain OFF.

◆ Regenerative status output (Y32) signal

- When the motor gets in a regenerative braking (dynamic braking) state under Vector control, the Regenerative status output (Y32) signal turns ON. Once the signal turns ON, the signal is retained ON for at least 100 ms.
- The signal is OFF during an inverter stop or during pre-excitation.
- To use the Y32 signal, set "32" (positive logic) or "132" (negative logic) in any parameter from **Pr.190 to Pr.197 (Output terminal function selection)** to assign the function to an output terminal.

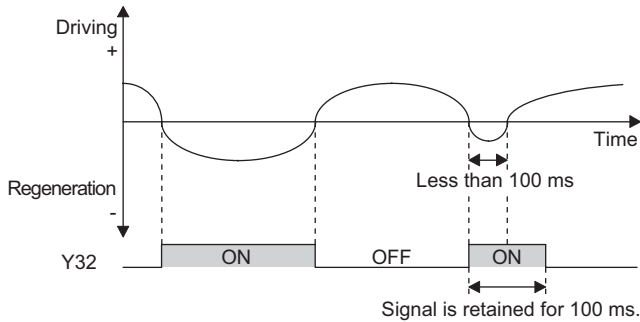

NOTE

- The Y32 signal is always OFF under V/F control, Advanced magnetic flux vector control, Real sensorless vector control, and PM sensorless vector control.

◆ Fault output (ALM) signal

- The fault signal (ALM signal) is output when an inverter protective function is activated.
- The ALM signal is assigned to the terminals A, B, and C in the initial status.

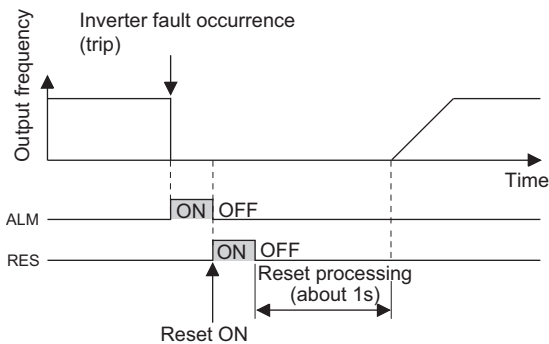

NOTE

- For details of the inverter faults, refer to the Instruction Manual (Maintenance).

◆ Input power shutoff like magnetic contactor (Y91 signal)

- The Fault output 3 (Y91) signal is output when a fault originating in the inverter circuit or a connection fault occurs.
- To use the Y91 signal, set "91" (positive logic) or "191" (negative logic) in any parameter from **Pr.190 to Pr.197 (Output terminal function selection)** to assign function to an output terminal.
- The following is the list of faults that output the Y91 signal. (For details on faults, refer to the Instruction Manual (Maintenance).)

Fault type
Inrush current limit circuit fault (E.IOH)
CPU fault (E.CPU)
CPU fault (E.6)
CPU fault (E.7)
Parameter storage device fault (control circuit board) (E.PE)
Parameter storage device fault (main circuit board) (E.PE2)
Internal storage device fault (E.PE6)
Output side earth (ground) fault overcurrent (E.GF)
Output phase loss (E.LF)
Brake transistor alarm detection (E.BE)
Internal circuit fault (E.13)

◆ Changing the special relay function for the PLC function

- For the PLC function, the function of special relays (SM1225 to SM1234) can be changed by setting **Pr.313 to Pr.322**. (For details on the PLC function, refer to the PLC Function Programming Manual.)

◀ Parameters referred to ▶

Pr.13 Starting frequency  page 274, page 275

12.7 Output frequency detection

If the inverter output frequency which reaches a specific value is detected, the relative signal is output.

Pr.	Name	Initial value ^{*1}		Setting range	Description
		Gr.1	Gr.2		
41 M441	Up-to-frequency sensitivity	10%		0% to 100%	Set the level where the SU signal turns ON.
42 M442	Output frequency detection	6 Hz		0 to 590 Hz	Set the frequency at which the FU (or FB) signal turns ON.
43 M443	Output frequency detection for reverse rotation	9999		0 to 590 Hz	Set the frequency at which the FU (or FB) signal turns ON only while the motor rotates in reverse direction.
				9999	The frequency same as the Pr.42 setting is set.
865 M446	Low speed detection	1.5 Hz		0 to 590 Hz	Set the frequency at which the LS signal turns ON.
870 M400	Speed detection hysteresis	0 Hz		0 to 15 Hz	Set the hysteresis width for the detected frequency.

*1 Gr.1 and Gr.2 are the parameter initial value groups. (Refer to page 54).

◆ Setting the notification zone of the output frequency reaching the set point (SU signal, Pr.41)

- The Up to frequency (SU) signal is output when the output frequency reaches the set frequency.
- Set the value in the range of 1% to 100% in **Pr.41** to determine tolerance for the set frequency (considered as 100% point).
- It may be useful to use this signal to start operating related equipment after checking that the set frequency has been reached.
- To use the SU signal, set "1" (positive logic) or "101" (negative logic) in any parameter from **Pr.190 to Pr.197 (Output terminal function selection)** to assign the function to an output terminal.

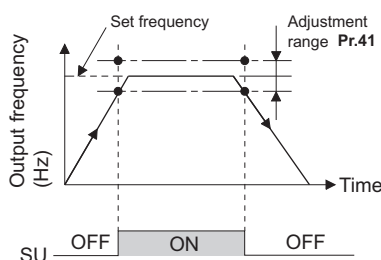

◆ Output frequency detection (FU (FB) signal, Pr.42, Pr.43)

- The Output frequency detection (FU) signal and the Speed detection (FB) signal are output when the output frequency reaches or exceeds the **Pr.42** setting.
- The FU signal is useful for applying or releasing electromagnetic brake, etc. Use the Inverter running (RUN) signal when releasing the brake from the motor with a brake under encoder feedback control. (The brake may not be released when the FU signal is used.)
- The FU signal is output when the output frequency (frequency command) reaches the set frequency. The FB signal is output when the detected actual speed (estimated speed under Real sensorless vector control, or feedback value under Vector control) of the motor reaches the set frequency. The FU signal and the FB signal are output at the same manner under V/F control or Advanced magnetic flux vector control or during the encoder feedback control operation.
- The frequency detection dedicated to motor rotation in reverse direction is enabled by setting the frequency in **Pr.43**. This setting is useful when the timing of the electromagnetic braking during forward rotation operation (for example, during lifting up in the lifts operation) is different from that during reverse rotation operation (lifting down).

- When **Pr.43** ≠ "9999", the **Pr.42** setting is for the forward rotation operation and the **Pr.43** setting is for the reverse rotation operation.

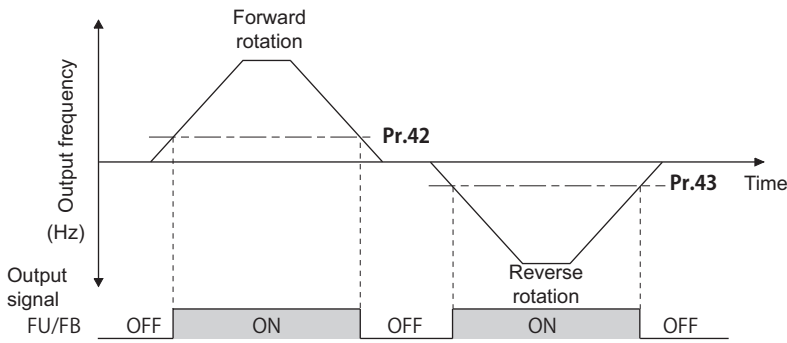

- To use each signal, set the corresponding number selected from the following table in any parameter from **Pr.190 to Pr.197 (Output terminal function selection)** to assign the function to an output terminal.

Output signal	Pr.190 to Pr.197 settings		Related parameter
	Positive logic	Negative logic	
FU	4	104	42, 43
FB	41	141	

◆ Low speed detection (LS signal, Pr.865)

- When the output frequency drops to the setting of **Pr.865 Low speed detection** or lower, the Low speed detection (LS) signal is output.
- The fault "E.OLT" displays and the inverter output shuts off if the torque limit operation causes the frequency to drop to the frequency set in **Pr.865** and the output torque to surpass the value set in **Pr.874 OLT level setting** for three seconds or longer in the speed control mode under Real sensorless vector control, Vector control, or PM sensorless vector control.
- For the LS signal, set "34" (positive logic) or "134" (negative logic) in any parameter from **Pr.190 to Pr.197 (Output terminal function selection)** to assign the function to an output terminal.

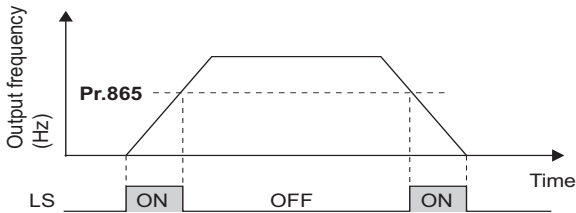

◆ Speed detection hysteresis (Pr.870)

This function prevents chattering of the speed detection signals. When an output frequency fluctuates, the following signals may chatter (turns ON and OFF repeatedly).

- Up to frequency (SU) signal
- Speed detection (FB) signal
- Low speed detection (LS) signal

Setting hysteresis to the detected frequency prevents chattering of these signals.

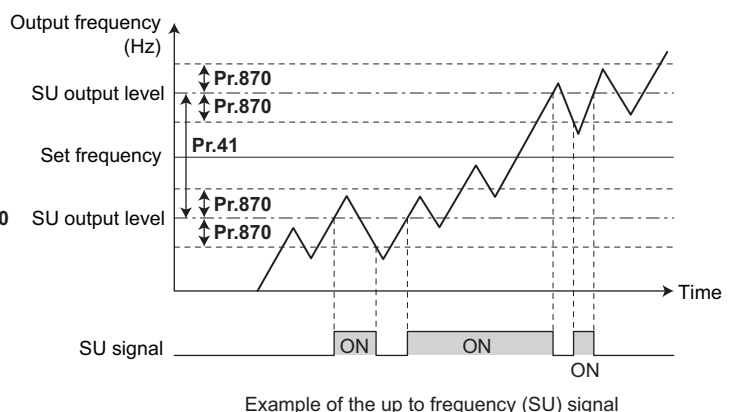
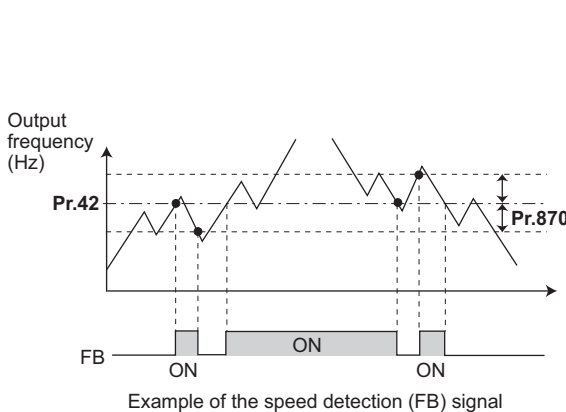

NOTE

- All signals are OFF during the DC injection brake operation and during tuning at start-up.
- The reference frequency in comparison with the set frequency differs depending on the control method.

Control method or function	Reference frequency	
	FU	FB, SU, LS
V/F control	Output frequency	Output frequency
Advanced magnetic flux vector control	Output frequency before the slip compensation	Output frequency before the slip compensation
Real sensorless vector control	Frequency command value	Estimated frequency (actual motor speed)
Encoder feedback control	Frequency converted from actual motor speed	Frequency converted from actual motor speed
Vector control	Frequency command value	Frequency converted from actual motor speed
PM sensorless vector control	Frequency command value	Estimated frequency (actual motor speed)

- Setting a higher value in **Pr.870** causes a lower responsivity of the signals for frequency detection (SU, FB, and LS signals).
- The logic (ON/OFF switching) of the LS signal is the reverse of that of the FB signal.
- Changing the terminal assignment using **Pr.190 to Pr.197 (Output terminal function selection)** may affect the other functions. Set parameters after confirming the function of each terminal.

«Parameters referred to»

Pr.190 to Pr.197 (Output terminal function selection)  page 371

Pr.874 OLT level setting  page 139

12.8 Output current detection function

If the inverter output current which reaches a specific value is detected, the relative signal is output via an output terminal.

Pr.	Name	Initial value	Setting range	Description
150 M460	Output current detection level	150%	0% to 400%	Set the level to detect the output current. The inverter rated current is regarded as 100%.
151 M461	Output current detection signal delay time	0 s	0 to 10 s	Set the time from when the output current exceeds the Pr.150 setting until the Output current detection (Y12) signal is output.
152 M462	Zero current detection level	5%	0% to 400%	Set the level to detect the zero current. The inverter rated current is regarded as 100%.
153 M463	Zero current detection time	0.5 s	0 to 10 s	Set the time from when the output current falls below the Pr.152 setting until the Zero current detection (Y13) signal is output.
166 M433	Output current detection signal retention time	0.1 s	0 to 10 s	Set the retention time period during which the Y12 signal is ON.
			9999	The Y12 signal is retained ON. The signal turns OFF at the next start-up of the inverter.
167 M464	Output current detection operation selection	0	0, 1, 10, 11	Select the inverter operation at the time when the Y12 signal and the Y13 signal turn ON.

◆ Output current detection (Y12 signal, Pr.150, Pr.151, Pr.166, Pr.167)

- The output current detection function is useful for overtorque detection.
- If the inverter output during inverter running remains higher than the **Pr.150** setting for the time set in **Pr.151** or longer, the Output current detection (Y12) signal is output.
- When the Y12 signal turns ON, the ON state is retained for the time set in **Pr.166**.
- When **Pr.166** = "9999", the ON state is retained until the next start-up of the inverter.
- Setting **Pr.167** = "1" while the Y12 signal is ON does not cause the fault E.CDO. The **Pr.167** setting becomes valid after the Y12 signal is turned OFF.
- For the Y12 signal, set "12" (positive logic) or "112" (negative logic) in any parameter from **Pr.190 to Pr.197 (Output terminal function selection)** to assign the function to an output terminal.
- Use **Pr.167** to select the inverter operation at the time when Y12 signal turns ON, whether the inverter output stops or the inverter operation continues.

Pr.167 setting	When the Y12 signal turns ON	When the Y13 signal turns ON
0 (initial value)	Operation continues.	Operation continues.
1	Operation stops by fault (E.CDO).	Operation continues.
10	Operation continues.	Operation stops by fault (E.CDO).
11	Operation stops by fault (E.CDO).	Operation stops by fault (E.CDO).

Pr.166 ≠ "9999", Pr.167 = "0"

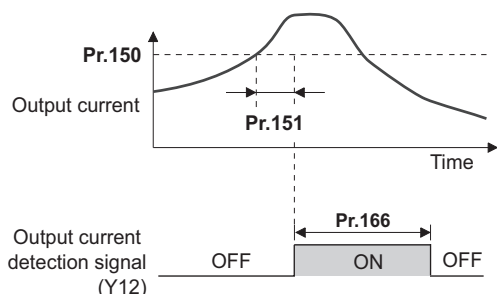

◆ Zero current detection (Y13 signal, Pr.152, Pr.153)

- If the inverter output during inverter running remains lower than the **Pr.152** setting for the time set in **Pr.153** or longer, the Zero current detection (Y13) signal is output.
- Once the Zero current detection (Y13) signal turns ON, the signal is retained ON for at least 0.1 second.

- If the inverter output current decreases, slippage due to gravity may occur, especially in a lift application, because the motor torque decreases. To prevent this, the Y13 signal can be output from the inverter to apply the mechanical brake when the output current falls below the **Pr.152** setting.
- For the Y13 signal, set "13" (positive logic) or "113" (negative logic) in any parameter from **Pr.190 to Pr.197 (Output terminal function selection)** to assign the function to an output terminal.
- Use **Pr.167** to select the inverter operation at the time when Y13 signal turns ON, whether the inverter output stops or the inverter operation continues.

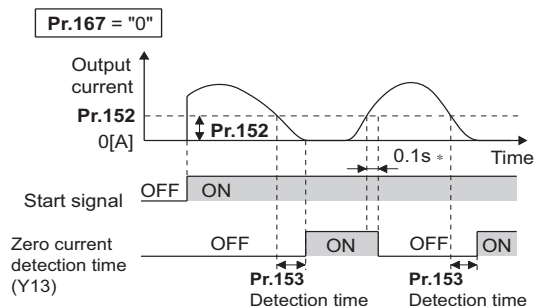

* When the output is restored to the **Pr.152** level, the Y13 signal is turned OFF after 0.1 s.

NOTE

- This function is enabled during online or offline auto tuning.
- The response time of the Y12 and Y13 signals is approximately 0.1 seconds. However, the response time varies according to the load condition.
- When **Pr.152 = "0"**, the zero current detection function is disabled.
- Changing the terminal assignment using **Pr.190 to Pr.197 (Output terminal function selection)** may affect the other functions. Set parameters after confirming the function of each terminal.

CAUTION

- The setting of the zero current detection level should not be too low, and the setting of the zero current detection time should not be too long. Doing so may cause the signal for the zero current detection not to be output when the output current is very low and the motor torque is not generated.
- A safety backup such as an emergency brake must be provided to prevent machines or equipment in hazardous conditions even if the Zero current detection is used.

Parameters referred to

Online auto tuning page 449

Offline auto tuning page 430, page 441

Pr.190 to Pr.197 (Output terminal function selection) page 371

12.9 Output torque detection function

Magnetic flux Vector Sensorless PM

If the motor torque which reaches a specific value is detected, the relative signal is output.

The signal is useful for applying or releasing electromagnetic brake, etc.

Pr.	Name	Initial value	Setting range	Description
864 M470	Torque detection	150%	0% to 400%	Set a value of the torque at which the TU signal turns ON.

- The Torque detection (TU) signal turns ON when the motor output torque reaches the value of torque set in **Pr.864** or higher. The TU signal turns OFF when the motor output torque drops lower than the set value.
- **Pr.864** is not available under V/F control.
- For the TU signal, set "35" (positive logic) or "135" (negative logic) in any parameter from **Pr.190 to Pr.197 (Output terminal function selection)** to assign the function to an output terminal.

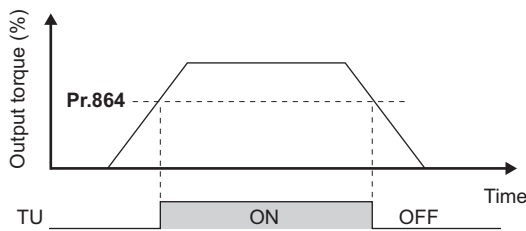

NOTE

- Changing the terminal assignment using **Pr.190 to Pr.197 (Output terminal function selection)** may affect the other functions. Set parameters after confirming the function of each terminal.

Parameters referred to

Pr.190 to Pr.197 (Output terminal function selection) [page 371](#)

12.10 Remote output function

The signal can be turned ON or OFF via the output terminal on the inverter as if the terminal is the remote output terminal for a programmable controller.

Pr.	Name	Initial value	Setting range	Description
495 M500	Remote output selection	0	0	Remote output data is cleared when the inverter power is turned OFF.
			1	Remote output data is retained even after the inverter power is turned OFF.
			10	Remote output data is cleared when the inverter power is turned OFF.
			11	Remote output data is retained even after the inverter power is turned OFF.
496 M501	Remote output data 1	0	0 to 4095	Set a decimal number to enter a binary number in every bit corresponding to each of the output terminals of the inverter or communication.
497 M502	Remote output data 2	0	0 to 4095	Set a decimal number to enter a binary number in every bit corresponding to each of the output terminals of the option FR-A8AY, FR-E8AXY, or FR-A8AR, or communication.

◆ Remote output setting (REM signal, Pr.496, Pr.497)

- The signal assigned to each of the output terminal can be turned ON or OFF according to the settings of **Pr.496** and **Pr.497**. The signal assigned to each of the remote output terminal can be turned ON or OFF through communication.
- For the Remote output (REM) signal, set "96" (positive logic) or "196" (negative logic) in any parameter from **Pr.190 to Pr.192, and Pr.197 (Output terminal function selection)** to assign the function to an output terminal.
- Refer to the following figures to check correspondences between the bit and the actual terminal. When "1" is set in the bit corresponding to the terminal to which the REM signal assigned by setting a number in **Pr.496** and **Pr.497** each, the signal turns ON (or OFF in negative logic setting). Also, setting "0" allows the signal to turn OFF (or ON in negative logic setting).
- For example, when **Pr.190 RUN terminal function selection** = "96" (positive logic) and "1" (H01) is set in **Pr.496**, the REM signal assigned to terminal RUN turns ON.

Pr.496

b11												b0
*1	*1	*1	*1	*1	ABC2*5	ABC	FU*5	*1	*1	*1	RUN*5	

Pr.497

b11												b0
*1	*1	RA3 *4	RA2 *4	RA1 *4	Y6 *2	Y5 *2	Y4 *2	Y3 *2	Y2 *2*3	Y1 *2*3	Y0 *2	

- *1 Any value
- *2 Y0 to Y6 are available by installing the output-extending option (FR-A8AY) or via communication.
- *3 Y1 and Y2 are available by installing the input/output-extending option (FR-E8AXY) or via communication.
- *4 RA1 to RA3 are available by installing the relay output option (FR-A8AR) or via communication.
- *5 For models without physical terminals, signals can be output only via communication.

◆ Remote output data retention (REM signal, Pr.495)

- When the inverter power is reset (or a power failure occurs) while **Pr.495** = "0 (initial value) or 10", the REM signal setting is cleared. (The ON/OFF state of the signal assigned to each terminal is determined by the settings in **Pr.190 to Pr.192, and Pr.197.**) The settings in **Pr.496** and **Pr.497** are reset to "0".
- When **Pr.495** = "1 or 11", the remote output data is stored in EEPROM before the inverter power is turned OFF. This means that the signal output setting after power restoration is the same as that before the power was turned OFF. However, when **Pr.495** = "1", the data during an inverter reset (terminal reset or reset request via communication) is not saved.

- When **Pr.495** = "10 or 11", the remote output data in the signal before the reset is stored even during an inverter reset.

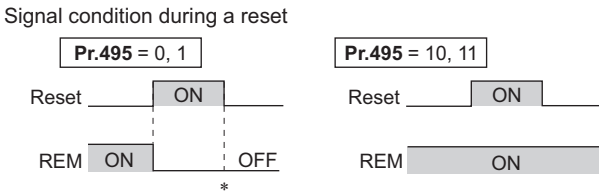
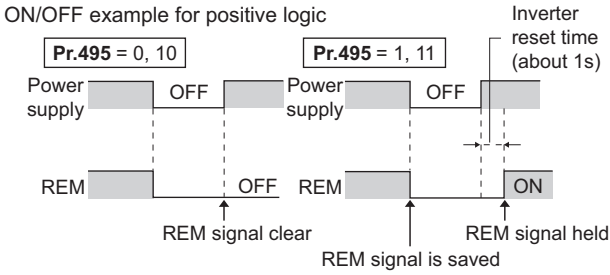

* When **Pr.495** = "1", the signal condition saved in EEPROM (condition of the last power OFF) is applied.

NOTE

- The output terminal to which the REM signal is not assigned by using **Pr.190 to Pr.192**, and **Pr.197** does not turn ON or OFF when "1 or 0" is set in bit corresponding to each of the terminals by using **Pr.496** and **Pr.497**. (ON/OFF command affects only the terminal to which the REM signal is assigned.)
- If the power supply is turned OFF during an inverter reset, the remote output data is not stored even when **Pr.495** = "1 or 11".

Parameters referred to

Pr.190 to Pr.197 (Output terminal function selection) [page 371](#)

MEMO

CHAPTER 13 (T) Multi-Function Input Terminal Parameters

13.1	Analog input selection.....	392
13.2	Analog input terminal (terminal 4) function assignment.....	397
13.3	Response level of analog input and noise elimination.....	398
13.4	Frequency setting voltage (current) bias and gain.....	400
13.5	Torque setting current (voltage) bias and gain	405
13.6	Input terminal function selection	410
13.7	Inverter output shutoff.....	416
13.8	Selecting the condition to activate the Second function selection (RT) signal.....	418
13.9	Start signal operation selection.....	420

13 (T) Multi-Function Input Terminal Parameters

Purpose	Parameter to set			Refer to page
To inverse the rotation direction with the voltage/current analog input selection (terminals 2 and 4)	Analog input selection	P.T000, P.T001	Pr.73, Pr.267	392
To assign functions to analog input terminals	Terminal 4 function assignment	P.T040	Pr.858	397
To eliminate noise on analog inputs	Analog input filter	P.T002 to P.T007	Pr.74, Pr.822, Pr.826, Pr.832, Pr.836, Pr.849	398
To adjust analog input frequency/voltage (current) (calibration)	Frequency setting voltage (current) bias and gain	P.T200 to P.T203, P.T400 to P.T403, P.M043	Pr.125, Pr.126, Pr.241, C2 to C7 (Pr.902 to Pr.905)	400
To adjust analog input torque/voltage (current) (calibration)	Torque setting voltage (current) bias and gain	P.T410 to P.T413, P.M043	Pr.241, C38 to C41 (Pr.932, Pr.933)	405
To assign functions to input terminals	Input terminal function selection	P.T700 to P.T711, P.T740	Pr.178 to Pr.189, Pr.699	410
To change the input specification (NO/NC contact) of input signals	Output stop signal (MRS) / Inverter run enable signal (X10) input selection	P.T720	Pr.17	416
To assign start and forward/reverse commands to different signals	Start signal (STF/STR) operation selection	P.G106	Pr.250	420

13.1 Analog input selection

The functions to switch the analog input terminal specifications and forward/reverse rotation by the input signal polarity are selectable. When the IP67 model is used, the terminal specifications are fixed (terminal 2: voltage input, terminal 4: current input). When the FR-E8TR or the FR-E8TE7 is installed, terminal 2 is used for voltage input only.

Pr.	Name	Initial value	Setting range	Description
73 T000	Analog input selection	1	0, 1, 10, 11	Switch 2: V (initial status)
			6, 16	Switch 2: I
267 T001	Terminal 4 input selection	0	0	Switch 4: I (initial status)
			1	Switch 4 - V
			2	

◆ Analog input specification selection

- For terminals 2 and 4 used for analog input, the voltage input (0 to 5 V, 0 to 10 V) and current input (0 to 20 mA) are selectable. To change the input specification, change the setting of **Pr.73 (Pr.267)** and the voltage/current input selection switch (switch 2 or switch 4).

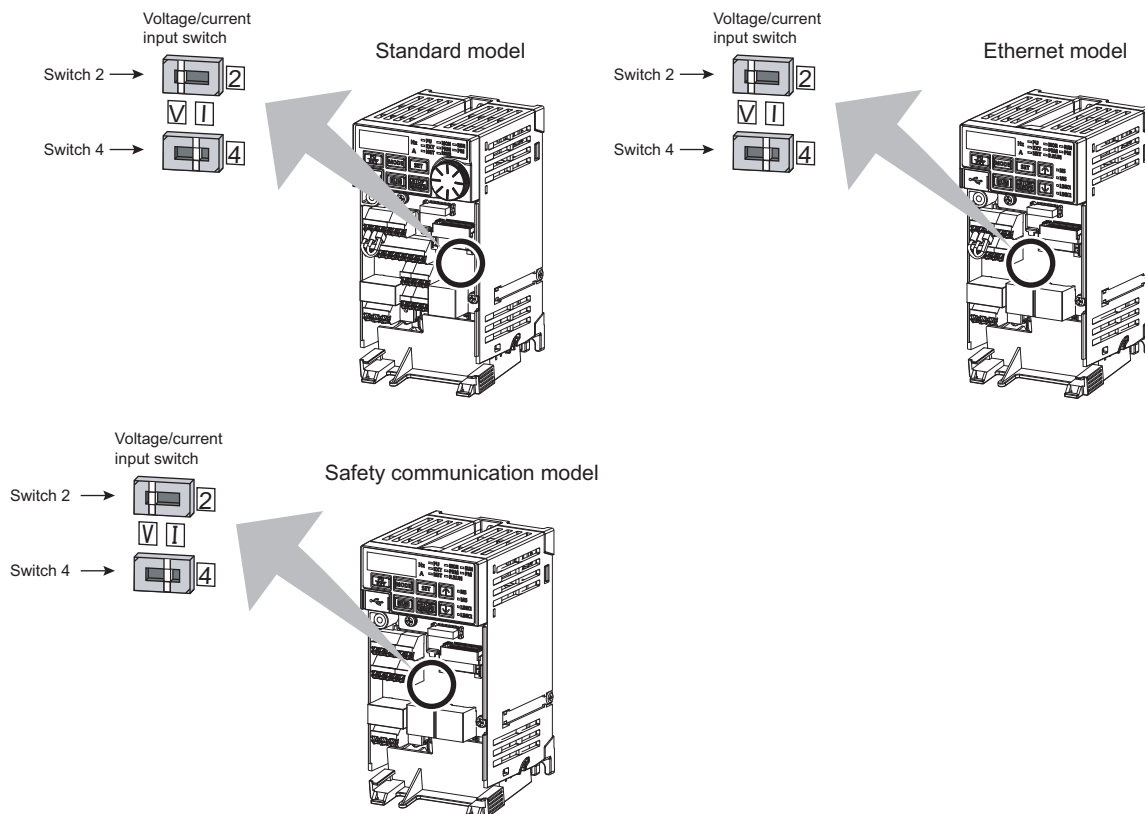

Switch state	Input specification	Input terminal	Rated specification
Switch 2	I	Terminal 2	For voltage input, the input resistance is $10 \pm 1 \text{ k}\Omega$ and the maximum permissible voltage is 20 VDC. For current input, the input resistance is $245 \pm 5 \Omega$ and the maximum permissible current is 30 mA.
	V		
Switch 4	I	Terminal 4	
	V		

- Change the setting of the voltage/current input selection switch to change the rated specification of terminal 2 or 4.
- Set **Pr.73 (Pr.267)** and the voltage/current input selection switch according to the analog signal input. The incorrect settings shown in the following table cause a failure. The inverter does not operate properly with other incorrect settings.

Setting causing a failure		Operation
Switch setting	Terminal input	
I (current input)	Voltage input	Causes an analog signal output circuit failure in an external device (due to increased loads on the signal output circuit of the external device).
V (voltage input)	Current input	Causes an input circuit failure in the inverter (due to an increased output power in the analog signal output circuit of an external device).

Set **Pr.73** and the voltage/current input selection switch according to the following table.

Pr.73 setting	Terminal 2 input	Switch 2	Reversible operation
0	0 to 10 V	V	Disabled
1 (initial value)	0 to 5 V	V	
6 ^{*1}	0 to 20 mA	I	
10	0 to 10 V	V	Enabled
11	0 to 5 V	V	
16 ^{*2}	0 to 20 mA	I	

*1 When the FR-E8TR or the FR-E8TE7 is installed, the operation is the same as the one when the setting is "1".

*2 When the FR-E8TR or the FR-E8TE7 is installed, the operation is the same as the one when the setting is "11".

- When the Terminal 4 input selection (AU) signal is turned ON, terminal 4 is used to set the main speed. In this case, terminal 2 is not used to set the main speed.
- Set **Pr.267** and the voltage/current input selection switch according to the following table.

Pr.267 setting	Terminal 4 input	Switch 4	Reversible operation
0 (initial value)	4 to 20 mA	I	Determined by Pr.73 setting
1	0 to 5 V	V	
2	0 to 10 V	V	

NOTE

- To enable terminal 4, turn ON the AU signal.
- Set the parameters and the switch settings so that they agree. Incorrect setting may cause a fault, failure, or malfunction.
- Use **Pr.125 (Pr.126) (frequency setting gain)** to change the maximum output frequency at the input of the maximum output frequency command voltage (current). At this time, the command voltage (current) need not be input. Also, the acceleration/ deceleration time, which is a slope up/down to the acceleration/deceleration reference frequency, is not affected by the change in **Pr.73** setting.
- To input frequency through terminal 4, set "0" (initial value) in **Pr.858**.
- Always calibrate the input after changing the voltage/current input signal with **Pr.73 (Pr.267)** and the voltage/current input selection switch.
- When **Pr.561 PTC thermistor protection level** ≠ "9999", terminal 2 is not used for the analog frequency command.

◆ Running with analog input voltage

- For the frequency setting signal, input 0 to 5 VDC (or 0 to 10 VDC) between terminals 2 and 5. The 5 V (10 V) input is the maximum output frequency.
- The power supply 5 V (10 V) can be input by either using the internal power supply or preparing an external power supply. The internal power supply is 5 VDC output via terminal 10.

Terminal	Inverter internal power source voltage	Frequency setting resolution	Pr.73 (terminal 2 input voltage)
10	5 VDC	0.030/60 Hz	0 to 5 VDC input

- To supply the 10 VDC input to terminal 2, set "0 or 10" in **Pr.73**. (The initial value is 0 to 5 V.)
- Set "1 (0 to 5 VDC)" or "2 (0 to 10 VDC)" in **Pr.267** and set the voltage/current input selection switch to "V" in order to input voltage through terminal 4. Turning ON the AU signal activates the terminal 4 input.

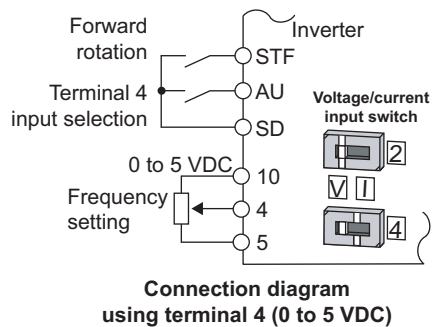
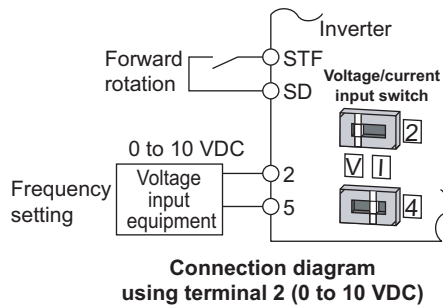
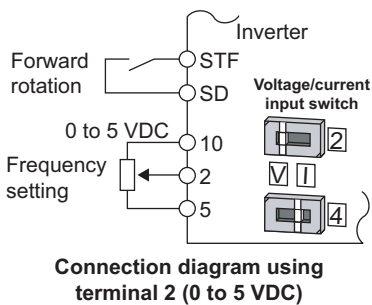

NOTE

- The wiring length of terminal 10, 2, and 5 should be 30 m at maximum.

◆ Running with analog input current

- For constant pressure or temperature control with fans, pumps, or other devices, automatic operation is available by setting the regulator output signal 4 to 20 mADC to between terminals 4 and 5.

- To use terminal 4, the AU signal needs to be turned ON.

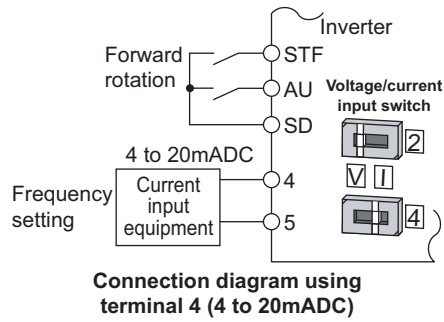

- Set "6 or 16" in **Pr.73** and set the voltage/current input selection switch to I in order to input current through terminal 2. In this case, the AU signal does not need to be turned ON.

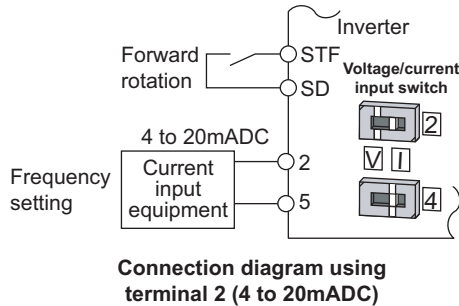

◆ Performing forward/reverse rotation with the analog input (reversible operation)

- The reversible operation by terminal 2 (terminal 4) is enabled by setting "10, 11, or 16" in **Pr.73** and adjusting **Pr.125 (Pr.126) Terminal 2 frequency setting gain frequency (Terminal 4 frequency setting gain frequency), C2 (Pr.902) Terminal 2 frequency setting bias frequency to C7 (Pr.905) Terminal 4 frequency setting gain**.
- The following shows the reversible operation by terminal 2 (0 to 5 V) input.
 - Set "11" in **Pr.73** to enable the reversible operation.
 - Set the frequency at 2.5 V analog input in **C2 (Pr.902)** and the frequency at maximum analog input in **Pr.125**.
 - Set 1/2 of the **C4 (Pr.903)** setting value (unit: %) in **C3 (Pr.902)**.
 - Reverse operation is performed when 0 to 2.5 VDC is input, and forward rotation when 2.5 to 5 VDC.

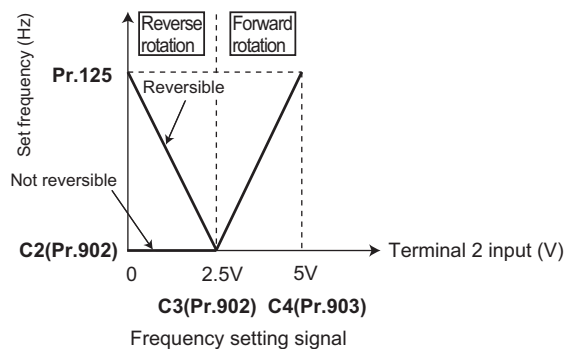



NOTE

- Note that the reverse rotation operation is performed when analog input stops (only the start signal is input) while the reversible operation is set.
- When the reversible operation is enabled, the reversible operation by terminal 4 is performed in the initial setting (reverse operation is performed when 0 to 4 mA is input, and forward operation when 4 to 20 mA).

« Parameters referred to »

Pr.125 Terminal 2 frequency setting gain frequency, Pr.126 Terminal 4 frequency setting gain frequency  [page 400](#)

Pr.561 PTC thermistor protection level  [page 306](#)

Pr.858 Terminal 4 function assignment  [page 397](#)

13.2 Analog input terminal (terminal 4) function assignment

The analog input terminal 4 function can be set and changed with parameters.

Pr.	Name	Initial value	Setting range	Description
858 T040	Terminal 4 function assignment	0	0, 4, 6, 9999	Select the terminal 4 function.

- For terminal 4 used for analog input, the frequency (speed) command, torque command, and other similar commands are usable. The functions available are different depending on the control method and control mode as shown in the following table. (For the details of the control methods, refer to [page 115](#).)
- Functions of terminal 4 under different control modes

Pr.858 setting	V/F control, Advanced magnetic flux vector control	Real sensorless vector control, Vector control, PM sensorless vector control		
		Speed control	Torque control	Position control
0 (initial value)	Frequency command (AU signal-ON)	Speed command (AU signal-ON)	Speed limit (AU signal-ON)	—
4	—	Torque limit (Pr.810 = "1")	Torque command (Pr.804 = "0")	Torque limit (Pr.810 = "1")
6	—	Torque bias input (Pr.840 = "1, 2, or 3")	—	—
9999	—	—	—	—

—: No function

«Parameters referred to»

- Advanced magnetic flux vector control [page 121](#)
- Real sensorless vector control [page 115](#)
- Pr.804 Torque command source selection [page 167](#)
- Pr.810 Torque limit input method selection [page 139](#)
- Pr.840 Torque bias selection [page 150](#)

13.3 Response level of analog input and noise elimination

The response level and stability of frequency command / torque command using the analog input signal (terminal 2 or 4) can be adjusted.

Pr.	Name	Initial value	Setting range	Description
74 T002	Input filter time constant	1	0 to 8	Set the primary delay filter time constant to the analog input command. If the setting is too large, response becomes slow.
822 T003	Speed setting filter 1	9999	0 to 5 s 9999	Set the primary delay filter time constant to the external speed command (analog input command). As set in Pr.74 .
826 T004	Torque setting filter 1	9999	0 to 5 s 9999	Set the primary delay filter time constant to the external torque command (analog input command). As set in Pr.74 .
832 T005	Speed setting filter 2	9999	0 to 5 s, 9999	Second function of Pr.822 (enabled when the RT signal is ON)
836 T006	Torque setting filter 2	9999	0 to 5 s, 9999	Second function of Pr.826 (enabled when the RT signal is ON)
849 T007	Analog input offset adjustment	100%	0% to 200%	Set offset for the analog speed input (terminal 2). The motor is prevented from rotating due to noise in the analog input or other factors when a zero speed command is given.

◆ Block diagram

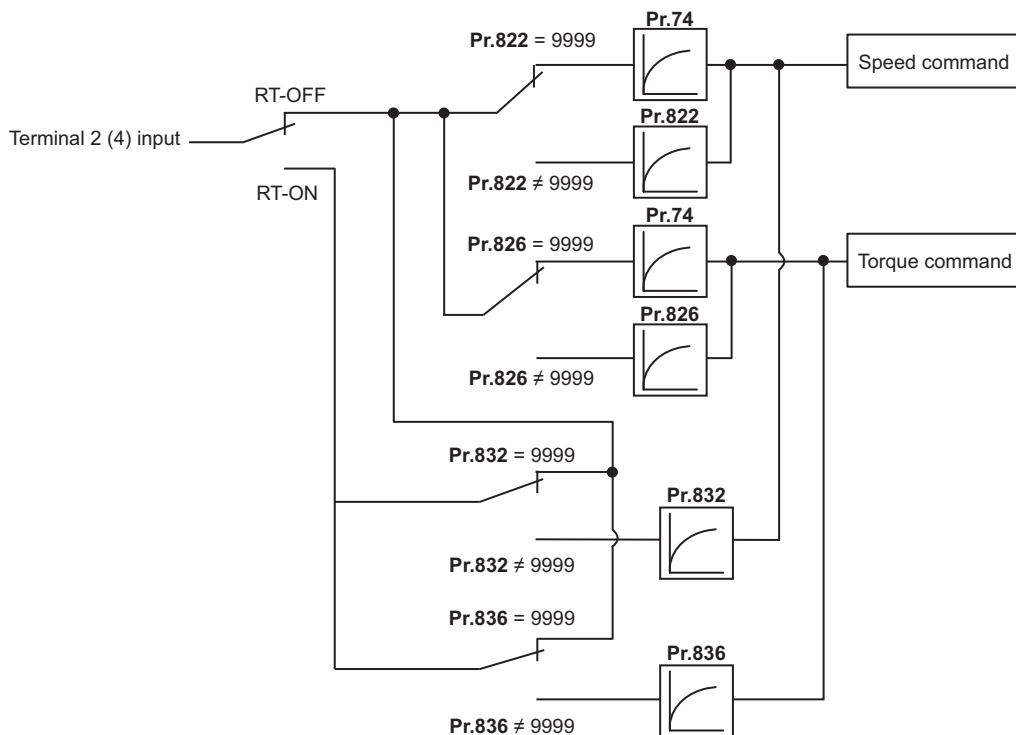

◆ Analog input time constant (Pr.74)

- Use this parameter to eliminate noise on the frequency setting circuit.
- Increase the filter time constant if the operation is unstable due to noise or other factors.

If the setting is too large, response becomes slow. (The time constant can be between 0 and 8, which are about 2 ms to 1 second.)

◆ Analog speed command input time constant (Pr.822, Pr.832)

- Use **Pr.822 Speed setting filter 1** to set the primary delay filter time constant to the external speed command (analog input command). Increase the setting of the time constant to allow delays in follow-up of the speed command or when the analog input voltage is unstable.
- Use **Pr.832 Speed setting filter 2** to change the time constant to use one inverter to switch operation between two or more motors.
- **Pr.832 Speed setting filter 2** is enabled when the RT signal is ON.

◆ Analog torque command input time constant (Pr.826, Pr.836)

- Use **Pr.826 Torque setting filter 1** to set the primary delay filter time constant to the external torque command (analog input command). Increase the setting of the time constant to allow delays in follow-up of the torque command or when the analog input voltage is unstable.
- Use **Pr.836 Torque setting filter 2** to change the time constant to use one inverter to switch operation between two or more motors.
- **Pr.836 Torque setting filter 2** is enabled when the RT signal is ON.

◆ Analog speed command input offset adjustment (Pr.849)

- Use this parameter to set a range in which the motor is stopped for prevention of incorrect motor operation in a very low speed rotation when the speed command is an analog input (voltage/current) via terminal 2.
- Example) Voltage command given

The voltage range is offset according to the setting in **Pr.849 Analog input offset adjustment**, assuming that 100% corresponds to zero.

100% < **Pr.849** Positive side

100% > **Pr.849** Negative side

The detailed calculation of the offset voltage is as follows:

$$\text{Offset voltage [V]} = \text{Voltage at the time of 100\% (5 V or 10 V}^{*1}\text{)} \times (\text{Pr.849} - 100) / 100$$

*1 It depends on the **Pr.73** setting.

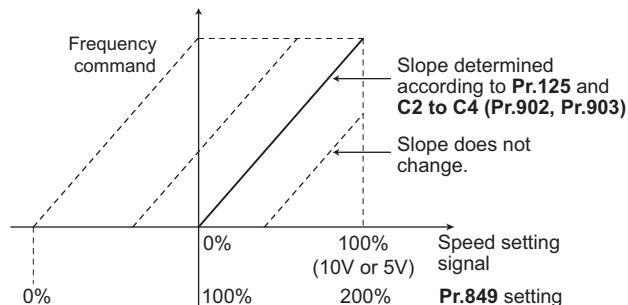

NOTE

- The analog input filter is invalid (no filter) during PID control operation.

Parameters referred to

Pr.73 Analog input selection [page 392](#)

Pr.125, C2 to C4 (Pr.902, Pr.903) (bias and gain of the terminal 2 frequency setting) [page 400](#)

13.4 Frequency setting voltage (current) bias and gain

The magnitude (slope) of the output frequency can be set as desired in relation to the frequency setting signal (0 to 5 VDC, 0 to 10 VDC, or 4 to 20 mA). Use **Pr.73 Analog input selection (Pr.267 Terminal 4 input selection)** and the voltage/current input selection switch to switch among input of 0 to 5 VDC, 0 to 10 V, and 0 to 20 mA. (Refer to [page 392](#).)

Pr.	Name	Initial value ^{*2}		Setting range	Description
		Gr.1	Gr.2		
C2 (902) T200^{*1}	Terminal 2 frequency setting bias frequency	0 Hz		0 to 590 Hz	Set the bias frequency for the terminal 2 input.
C3 (902) T201^{*1}	Terminal 2 frequency setting bias	0%		0% to 300%	Set the converted % of the bias voltage (current) for the terminal 2 input.
125 (903) T202 T022^{*1}	Terminal 2 frequency setting gain frequency	60 Hz	50 Hz	0 to 590 Hz	Set the gain (maximum) frequency for the terminal 2 input.
C4 (903) T203^{*1}	Terminal 2 frequency setting gain	100%		0% to 300%	Set the converted % of the gain voltage (current) for the terminal 2 input.
C5 (904) T400^{*1}	Terminal 4 frequency setting bias frequency	0 Hz		0 to 590 Hz	Set the bias frequency for the terminal 4 input.
C6 (904) T401^{*1}	Terminal 4 frequency setting bias	20%		0% to 300%	Set the converted % of the bias current (voltage) for the terminal 4 input.
126 (905) T402 T042^{*1}	Terminal 4 frequency setting gain frequency	60 Hz	50 Hz	0 to 590 Hz	Set the gain (maximum) frequency for the terminal 4 input.
C7 (905) T403^{*1}	Terminal 4 frequency setting gain	100%		0% to 300%	Set the converted % of the gain current (voltage) for the terminal 4 input.
241 M043	Analog input display unit switchover	0		% display	Select the unit for analog input display.
		1		V/mA display	

*1 On the LCD operation panel or the parameter unit used as the command source, the parameter number in parentheses appears.

*2 Gr.1 and Gr.2 are the parameter initial value groups. (Refer to [page 54](#).)

◆ Relationship between the analog input terminal function and the calibration parameter

- Calibration parameter according to the terminal 4 function

Pr.858 setting	Terminal function	Calibration parameter	
		Bias setting	Gain setting
0 (initial value)	Frequency command	C5 (Pr.904) Terminal 4 frequency setting bias frequency C6 (Pr.904) Terminal 4 frequency setting bias	Pr.126 Terminal 4 frequency setting gain frequency C7 (Pr.905) Terminal 4 frequency setting gain
4	Torque limit	C38 (Pr.932) Terminal 4 bias command (torque) C39 (Pr.932) Terminal 4 bias (torque)	C40 (Pr.933) Terminal 4 gain command (torque) C41 (Pr.933) Terminal 4 gain (torque)
6	Torque bias input	C38 (Pr.932) Terminal 4 bias command (torque) C39 (Pr.932) Terminal 4 bias (torque)	C40 (Pr.933) Terminal 4 gain command (torque) C41 (Pr.933) Terminal 4 gain (torque)
9999	No function	—	—

◆ Changing the frequency for the maximum analog input (Pr.125, Pr.126)

- Use **Pr.125 (Pr.126)** to change the frequency setting (gain) for the maximum analog input voltage (current). (**C2 (Pr.902)** to **C7 (Pr.905)** settings need not be changed.)

◆ Analog input bias/gain calibration (C2 (Pr.902) to C7 (Pr.905))

- The "bias" and "gain" functions serve to adjust the relationship between a setting input signal and the output frequency. A setting input signal is such as a 0 to 5 VDC, 0 to 10 VDC, or 4 to 20 mADC signal externally input to set the output frequency.
- Set the bias frequency of the terminal 2 input using **C2 (Pr.902)**. (It is initially set to the frequency at 0 V.)
- Use **Pr.125** to set the output frequency to the frequency command voltage (current) set by **Pr.73 Analog input selection**.
- Set the bias frequency of the terminal 4 input using **C5 (Pr.904)**. (It is initially set to the frequency at 4 mA.)

- Use **Pr.126** to set the output frequency to the 20 mA input of the frequency command current (4 to 20 mA).

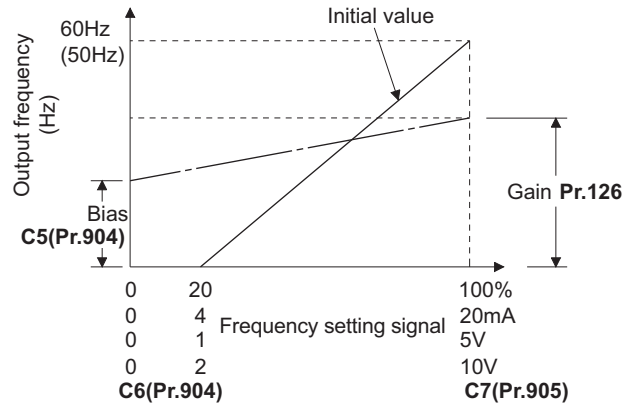
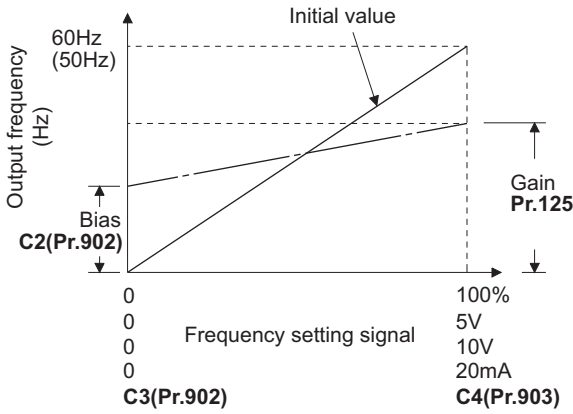

- There are three methods to adjust the bias/gain frequency setting voltage (current).
Adjustment by applying voltage (current) between terminals 2 and 5 (4 and 5) to set the voltage (current) at the bias/gain frequency. [page 402](#)
Adjustment by selecting the voltage (current) at the bias/gain frequency without applying voltage (current) between terminals 2 and 5 (4 and 5). [page 403](#)
Adjustment by changing the frequency without adjusting the voltage (current). [page 404](#)

NOTE

- Always calibrate the input after changing the voltage/current input signal with **Pr.73 (Pr.267)** and the voltage/current input selection switch.

◆ Display unit changing for analog input (Pr.241)

- The analog input display unit (%V/mA) can be changed for analog input bias/gain calibration.
- Depending on the terminal input specification setting of **Pr.73 (Pr.267)** and the voltage/current input switch, the unit of the displayed value of **C3 (Pr.902)**, **C4 (Pr.903)**, **C6 (Pr.904)** and **C7 (Pr.905)** changes as shown below:

Analog command (via terminal 2 or 4) (depending on the settings of Pr.73 (Pr.267) and the voltage/current input selection switch)	Pr.241 = "0 (initial value)"	Pr.241 = "1"
0 to 5 V input	0% to 100% (0.1%)	0 to 5 V (0.01 V)
0 to 10 V input	0% to 100% (0.1%)	0 to 10 V (0.01 V)
0 to 20 mA input	0% to 100% (0.1%)	0 to 20 mA (0.01 mA)

◆ Frequency setting voltage (current) bias/gain adjustment method

■ Adjustment by applying voltage (current) between terminals 2 and 5 (4 and 5) to set the voltage (current) at the bias/gain frequency (Example of adjustment at the gain frequency)

Operating procedure

- 1.** Turning ON the power of the inverter
The operation panel is in the monitor mode.
 - 2.** Changing the operation mode
Press the PU/EXT key to choose the PU operation mode. The PU LED turns ON.
 - 3.** Selecting the parameter setting mode
Press the MODE key to choose the parameter setting mode. (The parameter number read previously appears.)
 - 4.** Calibration parameter selection
Turn the setting dial or press the UP/DOWN key until "C..." appears. Press the SET key to display "C---".
 - 5.** Selecting a parameter
Turn the setting dial or press the UP/DOWN key until "C4" (**C4 (Pr.903) Terminal 2 frequency setting gain**) appears for terminal 2, or "C7" (**C7 (Pr.905) Terminal 4 frequency setting gain**) for terminal 4.
 - 6.** Analog voltage (current) display
Press the SET key to display the analog voltage (current) value (%) currently applied to terminal 2 (terminal 4).
Do not touch the setting dial and UP/DOWN key until calibration is completed.
 - 7.** Voltage (current) application
Apply 5 V (20 mA). (Turn the external potentiometer connected between terminals 2 and 5 (terminals 4 and 5) to a desired position.)
 - 8.** Setting completed
Press the SET key to confirm the setting. The analog voltage (current) value (%) blinks when it is applied.
- Turn the setting dial or press the UP/DOWN key to read another parameter.
 - Press the SET key to return to the "C---" display.
 - Press the SET key twice to show the next parameter.

■ **Adjustment by selecting the voltage (current) at the bias/gain frequency without applying voltage (current) between terminals 2 and 5 (4 and 5) (Example of adjustment at the gain frequency)**

Operating procedure

- 1.** Turning ON the power of the inverter
The operation panel is in the monitor mode.
 - 2.** Changing the operation mode
Press the PU/EXT key to choose the PU operation mode. The PU LED turns ON.
 - 3.** Selecting the parameter setting mode
Press the MODE key to choose the parameter setting mode. (The parameter number read previously appears.)
 - 4.** Calibration parameter selection
Turn the setting dial or press the UP/DOWN key until "C..." appears. Press the SET key to display "C---".
 - 5.** Selecting a parameter
Turn the setting dial or press the UP/DOWN key until "C4" (**C4 (Pr.903) Terminal 2 frequency setting gain**) appears for terminal 2, or "C7" (**C7 (Pr.905) Terminal 4 frequency setting gain**) for terminal 4.
 - 6.** Analog voltage (current) display
Press the SET key to display the analog voltage (current) value (%) currently applied to terminal 2 (terminal 4).
 - 7.** Analog voltage (current) adjustment
After the setting dial is turned or the UP/DOWN key is pressed, the gain voltage (current) value (%) currently set to the parameter appears.
Turn the setting dial or press the UP/DOWN key until the gain voltage (current) to be adjusted appears.
 - 8.** Setting completed
Press the SET key to confirm the setting. The analog voltage (current) value (%) blinks when it is applied.
- Turn the setting dial or press the UP/DOWN key to read another parameter.
 - Press the SET key to return to the "C---" display.
 - Press the SET key twice to show the next parameter.

NOTE

- The present frequency setting bias/gain setting can be checked by pressing the setting dial or pressing the UP/DOWN key one time after step 6. The setting cannot be checked after step 7.

■ Adjustment by changing the frequency without adjusting the voltage (current) (Example of changing the gain frequency from 60 Hz to 50 Hz)

Operating procedure

- 1.** Selecting the parameter
Turn the setting dial or press the UP/DOWN key until "P.125" (**Pr.125**) appears for terminal 2, or "P.126" (**Pr.126**) for terminal 4.
Press the SET key to show the present set value. (60.00 Hz)
- 2.** Changing the maximum frequency
Turn the setting dial or press the UP/DOWN key to change the value to "50.00". (50.00 Hz)
Press the SET key to confirm the setting. "50.00" blinks.
- 3.** Selecting the mode and the monitor item
Press the MODE key three times to select the monitor mode and to monitor a frequency.
- 4.** Start
Turn ON the start switch (STF/STR signal), and turn the frequency setting potentiometer clockwise slowly to full. (Refer to steps 2 and 3 in [page 38](#).)
The motor is operated at 50 Hz.

NOTE

- If the frequency meter (display meter) connected to terminal FM or terminal AM of the standard model does not indicate exactly 60 Hz, set the calibration parameter **C0** or **C1**. (Refer to [page 362](#).)
- If the voltage (current) values at the gain and bias frequencies are too close to each other, an error "Er3" may be indicated.
- Changing **C4** (**Pr.903**) or **C7** (**Pr.905**) (gain adjustment) will not change **Pr.20**.
- To set the value to 120 Hz or higher, the **Pr.18 High speed maximum frequency** needs to be 120 Hz or higher. (Refer to [page 331](#).)
- Use the calibration parameter **C2** (**Pr.902**) or **C5** (**Pr.904**) to set the bias frequency. (Refer to [page 400](#).)
- For operation outline of the parameter unit (FR-PU07), refer to the FR-PU07 Instruction Manual.

⚠ CAUTION

- Be cautious when setting any value other than "0" as the bias frequency at 0 V (0 mA). Even if a speed command is not given, simply turning ON the start signal will start the motor at the preset frequency.

◀ Parameters referred to ▶

Pr.1 Maximum frequency, **Pr.18** High speed maximum frequency [↗ page 331](#)
Pr.20 Acceleration/deceleration reference frequency [↗ page 262](#)
Pr.73 Analog input selection, **Pr.267** Terminal 4 input selection [↗ page 392](#)
Pr.79 Operation mode selection [↗ page 280](#)
Pr.858 Terminal 4 function assignment [↗ page 397](#)

13.5 Torque setting current (voltage) bias and gain

Sensorless Vector PM

The magnitude (slope) of the torque can be set as desired in relation to the torque setting signal (0 to 5 VDC, 0 to 10 VDC, or 0 to 20 mA).

Use **Pr.267 Terminal 4 input selection** to switch among input 0 to 5 VDC, 0 to 10 VDC, and 0 to 20 mA. (Refer to [page 392.](#))

Pr.	Name	Initial value	Setting range	Description	
C38 (932) T410 ^{*1}	Terminal 4 bias command (torque)	0%	0% to 400%	Set the bias torque for the terminal 4 input.	
C39 (932) T411 ^{*1}	Terminal 4 bias (torque)	0%	0% to 300%	Set the converted % of the bias current (voltage) for the terminal 4 input.	
C40 (933) T412 ^{*1}	Terminal 4 gain command (torque)	150%	0% to 400%	Set the gain (maximum) torque for the terminal 4 input.	
C41 (933) T413 ^{*1}	Terminal 4 gain (torque)	100%	0% to 300%	Set the converted % of the gain current (voltage) for the terminal 4 input.	
241 M043	Analog input display unit switchover	0	0	% display	Select the unit for analog input display.
			1	V/mA display	

*1 On the LCD operation panel or the parameter unit used as the command source, the parameter number in parentheses appears.

◆ Changing the function of analog input terminal

- In the initial setting, terminal 4 is used for analog input of the speed command (speed limit). To use the analog input terminal to input the torque command or torque limit, set **Pr.858 Terminal 4 function assignment** to change the function. (Refer to [page 397.](#))

◆ Relationship between the analog input terminal function and the calibration parameter

- Calibration parameter according to the terminal 4 function

Pr.858 setting	Terminal function	Calibration parameter	
		Bias setting	Gain setting
0 (initial value)	Frequency (speed) command / speed limit	C5 (Pr.904) Terminal 4 frequency setting bias frequency C6 (Pr.904) Terminal 4 frequency setting bias	Pr.126 Terminal 4 frequency setting gain frequency C7 (Pr.905) Terminal 4 frequency setting gain
4	Torque limit	C38 (Pr.932) Terminal 4 bias command (torque) C39 (Pr.932) Terminal 4 bias (torque)	C40 (Pr.933) Terminal 4 gain command (torque) C41 (Pr.933) Terminal 4 gain (torque)
6	Torque bias input	C38 (Pr.932) Terminal 4 bias command (torque) C39 (Pr.932) Terminal 4 bias (torque)	C40 (Pr.933) Terminal 4 gain command (torque) C41 (Pr.933) Terminal 4 gain (torque)
9999	No function	—	—

◆ Changing the torque for the maximum analog input (C40 (Pr.933))

- Use **C40 (Pr.933)** to change the torque setting (gain) for the maximum analog input current (voltage).

◆ Analog input bias/gain calibration (C38 (Pr.932) to C41 (Pr.933))

- The "bias"/"gain" function can adjust the relation between the torque and the torque limit setting input signal. Examples of setting input signals are 0 to 5 VDC, 0 to 10 VDC, or 0 to 20 mADC, and they are externally input.
- Set the bias torque of the terminal 4 input using **C38 (Pr.932)**. (The initial value is the torque for 0 mA.)

- Use **C40 (Pr.933)** to set the torque to the 20 mA input of the torque command current (0 to 20 mA).

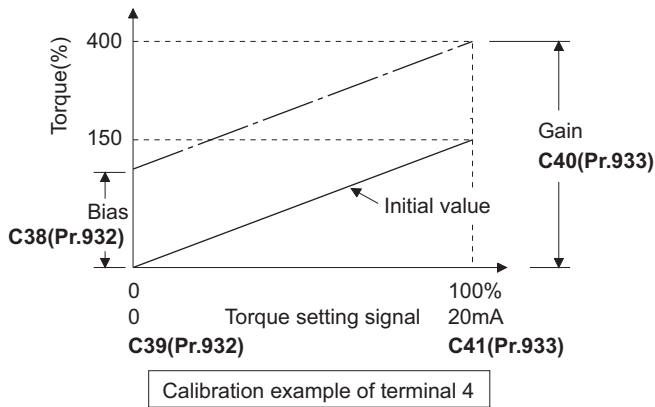

- There are three methods to adjust the bias/gain for torque setting current (voltage).
 Adjustment by applying current (voltage) between terminals 4 and 5 to set the current (voltage) at the bias/gain torque. [page 407](#)
 Adjustment by selecting the current (voltage) at the bias/gain torque without applying current (voltage) between terminals 4 and 5. [page 408](#)
 Adjustment by changing the torque without adjusting the current (voltage). [page 409](#)

NOTE

- Always calibrate the input after changing the voltage/current input signal with **Pr.267** and the voltage/current input selection switch.

◆ Display unit changing for analog input (Pr.241)

- The analog input display unit (%/V/mA) can be changed for analog input bias/gain calibration.
- Depending on the terminal input specification setting of **Pr.73 (Pr.267)**, the units of the displayed values of **C39 (Pr.932)** and **C41 (Pr.933)** change as shown below:

Analog command (via terminal 4) (depending on the Pr.267 setting)	Pr.241 = "0" (initial value)	Pr.241 = "1"
0 to 5 V input	0% to 100% (0.1%)	0 to 5 V (0.01 V)
0 to 10 V input	0% to 100% (0.1%)	0 to 10 V (0.01 V)
0 to 20 mA input	0% to 100% (0.1%)	0 to 20 mA (0.01 mA)

◆ Torque setting current (voltage) bias/gain adjustment method

■ Adjustment by applying current (voltage) between terminals 4 and 5 to set the current (voltage) at the bias/gain torque

Operating procedure

- 1.** Turning ON the power of the inverter
The operation panel is in the monitor mode.
 - 2.** Changing the operation mode
Press the PU/EXT key to choose the PU operation mode. The PU LED turns ON.
 - 3.** Selecting the parameter setting mode
Press the MODE key to choose the parameter setting mode. (The parameter number read previously appears.)
 - 4.** Calibration parameter selection
Turn the setting dial or press the UP/DOWN key until "C..." appears. Press the SET key to display "C---".
 - 5.** Selecting a parameter
Turn the setting dial or press the UP/DOWN key until "C41" (**C41 (Pr.933) Terminal 4 gain (torque)**) appears.
 - 6.** Displaying analog current (voltage) value
Press the SET key to display the analog current (voltage) value (%) currently applied to terminal 4.
Do not touch the setting dial and UP/DOWN key until calibration is completed.
 - 7.** Applying current (voltage)
Apply 20 mA (5 V). (Turn the external potentiometer connected between terminals 4 and 5 to a desired position.)
 - 8.** Setting completed
Press the SET key to confirm the setting. The analog current (voltage) value (%) blinks when it is applied.
- Turn the setting dial or press the UP/DOWN key to read another parameter.
 - Press the SET key to return to the "C---" display.
 - Press the SET key twice to show the next parameter.

■ Adjustment by selecting the current (voltage) at the bias/gain torque without applying current (voltage) between terminals 4 and 5

Operating procedure

- 1.** Turning ON the power of the inverter
The operation panel is in the monitor mode.
 - 2.** Changing the operation mode
Press the PU/EXT key to choose the PU operation mode. The PU LED turns ON.
 - 3.** Selecting the parameter setting mode
Press the MODE key to choose the parameter setting mode. (The parameter number read previously appears.)
 - 4.** Calibration parameter selection
Turn the setting dial or press the UP/DOWN key until "C..." appears. Press the SET key to display "C---".
 - 5.** Selecting a parameter
Turn the setting dial or press the UP/DOWN key until "C41" (**C41 (Pr.933) Terminal 4 gain (torque)**) appears.
 - 6.** Displaying analog current (voltage) value
Press the SET key to display the analog current (voltage) value (%) currently applied to terminal 4.
 - 7.** Analog current (voltage) adjustment
After the setting dial is turned or the UP/DOWN key is pressed, the gain current (voltage) value (%) currently set to the parameter appears.
Turn the setting dial or press the UP/DOWN key until the gain current (voltage) to be adjusted appears.
 - 8.** Setting completed
Press the SET key to confirm the setting. The analog current (voltage) value (%) blinks when it is applied.
- Turn the setting dial or press the UP/DOWN key to read another parameter.
 - Press the SET key to return to the "C---" display.
 - Press the SET key twice to show the next parameter.

NOTE

- The present torque setting bias/gain setting can be checked by pressing the setting dial or pressing the UP/DOWN key one time after step 6. The setting cannot be checked after step 7.

■ Adjustment by changing the torque without adjusting the current (voltage) (Example of changing the gain torque from 150% to 130%)

Operating procedure

- 1.** Selecting the parameter
Turn the setting dial or press the UP/DOWN key until "C40" (**Pr.933**) appears.
Press the SET key to show the present set value. (150.0%)
- 2.** Torque setting change
Turn the setting dial or press the UP/DOWN key to change the value to "130.0". (130.0%)
Press the SET key to confirm the setting. "130.0" blinks.
- 3.** Selecting the mode and the monitor item
Press the MODE key three times to select the monitor mode and to monitor a frequency.
- 4.** Start
Turn ON the start switch (STF or STR) to apply a voltage across terminals 4 and 5.
Operation is performed with 130% torque.

NOTE

- If the current (voltage) values at the gain and bias torques are too close to each other, an error ("Er3") may be indicated.
- Use the calibration parameter **C38 (Pr.932)** to set the bias torque. (Refer to [page 405.](#))
- For operation outline of the parameter unit (FR-PU07), refer to the FR-PU07 Instruction Manual.

CAUTION

- When setting a value other than "0" as the bias torque, note that simply turning ON the start signal will supply torque to the motor even if a torque command is not given.

Parameters referred to

Pr.20 Acceleration/deceleration reference frequency [page 262](#)

Pr.267 Terminal 4 input selection [page 392](#)

Pr.79 Operation mode selection [page 280](#)

Pr.858 Terminal 4 function assignment [page 397](#)

13.6 Input terminal function selection

Use the following parameters to select or change the input terminal functions.

Pr.	Name	Initial value	Initial signal	Setting range	
178 T700 ^{*1}	STF/DI0 terminal function selection	60	STF (Forward rotation command)	0 to 5, 7, 8, 10, 12 to 16, 18, 22 to 27, 30, 37, 42, 43, 46, 47, 50 to 52, 54, 60, 62, 65 to 67, 72, 74, 76, 84, 87 to 89, 92, 9999 ^{*2}	
179 T701 ^{*1}	STR/DI1 terminal function selection	61	STR (Reverse rotation command)	0 to 5, 7, 8, 10, 12 to 16, 18, 22 to 27, 30, 37, 42, 43, 46, 47, 50 to 52, 54, 61, 62, 65 to 67, 72, 74, 76, 84, 87 to 89, 92, 9999 ^{*2}	
180 T702	RL terminal function selection	0	RL (Low-speed operation command)	0 to 5, 7, 8, 10, 12 to 16, 18, 22 to 27, 30, 37, 42, 43, 46, 47, 50 to 52, 54, 62, 65 to 67, 72, 74, 76, 84, 87 to 89, 92, 9999 ^{*2}	
181 T703	RM terminal function selection	1	RM (Middle-speed operation command)		
182 T704	RH terminal function selection	2	RH (High-speed operation command)		
183 T709	MRS terminal function selection	24	MRS (Output stop)		
184 T711	RES terminal function selection	62 [E800]	RES (Inverter reset)	0 to 4, 8, 13 to 15, 18, 22 to 24, 26, 27, 30, 37, 42, 43, 46, 47, 50 to 52, 54, 72, 74, 76, 84, 87 to 89, 92, 9999 ^{*2}	
		9999 [E800-(SC)E][E806]	No function		
185 T751	NET X1 input selection	9999	No function		
186 T752	NET X2 input selection	9999	No function		
187 T753	NET X3 input selection	9999	No function		
188 T754	NET X4 input selection	9999	No function		
189 T755	NET X5 input selection	9999	No function		
Pr.	Name	Initial value	Setting range		Description
699 T740 ^{*1}	Input terminal filter	9999	5 to 50 ms		Set the time delay for the input terminal response.
			9999		No filter for the input terminal

*1 Available for the standard model, the Ethernet model, and the IP67 model.

*2 The setting range differs depending on the model. For more information, refer to the parameters available for each signal.

◆ Input terminal function assignment

- Signals can be input to the inverter by using physical terminals (except for the FR-E800-SCE) or via communication, or assigned to the extension terminals of the plug-in option (FR-E8AXY). Option input terminals are not available for the IP67 model as plug-in options are not available.
- Use parameters to assign functions to input terminals. Check the terminal available for each parameter.

Pr.	Terminal name	External input terminal (physical terminal)				Input via communication ^{*1}	Option input terminal (physical terminal) ^{*2}
		FR-E800	FR-E800-E	FR-E800-SCE	FR-E806		FR-E8AXY
178	STF/DI0	○ (STF)	○ (DI0)	—	○ (DI0)	Forward rotation command only	—
179	STR/DI1	○ (STR)	○ (DI1)	—	○ (DI1)	Reverse rotation command only	—
180	RL	○	—	—	—	○	—
181	RM	○	—	—	—	○	—
182	RH	○	—	—	—	○	—
183	MRS	○	—	—	—	○	—
184	RES	○	—	—	—	○	—
185	NET X1	—	—	—	—	○	—
186	NET X2	—	—	—	—	○	—
187	NET X3	—	—	—	—	○	—
188	NET X4	—	—	—	—	○	—
189	NET X5	—	—	—	—	○	—
525	X1	—	—	—	—	—	○
526	X2	—	—	—	—	—	○
527	X3	—	—	—	—	—	○
528	X4	—	—	—	—	—	○
529	X5	—	—	—	—	—	○
530	X6	—	—	—	—	—	○
531	X7	—	—	—	—	—	○

○: Assignment/input available, —: Assignment/input unavailable (no function)

*1 The communication protocol affects which terminals can be used. For details, refer to the Instruction Manual (Communication) or the Instruction Manual of each communication option.

*2 Refer to the Instruction Manual of the option for details on the option input terminals.

◆ Input signal list

- Refer to the following table and set the parameters.

Setting	Signal name	Function		Related parameter	Refer to page
0	RL	Pr.59 = "0" (initial value)	Low-speed operation command	Pr.4 to Pr.6, Pr.24 to Pr.27, Pr.232 to Pr.239	303
		Pr.59 ≠ "0" ^{*1}	Remote setting (setting clear)	Pr.59	269
		Pr.270 = "1, 11" ^{*2}	Stop-on-contact selection 0	Pr.270, Pr.275, Pr.276	461
1	RM	Pr.59 = "0" (initial value)	Middle-speed operation command	Pr.4 to Pr.6, Pr.24 to Pr.27, Pr.232 to Pr.239	303
		Pr.59 ≠ "0" ^{*1}	Remote setting (deceleration)	Pr.59	269
2	RH	Pr.59 = "0" (initial value)	High-speed operation command	Pr.4 to Pr.6, Pr.24 to Pr.27, Pr.232 to Pr.239	303
		Pr.59 ≠ "0" ^{*1}	Remote setting (acceleration)	Pr.59	269
3	RT	Second function selection		Pr.44 to Pr.48, Pr.51, Pr.450 to Pr.463, Pr.569, Pr.832, Pr.836, etc.	418
		Pr.270 = "1, 11" ^{*2}	Stop-on-contact selection 1	Pr.270, Pr.275, Pr.276	461
4	AU	Terminal 4 input selection		Pr.267	392
5	JOG	Jog operation selection		Pr.15, Pr.16	301
7	OH	External thermal relay input ^{*3}		Pr.9	306
8	REX	15-speed selection (Combination with multi-speeds of RL, RM, and RH)		Pr.4 to Pr.6, Pr.24 to Pr.27, Pr.232 to Pr.239	303
10	X10	Inverter run enable (FR-XC/FR-HC2/FR-CV connection)		Pr.17, Pr.30, Pr.70	545
12	X12	PU operation external interlock		Pr.79	280

Setting	Signal name	Function	Related parameter	Refer to page
13	X13	External DC injection brake operation start	Pr.10 to Pr.12	536
14	X14	PID control valid	Pr.127 to Pr.134, Pr.575 to Pr.577	479
15	BRI	Brake opening completion	Pr.278 to Pr.285	456
16	X16	PU/External operation switchover (External operation with X16-ON)	Pr.79, Pr.340	280
18	X18	V/F switchover (V/F control with X18-ON)	Pr.80, Pr.81, Pr.800	115
22	X22	Orientation command (for Vector control compatible options) ^{*5}	Pr.350 to Pr.359, Pr.361 to Pr.366, Pr.369, Pr.393, Pr.396 to Pr.399	468
23	LX	Pre-excitation/servo ON	Pr.850	536
24	MRS	Output stop	Pr.17	416
25	STP (STOP)	Start self-holding selection	Pr.250	420
26	MC	Control mode switchover	Pr.800	115
27	TL	Torque limit selection	Pr.815	139
30	JOG2	Jog operation selection 2	Pr.15, Pr.16	301
37	X37	Traverse function selection	Pr.592 to Pr.597	464
42	X42	Torque bias selection 1	Pr.840 to Pr.845	150
43	X43	Torque bias selection 2	Pr.840 to Pr.845	150
46	TRG	Trace trigger input	Pr.1020 to Pr.1047	518
47	TRC	Trace sampling start/end	Pr.1020 to Pr.1047	518
50	SQ	Sequence start	Pr.414	516
51	X51	Fault clear	Pr.414	*4
52	X52	Cumulative pulse monitor clear (for Vector control compatible options) ^{*5}	Pr.635	207
54	X54	Anti-sway control disabled	Pr.1072 to Pr.1079	466
60	STF	Forward rotation command (assignable to the STF terminal (Pr.178) only)	Pr.250	420
61	STR	Reverse rotation command (assignable to the STR terminal (Pr.179) only)	Pr.250	420
62	RES	Inverter reset	Pr.75	225
65	X65	PU/NET operation switchover (PU operation with X65-ON)	Pr.79, Pr.340	280
66	X66	External/NET operation switchover (NET operation with X66-ON)	Pr.79, Pr.340	280
67	X67	Command source switchover (command by Pr.338 or Pr.339 enabled with X67-ON)	Pr.338, Pr.339	291
72	X72	PID P control switchover	Pr.127 to Pr.134, Pr.575 to Pr.577	479
74	X74	Magnetic flux decay output shutoff	Pr.850	536
76	X76	Proximity dog	Pr.511, Pr.1282, Pr.1283, Pr.1285, Pr.1286	188
84	X84	Emergency drive execution command	Pr.514, Pr.515, Pr.523, Pr.524, Pr.1013	322
87	X87	Sudden stop	Pr.464 to Pr.478	192
88	LSP	Forward stroke end	Pr.1292	192
89	LSN	Reverse stroke end	Pr.1292	192
92	X92	Emergency stop	Pr.1103	262
9999	—	No function	—	—

*1 When Pr.59 Remote function selection ≠ "0", functions of the RL, RM, and RH signals are changed as shown in the table.

*2 When Pr.270 Stop-on-contact control selection = "1 or 11", functions of the RL and RT signals are changed as shown in the table.

*3 The OH signal is activated when the relay contact is open.

*4 Available when a value other than "0 (initial value)" is set in Pr.414 PLC function operation selection. For details, refer to the PLC Function Programming Manual.

*5 Available when the plug-in option is connected. For the IP67 model, the function is invalid as plug-in options are not available.

NOTE

- The same function can be assigned to two or more terminals. In this case, the logic of terminal input is OR.
- The priority of the frequency command given by the external signals is as follows: JOG operation (JOG/JOG2 signal) > stop-on-contact control (RL/RT signal) > multi-speed operation (RL/RM/RH/REX signal) > PID control (X14 signal) > terminal 4 analog input (AU signal) > pulse train input (option FR-E8AXY) > 16-bit digital input (option FR-A8AX) > terminal 2 analog input. Note that stop-on-contact control is disabled when PID control is enabled.
- When the Inverter run enable (X10) signal is not assigned, or when the PU operation external interlock (X12) signal is not assigned while **Pr.79 Operation mode selection = "7"**, the MRS signal performs the same function.
- The same terminals are used to assign the multi-speed (7-speed) setting and the remote setting. The multi-speed setting and the remote setting cannot be assigned separately.
- When the terminal assignment is changed using **Pr.178 to Pr.189 (Input terminal function selection)**, wiring may be mistaken due to different terminal name and signal contents, or may affect other functions. Set parameters after confirming the function of each terminal.

◆ Parameters available for each signal

- The following table shows the parameters to which the signals are assigned.

Setting value	Signal name	FR-E800				FR-E800-E		
		Pr.178	Pr.179	Pr.180 to Pr.184	Pr.185 to Pr.189	Pr.178	Pr.179	Pr.180 to Pr.189
0	RL	○	○	○	○	○	○	○
1	RM	○	○	○	○	○	○	○
2	RH	○	○	○	○	○	○	○
3	RT	○	○	○	○	○	○	○
4	AU	○	○	○	○	○	○	○
5	JOG	○	○	○	—	○	○	—
7	OH	○	○	○	—	○	○	—
8	REX	○	○	○	○	○	○	○
10	X10	○	○	○	—	○	○	—
12	X12	○	○	○	—	○	○	—
13	X13	○	○	○	○	○	○	○
14	X14	○	○	○	○	○	○	○
15	BRI	○	○	○	○	○	○	○
16	X16	○	○	○	—	○	○	—
18	X18	○	○	○	○	○	○	○
22	X22	○	○	○	○	○	○	○
23	LX	○	○	○	○	○	○	○
24	MRS	○	○	○	○	○	○	○
25	STP (STOP)	○	○	○	—	○	○	—
26	MC	○	○	○	○	○	○	○
27	TL	○	○	○	○	○	○	○
30	JOG2	○	○	○	○	○	○	○
37	X37	○	○	○	○	○	○	○
42	X42	○	○	○	○	○	○	○
43	X43	○	○	○	○	○	○	○
46	TRG	○	○	○	○	○	○	○
47	TRC	○	○	○	○	○	○	○
50	SQ	○	○	○	○	○	○	○
51	X51	○	○	○	○	○	○	○
52	X52	○	○	○	○	○	○	○
54	X54	○	○	○	○	○	○	○
60	STF	○	—	—	—	○	—	—
61	STR	—	○	—	—	—	○	—
62	RES	○	○	○	—	○	○	—
65	X65	○	○	○	—	○	○	—
66	X66	○	○	○	—	○	○	—
67	X67	○	○	○	—	○	○	—
72	X72	○	○	○	○	○	○	○
74	X74	○	○	○	○	○	○	○
76	X76	○	○	○	○	○	○	○

Setting value	Signal name	FR-E800				FR-E800-E		
		Pr.178	Pr.179	Pr.180 to Pr.184	Pr.185 to Pr.189	Pr.178	Pr.179	Pr.180 to Pr.189
84	X84	○	○	○	○	○	○	○
87	X87	○	○	○	○	○	○	○
88	LSP	○	○	○	○	○	○	○
89	LSN	○	○	○	○	○	○	○
92	X92	○	○	○	○	○	○	○
9999	No function	○	○	○	○	○	○	○

Setting value	Signal name	FR-E800-SCE	FR-E806		
		Pr.180 to Pr.189	Pr.178	Pr.179	Pr.180 to Pr.189
0	RL	○	○	○	○
1	RM	○	○	○	○
2	RH	○	○	○	○
3	RT	○	○	○	○
4	AU	○	○	○	○
5	JOG	—	○	○	—
7	OH	—	○	○	—
8	REX	○	○	○	○
10	X10	—	○	○	—
12	X12	—	○	○	—
13	X13	○	○	○	○
14	X14	○	○	○	○
15	BRI	○	○	○	○
16	X16	—	○	○	—
18	X18	○	○	○	○
22	X22	○	○	○	○
23	LX	○	○	○	○
24	MRS	○	○	○	○
25	STP (STOP)	—	○	○	—
26	MC	○	○	○	○
27	TL	○	○	○	○
30	JOG2	○	○	○	○
37	X37	○	○	○	○
42	X42	○	○	○	○
43	X43	○	○	○	○
46	TRG	○	○	○	○
47	TRC	○	○	○	○
50	SQ	○	○	○	○
51	X51	○	○	○	○
52	X52	○	○	○	○
54	X54	○	○	○	○
60	STF	—	○	—	—
61	STR	—	—	○	—
62	RES	—	○	○	—
65	X65	—	○	○	—
66	X66	—	○	○	—
67	X67	—	○	○	—
72	X72	○	○	○	○
74	X74	○	○	○	○
76	X76	○	○	○	○
84	X84	—	—	—	—
87	X87	○	○	○	○
88	LSP	○	○	○	○
89	LSN	○	○	○	○
92	X92	○	○	○	○
9999	No function	○	○	○	○

○: Assignment available, —: Assignment unavailable (no function)

◆ Adjusting the response of input terminals (Pr.699)

- Response of the input terminals (physical terminals) can be delayed in a range between 5 to 50 ms. (The following is the operation example of the STF signal.)

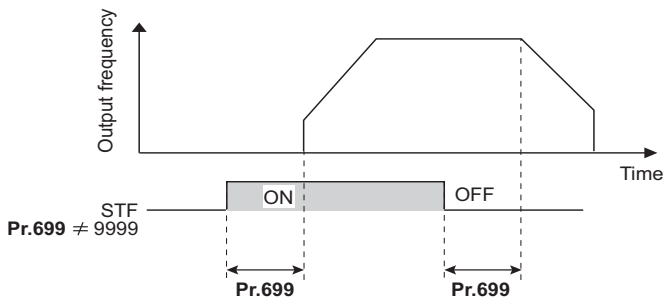

NOTE

- The **Pr.699** setting is invalid (no filter) for the following signals.
 - Input signals which are already in the ON state when the power is turned ON
 - Input signals used for the PLC function
 - Output stop (MRS) signal

13.7 Inverter output shutoff

The inverter output can be shut off with the MRS signal. The logic of the MRS signal can also be selected.

Pr.	Name	Initial value	Setting range	Description	
				MRS signal input	X10 signal input ^{*1}
17 T720	MRS/X10 terminal input selection	0	0	Normally open input	Normally open input
			1		Normally closed input (NC contact input specification)
			2	Normally closed input (NC contact input specification)	Normally open input
			3		Normally closed input (NC contact input specification)
			4	External terminal: Normally closed input (NC contact input specification) Communication: Normally open input	Normally open input
			5		Normally closed input (NC contact input specification)

*1 Refer to page 545 for the details of the X10 signal.

◆ Output shutoff signal (MRS signal)

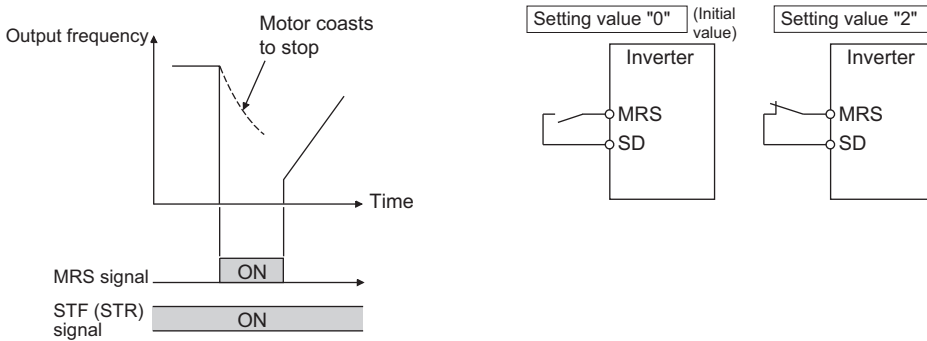

- When the Output stop (MRS) signal is turned ON while operating the inverter, the inverter output is instantaneously shut off.
- To input the MRS signal, set "24" in any parameter from **Pr.178 to Pr.189 (Input terminal function selection)** to assign the function.
- The response time of the MRS signal is within 2 ms (except for the FR-E800-SCE).
- The MRS signal is used in the following cases.

Application	Description
To stop the motor using a mechanical brake (e.g. electromagnetic brake)	The inverter output is shut off when the mechanical brake operates.
To provide interlock to disable the motor operation by the inverter	With the MRS signal ON, the motor cannot be driven by the inverter even if the start signal is input to the inverter.
To coast the motor to a stop	When the start signal is turned OFF, the inverter decelerates the motor to a stop in the preset deceleration time, but when the MRS signal is turned ON, the motor coasts to a stop.

◆ MRS signal logic inversion (Pr.17 = "2")

- When **Pr.17 = "2 or 3"**, the input specification of the MRS signal is changed to normally closed (NC contact). The inverter will shut off the output when the MRS signal is turned OFF (when the contact is opened).

◆ Assigning a different action for each MRS signal input via communication and external terminal (Pr.17 = "4 or 5")

- When Pr.17 = "4 or 5", the MRS signal input from an external terminal is normally closed (NC contact), and the MRS signal input from communication is normally open (NO contact). This function is useful to perform operation via communication while keeping the ON state of the MRS signal input from the external terminal.

External MRS	Communication MRS	Pr.17 setting		
		0, 1	2, 3	4, 5
OFF	OFF	Operation enabled	Output shutoff	Output shutoff
OFF	ON	Output shutoff	Output shutoff	Output shutoff
ON	OFF	Output shutoff	Output shutoff	Operation enabled
ON	ON	Output shutoff	Operation enabled	Output shutoff

◆ Operation when PU operation interlock enabled (Pr.79 = "7")

- When the X12 signal is not assigned to any input terminal while the PU operation interlock is enabled (Pr.79 = "7"), the MRS signal is used as the X12 signal. The logic for the MRS signal used as the X12 signal is changed by the Pr.17 setting.
- The operation when the PU operation interlock is enabled (Pr.79 = "7") is as follows.

Pr.17 setting	MRS signal	X12 signal	MRS function	X12 function
0, 1	Assigned	Not assigned	PU operation interlock (NO contact)	—
	Not assigned	Assigned	—	PU operation interlock (NO contact)
	Assigned	Assigned	Output shutoff (NO contact)	—
2 to 5	Assigned	Not assigned	PU operation interlock (NC contact)	—
	Not assigned	Assigned	—	PU operation interlock (NO contact)
	Assigned	Assigned	Output shutoff (NC contact)	—

NOTE

- When using an external terminal to input the MRS signal, the MRS signal shuts off the output in any of the operation modes.
- The MRS signal is valid regardless of whether it is input through the external terminal or via network (except for the FR-E800-SCE), but when the MRS signal is used as the Inverter run enable (X10) signal, input the signal through the external terminal.
- When the terminal assignment is changed using Pr.178 to Pr.189 (Input terminal function selection), wiring may be mistaken due to different terminal name and signal contents, or may affect other functions. Set parameters after confirming the function of each terminal.

Parameters referred to

Pr.79 Operation mode selection  page 280

Pr.178 to Pr.189 (Input terminal function selection)  page 410

13.8 Selecting the condition to activate the Second function selection (RT) signal

The second function can be selected using the RT signal.

- Turning ON the Second function selection (RT) signal enables the second functions. For the RT signal, set "3" in any parameter from **Pr.178 to Pr.189 (Input terminal function selection)** to assign the function.
- The following are the examples of the applications of the second functions.
 - Switching between regular use and emergency use
 - Switching between heavy load and light load
 - Changing the acceleration/deceleration time by break point acceleration/deceleration
 - Switching characteristics of main motor and sub motor

Connection diagram example for the second function

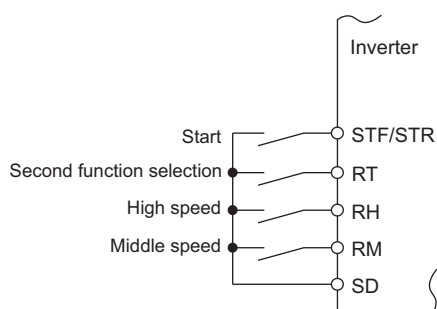

Example of the second acceleration/deceleration time function

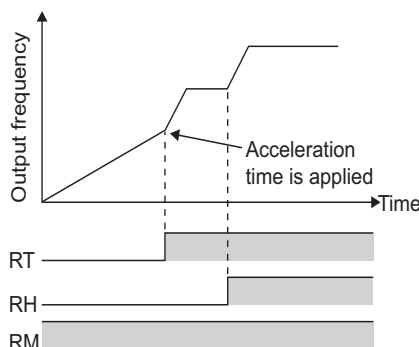

- When the RT signal is ON, second functions are selected. The following table shows the functions which can be changed to the second function.

Function	First function parameter number	Second function parameter number	Refer to page
Torque boost	Pr.0	Pr.46	528
Base frequency	Pr.3	Pr.47	530
Acceleration time	Pr.7	Pr.44	262
Deceleration time	Pr.8	Pr.44, Pr.45	262
Electronic thermal O/L relay	Pr.9	Pr.51	306
Free thermal	Pr.600 to Pr.604	Pr.692 to Pr.696	
Motor permissible load level	Pr.607	Pr.608	
Stall prevention	Pr.22	Pr.48	334
Applied motor ^{*1}	Pr.71	Pr.450	424
Motor constant ^{*1}	Pr.80 to Pr.84, Pr.90 to Pr.94, Pr.298, Pr.702, Pr.706, Pr.707, Pr.711, Pr.712, Pr.717, Pr.721, Pr.724, Pr.725, Pr.859, Pr.1412	Pr.453 to Pr.462, Pr.560, Pr.738 to Pr.746, Pr.860, Pr.1413	430, 441
Speed control gain (Advanced magnetic flux vector) ^{*1}	Pr.89	Pr.569	121
Offline auto tuning ^{*1}	Pr.96	Pr.463	430, 441
Online auto tuning ^{*1}	Pr.95	Pr.574	449
Motor control method ^{*1}	Pr.800	Pr.451	115
Speed control gain	Pr.820, Pr.821	Pr.830, Pr.831	146
Position control gain	Pr.422	Pr.1298	217, 536
Pre-excitation selection	Pr.802	Pr.1299	536
Analog input filter	Pr.822, Pr.826	Pr.832, Pr.836	398
Speed detection filter	Pr.823	Pr.833	557
Torque control gain	Pr.824, Pr.825	Pr.834, Pr.835	173

*1 The function can be changed by switching the RT signal ON/OFF while the inverter is stopped. If a signal is switched during operation, the operation method changes after the inverter stops. (Pr.450 ≠ 9999)

 **NOTE**

- Changing the terminal assignment using **Pr.178 to Pr.189 (Input terminal function selection)** may affect the other functions. Set parameters after confirming the function of each terminal.

« **Parameters referred to** »

Pr.178 to Pr.189 (Input terminal function selection)  [page 410](#)

13.9 Start signal operation selection

Operation of the start signal (STF/STR) can be selected.

The stopping method (deceleration stop or coasting) at turn-OFF of the start signal can also be selected. (For the stop operation selection, refer to [page 543](#).)

Pr.	Name	Initial value	Setting range	Description	
				Start signal (STF/STR)	Stop operation ^{*1}
250 G106	Stop selection	9999	0 to 100 s	STF signal: Forward rotation start STR signal: Reverse rotation start	The motor coasts to a stop after a lapse of the setting time when the start signal is turned OFF.
			1000 to 1100 s ^{*2}	STF signal: Start signal STR signal: Forward/reverse rotation signal	The motor coasts to a stop after a lapse of the (Pr.250 - 1000) seconds when the start signal is turned OFF.
			9999	STF signal: Forward rotation start STR signal: Reverse rotation start	The motor is decelerated to a stop when the start signal is turned OFF.
			8888 ^{*2}	STF signal: Start signal STR signal: Forward/reverse rotation signal	

*1 For the stop operation selection, refer to [page 543](#).

*2 The start signal operation selection is available in External operation mode or when the start command source is External in the Network operation mode.

◆ 2-wire type (STF signal, STR signal)

- The following figure shows the 2-wire type connection.
- As an initial setting, the forward/reverse rotation signals (STF/STR) acts as both start and stop signals. Either one turned ON will be enabled, and the operation will follow that signal. The motor will decelerate to a stop when both are turned OFF (or both are turned ON) during the operation.
- The frequency can be set by inputting 0 to 10 VDC between the speed setting input terminals 2 and 5, or with **Pr.4 to Pr.6 Multi-speed setting (high speed, middle speed, and low speed)**. (For the multi-speed operation, refer to [page 303](#).)
- By setting **Pr.250 = "1000 to 1100, 8888"**, the STF signal input becomes the start command and the STR signal input becomes the forward/reverse command.

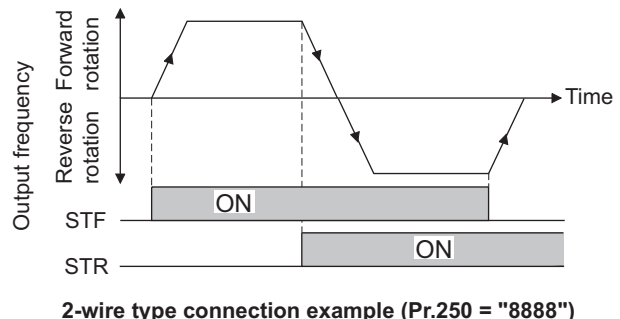
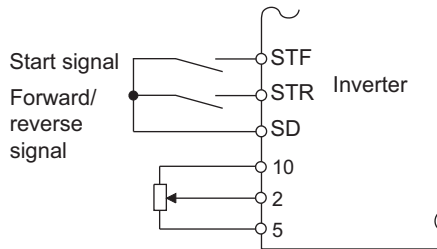
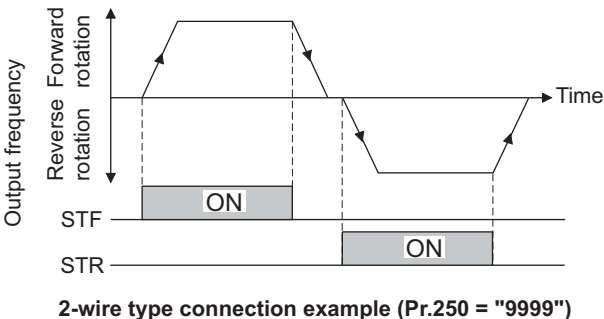
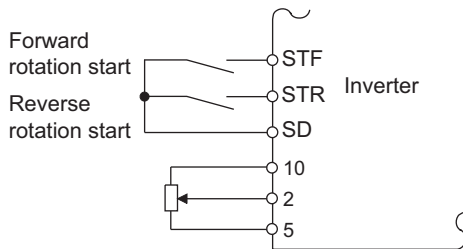

NOTE

- By setting **Pr.250** = "0 to 100, 1000 to 1100", the motor will coast to a stop when the start command is turned OFF. (Refer to page 543.)
- The STF and STR signals are assigned to **Pr.178 STF/DI0 terminal function selection** and **Pr.179 STR/DI1 terminal function selection** in the initial status. The STF signal can be assigned to only **Pr.178 STF/DI0 terminal function selection**, and the STR signal can be assigned to only **Pr.179 STR/DI1 terminal function selection**.

◆ 3-wire type (STF signal, STR signal, STP (STOP) signal)

- The following figure shows the 3-wire type connection.
- The self-holding function is enabled when the STP (STOP) signal is turned ON. In such case, the forward/reverse signal is simply used as a start signal. (The STP (STOP) signal can be input via an external terminal only.)
- For the STP (STOP) signal, set "25" in any parameter from **Pr.178 to Pr.184 (Input terminal function selection)** to assign the function.
- Even if a start signal (STF or STR) is turned ON and then OFF, the start command remains valid and the motor operation continues. To change the rotation direction, turn the STR (STF) signal ON once and then OFF.
- In order to decelerate the motor to a stop, turn OFF the STP (STOP) signal once.

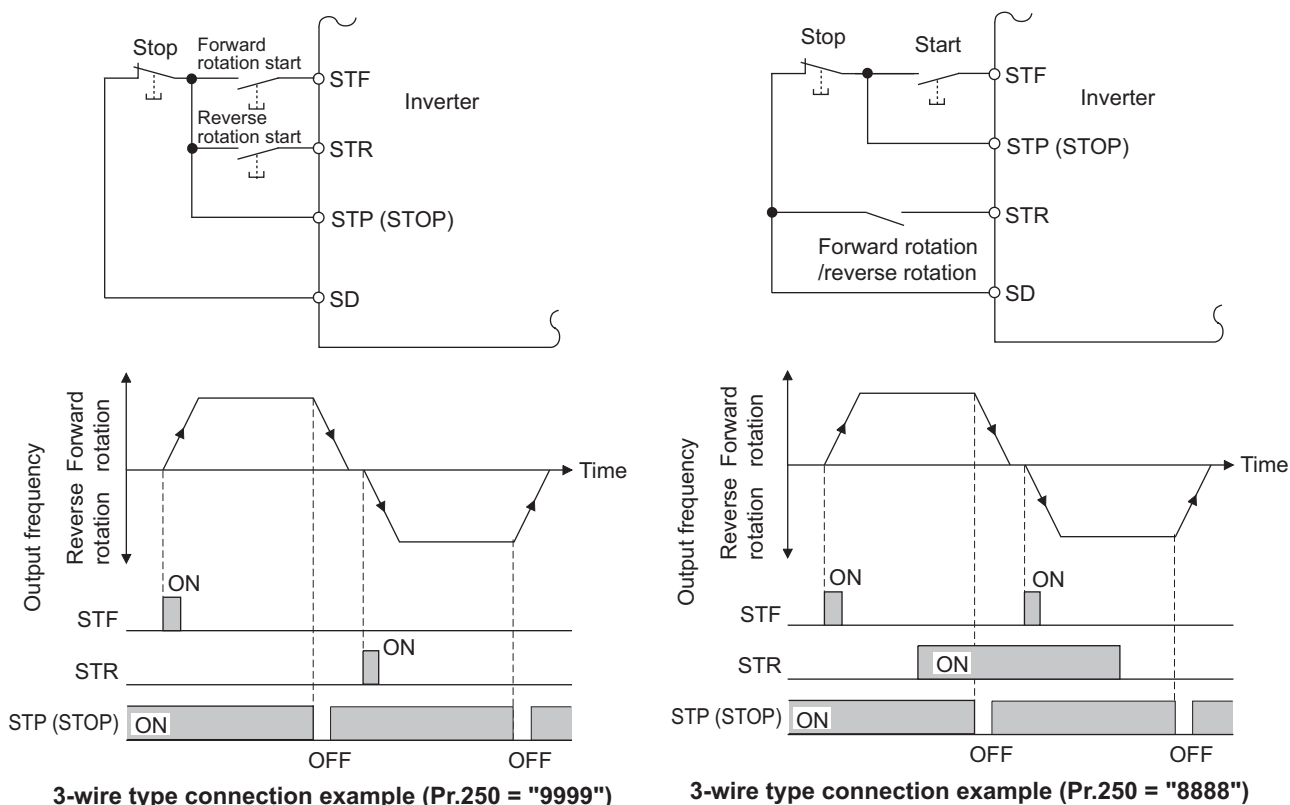

NOTE

- When the JOG operation is enabled by turning ON the JOG signal, the STP (STOP) signal will be disabled.
- Even when the output is stopped by turning ON the MRS signal, the self-holding function is not canceled.

◆ Start signal operation

STF	STR	Pr.250 setting and inverter condition	
		0 to 100 s, 9999	1000 to 1100 s, 8888
OFF	OFF	Stop	Stop
OFF	ON	Reverse rotation	
ON	OFF	Forward rotation	Forward rotation
ON	ON	Stop	Reverse rotation

« Parameters referred to »

Pr.4 to Pr.6 (multi-speed setting)  [page 303](#)

Pr.178 to Pr.189 (Input terminal function selection)  [page 410](#)

CHAPTER 14 (C) Motor Constant Parameters

14.1	Applied motor.....	424
14.2	Offline auto tuning.....	430
14.3	Offline auto tuning for a PM motor.....	441
14.4	Online auto tuning.....	449
14.5	Parameter settings for a motor with encoder.....	452
14.6	Signal loss detection of encoder signals.....	454

14 (C) Motor Constant Parameters

Purpose	Parameter to set			Refer to page
To select the motor to be used	Applied motor	P.C100, P.C200	Pr.71, Pr.450	424
To maximize the performance of the induction motor and the Vector control dedicated motor	Offline auto tuning	P.C100 to P.C105, P.C107, P.C108, P.C110, P.C120 to P.C126, P.C182, PC188, P.C200 to P.C205, P.C207, P.C208, P.C210, P.C220 to P.C226, P.C282, P.C288	Pr.9, Pr.51, Pr.71, Pr.80 to Pr.84, Pr.90 to Pr.94, Pr.96, Pr.450, Pr.453 to Pr.463, Pr.707, Pr.717, Pr.720, Pr.724, Pr.737, Pr.741, Pr.744, Pr.745, Pr.859, Pr.860	430
To maximize the performance of the PM motor	PM motor offline auto tuning	P.C100 to P.C108, P.C110, P.C120, P.C122, P.C123, P.C126, P.C130 to P.C133, P.C135, P.C150, P.C182, P.C185, P.C194 to P.C196, P.C200 to P.C208, P.C210, P.C220, P.C222, P.C223, P.C226, P.C230 to P.C233, P.C235, P.C282, P.C285	Pr.9, Pr.51, Pr.71, Pr.80, Pr.81, Pr.83, Pr.84, Pr.90, Pr.92, Pr.93, Pr.96, Pr.450, Pr.453, Pr.454, Pr.456 to Pr.458, Pr.460, Pr.461, Pr.463, Pr.702, Pr.706, Pr.707, Pr.711, Pr.712, Pr.717, Pr.721, Pr.724, Pr.725, Pr.738 to Pr.746, Pr.859, Pr.860, Pr.979 to Pr.981, Pr.1002, Pr.1412, Pr.1413	441
To perform high accuracy operation without being affected by temperature and high-torque/ultra-low speed	Online auto tuning	P.C111, P.C211	Pr.95, Pr.574	449
To use the motor with encoder	Encoder specifications	P.C140, P.C141	Pr.359, Pr.369	452
To detect loss of encoder signals	Signal loss detection	P.C148	Pr.376	454

14.1 Applied motor

By setting the applied motor type, the thermal characteristic appropriate for the motor can be selected.

When using a constant-torque or PM motor, the electronic thermal O/L relay function is set according to the motor.

When the Advanced magnetic flux vector control, Real sensorless vector control, Vector control, or PM sensorless vector control is selected, the motor constant necessary for control (for SF-PR, SF-PR-SC, SF-JR, SF-HR, SF-JRCA, SF-HRCA, SF-V5RU (1500 r/min series), GM-[], GM-DZ, GM-DP, MM-GKR, or EM-A) is also selected at the same time.

Pr.	Name	Initial value	Setting range	Description
71 C100	Applied motor	0	0, 3, 5, 6, 10, 13, 15, 16, 20, 23, 30, 33, 40, 43, 50, 53, 70, 73, 540, 1140, 1800, 1803, 8090, 8093, 9090, 9093 ^{*1}	By selecting a motor, the thermal characteristic and motor constant of each motor are set.
450 C200	Second applied motor	9999	0, 3, 5, 6, 10, 13, 15, 16, 20, 23, 30, 33, 40, 43, 50, 53, 70, 73, 540, 1140, 1800, 1803, 8090, 8093, 9090, 9093 ^{*1} 9999	Set this parameter when using the second motor (the same specifications as Pr.71). The function is disabled.

*1 The setting range for the 575 V class is "0, 3, 5, 6, 10, 13, 15, 16, 30, 33, 8090, 8093, 9090, and 9093".

◆ Motor settings (100/200/400 V class)

- Refer to the following list and set the parameters according to the applied motor.

Pr.71	Pr.450	Motor	Motor constant value range when performing offline auto tuning (increment)	Electronic thermal O/L relay function			
				Standard	Constant-torque	PM	
0 (Pr.71 initial value)		Standard motor (such as SF-JR)	Pr.82 (Pr.455), Pr.859 (Pr.860) • 0 to 500 A, 9999 (0.01 A) Pr.90 (Pr.458), Pr.91 (Pr.459) • 0 to 50 Ω, 9999 (0.001 Ω) Pr.92 (Pr.460), Pr.93 (Pr.461) (Induction motor) • 0 to 6000 mH, 9999 (0.1 mH) Pr.92 (Pr.460), Pr.93 (Pr.461) (PM motor) • 0 to 650 mH, 9999 (0.01 mH) Pr.94 (Pr.462) • 0% to 100%, 9999 (0.1%) Pr.706 (Pr.738) • 0 to 5000 mV (rad/s), 9999 (0.1 mV/(rad/s))	○			
10		Constant-torque motor (such as SF-JRCA)			○		
20		Mitsubishi Electric standard efficiency motor (SF-JR 4P 1.5 kW or lower)			○		
30		Mitsubishi Electric vector control dedicated motor (SF-V5RU (1500 r/min series))			○		
40		Mitsubishi Electric high-efficiency motor SF-HR			○		
50		Mitsubishi Electric constant-torque motor SF-HRCA			○		
70		Mitsubishi Electric high-performance energy-saving motor SF-PR			○		
		Mitsubishi Electric high-performance energy-saving motor with encoder SF-PR-SC			○		
540 ^{*2}		Mitsubishi Electric PM motor MM-GKR				○	
1140 ^{*3}		Mitsubishi Electric PM motor EM-A				○	
1800 ^{*1}		Mitsubishi Electric geared motor GM-[]			○		
		Mitsubishi Electric inverter-driven geared motor for encoder feedback control GM-DZ, GM-DP			○		
8090		IPM motor			○		
9090		SPM motor			○		
3		Standard motor (such as SF-JR)		Pr.82 (Pr.455), Pr.859 (Pr.860), Pr.90 (Pr.458), Pr.91 (Pr.459), Pr.92 (Pr.460), Pr.93 (Pr.461), Pr.94 (Pr.462), Pr.706 (Pr.738) • Internal data value 0 to 65534, 9999 (1)	○		
13		Constant-torque motor (such as SF-JRCA)				○	
23		Mitsubishi Electric standard efficiency motor (SF-JR 4P 1.5 kW or lower)			○		
33		Mitsubishi Electric vector control dedicated motor (SF-V5RU (1500 r/min series))			○		
43		Mitsubishi Electric high-efficiency motor SF-HR			○		
53		Mitsubishi Electric constant-torque motor SF-HRCA			○		
73		Mitsubishi Electric high-performance energy-saving motor SF-PR			○		
		Mitsubishi Electric high-performance energy-saving motor with encoder SF-PR-SC			○		
1803		Mitsubishi Electric geared motor GM-[]			○		
		Mitsubishi Electric inverter-driven geared motor for encoder feedback control GM-DZ, GM-DP			○		
8093		IPM motor			○		
9093		SPM motor			○		
5		Standard motor	Wye connection		○		
15		Constant-torque motor			○		
6		Standard motor	Delta connection		○		
16		Constant-torque motor			○		
—	9999 (initial value)	No second applied motor					

*1 To perform offline auto tuning for the 400 V class 0.1 kW Mitsubishi Electric geared motor (GM-[]), set "1803" in Pr.71 (Pr.450).

- *2 The value is valid only when the FR-E820-0080(1.5K) or lower, the FR-E820S-0080(1.5K) or lower, or FR-E810W-0050(0.75K) or lower is used and **Pr.80 (Pr.453)** ≤ 0.75 kW. Under other conditions, "SE" (Incorrect parameter setting) is displayed when the start command is turned ON.
- *3 The value is valid in any of the following conditions. Under other conditions, "SE" (Incorrect parameter setting) is displayed when the start command is turned ON.
 The FR-E820-0470(11K) or lower is used and **Pr.80 (Pr.453)** ≤ 7.5 kW.
 The FR-E840-0230(11K) or lower is used and **Pr.80 (Pr.453)** = 0.4 to 7.5 kW.
 The FR-E820S-0110(2.2K) or lower is used and **Pr.80 (Pr.453)** ≤ 2.2 kW.
 The FR-E810W-0050(0.75K) or lower is used and **Pr.80 (Pr.453)** ≤ 0.75 kW.
 The FR-E846-0095(3.7K) or lower is used and **Pr.80 (Pr.453)** = 2.2 or 3.7 kW.

NOTE

- Regardless of the **Pr.71 (Pr.450)** setting, offline auto tuning can be performed according to **Pr.96 (Pr.463) Auto tuning setting/status**. (Refer to [page 430](#) for offline auto tuning.)

◆ Motor settings (575 V class)

- Refer to the following list and set the parameters according to the applied motor.

Pr.71	Pr.450	Motor	Motor constant value range when performing offline auto tuning (increment)		Electronic thermal O/L relay function	
					Standard	Constant-torque
0 (Pr.71 initial value)		Standard motor	Pr.82 (Pr.455), Pr.859 (Pr.860) • 0 to 500 A, 9999 (0.01 A)		○	
10		Constant-torque motor	Pr.90 (Pr.458), Pr.91 (Pr.459) • 0 to 50 Ω, 9999 (0.001 Ω)			○
30		Vector control dedicated motor	Pr.92 (Pr.460), Pr.93 (Pr.461) (Induction motor) • 0 to 6000 mH, 9999 (0.1 mH)			○
8090		IPM motor	Pr.92 (Pr.460), Pr.93 (Pr.461) (PM motor) • 0 to 650 mH, 9999 (0.01 mH)			○
9090		SPM motor	Pr.94 (Pr.462) • 0% to 100%, 9999 (0.1%)			○
3		Standard motor	Pr.706 (Pr.738) • 0 to 5000 mV (rad/s), 9999 (0.1 mV/(rad/s))			○
13		Constant-torque motor	Pr.82 (Pr.455), Pr.859 (Pr.860), Pr.90 (Pr.458), Pr.91 (Pr.459), Pr.92 (Pr.460), Pr.93 (Pr.461), Pr.94 (Pr.462), Pr.706 (Pr.738)			○
33		Vector control dedicated motor				○
8093		IPM motor	• Internal data value 0 to 65534, 9999 (1)			○
9093		SPM motor				○
5		Standard motor	Wye connection	Pr.82 (Pr.455) and Pr.859 (Pr.860) • 0 to 500 A, 9999 (0.01 A)	○	
15		Constant-torque motor				
6		Standard motor	Delta connection	Pr.90 (Pr.458), Pr.91 (Pr.459), Pr.92 (Pr.460) and Pr.93 (Pr.461) • 0 to 50 Ω, 9999 (0.001 Ω)	○	
16		Constant-torque motor				
—	9999 (initial value)	No second applied motor				

NOTE

- Regardless of the **Pr.71 (Pr.450)** setting, offline auto tuning can be performed according to **Pr.96 (Pr.463) Auto tuning setting/status**. (Refer to [page 430](#) for offline auto tuning.)

◆ Using two types of motors (RT signal, Pr.450)

- When using two types of motors with one inverter, set **Pr.450 Second applied motor**.
- The setting value "9999" (initial value) disables the second motor.
- If **Pr.450** ≠ 9999, the following parameters will be enabled by turning ON the Second function selection (RT) signal.

Function	RT signal ON (second motor)	RT signal OFF (first motor)
Electronic thermal O/L relay	Pr.51	Pr.9
Applied motor	Pr.450	Pr.71
Control method selection	Pr.451	Pr.800
Motor capacity	Pr.453	Pr.80
Number of motor poles	Pr.454	Pr.81
Motor excitation current	Pr.455	Pr.82
Rated motor voltage	Pr.456	Pr.83
Rated motor frequency	Pr.457	Pr.84
Motor constant (R1)	Pr.458	Pr.90
Motor constant (R2)	Pr.459	Pr.91
Motor constant (L1)/d-axis inductance (Ld)	Pr.460	Pr.92
Motor constant (L2)/q-axis inductance (Lq)	Pr.461	Pr.93
Motor constant (X)	Pr.462	Pr.94
Auto tuning setting/status	Pr.463	Pr.96
Frequency search gain	Pr.560	Pr.298
Online auto tuning selection	Pr.574	Pr.95
Induced voltage constant (phi f)	Pr.738	Pr.706
Motor Ld decay ratio	Pr.739	Pr.711
Motor Lq decay ratio	Pr.740	Pr.712
Starting resistance tuning compensation coefficient 1	Pr.741	Pr.717
Starting resistance tuning compensation coefficient 2	Pr.737	Pr.720
Starting magnetic pole position detection pulse width	Pr.742	Pr.721
Maximum motor frequency	Pr.743	Pr.702
Motor inertia (integer)	Pr.744	Pr.707
Motor inertia (exponent)	Pr.745	Pr.724
Motor protection current level	Pr.746	Pr.725
Torque current/Rated PM motor current	Pr.860	Pr.859

NOTE

- The RT signal is the Second function selection signal. The RT signal also enables other second functions. (Refer to [page 418](#).)
- For the RT signal, set "3" in any parameter from **Pr.178 to Pr.189 (Input terminal function selection)** to assign the function.
- Changing the terminal assignment using **Pr.178 to Pr.189 (Input terminal function selection)** may affect the other functions. Set parameters after confirming the function of each terminal.

◆ Automatic change of torque boost for the SF-PR motor (100/200/400 V class)

- When the SF-PR motor is selected (**Pr.71** = "70 or 73"), the **Pr.0 Torque boost** setting is automatically changed to enable output of the 6 Hz 150% torque under V/F control by setting **Pr.81 Number of motor poles** according to the number of the SF-PR motor poles.

NOTE

- When selecting the automatic change of torque boost for the SF-PR motor, set **Pr.14 Load pattern selection** = "0 (initial value)".
- When the **Pr.0** setting is changed from its initial value, the automatic change is not performed.

◆ Automatic change of Pr.0 Torque boost and Pr.12 DC injection brake operation voltage (100/200/400 V class)

- When initial values are set in Pr.0 and Pr.12, the Pr.0 and Pr.12 settings are automatically changed to the values in the following table by changing the Pr.71 setting.

Inverter			Pr.0 value (%) after automatic change													
FR-E820-[]	FR-E840-[]	FR-E846-[]	Standard motor ^{*1}		Constant-torque motor ^{*2}		SF-PR ^{*3}								GM-[] ^{*4}	
			ND	LD	ND	LD	Pr.81 ≠ "2, 4, 6"		Pr.81 = "2"		Pr.81 = "4"		Pr.81 = "6"		ND	LD
							ND	LD	ND	LD	ND	LD	ND	LD		
0008(0.1K)	—	—	6	6	6	6	4	5.5	4	8.6	4	8.6	4	8.6	6	6
0015(0.2K)	—	—	6	6	6	6	5.5	5	8.6	8	8.6	6.5	8.6	7.5	6	6
0030(0.4K)	0016(0.4K)	—	6	6	6	6	5	4	8	7.4	6.5	6	7.5	6.4	6	4
0050(0.75K)	0026(0.75K)	0026(0.75K)	6	4	6	4	4	3	7.4	5.8	6	5	6.4	3.7	4	5
0080(1.5K)	0040(1.5K)	0040(1.5K)	4	4	4	4	3	2.5	5.8	6	5	4.5	3.7	3.3	5	4
0110(2.2K)	0060(2.2K)	0060(2.2K)	4	4	4	4	2.5	2.5	6	6.4	4.5	4.5	3.3	4.2	4	4.5
0175(3.7K)	0095(3.7K)	0095(3.7K)	4	3	4	2	2.5	2	6.4	4.5	4.5	3.7	4.2	3.3	4.5	3.7
0240(5.5K)	0120(5.5K)	—	3	3	2	2	2	2	4.5	4.4	3.7	4.5	3.3	3.8	3.7	4.5
0330(7.5K)	0170(7.5K)	—	3	2	2	2	2	1.5	4.4	3.5	4.5	3.3	3.8	3.5	4.5	3.3
0470(11K)	0230(11K)	—	2	2	2	2	1.5	1.5	3.5	4.5	3.3	3	3.5	3.5	3.3	3
0600(15K)	0300(15K)	—	2	2	2	2	1.5	1.5	4.5	4	3	3.2	3.5	3	3	—
0760(18.5K)	0380(18.5K)	—	2	2	2	2	1.5	1.5	4	2.5	3.2	3.4	3	3	—	3.4
0900(22K)	0440(22K)	—	2	2	2	2	1.5	1	2.5	3	3.4	2	3	2.5	3.4	2

Inverter		Pr.0 value (%) after automatic change						
FR-E820S-[]	FR-E810W-[]	Standard motor ^{*1}	Constant-torque motor ^{*2}	SF-PR ^{*3}				GM-[] ^{*4}
				Pr.81 ≠ "2, 4, 6"	Pr.81 = "2"	Pr.81 = "4"	Pr.81 = "6"	
		ND	ND	ND	ND	ND	ND	
0008(0.1K)	0008(0.1K)	6	6	4	4	4	4	6
0015(0.2K)	0015(0.2K)	6	6	5.5	8.6	8.6	8.6	6
0030(0.4K)	0030(0.4K)	6	6	5	8	6.5	7.5	6
0050(0.75K)	0050(0.75K)	6	6	4	7.4	6	6.4	4
0080(1.5K)	—	4	4	3	5.8	5	3.7	5
0110(2.2K)	—	4	4	2.5	6	4.5	3.3	4

Inverter			Pr.12 value (%) after automatic change							
FR-E820-[]	FR-E840-[]	FR-E846-[]	Standard motor ^{*1}		Constant-torque motor ^{*2}		SF-PR ^{*3}		GM-[] ^{*4}	
			ND	LD	ND	LD	ND	LD	ND	LD
0008(0.1K)	—	—	6	6	6	6	4	5.5	6	6
0015(0.2K)	—	—	6	4	6	4	5.5	5	6	4
0030(0.4K)	0016(0.4K)	—	4	4	4	4	5	4	4	4
0050(0.75K)	0026(0.75K)	0026(0.75K)	4	4	4	4	4	2.5	4	4
0080(1.5K)	0040(1.5K)	0040(1.5K)	4	4	4	4	2.5	2.5	4	4
0110(2.2K)	0060(2.2K)	0060(2.2K)	4	4	4	4	2.5	2.5	4	2.5
0175(3.7K)	0095(3.7K)	0095(3.7K)	4	4	4	2	2.5	2	2.5	2
0240(5.5K)	0120(5.5K)	—	4	4	2	2	2	2	2	2
0330(7.5K)	0170(7.5K)	—	4	2	2	2	2	1.5	2	1.5
0470(11K)	0230(11K)	—	2	2	2	2	1.5	1.5	1.5	1.5
0600(15K)	0300(15K)	—	2	2	2	2	1.5	1.5	1.5	—
0760(18.5K)	0380(18.5K)	—	2	2	2	2	1.5	1	—	1
0900(22K)	0440(22K)	—	2	2	2	2	1	1	1	1

Inverter		Pr.12 value (%) after automatic change			
FR-E820S-□	FR-E810W-□	Standard motor ^{*1}	Constant-torque motor ^{*2}	SF-PR ^{*3}	GM-□ ^{*4}
		ND	ND	ND	ND
0008(0.1K)	0008(0.1K)	6	6	4	6
0015(0.2K)	0015(0.2K)	6	6	5.5	6
0030(0.4K)	0030(0.4K)	4	4	5	4
0050(0.75K)	0050(0.75K)	4	4	4	4
0080(1.5K)	—	4	4	2.5	4
0110(2.2K)	—	4	4	2.5	4

*1 Pr.71 = "0, 3, 5, 6, 20, 23, 40, or 43" (standard motor)
 *2 Pr.71 = "10, 13, 15, 16, 50, or 53" (constant-torque motor)
 *3 Pr.71 = "70 or 73" (SF-PR)
 *4 Pr.71 = "1800 or 1803" (GM-□)

NOTE

- When the **Pr.0** and **Pr.12** settings are changed from their initial values, the automatic change is not performed.
- When the SF-PR motor is selected (**Pr.71** = "70 or 73"), the output current may become large due to a small load by setting **Pr.81 Number of motor poles** according to the number of the SF-PR motor poles.
- When the SF-PR motor is used, the output current tends to increase compared with the case where the SF-JR or SF-HR motor is used. Depending on the load conditions, the output current may increase even though the torque boost value has been automatically changed. When the protective function such as the electronic thermal O/L relay (E.THT, E.THM) or stall prevention (OL, E.OLT) is activated, adjust the **Pr.0 Torque boost** according to the load.

CAUTION

- Make sure to set this parameter correctly according to the motor used. Incorrect setting may cause the motor and the inverter to overheat and burn.

Parameters referred to

- Pr.0 Torque boost [page 528](#)
- Pr.12 DC injection brake operation voltage [page 536](#)
- Pr.14 Load pattern selection [page 532](#)
- Pr.96 Auto tuning setting/status [page 430](#)
- Pr.178 to Pr.189 (Input terminal function selection) [page 410](#)

14.2 Offline auto tuning

Magnetic flux Sensorless Vector

The offline auto tuning enables the optimal operation of a motor.

- Under Advanced magnetic flux vector control, Real sensorless vector control, or Vector control, automatic measurement of motor constants enables optimal operation of motors even when motor constants vary, when a motor of another company is used, or when the wiring distance is long.

For the offline auto tuning for a PM motor, refer to [page 441](#).

Pr.	Name	Initial value	Setting range	Description
71 C100	Applied motor	0	0, 3, 5, 6, 10, 13, 15, 16, 20, 23, 30, 33, 40, 43, 50, 53, 70, 73, 540, 1140, 1800 ^{*5} , 1803, 8090, 8093, 9090, 9093 ^{*1}	By selecting a motor, the thermal characteristic and motor constant of each motor are set.
80 C101	Motor capacity	9999	0.1 to 30 kW 9999	Set the applied motor capacity. No motor capacity setting
81 C102	Number of motor poles	9999	2, 4, 6, 8, 10, 12 9999	Set the number of motor poles. No number of motor poles setting
9 C103	Electronic thermal O/L relay	Inverter rated current ^{*2}	0 to 500 A	Set the rated motor current.
83 C104	Rated motor voltage	200/400/575 V ^{*3}	0 to 1000 V	Set the rated motor voltage (V).
84 C105	Rated motor frequency	9999	10 to 400 Hz 9999	Set the rated motor frequency (Hz). The setting value of Pr.3 Base frequency is used.
707 C107	Motor inertia (integer)	9999	10 to 999, 9999	Set the motor inertia. 9999: The constant value of Mitsubishi Electric motor (SF-PR, SF-PR-SC, SF-JR, SF-HR, SF-JRCA, SF-HRCA, SF-V5RU (1500 r/min series), GM-[], GM-DZ, or GM-DP) is used.
724 C108	Motor inertia (exponent)	9999	0 to 7, 9999	
96 C110	Auto tuning setting/status	0	0	No offline auto tuning
			1	Offline auto tuning is performed without the motor rotating.
			11	Offline auto tuning is performed without the motor rotating (under V/F control). (Refer to page 510 .)
			301	Position accuracy compensation gain tuning is performed (under PM sensorless vector control). (Refer to page 441 .)
90 C120	Motor constant (R1)	9999	0 to 50 Ω, 9999 ^{*4}	Tuning data (The value measured by offline auto tuning is automatically set.) 9999: The constant value of Mitsubishi Electric motor (SF-PR, SF-PR-SC, SF-JR, SF-HR, SF-JRCA, SF-HRCA, SF-V5RU (1500 r/min series), GM-[], GM-DZ, or GM-DP) is used.
91 C121	Motor constant (R2)	9999	0 to 50 Ω, 9999 ^{*4}	
92 C122	Motor constant (L1)/d-axis inductance (Ld)	9999	0 to 6000 mH, 9999 ^{*4}	
93 C123	Motor constant (L2)/q-axis inductance (Lq)	9999	0 to 6000 mH, 9999 ^{*4}	
94 C124	Motor constant (X)	9999	0% to 100%, 9999 ^{*4}	
82 C125	Motor excitation current	9999	0 to 500 A, 9999 ^{*4}	
859 C126	Torque current/ Rated PM motor current	9999	0 to 500 A, 9999 ^{*4}	
717 C182	Starting resistance tuning compensation coefficient 1	9999	0% to 200%, 9999	
720 C188	Starting resistance tuning compensation coefficient 2	9999	0% to 200%, 9999	

Pr.	Name	Initial value	Setting range	Description
298 A711	Frequency search gain	9999	0 to 32767	The offline auto tuning automatically sets the gain required for the frequency search.
			9999	The constant value of Mitsubishi Electric motor (SF-PR, SF-PR-SC, SF-JR, SF-HR, SF-JRCA, SF-HRCA, SF-V5RU (1500 r/min series), GM-[], GM-DZ, or GM-DP) is used.
450 C200	Second applied motor	9999	0, 3, 5, 6, 10, 13, 15, 16, 20, 23, 30, 33, 40, 43, 50, 53, 70, 73, 540, 1140, 1800 ^{*5} , 1803, 8090, 8093, 9090, 9093 ^{*1}	Set this parameter when using the second motor (the same specifications as Pr.71).
			9999	The function is disabled.
453 C201	Second motor capacity	9999	0.1 to 30 kW	Set the capacity of the second motor.
			9999	No second motor capacity setting
454 C202	Number of second motor poles	9999	2, 4, 6, 8, 10, 12	Set the number of poles of the second motor.
			9999	No number of second motor poles setting
51 C203	Second electronic thermal O/L relay	9999	0 to 500 A	This function is enabled when the RT signal is ON. Set the rated motor current.
			9999	Second electronic thermal O/L relay disabled.
456 C204	Rated second motor voltage	200/400/575 V ^{*3}	0 to 1000 V	Set the rated voltage (V) of the second motor.
457 C205	Rated second motor frequency	9999	10 to 400 Hz	Set the rated frequency (Hz) of the second motor.
			9999	The Pr.84 Rated motor frequency setting is used.
744 C207	Second motor inertia (integer)	9999	10 to 999, 9999	Set the inertia of the second motor. 9999: The constant value of Mitsubishi Electric motor (SF-PR, SF-PR-SC, SF-JR, SF-HR, SF-JRCA, SF-HRCA, SF-V5RU (1500 r/min series), GM-[], GM-DZ, or GM-DP) is used.
745 C208	Second motor inertia (exponent)	9999	0 to 7, 9999	
463 C210	Second motor auto tuning setting/status	0	0	No auto tuning for the second motor.
			1	Offline auto tuning is performed without the second motor rotating.
			11	Offline auto tuning is performed without the second motor rotating (under V/F control). (Refer to page 510 .)
458 C220	Second motor constant (R1)	9999	0 to 50 Ω, 9999 ^{*4}	Tuning data of the second motor. (The value measured by offline auto tuning is automatically set.) 9999: The constant value of Mitsubishi Electric motor (SF-PR, SF-PR-SC, SF-JR, SF-HR, SF-JRCA, SF-HRCA, SF-V5RU (1500 r/min series), GM-[], GM-DZ, or GM-DP) is used.
459 C221	Second motor constant (R2)	9999	0 to 50 Ω, 9999 ^{*4}	
460 C222	Second motor constant (L1) / d-axis inductance (Ld)	9999	0 to 6000 mH, 9999 ^{*4}	
461 C223	Second motor constant (L2) / q-axis inductance (Lq)	9999	0 to 6000 mH, 9999 ^{*4}	
462 C224	Second motor constant (X)	9999	0% to 100%, 9999 ^{*4}	
455 C225	Second motor excitation current	9999	0 to 500 A, 9999 ^{*4}	
860 C226	Second motor torque current/ Rated PM motor current	9999	0 to 500 A, 9999 ^{*4}	
741 C282	Second motor starting resistance tuning compensation coefficient 1	9999	0% to 200%, 9999	
737 C288	Second motor starting resistance tuning compensation coefficient 2	9999	0% to 200%, 9999	

Pr.	Name	Initial value	Setting range	Description
560 A712	Second frequency search gain	9999	0 to 32767	The offline auto tuning automatically sets the gain required for the frequency search of the second motor.
			9999	The constant value of Mitsubishi Electric motor (SF-PR, SF-PR-SC, SF-JR, SF-HR, SF-JRCA, SF-HRCA, SF-V5RU (1500 r/min series), GM-[], GM-DZ, or GM-DP) is used for the second motor.

*1 The setting range for the 575 V class is "0, 3, 5, 6, 10, 13, 15, 16, 30, 33, 8090, 8093, 9090, and 9093".

*2 The initial value for the FR-E820-0050(0.75K) or lower, FR-E840-0026(0.75K) or lower, FR-E860-0017(0.75K), FR-E820S-0050(0.75K) or lower, FR-E810W-0050(0.75K) or lower, and FR-E846-0026(0.75K) is set to the 85% of the inverter rated current.

*3 The initial value differs according to the voltage class (100/200 V, 400 V, or 575 V).

*4 The setting range and unit change according to the **Pr.71 (Pr.450)** setting.

*5 To perform offline auto tuning for the 400 V class 0.1 kW Mitsubishi Electric geared motor (GM-[]), set "1803" in **Pr.71 (Pr.450)**.

Point

- The setting is valid under Advanced magnetic flux vector control, Real sensorless vector control, or Vector control.
- By using the offline auto tuning function, the optimum operation characteristics are obtained for a motor other than Mitsubishi Electric standard efficiency motors (SF-JR 0.2 kW or higher), high-efficiency motors (SF-HR 0.2 kW or higher), Mitsubishi Electric constant-torque motors (SF-JRCA 4P, SF-HRCA 0.2 kW to 7.5 kW), Mitsubishi Electric high-performance energy-saving motor (SF-PR), Mitsubishi Electric high-performance energy-saving motor with encoder (SF-PR-SC), Mitsubishi Electric Vector control dedicated motor (SF-V5RU (1500 r/min series)), Mitsubishi Electric geared motor (GM-[]), or Mitsubishi Electric inverter-driven geared motor for encoder feedback control (GM-DP), such as an induction motor of other manufacturers or SF-JRC, GM-DZ, or with a long wiring length (exceeding 30 m as a reference).
- Tuning is enabled even when a load is connected to the motor.
- Reading/writing of the motor constants tuned by offline auto tuning are enabled.
- The offline auto tuning status can be monitored on the operation panel or the parameter unit.

◆ Before performing offline auto tuning

Check the following points before performing offline auto tuning:

- Check that a value other than "9999" is set in **Pr.80** and **Pr.81**, and Advanced magnetic flux vector control, Real sensorless vector control, or Vector control is selected (with **Pr.800**). (Refer to [page 115](#).)
- Check that a motor is connected. (Check that the motor is not rotated by an external force during tuning.)
- Select a motor with the rated current equal to or less than the inverter rated current.

If a motor with substantially low rated current compared with the inverter rated current is used, speed and torque accuracies may deteriorate due to torque ripples, etc. Set the rated motor current to about 40% or higher of the inverter rated current. (For details on the inverter rated current, refer to the inverter rated specifications in the Instruction Manual (Connection).)

- Tuning is not available for a high-slip motor, high-speed motor, or special motor.
- The maximum frequency is 400 Hz.
- Tuning is enabled even when a load is connected to the motor. The motor may run slightly. Fix the motor securely with a mechanical brake, or before tuning, make sure that it is safe even if the motor rotates. (Caution is required especially in vertical lift applications.) Note that even if the motor runs slightly, tuning performance is unaffected.
- Offline auto tuning is not performed correctly when the surge voltage suppression filter (FR-ASF-H/FR-BMF-H) is inserted between the inverter and motor. Be sure to remove it before performing tuning.
- Make sure to connect the encoder to the motor without coaxial misalignment for Vector control. Speed ratio must be 1:1.

◆ Settings

- To perform tuning, set the following parameters about the motor.

First motor Pr.	Second motor Pr.	Name	Initial value	Description
80	453	Motor capacity	9999 (V/F control)	Set the motor capacity (kW).
81	454	Number of motor poles	9999 (V/F control)	Set the number of motor poles (2 to 12).
800	451	Control method selection	40 (in Pr.800) / 9999 (in Pr.451)	Set this parameter under Advanced magnetic flux vector control, Real sensorless vector control, or Vector control.
9	51	Electronic thermal O/L relay	Inverter rated current	Set the rated motor current (A).
83	456	Rated motor voltage	200/400/575 V ^{*1}	Set the rated motor voltage (V) printed on the motor's rating plate. ^{*2}
84	457	Rated motor frequency	9999	Set the rated motor frequency (Hz). ^{*2} When the setting is "9999", the Pr.3 Base frequency setting is used.
71	450	Applied motor	0 (standard motor)	Set this parameter according to the motor. ^{*3} Three types of motor constant setting ranges, units and tuning data can be stored according to settings.
96	463	Auto tuning setting/status	0	Set "1". 1: Tuning is performed without the motor rotating. (Excitation noise occurs at this point.)

*1 The initial value differs according to the voltage class (100/200 V, 400 V, or 575 V).

*2 For the settings for the SF-V5RU, refer to [page 452](#).

*3 Set **Pr.71 Applied motor** according to the motor to be used and the motor constant setting range. According to the **Pr.71** setting, the range of the motor constant parameter setting values and units can be changed. (For other setting values of **Pr.71**, refer to [page 424](#).)

- 100/200/400 V class

Motor		Pr.71 setting		
		Motor constant parameter mH, %, and A unit setting	Motor constant parameter internal data setting	Motor constant parameter Ω, mΩ, and A unit setting
Mitsubishi Electric high-performance energy-saving motor	SF-PR	70	73	—
Mitsubishi Electric high-performance energy-saving motor with encoder	SF-PR-SC			
Mitsubishi Electric Vector control dedicated motor	SF-V5RU (1500 r/min series)	30	33	—
Mitsubishi Electric geared motor	GM-[]	1800	1803	—
Mitsubishi Electric inverter-driven geared motor for encoder feedback control	GM-DZ, GM-DP			
Mitsubishi Electric standard efficiency motor Mitsubishi Electric high-efficiency motor	SF-JR	0 (initial value)	3	—
	SF-JR 4P 1.5 kW or lower	20	23	—
	SF-HR	40	43	—
	Others	0 (initial value)	3	—
Mitsubishi Electric constant-torque motor	SF-JRCA 4P	10	13	—
	SF-HRCA	50	53	—
	Others (SF-JRC, etc.)	10	13	—
Other manufacturer's standard motor	—	0 (initial value)	3	5 (wye connection motor) 6 (delta connection motor)
Other manufacturer's constant-torque motor	—	10	13	15 (wye connection motor) 16 (delta connection motor)

- 575 V class

Motor	Pr.71 setting		
	Motor constant parameter mH, %, and A unit setting	Motor constant parameter internal data setting	Motor constant parameter Ω, mΩ, and A unit setting
Vector control dedicated motor	30	33	—
Standard motor	0 (initial value)	3	—
Constant-torque motor	10	13	—
Other manufacturer's standard motor	0 (initial value)	3	5 (wye connection motor) 6 (delta connection motor)
Other manufacturer's constant-torque motor	10	13	15 (wye connection motor) 16 (delta connection motor)

NOTE

- When **Pr.11 DC injection brake operation time** = "0" or **Pr.12 DC injection brake operation voltage** = "0", offline auto tuning is performed at the initial setting of **Pr.11** or **Pr.12**.
- Offline auto tuning is not performed when position control is selected (**Pr.800** = "3 or 4" (when the MC signal is ON) or "5" (when the MC signal is OFF)).
- If "wye connection" or "delta connection" is incorrectly selected in **Pr.71**, Advanced magnetic flux vector control, Real sensorless vector control, and Vector control are not performed properly.
- To perform offline auto tuning for the 400 V class 0.1 kW Mitsubishi Electric geared motor (GM-[]), set "1803" in **Pr.71 (Pr.450)**.

- For tuning accuracy improvement, set the following parameters when the motor constants are known in advance.

First motor Pr.	Second motor Pr.	Name	Mitsubishi Electric motor (SF-PR, SF-PR-SC, SF-JR, SF-HR, SF-JRCA, SF-HRCA, SF-V5RU, GM-[], GM-DZ, or GM-DP)	Other motors
707	744	Motor inertia (integer)	9999 (initial value)	Motor inertia ^{*1}
724	745	Motor inertia (exponent)		$J_m = \text{Pr.707} \times 10^{(-\text{Pr.724})} \text{ (kg}\cdot\text{m}^2\text{)}$

*1 The setting is valid only when a value other than "9999" is set in both **Pr.707 (Pr.744)** and **Pr.724 (Pr.745)**.

◆ Performing tuning

Point

- Before performing tuning, check the monitor display of the operation panel or parameter unit if the inverter is in the state ready for tuning. The motor starts by turning ON the start command while tuning is unavailable.

- In the PU operation mode, press the RUN key on the operation panel or the FWD/REV key on the parameter unit. In the External operation, turn ON the start command (STF signal or STR signal). Tuning starts.

NOTE

- Satisfy the required inverter start conditions to start offline auto tuning. For example, stop the input of the MRS signal.
- To force tuning to end, use the MRS or RES signal or the STOP/RESET key on the PU.
(Turning OFF the start signal (STF signal or STR signal) also ends tuning.)
- During offline auto tuning, only the following I/O signals are valid (initial value).
Input terminals <effective signals>: MRS, RES, STF, STR, S1, and S2
Output terminals: RUN, FU, FM, AM, ABC, and SO
- When the rotation speed and the output frequency are selected for terminals FM and AM, the progress status of offline auto tuning is output in 15 steps from FM and AM (in the standard model).
- Do not perform ON/OFF switching of the Second function selection (RT) signal during offline auto tuning. Auto tuning will not be performed properly.
- Since the Inverter running (RUN) signal turns ON when tuning is started, pay close attention especially when a sequence which releases a mechanical brake by the RUN signal has been designed.
- When executing offline auto tuning, input the operation command after switching ON the main circuit power (R/L1, S/L2, T/L3) of the inverter.
- While **Pr.79 Operation mode selection** = "7", turn ON the PU operation external interlock (X12) signal for tuning in the PU operation mode.
- Setting offline auto tuning (**Pr.96** = "1") will make pre-excitation invalid.

- During tuning, the monitor is displayed on the PU as follows.

Tuning status	Operation panel indication	LCD operation panel (FR-LU08) display
(1) Setting		
(2) During tuning		
(3) Normal completion		

- Note: Offline auto tuning time (with the initial setting)

Offline auto tuning setting	Time
Pr.96 (Pr.463) = "1"	About 25 to 100 s. (The time depends on the inverter capacity and motor type.)

- When offline auto tuning ends, press the STOP/RESET key on the PU during PU operation. In the External operation mode, turn OFF the start signal (STF signal or STR signal).
This operation resets the offline auto tuning, and the monitor display of the operation panel returns to normal.
(Without this operation, next operation cannot be started.)

NOTE

- The motor constants measured once during offline auto tuning are stored as parameters and their data are held until offline auto tuning is performed again. However, the tuning data is cleared when performing All parameter clear.
- Changing **Pr.71 (Pr.450)** after tuning completion will change the motor constant. For example, if "3" is set in **Pr.71** after tuning is performed with **Pr.71** = "0", the tuning data becomes invalid. To use the tuned data, set "0" again in **Pr.71**.

- If offline auto tuning has ended in error (see the following table), motor constants are not set. Perform an inverter reset and restart tuning.

Error display	Error cause	Countermeasures
8	Forced end	Set "1" in Pr.96 (Pr.463) and retry.
9	Inverter protective function operation	Make the setting again.
91	The current limit (stall prevention) function is activated.	Set the acceleration/deceleration time longer. Set Pr.156 Stall prevention operation selection = "1" .
92	The converter output voltage fell to 75% of the rated voltage.	Check for the power supply voltage fluctuation. Check the Pr.83 Rated motor voltage (Pr.456 Rated second motor voltage) setting.
93	Calculation error. The motor is not connected.	Check the Pr.83 and Pr.84 settings. Check the motor wiring and make the setting again.

- When tuning is ended forcibly by pressing the STOP/RESET key or turning OFF the start signal (STF or STR) during tuning, offline tuning does not end properly. (The motor constants have not been set.)
Perform an inverter reset and perform tuning again.
- When the rated power supply of the motor is 200/220 V (400/440 V) 60 Hz, set the rated motor current multiplied by 1.1 in **Pr.9 Electronic thermal O/L relay** after tuning is complete.
- For a motor with a PTC thermistor, thermal protector, or other thermal detection, set "0" (motor overheat protection by inverter invalid) in **Pr.9** to protect the motor from overheating.

NOTE

- An instantaneous power failure occurring during tuning will result in a tuning error. After power is restored, the inverter starts normal operation. Therefore, when the STF (STR) signal is ON, the motor starts forward (reverse) rotation.
- Any fault occurring during tuning is handled as in the normal operation. However, if the retry function is set, no retry is performed.
- The set frequency monitor displayed during the offline auto tuning is 0 Hz.

CAUTION

- Note that the motor may start running suddenly.
- For performing offline auto tuning with the motor rotating in vertical lift applications, etc., caution is required to avoid falling due to insufficient torque.

◆ Changing the motor constants

- The motor constants can be set directly when the motor constants are known in advance, or by using the data measured during offline auto tuning.
- According to the **Pr.71 (Pr.450)** setting, the range of the motor constant parameter setting values and units can be changed. The changed settings are stored in the EEPROM as the motor constant parameters.

◆ Changing the motor constants (when setting the Pr.92 and Pr.93 motor constants in units of mH)

- Set **Pr.71** as follows.
- 100/200/400 V class

Motor	Pr.71 setting
Mitsubishi Electric high-performance energy-saving motor	70
Mitsubishi Electric high-performance energy-saving motor with encoder	
Mitsubishi Electric Vector control dedicated motor	30
Mitsubishi Electric geared motor	1800
Mitsubishi Electric inverter-driven geared motor for encoder feedback control	
Mitsubishi Electric standard efficiency motor	0 (initial value)
Mitsubishi Electric high-efficiency motor	20
	40
	10
Mitsubishi Electric constant-torque motor	50

- 575 V class

Motor	Pr.71 setting
Vector control dedicated motor	30
Standard motor	0 (initial value)
Constant-torque motor	10

- Use the following formula to find the **Pr.94** setting value and set a desired value as the motor constant parameter.

$$\text{The setting value of Pr.94} = \left(1 - \frac{M^2}{L1 \times L2} \right) \times 100(\%)$$

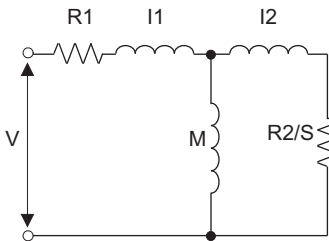

R1: Primary resistance
 R2: Secondary resistance
 I1: Primary leakage inductance
 I2: Secondary leakage inductance
 M: Excitation inductance
 S: Slip

 L1= I1+ M: Primary inductance
 L2= I2+ M: Secondary inductance

Equivalent circuit diagram of the motor

First motor Pr.	Second motor Pr.	Name	Setting range	Setting increments	Initial value
82	455	Motor excitation current (no load current)	0 to 500 A, 9999	0.01 A	9999
90	458	Motor constant (R1)	0 to 50 Ω, 9999	0.001 Ω	
91	459	Motor constant (R2)	0 to 50 Ω, 9999	0.001 Ω	
92	460	Motor constant (L1)/d-axis inductance (Ld)	0 to 6000 mH, 9999	0.1 mH	
93	461	Motor constant (L2)/q-axis inductance (Lq)	0 to 6000 mH, 9999	0.1 mH	
94	462	Motor constant (X)	0% to 100%, 9999	0.1%	
859	860	Torque current/Rated PM motor current	0 to 500 A, 9999	0.01 A	
298	560	Frequency search gain	0 to 32767, 9999	1	
717	741	Starting resistance tuning compensation coefficient 1	0% to 200%	0.1%	
720	737	Starting resistance tuning compensation coefficient 2	0% to 200%	0.1%	

NOTE

- If "9999" is set in the motor constant parameters, tuning data will be invalid and the constant values for Mitsubishi Electric motors (SF-PR, SF-PR-SC, SF-JR, SF-HR, SF-JRCA, SF-HRCA, SF-V5RU (1500 r/min series), GM-[], GM-DZ, GM-DP, and so on) are used.

◆ Changing the motor constants (when setting motor constants in the internal data of the inverter)

- Set **Pr.71** as follows.
- 100/200/400 V class

Motor		Pr.71 setting
Mitsubishi Electric high-performance energy-saving motor	SF-PR	73
Mitsubishi Electric high-performance energy-saving motor with encoder	SF-PR-SC	
Mitsubishi Electric Vector control dedicated motor	SF-V5RU (1500 r/min series)	33
Mitsubishi Electric geared motor	GM-[]	1803
Mitsubishi Electric inverter-driven geared motor for encoder feedback control	GM-DZ, GM-DP	
Mitsubishi Electric standard efficiency motor Mitsubishi Electric high-efficiency motor	SF-JR	3
	SF-JR 4P 1.5 kW or lower	23
	SF-HR	43
	Others	3
Mitsubishi Electric constant-torque motor	SF-JRCA 4P	13
	SF-HRCA	53
	Others (SF-JRC, etc.)	13
Other manufacturer's standard motor	—	3
Other manufacturer's constant-torque motor	—	13

- 575 V class

Motor	Pr.71 setting
Vector control dedicated motor	33
Standard motor	3
Constant-torque motor	13
Other manufacturer's standard motor	3
Other manufacturer's constant-torque motor	13

- Set desired values as the motor constant parameters.

First motor Pr.	Second motor Pr.	Name	Setting range	Setting increments	Initial value
82	455	Motor excitation current	0 to ***, 9999	1	9999
90	458	Motor constant (R1)			
91	459	Motor constant (R2)			
92	460	Motor constant (L1)/d-axis inductance (Ld)			
93	461	Motor constant (L2)/q-axis inductance (Lq)			
94	462	Motor constant (X)			
859	860	Torque current/Rated PM motor current	0 to 32767, 9999	1	
298	560	Frequency search gain	0% to 200%	0.1%	
717	741	Starting resistance tuning compensation coefficient 1	0% to 200%	0.1%	
720	737	Starting resistance tuning compensation coefficient 2	0% to 200%	0.1%	

NOTE

- As the motor constants measured in the offline auto tuning have been converted into internal data (****), refer to the following setting example when making setting. (The value displayed has been converted into a value for internal use. Therefore, simple addition of a value to the displayed value does not bring the desired effect.)

Setting example: To slightly increase the **Pr.90** value (5%)

When "2516" is displayed for **Pr.90**, set 2642 ($2516 \times 1.05 = 2641.8$) in **Pr.90**.

- If "9999" is set in the motor constant parameters, tuning data will be invalid and the constant values for Mitsubishi Electric motors (SF-PR, SF-PR-SC, SF-JR, SF-HR, SF-JRCA, SF-HRCA, SF-V5RU (1500 r/min series), GM-[], GM-DZ, GM-DP, and so on) are used.

◆ Changing the motor constants (when setting the Pr.92, Pr.93, and Pr.94 motor constants in units of Ω)

- Set Pr.71 as follows.

Applied motor	Pr.71 setting	
	Wye connection motor	Delta connection motor
Standard motor	5	6
Constant-torque motor	15	16

- Set desired values as the motor constant parameters.

I_q = torque current, I_{100} = rated current, I_0 = no load current

$$I_q = \sqrt{I_{100}^2 - I_0^2}$$

First motor Pr.	Second motor Pr.	Name	Setting range	Setting increments	Initial value
82	455	Motor excitation current (no load current)	0 to 500 A, 9999	0.01 A	9999
90	458	Motor constant (r1)	0 to 50 Ω, 9999	0.001 Ω	
91	459	Motor constant (r2)	0 to 50 Ω, 9999	0.001 Ω	
92	460	Motor constant (x1)	0 to 50 Ω, 9999	0.001 Ω	
93	461	Motor constant (x2)	0 to 50 Ω, 9999	0.001 Ω	
94	462	Motor constant (xm)	0 to 500 Ω, 9999	0.01 Ω	
859	860	Torque current/Rated PM motor current	0 to 500 A, 9999	0.01 A	
298	560	Frequency search gain	0 to 32767, 9999	1	
717	741	Starting resistance tuning compensation coefficient 1	0% to 200%	0.1%	
720	737	Starting resistance tuning compensation coefficient 2	0% to 200%	0.1%	

NOTE

- If "wye connection" or "delta connection" is incorrectly selected in Pr.71, Advanced magnetic flux vector control, Real sensorless vector control, and Vector control are not performed properly.
- If "9999" is set in the motor constant parameters, tuning data will be invalid and the constant values for Mitsubishi Electric motors (SF-PR, SF-PR-SC, SF-JR, SF-HR, SF-JRCA, SF-HRCA, SF-V5RU (1500 r/min series), GM-[], GM-DZ, GM-DP, and so on) are used.

◆ Tuning the second motor

- When one inverter switches the operation between two different motors, set the second motor in **Pr.450 Second applied motor**. (Refer to [page 424](#).) In the initial setting, no second motor is applied.
- Turning ON the RT signal enables the parameter settings for the second motor as follows. For the RT signal, set "3" in any parameter from **Pr.178 to Pr.189 (Input terminal function selection)** to assign the function.

Function	RT signal ON (second motor)	RT signal OFF (first motor)
Motor capacity	Pr.453	Pr.80
Number of motor poles	Pr.454	Pr.81
Motor excitation current	Pr.455	Pr.82
Rated motor voltage	Pr.456	Pr.83
Rated motor frequency	Pr.457	Pr.84
Motor constant (R1)	Pr.458	Pr.90
Motor constant (R2)	Pr.459	Pr.91
Motor constant (L1)/d-axis inductance (Ld)	Pr.460	Pr.92
Motor constant (L2)/q-axis inductance (Lq)	Pr.461	Pr.93
Motor constant (X)	Pr.462	Pr.94
Auto tuning setting/status	Pr.463	Pr.96
Frequency search gain	Pr.560	Pr.298
Starting resistance tuning compensation coefficient 1	Pr.741	Pr.717
Starting resistance tuning compensation coefficient 2	Pr.737	Pr.720

NOTE

- Changing the terminal assignment using **Pr.178 to Pr.189 (Input terminal function selection)** may affect the other functions. Set parameters after confirming the function of each terminal.

Parameters referred to

- Pr.1 Maximum frequency [page 331](#)
- Pr.9 Electronic thermal O/L relay [page 306](#)
- Pr.71 Applied motor [page 424](#)
- Pr.156 Stall prevention operation selection [page 334](#)
- Pr.178 to Pr.189 (Input terminal function selection) [page 410](#)
- Pr.190 to Pr.197 (Output terminal function selection) [page 371](#)
- Pr.800 Control method selection [page 115](#)

14.3 Offline auto tuning for a PM motor

PM

The offline auto tuning enables the optimal operation of a PM motor. Two types of the offline auto tuning, motor constant tuning and position accuracy compensation gain tuning, are available.

- Motor constant tuning: Automatic measurement of motor constants enables optimal operation of motors for PM sensorless vector control even when motor constants vary or when the wiring distance is long.
- Position accuracy compensation gain tuning: When an EM-A motor is used, automatic measurement of the position compensation amount improves the positioning accuracy.
- Tuning may be disabled depending on the motor characteristics.

For the offline auto tuning under Advanced magnetic flux vector control, Real sensorless vector control, and Vector control, refer to [page 430](#).

Pr.	Name	Initial value	Setting range	Description
71 C100	Applied motor	0	0, 3, 5, 6, 10, 13, 15, 16, 20, 23, 30, 33, 40, 43, 50, 53, 70, 73, 540 ^{*6} , 1140 ^{*7} , 1800, 1803, 8090, 8093, 9090, 9093 ^{*1}	By selecting a motor, the thermal characteristic and motor constant of each motor are set.
80 C101	Motor capacity	9999	0.1 to 30 kW 9999	Set the applied motor capacity. No motor capacity setting
81 C102	Number of motor poles	9999	2, 4, 6, 8, 10, 12 9999	Set the number of motor poles. No number of motor poles setting
9 C103	Electronic thermal O/L relay	Inverter rated current ^{*2}	0 to 500 A	Set the rated motor current.
83 C104	Rated motor voltage	200/400/575 V ^{*3}	0 to 1000 V	Set the rated motor voltage (V).
84 C105	Rated motor frequency	9999	10 to 400 Hz 9999	Set the rated motor frequency (Hz). Inverter internal data is used.
702 C106	Maximum motor frequency	9999	0 to 400 Hz 9999	Set the permissible speed (frequency) of the motor. The Pr.84 setting is used.
707 C107	Motor inertia (integer)	9999	10 to 999, 9999	Set the motor inertia.
724 C108	Motor inertia (exponent)	9999	0 to 7, 9999	9999: Inverter internal data is used.
96 C110	Auto tuning setting/status	0	0	No offline auto tuning
			1 ^{*5}	Offline auto tuning is performed without the motor rotating (when driving a motor other than the MM-GKR or EM-A).
			11	Offline auto tuning is performed without the motor rotating.
			301	Position accuracy compensation gain tuning is performed. (Note: The motor rotates within one mechanical revolution.) (EM-A motor only)
90 C120	Motor constant (R1)	9999	0 to 50 Ω, 9999 ^{*4}	Tuning data (The value measured by offline auto tuning is automatically set.) 9999: Inverter internal data is used.
92 C122	Motor constant (L1)/d-axis inductance (Ld)	9999	0 to 500 mH, 9999 ^{*4}	
93 C123	Motor constant (L2)/q-axis inductance (Lq)	9999	0 to 500 mH, 9999 ^{*4}	
859 C126	Torque current/Rated PM motor current	9999	0 to 500 A, 9999 ^{*4}	
706 C130	Induced voltage constant (phi f)	9999	0 to 5000 mV (rad/s) ^{*4}	Set this parameter according to the PM motor specifications.
			9999	The value calculated from the parameter setting for motor constant is used.
1412 C135	Motor induced voltage constant (phi f) exponent	9999	0 to 2	Set the exponent n when the induced voltage constant phi f (Pr.706) is multiplied by 10 ⁿ .
			9999	No exponent setting

Pr.	Name	Initial value	Setting range	Description
711 C131	Motor Ld decay ratio	9999	0% to 100%, 9999	Tuning data (The value measured by offline auto tuning is automatically set.) 9999: Inverter internal data is used.
712 C132	Motor Lq decay ratio	9999	0% to 100%, 9999	
717 C182	Starting resistance tuning compensation coefficient 1	9999	0% to 200%, 9999	
721 C185	Starting magnetic pole position detection pulse width	9999	0 to 6000 μ s, 9999	
725 C133	Motor protection current level	9999	100% to 500% 9999	Set the maximum current (OCT) level of the motor. 230% ^{*8}
1002 C150	Lq tuning target current adjustment coefficient	9999	50% to 150% 9999	Adjust the target current during tuning. 100%
979 C194	Position accuracy compensation gain 1	9999	90% to 110%, 9999	Tuning data (The value measured by position accuracy compensation gain tuning is automatically set.) 9999: No function ^{*9}
980 C195	Position accuracy compensation gain 2	9999	90% to 110%, 9999	
981 C196	Position accuracy compensation gain 3	9999	90% to 110%, 9999	
450 C200	Second applied motor	9999	0, 3, 5, 6, 10, 13, 15, 16, 20, 23, 30, 33, 40, 43, 50, 53, 70, 73, 540 ^{*6} , 1140 ^{*7} , 1800, 1803, 8090, 8093, 9090, 9093 ^{*1}	Set this parameter when using the second motor (the same specifications as Pr.71).
			9999	The function is disabled.
453 C201	Second motor capacity	9999	0.1 to 30 kW	Set the capacity of the second motor.
			9999	No second motor capacity setting
454 C202	Number of second motor poles	9999	2, 4, 6, 8, 10, 12	Set the number of poles of the second motor.
			9999	No number of second motor poles setting
51 C203	Second electronic thermal O/L relay	9999	0 to 500 A	Set the rated current of the second motor.
			9999	Second electronic thermal O/L relay disabled.
456 C204	Rated second motor voltage	200/400/ 575 V ^{*3}	0 to 1000 V	Set the rated voltage (V) of the second motor.
457 C205	Rated second motor frequency	9999	10 to 400 Hz	Set the rated frequency (Hz) of the second motor.
			9999	Inverter internal data is used.
743 C206	Second motor maximum frequency	9999	0 to 400 Hz	Set the permissible speed (frequency) of the second motor.
			9999	The Pr.457 setting is used.
744 C207	Second motor inertia (integer)	9999	10 to 999, 9999	Set the motor inertia of the second motor.
745 C208	Second motor inertia (exponent)	9999	0 to 7, 9999	9999: Inverter internal data is used.
463 C210	Second motor auto tuning setting/status	0	0	No auto tuning for the second motor.
			1 ^{*5}	Offline auto tuning is performed without the second motor rotating (when driving a motor other than the MM-GKR or EM-A).
			11	Offline auto tuning is performed without the second motor rotating.
458 C220	Second motor constant (R1)	9999	0 to 50 Ω , 9999 ^{*4}	Tuning data of the second motor. (The value measured by offline auto tuning is automatically set.) 9999: Inverter internal data is used.
460 C222	Second motor constant (L1) / d-axis inductance (Ld)	9999	0 to 500 mH, 9999 ^{*4}	
461 C223	Second motor constant (L2) / q-axis inductance (Lq)	9999	0 to 500 mH, 9999 ^{*4}	
860 C226	Second motor torque current/Rated PM motor current	9999	0 to 500 A, 9999 ^{*4}	
738 C230	Second motor induced voltage constant (phi f)	9999	0 to 5000 mV (rad/s) ^{*4}	Set this parameter according to the PM motor specifications.
			9999	The value calculated from the parameter setting for motor constant is used.

Pr.	Name	Initial value	Setting range	Description
1413 C235	Second motor induced voltage constant (ϕ f) exponent	9999	0 to 2	Set the exponent n when the induced voltage constant ϕ f (Pr.738) is multiplied by 10^n .
			9999	No exponent setting
739 C231	Second motor Ld decay ratio	9999	0% to 100%, 9999	Tuning data of the second motor. (The value measured by offline auto tuning is automatically set.) 9999: Inverter internal data is used.
740 C232	Second motor Lq decay ratio	9999	0% to 100%, 9999	
741 C282	Second motor starting resistance tuning compensation coefficient 1	9999	0% to 200%, 9999	
742 C285	Second motor magnetic pole detection pulse width	9999	0 to 6000 μ s, 9999	
746 C233	Second motor protection current level	9999	100% to 500%	Set the maximum current (OCT) level of the second motor.
			9999	230% ^{*8}

*1 The setting range for the 575 V class is "0, 3, 5, 6, 10, 13, 15, 16, 30, 33, 8090, 8093, 9090, and 9093".

*2 The initial value for the FR-E820-0050(0.75K) or lower, FR-E840-0026(0.75K) or lower, FR-E860-0017(0.75K), FR-E820S-0050(0.75K) or lower, FR-E810W-0050(0.75K) or lower, and FR-E846-0026(0.75K) is set to the 85% of the inverter rated current.

*3 The initial value differs according to the voltage class (100/200 V, 400 V, or 575 V).

*4 The setting range and unit change according to the **Pr.71 (Pr.450)** setting.

*5 When the MM-GKR or EM-A motor is used, the offline auto tuning cannot be performed.

*6 The value is valid only when the FR-E820-0080(1.5K) or lower, the FR-E820S-0080(1.5K) or lower, or FR-E810W-0050(0.75K) or lower is used and **Pr.80 (Pr.453)** \leq 0.75 kW. Under other conditions, "SE" (Incorrect parameter setting) is displayed when the start command is turned ON.

*7 The value is valid in any of the following conditions. Under other conditions, "SE" (Incorrect parameter setting) is displayed when the start command is turned ON.

The FR-E820-0470(11K) or lower is used and **Pr.80 (Pr.453)** \leq 7.5 kW.

The FR-E840-0230(11K) or lower is used and **Pr.80 (Pr.453)** = 0.4 to 7.5 kW.

The FR-E820S-0110(2.2K) or lower is used and **Pr.80 (Pr.453)** \leq 2.2 kW.

The FR-E810W-0050(0.75K) or lower is used and **Pr.80 (Pr.453)** \leq 0.75 kW.

The FR-E846-0095(3.7K) or lower is used and **Pr.80 (Pr.453)** = 2.2 or 3.7 kW.

*8 200% when a motor other than the MM-GKR or EM-A is used.

*9 When "9999" is set in any parameter from **Pr.979 to Pr.981**, the position accuracy compensation function is disabled.

Point

- The settings are valid under PM sensorless vector control.
- The offline auto tuning enables the operation with IPM motors and SPM motors. (When a PM motor other than the MM-GKR or EM-A is used, always perform offline auto tuning.)
- Tuning is not available for S-PM geared motors (GV-S series).
- Even when the MM-GKR or EM-A motor is used, offline auto tuning is required when the wiring length is long (exceeding 30 m as a reference), when the wiring length is changed, or when positioning accuracy for the EM-A motor need to be improved.
- Tuning is enabled even when a load is connected to the motor.
- Reading/writing of the motor constants tuned by offline auto tuning are enabled.
- The offline auto tuning status can be monitored on the operation panel or the parameter unit.

◆ Before performing offline auto tuning

Check the following points before performing offline auto tuning:

- Check that PM sensorless vector control is selected. Note that the motor constant tuning is invalid during position control. (Refer to [page 115](#).)
- Check that a motor is connected. (Check that the motor is not rotated by an external force during tuning.)
- Select a motor with the rated current equal to or less than the inverter rated current.

If a motor with substantially low rated current compared with the inverter rated current is used, speed and torque accuracies may deteriorate due to torque ripples, etc. Set the rated motor current to about 40% or higher of the inverter rated current. (For details on the inverter rated current, refer to the inverter rated specifications in the Instruction Manual (Connection).)

- The maximum frequency under PM sensorless vector control is 400 Hz.
- Tuning is enabled even when a load is connected to the motor. The motor may run slightly. Fix the motor securely with a mechanical brake, or before tuning, make sure that it is safe even if the motor rotates. (Caution is required especially in vertical lift applications.) Note that even if the motor runs slightly, tuning performance is unaffected.
- It is recommended that the position accuracy compensation gain tuning is performed for the motor alone. Tuning is not available under certain load conditions, such as when the motor shaft is locked or when the inertia is too large.

◆ Settings

■ Motor constant tuning

- To perform tuning, set the following parameters about the motor.

First motor Pr.	Second motor Pr.	Name	Setting
80	453	Motor capacity	Motor capacity (kW)
81	454	Number of motor poles	Number of motor poles (2 to 12)
9	51	Electronic thermal O/L relay	Rated motor current (A)
84	457	Rated motor frequency	Rated motor frequency (Hz)
83	456	Rated motor voltage	Rated motor voltage (V)
71	450	Applied motor	540 (MM-GKR) 1140 (EM-A) 8090, 8093 (IPM motor), 9090, 9093 (SPM motor) ^{*1}
800	451	Control method selection	10
96	463	Auto tuning setting/status	1 ^{*2} (motor other than MM-GKR or EM-A) 11

*1 Set **Pr.71 Applied motor** according to the motor to be used. According to the **Pr.71** setting, the range of the motor constant parameter setting values and units can be changed. (For other setting values of **Pr.71**, refer to [page 424](#).)

Motor	Pr.71 setting	
	Motor constant parameter Ω, mH, and A unit setting	Motor constant parameter internal data setting
MM-GKR	540	—
EM-A	1140	—
IPM motor	8090	8093
SPM motor	9090	9093

*2 When the MM-GKR or EM-A motor is used, the offline auto tuning cannot be performed.

- For tuning accuracy improvement, set the following parameters when the motor constants are known in advance.

First motor Pr.	Second motor Pr.	Name	Setting for a PM motor other than MM-GKR or EM-A	Setting for MM-GKR or EM-A
702	743	Maximum motor frequency	The maximum motor frequency (Hz)	9999 (initial value)
707	744	Motor inertia (integer)	Motor inertia ^{*1}	9999 (initial value)
724	745	Motor inertia (exponent)	$J_m = \text{Pr.707} \times 10^{(-\text{Pr.724})}$ (kg·m ²)	
725	746	Motor protection current level	Maximum current level of the motor (%)	9999 (initial value)

*1 The setting is valid only when a value other than "9999" is set in both **Pr.707 (Pr.744)** and **Pr.724 (Pr.745)**.

■ Position accuracy compensation gain tuning

- To perform tuning, set the following parameters about the motor.

First motor Pr.	Name	Setting
80	Motor capacity	Motor capacity (kW)
81	Number of motor poles	Number of motor poles (2 to 12)
71	Applied motor	1140 (EM-A)
800	Control method selection	10, 13, 14
96	Auto tuning setting/status	301 (EM-A)

NOTE

- The position accuracy compensation gain tuning is available only for the first motor.

◆ Performing tuning

Point

- Before performing tuning, check the monitor display of the operation panel or parameter unit if the inverter is in the state ready for tuning. The motor starts by turning ON the start command while tuning is unavailable.
- In the PU operation mode, press the RUN key on the operation panel or the FWD/REV key on the parameter unit. In the External operation, turn ON the start command (STF signal or STR signal). Tuning starts.

NOTE

- Satisfy the required inverter start conditions to start offline auto tuning. For example, stop the input of the MRS signal.
- To force tuning to end, use the MRS or RES signal or the STOP/RESET key on the PU. (Turning OFF the start signal (STF signal or STR signal) also ends tuning.)
- During offline auto tuning, only the following I/O signals are valid (initial value).
Input terminals <effective signals>: MRS, RES, STF, STR, S1, and S2
Output terminals: RUN, FM, AM, ABC, and SO
- When the rotation speed and the output frequency are selected for terminals FM and AM, the progress status of offline auto tuning is output in 15 steps from FM and AM (in the standard model).
- Do not perform ON/OFF switching of the Second function selection (RT) signal during offline auto tuning. Auto tuning will not be performed properly.
- A motor with 14 or more poles cannot be tuned.
- Since the Inverter running (RUN) signal turns ON when tuning is started, pay close attention especially when a sequence which releases a mechanical brake by the RUN signal has been designed.
- When executing offline auto tuning, input the operation command after switching ON the main circuit power (R/L1, S/L2, T/L3) of the inverter.
- While **Pr.79 Operation mode selection** = "7", turn ON the PU operation external interlock (X12) signal for tuning in the PU operation mode.
- Setting offline auto tuning (**Pr.96** = "1, 11, or 301") will make pre-excitation invalid.

- During tuning, the monitor is displayed on the PU as follows.

Tuning status	Operation panel indication		
	Pr.96 (Pr.463) = "1"	Pr.96 (Pr.463) = "11"	Pr.96 = "301"
(1) Setting			
(2) During tuning			
(3) Normal completion			

Tuning status	LCD operation panel (FR-LU08) display		
	Pr.96 (Pr.463) = "1"	Pr.96 (Pr.463) = "11"	Pr.96 = "301"
(1) Setting			
(2) During tuning			
(3) Normal completion			

- Note: Offline auto tuning time (with the initial setting)

Offline auto tuning setting	Time
Pr.96 (Pr.463) = "1"	Approx. 20 s
Pr.96 (Pr.463) = "11"	Approx. 10 s
Pr.96 = "301"	Approx. 40 to 280 s

- When offline auto tuning ends, press the STOP/RESET key on the PU during PU operation. In the External operation mode, turn OFF the start signal (STF signal or STR signal). This operation resets the offline auto tuning, and the monitor display of the operation panel returns to normal. (Without this operation, next operation cannot be started.)

NOTE

- The motor constants measured once during offline auto tuning are stored as parameters and their data are held until offline auto tuning is performed again. However, the tuning data is cleared when performing All parameter clear.
- Changing **Pr.71** after tuning completion will change the motor constant. For example, if the **Pr.71** setting is changed to "8093" after tuned with **Pr.71** = "8090", the tuning data become invalid. To use the tuned data, set "8090" again in **Pr.71**.

- If offline auto tuning has ended in error (refer to the following table), motor constants or position accuracy compensation gain values are not set. Perform an inverter reset and perform tuning again.

Error display	Error cause	Countermeasures
8	Forced end	Set "1, 11, or 301" in Pr.96 or "1 or 11" in Pr.463 and retry.
9	Inverter protective function operation	Make the setting again.
92	The converter output voltage fell to 75% of the rated voltage.	Check for the power supply voltage fluctuation. Check the Pr.83 Rated motor voltage (Pr.456 Rated second motor voltage) setting.
93	Motor constant tuning <ul style="list-style-type: none"> Calculation error. The motor is not connected. 	Check the motor wiring and parameter settings, and make the setting again.
	Position accuracy compensation gain tuning <ul style="list-style-type: none"> Calculation error. Motor shaft is locked (due to high inertia or other reason). 	<ul style="list-style-type: none"> Check the motor wiring and parameter settings, and make the setting again. Reduce the inertia.

- When tuning is ended forcibly by pressing the STOP/RESET key or turning OFF the start signal (STF or STR) during tuning, offline tuning does not end properly. (The motor constants or position accuracy compensation gain values have not been set.)

Perform an inverter reset and perform tuning again.

NOTE

- An instantaneous power failure occurring during tuning will result in a tuning error. After power is restored, the inverter starts normal operation. Therefore, when the STF (STR) signal is ON, the motor starts forward (reverse) rotation.
- Any fault occurring during tuning is handled as in the normal operation. However, if the retry function is set, no retry is performed even when a protective function that performs a retry is activated.
- The set frequency monitor displayed during the offline auto tuning is 0 Hz.

CAUTION

- Note that the motor may start running suddenly.

◆ Parameters updated by tuning results after tuning

First motor Pr.	Second motor Pr.	Name	Pr.96 (Pr.463) setting			Description
			1	11	301 ^{*1}	
90	458	Motor constant (R1)	○	○	—	Resistance per phase
92	460	Motor constant (L1)/d-axis inductance (Ld)	○	—	—	d-axis inductance
93	461	Motor constant (L2)/q-axis inductance (Lq)	○	—	—	q-axis inductance
711	739	Motor Ld decay ratio	○	—	—	d-axis inductance decay ratio
712	740	Motor Lq decay ratio	○	—	—	q-axis inductance decay ratio
717	741	Starting resistance tuning compensation coefficient 1	○	○	—	
721	742	Starting magnetic pole position detection pulse width	○	—	—	
859	860	Torque current/Rated PM motor current	○	—	—	
96	463	Auto tuning setting/status	○	○	○ ^{*1}	
979	—	Position accuracy compensation gain 1	—	—	○	
980	—	Position accuracy compensation gain 2	—	—	○	
981	—	Position accuracy compensation gain 3	—	—	○	

*1 This setting value cannot be set in Pr.463.

◆ Tuning adjustment (Pr.1002)

- The overcurrent protective function may be activated during Lq tuning for an easily magnetically saturated motor (motor with a large Lq decay ratio). In such case, adjust the target flowing current used for tuning with **Pr.1002 Lq tuning target current adjustment coefficient**.

◆ Changing the motor constants

- The motor constants can be set directly when the motor constants are known in advance, or by using the data measured during offline auto tuning.
- According to the **Pr.71 (Pr.450)** setting, the range of the motor constant parameter setting values and units can be changed. The changed settings are stored in the EEPROM as the motor constant parameters.

◆ Changing the motor constants (when setting motor constants in units of Ω, mH, or A)

- Set **Pr.71** as follows.

Motor	Pr.71 setting
MM-GKR	540
EM-A	1140
IPM motor	8090
SPM motor	9090

- Set desired values as the motor constant parameters.

First motor Pr.	Second motor Pr.	Name	Setting range	Setting increments	Initial value
90	458	Motor constant (R1)	0 to 50 Ω, 9999	0.001 Ω	9999
92	460	Motor constant (L1)/d-axis inductance (Ld)	0 to 500 mH, 9999	0.01 mH	
93	461	Motor constant (L2)/q-axis inductance (Lq)	0 to 500 mH, 9999	0.01 mH	
706	738	Induced voltage constant (phi f)	0 to 5000 mV (rad/s), 9999	0.1 mV (rad/s)	
859	860	Torque current/Rated PM motor current	0 to 500 A, 9999	0.01 A	
1412	1413	Motor induced voltage constant (phi f) exponent	0 to 2, 9999	1	

NOTE

- If "9999" is set in the motor constant parameters, tuning data will be invalid and the inverter internal constant is used.
- To change a motor induced voltage constant of PM motors, the setting in **Pr.706 Induced voltage constant (phi f)** or **Pr.738 Second motor induced voltage constant (phi f)** must be changed. If the constant after the change exceeds the setting range of **Pr.706** or **Pr.738** (0 to 5000 mV (rad/s)), set **Pr.1412 Motor induced voltage constant (phi f) exponent** or **Pr.1413 Second motor induced voltage constant (phi f) exponent**. Set a value in the exponent n in the formula, **Pr.706 (Pr.738) × 10ⁿ** [mV (rad/s)], to set the induced voltage constant (phi f).
- When **Pr.71 (Pr.450)** = "8093 or 9093", or **Pr.1412 (Pr.1413)** = "9999", the motor induced voltage constant is as set in **Pr.706 (Pr.738)**. (No exponent setting)

◆ Changing the motor constants (when setting a motor constants in the internal data of the inverter)

- Set **Pr.71** as follows.

Motor	Pr.71 setting
IPM motor	8093
SPM motor	9093

- Set desired values as the motor constant parameters.

First motor Pr.	Second motor Pr.	Name	Setting range	Setting increments	Initial value
90	458	Motor constant (R1)	0 to ***, 9999	1	9999
92	460	Motor constant (L1)/d-axis inductance (Ld)			
93	461	Motor constant (L2)/q-axis inductance (Lq)			
706	738	Induced voltage constant (phi f)			
859	860	Torque current/Rated PM motor current			
1412	1413	Motor induced voltage constant (phi f) exponent			

NOTE

- As the motor constants measured in the offline auto tuning have been converted into internal data (***) refer to the following setting example when making setting. (The value displayed has been converted into a value for internal use. Therefore, simple addition of a value to the displayed value does not bring the desired effect.)
Setting example: to slightly increase the **Pr.90** value (5%)
When "2516" is displayed for **Pr.90**, set 2642 (2516 × 1.05 = 2641.8) in **Pr.90**.
- If "9999" is set in the motor constant parameters, tuning data will be invalid and the inverter internal constant is used.
- To change a motor induced voltage constant of PM motors, the setting in **Pr.706 Induced voltage constant (phi f)** or **Pr.738 Second motor induced voltage constant (phi f)** must be changed. If the constant after the change exceeds the setting range of **Pr.706** or **Pr.738** (0 to 5000 mV (rad/s)), set **Pr.1412 Motor induced voltage constant (phi f) exponent** or **Pr.1413 Second motor induced voltage constant (phi f) exponent**. Set a value in the exponent n in the formula, **Pr.706 (Pr.738) × 10ⁿ** [mV (rad/s)], to set the induced voltage constant (phi f).
- When **Pr.71 (Pr.450)** = "8093 or 9093", or **Pr.1412 (Pr.1413)** = "9999", the motor induced voltage constant is as set in **Pr.706 (Pr.738)**. (No exponent setting)

Parameters referred to

- Pr.9 Electronic thermal O/L relay [page 306](#)
- Pr.71 Applied motor [page 424](#)
- Pr.178 to Pr.189 (Input terminal function selection) [page 410](#)

14.4 Online auto tuning

Magnetic flux Sensorless Vector

If online auto tuning is selected under Advanced magnetic flux vector control, Real sensorless vector control, or Vector control, favorable torque accuracy is retained by adjusting temperature even when the resistance value varies due to increase in the motor temperature.

Pr.	Name	Initial value	Setting range	Description
95 C111	Online auto tuning selection	0	0	Online auto tuning is not performed at startup.
			1	Online auto tuning is performed at startup.
574 C211	Second motor online auto tuning	0	0, 1	Select online auto tuning for the second motor. (The settings are the same as those in Pr.95.)
717 C182	Starting resistance tuning compensation coefficient 1	9999	9999	100%
			0% to 200%	R1 compensation coefficient for start-time tuning
720 C188	Starting resistance tuning compensation coefficient 2	9999	9999	100%
			0% to 200%	R2 compensation coefficient for start-time tuning
741 C282	Second motor starting resistance tuning compensation coefficient 1	9999	9999	100%
			0% to 200%	R1 compensation coefficient for start-time tuning (for the second motor)
737 C288	Second motor starting resistance tuning compensation coefficient 2	9999	9999	100%
			0% to 200%	R2 compensation coefficient for start-time tuning (for the second motor)

◆ Online auto tuning at startup (Pr.95 (Pr.574) = "1")

- By promptly tuning the motor status at startup, accurate operation without being affected by motor temperature is achieved. Also high torque can be provided at very low speed and stable operation is possible.
- Make sure to perform offline auto tuning before performing online auto tuning.

Operating procedure

1. Perform offline auto tuning. (Refer to page 430.)
2. Check that Pr.96 Auto tuning setting/status = "3" (offline auto tuning completion) and values other than "9999" are set in Pr.717 (Pr.741) and Pr.720 (Pr.737).
3. Set Pr.95 Online auto tuning selection = "1" (online auto tuning at start).
Online auto tuning is enabled at the next start.
4. Check that the following parameters are set before starting operation.

Pr.	Description
9	Rated motor current or electronic thermal O/L relay
71	Applied motor
80	Motor capacity (with the rated motor current equal to or less than the inverter rated current) ^{*1}
81	Number of motor poles

*1 If a motor with substantially low rated current compared with the inverter rated current is used, speed and torque accuracies may deteriorate due to torque ripples or other factors. Set the rated motor current to about 40% or higher of the inverter rated current. (For details on the inverter rated current, refer to the inverter rated specifications in the Instruction Manual (Connection).)

5. In the PU operation mode, press the RUN key on the operation panel or the FWD/REV key on the parameter unit.
In the External operation, turn ON the start command (STF signal or STR signal).

NOTE

- To perform the online auto tuning at startup for a lift, consider using a brake sequence function for the brake opening timing at a start. The tuning takes about 500 ms at the most after starting. However, during this time, it is possible that not enough torque is provided and caution is required to prevent the object from dropping. (Refer to [page 456](#)).
- Perform online auto tuning at startup when the motor is stopped.
- The online auto tuning is disabled when the MRS signal is being input, the setting speed is **Pr.13 Starting frequency** or lower (V/F control, Advanced magnetic flux vector control), an inverter fault is occurring, or the inverter's startup condition is not satisfied.
- Online auto tuning does not operate during deceleration and restart from DC injection brake operation.
- It is disabled during JOG operation.
- If automatic restart after instantaneous power failure is selected, automatic restart is prioritized. (Online auto tuning at startup is not performed during frequency search.)
- Zero current detection and output current detection are enabled during online auto tuning.
- The RUN signal is not output during online auto tuning. The RUN signal is turned ON at operation startup.
- If the time between the inverter stop and restart is within four seconds, tuning is performed at startup but its result will not be applied.

◆ Start-time tuning completion (Y39) signal

- The start-time tuning completion (Y39) signal can be output when the start-time tuning completes.
- To use the Y39 signal, set "39" (positive logic) or "139" (negative logic) in any parameter from **Pr.190 to Pr.197 (Output terminal function selection)** to assign the function to an output terminal.

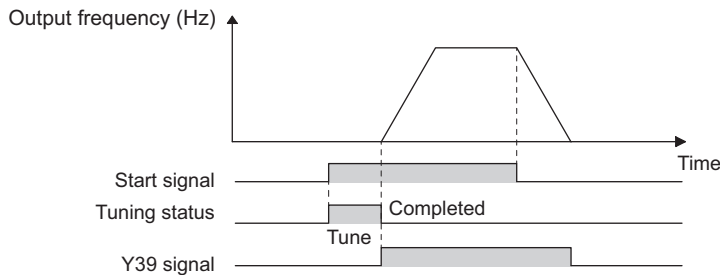

NOTE

- Changing the terminal assignment using **Pr.190 to Pr.197 (Output terminal function selection)** may affect the other functions. Set parameters after confirming the function of each terminal.

◆ Tuning the second motor (Pr.574)

- When one inverter switches the operation between two different motors, set the second motor in **Pr.450 Second applied motor**. (In the initial setting, no second motor is applied. (Refer to [page 424](#).)
- Perform tuning using **Pr.574 Second motor online auto tuning**.
- **Pr.574** is enabled when the Second function selection (RT) signal is turned ON.

Pr.	Description
450	Applied motor
453	Motor capacity (with the rated motor current equal to or less than the inverter rated current) ^{*1}
454	Number of motor poles

*1 If a motor with substantially low rated current compared with the inverter rated current is used, speed and torque accuracies may deteriorate due to torque ripples or other factors. Set the rated motor current to about 40% or higher of the inverter rated current. (For details on the inverter rated current, refer to the inverter rated specifications in the Instruction Manual (Connection).)

NOTE

- The RT signal is the Second function selection signal. The RT signal also enables other second functions. (Refer to [page 410](#).) To use the RT signal, set "3" in any parameter from **Pr.178 to Pr.189 (Input terminal function selection)** to assign the function to an input terminal.
- Changing the terminal assignment using **Pr.178 to Pr.189 (Input terminal function selection)** may affect the other functions. Set parameters after confirming the function of each terminal.



Parameters referred to

- Pr.9 Electronic thermal O/L relay [page 306](#)
- Pr.71 Applied motor [page 424](#)
- Pr.80 Motor capacity [page 115](#), [page 430](#), [page 441](#)
- Pr.81 Number of motor poles [page 115](#), [page 430](#), [page 441](#)
- Pr.96 Auto tuning setting/status [page 430](#), [page 441](#)
- Pr.178 to Pr.189 (Input terminal function selection) [page 410](#)
- Pr.190 to Pr.197 (Output terminal function selection) [page 371](#)
- Pr.800 Control method selection [page 115](#)

14.5 Parameter settings for a motor with encoder

◆ Parameters for the encoder (Pr.359, Pr.369)

- Set the encoder specifications.

Pr.	Name	Initial value	Setting range	Description
359 C141 ^{*1}	Encoder rotation direction	101	100	Set when using a motor (encoder) for which forward rotation is clockwise (CW) viewed from the shaft. 
			101	Set when using a motor for which forward rotation (encoder) is counterclockwise (CCW) viewed from the shaft. 
369 C140 ^{*1}	Number of encoder pulses	1024	2 to 4096	Set the number of encoder pulses. Set the number of pulses before it is multiplied by 4.

*1 The setting is available when a Vector control compatible option is installed. For the IP67 model, the setting is not available as plug-in options are not available.

◆ Parameter settings for the motor under Vector control

Motor model	Pr.9 Electronic thermal O/L relay	Pr.71 Applied motor	Pr.80 Motor capacity	Pr.81 Number of motor poles	Pr.359 Encoder rotation direction	Pr.369 Number of encoder pulses	
Mitsubishi Electric high-performance energy-saving motor with encoder	SF-PR-SC	Rated motor current ^{*4}	70	Motor capacity	Number of motor poles	101 (initial value)	2048
Mitsubishi Electric Vector control dedicated motor	SF-V5RU (1500 r/min series)	0 ^{*3}	30	Motor capacity	4	101 (initial value)	2048
Mitsubishi Electric inverter-driven geared motor for encoder feedback control	GM-DP	Rated motor current	1800	Motor capacity	4	101 (initial value)	1024 (initial value)
	GM-DZ	Rated motor current	1800 (1803) ^{*1}	Motor capacity	4	101 (initial value)	1024 (initial value)
Mitsubishi Electric standard efficiency motor Mitsubishi Electric high-efficiency motor	SF-JR	Rated motor current	0 (initial value)	Motor capacity	Number of motor poles	101 (initial value)	1024 (initial value)
	SF-JR 4P 1.5 kW or lower	Rated motor current	20	Motor capacity	4	101 (initial value)	1024 (initial value)
	SF-HR	Rated motor current	40	Motor capacity	Number of motor poles	101 (initial value)	1024 (initial value)
	Others	Rated motor current	0 (3) ^{*1}	Motor capacity	Number of motor poles	^{*2}	^{*2}
Mitsubishi Electric constant-torque motor	SF-JRCA 4P	Rated motor current	10	Motor capacity	4	101 (initial value)	1024 (initial value)
	SF-HRCA	Rated motor current	50	Motor capacity	Number of motor poles	101 (initial value)	1024 (initial value)
	Others	Rated motor current	10 (13) ^{*1}	Motor capacity	Number of motor poles	^{*2}	^{*2}
Other manufacturer's standard motor	—	Rated motor current	0 (3) ^{*1}	Motor capacity	Number of motor poles	^{*2}	^{*2}
Other manufacturer's constant-torque motor	—	Rated motor current	10 (13) ^{*1}	Motor capacity	Number of motor poles	^{*2}	^{*2}

*1 Offline auto tuning is required. (Refer to [page 430](#).)

*2 Set this parameter according to the motor.

*3 Use the thermal protector input provided with the motor.

*4 When using a motor equipped with a thermal protector, set "0" to protect the motor from overheating.

- When using the inverter with the SF-V5RU (1500 r/min series), refer to the following table to set **Pr.83 Rated motor voltage** and **Pr.84 Rated motor frequency**.

Motor capacity	SF-V5RU			
	200 V		400 V	
	Pr.83 (V)	Pr.84 (Hz)	Pr.83 (V)	Pr.84 (Hz)
1.5 kW	188	50	345	50
2.2 kW	188	50	360	50
3.7 kW	190	50	363	50
5.5 kW	165	50	322	50
7.5 kW	164	50	331	50
11 kW	171	50	320	50
15 kW	164	50	330	50
18.5 kW	171	50	346	50

◆ Combination with the Vector control dedicated motor

When using the inverter with a Vector control dedicated motor, refer to the following table.

- Combination with the SF-V5RU (ND rating)

Voltage	200 V class			400 V class		
Rated speed	1500 r/min					
Base frequency	50 Hz					
Maximum speed	3000 r/min					
Motor capacity	Motor frame No.	Motor model	Inverter model FR-E820-[]	Motor frame No.	Motor model	Inverter model FR-E840-[]
1.5 kW	90L	SF-V5RU1K	0110(2.2K)	90L	SF-V5RUH1K	0060(2.2K)
2.2 kW	100L	SF-V5RU2K	0175(3.7K)	100L	SF-V5RUH2K	0060(2.2K)
3.7 kW	112M	SF-V5RU3K	0240(5.5K)	112M	SF-V5RUH3K	0095(3.7K)
5.5 kW	132S	SF-V5RU5K	0330(7.5K)	132S	SF-V5RUH5K	0170(7.5K)
7.5 kW	132M	SF-V5RU7K	0470(11K)	132M	SF-V5RUH7K	0230(11K)
11 kW	160M	SF-V5RU11K	0600(15K)	160M	SF-V5RUH11K	0300(15K)
15 kW	160L	SF-V5RU15K	0760(18.5K)	160L	SF-V5RUH15K	0380(18.5K)
18.5 kW	180M	SF-V5RU18K	0900(22K)	180M	SF-V5RUH18K	0440(22K)

14.6 Signal loss detection of encoder signals



Signal loss detection (E.ECT) is activated to shut off the inverter output when the encoder signal is lost during encoder feedback control or orientation control, or under Vector control.

Pr.	Name	Initial value	Setting range	Description
376 C148 ^{*1}	Encoder signal loss detection enable/disable selection	0	0	Signal loss detection disabled
			1	Signal loss detection enabled

*1 The setting is available when a Vector control compatible option is installed. For the IP67 model, the setting is not available as plug-in options are not available.

CHAPTER 15 (A) Application Parameters

15.1	Brake sequence function	456
15.2	Stop-on-contact control.....	461
15.3	Traverse function	464
15.4	Anti-sway control	466
15.5	Orientation control	468
15.6	PID control	479
15.7	Calibration of PID display	492
15.8	Dancer control	495
15.9	Automatic restart after instantaneous power failure / flying start with an induction motor	502
15.10	Automatic restart after instantaneous power failure / flying start with a PM motor	508
15.11	Offline auto tuning for a frequency search.....	510
15.12	Power failure time deceleration-to-stop function.....	514
15.13	PLC function	516
15.14	Trace function	518

15 (A) Application Parameters

Purpose	Parameter to set		Refer to page
To stop the motor with a mechanical brake (operation timing of mechanical brake)	Brake sequence function	P.A100 to P.A107, P.F500, P.A108, P.A109	Pr.278 to Pr.285, Pr.292, Pr.639, Pr.640 456
To stop the motor with a mechanical brake (vibration control at stop-on-contact)	Stop-on-contact control	P.A200, P.A205, P.A206	Pr.270, Pr.275, Pr.276 461
To strengthen or weaken the frequency at a constant cycle	Traverse operation	P.A300 to P.A305	Pr.592 to Pr.597 464
To suppress the swinging of an object moved by crane control	Anti-sway control	P.A310 to P.A317	Pr.1072 to Pr.1079 466
To adjust the stop position (orientation control) of the rotating shaft	Orientation control	P.A510, P.A512, P.A520 to P.A533, P.A542 to P.A545, P.C140, P.C141	Pr.350 to Pr.359, Pr.361 to Pr.366, Pr.369, Pr.393, Pr.396 to Pr.399 468
To perform process control, such as for the pump flow volume and air volume	PID control	P.A601 to P.A604, P.A607, P.A610 to P.A615, P.A621 to P.A625	Pr.127 to Pr.134, Pr.553, Pr.554, Pr.575 to Pr.577, Pr.609, Pr.610, Pr.1015 479
	PID display adjustment	P.A630 to P.A633	C42 to C45 (Pr.934, Pr.935) 492
To control the dance roll for winding/unwinding	Dancer control	P.A601, P.A602, P.A610, P.A611, P.A613 to P.A615, P.A624, P.A625, P.F020 to P.F021	Pr.44, Pr.45, Pr.128 to Pr.134, Pr.609, Pr.610 495
To restart without stopping the motor at instantaneous power failure	Automatic restart after instantaneous power failure / flying start function for induction motors	P.A700 to P.A703, P.A710, P.F003	Pr.57, Pr.58, Pr.162, Pr.165, Pr.299, Pr.611 502
	Frequency search accuracy improvement (V/F control, offline auto tuning)	P.A700, P.A711, P.A712, P.C110, P.C210	Pr.96, Pr.162, Pr.298, Pr.463, Pr.560 510
	Automatic restart after instantaneous power failure / flying start function for PM motors	P.A700, P.A702, P.F003	Pr.57, Pr.162, Pr.611 508
To decelerate the motor to a stop at power failure	Power failure time deceleration-to-stop function	P.A730	Pr.261 514
To operate with sequence program	PLC function	P.A800, P.A801, P.A804, P.A805, P.A810 to P.A859	Pr.414, Pr.415, Pr.498, Pr.675, Pr.1150 to Pr.1199 516
To store the operating status of the inverter in the RAM in the inverter	Trace function	P.A900, P.A902 to P.A906, P.A910 to P.A920, P.A930 to P.A939	Pr.1020, Pr.1022 to Pr.1047 518

15.1 Brake sequence function

Magnetic flux Sensorless Vector

This function outputs operation timing signals of the mechanical brake from the inverter, such as for lift applications.

This function is useful in preventing load slippage at a start due to poor mechanical brake timing and overcurrent alarm in stop status and enable secure operation.

Pr.	Name	Initial value	Setting range	Description
278 A100	Brake opening frequency	3 Hz	0 to 30 Hz	Set the frequency value calculated by adding approx. 1.0 Hz to the rated slip frequency. This can be set only when Pr.278 ≤ Pr.282 .
279 A101	Brake opening current	130%	0% to 400%	Set between 50% and 90% because load slippage is more likely to occur when a start setting is too low. The inverter rated current is regarded as 100%, or the rated motor torque is regarded as 100%. (According to Pr.639 setting)
280 A102	Brake opening current detection time	0.3 s	0 to 2 s	Generally set between 0.1 and 0.3 s.
281 A103	Brake operation time at start	0.3 s	0 to 5 s	Set the mechanical delay time until braking eases. When Pr.292 = "8", set the value calculated by adding approx. 0.1 to 0.2 s to the mechanical delay time until braking eases.
282 A104	Brake operation frequency	6 Hz	0 to 30 Hz	Turn OFF the Brake opening request (BOF) signal and set the frequency for operating the electromagnetic brake. Generally, set the value calculated by adding 3 to 4 Hz to the Pr.278 setting value. This can be set only when Pr.282 ≥ Pr.278 .
283 A105	Brake operation time at stop	0.3 s	0 to 5 s	When Pr.292 = "7", set the value calculated by adding 0.1 s to the mechanical delay time until the brake closes. When Pr.292 = "8", set the value calculated by adding to approx. 0.2 to 0.3 s to the mechanical delay time until the brake closes.
284 A106	Deceleration detection function selection	0	0 1	0 Deceleration detection function disabled 1 The protective function is activated when the deceleration speed of the deceleration operation is not normal.
285 A107	Overspeed detection frequency ^{*1}	9999	0 to 30 Hz 9999	0 E.MB1 (Brake sequence fault) occurs when the difference between the detection frequency and output frequency exceeds the setting value under encoder feedback control. 9999 Overspeed detection disabled
292 F500	Automatic acceleration/ deceleration	0	0 1, 11 7 8	0 Normal operation 1, 11 Operation with the shortest acceleration/deceleration time. (Refer to page 276.) 7 Brake sequence mode 1 8 Brake sequence mode 2
639 A108	Brake opening current selection	0	0 1	0 Brake opening by output current 1 Brake opening by motor torque
640 A109	Brake operation frequency selection	0	0 1	0 Brake closing operation by frequency command 1 Brake closing operation by the actual motor rotation speed (estimated value)

*1 The speed deviation excess detection frequency is used under Vector control or PM sensorless vector control. (Refer to page 154 for details.)

◆ Connection diagram

- Sink logic
- **Pr.184** = 15
- **Pr.190** = 20

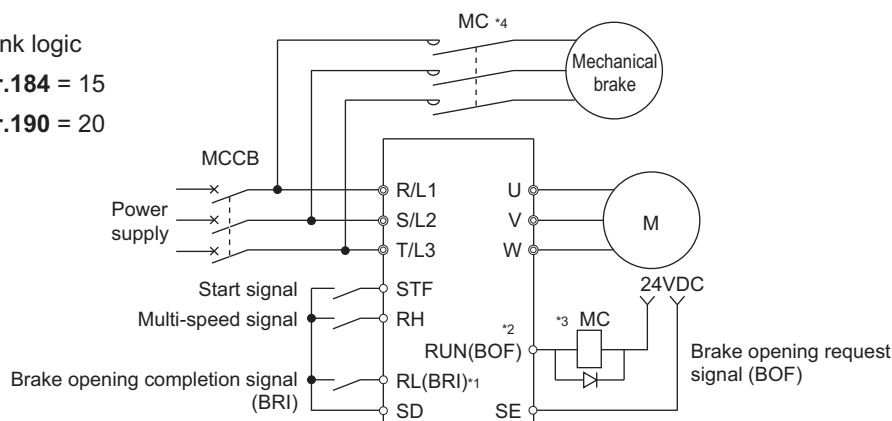

*1 The input signal terminals differ by the settings of **Pr.178** to **Pr.189**.

*2 The output signal terminals differ by the settings of **Pr.190** to **Pr.197**.

*3 Be careful of the permissible current of the built-in transistors on the inverter. (24 VDC 0.1 A)

*4 Use an appropriate power supply for mechanical brake control in accordance with the brake specifications. This must be noted especially for the single-phase 100 V power input model.

NOTE

- The automatic restart after instantaneous power failure function, orientation control, and emergency drive function do not operate when brake sequence is selected.
- To use this function, set the acceleration/deceleration time to 1 second or longer.
- Changing the terminal assignment using **Pr.178 to Pr.189 (Input terminal function selection)** or **Pr.190 to Pr.197 (Output terminal function selection)** may affect the other functions. Set parameters after confirming the function of each terminal.

◆ Setting the brake sequence operation

- Set **Pr.292 Automatic acceleration/deceleration** = "7 or 8 (braking sequence operation)".
To ensure sequence operation, it is recommended to use with **Pr.292** = "7" (with brake opening completion signal input).
- Set "15" in any parameter from **Pr.178 to Pr.189 (Input terminal function selection)**, and assign the Brake opening completion (BRI) signal to an input terminal.
- Set "20" (positive logic) or "120" (negative logic) in any parameter from **Pr.190 to Pr.197 (Output terminal function selection)**, and assign the Brake opening request (BOF) to an output terminal.
- Use **Pr.639 Brake opening current selection** to select whether the output current or the motor torque is used as a reference for the brake opening operation.
- Under Real sensorless vector control or Vector control, use **Pr.640 Brake operation frequency selection** to select whether the frequency command or the actual motor speed (estimated value) is used as a reference for brake closing operation. If the brake operation timing is different from the motor speed because of the load, set **Pr.640** = "1 (brake operation with the actual motor speed (estimated value))".
- Under Advanced magnetic flux vector control or encoder feedback control, the frequency command is used as a reference for brake operation regardless of the **Pr.640** setting.

NOTE

- Under torque control, the brake sequence function is disabled.

◆ Operation with brake opening completion signal input (Pr.292 = "7")

- When the start signal is input to the inverter, the inverter starts running, and when the output frequency reaches the frequency set in **Pr.278 Brake opening frequency** and the output current or the motor torque is equal to or greater than the **Pr.279 Brake opening current** setting, the brake opening request signal (BOF) is output after the time set in **Pr.280 Brake opening current detection time**. The Brake opening completion (BRI) signal is input, and the output frequency is increased to the set speed after the set time in **Pr.281 Brake operation time at start**.
- When the inverter decelerates to the frequency set in **Pr.282 Brake operation frequency** during deceleration, the inverter turns OFF the brake opening request signal (BOF) and decelerates further to the frequency set in **Pr.278**. After electromagnetic brake operation completes and the inverter recognizes the turn OFF of the BRI signal, the inverter holds the frequency set in **Pr.278** for the time set in **Pr.283 Brake operation time at stop**. And after the time set in **Pr.283** passes, the inverter decelerates again. The inverter outputs is shut off when the frequency reaches **Pr.13 Starting frequency** setting or 0.5 Hz, whichever is lower.

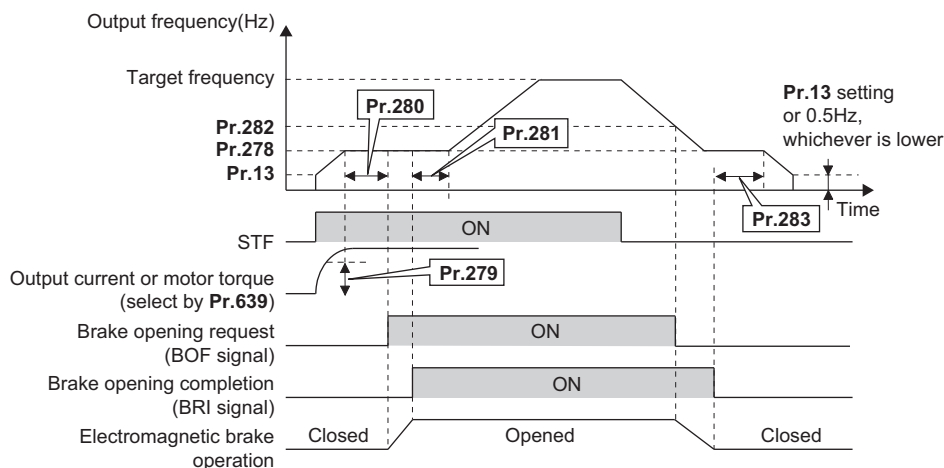

◆ Operation without Brake opening completion (Pr.292 = "8") signal input

- When the start signal is input to the inverter, the inverter starts running, and when the output frequency reaches the frequency set in **Pr.278 Brake opening frequency** and the output current or the motor torque is equal to or greater than the **Pr.279 Brake opening current** setting, the brake opening request signal (BOF) is output after the time set in **Pr.280 Brake opening current detection time**.

After the BOF signal is output, the output frequency is increased to the set speed after the set time in **Pr.281 Brake operation time at start**.

- When the inverter decelerates to the frequency set to **Pr.282 Brake operation frequency** during deceleration, the inverter turns OFF the brake opening request signal (BOF) and decelerates further to the frequency set in **Pr.278**. And after the time set in **Pr.283 Brake operation time at stop** passes, the inverter decelerates again. The inverter output is shut off when the frequency reaches **Pr.13 Starting frequency** setting or 0.5 Hz, whichever is lower.

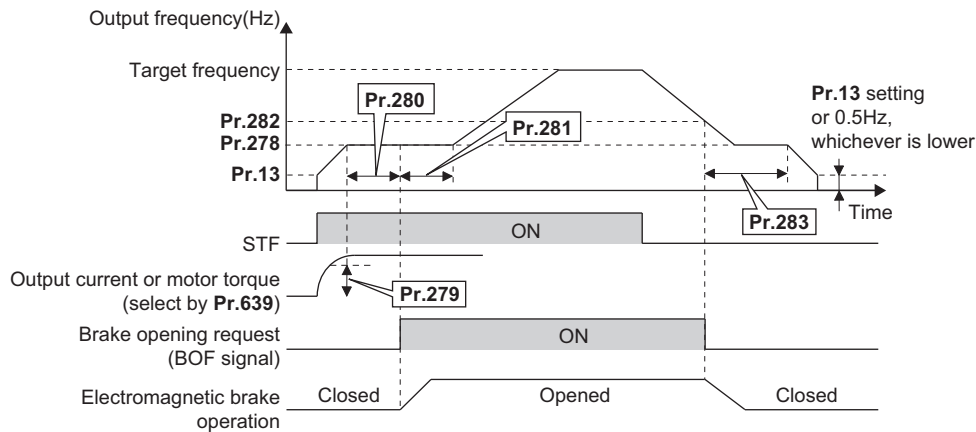

NOTE

- Even if the brake sequence operation has been selected, inputting the JOG signal (JOG operation) during an inverter stop changes the operation method to normal operation and give a priority to the JOG operation. Note that the JOG signal input by the brake sequence function is invalid during operation.

◆ Protective function

- If one of the following faults occurs while the brake sequence function is enabled, the inverter enters a fault status, shuts off output, and turns OFF the brake opening request signal (BOF).

Fault indication	Description
E.MB1	When (detection frequency) - (output frequency) > Pr.285 during encoder feedback control. (Overspeed detection function) When Pr.285 = "9999", overspeed is not detected.
E.MB2	When deceleration is not normal during deceleration operation from the set frequency to the frequency set in Pr.282 (when Pr.284 = "1") (except stall prevention operation). When Pr.284 = "0", deceleration is not detected.
E.MB3	When the BOF signal turned ON while the motor is at a stop. (Load slippage prevention function)
E.MB4	When 2 seconds or more have elapsed after the start command (forward or reverse rotation) is input, but the BOF signal does not turn ON.
E.MB5	When 2 seconds or more have elapsed after the BOF signal turned ON, but the BRI signal does not turn ON.
E.MB6	When the inverter had turned ON the brake opening request signal (BOF), but the BRI signal turned OFF.
E.MB7	When 2 seconds or more have elapsed after the BOF signal turned OFF at a stop, but the BRI signal does not turn OFF.

NOTE

- During deceleration, inverter output is shut OFF when the frequency reaches **Pr.13 Starting frequency** or 0.5 Hz, whichever is lower. For **Pr.278 Brake opening frequency**, set a frequency equal to or higher than the **Pr.13** setting or 0.5 Hz.
- **Pr.285 Overspeed detection frequency** is valid under encoder feedback control (used with the Vector control compatible option) even if a value other than "7 or 8" is set in **Pr.292 Automatic acceleration/deceleration**.
- Setting **Pr.278** too high activates the stall prevention and may cause E.MB4.
- E.MB4 occurs when the time period calculated by adding **Pr.280** to the acceleration time from **Pr.13** to **Pr.278** reaches or exceeds 2 seconds.

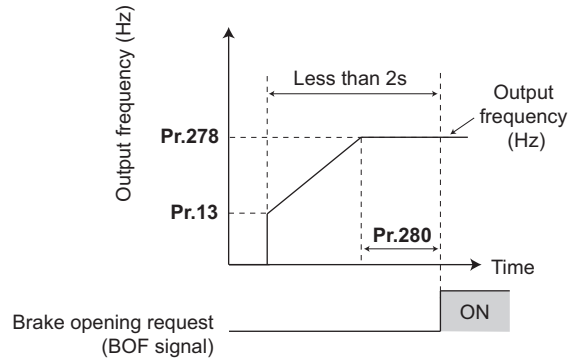
**Parameters referred to**

Pr.13 Starting frequency [page 274](#)

Pr.178 to Pr.189 (Input terminal function selection) [page 410](#)

Pr.190 to Pr.197 (Output terminal function selection) [page 371](#)

15.2 Stop-on-contact control

Magnetic flux Sensorless

To ensure accurate positioning at the upper limit, etc. of a lift, stop-on-contact control causes the mechanical brake to close while the motor creates a holding torque to keep the load in contact with a mechanical stopper, etc.

This function suppresses vibration that is likely to occur when the load is stopped upon contact in lift applications, thereby ensuring reliable and highly accurate positioning stop.

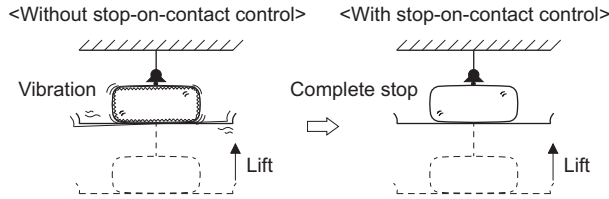

Pr.	Name	Initial value	Setting range	Description
6 D303	Multi-speed setting (low speed)	10 Hz	0 to 590 Hz	Set the output frequency for stop-on-contact control.
22 H500	Stall prevention operation level	150%	0% to 400%	Set the stall prevention operation level for stop-on-contact control. The smaller value set in either Pr.22 or Pr.48 has priority.
48 H600	Second stall prevention operation level	9999	0% to 400%, 9999	
270 A200	Stop-on-contact control selection	0	0	Normal operation
			1	Stop-on-contact control
			11	Stop-on-contact control (E.OLT is invalid)
275 A205	Stop-on contact excitation current low-speed scaling factor	9999	0% to 300%	Set the force (holding torque) for stop-on-contact control. Normally, set the scaling factor between 130% to 180%.
			9999	Not compensated.
276 A206	PWM carrier frequency at stop-on contact	9999	0 to 9	Set a PWM carrier frequency for stop-on-contact control. For Real sensorless vector control, the carrier frequency is always 2 kHz when the setting value is "0 to 5" and always 6 kHz when the setting value is "6 to 9". (Valid at the output frequency of 3 Hz or less.)
			9999	As set in Pr.72 PWM frequency selection.

◆ Connection and operation example

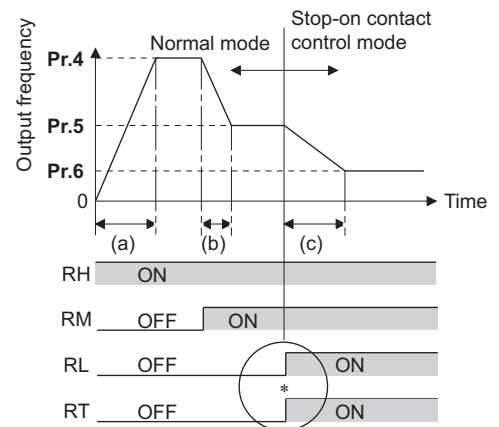
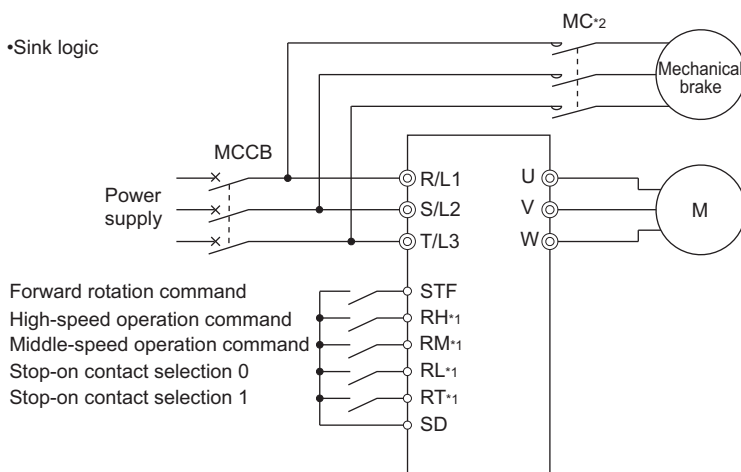

* Goes into stop-on-contact control mode when both RL and RT switch on. RL and RT may be switched on in any order with any time difference

- (a): Acceleration time(Pr.7)
- (b): Deceleration time(Pr.8)
- (c): Second deceleration time(Pr.44/Pr.45)

*1 The input terminals differ by the settings of Pr.180 to Pr.189.

*2 Use an appropriate power supply for mechanical brake control in accordance with the brake specifications. This must be noted especially for the single-phase 100 V power input model.

◆ Setting the stop-on-contact control

- Make sure that the inverter is in External or Network operation mode. (Refer to [page 280](#).)
- Select either Real sensorless vector control (speed control) or Advanced magnetic flux vector control.
- Set "1 or 11" in **Pr.270 Stop-on-contact control selection**.
- Set the output frequency for stop-on-contact control in **Pr.6 Multi-speed setting (low speed)**.
Set the frequency as low as possible (about 2 Hz). If a frequency higher than 30 Hz is set, it operates with 30 Hz.
- When both the RT and RL signals are switched ON, the inverter enters the stop-on-contact control, and operation is performed at the frequency set in **Pr.6** independently of the preceding speed.
- Setting **Pr.270** = "11" disables stall prevention stop (E.OLT) during stop-on-contact control (with both RL and RT signals ON).

NOTE

- The priority of the frequency command given by the external signals is as follows: JOG operation (JOG/JOG2 signal) > stop-on-contact control (RL/RT signal) > multi-speed operation (RL/RM/RH/REX signal) > terminal 4 analog input (AU signal) > pulse train input (option FR-E8AXY) > 16-bit digital input (option FR-A8AX) > terminal 2 analog input.
- By increasing the **Pr.275** setting, the low-speed (stop-on-contact) torque increases, but overcurrent fault (E.OC[]) may occur or the machine may oscillate in stop-on-contact status.
- The stop-on-contact function is different from the servo-lock function, and if used to stop or hold a load for an extended period, this function can cause the motor to overheat. After a stop, immediately switch to a mechanical brake to hold the load.
- Under the following operating conditions, the stop-on-contact function is invalid:
PU operation (**Pr.79**), JOG operation (JOG signal), PU + External operation (**Pr.79**), PID control function operation (**Pr.128**), Remote setting function operation (**Pr.59**), Automatic acceleration/deceleration operation (**Pr.292**), Start time tuning, Orientation control function operation
- When performing stop-on-contact control during encoder feedback control, encoder feedback control is invalid due to a transition to the stop-on-contact control mode.

◆ Function switching of stop-on-contact control selection

Main functions	Normal operation (Either RL or RT is OFF or both are OFF.)		Stop-on-contact control (Both RL and RT are ON.)	
	Real sensorless vector control	Advanced magnetic flux vector control	Real sensorless vector control	Advanced magnetic flux vector control
Output frequency	Multi-speed, 0 to 5 V, 0 to 10 V, 4 to 20 mA, etc.		Pr.6 setting	
Stall prevention operation level	—	Pr.22 setting	—	The smaller value set in either Pr.22 or Pr.48
Torque limit level	Pr.22 setting	—	Pr.22 setting	—
Excitation current low-speed scaling factor	—		The current is compensated by Pr.275 (0% to 300%) setting from normal operation.	
Carrier frequency	Pr.72 setting		When output frequency is 3 Hz or lower, Pr.276 setting (Pr.72 when Pr.276 = "9999")	
Fast-response current limit	—	Enabled	—	Disabled

◆ Set frequency and validity of the stop-on-contact control (Pr.270 = "1 or 11")

- The following table lists the frequencies set when the input terminals (RH, RM, RL, RT, JOG) are selected together.
- Stop-on-contact control is disabled when remote setting function is selected (Pr.59 = 1 to 3).

Input signal					Set frequency	Stop-on-contact control
RH	RM	RL	RT	JOG		
ON					Pr.4	
	ON				Pr.5	
		ON			Pr.6	
			ON		*1	
				ON	Pr.15	
ON	ON				Pr.26	
ON		ON			Pr.25	
ON			ON		Pr.4	
ON				ON	Pr.15	
	ON	ON			Pr.24	
	ON		ON		Pr.5	
	ON			ON	Pr.15	
		ON	ON		Pr.6	Enabled
		ON		ON	Pr.15	
			ON	ON	Pr.15	
		ON	ON	ON	Pr.15	

Input signal					Set frequency	Stop-on-contact control
RH	RM	RL	RT	JOG		
	ON		ON	ON	Pr.15	
	ON	ON		ON	Pr.15	
	ON	ON	ON		Pr.6	Enabled
ON			ON	ON	Pr.15	
ON		ON		ON	Pr.15	
ON		ON	ON		Pr.6	Enabled
ON	ON			ON	Pr.15	
ON	ON		ON		Pr.26	
ON	ON	ON			Pr.27	
	ON	ON	ON	ON	Pr.15	
ON		ON	ON	ON	Pr.15	
ON	ON		ON	ON	Pr.15	
ON	ON	ON		ON	Pr.15	
ON	ON	ON	ON		Pr.6	Enabled
ON	ON	ON	ON	ON	Pr.15	
					*1	

*1 By 0 to 5 V (0 to 10 V), 4 to 20 mA input

NOTE

- Changing the terminal assignment using Pr.178 to Pr.189 (Input terminal function selection) may affect the other functions. Set parameters after confirming the function of each terminal.

Parameters referred to

- Pr.4 to Pr.6, Pr.24 to Pr.27 (multi-speed setting) [page 303](#)
- Pr.15 Jog frequency [page 301](#)
- Pr.22 Stall prevention operation level, Pr.48 Second stall prevention operation level [page 334](#)
- Pr.22 Torque limit level [page 139](#)
- Pr.59 Remote function selection [page 269](#)
- Pr.72 PWM frequency selection [page 249](#)
- Pr.79 Operation mode selection [page 280](#)
- Pr.95 Online auto tuning selection [page 449](#)
- Pr.128 PID action selection [page 479](#)
- Pr.178 to Pr.189 (Input terminal function selection) [page 410](#)
- Pr.292 Automatic acceleration/deceleration [page 276](#)

15.3 Traverse function

The traverse operation, which oscillates the frequency at a constant cycle, is available.

Pr.	Name	Initial value	Setting range	Description
592 A300	Traverse function selection	0	0	Traverse function invalid
			1	Traverse function valid only in External operation mode
			2	Traverse function valid regardless of the operation mode
593 A301	Maximum amplitude amount	10%	0% to 25%	Level of amplitude during traverse operation
594 A302	Amplitude compensation amount during deceleration	10%	0% to 50%	Compensation amount during amplitude inversion (from acceleration to deceleration)
595 A303	Amplitude compensation amount during acceleration	10%	0% to 50%	Compensation amount during amplitude inversion (from deceleration to acceleration)
596 A304	Amplitude acceleration time	5 s	0.1 to 3600 s	Time period of acceleration during traverse operation
597 A305	Amplitude deceleration time	5 s	0.1 to 3600 s	Time period of deceleration during traverse operation

- **Setting Pr.592 Traverse function selection = "1 or 2"** enables the traverse function.
- Assigning the Traverse function selection (X37) signal to the input terminal enables the traverse function only when the X37 signal is ON. (When the X37 signal is not assigned, the traverse function is always available. When the Network operation mode is selected, the traverse function is always available regardless of ON/OFF state of the X37 signal.) To input the X37 signal, set "37" in any parameter from **Pr.178 to Pr.189 (Input terminal function selection)** to assign the function to a terminal.

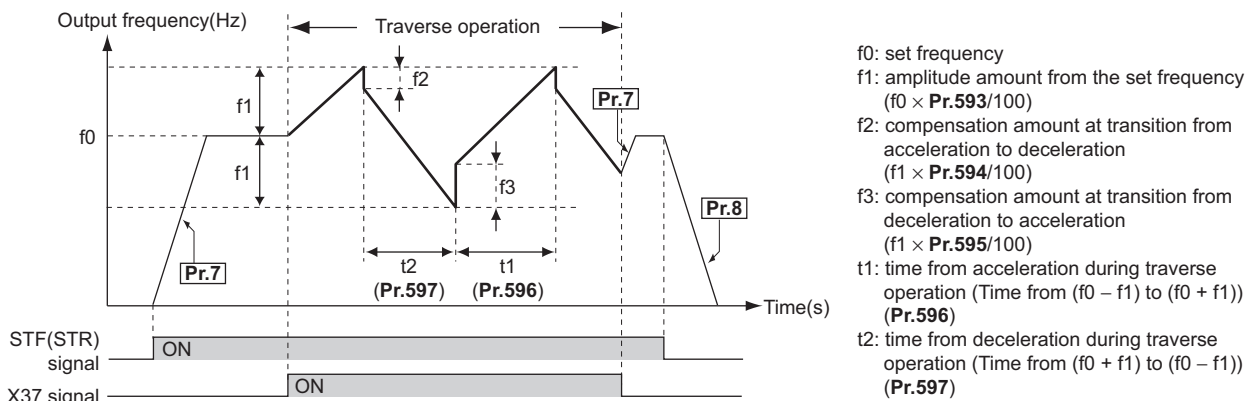



- The motor accelerates to the set frequency f_0 according to the normal **Pr.7 Acceleration time** at turn ON of the start command (STF or STR).
- When the output frequency reaches f_0 and the X37 signal turns ON, the inverter begins traverse operation and accelerates to $f_0 + f_1$. The acceleration time at this time is according to the **Pr.596** setting. (If the X37 signal turns ON before the output frequency reaches f_0 , traverse operation begins after the output frequency reaches f_0 .)
- After the inverter accelerates the motor to $f_0 + f_1$, this is compensated with f_2 ($f_1 \times \text{Pr.594}$), and the motor decelerates to $f_0 - f_1$. The deceleration time at this time is according to the **Pr.597** setting.
- After the inverter decelerates the motor to $f_0 - f_1$, this is compensated with f_3 ($f_1 \times \text{Pr.595}$), and the motor accelerates again to $f_0 + f_1$.
- When the X37 signal turns OFF during traverse operation, the inverter accelerates/decelerates the motor to f_0 according to the normal acceleration/deceleration time (**Pr.7, Pr.8**). If the start command (STF or STR) is turned OFF during traverse operation, the inverter decelerates the motor to a stop according to the normal deceleration time (**Pr.8**).

NOTE

- If the set frequency (f0) and traverse operation parameters (**Pr.593 to Pr.597**) are changed during traverse operation, this is applied in operations after the output frequency reaches f0 before the change was made.
- If the output frequency exceeds the setting of **Pr.1 Maximum frequency** or **Pr.2 Minimum frequency** during traverse operation, the output frequency is clamped at the maximum/minimum frequency when the set pattern exceeds the maximum/minimum frequency. (The output frequency is not clamped at minimum frequency during JOG operation.)
- When the traverse function and S-pattern acceleration/deceleration (**Pr.29** ≠ "0") are selected, S-pattern acceleration/deceleration operation occurs only in the range operated at the normal acceleration/deceleration time (**Pr.7, Pr.8**). Acceleration/deceleration during traverse operation is performed linearly.
- If stall prevention activates during traverse operation, traverse operation stops and normal operation begins. When stall prevention operation is completed, the inverter accelerates/decelerates the motor to f0 at the normal acceleration/deceleration time (**Pr.7, Pr.8**). After the output frequency reaches f0, the traverse operation begins again.
- If the value of the amplitude inversion compensation amount (**Pr.594, Pr.595**) is too large, an overvoltage trip or stall prevention occurs, and pattern operation cannot be performed as set.
- The traverse function is disabled during orientation control.
- Changing the terminal assignment using **Pr.178 to Pr.189 (Input terminal function selection)** may affect the other functions. Set parameters after confirming the function of each terminal.

Parameters referred to

Pr.29 Acceleration/deceleration pattern selection  [page 267](#)
Pr.178 to Pr.189 (Input terminal function selection)  [page 410](#)
Pr.190 to Pr.197 (Output terminal function selection)  [page 371](#)

15.4 Anti-sway control

When an object is moved by a gantry crane, swinging is suppressed on the crane's traveling axis.

Pr.	Name	Initial value	Setting range	Description
1072 A310	DC brake judgment time for anti-sway control operation	3 s	0 to 10 s	Set the time from when the output frequency becomes the Pr.10 DC injection brake operation frequency or less to when the DC injection brake (zero speed control or the servo lock) operation starts.
1073 A311	Anti-sway control operation selection	0	0 1	Anti-sway control disabled Anti-sway control enabled
1074 A312	Anti-sway control frequency	9999	0.05 to 3 Hz 9999	Set a swinging frequency of the object. Anti-sway control is performed using a swinging frequency estimated by the inverter according to the settings of Pr.1077 to Pr.1079 .
1075 A313	Anti-sway control depth	0	0 to 3	0 (Deep) → 3 (Shallow)
1076 A314	Anti-sway control width	0	0 to 3	0 (Narrow) → 3 (Wide)
1077 A315	Rope length	1 m	0.1 to 100 m	Set the rope length of the crane.
1078 A316	Trolley weight	0 kg	0 to 50000 kg	Set the weight of the trolley.
1079 A317	Load weight	0 kg	0 to 50000 kg	Set the weight of the object.

◆ Anti-sway control operation (Pr.1073)

- Setting **Pr.1073 Anti-sway control operation selection** = "1" enables anti-sway control. (Anti-sway control is not performed during DC injection brake operation (zero speed control / servo lock) operation.)
- During operation under anti-sway control, the travel distance becomes longer. Input a stop command earlier to avoid a collision with an obstacle.
- When the Anti-sway control disabled (X54) signal is assigned to an input terminal using **Pr.178 to Pr.189 (Input terminal function selection)**, turning ON the X54 signal can disable anti-sway control.
- A deceleration to stop without anti-sway control is applied for stopping as a result of PU stop, a deceleration stop due to a communication error, the Emergency stop (X92) signal input, or an emergency stop via communication.

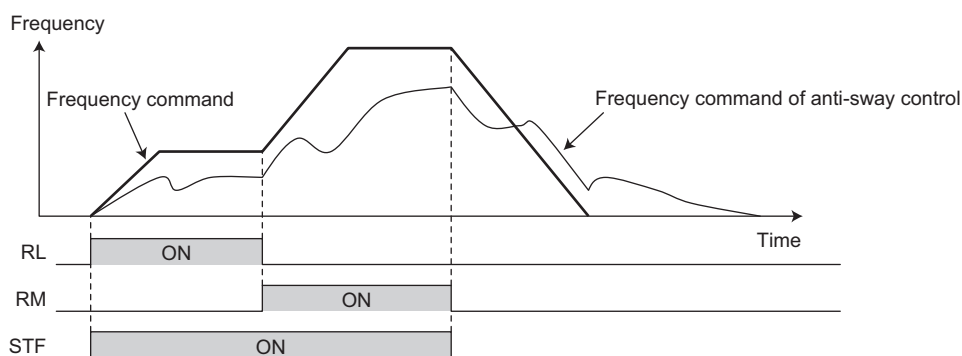

NOTE

- Under torque control or position control, the anti-sway control is disabled.
- During operation of the power failure time deceleration-to-stop function, or when the automatic restart after instantaneous power failure is enabled (**Pr.57** ≠ "9999"), the anti-sway control is disabled.

◆ Swinging frequency setting (Pr.1074 to Pr.1079)

- Set a swinging frequency in **Pr.1074 Anti-sway control frequency**. The swinging frequency is used as a notch filter frequency. Lower the response level of speed control in the frequency band with the width set in the **Pr.1076 Anti-sway control width** by the gain set in the **Pr.1075 Anti-sway control depth**.

- A deeper notch depth has a greater effect in reducing mechanical resonance but makes the phase delay larger, which may increase swinging. Adjust the depth by starting from the shallowest value.

Setting	3	2	1	0
Gain (depth)	-4 dB (shallow)	-8 dB	-14 dB	-∞ (deep)

- If the **Pr.1076** setting is too large (the width is too wide), the response level of speed control drops, and the system may become unstable.
- After setting **Pr.1074** = "9999", set the crane rope length in the **Pr.1077 Rope length**, the trolley weight in the **Pr.1078 Trolley weight**, and the weight of an object in the **Pr.1079 Load weight**. Then, anti-sway control is performed using a swinging frequency estimated by the inverter. When **Pr.1078** = "0" or **Pr.1079** = "0", anti-sway control is performed using a swinging frequency estimated by the inverter according to the **Pr.1077** setting.

◆ Delay time for brake operation of anti-sway control (Pr.1072)

- Set the time from when the output frequency becomes the **Pr.10 DC injection brake operation frequency** or less to when the zero speed control or the servo lock operation starts in the **Pr.1072 DC brake judgment time for anti-sway control operation**.

15

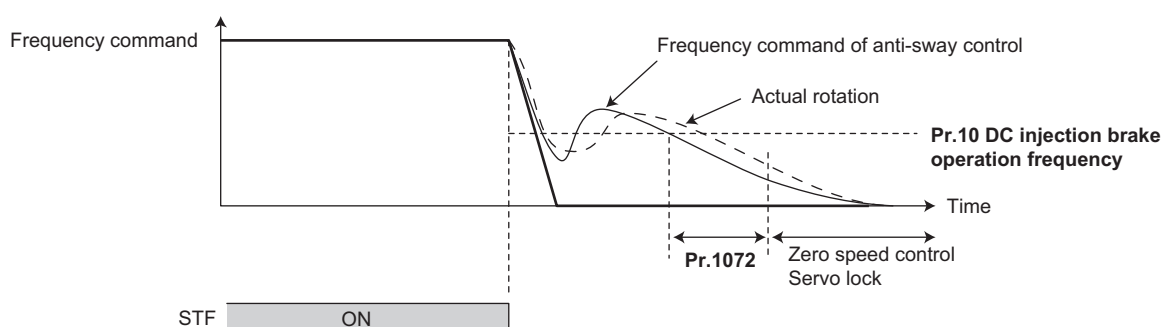

NOTE

- During anti-sway control operation, even if the motor rotation is restricted to one direction in the **Pr.78 Reverse rotation prevention selection**, the motor may rotate in a direction opposite to the setting.
- When anti-sway control is enabled, regeneration avoidance, shortest acceleration/deceleration, the traverse function, and deceleration check are disabled regardless of whether the X54 signal is ON or OFF.
- Do not set anti-sway control and droop control together.

Parameters referred to

- Pr.10 DC injection brake operation frequency [page 536](#)
- Pr.78 Reverse rotation prevention selection [page 300](#)
- Pr.286 Droop gain [page 561](#)
- Pr.292 Automatic acceleration/deceleration [page 276](#)
- Pr.592 Traverse function selection [page 464](#)
- Pr.690 Deceleration check time [page 154](#)
- Pr.882 Regeneration avoidance operation selection [page 551](#)



15.5 Orientation control



The inverter can adjust the stop position (Orientation control) using a position detector (encoder) attached to a place such as the main shaft of the machine.

A Vector control compatible option is required. Orientation control is not available for the IP67 model as plug-in options are not available.

Because **Pr.350 Stop position command selection** is initially set to "9999", the orientation control function is invalid.

Pr.*1	Name	Initial value	Setting range	Description
350 A510	Stop position command selection	9999	0	Internal stop position command (Pr.356)
			9999	Orientation control disabled
351 A526	Orientation speed	2 Hz	0 to 30 Hz	Turning ON the X22 signal decelerates the motor speed to the set value.
352 A527	Creep speed	0.5 Hz	0 to 10 Hz	After the speed reaches the orientation speed, the speed decreases to the creep speed set in Pr.352 as soon as the current position pulse reaches the creep switchover position set in Pr.353 . Set the distance from the DC injection brake start position in Pr.353 .
353 A528	Creep switchover position	511	0 to 16383	
354 A529	Position loop switchover position	96	0 to 8191	Set the distance from the DC injection brake start position. As soon as the current position pulses reach the set position loop switchover position, control is changed to the position loop.
355 A530	DC injection brake start position	5	0 to 255	Set the distance from the target stop position. After the motor moves into the position loop, the motor stops by the DC injection brake when the current position pulses reach the specified start position of the DC injection brake.
356 A531	Internal stop position command	0	0 to 16383	When "0" is set in Pr.350 , the internal position command is activated and the setting value of Pr.356 becomes the stop position.
357 A532	Orientation in-position zone	5	0 to 255	Set the in-position width at a stop of the orientation.
358 A533	Servo torque selection	1	0 to 13	Operation at orientation completion can be selected.
359 C141	Encoder rotation direction	101	100	Set when using a motor (encoder) for which forward rotation is clockwise (CW) viewed from the shaft. 
			101	Set when using a motor (encoder) for which forward rotation is counterclockwise (CCW) viewed from the shaft. 
361 A512	Position shift	0	0 to 16383	Shift the home position using a compensation value without changing the home position of the encoder. The stop position is a position obtained by adding the setting of Pr.361 to the position command.
362 A520	Orientation position loop gain	1	0.1 to 100	When the servo torque function is selected using Pr.358 , the output frequency for generating servo torque gradually increases to the Pr.352 according to the slope set in Pr.362 . Although the operation becomes faster when the value is increased, hunting may occur in the machine.
363 A521	Completion signal output delay time	0.5 s	0 to 5 s	The Orientation complete (ORA) signal turns ON after going into the in-position width and waiting for the set time. Also, the signal turns OFF after going out of the in-position width and waiting for the set time.
364 A522	Encoder stop check time	0.5 s	0 to 5 s	If the Orientation complete (ORA) signal has never been output and the encoder stays stopped for the set time without completing orientation, the Orientation fault (ORM) signal is output. If the ORA signal has been output before but the orientation cannot be completed within the set time, the ORM signal is also output.
365 A523	Orientation limit	9999	0 to 60 s	The time that elapsed after passing the creep switchover position is measured. If orientation cannot be completed within the set time, the Orientation fault (ORM) signal is output.
			9999	Set to 120 s.

Pr. ^{*1}	Name	Initial value	Setting range	Description
366 A524	Recheck time	9999	0 to 5 s	When the start signal is turned OFF with the Orientation command (X22) signal ON after stopping the motor by orientation control, the current position is checked again after the set time elapses, and the Orientation complete (ORA) signal or Orientation fault (ORM) signal is output.
			9999	Not checked.
369 C140	Number of encoder pulses	1024	2 to 4096	Set the number of encoder pulses. Set the number of pulses before it is multiplied by 4.
393 A525	Orientation selection	0	0	Orientation is executed from the current rotation direction.
			1	Orientation is executed from the forward rotation direction.
			2	Orientation is executed from the reverse rotation direction.
396 A542	Orientation speed gain (P term)	60	0 to 1000	Response level during position control loop (servo rigidity) can be adjusted at orientation stop.
397 A543	Orientation speed integral time	0.333	0 to 20 s	
398 A544	Orientation speed gain (D term)	1	0 to 100	Lag/advance compensation gain can be adjusted.
399 A545	Orientation deceleration ratio	20	0 to 1000	Make adjustment when the motor runs back at orientation stop or the orientation time is long.

*1 The setting is available when a Vector control compatible option is installed.

NOTE

- The PLC function is available when orientation control is enabled.

◆ Motor end orientation connection example

- Standard motor with encoder (GM-DZ, GM-DP, SF-JR, SF-HR, SF-JRCA, or SF-HRCA), 5 V differential line driver

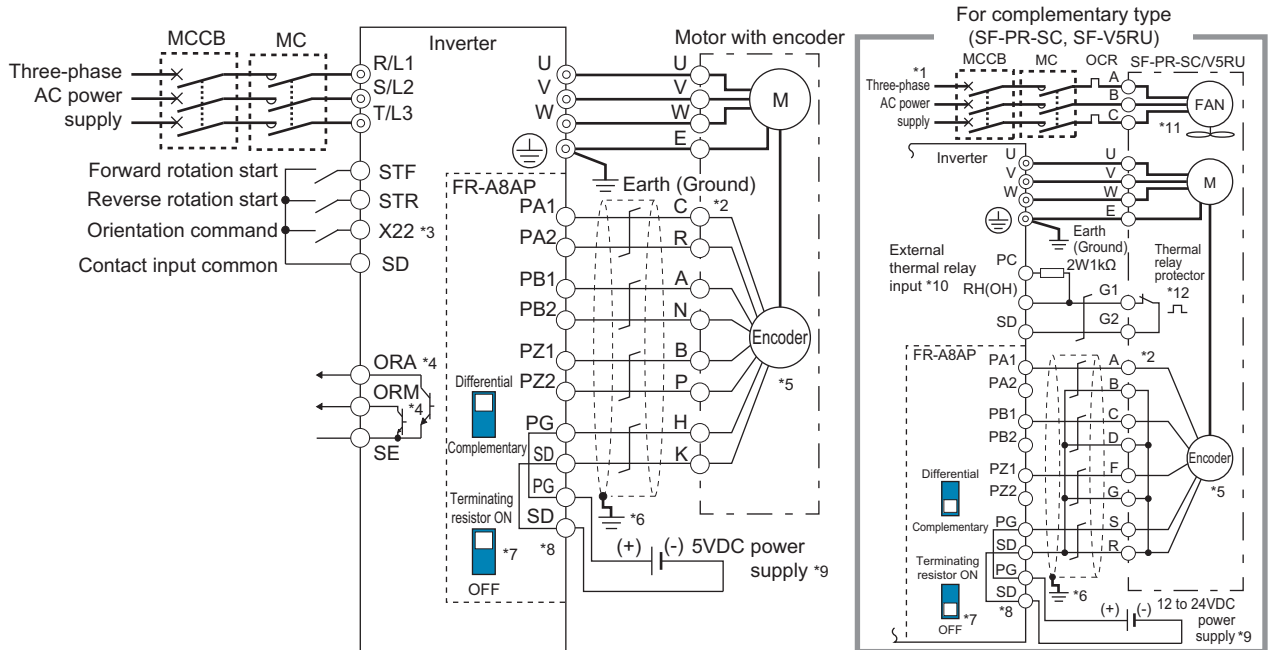

- *1 Single-phase power supply (200 V/50 Hz, 200 to 230 V/60 Hz) is used for the fan for a 7.5 kW or lower dedicated motor (SF-V5RU).
- *2 The pin number differs according to the encoder used.
- *3 Use Pr.178 to Pr.184 (Input terminal function selection) to assign the function to a terminal. (Refer to page 410.)
- *4 Use Pr.190 to Pr.192, and Pr.197 (Output terminal function selection) to assign the function to a terminal. (Refer to page 371.)
- *5 Connect the encoder so that there is no looseness between the motor and motor shaft. Speed ratio must be 1:1.
- *6 Earth (ground) the shield of the encoder cable to the enclosure using a tool such as a P-clip. (Refer to the Instruction Manual (Connection).)
- *7 For the differential line driver, set the terminating resistor selection switch to the ON position (initial status) to use. (Refer to the Instruction Manual (Connection).)
Note that the terminating resistor switch should be set to the OFF position when sharing the same encoder with another unit (NC, etc.) or when the terminating resistor is connected to another unit. For the complementary, set the terminating resistor selection switch in the OFF position.
- *8 For terminal compatibility between the FR-A8AP and the FR-JCBL/FR-V5CBL, refer to the Instruction Manual (Connection).

- *9 A separate power supply of 5 V /12 V /15 V /24 V is necessary according to the encoder power specification. When the encoder output is the differential line driver type, only 5 V can be input. Make the voltage of the external power supply same as the encoder output voltage, and connect the external power supply between PG and SD. When using orientation control function together, an encoder and power supply can be shared.
- *10 Connect the 2 W 1 kΩ resistor (MOS2C123J 2W1kΩ manufactured by KOA Corporation) between terminals PC and OH. Insert the input line and the resistor to a 2-wire blade terminal, and connect the blade terminal to terminal OH. (For the recommended 2-wire blade terminals, refer to the Instruction Manual (Connection).)

Remove jumpers connecting terminals PC and S1 and terminals PC and S2, and wire terminals as follows. Insulate the lead wire of the resistor, for example by applying a contraction tube, and shape the wires so that the resistor and its lead wire do not touch other cables. Caulk the lead wire securely together with the thermal protector input line using a 2-wire blade terminal. (Do not subject the lead wire's bottom area to an excessive pressure.)

The thermal protector can be connected to the standard model and the Ethernet model only.

To use a terminal as terminal OH, assign the OH (External thermal relay input) signal to an input terminal. (Set "7" in any parameter from **Pr.178** to **Pr.189**.)

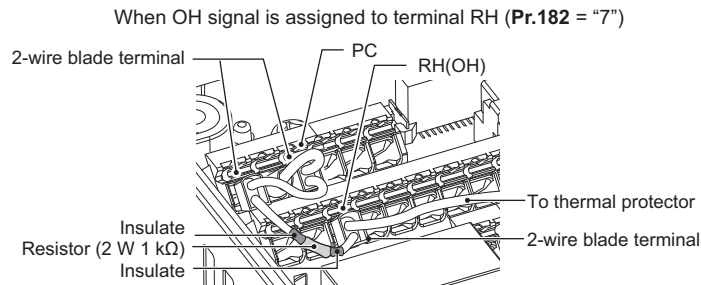

- *11 The SF-PR-SC does not have a cooling fan. When using other Vector control dedicated motors, perform wiring according to the specifications.
- *12 Some SF-PR-SC models have a thermal protector.

◆ Setting

- When the Orientation command (X22) signal is turned ON during operation after the parameters are set, the motor is decelerated to the orientation switchover speed. Then, the inverter calculates the orientation stop distance, further decelerates the motor and the motor enters the orientation state (servo lock). The Orientation complete (ORA) signal is output when the motor is within the orientation complete width.

◆ Setting I/O signals

Signal	Signal name	Description
X22	Orientation command	Turn ON the X22 signal to start the orientation operation. For the X22 signal input, set "22" in any parameter from Pr.178 to Pr.184 to assign the function.
ORA	Orientation complete	The output is in LOW state when the orientation stop can be made within the orientation complete width while the start signal and X22 signal are input (ON). For the ORA signal output, set "27" (positive logic) or "127" (negative logic) in any parameter from Pr.190 to Pr.192 , and Pr.197 to assign the function.
ORM	Orientation fault	The output is in LOW state when the orientation stop cannot be made within the orientation complete width while the start signal and X22 signal are input (ON). For the ORM signal output, set "28" (positive logic) or "128" (negative logic) in any parameter from Pr.190 to Pr.192 , and Pr.197 to assign the function.

◆ Selecting stop position command (Pr.350 Stop position command selection)

- Set **Pr.356 Internal stop position command** to enable orientation control.

Pr.350 setting	Stop position command source
0	Internal stop position command (Pr.356 : 0 to 16383)
9999 (initial value)	Orientation control disabled

- When the internal stop position command (**Pr.350** = "0") is selected, the **Pr.356** setting is used as the stop position.

- When the number of encoder pulses is 1024 pulses/r, one revolution (360°) of the encoder is divided by 4096 pulses (quadruplicated) so that the degree per pulse can be calculated as
 $360^\circ / 4096 \text{ pulses} = 0.0879^\circ/\text{pulse}$.

Refer to the following figure. Stop position (address) is shown within parentheses.

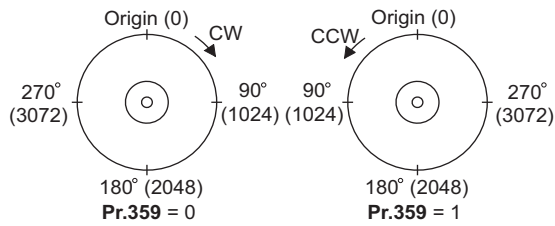

◆ Pr.361 Position shift (initial value "0")

- The stop position is a position obtained by adding the setting of **Pr.361** to the position command.
- Position shift function
 Shift the home position using a compensation value without changing the home position of the position detector (encoder).

NOTE

- When orientation control is valid using **Pr.350 Stop position command selection** with the Vector control compatible option installed, the rotation direction of the encoder is displayed on the rotation direction display of the PU (operation panel/parameter unit).
 Make settings so that "FWD" is displayed at turn ON of the STF signal and "REV" is displayed at turn ON of the STR signal.

◆ Monitor display change

Monitor	Remarks
Position pulse monitor	When "19" is set in Pr.52 Operation panel main monitor selection , the position pulse monitor is displayed instead of the output voltage monitor of the PU. (Displayed only when a Vector control compatible option is installed.)
Orientation status ^{*1}	When "22" is set in Pr.52 , the orientation status is displayed instead of the output voltage monitor of the PU. (Displayed only when a Vector control compatible option is installed.) 0: Other than orientation operation or orientation speed is not reached 1: Orientation speed is reached 2: Creep speed is reached 3: Position loop is reached 4: Orientation complete 5: Orientation fault (pulse stop) 6: Orientation fault (orientation limit) 7: Orientation fault (recheck)

*1 Invalid under Vector control. ("0" is always displayed.)

◆ Pr.357 Orientation in-position zone (initial value "5")

- The in-position width for orientation stop can be set.
 The initial value of **Pr.357** is "5". To change the $\Delta\theta$ value, make fine adjustments by changing in increments of ± 10 .
- If the position detection value from the encoder enters $\pm\Delta\theta$ during orientation stop, the Orientation complete (ORA) signal is output.

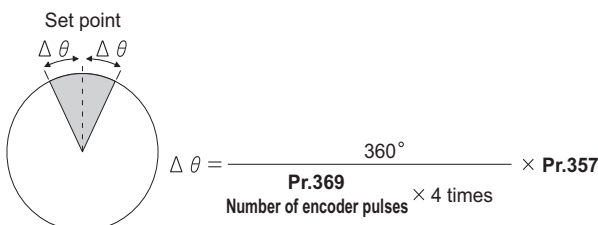

◆ Orientation at the running status (under V/F control, Advanced magnetic flux vector control)

- When the Orientation command (X22) signal turns ON, the motor speed decelerates to **Pr.351 Orientation speed**. (Pr.351 is initially set to 2 Hz.)

2. After the speed reaches the orientation speed, the speed further decreases to the **Pr.352 Creep speed** as soon as the current position pulse reaches the **Pr.353 Creep switchover position**. (Pr.352 is initially set to 0.5 Hz, Pr.353 is initially set to "511".)
3. Moreover, as soon as the current position pulse reaches **Pr.354 Position loop switchover position**, control is changed to the position loop. (Pr.354 is initially set to "96".)
4. After the motor moves into the position loop, the motor decelerates and stops by the DC injection brake as soon as the current position pulse reaches the **Pr.355 DC injection brake start position**. (Pr.355 is initially set to "5".)
5. When the motor stops in the in-position width set in **Pr.357 Orientation in-position zone**, the Orientation complete (ORA) signal is output after **Pr.363 Completion signal output delay time**. If the motor does not stop within the in-position width because of external force or other factors, the ORA signal turns OFF after the time set in **Pr.363**. (Pr.357 is initially set to "5", Pr.363 is initially set to 0.5 s.)
6. If the orientation is not completed continuously in **Pr.365 Orientation limit** after passing the creep switchover position*1, the Orientation fault (ORM) signal is output.
7. After the orientation starts, if the motor is stopped by external force or other factors before reaching the in-position width and the ORA signal is not output, the ORM signal is output after **Pr.364 Encoder stop check time**. If the motor is moved out of the in-position width by external force or other factors after the ORA signal has been output once, the ORA signal turns OFF after the time period set in **Pr.363**. If the orientation is not completed within the time period set in **Pr.364**, the ORM signal is output.
8. If the ORA and ORM signals have been output once, but the start signal (STF or STR) is turned OFF while the X22 signal is ON, the ORA or ORM signal is output again after **Pr.366 Recheck time**.
9. The ORA and ORM signals cannot be output while the X22 signal is OFF.

*1 It means that the current position pulse reaches the creep switchover absolute position and moves in the direction to the start command.
 Creep switchover absolute position is defined as follows.
 Forward rotation: Stop position command - DC injection brake start position (Pr.355) - Creep switchover position (Pr.353)
 Reverse rotation: Stop position command + DC injection brake start position (Pr.355) + Creep switchover position (Pr.353)

NOTE

- When the orientation command turns OFF while the start signal is ON, the speed accelerates to the command speed.

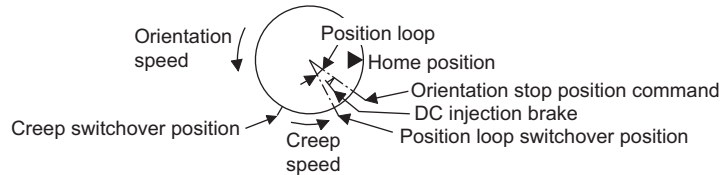

- If hunting of the motor shaft occurs during orientation stop, set a larger value in **Pr.354** or a smaller value in **Pr.352** to prevent it.

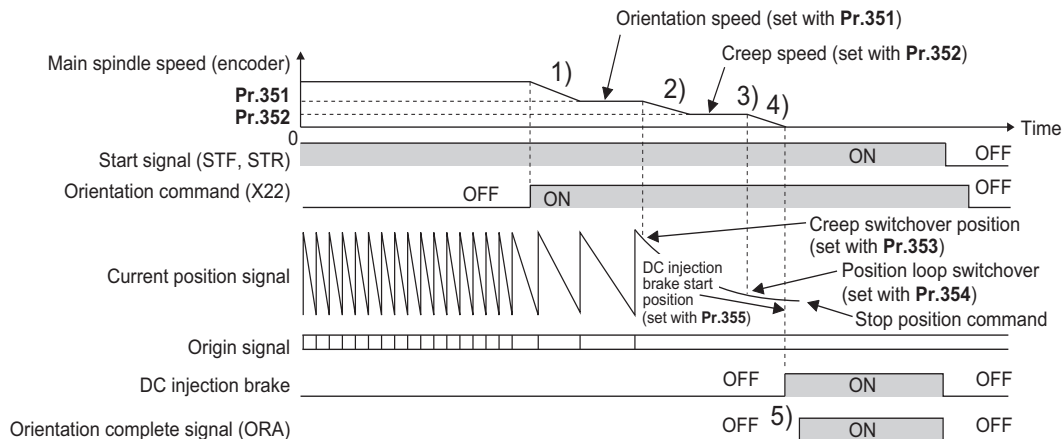

◆ Orientation from the stop status (under V/F control, Advanced magnetic flux vector control)

- Turning ON the start signal after turning ON the Orientation command (X22) signal increases the motor speed to the **Pr.351 Orientation speed**, and then the same orientation operation is performed as the operation shown in "Orientation at the running status".
- Note that the DC injection brake operates without increasing to the orientation speed when the following formula is satisfied: $(\text{Stop position command} - \text{Current position}) \leq (\text{Stop position command} - \text{DC injection brake start position})$

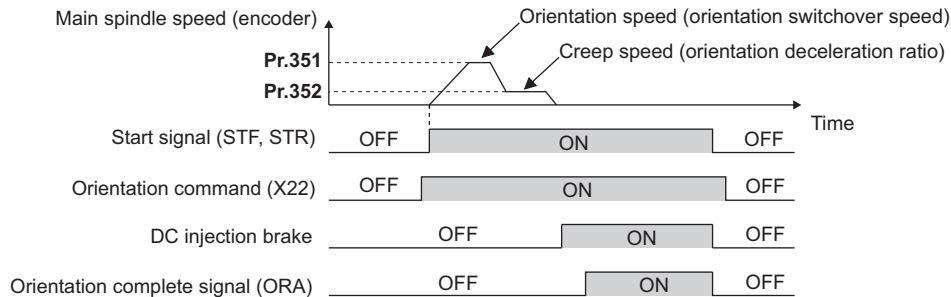

15

NOTE

- The following are precautions for the orientation operation under V/F control or Advanced magnetic flux vector control.
 - Couple the encoder with the motor shaft or with the shaft that stops the main shaft at the specified position. Couple it with the speed ratio of 1:1 and without any mechanical looseness.
 - The DC injection brake operates at orientation stop. Release the DC injection brake as soon as possible (within several seconds), as continuous operation of the DC injection brake will cause the motor to overheat, leading to burnout.
 - Because the servo lock function is not available after orientation stop, provide a holding mechanism, such as a mechanical brake or knock pin, when secure holding of the main shaft is required.
 - To ensure correct positioning, the encoder must be set in the proper rotation direction, and the A and B phases must be connected correctly.
 - If the pulse signal from the encoder stops due to encoder signal loss or other factors during orientation, the Orientation fault (ORM) signal may be output.
 - When performing orientation control, enable the DC injection brake (refer to [page 536](#)). When the DC injection brake is disabled, orientation operation cannot be completed.
 - When orientation control is performed, the DC injection brake operates regardless of the External DC injection brake operation start (X13) signal even when **Pr.11 DC injection brake operation time** = "8888" (DC injection brake external selection).
 - To terminate orientation, the start signal (STF or STR) must be first switched OFF, and then the Orientation command (X22) signal must be switched OFF. As soon as this X22 signal is switched OFF, orientation control ends. (Depending on the **Pr.358 Servo torque selection** setting, the orientation status continues if the X22 signal remains ON even if the DC injection brake is released by turning OFF the start signal. Because of this, the orientation status on the monitor does not show "0".)
 - When the retry function of **Pr.358 Servo torque selection** is selected, the retry operation is performed three times including the first orientation.
 - When performing orientation control, properly set **Pr.350 Stop position command selection**. If the values set are incorrect, proper orientation control will not be performed.
 - Orientation control is disabled under the following conditions:
 - During auto tuning, during PID control, when the automatic acceleration/deceleration function is enabled, when the brake sequence function is enabled, or when the second function is enabled

◆ Servo torque selection (Pr.358) (V/F control, Advanced magnetic flux vector control)

Function and description	Operation for each Pr.358 setting													Remarks	
	0	1	2	3	4	5	6	7	8	9	10	11	12		13
a. Servo torque function until output of the Orientation complete (ORA) signal	x	o	o	o	o	x	o	x	o	x	o	x	x	o	o: With servo torque function. x: Without servo torque function.
b. Retry function	x	x	x	x	x	x	x	o	x	x	x	o	x	x	o: With retry function. x: Without retry function.
c. Output frequency compensation when the motor stops outside the in-position zone	x	x	o	o	x	o	o	x	x	x	x	x	o	o	o: With frequency compensation. x: Without frequency compensation.
d. DC injection brake and servo torque when the motor exits the in-position zone after output of the Orientation complete (ORA) signal	o	x	x	x	x	o	o	o	o	o	o	o	o	o	o: DC injection brake enabled. x: Servo torque enabled.
e. Turning OFF the Orientation complete (ORA) signal when the orientation operation is ended	o	o	o	x	x	o	o	o	o	x	x	x	x	x	o: When the start signal (STF, STR) or orientation command is turned OFF. x: When the orientation command is turned OFF.
f. Complete signal when the motor exits the in-position zone after output of the Orientation complete (ORA) signal	o	o	o	o	o	x	x	x	x	x	x	x	x	x	o: Turns OFF the complete signal when the motor exits the in-position zone. x: Complete signal remains ON even if the motor exits the in-position zone (the Orientation fault (ORM) signal is not output).

NOTE

- When the orientation command turns OFF while the start signal is ON, the motor accelerates to the command speed.
- When the motor shaft stops outside of the set setting range of the stop position, the motor shaft is returned to the stop position by the servo torque function (if enough torque is generated).

- a. Servo torque function until output of the Orientation complete signal
Select whether or not servo torque is available using **Pr.358 Servo torque selection**. Servo torque is not generated if the current position pulse is in between the orientation stop position and DC injection brake start position. The shaft is fixed using the DC injection brake, and when the motor exits the width by external force or other factors, the servo torque is generated to move the motor back within the width. Once the Orientation complete (ORA) signal is output, the operation is performed as described in d.
- b. Retry function
Select retry function using **Pr.358**. Note that the retry function cannot be used together with the servo torque function. If the motor shaft does not stop within the in-position zone when the motor stop is checked, orientation operation is performed again by the retry function. This retry function is performed three times including the first orientation. The maximum retry number is three. (The Orientation fault (ORM) signal is not output during retry operation.)
- c. Frequency compensation when the motor stops outside the orientation complete width
When the motor stops before entering the in-position width due to external force or other factors, the output frequency is increased to move the shaft to the orientation stop position. The output frequency is gradually increased to the **Pr.352 Creep speed**. This function cannot be used with the retry function.
- d. DC injection brake and servo torque selection when the motor exits the in-position zone after output of the ORA signal
If the motor exits the in-position width, select the setting either to fix the shaft with the DC injection brake or by returning the motor to the orientation stop position with the servo torque.
- e. Turning OFF the Orientation complete (ORA) signal when the orientation operation is ended.
When ending the orientation operation, first turn OFF the start (STF or STR) signal, and then turn OFF the Orientation command X22 signal. At this time, select when to turn OFF the ORA signal from either the time the start signal is turned OFF or the time the X22 signal is turned OFF.
- f. Complete signal when the motor exits the in-position zone after output of the ORA signal
Select to turn OFF the ORA signal or to keep the ORA signal ON (the ORM signal is not output) when the motor exits the in-position width.

◆ **Position loop gain (Pr.362) (V/F control, Advanced magnetic flux vector control)**

- When the servo torque function is selected using **Pr.358 Servo torque selection**, the output frequency for generating servo torque gradually increases to the **Pr.352 Creep speed** according to the slope set in **Pr.362 Orientation position loop gain**.
- Although the operation becomes faster when the value is increased, hunting may occur in the machine.

◆ **Description of orientation operation (Vector control)**

- Setting the rotation direction (**Pr.393 Orientation selection**)

Pr.393 setting	Rotation direction	Remarks	
0 (initial value)	Pre-orientation	Orientation is executed to the current rotation direction.	Motor end orientation
1	Forward rotation orientation	Orientation is executed to the forward rotation direction. (If the motor is running in reverse, orientation is executed to the forward rotation direction after deceleration.)	
2	Reverse rotation orientation	Orientation is executed to the forward rotation direction. (If the motor is running forward, orientation is executed to the reverse rotation direction after deceleration.)	

◆ Orientation to the current rotation direction (Pr.393 = "0 (initial value)") (Vector control)

- When the Orientation command (X22) signal is input, the motor speed decelerates from the running speed to **Pr.351 Orientation speed**. At the same time, the orientation stop position command is read in. (The stop position command is determined by the setting of **Pr.350 Stop position command selection**.)



- When the orientation switchover speed is reached, the encoder Z phase pulse is confirmed, and the control changes from speed control to position control (**Pr.362 Orientation position loop gain**).
- The distance to the orientation stop position is calculated at switching of the control, and the motor decelerates to a stop with a set deceleration pattern (**Pr.399 Orientation deceleration ratio**) and enters the orientation (servo lock) state.
- Once in the **Pr.357 Orientation in-position zone**, the Orientation complete (ORA) signal is output.
- The home position can be moved using **Pr.361 Position shift**.

⚠ CAUTION

- If the X22 signal is turned OFF while the start signal is input, the motor accelerates toward the speed of the current speed command. To stop the motor, turn the Forward rotation (Reverse rotation) signal OFF.

◆ Orientation to the forward rotation direction (Pr.393 = "1") (Vector control)

- This method is used to improve the stopping precision and maintain the mechanical precision when the backlash is large.
- If the motor is running in forward, it executes an orientation stop with the same method as "orientation to the current rotation direction".
- If the motor is running in reverse, the motor decelerates and rotates to the forward rotation direction, and then orientation stop is executed.

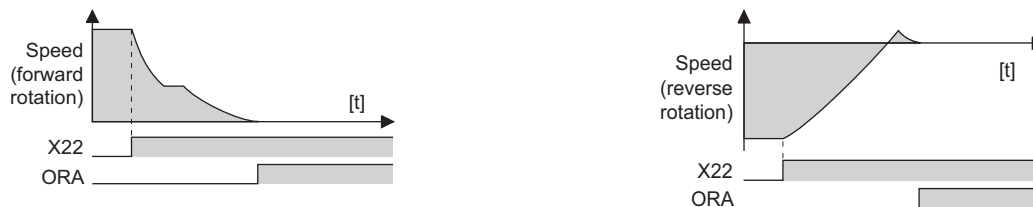

◆ Orientation to the reverse rotation direction (Pr.393 = "2") (Vector control)

- If the motor is running in reverse, it executes an orientation stop with the same method as "orientation to the current rotation direction".
- If the motor is running in forward, the motor decelerates and rotates to the reverse rotation direction, and then orientation stop is executed.



- The following are precautions for the orientation operation under V/F control.
 - Couple the encoder with the motor shaft that stops the shaft at the specified position. Couple it with the speed ratio of 1:1 and without any mechanical looseness.
 - To ensure correct positioning, the encoder must be set in the proper rotation direction, and the A and B phases must be connected correctly.
 - If the pulse signal from the encoder stops due to encoder signal loss or other factors during orientation, orientation may not be completed.
 - The X13 signal is valid until the speed reaches the orientation speed and the encoder Z phase pulse is detected.
 - To terminate orientation, the start signal (STF or STR) must be first switched OFF, and then the X22 signal must be switched OFF. As soon as this X22 signal is switched OFF, orientation control ends.
 - When performing orientation control, properly set **Pr.350 Stop position command selection**. If the values set are incorrect, proper orientation control will not be performed.
 - Orientation control is disabled under the following conditions:
 - During auto tuning, during PID control, when the automatic acceleration/deceleration function is enabled, when the brake sequence function is enabled, or when the second function is enabled
 - If Signal loss detection (E.ECT) is activated while the X22 signal is ON, check for a break in the cable of the Z phase of the encoder.

◆ Servo rigidity adjustment (Pr.362, Pr.396 to Pr.398) (Vector control)

- To increase the servo rigidity^{*1} during orientation stop using **Pr.396 Orientation speed gain (P term)** or **Pr.397 Orientation speed integral time**, make adjustments with the following procedures.

1. Increase the **Pr.362 Orientation position loop gain** setting value to the extent that rocking^{*2} does not occur during orientation stop.

2. Increase **Pr.396** and **Pr.397** at the same rate.

Normally, adjust **Pr.396** in the range from 10 to 100, and **Pr.397** from 0.1 to 1.0 s.

(Note that these do not need to be set to the same rate.)

<Example>

When the **Pr.396** setting value is multiplied by 1.2, divide the **Pr.397** setting value by 1.2.

If vibration occurs during orientation stop, the scale cannot be raised any higher.

3. **Pr.398 Orientation speed gain (D term)** is the lag/advance compensation gain.

The limit cycle^{*3} can be prevented by increasing the value, and operation can be stopped stably. However, the torque decreases in relation to the position deviation, and the motor stops with deviation.

*1 Servo rigidity: The response when a position control loop is configured.

When the servo rigidity is raised, the holding force increases and operation becomes stable, but vibration occurs more easily.

When the servo rigidity is lowered, the holding force decreases, and the settling time increases.

*2 Rocking: Movement in which return occurs when the stopping position is exceeded.

*3 Limit cycle: A phenomenon that generates \pm continuous vibration centering on the target position.

Point

- Application of lag/advance control and PI control
PI control can be applied by setting **Pr.398** = "0". Normally, use the lag/advance control. PI control should be used when using a machine with a high spindle static friction torque requires a stop position accuracy.
- During orientation control, gain cannot be adjusted using **Pr.820 Speed control P gain 1**, **Pr.821 Speed control integral time 1**, and **Pr.698 Speed control D gain**.

◆ Pr.399 Orientation deceleration ratio (initial value: 20) (Vector control)

- Make adjustments with the following procedures according to the orientation status. (Make adjustments in the order of a, b, and c.)

Normally, adjust **Pr.362 Orientation position loop gain** in the range from 5 to 20, and **Pr.399 Orientation deceleration ratio** from 5 to 50.

Condition	Adjustment procedure
Rocking occurs during stopping	a. Decrease the Pr.399 setting. b. Decrease the Pr.362 setting. c. Increase the Pr.396 and Pr.397 settings.
The orientation time is long.	a. Increase the Pr.399 setting. b. Increase the Pr.362 setting.
Hunting occurs during stopping	a. Decrease the Pr.362 setting. b. Decrease the Pr.396 setting and increase the Pr.397 setting.
Low servo rigidity during stopping	a. Increase the Pr.396 setting and decrease the Pr.397 setting. b. Increase the Pr.362 setting.

NOTE

- If the orientation stop operation fails and the Excessive position fault occurs, or if the motor performs forward/reverse reciprocation operation, review the settings of **Pr.393 Orientation selection** (on page 469) and **Pr.359 Encoder rotation direction** (on page 468).

◆ Pr.351 Orientation speed (initial value: 2 Hz) (Vector control)

- Set the speed when switching between the speed control mode and the position control mode is performed under orientation operation.

Decreasing the set speed enables stable orientation stop. Note that the orientation time increases.

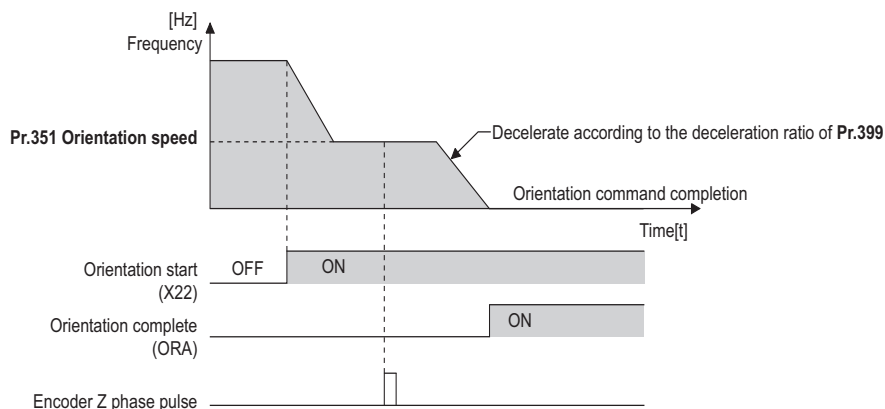

NOTE

- When "19" is set in **Pr.52 Operation panel main monitor selection**, the position pulse monitor is displayed instead of the output voltage monitor on the PU.

15.6 PID control

Process control such as flow rate, air volume or pressure are possible on the inverter.

A feedback system can be configured and PID control can be performed with the set point and feed back values set by analog input signals (terminals 2 and 4) or using parameter values given via communication or by the PLC function.

Pr.	Name	Initial value	Setting range	Description
127 A612	PID control automatic switchover frequency	9999	0 to 590 Hz	Set the value at which control is automatically switched to PID control.
			9999	No PID control automatic switchover function
128 A610	PID action selection	0	0, 20, 21, 50, 51, 60, 61, 1000, 1001, 1010, 1011, 2000, 2001, 2010, 2011	Select how to input the deviation value, measured value and set point, and forward and reverse action.
			40 to 43	Refer to page 495 .
129 A613	PID proportional band	100%	0.1% to 1000%	If a narrow proportional band is set (small parameter setting value), the manipulated amount changes considerably by slight changes in the measured value. As a result, response improves as the proportional band becomes narrower, though stability worsens as shown by the occurrence of hunting. Gain $K_p=1/\text{proportional band}$
			9999	No proportional control
130 A614	PID integral time	1 s	0.1 to 3600 s	With deviation step input, this is the time (Ti) used for obtaining the same manipulated amount as proportional band (P) by only integral (I) action. Arrival to the set point becomes quicker the shorter an integral time is set, though hunting is more likely to occur.
			9999	No integral control
131 A601	PID upper limit	9999	0% to 100%	Set the upper limit. The FUP signal is output when the feedback value exceeds this setting. The maximum input (20 mA/5 V/10 V) of the measured value is equivalent to 100%.
			9999	No function
132 A602	PID lower limit	9999	0% to 100%	Set the lower limit. The FDN signal is output when the measured value falls below the setting range. The maximum input (20 mA/5 V/10 V) of the measured value is equivalent to 100%.
			9999	No function
133 A611	PID action set point	9999	0% to 100%	Set the set point during PID control.
			9999	Set point set by Pr.128 .
134 A615	PID differential time	9999	0.01 to 10 s	With deviation ramp input, this is the time (Td) used for obtaining the manipulated amount only by proportional action (P). Response to changes in deviation increase greatly as the differential time increases.
			9999	No differential control
553 A603	PID deviation limit	9999	0% to 100%	The Y48 signal is output when the absolute value of the deviation exceeds the deviation limit value.
			9999	No function
554 A604	PID signal operation selection	0	0 to 3, 10 to 13	The action when the upper or lower limit for a measured value input is detected or when a limit for the deviation is detected can be selected. The operation for PID output suspension function can be selected.
575 A621	Output interruption detection time	1 s	0 to 3600 s	When the output frequency after PID calculation stays less than the Pr.576 setting for the time set in Pr.575 or more, the inverter operation is suspended.
			9999	No output interruption function
576 A622	Output interruption detection level	0 Hz	0 to 590 Hz	Set the frequency at which output interruption is performed.
577 A623	Output interruption cancel level	1000%	900% to 1100%	Level at which the PID output suspension function is released. Set " Pr.577 - 1000%".
609 A624	PID set point/deviation input selection	2	2	The set point or deviation value is input through terminal 2.
			3	The set point or deviation value is input through terminal 4.
			4	The set point or deviation value is input via communication.
			5	The set point or deviation value is input by the PLC function.

Pr.	Name	Initial value	Setting range	Description
610 A625	PID measured value input selection	3	2	The measured value is input through terminal 2.
			3	The measured value is input through terminal 4.
			4	The measured value is input via communication.
			5	The measured value is input by the PLC function.
1015 A607	Integral stop selection at limited frequency	0	0	The integral stops when the manipulated amount is limited. The range is $\pm 100\%$ for the manipulated amount.
			1	The integral does not stop when the manipulated amount is limited. The range is $\pm 100\%$ for the manipulated amount.
			2	The integral stops when the manipulated amount is limited. The range is 0% to 100% for the manipulated amount.

◆ Basic configuration of PID control

■ Pr.128 = "50, 51, 1010, 1011, 2010, 2011" (deviation input)

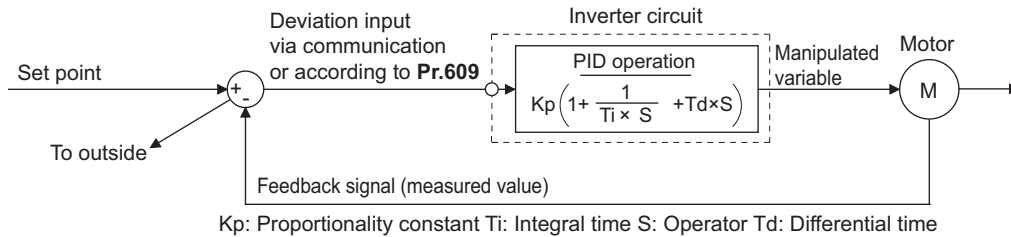

■ Pr.128 = "20, 21" (measured value input)

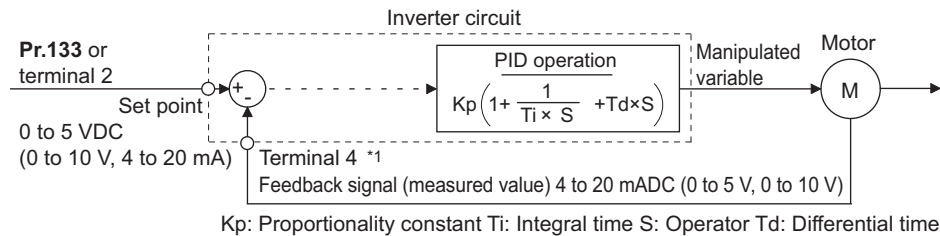

*1 Set "0" to Pr.858 Terminal 4 function assignment. When Pr.858 \neq "0", PID control is invalid.

◆ PID action outline

■ PI action

PI action is a combination of proportional action (P) and integral action (I), and applies a manipulated amount according to the size of the deviation and transition or changes over time.

[Example of action when the measured value changes in a stepped manner]

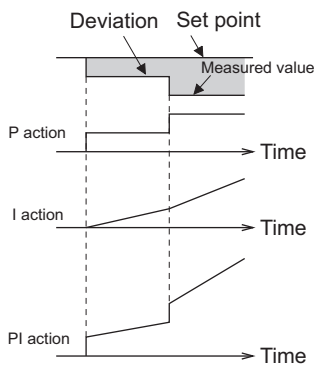

(Note) PI action is the result of P and I actions being added together.

■ PD action

PD action is a combination of proportional action (P) and differential action (D), and applies a manipulated amount according to the speed of the deviation to improve excessive characteristics.

[Example of action when the measured value changes proportionately]

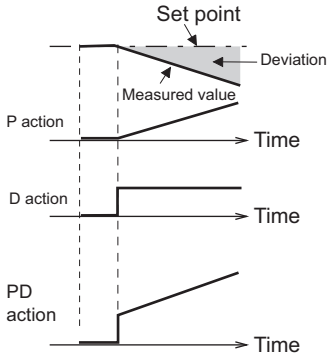

(Note) PD action is the result of P and D actions being added together.

■ PID action

PID action is a combination of PI and PD action, which enables control that incorporates the respective strengths of these actions.

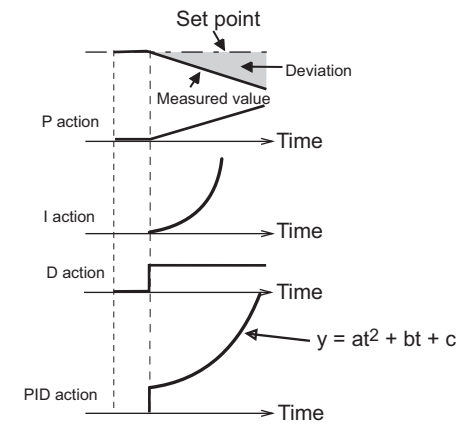

(Note) PID action is the result of all P, I, and D actions being added together.

■ Reverse action

When deviation $X = (\text{set point} - \text{measured value})$ is a plus value, the manipulated amount (output frequency) is increased, and when the deviation is a minus value, the manipulated amount is decreased.

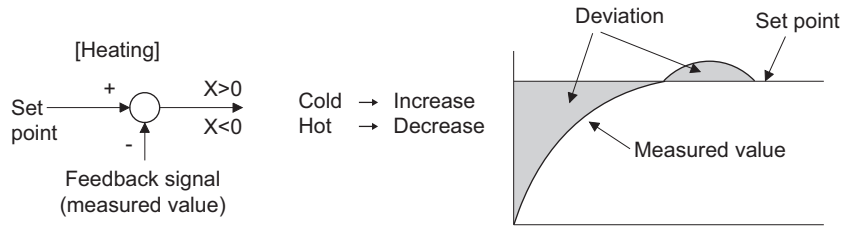

■ Forward action

When deviation $X = (\text{set point} - \text{measured value})$ is a minus value, the manipulated amount (output frequency) is increased, and when the deviation is a plus value, the manipulated amount is decreased.

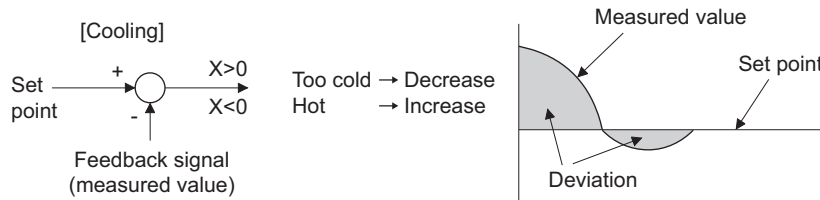

Relationship between deviation and manipulated amount (output frequency)

PID action setting	Deviation	
	Plus	Minus
Reverse action	↗	↘
Forward action	↘	↗

◆ Connection diagram

- Sink logic
- **Pr.128** = "20"
- **Pr.182** = "14"
- **Pr.190** = "15"
- **Pr.191** = "14"
- **Pr.192** = "16"

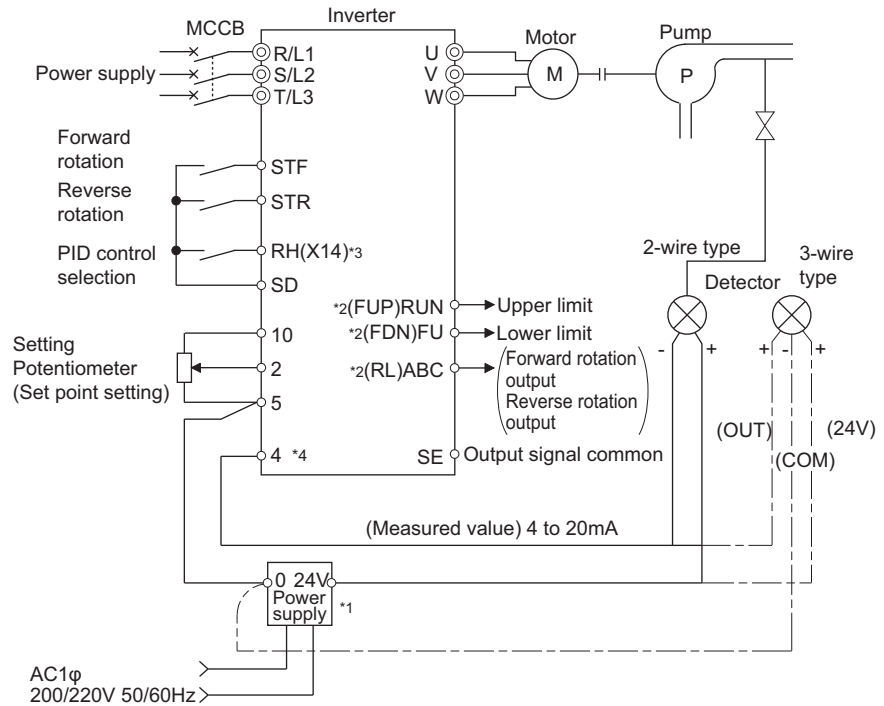

- *1 Prepare a power supply matched to the power supply specifications of the detector.
- *2 The applied output terminals differ by the settings of **Pr.190 to Pr.197 (Output terminal function selection)**.
- *3 The applied input terminals differ by the settings of **Pr.178 to Pr.189 (Input terminal function selection)**. Assigning the PID control valid (X14) signal to an input terminal enables PID control to be performed only when the X14 signal is turned ON.
- *4 The AU signal need not be input.

◆ Selection of deviation value, measured value and set point input method, and PID action method (Pr.128, Pr.609, Pr.610)

- Using **Pr.128**, select the input method for the PID set point, measured value detected by the meter, and externally calculated deviation. Also, select forward or reverse action.

- Switch the power voltage/current specifications of terminals 2 and 4 by **Pr.73 Analog input selection** or **Pr.267 Terminal 4 input selection** to match the specification of the input device. After changing the **Pr.73** or **Pr.267** settings, check the voltage/current input selection switch. Incorrect setting may cause a fault, failure, or malfunction. (Refer to [page 392](#) for the setting.)

Pr.128 setting	Pr.609 Pr.610	PID action	Set point input	Measured value input	Deviation input
0		PID invalid	—	—	—
20	Invalid	Reverse action	Terminal 2 or Pr.133 ^{*1}	Terminal 4	—
21		Forward action			
40 to 43	Enabled	Dancer control	For details on dancer control, refer to page 495 .		
50	Invalid	Reverse action	—	—	Communication ^{*2}
51		Forward action	—	—	Communication ^{*2}
60		Reverse action	Communication ^{*2}	Communication ^{*2}	—
61		Forward action	Communication ^{*2}	Communication ^{*2}	—
1000	Enabled	Reverse action	According to Pr.609 ^{*1}	According to Pr.610	—
1001		Forward action			
1010		Reverse action	—	—	According to Pr.609
1011		Forward action	—	—	According to Pr.609
2000		Reverse action (without frequency reflected)	According to Pr.609 ^{*1}	According to Pr.610	—
2001		Forward action (without frequency reflected)			
2010		Reverse action (without frequency reflected)	—	—	According to Pr.609
2011		Forward action (without frequency reflected)			

*1 When **Pr.133** ≠ "9999", the **Pr.133** setting is valid.

*2 CC-Link, CC-Link IE TSN, CC-Link IE Field Network Basic, BACnet/IP, and BACnet MS/TP are available. For details on each communication, refer to the FR-A8NC E kit Instruction Manual or the Instruction Manual (Communication). CC-Link communication is unavailable when the IP67 model is used.

- The set point/deviation input method can also be flexibly selected by **Pr.609 PID set point/deviation input selection** and the measured value input method can be selected by **Pr.610 PID measured value input selection**. Selection by **Pr.609** and **Pr.610** is valid when **Pr.128** = "1000 to 2011".

Pr.609 and Pr.610 settings	Input method
2	Terminal 2 ^{*3}
3	Terminal 4 ^{*3}
4	Communication ^{*4}
5	PLC function

*3 When the same input method has been selected for the set point and measured value at **Pr.609** and **Pr.610**, set point input is invalid. (Inverter runs at set point 0%)

*4 CC-Link, CC-Link IE TSN, CC-Link IE Field Network Basic, BACnet/IP, and BACnet MS/TP are available. For details on each communication, refer to the FR-A8NC E kit Instruction Manual or the Instruction Manual (Communication). CC-Link communication is unavailable when the IP67 model is used.

NOTE

- When terminals 2 and 4 are selected for deviation input, perform bias calibration using **C3 (Pr.902)** and **C6 (Pr.904)** to prevent a minus voltage from being entered as the deviation input signal. Input of a minus voltage might damage devices and the inverter.

- The following shows the relationship between the input values of the analog input terminals and set point, measured value and deviation. (Calibration parameter initial values)

Input terminal	Input specification ^{*5}	Relationship with analog input			Calibration parameter
		Set point	Result	Deviation	
Terminal 2	0 to 5 V	0 V = 0% 5 V = 100%	0 V = 0% 5 V = 100%	0 V = 0% 5 V = 100%	Pr.125, C2 to C4 (Pr.902, Pr.903)
	0 to 10 V	0 V = 0% 10 V = 100%	0 V = 0% 10 V = 100%	0 V = 0% 10 V = 100%	
	0 to 20 mA	0 mA = 0% 20 mA = 100%	0 mA = 0% 20 mA = 100%	0 mA = 0% 20 mA = 100%	
Terminal 4	0 to 5 V	0 to 1 V = 0% 5 V = 100%	0 to 1 V = 0% 5 V = 100%	0 V = -20% 1 V = 0% 5 V = 100%	Pr.126, C5 to C7 (Pr.904, Pr.905)
	0 to 10 V	0 to 2 V = 0% 10 V = 100%	0 to 2 V = 0% 10 V = 100%	0 V = -20% 2 V = 0% 10 V = 100%	
	0 to 20 mA	0 to 4 mA = 0% 20 mA = 100%	0 to 4 mA = 0% 20 mA = 100%	0 mA = -20% 4 mA = 0% 20 mA = 100%	

*5 Can be changed by Pr.73 Analog input selection, Pr.267 Terminal 4 input selection and the voltage/current input switch. (Refer to page 392.)

NOTE

- Always calibrate the input after changing the voltage/current input specification with Pr.73 and Pr.267, and the voltage/current input selection switch.

◆ PID input method according to the operation mode

- The input methods of the set point, measured value, and deviation differ depending on the operation mode as follows.
- Set point input

PID action selection		Command source	PU operation External operation	Network operation		PLC function
Pr.128	Pr.609			BACnet communication ^{*1}	Other communication ^{*2}	
60, 61	—	Communication	PID control disabled	ANALOG VALUE 310	Communication (PID set point) ^{*5}	—
1000, 1001	4			Pr.133 setting / ANALOG VALUE 310 ^{*4}	Pr.133 setting / Communication (PID set point) ^{*4*5}	
1000, 1001	5	PLC function	—	—	—	Pr.133 setting / SD1248 ^{*3*4}
20, 21	—	External	Pr.133 setting / External terminal ^{*4}	Pr.133 setting / External terminal ^{*4}	Pr.133 setting / External terminal ^{*4}	—
1000, 1001	2, 3					

*1 BACnet/IP and BACnet MS/TP are available.

*2 CC-Link, CC-Link IE TSN, and CC-Link IE Field Network Basic are available.

*3 Input value is "0" when the PLC function is disabled. PID control is disabled when bit 0 of SD1255 is "0".

*4 When Pr.133 ≠ "9999", the Pr.133 setting is used for the set point.

*5 When communication is not specified for the command source in the Network operation mode or when the speed command source is other than communication, the set point cannot be input via communication. Instead, it can be input via an external terminal (PID control is enabled).

- Measured value input

PID action selection		Command source	PU operation External operation	Network operation		PLC function
Pr.128	Pr.610			BACnet communication ^{*6}	Other communication ^{*7}	
60, 61	—	Communication	PID control disabled (terminal 4) ^{*8}	ANALOG VALUE 311	Communication (PID measured value) ^{*8}	—
1000, 1001	4					
1000, 1001	5	PLC function	—	—	—	SD1249 ^{*9}
20, 21	—	External	External terminal ^{*10}	External terminal ^{*10}	External terminal ^{*10}	—
1000, 1001	2, 3					

*6 BACnet/IP and BACnet MS/TP are available.

*7 CC-Link, CC-Link IE TSN, and CC-Link IE Field Network Basic are available.

*8 The item in the parentheses can be always monitored by the measured value monitor.

*9 Input value is "0" when the PLC function is disabled. PID control is disabled when bit 0 of SD1255 is "0".

*10 The measured value is input via the external terminal set in Pr.610.

- Deviation input

PID action selection		Command source	PU operation External operation	Network operation		PLC function
Pr.128	Pr.609			BACnet communication ^{*11}	Other communication ^{*12}	
60, 61	—	Communication	PID control disabled	ANALOG VALUE 312	Communication (PID deviation)	—
1010, 1011	4					
70, 71	—	PLC function	—	—	—	SD1248 ^{*13}
1010, 1011	5					
1010, 1011	2, 3	External	External terminal ^{*14}	External terminal ^{*14}	External terminal ^{*14}	—

*11 BACnet/IP and BACnet MS/TP are available.

*12 CC-Link, CC-Link IE TSN, and CC-Link IE Field Network Basic are available.

*13 Input value is "0" when the PLC function is disabled. PID control is disabled when bit 0 of SD1255 is "0".

*14 The deviation is input via the external terminal set in Pr.609.

◆ Input/output signals

- Assigning the PID control valid signal (X14) to the input terminal by **Pr.178 to Pr.189 (Input terminal function selection)** enables PID control to be performed only when the X14 signal is turned ON. When the X14 signal is OFF, regular inverter running is performed without PID action. (When the X14 signal is not assigned, PID control is enabled only by setting **Pr.128** ≠ "0".)
- Input signal

Signal	Function	Pr.178 to Pr.189 setting	Description
X14	PID control valid	14	When this signal is assigned to the input terminal, PID control is enabled when this signal is ON.
X72	PID P control switchover	72	Only proportional term is valid when this signal is turned ON. (Integral and differential values are reset.)

- Output signal

Signal	Function	Pr.190 to Pr.197 settings		Description
		Positive logic	Negative logic	
FUP	PID upper limit	15	115	Output when the measured value signal exceeds Pr.131 PID upper limit .
FDN	PID lower limit	14	114	Output when the measured value signal falls below Pr.132 PID lower limit .
RL	PID forward/reverse rotation output	16	116	"Hi" is output when the output display of the operation panel is forward rotation (the RUN LED is ON) and "Low" is output when the display is reverse rotation (the RUN LED blinks) and stop (the RUN LED is OFF). "Hi" is output when the output display of the parameter unit is forward rotation (FWD) and "Low" is output when the display is reverse rotation (REV) and stop (STOP).
PID	During PID control activated	47	147	Turns ON during PID control. When the PID calculation result is reflected to the output frequency (Pr.128 < "2000"), the PID signal turns OFF at turn OFF of the start signal. When the PID calculation result is not reflected to the output frequency (Pr.128 ≥ "2000"), the PID signal turns ON during PID calculation regardless of the start signal status.
Y48	PID deviation limit	48	148	Output when the absolute deviation value exceeds the limit value set in Pr.553 PID deviation limit .
SLEEP	PID output interruption	70	170	Set Pr.575 Output interruption detection time ≠ "9999". This signal turns ON when the PID output suspension function is activated.

NOTE

- Changing the terminal functions with **Pr.178 to Pr.189** and **Pr.190 to Pr.197** may affect other functions. Set parameters after confirming the function of each terminal.

◆ PID automatic switchover control (Pr.127)

- The system can be started up more quickly by starting up without PID control activated.

- When **Pr.127 PID control automatic switchover frequency** is set, the startup is made without PID control until the output frequency reaches the **Pr.127** setting. Once the PID control starts, the PID control is continued even if the output frequency drops to **Pr.127** setting or lower.

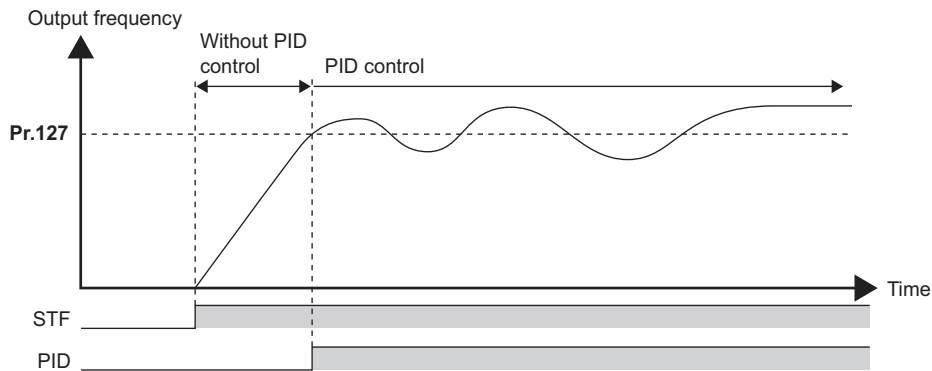

◆ Operation selection and sleep function stop selection when a value error is detected (FUP signal, FDN signal, Y48 signal, Pr.554)

- Using **Pr.554 PID signal operation selection**, set the action when the measured value input exceeds the upper limit (**Pr.131 PID upper limit**) or lower limit (**Pr.132 PID lower limit**), or when the deviation input exceeds the permissible value (**Pr.553 PID deviation limit**).
- Choose whether to output the signals (FUP, FDN, Y48) only or to activate the protective function to output the inverter shutoff.
- The stop action when the inverter output is shut off by the sleep function can be selected.

Pr.554 setting	Inverter operation		
	At FUP/FDN signal output ^{*1}	At Y48 signal output ^{*1}	At sleep operation start
0 (initial value)	Signal output only	Signal output only	Coasts to stop
1	Signal output + output shutoff (E.PID)		
2	Signal output only	Signal output + output shutoff (E.PID)	
3	Signal output + output shutoff (E.PID)	Signal output only	Deceleration stop
10	Signal output only		
11	Signal output + output shutoff (E.PID)		
12	Signal output only	Signal output + output shutoff (E.PID)	
13	Signal output + output shutoff (E.PID)		

*1 When each of **Pr.131**, **Pr.132** and **Pr.553** settings corresponding to each of the FUP, FDN and Y48 signals is "9999" (no function), signal output and protective function are not available.

◆ PID output suspension function (sleep function) (SLEEP signal, Pr.575 to Pr.577)

- When a status where the output frequency after PID calculation is less than **Pr.576 Output interruption detection level** has continued for the time set in **Pr.575 Output interruption detection time** or longer, inverter running is suspended. This allows the amount of energy consumed in the inefficient low-speed range to be reduced.
- When the deviation (set point - measured value) reaches the PID output shutoff release level (**Pr.577** setting value -1000%) while the PID output suspension function is activated, the PID output suspension function is released, and PID control operation is automatically restarted.
- Whether to allow motor to coast to a stop or perform a deceleration stop when sleep operation is started can be selected using **Pr.554**.
- While the PID output suspension function is activated, the PID output interruption (SLEEP) signal is output. During this time, the Inverter running (RUN) signal turns OFF and the During PID control activated (PID) signal turns ON.

- For the SLEEP signal output, set "70" (positive logic) or "170" (negative logic) in any parameter from **Pr.190 to Pr.197 (Output terminal function selection)** to assign the function.

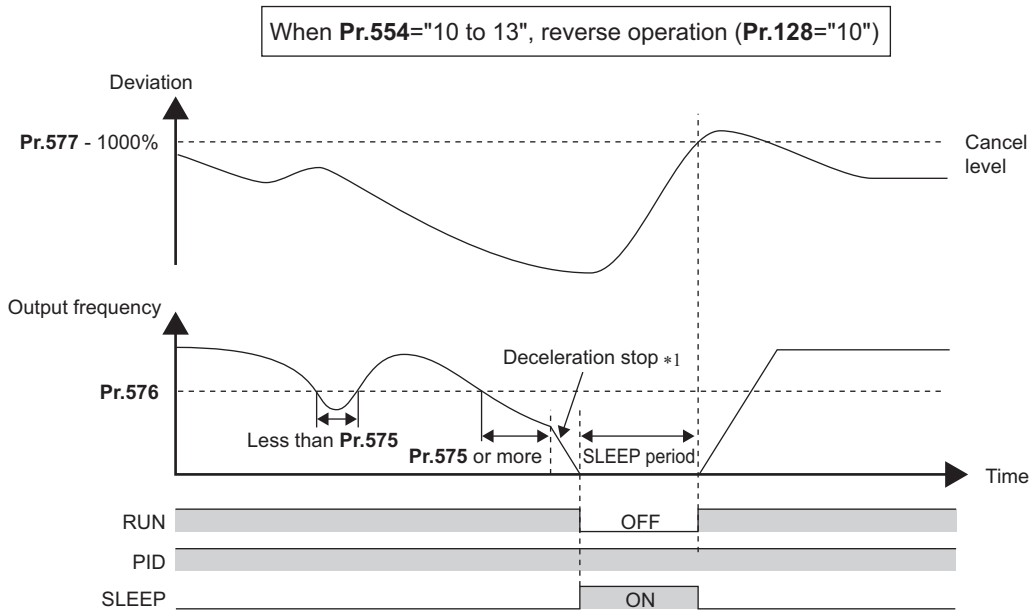
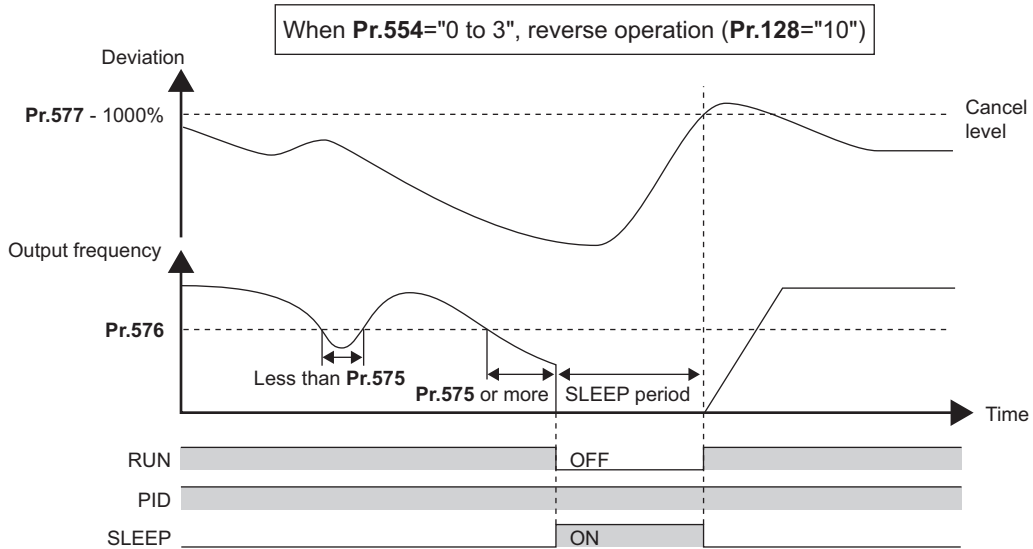

*1 When the PID output shutoff release level is reached during a deceleration stop, output shutoff is released, operation is re-accelerated and PID control is continued. During deceleration, **Pr.576 Output interruption detection level** is invalid.

◆ Integral stop selection when the frequency is limited (Pr.1015)

- The operation for the integral term can be selected when the frequency or the manipulated amount is limited during PID control.
- The manipulation range can be selected.

Pr.1015 setting	Operation at limited frequency	Range of manipulation
0 (initial value)	Integral stop	-100% to +100%
1	Integral does not stop.*1	
2	Integral stop	0% to 100%

*1 When the frequency reaches the upper limit, or when the PID manipulated amount reaches 100%, the integral stops and the integral term is retained. When the frequency decreases, the integral does not stop until the manipulated amount reaches -100%, regardless of the output frequency.

NOTE

- While the integral stop is selected, the integral stop is enabled when any of the following conditions is met.

Integral stop conditions
<ul style="list-style-type: none"> • The frequency reaches the upper or lower limit. • The manipulated amount reaches plus or minus 100% (Pr.1015 = "0"). • The manipulated amount reaches 0% or 100% (Pr.1015 = "2").

◆ PID monitor function

- This function displays the PID control set point, measured value and deviation on the operation panel, and can output these from the terminals FM and AM.
- An integral value indicating a negative % can be displayed on the deviation monitor. 0% is displayed as 1000. (These values cannot be output on the deviation monitor from terminals FM.)
- Set the following values to **Pr.52 Operation panel main monitor selection, Pr.774 to Pr.776 (Operation panel monitor selection), Pr.992 Operation panel setting dial push monitor selection, Pr.54 FM terminal function selection and Pr.158 AM terminal function selection** for each monitor.

Parameter Setting	Monitor description	Minimum increment	Monitor range			Remarks
			Terminal FM	Terminal AM	Operation panel	
52	PID set point	0.1%	0% to 100% ^{*1}			"0" is displayed at all times when PID control is based in deviation input.
53	PID measured value					
67	PID measured value 2	0.1%	0% to 100% ^{*1}			Displays PID measured value even if the PID control operating conditions are not satisfied while the PID control is enabled. "0" is displayed at all times when PID control is based in deviation input.
54	PID deviation	0.1%	Setting not available	-100% to 100% ^{**2}	900% to 1100%	Using Pr.290 Monitor negative output selection , negative values can be output to the terminal AM.
91	PID manipulated amount	0.1%	Setting not available	-100% to 100% ^{**2}	900% to 1100%	The indicated values are from "900%" to "1100%" on the operation panel. (0% is offset and displayed as "1000%.")

*1 When **C42 (Pr.934)** and **C44 (Pr.935)** are set, the minimum increment changes from unit % to no unit, and the monitor range can be changed. (Refer to [page 492](#).)

*2 When the minus value display is set disabled using **Pr.290**, the terminal AM output becomes "0".

◆ Adjustment procedure

1. Enable PID control
When **Pr.128** ≠ "0", PID control is enabled.
Set the set point, measured value and deviation input methods at **Pr.128, Pr.609 and Pr.610**.
2. Setting the parameter
Adjust the PID control parameters of **Pr.127, Pr.129 to Pr.134, Pr.553, Pr.554, Pr.575 to Pr.577**.
3. Terminal setting
Set the I/O terminals for PID control. (**Pr.178 to Pr.189 (Input terminal function selection), Pr.190 to Pr.197 (Output terminal function selection)**)
4. Turing ON the X14 signal assigned to the input terminal
When the X14 signal is assigned to the input terminal, PID control is enabled by the X14 signal turning ON.
5. Operation

◆ Calibration example

(Adjust room temperature to 25°C by PID control using a detector that outputs 4 mA at 0°C and 20 mA at 50°C.)

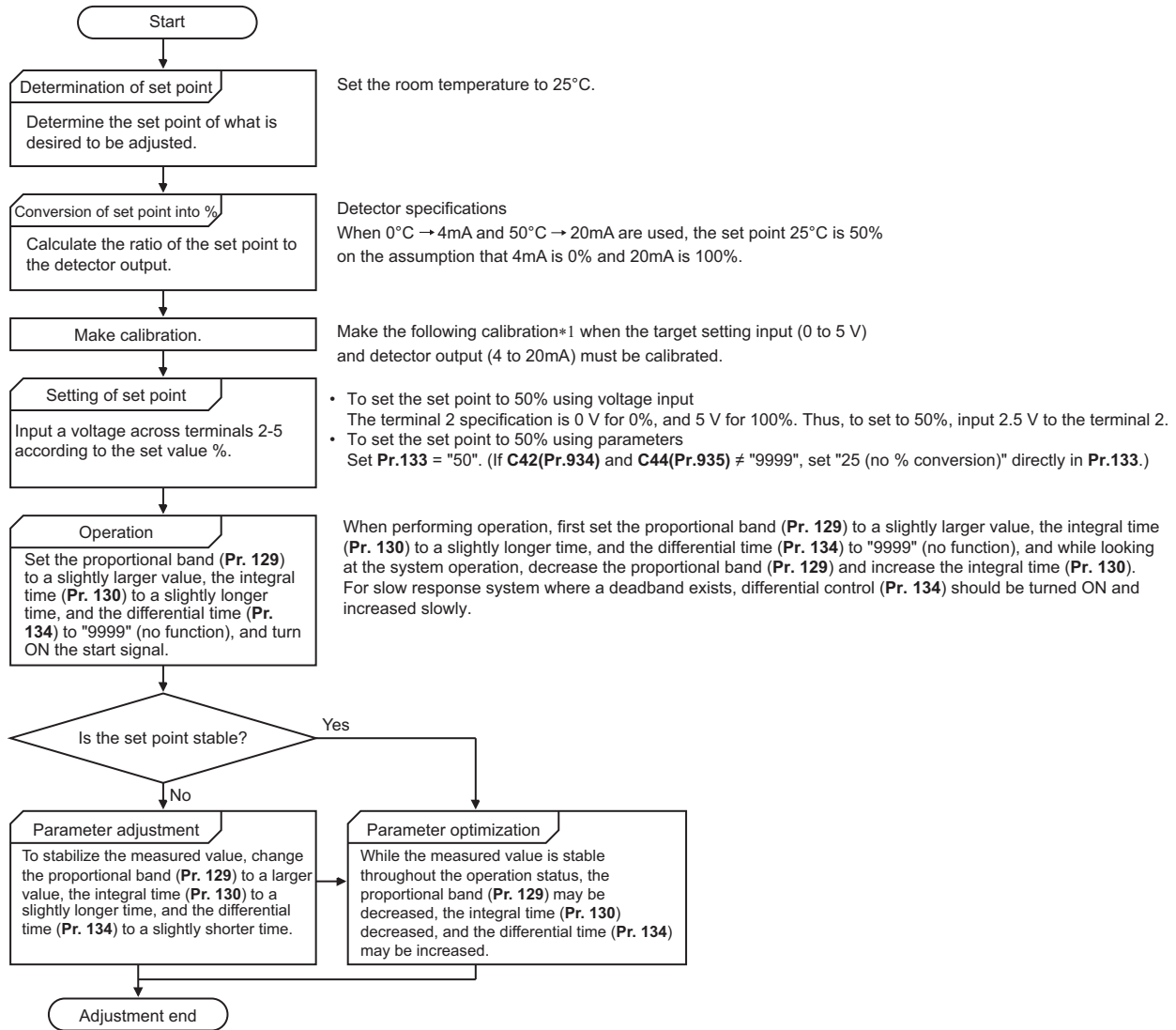

*1 When calibration is required
Calibrate the detector output and set point input by Pr.125, C2 (Pr.902) to C4 (Pr.903) (terminal 2) or Pr.126, C5 (Pr.904) to C7 (Pr.905) (terminal 4). (Refer to page 400.)
When both C42 (Pr.934) and C44 (Pr.935) ≠ "9999", calibrate the detector output and set point input by C42 (Pr.934) and C44 (Pr.935). (Refer to page 492.)
Make calibration in the PU operation mode during an inverter stop.

- Calibrating set point input

(Example: To enter the set point on terminal 2)

- 1.** 1. Apply the input (for example, 0 V) of set point setting 0% across terminals 2 and 5.
- 2.** Using **C2 (Pr.902)**, enter the frequency (for example, 0 Hz) to be output by the inverter when the deviation is 0%.
- 3.** Using **C3 (Pr.902)**, set the voltage value at 0%.
- 4.** Apply the input (for example, 5 V) of set point setting 100% across terminals 2 and 5.
- 5.** Using **Pr.125**, enter the frequency (for example, 60 Hz) to be output by the inverter when the deviation is 100%.
- 6.** Using **C4 (Pr.903)**, set the voltage value at 100%.

NOTE

- When the set point is set by using **Pr.133**, the setting frequency of **C2 (Pr.902)** is equivalent to 0% and the setting frequency of **Pr.125** is equivalent to 100%.

- Measured value input calibration

- 1.** Apply the input (for example, 4 mA) of measured value 0% across terminals 4 and 5.
- 2.** Perform calibration by **C6 (Pr.904)**.
- 3.** Apply the input (for example, 20 mA) of measured value 100% across terminals 4 and 5.
- 4.** Perform calibration by **C7 (Pr.905)**.

NOTE

- Set the frequencies set in **C5 (Pr.904)** and **Pr.126** to each of the same values set in **C2 (Pr.902)** and **Pr.125**.
- The display unit for analog input can be changed from "%" to "V" or "mA". (Refer to [page 400.](#))

- The following figure shows the results of having performed the calibration above.

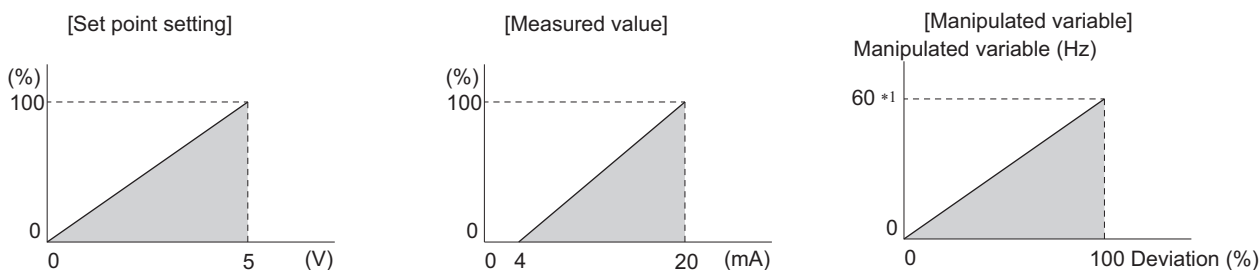

*1 The upper limit of the manipulated amount is the **Pr.125** setting value.

- The priority of the frequency command given by the external signals is as follows: JOG operation (JOG/JOG2 signal) > multi-speed operation (RL/RM/RH/REX signal) > PID control (X14 signal) > terminal 4 analog input (AU signal) > pulse train input (option FR-E8AXY) > 16-bit digital input (option FR-A8AX) > terminal 2 analog input.
- Even if the X14 signal is ON, PID control is stopped and multi-speed or JOG operation is performed when the multi-speed operation (RH, RM, RL, or REX) signal or JOG signal (JOG operation) is input.
- PID control is invalid under the following settings.
 - Pr.79 Operation mode selection = "6"** (Switchover mode)
- To use terminal 4 input in PID control, set "0" (initial value) to **Pr.858 Terminal 4 function assignment**. When a value other than "0", PID control is invalid.
- Changing the terminal functions with **Pr.178 to Pr.189** and **Pr.190 to Pr.197** may affect other functions. Set parameters after confirming the function of each terminal.
- When PID control is selected, the minimum frequency becomes the frequency of **C2 (Pr.902)** and the maximum frequency becomes the frequency of **Pr.125**.
(The **Pr.1 Maximum frequency** and **Pr.2 Minimum frequency** settings also are valid.)
- During PID operation, the remote operation function is invalid.
- When control is switched to PID control during normal operation, the frequency during that operation is not carried over, and the value resulting from PID calculation referenced to 0 Hz becomes the command frequency.

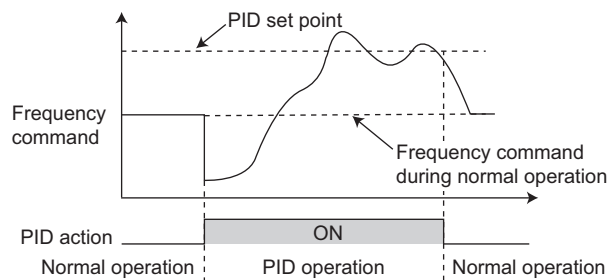

Operation when control is switched to PID control during normal operation

Parameters referred to

- Pr.59 Remote function selection [page 269](#)
- Pr.73 Analog input selection [page 392](#)
- Pr.79 Operation mode selection [page 280](#)
- Pr.178 to Pr.189 (Input terminal function selection) [page 410](#)
- Pr.190 to Pr.197 (Output terminal function selection) [page 371](#)
- Pr.290 Monitor negative output selection [page 358](#)
- C2 (Pr.902) to C7 (Pr.905) Frequency setting voltage (current) bias/gain [page 400](#)

15.7 Calibration of PID display

When the LCD operation panel (FR-LU08) or the parameter unit (FR-PU07) is used, the display unit of parameters and monitor items related to PID control can be changed to various units.

Pr.	Name	Initial value	Setting range	Description
759 A600	PID unit selection	0	0 to 43	Change the unit of the PID control-related values that is displayed on the LCD operation panel (FR-LU08) or the parameter unit (FR-PU07).
			9999	Without display unit switching
C42 (934) A630*1	PID display bias coefficient	9999	0 to 500	Set the coefficient of the bias side (minimum) of measured value input.
			9999	Displayed in %.
C43 (934) A631*1	PID display bias analog value	20%	0% to 300%	Set the converted % of the bias side (minimum) current/voltage of measured value input.
C44 (935) A632*1	PID display gain coefficient	9999	0 to 500	Set the coefficient of the gain side (maximum) of measured value input.
			9999	Displayed in %.
C45 (935) A633*1	PID display gain analog value	100%	0% to 300%	Set the converted % of the gain side (maximum) current/voltage of measured value input.

*1 On the LCD operation panel or the parameter unit used as the command source, the parameter number in parentheses appears instead of that starting with the letter C.

◆ Calibration of PID display bias and gain (C42 (Pr.934) to C45 (Pr.935))

- When both **C42 (Pr.934)** and **C44 (Pr.935)** ≠ "9999", the bias and gain values for the set point, measured value and deviation in PID control can be calibrated.
- "Bias"/"gain" function can adjust the relation between PID displayed coefficient and measured value input signal that is externally input. Examples of these measured value input signals are 0 to 5 VDC, 0 to 10 VDC, or 4 to 20 mA DC. (The terminals used for measured value input can be selected at **Pr.128**, **Pr.609**, **Pr.610**.)
- Set the value that is displayed when the PID measured value (control amount) is 0% to **C42 (Pr.934)** and the value that is displayed when the PID measured value (control amount) is 100% to **C44 (Pr.935)**.
- When both **C42 (Pr.934)** and **C44 (Pr.935)** ≠ "9999" and **Pr.133** is set as the set point, the setting of **C42 (Pr.934)** is treated as 0%, and **C44 (Pr.935)** as 100%.

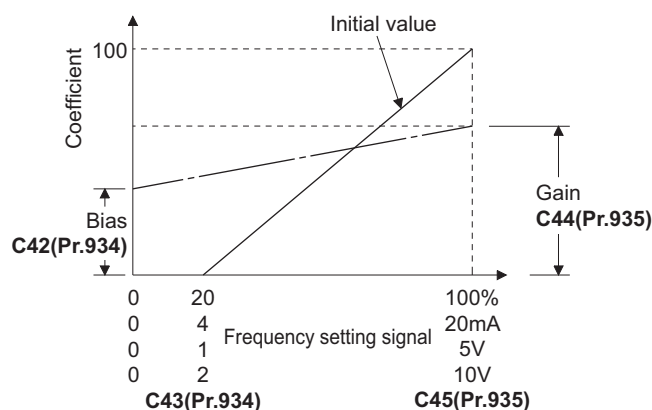

- There are three methods to adjust the PID display bias/gain.
 - Method to adjust any point by application of a current (voltage) to the measured value input terminal
 - Method to adjust any point without application of a current (voltage) to the measured value input terminal
 - Method to adjust only the display coefficient without adjustment of current (voltage)

(Refer to [page 400](#) for details, and make the necessary adjustments by considering **C7 (Pr.905)** as **C45 (Pr.935)** and **Pr.126** as **C44 (Pr.935)**.)

NOTE

- Always calibrate the input after changing the voltage/current input specification with **Pr.73** and **Pr.267**, and the voltage/current input selection switch.

- Take caution when the following condition is satisfied because the inverter recognizes the deviation value as a negative (positive) value even though a positive (negative) deviation is given: **C42** (PID bias coefficient) > **C44** (PID gain coefficient). To perform a reverse action, set **Pr.128 PID action selection** to forward action. Alternatively, to perform a forward action, set **Pr.128** to reverse action. In this case, the PID output shutoff release level is (1000 - **Pr.577**).

Pr.934 < Pr.935 (normal setting)		Pr.934 ≥ Pr.935	
Reverse action	Reverse action setting to Pr.128	Reverse action	Forward action setting to Pr.128
Forward action	Forward action setting to Pr.128	Forward action	Reverse action setting to Pr.128
PID output shutoff release level	Pr.577 - 1000	PID output shutoff release level	1000 - Pr.577

(Example) Set the following: **C42** (**Pr.934**) = "500", **C43** (**Pr.934**) = 20% (4 mA is applied), **C44** (**Pr.935**) = "100", and **C45** (**Pr.935**) = 100% (20 mA is applied).

When the set point = 400 and the measured value = 360, the deviation is +40 (>0), but the inverter recognizes the deviation as -10% (<0). Because of this, operation amount does not increase in the reverse operation setting.

The operation amount increases when the forward operation is set.

To perform PID output shutoff release at deviation of +40 or higher, set **Pr.577** = "960".

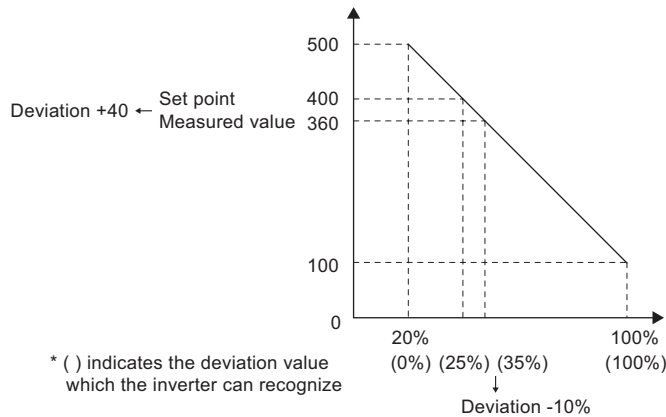

- The display of the following parameters is changed according to the **C42** (**Pr.934**) and **C44** (**Pr.935**) settings.

Pr.	Name
131	PID upper limit
132	PID lower limit
133	PID action set point
553	PID deviation limit
577	Output interruption cancel level

◆ Changing the PID display coefficient of the LCD operation panel (FR-LU08) or the parameter unit (FR-PU07) (Pr.759)

- Use **Pr.759 PID unit selection** to change the unit of the displayed value on the FR-LU08 or the FR-PU07. For the coefficient set in **C42 (Pr.934) to C44 (Pr.935)**, the units can be changed as follows.

Pr.759 setting	Unit indication	Unit name
9999	%	%
0	—	(No indication)
1	K	Kelvin
2	C	Degree Celsius
3	F	Degree Fahrenheit
4	PSI	Pound-force per Square Inch
5	MPa	Mega Pascal
6	kPa	Kilo Pascal
7	Pa	Pascal
8	bar	Bar
9	mbr	Millibar
10	GPH	Gallon per Hour
11	GPM	Gallon per Minute
12	GPS	Gallon per Second
13	L/H	Liter per Hour
14	L/M	Liter per Minute
15	L/S	Liter per Second
16	CFH	Cubic Feet per Hour
17	CFM	Cubic Feet per Minute
18	CFS	Cubic Feet per Second
19	CMH	Cubic Meter per Hour
20	CMM	Cubic Meter per Minute

Pr.759 setting	Unit indication	Unit name
21	CMS	Cubic Meter per Second
22	ftM	Feet per Minute
23	ftS	Feet per Second
24	m/M	Meter per Minute
25	m/S	Meter per Second
26	lbH	Pound per Hour
27	lbM	Pound per Minute
28	lbS	Pound per Second
29	iWC	Inch of Water Column
30	iWG	Inch of Water Gauge
31	fWG	Feet of Water Gauge
32	mWG	Meter of Water Gauge
33	iHg	Inches of Mercury
34	mHg	Millimeters of Mercury
35	kgH	Kilogram per Hour
36	kgM	Kilogram per Minute
37	kgS	Kilogram per Second
38	ppm	Pulse per Minute
39	pps	Pulse per Second
40	kW	Kilowatt
41	hp	Horse Power
42	Hz	Hertz
43	rpm	Revolution per Minute

15.8 Dancer control

PID control is performed using detected dancer roll position as feedback data. The dancer roll is controlled to be at a designated position.

Pr.	Name	Initial value	Setting range	Description	
44 F020	Second acceleration/ deceleration time	5 s ^{*1}	0 to 3600 s	Set the acceleration/deceleration time during dancer control. In dancer control, this parameter becomes the acceleration/deceleration time of the main speed. This setting does not operate as the second acceleration/deceleration time.	
		10 s ^{*2}			
		15 s ^{*3}			
45 F021	Second deceleration time	9999	0 to 3600 s	Set the deceleration time during dancer control. In dancer control, this parameter becomes the deceleration time of the main speed. This setting does not operate as the second deceleration time.	
			9999	Pr.44 is the deceleration time.	
128 A610	PID action selection	0	0	No PID action	
			40	PID reverse action	Additive method: Fixed
			41	PID forward action	Additive method: Fixed
			42	PID reverse action	Additive method: Ratio
			43	PID forward action	Additive method: Ratio
			Others	Refer to page 479 .	
129 A613	PID proportional band	100%	0.1% to 1000%	If a narrow proportional band is set (small parameter setting value), the manipulated amount changes considerably by slight changes in the measured value. As a result, response improves as the proportional band becomes narrower, though stability worsens as shown by the occurrence of hunting. Gain $K_p=1/\text{proportional band}$	
			9999	No proportional control	
130 A614	PID integral time	1 s	0.1 to 3600 s	With deviation step input, this is the time (Ti) used for obtaining the same manipulated amount as proportional band (P) by only integral (I) action. Arrival to the set point becomes quicker the shorter an integral time is set, though hunting is more likely to occur.	
			9999	No integral control	
131 A601	PID upper limit	9999	0% to 100%	Set the upper limit. The FUP signal is output when the feedback value exceeds this setting. The maximum input (20 mA/5 V/10 V) of the measured value (terminal 4) is equivalent to 100%.	
			9999	No function	
132 A602	PID lower limit	9999	0% to 100%	Set the lower limit. The FDN signal is output when the measured value (terminal 4) falls below the setting range. The maximum input (20 mA/5 V/10 V) of the measured value is equivalent to 100%.	
			9999	No function	
133 A611	PID action set point	9999	0% to 100%	Set the set point during PID control.	
			9999	Input of set point by terminal selected by Pr.609	
134 A615	PID differential time	9999	0.01 to 10 s	With deviation ramp input, this is the time (Td) used for obtaining the manipulated amount only by proportional action (P). Response to changes in deviation increase greatly as the differential time increases.	
			9999	No differential control	
609 A624	PID set point/deviation input selection	2	2	The set point is input through terminal 2.	
			3	The set point is input through terminal 4.	
			4	The set point is input via communication	
			5	The set point is input by the PLC function.	
610 A625	PID measured value input selection	3	2	The measured value is input through terminal 2.	
			3	The measured value is input through terminal 4.	
			4	The measured value is input via communication.	
			5	The measured value is input by the PLC function.	

*1 Initial value for the FR-E820-0175(3.7K) or lower, FR-E840-0095(3.7K) or lower, FR-E860-0061(3.7K) or lower, FR-E820S-0110(2.2K) or lower, FR-E810W-0050(0.75K) or lower, and FR-E846-0095(3.7K) or lower.

*2 Initial value for the FR-E820-0240(5.5K), FR-E820-0330(7.5K), FR-E840-0120(5.5K), FR-E840-0170(7.5K), and FR-E860-0090(5.5K) or higher.

*3 Initial value for the FR-E820-0470(11K) or higher and FR-E840-0230(11K) or higher.

◆ Block diagram of dancer control

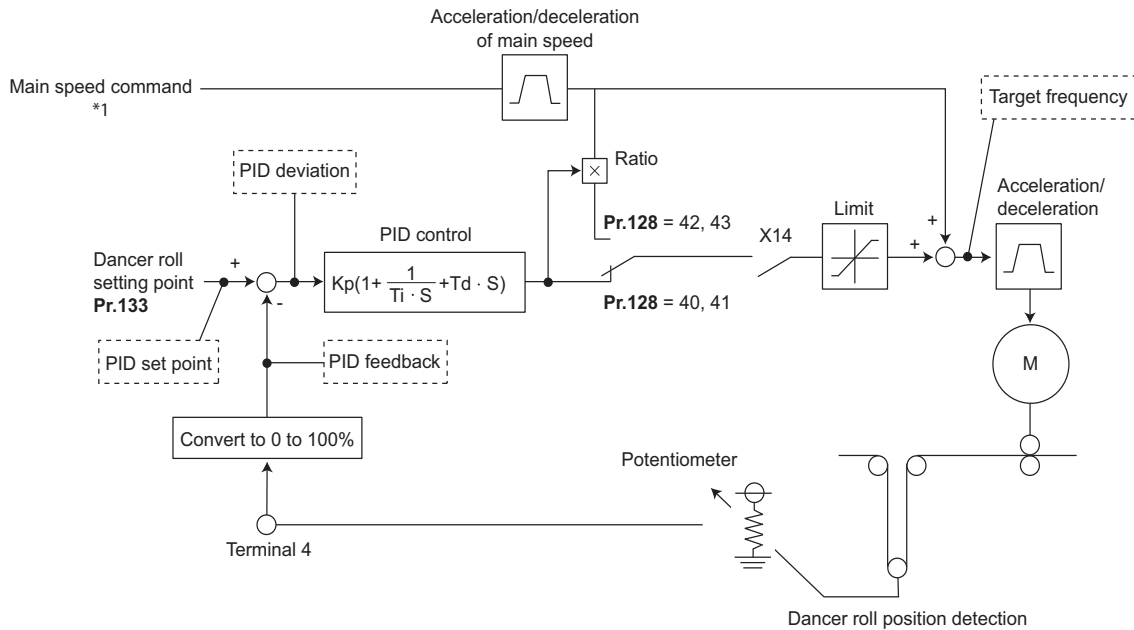

*1 The main speed can be selected in all operation modes, External (analog voltage input, multi-speed), PU (digital frequency setting) and Communication.

◆ Outline of dancer control

- Dancer control is performed by setting "40 to 43" in **Pr.128 PID action selection**. The main speed command is the speed command for each operation mode (External, PU, and communication). PID control is performed by the dancer roll position detection signal, and the control result is added to the main speed command. For the main speed acceleration/deceleration time, set the acceleration time to **Pr.44 Second acceleration/deceleration time** and the deceleration time to **Pr.45 Second deceleration time**.

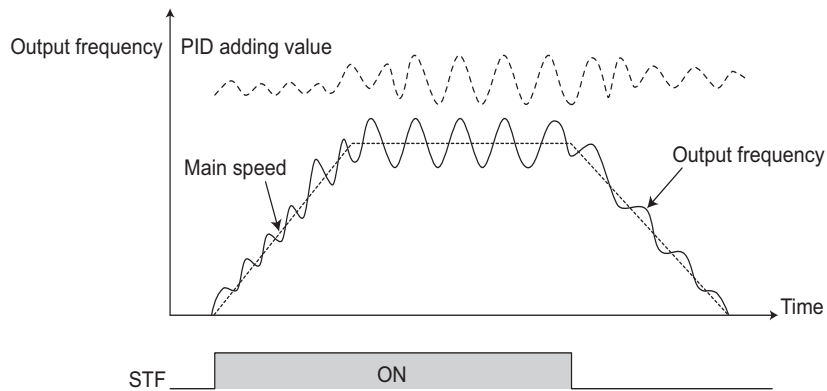

NOTE

- Normally, set **Pr.7 Acceleration time** and **Pr.8 Deceleration time** to 0 s. When the **Pr.7** and **Pr.8** settings are large, dancer control response becomes slow during acceleration/deceleration.
- If an automatic restart after instantaneous power failure is activated during dancer control, E.OC[] or E.OV[] is likely to occur. In such case, disable the automatic restart after instantaneous power failure function (**Pr.57 = "9999"**).

◆ Connection diagram

- Sink logic
- **Pr.128** = "14"
- **Pr.182** = "14"
- **Pr.193** = "14"
- **Pr.194** = "15"
- **Pr.133** = Set point

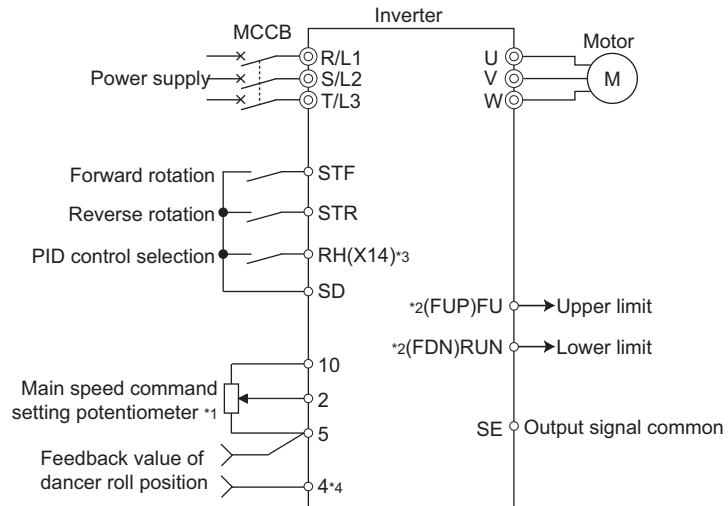

- *1 The main speed command differs according to each operation mode (External, PU, communication).
 *2 The applied output terminals differ by the settings of **Pr.190 to Pr.197 (Output terminal function selection)**.
 *3 The applied input terminals differ by the settings of **Pr.178 to Pr.189 (Input terminal function selection)**.
 *4 The AU signal need not be input.

◆ Dancer control operation selection (Pr.128)

Pr.128 setting	PID action	Additive method	Set point input	Measured value input
0	PID invalid	—	—	—
40	Reverse action	Fixed	Set by Pr.133 or input by terminal selected by Pr.609 ^{*1}	Input by terminal selected by Pr.610
41	Forward action			
42	Reverse action	Ratio		
43	Forward action			
Others	Refer to page 479 .			

*1 When **Pr.133** ≠ "9999", the **Pr.133** setting is valid.

- To enable dancer control, set "40 to 43" in **Pr.128 PID action selection**.
- Dancer control is enabled only when the PID control valid (X14) signal turns ON when "14" is set in any parameter from **Pr.178 to Pr.182 (Input terminal function selection)** and X14 signal is assigned. When the X14 signal is not assigned, dancer control is enabled only by the **Pr.128** setting.
- Input the main speed command (External, PU, Communication). Dancer control is also supported by the main speed command in all operation modes.
- Input the set point between the terminals 2 and 5 (the setting can be selected using **Pr.133** or **Pr.609**) and input the measured value signal (dancer roll position detection signal) between the inverter terminals 4 and 5 (the setting can be selected using **Pr.610**).
- The action of **Pr.129 PID proportional band**, **Pr.130 PID integral time**, **Pr.131 PID upper limit**, **Pr.132 PID lower limit** and **Pr.134 PID differential time** is the same as PID control action. In the relationship between the control amount (%) and frequency in PID control, 0% is equivalent to the frequencies set in **C2 (Pr.902)** and 100% is equivalent to the frequencies set in **Pr.125**.

NOTE

- When **Pr.128** is set to "0" or the X14 signal is OFF, regular inverter running not dancer control is performed.
- Dancer control is enabled by turning ON/OFF the bits of terminals assigned the X14 signal by RS-485 communication or over the network.
- When dancer control is selected, set the PID output suspension function (**Pr.575 Output interruption detection time** = "9999").
- When **Pr.561 PTC thermistor protection level** ≠ "9999", terminal 2 cannot be used for the main speed command. Terminal 2 becomes the PTC thermistor input terminal.

◆ Selection of set point/measured value input method (Pr.609, Pr.610)

- Select the set point input method by **Pr.609 PID set point/deviation input selection** and the measured value input method by **Pr.610 PID measured value input selection**. Switch the power voltage/current specifications of terminals 2 and 4 by **Pr.73 Analog input selection** or **Pr.267 Terminal 4 input selection** to match the specification of the input device.
- When **Pr.133 PID action set point** ≠ "9999", **Pr.133** is the set point. When the set point is set at **Pr.133**, the setting frequency of **C2 (Pr.902)** is equivalent to 0% and the setting frequency of **Pr.125** is equivalent to 100%.

Pr.609 and Pr.610 settings	Input method
2	Terminal 2 ^{*1}
3	Terminal 4 ^{*1}
4	Communication ^{*2}
5	PLC function

*1 When the same input method has been selected for the set point and measured value at **Pr.609** and **Pr.610**, set point input is invalid. (Inverter runs at set point 0%)

*2 CC-Link, CC-Link IE TSN, CC-Link IE Field Network Basic, BACnet/IP, and BACnet MS/TP are available. For details on each communication, refer to the FR-A8NC E kit Instruction Manual or the Instruction Manual (Communication). CC-Link communication is unavailable when the IP67 model is used.

NOTE

- After changing the **Pr.73** or **Pr.267** setting, check the voltage/current input selection switch. Incorrect setting may cause a fault, failure or malfunction. (Refer to [page 392](#) for the setting.)
 - When terminals 2 and 4 are selected for deviation input, perform bias calibration using **C3 (Pr.902)** and **C6 (Pr.904)** to prevent a minus voltage from being entered as the deviation input signal. Input of a minus voltage might damage devices and the inverter.
- The following shows the relationship between the input values of the analog input terminals, and the set point and measured value.

Input terminal	Input specification ^{*3}	Relationship with analog input		Calibration parameter
		Set point	Result	
Terminal 2	0 to 5 V	0 V = 0% 5 V = 100%	0 V = 0% 5 V = 100%	Pr.125, C2 to C4 (Pr.902, Pr.903)
	0 to 10 V	0 V = 0% 10 V = 100%	0 V = 0% 10 V = 100%	
	0 to 20 mA	0 mA = 0% 20 mA = 100%	0 mA = 0% 20 mA = 100%	
Terminal 4	0 to 5 V	0 to 1 V = 0% 5 V = 100%	0 to 1 V = 0% 5 V = 100%	Pr.126, C5 to C7 (Pr.904, Pr.905)
	0 to 10 V	0 to 2 V = 0% 10 V = 100%	0 to 2 V = 0% 10 V = 100%	
	0 to 20 mA	0 to 4 mA = 0% 20 mA = 100%	0 to 4 mA = 0% 20 mA = 100%	

*3 Can be changed by **Pr.73** and **Pr.267** and the voltage/current input switch. (Refer to [page 392](#).)

◆ Selection of additive method for PID calculation result

- When ratio is selected as the additive method (**Pr.128** = "42, 43"), PID calculation result × (ratio of main speed) is added to the main speed. The ratio is determined by the **Pr.125 Terminal 2 frequency setting gain frequency** and **C2 (Pr.902) Terminal 2 frequency setting bias frequency** settings. In the initial status, 0 to 60 Hz is set for 0% to 100%. Thus, 60 Hz main speed is regarded as 100%, and the 30 Hz main speed is regarded as 50%.

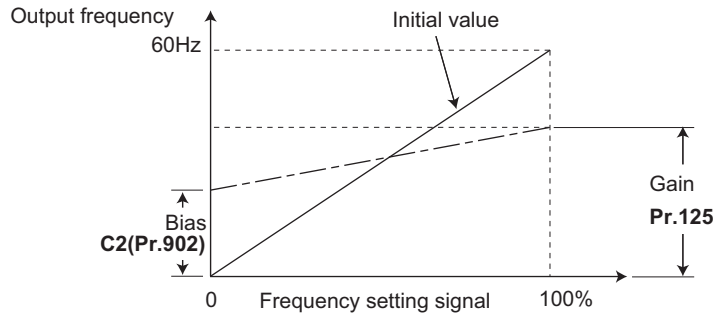

NOTE

- Even if **C4 (Pr.903)** is set to other than 100%, the frequency setting signal is treated as 100%.
- Even if **C3 (Pr.902)** is set to other than 0%, the frequency setting signal is treated as 0%.
- If **C2 (Pr.902)** is set to other than 0 Hz, the frequency setting signal is 0% at the **C2 (Pr.902)** frequency setting or below.

◆ Input/output signals

- The following signals can be used by assigning functions to **Pr.178 to Pr.189 (Input terminal function selection)** and **Pr.190 to Pr.197 (Output terminal function selection)**.

- Input signal

Signal	Function	Pr.178 to Pr.189 setting	Description
X14	PID control valid	14	When this signal is assigned to the input terminal, PID control is enabled when this signal is ON.
X72	PID P control switchover	72	Only proportional term is valid when this signal is turned ON. (Integral and differential values are reset.)

- Output signal

Signal	Function	Pr.190 to Pr.197 settings		Description
		Positive logic	Negative logic	
FUP	PID upper limit	15	115	Output when the measured value signal exceeds Pr.131 PID upper limit .
FDN	Lower limit output	14	114	Output when the measured value signal falls below Pr.132 PID lower limit .
RL	PID forward/reverse rotation output	16	116	"Hi" is output when the output display of the operation panel is forward rotation (the RUN LED is ON) and "Low" is output when the display is reverse rotation (the RUN LED blinks) and stop (the RUN LED is OFF). "Hi" is output when the output display of the parameter unit is forward rotation (FWD) and "Low" is output when the display is reverse rotation (REV) and stop (STOP).
PID	During PID control activated	47	147	Turns ON during PID control.

NOTE

- Changing the terminal functions with **Pr.178 to Pr.189** and **Pr.190 to Pr.197** may affect other functions. Set parameters after confirming the function of each terminal.

◆ PID monitor function

- This function displays the PID control set point and measured value on the operation panel, and can output these from the terminals FM and AM.

- Set the following values to **Pr.52 Operation panel main monitor selection**, **Pr.774 to Pr.776 (Operation panel monitor selection)**, **Pr.992 Operation panel setting dial push monitor selection**, **Pr.54 FM terminal function selection** and **Pr.158 AM terminal function selection** for each monitor.

Parameter setting	Monitor description	Minimum increment	Monitor range			Remarks
			Terminal FM	Terminal AM	Operation panel	
97	Dancer main set speed	0.01 Hz	0 to 590 Hz			When outputting through terminals FM and AM, the full scale value can be adjusted by Pr.55 Frequency monitoring reference .

NOTE

- Refer to [page 488](#) for details on other PID control monitors.

◆ Priority of main speed commands

- The priority of the frequency command given by the external signals is as follows: JOG operation (JOG/JOG2 signal) > multi-speed operation (RL/RM/RH/REX signal) > PID control (X14 signal) > terminal 4 analog input (AU signal) > pulse train input (option FR-E8AXY) > 16-bit digital input (option FR-A8AX) > terminal 2 analog input.
- The following is the frequency commands listed in descending order of priority when "3" is set in **Pr.79 Operation mode selection**: Multi-speed setting function (RL/RM/RH/REX signal) > PID control (X14 signal) > terminal 4 analog input (AU signal) > set frequency (digital input from the PU).
- Even if the remote operation function is selected by **Pr.59 Remote function selection** ≠ "0", compensation of the remote setting frequency against the main speed is ignored. (The value is "0".)
- If the same terminal as an external input terminal having a speed command source (external terminal where a main speed is input) is specified as the measured value input or set point input, the main speed is treated as "0".
- Setting **Pr.73** ≥ 10 enables the polarity reversible operation when the PID manipulated amount is added to the main speed command. (Polarity reversible operation of the main speed command without addition is not possible.)

◆ Adjustment procedure for dancer roll position detection signal

- When the input of terminal 4 is voltage input, 0 V is the lower limit position and 5 V (10 V) is the upper limit position (initial values). When it is current input, 4 mA is the lower limit position and 20 mA is the upper limit position (initial values). When the potentiometer has an output of 0 to 7 V, **C7 (Pr.905)** must be calibrated at 7 V.

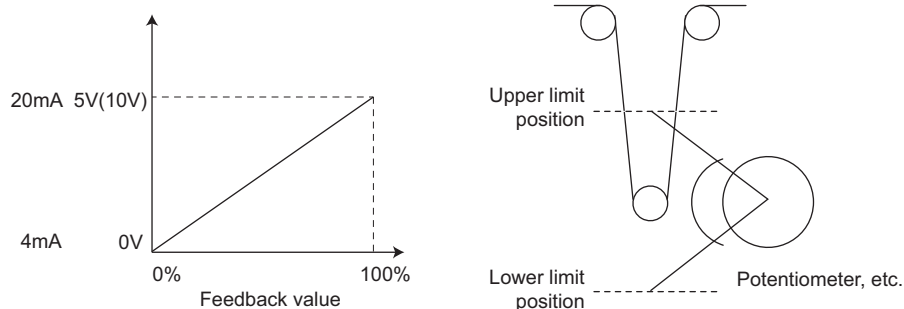

(Example) To execute control at the dancer center position using a 0 to 7 V potentiometer

1. Switch the voltage/current input selection switch (switch 4) to "V", set "2" in **Pr.267**, and set terminal 4 input to voltage input.
2. Input 0 V across terminals 4 and 5, and calibrate **C6 (Pr.904)**. (The % display that is indicated at analog calibration is not related to the % of the feedback value.)
3. Input 7 V across terminals 4 and 5, and calibrate **C7 (Pr.905)**. (The % display that is indicated at analog calibration is not related to the % of the feedback value.)
4. Set **Pr.133** to "50%".

- After changing the **Pr.267** setting, check the voltage/current selection switch. Incorrect setting may cause a fault, failure, or malfunction. (Refer to [page 392](#) for the setting.)
- If the Multi-speed operation (RH, RM, RL, or REX) signal, or JOG signal is input during regular PID control, PID control is interrupted. However, at dancer control, these signals are treated as main speed commands, so PID control is continued.
- During dancer control, **Pr.44 and Pr.45** (Second acceleration/deceleration time) is the parameter for setting the acceleration/deceleration time for the main speed command. This function does not work as a second function.
- When the switchover mode is set by setting "6" to **Pr.79**, dancer control (PID control) is invalid.
- The acceleration/deceleration action of the main speed command is the same as that when the frequency is increased or decreased by analog input. The SU signal sometimes stays ON even if operation is turned ON/OFF by the start signal. The set frequency monitor is the value "main speed command + PID control" which is constantly changing.
- With the main speed setting frequency setting, acceleration/deceleration is performed for the acceleration/deceleration time set in **Pr.44 and Pr.45**, and with the output frequency setting, acceleration/deceleration is performed for the acceleration/deceleration time set in **Pr.7 and Pr.8**. For this reason, with the output frequency, when the time set in **Pr.7 and Pr.8** is longer than the time set in **Pr.44 and Pr.45**, acceleration/deceleration is performed for the acceleration/deceleration time set in **Pr.7 and Pr.8**.
- The limit of the integral term is the smaller of 100% and the value after conversion of the straight line after interpolation of **Pr.1 Maximum frequency** by **C2 (Pr.902) and Pr.125** to the PID manipulated amount.
However, note that the lower limit frequency limits the output frequency, but does not restrict the action of the integral item.

Parameters referred to

- Pr.57 Restart coasting time** [page 502](#)
Pr.59 Remote function selection [page 269](#)
Pr.73 Analog input selection [page 392](#)
Pr.79 Operation mode selection [page 280](#)
Pr.178 to Pr.189 (Input terminal function selection) [page 410](#)
Pr.190 to Pr.197 (Output terminal function selection) [page 371](#)
Pr.561 PTC thermistor protection level [page 306](#)
C2 (Pr.902) to C7 (Pr.905) Frequency setting voltage (current) bias/gain [page 400](#)

15.9 Automatic restart after instantaneous power failure / flying start with an induction motor

V/F Magnetic flux Sensorless Vector

The inverter can be restarted without stopping the motor operation in the following situations:

- When an instantaneous power failure occurs during inverter running
- When the motor is coasting at start

Pr.	Name	Initial value	Setting range	Description
162 A700	Automatic restart after instantaneous power failure selection	0	0	Frequency search only performed at the first start
			1	Reduced voltage start only at the first start (no frequency search) or encoder detection frequency search
			10	Frequency search at every start
			11	Reduced voltage start at every start (no frequency search) or encoder detection frequency search
299 A701	Rotation direction detection selection at restarting	0	0	Rotation direction detection disabled
			1	Rotation direction detection enabled
			9999	When Pr.78 Reverse rotation prevention selection = "0", with rotation direction detection When Pr.78 Reverse rotation prevention selection = "1 or 2", without rotation direction detection
57 A702	Restart coasting time	9999	0	Coasting time differs according to the inverter capacity.*1
			0.1 to 30 s	Set the time delay for the inverter to perform a restart after restoring power due to an instantaneous power failure.
			9999	No restart
58 A703	Restart cushion time	1 s	0 to 60 s	Set the voltage cushion time for restart.
165 A710	Stall prevention operation level for restart	150%	0% to 400%	Set the stall prevention level at restart operation on the assumption that the inverter rated current is 100%.
611 F003	Acceleration time at a restart	9999	0 to 3600 s	Set the acceleration time to reach Pr.20 Acceleration/deceleration reference frequency at restart.
			9999	Standard acceleration time (for example, Pr.7) is applied as the acceleration time at restart.

*1 The coasting time when **Pr.57** = "0" is as shown below. (When **Pr.162** and **Pr.570** are set to the initial value.)

0.5 s for the FR-E860-0027(1.5K) or lower.

1 s for the FR-E820-0080(1.5K) or lower, FR-E840-0040(1.5K) or lower, FR-E860-0040(2.2K) or higher, FR-E820S-0080(1.5K) or lower, FR-E810W-0050(0.75K) or lower, and FR-E846-0040(1.5K) or lower.

2 s for the FR-E820-0110(2.2K) to FR-E820-0330(7.5K), FR-E840-0060(2.2K) to FR-E840-0170(7.5K), FR-E820S-0110(2.2K), FR-E846-0060(2.2K) or higher.

3 s for the FR-E820-0470(11K) or higher and FR-E840-0230(11K) or higher.

Point

- To operate the inverter with the automatic restart after instantaneous power failure function enabled, check the following points.
- Set **Pr.57 Restart coasting time** = "0".

◆ Setting for the automatic restart after instantaneous power failure operation (Pr.162)

- The Pr.162 settings and the instantaneous power failure automatic restart operation under each operation mode are as shown in the following table.

Pr.162 setting	Restart timing	V/F control, Advanced magnetic flux vector control		Real sensorless vector control	Vector control
		Without encoder	With encoder		
0 (initial value)	At first start	Frequency search	Frequency search	Frequency search	Encoder detection frequency search
1		Reduced voltage start	Encoder detection frequency search		
10	At every start	Frequency search	Frequency search		
11		Reduced voltage start	Encoder detection frequency search		

NOTE

- The wiring distance must be 100 m or less when the frequency search is performed.

15

◆ Restart operation with frequency search (Pr.162 = "0 or 10", Pr.299)

- When Pr.162 = "0 (initial value) or 10", the motor speed is detected at a power restoration so that the motor can re-start smoothly.
- The encoder also detects the rotation direction so that the inverter can re-start smoothly even during the reverse rotation.
- Whether or not to detect the rotation direction can be selected by **Pr.299 Rotation direction detection selection at restarting**. If the motor capacity is different from the inverter capacity, set Pr.299 = "0" (no rotation direction detection).
- When the rotation direction is detected, the following operation is performed according to **Pr.78 Reverse rotation prevention selection** setting.

Pr.299 setting	Pr.78 setting		
	0	1	2
9999	○	×	×
0 (initial value)	×	×	×
1	○	○	○

○: With rotation direction detection ×: Without rotation direction detection

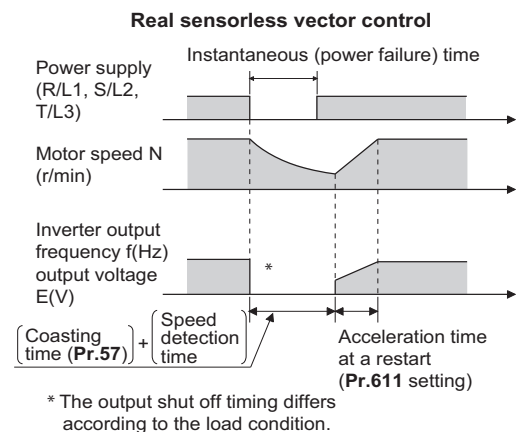
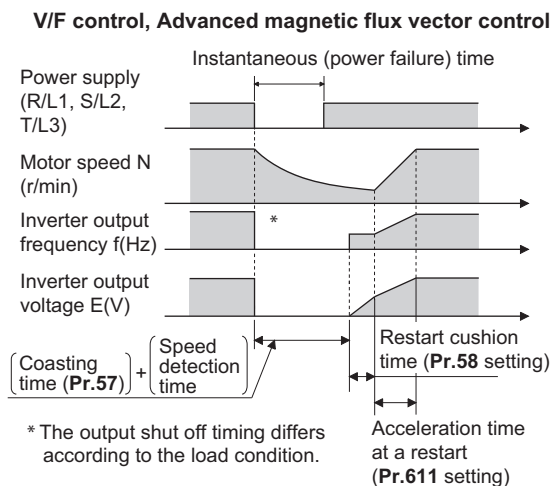

NOTE

- The rotation speed detection time (frequency search) changes according to the rotation speed of the motor (maximum 1 second).
- When the inverter capacity is two ranks or more higher than the motor capacity, the overcurrent protective function (E.OC[]) is sometimes activated and prevents the inverter from restarting.
- If two or more motors are connected to one inverter, this function operates abnormally. (The inverter does not restart successfully.)
- Because a DC injection brake is applied instantaneously at speed detection during a restart, the speed might drop if the moment of inertia (J) of the load is small.
- If reverse operation is detected when "1" (reverse rotation disabled) is set to **Pr.78**, operation decelerates by reverse rotation and then changes to forward rotation when the start command is forward rotation. The inverter does not restart when the start command is reverse rotation.
- When the automatic restart after instantaneous power failure is performed while the motor rotates at low speed (lower than 10 Hz), the motor rotates in the same direction as that before instantaneous power failure without detecting the rotation direction (even when **Pr.299** = "1").

◆ Restart operation without frequency search (Pr.162 = "1 or 11")

- When **Pr.162** = "1 or 11" while the encoder feedback control is disabled, reduced voltage start is used for the restart operation. In this method, the voltage is raised gradually while keeping the output frequency level at the level before an instantaneous power failure, regardless of the motor's coasting speed.

V/F control, Advanced magnetic flux vector control

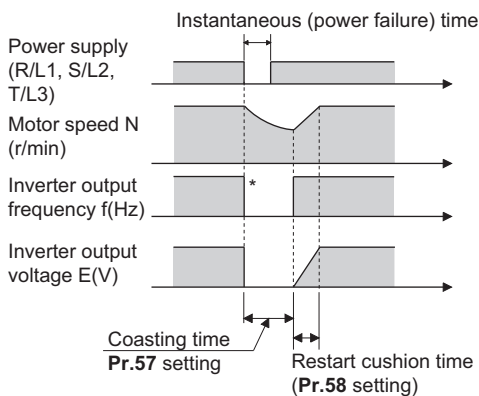

* The output shut off timing differs according to the load condition.

NOTE

- This restart method uses the output frequency that was active before the instantaneous power failure stored in memory. If the instantaneous power failure time is 0.2 second or more, the output frequency can no longer be stored and held in memory, so the restart is performed from **Pr.13 Starting frequency** (initial value: 0.5 Hz).
- During Real sensorless vector control, the operation is the same as one when **Pr.162** = "0 or 10".

◆ Restart operation with encoder detection frequency search (Pr.162 = "1 or 11")

- When "1 or 11" is set in **Pr.162** by encoder feedback control, the inverter is restarted by the motor speed and direction of rotation that were detected by the encoder at the power restoration.

- The **Pr.299 Rotation direction detection selection at restarting** setting is invalid by encoder detection frequency search.

V/F control, Advanced magnetic flux vector control

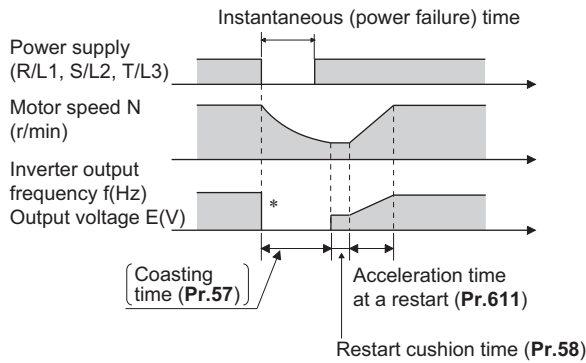

* The output shut off timing differs according to the load condition.

NOTE

- Under Vector control, encoder detection frequency search is used regardless of the **Pr.162** setting. The **Pr.58** and **Pr.299** settings are invalid at this time.
- For the encoder feedback control, refer to [page 559](#).
- During Real sensorless vector control, the operation is the same as one when **Pr.162** = "0 or 10".

◆ Restart at every start (Pr.162 = "10 or 11")

- When "10 or 11" is set in **Pr.162**, a restart operation is performed at each start and automatic restart after instantaneous power failure (after the time period set in **Pr.57** elapsed). When "0 (initial value) or 1" is set in **Pr.162**, a restart operation is performed at the first start after a power-ON, and from the second power-ON onwards, a start from the starting frequency is performed.

◆ Automatic restart operation of the MRS (X10) signal

- The restart operation after restoration from output shutoff by the MRS (X10) signal is as shown in the following table according to the **Pr.30** setting.

Pr.30 setting	Operation after restoration from output shutoff by the MRS (X10) signal
2, 102	Restart operation (starting from the coasting speed)
Other than the above	Starting from Pr.13 Starting frequency .

NOTE

- When output is shut off using safety stop function (terminals S1 and S2), the inverter restarts in the same way as when output is shut off by the MRS (X10) signal.
- Operation is selectable as shown in the table above when **Pr.162 Automatic restart after instantaneous power failure selection** = "0 or 1". When **Pr.162 Automatic restart after instantaneous power failure selection** = "10 or 11" (automatic restart operation at each start), a restart operation is performed regardless of the setting of **Pr.30 Regenerative function selection**.
- Set "24" in any parameter from **Pr.178 to Pr.189 (Input terminal function selection)** to assign the output stop (MRS) signal to the input terminal, and "10" to assign the Inverter operation enable (X10) signal.

◆ Adjustment of restart coasting time (Pr.57)

- Restart coasting time is the time period from the occurrence of instantaneous power failure until the operation is restarted after power is restored.

With frequency search, the motor speed is detected and operation is restarted after the coasting time.

- To enable restart operation, set "0" to **Pr.57 Restart coasting time**. If "0" is set to **Pr.57**, the coasting time is automatically set to the following number of seconds. Generally, this setting does not interfere with inverter operation.

Voltage class	Inverter		Coasting time (s)
	ND	LD	
100 V	FR-E810W-0050(0.75K) or lower	—	1
200 V	FR-E820-0080(1.5K) or lower FR-E820S-0080(1.5K) or lower	FR-E820-0050(0.75K) or lower	1
	FR-E820-0110(2.2K) to FR-E820-0330(7.5K) FR-E820S-0110(2.2K)	FR-E820-0080(1.5K) to FR-E820-0240(5.5K)	2
	FR-E820-0470(11K) or higher	FR-E820-0330(7.5K) or higher	3
400 V	FR-E840-0040(1.5K) or lower	FR-E840-0026(0.75K) or lower	1
	FR-E840-0060(2.2K) to FR-E840-0170(7.5K)	FR-E840-0040(1.5K) to FR-E840-0120(5.5K)	2
	FR-E840-0230(11K) or higher	FR-E840-0170(7.5K) or higher	3
575 V	FR-E860-0027(1.5K) or lower	FR-E860-0017(0.75K)	0.5
	FR-E860-0040(2.2K) or higher	FR-E860-0027(1.5K) or higher	1
400 V	FR-E846-0040(1.5K) or lower	FR-E846-0026(0.75K)	1
	FR-E846-0060(2.2K) or higher	FR-E846-0040(1.5K) or higher	2

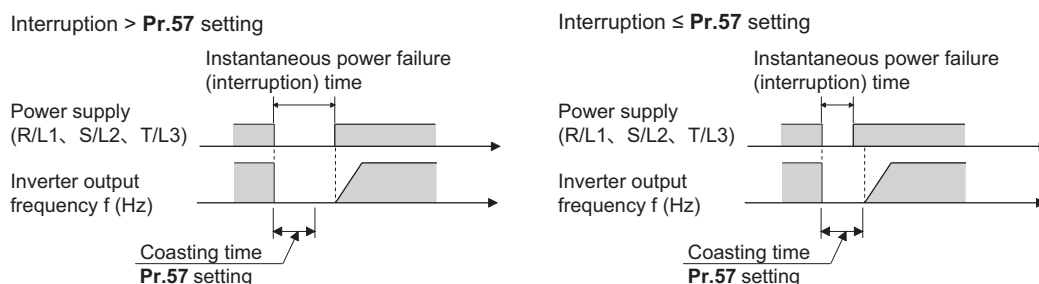

- Inverter operation is sometimes hindered by the size of the moment of inertia (J) of the load, output frequency, or the residual magnetic flux in the motor. Adjust this coasting time within the range 0.1 to 30 seconds to match the load specification.

◆ Restart cushion time (Pr.58)

- The cushion time is the time taken to raise the voltage to the level required for the specified speed after the motor speed detection (output frequency before the instantaneous power failure when **Pr.162** = "1 or 11").
- Normally, the motor runs at the initial value as it is. However, adjust to suit the moment of inertia (J) of the load or the size of the torque.

NOTE

- Pr.58** is invalid under Real sensorless vector control or Vector control.

◆ Adjustment of restart operation (Pr.165, Pr.611)

- The stall prevention operation level at a restart operation can be set in **Pr.165**.
- Using **Pr.611**, the acceleration time to reach **Pr.20 Acceleration/deceleration reference frequency** after a restart operation can be set. This can be set individually from the normal acceleration time.

NOTE

- **Pr.165** is invalid under Real sensorless vector control or Vector control.
- Changing the **Pr.21** setting does not affect the **Pr.611** setting increment.
- Changing the terminal assignment using **Pr.178 to Pr.189 (Input terminal function selection)** may affect the other functions. Set parameters after confirming the function of each terminal.
- The SU and FU signals are not output during the restart. These signals are output after the restart cushion time passes.
- Restart operation is also performed after the inverter reset is released or after the retry by the retry function occurs.

⚠ CAUTION

- When the automatic restart after instantaneous power failure function is selected, the motor suddenly starts (after reset time passes) when an instantaneous power failure occurs. Stay away from the motor and machinery.
When the automatic restart after instantaneous power failure function has been selected, apply the CAUTION sticker(s), which are found in the Inverter Safety Guideline enclosed with the inverter, to easily visible places.

◀ Parameters referred to ▶

Pr.7 Acceleration time, Pr.21 Acceleration/deceleration time increments [page 262](#)
Pr.13 Starting frequency [page 274](#), [page 275](#)
Pr.65, Pr.67 to Pr.69 Retry function [page 319](#)
Pr.78 Reverse rotation prevention selection [page 300](#)
Pr.178 to Pr.189 (Input terminal function selection) [page 410](#)

15.10 Automatic restart after instantaneous power failure / flying start with a PM motor

PM

The inverter can be restarted without stopping the motor operation.

When the automatic restart after instantaneous power failure function is selected, the motor driving is resumed in the following situations:

- When power comes back ON during inverter driving after an instantaneous power failure
- When the motor is coasting at start

Pr.	Name	Initial value	Setting range	Description
57 A702	Restart coasting time	9999	0	No delay
			0.1 to 30 s	Set the delay time for the inverter to perform a restart after restoring power due to an instantaneous power failure.
			9999	No restart
162 A700	Automatic restart after instantaneous power failure selection	0	0, 1	Frequency search only performed at the first start
			10, 11	Frequency search at every start
611 F003	Acceleration time at a restart	9999	0 to 3600 s	Set the acceleration time to reach Pr.20 Acceleration/deceleration reference frequency at restart.
			9999	Standard acceleration time (for example, Pr.7) is applied as the acceleration time at restart.

◆ Selection of restart operation (Pr.162)

- At a power restoration, the encoder detects the motor speed by a frequency search so that the inverter can re-start smoothly.
- The encoder also detects the rotation direction so that the inverter can re-start smoothly even during the reverse rotation.
- When "10 (or 11)" is set in **Pr.162**, a restart operation is performed at each start and automatic restart after instantaneous power failure. When "0 (or 1)" is set in **Pr.162**, a restart operation is performed at the first start after a power-ON, and from the second power-ON onwards, a start from the starting frequency is performed.

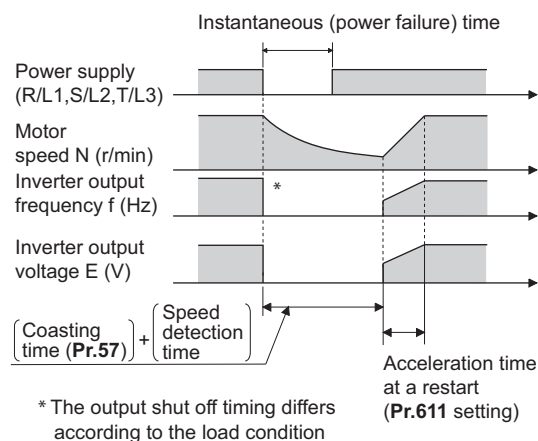

NOTE

- Because a DC injection brake is applied instantaneously at speed detection during a restart, the speed might drop if the moment of inertia (J) of the load is small.
- Restart operation with reduced voltage is not available for PM sensorless vector control.
- A protective function may be activated for some motor models or at certain running speeds, disabling restarting.

◆ Restart coasting time (Pr.57)

- Coasting time is the time from the motor speed detection to the restart operation start.
- To enable restart operation, set "0" (no coasting time) in **Pr.57 Restart coasting time**. Generally, this setting does not interfere with inverter operation.

- Inverter operation is sometimes hindered by the size of the moment of inertia (J) of the load or the output frequency. Adjust this coasting time within the range 0.1 to 30 seconds to match the load specification.

◆ Adjustment of restart operation (Pr.611)

- **Pr.611** can be used to set the acceleration time after a restart operation for the speed to reach **Pr.20 Acceleration/deceleration reference frequency**. This time can be set individually from the normal acceleration time.

NOTE

- Changing the **Pr.21 Acceleration/deceleration time increments** setting does not affect the **Pr.611** setting increment.
- A PM motor is a motor with interior permanent magnets. Regressive voltage is generated when the motor coasts at an instantaneous power failure or at a flying start. The inverter's DC bus voltage rises if the motor coasts fast or makes a flying start in this condition.
When using the automatic restart after instantaneous power failure function (**Pr.57** ≠ "9999"), it is recommended to also use the regenerative avoidance function (**Pr.882 Regeneration avoidance operation selection** = "1") to make startups stable. If the overvoltage protective function (E.OV[]) still occurs with the regeneration avoidance function, also use the retry function (**Pr.67**).
- When a built-in brake or a regeneration unit is used, the frequency search may not be available while the motor speed is equal to or higher than the motor rated speed plus 10%. The restart operation cannot be performed until the motor speed drops to a frequency where the frequency search is available.

⚠ CAUTION

- A PM motor is a motor with interior permanent magnets. High voltage is generated at motor terminals while the motor is running.
Do not touch motor terminals and other parts until the motor stops to prevent an electric shock.
- When the automatic restart after instantaneous power failure function is selected, the motor suddenly starts (after reset time passes) when an instantaneous power failure occurs.
Stay away from the motor and machinery.
When the automatic restart after instantaneous power failure function has been selected, apply the CAUTION sticker(s), which are found in the Inverter Safety Guideline enclosed with the inverter, to easily visible places.

Parameters referred to

- Pr.13 Starting frequency [page 274](#), [page 275](#)
 Pr.65, Pr.67 to Pr.69 Retry function [page 319](#)
 Pr.78 Reverse rotation prevention selection [page 300](#)
 Pr.882 Regeneration avoidance operation selection [page 551](#)

15.11 Offline auto tuning for a frequency search



Under V/F control, the accuracy of the "frequency search", which is used to detect the motor speed for the automatic restart after instantaneous power failure and flying start, can be improved.

Pr.	Name	Initial value	Setting range	Description
162 A700	Automatic restart after instantaneous power failure selection	0	0	Frequency search only performed at the first start
			1	Reduced voltage start only at the first start (no frequency search)
			10	Frequency search at every start
			11	Reduced voltage start at every start (no frequency search)
298 A711	Frequency search gain	9999	0 to 32767	The offline auto tuning automatically sets the gain required for the frequency search.
			9999	The constant value of Mitsubishi Electric motor (SF-PR, SF-JR, SF-HR, SF-JRCA, SF-HRCA, or GM-[]) is used.
560 A712	Second frequency search gain	9999	0 to 32767	The offline auto tuning automatically sets the gain required for the frequency search of the second motor.
			9999	The constant value of Mitsubishi Electric motor (SF-PR, SF-JR, SF-HR, SF-JRCA, SF-HRCA, or GM-[]) is used for the second motor.
96 C110	Auto tuning setting/status	0	0	No offline auto tuning
			1	Offline auto tuning is performed under Advanced magnetic flux vector control, Real sensorless vector control, Vector control, or PM sensorless vector control. (Refer to page 430 and page 441 .)
			11	Offline auto tuning is performed without the motor rotating (under V/F control).
			301	Position accuracy compensation gain tuning is performed (under PM sensorless vector control). (Refer to page 441 .)
90 C120	Motor constant (R1)	9999	0 to 50 Ω, 9999	Tuning data (The value measured by offline auto tuning is automatically set.) 9999: The constant value of Mitsubishi Electric motor (SF-PR, SF-JR, SF-HR, SF-JRCA, SF-HRCA, or GM-[]) is used.
463 C210	Second motor auto tuning setting/status	0	0	No auto tuning for the second motor.
			1	Offline auto tuning is performed for the second motor. (Refer to page 430 and page 441 .)
			11	Offline auto tuning is performed without the second motor rotating (under V/F control).
458 C220	Second motor constant (R1)	9999	0 to 50 Ω, 9999	Tuning data of the second motor (same as Pr.90)

◆ Offline auto tuning for a frequency search

- When the frequency search is selected by setting **Pr.162 Automatic restart after instantaneous power failure selection** = "0 or 10", perform offline auto tuning.

◆ Before performing offline auto tuning

Check the following points before performing offline auto tuning:

- V/F control is selected.
- Check that a motor is connected. (Check that the motor is not rotated by an external force during tuning.)
- The rated motor current should be equal to or less than the inverter rated current.

If a motor with substantially low rated current compared with the inverter rated current is used, speed and torque accuracies may deteriorate due to torque ripples, etc. Set the rated motor current to about 40% or higher of the inverter rated current. (For details on the inverter rated current, refer to the inverter rated specifications in the Instruction Manual (Connection).)

- The target motor is other than a high-slip motor, a high-speed motor, or a special motor.
- The motor may rotate slightly even if the offline auto tuning without the motor rotating (**Pr.96 Auto tuning setting/status** = "11") is selected. Fix the motor securely with a mechanical brake, or before tuning, make sure that it is safe even if the motor rotates. (Caution is required especially in vertical lift applications.) Note that even if the motor runs slightly, tuning performance is unaffected.

- Offline auto tuning is not performed correctly when the surge voltage suppression filter (FR-ASF-H/FR-BMF-H) is inserted between the inverter and motor. Be sure to remove them before performing tuning.

◆ Setting

1. Set "11" in **Pr.96 Auto tuning setting/status**.
2. Set the rated motor current (initial value is the inverter rated current) in **Pr.9 Electronic thermal O/L relay**. (Refer to [page 306](#).)
3. Set **Pr.71 Applied motor** according to the motor to be used.

Motor	Pr.71 setting	
Mitsubishi Electric standard efficiency motor Mitsubishi Electric high-efficiency motor	SF-JR	0 (3)
	SF-JR 4P 1.5 kW or lower	20 (23)
	SF-HR	40 (43)
	Others	0 (3)
Mitsubishi Electric constant-torque motor	SF-JRCA 4P	10 (13)
	SF-HRCA	50 (53)
	Others (SF-JRC, etc.)	10 (13)
Mitsubishi Electric high-performance energy-saving motor	SF-PR	70 (73)
Mitsubishi Electric geared motor	GM-[]	1800 (1803)
Other manufacturer's standard motor	—	0 (3)
Other manufacturer's constant-torque motor	—	10 (13)

15

◆ Performing tuning





Point

- Before performing tuning, check the monitor display of the operation panel or parameter unit if the inverter is in the state ready for tuning. The motor starts by turning ON the start command while tuning is unavailable.
- In the PU operation mode, press the RUN key on the operation panel or the FWD/REV key on the parameter unit. In the External operation, turn ON the start command (STF signal or STR signal). Tuning starts. (At this time, excitation noise occurs.)

NOTE

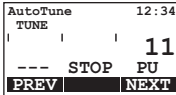
- It takes about 10 seconds for tuning to complete. (The time depends on the inverter capacity and motor type.)
- Satisfy the required inverter start conditions to start offline auto tuning. For example, stop the input of the MRS signal.
- To force tuning to end, use the MRS or RES signal or the STOP/RESET key on the PU. (Turning OFF the start signal (STF signal or STR signal) also ends tuning.)
- During offline auto tuning, only the following I/O signals are valid (initial value).
Input terminals <effective signals>: MRS, RES, STF, STR, S1, and S2
Output terminals: RUN, FM, AM, ABC, and SO
- When the rotation speed and the output frequency are selected for terminals FM and AM, the progress status of offline auto tuning is output in 15 steps from FM and AM.
- Do not perform ON/OFF switching of the Second function selection (RT) signal during offline auto tuning. Auto tuning will not be performed properly.
- Since the RUN signal turns ON when tuning is started, pay close attention especially when a sequence which releases a mechanical brake by the RUN signal has been designed.
- When executing offline auto tuning, input the operation command after switching ON the main circuit power (R/L1, S/L2, T/L3) of the inverter.
- While **Pr.79 Operation mode selection** = "7", turn ON the PU operation external interlock (X12) signal for tuning in the PU operation mode.

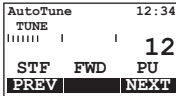
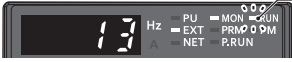
- During tuning, the monitor is displayed on the PU as follows.

Status	Operation panel indication	LCD operation panel (FR-LU08) display
Setting		
Tuning in progress		
Normal end		

- When offline auto tuning ends, press the STOP/RESET key on the PU during PU operation. For External operation, turn OFF the start signal (STF signal or STR signal). This operation resets the offline auto tuning, and the monitor display of the operation panel returns to normal. (Without this operation, next operation cannot be started.)
- At tuning completion, the tuning results are set in the following parameters:

Parameter	Name
90	Motor constant (R1)
298	Frequency search gain
96	Auto tuning setting/status

NOTE

- The motor constants measured once during offline auto tuning are stored as parameters and their data are held until offline auto tuning is performed again. However, the tuning data is cleared when performing All parameter clear.
- If offline auto tuning has ended in error, motor constants are not set.
Perform an inverter reset and perform tuning again.

Error display	Error cause	Countermeasures
8	Forced end	Set "11" in Pr.96 (Pr.463) and retry.
9	Inverter protective function operation	Make the setting again.
91	The current limit (stall prevention) function is activated.	Set the acceleration/deceleration time longer. Set Pr.156 Stall prevention operation selection = "1" .
92	The converter output voltage fell to 75% of the rated voltage.	Check for the power supply voltage fluctuation.
93	Calculation error. The motor is not connected.	Check the motor wiring and make the setting again.

- When tuning is ended forcibly by pressing the STOP/RESET key or turning OFF the start signal (STF or STR) during tuning, offline tuning does not end properly. (The motor constants have not been set.)
Perform an inverter reset and perform tuning again.
- When the rated power supply of the motor is 200/220 V (400/440 V) 60 Hz, set the rated motor current multiplied by 1.1 in **Pr.9 Electronic thermal O/L relay** after tuning is complete.
- For a motor with a PTC thermistor, thermal protector, or other thermal detection, set "0" (motor overheat protection by inverter invalid) in **Pr.9** to protect the motor from overheating.

NOTE

- An instantaneous power failure occurring during tuning will result in a tuning error. After power is restored, the inverter starts normal operation. Therefore, when the STF (STR) signal is ON, the motor starts forward (reverse) rotation.
- Any fault occurring during tuning is handled as in the normal operation. However, if the retry function is set, no retry is performed.
- The set frequency monitor displayed during the offline auto tuning is 0 Hz.

◆ Tuning the second motor (Pr.463)







- When one inverter switches the operation between two different motors, set the second motor in **Pr.450 Second applied motor**, set **Pr.463 Second motor auto tuning setting/status** = "11", and perform tuning of the second motor.
- Turning ON the RT signal enables the parameter settings for the second motor as shown in the following table.

Function	RT signal ON (second motor)	RT signal OFF (first motor)
Motor constant (R1)	Pr.458	Pr.90
Frequency search gain	Pr.560	Pr.298
Auto tuning setting/status	Pr.463	Pr.96

NOTE

- To use the RT signal, set "3" in any parameter from **Pr.178 to Pr.189 (Input terminal function selection)** to assign the function to an input terminal.
- Changing the terminal assignment using **Pr.178 to Pr.189 (Input terminal function selection)** may affect the other functions. Set parameters after confirming the function of each terminal.

◀◀ Parameters referred to ▶▶

Pr.9 Electronic thermal O/L relay  page 306
Pr.65, Pr.67 to Pr.69 Retry function  page 319
Pr.71 Applied motor, Pr.450 Second applied motor  page 424
Pr.79 Operation mode selection  page 280
Pr.156 Stall prevention operation selection  page 334
Pr.178 to Pr.189 (Input terminal function selection)  page 410

15.12 Power failure time deceleration-to-stop function

V/F Magnetic flux Sensorless Vector

This is a function to decelerate the motor to a stop when an instantaneous power failure or undervoltage occurs.

Pr.	Name	Initial value	Setting range	Description
261 A730	Power failure stop selection	0	0	The inverter output is shut off at an undervoltage or when a power failure occurs.
			1	The inverter decelerates the motor to a stop at an undervoltage or when a power failure occurs.
			2	The inverter decelerates the motor to a stop at an undervoltage or when a power failure occurs. The inverter re-accelerates the motor if the power restores during the deceleration.

◆ Power failure stop function (Pr.261 = "1")

- Even if power is restored during deceleration triggered by a power failure, deceleration stop is continued after which the inverter stays stopped. To restart operation, turn the start signal OFF then ON again.

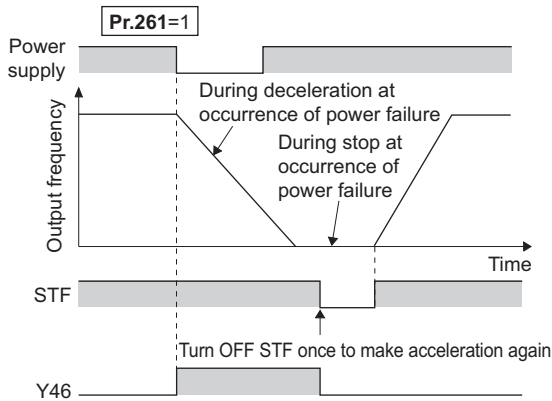

NOTE

- If the automatic restart after instantaneous power failure is selected (**Pr.57 Restart coasting time** ≠ "9999") while the power failure time deceleration stop function is set enabled (**Pr.261** = "1"), the power failure time deceleration stop function is disabled.
- When the power failure time deceleration stop function is enabled (**Pr.261** = "1"), the inverter does not start even if the power is turned ON or inverter reset is performed with the start signal (STF/STR) ON. Turn OFF the start signal once and then ON again to make a start.

When **Pr.30 Regenerative function selection** = "100 to 102" (no reset when power is supplied to the main circuit), the inverter does not start even when power is supplied to the main circuit with the start signal (STF/STR) ON. Turn OFF the start signal once and then ON again to make a start (refer to [page 545](#)). (Standard model and Ethernet model)

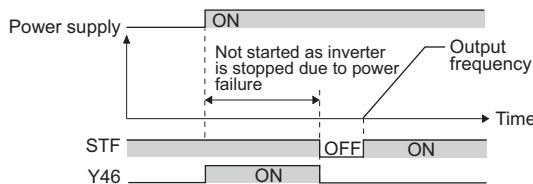

◆ Continuous operation function at instantaneous power failure (Pr.261 = "2")

- The motor re-accelerates to the set frequency when the power restores during the deceleration triggered by a power failure.

If the power is restored after stoppage by a power failure, a restart operation is performed when automatic restart after instantaneous power failure (Pr.57 ≠ "9999") is selected.

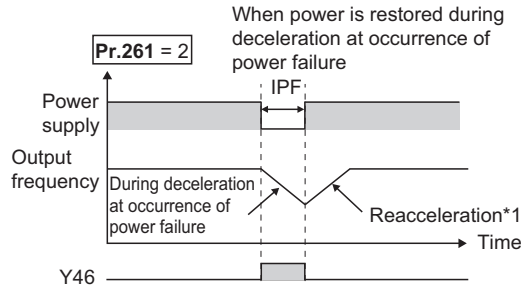

*1 Acceleration time depends on Pr.7 (Pr.44)

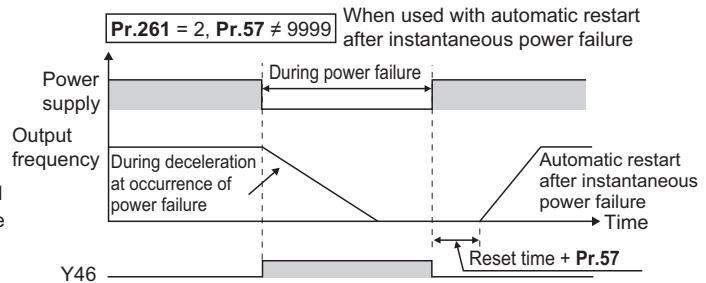

◆ During deceleration at occurrence of power failure (Y46) signal

- After deceleration by a power failure, the inverter is not restarted even though the start command is input. Check the During deceleration at occurrence of power failure (Y46) signal at a power failure. (For example, when input phase loss protection (E.I.LF) occurs.)
- The Y46 signal is turned ON during deceleration at occurrence of power failure and in a stop status after deceleration at occurrence of power failure.
- For the Y46 signal, set "46" (positive logic) or "146" (negative logic) in any parameter from Pr.190 to Pr.197 (Output terminal function selection) to assign the function.

NOTE

- The power failure time deceleration stop function is disabled during a stop or when the breaker is tripped.
- Changing the terminal assignment using Pr.190 to Pr.197 (Output terminal function selection) may affect the other functions. Set parameters after confirming the function of each terminal.

CAUTION

- Even if the power failure time deceleration-to-stop function is set, some loads might cause the inverter to trip and the motor to coast.
The motor coasts if sufficient regenerative power is not obtained from the motor.

Parameters referred to

Pr.57 Restart coasting time [page 502](#), [page 508](#)

Pr.190 to Pr.197 (Output terminal function selection) [page 371](#)

15.13 PLC function

The inverter can be run in accordance with a sequence program.

In accordance with the machine specifications, a user can set various operation patterns: inverter movements at signal inputs, signal outputs at particular inverter status, and monitor outputs, etc.

Pr.	Name	Initial value	Setting range	Description	
414 A800	PLC function operation selection	0	0	PLC function disabled	
			1, 11	PLC function enabled The conditions to enable the SQ signal depends on the Pr.338 setting. The SQ signal is enabled by input from an external input terminal.	
			2, 12		
415 A801	Inverter operation lock mode setting	0	0	The inverter start command is enabled regardless of the operating status of the sequence program.	
			1	The inverter start command is enabled only while the sequence program is running.	
498 A804	PLC function flash memory clear	0	0, 9696 (0 to 9999)	0: Clears the flash memory fault display (no operation after writing while the flash memory is in normal operation).	Write
				9696: Clears the flash memory (no operation after writing while the flash memory is at a fault).	
				Other than 0 and 9696: Outside the setting range	
				0: Normal display	Read
				1: The flash memory is not cleared because the PLC function is enabled.	
9696: During flash memory clearing operation or flash memory fault					
675 A805	User parameter auto storage function selection	9999	1	Auto storage function enabled	
			9999	Auto storage function disabled	
1150 to 1199 A810 to A859	User parameters 1 to User parameters 50	0	0 to 65535	Desired values can be set. Because devices D206 to D255 used by the PLC function can be mutually accessed, the values set to Pr.1150 to Pr.1199 can be used by the sequence program. The result of performing calculation by a sequence program can also be monitored by Pr.1150 to Pr.1199 .	

◆ Outline of PLC function

- To enable the PLC function, set a value other than "0" in **Pr.414 PLC function operation selection**. (The **Pr.414** setting change becomes valid after inverter reset.)
- Switch the execution key (RUN/STOP) of the sequence program by turning the SQ signal ON/OFF. The sequence program can be executed by turning the SQ signal ON. To input the SQ signal, set "50" in any parameter from **Pr.178 to Pr.189 (Input terminal function selection)** to assign the function to a terminal.
- When "1" is set in **Pr.415 Inverter operation lock mode setting**, the inverter can be operated only when the sequence program is running. By changing the PLC program status from RUN to STOP during inverter operation, the motor decelerates to stop. To stop the inverter operation at the STOP status of the PLC program while performing auto operation using SD1148 (or SM1200 to 1211) of the PLC program, set **Pr.415** = "1".
- For reading or writing sequence programs, use FR Configurator2 on the personal computer connected to the inverter via RS-485 communication or USB. (When **Pr.414** ≠ "0", sequence programs can be read from or written to FR Configurator2.)

◆ Sequence start (SQ) signal

- Switch the execution key (RUN/STOP) of the sequence program by turning the SQ signal ON/OFF. The sequence program can be executed by turning the SQ signal ON. To input the SQ signal, set "50" in any parameter from **Pr.178 to Pr.189 (Input terminal function selection)** to assign the function. When the SQ signal is assigned to any parameter from **Pr.185 to Pr.189 (Terminal NET X function selection)**, the sequence program can be executed just by inputting the SQ signal via terminal NET X. (The SQ signal needs not be input via an external terminal.)
- When **Pr.414** = "1 or 11", the SQ signal must be input according to the command source (except when the SQ signal is assigned to terminal NET X).

- When **Pr.414** = "2 or 12", the SQ signal can be input only via an external input terminal regardless of the **Pr.338** setting.
- The following shows the required conditions to enable the SQ signal.

Pr.414 setting	Pr.338 setting	SQ signal	
		Input via an external (physical) terminal	Input via a communication virtual terminal
1, 11	0	ON	ON
		—	ON (terminal NET X)
2, 12	1	ON	—
	—	ON	—

—: Not required to enable the SQ signal

◆ User parameter (data register (D)) auto storage function selection

- Setting **Pr.675** = "1" enables the auto storage function for user parameters.
- The user parameter auto storage function is used to store the setting of **Pr.1195 PLC function user parameters 46** (D251) to **Pr.1199 PLC function user parameters 50** (D255) automatically in EEPROM at power OFF or inverter reset.

NOTE

- The auto storage function may fail if the EEPROM is accessed by other functions at the same time at power OFF.

15

◆ User parameter reading from EEPROM

- User parameters (**Pr.1150 to Pr.1199**) are read from RAM or EEPROM according to the settings in **Pr.342 Communication EEPROM write selection** and **Pr.414 PLC function operation selection**. When **Pr.414** = "11 or 12", RAM data is read regardless of the **Pr.342** setting.

Device	Pr.342	Pr.414	Read from	Written to
Inverter (via communication), FR Configurator2	0	0, 1, 2	EEPROM	EEPROM
		11, 12	RAM	
	1	0, 1, 2	RAM	RAM
		11, 12	RAM	
Communication option	0	0, 1, 2	(Differs according to the option type.)	EEPROM
		11, 12	RAM	
	1	0, 1, 2	RAM	RAM
		11, 12	RAM	
Operation panel Parameter unit	0	0, 1, 2	EEPROM	EEPROM
		11, 12	RAM	
	1	0, 1, 2	EEPROM	RAM
		11, 12	RAM	

NOTE

- For details on the PLC function, refer to the PLC Function Programming Manual and the Instruction Manual of FR Configurator2.

15.14 Trace function

- The operating status of the inverter can be traced and temporarily stored in the RAM in the inverter. The data stored in the RAM is deleted when the power supply is turned OFF. (The data is retained at inverter reset.)
- Stored data can be monitored by FR Configurator2, and the status of the inverter can be analyzed.

Pr.	Name	Initial value	Setting range	Description
1020 A900	Trace operation selection	0 ^{*1}	0	Without trace operation
			1	Sampling start
			2	Forced trigger
			3	Sampling stop
1022 A902	Sampling cycle	1	1, 2, 5, 10, 50, 100, 500, 1000	Set the sampling cycle. 1: 1 ms, 2: 2 ms, 5: 5 ms, 10: 10 ms, 50: 50 ms, 100: 100 ms, 500: 500 ms, 1000: 1 s
1023 A903	Number of analog channels	4	1 to 8	Select the number of analog channels for sampling.
1024 A904	Sampling auto start	0	0	Manual sampling start
			1	Sampling starts automatically when the power supply is turned ON or at a reset
1025 A905	Trigger mode selection	0	0	Fault trigger
			1	Analog trigger
			2	Digital trigger
			3	Analog or digital trigger (OR logic)
			4	Both analog and digital triggers (AND logic)
1026 A906	Number of sampling before trigger	90%	0% to 100%	Set the percentage of the pre-trigger sampling time with respect to the overall sampling time.
1027 A910	Analog source selection (1ch)	201	1 to 3, 5 to 14, 17 to 20, 22 to 24, 32, 33, 35, 40 to 42, 52 to 54, 61, 62, 64, 65, 67, 68, 71, 72, 81 to 86, 91, 97, 201 to 210, 212, 213, 222 to 227, 229 to 232, 235 to 238 ^{*2}	Select the analog data (monitor item) for sampling on each channel.
1028 A911	Analog source selection (2ch)	202		
1029 A912	Analog source selection (3ch)	203		
1030 A913	Analog source selection (4ch)	204		
1031 A914	Analog source selection (5ch)	205		
1032 A915	Analog source selection (6ch)	206		
1033 A916	Analog source selection (7ch)	207		
1034 A917	Analog source selection (8ch)	208		
1035 A918	Analog trigger channel	1	1 to 8	Select the analog channel to be the trigger.
1036 A919	Analog trigger operation selection	0	0	Sampling starts when the value of the analog monitor exceeds the value set at the trigger level (Pr.1037)
			1	Sampling starts when the value of the analog monitor falls below the value set at the trigger level (Pr.1037)
1037 A920	Analog trigger level	1000	600 to 1400	Set the level at which the analog trigger turns ON. The trigger level is the value obtained by subtracting 1000 from the set value.

Pr.	Name	Initial value	Setting range	Description
1038 A930	Digital source selection (1ch)	0	0 to 255	Select the digital data (I/O signal) for sampling on each channel.
1039 A931	Digital source selection (2ch)	0		
1040 A932	Digital source selection (3ch)	0		
1041 A933	Digital source selection (4ch)	0		
1042 A934	Digital source selection (5ch)	0		
1043 A935	Digital source selection (6ch)	0		
1044 A936	Digital source selection (7ch)	0		
1045 A937	Digital source selection (8ch)	0		
1046 A938	Digital trigger channel	1	1 to 8	Select the digital channel to be the trigger.
1047 A939	Digital trigger operation selection	0	0	Tracing starts when the signal turns ON
			1	Tracing starts when the signal turns OFF

*1 The read value is always "0".

*2 The setting range differs depending on the model. For more information, refer to the monitor item list.

◆ Operation outline

- This function is used to sample the status data (analog monitor and digital monitor) of the inverter, trace the sampling data when a trigger (trace start condition) occurs, and stores the resulting trace data.
- When the trace function is set enabled, samplings are collected and the inverter goes into the pre-trigger status.
- In the pre-trigger status, samples are collected, and the trigger standby status is entered when sufficient samples for the number of pre-trigger samples have been collected.
- When a trigger occurs in the trigger standby status, tracing is started and the trace data is stored.

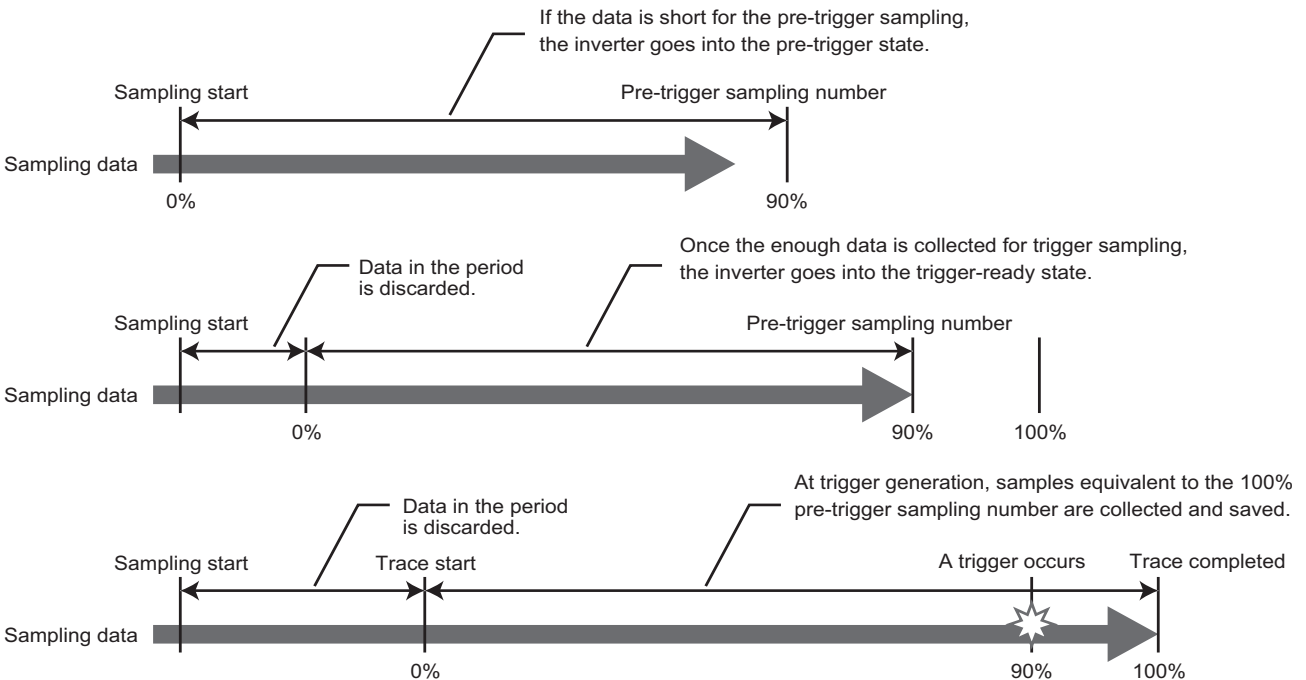

◆ Tracing procedure

- 1.** Prior setting for tracing
Set **Pr.1022 Sampling cycle** and **Pr.1023 Number of analog channels** according to the necessary sampling time.
Use **Pr.1027 to Pr.1034** to set analog sources, and **Pr.1038 to Pr.1045** to set digital sources.
Set a trigger type in **Pr.1025**.
- 2.** Tracing
Sampling starts according to the **Pr.1020 and Pr.1024** settings.
The trace status can be monitored. (Refer to [page 525](#).)
- 3.** Waveform check
By using FR Configurator2, trace data stored in the internal RAM can be displayed on a computer screen. For details, refer to the Instruction Manual of FR Configurator2.

◆ Selection of sampling time (Pr.1022, Pr.1023)

- The sampling time is determined by the sampling cycle and the number of data acquisition points. The number of data acquisition points varies depending on the setting in **Pr.1023 Number of analog channels**.

Pr.1023 Number of analog channels	Memory mode sampling time		Number of data acquisition points
	Minimum (Pr.1022 = "1")	Maximum (Pr.1022 = "1000")	
1	1704 ms	1704 s	1704
2	1280 ms	1280 s	1280
3	1024 ms	1024 s	1024
4	852 ms	852 s	852
5	728 ms	728 s	728
6	640 ms	640 s	640
7	568 ms	568 s	568
8	512 ms	512 s	512

◆ Analog source (monitor item) selection

- Select the analog sources (monitor items) to be set to Pr.1027 to Pr.1034 from the following table.

Setting value	Monitor item ^{*1}	Negative indication (-) ^{*2}	Trigger level criterion ^{*3}	Setting value	Monitor item ^{*1}	Negative indication (-) ^{*2}	Trigger level criterion ^{*3}
1	Output frequency/speed		*4	72	Cumulative pulse overflow times	○	*4
2	Output current		*4	81	BACnet reception status monitor (for the FR-E800 only)		65535
3	Output voltage		*4	82	BACnet token pass counter (for the FR-E800 only)		65535
5	Frequency setting value/motor speed setting		*4	83	BACnet valid APDU counter (for the FR-E800, FR-E800-(SC)EPA, and FR-E806-SCEPA)		65535
6	Running speed		*4	84	BACnet communication error counter (for the FR-E800 only)		65535
7	Motor torque		*4	85	BACnet terminal FM output level (for the FR-E800-1 only)		100%
8	Converter output voltage		*4	86	BACnet terminal AM output level (for the FR-E800-4 and FR-E800-5)		100%
9	Regenerative brake duty		*4	91	PID manipulated amount	○	*4
10	Electronic thermal O/L relay load factor		*4	97	Dancer main set speed		*4
11	Output current peak value		*4	201	*Output frequency		Rated motor frequency
12	Converter output voltage peak value		*4	202	*U-phase output current	○	ND rated current
13	Input power		*4	203	*V-phase output current	○	ND rated current
14	Output power		*4	204	*W-phase output current	○	ND rated current
17	Load meter		*4	205	Converter output voltage		400/800/1000 V
18	Motor excitation current		*4	206	*Output current (all three phases)		ND rated current
19	Position pulse		65535	207	*Excitation current (A)		ND rated current
20	Cumulative energization time		65535	208	*Torque current (A)		ND rated current
22	Orientation status		65535	209	Terminal 2		100%
23	Actual operation time		65535	210	Terminal 4		100%
24	Motor load factor		*4	212	*Excitation current (%)	○	100%
32	Torque command		*4	213	*Torque current (%)	○	100%
33	Torque current command		*4	222 ^{*6}	*Position command (lower)		32767
35	Feedback pulse		65535	223 ^{*6}	*Position command (upper)	○	32767
40	PLC function user monitor 1	○	*4	224 ^{*6}	*Current position (lower)		32767
41	PLC function user monitor 2	○	*4	225 ^{*6}	*Current position (upper)	○	32767
42	PLC function user monitor 3	○	*4	226 ^{*6}	*Droop pulse (lower)		32767
52	PID set point		*4	227 ^{*6}	*Droop pulse (upper)	○	32767
53	PID measured value		*4	229	*Ideal speed command	○	Rated motor frequency
54	PID deviation	○	*4	230	*Output frequency (signed)	○	Rated motor frequency
61	Motor thermal load factor		*4	231	*Motor speed (with sign)	○	*5
62	Inverter thermal load factor		*4	232	*Speed command (with sign)	○	*5
64	PTC thermistor resistance		Pr.561	235	*Torque command	○	100%
65	Ideal speed command	○	*4	236	*Motor torque	○	100%

Setting value	Monitor item ^{*1}	Negative indication (-) ^{*2}	Trigger level criterion ^{*3}
67	PID measured value 2		^{*4}
68	Emergency drive status (for the FR-E800 and FR-E800-E)		65535
71	Cumulative pulse	○	^{*4}

Setting value	Monitor item ^{*1}	Negative indication (-) ^{*2}	Trigger level criterion ^{*3}
237	*Excitation current command	○	100%
238	*Torque current command	○	100%

1 "" shows a monitor item with a high-speed sampling cycle.

*2 The monitor items with a circle (○) represents that its monitor value can be indicated with minus sign.

*3 Indicates a criterion at 100% when the analog trigger is set.

*4 Refer to the full-scale value of terminal FM or AM (on [page 358](#)).

*5 Rated motor frequency × 120 / number of motor poles

*6 When selecting the position command, current position, or droop pulse, select both upper and lower digits.

◆ Digital source (monitor item) selection

- Select the digital sources (input/output signals) to be set to **Pr.1038 to Pr.1045** from the following table. When a value other than the ones in the following table is set, "0" (OFF) is applied for indication.

Setting value	Signal name	Pr.	Remarks	
0	—	—	Input status of an external input terminal For details on the signals, refer to page 410 .	
1	STF ^{*1}	178		
2	STR ^{*1}	179		
5	RL ^{*2*3}	180		
6	RM ^{*2*3}	181		
7	RH ^{*2*3}	182		
9	MRS ^{*2*3}	183		
11	RES ^{*2*3}	184		
21	X0 ^{*3}	—		Input status of a terminal of the FR-A8AX (option)
22	X1 ^{*3}	—		
23	X2 ^{*3}	—		
24	X3 ^{*3}	—		
25	X4 ^{*3}	—		
26	X5 ^{*3}	—		
27	X6 ^{*3}	—		
28	X7 ^{*3}	—		
29	X8 ^{*3}	—		
30	X9 ^{*3}	—		
31	X10 ^{*3}	—		
32	X11 ^{*3}	—		
33	X12 ^{*3}	—		
34	X13 ^{*3}	—		
35	X14 ^{*3}	—		
36	X15 ^{*3}	—		
37	DY ^{*3}	—	Input status of a terminal of the FR-E8AXY (option)	
38	X1 ^{*3}	525		
39	X2 ^{*3}	526		
40	X3 ^{*3}	527		
41	X4 ^{*3}	528		
42	X5 ^{*3}	529		
43	X6 ^{*3}	530		
44	X7 ^{*3}	531		

Setting value	Signal name	Pr.	Remarks
101	RUN ^{*2}	190	For details on the signals, refer to page 371 .
105	FU ^{*2}	191	
106	A,B,C	192	
107	A2,B2,C2 ^{*4}	197	
121	DO0 ^{*3}	313	Output status of a terminal of the FR-A8AY (option)
122	DO1 ^{*3}	314	Output status of a terminal of the FR-A8AY or FR-E8AXY (option)
123	DO2 ^{*3}	315	Output status of a terminal of the FR-A8AY (option)
124	DO3 ^{*3}	316	
125	DO4 ^{*3}	317	
126	DO5 ^{*3}	318	
127	DO6 ^{*3}	319	Output status of a terminal of the FR-A8AR (option)
128	RA1 ^{*3}	320	
129	RA2 ^{*3}	321	
130	RA3 ^{*3}	322	Output status of the signal (via communication) For details on the signals, refer to page 371 .
152	Forward running	—	
153	Reverse running	—	
154	NET SU	—	
155	NET OL	—	
156	NET Y1	193	
159	NET Y2	194	
160	NET Y3	195	
161	NET Y4	196	
166	NET ALM	—	
201	NET AU	—	Input status of the signal (via communication) For details on the signals, refer to page 410 .
202	NET STF	—	
203	NET STR	—	
204	NET RL	180	
205	NET RM	181	
206	NET RH	182	
207	NET RT	—	
208	NET MRS	183	
209	NET JOG2	—	
210	NET X1	185	
211	NET X2	186	
212	NET RES	184	
213	NET X3	187	
214	NET X4	188	
215	NET X5	189	

*1 Fixed to OFF state in the safety communication model.

*2 Fixed to OFF state in the Ethernet model and safety communication model.

*3 Fixed to OFF state in the IP67 model.

*4 Fixed to OFF state in inverters other than the IP67 model.

◆ Trigger setting (Pr.1025, Pr.1035 to Pr.1037, Pr.1046, Pr.1047)

- Set the trigger generating conditions and the trigger target channels.

Pr.1025 setting	Trigger generating conditions	Selection of trigger target channel
0	Tracing starts when inverter enters a fault status (protective function activated)	—
1	Tracing starts when analog monitor satisfies trigger conditions	Pr.1035
2	Tracing starts when digital monitor satisfies trigger conditions	Pr.1046
3	Tracing starts when either of analog or digital monitor satisfies trigger conditions (OR)	Pr.1035, Pr.1046
4	Tracing starts when both of analog or digital monitor satisfies trigger conditions (AND)	Pr.1035, Pr.1046

- Set the trigger generation conditions for the analog monitor.

Pr.1036 setting	Trigger generation conditions	Trigger level setting
0	Sampling starts when the analog data targeted for the trigger exceeds the value specified at the trigger level	Set the trigger level from 600 to 1400 (-400% to 400% ^{*1}) in Pr.1037.
1	Sampling starts when the analog data targeted for the trigger falls below the value specified at the trigger level	

*1 In Pr.1037, set the number obtained by adding 1,000 to the trigger level.

- Set the trigger generation conditions for the digital monitor.

Pr.1047 setting	Trigger generation conditions
0	Tracing starts when the digital data targeted for the trigger turns ON
1	Tracing starts when the digital data targeted for the trigger turns OFF

◆ Start of sampling (Pr.1020, Pr.1024)

- Set the trace operation. The trace operation is set in **Pr.1020 Trace operation selection**.
- When "1" is set in **Pr.1020**, sampling starts.
- When "2" is set in **Pr.1020**, it is regarded that a trigger occurs (forced trigger), and the sampling stops and the tracing starts.
- When "3" is set in **Pr.1020**, sampling stops.
- To start sampling automatically when the power supply at power-ON or at a recovery after an inverter reset, set "1" in **Pr.1024 Sampling auto start**.

Pr.1020 setting	Operation
0	Sampling standby
1	Sampling start
2	Forced trigger (sampling stop)
3	Sampling stop

◆ Selection of trace operation by input terminal (TRG signal, TRC signal)

- Trace operation can be selected by signal inputs.
- A forced trigger can be applied when the Trace trigger input (TRG) signal is ON.
- Sampling is started and stopped by the Trace sampling start/end (TRC) signal turning ON and OFF, respectively.
- To input the TRG signal, set "46" in any parameter from **Pr.178 to Pr.189 (Input terminal function selection)**, and to input the TRC signal, set "47" to assign the function to a terminal.

NOTE

- Changing the terminal assignment using **Pr.178 to Pr.189 (Input terminal function selection)** may affect the other functions. Set parameters after confirming the function of each terminal.

◆ Sampling retry

- If any error is found in the trace data, the sampling stops and then restarts (sampling retry).
- If another error is found within a minute from when an error is found, the sampling stops (sampling retry count excess).
- The sampling retry status can be checked by monitoring the trace status.

◆ Monitoring the trace status

- The trace status can be monitored on the operation panel by setting "38" in **Pr.52 Operation panel main monitor selection**, **Pr.774 to Pr.776 (Operation panel monitor selection)**, or **Pr.992 Operation panel setting dial push monitor selection**.

The content depends on the digits on the operation panel.

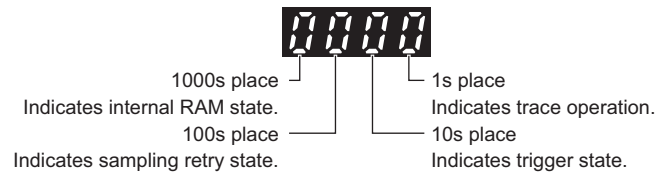

Monitor value	Trace status			
	Fourth digit	Third digit	Second digit	First digit
0 or no display ^{*1}	No trace data in internal RAM	Sampling retry not performed	Trigger not detected	Tracing stopped
1	Trace data in internal RAM	Sampling retry performed	Trigger detected	Trace operation
2	—	Sampling retry count excess	—	—

*1 The value(s) "0" to the left of the leftmost non-zero value is(are) not shown in the monitor display. For example, if no trace data is in internal RAM, sampling retry is not performed, no trigger is detected, and trace operation is performed, "1" appears (not "0001").

- During trace operation, the Trace status (Y40) signal can be output.
To use the Y40 signal, set "40" (positive logic) or "140" (negative logic) in any parameter from **Pr.190 to Pr.197 (Output terminal function selection)** to assign function to an output terminal.

NOTE

- Changing the terminal assignment using **Pr.190 to Pr.197 (Output terminal function selection)** may affect the other functions. Set parameters after confirming the function of each terminal.

Parameters referred to

Pr.52 Operation panel main monitor selection [page 348](#)
 Pr.178 to Pr.189 (Input terminal function selection) [page 392](#)
 Pr.190 to Pr.197 (Output terminal function selection) [page 371](#)

MEMO

CHAPTER 16 (G) Control Parameters

16.1	Manual torque boost	528
16.2	Base frequency voltage	530
16.3	Load pattern selection	532
16.4	Energy saving control	534
16.5	SF-PR slip amount adjustment mode	535
16.6	DC injection brake, zero speed control, servo lock, and magnetic flux decay output shutoff	536
16.7	Stop selection	543
16.8	Regenerative brake selection	545
16.9	Regeneration avoidance function	551
16.10	Increased magnetic excitation deceleration	554
16.11	Slip compensation	556
16.12	Speed detection filter	557
16.13	Excitation ratio	558
16.14	Encoder feedback control	559
16.15	Droop control	561
16.16	Speed smoothing control	562

16 (G) Control Parameters

Purpose	Parameter to set			Refer to page
To set the starting torque manually	Manual torque boost	P.G000, P.G010	Pr.0, Pr.46	528
To set the motor constant	Base frequency, base frequency voltage	P.G001, P.G002, P.G011	Pr.3, Pr.19, Pr.47	530
To select the V/F pattern matching the application	Load pattern selection	P.G003	Pr.14	532
To perform energy saving operation	Energy saving operation	P.G030	Pr.60	534
To compensate the motor slip amount when replacing an SF-JR motor with an SF-PR motor	SF-PR slip amount adjustment mode	P.G060, P.G061	Pr.673, Pr.674	535
To adjust the motor braking torque	DC injection brake, zero speed control, servo lock, and magnetic flux decay output shutoff	P.G100 to P.G103, P.G108, P.G110, P.B003, P.B013	Pr.10 to Pr.12, Pr.422, Pr.802, Pr.850, Pr.1298, Pr.1299	536
To coast the motor to a stop	Selection of motor stop method	P.G106	Pr.250	543
To use the regeneration unit to increase the motor braking torque	Regenerative brake selection	P.E300, P.G107, P.T720	Pr.17, Pr.30, Pr.70	545
To avoid overvoltage fault due to regenerative driving by automatic adjustment of output frequency	Regeneration avoidance function	P.G120, P.G121, P.G123 to P.G125	Pr.882, Pr.883, Pr.885, Pr.886, Pr.665	551
To decrease the deceleration time of the motor	Increased magnetic excitation deceleration	P.G130 to P.G132	Pr.660 to Pr.662	554
To select the control method	Control method selection	P.G200, P.G300	Pr.800, Pr.451	115
To secure the low-speed torque by compensating the slip of the motor	Slip compensation	P.G203 to P.G205	Pr.245 to Pr.247	556
To select the torque characteristic	Constant output range torque characteristic selection	P.G210	Pr.803	139, 167
To adjust the speed control gain	Speed control gain	P.G211, P.G212, P.G311, P.G312	Pr.820, Pr.821, Pr.830, Pr.831	146
To adjust the torque control gain	Torque control gain	P.G213, P.G214, P.G313, P.G314	Pr.824, P.825, Pr.834, P.835	173
To stabilize speed feedback signal	Speed detection filter	P.G215, P.G315	Pr.823, P.833	557
To change excitation ratio	Excitation ratio	P.G217	Pr.854	558
To improve the motor trackability for the speed command changes	Speed feed forward control, model adaptive speed control	P.G220 to P.G224, P.C114	Pr.828, Pr.877 to Pr.881	148
To make starting torque start-up faster	Torque bias	P.G230 to P.G238	Pr.840 to Pr.848	150
To make the motor speed constant by the encoder	Encoder feedback control	P.A107, P.C140, P.C141, P.C148, P.G240, P.G241	Pr.285, Pr.359, Pr.367 to Pr.369, Pr.376	559
To perform frequency control appropriate for load torque	Droop control	P.G400, P.G401	Pr.286, Pr.287	561
To suppress the machine resonance	Speed smoothing control	P.G410, P.G411	Pr.653, Pr.654	562
To adjust the speed gain for Advanced magnetic flux vector control	Speed control gain	P.G932, P.G942	Pr.89, Pr.569	121

16.1 Manual torque boost



Voltage drop in the low-frequency range can be compensated, improving reduction of the motor torque in the low-speed range.

- Motor torque in the low-frequency range can be adjusted according to the load, increasing the motor torque at the start up.
- By using the RT signal, it is possible to switch between 2 types of torque boost.

Pr.	Name	Initial value	Setting range	Description
0 G000	Torque boost	2% to 6%*1	0% to 30%	Set the output voltage at 0 Hz in %.
46 G010	Second torque boost	9999	0% to 30%	Set the torque boost value at when the RT signal is ON.
			9999	Without the second torque boost

*1 The initial value differs depending on the inverter capacity as follows. For the LD rating (Pr.570 = "1"), the initial value is changed. (Refer to [page 235](#)).

Inverter	Initial value
FR-E820-0050(0.75K) or lower FR-E840-0026(0.75K) or lower FR-E820S-0050(0.75K) or lower FR-E810W-0050(0.75K) or lower FR-E846-0026(0.75K)	6%
FR-E860-0017(0.75K)	5%
FR-E820-0080(1.5K) to FR-E820-0175(3.7K) FR-E840-0040(1.5K) to FR-E840-0095(3.7K) FR-E820S-0080(1.5K) or higher FR-E846-0040(1.5K) or higher	4%
FR-E820-0240(5.5K), FR-E820-0330(7.5K) FR-E840-0120(5.5K), FR-E840-0170(7.5K) FR-E860-0027(1.5K), FR-E860-0040(2.2K)	3%
FR-E820-0470(11K) or higher FR-E840-0230(11K) or higher FR-E860-0061(3.7K) or higher	2%

◆ Starting torque adjustment

- Assuming Pr.19 Base frequency voltage is 100%, set the output voltage at 0 Hz to Pr.0 (Pr.46) in percentage.
- Perform the adjustment of the parameter little by little (approximately 0.5%), and confirm the status of the motor each time. The motor may overheat when the value is set too high. Do not use more than 10% as a guideline.

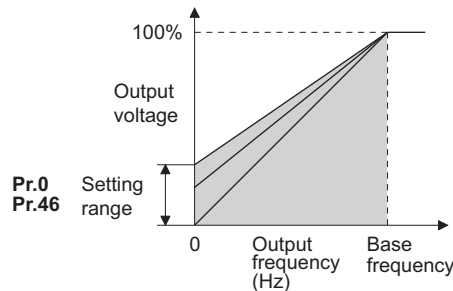

◆ Setting multiple torque boosts (RT signal, Pr.46)

- When changing the torque boost depending on the application or when using single inverter switching between multiple motors, use the second torque boost.
- Pr.46 Second torque boost is enabled when the RT signal is ON. To input the RT signal, set "3" in any parameter from Pr.178 to Pr.189 (Input terminal function selection) to assign the function.

NOTE

- The RT signal is the Second function selection signal which also enables other second functions. (Refer to [page 418](#).)
- Set a larger value when the distance between the inverter and the motor is long or when there is not enough motor torque in the low-speed range. It may cause overcurrent trip when it is set too large.
- Setting for Pr.0 and Pr.46 becomes enabled only when the V/F control is selected.
- When the initial value is set in Pr.0, the Pr.0 setting is automatically changed by changing the Pr.71 Applied motor or Pr.81 Number of motor poles setting. (Refer to [page 424](#).)
- Changing the terminal assignment using Pr.178 to Pr.189 (Input terminal function selection) may affect the other functions. Set parameters after confirming the function of each terminal.

Parameters referred to

- Pr.3 Base frequency, Pr.19 Base frequency voltage [page 530](#)
- Pr.71 Applied motor [page 424](#)
- Pr.178 to Pr.189 (Input terminal function selection) [page 410](#)

16.2 Base frequency voltage



Use this function to adjust the inverter outputs (voltage, frequency) to match with the motor rating.

Pr.	Name	Initial value ^{*1}		Setting range	Description
		Gr.1	Gr.2		
3 G001	Base frequency	60 Hz	50 Hz	0 to 590 Hz	Set the frequency at the rated motor torque. (50/60 Hz)
19 G002	Base frequency voltage	9999	8888	0 to 1000 V	Set the base voltage.
				8888	95% of the power supply voltage (For a single-phase 100 V power input model, 95% of twice of the power supply voltage)
				9999	Same as the power supply voltage (For a single-phase 100 V power input model, twice of the power supply voltage)
47 G011	Second V/F (base frequency)	9999		0 to 590 Hz	Set the base frequency when the RT signal is ON.
				9999	Second V/F disabled

*1 Gr.1 and Gr.2 are the parameter initial value groups. (Refer to page 54).

◆ Base frequency setting (Pr.3)

- When operating a standard motor, generally set the rated frequency of the motor in **Pr.3 Base frequency**. When the motor operation require switching to the commercial power supply, set the power supply frequency in **Pr.3**.
- When the frequency described on the motor rating plate is "50 Hz" only, make sure to set to 50 Hz. When it is set to 60 Hz, the voltage will drop too much, causing insufficient torque. As a result, the inverter output may be shut off due to overload. A caution is required especially in case of **Pr.14 Load pattern selection** = "1" (variable torque load).
- When using the Mitsubishi Electric constant torque motor, set **Pr.3** to 60 Hz.

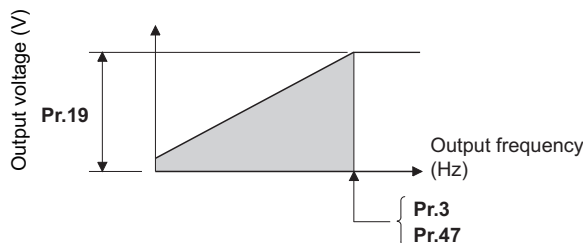

◆ Setting multiple base frequencies (Pr.47)

- To change the base frequency when using a single inverter switching between multiple motors, use **Pr.47 Second V/F (base frequency)**.
- **Pr.47** is enabled when the RT signal is ON. To input the RT signal, set "3" in any parameter from **Pr.178 to Pr.189 (Input terminal function selection)** to assign the function.

NOTE

- The RT signal is the Second function selection signal which also enables other second functions. (Refer to page 418.)

◆ Setting of base frequency voltage (Pr.19)

- Use **Pr.19 Base frequency voltage** to set the base voltage (for example, rated motor voltage).
- When it is set lower than the power supply voltage (approximately twice of the power supply voltage for a single-phase 100 V power input model), maximum output voltage of the inverter will be the voltage set in **Pr.19**.





- **Pr.19** can be used in the following cases.
 - (a) When regenerative driving (continuous regeneration, etc.) is performed frequently
Output voltage will get higher than the specification during the regenerative driving, which may cause overcurrent trip (E.OC[]) by the increase in motor current.
 - (b) When the fluctuation of power supply voltage is high
When the power supply voltage exceeds the rated voltage of the motor, fluctuation of rotation speed or overheating of motor may occur due to excessive torque or increase in motor current.
- To operate a Vector control dedicated motor (SF-V5RU) with V/F control, the setting is as shown in the following table.

Motor model	Pr.19 setting	Pr.3 setting
SF-V5RU, 3.7 kW or lower	170 V	50 Hz
SF-V5RU, 5.5 kW or higher	160 V	
SF-V5RUH, 3.7 kW or lower	340 V	
SF-V5RUH, 5.5 kW or higher	320 V	

NOTE

- When the operation becomes not possible due to failure in encoder or other reasons under Vector control, set "9999" in **Pr.80 Motor capacity** or **Pr.81 Number of motor poles** to perform V/F control.
- When the Advanced magnetic flux vector control, Real sensorless vector control, Vector control, or PM sensorless vector control is selected, **Pr.3**, **Pr.47**, and **Pr.19** will become disabled, and **Pr.83** and **Pr.84** will become enabled. However, S-pattern curve with **Pr.29 Acceleration/deceleration pattern selection** = "1" (S-pattern acceleration/deceleration A) enables **Pr.3** or **Pr.47**. (S-pattern curve under PM sensorless vector control is the rated frequency of the motor.)
- Changing the terminal assignment using **Pr.178 to Pr.189 (Input terminal function selection)** may affect the other functions. Set parameters after confirming the function of each terminal.

Parameters referred to

- Pr.14 Load pattern selection**  [page 532](#)
Pr.29 Acceleration/deceleration pattern selection  [page 267](#)
Pr.83 Rated motor voltage, Pr.84 Rated motor frequency  [page 532](#)
Pr.178 to Pr.189 (Input terminal function selection)  [page 410](#)

16.3 Load pattern selection



Optimal output characteristics (V/F characteristics) for application or load characteristics can be selected.

Pr.	Name	Initial value	Setting range	Description
14 G003	Load pattern selection	0	0	For constant-torque load
			1	For variable-torque load
			2	For constant-torque lift (boost at reverse rotation: 0%)
			3	For constant-torque lift (boost at forward rotation: 0%)

◆ Application for constant-torque load (Pr.14 = "0", initial value)

- The output voltage will change linearly against the output frequency at the base frequency or lower.
- Set this parameter when driving a load that has constant load torque even when the rotation speed is changed, such as conveyor, dolly, or roll drive.

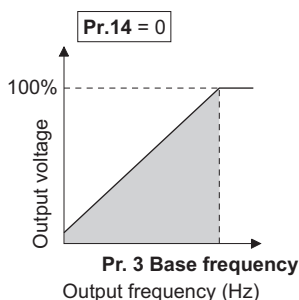

Point

Select for constant-torque load (setting value "0") even for fan and pump in the following cases.

- When accelerating a blower with large moment of inertia (J) in a short period of time.
- When it is a constant-torque load such as rotary pump or gear pump.
- When the load torque increases in low speed such as screw pump.

◆ Application for variable-torque load (Pr.14 = "1")

- The output voltage will change in square curve against the output frequency at the base frequency or lower.
- Set this parameter when driving a load with load torque change proportionally against the square of the rotation speed, such as a fan or pump.

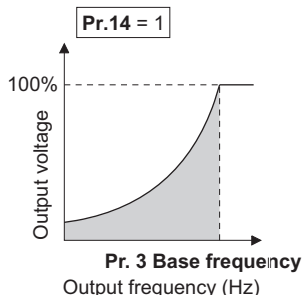

◆ Vertical lift load applications (Pr.14 = "2, 3")

- Set "2" when a vertical lift load is fixed as power driving load at forward rotation and regenerative load at reverse rotation.
- **Pr.0 Torque boost** is valid during forward rotation, and torque boost is automatically changed to "0%" during reverse rotation.
- Set "3" for an elevated load that is in the driving mode during reverse rotation and in the regenerative load mode during forward rotation according to the load weight, e.g. counterweight system.

- **Pr.46 Second torque boost** is enabled when the RT signal is ON. To input the RT signal, set "3" in any parameter from **Pr.178 to Pr.189 (Input terminal function selection)** to assign the function.

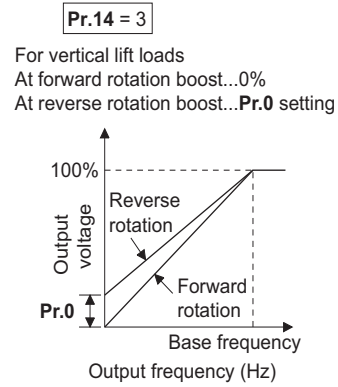
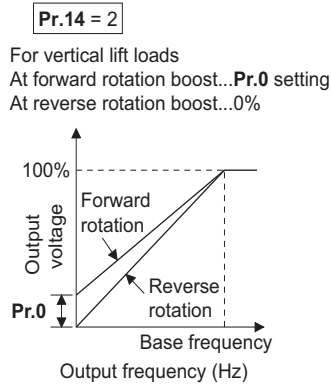

NOTE

- When torque is continuously regenerated as vertical lift load, it is effective to set the rated voltage in **Pr.19 Base frequency voltage** to prevent trip due to current at regeneration.

Parameters referred to

Pr.0 Torque boost [page 528](#)

Pr.178 to Pr.189 (Input terminal function selection) [page 410](#)

16.4 Energy saving control



The inverter will automatically perform energy saving operation without setting detailed parameters.

This control method is suitable for applications such as fans and pumps.

Pr.	Name	Initial value	Setting range	Description
60 G030	Energy saving control selection	0	0	Normal operation
			9	Optimum excitation control

◆ Optimum excitation control (Pr.60 = "9")

- Setting Pr.60 = "9" will select the Optimum excitation control.
- The Optimum excitation control is a control method to decide the output voltage by controlling the excitation current so the efficiency of the motor is maximized.
- Optimum excitation control will be enabled under V/F control and Advanced magnetic flux vector control.

NOTE

- In the Optimum excitation control mode, an energy saving effect is not expected when the motor capacity is extremely small compared with the inverter capacity or when multiple motors are connected to a single inverter.
- When the Optimum excitation control mode is selected, the deceleration time may become longer than the setting value. Also, it may cause overvoltage more often compared to constant-torque load characteristics, so set the deceleration time longer.
- When the motor becomes unstable during the acceleration, set the acceleration time longer.
- Output current may increase slightly with the energy saving operation mode or the Optimum excitation control mode since the output voltage is controlled.

16.5 SF-PR slip amount adjustment mode



- As compared to our conventional SF-JR motor, the slip amount is small for the high-performance energy-saving SF-PR motor. When replacing the SF-JR to the SF-PR, the slip amount is reduced and the rotations per minute increases. Therefore, when the SF-PR is used with the same frequency setting as that of the SF-JR, power consumption may increase as compared to the SF-JR.
- By setting the slip amount adjustment mode, the frequency command can be adjusted to keep the rotations per minute of the SF-PR equivalent to those of the SF-JR for power consumption reduction.

Pr.	Name	Initial value	Setting range	Description
673 G060 ^{*1}	SF-PR slip amount adjustment operation selection	9999	2, 4, 6 9999	Set the number of SF-PR motor poles. The slip amount adjustment is disabled.
674 G061 ^{*1}	SF-PR slip amount adjustment gain	100%	0% to 500%	Setting is available for fine adjustment of the slip amount.

*1 The setting is available for the 100/200/400 V class.

- By setting the number of SF-PR motor poles in **Pr.673 SF-PR slip amount adjustment operation selection**, the SF-PR slip amount adjustment mode is activated.
- The SF-PR slip amount adjustment mode is available only under V/F control.
- Use **Pr.674 SF-PR slip amount adjustment gain** to fine-tune the rotations per minute. To reduce the rotations per minute (to increase the compensation frequency), set a larger value in **Pr.674**. To increase the rotations per minute (to reduce the compensation frequency), set a smaller value in **Pr.674**. (Lower rotations per minute reduce the power consumption, and higher rotations per minute increase the power consumption.)

NOTE

- The slip amount adjustment is not available in the following conditions.
During acceleration/deceleration, during DC injection brake operation, during PID control, during orientation control, during encoder feedback control, during stall prevention operation, during regeneration avoidance operation, during traverse operation, and while the slip compensation is valid (**Pr.245**).
- The slip amount adjustment is not available when the applicable motor capacity of the inverter is not compatible with the SF-PR. (For the details of the applicable motor capacity, refer to the Instruction Manual (Connection).)

16.6 DC injection brake, zero speed control, servo lock, and magnetic flux decay output shutoff

- Adjust the braking torque and timing to stop the motor using the DC injection brake.
Zero speed control is also available under Real sensorless vector control, and zero speed control and servo lock are selectable under Vector control or PM sensorless vector control.
When the DC injection brake operation is used, DC voltage is applied to the motor to prevent rotation of the motor shaft, and when the zero speed control is used, Vector control is performed to keep 0 r/min. Either way, when a motor shaft is rotated by external force, it does not go back to the original position.
When the servo lock control is used, the position of the motor shaft is held. When a motor shaft is rotated by external force, it goes back to the original position.
- Select the magnetic flux decay output shutoff function to decay the magnetic flux before shutting off the output at a stop.

Pr.	Name	Initial value	Setting range	Description
10 G100	DC injection brake operation frequency	3 Hz	0 to 120 Hz	Set the operation frequency for the DC injection brake (zero speed control / servo lock).
11 G101	DC injection brake operation time	0.5 s	0	DC injection brake operation (zero speed control / servo lock) is not applied.
			0.1 to 10 s	Set the operation time for the DC injection brake (zero speed control / servo lock).
			8888	DC injection brake operation starts when the X13 signal is turned ON.
12 G110	DC injection brake operation voltage	6% / 4% / 2% / 1%*1*2*3	0% to 30%	Set the DC injection brake voltage (torque). When set to "0", the DC injection brake is not applied.
802 G102	Pre-excitation selection	0	0	Zero speed control
			1	Servo lock
1299 G108	Second pre-excitation selection	0	0	Zero speed control
			1	Servo lock
850 G103	Brake operation selection	0	0	DC injection brake operation is applied.
			1	Zero speed control (under Real sensorless vector control)
			2	Magnetic flux decay output shutoff (under Real sensorless vector control)
422 B003	Position control gain	10 s ⁻¹	0 to 150 s ⁻¹	Set the position control gain for servo lock.
1298 B013	Second position control gain	10 s ⁻¹	0 to 150 s ⁻¹	Set the position control gain for the second motor.

*1 The initial value differs depending on the inverter capacity as follows.

Inverter	Initial value
FR-E820-0015(0.2K) or lower FR-E820S-0015(0.2K) or lower FR-E810W-0015(0.2K) or lower	6%
FR-E820-0030(0.4K) to FR-E820-0330(7.5K) FR-E840-0016(0.4K) to FR-E840-0170(7.5K) FR-E820S-0030(0.4K) or higher FR-E810W-0030(0.4K) or higher FR-E846-0026(0.75K) or higher	4%
FR-E820-0470(11K) or higher FR-E840-0230(11K) or higher	2%
FR-E860-0017(0.75K) or higher	1%

*2 The initial value may be changed depending on the **Pr.570 Multiple rating setting** setting. (Refer to [page 235](#).)

*3 The setting value may be automatically changed according to the motor, depending on the **Pr.71 Applied motor** setting. (Refer to [page 428](#).)

◆ Setting of operating frequency (Pr.10)

- By setting the frequency for DC injection brake operation (zero speed control / servo lock) to **Pr.10 DC injection brake operation frequency**, DC injection brake operation (zero speed control / servo lock) starts when the frequency reaches the **Pr.10** setting during deceleration.

- The frequency values to start brake operation are as follows.

Motor	Stopping method	Parameter setting	Frequency to start brake operation	
Induction motor	Press the STOP/RESET key on the operation panel. Turn OFF the STF/STR signal.	Pr.11 ≠ "0, 8888"	0.5 Hz or higher in Pr.10	Pr.10 setting
			Lower than 0.5 Hz in Pr.10, and 0.5 Hz or higher in Pr.13	0.5 Hz
			Lower than 0.5 Hz in both Pr.10 and Pr.13	Pr.10 or Pr.13 setting, whichever larger
		Pr.11 = "0"	0.5 Hz or higher in Pr.10	Output shutoff at the Pr.10 setting value or lower
			Lower than 0.5 Hz in Pr.10, and 0.5 Hz or higher in Pr.13	Output shutoff at 0.5 Hz or lower
	Lower than 0.5 Hz in both Pr.10 and Pr.13	Output shutoff at the Pr.10 or Pr.13 setting value (whichever larger) or lower		
Pr.11 = "8888"	Output shutoff at 0.5 Hz or lower			
	Set frequency to 0 Hz	—	Pr.13 setting or 0.5 Hz, whichever smaller	
PM motor	Press the STOP/RESET key on the operation panel. Turn OFF the STF/STR signal.	Pr.11 ≠ "0, 8888"	MM-GKR or EM-A: Pr.10 setting Other PM motors: 0 Hz	
		Pr.11 = "0"	Output shutoff at the Pr.10 setting value or lower	
		Pr.11 = "8888"	MM-GKR or EM-A: Output shutoff at 0.5 Hz or lower Other PM motors: Output shutoff at 0 Hz	
	Set frequency to 0 Hz	—	0 Hz	

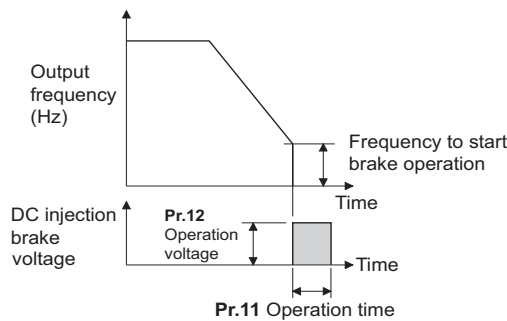

NOTE

- When executing pre-excitation (zero speed control) under Real sensorless vector control, set **Pr.10 DC injection brake operation frequency** to 0.5 Hz or lower since it may cause motor vibration, etc., at the time of deceleration stop.
- The initial value of **Pr.10** will automatically switch to 0.5 Hz under Vector control.

◆ Operation time setting (X13 signal, Pr.11)

- Set the operation time for DC injection brake (zero speed control / servo lock) in **Pr.11 DC injection brake operation time**.
- When the motor does not stop due to large load moment (J), increase the setting to ensure the effect.
- When **Pr.11 = "0 s"**, DC injection brake (zero speed control / servo lock) does not start. (The motor starts to coast when the output frequency drops to the **Pr.10** setting or lower at a stop.)
- When **Pr.11 = "8888"**, DC injection brake (zero speed control / servo lock) starts when the X13 signal is turned ON. DC injection brake (zero speed control / servo lock) will start when the X13 signal is turned ON, even during operation, during automatic restart after instantaneous power failure, or during offline auto tuning.

- For the X13 signal input, set "13" in any parameter from **Pr.178 to Pr.189** to assign the function.

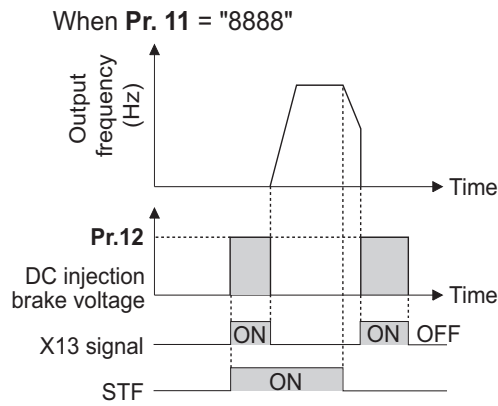

NOTE

- Under Real sensorless vector control, when the X13 signal turns ON while **Pr.11 = "8888"**, the zero speed control is activated regardless of the **Pr.850 Brake operation selection** setting.
- Under Vector control, zero speed control or servo lock starts depending on the setting of **Pr.802**.
- When the X13 signal is turned ON while online auto tuning is performed at startup, DC injection brake (zero speed control / servo lock) will start after the tuning is completed.

◆ Setting of operation voltage (torque) (Pr.12)

- Set the percentage against the power supply voltage in **Pr.12 DC injection brake operation voltage**. (The setting is not used for zero speed control or servo lock.)
- The DC injection brake operation is not available when the setting of **Pr.12** is 0%. (The motor starts to coast when the output frequency drops to the **Pr.10** setting or lower at a stop.)
- The **Pr.12** setting is disabled under PM sensorless vector control.

NOTE

- When the setting of **Pr.12** is the initial value, the setting corresponding to the motor is set according to the **Pr.71 Applied motor** setting. (Refer to [page 428](#).) However, when an energy saving motor (SF-HR or SF-HRCA) is used, change the **Pr.12** setting as shown below.

Motor capacity	Pr.12 setting
3.7 kW or lower	4%
5.5 kW, 7.5 kW	3%
11 kW or higher	2%

- Even if the setting value of **Pr.12** is made larger, braking torque will be limited so the output current will be within the rated current of the inverter.

◆ Braking operation selection under Real sensorless vector control (Pr.850 = "0 or 1")

- The braking operation under Real sensorless vector control can be selected between the DC injection brake operation (initial setting) and zero speed control.

By setting **Pr.850 Brake operation selection = "1"**, zero speed control will be performed at the frequency set in **Pr.10 DC injection brake operation frequency** or lower.

NOTE

- Under Real sensorless vector control, when the X13 signal turns ON while **Pr.11 = "8888"**, the zero speed control is activated regardless of the **Pr.850** setting.
- When restarting the operation after a brake operation under Real sensorless vector control, set **Pr.850 = "1"** (zero speed control). Setting "0" (DC injection brake) may cause a delay of about 2 seconds from the time the start up command is input until it actually is output.

◆ Magnetic flux decay output shutoff and the Magnetic flux decay output shutoff signal (X74 signal, Pr.850 = "2")

- Frequent starts/stops (inching) under Real sensorless vector control may cause an inverter failure or create a difference in operation with the motor. The reason is that some magnetic flux is left in the motor at shutoff of the inverter output. If this is the case, set **Pr.850 = "2"** (magnetic flux decay output shutoff) or turn ON the Magnetic flux decay output shutoff (X74) signal to decay the magnetic flux at a stop, and then shut off the output.
- While **Pr.850 = "2"**, deceleration starts at turning OFF of the start command, and the magnetic flux decay output shutoff is activated when the estimated speed becomes lower than **Pr.10 DC injection brake operation frequency**.
- While the brake sequence function is active, the magnetic flux decay output shutoff is activated when the running frequency drops to 0.5 Hz or **Pr.13 Starting frequency**, whichever is smaller.
- Inverter output voltage shutoff timing when **Pr.850 = "2"**

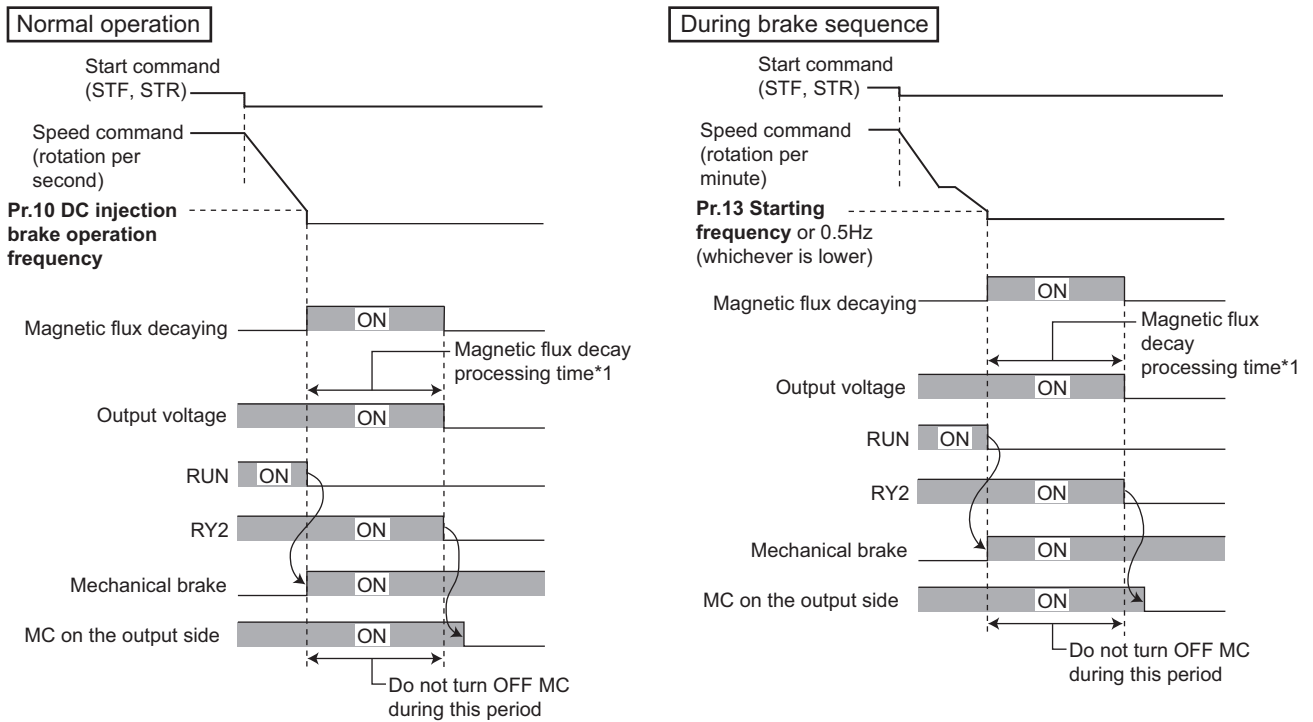

*1 Maximum processing time of the magnetic flux decay

- Turning ON the Magnetic flux decay output shutoff (X74) signal starts the magnetic flux decay output shutoff regardless of the **Pr.850** setting. For the X74 signal, set "74" in any parameter from **Pr.178 to Pr.189 (Input terminal function selection)** to assign the function.
- Inverter output shutoff timing with X74 signal

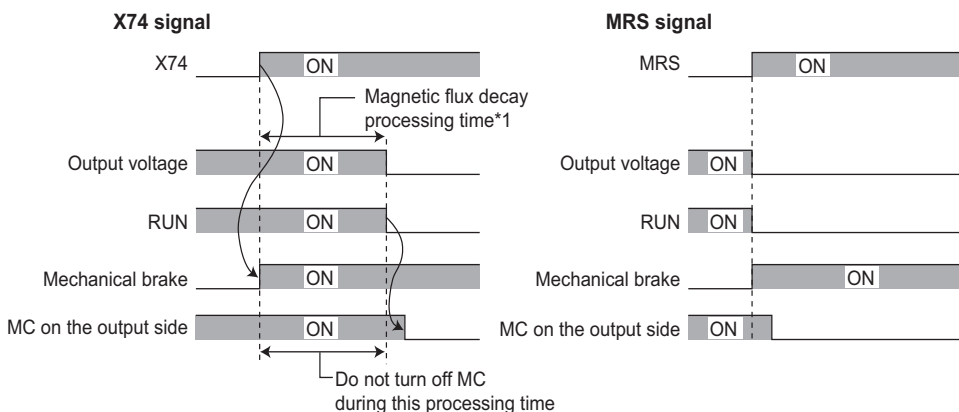

*1 Maximum processing time of the magnetic flux decay

- Since the torque will decrease at the time of magnetic flux decay output shutoff, set up so the mechanical brake will operate.

- The magnetic flux decay output shutoff will be canceled at the time of restart and when the Pre-excitation/servo ON (LX) signal or External DC injection brake operation start (X13) signal is turned ON.
- If an MC is installed at the inverter's output side, set to open the MC after the operation time of the magnetic flux decay output shutoff elapses. (See below.)

Motor capacity (Pr.80 setting)	2.2 kW or lower	3.7 kW to 11 kW	15 kW to 30 kW
Magnetic flux decay process time	250 ms	500 ms	800 ms

NOTE

- Under a control other than Real sensorless vector control, the inverter will immediately shutoff the output when the X74 signal is turned ON.
- Even under Real sensorless vector control, the inverter will immediately shutoff the output when the X74 signal is turned ON during the automatic restart after instantaneous power failure and online auto tuning during the start up.
- If another output-shutoff trigger (inverter fault, turning ON the MRS signal, etc.) occurs during the magnetic flux decay operation, the magnetic flux decay operation is terminated, and the output is shut off immediately.
- Unlike the MRS signal, voltage is output during the magnetic flux decay output shutoff operation, so take caution on electric shocks.
- When the release timing of the mechanical brake is too fast, the motor shaft may be rotated by dropping or external force. When the release timing is too late, the overcurrent prevention operation, stall prevention operation, or electronic thermal O/L relay function may be activated. Perform release of the mechanical brake matching the equipment using the Output frequency detection (FU) signal or Output current detection (Y12) signal.
- Changing the terminal assignment using **Pr.178 to Pr.189 (Input terminal function selection)** may affect the other functions. Set parameters after confirming the function of each terminal.

◆ Brake operation selection under Vector control (Pr.802, Pr.1299)

- Use **Pr.802 Pre-excitation selection** to select the braking operation when the pre-excitation is performed from either zero speed control or servo lock.

Pr.802 (Pr.1299) setting	Pre-excitation	Description
0 (initial value)	Zero speed control	Even under a load, the inverter does not rotate the motor and holds 0 r/min. However, it will not return to its original position when the shaft moves due to external force. This setting is invalid during position control. The inverter operates according to this setting only during speed control.
1	Servo lock	Even under a load, the inverter holds the position of the motor shaft. When the shaft moves due to external force, it will return to its original position after the external force is removed. To perform the position control, this loop gain can be adjusted using Pr.422 Position control gain (Pr.1298 Second position control gain) .

◆ Brake operation list

- The relation between the DC injection brake operation and pre-excitation operation is as follows.

Control method	Control mode	Pr.802 (Pr.1299)	Pr.850	Deceleration stop	LX-ON	X13-ON (Pr.11 = "8888")
V/F control	—	—	—	DC injection brake	—	DC injection brake
Advanced magnetic flux vector control	—	—	—	DC injection brake	—	DC injection brake
Real sensorless vector control	Speed	—	0	DC injection brake	Zero speed	Zero speed
		—	1	Zero speed		
		—	2	Magnetic flux decay output shutoff		
	Torque	—	0	DC injection brake	Zero speed	Zero speed
		—	1	Zero speed		
		—	2	Magnetic flux decay output shutoff		
Vector control	Speed	0	—	Zero speed	Zero speed	Zero speed
		1	—	Servo lock	Servo lock	Servo lock
	Torque	—	—	Zero speed	Zero speed	Zero speed
Position	—	—	—	—	Servo lock	—
PM sensorless vector control (motor other than MM-GKR or EM-A)	Speed	0	—	DC injection brake	—	DC injection brake
PM sensorless vector control (MM-GKR or EM-A)	Speed	0	—	Zero speed	Zero speed	Zero speed
		1	—	Servo lock	Servo lock	Servo lock
	Position	—	—	—	—	Servo lock

16

◆ Pre-excitation signal (LX signal)

- When the Pre-excitation/servo ON (LX) signal is turned ON while the motor stops under Real sensorless vector control, Vector control, or PM sensorless vector control, pre-excitation (zero speed control / servo lock) starts.
- To input the LX signal, set "23" in any parameter from **Pr.178 to Pr.189 (Input terminal function selection)** to assign the function.

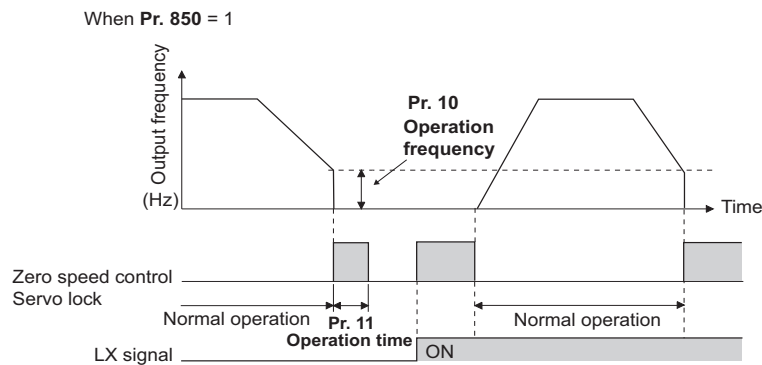

NOTE

- Changing the terminal assignment using **Pr.178 to Pr.189 (Input terminal function selection)** may affect the other functions. Set parameters after confirming the function of each terminal.
- Performing pre-excitation (LX signal and X13 signal) under torque control may start the motor running at a low speed even when the start signal (STF or STR) is not input. This product with the start command ON may also rotate the motor at a low speed when the speed limit value is set to zero. Confirm that the motor running does not cause any safety problems before performing pre-excitation.
- Note that during the pre-excitation operation, a voltage is applied to the motor even when the [RUN] LED on the operation panel or the FWD/REV indicator on the parameter unit is OFF.
- When offline auto tuning (**Pr.96 Auto tuning setting/status** = "1, 11, or 301") is performed during pre-excitation operation, pre-excitation is disabled.
- When the LX signal is ON and the start signal is OFF at the automatic restart after instantaneous power failure, the motor does not decelerates to stop from the detected motor speed, and pre-excitation (zero speed control / servo lock) is applied.

CAUTION

- During the orientation operation, do not set "0 or 8888" in **Pr.11** and do not set "0" in **Pr.12**. The motor may not stop properly.
- Install a mechanical brake to make an emergency stop or to stay stopped for a long time.
- Wait until the machine stops completely, and fix the motor with a mechanical brake, then turn the LX signal (pre-excitation) OFF.

« Parameters referred to »

Pr.13 Starting frequency  [page 274](#), [page 275](#)

Pr.71 Applied motor  [page 424](#)

Pr.80 Motor capacity  [page 430](#)

Pr.178 to Pr.189 (Input terminal function selection)  [page 410](#)

16.7 Stop selection

Select the stopping method (deceleration stop or coasting) at turn-OFF of the start signal.

Coasting can be selected for the cases such that the motor is stopped with a mechanical brake at turn-OFF of the start signal.

The operation of the start signal (STF/STR) can be selected. (For the start signal operation selection, refer to [page 420](#).)

Pr.	Name	Initial value	Setting range	Description	
				Start signal (STF/STR) ^{*1}	Stop operation
250 G106	Stop selection	9999	0 to 100 s	STF signal: Forward rotation start STR signal: Reverse rotation start	The motor coasts to a stop after a lapse of the setting time when the start signal is turned OFF.
			1000 to 1100 s ^{*2}	STF signal: Start signal STR signal: Forward/reverse rotation signal	The motor coasts to a stop after a lapse of the (Pr.250 - 1000) seconds when the start signal is turned OFF.
			9999	STF signal: Forward rotation start STR signal: Reverse rotation start	The motor is decelerated to a stop when the start signal is turned OFF.
			8888 ^{*2}	STF signal: Start signal STR signal: Forward/reverse rotation signal	

*1 For the start signal operation selection, refer to [page 420](#).

*2 The start signal operation selection is available in External operation mode or when the start command source is External in the Network operation mode.

◆ To decelerate the motor to a stop

- Set Pr.250 = "9999 (initial value) or 8888".
- The motor is decelerated to a stop when the start signal (STF/STR) is turned OFF.

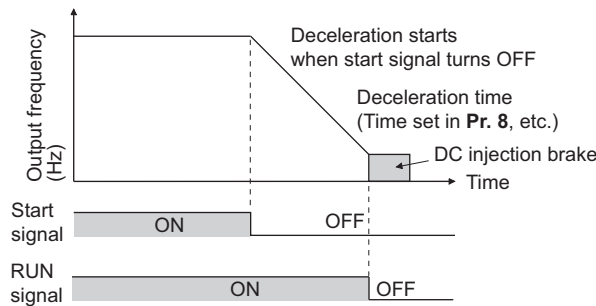

◆ To coast the motor to a stop

- Set the time required to shut off the output after the start signal is turned OFF in Pr.250. When "1000 to 1100" is set, output is shut off after a lapse of the (Pr.250 - 1000) seconds.
- The output is shut off after a lapse of the setting time of Pr.250 when the start signal is turned OFF. Motor coasts to a stop.
- The RUN signal is turned OFF when the output is shut off.

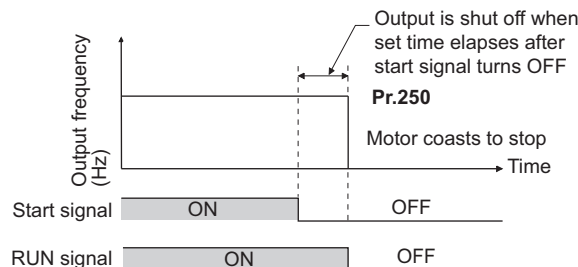



NOTE

- The stop selection setting is disabled when the following functions are operating.
 - Position control
 - Power failure stop function (**Pr.261**)
 - PU stop (**Pr.75**)
 - Deceleration stop due to a communication error (**Pr.502**)
 - JOG operation
 - Offline auto tuning
- When **Pr.250** ≠ "9999 or 8888", acceleration/deceleration is performed in accordance to the frequency command until the output is shut off by turning OFF the start signal.
- When the restart signal is turned ON during the motor coasting, the operation is resumed from **Pr.13 Starting frequency**.
- Even with the setting of coasting to a stop, when the LX signal is turned ON, the motor does not coast but zero speed control or servo lock is applied.

Parameters referred to

Pr.7 Acceleration time, Pr.8 Deceleration time  [page 262](#)

Pr.13 Starting frequency  [page 274](#), [page 275](#)

Pr.75 Reset selection/disconnected PU detection/PU stop selection  [page 225](#)

Pr.261 Power failure stop selection  [page 514](#)

Pr.502 Stop mode selection at communication error  Instruction Manual (Communication)

16.8 Regenerative brake selection

- When performing frequent start and stop operation, usage rate of the regenerative brake can be increased by using the optional high-duty brake resistor (FR-ABR) or the brake unit (FR-BU2, BU, or FR-BU).
- The multifunction regeneration converter (FR-XC in power regeneration mode) or power regeneration common converter (FR-CV) is used for the continuous operation in the regenerative status. The multifunction regeneration converter (FR-XC in common bus regeneration mode) and high power factor converter (FR-HC2) can also be used to reduce harmonics, improve power factor, and operate continuously during regenerative driving. The multifunction regeneration converter (FR-XC), power regeneration common converter (FR-CV), and high power factor converter (FR-HC2) cannot be used with the safety communication model and the IP67 model.
- When the FR-E8DS is installed, the reset operation when the power is supplied to the main circuit while 24 V external power is supplied to the inverter can be selected. (Standard model and Ethernet model)

Pr.	Name	Initial value	Setting range	Description	
30 E300	Regenerative function selection	0	0	No regenerative function Brake resistor (MRS, MYS type) Brake unit (FR-BU2)	Reset when power is supplied to the main circuit
			100 ^{*1}	Multifunction regeneration converter (FR-XC) Power regeneration common converter (FR-CV) High power factor converter (FR-HC2)	No reset when power is supplied to the main circuit
			1	Brake resistor (MYS type) used at 100% torque, 6%ED High-duty brake resistor (FR-ABR)	Reset when power is supplied to the main circuit
			101 ^{*1}		No reset when power is supplied to the main circuit
			2 ^{*1}	When the automatic restart operation after instantaneous power failure function is enabled while a brake resistor and a regeneration unit is used	Reset when power is supplied to the main circuit
			102 ^{*1}		No reset when power is supplied to the main circuit
70 G107	Special regenerative brake duty	0%	0% to 100%	Set the %ED of the built-in brake transistor operation.	
17 T720	MRS/X10 terminal input selection	0	0	X10: Normally open input	MRS: Normally open input
			1	X10: Normally closed input (NC contact input specification)	
			2	X10: Normally open input	MRS: Normally closed input (NC contact input specification)
			3	X10: Normally closed input (NC contact input specification)	
			4	X10: Normally open input	External terminal: Normally closed input (NC contact input specification) Communication: Normally open input
			5	X10: Normally closed input (NC contact input specification)	

*1 Available for the standard model and the Ethernet model.

◆ **When using the brake resistor (MRS, MYS type), brake unit (FR-BU2), multifunction regeneration converter (FR-XC), power regeneration common converter (FR-CV), and high power factor converter (FR-HC2)**

- Set **Pr.30** = "0 (initial setting) or 100". The **Pr.70** setting is invalid. At this time, the regenerative brake duty is as follows.

Inverter	Regenerative brake duty
FR-E820-0015(0.2K) or lower FR-E820S-0015(0.2K) or lower FR-E810W-0015(0.2K) or lower	0%
FR-E820-0030(0.4K) to FR-E820-0175(3.7K) FR-E820S-0030(0.4K) or higher FR-E810W-0030(0.4K) or higher	3%
FR-E820-0240(5.5K) or higher FR-E840-0016(0.4K) or higher FR-E860-0017(0.75K) or higher FR-E846-0026(0.75K) or higher	2%

- When connecting the converter unit (FR-XC, FR-HC2, or FR-CV), assign the Inverter run enable (X10) signal to a contact input terminal. To ensure coordinated protection of the converter unit, use the Inverter operation enable (X10) signal to shut off the inverter output. Input the Inverter operation enable (RYB/RDY/RDYB) signal of the converter unit. The X10 signal can be input only via an external input terminal. For the terminal used for the X10 signal input, set "10" (X10) in any parameter from **Pr.178** to **Pr.184** to assign the function.

◆ **When using the brake resistor (MYS type) at 100% torque, 6%ED (FR-E820-0175(3.7K) only)**

- Set **Pr.30** = "1 or 101".
- Set **Pr.70** = "6%".

◆ **When using the high-duty brake resistor (FR-ABR) (FR-E820-0030(0.4K) or higher, FR-E840-0016(0.4K) or higher, FR-E860-0017(0.75K) or higher, FR-E820S-0030(0.4K) or higher, FR-E810W-0030(0.4K) or higher, and FR-E846-0026(0.75K) or higher)**

- Set **Pr.30** = "1 or 101".
- Set **Pr.70** as follows.

Inverter	Pr.70 setting
FR-E820-0330(7.5K) or lower FR-E840-0170(7.5K) or lower FR-E860-0120(7.5K) or lower FR-E820S-0110(2.2K) or lower FR-E810W-0050(0.75K) or lower FR-E846-0095(3.7K) or lower	10%
FR-E820-0470(11K) or higher FR-E840-0230(11K) or higher	6%

◆ **When the automatic restart after instantaneous power failure function is enabled (standard model / Ethernet model)**

- Set **Pr.30** = "2 or 102" to enable the automatic restart after instantaneous power failure function when using the high-duty brake resistor (FR-ABR), brake resistor (MRS, MYS type), brake unit (FR-BU2), multifunction regeneration converter (FR-XC), power regeneration common converter (FR-CV), and high power factor converter (FR-HC2).

- Set **Pr.70** as follows.

Option used	Pr.70 setting	Remarks
FR-ABR	10%	FR-E820-0330(7.5K) or lower FR-E840-0170(7.5K) or lower FR-E860-0120(7.5K) or lower FR-E820S-0110(2.2K) or lower FR-E810W-0050(0.75K) or lower
	6%	FR-E820-0470(11K) or higher FR-E840-0230(11K) or higher
MRS type, MYS type	3%	FR-E820-0030(0.4K) or higher FR-E840-0016(0.4K) or higher FR-E860-0017(0.75K) or higher FR-E820S-0030(0.4K) or higher FR-E810W-0030(0.4K) or higher
MYS type (used at 100% torque / 6%ED)	6%	FR-E820-0175(3.7K)
FR-XC, FR-CV, FR-HC2, FR-BU2	0%	—

- When using the FR-XC or FR-HC2, enable the automatic restart after instantaneous power failure function in both the FR-XC/FR-HC2 and the inverter (**Pr.57 Restart coasting time** ≠ "9999").
- If the FR-XC or FR-HC2 detects the power failure during inverter running, the motor starts to coast since the Inverter operation enable (RYB or RDY) signal turns ON. After the power is restored and the Inverter operation enable (RYB or RDY) signal turns OFF, the inverter detects the motor speed (**Pr.162 Automatic restart after instantaneous power failure selection**) and restarts operation.

◆ Logic reversing of the Inverter run enable signal (X10 signal, Pr.17)

- Use **Pr.17 MRS/X10 terminal input selection** to select the X10 signal input specification between normally open (NO contact) and normally closed (NC contact). With the normally closed (NC contact) input specification, the inverter output is shut off by turning OFF (opening) the X10 signal.
- Change the **Pr.17** setting to change the inverter logic (NO/NC contact) according to the logic of the inverter operation enable signal sent from the converter unit.
- The logic of the MRS signal can also be selected by setting **Pr.17**. Refer to [page 416](#) to select the logic of the MRS signal.
- The response time of the X10 signal is within 2 ms.

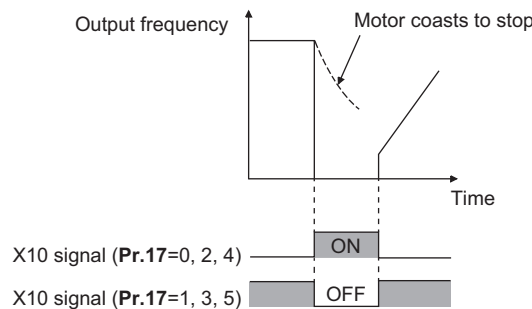

- Relationship between **Pr.17** and the Inverter run enable signal of each option unit

Pr.17 setting	Corresponding signals of the option unit			Operation according to the X10 signal status
	FR-HC2	FR-CV	FR-XC	
0/2/4 (initial values)	RDY (negative logic) (initial setting)	RDYB	RYB	X10-ON: Inverter output shutoff (NO contact)
1, 3, 5	RDY (positive logic)	RDYA	RYA	X10-OFF: Inverter output shutoff (NC contact)

NOTE

- When **Pr.30** = "0, 2, 100, or 102" and the X10 signal is not assigned to an input terminal, the MRS signal can be used as the X10 signal. The logic of the signal depends on that of the MRS signal (normally open input when **Pr.17** = "0 or 1", and normally closed input when **Pr.17** = "2 to 5").
- The MRS signal is valid regardless of whether it is input through the external terminal or via network (except for the FR-E800-SCE), but when the MRS signal is used as the Inverter run enable (X10) signal, input the signal through the external terminal.
- When the terminal assignment is changed with **Pr.178 to Pr.184 (Input terminal function selection)**, wiring may be mistaken due to different terminal name and signal contents, or may affect other functions. Set parameters after confirming the function of each terminal.

◆ Regenerative brake duty warning output and the warning signal (RBP signal)

- When the regenerative brake duty reaches 85% of the **Pr.70** setting, "RB" is indicated on the operation panel and the Regenerative brake prealarm (RBP) signal is output. When it reaches 100% of the **Pr.70** setting, it will become regenerative overvoltage (E.OV[]).
- The inverter output is not shut off with the warning signal.
- For the RBP signal output, set "7" (positive logic) or "107" (negative logic) to any parameter from **Pr.190 to Pr.197 (Output terminal function selection)** to assign the function.

100%: Regeneration overvoltage protection operation value

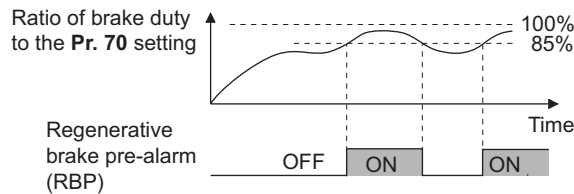

NOTE

- When **Pr.30** = "0 (initial value) or 100", "RB" is not indicated.
- Changing the terminal assignment using **Pr.190 to Pr.197 (Output terminal function selection)** may affect the other functions. Set parameters after confirming the function of each terminal.

◆ Connection of a brake resistor other than the FR-ABR, MRS type, and MYS type

A brake resistor can be used with the FR-E820-0030(0.4K) or higher, FR-E840-0016(0.4K) or higher, FR-E860-0017(0.75K) or higher, FR-E820S-0030(0.4K) or higher, FR-E810W-0030(0.4K) or higher, and FR-E846-0026(0.75K) or higher.

Use a brake resistor that has resistance and power consumption values higher than the following. Also, the brake resistor must have a sufficient capacity to consume the regenerative power.

Voltage class	Inverter	Minimum resistance (Ω)	Power consumption (kW)
100 V class	FR-E810W-0030(0.4K)	100	1.5
	FR-E810W-0050(0.75K)	80	1.9

Voltage class	Inverter	Minimum resistance (Ω)	Power consumption (kW)
200 V class	FR-E820-0030(0.4K)	100	1.5
	FR-E820-0050(0.75K)	80	1.9
	FR-E820-0080(1.5K)	60	2.5
	FR-E820-0110(2.2K)	60	2.5
	FR-E820-0175(3.7K)	40	3.8
	FR-E820-0240(5.5K)	25	6.1
	FR-E820-0330(7.5K)	20	7.6
	FR-E820-0470(11K)	13	11.7
	FR-E820-0600(15K)	9	16.9
	FR-E820-0760(18.5K)	6.5	23.4
	FR-E820-0900(22K)	6.5	23.4
	FR-E820S-0030(0.4K)	100	1.5
	FR-E820S-0050(0.75K)	80	1.9
	FR-E820S-0080(1.5K)	60	2.5
FR-E820S-0110(2.2K)	60	2.5	
400 V class	FR-E840-0016(0.4K)	371	1.6
	FR-E840-0026(0.75K)	236	2.4
	FR-E840-0040(1.5K)	205	2.8
	FR-E840-0060(2.2K)	180	3.2
	FR-E840-0095(3.7K)	130	4.4
	FR-E840-0120(5.5K)	94	6.1
	FR-E840-0170(7.5K)	67	8.6
	FR-E840-0230(11K)	49	11.8
	FR-E840-0300(15K)	36	16
	FR-E840-0380(18.5K)	26	22.2
FR-E840-0440(22K)	26	22.2	
575 V class	FR-E860-0017(0.75K)	350	2.4
	FR-E860-0027(1.5K)	300	2.8
	FR-E860-0040(2.2K)	260	3.3
	FR-E860-0061(3.7K)	190	4.5
	FR-E860-0090(5.5K)	140	6.1
	FR-E860-0120(7.5K)	100	8.5
400 V class	FR-E846-0026(0.75K)	236	2.4
	FR-E846-0040(1.5K)	205	2.8
	FR-E846-0060(2.2K)	180	3.2
	FR-E846-0095(3.7K)	130	4.4

*1 The resistance should be 200 Ω or more at 100% ED. The following shows the brake duty when the resistance is less than 200 Ω .

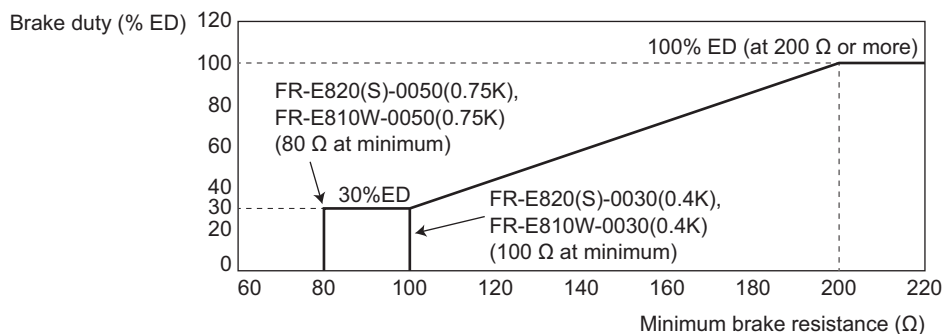

Set parameters as follows:

- **Pr.30 Regenerative function selection** = "1 or 101"
- Set **Pr.70 Special regenerative brake duty** according to the amount and frequency of the regenerative driving, and make sure that the resistor can consume the regenerative power properly.

- When the regenerative brake transistor is damaged, install a thermal relay to prevent overheat and burnout of the brake resistor. (Refer to the Instruction Manual (Connection) to install a thermal relay.) Properly select a thermal relay according to the regenerative driving frequency or the rated power or resistance of the brake resistor.

CAUTION

- If the resistor selection is incorrect, overcurrent may damage the inverter built-in brake transistor. Besides, the resistor may be burned due to overheat.
- If the selection of the thermal relay is incorrect, the resistor may be burned due to overheat.

◆ Selection between resetting or not resetting during power supply to main circuit (Pr.30 = "100 to 102") (standard model, Ethernet model)

- When Pr.30 = "100" or higher value and the FR-E8DS is installed, the inverter will not be reset when power is supplied to the main circuit (via terminals R/L1, S/L2, and T/L3) while 24 V power is supplied to the inverter.
- When the RS-485 communication or Ethernet communication is used, communication interruption due to the inverter reset can be avoided.

NOTE

- When supplying power to the main circuit is started while the protective function of the inverter is activated, inverter reset is performed at power-ON even when "no reset" is selected.
- When the emergency drive function is enabled and "no reset" is selected, the inverter may start immediately after supplying power to the main circuit.
- When "no reset" is selected, STW1 for PROFINET or the controlword for EtherCAT is retained. Check status transition commands before supplying power to the main circuit. (Refer to the Instruction Manual (Communication).)
- For the safety communication model and the IP67 model, the setting is fixed to "reset".

« Parameters referred to »»

Pr.57 Restart coasting time  page 502, page 508

Pr.178 to Pr.189 (Input terminal function selection)  page 410

Pr.190 to Pr.197 (Output terminal function selection)  page 371

16.9 Regeneration avoidance function

The regenerative status can be detected and avoided by raising the frequency.

- The operation frequency is automatically increased to prevent the regenerative operations. This function is useful when a load is forcibly rotated by another fan in the duct.

Pr.	Name	Initial value		Setting range	Description
882 G120	Regeneration avoidance operation selection	0		0	The regeneration avoidance function is disabled.
				1	The regeneration avoidance function is always enabled.
				2	The regeneration avoidance function is enabled only during constant-speed operation.
883 G121	Regeneration avoidance operation level	100/200 V class	400 VDC	300 to 1200 V	Set the bus voltage level to operate the regeneration avoidance operation. When the bus voltage level is set low, it will be harder to generate overvoltage error, but actual deceleration time will be longer. Set the setting value higher than the (power supply voltage × $\sqrt{2}$ *1) value.
		400 V class	780 VDC		
		575 V class	944 VDC		
885 G123	Regeneration avoidance compensation frequency limit value	6 Hz		0 to 45 Hz	Set the limit value for frequency to rise when the regeneration avoidance function is activated.
				9999	The frequency limit is disabled.
886 G124	Regeneration avoidance voltage gain	100%		0% to 200%	Adjust the response during the regeneration avoidance operation. Increasing the setting improves the response to change in the bus voltage. However, the output frequency may become unstable. If setting a smaller value in Pr.886 does not suppress the vibration, set a smaller value in Pr.665 .
665 G125	Regeneration avoidance frequency gain	100%		0% to 200%	

*1 For a single-phase 100 V power input model, power input voltage × 2 × $\sqrt{2}$.

◆ Regeneration avoidance operation (Pr.882, Pr.883)

- When the regenerative voltage increases, the DC bus voltage will rise, which may cause an overvoltage fault (E.OV[]). The regenerative status can be avoided by detecting this rise of bus voltage, and raising the frequency when the bus voltage level reaches or exceeds **Pr.883 Regeneration avoidance operation level**.
- The regeneration avoidance operation can be selected to operate constantly or operate only during constant speed.
- The regeneration avoidance function is enabled by setting "1 or 2" in **Pr.882 Regeneration avoidance operation selection**.

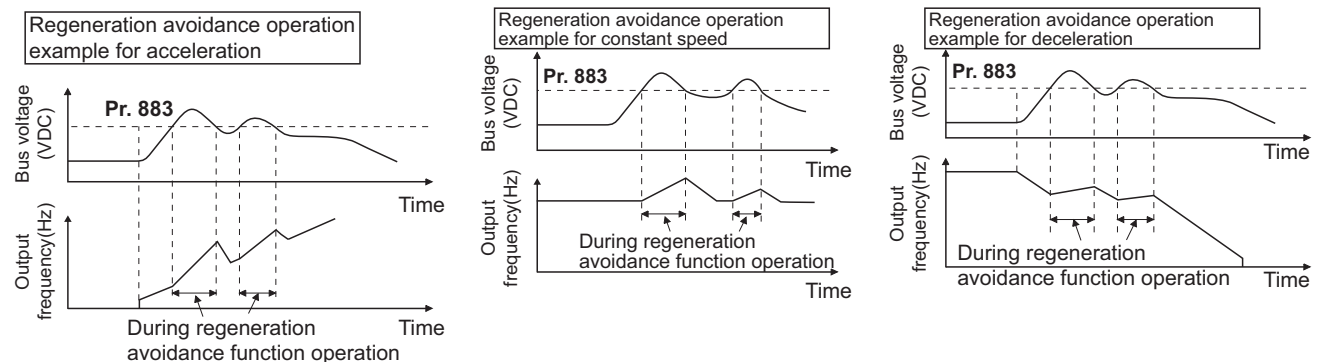

NOTE

- The slope of frequency rising or lowering by the regeneration avoidance operation will change depending on the regenerative status.
- The DC bus voltage of the inverter will be approximately $\sqrt{2}$ times of the normal input voltage (twice of the input voltage for the 100 V class).
The bus voltage is approx. 311 VDC at an input voltage of 220 VAC (283 VDC at 100 VAC, 622 VDC at 440 VAC, and 813 VDC at 575 VAC). However, it may vary depending on the input power supply waveform.
- Make sure that the setting value of **Pr.883** will not get under DC bus voltage level. The frequency will rise with operation of the regeneration avoidance function even during operation other than the regenerative operation.
- The stall prevention (overvoltage) (OLV) will be activated only during deceleration, stopping the lowering of output frequency. On the other hand, the regeneration avoidance function will be activated constantly (**Pr.882** = "1") or only at constant speed (**Pr.882** = "2"), and raise the frequency depending on the amount of regeneration.
- When the motor becomes unstable due to the stall prevention (overcurrent) (OLC) during the regeneration avoidance operation, increase the deceleration time or set a lower value in **Pr.883**.

◆ Limiting the regeneration avoidance operation frequency (Pr.885)

- It is possible to assign a limit to the output frequency corrected (rise) by the regeneration avoidance operation.
- Limit of the frequency is output frequency (frequency before regeneration avoidance operation) + **Pr.885 Regeneration avoidance compensation frequency limit value** for during acceleration and constant speed. During deceleration, when the frequency increases due to the regeneration avoidance operation and reaches the limit value, the limit value will be retained until the output frequency is reduced to be the half the **Pr.885** setting.
- The regeneration avoidance operation frequency is limited at the setting of **Pr.1 Maximum frequency**.
- When **Pr.885** = "9999", the regeneration avoidance compensation frequency limit is disabled.
- Set the frequency around the motor rated slip frequency. Increase the setting value if the overvoltage protection function (E.OV[]) is activated at the start of deceleration.

$$\text{Rated motor slip frequency} = \frac{\text{Synchronized speed at the time of base frequency} - \text{rated rotation speed}}{\text{Synchronized speed at the time of base frequency}} \times \text{Rated motor frequency}$$

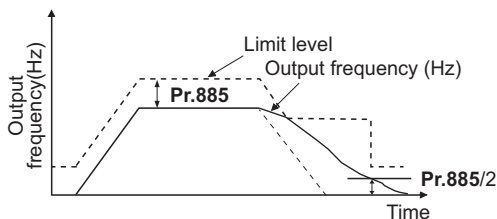

◆ Adjusting the regeneration avoidance operation (Pr.665, Pr.886)

- If the frequency becomes unstable during regeneration avoidance operation, decrease the setting of **Pr.886 Regeneration avoidance voltage gain**. On the other hand, if an overvoltage fault occurs due to a sudden regeneration, increase the setting.
- If setting a smaller value in **Pr.886** does not suppress the vibration, set a smaller value in **Pr.665 Regeneration avoidance frequency gain**.

NOTE

- During the regeneration avoidance operation, the stall prevention (overvoltage) "OLV" is displayed and the Overload warning (OL) signal is output. Set the operation pattern at an OL signal output using **Pr.156 Stall prevention operation selection**. Use **Pr.157 OL signal output timer** to set the OL signal output timing.
- The stall prevention is enabled even during regeneration avoidance operation.
- The regeneration avoidance function cannot decrease the actual deceleration time for the motor to stop. Since the actual deceleration time is determined by the regenerative power consumption performance, consider using a regeneration unit (FR-BU2, BU, FR-BU, FR-XC, FR-CV, FR-HC2) or brake resistor (FR-ABR, etc.) to decrease the deceleration time.
- When using a regeneration unit (FR-BU2, BU, FR-BU, FR-XC, FR-CV, FR-HC2) or brake resistor (FR-ABR, etc.) to consume the regenerative power at constant speed, set **Pr.882** = "0 (initial value)" (the regeneration avoidance function is disabled). When consuming the regenerative power at the time of deceleration with the regeneration unit, etc., set **Pr.882** = "2" (enables regeneration avoidance function only at the constant speed).
- When using the regeneration avoidance function under Vector control, noise may be generated from the motor during deceleration. In such case, adjust the gain. (Refer to [page 146](#).)

Parameters referred to

Pr.1 Maximum frequency [page 331](#)

Pr.8 Deceleration time [page 331](#)

Pr.22 Stall prevention operation level [page 334](#)

16.10 Increased magnetic excitation deceleration

V/F Magnetic flux Sensorless Vector

Increase the loss in the motor by increasing the magnetic flux during deceleration. The deceleration time can be reduced by suppressing the stall prevention (overvoltage) (oL).

The deceleration time can further be shortened without a brake resistor. (When a brake resistor is used, the duty can be reduced.)

Pr.	Name	Initial value	Setting range	Description
660 G130	Increased magnetic excitation deceleration operation selection	0	0	Without the increased magnetic excitation deceleration function
			1	With the increased magnetic excitation deceleration function
661 G131	Magnetic excitation increase rate	9999	0% to 40%	Set the increase of excitation.
			9999	The magnetic excitation increase rate is 10% under V/F control and Advanced magnetic flux vector control. The magnetic excitation increase rate is 0% under Real sensorless vector control and Vector control.
662 G132	Increased magnetic excitation current level	100%	0% to 200%	The increased magnetic excitation rate is automatically lowered when the output current reaches or exceeds the setting value during increased magnetic excitation deceleration.

◆ Setting of increased magnetic excitation rate (Pr.660, Pr.661)

- To enable the increased magnetic excitation deceleration, set **Pr.660 Increased magnetic excitation deceleration operation selection** = "1".
- Set the amount of excitation increase in **Pr.661 Magnetic excitation increase rate**.
- Increased magnetic excitation deceleration will be disabled when **Pr.661** = "0". When "8888 or 9999" is not set in **Pr.19** under V/F control, increased magnetic excitation deceleration will be enabled even when **Pr.661** = "0".
- When the DC bus voltage reaches or exceeds the increased magnetic excitation deceleration operation level during the deceleration, excitation is increased in accordance with the setting value in **Pr.661**.
- The increased magnetic excitation deceleration will continue even if the DC bus voltage goes under the increased magnetic excitation deceleration operation level during increased magnetic excitation deceleration.

Inverter	Increased magnetic excitation deceleration operation level
100/200 V class	340 V
400 V class	680 V
575 V class	850 V

- When the stall prevention (overvoltage) occurs during the increased magnetic excitation deceleration operation, increase the deceleration time or raise the setting value of **Pr.661**. When the stall prevention (overcurrent) occurs, increase the deceleration time or lower the setting value of **Pr.661**.
- Increased magnetic excitation deceleration is enabled under V/F control, Advanced magnetic flux vector control, Real sensorless vector control (speed control), and Vector control (speed control).

NOTE

- Increased magnetic excitation deceleration will be disabled in the following conditions:
During PM sensorless vector control, automatic restart after instantaneous power failure, power failure stop, orientation control, Optimum excitation control, and stop-on-contact control.

◆ Overcurrent prevention function (Pr.662)

- The overcurrent prevention function is enabled under V/F control and Advanced magnetic flux vector control.
- The increased magnetic excitation rate is lowered automatically when the output current reaches or exceeds the level set in **Pr.662** during increased magnetic excitation deceleration.
- When the inverter protective function (E.OC[], E.THT) is activated due to increased magnetic excitation deceleration, adjust the level set in **Pr.662**.
- The overcurrent prevention function is disabled when **Pr.662** = "0".

NOTE

- When the level set in **Pr.662** is more than the stall prevention operation level, the overcurrent preventive function is activated at the level set in **Pr.22 (Pr.48), Pr.23, or Pr.66**. (When **Pr.22 (Pr.48)** = "0" or the stall prevention operation is disabled by **Pr.156** setting, the overcurrent preventive function is activated at the level set in **Pr.662**.)

Parameters referred to

Pr.22 Stall prevention operation level [page 334](#)

Pr.60 Energy saving control selection [page 534](#)

Pr.162 Automatic restart after instantaneous power failure selection [page 502, page 508](#)

Pr.270 Stop-on-contact control selection [page 461](#)

Pr.261 Power failure stop selection [page 514](#)

16.11 Slip compensation



Under V/F control, the slip of the motor is estimated from the inverter output current to maintain the rotation of the motor constant.

Pr.	Name	Initial value	Setting range	Description
245 G203	Rated slip	9999	0.01% to 50%	Set the rated motor slip.
			0, 9999	No slip compensation
246 G204	Slip compensation time constant	0.5 s	0.01 to 10 s	Set the response time of the slip compensation. Reducing the value improves the response, but the regenerative overvoltage (E.OV[]) error is more likely to occur with a larger load inertia.
247 G205	Constant output range slip compensation selection	9999	0	No slip compensation in the constant power range (frequency range higher than the frequency set in Pr.3).
			9999	Slip compensation is performed in the constant power range.

- Calculate the rated motor slip and set the value in **Pr.245** to enable slip compensation.

Slip compensation is not performed when **Pr.245** = "0 or 9999".

$$\text{Rated slip} = \frac{\text{Synchronized speed at the time of base frequency} - \text{rated rotation speed}}{\text{Synchronized speed at the time of base frequency}} \times 100 [\%]$$

NOTE

- When the slip compensation is performed, the output frequency may become larger than the set frequency. Set **Pr.1 Maximum frequency** higher than the set frequency.
- Slip compensation will be disabled in the following conditions:
Stall prevention (OLC, OLV) operation, regeneration avoidance operation, auto tuning, stop-on-contact control, acceleration/ deceleration, encoder feedback control operation, and orientation control

Parameters referred to

Pr.1 Maximum frequency [page 331](#)

Pr.3 Base frequency [page 530](#)

16.12 Speed detection filter

Vector

Set the time constant of primary delay filter for speed feedback signal.

Speed loop response is reduced. Under ordinary circumstances, therefore, use the initial value as it is.

Pr.	Name	Initial value	Setting range	Description
823 G215*1	Speed detection filter 1	0.001 s	0	Without filter
			0.001 to 0.01 s	Set the time constant of primary delay filter for speed feedback signal.
833 G315*1	Speed detection filter 2	9999	0 to 0.01 s	Second function of Pr.823 (enabled when the RT signal is ON)
			9999	Same as Pr.823 setting

*1 The setting is available when a Vector control compatible option is installed. For the IP67 model, the setting is not available as plug-in options are not available.

◆ Stabilizing speed detection (Pr.823, Pr.833)

- Speed loop response is reduced. Under ordinary circumstances, therefore, use the initial value as it is.
If there is speed ripple due to high frequency disturbance, gradually raise the setting value until speed stabilizes. Speed is oppositely destabilized if the setting value is too large.
- This setting is valid under Vector control only.

◆ Employing multiple primary delay filters

- Use **Pr.833** if changing filter according to application. **Pr.833** is enabled when the Second function selection (RT) signal is turned ON.

NOTE

- The RT signal is the Second function selection signal. The RT signal also enables other second functions. (Refer to [page 418](#).)
- The RT signal is assigned to terminal RT in the initial status. Set "3" in one of **Pr.178 to Pr.189 (Input terminal function selection)** to assign the RT signal to another terminal.

16.13 Excitation ratio

Sensorless Vector

The excitation ratio can be lowered to enhance efficiency for light loads. (Motor magnetic noise can be reduced.)

Pr.	Name	Initial value	Setting range	Description
854 G217	Excitation ratio	100%	0% to 100%	Set an excitation ratio when there is no load.

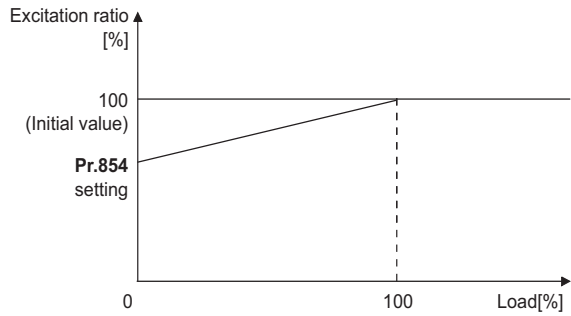

NOTE



- When excitation ratio is reduced, output torque startup is less responsive.

16.14 Encoder feedback control



This controls the inverter output frequency so that the motor speed is constant to the load variation by detecting the motor speed with the speed detector (encoder) to feed back to the inverter.

A Vector control compatible option is required. Encoder feedback control is not available for the IP67 model as plug-in options are not available.

Pr.	Name	Initial value	Setting range	Description
285 A107	Overspeed detection frequency ^{*1}	9999	0 to 30 Hz	E.MB1 (Brake sequence fault) occurs when the difference between the detection frequency and output frequency exceeds the setting value under encoder feedback control.
			9999	Overspeed detection is disabled.
359 ^{*2} C141	Encoder rotation direction	101	100	Set when using a motor (encoder) for which forward rotation is clockwise (CW) viewed from the shaft. 
			101	Set when using a motor for which forward rotation (encoder) is counterclockwise (CCW) viewed from the shaft. 
367 ^{*2} G240	Speed feedback range	9999	0 to 590 Hz	Set the range of speed feedback control.
			9999	The encoder feedback control is disabled.
368 ^{*2} G241	Feedback gain	1	0 to 100	Set when the rotation is unstable or response is slow.
369 ^{*2} C140	Number of encoder pulses	1024	2 to 4096	Set the number of encoder pulses. Set the number of pulses before it is multiplied by 4.
376 ^{*2} C148	Encoder signal loss detection enable/disable selection	0	0	Signal loss detection is disabled.
			1	Signal loss detection is enabled.

*1 The speed deviation excess detection frequency is used under Vector control or PM sensorless vector control. (Refer to page 154 for details.)

*2 The setting is available when a Vector control compatible option is installed.

◆ Setting before operation (Pr.359, Pr.369)

- Use **Pr.359 Encoder rotation direction** and **Pr.369 Number of encoder pulses** to set the rotation direction and the number of pulses for the encoder.

NOTE

- Control with correct speed is not possible if the number of poles for the applied motor is incorrect. Check first before operation. Operating the inverter with **Pr.81** = "10 or 12" causes "SE" (incorrect parameter setting) alarm.
- Encoder feedback control is not possible when the rotation direction setting of the encoder is incorrect. (Operation of the inverter is possible.)
Check the indicator on the parameter unit to confirm the direction.

◆ Selection of encoder feedback control (Pr.367)

- When a value other than "9999" is set in **Pr.367 Speed feedback range**, encoder feedback control is enabled. Set a target value (frequency at which stable speed operation is performed) and specify the range around the value. Normally, use the frequency converted from the slip amount (r/min) at the rated motor speed (rated load). If the setting is too large, response becomes slow.

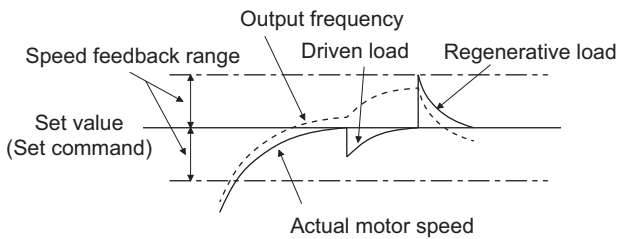

- Example: when the rated speed of a motor (4 poles) is 1740 r/min at 60 Hz

$$\begin{aligned} \text{Slip } N_{sp} &= \text{Synchronous speed} - \text{Rated speed} \\ &= 1800 - 1740 \\ &= 60 \text{ (r/min)} \end{aligned}$$

$$\begin{aligned} \text{Frequency equivalent to slip (fsp)} &= N_{sp} \times \text{Number of poles}/120 \\ &= 60 \times 4/120 \\ &= 2 \text{ (Hz)} \end{aligned}$$

◆ Feedback gain (Pr.368)

- Set **Pr.368 Feedback gain** when the rotation is unstable or response is slow.
- Response of the feedback will become slow when the acceleration/deceleration time is long. In such case, increase the setting value of **Pr.368**.

Pr.368 setting	Description
Pr.368 > 1	Response will become faster but it may cause overcurrent or unstable operation.
1 > Pr.368	Response will become slower but the operation will become more stable.

◆ Overspeed detection (Pr.285)

- To prevent malfunction when the correct pulse signal cannot be detected from the encoder, when [detection frequency] - [output frequency] > **Pr.285** during encoder feedback control, a protective function (E.MB1) will be activated to shut off the inverter output.
- Overspeed detection is not performed when **Pr.285** = "9999".

NOTE

- The encoder feedback control is disabled in the following conditions:
During offline auto tuning, when the PID control is enabled, during stop-on-contact control, during the current limit operation, when the second function is enabled, and during orientation control
- Couple the encoder on the same axis as the motor axis without any mechanical clatter, with speed ratio of 1:1.
- Encoder feedback control is not performed during the acceleration and deceleration to prevent unstable operation such as hunting.
- Encoder feedback control is performed after the output frequency has reached [set frequency] ± [speed feedback range] once.
- When the following status occurs during encoder feedback control operation, the inverter output is not shut off, the output frequency becomes the value obtained by [set frequency] ± [speed feedback range], and tracking of the motor speed is not performed.
When **Pr.376** = "0" and the pulse signal from the encoder is lost due to a break or other reasons
When correct pulse signal cannot be detected due to induction noise or other reasons
When the motor is forcefully accelerated (regenerative rotation) or decelerated (motor lock) due to large external force
- Use the Inverter running (RUN) signal when releasing the brake from the motor with a brake under encoder feedback control. (The brake may not be released when the Output frequency detection (FU) signal is used.)
- Do not turn OFF the external power supply for the encoder during encoder feedback control. Normal encoder feedback control will not be possible.

Parameters referred to

Pr.81 Number of motor poles page 115, page 430

16.15 Droop control

Magnetic flux Sensorless Vector PM

This is a function to give droop characteristics to the speed by balancing the load in proportion with the load torque during the Advanced magnetic flux vector control, Real sensorless vector control, Vector control, and PM sensorless vector control. This is effective in balancing the load when multiple inverters are connected.

Pr.	Name	Initial value	Setting range	Description
286 G400	Droop gain	0%	0	Normal operation
			0.1% to 100%	Droop control enabled. Set the droop amount at the time of rated torque as % value of the rated motor frequency.
287 G401	Droop filter time constant	0.3 s	0 to 1 s	Set the time constant of the filter relative to the torque current.

◆ Droop control

- Droop control is enabled under Advanced magnetic flux vector control, Real sensorless vector control, Vector control, and PM sensorless vector control.
- In the droop control, the speed command changes depending on the amount of the current for torque.

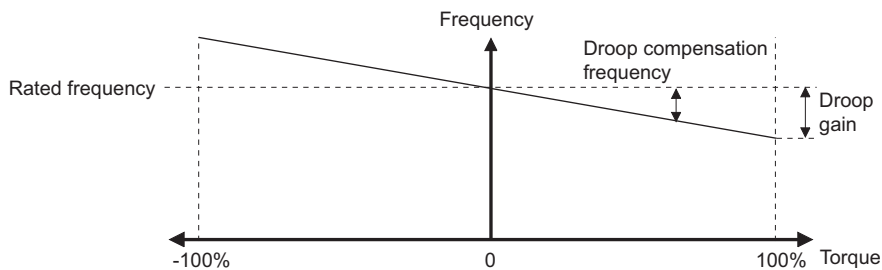

- The droop compensation frequency is calculated as follows.

$$\text{Droop compensation frequency} = \frac{\text{Current for torque after filtering}}{\text{Rated torque current}} \times K \times \frac{\text{Pr.84 Rated motor frequency} \times \text{Pr.286 Droop gain}}{100}$$

When the output frequency is equal to or lower than the rated frequency set in **Pr.84**: $K = 1$

When the output frequency is higher than the rated frequency set in **Pr.84**: $K = \frac{\text{Rated frequency (Pr.84)}}{\text{Output frequency}}$

- The droop compensation frequency is limited as follows.

Control	Upper limit	Lower limit
Advanced magnetic flux vector control	400 Hz or Pr.1 Maximum frequency , whichever is smaller	0.5 Hz
Real sensorless vector control		0 Hz
Vector control		0 Hz
(PM sensorless vector control)	Maximum motor frequency or Pr.1 Maximum frequency , whichever is smaller	10% of rated motor frequency

NOTE

- Set the droop gain equivalent to the rated slip of the motor.

$$\text{Rated slip} = \frac{\text{Synchronized speed at the time of base frequency} - \text{rated rotation speed}}{\text{Synchronized speed at the time of base frequency}} \times 100[\%]$$

- Droop control is disabled in the following conditions:
During DC injection brake operation, during PID control, during stall prevention operation, during traverse operation

Parameters referred to

Pr.1 Maximum frequency [page 331](#)

Pr.178 to Pr.189 Input terminal function selection [page 410](#)

16.16 Speed smoothing control



The output current (torque) of the inverter sometimes becomes unstable due to vibration caused by mechanical resonance. Such vibration can be suppressed by reducing fluctuation of the output current (torque) by changing the output frequency.

Pr.	Name	Initial value	Setting range	Description
653 G410	Speed smoothing control	0%	0% to 200%	Check the effect by increasing and decreasing the value at around 100%.
654 G411	Speed smoothing cutoff frequency	20 Hz	0 to 120 Hz	Set the minimum frequency for the torque variation cycle.

◆ Control block diagram

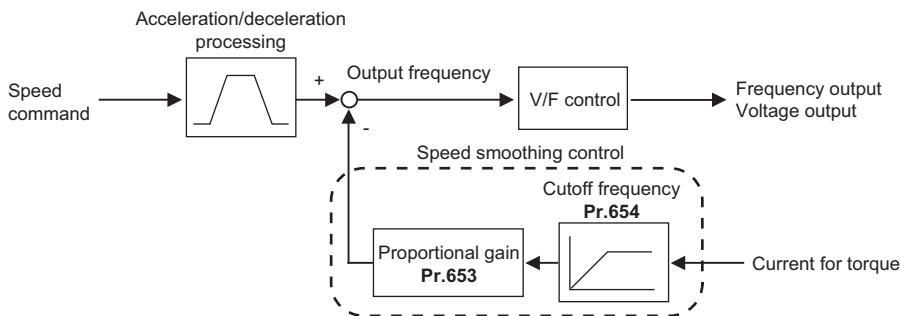

◆ Setting method

- When vibration caused by mechanical resonance occurs, set 100% in **Pr.653 Speed smoothing control**, perform operation at the frequency with the largest vibration, and check if the vibration is suppressed after few seconds.
- If the setting is not effective, gradually increase the value set in **Pr.653** and repeat the operation to check the effect to determine the most effective value (**Pr.653**).
- If the vibration increases by increasing the value in **Pr.653**, decrease the value in **Pr.653** from 100% to check the effect.
- When the vibrational frequency at which mechanical resonance occurs (during fluctuation of torque, speed, or converter output voltage) is measured using an instrument such as a tester, set 1/2 to 1 times of the vibrational frequency in **Pr.654 Speed smoothing cutoff frequency**. (Setting the resonance frequency range mitigates vibration more effectively.)

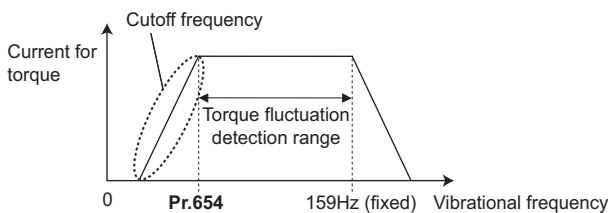

NOTE

- Depending on the equipment, the vibration may not be suppressed sufficiently or the setting is not effective.

CHAPTER 17 Checking and Clearing of Settings

17.1	Parameter clear / All parameter clear	564
17.2	List of parameters changed from the initial values	565
17.3	Fault history clear	566

17 Checking and Clearing of Settings

17.1 Parameter clear / All parameter clear

Point

- Set "1" to **Pr.CL Parameter clear** or **ALLC All parameter clear** to initialize the parameter. (The parameter cannot be cleared when **Pr.77 Parameter write selection** = "1".)
- Pr.CL does not clear calibration parameters or the terminal function selection parameters.
- Refer to the parameter list on [page 54](#) for parameters cleared with this operation.

Operating procedure

- 1.** Turning ON the power of the inverter
The operation panel is in the monitor mode.
- 2.** Changing the operation mode
Press the PU/EXT key to choose the PU operation mode. The PU LED turns ON.
- 3.** Selecting the parameter setting mode
Press the MODE key to choose the parameter setting mode. (The parameter number read previously appears.)
- 4.** Selecting the parameter
Turn the setting dial or press the UP/DOWN key until "Pr.CL" appears for Parameter clear or "ALLC" for All parameter clear, and press the SET key. "0" (initial value) appears.
- 5.** Parameter clear
Turn the setting dial or press the UP/DOWN key to change the value to "1". Press the SET key to confirm the setting. "1" and "Pr.CL" ("ALLC") are displayed alternately after parameters are cleared.
 - Turn the setting dial or press the UP/DOWN key to read another parameter.
 - Press the SET key to show the setting again.
 - Press the SET key twice to show the next parameter.

Setting	Description	
	Pr.CL Parameter clear	ALLC All parameter clear
0	Initial display (Parameters are not cleared.)	
1	The settings of parameters except for calibration parameters and terminal function selection parameters are initialized.	The settings of all the parameters, including calibration parameters and terminal function selection parameters, are initialized.

NOTE

- "1" and "Er4" are displayed alternately when the operation mode is other than the PU operation mode.
 - 1) Press the PU/EXT key.
The PU LED turns ON, and "1" appears on the monitor. (When **Pr.79** = "0" (initial value))
 - 2) Press the SET key to clear the parameter.
- Stop the inverter first. Writing error occurs if parameter clear is attempted while the inverter is running.
- To clear the parameter, the inverter must be in the PU operation mode even if "2" is set to **Pr.77**.
- For availability of the Parameter clear or All parameter clear operation for each parameter, refer to the parameter list on [page 574](#).

17.2 List of parameters changed from the initial values

Parameters changed from their initial values can be displayed.

Operating procedure

- 1.** Turning ON the power of the inverter
The operation panel is in the monitor mode.
- 2.** Selecting the parameter setting mode
Press the MODE key to choose the parameter setting mode. (The parameter number read previously appears.)
- 3.** Selecting the parameter
Turn the setting dial or press the UP/DOWN key until "Pr.CH" (Initial value change list) appears, and set the SET key. "P.---" blinks and then remains displayed.
- 4.** Checking the Initial value change list
Turn the setting dial or press the UP/DOWN key after blinking stops to display the parameter numbers that have been changed from their initial values in order.
 - When the SET key is pressed with a changed parameter displayed, the parameter settings can be changed as they are. (Parameter numbers are no longer displayed in the list when they are returned to their initial values.)
Turn the setting dial or press the UP/DOWN key to display another changed parameter.
 - The indication returns to "P.---" when the last changed parameter is displayed.

17

NOTE

- Calibration parameters (**C0 (Pr.900) to C7 (Pr.905)**, **C38 (Pr.932) to C45 (Pr.935)**) are not displayed even when these are changed from the initial settings.
- Only the simple mode parameters are displayed when the simple mode is set (**Pr.160** = "9999").
- Only user groups are displayed when user groups are set (**Pr.160** = "1").
- **Pr.160** is displayed independently of whether the setting value is changed or not.

17.3 Fault history clear

◆ Fault history clearing procedure

Point

- Set **Er.CL Fault history clear** = "1" to clear the fault history.
-

Operating procedure

- 1.** Turning ON the power of the inverter
The operation panel is in the monitor mode.
- 2.** Selecting the parameter setting mode
Press the MODE key to choose the parameter setting mode. (The parameter number read previously appears.)
- 3.** Selecting the parameter number
Turn the setting dial or press the UP/DOWN key until "ER.CL" (Fault history clear) appears. Press the SET key to read the present set value. "0" (initial value) appears.
- 4.** Fault history clear
Turn the setting dial or press the UP/DOWN key to change the value to "1". Press the SET key to start clearing. "1" and "ER.CL" are displayed alternately after the fault history is cleared.
 - Turn the setting dial or press the UP/DOWN key to read another parameter.
 - Press the SET key to show the setting again.
 - Press the SET key twice to show the next parameter.

CHAPTER 18 Appendix

18.1	For customers replacing the conventional model with this inverter	568
18.2	Specification comparison between PM sensorless vector control and induction motor control.....	571
18.3	Major differences between the FR-E840 and the FR-E846	572
18.4	Parameters (functions) and instruction codes under different control methods.....	574
18.5	How to check specification changes	599

18 Appendix

Appendix provides the reference information for use of this product.
Refer to the information as required.

18.1 For customers replacing the conventional model with this inverter

18.1.1 Replacement of the FR-E700 series

◆ Differences and compatibility with the FR-E700 series

Item		FR-E800	FR-E700
Applicable rating		Two ratings (LD/ND)	Not available (ND only)
Overload current rating	ND rating	150% 60 s, 200% 3 s at surrounding air temperature of 50°C	
	LD rating	120% 60 s, 150% 3 s at surrounding air temperature of 50°C	Not available
Built-in brake transistor		Provided in FR-E820-0030(0.4K) to 0900(22K), FR-E840-0016(0.4K) to 0440(22K), FR-E860-0017(0.75K) to 0120(7.5K), FR-E820S-0030(0.4K) to 0110(2.2K), FR-E810W-0030(0.4K) and 0050(0.75K)	Provided in FR-E720-030(0.4K) to 600(15K), FR-E740-016(0.4K) to 300(15K), FR-E720S-030(0.4K) to 110(2.2K), FR-E710W-030(0.4K) and 050(0.75K)
Control method	—	Soft-PWM control / High carrier frequency PWM control	
	V/F control	Available	
	Advanced magnetic flux vector control	Available	
	General-purpose magnetic flux vector control	Not available	Available
	Real sensorless vector control	Available	Not available
	Vector control	Available	Not available
	PM sensorless vector control	Available	Not available
Control mode	Speed control	Available	
	Torque control	Available	Not available
	Position control	Available	Not available
Output frequency		0.2 to 590 Hz (under V/F control) 0.2 to 400 Hz (under other than V/F control)	0.2 to 400 Hz
Frequency setting resolution	Terminal 2	0.015 Hz / 0 to 60 Hz (0 to 10 V / 12 bits) 0.03 Hz / 0 to 60 Hz (0 to 5 V / 11 bits) 0.03 Hz / 0 to 60 Hz (0 to 20 mA / 11 bits)	0.06 Hz / 0 to 60 Hz (0 to 10 V / 10 bits) 0.12 Hz / 0 to 60 Hz (0 to 5 V / 9 bits)
	Terminal 4	0.015 Hz / 0 to 60 Hz (0 to 10 V / 12 bits) 0.03 Hz / 0 to 60 Hz (0 to 5 V / 11 bits) 0.03 Hz / 0 to 60 Hz (0 to 20 mA / 11 bits)	0.06 Hz / 60 Hz (0 to 10 V / 10 bits) 0.12 Hz / 60 Hz (0 to 5 V / 9 bits) 0.06 Hz / 60 Hz (0 to 20 mA / 10 bits)
Output signal	Via terminal FM (pulse output)	1440 pulses/s at full scale (FM type only)	1440 pulses/s at full scale (FR-E700)
	Via terminal AM (analog output)	-10 to +10 V / 12 bits (AM type only)	0 to +10 V (FR-E700-NA/EC/CHT)
Operation panel	Standard equipment	Operation panel installed as standard (not removable). 7-segment LED 4-digit display.	
	Option	Enclosure surface operation panel (FR-PA07) LCD operation panel (FR-LU08) Parameter unit (FR-PU07(BB))	Enclosure surface operation panel (FR-PA07) Parameter unit (FR-PU07(BB))
Main circuit terminals		R, S, T, U, V, W, P, PR, N, P1, earth (ground) (screw terminal)	

Item		FR-E800	FR-E700
Control circuit terminal	Shape of terminal block	Spring clamp type	Standard control circuit terminal model: screw type Safety stop function model: Spring clamp type
	Contact input	Standard model: 7 Ethernet model: 2 Safety communication model: 0	Standard control circuit terminal model: 7 Safety stop function model: 6
	Analog input	2	2
	Relay output	1	1
	Open collector output	Standard model: 2 Ethernet model and safety communication model: 0	2
	Pulse output	1 (FM type only)	1 (FR-E700)
	Analog output	1 (AM type only)	1 (FR-E700-NA/EC/CHT)
	Safety input/output	Standard model and Ethernet model: S1, S2, PC, SO, SOC Safety communication model: SX1, SX2, SY1, SY2, PC, SC1, SC2	S1, S2, PC (safety stop function model only)
Communication	Ethernet	2 ports (Ethernet model and safety communication model) CC-Link IE TSN, CC-Link IE Field Network Basic, EtherNet/IP, PROFINET, MODBUS/TCP, BACnet/IP, EtherCAT	1 port (FR-E700-NE only) CC-Link IE Field Network Basic and MODBUS/TCP
	RS-485	1 port (standard model) Mitsubishi inverter protocol, MODBUS RTU, BACnet MS/TP	1 port Mitsubishi inverter protocol, MODBUS RTU
	USB	Mini B connector: USB bus power available (Maximum SCCR: 500 mA)	Mini B connector: USB bus power unavailable
Surrounding air temperature		100/200/400 V class: -20°C to +60°C (Derate the rated current when using the inverter in a temperature of 50°C or higher.) 575 V class: -10°C to +60°C (Derate the rated current when using the inverter in a temperature of 50°C or higher.)	-10°C to +50°C
Storage temperature		-40°C to +70°C	-20°C to +65°C
Plug-in option		Dedicated plug-in options (not interchangeable)	
Installation size		Compatible (Use the installation interchange attachment for replacement of the FR-E720-175(3.7K) and FR-E740-016(0.4K) to 040(1.5K).)	
Panel through attachment		Not compatible	
Machine speed display		The rotation speed is displayed when Pr.53 = "1". The machine speed is displayed when Pr.53 = "4". Use Pr.37 and Pr.505 to set the reference for machine speed.	The machine speed is displayed when Pr.37 ≠ "0".
Built-in potentiometer switching		Pr.146 unavailable (PA02 not supported)	Pr.146 available
Control mode selection		V/F control when "40" is set in Pr.800 .	V/F control when "9999" is set in Pr.80 or Pr.81 .
MRS input selection		Use Pr.17 to change the input specifications of the MRS and X10 signals.	Use Pr.17 to change the input specification of the MRS signal.
Offline auto tuning		Set Pr.96 = "11" to enable offline auto tuning for V/F control (frequency search for the automatic restart after instantaneous power failure).	Set Pr.96 = "21" to enable offline auto tuning for V/F control (frequency search for the automatic restart after instantaneous power failure).
Applicable motor		Offline auto tuning is enabled regardless of the Pr.71 setting. Set Pr.71 to a value whose last digit is 3 to change the setting range of the motor constant. Set "10" for the constant-torque motor.	Set Pr.71 to a value whose last digit is 3 to enable offline auto tuning. Set Pr.71 to a value whose last digit is 4 to read offline auto tuning data and change the setting. Set "1" for the constant-torque motor.
Increment/range of acceleration/deceleration time		The setting range cannot be changed from "0 to 3600 s" even when the increment is 0.01 s (Pr.21 = "1").	The setting range can be changed to "0 to 360 s" when the increment is 0.01 s (Pr.21 = "1").

◆ Installation precautions

- Removal procedure of the front cover is different. (Refer to the Instruction Manual (Connection).)
- Plug-in options of the FR-E700 series are not compatible.

◆ Wiring instructions

- When the FR-E700 standard control circuit terminal model is replaced, the terminal block type is changed from the screw type to the spring clamp type. Use of blade terminals is recommended.

- Installing the control terminal option FR-E8TR or FR-E8TE7 to the FR-E800 standard model can change the terminal block type from the spring clamp type to the screw type. (Refer to the Instruction Manual of each option.)
- To use the PU connector, note that wiring methods are different. (Refer to the Instruction Manual (Connection).)

◆ Copying parameter settings

- The FR-E700 series' parameter settings can be easily copied to the FR-E800 series by using the setup software (FR Configurator2). (Not supported by the setup software FR-SW3-SETUP or older.)

18.1.2 Replacement of the FR-E500 series

◆ Installation precautions

- Installation size is compatible. (Use the installation interchange attachment for replacement of the FR-E520-3.7K and FR-E540-0.4K to 1.5K.)
- Operation panel (PA02) cannot be used.

18.2 Specification comparison between PM sensorless vector control and induction motor control

Item	PM sensorless vector control	Induction motor control
Applicable motor	IPM motor or SPM motor ^{*1}	Induction motor ^{*1}
Starting torque	MM-GKR, EM-A: 200% Motor other than the above: 50%	200% (FR-E820-0175(3.7K) or lower, FR-E840-0095(3.7K) or lower, FR-E860-0061(3.7K) or lower, FR-E820S-0110(2.2K) or lower, FR-E810W-0050(0.75K) or lower, FR-E846-0095(3.7K) or lower) and 150% (FR-E820-0240(5.5K) or higher, FR-E840-0120(5.5K) or higher, FR-E860-0090(5.5K) or higher) under Real sensorless vector control or Vector control ^{*2}
Startup delay	Startup delay of about 0.1 s for magnetic pole position detection.	No startup delay (when online auto tuning is not performed at startup).
Driving by the commercial power supply	Cannot be driven by the commercial power supply.	Can be driven by the commercial power supply. (Other than vector control dedicated motor.)
Operation during coasting	While the motor is coasting, potential is generated across motor terminals.	While the motor is coasting, potential is not generated across motor terminals.
Torque control	Not available	Real sensorless vector control or Vector control ^{*2}

*1 The rated motor current should be equal to or less than the inverter rated current. If a motor with substantially low rated current compared with the inverter rated current is used, speed and torque accuracies may deteriorate due to torque ripples, etc. Set the rated motor current to about 40% or higher of the inverter rated current. (For details on the inverter rated current, refer to the inverter rated specifications in the Instruction Manual (Connection).)

*2 A Vector control compatible option is required. Vector control is not available for the IP67 model as plug-in options are not available.

NOTE

- Before wiring, make sure that the motor is stopped. Otherwise you may get an electric shock.
- Never connect a PM motor to a commercial power supply.
- No slippage occurs with a PM motor because of its characteristic. If an IPM motor, which took over an induction motor, is driven at the same speed as for the general-purpose motor, the running speed of the IPM motor becomes faster by the amount of the general-purpose motor's slippage. Adjust the speed command to run the IPM motor at the same speed as the induction motor, as required.

18.3 Major differences between the FR-E840 and the FR-E846

The following table shows major differences between the FR-E840 and the FR-E846. For parameters, refer to [page 55](#). For installation, wiring, inverter rated specifications, and outline dimensions, refer to the Instruction Manual (Connection).

Item	FR-E840	FR-E846	
Protective structure	Open type (IP20)	Enclosed type (IP66/IP67, UL Type 4X, indoor use only)	
Operation panel	Standard model: The setting dial and keys are provided. Ethernet model and safety communication model: The setting dial is not provided. (The UP and DOWN keys are provided.)	The setting dial and keys are not provided.	
Voltage/current input switch	Available	Not available	
Main circuit terminals	R/L1, S/L2, T/L3, U, V, W, P/+, PR, N/-, P1, earth (ground) (screw terminal)	R/L1, S/L2, T/L3, U, V, W, P/+, PR, N/-, PE (earth (ground)) (M23 connector)	
Control circuit terminal	Terminal shape	Spring clamp type	M12 connector
	Contact input	Standard model: STF, STR, RH, RM, RL, MRS, RES, SD, PC Ethernet model: DI0, DI1, SD, PC Safety communication model: Not provided.	DI0, DI1, SD, PC
	Analog input	10, 2, 4, 5	
	Relay output	A, B, C	A, B, C, A2, B2, C2
	Open collector output	Standard model: RUN, FU, SE Ethernet model and safety communication model: Not provided.	RUN, FU, SE
	Pulse output	Standard model (FM type only): FM Ethernet model and safety communication model: Not provided.	Not provided.
	Analog output	Standard model (AM type only): AM Ethernet model and safety communication model: Not provided.	Not provided.
	Safety input/output	Standard model and Ethernet model: S1, S2, PC, SO, SOC Safety communication model: SX1, SX2, SY1, SY2, PC, SC1, SC2	Not provided.
	Terminal +24V	Not provided. (When the FR-E8DS is installed, the 24 V external power supply operation is available.)	Provided. (The 24 V external power supply operation is available.)
EMC filter	Not provided.	Built-in (class C2)	
Plug-in option	Available	Not available	
Parameter unit (FR-PU07), LCD operation panel (FR-LU08), and enclosure surface operation panel (FR-PA07)	Available	Not available	
Converter unit (FR-XC, FR-HC2, FR-CV)	Standard model and Ethernet model: Available Safety communication model: Not available	Not available	
DC reactor (FR-HEL)	Available	Not available	
Communication	Standard model: RS-485 communication Ethernet model and safety communication model: Ethernet communication	Ethernet communication	
Functional safety	Standard model and Ethernet model: SIL2/PLd Safety communication model: SIL3/PLe (safety communication supported)	SIL3/PLe (safety communication supported)	

Item	FR-E840	FR-E846
Abnormal internal temperature (E.IAH)	Not available	Available
Surrounding air temperature	-20°C to +60°C (The rated current must be reduced at a temperature above 50°C.)	-20°C to +50°C (The rated current must be reduced at a temperature above 40°C.)

18.4 Parameters (functions) and instruction codes under different control methods

- *1 Instruction codes are used to read and write parameters in accordance with communication (such as the Mitsubishi inverter protocol). (For details of communication, refer to the Instruction Manual (Communication).)
- *2 Function availability under each control method is shown as follows:
 - : Available
 - ×: Not available
 - Δ: Available with some restrictions
- *3 For Parameter copy, Parameter clear, and All parameter clear, ○ indicates the function is available, and × indicates the function is not available.
- *4 Communication parameters that are not cleared by parameter clear or all parameter clear (H5A5A or H55AA) via communication. (For details of communication, refer to the Instruction Manual (Communication).)
- *5 When a communication option is installed, parameter clear (lock release) during password lock (Pr.297 Password lock/unlock ≠ "9999") can be performed only from the communication option.

Notation

Mark	Description	Mark	Description
	Available for the standard model.		Available for the 100 V class.
	Available for the FM type inverter (standard model).		Available for the 200 V class.
	Available for the AM (50 Hz) type inverter (standard model).		Available for the 400 V class.
	Available for the AM (60 Hz) type inverter (standard model).		Available for the three-phase power input model.
	Available for the Ethernet model.		Available when the FR-A8AP is installed.
	Available for the Protocol group A (Ethernet model / safety communication model / IP67 model).		Available when the FR-A8AX is installed.
	Available for the Protocol group B (Ethernet model / safety communication model / IP67 model).		Available when the FR-A8AY is installed.
	Available for the Protocol group C (Ethernet model).		Available when the FR-A8AR is installed.
	Available for the safety communication model.		Available when the FR-A8NC is installed.
	Available for the IP67 model.		Available when the FR-A8ND is installed.
			Available when the FR-A8NP is installed.
			Available when the FR-E8AXY is installed.

Pr.	Name	Instruction code ^{*1}			Control method ^{*2}										Parameter		
		Read	Write	Extended										Copy ^{*3}	Clear ^{*3}	All clear ^{*3}	
							Speed	Torque	Position	Speed	Torque	Speed	Position				
0	Torque boost	00	80	0	○	×	×	×	×	×	×	×	×	○	○	○	
1	Maximum frequency	01	81	0	○	○	○	○	○	○	○	○	○	○	○	○	
2	Minimum frequency	02	82	0	○	○	○	○	×	○	○	○	×	○	○	○	
3	Base frequency	03	83	0	○	×	×	×	×	×	×	×	×	○	○	○	
4	Multi-speed setting (high speed)	04	84	0	○	○	○	○	Δ	○	○	○	Δ	○	○	○	
5	Multi-speed setting (middle speed)	05	85	0	○	○	○	○	Δ	○	○	○	Δ	○	○	○	
6	Multi-speed setting (low speed)	06	86	0	○	○	○	○	Δ	○	○	○	Δ	○	○	○	
7	Acceleration time	07	87	0	○	○	○	○	Δ	○	○	○	Δ	○	○	○	
8	Deceleration time	08	88	0	○	○	○	○	Δ	○	○	○	Δ	○	○	○	
9	Electronic thermal O/L relay	09	89	0	○	○	○	○	○	○	○	○	○	○	○	○	
10	DC injection brake operation frequency	0A	8A	0	○	○	○	○	×	○	○	○	×	○	○	○	
11	DC injection brake operation time	0B	8B	0	○	○	○	○	×	○	○	○	×	○	○	○	
12	DC injection brake operation voltage	0C	8C	0	○	○	×	×	×	×	×	×	×	○	○	○	
13	Starting frequency	0D	8D	0	○	○	○	○	×	○	○	○	×	○	○	○	
14	Load pattern selection	0E	8E	0	○	×	×	×	×	×	×	×	×	○	○	○	
15	Jog frequency	0F	8F	0	○	○	○	○	○	○	○	○	×	○	○	○	

Pr.	Name	Instruction code ^{*1}			Control method ^{*2}										Parameter		
		Read	Write	Extended	V/F	Magnetic flux	Vector			Sensorless		PM		Copy ^{*3}	Clear ^{*3}	All clear ^{*3}	
							Speed	Torque	Position	Speed	Torque	Speed	Position				
16	Jog acceleration/deceleration time	10	90	0	○	○	○	○	○	○	○	○	○	○	○	○	○
17	MRS/X10 terminal input selection	11	91	0	○	○	○	○	○	○	○	○	○	○	○	○	○
18	High speed maximum frequency	12	92	0	○	○	○	○	○	○	○	○	○	○	○	○	○
19	Base frequency voltage	13	93	0	○	×	×	×	×	×	×	×	×	○	○	○	○
20	Acceleration/deceleration reference frequency	14	94	0	○	○	○	○	Δ	○	○	○	Δ	○	○	○	○
21	Acceleration/deceleration time increments	15	95	0	○	○	○	○	Δ	○	○	○	Δ	○	○	○	○
22	Stall prevention operation level (Torque limit level)	16	96	0	○	○	○	○	×	○	○	×	○	○	○	○	○
23	Stall prevention operation level compensation factor at double speed	17	97	0	○	○	×	×	×	×	×	×	×	○	○	○	○
24	Multi-speed setting (speed 4)	18	98	0	○	○	○	○	Δ	○	○	○	Δ	○	○	○	○
25	Multi-speed setting (speed 5)	19	99	0	○	○	○	○	Δ	○	○	○	Δ	○	○	○	○
26	Multi-speed setting (speed 6)	1A	9A	0	○	○	○	○	Δ	○	○	○	Δ	○	○	○	○
27	Multi-speed setting (speed 7)	1B	9B	0	○	○	○	○	Δ	○	○	○	Δ	○	○	○	○
29	Acceleration/deceleration pattern selection	1D	9D	0	○	○	○	○	×	○	○	○	×	○	○	○	○
30	Regenerative function selection	1E	9E	0	○	○	○	○	○	○	○	○	○	○	○	○	○
31	Frequency jump 1A	1F	9F	0	○	○	○	○	×	○	○	○	×	○	○	○	○
32	Frequency jump 1B	20	A0	0	○	○	○	○	×	○	○	○	×	○	○	○	○
33	Frequency jump 2A	21	A1	0	○	○	○	○	×	○	○	○	×	○	○	○	○
34	Frequency jump 2B	22	A2	0	○	○	○	○	×	○	○	○	×	○	○	○	○
35	Frequency jump 3A	23	A3	0	○	○	○	○	×	○	○	○	×	○	○	○	○
36	Frequency jump 3B	24	A4	0	○	○	○	○	×	○	○	○	×	○	○	○	○
37	Speed display	25	A5	0	○	○	○	○	○	○	○	○	○	○	○	○	○
40	RUN key rotation direction selection	28	A8	0	○	○	○	○	○	○	○	○	○	○	○	○	○
41	Up-to-frequency sensitivity	29	A9	0	○	○	○	○	×	×	○	×	○	×	○	○	○
42	Output frequency detection	2A	AA	0	○	○	○	○	Δ	Δ	○	Δ	○	Δ	○	○	○
43	Output frequency detection for reverse rotation	2B	AB	0	○	○	○	○	Δ	Δ	○	Δ	○	Δ	○	○	○
44	Second acceleration/deceleration time	2C	AC	0	○	○	×	×	×	○	○	○	Δ	○	○	○	○
45	Second deceleration time	2D	AD	0	○	○	×	×	×	○	○	○	Δ	○	○	○	○
46	Second torque boost	2E	AE	0	○	×	×	×	×	×	×	×	×	○	○	○	○
47	Second V/F (base frequency)	2F	AF	0	○	×	×	×	×	×	×	×	×	○	○	○	○
48	Second stall prevention operation level	30	B0	0	○	○	×	×	×	×	×	×	×	○	○	○	○
51	Second electronic thermal O/L relay	33	B3	0	○	○	×	×	×	○	○	○	○	○	○	○	○
52	Operation panel main monitor selection [E800] [E800-E] [E800-SC]	34	B4	0	○	○	○	○	○	○	○	○	○	○	○	○	○
53	Frequency / rotation speed unit switchover	35	B5	0	○	○	○	○	○	○	○	○	○	○	○	○	○
54	FM terminal function selection [E800-1]	36	B6	0	○	○	○	○	○	○	○	○	○	○	○	○	○
55	Frequency monitoring reference [E800] [AY] [AXY]	37	B7	0	○	○	○	○	○	○	○	○	○	○	○	○	○
56	Current monitoring reference [E800] [AY] [AXY]	38	B8	0	○	○	○	○	○	○	○	○	○	○	○	○	○
57	Restart coasting time	39	B9	0	○	○	○	○	×	○	○	○	×	○	○	○	○

Pr.	Name	Instruction code ^{*1}			Control method ^{*2}										Parameter		
		Read	Write	Extended	V/F	Magnetic flux	Vector			Sensorless		PM		Copy ^{*3}	Clear ^{*3}	All clear ^{*3}	
							Speed	Torque	Position	Speed	Torque	Speed	Position				
58	Restart cushion time	3A	BA	0	○	○	×	×	×	×	×	×	×	○	○	○	
59	Remote function selection	3B	BB	0	○	○	○	○	×	○	○	○	×	○	○	○	
60	Energy saving control selection	3C	BC	0	○	○	×	×	×	×	×	×	×	○	○	○	
61	Reference current	3D	BD	0	○	○	○	×	×	○	×	×	×	○	○	○	
62	Reference value at acceleration	3E	BE	0	○	○	○	×	×	○	×	×	×	○	○	○	
63	Reference value at deceleration	3F	BF	0	○	○	○	×	×	○	×	×	×	○	○	○	
65	Retry selection	41	C1	0	○	○	○	○	×	○	○	○	×	○	○	○	
66	Stall prevention operation reduction starting frequency	42	C2	0	○	○	×	×	×	×	×	×	×	○	○	○	
67	Number of retries at fault occurrence	43	C3	0	○	○	○	○	×	○	○	×	○	○	○	○	
68	Retry waiting time	44	C4	0	○	○	○	○	×	○	○	○	×	○	○	○	
69	Retry count display erase	45	C5	0	○	○	○	○	×	○	○	○	×	○	○	○	
70	Special regenerative brake duty	46	C6	0	○	○	○	○	○	○	○	○	○	○	○	○	
71	Applied motor	47	C7	0	○	○	○	○	○	○	○	○	○	○	○	○	
72	PWM frequency selection	48	C8	0	○	○	○	○	○	○	○	○	○	○	○	○	
73	Analog input selection	49	C9	0	○	○	○	○	×	○	○	○	×	○	×	○	
74	Input filter time constant	4A	CA	0	○	○	○	○	×	○	○	○	×	○	○	○	
75	Reset selection/disconnected PU detection/PU stop selection	4B	CB	0	○	○	○	○	○	○	○	○	○	○	×	×	
77	Parameter write selection	4D	CD	0	○	○	○	○	○	○	○	○	○	○	○	○	
78	Reverse rotation prevention selection	4E	CE	0	○	○	○	○	○	○	○	○	○	○	○	○	
79	Operation mode selection	4F	CF	0	○	○	○	○	○	○	○	○	○	○	○	○	
80	Motor capacity	50	D0	0	×	○	○	○	○	○	○	○	○	○	○	○	
81	Number of motor poles	51	D1	0	○	○	○	○	○	○	○	○	○	○	○	○	
82	Motor excitation current	52	D2	0	○	○	○	○	○	○	○	×	×	○	×	○	
83	Rated motor voltage	53	D3	0	×	○	○	○	○	○	○	○	×	○	○	○	
84	Rated motor frequency	54	D4	0	×	○	○	○	○	○	○	○	○	○	○	○	
89	Speed control gain (Advanced magnetic flux vector)	59	D9	0	×	○	×	×	×	×	×	×	×	○	×	○	
90	Motor constant (R1)	5A	DA	0	×	○	○	○	○	○	○	○	×	○	×	○	
91	Motor constant (R2)	5B	DB	0	×	○	○	○	○	○	○	×	×	○	×	○	
92	Motor constant (L1)/d-axis inductance (Ld)	5C	DC	0	×	○	○	○	○	○	○	○	×	○	×	○	
93	Motor constant (L2)/q-axis inductance (Lq)	5D	DD	0	×	○	○	○	○	○	○	○	×	○	×	○	
94	Motor constant (X)	5E	DE	0	×	○	○	○	○	○	○	×	×	○	×	○	
95	Online auto tuning selection	5F	DF	0	×	○	○	○	○	○	○	×	×	○	○	○	
96	Auto tuning setting/status	60	E0	0	×	○	○	○	○	○	○	○	×	○	×	○	
117	PU communication station number <small>E800</small>	11	91	1	○	○	○	○	○	○	○	○	○	○	○ ^{*4}	○ ^{*4}	
118	PU communication speed <small>E800</small>	12	92	1	○	○	○	○	○	○	○	○	○	○	○ ^{*4}	○ ^{*4}	
119	PU communication stop bit length / data length <small>E800</small>	13	93	1	○	○	○	○	○	○	○	○	○	○	○ ^{*4}	○ ^{*4}	
120	PU communication parity check <small>E800</small>	14	94	1	○	○	○	○	○	○	○	○	○	○	○ ^{*4}	○ ^{*4}	
121	PU communication retry count <small>E800</small>	15	95	1	○	○	○	○	○	○	○	○	○	○	○ ^{*4}	○ ^{*4}	
122	PU communication check time interval <small>E800</small>	16	96	1	○	○	○	○	○	○	○	○	○	○	○ ^{*4}	○ ^{*4}	

Pr.	Name	Instruction code ^{*1}			Control method ^{*2}									Parameter		
		Read	Write	Extended	V/F	Magnetic flux	Vector			Sensorless		PM		Copy ^{*3}	Clear ^{*3}	All clear ^{*3}
							Speed	Torque	Position	Speed	Torque	Speed	Position			
123	PU communication waiting time setting [E800]	17	97	1	○	○	○	○	○	○	○	○	○	○	○ ^{*4}	○ ^{*4}
124	PU communication CR/LF selection [E800]	18	98	1	○	○	○	○	○	○	○	○	○	○	○ ^{*4}	○ ^{*4}
125	Terminal 2 frequency setting gain frequency	19	99	1	○	○	○	○	×	○	○	○	×	○	×	○
126	Terminal 4 frequency setting gain frequency	1A	9A	1	○	○	○	○	×	○	○	○	×	○	×	○
127	PID control automatic switchover frequency	1B	9B	1	○	○	○	×	×	○	×	○	×	○	○	○
128	PID action selection	1C	9C	1	○	○	○	×	×	○	×	○	×	○	○	○
129	PID proportional band	1D	9D	1	○	○	○	×	×	○	×	○	×	○	○	○
130	PID integral time	1E	9E	1	○	○	○	×	×	○	×	○	×	○	○	○
131	PID upper limit	1F	9F	1	○	○	○	×	×	○	×	○	×	○	○	○
132	PID lower limit	20	A0	1	○	○	○	×	×	○	×	○	×	○	○	○
133	PID action set point	21	A1	1	○	○	○	×	×	○	×	○	×	○	○	○
134	PID differential time	22	A2	1	○	○	○	×	×	○	×	○	×	○	○	○
136	MC switchover interlock time [E800] [E800-E]	24	A4	1	○	○	○	×	×	○	×	×	×	○	○	○
139	Automatic switchover frequency from inverter to bypass operation [E800] [E800-E]	27	A7	1	○	○	○	×	×	○	×	×	×	○	○	○
145	PU display language selection [E800]	2D	AD	1	○	○	○	○	○	○	○	○	○	○	×	×
147	Acceleration/deceleration time switching frequency	2F	AF	1	○	○	○	○	Δ	○	○	○	Δ	○	○	○
150	Output current detection level	32	B2	1	○	○	○	○	○	○	○	○	○	○	○	○
151	Output current detection signal delay time	33	B3	1	○	○	○	○	○	○	○	○	○	○	○	○
152	Zero current detection level	34	B4	1	○	○	○	○	○	○	○	○	○	○	○	○
153	Zero current detection time	35	B5	1	○	○	○	○	○	○	○	○	○	○	○	○
154	Voltage reduction selection during stall prevention operation	36	B6	1	○	○	×	×	×	×	×	×	×	○	○	○
156	Stall prevention operation selection	38	B8	1	○	○	○	×	×	○	×	○	×	○	○	○
157	OL signal output timer	39	B9	1	○	○	○	○	○	○	○	○	○	○	○	○
158	AM terminal function selection [E800-4] [E800-5]	3A	BA	1	○	○	○	○	○	○	○	○	○	○	○	○
160	User group read selection	00	80	2	○	○	○	○	○	○	○	○	○	○	○	○
161	Frequency setting/key lock operation selection	01	81	2	○	○	○	○	Δ	○	○	○	Δ	○	×	○
162	Automatic restart after instantaneous power failure selection	02	82	2	○	○	○	○	×	○	○	○	×	○	○	○
165	Stall prevention operation level for restart	05	85	2	○	○	×	×	×	×	×	×	×	○	○	○
166	Output current detection signal retention time	06	86	2	○	○	○	○	○	○	○	○	○	○	○	○
167	Output current detection operation selection	07	87	2	○	○	○	○	○	○	○	○	○	○	○	○
168	Parameter for manufacturer setting. Do not set.															
169																
170	Watt-hour meter clear	0A	8A	2	○	○	○	○	○	○	○	○	○	○	×	○
171	Operation hour meter clear	0B	8B	2	○	○	○	○	○	○	○	○	○	×	×	×
172	User group registered display/batch clear	0C	8C	2	○	○	○	○	○	○	○	○	○	○	×	×

Pr.	Name	Instruction code ^{*1}			Control method ^{*2}										Parameter		
		Read	Write	Extended	V/F	Magnetic flux	Vector			Sensorless		PM		Copy ^{*3}	Clear ^{*3}	All clear ^{*3}	
							Speed	Torque	Position	Speed	Torque	Speed	Position				
173	User group registration	0D	8D	2	o	o	o	o	o	o	o	o	o	x	x	x	
174	User group clear	0E	8E	2	o	o	o	o	o	o	o	o	o	x	x	x	
178	STF/DI0 terminal function selection [E800] [E800-E] [E806]	12	92	2	o	o	o	o	o	o	o	o	o	o	x	o	
179	STR/DI1 terminal function selection [E800] [E800-E] [E806]	13	93	2	o	o	o	o	o	o	o	o	o	o	x	o	
180	RL terminal function selection	14	94	2	o	o	o	o	o	o	o	o	o	o	x	o	
181	RM terminal function selection	15	95	2	o	o	o	o	o	o	o	o	o	o	x	o	
182	RH terminal function selection	16	96	2	o	o	o	o	o	o	o	o	o	o	x	o	
183	MRS terminal function selection	17	97	2	o	o	o	o	o	o	o	o	o	o	x	o	
184	RES terminal function selection	18	98	2	o	o	o	o	o	o	o	o	o	o	x	o	
185	NET X1 input selection	19	99	2	o	o	o	o	o	o	o	o	o	o	x	o	
186	NET X2 input selection	1A	9A	2	o	o	o	o	o	o	o	o	o	o	x	o	
187	NET X3 input selection	1B	9B	2	o	o	o	o	o	o	o	o	o	o	x	o	
188	NET X4 input selection	1C	9C	2	o	o	o	o	o	o	o	o	o	o	x	o	
189	NET X5 input selection	1D	9D	2	o	o	o	o	o	o	o	o	o	o	x	o	
190	RUN terminal function selection	1E	9E	2	o	o	o	o	o	o	o	o	o	o	x	o	
191	FU terminal function selection	1F	9F	2	o	o	o	o	o	o	o	o	o	o	x	o	
192	ABC terminal function selection	20	A0	2	o	o	o	o	o	o	o	o	o	o	x	o	
193	NET Y1 output selection	21	A1	2	o	o	o	o	o	o	o	o	o	o	x	o	
194	NET Y2 output selection	22	A2	2	o	o	o	o	o	o	o	o	o	o	x	o	
195	NET Y3 output selection	23	A3	2	o	o	o	o	o	o	o	o	o	o	x	o	
196	NET Y4 output selection	24	A4	2	o	o	o	o	o	o	o	o	o	o	x	o	
197	ABC2 terminal function selection	25	A5	2	o	o	o	o	o	o	o	o	o	o	x	o	
198	Display corrosion level	26	A6	2	o	o	o	o	o	o	o	o	o	x	x	x	
232	Multi-speed setting (speed 8)	28	A8	2	o	o	o	o	x	o	o	o	Δ	o	o	o	
233	Multi-speed setting (speed 9)	29	A9	2	o	o	o	o	x	o	o	o	Δ	o	o	o	
234	Multi-speed setting (speed 10)	2A	AA	2	o	o	o	o	x	o	o	o	Δ	o	o	o	
235	Multi-speed setting (speed 11)	2B	AB	2	o	o	o	o	x	o	o	o	Δ	o	o	o	
236	Multi-speed setting (speed 12)	2C	AC	2	o	o	o	o	x	o	o	o	Δ	o	o	o	
237	Multi-speed setting (speed 13)	2D	AD	2	o	o	o	o	x	o	o	o	Δ	o	o	o	
238	Multi-speed setting (speed 14)	2E	AE	2	o	o	o	o	x	o	o	o	Δ	o	o	o	
239	Multi-speed setting (speed 15)	2F	AF	2	o	o	o	o	x	o	o	o	Δ	o	o	o	
240	Soft-PWM operation selection	30	B0	2	o	o	o	o	o	o	o	o	o	o	o	o	
241	Analog input display unit switchover	31	B1	2	o	o	o	o	o	o	o	o	o	o	o	o	
242	Terminal 1 added compensation amount (terminal 2) [AXY]	32	B2	2	o	o	o	o	x	o	o	o	x	o	o	o	
243	Terminal 1 added compensation amount (terminal 4) [AXY]	33	B3	2	o	o	o	o	x	o	o	o	x	o	o	o	
244	Cooling fan operation selection	34	B4	2	o	o	o	o	o	o	o	o	o	o	o	o	
245	Rated slip	35	B5	2	o	x	x	x	x	x	x	x	x	o	o	o	
246	Slip compensation time constant	36	B6	2	o	x	x	x	x	x	x	x	x	o	o	o	
247	Constant output range slip compensation selection	37	B7	2	o	x	x	x	x	x	x	x	x	o	o	o	
249	Earth (ground) fault detection at start	39	B9	2	o	o	o	o	o	o	o	o	o	o	o	o	
250	Stop selection	3A	BA	2	o	o	o	o	x	o	o	o	x	o	o	o	

Pr.	Name	Instruction code ^{*1}			Control method ^{*2}									Parameter		
		Read	Write	Extended	V/F	Magnetic flux	Vector			Sensorless		PM		Copy ^{*3}	Clear ^{*3}	All clear ^{*3}
							Speed	Torque	Position	Speed	Torque	Speed	Position			
251	Output phase loss protection selection	3B	BB	2	o	o	o	o	o	o	o	o	o	o	o	o
252	Override bias ^[AXY]	3C	BC	2	o	o	o	o	x	o	o	o	x	o	o	o
253	Override gain ^[AXY]	3D	BD	2	o	o	o	o	x	o	o	o	x	o	o	o
255	Life alarm status display	3F	BF	2	o	o	o	o	o	o	o	o	o	x	x	x
256	Inrush current limit circuit life display	40	C0	2	o	o	o	o	o	o	o	o	o	x	x	x
257	Control circuit capacitor life display	41	C1	2	o	o	o	o	o	o	o	o	o	x	x	x
258	Main circuit capacitor life display	42	C2	2	o	o	o	o	o	o	o	o	o	x	x	x
259	Main circuit capacitor life measuring	43	C3	2	o	o	o	o	o	o	o	o	o	o	o	o
260	PWM frequency automatic switchover	44	C4	2	o	o	o	o	o	o	o	o	o	o	o	o
261	Power failure stop selection	45	C5	2	o	o	o	o	x	o	o	o	x	o	o	o
267	Terminal 4 input selection	4B	CB	2	o	o	o	o	o	o	o	o	o	o	x	o
268	Monitor decimal digits selection	4C	CC	2	o	o	o	o	o	o	o	o	o	o	o	o
269	Parameter for manufacturer setting. Do not set.															
270	Stop-on-contact control selection	4E	CE	2	x	o	x	x	x	o	x	x	x	o	o	o
275	Stop-on contact excitation current low-speed scaling factor	53	D3	2	x	o	x	x	x	o	x	x	x	o	o	o
276	PWM carrier frequency at stop-on contact	54	D4	2	x	o	x	x	x	o	x	x	x	o	o	o
277	Stall prevention operation current switchover	55	D5	2	o	o	x	x	x	x	x	x	x	o	o	o
278	Brake opening frequency	56	D6	2	x	o	o	x	x	o	x	x	x	o	o	o
279	Brake opening current	57	D7	2	x	o	o	x	x	o	x	x	x	o	o	o
280	Brake opening current detection time	58	D8	2	x	o	o	x	x	o	x	x	x	o	o	o
281	Brake operation time at start	59	D9	2	x	o	o	x	x	o	x	x	x	o	o	o
282	Brake operation frequency	5A	DA	2	x	o	o	x	x	o	x	x	x	o	o	o
283	Brake operation time at stop	5B	DB	2	x	Δ	o	x	x	o	x	x	x	o	o	o
284	Deceleration detection function selection	5C	DC	2	x	Δ	o	x	x	o	x	x	x	o	o	o
285	Overspeed detection frequency (Speed deviation excess detection frequency)	5D	DD	2	Δ (x)	Δ (x)	x (o)	x	x	x	x	x (Δ)	x	o	o	o
286	Droop gain	5E	DE	2	x	o	o	x	x	o	x	o	x	o	o	o
287	Droop filter time constant	5F	DF	2	x	x	o	x	x	o	x	o	x	o	o	o
289	Inverter output terminal filter	61	E1	2	o	o	o	o	o	o	o	o	o	o	x	o
290	Monitor negative output selection	62	E2	2	o	o	o	o	o	o	o	o	o	o	o	o
291	Pulse train input selection ^[AXY]	63	E3	2	o	o	o	o	x	o	o	o	x	o	x	o
292	Automatic acceleration/deceleration	64	E4	2	Δ	Δ	Δ	x	x	Δ	x	x	x	o	o	o
293	Acceleration/deceleration separate selection	65	E5	2	o	o	o	x	x	o	x	x	x	o	o	o
295	Frequency change increment amount setting ^[E800]	67	E7	2	o	o	o	o	o	o	o	o	o	o	o	o
296	Password lock level	68	E8	2	o	o	o	o	o	o	o	o	o	o	x	o
297	Password lock/unlock	69	E9	2	o	o	o	o	o	o	o	o	o	o	o ^{*5}	o
298	Frequency search gain	6A	EA	2	o	o	x	x	x	o	o	x	x	o	x	o

Pr.	Name	Instruction code ^{*1}			Control method ^{*2}									Parameter		
		Read	Write	Extended	V/F	Magnetic flux	Vector			Sensorless		PM		Copy ^{*3}	Clear ^{*3}	All clear ^{*3}
							Speed	Torque	Position	Speed	Torque	Speed	Position			
299	Rotation direction detection selection at restarting	6B	EB	2	○	○	×	×	×	○	×	×	×	○	○	○
300	BCD input bias [AX]	00	80	3	○	○	○	○	×	○	○	○	×	○	○	○
301	BCD input gain [AX]	01	81	3	○	○	○	○	×	○	○	○	×	○	○	○
302	BIN input bias [AX]	02	82	3	○	○	○	○	×	○	○	○	×	○	○	○
303	BIN input gain [AX]	03	83	3	○	○	○	○	×	○	○	○	×	○	○	○
304	Digital input and analog input compensation enable/disable selection [AX]	04	84	3	○	○	○	○	×	○	○	○	×	○	○	○
305	Read timing operation selection [AX]	05	85	3	○	○	○	○	×	○	○	○	×	○	○	○
306	Analog output signal selection [AY] [AXY]	06	86	3	○	○	○	○	○	○	○	○	○	○	○	○
307	Setting for zero analog output [AY] [AXY]	07	87	3	○	○	○	○	○	○	○	○	○	○	○	○
308	Setting for maximum analog output [AY] [AXY]	08	88	3	○	○	○	○	○	○	○	○	○	○	○	○
309	Analog output signal voltage/current switchover [AY] [AXY]	09	89	3	○	○	○	○	○	○	○	○	○	○	○	○
310	Analog meter voltage output selection [AY]	0A	8A	3	○	○	○	○	○	○	○	○	○	○	○	○
311	Setting for zero analog meter voltage output [AY]	0B	8B	3	○	○	○	○	○	○	○	○	○	○	○	○
312	Setting for maximum analog meter voltage output [AY]	0C	8C	3	○	○	○	○	○	○	○	○	○	○	○	○
313	DO0 output selection [E800-EPA] [E800-EPB] [AY] [NC]	0D	8D	3	○	○	○	○	○	○	○	○	○	○	×	○
314	DO1 output selection [E800-EPA] [E800-EPB] [AY] [NC] [AXY]	0E	8E	3	○	○	○	○	○	○	○	○	○	○	×	○
315	DO2 output selection [E800-EPA] [E800-EPB] [AY] [NC] [AXY]	0F	8F	3	○	○	○	○	○	○	○	○	○	○	×	○
316	DO3 output selection [AY]	10	90	3	○	○	○	○	○	○	○	○	○	○	×	○
317	DO4 output selection [AY]	11	91	3	○	○	○	○	○	○	○	○	○	○	×	○
318	DO5 output selection [AY]	12	92	3	○	○	○	○	○	○	○	○	○	○	×	○
319	DO6 output selection [AY]	13	93	3	○	○	○	○	○	○	○	○	○	○	×	○
320	RA1 output selection [AR]	14	94	3	○	○	○	○	○	○	○	○	○	○	×	○
321	RA2 output selection [AR]	15	95	3	○	○	○	○	○	○	○	○	○	○	×	○
322	RA3 output selection [AR]	16	96	3	○	○	○	○	○	○	○	○	○	○	×	○
323	AM0 (A8AY) 0 V adjustment / AM1 (E8AXY) 0 V adjustment [AY] [AXY]	17	97	3	○	○	○	○	○	○	○	○	○	○	×	○
324	AM1 0mA adjustment [AY]	18	98	3	○	○	○	○	○	○	○	○	○	○	×	○
329	Digital input unit selection [AX]	1D	9D	3	○	○	○	○	×	○	○	○	×	○	×	○
338	Communication operation command source	26	A6	3	○	○	○	○	○	○	○	○	○	○	○ ^{*4}	○ ^{*4}
339	Communication speed command source	27	A7	3	○	○	○	○	○	○	○	○	○	○	○ ^{*4}	○ ^{*4}
340	Communication startup mode selection	28	A8	3	○	○	○	○	○	○	○	○	○	○	○ ^{*4}	○ ^{*4}
342	Communication EEPROM write selection	2A	AA	3	○	○	○	○	○	○	○	○	○	○	○	○
343	Communication error count [E800]	2B	AB	3	○	○	○	○	○	○	○	○	○	×	×	×

Pr.	Name	Instruction code ^{*1}			Control method ^{*2}										Parameter		
		Read	Write	Extended	V/F	Magnetic flux	Vector			Sensorless		PM		Copy ^{*3}	Clear ^{*3}	All clear ^{*3}	
							Speed	Torque	Position	Speed	Torque	Speed	Position				
345	DeviceNet address ^[ND]	2D	AD	3	○	○	○	○	○	○	○	○	○	○	○	○ ^{*4}	○ ^{*4}
346	DeviceNet baud rate ^[ND]	2E	AE	3	○	○	○	○	○	○	○	○	○	○	○	○ ^{*4}	○ ^{*4}
349	Communication reset selection ^{[E800-E][E800-SCE][E806][NC][ND][NP]}	31	B1	3	○	○	○	○	○	○	○	○	○	○	○	○ ^{*4}	○ ^{*4}
350	Stop position command selection ^[AP]	32	B2	3	○	○	○	×	×	×	×	×	×	○	○	○	○
351	Orientation speed ^[AP]	33	B3	3	○	○	○	×	×	×	×	×	×	○	○	○	○
352	Creep speed ^[AP]	34	B4	3	○	○	×	×	×	×	×	×	×	○	○	○	○
353	Creep switchover position ^[AP]	35	B5	3	○	○	×	×	×	×	×	×	×	○	○	○	○
354	Position loop switchover position ^[AP]	36	B6	3	○	○	×	×	×	×	×	×	×	○	○	○	○
355	DC injection brake start position ^[AP]	37	B7	3	○	○	×	×	×	×	×	×	×	○	○	○	○
356	Internal stop position command ^[AP]	38	B8	3	○	○	○	×	×	×	×	×	×	○	○	○	○
357	Orientation in-position zone ^[AP]	39	B9	3	○	○	○	×	×	×	×	×	×	○	○	○	○
358	Servo torque selection ^[AP]	3A	BA	3	○	○	×	×	×	×	×	×	×	○	○	○	○
359	Encoder rotation direction ^[AP]	3B	BB	3	○	○	○	○	○	×	×	×	×	○	○	○	○
361	Position shift ^[AP]	3D	BD	3	○	○	○	×	×	×	×	×	×	○	○	○	○
362	Orientation position loop gain ^[AP]	3E	BE	3	○	○	○	×	×	×	×	×	×	○	○	○	○
363	Completion signal output delay time ^[AP]	3F	BF	3	○	○	×	×	×	×	×	×	×	○	○	○	○
364	Encoder stop check time ^[AP]	40	C0	3	○	○	×	×	×	×	×	×	×	○	○	○	○
365	Orientation limit ^[AP]	41	C1	3	○	○	×	×	×	×	×	×	×	○	○	○	○
366	Recheck time ^[AP]	42	C2	3	○	○	×	×	×	×	×	×	×	○	○	○	○
367	Speed feedback range ^[AP]	43	C3	3	○	○	×	×	×	×	×	×	×	○	○	○	○
368	Feedback gain ^[AP]	44	C4	3	○	○	×	×	×	×	×	×	×	○	○	○	○
369	Number of encoder pulses ^[AP]	45	C5	3	○	○	○	○	○	×	×	×	×	○	○	○	○
374	Overspeed detection level	4A	CA	3	×	×	○	○	○	○	○	○	○	○	○	○	○
375	Faulty acceleration rate detection level	4B	CB	3	×	×	×	×	×	×	○	○	○	○	○	○	○
376	Encoder signal loss detection enable/disable selection ^[AP]	4C	CC	3	×	×	○	○	○	×	×	×	×	○	○	○	○
384	Input pulse division scaling factor ^[AXY]	54	D4	3	○	○	○	○	×	○	○	○	×	○	○	○	○
385	Frequency for zero input pulse ^[AXY]	55	D5	3	○	○	○	○	×	○	○	○	×	○	○	○	○
386	Frequency for maximum input pulse ^[AXY]	56	D6	3	○	○	○	○	×	○	○	○	×	○	○	○	○
390	% setting reference frequency ^{[E800][E800-EPA]}	5A	DA	3	○	○	○	○	○	○	○	○	○	○	○	○	○
393	Orientation selection ^[AP]	5D	DD	3	×	×	○	×	×	×	×	×	×	○	○	○	○
396	Orientation speed gain (P term) ^[AP]	60	E0	3	×	×	○	×	×	×	×	×	×	○	○	○	○
397	Orientation speed integral time ^[AP]	61	E1	3	×	×	○	×	×	×	×	×	×	○	○	○	○
398	Orientation speed gain (D term) ^[AP]	62	E2	3	×	×	○	×	×	×	×	×	×	○	○	○	○
399	Orientation deceleration ratio ^[AP]	63	E3	3	×	×	○	×	×	×	×	×	×	○	○	○	○

Pr.	Name	Instruction code ^{*1}			Control method ^{*2}									Parameter			
		Read	Write	Extended	V/F	Magnetic flux	Vector			Sensorless		PM		Copy ^{*3}	Clear ^{*3}	All clear ^{*3}	
							Speed	Torque	Position	Speed	Torque	Speed	Position				
414	PLC function operation selection	0E	8E	4	○	○	○	○	○	○	○	○	○	○	○	○	○
415	Inverter operation lock mode setting	0F	8F	4	○	○	○	○	○	○	○	○	○	○	○	○	○
416	Pre-scale function selection	10	90	4	○	○	○	○	○	○	○	○	○	○	○	○	○
417	Pre-scale setting value	11	91	4	○	○	○	○	○	○	○	○	○	○	○	○	○
418	Extension output terminal filter <input type="checkbox"/> AY <input type="checkbox"/> AR <input type="checkbox"/> AXY	12	92	4	○	○	○	○	○	○	○	○	○	○	○	○	○
420	Command pulse scaling factor numerator (electronic gear numerator)	14	94	4	×	×	×	×	○	×	×	×	○	○	○	○	○
421	Command pulse multiplication denominator (electronic gear denominator)	15	95	4	×	×	×	×	○	×	×	×	○	○	○	○	○
422	Position control gain	16	96	4	×	×	○	×	○	×	×	×	○	○	○	○	○
423	Position feed forward gain	17	97	4	×	×	×	×	○	×	×	×	○	○	○	○	○
425	Position feed forward command filter	19	99	4	×	×	×	×	○	×	×	×	○	○	○	○	○
426	In-position width	1A	9A	4	×	×	×	×	○	×	×	×	○	○	○	○	○
427	Excessive level error	1B	9B	4	×	×	×	×	○	×	×	×	○	○	○	○	○
430	Pulse monitor selection	1E	9E	4	×	×	×	×	○	×	×	×	○	○	○	○	○
442	Default gateway address 1 <input type="checkbox"/> E800-EPA <input type="checkbox"/> E800-EPB	2A	AA	4	○	○	○	○	○	○	○	○	○	○	○	○ ^{*4}	○ ^{*4}
443	Default gateway address 2 <input type="checkbox"/> E800-EPA <input type="checkbox"/> E800-EPB	2B	AB	4	○	○	○	○	○	○	○	○	○	○	○	○ ^{*4}	○ ^{*4}
444	Default gateway address 3 <input type="checkbox"/> E800-EPA <input type="checkbox"/> E800-EPB	2C	AC	4	○	○	○	○	○	○	○	○	○	○	○	○ ^{*4}	○ ^{*4}
445	Default gateway address 4 <input type="checkbox"/> E800-EPA <input type="checkbox"/> E800-EPB	2D	AD	4	○	○	○	○	○	○	○	○	○	○	○	○ ^{*4}	○ ^{*4}
446	Model position control gain	2E	AE	4	×	×	×	×	○	×	×	×	○	○	○	○	○
447	Digital torque command bias <input type="checkbox"/> AX	2F	AF	4	×	×	×	○	×	×	○	×	×	○	○	○	○
448	Digital torque command gain <input type="checkbox"/> AX	30	B0	4	×	×	×	○	×	×	○	×	×	○	○	○	○
450	Second applied motor	32	B2	4	○	○	×	×	×	○	○	○	○	○	○	○	○
451	Second motor control method selection	33	B3	4	○	○	×	×	×	○	○	○	○	○	○	○	○
453	Second motor capacity	35	B5	4	×	○	×	×	×	○	○	○	○	○	○	○	○
454	Number of second motor poles	36	B6	4	○	○	×	×	×	○	○	○	○	○	○	○	○
455	Second motor excitation current	37	B7	4	○	○	×	×	×	○	○	×	×	○	○	×	○
456	Rated second motor voltage	38	B8	4	×	○	×	×	×	○	○	○	×	○	○	○	○
457	Rated second motor frequency	39	B9	4	×	○	×	×	×	○	○	○	○	○	○	○	○
458	Second motor constant (R1)	3A	BA	4	×	○	×	×	×	○	○	○	×	○	○	×	○
459	Second motor constant (R2)	3B	BB	4	×	○	×	×	×	○	○	×	×	○	○	×	○
460	Second motor constant (L1) / d-axis inductance (Ld)	3C	BC	4	×	○	×	×	×	○	○	○	×	○	○	×	○
461	Second motor constant (L2) / q-axis inductance (Lq)	3D	BD	4	×	○	×	×	×	○	○	○	×	○	○	×	○
462	Second motor constant (X)	3E	BE	4	×	○	×	×	×	○	○	×	×	○	○	×	○
463	Second motor auto tuning setting/status	3F	BF	4	×	○	×	×	×	○	○	○	×	○	○	×	○
464	Digital position control sudden stop deceleration time	40	C0	4	×	×	×	×	○	×	×	×	○	○	○	○	○
465	First target position lower 4 digits	41	C1	4	×	×	×	×	○	×	×	×	○	○	○	○	○

Pr.	Name	Instruction code ^{*1}			Control method ^{*2}										Parameter		
		Read	Write	Extended	V/F	Magnetic flux	Vector			Sensorless		PM		Copy ^{*3}	Clear ^{*3}	All clear ^{*3}	
							Speed	Torque	Position	Speed	Torque	Speed	Position				
466	First target position upper 4 digits	42	C2	4	x	x	x	x	o	x	x	x	o	o	o	o	
467	Second target position lower 4 digits	43	C3	4	x	x	x	x	o	x	x	x	o	o	o	o	
468	Second target position upper 4 digits	44	C4	4	x	x	x	x	o	x	x	x	o	o	o	o	
469	Third target position lower 4 digits	45	C5	4	x	x	x	x	o	x	x	x	o	o	o	o	
470	Third target position upper 4 digits	46	C6	4	x	x	x	x	o	x	x	x	o	o	o	o	
471	Fourth target position lower 4 digits	47	C7	4	x	x	x	x	o	x	x	x	o	o	o	o	
472	Fourth target position upper 4 digits	48	C8	4	x	x	x	x	o	x	x	x	o	o	o	o	
473	Fifth target position lower 4 digits	49	C9	4	x	x	x	x	o	x	x	x	o	o	o	o	
474	Fifth target position upper 4 digits	4A	CA	4	x	x	x	x	o	x	x	x	o	o	o	o	
475	Sixth target position lower 4 digits	4B	CB	4	x	x	x	x	o	x	x	x	o	o	o	o	
476	Sixth target position upper 4 digits	4C	CC	4	x	x	x	x	o	x	x	x	o	o	o	o	
477	Seventh target position lower 4 digits	4D	CD	4	x	x	x	x	o	x	x	x	o	o	o	o	
478	Seventh target position upper 4 digits	4E	CE	4	x	x	x	x	o	x	x	x	o	o	o	o	
495	Remote output selection	5F	DF	4	o	o	o	o	o	o	o	o	o	o	o	o	
496	Remote output data 1	60	E0	4	o	o	o	o	o	o	o	o	o	x	x	x	
497	Remote output data 2	61	E1	4	o	o	o	o	o	o	o	o	o	x	x	x	
498	PLC function flash memory clear	62	E2	4	o	o	o	o	o	o	o	o	o	x	o	o	
500	Communication error execution waiting time [NC] [ND] [NP]	00	80	5	o	o	o	o	o	o	o	o	o	o	o	o	
501	Communication error occurrence count display [NC] [ND] [NP]	01	81	5	o	o	o	o	o	o	o	o	o	x	o	o	
502	Stop mode selection at communication error	02	82	5	o	o	o	o	o	o	o	o	o	o	o	o	
503	Maintenance timer	03	83	5	o	o	o	o	o	o	o	o	o	x	x	x	
504	Maintenance timer warning output set time	04	84	5	o	o	o	o	o	o	o	o	o	o	x	o	
505	Speed setting reference	05	85	5	o	o	o	o	o	o	o	o	o	o	o	o	
506	Display estimated main circuit capacitor residual life	06	86	5	o	o	o	o	o	o	o	o	o	x	x	x	
507	Display/reset ABC relay contact life	07	87	5	o	o	o	o	o	o	o	o	o	x	x	x	
508	Display/reset ABC2 relay contact life [E806]	08	88	5	o	o	o	o	o	o	o	o	o	x	x	x	
509	Display power cycle life	09	89	5	o	o	o	o	o	o	o	o	o	x	x	x	
510	Rough match output range	0A	8A	5	x	x	x	x	o	x	x	x	o	o	o	o	
511	Home position return shifting speed	0B	8B	5	x	x	x	x	o	x	x	x	o	o	o	o	
514	Emergency drive dedicated retry waiting time [E800] [E800-E]	0E	8E	5	o	o	x	x	x	o	x	o	x	o	x	o	
515	Emergency drive dedicated retry count [E800] [E800-E]	0F	8F	5	o	o	x	x	x	o	x	o	x	o	x	o	

Pr.	Name	Instruction code ^{*1}			Control method ^{*2}										Parameter		
		Read	Write	Extended	V/F	Magnetic flux	Vector			Sensorless		PM		Copy ^{*3}	Clear ^{*3}	All clear ^{*3}	
							Speed	Torque	Position	Speed	Torque	Speed	Position				
523	Emergency drive mode selection [E800] [E800-E]	17	97	5	○	○	×	×	×	○	×	○	×	○	×	○	
524	Emergency drive running speed [E800] [E800-E]	18	98	5	○	○	×	×	×	○	×	○	×	○	×	○	
525	X1 terminal function selection [AXY]	19	99	5	○	○	○	○	○	○	○	○	○	○	×	○	
526	X2 terminal function selection [AXY]	1A	9A	5	○	○	○	○	○	○	○	○	○	○	×	○	
527	X3 terminal function selection [AXY]	1B	9B	5	○	○	○	○	○	○	○	○	○	○	×	○	
528	X4 terminal function selection [AXY]	1C	9C	5	○	○	○	○	○	○	○	○	○	○	×	○	
529	X5 terminal function selection [AXY]	1D	9D	5	○	○	○	○	○	○	○	○	○	○	×	○	
530	X6 terminal function selection [AXY]	1E	9E	5	○	○	○	○	○	○	○	○	○	○	×	○	
531	X7 terminal function selection [AXY]	1F	9F	5	○	○	○	○	○	○	○	○	○	○	×	○	
538	Current position retention selection	26	A6	5	×	×	○	○	○	×	×	×	○	○	○	○	
541	Frequency command sign selection [E800-E] [E800-SCE] [E806] [NC] [NP]	29	A9	5	○	○	○	×	×	○	×	○	×	○	○ ^{*4}	○ ^{*4}	
542	Communication station number (CC-Link) [NC]	2A	AA	5	○	○	○	○	○	○	○	○	○	○	○ ^{*4}	○ ^{*4}	
543	Baud rate selection (CC-Link) [NC]	2B	AB	5	○	○	○	○	○	○	○	○	○	○	○ ^{*4}	○ ^{*4}	
544	CC-Link extended setting [E800-E] [E800-SCE] [E806] [NC]	2C	AC	5	○	○	○	○	○	○	○	○	○	○	○ ^{*4}	○ ^{*4}	
547	USB communication station number	2F	AF	5	○	○	○	○	○	○	○	○	○	○	○ ^{*4}	○ ^{*4}	
548	USB communication check time interval	30	B0	5	○	○	○	○	○	○	○	○	○	○	○ ^{*4}	○ ^{*4}	
549	Protocol selection [E800]	31	B1	5	○	○	○	○	○	○	○	○	○	○	○ ^{*4}	○ ^{*4}	
550	NET mode operation command source selection	32	B2	5	○	○	○	○	○	○	○	○	○	○	○ ^{*4}	○ ^{*4}	
551	PU mode operation command source selection	33	B3	5	○	○	○	○	○	○	○	○	○	○	○ ^{*4}	○ ^{*4}	
552	Frequency jump range	34	B4	5	○	○	○	○	×	○	○	○	×	○	○	○	
553	PID deviation limit	35	B5	5	○	○	○	×	×	○	×	○	×	○	○	○	
554	PID signal operation selection	36	B6	5	○	○	○	×	×	○	×	○	×	○	○	○	
555	Current average time	37	B7	5	○	○	○	○	○	○	○	○	○	○	○	○	
556	Data output mask time	38	B8	5	○	○	○	○	○	○	○	○	○	○	○	○	
557	Current average value monitor signal output reference current	39	B9	5	○	○	○	○	○	○	○	○	○	○	○	○	
560	Second frequency search gain	3C	BC	5	○	○	×	×	×	○	○	×	×	○	×	○	
561	PTC thermistor protection level	3D	BD	5	○	○	○	○	○	○	○	○	○	○	×	○	
563	Energization time carrying-over times	3F	BF	5	○	○	○	○	○	○	○	○	○	×	×	×	
564	Operating time carrying-over times	40	C0	5	○	○	○	○	○	○	○	○	○	×	×	×	
569	Second motor speed control gain	45	C5	5	×	○	×	×	×	×	×	×	×	○	×	○	
570	Multiple rating setting [3-phase]	46	C6	5	○	○	○	○	○	○	○	○	○	○	×	×	
571	Holding time at a start	47	C7	5	○	○	○	○	×	○	○	×	×	○	○	○	

Pr.	Name	Instruction code ^{*1}			Control method ^{*2}										Parameter		
		Read	Write	Extended	V/F	Magnetic flux	Vector			Sensorless		PM		Copy ^{*3}	Clear ^{*3}	All clear ^{*3}	
							Speed	Torque	Position	Speed	Torque	Speed	Position				
574	Second motor online auto tuning	4A	CA	5	x	o	x	x	x	o	o	x	x	o	o	o	
575	Output interruption detection time	4B	CB	5	o	o	o	x	x	o	x	o	x	o	o	o	
576	Output interruption detection level	4C	CC	5	o	o	o	x	x	o	x	o	x	o	o	o	
577	Output interruption cancel level	4D	CD	5	o	o	o	x	x	o	x	o	x	o	o	o	
592	Traverse function selection	5C	DC	5	o	o	o	x	x	o	x	o	x	o	o	o	
593	Maximum amplitude amount	5D	DD	5	o	o	o	x	x	o	x	o	x	o	o	o	
594	Amplitude compensation amount during deceleration	5E	DE	5	o	o	o	x	x	o	x	o	x	o	o	o	
595	Amplitude compensation amount during acceleration	5F	DF	5	o	o	o	x	x	o	x	o	x	o	o	o	
596	Amplitude acceleration time	60	E0	5	o	o	o	x	x	o	x	o	x	o	o	o	
597	Amplitude deceleration time	61	E1	5	o	o	o	x	x	o	x	o	x	o	o	o	
600	First free thermal reduction frequency 1	00	80	6	o	o	o	o	o	o	o	o	o	o	o	o	
601	First free thermal reduction ratio 1	01	81	6	o	o	o	o	o	o	o	o	o	o	o	o	
602	First free thermal reduction frequency 2	02	82	6	o	o	o	o	o	o	o	o	o	o	o	o	
603	First free thermal reduction ratio 2	03	83	6	o	o	o	o	o	o	o	o	o	o	o	o	
604	First free thermal reduction frequency 3	04	84	6	o	o	o	o	o	o	o	o	o	o	o	o	
607	Motor permissible load level	07	87	6	o	o	o	o	o	o	o	o	o	o	o	o	
608	Second motor permissible load level	08	88	6	o	o	x	x	x	o	o	o	o	o	o	o	
609	PID set point/deviation input selection	09	89	6	o	o	o	x	x	o	x	o	x	o	o	o	
610	PID measured value input selection	0A	8A	6	o	o	o	x	x	o	x	o	x	o	o	o	
611	Acceleration time at a restart	0B	8B	6	o	o	o	x	x	o	x	o	x	o	o	o	
631	Inverter output fault detection enable/disable selection	1F	9F	6	o	o	o	o	o	o	o	o	o	x	x	x	
635	Cumulative pulse clear signal selection ^[AP]	23	A3	6	o	o	o	o	o	o	o	o	o	o	o	o	
636	Cumulative pulse division scaling factor ^[AP]	24	A4	6	o	o	o	o	o	o	o	o	o	o	o	o	
638	Cumulative pulse storage ^[AP]	26	A6	6	o	o	o	o	o	o	o	o	o	o	o	o	
639	Brake opening current selection	27	A7	6	x	o	o	x	x	o	x	x	x	o	o	o	
640	Brake operation frequency selection	28	A8	6	x	x	o	x	x	o	x	x	x	o	o	o	
653	Speed smoothing control	35	B5	6	o	o	x	x	x	x	x	x	x	o	o	o	
654	Speed smoothing cutoff frequency	36	B6	6	o	o	x	x	x	x	x	x	x	o	o	o	
660	Increased magnetic excitation deceleration operation selection	3C	BC	6	o	o	o	x	x	o	x	x	x	o	o	o	
661	Magnetic excitation increase rate	3D	BD	6	o	o	o	x	x	o	x	x	x	o	o	o	
662	Increased magnetic excitation current level	3E	BE	6	o	o	x	x	x	x	x	x	x	o	o	o	
665	Regeneration avoidance frequency gain	41	C1	6	o	o	o	x	x	o	x	o	x	o	o	o	
673	SF-PR slip amount adjustment operation selection ^{[100V][200V][400V]}	49	C9	6	o	x	x	x	x	x	x	x	x	o	o	o	

Pr.	Name	Instruction code ^{*1}			Control method ^{*2}										Parameter		
		Read	Write	Extended	V/F	Magnetic flux	Vector			Sensorless		PM		Copy ^{*3}	Clear ^{*3}	All clear ^{*3}	
							Speed	Torque	Position	Speed	Torque	Speed	Position				
674	SF-PR slip amount adjustment gain _(100V/200V/400V)	4A	CA	6	○	×	×	×	×	×	×	×	×	×	○	○	○
675	User parameter auto storage function selection	4B	CB	6	○	○	○	○	○	○	○	○	○	○	○	○	○
690	Deceleration check time	5A	DA	6	×	×	○	×	×	×	×	×	×	×	○	○	○
692	Second free thermal reduction frequency 1	5C	DC	6	○	○	×	×	×	○	○	○	○	○	○	○	○
693	Second free thermal reduction ratio 1	5D	DD	6	○	○	×	×	×	○	○	○	○	○	○	○	○
694	Second free thermal reduction frequency 2	5E	DE	6	○	○	×	×	×	○	○	○	○	○	○	○	○
695	Second free thermal reduction ratio 2	5F	DF	6	○	○	×	×	×	○	○	○	○	○	○	○	○
696	Second free thermal reduction frequency 3	60	E0	6	○	○	×	×	×	○	○	○	○	○	○	○	○
698	Speed control D gain	62	E2	6	×	×	○	×	○	×	×	×	○	○	○	○	○
699	Input terminal filter _(E800 E800-E E806)	63	E3	6	○	○	○	○	○	○	○	○	○	○	○	×	○
702	Maximum motor frequency	02	82	7	×	×	×	×	×	×	×	○	○	○	○	○	○
706	Induced voltage constant (phi f)	06	86	7	×	×	×	×	×	×	×	○	○	○	○	×	○
707	Motor inertia (integer)	07	87	7	×	×	○	×	○	○	×	○	○	○	○	○	○
711	Motor Ld decay ratio	0B	8B	7	×	×	×	×	×	×	×	○	○	○	○	×	○
712	Motor Lq decay ratio	0C	8C	7	×	×	×	×	×	×	×	○	○	○	○	×	○
717	Starting resistance tuning compensation coefficient 1	11	91	7	×	○	○	○	○	○	○	○	○	○	○	×	○
720	Starting resistance tuning compensation coefficient 2	14	94	7	×	○	○	○	○	○	○	×	×	○	○	×	○
721	Starting magnetic pole position detection pulse width	15	95	7	×	×	×	×	×	×	×	○	○	○	○	×	○
724	Motor inertia (exponent)	18	98	7	×	×	○	×	○	○	×	○	○	○	○	○	○
725	Motor protection current level	19	99	7	×	×	×	×	×	×	×	○	○	○	○	○	○
726	Auto Baudrate/Max Master _(E800)	1A	9A	7	○	○	○	○	○	○	○	○	○	○	○	○ ^{*4}	○ ^{*4}
727	Max Info Frames _(E800)	1B	9B	7	○	○	○	○	○	○	○	○	○	○	○	○ ^{*4}	○ ^{*4}
728	Device instance number (Upper 3 digits) _(E800 E800-EPA)	1C	9C	7	○	○	○	○	○	○	○	○	○	○	○	○ ^{*4}	○ ^{*4}
729	Device instance number (Lower 4 digits) _(E800 E800-EPA)	1D	9D	7	○	○	○	○	○	○	○	○	○	○	○	○ ^{*4}	○ ^{*4}
737	Second motor starting resistance tuning compensation coefficient 2	25	A5	7	×	○	×	×	×	○	○	×	×	○	○	×	○
738	Second motor induced voltage constant (phi f)	26	A6	7	×	×	×	×	×	×	×	○	○	○	○	×	○
739	Second motor Ld decay ratio	27	A7	7	×	×	×	×	×	×	×	○	○	○	○	×	○
740	Second motor Lq decay ratio	28	A8	7	×	×	×	×	×	×	×	○	○	○	○	×	○
741	Second motor starting resistance tuning compensation coefficient 1	29	A9	7	×	○	×	×	×	○	○	○	○	○	○	×	○
742	Second motor magnetic pole position detection pulse width	2A	AA	7	×	×	×	×	×	×	×	○	○	○	○	×	○
743	Second motor maximum frequency	2B	AB	7	×	×	×	×	×	×	×	○	○	○	○	○	○
744	Second motor inertia (integer)	2C	AC	7	×	×	×	×	×	○	×	○	○	○	○	○	○
745	Second motor inertia (exponent)	2D	AD	7	×	×	×	×	×	○	×	○	○	○	○	○	○

Pr.	Name	Instruction code ^{*1}			Control method ^{*2}										Parameter		
		Read	Write	Extended	V/F	Magnetic flux	Vector			Sensorless		PM		Copy ^{*3}	Clear ^{*3}	All clear ^{*3}	
							Speed	Torque	Position	Speed	Torque	Speed	Position				
746	Second motor protection current level	2E	AE	7	x	x	x	x	x	x	x	o	o	o	o	o	
759	PID unit selection	3B	BB	7	o	o	o	x	x	o	x	o	x	o	o	o	
774	Operation panel monitor selection 1	4A	CA	7	o	o	o	o	o	o	o	o	o	o	o	o	
775	Operation panel monitor selection 2 <input type="checkbox"/> E800 <input type="checkbox"/> E800-E <input type="checkbox"/> E800-SCB	4B	CB	7	o	o	o	o	o	o	o	o	o	o	o	o	
776	Operation panel monitor selection 3 <input type="checkbox"/> E800 <input type="checkbox"/> E800-E <input type="checkbox"/> E800-SCB	4C	CC	7	o	o	o	o	o	o	o	o	o	o	o	o	
779	Operation frequency during communication error	4F	CF	7	o	o	o	o	o	o	o	o	o	o	o	o	
791	Acceleration time in low-speed range	5B	DB	7	x	x	x	x	x	x	x	o	o	o	o	o	
792	Deceleration time in low-speed range	5C	DC	7	x	x	x	x	x	x	x	o	o	o	o	o	
800	Control method selection	00	80	8	o	o	o	o	o	o	o	o	o	o	o	o	
801	Output limit level	01	81	8	x	x	o	o	o	o	o	x	x	o	o	o	
802	Pre-excitation selection	02	82	8	x	x	o	x	x	x	x	x	x	o	o	o	
803	Constant output range torque characteristic selection	03	83	8	x	x	o	o	o	o	o	x	x	o	o	o	
804	Torque command source selection	04	84	8	x	x	x	o	x	x	o	x	x	o	o	o	
805	Torque command value (RAM)	05	85	8	x	x	o	o	o	o	o	o	o	x	o	o	
806	Torque command value (RAM, EEPROM)	06	86	8	x	x	o	o	o	o	o	o	o	o	o	o	
807	Speed limit selection	07	87	8	x	x	x	o	x	x	o	x	x	o	o	o	
808	Speed limit	08	88	8	x	x	x	o	x	x	o	x	x	o	o	o	
809	Reverse-side speed limit	09	89	8	x	x	x	o	x	x	o	x	x	o	o	o	
810	Torque limit input method selection	0A	8A	8	x	x	o	x	o	o	x	o	o	o	o	o	
811	Set resolution switchover	0B	8B	8	x	x	o	x	o	o	x	o	o	o	o	o	
812	Torque limit level (regeneration)	0C	8C	8	x	x	o	x	o	o	x	o	o	o	o	o	
813	Torque limit level (3rd quadrant)	0D	8D	8	x	x	o	x	o	o	x	o	o	o	o	o	
814	Torque limit level (4th quadrant)	0E	8E	8	x	x	o	x	o	o	x	o	o	o	o	o	
815	Torque limit level 2	0F	8F	8	x	x	o	x	o	o	x	o	o	o	o	o	
816	Torque limit level during acceleration	10	90	8	x	x	o	x	o	o	x	o	o	o	o	o	
817	Torque limit level during deceleration	11	91	8	x	x	o	x	o	o	x	o	o	o	o	o	
820	Speed control P gain 1	14	94	8	x	x	o	x	o	o	x	o	o	o	o	o	
821	Speed control integral time 1	15	95	8	x	x	o	x	o	o	x	o	o	o	o	o	
822	Speed setting filter 1	16	96	8	x	x	o	o	x	o	o	o	x	o	o	o	
823	Speed detection filter 1 <input type="checkbox"/> AP	17	97	8	x	x	o	o	o	x	x	x	x	o	o	o	
824	Torque control P gain 1 (current loop proportional gain)	18	98	8	x	x	o	o	o	o	o	o	o	o	o	o	
825	Torque control integral time 1 (current loop integral time)	19	99	8	x	x	o	o	o	o	o	o	o	o	o	o	
826	Torque setting filter 1	1A	9A	8	x	x	o	o	o	o	o	o	o	o	o	o	
828	Model speed control gain	1C	9C	8	x	x	o	x	o	o	x	Δ	o	o	o	o	
830	Speed control P gain 2	1E	9E	8	x	x	x	x	x	o	x	o	o	o	o	o	
831	Speed control integral time 2	1F	9F	8	x	x	x	x	x	o	x	o	o	o	o	o	
832	Speed setting filter 2	20	A0	8	x	x	x	x	x	o	o	o	x	o	o	o	
833	Speed detection filter 2 <input type="checkbox"/> AP	21	A1	8	x	x	x	x	x	x	x	x	o	o	o	o	

Pr.	Name	Instruction code ^{*1}			Control method ^{*2}										Parameter		
		Read	Write	Extended	V/F	Magnetic flux	Vector			Sensorless		PM		Copy ^{*3}	Clear ^{*3}	All clear ^{*3}	
							Speed	Torque	Position	Speed	Torque	Speed	Position				
834	Torque control P gain 2 (current loop proportional gain)	22	A2	8	x	x	x	x	x	o	o	o	o	o	o	o	
835	Torque control integral time 2 (current loop integral time)	23	A3	8	x	x	x	x	x	o	o	o	o	o	o	o	
836	Torque setting filter 2	24	A4	8	x	x	x	x	x	o	o	o	o	o	o	o	
840	Torque bias selection	28	A8	8	x	x	o	x	x	o	x	x	x	o	o	o	
841	Torque bias 1	29	A9	8	x	x	o	x	x	o	x	x	x	o	o	o	
842	Torque bias 2	2A	AA	8	x	x	o	x	x	o	x	x	x	o	o	o	
843	Torque bias 3	2B	AB	8	x	x	o	x	x	o	x	x	x	o	o	o	
844	Torque bias filter	2C	AC	8	x	x	o	x	x	o	x	x	x	o	o	o	
845	Torque bias operation time	2D	AD	8	x	x	o	x	x	o	x	x	x	o	o	o	
846	Torque bias balance compensation	2E	AE	8	x	x	o	x	x	o	x	x	x	o	o	o	
847	Fall-time torque bias terminal 4 bias	2F	AF	8	x	x	o	x	x	o	x	x	x	o	o	o	
848	Fall-time torque bias terminal 4 gain	30	B0	8	x	x	o	x	x	o	x	x	x	o	o	o	
849	Analog input offset adjustment	31	B1	8	o	o	o	o	o	o	o	o	o	o	o	o	
850	Brake operation selection	32	B2	8	x	x	x	x	x	o	o	x	x	o	o	o	
853	Speed deviation time	35	B5	8	x	x	o	x	x	x	x	Δ	x	o	o	o	
854	Excitation ratio	36	B6	8	x	x	o	o	o	o	o	x	x	o	o	o	
858	Terminal 4 function assignment	3A	BA	8	o	o	o	o	o	o	o	o	o	o	x	o	
859	Torque current/Rated PM motor current	3B	BB	8	x	o	o	o	o	o	o	o	x	o	x	o	
860	Second motor torque current/Rated PM motor current	3C	BC	8	x	o	x	x	x	o	o	o	x	o	x	o	
864	Torque detection	40	C0	8	x	x	o	o	o	o	o	o	o	o	o	o	
865	Low speed detection	41	C1	8	o	o	o	o	o	o	o	o	o	o	o	o	
866	Torque monitoring reference	42	C2	8	x	o	o	o	o	o	o	o	o	o	o	o	
867	AM output filter[E800-4][E800-5]	43	C3	8	o	o	o	o	o	o	o	o	o	o	o	o	
868	Terminal 1 function assignment[AXY]	44	C4	8	o	o	o	o	o	o	o	o	o	o	x	o	
870	Speed detection hysteresis	46	C6	8	o	o	o	o	o	o	o	o	o	o	o	o	
872	Input phase loss protection selection[3-phase]	48	C8	8	o	o	o	o	o	o	o	o	o	o	o	o	
873	Speed limit[AP]	49	C9	8	x	x	o	x	x	x	x	x	x	o	o	o	
874	OLT level setting	4A	CA	8	x	x	o	x	o	o	x	o	o	o	o	o	
877	Speed feed forward control/model adaptive speed control selection	4D	CD	8	x	x	o	x	o	o	x	Δ	o	o	o	o	
878	Speed feed forward filter	4E	CE	8	x	x	o	x	o	o	x	Δ	o	o	o	o	
879	Speed feed forward torque limit	4F	CF	8	x	x	o	x	o	o	x	Δ	o	o	o	o	
880	Load inertia ratio	50	D0	8	x	x	o	x	o	o	x	Δ	o	o	o	o	
881	Speed feed forward gain	51	D1	8	x	x	o	x	o	o	x	Δ	o	o	o	o	
882	Regeneration avoidance operation selection	52	D2	8	o	o	o	x	x	o	x	o	x	o	o	o	
883	Regeneration avoidance operation level	53	D3	8	o	o	o	x	x	o	x	o	x	o	o	o	
885	Regeneration avoidance compensation frequency limit value	55	D5	8	o	o	o	x	x	o	x	o	x	o	o	o	
886	Regeneration avoidance voltage gain	56	D6	8	o	o	o	x	x	o	x	o	x	o	o	o	
888	Free parameter 1	58	D8	8	o	o	o	o	o	o	o	o	o	o	x	x	

Pr.	Name	Instruction code ^{*1}			Control method ^{*2}										Parameter		
		Read	Write	Extended	V/F	Magnetic flux	Vector			Sensorless		PM		Copy ^{*3}	Clear ^{*3}	All clear ^{*3}	
							Speed	Torque	Position	Speed	Torque	Speed	Position				
889	Free parameter 2	59	D9	8	o	o	o	o	o	o	o	o	o	o	o	x	x
890	Internal storage device status indication	5A	DA	8	o	o	o	o	o	o	o	o	o	o	x	x	x
891	Cumulative power monitor digit shifted times	5B	DB	8	o	o	o	o	o	o	o	o	o	o	o	o	o
892	Load factor	5C	DC	8	o	o	o	o	o	o	o	o	o	o	o	o	o
893	Energy saving monitor reference (motor capacity)	5D	DD	8	o	o	o	o	o	o	o	o	o	o	o	o	o
894	Control selection during commercial power-supply operation	5E	DE	8	o	o	o	o	o	o	o	o	o	o	o	o	o
895	Power saving rate reference value	5F	DF	8	o	o	o	o	o	o	o	o	o	o	o	o	o
896	Power unit cost	60	E0	8	o	o	o	o	o	o	o	o	o	o	o	o	o
897	Power saving monitor average time	61	E1	8	o	o	o	o	o	o	o	o	o	o	o	o	o
898	Power saving cumulative monitor clear	62	E2	8	o	o	o	o	o	o	o	o	o	o	x	o	o
899	Operation time rate (estimated value)	63	E3	8	o	o	o	o	o	o	o	o	o	o	o	o	o
C0 (900)	FM terminal calibration [E800-1]	5C	DC	1	o	o	o	o	o	o	o	o	o	o	x	o	o
C1 (901)	AM terminal calibration [E800-4] [E800-5]	5D	DD	1	o	o	o	o	o	o	o	o	o	o	x	o	o
C2 (902)	Terminal 2 frequency setting bias frequency	5E	DE	1	o	o	o	o	o	o	o	o	o	o	x	o	o
C3 (902)	Terminal 2 frequency setting bias	5E	DE	1	o	o	o	o	o	o	o	o	o	o	x	o	o
125 (903)	Terminal 2 frequency setting gain frequency	5F	DF	1	o	o	o	o	o	o	o	o	o	o	x	o	o
C4 (903)	Terminal 2 frequency setting gain	5F	DF	1	o	o	o	o	o	o	o	o	o	o	x	o	o
C5 (904)	Terminal 4 frequency setting bias frequency	60	E0	1	o	o	o	o	o	o	o	o	o	o	x	o	o
C6 (904)	Terminal 4 frequency setting bias	60	E0	1	o	o	o	o	o	o	o	o	o	o	x	o	o
126 (905)	Terminal 4 frequency setting gain frequency	61	E1	1	o	o	o	o	o	o	o	o	o	o	x	o	o
C7 (905)	Terminal 4 frequency setting gain	61	E1	1	o	o	o	o	o	o	o	o	o	o	x	o	o
C12 (917)	Terminal 1 bias frequency (speed) [AXY]	11	91	9	x	x	o	o	o	o	o	o	o	o	x	o	o
C13 (917)	Terminal 1 bias (speed) [AXY]	11	91	9	x	x	o	o	o	o	o	o	o	o	x	o	o
C14 (918)	Terminal 1 gain frequency (speed) [AXY]	12	92	9	x	x	o	o	o	o	o	o	o	o	x	o	o
C15 (918)	Terminal 1 gain (speed) [AXY]	12	92	9	x	x	o	o	o	o	o	o	o	o	x	o	o
C16 (919)	Terminal 1 bias command (torque) [AXY]	13	93	9	x	x	o	o	o	o	o	o	o	o	x	o	o
C17 (919)	Terminal 1 bias (torque) [AXY]	13	93	9	x	x	o	o	o	o	o	o	o	o	x	o	o
C18 (920)	Terminal 1 gain command (torque) [AXY]	14	94	9	x	x	o	o	o	o	o	o	o	o	x	o	o
C19 (920)	Terminal 1 gain (torque) [AXY]	14	94	9	x	x	o	o	o	o	o	o	o	o	x	o	o
C38 (932)	Terminal 4 bias command (torque)	20	A0	9	x	x	o	o	o	o	o	o	o	o	x	o	o

Pr.	Name	Instruction code ^{*1}			Control method ^{*2}										Parameter		
		Read	Write	Extended	V/F	Magnetic flux	Vector			Sensorless		PM		Copy ^{*3}	Clear ^{*3}	All clear ^{*3}	
							Speed	Torque	Position	Speed	Torque	Speed	Position				
C39 (932)	Terminal 4 bias (torque)	20	A0	9	x	x	o	o	o	o	o	o	o	o	x	o	
C40 (933)	Terminal 4 gain command (torque)	21	A1	9	x	x	o	o	o	o	o	o	o	o	x	o	
C41 (933)	Terminal 4 gain (torque)	21	A1	9	x	x	o	o	o	o	o	o	o	o	x	o	
C42 (934)	PID display bias coefficient	22	A2	9	o	o	o	x	x	o	x	o	x	o	x	o	
C43 (934)	PID display bias analog value	22	A2	9	o	o	o	x	x	o	x	o	x	o	x	o	
C44 (935)	PID display gain coefficient	23	A3	9	o	o	o	x	x	o	x	o	x	o	x	o	
C45 (935)	PID display gain analog value	23	A3	9	o	o	o	x	x	o	x	o	x	o	x	o	
979	Position accuracy compensation gain 1	4F	CF	9	x	x	x	x	x	x	x	x	o	o	x	o	
980	Position accuracy compensation gain 2	50	D0	9	x	x	x	x	x	x	x	x	o	o	x	o	
981	Position accuracy compensation gain 3	51	D1	9	x	x	x	x	x	x	x	x	o	o	x	o	
986	Display safety fault code [E800-SCE] [E806]	56	D6	9	o	o	o	o	o	o	o	o	o	x	x	x	
990	PU buzzer control [E800]	5A	DA	9	o	o	o	o	o	o	o	o	o	o	o	o	
991	PU contrast adjustment [E800]	5B	DB	9	o	o	o	o	o	o	o	o	o	o	x	o	
992	Operation panel setting dial push monitor selection [E800]	5C	DC	9	o	o	o	o	o	o	o	o	o	o	o	o	
997	Fault initiation	61	E1	9	o	o	o	o	o	o	o	o	o	x	o	o	
998	PM parameter initialization	62	E2	9	o	o	o	o	o	o	o	o	o	o	o	o	
999	Automatic parameter setting	63	E3	9	o	o	o	o	o	o	o	o	o	x	x	o	
1002	Lq tuning target current adjustment coefficient	02	82	A	x	x	x	x	x	x	x	o	x	o	o	o	
1006	Clock (year)	06	86	A	o	o	o	o	o	o	o	o	o	x	x	x	
1007	Clock (month, day)	07	87	A	o	o	o	o	o	o	o	o	o	x	x	x	
1008	Clock (hour, minute)	08	88	A	o	o	o	o	o	o	o	o	o	x	x	x	
1013	Running speed after emergency drive retry reset [E800] [E800-E]	0D	8D	A	o	o	x	x	x	o	x	o	x	o	x	o	
1015	Integral stop selection at limited frequency	0F	8F	A	o	o	o	x	x	o	x	o	x	o	o	o	
1016	PTC thermistor protection detection time	10	90	A	o	o	o	o	o	o	o	o	o	o	x	o	
1020	Trace operation selection	14	94	A	o	o	o	o	o	o	o	o	o	o	o	o	
1022	Sampling cycle	16	96	A	o	o	o	o	o	o	o	o	o	o	o	o	
1023	Number of analog channels	17	97	A	o	o	o	o	o	o	o	o	o	o	o	o	
1024	Sampling auto start	18	98	A	o	o	o	o	o	o	o	o	o	o	o	o	
1025	Trigger mode selection	19	99	A	o	o	o	o	o	o	o	o	o	o	o	o	
1026	Number of sampling before trigger	1A	9A	A	o	o	o	o	o	o	o	o	o	o	o	o	
1027	Analog source selection (1ch)	1B	9B	A	o	o	o	o	o	o	o	o	o	o	o	o	
1028	Analog source selection (2ch)	1C	9C	A	o	o	o	o	o	o	o	o	o	o	o	o	
1029	Analog source selection (3ch)	1D	9D	A	o	o	o	o	o	o	o	o	o	o	o	o	
1030	Analog source selection (4ch)	1E	9E	A	o	o	o	o	o	o	o	o	o	o	o	o	
1031	Analog source selection (5ch)	1F	9F	A	o	o	o	o	o	o	o	o	o	o	o	o	
1032	Analog source selection (6ch)	20	A0	A	o	o	o	o	o	o	o	o	o	o	o	o	
1033	Analog source selection (7ch)	21	A1	A	o	o	o	o	o	o	o	o	o	o	o	o	
1034	Analog source selection (8ch)	22	A2	A	o	o	o	o	o	o	o	o	o	o	o	o	

Pr.	Name	Instruction code ^{*1}			Control method ^{*2}										Parameter		
		Read	Write	Extended	V/F	Magnetic flux	Vector			Sensorless		PM		Copy ^{*3}	Clear ^{*3}	All clear ^{*3}	
							Speed	Torque	Position	Speed	Torque	Speed	Position				
1035	Analog trigger channel	23	A3	A	○	○	○	○	○	○	○	○	○	○	○	○	○
1036	Analog trigger operation selection	24	A4	A	○	○	○	○	○	○	○	○	○	○	○	○	○
1037	Analog trigger level	25	A5	A	○	○	○	○	○	○	○	○	○	○	○	○	○
1038	Digital source selection (1ch)	26	A6	A	○	○	○	○	○	○	○	○	○	○	○	○	○
1039	Digital source selection (2ch)	27	A7	A	○	○	○	○	○	○	○	○	○	○	○	○	○
1040	Digital source selection (3ch)	28	A8	A	○	○	○	○	○	○	○	○	○	○	○	○	○
1041	Digital source selection (4ch)	29	A9	A	○	○	○	○	○	○	○	○	○	○	○	○	○
1042	Digital source selection (5ch)	2A	AA	A	○	○	○	○	○	○	○	○	○	○	○	○	○
1043	Digital source selection (6ch)	2B	AB	A	○	○	○	○	○	○	○	○	○	○	○	○	○
1044	Digital source selection (7ch)	2C	AC	A	○	○	○	○	○	○	○	○	○	○	○	○	○
1045	Digital source selection (8ch)	2D	AD	A	○	○	○	○	○	○	○	○	○	○	○	○	○
1046	Digital trigger channel	2E	AE	A	○	○	○	○	○	○	○	○	○	○	○	○	○
1047	Digital trigger operation selection	2F	AF	A	○	○	○	○	○	○	○	○	○	○	○	○	○
1072	DC brake judgment time for anti-sway control operation	48	C8	A	○	○	○	×	×	○	×	○	×	○	○	○	○
1073	Anti-sway control operation selection	49	C9	A	○	○	○	×	×	○	×	○	×	○	○	○	○
1074	Anti-sway control frequency	4A	CA	A	○	○	○	×	×	○	×	○	×	○	○	○	○
1075	Anti-sway control depth	4B	CB	A	○	○	○	×	×	○	×	○	×	○	○	○	○
1076	Anti-sway control width	4C	CC	A	○	○	○	×	×	○	×	○	×	○	○	○	○
1077	Rope length	4D	CD	A	○	○	○	×	×	○	×	○	×	○	○	○	○
1078	Trolley weight	4E	CE	A	○	○	○	×	×	○	×	○	×	○	○	○	○
1079	Load weight	4F	CF	A	○	○	○	×	×	○	×	○	×	○	○	○	○
1095	Home position return function selection	5F	DF	A	×	×	×	×	○	×	×	×	○	○	○	○	○
1096	Home position return position data lower 4 digits	60	E0	A	×	×	×	×	○	×	×	×	○	○	○	○	○
1097	Home position return position data upper 4 digits	61	E1	A	×	×	×	×	○	×	×	×	○	○	○	○	○
1103	Deceleration time at emergency stop	03	83	B	○	○	○	○	×	○	○	○	○	○	○	○	○
1106	Torque monitor filter	06	86	B	○	○	○	○	○	○	○	○	○	○	○	○	○
1107	Running speed monitor filter	07	87	B	○	○	○	○	○	○	○	○	○	○	○	○	○
1108	Excitation current monitor filter	08	88	B	○	○	○	○	○	○	○	○	○	○	○	○	○
1124	Station number in inverter-to-inverter link <small>[E800-EPA][E800-EPB]</small>	18	98	B	○	○	○	○	○	○	○	○	○	○	○ ^{*4}	○ ^{*4}	○
1125	Number of inverters in inverter-to-inverter link system <small>[E800-EPA][E800-EPB]</small>	19	99	B	○	○	○	○	○	○	○	○	○	○	○ ^{*4}	○ ^{*4}	○
1150	PLC function user parameters 1	32	B2	B	○	○	○	○	○	○	○	○	○	○	○	○	○
1151	PLC function user parameters 2	33	B3	B	○	○	○	○	○	○	○	○	○	○	○	○	○
1152	PLC function user parameters 3	34	B4	B	○	○	○	○	○	○	○	○	○	○	○	○	○
1153	PLC function user parameters 4	35	B5	B	○	○	○	○	○	○	○	○	○	○	○	○	○
1154	PLC function user parameters 5	36	B6	B	○	○	○	○	○	○	○	○	○	○	○	○	○
1155	PLC function user parameters 6	37	B7	B	○	○	○	○	○	○	○	○	○	○	○	○	○
1156	PLC function user parameters 7	38	B8	B	○	○	○	○	○	○	○	○	○	○	○	○	○
1157	PLC function user parameters 8	39	B9	B	○	○	○	○	○	○	○	○	○	○	○	○	○

Pr.	Name	Instruction code ^{*1}			Control method ^{*2}										Parameter		
		Read	Write	Extended	V/F	Magnetic flux	Vector			Sensorless		PM		Copy ^{*3}	Clear ^{*3}	All clear ^{*3}	
							Speed	Torque	Position	Speed	Torque	Speed	Position				
1158	PLC function user parameters 9	3A	BA	B	o	o	o	o	o	o	o	o	o	o	o	o	o
1159	PLC function user parameters 10	3B	BB	B	o	o	o	o	o	o	o	o	o	o	o	o	o
1160	PLC function user parameters 11	3C	BC	B	o	o	o	o	o	o	o	o	o	o	o	o	o
1161	PLC function user parameters 12	3D	BD	B	o	o	o	o	o	o	o	o	o	o	o	o	o
1162	PLC function user parameters 13	3E	BE	B	o	o	o	o	o	o	o	o	o	o	o	o	o
1163	PLC function user parameters 14	3F	BF	B	o	o	o	o	o	o	o	o	o	o	o	o	o
1164	PLC function user parameters 15	40	C0	B	o	o	o	o	o	o	o	o	o	o	o	o	o
1165	PLC function user parameters 16	41	C1	B	o	o	o	o	o	o	o	o	o	o	o	o	o
1166	PLC function user parameters 17	42	C2	B	o	o	o	o	o	o	o	o	o	o	o	o	o
1167	PLC function user parameters 18	43	C3	B	o	o	o	o	o	o	o	o	o	o	o	o	o
1168	PLC function user parameters 19	44	C4	B	o	o	o	o	o	o	o	o	o	o	o	o	o
1169	PLC function user parameters 20	45	C5	B	o	o	o	o	o	o	o	o	o	o	o	o	o
1170	PLC function user parameters 21	46	C6	B	o	o	o	o	o	o	o	o	o	o	o	o	o
1171	PLC function user parameters 22	47	C7	B	o	o	o	o	o	o	o	o	o	o	o	o	o
1172	PLC function user parameters 23	48	C8	B	o	o	o	o	o	o	o	o	o	o	o	o	o
1173	PLC function user parameters 24	49	C9	B	o	o	o	o	o	o	o	o	o	o	o	o	o
1174	PLC function user parameters 25	4A	CA	B	o	o	o	o	o	o	o	o	o	o	o	o	o
1175	PLC function user parameters 26	4B	CB	B	o	o	o	o	o	o	o	o	o	o	o	o	o
1176	PLC function user parameters 27	4C	CC	B	o	o	o	o	o	o	o	o	o	o	o	o	o
1177	PLC function user parameters 28	4D	CD	B	o	o	o	o	o	o	o	o	o	o	o	o	o
1178	PLC function user parameters 29	4E	CE	B	o	o	o	o	o	o	o	o	o	o	o	o	o
1179	PLC function user parameters 30	4F	CF	B	o	o	o	o	o	o	o	o	o	o	o	o	o
1180	PLC function user parameters 31	50	D0	B	o	o	o	o	o	o	o	o	o	o	o	o	o
1181	PLC function user parameters 32	51	D1	B	o	o	o	o	o	o	o	o	o	o	o	o	o
1182	PLC function user parameters 33	52	D2	B	o	o	o	o	o	o	o	o	o	o	o	o	o
1183	PLC function user parameters 34	53	D3	B	o	o	o	o	o	o	o	o	o	o	o	o	o
1184	PLC function user parameters 35	54	D4	B	o	o	o	o	o	o	o	o	o	o	o	o	o
1185	PLC function user parameters 36	55	D5	B	o	o	o	o	o	o	o	o	o	o	o	o	o
1186	PLC function user parameters 37	56	D6	B	o	o	o	o	o	o	o	o	o	o	o	o	o

Pr.	Name	Instruction code ^{*1}			Control method ^{*2}									Parameter		
		Read	Write	Extended	V/F	Magnetic flux	Vector			Sensorless		PM		Copy ^{*3}	Clear ^{*3}	All clear ^{*3}
							Speed	Torque	Position	Speed	Torque	Speed	Position			
1187	PLC function user parameters 38	57	D7	B	o	o	o	o	o	o	o	o	o	o	o	o
1188	PLC function user parameters 39	58	D8	B	o	o	o	o	o	o	o	o	o	o	o	o
1189	PLC function user parameters 40	59	D9	B	o	o	o	o	o	o	o	o	o	o	o	o
1190	PLC function user parameters 41	5A	DA	B	o	o	o	o	o	o	o	o	o	o	o	o
1191	PLC function user parameters 42	5B	DB	B	o	o	o	o	o	o	o	o	o	o	o	o
1192	PLC function user parameters 43	5C	DC	B	o	o	o	o	o	o	o	o	o	o	o	o
1193	PLC function user parameters 44	5D	DD	B	o	o	o	o	o	o	o	o	o	o	o	o
1194	PLC function user parameters 45	5E	DE	B	o	o	o	o	o	o	o	o	o	o	o	o
1195	PLC function user parameters 46	5F	DF	B	o	o	o	o	o	o	o	o	o	o	o	o
1196	PLC function user parameters 47	60	E0	B	o	o	o	o	o	o	o	o	o	o	o	o
1197	PLC function user parameters 48	61	E1	B	o	o	o	o	o	o	o	o	o	o	o	o
1198	PLC function user parameters 49	62	E2	B	o	o	o	o	o	o	o	o	o	o	o	o
1199	PLC function user parameters 50	63	E3	B	o	o	o	o	o	o	o	o	o	o	o	o
1200	AM output offset calibration [E800-4] [E800-5]	00	80	C	o	o	o	o	o	o	o	o	o	x	o	o
1210	CC-Link IE TSN protocol version selection [E800-EPA] [E800-EPB]	0A	8A	C	o	o	o	o	o	o	o	o	o	o	o ^{*4}	o ^{*4}
1220	Direct command mode selection [E800-E] [E800-SCB] [E806]	14	94	C	x	x	x	x	o	x	x	x	o	o	o	o
1222	First positioning acceleration time	16	96	C	x	x	x	x	o	x	x	x	o	o	o	o
1223	First positioning deceleration time	17	97	C	x	x	x	x	o	x	x	x	o	o	o	o
1225	First positioning sub-function	19	99	C	x	x	x	x	o	x	x	x	o	o	o	o
1226	Second positioning acceleration time	1A	9A	C	x	x	x	x	o	x	x	x	o	o	o	o
1227	Second positioning deceleration time	1B	9B	C	x	x	x	x	o	x	x	x	o	o	o	o
1229	Second positioning sub-function	1D	9D	C	x	x	x	x	o	x	x	x	o	o	o	o
1230	Third positioning acceleration time	1E	9E	C	x	x	x	x	o	x	x	x	o	o	o	o
1231	Third positioning deceleration time	1F	9F	C	x	x	x	x	o	x	x	x	o	o	o	o
1233	Third positioning sub-function	21	A1	C	x	x	x	x	o	x	x	x	o	o	o	o
1234	Fourth positioning acceleration time	22	A2	C	x	x	x	x	o	x	x	x	o	o	o	o
1235	Fourth positioning deceleration time	23	A3	C	x	x	x	x	o	x	x	x	o	o	o	o
1237	Fourth positioning sub-function	25	A5	C	x	x	x	x	o	x	x	x	o	o	o	o
1238	Fifth positioning acceleration time	26	A6	C	x	x	x	x	o	x	x	x	o	o	o	o
1239	Fifth positioning deceleration time	27	A7	C	x	x	x	x	o	x	x	x	o	o	o	o
1241	Fifth positioning sub-function	29	A9	C	x	x	x	x	o	x	x	x	o	o	o	o

Pr.	Name	Instruction code ^{*1}			Control method ^{*2}										Parameter		
		Read	Write	Extended	V/F	Magnetic flux	Vector			Sensorless		PM		Copy ^{*3}	Clear ^{*3}	All clear ^{*3}	
							Speed	Torque	Position	Speed	Torque	Speed	Position				
1242	Sixth positioning acceleration time	2A	AA	C	x	x	x	x	o	x	x	x	o	o	o	o	
1243	Sixth positioning deceleration time	2B	AB	C	x	x	x	x	o	x	x	x	o	o	o	o	
1245	Sixth positioning sub-function	2D	AD	C	x	x	x	x	o	x	x	x	o	o	o	o	
1246	Seventh positioning acceleration time	2E	AE	C	x	x	x	x	o	x	x	x	o	o	o	o	
1247	Seventh positioning deceleration time	2F	AF	C	x	x	x	x	o	x	x	x	o	o	o	o	
1249	Seventh positioning sub-function	31	B1	C	x	x	x	x	o	x	x	x	o	o	o	o	
1282	Home position return method selection	52	D2	C	x	x	x	x	o	x	x	x	o	o	o	o	
1283	Home position return speed	53	D3	C	x	x	x	x	o	x	x	x	o	o	o	o	
1285	Home position shift amount lower 4 digits	55	D5	C	x	x	x	x	o	x	x	x	o	o	o	o	
1286	Home position shift amount upper 4 digits	56	D6	C	x	x	x	x	o	x	x	x	o	o	o	o	
1289	Home position return stopper torque	59	D9	C	x	x	x	x	o	x	x	x	o	o	o	o	
1290	Home position return stopper waiting time	5A	DA	C	x	x	x	x	o	x	x	x	o	o	o	o	
1292	Position control terminal input selection	5C	DC	C	x	x	x	x	o	x	x	x	o	o	o	o	
1293	Roll feeding mode selection	5D	DD	C	x	x	x	x	o	x	x	x	o	o	o	o	
1294	Position detection lower 4 digits	5E	DE	C	x	x	x	x	o	x	x	x	o	o	o	o	
1295	Position detection upper 4 digits	5F	DF	C	x	x	x	x	o	x	x	x	o	o	o	o	
1296	Position detection selection	60	E0	C	x	x	x	x	o	x	x	x	o	o	o	o	
1297	Position detection hysteresis width	61	E1	C	x	x	x	x	o	x	x	x	o	o	o	o	
1298	Second position control gain	62	E2	C	x	x	x	x	x	x	x	x	o	o	o	o	
1299	Second pre-excitation selection	63	E3	C	x	x	x	x	x	x	x	o	x	o	o	o	
1305	EtherCAT node address setting <small>[E800-EPC]</small>	05	85	D	o	o	o	o	o	o	o	o	o	o	o ^{*4}	o ^{*4}	
1318	User Defined Cyclic Communication Input fixing format selection <small>[E800-EPA]</small>	12	92	D	o	o	o	o	o	o	o	o	o	o	o ^{*4}	o ^{*4}	
1319	User Defined Cyclic Communication Output fixing format selection <small>[E800-EPA]</small>	13	93	D	o	o	o	o	o	o	o	o	o	o	o ^{*4}	o ^{*4}	
1320	User Defined Cyclic Communication Input 1 Mapping <small>[E800-E] [E800-SCE] [E806]</small>	14	94	D	o	o	o	o	o	o	o	o	o	o	o ^{*4}	o ^{*4}	
1321	User Defined Cyclic Communication Input 2 Mapping <small>[E800-E] [E800-SCE] [E806]</small>	15	95	D	o	o	o	o	o	o	o	o	o	o	o ^{*4}	o ^{*4}	
1322	User Defined Cyclic Communication Input 3 Mapping <small>[E800-E] [E800-SCE] [E806]</small>	16	96	D	o	o	o	o	o	o	o	o	o	o	o ^{*4}	o ^{*4}	
1323	User Defined Cyclic Communication Input 4 Mapping <small>[E800-E] [E800-SCE] [E806]</small>	17	97	D	o	o	o	o	o	o	o	o	o	o	o ^{*4}	o ^{*4}	
1324	User Defined Cyclic Communication Input 5 Mapping <small>[E800-E] [E800-SCE] [E806]</small>	18	98	D	o	o	o	o	o	o	o	o	o	o	o ^{*4}	o ^{*4}	

Pr.	Name	Instruction code ^{*1}			Control method ^{*2}									Parameter		
		Read	Write	Extended	V/F	Magnetic flux	Vector			Sensorless		PM		Copy ^{*3}	Clear ^{*3}	All clear ^{*3}
							Speed	Torque	Position	Speed	Torque	Speed	Position			
1325	User Defined Cyclic Communication Input 6 Mapping [E800-E] [E800-SCE] [E806]	19	99	D	○	○	○	○	○	○	○	○	○	○	○ ^{*4}	○ ^{*4}
1326	User Defined Cyclic Communication Input 7 Mapping [E800-E] [E800-SCE] [E806]	1A	9A	D	○	○	○	○	○	○	○	○	○	○	○ ^{*4}	○ ^{*4}
1327	User Defined Cyclic Communication Input 8 Mapping [E800-E] [E800-SCE] [E806]	1B	9B	D	○	○	○	○	○	○	○	○	○	○	○ ^{*4}	○ ^{*4}
1328	User Defined Cyclic Communication Input 9 Mapping [E800-E] [E800-SCE] [E806]	1C	9C	D	○	○	○	○	○	○	○	○	○	○	○ ^{*4}	○ ^{*4}
1329	User Defined Cyclic Communication Input 10 Mapping [E800-E] [E800-SCE] [E806]	1D	9D	D	○	○	○	○	○	○	○	○	○	○	○ ^{*4}	○ ^{*4}
1330	User Defined Cyclic Communication Output 1 Mapping [E800-E] [E800-SCE] [E806]	1E	9E	D	○	○	○	○	○	○	○	○	○	○	○ ^{*4}	○ ^{*4}
1331	User Defined Cyclic Communication Output 2 Mapping [E800-E] [E800-SCE] [E806]	1F	9F	D	○	○	○	○	○	○	○	○	○	○	○ ^{*4}	○ ^{*4}
1332	User Defined Cyclic Communication Output 3 Mapping [E800-E] [E800-SCE] [E806]	20	A0	D	○	○	○	○	○	○	○	○	○	○	○ ^{*4}	○ ^{*4}
1333	User Defined Cyclic Communication Output 4 Mapping [E800-E] [E800-SCE] [E806]	21	A1	D	○	○	○	○	○	○	○	○	○	○	○ ^{*4}	○ ^{*4}
1334	User Defined Cyclic Communication Output 5 Mapping [E800-E] [E800-SCE] [E806]	22	A2	D	○	○	○	○	○	○	○	○	○	○	○ ^{*4}	○ ^{*4}
1335	User Defined Cyclic Communication Output 6 Mapping [E800-E] [E800-SCE] [E806]	23	A3	D	○	○	○	○	○	○	○	○	○	○	○ ^{*4}	○ ^{*4}
1336	User Defined Cyclic Communication Output 7 Mapping [E800-E] [E800-SCE] [E806]	24	A4	D	○	○	○	○	○	○	○	○	○	○	○ ^{*4}	○ ^{*4}
1337	User Defined Cyclic Communication Output 8 Mapping [E800-E] [E800-SCE] [E806]	25	A5	D	○	○	○	○	○	○	○	○	○	○	○ ^{*4}	○ ^{*4}
1338	User Defined Cyclic Communication Output 9 Mapping [E800-E] [E800-SCE] [E806]	26	A6	D	○	○	○	○	○	○	○	○	○	○	○ ^{*4}	○ ^{*4}
1339	User Defined Cyclic Communication Output 10 Mapping [E800-E] [E800-SCE] [E806]	27	A7	D	○	○	○	○	○	○	○	○	○	○	○ ^{*4}	○ ^{*4}
1340	User Defined Cyclic Communication Output 11 Mapping [E800-E] [E800-SCE] [E806]	28	A8	D	○	○	○	○	○	○	○	○	○	○	○ ^{*4}	○ ^{*4}
1341	User Defined Cyclic Communication Output 12 Mapping [E800-E] [E800-SCE] [E806]	29	A9	D	○	○	○	○	○	○	○	○	○	○	○ ^{*4}	○ ^{*4}
1342	User Defined Cyclic Communication Output 13 Mapping [E800-E] [E800-SCE] [E806]	2A	AA	D	○	○	○	○	○	○	○	○	○	○	○ ^{*4}	○ ^{*4}
1343	User Defined Cyclic Communication Output 14 Mapping [E800-E] [E800-SCE] [E806]	2B	AB	D	○	○	○	○	○	○	○	○	○	○	○ ^{*4}	○ ^{*4}

Pr.	Name	Instruction code ^{*1}			Control method ^{*2}									Parameter		
		Read	Write	Extended	V/F	Magnetic flux	Vector			Sensorless		PM		Copy ^{*3}	Clear ^{*3}	All clear ^{*3}
							Speed	Torque	Position	Speed	Torque	Speed	Position			
1386	Ethernet relay operation at reset selection [E800-EPA] [E800-EPB]	56	D6	D	○	○	○	○	○	○	○	○	○	○	○ ^{*4}	○ ^{*4}
1389	User Defined Cyclic Communication Input Sub 1 and 2 Mapping [E800-E] [E800-SCE] [E806]	59	D9	D	○	○	○	○	○	○	○	○	○	○	○ ^{*4}	○ ^{*4}
1390	User Defined Cyclic Communication Input Sub 3 and 4 Mapping [E800-E] [E800-SCE] [E806]	5A	DA	D	○	○	○	○	○	○	○	○	○	○	○ ^{*4}	○ ^{*4}
1391	User Defined Cyclic Communication Input Sub 5 and 6 Mapping [E800-E] [E800-SCE] [E806]	5B	DB	D	○	○	○	○	○	○	○	○	○	○	○ ^{*4}	○ ^{*4}
1392	User Defined Cyclic Communication Input Sub 7 and 8 Mapping [E800-E] [E800-SCE] [E806]	5C	DC	D	○	○	○	○	○	○	○	○	○	○	○ ^{*4}	○ ^{*4}
1393	User Defined Cyclic Communication Input Sub 9 and 10 Mapping [E800-E] [E800-SCE] [E806]	5D	DD	D	○	○	○	○	○	○	○	○	○	○	○ ^{*4}	○ ^{*4}
1394	User Defined Cyclic Communication Output Sub 1 and 2 Mapping [E800-E] [E800-SCE] [E806]	5E	DE	D	○	○	○	○	○	○	○	○	○	○	○ ^{*4}	○ ^{*4}
1395	User Defined Cyclic Communication Output Sub 3 and 4 Mapping [E800-E] [E800-SCE] [E806]	5F	DF	D	○	○	○	○	○	○	○	○	○	○	○ ^{*4}	○ ^{*4}
1396	User Defined Cyclic Communication Output Sub 5 and 6 Mapping [E800-E] [E800-SCE] [E806]	60	E0	D	○	○	○	○	○	○	○	○	○	○	○ ^{*4}	○ ^{*4}
1397	User Defined Cyclic Communication Output Sub 7 and 8 Mapping [E800-E] [E800-SCE] [E806]	61	E1	D	○	○	○	○	○	○	○	○	○	○	○ ^{*4}	○ ^{*4}
1398	User Defined Cyclic Communication Output Sub 9 and 10 Mapping [E800-E] [E800-SCE] [E806]	62	E2	D	○	○	○	○	○	○	○	○	○	○	○ ^{*4}	○ ^{*4}
1399	Inverter identification enable/disable selection [E800-EPA] [E800-EPB]	63	E3	D	○	○	○	○	○	○	○	○	○	○	○ ^{*4}	○ ^{*4}
1412	Motor induced voltage constant (phi f) exponent	0C	8C	E	×	×	×	×	×	×	×	○	○	○	×	○
1413	Second motor induced voltage constant (phi f) exponent	0D	8D	E	×	×	×	×	×	×	×	○	○	○	×	○
1424	Ethernet communication network number [E800-EPA] [E800-EPB]	18	98	E	○	○	○	○	○	○	○	○	○	○	○ ^{*4}	○ ^{*4}
1425	Ethernet communication station number [E800-EPA] [E800-EPB]	19	99	E	○	○	○	○	○	○	○	○	○	○	○ ^{*4}	○ ^{*4}
1426	Link speed and duplex mode selection [E800-EPA] [E800-EPB]	1A	9A	E	○	○	○	○	○	○	○	○	○	○	○ ^{*4}	○ ^{*4}
1427	Ethernet function selection 1 [E800-EPA] [E800-EPB]	1B	9B	E	○	○	○	○	○	○	○	○	○	○	○ ^{*4}	○ ^{*4}
1428	Ethernet function selection 2 [E800-EPA] [E800-EPB]	1C	9C	E	○	○	○	○	○	○	○	○	○	○	○ ^{*4}	○ ^{*4}

Pr.	Name	Instruction code ^{*1}			Control method ^{*2}									Parameter		
		Read	Write	Extended	V/F	Magnetic flux	Vector			Sensorless		PM		Copy ^{*3}	Clear ^{*3}	All clear ^{*3}
							Speed	Torque	Position	Speed	Torque	Speed	Position			
1429	Ethernet function selection 3 [E800-EPA] [E800-EPB]	1D	9D	E	○	○	○	○	○	○	○	○	○	○	○ ^{*4}	○ ^{*4}
1430	Ethernet function selection 4 [E800-EPA] [E800-EPB]	1E	9E	E	○	○	○	○	○	○	○	○	○	○	○ ^{*4}	○ ^{*4}
1431	Ethernet signal loss detection function selection [E800-E] [E800-SCB] [E806]	1F	9F	E	○	○	○	○	○	○	○	○	○	○	○ ^{*4}	○ ^{*4}
1432	Ethernet communication check time interval [E800-EPA] [E800-EPB]	20	A0	E	○	○	○	○	○	○	○	○	○	○	○ ^{*4}	○ ^{*4}
1434	IP address 1 (Ethernet) [E800-EPA] [E800-EPB]	22	A2	E	○	○	○	○	○	○	○	○	○	×	○ ^{*4}	○ ^{*4}
1435	IP address 2 (Ethernet) [E800-EPA] [E800-EPB]	23	A3	E	○	○	○	○	○	○	○	○	○	×	○ ^{*4}	○ ^{*4}
1436	IP address 3 (Ethernet) [E800-EPA] [E800-EPB]	24	A4	E	○	○	○	○	○	○	○	○	○	×	○ ^{*4}	○ ^{*4}
1437	IP address 4 (Ethernet) [E800-EPA] [E800-EPB]	25	A5	E	○	○	○	○	○	○	○	○	○	×	○ ^{*4}	○ ^{*4}
1438	Subnet mask 1 [E800-EPA] [E800-EPB]	26	A6	E	○	○	○	○	○	○	○	○	○	○	○ ^{*4}	○ ^{*4}
1439	Subnet mask 2 [E800-EPA] [E800-EPB]	27	A7	E	○	○	○	○	○	○	○	○	○	○	○ ^{*4}	○ ^{*4}
1440	Subnet mask 3 [E800-EPA] [E800-EPB]	28	A8	E	○	○	○	○	○	○	○	○	○	○	○ ^{*4}	○ ^{*4}
1441	Subnet mask 4 [E800-EPA] [E800-EPB]	29	A9	E	○	○	○	○	○	○	○	○	○	○	○ ^{*4}	○ ^{*4}
1442	IP filter address 1 (Ethernet) [E800-EPA] [E800-EPB]	2A	AA	E	○	○	○	○	○	○	○	○	○	○	○ ^{*4}	○ ^{*4}
1443	IP filter address 2 (Ethernet) [E800-EPA] [E800-EPB]	2B	AB	E	○	○	○	○	○	○	○	○	○	○	○ ^{*4}	○ ^{*4}
1444	IP filter address 3 (Ethernet) [E800-EPA] [E800-EPB]	2C	AC	E	○	○	○	○	○	○	○	○	○	○	○ ^{*4}	○ ^{*4}
1445	IP filter address 4 (Ethernet) [E800-EPA] [E800-EPB]	2D	AD	E	○	○	○	○	○	○	○	○	○	○	○ ^{*4}	○ ^{*4}
1446	IP filter address 2 range specification (Ethernet) [E800-EPA] [E800-EPB]	2E	AE	E	○	○	○	○	○	○	○	○	○	○	○ ^{*4}	○ ^{*4}
1447	IP filter address 3 range specification (Ethernet) [E800-EPA] [E800-EPB]	2F	AF	E	○	○	○	○	○	○	○	○	○	○	○ ^{*4}	○ ^{*4}
1448	IP filter address 4 range specification (Ethernet) [E800-EPA] [E800-EPB]	30	B0	E	○	○	○	○	○	○	○	○	○	○	○ ^{*4}	○ ^{*4}
1449	Ethernet command source selection IP address 1 [E800-EPA] [E800-EPB]	31	B1	E	○	○	○	○	○	○	○	○	○	○	○ ^{*4}	○ ^{*4}
1450	Ethernet command source selection IP address 2 [E800-EPA] [E800-EPB]	32	B2	E	○	○	○	○	○	○	○	○	○	○	○ ^{*4}	○ ^{*4}
1451	Ethernet command source selection IP address 3 [E800-EPA] [E800-EPB]	33	B3	E	○	○	○	○	○	○	○	○	○	○	○ ^{*4}	○ ^{*4}
1452	Ethernet command source selection IP address 4 [E800-EPA] [E800-EPB]	34	B4	E	○	○	○	○	○	○	○	○	○	○	○ ^{*4}	○ ^{*4}
1453	Ethernet command source selection IP address 3 range specification [E800-EPA] [E800-EPB]	35	B5	E	○	○	○	○	○	○	○	○	○	○	○ ^{*4}	○ ^{*4}
1454	Ethernet command source selection IP address 4 range specification [E800-EPA] [E800-EPB]	36	B6	E	○	○	○	○	○	○	○	○	○	○	○ ^{*4}	○ ^{*4}

Pr.	Name	Instruction code ^{*1}			Control method ^{*2}										Parameter		
		Read	Write	Extended	V/F	Magnetic flux	Vector			Sensorless		PM		Copy ^{*3}	Clear ^{*3}	All clear ^{*3}	
							Speed	Torque	Position	Speed	Torque	Speed	Position				
1455	Keepalive time <small>E800-EPA E800-EPB</small>	37	B7	E	○	○	○	○	○	○	○	○	○	○	○ ^{*4}	○ ^{*4}	
1456	Network diagnosis selection <small>E800-EPA E800-EPB</small>	38	B8	E	○	○	○	○	○	○	○	○	○	○	○ ^{*4}	○ ^{*4}	
1457	Extended setting for Ethernet signal loss detection function selection <small>E800-EPA E800-EPB</small>	39	B9	E	○	○	○	○	○	○	○	○	○	○	○ ^{*4}	○ ^{*4}	
1480	Load characteristics measurement mode	50	D0	E	○	○	○	○	×	○	○	○	×	○	○	○	
1481	Load characteristics load reference 1	51	D1	E	○	○	○	○	×	○	○	○	×	○	○	○	
1482	Load characteristics load reference 2	52	D2	E	○	○	○	○	×	○	○	○	×	○	○	○	
1483	Load characteristics load reference 3	53	D3	E	○	○	○	○	×	○	○	○	×	○	○	○	
1484	Load characteristics load reference 4	54	D4	E	○	○	○	○	×	○	○	○	×	○	○	○	
1485	Load characteristics load reference 5	55	D5	E	○	○	○	○	×	○	○	○	×	○	○	○	
1486	Load characteristics maximum frequency	56	D6	E	○	○	○	○	×	○	○	○	×	○	○	○	
1487	Load characteristics minimum frequency	57	D7	E	○	○	○	○	×	○	○	○	×	○	○	○	
1488	Upper limit warning detection width	58	D8	E	○	○	○	○	×	○	○	○	×	○	○	○	
1489	Lower limit warning detection width	59	D9	E	○	○	○	○	×	○	○	○	×	○	○	○	
1490	Upper limit fault detection width	5A	DA	E	○	○	○	○	×	○	○	○	×	○	○	○	
1491	Lower limit fault detection width	5B	DB	E	○	○	○	○	×	○	○	○	×	○	○	○	
1492	Load status detection signal delay time / load reference measurement waiting time	5C	DC	E	○	○	○	○	×	○	○	○	×	○	○	○	
1499	Parameter for manufacturer setting. Do not set.																

18.5 How to check specification changes

Check the SERIAL number indicated on the inverter rating plate or packaging. For how to read the SERIAL number, refer to [page 14](#).

The inverter firmware can be updated by using Firmware Update Tool of FR Configurator2. The functions added due to specification changes are available.

For details on firmware update, refer to the FR Configurator2 Instruction Manual.

18.5.1 Details of specification changes

◆ Number of connectable units on the CC-Link IE Field Network Basic

Number of connectable units	SERIAL
Master: 1 Remote: up to 16 stations (16 stations × 1 group)	□□ 204 ○○○○○○ or earlier
Master: 1 Remote: up to 64 stations (16 stations × 4 groups)	□□ 205 ○○○○○○ or later

◆ Functions available for the inverters manufactured in May 2020 or later

- Firmware version: 1 or later

Item	Details
Mitsubishi Electric geared motor	GM-[]
Plug-in option	FR-A8ND E kit, FR-A8NP E-kit
Stand-alone option	Parameter unit (FR-PU07), LCD operation panel (FR-LU08)
Added parameters	Pr.1499, P.E107 (Pr.75)
Changed parameter setting range	<ul style="list-style-type: none"> • Setting value "13" added for Pr.52, Pr.54, Pr.158, Pr.774 to Pr.776, Pr.992, Pr.1027 to Pr.1034 • Setting values "1800 and 1803" added for Pr.71 and Pr.450 (for 200/400 V class only) • Setting values "10000 to 10003, and 10014 to 10017" added for Pr.75 (for the safety communication model only)

◆ Functions available for the inverters manufactured in August 2020 or later

- Firmware version: 2 or later

Item	Details
Mitsubishi Electric Vector control dedicated motor (SF-V5RU (1500 r/min series))	The SF-V5RU 1.5 to 5.5 kW motors can be driven by the FR-E820-0110(2.2K) to 0330(7.5K) inverters. The SF-V5RUH 1.5 to 5.5 kW motors can be driven by the FR-E840-0060(2.2K) to 0170(7.5K) inverters.
Mitsubishi Electric high-performance energy-saving motor with encoder	SF-PR-SC
Mitsubishi Electric inverter-driven geared motor for encoder feedback control	GM-DZ, GM-DP
Plug-in option	FR-A8AP E kit
EtherNet/IP communication specifications	Access to the parameters, monitor data, and terminals is available. Inverter Configuration Object (64h) <ul style="list-style-type: none"> • Inverter Parameters (12288 to 16383) • Monitor Data (16384 to 20479) • Inverter Control Parameters (20480 to 24575)
PROFINET communication specifications	Access to the parameters, monitor data, and terminals is available. <ul style="list-style-type: none"> • Inverter Parameters (12288 to 16383) • Monitor Data (16384 to 20479) • Inverter Control Parameters (20480 to 24575)
Added parameters	Pr.284, Pr.359, Pr.367, Pr.368, Pr.369, Pr.376, Pr.422, Pr.552, Pr.600 to Pr.604, Pr.607, Pr.608, Pr.690, Pr.692 to Pr.696, Pr.802, Pr.823, Pr.828, Pr.833, Pr.840 to Pr.848, Pr.854, Pr.873, Pr.877 to Pr.881, P.A107 (Pr.285)
Changed parameter setting range	<ul style="list-style-type: none"> • Setting value "8888" added for Pr.11 • Setting values "19 and 35" added for Pr.52, Pr.774 to Pr.776, Pr.992, and Pr.1027 to Pr.1034 • Setting values "30 and 33" added for Pr.71 and Pr.450 • Setting values "13, 23, 42, 43, and 74" added for Pr.178 to Pr.189 • Setting values "30 to 33, and 130 to 133" added for Pr.190 to Pr.196, and Pr.313 to Pr.319 • Setting values "30 to 33" added for Pr.320 to Pr.322 • Setting values "0 to 2, and 9" added for Pr.800 • Setting value "2" added for Pr.850 • Setting value "6" added for Pr.858
Added faults	<ul style="list-style-type: none"> • Signal loss detection (E.ECT) • Brake sequence fault (E.MB1 to E.MB3)

◆ Functions available for the inverters manufactured in January 2021 or later

- Firmware version: 3 or later

Item	Details	Related manuals
Position control (Vector control)	Position control (Vector control) is supported for induction motors. • Pr.420, Pr.421, Pr.423, Pr.425 to Pr.427, Pr.430, Pr.446, Pr.464 to Pr.478, Pr.510, Pr.511, Pr.538, Pr.698, Pr.1222, Pr.1223, Pr.1225 to Pr.1227, Pr.1229 to Pr.1231, Pr.1233 to Pr.1235, Pr.1237 to Pr.1239, Pr.1241 to Pr.1243, Pr.1245 to Pr.1247, Pr.1249, Pr.1282, Pr.1283, Pr.1285, Pr.1286, Pr.1289, Pr.1290, Pr.1292 to Pr.1297	Connection/ Function/ Communication/ Maintenance
	Position control is available. • Setting values "3 to 5" added for Pr.800	
	Signals for position control can be assigned to I/O terminals. • Setting values "76, and 87 to 89" added for Pr.178 to Pr.189 • Setting values "24, 36, 38, 56, 60 to 63, 84, 124, 136, 138, 156, 160 to 163, and 184" added for Pr.190 to Pr.196 and Pr.313 to Pr.319 • Setting values "24, 36, 38, 56, 60 to 63, and 84" added for Pr.320 to Pr.322	
	Monitoring during position control is available (multifunction monitor). • Setting values "26 to 31, and 65" added for Pr.52, Pr.774 to Pr.776, and Pr.992 • Setting value "65" added for Pr.54 and Pr.158 • Setting values "65, 222 to 227, and 229" added for Pr.1027 to Pr.1034	
	The following warnings are added: LP (Stroke limit warning), HP1 (Home position return setting error), and HP2 (Home position return uncompleted)	
	The following faults are added: E.OD (Excessive position fault) and E.OA (acceleration error).	
CC-Link IE TSN communication specifications	User defined cyclic communication is supported. • Setting values "38 and 138" of Pr.544 are available for remote registers.	Function/ Communication
EtherNet/IP communication specifications	User defined cyclic communication is supported. • "Configurable" is added for the connections of Class 1 communication (I/O Message communication) (Instances 100 and 150).	Communication
PROFINET communication specifications	User defined cyclic communication is supported. • Telegram 102 is added for Process Data (Cyclic Data Exchange).	Communication
MODBUS/TCP communication specifications	CiA402 drive profile (24642 to 24644, 24646, 24648, 24649, and 26623) is added for MODBUS registers.	Communication
PTC thermistor	Motor overheat protection by the motor's built-in PTC thermistor is supported. • Pr.561 and Pr.1016 are added. • Setting value "64" of Pr.52, Pr.774 to Pr.776, Pr.992, Pr.1027 to Pr.1034 is available (multifunction monitor). • E.PTC (PTC thermistor operation) is added.	Connection/ Function/ Maintenance
Backup/restore function	Inverter parameters and the data used in the PLC function of inverter can be backed up and restored. • RD (Backup in progress) and WR (Restoration in progress) indications are added.	Communication/ Maintenance
Increased magnetic excitation deceleration	Added functions • Pr.660 to Pr.662 are added.	Function
Optimum excitation control	The control can be enabled under Advanced magnetic flux vector control.	Function
PLC function	The structured text (ST) language is supported, and jump commands are supported.	PLC Function Programming Manual
Capacity	200 V class: 11K to 22K are added. 400 V class: 11K to 22K are added.	Connection/ Function/ Communication/ Maintenance
Parameters	Pr.375 added User Defined Cyclic Communication Input/Output Mapping parameters (Pr.1318 to Pr.1343) added	Function/ Communication

◆ Functions available for the inverters manufactured in May 2021 or later

- Firmware version: 5 or later

Item	Details	Related manuals
PM motor (MM-GKR 0.4kW and 0.75kW, and EM-A 5.5kW and 7.5kW)	Applied motor setting • Setting values "540 and 1140" (200 V class) added for Pr.71 and Pr.450	Connection/ Function/ Communication/ Maintenance
	Parameter initial setting • Setting values "3024, 3044, 3124, and 3144" (200 V class) added for Pr.998	
	Position control (Vector control) is supported for PM motors (MM-GKR and EM-A). Control mode setting • Setting values "13 and 14" added for Pr.451 and Pr.800	
Orientation control	Added parameters • Pr.350 to Pr.358, Pr.361 to Pr.366, Pr.393, Pr.396 to Pr.399	Function/ Communication/ Maintenance
	Setting values • Setting value "22" added for Pr.52 • Setting value "22" added for Pr.178 to Pr.189 • Setting values "27, 28, 127, and 128" added for Pr.190 to Pr.196 • Setting values "27, 28, 127, and 128" added for Pr.313 to Pr.319 • Setting values "27 and 28" added for Pr.320 to Pr.322 • Setting value "22" added for Pr.774 to Pr.776 • Setting value "22" added for Pr.992 • Setting value "22" added for Pr.1027 to Pr.1034	
EtherCAT communication specifications	The FR-E800-EPC models are added.	Connection/ Function/ Communication/ Maintenance
	Added parameters • Pr.1305	
Emergency drive (except for the E800-SCE inverters)	Added parameters • Pr.136, Pr.139, Pr.514, Pr.515, Pr.523, Pr.524, and Pr.1013	Connection/ Function/ Maintenance
	Setting values • Setting value "68" added for Pr.52 • Setting value "84" added for Pr.178 to Pr.189 • Setting values "18, 19, 65, 66, 165, and 166" added for Pr.190 to Pr.196 • Setting values "18, 19, 65, 66, 165, and 166" added for Pr.313 to Pr.319 • Setting values "18, 19, 65, and 66" added for Pr.320 to Pr.322 • Setting value "68" added for Pr.774 to Pr.776 • Setting value "68" added for Pr.992 • Setting value "68" added for Pr.1027 to Pr.1034	
	ED (Emergency drive) warning added	
Ethernet communication specifications	Simple positioning using CiA402 drive profile Added parameters • Pr.1220 added Setting values • Setting values added for Pr.1320 to Pr.1329 [E800-(SC)EPA][E800-(SC)EPB] "24672, 24689, 24698, 24703, 24705, 24707, 24708, 24719, 24721, and 24728 to 24730" [E800-EPC] "12288 to 13787, 20488, 20489, 24642, 24646, 24648 to 24650, 24672, 24677 to 24680, 24689, 24698, 24702, 24703, 24705, 24707 to 24709, 24719, 24721, 24728 to 24730, 24831, and 9999" • Setting values added for Pr.1330 to Pr.1343 [E800-(SC)EPA][E800-(SC)EPB] "20992, 24639, 24643, 24644, 24673 to 24676, 24692, 24695, 24820, 24826, 24828, and 25858" [E800-EPC] "12288 to 13787, 16384 to 16483, 20488, 20489, 20981 to 20990, 20992, 24639, 24643, 24644, 24673 to 24676, 24692, 24695, 24820, 24826, 24828, 25858, and 9999"	Communication
	User defined cyclic communication specifications Added parameters • Pr.1389 to Pr.1398	
	Ethernet relay operation at reset selection Added parameter • Pr.1386	
Parameters	Parameters added for the second functions • Pr.1298 and Pr.1299	Function

◆ Functions available for the inverters manufactured in September 2021 or later

- Firmware version: 6 or later

Item	Details	Related manuals
BACnet MS/TP communication specifications	Added parameters • Pr.726 and Pr.727	Function/ Communication
	Setting values • Setting values "81, 82, and 84 to 86" added for Pr.52, Pr.774 to Pr.776, and Pr.1027 to Pr.1034 • Setting values "81 to 86" added for Pr.992 • Setting value "85" added for Pr.54 • Setting value "86" added for Pr.158 • Setting values "82 and 182" added for Pr.190 and Pr.191 • Setting value "2" added for Pr.549	

◆ Functions available for the inverters manufactured in December 2021 or later

- Firmware version: 7 or later

Item	Details	Related manuals
Cumulative pulse monitoring	Added parameters • Pr.635, Pr.636, and Pr.638	Function
	Setting values • Setting values "71 and 72" added for Pr.52, Pr.774 to Pr.776, Pr.992, and Pr.1027 to Pr.1034 • Setting value "52" added for Pr.178 to Pr.189	
24 V external power supply operation	Plug-in option FR-E8DS E kit is available.	Function/ Maintenance/ FR-E8DS E Kit Instruction Manual
	Setting values • Setting values "68 and 168" added for Pr.190 to Pr.196, and Pr.313 to Pr.319 • Setting value "68" added for Pr.320 to Pr.322	
	Operation panel indication "EV" (24 V external power supply operation) is added.	
Internal storage device status indication	Added parameters • Pr.890	Function/ Maintenance
	E.PE6 (Internal storage device fault) fault added	
MM-GKR motor capacity	0.1 kW and 0.2 kW are added.	Connection/ Function
Environmental impact diagnosis function	Cor (Corrosion warning) warning added	Maintenance

18

◆ Functions available for the inverters manufactured in May 2022 or later

- Firmware version: 9 or later

Item	Details	Related manuals
EM-A motor capacity	200 V class: 0.75 kW to 3.7 kW are added. 400 V class: 3.7 kW and 5.5 kW are added.	Connection/ Function
Anti-sway control	Added parameters • Pr.1072 to Pr.1079	Function
CC-Link IE TSN communication specifications	Added parameters • Pr.1210	Function/ Communication
EtherNet/IP communication specifications	Instance 21216 (Speed scale (numerator)) and instance 21217 (Speed scale (denominator)) are added for Inverter Configuration Object (64h)	Communication

◆ Functions available for the inverters manufactured in October 2022 or later

- Firmware version: 11 or later

Item	Details	Related manuals
Inverter capacity	100 V class: 0.1K to 0.75K are added.	Connection/ Function/ Communication/ Maintenance

◆ Functions available for the inverters manufactured in November 2022 or later

- Firmware version: 11 or later

Item	Details	Related manuals
EM-A motor capacity	200 V class: 0.1 kW to 0.4 kW are added. 400 V class: 2.2 kW is added.	Connection/ Function
Position accuracy compensation gain tuning	Added parameters • Pr.979 to Pr.981	Function
	Setting values • Setting value "301" added for Pr.96	
Anti-sway control function	Setting values • Setting value "54" added for Pr.178 to Pr.189	Function
BACnet/IP and BACnet MS/TP communication specifications	Network Port Object is added.	Communication
PROFINET communication specifications	E.SAF can be reset by bit 7 of Control word 1 (STW1).	Communication

◆ Functions available for the inverters manufactured in July 2023 or later

- Firmware version: 12 or later

Item	Details	Related manuals
SF-PR motor capacity	200 V class: 0.2 kW and 0.4 kW are added. 400 V class: 0.2 kW and 0.4 kW are added.	Function
EM-A motor capacity	400 V class: 0.4 kW to 1.5 kW, and 7.5 kW are added.	Connection/ Function
Position control function	Added parameters • Pr.1095 to Pr.1097	Function
	Setting values • Setting values "21 and 22" added for Pr.538	
SLMP communication specifications	Added link registers • W5807 and W5808 (inverter status) • W5900 to W5969 (fault history)	Communication
Plug-in option	FR-E8AXY E kit	FR-E8AXY E Kit Instruction Manual
Control terminal option	FR-E8TR and FR-E8TE7	FR-E8TR Instruction Manual FR-E8TE7 Instruction Manual

◆ Functions available for the inverters manufactured in October 2023 or later

- Firmware version: 12 or later

Item	Details	Related manuals
IP67 model	400 V class: 0.75 kW to 3.7 kW	Connection/ Function/ Communication/ Maintenance
	Added parameters • Pr.508	
	BACnet/IP communication specifications • Binary input: object identifiers 100, 104, and 106 added. • Binary output: object identifiers 0, 4, and 6 added.	
	E.IAH (Abnormal internal temperature) fault added	
Parameters	Pr.197 added	Function

◆ Functions available for firmware version 13 or later

Item	Details	Related manuals
Selection between resetting or not resetting during power supply to main circuit	Setting values • Setting values "100 to 102" added for Pr.30	Function

MEMO

Warranty

When using this product, make sure to understand the warranty described below.

1. Warranty period and coverage

We will repair any failure or defect (hereinafter referred to as "failure") in our FA equipment (hereinafter referred to as the "Product") arisen during warranty period at no charge due to causes for which we are responsible through the distributor from which you purchased the Product or our service provider. However, we will charge the actual cost of dispatching our engineer for an on-site repair work on request by customer in Japan or overseas countries. We are not responsible for any on-site readjustment and/or trial run that may be required after a defective unit are repaired or replaced.

[Term]

The term of warranty for Product is twelve months after your purchase or delivery of the Product to a place designated by you or eighteen months from the date of manufacture whichever comes first ("Warranty Period"). Warranty period for repaired Product cannot exceed beyond the original warranty period before any repair work.

[Limitations]

- (1) You are requested to conduct an initial failure diagnosis by yourself, as a general rule. It can also be carried out by us or our service company upon your request and the actual cost will be charged.
However, it will not be charged if we are responsible for the cause of the failure.
- (2) This limited warranty applies only when the condition, method, environment, etc. of use are in compliance with the terms and conditions and instructions that are set forth in the instruction manual and user manual for the Product and the caution label affixed to the Product.
- (3) Even during the term of warranty, the repair cost will be charged on you in the following cases;
 - a failure caused by your improper storing or handling, carelessness or negligence, etc., and a failure caused by your hardware or software problem
 - a failure caused by any alteration, etc. to the Product made on your side without our approval
 - a failure which may be regarded as avoidable, if your equipment in which the Product is incorporated is equipped with a safety device required by applicable laws and has any function or structure considered to be indispensable according to a common sense in the industry
 - a failure which may be regarded as avoidable if consumable parts designated in the instruction manual, etc. are duly maintained and replaced
 - any replacement of consumable parts (condenser, cooling fan, etc.)
 - a failure caused by external factors such as inevitable accidents, including without limitation fire and abnormal fluctuation of voltage, and acts of God, including without limitation earthquake, lightning and natural disasters
 - a failure caused by using the emergency drive function
 - a failure generated by an unforeseeable cause with a scientific technology that was not available at the time of the shipment of the Product from our company
 - any other failures which we are not responsible for or which you acknowledge we are not responsible for

2. Term of warranty after the stop of production

- (1) We may accept the repair at charge for another seven (7) years after the production of the product is discontinued. The announcement of the stop of production for each model can be seen in our Sales and Service, etc.
- (2) Please note that the Product (including its spare parts) cannot be ordered after its stop of production.

3. Service in overseas

Our regional FA Center in overseas countries will accept the repair work of the Product; however, the terms and conditions of the repair work may differ depending on each FA Center. Please ask your local FA center for details.

4. Exclusion of loss in opportunity and secondary loss from warranty liability

Regardless of the gratis warranty term, Mitsubishi Electric shall not be liable for compensation to:

- (1) Damages caused by any cause found not to be the responsibility of Mitsubishi Electric.
- (2) Loss in opportunity, lost profits incurred to the user by Failures of Mitsubishi Electric products.
- (3) Special damages and secondary damages whether foreseeable or not, compensation for accidents, and compensation for damages to products other than Mitsubishi Electric products.
- (4) Replacement by the user, maintenance of on-site equipment, start-up test run and other tasks.

5. Change of Product specifications

Specifications listed in our catalogs, manuals or technical documents may be changed without notice.

6. Application and use of the Product

- (1) For the use of our product, its applications should be those that may not result in a serious damage even if any failure or malfunction occurs in product, and a backup or fail-safe function should operate on an external system to product when any failure or malfunction occurs.
- (2) Our product is designed and manufactured as a general purpose product for use at general industries.
Therefore, applications substantially influential on the public interest for such as atomic power plants and other power plants of electric power companies, and also which require a special quality assurance system, including applications for railway companies and government or public offices are not recommended, and we assume no responsibility for any failure caused by these applications when used.

In addition, applications which may be substantially influential to human lives or properties for such as airlines, medical treatments, railway service, incineration and fuel systems, man-operated material handling equipment, entertainment machines, safety machines, etc. are not recommended, and we assume no responsibility for any failure caused by these applications when used. We will review the acceptability of the abovementioned applications, if you agree not to require a specific quality for a specific application. Please contact us for consultation.

Revisions

*The manual number is given on the bottom left of the back cover.

Revision date	*Manual number	Revision
Dec. 2019	IB(NA)-0600868ENG-A	First edition
Apr. 2020	IB(NA)-0600868ENG-B	Added <ul style="list-style-type: none"> FR-E820S-0008(0.1K) to 0110(2.2K)(E)(SCE) FR-E800-SCE (safety communication model) Input power monitor Mitsubishi Electric geared motor (GM-[]) Reset selection / disconnected PU detection / PU stop selection (Pr.75 = "10000 to 10003, 10014 to 10017")
Jun. 2020	IB(NA)-0600868ENG-C	Added <ul style="list-style-type: none"> Vector control Parameter unit (FR-PU07) Pr.284, Pr.359, Pr.367, Pr.368, Pr.369, Pr.376, Pr.422, Pr.552, Pr.600 to Pr.604, Pr.607, Pr.608, Pr.690, Pr.692 to Pr.696, Pr.802, Pr.823, Pr.828, Pr.833, Pr.840 to Pr.848, Pr.854, Pr.873, Pr.877 to Pr.881, P.A107 (Pr.285) Setting value "8888" for Pr.11 Setting values "19 and 35" for Pr.52, Pr.774 to Pr.776, Pr.992, and Pr.1027 to Pr.1034 Setting values "30 and 33" for Pr.71 and Pr.450 Setting values "13, 23, 42, 43, and 74" for Pr.178 to Pr.189 Setting values "30 to 33 and 130 to 133" for Pr.190 to Pr.196, and Pr.313 to Pr.319 Setting values "30 and 33" for Pr.320 to Pr.322 Setting values "0 to 2, and 9" for Pr.800 Setting value "2" for Pr.850 Setting value "6" for Pr.858 Edited <ul style="list-style-type: none"> Initial value "0(%)" for C39 (Pr.932)
Nov. 2020	IB(NA)-0600868ENG-D	Added <ul style="list-style-type: none"> FR-E820-0470(11K) to 0900(22K)(E)(SCE), FR-E840-0230(11K) to 0440(22K)(E)(SCE) Position control (Vector control) PTC thermistor Increased magnetic excitation deceleration Optimum excitation control Pr.375, Pr.1318 to Pr.1343 Setting values "38 and 138" for Pr.544
Jan. 2021	IB(NA)-0600868ENG-E	Edited <ul style="list-style-type: none"> Models listed on the front cover
Apr. 2021	IB(NA)-0600868ENG-F	Added <ul style="list-style-type: none"> Compatibility with FR-E800-EPC Position control (PM sensorless vector control) Orientation control Emergency drive Simple positioning using CiA402 drive profile Ethernet communication specifications (Pr.1386, Pr.1389 to Pr.1398) Parameters added for the second functions (Pr.1298, Pr.1299)
Jul. 2021	IB(NA)-0600868ENG-G	Added <ul style="list-style-type: none"> BACnet MS/TP
Oct. 2021	IB(NA)-0600868ENG-H	Added <ul style="list-style-type: none"> Cumulative pulse monitoring 24 V external power supply operation Internal storage device status indication MM-GKR motor capacity expanded (0.1 kW and 0.2 kW) Environmental impact diagnosis function
Mar. 2022	IB(NA)-0600868ENG-J	Added <ul style="list-style-type: none"> EM-A motor capacity expanded (200 V: 0.75 kW to 3.7 kW, 400 V: 3.7 kW, 5.5 kW) Anti-sway control (Pr.1072 or Pr.1079) CC-Link IE TSN communication specifications (Pr.1210)
Aug. 2022	IB(NA)-0600868ENG-K	Added <ul style="list-style-type: none"> FR-E810W-0008(0.1K) to 0050(0.75K)(E)(SCE)
Sep. 2022	IB(NA)-0600868ENG-L	Added <ul style="list-style-type: none"> EM-A motor capacity (200 V: 0.1 kW to 0.4 kW, 400 V: 2.2 kW) Position accuracy compensation gain tuning (Pr.96 = "301", Pr.979 to Pr.981) Setting value "54" for Pr.178 to Pr.189
May 2023	IB(NA)-0600868ENG-M	Added <ul style="list-style-type: none"> SF-PR motor capacity (200 V: 0.2 kW and 0.4 kW, 400 V: 0.2 kW and 0.4 kW) EM-A motor capacity (400 V: 0.4 kW to 1.5 kW, 7.5 kW) Position control functions (Pr.538 = "21 or 22", and Pr.1095 to Pr.1097) Compatibility with FR-E8AXY, FR-E8TR, and FR-E8TE7

Revision date	*Manual number	Revision
Jul. 2023	IB(NA)-0600868ENG-N	Added <ul style="list-style-type: none">• Setting values "100 to 102" for Pr.30• Pr.197 and Pr.508• FR-E806 (IP67 model)

Model	FR-E800 Instruction Manual (Function)
Model code	1A2-P91

MITSUBISHI ELECTRIC CORPORATION

HEAD OFFICE: TOKYO BUILDING 2-7-3, MARUNOUCHI, CHIYODA-KU, TOKYO 100-8310, JAPAN