

**Graphic Operation Terminal  
GOT SIMPLE Series**



**GOT SIMPLE**

Graphic Operation Terminal



**New Version**

- User memory capacity expanded to 15 MB
- Support RS-485 connection
- Support outline font
- Enhanced traceability
- Support remote maintenance

# GLOBAL IMPACT OF MITSUBISHI ELECTRIC



Through Mitsubishi Electric's vision, "Changes for the Better" are possible for a brighter future.

## ***Changes for the Better***

"Changes for the Better" represents the Mitsubishi Electric Group's attitude to "always strive to achieve something better", as we continue to change and grow. Each one of us shares a strong will and passion to continuously aim for change, reinforcing our commitment to creating "an even better tomorrow".

Mitsubishi Electric is involved in many areas including the following:

### **Energy and Electric Systems**

A wide range of power and electrical products from generators to large-scale displays.

### **Electronic Devices**

A wide portfolio of cutting-edge semiconductor devices for systems and products.

### **Home Appliance**

Dependable consumer products like air conditioners and home entertainment systems.

### **Information and Communication Systems**

Commercial and consumer-centric equipment, products and systems.

### **Industrial Automation Systems**

Maximizing productivity and efficiency with cutting-edge automation technology.

Our advances in AI and IoT are adding new value to society in diverse areas from automation to information systems. The creation of game-changing solutions is helping to transform the world, which is why we are honored to be recognized in the 2019 'Forbes Digital 100' as one of world's most influential digital corporations.



# INDEX

<b>1. GOT SIMPLE Series New Features</b>	<b>06</b>
<b>2. GOT SIMPLE Series remote solutions</b>	<b>08</b>
<b>3. GOT Drive Control (Inverter) Interactive Solutions</b>	<b>10</b>
<b>4. GOT Drive Control (Servo) Interactive Solutions</b>	<b>12</b>
<b>5. Reduce design, setup, and maintenance cost</b>	<b>14</b>
<b>6. Add value to your installation and machine</b>	<b>18</b>
<b>7. Streamlined screen design</b>	<b>20</b>
<b>8. Mitsubishi Electric Industrial Devices GOT SIMPLE Solutions</b>	<b>22</b>
<b>9. Function list</b>	<b>34</b>
<b>10. Specifications</b>	<b>38</b>
<b>11. Product list</b>	<b>41</b>
<b>12. HMI lineup</b>	<b>42</b>
<b>13. Support</b>	<b>44</b>
<b>14. Related materials</b>	<b>45</b>



# The GOT SIMPLE Series upgrade includes the five most demanded new features

**MITSUBISHI ELECTRIC**

## Operation monitor

OFF ON 120

**MITSUBISHI ELECTRIC**

### Operation monitor

OFF ON

Output Current: 115.6

Output Frequency: 0.75

Operation Speed: Low Middle High

Frequency Setting: 123

TOP Menu Parameter 1 **Operation Monitor** Graph

10" widescreen GS2110-WTBD-N      7" widescreen GS2107-WTBD-N





## Upgraded

### New Features

- 1 **Expanded user memory capacity**  
Increased from 9 MB to 15 MB
- 2 **Support RS-485 connection**  
Wide variety of connectable devices
- 3 **Support outline font**  
Improve visibility of screen display
- 4 **Enhanced traceability**  
Operation log for easy troubleshooting
- 5 **Support remote maintenance**  
VNC server function for monitoring from a remote location

➔ See next page for details

GS2110-WTBD-N	10" widescreen
GS2107-WTBD-N	7" widescreen

WVGA 800 × 480 dots	TFT color LCD 65536 colors	24 V DC
Memory for storage (ROM) 15 MB		

#### Built-in interfaces

Ethernet	RS-232	RS-422/485
USB device	SD memory card interface	

# GOT SIMPLE

For details

Concept movie



## The GOT SIMPLE Series upgrade brings the most demanded new features

10" widescreen, GS2110-WTBD-N **NEW**



7" widescreen, GS2107-WTBD-N **NEW**



### The GOT SIMPLE Series with the most demanded features enables remote maintenance

User memory capacity is now increased to 15 MB. Outline fonts offer improved visibility of screen display.

In addition, remote maintenance is possible using the VNC server function, and thus monitoring devices from a remote location improves work efficiency.

\* To design screens of the upgraded GOT SIMPLE Series, it is required to use GT Works3 Version1.250L or later.

Item	Specifications	
	GS2110-WTBD-N	GS2107-WTBD-N
Display	10" widescreen, TFT color LCD, 65536 colors	7" widescreen, TFT color LCD, 65536 colors
Resolution	WVGA: 800 × 480 dots	
Backlight	White LED	
User memory	Memory for storage (ROM): 15 MB <b>NEW</b>	
Standard interface	Ethernet, RS-232, RS-422/485 <b>NEW</b> USB device (USB Mini-B): 1 channel (USB1.1 (Full-Speed 12 Mbps)) SD memory card interface	

### GOT SIMPLE Series built-in interfaces

#### Ethernet interface

Use Ethernet to simultaneously connect up to two types of industrial devices (programmable controllers, inverters, servo amplifiers, etc.) from different manufacturers. CC-Link IE Field Network Basic compatible devices can also be connected.

#### RS-232 interface

Connect to various industrial devices, barcode readers and serial printers.

**NEW**

Supported connection to BRIGHTTEK printers by using the RS-232 interface.

\* For the connectable printers, please refer to the Technical Bulletin "List of Valid Devices Applicable for GOT2000 Series and GOT SIMPLE Series for Overseas" (GOT-A-0160).

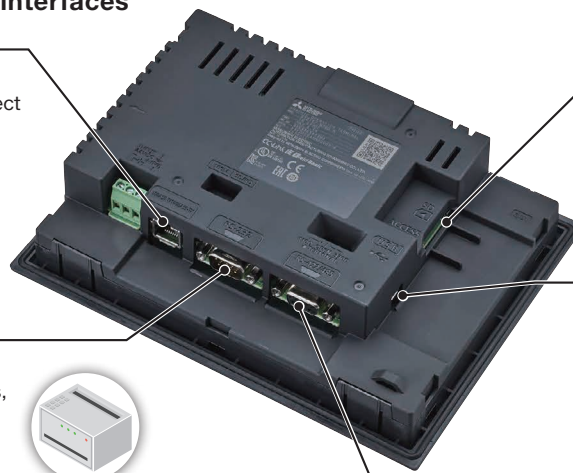

#### SD memory card interface

Save large volumes of data, including alarms and logging data.

#### USB interface: device (USB Mini-B)

Connect to a personal computer and transfer data.

#### RS-422/485 interface **NEW**

Connect to various industrial devices (programmable controllers, inverters, servo amplifiers, etc.), barcode readers, temperature controllers, and MODBUS® devices.



GOT SIMPLE Series New Features

## 1 Expanded user memory capacity (9 MB → 15 MB) **NEW**

The user memory capacity has been expanded to 15 MB from the GOT SIMPLE Series previous model. There is no need to worry about the project data size when designing screens.

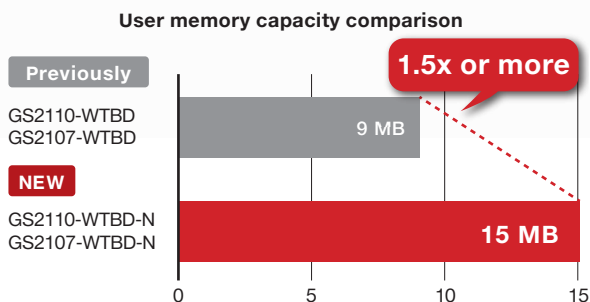

## 2 Support RS-485 connection **NEW**

A common interface for RS-422 and RS-485 connections is available. Temperature controllers and MODBUS® devices can be connected.



\* For the MODBUS® communication, please refer to page 16.

## 3 Support outline font **NEW**

Outline fonts can now be used on the GOT SIMPLE Series. Antialiasing smoothes out text edges and displays clear characters, offering improved visibility of screen display.

**Previously**

Trend graph  
16dot HQ Gothic

**NEW**

Trend graph  
Outline Gothic (antialiasing enabled)

Clear characters improves visibility

## 4 Enhanced traceability for easy troubleshooting

### Operation log function **NEW**

GOT records the operation information, such as the “what, when, and how” of an operation performed, in chronological order in an SD memory card. Use of the operation log function combined with the operator authentication function records additional information of “who” performed the operation.

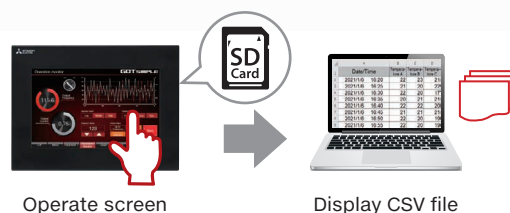

Using login management of the operator authentication function and recording operations by the operators enables you to check the “who, what, when, and how” of an operation performed. This is useful for preventing invalid operations and identify the cause of problems.

\* For the operator authentication function, please refer to page 18.



## 5 Remote maintenance by using the VNC server function

### VNC server function **NEW**

If a problem occurred in a remote location, it is easy to monitor the GOT from your office and take corrective actions quickly.



See the following page for the GOT SIMPLE Series remote solutions



# GOT SIMPLE Series remote solutions make it possible to monitor production from remote locations

## Monitor from remote locations

### VNC server function\*1\*2 **NEW**

#### Monitor production remotely

Remotely view the GOT screen from information devices such as a personal computer and tablet. No dedicated screens are required.

\*1 A separate license (GT25-VNCSKEY) is required.

\*2 One client can connect to one GOT at the same time.

On a personal computer in your office

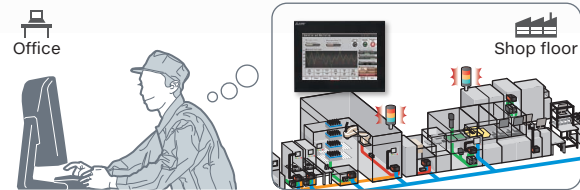

On a tablet from a remote location



#### Same functions as GOT

Utility functions including the backup/restoration function and the device monitor are also supported on computers and tablets.

#### Safe operation avoiding simultaneous operations

Exclusive control of authorization prevents accidents that might be caused by simultaneous operations by multiple operators.

With operating authority

Input operations enabled



GOT + VNC server function license GT25-VNCSKEY

Ethernet

Without operating authority

Input operations disabled



Personal computer

## Application examples

### Check the alarm without visiting the shop floor

From a remote office, you can easily monitor the alarms. Check the alarm and corrective actions in detail, and you can solve the problem quickly and reduce downtime.

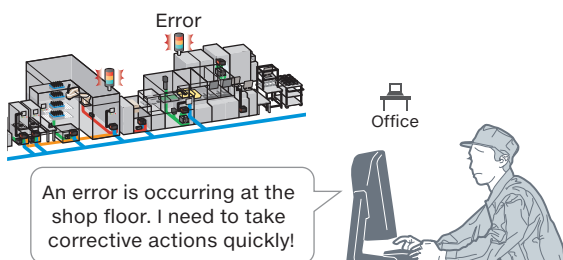

### Easily startup the large equipment

When starting up and adjusting the large-scale equipment, you may have to work away from the GOT. You can now check the GOT screen using a tablet from a remote location so that all the work can be done by a single operator efficiently.



### Safety precautions

When the VNC Server function or iQ Monozukuri products are used to perform remote control of control equipment, the field operator may not notice the remote control, possibly leading to an accident. In addition, a communication delay or interruption may occur depending on the network environment, and remote control of control equipment cannot be performed normally in some cases. Before using these functions to perform remote control, fully grasp the circumstances of the field site and ensure safety.

## Improve manufacturing process and productivity of the whole production



### iQ Monozukuri Process Remote Monitoring\*1 **NEW**



#### Easily monitor multiple devices from a remote office

IoT technologies can be easily introduced to the shop floor, and the information of multiple equipment can be collected, visualized, and managed collectively. Manufacturing process and productivity of the whole production can be improved by analyzing the data displayed on GT SoftGOT2000\*2. The operation status of the shop floor and the information such as operation logs and alarms can be collected from each device via an onsite GOT.

\*1 iQ Monozukuri Process Remote Monitoring application package is required separately. For more details, please refer to the iQ Monozukuri Process Remote Monitoring catalog (L(NA)08674ENG).

\*2 A license key (GT27-SGTKEY-U) is required separately.

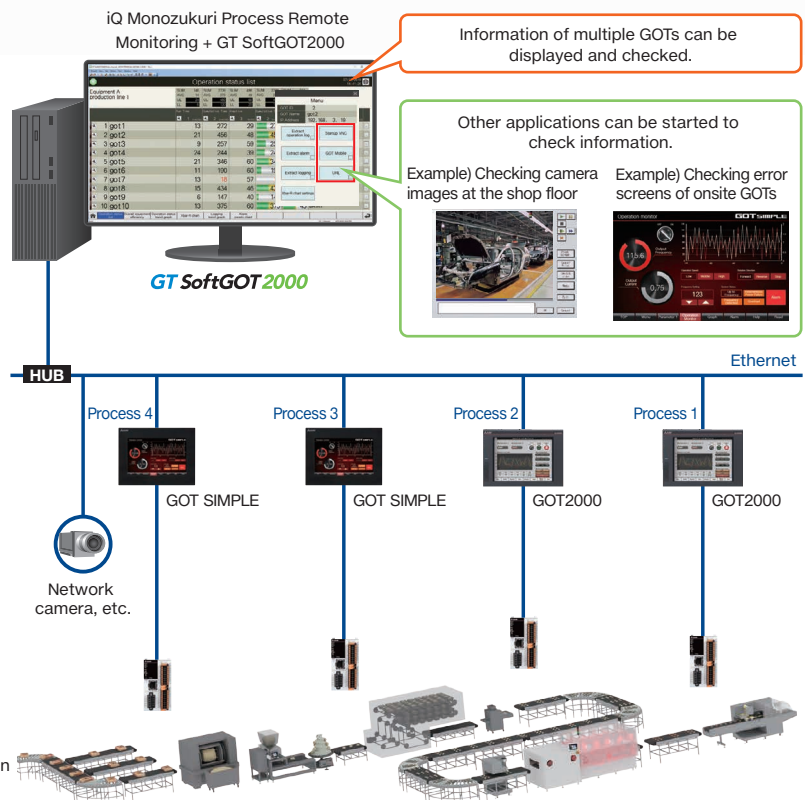

Information of multiple GOTs can be displayed and checked.

Other applications can be started to check information.



Example) Checking camera images at the shop floor

Example) Checking error screens of onsite GOTs

#### Easily implement production visualization system

The template project for GT SoftGOT2000 makes it easy to startup systems.

Production line

### Application examples

#### Monitoring wide variety of targets with various kinds of equipment connectable to on-site GOT

GOT collects information of industrial devices that are connected in various connection types (Ethernet, serial, etc.) and iQ Monozukuri Process Remote Monitoring aggregates the information.

GOTs can be connected to a wide variety of industrial devices because various types of communication drivers are supported. Any types of equipment that can be connected to GOTs and can be monitored with iQ Monozukuri Process Remote Monitoring so that each equipment can be visualized and monitored collectively.

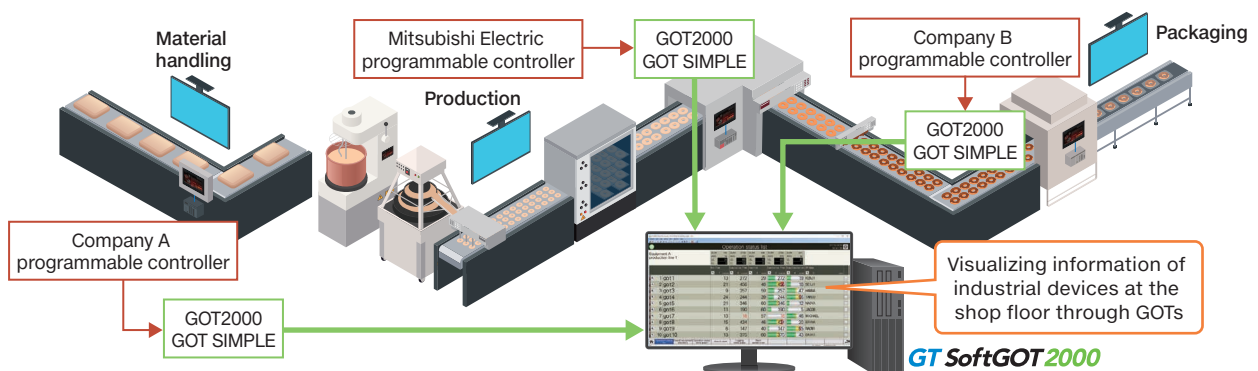

Visualizing information of industrial devices at the shop floor through GOTs

Recommended

# GOT Drive Control

Inverter

## Interactive Solutions



Challenges that cannot be resolved just with the inverter can now be resolved with GOT2000 and inverter interactive functions.

The GOT Drive enhanced functionality is designed to eliminate need for additional hardware, software and suits customer's applications to realize central monitoring, speed up system startup, improve predictive maintenance and troubleshooting.

### [System configurations]

Select the required connection type to match your system configuration. Multiple inverters can be monitored with one GOT by switching the target station number.

#### CASE1 Direct connection with Ethernet

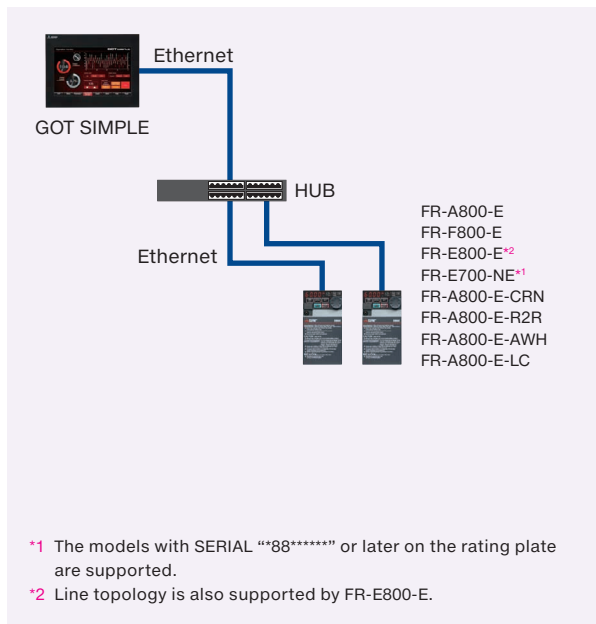

#### CASE2 CC-Link IE connection via programmable controller

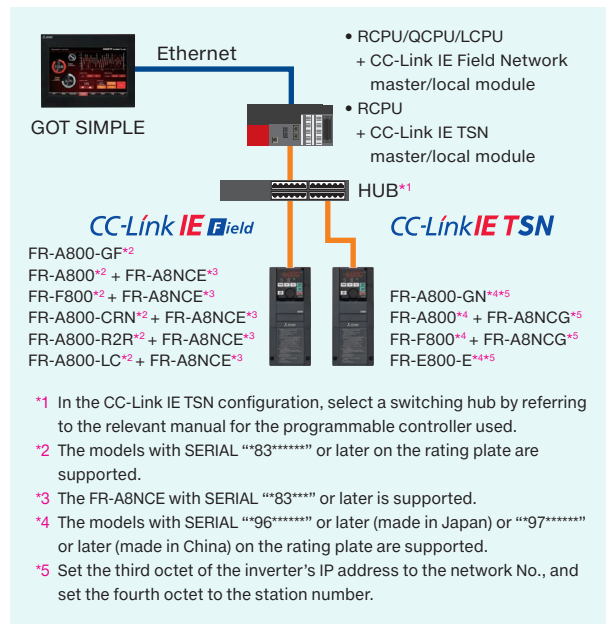

#### CASE3 Ethernet connection via programmable controller

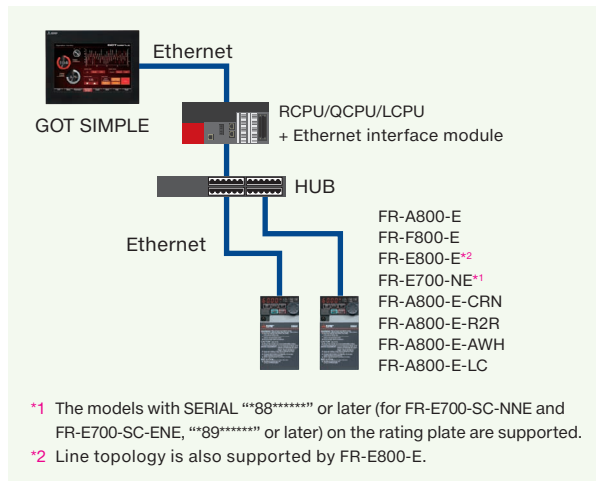

#### CASE4 Direct connection with RS-485

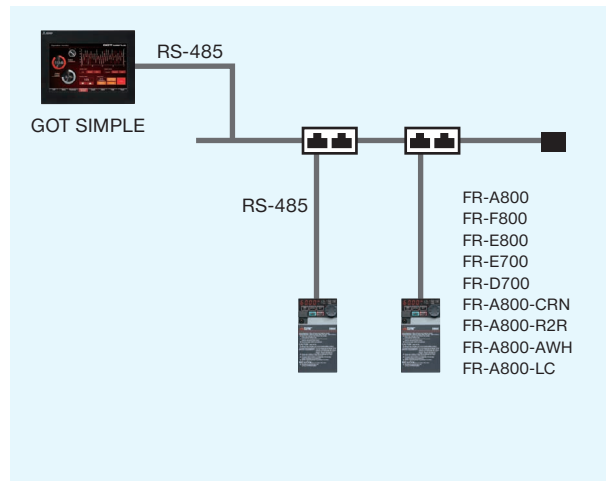



With GOT, the inverter's parameters can be adjusted with the control panel closed!

### Parameter settings (simple mode)

Use the GOT on the front of the control panel to adjust the inverter's simple mode parameters. The parameter names can be confirmed on a list, so the required parameters can be easily found and set.

Parameter Setting screen\*1



Back up (save) or restore (write) parameters as a recipe file when necessary.

With GOT, the inverter's parameters can be monitored in a batch with the control panel closed!

### Batch monitor

The inverter's current values such as the output frequency, output current, and output voltage can be monitored with the GOT without preparing the personal computer or directly confirming the inverter.

Batch Monitor screen\*1



With GOT, the replacement timing of the inverter's components can be displayed and predictive maintenance can be performed!

### Inverter life diagnosis

GOT can be used to monitor the operation status of the inverter's components (main circuit capacitor, control circuit capacitor, cooling fan, etc.) and confirm the replacement timing. Perform predictive maintenance by replacing parts before the inverter fails.

Inverter Life Diagnosis screen\*1

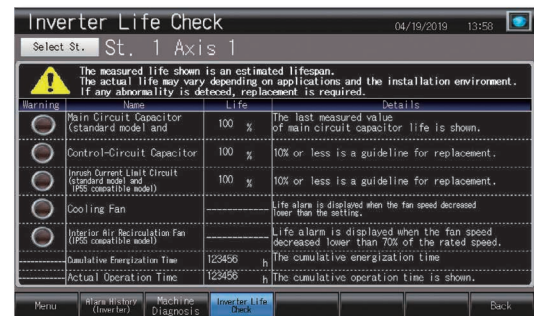

\*1 Parameters and devices to be monitored can be set and displayed on a screen. The above is an example for screen design.

Recommended

# GOT Drive Control

Servo

## Interactive Solutions

# GOT Drive



The GOT Drive easily visualizes the servo system status to realize speed up of the system startup and improve predictive maintenance and troubleshooting.

### [System configurations]

Select the required connection type to match your system configuration. Multiple servo amplifiers can be monitored with one GOT by switching the target station number and axis number.

#### CASE1 Ethernet/Serial direct connection

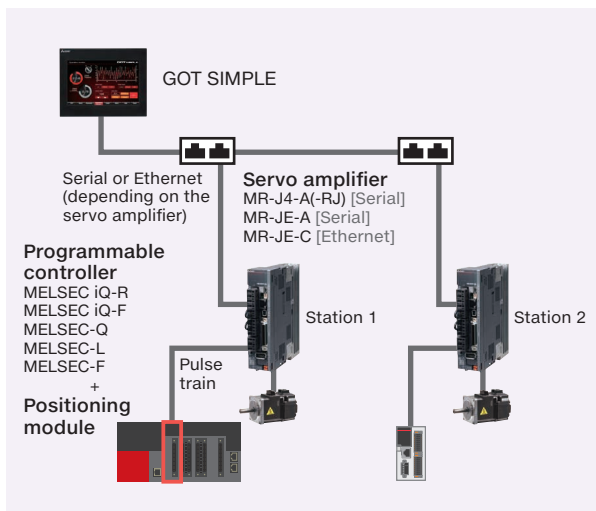

#### CASE2 Simple Motion module connection

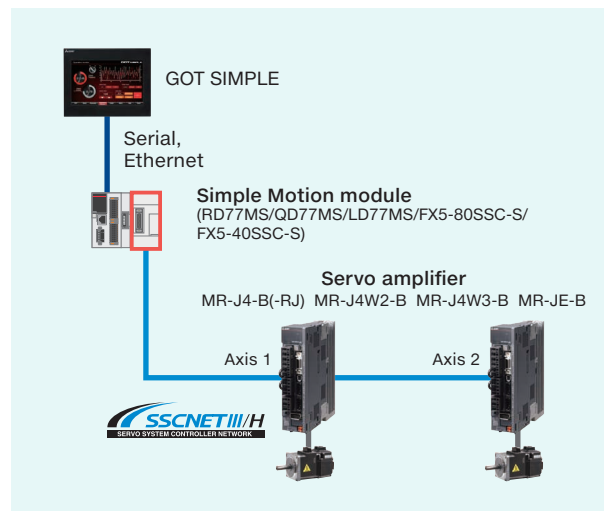

#### CASE3 Motion controller connection

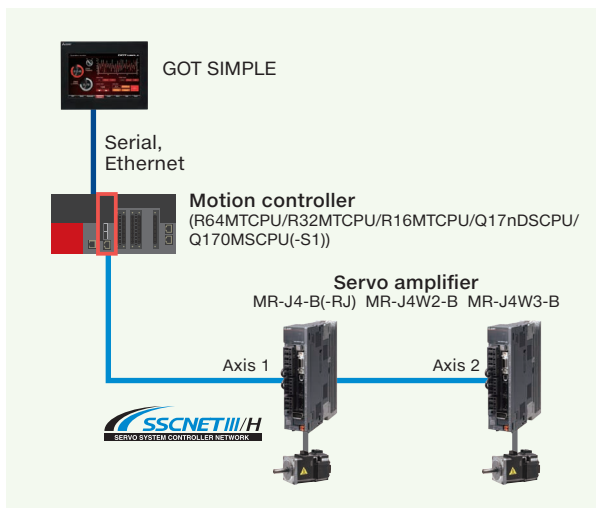

#### CASE4 CC-Link IE Field Network connection

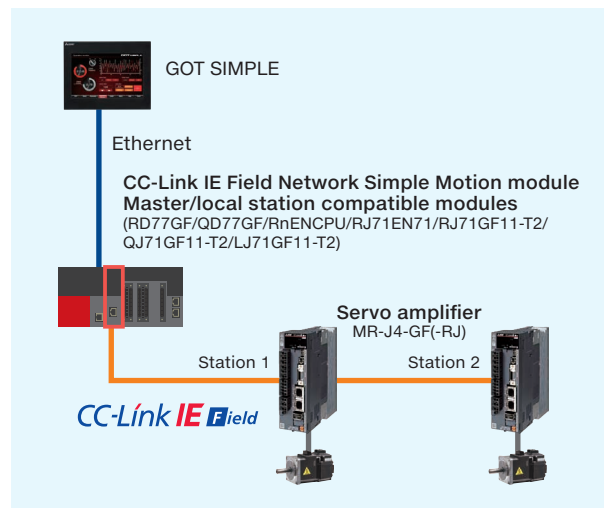

## Adjust servos without a personal computer!

### One-touch tuning function

Just a single touch on the switch on the GOT screen to perform adjustment work, which is difficult without experience. You can adjust servo amplifier automatically by selecting from three response modes.

One-touch tuning screen\*1

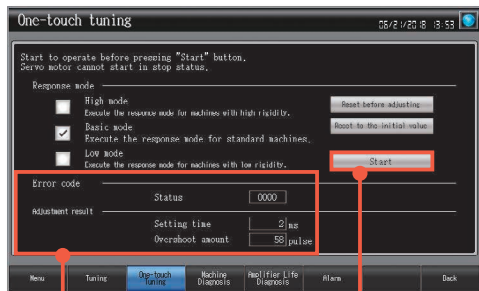

Adjustment results are shown

Just a single touch on the switch

### Tuning function

After one-touch tuning, to obtain higher performance, you can perform fine tuning of gain parameters, machine resonance suppression filter, and vibration suppression control parameters in the tuning screen.

Tuning screen\*1

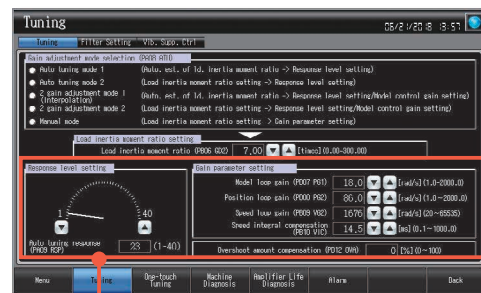

Perform fine tuning of gain parameters, tuning response, and overshoot amount.

## Predict machine deterioration and improve system predictive maintenance without a personal computer!

### Machine diagnosis function

GOT can display estimated values (machine friction, torque vibration, etc.) that are collected by the machine diagnosis function of the servo amplifier. The difference between the initial value (at the startup) and the current value can be used to predict deterioration of the machine. Using this function with the GOT's alarm function will help you perform timely maintenance of machine parts.

Machine diagnosis screen\*1

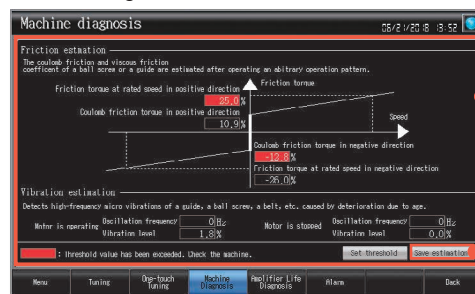

Displays the estimated value upon completion of the machine diagnosis. When any of the estimation values exceed the threshold values that are set on the GOT, the numerical value display area turns red.

Save estimation values to file and compare the values to check the deterioration of the machine.

## Supports predictive maintenance functions of servo amplifiers!

### Servo amplifier life diagnosis function

Check cumulative operation time, on/off counts of inrush relay on GOT. In addition, replacement timing of servo amplifier components (capacitor, relay) can be displayed on the GOT.



Periodic check

Servo amplifier life diagnosis screen\*1

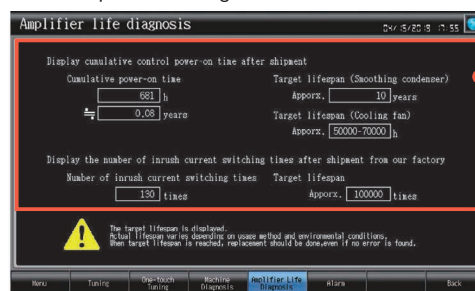

Check the smoothing capacitor energization time or the inrush relay on/off times at a glance.

\*1 Sample screens are available for connection with MR-JE-A and MR-JE-B for the GOT SIMPLE series.



# Reduce design, setup, and maintenance cost

## Reduce mass production installation setup costs

SD memory card interface

### Start from SD memory card

Transfer the screen data and all the necessary system data to make a GOT operate to a SD memory card in advance. Then the GOT can be used just by inserting the SD memory card.

Useful for replacement or maintenance of GOT.



## Industrial devices data collection

SD memory card interface

### Logging function

GOT manages the data of all connected industrial devices. The data can be collected at any arbitrary timing and can be used for data analysis and feedback.

Point

Logged data can be displayed on the GOT as a graph, so status change such as temperature change can be understood in a single glance.

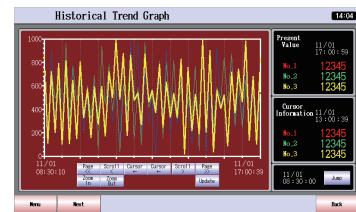
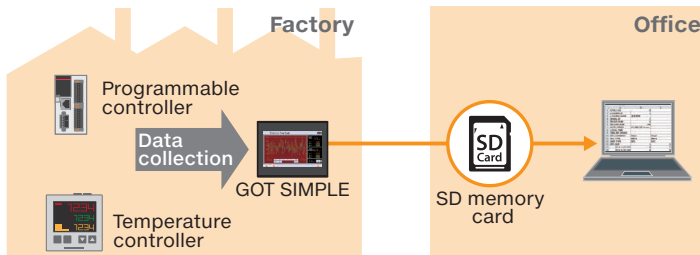

Historical trend graph display

Date	No. 1	No. 2	No. 3	No. 4
2014/07/01 11:30:00	12345	12345	12345	12345
2014/07/01 17:30:00	12345	12345	12345	12345
2014/07/01 11:30:00	12345	12345	12345	12345
2014/07/01 17:30:00	12345	12345	12345	12345
2014/07/01 11:30:00	12345	12345	12345	12345
2014/07/01 17:30:00	12345	12345	12345	12345
2014/07/01 11:30:00	12345	12345	12345	12345
2014/07/01 17:30:00	12345	12345	12345	12345
2014/07/01 11:30:00	12345	12345	12345	12345
2014/07/01 17:30:00	12345	12345	12345	12345

Historical data list display

## Recommended

### Backup important programs

SD memory card interface

#### Backup/Restoration function

Sequence programs can be replaced even without a personal computer. When the programs and parameters are backed up to GOT\*1, the data and machine operation can instantly be restored even if an unexpected failure occurs.



\*1 A separate SD memory card is required.

\*2 The target connection devices are QCPU, LCPU, FX5CPU and FXCPU.

For the details of connectable devices, please refer to the GOT2000 Series User's Manual (Monitor).



**Useful**

**Setup and modification on-site**



**FA transparent function**

Set up and modify devices without changing cable connections.

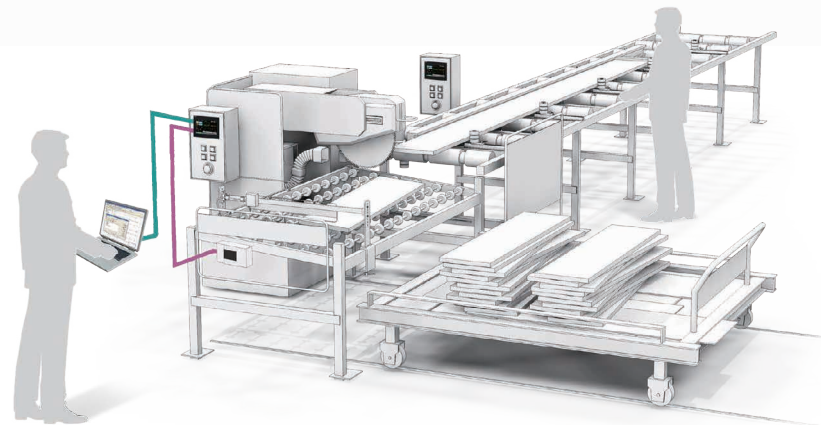

The GOT acts as a transparent gateway to enable programming, start up, and adjustment of Mitsubishi Electric industrial devices.

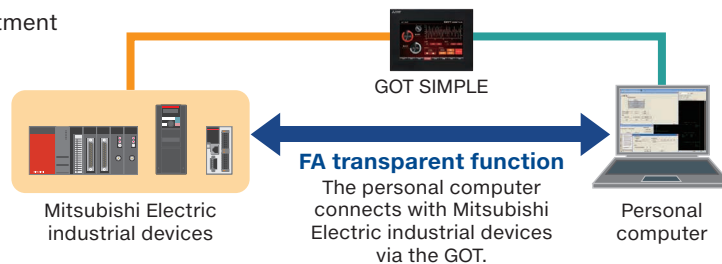

Reduce design, setup, and maintenance cost

**Remote maintenance**



**Ethernet connection**

Office personal computer can connect to GOT on the factory floor for maintenance via Ethernet.

With Ethernet, it is possible to connect a system of mixed vendors and models, expanding the possibilities at the factory floor.

In addition, Ethernet printers\*1 are supported so that the data (such as reports and screen images) can be printed by an Ethernet printer on the network, thus reducing hardware cost.



[Connection example]

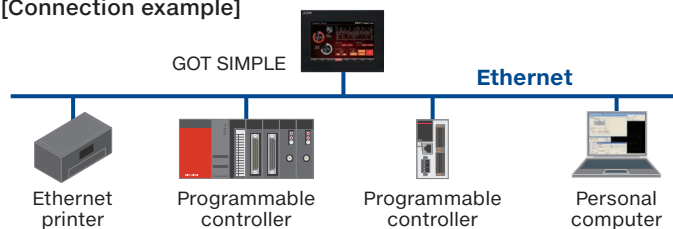

\*1 For the connectable printers, please refer to the Technical Bulletin "List of Valid Devices Applicable for GOT2000 Series and GOT SIMPLE Series for Overseas" (GOT-A-0160).

## Use GOT SIMPLE to control industrial devices

### Multi-channel function

GOT supports various industrial devices and connection types. With the multi-channel function, two channels of industrial devices can be monitored on a single GOT.

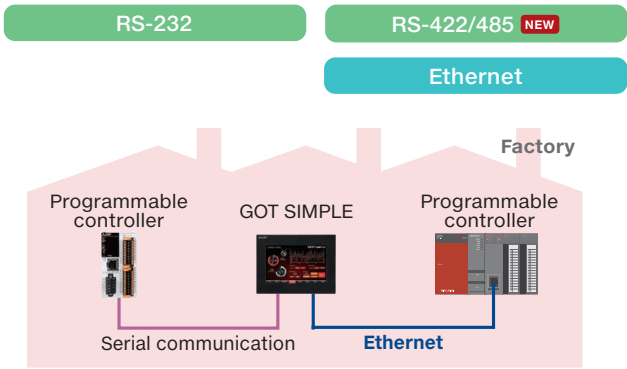

## Easily collect data from connected devices

### Device data transfer function

Using GT Works3, simply set source devices, destination devices, and triggers and you can transfer data between industrial devices. Data on the connected devices can be collected in the programmable controller without a sequence program.

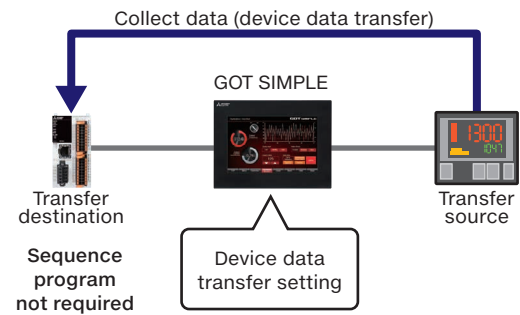

## MODBUS® communication also supported

### MODBUS® communication

As a master station, GOT can communicate with a MODBUS®/RTU slave device. Up to 31 devices (RS-485) can be connected for monitoring of production line, etc.

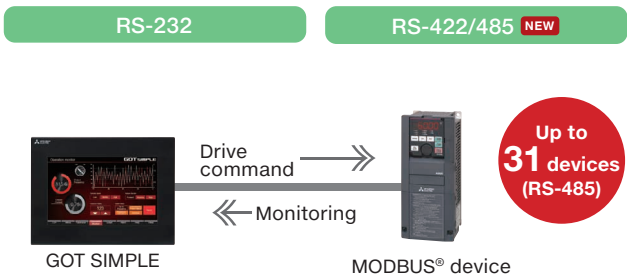

## Simple, easy-to-understand setup

### Recipe function & recipe display (record list)

GOT saves the recipe information (device values) such as material blend and machine conditions. You can change the recipe on the GOT and write it to a programmable controller to quickly perform the changeover. Changing recipes (changeover) is easy on a user-created screen or on the utility screen. The users can easily create screens by using the recipe display (record list).

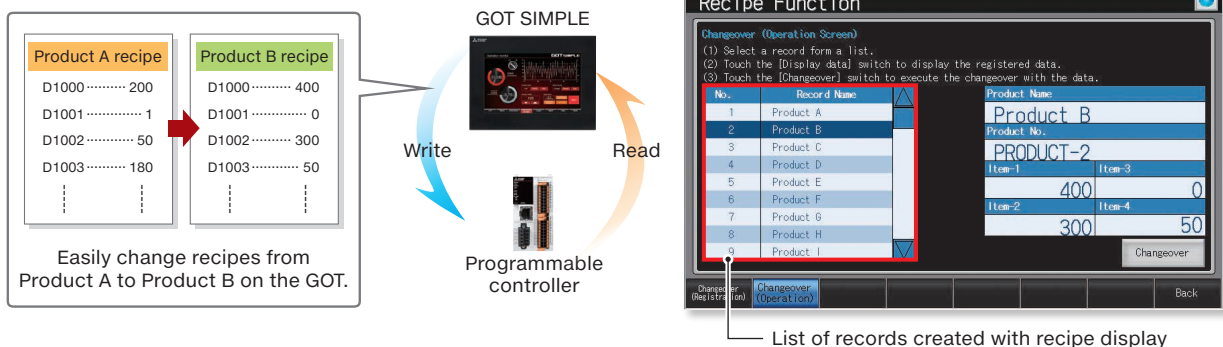



## Display industrial devices alarms

### Alarm function

Use the GOT to display and check alarms set by the users. Alarms of the connected device can be monitored and the equipment status can be checked. When a problem occurs, you can quickly troubleshoot the problem.

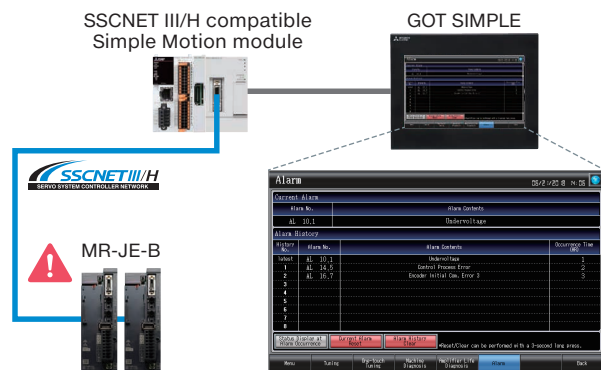

## Increase efficiency of maintenance work

### Reading/writing resource data

The GOT resource data can be read out to the personal computer, corrected, and then written back\*1. The efficiency of maintenance work is enhanced as there is no need to exchange data with an SD memory card.

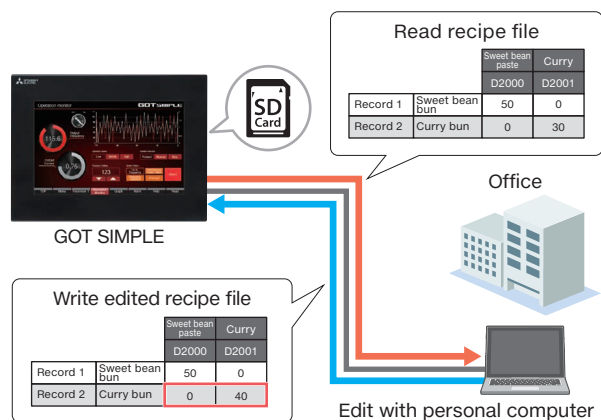

\*1 For the details on resource data that can be read and written, please refer to the GT Designer3 (GOT2000) Screen Design Manual.

## Recommended

## Monitor device value and set values for timer, etc.

### Device monitor function

Monitor and change internal device ON/OFF status, word values, timer and counter values of connected devices such as MELSEC programmable controllers.

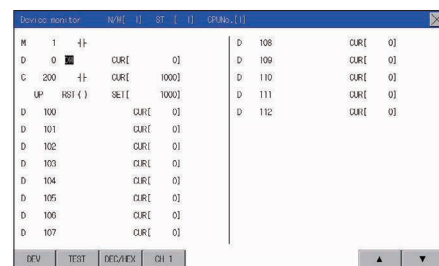

## Program change without a personal computer on-site

### MELSEC FX list editor

With the GOT, sequence programs of FX Series programmable controllers\*1 can be edited in the list format. Convenient for minor on-site program changes.

\*1 FX5CPU is not supported. For the details of connectable devices, please refer to the GOT2000 Series User's Manual (Monitor).

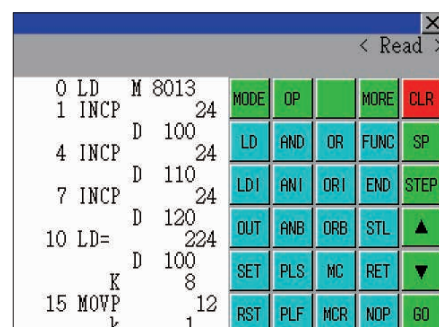

# Add value to your installation and machine

## Security with password management

### Operator authentication function

Setting the operation authority and the viewing authority per operator achieves “enhanced security” and “prevention of improper operation”. Operator authentication can be performed at startup and when the screen is switched.

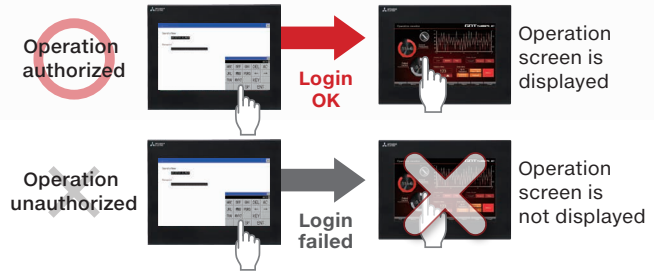

## Reduce risk of unauthorized access through network

Ethernet

### IP filter function

Registering the IP address of the device which can access the GOT restricts the access from unauthorized devices.

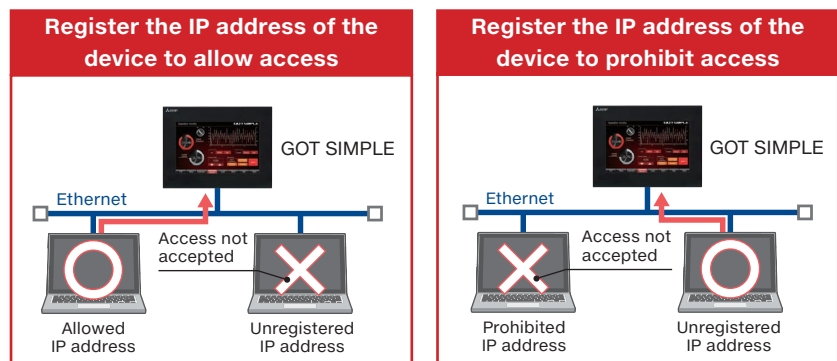

## Easily exchange data with FTP

Ethernet

### File transfer function

By using GOT, production results and alarm logs can be stored in an SD memory card of the GOT (FTP client) and sent to a personal computer (FTP server). The GOT can also receive the production instruction data from the personal computer.

By using the GOT as an FTP server, files can be read to and written from the personal computer that acts as an FTP client. (FTP server function)

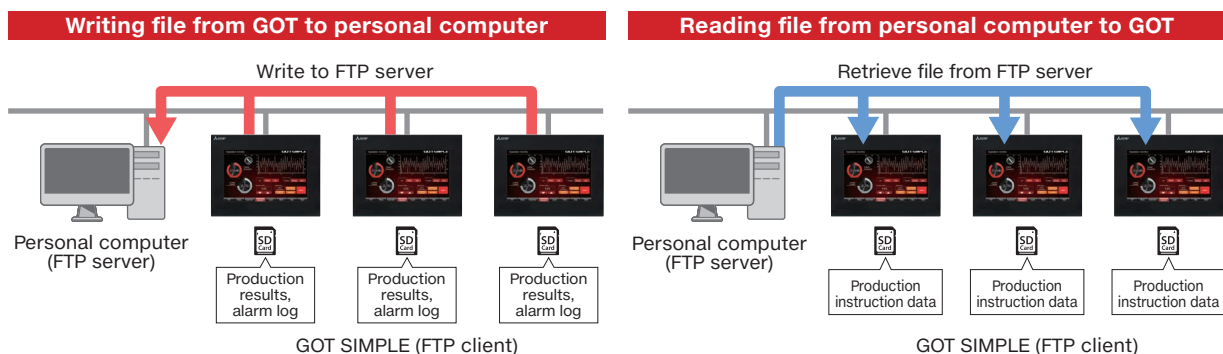



## Setting multiple functions with one switch

### Multi-action switch function

Multiple functions can be set to one switch, so there is no need for multiple switches for separate functions. By setting execution sequence and conditions, delay, repeat, interlock settings can be combined, reducing the burden of programmable controller programming.

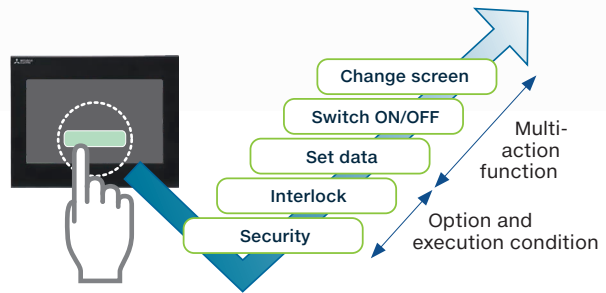

## Language change according to country of the operator

### Language switching

Screen can be easily made for switching between Japanese, Chinese, English, etc. 30 languages can be set for each comment. Screens, not only languages, can be switched based on purpose.

Column No.	Japan	China(GB)-Mincho	Japan
Comment No. (DEC)	1 Japanese	2 Chinese	3 English
113	言語切り換え	语言切换	Language switching
114	日本語	日语	Japanese
115	中国語	汉语	Chinese
116	英語	英语	English

## Easily installed on compact equipment

### Vertical display

By using a GOT vertically, it can be easily installed on compact equipment and can neatly display vertical letters. Less scrolling is needed when displaying lists.



## Saving energy when operator is not present

### Screen saver function

Screen save time can be set from 1 to 60 minutes. By setting the backlight ON/OFF, energy can be saved when no operator is present. Programmable controller can also control the ON/OFF status, so the backlight will turn ON and alarm screen will display when an alarm occurs.

# Streamlined screen design

## Pick and place intuitive screen design is easy even for beginners

Using parts is simple. Just select a part and place on the screen! Design your screen with intuitive pick and place operation.

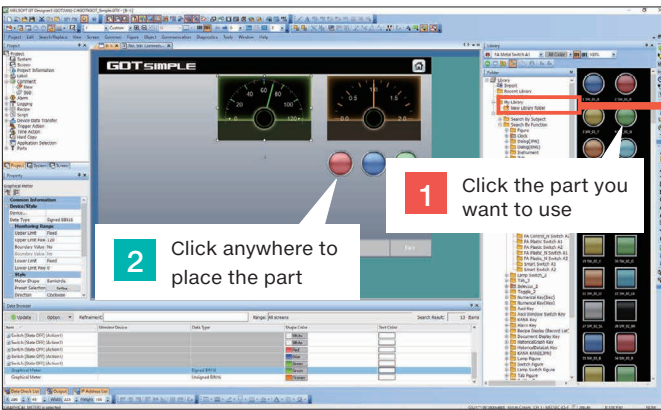

Reduce design time by registering frequently used parts to 'My Favorites' or 'My Library'. Import/export is also possible.

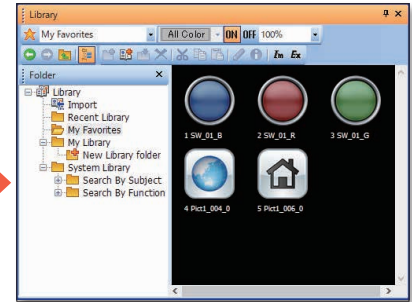

## Utilize the past assets and sample screens

Individual screens can be utilized from past projects and sample projects. Select the screens to utilize, then drag and drop to launch the utilization wizard.

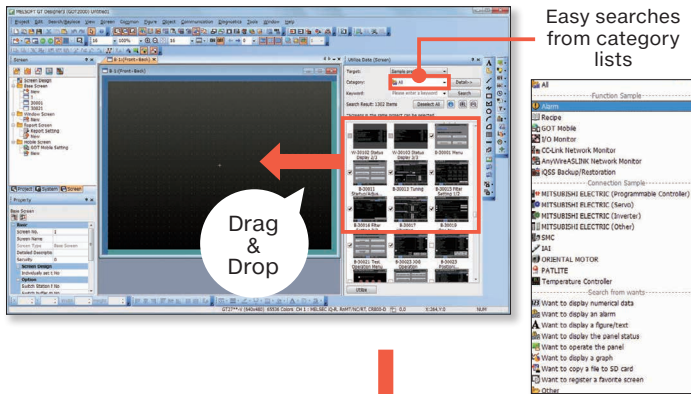

### Utilization wizard

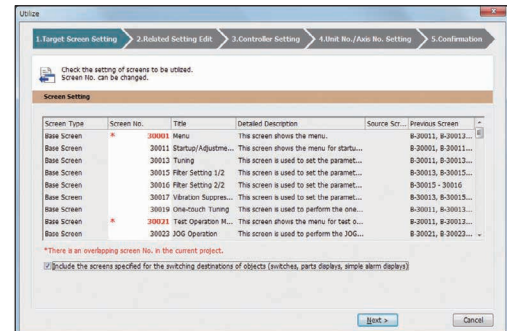

Simple step navigation. Settings related to target screen (comment group, logging, scripts, etc.) can also be utilized.

Streamlined screen design



# GOT Screen Design Software MELSOFT GT Works3

## Easily create stylish meters with a graphical meter

Just select a meter from the preset list and you can create stylish, clear meters. The position and angle of scales can be adjusted by mouse operation and the shape and design can be changed easily. Warning color display indicates the machine status clearly.

Select from the toolbar

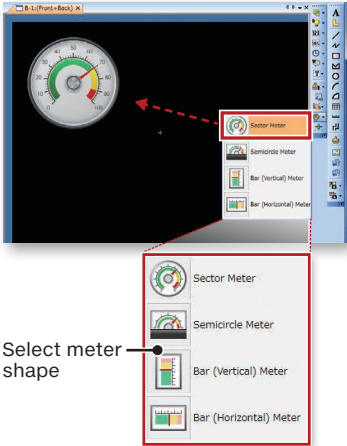

Select from the preset list



Easy to adjust settings by mouse operation

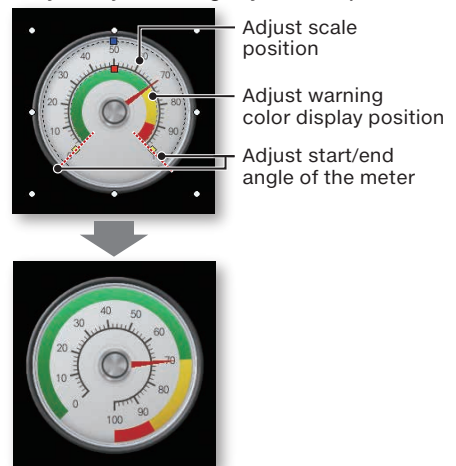

## More beautiful graphics

With GOT Graphic Ver.2, you can select the required screen design and change it in a batch. Gradation drawing and transparency setting can be performed.

Screen design list



Gradation background and transparency setting of the window screen

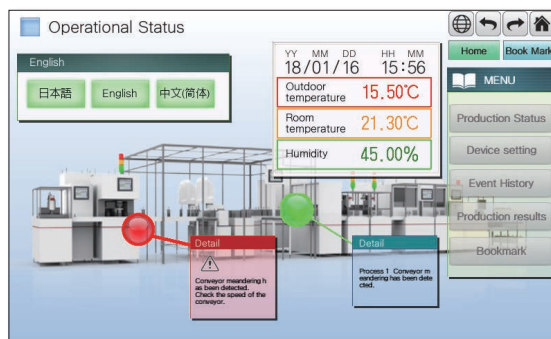

# Mitsubishi Electric Industrial Devices

## GOT SIMPLE Solutions

Using Mitsubishi Electric industrial devices together provides ideal, simple solutions that enhance efficiency and reduce production costs.

### 01 Material handling

### 02 Production



Recommended for simple control!



GOT SIMPLE



FR-D700

Recommended for simple positioning control!



GOT SIMPLE



MR-JE-A



**Recommended for smooth drive control!**



**GOT SIMPLE**



**FX5 CPU module (FX5U(C)/FX5UJ) + Simple Motion module (FX5-40SSC-S/FX5-80SSC-S)**



**MR-JE-B**

# 03 Packaging

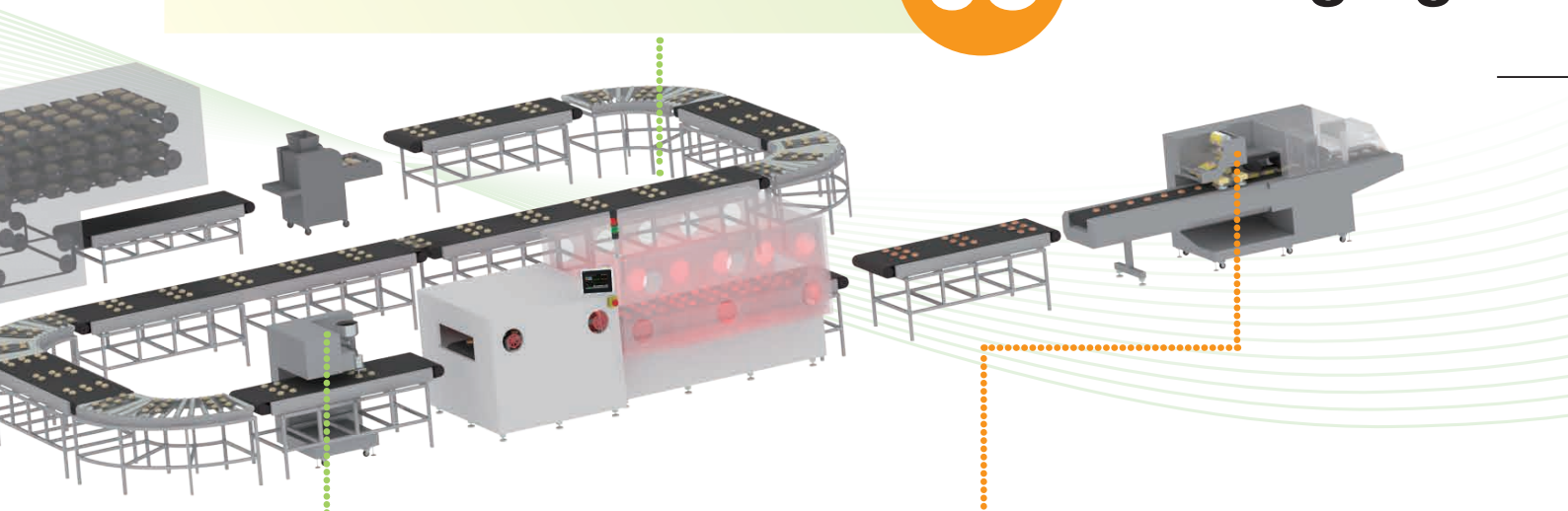

**Recommended for easy automation!**



**GOT SIMPLE**



**FX5 CPU module (FX5U(C)/FX5UJ)**



**FR-D700**

**Recommended for building networks!**



**GOT SIMPLE**



**FX5 CPU module (FX5U(C)/FX5UJ)**



**MR-JE-C**



# 01

## Material handling

# Easy and simple control with inverters

GOT SIMPLE

FR-D700



RS-485 communication

Point

Issue operation commands to inverter from the GOT.

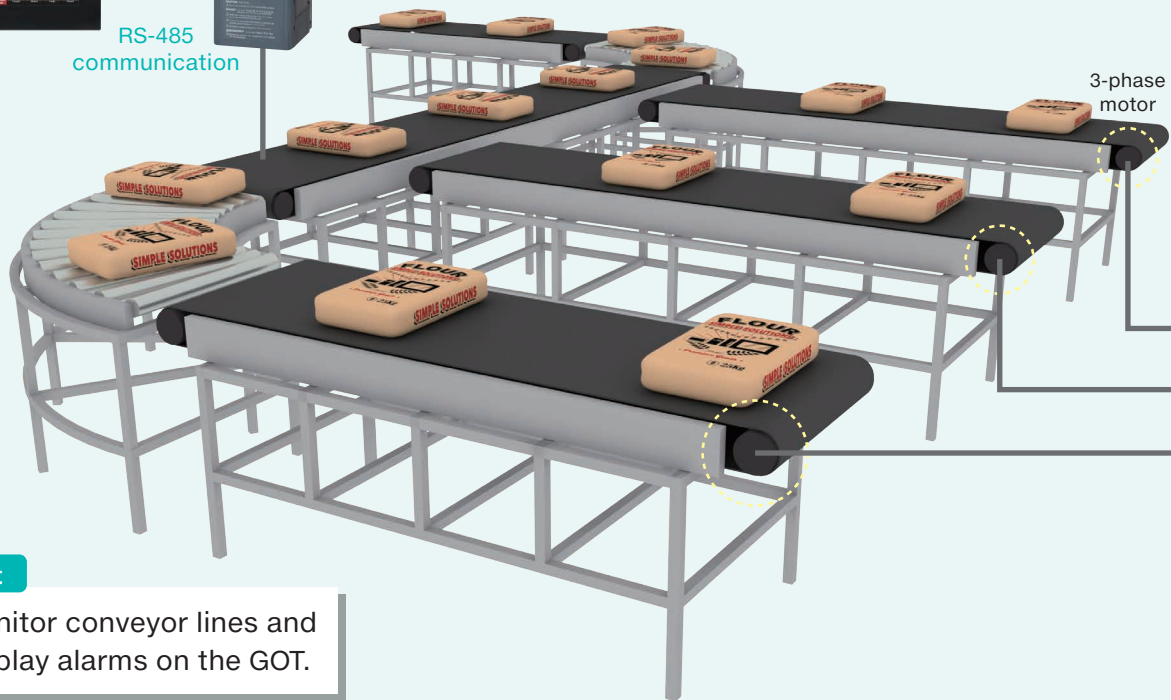

Point

Monitor conveyor lines and display alarms on the GOT.

## Recommended functions for each application

FR-D700

### General-purpose magnetic flux vector control

General-purpose magnetic flux vector control and auto tuning functions are available. These functions ensure the applications that require high starting torque, such as washing machines, agitators, and transfer machines including conveyors, hoists, and elevators.

- High torque of 150%/1 Hz is realized (when the slip compensation function is valid).

- Auto tuning

With our “non-rotation” auto tuning function the motor constant (R1) can be automatically calculated.

### Communication operation (RS-485 communication)

Conveyor belts can be controlled individually by using multiple inverters. Automatic operation is possible by collectively managing multiple inverters.

### S-pattern acceleration/deceleration

An S-pattern is maintained from the present frequency to the target frequency; therefore it is possible to reduce shock during acceleration/deceleration and prevent load shifts.

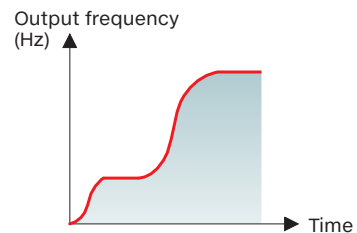



Recommended for simple control!

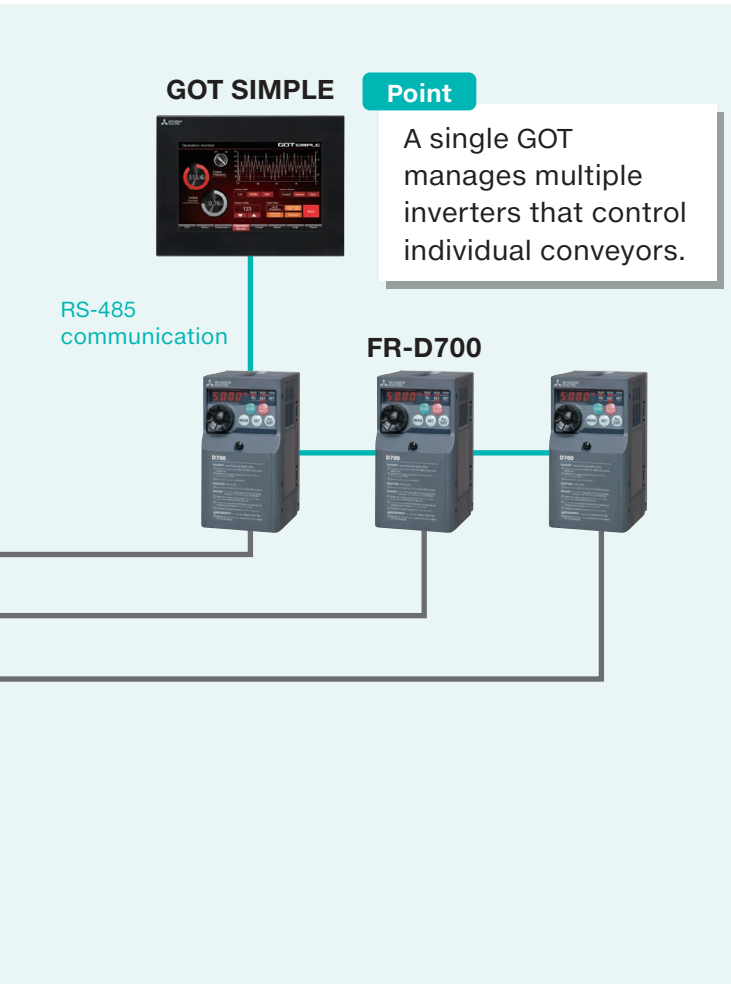

Inverter  
**FR-D700**



## Application examples

### Spinning



**Recommended function: Traverse function**  
The traverse function, used for the traverse axis of spinning machine, prevents uneven winding or collapsing.

### Fan and pump



**Recommended function: PID function**  
Flow rate and air volume is controlled by an inverter. It is possible to regulate flow rate and air volume so that they stay at a pre-set level.

# 02

## Production 1

## Simple positioning control with

### Molding

MR-JE-A

RS-485 communication

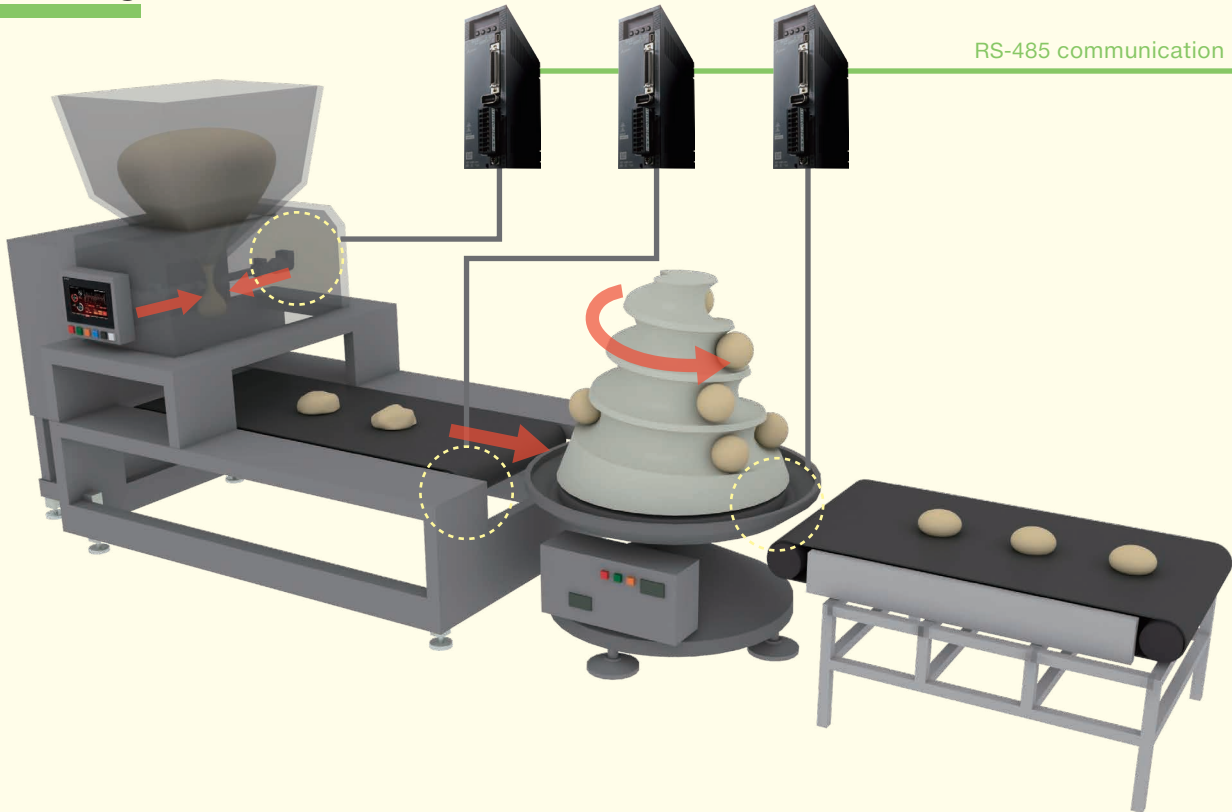

Mitsubishi Electric Industrial Devices  
GOT-SIMPLE Solutions



## Recommended functions for each application

MR-JE-A

### Simple cam function

Smooth conveyance and stopping are realized by cam control based on cam data. Cam operations include linear motion, reciprocating motions, which can be selected according to your application.

**+** MR Configurator2  
Various patterns of cam data can be created easily.

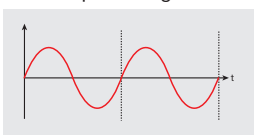
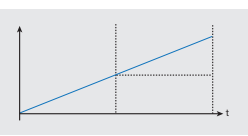
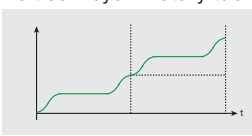
Reciprocating motion	Linear motion	Feeding motion
 Reciprocating cam	 Ball screw Rotary table	 Belt conveyor Rotary table
		
Reciprocating cam motion within a cam stroke range	Linear cam motion by one cycle	Cam motion which resets a cam reference position per cycle

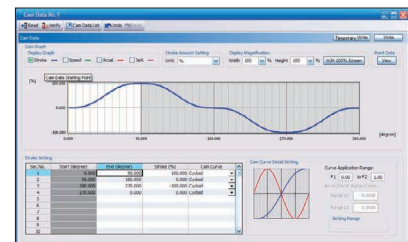

MR Configurator2  
Simple cam setting window

# GOT and servo

## GOT SIMPLE



### Point

Positioning function is built-in MR-JE-A. Directly connect to the GOT, and perform positioning and adjustments.



### FX5 CPU module (FX5U(C))\*1

FX5 CPU module (FX5U(C)) has built-in high-speed I/O, and up to four MR-JE-A AC servos can be connected!

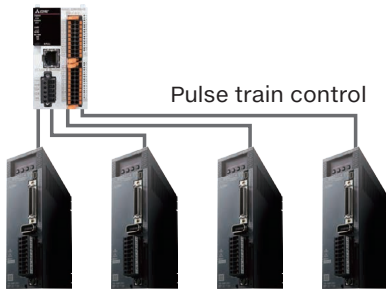

\*1 Up to three MR-JE-A AC servos can be connected to FX5UJ.

Recommended for simple positioning control!

## GOT SIMPLE



## AC Servo MELSERVO-JE MR-JE-A



## Application examples

### Rotary knife

#### Recommended function: Current position latch function and interrupt positioning function

The actual position of the servo motor can be obtained based on the inputs from the sensor that detects the registration marks printed on the high-speed moving film. The servo amplifier calculates compensation amounts and corrects position errors of the rotary knife axis based on those inputs from the sensor so that the film can be cut at the set position.

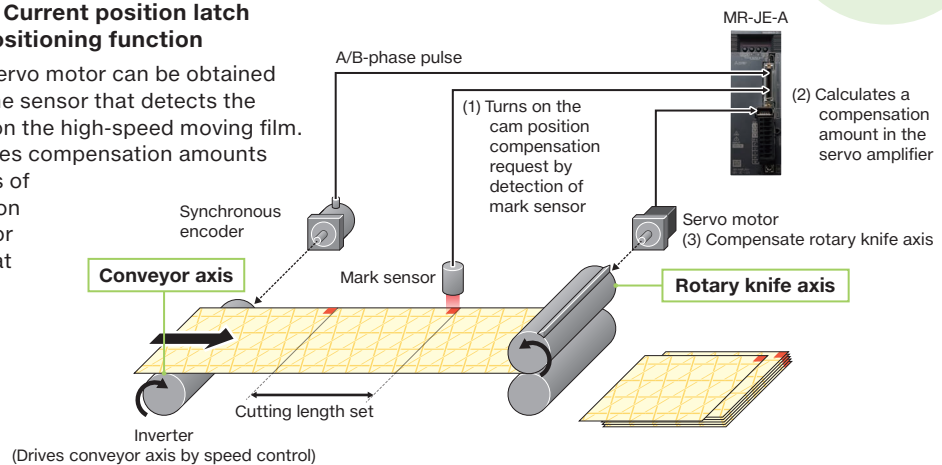

## Filling machine

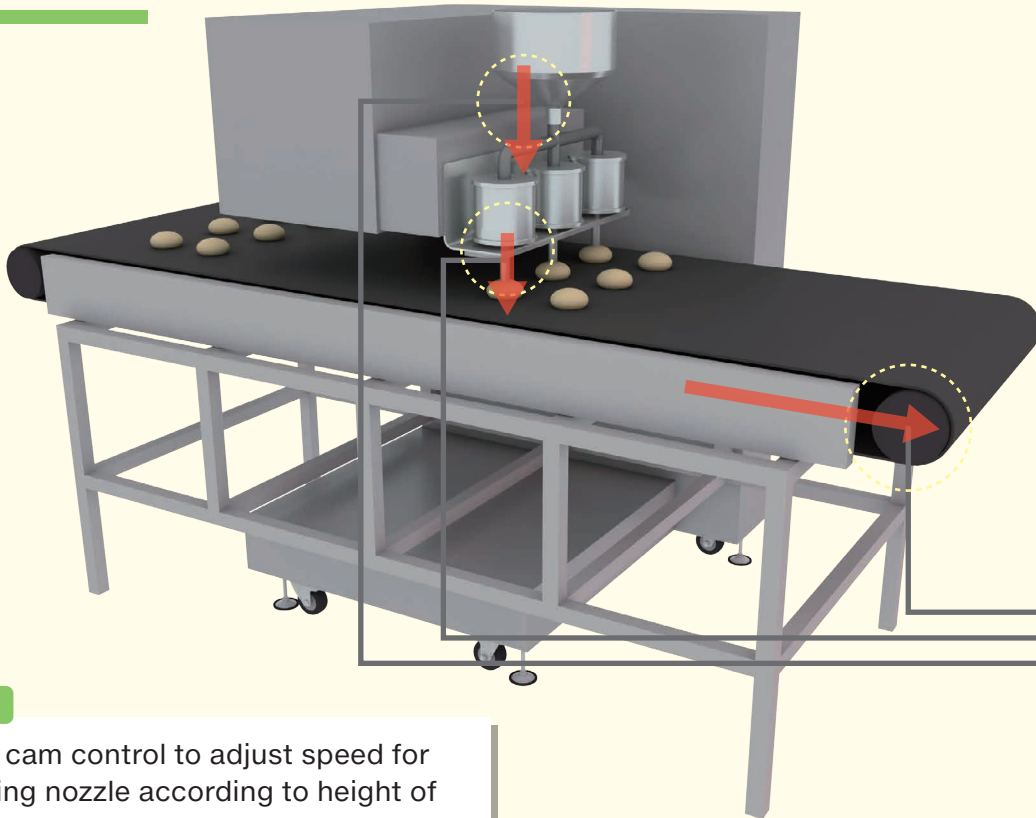

### Point

Use cam control to adjust speed for raising nozzle according to height of the work piece being filled.

## Recommended functions for each application

FX5 CPU module + Simple Motion module + MR-JE-B

### Position, speed, torque control

Smoothly change to torque control mode from position/speed control mode without a stop or a sudden change in speed and torque, and thus reduce load to a machine. This function is ideal for applications where control switches from position to torque such as tightening and press-fit control or insertion of a work piece, and cap or screw tightening.

### Deterministic and synchronized communication

Complete deterministic and synchronized communication is achieved with SSCNET III/H, offering technical advantages in machines such as printing and food processing machines that require synchronous accuracy.

### Synchronous control without program

Just set parameters using software to easily realize synchronous control instead of controlling mechanical with physical gears, shafts, speed change gears or cams.

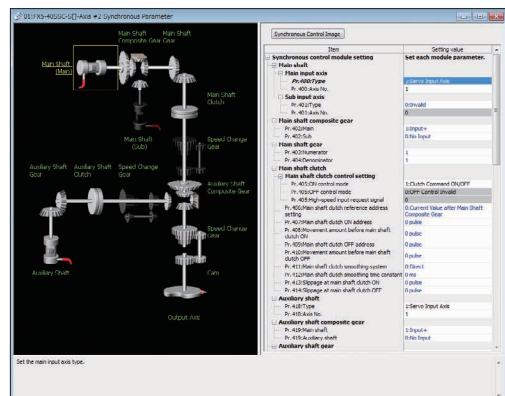



# Motion and servo

Recommended for smooth drive control!

FX5 CPU module (FX5U(C)/FX5UJ) + Simple Motion module\*1 (FX5-40SSC-S/FX5-80SSC-S) GOT SIMPLE

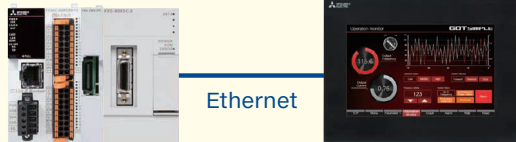

SSCNET III/H SERVO SYSTEM CONTROLLER NETWORK

MR-JE-B



GOT SIMPLE

+

Point

Compatible with fiber optic network "SSCNET III/H", which accelerates system responsiveness.

\*1 Connection with FX5UC requires FX5-CNV-IFC or FX5-C1PS-5V.



Programmable Controller MELSEC iQ-F Series  
**FX5 CPU module (FX5U(C)/FX5UJ) + Simple Motion module\*1 (FX5-40SSC-S/FX5-80SSC-S)**



AC Servo MELSERVO-JE  
**MR-JE-B**

## Application examples — FX5 CPU module + Simple Motion module +

MR-JE-B is an ideal choice

### Unwinders and rewinders



SSCNET III/H allows configuration of a multi-axis synchronous control system even for unwinders and rewinders with multiple axes. For machines with a machining axis, further high-level synchronous control system is possible by using cam control and advanced synchronous control.

### Simplified machine tools



In positioning operation of XY table, the workpiece can be processed with high quality by using machine resonance suppression filter that suppresses machine vibration and lost motion compensation function that suppresses quadrant protrusion.

# 02

## Production 3

# Connectivity with Mitsubishi Electric

Mitsubishi Electric Industrial Devices  
GOT-SIMPLE Solutions

### Oven

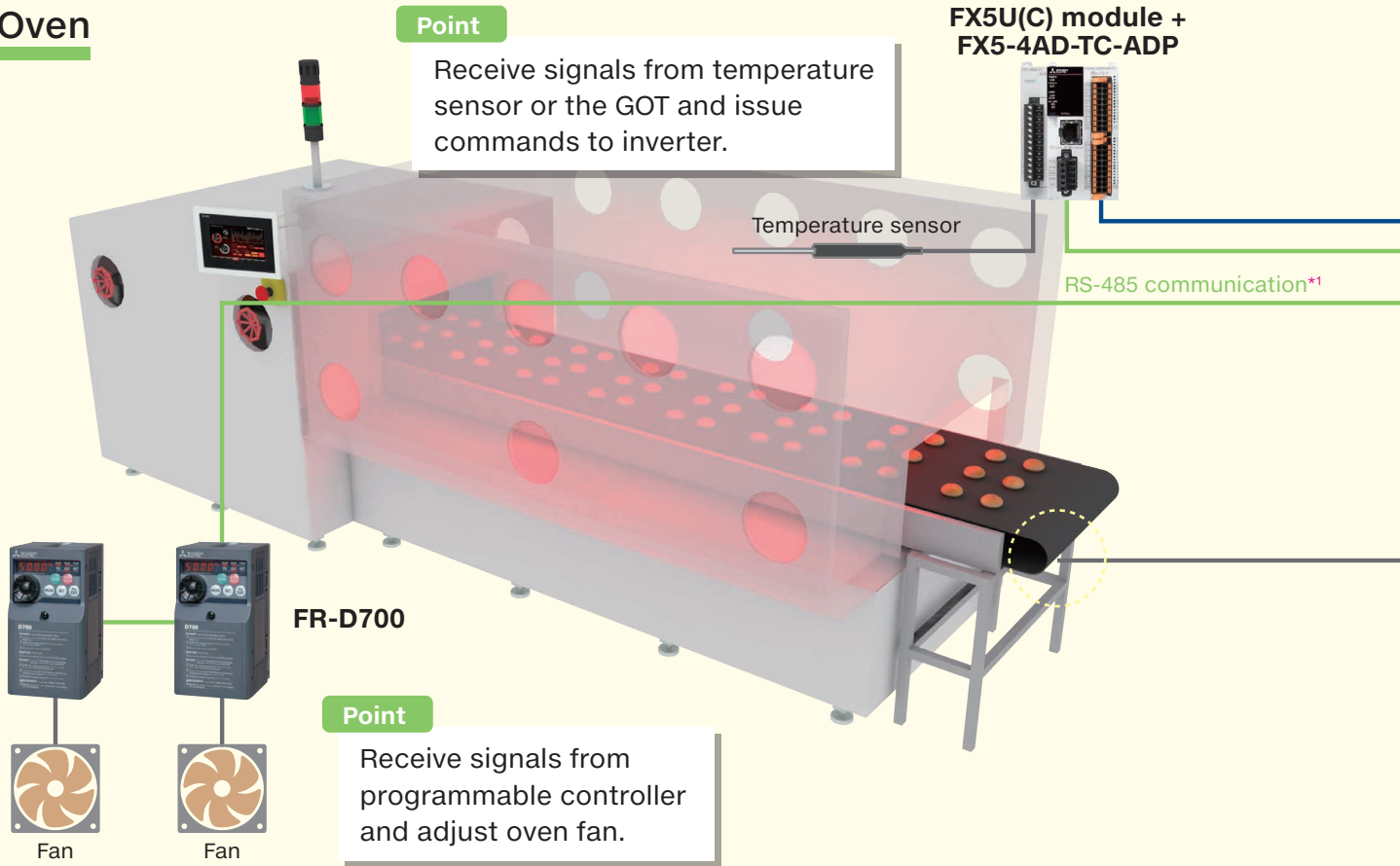

## Recommended functions for each application

### Optimum excitation control FR-D700

This control enables the motor to perform with optimum efficiency. More energy saving is possible in applications with variable load torque characteristic such as fan and pump.

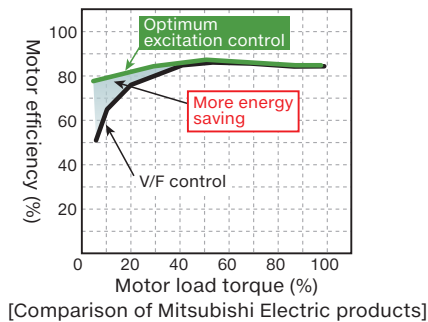

### Inverter communication commands FX5 CPU

Dedicated instructions for Mitsubishi Electric inverter protocol and communication control are built in FX5 CPU module (FX5U(C)/FX5UJ). Connecting an inverter enables simple control of inverter.

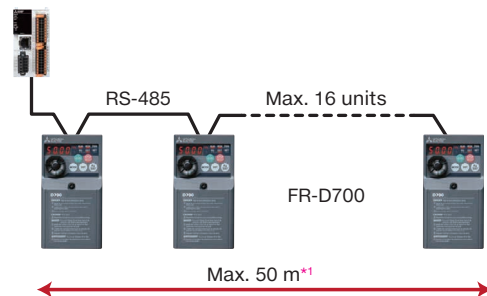

\*1 For built-in RS-485 port. 1200 m when configured with FX5-485ADP.

# industrial devices for easy automation

Recommended for easy automation!

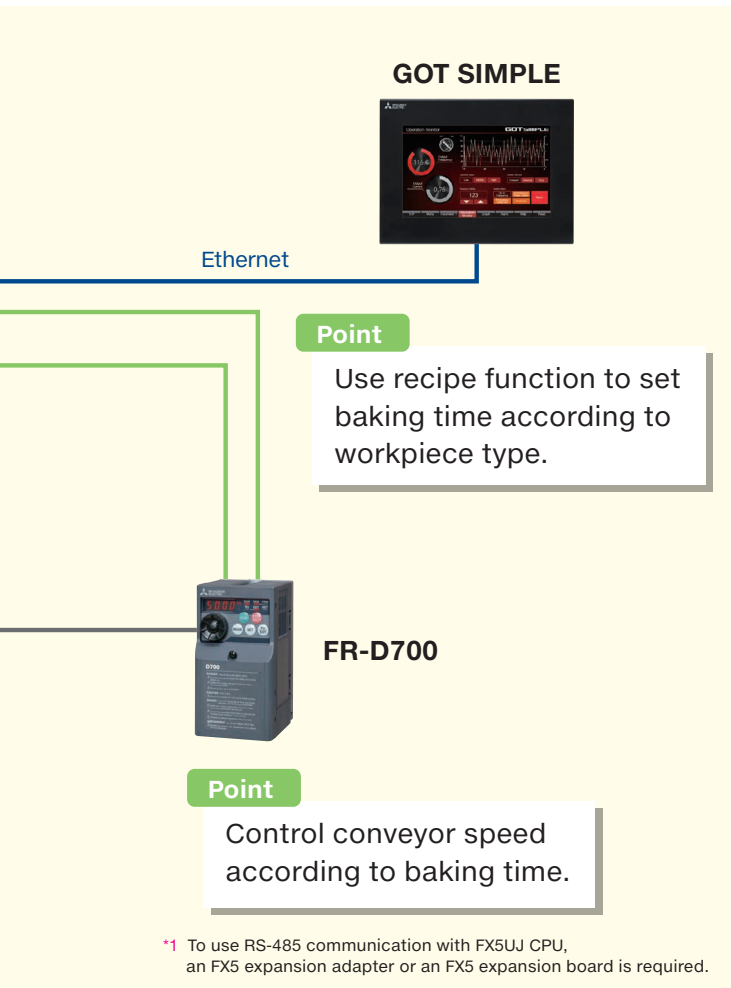

Programmable Controller  
MELSEC iQ-F Series  
**FX5 CPU module**  
(FX5U(C)/FX5UJ)



Inverter  
**FR-D700**

\*1 To use RS-485 communication with FX5UJ CPU, an FX5 expansion adapter or an FX5 expansion board is required.

Mitsubishi Electric Industrial Devices  
GOT-SIMPLE Solutions

## Application examples

### Fountain



**Recommended functions: General-purpose magnetic flux vector control, brake transistor built-in connection**

A variety of fountain displays are possible by connecting a brake resistor which allows high starting torque and improved braking efficiency during deceleration under general-purpose magnetic flux vector control.

### Mixing



**Recommended function: Analog I/O (with alarm output) control**

The FX5U CPU module is equipped with analog input and analog output. No program is required; just set the parameters to start using it.

# 03 Packaging

## Easily build a network with

Mitsubishi Electric Industrial Devices  
GOT-SIMPLE Solutions

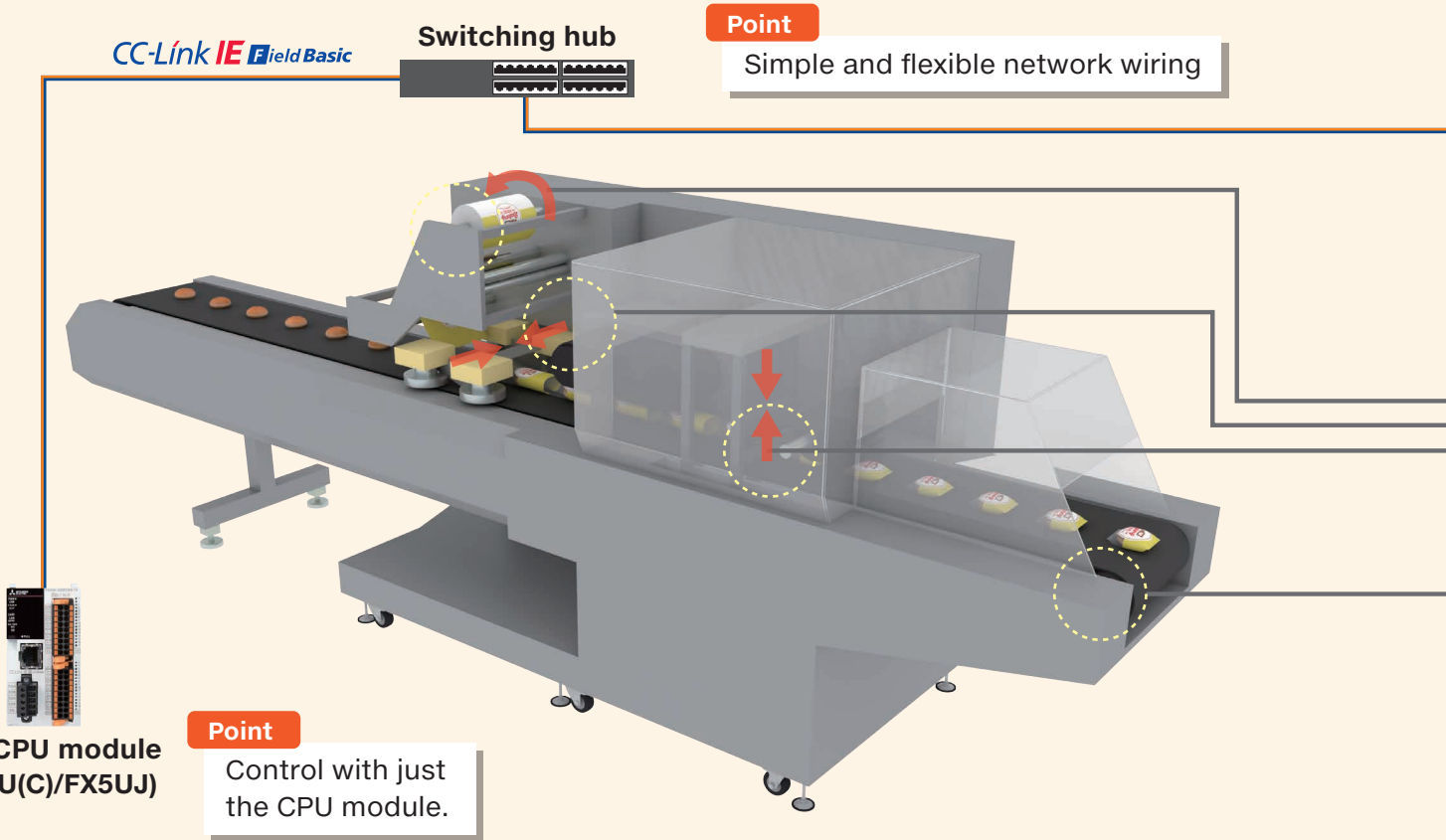

## Recommended functions for each application

MR-JE-C

### Point table method

Perform positioning operation with the point table method or the indexer method. With the point table method, just set the point table No. and turn on the start signal, and then the positioning operation will start. A continuous operation of the next point table is also possible without stopping. In the indexer method, the travel amount is automatically calculated based on the number of stations set in the parameter.

<MR-JE Series servo amplifier lineup\*1>

●: Compatible —: Not compatible

Model	Command interface					
	SSCNET III/H	CC-Link IE Field Basic	MODBUS®/TCP	MODBUS®/RTU	Pulse train	Analog voltage
MR-JE-C	—	●	●	●	●	●
MR-JE-B	●	—	—	—	—	—
MR-JE-A	—	—	—	●	●	●

\*1 Functions compatible with the latest servo amplifier version are listed (as of July 2019). For the details on function compatibility according to the version, please refer to the relevant product manual.



# Mitsubishi Electric AC Servo

Recommended for building networks!

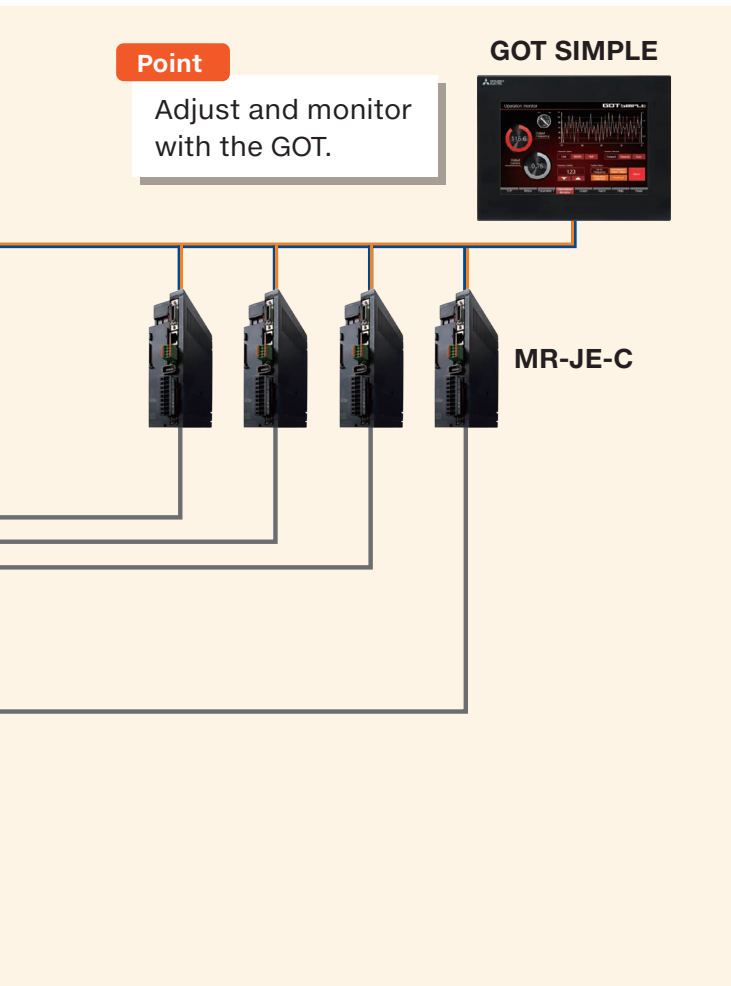

Programmable Controller  
MELSEC iQ-F Series  
**FX5 CPU module**  
(FX5U(C)/FX5UJ)



AC Servo  
MELSERVO-JE  
**MR-JE-C**



## Application examples

### Packaging



Simple synchronous operations including horizontal, vertical, and rotational movements are possible with a start signal to all axes via cyclic transmission. This function can be used to easily build a multi-axis system for packaging, etc.

### Machining center

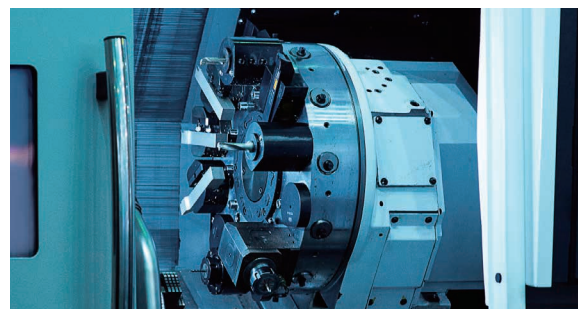

#### Recommended function: Indexer method

Positioning operation is performed by specifying equally divided stations (up to 255 stations). The travel distance is calculated automatically based on the number of stations and the number of gear teeth on the motor and machine sides set in parameters.

# Function list

Category	Function name	Necessary devices <sup>*1</sup>	GT27	GT25	GT25 Wide	GT25 Handy	
Hardware specifications	Screen size						
		15"	●	—	—	—	
		12.1"	●	●	—	—	
		10.4"	●	●	—	—	
		10.1" Wide	—	—	●	—	
		10" Wide	—	—	—	—	
		8.4"	●	●	—	—	
		7" Wide	—	—	●	—	
		6.5"	—	—	—	●	
		5.7"	●	●	—	●	
		4.3"	—	—	—	—	
		3.8"	—	—	—	—	
		Resolution					
		WXGA 1280×800	—	—	●	—	
		XGA 1024×768	●	—	—	—	
		SVGA 800×600	—	●	—	—	
		WVGA 800×480	—	—	●	—	
		VGA 640×480	●	●	—	●	
		Other	—	—	—	—	
	Color						
	65536 colors	●	●	●	●		
	Monochrome (black/white) 32 shade grayscale	—	—	—	—		
	Touch panel simultaneous press (2 points)	●	—	—	—		
	Human sensor	● <sup>*10</sup>	—	—	—		
	Memory						
	Memory for storage (ROM)		Other than below: 57 MB GT2705: 32 MB	32 MB	32 MB	32 MB	
	Memory for operation (RAM)		Other than below: 128 MB GT2705: 80 MB	80 MB	128 MB	80 MB	
	Interface						
	RS-232		●	●	●	●	
	RS-422/485		●	●	●	GT2505HS supports RS-422 only	
	Ethernet	(Ethernet communication unit)	2 ports by installing communication unit	2 ports by installing communication unit <sup>*12</sup>	2 ports as standard	●	
	USB host		●	●	●	●	
	USB device		●	●	●	●	
	SD memory card interface		●	●	●	●	
	Extension interface, Side interface, Wireless LAN communication unit interface	Communication units, option units	● <sup>*11</sup>	● <sup>*11*17</sup>	● <sup>*11</sup>	—	
Screen design	Figure/object functions						
		Figure	●	●	●	●	
		Logo text	●	●	●	●	
		Outline font	●	●	●	●	
		Touch switch	●	●	●	●	
		Lamp	●	●	●	●	
		Numerical display, Numerical input	●	●	●	●	
		Text display, Text input	●	●	●	●	
		Date display, Time display	(Battery)	●	●	●	●
		Comment display		●	●	●	●
		Parts display	(SD memory card or USB memory)	●	●	●	●
		Parts movement	(SD memory card or USB memory)	●	●	●	●
		Historical data list display	(SD memory card or USB memory)	●	●	●	●
		Simple alarm display		●	●	●	●
		System alarm display		●	●	●	●
		Alarm display (user)	(SD memory card or USB memory, battery)	●	●	●	●
		Alarm display (system)	(SD memory card or USB memory, battery)	●	●	●	●
		Recipe display (record list)		●	●	●	●
		Line graph		●	●	●	●
		Trend graph		●	●	●	●
		Bar graph		●	●	●	●
		Statistic bar graph		●	●	●	●
		Statistic pie graph		●	●	●	●
		Scatter graph		●	●	●	●
		Historical trend graph	(SD memory card or USB memory)	●	●	●	●
		Graphical meter		●	●	●	●
		Level		●	●	●	●
		Panelmeter		●	●	●	●
		Slider		●	●	●	●
		Document display	SD memory card	●	●	●	●
		Script parts		●	●	●	●
		Functions performed on background of GOT					
	Logging	(SD memory card or USB memory, battery)	●	●	●	●	
	Recipe	(SD memory card or USB memory, battery)	●	●	●	●	
	Device data transfer		●	●	●	●	
	Trigger action		●	●	●	●	
	Time action	(SD memory card or USB memory)	●	●	●	●	
	Hard copy	File output	(SD memory card or USB memory)	●	●	●	●
		Serial printer output		●	●	●	—
		Ethernet printer output		●	●	●	—
		PictBridge printer output	Printer unit	●	● <sup>*17</sup>	—	—
	Project script, Screen script		●	●	●	●	
	Object script		●	●	●	●	

<sup>\*1</sup> Necessary units when using GT27, GT25 wide, GT25 handy, GT25 rugged, GT21 wide, GT21, or GS21 models are shown. Parenthesized devices are required depending on conditions of use.

<sup>\*2</sup> Data is output to the printer that is recognized by the personal computer.

<sup>\*3</sup> CSV files are saved in the virtual drive of the personal computer so that it is recommended to output the files to printers.

<sup>\*4</sup> Only the GOTs with SVGA or higher resolution are supported.

<sup>\*5</sup> Remote personal computer operation function (Ethernet) cannot be used. The following screens are displayed horizontally: utility screen, monitor and data management screens that are displayed from the utility screen (sequence program monitor, etc.), video camera images in the multimedia and video display functions. For the details of other GOT operations when placed vertically, please refer to the relevant product manual or Help.

<sup>\*6</sup> Excluding GT2103-PMBS.

<sup>\*7</sup> GT2104-RTBD only.

<sup>\*8</sup> Excluding GT2705-VTBD.

<sup>\*9</sup> To use multiple units such as extension units, barcode readers, or RFID controllers with a GT2705-VTBD, the total current consumption of the units should be less than the value that the GT2705-VTBD can provide. For the details, please refer to the relevant manual of the GOT2000 Series.

<sup>\*10</sup> GT2715-XTBA, GT2715-XTBD, GT2712-STBA, GT2712-STBD, GT2712-STWA, GT2712-STWD only.

For the details of functions, supported controllers, and connection types, please refer to the relevant manual or Help of the GOT2000/GOT SIMPLE Series.

●: Supported —: Not supported

Category	Function name	Necessary devices*1	GT25 Rugged	GT21 Wide	GT21	GS21-N <b>NEW</b>	GT SoftGOT2000	
Screen size	15"		—	—	—	—	Flexible resolution 640 to 1920 x 480 to 1200	
	12.1"		—	—	—	—		
	10.4"		—	—	—	—		
	10.1" Wide		—	—	—	—		
	10" Wide		—	—	—	●		
	8.4"		—	—	—	—		
	7" Wide		●	●	—	●		
	6.5"		—	—	—	—		
	5.7"		—	—	—	—		
	4.3"		—	—	●	—		
3.8"		—	—	●	—			
Resolution	WXGA 1280x800		—	—	—	—	Flexible resolution 640 to 1920 x 480 to 1200	
	XGA 1024x768		—	—	—	—		
	SVGA 800x600		—	—	—	—		
	WVGA 800x480		●	●	—	●		
	VGA 640x480		—	—	—	—		
	Other		—	—	GT2104-R: 480x272 GT2103-P: 320x128	—		
			—	—	—	—		
Color	65536 colors		●	●	●	●	●	
	Monochrome (black/white) 32 shade grayscale		—	—	●	—	—	
	Touch panel simultaneous press (2 points)		—	—	—	—	—	
	Human sensor		—	—	—	—	—	
Memory	Memory for storage (ROM)		32 MB	15 MB	GT2104-R: 9 MB GT2103-P: 3 MB	15 MB <b>NEW</b>	57 MB	
	Memory for operation (RAM)		128 MB	—	—	—	—	
	RS-232		●	●	●*20	●	●*12	
	RS-422/485		●	●	●*20	<b>NEW</b>	●*12	
Interface	Ethernet	(Ethernet communication unit)	2 ports as standard	●	●*20	●	●*11	
	USB host		●	●	—	—	●*13	
	USB device		●	●	●	●	—	
	SD memory card interface		●	●	●*14	●	●*13	
	Extension interface, Side interface, Wireless LAN communication unit interface	Communication units, option units	●*11	—	—	—	●*11	
		Figure	●	●	●	●	●	
		Logo text	●	●	●	●	●	
Screen design	Outline font		●	●	—	<b>NEW</b>	●	
	Touch switch		●	●	●	●	●	
	Lamp		●	●	●	●	●	
	Numerical display, Numerical input		●	●	●	●	●	
	Text display, Text input		●	●	●	●	●	
	Date display, Time display	(Battery)	●	●	●	●	●	
	Comment display		●	●	●	●	●	
	Parts display	(SD memory card or USB memory)	●	●	●*16	●	●	
	Parts movement	(SD memory card or USB memory)	●	●	●*16	●	●	
	Historical data list display	(SD memory card or USB memory)	●	●	●*16	●	●	
	Simple alarm display		●	●	●	●	●	
	System alarm display		●	—	—	—	●	
	Alarm display (user)	(SD memory card or USB memory, battery)	●	●	●*16	●	●	
	Alarm display (system)	(SD memory card or USB memory, battery)	●	—	—	—	●	
	Recipe display (record list)		●	●	●	●	●	
	Line graph		●	●	●	●	●	
	Trend graph		●	●	●	●	●	
	Bar graph		●	●	●	●	●	
	Statistic bar graph		●	●	●	●	●	
	Statistic pie graph		●	●	●	●	●	
	Scatter graph		●	●	●	●	●	
	Historical trend graph	(SD memory card or USB memory)	●	●	●*16	●	●	
	Graphical meter		●	●	●	●	●	
	Level		●	●	●	●	●	
	Panelmeter		●	●	●	●	●	
	Slider		●	●	●	●	●	
	Document display	SD memory card	●	—	—	—	●	
	Script parts		●	●	●	●	●	
	Functions performed on background of GOT	Logging	(SD memory card or USB memory, battery)	●	●	●*6	●	●
		Recipe	(SD memory card or USB memory, battery)	●	●	●*16	●	●
Device data transfer			●	●	●	●	●	
Trigger action			●	●	●	●	●	
Time action		(SD memory card or USB memory)	●	●	●	●	●	
Hard copy		File output	(SD memory card or USB memory)	●	●	●*6	●	●
		Serial printer output		●	●	●*6	●	●*2
		Ethernet printer output		●	●	●*15	●	—
		PictBridge printer output	Printer unit	—	—	—	—	●*2
		Project script, Screen script		●	●	●	●	
	Object script		●	—	—	●		

\*11 For the applicable communication units and option units, please refer to the relevant product manual.

\*12 Use the standard interface of the personal computer.

\*13 When using functions that require a USB memory or SD memory card, a virtual drive in the personal computer is used.

\*14 GT2103-PMBD, GT2103-PMBDS, and GT2103-PMBDS2 require an SD memory card unit (GT21-03SDCD) separately. GT2103-PMBLS does not allow for SD memory cards.

\*15 GT2104-RTBD, GT2103-PMBD only.

\*16 On GT2103-PMBLS, only the functions that do not require SD memory card can be used.

\*17 Excluding GT2505-VTBD.

\*18 GT25 wide and GT25 rugged models have a built-in sound output interface so that the sound output unit is not required.

\*19 GT2505HS-VTBD supports the function with Ethernet connection only.

\*20 GT21 has different interfaces depending on the model. For the details, please refer to the relevant product manual.

\*21 Only Ethernet, OPC UA client, and microcomputer connections are supported.

For the details of functions, supported controllers, and connection types, please refer to the relevant manual or Help of the GOT2000/GOT SIMPLE Series.  
 ●: Supported –: Not supported

Category	Function name	Necessary devices*1	GT27	GT25	GT25 Wide	GT25 Handy	
Screen design	Barcode function		●	●	●	–	
	RFID function		●	●	●	–	
	GOT Mobile function	License, (SD memory card)	●	●	●	●	
	VNC server function	License	●	●	●	●	
	Remote personal computer operation function (Ethernet)	License	●	●	●	●	
	Remote personal computer operation function (serial)	RGB input unit or Video/RGB input unit	●*8	–	–	–	
	Video display function	Video input unit or Video/RGB input unit	●*8	–	–	–	
	RGB display function	RGB input unit or Video/RGB input unit	●*8	–	–	–	
	Multimedia function	Multimedia unit, CF card	●*8	–	–	–	
	External I/O function	External I/O unit	●	●*17	–	–	
	Operation panel function	External I/O unit	●	●*17	–	–	
	Video output function	HDMI output	Digital video output unit	●*8	–	–	–
		RGB output	RGB output unit	●*8	–	–	–
	Report function	File output	(SD memory card or USB memory)	●	●	●	●
		Serial printer output	(SD memory card or USB memory)	●	●	●	–
		Ethernet printer output	(SD memory card or USB memory)	●	●	●	●
		PictBridge printer output	SD memory card or USB memory, printer unit	●	●*17	–	–
	Sound output function	Sound output unit*18	●	●*17	●*18	–	
	Server function, Client function		●	●	●	●	
	Mail send function		●	●	●	●	
	Network drive function		●	●	●	●	
	FTP server function	(SD memory card or USB memory)	●	●	●	●	
	File transfer function (FTP transfer)	SD memory card or USB memory	●	●	●	●	
	File transfer function (GOT internal transfer)	SD memory card or USB memory	●	●	●	●	
	MES interface function	License, (SD memory card)	●	●	●	●	
	Wireless LAN function	Wireless LAN communication unit	●	●*17	●	–	
	USB mouse, USB keyboard		●	●	●	●	
	GOT functions	Base screen		●	●	●	●
		Overlap window		●	●	●	●
		Superimpose window		●	●	●	●
Dialog window			●	●	●	●	
Mobile screen			●	●	●	●	
Key window			●	●	●	●	
Language switching			●	●	●	●	
System information			●	●	●	●	
Operator authentication function		(SD memory card or USB memory)	●	●	●	●	
Operation log		SD memory card or USB memory	●	●	●	●	
Startup logo			●	●	●	●	
KANA KANJI conversion			●	●	●	●	
FA transparent			●	●	●	●	
SoftGOT-GOT link		License key	●	●	●	●	
Backup/Restoration		SD memory card or USB memory	●	●	●	●*19	
Multi-channel function			●*9 4 channels (Up to 3 units)	● 4 channels (Up to 3 units)*17	● 4 channels (No units can be mounted.)	●*19 4 channels (No units can be mounted.)	
Station No. switching			●	●	●	●	
GOT network interaction			●	●	●	●	
Screen gesture function			–	–	–	–	
Object gesture function			–	–	–	–	
Security key authentication function		●	●	●	●		
IP filter function		●	●	●	●		
File manager	(SD memory card or USB memory)	●	●	●	●		
Vertical display*5		● (Rotate 90° to left)	● Other than below: rotate 90° to left GT2505: rotate 90° to right	● (Rotate 90° to left)	–		
Maintenance functions	Device monitor	(SD memory card or USB memory)	●	●	●	●	
	Sequence program monitor (iQ-R ladder)	SD memory card or USB memory	●	●	●	●	
	Sequence program monitor (Ladder)	SD memory card or USB memory	●	●	●	●	
	Sequence program monitor (SFC)	SD memory card or USB memory	●	●	●	●	
	Network monitor		●	●	●	●	
	CC-Link IE Field Network diagnostics		●	●	●	●	
	Intelligent module monitor		●	●	●	●	
	Drive recorder	(SD memory card or USB memory)	●	●	●	●	
	Servo amplifier graph	(SD memory card or USB memory)	●	●	●	●	
	Motion program editor		●*4	●*4	●*4	–	
	Motion program I/O	SD memory card or USB memory	●*4	●*4	●*4	–	
	Servo amplifier monitor		●	●	●	●	
	R motion monitor		●	●	●	●	
	Q motion monitor		●	●	●	●	
	Motion SFC monitor	SD memory card or USB memory	●	●	●	●	
	CNC monitor 2		●	●	–	●	
	CNC monitor		●*4	●*4	–	–	
	CNC data I/O	SD memory card or USB memory	●*4	●*4	–	–	
	CNC machining program edit		●*4	●*4	–	–	
	Log viewer	(SD memory card or USB memory)	●	●	●	●	
	FX list editor		●	●	–	●	
	FX ladder monitor		●	●	●	●	
iQSS utility	SD memory card or USB memory	●	●	●	●		
System launcher		●	●	●	●		
System launcher (servo network)		●	●	●	●		
MELSEC-L troubleshooting		●	●	●	●		

\*1 Necessary units when using GT27, GT25, GT25 wide, GT25 handy, GT25 rugged, GT21 wide, GT21, or GS21 models are shown. Parenthesized devices are required depending on conditions of use.  
 \*2 Data is output to the printer that is recognized by the personal computer.  
 \*3 CSV files are saved in the virtual drive of the personal computer so that it is recommended to output the files to printers.  
 \*4 Only the GOTs with SVGA or higher resolution are supported.  
 \*5 Remote personal computer operation function (Ethernet) cannot be used. The following screens are displayed horizontally: utility screen, monitor and data management screens that are displayed from the utility screen (sequence program monitor, etc.), video camera images in the multimedia and video display functions. For the details of other GOT operations when placed vertically, please refer to the relevant product manual or Help.

\*6 Excluding GT2103-PMBSL.  
 \*7 GT2104-RTBD only.  
 \*8 Excluding GT2705-VTBD.  
 \*9 To use multiple units such as extension units, barcode readers, or RFID controllers with a GT2705-VTBD, the total current consumption of the units should be less than the value that the GT2705-VTBD can provide. For the details, please refer to the relevant manual of the GOT2000 Series.  
 \*10 GT2715-XTBA, GT2715-XTBD, GT2712-STBA, GT2712-STBD, GT2712-STWA, GT2712-STWD only.



For the details of functions, supported controllers, and connection types, please refer to the relevant manual or Help of the GOT2000/GOT SIMPLE Series.  
 ●: Supported —: Not supported

Category	Function name	Necessary devices*1	GT25 Rugged	GT21 Wide	GT21	GS21-N NEW	GT SoftGOT2000	
Screen design	Barcode function		●	●	●*6	●	●	
	RFID function		●	●	●*6	●	●	
	GOT Mobile function	License, (SD memory card)	●	—	—	—	—	
	VNC server function	License	●	●	—	NEW	—	
	Remote personal computer operation function (Ethernet)	License	●	—	—	—	—	
	Remote personal computer operation function (serial)	RGB input unit or Video/RGB input unit	—	—	—	—	—	
	Video display function	Video input unit or Video/RGB input unit	—	—	—	—	—	
	RGB display function	RGB input unit or Video/RGB input unit	—	—	—	—	—	
	Multimedia function	Multimedia unit, CF card	—	—	—	—	—	
	External I/O function	External I/O unit	—	—	—	—	—	
	Operation panel function	External I/O unit	—	—	—	—	●	
	Video output function	HDMI output	Digital video output unit	—	—	—	—	—
		RGB output	RGB output unit	—	—	—	—	—
	Report function	File output	(SD memory card or USB memory)	●	—	—	—	●*3
		Serial printer output	(SD memory card or USB memory)	●	●	●*6	●	●*3
		Ethernet printer output	(SD memory card or USB memory)	●	●	●*15	●	●*3
		PictBridge printer output	SD memory card or USB memory, printer unit	—	—	—	—	●
	Sound output function	Sound output unit*18	●*18	—	—	—	●	
	Server function, Client function		●	—	—	—	—	
	Mail send function		●	—	—	—	●	
	Network drive function		●	—	—	—	●	
	FTP server function	(SD memory card or USB memory)	●	●	●*15	●	—	
	File transfer function (FTP transfer)	SD memory card or USB memory	●	●	●*15	●	—	
	File transfer function (GOT internal transfer)	SD memory card or USB memory	●	—	—	—	—	
	MES interface function	License, (SD memory card)	●	—	—	—	—	
Wireless LAN function	Wireless LAN communication unit	●	—	—	—	—		
USB mouse, USB keyboard		●	●	—	—	●		
GOT functions	Base screen		●	●	●	●	●	
	Overlap window		●	●	●	●	●	
	Superimpose window		●	●	●	●	●	
	Dialog window		●	●	●	●	●	
	Mobile screen		●	—	—	—	—	
	Key window		●	●	●	●	●	
	Language switching		●	●	●	●	●	
	System information		●	●	●	●	●	
	Operator authentication function	(SD memory card or USB memory)	●	●	●*16	—	●	
	Operation log	SD memory card or USB memory	●	●	—	NEW	●	
	Startup logo		●	●	●	●	●	
	KANA KANJI conversion		●	—	—	—	●	
	FA transparent		●	●	●	●	—	
	SoftGOT-GOT link	License key	●	—	—	—	●	
	Backup/Restoration	SD memory card or USB memory	●	●	●*6	●	—	
	Multi-channel function		4 channels (No units can be mounted.)	2 channels (No units can be mounted.)	2 channels (No units can be mounted.)	2 channels (No units can be mounted.)	4 channels	
	Station No. switching		●	●	●	●	●	
	GOT network interaction		●	—	—	—	●	
	Screen gesture function		—	—	—	—	—	
	Object gesture function		—	—	—	—	—	
	Security key authentication function		●	—	—	—	—	
	IP filter function		●	●	●	●	—	
	File manager	(SD memory card or USB memory)	●	—	—	—	—	
	Vertical display*5		(Rotate 90° to left)	(Rotate 90° to left)	(Rotate 90° to right)	(Rotate 90° to left)	—	
	Maintenance functions	Device monitor	(SD memory card or USB memory)	●	●	●	●	—
Sequence program monitor (iQ-R ladder)		SD memory card or USB memory	●	—	—	—	—	
Sequence program monitor (Ladder)		SD memory card or USB memory	●	—	—	—	—	
Sequence program monitor (SFC)		SD memory card or USB memory	●	—	—	—	—	
Network monitor			●	—	—	—	—	
CC-Link IE Field Network diagnostics			●	—	—	—	—	
Intelligent module monitor			●	—	—	—	—	
Drive recorder		(SD memory card or USB memory)	●	—	—	—	—	
Servo amplifier graph		(SD memory card or USB memory)	●	—	—	—	—	
Motion program editor			—	—	—	—	—	
Motion program I/O		SD memory card or USB memory	—	—	—	—	—	
Servo amplifier monitor			●	—	—	—	—	
R motion monitor			●	—	—	—	—	
Q motion monitor			●	—	—	—	—	
Motion SFC monitor		SD memory card or USB memory	●	—	—	—	—	
CNC monitor 2			—	—	—	—	—	
CNC monitor			—	—	—	—	—	
CNC data I/O		SD memory card or USB memory	—	—	—	—	—	
CNC machining program edit			—	—	—	—	—	
Log viewer		(SD memory card or USB memory)	●	—	—	—	—	
FX list editor			—	●	●*7	●	—	
FX ladder monitor			●	—	—	—	—	
iQSS utility		SD memory card or USB memory	●	—	—	—	—	
System launcher			●	—	—	—	—	
System launcher (servo network)			●	—	—	—	—	
MELSEC-L troubleshooting		●	—	—	—	—		

\*11 For the applicable communication units and option units, please refer to the relevant product manual.  
 \*12 Use the standard interface of the personal computer.  
 \*13 When using functions that require a USB memory or SD memory card, a virtual drive in the personal computer is used.  
 \*14 GT2103-PMBD, GT2103-PMBDS, and GT2103-PMBDS2 require an SD memory card unit (GT21-03SDCD) separately. GT2103-PMBLS does not allow for SD memory cards.  
 \*15 GT2104-RTBD, GT2103-PMBD only.

\*16 On GT2103-PMBLS, only the functions that do not require SD memory card can be used.  
 \*17 Excluding GT2505-VTBD.  
 \*18 GT25 wide and GT25 rugged models have a built-in sound output interface so that the sound output unit is not required.  
 \*19 GT2505HS-VTBD supports the function with Ethernet connection only.  
 \*20 GT21 has different interfaces depending on the model. For the details, please refer to the relevant product manual.  
 \*21 Only Ethernet, OPC UA client, and microcomputer connections are supported.

# Specifications

## General specifications

Item	Specifications					
Operating ambient temperature*1	0 to 50°C					
Storage ambient temperature	-20 to 60°C					
Operating/Storage ambient humidity	10% RH to 90% RH, non-condensing*2					
Vibration resistance	Compliant with IEC 61131-2	Under intermittent vibration	Frequency	Acceleration	Half amplitude	Sweep count
			5 to 8.4 Hz	—	3.5 mm	10 times in each X, Y, or Z direction
		Under continuous vibration	8.4 to 150 Hz	9.8 m/s <sup>2</sup>	—	—
			5 to 8.4 Hz	—	1.75 mm	—
Shock resistance	Compliant with IEC 61131-2 (147 m/s <sup>2</sup> (15G), 3 times in each X, Y, or Z direction)					
Operating atmosphere	No greasy fumes, corrosive gas, flammable gas, excessive conductive dust, and direct sunlight (as well as at storage)					
Operating altitude*3	2000 m or less					
Installation location	Inside control panel					
Overvoltage category*4	II or less					
Pollution degree*5	2 or less					
Cooling method	Self-cooling					
Grounding	Grounding with a ground resistance of 100 Ω or less by using a ground cable that has a cross-sectional area of 2 mm <sup>2</sup> or more. If impossible, connect the ground cable to the control panel.					

For the status of conforming to various standards and laws (CE, ATEX, UL/cUL, Class I Division 2, EAC, KC, KCS, and maritime certifications [ABS/BV/DNV GL/LR/NK/RINA]), please refer to the Mitsubishi Electric Factory Automation Global website ([www.MitsubishiElectric.com/fa/](http://www.MitsubishiElectric.com/fa/)).

## Power supply specifications

Item	Specifications	
	GS2110-WTBD-N	GS2107-WTBD-N
Power supply voltage	24 V DC (+10%, -15%), ripple voltage 200 mV or less	
Power consumption	Under the maximum load	7.6 W (317 mA/24 V) or less
	Backlight OFF	6.5 W (271 mA/24 V) or less
Inrush current	3.8 W (158 mA/24 V) or less	
	17 A or less (6 ms, ambient temperature 25°C, at the maximum load)	
Permissible instantaneous power failure time	Within 5 ms	
Noise immunity	Conforms to IEC61000-4-4, 2 kV (power supply line)	
Withstand voltage	350 V AC for 1 minute across power terminals and earth	
Insulation resistance	500 V DC across power terminals and earth, 10 MΩ or more by an insulation resistance tester	

\*1 Includes the temperature inside the enclosure of the control panel to which the GOT is installed.

\*2 If the ambient temperature exceeds 40°C, the absolute humidity must not exceed 90% RH at 40°C.

\*3 Do not use or store the GOT under a pressure higher than the atmospheric pressure at altitude 0 m. Doing so may cause a malfunction. Air purging by applying pressure to the control panel may create clearance between the surface sheet and the touch panel. This may cause the touch panel to be not sensitive enough or the sheet to come off.

\*4 This indicates the section of the power supply to which the equipment is assumed to be connected between the public electrical power distribution network and the machinery within the premises. Category II applies to equipment that is supplied with power from fixed facilities. The withstand surge voltage for the equipment with the rated voltage up to 300 V is 2500 V.

\*5 This indicates the occurrence rate of conductive material in an environment where a device is used. Pollution degree 2 indicates an environment where only non-conductive pollution occurs normally and a temporary conductivity caused by condensation shall be expected depending on the conditions.

Operate and store the GOT in environments without direct sunlight, high temperature, dust, humidity, and vibrations.

## Performance specifications

Item	Specifications	
	GS2110-WTBD-N	GS2107-WTBD-N
Display section*1*2	Display device	TFT color LCD
	Screen size	10" widescreen
	Resolution	7" widescreen
	Resolution	WVGA: 800 × 480 dots
	Display size	222(8.74) (W) × 132.5(5.22) (H) mm(inch)
	Number of displayed characters	154(6.06) (W) × 85.9(3.38) (H) mm(inch)
	Display color	16-dot standard font: 50 characters × 30 lines (two-byte characters) 12-dot standard font: 66 characters × 40 lines (two-byte characters)
Touch panel*3*9	Display color	65536 colors
	Brightness adjustment	32 levels
	Backlight*4	LED (not replaceable)
	Type	Analog resistive film
Panel color	Key size	Minimum 2 × 2 dots*7 (per key)
	Simultaneous press	Not available*5 (Only 1 point can be touched.)
	Life	1 million touches or more (operating force: 0.98 N or less)
User memory	Panel color	Black
	User memory capacity	Memory for storage (ROM)*10: 15 MB
Built-in interface	Life (number of write times)	100000 times
	RS-422/485	1 channel Transmission speed: 115200, 57600, 38400, 19200, 9600, 4800 bps Connector shape: D-sub 9-pin (female) Terminating resistor: 330 Ω, 110 Ω, OPEN (Selectable by the terminating resistor setting switch.)
	RS-232	1 channel Transmission speed: 115200, 57600, 38400, 19200, 9600, 4800 bps Connector shape: D-sub 9-pin (male)
	Ethernet	1 channel Data transfer method: 100BASE-TX, 10BASE-T Connector shape: RJ-45 (modular jack)
	USB (device)	1 channel (rear face) USB version: USB 1.1 (Full-Speed 12 Mbps) Connector shape: USB Mini-B
Buzzer output	SD memory card*10	1 channel, SDHC compliant (maximum 32 GB)
Protective structure*6	Buzzer output	Single tone (tone length adjustable)
Safety standards, radio laws (as of January 2021)	Protective structure*6	Front: IP65F*8
External dimensions	Safety standards, radio laws (as of January 2021)	CE, UL, cUL, EAC, KC
Panel cut dimensions	External dimensions	272(10.71) (W) × 214(8.43) (H) × 56(2.21) (D) mm(inch)
Weight (excluding a fitting)	Panel cut dimensions	259(10.16) (W) × 200(7.88) (H) mm(inch)
Compatible software package	Weight (excluding a fitting)	1.3(2.9) kg(lb)
	Compatible software package	0.9(2.0) kg(lb)
		GT Works3 Version1.250L or later

\*1 As a characteristic of liquid crystal display panels, bright dots (always lit) and dark dots (never lit) may appear on the panel. Since liquid crystal display panels comprise a great number of display elements, the appearance of bright and dark dots cannot be reduced to zero. Individual differences in liquid crystal display panels may cause differences in color, uneven brightness and flickering. Note that these phenomena are characteristics of liquid crystal display panels and it does not mean the products are defective or damaged.

\*2 Flickering may occur due to vibration, shock, or the display colors.

\*3 When a stylus is used, the touch panel has a life of 100 thousand touches. The stylus must satisfy the following specifications.  
• Material: polyacetal resin • Tip radius: 0.8 mm or more

\*4 To prevent the display section from burning in and lengthen the backlight life, enable the screen save function and turn off the backlight.

\*5 If you touch two points or more simultaneously on the touch panel, a touch switch near the touched points may operate unexpectedly. Do not touch two points or more simultaneously on the touch panel.

\*6 Note that the structure does not guarantee protection in all users' environments. The GOT may not be used in certain environments where it is subjected to splashing oil or chemicals for a long period of time or soaked in oil mist.

\*7 The minimum size of a key that can be arranged. To ensure safe use of the product, the following settings are recommended.

• Key size: 16 × 16 dots or larger • Distance between keys: 16 dots or more

\*8 The suffix "F" of IP65F is a symbol that indicates protection rate against oil. It is described in the Appendix of Japanese Industrial Standard JIS C 0920.

\*9 Repeatedly touching the outer edge of the actual display area may cause the product to fail.

\*10 While writing data to the memory for storage (ROM) or an SD memory card, if GOT is powered off, the data may be corrupted which may cause the GOT to stop operating.

## Panel cutting dimensions

Horizontal format (If the vertical format is selected, the dimension must be rotated 90°.)

Unit: mm (inch)

Cut holes in the following dimensions on the panel.  
Ensure 10 mm of space in upper and lower parts of the panel for mounting fixtures.

Model	A	B
GS2110-WTBD-N	258 (10.16")	200 (7.88")
GS2107-WTBD-N	191 (7.52")	137 (5.40")

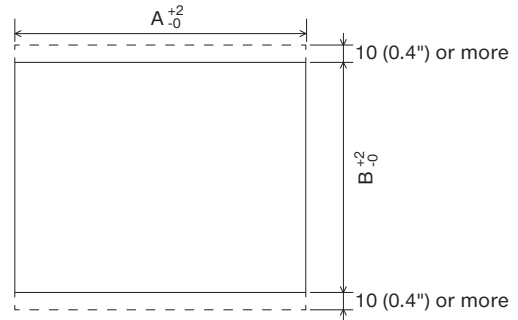

Panel thickness: 1.6 to 4 mm  
(0.06 to 0.16 inch)

## External dimensions

### ■ GS2110-WTBD-N

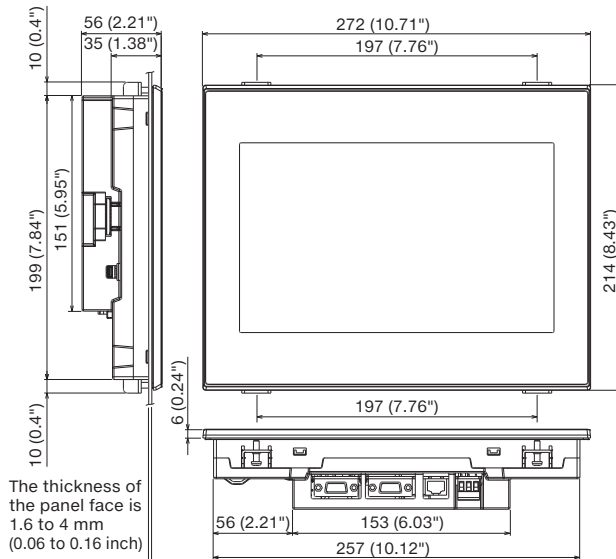

### ■ GS2107-WTBD-N

Unit: mm (inch)

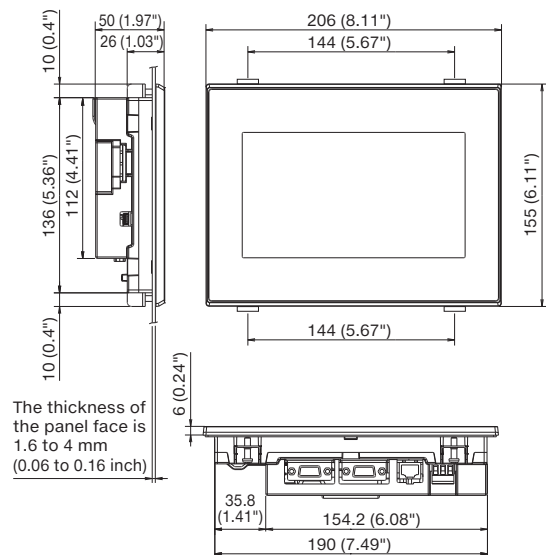

## Components names

### ■ GS2110-WTBD-N

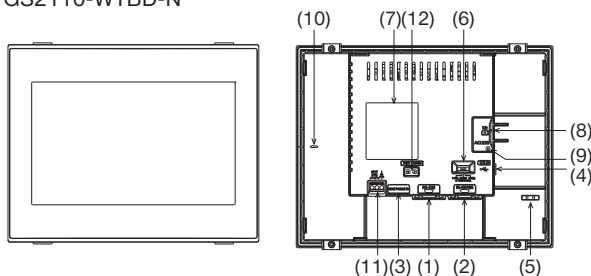

### ■ GS2107-WTBD-N

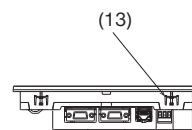
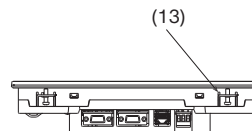
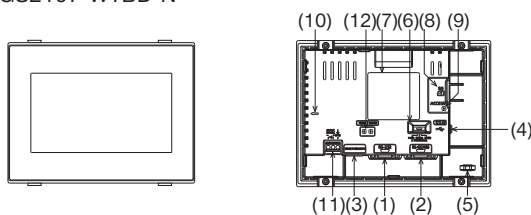

- (1) RS-232 interface
- (2) RS-422/485 interface
- (3) Ethernet interface
- (4) USB interface (device)
- (5) Cable clamp mounting hole
- (6) Terminating resistor setting switch
- (7) Rating plate
- (8) SD memory card interface
- (9) SD memory card access LED
- (10) Vertical installation arrow mark
- (11) Power terminal
- (12) Ethernet communication status LED
- (13) Hole for unit installation fittings

## Interaction with various Mitsubishi Electric industrial devices

In addition to various built-in functions, direct connection between Mitsubishi Electric industrial devices will improve productivity and reduce costs.

### Programmable controller

MELSEC iQ-R series



MELSEC iQ-F series



etc.

### Servo

MITSUBISHI SERVO AMPLIFIERS & MOTORS  
MELSERVO

J4

JE



etc.

### Inverter

A800

F800



etc.

## Main connectable products (programmable controllers) of other companies

Manufacturer	Series/Model name		Serial communication connection		Direct CPU connection		Ethernet connection
			RS-422/485	RS-232	RS-422/485	RS-232	
KEYENCE CORPORATION	KV Nano	KV-N24□□/KV-N40□□/KV-N60□□/KV-NC32T	○	○	×	○	○
		KV-N14□□	○	○	×	○	×
	KV-700		○	○	×	○	○
	KV-1000		○	○	×	○	○
	KV-3000		○	○	×	○	○
	KV-5000	KV-5500/KV-5000	○	○	×	×	○
	KV-7000	KV-7500/KV-7300	○	○	×	○	○
	KV-8000		○	○	×	×	○
OMRON Corporation	SYSMAC CJ1	CJ1H	○	○	×	○	○*2
		CJ1G	○	○	×	○	○*2
		CJ1M	○	○	×	○	○*2
	SYSMAC CJ2	CJ2H	○	○	×	○	○*2
		CJ2M	○	○	×	○*1	○*2
	SYSMAC CP1	CP1H	○	○	×	×	×
		CP1L	○	○	×	×	×
		CP1E (N type)*3	○	○	×	○	×
	SYSMAC CP2	CP2E-E	○	○	×	○	○
		CP2E-S	○	○	×	○	○
		CP2E-N	○	○	×	○	○
	NJ	NJ501-1500/NJ501-1400/NJ501-1300/NJ501-1520/ NJ501-1420/NJ501-1320/NJ501-1340	×	×	×	×	○
		NJ301-1200/NJ301-1100	×	×	×	×	○
NJ101-1000/NJ101-9000/NJ101-1020/NJ101-9020		×	×	×	×	○	
NX	NX1P2-1140DT/NX1P2-1140DT1/NX1P2-1040DT/ NX1P2-1040DT1/NX1P2-9024DT/NX1P2-9024DT1	×	×	×	×	○	
	NX701-1700/NX701-1600	×	×	×	×	○	
	NX102-1200/1100/1000/9000	×	×	×	×	○	
Panasonic Industrial Devices SUNX Co., Ltd.	FP0		×	×	×	○	×
	FP1		×	○	×	○	×
	FP2		×	○	×	○	×
	FP3		×	○	×	○	×
	FP5		×	○	×	○	×
	FP10		×	○	×	○	×
	FP-M		×	×	×	○	×
	FPΣ		×	×	×	○	×
	FP-X		○	○	×	○	×
	FP7		○	○	×	○	×
FP0H		×	×	×	○	×	
Siemens AG	SIMATIC S7-200/SIMATIC S7-200 SMART		×	×	×	○	○
	SIMATIC S7-200 CN		×	×	×	○	×
	SIMATIC S7-300		×	×	×	○	○
	SIMATIC S7-400		×	×	×	○	○
	SIMATIC S7-1200		×	×	×	×	○

\*1 Only CJ2M-CPU1□ can be directly connected.

\*2 Duplex Ethernet is not supported.

\*3 Among CP1E (N type), only direct connection is possible for CPU units of 20 I/O points or less.

For details of connection, refer to the following "GOT2000 Series Connection Manual".

■ Mitsubishi Electric Products (SH-081197ENG)

■ Non-Mitsubishi Electric Products 2 (SH-081199ENG)

■ Non-Mitsubishi Electric Products 1 (SH-081198ENG)

■ Microcomputers, MODBUS/Fieldbus Products, Peripherals (SH-081200ENG)



## Product list

### ■ GOTs

Product name	Model	Screen size	Display section/Display color	Panel color	Power
GOT SIMPLE Series	GS2110-WTBD-N <b>NEW</b>	10" widescreen	TFT color/65536 colors	Black	24 V DC
	GS2107-WTBD-N <b>NEW</b>	7" widescreen			

### ■ Communication units

Product name	Model	Specifications
Serial multi-drop connection unit	GT01-RS4-M	For GOT multi-drop connection

### ■ Software

Product name	Model	Description		
HMI/GOT Screen Design Software MELSOFT GT Works3	SW1DND-GTWK3-E	English Version	Standard license product*1	DVD-ROM
VNC Server Function License*2	GT25-VNCSKEY-1	1 license product*4		
License key for GT SoftGOT2000*3	GT27-SGTKEY-U	USB port license key		

\*1 Volume license product and additional license product are also available. For details, please contact your local sales office.

\*2 Each GOT requires one license.

\*3 License key for GT SoftGOT2000 is required for each personal computer that uses iQ Monozukuri Process Remote Monitoring.

\*4 Products with 5, 10, or 20 licenses are also available. For details, please contact your local sales office.

### ■ Options

Product name	Model	Specifications
SD memory card	NZ1MEM-2GBSD	SD memory card for GOT, 2 GB
	NZ1MEM-4GBSD	SDHC memory card for GOT, 4 GB
	NZ1MEM-8GBSD	SDHC memory card for GOT, 8 GB
	NZ1MEM-16GBSD	SDHC memory card for GOT, 16 GB

### ■ Application package

Product name	Model	Number of licenses	Number of monitorable GOTs
iQ Monozukuri Process Remote Monitoring*1	AP30-PRM001AA-MA	1 license	5
	AP30-PRM001AA-MB	5 licenses	25
	AP30-PRM001AA-MC	10 licenses	50

\*1 Process Remote Monitoring setting tool, iQ Monozukuri Process Remote Monitoring template project for GT SoftGOT2000, and the Process Remote Monitoring license are included.

### ■ Cables

Product name	Model	Cable length	Specifications	
RS-422 cable	FXCPU direct connection cable, FXCPU communication expansion board connection cable	GT01-C10R4-8P	1 m	FXCPU ⇔ GOT FXCPU communication expansion board ⇔ GOT [MINI-DIN 8-pin ⇔ D-sub 9-pin]
		GT01-C30R4-8P	3 m	
		GT01-C100R4-8P	10 m	
		GT01-C200R4-8P	20 m	
	QnA/FXCPU direct connection cable, Computer link connection cable, CC-Link (G4) connection cable	GT01-C30R4-25P	3 m	QnA/ACPU/motion CPU (A series)/FXCPU ⇔ GOT RS-422 connector conversion cable (FA-CNV□CBL) ⇔ GOT Serial communication module ⇔ GOT Peripheral connection module (AJ65BT-G4-S3) ⇔ GOT [D-sub 25-pin ⇔ D-sub 9-pin]
		GT01-C100R4-25P	10 m	
		GT01-C200R4-25P	20 m	
		GT01-C300R4-25P	30 m	
	Computer link connection cable	GT09-C30R4-6C	3 m	Serial communication module ⇔ GOT Computer link module ⇔ GOT [Separate wire ⇔ D-sub 9-pin]
		GT09-C100R4-6C	10 m	
		GT09-C200R4-6C	20 m	
		GT09-C300R4-6C	30 m	
RS-232 cable	Q/LCPU direct connection cable	GT01-C30R2-6P	3 m	Q/LCPU ⇔ GOT L6ADP-R2 ⇔ GOT/personal computer (GT SoftGOT2000) [MINI-DIN 6-pin ⇔ D-sub 9-pin]
	FXCPU communication expansion board connection cable, FXCPU communication special adapter connection cable	GT01-C30R2-9S	3 m	FXCPU communication expansion board ⇔ GOT/personal computer (GT SoftGOT2000) FXCPU communication special adapter ⇔ GOT/personal computer (GT SoftGOT2000) [D-sub 9-pin ⇔ D-sub 9-pin]
				FXCPU communication special adapter ⇔ GOT/personal computer (GT SoftGOT2000) [D-sub 25-pin ⇔ D-sub 9-pin]
	FXCPU communication special adapter connection cable	GT01-C30R2-25P	3 m	FXCPU communication special adapter ⇔ GOT/personal computer (GT SoftGOT2000) [D-sub 25-pin ⇔ D-sub 9-pin]
	Computer link connection cable, CC-Link (G4) connection cable	GT09-C30R2-9P	3 m	Serial communication module ⇔ GOT Computer link module ⇔ GOT Peripheral connection module (AJ65BT-R2N) ⇔ GOT [D-sub 9-pin ⇔ D-sub 9-pin]
GT09-C30R2-25P		3 m	Serial communication module ⇔ GOT Computer link module ⇔ GOT [D-sub 25-pin ⇔ D-sub 9-pin]	
USB cable	Data transfer cable	GT09-C30USB-5P	3 m	Personal computer (screen design software) ⇔ GOT Personal computer (GT SoftGOT2000) ⇔ QnU/L/FXCPU [USB-A ⇔ USB Mini-B]

# HMI lineup

## GOT2000 Series

Advanced model with multi-touch gesture functions

### GT27

Ethernet RS-232 RS-422/485 CC-Link IE TSN CC-Link IE Control CC-Link IE Field\*1 CC-Link IE Field Basic CC-Link Bus MELSECNET

\*1 The CC-Link IE Field Network communication unit and GOT set is also available.

15 inch

TFT  
65536  
colors AC  
DC



XGA  
1024 x 768

GT2715-STBA  
GT2715-STBD

12.1 inch

TFT  
65536  
colors AC  
DC



SVGA  
800 x 600

GT2712-STBA  
GT2712-STBD  
GT2712-STWA [White model]  
GT2712-STWD [White model]

10.4 inch

TFT  
65536  
colors AC  
DC



SVGA  
800 x 600

GT2710-STBA  
GT2710-STBD

VGA  
640 x 480

GT2710-VTBA  
GT2710-VTBD  
GT2710-VTWA [White model]  
GT2710-VTWD [White model]

High performance, cost efficient, mid-range model

### GT25

Ethernet RS-232 RS-422/485 CC-Link IE TSN\*2 CC-Link IE Control\*2 CC-Link IE Field\*1\*2 CC-Link IE Field Basic CC-Link\*2 Bus\*2

\*1 The CC-Link IE Field Network communication unit and GOT set is also available. \*2 Not supported by GT2505.

12.1 inch

TFT  
65536  
colors AC  
DC



SVGA  
800 x 600

GT2512-STBA  
GT2512-STBD

10.4 inch

TFT  
65536  
colors AC  
DC



VGA  
640 x 480

GT2510-VTBA  
GT2510-VTBD  
GT2510-VTWA [White model]  
GT2510-VTWD [White model]

8.4 inch

TFT  
65536  
colors AC  
DC



VGA  
640 x 480

GT2508-VTBA  
GT2508-VTBD  
GT2508-VTWA [White model]  
GT2508-VTWD [White model]

### GT25

GOT2000 widescreen expands your view

Wide

Ethernet (2 ports) RS-232 RS-422/485 CC-Link IE Field Basic Sound output (built-in)

10.1 inch

TFT  
65536  
colors DC



WXGA  
1280 x 800

GT2510-WXTBD  
GT2510-WXTSD

7 inch

TFT  
65536  
colors DC



WVGA  
800 x 480

GT2507-WTBD  
GT2507-WTSD

### GT25

Rugged

Ethernet (2 ports) RS-232  
RS-422/485 CC-Link IE Field Basic  
Sound output (built-in)

7 inch

TFT  
65536  
colors DC



WVGA  
800 x 480

GT2507T-WTSD

Suitable for a wide range of applications

### GT21

Wide

Ethernet RS-232  
RS-422/485 CC-Link IE Field Basic

7 inch

TFT  
65536  
colors DC



WVGA  
800 x 480

GT2107-WTBD  
GT2107-WTSD

### GT21

Compact models with basic functions

Ethernet\*1 RS-232\*1 RS-422/485\*1 CC-Link IE Field Basic\*2

\*1 Supported interfaces vary depending on the model. Please refer to descriptions in [ ] after the model.

\*2 Supported only by the models equipped with an Ethernet port.

4.3 inch

TFT  
65536  
colors DC



480 x 272

GT2104-RTBD  
[Ethernet, RS-232,  
RS-422/485]

3.8 inch

TFT  
mono-  
chrome DC



5-color LED

320 x 128

GT2103-PMBD [Ethernet, RS-422/485]  
GT2103-PMBDS [RS-232, RS-422/485]  
GT2103-PMBDS2 [RS-232x2 ch]  
GT2103-PMBLS [RS-422] 5 V DC type

For the status of conforming to various standards and laws, please refer to the Mitsubishi Electric Factory Automation Global website ([www.MitsubishiElectric.com/fa/](http://www.MitsubishiElectric.com/fa/)).

Multi-touch gesture Multimedia\*2 Video/RGB\*2 Sound output External I/O

\*2 Not supported by GT2705.

8.4 inch

TFT  
65536  
colors

AC  
DC



SVGA  
800 x 600

GT2708-STBA  
GT2708-STBD

VGA  
640 x 480

GT2708-VTBA  
GT2708-VTBD

5.7 inch

TFT  
65536  
colors

AC  
DC



VGA  
640 x 480

GT2705-VTBD

## MELIPC Series

Panel computer with Windows® OS

# MI3000

Ethernet (3 ports) RS-232  
RS-422/485 DisplayPort  
Sound output (built-in)

21.5 inch/  
15 inch

TFT  
16.77  
million  
colors

DC



Full HD  
1920 x 1080

MI3321G-W

XGA  
1024 x 768

MI3315G-W

MELSECNET\*2 Sound output\*2 External I/O\*2

## GT25 Handy

HMI functionality in the palm of your hand

Ethernet RS-232 RS-422/485\*1 CC-Link IE Field Basic

\*1 GT2505HS supports RS-422 only.

5.7 inch

TFT  
65536  
colors

DC



VGA  
640 x 480

GT2505-VTBD

6.5 inch

TFT  
65536  
colors

DC



VGA  
640 x 480

GT2506HS-VTBD

5.7 inch

TFT  
65536  
colors

DC



VGA  
640 x 480

GT2505HS-VTBD

A new style of GOT2000

## GT25 Open frame

Ethernet RS-232 RS-422/485 CC-Link IE TSN CC-Link IE Control CC-Link IE Field CC-Link IE Field Basic CC-Link Bus MELSECNET  
Sound output External I/O

12.1 inch

TFT  
65536  
colors

AC  
DC



SVGA  
800 x 600

GT2512F-STNA  
GT2512F-STND

10.4 inch

TFT  
65536  
colors

AC  
DC



VGA  
640 x 480

GT2510F-VTNA  
GT2510F-VTND

8.4 inch

TFT  
65536  
colors

AC  
DC



VGA  
640 x 480

GT2508F-VTNA  
GT2508F-VTND

## SoftGOT

GOT2000  
compatible  
software

65536 colors



USB port  
license key



GT SoftGOT2000 Version1

GT SoftGOT2000 is an HMI software that allows GOT2000 functions to operate on a personal computer or panel computer. Various industrial devices can be connected and monitored. Resolution: 640 to 1920 x 480 to 1200

\* A separate license key must be installed during use.

## GOT SIMPLE Series

Simple model having excellent cost performance

# GS21

Ethernet RS-232 RS-422/485 CC-Link IE Field Basic

10 inch

TFT  
65536  
colors

DC



WVGA  
800 x 480

GS2110-WTBD-N  
NEW

7 inch

TFT  
65536  
colors

DC



WVGA  
800 x 480

GS2107-WTBD-N  
NEW

## Global FA Centers

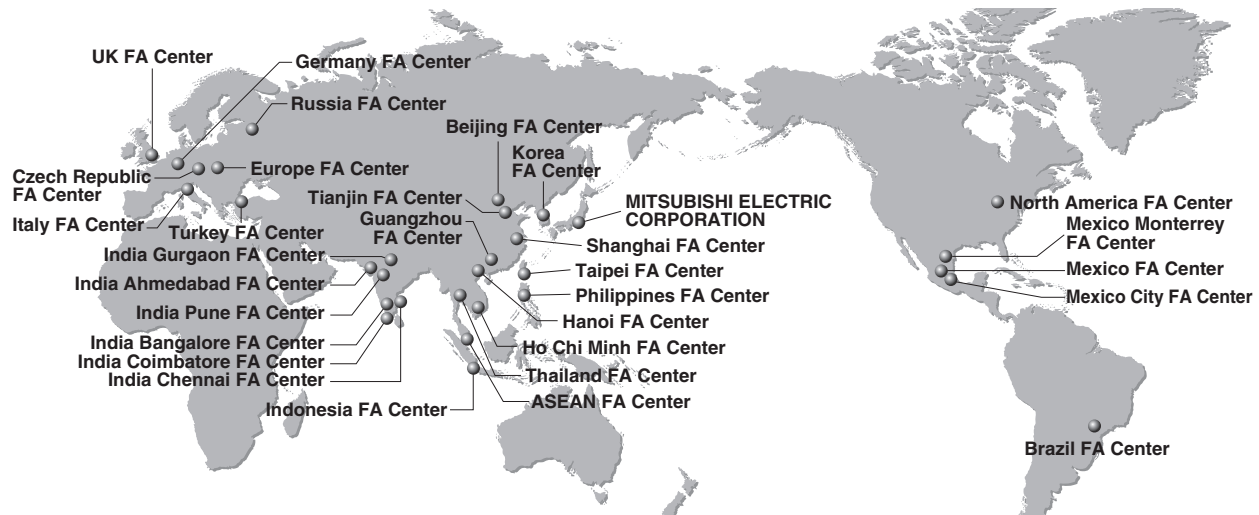

### China Mainland

#### Shanghai FA Center

Mitsubishi Electric Automation (China) Ltd.  
Mitsubishi Electric Automation Center, No.1386  
Hongqiao Road, Shanghai, China  
Tel: +86-21-2322-3030 / Fax: +86-21-2322-3000(9611#)

#### Beijing FA Center

Mitsubishi Electric Automation (China) Ltd.  
Beijing Branch  
5/F, ONE INDIGO, 20 Jiuxianqiao Road Chaoyang  
District, Beijing, China  
Tel: +86-10-6518-8830 / Fax: +86-10-6518-2938

#### Tianjin FA Center

Mitsubishi Electric Automation (China) Ltd.  
Tianjin Branch  
Room 3203 City Tower, No.35, Youyi Road, Hexi  
District, Tianjin, China  
Tel: +86-22-2813-1015 / Fax: +86-22-2813-1017

#### Guangzhou FA Center

Mitsubishi Electric Automation (China) Ltd.  
Guangzhou Branch  
Room 1609, North Tower, The Hub Center, No.1068,  
Xingang East Road, Haizhu District, Guangzhou, China  
Tel: +86-20-8923-6730 / Fax: +86-20-8923-6715

### Taiwan

#### Taipei FA Center

SETSUYO ENTERPRISE CO., LTD.  
3F, No.105, Wugong 3rd Road, Wugu District,  
New Taipei City 24889, Taiwan  
Tel: +886-2-2299-9917 / Fax: +886-2-2299-9963

### Korea

#### Korea FA Center

Mitsubishi Electric Automation Korea Co., Ltd.  
8F, Gangseo Hangang Xi-tower A, 401,  
Yangcheon-ro, Gangseo-Gu, Seoul 07528, Korea  
Tel: +82-2-3660-9632 / Fax: +82-2-3664-0475

### ASEAN

#### ASEAN FA Center

Mitsubishi Electric Asia Pte. Ltd.  
307 Alexandra Road, Mitsubishi Electric Building,  
Singapore 159943  
Tel: +65-6470-2475 / Fax: +65-6476-7439

### Indonesia

#### Indonesia FA Center

PT. Mitsubishi Electric Indonesia Cikarang Office  
Jl. Kenari Raya Blok G2-07A Delta Silicon 5,  
Lippo Cikarang - Bekasi 17550, Indonesia  
Tel: +62-21-2961-7797 / Fax: +62-21-2961-7794

### Vietnam

#### Hanoi FA Center

Mitsubishi Electric Vietnam Co., LTD.  
Hanoi Branch  
6th Floor, Detech Tower, 8 Ton That Thuyet Street,  
My Dinh 2 Ward, Nam Tu Liem District, Hanoi,  
Vietnam  
Tel: +84-24-3937-8075 / Fax: +84-24-3937-8076

#### Ho Chi Minh FA Center

Mitsubishi Electric Vietnam Co., LTD.  
Ho Chi Minh Head Office  
11th & 12th Floor, Viettel Tower B, 285 Cach Mang  
Thang 8 Street, Ward 12, District 10, Ho Chi Minh City,  
Vietnam  
Tel: +84-28-3910-5945 / Fax: +84-28-3910-5947

### Thailand

#### Thailand FA Center

MELCO Factory Automation Thailand  
(Thailand) Co., Ltd.  
101, True Digital Park Office, 5th Floor, Sukhumvit Road,  
Bangchak, Phra Khanong, Bangkok 10260, Thailand  
Tel: +66-2092-8600 / Fax: +66-2043-1231-33

### Philippines

#### Philippines FA Center

MELCO Factory Automation Philippines Inc.  
128, Lopez-Rizal St. Brgy, Highway Hills,  
Mandaluyong City, MM, Philippines  
Tel: +63-(0)2-8256-8042 / Fax: -

### India

#### India Pune FA Center

Mitsubishi Electric India Pvt. Ltd.  
Pune Branch  
Emerald House, EL-3, J Block, M.I.D.C., Bhosari,  
Pune - 411026, Maharashtra, India  
Tel: +91-20-2710-2000 / Fax: +91-20-2710-2100

#### India Gurgaon FA Center

Mitsubishi Electric India Pvt. Ltd.  
Gurgaon Second office MEI-GGN (UDY)  
Plot 517, Ground floor, Udyog Vihar Phase 3,  
Gurugram 122008, Haryana, India  
Tel: +91-124-463-0300 / Fax: +91-124-463-0399

#### India Bangalore FA Center

Mitsubishi Electric India Pvt. Ltd.  
Bangalore Branch  
Prestige Emerald, 6th Floor, Municipal No.2,  
Madras Bank Road, Bangalore - 560001, Karnataka, India  
Tel: +91-80-4020-1600 / Fax: +91-80-4020-1699

#### India Chennai FA Center

Mitsubishi Electric India Pvt. Ltd.  
Chennai Branch  
Citilights Corporate Centre No.1, Vivekananda  
Road, Srinivasa Nagar, Chetpet, Chennai - 600031,  
Tamil Nadu, India  
Tel: +91-44-4554-8772 / Fax: +91-44-4554-8773

#### India Ahmedabad FA Center

Mitsubishi Electric India Pvt. Ltd.  
Ahmedabad Branch  
B/4, 3rd Floor, SAFAL Profitaire, Corporate Road,  
Prahaldnagar, Satellite, Ahmedabad - 380015,  
Gujarat, India  
Tel: +91-79-6512-0063 / Fax: -

#### India Coimbatore FA Center

Mitsubishi Electric India Pvt. Ltd.  
Coimbatore Branch  
BMH Srinivas, 2nd Floor, Door No.1604, Trichy Road,  
Near ICICI Bank, Coimbatore - 641018, Tamil Nadu, India  
Tel: +91-422-438-5606 / Fax: -

### Americas

#### North America FA Center

Mitsubishi Electric Automation, Inc.  
500 Corporate Woods Parkway, Vernon Hills, IL 60061, U.S.A.  
Tel: +1-847-478-2100 / Fax: +1-847-478-2253

### Mexico

#### Mexico FA Center

Mitsubishi Electric Automation, Inc.  
Queretaro Office  
Parque Tecnológico Innovacion Queretaro Lateral  
Carretera Estatal 431, Km 2+200, Lote 91  
Modulos 1 y 2 Hacienda la  
Machorra, CP 76246, El Marques, Queretaro, Mexico  
Tel: +52-442-153-6014 / Fax: -

#### Mexico City FA Center

Mitsubishi Electric Automation, Inc.  
Mexico Branch  
Mariano Escobedo #69, Col. Zona Industrial,  
Tlalnepan Edo. Mexico, C.P.54030  
Tel: +52-55-3067-7511 / Fax: -

#### Mexico Monterrey FA Center

Mitsubishi Electric Automation, Inc.  
Monterrey Office  
Plaza Mirage, Av. Gonzalitos 460 Sur, Local 28, Col. San  
Jeronimo, Monterrey, Nuevo Leon, C.P. 64640, Mexico  
Tel: +52-55-3067-7521 / Fax: -

### Brazil

#### Brazil FA Center

Mitsubishi Electric do Brasil Comercio e  
Servicos Ltda.  
Avenida Adelino Cardana, 293, 21 andar, Bethaville,  
Barueri SP, Brasil  
Tel: +55-11-4689-3000 / Fax: +55-11-4689-3016

### Europe

#### Europe FA Center

Mitsubishi Electric Europe B.V. Polish Branch  
ul. Krakowska 48, 32-083 Balice, Poland  
Tel: +48-12-347-65-00 / Fax: -

#### Germany FA Center

Mitsubishi Electric Europe B.V. German Branch  
Mitsubishi-Electric-Platz 1, 40882 Ratingen, Germany  
Tel: +49-2102-486-0 / Fax: +49-2102-486-1120

#### UK FA Center

Mitsubishi Electric Europe B.V. UK Branch  
Travellers Lane, Hatfield, Hertfordshire, AL10 8XB, U.K.  
Tel: +44-1707-27-8780 / Fax: +44-1707-27-8695

#### Italy FA Center

Mitsubishi Electric Europe B.V. Italian Branch  
Centro Direzionale Colleoni - Palazzo Sirio, Viale  
Colleoni 7, 20864 Agrate Brianza (MB), Italy  
Tel: +39-039-60531 / Fax: +39-039-6053-312

#### Czech Republic FA Center

Mitsubishi Electric Europe B.V. Czech Branch  
Pekarska 621/7, 155 00 Praha 5, Czech Republic  
Tel: +420-255-719-200 / Fax: -

#### Russia FA Center

Mitsubishi Electric (Russia) LLC  
St. Petersburg Branch  
Piskarevsky pr. 2, bld 2, lit "Sch", BC "Benua",  
office 720; 195027, St. Petersburg, Russia  
Tel: +7-812-633-3497 / Fax: +7-812-633-3499

#### Turkey FA Center

Mitsubishi Electric Turkey A.S. Umraniye Branch  
Serifali Mah. Kale Sok. No:41 34775 Umraniye,  
Istanbul, Turkey  
Tel: +90-216-969-2500 / Fax: +90-216-526-3995



## Related materials

### ■ GOT SIMPLE Series solution catalogs

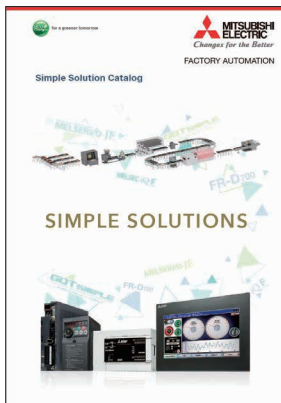

Simple Solution Catalog  
L(NA)08602ENG

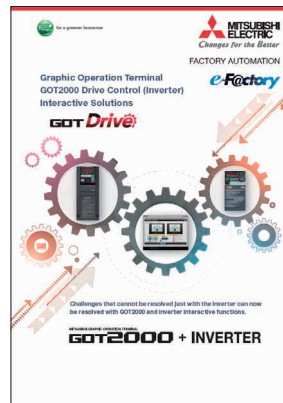

Graphic Operation Terminal  
GOT2000 Drive Control (Inverter)  
Interactive Solutions  
L(NA)08572ENG

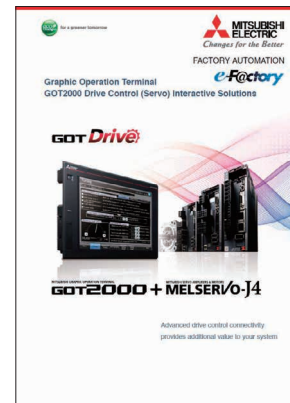

Graphic Operation Terminal  
GOT2000 Drive Control (Servo)  
Interactive Solutions  
L(NA)08335ENG

### ■ HMI catalogs



Graphic Operation Terminal  
GOT2000 Series/GOT SIMPLE Series  
L(NA)08270ENG

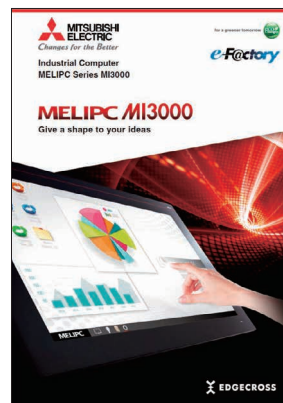

Industrial Computer  
MELIPC Series MI3000  
L(NA)08600ENG



FA Application Package  
iQ Monozukuri  
Process Remote Monitoring  
L(NA)08674ENG

#### Trademarks and registered trademarks

ETHERNET is a registered trademark of Xerox Corporation.

MODBUS is a registered trademark of SCHNEIDER ELECTRIC USA, INC.

SD and SDHC Logos are registered trademarks or trademarks of SD-3C, LLC.

VNC is a registered trademark of RealVNC Ltd. in the United States and other countries.

Windows is a registered trademark or trademark of Microsoft Corporation in the United States, Japan and other countries.

Other product and company names are either trademarks or registered trademarks of their respective owners.

The actual color may differ slightly from the pictures in this catalog.  
The actual display may differ from what are shown on GOT screen images.

#### Precautions before use

This publication explains the typical features and functions of the products herein and does not provide restrictions or other information related to usage and module combinations. Before using the products, always read the product user manuals. Mitsubishi Electric will not be held liable for damage caused by factors found not to be the cause of Mitsubishi Electric; opportunity loss or lost profits caused by faults in Mitsubishi Electric products; damage, secondary damage, or accident compensation, whether foreseeable or not, caused by special factors; damage to products other than Mitsubishi Electric products; or any other duties.

#### For safe use

- To use the products given in this publication properly, always read the relevant manuals before beginning operation.
- The products have been manufactured as general-purpose parts for general industries, and are not designed or manufactured to be incorporated in a device or system used in purposes related to human life.
- Before using the products for special purposes such as nuclear power, electric power, aerospace, medicine or passenger-carrying vehicles, consult with Mitsubishi Electric.
- The products have been manufactured under strict quality control. However, when installing the products where major accidents or losses could occur if the products fail, install appropriate backup or fail-safe functions in the system.

# YOUR SOLUTION PARTNER

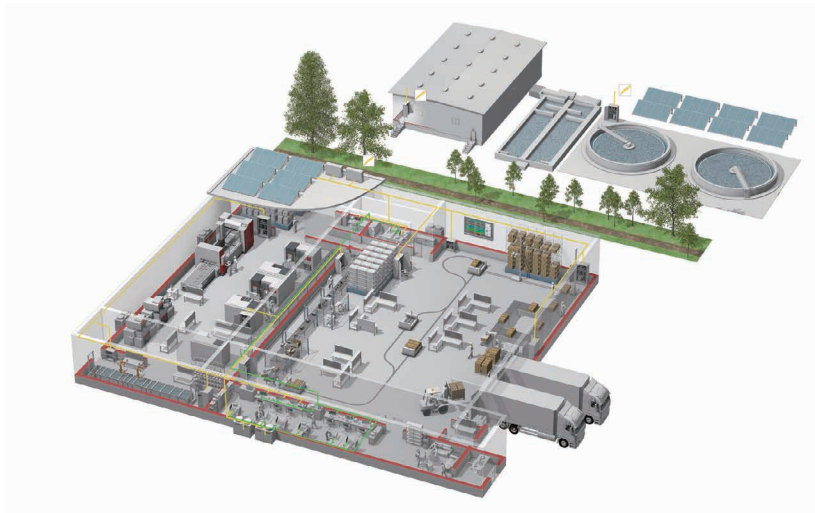

Mitsubishi Electric offers a wide range of automation equipment from PLCs and HMIs to CNC and EDM machines.

## A NAME TO TRUST

Since its beginnings in 1870, some 45 companies use the Mitsubishi name, covering a spectrum of finance, commerce and industry.

The Mitsubishi brand name is recognized around the world as a symbol of premium quality.

Mitsubishi Electric Corporation is active in space development, transportation, semi-conductors, energy systems, communications and information processing, audio visual equipment and home electronics, building and energy management and automation systems, and has 237 factories and laboratories worldwide in over 121 countries.

This is why you can rely on Mitsubishi Electric automation solution - because we know first hand about the need for reliable, efficient, easy-to-use automation and control in our own factories.

As one of the world's leading companies with a global turnover of over 4 trillion Yen (over \$40 billion), employing over 100,000 people, Mitsubishi Electric has the resource and the commitment to deliver the ultimate in service and support as well as the best products.



Low voltage: MCCB, MCB, ACB



Medium voltage: VCB, VCC



Power monitoring, energy management



Compact and Modular Controllers



Inverters, Servos and Motors



Visualisation: HMIs



Numerical Control (NC)



Industrial / Collaborative Robots



Processing machines: EDM, Lasers, IDS



Transformers, Air conditioning, Photovoltaic systems

\* Not all products are available in all countries.

# Global Partner. Local Friend.

## American Offices

<b>USA</b> <b>Mitsubishi Electric Automation, Inc.</b> 500 Corporate Woods Parkway, Vernon Hills, IL 60061, U.S.A. Tel: +1-847-478-2100	<b>Mexico</b> <b>Mitsubishi Electric Automation, Inc.</b> <b>Mexico Branch</b> Boulevard Miguel de Cervantes Saavedra 301, Torre Norte Piso 5, Ampliacion Granada, Miguel Hidalgo, Ciudad de Mexico, Mexico, C.P.11520 Tel: +52-55-3067-7512	<b>Brazil</b> <b>Mitsubishi Electric do Brasil Comercio e Servicos Ltda.</b> Avenida Adelino Cardana, 293, 21 andar, Bethaville, Barueri SP, Brazil Tel: +55-11-4689-3000
--	---	--

## Asia-Pacific Offices

<b>China</b> <b>Mitsubishi Electric Automation (China) Ltd.</b> Mitsubishi Electric Automation Center, No.1386 Hongqiao Road, Shanghai, China Tel: +86-21-2322-3030	<b>Taiwan</b> <b>SETSUYO ENTERPRISE CO., LTD.</b> 6F, No.105, Wugong 3rd Road, Wugu District, New Taipei City 24889, Taiwan Tel: +886-2-2299-2499	<b>Korea</b> <b>Mitsubishi Electric Automation Korea Co., Ltd.</b> 7F to 9F, Gangseo Hangang Xi-tower A, 401, Yangcheon-ro, Gangseo-Gu, Seoul 07528, Korea Tel: +82-2-3660-9569
<b>Singapore</b> <b>Mitsubishi Electric Asia Pte. Ltd.</b> 307 Alexandra Road, Mitsubishi Electric Building, Singapore 159943 Tel: +65-6473-2308	<b>Malaysia</b> <b>Mitsubishi Electric Sales Malaysia Sdn. Bhd.</b> Lot 11, Jalan 219, 46100 Petaling Jaya, Selangor Darul Ehsan, Malaysia Tel: +60-3-7958-3544	<b>Indonesia</b> <b>PT. Mitsubishi Electric Indonesia</b> Gedung Jaya 8th Floor, JL. MH. Thamrin No.12, Jakarta Pusat 10340, Indonesia Tel: +62-21-3192-6461
<b>Vietnam</b> <b>Mitsubishi Electric Vietnam Co., Ltd.</b> 11th & 12th Floor, Viettel Tower B, 285 Cach Mang Thang 8 Street, Ward 12, District 10, Ho Chi Minh City, Vietnam Tel: +84-28-3910-5945	<b>Thailand</b> <b>Mitsubishi Electric Factory Automation (Thailand) Co., Ltd.</b> 101, True Digital Park Office, 5th Floor, Sukhumvit Road, Bangchak, Phra Khanong, Bangkok 10260, Thailand Tel: +66-2092-8600	<b>Philippines</b> <b>MELCO Factory Automation Philippines Inc.</b> 128, Lopez-Rizal St. Brgy, Highway Hills, Mandaluyong City, MM, Philippines Tel: +63-(0)2-8256-8042
<b>India</b> <b>Mitsubishi Electric India Pvt. Ltd.</b> <b>Pune Branch</b> Emerald House, EL-3, J Block, M.I.D.C., Bhosari, Pune - 411026, Maharashtra, India Tel: +91-20-2710-2000	<b>Australia</b> <b>Mitsubishi Electric Australia Pty. Ltd.</b> 348 Victoria Road, P.O. Box 11, Rydalmere, N.S.W. 2116, Australia Tel: +61-2-9684-7777	

## European Offices

<b>Germany</b> <b>Mitsubishi Electric Europe B.V.</b> <b>German Branch</b> Mitsubishi-Electric-Platz 1, 40882 Ratingen, Germany Tel: +49-2102-486-0	<b>UK</b> <b>Mitsubishi Electric Europe B.V.</b> <b>UK Branch</b> Travellers Lane, UK-Hatfield, Hertfordshire, AL10 8XB, U.K. Tel: +44-1707-28-8780	<b>Italy</b> <b>Mitsubishi Electric Europe B.V.</b> <b>Italian Branch</b> Centro Direzionale Colleoni - Palazzo Sirio, Viale Colleoni 7, 20864 Agrate Brianza (MB), Italy Tel: +39-039-60531
<b>Spain</b> <b>Mitsubishi Electric Europe B.V.</b> <b>Spanish Branch</b> Carretera de Rubi 76-80-Apdo. 420, E-08190 Sant Cugat del Valles (Barcelona), Spain Tel: +34-935-65-3131	<b>France</b> <b>Mitsubishi Electric Europe B.V.</b> <b>French Branch</b> 25, Boulevard des Bouvets, 92741 Nanterre Cedex, France Tel: +33-1-55-68-55-68	<b>Czech Republic</b> <b>Mitsubishi Electric Europe B.V.</b> <b>Czech Branch</b> Pekarska 621/7, 155 00 Praha 5, Czech Republic Tel: +420-255-719-200
<b>Turkey</b> <b>Mitsubishi Electric Turkey A.S.</b> <b>Umraniye Branch</b> Serifali Mah. Kale Sok. No:41 34775 Umraniye, Istanbul, Turkey Tel: +90-216-969-2500	<b>Poland</b> <b>Mitsubishi Electric Europe B.V.</b> <b>Polish Branch</b> ul. Krakowska 48, 32-083 Balice, Poland Tel: +48-12-347-65-00	<b>Russia</b> <b>Mitsubishi Electric (Russia) LLC</b> <b>St. Petersburg Branch</b> Startovaya street, 8, BC "Aeroplaza", office 607; 196210, St. Petersburg, Russia Tel: +7-812-449-51-34
<b>South Africa</b> <b>Adroit Technologies</b> 20 Waterford Office Park, 189 Witkoppen Road, Fourways, South Africa Tel: +27-11-658-8100		

The release date varies depending on the product and your region. For details, please contact your local sales office.

## MITSUBISHI ELECTRIC CORPORATION

HEAD OFFICE: TOKYO BLDG., 2-7-3, MARUNOUCHI, CHIYODA-KU, TOKYO 100-8310, JAPAN  
 NAGOYA WORKS: 1-14, YADA-MINAMI 5, HIGASHI-KU, NAGOYA, JAPAN