

GRAPHIC OPERATION TERMINAL

GOT SIMPLE
Graphic Operation Terminal

GOT SIMPLE Series User's Manual

-GS25 model
-GS21 model

SAFETY PRECAUTIONS

(Always read these precautions before using this equipment.)

Before using this product, please read this manual and the relevant manuals introduced in this manual carefully and pay full attention to safety to handle the product correctly.

The precautions given in this manual are concerned with this product.

In this manual, the safety precautions are ranked as "WARNING" and "CAUTION".



Indicates that incorrect handling may cause hazardous conditions, resulting in death or severe injury.



Indicates that incorrect handling may cause hazardous conditions, resulting in medium or slight personal injury or physical damage.

Note that the  caution level may lead to a serious accident according to the circumstances.

Always follow the instructions of both levels because they are important to personal safety.

Please save this manual to make it accessible when required and always forward it to the end user.

[DESIGN PRECAUTIONS]

WARNING

- Some failures of the GOT or cable may keep the outputs on or off. Some failures of a touch panel may cause malfunction of the input objects such as a touch switch. An external monitoring circuit should be provided to check for output signals which may lead to a serious accident. Not doing so can cause an accident due to false output or malfunction.

- Do not use the GOT as the warning device that may cause a serious accident. An independent and redundant hardware or mechanical interlock is required to configure the device that displays and outputs serious warning. Not doing so can cause an accident due to false output or malfunction.

- When the GOT backlight has a failure, the GOT status will be as follows.

Failure to observe this instruction may result in an accident due to incorrect output or malfunction.

[GS25]

The POWER LED blinks (orange/blue), the display section dims, and inputs by a touch switch are disabled.

[GS21]

The POWER LED blinks (orange/blue), and the display section dims. However, inputs by a touch switch are still available.

The GOT backlight failure can be checked with a system signal of the GOT.

Even if the display section dims, inputs by a touch switch may still be available. This may cause an unintended operation of the touch switch.

For example, if an operator assumes that the display section has dimmed because of the screen save function and touches the display section to cancel the screen save, a touch switch may be activated.

[DESIGN PRECAUTIONS]

WARNING

- The display section of the GOT is an analog-resistive type touch panel.
When multiple points of the display section are touched simultaneously, an accident may occur due to incorrect output or malfunction.
Do not touch two points or more simultaneously on the display section.
Doing so may cause a touch switch near the touched points to operate unexpectedly, or may cause an accident due to an incorrect output or malfunction.
 - When programs or parameters of the controller (such as a PLC) that is monitored by the GOT are changed, be sure to reset the GOT, or turn on the unit again after shutting off the power as soon as possible.
Not doing so can cause an accident due to false output or malfunction.
 - If a communication fault (including cable disconnection) occurs during monitoring on the GOT, communication between the GOT and PLC CPU is suspended and the GOT becomes inoperative. A system where the GOT is used should be configured to perform any significant operation to the system by using the switches of a device other than the GOT on the assumption that a GOT communication fault will occur. Not doing so can cause an accident due to false output or malfunction.
 - To maintain the security (confidentiality, integrity, and availability) of the GOT and the system against unauthorized access, DoS^{*1} attacks, computer viruses, and other cyberattacks from unreliable networks and devices via network, take appropriate measures such as firewalls, virtual private networks (VPNs), and antivirus solutions.
Mitsubishi Electric shall have no responsibility or liability for any problems involving GOT trouble and system trouble by unauthorized access, DoS attacks, computer viruses, and other cyberattacks.
^{*1} DoS: A denial-of-service (DoS) attack disrupts services by overloading systems or exploiting vulnerabilities, resulting in a denial-of-service (DoS) state.
-

[DESIGN PRECAUTIONS]

CAUTION

- Do not run the control line cables and communication cables together with or near the main circuit cables, power line cables, or other cables.
Keep a distance of 100 mm or more between them as a guide.
Not doing so may cause a malfunction due to noise.
 - Do not press the GOT display section with a pointed material as a pen or driver. Doing so can result in a damage or failure of the display section.
 - When the GOT connects to an Ethernet network, the IP address setting is restricted according to the system configuration.
[GS25]
When a GS25 model and a GOT1000 series model are on an Ethernet network, do not set the IP address 192.168.0.18 for the GOTs and the controllers on this network.
Doing so can cause IP address duplication at the GOT startup, adversely affecting the communication of the device with the IP address 192.168.0.18.
The operation at IP address duplication depends on the devices and the system.
[GS21]
Setting the IP address (192.168.3.18) in the following system configurations can cause IP address duplication at GOT startup, adversely affecting communications of the device whose IP address is 192.168.3.18.
The operation at IP address duplication depends on the devices and the system.
When multiple GOTs connect to the Ethernet network: Do not set the IP address (192.168.3.18) for the GOTs and the controllers in the network.
When one GOT connects to the Ethernet network: Do not set the IP address (192.168.3.18) for the controllers other than the GOT in the network.
 - When using the Ethernet interfaces, set an IP address for each interface to access a different network.
 - Turn on the controllers and the network devices to be ready for communication before they communicate with the GOT. Failure to do so can cause a communication error on the GOT.
 - When the GOT is subject to shock or vibration, or some colors appear on the screen of the GOT, the screen of the GOT might flicker.
-

[MOUNTING PRECAUTIONS]

WARNING

- Be sure to shut off all phases of the external power supply used by the system before mounting or removing the GOT main unit to/from the panel.
Not doing so can cause the unit to fail or malfunction.
 - Be sure to shut off all phases of the external power supply used by the system before mounting or removing the communication unit to/from the GOT.
Not doing so can cause the unit to fail or malfunction.
-

[MOUNTING PRECAUTIONS]

CAUTION

- Use the GOT in the environment that satisfies the general specifications described in this manual. Not doing so can cause an electric shock, fire, malfunction or product damage or deterioration.
 - When mounting the GOT to the control panel, tighten the mounting screws in the specified torque range with a Phillips-head screwdriver No. 2.
Specified torque range (0.36 N•m to 0.48 N•m)
Undertightening can cause the GOT to drop, short circuit or malfunction.
Overtightening can cause a drop, short circuit or malfunction due to the damage of the screws or the GOT.
 - When mounting a unit on the GOT, tighten the mounting screws in the following specified torque range.
[GS25]
When mounting the wireless LAN communication unit on the GOT, fit it to the wireless LAN communication unit interface and tighten the mounting screws in the specified torque range (0.10 N•m to 0.14 N•m) with a Phillips-head screwdriver No.1.
Under tightening can cause the GOT to drop, short circuit or malfunction.
Overtightening can cause a drop, failure or malfunction due to the damage of the screws or unit.
 - When closing the USB environmental protection cover, note the following points to ensure the IP rating.
[GS25]
Push the USB mark on the latch firmly to fix the cover to the GOT.
 - Remove the protective film of the GOT. When the user continues using the GOT with the protective film, the film may not be removed.
 - Do not operate or store the GOT in the environment exposed to direct sunlight, rain, high temperature, dust, humidity, or vibrations.
 - Do not use the GOT in an environment with oil or chemicals. Doing so may cause failure or malfunction due to the oil or chemical entering into the GOT.
 - Do not operate the GOT with its display section frozen.
The water droplets on the display section may freeze at a low temperature.
Touch switches and other input objects may malfunction if the display section is frozen.
-

[WIRING PRECAUTIONS]

WARNING

- Be sure to shut off all phases of the external power supply used by the system before wiring. Failure to do so may result in an electric shock, product damage or malfunctions.
-

[WIRING PRECAUTIONS]

CAUTION

- Make sure to ground the FG terminal of the GOT power supply section solely for the GOT (ground resistance: 100 Ω or less, ground cable diameter: 1.6 mm or more).
Not doing so may cause an electric shock or malfunction.
 - When tightening the terminal screws, use a Phillips-head screwdriver No.2.
 - Tighten the terminal screws of the GOT power supply section in the following specified torque range.
[GS25]
Specified torque range (0.5 N•m to 0.8 N•m)
[GS21]
Specified torque range (0.5 N•m to 0.6 N•m)
 - Use applicable solderless terminals and tighten them with the specified torque.
If any solderless spade terminal is used, it may be disconnected when the terminal screw comes loose, resulting in failure.
 - Correctly wire the GOT power supply section after confirming the rated voltage and terminal arrangement of the product. Not doing so can cause a fire or failure.
 - Tighten the terminal screws of the GOT power supply section in the following specified torque range.
[GS25]
Specified torque range (0.5 N•m to 0.8 N•m)
[GS21]
Specified torque range (0.5 N•m to 0.6 N•m)
Undertightening can cause a short circuit or malfunction.
Overtightening can cause a short circuit or malfunction due to the damage of the screws or unit.
 - Exercise care to avoid foreign matter such as chips and wire offcuts entering the GOT.
Not doing so can cause a fire, failure or malfunction.
 - Plug the communication cable into the GOT interface or the connector of the connected unit, and tighten the mounting screws and the terminal screws in the specified torque range.
Undertightening can cause a short circuit or malfunction.
Overtightening can cause a short circuit or malfunction due to the damage of the screws or unit.
-

[TEST OPERATION PRECAUTIONS]

WARNING

- Before testing the operation of a user-created screen (such as turning on or off a bit device, changing the current value of a word device, changing the set value or current value of a timer or counter, and changing the current value of a buffer memory), thoroughly read the manual to fully understand the operating procedure.

During the test operation, never change the data of the devices which are used to perform significant operation for the system.

False output or malfunction can cause an accident.

[STARTUP/MAINTENANCE PRECAUTIONS]

WARNING

- When power is on, do not touch the terminals. Doing so can cause an electric shock or malfunction.

- Correctly connect the battery connector.

Do not charge, disassemble, heat, short-circuit, solder, or throw the battery into the fire.

Doing so will cause the battery to produce heat, explode, or ignite, resulting in injury and fire.

- Before starting cleaning or terminal screw retightening, always switch off the power externally in all phases.

Not switching the power off in all phases can cause a unit failure or malfunction.

Undertightening can cause a short circuit or malfunction.

Overtightening can cause a short circuit or malfunction due to the damage of the screws or unit.

[STARTUP/MAINTENANCE PRECAUTIONS]

CAUTION

- Do not disassemble or modify the unit. Doing so can cause a failure, malfunction, injury or fire.
 - Do not touch the conductive and electronic parts of the unit directly. Doing so can cause a unit malfunction or failure.
 - The cables connected to the unit must be run in ducts or clamped. Not doing so can cause the unit or cable to be damaged due to the dangling, motion or accidental pulling of the cables or can cause a malfunction due to a cable connection fault.
 - When unplugging the cable connected to the unit, do not hold and pull from the cable portion. Doing so can cause the unit or cable to be damaged or can cause a malfunction due to a cable connection fault.
 - Do not drop the module or subject it to strong shock. A module damage may result.
 - Do not drop or give an impact to the battery mounted to the unit. Doing so may damage the battery, causing the battery fluid to leak inside the battery. If the battery is dropped or given an impact, dispose of it without using.
 - Before touching the unit, always touch grounded metals, etc. to discharge static electricity from human body, etc. Not doing so can cause the unit to fail or malfunction.
 - Use the battery manufactured by Mitsubishi Electric Corporation. Use of other batteries may cause a risk of fire or explosion.
 - Dispose of used battery promptly. Keep away from children. Do not disassemble and do not dispose of in fire.
 - Be sure to shut off all phases of the external power supply before replacing the battery or using the dip switch of the terminating resistor. Not doing so can cause the unit to fail or malfunction by static electricity.
-

[TOUCH PANEL PRECAUTIONS]

CAUTION

- For the analog-resistive film type touch panels, normally the adjustment is not required. However, the difference between a touched position and the object position may occur as the period of use elapses. When any difference between a touched position and the object position occurs, execute the touch panel calibration.
 - When any difference between a touched position and the object position occurs, other object may be activated. This may cause an unexpected operation due to incorrect output or malfunction.
-

[PRECAUTIONS FOR USING A DATA STORAGE]

WARNING

- If the SD card is removed from drive A of the GOT while being accessed by the GOT, the GOT may stop processing data for about 20 seconds.
The GOT cannot be operated during this period. The functions that run in the background including a screen updating, alarm, logging, scripts, and others are also interrupted.
This stop affects the system operation, causing an accident.
Before removing the SD card, check the following items.
[GS25]
Check that the SD card access LED is off before removing the SD card.
[GS21]
Disable the SD card access in the GOT utility, and then check that the SD card access LED is off before removing the SD card.
-

[PRECAUTIONS FOR USING A DATA STORAGE]

CAUTION

- Do not remove the data storage from the GOT while the data storage is being accessed by the GOT, or the data storage and files may be damaged.
Before removing the data storage, check the SD card access LED, relevant system signal, or others to make sure that the data storage is not being accessed.
 - Turning off the GOT while it accesses the SD card results in damage to the SD card and files.
 - When using the GOT with an SD card inserted, check the following items.
[GS25]
After inserting an SD card into the GOT, make sure to close the SD card cover.
Otherwise, data cannot be read or written.
[GS21]
After inserting an SD card into the SD card unit, make sure to enable the SD card access in the GOT utility.
Otherwise, data cannot be read or written.
 - When removing the SD card from the GOT, make sure to support the SD card by hand as it may pop out. Not doing so may cause the SD card to drop from the GOT, resulting in a failure or break.
 - When inserting a USB device into a USB interface of the GOT, make sure to insert the device into the interface firmly.
Not doing so may cause a malfunction due to poor contact.
 - Before removing the data storage from the GOT, follow the procedure for removal on the utility screen of the GOT. After the successful completion dialog is displayed, remove the data storage by hand carefully.
Not doing so may cause the data storage to drop from the GOT, resulting in a failure or break.
-

[PRECAUTIONS FOR USE]

CAUTION

- Do not touch the edges of the touch panel (display section) repeatedly.
Doing so may result in a failure.
 - Do not turn off the GOT while data is being written to the storage memory (ROM) or SD card.
Doing so may corrupt the data, rendering the GOT inoperative.
-

[PRECAUTIONS FOR REMOTE CONTROL]

WARNING

- Remote control is available through a network by using GOT functions, including the SoftGOT-GOT link function, the remote personal computer operation function, the VNC server function, and the GOT Mobile function.

If you remotely operate control equipment using such functions, the field operator may not notice the remote operation, leading to an accident.

In addition, a communication delay or interruption may occur depending on the network environment, and remote control of control equipment cannot be performed normally in some cases.

Before using the above functions to perform remote control, fully grasp the circumstances of the field site and ensure safety.

- When operating the server (GOT) of the GOT Mobile function to disconnect a client, notify the operator of the client about the disconnection beforehand.

Not doing so may cause an accident.

[PRECAUTIONS FOR EXCLUSIVE AUTHORIZATION CONTROL]

WARNING

- Before using the GOT network interaction function to prevent simultaneous operations from multiple pieces of equipment, make sure you understand the function.

You can enable or disable the exclusive authorization control of the GOT network interaction function for each screen. (For all screens, the exclusive authorization control is disabled by default.)

Properly determine the screens for which the exclusive authorization control is required, and set the control by screen.

A screen for which the exclusive authorization control is disabled is operable simultaneously from multiple pieces of equipment. Make sure to determine the operation period for each operator, fully grasp the circumstances of the field site, and ensure safety to perform operations.

[DISPOSAL PRECAUTIONS]

CAUTION

- When disposing of this product, treat it as industrial waste.
When disposing of batteries, separate them from other wastes according to the local regulations. (Refer to Page 103 Low-voltage Battery Detection and Battery Replacement for details of the battery directive in the EU member states.)
-

[TRANSPORTATION PRECAUTIONS]

CAUTION

- When transporting lithium batteries, make sure to treat them based on the transport regulations. (Refer to Page 124 Transportation Precautions for details of the regulated models.)
 - Make sure to transport the GOT main unit and/or relevant unit(s) in the manner they will not be exposed to the impact exceeding the impact resistance described in the general specifications of this manual, as they are precision devices. Failure to do so may cause the unit to fail. Check if the unit operates correctly after transportation.
 - When fumigants that contain halogen materials such as fluorine, chlorine, bromine, and iodine are used for disinfecting and protecting wooden packaging from insects, they cause malfunction when entering our products. Please take necessary precautions to ensure that remaining materials from fumigant do not enter our products, or treat packaging with methods other than fumigation (heat method). Additionally, disinfect and protect wood from insects before packing products.
-

MEMO

CONTENTS

SAFETY PRECAUTIONS	1
INTRODUCTION	20
Manuals for GT Works3	20
Quick Reference	22
Abbreviations and Generic Terms	23

PART 1 GS25 model

CHAPTER 1 REFERRING TO THE RELATED MANUALS	28
CHAPTER 2 OVERVIEW	31
2.1 GOT	31
2.2 Features	31
CHAPTER 3 System configuration	33
3.1 Overall Configuration	33
3.2 System Equipment	34
GOT	34
Extension unit	35
Software	36
Option	37
Cable	38
Others	44
CHAPTER 4 SPECIFICATIONS	45
4.1 General Specifications	45
4.2 Performance Specifications	46
4.3 Specifications of Power Supply Section	48
4.4 Battery Specifications	49
CHAPTER 5 PART NAMES AND SETTINGS	51
CHAPTER 6 EMC DIRECTIVE	53
6.1 Overview	53
Conforming standards in the EMC Directive	54
6.2 EMC Directive Requirements	55
Installing the GOT on the control panel	55
Installing a noise filter (power supply line filter)	57
System configuration	58
Connection of power cables and ground cables	59
Fabricating a connection cable	60
Grounding a cable	63
CHAPTER 7 INSTALLATION AND REMOVAL	65
7.1 Installation Precautions	65
7.2 Panel Cut Dimensions	66
7.3 Installation Position	67

7.4	Control Panel Inside Temperature and GOT Installation Angle	69
7.5	Installing and Removing the GOT	70
	Installing the GOT	70
	Removing the GOT	71
7.6	Installing and Removing the Battery	72
	Installing the Battery	72
	Removing the Battery	74
7.7	Installing and Removing the SD Card	76
	Installing the SD Card	76
	Removing the SD Card	78
7.8	Installing and Removing the USB Devices	80
	Installing the USB devices	80
	Removing the USB devices	80
7.9	Installing and Removing the USB cable	81
	Installing the USB cable	81
	Removing the USB cable	82
7.10	Installing and Removing the Panel-Mounted USB Port Extension	83
	Parts name	83
	Installing and removing the panel-mounted USB port extension	83
CHAPTER 8 WIRING OF POWER SUPPLY SECTION		85
8.1	Wiring of External Power Supply	87
8.2	Power Supply Wiring to the GOT	88
8.3	Grounding	89
	Grounding the GOT	89
	Causes of wiring-related malfunction and countermeasure examples	91
8.4	Wiring Inside and Outside the Control Panel	93
	Control panel inside wiring	93
	Control panel outside wiring	93
8.5	Attaching a Surge Suppressor to Control Equipment	94
CHAPTER 9 OPERATING THE GOT		95
9.1	Outline Procedure to Start the GOT	95
9.2	Creating Project Data	98
CHAPTER 10 MAINTENANCE AND INSPECTION		99
10.1	Daily Inspection	100
10.2	Periodic Inspection	101
10.3	Screen Cleaning Method	102
10.4	Low-voltage Battery Detection and Battery Replacement	103
CHAPTER 11 TROUBLESHOOTING		105
11.1	GOT Restoration Sheets	105
	GOT status check sheet	105
	GOT installation status check sheet	109
	System configuration check sheet	115
11.2	Error Messages and System Alarms	116
	Displayed contents	116
	Error messages and system alarms	118

CHAPTER 12 APPENDICES	119
12.1 External Dimension Diagrams	120
12.2 External Dimension Diagrams of the Communication Cable	121
12.3 Confirming of Versions and Conforming Standards	123
12.4 Transportation Precautions	124
Relevant models	124
Transportation guidelines	124
12.5 Open Source Software	125
u-boot	125

PART 2 GS21 model

CHAPTER 13 OVERVIEW	133
13.1 Features	134
Rough procedure	135

CHAPTER 14 SYSTEM CONFIGURATION	137
14.1 Overall Configuration	137
14.2 Component List	137
Explanation of the GOT model name	137
GOT	138
Extension unit	138
Software	138
Option	139

CHAPTER 15 SPECIFICATIONS	141
15.1 General Specifications	141
15.2 Performance Specifications	142
15.3 Power Supply Specifications	144
15.4 GOT Connector Specifications	145
RS-232 interface	145
RS-422 interface and RS-422/485 interface	145

CHAPTER 16 PART NAME	147
16.1 Front Panel	147
16.2 Back Panel	148
16.3 Bottom	151

CHAPTER 17 EMC DIRECTIVE	153
17.1 Overview	153
Conforming standards in the EMC Directive	154
17.2 EMC Directive Requirements	155
Installing the GOT on the control panel	155
Installing a noise filter (power supply line filter)	156
System configuration	157
Connection of power cables and ground cables	157
Fabricating a connection cable	158
Grounding a cable	161

CHAPTER 18 INSTALLATION	163
18.1 Control Panel Inside Dimensions for Mounting GOT	163
18.2 Panel Cutting Dimensions	164
18.3 Mounting Position	165
18.4 Control Panel Temperature and Mounting Angle	166
18.5 Installation Procedure	167
CHAPTER 19 WIRING	169
19.1 Power Supply Wiring	170
Cable types and wire end processing	170
Wiring example	171
GOT's ground	171
The cause of malfunctions related wiring/Remedy	172
19.2 Wiring Inside and Outside the Panel	174
Wiring inside	174
Outside the panel	174
Attaching surge killers to control equipment	175
CHAPTER 20 OPTION	177
20.1 SD Card	177
Applicable SD card	177
Installation/removal procedure of SD card	177
CHAPTER 21 UTILITY FUNCTION	179
21.1 Utility Execution	179
21.2 Utility Function List	180
21.3 Utility Display	182
Display operation of main menu	184
Utility basic configuration	186
Basic operation of settings change	187
CHAPTER 22 LANGUAGE SETTING (LANGUAGE)	189
22.1 Display language setting	189
Display language setting function	189
Language setting operation	189
CHAPTER 23 COMMUNICATION INTERFACE SETTING (COMMUNICATION SETTING)	191
23.1 Standard I/F Setting	191
Standard I/F functions	191
Standard I/F display operation	191
Display contents of standard I/F	192
Detail information setting operation	195
Channel setting operation	198
Driver setting operation	199
23.2 GOT IP Address Setting	200
Standard	200
Display operation of GOT IP address	200
Setting operation	201

23.3 Ethernet Communication	202
Setting function for Ethernet communication	202
Display operation of Ethernet communication	202
Display contents of Ethernet setting	203
23.4 Communication Monitor	206
Communication monitor functions	206
Communication monitor display operation	206
Screen display content	207
23.5 Ethernet Check	209
23.6 Setting the Transparent Mode	211
23.7 Keyword	212
Keyword functions	212
Keyword display operation	212
Regist	213
Delete	216
Clear	218
Protect	220

CHAPTER 24 DISPLAY AND OPERATION SETTINGS (GOT SET UP) 221

24.1 Display Settings	221
Display setting functions	221
Display operation of display setting	222
Display setting operations	223
24.2 Operation Setting (Settings for Operation)	224
Operation setting functions	224
Display operation of operation setting	225
Setting operation of operation	226
Position correction of the touch panel (touch panel calibration setting)	227
Setting the utility call keys	229
24.3 Inherent Information	231
Setting function for inherent information	231
Display operation of inherent information	231
Setting operation for inherent information	231
24.4 GOT Internal Device Monitor	232
Setting the GOT internal device monitor	232
GOT internal device monitor display operation	232
GOT internal device monitor setting operation	233
24.5 VNC Server Function	234
VNC server function setting	234
Display operation of the VNC server function setting	234
VNC server function setting operation	235
24.6 License Management	236
License management setting	236
Display operation of the license management setting	236
Setting operation of license management	237
24.7 IP Filter Setting	238
IP filter setting	238
Display operation of the IP filter setting	238
Setting procedure for the IP filter	239

CHAPTER 25 SECURITY LEVEL AND OPERATOR SETTINGS (SECURITY SETTING)	245
25.1 Security Level Authentication	245
25.2 Operator Authentication	247
Operator information management	247
Password change	257
Function setting	259
25.3 Login/Logout	261
CHAPTER 26 CLOCK SETTINGS (TIME SETTING AND DISPLAY)	263
26.1 Time Setting and Display	263
Time setting and display functions	263
Clock synchronization method	264
Time setting	265
Adjusting the clock	267
Local time	271
CHAPTER 27 CONTROL OF VARIOUS DATA (DATA CONTROL)	275
27.1 Data Storage Location	275
Data type and storage location	275
Checking version of basic system application	277
27.2 OS information	279
27.3 Resource Data Information	281
Alarm information	281
Recipe information	286
Logging information	292
Image file management	296
Operation log information	300
27.4 SD Card Access	306
Functions of SD card access	306
Display operation of SD card access	306
Operation of SD card access	306
27.5 SD Card Format	307
27.6 Clear data	309
Clear data functions	309
Clear data display	309
Clear data operation	309
27.7 Data Copy	310
Display operation of data copy	310
Operation of data copy	311
27.8 BACKUP/RESTORE	313
BACKUP/RESTORE	313
System configuration	314
Access range	318
Precautions	318
Security and password	321
Operation of backup/restore	327
Operation of backup	328
Operation of restore	330
Operation of keyword	332

27.9	Errors and Corrective Actions	333
CHAPTER 28 GOT SELF CHECK (DEBUG)		335
28.1	Device Monitor Function	335
	System configuration	335
	Devices that can be monitored	336
	Precautions	336
	Display operation of device monitor	337
	Information displayed on the device monitor screen and key functions	338
	Basic operation of device monitor	340
	Device registration	341
	Quick test	344
28.2	FX List Editor	348
	Display operation of FX list editor	348
	Specifications	350
	Access range	351
	Precautions	351
	Display operation	352
	Operation procedures	354
	Selection and operation of modes	356
	Displaying sequence programs	357
	Searching commands/devices	359
	Writing commands	361
	Changing operands, set values	365
	Deleting commands	366
	Sequence program all clear	367
	PLC diagnostics	368
	Parameter setting	370
	Keyword	372
	List monitor	374
	Action for an incorrect key input	375
	Error messages and corrective actions	376
28.3	FX3U-ENET-ADP Communication Setting Function	377
	Specifications	377
	Display operation of FX3U-ENET-ADP communication setting function	378
	Setting operation	379
CHAPTER 29 MAINTENANCE		383
29.1	Touch Panel Calibration	383
29.2	Touch Panel Check	385
29.3	Clean	387
CHAPTER 30 BootOS and System Application Installation Using Data Storage		389
30.1	Installing when starting the GOT	390
30.2	Installing using the data control function (Utility)	390
CHAPTER 31 INSTALLATION OF Boot OS AND BASIC SYSTEM APPLICATION		391
31.1	Boot OS and Basic System Application to be Installed	391
31.2	Prior Preparations for Installing Boot OS and System Application	392

CHAPTER 32 ERROR MESSAGE LIST	393
<hr/>	
CHAPTER 33 MAINTENANCE AND INSPECTION	395
<hr/>	
33.1 Daily Inspection	396
33.2 Periodic Inspection	396
33.3 Cleaning Method	397
33.4 Backlight Shutoff Detection	398
Backlight shutoff detection and external alarm	398
<hr/>	
CHAPTER 34 TROUBLESHOOTING	399
<hr/>	
34.1 GOT Restoration Sheets	399
GOT status check sheet	400
GOT installation status check sheet	403
System configuration check sheet	409
<hr/>	
CHAPTER 35 CONNECTION	411
<hr/>	
CHAPTER 36 APPENDIX	413
<hr/>	
36.1 External Dimensions	413
REVISIONS	420
WARRANTY	421
Intellectual Property Rights	422

INTRODUCTION

Thank you for choosing Mitsubishi Electric Graphic Operation Terminal (GOT).

Before using the product, read this manual carefully and make sure you understand the functions and performance of the GOT for correct use.

 Manuals for GT Works3

 Abbreviations and Generic Terms

Manuals for GT Works3

The electronic manuals related to this product are installed together with the screen design software.

If you need the printed manuals, consult your local sales office.

Manuals for GT Designer3 (GOT2000)

Point

e-Manual refers to the Mitsubishi Electric FA electronic book manuals that can be browsed using a dedicated tool.

e-Manual has the following features:

- Required information can be cross-searched in multiple manuals.
- Other manuals can be accessed from the links in the manual.
- Hardware specifications of each part can be found from the product figures.
- Pages that users often browse can be bookmarked.
- Sample programs can be copied to the engineering tool.

■Screen design software-related manuals

Manual name	Manual number (Model code)	Format
GT Works3 Installation Instructions	-	PDF
GT Designer3 (GOT2000) Screen Design Manual	SH-081220ENG (1D7ML9)	PDF e-Manual
GT Converter2 Version3 Operating Manual for GT Works3	SH-080862ENG (1D7MB2)	PDF e-Manual
GOT2000 Series MES Interface Function Manual for GT Works3 Version1	SH-081228ENG	PDF e-Manual

■Connection manuals

Manual name	Manual number (Model code)	Format
GOT2000 Series Connection Manual (Mitsubishi Product) For GT Works3 Version1	SH-081197ENG (1D7MJ8)	PDF e-Manual
GOT2000 Series Connection Manual (Non Mitsubishi Product 1) For GT Works3 Version1	SH-081198ENG	PDF e-Manual
GOT2000 Series Connection Manual (Non Mitsubishi Connecting Non-Mitsubishi products to the GOT Product 2) For GT Works3 Version1	SH-081199ENG	PDF e-Manual
GOT2000 Series Connection Manual (Microcomputers, MODBUS/Fieldbus Products, Peripherals) For GT Works3 Version1	SH-081200ENG	PDF e-Manual
GOT2000 Series Connection Manual (α2 Connection) for GT Works3 Version1	JY997D52301	PDF e-Manual

■GT SoftGOT2000 manuals

Manual name	Manual number (Model code)	Format
GT SoftGOT2000 Version1 Operating Manual	SH-081201ENG	PDF e-Manual

■GOT2000 series user's manuals

Manual name	Manual number (Model code)	Format
GOT2000 Series User's Manual (Utility)	SH-081195ENG (1D7MJ6)	PDF e-Manual
GOT2000 Series User's Manual (Monitor)	SH-081196ENG (1D7MJ7)	PDF e-Manual

■GOT SIMPLE series user's manuals

Manual name	Manual number	Format
GOT SIMPLE Series User's Manual	JY997D52901	PDF e-Manual

■Manuals related to GT Works3 add-on projects

Manual name	Manual number (Model code)	Format
GT Works3 Add-on License for GOT2000 Enhanced Drive Control (Servo) Project Data Manual (Fundamentals)	SH-082072ENG (1D7MV1)	PDF e-Manual
GT Works3 Add-on License for GOT2000 Enhanced Drive Control (Servo) Project Data Manual (Screen Details)	SH-082074ENG (1D7MV3)	PDF e-Manual

Quick Reference

Creating projects

- Obtaining the specifications and operation methods of GT Designer3
- Setting available functions on GT Designer3
- Creating a screen displayed on the GOT
- Obtaining useful functions to increase the screen design efficiency
- Setting details for figures and objects
- Setting functions for the data collection or trigger action
- Setting functions to use peripheral devices
- Simulating a created project on a personal computer

 GT Designer3 (GOT2000) Screen Design Manual

Connecting a controller to the GOT

- Obtaining information of Mitsubishi products applicable to the GOT
- Connecting Mitsubishi products to the GOT
- Connecting multiple controllers to one GOT (Multi-channel function)
- Establishing communication between a personal computer and a controller via the GOT (FA transparent function)

 GOT2000 Series Connection Manual (Mitsubishi Product) For GT Works3 Version1

- Obtaining information of Non-Mitsubishi products applicable to the GOT
- Connecting Non-Mitsubishi products to the GOT

 GOT2000 Series Connection Manual (Non Mitsubishi Product 1) For GT Works3 Version1

 GOT2000 Series Connection Manual (Non Mitsubishi Connecting Non-Mitsubishi products to the GOT Product 2) For GT Works3 Version1

- Obtaining information of peripheral devices applicable to the GOT
- Connecting peripheral devices including a barcode reader to the GOT

 GOT2000 Series Connection Manual (Microcomputers, MODBUS/Fieldbus Products, Peripherals) For GT Works3 Version1

Transferring data to the GOT

- Writing data to the GOT
- Reading data from the GOT
- Verifying an editing project to a GOT project

 GT Designer3 (GOT2000) Screen Design Manual

Others

- Obtaining specifications (including part names, external dimensions, and options) of each GOT
- Installing the GOT

 GOT SIMPLE Series User's Manual

- Operating the utility

 GOT SIMPLE Series User's Manual

- Configuring the gateway function

 GT Designer3 (GOT2000) Screen Design Manual

Abbreviations and Generic Terms

The following shows the abbreviations and generic terms used in this manual.

GOT

Abbreviations and generic terms		Description
GS25	GS25-W	GS2512-WXTBD
GS21	GS21-W-N	GS2110-WTBD-N GS2107-WTBD-N
	GS21-W	GS2110-WTBD GS2107-WTBD

Communication interface

Abbreviations and generic terms	Description
Wireless LAN communication unit	GT25-WLAN
Serial multi-drop connection unit	GT01-RS4-M

Option

Abbreviations and generic terms	Description
SD card	NZ1MEM-2GBSD NZ1MEM-4GBSD NZ1MEM-8GBSD NZ1MEM-16GBSD L1MEM-2GBSD L1MEM-4GBSD
Battery	GT11-50BAT
USB environmental protection cover	GT21-WUCOV
Panel-mounted USB port extension	GT14-C10EXUSB-4S

Software

■ Software related to GOT

Abbreviations and generic terms	Description
GT Works3	SW1DND-GTWK3-E, SW1DND-GTWK3-C
GT Designer3 Version1	Screen design software GT Designer3 for GOT2000 and GOT1000 series
GT Designer3	Screen design software for GOT2000 series included in GT Works3
GT Designer3 (GOT2000)	
GT Designer3 (GOT1000)	Screen design software for GOT1000 series included in GT Works3
Speech synthesis license	GT Works Text to Speech License (SW1DND-GTVO-M)
Add-on license	GT Works3 add-on license for GOT2000 enhanced drive control (servo) project data (SW1DND-GTSV-MZ)
GOT Mobile function license for GT SoftGOT2000	License required to use the GOT Mobile function with GT SoftGOT2000 (SGT2K-WEBSKEY-□)
GT Simulator3	Screen simulator GT Simulator3 for GOT2000/GOT1000/GOT900 series
GT SoftGOT2000	GOT2000 compatible HMI software GT SoftGOT2000

■ Software related to iQ Works

Abbreviations and generic terms	Description
iQ Works	iQ Platform compatible engineering environment MELSOFT iQ Works
MELSOFT Navigator	Integrated development environment software included in SW □ DND-IQWK (iQ Platform compatible engineering environment MELSOFT iQ Works) (□ represents a version.)
MELSOFT iQ AppPortal	SW□DND-IQAPL-M type integrated application management software (□ represents a version.)

Other software

Abbreviations and generic terms		Description
GX Works3		SW□DND-GXW3-E (-EA, -EAZ) type programmable controller engineering software (□ represents a version.)
GX Works2		SW□DNC-GXW2-E (-EA, -EAZ) type programmable controller engineering software (□ represents a version.)
Controller simulator	GX Simulator3	Simulation function of GX Works3
	GX Simulator2	Simulation function of GX Works2
	GX Simulator	SW□D5C-LLT-E (-EV) type ladder logic test tool function software package (SW5D5C-LLT (-V) or later versions) (□ represents a version.)
GX Developer		SW□D5C-GPPW-E (-EV)/SW□D5F-GPPW (-V) type software package (□ represents a version.)
GX LogViewer		SW□DNN-VIEWER-E type software package (□ represents a version.)
PX Developer		SW□D5C-FBDQ-E type FBD software package for process control (□ represents a version.)
MT Works2		Motion controller engineering environment MELSOFT MT Works2 (SW □ DNDMTW2-E) (□ represents a version.)
MT Developer		SW□RNC-GSV type integrated start-up support software for motion controller Q series (□ indicates a version.)
CW Configurator		Setting/monitoring tools for the C Controller module and MELSECWinCPU (SW□DND-RCCPU-E) (□ represents a version.)
MR Configurator2		SW□DNC-MRC2-E type servo configuration software (□ represents a version.)
MR Configurator		MRZJW□-SETUP type servo configuration software (□ indicates a version.)
FR Configurator		Inverter setup software (SW□DND-FRC2-E) (□ represents a version.)
NC Configurator2		CNC parameter setting support tool (FCSB1221)
NC Configurator		CNC parameter setting support tool
FX Configurator-FP		Parameter setting, monitoring, and testing software package for FX3U-20SSC-H (SW□D5CFXSSCE) (□ represents a version.)
FX Configurator-EN-L		FX3U-ENET-L type Ethernet module setting software (SW1D5-FXENETL-E)
FX Configurator-EN		FX3U-ENET type Ethernet module setting software (SW1D5C-FXENET-E)
RT ToolBox2		Robot program creation software (3D-11C-WINE)
RT ToolBox3		Robot program creation software (3F-14C-WINE)
MX Component		MX Component Version□ (SW□D5C-ACT-E, SW□D5C-ACT-EA) (□ represents a version.)
MX Sheet		MX Sheet Version□ (SW□D5C-SHEET-E, SW□D5C-SHEET-EA) (□ represents a version.)
CPU Module Logging Configuration Tool		CPU module logging configuration tool (SW1DNN-LLUTL-E)

License key (for GT SoftGOT2000)

Abbreviations and generic terms	Description
License key	GT27-SGTKEY-U

Others

Abbreviations and generic terms	Description
IAI	IAI Corporation
AZBIL	Azbil Corporation
OMRON	OMRON Corporation
KEYENCE	KEYENCE CORPORATION
KOYO EI	KOYO ELECTRONICS INDUSTRIES CO., LTD.
JTEKT	JTEKT CORPORATION
SHARP	Sharp Corporation
SHINKO	Shinko Technos Co., Ltd.
CHINO	CHINO CORPORATION
TOSHIBA	TOSHIBA CORPORATION
SHIBAURA MACHINE	SHIBAURA MACHINE CO., LTD.
PANASONIC	Panasonic Corporation
PANASONIC IDS	Panasonic Industrial Devices SUNX Co., Ltd.
HITACHI IES	Hitachi Industrial Equipment Systems Co., Ltd.
HITACHI	Hitachi, Ltd.
HIRATA	Hirata Corporation
FUJI	FUJI ELECTRIC CO., LTD.
MURATEC	Muratec products manufactured by Murata Machinery, Ltd.
YASKAWA	YASKAWA Electric Corporation
YOKOGAWA	Yokogawa Electric Corporation
RKC	RKC INSTRUMENT INC.
ALLEN-BRADLEY	Allen-Bradley products manufactured by Rockwell Automation, Inc.
CLPA	CC-Link Partner Association
GE	GE Intelligent Platforms, Inc.
HMS	HMS Industrial Networks
LS IS	LS Industrial Systems Co., Ltd.
MITSUBISHI INDIA	Mitsubishi Electric India Pvt. Ltd.
ODVA	Open DeviceNet Vendor Association, Inc.
SCHNEIDER	Schneider Electric SA
SICK	SICK AG
SIEMENS	Siemens AG
SCHNEIDER EJH	Schneider Electric Japan Holdings Ltd.
PLC	Programmable controller manufactured by its respective company
Control equipment	Control equipment manufactured by its respective company
Temperature controller	Temperature controller manufactured by its respective company
Indicating controller	Indicating controller manufactured by its respective company
Controller	Controller manufactured by its respective company

MEMO

PART 1

GS25 model

1 REFERRING TO THE RELATED MANUALS

2 OVERVIEW

3 System configuration

4 SPECIFICATIONS

5 PART NAMES AND SETTINGS

6 EMC DIRECTIVE

7 INSTALLATION AND REMOVAL

8 WIRING OF POWER SUPPLY SECTION

9 OPERATING THE GOT

10 MAINTENANCE AND INSPECTION

11 TROUBLESHOOTING

12 APPENDICES

1 REFERRING TO THE RELATED MANUALS





For details on using the GS25 model, refer to the GOT2000 series related manuals.

The GOT2000 series related manuals do not describe the GS25 model. However, the GS25 model is equivalent to GT2512-WX and thus GT2512-WX can be read as GS25.

Related manuals



■Creating a project and connecting a controller

For how to create a project and connect a controller for the GS25 model, refer to the following related manuals.

-  GT Designer3 (GOT2000) Screen Design Manual
-  GOT2000 Series Connection Manual (Mitsubishi Electric Products) For GT Works3 Version1
-  GOT2000 Series Connection Manual (Non-Mitsubishi Electric Products 1) For GT Works3 Version1
-  GOT2000 Series Connection Manual (Non-Mitsubishi Electric Products 2) For GT Works3 Version1
-  GOT2000 Series Connection Manual (Microcomputers, MODBUS/Fieldbus Products, Peripherals) For GT Works3 Version1



■Utility operations and monitoring functions

For details on the utility operations and monitoring functions of the GS25 model, refer to the following related manuals.

-  GOT2000 Series User's Manual (Utility)
-  GOT2000 Series User's Manual (Monitor)

Read as

Read the related manuals as shown below.

Item	Description in the GOT2000 series manuals	Read as
Model	GT2512-WXTBD	Read as GS2512-WXTBD.
Abbreviations and generic terms	GT25	Read as GS25.
	GT25-W	
	GT2512-WX	
Icon*1	GT Designer3 (GOT2000) Screen Design Manual 	There is no icon for GS25. Read the GT25 icons as GS25 icons.
	GOT2000 Series Connection Manuals GOT2000 Series User's Manual (Monitor) 	

*1 GOT2000 Series User's Manual (Utility) does not use icons.

Creating a project for the GS25 model in GT Designer3

The GT Designer3 (GOT2000) screen design manual does not describe [GOT System Setting] to be set when you create a project for the GS25 model in GT Designer3.

To create a project for the GS25 model, set [Series] and [GOT Type] in [GOT System Setting] as shown below.

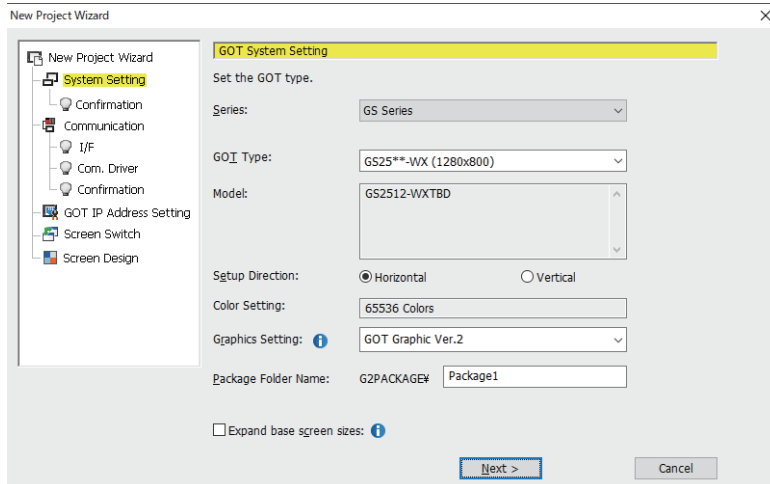

Item	Setting
[Series]	[GS Series]
[GOT Type]	[GS25**-WX (1280x800)]

MEMO

2 OVERVIEW

- Page 31 GOT
- Page 31 Features

2.1 GOT

The GOT is designed to connect to a PLC or other equipment, and to display operation switches, lamps, data, and messages. To use the GOT, mount it on a control panel or an operation panel.

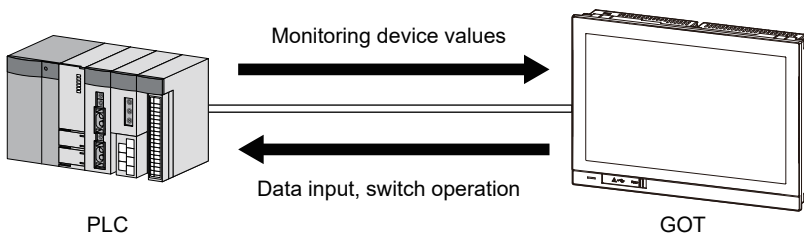

2.2 Features

Enhanced standard equipment

■ Variety of connections with various FA devices

The GOT has different types of interfaces with various FA devices.

For the available interfaces for each model, refer to the following.

☞ Page 46 Performance Specifications

■ SD card interface compatible with a large-capacity SDHC card allowing high-speed communication

You can use a large-capacity SDHC card allowing high-speed communication as a data storage.

■ Connection with various peripheral devices via the USB host

You can connect the GOT to various peripherals via the USB (Host) interface.

Using a USB memory, USB mouse, USB keyboard, or others enhances your convenience.

■ Sound output interface as standard equipment

The speaker with a built-in amplifier is connectable to the GOT.

■ Two Ethernet interfaces as standard equipment

The GOT is connectable to multiple networks.

Improved usability

■ Enhanced troubleshooting functions

The enhanced diagnosis functions and the guidance display reduce the time required for startup or troubleshooting.

📖 GOT2000 Series User's Manual (Utility)

📖 GOT2000 Series User's Manual (Monitor)

■ Easy and simple screen creation

You can create screens easily and simply with the screen design software, GT Designer3 Version1.

📖 GT Designer3 (GOT2000) Screen Design Manual

■ Personal computer-like operation screen

The personal computer-like operation screen enables intuitive operations.

■ Support for the vertical installation

Since the vertical installation is supported, the GOT can be installed in even a vertically oriented space.

Enhanced compatibility with Mitsubishi FA devices

The sequence program monitor function enables enhanced compatibility with Mitsubishi FA devices.

By using the backup/restoration function, you can save the programs and data of Mitsubishi FA devices (such as PLCs) to an SD card.

 GOT2000 Series User's Manual (Utility)

 GOT2000 Series User's Manual (Monitor)

Adoption of LED backlight

The GOT adopts a long-life LED backlight, and you do not have to replace the backlight.

Abundant functions

The GOT supports abundant functions such as the recipe, alarm, operation log, and operator authentication.

 GT Designer3 (GOT2000) Screen Design Manual

3 System configuration

- Page 33 Overall Configuration
- Page 34 System Equipment

3.1 Overall Configuration

The following shows the overall configuration of the GS25 model.

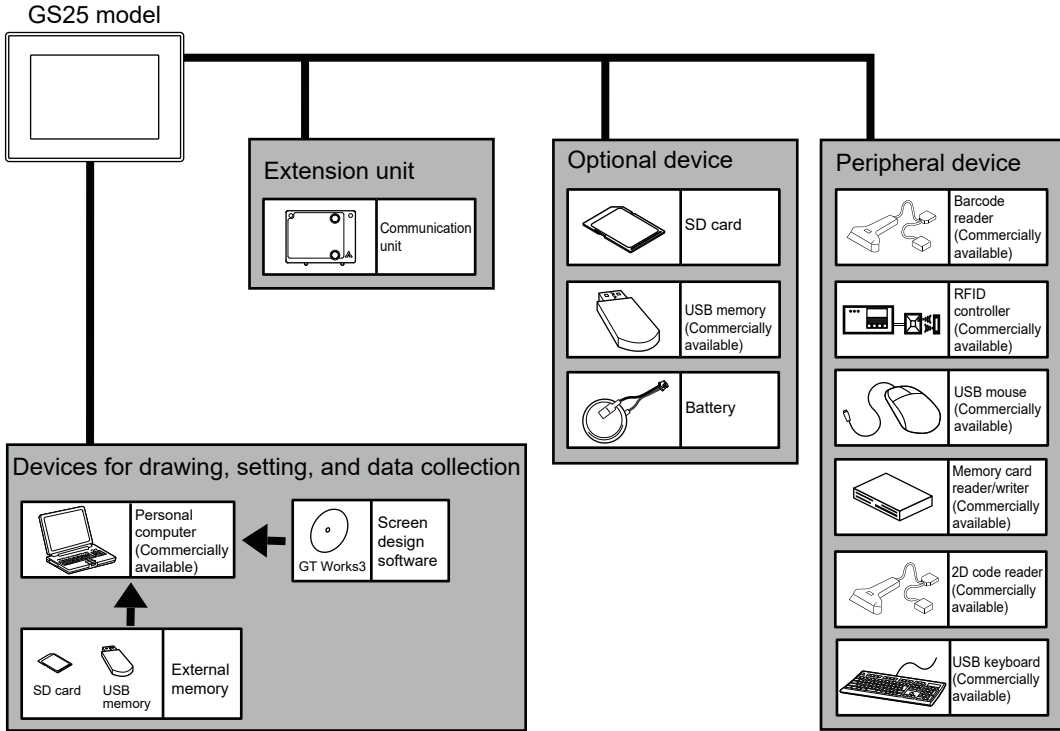

3.2 System Equipment

The following shows the system equipment of the GS25 model.

- ☞ Page 34 GOT
- ☞ Page 35 Extension unit
- ☞ Page 36 Software
- ☞ Page 37 Option
- ☞ Page 38 Cable
- ☞ Page 44 Others

GOT

The following shows the meaning of the GOT model name.

GS25 12 - WX T B D

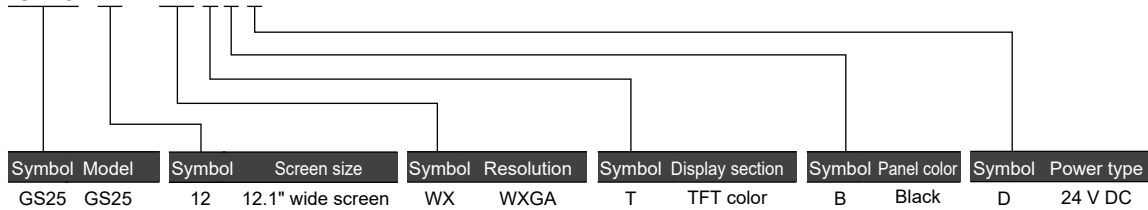

Classification	Model	Screen size	Display section	Front panel color	Power supply	Remarks
GS25	GS2512	GS2512-WXTBD	12.1" WXGA	TFT color 65536 colors	Black	DC

For the status of compliance with Japanese and international standards and laws (CE, UKCA, ATEX, UL/cUL, Class I, Division 2, EAC, KC, KCs, and maritime certifications (ABS/BV/DNV/LR/NK/RINA and others), contact your local sales office.

Extension unit

Communication unit

Product name	Model	Specifications
Wireless LAN communication unit ^{*1*2}	GT25-WLAN	IEEE802.11b/g/n compliant, built-in antenna, wireless LAN access point (base station), station (client), connection to personal computer, tablet, smartphone Compliance with <ul style="list-style-type: none"> • Japan Radio Law ^{*3} • FCC standards ^{*4} • RE Directive (R&TTE Directive) ^{*4*6} • SRRC ^{*5} • KC ^{*5} • Radio Equipment Regulations (UKCA) ^{*7}
Serial multi-drop connection unit	GT01-RS4-M	For the GOT multi-drop connection

*1 Data transfer in wireless LAN communication may not be as stable as that in cable communication. A packet loss may occur depending on the surrounding environment and the installation location.

Make sure to validate the operation before using this product.

*2 When [Operation Mode] is set to [Access Point] in [Wireless LAN Setting] of GT Designer3, up to five stations are connectable to the wireless LAN access point (base station).

*3 The product with hardware version A or later (manufactured in December 2013) complies with the regulation.
The product with hardware version A can be used only in Japan.

*4 The product with hardware version B or later (manufactured from October 2014) complies with the regulation.
The product with hardware version B or later can be used in Japan, the United States, the EU member states, Switzerland, Norway, Iceland, and Liechtenstein.

*5 The product with hardware version D or later (manufactured from May 2016) complies with the regulation.
The product with hardware version D or later can be used in Japan, the United States, the EU member states, Switzerland, Norway, Iceland, Liechtenstein, China (excluding Hong Kong, Macao, and Taiwan), and South Korea.

*6 The product complies with the RE Directive from March 31, 2017.

*7 The product with hardware version G or later (manufactured from October 2021) complies with the regulation.
The product with hardware version G or later can be used in Japan, the United States, the EU member states, the UK, Switzerland, Norway, Iceland, Liechtenstein, China (excluding Hong Kong, Macao, and Taiwan), and South Korea.

Software

Product name	Model	Description		
HMI/GOT Screen Design Software MELSOFT GT Works3	SW1DND-GTWK3-E	English version	Standard license product	DVD
	SW1DND-GTWK3-EC		Site license product ^{*1}	
	SW1DND-GTWK3-EA		Volume license product ^{*2}	
	SW1DND-GTWK3-EAZ		Additional license product ^{*2*7}	
	SW1DND-GTWK3-C	Simplified Chinese version	Standard license product	DVD
FA Integrated Engineering Software MELSOFT iQ Works ^{*3*4}	SW2DND-IQWK-E	English version	Standard license product	DVD
License key for GT SoftGOT2000 ^{*5}	GT27-SGTKEY-U	For USB port		
Remote Personal Computer Operation Function (Ethernet) License ^{*6}	GT25-PCRAKEY-1	1 license		
	GT25-PCRAKEY-5	5 licenses		
	GT25-PCRAKEY-10	10 licenses		
	GT25-PCRAKEY-20	20 licenses		
VNC Server Function License ^{*6}	GT25-VNCSKEY-1	1 license (License for GOT remote access function)		
	GT25-VNCSKEY-5	5 licenses		
	GT25-VNCSKEY-10	10 licenses		
	GT25-VNCSKEY-20	20 licenses		
MES I/F Function License ^{*6}	GT25-MESIFKEY-1	1 license		
	GT25-MESIFKEY-5	5 licenses		
	GT25-MESIFKEY-10	10 licenses		
	GT25-MESIFKEY-20	20 licenses		
GOT Mobile Function License ^{*6}	GT25-WEBSKEY-1	1 license		
	GT25-WEBSKEY-5	5 licenses		
	GT25-WEBSKEY-10	10 licenses		
	GT25-WEBSKEY-20	20 licenses		
GOT Mobile Function License for GT SoftGOT2000 ^{*10}	SGT2K-WEBSKEY-1	1 license		
	SGT2K-WEBSKEY-5	5 licenses		
GT Works Text to Speech License ^{*8}	SW1DND-GTVO-M	Standard license product		
GT Works3 add-on license for GOT2000 enhanced drive control (servo) project data ^{*9}	SW1DND-GTSV-MZ	Standard license product		

*1 Anyone can use the product as long as that person belongs to the business office (including overseas offices) of the corporation that purchased the product, or to the same public vocational training facility or other educational institution as the corporation.

*2 The desired number of licenses (2 or more) can be purchased. For details, please contact your local sales office.

*3 Volume license product and additional license product are also available. For more details, please refer to the MELSOFT iQ Works catalog (L(NA)08232ENG).

*4 The product includes the following software.

System Management Software [MELSOFT Navigator]

Programmable Controller Engineering Software [MELSOFT GX Works3, GX Works2, GX Developer]

Motion Controller Engineering Software [MELSOFT MT Works2]

GOT Screen Design Software [MELSOFT GT Works3]

Robot Engineering Software [MELSOFT RT ToolBox3 mini]

Inverter Setup Software [MELSOFT FR Configurator2]

Setting/monitoring tools for the C Controller module and MELSECWinCPU [MELSOFT CW Configurator]

Servo Setup Software [MELSOFT MR Configurator2]

mitsubishi electric fa library

*5 To use GT SoftGOT2000, each personal computer requires a license key for GT SoftGOT2000.

*6 One license is required for one GOT.

*7 This product does not include a DVD. The license certificate indicating the product ID number is issued only.

*8 To edit sound files, each personal computer requires one license.

*9 Each personal computer requires an add-on license to use add-on projects.

*10 Each personal computer requires one license.

Option

Product name	Model	Description	
USB environmental protection cover	GT21-WUCOV	For 12.1" wide models	Environmental protection cover for the USB interface on the GOT front face (for replacement)
SD card	NZ1MEM-2GBSD	SD memory card for GOT, 2 GB	
	NZ1MEM-4GBSD	SDHC memory card for GOT, 4 GB	
	NZ1MEM-8GBSD	SDHC memory card for GOT, 8GB	
	NZ1MEM-16GBSD	SDHC memory card for GOT, 16GB	
	L1MEM-2GBSD	SD memory card for GOT, 2 GB	
	L1MEM-4GBSD	SDHC memory card for GOT, 4 GB	
Battery	GT11-50BAT	Battery for backup of SRAM data, clock data, and system status log data.(Replacement)	

Cable

Cable for MITSUBISHI PLC

For external dimensions of cable for MITSUBISHI PLC, refer to the following.

 Page 121 External Dimension Diagrams of the Communication Cable

Product name	Model	Cable length	Recommended product *1	Specifications	
RS-485 terminal block conversion unit	FA-LTBGT2R4CBL05	0.5 m	○	RS-485 terminal block conversion unit with a cable for connecting RS-422/485 (connector) of GOT2000 and a RS-485 terminal block conversion unit	
	FA-LTBGT2R4CBL10	1 m			
	FA-LTBGT2R4CBL20	2 m			
RS-422 connector conversion cable	FA-CNV2402CBL	0.2 m	○	For connecting the QCPU/L02SCPU(-P) and the RS-422 cable (GT01-C□R4-25P, GT10-C□R4-25P, GT21-C□R4-25P5) For connecting the L6ADPR2 and the RS-422 cable (GT01-C□R4-25P, GT10-C□R4-25P, GT21-C□R4-25P5) [MINI-DIN 6-pin ← → D-sub 25-pin]	
	FA-CNV2405CBL	0.5 m			
RS-422 cable	QnA/FXCPU direct connection cable Computer link connection cable CC-Link (G4) connection cable	GT01-C30R4-25P	3 m	-	For connecting the QnA/ACPU/Motion CPU (A series)/FXCPU and the GOT For connection between the RS-422 connector conversion cable (FACNV□CBL) and the GOT For connection between the serial communication module and the GOT For connection between the peripheral connection module (AJ65BT-G4-S3) and the GOT [D-sub 25-pin ↔ D-sub 9-pin]
		GT01-C100R4-25P	10 m		
		GT01-C200R4-25P	20 m		
		GT01-C300R4-25P	30 m		
	Computer link connection cable	GT09-C30R4-6C	3 m	○	For connecting the serial communication module and the GOT For connection between the computer link module and the GOT [Separate wire ↔ D-sub 9-pin]
		GT09-C100R4-6C	10 m		
		GT09-C200R4-6C	20 m		
		GT09-C300R4-6C	30 m		
	FXCPU direct connection cable FXCPU communication function extension board connection cable	GT01-C10R4-8P	1 m	-	For connection between the FXCPU and the GOT For connecting the FXCPU communication function extension board and the GOT [MINI-DIN 8-pin ↔ D-sub 9-pin]
		GT01-C30R4-8P	3 m		
		GT01-C100R4-8P	10 m		
		GT01-C200R4-8P	20 m		
GT01-C300R4-8P		30 m			

Product name		Model	Cable length	Recommended product *1	Specifications
RS-232 cable	Q/LCPU direct connection cable	GT01-C30R2-6P	3 m	-	For connection between the Q/LCPU and the GOT For connection between the L6ADP-R2 and the GOT/personal computer (GT SoftGOT2000) [MINI-DIN 6-pin ← → D-sub 9-pin]
	FXCPU communication function extension board connection cable FXCPU communication special adapter connection cable	GT01-C30R2-9S	3 m	-	For connecting the FXCPU communication expansion board and the GOT/personal computer (GT SoftGOT2000) For connecting an FXCPU communication special adapter and the GOT/personal computer (GT SoftGOT2000) [D-sub 9-pin ↔ D-sub 9-pin]
	FXCPU communication special adapter connection cable	GT01-C30R2-25P	3 m	-	For connecting an FXCPU communication special adapter and the GOT/personal computer (GT SoftGOT2000) [D-sub 25-pin ↔ D-sub 9-pin]
	Computer link connection cable CC-Link (G4) connection cable	GT09-C30R2-9P	3 m	o	For connecting the serial communication module and the GOT For connection between the computer link module and the GOT For connecting the peripheral connection module (AJ65BTR2N) and the GOT [D-sub 9-pin ↔ D-sub 9-pin]
	Computer link connection cable	GT09-C30R2-25P	3 m	o	For connecting the serial communication module and the GOT For connection between the computer link module and the GOT [D-sub 25-pin ↔ D-sub 9-pin]
USB cable	Data transfer cable	GT09-C30USB-5P	3 m	o	For connecting a personal computer (screen design software) and the GOT For connecting a personal computer (GT SoftGOT2000) and QnU/L/FXCPU
Extended USB waterproof cable		GT14-C10EXUSB-4S	1 m	-	For routing the USB port (Host) of the GOT rear face to the front side of the control panel

*1 FA-LTBGT2R4CBL□, FA-CNV240□CBL are developed by Mitsubishi Electric Engineering Company Limited and sold through your local sales office.

The other products listed are developed by Mitsubishi Electric Systems & Service Co., LTD. and sold through your local sales office.

Cable for OMRON PLC

Product name	Model	Cable length	Specifications
RS-232 cable	GT09-C30R20101-9P	3 m	For connecting the OMRON PLC/serial communication module/communication board and the GOT
	GT09-C30R20102-25S	3 m	For connecting the OMRON connection cable and the GOT
	GT09-C30R20103-25P	3 m	For connecting the OMRON rack type host link unit and the GOT
RS-422 cable	GT09-C30R40101-9P	3 m	For connecting the OMRON PLC/serial communication module/serial communication board and the GOT
	GT09-C100R40101-9P	10 m	
	GT09-C200R40101-9P	20 m	
	GT09-C300R40101-9P	30 m	
	GT09-C30R40102-9P	3 m	For connecting the OMRON rack type host link unit and the GOT
	GT09-C100R40102-9P	10 m	
	GT09-C200R40102-9P	20 m	
	GT09-C300R40102-9P	30 m	
	GT09-C30R40103-5T	3 m	For connecting the OMRON communication board and the GOT
	GT09-C100R40103-5T	10 m	
	GT09-C200R40103-5T	20 m	
	GT09-C300R40103-5T	30 m	

Cable for KEYENCE PLC

Product name	Model	Cable length	Specifications
RS-232 cable	GT09-C30R21101-6P	3 m	For connecting the KEYENCE PLC and the GOT
	GT09-C30R21102-9S	3 m	For connecting the KEYENCE multi-communication unit and the GOT
	GT09-C30R21103-3T	3 m	
RS-422 cable	GT09-C30R41101-5T	3 m	For connecting the KEYENCE multi-communication unit and the GOT
	GT09-C100R41101-5T	10 m	
	GT09-C200R41101-5T	20 m	
	GT09-C300R41101-5T	30 m	

Cable for SHARP PLC

Product name	Model	Cable length	Specifications
RS-232 cable	GT09-C30R20601-15P	3 m	For connecting the SHARP PLC and the GOT
	GT09-C30R20602-15P	3 m	
RS-422 cable	GT09-C30R40601-15P	3 m	For connecting the SHARP PLC and the GOT
	GT09-C100R40601-15P	10 m	
	GT09-C200R40601-15P	20 m	
	GT09-C300R40601-15P	30 m	
	GT09-C30R40602-15P	3 m	
	GT09-C100R40602-15P	10 m	
	GT09-C200R40602-15P	20 m	
	GT09-C300R40602-15P	30 m	
	GT09-C30R40603-6T	3 m	
	GT09-C100R40603-6T	10 m	
	GT09-C200R40603-6T	20 m	
GT09-C300R40603-6T	30 m		

Cable for JTEKT PLC

Product name	Model	Cable length	Specifications
RS-232 cable	GT09-C30R21201-25P	3 m	For connecting the JTEKT PLC and the GOT
RS-422 cable	GT09-C30R41201-6C	3 m	For connecting the JTEKT PLC and the GOT
	GT09-C100R41201-6C	10 m	
	GT09-C200R41201-6C	20 m	
	GT09-C300R41201-6C	30 m	

Cable for SHINKO indicating controller

Product name	Model	Cable length	Specifications
RS-232 cable	GT09-C30R21401-4T	3 m	For connecting the SHINKO indicating controller and the GOT

Cable for TOSHIBA PLC

Product name	Model	Cable length	Specifications
RS-232 cable	GT09-C30R20501-9P	3 m	For connecting the TOSHIBA PLC and the GOT
	GT09-C30R20502-15P	3 m	
RS-422 cable	GT09-C30R40501-15P	3 m	For connecting the TOSHIBA PLC and the GOT
	GT09-C100R40501-15P	10 m	
	GT09-C200R40501-15P	20 m	
	GT09-C300R40501-15P	30 m	
	GT09-C30R40502-6C	3 m	
	GT09-C100R40502-6C	10 m	
	GT09-C200R40502-6C	20 m	
	GT09-C300R40502-6C	30 m	
	GT09-C30R40503-15P	3 m	
	GT09-C100R40503-15P	10 m	
	GT09-C200R40503-15P	20 m	
	GT09-C300R40503-15P	30 m	

Cable for TOSHIBA PLC

Product name	Model	Cable length	Specifications
RS-232 cable	GT09-C30R20401-15P	3 m	For connecting the HITACHI IES PLC/intelligent serial port module and the GOT
	GT09-C30R20402-15P	3 m	For connecting the HITACHI IES PLC and the GOT
RS-422 cable	GT09-C30R40401-7T	3 m	For connecting the HITACHI IES intelligent serial port module and the GOT
	GT09-C100R40401-7T	10 m	
	GT09-C200R40401-7T	20 m	
	GT09-C300R40401-7T	30 m	

Cable for HITACHI PLC

Product name	Model	Cable length	Specifications
RS-232 cable	GT09-C30R21301-9S	3 m	For connecting the HITACHI communication module and the GOT
RS-422 cable	GT09-C30R41301-9S	3 m	For connecting the HITACHI PLC/communication module and the GOT
	GT09-C100R41301-9S	10 m	
	GT09-C200R41301-9S	20 m	
	GT09-C300R41301-9S	30 m	

Cable for FUJI FA PLC

Product name	Model	Cable length	Specifications
RS-232 cable	GT09-C30R21003-25P	3 m	For connecting the FUJI FA RS-232C interface card/RS-232C interface capsule/RS-485 interface capsule/general-purpose interface module and the GOT
RS-422 cable	GT09-C30R41001-6T	3 m	For connecting the FUJI FA RS-232C interface capsule/485 interface capsule/general-purpose interface module and the GOT
	GT09-C100R41001-6T	10 m	
	GT09-C200R41001-6T	20 m	
	GT09-C300R41001-6T	30 m	

Cable for Panasonic IDS PLC

Product name	Model	Cable length	Specifications
RS-232 cable	GT09-C30R20901-25P	3 m	For connecting the Panasonic IDS RS-422/RS-232C conversion adapter and the GOT
	GT09-C30R20902-9P	3 m	For connecting the Panasonic IDS PLC/computer communication unit and the GOT
	GT09-C30R20903-9P	3 m	For connecting the Panasonic IDS PLC and the GOT
	GT09-C30R20904-3C	3 m	

Cable for YASKAWA PLC

Product name	Model	Cable length	Specifications
RS-232 cable	GT09-C30R20201-9P	3 m	For connecting the YASKAWA PLC and the GOT
	GT09-C30R20202-15P	3 m	
	GT09-C30R20203-9P	3 m	
	GT09-C30R20204-14P	3 m	
	GT09-C30R20205-25P	3 m	For connecting the YASKAWA MEMOBUS module and the GOT
RS-422 cable	GT09-C30R40201-9P	3 m	For connecting the YASKAWA MEMOBUS module and the GOT
	GT09-C100R40201-9P	10 m	
	GT09-C200R40201-9P	20 m	
	GT09-C300R40201-9P	30 m	
	GT09-C30R40202-14P	3 m	For connecting the YASKAWA PLC and the GOT
	GT09-C100R40202-14P	10 m	
	GT09-C200R40202-14P	20 m	
	GT09-C300R40202-14P	30 m	

Cable for YOKOGAWA PLC and temperature controller

Product name	Model	Cable length	Specifications
RS-232 cable	GT09-C30R20301-9P	3 m	For connecting the YOKOGAWA CPU port/D-sub 9-pin conversion cable and the GOT
	GT09-C30R20302-9P	3 m	For connecting the YOKOGAWA PC link module and the GOT
	GT09-C30R20304-9S	3 m	For connection the YOKOGAWA converter (ML2-□) and the GOT
	GT09-C30R20305-9S	3 m	For connecting the YOKOGAWA PLC and the GOT
RS-422 cable	GT09-C30R40301-6T	3 m	For connecting the YOKOGAWA PC link module and the GOT
	GT09-C100R40301-6T	10 m	
	GT09-C200R40301-6T	20 m	
	GT09-C300R40301-6T	30 m	
	GT09-C30R40302-6T	3 m	
	GT09-C100R40302-6T	10 m	
	GT09-C200R40302-6T	20 m	
	GT09-C300R40302-6T	30 m	
	GT09-C30R40303-6T	3 m	For connecting the YOKOGAWA temperature controller (GREEN series) and the GOT
	GT09-C100R40303-6T	10 m	
	GT09-C200R40303-6T	20 m	
	GT09-C300R40303-6T	30 m	
	GT09-C30R40304-6T	3 m	For connecting the YOKOGAWA temperature controller (UT2000 series) and the GOT
	GT09-C100R40304-6T	10 m	
	GT09-C200R40304-6T	20 m	
	GT09-C300R40304-6T	30 m	

ALLEN-BRADLEY PLC cables

Product name	Model	Cable length	Specifications
RS-232 cable	GT09-C30R20701-9S	3 m	For connecting the ALLEN-BRADLEY PLC and the GOT

Cable for SIEMENS PLC

Product name	Model	Cable length	Specifications
RS-232 cable	GT09-C30R20801-9S	3 m	For connecting the SIEMENS HMI Adapter and the GOT

Others

Peripherals

Of the following peripheral devices, you can use some models that we validated.

For the validated models expect the SD cards, refer to the following Technical Bulletin.

 List of Valid Devices Applicable for GOT2000 Series and GOT SIMPLE Series (for Overseas) (GOT-A-0160)

For the validated models of the SD cards, refer to the following Technical Bulletin.

 Operation Check Results of Non-Mitsubishi SD Cards on GOT2000 Series Units (GOT-A-0065)

For Technical Bulletins, go to the MITSUBISHI ELECTRIC FA Global Website.

www.MitsubishiElectric.com/fa

Product name		Overview
Barcode reader	RS-232 connection	Commercially available product
	USB connection	
2D code reader	RS-232 connection	
	USB connection	
RFID controller	RS-232 connection	
	USB connection	
USB mouse		
USB keyboard		
Memory card reader/writer		
SD card		
USB memory		
Hub		
Wireless LAN access point		
Speaker		

4 SPECIFICATIONS

- Page 45 General Specifications
- Page 46 Performance Specifications
- Page 48 Specifications of Power Supply Section
- Page 49 Battery Specifications

4.1 General Specifications

This section describes the general specifications of the GOT.

GS2512-WXTBD

Item	Specifications					
Operating ambient temperature *1	0 °C to 50 °C					
Storage ambient temperature	-20°C to 60°C					
Operating ambient humidity	10% RH to 90% RH, non-condensing					
Storage ambient humidity	10% RH to 90% RH, non-condensing					
Vibration resistance	Compliant with JIS B3502 and IEC 61131-2		Frequency	Acceleration	Half amplitude	Sweep count
		Under intermittent vibration	5 Hz to 8.4 Hz	-	3.5 mm	X, Y, or Z 10 times in each direction
			8.4 Hz to 150 Hz	9.8m/s ²	-	
		Under continuous vibration	5 Hz to 8.4 Hz	-	1.75 mm	-
8.4 Hz to 150 Hz	4.9m/s ²		-			
Shock resistance	Compliant with JIS B3502 and IEC 61131-2 (147 m/s ² (15 G), 3 times in each X, Y, or Z direction)					
Operating atmosphere	No greasy fumes, corrosive gas, flammable gas, excessive conductive dust, and direct sunlight (as well as at storage)					
Operating altitude *2	2000 m or less					
Installation location	Inside control panel					
Overvoltage category *3	II or less					
Pollution degree *4	2 or less					
Cooling method	Self-cooling					
Grounding	Grounding with a ground resistance of 100 Ω or less by using a ground cable that has a cross-sectional area of 2 mm ² or more. If impossible, connect the ground cable to the control panel.					

*1 Indicates the temperature inside the enclosure of the control panel on which the GOT is installed.

*2 Do not use or store the GOT under a pressure higher than the atmospheric pressure at an altitude 0 m. Doing so may cause a malfunction.

Air purging by applying pressure to the control panel may create clearance between the surface sheet and the touch panel. This may cause the touch panel to be not sensitive enough or the sheet to come off.

*3 This indicates the power distribution section to which the equipment is assumed to be connected, between the public power grid and the machinery within the premises.

Category II applies to equipment for which electrical power is supplied from fixed facilities.

The withstand surge voltage for the equipment with the rated voltage up to 300 V is 2500 V.

*4 This indicates the occurrence rate of conductive material in an environment where a device is used. Pollution degree 2 indicates an environment where only non-conductive pollution occurs normally and a temporary conductivity caused by condensation shall be expected depending on the conditions.

4.2 Performance Specifications

The following shows the performance specifications of the GOT.

GS2512-WXTBD

Item	Specifications	
Display section ^{**12}	Display device	TFT color LCD
	Screen size	12.1" wide screen
	Resolution	WXGA: 1280 × 800 dots
	Display size	261.12 (10.28) (W) × 163.2 (6.43) (H) mm (inch)
	Number of displayed characters	16-dot standard font: 80 characters × 50 lines (two-byte characters) 12-dot standard font: 106 characters × 66 lines (two-byte characters)
	Display color	65536 colors
	Brightness Adjustment	32 levels
	Backlight ⁴	LED (Not replaceable)
Touch panel ^{*3}	Type	Analog resistive film
	Key size	Minimum 2 × 2 dots (per key) ^{*7}
	Simultaneous press	Not available (Only 1 point can be touched.) ^{*5}
	Life	1 million touches or more (Operating force: 0.98 N or less)
Human sensor	Detection length	—
	Detection temperature	—
User memory	User memory capacity	Memory for storage (ROM): 32 MB, Memory for operation (RAM): 128 MB
	Life (number of write times)	100000 times
Built-in clock precision	±90 seconds/month (Ambient temperature: 25 °C)	
Battery		GT11-50BAT lithium battery
	Life	Approx. 5 years (Ambient temperature: 25 °C)
Built-in interface	RS-232	1 channel, transmission speed: 115200, 57600, 38400, 19200, 9600, 4800 bps Connector shape: D-sub 9-pin (male)
	RS-422/485	1 channel, transmission speed: 115200, 57600, 38400, 19200, 9600, 4800 bps Connector shape: D-sub 9-pin (female)
	Ethernet	2 channels, data transfer method: 100BASE-TX, 10BASE-T Connector shape: RJ45 (modular jack) AUTO MDI/MDI-X
	USB (Host)	1 channel (rear face)
		USB 2.0 (High-Speed 480 Mbps), Connector shape: USB-A
	USB (Device)	1 channel (front face)
		USB 2.0 (High-Speed 480 Mbps), Connector shape: USB Mini-B
	SD card	1 channel, SDHC compliant (maximum 32 GB)
	Extension interface	—
	Auxiliary extension interface	—
	Wireless LAN communication unit interface	For installing a wireless LAN communication unit
	Sound output interface	1 channel, WAV format (16 bits, 8.000 kHz/16.000 kHz, monoral) Applicable plug: Φ3.5 stereo mini-plug (3-prong)
Buzzer output	Single tone (tone and tone length adjustable)	
POWER LED	2 colors (blue and orange)	
Protective structure	Front: IP67F ^{*6*8} In control panel: IP2X	
External dimensions	299 (11.77) (W) × 219 (8.62) (H) × 48 (1.89) (D) mm (inch)	
Panel cutting dimensions	290.5 (11.44) (W) × 210.5 (8.29) (H) mm (inch)	
Weight (excluding a fitting)	1.7 kg (3.7 lb)	
Compatible software package	GT Works3 Version1.290C or later	

- *1 As a characteristic of liquid crystal display panels, bright dots (always lit) and dark dots (never lit) may appear on the panel. Since liquid crystal display panels comprise a great number of display elements, the appearance of bright and dark dots cannot be reduced to zero.
Individual differences in liquid crystal display panels may cause differences in color, uneven brightness and flickering.
Note that these phenomena are characteristics of liquid crystal display panels and it does not mean the products are defective or damaged.
- *2 Flickering may occur due to vibration, shock, or the display colors.
- *3 When a stylus is used, the touch panel has a life of 100 thousand touches.
The stylus must satisfy the following specifications.
Material: Polyacetal resin
Tip radius: 0.8 mm or more
- *4 To prevent the display section from burning in and lengthen the backlight life, enable the screen save function and turn off the backlight.
- *5 If you touch two points or more simultaneously on the touch panel, a switch in an unintended location may operate.
Do not touch two points or more simultaneously on the touch panel.
- *6 To conform to IP67F, close the USB environmental protection cover by pushing the USB mark firmly. (The GOT conforms to IP2X when the USB environmental protection cover is open.)
Note that the structure does not guarantee protection in all users' environments. The GOT may not be used in an environment where the GOT is exposed to oil or chemicals for a long time, or where oil mist fills the air.
- *7 Minimum size of a key that can be arranged.
To ensure safe use of the product, the following settings are recommended.
Key size: 16 × 16 dots or larger
Distance between keys: 16 dots or more
- *8 The suffix "F" of IP67F is a symbol that indicates protection rate against oil.
It is described in the Appendix of JIS C 0920 of the Japanese Industrial Standards.

4.3 Specifications of Power Supply Section

The following shows the power supply specifications of the GOT.

Point

Operation at instantaneous power failure

If an instantaneous power failure occurs in the power supply and continues for more than the permissible period, the GOT may be reset.

Make sure to power on the unit more than 5 seconds after power-off.

GS2512-WXTBD

Item	Specifications	
Power supply voltage	24 V DC (+10%, -15%)	
Power consumption	Under the maximum load	20 W or less
	Main unit	14 W
	Main unit (Backlight OFF)	8 W
Inrush current	59 A or less (2 ms, ambient temperature: 25 °C, under the maximum load)	
Permissible instantaneous power failure time	5 ms or less	
Noise immunity	Noise voltage: 500 Vp-p, noise width: 1 μs, measured by a noise simulator with noise frequency ranging from 25 Hz to 60 Hz	
Withstand voltage	350 V AC for 1 minute across power terminals and earth	
Insulation resistance	500 V DC across power terminals and earth, 10 MΩ or more by an insulation resistance tester	
Applicable wire size	0.75mm ² to 2 mm ² (AWG 14 to 18)	
Applicable solderless terminal	Solderless terminal for M3 screw RAV1.25-3, V2-S3.3, V2-N3A, FV2-N3A	
Applicable tightening torque (Terminal block terminal screw)	0.5 N·m to 0.8 N·m	

4.4 Battery Specifications

Applicable battery

The following batteries are applicable for the GS25 model.

Model name	Description
GT11-50BAT	Battery for backup of SRAM data, clock data, and system status log data

Battery specifications

The following shows the battery specifications.

Item	Specifications
Model name	GT11-50BAT
Type	Magnesium manganese dioxide lithium primary battery
Initial voltage	3.0 V
Nominal current	550 mAh
Storage life	Approx.5 years (Operating ambient temperature of 25°C)
Total power stoppage time	Page 49 Retention period of the battery-backed data
Lithium content	0.00015 kg (1.7 lb)

Point

For the battery directive in EU member states, refer to the following.

Page 104 Handling of batteries and devices with built-in batteries in EU member states

Retention period of the battery-backed data

The following shows the retainable period of battery-backed data when the GOT is turned off.

Ambient temperature 0 to 25°C	Operating ambient temperature of 25 to 45°C	Operating ambient temperature of 45 to 50°C	Data backup time after detection of battery voltage low *1
3 years	4 years	3 years	14 days

*1 In the following conditions, the data backup time is 5 minutes after the power supply is turned off.
 The battery connector is disconnected.
 A battery lead is broken.

Point



- Battery life and replacement time
 Battery life reference: Approx.5 years in actual use (Ambient temperature: 25°C)
 Battery replacement time reference: 3 to 4 years
 The battery is susceptible to self-discharge. Consult your local sales office when necessary.
 - Check if the battery condition is normal within the utility.
- Refer to the following for details on the battery status display.
 GOT2000 Series User's Manual (Utility)

5 PART NAMES AND SETTINGS

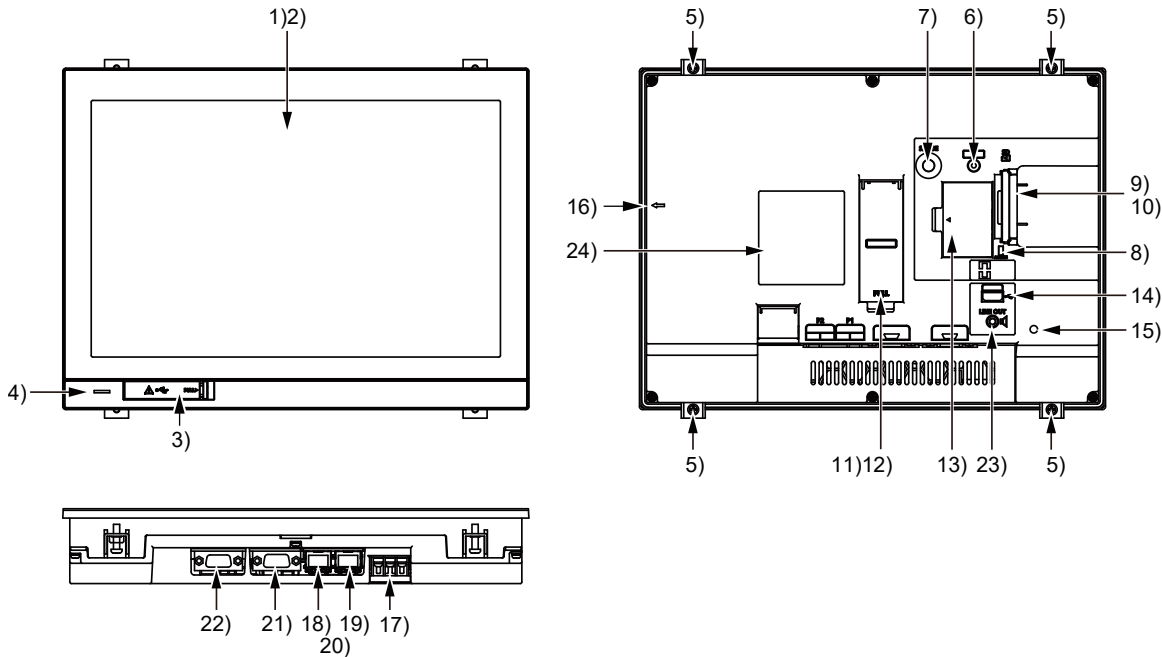
GS2512-WXTBD



No.	Name	Description
1)	Display section	Displays the utility and the user-created screen.
2)	Touch panel	For operating the touch switches in the utility and the user-created screen
3)	USB interface (Device/front)	For connecting a personal computer (Connector shape: Mini-B) ▲mark: *1
4)	POWER LED	Lit in blue: Power is properly supplied. Lit in orange: Screen saving Blinks in orange and blue: Backlight failure Not lit: Power is not supplied.
5)	Unit installation fitting	Mounting fixtures for fixing the GOT to the control panel
6)	Reset switch	Hardware reset switch
7)	S.MODE switch	Used for OS installation at the GOT startup
8)	SD card access LED	ON: SD card installed Blink: SD card accessed OFF: SD card not installed or SD card installed but removal possible
9)	SD card interface (inside the cover)	For installing an SD card
10)	SD card cover	Has the function to switch the access to the SD card between enabled and disabled states. When the cover is opened: Access prohibited When the cover is closed: Access allowed
11)	Battery (inside the cover)	Space for housing the battery
12)	Terminating resistor setting switch (inside the cover)	Switches the terminating resistor for the RS-422/485 communication port between used and unused states (initial setting (unused))
13)	Wireless LAN communication unit interface (inside the cover)	For installing a wireless LAN communication unit
14)	USB interface (Host/back)	For connecting a USB mouse, a USB keyboard, or a USB barcode reader, and transferring or saving data (Connector shape: TYPE-A)
15)	Cable clamp mounting hole	For attaching a cable clamp to prevent the USB cable or the sound output cable from being accidentally pulled out
16)	Vertical installation arrow mark	For the vertical installation, install the GOT so that the arrow points upward.
17)	Power terminal	Power input terminal, FG terminal
18)	Ethernet interface (port 1)	For communicating with a controller or connecting a personal computer (connector shape: RJ45 (modular jack))
19)	Ethernet interface (port 2)	

No.	Name	Description
20)	Ethernet communication status LED	SD/RD LED ON: Data sent or received SD/RD LED OFF: Data not sent or received SPEED LED ON: Communicating at 100 Mbps SPEED LED OFF: Communicating at 10 Mbps or disconnected
21)	RS-422/485 interface	For communicating with a controller (connector shape: D-sub 9-pin (female), M2.6 metric screw thread) For the pin layout of the connector, refer to the following.  GOT2000 Series Connection Manual (Mitsubishi Electric Products) For GT Works3 Version1
22)	RS-232 interface	For communicating with a controller (connector shape: D-sub 9-pin (male), #4-40UNC inch screw thread) For the pin layout of the connector, refer to the following.  GOT2000 Series Connection Manual (Mitsubishi Electric Products) For GT Works3 Version1
23)	Sound output interface	For outputting sounds (applicable plug: Φ3.5 stereo mini-plug (3-prong))
24)	Rating plate	 mark: *2*3

- *1 When you remove the USB cable from the GOT, support it by hand after the successful completion dialog is displayed.
For closing the USB environmental protection cover, fix the cover to the GOT by firmly pushing the USB mark on the latch to comply with the protective structure.
- *2 Leave the GOT on for more than 10 minutes before replacing the battery.
Replace the battery within five minutes.
Use GT11-50BAT for the battery. Incorrect handling may cause the battery to explode.
Dispose of the battery as industrial waste.
- *3 Use the copper wires for the wires to be connected to the power supply terminal.

6 EMC DIRECTIVE

- Page 53 Overview
- Page 55 EMC Directive Requirements

6.1 Overview

For electromagnetic compatibility (EMC) and electrical safety, regulatory standards are established in each country. Especially, for the products to be sold in European countries, conformance to the EMC Directive, which is one of the European Directives, has been mandatory as the EMC standards since 1996. In addition, conformance to the Low Voltage Directive, another European Directive, has also been mandatory as the electrical safety standards since 1997. In European countries, if a product meets the requirements of the EMC Directive or the Low Voltage Directive, the product's manufacturer must declare conformity of the product and affix the CE mark to the product. In some countries or regions other than European countries, the product's manufacturer also must declare conformity of the product and affix a designated mark to the product (example: UKCA mark in the UK).

This section describes the EMC Directive and Low Voltage Directive as examples for conformance to EMC and electrical safety standards. EMC and electrical safety standards in each country are stipulated to be consistent with the corresponding international standards. When the requirements are consistent with the same standards, common measures are taken to conform to the standards in different countries. For the EMC Directive, regulatory compliance with equivalent EMC standards are required for example in the UK and Korea. For the Low Voltage Directive, regulatory compliance with equivalent electrical safety standards are required for example in the UK.

Authorized representative in the EU and the UK

The authorized representative in the EU and the UK is shown below.

Company name: Mitsubishi Electric Europe BV

Address: Mitsubishi-Electric-Platz 1, 40882 Ratingen, Germany

Conforming standards in the EMC Directive

The GOT complies with the following standards in the EMC Directive.

Applied standard	Test standard	Test details	Standard value
EN61131-2: 2007	CISPR16-2-3 Radiated noise ^{*1*2}	Test for measuring electromagnetic emissions from the product	<ul style="list-style-type: none"> • 30 MHz to 230 MHz QP: 30 dBμV/m (measured at 30 m) ^{*3*4} • 230MHz to 1000MHz QP: 37 dBμV/m (measured at 30 m) ^{*3*4}
	CISPR16-2-1 Conducted noise ^{*1*2}	Test for measuring electromagnetic emissions from the product to the power cables	<ul style="list-style-type: none"> • 150kHz to 500kHz QP: 79dB, Mean: 66dB ^{*3} • 500kHz to 30MHz QP: 73dB, Mean: 60dB ^{*3}
	IEC61000-4-2 Electrostatic immunity ^{*1*2}	Immunity test in which static electricity is applied to the cabinet of the equipment	<ul style="list-style-type: none"> • Contact discharge: \pm4 kV • Aerial discharge: \pm8 kV
	IEC61000-4-3 Radiated electromagnetic field, amplitude modulation ^{*1*2}	Immunity test in which an electric field is applied to the product	80 MHz to 1000 MHz: 10 V/m 1.4GHz to 2GHz: 3V/m 2.0GHz to 2.7GHz: 1V/m (80% amplitude modulation at 1 kHz)
	IEC61000-4-4 Fast transient burst noise ^{*1*2}	Immunity test in which burst noise is applied to the power cables and the signal lines	Power cable: 2kV Digital I/O: 1 kV Analog I/O: 1 kV Signal cable: 1kV
	IEC61000-4-5 Surge immunity ^{*1*2}	Immunity test in which lightening surge is applied to the product	<ul style="list-style-type: none"> • DC power type Power cable (between cable and ground): \pm0.5kV Power cable (between cables): \pm0.5kV Data communication port: \pm1 kV
	IEC61000-4-6 Conducted RF immunity ^{*1*2}	Immunity test in which a noise inducted on the power cable and the signal lines is applied	Power cable: 10V Data communication port: 10 V
	IEC61000-4-8 Power supply frequency magnetic field immunity ^{*1*2}	Test for checking normal operations under the circumstance exposed to the ferromagnetic field noise of the power supply frequency (50/60 Hz)	30 A/m

*1 The GOT is an open type device (designed to be integrated in equipment).

Make sure to install the GOT on a control panel.

This test item is conducted in the condition where the GOT is installed on a control panel and combined with the MITSUBISHI ELECTRIC PLC.

*2 The length of a sound output cable must be 30 m or less.

*3 QP: Quasi-peak value, Mean: Average value

*4 This test item is conducted in the following conditions.

30 MHz to 230 MHz

QP: 40 dB μ V/m (measured at 10 m)

230MHz to 1000MHz

QP: 47 dB μ V/m (measured at 10 m)

6.2 EMC Directive Requirements

The EMC Directive requires the following.

Strong electromagnetic waves are not emitted to the outside.: Emission (Electromagnetic interference)

The product is not affected by the electromagnetic waves from the outside.: Immunity (Electromagnetic sensitivity)

To comply with the EMC Directive, this section explains the precautions for configuring equipment integrating the GOT.

The data described herein are produced with our best, based on the regulation requirements and standards obtained by Mitsubishi Electric. However, the data do not guarantee that the whole equipment produced according to the data comply with the above directive.

The manufacturer of the equipment must determine the method to comply with the EMC Directive and conformance to the directive.

Installing the GOT on the control panel

The GOT is an open type device (designed to be integrated in equipment).

Make sure to install the GOT in a control panel.

This restriction ensures safety and also has a large effect of suppressing noise generated from the GOT by using the control panel.

Control panel

The control panel must be conductive.

When fixing a top or bottom plate of the control panel with bolts, do not coat the plate and bolt surfaces so that they contact each other.

Connect the door and the box using a thick grounding cable to ensure the low impedance under high frequency.

To ensure electric conductivity in the large area as much as possible between an inner plate and the control panel, do not coat the fixing bolt area of the inner plate and the control panel.

Ground the control panel using a thick grounding cable to ensure the low impedance under high frequency.

The diameter of cable holes on the control panel must be 10 cm or less.

If the diameter of the hole is 10 cm or more, radio waves may leak.

To reduce the chance of radio waves leaking out, ensure that the space between the control panel and its door is as small as possible.

Pasting the following EMI gasket directly on the painted surface seals the space, reducing the leak of electric waves.

Manufacturer	Series name	Contact
KITAGAWA INDUSTRIES CO., LTD.	RFSG series (Recommended Product)	+81-587-34-3561

Our test has been carried out on a panel having the damping characteristics of 37 dB max. and 30 dB mean (measured by 3m method with 30 MHz to 300 MHz).

Connection of power and ground cables

Ground the GOT and connect power supply cables as shown below.

■Wiring the ground cable

Provide a ground point near the GOT. Short-circuit the frame ground terminal (FG terminal) of the GOT with as thick and short a cable as possible.

■Ground cable length

The ground cable length must be 30 cm or shorter.

The FG terminal passes the noise generated in the GOT system to the ground.

Therefore, ensure an impedance as low as possible.

Since the ground cables relieve the noise, the cables themselves carry a large noise.

Thus, short wiring prevents the cable from acting as an antenna.

(A long conductor is an antenna radiating noise more efficiently.)

■Treatment of the power cable and the ground cable

Twist the ground cable led from the ground point with the power cable.

Twisting with the ground cable relieves more noise from the power cable to the ground.

When a noise filter is installed to the power cable, twisting the power cable and the ground cable may not be required.

Installing a noise filter (power supply line filter)

A noise filter is a part to effectively reduce conducted noise.

Except some models, installation of a noise filter to the power supply lines is not necessary. However, installing the noise filter can reduce conducted noise.

The noise filter is effective to reduce conducted noise in the band of 10 MHz or less.

Use a noise filter equivalent to the following noise filters (double π-type filters).

Model	Manufacturer	Rated current	Rated voltage
FN343-3/05	SCHAFFNER	3A	250V
FN660-6/06	SCHAFFNER	6A	
RSHN-2003	TDK	3A	

Precautions

The following shows the precautions for installing a noise filter.

■ Prohibition of bundling cables

Do not bundle the input and output cables of the noise filter.

Bundling the cables induces the noise from the output-side cable into the input-side cable where noise has been eliminated by the noise filter.

Wire the input and output cables separately.

Bundling the input and output cables induces noise.

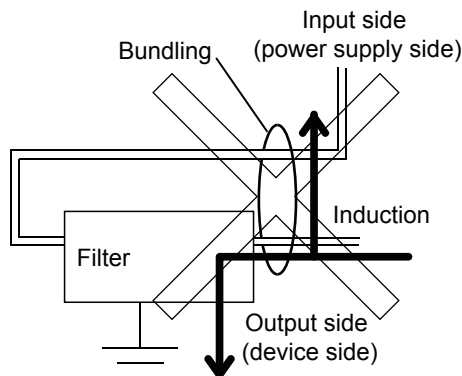
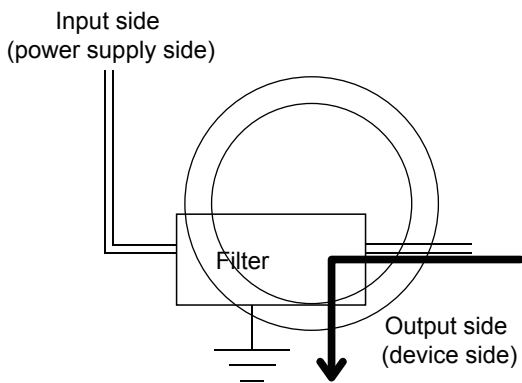

■ Grounding the noise filter

Connect the ground terminal of the noise filter to the control panel with a short cable as much as possible (approximately 10 cm).

System configuration

GOT

Use the following GOTs having a CE mark on the rating plate.

For how to check the hardware version of the GOT, refer to the following.

 Page 123 Confirming of Versions and Conforming Standards

○: Compliant ×: Not compliant

Product name	Model	Hardware version (Manufacture year and month)	EMC Directive
GS2512	GS2512-WXTBD	Version A or later (December 2022)	○

Connection type

The following table lists the connection types compliant with the EMC Directive.

○: Compliant ×: Not compliant

Connection type *1	GS25
Ethernet connection	○
Direct CPU connection (serial)	○
Serial communication connection	○
CC-Link connection (Via G4)	×
GOT multi-drop connection	○
Other connections (Connection with non-Mitsubishi Electric PLC, microcomputer, inverter, temperature controller, servo amplifier, CNC, and MODBUS equipment) *2	○

*1 For the details of each connection type, refer to the following manual.

 GOT2000 Series Connection Manual For GT Works3 Version1 that covers the controller used

*2 When connecting the GOT to other controllers such as a non-Mitsubishi Electric PLC, fabricate connection cables and configure the system following the EMC Directive specifications.

 Page 62 Non-Mitsubishi Electric PLC, microcomputer, temperature controller, inverter, servo amplifier, CNC, MODBUS/RTU, and MODBUS/TCP connections

Point

Connected devices

When connecting the GOT to a non-Mitsubishi Electric PLC, refer to the manual about the EMC Directive compliance of the connected device (such as a PLC and a microcomputer).

Cable

For the details of the cables used, refer to the following manual.

 GOT2000 Series Connection Manual For GT Works3 Version1 that covers the controller used

Point

Fabricating cables

To comply with the EMC Directive, fabricate cables (including user-created cables).

For how to fabricate a cable, refer to the following.

 Page 60 Fabricating a connection cable

Connection of power cables and ground cables

Carry out wiring and connect the power and ground cables according to the following instruction.
By the different wiring or connection method, the system may not comply with EMC Directive.

Wiring method

As shown in the figure below, connect the power cable and the ground cable, and then attach a ferrite core (ZCAT3035-1330, manufactured by TDK Corporation) within the specified range.

Make sure to ground the FG cable.

For connection of power cables and ground cables, refer to the following.

☞ Page 55 Connection of power and ground cables

■GS2512-WXTBD

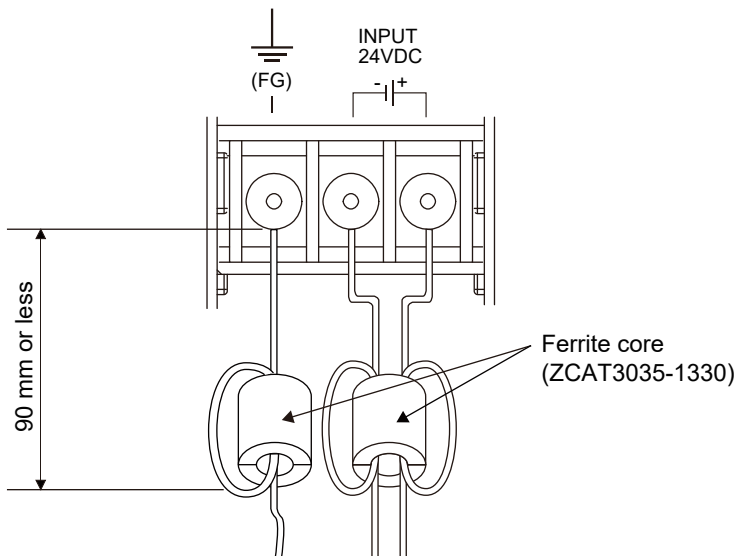

Fabricating a connection cable

Fabricate the cables used for the GOT by the methods as shown in this section.

The fabrication requires a ferrite core, cable clamp, and cable shielding materials.

The following products have passed the Mitsubishi Electric EMC Directive compliance test.

ZCAT3035-1330 ferrite core (TDK Corporation)

AD75CK-type cable clamp (Mitsubishi Electric Corporation)

Zipper tubing SHNJ type (Zippertubing (Japan),Ltd)

Ethernet connection

■Ethernet cable

Strip off the sheath at both ends of the cable as shown in the figure below to expose braided shield for grounding.

The braided shield sections are used for grounding with a cable clamp.

☞ Page 63 Grounding a cable

Connecting to the Ethernet interface of the GOT

GOT side

PLC/personal computer side

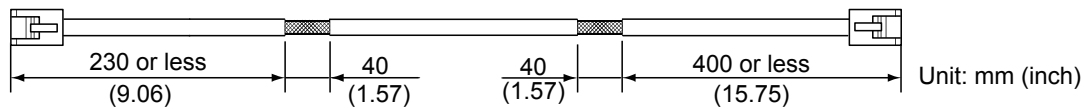

Unit: mm (inch)

Direct CPU connection (serial)

■RS-232 cable and RS-422 cable

Install a ferrite core to the cable in the positions as shown in the figure below.

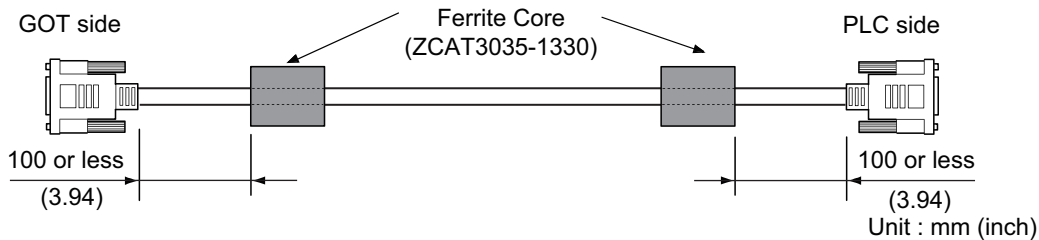

Unit : mm (inch)

Serial communication connection

■RS-232 cable and RS-422 cable

Strip off the sheath at both ends of the cable as shown in the figure below to expose braided shield sections for grounding.

The braided shield sections are used for grounding with a cable clamp.

☞ Page 63 Grounding a cable

GOT side

PLC CPU side

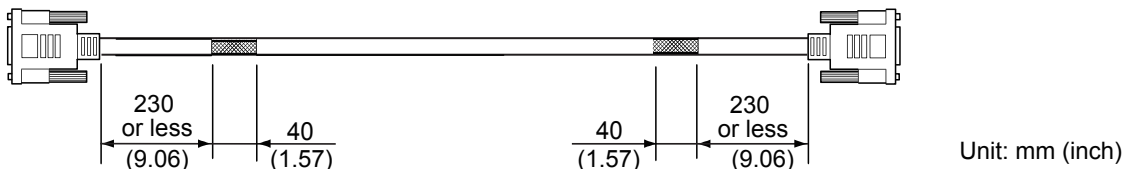

Unit: mm (inch)

Sound output device connection

Install a ferrite core to the cable in the positions as shown in the figure below.

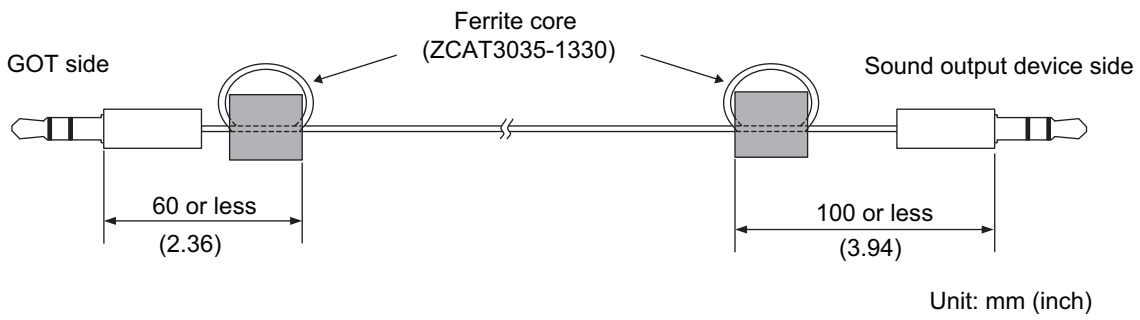

Non-Mitsubishi Electric PLC, microcomputer, temperature controller, inverter, servo amplifier, CNC, MODBUS/RTU, and MODBUS/TCP connections

Create the cables (RS-232 cable, RS-422/485 cable) for connecting the GOT and a controller by yourself.

For how to create a cable, refer to the following.

📖 GOT2000 Series Connection Manual For GT Works3 Version1 that covers the controller used

Point

Treatment of the RS-232 cable and RS-422/485 cable

When the GOT is connected to a controller, configure the system according to the EMC Directive specifications for the controller.

The following shows the recommended instructions to comply with the EMC Directive.

However, the manufacturer of the equipment must determine the method to comply with the EMC Directive and conformance to the directive.

- RS-422/485 cable

When connecting each signal wire (except SG and FG wires), twist two signal wires as shown below.

Connect two or more SG wires.

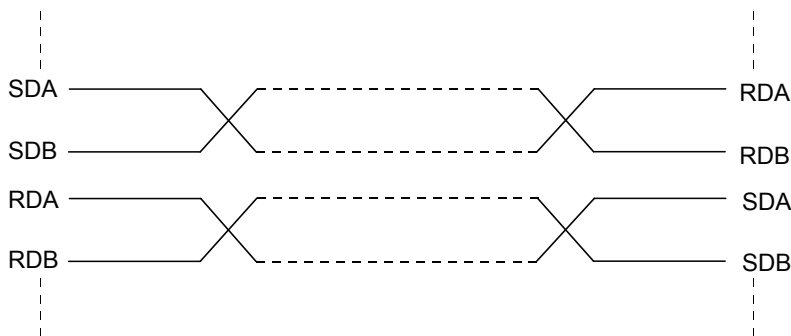

- RS-232 cable

Twist each signal wire (except SG and FG wires) with the SG wire.

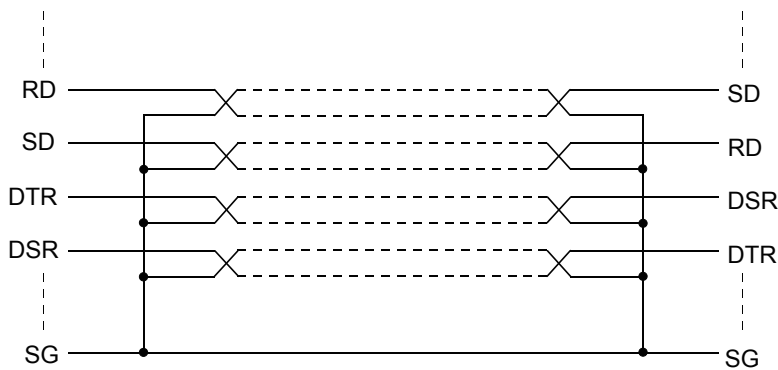

Install a ferrite core to the cable in the positions as shown in the figure below.

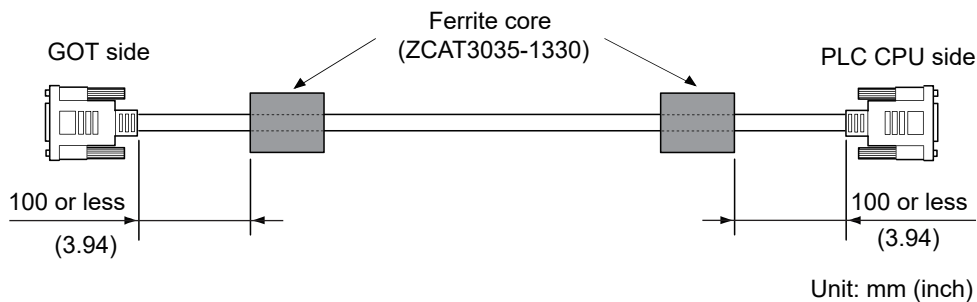

Grounding a cable

Grounding method

Ground the cable and ground cable to the control panel where the GOT and the PLC are installed.
Ground the braided shield section of the cable to the control panel with the cable clamp (AD75CK).

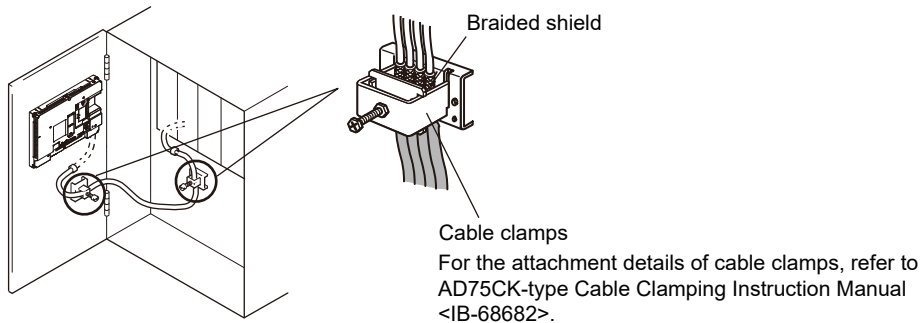

Precautions

Do not arrange the cable clamp close to the other cables that are not clamped.
The noise from the control panel may enter the cable clamp and adversely affect the GOT.

7 INSTALLATION AND REMOVAL

- Page 65 Installation Precautions
- Page 66 Panel Cut Dimensions
- Page 67 Installation Position
- Page 69 Control Panel Inside Temperature and GOT Installation Angle
- Page 70 Installing and Removing the GOT
- Page 72 Installing and Removing the Battery
- Page 76 Installing and Removing the SD Card
- Page 80 Installing and Removing the USB Devices
- Page 81 Installing and Removing the USB cable
- Page 83 Installing and Removing the Panel-Mounted USB Port Extension

7.1 Installation Precautions

Install the GOT with consideration of the control panel inside dimensions and the installation prohibited area.

Depending on the types of connection cables connected to the GOT, the distance more than the described dimensions may be required.

Install the GOT with consideration of the connector dimensions and the cable bend radius.

7.2 Panel Cut Dimensions

GS2512-WXTBD

Open an installation hole on the control panel with the dimensions shown below.

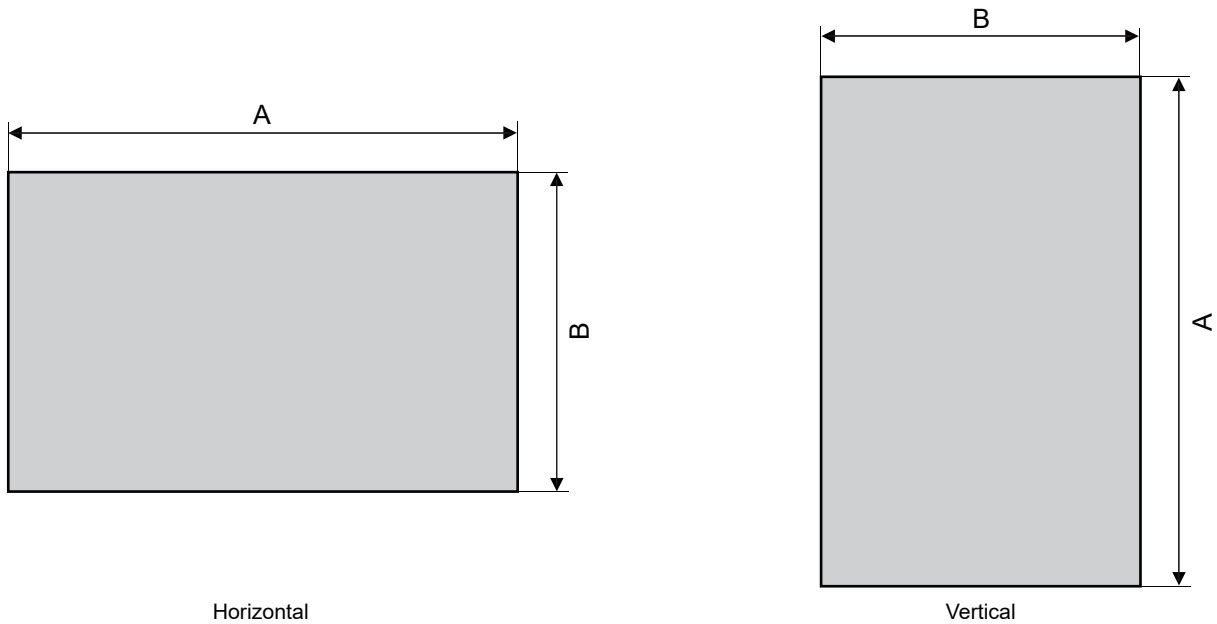

Unit: mm (inch)

Model	A	B	Panel thickness
GS2512-WXTBD	290.5 (11.44) (+1 (0.04), 0 (0))	210.5 (8.29) (+1 (0.04), 0 (0))	1.6 (0.06) to 4 (0.16)

7.3 Installation Position

To install the GOT, some distance is required between the GOT and the other devices.

GS2512-WXTBD

Depending on the units and cables used for the GOT, the distance more than the described dimensions may be required. Install the GOT with consideration of the connector dimensions and the cable bend radius.

For the vertical installation, install the GOT so that the vertical installation arrow printed on the GOT rear face points upward.

Page 51 PART NAMES AND SETTINGS

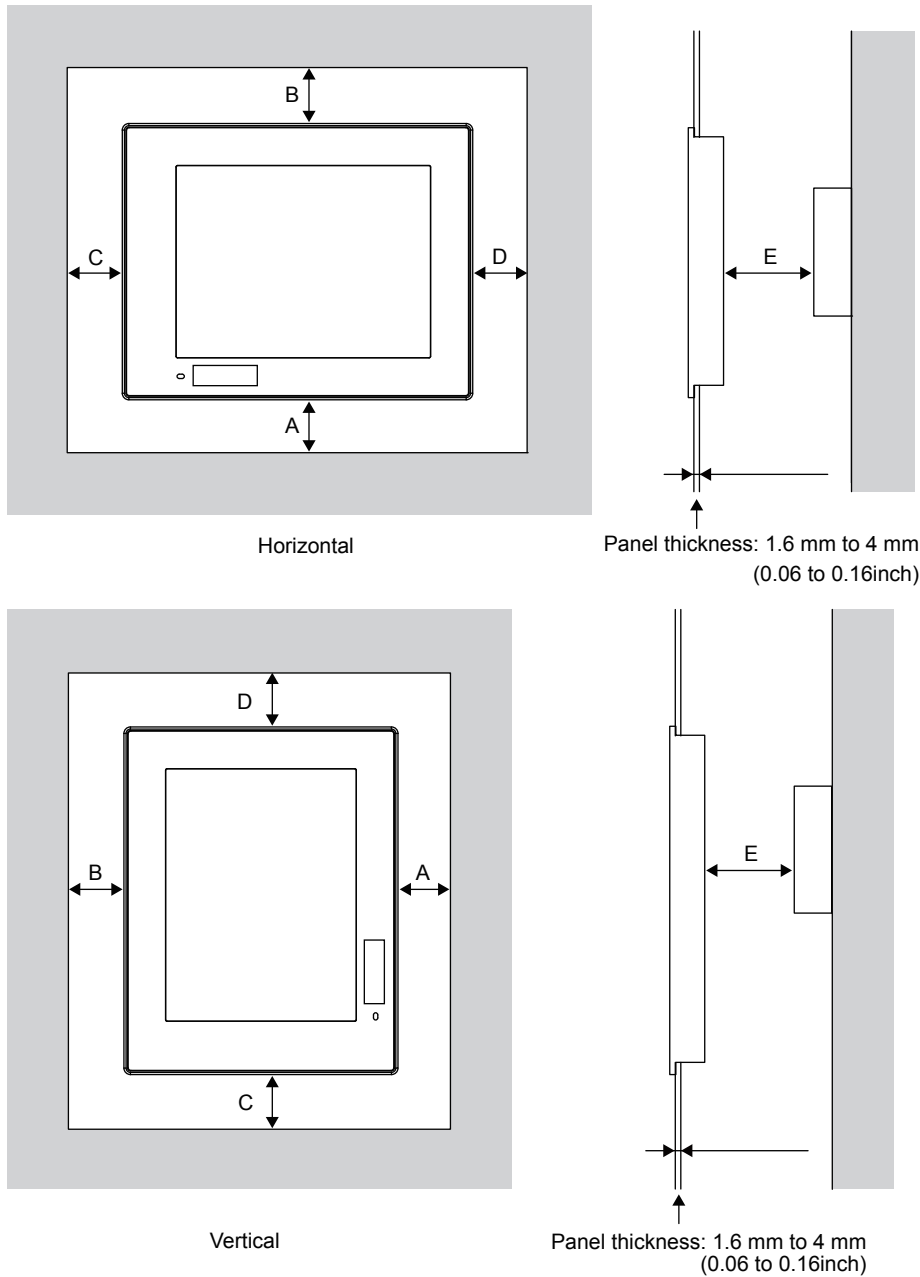

The following tables list the distance required between the GOT and the other devices.

The dimensions within the parentheses apply when no equipment generating radiated noise (such as a contactor) or heat is installed near the GOT.

However, always keep the ambient temperature of the GOT to 50 °C or lower.

Unit: mm (inch)

Item	GS2512-WXTBD
A	51 (2.01) or more [23 (0.91) or more]
B	Horizontal: 81 (3.19) or more [23(0.91) or more] Vertical: 53 (2.09) or more [23(0.91) or more]
C	53 (2.09) or more [23 (0.91) or more]
D	Horizontal: 53 (2.09) or more [23(0.91) or more] Vertical: 81 (3.19) or more [23(0.91) or more]
E *1	100 (3.94) or more [20 (0.79) or more]

*1 When opening or closing the battery cover: 72 (2.83) or more.

7.4 Control Panel Inside Temperature and GOT Installation Angle

Install the GOT with its display section positioned as shown below.

Using the GOT with the installation angle other than the following accelerates the deterioration of the GOT.

GS2512-WXTBD

■Installing the GOT horizontally

When the GOT is installed at any angle from 60 ° to 105 °, the control panel inside temperature must be within 50 °C.

When the GOT is installed at any angle outside the range from 60 ° to 105 °, the control panel inside temperature must be within 40 °C.

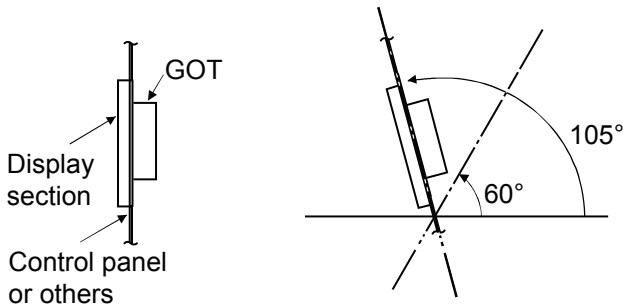

■Installing the GOT vertically

When the GOT is installed at a 90-degree angle, the control panel inside temperature must be within 50 °C.

When the GOT is installed at any angle other than 90°, the control panel inside temperature must be within 40 °C.

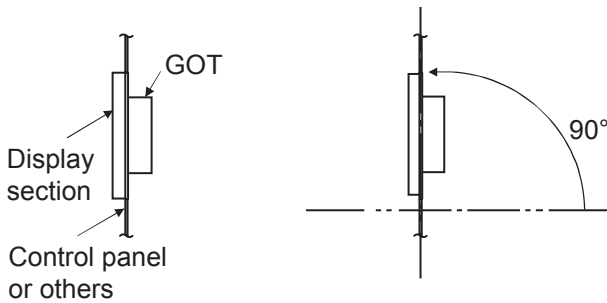

7.5 Installing and Removing the GOT

The following shows the procedure for installing and removing the GOT.

For the panel cut dimensions for the GOT, refer to the following.

☞ Page 66 Panel Cut Dimensions

Installing the GOT

The following shows an installation example for the horizontal direction.

For the vertical installation, install the GOT so that the vertical installation arrow printed on the GOT rear face points upward.

☞ Page 51 PART NAMES AND SETTINGS

GS2512-WXTBD

The following shows the procedure for installing the GOT.

1. Insert the GOT rear face into the panel opening.

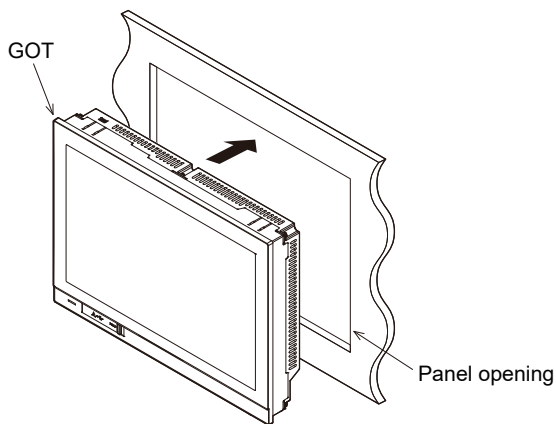

2. Align the fittings (four fittings) on the installation holes on the GOT, and tighten the screws within the specified torque range (0.36 N·m to 0.48 N·m).

Tightening the screws with a torque exceeding the specified torque range may deform the GOT front panel.

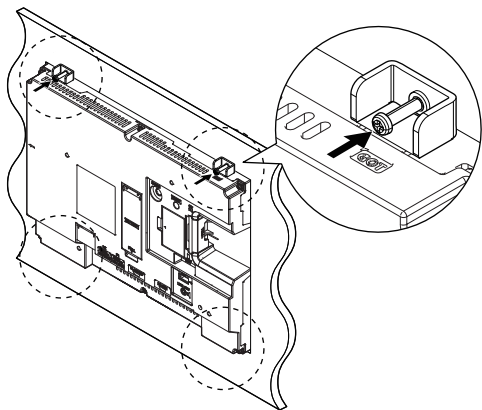

3. Remove the protective film from the GOT.

Removing the GOT

GS2512-WXTBD

The following shows the procedure for removing the GOT.

1. Remove the screws from the GOT.

Remove the fittings (four fittings) from the GOT.

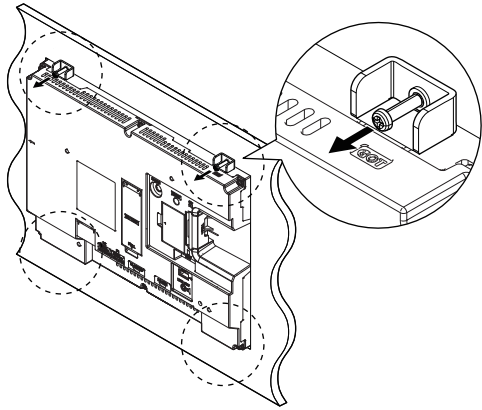

2. Remove the GOT from the panel opening.

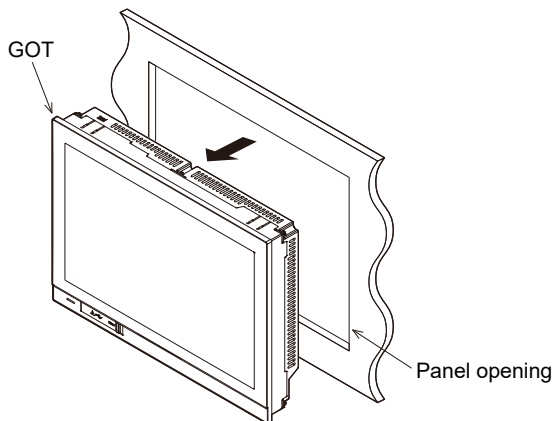

7.6 Installing and Removing the Battery

The following shows the procedure for installing and removing the battery.
(Described with the GOT rear face facing up.)

Point

- Battery

The GOT comes with a battery in the battery holder.

Before using the GOT, connect the battery connector to the GOT connector.

- Battery replacement time

To replace the battery, leave the GOT on for more than 10 minutes before replacing the battery.

Replace the battery within 5 minutes.

Installing the Battery

Install a battery to the GOT before the first startup.

GS2512-WXTBD

The following shows the procedure for installing the battery.

1. Make sure that the GOT power is off.
2. Install the battery to the GOT rear face.

Open the battery cover as shown below.

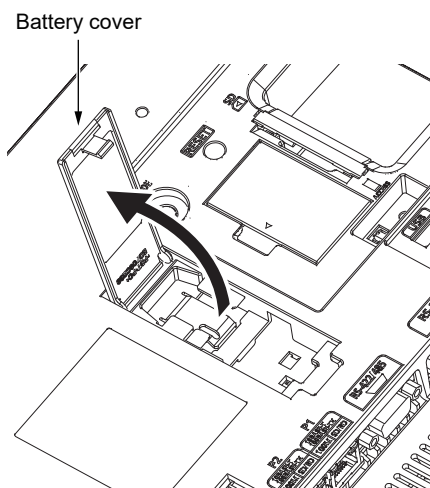

3. To replace the battery, remove the old battery, and then disconnect the connector.

For information on how to remove the battery, refer to the following.

☞ Page 74 Removing the Battery

4. Insert the battery connector to the GOT connector.

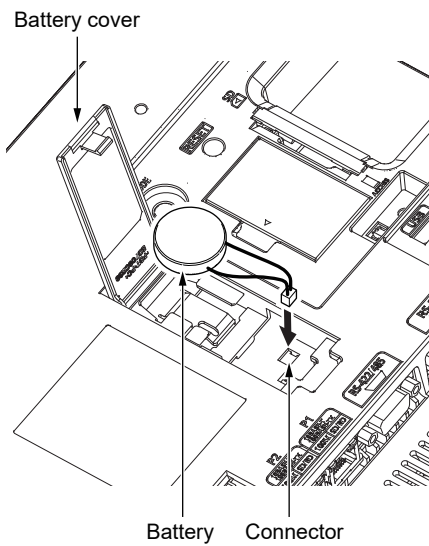

5. After installing the battery to the battery holder of the GOT, close the battery cover until it clicks.

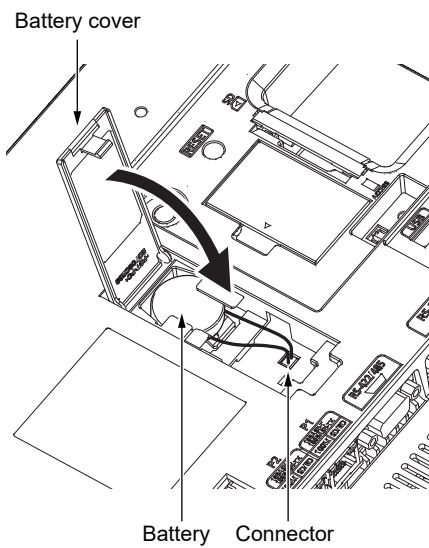

6. Turn on the GOT.

7. Check that the battery condition is normal with the utility.
For the details of the battery condition display, refer to the following.

📖 GOT2000 Series User's Manual (Utility)

Removing the Battery

GS2512-WXTBD

The following shows the battery removal procedure.

1. Make sure that the GOT power is off.
2. The battery is stored in the GOT rear face.

Open the battery cover as shown below.

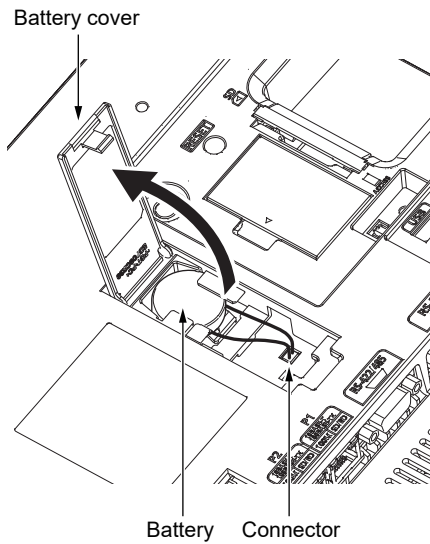

3. After removing the battery from the battery holder of the GOT, unplug the connector.

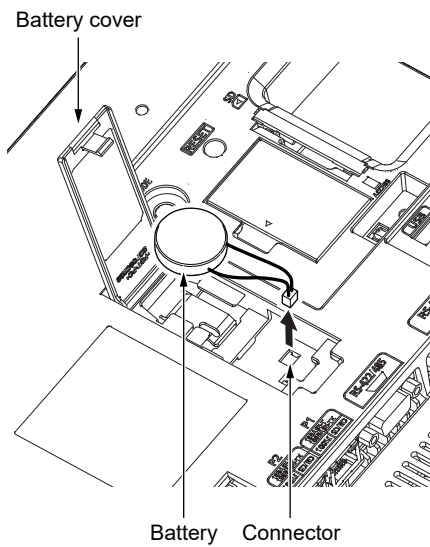

4. Push and close the battery cover until it clicks.

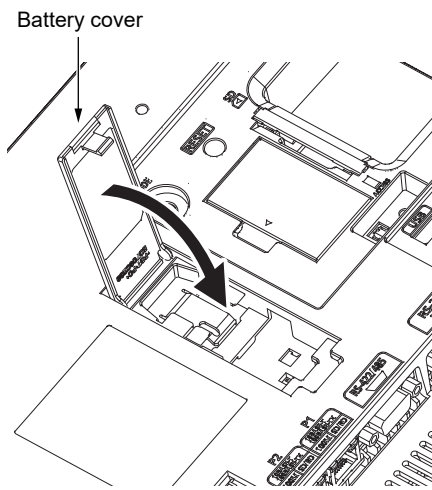

7.7 Installing and Removing the SD Card

The following shows the procedure for installing and removing an SD card.

Installing the SD Card

CAUTION

- Turning off the GOT while it accesses the SD card results in damage to the SD card and files.
- After inserting an SD card into the GOT, make sure to close the SD card cover. Otherwise, data cannot be read or written.

GS2512-WXTBD

The following shows the procedure for installing an SD card.

1. Open the SD card cover as shown below.
(Described with the GOT rear face facing up.)

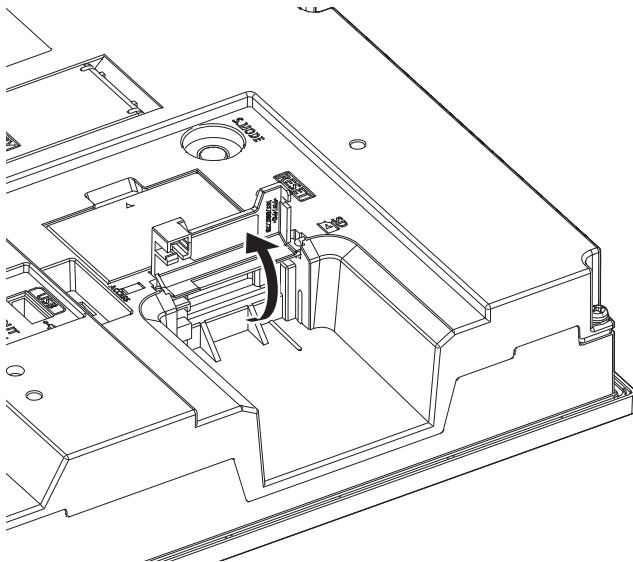

2. Open the SD card cover completely, and check that the SD card access LED is off. Then, hold an SD card with its front side facing up, and insert the card into the SD card interface.

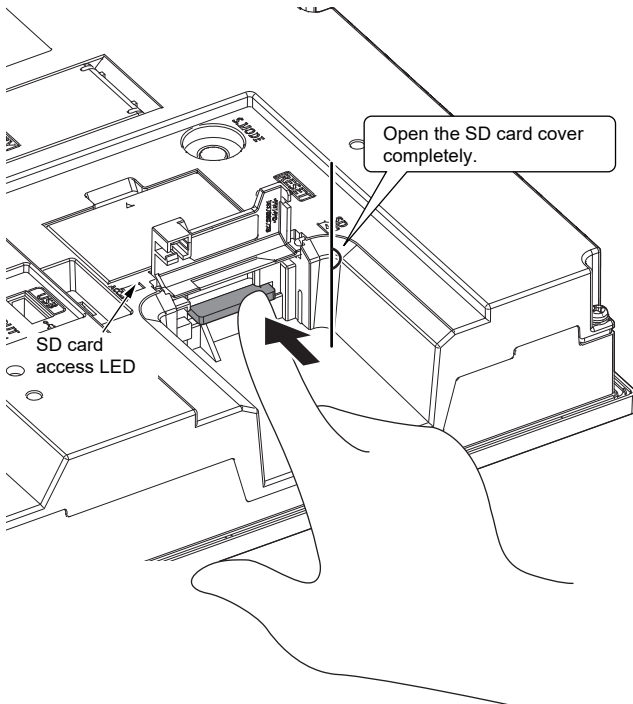

3. Push and close the SD card cover until it clicks.

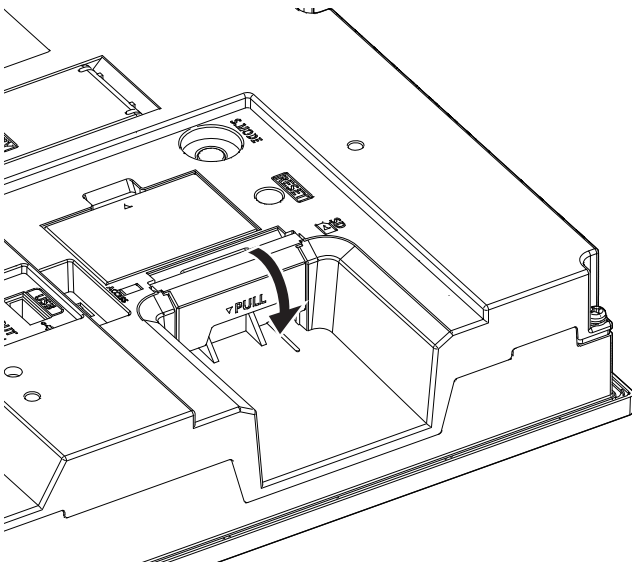

4. When the SD card cover is closed, the access to the SD card is allowed.

Removing the SD Card

WARNING

- Do not remove the SD card from drive A while the SD card is being accessed by the GOT, or the GOT may stop processing for about 20 seconds.
The GOT cannot be operated during this period. The functions that run in the background including a screen updating, alarm, logging, scripts, and others are also interrupted.
This stop affects the system operation, causing an accident.
Check that the SD card access LED is off before removing the SD card.

CAUTION

- Do not remove the data storage from the GOT while the data storage is being accessed by the GOT, or the data storage and files may be damaged.
To remove the data storage from the GOT, check that the access to the data storage in SD card access LED, the system signal, and others is not performed.
- Turning off the GOT while it accesses the SD card results in damage to the SD card and files.
- When removing the SD card from the GOT, make sure to support the SD card by hand as it may pop out.
Failure to do so may cause the SD card to drop from the GOT, resulting in a failure or break.
- To remove the data storage from the GOT, follow the procedure for removal on the utility screen of the GOT. After the successful completion dialog is displayed, remove the data storage by hand carefully.
Failure to do so may cause the data storage to drop from the GOT, resulting in a failure or break.

GS2512-WXTBD

The following shows the procedure for removing the SD card.

1. Open the SD card cover as shown below.

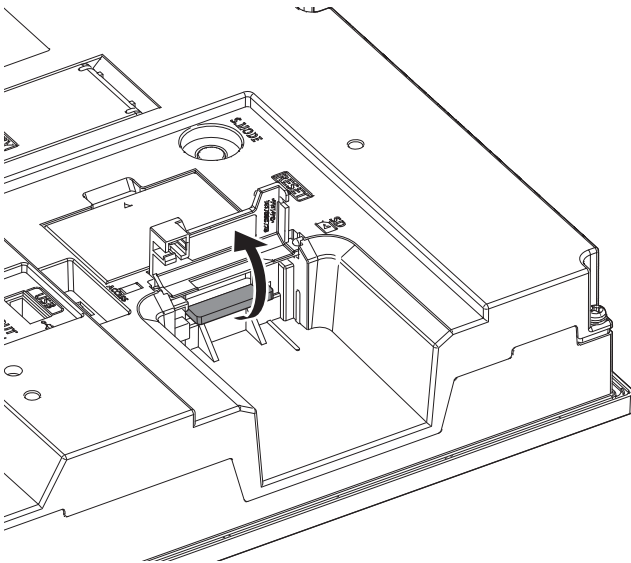

2. Open the SD card cover completely, and check that the SD card access LED is off. Then, push the SD card in to eject it.

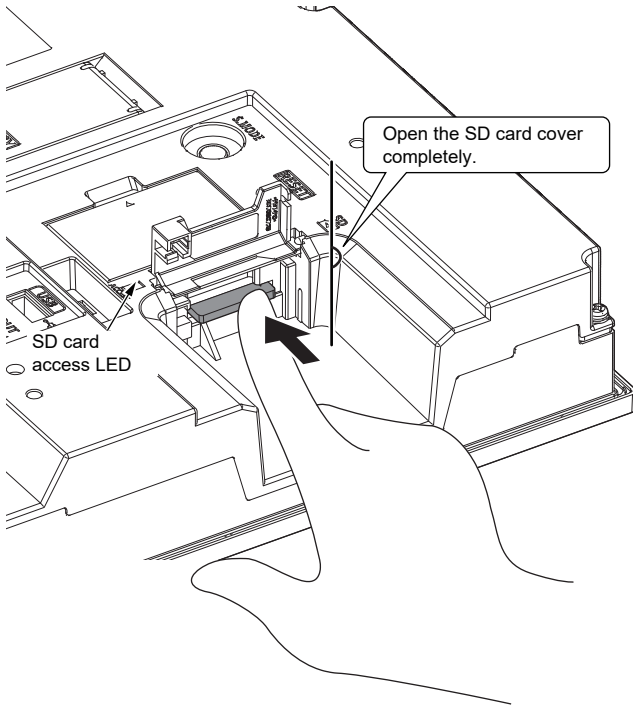

3. Close the cover of the SD card interface.

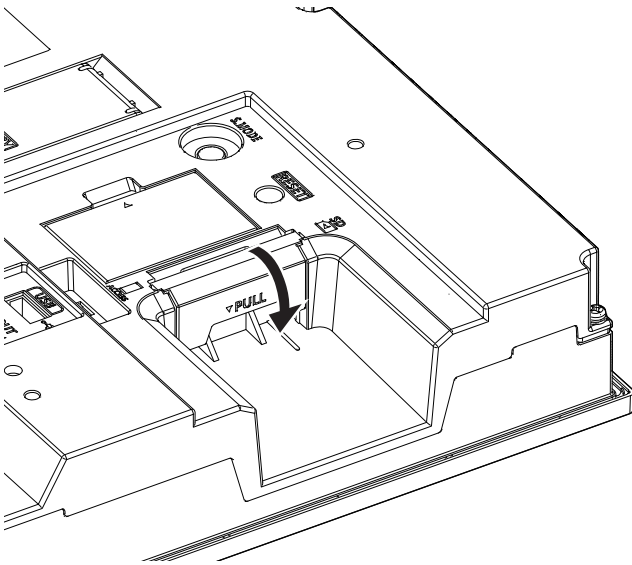

7.8 Installing and Removing the USB Devices

The following shows the procedure for installing and removing a USB device.

Point

Connecting the USB hub devices to the USB interface (Host)
When connecting the devices to the USB interface (Host) using USB hub with the GOT power on, drive assignment of connected USB devices may be changed. To use the USB hub devices, turn on the GOT with the devices connected.

Installing the USB devices

GS2512-WXTBD

The following shows the procedure for installing a USB device.

1. Insert the USB device to the USB interface (Host) as shown below. Make sure to insert the USB interface connector in the correct direction.

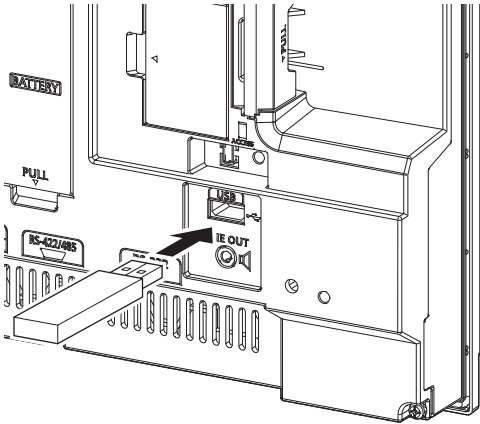

Removing the USB devices

GS2512-WXTBD

The following shows the procedure for removing the USB device.

1. Place the USB device in removable mode. For the setting method, refer to the following.
 GOT2000 Series User's Manual (Utility)
2. Remove the USB device from the USB interface (Host) as shown below.

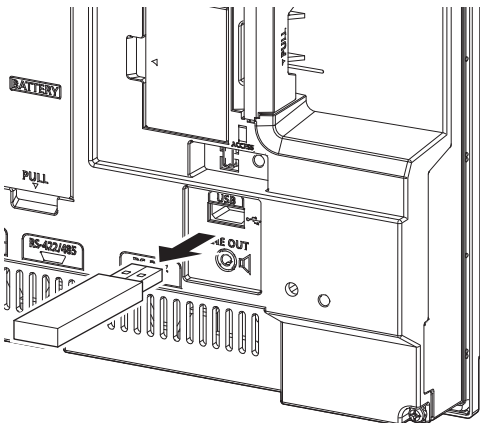

7.9 Installing and Removing the USB cable

The following shows the procedure for installing and removing a USB cable to the USB interface (Host) on the GOT rear face. For the position of the USB interface (Host), refer to the following.

☞ Page 51 PART NAMES AND SETTINGS

Attach a cable clamp depending on the usage environment, such as when fixing a cable is difficult. Use a cable clamp RSG-130-V0 manufactured by KITAGAWA INDUSTRIES CO.,LTD. or equivalent.

Installing the USB cable

The following shows the procedure for installing the USB cable.

1. Install the USB cable to a USB interface (Host) on the GOT rear face.

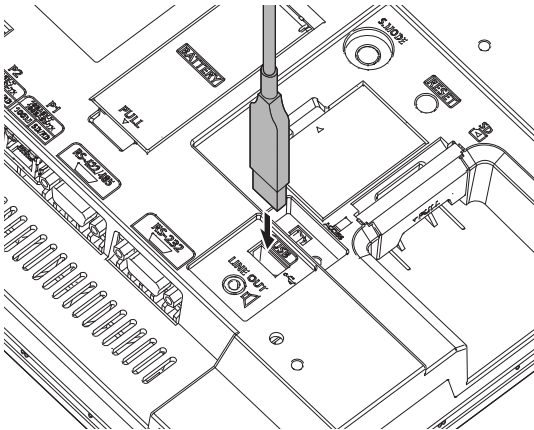

2. Insert a cable clamp to the mounting hole for a cable clamp shown in the following figure and push it until you hear a clicking sound.

For the direction that the band goes through, refer to the arrow in the figure.

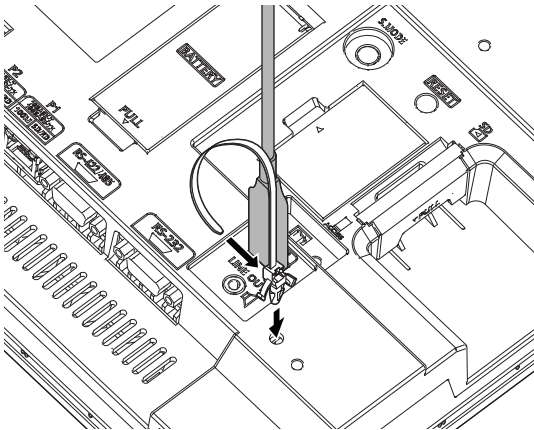

3. Pass the USB cable through a hole of the cable clamp and pull the band to fix the cable.

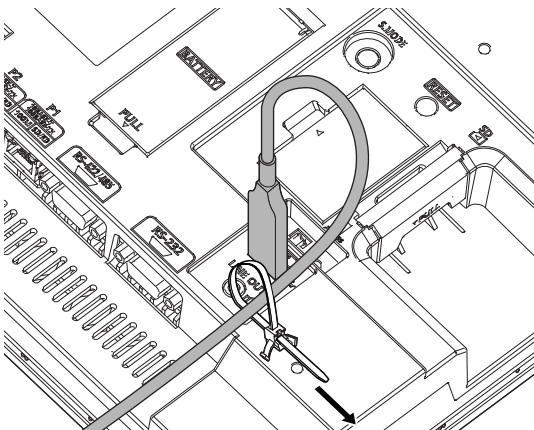

Removing the USB cable

The following shows the procedure for removing the USB cable.

1. Remove the cable clamp band.

Draw out the band while pushing up the tab of the cable clamp with a screwdriver or other tools.

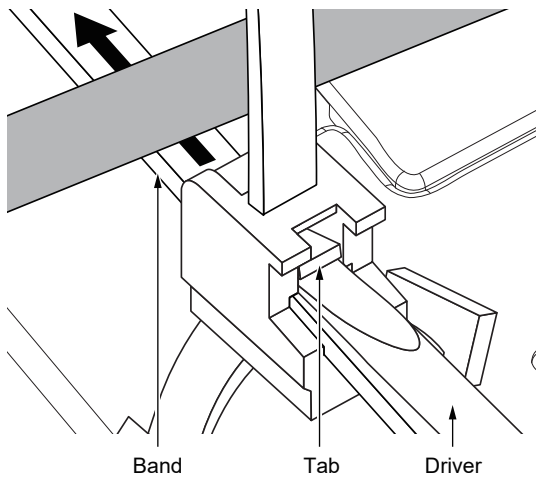

2. Remove the cable clamp while holding its both sides (Arrow A in the figure). Removing the USB cable.

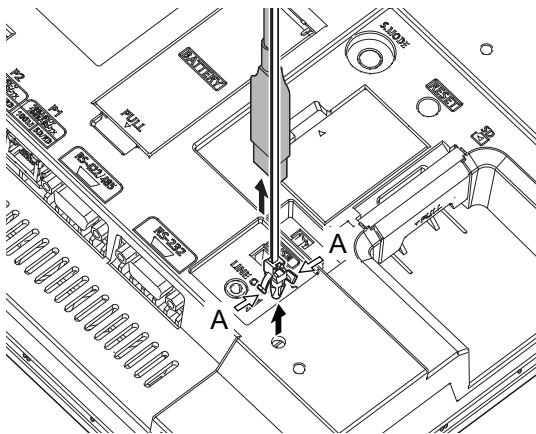

Point

The USB cable can be removed from the unit with the cable clamp. Remove the cable with holding both sides of the cable clamp (Arrow A in the figure).

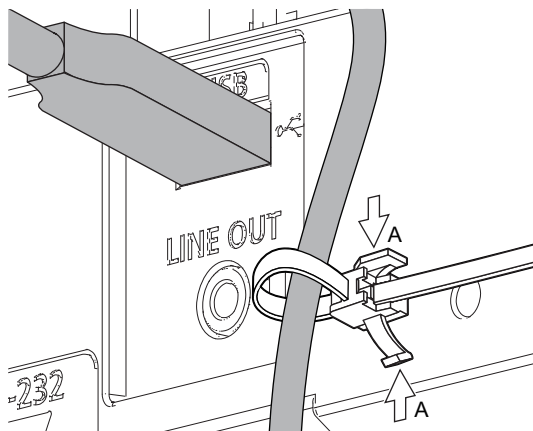

7.10 Installing and Removing the Panel-Mounted USB Port Extension

The panel-mounted USB port extension is a waterproof USB extension cable. The cable is used to route the USB interface (Host) of the GOT rear face to the front side of the control panel.

Parts name

The following shows the part names of the panel-mounted USB port extension.

GT14-C10EXUSB-4S

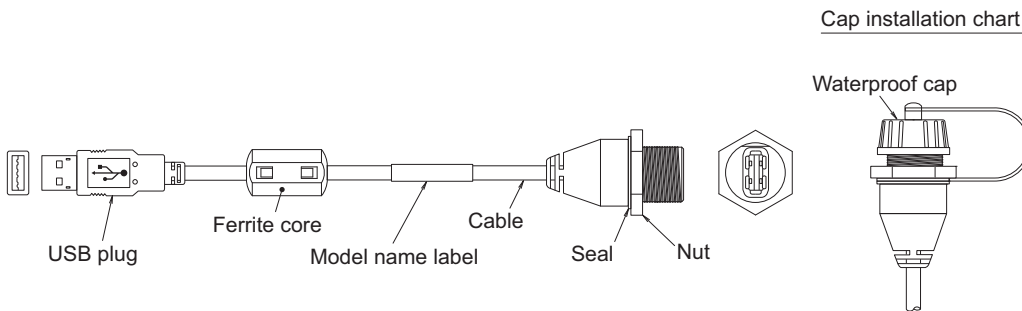

Installing and removing the panel-mounted USB port extension

Installing and removing the panel-mounted USB port extension to/from the control panel

Install or remove the panel-mounted USB port extension as follows with attention to the curve or twist of the waterproof cap, seal, and nut.

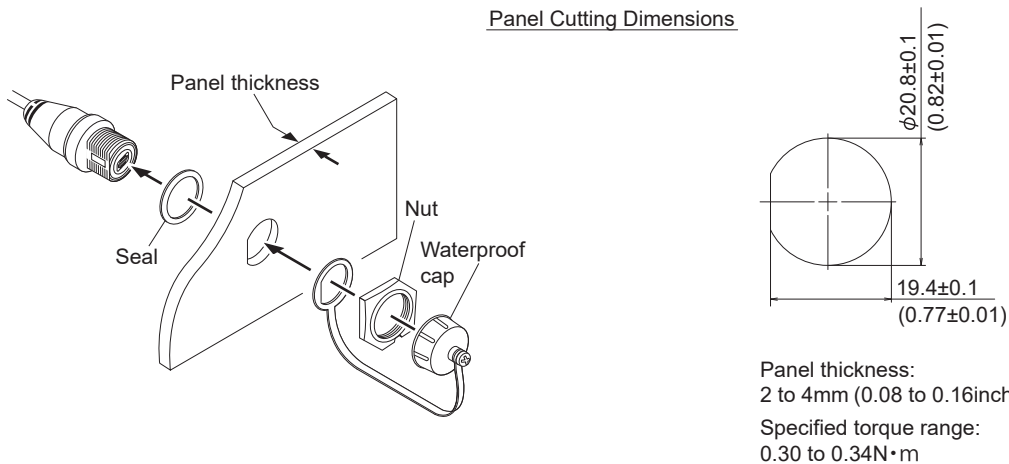

Install the waterproof cap to the panel-mounted USB port extension so that the control panel surface is IP67F-rated. Overtightening or undertightening may disable the waterproof effect. Tighten the waterproof cap properly when the cable is not used.

Precautions on installing the panel-mounted USB port extension

Run power lines, servo amplifier drive wires, and panel-mounted USB port extensions so that they do not cross each other. Install the panel-mounted USB port extension away from noise sources such as equipment.

Do not twist, bend at a sharp angle or a right angle, and stretch the panel-mounted USB port extension since the cable may be broken.

Install it while considering the following control panel inside dimensions.

Dimensions in the depth direction of the GOT

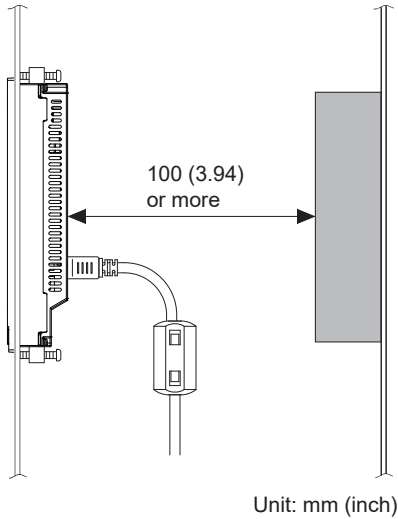

Dimension of the protruding cable

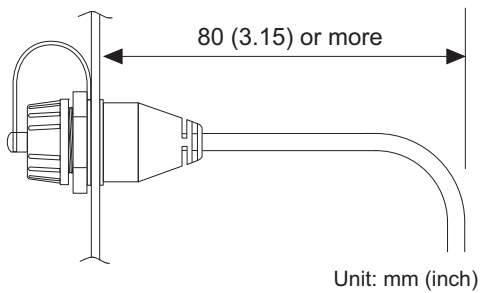

Insert the USB plug part of the tip of the panel-mounted USB interface (Host) extension securely to the USB port of the GOT. The USB plug part may work loose or become unplugged due to vibrations, impacts, or being yanked.

Use cable ties or others to fix the cable portion to the structure inside the control panel, the cable fixing hole on the GOT, or others.

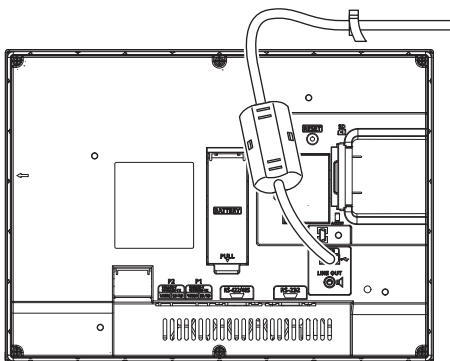

8

WIRING OF POWER SUPPLY SECTION

- Page 87 Wiring of External Power Supply
- Page 88 Power Supply Wiring to the GOT
- Page 89 Grounding
- Page 93 Wiring Inside and Outside the Control Panel
- Page 94 Attaching a Surge Suppressor to Control Equipment

WARNING

- Be sure to shut off all phases of the external power supply used by the system before wiring. Failure to do so may result in an electric shock, product damage or malfunctions.
- Make sure to ground the FG terminal of the GOT power supply section solely for the GOT (ground resistance: 100 Ω or less, ground cable diameter: 1.6 mm or more). Not doing so may cause an electric shock or malfunction.
- Correctly wire the GOT power supply section after confirming the rated voltage and terminal arrangement of the product. Not doing so can cause a fire or failure.
- Tighten the terminal screws of the GOT power supply section in the specified torque range. Undertightening can cause a short circuit or malfunction. Overtightening can cause a short circuit or malfunction due to the damage of the screws or the GOT.
- Exercise care to avoid foreign matter such as chips and wire offcuts entering the GOT. Not doing so can cause a fire, failure or malfunction.

CAUTION

- Plug the communication cable into the connector to be connected, and tighten the mounting screws and the terminal screws in the specified torque range. Undertightening can cause a short circuit or malfunction. Overtightening can cause a short circuit or malfunction due to the damage of the screws or unit.

This section describes wiring to the GOT power supply section.

For the connection to a controller, refer to the following manual.

 GOT2000 Series Connection Manual For GT Works3 Version1 that covers the controller used

For external dimensions of connection cable, refer to the following.

 Page 119 APPENDICES

General preventive measures against noise

There are two kinds of noises: Radiated noise that is transmitted into the air and Conductive noise that is directly transmitted along connected lines.

Countermeasures must be taken considering both kinds of noises and referring to the following 3 points.

- Protecting against noise
 - (a) Keep signal lines away from noise sources such as a power cable or a high-power drive circuit.
 - (b) Shield the signal lines.
 - Reducing generated noise
 - (a) Use a noise filter, etc. to reduce the level of the noise generated due to a source such as a high-power motor drive circuit.
 - (b) Attach a surge suppressor on the terminal of the molded case circuit breaker (MCCB), electromagnetic contactor, relay, solenoid valve, or induction motor to suppress the noise.
 - Releasing noise to the ground
 - (a) Make sure to connect the ground cable to the ground.
 - (b) Use a short and thick cable to lower its ground resistance.
 - (c) Ground the power system and the control system separately.
-

8.1 Wiring of External Power Supply

Separating the power supply system

Carry out wiring so that the power supply system is separated into the GOT, I/O equipment, and power equipment as shown below.

When frequent noise is identified, connect an isolation transformer.

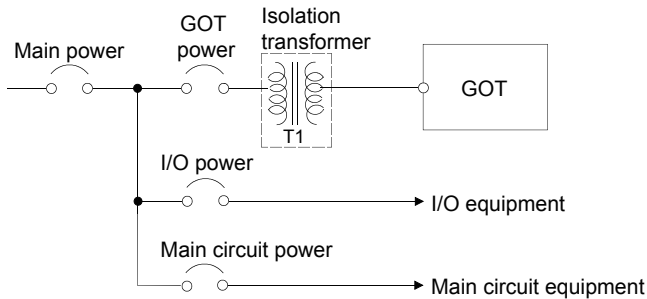

Separating the power cables from the main circuit line and the I/O signal line

Separate the 24 V DC cables from the main circuit lines (high voltage, large current) and I/O signal lines.

Keep a distance of 100 mm or more between them as a guide.

Treatment on power cables

Twist the 24 V DC cables as closely as possible, and connect the cables with the minimum length between the power supply and each device.

Use a thick wire (cross-sectional area: about 0.75 mm² to 2 mm²) for less voltage drop.

Use the solderless terminal for M3, and tighten the terminal firmly with a torque of 0.5 N•m to 0.8 N•m.

8.2 Power Supply Wiring to the GOT

The following shows the examples of wiring the power cable, ground cable and other cables to the GOT power supply terminal.

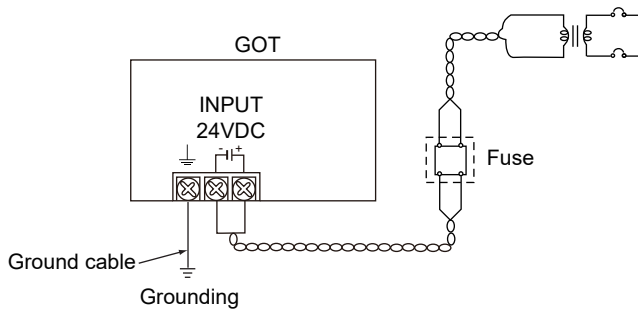

Precautions

■Treatment on power cables

For 24 V DC cables, use thick wires as much as possible (Cable cross section: 0.75 mm² to 2 mm²), and make sure to twist them to the terminals.

To prevent a short circuit due to loose screws, use a solderless terminal with an insulation sleeve.

■Grounding

After connecting the FG terminal, make sure to connect it to the ground.

Otherwise, the system is susceptible to noise.

8.3 Grounding

The following describes the grounding of the GOT.

Grounding the GOT

Grounding method

Ground the GOT as shown below.

Use independent grounding as much as possible for the GOT. Ground the GOT with a ground resistance of 100 Ω or less. When independent grounding cannot be applied for the GOT, use shared grounding as shown in (2) below.

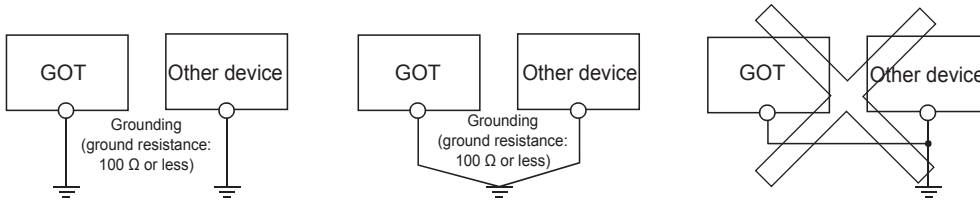

(1) Independent grounding..... Best (2) Shared grounding..... Good (3) Common grounding..... Not allowed

For the grounding methods of (1) and (2) above, use a cable with 2 mm² or more cross section.

Make a ground point near the GOT as much as possible to shorten the ground cable.

Grounding examples

■Independent grounding (Best)

For grounding for control system, ground the system at one end.

Especially for the control devices communicating each other, ground the system at one end.

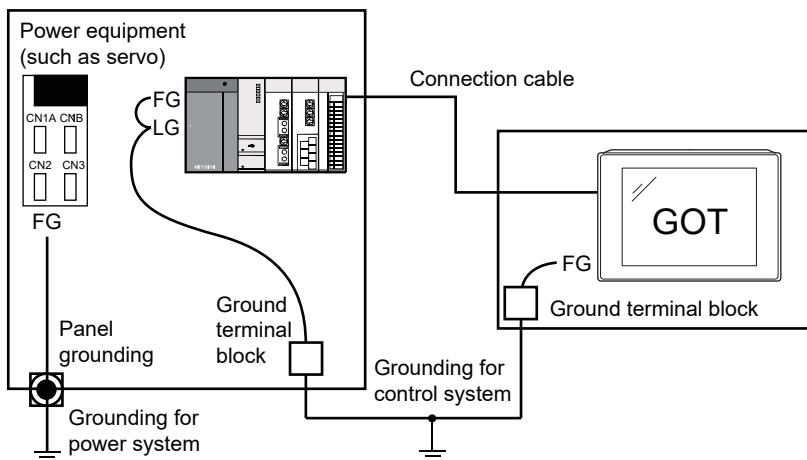

■ Shared grounding (Good)

Ground the system at one end.

To prevent noise from entering the GOT, use a short and thick wire for grounding between the ground and the control panel to lower ground resistance.

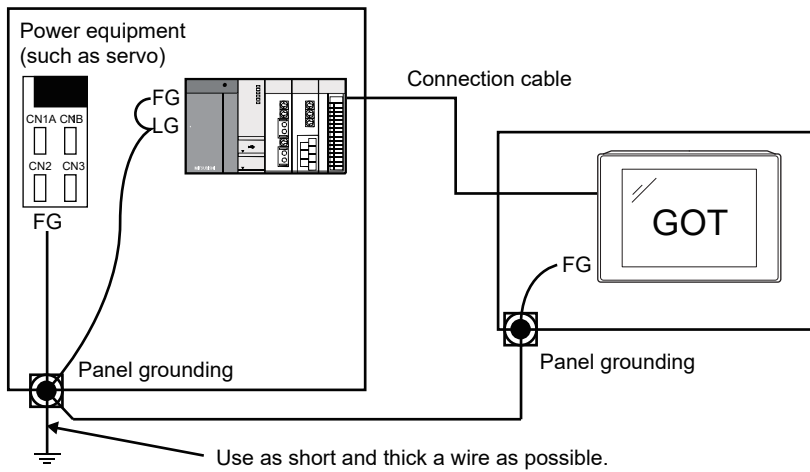

■ Common grounding (Not allowed)

Do not connect the ground cables of the power equipment and control equipment with a wire.

When the cables are connected, noise from the power equipment may affect the control equipment, causing a malfunction.

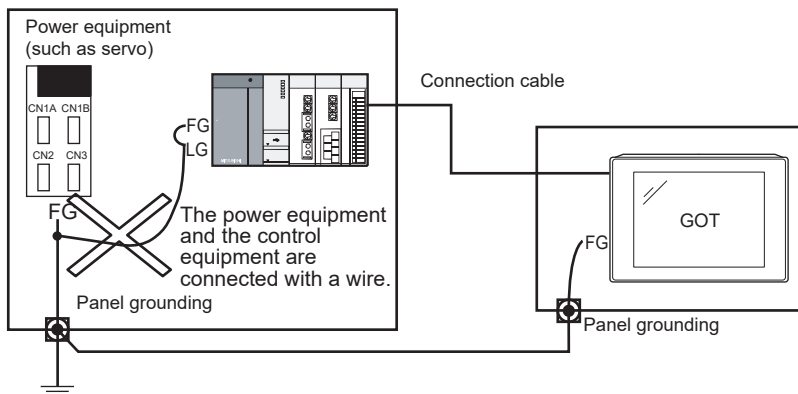

Recommended terminal shape

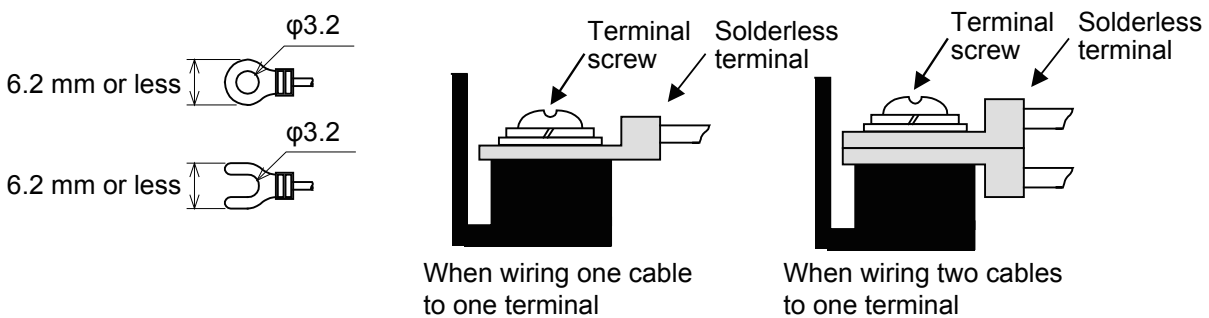

Applicable solderless terminal

RAV1.25-3, V2-S3.3, V2-N3A, FV2-N3A

Causes of wiring-related malfunction and countermeasure examples

Causes of a malfunction due to grounding of the GOT include potential difference caused by grounding and noise. The following measures may reduce potential difference and noise.

Wiring of the ground cable and power line of the GOT

When the ground cable and power line of the GOT are installed together, the GOT may malfunction due to noise. Separating the ground cable and power line of the GOT in wiring reduces the influence of noise.

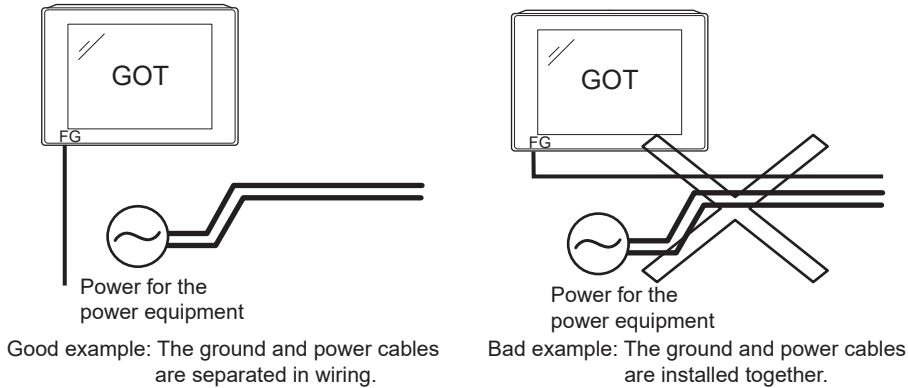

When leading the ground cable from the control panel having control equipment into the control panel having the GOT

When a single ground cable is led from the control panel having control equipment, including a PLC, into the control panel having the GOT, the cable may be directly connected to the power terminal of the GOT.

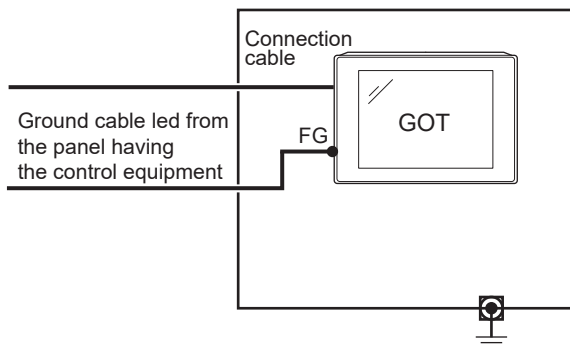

The malfunction due to the potential difference caused by the grounding in such a case may be prevented by reducing the voltage as shown in countermeasure example 1 below.

■Countermeasure example 1

When any potential difference between the ground cable and the control panel having the GOT affects the GOT, also connect the ground cable to the control panel.

When Countermeasure example 1-1 is difficult to be taken, such as the wiring is impossible, carry out wiring as shown in Countermeasure example 1-2.

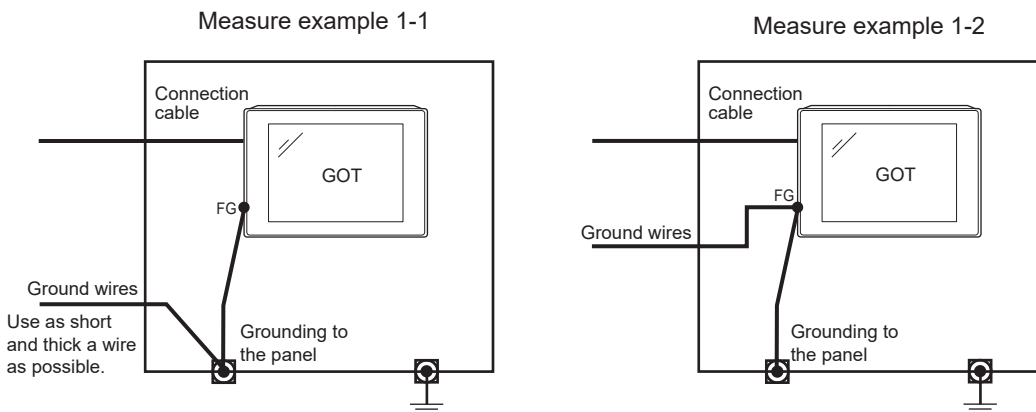

If noise further affects the GOT by taking Countermeasure example 1, Countermeasure example 2 may reduce the influence of noise.

■Countermeasure example 2

If the noise from the control panel having the GOT adversely affects the GOT even after Countermeasure example 1 is taken, attach the ferrite core (KITAGAWA INDUSTRIES CO.,LTD. RFC-H13 or equivalent).

When attaching a ferrite core, insert the cable through the ferrite core several times (approximately three times).

When Countermeasure example 2-1 is difficult to be taken, such as the wiring is impossible, carry out wiring as shown in Countermeasure example 2-2.

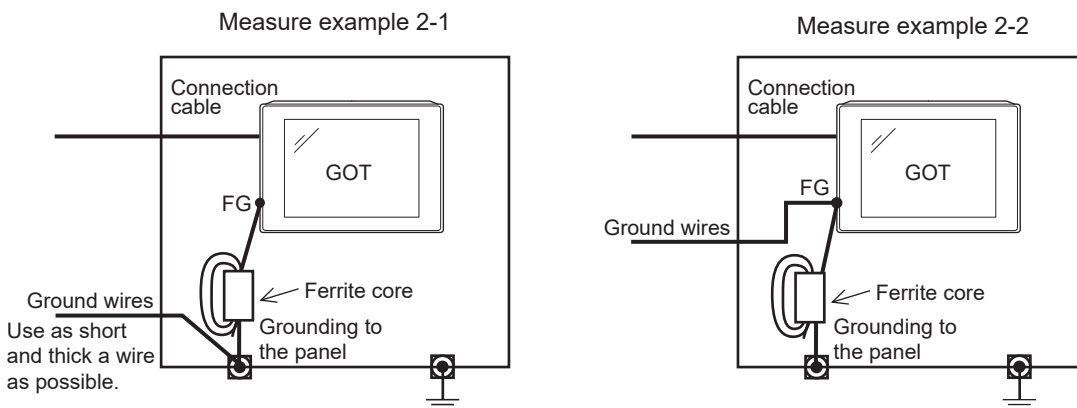

8.4 Wiring Inside and Outside the Control Panel

Control panel inside wiring

As shown in the following figure, power lines, including power cables and servo amplifier driving cables, and communication cables, including network cables, must not be mixed.

Mixing the power lines and communication cables may cause a malfunction due to noise.

When devices that generate surge noise, including a molded case circuit breaker (MCCB), electromagnetic contactor (MC), relay (RA), solenoid valve, and induction motor, are used, a surge suppressor is effective.

For the surge suppressor, refer to the following.

☞ Page 94 Attaching a Surge Suppressor to Control Equipment

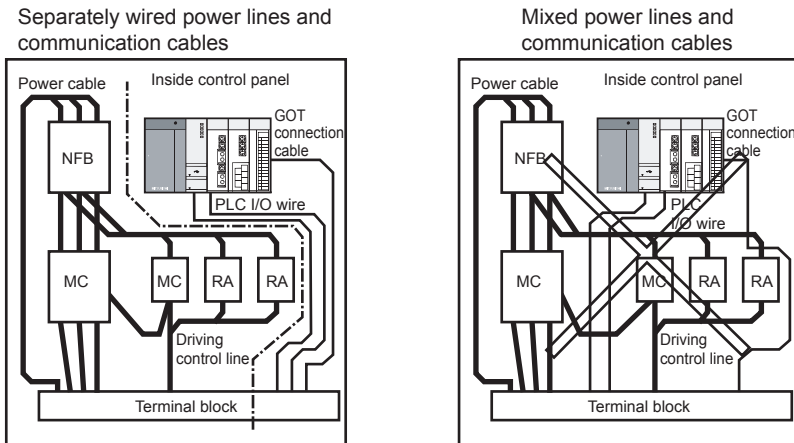

Control panel outside wiring

To lead the power line and the communication cable outside the control panel, open cable holes at two separate places to lead the cables separately out.

When the cables are led out through the same cable hole for wiring reasons, the cables are more easily affected by noise.

Wiring the power lines and the communication cables outside the control panel

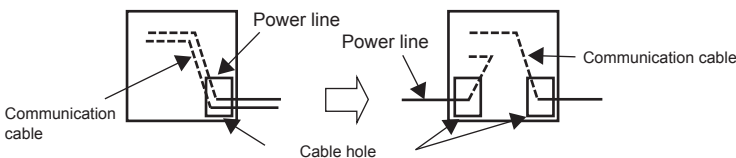

Separate the power line and communication cable each other 100 mm or more in the duct.

When the cables are close each other for wiring reasons, use a separator (made of metal).

Doing so reduces the noise influence.

Wiring of power line and communication cable in the duct

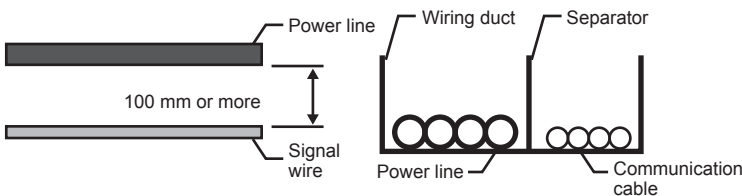

8.5 Attaching a Surge Suppressor to Control Equipment

When the GOT fails to work properly, for example a communication error occurs, in synchronization with the ON/OFF status of the specific control equipment, including a molded case circuit breaker, electromagnetic contactor, relay, solenoid valve, and induction motor (hereinafter described as load), the GOT may be affected by surge noise.

In such a case, separate the ground cable and the communication cable from the load.

When the ground cable or communication cable has to be installed close to the load, attaching a surge suppressor is effective.

Attach a surge suppressor closest to the load.

Measures against AC inductive load

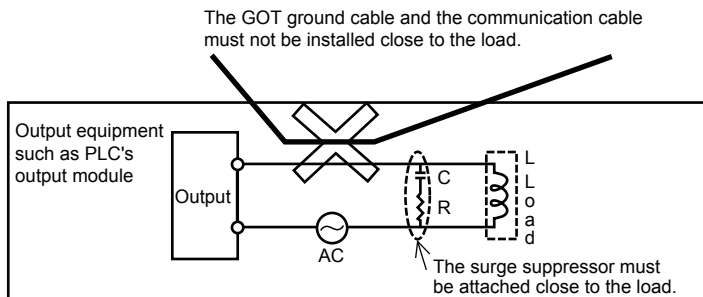

Measures against DC inductive load

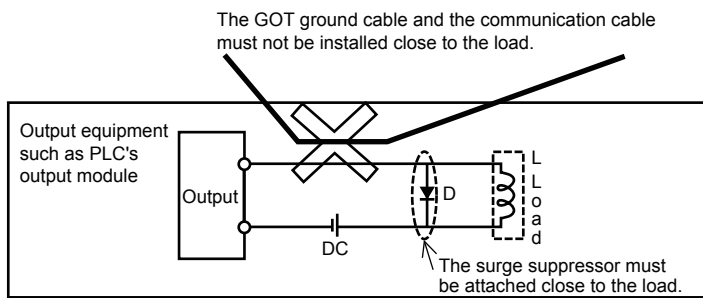

9 OPERATING THE GOT

- Page 95 Outline Procedure to Start the GOT
- Page 98 Creating Project Data

9.1 Outline Procedure to Start the GOT

This section explains the outline procedure to operate the GOT.

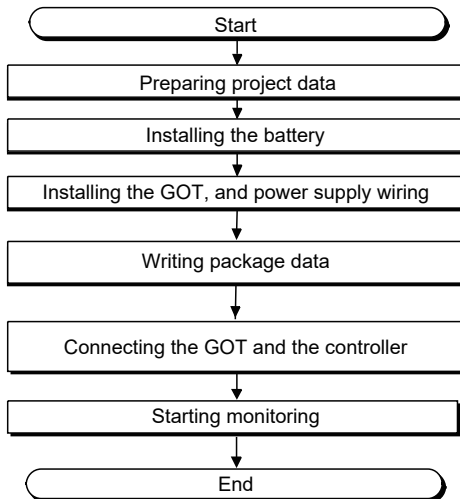

Preparing project data

1. Install GT Designer3 Version1 on the personal computer.

For how to install GT Designer3 Version1, refer to the following.

GT Works3 Version1 Installation Instructions

2. Create project data with GT Designer3 Version1.

For how to use GT Designer3 Version1 and create project data, refer to the following.

GT Designer3 (GOT2000) Screen Design Manual

Installing the battery

Install the battery to the GOT.

For how to install the battery, refer to the following.

Page 72 Installing the Battery

Installing the GOT, and power supply wiring

1. Install the GOT to the control panel.

For how to install the GOT, refer to the following.

Page 70 Installing the GOT

2. Carry out wiring of power cables for the GOT.

For the wiring of power cables, refer to the following.

Page 85 WIRING OF POWER SUPPLY SECTION

Writing package data

Write package data with GT Designer3 Version1.

The writing procedure differs depending on the data writing method.

Point

Terms

- Basic software

The basic software is equivalent to an operating system of the GOT.

A GOT in which no basic software is written cannot be started.

- Package data

The package data contains project data and applications necessary to execute the project data.

Writing the package data into the GOT enables you to use the user-created project data on the GOT.

■ Writing package data directly from a personal computer to the GOT

Connect the GOT and a personal computer, and write the package data to the GOT.

1. Connect the personal computer with the GOT.

- USB

Connect the USB interface (Device) and the USB port of the personal computer with a USB cable.

- Ethernet

Connect the Ethernet interface and the Ethernet port of the personal computer with an Ethernet cable.

To write the package data to the GOT by Ethernet, install the basic software to the GOT and configure the communication settings to enable the communication between the GOT and the personal computer by Ethernet in advance.

- Via PLC

Connect the GOT and a personal computer via the PLC connected to the GOT.

For each connection setting, refer to the following.

 GT Designer3 (GOT2000) Screen Design Manual

2. Turn on the GOT.

3. Write the package data with GT Designer3 Version1.

For how to write the package data, refer to the following.

 GT Designer3 (GOT2000) Screen Design Manual

■ Writing package data from the data storage to the GOT

Write the package data to the GOT using the data storage such as an SD card.

1. Install a data storage such as an SD card to the personal computer.

2. Write the package data to the data storage with GT Designer3 Version1.

For how to write the package data, refer to the following.

 GT Designer3 (GOT2000) Screen Design Manual

3. Install the data storage to the GOT.

SD card (drive A): installed to the SD card interface

Data storage (drive B, E, F, or G): installed to the USB interface (Host)

4. Turn on the GOT.

To start the GOT with the built-in flash memory (drive C), write the package data to the built-in flash memory (drive C) of the GOT.

For how to write the package data, refer to the following.

 GOT2000 Series User's Manual (Utility)

To start the GOT with the data storage (drive A, B, D to G), writing the package data to the built-in flash memory (drive C) of the GOT is not required.

Connecting the GOT and the controller

1. Check the communication settings in the utility screen of the GOT.

 GOT2000 Series User's Manual (Utility)

2. Turn off the power of the GOT.

3. Connect the GOT and controller with a cable.

 GOT2000 Series Connection Manual For GT Works3 Version1 that covers the controller used

Starting monitoring

1. Turn on the GOT and the connected system.

2. The GOT starts monitoring.

Point

Precautions when the startup source of the GOT is any other than the built-in flash memory (drive C)

- GOT startup time

The GOT startup time is longer than the normal startup time.

The GOT startup time differs depending on the data storage type, number of written applications, and package data size.

- Handling the SD card during the GOT startup

When the startup source is the SD card (drive A), do not open the cover of the SD card interface during the GOT startup.

Doing so causes the GOT to fail to start normally.

- Corrective actions when the GOT cannot be started

The GOT cannot be started in any of the following conditions.

Take the following corrective actions, and turn on the GOT again.

Condition	Corrective action
The type of the physical GOT differs from the GOT type of the package data stored in the SD card.	Prepare the SD card that stores the package data containing the GOT type same as the GOT to be used.
The GOT has insufficient memory.	Delete unnecessary data in the memory of the GOT.  GT Designer3 (GOT2000) Screen Design Manual

9.2 Creating Project Data

Create project data with GT Designer3 Version1.

For how to operate GT Designer3 Version1, refer to the following.

 GT Designer3 (GOT2000) Screen Design Manual

Precautions for drawing

■ Starting GT Designer3 Version1

When starting GT Designer3 Version1, make sure to start the GOT2000 application.

You cannot create the GOT2000 screens with the GOT1000 application.

10 MAINTENANCE AND INSPECTION

- Page 100 Daily Inspection
- Page 101 Periodic Inspection
- Page 102 Screen Cleaning Method
- Page 103 Low-voltage Battery Detection and Battery Replacement

WARNING

- When power is on, do not touch the terminals.
Doing so can cause an electric shock or malfunction.
- Correctly connect the battery connector.
Do not charge, disassemble, heat, short-circuit, solder, or throw the battery into the fire.
Doing so will cause the battery to produce heat, explode, or ignite, resulting in injury and fire.
- Before starting cleaning or terminal screw retightening, always switch off the power externally in all phases.
Not switching the power off in all phases can cause a unit failure or malfunction.
Undertightening can cause a short circuit or malfunction.
Overtightening can cause a short circuit or malfunction due to the damage of the screws or unit.

CAUTION

- Do not disassemble or modify the unit.
Doing so can cause a failure, malfunction, injury or fire.
- Do not touch the conductive and electronic parts of the unit directly.
Doing so can cause a unit malfunction or failure.
- The cables connected to the unit must be run in ducts or clamped.
Not doing so can cause the unit or cable to be damaged due to the dangling, motion or accidental pulling of the cables or can cause a malfunction due to a cable connection fault.
- When unplugging the cable connected to the unit, do not hold and pull from the cable portion.
Doing so can cause the unit or cable to be damaged or can cause a malfunction due to a cable connection fault.
- Before touching the unit, always touch grounded metals, etc. to discharge static electricity from human body, etc.
Not doing so can cause the unit to fail or malfunction.
- When disposing of this product, treat it as industrial waste.
When disposing of batteries, separate them from other wastes according to the local regulations.
(Refer to 9.4 Low-voltage Battery Detection and Battery Replacement for details of the battery directive in the EU member states.)

10.1 Daily Inspection

The GOT does not have consumable components that shorten its life.

However, the battery and liquid crystal display have limited life.

The periodical replacement of the battery is recommended.

For the battery and the liquid crystal display, refer to the following.

☞ Page 46 Performance Specifications

Daily inspection items

Item	Inspection item		Inspection method	Criterion	Corrective action
1)	GOT installation status		Check for loose screws.	Securely tightened	Retighten screws with the specified torque.
2)	Connection status	Loose terminal screws	Retighten screws with a screwdriver.	Not loose	Retighten terminal screws.
		Proximity of solderless terminals	Visual check	Proper intervals	Correct intervals.
		Loose contactors	Visual check	Not loose	Retighten contactor fixing screws.
3)	Usage status	Foreign material adherence	Visual check	No foreign matter adherence	Remove the foreign material and clean.

10.2 Periodic Inspection

Half-yearly or yearly inspection items

Inspect the following items when moving or modifying equipment, or changing wiring.

Item	Inspection item	Inspection method	Criterion	Corrective action		
1	Surrounding environment	Ambient temperature	Measure corrosive gas with a thermometer or hygrometer.	Display section	0 °C to 40 °C	For use in a control panel, the control panel inside temperature is the ambient temperature.
			Other sections	*1		
			Ambient humidity	10 % RH to 90% RH		
			Atmosphere	No corrosive gas		
2	Input polarity of 24 V DC power	Measure voltage across 24 V DC terminals.	Connected according to terminal markings on the GOT power supply section	Change wiring.		
3	Installation status	Looseness	Move the unit.	Mounted firmly	Retighten screws.	
		Foreign material adherence	Visual check	No foreign matter adherence	Remove the foreign material and clean.	
4	Connection status	Loose terminal screws	Retighten screws with a screwdriver.	Not loose	Retighten terminal screws.	
		Proximity of solderless terminals	Visual check	Proper intervals	Correct intervals.	
		Loose contactors	Visual check	Not loose	Retighten contactor fixing screws.	
5	Battery	Check the voltage status of the GOT built-in battery in [Time] of the utility.  GOT2000 Series User's Manual (Utility)	No alarm	Replace the battery with a new battery when the current battery has reached the specified life span, even if the low voltage is not indicated.		

*1 The criterion varies with the installation orientation.
 For the details, refer to the following.

 Page 69 Control Panel Inside Temperature and GOT Installation Angle

10.3 Screen Cleaning Method

Use the GOT always in a clean condition.

Cleaning and disinfecting the GOT

- For your safety, be sure to turn off the GOT before cleaning and disinfecting the surface.
- Carefully wipe the GOT screen with a soft cloth moistened with neutral detergent or ethanol.

Do not apply too much disinfectant to the cloth.

If you use alcohol for disinfection, the main component of the alcohol must be ethanol or isopropyl alcohol.

- Do not spray disinfectant directly to the GOT because doing so may cause electrical failure of the GOT and peripheral devices.
- After wiping the surface, dry the GOT completely before turning it on.

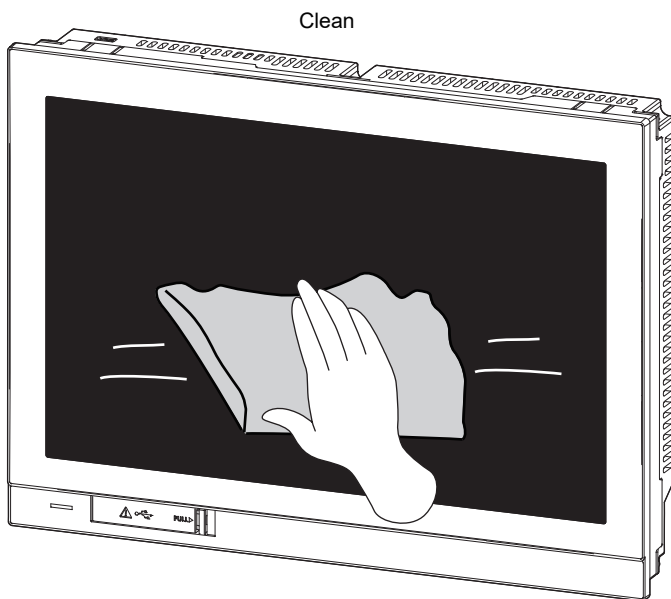

Precautions

Do not use the following solvents.

Solvents may dissolve the surface or peel the paint on the surface.

- Chlorine-based cleaners (bleach or other solvents)
- Peroxides (including hydrogen peroxide)
- Acetone, ammonia, paint thinner, benzene, methylene chloride, toluene, or other solvents

10.4 Low-voltage Battery Detection and Battery Replacement

Low-voltage battery detection and battery replacement

The battery is used to hold the SRAM data, clock data, and backup data of the system status log data.

The periodical replacement of the battery is recommended.

For the battery replacement procedure, refer to the following.

📖 Page 72 Installing and Removing the Battery

You can check if the battery has a low voltage by using the utility and the system alarm.

For details of the battery status display by using the utility, refer to the following.

📖 GOT2000 Series User's Manual (Utility)

The GOT can display a low battery voltage message with the system alarm on such an occasion.

To display the message by the system alarm, set [Battery alarm display] to ON.

📖 GOT2000 Series User's Manual (Utility)

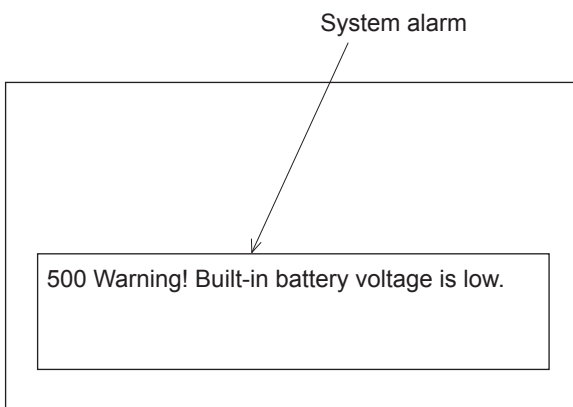

For the details of the system alarm, refer to the following.

📖 GT Designer3 (GOT2000) Screen Design Manual

Point 🔍

Battery replacement timing

When a low-voltage battery is detected, replace the battery immediately.

The GOT retains the data for 14 days after the low-voltage battery detection. However, after the period, the GOT cannot retain the data.

Handling of batteries and devices with built-in batteries in EU member states

This section explains the precautions for disposing of waste batteries in EU member states and for exporting batteries and devices with built-in batteries to EU member states.

■Precautions for disposal

EU member states have a separate collection system for waste batteries.

Dispose of batteries properly at the local community waste collection/recycling center.

The following symbol is printed on batteries and packaging of devices with built-in batteries used for Mitsubishi Electric Graphic Operation Terminal (GOT).



Point

This symbol is valid in the EU member states only.

The symbol is specified in Article 20 "Information for end-users" and ANNEX II of the new EU Battery Directive (2006/66/EC).

The symbol indicates that batteries need to be disposed of separately from other wastes.

■Precautions for export

The new EU Battery Directive (2006/66/EC) requires the following when batteries and/or devices with built-in batteries are sold and exported to EU member states.

To print the symbol on batteries, devices, or their packaging

To explain the symbol in the manuals of the products

The batteries and/or devices with built-in batteries manufactured before the EU Battery Directive (2006/66/EC) took effect are also subject to the directive.

- Labelling the symbol

To market or export batteries and/or devices with built-in batteries, which have no symbol, to EU member states, print the symbol as shown in (1) above on the GOT or its packaging.

- Attaching the manual

To export devices incorporating the GOT to EU member states, attach this manual.

If no GOT manual is included with the equipment, separately attach an explanatory note regarding the symbol to the manuals of each device.

11 TROUBLESHOOTING

- Page 105 GOT Restoration Sheets
- Page 116 Error Messages and System Alarms

11.1 GOT Restoration Sheets

This section provides check sheets for restoration in cases where the GOT does not operate normally. The following explains how to use each sheet.

When the GOT does not operate or malfunctions (GOT status check sheet)

When the GOT does not operate or malfunctions, identify the cause of the malfunction using the GOT status check sheet, and take a corrective action.

When the GOT is restored, see the status for a while.

When the wiring needs to be improved (GOT installation status check sheet)

As a result of the GOT status check, if the cause of the malfunction or others is due to the noise generated by the GOT wiring status, take a corrective action for wiring by using the GOT installation status check sheet.

When the GOT is restored, see the status for a while.

When a corrective action other than the above is required (System configuration check sheet)

If a malfunction or others still occurs even after the above checks, fill out the system configuration check sheet with details about your system, and consult your local sales office.

When sending a faulty product, attach the GOT restoration sheets (GOT status check sheet, GOT installation status check sheet, and the system configuration check sheet) checked in this section.

Keep copies of the GOT restoration sheets.

GOT status check sheet

Check the GOT starting from GOT status.

Mark checkboxes that apply to the symptom of your GOT.

Proceed according to the corrective actions.

GOT status

■ Check of failure frequency, such as the GOT does not operate and an error occurs on the screen

Check	Symptom	Cause	Corrective action
<input type="checkbox"/>	Always occurs.	Frequency: • Example: Once a month	Proceed to the following. ☞ Check of the displayed error code (system alarm)
<input type="checkbox"/>	Occurs sometimes.		

■ Check of the displayed error code (system alarm)

Check	Symptom	Cause	Corrective action
<input type="checkbox"/>	Can be checked.	Error code (system alarm): • Example: 460 Communication unit error	Take the corrective action for the error code (system alarm) or error message. If the status does not change with the corrective action, proceed to the following. ☞ Check of the POWER LED
<input type="checkbox"/>	Cannot be checked.		

■ Check of the POWER LED

Check	Symptom	Cause/status	Corrective action
<input type="checkbox"/>	Lit in blue.	The power is supplied normally.	Proceed to the following. ☞ Check of the screen display
<input type="checkbox"/>	Lit in orange.	Screen saving is being performed. When the read device of the system information was set, the device was turned on and the screen was switched to the forced screen saving status.	Check the setting of the read device. If no problem is found in the setting, proceed to the following. ☞ Check of the screen display
<input type="checkbox"/>	Blinking in orange and blue.	A backlight failure has occurred.	Proceed to the following. ☞ Faulty product investigation
<input type="checkbox"/>	Not lit	The power is not supplied. If the power is supplied, the GOT hardware may be faulty.	Check if the power is supplied. If the GOT is not restored, proceed to the following. ☞ Faulty product investigation

■ Check of the screen display

Check	Symptom	Cause/status	Corrective action
<input type="checkbox"/>	The screen is black.	The LCD or basic software may be faulty.	Perform the following in order. 1) Write the package data again. 2) Install the basic software again. If the GOT is not restored by the above operations, proceed to the following. ☞ Faulty product investigation
<input type="checkbox"/>	The screen is white.	The GOT hardware may be faulty.	Proceed to the following. ☞ Faulty product investigation
<input type="checkbox"/>	A line is displayed on the screen.	The GOT hardware may be faulty. Example: A vertical line is displayed.	☞ Faulty product investigation
<input type="checkbox"/>	Other faulty displays		
<input type="checkbox"/>	The screen freezes.	The screen display is not updated and operation is unavailable.	Proceed to the following. ☞ Check of buzzer sound

■ Check of buzzer sound

Check	Symptom	Cause/status	Corrective action
<input type="checkbox"/>	No buzzer sound	-	Proceed to the following. ☞ Status of the GOT when it freezes (screen operation stopped)
<input type="checkbox"/>	Continues to beep randomly.	Buzzer sound: • Example: The rhythm repeats as three beeps, one beep, and two beeps.	☞ Status of the GOT when it freezes (screen operation stopped)
<input type="checkbox"/>	Continues to beep in a particular pattern.		
<input type="checkbox"/>	Beeps continuously.	When the read device of the system information was set, the device was turned on and the Buzzer Output signal was input.	Check the setting of the read device. If the Buzzer Output signal has no error, proceed to the following. ☞ Status of the GOT when it freezes (screen operation stopped)

Status of the GOT when it freezes (screen operation stopped)

■Check of switching to the utility screen

Check	Symptom	Cause/status	Corrective action
<input type="checkbox"/>	Possible	Error code (system alarm): • Example: 460 Communication unit error	When the system alarm display function can be used, take the action for the error code (system alarm) displayed. If the corrective action cannot be taken, proceed to the following. ☞ Executing the I/O check from the GOT utility
<input type="checkbox"/>	Impossible	The system alarm cannot be used.	Proceed to the following. ☞ Check of the objects that are not displayed on the monitor screen

■Executing the I/O check from the GOT utility

Check	Symptom	Cause/status	Corrective action
<input type="checkbox"/>	Communication error	Display details: • Example: A message indicating that the cause may be a connection error has been displayed.	Proceed to the following. ☞ Check of the objects that are not displayed on the monitor screen
<input type="checkbox"/>	No error	The hardware such as a communication interface has no error.	Proceed to the following. ☞ PLC status

■Check of the objects that are not displayed on the monitor screen

Check	Symptom	Cause/status	Corrective action
<input type="checkbox"/>	Found	Details: • Example: The numerical display object is not displayed.	Proceed to the following. ☞ PLC status
<input type="checkbox"/>	Not found		

PLC status

■PLC failure

Check	Symptom	Cause/status	Corrective action
<input type="checkbox"/>	Always occurs.	CONTROL-BUS. ERROR, SP. UNIT LAY. ERROR, or others is considered. Error code (system alarm): • Example: 1204 CPU H/W failure	Proceed to the following. ☞ Page 105 GOT Restoration Sheets
<input type="checkbox"/>	Occurs sometimes.	The PLC CPU may be affected by noise or the hardware may be faulty. Frequency: • Example: Once a month Error code (system alarm): • Example: 1204 CPU H/W failure	Proceed to the following. ☞ GOT restoration procedure
<input type="checkbox"/>	Operates normally.	-	

GOT restoration procedure

Follow the procedure below starting from 1), and check if the GOT is restored.

Perform the action in each check item and mark the corresponding checkbox.

If the GOT is restored, take the action after restoration.

If the GOT is not restored, proceed to the next check item.

No.	Check item	Check	Cause/status	Action after restoration
1)	Press the GOT reset switch.	<input type="checkbox"/> Restored <input type="checkbox"/> Not restored	If the GOT is restored by the operation on the left, a temporary malfunction or others due to noise is considered.	Perform the following. ☞ Page 109 GOT installation status check sheet
2)	Power on/off the GOT.	<input type="checkbox"/> Restored <input type="checkbox"/> Not restored		
3)	Reset or power on/off the PLC CPU.	<input type="checkbox"/> Restored <input type="checkbox"/> Not restored		
4)	Power on/off the GOT and PLC CPU simultaneously.	<input type="checkbox"/> Restored <input type="checkbox"/> Not restored		
5)	Connect the cable again.	<input type="checkbox"/> Restored <input type="checkbox"/> Not restored	If the GOT is restored by the operation on the left, the cable connection may be faulty.	Securely connect the cable. If an error occurs again, proceed to the following. ☞ Faulty product investigation
6)	Write the package data again.	<input type="checkbox"/> Restored <input type="checkbox"/> Not restored	If the GOT is restored by the operation on the left, data may have been destroyed by an action such as powering off the GOT during the package data writing or basic software installation.	Do not power off the GOT during data transfer. If an error occurs again, proceed to the following. ☞ Faulty product investigation
7)	Install the basic software again.	<input type="checkbox"/> Restored <input type="checkbox"/> Not restored		
8)	Take the preventive measures against noise, which is described in the following. ☞ Page 109 GOT installation status check sheet	<input type="checkbox"/> Restored <input type="checkbox"/> Not restored	A temporary malfunction or others due to noise is considered.	Perform the following. ☞ Page 109 GOT installation status check sheet
9)	Replace the unit.	<input type="checkbox"/> Restored <input type="checkbox"/> Not restored	If the GOT is restored by the operation on the left, the unit may have a hardware failure.	Install the failure unit to the GOT again to check that the unit causes the malfunction. After the check, proceed to the following. ☞ Faulty product investigation
10)	If the GOT is not restored by 1) to 9), proceed to the following. ☞ Faulty product investigation			

Faulty product investigation

If you cannot restore the GOT, consult your local sales office.

Depending on the problem details, we may ask you to send the faulty product to us.

In that case, attach the GOT status check sheet, GOT installation status check sheet, and system configuration check sheet filled with details about your system.

GOT installation status check sheet

Check the installation status of your GOT regarding the following items.

- Control panel inside wiring
- Control panel outside wiring
- Wiring of the FG cable and power line for the GOT
- Measures against surge
- Installation status
- Grounding status of the control panel having the GOT
- Power supply system

Mark the checkboxes that apply to the current status, and take the relevant measures if necessary.

If the measures is taken, mark the checkbox of the effect.

Control panel inside wiring

■Current status

Check if power lines, such as power cables and servo amplifier driving cables, and communication cables, such as network cables, are mixed in the wiring duct inside the control panel.

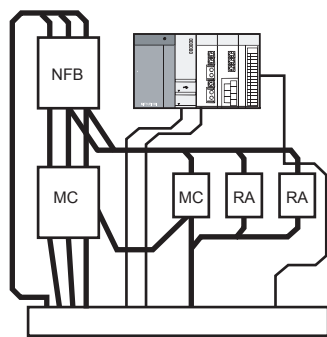

- Check result
- Mixed
 - Not mixed

■Measure for the mixed cables

Wiring the power lines and the communication cables inside the control panel without mixing them in the duct reduces the influence of noise.

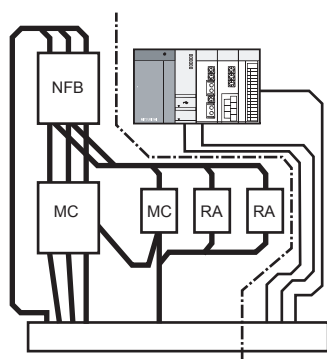

- Effect
- Effective
 - Ineffective

Control panel outside wiring

■Current status

Check if the power line and the communication cable are installed together.

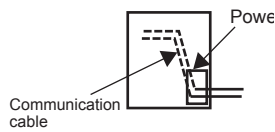

- Check result
- Installed together
 - Not installed together

■Measure for the cables tied in a bundle

As shown in the figure below, leading the power line and communication cable separately from different places to the outside of the control panel reduces the influence of noise from the power line.

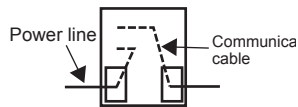

- Effect
- Effective
 - Ineffective

Separating the communication cable from the power line or using a separator (made of metal) in the duct, as shown below, reduces the influence of noise.

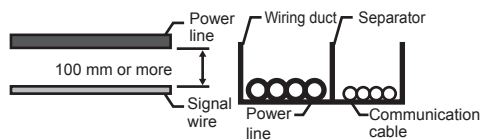

- Effect
- Effective
 - Ineffective

Wiring of the FG cable and power line for the GOT

■Current status

Check if the FG cable and power line of the GOT are installed together.

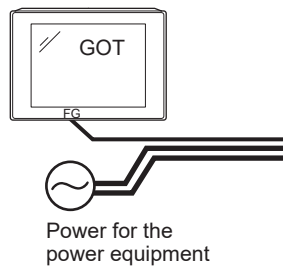

- Check result
- Installed together
 - Not installed together

■Measure for the cables tied in a bundle

Separating the FG cable and power line of the GOT reduces the influence of noise.

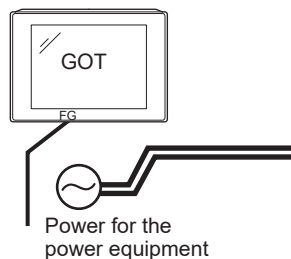

- Effect
- Effective
 - Ineffective

Measures against surge

■Current status

Check if a surge suppressor is used for the wiring of the load such as a molded case circuit breaker, electromagnetic contactor, relay, solenoid valve, or induction motor.

When a surge suppressor is used, enter the surge suppressor model and the name of the equipment that uses the surge suppressor in the columns.

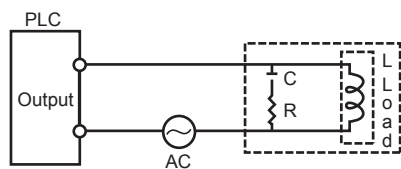

Check result

- Used
- Not used

• Entry column

Surge suppressor model	Equipment name

■Measure for the equipment without a surge suppressor

Attaching a surge suppressor close to the load reduces the influence of surge on the GOT.

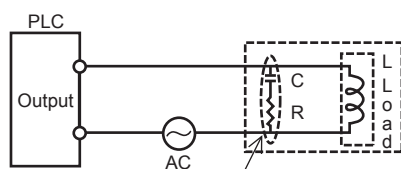

Effect

- Effective
- Ineffective

The surge suppressor must be attached close to the load.

Installation status

■ Current status

Check if the FG cables of the control equipment (such as a PLC) and the power equipment (such as a servo amplifier) are connected as shown in "a" of the following figure.

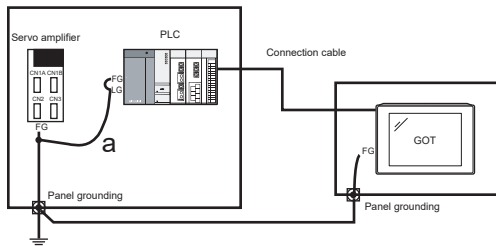

Check result

- Applicable
- Not applicable

■ Measure when a single ground cable is led

Perform independent grounding at two places as shown in Figure A.

The independent grounding reduces the influence of noise.

When independent grounding is unavailable, perform shared grounding as shown in Figure B.

Figure A

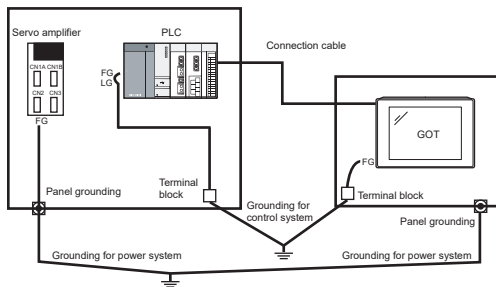
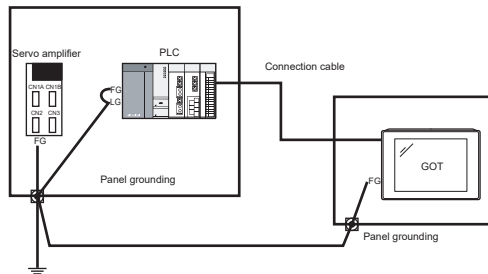

Figure B



Effect

- Effective
- Ineffective

Grounding status of the control panel having the GOT

■Current status

Check if a single ground cable is led from the control panel having the control equipment such as a PLC to the control panel having the GOT.

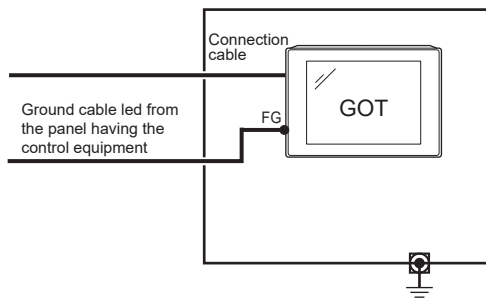

- Check result
- Applicable
 - Not applicable

11

■Measure when a single ground cable is led

• Measure 1

A malfunction may be prevented by connecting the ground cable to the control panel having the GOT as shown in Figure A to reduce the potential difference.

If wiring as shown in Figure A is unavailable, perform wiring as shown in Figure B.

Figure A

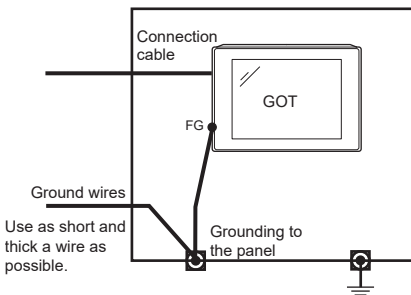
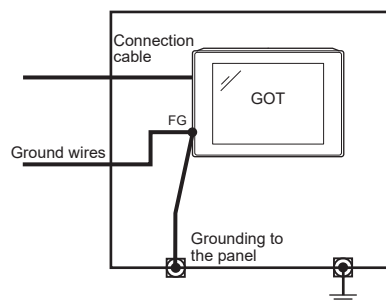

Figure B



- Effect
- Effective
 - Ineffective

• Measure 2

By attaching a ferrite core (KITAGAWA INDUSTRIES CO.,LTD. RFC-H13 or equivalent) to the ground cable connected to the control panel having the GOT as shown in Figure C, the influence of noise is reduced.

If wiring as shown in Figure C is unavailable, perform wiring as shown in Figure D.

Figure C

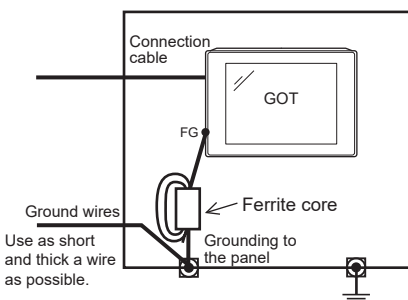
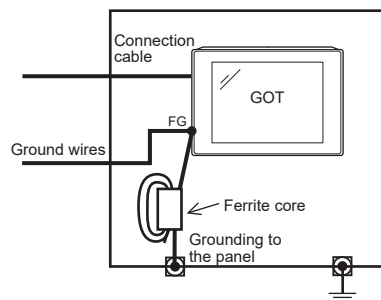

Figure D



- Effect
- Effective
 - Ineffective

Power supply system

■Current status

Check if the power is supplied for the GOT, I/O equipment (such as a relay), and power equipment (such as a servo amplifier) from the same system.

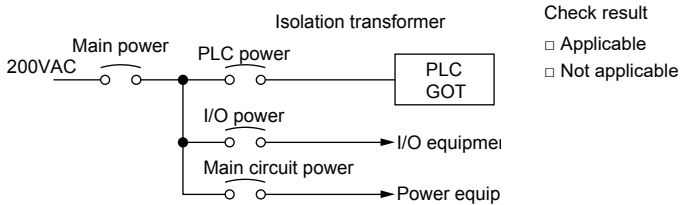

■Measure when a single ground cable is led

By separately wiring the GOT power and the I/O equipment power/power equipment power, and connecting an isolation transformer, the influence of noise is reduced.

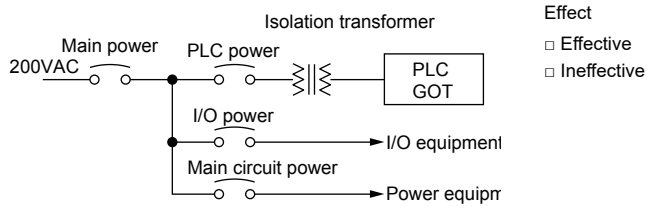

System configuration check sheet

Fill in the following table with the details of the system configuration, such as the GOT type and unit model.

System configuration for the GOT

Item	System configuration	
	Usage	Model
GOT	-	
Communication interface	Communication unit	Used, Not used
	GOT built-in interface	Used, Not used
Option unit	Used, Not used	
Cable between the controller and GOT	-	
Cable length	-	
When using any other units or options, describe them.		

System configuration for the PLC

Item	System configuration	
	Usage	Model
Power supply module	-	
CPU	-	
Serial communication module Computer link module	Used, Not used	
Network module	Used, Not used	
Interrupt module	Used, Not used	
Positioning module	Used, Not used	
Number of PLC extension base units	-	extension base units
When using any other units or others, describe them.		

Entry column for recurrence (when the malfunction has occurred after the corrective action was taken)

Describe the operation situation when the GOT screen froze or the GOT display is faulty at the recurrence.

11.2 Error Messages and System Alarms

This section explains the error messages and system alarms displayed on the GOT.

The system alarm function displays the error code and error message when an error occurs in the GOT, controller, or network.

For the details of the system alarm, refer to the following.

📖 GT Designer3 (GOT2000) Screen Design Manual

Point 🔍

Error code and channel No.

You can check error codes in the error code storage area of the system information function.

You can check the channel No. where an error occurs with the GOT special register (GS262 to 264).

For the details of the system information and GOT special register, refer to the following.

📖 GT Designer3 (GOT2000) Screen Design Manual

Displayed contents

The section explains an example of displaying an error code and error message on the GOT.

Displaying the error codes and error messages with the popup display (Alarm popup display)

When an error occurs, the GOT can display the error code and error message with the popup display at the front of the monitor screen.

Since an alarm pops up regardless of the screen, you cannot miss the error.



Generated alarms are popped up regardless of the screen.

Displaying the error codes and error messages in a list (System alarm display)

When an error occurs, the GOT can display the error codes and error messages in the list set on the screen.

Displaying multiple errors and recording the events as history are available.

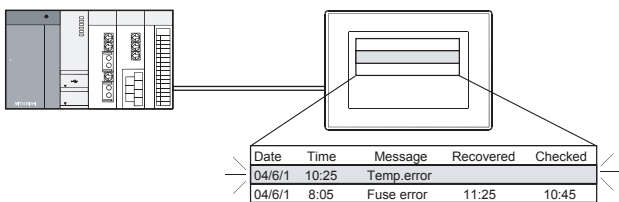



Create a screen to display alarms, and confirm the details of the alarms and take measures for the errors.



Checking error messages with the utility (Utility)

You can check the error codes and error messages using the system alarm display of the utility even though its object is not set.

 GOT2000 Series User's Manual (Utility)

Error codes and reference manuals

Error source	Error code	Description	Storage location of channel No. with error ^{*1}	Reference
Controller	0 to 99 (Value of D9008)	Error code of CPU (ACPU)	GS263	User's Manual of the ACPUs connected to the GOT
	100 to 299	Error code of the following controllers FXCPU ^{*2} Non-Mitsubishi Electric PLC Temperature controller (OMRON temperature controller only)		Manual of the controller connected to the GOT Deal with errors according to the error messages.
GOT ^{*5}	300 to 399	Error code of the GOT main unit function	GS262 ^{*4}	GOT2000 Series User's Manual (Utility)
	400 to 499	Error code of the GOT communication function		
	500 to 699	Error code of the GOT main unit function		
Network	800 to 999	Error code of the network	GS264	
CPU	1000 to 10000 (Value of SD0)	Error code of the CPU (QCPU, LCPU, or QnACPU)	GS263	User's Manual of the QCPU, LCPU, or QnACPU connected to the GOT
		Error code of an RCPUs or Motion CPU (MELSEC iQ-R series)		A system alarm message appears to indicate the code of the error occurring in an RCPUs. For the displayed contents of the system alarms, refer to the following.  GOT2000 Series User's Manual (Utility) For error handling, check the manual of the RCPUs.
		Error code of an FX5CPU		A system alarm message appears to indicate the code of the error occurring in an FX5CPU. For the displayed contents of the system alarms, refer to the following.  GOT2000 Series User's Manual (Utility) For error handling, check the manual of the FX5CPU.
Motion CPU	10001 to 10999	Error code of a Motion CPU (Q173D(S)CPU/Q172D(S)CPU/Q170M(S)CPU)		^{*6}
CNC C70	11000 to 11999	Error code of the CNC (Q173NCCPU)		^{*7}
Robot controller	12000 to 12999	Error code of the robot controller		^{*8}
CPU	15000 to 15999	Error code of an RCPUs		^{*9}
	16000	Error code of an FX5CPU		^{*10}
Servo amplifier ^{*3}	20016 to 21121	Error code of the servo amplifier		User's Manual of the servo amplifier connected to the GOT

- *1 For the details of the GOT special registers (GS262 to GS264), refer to the following.
 GT Designer3 (GOT2000) Screen Design Manual
- *2 FXCPU has error codes 100 to 109, indicating the status of M8060 to M8069.
 (Example) If error code (100) occurs, handle the error according to the M8060 description.
- *3 The GOT displays the error code displayed on the servo amplifier (hexadecimal) in decimal + 20000.
 Therefore, when referring to the manual of the servo amplifier with the error code displayed on the GOT using the system alarm, subtract 20000 from the GOT error code and convert the last 3 digits into the hexadecimal number.
 (Example: When the GOT system alarm shows 20144, the error code of the servo amplifier is 90H.)
- *4 Depending on the error code, the channel No. is not stored.
 For channel No. storage availability of each error code, refer to the following.
 GT Designer3 (GOT2000) Screen Design Manual
- *5 With the system alarm related to the file access, you cannot identify the drive where the alarm occurs. However, you can identify the drive by checking the File Access Error signal (b7 to b10) of System signal 2-2.
- *6 The GOT displays the error code corresponding to an error occurring in the multiple CPU system.
 Check the error details with MT Developer or MT Works2.
 For error handling, refer to the manual of the Motion CPU.
- *7 The GOT displays the error code corresponding to an error occurring in the multiple CPU system.
 Check the error details with the CNC monitor.
 For error handling, refer to the manual of the CNC.
- *8 The GOT displays the error code corresponding to an error occurring in a robot controller in the multiple CPU system or a standalone robot controller.
 Check the error details with RT ToolBox2 or RT ToolBox3.
 For error handling, refer to the manual of the robot controller.
- *9 The GOT displays the error code corresponding to an error occurring in an RCPU or Motion CPU (MELSEC iQ-R series).
 Check the error details with GX Works3 or MT Works2.
 For error handling, refer to the manual of the RCPU or Motion CPU (MELSEC iQ-R series).
- *10 The GOT displays the error code corresponding to an error occurring in an FX5CPU.
 Check the error details with GX Works3.
 For error handling, refer to the manual of the FX5CPU.

Error messages and system alarms

For the details of the error messages and the system alarms displayed on the GOT, refer to the following.

 GOT2000 Series User's Manual (Utility)

12 APPENDICES

- Page 120 External Dimension Diagrams
- Page 121 External Dimension Diagrams of the Communication Cable
- Page 123 Confirming of Versions and Conforming Standards
- Page 124 Transportation Precautions
- Page 125 Open Source Software

12.1 External Dimension Diagrams

GS2512-WXTBD

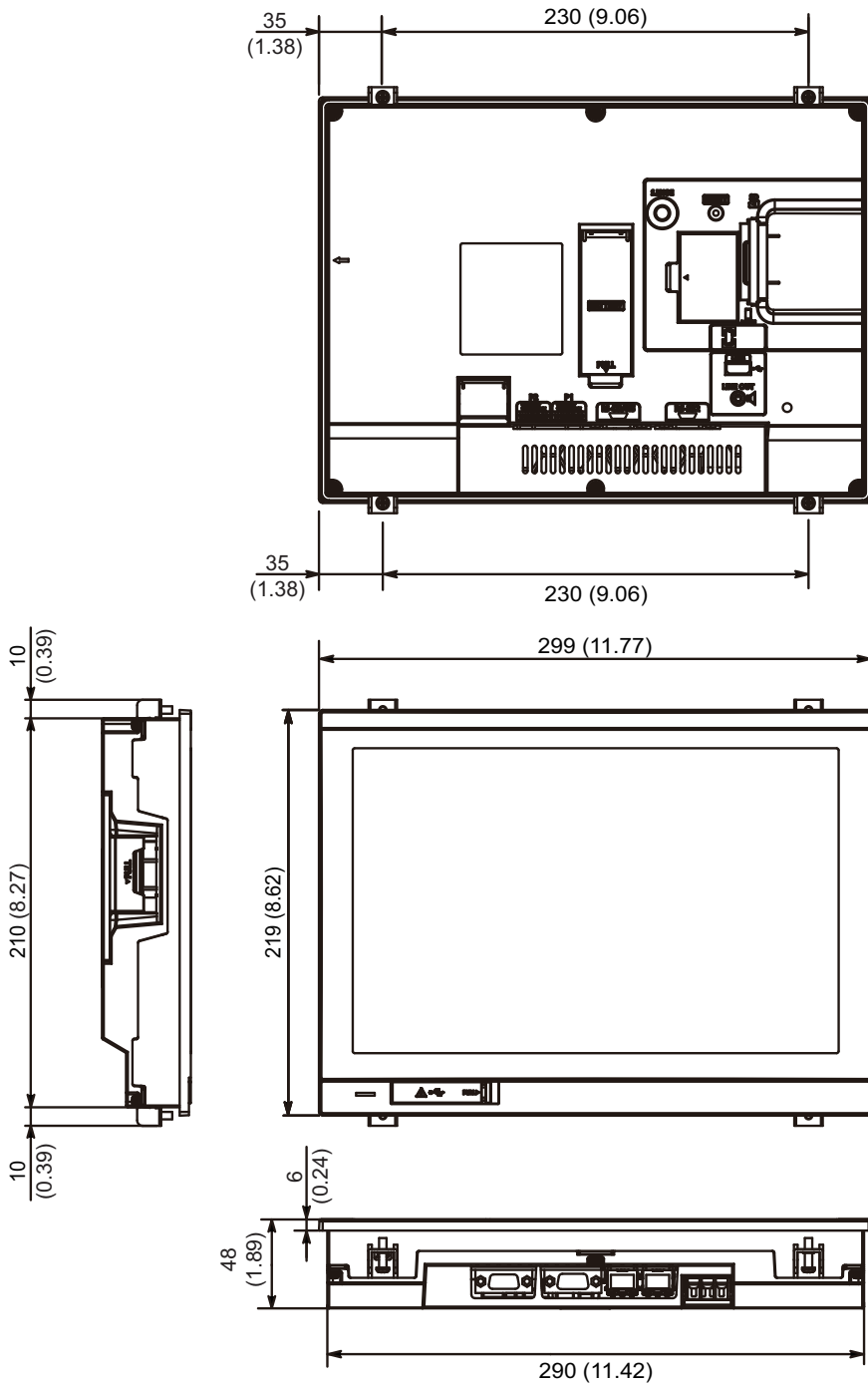

Unit: mm (inch)

12.2 External Dimension Diagrams of the Communication Cable

External dimension diagrams of the RS-232 connection cable connector

Unit: m (ft.)

Cable model	Cable length	External dimensions
GT01-C30R2-6P	3 (10)	☞ Page 121 GT01-C30R2-6P
GT01-C30R2-9S	3 (10)	☞ Page 121 GT01-C30R2-9S
GT01-C30R2-25P	3 (10)	☞ Page 121 GT01-C30R2-25P

■GT01-C30R2-6P

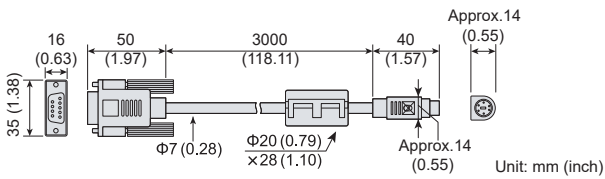

■GT01-C30R2-9S

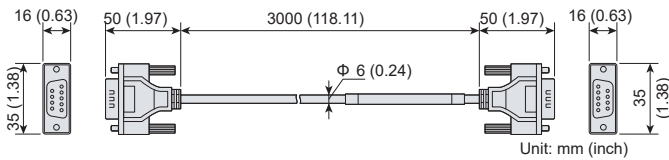

■GT01-C30R2-25P

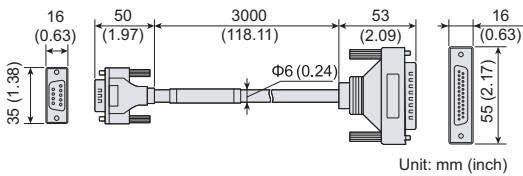

External dimension diagrams of the RS-422 connection cable connector

Unit: m (ft.)

Cable model	Cable length	External dimensions
GT01-C30R4-25P	3 (10)	☞ Page 122 GT01-C30R4-25P
GT01-C□R4-25P	10 (33), 20 (66), 30 (98)	☞ Page 122 GT01-C□R4-25P
GT01-C□R4-8P	1 (3.3), 3 (10), 10 (33), 20 (66), 30 (98)	☞ Page 122 GT01-C□R4-8P

■GT01-C30R4-25P

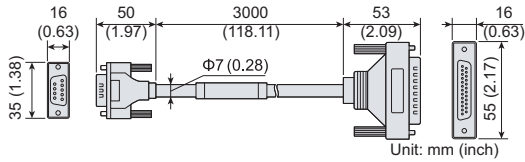

■GT01-C□R4-25P

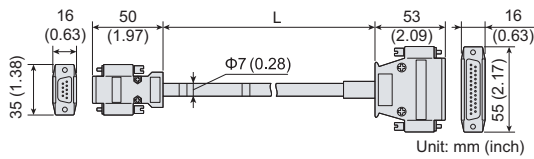

■GT01-C□R4-8P

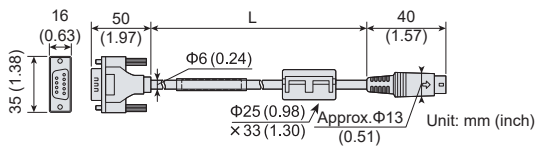

External dimension diagrams of RS-485 terminal block conversion unit

Unit: m (ft.)

Cable model	Cable length	External dimensions
FA-LTBGT2R4CBL□	0.5 (1.6), 1 (3.3), 2 (6.6)	☞ Page 122 FA-LTBGT2R4CBL□

■FA-LTBGT2R4CBL□

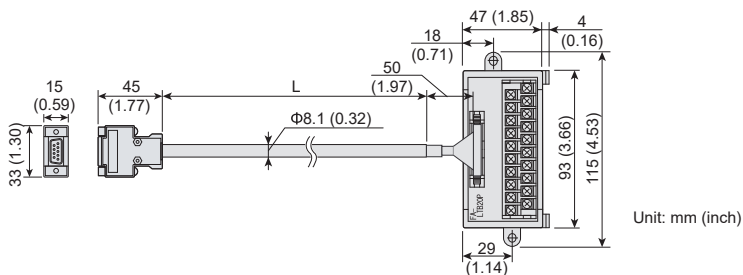

12.3 Confirming of Versions and Conforming Standards

Rating plate

The GOT hardware version, BootOS version at factory default, function version, and conforming standards can be checked with the rating plate on the GOT rear face.

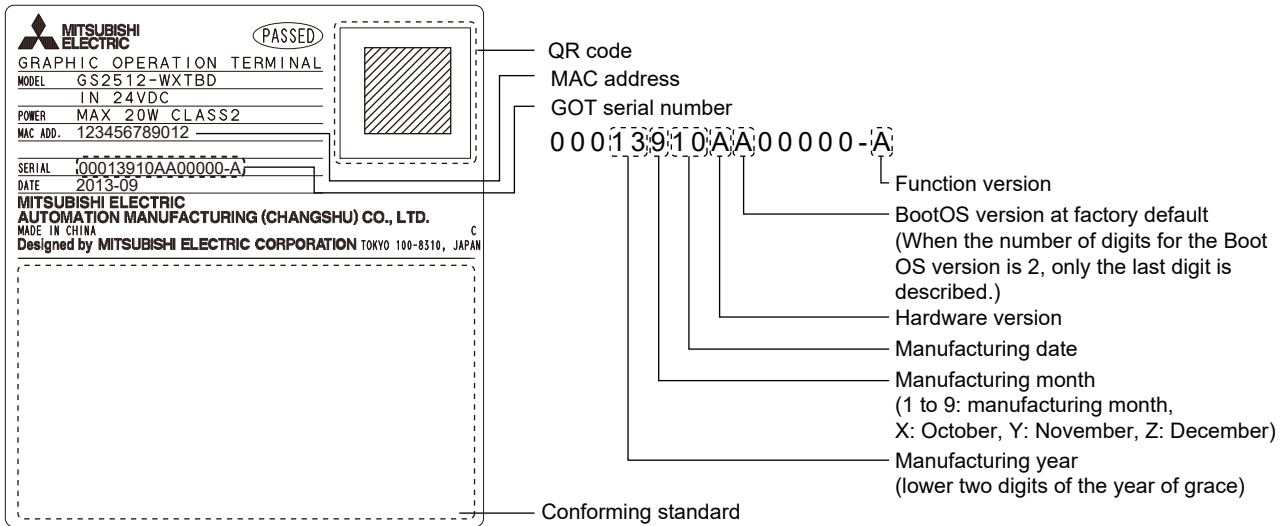

Packing box

The conforming standards can be confirmed by the label on the packing box. Note that the position of the label differs depending on the model or the shipment date.

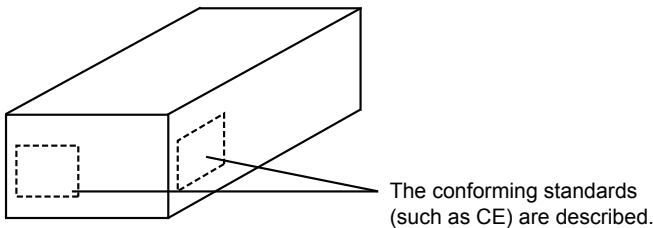

12.4 Transportation Precautions

When transporting lithium batteries, make sure to treat them based on the transport regulations.

Relevant models

The battery for GS2512-WXTBD is classified as shown in the table below.

Product name	Model	Description	Handled as
Battery	GT11-50BAT	Lithium battery	Non-dangerous goods

Transportation guidelines

Products are packed properly in compliance with the transportation regulations prior to shipment. When repacking any of the unpacked products to transport it to another location, make sure to observe the IATA Dangerous Goods Regulations, IMDG Code, and other local transportation regulations.

For details, please consult your transportation company.

12.5 Open Source Software

u-boot

The GS25 model uses U-Boot under the GNU General Public License (GPLv2).

You can obtain the source code of the software and copy, distribute, or modify the software under the GPL.

Mitsubishi Electric Corporation can provide the source code of U-Boot licensed under the GPL.

To obtain the source code, contact your local sales office.

Mitsubishi Electric Corporation will not guarantee the source code we provide if it is reused.

Mitsubishi Electric Corporation will not take any responsibility for the source code.

Please refrain from asking information on the source code of open source.

NOTE! This copyright does *not* cover the so-called "standalone" applications that use U-Boot services by means of the jump table provided by U-Boot exactly for this purpose - this is merely considered normal use of U-Boot, and does *not* fall under the heading of "derived work".

The header files "include/image.h" and "include/asm-*/u-boot.h" define interfaces to U-Boot. Including these (unmodified) header files in another file is considered normal use of U-Boot, and does *not* fall under the heading of "derived work".

Also note that the GPL below is copyrighted by the Free Software Foundation, but the instance of code that it refers to (the U-Boot source code) is copyrighted by me and others who actually wrote it.
-- Wolfgang Denk

=====

GNU GENERAL PUBLIC LICENSE Version 2, June 1991

Copyright (C) 1989, 1991 Free Software Foundation, Inc.
59 Temple Place, Suite 330, Boston, MA 02111-1307 USA
Everyone is permitted to copy and distribute verbatim copies of this license document, but changing it is not allowed.

Preamble

The licenses for most software are designed to take away your freedom to share and change it. By contrast, the GNU General Public License is intended to guarantee your freedom to share and change free software--to make sure the software is free for all its users. This General Public License applies to most of the Free Software Foundation's software and to any other program whose authors commit to using it. (Some other Free Software Foundation software is covered by the GNU Library General Public License instead.) You can apply it to your programs, too.

When we speak of free software, we are referring to freedom, not price. Our General Public Licenses are designed to make sure that you have the freedom to distribute copies of free software (and charge for this service if you wish), that you receive source code or can get it if you want it, that you can change the software or use pieces of it in new free programs; and that you know you can do these things.

To protect your rights, we need to make restrictions that forbid anyone to deny you these rights or to ask you to surrender the rights. These restrictions translate to certain responsibilities for you if you distribute copies of the software, or if you modify it.

For example, if you distribute copies of such a program, whether gratis or for a fee, you must give the recipients all the rights that you have. You must make sure that they, too, receive or can get the source code. And you must show them these terms so they know their rights.

We protect your rights with two steps: (1) copyright the software, and (2) offer you this license which gives you legal permission to copy, distribute and/or modify the software.

Also, for each author's protection and ours, we want to make certain that everyone understands that there is no warranty for this free software. If the software is modified by someone else and passed on, we want its recipients to know that what they have is not the original, so that any problems introduced by others will not reflect on the original authors' reputations.

Finally, any free program is threatened constantly by software patents. We wish to avoid the danger that redistributors of a free program will individually obtain patent licenses, in effect making the program proprietary. To prevent this, we have made it clear that any patent must be licensed for everyone's free use or not licensed at all.

The precise terms and conditions for copying, distribution and modification follow.

GNU GENERAL PUBLIC LICENSE TERMS AND CONDITIONS FOR COPYING, DISTRIBUTION AND MODIFICATION

0. This License applies to any program or other work which contains a notice placed by the copyright holder saying it may be distributed under the terms of this General Public License. The "Program", below, refers to any such program or work, and a "work based on the Program" means either the Program or any derivative work under copyright law: that is to say, a work containing the Program or a portion of it, either verbatim or with modifications and/or translated into another language. (Hereinafter, translation is included without limitation in the term "modification".) Each licensee is addressed as "you".

Activities other than copying, distribution and modification are not covered by this License; they are outside its scope. The act of running the Program is not restricted, and the output from the Program is covered only if its contents constitute a work based on the Program (independent of having been made by running the Program). Whether that is true depends on what the Program does.

1. You may copy and distribute verbatim copies of the Program's source code as you receive it, in any medium, provided that you conspicuously and appropriately publish on each copy an appropriate copyright notice and disclaimer of warranty; keep intact all the notices that refer to this License and to the absence of any warranty; and give any other recipients of the Program a copy of this License along with the Program.

You may charge a fee for the physical act of transferring a copy, and you may at your option offer warranty protection in exchange for a fee.

2. You may modify your copy or copies of the Program or any portion of it, thus forming a work based on the Program, and copy and distribute such modifications or work under the terms of Section 1 above, provided that you also meet all of these conditions:

- a) You must cause the modified files to carry prominent notices stating that you changed the files and the date of any change.
- b) You must cause any work that you distribute or publish, that in whole or in part contains or is derived from the Program or any part thereof, to be licensed as a whole at no charge to all third parties under the terms of this License.
- c) If the modified program normally reads commands interactively when run, you must cause it, when started running for such interactive use in the most ordinary way, to print or display an announcement including an appropriate copyright notice and a notice that there is no warranty (or else, saying that you provide a warranty) and that users may redistribute the program under these conditions, and telling the user how to view a copy of this License. (Exception: if the Program itself is interactive but does not normally print such an announcement, your work based on the Program is not required to print an announcement.)

These requirements apply to the modified work as a whole. If identifiable sections of that work are not derived from the Program, and can be reasonably considered independent and separate works in themselves, then this License, and its terms, do not apply to those sections when you distribute them as separate works. But when you distribute the same sections as part of a whole which is a work based on the Program, the distribution of the whole must be on the terms of this License, whose permissions for other licensees extend to the entire whole, and thus to each and every part regardless of who wrote it.

Thus, it is not the intent of this section to claim rights or contest your rights to work written entirely by you; rather, the intent is to exercise the right to control the distribution of derivative or collective works based on the Program.

In addition, mere aggregation of another work not based on the Program with the Program (or with a work based on the Program) on a volume of a storage or distribution medium does not bring the other work under the scope of this License.

3. You may copy and distribute the Program (or a work based on it, under Section 2) in object code or executable form under the terms of Sections 1 and 2 above provided that you also do one of the following:

- a) Accompany it with the complete corresponding machine-readable source code, which must be distributed under the terms of Sections 1 and 2 above on a medium customarily used for software interchange; or,
- b) Accompany it with a written offer, valid for at least three years, to give any third party, for a charge no more than your cost of physically performing source distribution, a complete machine-readable copy of the corresponding source code, to be distributed under the terms of Sections 1 and 2 above on a medium customarily used for software interchange; or,
- c) Accompany it with the information you received as to the offer to distribute corresponding source code. (This alternative is allowed only for noncommercial distribution and only if you received the program in object code or executable form with such an offer, in accord with Subsection b above.)

The source code for a work means the preferred form of the work for making modifications to it. For an executable work, complete source code means all the source code for all modules it contains, plus any associated interface definition files, plus the scripts used to control compilation and installation of the executable. However, as a special exception, the source code distributed need not include anything that is normally distributed (in either source or binary form) with the major components (compiler, kernel, and so on) of the operating system on which the executable runs, unless that component itself accompanies the executable.

If distribution of executable or object code is made by offering access to copy from a designated place, then offering equivalent access to copy the source code from the same place counts as distribution of the source code, even though third parties are not compelled to copy the source along with the object code.

4. You may not copy, modify, sublicense, or distribute the Program except as expressly provided under this License. Any attempt otherwise to copy, modify, sublicense or distribute the Program is void, and will automatically terminate your rights under this License. However, parties who have received copies, or rights, from you under this License will not have their licenses terminated so long as such parties remain in full compliance.

5. You are not required to accept this License, since you have not signed it. However, nothing else grants you permission to modify or distribute the Program or its derivative works. These actions are prohibited by law if you do not accept this License. Therefore, by modifying or distributing the Program (or any work based on the Program), you indicate your acceptance of this License to do so, and all its terms and conditions for copying, distributing or modifying the Program or works based on it.

6. Each time you redistribute the Program (or any work based on the Program), the recipient automatically receives a license from the original licensor to copy, distribute or modify the Program subject to these terms and conditions. You may not impose any further restrictions on the recipients' exercise of the rights granted herein. You are not responsible for enforcing compliance by third parties to this License.

7. If, as a consequence of a court judgment or allegation of patent infringement or for any other reason (not limited to patent issues), conditions are imposed on you (whether by court order, agreement or otherwise) that contradict the conditions of this License, they do not excuse you from the conditions of this License. If you cannot distribute so as to satisfy simultaneously your obligations under this License and any other pertinent obligations, then as a consequence you may not distribute the Program at all. For example, if a patent license would not permit royalty-free redistribution of the Program by all those who receive copies directly or indirectly through you, then the only way you could satisfy both it and this License would be to refrain entirely from distribution of the Program.

If any portion of this section is held invalid or unenforceable under any particular circumstance, the balance of the section is intended to apply and the section as a whole is intended to apply in other circumstances.

It is not the purpose of this section to induce you to infringe any patents or other property right claims or to contest validity of any such claims; this section has the sole purpose of protecting the integrity of the free software distribution system, which is implemented by public license practices. Many people have made generous contributions to the wide range of software distributed through that system in reliance on consistent application of that system; it is up to the author/donor to decide if he or she is willing to distribute software through any other system and a licensee cannot impose that choice.

This section is intended to make thoroughly clear what is believed to be a consequence of the rest of this License.

8. If the distribution and/or use of the Program is restricted in certain countries either by patents or by copyrighted interfaces, the original copyright holder who places the Program under this License may add an explicit geographical distribution limitation excluding those countries, so that distribution is permitted only in or among countries not thus excluded. In such case, this License incorporates the limitation as if written in the body of this License.

9. The Free Software Foundation may publish revised and/or new versions of the General Public License from time to time. Such new versions will be similar in spirit to the present version, but may differ in detail to address new problems or concerns.

Each version is given a distinguishing version number. If the Program specifies a version number of this License which applies to it and "any later version", you have the option of following the terms and conditions either of that version or of any later version published by the Free Software Foundation. If the Program does not specify a version number of this License, you may choose any version ever published by the Free Software Foundation.

10. If you wish to incorporate parts of the Program into other free programs whose distribution conditions are different, write to the author to ask for permission. For software which is copyrighted by the Free Software Foundation, write to the Free Software Foundation; we sometimes make exceptions for this. Our decision will be guided by the two goals of preserving the free status of all derivatives of our free software and of promoting the sharing and reuse of software generally.

NO WARRANTY

11. BECAUSE THE PROGRAM IS LICENSED FREE OF CHARGE, THERE IS NO WARRANTY FOR THE PROGRAM, TO THE EXTENT PERMITTED BY APPLICABLE LAW. EXCEPT WHEN OTHERWISE STATED IN WRITING THE COPYRIGHT HOLDERS AND/OR OTHER PARTIES PROVIDE THE PROGRAM "AS IS" WITHOUT WARRANTY OF ANY KIND, EITHER EXPRESSED OR IMPLIED, INCLUDING, BUT NOT LIMITED TO, THE IMPLIED WARRANTIES OF MERCHANTABILITY AND FITNESS FOR A PARTICULAR PURPOSE. THE ENTIRE RISK AS TO THE QUALITY AND PERFORMANCE OF THE PROGRAM IS WITH YOU. SHOULD THE PROGRAM PROVE DEFECTIVE, YOU ASSUME THE COST OF ALL NECESSARY SERVICING, REPAIR OR CORRECTION.

12. IN NO EVENT UNLESS REQUIRED BY APPLICABLE LAW OR AGREED TO IN WRITING WILL ANY COPYRIGHT HOLDER, OR ANY OTHER PARTY WHO MAY MODIFY AND/OR REDISTRIBUTE THE PROGRAM AS PERMITTED ABOVE, BE LIABLE TO YOU FOR DAMAGES, INCLUDING ANY GENERAL, SPECIAL, INCIDENTAL OR CONSEQUENTIAL DAMAGES ARISING OUT OF THE USE OR INABILITY TO USE THE PROGRAM (INCLUDING BUT NOT LIMITED TO LOSS OF DATA OR DATA BEING RENDERED INACCURATE OR LOSSES SUSTAINED BY YOU OR THIRD PARTIES OR A FAILURE OF THE PROGRAM TO OPERATE WITH ANY OTHER PROGRAMS), EVEN IF SUCH HOLDER OR OTHER PARTY HAS BEEN ADVISED OF THE POSSIBILITY OF SUCH DAMAGES.

END OF TERMS AND CONDITIONS

MEMO

PART 2

GS21 model

13 OVERVIEW

14 SYSTEM CONFIGURATION

15 SPECIFICATIONS

16 PART NAME

17 EMC DIRECTIVE

18 INSTALLATION

19 WIRING

20 OPTION

21 UTILITY FUNCTION

22 LANGUAGE SETTING (LANGUAGE)

23 COMMUNICATION INTERFACE SETTING (COMMUNICATION SETTING)

24 DISPLAY AND OPERATION SETTINGS (GOT SET UP)

25 SECURITY LEVEL AND OPERATOR SETTINGS (SECURITY SETTING)

26 CLOCK SETTINGS (TIME SETTING AND DISPLAY)

27 CONTROL OF VARIOUS DATA (DATA CONTROL)

28 GOT SELF CHECK (DEBUG)

29 MAINTENANCE

30 BootOS and System Application Installation Using Data Storage

31 INSTALLATION OF Boot OS AND BASIC SYSTEM APPLICATION

32 ERROR MESSAGE LIST

33 MAINTENANCE AND INSPECTION

34 TROUBLESHOOTING

35 CONNECTION

36 APPENDIX

13 OVERVIEW

About GOT

A GOT is installed on the panel surface of a control panel or operating panel and connects to the PLC within the control panel. The GOT carries out switch operation, lamp display, data display, message display, etc.

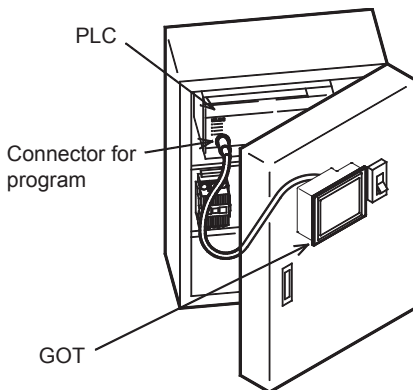

For the display screen, two kinds of screens are available: user screen and utility screen.

■User screen

The user screen refers to a screen created using the screen design software.

The objects "Touch switch", "Lamp display", "Comment display", and "Numeric display" can be arbitrarily arranged on the display.

Moreover, multiple screens created within the screen design software can be individually selected or overlapped for the display.

For details, refer to the following.

📖 GT Designer3 (GOT2000) Screen Design Manual

■Utility Screen

The utility screen is a factory drawn horizontal screen that cannot be edited.

The utility screen can be displayed on the GOT by installing the standard monitor OS from the screen design software or an SD card to the GOT.

Such as [Brightness] and [Time setting] can be set from the utility screen.

For details, refer to the following.

📖 Page 179 UTILITY FUNCTION to Page 399 TROUBLESHOOTING

13.1 Features

Monitoring for turning on or off bit devices of a PLC, forcibly turning on or off the bit devices of a PLC, monitoring the word device set value/current value and changing that numeric values are easily made.

General-purpose properties of the display unit

The display unit is used for engineers' stage replacement, setting change and troubleshooting or for operation guidance to an operator.

- Monitor
- Forcibly turning on or off
- Set value change
- Trouble check

Improved monitoring performance and connectivity to FA devices

- Multiple languages are displayed using the Unicode2.1-compatible fonts and beautiful characters are drawn using the TrueType, high quality fonts, and outline fonts ^{*1}
- Two types of display modes are available: 65536-color display and monochrome

A fine and beautiful full-color display which shows even small characters clearly, is enabled in the 65536-color display by adopting the high intensity, wide viewing angle and high definition TFT color liquid crystal display.

(Also compatible with digital screen displays with 65536 colors, BMP, etc.)

High speed monitoring through high speed communication at maximum of 115.2 kbps

- High speed display and high speed touch switch response
- The operation performance is improved by the analog touch panel.

^{*1} Outline fonts are compatible only with GS21-W-N.

More efficient GOT operations including screen design, startup, adjustment, management and maintenance works

- The 9 MB/15 MB built-in flash memory is included as standard. ^{*1}
- SD card interface is included as standard.
- RS-232 interface is included as standard.
- RS-422 interface and RS-422/485 interface are included as standard. ^{*2}
- USB interface (device) is included as standard.
- Ethernet interface is included as standard.
- System font types are increased by the adoption of the font installation system.
- Three types of alarms (user alarm, alarm history, and alarm popup display) are integrated, which has realized efficient alarm notification.
- "When, what, and how" the operation was performed can be checked with the GOT by using the operation log function (GS21-W-N only).

^{*1} The memory capacity varies by model.

^{*2} The available interfaces vary by model.

Enhanced support of FA setup tools

Connecting the GOT and the personal computer enables programming, startup, and adjustment of Mitsubishi Electric FA devices from the personal computer via the GOT.

Rough procedure

The following shows the procedures before operating a GOT and the descriptions of each item.

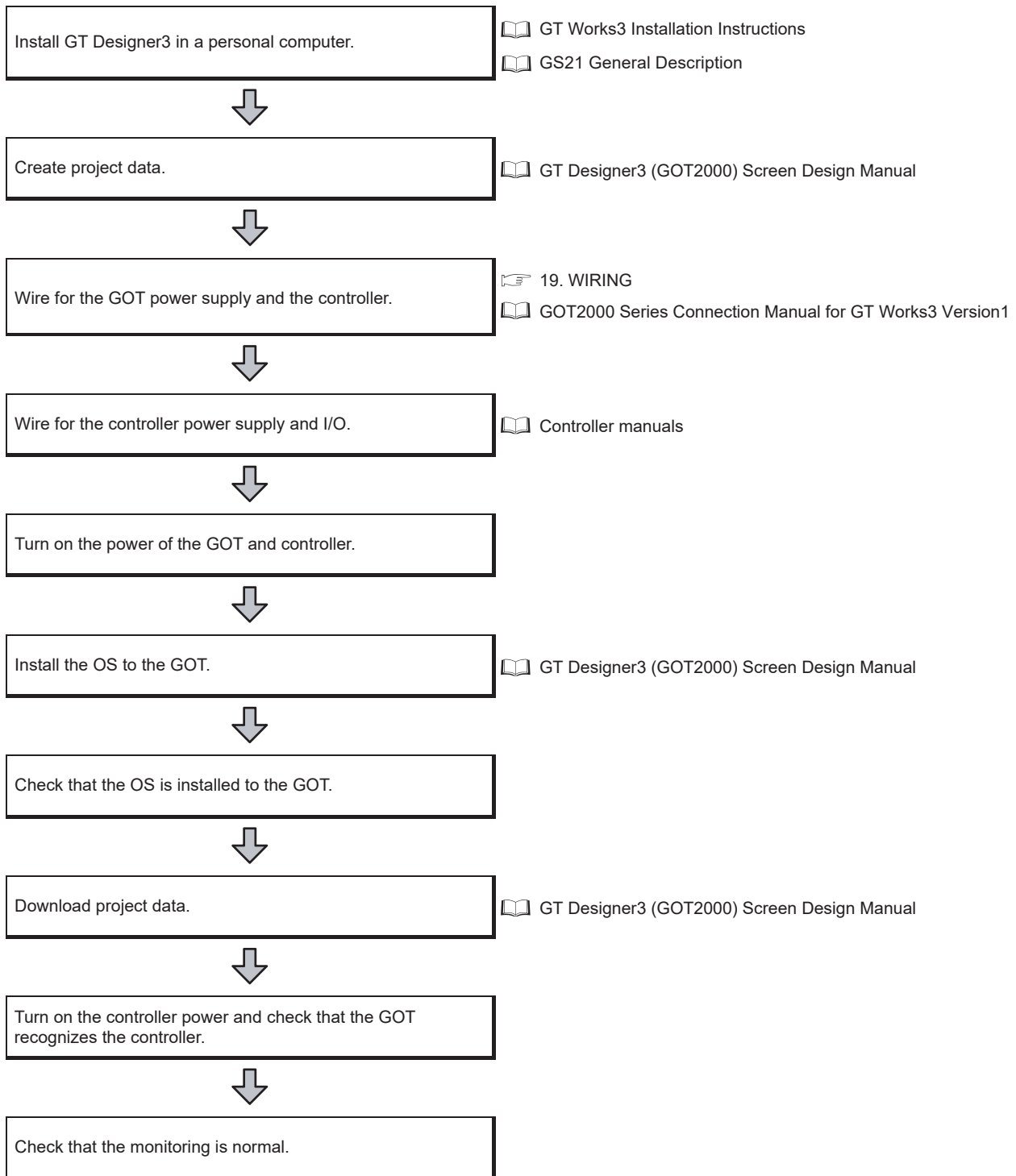

14 SYSTEM CONFIGURATION

14.1 Overall Configuration

The overall configuration of GOT is as follows.

For the controllers and cables that can be used with the GS21 models, refer to the following.

GOT2000 Series Connection Manual For GT Works3 Version1

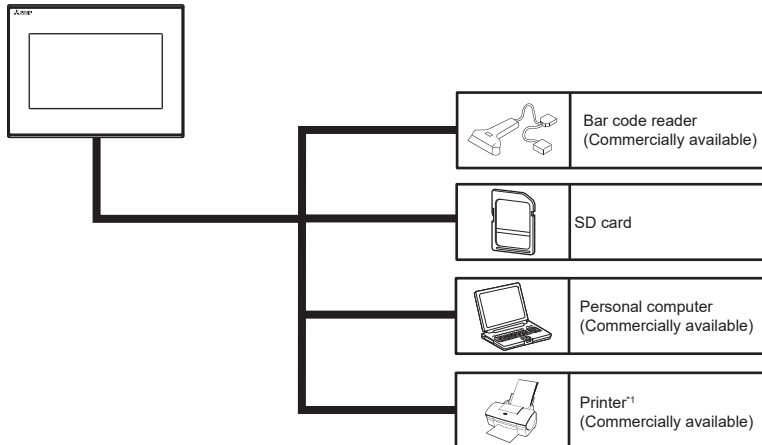

*1 Only hard copy of the screen can be printed.

14.2 Component List

Explanation of the GOT model name

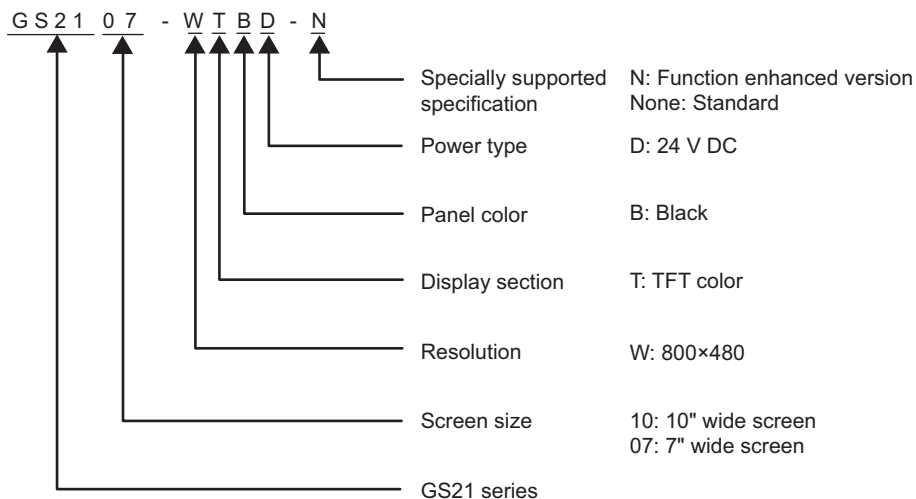

GOT

Product name	Model	Specifications
GOT	GS2110-WTBD-N	10" [800 × 480 dots], TFT color LCD, 65536 colors 24 V DC, Memory capacity: 15 MB, built-in Ethernet interface, built in RS-232 interface, built in RS-422/485 interface
	GS2107-WTBD-N	7" [800 × 480 dots], TFT color LCD, 65536 colors 24 V DC, Memory capacity: 15 MB, built-in Ethernet interface, built in RS-232 interface, built in RS-422/485 interface
	GS2110-WTBD	10" [800 × 480 dots], TFT color LCD, 65536 colors 24 V DC, Memory capacity: 9 MB, built-in Ethernet interface, built in RS-232 interface, built in RS-422 interface
	GS2107-WTBD	7" [800 × 480 dots], TFT color LCD, 65536 colors 24 V DC, Memory capacity: 9 MB, built-in Ethernet interface, built in RS-232 interface, built in RS-422 interface

Extension unit

Only available to GS21-W-N.

Communication unit

Product name	Model	Specifications
Serial multi-drop connection unit	GT01-RS4-M	For the GOT multi-drop connection

Software

Product name	Model	Description		
HMI/GOT Screen Design Software MELSOFT GT Works3	SW1DND-GTWK3-E	English version	Standard license product	DVD
	SW1DND-GTWK3-EC		Site license product *7	
	SW1DND-GTWK3-EA		Volume license product *1	
	SW1DND-GTWK3-EAZ		Additional license product *1*4	
	SW1DND-GTWK3-C	Simplified Chinese version	Standard license product	DVD
FA Integrated Engineering Software MELSOFT iQ Works *2*3	SW2DND-IQWK-E	English version	Standard license product	DVD
VNC server function license *5*6	GT25-VNCSKEY-1	1 license		
	GT25-VNCSKEY-5	5 licenses		
	GT25-VNCSKEY-10	10 licenses		
	GT25-VNCSKEY-20	20 licenses		

*1 The desired number of licenses (2 or more) can be purchased. For details, please contact your local sales office.

*2 Volume license product and additional license product are also available. For more details, please refer to the MELSOFT iQ Works catalog (L(NA)08232ENG).

*3 The product includes the following software.

System Management Software [MELSOFT Navigator]
 Programmable Controller Engineering Software [MELSOFT GX Works3, GX Works2, GX Developer]
 Motion Controller Engineering Software [MELSOFT MT Works2]
 GOT Screen Design Software [MELSOFT GT Works3]
 Robot Engineering Software [MELSOFT RT ToolBox3 mini]
 Inverter Setup Software [MELSOFT FR Configurator2]
 Setting/monitoring tools for the C Controller module and MELSECWinCPU [MELSOFT CW Configurator]
 Servo Setup Software [MELSOFT MR Configurator2]
 MITSUBISHI ELECTRIC FA Library

*4 This product does not include a DVD. The license certificate indicating the product ID number is issued only.

*5 Each GOT requires one license.

*6 Only available to GS21-W-N.

*7 Anyone can use the product as long as that person belongs to the business office (including overseas offices) of the corporation that purchased the product, or to the same public vocational training facility or other educational institution as the corporation.

Option

Connection cables for MITSUBISHI PLCs (Sold separately)

Product name		Model	Cable length	Description	
RS-422 conversion cable		FA-CNV2402CBL	0.2 m	For connecting the QCPU/L02SCPU(-P) and the RS-422 cable (GT01-C□R4-25P, GT10-C□R4-25P, GT21-C□R4-25P5) For connecting the L6ADP-R2 and the RS-422 cable (GT01-C□R4-25P, GT10-C□R4-25P, GT21-C□R4-25P5) [MINI-DIN 6-pin ↔ D-sub 25-pin]	
		FA-CNV2405CBL	0.5 m		
RS-422 cable	FXCPU direct connection cable, FX expansion board connection cable	GT01-C10R4-8P	1 m	For connecting FXCPU (MINI DIN 8-pin connector) and GOT For connecting FXCPU expansion board (MINI DIN 8-pin connector) and GOT	
		GT01-C30R4-8P	3 m		
		GT01-C100R4-8P	10 m		
		GT01-C200R4-8P	20 m		
		GT01-C300R4-8P	30 m		
	QnA/A/FXCPU direct connection cable, computer link connection cable	GT01-C30R4-25P	3 m	QnA/A motion controller (A series) For connecting FXCPU (D-sub 25-pin connector) and GOT For connecting FA-CNV□CBL and GOT For connecting serial communication unit (AJ71QC24(N)-R4) and GOT	
		GT01-C100R4-25P	10 m		
		GT01-C200R4-25P	20 m		
		GT01-C300R4-25P	30 m		
	Computer link connection cable	GT09-C30R4-6C	3 m	For connecting computer link unit/serial communication unit and GOT	
		GT09-C100R4-6C	10 m		
		GT09-C200R4-6C	20 m		
		GT09-C300R4-6C	30 m		
	RS-232 cable	QCPU direct connection cable	GT01-C30R2-6P	3 m	For connecting QCPU and GOT
		FX expansion board connection cable, FX special adaptor connection cable	GT01-C30R2-9S	3 m	For connecting FXCPU expansion board (D-sub 9-pin connector) and GOT For connecting FXCPU special adaptor (D-sub 9-pin connector) and GOT
			GT01-C30R2-25P	3 m	
FX special adaptor connection		GT01-C30R2-25P	3 m	For connecting FXCPU special adaptor (D-sub 25-pin connector) and GOT	
Computer link connection cable		GT09-C30R2-9P	3 m	For connecting computer link unit/serial communication unit and GOT	
		GT09-C30R2-25P	3 m		

Connection cables for SIEMENS PLCs (Sold separately)

Product name	Model	Cable length	Description
RS-232 cable	GT09-C30R20801-9S	3 m	For connecting SIEMENS HMI Adapter and GOT

SD card (Sold separately)

Product name	Model	Description
SD card	NZ1MEM-2GBSD	SD memory card 2 GB
	NZ1MEM-4GBSD	SDHC memory card 4 GB
	NZ1MEM-8GBSD	SDHC memory card 8 GB
	NZ1MEM-16GBSD	SDHC memory card 16 GB
	L1MEM-2GBSD	SD memory card 2 GB
	L1MEM-4GBSD	SDHC memory card 4 GB

PC connection cable (Sold separately)

Product name	Model	Cable length	Description
Project data transfer cable	GT09-C30USB-5P	3 m	For connecting GOT (USB Mini-B) and personal computer (USB)

Barcode reader (Sold separately)

Product name	Model	Description
Barcode	-	Commercially-available barcode reader*1

*1 Some models with the operations checked by our company are usable. For the operation-checked models, contact your local distributor.

15 SPECIFICATIONS

15.1 General Specifications

Item	Specifications					
Operating ambient temperature ^{*1}	0 to 50°C					
Storage ambient temperature	-20 to 60°C					
Operating/storage ambient humidity	10% RH to 90% RH, non-condensing ^{*2}					
Vibration resistance	Conforms to IEC 61131-2		Frequency	Acceleration	Half amplitude	Sweep Count
		Under intermittent vibration	5 to 8.4 Hz	-	3.5 mm	10 times each in X, Y and Z directions
			8.4 to 150 Hz	9.8 m/s ²	-	
		Under continuous vibration	5 to 8.4 Hz	-	1.75 mm	-
8.4 to 150 Hz	4.9 m/s ²		-			
Shock resistance	Conforms to IEC 61131-2 (147 m/s ² , 3 times each in the X, Y, and Z directions)					
Operating atmosphere	No greasy fumes, corrosive gas, flammable gas, excessive conductive dust, and direct sunlight (as well as at storage)					
Operating altitude ^{*3}	2000m (6562ft) max.					
Installation location	Inside control panel					
Overvoltage category ^{*4}	II or less					
Pollution degree ^{*5}	2 or less					
Cooling method	Self-cooling					
Grounding	Grounding with a ground resistance of 100 Ω or less by using a ground cable that has a cross-sectional area of 2 mm ² or more. If impossible, connect the ground cable to the control panel.					

*1 Includes the temperature inside the enclosure of the control panel on which the GOT is installed.

*2 If the ambient temperature exceeds 40°C, the absolute humidity must not exceed 90% RH at 40°C.

*3 Do not use or store the GOT under pressures higher than the atmospheric pressure of altitude 0 m (0 ft.). Failure to observe this instruction may cause a malfunction. When the air inside the control panel is purged by pressurization, the surface sheet may be lifted by high pressure. As a result, the touch panel may be difficult to press, and the sheet may be peeled off.

*4 This indicates the section of the power supply to which the equipment is assumed to be connected between the public electrical power distribution network and the machinery within the premises. Category II applies to equipment for which electrical power is supplied from fixed facilities. The surge voltage withstand level for up to the rated voltage of 300 V is 2500 V.

*5 This index indicates the degree to which conductive pollution is generated in the environment where the equipment is used. In pollution degree 2, only non-conductive pollution occurs but temporary conductivity may be produced due to condensation.

15.2 Performance Specifications

The following shows the performance specifications.

Item		Specifications			
		GS2110-WTBD-N	GS2107-WTBD-N	GS2110-WTBD	GS2107-WTBD
Display section ^{*1*2}	Type	TFT color liquid crystal			
	Screen size	10"	7"	10"	7"
	Resolution	WVGA: 800 × 480 dots			
	Display size	222 (8.74) (W) × 132.5 (5.22) (H) mm (inch)	154 (6.06) (W) × 85.9 (3.38) (H) mm (inch)	222 (8.74) (W) × 132.5 (5.22) (H) mm (inch)	154 (6.06) (W) × 85.9 (3.38) (H) mm (inch)
	Display character	16-dot standard font: 50 characters × 30 rows (two-byte characters) 12-dot standard font: 66 characters × 40 rows (two-byte characters)			
	Display color	65536 colors			
	Brightness	32-level adjustment			
	Backlight ^{*3}	LED-type (no replacement required)			
Touch panel ^{*4}	Type	Analog-resistive film type			
	Key size	Minimum 2 × 2 dots (per key) ^{*7}			
	Number of points touched simultaneously	Simultaneous 2-point presses prohibited (Only one point can be touched.) ^{*5}			
	Life	1 million times (operating force 0.98 N max.)			
Memory	C drive	Flash memory (Internal) (15 MB), for storing project data, OS		Flash memory (Internal) (9 MB), for storing project data, OS	
		Life (Number of write times) 100,000 times			
Built-in interface	RS-422/485	RS-422/485, 1ch Transmission speed: 115200/57600/38400/19200/9600/4800 bps Connector shape: D-sub 9-pin (female) Application: For communication with controllers Terminating resistor: 330 Ω, 110 Ω, OPEN (selectable by the terminating resistor setting switch) ^{*9}		-	
	RS-422	-		RS-422, 1ch Transmission speed: 115200/57600/38400/19200/9600/4800 bps Connector shape: D-sub 9-pin (female) Application: For communication with controllers Terminating resistor: 330 Ω fixed	
	RS-232	RS-232, 1ch Transmission speed: 115200/57600/38400/19200/9600/4800 bps Connector shape: D-sub 9-pin (male) Application: For communication with controllers and a barcode reader For PC connection (Project data read/write, FA transparent function)			
	Ethernet	Data Transfer method: 100BASE-TX, 10BASE-T, 1ch Connector shape: RJ45 (modular jack) AUTO MDI/MDI-X Application: For communication with controllers For PC connection (Project data read/write, FA transparent function)			
	USB (Device)	1 channel (rear face) USB version: USB1.1 (Full-Speed 12 Mbps) Connector shape: Mini-B Application: For PC connection (Project data read/write, FA transparent function)			
	SD card	Conforms to the SD standard, 1ch Supported memory card: SDHC memory card, SD memory card Application: Project data read/write, logging data save			
Buzzer output	Single tone (LONG/SHORT/OFF adjustable)				
Protective structure	IP65F (only the front part of the panel) ^{*6*8}				
External dimensions	272 (10.71) (W) × 214 (8.43) (H) × 56 (2.21) (D) mm (inch)	206 (8.11) (W) × 155 (6.11) (H) × 50 (1.97) (D) mm (inch)	272 (10.71) (W) × 214 (8.43) (H) × 56 (2.21) (D) mm (inch)	206 (8.11) (W) × 155 (6.11) (H) × 50 (1.97) (D) mm (inch)	
Panel cutting dimensions	258 (10.16) (W) × 200 (7.88) (H) mm (inch)	191 (7.52) (W) × 137 (5.40) (H) mm (inch)	258 (10.16) (W) × 200 (7.88) (H) mm (inch)	191 (7.52) (W) × 137 (5.40) (H) mm (inch)	

Item	Specifications			
	GS2110-WTBD-N	GS2107-WTBD-N	GS2110-WTBD	GS2107-WTBD
Weight (excluding a fitting)	Approx. 1.3 (2.9) kg (lb)	Approx. 0.9 (2.0) kg (lb)	Approx. 1.3 (2.9) kg (lb)	Approx. 0.9 (2.0) kg (lb)
Compatible software package (Version of GT Designer3)	Version 1.250L or later		Version 1.105K or later	

- *1 Bright dots (always lit) and dark dots (unlit) may appear on a liquid crystal display panel. It is impossible to completely avoid this symptom, as the liquid crystal display comprises of a great number of display elements. Flickers and partial discoloration may be generated on the liquid crystal display panel due to individual differences of panels. Please note that these phenomena appear due to its characteristic and are not caused by product defect.
- *2 Flickering may occur due to vibration, shock, or the display colors.
- *3 To prevent the display section from burning in and lengthen the backlight life, enable the screen save function and turn off the backlight.
- *4 When a stylus is used, the touch panel has a life of 100 thousand touches.
The stylus must satisfy the following specifications.
Material: Polyacetal resin
Tip radius: 0.8 mm or more
- *5 If you touch two points or more simultaneously on the touch panel, a switch in an unintended location may operate. Do not press two or more areas simultaneously on the touch panel.
- *6 Note that this does not guarantee all users' operation environment.
The GOT may not be used in an environment where the GOT is exposed to oil or chemicals for a long time, or where oil mist fills the air.
- *7 Minimum size of a key that can be arranged.
To ensure safe use of the product, the following settings are recommended.
Key size: 16 × 16 dots or larger
Distance between keys: 16 dots or more
- *8 The suffix "F" of IP65F is a symbol that indicates protection rate against oil. It is described in the Appendix of JIS C 0920 of the Japanese Industrial Standards.
- *9 For the GOT multi-drop connection, set the terminating resistor setting switch of the GOT according to the connection type.
For details on the GOT multi-drop connection, refer to the following.
 GOT2000 Series Connection Manual (Mitsubishi Electric Products) For GT Works3 Version1

15.3 Power Supply Specifications

Item	Specifications			
	GS2110-WTBD-N	GS2107-WTBD-N	GS2110-WTBD	GS2107-WTBD
Input power supply voltage	24 V DC (+10% -15%), ripple voltage 200 mV or less			
Power consumption	7.6 W (317 mA/24 V) or less	6.5 W (271 mA/24 V) or less	7.6 W (317 mA/24 V) or less	6.5 W (271 mA/24 V) or less
Power consumption (At backlight off)	3.8 W (158 mA/24 V) or less	3.8 W (158 mA/24 V) or less	3.8 W (158 mA/24 V) or less	3.8 W (158 mA/24 V) or less
Inrush current	17 A or less (6 ms, 25°C, at the maximum load)			
Permissible instantaneous power failure time	Within 5 ms			
Noise immunity	Conforms to IEC61000-4-4, 2 kV (power supply line)			
Dielectric withstand voltage	350 V AC for 1 minute (across power supply terminals and earth)			
Insulation resistance	500 V DC across power terminals and earth, 10 MΩ or more by an insulation resistance tester			

Point

Operation at momentary power failure

The GOT continues to operate even upon 5 ms or shorter instantaneous power failure.

The GOT stops operating if there is extended power failure or voltage drop, while it automatically resumes operation as soon as the power is restored.

15.4 GOT Connector Specifications

The following shows the specifications of connectors for the GOT.
 Refer to this section for creating a connection cable by the user.

RS-232 interface

The following shows the connector for the RS-232 interface of the GOT.
 For the connection cable connector of the GOT side, use a connector and a connector cover which can be connected to the GOT connector.

Connector specifications

GOT	Connector type	Connector model	Manufacturer
GS21 models	D-sub 9 pins (Male) #4-40UNC inch screw thread	17LE-23090-27(D3CC)	DDK Ltd.

Connector pin arrangement

GOT main part connector
 see from the front

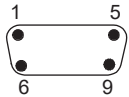

D-Sub 9 pin male

RS-422 interface and RS-422/485 interface

The following shows the connector for the RS-422 interface and RS-422/485 interface of the GOT.
 For the connection cable connector of the GOT side, use a connector and a connector cover which can be connected to the GOT connector.

Connector specifications

GOT	Connector type	Connector model	Manufacturer
GS21 models	D-sub 9 pins (Female) M2.6 metric screw thread	17LE-13090-27(D3AC)	DDK Ltd.

Connector pin arrangement

GOT main part connector
 see from the front

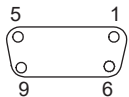

D-Sub 9 pin female

16 PART NAME

16.1 Front Panel

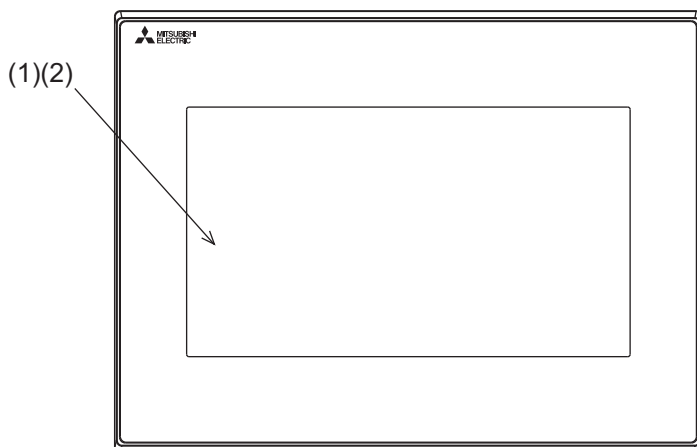

No.	Name	Specifications
(1)	Display section	Displays the utility screen and the user creation screen.
(2)	Touch panel	For operating the touch switches in the utility screen and the user creation screen

16.2 Back Panel

GS21-W-N

- GS2110-WTBD-N

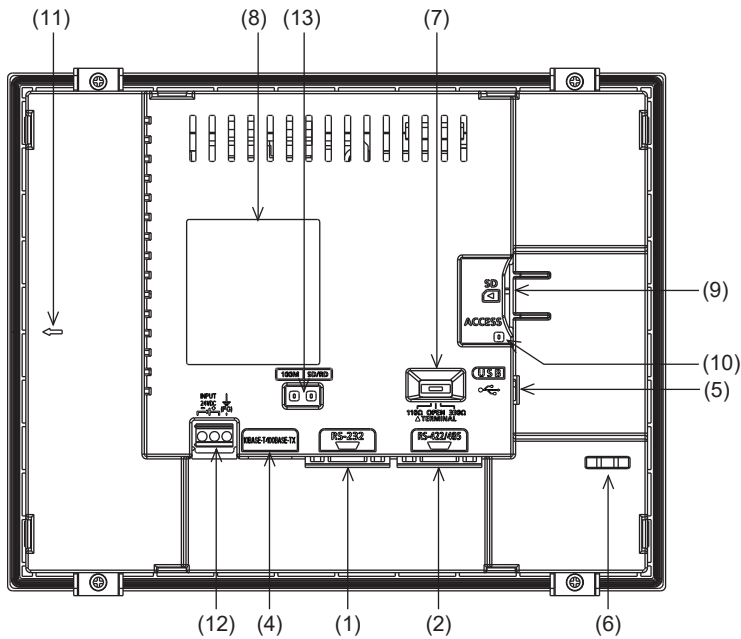

- GS2107-WTBD-N

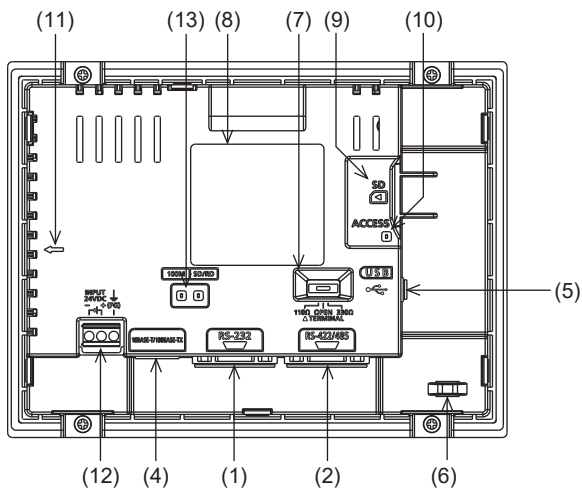

For the names of parts, refer to the following.

☞ Page 150 Part names of the back panel

GS21-W

- GS2110-WTBD

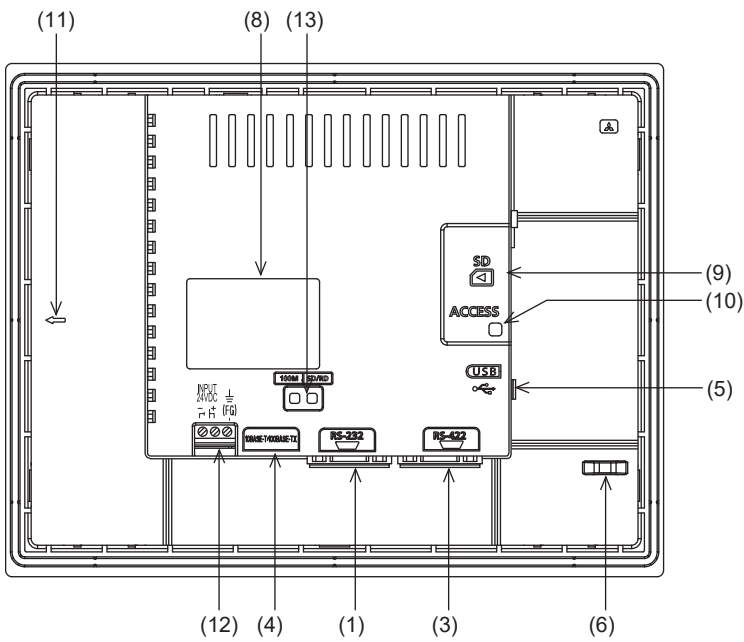

- GS2107-WTBD

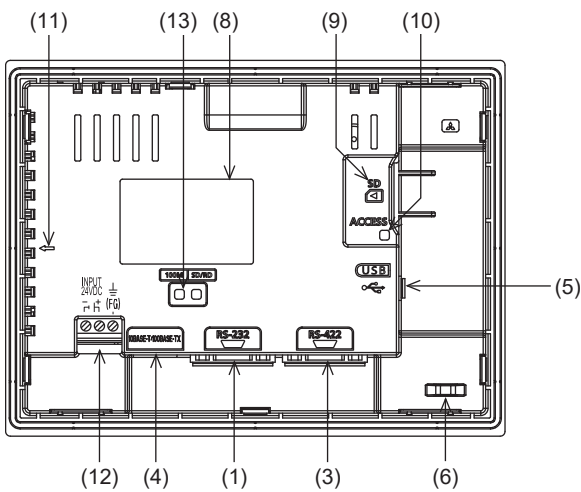

For the names of parts, refer to the following.

☞ Page 150 Part names of the back panel

Part names of the back panel

No.	Name	Specifications
(1)	RS-232 interface	For communicating with a controller (connector shape: D-sub 9-pin (male), #4-40UNC inch screw thread) For the connector specifications (such as pin layout and screw type) of the RS-232 interface, refer to the following. ☞ Page 145 RS-232 interface
(2)	RS-422/485 interface	For communicating with a controller (connector shape: D-sub 9-pin (female), M2.6 metric screw thread) For the connector specifications (such as pin layout and screw type) of the RS-422/485 interface, refer to the following. ☞ Page 145 RS-422 interface and RS-422/485 interface
(3)	RS-422 interface	For communicating with a controller (connector shape: D-sub 9-pin (female), M2.6 metric screw thread) For the connector specifications (such as pin layout and screw type) of the RS-422 interface, refer to the following. ☞ Page 145 RS-422 interface and RS-422/485 interface
(4)	Ethernet interface	For communicating with a controller or connecting a personal computer (Connector shape: RJ45 (modular jack))
(5)	USB interface (Device)	USB interface for data transfer and saving
(6)	Hole for preventing the USB cable from unplugging	Hole for preventing the USB cable from unplugging with a banding band
(7)	Terminating resistor setting switch	For switching the terminating resistor setting of the RS-422/485 communication port to 330 Ω, 110 Ω, or OPEN
(8)	Rating plate	Model name, current consumption, production number, hardware version, and Boot OS version are described.
(9)	SD card interface	Interface for mounting an SD card to the GOT
(10)	SD card access LED	ON: SD card is accessed, OFF: SD card is not accessed
(11)	Vertical installation arrow mark	For the vertical installation, install the GOT so that the arrow points upward.
(12)	Power terminal	Power terminal and FG terminal (for power supply (24 V DC) to GOT and grounding)
(13)	Ethernet communication status LED	SD RD: Green light while data are being sent or received, 100 M: Green light when the transmission speed is 100 Mbps

16.3 Bottom

GS21-W-N

- GS2110-WTBD-N

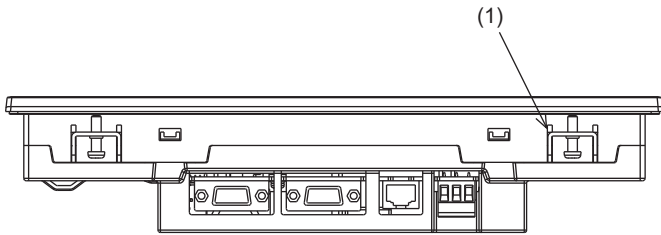

- GS2107-WTBD-N

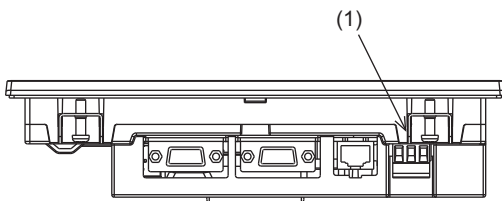

For the names of parts, refer to the following.

☞ Page 151 Bottom part names

GS21-W

- GS2110-WTBD

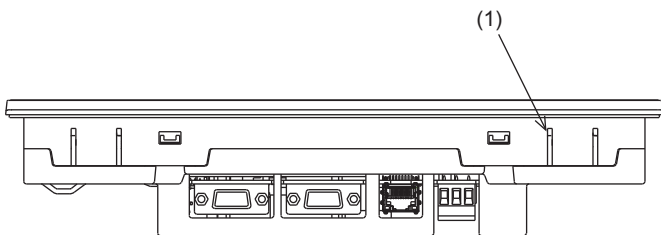

- GS2107-WTBD

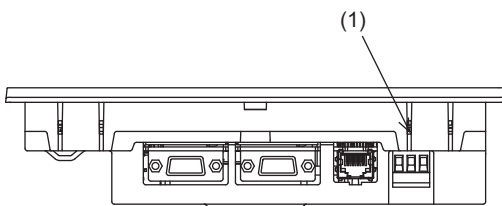

For the names of parts, refer to the following.

☞ Page 151 Bottom part names

Bottom part names

No.	Name	Specifications
(1)	Hole for a unit installation fitting	Hole for inserting a fitting (accessory) used to install the GOT to the panel (4 holes each at the top and bottom)

MEMO

17.1 Overview

For electromagnetic compatibility (EMC) and electrical safety, regulatory standards are established in each country. Especially, for the products to be sold in European countries, conformance to the EMC Directive, which is one of the European Directives, has been mandatory as the EMC standards since 1996. In addition, conformance to the Low Voltage Directive, another European Directive, has also been mandatory as the electrical safety standards since 1997. In European countries, if a product meets the requirements of the EMC Directive or the Low Voltage Directive, the product's manufacturer must declare conformity of the product and affix the CE mark to the product. In some countries or regions other than European countries, the product's manufacturer also must declare conformity of the product and affix a designated mark to the product (example: UKCA mark in the UK).

This section describes the EMC Directive and Low Voltage Directive as examples for conformance to EMC and electrical safety standards. EMC and electrical safety standards in each country are stipulated to be consistent with the corresponding international standards. When the requirements are consistent with the same standards, common measures are taken to conform to the standards in different countries. For the EMC Directive, regulatory compliance with equivalent EMC standards are required for example in the UK and Korea. For the Low Voltage Directive, regulatory compliance with equivalent electrical safety standards are required for example in the UK.

Authorized representative in the EU and the UK

The authorized representative in the EU and the UK is shown below.

Company name: Mitsubishi Electric Europe BV

Address: Mitsubishi-Electric-Platz 1, 40882 Ratingen, Germany

Conforming standards in the EMC Directive

The GOT complies with the following standards in the EMC Directive.

Applied standard	Test standard	Test details	Standard value
EN61131-2: 2007	CISPR16-2-3 Radiated noise ^{*1}	Test for measuring electromagnetic emissions from the product	<ul style="list-style-type: none"> • 30 MHz to 230 MHz QP: 30 dBμV/m (measured at 30 m)^{*2*3} • 230 MHz to 1000 MHz QP: 37 dBμV/m (measured at 30 m)^{*2*3}
	IEC61000-4-2 Electrostatic immunity ^{*1}	Immunity test in which static electricity is applied to the cabinet of the equipment	<ul style="list-style-type: none"> • Contact discharge: \pm4 kV • Aerial discharge: \pm8 kV
	IEC61000-4-3 Radiated electromagnetic field, amplitude modulation ^{*1}	Immunity test in which an electric field is applied to the product	80 MHz to 1000 MHz: 10 V/m 1.4 GHz to 2 GHz: 3 V/m 2.0 GHz to 2.7 GHz: 1 V/m (80% amplitude modulation at 1 kHz)
	IEC61000-4-4 Fast transient burst noise ^{*1}	Immunity test in which burst noise is applied to the power cables and the signal lines	Power cable: 2 kV Digital I/O: 1 kV Analog I/O: 1 kV Signal cable: 1 kV
	IEC61000-4-5 Surge immunity ^{*1}	Immunity test in which lightning surge is applied to the product	<ul style="list-style-type: none"> • DC power type Power cable (between cable and ground): \pm0.5 kV Power cable (between cables): \pm0.5 kV Data communication port: \pm1 kV
	IEC61000-4-6 Conducted RF immunity ^{*1}	Immunity test in which a noise inducted on the power cable and the signal lines is applied	Power cable: 10 V Data communication port: 10 V
	IEC61000-4-8 Power supply frequency magnetic field immunity	Test for checking normal operations under the circumstance exposed to the ferromagnetic field noise of the power supply frequency (50/60 Hz)	30 A/m

*1 The GOT is an open type device (designed to be integrated in equipment).

Make sure to install the GOT on a control panel.

This test item is conducted in the condition where the GOT is installed on a control panel and combined with the MITSUBISHI PLC.

*2 QP: Quasi-peak value, Mean: Average value

*3 This test item is conducted in the following conditions.

30 MHz to 230 MHz

QP: 40 dB μ V/m (measured at 10 m)

230 MHz to 1000 MHz

QP: 47 dB μ V/m (measured at 10 m)

17.2 EMC Directive Requirements

The EMC Directive requires the following.

- Strong electromagnetic waves are not emitted to the outside.: Emission (Electromagnetic interference)
- The product is not affected by the electromagnetic waves from the outside.: Immunity (Electromagnetic sensitivity)

To comply with the EMC Directive, this section explains the precautions for configuring equipment integrating the GOT.

The data described herein are produced with our best, based on the regulation requirements and standards obtained by Mitsubishi. However, the data do not guarantee that the whole equipment produced according to the data comply with the above directive.

The manufacturer of the equipment must determine the method to comply with the EMC Directive and conformance to the directive.

Installing the GOT on the control panel

The GOT is an open type device (designed to be integrated in equipment).

Make sure to install the GOT on a control panel.

This restriction ensures safety and also has a large effect of suppressing noise generated from the GOT by using the control panel.

Control panel

- The control panel must be conductive.
- When fixing a top or bottom plate of the control panel with bolts, do not coat the plate and bolt surfaces so that they contact each other. Connect the door and the box using a thick grounding cable to ensure the low impedance under high frequency.
- To ensure electric conductivity in the large area as much as possible between an inner plate and the control panel, do not coat the fixing bolt area of the inner plate and the control panel.
- Ground the control panel using a thick grounding cable to ensure the low impedance under high frequency.
- The diameter of cable holes on the control panel must be 10 cm or less. If the diameter of the hole is 10 cm or more, radio waves may leak. To reduce the chance of radio waves leaking out, ensure that the space between the control panel and its door is as small as possible. Pasting the following EMI gasket directly on the painted surface seals the space, reducing the leak of electric waves.

Manufacturer	Series name	Contact
KITAGAWA INDUSTRIES CO., LTD.	RFSG series (Recommended Product)	+81-587-34-3561

Our test has been carried out on a panel having the damping characteristics of 37 dB max. and 30 dB mean (measured by 3 m method with 30 to 300 MHz).

Connection of power and ground cables

Ground the GOT and connect power supply cables as shown below.

■Wiring the ground cable

Provide a ground point near the GOT.

Ground the frame ground terminal (FG terminal) of the GOT with the thickest and shortest cable as possible.

■Ground cable length

The ground cable length must be 30 cm or shorter.

The FG terminals pass the noise generated in the PLC system to the ground.

Therefore, ensure an impedance as low as possible.

Since the ground cables relieve the noise, the cables themselves carry a large noise.

Thus, short wiring prevents the cable from acting as an antenna.

(A long conductor is an antenna radiating noise more efficiently.)

■Treatment of the power cable and the ground cable

Twist the ground cable led from the ground point with the power cable.

Twisting with the ground cable relieves more noise from the power cable to the ground.

When a noise filter is installed to the power cable, twisting the power cable and the ground cable may not be required.

Installing a noise filter (power supply line filter)

A noise filter is a part to effectively reduce conducted noise.

Except some models, installation of a noise filter to the power supply lines is not necessary. However, installing the noise filter can reduce conducted noise.

The noise filter is effective to reduce conducted noise in the band of 10 MHz or less.

Use a noise filter equivalent to the following noise filters (double π -type filters).

Model	Manufacturer	Rated current	Rated voltage
FN343-3/05	SCHAFFNER	3 A	250 V
FN660-6/06	SCHAFFNER	6 A	
RSHN-2003	TDK	3 A	

Precautions

The following shows the precautions for installing a noise filter.

■Prohibition of bundling cables

Do not bundle the input and output cables of the noise filter.

Bundling the cables inducts the noise from the output-side cable into the input-side cable where noise has been eliminated by the noise filter.

Wire the input and output cables separately.

Bundling the input and output cables inducts noise.

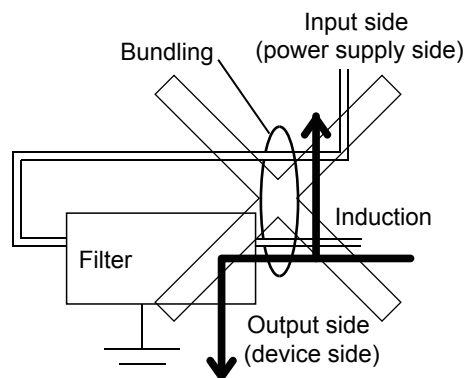
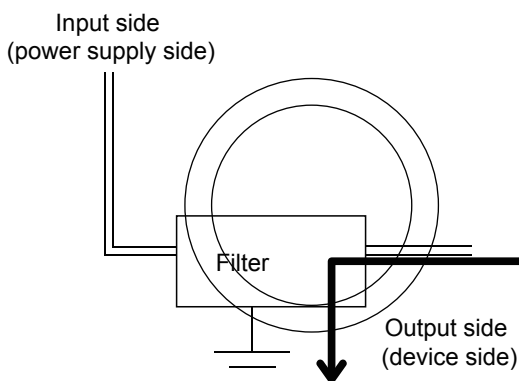

■Grounding the noise filter

Connect the ground terminal of the noise filter to the control panel with a short cable as much as possible (approximately 10 cm).

System configuration

GOT

Use the following GOTs having a CE mark on the rating plate.

The following models are compliant with the EMC Directive at factory shipment.

When any GOT other than the following does not comply with the EMC Directive.

Product name	Model
GS2110	GS2110-WTBD-N
	GS2110-WTBD
GS2107	GS2107-WTBD-N
	GS2107-WTBD

Connection type

The following table lists the connection types compliant with the EMC Directive.

○: Compliant with EMC Directive, ×: Not compliant with EMC Directive

Connection type*1	GS21
Ethernet connection	○
Direct CPU connection (serial)	○
Serial communication connection	○
Other connections (Connection with non-Mitsubishi PLC, inverter, servo amplifier)	○*2

*1 For the details of each connection type, refer to the following manual.

 GOT2000 Series Connection Manual (GT Works3 Version1) for the controller used

*2 When connecting the GOT to other controllers such as a non-Mitsubishi PLC, fabricate connection cables and configure the system following the EMC Directive specifications.

 Page 159 Non-Mitsubishi PLC, inverter, and servo amplifier connections

Point

Connected devices

When connecting the GOT to a non-Mitsubishi PLC, refer to the manual about the EMC Directive compliance of the connected device (such as a PLC and a microcomputer).

Connection of power cables and ground cables

Carry out wiring and connect the power and ground cables according to the following instruction.

By the different wiring or connection method, the system may not comply with EMC Directive.

Wiring method

For connection of power cables and ground cables, refer to the following.

Ground the frame ground terminal (FG terminal) of the GOT with the thickest and shortest cable as possible.

 Page 174 Wiring Inside and Outside the Panel

Fabricating a connection cable

Fabricate the cables used for the GOT by the methods as shown in this section.

The fabrication requires a ferrite core, cable clamp, and cable shielding materials.

The following products have passed the Mitsubishi EMC Directive compliance test.

- ZCAT3035-1330 ferrite core (TDK Corporation)
- AD75CK-type cable clamp (Mitsubishi Electric Corporation)

Ethernet connection

■Ethernet cable

Strip off the sheath at both ends of the cable as shown in the figure below to expose braided shield for grounding. The braided shield sections are used for grounding with a cable clamp.

☞ Page 161 Grounding a cable

- Connecting to the Ethernet interface of the GOT

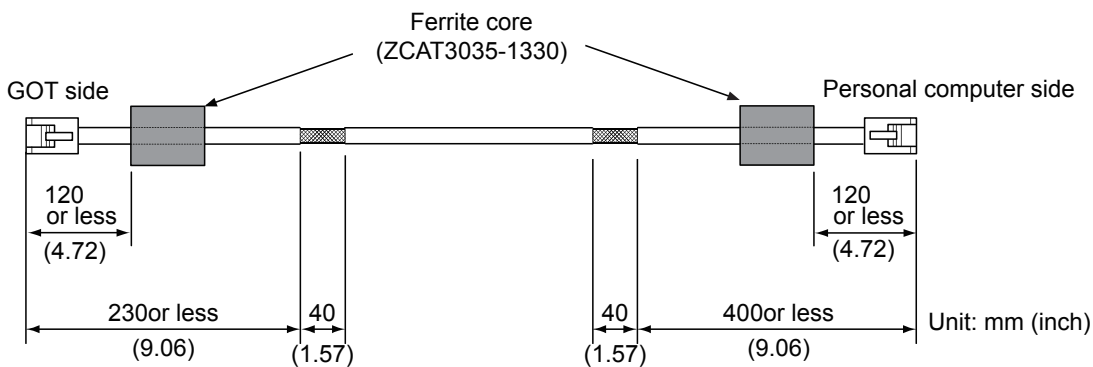

Direct CPU connection (serial)

■RS-232 cable and RS-422 cable

Install a ferrite core to the cable in the positions as shown in the figure below.

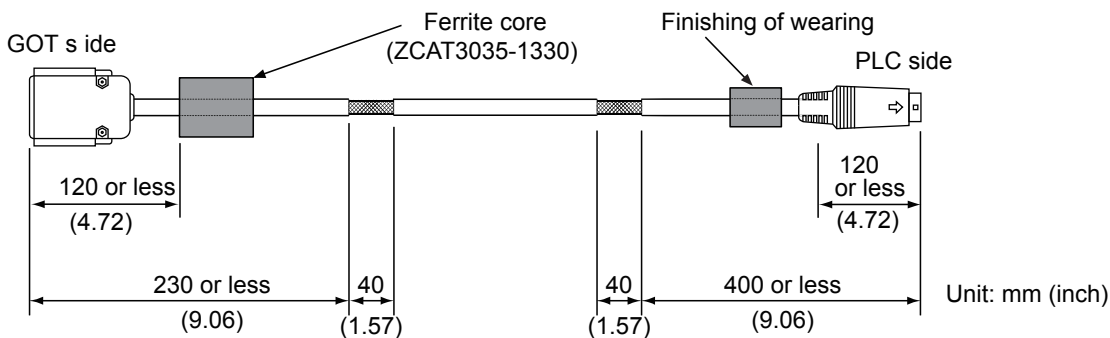

Serial communication connection

■RS-232 cable and RS-422 cable

Strip off the sheath at both ends of the cable as shown in the figure below to expose braided shield for grounding. The braided shield sections are used for grounding with a cable clamp.

☞ Page 161 Grounding a cable

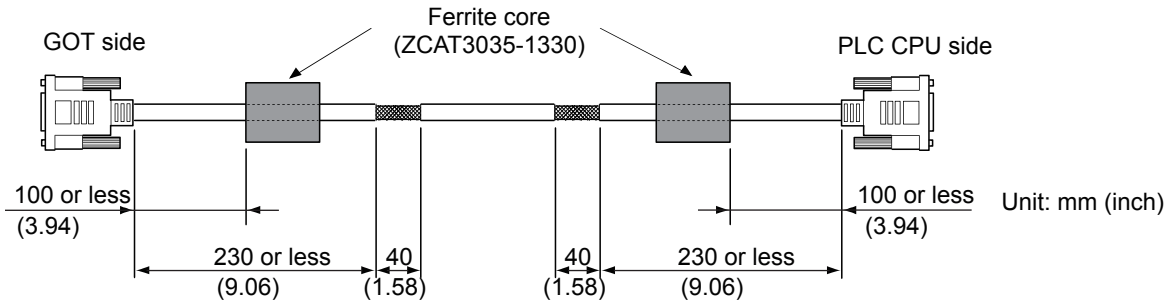

Non-Mitsubishi PLC, inverter, and servo amplifier connections

Create the cables (RS-232 cable, RS-422/485 cable) for connecting the GOT and a controller by yourself.

For how to create a cable, refer to the following.

☞ GOT2000 Series Connection Manual For GT Works3 Version1

Treatment of the RS-232 cable and RS-422/485 cable

When the GOT is connected to a controller, configure the system according to the EMC Directive specifications for the controller.

The following shows the recommended instructions to comply with the EMC Directive.

However, the manufacturer of the equipment must determine the method to comply with the EMC Directive and conformance to the directive.

- RS-422/485 cable

When connecting each signal wire (except SG and FG wires), twist two signal wires as shown below.

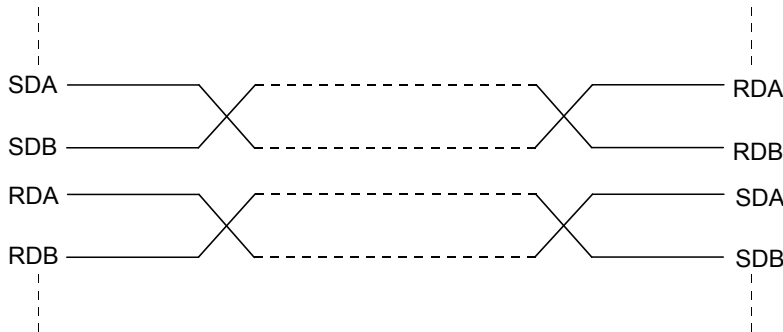

Connect two or more SG wires.

- RS-232 cable

Twist each signal wire (except SG and FG wires) with the SG wire.

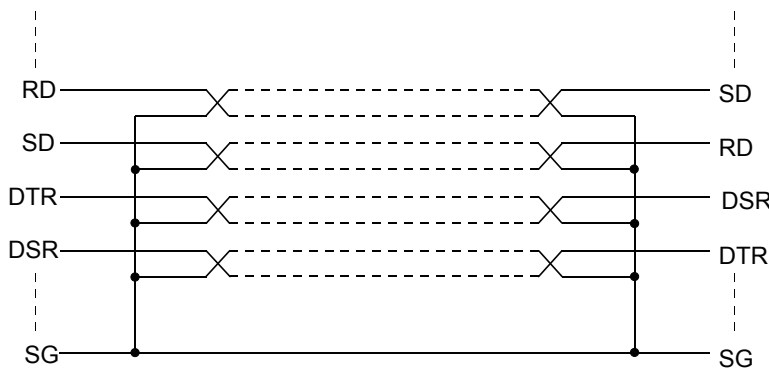

Install a ferrite core to the cable in the positions as shown in the figure below.

Strip off the sheath at both ends of the cable as shown in the figure below to expose braided shield for grounding. The braided shield sections are used for grounding with a cable clamp.

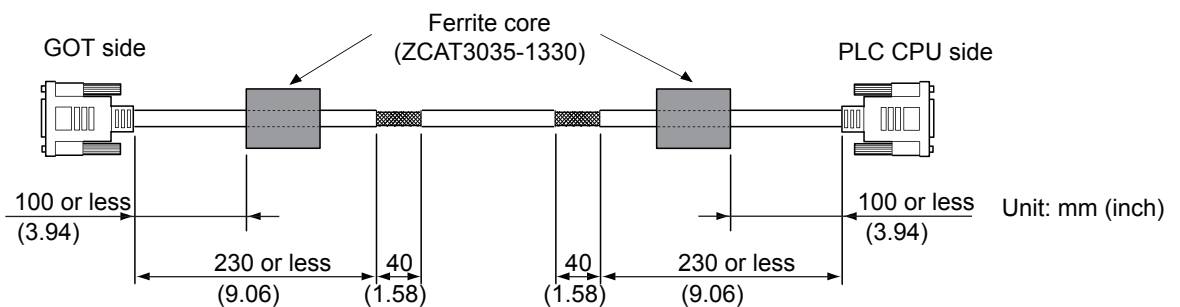

Grounding a cable

Grounding method

Ground the cable and ground cable to the control panel where the GOT and the PLC are installed.
Ground the braided shield section of the cable to the control panel with the cable clamp (AD75CK).

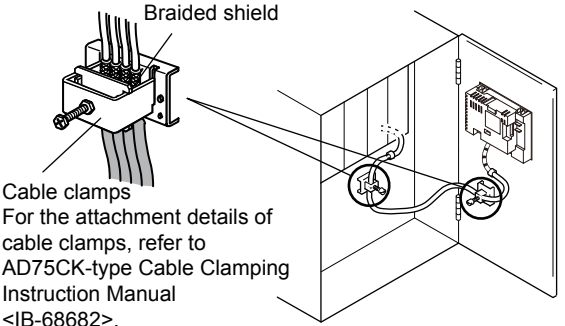

Precautions

Do not arrange the cable clamp close to the other cables that are not clamped.
The noise from the control panel may enter the cable clamp and adversely affect the GOT.

18 INSTALLATION

MOUNTING PRECAUTIONS

! WARNING

- Be sure to shut off all phases of the external power supply used by the system before mounting or removing the GOT main unit to/from the controller.
Not doing so can cause the unit to fail or malfunction.

MOUNTING PRECAUTIONS

! CAUTION

- Use the GOT in the environment that satisfies the general specifications described in this manual. Not doing so can cause an electric shock, fire, malfunction or product damage or deterioration.
- Never drop cutting chips and electric wire chips into the ventilation window of the GOT when you drill screw holes or perform wiring. Otherwise, fire, failure or malfunction may be caused.
- Connect connection cables securely to the specified connectors while the power is turned OFF. Imperfect connection may cause malfunction or failure.
- Operate and store the GOT in environments without direct sunlight, dust, lamp black, conductive dust, corrosive gas, combustible gas, high temperature, condensation, wind, rain, vibrations and impacts. Electric shock, fire, malfunction, product damage or deterioration can be caused.
- Tighten the mounting screws within the specified torque range. Undertightening can cause the GOT to drop, short circuit or malfunction. In addition, undertightening can disable waterproof or oil proof effect. Overtightening can cause a drop, short circuit or malfunction due to the damage of the screws or the GOT. In addition, the waterproof effect and oilproof effect may not be available due to the "distortion" of GOT or panel.

18.1 Control Panel Inside Dimensions for Mounting GOT

Mount the GOT onto the control panel while considering the following control panel inside dimensions. For the vertical installation, install the GOT so that the vertical installation arrow printed on the GOT rear face points upward.

Point

Applicable cable

Depending on the types of cables connected to the GOT, the distance more than the described dimensions may be required. Install the GOT considering the connector dimensions and cable bend radius.

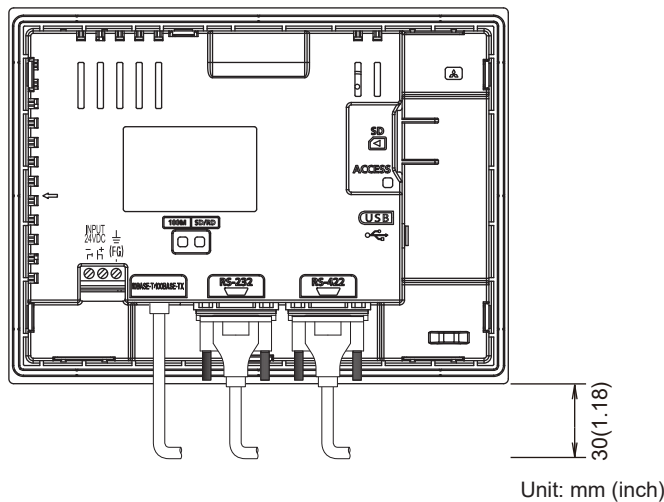

18.2 Panel Cutting Dimensions

Cut holes in the following dimensions on the panel.

Ensure 10 mm of space in upper and lower parts of the panel for mounting fixtures.

For the vertical installation, install the GOT so that the vertical installation arrow printed on the GOT rear face points upward.

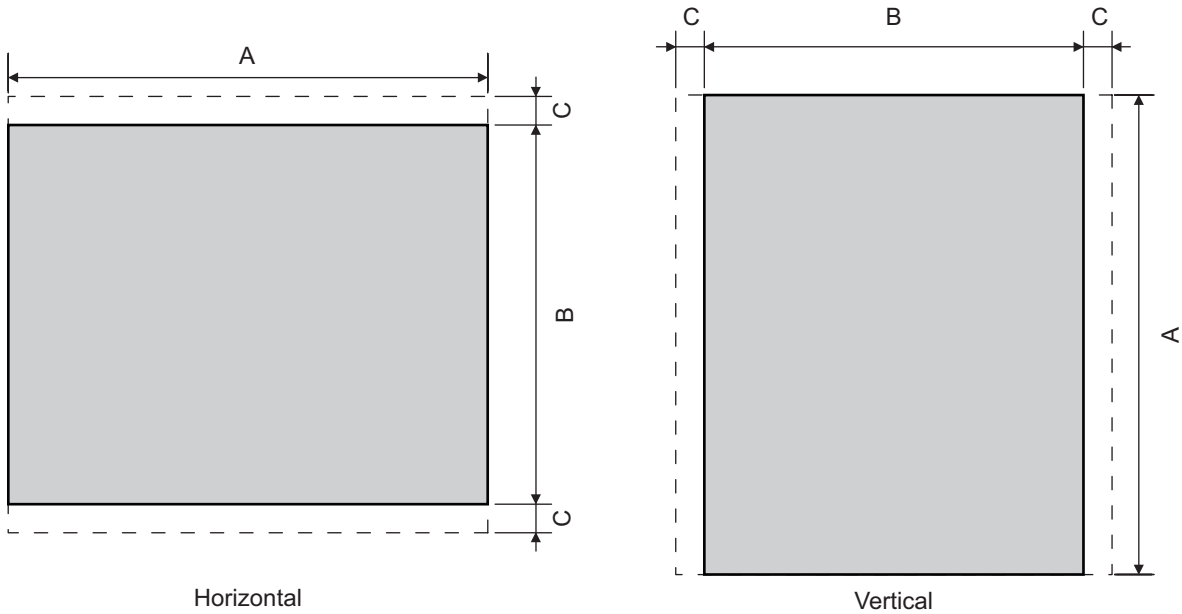

Unit: mm (inch)

Model	A	B	C	Panel thickness
GS2110-WTBD-N GS2110-WTBD	258 (10.16) (+2 (0.08), 0 (0))	200 (7.88) (+2 (0.08), 0 (0))	10 (0.39) or more	1.6 (0.06) to 4 (0.16)
GS2107-WTBD-N GS2107-WTBD	191 (7.52) (+2 (0.08), 0 (0))	137 (5.40) (+2 (0.08), 0 (0))	10 (0.39) or more	1.6 (0.06) to 4 (0.16)

Dimension C is required for installing fittings on the control panel.

18.3 Mounting Position

When mounting the GOT, the following clearances must be maintained from other structures and devices.

For the vertical installation, install the GOT so that the vertical installation arrow printed on the GOT rear face points upward.

Unit: mm (inch)

Installation environment	A, D	B	C	E
In the presence of radiated-noise or heat-generating equipment nearby	50 (1.97) or more	Horizontal: 80 (3.15) or more Vertical: 50 (1.97) or more	Horizontal: 50 (1.97) or more Vertical: 80 (3.15) or more	100 (3.94) or more
In the absence of radiated-noise or heat-generating equipment nearby	20 (0.79) or more	20 (0.79) or more	20 (0.79) or more	20 (0.79) or more

Horizontal installation

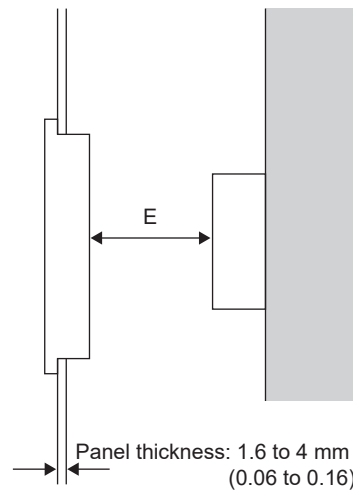
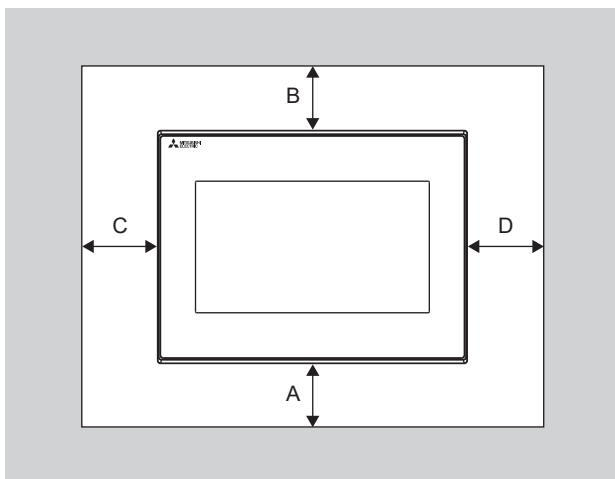

Vertical installation

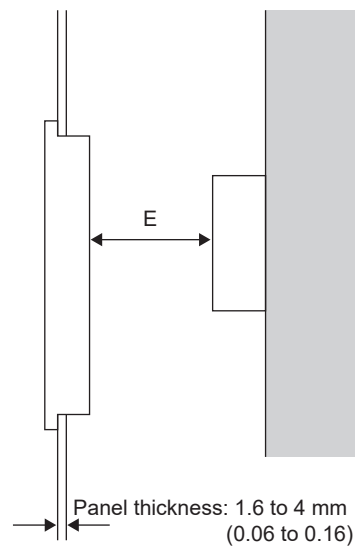
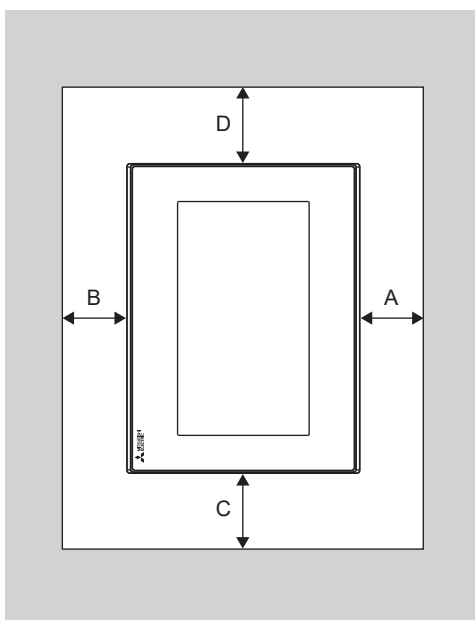

18.4 Control Panel Temperature and Mounting Angle

When mounting the main unit to a control panel or similar fixture, set the GOT display section as shown below.

Horizontal installation

When the temperature inside the control panel is 40 to 50°C, the mounting angle should be in the range from 60 to 105 degrees.

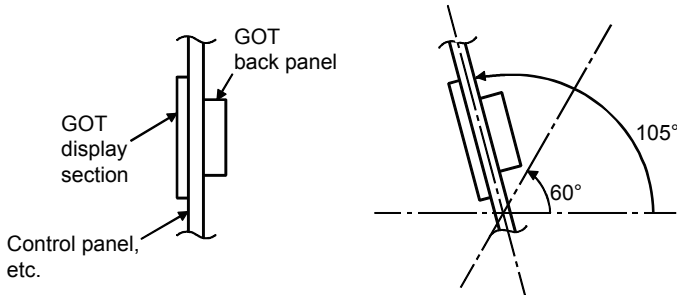

The GOT will have a longer lifetime if used within the mounting angles shown above. Ideally, the temperature inside the control panel should not exceed 0 to 40°C.

Vertical installation

When the temperature inside the control panel is 40 to 50°C, the mounting angle should be in the range from 60 to 105 degrees.

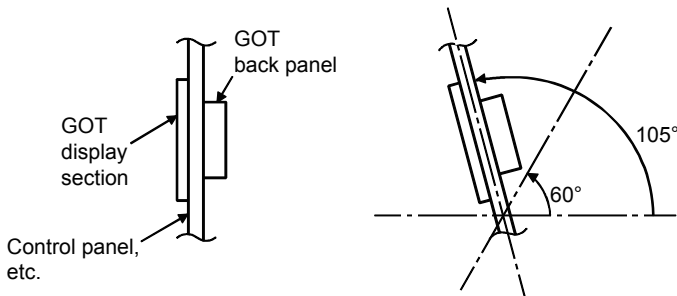

The GOT will have a longer lifetime if used within the mounting angles shown above. Ideally, the temperature inside the control panel should not exceed 0 to 40°C.

18.5 Installation Procedure

The GOT is designed to be embedded into a panel. Mount the GOT by following the procedure below.
Refer to Page 164 Panel Cutting Dimensions for the panel cutting dimensions.

In addition, the thickness of the installation panel face must be 1.6 to 4 mm.

- 1. Inserting into the panel face**
Insert the GOT from the front side of the panel.

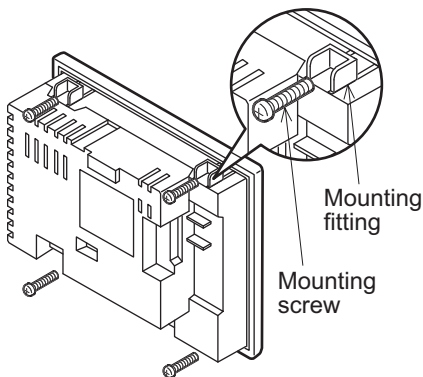
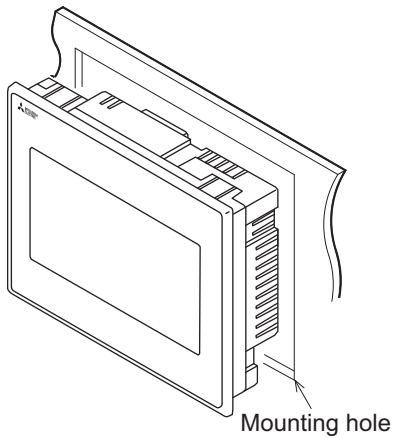

- 2. Fixing the GOT**
Engage the hook of the mounting fixture (accessory) to the unit fixing hole of the GOT and fix them by tightening the mounting screws (accessory) in the torque range of 0.36 to 0.48 N·m.

- 3. A protection film is attached on the display section of GOT prior to shipment. Remove the film when the installation is completed.**

Point

Check that the packing is firmly attached with the GOT.
If the packing is loose, attach the packing to the GOT securely.

Cautions on installation

- Tightening torque of the mounting screws

Tighten mounting screws within the specified torque range.

Undertightening can cause the GOT to drop.

In addition, waterproof effect or oilproof effect may not be obtained.

Overtightening may damage the GOT or distort the panel, causing wrinkles on the surface of the display section. The wrinkles may lower visibility and lead to an incorrect input to the touch panel.

Waterproof effect or oilproof effect may not be obtained because of distortion of the GOT or panel.

Specified torque range: 0.36 to 0.48 N·m

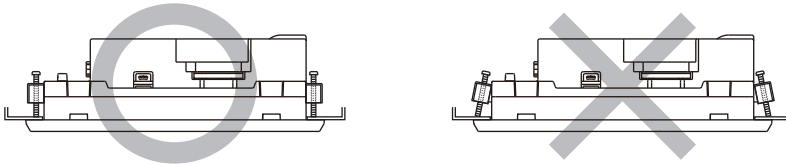

- Installation panel surface

Make sure that the panel surface is free from warpage, flaws and irregularities. Warpage, flaws and irregularities may disable the waterproof effect.

Select proper panel thickness under consideration of the panel strength.

(For example, the panel strength may be insufficient depending on the panel material and dimensions even if the panel thickness is acceptable.

Insufficient panel strength may cause warpage depending on the installation positions of the GOT and other equipment.)

WIRING PRECAUTIONS **WARNING**

- Be sure to shut off all phases of the external power supply used by the system before wiring. Failure to do so may result in an electric shock, product damage or malfunctions.
- Please make sure to ground FG terminal of the GOT power supply section by applying 100Ω or less which is used exclusively for the GOT. Not doing so may cause an electric shock or malfunction.
- Correctly wire the GOT power supply section after confirming the rated voltage and terminal arrangement of the product. Not doing so can cause a fire or failure.
- Tighten the terminal screws of the GOT power supply section in the specified torque range. Undertightening can cause a short circuit or malfunction. Overtightening can cause a short circuit or malfunction due to the damage of the screws or the GOT.
- Exercise care to avoid foreign matter such as chips and wire offcuts entering the GOT. Not doing so can cause a fire, failure or malfunction.

WIRING PRECAUTIONS **CAUTION**

- Plug the communication cable into the connector to be connected, and tighten the mounting screws and the terminal screws in the specified torque range. Undertightening can cause a short circuit or malfunction. Overtightening can cause a short circuit or malfunction due to the damage of the screws or unit.

This chapter describes the wiring to the GOT power supply section.

For the connection with a PLC, refer to the following.

 GOT2000 Series Connection Manual For GT Works3 Version1

For the dimensional drawing of connection cables, refer to the following.

 Page 413 External Dimensions

Point**General preventive measures against noise**

There are two kinds of noises: Radiated noise that is transmitted into the air and Conductive noise that is directly transmitted along connected lines. Countermeasures must be taken considering both kinds of noises and referring to the following 3 points.

- Protecting against noise

Keep signal lines away from noise sources such as a power cable or a high-power drive circuit.

Shield the signal lines.

- Reducing generated noise

Use a noise filter, etc. to reduce the level of the noise generated due to a source such as a high-power motor drive circuit.

Attach surge killers to the terminals on the no fuse breakers (NFB), electromagnetic contactors, relays, solenoid valves, and generators to suppress noise interference.

- Releasing noise to the ground

Make sure to connect the ground cable to the ground.

Use a short and thick cable to lower its ground resistance.

Ground the power system and the control system separately.

19.1 Power Supply Wiring

Connect the power supply to the power terminals on the back panel of the GOT.

Use a specified size power supply wire to prevent voltage drop, and tighten the terminal screws firmly to a specified torque.

Do not exceed the number of wires that are allowed to be connected.

Secure the wires to prevent stress from being directly applied to the terminal block or wire connections.

Cable types and wire end processing

Process the end of the electrical wire (solid or stranded), or attach a ferrules with plastic sleeve to the wire end.

Terminal screws should be tightened to between 0.5 to 0.6 N·m. Terminal screws must be secured to prevent a loose connection thus avoiding a malfunction.

Do not tighten the terminal screws with a torque outside the specified range. Failure or malfunction may result.

Electrical wire size

Electrical wire size		
Solid wire	Stranded wire	Ferrules with plastic sleeve
0.5 to 2.5 mm ² AWG20 to AWG14	0.5 to 2.5 mm ² AWG20 to AWG14	0.5 to 2.5 mm ² AWG20 to AWG14

Wire end processing

■Connecting the wire directly

Twist the end of the stranded wire. Make sure there are no wire whiskers.

Do not solder the wire end.

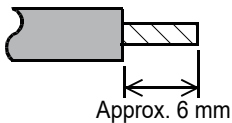

■Using a ferrules with plastic sleeve to connect the wire

A wire with a too thick of a wire sheath may not fit the insulation sleeve. Refer to the outline drawing for how to select the proper size wire.

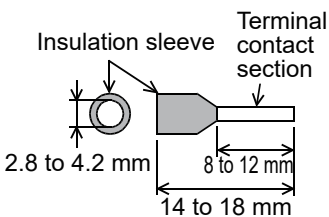

Manufacturer	Model	Crimper type
Phoenix Contact Inc.	Al 0.75-8GY (0.5 to 0.75 mm ²)	CRIMPFOX UD6
	Al 1.0-8RD (0.75 to 1.0 mm ²)	
	Al 1.5-8BK (1.0 to 1.5 mm ²)	
	Al 2.5-8BU (1.5 to 2.5 mm ²)	

Tools

Use a small driver with a straight, untapered blade as shown below to tighten the power terminals.

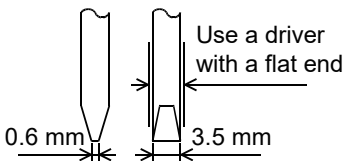

Manufacturer	Model
Phoenix Contact Inc.	SZS 0.6 × 3.5

19

Wiring example

Connect the power supply to the power terminals on the back panel of the GOT.

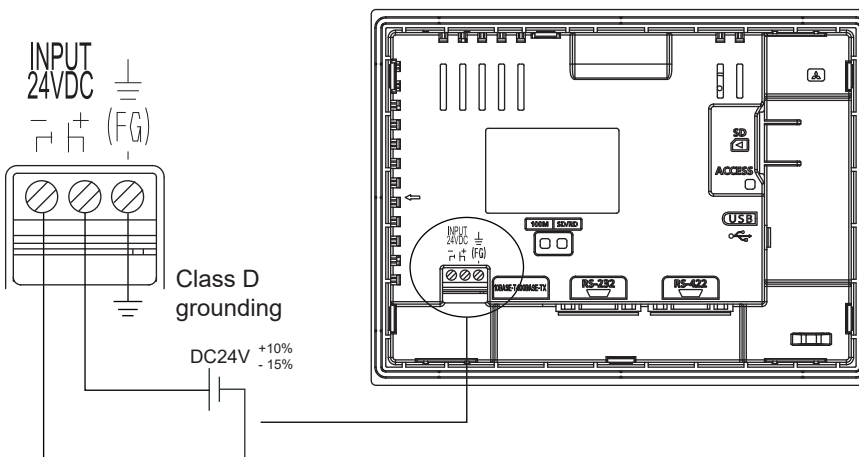

Tightening torque for the power terminals: 0.5 to 0.6 N·m

GOT's ground

Grounding the GOT and other devices

Make sure to carry out the followings for grounding.

- Carry out the independent grounding if possible. Provide class D (class 3) grounding. (Ground resistance must be 100 Ω or less.)
- If the independent grounding is impossible, carry out the shared grounding as shown in fig.2) below.

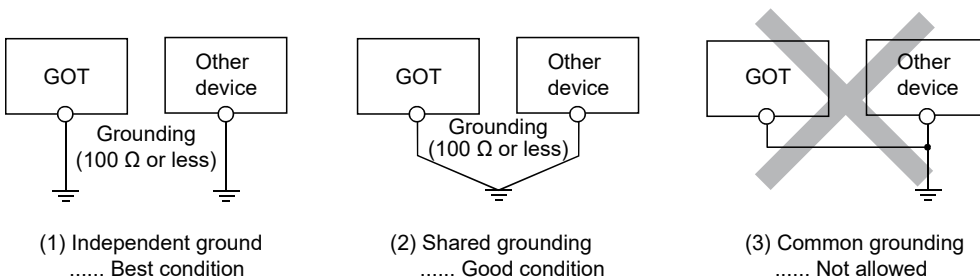

- Use the cable of 2 mm² or longer for grounding. Set the ground point as close to the GOT as possible to shorten the grounding cable.

The cause of malfunctions related wiring/Remedy

Grounding of the GOT may cause electric potential difference and noise interference, which may result in GOT malfunctions. These problems may be resolved by taking the following measures.

Wiring path of the GOT's ground cable and power line

Bundling the GOT's ground cable and power line together can cause interference noise, which may result in malfunctions. Keeping the GOT's ground cable and power line away from each other will help minimize noise interference.

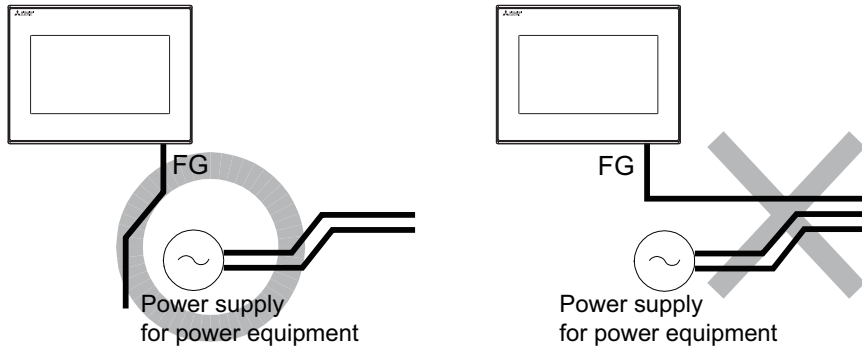

Good: Wiring the ground cable away from the power cable

Bad: Bundling the ground cable and the power cable

Connecting the ground cable from the panel that houses control equipment to the panel to which the GOT is grounded

When running a single ground cable from the panel that houses such piece of control equipment as a sequencer to the panel to which the GOT is grounded, the ground cable may have to be directly connected to the terminal on the GOT.

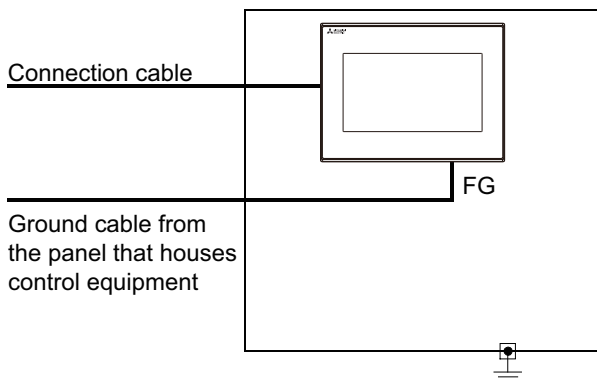

If electric potential difference between the ground points created by it causes malfunctions, lowering the voltage as shown in Remedy 1 below may solve the problem.

- Remedy 1 (Refer to the figures Remedy 1-1 and 1-2 below.)

If the electric potential difference between the ground cable and the panel that houses the GOT is creating problems, connect the ground cable to the panel also. If the wiring method as shown in Remedy 1-1 is not feasible, follow Remedy 1-2.

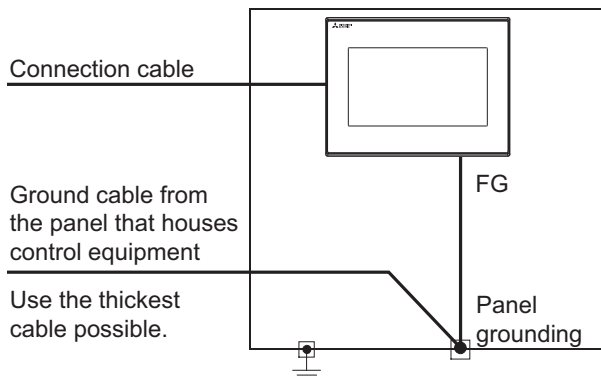

Remedy1-1

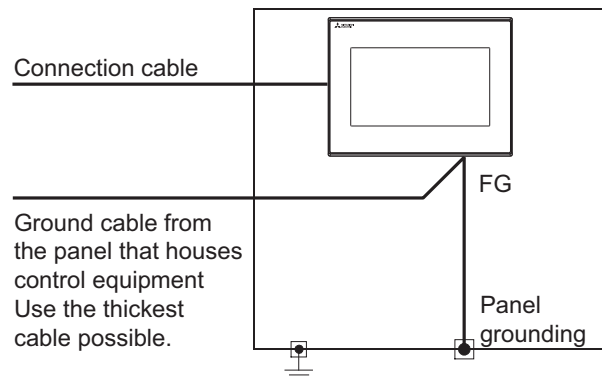

Remedy1-2

If taking Remedy 1 worsens noise interference, taking Remedy 2 may alleviate it.

- Remedy 2 (Refer to the figures Remedy 2-1 and 2-2 below.)

Attach a ferrite core to the cable if noise from the GOT panel has adverse effects on the GOT when Remedy 1 is taken. Wind the wire around the ferrite core several times (approx. 3 times), if a ferrite core is used. If the wiring method as shown in Remedy 2-1 is not feasible, follow Remedy 2-2.

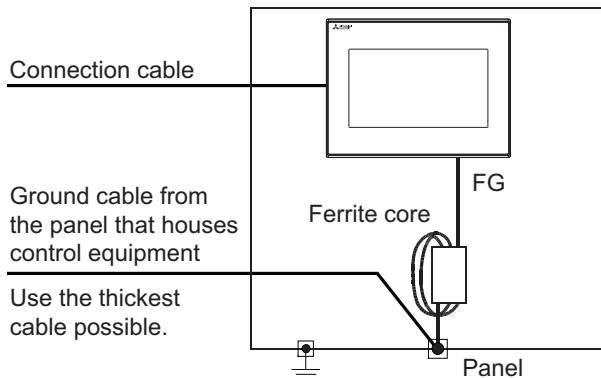

Remedy2-1

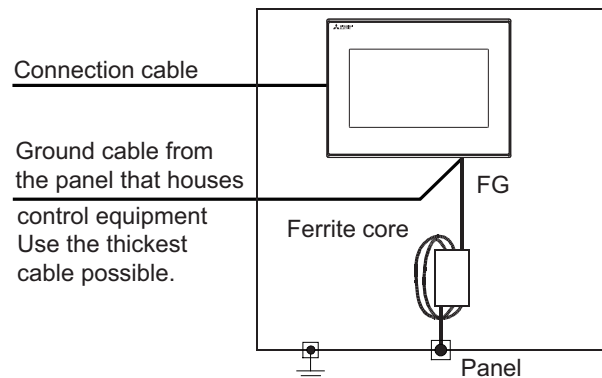

Remedy2-2

19.2 Wiring Inside and Outside the Panel

Wiring inside

Run power lines, servo amplifier drive wires, and communication cables so that they do not cross each other.

Noise interference that is generated by cables that cross each other may cause malfunctions.

Surge suppressors are an effective way to filter out surge noise that is generated from no fuse breakers (NFB), electromagnetic contactors (MC), relays (RA), solenoid valves, and induction motors.

Refer to the section to follow for surge killers.

☞ Page 175 Attaching surge killers to control equipment

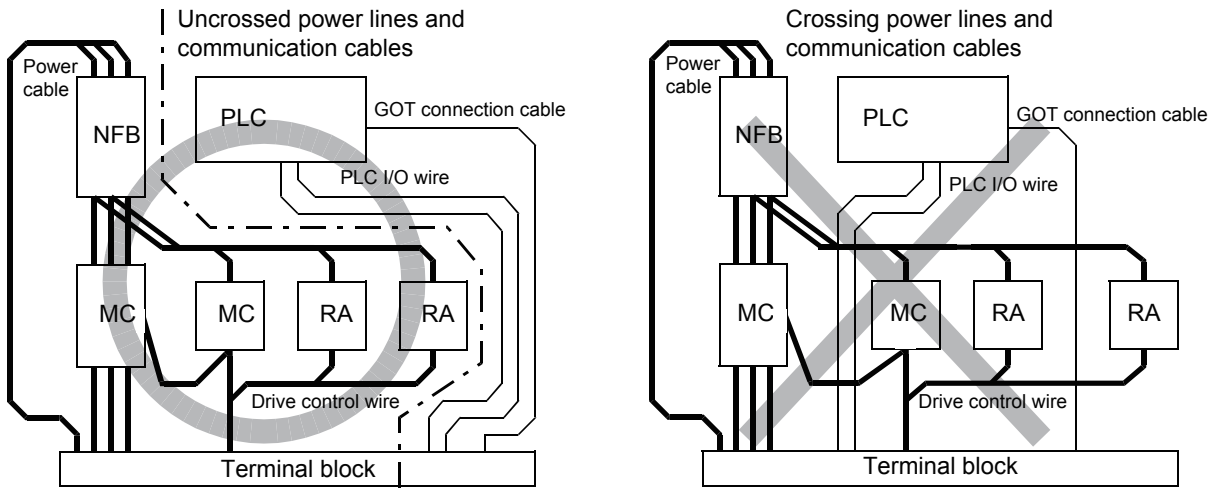

Outside the panel

To pull the power line and communication cable out of the panel, make two pullout holes away from each other and pull the cables through.

Putting both cables through the same pullout hole will increase noise interference.

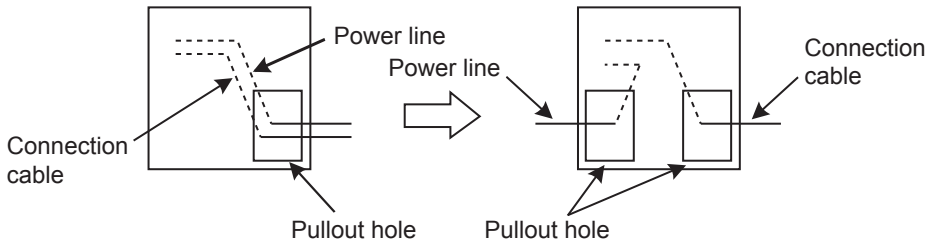

Keep the power line and communication cable inside the duct at least 100 mm away from each other.

If that is not possible, the use of a metal separator inside the duct can reduce noise interference.

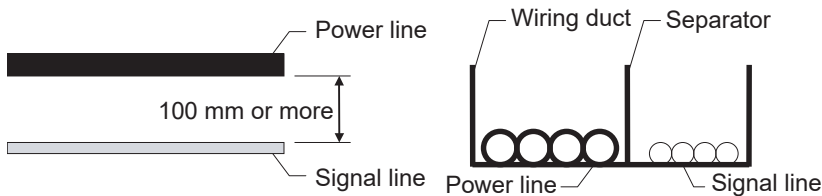

Attaching surge killers to control equipment

If communication errors happen in synch with the on/off signals from certain control equipment (referred to as "load" hereafter) such as no fuse breakers, electromagnetic contactors, relays, solenoid valves, and induction motors, surge noise interference is suspected.

If this problem happens, keep the ground cable and communication cable away from the load.

If that is not possible, an installation of a surge killer will help reduce noise interference.

Place the surge killer as close to the load as possible.

Remedy for AC inductive load

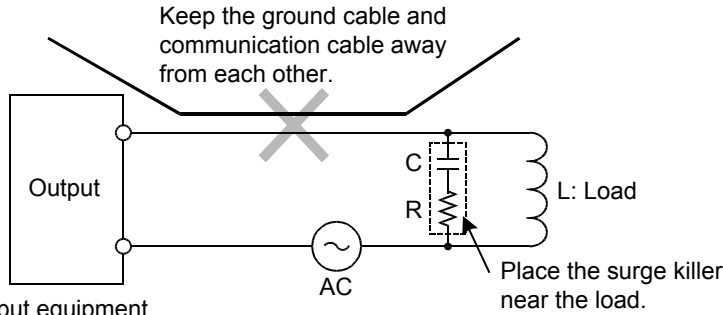

Output equipment such as PLC output unit

Remedy for DC inductive load

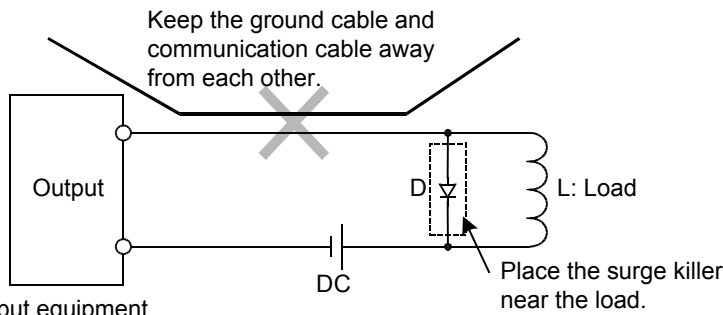

Output equipment such as PLC output unit

MEMO

20 OPTION

20.1 SD Card

The SD card is used to transfer the OS or project data and to save the data of the alarm history function.
For details, refer to the following.

☞ Page 275 CONTROL OF VARIOUS DATA (DATA CONTROL)

Applicable SD card

The following SD cards are applicable for GOT.

Model	Specifications
L1MEM-2GBSD	SD memory card 2 GB
L1MEM-4GBSD	SDHC memory card 4 GB
NZ1MEM-2GBSD	SD memory card 2 GB
NZ1MEM-4GBSD	SDHC memory card 4 GB
NZ1MEM-8GBSD	SDHC memory card 8 GB
NZ1MEM-16GBSD	SDHC memory card 16 GB

Installation/removal procedure of SD card

Install/remove the SD card when the power supply of the GOT is OFF or [Access inhibit] is set in the [SD card access] setting of the GOT.

Installation

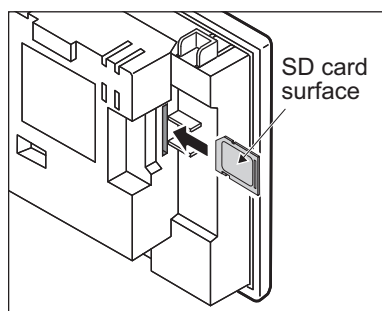
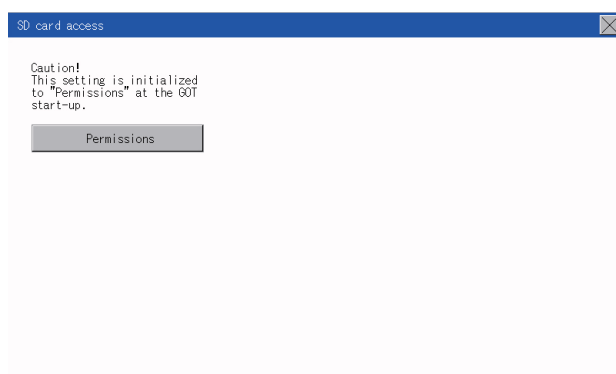

1. Touch [Main Menu] → [Data] → [SD card access] → [Permissions] to set [Access inhibit].

☞ Page 306 SD Card Access

Check that the SD card access LED turns off.

When the SD card access LED is off, the SD card can be installed or removed even when the GOT is on.

2. Insert a SD card into the SD card interface with its front side (nameplate side) outside.

3. Touch [SD card access] → [Access inhibit] to set [Permissions]. Check that the SD card access LED turns on.

Removal

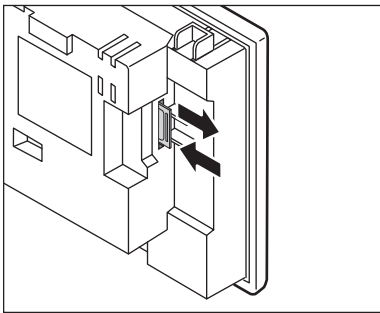
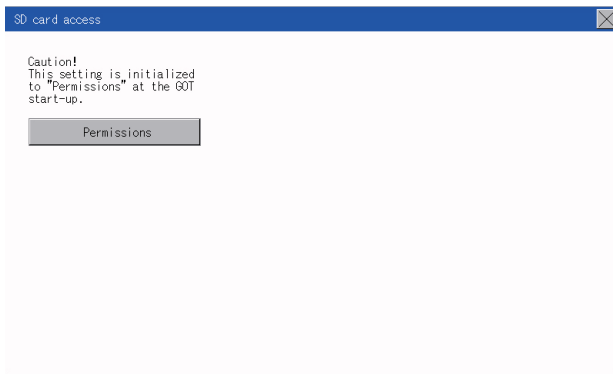

1. Touch [Main Menu] → [Data] → [SD card access] → [Permissions] to set [Access inhibit].

☞ Page 306 SD Card Access

Check that the SD card access LED turns off.

When the SD card access LED is off, the SD card can be installed or removed even when the GOT is on.

2. Push the SD card all the way inside and leave your finger once, then remove the SD card.

Point

Precautions when removing the SD card

- Do not pull out the SD card or power OFF the GOT while the SD card access LED is lit. To do so may cause data corruption or malfunction.
- When removing the SD card from the GOT, make sure to support the SD card by hand as it may pop out. Failure to do so may cause the SD card to drop from the GOT, resulting in a failure or break.

21 UTILITY FUNCTION

Utility is a function, which carries out connection of GOT and controller, screen display and operation method settings, program/data control and self-check etc.

21.1 Utility Execution

For utility execution, utility has to be displayed by installing Boot OS and package data in the C drive (built in flash memory). There are following two methods for installing Boot OS and package data.

1) GT Designer3→GOT

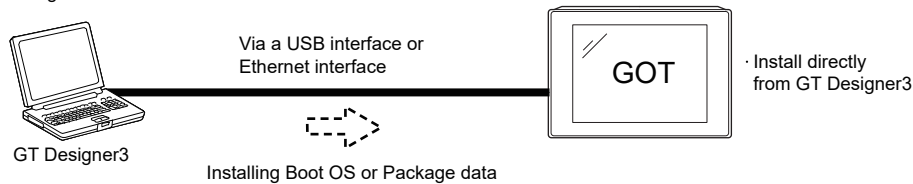

2) GT Designer3→SD card→GOT

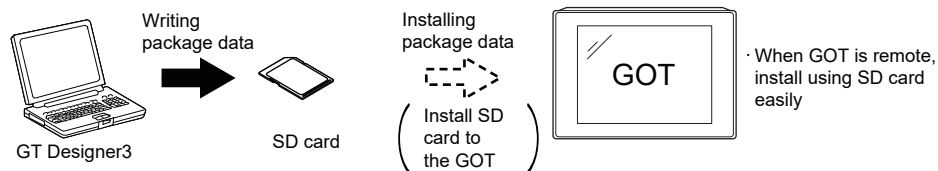

Refer to the following for the installation which uses GT Designer3.

📖 GT Designer3 (GOT2000) Screen Design Manual

For the installation methods of package data with an SD card, refer to the following.

📖 Page 389 BootOS and System Application Installation Using Data Storage

21.2 Utility Function List

The items in the following list can be set/operated on the utility screens.

Item		Functions overview	Reference
Language		Switching message languages	☞ Page 189 LANGUAGE SETTING (LANGUAGE)
Comm. Setting	Standard I/F	Assigning channel number and communication driver to communication interface	☞ Page 191 Standard I/F Setting
	GOT IP Address	Configuring GOT Ethernet setting	☞ Page 200 GOT IP Address Setting
	Ethernet communication	Displaying the contents of Ethernet setting, changing the host	☞ Page 202 Ethernet Communication
	Comm. Monitor	Checking the serial communication port communication	☞ Page 206 Communication Monitor
	Ethernet check	Checking the Ethernet communication port communication	☞ Page 209 Ethernet Check
	Transparent mode	Setting the channel No. to be used for the communication for the FA transparent function	☞ Page 211 Setting the Transparent Mode
	Keyword	Setting or deleting sequence program protection key words and canceling sequence program protection status for the FXCPU connection	☞ Page 212 Keyword
GOT setup	Display	Setting the title display period	☞ Page 221 Display Settings
		Setting the screen save time	
		Adjusting brightness	
	Operation	Setting the buzzer sound	☞ Page 224 Operation Setting (Settings for Operation)
		Setting the window move buzzer	
		Setting the key reaction speed	
		Touch panel calibration	
		Setting the utility call keys	
	Unique info	Setting the GOT ID No.	☞ Page 231 Inherent Information
	GOT internal device monitor	Setting the Use/Disuse the GOT internal device monitor of GOT diagnostics	☞ Page 232 GOT Internal Device Monitor
	VNC server function	VNC server function setting (GS21-W-N)	☞ Page 234 VNC Server Function
License management	Displaying the screen for registering and canceling a license (GS21-W-N)	☞ Page 236 License Management	
IP filter setting	Setting the IP filter usage, filtering method, target IP address, and exception IP address	☞ Page 238 IP Filter Setting	
Security Setting	Security level	Changing the security level	☞ Page 245 Security Level Authentication
	Operator	Operator management	☞ Page 247 Operator Authentication
		Password change	
		Function setting	
Login/Logout	-	☞ Page 261 Login/Logout	
Time setting	Time setting	☞ Page 263 Time Setting and Display	

Item		Functions overview	Reference	
Data	OS information	OS information	☞ Page 279 OS information	
	Resource Data	Alarm info.	Converting alarm log files in G2A format → CSV/TXT format Deleting or copying alarm log files	☞ Page 281 Alarm information
		Recipe info.	Converting recipe files in G2P format → CSV/TXT format Converting CSV/TXT format → Recipe files in G2P format Deleting or copying recipe files	☞ Page 286 Recipe information
		Logging info.	Deleting or copying logging files	☞ Page 292 Logging information
		Image file	Deleting or copying hard copy files	☞ Page 296 Image file management
		Operation log information	Converting operation log files in G2O format → CSV/TXT format Deleting or copying operation log files	☞ Page 300 Operation log information
	SD card access	Setting the access permission of the SD card	☞ Page 306 SD Card Access	
	SD card format	Formatting the SD card	☞ Page 307 SD Card Format	
	Clear data	Clearing the project data and resource data on the GOT	☞ Page 309 Clear data	
	Data copy	Transferring the project data or OS to the SD card	☞ Page 310 Data Copy	
	Backup/restore	Setting the backup and restoration	☞ Page 313 BACKUP/RESTORE	
Debug	Device monitor	Device monitor of PLC, test function, current value change of the buffer memory and the buffer memory monitor of intelligent module	☞ Page 335 Device Monitor Function	
	FX list editor	Changing parameters and sequence program of FX PLC	☞ Page 348 FX List Editor	
	FX3U-ENET-ADP	Configuring the communication setting for FX3U-ENET-ADP stored in the FXCPU	☞ Page 377 FX3U-ENET-ADP Communication Setting Function	
Maintenance	Touch panel calibration	Calibrating the touch panel reading error	☞ Page 383 Touch Panel Calibration	
	Touch panel check	Checking the touch panel operation	☞ Page 385 Touch Panel Check	
	Clean	Displaying the screen for cleaning the display	☞ Page 387 Clean	

21.3 Utility Display

To display setting screens for each utility, the main menu has to be displayed first.

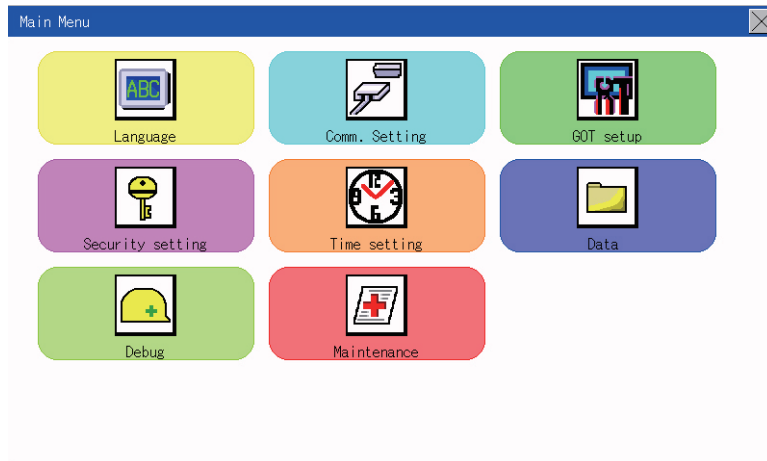

Main menu

The menu items that can be set at the GOT utility are displayed.

Touching a menu item in the main menu will display the setting screen or following selection screen for the item.

System message switch button

This button switches the language used for the utility.

When touching the [Language] button, the Select Language screen is displayed.



1. Touch the language button of a desired language and touch the [OK] button to select the language.
2. Touching the [x] button switches the language on the utility to the selected one.

- When starting the GOT without selecting any language or the selected language and the installed fonts are not matched

The following screen will be displayed.

Touching the button of a desired language restarts the GOT and the language is switched to the selected one.



- Selectable languages

The system message switch button is displayed only for the selectable languages.

The selectable languages differ depending on the fonts installed in the GOT.

For the relation between the selectable languages and the fonts, refer to the following.

 GT Designer3 (GOT2000) Screen Design Manual

- System language switching using the device

The system language can be switched using the system language switching device set with GT Designer3.

For the setting method of the system language switching device, refer to the following.

 GT Designer3 (GOT2000) Screen Design Manual

Display operation of main menu

The following four types of operation can display the main menu.

(Display the main menu after installing the standard monitor OS from GT Designer3 to the GOT built in flash memory.)

When project data is undownloaded

After the GOT is turned on, a dialog box for notifying of absence of project data is displayed. After the dialog box is displayed, touch the [OK] button to display the main menu.

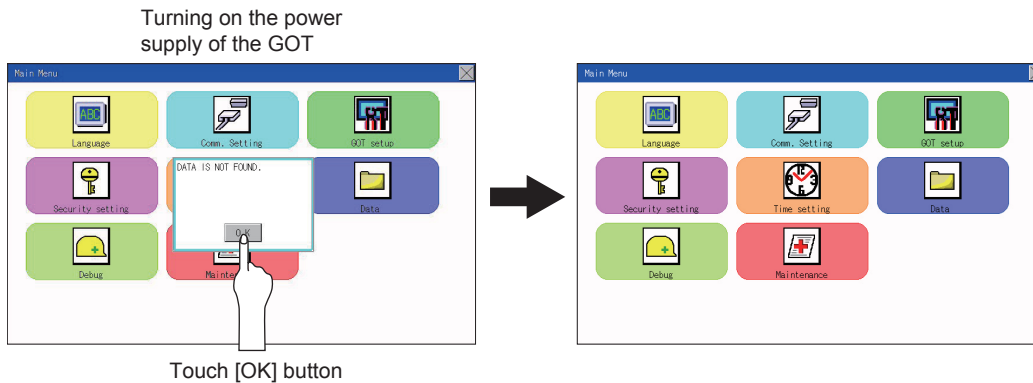

When touching utility call key

If you touch the utility call key while user-created screen is displayed, the main menu is displayed.

The utility call key is set in the position on the GOT screen upper left corner at factory shipment.

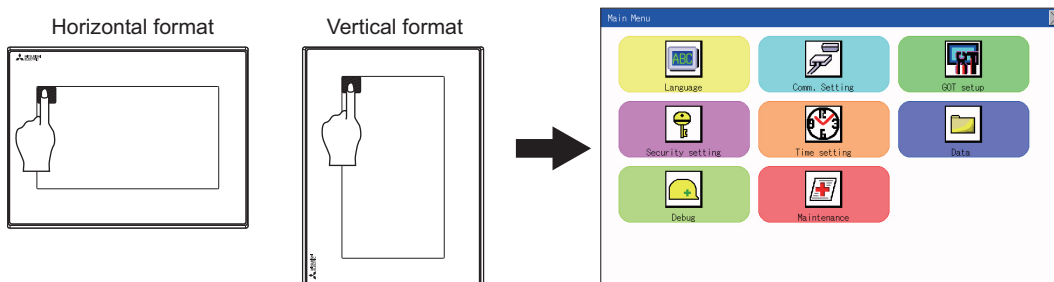

The utility function windows appear in the horizontal format, and this format cannot be changed.

The utility call key can be set by the GOT utility or GT Designer3.

For the setting method of the utility call key, refer to the following.

☞ Page 229 Setting the utility call keys

📖 GT Designer3 (GOT2000) Screen Design Manual

Point

- Prohibited simultaneous 2-point presses

Do not touch 2 points or more on the GOT screen simultaneously. Touching 2 points or more simultaneously may activate a part other than the touched point.

- Press time of the utility call key

When having set [Press time] of the utility call key setting screen to other than "0 (s)", keep pressing the touch panel for the period set to [Press time] or more before leaving the finger from the touch panel.

For utility call key setting, refer to the following.

☞ Page 229 Setting the utility call keys

- When the utility call key is not set

Even when the utility call key is not set (set to the zero point), you can display the main menu by performing the following operation.

Pressing the special function switch set on the user-created screen

When touching special function switch (utility)

If you touch the special function switch (utility) while user-created screen is displayed, the main menu is displayed.

The special function switch (utility) can be set as a touch switch that is displayed on a user-created screen by GT Designer3.

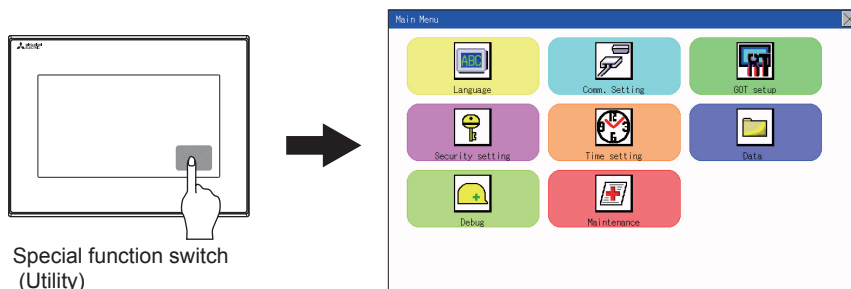

For the details of the special function switch, refer to the following.

GT Designer3 (GOT2000) Screen Design Manual

Point

When limiting the display and operation of the utility

When limiting the display and operating users, set a password to the GOT using GT Designer3.

If a user tries to display the main menu of the utility, the password is displayed.

Refer to the following for the details related to the password setting.

GT Designer3 (GOT2000) Screen Design Manual

Utility basic configuration

The basic configuration of utility is as follows.

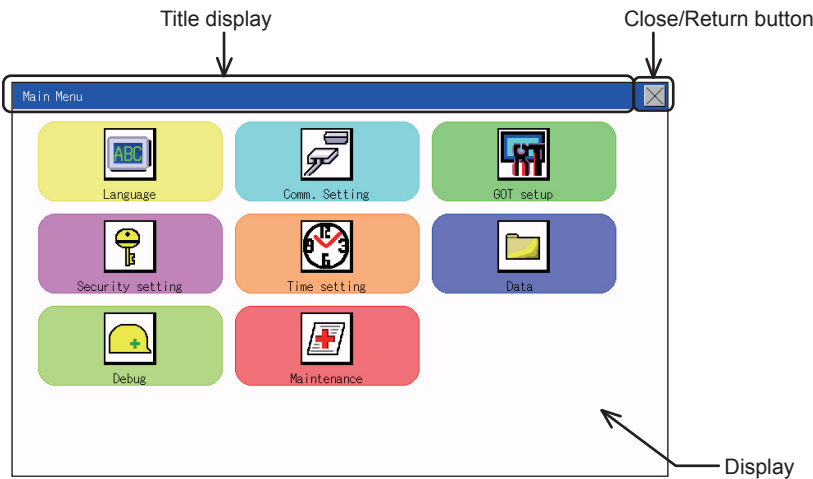

Title display

The screen title name is displayed in title display part.

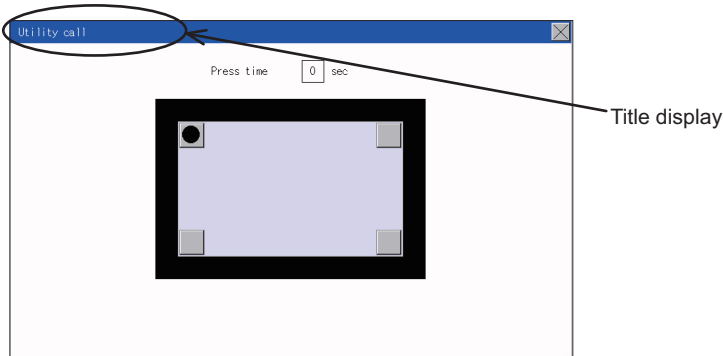
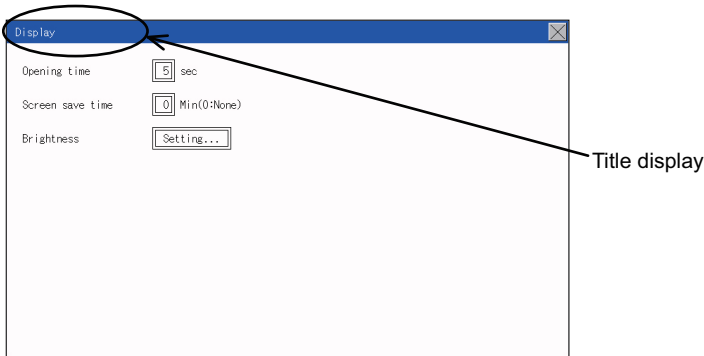

Close/Return button

When a middle screen of the layers is displayed, if the [x] (Close/return) button in the right corner of screen is touched, returns to the previous screen.

If this button is touched when directly displayed from monitor screen, the screen is closed and returns to monitor screen.

Scroll button

For screens in which the content does not fit on one screen page, there is a right or down scroll button on the screen.

▲▼◀▶ Scroll one line/column.

▲▼◀▶ Scroll window.

Basic operation of settings change

Change of setting value

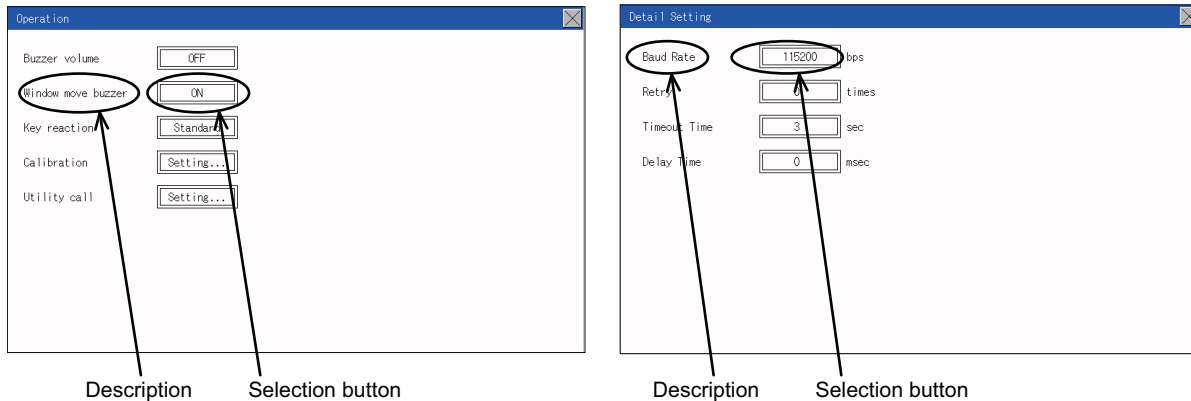

■Setting item, select button

Touch the select button to change the settings.
The setting methods differ depending on the setting items.
The following types of setting method are available.

Switching the setting value

The button repeats SHORT → LONG → OFF every time it is pressed.
Enter the setting value with a keyboard.

Use these keys to enter numerical values. Touch the button to display a keyboard on the GOT screen.

For the keyboard operations, refer to the next page.

Move to another setting screen.

Touch the button to move to each setting screen.

For the setting method of each setting item, refer to the setting operation of each setting screen.

■[×] (Close/Return) button

Reflect or cancel the changed settings.

[×] (Close/Return) button

Touching this button closes the screen. Depending on the setting item, the GOT restarts.

Touch the [×] button, and then the dialog box shown below is displayed.

(If no setting is changed, the dialog is not displayed.)

Operate following the message of the dialog box.

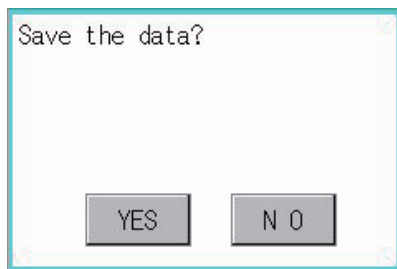

Keyboard operations

1. Touch the numerical value to be changed.
2. The keyboard for entering numerical values and a cursor are displayed. The display position of the keyboard differs depending on the position of the touched numerical value. (The keyboard is displayed at a position that does not disturb users to input numerical values.)

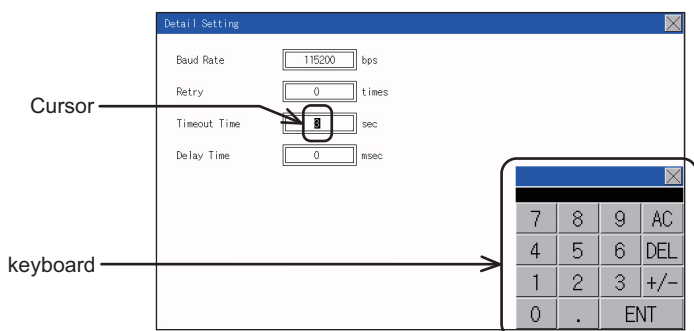

3. Input numerical value by the keyboard.
 - [0] to [9] Key: Enter numerical values.
 - [Enter] Key: Completes the numerical value input and closes the keyboard.
 - [Cancel] Key: Cancels the numerical value input and closes the keyboard.
 - [Del] Key: Deletes one character.
 - [AC] Key: Deletes all characters.
 - [*] key and the keys which are not mentioned do not function.
4. Touching the [Enter] key completes the numerical value input and closes the keyboard.

22 LANGUAGE SETTING (LANGUAGE)

22.1 Display language setting

Display language setting function

This function allows display language selection.

The items which can be set are shown below.

Item	Description	Setting range
Language	Display language in which the utility functions and dialog windows are displayed can be selected or confirmed in this menu	Japanese/English/Chinese <At factory shipment: Chinese>

Language setting operation

Language

Main Menu

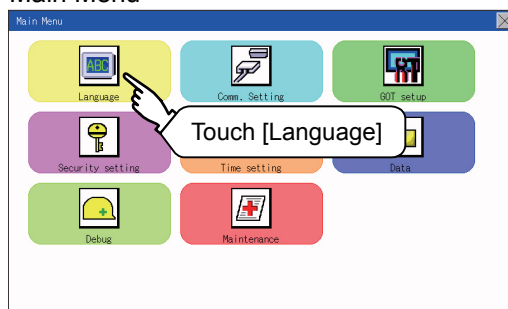

1. Touch [Language] to bring up the set up screen.

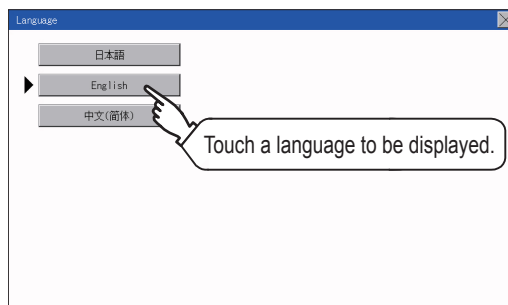

2. Select a display language by touching the corresponding button.



3. After changing the setting, touch the [x] button. The setting is saved and the setting screen is closed.

Point

Switching the display language of the utility by devices

Any device can be used for switching the display language of the utility. For details, refer to the following.

📖GT Designer3 (GOT2000) Screen Design Manual

When using devices to switch the display language of the utility, it does not change even if the display language is switched from the GOT utility screen.

23 COMMUNICATION INTERFACE SETTING (COMMUNICATION SETTING)

The following communication interfaces can be set.

Item	Functions overview	Reference
Comm. Setting	Standard I/F	Assigning channel number and communication driver to communication interface
	GOT IP Address	Configuring GOT Ethernet setting
	Ethernet communication	Displaying the contents of Ethernet setting, changing the host
	Comm. Monitor	Checking the serial communication port communication
	Ethernet check	Checking the Ethernet communication port communication
	Transparent mode	Setting the channel No. to be used for the communication for the FA transparent function
	Keyword	Setting or deleting sequence program protection key words and canceling sequence program protection status for the FXCPU connection
		Page 191 Standard I/F Setting interface
		Page 200 GOT IP Address Setting
		Page 202 Ethernet Communication
		Page 206 Communication Monitor
		Page 209 Ethernet Check
		Page 211 Setting the Transparent Mode
		Page 212 Keyword

23.1 Standard I/F Setting

Standard I/F functions

Function	Description
Channel no. display	Displays the channel number (CH No) that has been assigned in the screen design software.
Communication driver display	Displays the communication driver that has been assigned in the screen design software.
Communication parameters display	Displays the communication parameters of the controllers that has been assigned in the screen design software.

Standard I/F display operation

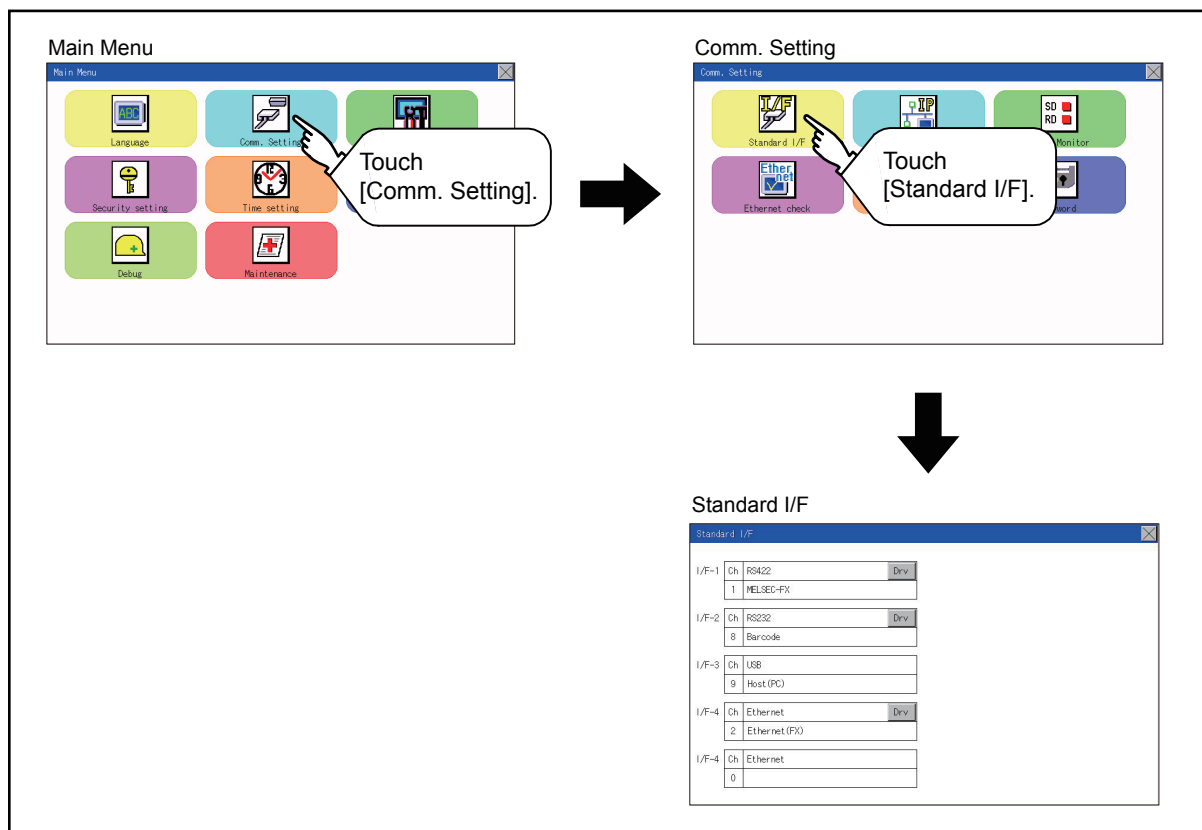

Display contents of standard I/F

Described below are the display items on the standard I/F setting menu and their functions.

Display item

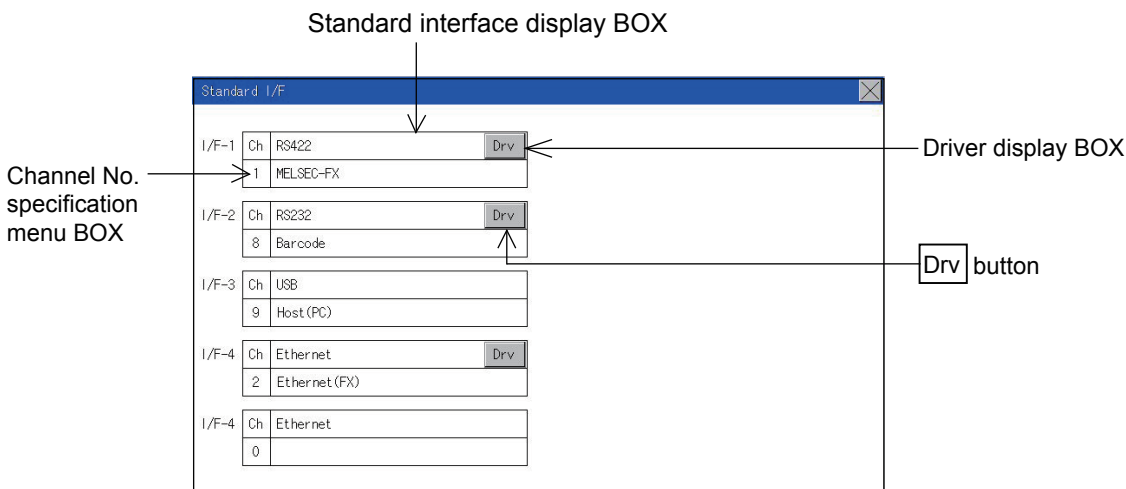

Standard interface display BOX

The standard interface includes the following four types.

- Standard I/F-1(RS-422/485 or RS-422): For communication with a controller
- Standard I/F-2(RS232): For communication with a controller, personal computer (screen design software), modem, or barcode reader, or for the FA transparent function
- Standard I/F-3(USB): For communication with the personal computer (screen design software) or for the FA transparent function
- Standard I/F-4(Ethernet): For communication with the personal computer (screen design software) or a controller

Available standard interfaces differ depending on the GOT model used.

o: Available, x: Not available

GOT	Standard I/F-1		Standard I/F-2	Standard I/F-3	Standard I/F-4
	RS-422/485	RS-422	RS-232	USB	Ethernet
GS2110-WTBD-N GS2107-WTBD-N	o	x	o	o	o
GS2110-WTBD GS2107-WTBD	x	o	o	o	o

- For GS2110-WTBD-N, GS2107-WTBD-N

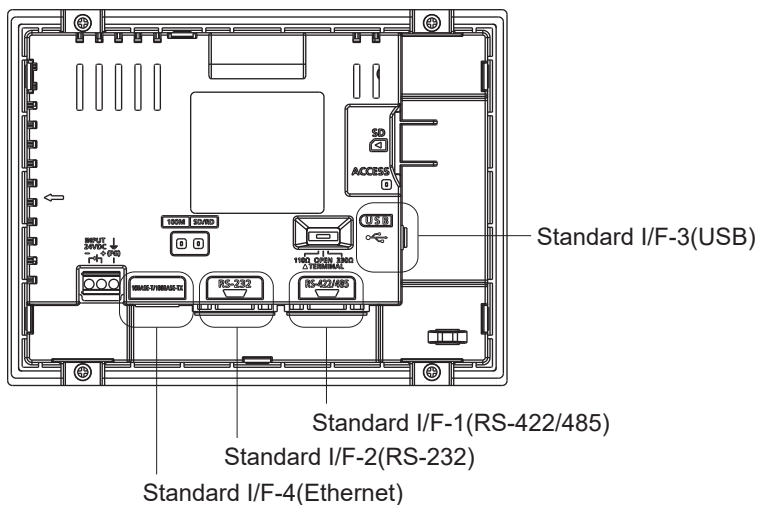

- For GS2110-WTBD, GS2107-WTBD

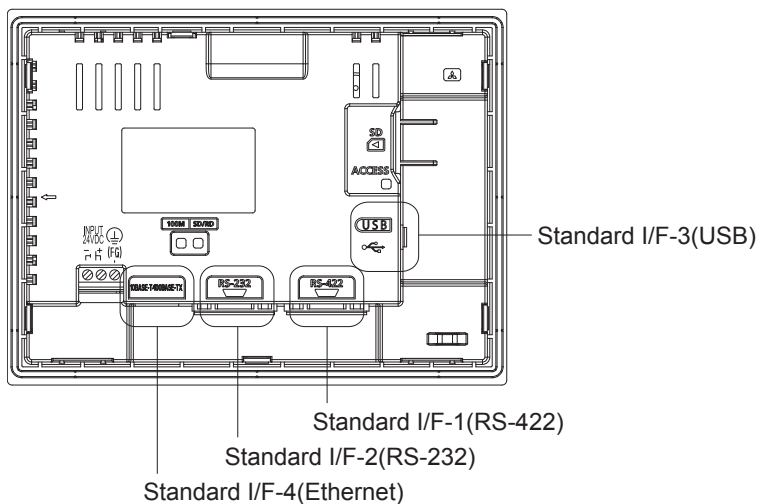

■Channel No. specification menu BOX

Set a channel number to be used by the standard interface.

☞ Page 198 Channel setting operation

For the detail of the drivers which can be assigned to each channel, refer to the following.

☞ Page 193 Driver display BOX

- 0: Set when the communication interface is not used.
- 1, 2: Set when connecting to a controller.
- 8: Set when connecting to a barcode reader or RFID.
- 9: *1 Set when connecting to a personal computer (screen design software).
- *: Set this channel when the gateway function (except when the connection with controllers is the Ethernet connection) or the Ethernet download function is used.

*1 "9" is automatically set to the standard I/F-3(USB).

■Driver display BOX

The driver display box displays the names of communication drivers assigned to channels or the communication drivers set in the communication settings of the screen design software.

For details of the communication drivers to be displayed, refer to the following.

📖 GT Designer3 (GOT2000) Screen Design Manual

"Disuse" is displayed in the driver display box in the following cases:

- The communication driver is not installed.

☞ Page 199 Driver setting operation

- "0" is set in the channel number specification menu box.

The channel number of the standard I/F-3(USB) is fixed to "9".

■[Drv] button

Displays the driver setting screen.

Select the driver to use on the driver setting screen.

☞ Page 199 Driver setting operation

The [Drv] button is displayed in the following case.

- When a channel number other than channel 0 or 9 is set to the standard I/F-1, standard I/F-2, and standard I/F-4

Precautions for communication between GOT and connected devices

- Installing [Communication driver] and downloading [Communication Settings]

To perform communication with the connected device, the following actions are necessary.

- 1) Installing communication drivers (Up to 2 drivers)
- 2) Assigning channel numbers and communication drivers to communication interfaces
- 3) Downloading contents (project data) assigned in step 2)

Perform 1), 2) and 3) with the screen design software.

	CH No.	Driver	
I/F-1: RS422/485	1	MELSEC-FX	Detail Setting...
I/F-2: RS232	8	Barcode	Detail Setting...
I/F-3: USB	9	Host (PC)	
I/F-4: Ethernet	0	None	Detail Setting...

For details, refer to the following.

GT Designer3 (GOT2000) Screen Design Manual

- When communication setting data is not downloaded

When communication setting data is not downloaded in the screen design software, configure the communication settings in the software or on the GOT utility screen.

Detail information setting operation

For Standard I/F-1(RS422) and Standard I/F-2(RS232)

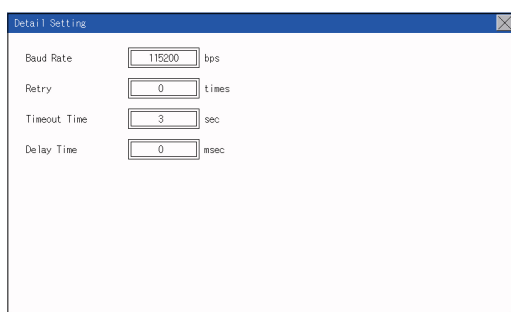
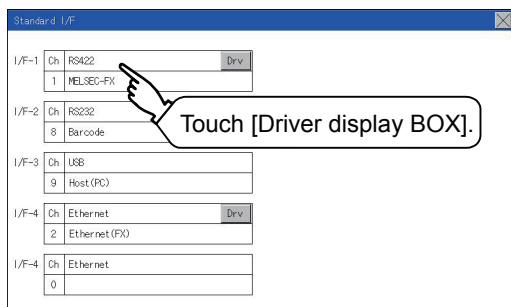

1. Touch each driver display box of the standard I/F-1 and standard I/F-2.

2. The screen jumps to the detailed information screen and the communication parameter will appear.

3. Touch the numerical values of baud rate to switch them repeatedly.

Ex. 4800bps → 9600bps → 19200bps

The numerical values are set using the ten-key depending on the setting.

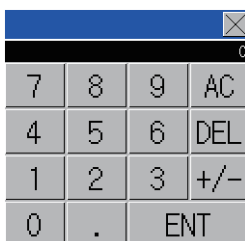

"0" to "9":

Use these keys to enter numerical values. Enter "0" to disable the screen saver function.

"ESC":

Closes the ten-key window without saving any value entered.

"AC":

Deletes the entire string of numerical characters that are being entered.

"DEL":

Deletes a digit from a string of numerical characters that are being entered.

"ENT":

Enters the value for the clock that has been entered and closes the ten-key pad window.

"+/-":

Switches between positive and negative values. (Only positive values are valid for the clock setting.)

".":

Invalid key (not used)

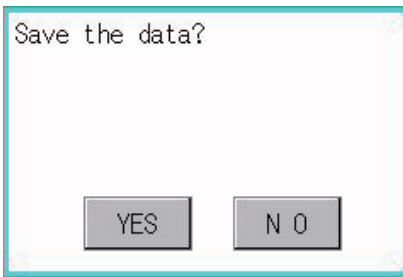

4. Touch the [X] button to display the window confirming whether to save the settings.

5. Touch the [YES] button to save the settings and restart. Touch the [NO] button to discard the changes.

Point 

Communication parameters

The types of items that are in the communication parameter setting menu depend on the type of communication driver that is installed on the GOT in use.

Refer to the section below for the setting contents of various drivers.

 GT Designer3 (GOT2000) Screen Design Manual

For Standard I/F-4(Ethernet)

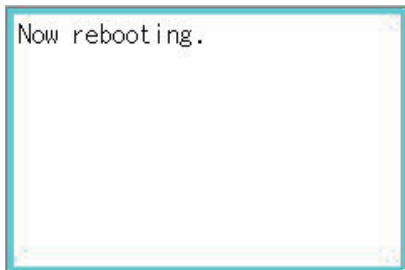
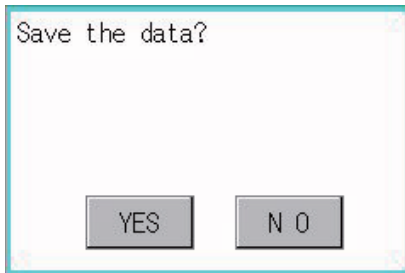
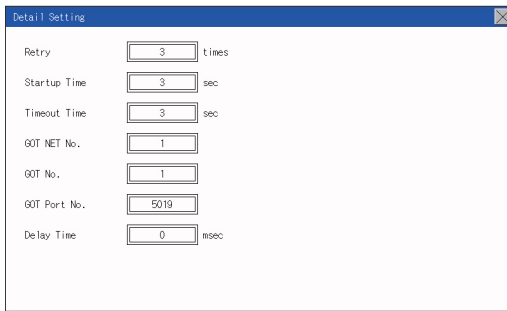
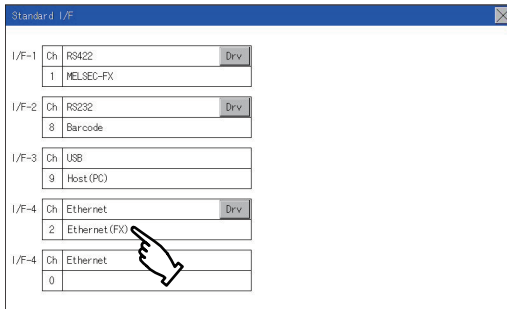

1. Touch the driver display box of a communication parameter to be set.
2. The screen is switched to the communication detail setting. Set the communication parameter on this screen.
GOT IP address setting
☞ Page 200 GOT IP Address Setting
3. When the [×] button is touched, it returns to the previous screen.
4. Touch the [×] button to display the window confirming whether to save the settings.
5. Touch the [YES] button to save the settings and restart. Touch the [NO] button to discard the changes.

Point

Communication parameter setting in the screen design software
Set the communication parameter for each communication driver by selecting [Common] → [Controller Setting].

📖 GT Designer3 (GOT2000) Screen Design Manual

Channel setting operation

Channel number setting operation

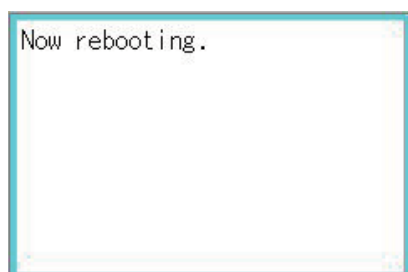
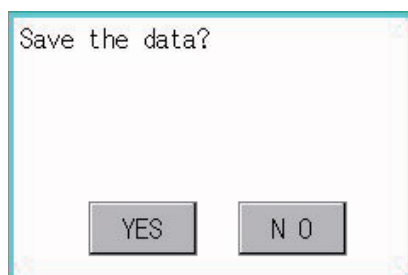
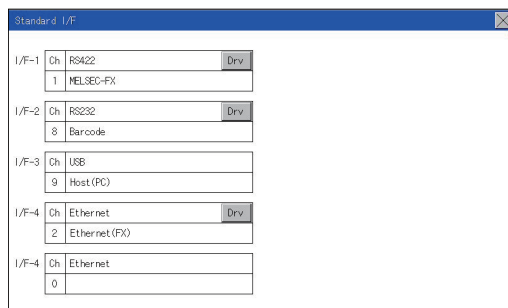
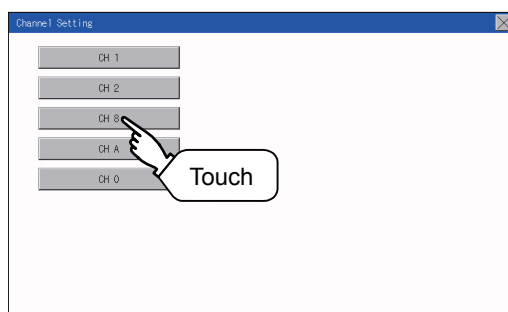
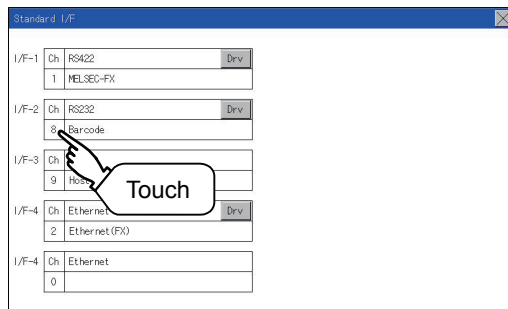

1. Touch the channel No. specification menu box to be set.
2. When the channel setting window appears, select the channel number.
3. When the channel number is selected, the settings are fixed and the window returns to the previous one. Therefore, touch the [×] button.
4. Touch the [×] button to display the window confirming whether to save the settings.
5. Touch the [YES] button to save the settings and restart. Touch the [NO] button to discard the changes.

Driver setting operation

Driver setting operation

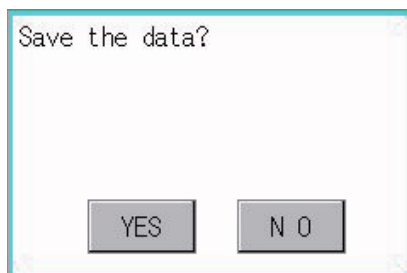
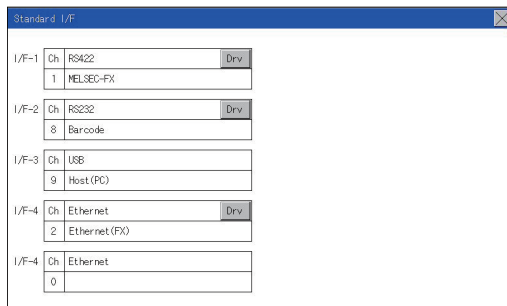
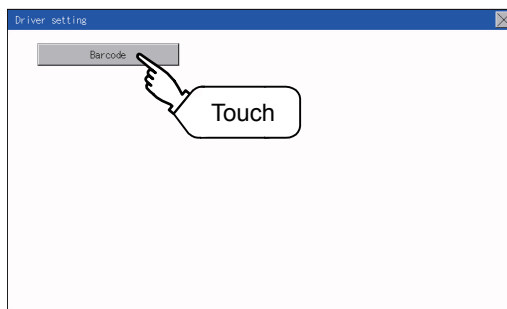
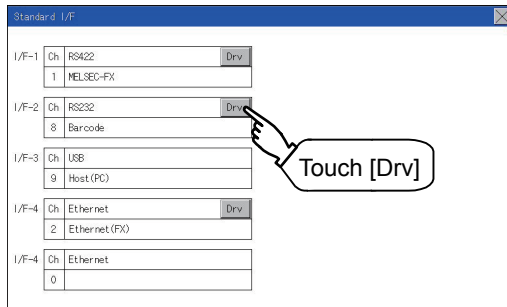

1. Touch [Drv] button to bring up the driver setting window.
2. The available driver names are displayed on the driver setting screen. Select the driver to use.
3. When the channel number is selected, the settings are fixed and the window returns to the previous one. Therefore, touch the [×] button.
4. Touch the [×] button to display the window confirming whether to save the settings.
5. Touch the [YES] button to save the settings and restart. Touch the [NO] button to discard the changes.

23.2 GOT IP Address Setting

This section describes the GOT Ethernet setting.

The GOT Ethernet setting can also be set with the screen design software. For details, refer to the following.

 GT Designer3 (GOT2000) Screen Design Manual

Standard

The table below shows the communication setting items and setting range.

Communication setting items	Setting range	Remark
IP Address	0.0.0.1 to 223.255.255.254	If a value outside the setting range is entered, the error message "SET NUMBER IS INCORRECT." appears.
Subnet Mask* ¹	192.0.0.0 to 255.255.255.252	
Default gateway* ¹	0.0.0.1 to 223.255.255.254	
Per. S/W port No.	1024 to 5010, 5014 to 49152, 49171 to 65534	Set the port number for the GOT download.
Transparent port No.	1024 to 5010, 5014 to 49152, 49171 to 65534	Set the port number for the transparent of the GOT.

*1 Set the value "0.0.0.0" when not using the subnet mask and default gateway.

Display operation of GOT IP address

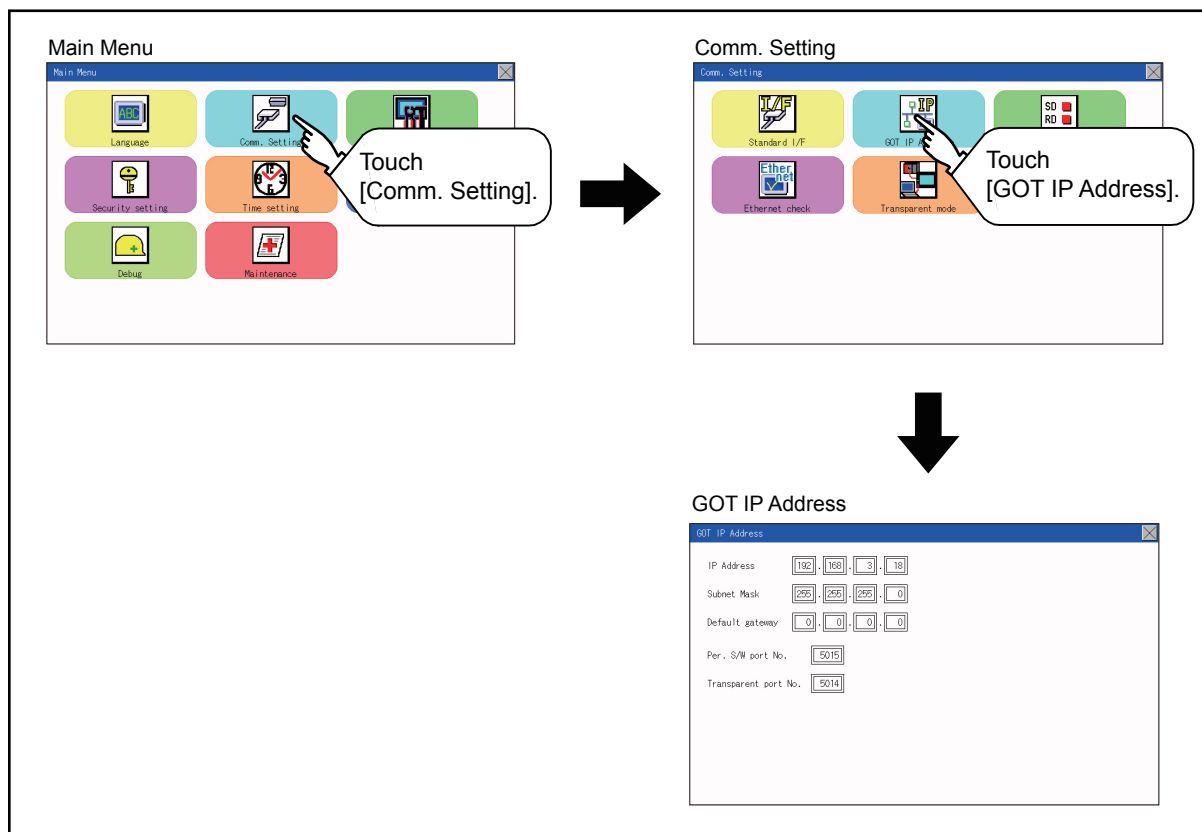

Setting operation

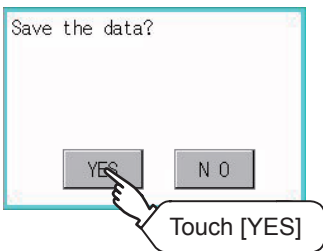
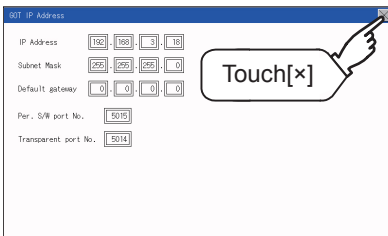
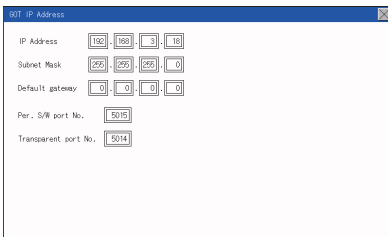
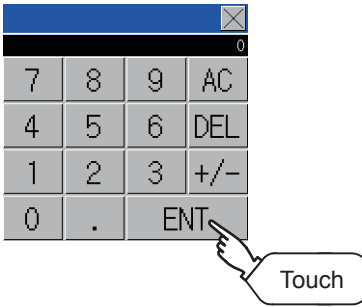
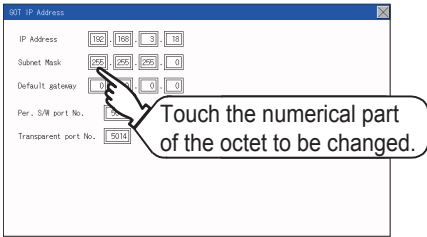

1. Touch the numerical part of the octet to be changed among the 1st to 4th octets.
2. When the ten-key pad appears, enter a numerical value in up to 3 digits, and touch the **ENT** key. If a numerical value outside the setting range is entered, the following error message appears. Enter a numerical value again.

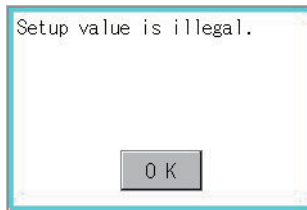

For the details of the setting range, refer to the following.

☞ Page 377 Specifications

3. If necessary, change the setting of [Per. S/W port No.] and [Transparent port No.].

4. After the setting change, touch the **[x]** key.

5. When the screen shown on the left appears, touch the **[YES]** key.

23.3 Ethernet Communication

Setting function for Ethernet communication

The contents of the Ethernet set in GT Designer3 can be checked.

The setting of the host station can be changed.

For the Ethernet setting, refer to the following.

GOT2000 Series Connection Manual for the controller used

Display operation of Ethernet communication

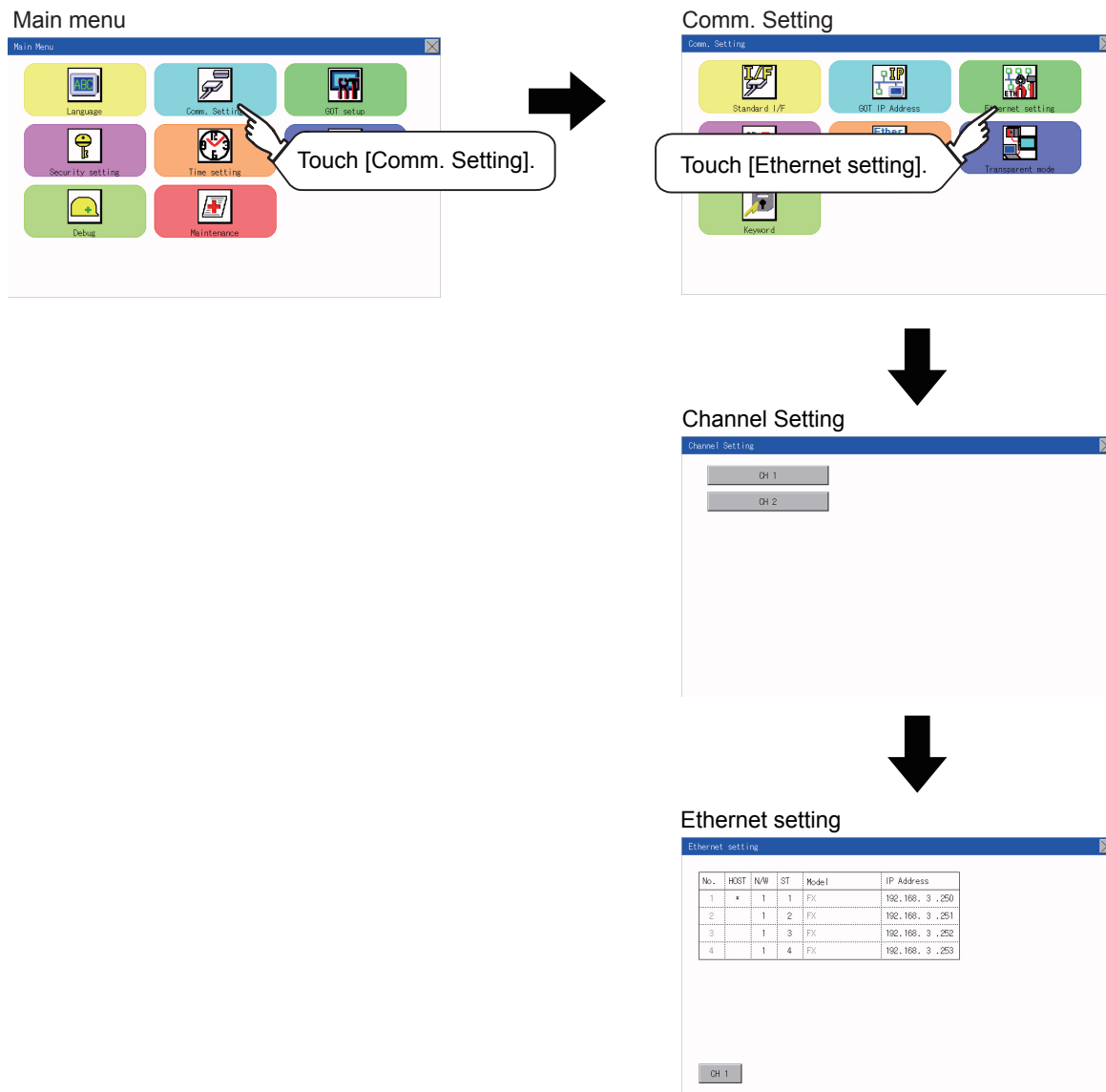

Display contents of Ethernet setting

The following describes the setting items and the display contents of the Ethernet setting.



Channel select tab

Channels can be switched.

Switching to the channel which does not have the Ethernet setting is not available.

Ethernet setting items

The contents of the Ethernet setting configured in GT Designer3 are displayed.

Changing [Host], [Net No.], [Station No.] and [IP Address] are available.

- ☞ Page 204 Change of host
- ☞ Page 204 Change of Net No.
- ☞ Page 205 Change of station No.
- ☞ Page 205 Change of IP address

Point

How to cancel the change of the setting in the [Ethernet setting] screen

Cancel the settings changed in the [Ethernet setting] screen with the [Restore default settings] button.

The changed settings remain until they are canceled with the [Restore default settings] button.

The changed settings are not canceled even if writing the project data or system application to the GOT.

When the project data is written to the GOT without canceling the changed settings, those changed settings are reflected to the Ethernet setting of the written project data.

(If the written project data does not have a channel with same Ethernet settings as that of the channel changed in [Ethernet setting] screen, the changed settings are not reflected.)

Change of host

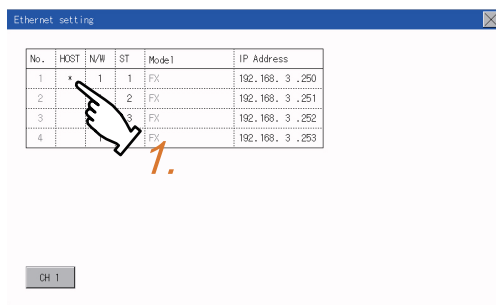

1. Touch the device to be set as the host.

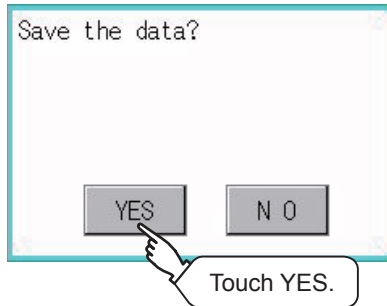

2. After the setting change, touch the [x] key. When the screen shown on the left appears, touch the [YES] key.

Change of Net No.

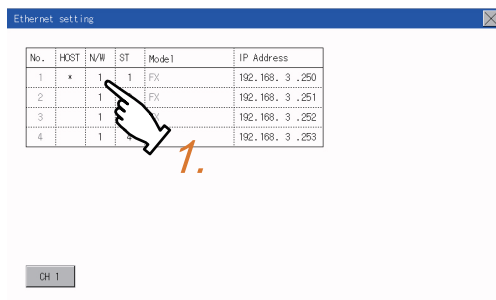

1. Touch the Net No. to be changed, and input the network No. to be changed by the numeric keypad displayed.

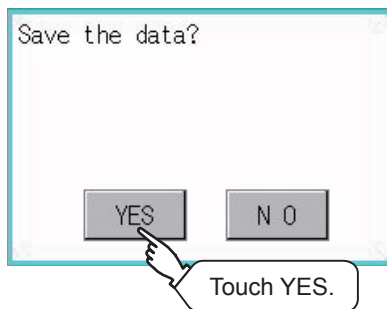

2. After the setting change, touch the [x] key. When the screen shown on the left appears, touch the [YES] key.

Change of station No.

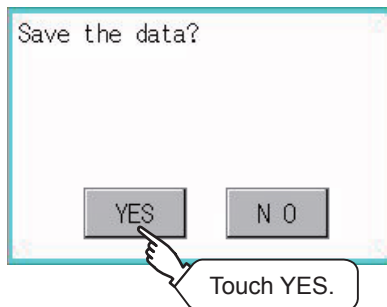
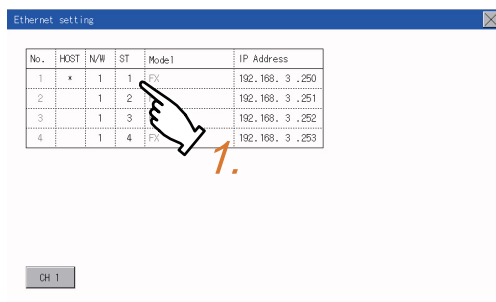

1. Touch the station No. to be changed, and input the station No. of the destination Ethernet module to be changed by the numeric keypad displayed.
2. After the setting change, touch the [x] key. When the screen shown on the left appears, touch the [YES] key.

Change of IP address

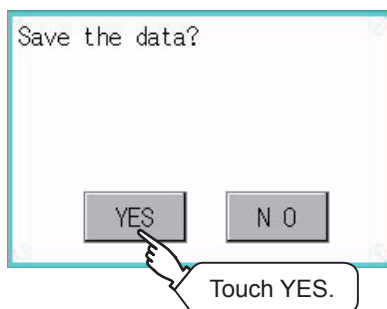
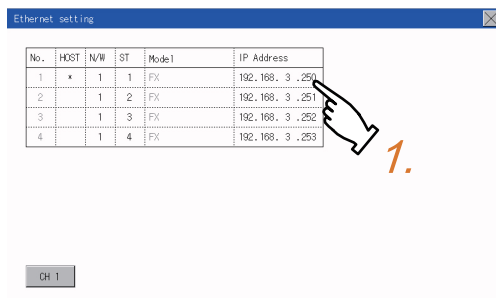

1. Touch the IP address to be changed, input the destination IP address to be changed by the numeric keypad displayed.
2. After the setting change, touch the [x] key. When the screen shown on the left appears, touch the [YES] key.

23.4 Communication Monitor

Communication monitor functions

Function	Description
Communication port-selection status display	Indicates the connection status of Standard I/F-1 and I/F-2.
Communication status display	Displays the communication status (SD: send, RD: receive).
Communication error status display	Displays an error message when a communication error occurs.

Communication monitor display operation

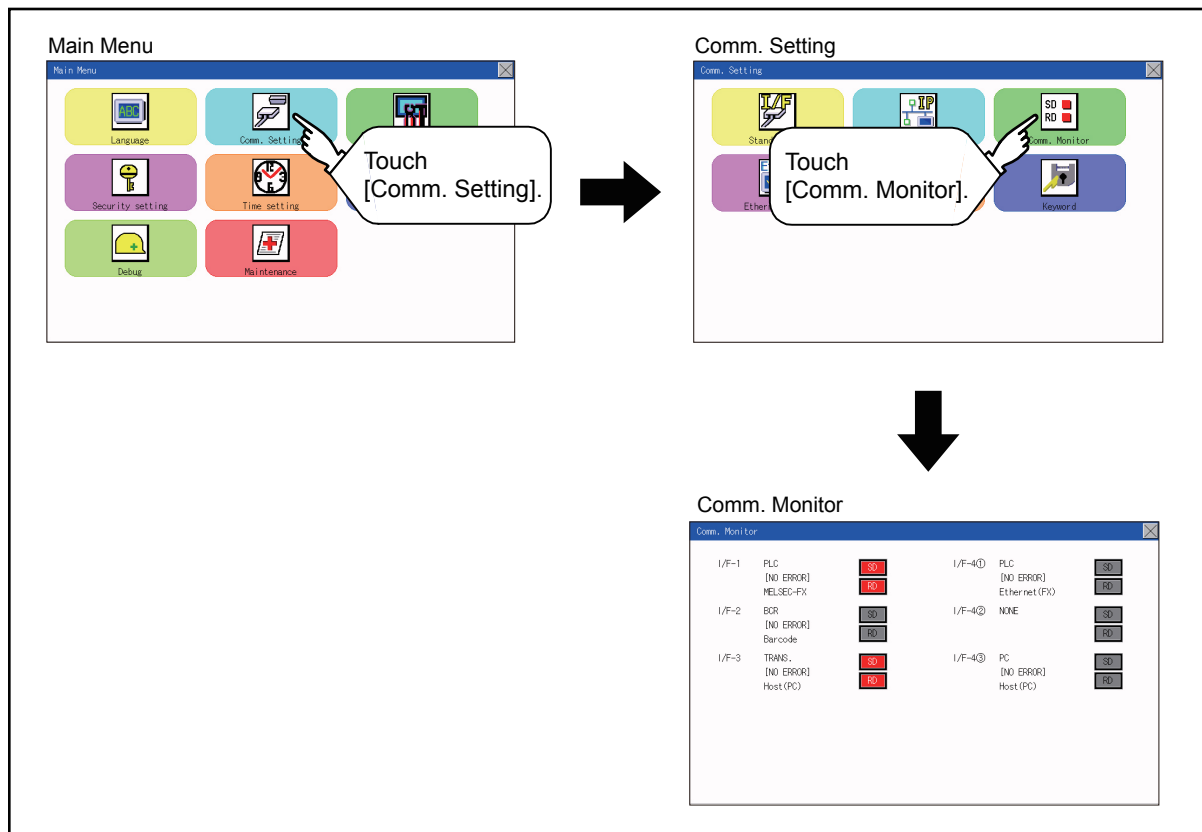

Screen display content

Connection status of the communication ports

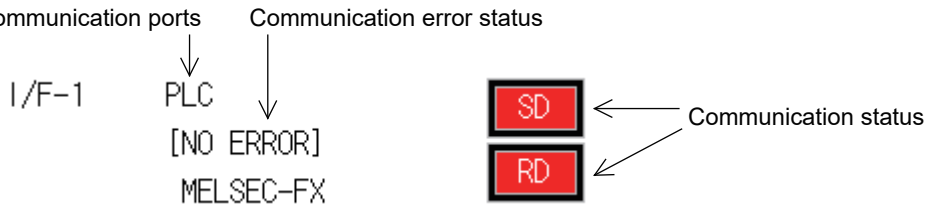

Connection status of the communication ports

Indicates the connection status of Standard I/F-1 and I/F-2.

Listed in the table below are display items and the connection status (channel number).

Display item	Channel number	Remark
PLC	Ch1	"PLC" appears when connected to a controller (PLC or microcomputer).
Barcode	Ch8	"BCR" appears when connected to a barcode reader.
TRANS.	Ch9	"TRANS." appears when the controller that is allocated to one of the communication ports supports the transparent mode. "TRANS." automatically changes to "PC" when communicating with the screen design software.
Host(PC)	Ch9	"PC" appears when the controller that is allocated to one of the communication ports does not support the transparent mode.
Printer	ChA	Appears when connected to a printer.

Communication status

Displays the communication status of each communication port.

The SD and RD symbols appear in white on red (SD, RD) while data are being sent or received, and in black on gray (SD, RD) at other times. They may appear lit depending on the communication status.

The SD and RD symbols on the screen indicate normal communication or cable disconnection.

Setting example

Port	Channel number	Controller type
I/F-1	Ch1	MELSEC-FX
I/F-2	Ch8, Ch9	-

■[During normal communication (with connection to a device that supports the transparent mode)]

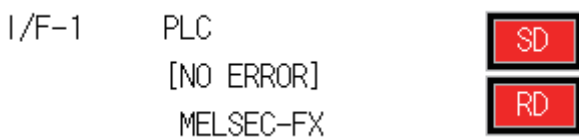

The SD and RD symbols for I/F-1

■[When the connecting cable with the controller is disconnected]

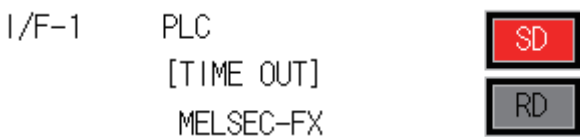

Only the SD symbol next to I/F-1 blinks.

Communication error status

Communication error status of each port is displayed on this screen.

The following table describes the communication status that each display item shows.

Display item	Status	Action
NO ERROR	No error	Communication is executed normally.
ERR Ovr.	Overrun error	The receive data is sent continuously with a short interval. Let the baud rate (communication speed) be equivalent between the GOT and counterpart equipment.
ERR Frm.	Framing error	The communication frames of GOT and PLC are inconsistent. Confirm the communication settings of GOT and PLC, such as data length, stop bit and baud rate.
ERR Prt.	Parity error	The parity check conditions of GOT and PLC are inconsistent. Let the parity check condition (odd or even) of GOT and PLC be consistent.
ERR Text	Text error	The sum data is inconsistent. Or the contents of the receive data are not consistent with the send command from the GOT. Let the communication settings and contents of data be consistent between the GOT and counterpart equipment. (If NAK is received while the GOT is connected to the microcomputer board, a text error occurs.)
TIME OUT	Communication timeout	Though receiving is started, receive data is not sent. Check the wiring between the GOT and its communication target. (When the GOT is connected to the microcomputer board, confirm the terminator, CR, wiring, etc.)
ERR Line	Control line error	The control line is not operating correctly. Confirm the wiring of the control line.
ERR Cmd.	Command error	A command contained in the receive data is not consistent with the send command from the GOT.

23.5 Ethernet Check

Ethernet check function

The Ethernet status check function sends a ping to check the connection status of Ethernet.

Display operation of Ethernet check

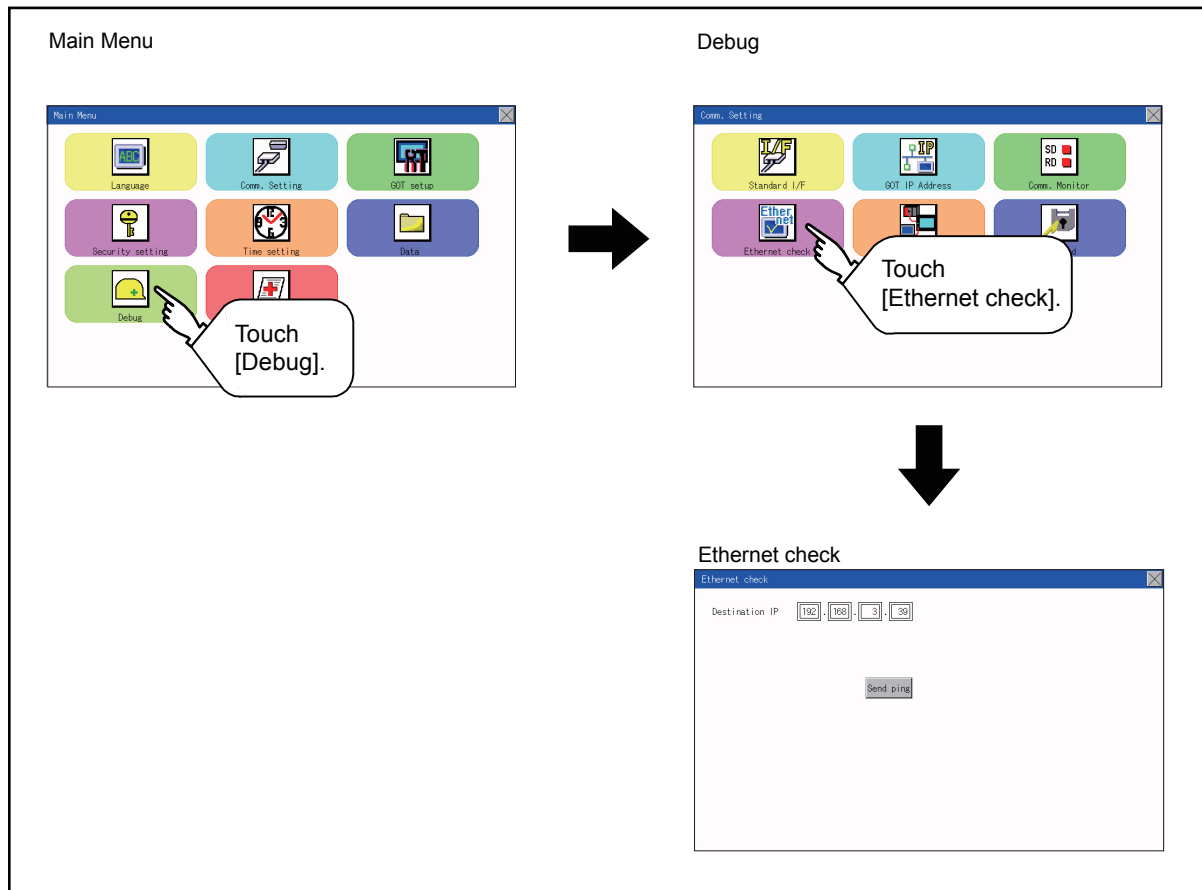

Operation of Ethernet status check

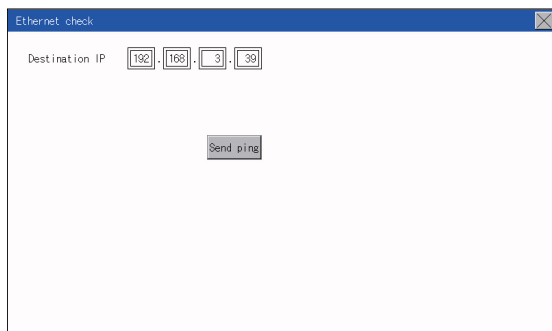

1. If the select button of [Destination IP] is touched, a keyboard is displayed. Enter the IP address of the other terminal with the keyboard. <Default: 192.168.3.39>

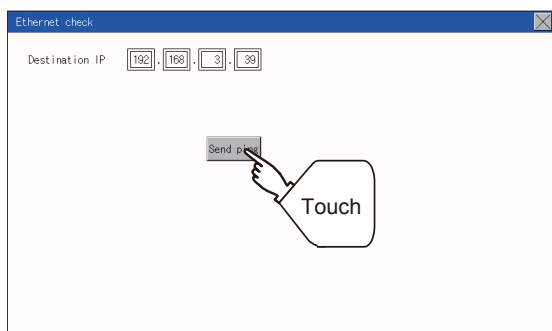

2. If the [Send ping] button is touched, a ping is sent to the IP address entered in [Destination IP]. The timeout time is five seconds.

When the communication is completed

The [Response received.] dialog box is displayed.

When a communication error occurs

The [Timeout occurred.] dialog box is displayed.

23.6 Setting the Transparent Mode

Function of the transparent mode

When using the multi-channel function, the channel No. of a controller to which the FA transparent function is executed can be set. For the multi-channel function and the FA transparent function, refer to the following.

📖 GOT2000 Series Connection Manual (Mitsubishi Product) For GT Works3 Version1

Function	Description	Setting range
ChNo.	The channel No. of a controller to which the FA transparent function is executed can be set.	1/2 (Default: 1)

Display operation the transparent mode setting

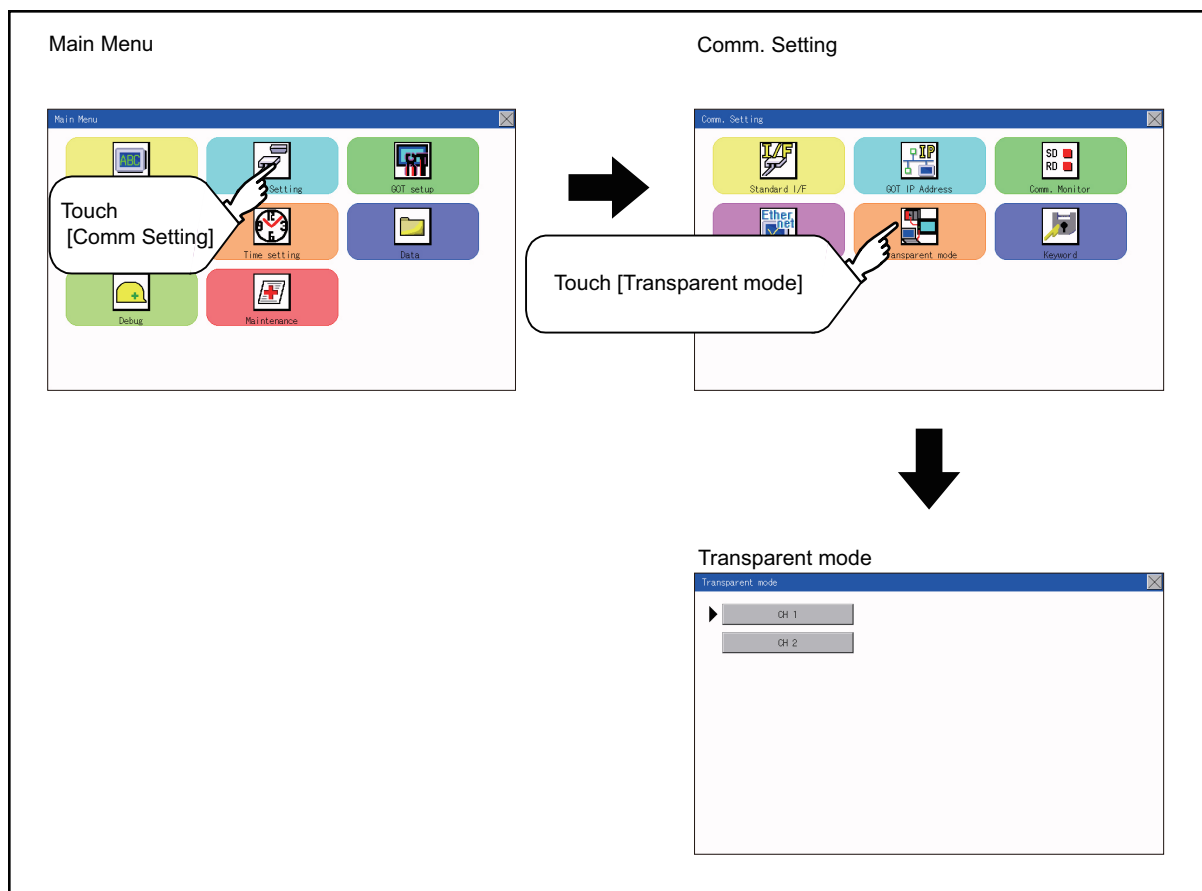

Operation the transparent mode

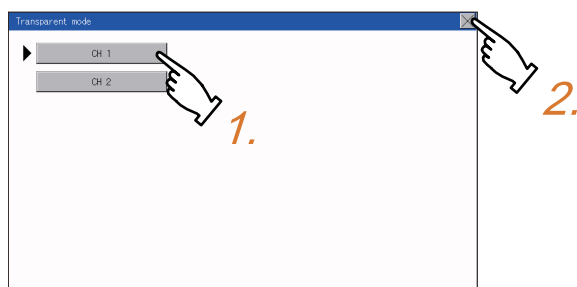

1. When the transparent ChNo. (numerical part) on the left is touched, the screen for selecting a communication driver is displayed. Select the channel to execute the FA transparent function.
2. If the [X] button is touched, it returns to the GOT setup screen.

23.7 Keyword

Keyword functions

The operation related to a keyword of the FX series PLC can be performed.

Function	Description
Regist	Keyword is registered.
Delete	Registered keyword is deleted.
Clear	Keyword protection is cleared.
Protect	A keyword with cleared protection is reactivated for protection.

Keyword display operation

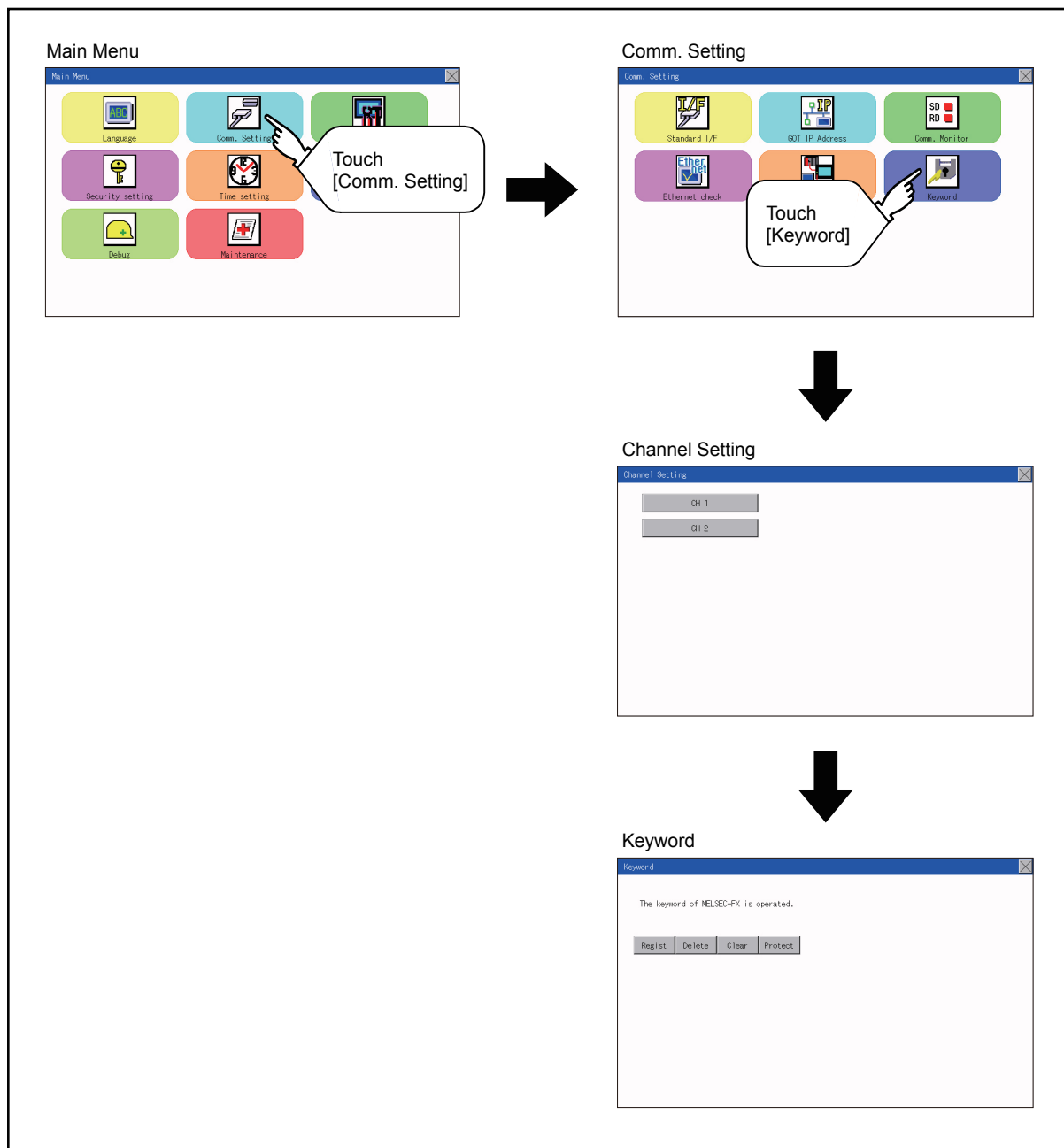

Regist

Keyword is registered.

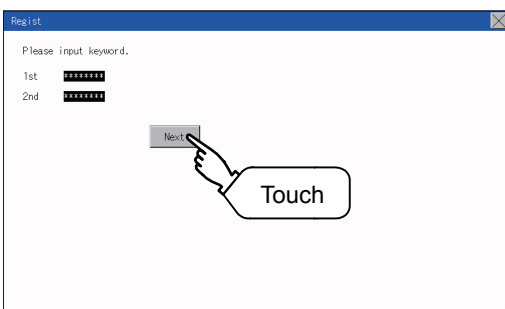
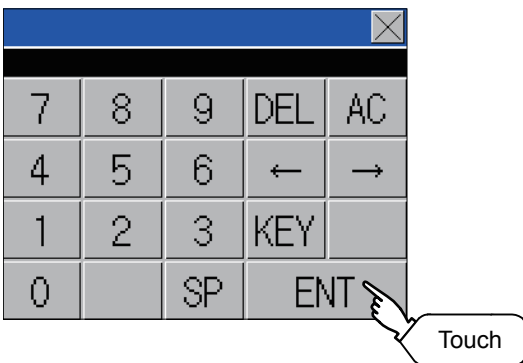
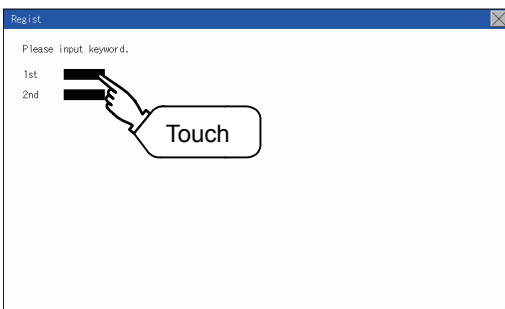
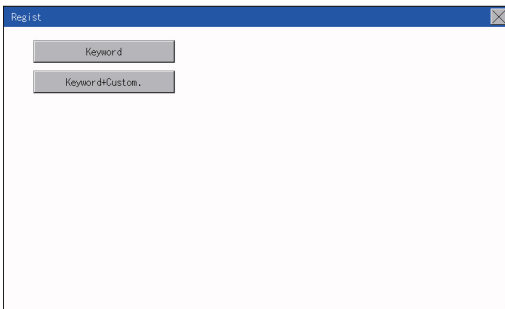
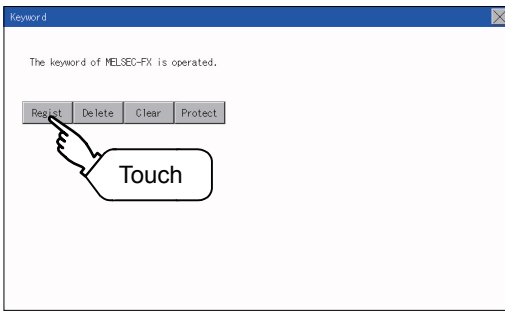

1. Touch "Regist" to display the selection screen for the registration. For the FX series PLC, which is not compatible with Customer Keyword, the keyword entry screen of [Step3] is displayed. Start the operation from [Step3]. For the Customer Keyword compatible models, refer to the manual of the PLC to be used.
2. Select [Keyword] or [Keyword+Custom]. To register only Keyword and 2nd keyword, touch [Keyword]. To register Customer Keyword, touch [Keyword+Custom].
3. Input a keyword. Touch the display part of the keyword to be registered.
4. The keyboard for entering a keyword is displayed. Character types to be input can be changed by touching the [KEY] button. Enter a keyword and touch the [ENT] key. For the keyword, 8 digits from 0 to 9 or A to F must be set.
5. After completing the keyword entry, touch [Next]. When [Keyword+Custom] is selected on the selection screen for the registration, the Customer Keyword entry screen is displayed. Enter it in the same way as for Keyword and 2nd keyword.

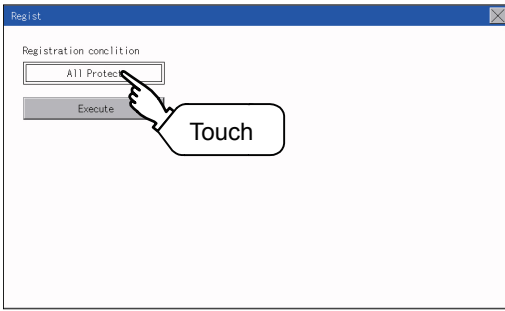

6. Set the registration condition. Touch the condition to change the selection.

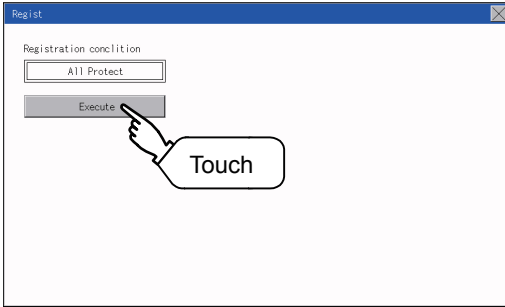

7. After setting the registration condition, touch the [Execute] key. The registration of the keyword is completed.

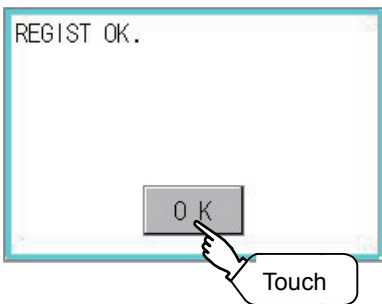

8. The registration of the keyword is completed. Touch [OK].

Selection availability of Registration condition

The following table lists the PLCs for which registration condition can be selected.

Target PLC	Setting	
	When keyword and 2nd keyword are registered	When only keyword is registered
FX PLC compatible with 2nd keyword*1	Registration options can be selected.*2	Registration options cannot be selected.
FX PLC not compatible with 2nd keyword*1	-	

*1 Refer to the manual for the PLC in use for the models that are compatible with the 2nd keyword.

*2 Registration options can be selected among "R/W Protect", "Write Protect", or "All online operation protection". For access restrictions of each setting, refer to the manual of the PLC to be used.

Selection of keyword protection level

For the devices which can perform the online operation of FX PLC, 3 levels of protection can be set.

When the monitoring or setting change by online devices is needed, set the keyword taking the following into consideration.

■When only keyword is registered

Protection level is selected by the head character of keyword.

All Protect: Set the keyword starting with one of A, D to F, or 0 to 9.

Read/incorrect write protection: Set the keyword starting with B.

Erroneous write prohibition: Set the keyword starting with C.

■When keyword and 2nd keyword are registered

23

Applicability of monitoring for each keyword protection level

The applicability of monitoring for each protection level is as follows.

Item	When only keyword is registered			When keyword and 2nd keyword are registered			Keyword unregistered /protection canceled
	All protection	Erroneous write/read protection	Erroneous write protection	All online operation protection	Read/write protection	Write protection	
Device monitoring	○	○	○	×	○	○	○
Device change	T, C setting values and file register (from D1000)	×*1	×*1	×*1	×	○	○
	Other than the above	○	○	○	×	○	○

*1 When the T, C set values are specified indirectly, changing devices is available.

Difference between "All online operation protection" and "All Protect"

When "All online operation protection" is selected, both device display and input by the programming tool or GOT are prohibited.

When "All Protect" is selected, device display and input are possible although operations by the programming tool are all prohibited.

Delete

Registered keyword is deleted.

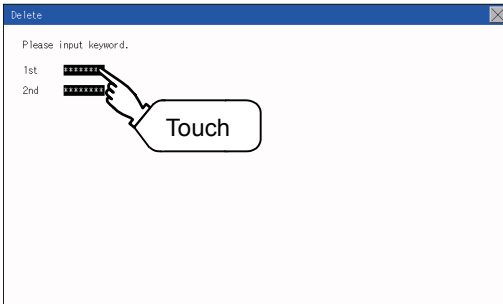
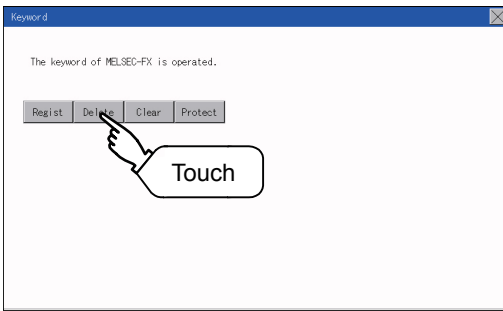

1. Touch [Delete] to display the keyword entry screen.

2. Input a keyword. Touch the display part of the registered keyword.

Target PLC	Setting
FX PLC compatible with 2nd keyword	Input a keyword to be deleted.
FX PLC not compatible with 2nd keyword	Input a keyword to be deleted only into "keyword". "2nd keyword" is ignored.

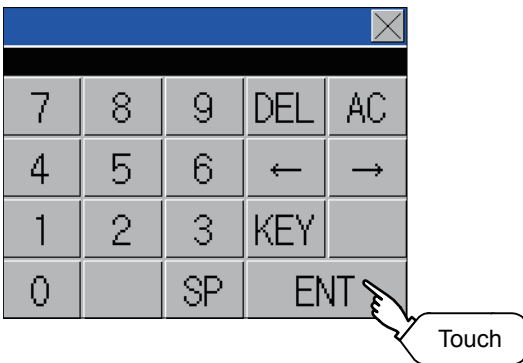

3. The keyboard for entering a keyword is displayed. Enter a keyword and touch the [ENT] key. Character types to be input can be changed by touching the [KEY] button.

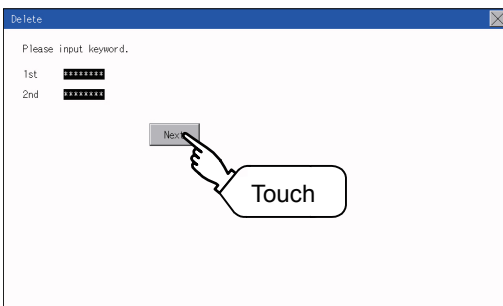

4. After completing the keyword entry, touch [Next].

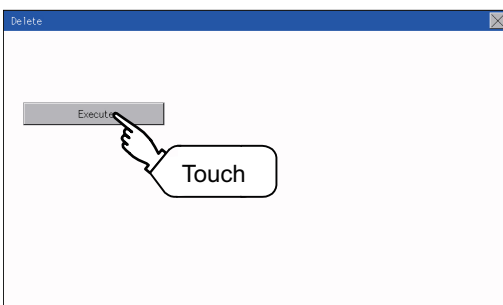

5. Touch the [Execute] key.

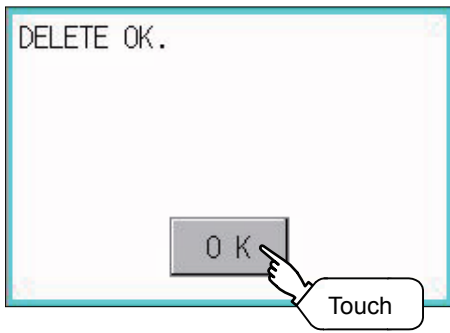

6. The keyword is deleted. Touch [OK].

Clear

To access an FX PLC where a keyword has been registered, keyword protection is cleared.

1. Touch [Clear] to display the keyword entry screen.

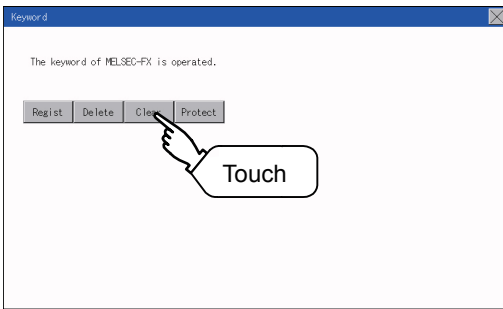

2. Input a keyword. Touch the display part of the registered keyword.

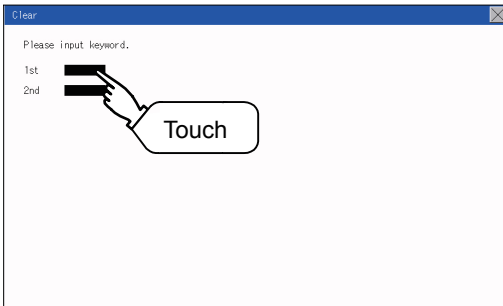

Target PLC	Setting
FX PLC compatible with customer keyword	Input a keyword or customer keyword to clear the protection.
FX PLC compatible with 2nd keyword	Input a keyword to clear the protection.
FX PLC not compatible with 2nd keyword	Input a keyword into "keyword" to clear the protection. "2nd keyword" is ignored.

3. The keyboard for entering a keyword is displayed. Enter a keyword and touch the [ENT] key. Character types to be input can be changed by touching the [KEY] button.

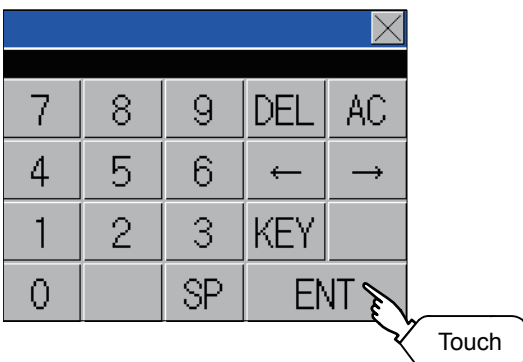

4. After completing the keyword entry, touch [Next].

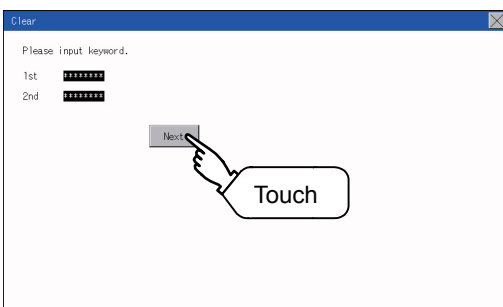

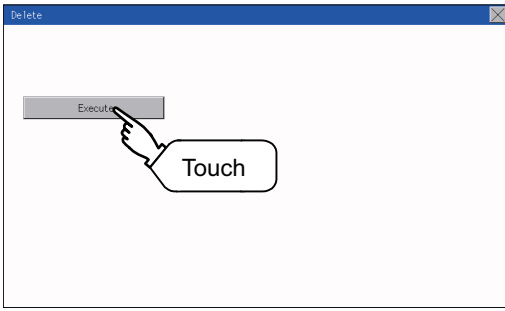

5. Touch the [Execute] key.

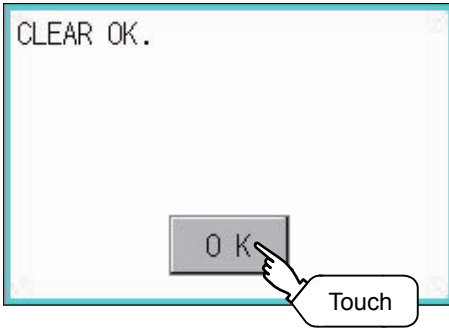

6. The protection is cleared. Touch [OK].

Protect

A keyword with cleared protection is reactivated for protection. Keyword protection function is valid when the 2nd keyword is registered.

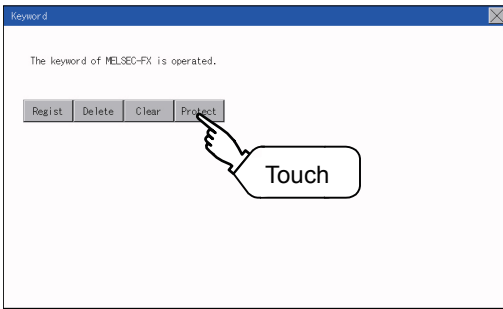

1. Touch [Protect] to switch to the keyword protection status.

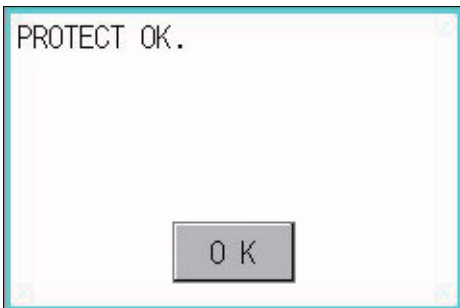

2. The keyword is protected. Touch [OK].

24 DISPLAY AND OPERATION SETTINGS (GOT SET UP)

The setting screens related to the display or operation can be displayed from the utility screen.

In the setting screen for display and the setting screen for operation, the following settings can be set.

Item	Description	Reference
Display settings	Setting the title display period and screen saving time	☞ Page 221 Display setting functions
	Brightness	
Operation settings	Setting buzzer volume, window move buzzer, and key reaction speed	☞ Page 226 Setting operation of operation
	Touch panel calibration	☞ Page 227 Position correction of the touch panel (touch panel calibration setting)
	Utility call key	☞ Page 229 Setting the utility call keys

24.1 Display Settings

Display setting functions

Display-related settings can be configured.

The following items can be set. Touch each item to make the settings configurable.

Item	Description	Setting range
Opening time	The title display period at the main unit boot can be set.	0 to 60 seconds ^{*1} (At factory shipment: 5 seconds)
Screen save time	The period from the user stops the touch panel operation till the screen save function starts can be set.	0 to 60 minutes (At factory shipment: 0 minute)
Brightness	Brightness can be adjusted. ☞ Page 223 Brightness	-

*1 Even if 0 is set, the title screen is still displayed. The title screen is always displayed for 4 seconds or more (depending on the project data).

Point

- Display setting by GT Designer3

Set title display period, screen save time and screen save backlight by selecting [Common] → [GOT Environmental Setting] → [GOT Setup] on GT Designer3.

When change a part of the setting, change the setting by the GOT display setting after downloading the project data.

☞ GT Designer3 (GOT2000) Screen Design Manual

- Screen save time

By using the system information function, the screen save function can forcibly enabled from a controller (Forced Screen Saver Disable Signal) or the screen saving time set in the utility can be disabled (Automatic Screen Saver Disable Signal).

☞ GT Designer3 (GOT2000) Screen Design Manual

Display operation of display setting

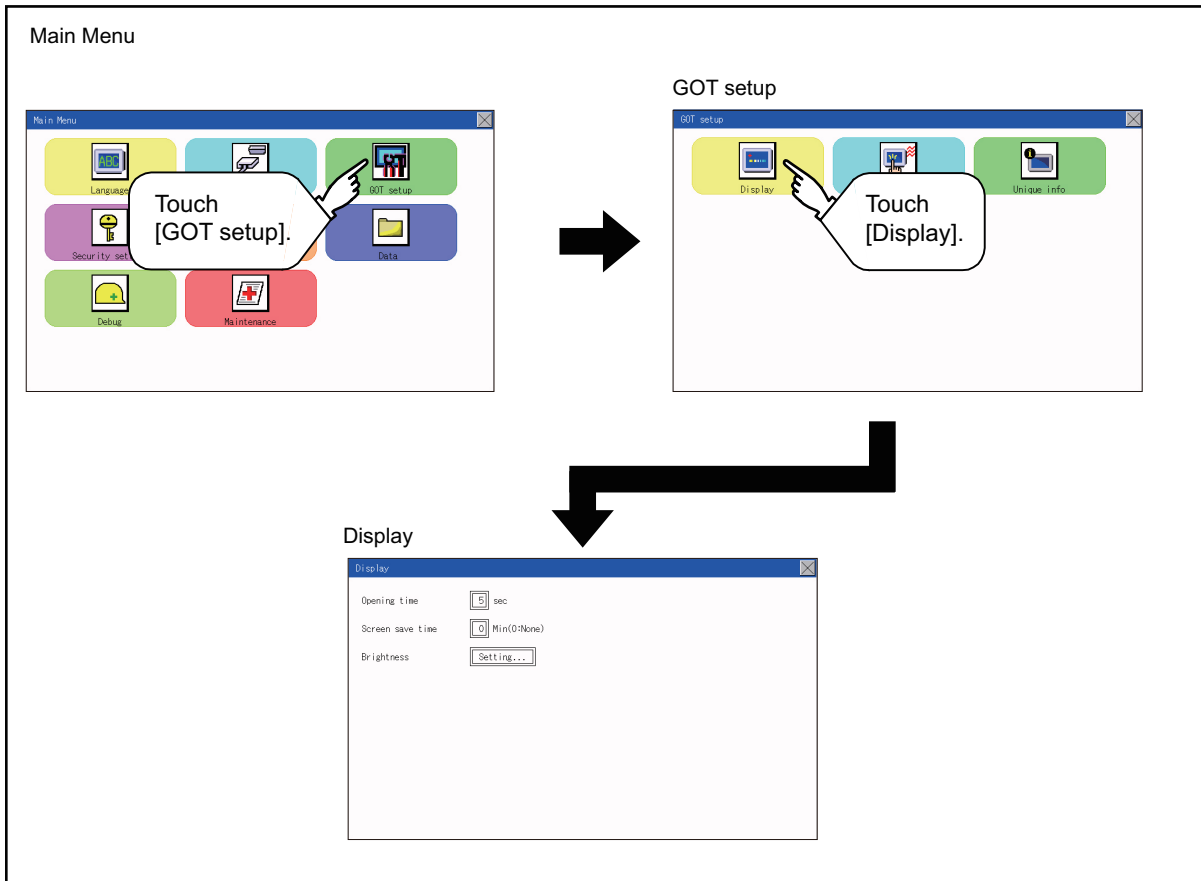

Display setting operations

The title display period and screen saving time

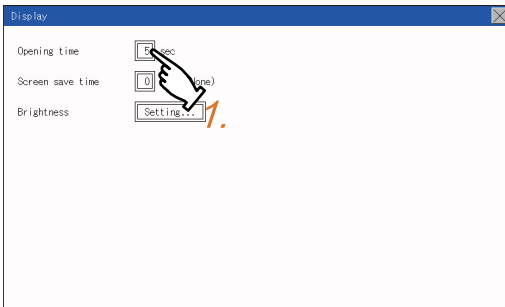

1. If the setting items (numbers) are touched, a keyboard is displayed. Input numeric with the keyboard.

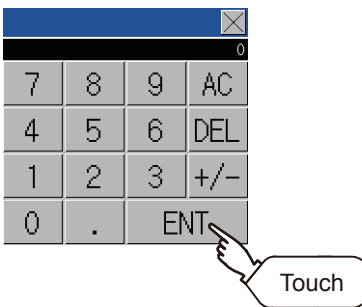

2. Set the title display period with the ten-key pad window and touch "ENT".

Brightness

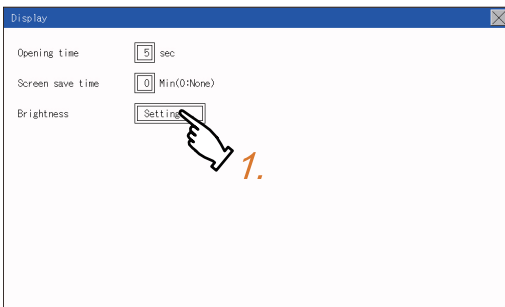

1. Touch [Brightness] to bring up the Brightness setting window.

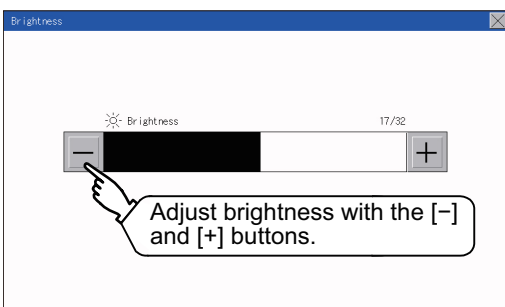

2. Touch the [+] and [-] buttons to adjust the brightness of the screen.

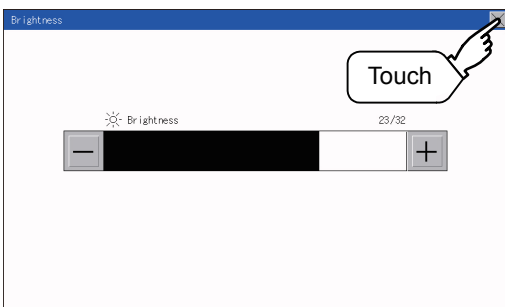



3. Touch the [X] button to reflect the setting.

24.2 Operation Setting (Settings for Operation)

Operation setting functions

Setting regarding GOT operation can be set.

The following items can be set. Touch each item to make the settings configurable.

Function	Description	Setting range
Buzzer volume	Buzzer volume setting can be changed.	OFF/SHORT/LONG (At factory shipment: SHORT)
Window move buzzer	Whether turn ON/OFF buzzer when move window can be selected.	ON/OFF (At factory shipment: ON)
Key reaction	The touch panel sensitivity when touching the GOT screen can be set. (For preventing chattering)	± 0 to $+120^{*1}$
Calibration	Calibrates the touch panel sensitivity.  Page 227 Position correction of the touch panel (touch panel calibration setting)	-
Utility call	Utility call key setting screen can be displayed.  Page 229 Setting the utility call keys	-

*1 At higher value set for [Key reaction], the slower the key responds.

"Key reaction" [ms]	Standard (± 0)	+10	+20	+40	+80	+120
---------------------	----------------------	-----	-----	-----	-----	------

For example, when the GOT recognizes touching the GOT screen once as touching the screen twice, set a higher value for [Key reaction].

Point

Operation setting by GT Designer3

Set buzzer volume and window move buzzer volume by selecting [Common] → [GOT Environmental Setting] → [GOT Setup] of GT Designer3.

When change a part of the setting, change the setting by the GOT display setting after downloading the project data.

 GT Designer3 (GOT2000) Screen Design Manual

Display operation of operation setting

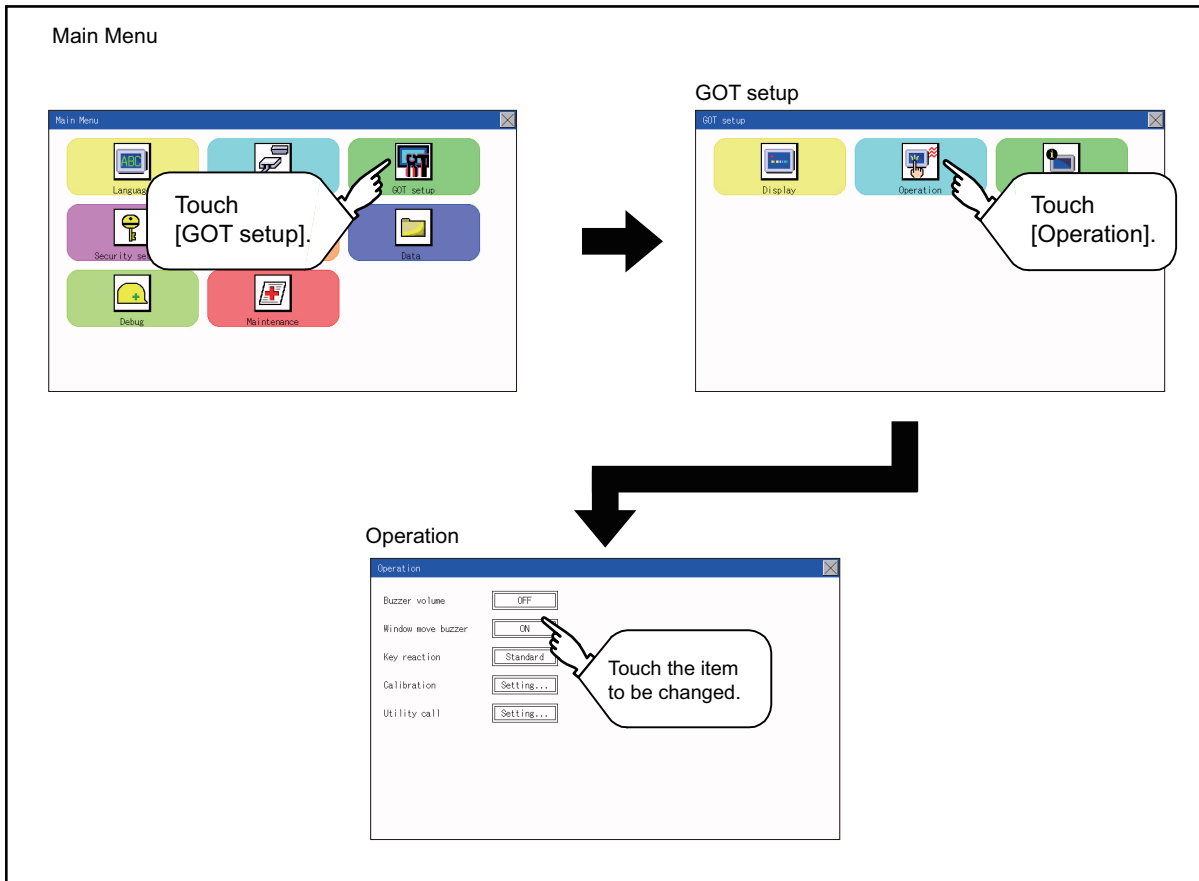

Setting operation of operation

Buzzer volume

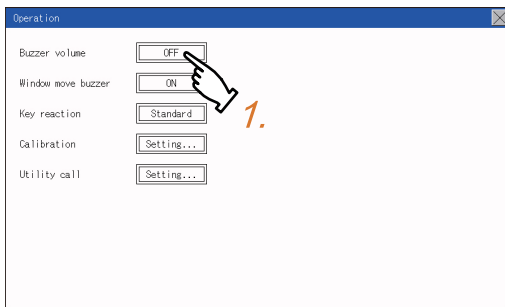

1. Touch a setting item to change the setting.
(Buzzer volume: SHORT LONG OFF)

2. Touch the [x] button to save the changes.

Window move buzzer

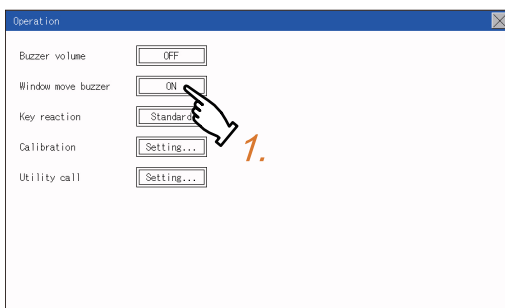

1. Touch a setting item to change the setting.
(Window move buzzer: ON OFF)

2. Touch the [x] button to save the changes.

Key reaction setting

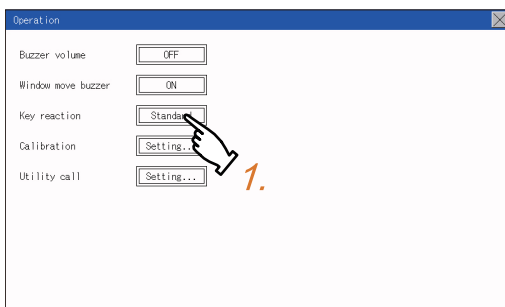

1. If touching the setup item, the setup contents are changed.*1

2. After changing the setting, touch the [x] button. The setting is saved and the setting screen is closed.

*1 At higher value set for [Key reaction], the slower the key responds.

"Key reaction" [ms]	Standard (±0)	+10	+20	+40	+80	+120

For example, when the GOT recognizes touching the GOT screen once as touching the screen twice, set a higher value for [Key reaction].

Position correction of the touch panel (touch panel calibration setting)

Touch panel calibration setting function

Touch panel reading error can be corrected.

Normally the adjustment is not required, however, the difference between a touched position and the object position may occur as the period of use elapses.

When any difference between a touched position and the object position occurs, correct the position with this function.

Before adjustment

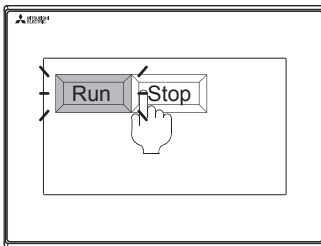

The [Run] will operate though you intended to touch the [Stop] button.

After adjustment

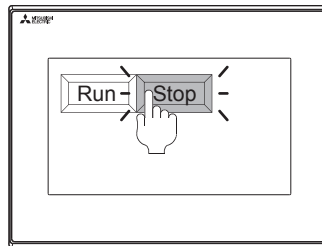

The [Stop] button can be touched without fail.

Touch panel calibration setting display operation

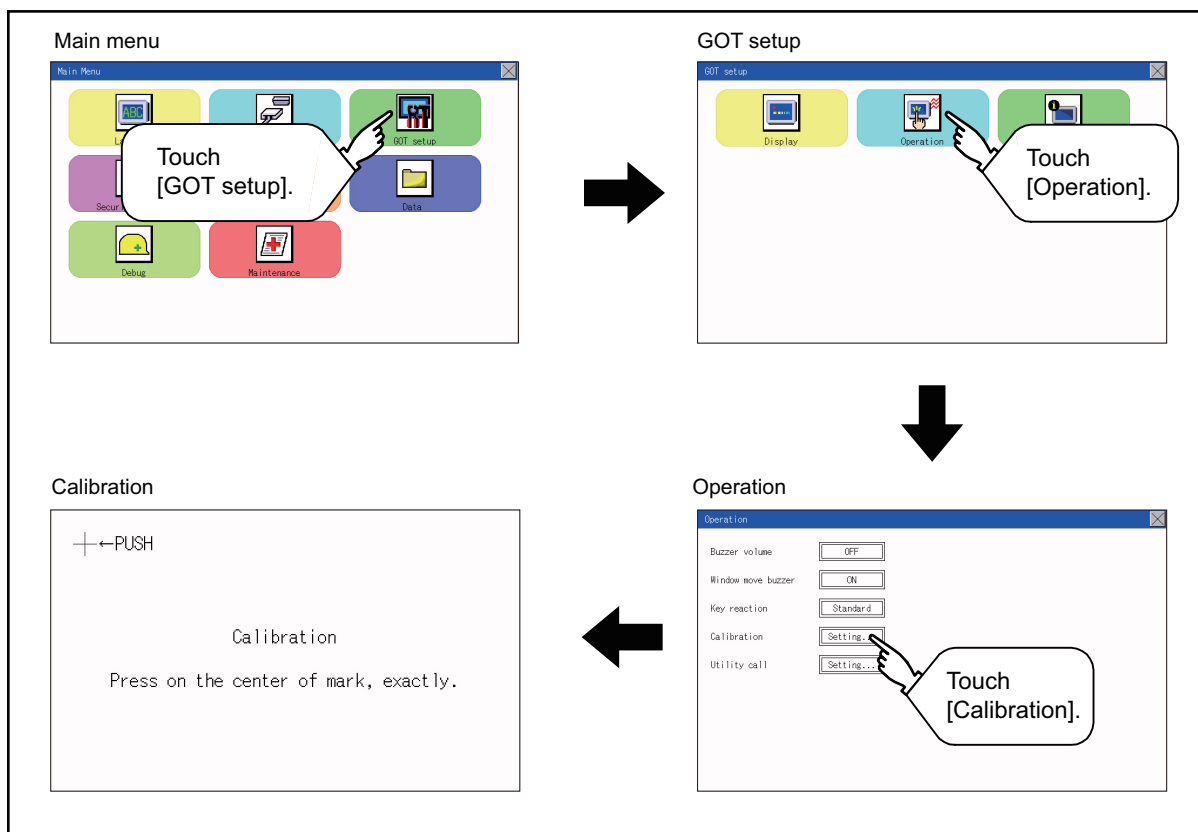

Touch panel calibration operation

Touch [+] displayed on the screen with the finger one by one to make the setting.

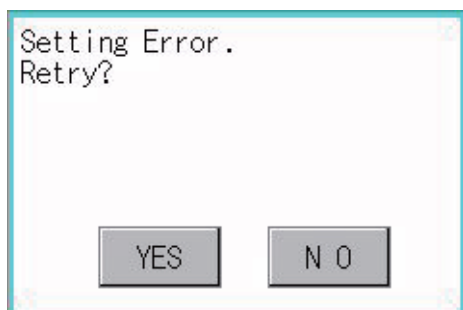
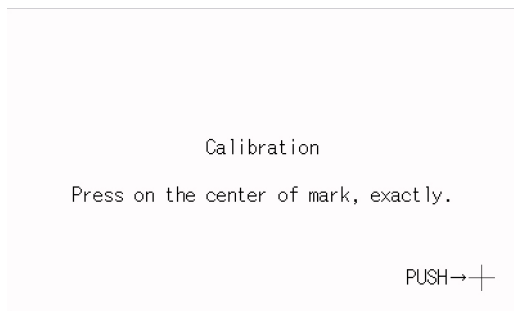
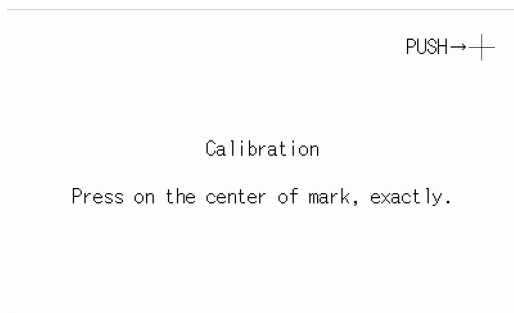
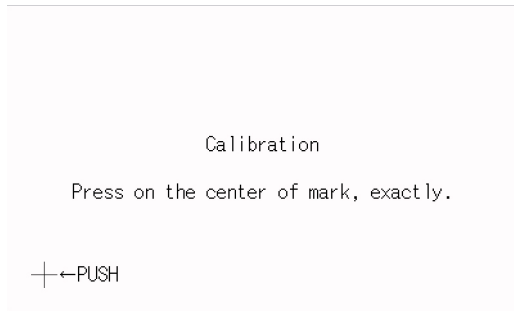
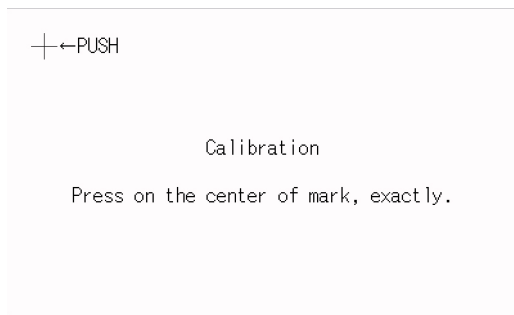

1. Touch the center of [+] displayed on the upper left precisely.
2. Touch [+] displayed on the lower left.
3. Touch [+] displayed on the upper right.
4. Touch [+] displayed on the lower right.
5. When the precise touch could not be made, touch the [YES] button to make the setting from Step1 again.

Setting the utility call keys

Utility call key setting function

The key position for calling the main menu of the utility can be specified.

For the key position, the specification of 1 point from 4 corners on the screen, or no specification (0 point), can be set.

By keeping pressing the screen, a setting to switch the screen to the utility is available.

This prevents a switching to the utility by an unintentional operation.

Point

Operation setting by GT Designer3

Set the utility call key by selecting [Common] → [GOT Environmental Setting] → [GOT Setup] from GT Designer3.

When change a part of the setting, change the setting by the GOT display setting after downloading the project data.



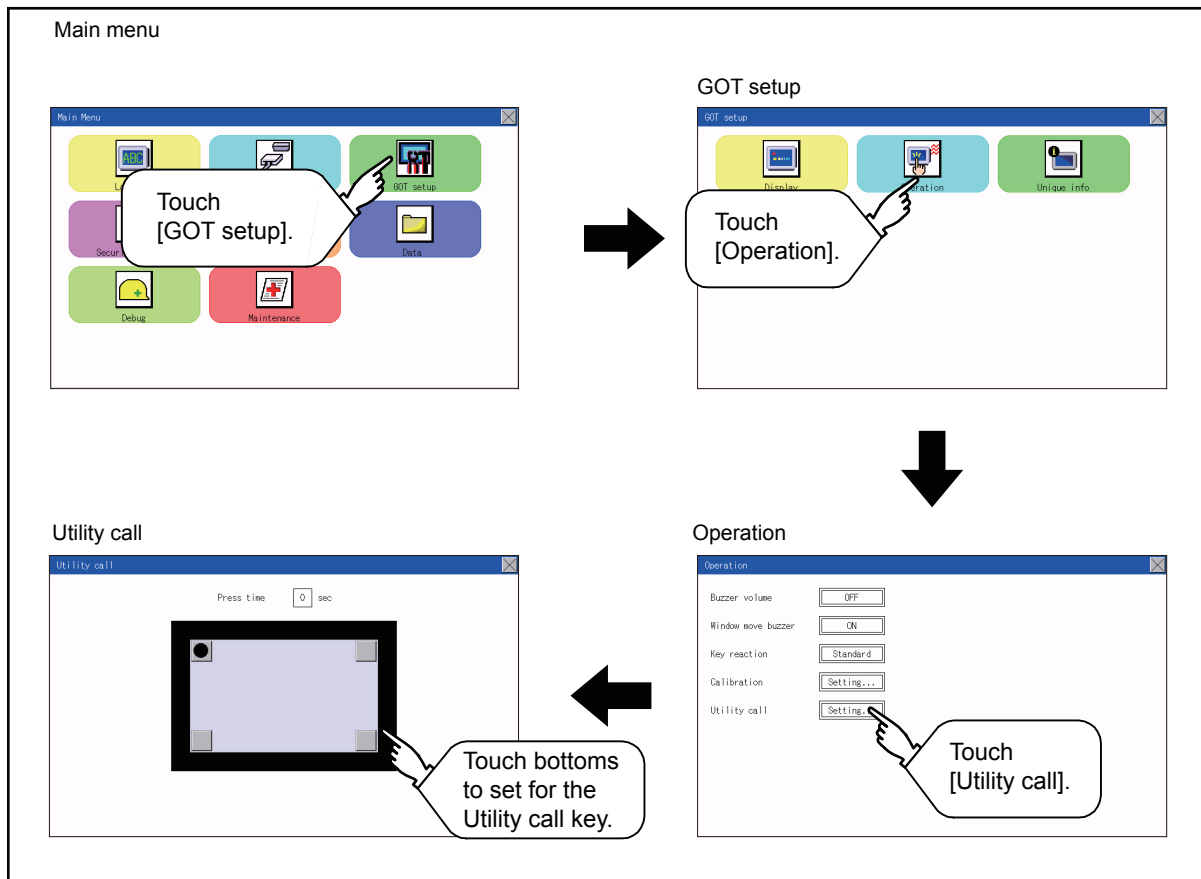

📖GT Designer3 (GOT2000) Screen Design Manual

Utility call key display operation

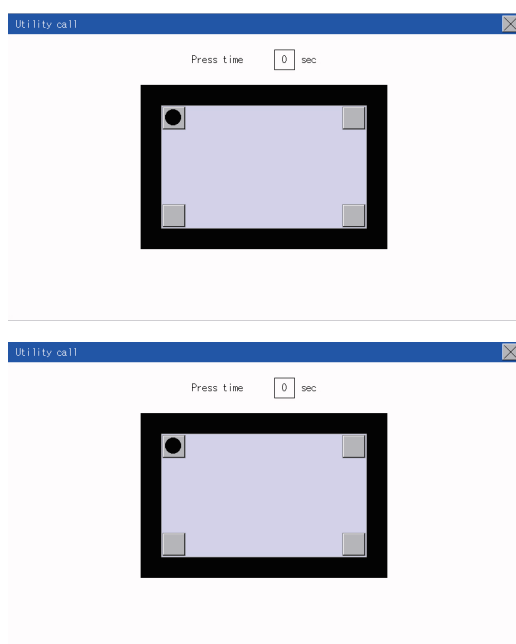

Utility call key setting operation



1. Touch  or  displayed at the four corners of the setting screen. The button repeats   every time it is pressed. Change the part to be set as a key position to . For the key position, 0 or 1 point can be specified.
2. When setting 1 point, specify the time to switch to the utility in case of keeping pressing the key position. Touch the time input area.
3. Touching the input area displays a keyboard. Input numeric with the keyboard.
4. Touch the [X] button to save the changes.

Point

- When the utility call key is not set (set to 0-point)

Even when the utility call key is not set (set to the zero point), you can display the main menu by performing the following operation.

Pressing the special function switch set on the user-created screen

 Page 184 Display operation of main menu

- Precautions on using the alarm popup display

When [Display Position Switching] is set to [Yes] in the alarm popup display setting, set either of the following for the utility call key.

Setting the position of the utility call key to the upper-right or lower-left corner

Setting [Press Time] of the utility call key to 1 or more seconds

When [Press Time] is set to 0 and the key position is set to the lower-left corner, the operation is as described below. If the positions of the key and the alarm popup display overlap, the utility screen appears by switching the display position of the alarm popup display.

For the alarm popup display, refer to the following.

 GT Designer3 (GOT2000) Screen Design Manual

- When limiting the display and operation of the utility

When limiting the display and operating users, set a password to the GOT using GT Designer3. If a user tries to display the main menu of the utility, the password is displayed.

Refer to the following for the details related to the password setting.

 GT Designer3 (GOT2000) Screen Design Manual

24.3 Inherent Information

Setting function for inherent information

Configure inherent information settings.

Item	Description	Setting range
GOT ID No.	Set the ID No. as the inherent information for the GOT.	0 to 32767 <Default: 0>

Display operation of inherent information

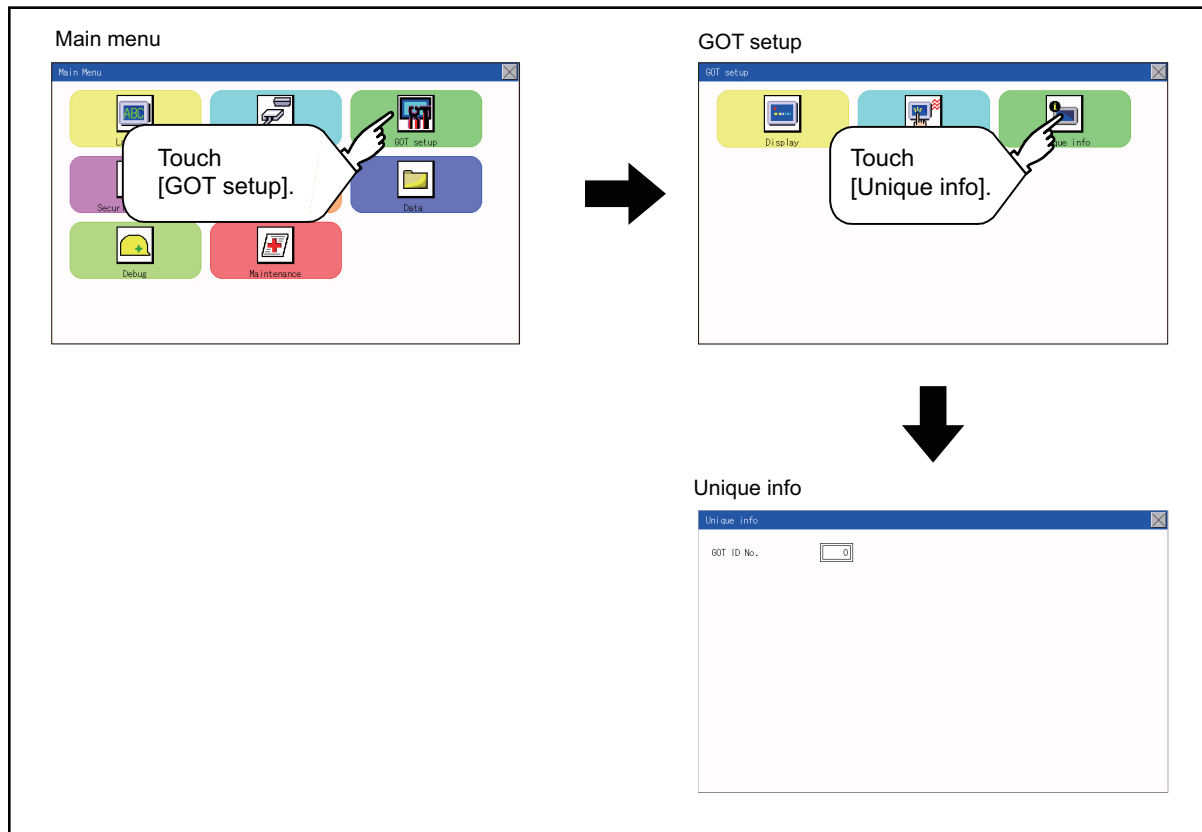

Setting operation for inherent information

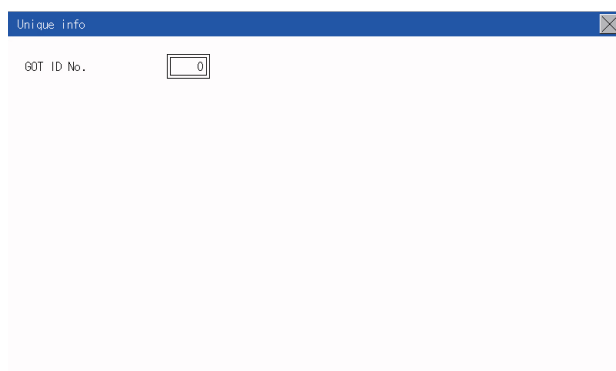

1. If touching the setting items, keyboard is displayed. Input numeric with the keyboard.
2. If touching the [x] button, the GOT restarts and operates with the changed settings.

24.4 GOT Internal Device Monitor

Setting the GOT internal device monitor

Set whether to Use/Disuse the GOT internal device monitor of GOT diagnostics.

Item	Description	Setting range
GOT dev. monitor	Set whether to Use/Disuse the GOT internal device monitor of GOT diagnostics.	Disuse/Use <Default: Disuse>
GOT device change	Set whether to Allow/Forbid the GOT internal devices to be changed.	Forbid/Allow <Default: Forbid>

GOT internal device monitor display operation

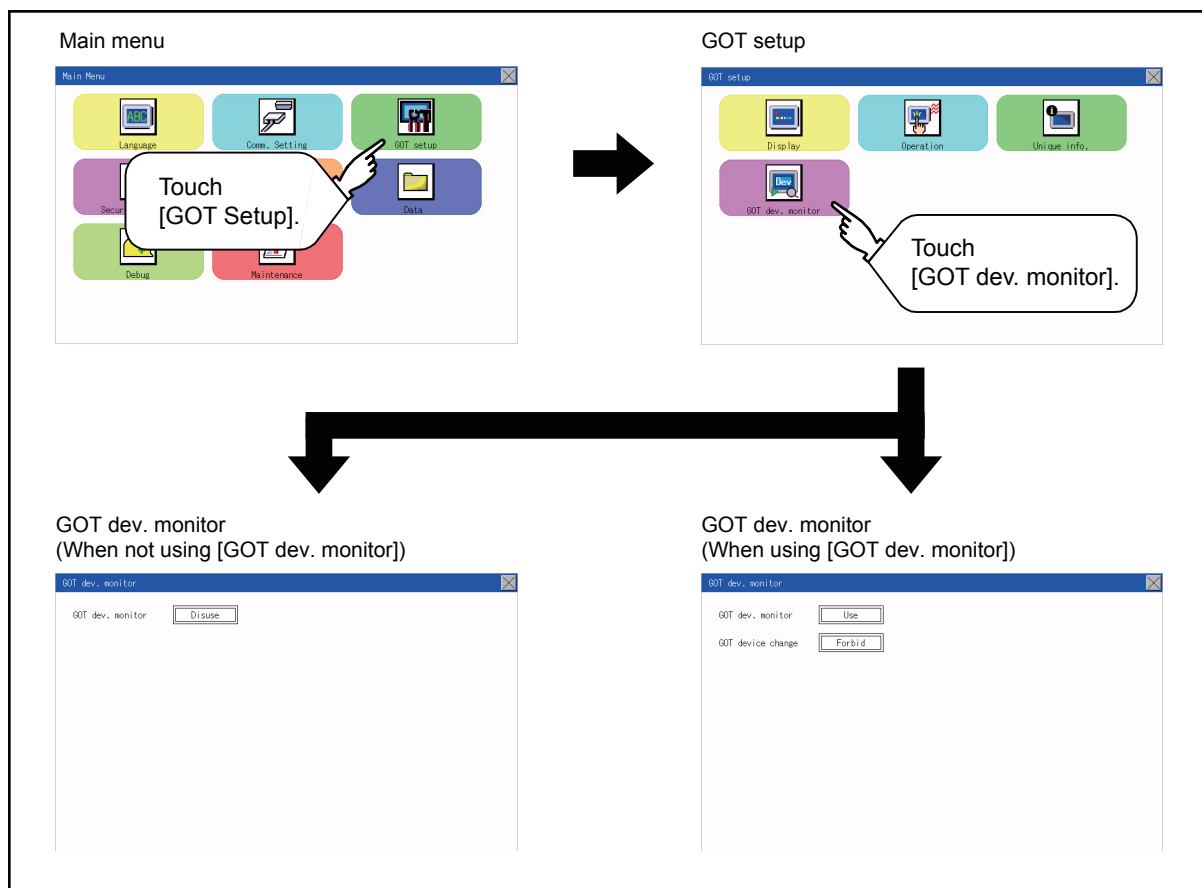

GOT internal device monitor setting operation

1. When using the GOT internal device monitor of GOT diagnostics, touch the setting item and set [Use].

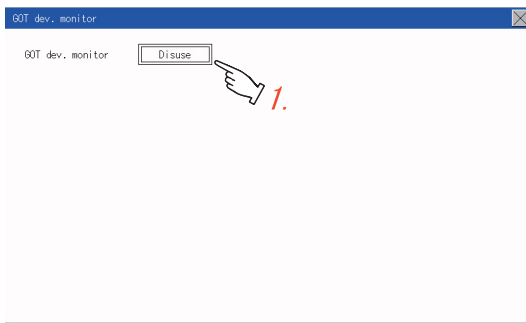

2. When allowing the GOT internal devices to be changed, touch the setting item of [GOT device change] and set [Allow].

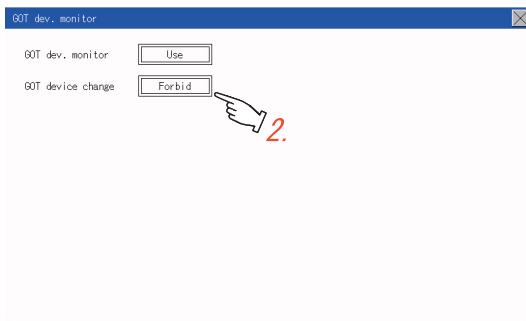

3. After changing the settings, touch the [×] button to save the changes and close the setting window.

24.5 VNC Server Function

Only available to GS21-W-N.

VNC server function setting

In the VNC server function setting, the authorization guarantee time for the VNC server function can be set. For the details of the VNC server function, refer to the following.

📖 GT Designer3 (GOT2000) Screen Design Manual

Item	Description	Setting range
Authorization guarantee time	The time that the authorized equipment holds the authorization after you operate the authorized equipment can be set. (The unauthorized equipment cannot obtain the authorization until the set time elapses.)	0 to 3600 seconds <At factory shipment: 0 seconds>

Point

- Authorization guarantee time cancel signal (GS1792.b8)
When the Authorization guarantee time cancel signal (GS1792.b8) turns on, the authorization guarantee time setting is disabled.
- Relationship with the GOT network interaction function setting
The VNC server function setting is independent of the GOT network interaction function setting. Both of the settings are enabled.

Display operation of the VNC server function setting

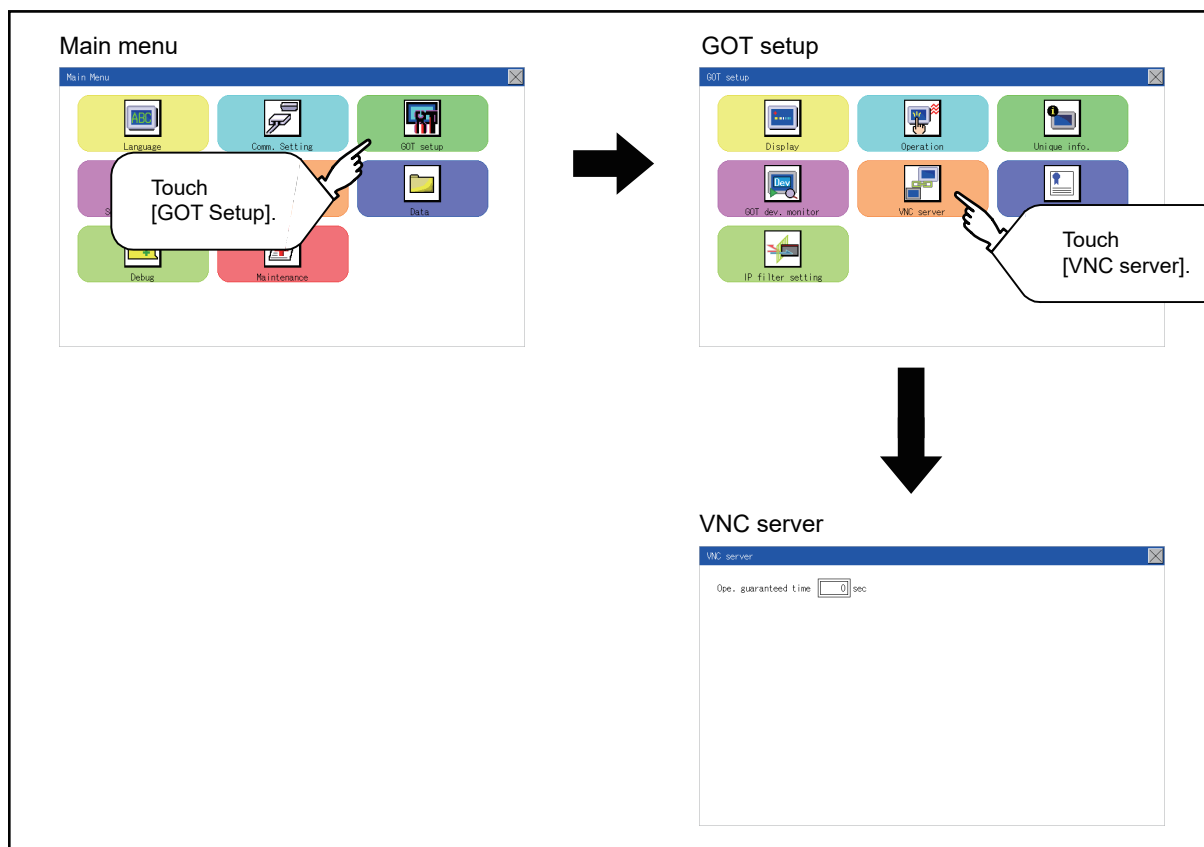

VNC server function setting operation

Authorization guarantee time

1. Touch the input field for [Ope. guaranteed time] to display a keyboard.
Input the authorization guarantee time with the keyboard.

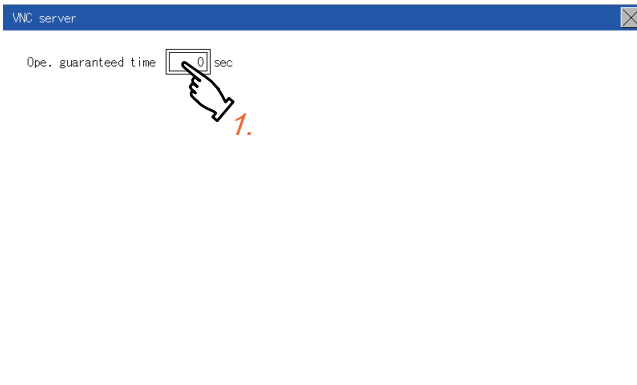

2. Touch the [x] button to apply the new setting and close the setting screen.

24.6 License Management

Only available to GS21-W-N.

License management setting

To use functions which require a license, register the license to the GOT.

To delete the license registered to the GOT, perform the operation also on the license management screen.

Item	Description	Setting range
VNC server function	Register or delete the license for the VNC server function.	-

You can register or delete licenses for the VNC server function.

For details on the VNC server function, refer to the following.

📖 Page 234 VNC Server Function

Display operation of the license management setting

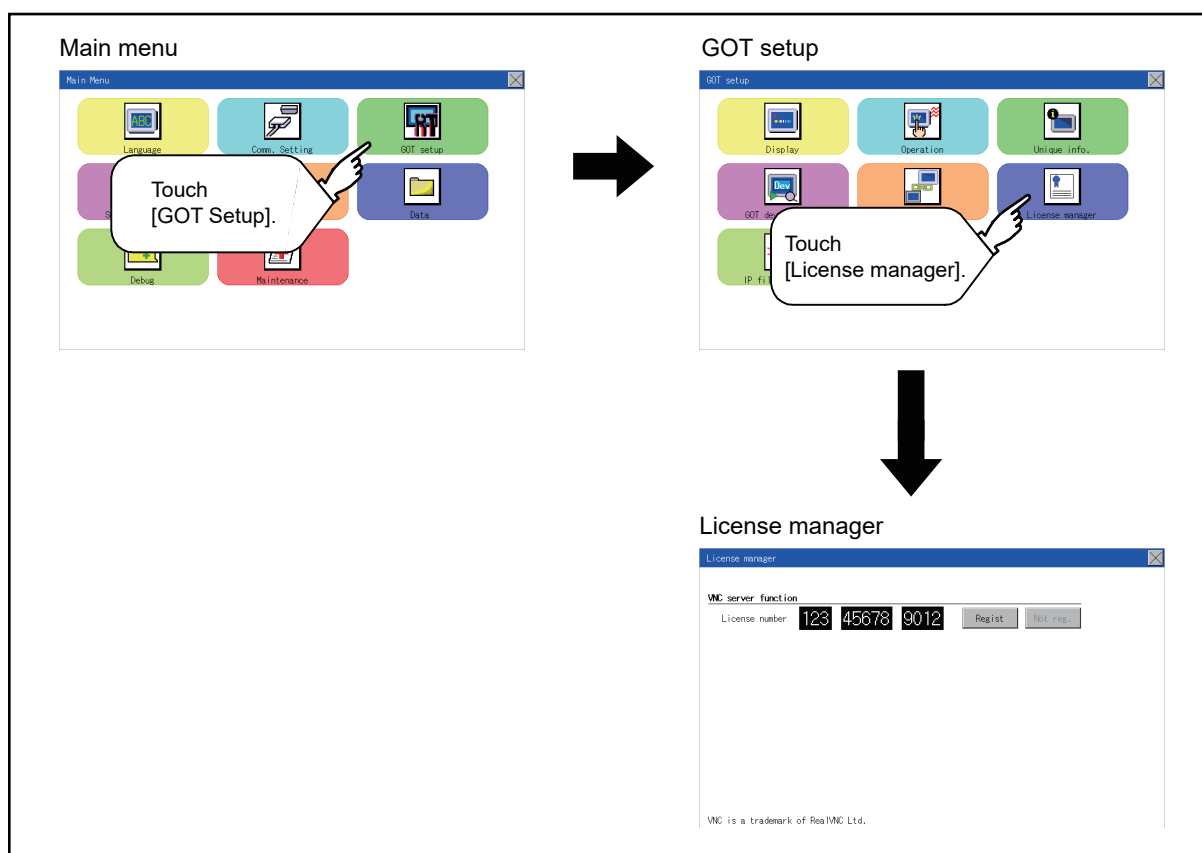

Setting operation of license management

When registering a license number for the GOT

1. Touch the license number input area on the license management screen, and then the keyboard appears on the bottom of the screen.

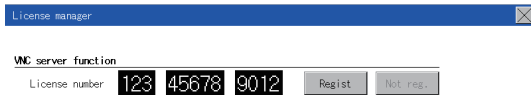

VNC is a trademark of RealVNC Ltd.

2. Touch the [Register] button to register the input license number.
If the [X] button is touched without touching the [Register] button, the license number is not registered.
3. After a license number is registered, touch the [X] button to close the license management screen.

When unregistering a license number for the GOT

1. Touch the [Cancel reg.] button to release the registered license number.

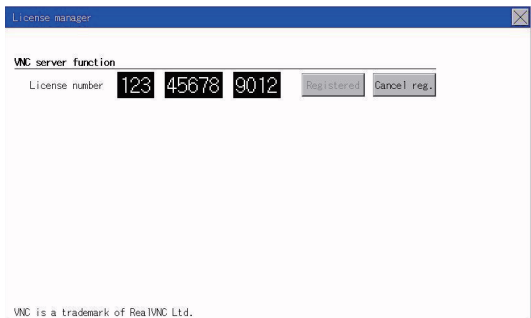

VNC is a trademark of RealVNC Ltd.

2. Touch the [X] button to close the license management screen.



How to acquire a license number
For how to obtain a license number, consult your local sales office.

24.7 IP Filter Setting

IP filter setting

IP addresses from which access to the GOT is allowed or blocked can be set.

For the details of the IP filter setting, refer to the following.

📖 GT Designer3 (GOT2000) Screen Design Manual

Item	Description	Setting range
IP filter usage	You can set whether to use or not the IP filter function.	Yes/No <Default: No>
Transmit/Block	You can set whether to allow or block access from the IP addresses specified in [IP address setting]. <ul style="list-style-type: none"> If [Transmit] is selected Access from the IP addresses that are set for [Target IP address] is allowed. Access from the IP addresses that are set for [Exception IP address] is blocked. If [Block] is selected Access from the IP addresses that are set for [Target IP address] is blocked. Access from the IP addresses that are set for [Exception IP address] is allowed. 	Transmit/Block <Default: Transmit>
IP address setting	Range	You can set whether to register IP addresses by specifying a range. To specify a range, set the start IP address and the end IP address for [Target IP address].
	Target IP address	You can set IP addresses or IP address ranges to be filtered. Up to 4 ranges can be set.
	Exception IP address	This item can be set only when [Range] is selected. For an IP address range specified in [Target IP address], set IP addresses excluded from being filtered. Up to 16 addresses can be set for one range specified in [Target IP address].

*1 Leave the boxes blank if you do not set any IP addresses.

Display operation of the IP filter setting

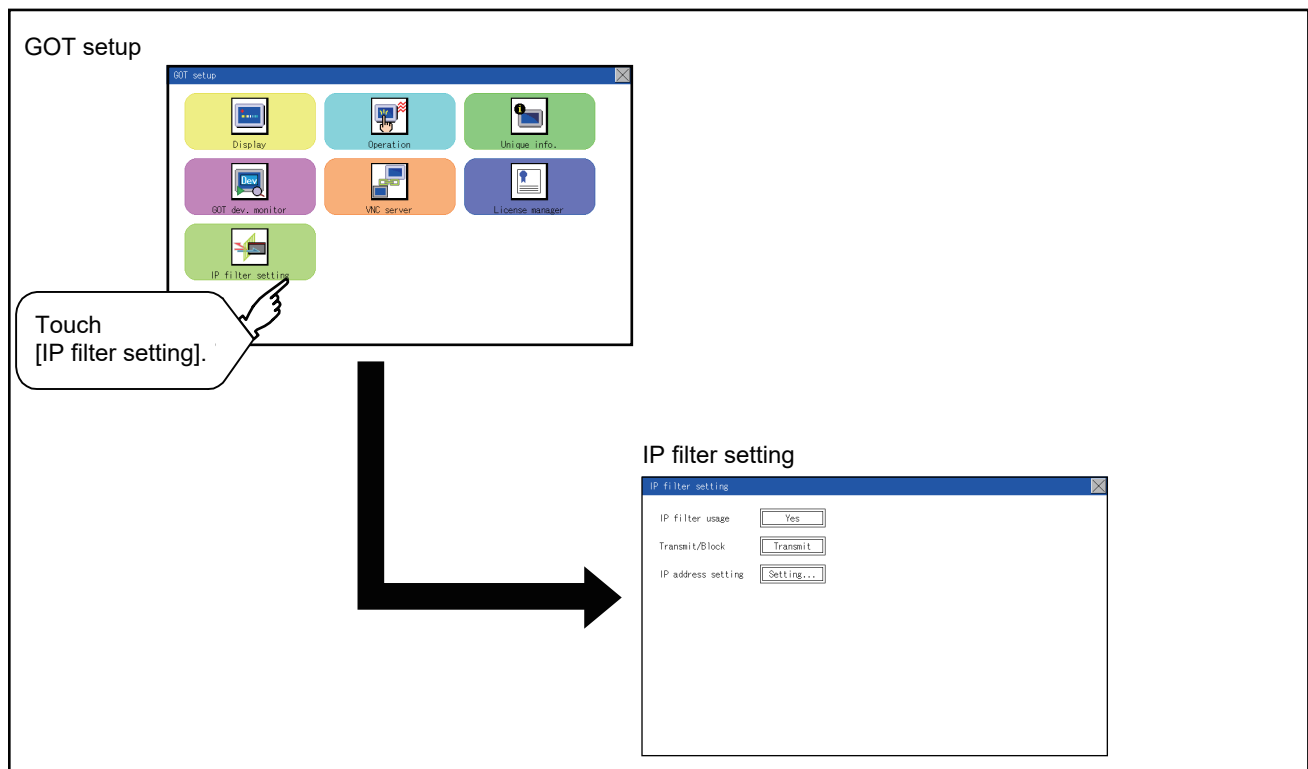

Setting procedure for the IP filter

Setting the IP filter

1. Select [Yes] for [IP filter usage] by touching the current selection.

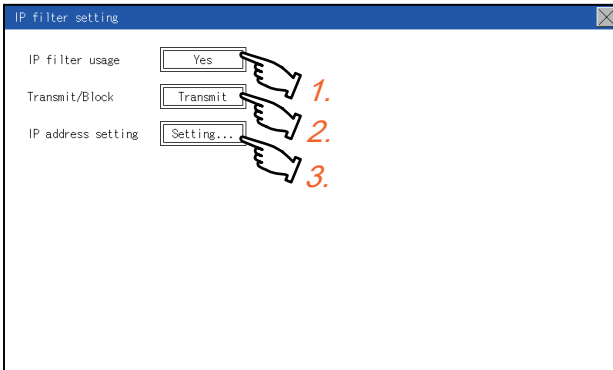

2. Select [Transmit] or [Block] for [Transmit/Block] by touching the current selection.
3. Touch the [Setting] button of [IP address setting] to display the [IP address setting] screen.

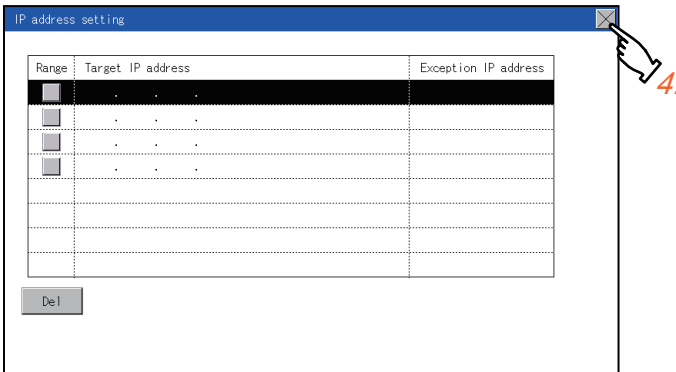

Refer to the following, and set an IP address.

- ☞ Page 240 Adding a target IP address
- ☞ Page 241 Deleting a target IP address
- ☞ Page 242 Specifying IP address ranges
- ☞ Page 243 Setting exception IP addresses

4. After configuring the settings, touch the [×] button to display the [IP filter setting] screen.
5. Touch the [×] button to display the following screen.

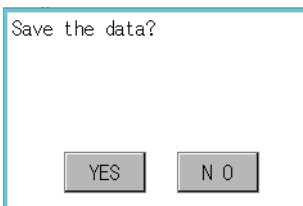

6. Touch the [YES] button to restart the GOT and reflect the setting.
To cancel the new settings, touch the [NO] button to return to the [GOT setup] screen.

■ Adding a target IP address

1. Touch a target row to select it.

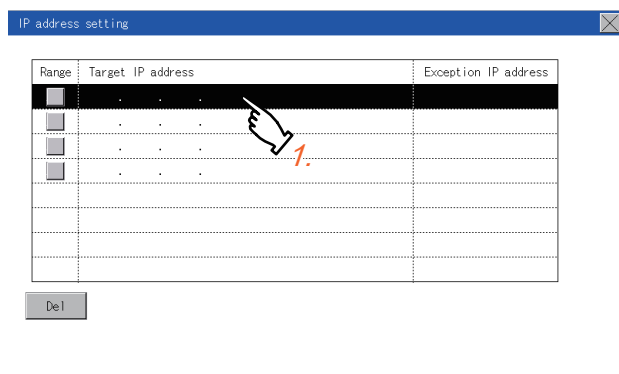

2. Touch the same row again to display the following screen.

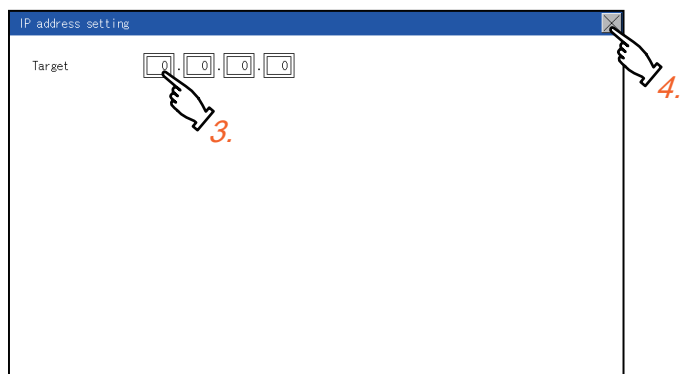

3. Touch a number to display a software keyboard.
Input an IP address to be added.
4. Touch the [x] button to display the previous screen.

■Deleting a target IP address

1. Touch a target row to select it.

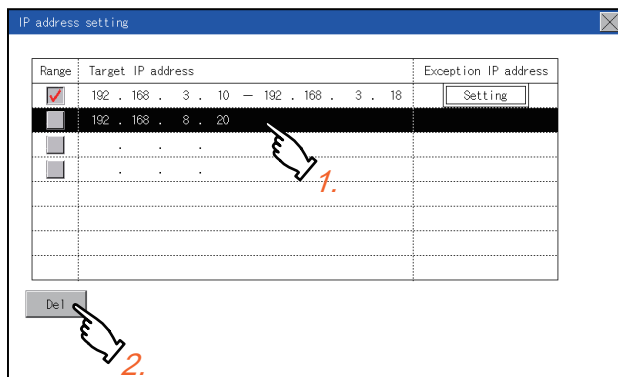

2. Touch the [Del] button to display the following screen.

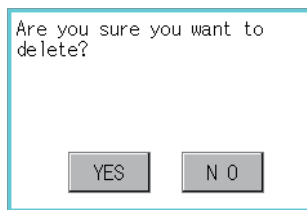

3. Touch the [YES] button to delete the selected IP address.
To cancel the deletion and return to the previous screen, touch the [NO] button.

■ Specifying IP address ranges

1. Touch a checkbox in [Range] to select the row.

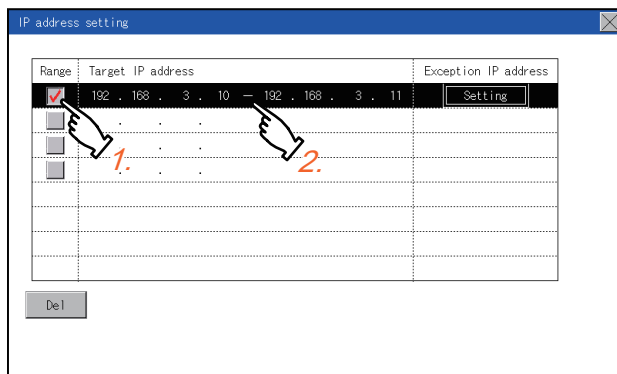

2. Touch the same row again to display the screen shown below.

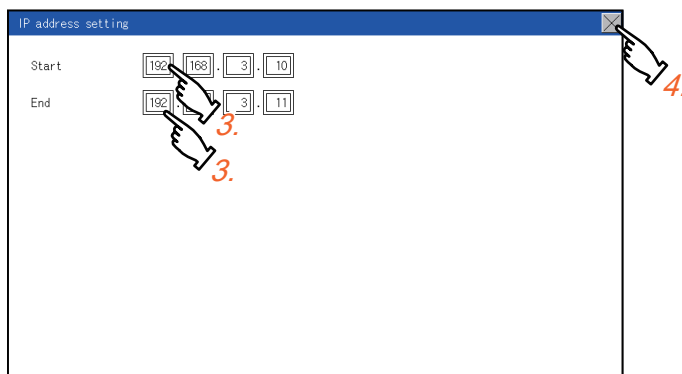

3. Touch a number to display a software keyboard. Input the start IP address and end IP address of the range to be filtered.

4. Touch the [x] button to display the previous screen.

■ Setting exception IP addresses

[Exception IP address] can be set only when [Range] is selected.

1. Select a target row, and touch the [Setting] button.

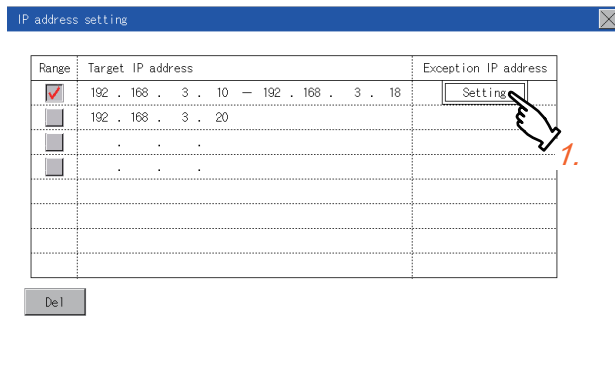

2. Touch a target row to select it.

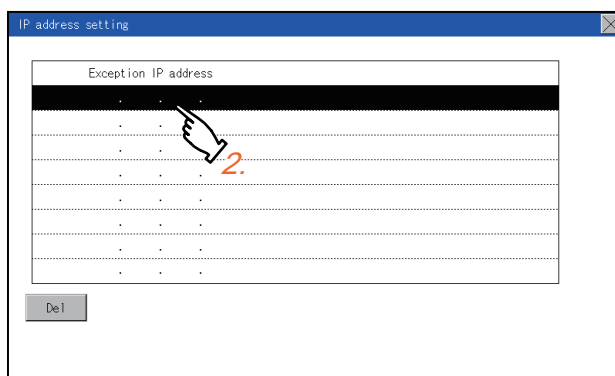

3. Touch the same row again to display the screen shown below.

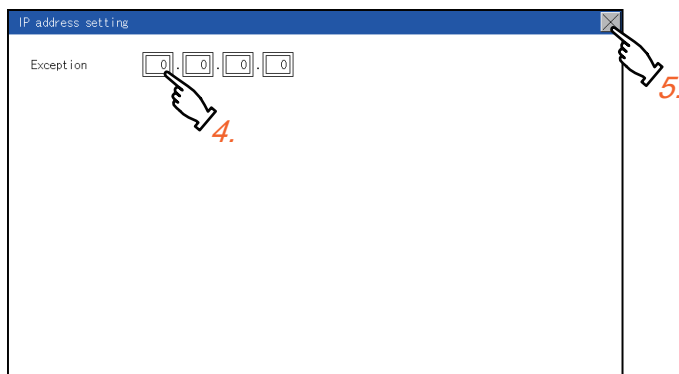

4. Touch a number to display a software keyboard. Input an exception IP address.
5. After completing the entry, touch the [x] button.
6. On the displayed screen, touch the [x] button to display the previous screen.

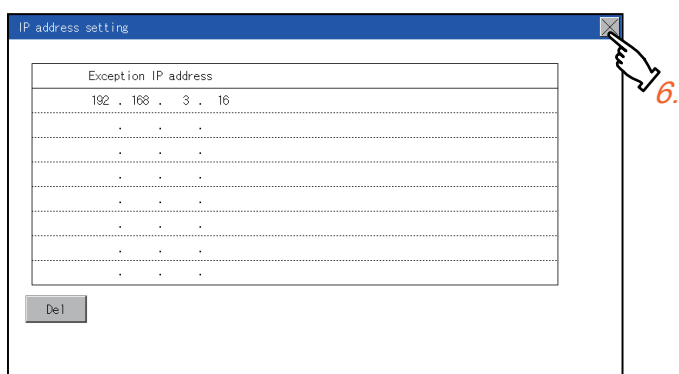

MEMO

25 SECURITY LEVEL AND OPERATOR SETTINGS (SECURITY SETTING)

25.1 Security Level Authentication

Security level change functions

Changes the security level to the same security level set by each object or screen switch.

To change the security level, enter the password for the security level set with GT Designer3.

📖 GT Designer3 (GOT2000) Screen Design Manual

Point

Restrictions on screen display

The security level change screen cannot be displayed when project data do not exist in GOT.

Change the security level after downloading the project data to GOT.

Display operation of security level change

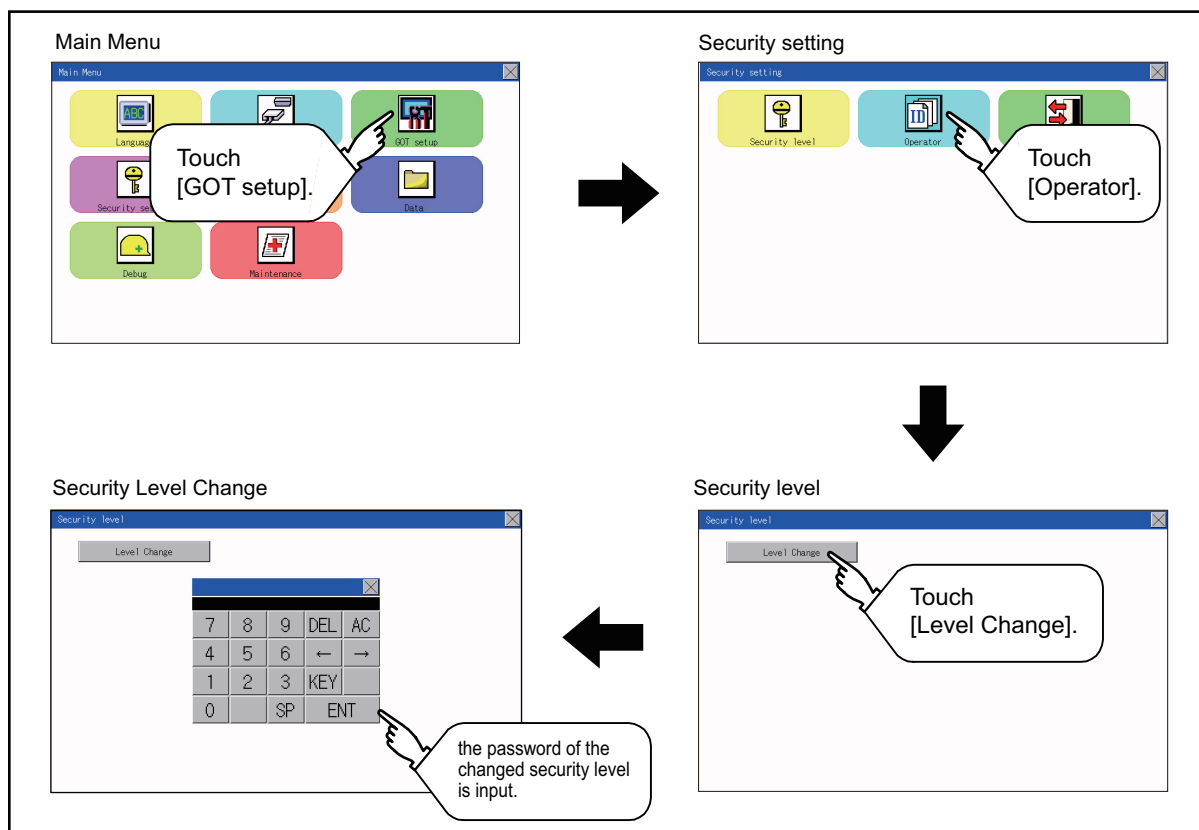

Security level change operation

■ Input operation of password

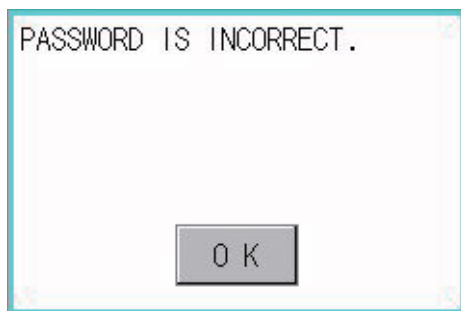
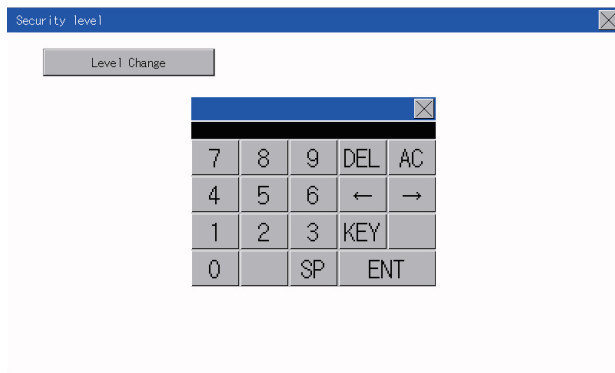

1. By touching [0] to [9], [A] to [F] key, the password of the changed security level is input. Character types to be input can be changed by touching the [KEY] button.
2. When correcting the input character, touch [Del] key to delete the correcting character and input the password again.
3. After inputting password, touch the [Enter] key. When the password is not matched, displays the error message.
4. If [OK] button is touched it returns to the password input screen again.
5. If the [x] button is touched, it returns to the security setting screen.

Point

About forgetting to return to the original level after changing security level temporarily

When use GOT after temporarily changing the security level, do not forget to return the security level to the original level.

25.2 Operator Authentication

Operator information management

Operator management

Operator management function

The function enables displaying a list of the operator information and adding, changing, or deleting the operator information to be used.

A password for operator authentication can be changed when the password is out of date.

Functions for the operator authentication (automatic logout time, authentication method, password expiration date, etc.) can be set.

For details of the operator authentication functions, refer to the following.

📖 GT Designer3 (GOT2000) Screen Design Manual

Function	Description	Reference
Operator info.	Enables adding, editing, deleting, importing, and exporting the operator information.	📖 Page 247 Operator management 📖 Page 250 Operator management
Add	Add operator information to the GOT.	📖 Page 251 Add operation
Edit	Edit the operator information stored in the GOT.	📖 Page 253 Edit operation
Delete	Delete the operator information stored in the GOT.	📖 Page 254 Deletion operation
Restore	Restore the current operator information to the previous saved one.	📖 Page 255 Import operation
Import	Import the operator information that is already exported to an SD card to the GOT.	📖 Page 255 Import operation
Export	Export the operator information stored in the GOT to an SD card.	📖 Page 256 Export operation
Password change	Enables changing passwords to be used for login and logout in/out of the GOT.	📖 Page 257 Password change
Function	Enables setting the automatic logout time and password expiration date.	📖 Page 259 Function setting

Display operation of operator management

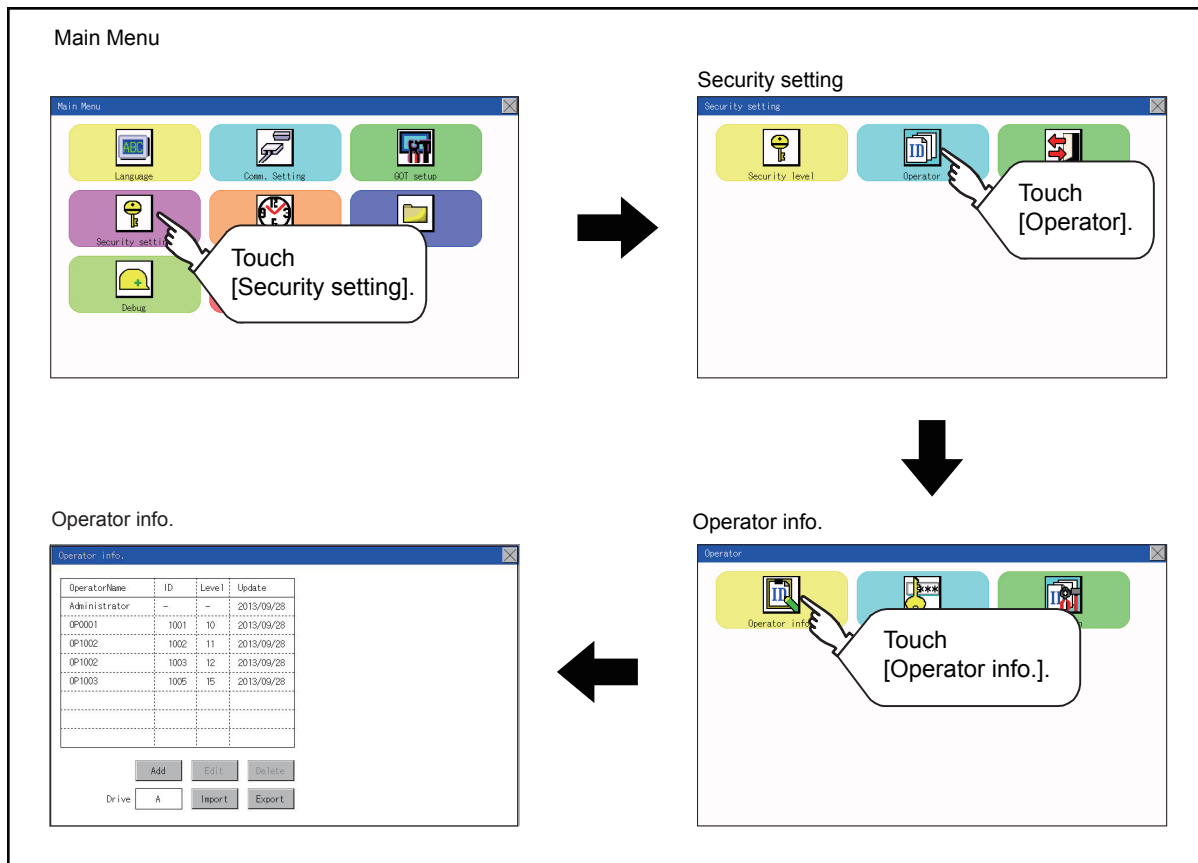

■ Display example of operator management

Operator information management screen

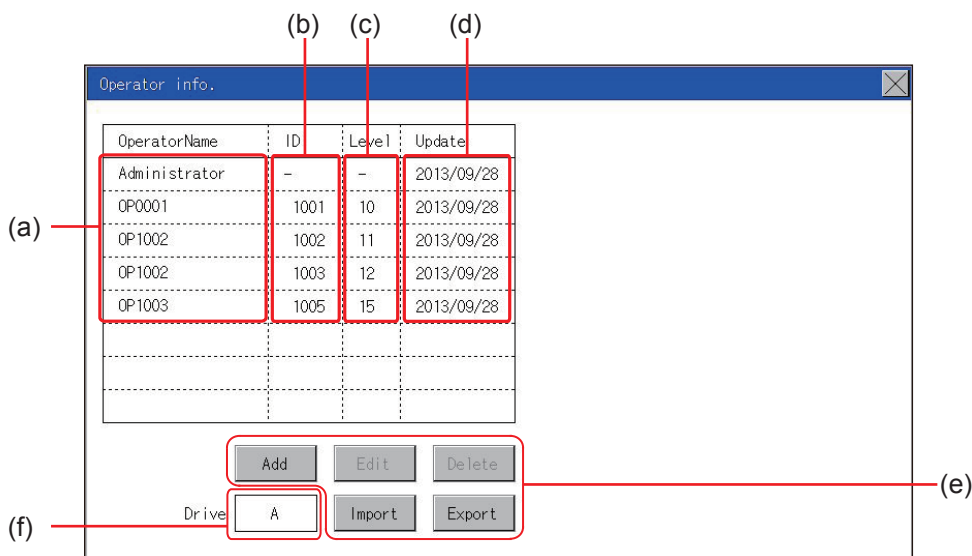

No.	Item	Description
(a)	Operator Name	Displays operator names.
(b)	ID	Displays operator IDs.
(c)	Level	Displays security levels for operators.
(d)	Update	Displays the last updated dates of the operator information.
(e)	Operation keys	Execution keys for each function
(f)	Drive in use	Displays and sets the storage location for imported and exported operator information. To switch the drive, touch the key. (A: Standard SD card) Only when the drive E is installed on the GOT, the user can switch the drive in use.

■ Operator information edit screen

Touch the [Add] button or touch the [Edit] button with the operator information selected on the Operator information management screen, and then the Operator information edit screen is displayed.

The operator information can be edited.

The screenshot shows the 'Operator edit' screen with the following fields and labels:

- (a) OperatorName: OP1002
- (b) Operator ID: 1002
- (c) Level: 11
- (d) Password: *****
- (e) Expiration: Terminable
- (f) External auth: Disuse
- (g) Ext.auth. ID: A000000100000000
- (h) Save button

No.	Item	Description
(a)	Operator Name	The operator name to be edited is displayed or input an operator name to be added. (Up to 16 alphanumeric characters)
(b)	Operator ID	The operator ID to be edited is displayed or input an operator name to be added. (Setting range: 1 to 32766, Maximum number of registrations: 255)
(c)	Level	Displays the security level for the operator or input the security level for an operator to be added. (0 to 15)
(d)	Password	Input a password. (Up to 16 alphanumeric characters)
(e)	Expiration	Switches the setting of the item disabled and enabled.
(f)	External auth	Switches the setting of the item [Disuse] and [Use].
(g)	Ext.auth. ID	The external authentication ID is displayed or input an external authentication ID. (External authentication ID setting range: alphanumerics ^{*1} 4 to 32 digits)
(h)	Save	Saves the settings.

*1 Since the key window is for hexadecimal format, the setting range can be input in the range of A to F or 0 to 9.

Operator management operation

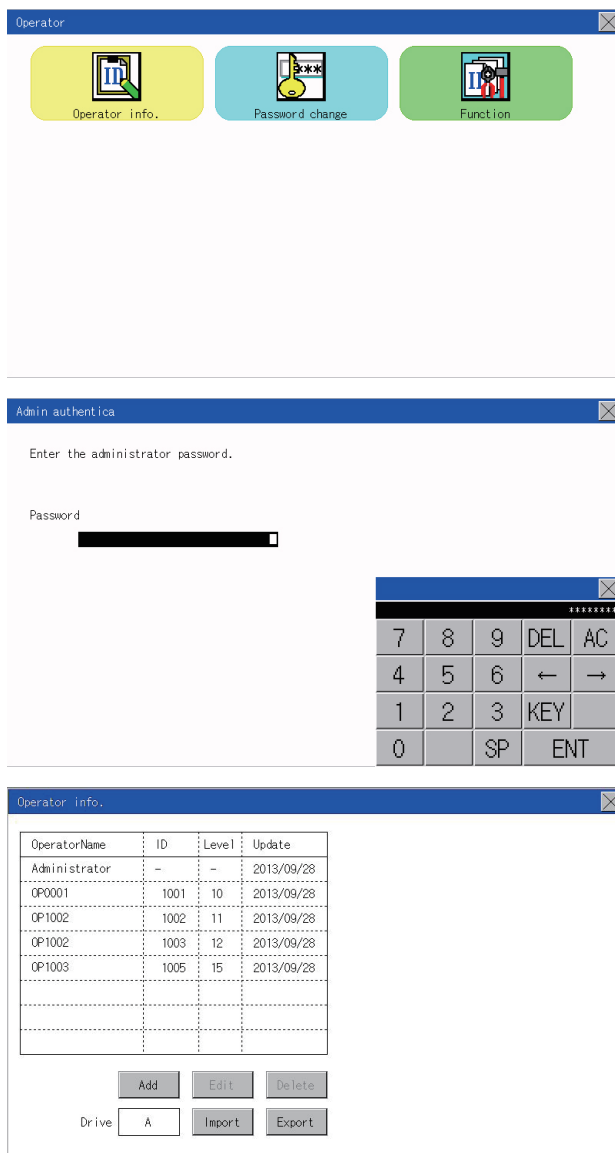

1. Touch [Operator] → [Operator info.].

2. The Admin password authentication screen is displayed, and then input the administrator password. Character types to be input can be changed by touching the [KEY] button.

When the input is completed, touch the [Enter] key.

3. When the administrator password is correctly input, the Operator information management screen is displayed. For operation of operating switches, refer to the following.

[Add]

☞ Page 251 Add operation

[Edit]

☞ Page 253 Edit operation

[Delete]

☞ Page 254 Deletion operation

[Import]

☞ Page 255 Import operation

[Export]

☞ Page 256 Export operation

4. Touching the [×] button displayed on the upper right returns to the previous screen.

■Add operation

Add operator information to the GOT.

OperatorName	ID	Level	Update
Administrator	-	-	2013/09/28
OP0001	1001	10	2013/09/28
OP1002	1002	11	2013/09/28
OP1002	1003	12	2013/09/28
OP1003	1005	15	2013/09/28

Buttons: Add, Edit, Delete, Drive: A, Import, Export

OperatorName: OP1002
 Operator ID: 1002
 Level: 11
 Password: [masked]
 Expiration: Terminable
 External auth: Disuse
 Ext.auth. ID: A000000100000000
 Save

7	8	9	DEL	AC
4	5	6	←	→
1	2	3	KEY	
0		SP	ENT	

New password inp.
 Input a new password.
 New password: [masked]

ABC	DEF	GHI	DEL	AC
JKL	MNO	PQRS	←	→
TUV	WXYZ		KEY	
		SP	ENT	

1. Touch the [Add] button.

2. The Operator information edit screen is displayed, and then touch an item to be edited.

- (a) OperatorName
- (b) OperatorID
- (c) Level
- (d) Password
- (e) Expiration
- (f) External auth
- (g) Ext.auth. ID

(a) If the operator name is touched, a keyboard is displayed. Input an operator name with the keyboard. Character types to be input can be changed by touching the [KEY] button. When the input is completed, touch the [ENT] key.

(b) If the operator ID is touched, a keyboard is displayed. Input an operator ID. Character types to be input can be changed by touching the [KEY] button. When the input is completed, touch the [ENT] key.

(c) If the level is touched, a keyboard is displayed. Input an operator level. Character types to be input can be changed by touching the [KEY] button. When the input is completed, touch the [ENT] key. When the level of the logged-in operator is changed during editing of the operator information, a new level is not reflected until you log out of the GOT once and log in the GOT again.

(d) For changing passwords during editing, touch the password. A keyboard is displayed, and then input a password. When the input is completed, touch the [ENT] key. When the password input is completed, the New password input confirmation dialog box is displayed. Input the same password.

Operator edit

OperatorName: OP1002

Operator ID: 1002

Level: 11

Password: *****

Expiration: Terminable

External auth: Disuse

Ext.auth. ID: A000000100000000

Save

- (e) For switching the setting of [Make a permanent password], touch the [Expiration] dialog box to switch the setting.
- [Terminable] ↔ [Permanent]
- (f) For using the external authentication, touch the [External auth] dialog box to switch the setting.

- [Disuse] ↔ [Use]
- (g) Touch Ext.auth ID to display the external authentication ID input dialog, and enter the external recognition ID. When the input is completed, touch the [Enter] key. When the authentication method is set to "External auth", the external authentication ID can be input with the external authentication device.

- 3.** When the [Save] button is touched after all items are input, the input operator information is saved. Touching the [×] button displayed on the upper right returns to the previous screen.

■ Edit operation

Edit the operator information stored in the GOT.

OperatorName	ID	Level	Update
Administrator	-	-	2013/09/28
OP0001	1001	10	2013/09/28
OP1002	1002	11	2013/09/28
OP1002	1003	12	2013/09/28
OP1003	1005	15	2013/09/28

Drive

OperatorName

Operator ID

Level

Password

Expiration

External auth

Ext.auth. ID

1. Select the operator information to be edited with touching the operator information.
2. Touch the [Edit] button.
3. The Operator information edit screen is displayed, and then touch an item to be edited.
 - (a) Level
 - (b) Password
 - (c) Expiration
 - (f) External auth
 - (g) Ext.auth. ID

For how to edit operator information, refer to the following.

☞ Page 250 Operator management operation
4. When the [Save] button is touched after all items are input, the input operator information is saved. Touching the [x] button displayed on the upper right returns to the previous screen.

■ Deletion operation

Delete the operator information stored in the GOT.

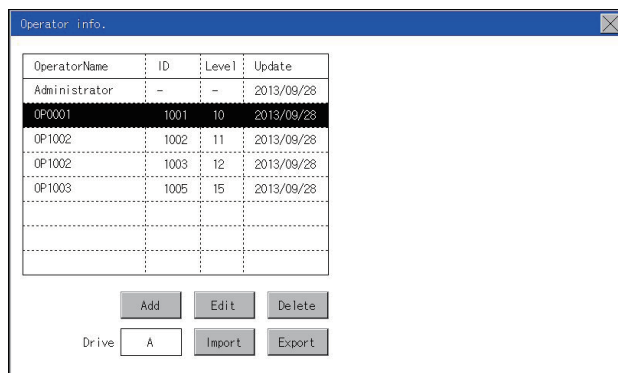

1. Select the operator information to be deleted with touching the operator information.
2. Touching the [Delete] button deletes the selected operator information. Touching the [×] button displayed on the upper right returns to the previous screen.

■ Import operation

Import the operator information that is already exported to an SD card to the GOT.

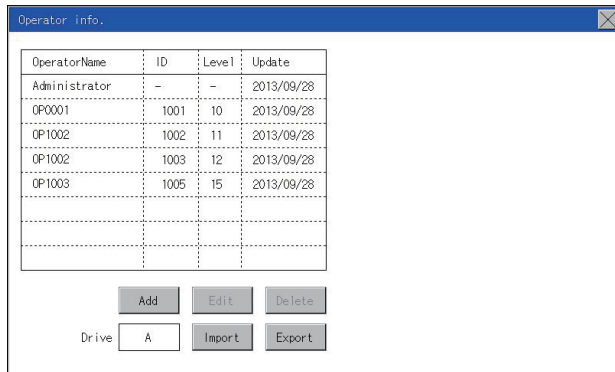

OperatorName	ID	Level	Update
Administrator	-	-	2013/09/28
OP0001	1001	10	2013/09/28
OP1002	1002	11	2013/09/28
OP1002	1003	12	2013/09/28
OP1003	1005	15	2013/09/28

Buttons: Add, Edit, Delete

Drive: A, Import, Export

1. Touch the [Import] button.

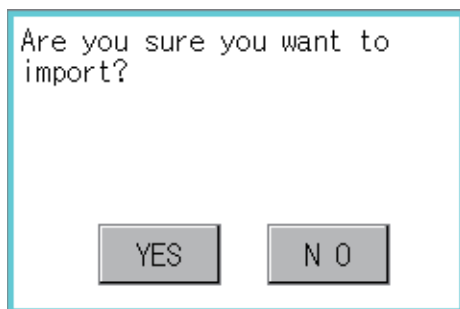

2. The dialog box shown left is displayed. When the [YES] button is touched, the Admin password authentication screen is displayed. Input the administrator password. Character types to be input can be changed by touching the [KEY] button. When the input is completed, touch the [Enter] key.

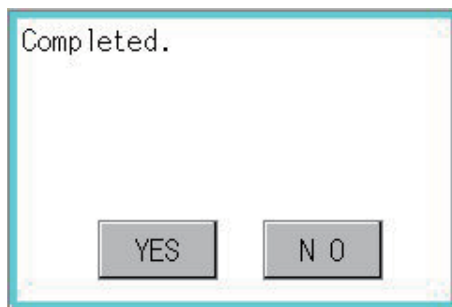

3. When the administrator password is correctly input, the dialog box shown left is displayed and the operator information stored in an SD card is imported to the GOT.

■Export operation

Export the operator information stored in the GOT to an SD card.

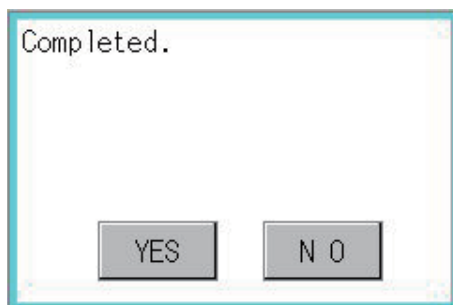
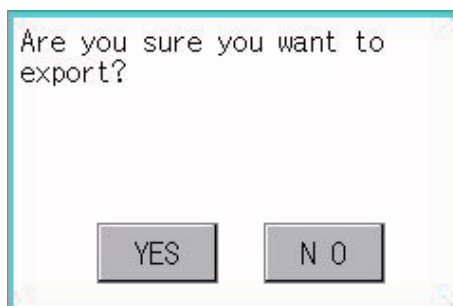
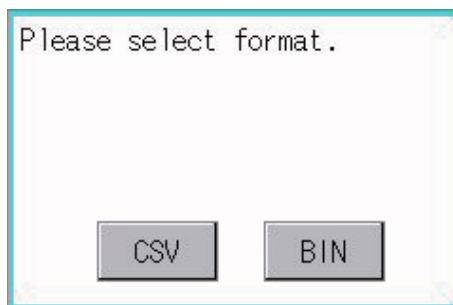
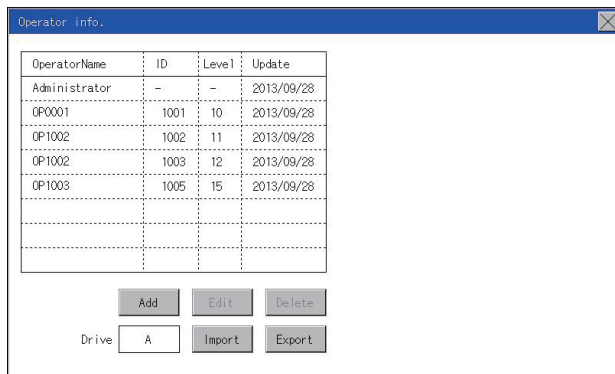

1. Touch the [Export] button.

2. The dialog box shown left is displayed.

3. Touch the following buttons according to the output format for the file.

Binary file:

[BINARY] button

CSV file:

[CSV] button

4. The dialog box shown left is displayed. When the [YES] button is touched, the Admin password authentication screen is displayed. Input the administrator password. Character types to be input can be changed by touching the [KEY] button.

When the input is completed, touch the [Enter] key.

5. When the administrator password is correctly input, the dialog box shown left is displayed and the operator information stored in the GOT is exported to an SD card. (file name: AUTHINF.G2U)

Password change

Password change function

The passwords to be used for the operator authentication can be changed.

For the password change, log into the GOT in advance with the operator name corresponding to the password to be changed.

Display operation of password change

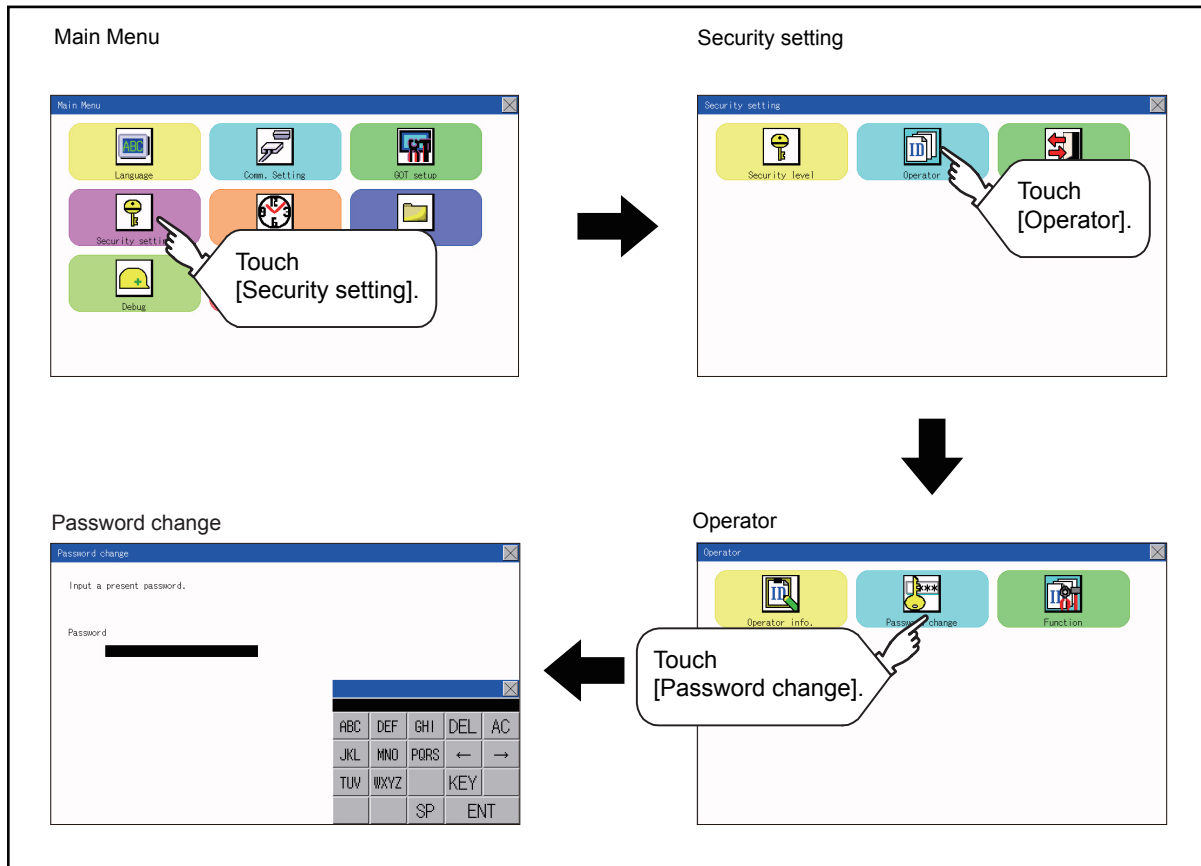

Password change operation

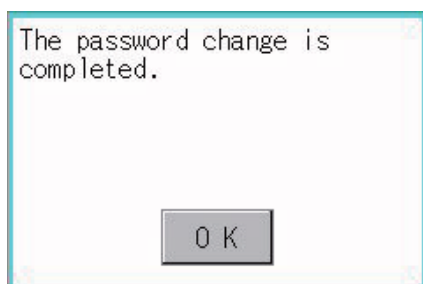
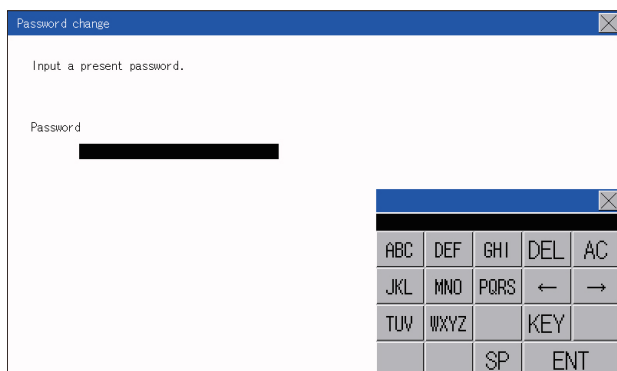
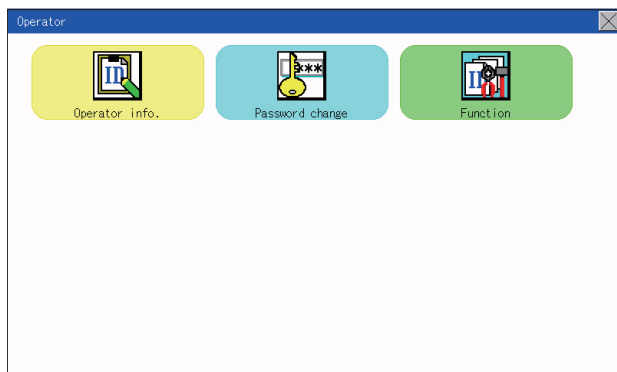
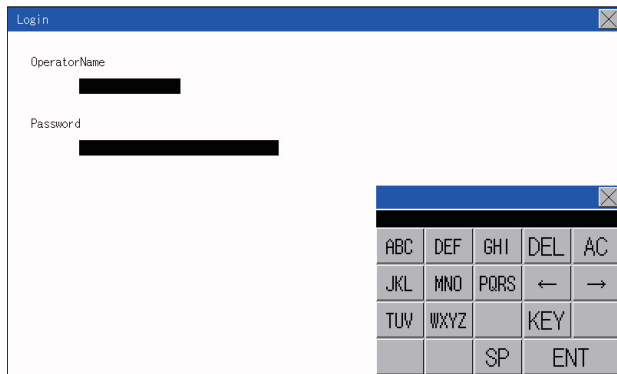

1. Touch [Security setting] → [Login/Logout] to log into the GOT with the operator ID whose password is to be changed.
2. Touch [Password change] in the operator setting menu, and then the Password change dialog box is displayed.
3. Input the current password on the Password change dialog box. Character types to be input can be changed by touching the [KEY] button.
When the input is completed, touch the [Enter] key.
4. Input a new password.
5. After inputting a new password, input the new password again.
6. When the new password is correctly input, the dialog box shown left is displayed and the password is changed.

Function setting function

The functions for the operator information can be set. The following items can be set.

Item	Description	Reference
Auth method	The authentication method is fixed to the password authentication.	☞ Page 261 Login/Logout
Auto logout time	The time from when the last time the GOT is operated until when you automatically log out of the GOT can be set. (1 to 60 minutes, 0 is invalid.)	☞ Page 260 Function setting operation
Expiration date	Set the item for regularly changing the password to be used for the operator authentication. (1 to 1000 days, 0 is invalid.) When the password is out of date after setting the password, the GOT requests the password change.	☞ Page 260 Function setting operation

Display operation of function setting

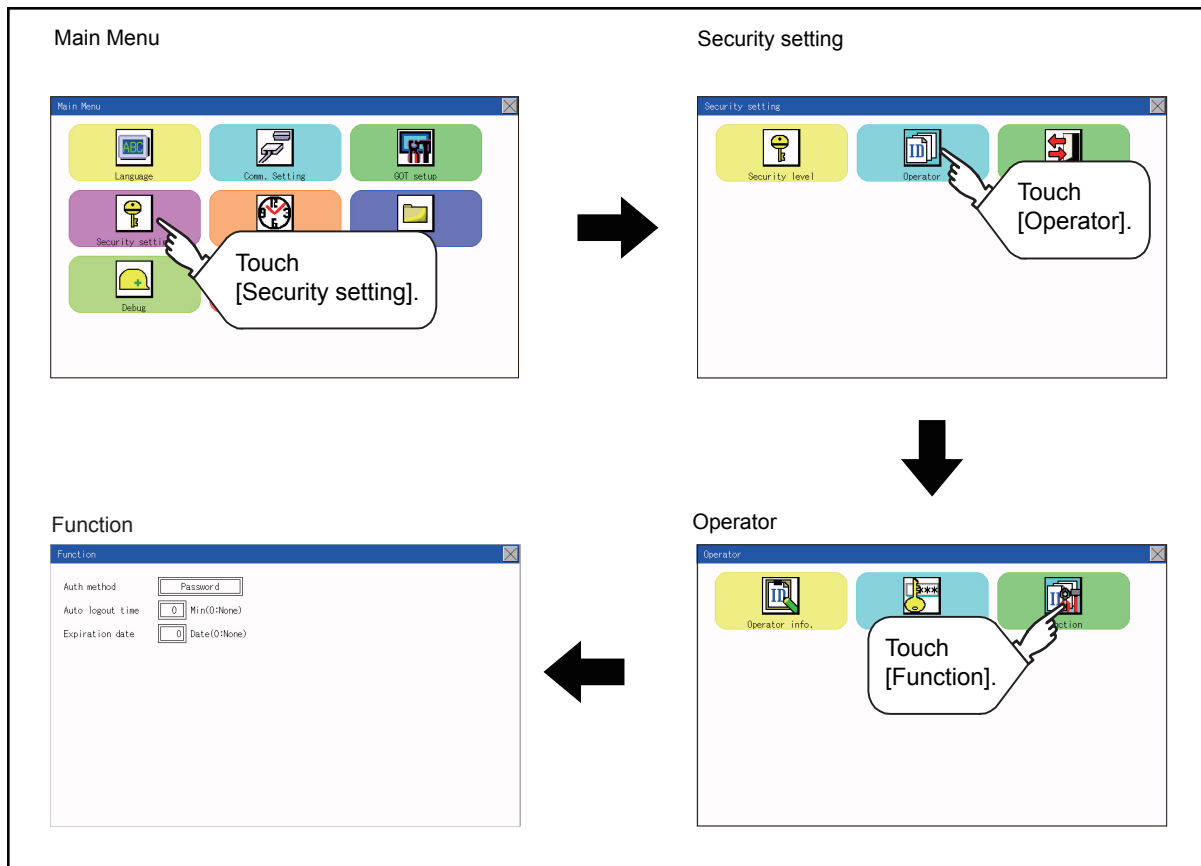

Function setting operation

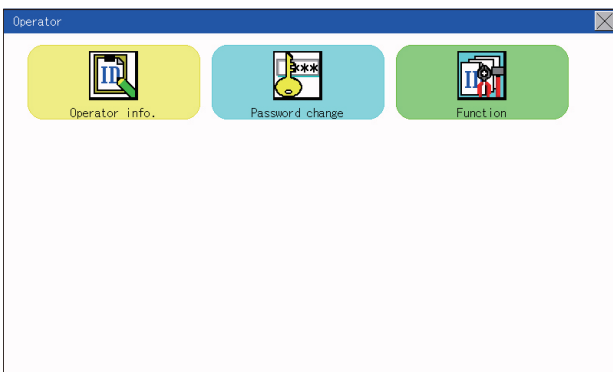
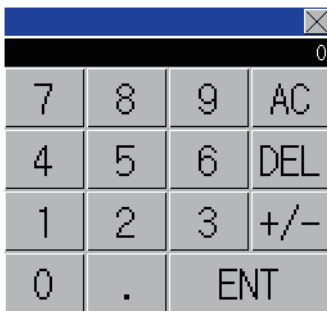
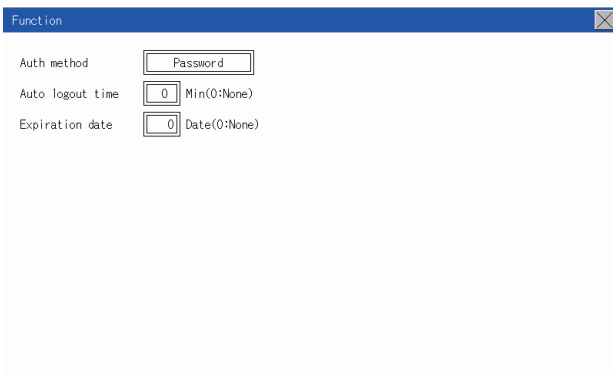
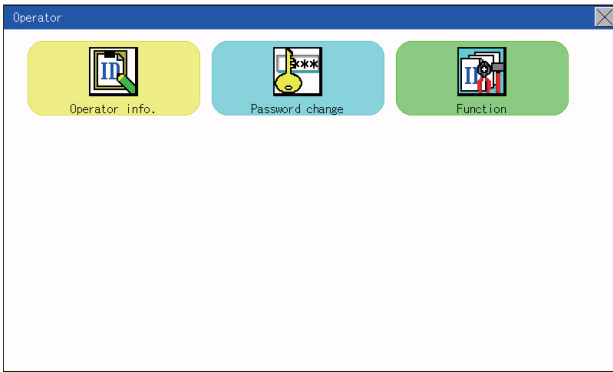

1. Touch [Operator] → [Function], and then the Admin password authentication dialog box is displayed.

2. When the administrator password is correctly input, the Function setting screen is displayed. Touch an item to be set.

- (a) Auto logout time
- (b) Expiration date

(a) Touch [Auto logout time], and then the Auto logout time edit dialog box is displayed. Input the time. When the input is completed, touch the [ENT] key.

(b) Valid byte count
Set the valid byte count for external authentication ID.
(Only available when [External auth] is set as the authentication method.)

3. Touching the [×] button displayed on the upper right returns to the previous screen.

25.3 Login/Logout

To manage the operator or change the password, log into the GOT.

Display operation of login/logout

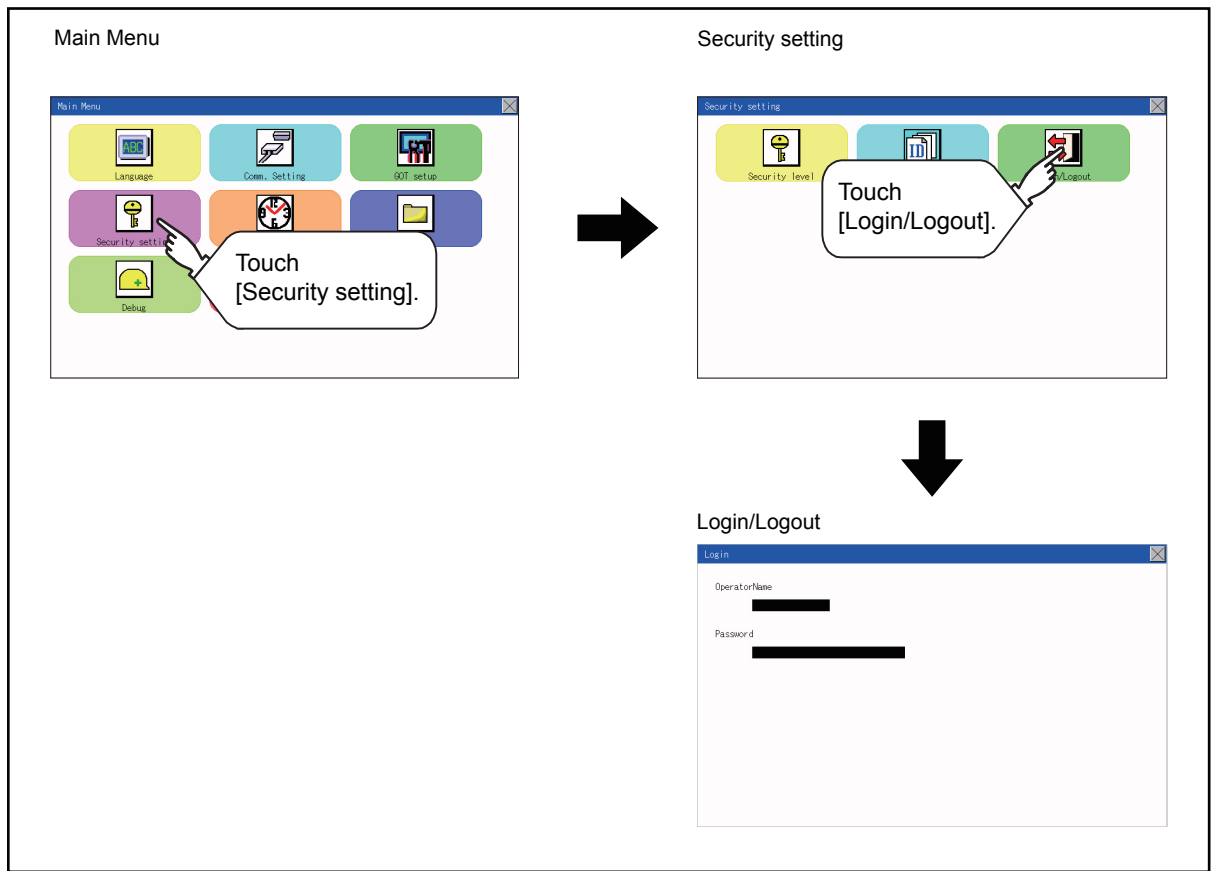

Operation of login/logout

■Login

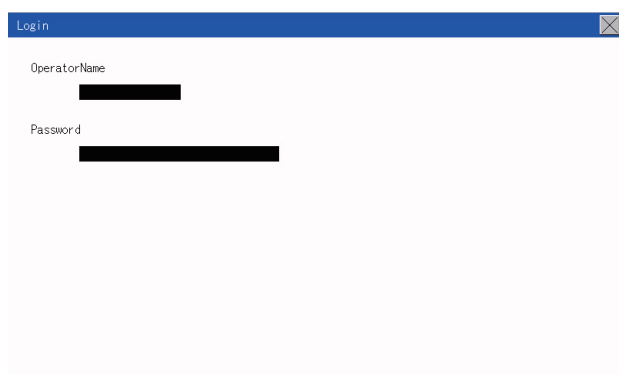

A screenshot of a 'Login' dialog box. It has a blue title bar with the text 'Login' and a close button. Below the title bar, there are two input fields. The first is labeled 'OperatorName' and contains a blacked-out text. The second is labeled 'Password' and also contains a blacked-out text.

1. Log into the GOT by inputting an operator name and its password.

■Logout

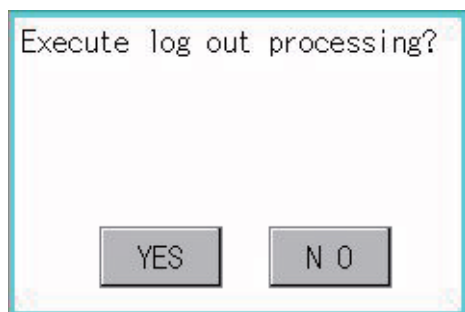

A screenshot of a confirmation dialog box. The text inside reads 'Execute log out processing?'. At the bottom of the dialog, there are two buttons: 'YES' on the left and 'NO' on the right.

1. Touch [Security setting] → [Login/Logout], and then the screen shown left is displayed. Touch the [YES] button.



26 CLOCK SETTINGS (TIME SETTING AND DISPLAY)

The clock data (date and time) are displayed and set in the clock setting menu.

26.1 Time Setting and Display

Time setting and display functions

Configure the time related settings.

Function	Description	Reference
Time setting	Set the current time.	 Page 265 Time setting
Adjust	Synchronize the clock data of the GOT with the clock data of the controller.	 Page 267 Adjusting the clock
Local time	Set the time zone of the local time in the clock data of the GOT.	 Page 271 Local time

Point

Changing times

When the time is changed on the Time setting & display screen, the changed time is written in a programmable controller.

As a result, the time of the programmable controller can be changed on the GOT even though [Adjust] is set for [Time setting].

(The clock data of the controller set as [Adjust CH No.] of [Adjust the clock] in [GOT Setup] ([Clock Setting]) of GT Designer3 is changed.)

For details of [Adjust], refer to the following.

 GT Designer3 (GOT2000) Screen Design Manual

Clock synchronization method

The following shows the clock synchronization method on the GOT.

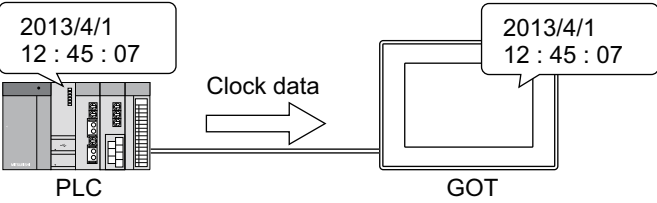
Clock synchronization method	Description
Adjust	<p>Acquire the clock data of the controller and change the clock data of the GOT.</p>  <p>When the GOT is powered on, set the clock data of the GOT to that of the controller. Since the GOT does not have to hold the clock data while the GOT is powered off, no battery is required. To set the controller clock data of the controller, refer to the manual of the controller you use.</p>

Point

Details of the clock synchronization method

For the details of the clock synchronization method, refer to the following.

 GT Designer3 (GOT2000) Screen Design Manual

Time setting

Set the current time.

Time setting

Function	Description	Reference
Current time	Carry out the display and setup of GOT clock data.	Page 266 Current time

Display operation of the time setting

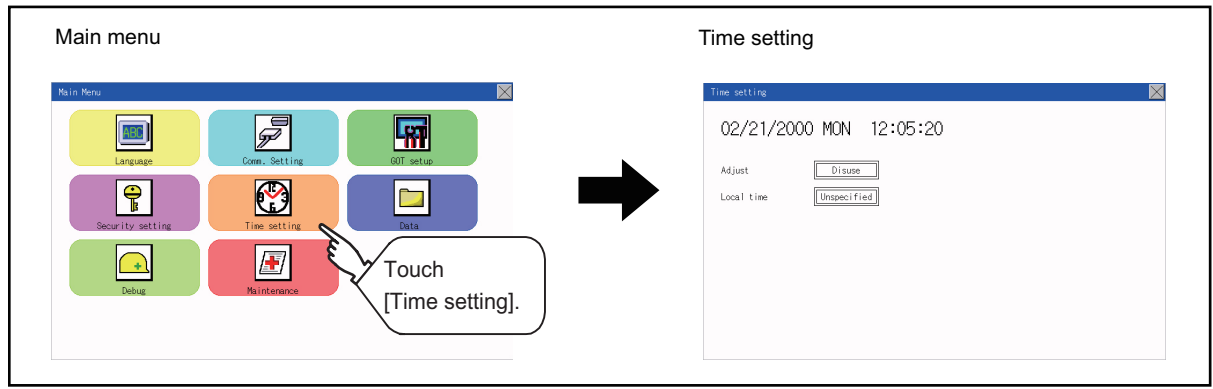

Setting procedure for the time setting

■Current time

Carry out the display and setting of GOT clock data.

The setup methods of clock data are shown below.

1. Touch either the date or time to be changed.

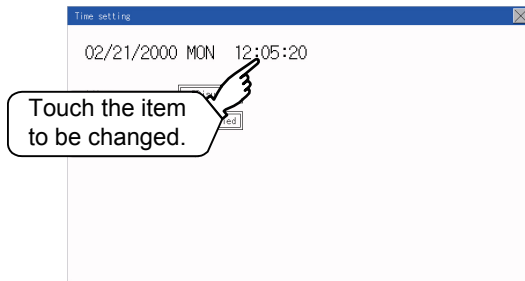

2. Enter date or time on the ten-key pad.

The day of the week is displayed automatically according to the input date.

The following shows the setting range of the date.

Jan. 1, 2000 to Dec. 31, 2037

"0" to "9":

Use these keys to enter numerical values.

"ESC":

Closes the ten-key window without saving any value entered for the date or time.

"AC":

Deletes the entire string of numerical characters that are being entered.

"DEL":

Deletes a digit from a string of numerical characters that are being entered.

"ENT":

Enters the value for the date or clock that has been entered and closes the ten-key pad window.

"+/-":

Switches between positive and negative values. (Only positive values are valid for the date or clock setting.)

".":

Invalid key (not used)

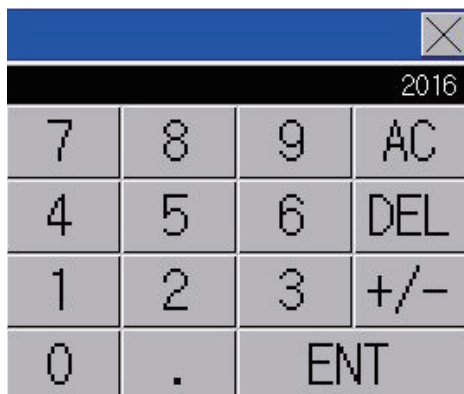

3. After setting either the date or time, touch the [x] button to save the changes and close the setting window.

Adjusting the clock

Synchronize the clock data of the GOT with the clock data of the controller.

Clock adjustment setting

Function	Description	Setting range
Time setting	Switch the Use/Disuse of Adjust.	Disuse/Use <Default: Disuse>
Reference CH No.	Set a reference channel of the external controller.	1 to 2 <Default: 1>
Trigger type	Set the trigger type for the clock adjustment.*1 <ul style="list-style-type: none"> When selecting [Sampling] for [Trigger type], set the sampling interval for the clock adjustment. When selecting [Rise] or [Fall] for [Trigger type], information on the device set as a trigger is displayed.*2 	Trigger type: Rise/Fall/Sampling <Default: Sampling> Sampling interval: 1 to 1440 <Default: 60>
Time zone of target unit	Switch Specified/Unspecified of the time zone of target.	Unspecified/Specified <Default: Unspecified>
Time zone	When selecting [Specify the time zone of target unit], set the time zone.	GMT-12:00 to GMT+13:00 <Default: GMT+9:00>
Time difference from GMT	Time zone of target is set by specifying the time difference from GMT.	Hour: -12 to 13 Minute: 0, 15, 30, or 45 <Default: 0 hour 0 minute>

*1 If [Adjust the clock] is deselected or [Trigger Type] is set to [Sampling] in [GOT Setup] in the project data, only [Sampling] is selectable as the trigger type for the clock adjustment in the utility.

*2 If [Adjust the clock] is deselected or [Trigger Type] is set to [Sampling] in [GOT Setup] in the project data, [No setting] is displayed in [Device].

Point

Settings of [Adjust] in the utility

Configure the settings in the utility and in [GOT Setup] on GT Designer3 by the same method.

 GT Designer3 (GOT2000) Screen Design Manual

Display operation of the clock adjustment

Main menu

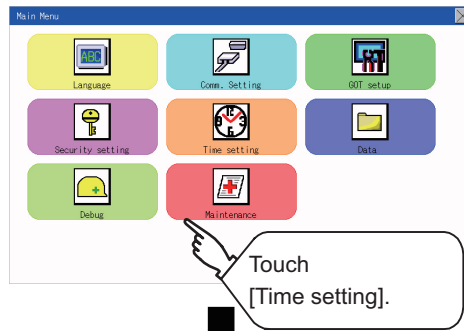

Time setting
(When not using "Adjust")

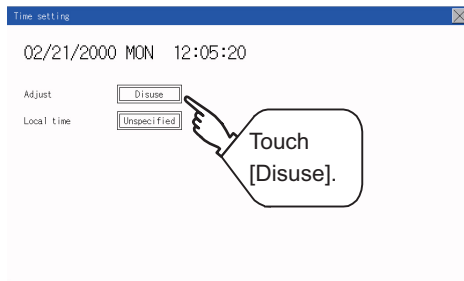

Time setting
(When using "Adjust")

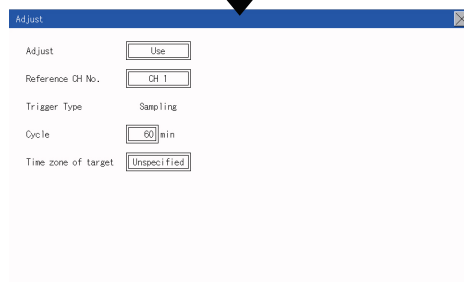
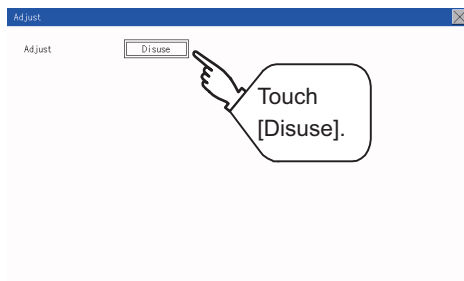
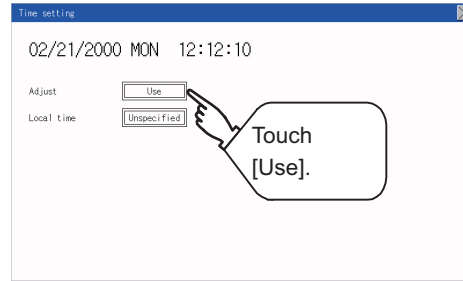

Display operation of the clock adjustment

■Reference CH No.

1. Touch the setting item to change the selection.

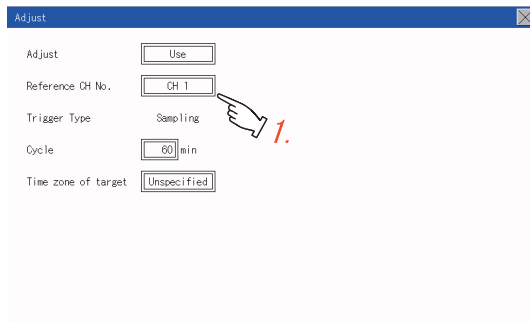

2. After changing the settings, touch the [×] button to save the changes and close the setting window.

■Trigger Type

1. Touch the setting item to change the selection.

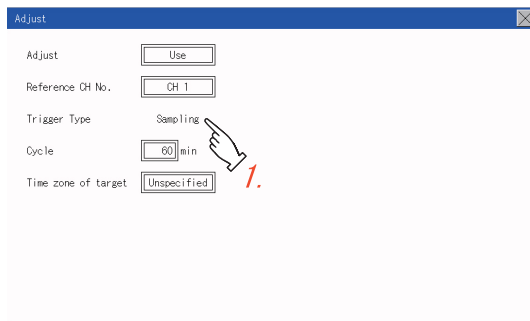

2. If you select [Sampling], set the sampling interval for the clock adjustment.

Touch the entry box on the left side of [Min.] to display a software keyboard.

Input a value with the keyboard.

3. After changing the settings, touch the [×] button to save the changes and close the setting window.

■Set the time zone of target.

1. When specifying the time zone of target, touch the setting item of [Time zone of target].

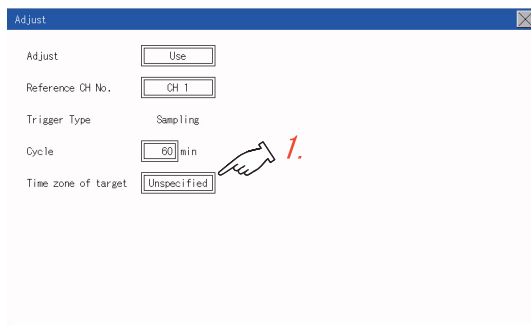

2. Touch the setting item of [Time zone of target].

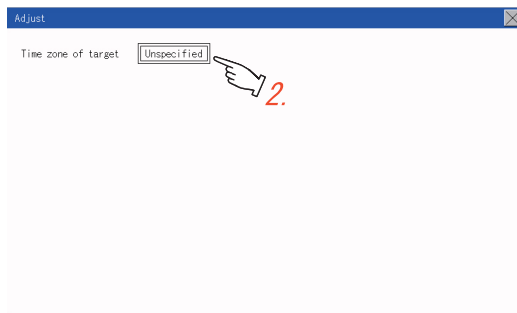

3. Touch the setting item to set the time difference from GMT.

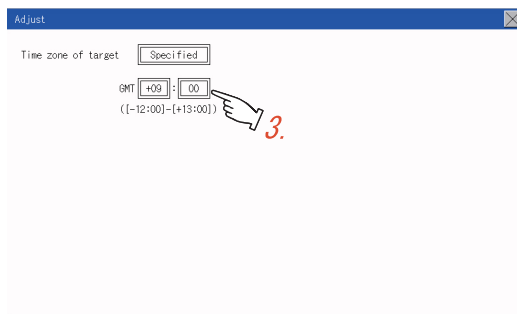

4. After changing the settings, touch the [×] button to save the changes and close the setting window.

Local time

Set the time zone of the local time in the clock data of the GOT.

Local time setting

Function	Description	Setting range
Local time	Switch Spcified/Unspecified the time zone in the clock data of the GOT.	Unspecified/Specified <Default: Unspecified>
Time zone of GOT	Set the time zone in the clock data of the GOT.	GMT-12:00 to GMT+13:00/Custom <Default: GMT+9:00>
Time difference from GMT	[Time zone of GOT] is set by specifying the time difference from GMT.	Hour: -12 to 13 Minute: 0, 15, 30, or 45 <Default: 0 hour 0 minute>

Display operation of the local time

Main menu

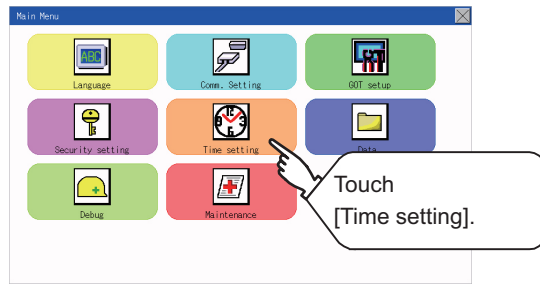

Time setting
(When not using "Local time")

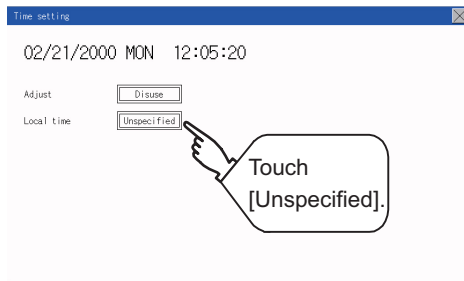

Time setting
(When using "Local time")

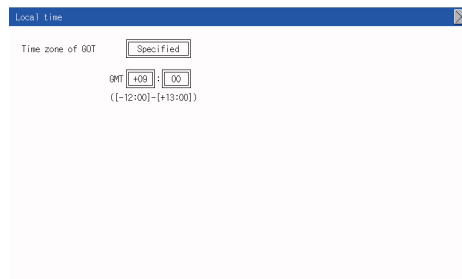
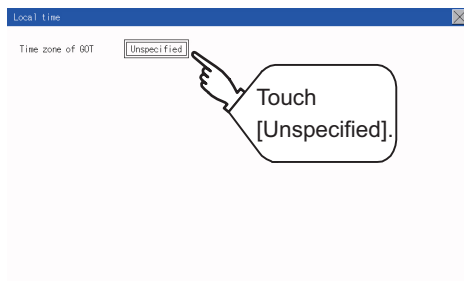
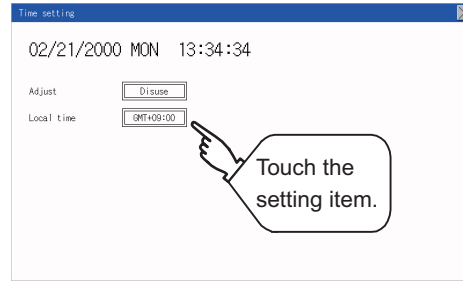

Set the local time.

1. Touch the setting item to set the time difference from GMT.

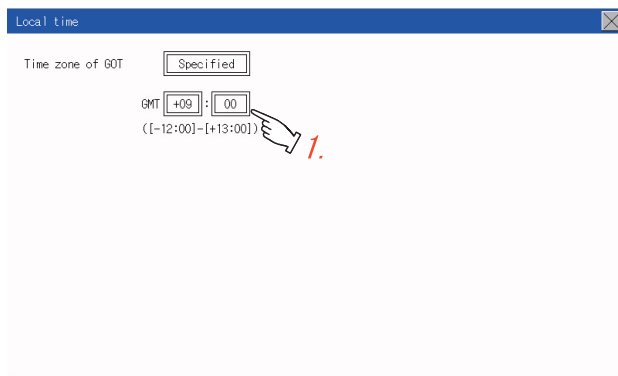

2. After changing the settings, touch the [×] button to save the changes and close the setting window.

Point

- When connecting to an external device which does not have clock function

If the GOT is connected to an external device (such as a PLC or microcomputer) that has no clock function, setting [Adjust] does not synchronize the clock data between the GOT and external device.

For the list of the PLCs having the clock function, refer to the following.

GOT2000 Series Connection Manual for the controller used

For details of [Adjust], refer to the following.

GT Designer3 (GOT2000) Screen Design Manual

- Time display

The GOT displays the current time to which the local time setting is reflected.

For the local time setting, refer to the following.

Page 271 Local time

- Changing times

If you have changed the present time of the GOT where the time setting function was being used, the new time setting will be written to the PLC.

Thus, you can change the time of the PLC from the GOT even when the time setting function is being used.

For details of [Adjust], refer to the following.

GT Designer3 (GOT2000) Screen Design Manual

MEMO

27 CONTROL OF VARIOUS DATA (DATA CONTROL)

A system application, project data (screen data), or alarm data which is written in the GOT or SD card can be displayed, and the data can be transferred between the GOT and SD card.

The format of the SD card is also possible.

27.1 Data Storage Location

Data type and storage location

System

The data storage location and transferring (write/read) route for each data type are shown below.

Also, the data storage locations are shown below.

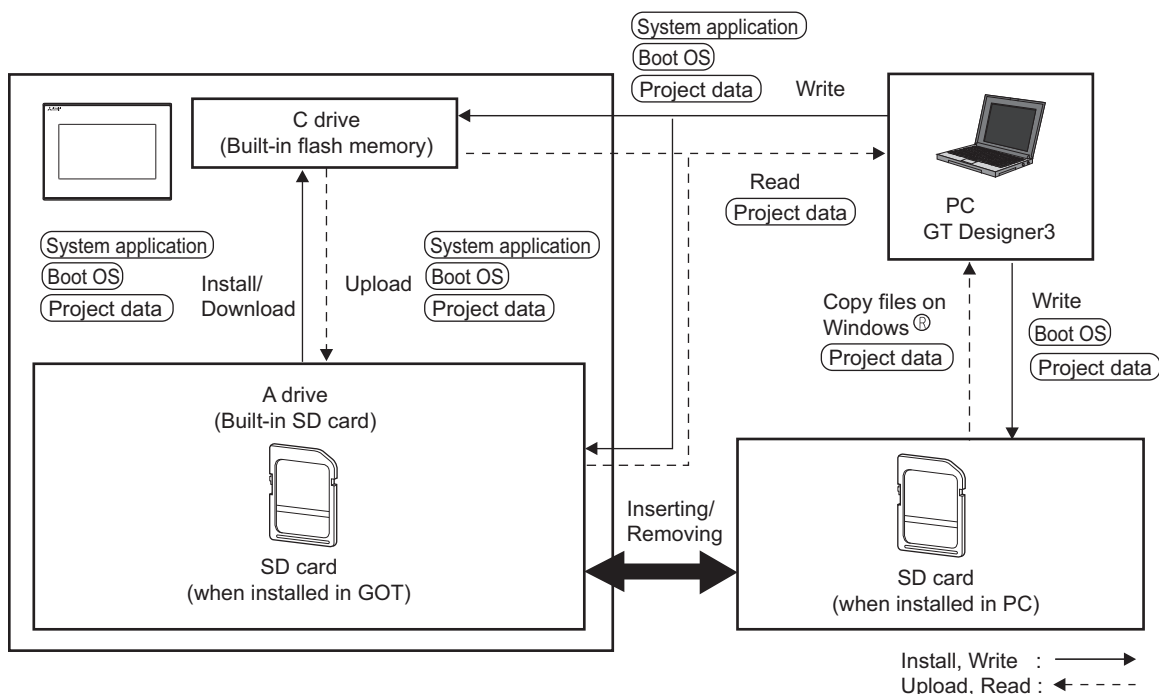

The data of the build in flash memory (Project data, etc.) can be saved.

Item	Data type	Storage location
(Boot OS)	Boot OS	Built in flash memory (C drive)
(System application) *1	Basic system application	Standard SD card (A drive)
	Communication driver	Built in flash memory (C drive)*2
	Advanced system application	
(Project data) *1	Project data (Including recipe setting, alarm conditions, time action, and GOT setup.)	Standard SD card (A drive) Built in flash memory (C drive)*2

*1 The SD card can be used from Utility.

☞ Page 279 OS information

*2 When using the project data stored in the Standard SD Card (A drive) with the GOT, hold the SD card installed to the GOT.

At maintenance

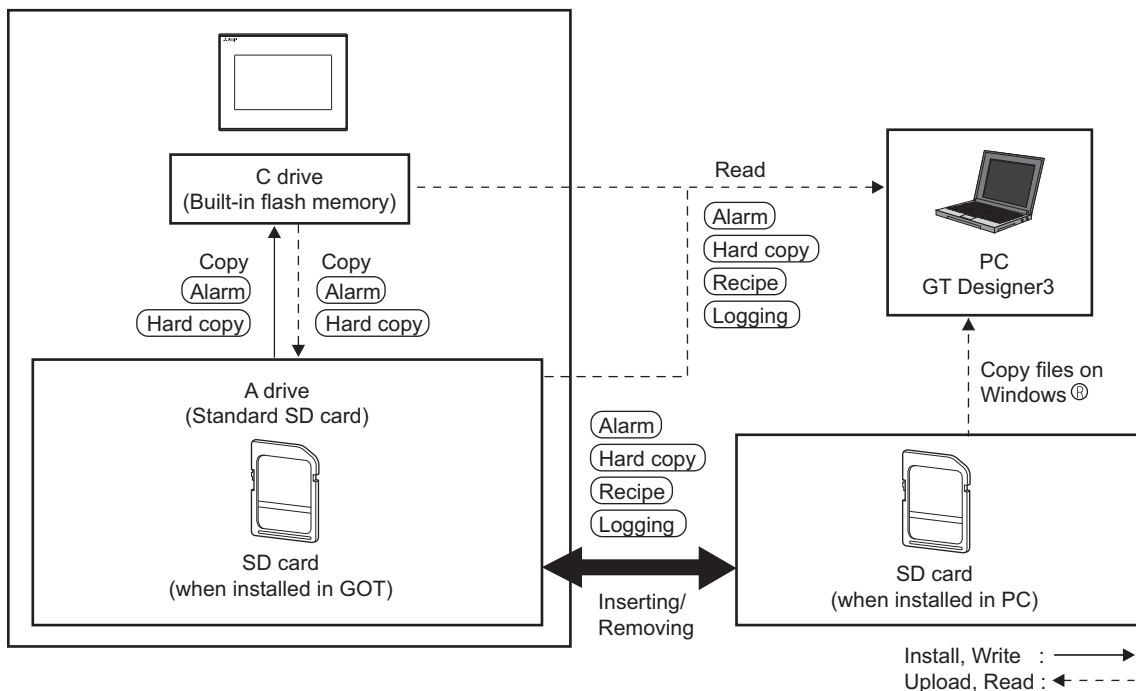

Item	Data type	Storage location
Alarm	Alarm data (Advanced alarm log file, alarm log file)	Standard SD card (A drive) C drive (Built-in flash memory)
Recipe	Recipe data (Advanced recipe file, Recipe file)	
Logging	Logging (Logging file)	
Hard copy	Image file (Hard copy function)	

Point

Checking available space of the storage memory
 To save resource data, check available space of the storage memory.

Checking version of basic system application

Confirm the basic system application version carefully when installing the Boot OS and basic system application. When the basic system application is installed, the GOT checks and compares the basic system application version automatically.

When install Boot OS

When the Boot OS to be installed has the older major version, GOT displays the installation disapproving message to cancel the installation so that the older version may not be written.

(Even when the version of the Boot OS to be installed has the same or later version, the version information and the dialog box for selecting continue/not continue will be displayed.)

When install basic system application or communication driver

When a basic system application or communication driver has already been installed, the version information of the basic system application which has been installed and the dialog box for selecting whether to continue the installation or not will be displayed.

Moreover, when the different versions will coexist among all applications (basic system application and communication driver) by installing the basic system application, the installation disapproving dialog box will be displayed and the installation process is canceled.

When download project data

The GOT automatically compares the version between the project data to be downloaded and the installed basic system application.

When the versions are different, the dialog box confirming whether to install the basic system application together is displayed.

When downloading the project data from an SD card, storing the project data and basic system application beforehand is recommended.

The version of each system application installed in the GOT can be checked by displaying the property of the system application information screen.

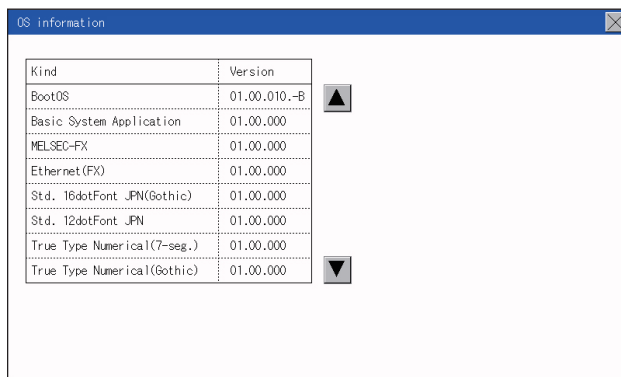

Kind	Version
BootOS	01.00.010.-B ▲
Basic System Application	01.00.000
MELSEC-FX	01.00.000
Ethernet (FX)	01.00.000
Std. 16dotFont_JPN(Gothic)	01.00.000
Std. 12dotFont_JPN	01.00.000
True Type Numerical(7-seg.)	01.00.000
True Type Numerical(Gothic)	01.00.000 ▼

Explanation of OS version

01.00.00.B

└─ Boot OS version
(Appears only when the property
of the Boot OS is displayed.)

└─ Minor version

└─ Major version

For the display operation of the screen, refer to the following.

☞ Page 279 OS information

Version confirmation of Boot OS by rating plate

Confirm the version of Boot OS installed in the GOT at product shipment by rating plate of GOT rear face.

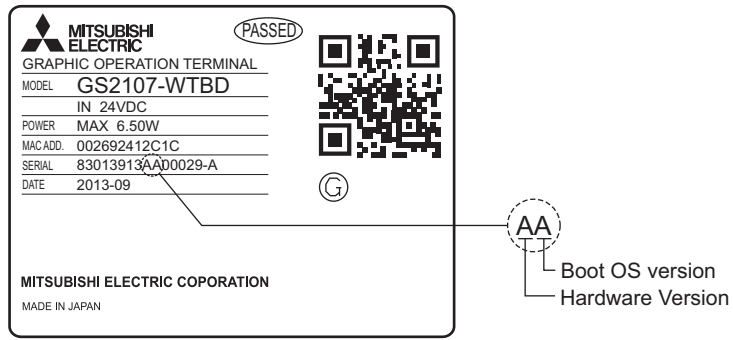

27.2 OS information

OS information

Each file name or folder name of Boot OS and package data stored in each drive (A: Standard SD card or C: Built-in flash memory) can be displayed in a list.

Also, each file can be installed and updated.

Function	Description	Reference
Information display of files and folders	Displays the kind, name, data size, creation date and time of the file or folder.	Page 280 Display example of system application information

Point

Precautions when basic system application file is used
 When the boot drive of the basic system application is set to "A: Standard SD card", a basic system application file cannot be installed or updated.

OS information

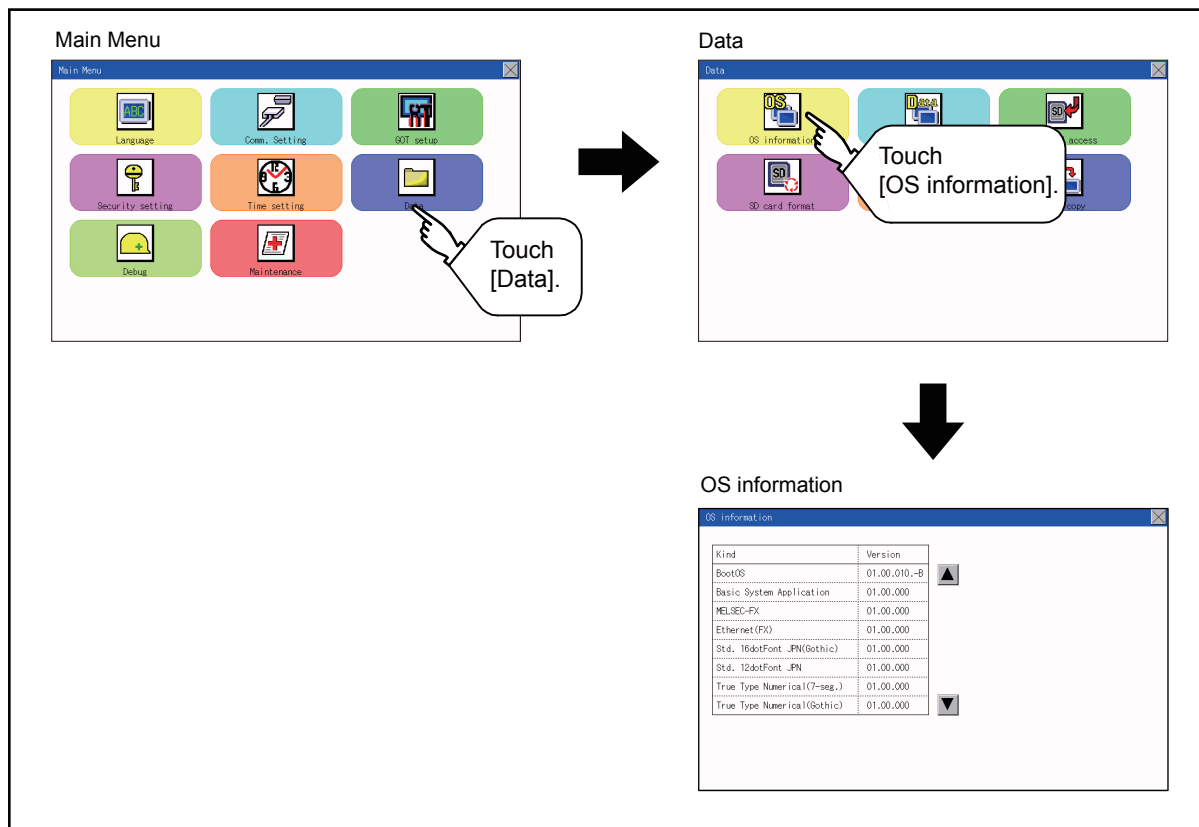

Display example of system application information

OS information Storage file/folder display screen

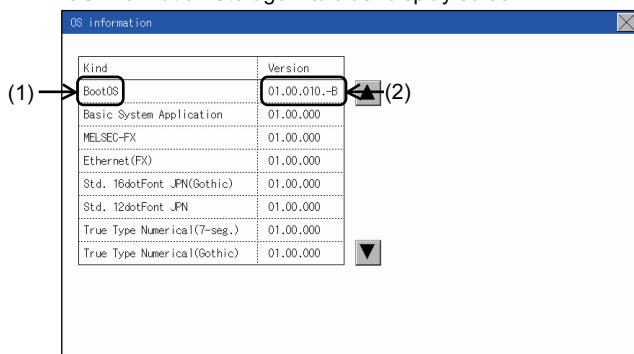

No.	Item	Description
(1)	Name	Displays the file name or folder name in the selected drive or folder. When the number of the characters of the file name or folder name exceeds 20, the 21th character and later are not displayed.
(2)	Version information	Displays the software version.

27.3 Resource Data Information

Alarm information

Function of alarm information

Advanced alarm log files and alarm log files stored in each drive (A: Standard SD card or C: Built-in flash memory) is displayed.

The functions below can be carried out for files.

For details of the advanced alarms, refer to the following manual.

📖 GT Designer3 (GOT2000) Screen Design Manual

Function	Description	Reference
Information display of files and folders	Displays name, data size, creation date and time of file or folder.	📖 Page 282 The display example of alarm information 📖 Page 283 The display operation of alarm information
G2A → CSV conversion	Converts the G2A file of an alarm log file to a CSV file.	📖 Page 284 G2A → CSV conversion operation, G2A → TXT conversion operation
G2A → TXT conversion	Converts the G2A file of an alarm log file to a Unicode text file.	📖 Page 284 G2A → CSV conversion operation, G2A → TXT conversion operation
Del	Deletes the file.	📖 Page 284 Deletion operation
Copy	Copies the file.	📖 Page 285 Copy operation

The display operation of alarm information

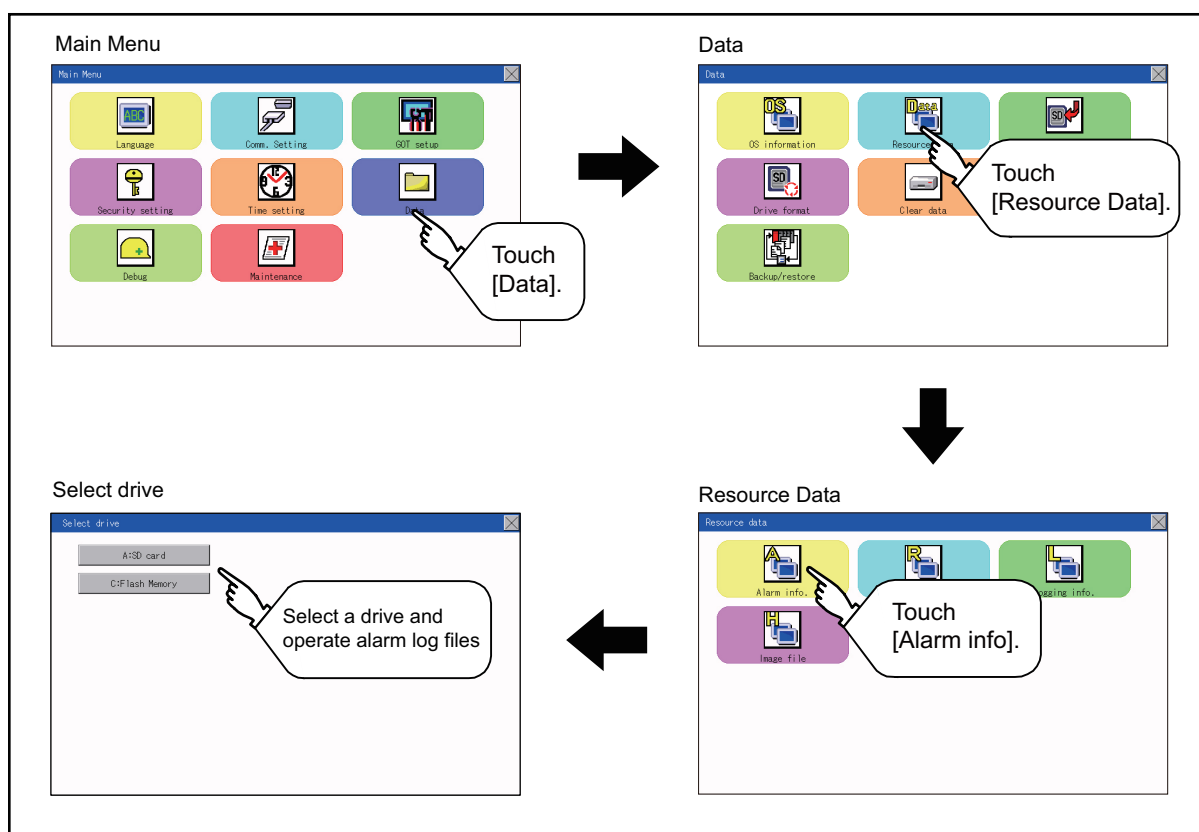

The display example of alarm information

Alarm information screen

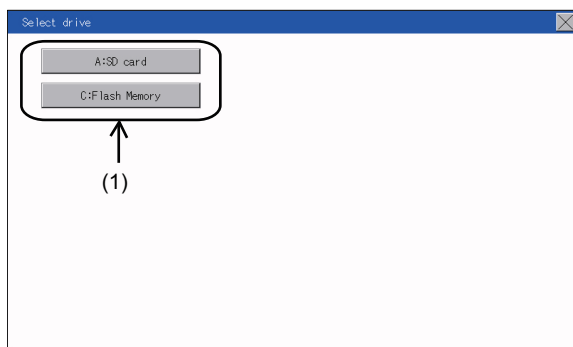

Alarm information: Storage file/folder display screen

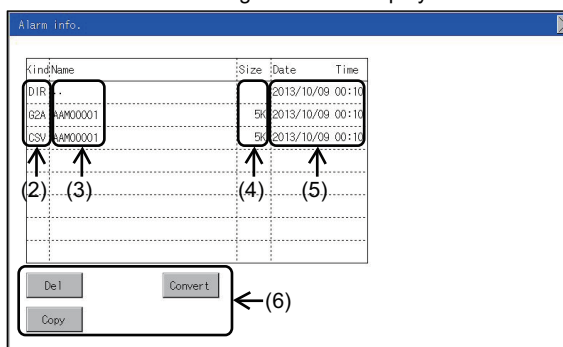

No.	Item	Description
(1)	Select drive	The drive which displays file or folder can be selected. When an SD card is not installed, the following drives are not displayed. • SD card: [A: Standard SD card]
(2)	Kind	Indicates whether the displayed name is file or folder. Displays the extension for a file and "DIR" for a folder.
(3)	Name	Displays the file name or folder name. For the long file/folder name, entire part may not be displayed. Confirm the non-displayed part with the [Copy] button, etc. ☞ Page 283 Alarm information operation After confirmation, touch the [Cancel] button to cancel the operation.
(4)	Size	Displays the size of the file displayed in Name.
(5)	Date, Time	Displays the creation date and time of each file.
(6)	Operation switch	Execution switch of each function.

Point

Display of creation date and time

The creation date and time display is not updated even if a file is created or updated while displaying the alarm information display screen.

If the screen currently displayed is closed (by moving the screen to the folder of the upper hierarchy, etc.) and the same screen is displayed again, the updated contents are displayed.

Alarm information operation

■The display operation of alarm information

Alarm information screen

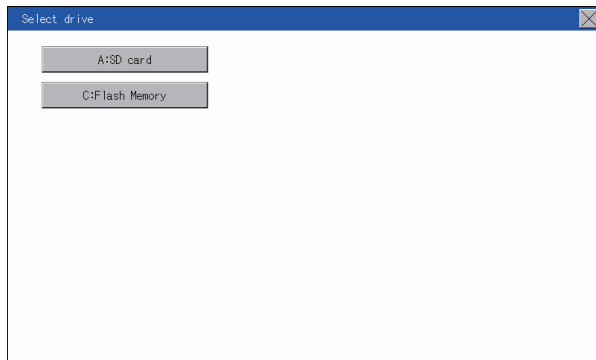

Alarm information: Storage file/folder display screen

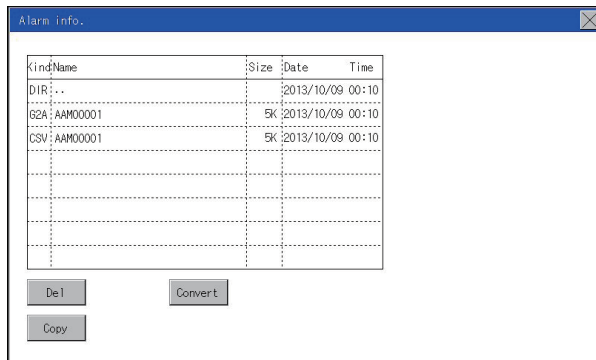

1. Touch a drive in [Select drive] to display the information of the driver.
2. Touch a folder name to display the information of the folder.
3. Touch a [.] folder to return to the parent folder and display its information.
4. Touch the ▲ ▼ button of the scrollbar to scroll the file display area up or down one row. To scroll up or down one page, touch the ▲ ▼ button.
5. If a file name is touched, the file is selected.
6. For operations of G2A → CSV conversion, G2A → TXT conversion, deletion, copy, and graph, refer to the following.

G2A → CSV, G2A → TXT

☞ Page 284 G2A → CSV conversion operation, G2A → TXT conversion operation

Delete

☞ Page 284 Deletion operation

Copy

☞ Page 285 Copy operation

7. Touch the [×] button to close the screen.

■G2A → CSV conversion operation, G2A → TXT conversion operation

The selected G2A file is converted to a CSV file or Unicode text file.

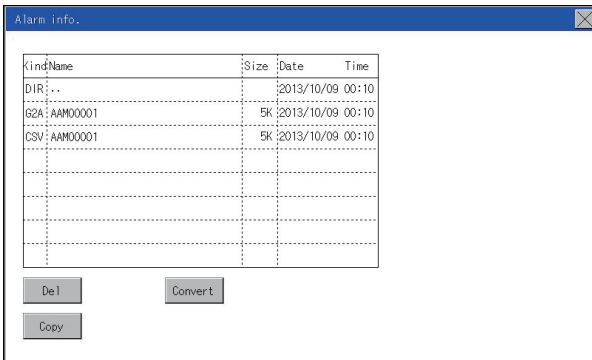

1. Touch the G2A file to be converted.

2. Touch [Convert].

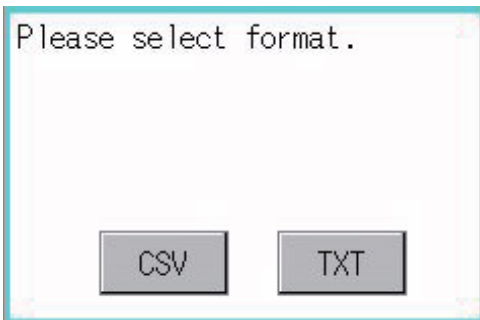

3. The following dialog box is displayed when touching the following button according to the file type to convert to.

CSV file:

[CSV] button

Unicode text file:

[TXT] button

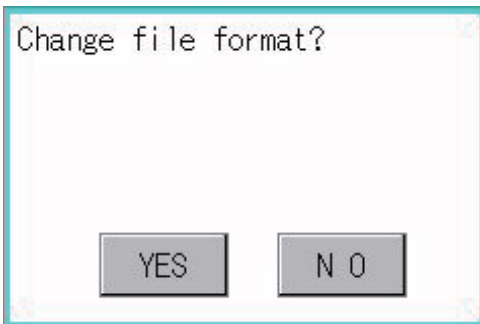

4. Touch the [OK] button. The file is overwritten with the converted file.

■Deletion operation

Deletes the selected file.

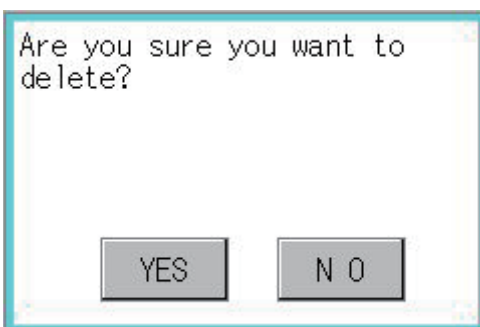

1. Touch the file to be deleted.

2. Touch the [Delete] button to display the dialog shown left. To delete the file, touch the [YES] button. To cancel the deletion, touch the [NO] button.

■ Copy operation

Copies the selected file.

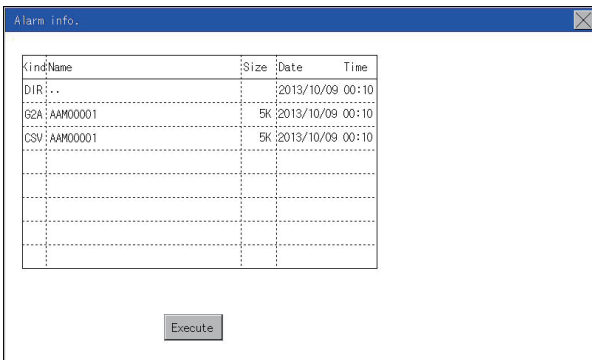
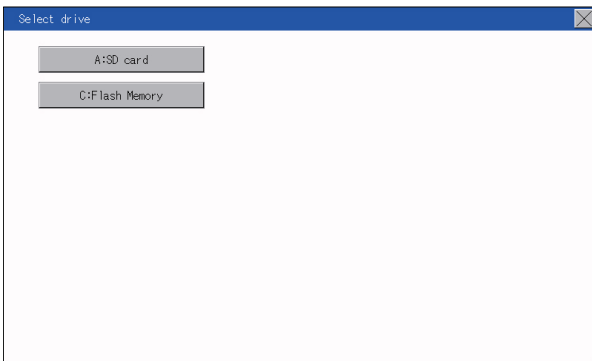
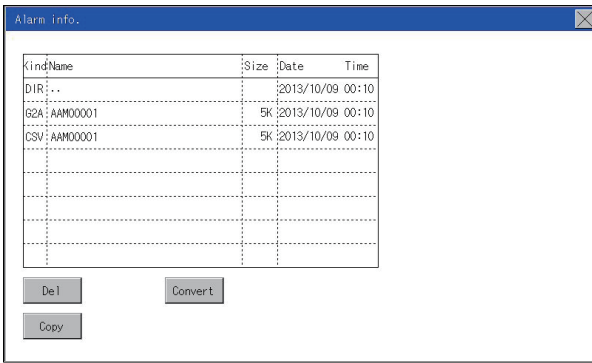

1. Touch the file to be copied.
2. If the [Copy] button is touched, the Select drive screen is displayed.
3. Select a drive.
4. Select the copy destination folder and touch [Execute].
The file is copied.

Recipe information

Point

Before using recipe information

For writing/reading into/from a controller with this function or editing of recipe files on the personal computer, refer to the following.

Specifications and operating procedure are described.

📖 GT Designer3 (GOT2000) Screen Design Manual

Function of recipe information

The recipe file used in the recipe function can be copied, deleted, and output in a file.

In addition, it is possible to writing/reading into/from a controller by using this function, without creating the screen to operate the recipe. (Recipe setting of GT Designer3 is required.)

Function	Description	Reference
Recipe information screen	Information display of files and folders	<ul style="list-style-type: none"> ☞ Page 287 Example of advanced recipe information display ☞ Page 288 Recipe information operation
G2P → CSV conversion	Converts a G2P file of a recipe file to a CSV file.	☞ Page 289 G2P → CSV conversion operation, G2P → TXT conversion operation
G2P → TXT conversion	Converts a G2P file of a recipe file to a Unicode text file.	☞ Page 289 G2P → CSV conversion operation, G2P → TXT conversion operation
CSV/TXT → G2P conversion	Converts a CSV file or Unicode text file to a G2P recipe file.	☞ Page 290 CSV/TXT → G2P conversion operation
Delete	Deletes the file or folder.	☞ Page 290 Deletion operation
Copy	Copies the file.	☞ Page 291 Copy operation

Display operation of recipe information

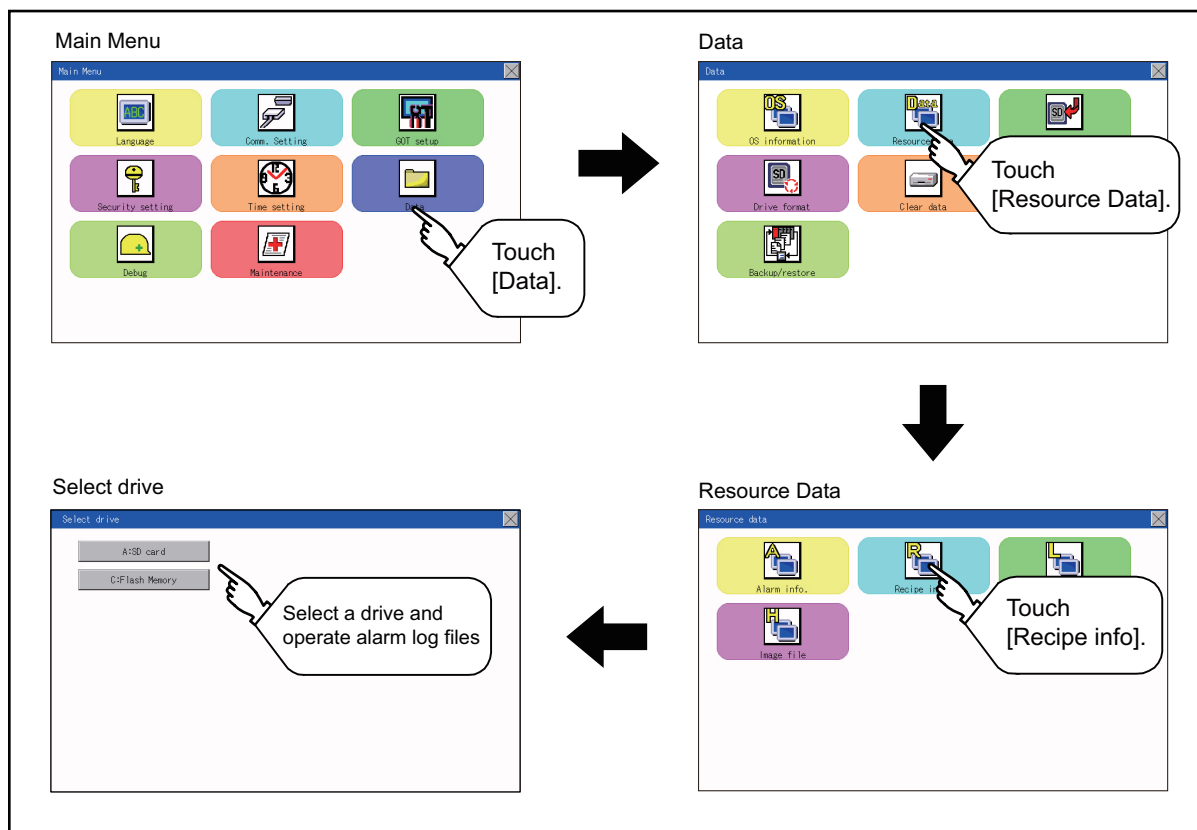

Example of advanced recipe information display

■Recipe information screen

Recipe Information screen

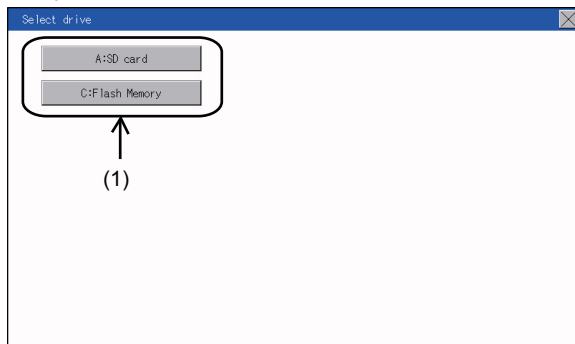

Recipe Information
Storage file/folder display screen

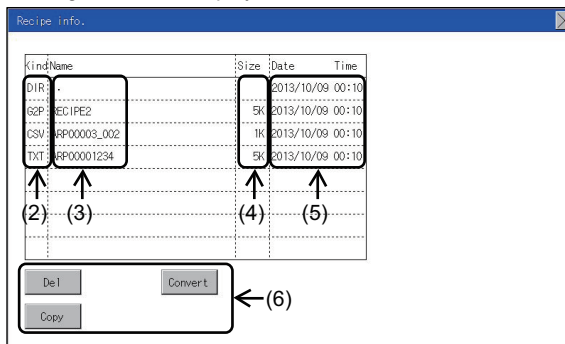

No.	Item	Description
(1)	Select drive	The target drive can be selected. (Even if an SD card is not installed, this message appears.)
(2)	Kind	Indicates whether the displayed name is file or folder. Displays the extension for a file and "DIR" for a folder.
(3)	Name	Displays the file name or folder name. For the long file/folder name, entire part may not be displayed.
(4)	Size	Displays the size of the file displayed in Name.
(5)	Date, Time	Displays the creation date and time of each file.
(6)	Operation switch	Execution switch of each function.

Point

About the displayed file

The files other than that for recipe are not displayed on the recipe information screen.

Recipe information operation

■ Display operation of recipe information

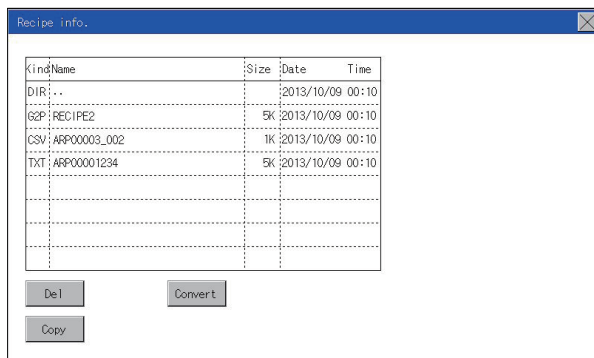

1. Touch a drive in [Select drive] to display the information of the driver.
2. Touch a folder name to display the information of the folder.
3. Touch a [.] folder to return to the parent folder and display its information.
4. Touch the ▲ ▼ button of the scrollbar to scroll the file display area up or down one row. To scroll up or down one page, touch the ▲ ▼ button.
5. If a file name is touched, the file is selected.
6. For operation of operating switches, refer to the following.
 - G2P → CSV, G2P → TXT
 - ☞ Page 289 G2P → CSV conversion operation, G2P → TXT conversion operation
 - CSV/TXT → G2P
 - ☞ Page 290 CSV/TXT → G2P conversion operation
 - Delete
 - ☞ Page 290 Deletion operation
 - Copy
 - ☞ Page 291 Copy operation
7. Touch the [×] button to close the screen.

■G2P → CSV conversion operation, G2P → TXT conversion operation

A recipe file (G2P file) is converted to a CSV file or Unicode text file that can be displayed/edited on a personal computer.

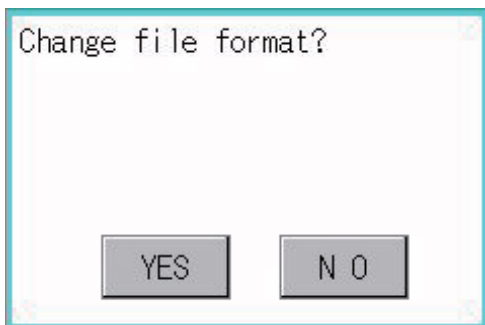
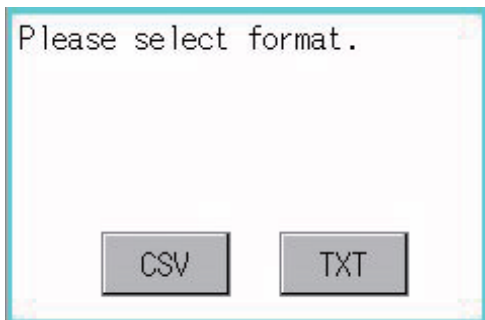
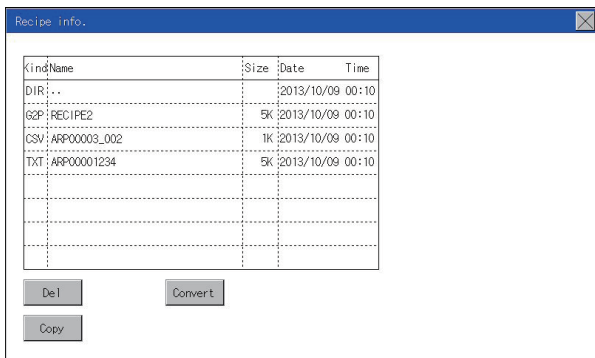

1. Touch the G2P file to be converted.

2. Touch [Convert].

3. Touch either of the following buttons according to the file type to convert to.

CSV file:

[CSV] button

Unicode text file:

[TXT] button

4. Touch the [OK] button. The file is overwritten with the converted file.

■CSV/TXT → G2P conversion operation

A CSV file or Unicode text file is converted to a recipe file (G2P file).

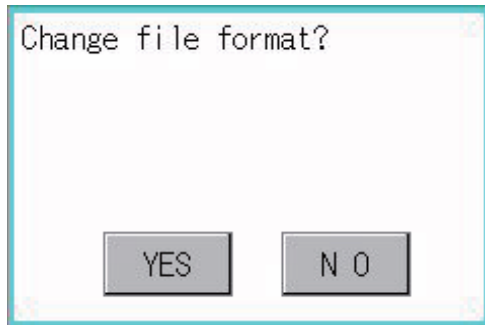
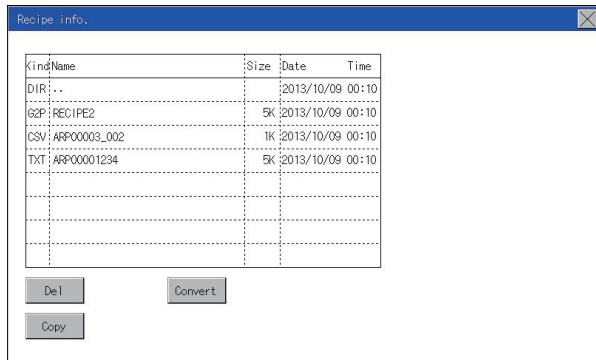

1. Touch the CSV file or Unicode text file to be converted.
2. Touch the [Convert] button.

3. If the [OK] button is touched, the file is overwritten with the converted file.

■Deletion operation

Folders and files to be used on recipe are deleted.

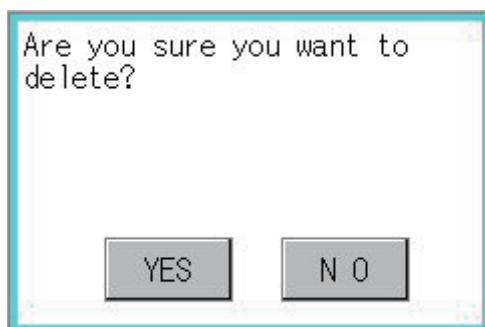
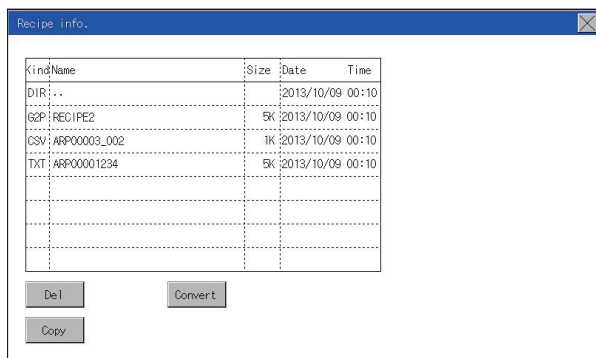

1. Touch the folder or file to be deleted.

2. Touch the [Delete] button to display the dialog shown left. To delete the file or folder, touch the [YES] button. (The message "Processing" is displayed during processing.) To cancel the deletion, touch the [NO] button.

■Copy operation

Files to be used in recipe are copied.

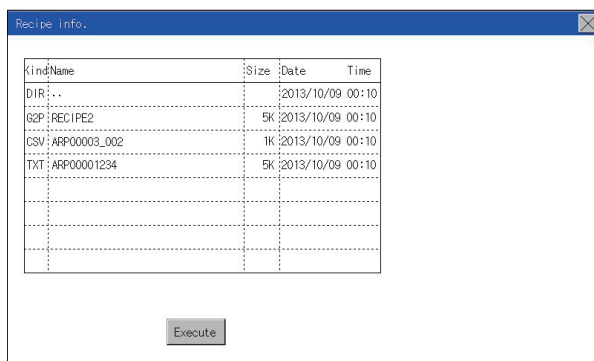
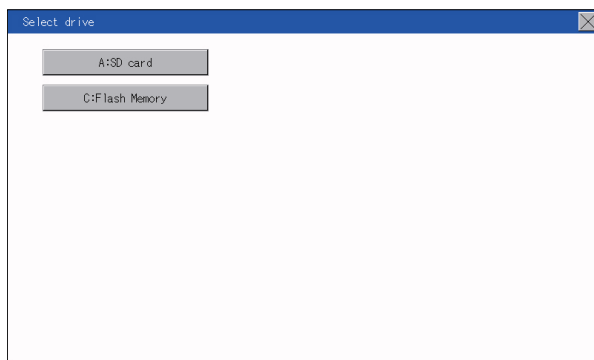
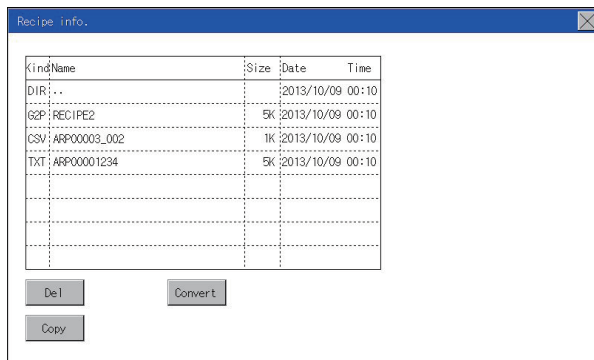

1. Touch the file to be copied.
2. If the [Copy] button is touched, the Select drive screen is displayed.
3. Select a drive.
4. Select the copy destination folder and touch [Execute]. The file is copied.

Precautions

■Precautions for operation

Precautions during folder/file operation (Create/Delete/Copy/File output, etc.)

Even if the access to the SD card is inhibited while the GOT is processing folders and files, the processing continues.

(Example: Even if the access to the SD card is inhibited while the GOT is creating a folder, the folder is created.)

Therefore, do not pull out the SD card while the "Processing..." message is on the screen after the access to the SD card is inhibited.

While the GOT is accessing another file (such as alarm data)

When folder/file processing for the recipe is executed while the GOT is in access to other file (SD card access LED ON), the GOT executes folder/file processing for the recipe after the processing for other file has completed.

Therefore, it may take some time to finish the process of the recipe folder/file. (The "Processing..." message is displayed on the screen.)



Estimation of processing time

The process may take time depending on the setting of advanced recipe file to be operated. (The more number of blocks increases, the longer it takes to process recipe folder/file.)

The process for creating the first file may take time depending on the setting of advanced recipe file.

Logging information

Function of logging information

Logging files created with the logging function can be copied, deleted or renamed, etc.

Without using a personal computer, you can manage logging files on the GOT.

For details of the logging function, refer to the following.

📖 GT Designer3 (GOT2000) Screen Design Manual

Function	Description	Reference
Information display of files and folders	Displays name, data size, creation date and time of file or folder.	☞ Page 293 Example of logging information display ☞ Page 293 Logging information operation
Delete	Deletes the file or folder.	☞ Page 294 Deletion operation
Copy	Copies the file.	☞ Page 295 Copy operation

Display operation of logging information

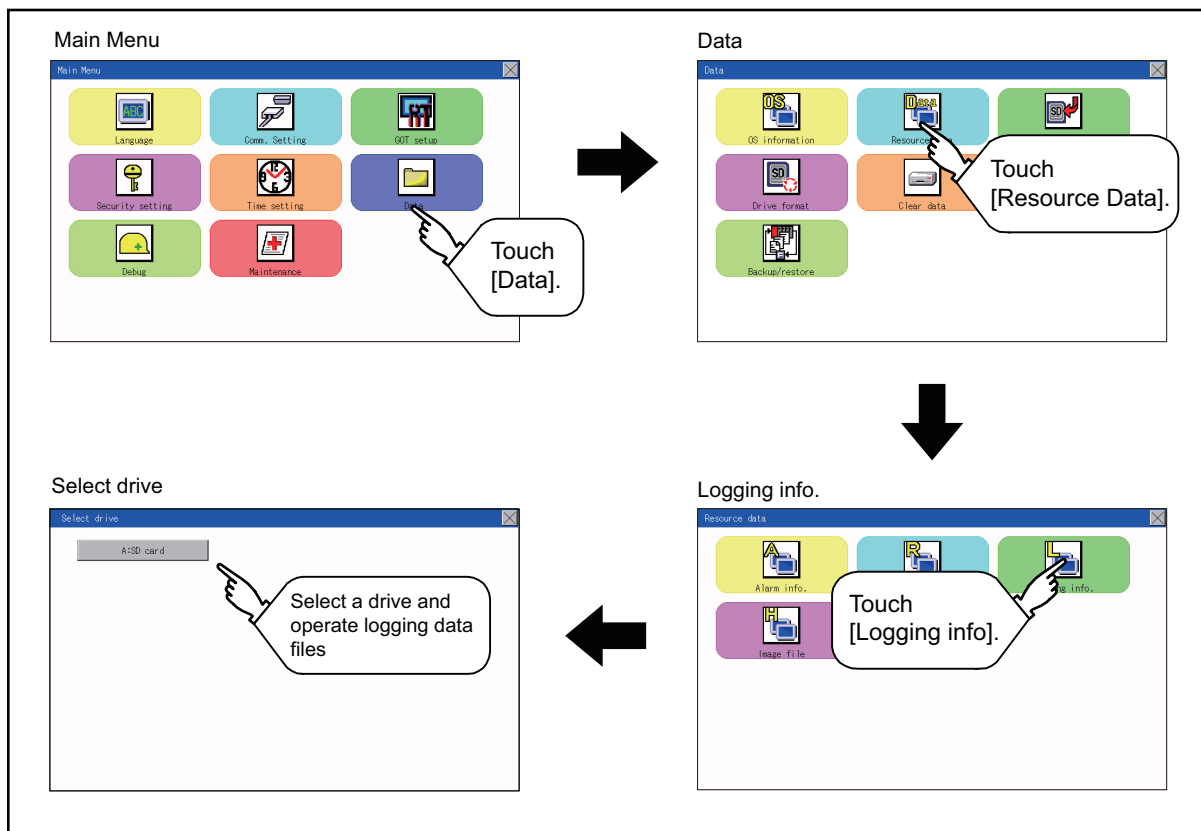

Example of logging information display

Logging Information

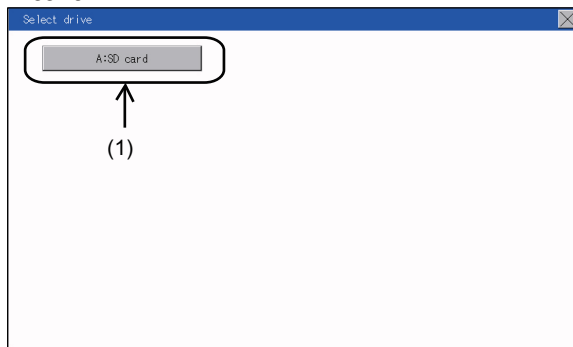

Logging Information Storage file/folder display screen

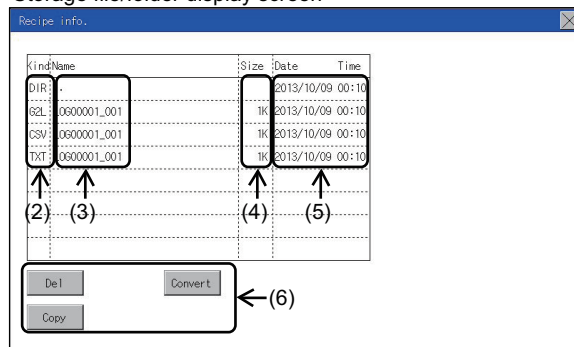

No.	Item	Description
(1)	Select drive	The target drive can be selected. (Even if an SD card is not installed, this message appears.)
(2)	Kind	Indicates whether the displayed name is file or folder. Displays the extension for a file and "DIR" for a folder.
(3)	Name	Displays the file name or folder name. For the long file/folder name, entire part may not be displayed.
(4)	Size	Displays the size of the file displayed in Name.
(5)	Date, Time	Displays the creation date and time of each file.
(6)	Operation switch	Execution switch of each function.

Point

About the displayed file

The files other than that for logging are not displayed on the logging information screen.

Logging information operation

■ Display operation of logging information

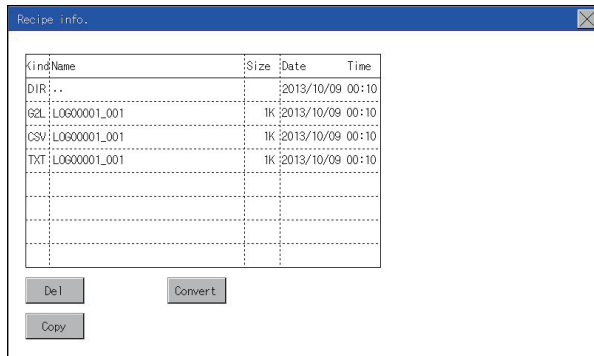

1. Touch a drive in [Select drive] to display the information of the driver.
2. Touch a folder name to display the information of the folder.
3. Touch a [.] folder to return to the parent folder and display its information.
4. Touch the ▲ ▼ button of the scrollbar to scroll the file display area up or down one row. To scroll up or down one page, touch the ▲ ▼ button.
5. If a file name is touched, the file is selected.
6. For operation of operating switches, refer to the following.

Delete

☞ Page 294 Deletion operation

Copy

☞ Page 295 Copy operation

7. Touch the [×] button to close the screen.

■ Deletion operation

Folder and file to be used on logging are deleted.

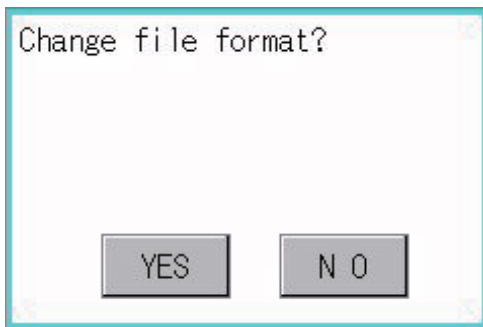
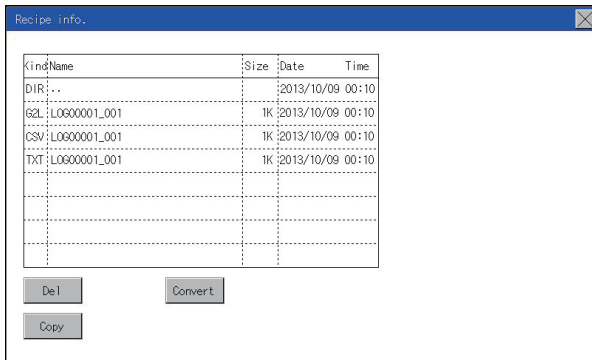

1. Touch the folder or file to be deleted.
2. Touch the [Delete] button to display the dialog shown left. To delete the file or folder, touch the [YES] button. (The message "Processing" is displayed during processing.) To cancel the deletion, touch the [NO] button.

■Copy operation

Folder to be used in logging is copied.

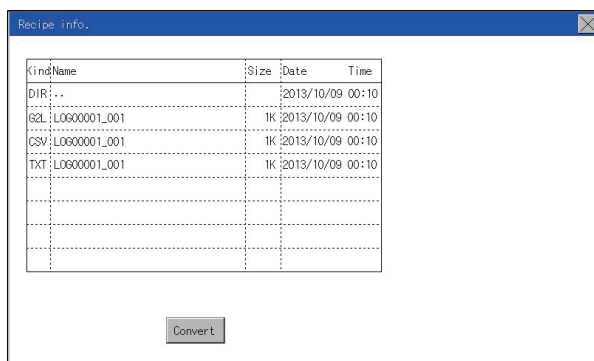
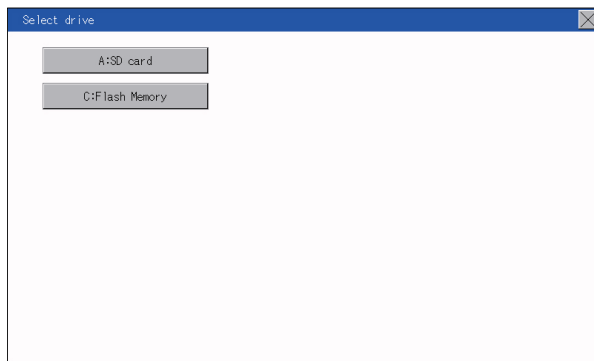
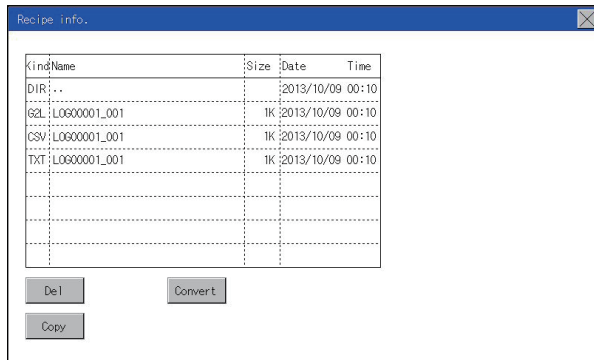

1. Touch the file to be copied.
2. If the [Copy] button is touched, the Select drive screen is displayed.
3. Select a drive.
4. Select the copy destination folder and touch [Execute]. The file is copied.

Precautions

■Precautions for operation

Precautions during folder/file operation (Create/Delete/Copy/File output, etc.)

Even if the access to the SD card is inhibited while the GOT is processing folders and files, the processing continues.

(Example: Even if the access to the SD card is inhibited while the GOT is creating a folder, the folder is created.)

Therefore, do not pull out the SD card while the "Processing..." message is on the screen after the access to the SD card is inhibited.

While the GOT is accessing another file (such as alarm data)

When folder/file processing for the logging is executed while the GOT is in access to other files (SD card access LED ON), the GOT executes folder/file processing for the logging after the processing for other files is completed.

Therefore, it may take some time to finish the process of the logging folder/file.

(The "Processing..." message is displayed on the screen.)

Image file management

Function of image file management

Deletes, copies, and moves the file created by the hard copy function. For details of the hard copy function, refer to the following.

📖 GT Designer3 (GOT2000) Screen Design Manual

Function	Description	Reference
Information display of files and folders	Displays the kind, name, data size, creation date and time of the file or folder.	☞ Page 297 Display example of image file management ☞ Page 298 Operation of image file management
Delete	Deletes the file.	☞ Page 298 Deletion operation
Copy	Copies the file.	☞ Page 299 Copy operation

Display operation of image file management

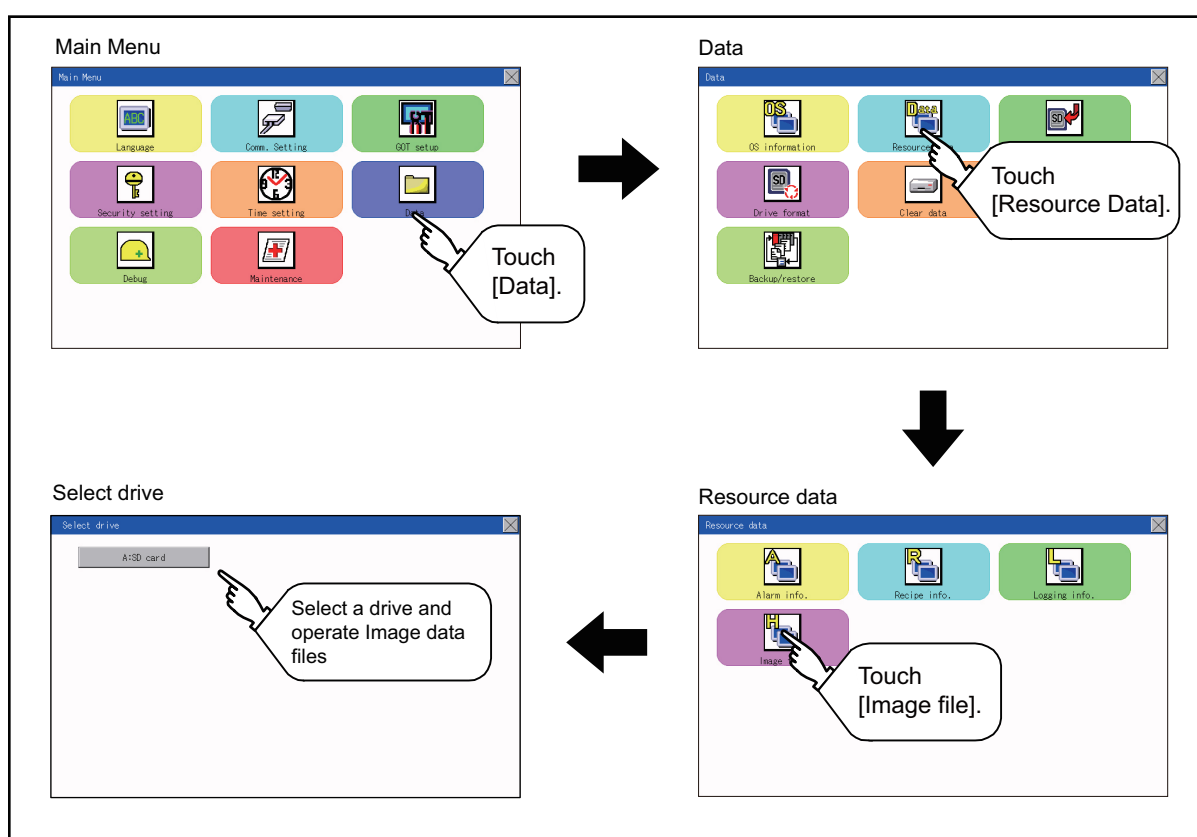

Display example of image file management

Image file Information

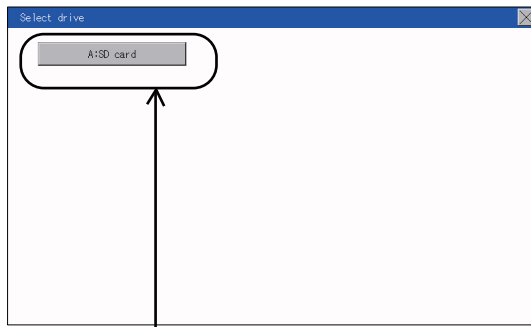

(1)

Image file Information
Storage file/folder display screen

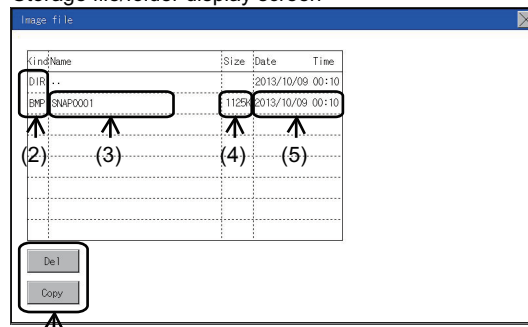

(6)

No.	Item	Description
(1)	Select drive	The drive which displays file or folder can be selected. When an SD card is not installed, the following drives are not displayed. • SD card: [A: Standard SD card]
(2)	Kind	Indicates whether the displayed name is file or folder. Displays the extension for a file and "DIR" for a folder.
(3)	Name	Displays the file name or folder name. For the long file/folder name, entire part may not be displayed. Confirm the non-displayed part with the [Copy] button, etc. ☞ Page 299 Copy operation After confirmation, touch the [Cancel] button to cancel the operation.
(4)	Size	Displays the size of the file displayed in Name.
(5)	Date, Time	Displays the creation date and time of each file.
(6)	Operation switch	Execution switch of each function.

Point

Display of creation date and time

The creation date and time display is not updated even if a file is created or updated while the image file management screen is displayed. To display the updated creation date and time, close the screen currently displayed (by moving to the upper hierarchy folder, etc.) and display the screen again.

Operation of image file management

■Display operation of image file management

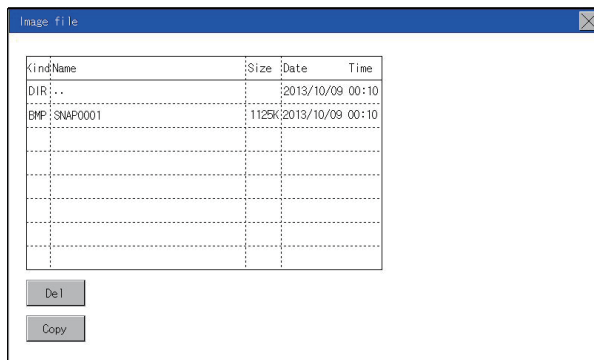

1. Touch a drive in [Select drive] to display the information of the driver.
2. Touch a folder name to display the information of the folder.
3. Touch a [.] folder to return to the parent folder and display its information.
4. Touch the ▲ ▼ button of the scrollbar to scroll the file display area up or down one row. To scroll up or down one page, touch the ▲ ▼ button.
5. If a file name is touched, the file is selected.
6. For the operations of the delete, copy, and rename, refer to the following.

Delete

☞ Page 298 Deletion operation

Copy

☞ Page 299 Copy operation

7. Touch the [X] button to close the screen.

■Deletion operation

Deletes the selected file.

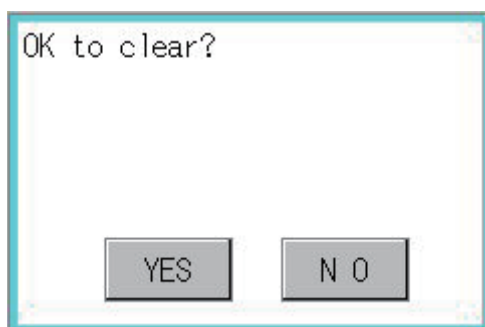
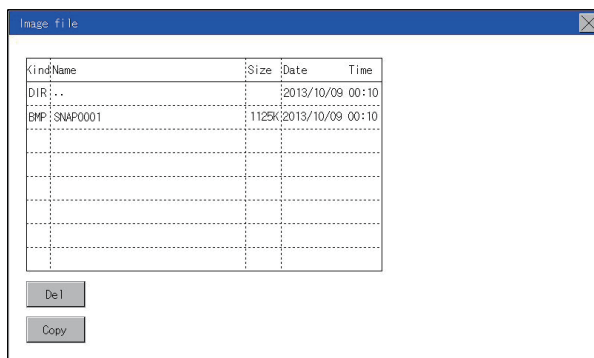

1. Touch the file to be deleted.
2. Touch the [Delete] button to display the screen shown left. To delete the file, touch the [YES] button. To cancel the deletion, touch the [NO] button.

■ Copy operation

Copies the selected file.

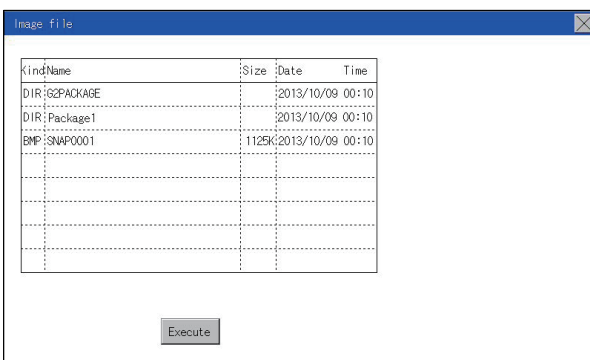
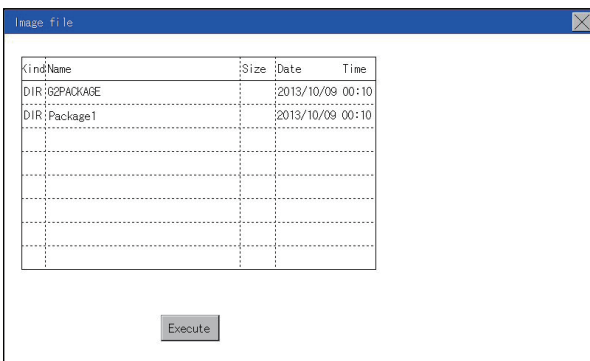
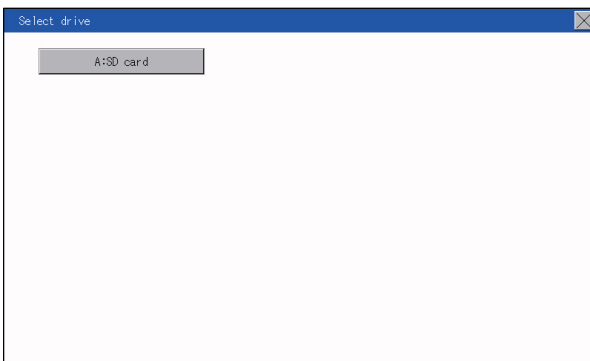
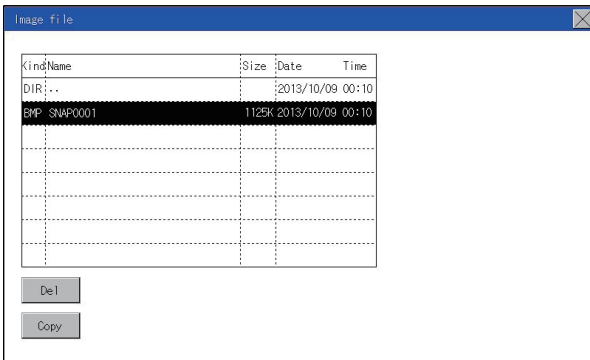

1. Touch the file to be copied.

2. If the [Copy] button is touched, the Select drive screen is displayed. Select a drive.

3. If the copy destination folder is touched, the screen display is changed to the folder of copy destination. At this time, it cannot be copied into the same folder where the file exists. Select other folders.

4. Touch the [Execute] button to copy the file.

Operation log information

Function of operation log information

This function displays the operation log files.

The functions below can be carried out for files.

Only GS21-W-N supports this function.

For details on operation logs, refer to the following.

📖 GT Designer3 (GOT2000) Screen Design Manual

Function	Description	Reference
Information display of files and folders	Displays name, data size, creation date and time of file or folder.	<ul style="list-style-type: none"> ☞ Page 301 Display example of operation log information ☞ Page 302 Operation of operation log information
G2O → CSV conversion	Converts an operation log file (G2O file) to a CSV file.	☞ Page 303 G2O → CSV conversion operation, G2O → TXT conversion operation
G2O → TXT conversion	Converts an operation log file (G2O file) to a Unicode text file.	☞ Page 303 G2O → CSV conversion operation, G2O → TXT conversion operation
Delete	Deletes the file.	☞ Page 304 Deletion operation
Copy	Copies the file.	☞ Page 305 Copy operation

Display operation of operation log information

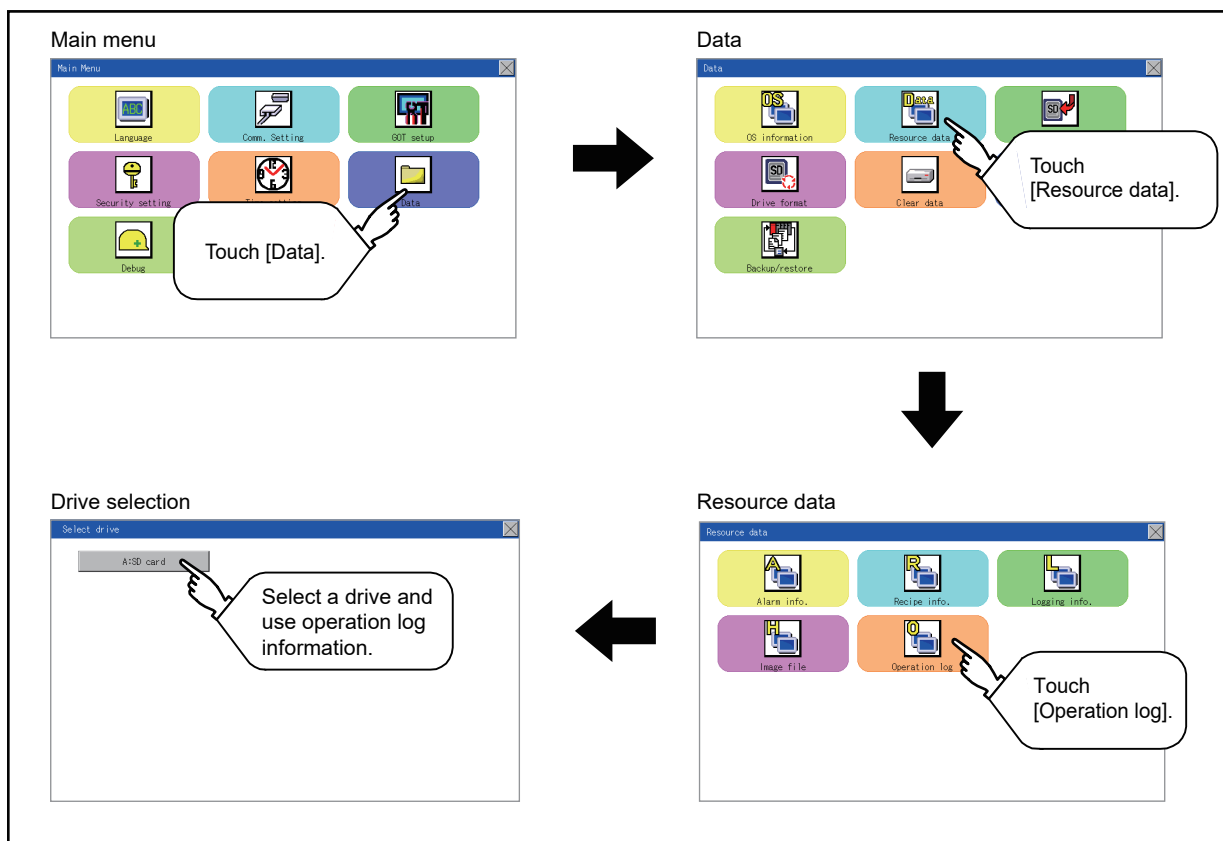

Display example of operation log information

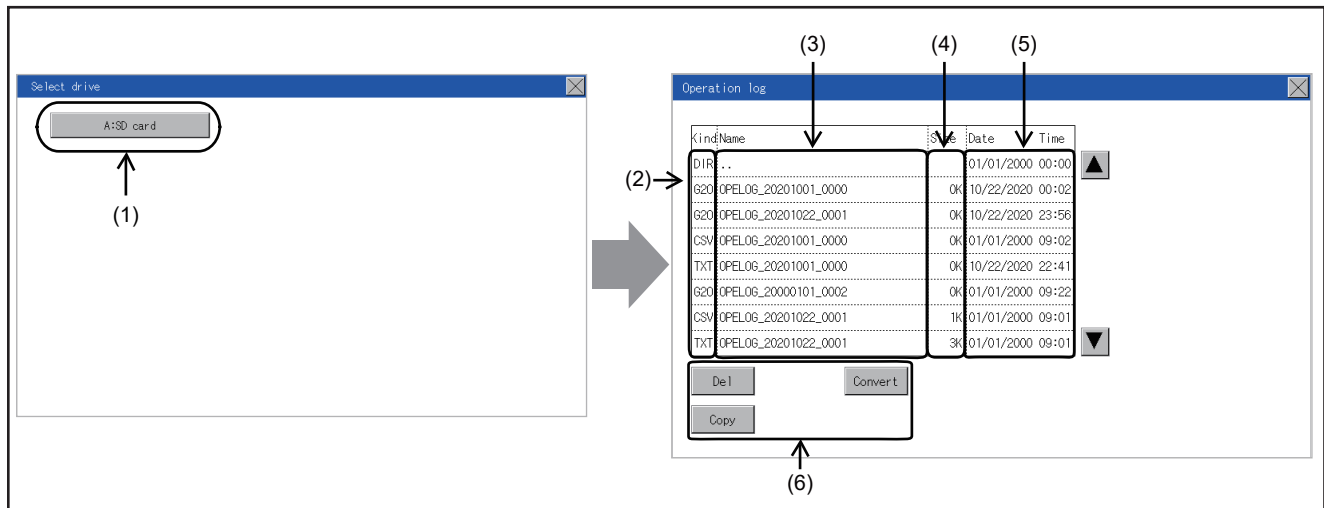

No.	Item	Description
(1)	Select drive	The drive which displays file or folder can be selected. (Data storage drives are displayed even no data storage is installed.)
(2)	Kind	Indicates whether the displayed name is file or folder. Displays the extension for a file and "DIR" for a folder.
(3)	Name	Displays the file name or folder name. For the long file/folder name, entire part may not be displayed.
(4)	Size	Displays the size of the file displayed in Name.
(5)	Date, Time	Displays the creation date and time of each file.
(6)	Operation switch	Execution switch of each function.

Operation of operation log information

■ Display operation of operation log information

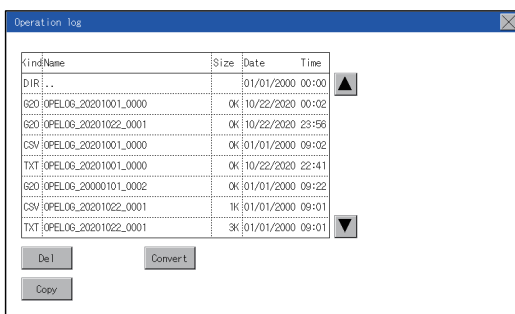
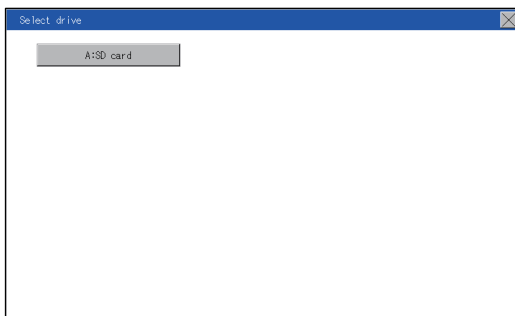

1. If a drive of [Select drive] is touched, the information of the touched drive is displayed.
2. If a folder name is touched, the information of the touched folder is displayed.
3. If a folder of ". ." is touched, the information of the folder in one upper hierarchy is displayed.
4. If the ▲ ▼ button of the scrollbar is touched, the screen scrolls up/down by one line.
5. If a file name is touched, the file is selected.
6. For G2O → CSV conversion, G2O → TXT conversion, deleting, copying, and renaming, refer to the following.
G2O → CSV or G2O → TXT conversion
 Page 303 G2O → CSV conversion operation, G2O → TXT conversion operation
Delete
 Page 304 Deletion operation
Copy
 Page 305 Copy operation
7. If the [x] button is touched, the screen is closed.

Point

When the Prohibit Operation Log Information Operation signal (GS522.b3) is turned on, the [Del], [Copy], and [Convert] buttons are not displayed.

For the details, refer to the following.

GT Designer3 (GOT2000) Screen Design Manual

■G2O → CSV conversion operation, G2O → TXT conversion operation

A selected G2O file is converted to a CSV file or Unicode text file.

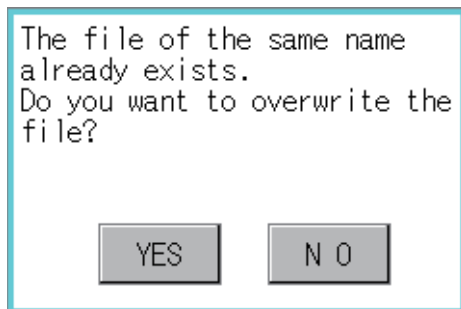
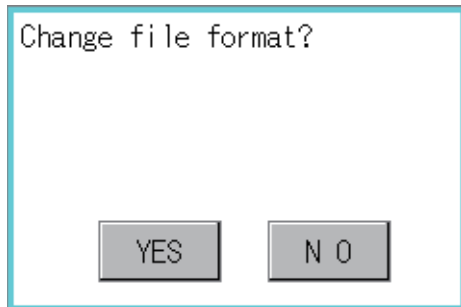
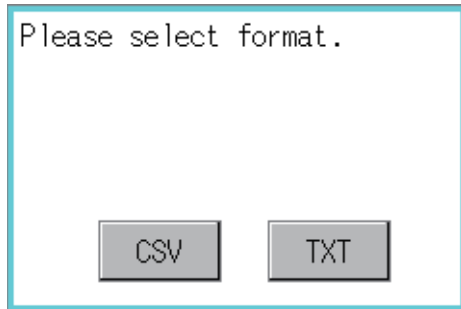
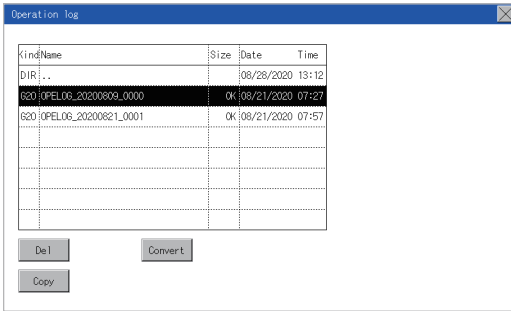

1. Touch the G2O file to be converted.
2. Touch [Convert].
3. The destination selection screen appears. Select the destination.
4. The following dialog box is displayed when touching the following button according to the file type to convert to.
 - CSV file: [CSV] button
 - Unicode text file: [TXT] button
5. Touch the [YES] button. The converted file is created.
6. If a file with the same name exists, the overwrite confirmation dialog appears. Touch the [YES] button to overwrite the file. Touch the [NO] button to cancel the conversion.

■ Deletion operation

Deletes the selected file.

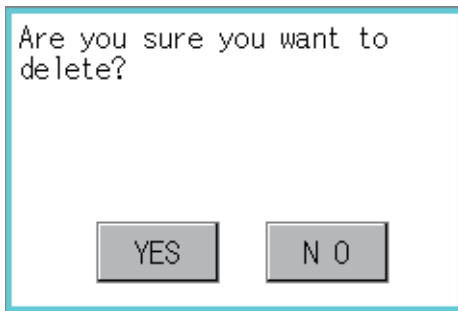
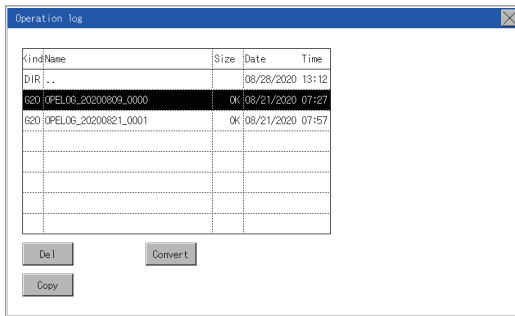

1. Touch the file to be deleted.

2. If the [Delete] button is touched, the dialog box mentioned below is displayed.

If the [YES] button is touched, the file is deleted.

If the [NO] button is touched, the deletion is canceled.

■ Copy operation

Copies the selected file.

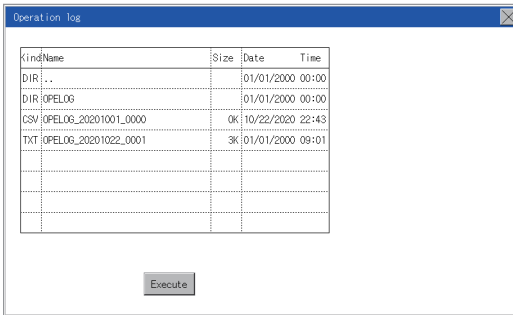
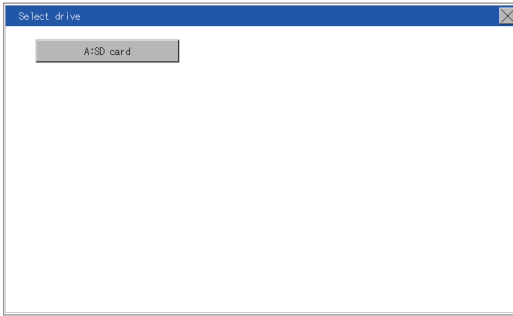
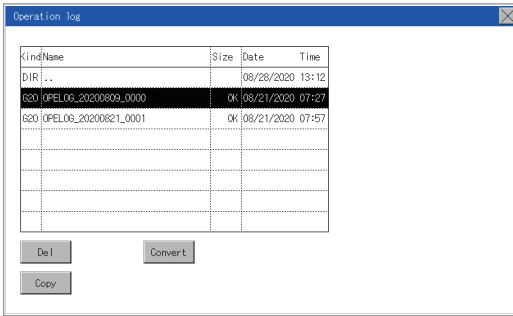

1. Touch the file to be copied.
2. If the [Copy] button is touched, the Select drive screen is displayed.
3. Select a drive.
4. Select the copy destination folder and touch [Execute]. The file is copied.

27.4 SD Card Access

Functions of SD card access

When the GOT is turned on, an SD card can be installed or removed to/from the GOT without damage to the data in the SD card.

Display operation of SD card access

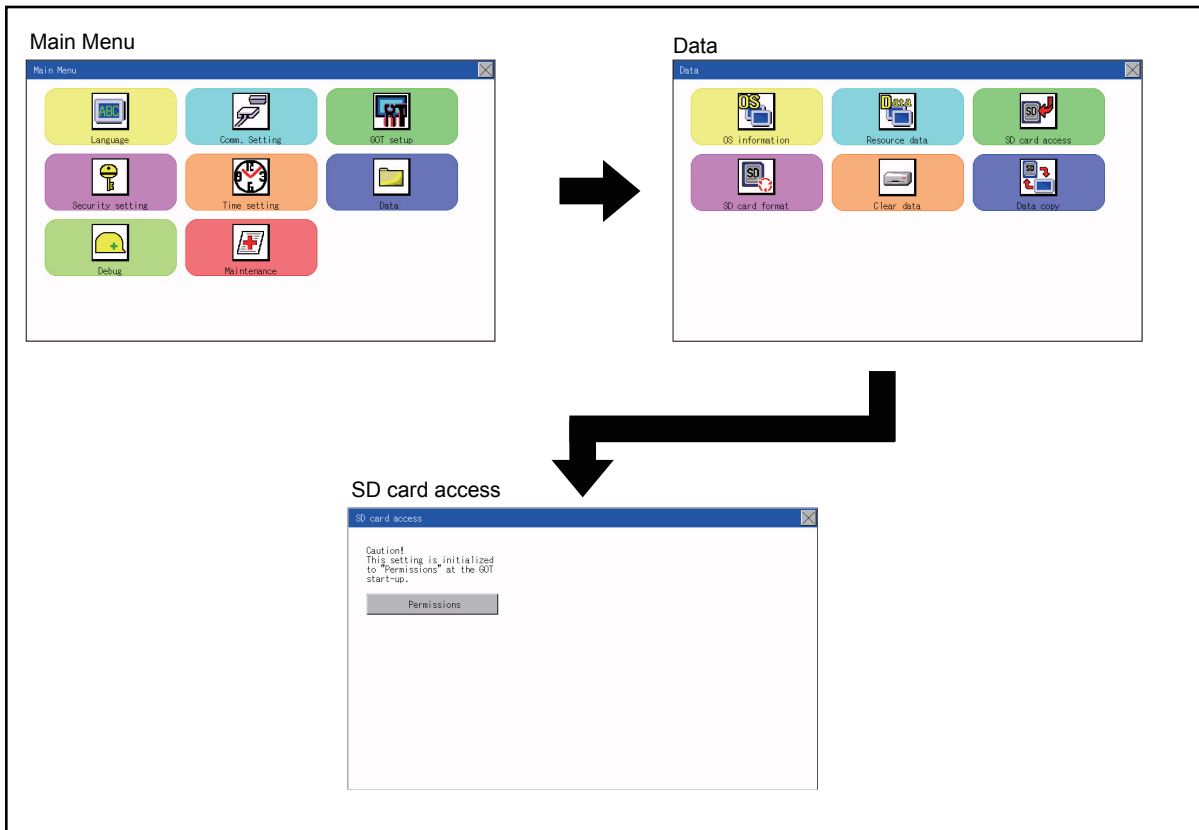

Operation of SD card access

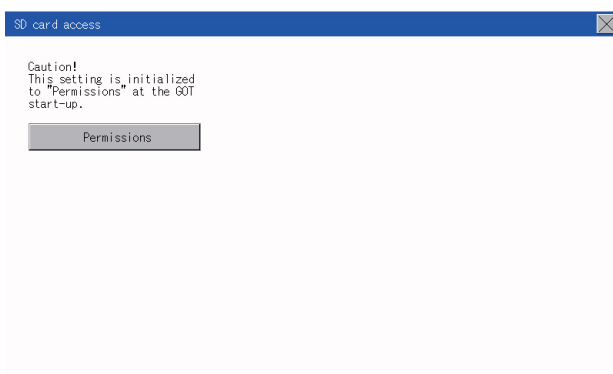

1. Touch a setting item to change the setting.

[Permissions] ↔ [Access inhibit]

When installing or removing an SD card, always set [Access inhibit].

27.5 SD Card Format

Function of SD card format

An SD card is formatted.

Display operation of SD card format

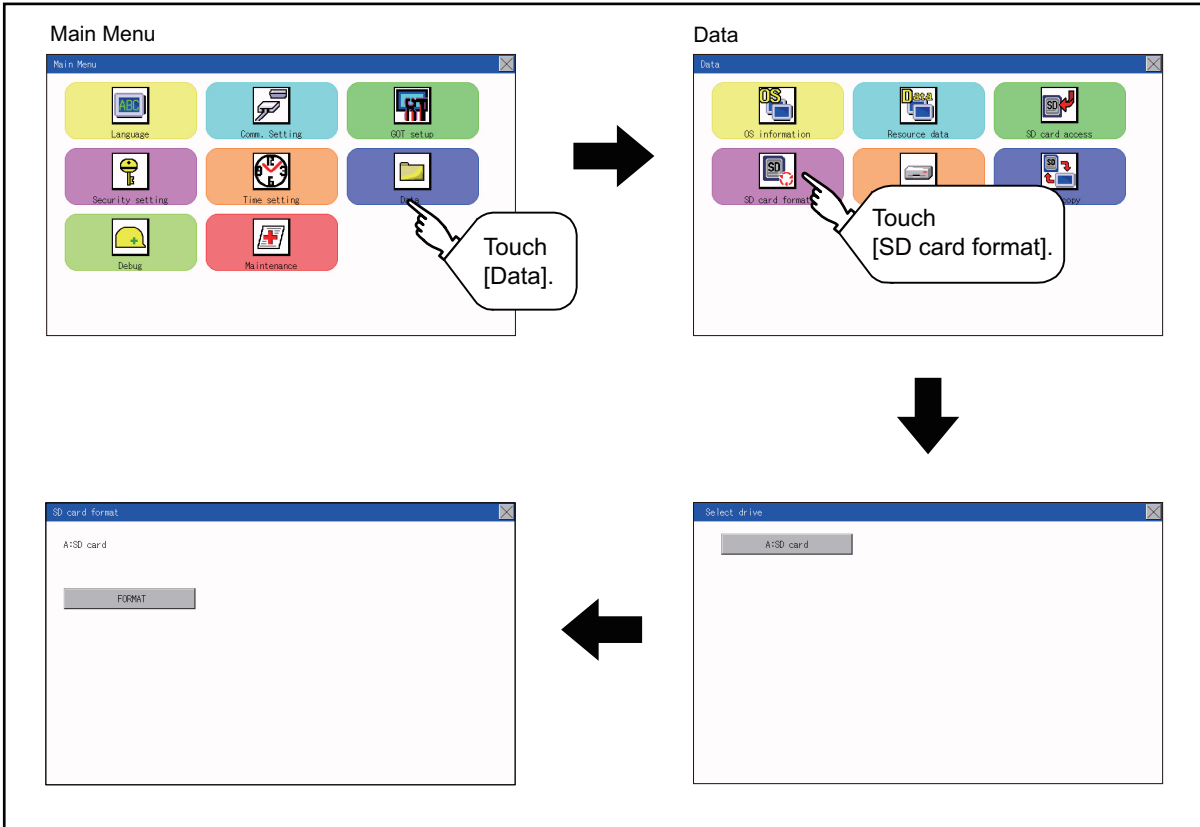

Operation of SD card format

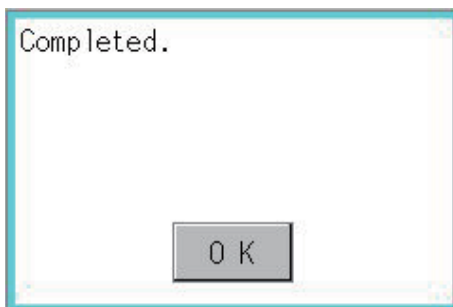
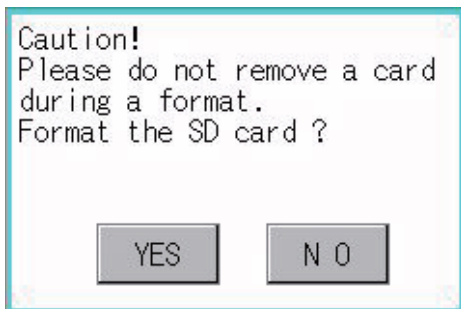
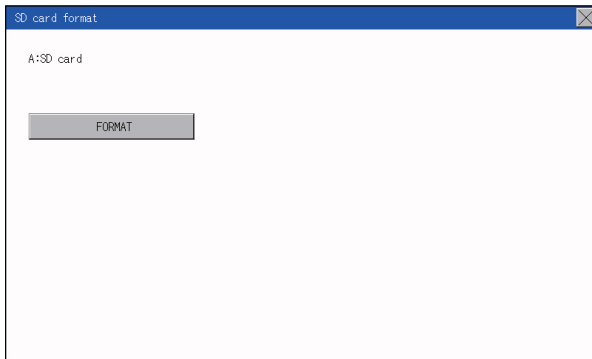
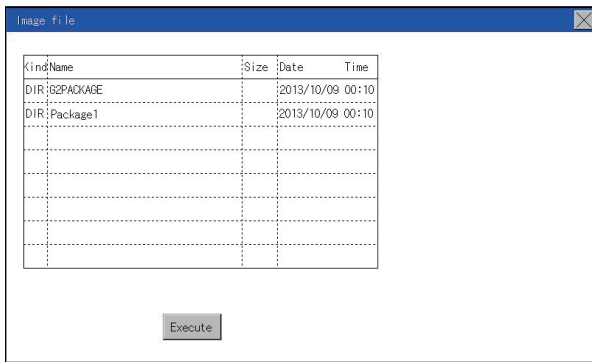

1. Install an SD card to the GOT. For installation/removal procedure of an SD card, refer to the following.
☞ Page 177 Installation/removal procedure of SD card
2. Touch and select the drive to format by drive selection.

3. Touch the [FORMAT] button to display the password input screen.

4. Type and touch the [Enter] key. The dialog shown left will appear. (The password is fixed to 1111.) Check the description in the dialog, and touch the [YES] button to format the SD card. To cancel the format, touch the [NO] button.

5. When the formatting is completed, the completion dialog mentioned left is displayed.

6. To close the dialog box, touch the [OK] button.

Point

Restrictions on formatting

- When using an unformatted SD card in the GOT, format it by a personal computer. The GOT cannot format the unformatted SD card.
- The format of the GOT does not change the file system (Example: FAT16) of the SD card and inherits the file system before the format.

27.6 Clear data

Clear data functions

This function deletes the project data and resource data that are written to the GOT.

Clear data display

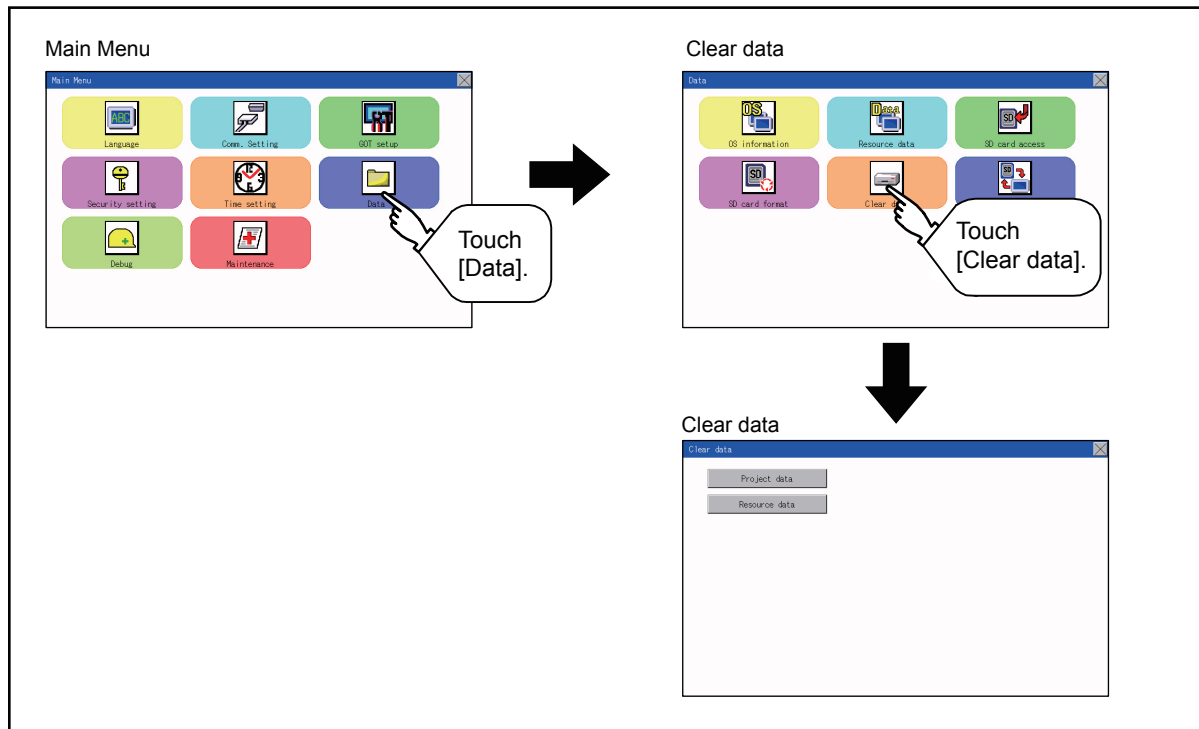

Clear data operation

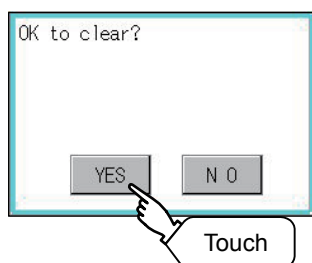
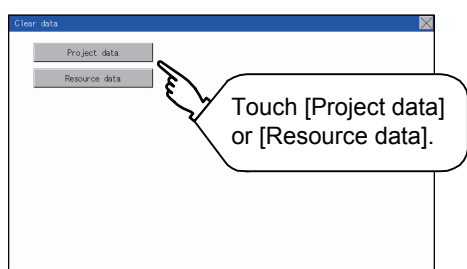

1. Touch the type of data on the screen to be deleted.
2. The dialog box on the left is displayed for confirmation. Touch the [YES] button to delete the data, or the [NO] button to cancel.

Point

Canceling deletion

Data deletion cannot be canceled once the [YES] button is pressed at the confirm deletion prompt. Double check before touching the [YES] button.

27.7 Data Copy

The project data and basic system application are transferred by using an SD card.

Point

Copy from the memory board to the GOT

Copying from the memory board to the GOT when turning on the power to the GOT.

Refer to the following.

☞ Page 390 Installing using the data control function (Utility)

Display operation of data copy

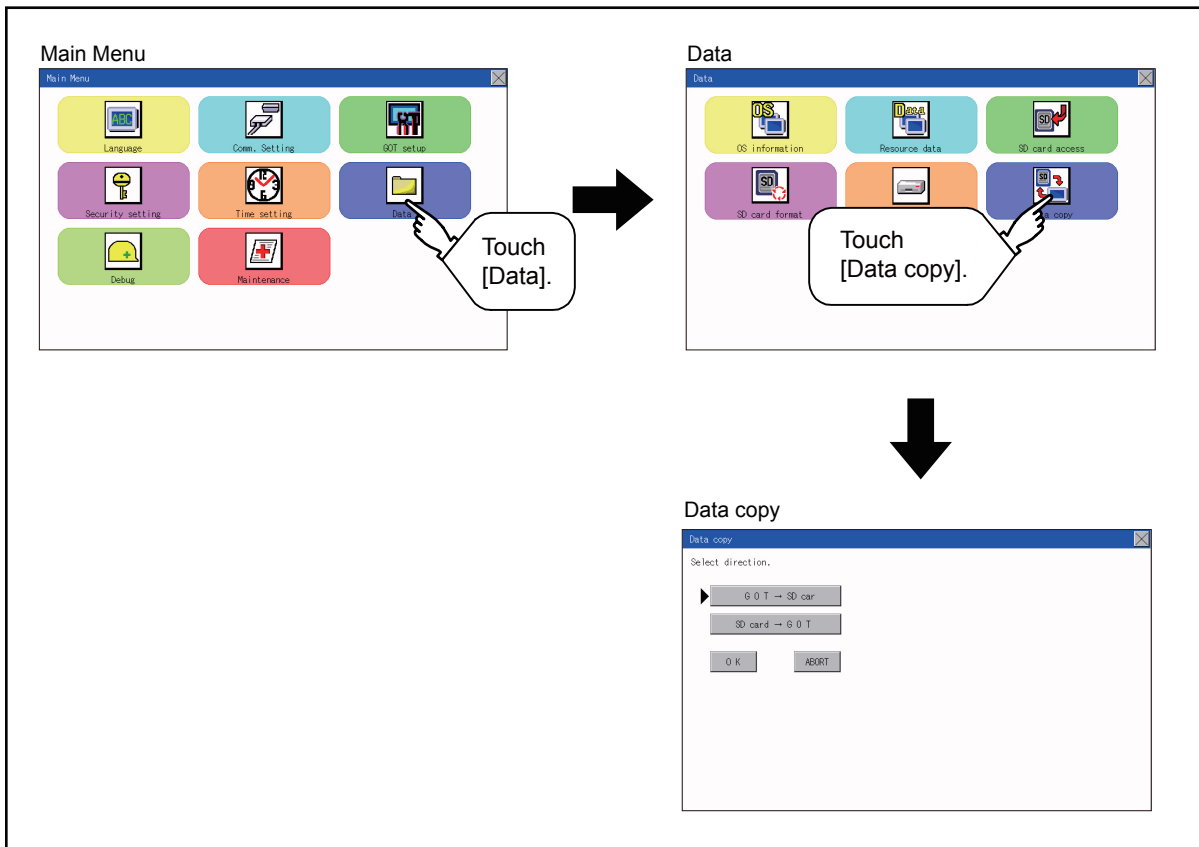

Operation of data copy

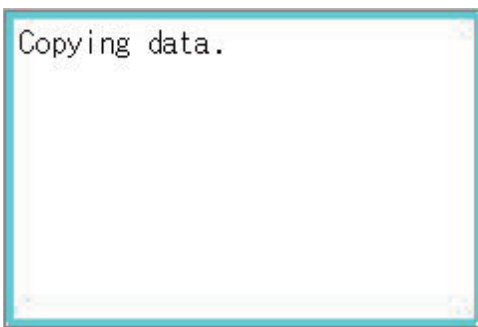
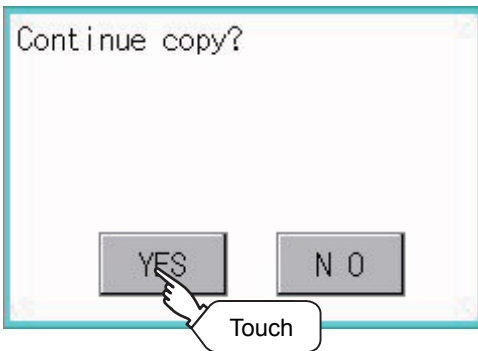
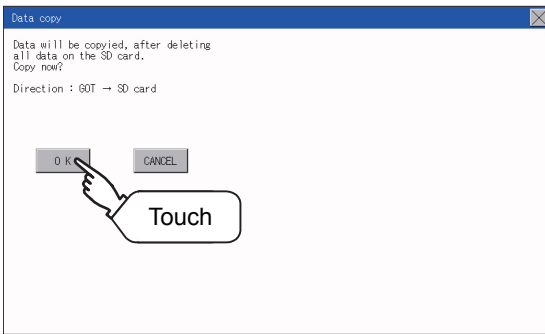
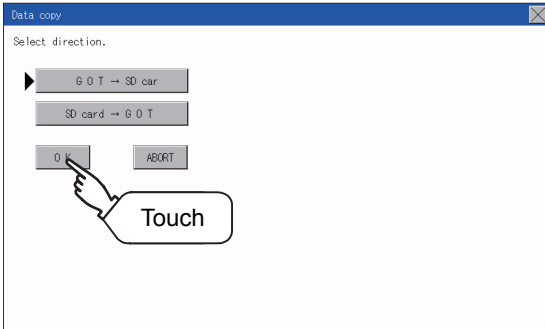
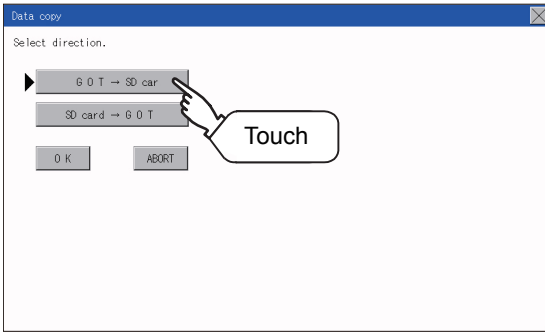

1. Select the copy direction. The selection mark is displayed on the side of the selected key.

GOT → SD card:

Copy the data from the GOT to the SD card.

SD card → GOT:

Copy from the SD card to the GOT

2. After selecting the direction, touch the [OK] button. To abort copy, touch the [ABORT] button.

3. Confirm the copy direction and copy target. When they are set correctly, touch the [OK] button. To change the setting, touch the [CANCEL] button.

4. The dialog box on the left is displayed for confirmation. Touch the [YES] button to start copying and [NO] button to abort.

5. While the copy is executed, the dialog box on the left is displayed.



6. Copy is completed. If the [×] button is touched, the screen is closed. If an error occurs during copy, an error message appears. For details of error messages, refer to the following.

☞ Page 312 Error display

When only the project data was copied to the GOT, touch the [ESC] button to restart the GOT and display the user-created screen.

When the basic system application was copied, the GOT will automatically start up and display the user-created screen.

(If the project data does not exist, a message appears to notify that the project data does not exist.)

Point

When installing or removing an SD card

Always set [Permissions] on the GOT. For details, refer to the following.

☞ Page 306 SD Card Access

Error display

When copying is not available between the GOT and the SD card, check the following contents according to the GOT error display.

Error message	Remedy
SD card is not attached.	Install an SD card to the GOT.
GOT type is unmatch.	The model set for the data in the SD card does not match with that of the copy target GOT. Use the same model data as that of the copy target GOT.
Write protection switch ON.	The write protection switch of the SD card is ON. Turn off the write protection switch.
Available package data is notexisted.	There is no data to be a copy target in the copy source. Store the data to be copied in the copy source and copy it again.

27.8 BACKUP/RESTORE

BACKUP/RESTORE

Setting data, including a sequence program, parameters, and setting values, for a controller connected to the GOT can be saved (backed up) in a memory card or USB memory in the GOT.

The following shows features of the backup/restore function.

Backing up or restoring system without personal computer for reducing downtime

Setting data for a controller connected to the GOT can be backed up, and the data can be restored to the controller. With backing up setting data for a controller, the data can be restored to the controller with the GOT connected to the controller even though the controller has to be replaced because of problems, including failures. As a result, the system can be easily restored.

Backing up setting data to a SD card

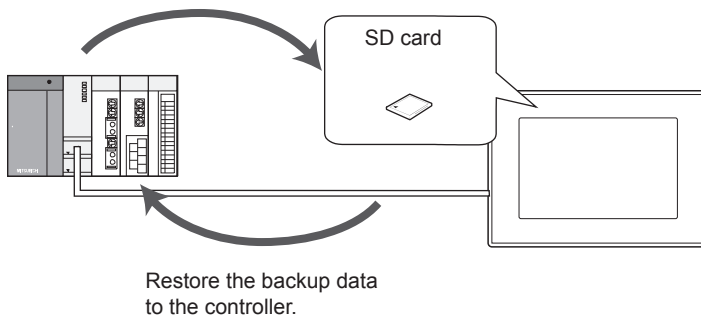

Enabling creating the same system without personal computer

With restoring the backed up setting data to controllers in other systems, the same system can be created without a personal computer.

Improving security

When the backup/restore function is used, browsing and changing setting data is limited with a password and the security is improved.

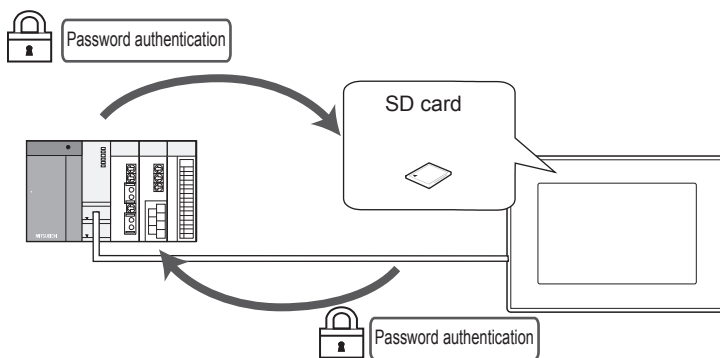

System configuration

This section describes the system configuration for the backup/restore function.

For connection type settings and precautions regarding the communication unit/cable and connection type, refer to the following.

📖 GOT2000 Series Connection Manual (Mitsubishi Products) for GT Works3 Version1

Target controller

Controller		Model
MELSEC iQ-F		FX5U, FX5UC, FX5UJ
QCPU (Q mode)	Basic model* ¹	Q00JCPU, Q00CPU, Q01CPU
	High performance model* ¹	Q02CPU, Q02HCPU, Q06HCPU, Q12HCPU, Q25HCPU
	Universal model	Q00JCPU, Q00UCPU, Q01UCPU, Q02UCPU, Q03UDCPU, Q04UDHCPU, Q06UDHCPU, Q10UDHCPU, Q13UDHCPU, Q20UDHCPU, Q26UDHCPU, Q03UDECPU, Q04UDEHCPU, Q06UDEHCPU, Q10UDEHCPU, Q13UDEHCPU, Q20UDEHCPU, Q26UDEHCPU, Q50UDEHCPU, Q100UDEHCPU, Q03UDVCPU, Q04UDVCPU, Q06UDVCPU, Q13UDVCPU, Q26UDVCPU
LCPU		L02CPU, L06CPU, L26CPU, L26CPU-BT, L26CPU-PBT, L02CPU-P, L06CPU-P, L26CPU-P, L02SCPU, L02SCPU-P
FX CPU* ²		FX0, FX0S, FX0N, FX1, FX2, FX2C, FX1S, FX1N, FX1NC, FX2N, FX2NC, FX3U, FX3UC, FX3G, FX3GC, FX3S

*1 Use a PLC CPU with the function version of B or later.

*2 To restore the backup data containing a special parameter, use the following version of CPU.

· FX3U(C) version: 3.10 or later · FX3G(C) version: 2.00 or later

Connection type

This function can be used in the following connection types.

(○: Applicable, △: Partly restricted, ×: Inapplicable)

Function		Connection type between GOT and controller		
Name	Description	Direct CPU connection (serial)	Serial communication connection	Ethernet connection
Backup/restore	Backs up setting data for a controller connected to the GOT and restores the data to the controller.	△ * ¹	△ * ³	△ * ^{2,3}

*1 When the GOT is connected to LCPU, use L6ADP-R2.

*2 Backup/Restore cannot be used when using CC-Link IE field network Ethernet adapter.

*3 The restoration cannot be performed to a QCPU with the factory-settings or whose memory is formatted.

Required hardware

The backup / restore, SD card is required.

Data to be backed up and restored

The following shows data to be backed up and restored.

Data other than the following data cannot be backed up and restored.

■Basic model QCPU

Item	Description	File name
Parameter	Parameter for operating a programmable controller	PARAM.QPA
Intelligent function module parameter	Parameter for intelligent function modules	IPARAM.QPA
Sequence program	Program that the CPU operates	MAIN.QPG
SFC program	Sequence program with the SFC programming format	MAIN-SFC.QPG
File register ^{*1}	Data stored in file registers	MAIN.QDR
Device comment	Device comment to be stored in a programmable controller	MAIN.QCD
Device initial value	Setting the device initial value	MAIN.QDI

- *1 The file register in the Flash card installed in the CPU is always restored without confirming saving.
 Select whether restoring or not the file register stored in the SRAM card or standard RAM in the dialog box displayed when restoration is executed.
 When the file register is not restored, the existing file register is deleted.
 Therefore, programs of the controller may not work normally.
 If a problem occurs in the operation of the controller after restoration, perform the restoration again, including to the file register.

■High Performance model QCPU

Item	Description	File name
Parameter	Parameter for operating a programmable controller	PARAM.QPA
Intelligent function module parameter	Parameter for intelligent function modules	IPARAM.QPA
Program	Program that the CPU operates (Including SFC program)	***.QPG
Device comment	Device comment to be stored in a programmable controller	***.QCD
Boot operation specification file	Batch file for starting programs stored in ROM and others	AUTOEXEC.QBT
Device initial value	Setting the device initial value	***.QDI
File register ^{*1}	Data stored in file registers	***.QDR
Sampling trace file ^{*2}	Sampling trace data that the specified device data is continuously collected with the specified timing	***.QTD
Failure history data ^{*2}	Failure history data that are recorded self-diagnostic results	***.QFD
Programmable controller user data	Any user-created data stored in a memory card	***.*** (Optional)

- *1 The file register in the Flash card installed in the CPU is always restored without confirming saving.
 Select whether restoring or not the file register stored in the SRAM card or standard RAM in the dialog box displayed when restoration is executed.
 When the file register is not restored, the existing file register is deleted.
 Therefore, programs of the controller may not work normally.
 If a problem occurs in the operation of the controller after restoration, perform the restoration again, including to the file register.
- *2 The item can be backed up only.

■ Universal model QCPU

Item	Description	File name
Parameter	Parameter for operating a programmable controller	PARAM.QPA
Intelligent function module parameter	Parameter for intelligent function modules	IPARAM.QPA
Program	Program that the CPU operates (Including SFC program)	***.QPG
Device comment	Device comment to be stored in a programmable controller	***.QCD
Boot operation specification file	Batch file for starting programs stored in ROM and others	AUTOEXEC.QBT
Device initial value	Setting the device initial value	***.QDI
File register ^{*1}	Data stored in file registers	***.QDR
Sampling trace file ^{*2}	Sampling trace data that the specified device data is continuously collected with the specified timing	***.QTD
Programmable controller user data	Any user-created data stored in a memory card	***.*** (Optional)
File for storing device data	Device data used for the SP.DEVST and S.DEVLD instructions	DEVSTORE.QST
Drive heading	The heading of the drive	QN.DAT
Remote password	Remote password settings	00000000.QTM
Monitor sequence extension	Data to increase the speed of monitors from other stations	MONITOR.Q0*
Latch data backup file	Stores the backup data for the latch data backup function to the standard ROM.	LCHDAT00.QBK

*1 The file register in the Flash card installed in the CPU is always restored without confirming saving. Select whether restoring or not the file register stored in the SRAM card or standard RAM in the dialog box displayed when restoration is executed.

When the file register is not restored, the existing file register is deleted.

Therefore, programs of the controller may not work normally.

If a problem occurs in the operation of the controller after restoration, perform the restoration again, including to the file register.

*2 The item can be backed up only.

■ LCPU

Item	Description	File name
Parameter	Parameter for operating a programmable controller	PARAM.QPA
Intelligent function module parameter	Parameter for intelligent function modules	IPARAM.QPA
Program	Program that the CPU operates (Including SFC program)	***.QPG
Device comment	Device comment to be stored in a programmable controller	***.QCD
Boot operation specification file	Batch file for starting programs stored in ROM and others	AUTOEXEC.QBT
Device initial value	Setting the device initial value	***.QDI
File register ^{*1}	Data stored in file registers	***.QDR
Sampling trace file ^{*2}	Sampling trace data that the specified device data is continuously collected with the specified timing	***.QTD
Programmable controller user data	Any user-created data stored in a memory card	***.*** (Optional)
File for storing device data	Device data used for the SP.DEVST and S.DEVLD instructions	DEVSTORE.QST
Drive heading	The heading of the drive	QN.DAT
Remote password	Remote password settings	00000000.QTM
Monitor sequence extension	Data to increase the speed of monitors from other stations	MONITOR.Q0*
Latch data backup file	Stores the backup data for the latch data backup function to the standard ROM.	LCHDAT00.QBK
Data logging setting file	Setting the data logging	LOGCOM.QLG LOG01.QLG to LOG10.QLG
Menu definition file	Menu defining files	MENUDEF.QDF

*1 The file register in the Flash card installed in the CPU is always restored without confirming saving. Select whether restoring or not the file register stored in the SRAM card or standard RAM in the dialog box displayed when restoration is executed.

When the file register is not restored, the existing file register is deleted.

Therefore, programs of the controller may not work normally.

If a problem occurs in the operation of the controller after restoration, perform the restoration again, including to the file register.

*2 The item can be backed up only.

■FX CPU

Item	Description	File name
Parameter	Parameter for operating a programmable controller	INFO.FPG
Device comment	Device comment to be stored in a programmable controller	
Sequence program	Program that the CPU operates	
Special program*1	Positioning setting/Initial value parameter	
File register	Data stored in file registers	
Extension file register*2	Data stored in extension file registers	
Built-in CC-Link/LT setting*3	CC-Link/LT parameter	
Special parameter*1	Special adapter/special block parameter saved in the main unit	

- *1 The data can be backed up or restored with the FX3U(C) series and FX3G(C) series only.
- *2 The data can be backed up or restored with the FX3U(C) series only.
- *3 The data are stored in the FX3U-32MT-LT-2 only.

■Data for software

Item	Description	File name
Label program	Data for GX Developer	PROJINFO.CAB
Symbolic data	Symbolic data for PX Developer	#FBDQINF.BIN
Source information	Simple project (with label)	SRCINFOM.CAB SRCINFOM.C32
	Structured project	SRCINFOI.CAB SRCINFOI.C32
New source information	Simple project (with label)	SRCINF1M.CAB SRCINF2M.CAB SRCINF1M.C32 SRCINF2M.C32
	Structured project	SRCINF1I.CAB SRCINF2I.CAB SRCINF1I.C32 SRCINF2I.C32

Backup data

■Storing backup data

When backups for the same channel are executed several times, the backup data is overwritten by SD card.

■Storage location for backup

Backup data are stored in a SD card with the following folder structure.

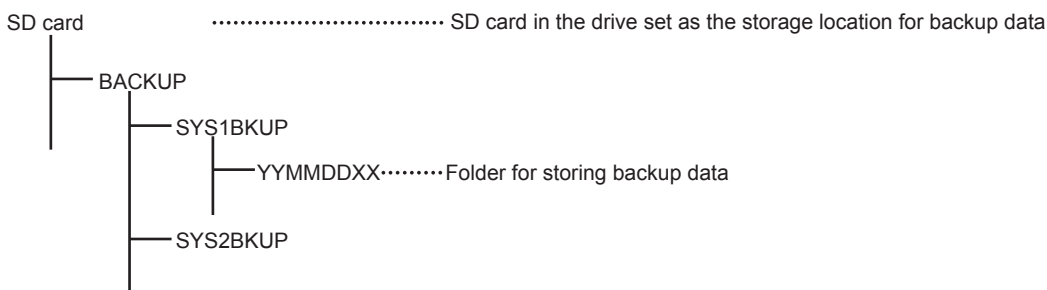

■Folders for backup data

Backup data are stored by the folder, and a folder name (YYYYMMDDXX) is set as follows.

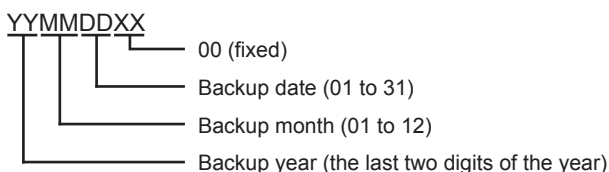

Access range

Access range with connection types

The following shows a target controller of the backup/restore execution with each connection type.

Connection type	Target controller
Serial communication connection	Host station
Ethernet connection	Host station

With multi-channel function

With the multi-channel function, the backup and restoration is executed per channel.

Backing up/restoring data for multiple CPU system

Only batch backup of all controllers is executed.

Backup of only specified ones among the controllers Nos. 1 to 4 is not supported.

Precautions

Precautions for backup

■Data that cannot be backed up

The GOT cannot back up device current values and data stored in device memories.

For collecting device current values, use the recipe function.

For how to use the recipe function, refer to the following manual.

 GT Designer3 (GOT2000) Screen Design Manual

For collecting data stored in device memories, use GX Developer.

■Names of files to be backed up

When characters other than the characters defined in the shift JIS code and ASCII code are used for file names, the file names may not be correctly displayed with the data backed up on the GOT.

For using the backup/restore function, use characters in the JIS code and ASCII code for file names.

■Backing up intelligent function module parameters

For backing up an intelligent function module parameter (IPARAM.QPA), only the parameters that can be stored in the PLC CPU are the target parameters.

To store other intelligent function module parameters than those, GX Configurator applied to GX Works2 and the intelligent function module is required.

For the intelligent function module parameters that can be stored in the PLC CPU, refer to the following.

 GX Works2 Version 1 Operating Manual (Intelligent Function Module)

■Compatibility of backup data

The backup data used in GS21 cannot be used in GT27, GT25, and GT23.

The backup data used in GT27, GT25, and GT23 cannot be used in GS21.

Precautions for restore

■Communication status between GOT and target controllers

For restoring data, enable the target controllers of the restoration to communicate with the GOT.

When the target controllers of the restoration cannot communicate with the GOT, the restoration cannot be executed.

■STOP status during restoration

CPUs for the programmable controller is in the STOP status with the remote STOP before the restoration.

For the CNC C70, the CNC ladder is in the STOP status.

The CPUs and CNC ladder remain in the STOP status after the restoration is completed.

Restart the controllers.

■When restoration is canceled

When the restoration is canceled, all the data are not restored to the controllers and the controllers may not correctly operate.

When the restoration is canceled, be sure to execute the restoration again.

The CPUs and CNC ladder remain in the STOP status after the restoration is canceled.

Restart the controllers.

■System configuration with controllers for restoration

Set the same system configuration with the controllers for the restoration as those for the backup.

Failure to do so disables the GOT to restore data to the controllers.

When the system configuration with the controllers for the restoration is the same as those for the backup, the GOT can restore data to the controllers even if the connection type and CH No. for the restoration differ from those for the backup.

■Controller operations

Controllers may malfunction by changing set values, device values, and others during the restoration.

Check that data to be restored is the appropriate data, and then execute the restoration with paying attention to the controller operations.

Common precautions for backup and restore

■Password for backup/restore

When a password for a controller is changed after setting the password for the backup/restore, set a new password for the backup/restore.

For setting the password for the backup/restore, refer to the following.

 Page 321 Security and password

■Precautions for GT Designer3 (GOT2000)

Do not execute the following operations with GT Designer3 (GOT2000) during the backup/restore.

Boot OS installation, package data, the communication driver, the standard monitor OS, and the extended function system application download

When the above operations are executed, the backup/restore is stopped.

■Precautions for GX Developer

Do not access the target controller of the backup/restore with GX Developer during the backup/restore.

Doing so stops the backup/restore.

Do not execute the backup/restore on the GOT while the target controller of the backup/restore is accessed by GX Developer.

Doing so causes a communication error on GX Developer. (The backup/restore is executed.)

■CPU with a security key

The backup/restore cannot be executed on the CPU on which the security key is set.

To execute the backup/restore, check the setting of the CPU.

When the target controllers of the backup/restore include both the CPU with the security key and the CPU without the security key, the backup/restore is executed only for the CPU without the security key.

Precautions for QCPU

The restoration to QCPU with the factory-settings or whose memory is formatted is available only in the following cases.

- For a single CPU system: When the connection type is the bus connection or direct CPU connection (serial)
- For a multiple CPU system: When the connection type is the direct CPU connection (serial)

However, in a multiple CPU system which includes a QCPU with the factory-settings or whose memory is formatted, batch restoration to multiple controllers cannot be performed.

Restore each controller with the following procedure.

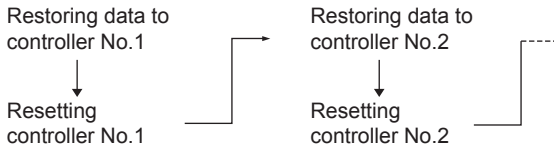

Precautions for FXCPU

■Attaching a memory cassette

When a memory cassette is attached to a FXCPU, data in the memory cassette is backed up.

When a memory cassette is not attached to the FXCPU, data in the built-in memory is backed up.

■Keyword setting

The following table shows whether the backup/restore function is executed or not by each keyword setting.

(Executed: ○ Not executed: ×)

Function	Protection that cannot be disabled by keyword			With keyword						Without keyword
	Write protection	Read/Write protection	All operation protection	Write protection		Read/Write protection		All operation protection		
				Enabled	Disabled	Enabled	Disabled	Enabled	Disabled	
(Trigger) Backup	○	×	×	○	○	×	○	×	○	○
Restore	×	×	×	×	○	×	○	×	○	○

■Keyword for restoring data

When data are restored to a target FXCPU, a keyword in the FXCPU is held.

For setting or disabling a keyword for the FXCPU, refer to the following manual.

GOT2000 Series User's Manual (Utility)

Programming manual for the FXCPU used

■Backup data which contains source information

When the target FXCPU of the restoration does not support source information, the backup data which contains source information cannot be restored.

Security and password

By setting the passwords, the password authentication is available when the backup/restore is executed. The password authentication uses the password for the backup/restore and passwords for controllers.

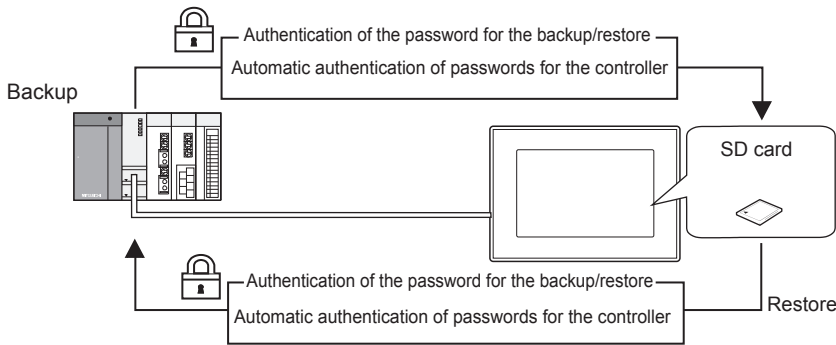

The following shows the passwords used for the backup/restore.

Password	Description
Password for backup/restore	Password for the backup/restore function Set the password on the GOT at the first backup. Before setting the password, set passwords for controllers in advance.
Passwords for controllers	Passwords set for the files for the target controllers of the backup/restore Set this password using the setting software of the controller when the file is written to the controller.

After the first backup (after setting the password for the backup/restore), the user has no need to input the passwords for the controllers. (The passwords for the controllers are automatically verified.)

The following shows the security advantages.

User	Advantage
Administrator	No need to disclose the passwords for the controllers to the operator (Preventing anyone other than the administrator to browse or edit setting data for the controllers.)
Operator	The backup/restore is executed by using the password for the backup/restore only. (No need to input passwords for the controllers)

Point

Before setting password for backup/restore

When the user forgets the password for the backup/restore, the backup/restore cannot be executed.

In that case, execute the backup again by using a formatted or new SD card.

For how to set the password for the backup/restore, refer to the following.

☞ Page 322 Setting password for backup/restore

How to use the password for the backup/restore, refer to the following.

☞ Page 324 How to use password for backup/restore

Setting password for backup/restore

The password for the backup/restore can be set only when the following condition is satisfied at the first backup.

- When passwords are set for the files for the backup target controller

At the first backup, the password authentication for the controller is required.

The following shows the operating procedure at the first backup.

For details, refer to the following.

☞ Page 327 Operation of backup/restore

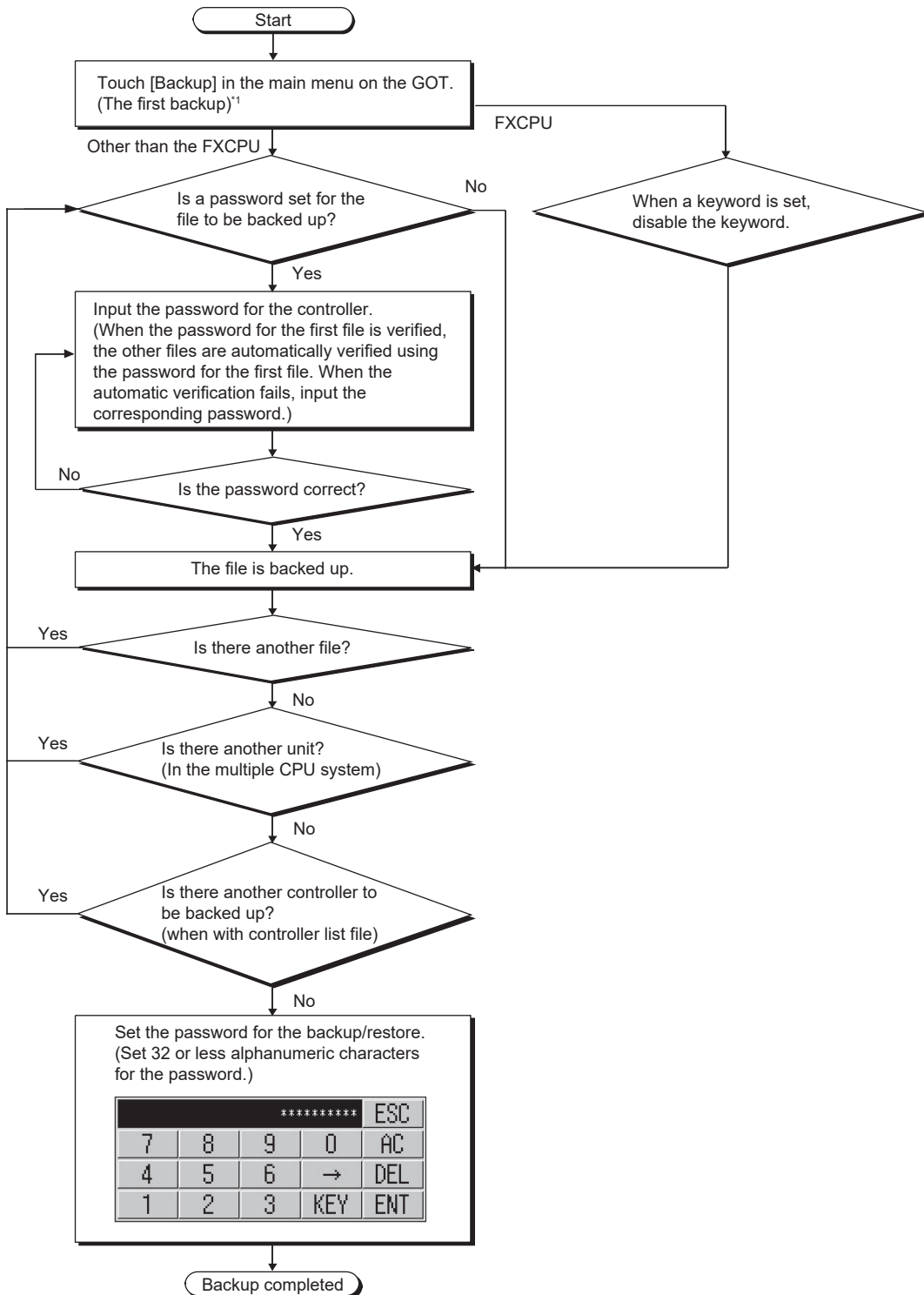

*1 For details, refer to the following.

☞ Page 327 Operation of backup/restore

- Setting password

For ensuring the security, setting a password of 8 or more characters that cannot be easily guessed is recommended.

When the password is leaked, the same system can be created. Pay enough attention to managing the password.

- FXCPU keyword

To back up or restore data in the FXCPU, disable a keyword in advance.

 Page 332 Operation of keyword

How to use password for backup/restore

■Backup

The following shows the operating procedure for the backup after setting the password for the backup/restore.

☞ Page 327 Operation of backup/restore

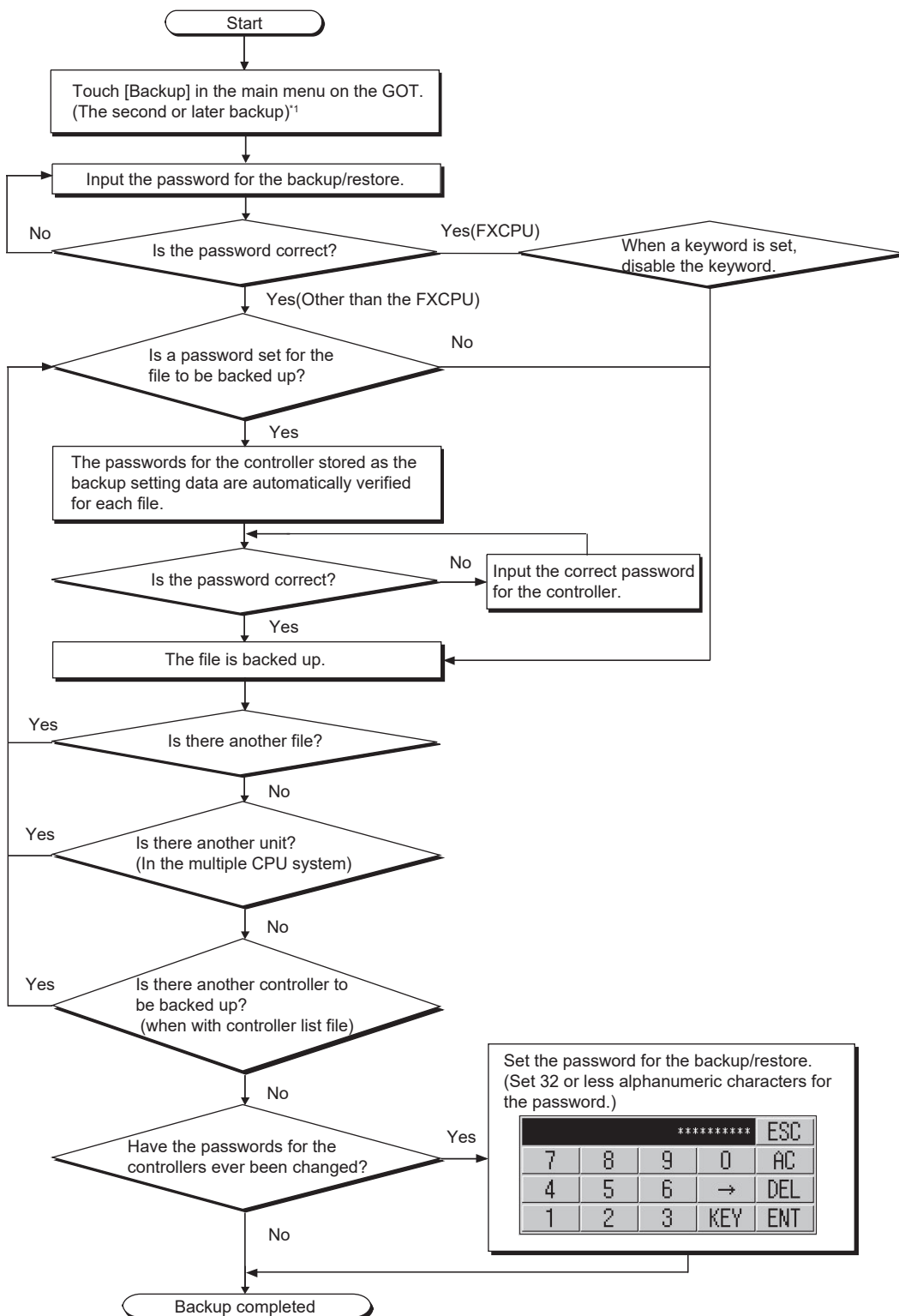

*1 For details, refer to the following.

☞ Page 327 Operation of backup/restore

Point 

When passwords for controllers are changed

When the password input is cancelled and the backup is stopped, the backed up files until the backup is stopped are all deleted.

■ Restoration

The following shows the operating procedure for the restoration after setting the password for the backup/restore.

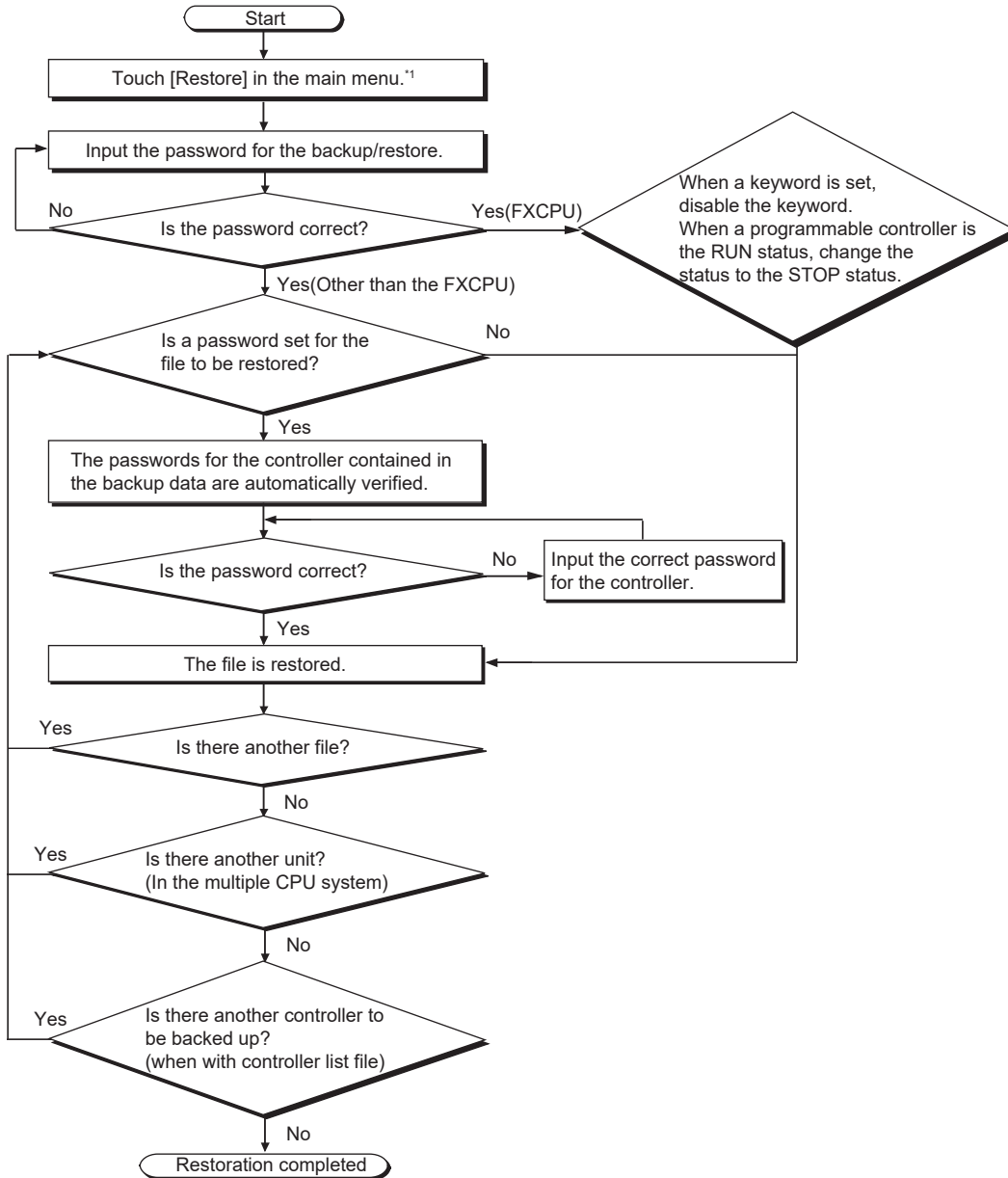

*1 For details, refer to the following.

☞ Page 327 Operation of backup/restore

When passwords for controllers are changed

When the password input is cancelled and the restoration is stopped, the restored files until the restoration is stopped remain in the controller.

When only any of the files are restored, the data can be inconsistent in the entire system.

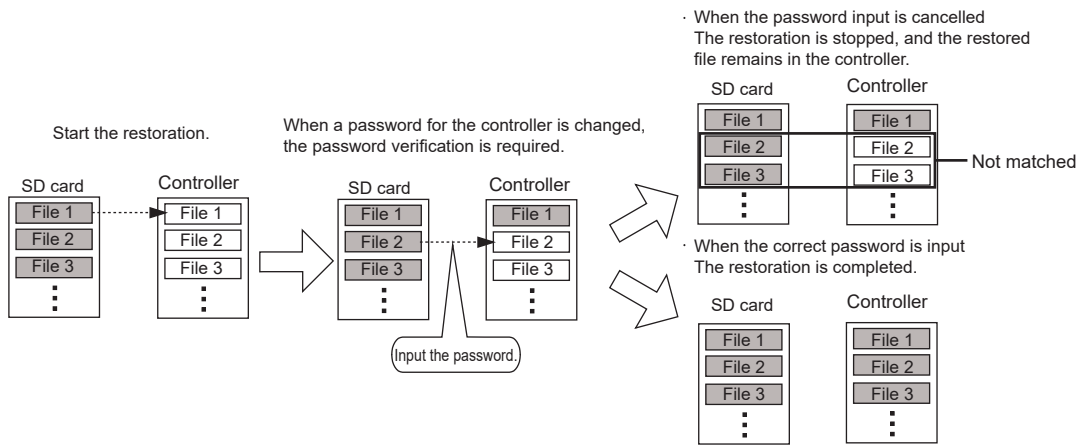

Operation of backup/restore

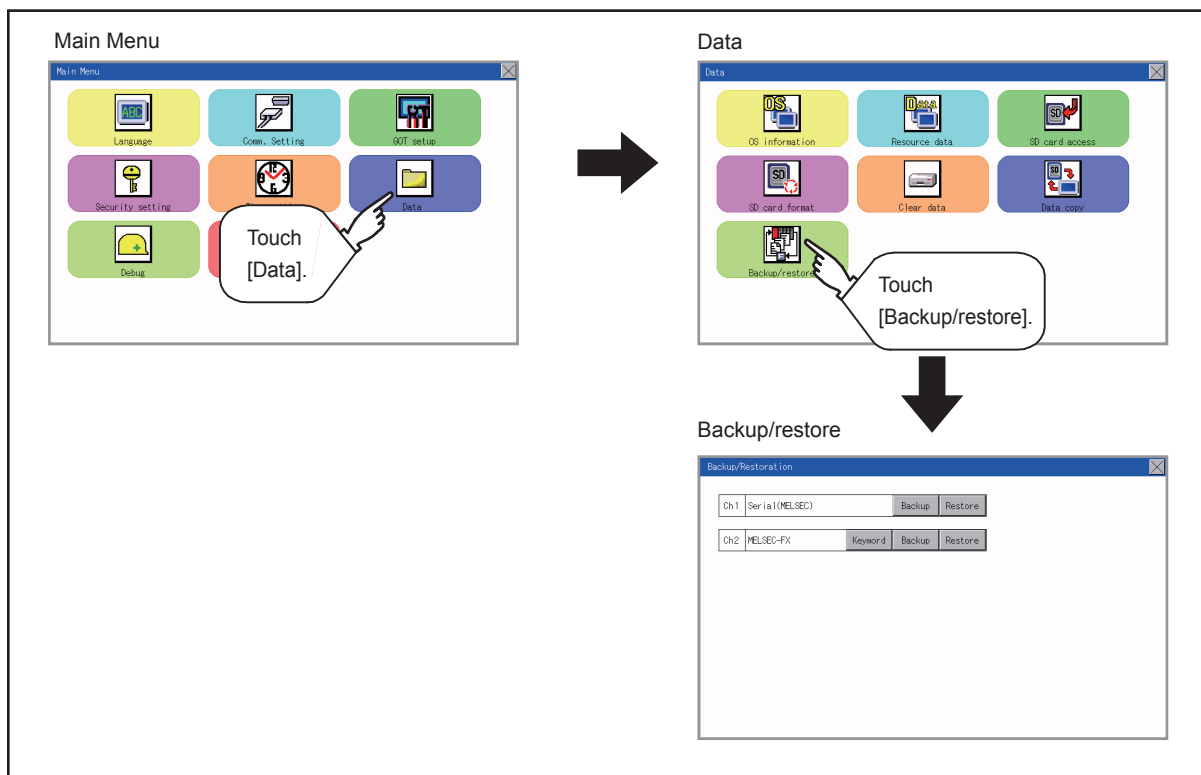

When the connected equipment is not an FX CPU, the [Keyword] switch is not displayed.

Operation of backup

This section describes the backup operation screen.

The screen operation procedure varies depending on the PLC CPU type and password status. For the details of the operation procedure, refer to the following.

☞ Page 321 Security and password

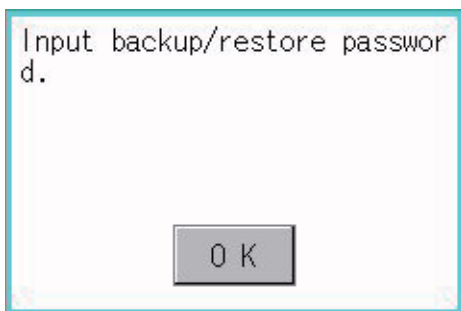
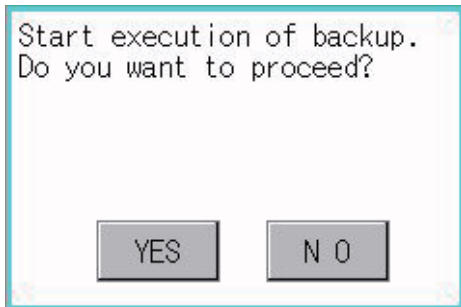
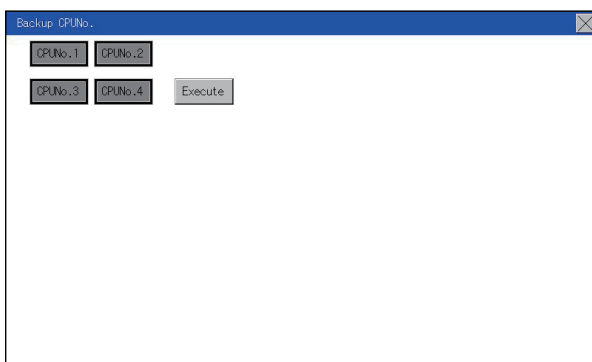
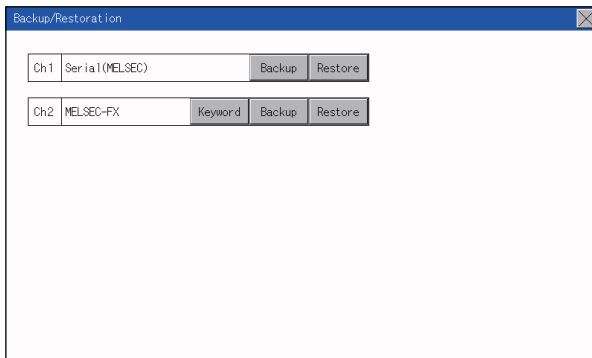

1. Touch [Backup].
2. Touch [Execute]. Touching any switch (among [CPU No. 1], [CPU No. 2], [CPU No. 3] and [CPU No. 4]) is invalid.
3. When the left screen appears, touch [YES].
4. When the left screen appears, touch [OK], and input the password on the key window.



5. When the password is set in a program in the PLC CPU, the left screen appears. Touch [OK], and input the password on the key window. When the input of the password is completed, the backup processing is executed.

6. The left screen is displayed while the backup processing is executed.

7. When the backup processing is finished, the left screen appears. Touch [OK]. In the case of FX CPU, the following screen appears. Touch [OK], and input the password.

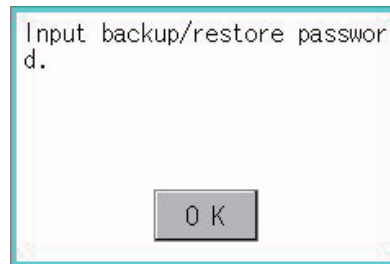

Operation of restore

This section describes the restoration operation screen.

The screen operation procedure varies depending on the PLC CPU type and password status. For the details of the operation procedure, refer to the following.

☞ Page 321 Security and password

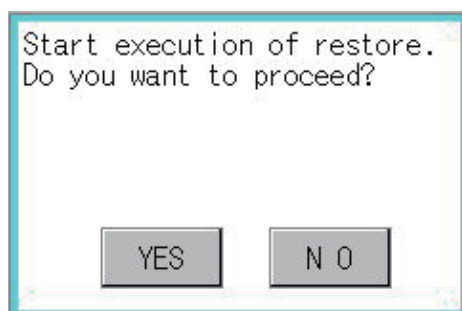
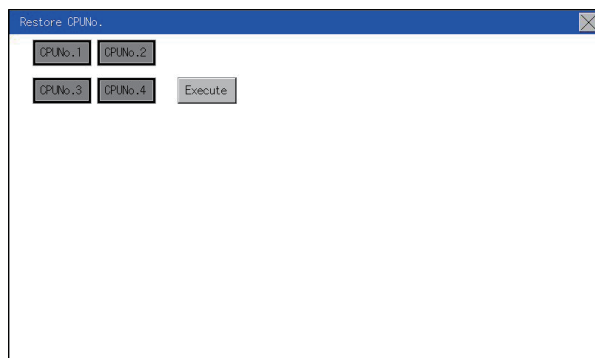
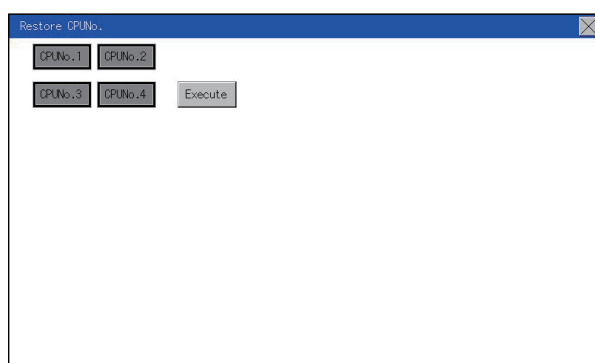
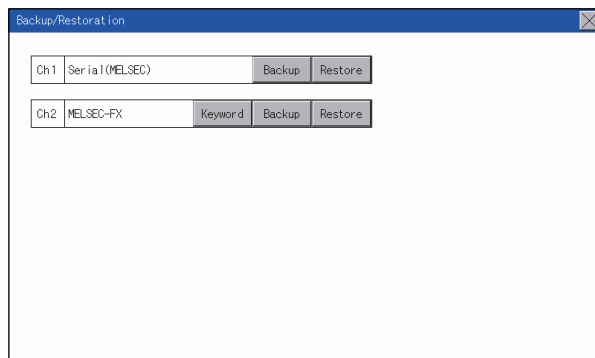

1. Touch [Restore].
2. Select the CPU unit to be restored by pressing a switch (among [CPU No. 1], [CPU No. 2], [CPU No. 3] and [CPU No. 4]). When the connected equipment is an FX CPU, touching any switch (among [CPU No. 1], [CPU No. 2], [CPU No. 3] and [CPU No. 4]) is invalid.
3. Touch [Execute].
4. When the left screen appears, touch [YES].

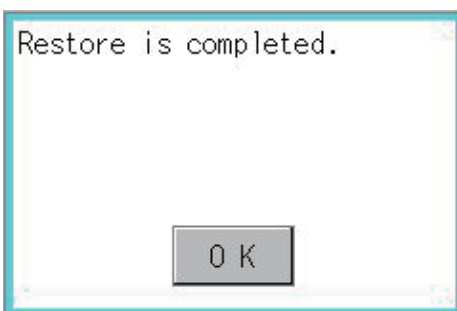
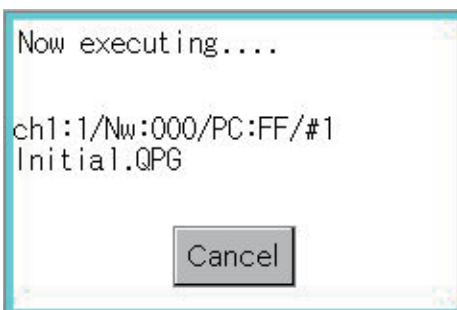
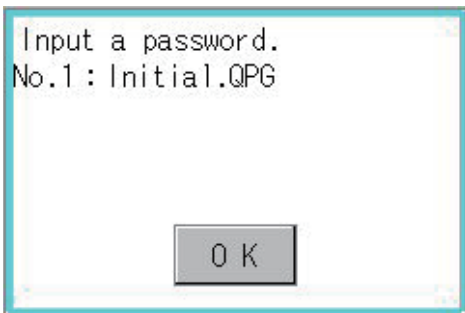

5. When the left screen appears, touch [OK], and input the password on the key window.
6. When the password is set in a program in the PLC CPU, the left screen appears. Touch [OK], and input the password on the key window. When the input of the password is completed, the restoration processing is executed.
7. The left screen is displayed while the restoration processing is executed.
8. When the restoration processing is finished, the left screen appears. Touch [OK].

Operation of keyword

When the connected FX Series PLC is protected by the keyword, the protection disabling operation is available.

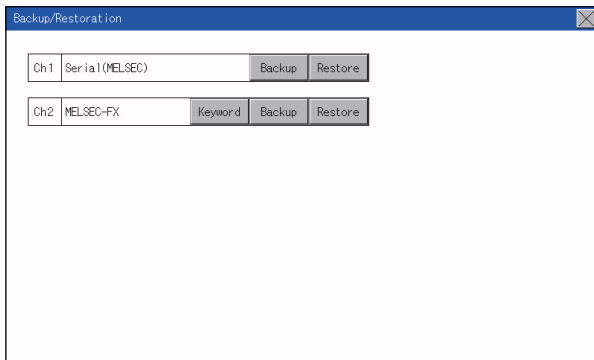

1. Touch [Keyword].

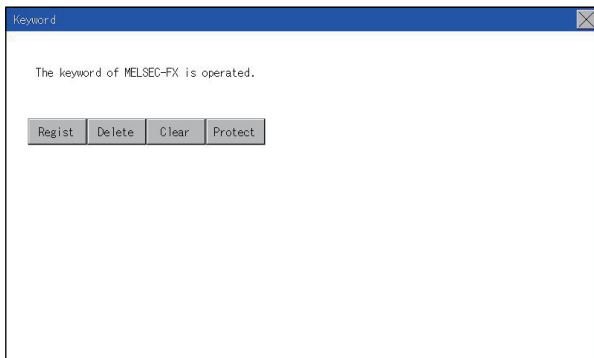

2. The left screen appears. Disable the protection of the FX Series PLC.

 Page 212 Keyword

27.9 Errors and Corrective Actions

Common to backup and restoration

Error	Cause	Corrective action
The backup data are not found.	The backup data are not stored in the SD card in the GOT. No SD card is installed to the drive specified for storing the backup data.	<ul style="list-style-type: none"> • Install SD card with the backup data stored. • Check the storage location for the backup data with the utility.
The backup/restore cannot be executed because the user does not know the password for the backup/restore.	The user does not remember the password. The password is incorrect.	<ul style="list-style-type: none"> • Check with the administrator of the system regarding the password for the backup/restore. • Execute the backup again by using a formatted or new SD card.
The backup/restore cannot be completed because a communication error occurs between the GOT and a controller during the backup/restore.	The communication settings and communication driver for the GOT are incorrectly set.	Check if the communication settings and communication driver for the GOT are correctly set.
	Because parameters for the controller are incorrectly set, the controller does not recognize the GOT.	Check if the parameters for the controller is correctly set with tools, including GX Developer, for the controller.
	The controller is turned off.	Turn on the controller.
	The cable is not correctly connected.	Check the cable.

Backup

Error	Cause	Corrective action
The backup data cannot be written into SD card.	No SD card is installed to the GOT.	Install a SD card to the drive specified for storing the backup setting or backup data.
	The SD card does not have free space.	Install a SD card with enough free space. Delete unnecessary files in the SD card.
	The SD card is set to write-protect.	Set the SD card to writable. The attributes of backup data files stored in the SD card cannot be changed with the GOT. Set the files to writable with a personal computer.
	The drive does not exist.	Check if the drive specified for storing the backup setting or backup data exists. (Check if the SD card is connected on the GOT.)
Setting data (files and data) cannot be obtained from the controller.	The GOT cannot communicate with the controller.	Check the following. GOT <ul style="list-style-type: none"> • Check if the cable is correctly connected to the GOT. • Check if the correct communication driver is installed on the GOT. • Check if the communication settings are correctly set. Controller <ul style="list-style-type: none"> • Check if the parameters are set. • Check if the cable is correctly connected to the controller. • Check if the controller is turned on.
The backup cannot be executed because passwords for files of the controller are set.	The user does not remember the password. The password is incorrect. (The first backup) Passwords for files of the controller are changed.	Check with the administrator of the system regarding the passwords for files of the controller.

Restoration

Error	Cause	Corrective action
Setting data (files and data) cannot be written into the controller.	The GOT cannot communicate with the controller.	Check the following. GOT <ul style="list-style-type: none"> • Check if the cable is correctly connected to the GOT. • Check if the correct communication driver is installed on the GOT. • Check if the communication settings are correctly set. Controller <ul style="list-style-type: none"> • Check if the parameters are set. • Check if the cable is correctly connected to the controller. • Check if the controller is turned on.
	The target controller of the restoration is a different kind of controller from the target controller of the backup.	<ul style="list-style-type: none"> • Check if the system configuration for the restoration is the same as that for the backup. • Check if the target controller of the restoration is the same as that of the backup or the same kind of controller.
The restoration cannot be executed because passwords for files of the controller are set.	<ul style="list-style-type: none"> • The passwords for files written in the controller are changed. 	Check with the administrator of the system regarding the passwords for files of the controller.

28 GOT SELF CHECK (DEBUG)

The debug includes functions to check the PLC system status and to improve troubleshooting efficiency. The following is available as the debug.

Item	Description	Reference
Device monitor	For a controller connected to the GOT, forcibly turning on or off devices of the controller and changing the set value or present value are available.	☞ Page 335 Device Monitor Function
FX list editor	The sequence program of FX PLC can be edited.	☞ Page 348 FX List Editor
FX3U-ENET-ADP communication setting function	The communication set value of the FX3U-ENET-ADP stored in the CPU can be changed.	☞ Page 377 FX3U-ENET-ADP Communication Setting Function

28.1 Device Monitor Function

For a controller connected to the GOT, forcibly turning on or off devices of the controller and changing the set value or present value are available.

System configuration

This section describes the controller names and connection types between the GOT and a controller that are applicable to the device monitor function.

For details of communication units and cables for each connection type, refer to the following manual.

📖 GOT2000 Series Connection Manual For GT Works3 Version1

Target controller

Controller	Connection type
QCPU (Q mode)	Direct CPU connection (serial), Serial communication connection, CC-Link connection (Via G4)
QnACPU	Direct CPU connection (serial), Serial communication connection
FX CPU	Direct CPU connection (serial)

Required system application

System application	Version	
Basic system application	-	
Communication driver	MELSEC-Q/L/QnA	-
	MELSEC-FX	-
	CC-Link(G4)	-

Point

Checking method of the version of basic system application and communication driver

Check the version of the basic system application and communication driver installed in the GOT at [System Application Information] of the utility.

Refer to the following for details.

☞ Page 279 OS information

Devices that can be monitored

For further information about the monitor device names that can be monitored and the scope, see the following:

📖 GT Designer3 (GOT2000) Screen Design Manual

Precautions

Monitoring and testing real number data

Real number data cannot be monitored and tested.

All word devices containing real number data are monitored in integer data (binary data).

Monitoring devices in 32-bit (two-word) module

When monitoring word devices (T, C, D, W, etc.) in 32-bit (two-word) module, those with 32 bits of data remaining are monitored.

Devices with 16 bits (one-word) of data remaining are not monitored.

If an odd number is specified for the first monitor device number, the last device number of the specified controller will not be displayed.

(Example) When the data entry of the QnACPU is monitored in units of 32 bits from odd numbers (D1, D3...)

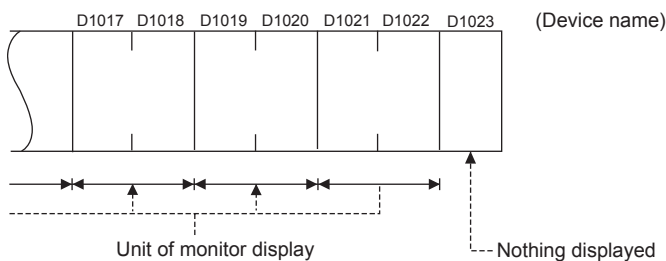

Changing the timer/counter set values of QnACPU

The timer/counter set values of QnACPU whose date on the CPU rating plate is after [9707B] can be changed.

<Information on the rating plate>

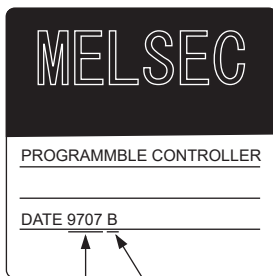

Date of manufacture Function version

Display operation of device monitor

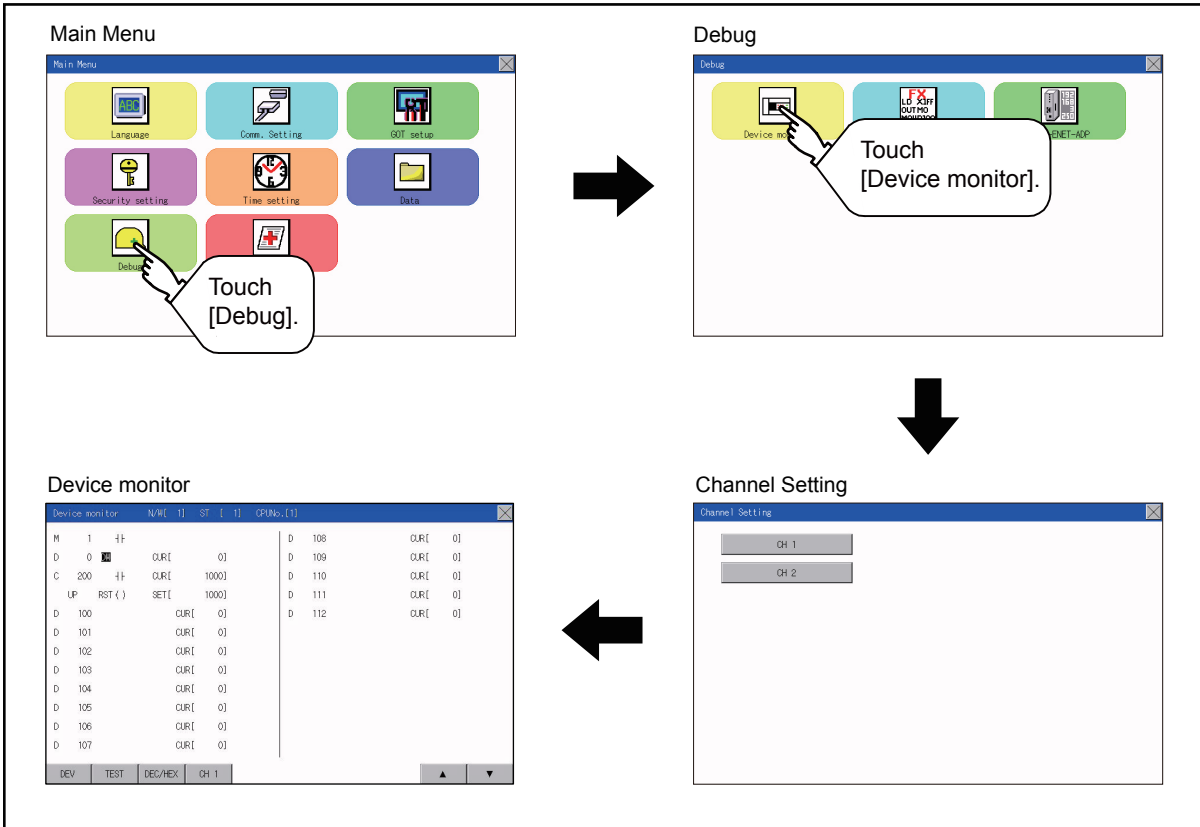



Information displayed on the device monitor screen and key functions

Device monitor screen

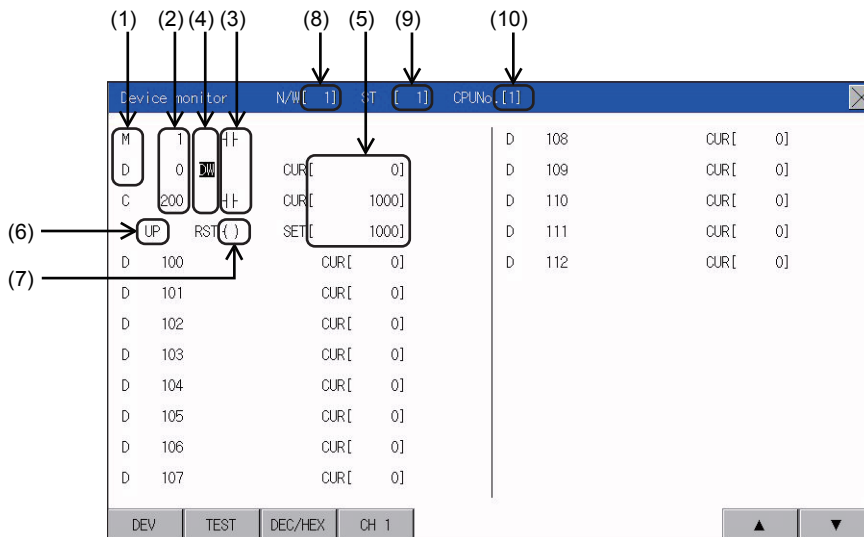
The information displayed on the device monitor screen is described below.

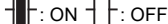
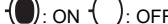

No.	Item	Settings
1)	Device name	Displays the device name.
2)	Device No.	Displays the device number.
3)	Bit device ON/OFF Timer/Counter contact ON/OFF	Displays ON/OFF information of bit devices and timer/counter contacts 
4)	Data type	DW: Indicates that the device value is a 32-bit (two-word) module. Nothing displayed: Indicates that the device value is a 16-bit (one-word) module.
5)	Present value of word device Present value and set value of timer/ counter*1	[Decimal number] 16-bit (one-word) module: Six digits (including a digit for a sign) are displayed. (Display example: -12345) 32-bit (two-word) module: Ten digits (including a digit for a sign) are displayed. (Display example: -123456789) [Hexadecimal number] 16-bit (one-word) module: Four digits are displayed. (Display example: H AB12) 32-bit (two-word) module: Eight digits are displayed. (Display example: H ABCDE123)
6)	Counting method	Displays the counting method when registering the counters from C200 to C255. UP: Up count mode DOWN: Down count mode
7)	Reset coil ON/OFF	Displays the reset coil state when registering the timer/counter for the FXCPU. 
8)	N/W	Sets or displays the network No. when the PLC is on the network.
9)	ST	Sets or displays the station No. when the station No. is assigned to the PLC.
10)	CPU No.	0 to 4: This item must be set only when the GOT is connected to the Q series CPU in the multiple CPU system or QnUCPU. Changing the CPU No. cancels the registration for all the devices.  Page 341 Device registration

Key functions

The following table describes the key functions displayed on the device monitor screen.

Key switch	Function
DEV	Switches the screen to the device registration key window for registering devices to be monitored. ☞ Page 341 Device registration
TEST	Switches the quick test mode between enabled and disabled states. ☞ Page 344 Quick test
DEC/HEX	Switches the numerical notation of word device values between decimal and hexadecimal numbers.
▲▼	Scrolls the data list up and down by one line and displays the devices before or after the device which is currently registered and placed in the top or bottom line. ▲: Scrolls the list up by one line to display the device number right before the device number displayed in the top line. ▼: Scrolls the list down by one line to display the device number right after the device number displayed in the bottom line.
×	Exits the device monitor, and then the screen returns to the debug screen.

Basic operation of device monitor

The following explains basic operations of the device monitor.

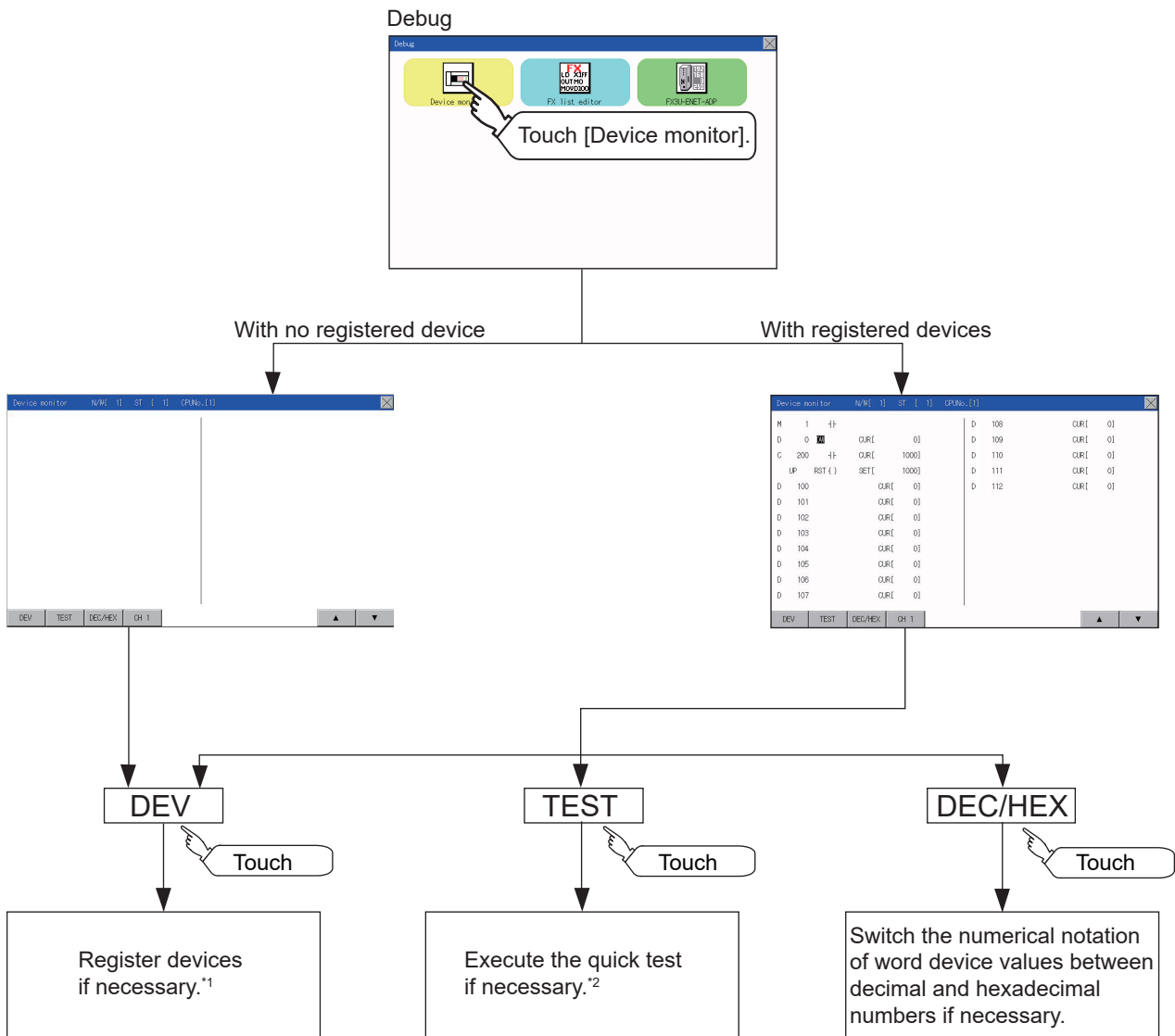

*1 For the details, refer to the following.

☞ Page 341 Device registration

*2 For the details, refer to the following.

☞ Page 344 Quick test

Device registration

The following explains the procedures for device registration.

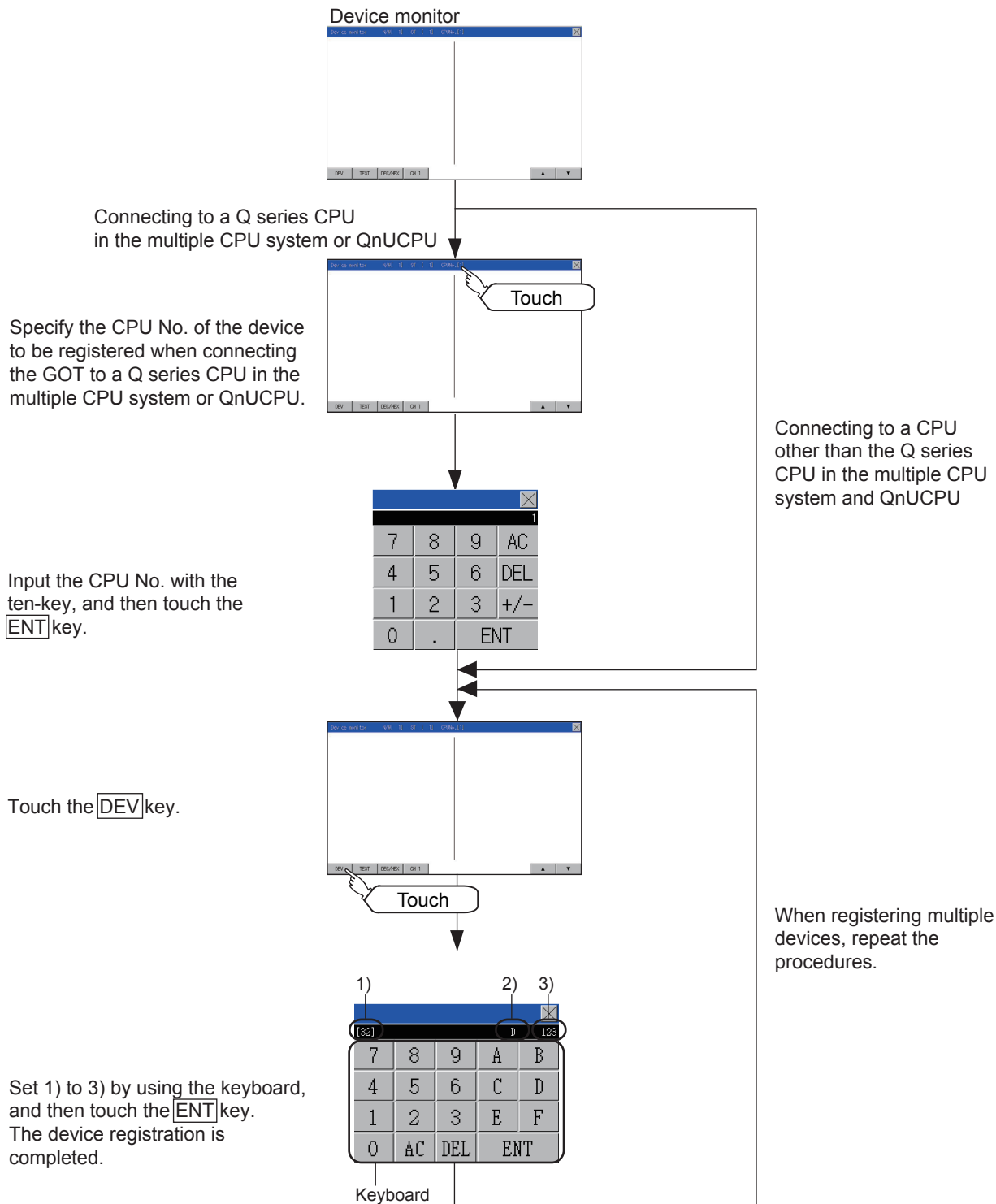

For the keyboard operations, refer to the next page.

No.	Item	Settings
1)	Data type	32: Indicates that the device value is a 32-bit (two-word) module. Nothing displayed: Indicates that the device value is a 16-bit (one-word) module.
2)	Device name	Set the device name and device number to be monitored.
3)	Device No.	

Keyboard operations

- Keyboard functions

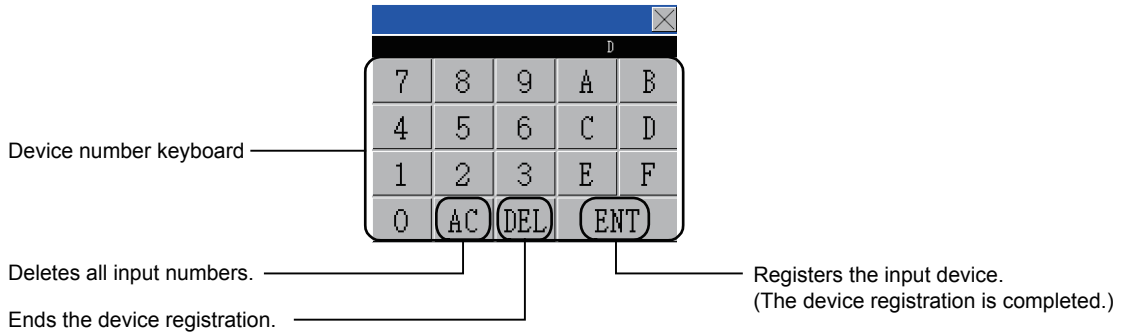
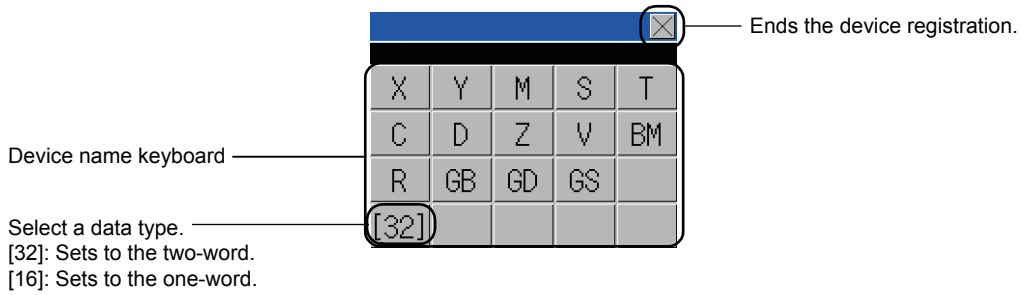

- Input procedures

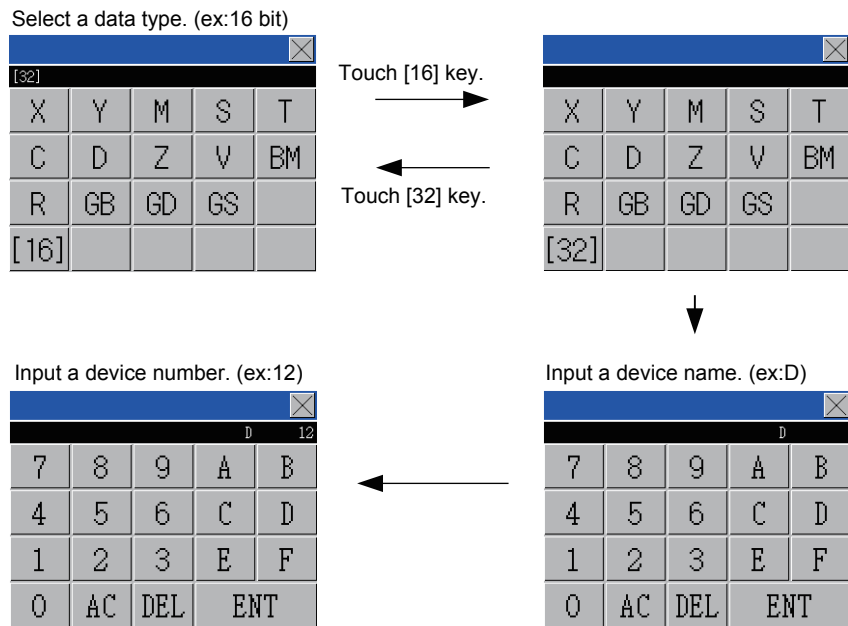

The device registration is completed by touching the [ENT] key.

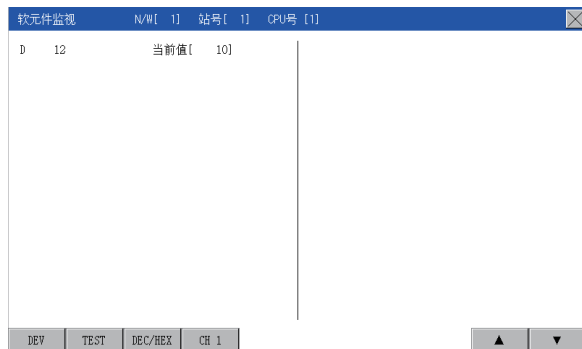

Precautions for device registration

- Data type

Device monitor screens display the data type as shown below.

DW: 32-bit (two-word) module

Nothing displayed: 16-bit (one-word) module

- CPU No. specification

Changing the CPU No. after registering devices cancels the registration for all the devices.

Check the CPU No. before registering the devices.

- Station No. specification

Changing the station No. after registering devices cancels the registration for all the devices.

Check the station No. before registering the devices.

- Holding registered devices

The registration for the devices is not canceled after exiting the device monitor.

Restarting the GOT cancels the registration for all the devices.

- The number of registered devices

The number of registered devices must be within the maximum number of devices that can be displayed on the GOT.

For registering an additional device, the registration for the device in the top line is canceled and the additional device is displayed in the bottom.

Quick test

! WARNING

- Before performing the quick test operations of device monitor (such as turning ON or OFF bit device, changing the word device current value, changing the settings or current values of the timer or counter), read through the manual carefully and make yourself familiar with the operation method.
During quick test operation, never change the data of the devices which are used to perform significant operation for the system. False output or malfunction can cause an accident.

The quick test operation procedure for monitor devices is described below.

Device monitor

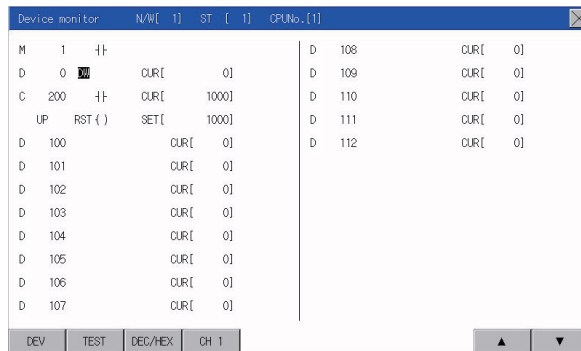

Enable the quick test mode.

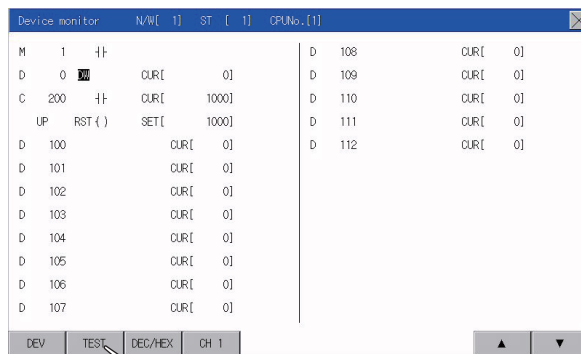

Touch

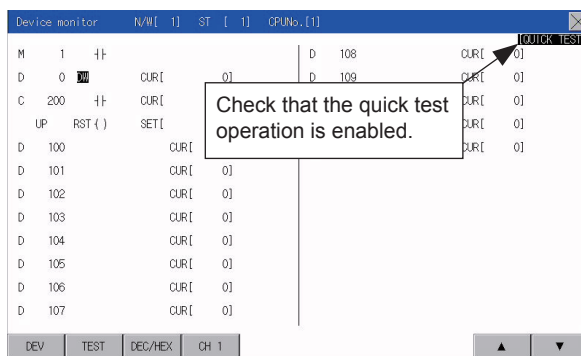



(1) Quick test of bit devices

(2) Quick test of word devices

Quick test of bit devices

(Operation example)

Change the status of bit device M12 from OFF  to ON .

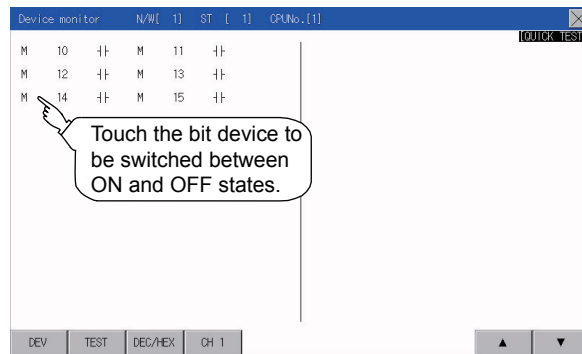

The device name and device number of the selected bit device are highlighted.

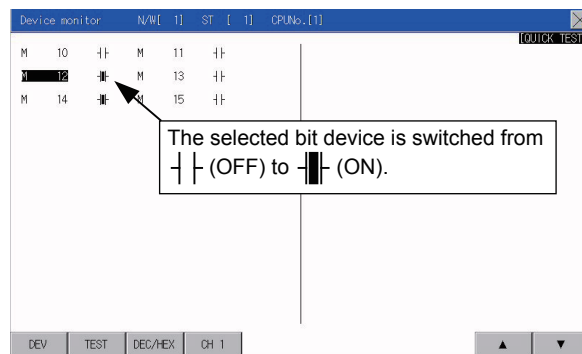
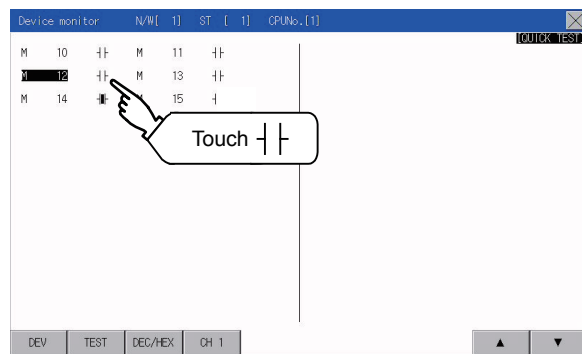
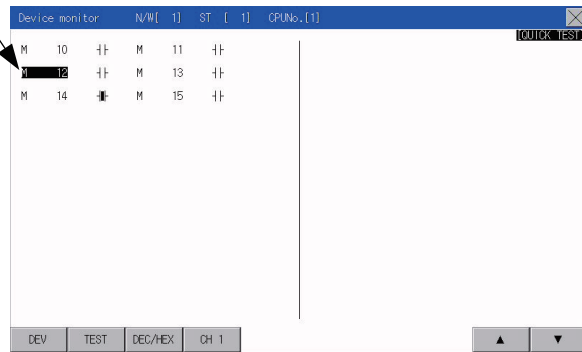

Quick test of word devices

(Operation example)

Change the device value of word device D200 from 43 to 100.

Conditions: Data range: 16 bits, device value display format: decimal number

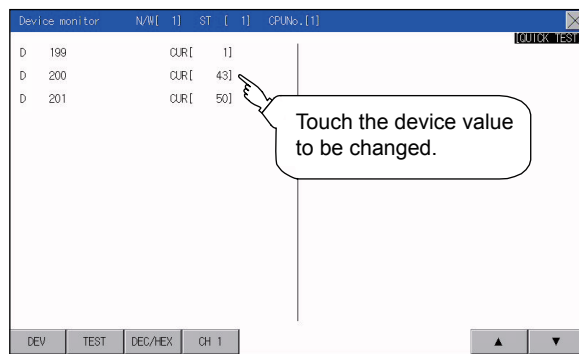

Input a device value by using the keyboard.
Input "100" for the operation example.

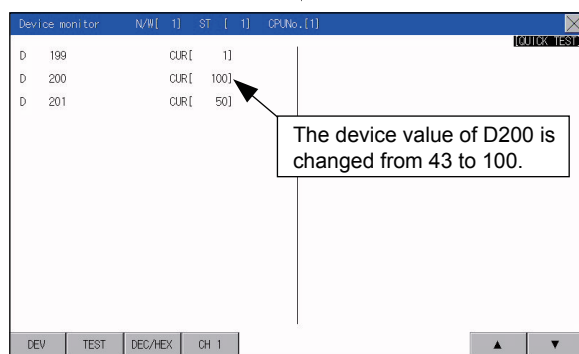
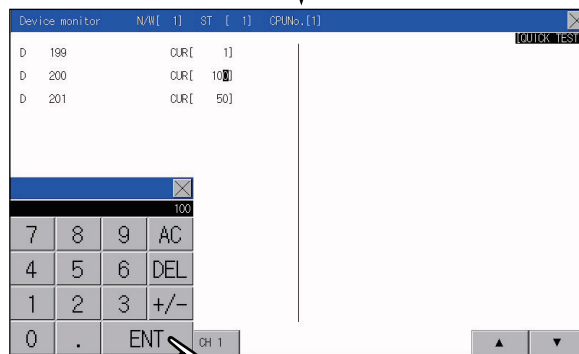
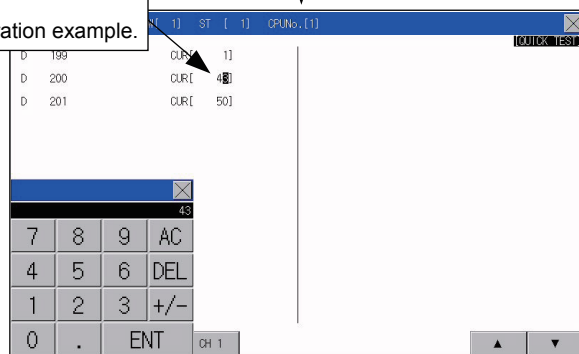

When the cursor is displayed

When the cursor is displayed, touch the [▲] or [▼] key to move the cursor to the upper or lower registered device.

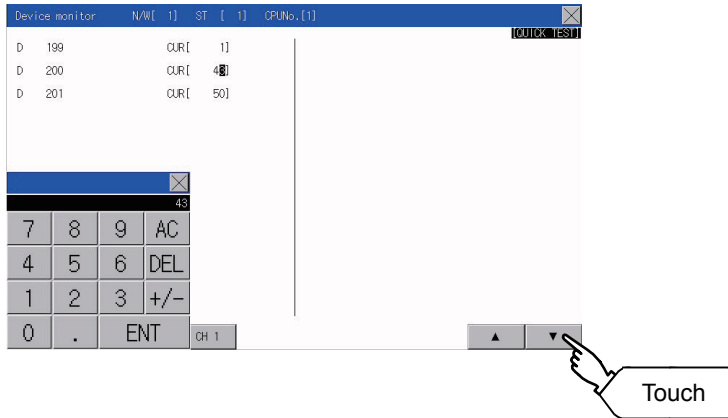

28.2 FX List Editor

The MELSEC-FX list editor can change the sequence programs on the FX PLC.

Display operation of FX list editor

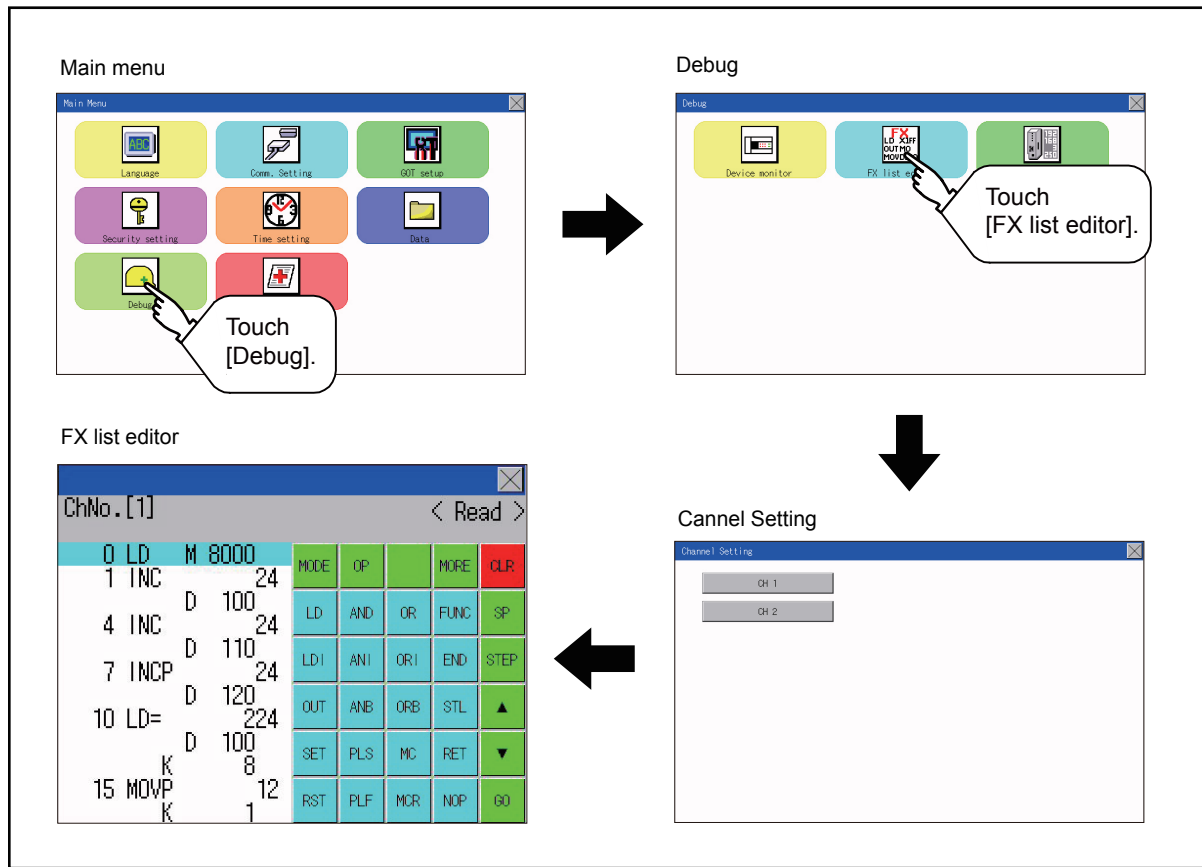

Parameters and sequence programs are easy to maintain.

You can check or partly correct, change or add FX PLC parameters and sequence programs simply by operating keys. You can easily edit sequence programs without preparing any peripheral unit other than the GOT.

(Example of changing sequence program commands)

LD X000	Changed	LD X000
OUT Y020	→	OUT Y030
LD X001		LD X001

Errors that occur during list editing can be checked easily.

Error messages, error codes, and number of steps for errors that occur in the FX PLC can be checked. Details can be checked immediately even for errors that occur during list editing.

Error message	Detail	Step
I/O configuration error	1010	
PC/HPP communication error	6201	

Commands and devices can be searched and displayed.

Commands and devices used in sequence programs can be searched. The correction position can be searched for cases such as when you want to correct a specific device.

Searched device
M800

ChNo. [1]	Search device	MODE	DP	MORE	CLR
	M 800	.	V	Z	SP
	D 0				STEP
	D 10				
8	LD M 10	8	9		▲
9	OUT T 10				
	K 100				
12	LD X 002	4	5	6	7 ▼
13	OR X 020				
14	AND M 100	0	1	2	3 60

Displays the searched device.

```

LD M 800
OUT T 10
LD X 002
    
```

Specifications

System configuration

This section describes the system configuration of the MELSEC-FX list editor.

For the setting method in each connection form, used communication unit/cable and cautions on connection form, refer to the following manual.

GOT2000 Series Connection Manual For GT Works3 Version1

Controllers that can be edited with the MELSEC-FX list editor

Target controller*¹: FXCPU

*¹ FX list editor is not applicable to for MELSEC iQ-F series.

Connection type

This function can be used in the following connection types.

(○: Available, △: Unavailable)

Function		Connection type between GOT and PLC		
Name	Description	Direct CPU connection (serial)	Ethernet connection * ¹	
MELSEC-FX list editor	Sequence program writing, parameter setting, PLC diagnostics and keyword registration, etc.	○	○ * ²	△

*¹ MELSEC-FX list editor cannot be used when using CC-Link IE field network Ethernet adapter.

*² Available only when using FX3 series.

Functions list and monitor conditions

The following shows the memory that can be monitored by the MELSEC-FX list editor and the FX PLC status conditions.

(○: Can be monitored △: Can be monitored under certain conditions ×: Cannot be monitored)

Function		Memory that can be monitored* ²				FX PLC status	Reference
		Built-in memory	RAM memory cassette	EEPROM memory cassette, flash memory cassette	EPROM memory cassette		
Reading sequence programs	Displaying sequence programs	○	○	○	○	RUN/STOP	Page 357 Displaying sequence programs
	Searching commands/devices						Page 359 Searching commands/devices
Writing sequence programs	Writing commands	○	○	△ * ¹	×	For Stop only	Page 361 Writing commands
	Changing operands/set values						Page 366 Deleting commands
	Inserting commands						Page 361 Writing commands
	Deleting commands						Page 366 Deleting commands
Sequence program all clear							Page 367 Sequence program all clear
PLC diagnostics		○	○	○	○	RUN/STOP	Page 368 PLC diagnostics
Parameter setting	Display						Page 370 Parameter setting
	Setting	○	○	△ * ¹	×	For Stop only	
Keyword		○	○	○	○	RUN/STOP	Page 372 Keyword

*¹ The operation is available only when the protect switch is OFF.

*² The available memory differs depending on the FX PLC being used.

For details, refer to the following.

The hardware manual of the FX PLC being used

Access range

For the FXCPU in Ethernet connection, the GOT can monitor only the host station.

The access range other than the above is the same as the access range when the GOT is connected to a controller.

For details of the access range, refer to the following.

 GT Designer3 (GOT2000) Screen Design Manual

 GOT2000 Series Connection Manual (Mitsubishi Product) For GT Works3 Version1

Precautions

Using other peripheral equipment for sequence program/parameter change

When using the MELSEC-FX list editor, do not change programs or parameters in the PLC CPU from other peripheral equipment.

If programs or parameters are changed, exit the MELSEC-FX list editor once and start the MELSEC-FX list editor again.

If the program on one PLC is changed carelessly from multiple units of peripheral equipment (including GOT), the contents of the program in the PLC CPU and the peripheral equipment may not be the same, resulting in an unintended operation of the PLC CPU.

Sequence program change

Stop the FX PLC before changing (writing, inserting, deleting) a sequence program or changing parameters.

Operation is not possible with the FX PLC running.

If you press the [GO] key but the system does not proceed to the next operation (for example, a search)

Check the input contents (applied instruction number, device value, etc.).

When using list monitor

Only devices to be used for basic instructions can be monitored.

The status of devices (word, bit) to be used for application instructions cannot be monitored.

Display operation

Operation to display

The following describes the outline for displaying the operation screen of the MELSEC-FX list editor.

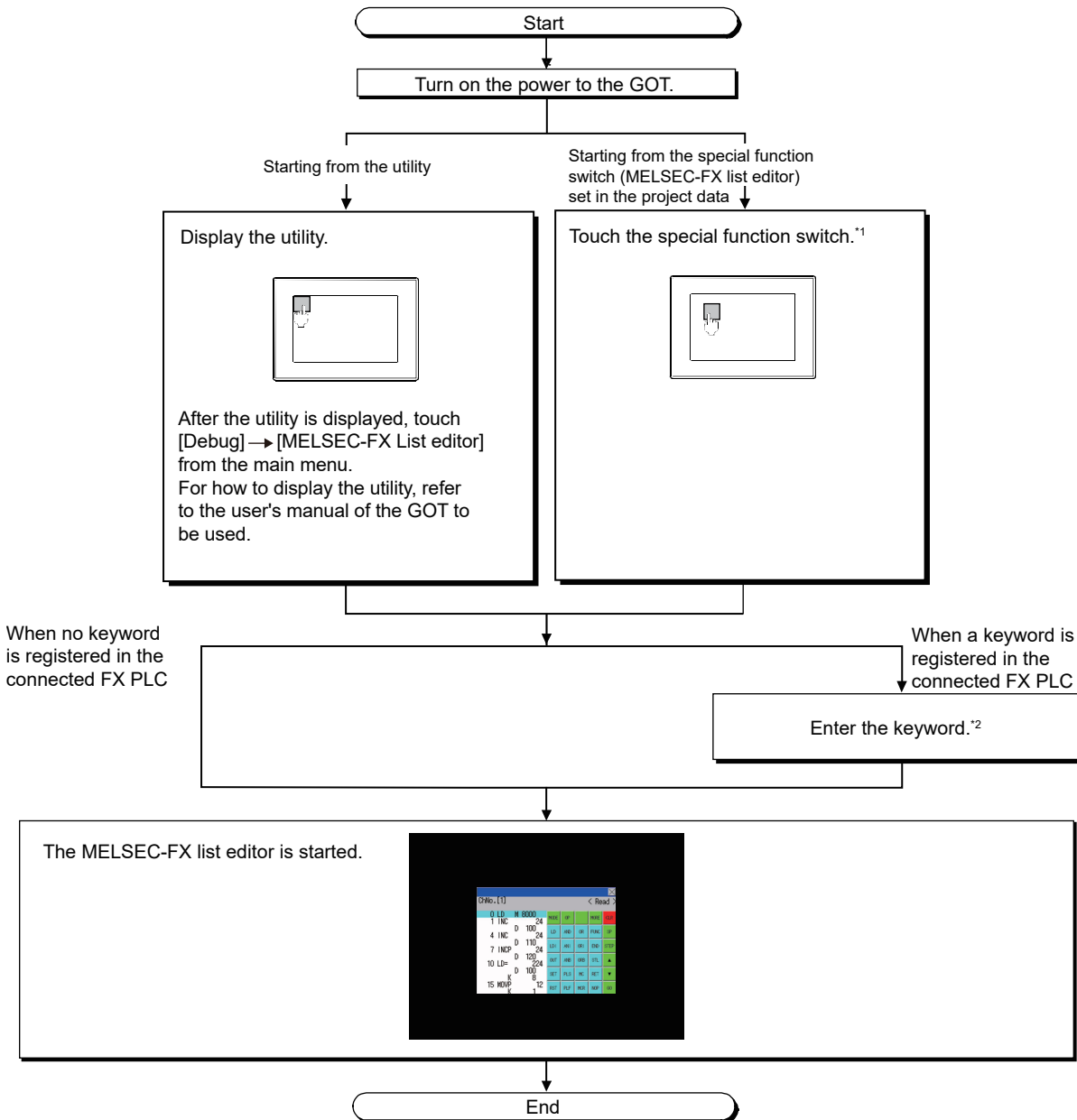

*1 For information on how to set a special function switch, refer to the following.

📖 GT Designer3 (GOT2000) Screen Design Manual

*2 For details on the operation method, refer to the following.

📖 Page 372 Keyword

Point

- How to display the utility

For how to display the utility, refer to the following.

📖 Page 180 Utility Function List

- If the project data has not been downloaded

The MELSEC-FX list editor can be started from the utility even if the project data has not been downloaded to the GOT.

Changing screens

This section describes how to change the screen.

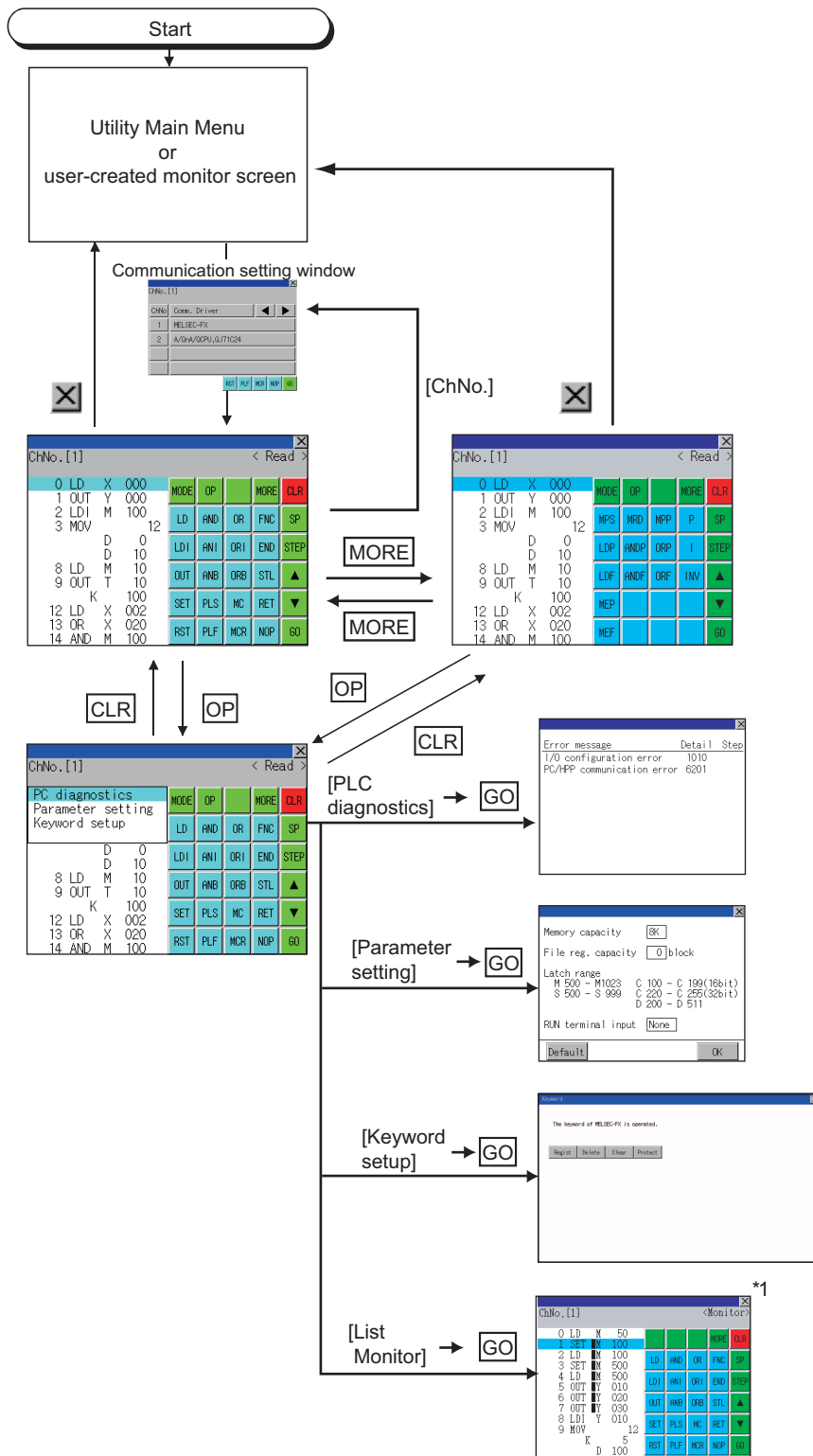

*1 With setting special function switches (FX list monitor), the list monitor can be started on the monitor screen. When the list monitor is started on the monitor screen, the list editor cannot be used. For how to set special function switches, refer to the following.
 GT Designer3 (GOT2000) Screen Design Manual

Operation procedures

This section describes the contents of the MELSEC-FX list editor and the key functions displayed on the screen.

Key arrangement and a list of key functions

The arrangement and functions of the keys displayed on the MELSEC-FX List Editor window are described below.

Displayed contents

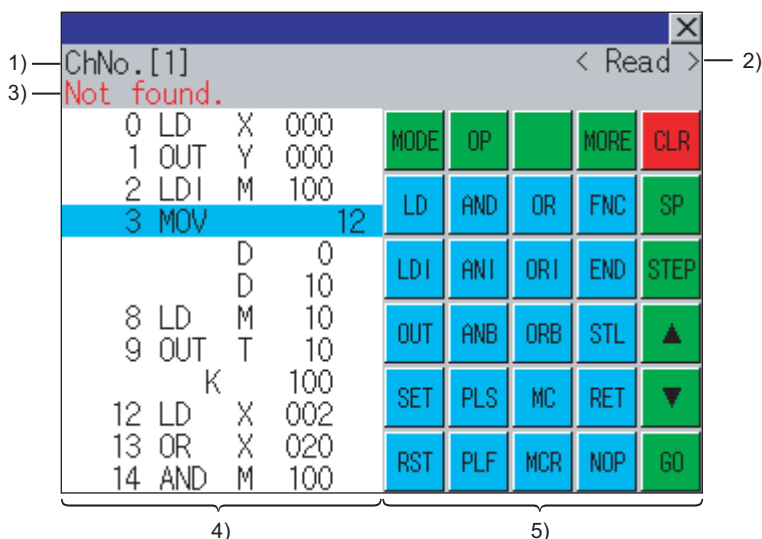

No.	Item	Display contents
1)	Channel No.	Displays the currently selected channel number. Touching "ChNo." displays the communication setting window. The communication setting window is not displayed if the MELSEC-FX list editor is started from the FX ladder monitor.
2)	Mode	Displays a mode for MELSEC-FX list editor. ☞ Page 356 Selection and operation of modes [Monitor] is displayed when the list monitor is executed. ☞ Page 374 List monitor
3)	Error message	Displays the contents of errors that occur with the MELSEC-FX list editor. ☞ Page 376 Error messages and corrective actions
4)	List display area	Displays the sequence program in list format (12 digits). The position (line) that can be edited is displayed with a bar.
5)	Key area	Displays the keys that can be used with the MELSEC-FX list editor.

Key functions

The table below shows the functions of the keys that are used for the operation on the MELSEC-FX list editor screen.

Key	Function
ChNo. [1]	Displays the currently selected channel number. The communication setting window is not displayed if the MELSEC-FX list editor is started from the FX ladder monitor.
MODE	Selects a mode for MELSEC-FX list editor. ☞ Page 356 Selection and operation of modes
OP	Displays the PLC diagnostics, parameter setting, and keyword selection menu.
MORE	Switches between command keyboard 1 and command keyboard 2. ☞ Page 355 Keyboard switching
CLR	When inputting commands: Cancels the key input when only part of the command has been input. ☞ Page 375 Action for an incorrect key input When option menu is displayed: Closes the option menu. Commands cannot be deleted with this key. ☞ Page 366 Deleting commands
SP	Space key. This key is used when setting timers and counters, writing applied commands, etc.
STEP	Displays the list from a specified step number when the step number is input.
▲ ▼	Moves the list display area bar up and down and switches the line being edited.
GO	Determines the key operation.
LD to INV, 0 to 9, etc.	Inputs commands, device names, etc. The key contents depend on the input contents. The commands that can be used differ depending on the target FX PLC. Refer to the manual for the FX PLC to be used.
⊗	Exits the MELSEC-FX list editor.

Keyboard switching

Touching the MORE button switches the command keyboard 1 and command keyboard 2.

When you touch the button for a keyboard function, the optimum keyboard for input for that function is displayed automatically.

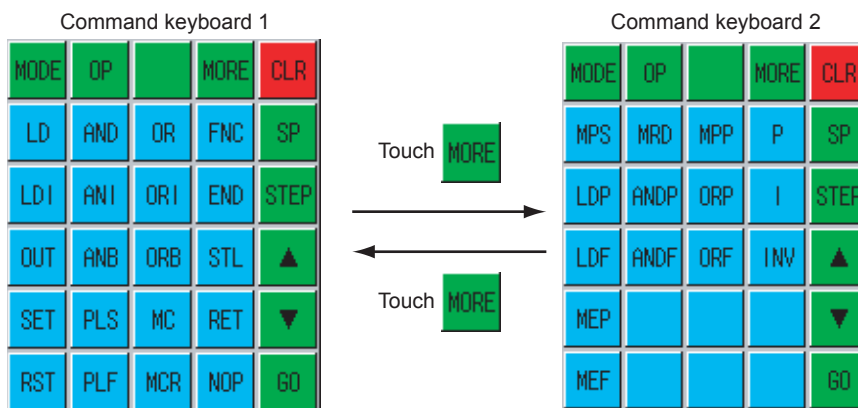

Selection and operation of modes

The MELSEC-FX list editor has four modes: READ, WRITE, INSERT, and DELETE.

Select an appropriate mode for the intended operation.

For more information on the mode to select, refer to the function operations from subsection 15.3.8.

How to change modes

Touch the MODE button.

Each time you touch this button, the mode changes.

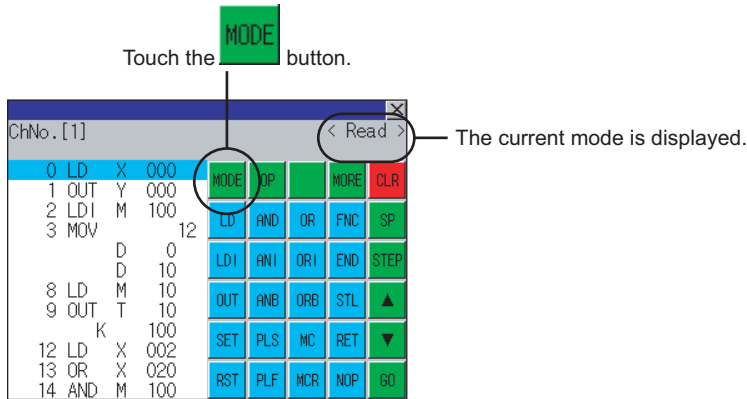

In the case the mode cannot be changed

In the following cases, the mode can be changed to the READ mode only.

If you try to change to other than READ mode, an error message is displayed.

To change to other than READ mode, take the action below.

Error message	Cause	Corrective action
PLC is running	The FX PLC is in the RUN status.	Stop the FX PLC.
Can not write.	The protect switch of the EEPROM memory cassette is on.	Switch off the protect switch of the EEPROM memory cassette.
	The EPROM memory cassette is enabled.	Set a memory other than EPROM as the memory to write to.

Displaying sequence programs

Sequence programs are read from the FX PLC to the GOT and displayed.

There are two displaying methods: specifying the step number, and scrolling one screen at a time.

Display using cursor keys

■Operation

Scroll with  OR 

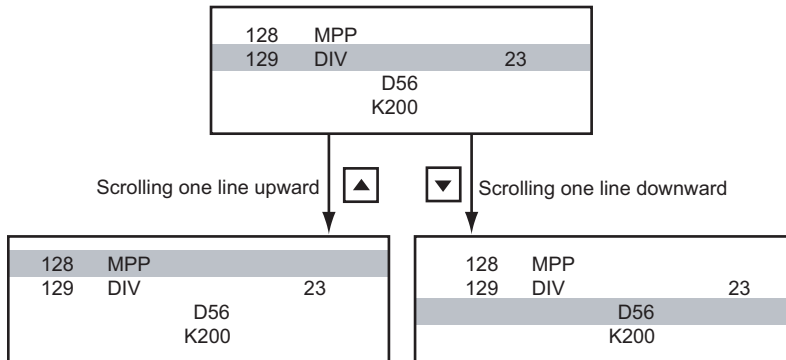

■Example

Scroll one line upward or downward.



Display specifying the step number

■Operation

 → [Input the step number.] → 

■Example

Displaying step number 123.

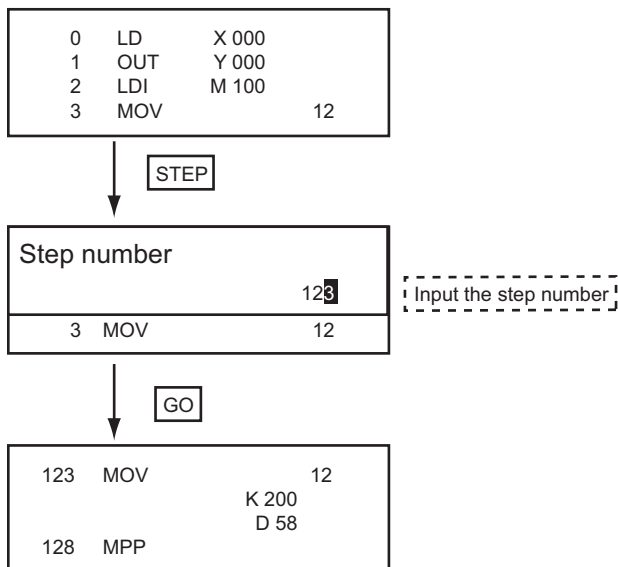

Point

When the specified step number is the operand of an applied instruction

If the specified step number is a timer (T) or counter (C) set value or the operand of an applied instruction, that command section is displayed at the head.

Display scrolling one screen at a time

■ Operation

MODE → GO
(Read mode)

■ Example

Displaying with scrolling one screen at a time.

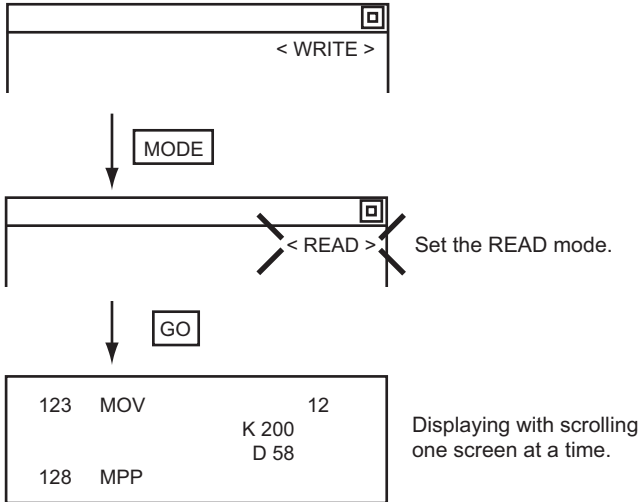

Searching commands/devices

Displays a command or device by searching it in sequence program from Step 0.

Command search

Operation



- *1 If the command you want to search for is not on the keyboard, touch the **MORE** key to switch to the other keyboard.
 When searching for an applied instruction, touch the **FNC** key and input the applied instruction number.
 When searching for a label, touch **P** or **I** and input the pointer number.
 Page 361 Writing commands
- *2 Input only when searching for commands requiring a device name and device number.
- *3 After the search results are displayed, you can continue searching with the same conditions by touching the **GO** key. Touching any key other than the **GO** key ends the search.

Example

Searching for LD M8000

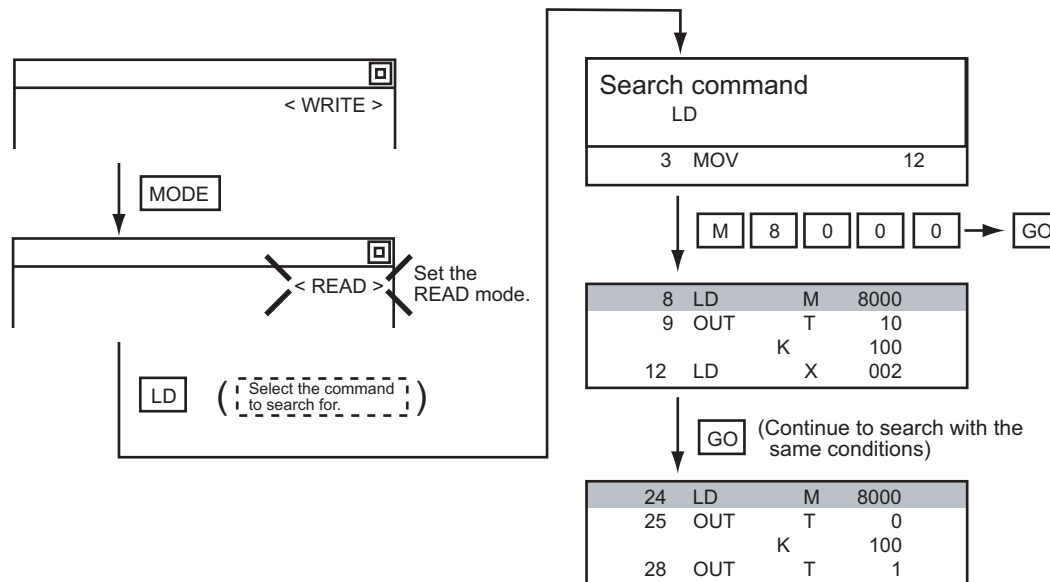

Point

- Pointer (P, I) searches
- For pointer searches, only labels are searched.
- Pointers specified as operands in applied instructions are not searched.

Device search

Operation

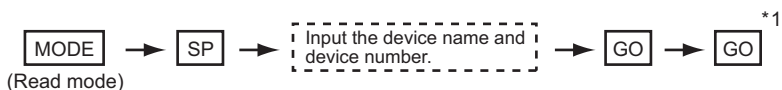

*1 After the search results are displayed, you can continue searching with the same conditions by touching the GO key. Touching any key other than the GO key ends the search.

Example

Searching for LD M8000

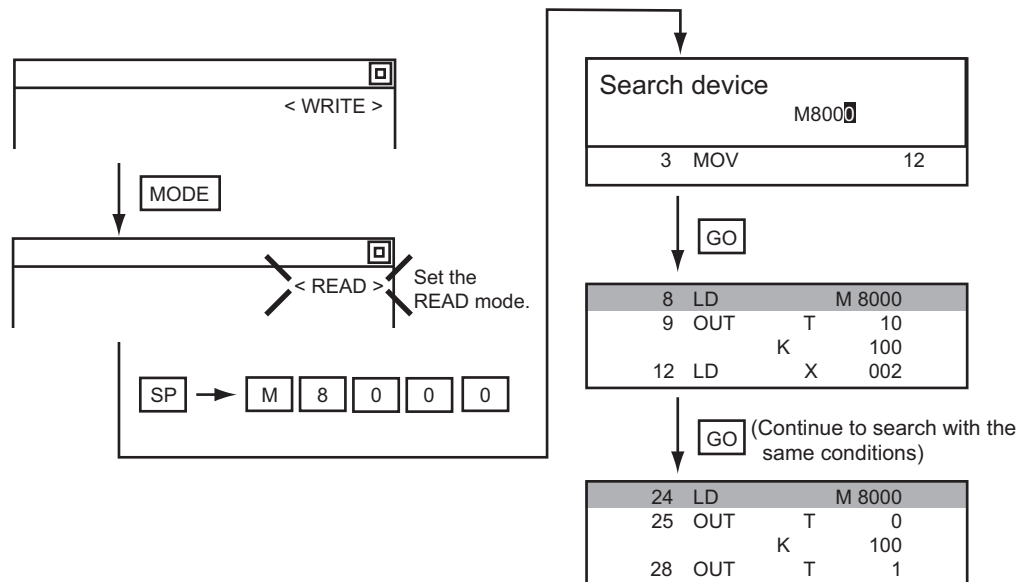

Point

Devices that cannot be searched

The following devices cannot be searched.

- Pointers, interrupt pointers
- Constant K, constant H, constant E
- Digit specification of bit device
- Special function unit/block buffer memory
- Devices specified with the operand of an applied instruction

Pointers and interrupt pointers can be searched for with command searches.

☞ Page 359 Command search

Writing commands

Writes a sequence program to the FX PLC. (Overwrite/Insert)

Writing basic commands

■ Operations

Inputting command only (Ex.: ANB, ORB command etc.)

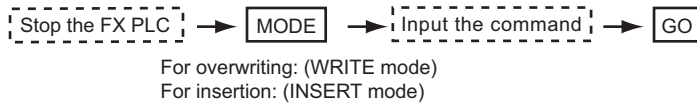

Inputting command and device (LD, AND commands etc.)

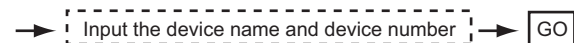
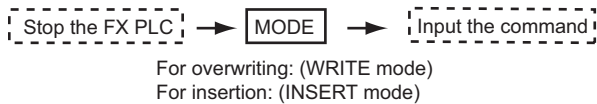

Inputting command, No. 1 device, No. 2 device (MC, OUT (T, C) commands, etc.)

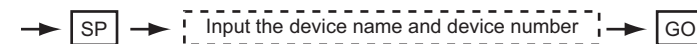
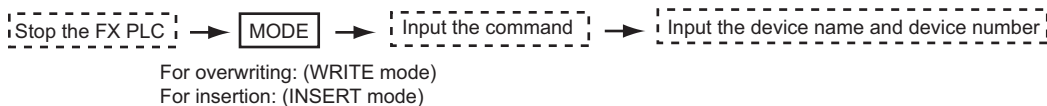

Point

Moving the cursor to the position to write the command
When starting to write a command, place the cursor on the command line (the line on which the step number is displayed).
You cannot write a command with the cursor on an operand or set value line.

2	LDI	M	100	} Command line (Place the cursor on this line.)
3	MOV		12	
		D	0	} Operand, set value line (Cannot operate on this line.)
		D	10	

■ Example

Writing ORB command

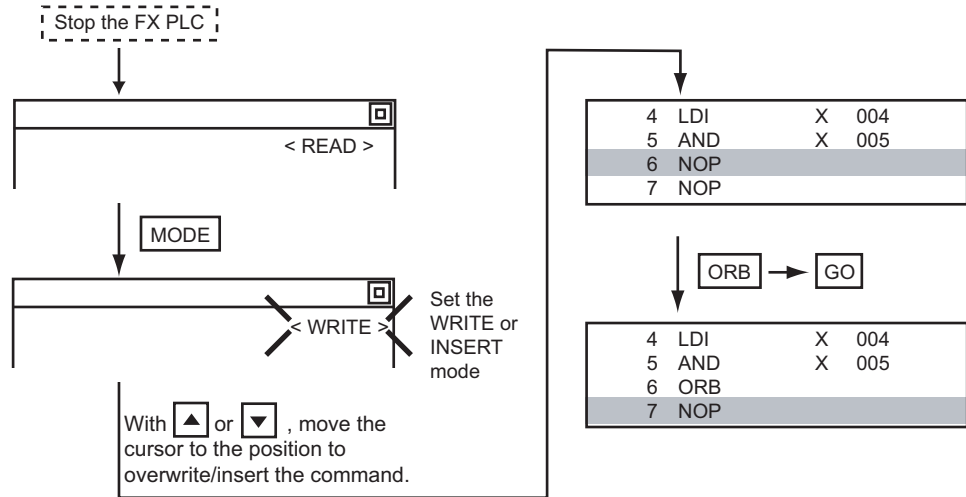

Inputting LD X000

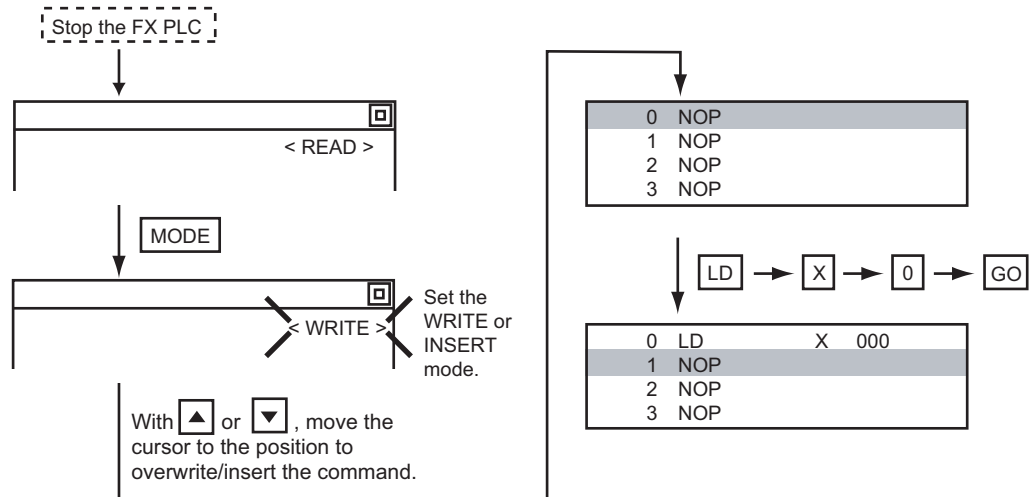

Inputting OUT T100 K19

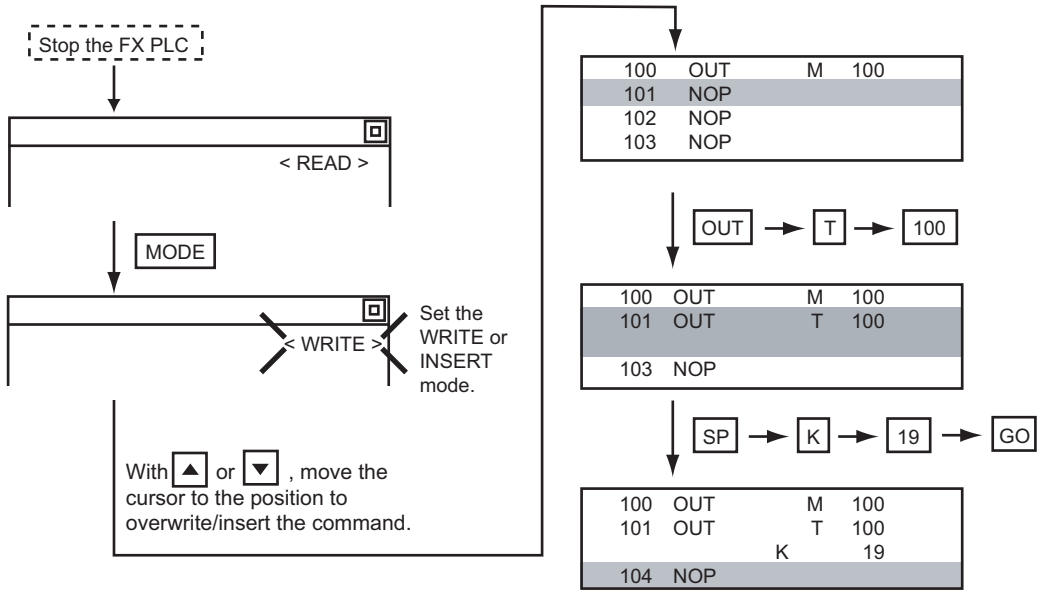

Writing applied instructions

■ Operation

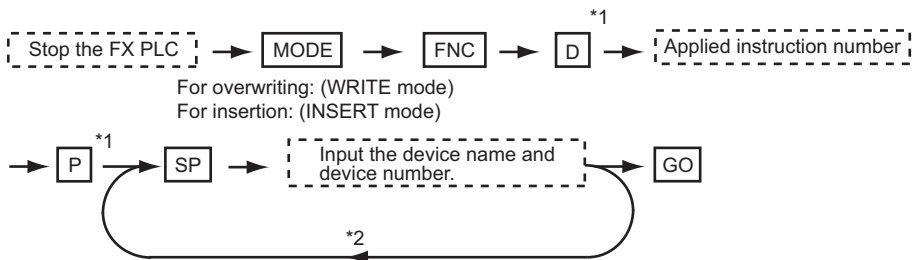

*1 \square (double word command) and \square (pulse execution format command) can also be input after the applied instruction number is input.

*2 Inputting in the order \square → \square is also possible.

*3 When a command specifies multiple devices for operations, input the \square key followed by the device name and device number.

Point

- Moving the cursor to the position to write the command

When starting to write a command, place the cursor on the command line (the line on which the step number is displayed).

You cannot write a command with the cursor on any other line.

2	LDI	M	100	} Command line (Place the cursor on this line.)
3	MOV		12	
		D	0	} Operand, set value line (Cannot operate on this line.)
		D	10	

- Commands using a text string constant for a command operand (such as ASC command)

With the MELSEC-FX list editor, text string constants cannot be written as operands. (such as ASC commands)

Use GX Developer for writing such commands.

■ Example

Input "DMOVP D0 D2".

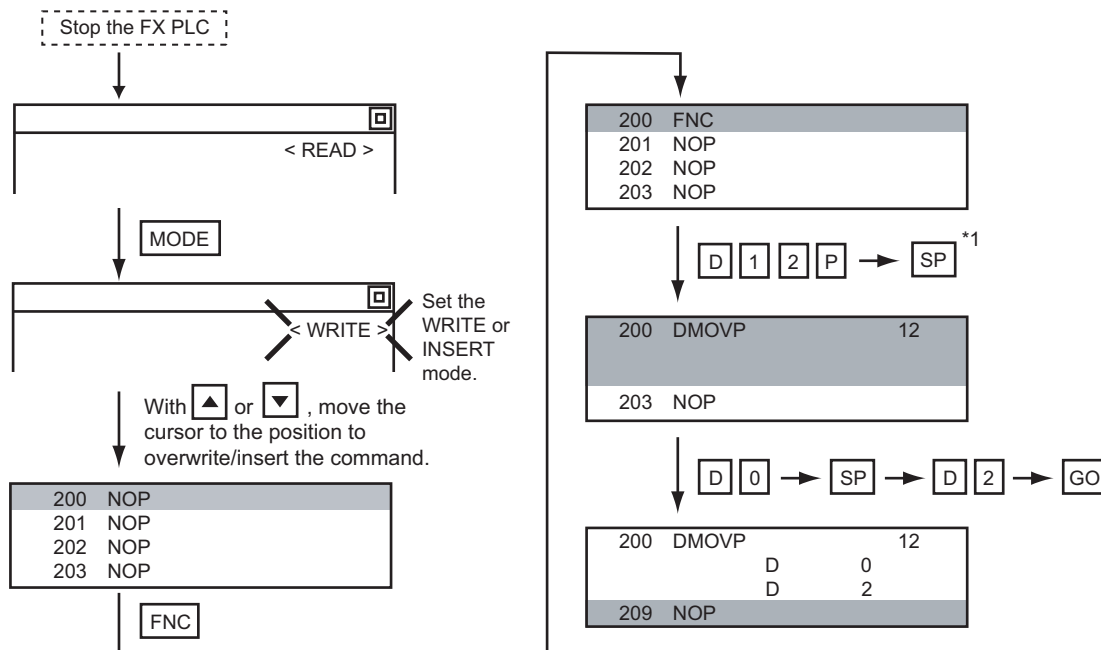

Changing operands, set values

Changes the operand section of an applied instruction and OUT (T, C) command set value.

Operation

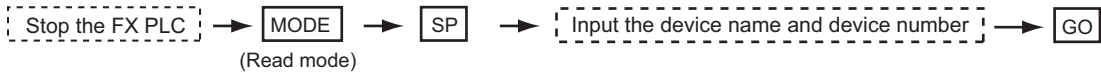

- *1 For decimal numbers, input K, then the number.
- For hexadecimal numbers, input H, then the number.

Point

Moving the cursor to the line on which the operand or set value is to be changed
 When starting to change an operand or a set value, place the cursor on the line of the operand or set value to be changed (the line on which the step number is not displayed).
 If you place the cursor on the command line, the input operation is not possible.

Example

Changing "MOV D0 D10" to "MOV D0 D123"

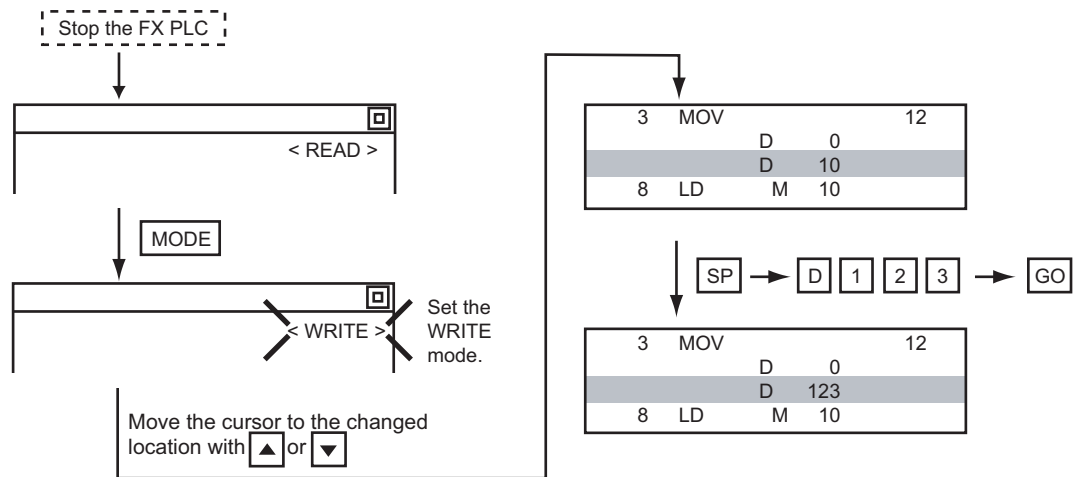

Deleting commands

Deletes one command at a time from a sequence program.

Operation

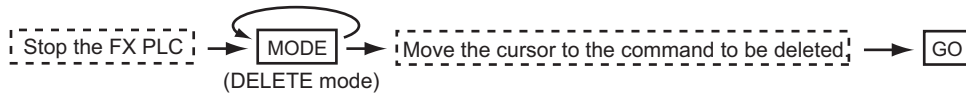

Point

When moving the cursor to the position where the command is to be deleted
Place the cursor on the command line (the line on which the step number is displayed).
You cannot delete the command if the cursor is placed on the line of an operand or set value.

Example

Deleting "OUT T10 K100"

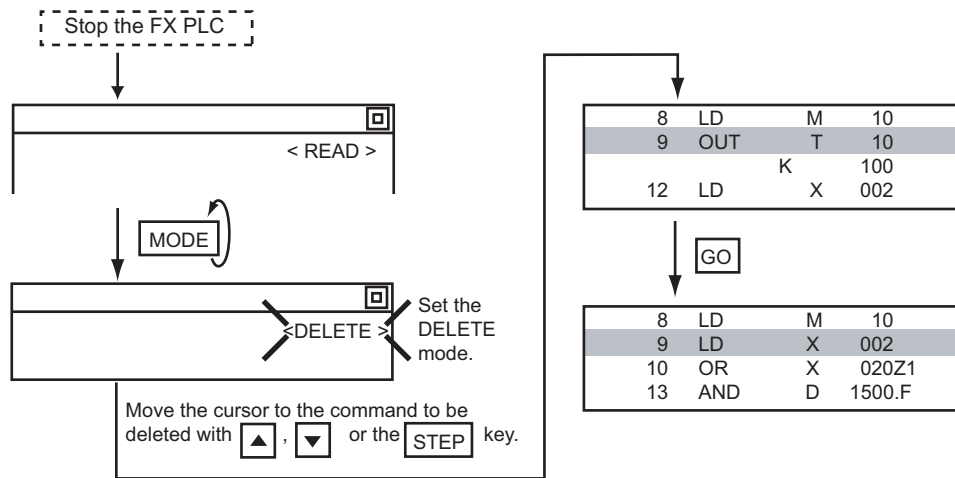

Sequence program all clear

Clears all the sequence programs.

Operation

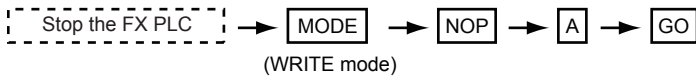

Example

Clears all the sequence programs.

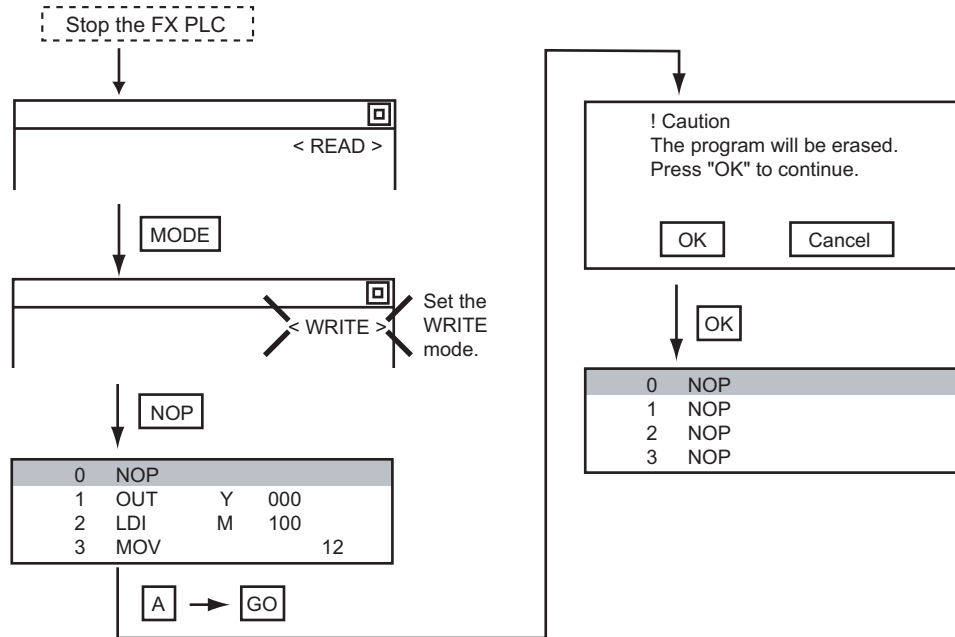

Point

Items cleared when All Clear for a sequence program is performed
 When All Clear is executed, the parameters before program execution are initialized and Latch Clear is executed.
 The memory space becomes the default value, the comment area a 0 block, the file register space a 0 block, and keywords unregistered.
 After All Clear, set the above parameters etc. again.

PLC diagnostics

Displays the FX PLC error message, error code, and step at which the error occurred.

Operation

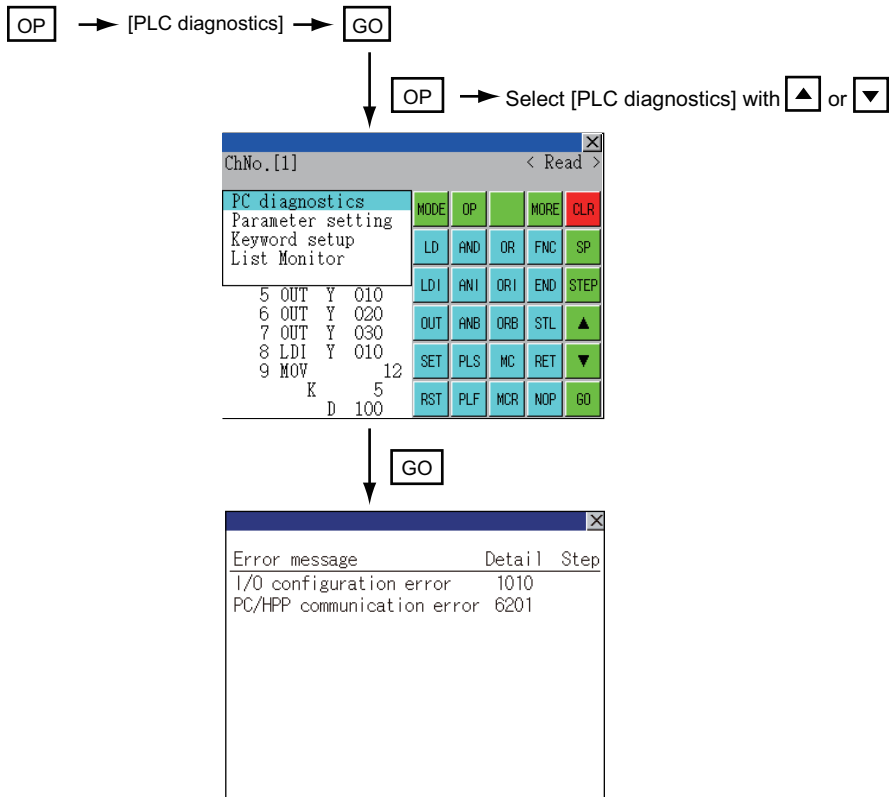

PLC diagnostics screen

The following describes the contents displayed on the PLC diagnostics screen and the function of on-screen key.

■Displayed contents

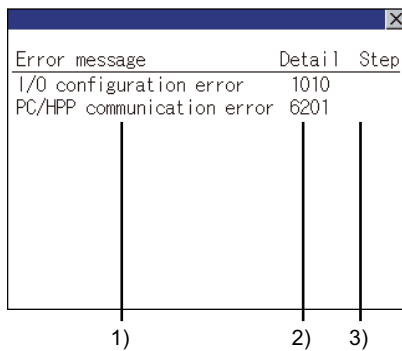

No.	Item	Display contents
1)	Error message	Displays the error message. (I/O configuration error/PLC hardware error/PC/HPP communication error/Serial communication error/Parameter error/Syntax error/Circuit error/Operation error)
2)	Detail	Displays the error code.
3)	Step	Displays the step number in the sequence program at which the error occurred. (This is displayed only for a syntax error, circuit error, or operation error.)

Point

Error details

For details of the FX PLC errors, refer to the following.

Programming manual for the FXCPU used

■Key function

The table below shows the functions of the keys that are used for the operation on the PLC diagnostics screen.

Key	Function
✕	Exits the PLC diagnostics.

Parameter setting

Sets FX PLC parameters.

Parameters that can be changed and change targets

Parameters that can be changed

The parameters that can be changed with the MELSEC-FX list editor and the target FX PLCs are as follows.

○: Can be set/changed ×: Cannot be set/changed

Item	Target CPU								
	FX0(S) /FX0N	FX1	FX2(C)	FX1S	FX1N(C)	FX2N(C)	FX3S	FX3G(C)	FX3U(C)
Memory space setting	×	○	○	×	×	○	○	○	○
File register space setting	○ *1	×	○	○	○	○	○	○	○
Latch range setting	×	○	○	×	×	○	×	×	○
RUN terminal setting	×	×	×	○	○	○	○	○	○
Initialization of parameters	○	○	○	○	○	○	○	○	○

*1 When connecting an FX0(S), set "0". Setting other than "0" causes a parameter error.

*2 When the parameters are initialized, the display on the MELSEC-FX list editor is different from the FX PLC default values, but do not change the latch range. Changing the latch range causes an error.

Change targets

When a memory cassette is mounted, the parameters in the memory cassette are targeted for changes.

Operation

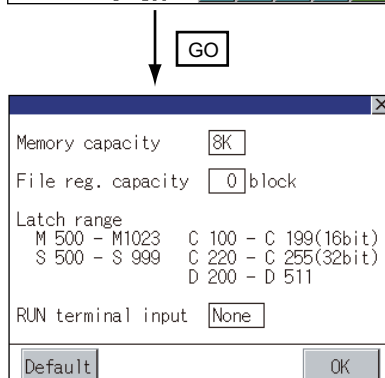
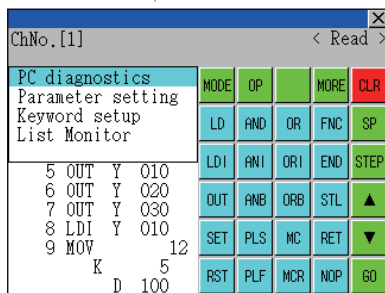
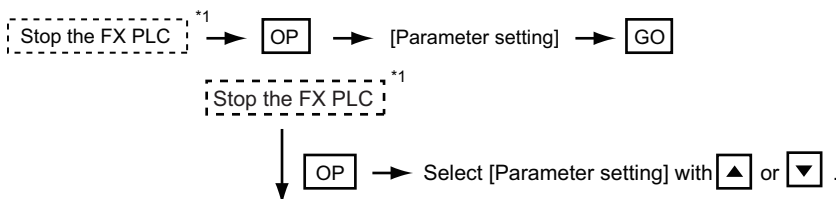

*1 When checking parameters (not changing), it is not necessary to stop the PLC.

Parameter setting screen

The following describes the contents displayed on the PLC diagnostics screen and the function of on-screen key.

■Displayed contents

No.	Item	Display contents
1)	Memory capacity	Sets the memory space (number of steps). If you touch the <input type="checkbox"/> section, you can change the memory space.
2)	File reg. capacity	Sets the memory space (number of blocks) allocated to the file register. Touch the <input type="checkbox"/> section and input the number of blocks.
3)	Latch range	Sets the latch range (power failure hold area). Touch the number display section and input the value.
4)	RUN terminal input	Sets whether or not to use one of the FX PLC input terminals for RUN input. Touch the <input type="checkbox"/> section and set the device to be set for the RUN terminal.
5)	Default	Initializes the parameters

Point

- Memory space for kana comments after changing memory space, file register space

If the memory space is set smaller than the total of the file register space and kana comment space, the kana comment space is automatically reduced.

(With the MELSEC-FX list editor, the kana comment space is not displayed.)

Note that if any setting as described below is made, the kana comment space is reduced.

(Settings that reduce kana comment space and the kana comment space after setting change)

Settings resulting in $N_m < N_f \times 500 + N_k \times 500 + 500$

$$\text{Kana comment space (steps) after setting change} = \frac{N_m - N_f \times 500 - 500}{500}$$

N_m : Memory space after change (steps)

N_f : File register space after change (blocks)

N_k : Comment space before change (blocks)

- Settable range and default value

The settable range and the default value depend on the FX PLC type.

For details of the settable range and the default value, refer to the following.

Programming manual for the FXCPU used

■Key functions

The table below shows the functions of the keys that are used for the operation on the parameter setting screen.

Key	Function
	Initializes the parameters
	Completes the changed setting contents.
	Ends parameter setting.

Keyword

Registers, deletes, releases protection for, and sets protection for the FX PLC keywords.

Function usability of the MELSEC-FX list editor for keyword protection levels

The functions that can be used with the MELSEC-FX list editor depend on the keyword protection level.

○: Available, ×: Unavailable

Function		Keyword protection level				Reference
		All operation protect (All on-line operation protect)* ²	Read/Incorrect write protection (Read/Write protection)* ²	Erroneous write prohibition (Write protection)* ²	Keyword not registered/ keyword protection canceled	
Reading sequence programs	Displaying sequence programs	×	×	○	○	Page 357 Displaying sequence programs
	Searching commands/devices	×	×	○	○	Page 359 Searching commands/devices
Writing sequence programs	Writing commands	×	×	×	○	Page 361 Writing commands
	Changing operands/set values	×	×	×	○	Page 366 Deleting commands
Inserting commands		×	×	×	○	Page 361 Writing commands
Deleting commands		×	×	×	○	Page 366 Deleting commands
Sequence program all clear		×	×	×	○	Page 367 Sequence program all clear
PLC diagnostics		○ * ¹	○	○	○	Page 368 PLC diagnostics
Parameter setting		×	×	×	○	Page 370 Parameter setting

*1 When the 2nd keyword is set to an FX PLC that supports 2nd keyword, it becomes "×" (cannot be used).

*2 The names within the parentheses () are for when a keyword + 2nd keyword is set.

Operation

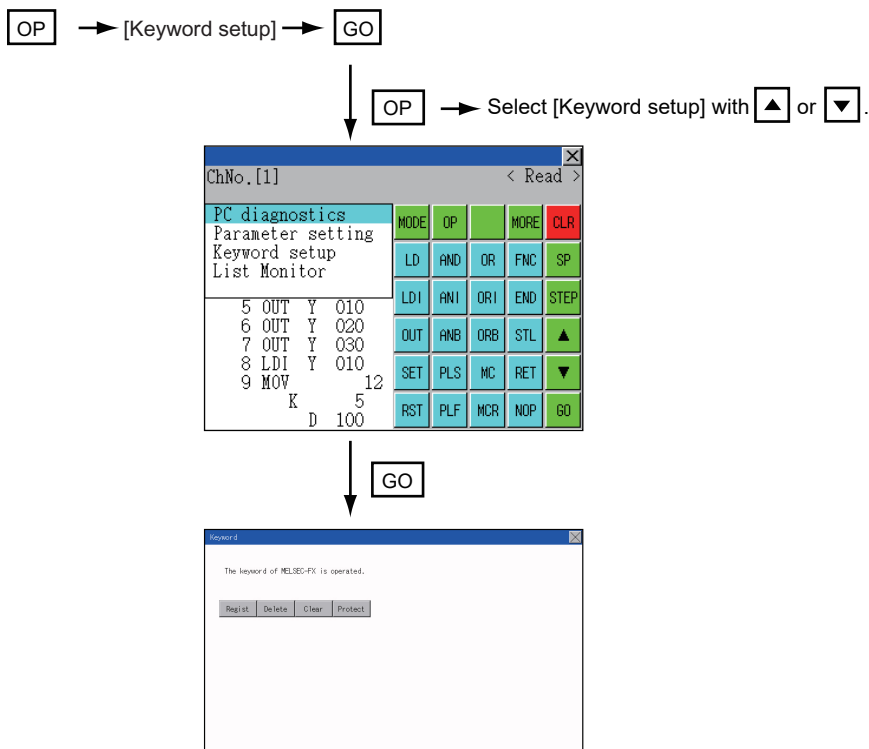

Keyword screen and protection level

When [Keyword setup] is selected with the MELSEC-FX list editor, the keyword screen is displayed.

For the keyword operation, refer to the following.

 Page 212 Keyword

Point

Keywords

For details of the keyword, refer to the following.

 Programming manual for the FXCPU used

List monitor

The status of contacts and coils in a sequence program is displayed.

Operation

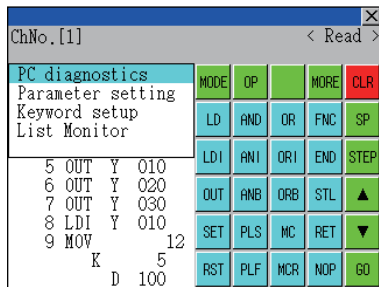
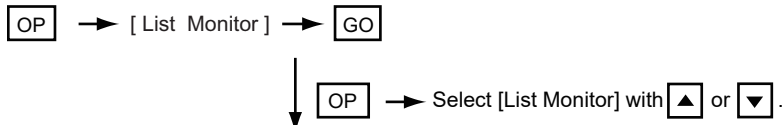

GO

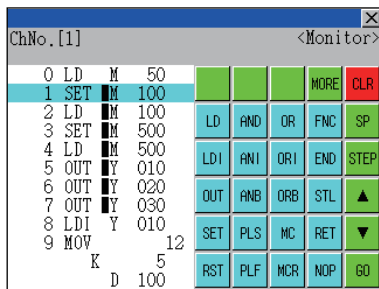

When the list monitor is started on the FX list editor screen, the step numbers displayed on the FX list editor screen is displayed on the list monitor screen.

Point

Starting list monitor with special function switches (FX list monitor)

With setting special function switches (FX list monitor), the list monitor can be started on the monitor screen.

When the list monitor is started on the monitor screen, the list editor cannot be used.

For how to set special function switches, refer to the following.

GT Designer3 (GOT2000) Screen Design Manual

Displays and key functions

The following describes the displays for the list monitor.

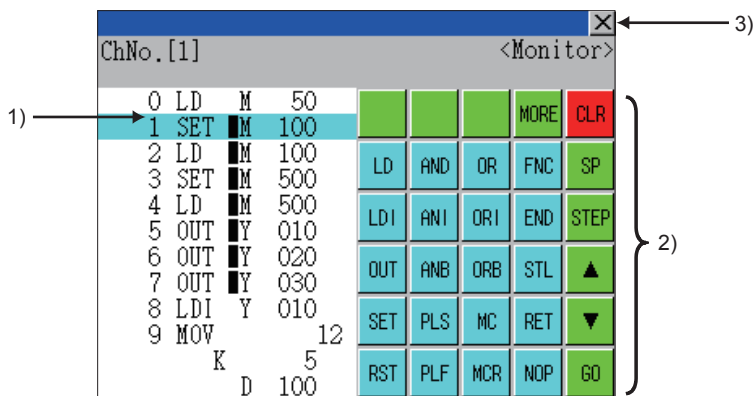

No.	Item	Display contents
1)	List display area*1	The status of contacts and coils is displayed on the left of device displays.
2)	Keys	The same operations as in the READ mode of the FX list editor can be executed. Page 357 Displaying sequence programs
3)	[X]	Ends the list monitor. (When the list monitor is executed on the FX list editor screen, the screen is switched to the FX list editor screen.)

*1 The status of contacts and coils is displayed as below.

Type of instruction	Description	Status	
		■ Displayed	■ Not displayed
LD, AND, OR (Contact instruction (Normal open))	Contact	ON	OFF
LDI, ANI, ORI (Contact instruction (Normal close))	Contact	OFF	ON
OUT, SET	TC: Coil	ON	OFF
	Except TC: Contact	ON	OFF
RST	TC: Reset	ON	OFF
	Word device	Value: 0	Value: Except 0
	Except TC and word device: Contact	OFF	ON
MC, STL	Contact	ON	OFF
LDP, ANDP, ORP, LDF, ANDF, ORF (Rise or fall contact instruction)	Not monitored	Always ■ not displayed	

Action for an incorrect key input

If an incorrect key is input, cancel the input contents.

Operations

■ Before touching the **GO** key (before reading/writing the input contents)

Before touching the **GO** key, touch the **CLR** key.

■ After touching the **GO** key (after reading/writing the input contents)



Write the command again.

Page 361 Writing commands

Commands finalized by writing and inserting operations are revised (overwritten) with the program writing.

Error messages and corrective actions

This section describes the error messages displayed when the MELSEC-FX list editor is executed, and corrective action.

Error message	Description	Corrective action
Can not display while protected. Can not operate while protected.	The all-operation protect, anti-plagiarism, or incorrect write protect keyword is set.	<ul style="list-style-type: none">• Check the protected operation.• Clear the keyword protection or delete the keyword.  Page 372 Keyword
PLC parameter error.	An FX PLC parameter is defective.	Set correct parameters in the FX PLC.
PLC communications error.	The communication with the FX PLC is defective.	<ul style="list-style-type: none">• Check the FX PLC, cable, and GOT for abnormality.• Check whether the communication settings are correct or not.
PLC is running.	A writing operation etc. has been made while the FX PLC is running.	Stop the FX PLC.
Can not write.	<ul style="list-style-type: none">• The memory to write to is EPROM.• The protect switch of the EEPROM is on.	<ul style="list-style-type: none">• Set other than EPROM for the memory to write to.• Switch off the protect switch of the EEPROM.
Step number is out of a range.	The specified step number exceeded the maximum number.	Specify a step number below the maximum value.
Not found.	The specified command cannot be found.	Proceed to the next operation.
Not found.	The specified device cannot be found.	Proceed to the next operation.
Step overflow.	The program may exceed the available space. (Writing is not executed.)	Check the program memory space and delete commands to keep it within the space.  Page 366 Deleting commands
Command error.	An invalid command (non-existent command) was specified.	Input the correct command.

Point

How to erase an error message

An error message is not erased even if the cause of the error is eliminated.

To erase an error message, touch a key on the MELSEC-FX list editor screen.

28.3 FX3U-ENET-ADP Communication Setting Function

In GX Works2, the communication set value of the FX3U-ENET-ADP stored in the CPU can be changed.

This function is not available when the communication set value of the FX3U-ENET-ADP is not set in advance in the CPU.

Point

Communication setting in the CPU

In GX Works2, set in advance the communication set value of the FX3U-ENET-ADP to the CPU.

For the details of the communication setting, refer to the following.

 FX3U-ENET-ADP User's manual

Specifications

28

System configuration

This section describes the system configuration of the FX3U-ENET-ADP communication setting function.

For the setting method in each connection form, used communication unit/cable and cautions on connection form, refer to the following manual.

 GOT2000 Series Connection Manual For GT Works3 Version1

Required basic system application

Operating system		Version
Basic system application		-
Communication driver	MELSEC-FX	-

Connection type

(○: Applicable, △: Partly restricted, ×: Inapplicable)

Function		Connection type between GOT and controller	
Name	Description	Direct CPU connection (serial)	GOT multi-drop connection
FX3U-ENET-ADP communication setting function	The communication set value of the FX3U-ENET-ADP stored in the CPU can be changed.	○	×

Communication setting items

The table below shows the communication setting items and setting range.

Communication setting items	Setting range	Remark
IP address	0.0.0.1 to 223.255.255.254	If a value outside the setting range is entered, the error message "SET NUMBER IS INCORRECT." appears.
Subnet mask pattern*1	192.0.0.0 to 255.255.255.252	
Default router IP address*1	0.0.0.1 to 223.255.255.254	

*1 Set the value "0.0.0.0" when not using the subnet mask pattern and default router IP address.

Display operation of FX3U-ENET-ADP communication setting function

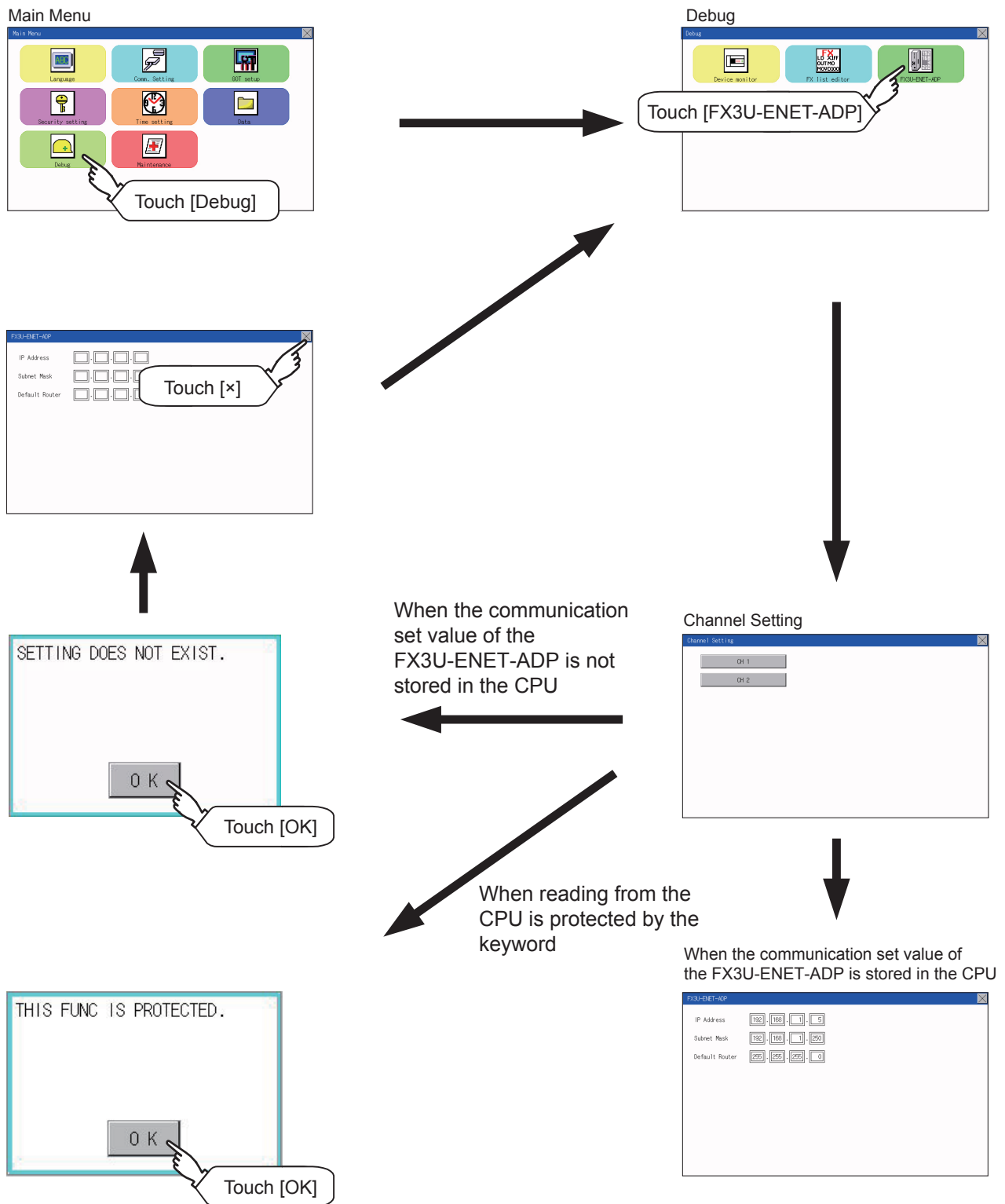

Setting operation

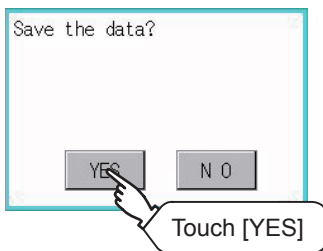
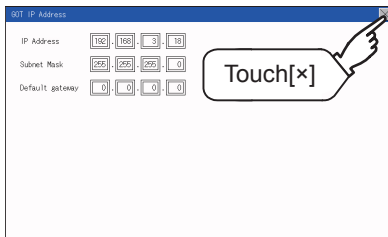
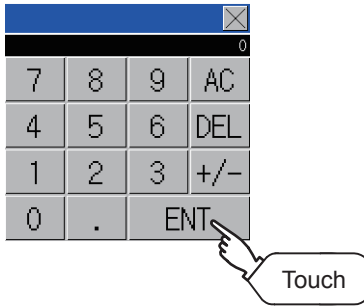
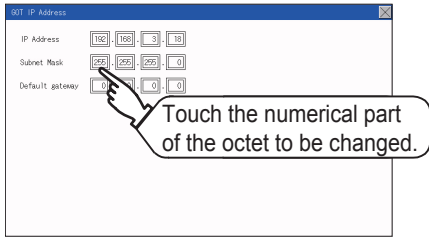

1. Touch the numerical part of the octet to be changed among the 1st to 4th octets.

2. When the ten-key pad appears, enter a numerical value in up to 3 digits, and touch the **ENT** key. If a numerical value outside the setting range is entered, the following error message appears. Enter a numerical value again.

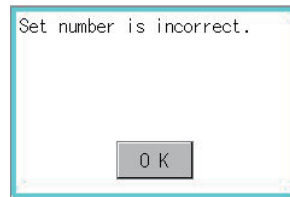

For the details of the setting range, refer to the following.

☞ Page 377 Specifications

3. The changed IP address is displayed. At this time, the changed communication set value of the FX3U-ENET-ADP is not written to the CPU. Touch the **[x]** key.

4. When the screen shown on the left appears, touch the **[YES]** key.

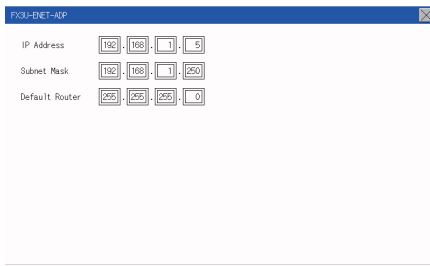

- When the screen shown on the left appears, the changed communication set value of the FX3U-ENETADP is written normally to the CPU. To enable the setting, power OFF the CPU, and then power it ON again. Change the setting of the subnet mask pattern and default router IP address using the same procedure if necessary. An error message appears in the following cases. Touch the **OK** key to return to the step 1., and perform the setting procedure again.

When the CPU is running

The following error message appears. Stop the running status of the CPU.



When a communication error occurs

Set the communication between the GOT and the CPU to the normal status.



When the memory cassette is write-protected

Set to OFF the write-protect switch of the memory cassette.

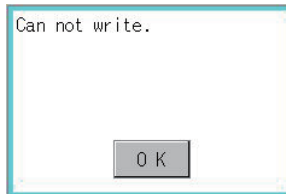

When writing to the CPU is protected by the keyword

Clear the protection by the keyword against writing.



When the CPU stores the symbolic information

When the setting such as IP address is changed using this function and then the program is read by the programming tool from the CPU that stores the symbolic information, the following warning appears. However, the changed value is read correctly. Convert and compile the project again.

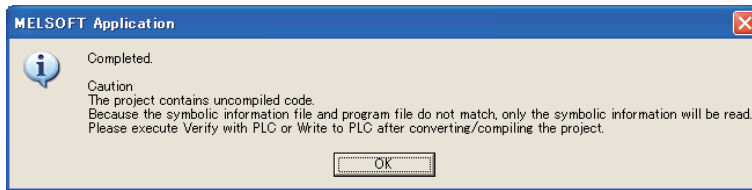

29 MAINTENANCE

29.1 Touch Panel Calibration

Touch panel calibration setting function

Touch panel reading error can be corrected.

Normally the adjustment is not required, however, the difference between a touched position and the object position may occur as the period of use elapses.

When any difference between a touched position and the object position occurs, correct the position with this function.

Before adjustment

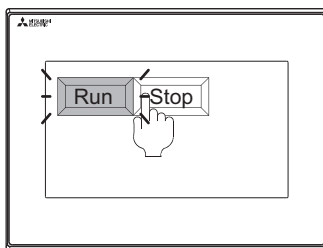

The [Run] will operate though you intended to touch the [Stop] button.

After adjustment

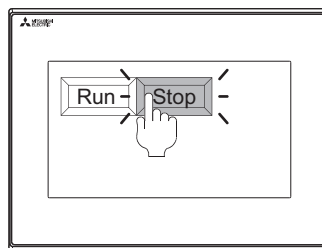

The [Stop] button can be touched without fail.

Touch panel calibration setting display operation

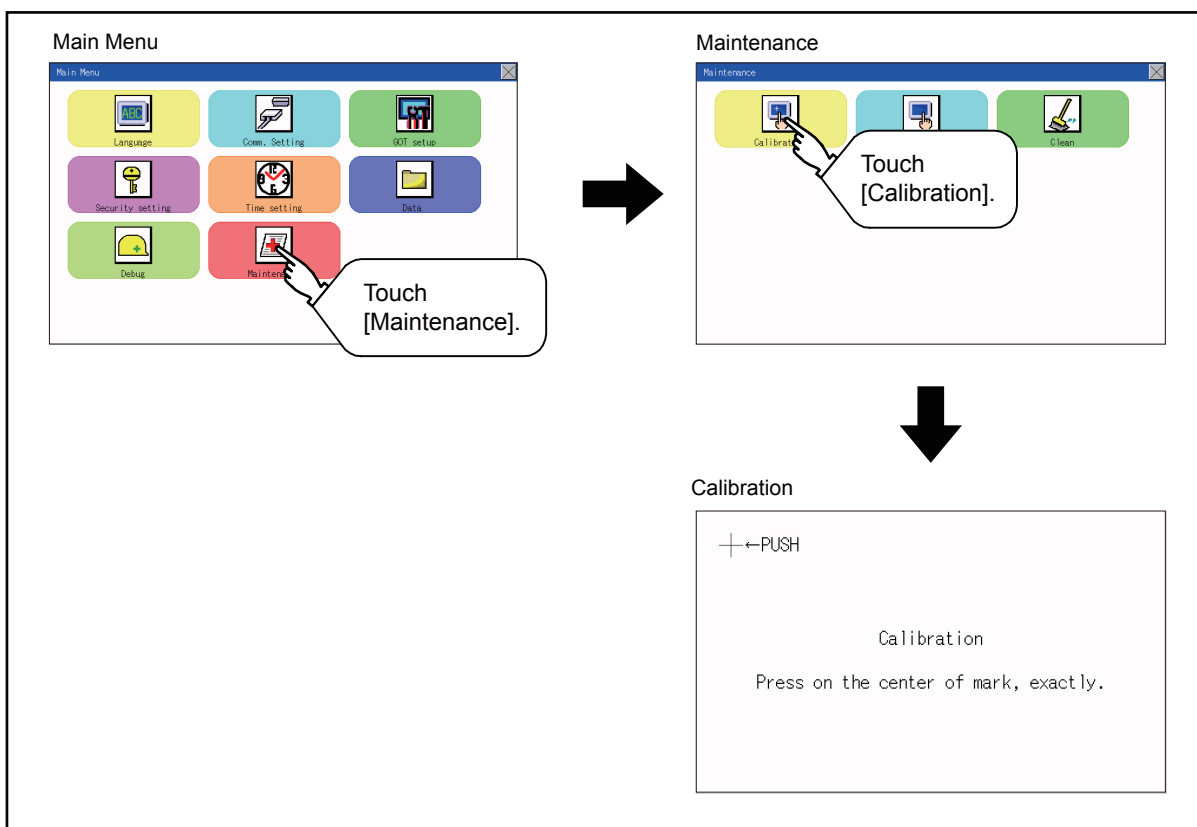

Touch panel calibration operation

Touch [+] displayed on the screen with the finger one by one to make the setting.

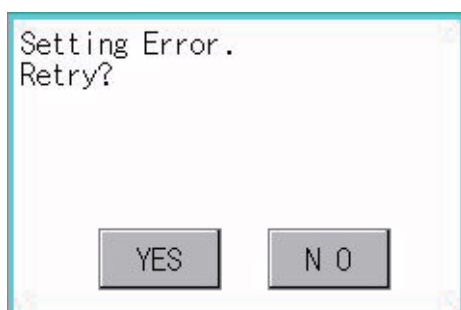
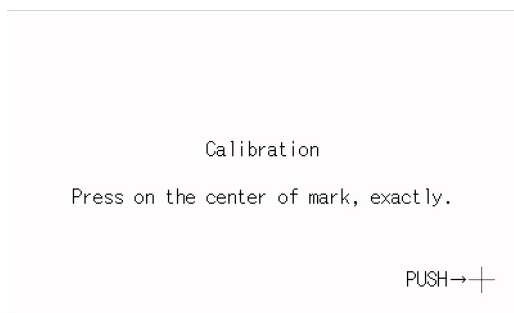
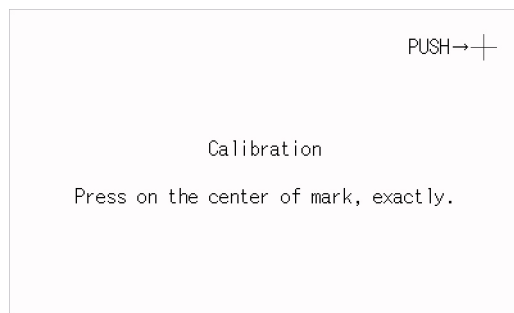
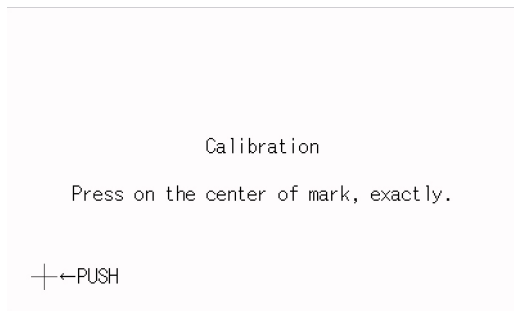
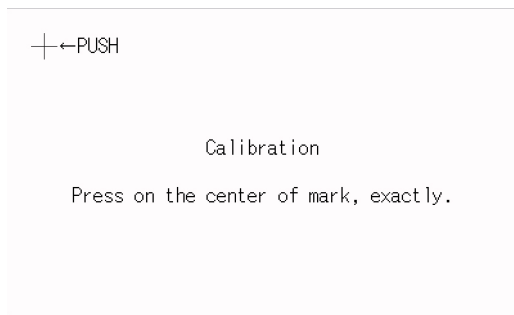

1. Touch the center of [+] displayed on the upper left precisely.
2. Touch [+] displayed on the lower left.
3. Touch [+] displayed on the upper right.
4. Touch [+] displayed on the lower right.
5. When the precise touch could not be made, touch the [YES] button to make the setting from Step1 again.

29.2 Touch Panel Check

Touch panel check function

Touch panel check function checks whether there is no dead zone area of 2 dots × 2 dots.

Display operation of Touch panel check

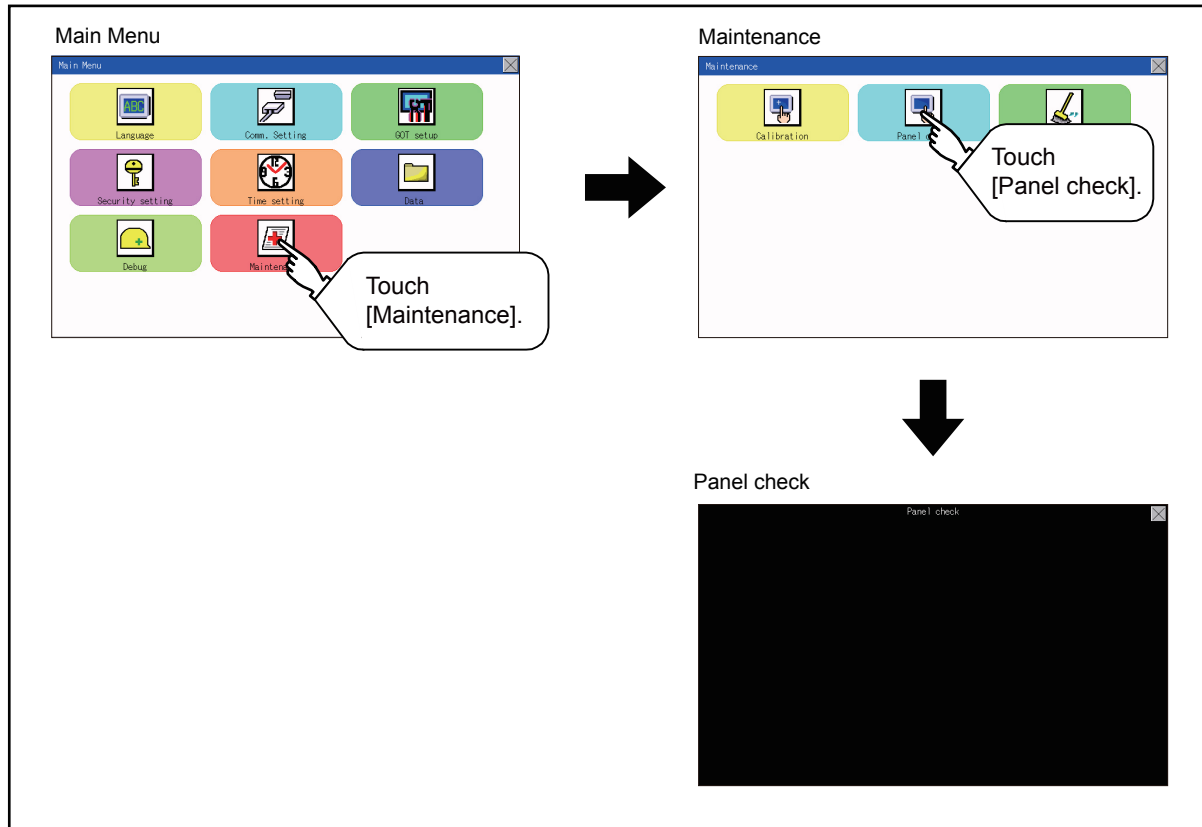

29

Point

Notes on Touch panel check

If the touched part is not filled with yellow color, there are the following two possible causes.

1. Display part failure
2. Touch panel failure

In that case, contact your local Mitsubishi (Electric System) Service.

Touch panel check operations

If touching [Panel check] of self-check, a black-filled screen is displayed over the entire screen area.

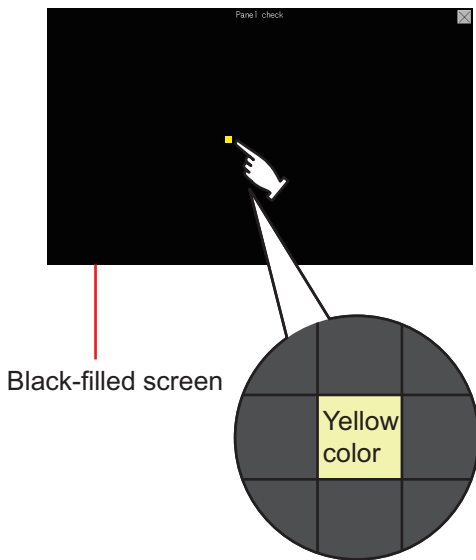

1. Touch a part of the screen. The touched part becomes a yellow-filled display. Up to 40 parts becomes yellow-filled displays.

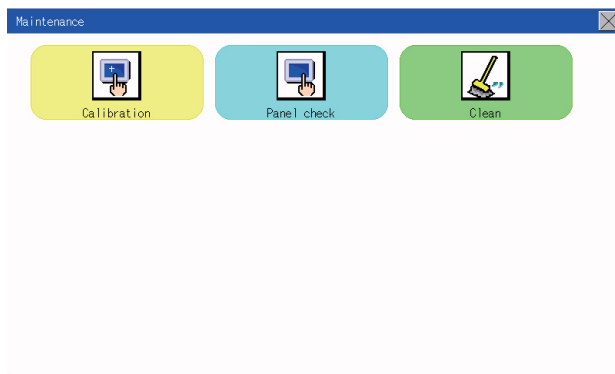

2. If [×] on the upper right is touched, the screen returns to the self-check.

Point

Checking the upper left part of the screen

Only the upper left part of the screen cannot be filled with yellow.

If the screen returns to the self-check by touching the upper left part, judge that the upper left area operates normally.

29.3 Clean

In utility, the screen can be set as not to be effected by touching the screen when clean with clothes.
For cleaning method, refer to the following.

☞ Page 397 Cleaning Method

Display operation of clean

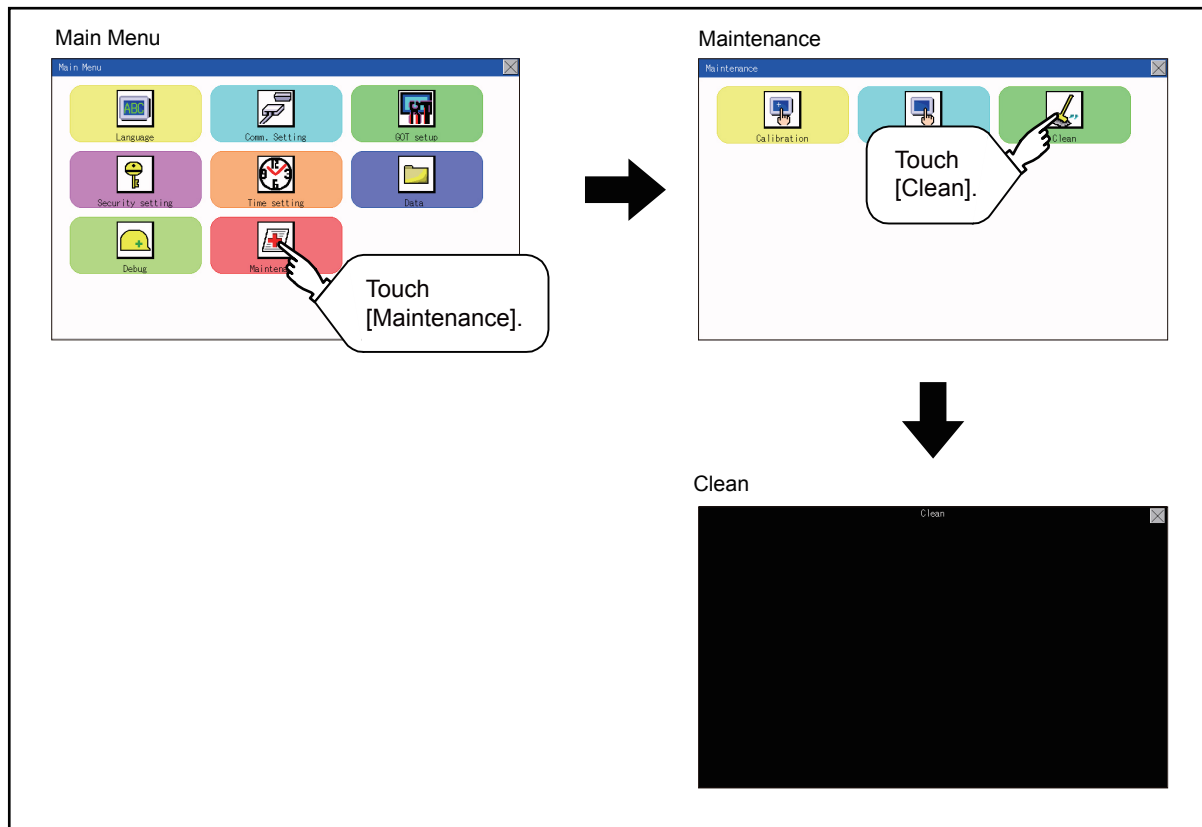

Display operation of clean



1. Touching the [x] key closes the screen. Even if touch points other than the upper left corner and upper right corner of the screen, the GOT does not operate.

For details of cleaning method, refer to the following.
☞ Page 397 Cleaning Method

MEMO

30 BootOS and System Application Installation Using Data Storage

There are the following two types for the installation of BootOS and system applications using a data storage.

Installing when starting the GOT

 Page 390 Installing when starting the GOT

All the system applications and project data stored in the data storage are transferred to the GOT when powering on the GOT.

This installing method is effective in the following cases.

- The GOT utility cannot be displayed.
- The system application is not installed.

Installing using the data control function (Utility)

 Page 390 Installing when starting the GOT

By operating the utility, select the system application or project data stored in the data storage and transfer them to the GOT.

Point

Precautions on installing BootOS, system applications

- Installing both BootOS and system applications

After completing BootOS installation, install system applications. When installing BootOS, the built-in flash memory in the GOT is initialized and goes to the status at factory shipment. (All system applications and project data are erased.)

BootOS is installed in the GOT at factory shipment. It is not necessary to install BootOS when not upgrading it.

- Installation cannot be interrupted.

Do not perform any of the following during a BootOS or system application installation.

Failure to do so may result in installation failure, causing the GOT malfunction.

Powering off the GOT

Pressing the reset button of the GOT

Removing the data storage

If the installation failure and the GOT malfunction occur, take the following action.

If BootOS installation failed:

Please consult your local Mitsubishi (Electric System) Service center or representative.

If the basic system application installation failed:

 Page 390 Installing when starting the GOT

30.1 Installing when starting the GOT

When installing with an SD card

1. Power OFF the GOT, and install the SD card where the BootOS, system application or project data is stored in the SD card interface of the GOT.
2. Power on the GOT. While touching the lower right side of the GOT screen, power on the GOT. (1-point press installation function)
3. The BootOS or system application is installed in the built-in flash memory. Do not pull out the SD card or power OFF the GOT.

パッケージデータをインストール中です。
Now installing the package data.
正在安装软件包数据。

4. The GOT restarts automatically after the installation is completed.

完了しました。再起動します。
Finished. Now rebooting.
安装已结束。再启动GOT。

5. After confirming normal restart, confirm that the SD card access LED is not lit, and remove the SD card from the SD card interface of the GOT.

30.2 Installing using the data control function (Utility)

Operation procedure

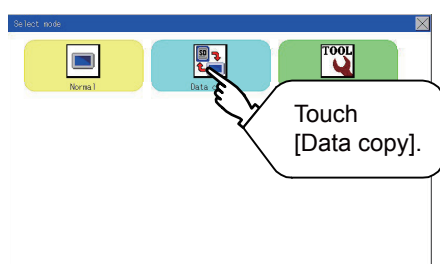
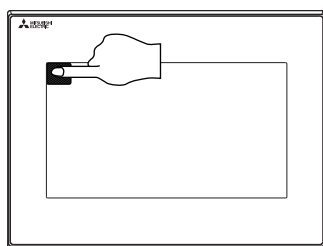

1. Power OFF the GOT, and attach the SD card which stores the basic system application and communication driver to the GOT.
2. While touching the upper left corner of the GOT screen, power ON the GOT.
3. When the screen shown on the left appears, select the [Data copy].
For details of install, refer to the following.
☞ Page 310 Data Copy

31 INSTALLATION OF Boot OS AND BASIC SYSTEM APPLICATION

To execute the GOT utility, install the Boot OS and system applications on the C drive (built-in flash memory) of the GOT, or set the boot drive of the package data to [A: Standard SD card] and insert an SD card with the package data into the GOT. (Boot OS is installed in the GOT at factory shipment. It is not necessary to install Boot OS when upgrading of it is unnecessary.)

This chapter explains the installation using GOT.

GT Designer3 → SD card → GOT

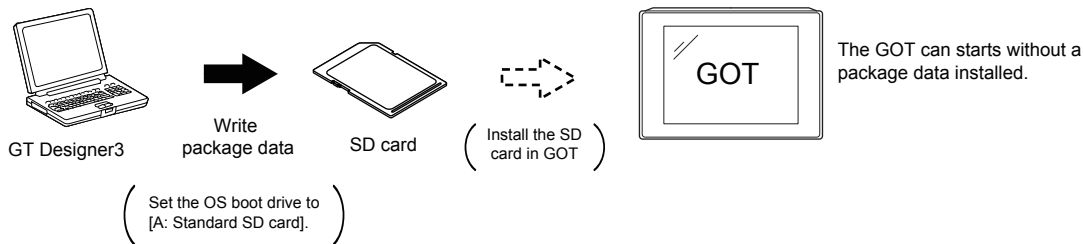

GOT → SD card → GOT

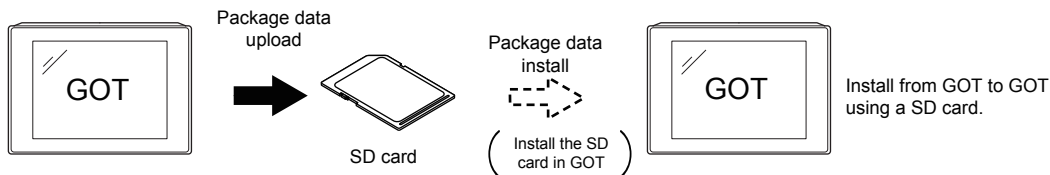

Refer to the following for the installation which uses GT Designer3.

📖 GT Designer3 (GOT2000) Screen Design Manual

31.1 Boot OS and Basic System Application to be Installed

Under-mentioned Boot OS and basic system application are necessary to execute utility.

System application name	Function overview
Boot OS	Required for the control of GOT and the communication between PC and GOT. Installed at factory shipment. (Boot OS can also be installed from GT Designer3. When Boot OS is installed, the GOT is initialized and goes to the status at factory shipment. When Boot OS needs to be reinstalled, the basic system application has to be installed in the GOT.)
System application	Required for the GOT operation as the monitoring function of GOT, installation and deletion of the system application or project data, touch key control or display function of the screen and guidance. Required for display and operation of the user-created screen and utility screen. Not installed in GOT at factory shipment. Install it from GT Designer3 or an SD card.

31.2 Prior Preparations for Installing Boot OS and System Application

For the installation using GOT, the data storage that is storing Boot OS or the system application is required. There are the following three methods for the installation of Boot OS and system application.

[To Memory Card] from GT Designer3

📖 GT Designer3 (GOT2000) Screen Design Manual

Uploading from another GOT (the package data has been installed)

📖 Page 389 BootOS and System Application Installation Using Data Storage

Using an SD card that stores data with OS boot drive set to A drive

📖 GT Designer3 (GOT2000) Screen Design Manual



Precautions when installing Boot OS and the package data into an SD card

When installing Boot OS and the package data into the SD card, be sure to execute by the utility of another GOT or GT Designer3.

The installation is not executed properly with the SD card to which data is uploaded from the utility of GOT or copied by software other than GT Designer3.

Note the available capacity of the SD card.

The available capacity of Boot OS and system applications can be confirmed by [To Memory Card] or [Write Option] of GT Designer3.

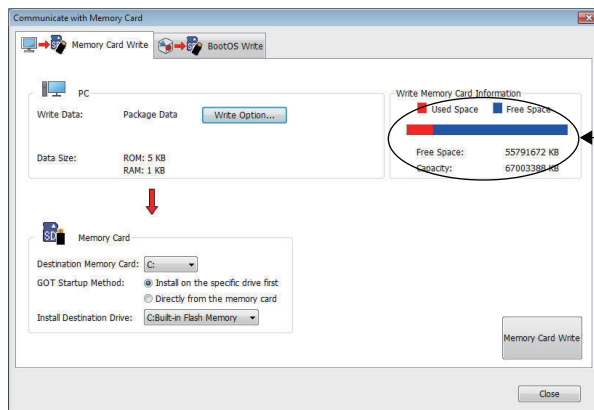

Write Option

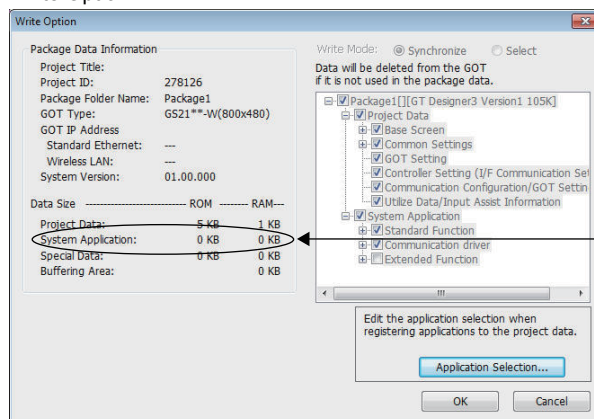

32 ERROR MESSAGE LIST

This chapter describes the error message and the corrective actions displayed on the GOT.

Error message	Action
SCREEN DOES NOT EXIST.	<ul style="list-style-type: none"> Specified base screen does not exist in the project data. Specified base screen is out of the permissible area. Specify the existing base screen.
SCREEN ERROR	The monitored device No. is out of the permissible area of the targeted PLC CPU. Set the device within the range that can be monitored by the monitored PLC CPU and parameter settings.
COMM. ERROR	Error occurred while writing in the device. <ul style="list-style-type: none"> Check the cable omission and the status of the PLC.
DEVICE ERROR.	Error occurred while writing in the device Correct the device.
SET NUMBER IS INCORRECT.	The input value was illegal when writing to the device. Check the input value.
PLC IS RUNNING.	The operation, which could not be performed during RUN of PLC CPU, was performed. Stop the PLC CPU.
CAN NOT WRITE.	The memory cassette installed in the PLC CPU is EPROM or E ² PROM, and it is in a protected status. Confirm the memory cassette installed in PLC CPU.
THIS FUNC IS PROTECTED.	The key word is set in PLC CPU. Cancel the key word.
CAN NOT USE THE FUNCTION.	The function cannot be used with the package data configuration written in the GOT. <ul style="list-style-type: none"> Review the package data configuration. Install the latest version of GT Designer3 and write the package data again to the GOT.
DATA IS NOT FOUND.	The package data is not downloaded or the package data is not sufficient. Download the package data.
PASSWORD IS INCORRECT.	The input password does not match the security level password or the utility start-up password. Check the target password.
Password cannot be changed because you are not logged in.	When authenticating the operator, the password cannot be changed before logging in. Log in.
The password does not match, the GOT cannot be booted.	The passwords for transmitting the data from package data on Drive C and package data directly started from memory card do not match, so the GOT cannot be started. Match the data transmission passwords.

MEMO

STARTUP AND MAINTENANCE PRECAUTIONS

 **WARNING**

- When power is on, do not touch the terminals.
Doing so can cause an electric shock or malfunction.
- Before starting cleaning or terminal screw retightening, always switch off the power externally in all phases.
Not doing so can cause the unit to fail or malfunction.
Undertightening can cause a short circuit or malfunction.
Overtightening can cause a short circuit or malfunction due to the damage of the screws or unit.

STARTUP AND MAINTENANCE PRECAUTIONS

 **CAUTION**

- Do not disassemble or modify the unit.
Doing so can cause a failure, malfunction, injury or fire.
- Do not touch the conductive and electronic parts of the unit directly.
Doing so can cause a unit malfunction or failure.
- The cables connected to the unit must be run in ducts or clamped.
Not doing so can cause the unit or cable to be damaged due to the dangling, motion or accidental pulling of the cables or can cause a malfunction due to a cable connection fault.
- When unplugging the cable connected to the unit, do not hold and pull from the cable portion.
Doing so can cause the unit or cable to be damaged or can cause a malfunction due to a cable connection fault.
- Before touching the unit, always touch grounded metals, etc. to discharge static electricity from human body, etc.
Not doing so can cause the unit to fail or malfunction.

DISPOSAL PRECAUTIONS

 **CAUTION**

- When disposing of this product, treat it as industrial waste.

The GOT does not include consumable components that will cause the shorten life.

However, the liquid crystal screen and backlight have life length.

For the life of the LCD screen or backlight, refer to the following.

 Page 142 Performance Specifications

33.1 Daily Inspection

Daily inspection items

Item	Inspection Item	Inspection Method	Criterion	Corrective action	
1	GOT mounting status	Check for loose mounting screws.	Securely mounted	Retighten screws within the specified torque range	
2	Connection status	Loose terminal screws	Retighten screws with screwdriver	Not loose	Retighten terminal screws
		Proximate solderless terminals	Visual check	Proper space	Correction
		Loose connectors	Visual check	Not loose	Retighten connector fixing screws
3	Usage status	Foreign material attachment	Visual check	No foreign matter sticking	Remove, clean

33.2 Periodic Inspection

Yearly or half-yearly inspection items

The following inspection should also be performed when equipment has been moved or modified or the wiring changed.

Item	Inspection Item	Inspection Method	Criterion	Action	
1	Surrounding environment	Ambient temperature	Make measurement with thermometer or hygrometer.	0 to 50°C	For use in control panel, temperature inside control panel is ambient temperature
		Ambient humidity	Measure corrosive gas.	10 to 90%RH	
		Atmosphere		No corrosive gas	
2	Power supply voltage check	Measure the voltage between 24 V DC terminals.	20.4 to 26.4 V DC	Change supply power	
3	Mounting status	Looseness	Move module	Should be mounted firmly	Retighten screws
		Foreign material attachment	Visual check	No foreign matter sticking	Remove, clean
4	Connection status	Loose terminal screws	Retighten screws with screwdriver	Not loose	Retighten terminal screws
		Proximate solderless terminals	Visual check	Proper space	Correction
		Loose connectors	Visual check	Not loose	Retighten connector fixing screws

33.3 Cleaning Method

Use the GOT always in a clean condition.

Cleaning and disinfecting the GOT

- For your safety, be sure to turn off the GOT before cleaning and disinfecting the surface.
- Carefully wipe the GOT screen with a soft cloth moistened with neutral detergent or ethanol.

Do not apply too much disinfectant to the cloth.

If you use alcohol for disinfection, the main component of the alcohol must be ethanol or isopropyl alcohol.

- Do not spray disinfectant directly to the GOT because doing so may cause electrical failure of the GOT and peripheral devices.
- After wiping the surface, dry the GOT completely before turning it on.

For the display operation of the [Clean] screen, refer to the following.

☞ Page 387 Clean

Clean

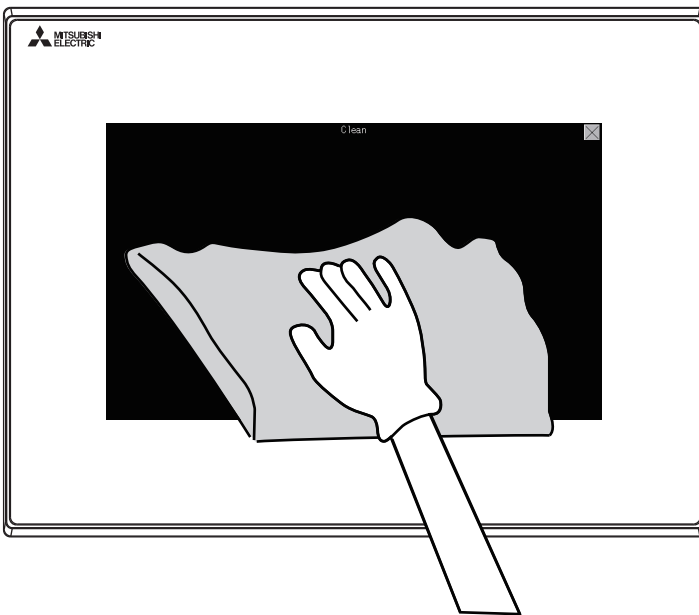

Precautions

Do not use the following solvents.

Solvents may deform the protective sheet, dissolve the surface, or peel the paint on the surface.

- Chlorine-based cleaners (bleach or other solvents)
- Peroxides (including hydrogen peroxide)
- Acetone, ammonia, paint thinner, benzene, methylene chloride, toluene, or other solvents

33.4 Backlight Shutoff Detection

A GOT has a built-in backlight for the liquid crystal display.

When the GOT detects backlight shutoff, it blinks the POWER LED alternately in orange and green.

The brightness of the backlight degrades as the usage period passes. Replace the backlight when it is shut off or the display gets blurry.

For the replacement of the backlight, contact your local distributor.

Backlight life

The usage period of the backlight can be extended by setting [Screen saving backlight off] in the GOT utility function (GOT setup). For details, refer to the following.

☞ Page 221 DISPLAY AND OPERATION SETTINGS (GOT SET UP)

Backlight shutoff detection and external alarm

When the GOT detects backlight shut off, the system information set in the screen design software turns on.

The information of the backlight shutoff can be output from a PLC to an external device (such as lamp and buzzer) by using the system information.

An alarm for prevention of touch operation should be set and the external interlock should also be set for the dangerous load.

For system information details, refer the following.

📖 GT Designer3 (GOT2000) Screen Design Manual

Point

- Example of alarm for external devices (such as lamp and buzzer)

System information is used to output the backlight shutoff detection signal from a FX series PLC to an external device.

Condition: The write device is D20 and all data is used (the [Select All] button on the setting screen in the screen design software is clicked) for the system information assignment.

D36 b14: Backlight shutoff detection (System number 2-2)

This signal turns on when the backlight shutoff is detected.

This signal is used in a sequence programs shown below.

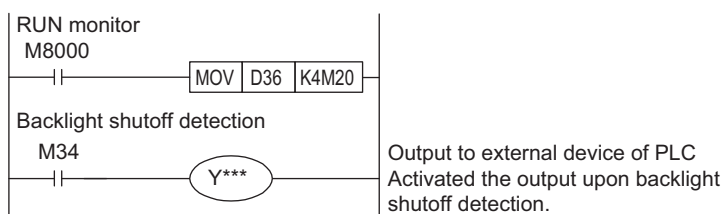

*indicates the output number at which the external device is connected.

- Caution when the backlight is shut off

Even when the backlight is shut off, the touch keys are available.

Replace the dead backlight as soon as possible.

34 TROUBLESHOOTING

This chapter describes the GOT restoration sheets.

34.1 GOT Restoration Sheets

34

This section describes how to restore the GOT that operates improperly in the check sheet format.

The following describes how to use each sheet.

When the GOT does not operate or operates improperly (GOT status check sheet)

When the GOT does not operate or operates improperly, check the cause of a malfunction by following the GOT status check sheet and take corrective actions.

After the GOT is restored, see how the GOT works.

When wiring needs to be modified (GOT installation status check sheet)

As a result of the GOT status check, if the cause of the malfunction or others is due to the noise generated by the GOT wiring status, take a corrective action for wiring by using the GOT installation status check sheet.

After the GOT is restored, see how the GOT works.

When a corrective action other than the above is required (System configuration check sheet)

If a malfunction or others still occurs even after the above checks, fill out the system configuration check sheet with details about your system, and consult your local sales office.

When sending the actual product, attach the GOT restoration sheets (GOT status check sheet, GOT installation status check sheet, and System configuration check sheet) which are checked in this section.

Keep a copy of each sheet.

GOT status check sheet

Check the GOT starting from the GOT status.

Mark checkboxes that apply to the symptom of your GOT.

Follow the instructions in the corrective action column.

GOT status

■Frequency of a case where the GOT does not operate or the screen is not displayed properly

Check	Symptom	Cause/Status	Corrective action
<input type="checkbox"/>	Always	Frequency: • Example: Once a month	Proceed to the following. ☞ Display of error message
<input type="checkbox"/>	Sometimes		

■Display of error message

Check	Symptom	Cause/Status	Corrective action
<input type="checkbox"/>	Can be confirmed	Error message:	Take the corrective action for the confirmed error message. If the status does not change with the corrective action, proceed to the following. ☞ Screen display
<input type="checkbox"/>	Cannot be confirmed	• Example: Communication error	Proceed to the following. ☞ Screen display

■Screen display

Check	Symptom	Cause/Status	Corrective action
<input type="checkbox"/>	The screen is black.	The possible cause is a failure of the liquid crystal or an error of the Boot OS.	Take corrective actions in the following order. 1) Re-install the Boot OS. 2) Re-install the standard monitor OS. If the GOT is not restored by the above operations, proceed to the following. ☞ Actual product investigation
<input type="checkbox"/>	The screen is white.	The possible cause is a hardware failure of the GOT.	Proceed to the following. ☞ Actual product investigation
<input type="checkbox"/>	A line appears on the screen.	The possible cause is a hardware failure of the GOT. Example: A vertical line appears on the screen.	Proceed to the following. ☞ Actual product investigation
<input type="checkbox"/>	Other display errors		
<input type="checkbox"/>	The screen is frozen.	The screen display is not updated and operation is unavailable.	Proceed to the following. ☞ Buzzer sound

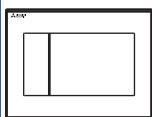

■ Buzzer sound

Check	Symptom	Cause/Status	Corrective action
<input type="checkbox"/>	No buzzer sound	Buzzer sound: • Example: The buzzer repeats in the rhythm of "beep-beep-beep, beep, beep-beep".	Proceed to the following. ☞ Status where the GOT screen is frozen (When the screen operation stops)
<input type="checkbox"/>	Beeps randomly		
<input type="checkbox"/>	Beeps in a pattern		
<input type="checkbox"/>	Beeps without a pause	The possible cause is the activated Buzzer Output signal. When the reading device of the system information is set, the device may be turned on and the Buzzer Output signal may be activated.	Check the setting of the reading device. If the Buzzer Output signal has no error, proceed to the following. ☞ Status where the GOT screen is frozen (When the screen operation stops)

Status where the GOT screen is frozen (When the screen operation stops)

■ Objects that are not displayed on the monitor screen

Check	Symptom	Cause/Status	Corrective action
<input type="checkbox"/>	Exists	Detail: • Example: The numerical display is not displayed.	Proceed to the following. ☞ PLC CPU status
<input type="checkbox"/>	None		

PLC CPU status

■ PLC error

Check	Symptom	Cause/Status	Corrective action
<input type="checkbox"/>	Always	The possible cause is CONTROL-BUS. ERROR, SP. UNIT LAY. ERROR, or other errors.	Proceed to the following. ☞ GOT Restoration Sheets
<input type="checkbox"/>	Sometimes	The possible cause is noise or a hardware failure. Frequency: • Example: Once a month	Proceed to the following. ☞ GOT restoration procedure
<input type="checkbox"/>	Normal operation	-	

GOT restoration procedure

Follow the procedure below starting from 1), and check if the GOT is restored.

Perform the action in each check item and mark the corresponding checkbox.

If the GOT is restored, take the action after restoration.

If the GOT is not restored, proceed to the next check item.

No.	Check item	Check	Cause	Action after restoration
1)	The GOT is restored by using the reset switch on the GOT.	<input type="checkbox"/> Restored <input type="checkbox"/> Not restored	It may be a temporary malfunction due to noise.	Perform the following. ☞ Page 403 GOT installation status check sheet
2)	The GOT is restored by powering on and off the GOT.*1	<input type="checkbox"/> Restored <input type="checkbox"/> Not restored		
3)	The GOT is restored by resetting or powering on and off the PLC CPU.	<input type="checkbox"/> Restored <input type="checkbox"/> Not restored		
4)	The GOT is restored by powering on and off the GOT and the PLC CPU simultaneously.	<input type="checkbox"/> Restored <input type="checkbox"/> Not restored		
5)	The GOT is restored by reconnecting cables.	<input type="checkbox"/> Restored <input type="checkbox"/> Not restored	The possible cause is a cable connection fault.	Connect cables securely. If an error occurs again, proceed to the following. ☞ Actual product investigation
6)	The GOT is restored by reinstalling project data.	<input type="checkbox"/> Restored <input type="checkbox"/> Not restored	In such a case where the GOT is powered off during installation of project data or OS, the data may be corrupted.	Do not power off the GOT during data transmission. If an error occurs again, proceed to the following. ☞ Actual product investigation
7)	The GOT is restored by reinstalling OS.	<input type="checkbox"/> Restored <input type="checkbox"/> Not restored		
8)	Take the preventive measures against noise, which is described in the following. ☞ Page 403 GOT installation status check sheet	<input type="checkbox"/> Restored <input type="checkbox"/> Not restored	It may be a temporary malfunction due to noise.	Perform the following. ☞ Page 403 GOT installation status check sheet
9)	The GOT is not restored even after the corrective actions in 1) to 8) are taken.	-		Proceed to the following. ☞ Actual product investigation

*1 Make sure to turn off the PLC first, and turn off and then on the GOT.

Actual product investigation

When the GOT still operates improperly even after the corrective actions described above are taken, contact your local distributor.

Depending on the error status, the actual product may need to be returned to us.

In that case, attach the GOT status check sheet, GOT installation status check sheet, and system configuration check sheet (Write down your system configuration used on the sheet).

GOT installation status check sheet

Check the installation status of your GOT regarding the following items.

- Wiring inside
- Outside the panel
- Wiring of the GOT's FG cables and power lines
- Countermeasures to prevent surges
- Installation status
- Grounding status of the control panel where the GOT is installed
- Power supply system

Mark the checkboxes that apply to the current status, and take the measures if necessary.

Only when the corrective actions are taken, put a check mark in the check box of "Effective" or "Ineffective" depending on the results of the actions.

Wiring inside

Actual status

Power lines such as power supply cables or servo amplifier drive cables and communication cables are crossed each other in the wiring duct in the control panel.

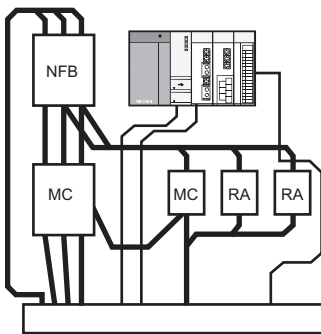

- Check result
- Crossed
 - Not crossed

Corrective action for when the cables are crossed each other

Wiring the power lines and the communication cables to keep them away from each other in the control panel will help minimize noise interference.

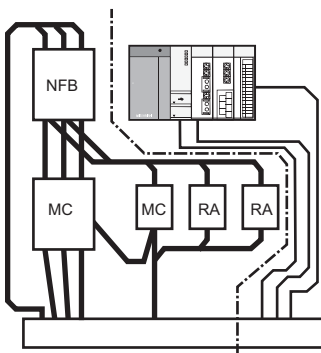

- Result
- Effective
 - Ineffective

Outside the panel

Actual status

Power lines and communication cables are bundled together.

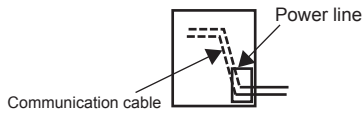

- Check result
- Bundled
 - Not bundled

Corrective action for when they are bundled

As shown in the figure below, leading the power line and communication cable separately from different places to the outside of the control panel reduces the influence of noise from the power line.

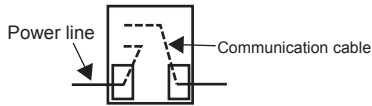

- Result
- Effective
 - Ineffective

Separating the communication cable from the power line or using a separator (made of metal) in the duct, as shown below, reduces the influence of noise.

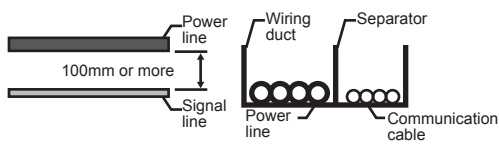

- Result
- Effective
 - Ineffective

Wiring of the GOT's FG cables and power lines

Actual status

The GOT's FG cables and power lines are bundled together.

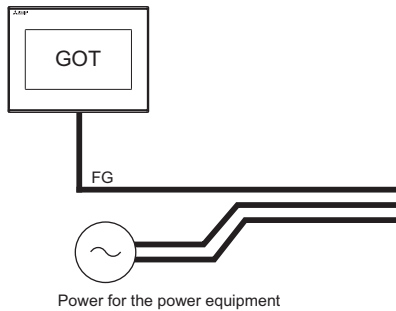

- Check result
- Bundled
 - Not bundled

Corrective action for when they are bundled

Keeping the GOT's FG cables and power lines away from each other will help minimize noise interference.

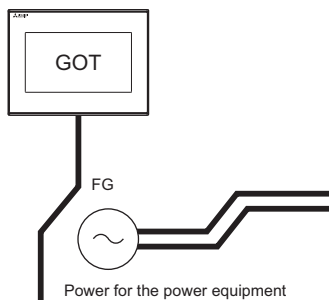

- Result
- Effective
 - Ineffective

Countermeasures to prevent surges

Actual status

Surge suppressors are used for wiring equipment (loads) such as no fuse breakers, electromagnetic contactors, relays, solenoid valves, and induction motors.

(When surge suppressors are used, write their models and the names of devices for which the surge suppressors are used in the following table.)

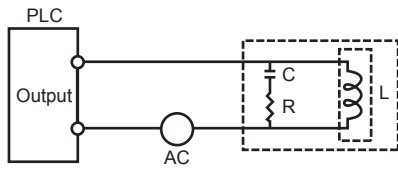

Check result

- Used
- Not used

- Entry column for surge suppressors

Model of surge suppressor	Device for which the surge suppressor is used

Corrective action for when surge suppressors are not used

Using surge suppressors on the wiring near loads can reduce interference of the GOT surge.

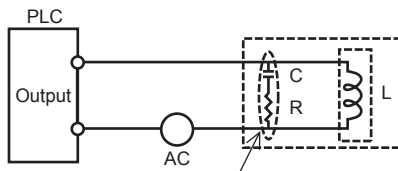

Result

- Effective
- Ineffective

The surge suppressor must be attached close to the load

Installation status

Actual status

The FG cables of control equipment (such as a PLC) and power equipment (such as a servo amplifier) are connected each other as shown in a.

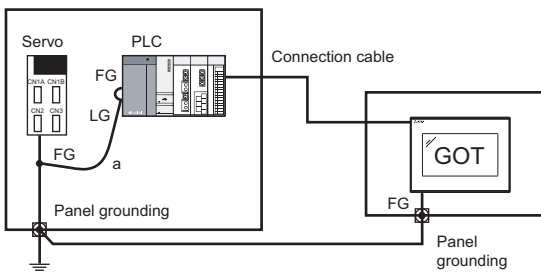

Check result

- True
- False

Corrective action for when it is true

Carry out the independent grounding at two points as shown in Figure A.

Independent grounding will help minimize noise interference.

If the independent grounding is impossible, carry out the shared grounding as shown in Figure B.

Figure A

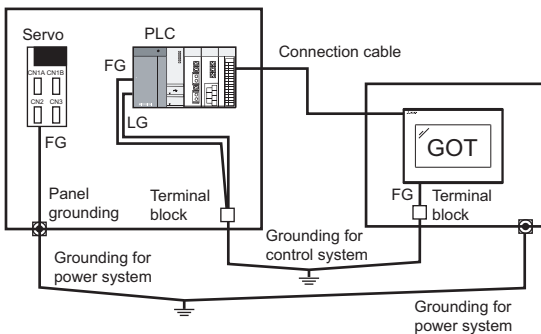
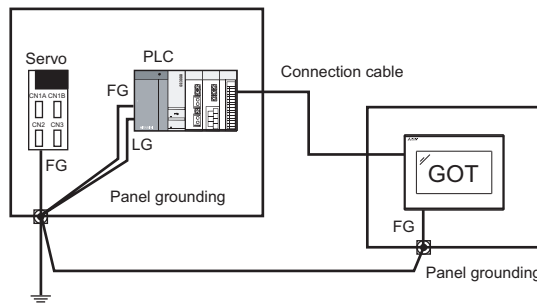

Figure B



Result

- Effective
- Ineffective

Grounding status of the control panel where the GOT is installed

Actual status

A ground cable is led from the control panel where control equipment such as a PLC is installed to the control panel where the GOT is installed.

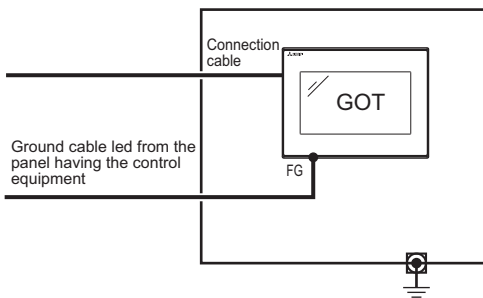

Check result

- True
- False

Corrective action for when it is true

• Measure 1

Connecting a ground cable to the panel where the GOT is installed as shown in Figure A reduces electric potential difference between the ground points, which may avoid malfunction of the GOT.

If the wiring shown in Figure A cannot be carried out, perform the wiring as shown in Figure B.

Figure A

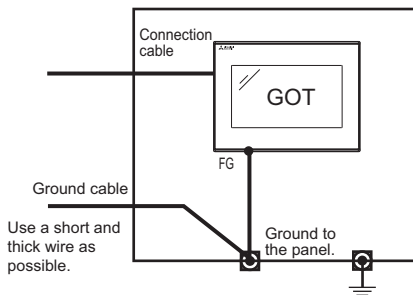
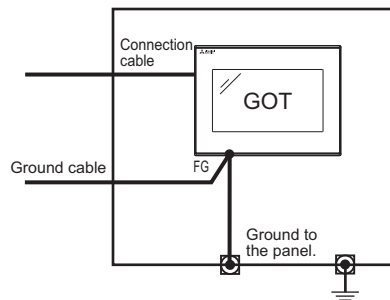

Figure B



Result

- Effective
- Ineffective

• Measure 2

Attaching a ferrite core to the ground cable connected to the control panel where the GOT is installed, as shown in Figure C, will help minimize noise interference.

If the wiring shown in Figure C cannot be carried out, perform the wiring as shown in Figure D.

Figure C

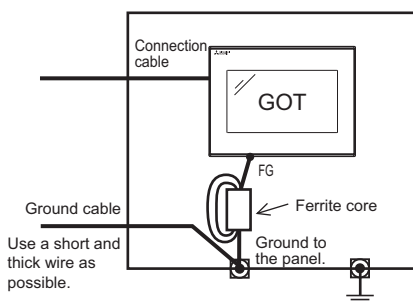
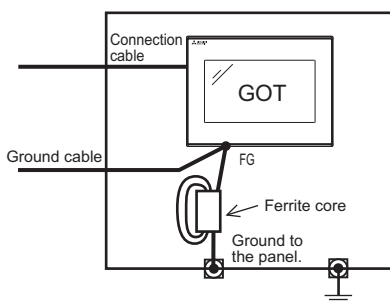

Figure D



Result

- Effective
- Ineffective

Power supply system

Actual status

I/O equipment (such as a relay) and power equipment (such as a servo amplifier) use the power supply in the same system as the one of the GOT.

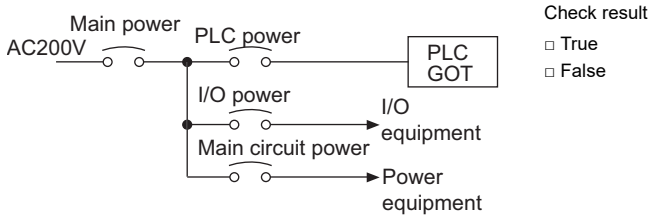

Corrective action for when it is true

Carry out the wiring with the power supply of the GOT separated from the one of the I/O equipment and power equipment and connect an isolation transformer. This will help minimize noise interference.

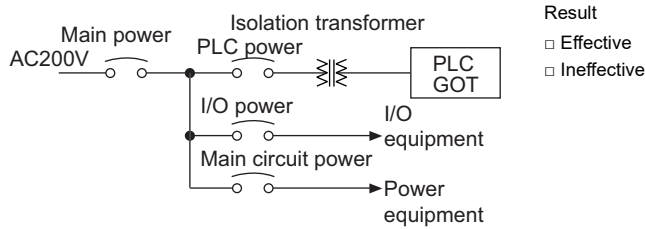

System configuration check sheet

Fill in the following table with the details of the system configuration, such as the GOT type and unit model.

System configuration for the GOT

Item	System configuration	
	Usage	Model
GOT	-	
Communication interface	Used, Not used	
Cable between the PLC and GOT	-	
Cable length	-	m

System configuration of the PLC

Item	System configuration	
	Usage	Model
Power supply unit	-	
CPU module	-	
Serial communication unit /computer link unit	Used, Not used	
Network unit	Used, Not used	
Interrupt module	Used, Not used	
Positioning module	Used, Not used	
Number of extended PLC stages	-	stages
When other units or devices are used, write their names.	-	

Entry column for writing the status of the phenomenon (when the GOT still operates improperly after corrective actions are taken)

Write the details of the error operations. (Such as when the GOT screen is frozen or the screen is displayed improperly)

MEMO

35 CONNECTION

This chapter describes connection types which are supported by GOT SIMPLE series.

Refer to the following manuals.

GOT2000 Series Connection Manual (Mitsubishi Product) For GT Works3 Version1^{*1}

GOT2000 Series Connection Manual (Non Mitsubishi Product 1) For GT Works3 Version1^{*1}

GOT2000 Series Connection Manual (Non Mitsubishi Product 2) For GT Works3 Version1^{*1}

GOT2000 Series Connection Manual (Microcomputers, MODBUS/Fieldbus Products, Peripherals) For GT Works3 Version1^{*1}

^{*1} An icon  is given in these manuals.
The icon indicates the following.

The presence of  refers to the connection type supported by the GOT SIMPLE series.

The absence of  refers to the connection type unsupported by the GOT SIMPLE series.

MEMO

36 APPENDIX

36.1 External Dimensions

GS2110-WTBD-N

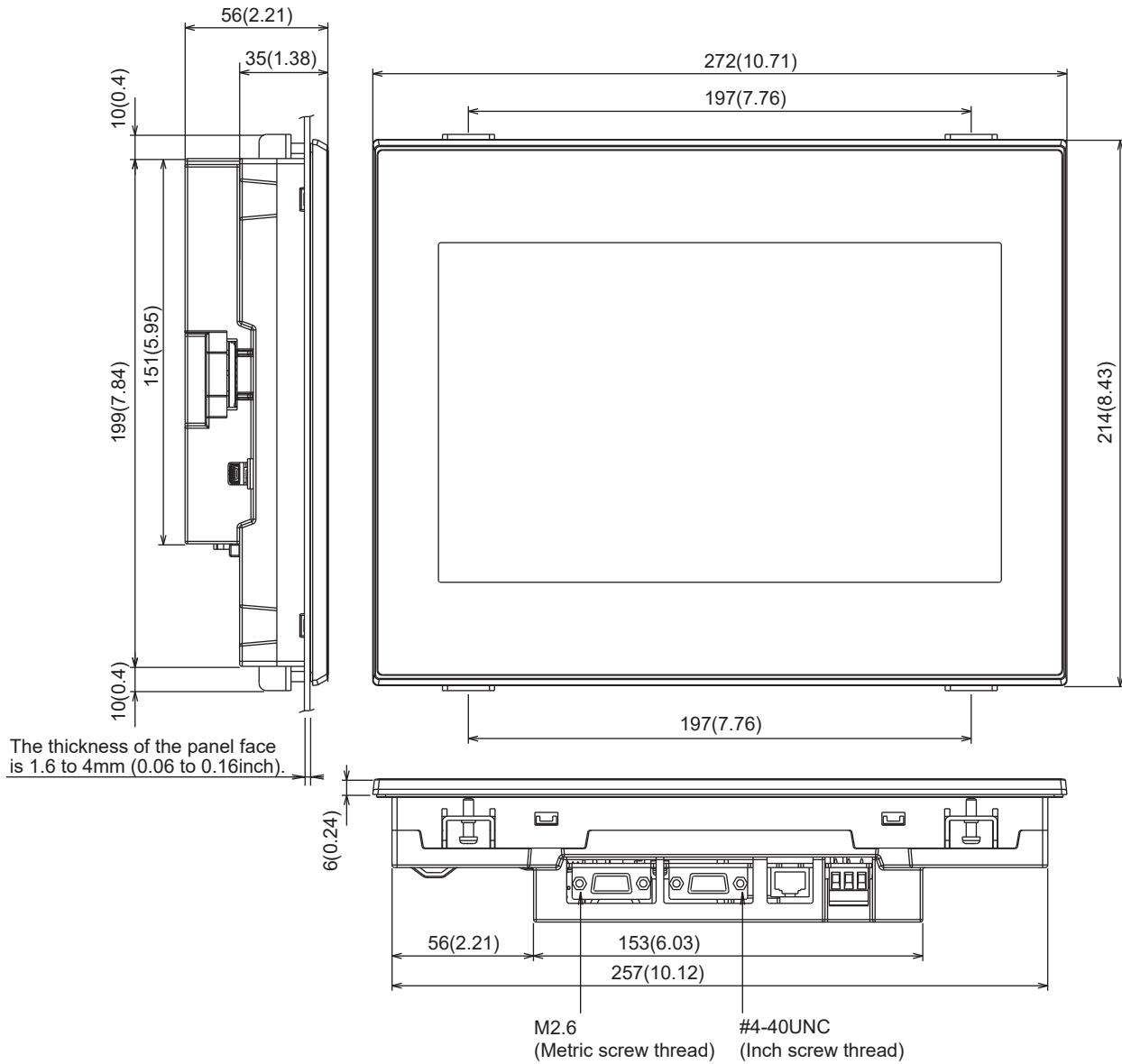

Unit: mm (inch)

GS2107-WTBD-N

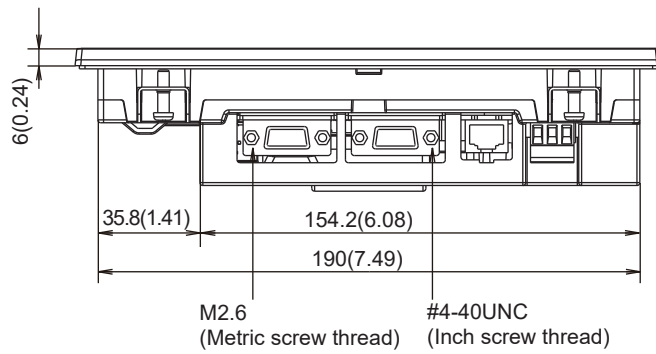
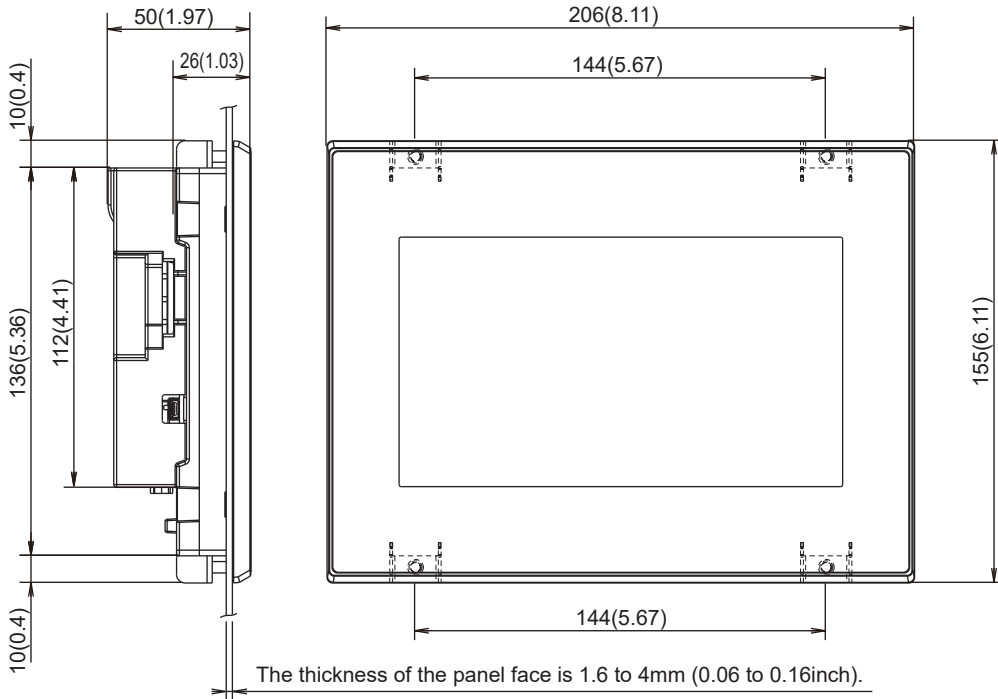

Unit: mm (inch)

GS2110-WTBD

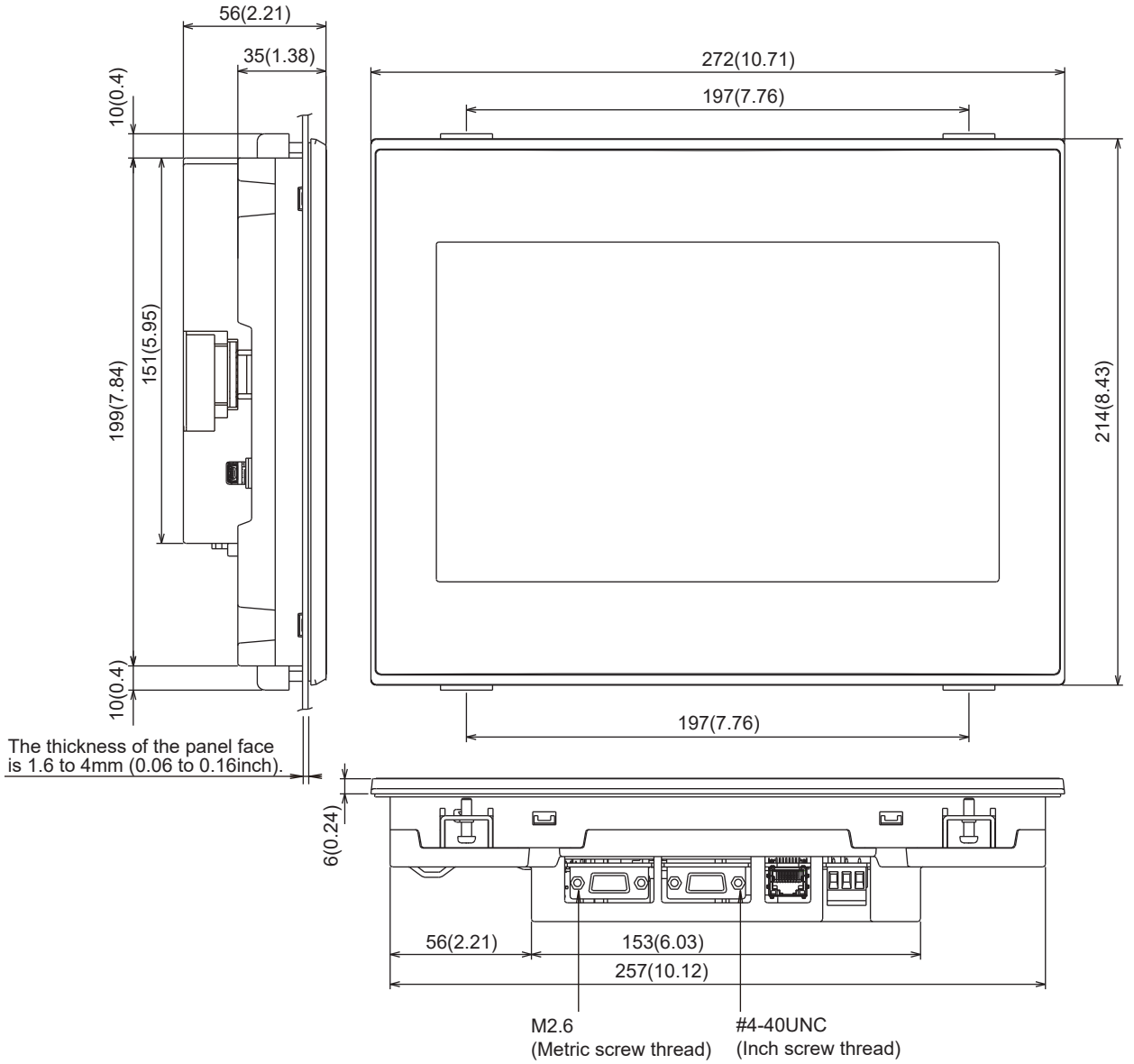

Unit: mm (inch)

GS2107-WTBD

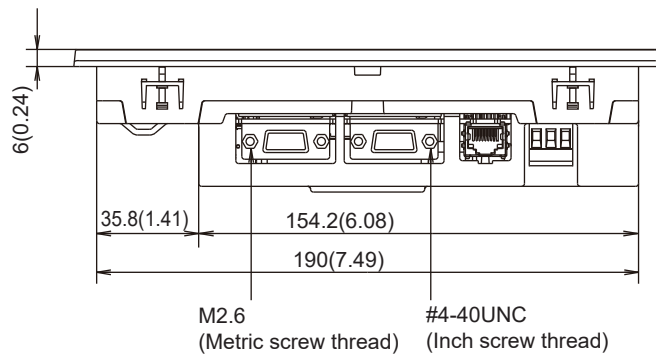
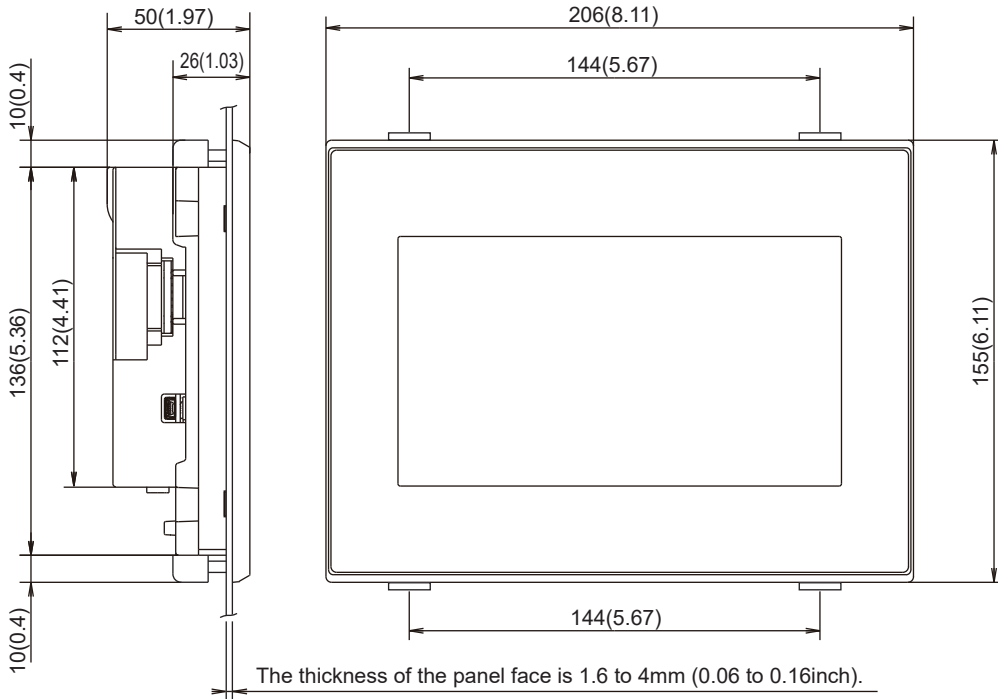

Unit: mm (inch)

Communication cable

GT01-C30R4-25P

Unit: mm (inch)

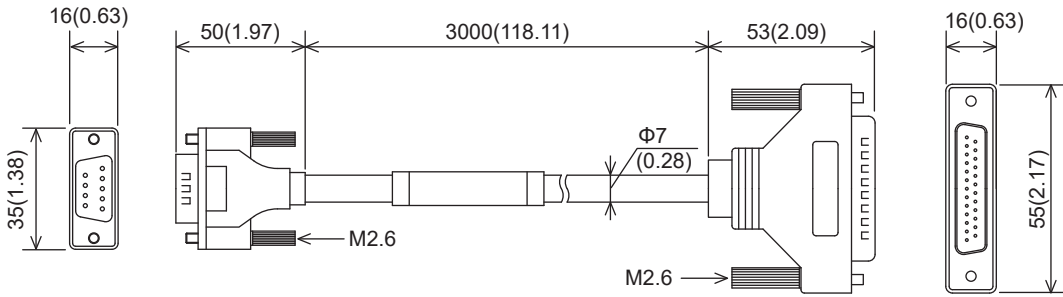

GT01-C□□□R4-25P

Unit: mm (inch)

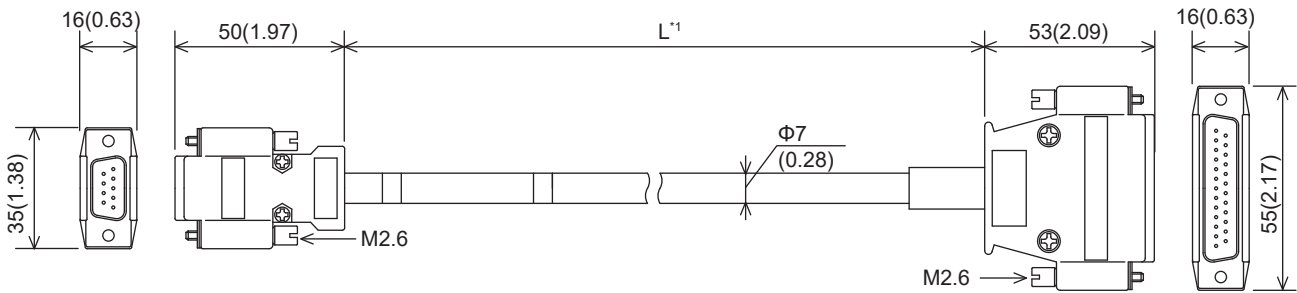

*1 For the cable length (L), refer to the following table.

Unit: mm (inch)

□□ value	L
100	10000 (393.7)
200	20000 (787.4)
300	30000 (1181.1)

GT01-C□□□R4-8P

Unit: mm (inch)

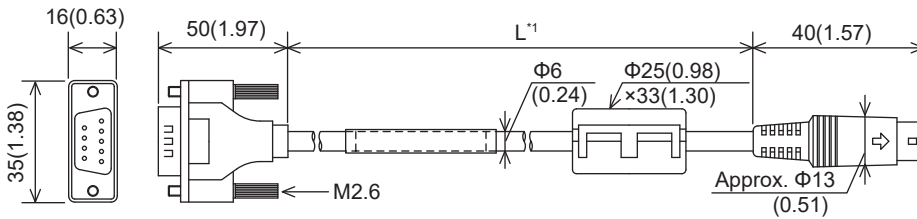

*1 For the cable length (L), refer to the following table.

Unit: mm (inch)

□□ value	L
10	1000 (39.37)
30	3000 (118.11)
100	10000 (393.7)
200	20000 (787.4)
300	30000 (1181.1)

GT01-C30R2-25P

Unit: mm (inch)

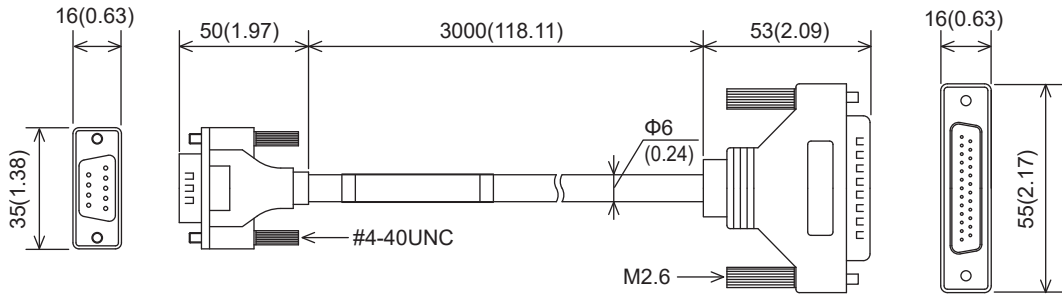

GT01-C30R2-9S

Unit: mm (inch)

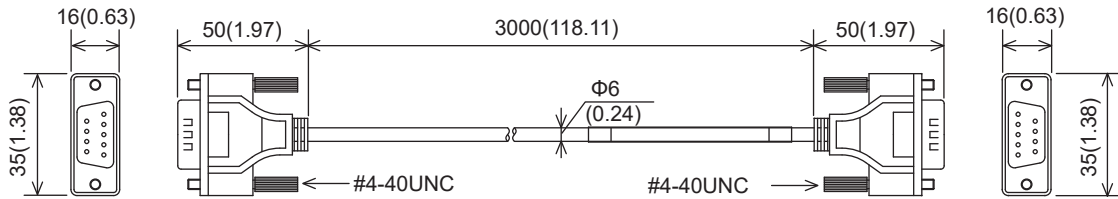

GT01-C30R2-6P

Unit: mm (inch)

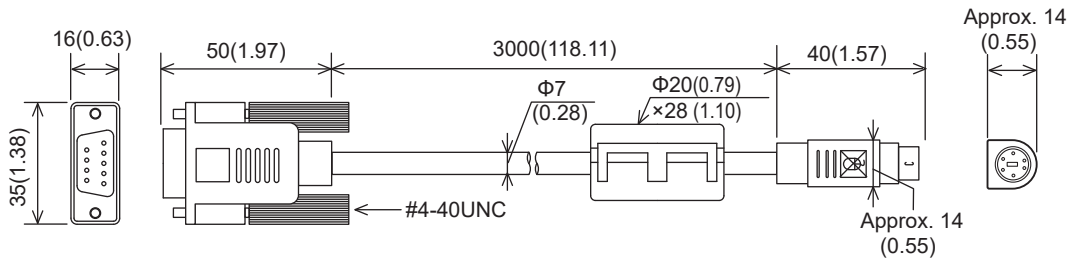

REVISIONS

* The manual number is given on the bottom left of the back cover.

Revision date	* Manual Number	Revision
Jan., 2014	JY997D52901A	First printing
Jul., 2014	JY997D52901B	Compatible with GT Works3 Version1.118Y • BACKUP/RESTORE function compatible
Oct., 2014	JY997D52901C	WARRANTY is changed.
Jan., 2015	JY997D52901D	Clerical error correction
Dec., 2015	JY997D52901E	Some correction
May, 2016	JY997D52901F	Some correction
Jan., 2017	JY997D52901G	Some correction
Apr., 2017	JY997D52901H	Compatible with GT Works3 Version1.175H • GOT internal device monitor is supported. • Clock synchronization is supported.
Jan., 2019	JY997D52901I	Some correction
Jan., 2020	JY997D52901J	Compatible with GT Works3 Version1.230Q • The backup/restoration function supports FX5UJ.
Oct., 2020	JY997D52901K	Some correction
Jan., 2021	JY997D52901L	Compatible with GT Works3 Version1.250L • Abbreviations and generic terms used in this manual are changed. • The models (GS2110-WTBD-N, GS2107-WTBD-N) are added. • GS21-W-N supports the RS-485 communication, VNC server function, license management, and operation log information.
Feb., 2021	JY997D52901M	Some correction
Jul., 2021	JY997D52901N	• Changed the name of the direct CPU connection to the direct CPU connection (serial). • Some correction
Oct., 2021	JY997D52901P	Some correction
Apr., 2022	JY997D52901Q	Compatible with GT Works3 Version1.275M • Some correction
Jul., 2022	JY997D52901R	• The MELSOFT GT Works3 site license product (SW1DND-GTWK3-EC) has been added.
Jan., 2023	JY997D52901S	Compatible with GT Works3 Version1.290C • A model (GS2512-WXTBD) has been added.

This manual confers no industrial property rights or any rights of any other kind, nor does it confer any patent licenses. Mitsubishi Electric Corporation cannot be held responsible for any problems involving industrial property rights which may occur as a result of using the contents noted in this manual.

© 2014 MITSUBISHI ELECTRIC CORPORATION

WARRANTY

Please confirm the following product warranty details before using this product.

■ 1. Gratis Warranty Term and Gratis Warranty Range

If any faults or defects (hereinafter "Failure") found to be the responsibility of Mitsubishi occurs during use of the product within the gratis warranty term, the product shall be replaced at no cost via the sales representative.

(1) Gratis Warranty Term

The gratis warranty term of the product shall be for twelve (12) months after the date of purchase or delivery to a designated place. Note that after manufacture and shipment from Mitsubishi, the maximum distribution period shall be six (6) months, and the longest gratis warranty term after manufacturing shall be eighteen (18) months.

(2) Gratis Warranty Range

- (a) The customer shall be responsible for the primary failure diagnosis unless otherwise specified.
- (b) The range shall be limited to normal use within the usage state, usage methods and usage environment, etc., which follow the conditions and precautions, etc., given in the instruction manual, user's manual and caution labels on the product.
- (c) Even within the gratis warranty term, the following cases are not guaranteed.
 - Failure occurring from inappropriate storage or handling, carelessness or negligence by the user. Failure caused by the user's hardware or software design.
 - Failure caused by unapproved modifications, etc., to the product by the user.
 - When the Mitsubishi product is assembled into a user's device, Failure that could have been avoided if functions or structures, judged as necessary in the legal safety measures the user's device is subject to or as necessary by industry standards, had been provided.
 - Failure that could have been avoided if consumable parts designated in the instruction manual had been correctly serviced or replaced.
 - Replacing consumable parts such as the battery, backlight and fuses.
 - Failure caused by external irresistible forces such as fires or abnormal voltages, and Failure caused by force majeure such as earthquakes, lightning, wind and water damage.
 - Failure caused by reasons unpredictable by scientific technology standards at time of shipment from Mitsubishi.
 - Any other failure found not to be the responsibility of Mitsubishi or that admitted not to be so by the user.

■ 2. Repair and Analysis

The repair and the failure analysis are not executed to the product.

■ 3. Discontinuation of production

- (1) Discontinuation of production shall be notified with Mitsubishi Technical Bulletins, etc.
- (2) Product supply (including spare parts) is not available after production is discontinued.

■ 4. Exclusion of loss in opportunity and secondary loss from warranty liability

Regardless of the gratis warranty term, Mitsubishi shall not be liable for compensation to:

- (1) Damages caused by any cause found not to be the responsibility of Mitsubishi.
- (2) Loss in opportunity, lost profits incurred to the user by Failures of Mitsubishi products.
- (3) Special damages and secondary damages whether foreseeable or not, compensation for accidents, and compensation for damages to products other than Mitsubishi products.
- (4) Replacement by the user, maintenance of on-site equipment, start-up test run and other tasks.

■ 5. Changes in product specifications

The specifications given in the catalogs, manuals or technical documents are subject to change without prior notice.

■ 6. Product application

- (1) In using the Mitsubishi graphic operation terminal, the usage conditions shall be that the application will not lead to a major accident even if any problem or fault should occur in the graphic operation terminal device, and that backup and fail-safe functions are systematically provided outside of the device for any problem or fault.
- (2) The Mitsubishi graphic operation terminal has been designed and manufactured for applications in general industries, etc. Thus, applications in which the public could be affected such as in nuclear power plants and other power plants operated by respective power companies, and applications in which a special quality assurance system is required, such as for Railway companies or Public service purposes shall be excluded from the graphic operation terminal applications. In addition, applications in which human life or property that could be greatly affected, such as in aircraft, medical applications, incineration and fuel devices, manned transportation equipment for recreation and amusement, and safety devices, shall also be excluded from the graphic operation terminal range of applications. However, in certain cases, some applications may be possible, providing the user consults the local Mitsubishi representative outlining the special requirements of the project, and providing that all parties concerned agree to the special circumstances, solely at our discretion. In some of three cases, however, Mitsubishi Electric Corporation may consider the possibility of an application, provided that the customer notifies Mitsubishi Electric Corporation of the intention, the application is clearly defined and any special quality is not required.

Intellectual Property Rights

■Trademarks

MELDAS, MELSEC, iQ Platform, MELSOFT, GOT, CC-Link, CC-Link/LT, and CC-Link IE are trademarks or registered trademarks of Mitsubishi Electric Corporation in Japan and other countries.

Microsoft, Microsoft Access, Excel, SQL Server, Visual Basic, Visual C++, Visual C#, Windows, Windows NT, Windows Server, and Windows Vista are trademarks of the Microsoft group of companies.

MODBUS is a trademark of Schneider Electric SA.

DeviceNet is a trademark of ODVA (Open DeviceNet Vendor Association, Inc.).

VNC is a registered trademark of RealVNC Ltd. in the United States and other countries.

Unicode is a trademark or registered trademark of Unicode, Inc. in the United States and other countries.

PictBridge is a registered trademark of Canon Inc.

Adobe and Adobe Reader are registered trademarks of Adobe Systems Incorporated.

Oracle and JavaScript are registered trademarks of Oracle Corporation and/or its affiliates in the United States and other countries.

QR Code is a registered trademark of DENSO WAVE INCORPORATED.

Anybus is a registered trademark of HMS Industrial Networks AB.

Android and Google Chrome are trademarks or registered trademarks of Google Inc.

IOS is a trademark or registered trademark of Cisco in the U.S. and other countries and is used under license.

Safari and iPhone are trademarks of Apple Inc. registered in the United States and other countries. The iPhone trademark is used under license from AIPHONE CO., LTD.

Intel and Intel Core are trademarks or registered trademarks of Intel Corporation in the United States and other countries.

Other company and product names herein are trademarks or registered trademarks of their respective owners.

■Copyrights

The screens (screenshots) are used in accordance with the Microsoft Corporation guideline.

JY997D52901S(2301)MEE

MODEL: -

MODEL CODE: -

mitsubishi electric corporation

HEAD OFFICE : TOKYO BUILDING, 2-7-3 MARUNOUCHI, CHIYODA-KU, TOKYO 100-8310, JAPAN
NAGOYA WORKS : 1-14, YADA-MINAMI 5-CHOME, HIGASHI-KU, NAGOYA, JAPAN

When exported from Japan, this manual does not require application to the
Ministry of Economy, Trade and Industry for service transaction permission.

Specifications subject to change without notice.