

Industrial Computer
MELIPC Series



MELIPC



GLOBAL IMPACT OF MITSUBISHI ELECTRIC



Through Mitsubishi Electric's vision, "Changes for the Better" are possible for a brighter future.

Changes for the Better

We bring together the best minds to create the best technologies. At Mitsubishi Electric, we understand that technology is the driving force of change in our lives. By bringing greater comfort to daily life, maximizing the efficiency of businesses and keeping things running across society, we integrate technology and innovation to bring changes for the better.

Mitsubishi Electric is involved in many areas including the following:

Energy and Electric Systems

A wide range of power and electrical products from generators to large-scale displays.

Electronic Devices

A wide portfolio of cutting-edge semiconductor devices for systems and products.

Home Appliance

Dependable consumer products like air conditioners and home entertainment systems.

Information and Communication Systems

Commercial and consumer-centric equipment, products and systems.

Industrial Automation Systems

Maximizing productivity and efficiency with cutting-edge automation technology.

Committed to ever higher customer satisfaction

Mitsubishi Electric is a global leader in the research, manufacturing and marketing of electrical and electronic equipment used in areas such as communications, consumer electronics, industrial technology, energy and transportation. Within this, the industrial automation business has grown significantly since the first induction motor was manufactured over 90 years ago and has closely followed the automation industry in the world. Mitsubishi Electric industrial automation boasts a wide-range of product areas such as production control, drives, and mechatronics, power distribution products that are used in various industries. Mitsubishi Electric offers TCO reduction solution by e-F@ctory with a wide range of FA products and accumulated production technology.



Industrial computer opens up new possibilities of manufacturing

Industrial computer has been developed maximizing highly reliable device control technology accumulated through development of the MELSEC Series programmable controller. Mitsubishi Electric industrial computer MELIPC Series offers new values for Edge computing, IT system coordination, and device control with its robust features and flexibility utilizing general purpose applications.

INDEX

MELIPC	6	Solution template	14
MI5000	6	iQ Edgecross	16
MI3000	8	Real-time Data Analyzer	18
MI2000/MI1000	10	Product specifications/list	22
Setting/programming software	12		
MI Configurator	12		
CW Workbench 4	13		

MELIPC

The MELIPC realizes “real-time control” for device control and “Edge computing” enabling data collection/analysis in the middle level between the IT system and shop floor. A wide range of products from a high-end model supporting CC-Link IE Field Network capable of high performance processing and high-speed communications to simple and compact range models are available. The MELIPC corresponds with requirements such as real-time control, preventative maintenance, and quality improvement on the shop floor, contributing to productivity enhancement through utilization of production data.

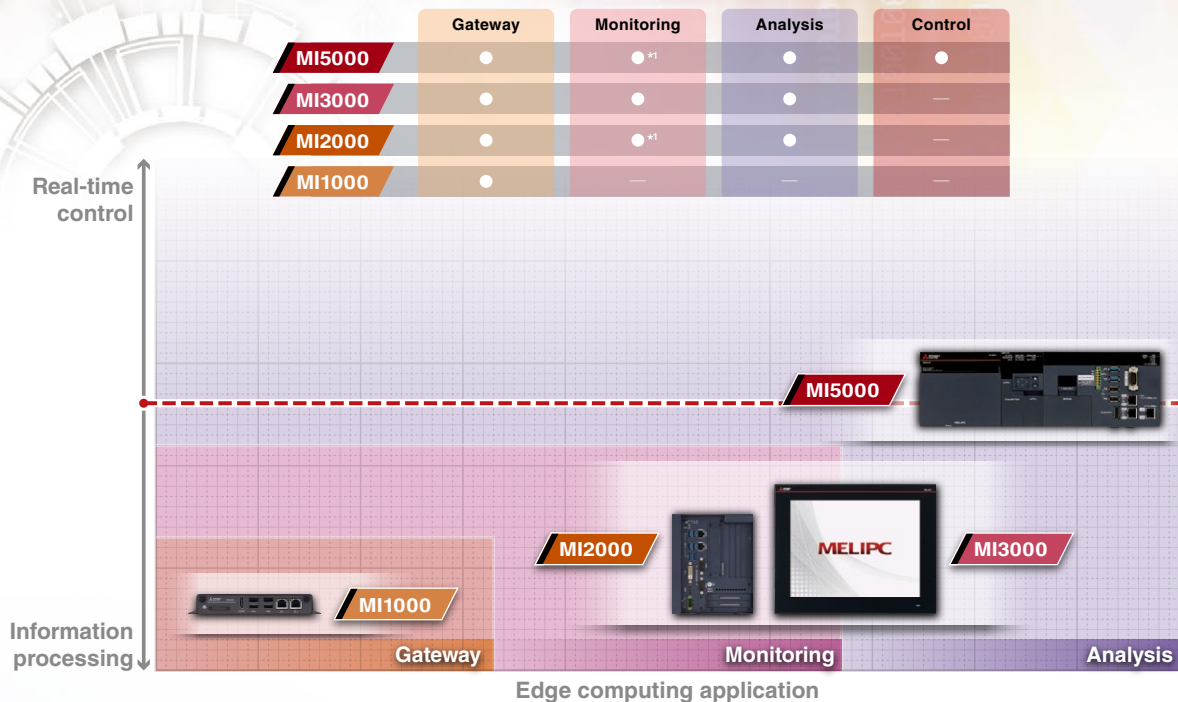

*1. Connect an external monitoring screen for monitoring.

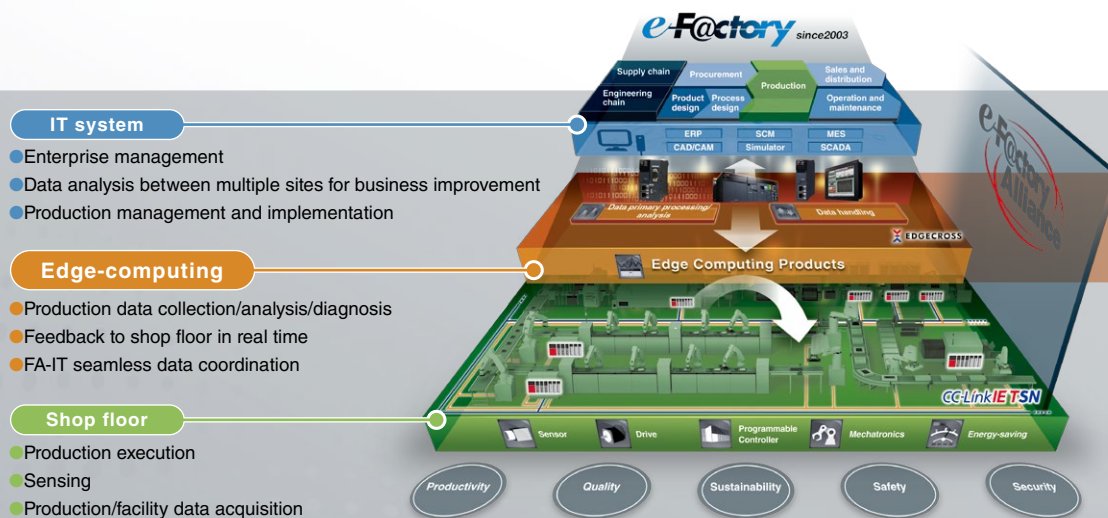

e-F@ctory is the Mitsubishi Electric solution for improving the performance of any manufacturing enterprise by enhancing productivity, and reducing the maintenance and operations costs together with seamless information flow throughout the plant by using a combination of factory automation and IT technologies.



Real-time control application

• MELIPC MI5000

One module realizes device control and information processing which were previously managed with a combination of computer and dedicated device for example. Equipped with real-time OS VxWorks®, the MELIPC realizes real-time control which cannot be achieved with general industrial computers, contributing to high-accuracy device control and information processing at high speed.

Cloud/IT system coordination

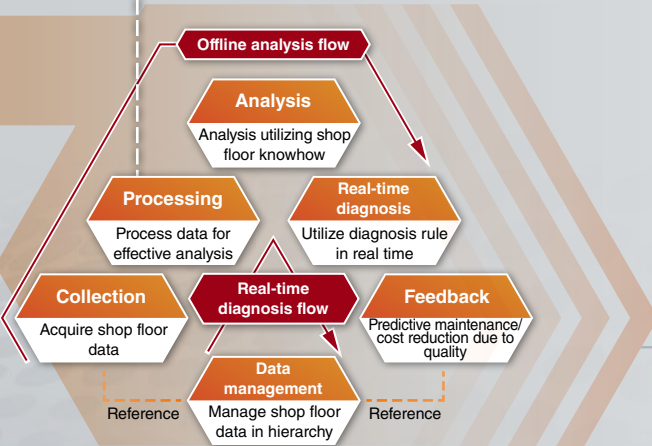

Data utilization flow

Edge computing application

- MELIPC MI5000/MI3000/MI2000/MI1000
- Real-time Data Analyzer

Real-time utilization of production data and coordination with IT system are necessary to realize e-F@ctory. “Edge computing” enabling information processing between the shop floor and IT system is required.



Utilization of open software platform “Edgecross*1” which realizes FA-IT coordination in the edge computing level enhances Edge computing and e-F@ctory.

*1. Edgecross is a product of Edgecross Consortium

MI5000



Edgecross Basic Software
Data Collector pre-installed

■ Windows® and VxWorks® pre-installed

The module can run two operating systems at the same time, VxWorks® with deterministic performance for device control and data collection and Windows® for displaying analysis results of collected data, allowing superior processing according to OS. This feature allows one module to realize device control and information processing which were previously managed using a computer and dedicated device, reducing system configuration cost and space for devices.

• Easy data passing between OSs

Passing data between OSs is easy via share memory and share folder.



Regularly used familiar Windows® assets can be utilized.



Deterministic data communication necessary for control is assured. C Controller module assets can be utilized.

• Individually reboot Windows®

Even if Windows® freezes, restarting Windows® is possible while VxWorks® is running.

■ CC-Link IE Field Network realizes highly accurate device control

Control data and production data of devices can be communicated at 1 ms via CC-Link IE Field Network, realizing highly accurate device control and high-speed production data collection. The module is equipped with CC-Link IE Field Network port and CC-Link IE Field Network Basic port which enable easy connection with compatible products just by setting.



Easier programming

Using Windows® and VxWorks® API, high-speed data communications between OSs and access to various devices are easily realized and programming is also easy. In addition, the module uses same functions as the C Controller such as CCPU functions and MD functions, program assets of the C Controller can be utilized.

Hardware features

Inheriting highly robust features of the MELSEC programmable controllers, the module can continuously operate in various environments for a long term. In addition, consumable items are easily removed and replaced, making maintenance easy.

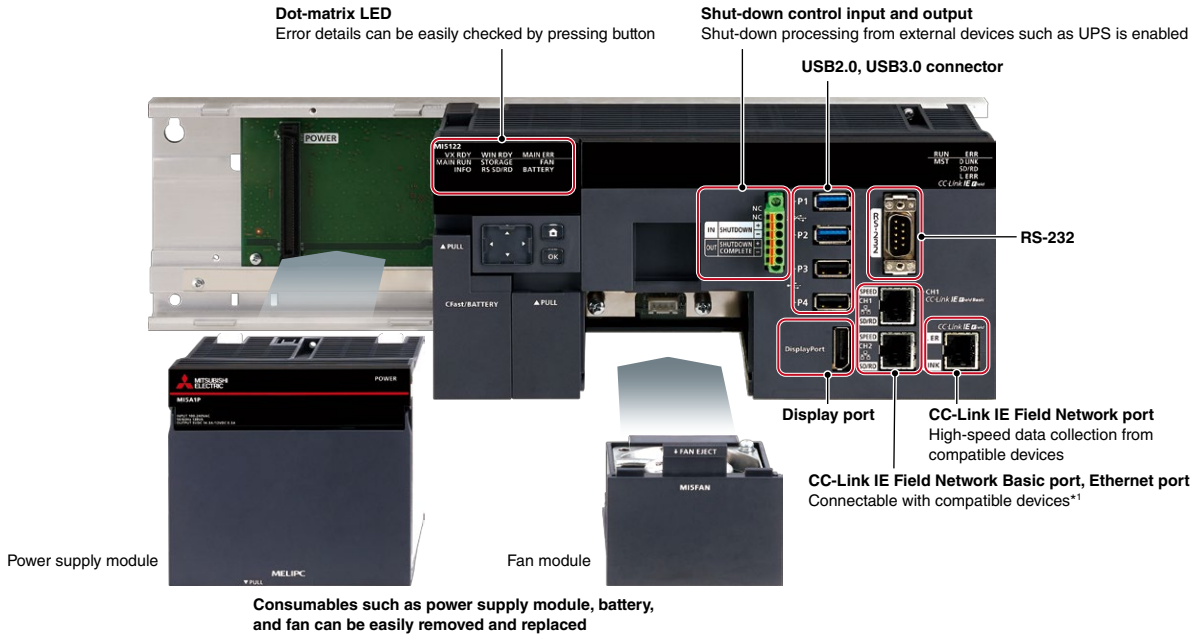

*1. CC-Link IE Field Network Basic supports CH1 only.

System configuration

Utilization of pre-installed software enables easier collection of Mitsubishi Electric FA products data. In addition, installing additional software allows easier collection of third-party company products data. The module is equipped with CC-Link IE Field Network port and CC-Link IE Field Network Basic port, enabling easy connection with compatible products just by setting.

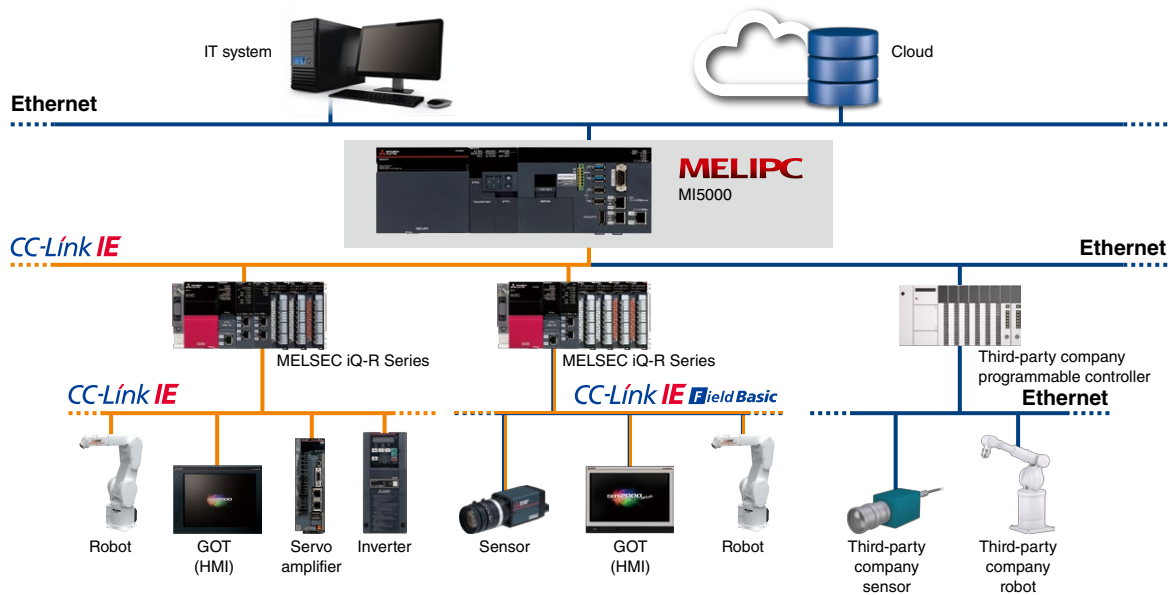

MELIPC

Setting/programming software

Solution template

IO Edgecross

Real-time Data Analyzer

Product specifications/list

MI3000



Edgecross Basic Software
Data Collector
GT SoftGOT2000 pre-installed

■ Beautiful, stunning, large screen monitor offers easy-to-view display and user-friendly operation

Large screen and high resolution LCD panel is equipped as standard for data display and touch operation. Light-touch operation is realized with a PCAP touch panel that is widely used for smartphones and tablet devices. The touch panel with high transmittance offers clear and high visibility display.

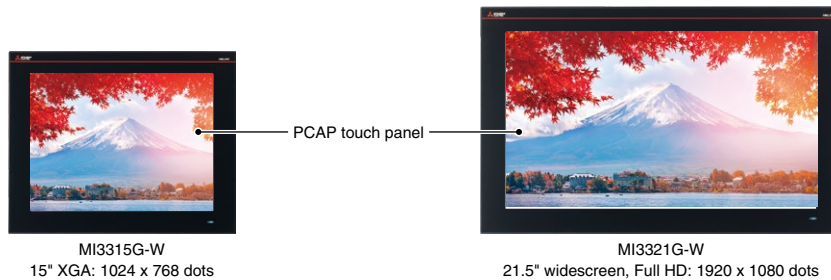

■ System expansion according to needs

Equipped with various interfaces, systems can be configured according to the customers' needs.

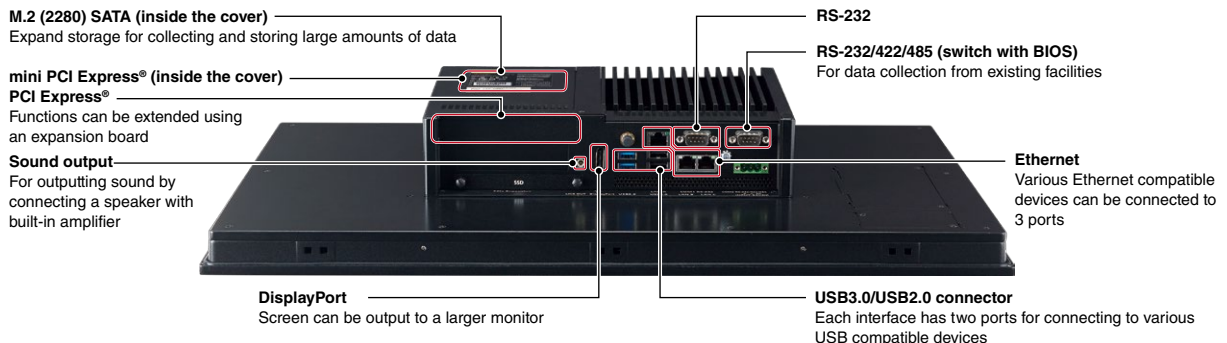

■ Equipped with all necessary functions to visualize factories in one body

Edgecross Basic Software, SLMP Data Collector, and GT SoftGOT2000 are pre-installed on MI3000. The data collected by Edgecross using SLMP Data Collector and the data collected by GT SoftGOT2000 can be monitored on the GT SoftGOT2000 screen. Since Windows® OS is pre-installed, Windows® applications can be utilized. One MI3000 can easily realize visualization of shop floors and execution of various applications.

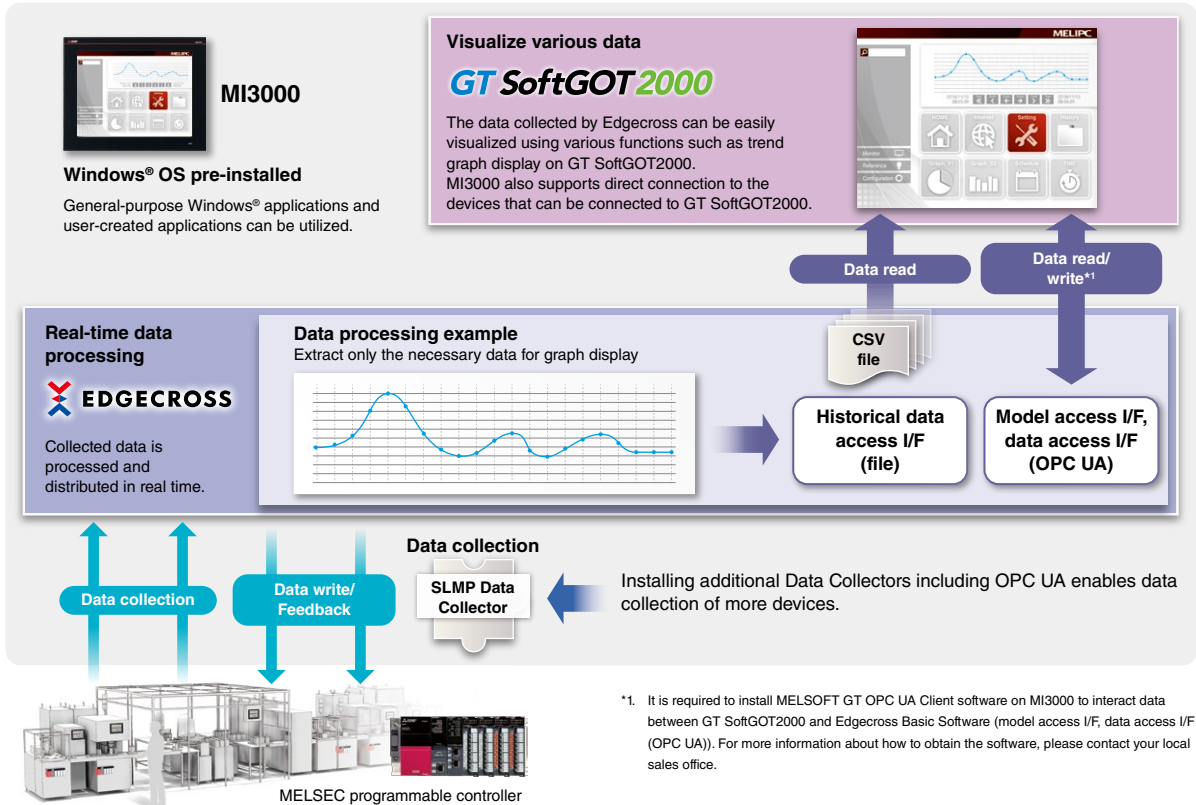

■ System configuration

Utilization of pre-installed Edgecross Basic Software and SLMP Data Collector enables real-time monitoring of shop floor data and realizes coordination with IT systems. With GT SoftGOT2000, data collected by Edgecross and factory automation products can be easily monitored. MI3000 is useful for a wide range of applications.

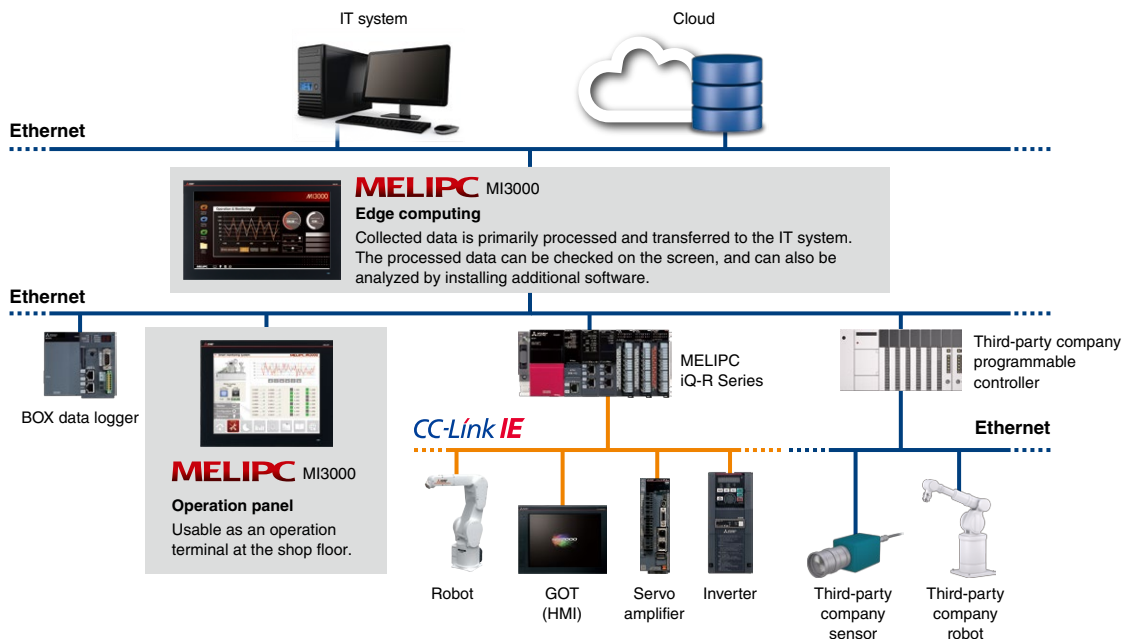

MI2000/MI1000



Edgecross Basic Software
Data Collector pre-installed

■ Data analysis/diagnosis/monitoring / MI2000

Intel® Core™ i3 CPU realizes simple analysis/diagnosis/monitoring of collected data, contributing to quality improvement.

■ Flexible system expansion / MI2000

Equipped with 2.5-inch HDD/SSD slot and PCI Express®/PCI slot, a large volume of data can be stored and functions can be extended. Fitting the CC-Link IE Field Network interface board to the PCI Express® slot allows the module to operate as a CC-Link IE Field master station or local station.

Various expandable interfaces easily realize coordination with the existing system and FA devices.

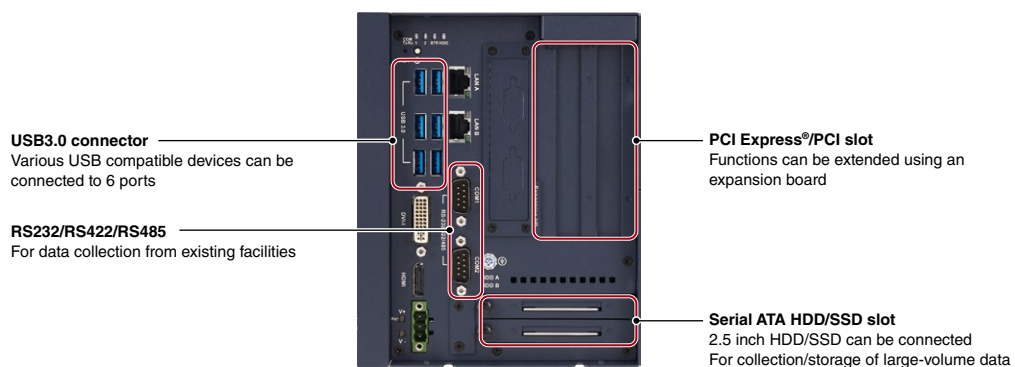

■ Compact size realizes computer functions / MI1000

Energy saving Intel® Atom™ E3826 in a compact 26-mm-tall module enables computer functions. Installation in the existing facility is easy as it requires minimal space, contributing to network connection of facilities.

USB connectors and RS232/485 connection ports are available with the compact module.



■ Fan-less hardware design reduces maintenance / MI2000 / MI1000

Both MI2000 and MI1000 have a fan-less structure. Maintenance such as replacement and cleaning are not required.

■ System configuration

Utilization of pre-installed software enables easier collection of Mitsubishi Electric FA products data. In addition, installing additional software allows easier collection of third-party company products data. Primary processing of collected data can reduce the data amount to be transferred to the IT system, preventing data delay and such.

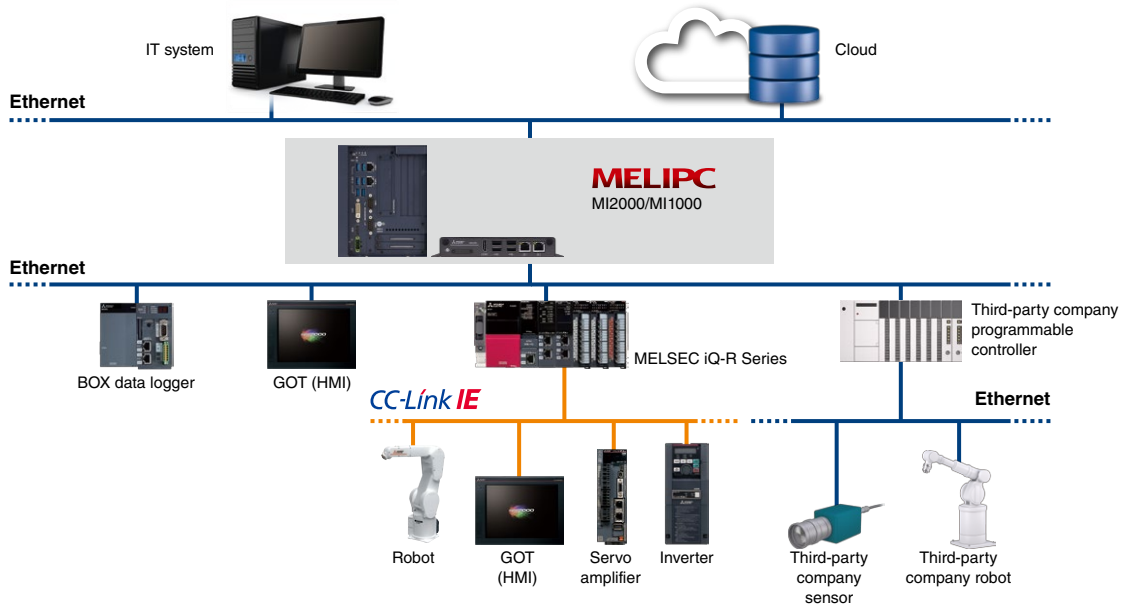

Setting/monitoring tool for MELIPC MI5000

MI Configurator

MI5000 / MI3000 / MI2000 / MI1000

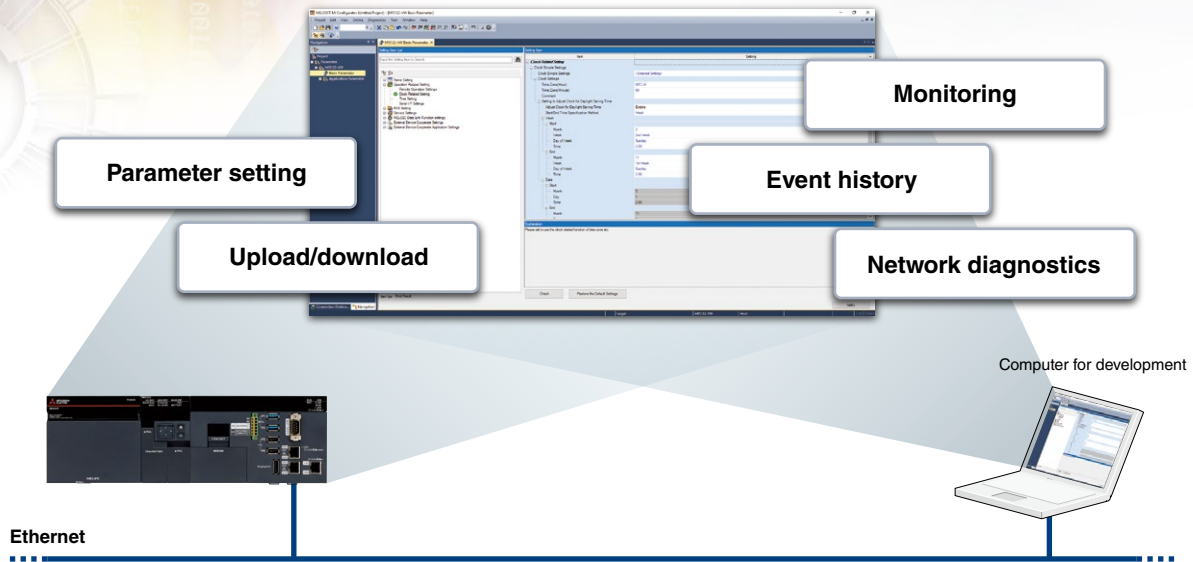

■ Easier setting and monitoring

MI Configurator is software consists of various features such as parameter setting/diagnostics/monitoring/testing of MELIPC. Parameter items are categorized by purposes, allowing to display necessary setting items preferentially. Target parameters can be easily found, reducing implementation cost.

This section shows two screenshots from the MI Configurator. The left screenshot displays the 'Clock Related Setting' menu with a 'Click' callout pointing to a parameter. The right screenshot shows the 'MELIPC Diagnostics' window with a 'Dot matrix display' showing 'Err' and 'No Error'.

MELIPC operation can be easily checked with diagnostics function

Easy parameter setting

■ Faster troubleshooting

Error information are logged in the event history at an error occurrence. Error causes and countermeasures can be checked with event history, thereby helping to reduce troubleshooting time.

Note: MI Configurator is pre-installed on MI5000. For updating of MI Configurator to the latest version and installation in other controller, please contact your local Mitsubishi Electric sales office or representative.

Engineering tool for MELIPC MI5000

CW Workbench 4

MI5000 / MI3000 / MI2000 / MI1000

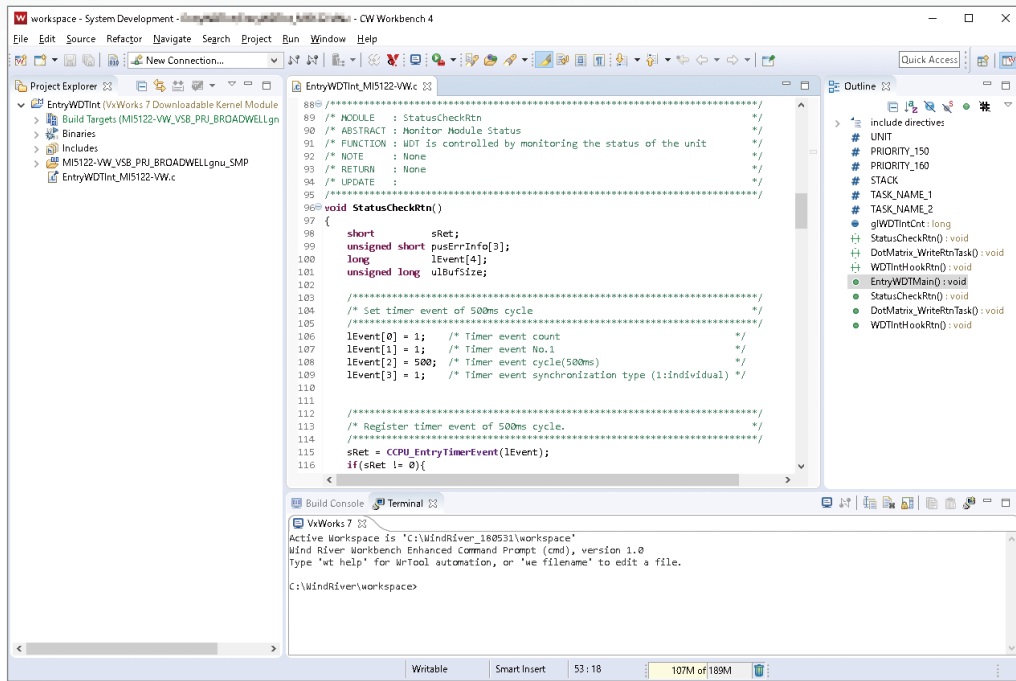

■ Easily develop real-time control program

Development environment for a full-fledged real-time OS which is normally expensive can be implemented at a lower cost. Main functions include such as programming, compiling, source code debugging, allowing easier programming of VxWorks® user application. API such as CCPU function and MD function which realizes high-speed data communication between OSs and easier access to various connected devices is provided, making real-time control programming easy.

■ Multiple language functionality available with plug-in tool

Functionality of Eclipse based CW Workbench 4 can be expanded to support multiple languages, source code management, etc. with third-party plug-in tools.

Solution template

MI5000 / MI3000 / MI2000 / MI1000

Solution templates are sample programs designed with customer's applications in mind such as inspection by image processing and monitoring/control by model-based development. Multiple solution templates are available for selection according to the application. Using the template as a system development base enables MELIPC application development easier.

Specifically presents compatible devices and software

Combination and connection method of compatible devices and software are presented in solution templates, making it easy to select connectable devices, thereby reducing development time.

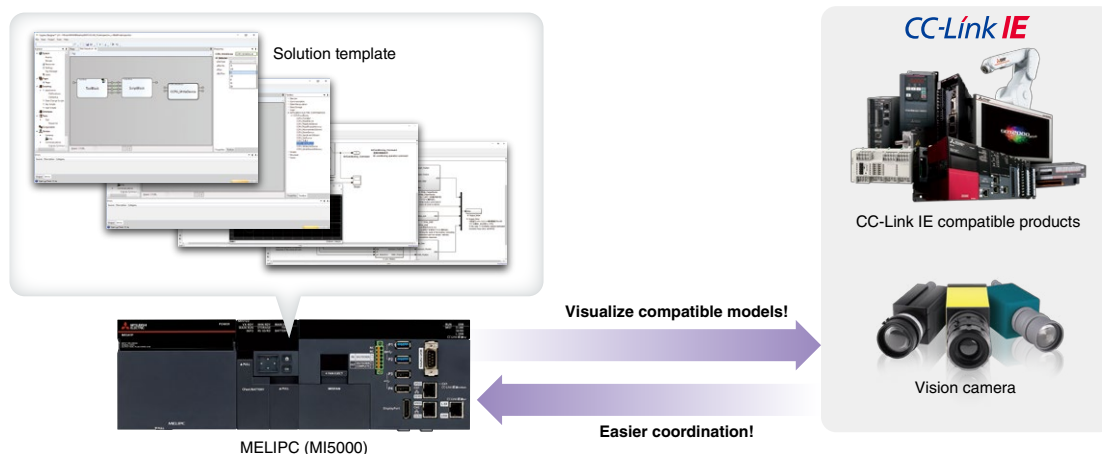

Plug-in for coordination with MELIPC

Solution templates offer a plug-in for coordination between MELIPC and compatible devices/software, realizing easier access to compatible devices/software.

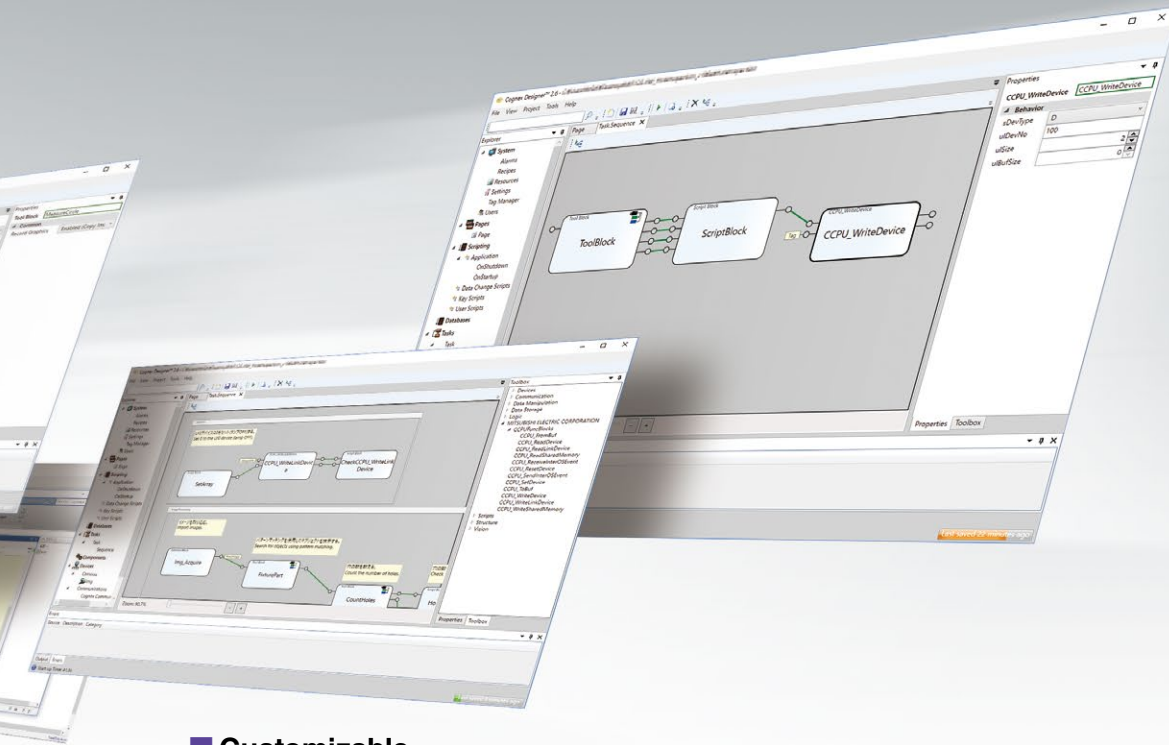

Customizable

Contents of solution templates can be customized by modifying and adding processing according to applications. Customizing solution templates according to requirements can reduce tasks for implementation.

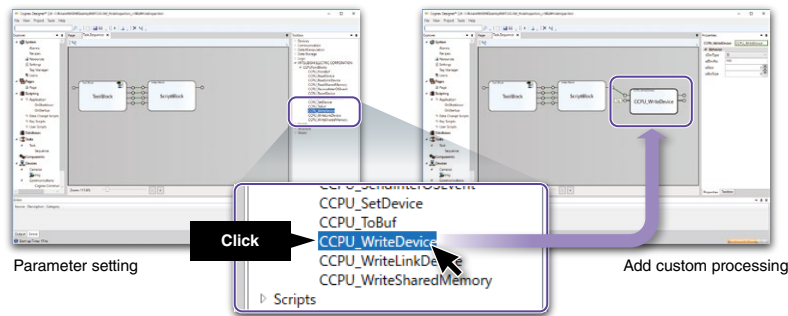

Lineup

Image processing support function

Function to support creation of vision processing application*1

Sample	Outline
Hole dimensions check	Check the work hole position and dimensions
Wire harness incorrect wiring detection	Check whether the wire shape and color order connected to the harness is correct or not
Delivered product check	Check letters printed on the carton
Electronic parts check	Check whether the number of pins connected to the IC is correct or not



Model-based development support function*2

Sample	Outline
Automated warehouse	Entering and dispatching of products from warehouse
Tension test	Realize equivalent function as tension test machine
Air-conditioning management	Perform air-conditioning control and cost calculation

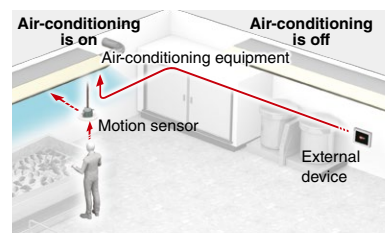

*1. COGNEX image processing software "Cognex Designer" is used.

*2. MathWorks multiple domain simulation "Simulink" is used.

Note: For details on how to obtain solution templates, please contact your local Mitsubishi Electric sales office or representative.

iQ Edgecross

Utilization of open software platform “Edgecross” which realizes FA-IT coordination in the edge computing level enhances Mitsubishi Electric edge computing and e-F@ctory, contributing to manufacturing improvement.

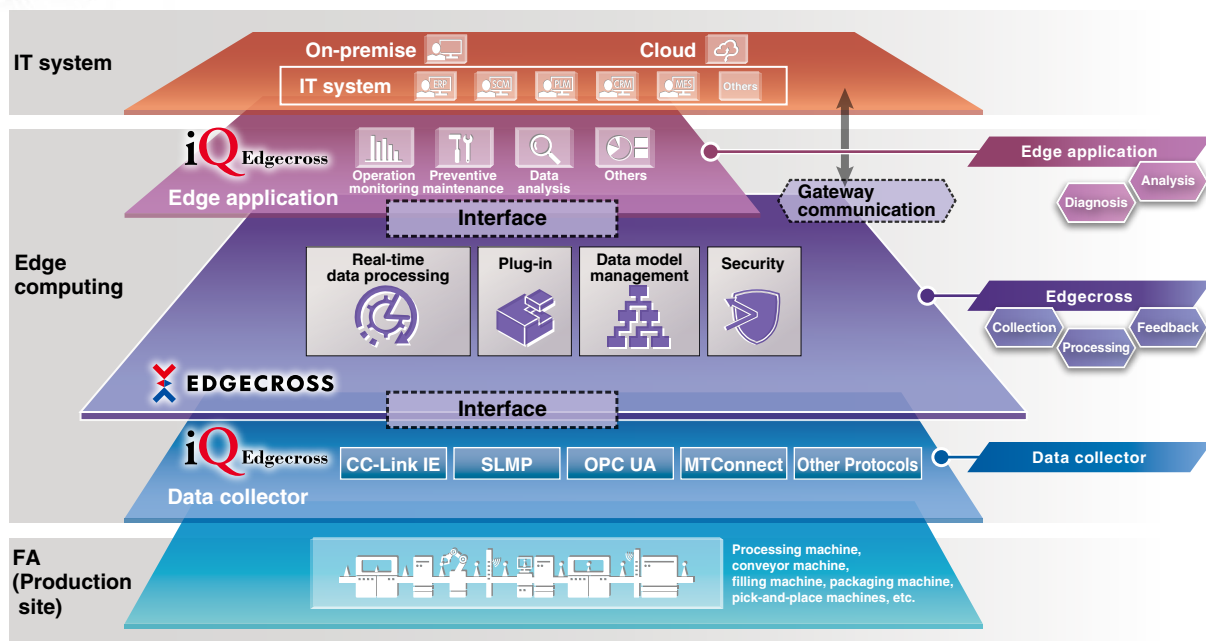

"iQ Edgecross" is Mitsubishi Electric edge-computing software supporting open software platform "Edgecross"

Edge application

Software that performs various processing for data utilization on the shop floor using functions provided by Edgecross in the edge computing level. A wide range of software according to applications is available.

Data collector

A software component that collects data on the shop floor through each network. Data collectors supporting different protocols are available, enabling data collection from various devices. CC-Link IE Field Network Data Collector enables accurate shop floor data collection at high speed.

Edgecross

Real-time data processing

Real-time data continuously collected on the shop floor is processed and distributed to Edge applications for processing, then returned to the shop floor machines. Waveforms per action cycle for example are extracted so that Edge applications can handle easily, then the grouped waveforms are distributed to Edge applications. Finally, the diagnosis results by Edge applications are fed back to the shop floor machines.

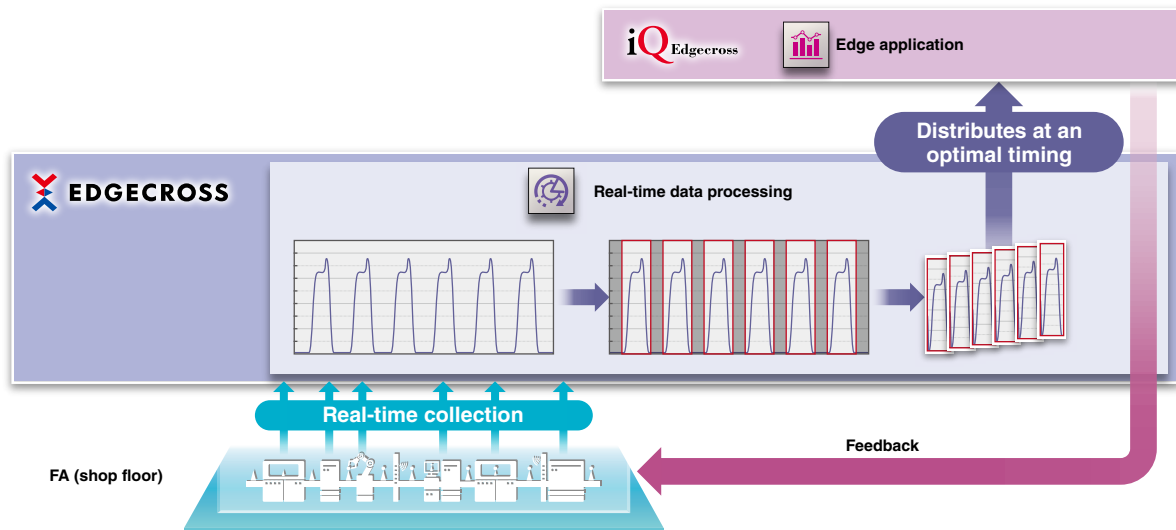

Data model management

Data model management is a function to manage devices, machines, and production lines on the shop floor as abstract models in a hierarchical structure, allowing graphic-based setting and operations similar to Windows® explorer. Centralized management and maintenance of the entire factory is realized by managing all data in the whole production facilities previously managed individually.

Gateway communications

Gateway communications allow effective data coordination with IT system including Cloud. Protocols (MQTT, etc.) highly compatible with IT system is supported, realizing seamless data coordination with IT system.



Reference: Edgecross Consortium
 URL: <https://www.edgecross.org/en/>

Edgecross compatible software



Real-time Data Analyzer

MI5000 MI3000 MI2000 MI1000



- ▶ One software realizes real-time diagnosis and offline analysis
- ▶ Preventative maintenance and quality control using Artificial Intelligence (AI) without relying on individual knowledge
- ▶ Analysis and diagnosis methods according to requirements such as preventative maintenance and quality improvement
- ▶ Efficient graphic-based analysis without a program

Data analysis and diagnosis software that easily realizes preventative maintenance and production quality improvement on the shop floor. One software enables real-time diagnosis and offline analysis of production data. Utilization of shop floor data with AI technology and various statistical methods will improve manufacturing productivity and also industrial quality.

Real-time diagnosis and offline analysis improve production in real time

In industrial automation, it is important to detect any sign of fault developing from shop floor data in real time to quickly take corrective measures. In “real-time diagnosis”, continuous data is diagnosed by AI and the result is immediately returned to the shop floor machines when a sign of error developing is detected. In addition, to realize highly-accurate real-time diagnosis, accurate diagnosis rules should be calculated by analyzing past data based on knowledge about production facilities and devices. “Offline analysis” realizes efficient graphic-based analysis and utilization of various analysis methods.

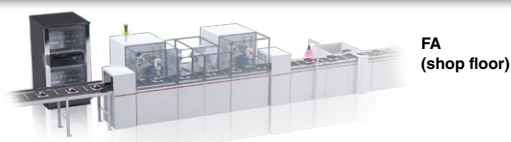
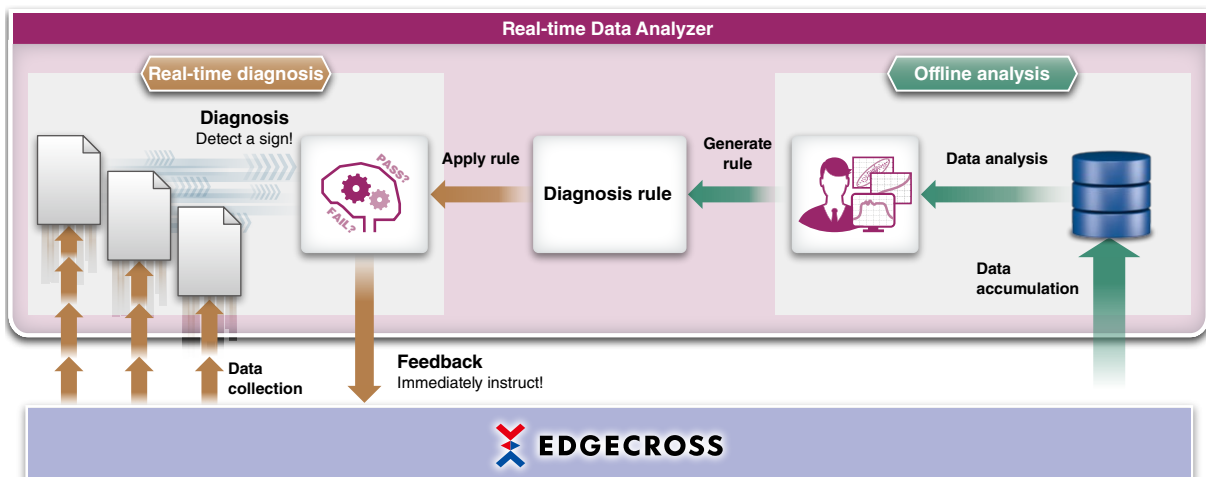

Equipped with analysis and diagnosis methods according to various requirements

Similar waveform recognition detects “difference from usual”

AI technology



Detecting “difference from usual” by AI that learns and recognizes similar waveforms, preventative maintenance and quality control without relying on individual knowledge are realized. In offline analysis, AI learns waveforms such as current at normal operation as normal patterns. Then, in real-time diagnosis, AI compares the real-time waveform data with normal patterns learned, determining whether it passes or fails. Signs of abnormality that are unable to be detected by simple upper lower limit judgment can be detected.

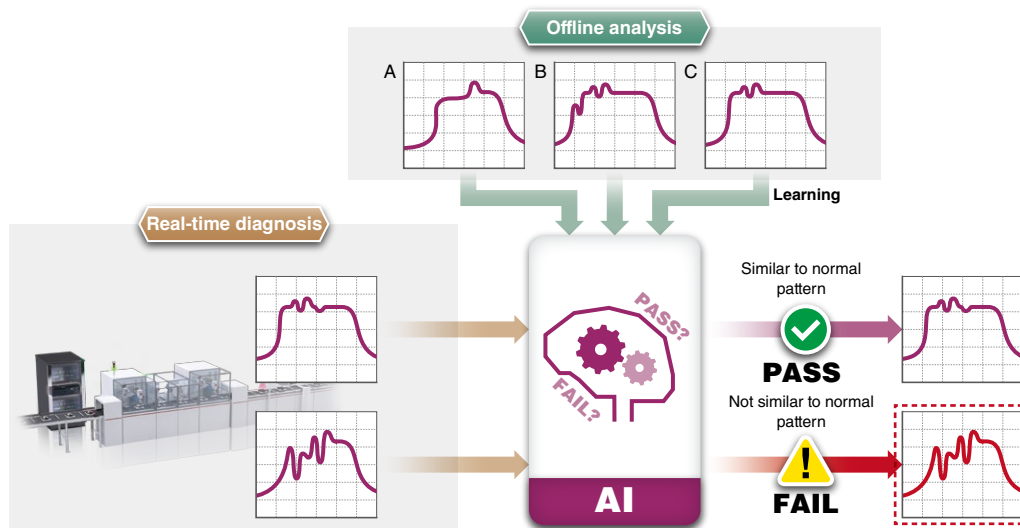

Detects “difference from usual” with the Mahalanobis-Taguchi system

Using data distribution in normal operation as a reference, “difference from usual” is detected according to the level of abnormality from the reference. First, data distribution of the normal pattern is determined with offline analysis. Then the level of abnormality is judged by comparing the real-time data with the normal data in real-time diagnosis. “Mahalanobis distance”, which is calculated by distribution of sensor data obtained from multiple sensors, is used to judge the level of abnormality. Normality or abnormality of data which is unable to be judged by upper and lower limit of one sensor data can be judged. Mahalanobis distance can quantify the level of abnormality, it is possible to quantitatively detect a sign of error developing.

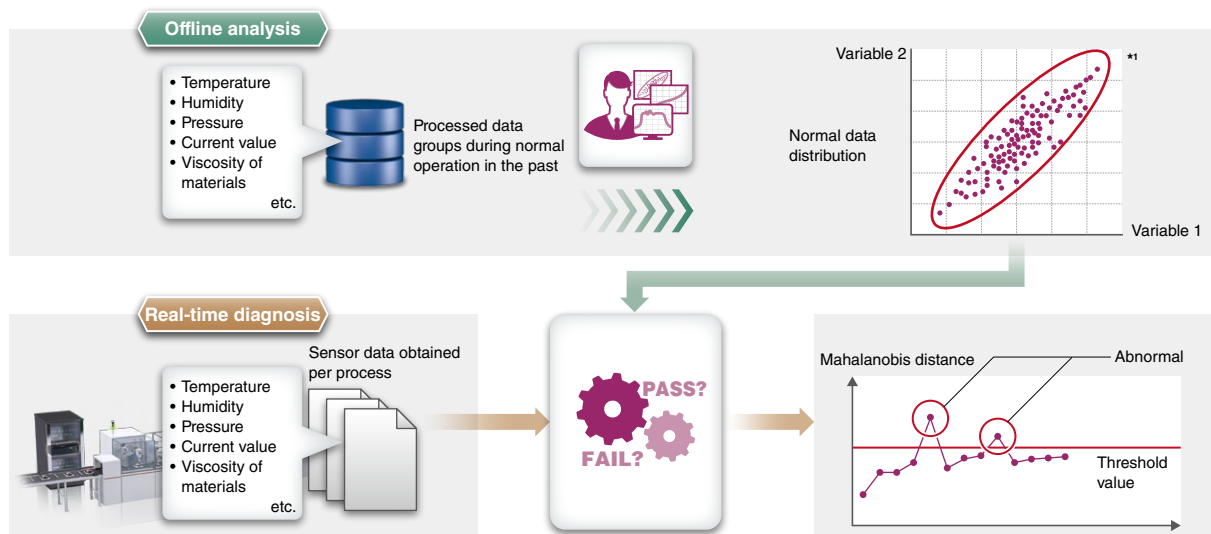

*1. Example is a 2-variable scatter diagram.

Estimates “unmeasurable things” with Multiple regression analysis

Target data such as product strength that is unable to be measured is estimated from multiple measurable sensor data. First, a predictive formula for obtaining a target data is calculated using multiple sensor data in offline analysis. Then, the quality of products and an error in the facility are predicted from a predictive formula using real-time data in real-time diagnosis. Preventative maintenance and quality improvement are realized by predicting data that is unmeasurable unless a product or facility is broken down and results that are unmeasurable until the process proceeds.

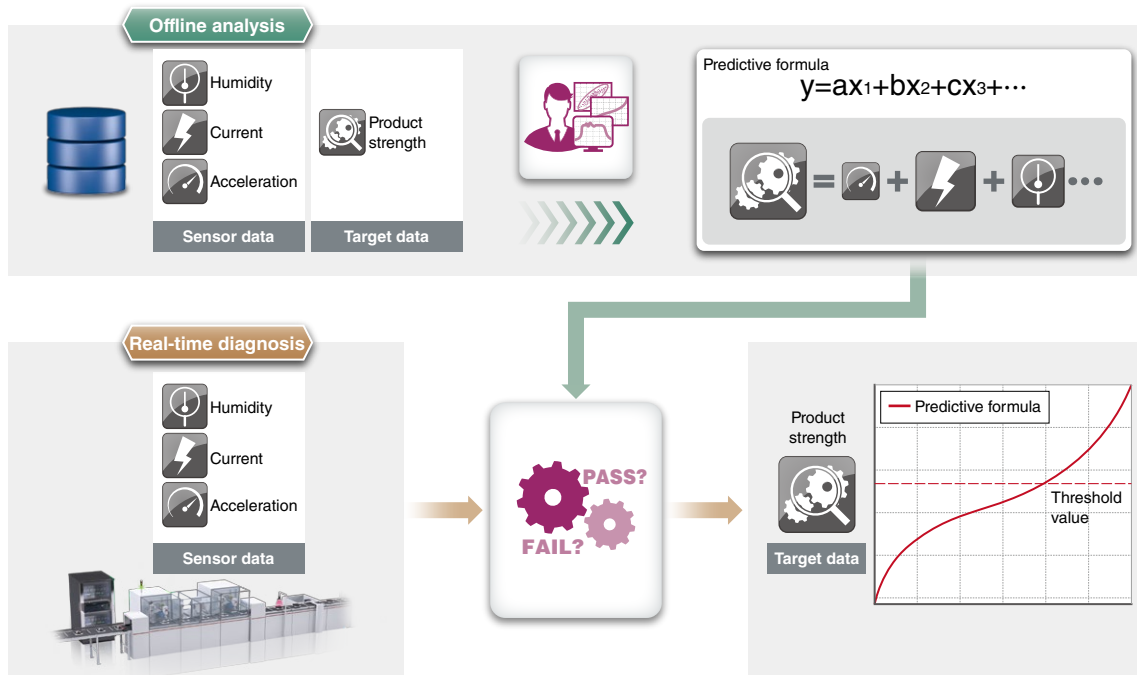

Efficient graphic-based offline analysis without a program

Filtering of data based on knowledge about production facilities/devices and statistical methods is necessary to analyze a large volume of data collected on the shop floor and create diagnosis rule based on analysis results. Real-time Data Analyzer functions, such as data display functions and graphic-based data analysis/diagnostic function without a program strongly support works in each steps of offline analysis, making data analytical works efficient.

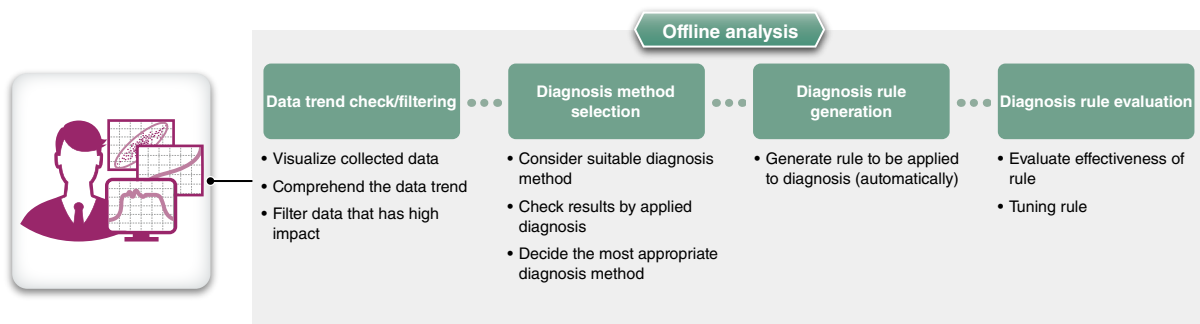

Various waveform display functions for trend check and filtering of data

For analysis of shop floor data, checking data from diversified standpoints based on knowledge of production facilities/devices is important. Pressing buttons can switch multiple waveforms display mode and display data conversion screen. Therefore, data feature quantities can be easily extracted, enabling efficient data trend check and data filtering.

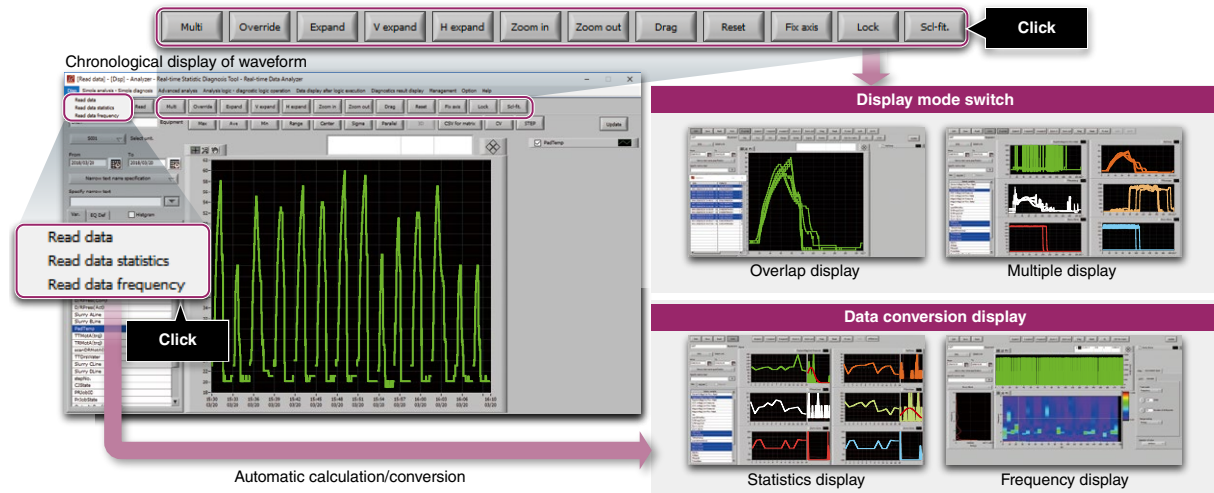

Data analysis by optimal diagnosis method

Most appropriate method according to data characteristics and trend can be selected from many analysis methods. Advanced statistical methods such as AI analysis, Mahalanobis-Taguchi system, and multiple regression analysis are performed by specifying analysis target data with graphic-based operation.

Diagnosis rule generation without a program

Diagnosis rule can be generated without programming by simply registering parameters according to diagnosis method. Diagnosis rule generation is easy, allowing to flexibly re-examine diagnosis rule to maintain the most appropriate diagnosis rule.

Diagnosis rule evaluation without affecting facilities

Before performing real-time diagnosis with the actual facility, evaluation of diagnosis rule validity can be done offline using previously collected data. There is no need to operate the facility, evaluation of diagnosis rule and tuning are possible without affecting the facility.

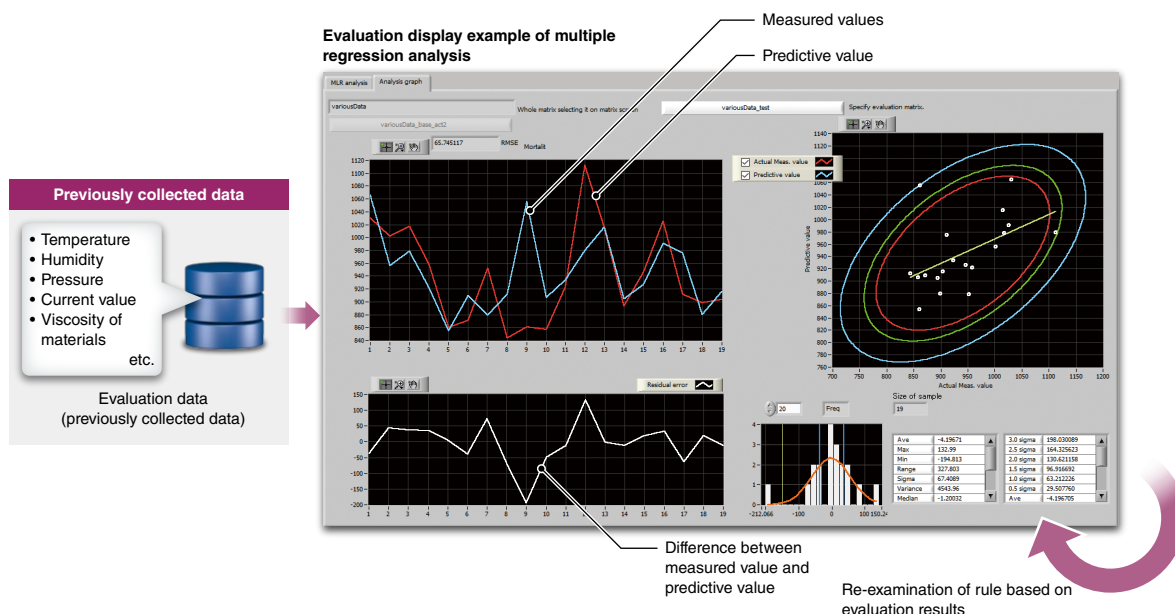

Product specifications

General specifications

MELIPC MI5000

Item	MI5000					
Operating ambient temperature (°C)	0...55					
Storage ambient temperature*1 (°C)	-25...75					
Operating ambient humidity	5...95% RH, non-condensing					
Storage ambient humidity*1	5...95% RH, non-condensing					
Vibration resistance	Compliant with JIS B 3502 and IEC 61131-2	-	Frequency	Constant acceleration	Half amplitude	Sweep count
		Under intermittent vibration	5...8.4 Hz	-	3.5 mm	10 times each in directions X, Y, Z
			8.4...150 Hz	9.8 m/s ²	-	
		Under continuous vibration	5...8.4 Hz	-	1.75 mm	-
8.4...150 Hz	4.9 m/s ²		-			
Shock resistance	Compliant with JIS B 3502 and IEC 61131-2 (147 m/s ² , 3 times each in directions X, Y, Z)					
Operating atmosphere	No corrosive gases, no flammable gases, no excessive conductive dust					
Operating altitude*2*3 (m)	0...2000					
Installation location	Inside the control panel*4					
Overvoltage category*5	≤ II					
Pollution degree*6	≤ 2					
Equipment class	Class I					

MELIPC MI3000

Item	MI3000	
Operating ambient temperature (°C)	0...55	
Storage ambient temperature (°C)	-20...60	
Operating ambient humidity	10...90% RH, non-condensing	
Storage ambient humidity	10...90% RH, non-condensing	
Vibration resistance	Random vibration	Compliant with IEC60068-2-64, 5...500Hz, one hour in direction X, Y, Z each
		3 Grms
Shock resistance	Compliant with IEC-60068-2-27, 10 G, half sine wave, 11 msec	
Operating atmosphere	No greasy fumes, no corrosive gases, no flammable gases, no excessive conductive dust, no direct sunlight (as well as at storage)	
Operating altitude*2*7 (m)	-	
Installation location	Inside the control panel	
Overvoltage category*5	≤ II	
Pollution degree*6	≤ 2	

MELIPC MI2000/MI1000

Item	MI2000	MI1000
Operating ambient temperature (°C)	0...55	0...55
Storage ambient temperature (°C)	-40...75	-20...75
Operating ambient humidity	10...90% RH, non-condensing	10...85% RH, non-condensing
Storage ambient humidity	10...90% RH, non-condensing	10...85% RH, non-condensing
Vibration resistance	Sine wave vibration	Compliant with IEC60068-2-6, 5...500 Hz, 1 oct/min, one hour in direction X, Y, Z each
	Random vibration	Compliant with IEC60068-2-64, 5...500 Hz, 1 oct/min, one hour in direction X, Y, Z each
Shock resistance	Compliant with IEC-60068-2-27, 50 G, half sine wave, 11 msec	
Operating atmosphere	No corrosive gases, no flammable gases, no excessive conductive dust	
Operating altitude*2*7 (m)	-	
Operating location	Stable location where product is less affected by electric field and magnetic field	
Overvoltage category*5	≤ II	
Pollution degree*6	≤ 2	

*1. The storage ambient temperature of the fan is -25 to 70°C, and the storage ambient humidity is 20 to 95 % RH.

*2. Do not use nor store the product under pressure higher than the atmospheric pressure of altitude 0 m. Doing so may cause malfunction.

*3. When used at an altitude higher than 2000 m, the upper limits of the permissible voltage and the operating ambient temperature become lower.

*4. When installing a ventilation fan in the control panel, situate in order that this does not interfere with the exhaust flow from the product fan.

*5. This indicates the section of the power supply to which the equipment is assumed to be connected between the public electrical power distribution network and the machinery within premises.

Category II applies to equipment for which electrical power is supplied from fixed facilities. The surge voltage withstand level for up to the rated voltage of 300 V is 2500 V.

*6. This index indicates the degree to which conductive material is generated in terms of the environment in which the equipment is used. Pollution level 2 is when only non-conductive pollution occurs. A temporary conductivity caused by condensing must be expected occasionally.

*7. No limitations to altitude. When used at a high altitude, the upper limits of the permissible voltage and the operating ambient temperature become lower. Please check performance before use at the customer side.

Performance specifications

■ MELIPC MI5000

Item	MI5000	
	Windows® section	VxWorks® section
Hardware		
MPU	Intel® Core™ i7-5700EQ 2.60G Hz(Quad Core)	
Main memory (byte)	12G*1	1G*1
Internal storage capacity (byte)	45G	4G
Extended storage interface	CFastcard x 1*2	-
Software		
OS	Windows® 10 IoT Enterprise 2016 LTSB (64bit)	VxWorks®7.0
Programming language	Language supporting above OS	C/C++
Format of dedicated APIs	Standard DLL	C/C++ format
Display interface		
Interface	DisplayPort x 1	-
Resolution*3	Max. 3840 x 2160	-
Extended slot		
PCI Express®	-	-
mini PCI Express®	-	-
PCI	-	-
RS-232		
Number of channels	1*4	
Transmission rate (bps)	9600...115200	
RS-422		
Number of channels	-	
Transmission rate (bps)	-	
RS-485		
Number of channels	-	
Transmission rate (bps)	-	
USB		
USB3.0	2	
USB2.0	2	
I/O terminal		
OS shutdown request input	●	
OS shutdown completed notification output	●	
Power supply (AC input)		
Rated input voltage	100...240 V AC	
Input voltage variable range (V AC)	85...264	
Input frequency (Hz)	47...63	
Maximum input apparent power (VA)	≤ 139	
Others		
External dimensions (H x W x D, mm)	106 x 362 x 119	
Weight (kg)	2.7	

*1. Shared memory is 0.25 GB.

*2. Maximum capacity of option product is 64 GB.

*3. Maximum resolution at 60 Hz.

*4. Can be allocated to the Windows® section or VxWorks® section through parameter settings.

MELIPC

Setting/programming software

Solution template

IO Edgecross

Real-time Data Analyzer

Product specifications/list

Performance specifications

■ MELIPC MI3000

Item	MI3000	
	MI3321G-W	MI3315G-W
Hardware		
MPU	Intel® Core™ i3-6100U 2.30GHz (Dual Core)	
Main memory (byte)	8G	
Internal storage capacity (byte)	64G	
Extended storage interface	M.2 (2280) SATA SSD x 1	
Software		
OS	Windows® 10 IoT Enterprise 2016 LTSB (64 bit)	
Programming language	Language supporting above OS	
Format of dedicated APIs	-	
Display specifications		
Display device ^{*1*}	TFT color LCD	
Screen size	21.5" widescreen	15"
Resolution (dot)	Full HD: 1920 x 1080	XGA: 1024 x 768
Display colors	16.77 million	
Contrast ratio	5000:1	700:1
Backlight specification	LED backlight (not replaceable)	
Life	50,000 hours	
Touch panel		
Type	PCAP (Projected Capacitive)	
Simultaneous press	Max. 10 keys ^{*3}	
Transmittance	90%±3%	
Display interface (for external monitor output)		
Interface	DisplayPort x 1	
Resolution ^{*4}	Max. 3840 x 2160	
Extended slot		
PCI Express®	x1 slot (half size) x 1	
mini PCI Express®	Full size x 2	
PCI	-	
RS-232		
Number of channels	2 (RS-422/485 can also be used for one of the two channels)	
Transmission rate (bps)	300...115200	
RS-422		
Number of channels	1 (RS-232/485 can also be used)	
Transmission rate (bps)	300...115200	
RS-485		
Number of channels	1 (RS-232/422 can also be used)	
Transmission rate (bps)	300...115200	
USB		
USB3.0	2	
USB2.0	2	
Sound output (ø3.5 mini-jack (3-prong))		
Interface	Audio Line-Out	
Number of ports	1	
I/O terminal		
OS shutdown request input	-	
OS shutdown completed notification output	-	
Power supply (DC input)		
Rated input voltage	24 V DC	
Input voltage variable range (V DC)	19.2...28.8	
Input frequency (Hz)	-	
Maximum input apparent power (VA)	-	
Others		
POWER LED	2 colors (blue and orange)	
Environmental protective structure	IP66 (front face)	
External dimensions (H x W x D, mm)	349.8 x 558.4 x 88.8	307.3 x 383.2 x 86
Panel cutting dimensions (H x W, mm)	341.8 x 550.3	298.5 x 374.5
Weight (kg)	9.8	7.0

*1. As a characteristic of liquid crystal display panels, bright dots (always lit) and dark dots (never lit) may appear on the panel. Since liquid crystal display panels comprise a great number of display elements, the appearance of bright and dark dots cannot be reduced to zero. Individual differences in liquid crystal display panels may cause differences in color, uneven brightness and flickering. Note that these phenomena are characteristics of liquid crystal display panels and it does not mean the products are defective or damaged.

*2. Flickering may occur due to vibration, shock, or the display colors.

*3. Multiple touch keys cannot be pressed simultaneously while GT SoftGOT2000 is used.

*4. Maximum resolution at 60 Hz.

■ MELIPC MI2000/MI1000

Item	MI2000	MI1000
	MI2012-W(-CL)	MI1002-W(-CL)
Hardware		
MPU	Intel® Core™ i3-6102E 1.90G Hz (Dual Core)	Intel® Atom™ E3826 1.46G Hz (Dual Core)
Main memory (byte)	8G	4G
Internal storage capacity (byte)	64G	60G
Extended storage interface	2.5"SATA SSD/HDD x 2 CFAST card x 1**	-
Software		
OS	Windows® 10 IoT Enterprise 2016 LTSC (64bit)	
Programming language	Language supporting above OS	
Format of dedicated APIs	-	
Display interface		
Interface	HDMI v1.4 x 1, DVI-I x 1	HDMI v1.4a x 1
Resolution*2	Max. 1920 x 1080	Max. 1920 x 1080
Extended slot		
PCI Express®	x1, x2, x4, x8, x16 (half-size) x 1	-
mini PCI Express®	Full-size x 2	-
PCI	Half-size x 1	-
RS-232		
Number of channels	2 (RS-422/485 can also be used)	2
Transmission rate (bps)	9600...115200	9600...115200
RS-422		
Number of channels	2 (RS-232/485 can also be used)	-
Transmission rate (bps)	50...115200	-
RS-485		
Number of channels	2 (RS-232/422 can also be used)	1
Transmission rate (bps)	50...115200	50...115200
USB		
USB3.0	6	-
USB2.0	-	4
I/O terminal		
OS shutdown request input	-	-
OS shutdown completed notification output	-	-
Power supply (AC input)		
Rated input voltage	AC adapter (input voltage: 100...240 V AC, output voltage: 24 V DC)*3	AC adapter (input voltage: 100...264 V AC, output voltage: 12 V DC)*3
Input voltage variable range (V AC)	85...264	85...264
Input frequency (Hz)	47...63	47...63
Maximum input apparent power (VA)	≤ 170	≤ 140
Others		
External dimensions (H x W x D, mm)	177 x 142 x 238	26 x 186 x 150
Weight (kg)	3.9 (excluding AC adapter)	0.90 (excluding AC adapter)

*1. Maximum capacity of option product is 64 GB.

*2. Maximum resolution at 60 Hz.

*3. A power supply cable included with MI□-W is exclusively for 100 V AC in Japan. When using with other than 100 V AC or abroad, please purchase MI□-W-CL and use an appropriate cable complying with the power supply used and the safety standard of the area.

Product specifications

Field network specifications

MELIPC

Item	MI5000		MI3000	MI2000	MI1000
	Windows® section	VxWorks® section			
Ethernet					
Interface	10BASE-T/100BASE-TX/1000BASE-T				
Number of channels	1 (CH2)	1 (CH1)	3	2	2
CC-Link IE Field Network					
Station type	Master/local station		-	-	-
Transmission speed (Gbps)	1		-	-	-
Max. number of connectable stations	120*1		-	-	-
Number of ports	1		-	-	-
Communications cable	Ethernet cable (Category 5e or higher, double shielded/STP) straight cable		-	-	-
Network topology	Line type and star type*2		-	-	-
Overall cable distance (m)	Line type: 12,000 Star type: Depends on the system configuration		-	-	-
Max. station-to-station distance (m)	100		-	-	-
CC-Link IE Field Network Basic					
Station type	Master station		-	-	-
Number of slave stations on 1 network*3	64 (16 x 4 groups)		-	-	-
Number of ports	1		-	-	-
Network topology	Star type		-	-	-

*1. 120 (up to a maximum of 120 slave stations can be connected)

*2. For star type connections, use a switching hub that supports CC-Link IE Field Network synchronized communications.

*3. Maximum number of slave stations managed by the master station. Changes depending on numbers of occupied slave stations. However, configure so the total number of occupied slave stations does not exceed the total number of connected devices.

Pre-installed software list

Edge application

Item	MI5000	MI3000	MI2000	MI1000
GT SoftGOT2000	-	●	-	-

Edgecross

Item	MI5000	MI3000	MI2000	MI1000
Edgecross Basic Software	●	●	●	●

Data collector

Item	MI5000	MI3000	MI2000	MI1000
CC-Link IE Field Network Data Collector (MELIPC MI5122-VW)	●	-	-	-
SLMP Data Collector	●	●	●	●

Engineering tool

Item	MI5000	MI3000	MI2000	MI1000
MELSOFT MI Configurator	●	-	-	-

iQ-Edgecross compatible software list

Edge application

Item	MI5000	MI3000	MI2000	MI1000
Real-time Data Analyzer	●	●**4	●	-
GT SoftGOT2000	●	● Pre-installed	●	-
MC Works64 Edge Computing Edition	●	●	●	-

Data collector

Item	MI5000	MI3000	MI2000	MI1000
CC-Link IE Field Network Data Collector (MELIPC MI5122-VW)	●	-	-	-
CC-Link IE Field Network Data Collector *5	-	●	●	-
CC-Link IE Controller Network Data Collector *5	-	●	●	-
SLMP Data Collector	●	●	●	●
OPC UA Data Collector	●	●	●	●
MTCConnect Data Collector	●	●	●	-

*4. Since MI3315G-W does not support the resolution that is recommended by Real-time Data Analyzer, some parts of the screen are not shown on the display. However, the hidden parts can be displayed by moving the display position.

*5. The network interface board by Mitsubishi Electric is required separately. For further details, please refer to the option list on page 28.

Product functions

■ Real-time Data Analyzer

Item	Outline
Display functions	
Read data display	To display data of a CSV file as a waveform. Analysis by overlapping or connecting data can be performed.
Read data statistics display	To calculate and display the statistics of CSV file data. The changes of statistics and correlation of data can be analyzed.
Read data frequency display	To perform STFT conversion and display the spectrogram, or perform Wavelet conversion and display the scalogram on data in a CSV file. Facility failure can be analyzed by visualizing the frequencies.
Simplified analysis/diagnosis function	
SPC	To calculate the statistics for each unit of collected data and diagnose it according to the SPC rule. A sign of failure can be detected based on the changes of statistics.
Multivariate analysis	To detect an event to be a trigger based on the model of the multivariate analysis result.
Guard band diagnostic	To diagnose data by using a guard band created based on the normal waveform data. The upper and lower limit values can be specified without using the reference waveform.
Advanced analysis function	
Correlation matrix creating	To create a correlation matrix for correlation analysis.
Multiple regression analysis (LMR)	To perform multiple regression calculation by selecting one objective variable and multiple explanatory variables to obtain the correlation between multiple variables.
Mahalanobis-Taguchi system (MT)	To collect the sample of multiple variables to be referenced and calculate the Mahalanobis distance for the standard section and the changes in variation based on the correlation of multiple variables.
Analysis/diagnosis logic operation function	
Logic editing	To edit the analysis and data diagnosis logics.
Logic variable setting	To edit variables used in the analysis and data diagnosis logics.
Diagnostic result display function	
Simplified diagnostic result display	To display the result of simplified diagnostic (SPC, multivariate analysis, or guard band).
Diagnostic logic result display	To display the result of diagnostic logic (expansion trace GB, SPC diagnostic, log writing, and error notification).
Similar waveform recognition function	
Waveform learning function	To create the reference waveform learning data used for similar waveform recognition. It extracts unit waveforms from a reference waveform for diagnosing the similarity.
Data diagnostic function	To monitor an inspection waveform that was input from Real-time Flow Manager and notify Real-time Flow Manager of a waveform determined to be different, that is the similarity score is lower than a threshold value, if found.
GX LogViewer interaction function	To display the diagnostic status of a similar waveform recognition in GX LogViewer.

Operating environment

■ Real-time Data Analyzer

Item	Outline
Industrial computer	
CPU	Intel® Core™ i3 2 cores or more
Required memory	8 GB or more
OS	
Supported OS*1	Microsoft® Windows® 10 (Pro, Enterprise, IoT Enterprise)
Language	Japanese, English, Chinese (simplified)
Display	
Resolution	1280 x 800 dot or more

*1. Only 64-bit version is supported.

Product list

MELIPC

Type	Model	Outline
MELIPC MI5000	MI5122-VW	Edgecross Basic Software, CC-Link IE Field Network Data Collector (MELIPC MI5122-VW), SLMP Data Collector, MI Configurator pre-installed
MELIPC MI3000	MI3321G-W	TFT color LCD, 21.5" widescreen, Full HD, Panel color Black Edgecross Basic Software, SLMP Data Collector, GT SoftGOT2000 pre-installed
	MI3315G-W	TFT color LCD, 15" XGA, Panel color Black Edgecross Basic Software, SLMP Data Collector, GT SoftGOT2000 pre-installed
MELIPC MI2000	MI2012-W	Edgecross Basic Software, SLMP Data Collector pre-installed
	MI2012-W-CL	Edgecross Basic Software, SLMP Data Collector pre-installed power supply cable is not included
MELIPC MI1000	MI1002-W	Edgecross Basic Software, SLMP Data Collector pre-installed
	MI1002-W-CL	Edgecross Basic Software, SLMP Data Collector pre-installed power supply cable is not included

Option

Type	Model	Outline
Power supply module	MI5A1P	Replacement module for MI5000
Fan unit	MI5FAN	Replacement module for MI5000
Battery	FX3U-32BL	For MI5000, for preserving clock data*1
CFast card	NZ1MEM-16GBCFT	For MI2000/MI5000 expansion storage 16GB
	NZ1MEM-32GBCFT	For MI2000/MI5000 expansion storage 32GB
	NZ1MEM-64GBCFT	For MI2000/MI5000 expansion storage 64GB
CC-Link IE Field Network interface board	Q81BD-J71GF11-T2	Master/local station, PCI Express® slot*2
	Q80BD-J71GF11-T2	Master/local station, PCI/PCI-X® slot*2
CC-Link IE Control Network interface board	Q81BD-J71GP21-SX	Control/normal station, PCI Express® slot*3
	Q81BD-J71GP21S-SX	Control/normal station, PCI Express® slot, with external power supply input terminals*3
	Q80BD-J71GP21-SX	Control/normal station, PCI/PCI-X® slot*3
	Q80BD-J71GP21S-SX	Control/normal station, PCI/PCI-X® slot, with external power supply input terminals*3

*1. Same battery as the MELSEC iQ-F/F Series

*2. Required when using CC-Link IE Field Network Data Collector.

*3. Required when using CC-Link IE Control Network Data Collector.

Engineering tool

Type	Model	Outline
CW Workbench 4	SW1DND-CWW4-E	For MI5000, C/C++ development environment (product with license)
	SW1DND-CWW4-EZ	For MI5000, C/C++ development environment (additional license product)
	SW1DND-CWW4-EVZ	For MI5000, C/C++ development environment (update license product)
MELSOFT GT Works3	SW1DND-GTWK3-E	For MI3000, software to design GT SoftGOT2000 screens (English version, standard license product)

iQ Edgecross

Type	Model	Outline
Real-time Data Analyzer*4	SW1DND-RDA-MQ12	One year subscription license, DVD included
	SW1DND-RDA-MZQ12	One year subscription license

*4. This product can be used when one year subscription license is purchased. Please consult your local Mitsubishi Electric representative, if other license agreement is required.

■ CW Workbench 4 license

For new CW Workbench 4 customers

Purchase one permanent license for each computer using CW Workbench 4. To install CW Workbench 4 in more than two computers, purchase additional permanent licenses for required number of computers.

■ CW Workbench 4 Product with license

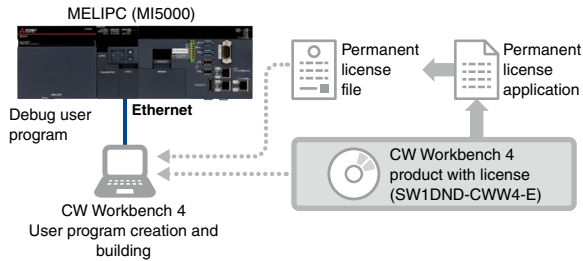

■ CW Workbench 4 Additional license product

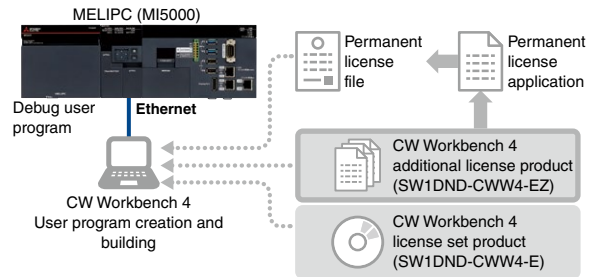

For customers already having CW Workbench

When already using CW Workbench for MELSEC iQ-R/Q Series C controller module, purchase an update license product of CW Workbench 4. *1

■ CW Workbench 4 Update license product

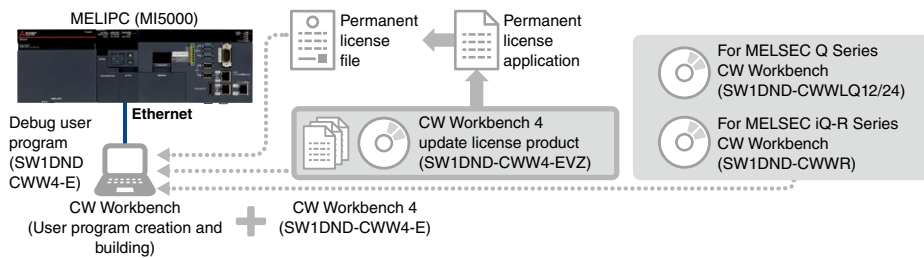

*1. Install CW Workbench (SW1DND-CWWLQ12/24*SW1DND-CWWR) and CW Workbench 4 (SW1DND-CWW4) in a separate folder. Also, CW Workbench and CW Workbench 4 cannot be started at the same time.

Product purchasing information

■ Necessary interactions for using CW Workbench 4

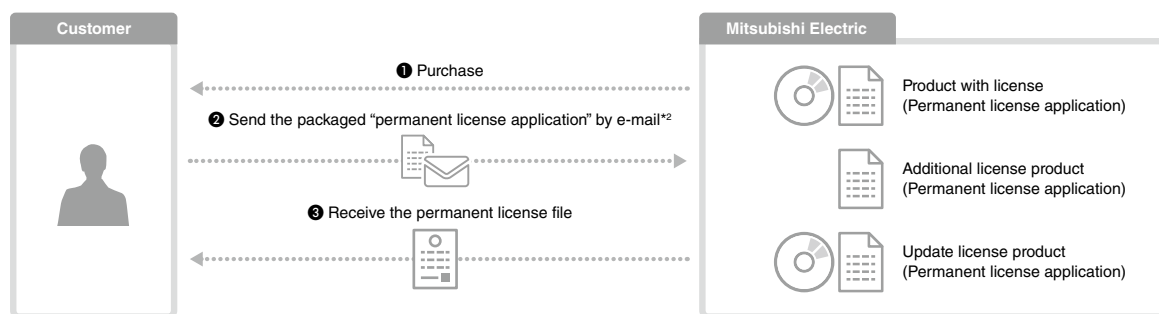

*2. A temporary license can be used until the permanent license is received (approximately 1 month).

Extensive global support coverage providing expert help whenever needed

■ Global FA centers

■ EMEA

Europe FA Center

MITSUBISHI ELECTRIC EUROPE B.V. Polish Branch
Tel: +48-12-347-65-81

Germany FA Center

MITSUBISHI ELECTRIC EUROPE B.V. German Branch
Tel: +49-2102-486-0 / Fax: +49-2102-486-1120

UK FA Center

MITSUBISHI ELECTRIC EUROPE B.V. UK Branch
Tel: +44-1707-27-8780 / Fax: +44-1707-27-8695

Czech Republic FA Center

MITSUBISHI ELECTRIC EUROPE B.V. Czech Branch
Tel: +420-255 719 200

Italy FA Center

MITSUBISHI ELECTRIC EUROPE B.V. Italian Branch
Tel: +39-039-60531 / Fax: +39-039-6053-312

Russia FA Center

MITSUBISHI ELECTRIC (RUSSIA) LLC ST.
Petersburg Branch
Tel: +7-812-633-3497 / Fax: +7-812-633-3499

Turkey FA Center

MITSUBISHI ELECTRIC TURKEY A.S Umraniye Branch
Tel: +90-216-526-3990 / Fax: +90-216-526-3995

■ Asia-Pacific

China

Beijing FA Center

MITSUBISHI ELECTRIC AUTOMATION (CHINA) LTD.
Beijing FA Center
Tel: +86-10-6518-8830 / Fax: +86-10-6518-2938

Guangzhou FA Center

MITSUBISHI ELECTRIC AUTOMATION (CHINA) LTD.
Guangzhou FA Center
Tel: +86-20-8923-6730 / Fax: +86-20-8923-6715

Shanghai FA Center

MITSUBISHI ELECTRIC AUTOMATION (CHINA) LTD.
Shanghai FA Center
Tel: +86-21-2322-3030 / Fax: +86-21-2322-3000

Tianjin FA Center

MITSUBISHI ELECTRIC AUTOMATION (CHINA) LTD.
Tianjin FA Center
Tel: +86-22-2813-1015 / Fax: +86-22-2813-1017

Taiwan

Taipei FA Center

SETSUYO ENTERPRISE CO., LTD.
Tel: +886-2-2299-9917 / Fax: +886-2-2299-9963

Korea

Korea FA Center

MITSUBISHI ELECTRIC AUTOMATION KOREA CO., LTD.
Tel: +82-2-3660-9632 / Fax: +82-2-3664-0475

Thailand

Thailand FA Center

MITSUBISHI ELECTRIC FACTORY AUTOMATION
(THAILAND) CO., LTD.
Tel: +66-2092-8600 / Fax: +66-2043-1231-33

ASEAN

ASEAN FA Center

MITSUBISHI ELECTRIC ASIA PTE. LTD.
Tel: +65-6470-2480 / Fax: +65-6476-7439

Indonesia

Indonesia FA Center

PT. MITSUBISHI ELECTRIC INDONESIA
Cikarang Office
Tel: +62-21-2961-7797 / Fax: +62-21-2961-7794

Vietnam

Hanoi FA Center

MITSUBISHI ELECTRIC VIETNAM COMPANY LIMITED
Hanoi Branch Office
Tel: +84-24-3937-8075 / Fax: +84-24-3937-8076

Ho Chi Minh FA Center

MITSUBISHI ELECTRIC VIETNAM COMPANY LIMITED
Tel: +84-28-3910-5945 / Fax: +84-28-3910-5947

India

India Ahmedabad FA Center

MITSUBISHI ELECTRIC INDIA PVT. LTD.
Ahmedabad Branch
Tel: +91-7965120063

India Bangalore FA Center

MITSUBISHI ELECTRIC INDIA PVT. LTD.
Bangalore Branch
Tel: +91-80-4020-1600 / Fax: +91-80-4020-1699

India Chennai FA Center

MITSUBISHI ELECTRIC INDIA PVT. LTD.
Chennai Branch
Tel: +91-4445548772 / Fax: +91-4445548773

India Coimbatore FA Center

MITSUBISHI ELECTRIC INDIA PVT. LTD.
Coimbatore Branch
Tel: +91-422-438-5606

India Gurgaon FA Center

MITSUBISHI ELECTRIC INDIA PVT. LTD.
Gurgaon Head Office
Tel: +91-124-463-0300 / Fax: +91-124-463-0399

India Pune FA Center

MITSUBISHI ELECTRIC INDIA PVT. LTD.
Pune Branch
Tel: +91-20-2710-2000 / Fax: +91-20-2710-2100

■ Americas

USA

North America FA Center

MITSUBISHI ELECTRIC AUTOMATION, INC.
Tel: +1-847-478-2469 / Fax: +1-847-478-2253

Mexico

Mexico City FA Center

MITSUBISHI ELECTRIC AUTOMATION, INC.
Mexico Branch
Tel: +52-55-3067-7511

Mexico FA Center

MITSUBISHI ELECTRIC AUTOMATION, INC.
Queretaro Office
Tel: +52-442-153-6014

Mexico Monterrey FA Center

MITSUBISHI ELECTRIC AUTOMATION, INC.
Monterrey Office
Tel: +52-55-3067-7521

Brazil

Brazil FA Center

MITSUBISHI ELECTRIC DO BRASIL COMERCIO E
SERVICOS LTDA.
Tel: +55-11-4689-3000 / Fax: +55-11-4689-3016

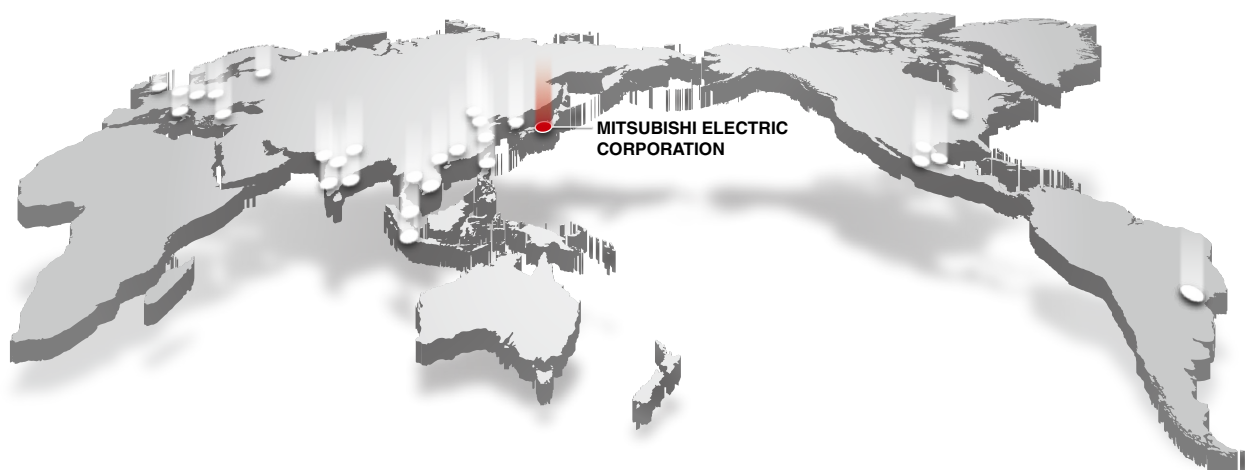

Factory Automation Global website

Mitsubishi Electric Factory Automation provides a mix of services to support its customers worldwide. A consolidated global website is the main portal, offering a selection of support tools and a window to its local Mitsubishi Electric sales and support network.

■ From here you can find:

- Overview of available factory automation products
- Library of downloadable literature
- Support tools such as online e-learning courses, terminology dictionary, etc.
- Global sales and service network portal
- Latest news related to Mitsubishi Electric factory automation

**Mitsubishi Electric Factory Automation
Global website:
www.MitsubishiElectric.com/fa**

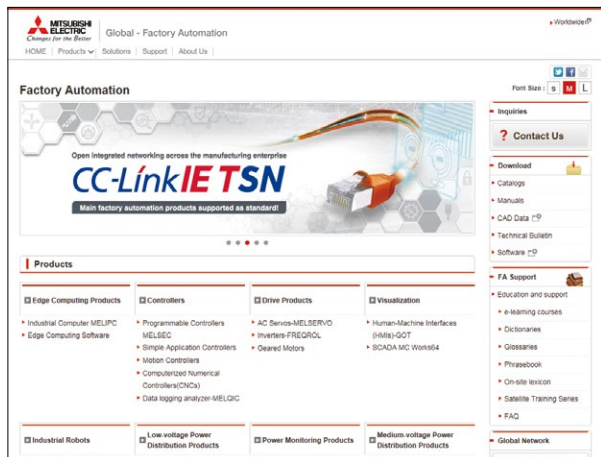

Online e-learning

An extensive library of e-learning courses covering the factory automation product range has been prepared. Courses from beginner to advanced levels of difficulty are available in various languages.

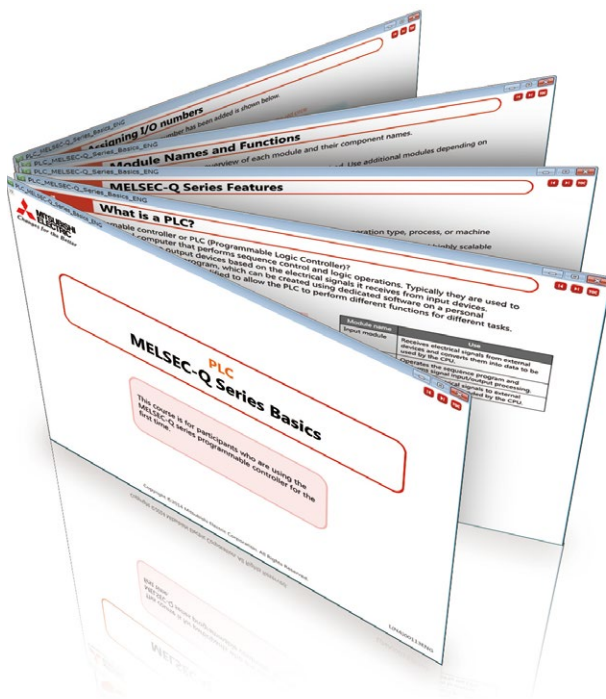

■ Beginner level

Designed for newcomers to Mitsubishi Electric Factory Automation products gaining a background of the fundamentals and an overview of various products related to the course.

■ Basic to Advanced levels

These courses are designed to provide education at all levels. Various different features are explained with application examples providing an easy and informative resource for in-house company training.

Innovative next-generation, e-Manual

e-Manual Viewer

The e-Manual viewer is a next-generation digital manual offered by Mitsubishi Electric that consolidates factory automation products manuals into an easy-to-use package with various useful features integrated into the viewer. The e-Manual allows multiple manuals to be cross-searched at once, further reducing time for setting up products and troubleshooting.



Key features included

- One-stop database containing all required manuals, with local file cache
- Included with GX Works3 engineering software
- Also available in tablet version
- Easily download manuals all at once
- Multiple users can share the latest manuals and knowhow with document sharing function
- Directly port sample programs within manuals to GX Works3
- Downloaded manuals are usable offline



e-Manual Create

e-Manual Create is software for converting word files and chm files to e-Manual documents. e-Manual Create allows users to directly refer to Mitsubishi Electric e-Manuals from user's customized device maintenance manuals and such, supporting quick troubleshooting and reduction in document creation process.

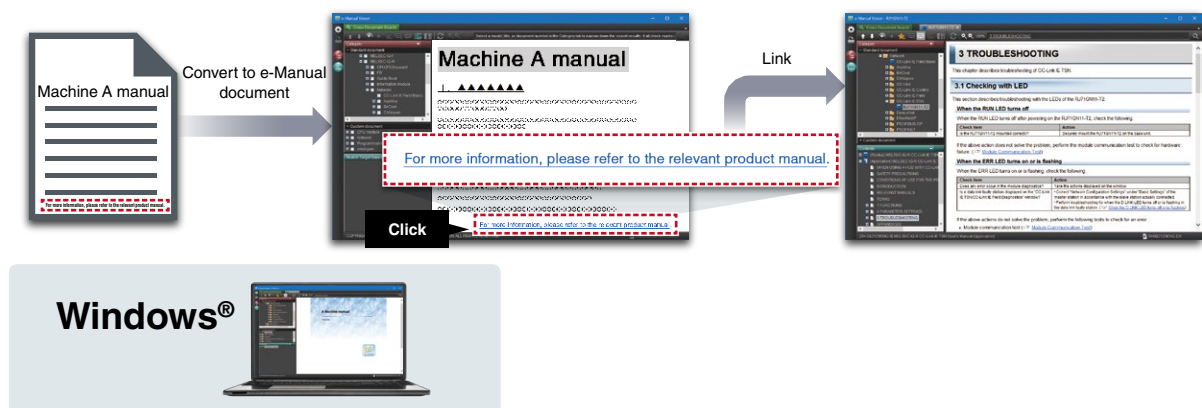

* To obtain the Windows® version of e-Manual Viewer and e-Manual Create, please contact your local Mitsubishi Electric sales office or representative.



EDGECROSS
CONSORTIUM



Reference: Edgexross Consortium
URL: <https://www.edgexross.org/en/>

Android and Google Play are trademarks of Google LLC.
Apple, iPad, iPad Air, iPad mini, and App Store are trademarks of Apple Inc., registered in the U.S. and other countries.
DisplayPort is a registered trademark of Video Electronics Standards Association in the United States and other countries.
Ethernet is a trademark of Xerox Corporation.
Intel and Intel Atom are trademarks of Intel Corporation in the United States and other countries.
Microsoft, Windows, and Azure are registered trademarks of Microsoft Corporation in the United States and other countries.
MTCConnect is a registered trademark of AMT - The Association For Manufacturing Technology.
PCI Express is a registered trademark of PCI-SIG.
QR Code is a trademark or a registered trademark of DENSO WAVE INCORPORATED in JAPAN, the United States and/or other countries.
Simulink is a registered trademark of The Math Works, Inc.
VxWorks is a registered trademark of Wind River Systems, Inc. in the United States and other countries.
All other company names and product names used in this document are trademarks or registered trademarks of their respective companies.

Precautions before use

This publication explains the typical features and functions of the products herein and does not provide restrictions or other information related to usage and module combinations. Before using the products, always read the product user manuals. Mitsubishi Electric will not be held liable for damage caused by factors found not to be the cause of Mitsubishi Electric; opportunity loss or lost profits caused by faults in Mitsubishi Electric products; damage, secondary damage, or accident compensation, whether foreseeable or not, caused by special factors; damage to products other than Mitsubishi Electric products; or any other duties.

For safe use

- To use the products given in this publication properly, always read the relevant manuals before beginning operation.
- The products have been manufactured as general-purpose parts for general industries, and are not designed or manufactured to be incorporated in a device or system used in purposes related to human life.
- Before using the products for special purposes such as nuclear power, electric power, aerospace, medicine or passenger-carrying vehicles, consult with Mitsubishi Electric.
- The products have been manufactured under strict quality control. However, when installing the products where major accidents or losses could occur if the products fail, install appropriate backup or fail-safe functions in the system.

YOUR SOLUTION PARTNER

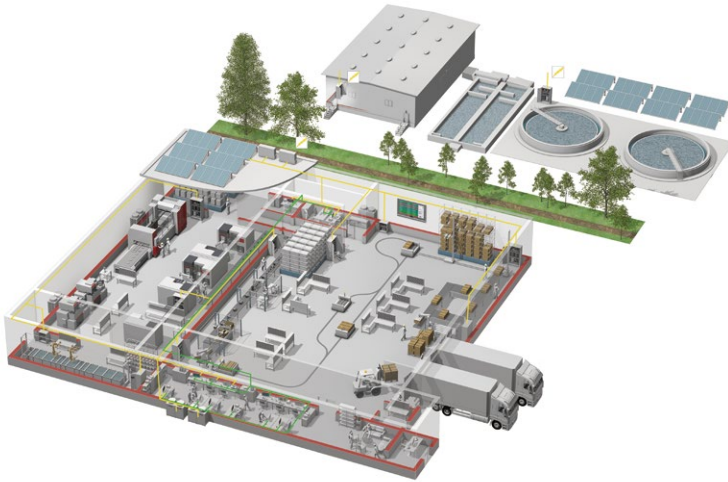

Mitsubishi Electric offers a wide range of automation equipment from PLCs and HMIs to CNC and EDM machines.

A NAME TO TRUST

Since its beginnings in 1870, some 45 companies use the Mitsubishi name, covering a spectrum of finance, commerce and industry.

The Mitsubishi brand name is recognized around the world as a symbol of premium quality.

Mitsubishi Electric Corporation is active in space development, transportation, semi-conductors, energy systems, communications and information processing, audio visual equipment and home electronics, building and energy management and automation systems, and has 237 factories and laboratories worldwide in over 121 countries.

This is why you can rely on Mitsubishi Electric automation solution - because we know first hand about the need for reliable, efficient, easy-to-use automation and control in our own factories.

As one of the world's leading companies with a global turnover of over 4 trillion Yen (over \$40 billion), employing over 100,000 people, Mitsubishi Electric has the resource and the commitment to deliver the ultimate in service and support as well as the best products.



Low voltage: MCCB, MCB, ACB



Medium voltage: VCB, VCC



Power monitoring, energy management



Compact and Modular Controllers



Inverters, Servos and Motors



Visualisation: HMIs



Numerical Control (NC)



Robots: SCARA, Articulated arm

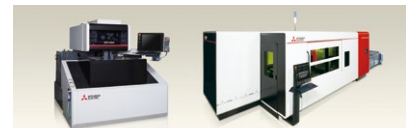

Processing machines: EDM, Lasers, IDS



Transformers, Air conditioning, Photovoltaic systems

* Not all products are available in all countries.

Country/Region	Sales office	Tel/Fax
USA	MITSUBISHI ELECTRIC AUTOMATION, INC. 500 Corporate Woods Parkway, Vernon Hills, IL 60061, U.S.A.	Tel : +1-847-478-2100 Fax : +1-847-478-2253
Mexico	MITSUBISHI ELECTRIC AUTOMATION, INC. Mexico Branch Boulevard Miguel de Cervantes Saavedra 301, Torre Norte Piso 5, Ampliacion Granada, Miguel Hidalgo, Ciudad de Mexico, Mexico, C.P.115200	Tel : +52-55-3067-7512
Brazil	MITSUBISHI ELECTRIC DO BRASIL COMERCIO E SERVICOS LTDA. Avenida Adelino Cardana, 293, 21 andar, Bethaville, Barueri SP, Brasil	Tel : +55-11-4689-3000 Fax : +55-11-4689-3016
Germany	MITSUBISHI ELECTRIC EUROPE B.V. German Branch Mitsubishi-Electric-Platz 1, 40882 Ratingen, Germany	Tel : +49-2102-486-0 Fax : +49-2102-486-7780
UK	MITSUBISHI ELECTRIC EUROPE B.V. UK Branch Travellers Lane, UK-Hatfield, Hertfordshire, AL10 8XB, U.K.	Tel : +44-1707-28-8780 Fax : +44-1707-27-8695
Ireland	MITSUBISHI ELECTRIC EUROPE B.V. Irish Branch Westgate Business Park, Ballymount, Dublin 24, Ireland	Tel : +353-1-4198800 Fax : +353-1-4198890
Italy	MITSUBISHI ELECTRIC EUROPE B.V. Italian Branch Centro Direzionale Colleoni - Palazzo Sirio, Viale Colleoni 7, 20864 Agrate Brianza (MB), Italy	Tel : +39-039-60531 Fax : +39-039-6053-312
Spain	MITSUBISHI ELECTRIC EUROPE, B.V. Spanish Branch Carretera de Rubi, 76-80-Apdo. 420, E-08190 Sant Cugat del Valles (Barcelona), Spain	Tel : +34-935-65-3131 Fax : +34-935-89-1579
France	MITSUBISHI ELECTRIC EUROPE B.V. French Branch 25, Boulevard des Bouvets, 92741 Nanterre Cedex, France	Tel : +33-1-55-68-55-68 Fax : +33-1-55-68-57-57
Czech Republic	MITSUBISHI ELECTRIC EUROPE B.V. Czech Branch, Prague Office Pekarska 621/7, 155 00 Praha 5, Czech Republic	Tel : +420-255-719-200
Poland	MITSUBISHI ELECTRIC EUROPE B.V. Polish Branch ul. Krakowska 48, 32-083 Balice, Poland	Tel : +48-12-347-65-00
Sweden	MITSUBISHI ELECTRIC EUROPE B.V. (Scandinavia) Hedvig Mollersgata 6, 223 55 Lund, Sweden	Tel : +46-8-625-10-00 Fax : +46-46-39-70-18
Russia	MITSUBISHI ELECTRIC (RUSSIA) LLC St. Petersburg Branch Piskarevsky pr. 2, bld 2, lit "Sch", BC "Benua", office 720; 195027 St. Petersburg, Russia	Tel : +7-812-633-3497 Fax : +7-812-633-3499
Turkey	MITSUBISHI ELECTRIC TURKEY A.S Umraniye Branch Serifali Mahallesi Nutuk Sokak No:5, TR-34775 Umraniye/Istanbul, Turkey	Tel : +90-216-526-3990 Fax : +90-216-526-3995
UAE	MITSUBISHI ELECTRIC EUROPE B.V. Dubai Branch Dubai Silicon Oasis, P.O.BOX 341241, Dubai, U.A.E.	Tel : +971-4-3724716 Fax : +971-4-3724721
South Africa	ADROIT TECHNOLOGIES 20 Waterford Office Park, 189 Witkoppen Road, Fourways, South Africa	Tel : +27-11-658-8100 Fax : +27-11-658-8101
China	MITSUBISHI ELECTRIC AUTOMATION (CHINA) LTD. Mitsubishi Electric Automation Center, No.1386 Hongqiao Road, Shanghai, China	Tel : +86-21-2322-3030 Fax : +86-21-2322-3000
Taiwan	SETSUYO ENTERPRISE CO., LTD. 6F, No.105, Wugong 3rd Road, Wugu District, New Taipei City 24889, Taiwan	Tel : +886-2-2299-2499 Fax : +886-2-2299-2509
Korea	MITSUBISHI ELECTRIC AUTOMATION KOREA CO., LTD. 7F to 9F, Gangseo Hangang Xi-tower A, 401, Yangcheon-ro, Gangseo-Gu, Seoul 07528, Korea	Tel : +82-2-3660-9569 Fax : +82-2-3664-8372
Singapore	MITSUBISHI ELECTRIC ASIA PTE. LTD. 307 Alexandra Road, Mitsubishi Electric Building, Singapore 159943	Tel : +65-6473-2308 Fax : +65-6476-7439
Thailand	MITSUBISHI ELECTRIC FACTORY AUTOMATION (THAILAND) CO., LTD. 12th Floor, SV.City Building, Office Tower 1, No. 896/19 and 20 Rama 3 Road, Kwaeng Bangpongpan, Khet Yannawa, Bangkok 10120, Thailand	Tel : +66-2092-8600 Fax : +66-2043-1231-33
Vietnam	MITSUBISHI ELECTRIC VIETNAM COMPANY LIMITED Unit 01-04, 10th Floor, Vincom Center, 72 Le Thanh Ton Street, District 1, Ho Chi Minh City, Vietnam	Tel : +84-28-3910-5945 Fax : +84-28-3910-5947
Indonesia	PT. MITSUBISHI ELECTRIC INDONESIA Gedung Jaya 8th Floor, JL. MH. Thamrin No.12, Jakarta Pusat 10340, Indonesia	Tel : +62-21-31926461 Fax : +62-21-31923942
India	MITSUBISHI ELECTRIC INDIA PVT. LTD. Pune Branch Emerald House, EL-3, J Block, M.I.D.C., Bhosari, Pune-411026, Maharashtra, India	Tel : +91-20-2710-2000 Fax : +91-20-2710-2100
Australia	MITSUBISHI ELECTRIC AUSTRALIA PTY. LTD. 348 Victoria Road, P.O. Box 11, Rydalmere, N.S.W 2116, Australia	Tel : +61-2-9684-7777 Fax : +61-2-9684-7245

Mitsubishi Electric Corporation Nagoya Works is a factory certified for ISO 14001 (standards for environmental management systems) and ISO 9001 (standards for quality assurance management systems).

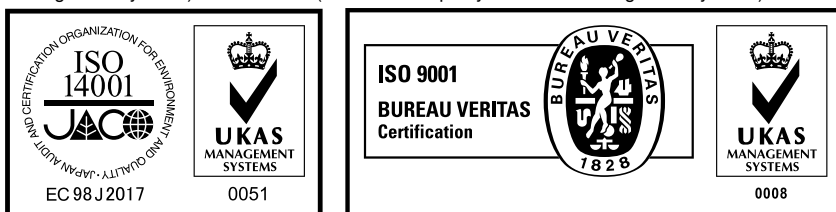

MITSUBISHI ELECTRIC CORPORATION
 HEAD OFFICE: TOKYO BLDG., 2-7-3, MARUNOUCHI, CHIYODA-KU, TOKYO 100-8310, JAPAN
www.MitsubishiElectric.com