

MITSUBISHI

Mitsubishi Programmable Controller

MELSEC *L* series

MELSEC-L CPU Module User's Manual

Built-In I/O Function

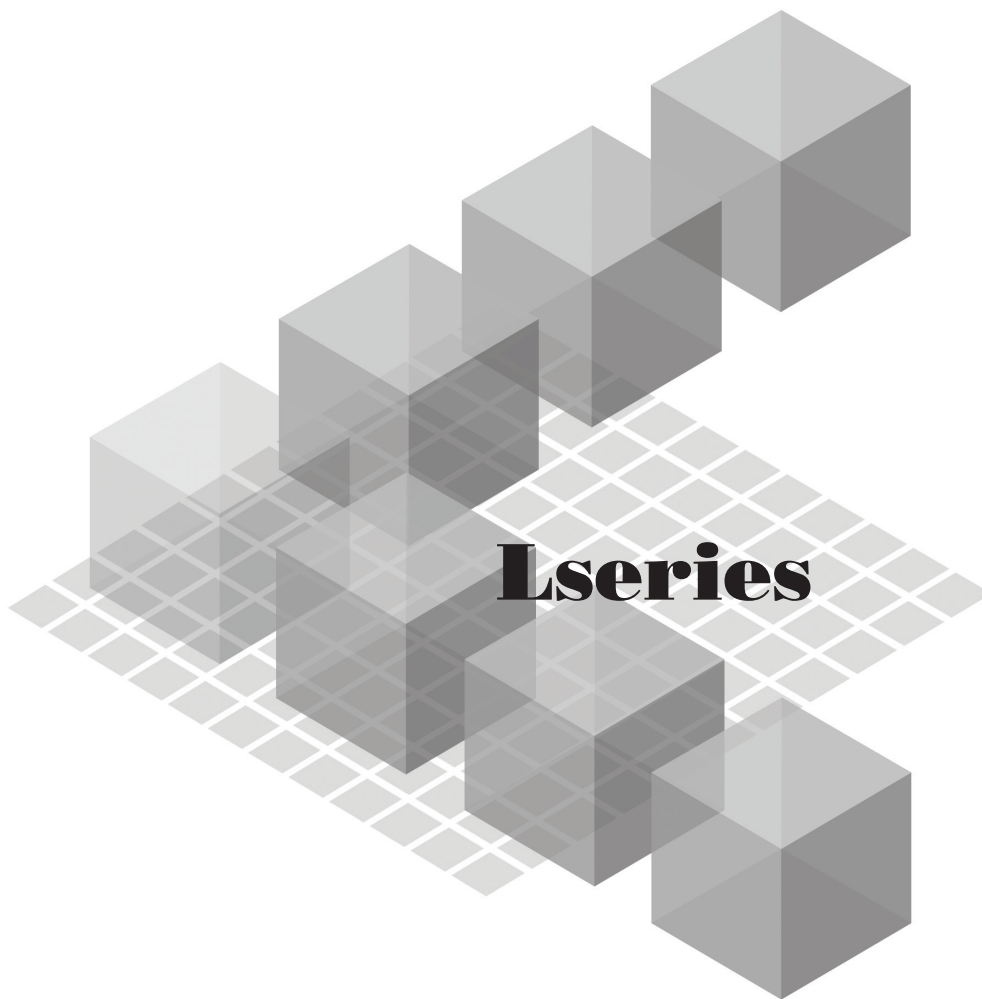

-L02SCPU	-L06CPU-P
-L02SCPU-P	-L26CPU
-L02CPU	-L26CPU-P
-L02CPU-P	-L26CPU-BT
-L06CPU	-L26CPU-PBT

MODEL

● SAFETY PRECAUTIONS ●

(Read these precautions before using this product.)

Before using this product, please read this manual and the relevant manuals carefully and pay full attention to safety to handle the product correctly.

In this manual, the safety precautions are classified into two levels: "⚠ WARNING" and "⚠ CAUTION".



Indicates that incorrect handling may cause hazardous conditions, resulting in death or severe injury.



Indicates that incorrect handling may cause hazardous conditions, resulting in minor or moderate injury or property damage.

Under some circumstances, failure to observe the precautions given under "⚠ CAUTION" may lead to serious consequences.

Observe the precautions of both levels because they are important for personal and system safety.

Make sure that the end users read this manual and then keep the manual in a safe place for future reference.

[Design Precautions]

⚠ WARNING

- Configure safety circuits external to the programmable controller to ensure that the entire system operates safely even when a fault occurs in the external power supply or the programmable controller. Failure to do so may result in an accident due to an incorrect output or malfunction.
 - (1) Emergency stop circuits, protection circuits, and protective interlock circuits for conflicting operations (such as forward/reverse rotations or upper/lower limit positioning) must be configured external to the programmable controller.
 - (2) Machine OPR (Original Point Return) of the positioning function is controlled by two kinds of data: an OPR direction and an OPR speed. Deceleration starts when the near-point watchdog signal turns on. If an incorrect OPR direction is set, motion control may continue without deceleration. To prevent machine damage caused by this, configure an interlock circuit external to the programmable controller.
 - (3) When the CPU module detects an error during control by the positioning function, the motion slows down and stops.

[Design Precautions]

WARNING

- (4) When the programmable controller detects an abnormal condition, it stops the operation and all outputs are:
- Turned off if the overcurrent or overvoltage protection of the power supply module is activated.
 - Held or turned off according to the parameter setting if the self-diagnostic function of the CPU module detects an error such as a watchdog timer error.
- Also, all outputs may be turned on if an error occurs in a part, such as an I/O control part, where the CPU module cannot detect any error. To ensure safety operation in such a case, provide a safety mechanism or a fail-safe circuit external to the programmable controller. For a fail-safe circuit example, refer to "General Safety Requirements" in the MELSEC-L CPU Module User's Manual (Hardware Design, Maintenance and Inspection).
- (5) Outputs may remain on or off due to a failure of a component such as a transistor in an output circuit. Configure an external circuit for monitoring output signals that could cause a serious accident.
- In an output circuit, when a load current exceeding the rated current or an overcurrent caused by a load short-circuit flows for a long time, it may cause smoke and fire. To prevent this, configure an external safety circuit, such as a fuse.
 - Configure a circuit so that the programmable controller is turned on first and then the external power supply. If the external power supply is turned on first, an accident may occur due to an incorrect output or malfunction.
 - Configure a circuit so that the external power supply is turned off first and then the programmable controller. If the programmable controller is turned off first, an accident may occur due to an incorrect output or malfunction.
 - For the operating status of each station after a communication failure, refer to relevant manuals for each network. Incorrect output or malfunction due to a communication failure may result in an accident.
 - When changing data from a peripheral device connected to the CPU module during operation, configure an interlock circuit in the program to ensure that the entire system will always operate safely. For other controls to a running programmable controller (such as program modification or operating status change), read relevant manuals carefully and ensure the safety before the operation. Especially, in the case of a control from an external device to a remote programmable controller, immediate action cannot be taken for a problem on the programmable controller due to a communication failure. To prevent this, configure an interlock circuit in the program, and determine corrective actions to be taken between the external device and CPU module in case of a communication failure.
 - An absolute position restoration by the positioning function may turn off the servo-on signal (servo off) for approximately 20ms, and the motor may run unexpectedly. If this causes a problem, provide an electromagnetic brake to lock the motor during absolute position restoration.

[Design Precautions]

CAUTION

- Do not install the control lines or communication cables together with the main circuit lines or power cables. Keep a distance of 100mm or more between them. Failure to do so may result in malfunction due to noise.
- During control of an inductive load such as a lamp, heater, or solenoid valve, a large current (approximately ten times greater than normal) may flow when the output is turned from off to on. Therefore, use a module that has a sufficient current rating.
- Time from when the CPU module is powered on or is reset to when it enters in RUN status depends on the system configuration, parameter settings, and program size.
Design the program so that the entire system will always operate safely, regardless of the time.

[Installation Precautions]

WARNING

- Shut off the external power supply (all phases) used in the system before connecting or removing a module. Failure to do so may result in electric shock or cause the module to fail or malfunction.

[Installation Precautions]

CAUTION

- Use the programmable controller in an environment that meets the general specifications in the MELSEC-L CPU Module User's Manual (Hardware Design, Maintenance and Inspection). Failure to do so may result in electric shock, fire, malfunction, or damage to or deterioration of the product.
- To interconnect modules, engage the respective connectors and securely lock the module joint levers until they click. Incorrect interconnection may cause malfunction, failure, or drop of the module.
- Do not directly touch any conductive parts and electronic components of the module. Doing so can cause malfunction or failure of the module.
- Securely connect an extension cable to the connectors of a branch module and an extension module. After connections, check that the cable is inserted completely. Poor contact may cause malfunction.
- When using an SD memory card, fully insert it into the SD memory card slot. Check that it is inserted completely. Poor contact may cause malfunction.
- Do not directly touch any conductive parts and electronic components of the module or SD memory card. Doing so can cause malfunction or failure of the module.

[Wiring Precautions]

WARNING

- Shut off the external power supply (all phases) used in the system before wiring. Failure to do so may result in electric shock or cause the module to fail or malfunction.
- After installation and wiring, attach the included terminal cover to the module before turning it on for operation. Failure to do so may result in electric shock.

[Wiring Precautions]

CAUTION

- Individually ground the FG terminal of the programmable controller with a ground resistance of 100Ω or less. Failure to do so may result in electric shock or malfunction.
- Use applicable solderless terminals and tighten them within the specified torque range.
If any spade solderless terminal is used, it may be disconnected when a terminal block screw comes loose, resulting in failure.
- Check the rated voltage and terminal layout before wiring to the module, and connect the cables correctly. Connecting a power supply with a different voltage rating or incorrect wiring may cause a fire or failure.
- Connectors for external devices must be crimped or pressed with the tool specified by the manufacturer, or must be correctly soldered. Incomplete connections may cause short circuit, fire, or malfunction.
- Securely connect the connector to the module.
- Do not install the control lines or communication cables together with the main circuit lines or power cables. Failure to do so may result in malfunction due to noise.
- Place the cables in a duct or clamp them. If not, dangling cable may swing or inadvertently be pulled, resulting in damage to the module or cables or malfunction due to poor contact.
- Check the interface type and correctly connect the cable.
Incorrect wiring (connecting the cable to an incorrect interface) may cause failure of the module and external device.
- Tighten the terminal block screw within the specified torque range. Undertightening can cause short circuit, fire, or malfunction. Overtightening can damage the screw and/or module, resulting in drop, short circuit, or malfunction.
- When disconnecting the cable from the module, do not pull the cable by the cable part. For the cable with connector, hold the connector part of the cable. For the cable connected to the terminal block, loosen the terminal screw. Pulling the cable connected to the module may result in malfunction or damage to the module or cable.
- Prevent foreign matter such as dust or wire chips from entering the module. Such foreign matter can cause a fire, failure, or malfunction.
- A protective film is attached to the top of the module to prevent foreign matter, such as wire chips, from entering the module during wiring. Do not remove the film during wiring. Remove it for heat dissipation before system operation.
- To use the high-speed counter function, ground the shield cable on the encoder side (relay box). Always ground the FG and LG terminals to the protective ground conductor.
Failure to do so may cause malfunction.
- Mitsubishi programmable controllers must be installed in control panels. Connect the main power supply to the power supply module in the control panel through a relay terminal block.
Wiring and replacement of a power supply module must be performed by qualified maintenance personnel with knowledge of protection against electric shock.
For wiring methods, refer to the MELSEC-L CPU Module User's Manual (Hardware Design, Maintenance and Inspection).

[Startup and Maintenance Precautions]

WARNING

- Do not touch any terminal while power is on. Doing so will cause electric shock or malfunction.
- Correctly connect the battery connector. Do not charge, disassemble, heat, short-circuit, solder, or throw the battery into the fire. Also, do not expose it to liquid or strong shock.
Doing so will cause the battery to produce heat, explode, ignite, or leak, resulting in injury and fire.
- Shut off the external power supply (all phases) used in the system before cleaning the module or retightening the terminal block screws. Failure to do so may result in electric shock.

[Startup and Maintenance Precautions]

CAUTION

- Before performing online operations (especially, program modification, forced output, and operating status change) for the running CPU module from the peripheral device connected, read relevant manuals carefully and ensure the safety. Improper operation may damage machines or cause accidents.
- Do not disassemble or modify the modules. Doing so may cause failure, malfunction, injury, or a fire.
- Use any radio communication device such as a cellular phone or PHS (Personal Handy-phone System) more than 25cm away in all directions from the programmable controller. Failure to do so may cause malfunction.
- Shut off the external power supply (all phases) used in the system before connecting or removing a module. Failure to do so may cause the module to fail or malfunction.
- Tighten the terminal block screw within the specified torque range. Undertightening can cause drop of the component or wire, short circuit, or malfunction. Overtightening can damage the screw and/or module, resulting in drop, short circuit, or malfunction.
- After the first use of the product (module, display unit, and terminal block), the number of connections/disconnections is limited to 50 times (in accordance with IEC 61131-2). Exceeding the limit may cause malfunction.
- After the first use of the SD memory card, the number of insertions/removals is limited to 500 times. Exceeding the limit may cause malfunction.
- Do not drop or apply shock to the battery to be installed in the module. Doing so may damage the battery, causing the battery fluid to leak inside the battery. If the battery is dropped or any shock is applied to it, dispose of it without using.
- Before handling the module, touch a conducting object such as a grounded metal to discharge the static electricity from the human body. Failure to do so may cause the module to fail or malfunction.
- Before testing the operation by the positioning function, set a low speed value for the speed limit parameter so that the operation can be stopped immediately upon occurrence of a hazardous condition.

[Disposal Precautions]

CAUTION

- When disposing of this product, treat it as industrial waste. When disposing of batteries, separate them from other wastes according to the local regulations. (For details on battery regulations in EU member states, refer to the MELSEC-L CPU Module User's Manual (Hardware Design, Maintenance and Inspection).)

[Transportation Precautions]

CAUTION

- When transporting lithium batteries, follow the transportation regulations. (For details on the regulated models, refer to the MELSEC-L CPU Module User's Manual (Hardware Design, Maintenance and Inspection).)

● CONDITIONS OF USE FOR THE PRODUCT ●

- (1) Mitsubishi programmable controller ("the PRODUCT") shall be used in conditions;
- i) where any problem, fault or failure occurring in the PRODUCT, if any, shall not lead to any major or serious accident; and
 - ii) where the backup and fail-safe function are systematically or automatically provided outside of the PRODUCT for the case of any problem, fault or failure occurring in the PRODUCT.
- (2) The PRODUCT has been designed and manufactured for the purpose of being used in general industries.

MITSUBISHI SHALL HAVE NO RESPONSIBILITY OR LIABILITY (INCLUDING, BUT NOT LIMITED TO ANY AND ALL RESPONSIBILITY OR LIABILITY BASED ON CONTRACT, WARRANTY, TORT, PRODUCT LIABILITY) FOR ANY INJURY OR DEATH TO PERSONS OR LOSS OR DAMAGE TO PROPERTY CAUSED BY THE PRODUCT THAT ARE OPERATED OR USED IN APPLICATION NOT INTENDED OR EXCLUDED BY INSTRUCTIONS, PRECAUTIONS, OR WARNING CONTAINED IN MITSUBISHI'S USER, INSTRUCTION AND/OR SAFETY MANUALS, TECHNICAL BULLETINS AND GUIDELINES FOR THE PRODUCT.

("Prohibited Application")

Prohibited Applications include, but not limited to, the use of the PRODUCT in;

- Nuclear Power Plants and any other power plants operated by Power companies, and/or any other cases in which the public could be affected if any problem or fault occurs in the PRODUCT.
- Railway companies or Public service purposes, and/or any other cases in which establishment of a special quality assurance system is required by the Purchaser or End User.
- Aircraft or Aerospace, Medical applications, Train equipment, transport equipment such as Elevator and Escalator, Incineration and Fuel devices, Vehicles, Manned transportation, Equipment for Recreation and Amusement, and Safety devices, handling of Nuclear or Hazardous Materials or Chemicals, Mining and Drilling, and/or other applications where there is a significant risk of injury to the public or property.

Notwithstanding the above, restrictions Mitsubishi may in its sole discretion, authorize use of the PRODUCT in one or more of the Prohibited Applications, provided that the usage of the PRODUCT is limited only for the specific applications agreed to by Mitsubishi and provided further that no special quality assurance or fail-safe, redundant or other safety features which exceed the general specifications of the PRODUCTS are required. For details, please contact the Mitsubishi representative in your region.

INTRODUCTION

Thank you for purchasing the Mitsubishi MELSEC-L series programmable controllers.
This manual describes the functions of the external I/O interface of the LCPU and programming.

Before using this product, please read this manual and the relevant manuals carefully and develop familiarity with the functions and performance of the MELSEC-L series programmable controller to handle the product correctly.
When applying the program examples introduced in this manual to the actual system, ensure the applicability and confirm that it will not cause system control problems.

Please make sure that the end users read this manual.

■ Relevant CPU modules

CPU module	Model
LCPU	L02SCPU, L02SCPU-P, L02CPU, L02CPU-P, L06CPU, L06CPU-P, L26CPU, L26CPU-P, L26CPU-BT, L26CPU-PBT

Remark

- This manual describes only built-in I/O functions for the CPU module.
For the functions except for built-in I/O functions of the CPU module, refer to the following.
 - 📖 MELSEC-L CPU Module User's Manual (Function Explanation, Program Fundamentals)
 - 📖 MELSEC-L CPU Module User's Manual (Built-In Ethernet Function)
 - 📖 QnUDVCP/LCPU User's Manual (Data Logging Function)
- Unless otherwise specified, this manual describes examples of assigning from X0 to XF for input numbers and from Y0 to Y7 for output numbers in each function. For I/O number assignment, refer to the following.
 - 📖 MELSEC-L CPU Module User's Manual (Function Explanation, Program Fundamentals)
- Unless otherwise specified, Chapter 7 POSITIONING FUNCTION in this manual is described as using examples of the setting, special relay, special register, dedicated instruction, error code and warning code supported for Axis #1.
- Unless otherwise specified, Chapter 8 HIGH-SPEED COUNTER FUNCTION in this manual is described as using examples of the setting, special relay, special register, dedicated instruction, error code and warning code supported for CH1.

RELEVANT MANUALS

(1) CPU module user's manual

Manual name <manual number (model code)>	Description
MELSEC-L CPU Module User's Manual (Hardware Design, Maintenance and Inspection) <SH-080890ENG, 13JZ36>	Specifications of the CPU modules, power supply modules, display unit, branch module, extension module, SD memory cards, and batteries, information on how to establish a system, maintenance and inspection, and troubleshooting
MELSEC-L CPU Module User's Manual (Function Explanation, Program Fundamentals) <SH-080889ENG, 13JZ35>	Functions and devices of the CPU module, and programming
MELSEC-L CPU Module User's Manual (Built-In Ethernet Function) <SH-080891ENG, 13JZ37>	The built-in Ethernet function of the CPU module
QnUDVCPULCPU User's Manual (Data Logging Function) <SH-080893ENG, 13JZ39>	The data logging function of the CPU module

(2) Programming manual

Manual name <manual number (model code)>	Description
MELSEC-Q/L Programming Manual (Common Instruction) <SH-080809ENG, 13JW10>	Detailed description and usage of instructions used in programs

(3) Operating manual

Manual name <manual number (model code)>	Description
GX Works2 Version1 Operating Manual (Common) <SH-080779ENG, 13JU63>	System configuration, parameter settings, and online operations (common to Simple project and Structured project) of GX Works2
GX Developer Version 8 Operating Manual <SH-080373ENG, 13JU41>	Operating methods of GX Developer, such as programming, printing, monitoring, and debugging

(4) I/O module and intelligent function module manual

Manual name <manual number (model code)>	Description
MELSEC-L I/O Module User's Manual <SH-080888ENG, 13JZ34>	Specifications and troubleshooting of the I/O module

CONTENTS

SAFETY PRECAUTIONS	1
CONDITIONS OF USE FOR THE PRODUCT	7
INTRODUCTION	8
RELEVANT MANUALS	9
MANUAL PAGE ORGANIZATION	13
TERMS	16
<hr/>	
CHAPTER 1 OVERVIEW	18
<hr/>	
CHAPTER 2 EXTERNAL I/O SPECIFICATIONS	20
<hr/>	
CHAPTER 3 GENERAL-PURPOSE INPUT FUNCTION	28
<hr/>	
CHAPTER 4 GENERAL-PURPOSE OUTPUT FUNCTION	30
<hr/>	
CHAPTER 5 INTERRUPT INPUT FUNCTION	32
<hr/>	
CHAPTER 6 PULSE CATCH FUNCTION	36
<hr/>	
CHAPTER 7 POSITIONING FUNCTION	39
<hr/>	
7.1 Overview	39
7.1.1 Procedure for performing the positioning function	47
7.2 Connection to External Devices	48
7.2.1 I/O signals	48
7.2.2 Wiring	52
7.3 Parameter Setting	53
7.3.1 Positioning parameter	55
7.4 Specifications	59
7.5 Checking Current Position and Operation Status	61
7.6 OPR Control	62
7.6.1 Machine OPR	70
7.6.2 Fast OPR	90
7.6.3 Forced off of Axis 1 OPR request (SM1842)	92
7.6.4 Precautions on Axis 1 OPR request (SM1842)	92
7.7 Positioning Control	93
7.7.1 Start of positioning control	97
7.7.2 Position control	99
7.7.3 Speed/position switching control	100
7.7.4 Current value change	102
7.7.5 Speed control	103
7.8 Multiple Axes Simultaneous Start Control	104
7.9 JOG Operation	106
7.10 Subfunction	110
7.10.1 OPR retry function	111
7.10.2 Speed limit function	115
7.10.3 Speed change function	116

7.10.4	Software stroke limit function	121
7.10.5	Hardware stroke limit function	124
7.10.6	Target position change function	125
7.10.7	Acceleration/deceleration processing function	129
7.10.8	Stop processing function	131
7.11	Absolute Position Restoration Function	134
7.12	Dedicated Instructions	139
7.12.1	Details of dedicated instructions	140
7.12.2	Precautions on dedicated instructions	163
7.13	Programming	165
7.14	Errors and Warnings	175
7.15	Monitoring with a Programming Tool	180

CHAPTER 8 HIGH-SPEED COUNTER FUNCTION	181
--	------------

8.1	Overview	181
8.1.1	Procedure for performing the high-speed counter function	184
8.2	Connection to External Devices	185
8.2.1	I/O signals	185
8.2.2	Wiring	188
8.3	Parameter Setting	194
8.3.1	Common settings	196
8.4	Normal Mode	201
8.4.1	Preset	206
8.4.2	Coincidence output	209
8.4.3	Coincidence detection	213
8.4.4	Counter function selection	216
8.5	Frequency Measurement Mode	225
8.6	Rotation Speed Measurement Mode	231
8.7	Pulse Measurement Mode	237
8.8	PWM Output Mode	240
8.9	Specifications	243
8.10	Dedicated Instructions	245
8.10.1	Details of dedicated instructions	246
8.10.2	Precautions on dedicated instructions	261
8.11	Programming	262
8.12	Errors and Warnings	269
8.13	When the LCPU Stops Operation	271
8.14	Monitoring with a Programming Tool	272

APPENDICES	273
-------------------	------------

Appendix 1	Processing Time of Each Instruction	273
Appendix 2	Connection Examples with Servo Amplifiers	275
Appendix 2.1	Connection examples with servo amplifiers manufactured by Mitsubishi	275
Appendix 2.2	Connection examples with stepping motors manufactured by ORIENTAL MOTOR CO.,LTD.	277

Appendix 2.3 Connection examples with servo amplifiers manufactured by Panasonic Corporation	281
Appendix 2.4 Connection examples with servo amplifiers manufactured by SANYODENKI CO.,LTD.	283
Appendix 2.5 Connection examples with servo amplifiers manufactured by YASKAWA Electric Corporation	284

INDEX	286
-------	-----

INSTRUCTION INDEX	289
REVISIONS	290
WARRANTY	291

MANUAL PAGE ORGANIZATION

In this manual, pages are organized and the symbols are used as shown below.

The following page illustration is for explanation purpose only, and is different from the actual pages.

Diagram illustrating the organization of a manual page, showing various symbols and their meanings:

- ""** is used for screen names and items.
- 1.** shows operating procedures.
- shows mouse operations.*1
- []** is used for items in the menu bar and the project window.
- Ex.** shows setting or operating examples.
- shows reference manuals.
- shows reference pages.
- Point** shows notes that require attention.
- Remark** shows useful information.

The diagram also shows the page structure:

- CHAPTER 7 VARIOUS SETTINGS** (The chapter of the current page is shown.)
- 7.1.1 Setting method** (The section of the current page is shown.)
- (1) Setting parameters**
- (a) Operating procedure**
- 1.** Open the "PLC Parameter" dialog box.
- 2.** Select the "IO Assignment" tab.

The diagram includes a screenshot of the "Parameter Setting" dialog box and a table of settings:

Item	Description	Reference
Type	Select the type of the connected module.	Page 74, Section 7.1.2
Model Name	Select the model name of the connected module.	Page 74, Section 7.1.3
Points	Set the number of points assigned to each slot.	Page 74, Section 7.1.4
Start XY	Specify a start I/O number for each slot.	Page 74, Section 7.1.5
Switch Setting	Configure the switch setting of the built-in I/O or intelligent function modules.	Page 74, Section 7.1.6
Response Setting	Set the following: - Error Time Output Mode - PLC Operation Mode at HW Error - I/O Response Time	Page 75, Section 7.1.7

Setting "Start.XY" enables modification on the start I/O numbers assigned to connected modules.
 When "1000" is specified in "Start.XY" to the slot where a 16-point module is connected, the assignment range of an input module is changed to X1000 to X100F.
 For details, refer to the following:
 MELSEC-CPU Module User's Manual (Function Explanation, Program Fundamentals)
Point
 Set the type of the connected module in "Type". Setting a different type results in "SPUNIT LAV ERR."
 For the intelligent function module, the I/O points must also be the same in addition to the I/O assignment setting.
Remark
 When an intelligent module is connected, I/O assignment can be omitted by selecting connected modules from "Intelligent Function Module" in the Project window.

*1 The mouse operation example is provided below. (For GX Works2)

Diagram illustrating the software interface (MELSOFT Series GX Works2) and the steps to access the PLC Parameter dialog box:

- Menu bar:** Select [Online] on the menu bar, and then select [Write to PLC...].
- View selection area:** A window selected in the view selection area is displayed. Select [Project] from the view selection area to open the Project window. In the Project window, expand [Parameter] and select [PLC Parameter].

The screenshot shows the MELSOFT Series GX Works2 interface with the following components:

- Menu bar:** Project, Edit, Find/Replace, Compile, View, Online, Debug, Diagnostics.
- Navigation:** Project, Parameter, Intelligent Function Module, Global Device Comment, Program Setting, POU, Program MAIN, Local Device Comment, Device Memory, Device Initial Value.
- Project window:** Project, User Library, Connection Destination.

Pages describing instructions are organized as shown below.

The following page illustration is for explanation purpose only, and is different from the actual pages.

CHAPTER 6 SOCKET COMMUNICATION FUNCTION

6.4.2 Disconnecting a connection (SP.SOCPCLOSE)

SP.SOCPCLOSE Command: SP.SOCPCLOSE U0 ④ ⑤ ⑥

Setting data	Internal device		R, ZR		JIC□		UIC□□	Zn	Const nt K, H	Others
	Bit	Word	Bit	Word	Bit	Word				
④	—	O	O	—	—	—	—	—	O	—
⑤	—	△ ¹	△ ¹	—	—	—	—	—	—	—
⑥	—	△ ¹	△ ¹	—	—	—	—	—	—	—

*1 File registers set for each local device or program cannot be used.

(1) Setting data

Setting data	Description	Set by	Data type
U0	Dummy	—	Character string
④	Connection number (Setting range: 1 to 16)	User	BIN 16-bit
⑤	Start number of the device from which control data are stored	—	Device name
⑥	Start number of the device which turns on for one scan upon completion of the instruction ⑥+1 also turns on when failed.	System	Bit

(2) Control data

Device	Item	Description	Setting range	Set by
⑥+0	System area	—	—	—
⑥+1	Completion status	Completion status is stored 0000h: Completed Other than 0000h: Failed (Error code)	—	System

Setting side
User : Device value is set by the user.
System: Device value is set by the CPU module.

(3) Function

This instruction closes a connection specified in ④. (Disconnection of a connection)
 The result of the SP.SOCPCLOSE instruction can be checked with the completion device, ⑥+0 and ⑥+1.

- Completion device ⑥+0
Turns on in the END processing of a scan after completion of the SP.SOCPCLOSE instruction, and turns off in the next END processing.
- Completion device ⑥+1
Turns on or off according to the result of the SP.SOCPCLOSE instruction.

State	Description
When completed	Remains off.
When failed	Turns on in the END processing of a scan after completion of the SP.SOCPCLOSE instruction, and turns off in the next END processing.

(4) Error

A detection of an operation error turns on the Error flag (SM0) and a corresponding error code is stored in S00 when:

- The connection number specified for ④ is other than 1 to 16. (Error code: 4101)
- The device numbers specified for ⑤ and ⑥ exceed the device point range. (Error code: 4101)
- An invalid device is specified. (Error code: 4004)

(5) Program example

When M2000 is turned on or when the connected device disconnects connection No. 1, connection No. 1 is disconnected by the following program.

- Device used

Device number	Application
SD1282	Open completion signal
SD1284	Open request signal
D200	SP.SOCPCLOSE instruction control data
M200	SP.SOCPCLOSE instruction completion device





• Program

```

SD1282 SD1284
M200 SP.SOCPCLOSE M200
M200 SET M210
M200 SET M202
M201 SET M202
M201 RST M210
END
    
```

Processing for disconnection of Connection No. 1: close Connection No. 1: close
 Setting SP.SOCPCLOSE instruction control data
 Normal completion
 Error completion
 Resetting SP.SOCPCLOSE instruction control data

- Instructions can be executed under the following conditions.

Execution condition	Any time	During on	On the rising edge	During off	On the falling edge
Symbol	No symbol				

- The following devices can be used.

Setting data	Internal device (system, user)		File register	Link direct device J□□□		Intelligent function module device U□\G□	Index register Zn	Constant *3	Others *3
	Bit	Word		Bit	Word				
Applicable device*1	X, Y, M, L, S, M, F, B, SB, FX, FY*2	T, ST, C, D, W, SD, SW, FD, @□	R, ZR	—		U□\G□	Z	K,H,E,\$	P, I, J, U, D, X, DY, N, BL, TR, BL\S,V

*1 For details on each device, refer to the following.

 MELSEC-L CPU Module User's Manual (Function Explanation, Program Fundamentals)

*2 FX and FY can be used for bit data only, and FD for word data only.

*3 In the "Constant" and "Other" columns, a device(s) that can be set for each instruction is shown.

- The following data types can be used.

Data type	Description
Bit	Bit data or the start number of bit data
BIN 16-bit	16-bit binary data or the start number of word device
BIN 32-bit	32-bit binary data or the start number of double-word device
BCD 4-digit	Four-digit binary-coded decimal data
BCD 8-digit	Eight-digit binary-coded decimal data
Real number	Floating-point data
Character string	Character string data
Device name	Device name data

TERMS

Unless otherwise specified, this manual uses the following terms.

Term	Description
CPU module	The abbreviation for the MELSEC-L series CPU module
Power supply module	The abbreviation for the MELSEC-L series power supply module
Branch module	The abbreviation for the MELSEC-L series branch module
Extension module	The abbreviation for the MELSEC-L series extension module
END cover	A cover to be attached to the right side of the rightmost MELSEC-L series module
Display unit	A liquid crystal display to be attached to the CPU module
Extension cable	The abbreviation for the MELSEC-L series extension cable
LCPU	Another term for the MELSEC-L series CPU module
Programming tool	A generic term for GX Works2 and GX Developer
GX Works2	The product name of the software package for the MELSEC programmable controllers
GX Developer	
Encoder	One of the pulse generators that converts input data into binary data (on and off)
Near-point watchdog	A switch used in positioning systems, placed in front of the starting point of a workpiece. When this switch turns on, the feed speed is switched to creep speed. Therefore, the deceleration time is required while this switch is on.
Servo on	A signal that indicates the normal status of a servo amplifier. A servo amplifier is operable only when this signal is on.
Servo motor	A motor that rotates according to a command. This motor is highly responsive, therefore frequent and rapid start and stop are available with high precision. DC and AC type motors are available. Feedback control is available with the included pulse generator that detects the number of rotations.
Stepping motor	A motor that rotates by the predetermined angle for every pulse. The number of rotations is proportional to the number of pulses. A small power motor is applied, and it rotates accurately without feedbacks. Do not overload the motor, otherwise it will be out of step.
Zero signal	PG0 of a pulse generator (encoder), that is detected once in one rotation.
Drive unit (servo amplifier)	A unit used to amplify the power and control the motor in the operation by the positioning function since the signals, such as pulses, that are output from the CPU module are low voltage and small current. The unit, also called a servo amplifier, is provided with a servomotor and step motor.
Pulse generator	A device that generates pulses. For example, by attaching this device on a motor axis, pulses can be generated by the rotation of the axis.
Warning	Different from an error, a warning is a minor error that does not terminate or stop the operation even if it is detected.
PWM	The abbreviation for pulse-width modulation, a method of changing a ratio of on width to off width of a pulse wave

Memo

CHAPTER 1 OVERVIEW

The LCPU is equipped with the following built-in I/O functions.

The built-in I/O functions allow constructing a small-scale system using the LCPU module alone because dedicated modules for these functions are not required. Therefore, the system cost can be reduced.

- General-purpose input function
- General-purpose output function
- Interrupt input function
- Pulse catch function
- Positioning function
- High-speed counter function

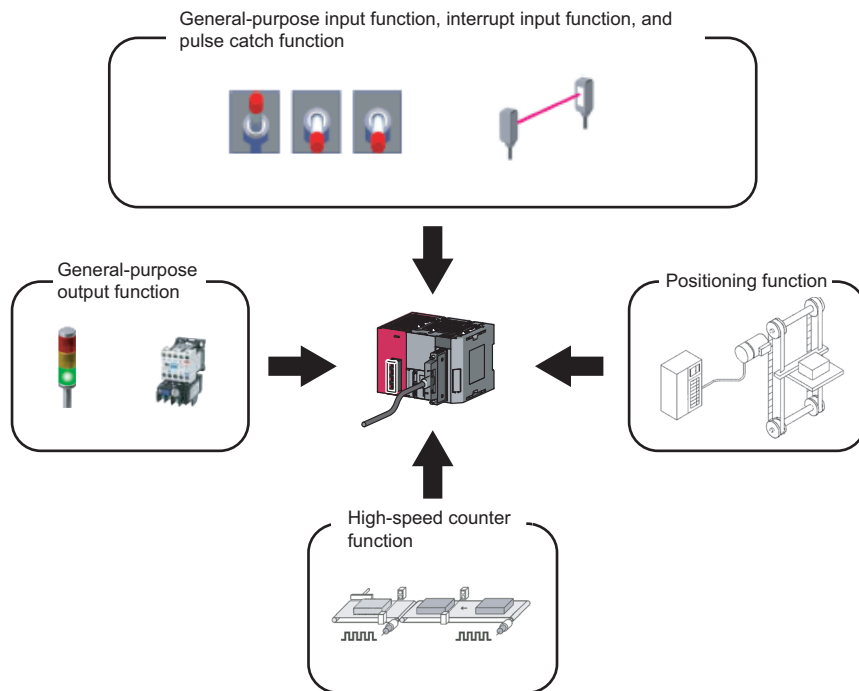

(1) Number of points used for each function

X0 to XF and Y0 to Y7 are sorted for each function.

Function	Available range	Number of points	
		Input	Output
General-purpose input function	0 to 16 points (input signal)	0 to 16 points	—
General-purpose output function	0 to 8 points (output signal)	—	0 to 8 points
Interrupt input function	0 to 16 points (input signal)	0 to 16 points	—
Pulse catch function	0 to 16 points (input signal)	0 to 16 points	—
High-speed counter function* ¹	0 to 2CH <ul style="list-style-type: none"> • Input signal: 0 to 5 points (points/channel) (depending on settings) • Output Signal: 0 to 2 points (points/channel) (depending on settings) 	<ul style="list-style-type: none"> • When using only one channel: 0 to 5 points • When using two channels simultaneously: 0 to 10 points 	<ul style="list-style-type: none"> • When using only one channel: 0 to 2 points • When using two channels simultaneously: 0 to 4 points
Positioning function* ¹	0 to 2 axes Input: 0 to 6 points (points/axis) (depending on settings) Output: 2 to 3 points (points/axis) (depending on settings)	<ul style="list-style-type: none"> • When using only one axis: 0 to 6 points • When using two axes simultaneously: 0 to 12 points 	<ul style="list-style-type: none"> • When using only one axis: 2 to 3 points • When using two axes simultaneously: 4 to 6 points

*¹ Assignment of some signals used for the high-speed counter function and positioning function (such as A phase, B phase, and near-point watchdog) are fixed. When using these functions, no signal can be assigned in place of the signals.

CHAPTER 2 EXTERNAL I/O SPECIFICATIONS

This chapter describes internal circuits, pin numbers and corresponding signal names, and specifications of external I/O interface.

For connectors used for external wiring, refer to  MELSEC-L CPU Module User's Manual (Hardware Design, Maintenance and Inspection).

(1) Input specifications

Item	Specification		
Signal name	High-speed input (IN0-IN5)		Standard input (IN6-INF)
	24V input	Differential input	24V input
Rated input voltage	24VDC (+20%/-15%, ripple ratio within 5%)	EIA Standard RS-422-A Differential line driver level (AM26L31 (Manufactured by Texas Instruments Incorporated) or equivalent)	24VDC (+20%/-15%, ripple ratio within 5%)
Rated input current	6.0mA (TYP.) (At 24VDC)		4.1mA (TYP.) (At 24VDC)
ON voltage/ON current	19.0V or higher/5.0mA or higher		19.0V or higher/3.5mA or higher
OFF voltage/OFF current	8V or lower/1.5mA or lower		8V or lower/1.0mA or lower
Input resistance	3.8kΩ		5.6kΩ
Response time	On	10μs or less	100μs or less
	Off	10μs or less	100μs or less
Withstand voltage	510VAC for 1 minute between input terminal and internal power supply (altitude: 0 to 2000m)		
Insulation resistance	10MΩ or higher between input terminals and internal power supply (500VDC insulation resistance tester)		
Wiring method for common	Independent common	-	10 points/common

The following shows a temperature derating curve for the input signal.

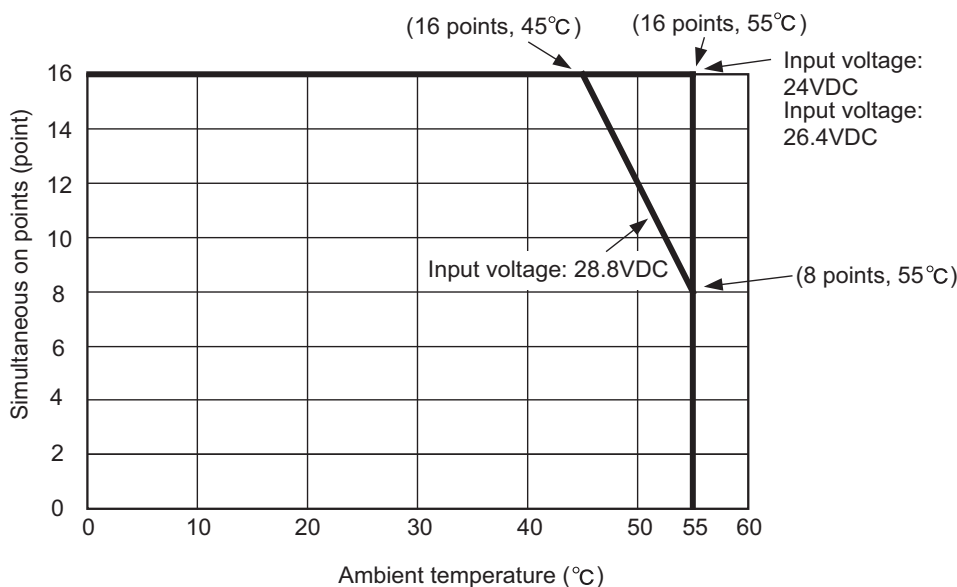

(2) Output specifications

Item		Specification
Signal name		Output (OUT0-OUT7)
Rated load voltage		5 to 24VDC
Rated load current		0.1A/point
Maximum voltage drop at ON		0.2V (TYP.)
Leakage current at OFF		0.1mA or lower
Response time	On	1μs or less (rated load, resistive load)
	Off	1μs or less (rated load, resistive load)
Withstand voltage		510VAC for 1 minute between input terminal and internal power supply (altitude: 0 to 2000m)
Insulation resistance		10MΩ or higher between input terminals and internal power supply (500VDC insulation resistance tester)
Wiring method for common		L02SCPU, L02CPU, L06CPU, L26CPU, L26CPU-BT: 8 points/common (sink type) L02SCPU-P, L02CPU-P, L06CPU-P, L26CPU-P, L26CPU-PBT: 8 points/common (source type)

(3) Signal assignment of the connector for external devices

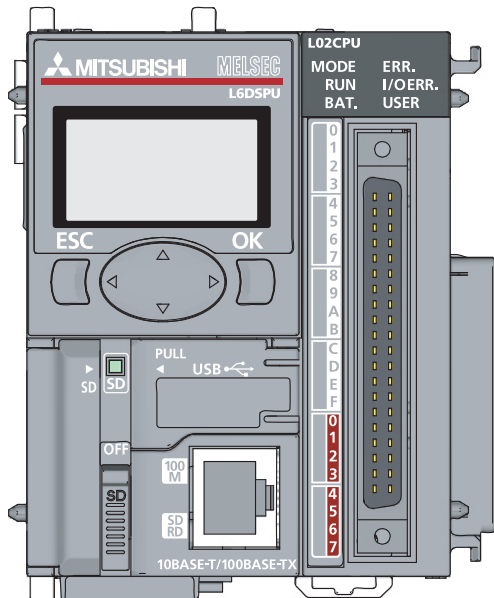

B20	□ □	A20
B19	□ □	A19
B18	□ □	A18
B17	□ □	A17
B16	□ □	A16
B15	□ □	A15
B14	□ □	A14
B13	□ □	A13
B12	□ □	A12
B11	□ □	A11
B10	□ □	A10
B09	□ □	A09
B08	□ □	A08
B07	□ □	A07
B06	□ □	A06
B05	□ □	A05
B04	□ □	A04
B03	□ □	A03
B02	□ □	A02
B01	□ □	A01

Viewed from the front of the module

(4) Internal circuits

(a) L02SCPU, L02CPU, L06CPU, L26CPU, L26CPU-BT

Classification	External wiring	Pin number	Internal circuit	Signal name*2	
				B line	A line
Input		B20 A20		High-speed 24V input (IN0-24V)	High-speed 24V input (IN2-24V)
		B19 A19		High-speed differential input (IN0-DIFF)	High-speed differential input (IN2-DIFF)
		B18 A18		High-speed input common (IN0-COM)	High-speed input common (IN2-COM)
		B17 A17		High-speed 24V input (IN1-24V)	High-speed 24V input (IN3-24V)
		B16 A16		High-speed differential input (IN1-DIFF)	High-speed differential input (IN3-DIFF)
		B15 A15		High-speed input common (IN1-COM)	High-speed input common (IN3-COM)
		B14 A14		High-speed 24V input (IN4-24V)	High-speed 24V input (IN5-24V)
		B13 A13		High-speed differential input (IN4-DIFF)	High-speed differential input (IN5-DIFF)
		B12 A12		High-speed input common (IN4-COM)	High-speed input common (IN5-COM)
		B11 A11		Standard input common (INCOM)	
		B10 A10		Standard input (IN6)	Standard input (IN7)
		B09 A09		Standard input (IN8)	Standard input (IN9)
B08 A08		Standard input (INA)		Standard input (INB)	
B07 A07		Standard input (INC)		Standard input (IND)	
B06 A06		Standard input (INE)		Standard input (INF)	
Output		B05 A05		Output (OUT0)	Output (OUT1)
		B04 A04		Output (OUT2)	Output (OUT3)
		B03 A03		Output (OUT4)	Output (OUT5)
		B02 A02		Output (OUT6)	Output (OUT7)
		B01 A01		Output common (OUTCOM)	

*1 High-speed inputs can be connected based on the 24V input mode or differential input mode.

*2 For signal names when using the positioning function or high-speed counter function, refer to the following.

• Positioning function: Page 48, Section 7.2.1

• High-speed counter function: Page 185, Section 8.2.1

(b) L02SCPU-P, L02CPU-P, L06CPU-P, L26CPU-P, L26CPU-PBT

Classification	External wiring	Pin number		Internal circuit	Signal name*2	
					B line	A line
Input		B20	A20		High-speed 24V input (IN0-24V)	High-speed 24V input (IN2-24V)
		B19	A19		High-speed differential input (IN0-DIFF)	High-speed differential input (IN2-DIFF)
		B18	A18		High-speed input common (IN0-COM)	High-speed input common (IN2-COM)
		B17	A17		High-speed 24V input (IN1-24V)	High-speed 24V input (IN3-24V)
		B16	A16		High-speed differential input (IN1-DIFF)	High-speed differential input (IN3-DIFF)
		B15	A15		High-speed input common (IN1-COM)	High-speed input common (IN3-COM)
		B14	A14		High-speed 24V input (IN4-24V)	High-speed 24V input (IN5-24V)
		B13	A13		High-speed differential input (IN4-DIFF)	High-speed differential input (IN5-DIFF)
		B12	A12		High-speed input common (IN4-COM)	High-speed input common (IN5-COM)
		B11	A11		Standard input common (INCOM)	
		B10	A10		Standard input (IN6)	Standard input (IN7)
		B09	A09		Standard input (IN8)	Standard input (IN9)
B08		A08	Standard input (INA)		Standard input (INB)	
B07		A07	Standard input (INC)		Standard input (IND)	
B06		A06	Standard input (INE)		Standard input (INF)	
Output		B05	A05		Output (OUT0)	Output (OUT1)
		B04	A04		Output (OUT2)	Output (OUT3)
		B03	A03		Output (OUT4)	Output (OUT5)
		B02	A02		Output (OUT6)	Output (OUT7)
		B01	A01		Output common (OUT24V)	

*1 High-speed inputs can be connected based on the 24V input mode or differential input mode.

*2 For signal names when using the positioning function or high-speed counter function, refer to the following.

- Positioning function: Page 48, Section 7.2.1
- High-speed counter function: Page 185, Section 8.2.1

(5) I/O connector pin numbers and corresponding I/O signals

Pin number	Category	Type	Correspondence for line driver	Corresponding I/O signal	Pin number	Category	Type	Compatibility with line driver	Corresponding I/O signal		
B20	Input	High-speed	○	X0	A20	Input	High-speed	○	X2		
B19					A19						
B18					A18						
B17		High-speed	○	X1	A17		High-speed	○	X3		
B16					A16						
B15					A15						
B14		High-speed	○	X4	A14		High-speed	○	X5		
B13					A13						
B12					A12						
B11		Input common					A11	Input common			
B10		Standard	—	X6	A10		Standard	—	X7		
B09		Standard	—	X8	A09		Standard	—	X9		
B08		Standard	—	XA	A08		Standard	—	XB		
B07		Standard	—	XC	A07		Standard	—	XD		
B06		Standard	—	XE	A06		Standard	—	XF		
B05	Output	High-speed	—	Y0	A05	Output	High-speed	—	Y1		
B04		High-speed	—	Y2	A04		High-speed	—	Y3		
B03		High-speed	—	Y4	A03		High-speed	—	Y5		
B02		High-speed	—	Y6	A02		High-speed	—	Y7		
B01		Output common ^{*1}					A01	Output common ^{*1}			

*1 B01 and A01 are used as negative common on the L02SCPU, L02CPU, L06CPU, L26CPU, and L26CPU-BT, while they are used as positive common on the L02SCPU-P, L02CPU-P, L06CPU-P, L26CPU-P, and L26CPU-PBT.

(6) Input signal assignment

○: Selectable, ×: No combination

External input signal	Function				
	General-purpose input	Interrupt input	Pulse catch	High-speed counter	Positioning
X0(High-speed)	○	○ ^{*1}	○	Counter CH1 A Phase ^{*1}	x ^{*3}
X1(High-speed)	○	○ ^{*1}	○	Counter CH1 B Phase ^{*1}	x ^{*3}
X2(High-speed)	○	○ ^{*1}	○	Counter CH2 A Phase ^{*1}	x ^{*3}
X3(High-speed)	○	○ ^{*1}	○	Counter CH2 B Phase ^{*1}	x ^{*3}
X4(High-speed)	○	○	○	Counter CH1 Z Phase ^{*2}	Axis #1 Zero Signal ^{*2}
X5(High-speed)	○	○	○	Counter CH2 Z Phase ^{*2}	Axis #2 Zero Signal ^{*2}
X6(Standard)	○	○	○	Counter CH1 Function Input ^{*2}	Axis #1 External Command Signal ^{*2}
X7(Standard)	○	○	○	Counter CH2 Function Input ^{*2}	Axis #2 External Command Signal ^{*2}
X8(Standard)	○	○	○	Counter CH1 Latch Counter ^{*2}	Axis #1 Drive Module READY Signal ^{*2}
X9(Standard)	○	○	○	Counter CH2 Latch Counter ^{*2}	Axis #2 Drive Module READY Signal ^{*2}
XA(Standard)	○	○	○	x ^{*3}	Axis #1 Near-point Dog Signal ^{*2}
XB(Standard)	○	○	○	x ^{*3}	Axis #2 Near-point Dog Signal ^{*2}
XC(Standard)	○	○	○	x ^{*3}	Axis #1 Upper Limit Signal ^{*2}
XD(Standard)	○	○	○	x ^{*3}	Axis #2 Upper Limit Signal ^{*2}
XE(Standard)	○	○	○	x ^{*3}	Axis #1 Lower Limit Signal ^{*2}
XF(Standard)	○	○	○	x ^{*3}	Axis #2 Lower Limit Signal ^{*2}

*1 When using CH1 for the high-speed counter function, X0 and X1 cannot be used as interrupt inputs. Also, when using CH2 for the high-speed counter function, X2 and X3 cannot be used as interrupt inputs. Other functions such as the general-purpose input can be used.

*2 When this signal is not required, the input signal can be used for other functions such as the general-purpose input.

*3 When the high-speed counter function or positioning function is selected, this signal is not used for that function. This signal can be used for another function such as the general-purpose input function.

(7) Output signal assignment

○: Selectable, ×: No combination

External output signal	Function		
	General-purpose output	High-speed Counter	Positioning
Y0	○	CH1 Coincidence Output No.1 ^{*1}	× ^{*3}
Y1	○	CH2 Coincidence Output No.1 ^{*1}	× ^{*3}
Y2	○	CH1 Coincidence Output No.2 ^{*2}	Axis #1 Deviation Counter Clear ^{*1}
Y3	○	CH2 Coincidence Output No.2 ^{*2}	Axis #2 Deviation Counter Clear ^{*1}
Y4	○	× ^{*3}	Axis #1 CW/PULSE/A Phase Output ^{*1}
Y5	○	× ^{*3}	Axis #2 CW/PULSE/A Phase Output ^{*1}
Y6	○	× ^{*3}	Axis #1 CCW/SIGN/B Phase Output ^{*1}
Y7	○	× ^{*3}	Axis #2 CCW/SIGN/B Phase Output ^{*1}

*1 This signal must be used depending on parameter settings.

When this signal is not used, the output signal can be used for the general-purpose output function.

*2 When this signal is not used, the output signal can be used for the general-purpose output function.

*3 When the high-speed counter function or positioning function is selected, this signal is not used for that function. This signal can be used for the general-purpose output function.

(8) Simplified chart of I/O signals

The following shows a simplified chart of I/O signals for the high-speed counter function and positioning function.

High-speed Counter		Positioning	
CH1	CH2	Axis#1	Axis#2
		X4	X5
X0	X2	X6	X7
X1	X3	X8	X9
X4	X5	XA	XB
X6	X7	XC	XD
X8	X9	XE	XF
Y0	Y1	Y2	Y3
Y2	Y3	Y4	Y5
		Y6	Y7

(9) External input signals (X0 to XF) when using the functions

The on/off statuses of the external input signals (X0 to XF) are reflected to the input devices (X0 to XF) in the program when using any built-in I/O functions (except the pulse catch function). When using the pulse catch function, an input device is turned on for one scan by detecting the rising edge of the external input signal

(☞ Page 36, CHAPTER 6).

When selecting positioning function or high-speed counter function, an input signal that is not used due to settings of the functions operates as the general-purpose input.

Remark

The IN0 to IN F LEDs indicate statuses of the external input signals (X0 to XF). However, the indicating status is not affected by turning on or off the input devices (X0 to XF) in the program.

(10)External output signals (Y0 to Y7) when using the functions

The external output signals (Y0 to Y7) reflect the output statuses of the functions selected from the general-purpose output, positioning, and high-speed counter function. Therefore, the output statuses are not affected by turning on or off the output devices (Y0 to Y7) in the program when using the output signals for the positioning or high-speed counter function.

In addition, the output devices (Y0 to Y7) do not reflect statuses of the output signals used for the positioning or the high-speed counter function.

Remark

The OUT 0 to OUT 7 LEDs indicate statuses of the external output signals. So the output statuses of the output devices (Y0 to Y7) are indicated when the output signals are used for the general-purpose output. Actual output statuses of the positioning or the high-speed counter function are indicated when the output signals are used for the functions. (The indicating status is not affected by turning on or off the output devices in the program.)

.....

(11)Monitoring by the programming tool

To check the I/O settings, open the "I/O Monitor" dialog box of the programming tool.

 [Tool] => [Built-in I/O Module Tool]

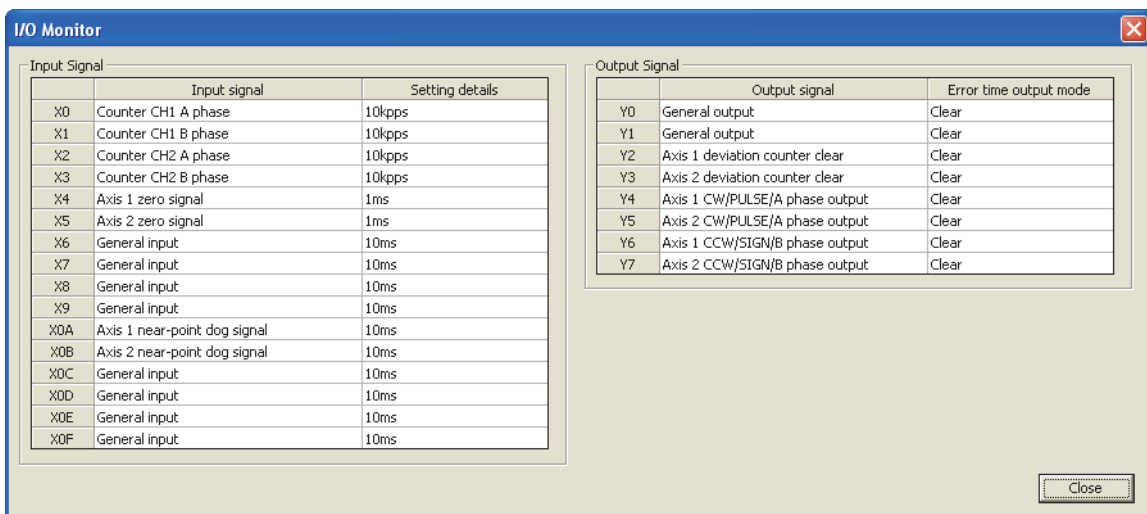

For details, refer to the following.

 GX Works2 Version1 Operating Manual (Common).

CHAPTER 3 GENERAL-PURPOSE INPUT FUNCTION

This function uses the built-in external input signals (16 points) as general-purpose inputs to read the on/off status of external devices such as switches and sensors.

The on/off status of the external input signals are refreshed to the input device (X0 to XF) and used in programs.

(1) Parameter setting

Set the input signal and input response time value.

 Project window ⇨ [Parameter] ⇨ [PLC Parameter] ⇨ "Built-in I/O Function Setting" tab

Select "General-purpose input".

Select a response time.

Input Signal	Input Signal Function Selection	Input Response Time	Interrupt Processing Condition
Xn0	General Input	0.1ms	Rising
Xn1	Interrupt Input	1ms	Falling
Xn2	Counter CH2 A Phase	1ms	Rising
Xn3	Counter CH2 B Phase	1ms	Rising
Xn4	Axis #1 Zero Signal	1ms	Rising
Xn5	Pulse Catch	0.2ms	Rising
Xn6	General Input	10ms	Rising
Xn7	General Input	10ms	Rising
Xn8	General Input	10ms	Rising
Xn9	General Input	10ms	Rising
XnA	Axis #1 Near-point Dog Signal	10ms	Rising
XnB	General Input	10ms	Rising
XnC	General Input	10ms	Rising
XnD	General Input	10ms	Rising
XnE	General Input	10ms	Rising
XnF	General Input	10ms	Rising

(2) External input signal types

The following two types are available.

- High-speed input: X0 to X5 (6 points)
- Standard input: X6 to XF (10 points)

(3) Read timing for external input signals

The on/off statuses of the external input signals are reflected to input devices (X0 to XF) by performing the refresh at execution of END instructions. Therefore, a delay for one scan (maximum) occurs from when an external input signal changes until when the input device turns on.

(4) Direct input

When using the external input signals for the direct input devices (DX0 to DXF), the external input statuses are read at execution of sequence instructions using the direct input devices.

(5) Partial refresh

The LCPU can read the current external input status by executing partial refresh using the RFS instruction to the input device (X0 to XF). For the RFS instruction, refer to the following.

 MELSEC-Q/L Programming Manual (Common Instruction)

(6) Performance specifications

The following is the performance specifications of the general-purpose output function.

Item		Description	
Standard input	Points	10	
	Input voltage/current	24VDC, 4.1mA (TYP.)	
	Minimum input response time	100 μ s	
	Input response time setting	0.1ms/1ms/5ms/10ms/20ms/70ms	
High-speed input	Points	6	
	Input voltage/current	DC input	24VDC 6.0mA (TYP.)
		Differential input	EIA Standard RS-422-A Differential line driver level AM26L31 (manufactured by Texas Instruments Incorporated) or equivalent
	Minimum input response time	10 μ s	
	Input response time setting ^{*1}	0.01ms/0.1ms/0.2ms/0.4ms/0.6ms/1ms	

*1 The shorter the input response time is, the more the module is susceptible to noise. When setting the input response time, check that the module will not be affected by noise. For details of measures against noise, refer to the following.

 MELSEC-L CPU Module User's Manual (Hardware Design, Maintenance and Inspection)

CHAPTER 4 GENERAL-PURPOSE OUTPUT FUNCTION

This function uses the built-in external output signals (8 points) as general-purpose outputs for external devices such as lamps.

By turning on/off the output device (Y0 to Y7) in programs, the LCPU can output the signals externally.

(1) Parameter setting

Set the output signal and error time output mode.

 Project window ⇨ [Parameter] ⇨ [PLC Parameter] ⇨ "Built-in I/O Function Setting" tab

Select an error time output mode.

Select "General Output".

	Output Signal Function Selection	Error Time Output Mode
Yn0	General Output	Hold
Yn1	General Output	Clear
Yn2	Axis #1 Deviation Counter Clear	Clear
Yn3	Axis #2 Deviation Counter Clear	Clear
Yn4	Axis #1 CW/PULSE/A Phase Output	Clear
Yn5	Axis #2 CW/PULSE/A Phase Output	Clear
Yn6	Axis #1 CCW/SIGN/B Phase Output	Clear
Yn7	Axis #2 CCW/SIGN/B Phase Output	Clear

(2) External output timing

On/off statuses of the output devices are reflected to external outputs (Y0 to YF) by performing the refresh at execution of the END instructions. Therefore, a delay for one scan (maximum) occurs from when an external device turns on/off in programs until when the external output is reflected.

(3) Direct output

When using the output devices (Y0 to Y7) for the direct output devices (DY0 to DY7), on/off statuses of the devices are reflected to external outputs by instructions such as the SET instructions to the devices.

(4) Partial refresh

The output device status (only specified range) is reflected to the external output by executing partial refresh using the RFS instruction to the output device (Y0 to Y7). ( MELSEC-Q/L Programming Manual (Common Instruction)).

(5) Error time output mode

Select Hold or Clear for output statuses of the output devices (Y0 to Y7) when an error to stop the program occurs. (This is not setting for output of the output modules and the intelligent function modules. For details on setting of the error time output mode for modules, refer to the following.

 MELSEC-L CPU Module User's Manual (Function Explanation, Program Fundamentals)

(6) Performance specifications

The following is the performance specifications of the general-purpose output function.

Item	Description	
	L02SCPU, L02CPU, L06CPU, L26CPU, L26CPU-BT	L02SCPU-P, L02CPU-P, L06CPU-P, L26CPU-P, L26CPU-PBT
Output type	Sink type	Source type
Points	8	
Output voltage/current	5 to 24VDC, 0.1A	
Response time	On	1 μ s or less (rated load, resistive load)
	Off	1 μ s or less (rated load, resistive load)

CHAPTER 5 INTERRUPT INPUT FUNCTION

This function executes an interrupt program when triggered by the input signal (X0 to XF).

(1) Parameter setting

Set the input signal, input response time value, and interrupt processing condition.

 Project window ⇨ [Parameter] ⇨ [PLC Parameter] ⇨ "Built-in I/O Function Setting" tab

Select a response time. Select an interrupt processing condition.

Select "Interrupt input".

Input Signal	Input Signal Function Selection	Input Response Time	Interrupt Processing Condition
Xn0	Interrupt Input	0.4ms	Falling
Xn1	Interrupt Input	1ms	Falling
Xn2	Counter CH2 A Phase	1ms	Rising
Xn3	Counter CH2 B Phase	1ms	Rising
Xn4	Axis #1 Zero Signal	1ms	Rising
Xn5	Pulse Catch	0.2ms	Rising
Xn6	General Input	10ms	Rising
Xn7	General Input	10ms	Rising
Xn8	General Input	10ms	Rising
Xn9	General Input	10ms	Rising
XnA	Axis #1 Near-point Dog Signal	10ms	Rising
XnB	General Input	10ms	Rising
XnC	General Input	10ms	Rising
XnD	General Input	10ms	Rising
XnE	General Input	10ms	Rising
XnF	General Input	10ms	Rising

(2) Interrupt pointer assignment and interrupt priority

The following shows interrupt pointers corresponding to input signals (X0 to XF)

I/O signals	Interrupt pointer	Priority ^{*1}
X0	I0	5
X1	I1	6
X2	I2	7
X3	I3	8
X4	I4	9
X5	I5	10
X6	I6	11
X7	I7	12
X8	I8	13
X9	I9	14
XA	I10	15
XB	I11	16
XC	I12	17
XD	I13	18
XE	I14	19
XF	I15	20

*1 The priority 1 to 4 are used for interrupt pointers I28 to I31 (interrupt by build-in timers)

Interrupt pointer numbers can be changed. (Page 34, (2) (a))

(a) Changing the interrupt pointer numbers

1. Click the **Interrupt Pointer Setting** button in the "PLC System" tab.

Project window ⇨ [Parameter] ⇨ [PLC Parameter] ⇨ [PLC System]

2. Set the interrupt pointer start No., interrupt pointer count, start I/O No., and start SI No.
3. Click the **End** button to exit.

Ex. When assigning the interrupt inputs X0 and X1 to the interrupt pointers I50 and later.

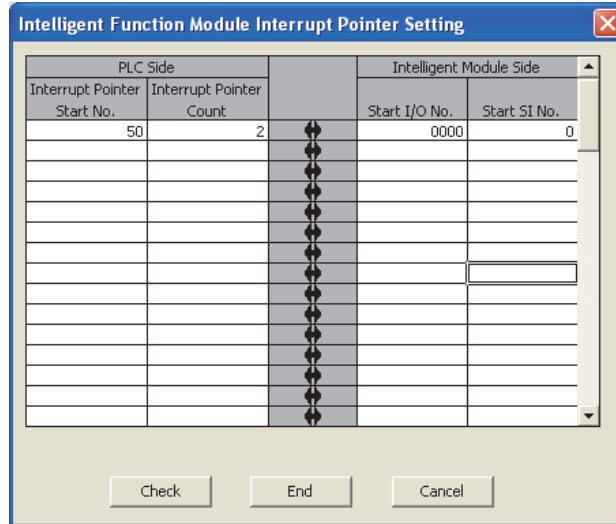

- Precautions

When the range of interrupt input that is specified in the "Intelligent Function Module Interrupt Pointer Setting" and the interrupt input is not selected for the built-in I/O function in the range, "PARAMETER ERROR" (error cord: 3000) occurs.

The following shows a correct example and an incorrect example of assigning the interrupt inputs to the interrupt pointers I50 and later as shown above.

- Correct example

As shown below, the interrupt inputs are set within the range specified in "Intelligent Function Module Interrupt Pointer Setting", so the error will not occur.

Input signal function selection: X0 and X1 are set to the interrupt inputs.

Input Signal Function Selection		Res
Xn0	Interrupt Input	1ms
Xn1	Interrupt Input	1ms
Xn2	General Input	1ms
Xn3	General Input	1ms

- Incorrect example

As shown below, input signal X2 and X3 are set to the interrupt inputs, but no interrupt input are set within the range specified in "Intelligent Function Module Interrupt Pointer Setting", so the error will occur.

Input signal function selection: X2 and X3 are set to the interrupt inputs.

Input Signal Function Selection		Res
Xn0	General Input	1ms
Xn1	General Input	1ms
Xn2	Interrupt Input	1ms
Xn3	Interrupt Input	1ms

(3) Interrupt processing condition

The following shows three types of conditions to execute the interrupt programs by the interrupt inputs.

Interrupt processing condition	Description
Rising edge	Executes the program at the rising edge of the interrupt input signal.
Falling edge	Executes the program at the falling edge of the interrupt input signal.
Rising edge + Falling edge	Executes the program at both the rising edge and the falling edge of the interrupt input signal.

When "Rising edge + Falling edge" is set for the interrupt processing function, only the first interrupt factor is stored but the second one and later are ignored.

When the second rising edge (falling edge) of the signal is detected after the falling edge (rising edge) during execution of the interrupt program due to the first one, the second one cannot execute the interrupt program. To avoid this, keep an enough interval between on and off of the interrupt input.

Also, when the signals that the on width and off width are short are detected frequently, the main routine program is interrupted frequently. Keep an enough on width and off width so that execution of the main routine program may not be interrupted.

(4) Interrupt enable/disable

Use the EI instruction to enable the interrupt. Also, use the DI instruction to disable interrupt and IMASK instruction to mask the interrupt program. ( MELSEC-Q/L Programming Manual (Common Instruction))

(5) Performance specifications

The following is the performance specifications of the interrupt input function.

Item		Description	
Standard input	Points	10	
	Input voltage/current	24VDC, 4.1mA (TYP.)	
	Minimum input response time	100 μ s	
	Input response time setting	0.1ms/1ms/5ms/10ms/20ms/70ms	
High-speed input	Points	6	
	Input voltage/current	DC input	24VDC, 6.0mA (TYP.)
		Differential input	EIA Standard RS-422-A Differential line driver level AM26L31 (manufactured by Texas Instruments Incorporated) or equivalent
	Minimum input response time	10 μ s	
	Input response time setting	0.01ms/0.1ms/0.2ms/0.4ms/0.6ms/1ms	

CHAPTER 6 PULSE CATCH FUNCTION

This function can catch pulse signals that the general-purpose input function cannot catch because the on time is shorter than the scan time.

(1) Parameter setting

Set the input signal and input response time value.

Project window ⇨ [Parameter] ⇨ [PLC Parameter] ⇨ "Built-in I/O Function Setting" tab

Select "Pulse Catch".

Select a response time.

Input Signal	Input Signal Function Selection	Input Response Time	Interrupt Processing Condition
Xn0	Pulse Catch	0.01ms	Rising
Xn1	Interrupt Input	1ms	Falling
Xn2	Counter CH2 A Phase	1ms	Rising
Xn3	Counter CH2 B Phase	1ms	Rising
Xn4	Axis #1 Zero Signal	1ms	Rising
Xn5	Pulse Catch	0.2ms	Rising
Xn6	General Input	10ms	Rising
Xn7	General Input	10ms	Rising
Xn8	General Input	10ms	Rising
Xn9	General Input	10ms	Rising
XnA	Axis #1 Near-point Dog Signal	10ms	Rising
XnB	General Input	10ms	Rising
XnC	General Input	10ms	Rising
XnD	General Input	10ms	Rising
XnE	General Input	10ms	Rising
XnF	General Input	10ms	Rising

(2) Basic operation of the pulse catch function

An input device is turned on for one scan after detecting a pulse signal and turned off by the END instruction.

(a) Operation when using an input signal (X0) as the pulse catch function

An input device is turned on for one scan after detecting a rising edge of an external input signal (X0).

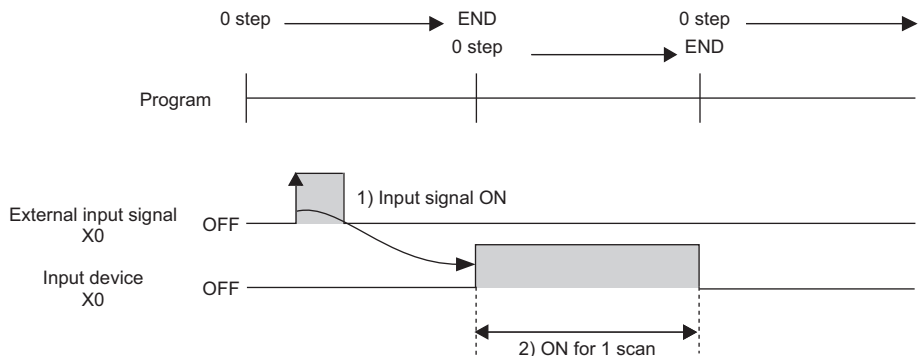

(b) Operation when detecting more than one pulse in one scan

Second pulse and later are ignored. Input pulse signals at intervals of one scan or more.

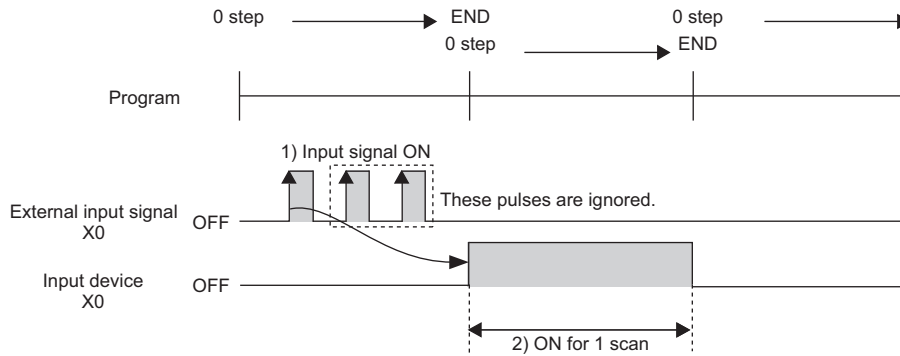

Point

When counting second and third pulse input is required, use the interrupt input function.

However, if third pulse is detected before the end of the execution of the interrupt program, the pulse cannot be counted.

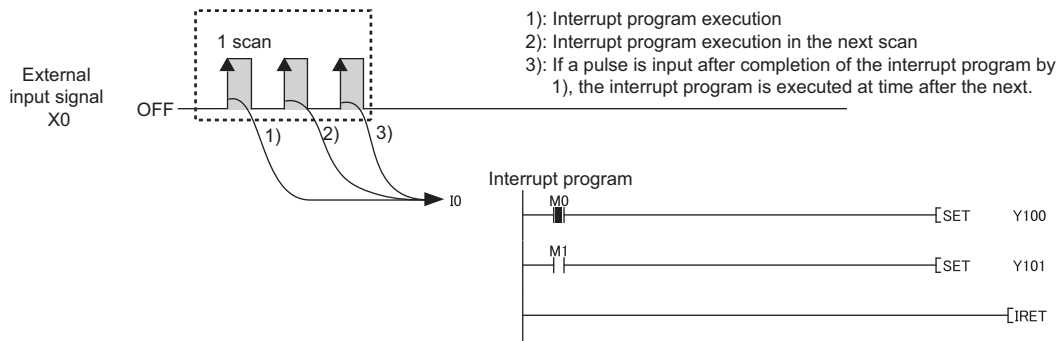

(c) Operation when detecting same pulses in two scans or more.

The input device is turned on for scans by the amount of detected pulses. Input pulse signals at intervals of one scan or more.

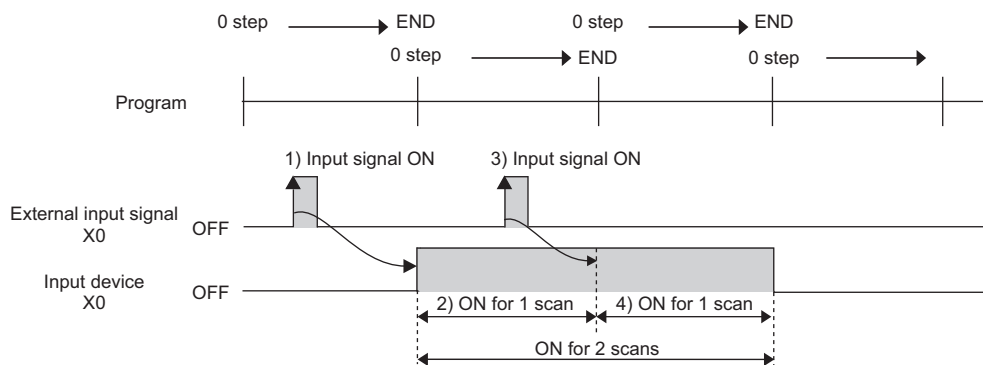

(d) Operation when detecting a pulse that has on width of two scans or more.

The input device is turned on for one scan.

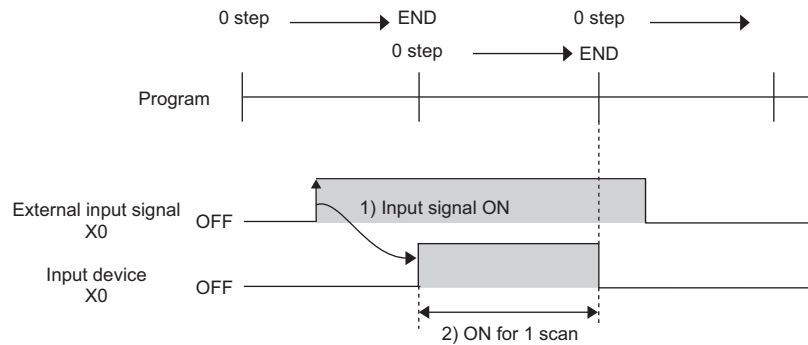

(3) Detectable pulse width

Pulse width that meets the following condition can be detected.

On or off width of the pulse input > Input response time

When the condition is not met, the pulse cannot be detected correctly. Set the input response time to meet it.

(4) Precautions

Avoid the following actions for the input device (X0 to XF) that is set to the pulse catch function.

Otherwise, the input device cannot be turned on correctly for one scan after detecting a pulse.

- Using the direct devices DX
- Executing the instruction such as the RFS, COM, CCOM (P), and MTR that perform the input refresh at the execution

(5) Performance specifications

The following is the performance specifications of the pulse catch function.

Item		Description	
Standard input	Points	10	
	Input voltage/current	24VDC, 4.1mA (TYP.)	
	Minimum input response time	100µs	
	Input response time setting	0.1ms/1ms/5ms/10ms/20ms/70ms	
High-speed input	Points	6	
	Input voltage/current	DC input	24VDC, 6.0mA (TYP.)
		Differential input	EIA Standard RS-422-A Differential line driver level AM26L31 (manufactured by Texas Instruments Incorporated) or equivalent
	Minimum input response time	10µs	
	Input response time setting	0.01ms/0.1ms/0.2ms/0.4ms/0.6ms/1ms	

CHAPTER 7 POSITIONING FUNCTION

7.1 Overview

(1) Definition

This function is used to move a table, machining target, tool, or other moving body (workpiece) at a specified speed with the purpose of stopping it accurately at a target position.

(2) Features

The positioning function is controlled by dedicated instructions.

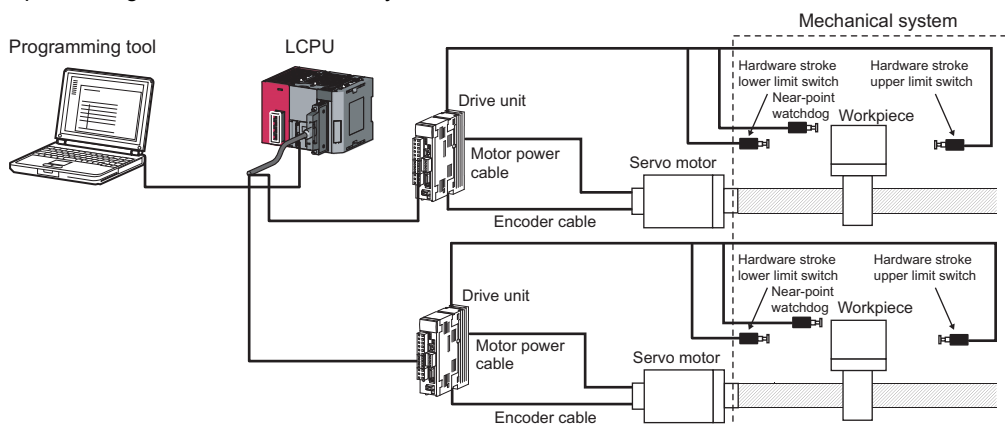

(a) 2-axis control

Two drive units (two motors) can be connected and two coordinates can be controlled independently or simultaneously.

(b) OPR (Original point return)

Six types of OPR methods are available. A near-point dog (OP sensor), etc., can be used to establish the OP (position that becomes the starting point of each control) and "address" of this position. (Machine OPR) OPR can also be performed automatically within the range defined by the upper and lower limit switch. (OPR retry function)

(c) Target position and speed

- The workpiece can be moved to the target position based on a specified address or movement amount. (Position control)
- The workpiece can be moved until a stop instruction is executed. (Speed control)
- The current position can be changed to a specified value. (Current value change function)
- The target position can be changed while the workpiece is moving. (Target position change function)
- The speed can be changed while the workpiece is moving. (Speed change function)

(d) Limitation of the moving range of the workpiece

Desired positions can be set as the logical upper limit and lower limit of the moving range of the workpiece, without using switches. (Software stroke limit function)

Also, upper and lower limit switches can be used to limit the moving range. (Hardware stroke limit function)

(e) JOG operation

The workpiece can be moved to a desired position according to the pulses that are output continuously while a JOG operation instruction is executed. (JOG operation function)

(f) Absolute position detection

A servomotor with absolute position detector can be used to restore the current position after a power failure, etc. (Absolute position restoration function)

(3) Function list

The following table lists and describes functions available for the positioning function.

Item	Description	Reference	
OPR control	Machine OPR	A function to mechanically establish the reference point (OP) for positioning control using a near-point dog, stopper, etc.	Page 70, Section 7.6.1
	Fast OPR	A function to execute positioning control to the OP address stored by machine OPR or standby address that has been set	Page 90, Section 7.6.2
Positioning control	Position control (1-axis linear control)	A function to execute positioning control to a specified position according to the address or movement amount set by positioning data	Page 99, Section 7.7.2
	Speed/position switching control	A function to start under speed control and then switch to position control (positioning control based on specified movement amount) via an external command signal	Page 100, Section 7.7.3
	Current value change function	A function to change the address (current feed value)	Page 102, Section 7.7.4
	Speed control	A function to implement positioning control via operation at a specified speed	Page 103, Section 7.7.5
Multiple axes simultaneous start control		A function to start two axes simultaneously at the pulse output level	Page 104, Section 7.8
JOG operation function		A function to output pulses only while a JOG start instruction(IPJOG1) is executed to move the workpiece to a desired position	Page 106, Section 7.9
Subfunction	OPR retry function	A function to perform machine OPR automatically by detecting an off edge of the limit signal and moving to a position where machine OPR is possible, even when the OP is not located in the OPR direction	Page 111, Section 7.10.1
	Speed limit function	A function to limit the speed to within the setting range of speed limit when the operating speed exceeds the positioning parameter "Speed Limit Value"	Page 115, Section 7.10.2
	Speed change function	A function to change the speed during operation	Page 116, Section 7.10.3
	Software stroke limit function	A function to not start operation when a start instruction is given to move to the target position which is outside the range set by the upper stroke limit and lower stroke limit The limit function also stops operation when the current position (current feed value) deviates from the setting range.	Page 121, Section 7.10.4
	Hardware stroke limit function	A function to decelerate the axis to a stop using a limit switch connected to the external device connector	Page 124, Section 7.10.5
	Target position change function	A function to change the address or movement amount during positioning control	Page 125, Section 7.10.6
	Acceleration/deceleration processing function	A function to adjust the acceleration/deceleration processing as part of control	Page 129, Section 7.10.7
	Stop processing function	A function to control the stopping method to be applied when a stop cause occurs during operation	Page 131, Section 7.10.8
Absolute position restoration function		A function to restore the current position (current feed value) using a servomotor with absolute position detector, without executing machine OPR, in the event of a momentary power failure, emergency stop, etc. (Connectable servo amplifiers are limited to those products in the general-purpose AC servo MEL SERVO series (pulse-train type) supporting absolute position detection systems.)	Page 134, Section 7.11

(4) Mechanism of a positioning control system

Positioning control is implemented based on pulses output from the LCPU. In a positioning system, software and external devices are used to perform the roles shown below.

- Parameter setting
- Start instruction for the positioning control such as a JOG operation
- Positioning operation monitoring

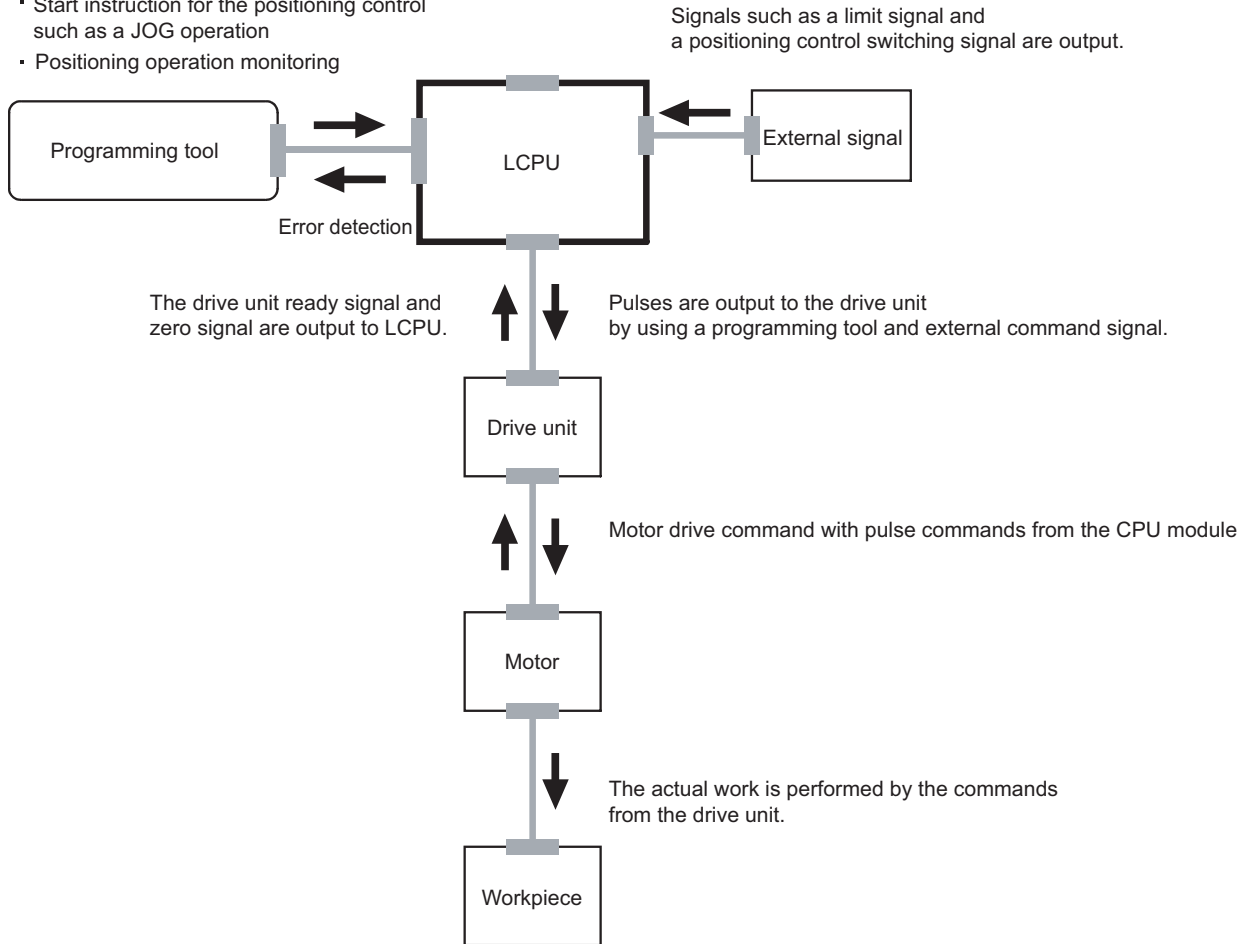

(5) Operation inside the drive unit

After receiving a pulse input from the LCPU, the following operations occur in the drive unit.

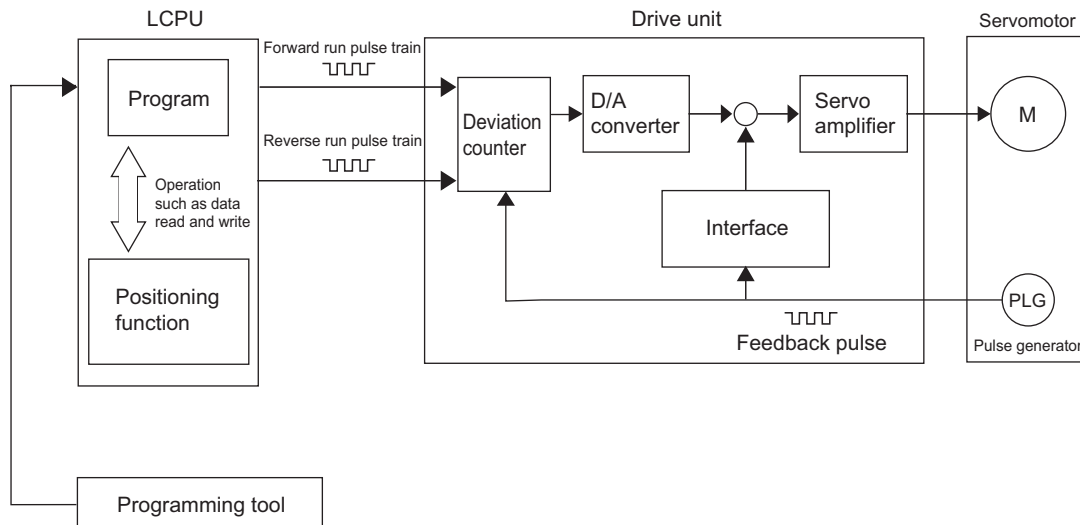

(a) Starting

When pulses are output from the LCPU, the input pulses are retained in the deviation counter of the drive unit. The integration value of this pulse (droop pulse) is converted to a DC analog voltage by the D/A converter to give a speed command for the servomotor (M). The servomotor starts rotating by the speed command from the drive unit.

(b) During operation

As the servomotor rotates, the pulse generator (PLG) supplied with the servomotor generates feedback pulses in proportion to the speed. The generated feedback pulses are fed back to the drive unit and the deviation counter droop pulse are decremented accordingly. The servomotor continues to rotate with the deviation counter maintaining a certain amount of droop pulses.

(c) Stopping

When the command pulse output from the LCPU stops, the deviation counter droop pulse decrease and the speed drops. The servomotor stops once the droop pulses become 0.

The rotation speed of the servomotor is proportional to the command pulse frequency, while the rotation angle of the servomotor is proportional to the number of output command pulses. Therefore, the workpiece can be fed to a position proportional to the number of pulses in the pulse train by specifying the movement amount per pulse beforehand. Note that the pulse frequency defines the rotation speed of the servomotor (feed speed).

(6) Principles of position control and speed control

(a) Position control

The total No. of pulses needed to move a specified distance can be obtained by the formula below.

$$\left(\begin{array}{l} \text{Total number of pulses} \\ \text{required to move designated distance} \end{array} \right) = \frac{\left(\begin{array}{l} \text{Designated distance} \end{array} \right)}{\left(\begin{array}{l} \text{Movement amount of} \\ \text{machine (load) side} \\ \text{when motor rotates once} \end{array} \right)} \times \left(\begin{array}{l} \text{Number of pulses required for} \\ \text{motor to rotate once} \end{array} \right)^{*1}$$

*1 Encoder resolution.

Give the calculated total No. of pulses to the drive unit from the LCPU, and the workpiece will be controlled to move the specified distance. Note that the movement amount of the machine when one pulse is output to the drive unit is called "movement amount per pulse." This value corresponds to the minimum movement of the workpiece and determines the accuracy of electrical positioning control.

(b) Speed control

The speed is controlled by the "pulse frequency" output to the drive unit from the LCPU.

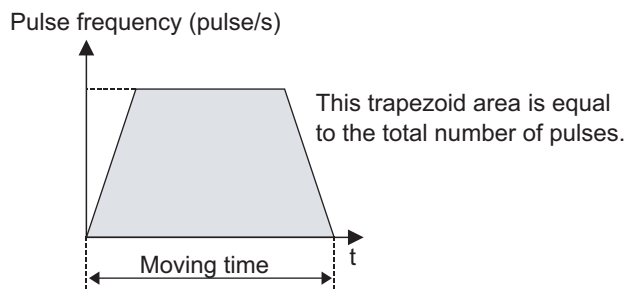

Point

- The value of "movement amount per pulse" is determined by the machine.
- The LCPU controls the position and speed based on the "total No. of pulses" and "pulse frequency," respectively.

(7) Pulses output from the LCPU

- Pulse trains are sparse when the servomotor is accelerating, and become denser as the servomotor approaches the stable speed that has been set.
- At the stable speed, constant pulse trains are output.
- When the pulses output from the LCPU become sparse, the servomotor decelerates until pulses are no longer output. There is a slight delay from the LCPU command pulses to the time the servomotor decelerates and stops. This difference is necessary to ensure sufficient stopping accuracy and is referred to as the "stop setting time".

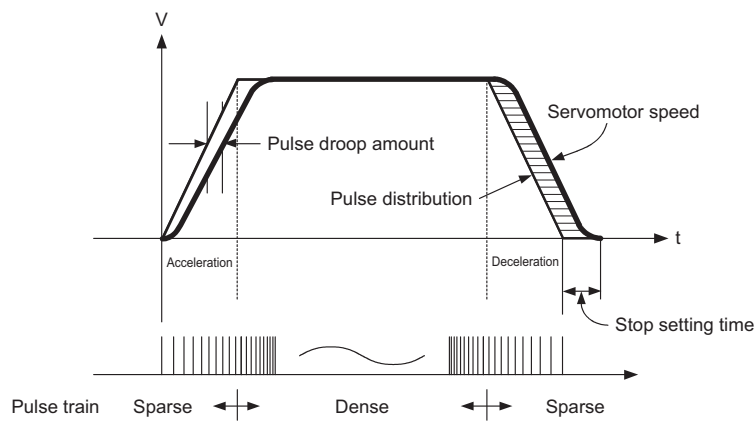

(8) Movement amount and speed of a worm gear system

This section explains methods of calculations required for positioning control by using worm gear system. The worm gear consists of a balls lined up in an engagement part, just like a ball bearing. The ball screw has no backlash and can rotate with a small force.

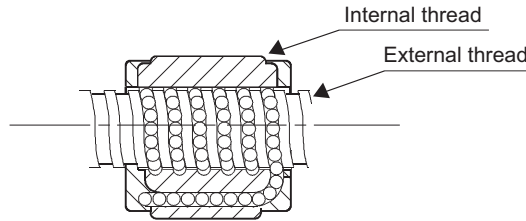

The calculations are performed based on the system described below.

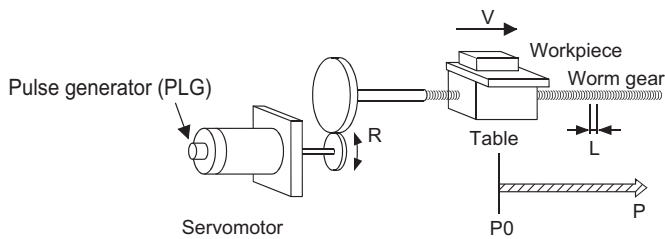

A : Movement amount per pulse (mm/pulse)
 V_s : Command pulse frequency (pulse/s)
 n : Pulse generator resolution (pulse/rev)
 L : Worm gear lead (mm/rev)
 R : Deceleration ratio
 V : Movable section speed (mm/s)
 N : Motor speed (r/min)
 K : Position loop gain (1/s)
 ε : Deviation counter droop pulse amount
 P_0 : OP (pulse)
 P : Address (pulse)

(a) Movement amount per pulse

Calculated from the worm gear lead, deceleration ratio and pulse generator resolution.

$$A = \frac{L}{R \times n} \text{ (mm/pulse)}$$

The movement amount is calculated by (Number of output pulses) x (Movement amount per pulse)

(b) Command pulse frequency

Calculated from the movable section speed and movement amount per pulse.

$$V_s = \frac{V}{A} \text{ (pulse/s)}$$

(c) Deviation counter droop pulse amount

Calculated from the command pulse frequency and position loop gain^{*1}.

$$\varepsilon = \frac{V_s}{K} \text{ (pulse)}$$

*1 Ratio of the command pulse frequency to the number of deviation counter droop pulses. A desired position loop gain can be set adjusting the drive unit. To improve the stopping accuracy, increase the gain. Note, however, that an excessively high gain may cause overshooting (beyond the target position) to make the operation unstable. An excessively low gain increases the stopping error, although the movement becomes smoother at stopping.

7.1.1 Procedure for performing the positioning function

The following shows the procedure.

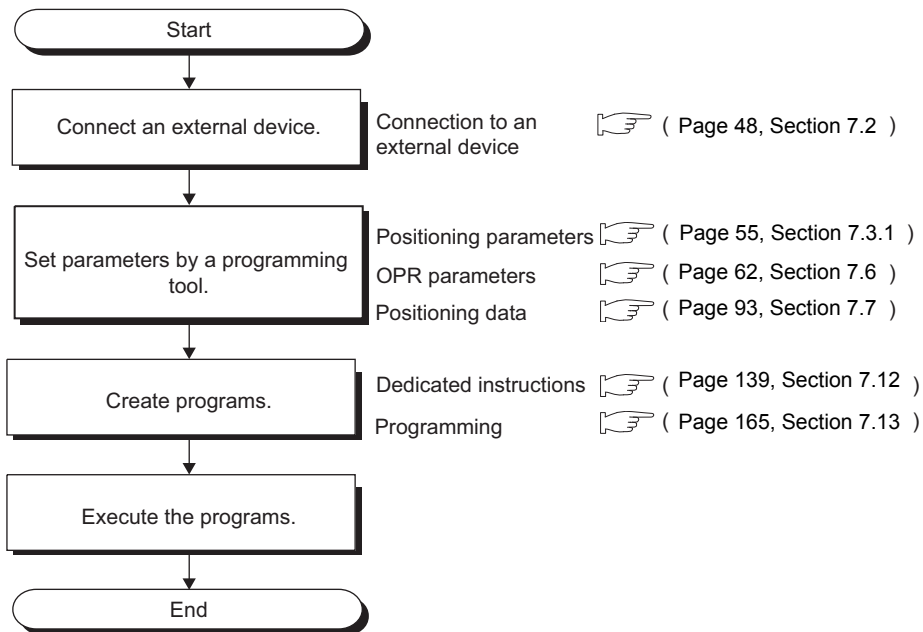

7.2 Connection to External Devices

7.2.1 I/O signals

The following shows the simplified diagrams of the internal circuits of LCPUI external device connection interface.

"□" in the signal name indicates either 1 (Axis 1) or 2 (Axis 2). For I/O signal settings, refer to Page 53, Section 7.3.

(1) Input

External wiring	Pin number		Internal circuit	Signal name	
	Axis 1	Axis 2			
	B20	A20		-	
	B19	A19			
	B18	A18			
	B17	A17		(Not used for the positioning function)	
	B16	A16			
	B15	A15			
	B14	A14		Zero signal (PG0□)	+24V (PG0□ -24V)
	B13	A13			Differential (PG0□ -DIFF)
	B12	A12			COM (PG0□ -COM)
	B11	A11		Input common	
	B10	A10		External command signal (CHG□)	
	B09	A09		Drive unit ready signal (READY□)	
	B08	A08		Near-point watchdog signal (DOG□)	
	B07	A07		Upper limit signal (FLS□)	
	B06	A06		Lower limit signal (RLS□)	

*1 High-speed inputs can be connected based on the 24V input mode or differential input mode.

(2) Output

(a) L02SCPU, L02CPU, L06CPU, L26CPU, L26CPU-BT

Pin number		Internal circuit	Signal name
Axis 1	Axis 2		
B05	A05		- (Not used for the positioning function)
B04	A04		Deviation counter clear signal (CLEAR□)
B03	A03		CW/PULSE/A phase output (PULSE F□)
B02	A02		CCW/SIGN/B phase output (PULSE R□)
B01	A01		Output common

(b) L02SCPU-P, L02CPU-P, L06CPU-P, L26CPU-P, L26CPU-PBT

Pin number		Internal circuit	Signal name
Axis 1	Axis 2		
B05	A05		- (Not used for the positioning function)
B04	A04		Deviation counter clear signal (CLEAR□)
B03	A03		CW/PULSE/A phase output (PULSE F□)
B02	A02		CCW/SIGN/B phase output (PULSE R□)
B01	A01		Output common

(3) Details of I/O signals

The following table lists and describes the I/O signals of the connector for external devices.

Category	Signal name	Description
Input	Zero Signal (PG0□)	<ul style="list-style-type: none"> The zero signal from the pulse generator etc. is used to input the OP signal for performing the machine OPR. This signal is also used to indicate the completion of the machine OPR that uses a stopper method for the machine OPR method. This signal is detected at the leading edge.
	Input Common	Common line for the external command signals, drive unit ready signal, near-point dog signal, upper limit signal and lower limit signal
	External Command Signal (CHG□)	Used to input control switching signals in speed/position switching control.
	Drive Unit Ready Signal(READY□)	<ul style="list-style-type: none"> This signal turns on when the drive unit is normal and able to accept pulses. The LCPU checks this signal and if the drive unit is not ready, it turns on the Axis 1 OPR request (SM1842). This signal turns off when the drive unit malfunctions, such as when the drive unit control power generates an error. Turning off this signal during positioning control stops the axis. The axis will no longer move even when the signal is turned on again. When this signal turns off, the Axis 1 OPR completion (SM1843) also turns off. If this signal is not selected for the input signal function selection, the signal is regarded as being on.
	Near-point DOG Signal (DOG□)	<ul style="list-style-type: none"> This signal is used to detect the near-point dog during machine OPR. The near-point dog signal is detected at the leading edge.
	Upper Limit Signal (FLS□)	<ul style="list-style-type: none"> This signal is input from the limit switch installed at the upper limit position of the stroke. When this signal turns off, positioning stops. This signal defines the upper limit which is used to find the near-point dog when the OPR retry function is enabled. If this signal is not selected for the input signal function selection, the signal is regarded as being on.
	Lower Limit Signal (RLS□)	<ul style="list-style-type: none"> This signal is input from the limit switch installed at the lower limit position of the stroke. When this signal turns off, positioning stops. This signal defines the lower limit which is used to find the near-point dog when the OPR retry function is enabled. If this signal is not selected for the input signal function selection, the signal is regarded as being on.
Output	Deviation Counter Clear Signal (CLEAR□)	This signal is output during machine OPR. (Count 2 is excluded.) For the drive unit, use a model capable of resetting the internal deviation counter droop pulse amount when the LCPU turns this signal on.
	CW/PULSE/A Phase Output (PULSE F□)	These signals are output as positioning pulses with pulse code to the drive unit.
	CCW/SIGN/B Phase Output (PULSE R□)	
	Output Common	Common line for the deviation counter clear signal, CW/PULSE/phase A outputs and CCW/SIGN/phase B outputs.

(4) On/off status of input signals

(a) On/off status of input signals

On/off status of input signals is determined according to external wiring.

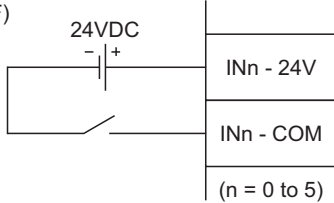
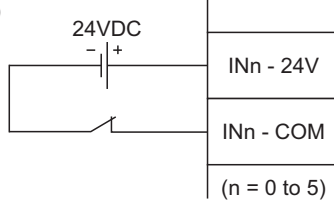
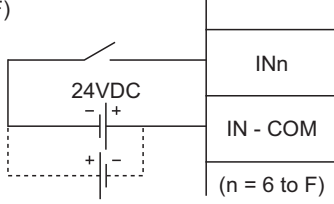
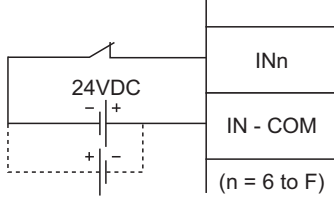
Signal name	External wiring	Signal on/off status as viewed from LCPU
High-speed input IN0 to IN5	(Photocoupler OFF) 	OFF
	(Photocoupler ON) 	ON
Standard input IN6 to INF	(Photocoupler OFF) 	OFF
	(Photocoupler ON) 	ON



In the context of the LCPU's positioning function, the statuses shown above are defined as representing the "negative logic".

(b) Internal circuit

With the LCPU, the "input signal OFF" status is defined as the off status of the corresponding internal circuit (photocoupler).

- Voltage not applied: Photocoupler OFF
- Voltage applied: Photocoupler ON

7.2.2 Wiring

For connectors used for external wiring, refer to  MELSEC-L CPU Module User's Manual (Hardware Design, Maintenance and Inspection). For examples of connection with servo amplifiers, refer to  Page 275, Appendix 2.

7.3 Parameter Setting

Set parameters for each axis.

1. Click the **Positioning Axis #1 Setting** button in the "Built-in I/O Function Setting" tab.
 - Project window ⇨ [Parameter] ⇨ [PLC Parameter] ⇨ "Built-in I/O Function Setting" tab
2. Select the "Use positioning function (Axis #1)" checkbox on the top left on the "Positioning Axis #1 Detailed Setting" screen.
3. Configure required settings.
4. Click the **End** button to exit.

Select the "Use positioning function (Axis #1)" checkbox.

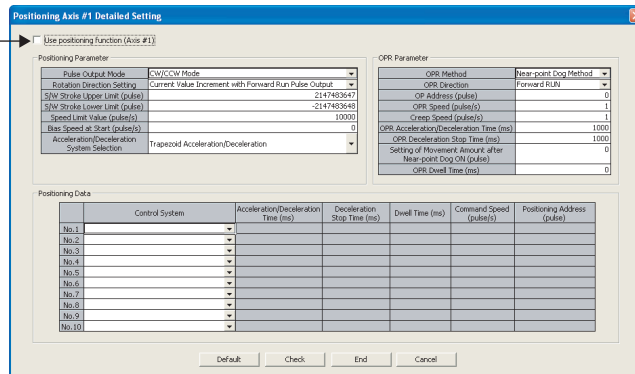

Item	Description	Reference
Positioning Parameter	These parameters define data that must be set upon system start-up according to the drive unit, motor and system configuration used.	Page 55, Section 7.3.1
OPR Parameter	These parameters define data used in OPR control.	Page 62, Section 7.6
Positioning Data	A group of data required in a single positioning operation.	Page 93, Section 7.7

When the setting is complete, the necessary external signals are assigned automatically. The drive unit ready signal and limit signals should be set as necessary. Set the input response time for input signals. The Error time output mode is fixed to "Clear."

Input Signal			
	Input Signal Function Selection	Input Response Time	Interrupt Processing Condition
Xn0	General Input	1ms	Rising
Xn1	General Input	1ms	Rising
Xn2	General Input	1ms	Rising
Xn3	General Input	1ms	Rising
Xn4	Axis #1 Zero Signal	1ms	Rising
Xn5	General Input	1ms	Rising
Xn6	General Input	10ms	Rising
Xn7	General Input	10ms	Rising
Xn8	Axis #1 Drive Module READY Signal	10ms	Rising
Xn9	General Input	10ms	Rising
XnA	Axis #1 Near-point Dog Signal	10ms	Rising
XnB	General Input	10ms	Rising
XnC	Axis #1 Upper Limit Signal	10ms	Rising
XnD	General Input	10ms	Rising
XnE	Axis #1 Lower Limit Signal	10ms	Rising
XnF	General Input	10ms	Rising

Output Signal	
	Error Time Output Mode
Yn0	General Output
Yn1	General Output
Yn2	Axis #1 Deviation Counter Clear
Yn3	General Output
Yn4	Axis #1 CW/PULSE/A Phase Output
Yn5	General Output
Yn6	Axis #1 CCW/SIGN/B Phase Output
Yn7	General Output

Select an option from the pull-down menu as necessary. According to the settings, external signals are assigned.

7.3.1 Positioning parameter

Positioning parameters are common to all controls. Set these parameters for each axis.

Setting item	Setting range	Default
Pulse Output Mode	CW/CCW Mode	CW/CCW Mode
	PULSE/SIGN Mode	
	A Phase/B Phase Mode (Multiple of 1)	
	A Phase/B Phase Mode (Multiple of 4)	
Rotation Direction Setting	Current Value Increment with Forward Run Pulse Output	Current Value Increment with Forward Run Pulse Output
	Current Value Increment with Reverse Run Pulse Output	
S/W Stroke Upper Limit (pulse)	-2147483648 to 2147483647	2147483647
S/W Stroke Lower Limit (pulse)		-2147483648
Speed Limit Value (pulse/s)	1 to 200000	10000
Bias Speed at Start (pulse/s)	0 to 200000	0
Acceleration/Deceleration System Selection	Trapezoid Acceleration/Deceleration	Trapezoid Acceleration/Deceleration
	S-curve Acceleration/Deceleration	

Executable controls and corresponding positioning parameters are shown below.

○: Must be set, △: Set as necessary, —: Need not be set

Positioning parameter	OPR control	Positioning control				JOG operation
		Position control	Speed control	Speed/position switching control	Current value change	
Pulse Output Mode	○	○	○	○	○	○
Rotation Direction Setting	○	○	○	○	○	○
S/W Stroke Upper Limit (pulse)	—	△	△	△	△	△
S/W Stroke Lower Limit (pulse)	—	△	△	△	△	△
Speed Limit Value (pulse/s)	○	○	○	○	—	○
Bias Speed at Start (pulse/s)	△	△	△	△	—	△
Acceleration/Deceleration System Selection	△	△	△	△	—	△

(1) Pulse output mode

Set the pulse output mode applicable to the drive unit used.

(a) CW/CCW mode

Forward run feed pulses (CW) are output when the motor is rotating forward. Reverse run feed pulses (CCW) are output when the motor is rotating in reverse.

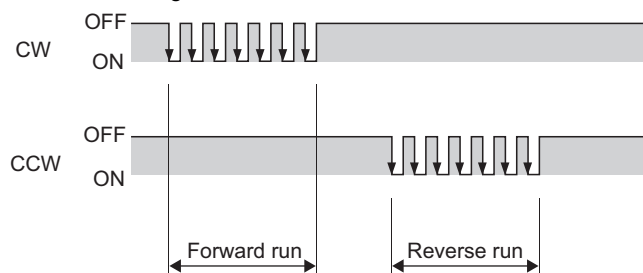

(b) PULSE/SIGN mode

Forward/reverse control is based on on/off of the direction sign (SIGN).

- The direction sign turns on when the motor is rotating forward.
- The direction sign turns off when the motor is rotating in reverse.

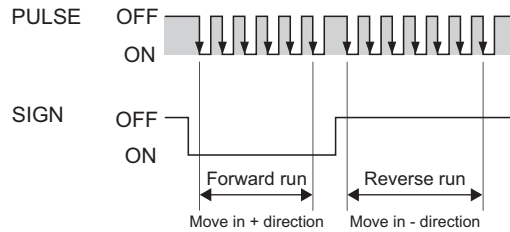

For CCW, pulses are output 100µs after the direction sign turns off.

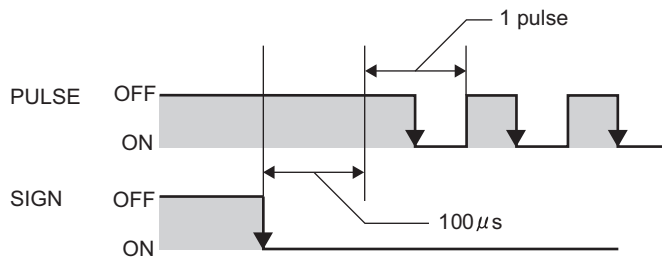

(c) A phase/B phase mode (multiple of 1), A phase/B phase mode (multiple of 4)

Forward/reverse control is based on the difference between phase A (Aφ) and phase B (Bφ).

- Phase B lags phase A by 90° when the motor is rotating forward.
- Phase A lags phase B by 90° when the motor is rotating in reverse.
- When "A Phase/B Phase Mode (Multiple of 1)" is set

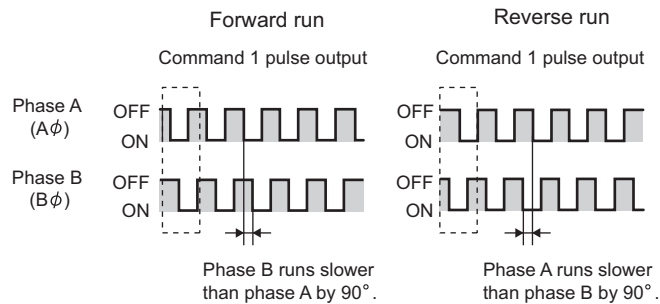

Ex. When one command pulse output corresponds to 1 pulse/s, there are four leading/trailing edges per second.

- When "A Phase/B Phase Mode (Multiple of 4)" is set

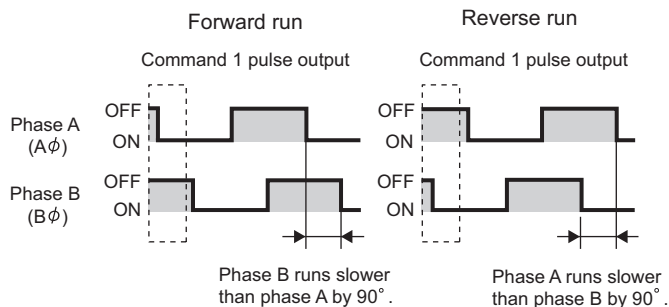

Ex. When one command pulse output corresponds to 1 pulse/s, there is one leading/trailing edge per second.

(2) Rotation direction setting

Set how the current position would increase/decrease in each rotation direction of the motor. Check the settings by JOG operation. (☞ Page 106, Section 7.9)

1. Set "Current Value Increment with Forward Run Pulse Output" for the rotation direction setting and perform forward JOG operation.
2. If the workpiece moves in the address decreasing direction defined by the system, set "Current Value Increment with Reverse Run Pulse Output" for the rotation direction setting to change the rotation direction.
(If the workpiece moves in the address increasing direction defined by the system, the current setting need not be changed.)
3. Perform forward JOG operation again and if the workpiece (W) moves in the address increasing direction, the setting is complete.

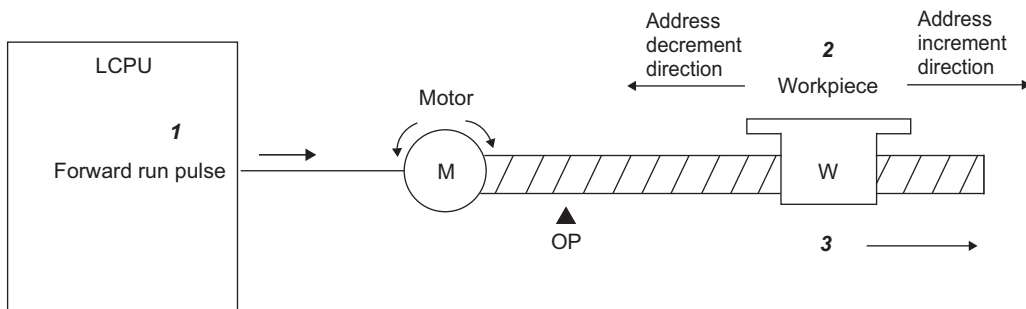

Point

If Rotation Direction Setting was changed from "Current Value Increment with Forward Run Pulse Output" to "Current Value Increment with Reverse Run Pulse Output," perform JOG operation to check if the upper limit switch and lower limit switch operate correctly. If any operation problem was found, review the wirings.

(3) S/W stroke upper limit, S/W stroke lower limit

Set the upper/lower limits of the moving range of the workpiece.

- Set the software stroke limits according to the condition specified below:

Software lower stroke limit < Software upper stroke limit

- To disable the software stroke limits, set the same value for both the upper limit and lower limit. (Desired values can be set as long as they are within the setting range.)

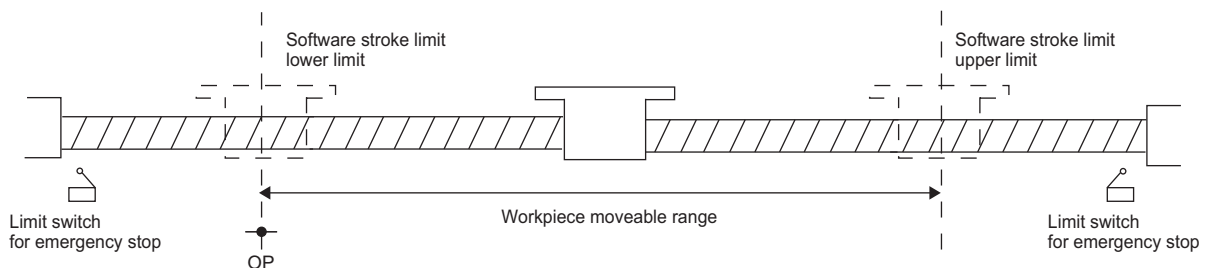

Remark

In general, the OP is set at the lower limit or upper limit of the software stroke.

(4) Speed Limit Value

Set the maximum speed for OPR control, positioning control and JOG operation. If any of the following settings exceeds the speed limit, the speed is limited to the specified limit.

- OPR speed
- Command speed
- JOG speed
- New speed value
- Bias speed at start

The speed limit is determined by the two conditions specified below:

- Motor speed
- Moving speed of the workpiece

(5) Bias speed at start

Set the minimum speed for OPR control, positioning control and JOG operation. When a stepping motor etc. is used, set this speed to ensure smooth starting of the motor. (Stepping motors do not start smoothly if the motor speed at start is low.) For the bias speed at start, set a value not exceeding the speed limit.

(6) Acceleration/deceleration system selection

Set "Trapezoid Acceleration/Deceleration" or "S-curve Acceleration/Deceleration" for acceleration/deceleration processing.

If S-curve Acceleration/Deceleration is set when a stepping motor is used, the motor does not operate normally.

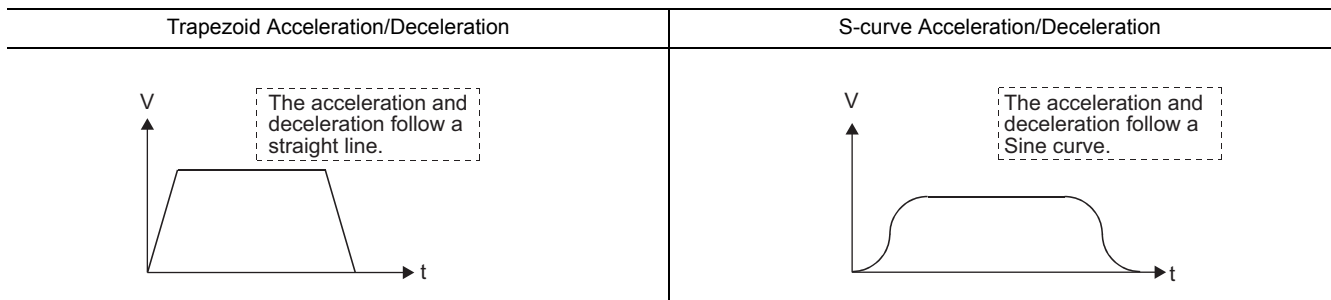

7.4 Specifications

(1) Performance specifications

The following is the performance specifications of the positioning function.

Item		Description	
		L02SCPU, L02CPU, L06CPU, L26CPU, L26CPU-BT	L02SCPU-P, L02CPU-P, L06CPU-P, L26CPU-P, L26CPU-PBT
Number of controlled axes		2	
Control unit		pulse	
Operation pattern	PTP*1 control	Available	
	Path control	Not usable	
Number of positioning data		10 data/axis	
Positioning control	Positioning control method	PTP*1 control	ABS/INC
		Speed/position switching control	INC
	Positioning range	PTP*1 control	-2147483648 to 2147483647 pulses
		Speed/position switching control	0 to 2147483647 pulses
	Speed command		0 to 200k pulses/s
	Acceleration/deceleration system selection		Automatic trapezoid acceleration/deceleration and S-curve acceleration/deceleration
	Acceleration/deceleration time		0 to 32767 ms
OPR method		6 types	
Starting time (1-axis linear control)		Trapezoid acceleration/deceleration (single-axis start): 30 μs/axis S-curve acceleration/deceleration (single-axis start): 35 μs/axis	
Command pulse output	Pulse output type		Sink type Source type
	Pulse output mode		4 modes
	Maximum output pulse		200k pulses/s
	Maximum connection distance with drive unit		2 m
External input	Zero signal	DC input	24VDC, 6.0 mA (TYP.)
		Differential input	EIA RS-422-A differential line driver level (AM26LS31 (by Texas Instruments Japan Limited.) or equivalent)
	Speed/position switching signal		24VDC, 4.1 mA (TYP.)
	Near-point dog signal		
	Upper and lower limit signal		
	Drive unit ready signal		
Input response time		Zero signal: 10μs Speed/position switching control, near-point dog signal: 100μs Upper and lower limit signal, drive unit ready signal: 2ms	
External output	Deviation counter clear signal		Sink type (5 to 24VDC, 0.1A) Source type (5 to 24VDC, 0.1A)
	Response time	ON	1 μs or less (rated load, resistive load)
		OFF	1 μs or less (rated load, resistive load)

*1 Abbreviation for "Point to Point". This is a type of position control.

(2) Special relay and special register

The following table lists the special relay (SM) and special register (SD) related to the positioning function. □ in the name indicates either 1 (Axis 1) or 2 (Axis 2). For details of the special relay and special register other than the Axis 1 axis operation status (SD1844) (☞ Page 61, Section 7.5), refer to " MELSEC-L CPU Module User's Manual (Hardware Design, Maintenance and Inspection)".

Special relay number		Name	Special register number		Name
Axis 1	Axis 2		Axis 1	Axis 2	
SM1840	SM1860	Axis □ busy	SD1840	SD1860	Axis □ current feed value
SM1841	SM1861	Axis □ positioning completion	SD1841	SD1861	
SM1842	SM1862	Axis □ OPR request	SD1842	SD1862	Axis □ current speed
SM1843	SM1863	Axis □ completed	SD1843	SD1863	
SM1844	SM1864	Axis □ speed 0	SD1844	SD1864	Axis □ axis operation status
SM1845	SM1865	Axis □ error	SD1845	SD1865	Axis □ error code
SM1846	SM1866	Axis □ warning	SD1846	SD1866	Axis □ warning code
SM1847	SM1867	Axis □ start in busy status	SD1847	SD1867	Axis □ external I/O signals
SM1848	SM1868	Axis □ start instruction	SD1848	SD1868	Axis □ movement amount after near-point dog ON
SM1850	SM1870	Axis □ error reset	SD1849	SD1869	
SM1851	SM1871	Axis □ OPR request off	SD1850	SD1870	Axis □ data No. of positioning being executed
SM1852	SM1872	Axis □ speed/position switching	—		—

7.5 Checking Current Position and Operation Status

The current position and operation status of the moving workpiece can be monitored in the special register.

(1) Checking a current position

Values indicating the current position are stored in the Axis 1 current feed value (SD1840, SD1841). The address established by machine OPR is used as the reference.

(2) Checking an operation status

The Axis 1 axis operation status (SD1844) indicates the operation status of the axis.

Stored value	Operation status	Description
0	Standing by	This is the status after the following operations: <ul style="list-style-type: none"> • (Successful) completion of operation • Power-on • When the CPU module is reset • Error reset • After JOG operation • End of absolute position restoration
1	Stopped	The axis has stopped successfully according to the Axis stop instruction (IPSTOP1).
2	In JOG operation	JOG operation is in progress.
3	In OPR	Machine OPR is in progress.
4	In position control	Position control is in progress.
5	In speed-position control (speed)	Speed control of speed/position switching control is in progress.
6	In speed-position control (position)	Position control of speed/position switching control is in progress.
7	Decelerating (axis stop ON)	The axis is decelerating according to the Axis stop instruction (IPSTOP1).
8	Decelerating (JOG start OFF)	The axis is decelerating after the execution command for JOG start instruction turned off.
9	In high-speed OPR	Fast OPR is in progress.
10	In speed control	Speed control is in progress.
11	Analyzing	Absolute position restoration is in progress.
-1	Error occurring	An error is present.

7.6 OPR Control



Two controls (machine OPR and fast OPR) are defined as OPR controls in line with the flow of OPR operation of the LCPU.

OPR control	Overview	Reference
Machine OPR	This is control to establish the reference position (= OP) to be used when positioning control is started. This control is executed when requested by the LCPU at power-on, etc. The OP is established by using a near-point dog, zero signal, etc. Set machine OPR for the original position return type of the OPR start instruction (IOPR1(P)) and execute the instruction to start the operation.	Page 70, Section 7.6.1
Fast OPR	Fast OPR is used to return the axis, which has stopped at a position other than the OP after positioning control, to the OP. After the machine OPR establishes the OP position, the workpiece is moved to the OP address or standby address by the fast OPR without using a near-point dog, zero signal, etc. Set fast OPR (OP address) or fast OPR (standby address) for the original position return type of the OPR start instruction (IOPR1(P)) and execute the instruction to start the operation.	Page 90, Section 7.6.2

To implement OPR control, the OPR parameters must be set on the "Positioning Function Parameter Setting" screen. The OPR parameters that have been set apply commonly to each axis. Setting details are explained below.

Setting item	Setting range	Default
OPR Method	Near-point Dog Method	Near-point Dog Method
	Stopper 1	
	Stopper 2	
	Stopper 3	
	Count 1	
	Count 2	
	No Method	
OPR Direction	Forward RUN	Forward RUN
	Reverse RUN	
OP Address (pulse)	-2147483648 to 2147483647	0
OPR Speed (pulse/s)	1 to 200000	1
Creep Speed (pulse/s)		
OPR Acceleration/Deceleration Time (ms)	0 to 32767	1000
OPR Deceleration Stop Time (ms)		
Setting of Movement Amount after Near-point Dog ON (pulse)	0 to 2147483647	0
OPR Dwell Time (ms)	0 to 65535	

Note that the explanations in this section assume use of Axis 1. For the special relay, special register, dedicated instructions, and error codes for Axis 2, refer to the following.

- Special relay and special register:  Page 60, Section 7.4 (2)
- Dedicated instructions:  Page 139, Section 7.12
- Error codes:  Page 179, Section 7.14 (2)

(1) OPR method

Set the method of machine OPR. (This setting does not affect the fast OPR.) Operations under each method are explained below. For the details of each method and applicable precautions, refer to (📖 Page 70, Section 7.6.1).

Near-point dog method	
	<ol style="list-style-type: none"> 1) Start of machine OPR. ↓ 2) The axis starts to decelerate upon detection of turning on of the near-point dog. ↓ 3) The axis decelerates to the creep speed and moves at the creep speed thereafter. ↓ 4) Pulse output from the LCPU stops when the first zero signal is issued after the near-point dog has turned off, and machine OPR is complete.
Stopper 1	
	<ol style="list-style-type: none"> 1) Start of machine OPR. ↓ 2) The axis starts to decelerate upon detection of turning on of the near-point dog. ↓ 3) The axis decelerates to the creep speed and moves at the creep speed thereafter. ↓ 4) The axis contacts the stopper at the creep speed and stops. ↓ 5) Upon elapse of the OPR dwell time after the near-point dog has turned on, pulse output from the LCPU stops and machine OPR is complete.
Stopper 2	
	<ol style="list-style-type: none"> 1) Start of machine OPR. ↓ 2) The axis starts to decelerate upon detection of turning on of the near-point dog. ↓ 3) The axis decelerates to the creep speed and moves at the creep speed thereafter. ↓ 4) The axis contacts the stopper at the creep speed and stops. ↓ 5) When the zero signal is detected, pulse output from the LCPU stops and machine OPR is complete.

Stopper 3	
	<ol style="list-style-type: none"> 1) Start of machine OPR. ↓ 2) The axis contacts the stopper at the creep speed and stops. ↓ 3) When the zero signal is detected, pulse output from the LCPU stops and machine OPR is complete.
Count 1	
	<ol style="list-style-type: none"> 1) Start of machine OPR. ↓ 2) The axis starts to decelerate upon detection of turning on of the near-point dog. ↓ 3) The axis decelerates to the creep speed and moves at the creep speed thereafter. ↓ 4) Pulse output from the LCPU stops at the first zero signal after the near-point dog has turned on and the axis has moved the distance set by "Movement amount after near-point dog ON", and the machine OPR is complete.
Count 2	
	<ol style="list-style-type: none"> 1) Start of machine OPR. ↓ 2) The axis starts to decelerate upon detection of turning on of the near-point dog. ↓ 3) The axis decelerates to the creep speed and moves at the creep speed thereafter. ↓ 4) Pulse output from the LCPU stops after the axis has moved the distance set by "Movement amount after near-point dog ON" (the axis starts to decelerate from the creep speed over the OPR deceleration stop time), and the machine OPR is complete.

(a) OPR methods and OPR parameters

Different I/O signals are required depending on each OPR method. The relationships are shown below.

For the settings required for the fast OPR, refer to Page 90, Section 7.6.2.

○: Must be set, —: Need not be set

OPR parameter	OPR method					
	Near-point Dog Method	Stopper 1	Stopper 2	Stopper 3	Count 1	Count 2
OPR Direction	○	○	○	○	○	○
OP Address	○	○	○	○	○	○
OPR Speed	○	○	○	○	○	○
Creep Speed	○	○	○	○	○	○
OPR Acceleration/Deceleration Time	○	○	○	○	○	○
OPR Deceleration Stop Time	○	○	○	○	○	○
Setting of Movement Amount after near-point Dog ON	—	—	—	—	○	○
OPR Dwell Time	○*1	○	—	—	○*1	○*1

*1 This setting becomes effective when OPR is retried.

(2) OPR direction

Set the direction in which to start machine OPR. (This setting does not affect fast OPR.)

Forward RUN: The axis operates in the direction of increasing address (arrow 2)).

Reverse RUN: The axis operates in the direction of decreasing address (arrow 1)).

Normally the OP is set near the lower limit switch or upper limit switch. Accordingly, set the OPR direction as shown below.

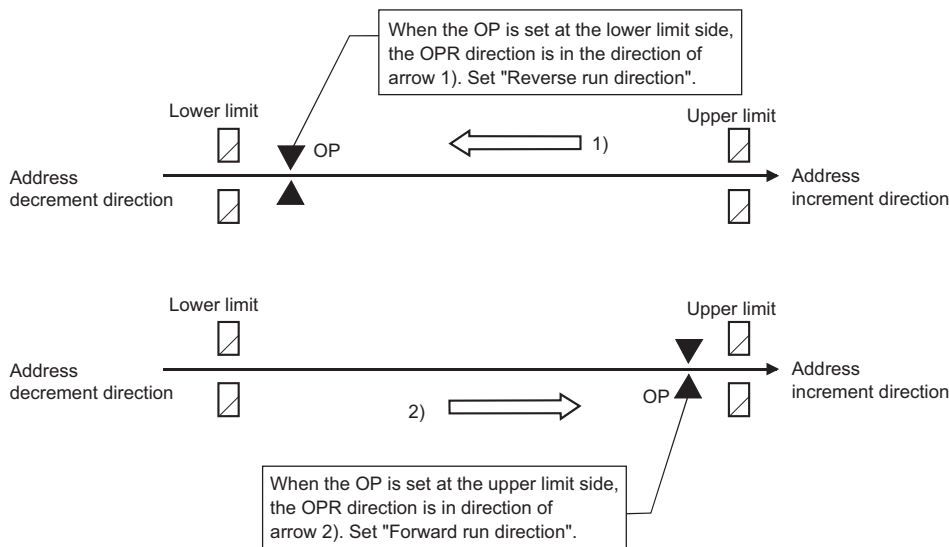

(3) OP address

Set the position that becomes the reference point of position control (ABS). Upon completion of machine OPR, the address of the stop position (Axis 1 current feed value (SD1840, SD1841) changes to the OP address that has been set.

(4) OPR speed

Set the speed of OPR control. The following condition must be met:

Bias speed at start \leq Creep speed \leq OPR speed \leq Speed limit

(5) Creep speed

Set the low speed at which the axis moves immediately before stopping after decelerating from the OPR speed following the turning on of the near-point dog. The following condition must be met: (This setting does not affect fast OPR.)

$$\text{Bias speed at start} \leq \text{Creep speed} \leq \text{OPR speed} \leq \text{Speed limit}$$

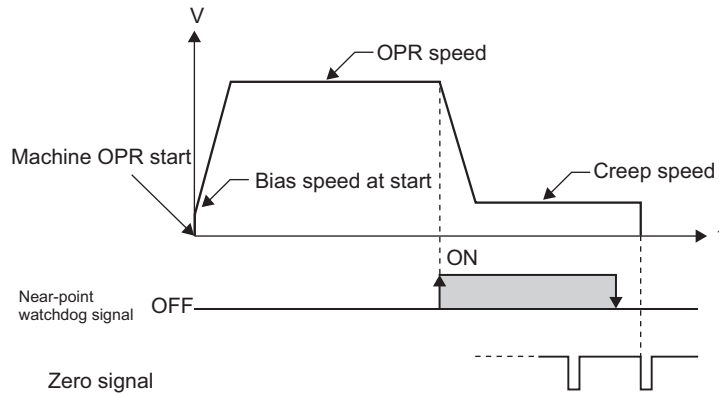

The creep speed affects the detection error in an OPR method using a zero signal, or degree of impact of collision in the OPR Method using a stopper method.

(6) OPR acceleration/deceleration time

Set the time required to reach the OPR speed from the bias speed at start, or creep speed from the OPR speed.

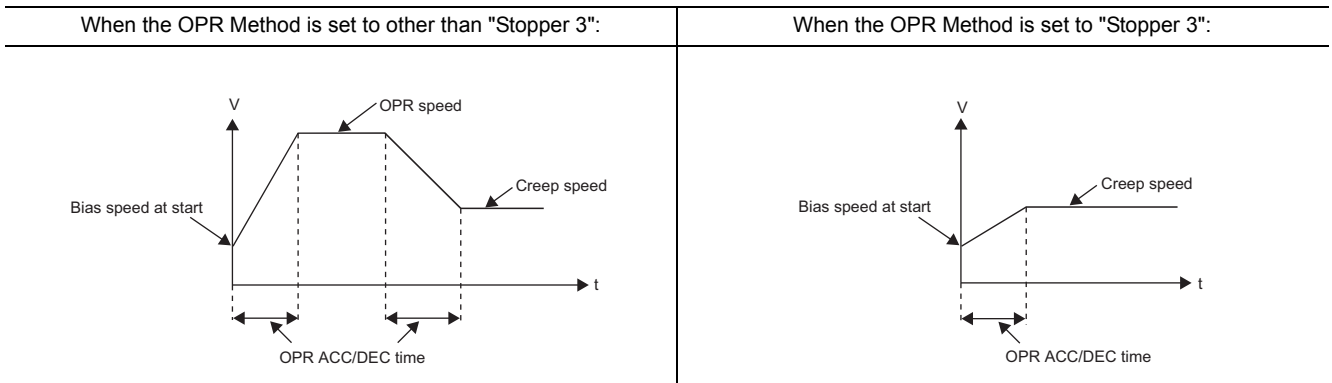

(7) OPR deceleration stop time

Set the time required for the following conditions.

- For "Count 2"
This time is from when the axis decelerates the speed from the creep speed to when it stops at the bias speed at start.
- For all OPR method
This time is from when a stop cause occurs during OPR control to when the axis stops at the bias speed at start from the OPR speed.
- For the fast OPR
This time is from when the axis decelerates the speed from the OPR speed to when it stops at the bias speed at start. (☞ Page 90, Section 7.6.2)

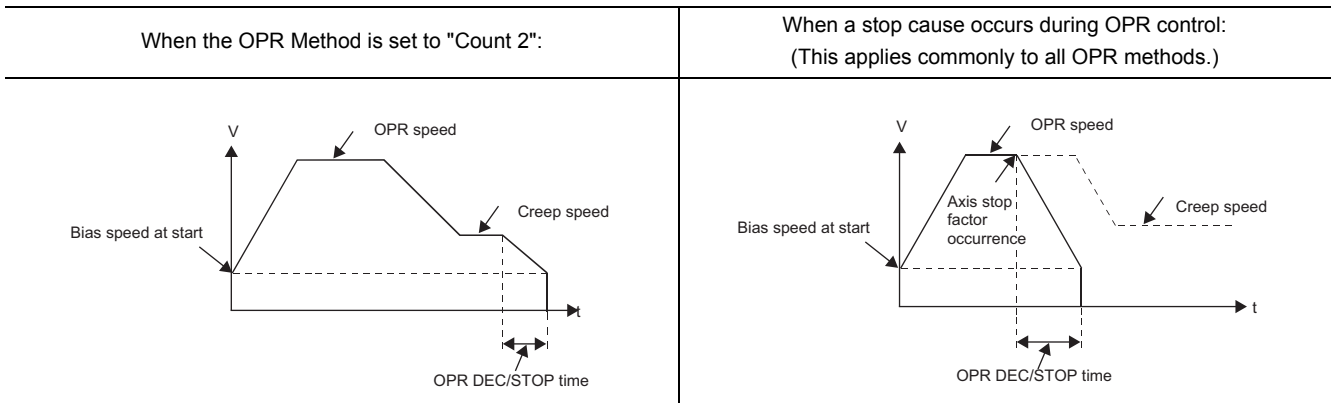

(8) Setting of movement amount after near-point dog ON

- Set the movement amount from the position at which the near-point dog turns on until a zero signal is input when the OPR Method is set to "Count 1."
- Set the movement amount from the position at which the near-point dog turns on to the OP when the OPR Method is set to "Count 2."

For "Setting of Movement Amount after Near-point Dog ON", set a value equal to or greater than the deceleration distance from the OPR speed to creep speed. (This setting does not affect fast OPR.)

Ex. Calculation of "Movement Amount after Near-point Dog ON" when "OPR Speed" is set to 10 kpulses/s, "Creep Speed" to 2 kpulses/s, and "OPR Acceleration/Deceleration Time" to 320ms

[Machine OPR control operation]

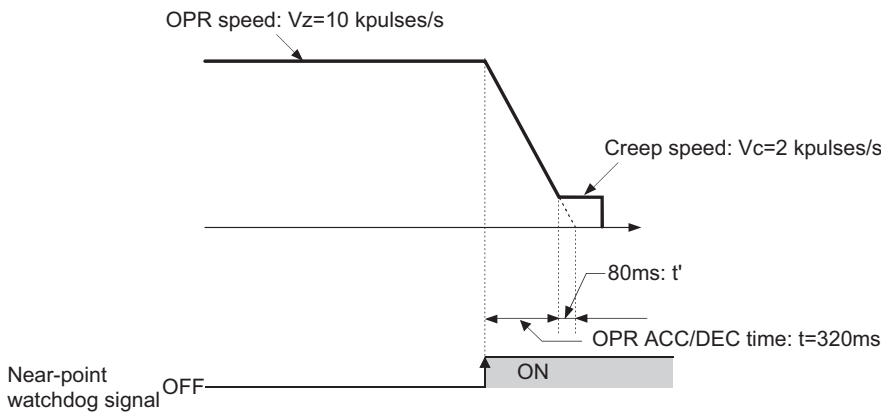

$$[\text{Deceleration distance}] = \frac{1}{2} \times V_z \times \frac{t+t'}{1000}$$

$$= \frac{V_z \times (t+t')}{2000}$$

$$= \frac{10 \times 10^3 \times (320+80)}{2000}$$

$$= 2000$$

Set 2000 pulses or more in "Setting of Movement Amount after near-point Dog ON".

(9) OPR dwell time

Set this parameter in the conditions specified below. (This setting does not affect the fast OPR.)

(a) When the OPR Method is set to "Stopper 1":

Set the time required for machine OPR to complete after the near-point dog turns on. For the OPR dwell time, set a value equal to or greater than the moving time after the near-point dog turns on until the axis stops at the stopper.

(b) When the OPR retry function is enabled:

Set the stopping time after the axis decelerates to a stop. (☞ Page 111, Section 7.10.1)

7.6.1 Machine OPR

The machine OPR establishes the machine OP using the OPR start instruction (IPOP1(P)). (Page 148, Section 7.12.1 (4)) Once the machine OPR is complete, the mechanically established position becomes the "OP" which defines the starting point of positioning control. (No address information stored in the LCPU or servo amplifier is used.) How the OP is established by machine OPR varies depending on the "OPR method." Select one of the six methods that best suits your system.

(1) OPR method and I/O signal

Different I/O signals are used under each OPR method. A correspondence table of OPR methods and I/O signals is shown below.

○: Wiring required, △: Wire as necessary, —: Wiring not required

I/O signal	OPR method						
	Near-point dog method	Stopper 1	Stopper 2	Stopper 3	Count 1	Count 2	No method
Zero Signal	○	— ^{*1}	○	○	○	— ^{*1}	— ^{*1}
Near-point Dog Signal	○	○	○	— ^{*1}	○	○	— ^{*1}
Deviation Counter Clear Signal	○	○	○	○	○	— ^{*1}	— ^{*1}
External Command Signal ^{*1}	—	—	—	—	—	—	—
CW/PULSE/A Phase Output	○	○	○	○	○	○	— ^{*1}
CCW/SIGN /B Phase Output	○	○	○	○	○	○	— ^{*1}
Drive Unit Ready Signal ^{*1}	△	△	△	△	△	△	—
Upper Limit Signal ^{*1*2}	△	△	△	△	△	△	△
Lower Limit Signal ^{*1*2}	△	△	△	△	△	△	△

*1 When this signal is not required, it can be used for other functions such as the general-purpose input and general-purpose output.

*2 These signals are required when the OPR retry function or hardware stroke limit function is used.

(2) Subfunction

The OPR retry function can be used when the upper and lower limit signals are input.

(Page 111, Section 7.10.1)

Important

• OPR direction

(1) The direction of the OP must always be the same when viewed from any arbitrary position in the moving area of the workpiece (= the OP must be positioned near the upper limit or lower limit of the machine).



(2) Set the OPR direction correctly so that the workpiece moves toward the OP.

If the above two conditions are not met, the OPR retry function may actuate inadvertently.

The following situations may also result:

- The near-point dog is already off at the start of machine OPR.
- Machine OPR starts in the opposite direction of near-point dog.

In this case, no near-point dog is detected after machine OPR is started. As a result, the axis may continue to operate at the OPR speed until reaching the limit switch and damage the machine system. If this is the possibility, use the OPR retry function

( Page 111, Section 7.10.1) or perform JOG operation ( Page 106, Section 7.9) to move the workpiece until just before the near-point dog as viewed from the OPR direction.

• Deceleration stop time

If any of the following stop causes occurs during OPR operation, the axis decelerates to a stop over the "OPR deceleration stop time," not "OPR acceleration/deceleration time":

- The program is stopped.
- The drive unit ready signal is turned off.
- A hardware stroke limit is reached. (If the OPR retry function is enabled, the axis decelerates to a stop and then starts moving in the opposite direction.)
- The Axis stop instruction (IPSTOP1) is issued.

When decelerating from the OPR speed, for example, the data to be used as the deceleration time varies between "deceleration due to near-point dog ON" and "deceleration by Axis stop instruction (IPSTOP1) execution command ON." Since the motor load changes according to the deceleration time, set this time properly by giving full consideration to the impact on the machine.

(3) Operations of Near-point dog method and precautions

Under the near-point dog method, machine OPR completes when a zero signal is input after the near-point dog has turned off. The following operations take place.

Operation step	Description of operation
1)	Machine OPR starts upon execution of the OPR start instruction (IOPR1(P)). The axis accelerates from the bias speed at start to the OPR speed in the OPR direction over the OPR acceleration/deceleration time and moves at the OPR speed.
2)	The axis starts to decelerate upon detection of turning on of the near-point dog. The axis decelerates to the creep speed and moves at the creep speed thereafter.
3)	When the first zero signal (signal for outputting one pulse per motor rotation) is issued after the near-point dog has turned off, the LCPU stops outputting pulses and outputs a deviation counter clear signal to the drive unit.
4)	Upon completion of output of the deviation counter clear signal (output for 10 ms), the Axis 1 OPR completion (SM1843) turns on and Axis 1 OPR request (SM1842) turns off.

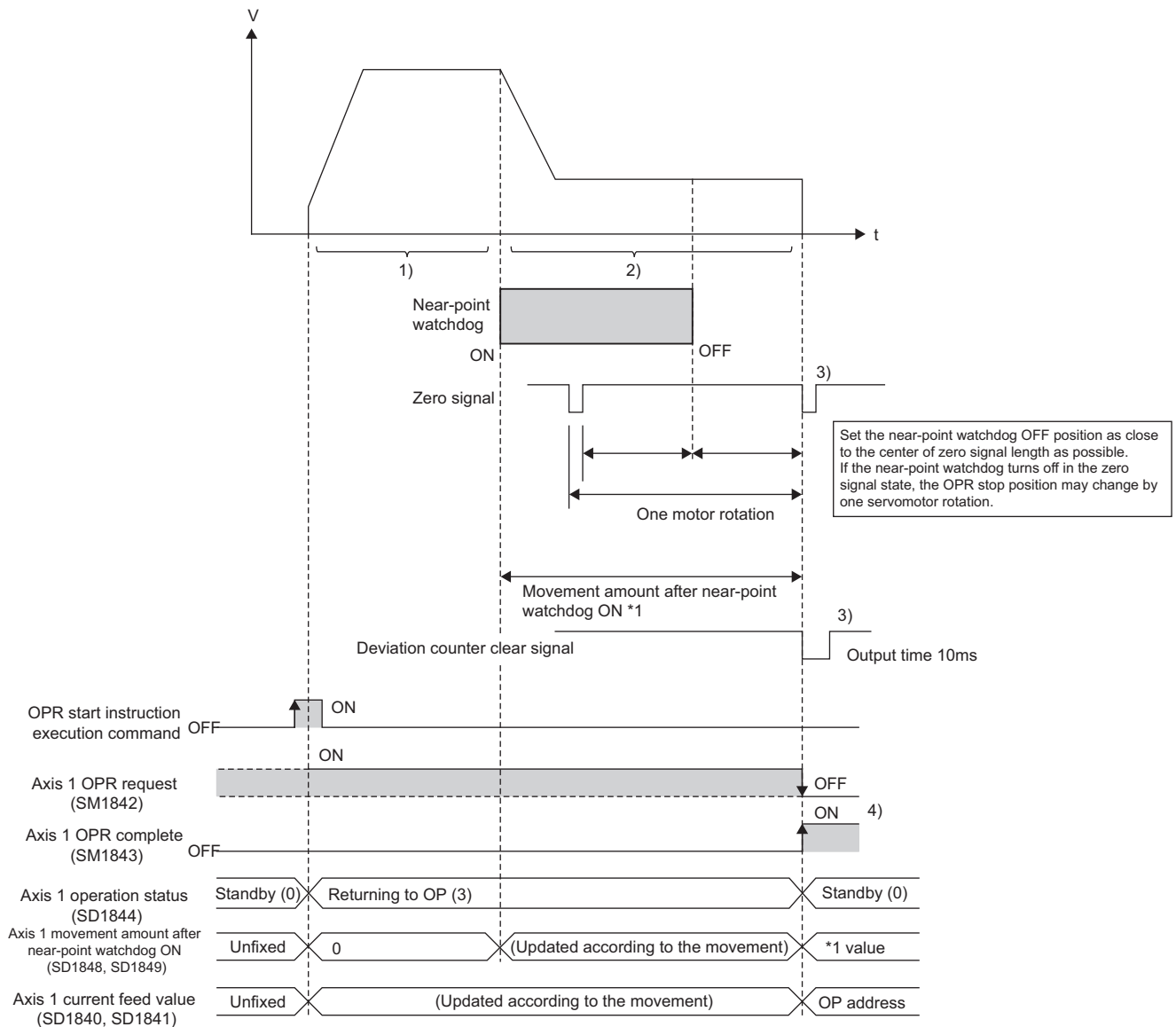



(a) Required pulse generator

Use a pulse generator with zero signal. If a pulse generator without zero signal is used, generate a zero signal using an external signal.

(b) Near-point dog length

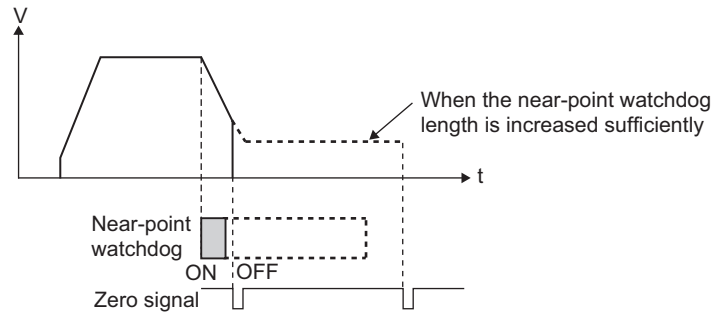
The near-point dog length should be equal to or longer than the distance moved by the axis as it decelerates from the OPR speed to creep speed. If the length is short, the near-point dog turns off while the axis is still decelerating from the OPR speed to creep speed. When the zero signal turns on in this condition, the axis stops immediately to complete machine OPR. As a result, the OP position deviates and the motor load also increases because the axis stops suddenly at the creep speed or higher.



For the method to calculate the distance from the near-point dog ON position to OP, refer to  Page 68, Section 7.6 (8).

(c) Advantages of using limit switches

The following functions can be used when the upper and lower limit signals are selected:

- OPR retry function

When machine OPR is started in a position indicated as interval A (where the near-point dog is turned off and no near-point dog is found in the OPR direction) in the figure below, the axis continues to operate at the OPR speed until reaching the limit switch of the machine system because it cannot detect the near-point dog.

When the limit signal in the OPR direction turns off, the OPR retry function actuates. As a result, the axis decelerates to a stop and then move in the opposite direction to complete machine OPR successfully.

( Page 111, Section 7.10.1). This eliminates the need to perform JOG operation, etc., to return to the position before the near-point dog turns on.

- Hardware stroke limit function

When the limit signal in the direction opposite the OPR direction turns off, the axis decelerates to a stop due to the hardware stroke limit function ( Page 124, Section 7.10.5). This prevents damage to the machine system.

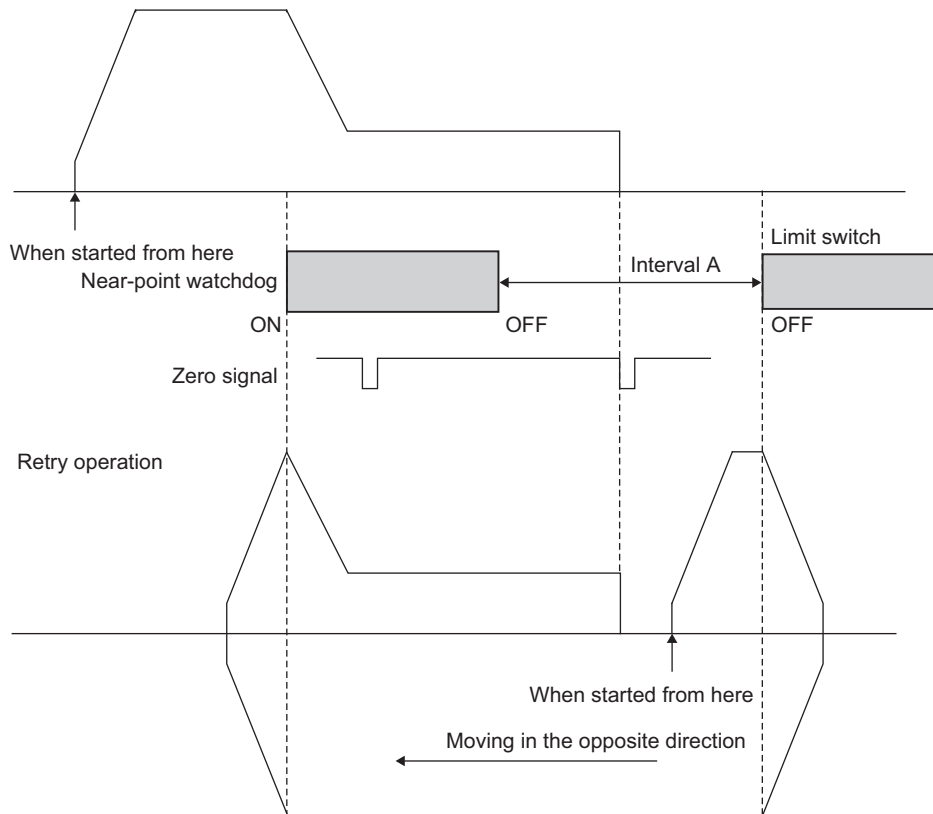

(d) Machine OPR from a position where the near-point dog is turned on

When machine OPR is started at a position indicated as interval B (where the near-point dog is turned on) in the figure below, the OPR retry function does not operate. The axis moves at the creep speed to complete machine OPR.

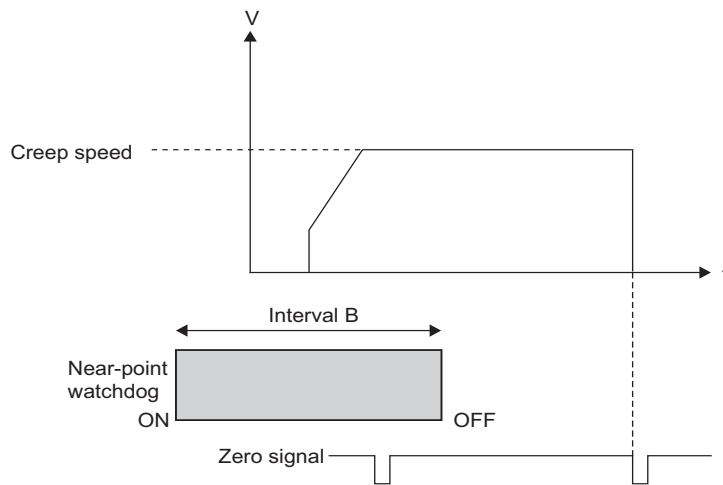

(4) Operations of Stopper 1 and precautions

Under this method, machine OPR completes upon elapse of the OPR dwell time after the detection of near-point dog ON. The following operations take place.

Operation step	Description of operation
1)	Machine OPR starts upon execution of the OPR start instruction (IOPR1(P)). The axis accelerates from the bias speed at start to the OPR speed in the OPR direction over the "OPR acceleration/deceleration time" and moves at the OPR speed.
2)	The axis starts to decelerate upon detection of turning on of the near-point dog. The axis decelerates to the creep speed and moves at the creep speed thereafter.
3)	The axis contacts the stopper at the creep speed and stops.
4)	Upon elapse of the OPR dwell time after the near-point dog has turned on, the LCPU stops outputting pulses and outputs a deviation counter clear signal to the drive unit.
5)	Upon completion of output of the deviation counter clear signal (output for 10 ms), the Axis 1 OPR completion (SM1843) turns on and Axis 1 OPR request (SM1842) turns off.

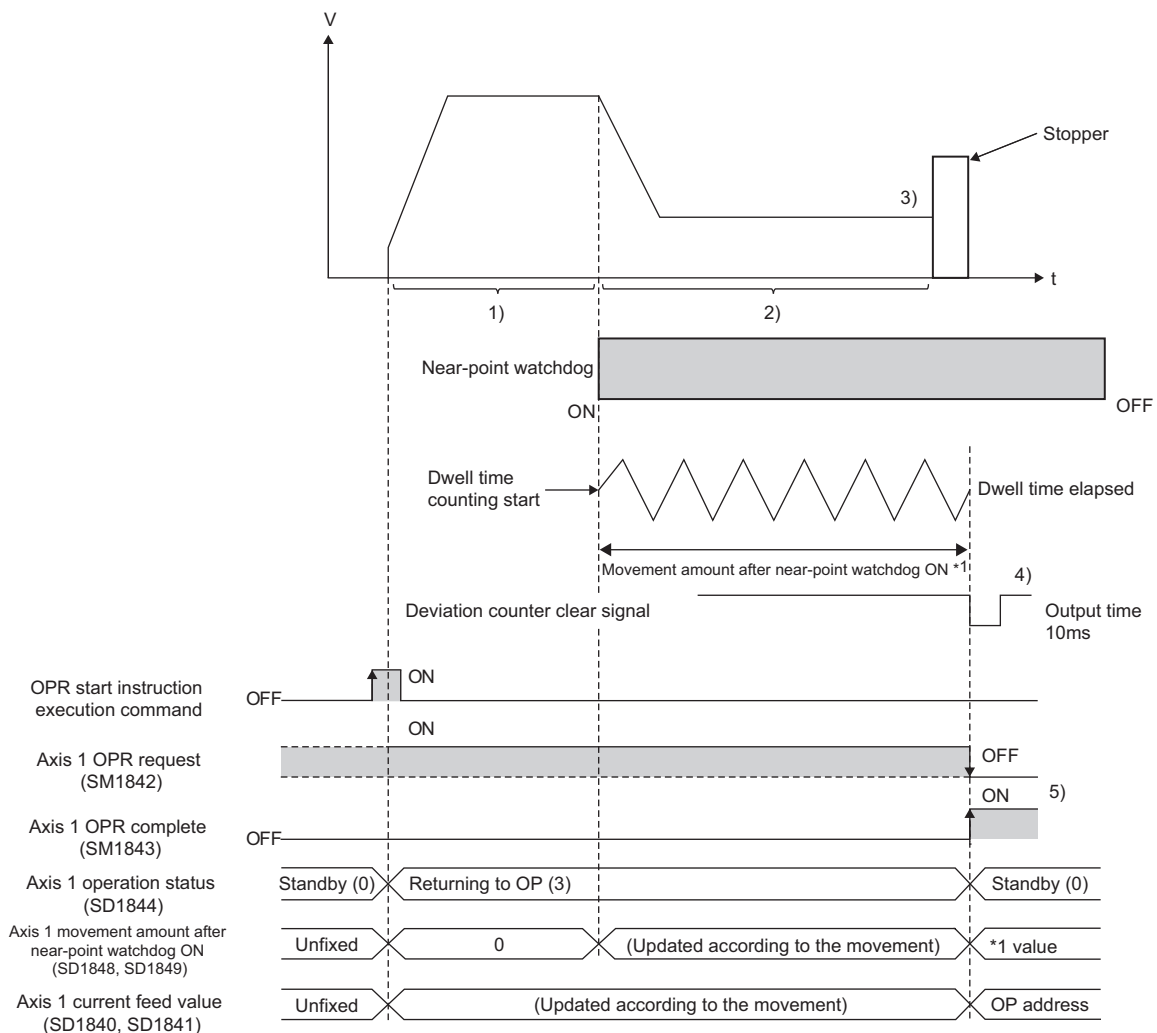

(a) Motor torque limit

Be sure to limit the motor torque after the creep speed is reached. If the torque is not limited, the motor may be damaged when the stopper is contacted. For limitation of torque, refer to the manual for the drive unit.

(b) Setting of OPR dwell time

For "OPR dwell time," set a value equal to or greater than the moving time from the near-point dog ON position until the stopper is contacted. If the OPR dwell time is short, machine OPR completes before the stopper is contacted and the OP position deviates. If the OPR dwell time is shorter than the OPR acceleration/ deceleration time, the motor stops suddenly at the higher speed than the creep speed. As a result, load for motor is increased.

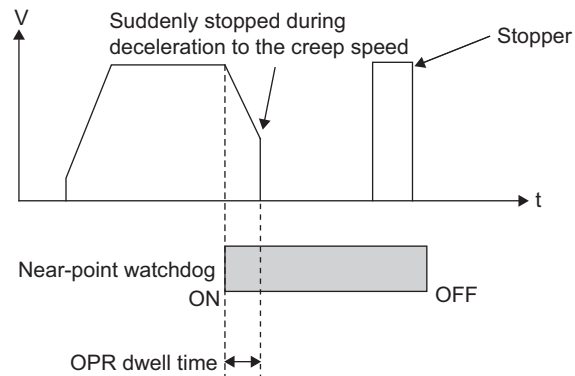

(c) Near-point dog and starting position

- When machine OPR is started in a position indicated as interval A (where the near-point dog is turned on) in the figure below, the axis moves at the creep speed to complete machine OPR.

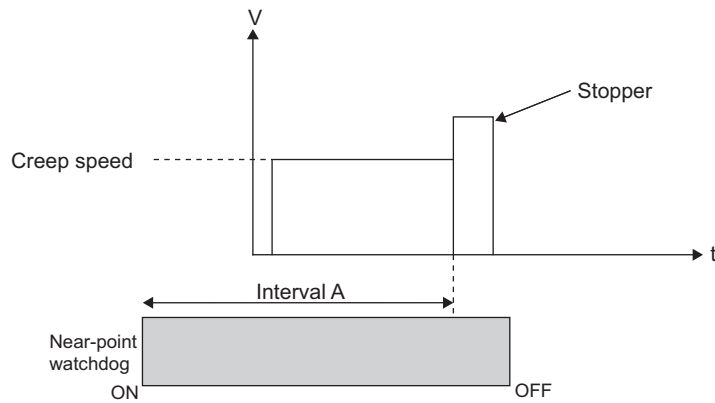

- When starting position is in interval B (between the near-point dog OFF position and stopper) in the figure below, no near-point dog is detected and thus the axis may collide with the stopper at the OPR speed. Make sure the near-point dog is longer than the distance to the stopper.

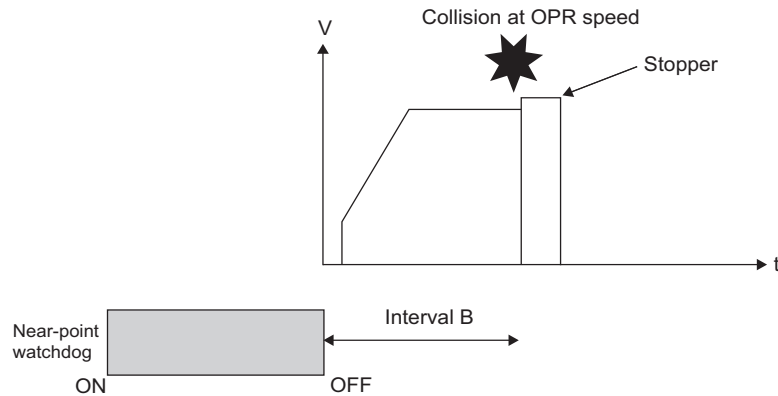

(d) OPR retry function

The OPR retry function cannot be used.

(5) Operations of Stopper 2 and precautions

Under this method, machine OPR completes upon input of a zero signal via an external switch, etc., following stopper contact. The following operations take place.

Operation step	Description of operation
1)	Machine OPR starts upon execution of the OPR start instruction (IOPR1(P)). The axis accelerates from the bias speed at start to the OPR speed in the OPR direction over the "OPR acceleration/deceleration time" and moves at the OPR speed.
2)	The axis starts to decelerate upon detection of turning on of the near-point dog. The axis decelerates to the creep speed and moves at the creep speed thereafter.
3)	The axis contacts the stopper at the creep speed and stops.
4)	When a zero signal (output upon detection of stopper contact) is issued after the axis has stopped, the LCPU stops outputting pulses and outputs a deviation counter clear signal to the drive unit.
5)	Upon completion of output of the deviation counter clear signal (output for 10 ms), the Axis 1 OPR completion (SM1843) turns on and Axis 1 OPR request (SM1842) turns off.

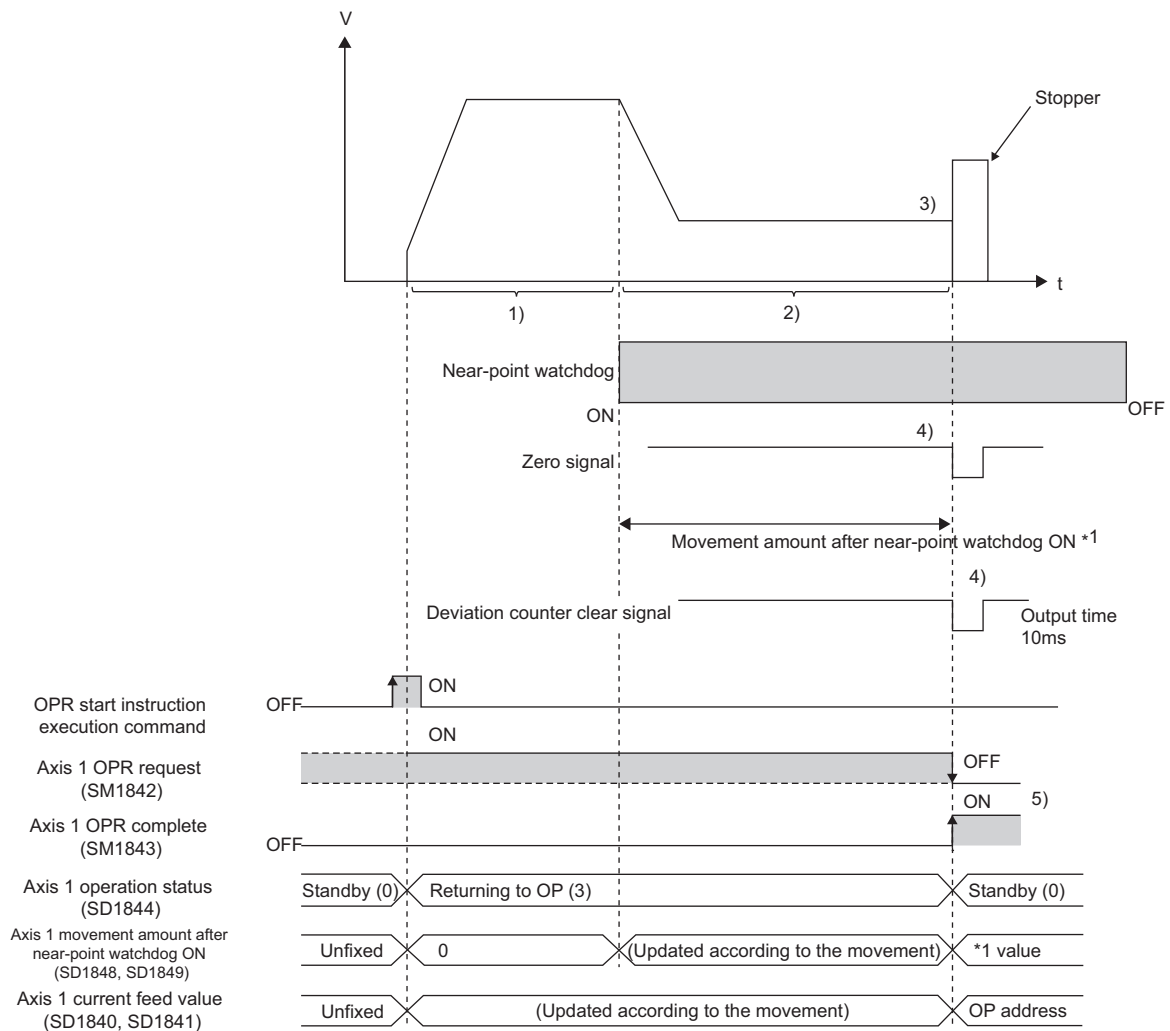

(a) Motor torque limit

Limit the motor torque after the creep speed is reached. If the torque is not limited, the motor may be damaged when the stopper is contacted. For limitation of torque, refer to the manual for the drive unit.

(b) Near-point dog and starting position

- When machine OPR is started in a position indicated as interval A (where the near-point dog is turned on) in the figure below, the axis moves at the creep speed to complete machine OPR.

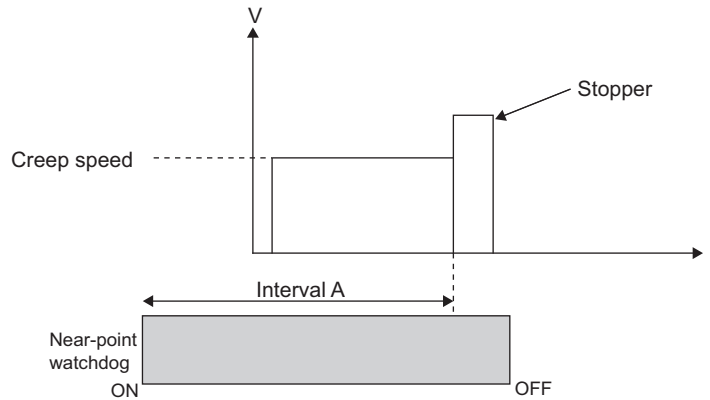

- When starting position is in interval B (between the near-point dog OFF position and stopper
-) in the figure below, no near-point dog is detected and thus the axis may collide with the stopper at the OPR speed. Make sure the near-point dog is longer than the distance to the stopper.

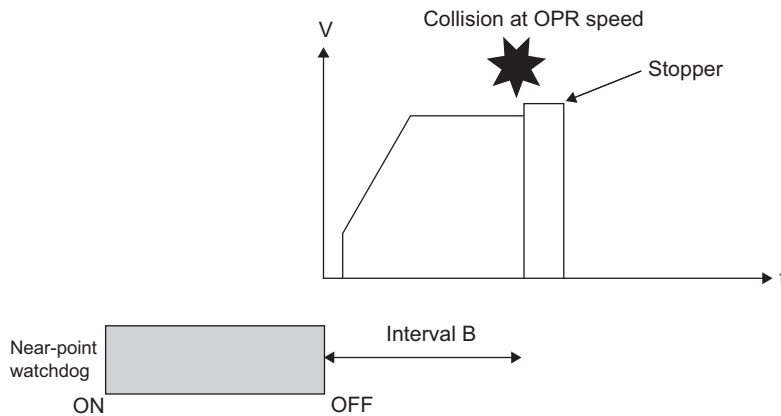

(c) OPR retry function

The OPR retry function cannot be used.

(d) Zero signal input

- Input a zero signal after the stopper has been contacted. If a zero signal is input before the stopper is contacted, machine OPR completes at that point. As a result, the OP position deviates and if a zero signal is input while the axis is decelerating to the creep speed, the motor load also increases because the axis stops suddenly at the creep speed or higher.

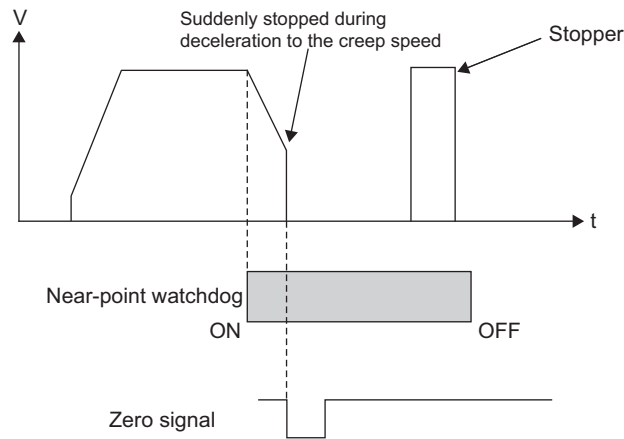

- Do not input a zero signal before machine OPR is started. If a zero signal is already input externally when machine OPR is started, a "Zero signal ON" error (Axis 1 error code: 1200) occurs and machine OPR is not performed.

(6) Operations of Stopper 3 and precautions

Under this method, machine OPR completes upon input of a zero signal via an external switch etc. following stopper contact. This method is effective when no near-point dog is installed. Note, however, that it takes a longer time to complete machine OPR because the axis operates at the creep speed, not at the OPR speed. The following operations take place.

Operation step	Description of operation
1)	Machine OPR starts upon execution of the OPR start instruction (IOPR1(P)). The axis accelerates from the bias speed at start to the creep speed in the OPR direction over the "OPR acceleration/deceleration time" and moves at the creep speed.
2)	The axis contacts the stopper at the creep speed and stops.
3)	When a zero signal (output upon detection of stopper contact) is issued after the axis has stopped, the LCPU stops outputting pulses and outputs a deviation counter clear signal to the drive unit.
4)	Upon completion of output of the deviation counter clear signal (output for 10 ms), the Axis 1 OPR completion (SM1843) turns on and Axis 1 OPR request (SM1842) turns off.

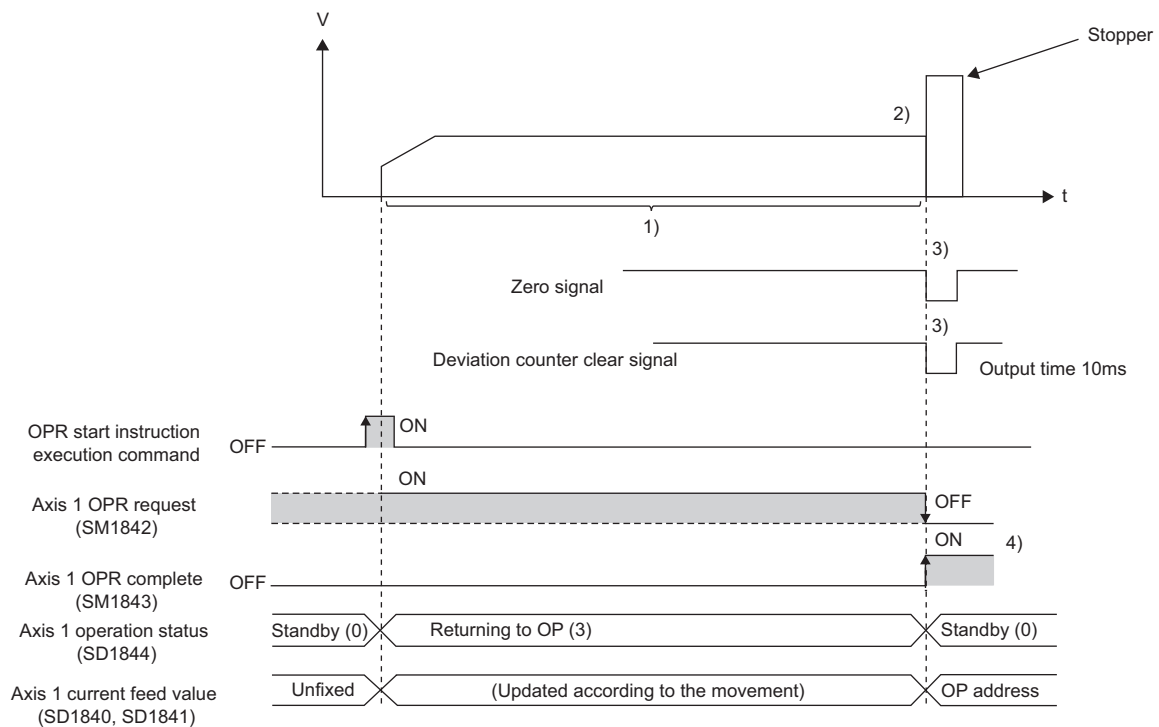

(a) Motor torque limit

Limit the motor torque after the creep speed is reached. If the torque is not limited, the motor may be damaged when the stopper is contacted. For limitation of torque, refer to the manual for the drive unit used.

(b) OPR retry function

The OPR retry function cannot be used.

(c) Zero signal input

- Input a zero signal after the stopper has been contacted. If a zero signal is input before the stopper is contacted, machine OPR completes at that point and the OP position deviates.
- Do not input a zero signal before machine OPR is started. If a zero signal is already input externally when machine OPR is started, a "Zero signal ON" error (Axis 1 error code: 1200) occurs and machine OPR is not performed.

(7) Operations of Count 1 and precautions

Under this method, machine OPR completes when the first zero signal is input after the axis has moved the distance set by "Movement amount after near-point dog ON" from the near-point dog ON point. The following operations take place.

Operation step	Description of operation
1)	Machine OPR starts upon execution of the OPR start instruction (IOPR1(P)). The axis accelerates from the bias speed at start to the OPR speed in the OPR direction over the "OPR acceleration/deceleration time" and moves at the OPR speed.
2)	The axis starts to decelerate upon detection of turning on of the near-point dog. The axis decelerates to the creep speed and moves at the creep speed thereafter.
3)	When the first zero signal (signal for outputting one pulse per motor rotation) is issued after the axis has moved the distance set by "Movement amount after near-point dog ON," the LCPU stops outputting pulses and outputs a deviation counter clear signal to the drive unit.
4)	Upon completion of output of the deviation counter clear signal (output for 10 ms), the Axis 1 OPR completion (SM1843) turns on and Axis 1 OPR request (SM1842) turns off.

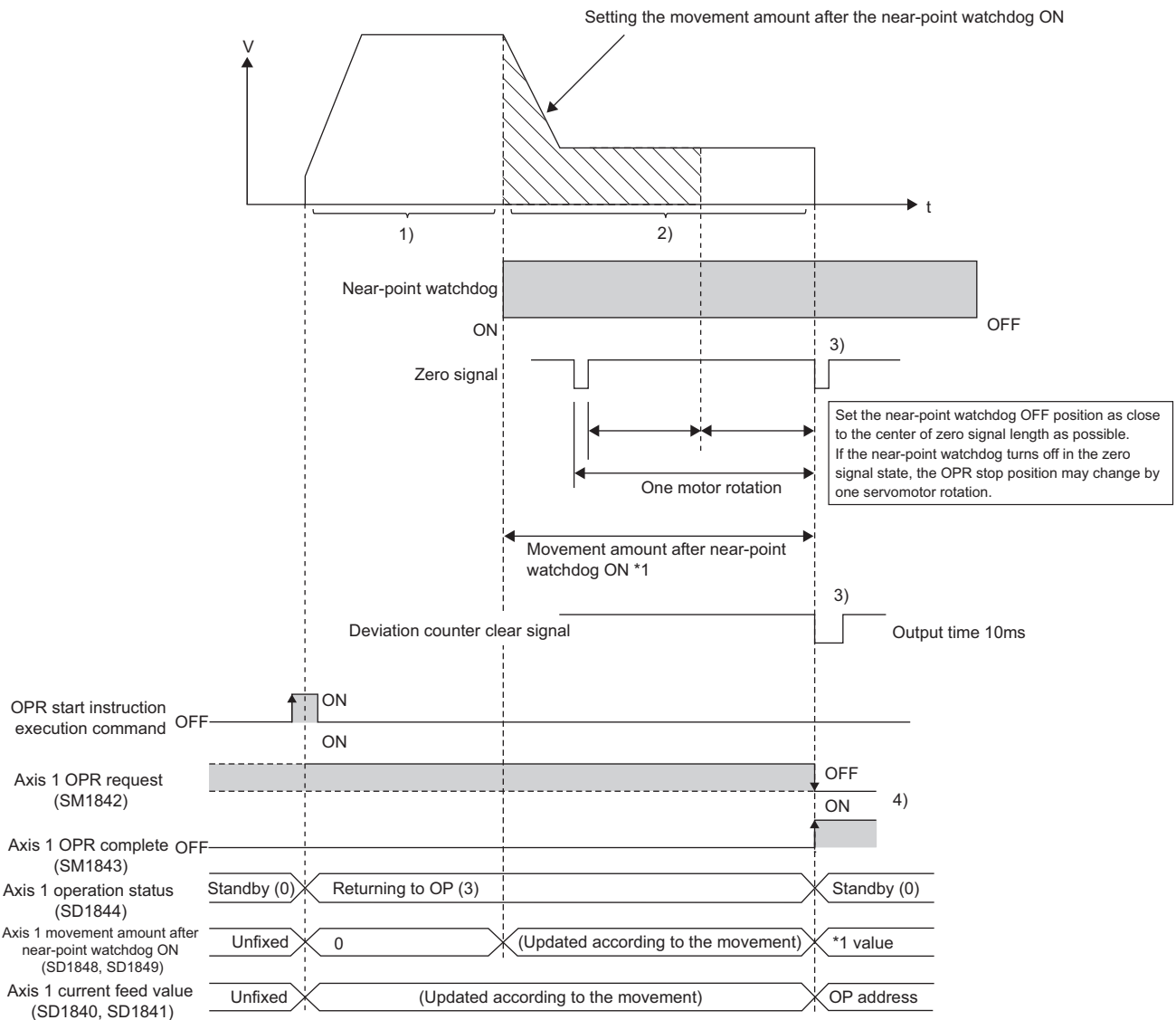

(a) Required pulse generator

A pulse generator with zero signal is required. If a pulse generator without zero signal is used, generate a zero signal using an external signal.

(b) Movement amount after near-point dog ON

The "Movement amount after near-point dog ON" should be equal to or greater than the distance moved by the axis as it decelerates from the OPR speed to creep speed (Page 68, Section 7.6 (8)). If a zero signal is input after the axis has moved the distance set by "Movement amount after near-point dog ON" while still decelerating from the OPR speed to creep speed, the axis stops immediately at that point to complete machine OPR. As a result, the OP position deviates and the motor load also increases because the axis stops suddenly at the creep speed or higher.

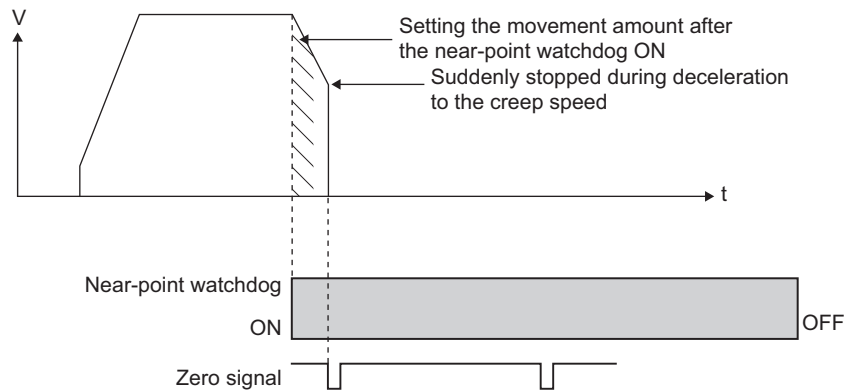

(c) Advantages of using limit switches

The following functions can be used when the upper and lower limit signals are selected:

- OPR retry function

When machine OPR is started in a position indicated as interval A (where the near-point dog is turned off and no near-point dog is found in the OPR direction) in the figure below, the axis continues to operate at the OPR speed until reaching the limit switch of the machine system because it cannot detect the near-point watchdog.

When the limit signal in the OPR direction turns off, the OPR retry function actuates. As a result, the axis decelerates to a stop and then move in the opposite direction to complete machine OPR successfully.

(☞ Page 111, Section 7.10.1). This eliminates the need to perform JOG operation, etc., to return to the position before the near-point dog turned on.

- Hardware stroke limit function

When the limit signal in the direction opposite the OPR direction turns off, the axis decelerates to a stop due to the hardware stroke limit function (☞ Page 124, Section 7.10.5). This prevents damage to the machine system.

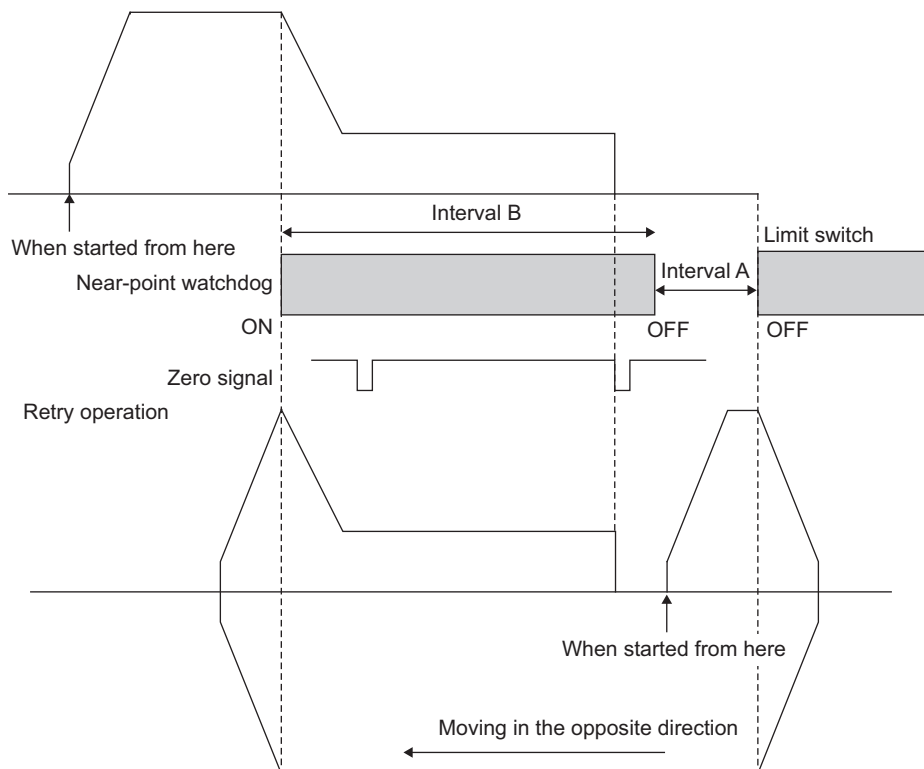

(d) Machine OPR from near-point dog ON

When machine OPR is started in a position indicated as interval B (where the near-point dog is turned on) in the figure below, the axis starts moving at the OPR speed in the direction opposite the OPR direction due to the OPR retry function to perform machine OPR (☞ Page 114, Section 7.10.1 (4)).

(8) Operations of Count 2 and precautions

Under this method, the position achieved by moving the distance set by "Movement amount after near-point dog ON" from the near-point dog ON point is set as the OP. This method is effective when a stepping motor is used or otherwise a zero signal cannot be issued. Note that the stop position varies more than when the count 1 method is used. The following operations take place.

Operation step	Description of operation
1)	Machine OPR starts upon execution of the OPR start instruction (IOPR1(P)). The axis accelerates from the bias speed at start to the OPR speed in the OPR direction over the OPR acceleration/deceleration time and moves at the OPR speed.
2)	The axis starts to decelerate upon detection of turning on of the near-point dog. The axis decelerates to the creep speed and moves at the creep speed thereafter.
3)	After the axis has moved the distance set by "Movement amount after near-point dog ON," the LCPU stops outputting pulses (the axis starts decelerating from the creep speed over the OPR deceleration stop time). The Axis 1 OPR completion (SM1843) turns on, while the Axis1 OPR request (SM1842) turns off.

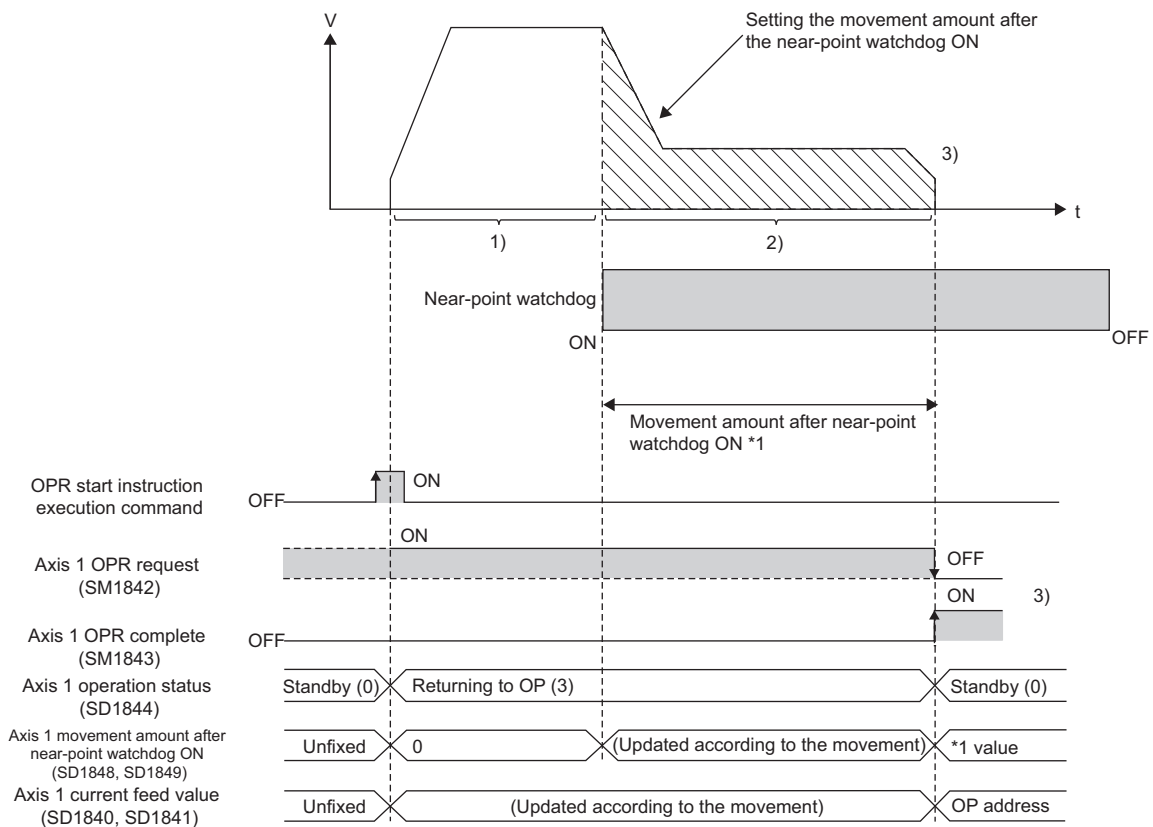

(a) Wiring of deviation counter clear signal

Deviation counter clear signals are not output in the count 2 method. Use a general-purpose output signal and output it to the servo amplifier.

(b) Movement amount after near-point dog ON

The "Movement amount after near-point dog ON" should be equal to or greater than the distance moved by the axis as it decelerates from the OPR speed to creep speed (☞ Page 68, Section 7.6 (8)). If the axis has moved the distance set by "Movement amount after near-point dog ON" while still decelerating from the OPR speed to creep speed, the axis stops immediately at that point to complete machine OPR. As a result, the OP position deviates and the motor load also increases because the axis stops suddenly at the creep speed or higher.

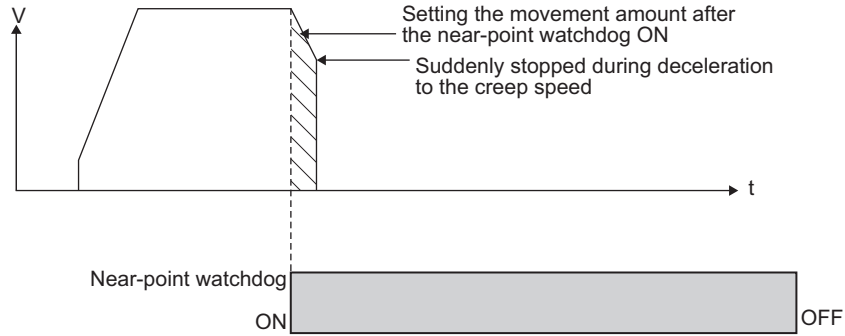

(c) Advantages of using limit switches

The following functions can be used when the upper and lower limit signals are selected:

- OPR retry function

When machine OPR is started in a position indicated as interval A (where the near-point dog is turned off and no near-point dog is found in the OPR direction) in the figure below, the axis continues to operate at the OPR speed until reaching the limit switch of the machine system because it cannot detect the near-point watchdog.

When the limit signal in the OPR direction turns off, the OPR retry function actuates. As a result, the axis decelerates to a stop and then move in the opposite direction to complete machine OPR successfully (☞ Page 111, Section 7.10.1). This eliminates the need to perform JOG operation, etc., to return to the position before the near-point dog turned on.

- Hardware stroke limit function

When the limit signal in the direction opposite the OPR direction turns off, the axis decelerates to a stop due to the hardware stroke limit function (☞ Page 124, Section 7.10.5). This prevents damage to the machine system.

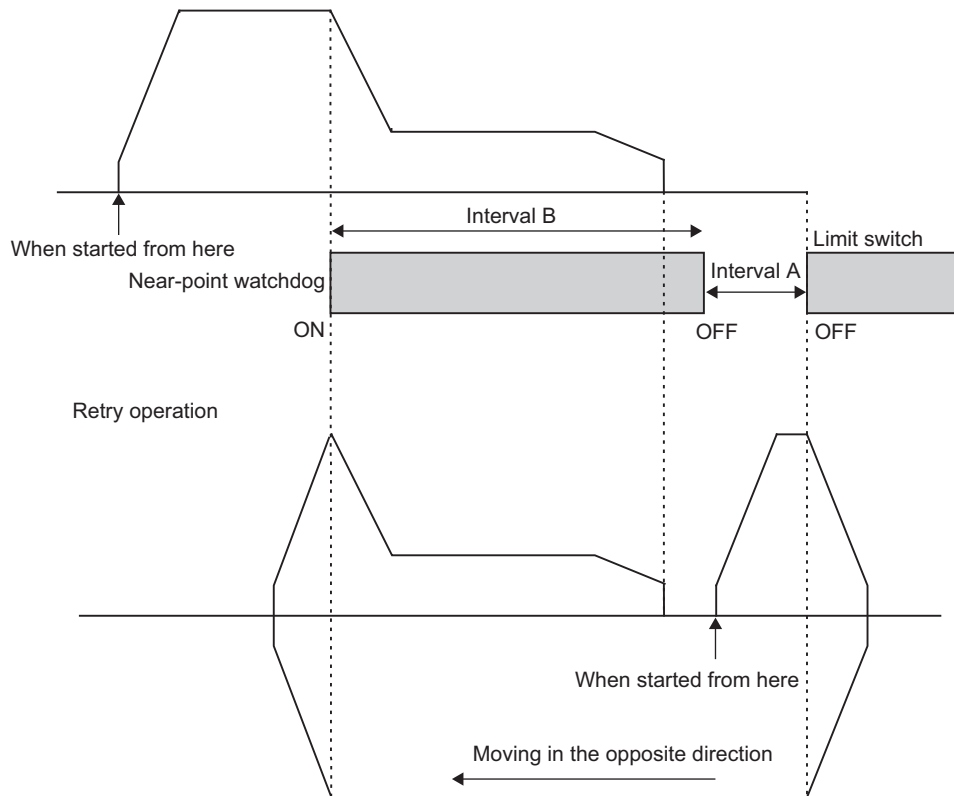

(d) Machine OPR from a position where the near-point dog is turned on

When starting position is in interval B (where the near-point dog is turned on) in the figure above, the axis starts moving at the OPR speed in the direction opposite the OPR direction due to the OPR retry function to perform machine OPR (☞ Page 114, Section 7.10.1 (4)).

(9) Setting of no method

"No method" is provided as an OPR method for those systems that do not use machine OPR. The I/O signals used for OPR can be used with other functions. If "No method" is set, an attempt to start machine OPR with the OPR start instruction (IPOP1(P)) generates "OPERATION ERROR" (error code: 4116).

7.6.2 Fast OPR

The fast OPR is a function to perform positioning to the "OP address" established by machine OPR or other position (standby address).

Address	Description
OP address	This address is used to perform positioning using the OP established by machine OPR as the starting point.
Standby address	This address is used to perform positioning using a position other than the OP established by machine OPR as the starting point. In certain situations such as when a near-point dog cannot be installed near the standby address and thus the standby address is not the same as the OP in machine system design, fast OPR can be implemented to the standby address to return the workpiece to the starting point (\neq OP).

High-speed positioning control is started with the OPR start instruction (IOPR1(P)) and implemented without using a near-point dog or zero signal (☞ Page 148, Section 7.12.1 (4)).

(1) Fast OPR operation

This operation uses the following OPR parameters, except for the OP address and standby address set for the OPR start instruction (IOPR1(P)).

Setting item	Data type
OPR Speed	OPR Parameter
OPR Acceleration/ Deceleration Time	
OPR Deceleration Stop Time	

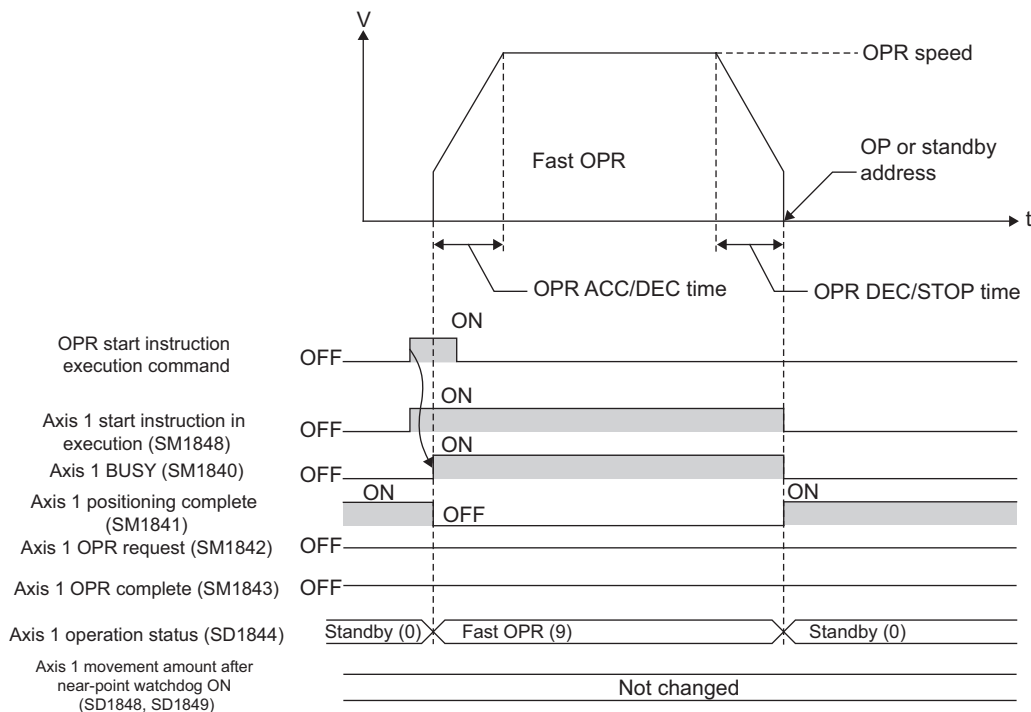

(2) Precautions

- Establish the OP via machine OPR before starting fast OPR. Otherwise, the "Machine OPR not performed" error (Axis 1 error code: 1201) occurs and operation does not start.
- If the system uses speed control, speed/position switching control and current value change, the Axis 1 current feed value (SD1840, SD1841) is different from the coordinate calculated with reference to the machine OP and thus fast OPR to the machine OP or standby address cannot be performed.

7.6.3 Forced off of Axis 1 OPR request (SM1842)

When the LCPU requests machine OPR upon power on, etc., the Axis 1 OPR request (SM1842) turns on. If the system does not require machine OPR, the Axis 1 OPR request (SM1842) can be forcibly turned off by turning on the Axis 1 OPR request off (SM1851). The Axis 1 OPR request off (SM1851) should be turned off again after confirming that the Axis 1 OPR request (SM1842) has turned off.

7.6.4 Precautions on Axis 1 OPR request (SM1842)

In the following condition, the Axis 1 OPR request (SM1842) needs to be turned on to perform the machine OPR.

- At power on
- At reset
- When the operating status is switched from STOP to RUN
- When the drive unit ready signal is turned off
- At the start of machine OPR control

While the Axis 1 OPR request (SM1842) is on, address information stored in the LCPU cannot be guaranteed. When the machine OPR is performed and successfully completed, the Axis 1 OPR request (SM1842) turns off and the Axis 1 OPR completion (SM1843) turns on.

7.7 Positioning Control

The positioning control method is set by the positioning data "Control System". 10 positioning data can be set for each axis with the programming tool. To start positioning control using positioning data set with the programming tool, use the Table start instruction (IPPSTRT1(P)) (☞ Page 140, Section 7.12.1 (1)). To start positioning control using 10 or more positioning data, set them as the setting data of the Positioning start instruction (IPDSTRT1(P)) (☞ Page 142, Section 7.12.1 (2)).

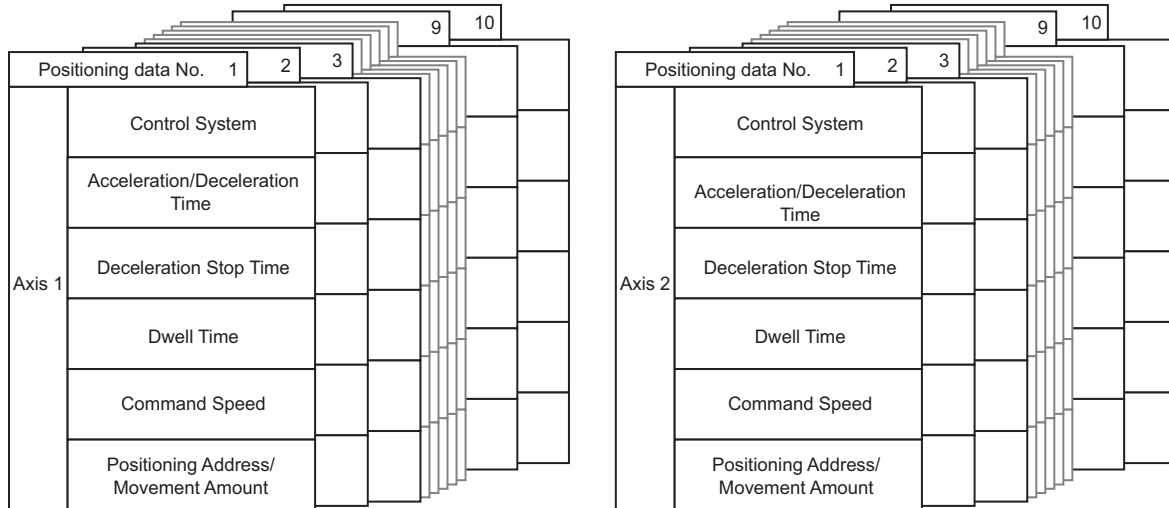

Setting item	Setting range	Default
Control System	Not selected (blank)	Not selected (blank)
	Positioning Control (ABS)	
	Positioning Control (INC)	
	Speed-position Control (Forward RUN)	
	Speed-position Control (Reverse RUN)	
	Current Value Changing	
	Speed Control (Forward RUN)	
	Speed Control (Reverse RUN)	
Acceleration/Deceleration Time (ms)	0 to 32767	1000
Deceleration Stop Time (ms)		
Dwell Time (ms)	0 to 65535	0
Command Speed (pulse/s)	0 to 200000	
Positioning Address/Movement Amount (pulse)	-2147483648 to 2147483647 (0 to 2147483647 if the control method is speed/position switching control)	

Setting details are explained below.

Note that the explanations in this section assume use of Axis 1. For the special relay, special register, dedicated instructions, error codes, and warning codes for Axis 2, refer to the following.

- Special relay and special register: ☞ Page 60, Section 7.4 (2)
- Dedicated instructions: ☞ Page 139, Section 7.12
- Error codes: ☞ Page 175, Section 7.14 (1)
- Warning codes: ☞ Page 179, Section 7.14 (2)

(1) Control system

Set the positioning control system.

Control system	Overview	Reference
Not selected (blank)	Set this option if positioning control is not performed.	—
Positioning Control (ABS)	Positioning control is implemented from the position at which the axis is currently stopped, to the specified position.	Page 99, Section 7.7.2
Positioning Control (INC)		
Speed-position Control (Forward RUN)	Speed control is implemented first and when the external command signal is turned on, position control (positioning control based on specified movement amount) is implemented successively.	Page 100, Section 7.7.3
Speed-position Control (Reverse RUN)		
Current Value Changing	The Axis 1 current feed value (SD1840, SD1841) is changed to the set address.	Page 102, Section 7.7.4
Speed Control (Forward RUN)	After acceleration, operation continues until the execution command for Axis stop instruction (IPSTOP1) turns on.	Page 103, Section 7.7.5
Speed Control (Reverse RUN)		

The following lists the control systems and the required positioning data.

○: Must be set, △: Set as necessary, —: Need not be set

Positioning data	Control system			
	Positioning control	Speed control	Speed-position control	Current value changing
Acceleration/Deceleration Time	○	○	○	—
Deceleration Stop Time	○	○	○	—
Dwell Time	△	△	△	△
Command Speed	○	○	○	—
Positioning Address/Movement Amount	○	—	○	○

(2) Acceleration/deceleration time, deceleration stop time, dwell time, and command speed

- Set the time required for the axis to reach the command speed from the bias speed at start.
- Deceleration stop time: Set the time required for the axis to reach the bias speed at start from the command speed and then stop upon completion of position control or occurrence of a stop cause.
- Dwell time: Set the time required for Axis 1 positioning completion (SM1841) to turn on after completion of positioning control.
- Command speed: Set the speed at which to implement positioning control. If the set command speed exceeds the speed limit, positioning control is implemented at the speed limit. If the set command speed is less than the bias speed at start, positioning control is implemented at the bias speed at start.

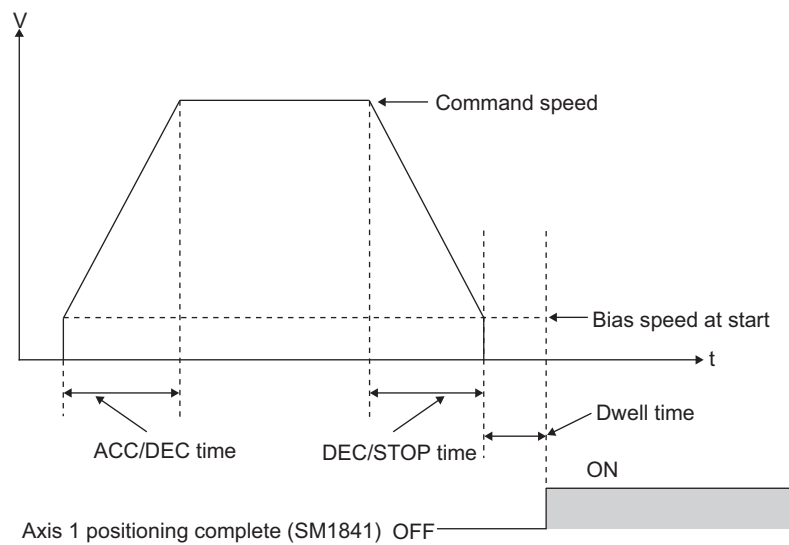

(3) Positioning address/movement amount

Set the address or movement amount to be used as the target value for positioning control. The setting range of values varies depending on the control system.

(a) Positioning control (ABS), current value changing

Set the address from the OP.

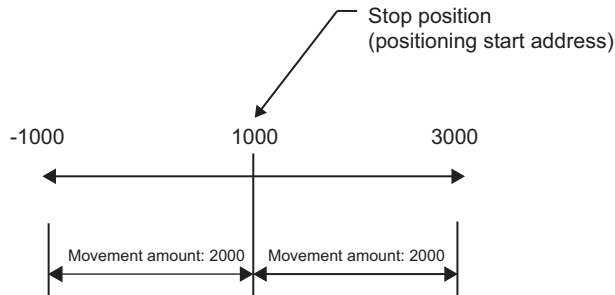

(b) Positioning control (INC)

Set the movement amount with sign.

- When the movement amount is positive: Move in the positive direction (address increasing direction)
- When the movement amount is negative: Move in the negative direction (address decreasing direction)

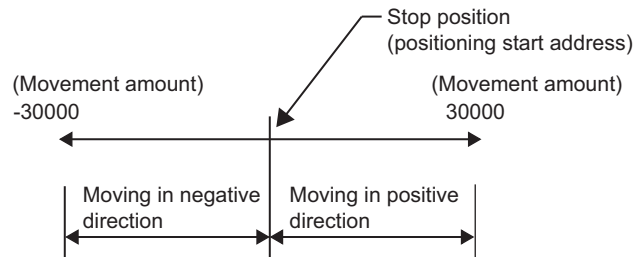

(c) Speed-position control (forward RUN/reverse RUN)

Set the movement amount after switching from speed control to position control.

The setting range is 0 to 2147483647 (pulses).

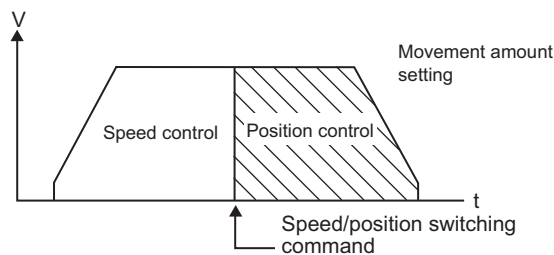

(d) Speed control (forward RUN/reverse RUN)

The set value is ignored.

7.7.1 Start of positioning control

Positioning control can be started using positioning data set with the programming tool or by setting positioning data in a program. The I/O signals used under each control method are shown below.

○: Wiring required, △: Wire as necessary, —: Wiring not required

I/O signal	Control system		
	Position control	Speed control	Speed/position switching control
Zero Signal ^{*1}	—	—	—
Near-point Dog Signal ^{*1}	—	—	—
Deviation Counter Clear Signal ^{*1}	—	—	—
External Command Signal	— ^{*1}	— ^{*1}	○
CW/PULSE/A Phase output	○	○	○
CCW/SIGN/B Phase output	○	○	○
Drive Unit Ready Signal ^{*1}	△	△	△
Upper Limit Signal ^{*1*2}	△	△	△
Lower Limit Signal ^{*1*2}	△	△	△

*1 When this signal is not required, it can be used for other functions such as the general-purpose input and general-purpose output.

*2 These signals are required when the hardware stroke limit and OPR retry functions are used.

(1) Starting with positioning data set by the programming tool

Positioning data (up to 10 sets of data for each axis) can be set easily using the programming tool. Note that once set, positioning data cannot be changed in a program. Two axes can be started simultaneously at the pulse output level using the Two axes simultaneous start instruction (IPSIMUL(P)).

(a) Setting

Set positioning data (10 sets of data for each axis) using the programming tool and write the data to the LCPU.

(b) Starting

Start positioning with the Table start instruction (IPPSTRT1(P)) by specifying a positioning data No.

( Page 140, Section 7.12.1 (1)). Only one set of positioning data can be executed with each instruction. To start two axes simultaneously, use the Two axes simultaneous start instruction (IPSIMUL(P)).

(2) Starting by setting positioning data with a device

Start positioning with the Positioning start instruction (IPDSTRT1(P)) by specifying the device in which positioning data is stored. Positioning data can be changed every time positioning is started. Use this mode when there are many positioning points and 10 sets of positioning data are not enough, or when positioning addresses and command speeds are calculated by a program, among others.

(a) Setting

Set positioning data to a device by a program.

(b) Starting

Positioning is started when the set device is specified as setting data and the Positioning start instruction (IPDSTRT1(P)) is executed in the program ( Page 142, Section 7.12.1 (2)). Two axes cannot be started simultaneously.

(3) Subfunction

- The command speed can be changed using the Speed change instruction (IPSPCHG1(P))
(☞ Page 116, Section 7.10.3).
- The software stroke limit function can be used when the software upper/lower stroke limits are set
(☞ Page 121, Section 7.10.4).
- The hardware stroke limit function can be used when upper/lower limit signals are input
(☞ Page 124, Section 7.10.5).
- The target position can be changed using the Target position change instruction (IPTPCHG1(P))
(☞ Page 125, Section 7.10.6).

7.7.2 Position control

Positioning control is implemented for the specified axis from the current position to specified position.

(1) Positioning control by ABS (absolute) method

Positioning is performed by specifying a position with reference to the OP. The moving direction is determined by the current position.

Ex. Operation when the starting point address is 2000 and "Positioning address/movement amount" is set to 11000:

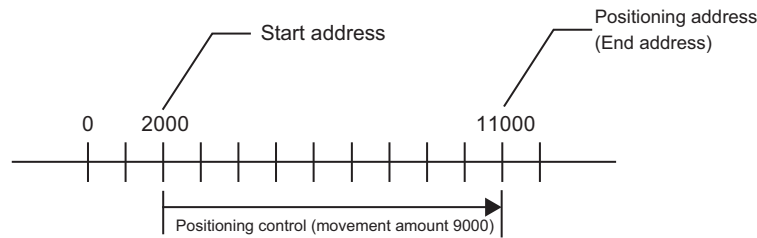

(2) Positioning control by INC (incremental) method

Positioning is performed by the set movement amount from the current position being the starting point. The moving direction is determined by the sign of "Positioning address/movement amount."

Ex. Operation when the starting point address is 2000 and "Positioning address/movement amount" is set to -11000:

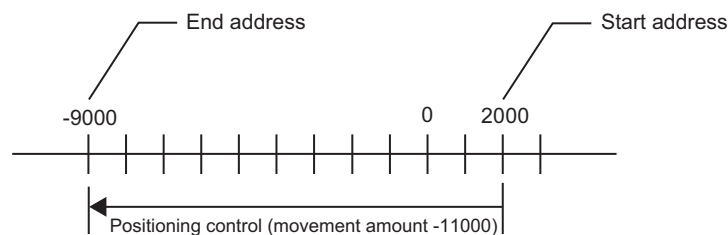

(3) Precautions

If the value of "Positioning address/movement amount" exceeds the upper limit of the software stroke, a "Software stroke limit+" error (Axis 1 error code: 1103) occurs. If the value is smaller than the lower limit of the software stroke, a "Software stroke limit-" error (Axis 1 error code: 1104) occurs. In these cases, position control does not start.

7.7.3 Speed/position switching control

After the start instruction has been executed, position control is started via speed control first. When the external command signal turns on, speed control switches to position control and positioning control is implemented by the movement amount set by "Positioning address/movement amount." Speed/position switching control is implemented in forward and reverse directions. To switch from speed control to position control, the Axis 1 Speed/position switching enable (SM1852) must be turned on beforehand.

(1) Speed/position switching control operations

(a) Operation timings

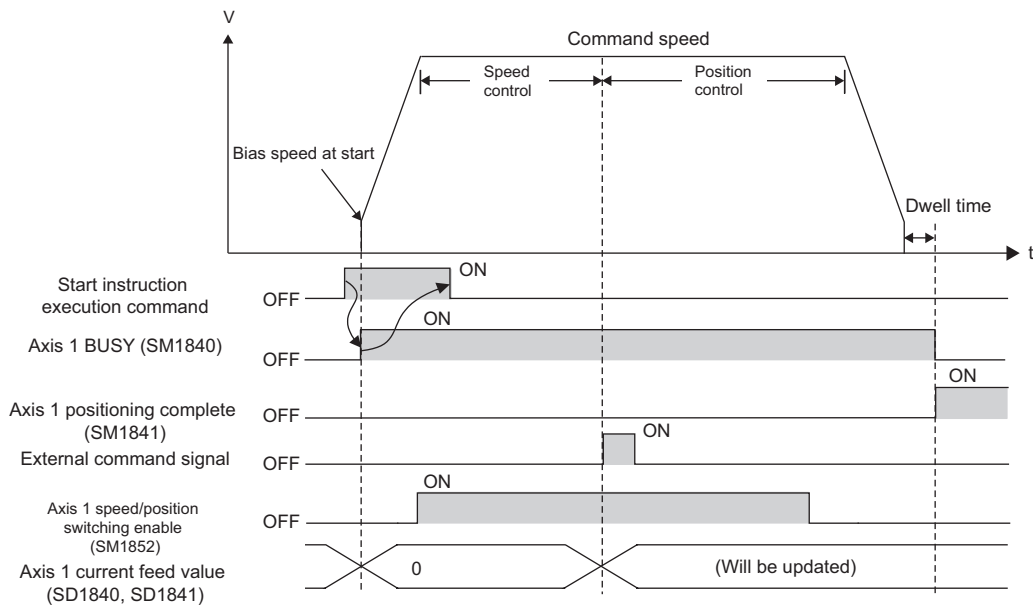

(b) Axis 1 current feed value (SD1840, SD1841)

This value is cleared to 0 at the start of speed control. It is not refreshed during speed control, and refreshed only after switching to position control.

(2) Precautions

(a) Selection of external command signal

An attempt to start speed/position switching control without selecting an external command signal generates a "Speed/position switching control start not possible" error (Axis 1 error code: 1505).

(b) External command signal on timing and operation

- If speed/position switching control is started while the external command signal is still on, position control is implemented first. (The Axis 1 current feed value (SD1840, SD1841) is cleared to 0 and then refreshed accordingly thereafter.)
- If the external command signal is turned on before the command speed is reached, position control is implemented at the speed effective at that point.

(c) External command signal and positioning data

If the following condition is met, deceleration starts at the moment an external command signal is input:

Positioning address/Movement amount < Deceleration distance from command speed

In this case, the axis moves only by the movement amount set by "Positioning address/movement amount," before decelerating to the bias speed at start, and then stops immediately.

(d) Speed 0

When the bias speed at start is set to 0 and the command speed is also set to 0 under the speed control, operation does not start. At this time, the special relays and registers assume the following statuses. To continue with the operation, set a value other than 0 for the new speed value and then turn off the Axis 1 speed 0 (SM1844) using a speed change request with the Speed change instruction (IPSPCHG1(P)).

- Axis 1 speed 0 (SM1844): On
- Axis status: Stop
- Axis 1 axis operation status (SD1844): 5 (In speed-position control (speed))
- Axis 1 busy (SM1840): On

If the bias speed at start is other than 0, changing the command speed to 0 generates an "Out of speed range" warning (Axis 1 warning code: 1020) and the axis operates at the bias speed at start.

(e) Software stroke limit

Do not implement speed/position switching control beyond the range of software stroke limits. If the value of "Positioning address/movement amount" exceeds the range of software stroke limits during speed control, a "Software stroke limit+" error (Axis 1 error code: 1103) or "Software stroke limit-" error (Axis 1 error code: 1104) occurs the moment it switches to position control, and the axis decelerates to a stop.

(f) Set value of "Positioning address/movement amount"

Do not set a negative value for "Positioning address/movement amount." A "Movement amount setting out of range under speed/position switching control" error (Axis 1 error code: 1504) occurs.

(g) Stop position

To suppress fluctuation of the stop position after switching to position control, turn the external command signal on in a stable speed area.

7.7.4 Current value change

The Axis 1 current feed value (SD1840, SD1841) of a stationary axis is changed to a specified address.

(1) Timing of current value change

When the execution command for start instruction turns on, the specified address is stored in the Axis 1 current feed value (SD1840, SD1841).

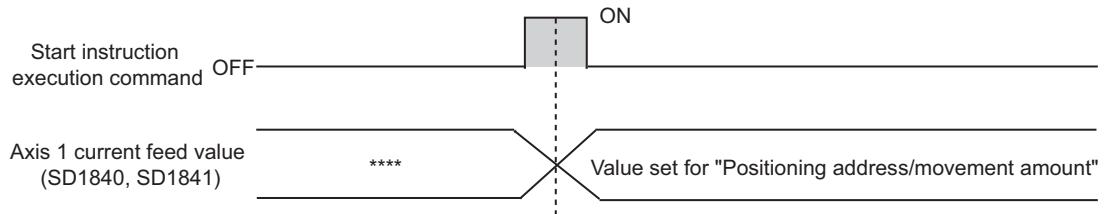

(2) Precautions

If the new current value exceeds the upper limit of the software stroke, "Software stroke limit +" (Axis 1 error code: 1103) occurs. If the value is smaller than the lower limit of the software stroke, "Software stroke limit -" (Axis 1 error code: 1104) occurs. In these cases, the current value is not changed.

7.7.5 Speed control

After accelerating to the command speed, the axis continues to operate at the command speed until the Axis stop instruction (IPSTOP1) is executed. Speed control is implemented in forward and reverse directions. Operation timings are shown in the figure below.

(1) Speed control operation

(a) Operation timings

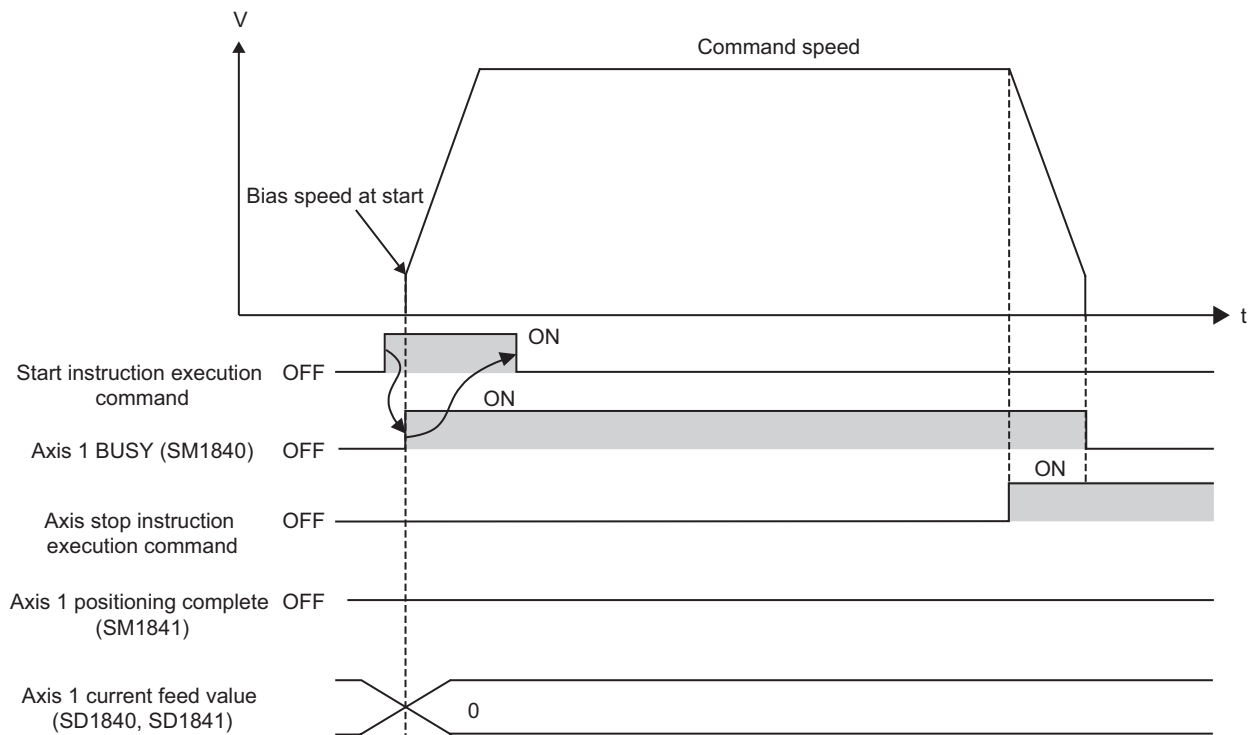

(b) Axis 1 positioning completion (SM1841) and Axis 1 current feed value (SD1840, SD1841)

The Axis 1 positioning completion (SM1841) does not turn on during speed control. Also note that the Axis 1 current feed value (SD1840, SD1841) is fixed to 0 during speed control.

(2) Precautions

(a) Speed 0

When the bias speed at start is set to 0 and the command speed is also set to 0 under the speed control, the special relays and register assume the following statuses. To continue with the operation, set a value other than 0 for the new speed value and then turn off the Axis 1 speed 0 (SM1844) using a speed change request with the Speed change instruction (IPSPCHG1(P)).

- Axis 1 speed 0 (SM1844): On
- Axis status: Stop
- Axis 1 axis operation status (SD1844): 10 (In speed control)
- Axis 1 busy (SM1840): On

If the bias speed at start is other than 0, changing the command speed to 0 generates an "Out of speed range" warning (Axis 1 warning code: 1020) and the axis operates at the bias speed at start.

7.8 Multiple Axes Simultaneous Start Control

Two axes can be started simultaneously using the Two axes simultaneous start instruction (IPSIMUL(P))

( Page 145, Section 7.12.1 (3)).

(1) Operation details

Two axes can be started simultaneously. The stop timing varies depending on the data of each axis.

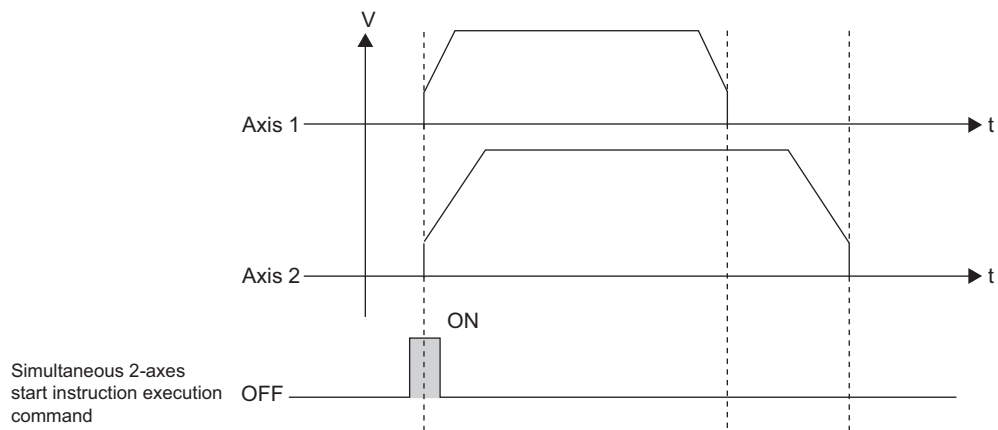

Point

If you want the two axes to generate a linear composite locus, simulated interpolation control can be performed. In this case, take note of the following points:

- Calculate the speed according to the ratio of movement amounts of two axes.
- Use identical acceleration and deceleration time and deceleration stop time for the two axes.

Ex. "Positioning address/movement amount" ratio Axis 1: Axis 2 = 2:1
Command speed ratio Axis 1:Axis 2 = 2:1

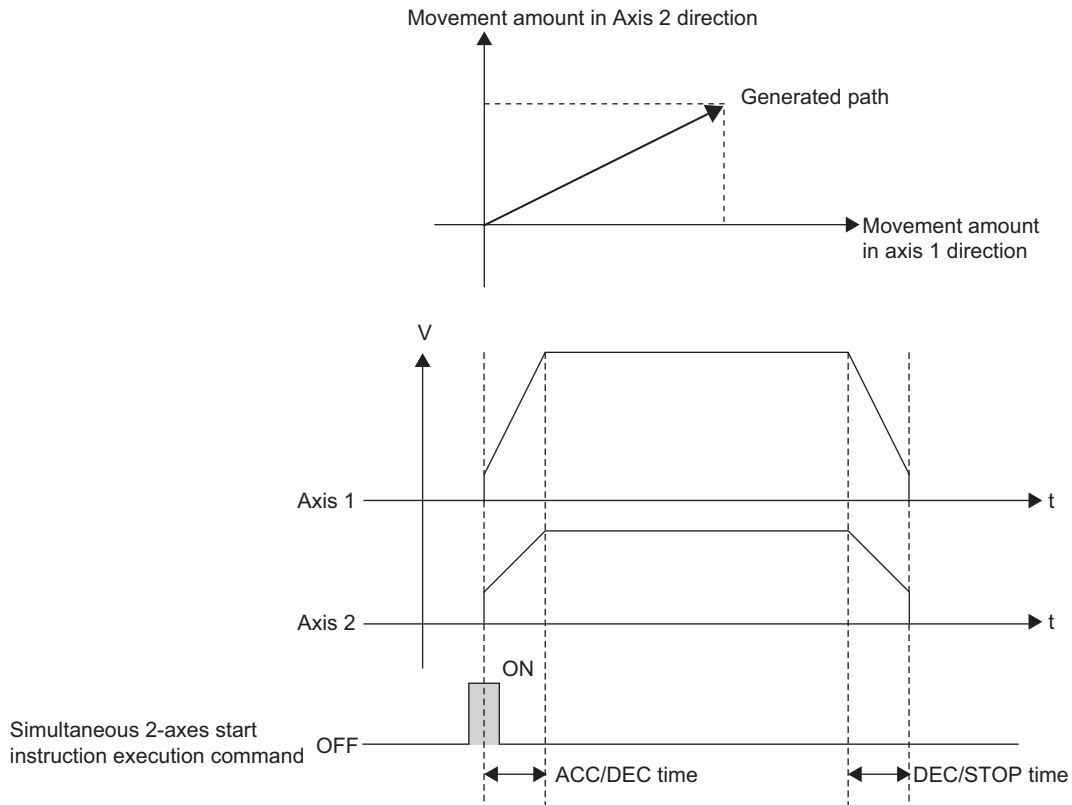

(2) Precautions

- Errors are handled for each axis. If Axis 1 data is abnormal but Axis 2 data is normal, for example, only Axis 2 is started.
- If either axis or both axes is/are operating when the Two axes simultaneous start instruction (IPSIMUL(P)) is executed, the two axes do not start simultaneously. The operating axis or axes continue(s) with the current positioning operation.
- To stop each axis, execute the Axis stop instruction (IPSTOP1) for the axis.

7.9 JOG Operation

JOG operation is used for moving the axis only by a desired movement amount without using positioning data. Use this operation when checking the connection of the positioning control system, or to move the workpiece to inside the range of software stroke limits after operation has stopped by the software stroke limit function. JOG operation is started with the JOG start instruction by setting the JOG speed, JOG ACC time, JOG DEC time and direction (☞ Page 151, Section 7.12.1 (5)).

Note that the explanations in this section assume use of Axis 1. For the special relay, special register, dedicated instructions, error codes, and warning codes for Axis 2, refer to the following.

- Special relay and special register: ☞ Page 60, Section 7.4 (2)
- Dedicated instructions: ☞ Page 139, Section 7.12
- Error codes: ☞ Page 175, Section 7.14 (1)
- Warning codes: ☞ Page 179, Section 7.14 (2)

(1) Flow of operation

Operation step	Description of operation
1)	JOG operation is started with the JOG start instruction (IPJOG1). When the execution command for JOG start instruction turns on, the axis starts to accelerate in the set direction over the JOG ACC time. The Axis 1 busy (SM1840) turns on.
2)	Once the accelerating workpiece reaches the JOG speed, the axis continues to move by maintaining the JOG speed.
3)	When the execution command for JOG start instruction turns off, the axis starts to decelerate from the JOG speed over the JOG DEC time.
4)	The axis stops when the speed drops to 0. The Axis 1 busy (SM1840) turns off.

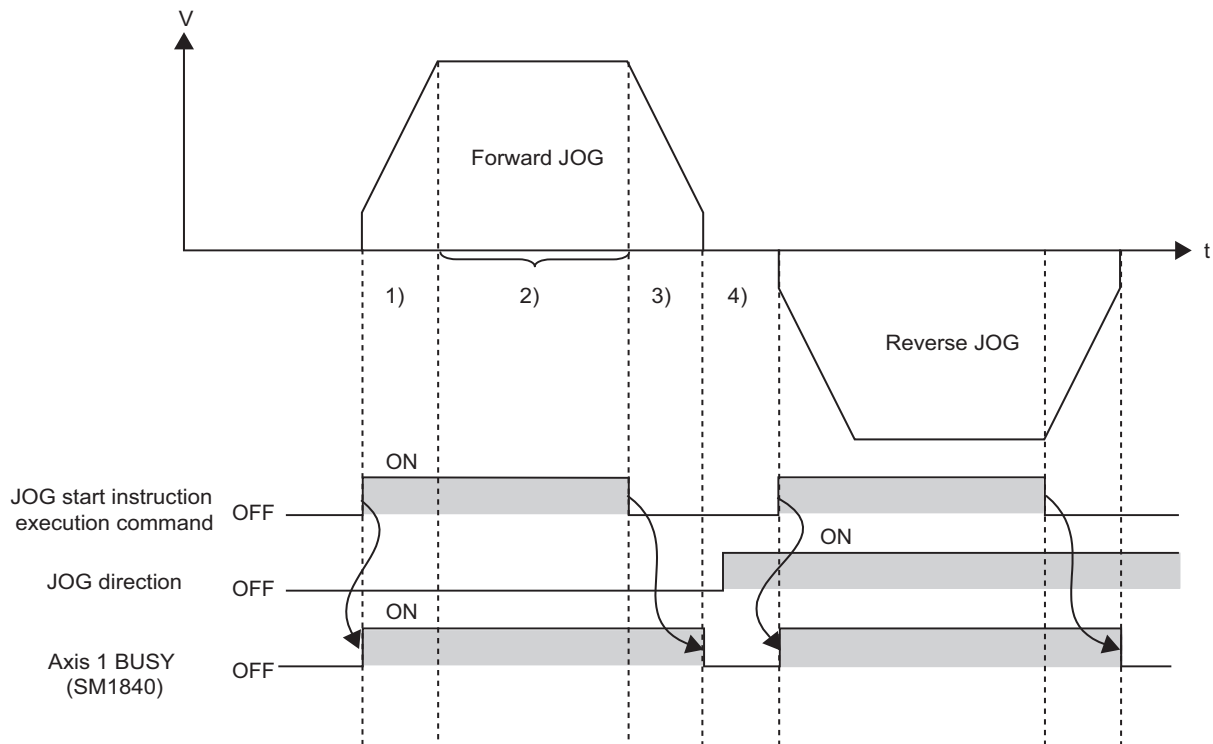

(2) Precautions

(a) JOG speed adjustment

It is dangerous to set a high JOG speed from the beginning. To ensure safety, set a small value first and gradually increase it while checking the operation to adjust to an optimal speed for control.

(b) Axis stop instruction command during JOG operation

When the execution command for Axis stop instruction (IPSTOP1) turns on during JOG operation, the axis decelerates to a stop. If the execution command for JOG start instruction turns on while the execution command for Axis stop instruction (IPSTOP1) is on, a "Stop instruction ON at start" error (Axis 1 error code: 1102) occurs and JOG does not start.

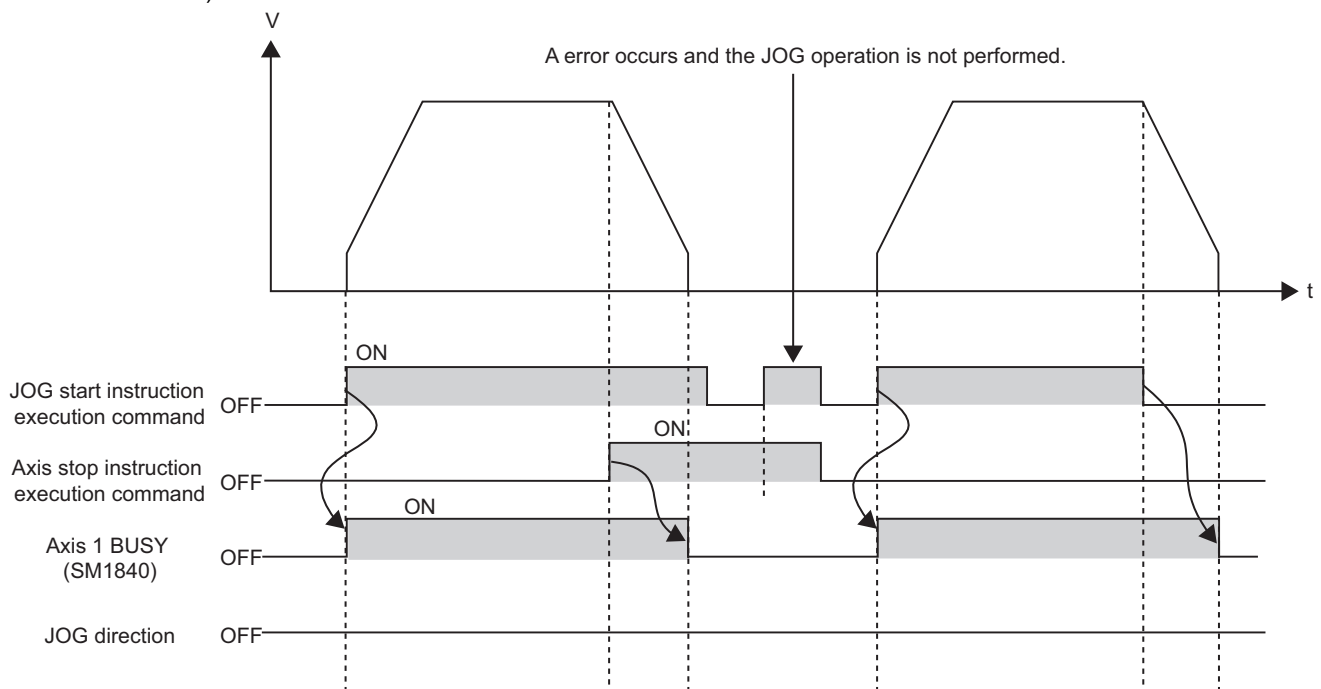

To start JOG operation, follow the steps below.

- 1. Turn off the execution command for JOG start instruction.**
- 2. Reset the axis error.**
- 3. Turn off the execution command for Axis stop instruction (IPSTOP1).**
- 4. Turn on the execution command for JOG start instruction again.**

If the execution command for Axis stop instruction (IPSTOP1) is turned on while the execution command for the JOG start instruction (IPJOG1) is on and then the execution command for Axis stop instruction (IPSTOP1) is turned off, JOG operation cannot be performed. To start JOG operation, turn on the execution command for JOG start instruction again.

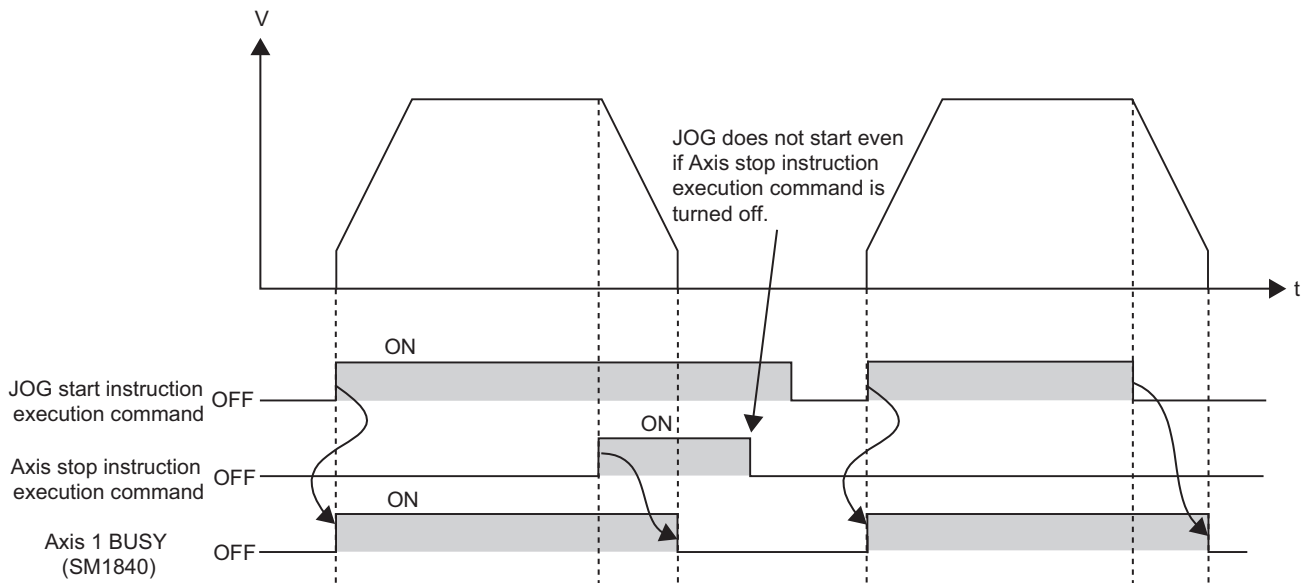

(c) Multiple instruction executions

If the execution command for JOG start instruction is turned off and then turned on again while the axis is decelerating, JOG operation cannot be performed.

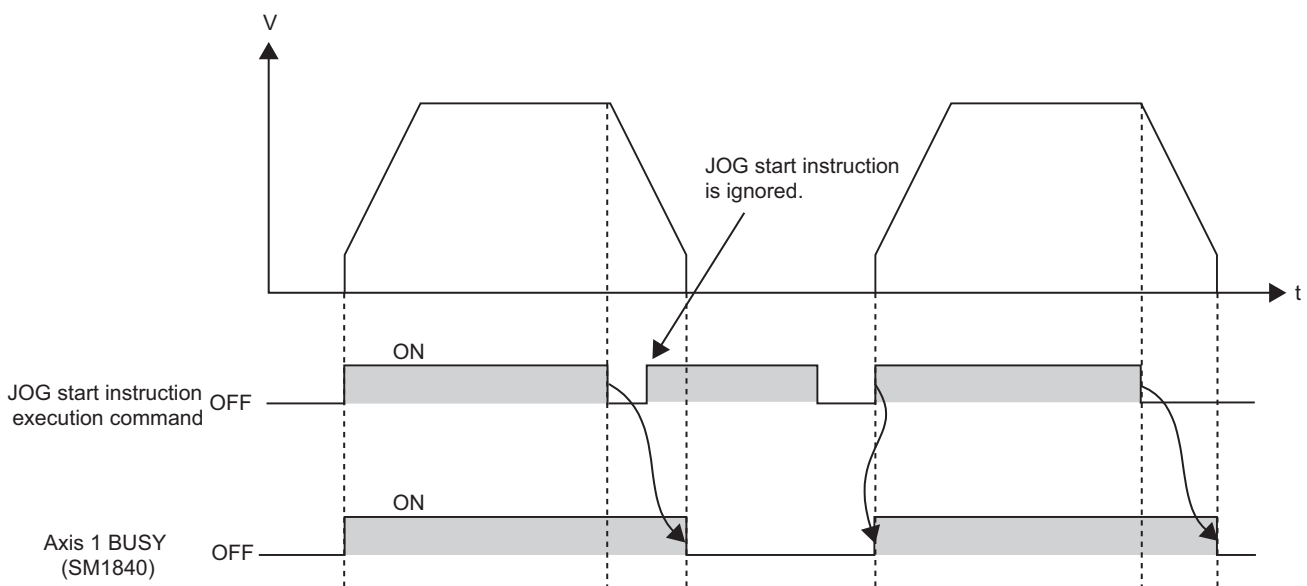

(d) Limitation of JOG speed

If the JOG speed exceeds the set speed limit, the axis operates at the speed limit and an "Out of speed range" warning (Axis 1 warning code: 1020) occurs. If the JOG speed is less than the bias speed at start, the same warning occurs and the bias speed at start is applied.

(e) JOG speed 0

If the bias speed at start is 0 and JOG operation is started by setting 0 for the JOG speed, the special relays and registers assume the following statuses. If the new speed value is set to other than 0 and the speed is changed accordingly using the Speed change instruction (IPSPCHG1(P)), the Axis 1 speed 0 (SM1844) turns off and JOG operation continues.

- Axis 1 speed 0 (SM1844): On
- Axis status: Stop
- Axis 1 axis operation status (SD1844): 2 (In JOG control)
- Axis 1 busy (SM1840): On

If the bias speed at start is other than 0, changing the JOG speed to 0 generates an "Out of speed range" warning (Axis 1 warning code: 1020) and the axis operates at the bias speed at start.

(f) Speed change

The speed cannot be changed while the axis is decelerating.

(g) Forward/reverse switching

To switch between forward and reverse directions, confirm that the Axis 1 busy (SM1840) is off and then turn on the execution command for JOG start instruction. While the Axis 1 busy (SM1840) is on, establishment of the execution command for JOG start instruction is ignored.

(3) Subfunction

- The software stroke limit function can be used when the software upper/lower stroke limits are set (☞ Page 121, Section 7.10.4).
- The hardware stroke limit function can be used when upper/lower limit signals are input (☞ Page 124, Section 7.10.5).
- The JOG speed can be changed using the Speed change instruction (IPSPCHG1(P)).

Important

To perform JOG operation near the perimeter of the moving range, use the hardware stroke limit function (☞ Page 124, Section 7.10.5).





If the hardware stroke limit function is not used, the workpiece may go out of the moving range and cause an accident.

7.10 Subfunction

"Subfunctions" govern control limitation, addition of function, etc., when OPR control, positioning control and JOG operation are performed. These subfunctions are implemented by setting parameters or in programs.

Subfunction	Overview	Reference
OPR retry function	A function to perform machine OPR automatically by detecting an off edge of the limit signal and moving to a position where machine OPR is possible, even when the OP is not located in the OPR direction.	Page 111, Section 7.10.1
Speed limit function	A function to limit the speed to within the setting range of speed limit values when the operating speed exceeds the positioning parameter "Speed limit".	Page 115, Section 7.10.2
Speed change function	A function to change the speed during operation.	Page 116, Section 7.10.3
Software stroke limit function	A function to not start operation when a start instruction is given to move to the target position which is outside the range set by the upper stroke limit and lower stroke limit. The limit function also stops operation when the current feed value deviates from the setting range.	Page 121, Section 7.10.4
Hardware stroke limit function	A function to decelerate the axis to a stop using a limit switch connected to the external device connector.	Page 124, Section 7.10.5
Target position change function	A function to change the target value during positioning control.	Page 125, Section 7.10.6
Acceleration/ deceleration processing function	A function to adjust the acceleration/deceleration processing as part of control.	Page 129, Section 7.10.7
Stop processing function	A function to control the stopping method to be applied when a stop cause occurs during operation.	Page 131, Section 7.10.8

Note that the explanations in this section assume use of Axis 1. For the special relay, special register, dedicated instructions, error codes, and warning codes for Axis 2, refer to the following.

- Special relay and special register:  Page 60, Section 7.4 (2)
- Dedicated instructions:  Page 139, Section 7.12
- Error codes:  Page 175, Section 7.14 (1)
- Warning codes:  Page 179, Section 7.14 (2)

(1) Subfunction and external input signal

When the OPR retry function and hardware stroke limit function are used, upper and lower limit signals are required.

7.10.1 OPR retry function

The workpiece may not move toward the OP depending on the position (for example, when it has already exceeded the OP during position control). In this case, normally machine OPR is started again after moving the workpiece to just before the near-point dog after JOG operation, etc. If the OPR retry function is used, however, machine OPR can be performed regardless of where the workpiece is. To operate the OPR retry function, select the limit signal in the OPR direction (upper limit signal or lower limit signal) using the built-in I/O function setting.

(1) OPR methods in which this function is enabled

This function is always enabled when the following OPR methods are used:

- Near-point dog method
- Count 1
- Count 2

(2) Flow of operation

The following shows OPR retry function When the workpiece is outside the range of upper or lower limit switches.

Operation step	Description of operation
1)	Machine OPR starts upon execution of the OPR start instruction (IOPR1(P)). The axis starts moving in the OPR direction.
2)	The axis decelerates upon detection of turning off of the limit signal.
3)	After stopping upon detection of turning off of the limit signal, it moves in the direction opposite the OPR direction at the OPR speed. "OPR dwell time" is enabled, if set.
4)	The axis decelerates upon turning off of the near-point dog.
5)	After stopping upon turning off of the near-point dog, the axis performs machine OPR in the OPR direction. The OPR dwell time is enabled, if set.
6)	Machine OPR is complete. <ul style="list-style-type: none"> Near-point dog method: Machine OPR completes upon detection of the first zero signal after the near-point dog has turned off. Count 1: Machine OPR completes upon detection of the first zero signal after reaching a position corresponding to "Movement amount after near-point dog ON." Count 2: Machine OPR completes upon reaching a position corresponding to "Movement amount after near-point dog ON." (Before machine OPR is complete, the axis decelerates from the creep speed over the OPR deceleration stop time.)

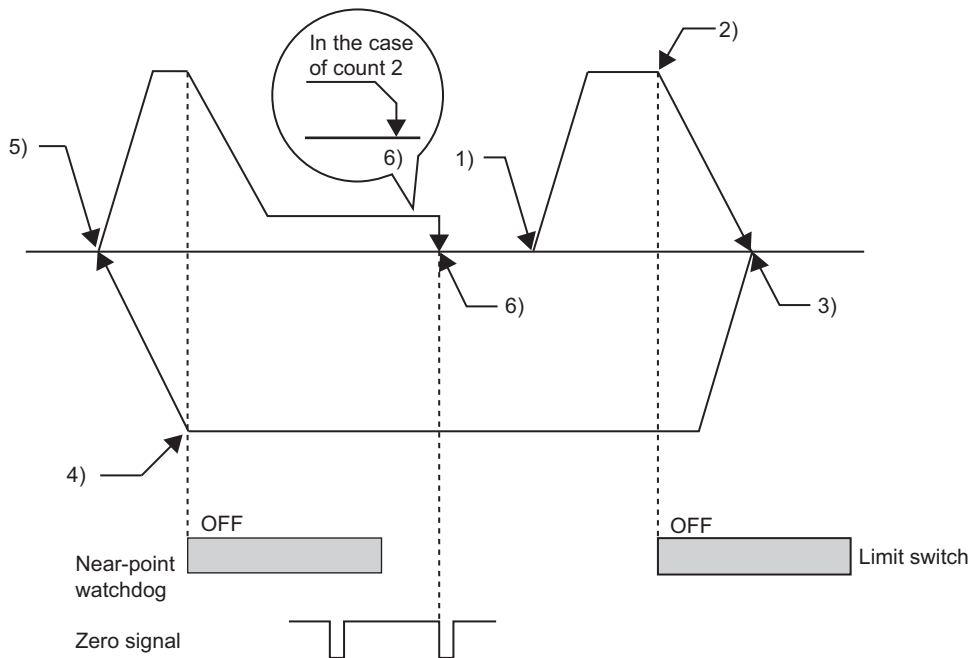

(3) When the workpiece is outside the range of upper or lower limit switches

(a) When the OP direction is the same as the OPR direction

Machine OPR is not performed. A "Hardware stroke limit +" error (Axis 1 error code: 1100) or "Hardware stroke limit -" error (Axis 1 error code: 1101) occurs.

Ex. When "OPR direction" is set to "Forward RUN":

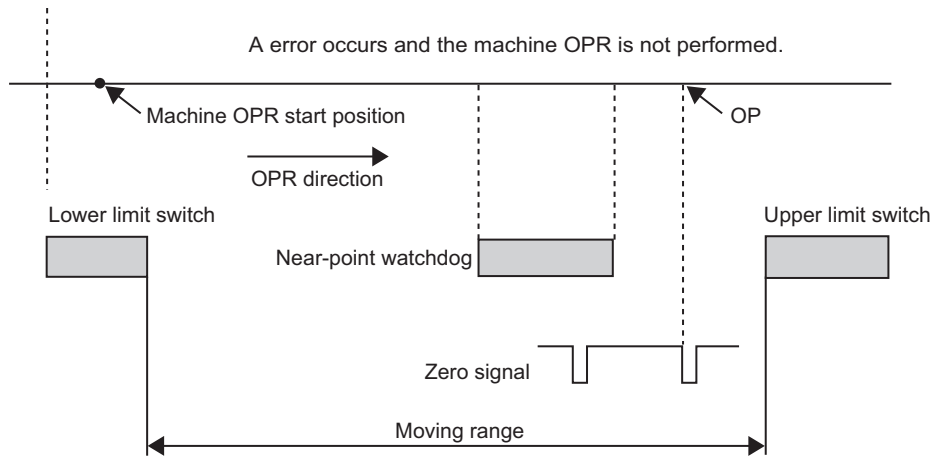

(b) When the OP direction is opposite to "OPR direction":

The axis decelerates to a stop upon turning off of the near-point dog and then performs machine OPR in the direction set as "OPR direction."

Ex. When "OPR direction" is set to "Forward RUN":

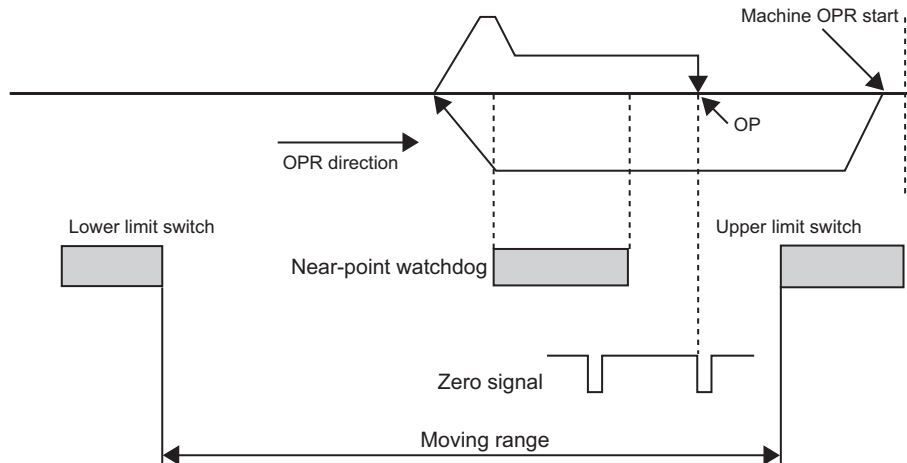

(4) Near-point dog and starting position of machine OPR

If machine OPR is performed at a position where the near-point dog is turned on, the following operations take place under each OPR method:

- Near-point dog method: Machine OPR starts at the creep speed.
- Count 1 or count 2: Machine OPR is performed according to the OPR retry function.

Ex. Count 1

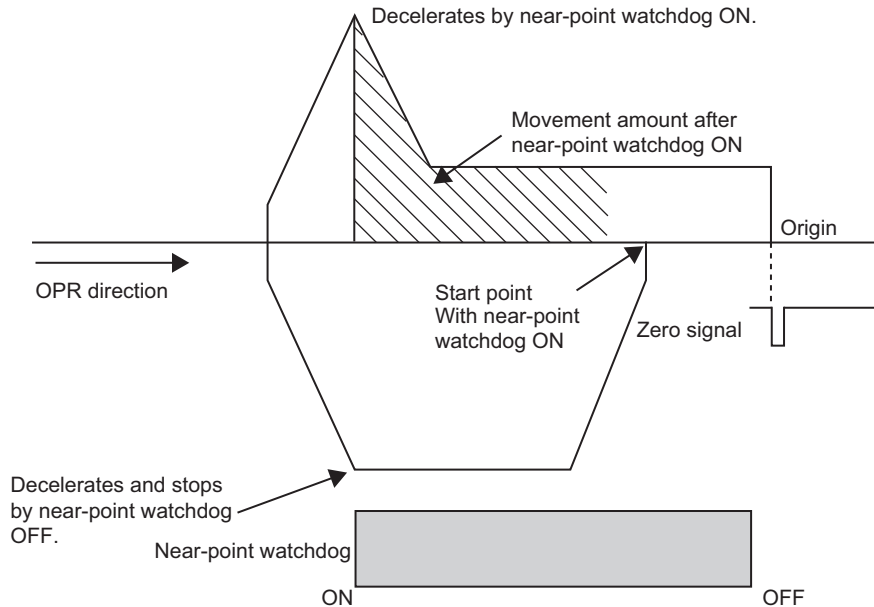

(5) Precautions

- If a limit signal is not selected by the built-in I/O function setting, the OPR retry function does not operate and the mechanical system may also be damaged as the axis continues to operate to the limit of the machine system.
- If the near-point dog method is used, make sure the area in which the limit switch turns off does not overlap with the area in which the near-point dog turns on. An attempt to start machine OPR in an overlapped area generates "Retry error" (Axis 1 error code: 1202) and the axis stops. If the two areas are overlapped during OPR retry, "Retry error" (Axis 1 error code: 1202) may occur regardless of the OPR method (near-point dog method, Count 1 or Count 2) and the axis may stop.
- Make sure the limit signal in the direction opposite the OPR direction does not turn off during machine OPR. A "Hardware stroke limit +" error (Axis 1 error code: 1100) or "Hardware stroke limit -" error (Axis 1 error code: 1101) occurs and the axis stops.
- Do not start machine OPR in an area where the limit signal in the direction opposite the OPR direction is off. A "Hardware stroke limit +" error (Axis 1 error code: 1100) or "Hardware stroke limit -" error (Axis 1 error code: 1101) occurs and machine OPR does not start.

7.10.2 Speed limit function

If the operating speed exceeds the speed limit, this function limits the speed to within the setting range of speed limits. To use this function, set the positioning parameter "Speed limit."

(1) Relationship of speed limit function and control

Control		Operation when the speed limit is exceeded
OPR control	Machine OPR	No operation occurs. (The OPR speed cannot be set higher than the speed limit using the programming tool.)
	Fast OPR	
Positioning control	Position control	An "Out of speed range" warning (Axis 1 warning code: 1020) occurs and the command speed is limited to the speed limit.
	Speed control	
	Speed/position switching control	
	Current value change	—
JOG operation		An "Out of speed range" warning (Axis 1 warning code: 1020) occurs and the JOG speed is limited to the speed limit.

7.10.3 Speed change function

The speed change function changes the operating speed to a newly specified speed at a desired timing. This function is implemented with the Speed change instruction (IPSPCHG1(P)) by setting the new speed value, ACC/DEC time at speed change and DEC/STOP time at speed change (☞ Page 158, Section 7.12.1 (8)).

(1) Controls that permit speed change and timings of change

The speed can be changed during the controls denoted by "Speed change possible" in the table below, at the specified timings. If speed change is not possible, a "Speed change not possible" warning (Axis 1 warning code: 1022) occurs and the instruction is ignored, or the instruction is simply ignored without any warning.

Control		During acceleration	During constant-speed operation	During speed change by the Speed change instruction (IPSPCHG1(P))	During deceleration	During deceleration by the Axis stop instruction (IPSTOP1)
OPR control	Machine OPR	Warning	Warning	—	Warning	Ignored.
	Fast OPR					
Positioning control	Position control	Warning	Speed change possible	Warning	Warning	Ignored.
	Speed control	Speed change possible	Speed change possible	Speed change possible	—	Ignored.
	Speed control of speed/position switching control	Speed change possible	Speed change possible	Speed change possible	—	Ignored.
	Position control of speed/position switching control	Warning	Speed change possible	Warning	Warning	Ignored.
JOG operation		Speed change possible	Speed change possible	Speed change possible	Ignored.	Ignored.

(2) Description of operation

Speed change under speed control

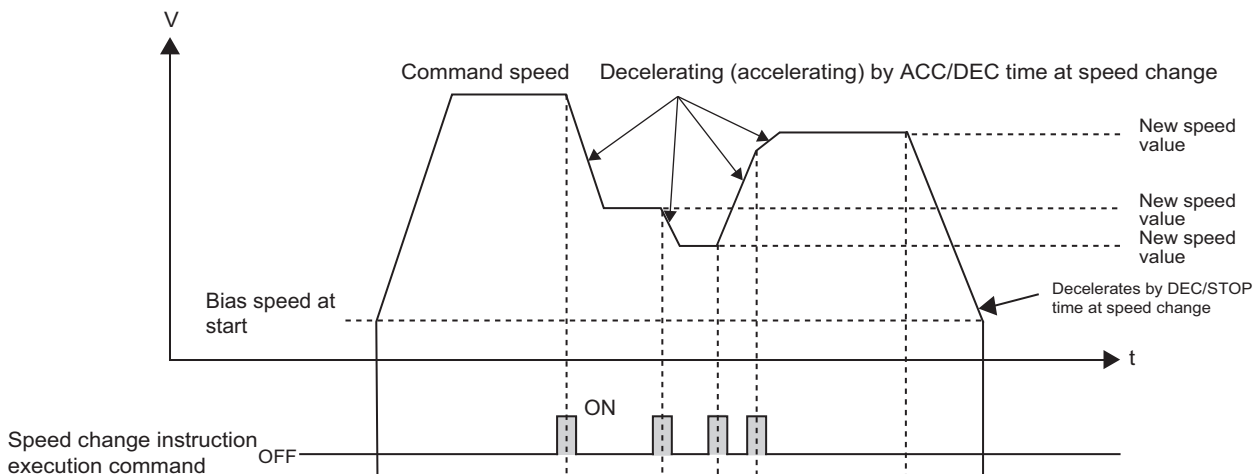

(3) Precautions

(a) Limitation of new speed value

If the new speed value exceeds the speed limit, the axis operates at the speed limit and an "Out of speed range" warning (Axis 1 warning code: 1020) occurs. If the new speed value is less than the bias speed at start, the same warning occurs and the bias speed at start is applied.

(b) Operation during processing

Even when the workpiece is moving at the command speed or JOG speed, speed change is not accepted if calculations are in progress following the establishment of the execution command for Speed change instruction (IPSPCHG1(P)).

Ex. Timings at which speed change is permitted during position control

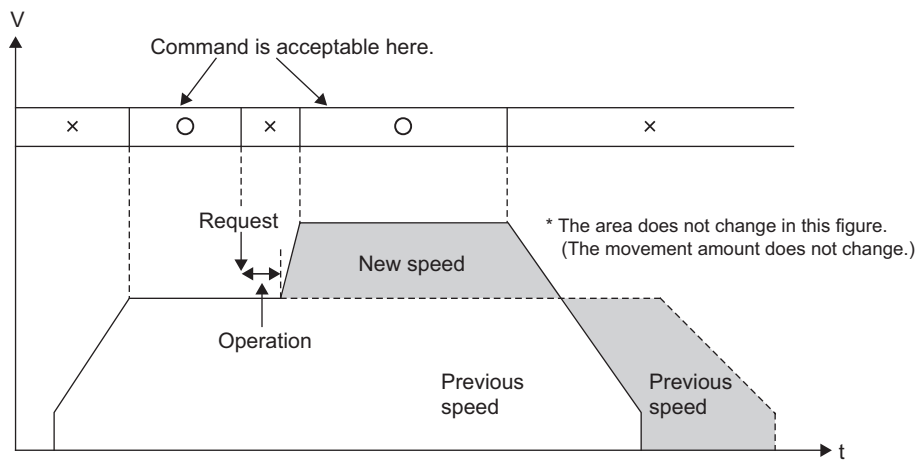

Remark

Change to a new speed occurs after completion of pulse output at the current speed.

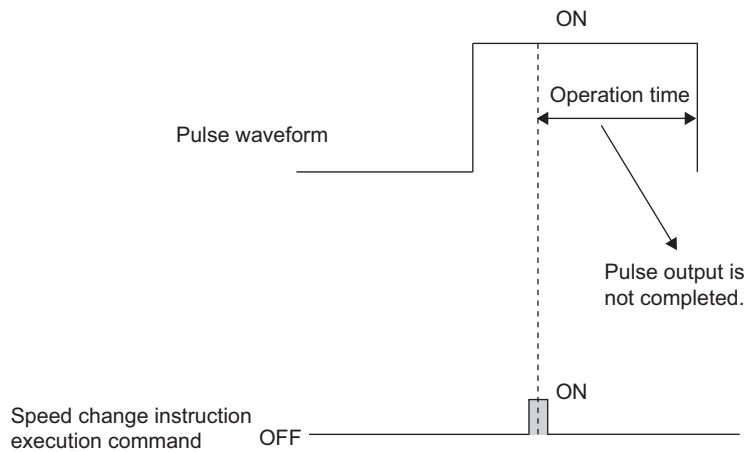

(c) Speed change during position control

If the target position is reached during the processing for speed change in the case of a speed change during position control or position control of speed/position switching control, a "Speed change not possible" warning (Axis 1 warning code: 1022) occurs and the speed is not changed.

(d) Target position change and speed change

If the Target position change instruction (IPTPCHG1(P)) is accepted simultaneously as the execution command for Speed change instruction (IPSPCHG1(P)) is established, a "Speed change not possible" warning (Axis 1 warning code: 1022) generates and the Speed change instruction (IPSPCHG1(P)) is cancelled. (For example, if the execution command for Target position change instruction (IPTPCHG1(P)) is established during acceleration, the operation switches to a constant speed and the target position change is accepted. If the execution command for Speed change instruction (IPSPCHG1(P)) is established at this timing, it means that the execution commands for both instructions are established simultaneously.) (Page 125, Section 7.10.6)

(e) Speed change and deceleration stop time

When the speed is changed during position control or position control of speed/position switching control in the following condition, positioning completes before the stop speed reaches the bias speed at start.

- The deceleration stop time is longer than the remaining movement amount at the end of speed change and thus the constant-speed part of operation cannot be performed after the speed has changed.

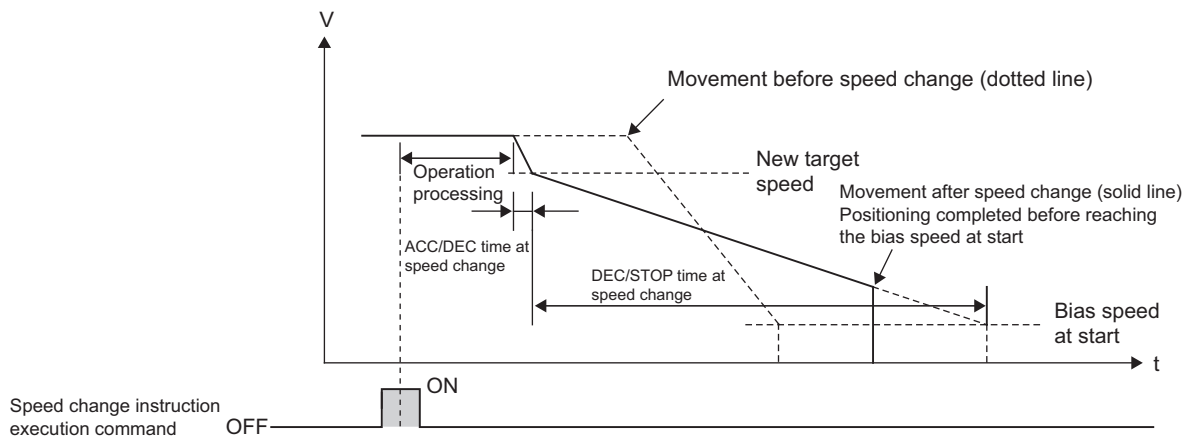

(f) Speed change to 0

- When Bias speed at start is 0

If the bias speed at start is set to 0 and new speed value is changed to 0, the axis stops.

However, the Axis 1 busy (SM1840) does not turn off. Even when the axis is stopped, the Axis 1 axis operation status (SD1844) does not change.

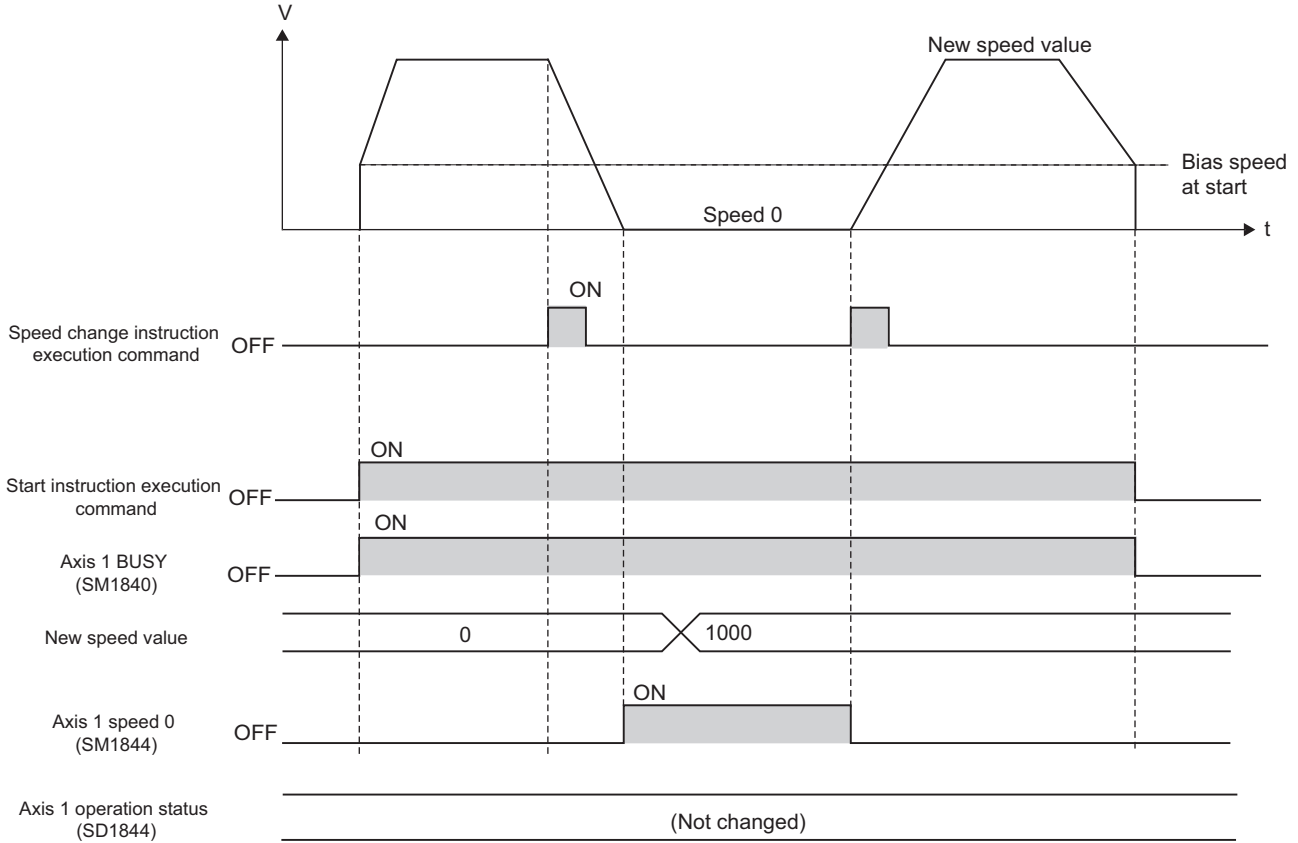

- When bias speed at start is other than 0

When the speed is changed to 0, an "Out of speed range" warning (Axis 1 warning code: 1020) occurs and the axis operates at the bias speed at start.

- Occurrence of error

If the speed is changed and "Outside the acceleration/deceleration time setting" error (Axis 1 error code: 1502) or "Deceleration stop time out of range" error (Axis 1 error code: 1503) occurs under operation at speed 0, the axis stops and the Axis 1 axis operation status (SD1844) changes to Error occurring (-1).

(g) Speed change and "setting out of range" error

If an "Outside the acceleration/deceleration time setting" error (Axis 1 error code: 1502) or "Deceleration stop time out of range" error (Axis 1 error code: 1503) occurs at the start of speed change, the Axis 1 axis operation status (SD1844) change changes to Error occurring (-1). When each control is active, the following operations are performed according to the control.

- In position control (including it of speed/position switching control)
Position control continues until the end and the axis decelerates to a stop over the deceleration stop time effective before the speed change.
- In speed control
The axis decelerates to a stop over the deceleration stop time effective before the speed change.
- In JOG operation
The axis decelerates to a stop over the JOG deceleration time effective before the speed change or DEC/STOP time at speed change (if the last speed change was successful).

Point

The DEC/STOP time at speed change represents the "time until the axis stops at the new speed value" and not the "time until the axis stops at the current speed."

7.10.4 Software stroke limit function

This function prevents execution of a moving command to a position outside the upper/lower limit of the moving range of the workpiece. The range is set using the address established by machine OPR.

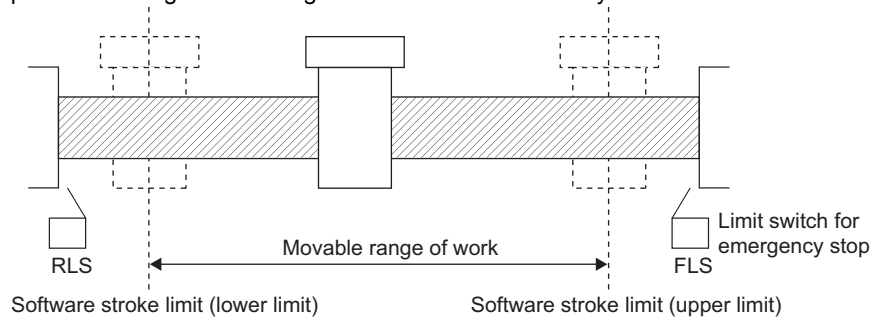

(1) Range check

A software stroke limit range check is executed at the start of operation and also during operation.

(a) Range check at start of operation

The following are checked at start of operation

- Whether operation starts from outside the range of software stroke limits
- Whether operation starts to outside the range of software stroke limits

The software stroke limit range check is processed as follows depending on the applicable control.

In the table, "Error" indicates "Software stroke limit +" (Axis 1 error code: 1103) or "Software stroke limit -" (Axis 1 error code: 1104).

Control		Operation after range check
Machine OPR		Check is not performed.
Fast OPR	OP address	<ul style="list-style-type: none"> • If the Axis 1 current feed value (SD1840, SD1841) is outside the range of software stroke limits, an error occurs and operation does not start. • If the OP address is outside the range of software stroke limits, an error occurs and operation does not start.
	Standby address	<ul style="list-style-type: none"> • If the Axis 1 current feed value (SD1840, SD1841) is outside the range of software stroke limits, an error occurs and operation does not start. • If the standby address is outside the range of software stroke limits, an error occurs and operation does not start.
Positioning control	Position control	<ul style="list-style-type: none"> • If the Axis 1 current feed value (SD1840, SD1841) is outside the range of software stroke limits, an error occurs and operation does not start. • If the value of "Positioning address/movement amount" is outside the range of software stroke limits, an error occurs and operation does not start.
	Speed control	Check is not performed.
	Speed/position switching control (in speed control)	
	Speed/position switching control (in position control)*1	<ul style="list-style-type: none"> • If the Axis 1 current feed value (SD1840, SD1841) is outside the range of software stroke limits, an error occurs and operation does not start. • If the value of "Positioning address/movement amount" is outside the range of software stroke limits, an error occurs and operation does not start.
	Current value change	If the new current value is outside the range of software stroke limits, an error occurs and the current value is not changed.
JOG operation		When the Axis 1 current feed value (SD1840, SD1841) is outside the range of software stroke limits and: <ul style="list-style-type: none"> • If operation is started in the direction of going out of the range of software stroke limits, an error occurs and operation does not start. • If operation is started in the direction of going into the range of software stroke limits, an error does not occur and operation starts.
Absolute position restoration		Check is not performed.

*1 If speed/position switching control is started while the external command signal is still on, operation starts under position control.

(b) Range check during operation

The software stroke limit range check is processed as follows depending on the applicable control.

In the table, "Error" indicates "Software stroke limit +" (Axis 1 error code: 1103) or "Software stroke limit -" (Axis 1 error code: 1104).

Control		Operation after range check
OPR control	Machine OPR	Check is not performed.
	Fast OPR	
Positioning control	Position control	If the Axis 1 current feed value (SD1840,SD1841) may exceed the software stroke limit by changing the target position, the change is not executed and the original positioning operation is continued. An error occurs after the positioning is completed.
	Speed control	Check is not performed.
	Speed/position switching control (in speed control)	
	Speed/position switching control (in position control)	<ul style="list-style-type: none"> • If the Axis 1 current feed value (SD1840, SD1841) is outside the range of software stroke limits upon switching to position control, an error occurs and the axis decelerates to a stop. • If the value of "Positioning address/movement amount" is outside the range of software stroke limits upon switching to position control, an error occurs and the axis decelerates to a stop. • If the target position is changed and the Axis 1 current feed value (SD1840, SD1841) exceeds the software stroke limit as a result, the target position change is ignored and the control continues based on the original value of "Positioning address/movement amount." An error occurs after the positioning is completed.
Current value change	—	
JOG operation		An error occurs at the moment the Axis 1 current feed value (SD1840, SD1841) exceeds the software stroke limit, and the axis decelerates to a stop.
Absolute position restoration		Check is not performed.

(2) Precautions

- So that the software stroke limit function operates normally, execute machine OPR beforehand.
- Setting the upper and lower software stroke limits prevents a software overrun. To make doubly sure, also provide emergency stop limit switches near the outer perimeter of the range.

Remark

With the Two axes simultaneous start instruction (IPSIMUL(P)), the current values of the two axes to be started simultaneously are checked against the stroke limits. If either axis generates an error, only the other axis is started.

7.10.5 Hardware stroke limit function

The hardware stroke limit function stops the control (after deceleration) by detecting an input from the upper and lower limit switches that are installed at the upper and lower limit of the physical moving range. Equipment damage can be prevented by this function. Normally a hardware stroke limit is set on the inside of the stroke limit or stroke end on the drive unit side, to stop the control before this stroke limit or stroke end is reached. For the limit signal, select either the upper limit signal or lower limit signal using the built-in I/O function setting.

(1) System overview

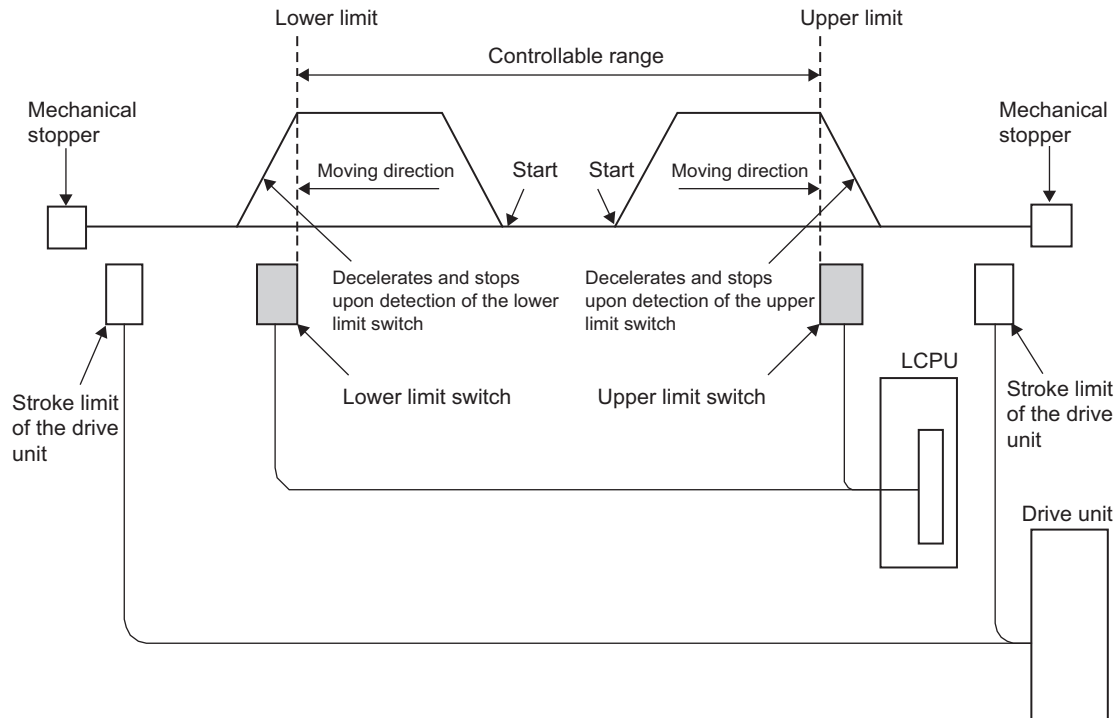

(2) Precautions

While the axis is stopped outside the controllable range (outside the upper or lower limit switch) or after detection of a limit switch, OPR control and positioning control cannot be started. Start each control after moving the workpiece to inside the controllable range via JOG operation.

7.10.6 Target position change function

The target position change function changes the target position set by "Positioning address/movement amount" during position control (including it of speed/position switching control), to a new target position at a desired timing. This function is implemented with the Target position change instruction (IPTPCHG1(P)) (☞ Page 161, Section 7.12.1 (9)). The following shows the target position of each control method.

- Position control (ABS): Address with reference to the OP address
- Position control (INC): Movement amount from the starting address
- Position control of speed/position switching control: Movement amount from the address at which speed control switched to position control

(1) Control details

- If the position of the workpiece upon establishment of the execution command for Target position change instruction (IPTPCHG1(P)) is located before the position at which to start decelerating to the new target value over the deceleration stop time, positioning is performed to the new target position.

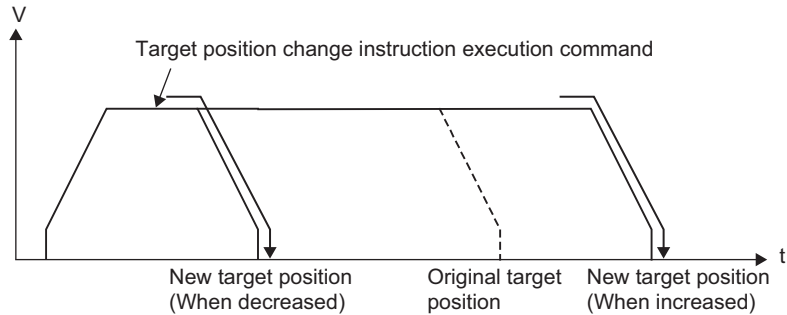

- If the position of the workpiece upon establishment of the execution command for Target position change instruction (IPTPCHG1(P)) exceeds the position at which to start decelerating to the new target value over the deceleration stop time, the axis decelerates to a stop and then positions itself to the new target position.

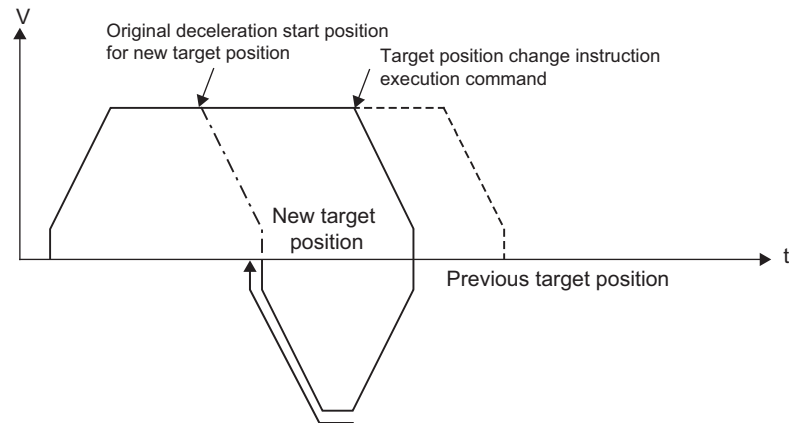

- If the workpiece is decelerating when the execution command for Target position change instruction (IPTPCHG1(P)) is established, the axis decelerates to a stop and then positions itself to the new target position.

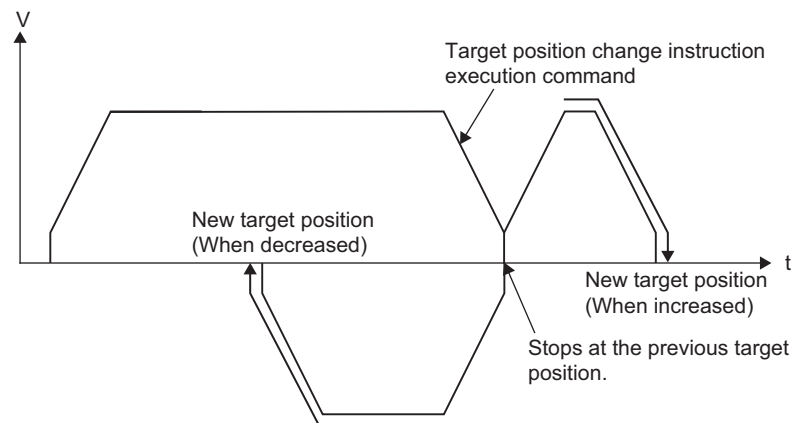

(2) Precautions

(a) Instruction execution during acceleration/deceleration

If the axis was accelerating/decelerating to the command speed when the execution command for Target position change instruction (IPTPCHG1(P)) was established, the workpiece is allowed to reach the command speed, after which positioning to the new target position is performed. If the axis starts decelerating to a stop before reaching the command speed, positioning to the new target position is performed after the axis has decelerated to a stop.

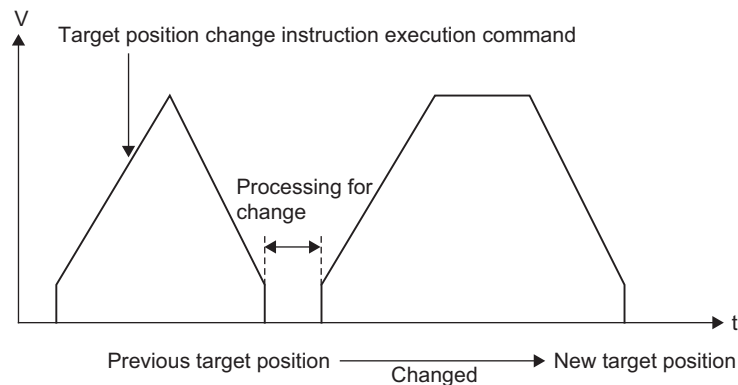

(b) Software stroke limit

If the new target value exceeds the range of software stroke limits, the target position is not changed and the positioning control effective before the establishment of the execution command for Target position change instruction (IPTPCHG1(P)) continues. When the positioning control is complete, a "Software stroke limit +" error (Axis 1 error code: 1103) or "Software stroke limit -" error (Axis 1 error code: 1104) occurs. (If causes of both "Software stroke limit +" error (Axis 1 error code: 1103) and "Software stroke limit -" (Axis 1 error code: 1104) error are present, a "Software stroke limit -" error (Axis 1 error code: 1104) occurs.)

(c) Multiple target position changes

The target position can be changed as many times as desired during a single operation.

- During operation under position control (INC), a new target position is always defined by the movement amount from the current value from which positioning is started.
- During position control of speed/position switching control, a new target position is always defined by the movement amount from the current value (0) at which speed control switched to position control.

If the target position is changed multiple times while the workpiece is accelerating/decelerating to the command speed or simply decelerating, only the last target position change is implemented.

(d) Target position change and speed change

If the execution command for Target position change instruction (IPTPCHG1(P)) is established during speed change, the target position change is executed upon completion of the speed change. Note that if the new speed value is 0, only the target position is changed and the workpiece does not move. If the speed is set to other than 0, positioning is performed to the target position.

(e) Positioning control and target position change

The target position cannot be changed during operation other than when position control is active. A "Target position change not possible" warning (Axis 1 warning code: 1021) occurs.

(f) When Axis 1 speed 0 (SM1844) is on

If the Target position change instruction (IPTPCHG1(P)) is executed when the Axis 1 speed 0 (SM1844) is on, a "Target position change not possible" warning (Axis 1 warning code: 1021) occurs and the target position is not changed.

(g) Axis 1 axis operation status (SD1844) and target position change

If the Axis 1 axis operation status (SD1844) is indicating a stopped status (1) or indicating a standby status (0), the target position is not changed.

(h) Instruction calculation and positioning completion

If positioning based on positioning data completes while the calculation relating to the Target position change instruction (IPTPCHG1(P)) is still in progress, the target position is not changed. A "Target position change not possible" warning (Axis 1 warning code: 1021) occurs.

(i) Acceleration and deceleration

Target position change does not involve acceleration or deceleration change. (The slope in the VT diagram does not change.)

(j) Target position change value during position control of speed/position switching control

For the target position change value during position control of speed/position switching control, do not set a negative value. If a negative value is set, a "Movement amount setting out of range under speed/position switching control" error (Axis 1 error code: 1504) occurs. (The target position change is ignored and position control continues.)

7.10.7 Acceleration/deceleration processing function

The acceleration/deceleration processing function is used to adjust the acceleration/deceleration when OPR control, positioning control or JOG operation is performed. By adjusting the acceleration/deceleration processing according to each control, the control can be implemented in a more detailed manner.

(1) Decision of acceleration/deceleration processing method

The acceleration/deceleration method is determined by the setting items specified below.

Function	Operation start speed	Acceleration time	Target speed	Deceleration time
OPR control	Bias speed at start ^{*1}	OPR acceleration/ deceleration time	OPR speed ^{*2}	OPR acceleration/ deceleration time ^{*1}
Positioning control	Bias speed at start	Acceleration/deceleration time	Command speed	Deceleration stop time
JOG operation		JOG ACC time	JOG speed	JOG DEC time
Speed change function		ACC/DEC time at speed change	New speed value	DEC/STOP time at speed change

*1 Deceleration is to the creep speed. In the Count 2 method, the axis decelerates from the creep speed over the OPR deceleration stop time prior to the completion of machine OPR (☞ Page 70, Section 7.6.1). Also during fast OPR, the axis decelerates from the OPR speed over the OPR deceleration stop time.

*2 In the Stopper 3 method, the creep speed applies (☞ Page 82, Section 7.6.1 (6)).

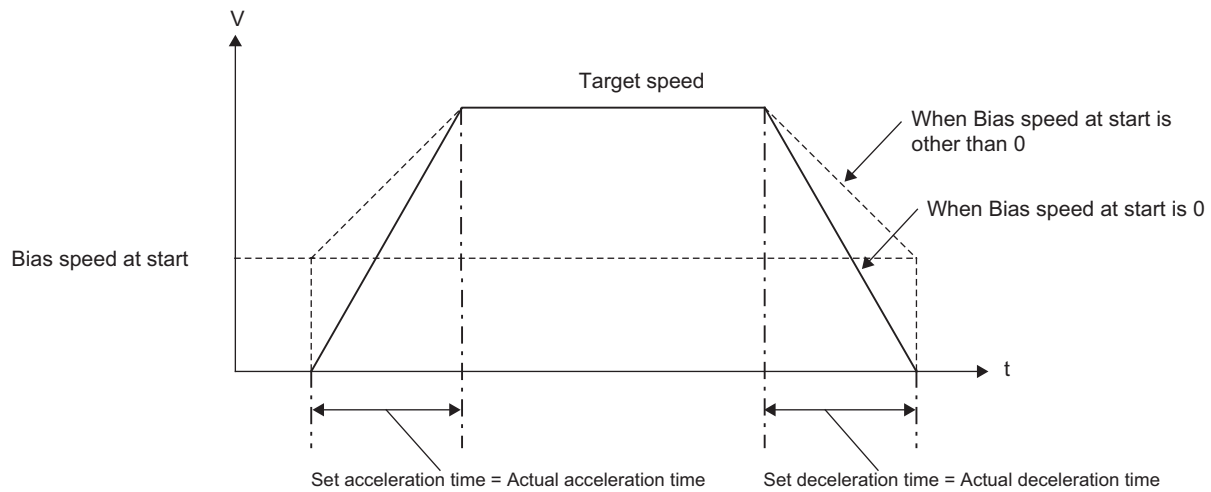

(2) Trapezoid acceleration/deceleration, S-curve acceleration/deceleration

Set an appropriate method by the positioning parameter "Acceleration/deceleration method selection".

(☞ Page 58, Section 7.3.1 (6))

When S-curve acceleration/deceleration is selected, the motor load can be reduced upon start and during standstill.

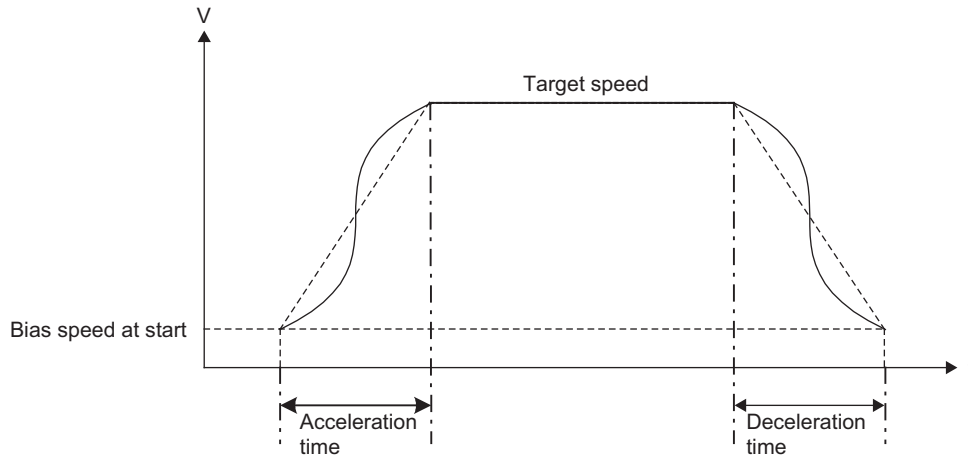

(3) Set acceleration/deceleration time and actual acceleration/deceleration time

Basically the acceleration/deceleration set by the parameter becomes the actual acceleration/deceleration, so the speed limit does not affect the acceleration/deceleration time. However, the following differences apply depending on the acceleration/deceleration method selected:

(a) Trapezoid acceleration/deceleration method

Both become equal regardless of whether the bias speed at start is 0 or not 0.

(b) S-curve acceleration/deceleration method

Since the final speed of deceleration becomes 1 pulse/s faster than the bias speed at start, the actual deceleration time becomes longer than the set deceleration time. In this case, the actual deceleration time can be shortened by setting the bias speed at start to other than 0.

(4) Precautions

- If the target speed is 1 pulse/s, the set acceleration/deceleration time is ignored.
- If the constant speed is not performed during operation (for example, when the axis starts decelerating to a stop during acceleration/deceleration), the axis does not operate at the set acceleration/deceleration time.

7.10.8 Stop processing function

The following explains the stop processing that takes place when a stop cause occurs during operation. The deceleration time after the occurrence of a stop cause varies according to the specific control.

Control details	Deceleration time
Positioning control	<ul style="list-style-type: none"> Positioning using the Table start instruction (IPPSTRT1(P)): Positioning data "Deceleration stop time" Positioning using the Positioning start instruction (IPDSTRT1(P)): Setting data "Deceleration stop time"
JOG operation	JOG DEC time set as control data in the JOG start instruction
OPR control	OPR parameter "OPR deceleration stop time"
After speed change	DEC/STOP time at speed change, set by the Speed change instruction (IPSPCHG1(P))

(1) Details of stop processing control

- When a stop cause occurs, the axis decelerates to the bias speed at start and then stops.
- If the axis reaches the specified position while decelerating following the occurrence of a stop cause, it stops immediately.

(2) Stop cause

A stop cause occurs at the following conditions.

- Each control ends successfully
- An error occurs
- The Axis stop instruction (IPSTOP1) is executed
- A return operation occurs during target position change

The following shows operations when above conditions occur except "each control ends successfully".

Stop cause	Positioning control	OPR control	JOG operation	Target axis	Axis 1 axis operation status (SD1844) after stopping
Software upper stroke limit	Deceleration to a stop	—	Deceleration to a stop	For each axis	Error occurring (-1)
Software lower stroke limit					
Hardware upper stroke limit	Deceleration to a stop	Deceleration to a stop	Deceleration to a stop	For each axis	Error occurring (-1) (Except when OPR retry is performed.)
Hardware lower stroke limit					
Program execution is stopped.	Deceleration to a stop	Deceleration to a stop	Deceleration to a stop	All axes	Error occurring (-1)
Drive unit ready signal is off.	Deceleration to a stop	Deceleration to a stop	Deceleration to a stop	For each axis	Error occurring (-1)
The Axis stop instruction (IPSTOP1) is executed.	Deceleration to a stop	Deceleration to a stop	Deceleration to a stop	For each axis	Stopped (1)
A return operation occurs during target position change. (Operating normally)	Deceleration to a stop	—	—	—	—

(3) Stop processing during speed change

If the axis starts decelerating to a stop before the new speed value is reached, the actual deceleration stop time may not become the same as the set value of "Deceleration stop time."

Ex. When a stop cause occurs in the middle of speed change during speed control

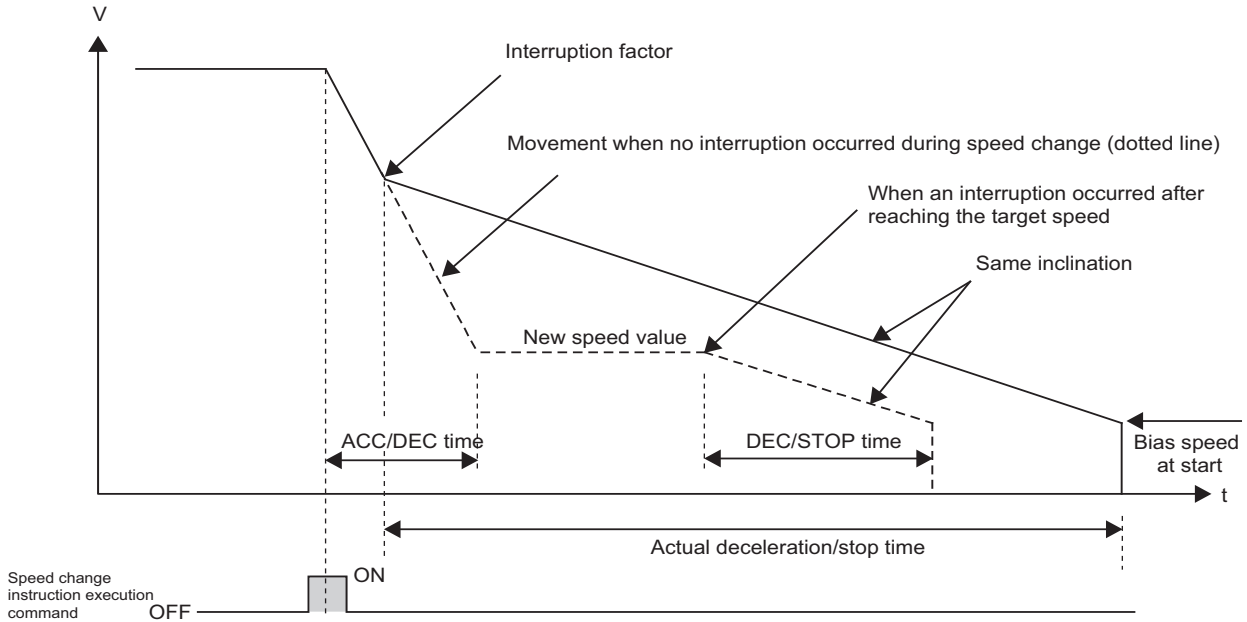

(4) Stop processing during S-curve acceleration/deceleration

If a stop cause occurs while the axis is accelerating according to "S-curve acceleration/deceleration," the S-curve needed to decelerate from the current speed is recalculated. The axis moves at a constant speed while the calculation is in progress.

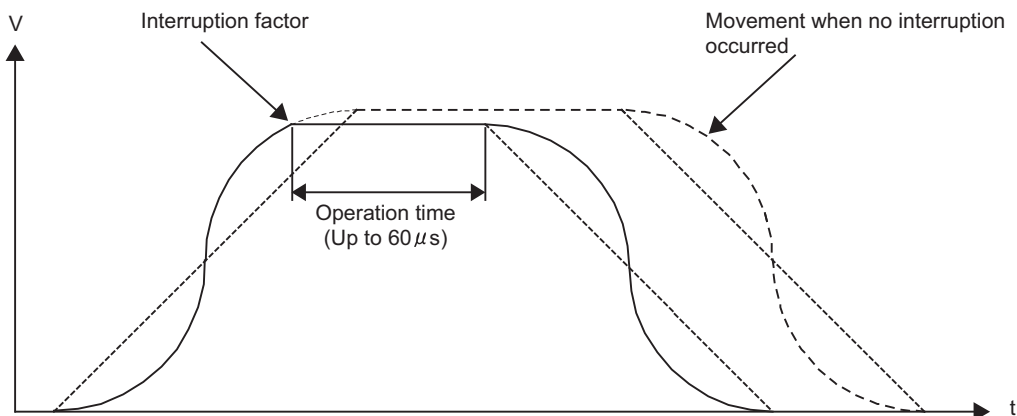

Since pulses are output during constant-speed operation, the positioning address may be reached during deceleration. In this case, the axis stops immediately upon reaching the positioning address.

(5) Stopping after simultaneous starting of two axes

The axes started by the Two axes simultaneous start instruction (IPSIMUL(P)) are not stopped simultaneously. Each axis must be stopped separately. (Page 103, Section 7.7.5)

(6) Pulse output processing upon stop

If the axis stops due to occurrence of a stop cause, pulse output currently in progress after elapse of the set deceleration stop time after the start of deceleration stop will continue until one pulse is output. The actual deceleration time may become longer by a maximum of 1s than the deceleration stop time. As indicated by the calculation formula below, the extended deceleration stop time can be reduced by increasing the value of "Bias speed at start."

$$\text{Increase in DEC/STOP time} = \frac{1}{\text{Bias speed at start}} \text{ (S)}$$

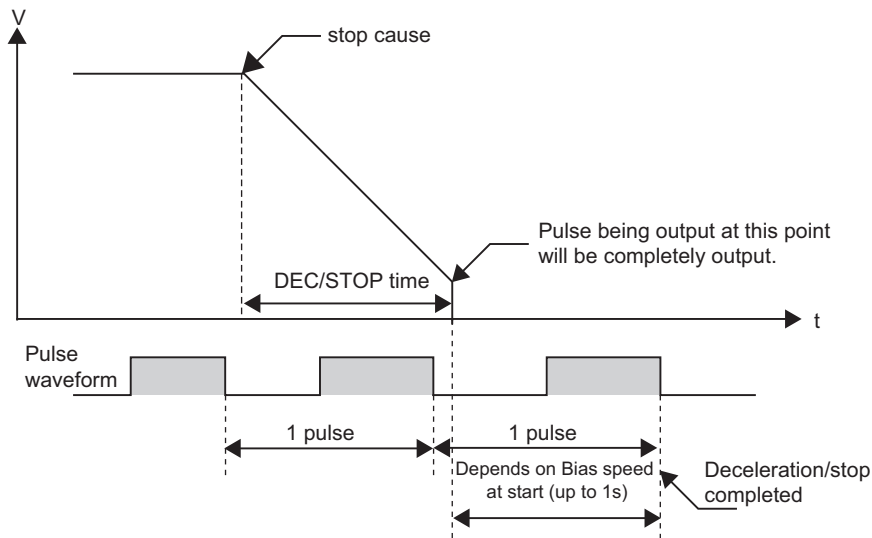

(7) The Axis stop instruction (IPSTOP1) is executed

Even if the execution command for axis stop instruction is established in the middle of deceleration, the current deceleration is continued until the axis stops. (Page 156, Section 7.12.1 (7))

7.11 Absolute Position Restoration Function

The absolute position restoration function restores the absolute position of the specified axis using the absolute position detection system. The Absolute position restoration function (IPABRST1) (Page 154, Section 7.12.1 (6)) is used to adjust the Axis 1 current feed value (SD1840, SD1841) to the actual motor position. This way, machine OPR is no longer necessary after the power was cut off due to a momentary power failure or emergency stop, and the on-site recovery work can be performed easily.

(1) Configuration of Absolute position detection system

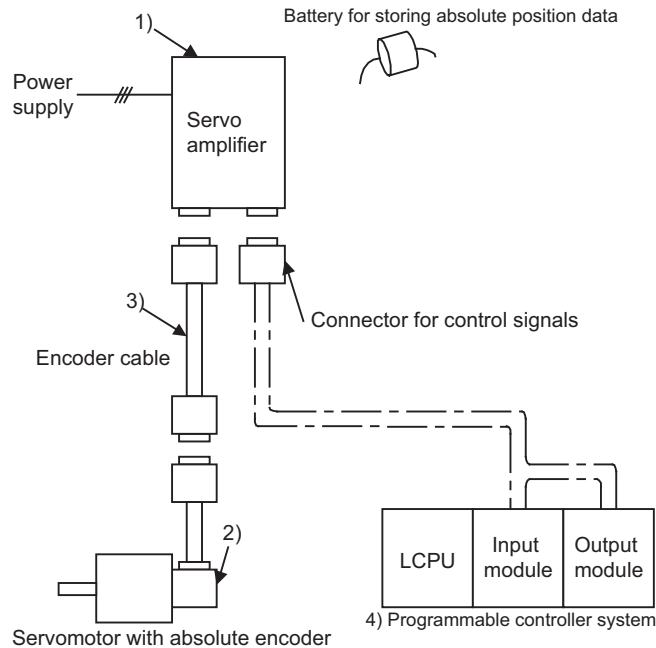

Number	Component	Description
1)	Servo amplifier*1	<ul style="list-style-type: none"> • Install the battery in the servo amplifier. • Enable the absolute position detection function of the servo amplifier. For other details, refer to the instruction manual for the servo amplifier.
2)	Servomotor	<ul style="list-style-type: none"> • Use a servomotor with absolute position detector. For other details, refer to the instruction manual for the servomotor.
3)	Encoder cable	<ul style="list-style-type: none"> • Wire the battery power connection lines (BAT/LG signals) to the incremental encoder cable. For other details, refer to the instruction manual for the cables.
4)	Programmable controller system	<ul style="list-style-type: none"> • Absolute position detection data is sent/received using general-purpose I/Os or the I/O unit (three input points, three output points*2).

*1 Any Mitsubishi general-purpose AC servomotor (pulse-train type) supporting absolute position detection systems.

*2 The orders of three input points and three output points are determined, and the device numbers must be consecutive.

(2) Communication overview of absolute position detection data

As shown below, the detector consists of phase A/B/Z signals for position control during normal operation, an encoder for detecting positions within one rotation, and an accumulative revolution counter for detecting the rotation amount. This absolute position detection system always detects the absolute position of the machine and stores it in a memory backed up by a battery, regardless of the power condition of the programmable controller system. Accordingly, once the OP is initially set when the machine is installed^{*1}, machine OPR is no longer necessary at subsequent power-on operations and recovery also becomes easy in the event of a momentary power failure or emergency stop. Also, absolute position data is backed up using a super capacitor in the detector, which means that absolute position data is retained for a specified time even when the cable is disconnected or breaks.

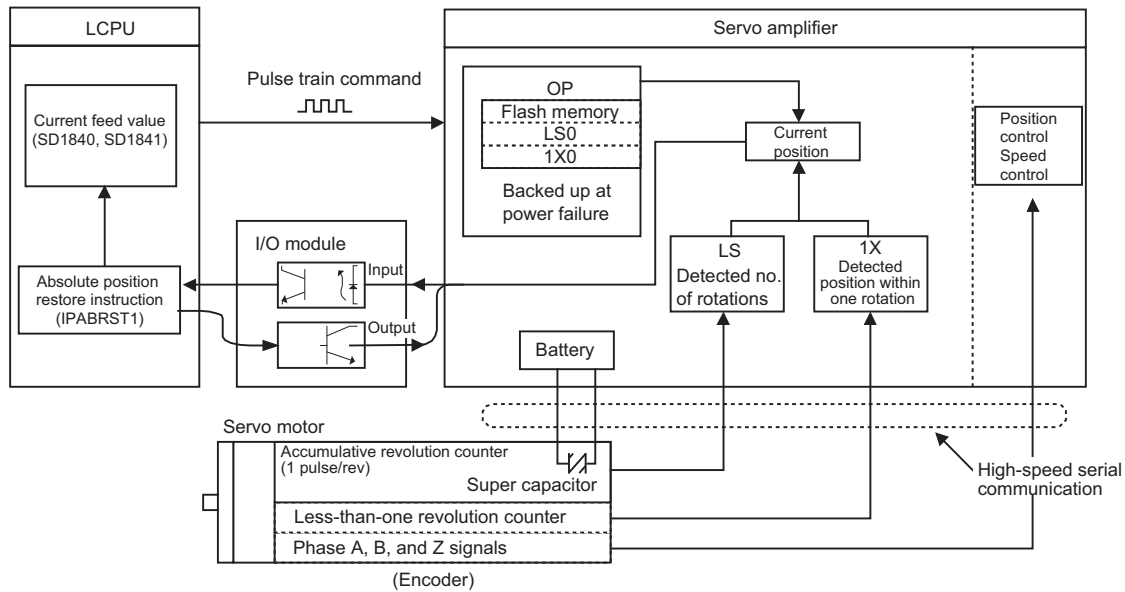

- *1 Operation to output a deviation counter clear signal to the servo amplifier at the OP position. This operation must be performed before absolute position restoration.
- When other than Count2 is selected: Perform machine OPR, output a deviation counter clear signal.
- When Count2 is selected: Wire a general-purpose output signal to the deviation counter clear signal line of the servo amplifier, perform JOG operation to adjust the position, and then turn the signal on.

(3) Connection example with a servo amplifier (MR-J3-A) manufactured by Mitsubishi

For details, refer to the instruction manual for the MR-J3-A specification.

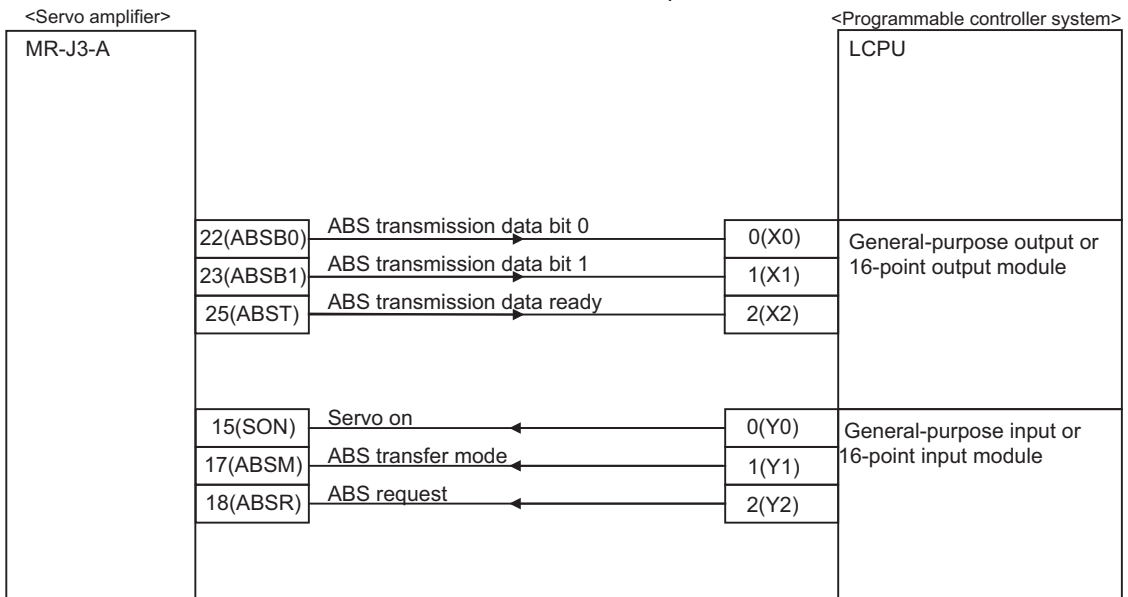

(a) Connector pin on servo side

Signal name	Abbreviation	Pin number	Function/application
Servo on	SON	15	This signal is on when the servo amplifier is normal.
ABS transfer mode	ABSM	17	While this signal is on, the servo amplifier operates in the ABS transfer mode and the functions of CN1-22, 23 and 25 conform to those shown in this table.
ABS request flag	ABSR	18	This signal turns on when ABS data is requested in the ABS transfer mode.
ABS transmission data bit 0	ABSB0	22	Lower bit of the two ABS data bits to be transferred to the programmable controller system from the servo in the ABS transfer mode.
ABS transmission data bit 1	ABSB1	23	Upper bit of the two ABS data bits to be transferred to the programmable controller system from the servo in the ABS transfer mode.
ABS transmission data ready	ABST	25	This signal turns on when the ABS transmission data is ready in the ABS transfer mode.

(4) Condition for starting positioning using the absolute position detection system

Use the system within the range where conditions 1 and 2 specified below are satisfied. If this range is exceeded, the current value cannot be successfully restored by absolute position restoration.

(a) Condition 1: Number of output pulses

This is the number of pulses that can be output to the servo amplifier when positioning is performed from the OP using the absolute position detection system. With the absolute position detection system, pulses within the range calculated by the formula below, around the OP, can be output to the servo amplifier:

$$\{-32678 \times (\text{Number of feedback pulses})\} \leq \text{Number of output pulses} \leq \{32768 \times (\text{Number of feedback pulses}) - 1\}$$

The number of feedback pulses indicates pulses per servomotor rotation as recognized by the LCPU.

Ex. Number of feedback pulses = 8192: -268435456 (pulses) to 268435455 (pulses)

Number of feedback pulses = 16384: -536870912 (pulses) to 536870911 (pulses)

(b) Condition 2: Positioning address

Set an appropriate address within the settable range of "Positioning address/movement amount."

- Setting range: -2147483648 (pulses) to 2147483647 (pulses)

(5) Precautions

- With the absolute position detection system, the following controls cannot be performed:
 - Feed control of the turntable, etc., for unlimited length in one direction only
 - Control where the movement amount from the OP address exceeds the ranges of conditions 1 and 2 explained in  Page 137, Section 7.11 (4)
- With the Absolute position restoration function (IPABRST1), three consecutive bits starting from the input signal and output signal set by the arguments are used, respectively. Do not mistakenly use them as I/O signals for other purposes.
- If you have built an absolute position detection system, perform absolute position restoration at least once after the power on or reset.

Important

When absolute position restoration is performed, the servo ON signal may turn off (thereby causing the servo to turn off) for approx. 20 ms and the motor may move as a result. If this movement of motor may present problems, provide an electromagnetic brake and lock the motor during absolute position restoration.

7.12 Dedicated Instructions

The following table lists and describes dedicated instructions for the positioning function.

Ex. The table start instruction for Axis 1 is IPPSTRT1(P), and for Axis 2 is IPPSTRT2(P).

Instruction		Description	Reference
Axis 1	Axis 2		
IPPSTRT1(P)	IPPSTRT2 (P)	Start operation based on the desired data number specified from among "Positioning data" Nos. 1 to 10 set beforehand using the programming tool.	Page 140, Section 7.12.1 (1)
IPDSTRT1(P)	IPDSTRT2 (P)	Start positioning with data stored in the device specified by control data and subsequent devices, without using "Positioning data" Nos. 1 to 10 set beforehand using the programming tool.	Page 142, Section 7.12.1 (2)
IPSIMUL(P)		Start positioning using the specified "Positioning data" number for Axis 1, and positioning using the specified "Positioning data" number for Axis 2, simultaneously.	Page 145, Section 7.12.1 (3)
IPOPR1(P)	IPOPR2 (P)	Start OPR of the specified axis based on the specified method.	Page 148, Section 7.12.1 (4)
IPJOG1	IPJOG2	JOG operation of the specified axis is started.	Page 151, Section 7.12.1 (5)
IPABRST1	IPABRST2	Perform absolute position restoration of the specified axis.	Page 154, Section 7.12.1 (6)
IPSTOP1	IPSTOP2	Stop the operating axis.	Page 156, Section 7.12.1 (7)
IPSPCHG1(P)	IPSPCHG2(P)	Change the speed of the specified axis.	Page 158, Section 7.12.1 (8)
IPTPCHG1(P)	IPTPCHG2(P)	Change the target position of the specified axis.	Page 161, Section 7.12.1 (9)

7.12.1 Details of dedicated instructions

(1) Table start instructions: IPPSTRT1(P), IPPSTRT2(P)

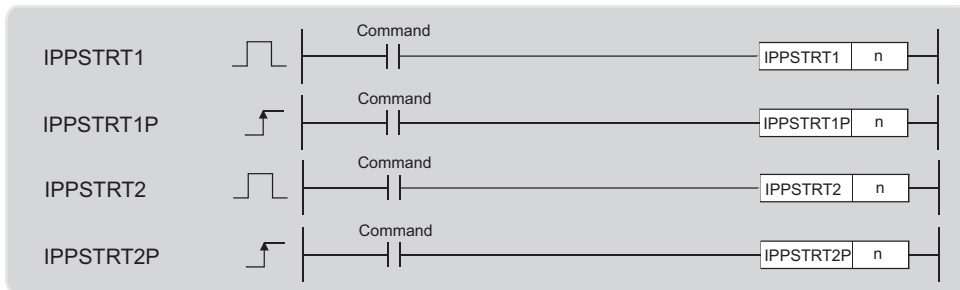

Setting data	Internal device		R, ZR		J□□		U□\G□	Z□	Constant		Others
	Bit	Word	Bit	Word	Bit	Word			K, H	\$	
n	—	○	—	○	—	—	—	○	○	—	—

(a) Setting data

Setting data	Setting item	Setting range	Data type
n	Positioning data No.	1 to 10	BIN 16bit

(b) Function

- These instructions start operation based on the desired data number specified by "n" from among "Positioning data" No. 1 to 10 set beforehand using the programming tool.

Ex. Timing chart when "Positioning data" No. 1 is executed

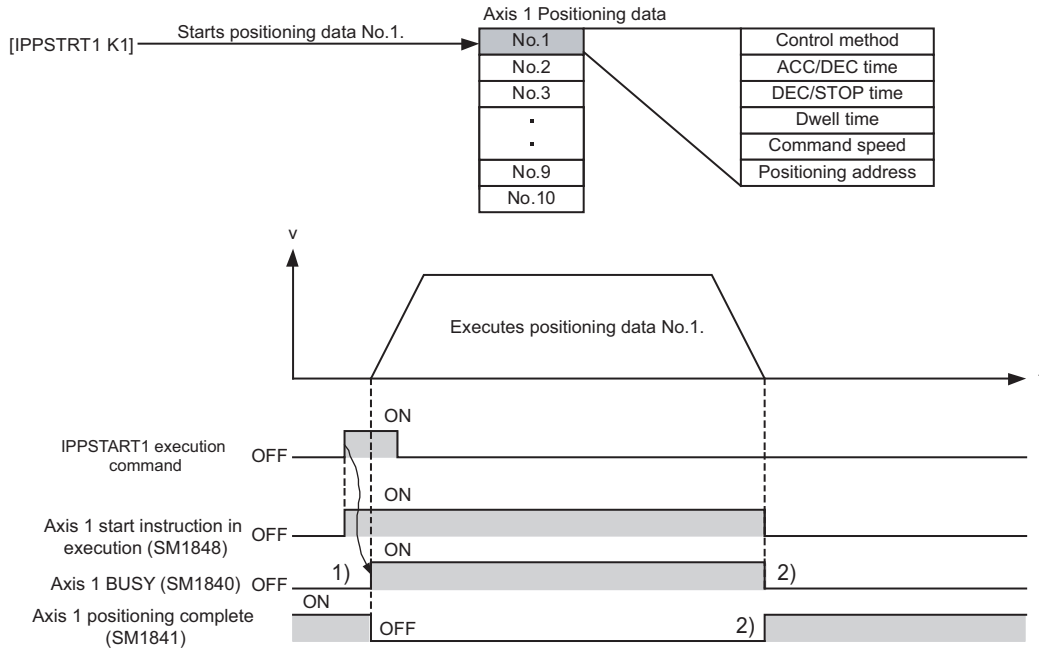

- When positioning control starts successfully, the Axis 1 busy (SM1840) turns on. (1))
- When positioning is complete, the Axis 1 busy (SM1840) turns off and Axis 1 positioning completion (SM1841) turns on. (2))
- The Axis 1 positioning completion (SM1841) will turn off the next time the applicable axis is started.
- If the Axis stop instruction (IPSTOP1) is executed or an error is detected during positioning, the axis decelerates to a stop and the Axis 1 positioning completion (SM1841) does not turn on.

The basic number of steps is 2.

(c) Error

If an operation error occurs, the error flag (SM0) turns on and the corresponding error code is stored in SD0.

- When a value other than 1 to 10 is specified in "n": (Error code: 4100)
- When an unusable device is specified in "n": (Error code: 4101)
- When the positioning function for the target axis is not set to "Use": (Error code: 4116)

(d) Program example

Program that starts "Positioning data" No. 1 for Axis 1 when M0 turns on

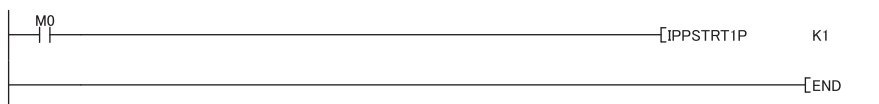

(2) Positioning start instructions: IPDSTR1(P), IPDSTR2(P)

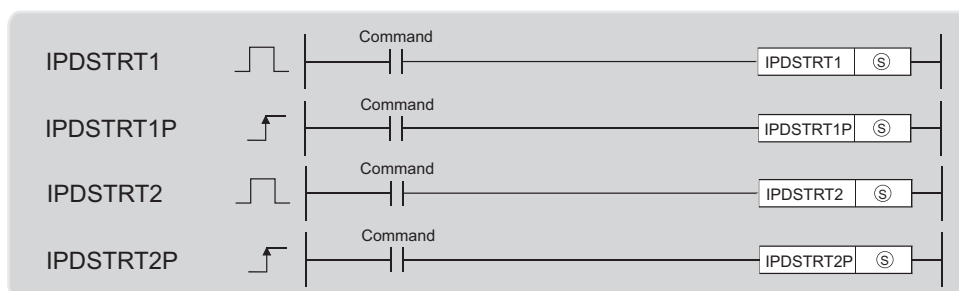

Setting data	Internal device		R, ZR		J□□		U□\G□	Z□	Constant		Others
	Bit	Word	Bit	Word	Bit	Word			K, H	\$	
Ⓢ	—	○	—	○	—	—	—	—	—	—	—

(a) Setting data

Setting data	Setting item	Setting range	Data type
Ⓢ	Device start number of the device storing control data	Within the specified range of devices	Device name

(b) Control data

Device	Item	Setting data	Setting range	Set by
Ⓢ	Control System	1: Position control (ABS) 2: Position control (INC) 3: Speed/position switching control (forward RUN) 4: Speed/position switching control (reverse RUN) 5: Current value change 6: Speed control (forward RUN) 7: Speed control (reverse RUN)	1 to 7	User
Ⓢ + 1	Acceleration/ deceleration time	—	0 to 32767 (ms)	
Ⓢ + 2	Deceleration stop time	—	0 to 32767 (ms)	
Ⓢ + 3	Dwell time	—	0 to 65535 (ms) ^{*1}	
Ⓢ + 4	Command speed	—	0 to 200000 (pulse/s) ^{*2}	
Ⓢ + 5				
Ⓢ + 6	Positioning address/ movement amount	—	-2147483648 to 2147483647 (pulses)	
Ⓢ + 7				

*1 In the program, enter the set values as follows:

1 to 32767: Enter as decimals.

32768 to 65535: Convert to hexadecimal and enter the resulting hexadecimal.

*2 If the set value of command speed is outside 0 to 200000, the axis may operate at the speed limit.

(c) Function

- These instructions start positioning with data stored in the device specified by \textcircled{S} and subsequent devices, without using "Positioning data" Nos. 1 to 10 set beforehand using the programming tool.

Ex. Timing chart when position control is performed by setting the start device number in D0

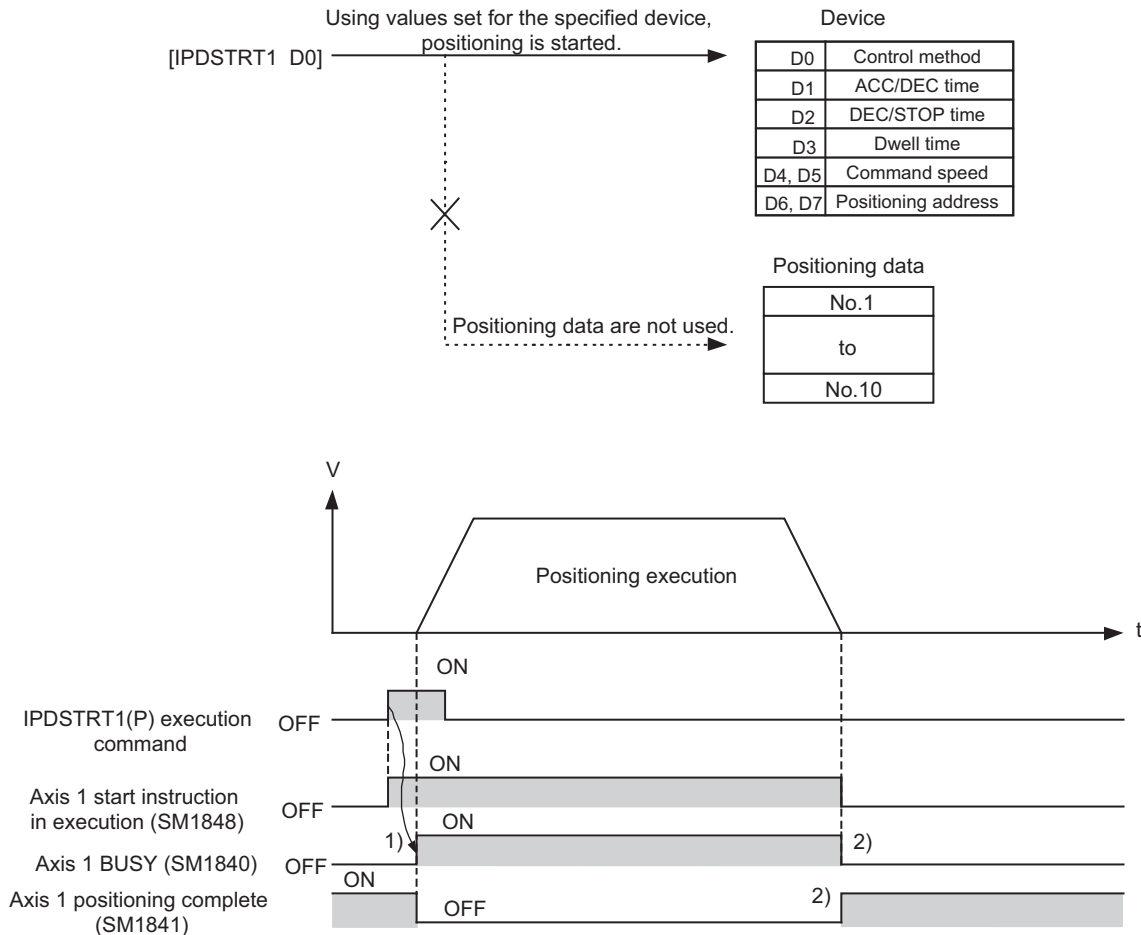

- When positioning control starts successfully, the Axis 1 busy (SM1840) turns on. (1))
- When positioning is complete, the Axis 1 busy (SM1840) turns off and Axis 1 positioning completion (SM1841) turns on. (2)) (During speed control, causes that stop the axis include execution of the Axis stop instruction (IPSTOP1) and aborted operation due to error detection. Accordingly, the Axis 1 positioning completion (SM1841) does not turn on.)
- The Axis 1 positioning completion (SM1841) will turn off the next time the applicable axis is started.
- If operation cannot be started because \textcircled{S} is outside the setting range, etc., the Axis 1 error (SM1845) turns on.
- If the Axis stop instruction (IPSTOP1) is executed or an error is detected during positioning, the axis decelerates to a stop and the Axis 1 positioning completion (SM1841) does not turn on.

The basic number of steps is 2.

(d) Error

If an operation error occurs, the error flag (SM0) turns on and the corresponding error code is stored in SD0.

- When an unusable device is specified in \textcircled{S} : (Error code: 4101)
- When the positioning function for the target axis is not set to "Use": (Error code: 4116)

(e) Program example

Program that starts Axis 1 based on the set positioning data below when M0 turns on

Device used	Item	Setting item
D0	Control method	Position control (ABS)
D1	Acceleration/deceleration time	1000 (ms)
D2	Deceleration stop time	1000 (ms)
D3	Dwell time	0 (ms)
D4, D5	Command speed	20000 (pulse/s)
D6, D7	Positioning address/movement amount	100000 (pulse)



(3) Two-axes simultaneous start instruction: IPSIMUL(P)

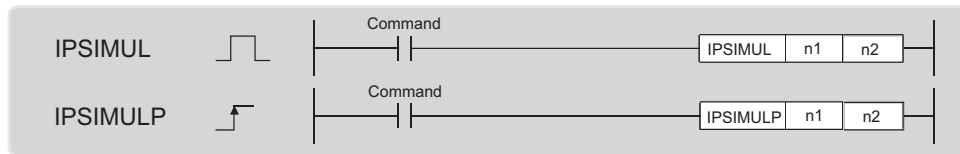

Setting data	Internal device		R, ZR		J□\□		U□\G□	Z□	Constant		Others
	Bit	Word	Bit	Word	Bit	Word			K, H	\$	
n1	—	○	—	○	—	—	—	○	○	—	—
n2	—	○	—	○	—	—	—	○	○	—	—

(a) Setting data

Setting data	Setting item	Setting range	Data type
n1	Axis 1 positioning data No.	1 to 10	BIN 16-bit
n2	Axis 2 positioning data No.		

(b) Function

- This instruction start positioning using the "Positioning data" number for Axis 1 specified by "n1", and positioning using the "Positioning data" number for Axis 2 specified by "n2", simultaneously.

Ex. Timing chart when positioning data No. 1 for Axis 1 and positioning data No. 10 for Axis 2 are started simultaneously

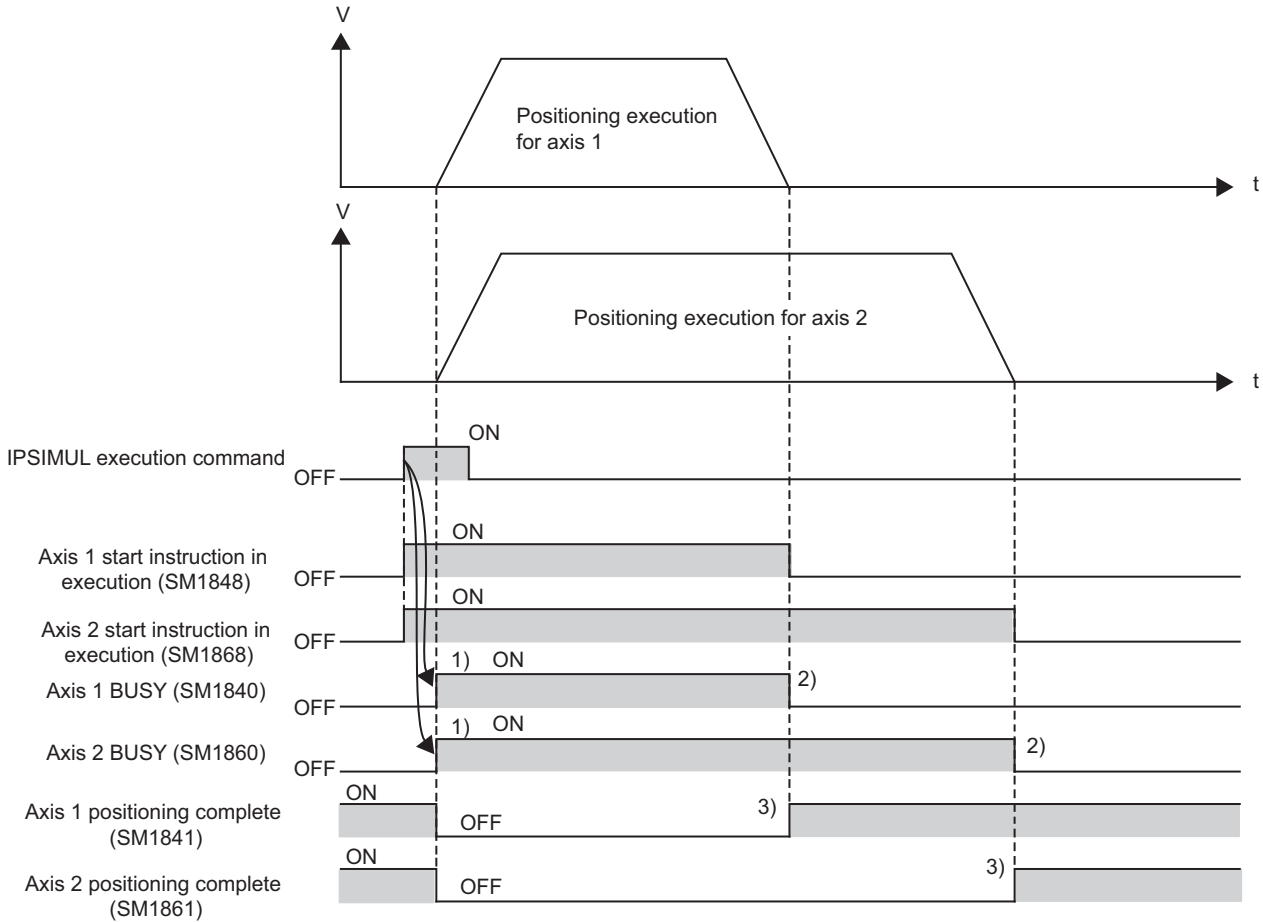

- When positioning control starts successfully, both of the Axis □ busy signals (SM1840, SM1860) turn on. (1))
- The Axis □ busy (SM1840 or SM1860) turns off and Axis □ positioning completion (SM1841 or SM1861) turns on, starting from the axis whose positioning has completed. (2) (3))
- The Axis □ positioning completion (SM1841 or SM1861) will turn off the next time the applicable axis is started.
- If the Axis stop instruction (IPSTOP□) is executed for each axis or an error is detected during positioning, the axis decelerates to a stop and the Axis □ positioning completion (SM1841 or SM1861) does not turn on.

The basic number of steps is three.

(c) Error

If an operation error occurs, the error flag (SM0) turns on and the corresponding error code is stored in SD0.

- When a value other than 1 to 10 is specified in "n1" or "n2": (Error code: 4100)
- When an unusable device is specified in "n1" or "n2": (Error code: 4101)
- When the positioning function for the target axis is not set to "Use": (Error code: 4116)

(d) Program example

Program that simultaneously starts positioning data No. 1 for Axis 1 and positioning data No. 10 for Axis 2 when M0 turns on

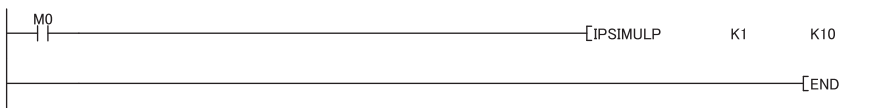

(4) Original position return start instructions: IPOPR1(P), IPOPR2(P)

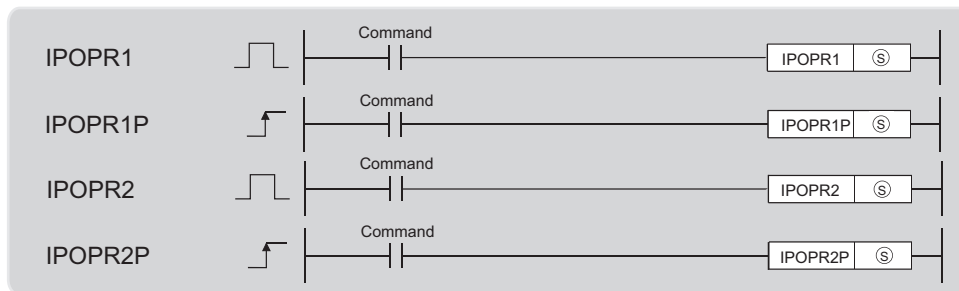

Setting data	Internal device		R, ZR		J□□		U□\G□	Z□	Constant		Others
	Bit	Word	Bit	Word	Bit	Word			K, H	\$	
⑤	—	○	—	○	—	—	—	—	—	—	—

(a) Setting data

Setting data	Setting item	Setting range	Data type
⑤	Device start number of the device storing control data	Within the specified range of devices	Device name

(b) Control data

Device	Item	Setting data	Setting range	Set by
⑤	Original position return type	1: Machine OPR 2: Fast OPR (OP address) 3: Fast OPR (standby address)	1 to 3	User
⑤+1	Standby address (This address is set only when fast OPR (standby address (3)) is specified for original position return type)	—	-2147483648 to 2147483647 (pulses) (Other than standby address (3) is ignored)	
⑤+2				

(c) Function

- These instructions start OPR of the type specified by ⑤

Ex. Near-point dog method

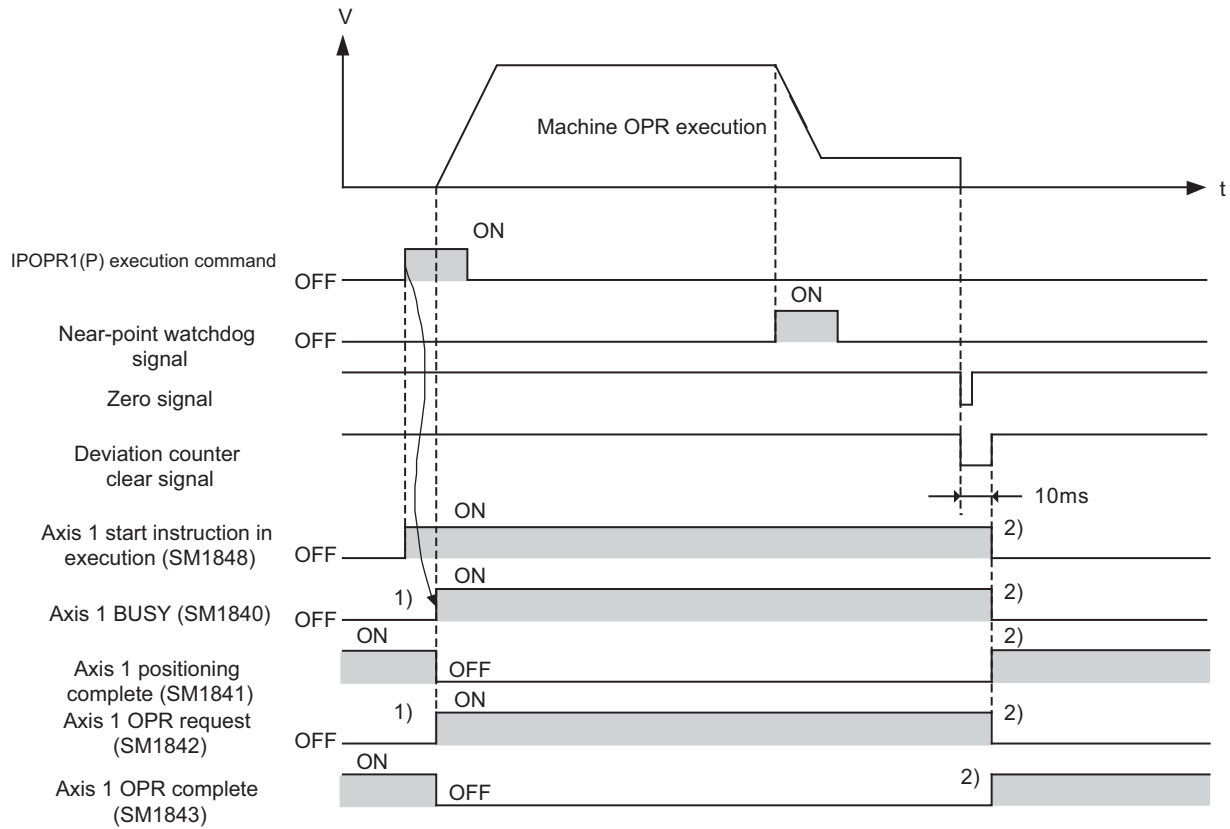

- When machine OPR starts successfully, the Axis 1 busy (SM1840) and Axis 1 OPR request (SM1842) turn on. (1))
- When machine OPR is complete, the Axis 1 busy (SM1840) turns off and Axis 1 positioning completion (SM1841) turns on. Also, the Axis 1 OPR request (SM1842) turns off and Axis 1 OPR completion (SM1843) turns on. (2))
The Axis 1 OPR completion (SM1843) will turn off the next time the applicable axis is started.
- If operation cannot be started because ⑤ is outside the setting range, etc., the Axis 1 error (SM1845) turns on.
- If the Axis stop instruction (IPSTOP1) is executed or an error is detected during machine OPR, the axis decelerates to a stop and the Axis 1 OPR completion (SM1843) does not turn on.

The following operations take place in the case of fast OPR:

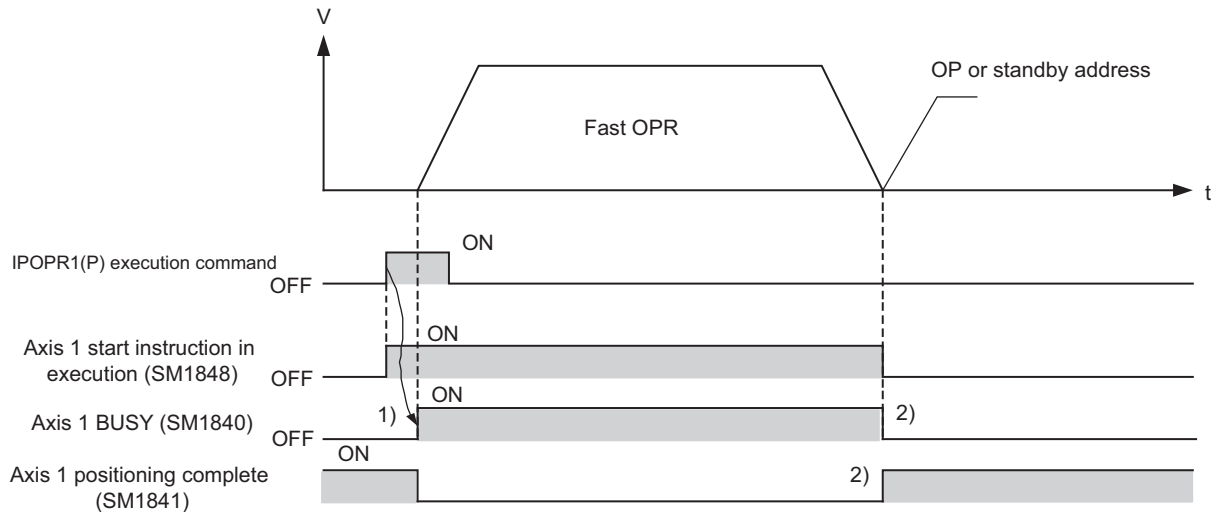

- When fast OPR starts successfully, the Axis 1 busy (SM1840) turns on. (1))
- When fast OPR is complete, the Axis 1 busy (SM1840) turns off and Axis 1 positioning completion (SM1841) turns on. (2))
- The Axis 1 positioning completion (SM1841) will turn off the next time the applicable axis is started.
- If operation cannot be started because ⑤ is outside the setting range, etc., the Axis 1 error (SM1845) turns on.
- If the Axis stop instruction (IPSTOP1) is executed or an error is detected during fast OPR, the axis decelerates to a stop and the Axis 1 positioning completion (SM1841) does not turn on.

The basic number of steps is 2.

(d) Error

If an operation error occurs, the error flag (SM0) turns on and the corresponding error code is stored in SD0.

- When an unusable device is specified in ⑤: (Error code: 4101)
- When the OPR Method for the target axis is set to "No method": (Error code: 4116)
- When the positioning function for the target axis is not set to "Use": (Error code: 4116)

(e) Program example

Program that starts machine OPR of Axis 1 when M0 turns on

Device used	Item	Setting item
D0	Original position return type	Machine OPR
D1, D2	Standby address	0 (Ignored)



(5) JOG start instructions: IPJOG1, IPJOG2

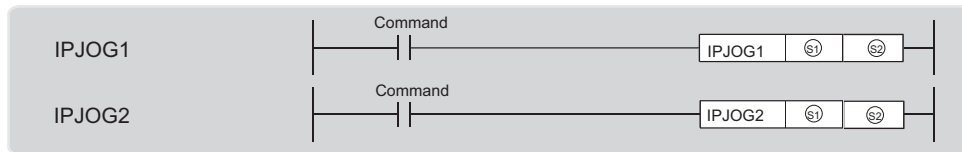

Setting data	Internal device		R, ZR		J□\□		U□\G□	Z□	Constant		Others
	Bit	Word	Bit	Word	Bit	Word			K, H	\$	
Ⓢ1	—	○	—	○	—	—	—	—	—	—	—
Ⓢ2	○	—	○	—	—	—	—	—	—	—	—

7

(a) Setting data

Setting data	Setting item	Setting range	Data type
Ⓢ1	Device start number of the device storing control data	Within the specified range of devices	Device name
Ⓢ2	Specification of JOG operation direction 0: Forward RUN 1: Reverse RUN	0,1	Bit

(b) Control data

Device	Setting data	Setting range	Set by
Ⓢ1	JOG speed	0 to 200000 (pulse/s)*1	User
Ⓢ1 + 1			
Ⓢ1 + 2	JOG ACC time	0 to 32767 (ms)	
Ⓢ1 + 3			

*1 If the set value of JOG speed is outside 0 to 200000, the axis may operate at the speed limit.

7.12 Dedicated Instructions
7.12.1 Details of dedicated Instructions

(c) Function

- These instructions perform JOG operation in the direction specified by $\textcircled{S2}$ using the JOG speed, JOG ACC time and JOG DEC time stored in $\textcircled{S1}$ onwards.

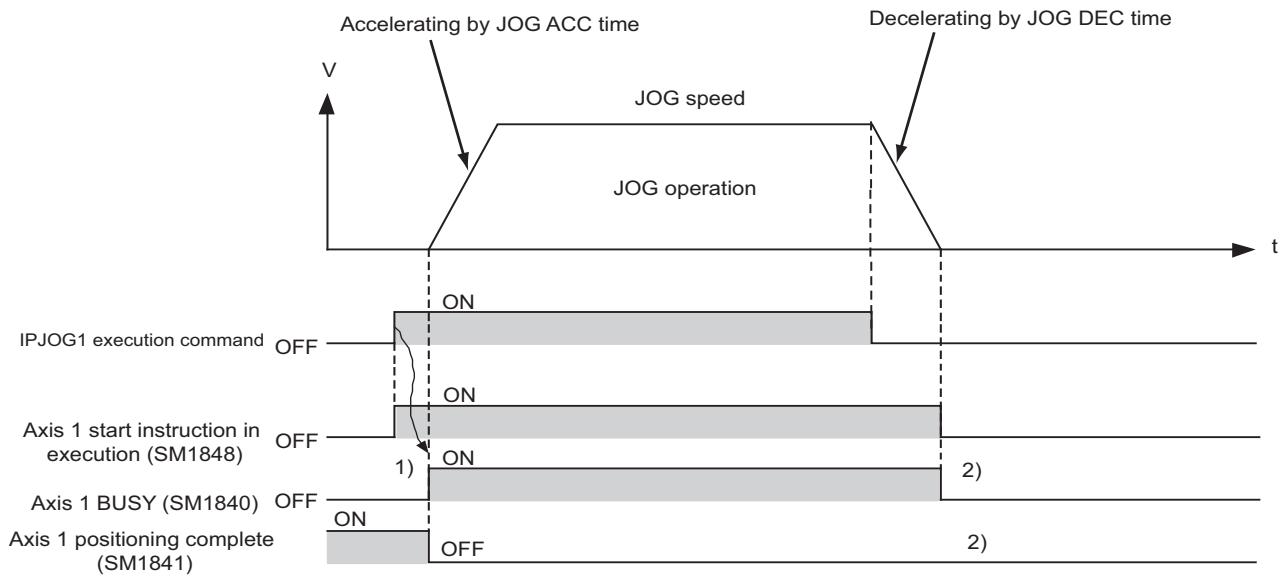

- When JOG operation starts successfully, the Axis 1 busy (SM1840) turns on. (1))
- When JOG operation ends, the Axis 1 busy (SM1840) turns off but the Axis 1 positioning completion (SM1841) does not turn on. (2))
- If operation cannot be started because $\textcircled{S1}$ is outside the setting range, etc., the Axis 1 error (SM1845) turns on.

The basic number of steps is 3.

(d) Error

If an operation error occurs, the error flag (SM0) turns on and the corresponding error code is stored in SD0.

- When an unusable device is specified in $\textcircled{S1}$, $\textcircled{S2}$:
(Error code: 4101)
- When the positioning function for the target axis is not set to "Use":
(Error code: 4116)

(e) Program example

Program that starts forward JOG when M0 turns on, and reverse JOG when M1 turns on.

Device used	Item	Setting item
D0, D1	JOG speed	10000 (pulse/s)
D2	JOG ACC time	1000 (ms)
D3	JOG DEC time	

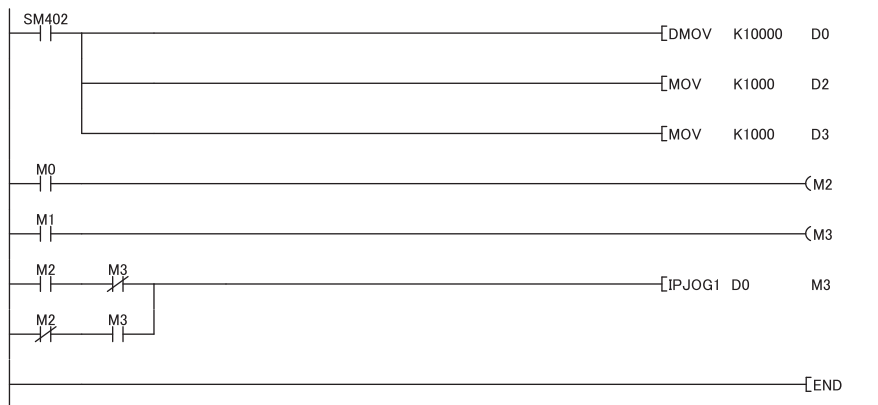

(6) Absolute position restoration instructions: IPABRST1, IPABRST2

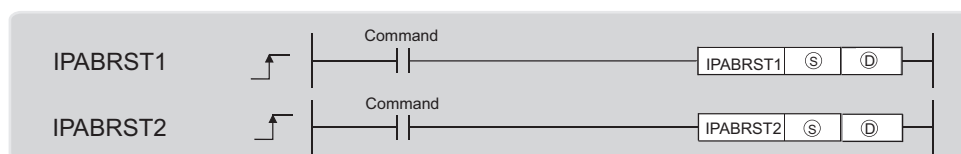

Setting data	Internal device		R, ZR		J□□		U□\G□	Z□	Constant		Others
	Bit	Word	Bit	Word	Bit	Word			K, H	\$	
Ⓢ	○	—	—	—	—	—	—	—	—	—	—
Ⓓ	○	—	—	—	—	—	—	—	—	—	—

(a) Setting data

Setting data	Setting item	Setting range	Data type
Ⓢ	Start input device number	Within the specified range of devices	Device name
Ⓓ	Start output device number	Within the specified range of devices	

(b) Control data

Device	Item	Setting data	Setting range	Set by
Ⓢ	Signal loaded from the servo amplifier	ABS transmission data bit 0	0,1	User
Ⓢ + 1		ABS transmission data bit 1		
Ⓢ + 2		ABS transmission data ready		

Device	Item	Setting data	Setting range	Set by
Ⓓ	Signal output to the servo amplifier	Servo on	—	System
Ⓓ + 1		ABS transfer mode		
Ⓓ + 2		ABS request flag		

(c) Function

- These instructions perform absolute position restoration of the specified axis via communication with the servo amplifier using the input device and output device specified by (S) and (D), respectively.

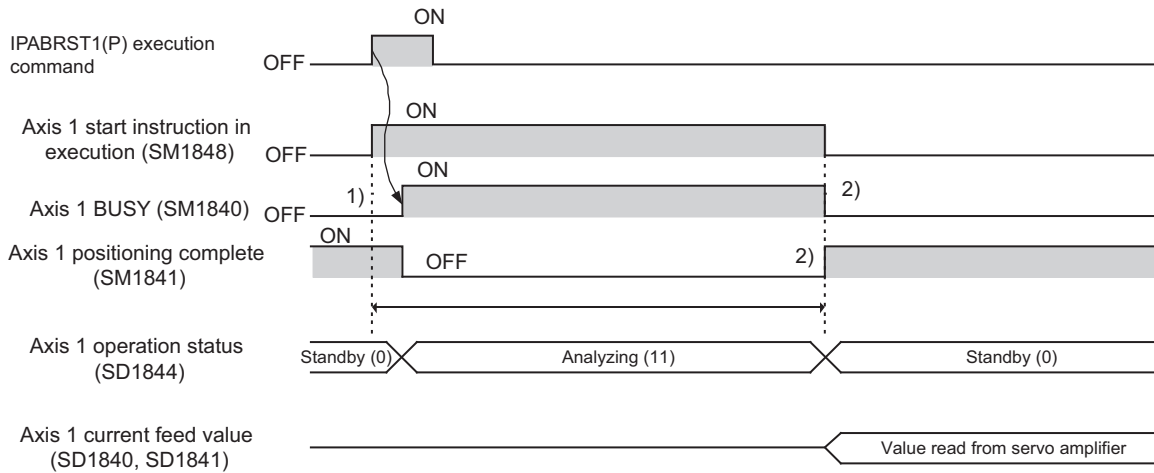

- When absolute position restoration starts successfully, the Axis 1 busy (SM1840) turns on. 1)
- The current position data retained by the servo amplifier is read. The read data is stored in the Axis 1 current feed value (SD1840, SD1841).
- When absolute position restoration is complete, the Axis 1 busy (SM1840) turns off and Axis 1 positioning completion (SM1841) turns on.
- The Axis 1 positioning completion (SM1841) will turn off the next time the applicable axis is started. 2)
- The Axis stop instruction (IPSTOP1) is ignored during absolute position restoration.
- If an error occurs during absolute position restoration, the Axis 1 positioning completion (SM1841) does not turn on.

The basic number of steps is 3.

(d) Error

If an operation error occurs, the error flag (SM0) turns on and the corresponding error code is stored in SD0.

- When an unusable device is specified in (S), (D): (Error code: 4101)
- When the positioning function for the target axis is not set to "Use": (Error code: 4116)

(e) Program example

Program that performs absolute position restoration of Axis 1 when M0 turns on

- X20 to X22: Signal loaded from the servo amplifier
- Y30 to Y32: Signal output to the servo amplifier



(7) Axis stop instructions: IPSTOP1, IPSTOP2

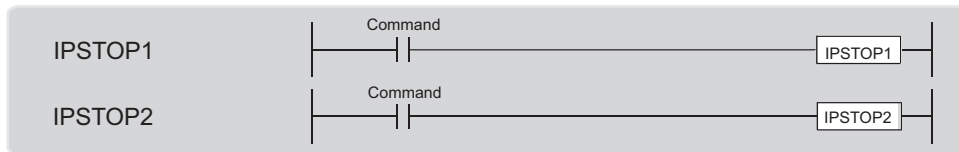

Setting data	Internal device		R, ZR		J□\□		U□\□	Z□	Constant		Others
	Bit	Word	Bit	Word	Bit	Word			K, H	\$	
—	—	—	—	—	—	—	—	—	—	—	—

(a) Function

- These instructions stop the operation of the specified axis.

Ex. Timing chart when the positioning started by the Table start instruction (IPPSTR1(P)) is stopped

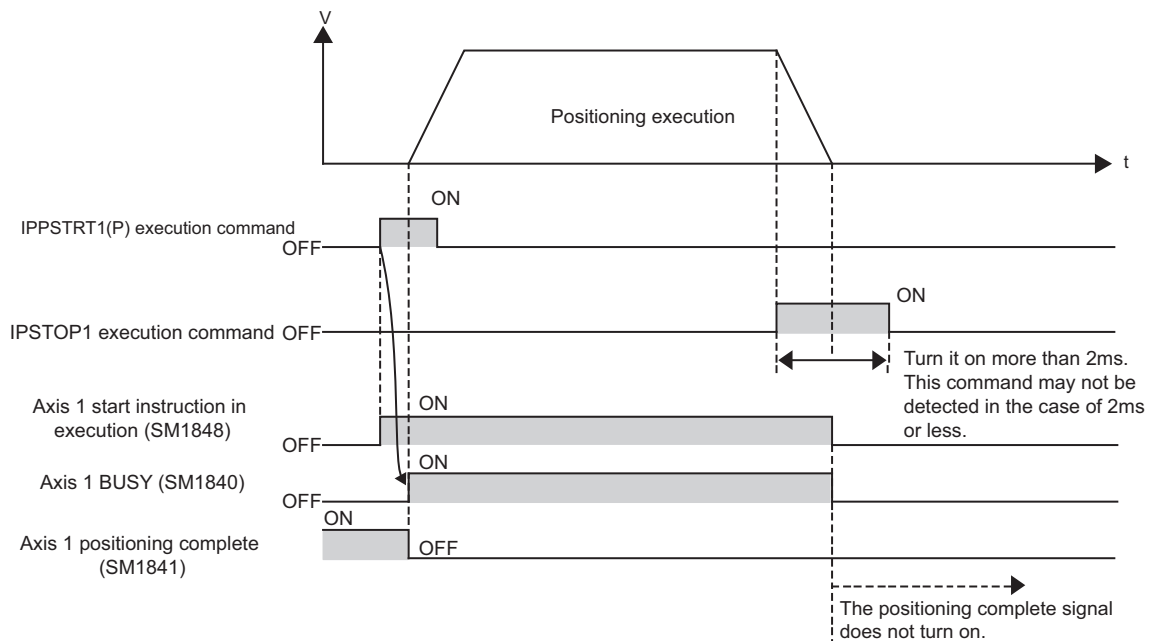

- No processing is performed if IPSTOP1 is executed while the Axis 1 axis operation status (SD1844) is indicating one of the following values:
 - Standing by (0)
 - Stopped (1)
 - Error occurring (-1)
 - Decelerating (axis stop ON) (7)
 - Decelerating (JOG start OFF) (8)
 - Analyzing (11)
- If an attempt is made to start positioning while IPSTOP1 is still being executed, a "Stop instruction ON at start" error (Axis 1 error code: 1102) occurs and positioning does not start.
- When the deceleration stop is complete due to IPSTOP1, the Axis 1 positioning completion (SM1841) does not turn on.

The basic number of step is 1.

(b) Operation error

If an operation error occurs, the error flag (SM0) turns on and the corresponding error code is stored in SD0.

- When the positioning function for the target axis is not set to "Use":

(Error code: 4116)

(c) Program example

Program that stops Axis 1 when M0 turns on

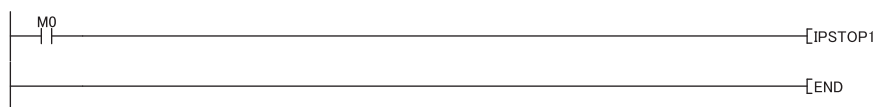

(8) Speed change instructions: IPSPCHG1(P), IPSPCHG2(P)

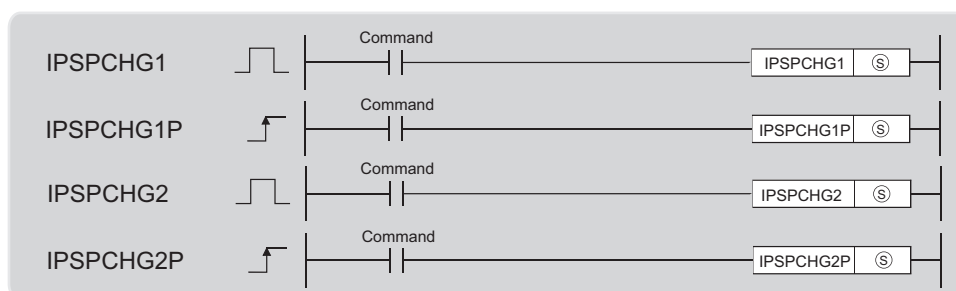

Setting data	Internal device		R, ZR		J□□		U□\G□	Z□	Constant		Others
	Bit	Word	Bit	Word	Bit	Word			K, H	\$	
Ⓢ	—	○	—	○	—	—	—	—	—	—	—

(a) Setting data

Setting data	Setting item	Setting range	Data type
Ⓢ	Device start number of the device storing control data	Within the specified range of devices	Device name

(b) Control data

Device	Setting data	Setting range	Set by
Ⓢ	ACC/DEC time at speed change	0 to 32767 (ms)	User
Ⓢ + 1	DEC/STOP time at speed change		
Ⓢ + 2	New speed value	0 to 200000 (pulse/s) ^{*1}	
Ⓢ + 3			

*1 If the set new speed value is outside 0 to 200000, the axis may operate at the speed limit.

(c) Function

- These instructions change the speed using the ACC/DEC at speed change, DEC/STOP time at speed change and new speed value stored in \textcircled{S} onward.

Ex. Timing chart when the speed is changed during positioning which was started by the Table start instruction (IPPSTR1(P))

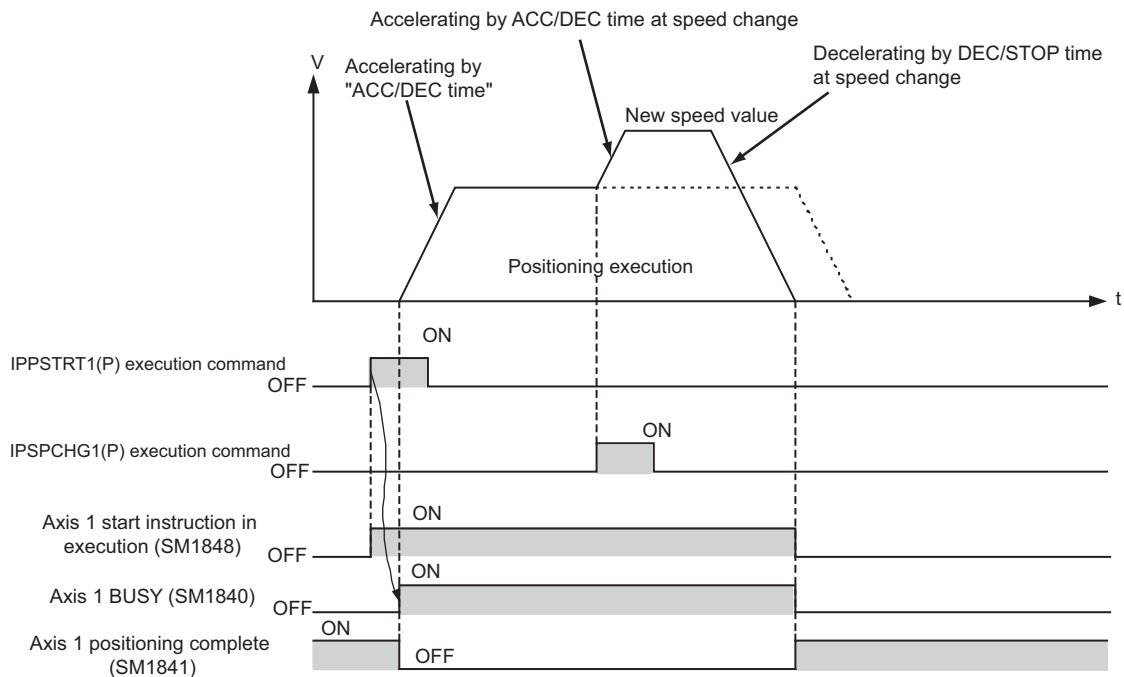

- If IPSPCHG1(P) is executed while the Axis 1 axis operation status (SD1844) is indicating one of the following values, the instruction is ignored:
 - Standing by (0)
 - Stopped (1)
 - Error occurring (-1)
 - Decelerating (axis stop ON) (7)
 - Decelerating (JOG start OFF) (8)
 - Analyzing (11)

The basic number of steps is two.

(d) Error

If an operation error occurs, the error flag (SM0) turns on and the corresponding error code is stored in SD0.

- When an unusable device is specified in \textcircled{S} : (Error code: 4101)
- When the positioning function for the target axis is not set to "Use": (Error code: 4116)

(e) Program example

Program that changes the Axis 1 speed when M0 turns on

Device used	Item	Setting item
D0	ACC/DEC time at speed change	2000 (ms)
D1	DEC/STOP time at speed change	1000 (ms)
D2, D3	New speed value	20000 (pulse/s)



(9) Target position change instructions: ITPCHG1(P), ITPCHG2(P)

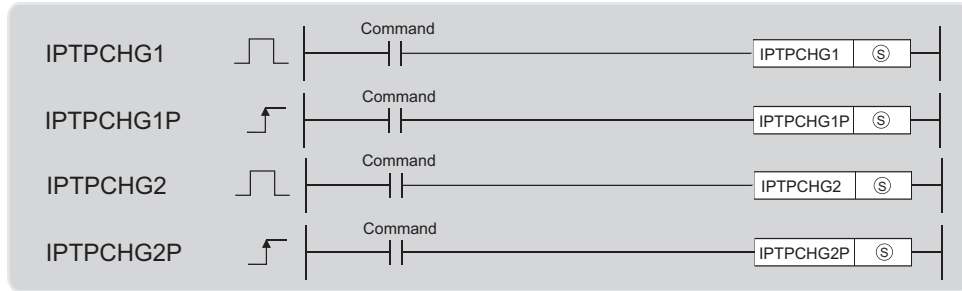

Setting data	Internal device		R, ZR		J□\□		U□\G□	Z□	Constant		Others
	Bit	Word	Bit	Word	Bit	Word			K, H	\$	
Ⓢ	—	○	—	○	—	—	—	○	○	—	—

7

(a) Setting data

Setting data	Setting item	Setting range	Data type
Ⓢ	<ul style="list-style-type: none"> Target position change value (constant) Device start number of the device storing control data 	<ul style="list-style-type: none"> Constant: -2147483648 to 2147483647 Device: Within the specified range of devices 	<ul style="list-style-type: none"> Constant: BIN 32 bits Device: Device name

(b) Control data

Device	Setting data	Setting range	Set by
Ⓢ	Target position change value	-2147483648 to 2147483647 (pulses)	User
Ⓢ + 1			

7.12 Dedicated Instructions
7.12.1 Details of dedicated Instructions

(c) Function

- These instructions change the target position to the new value specified by \textcircled{S} .

Ex. Timing chart when the address is changed during positioning which was started by the Table start instruction (IPPSTR1(P))

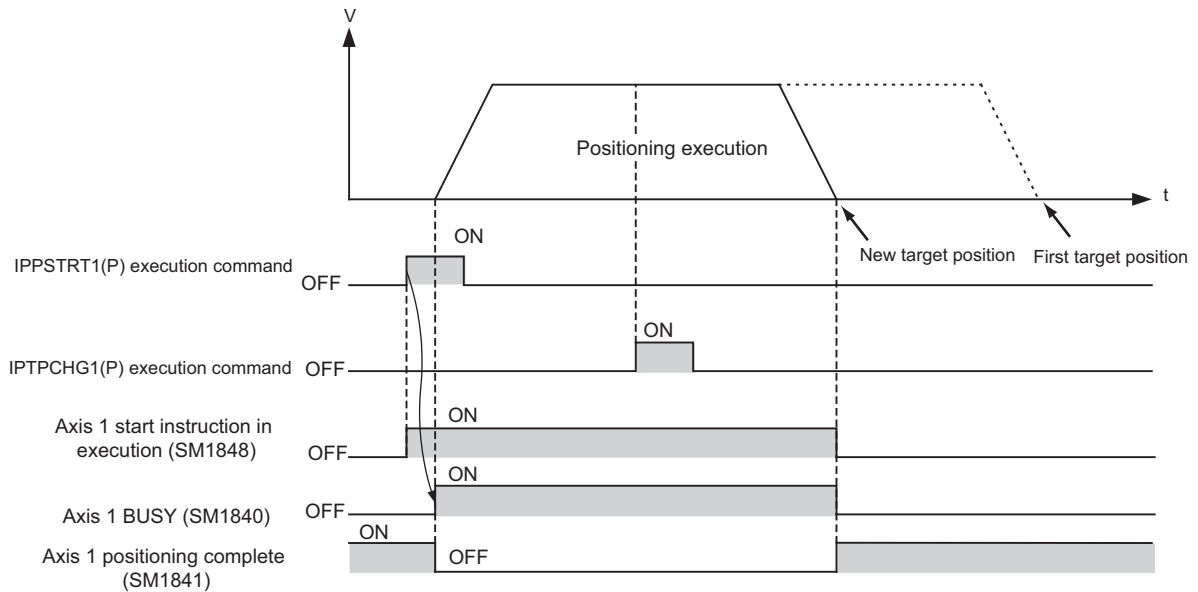

- No processing is performed if IPTPCHG1(P) is executed while the Axis 1 axis operation status (SD1844) is indicating one of the following values:
 - Standing by (0)
 - Stopped (1)
 - Error occurring (-1)
 - Decelerating (axis stop ON) (7)
 - Decelerating (JOG start OFF) (8)
 - Analyzing (11)

The basic number of steps is 2.

(d) Error

If an operation error occurs, the error flag (SM0) turns on and the corresponding error code is stored in SD0.

- When an unusable device is specified in \textcircled{S} : (Error code: 4101)
- When the positioning function for the target axis is not set to "Use": (Error code: 4116)

(e) Program example

Program that changes the target position of Axis 1 to 2000 when M0 turns on

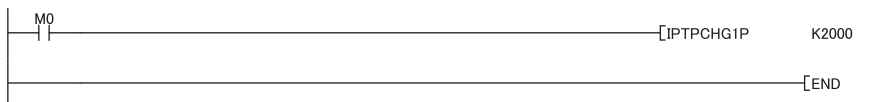

7.12.2 Precautions on dedicated instructions

(1) Multiple instruction executions

(a) Axis 1 start instruction (SM1848) and execution of instructions

When the Axis 1 start instruction (SM1848) is on, any attempt to perform positioning of the same axis by each of the following instructions is ignored. (If an instruction to start positioning is executed again after the Axis 1 start instruction (SM1848) has turned off, positioning starts even when the Axis 1 start during operation (SM1847) is on.)

- IPPSTR1(P)
- IPDSTR1(P)
- IPSIMUL(P)
- IPOPR1(P)
- IPJOG1
- IPABRST1

(b) Multiple executions during one scan

If each of the following instructions is used multiple times on the same axis during one scan, normal operation cannot be guaranteed.

- IPJOG1
- IPSTOP1

(2) Program executed only once and execution of instructions

If the following instructions are executed in a program which is executed only once, turning off of execution commands cannot be detected and thus normal operation is not possible. Use these instructions in a program where turning off of execution commands can be detected (such as a scan program).

- IPJOG1
- IPSTOP1

(3) Axis 1 axis operation status (SD1844) and execution of instructions

If IPSTOP1, IPSPCHG1(P) or IPTPCHG1(P) is executed while the Axis 1 axis operation status (SD1844) is indicating one of the following values, the instruction is ignored:

- Standing by (0)
- Stopped (1)
- Error occurring (-1)
- Decelerating (axis stop ON) (7)
- Decelerating (JOG start OFF) (8)
- Analyzing (11)

(4) Instructions not requiring execution command

The following instructions are always executed, which means that they are executed even when their execution command is off. Accordingly, an error occurs, if it is bound to occur when the instruction is executed, even when the execution command is off:

- IPJOG1
- IPSTOP1

(5) Pulse instructions

IPPSTR1P, IPSIMULP and other pulse instructions are executed at the leading edge of their execution command. If these instructions are used in an interrupt program or subroutine, they are not executed until the second or later leading edge of their execution command.

Ex. Executing IPPSTR1P in an interrupt program

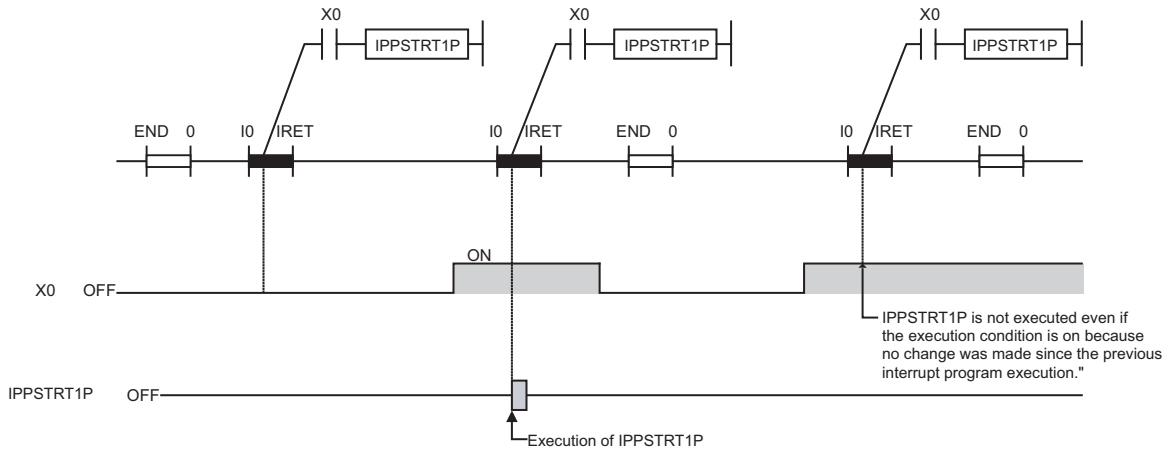

(6) Precautions on IPSTOP1

(a) IPSTOP1 and positioning control

If an attempt is made to start positioning control while IPSTOP1 is still being executed, a "Stop instruction ON at start" error (Axis 1 error code: 1102) occurs and positioning does not start.

(b) IPSTOP1 and Axis 1 positioning completion (SM1841)

When the deceleration stop is complete due to IPSTOP1, the Axis 1 positioning completion (SM1841) does not turn on.

(c) Execution command for IPSTOP1

The execution command for IPSTOP1 must remain on for at least 2 ms. If the execution command does not remain on for at least 2 ms, it may not be detected.

(7) Speed setting

If the speed set for IPDSTR1(P), IPJOG1 or IPSPCHG1(P) is outside 0 to 200000, the axis may operate at the speed limit.

7.13 Programming

This section describes the programs for the positioning function. When applying the program examples introduced in this section to an actual system, ensure the applicability and confirm that it will not cause system control problems.

(1) Programming procedure

For program examples, refer to  Page 171, Section 7.13 (3)

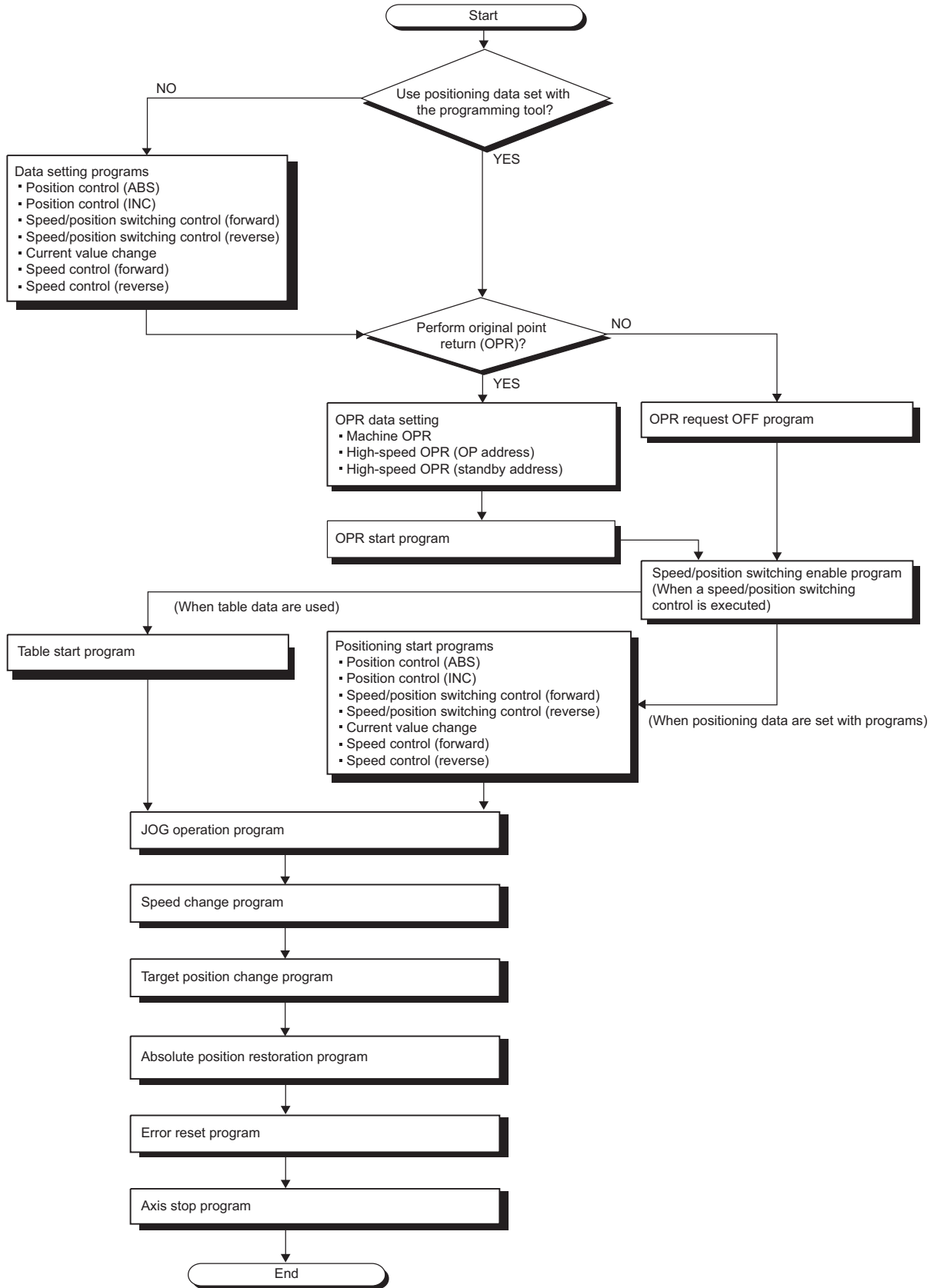

(2) System configuration and programming condition

The following system configuration is used to introduce program examples.

(a) System configuration

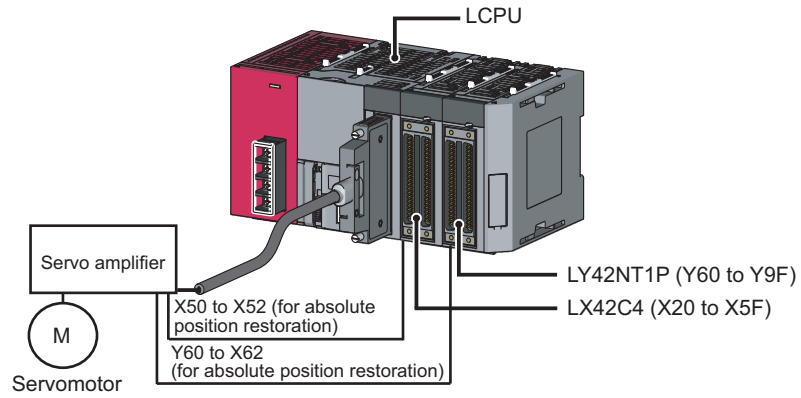

(b) Programming conditions

Device	Function		
X30	Stop command	LX42C4 (X20 to X5F)	
X31	Axis 1 machine original position return start selection		
X32	Axis 1 fast OPR (OP address) start selection		
X33	Axis 1 fast OPR (standby address) start selection		
X34	Axis 1 original position return start command		
X35	Axis 1 positioning start command (table start)		
X36	Current start command		
X37	Axis 1 position control (ABS) start selection		
X38	Axis 1 position control (INC) start selection		
X39	Axis 1 speed control (forward run) start selection		
X3A	Axis 1 speed control (reverse run) start selection		
X3B	Axis 1 speed-position switching control (forward run) start selection		
X3C	Axis 1 speed-position switching control (reverse run) start selection		
X3D	Axis 1 current value change selection		
X3E	Axis 1 positioning start instruction		
X40	Axis 1 forward run JOG command		
X41	Axis 1 reverse run JOG command		
X42	Speed change command		
X43	Target position change command		
X44	Error reset command		
X45	OPR request off command		
X46	Absolute position restoration		
X47	Axis 1 speed/position switching command		
X48	Axis 1 speed/position switching prohibition command		
X50	Absolute position restoration ABS transmission data bit 0		
X51	Absolute position restoration ABS transmission data bit 1		
X52	Absolute position restoration Transmission data ready		
Y60	Absolute position restoration Servo on		LY42NT1P (Y60 to Y9F)
Y61	Absolute position restoration ABS transfer mode		
Y62	Absolute position restoration ABS request		

(To the next page)

Device	Function	
D0	Table start number	
D1	Concurrent start data No. (axis 1)	
D2	Concurrent start data No. (axis 2)	
D20	JOG speed	
D21		
D22	JOG ACC time	
D23	JOG DEC time	
D30	ACC/DEC time at speed change	
D31	DEC/STOP time at speed change	
D32	New speed value	
D33		
D40	Target position change value	
D41		
D100	Position control (ABS) start data	Control method
D101		Acceleration/deceleration time
D102		Deceleration stop time
D103		Dwell time
D104		Command speed
D105		
D106		Positioning address/movement amount
D107		
D110	Position control (INC) start data	Control method
D111		Acceleration/deceleration time
D112		Deceleration stop time
D113		Dwell time
D114		Command speed
D115		
D116		Positioning address/movement amount
D117		
D120	Speed/position switching control (forward) start data	Control method
D121		Acceleration/deceleration time
D122		Deceleration stop time
D123		Dwell time
D124		Command speed
D125		
D126		Positioning address/movement amount
D127		
D130	Speed/position switching control (reverse) start data	Control method
D131		Acceleration/deceleration time
D132		Deceleration stop time
D133		Dwell time
D134		Command speed
D135		
D136		Positioning address/movement amount
D137		

(To the next page)

Device	Function	
D140	Current value change start data	Control method
D141		Acceleration/deceleration time
D142		Deceleration stop time
D143		Dwell time
D144		Command speed
D145		
D146		Positioning address/movement amount
D147		
D150	Speed control (forward run) start data	Control method
D151		Acceleration/deceleration time
D152		Deceleration stop time
D153		Dwell time
D154		Command speed
D155		
D156		Positioning address/movement amount
D157		
D160	Speed control (reverse run) start data	Control method
D161		Acceleration/deceleration time
D162		Deceleration stop time
D163		Dwell time
D164		Command speed
D165		
D166		Positioning address/movement amount
D167		
D200	Machine OPR start data	Original position return type
D201		Standby address (unused)
D202		
D210	OP address of fast OPR start data	Original position return type
D211		Standby address (unused)
D212		
D220	Standby address of fast OPR start data	Original position return type
D221		Standby address
D222		
M10	Axis 1 OPR start permission/prohibition storage	
M20	Forward run JOG command	
M21	Reverse run JOG command	
M22	JOG operation direction	
Z0	OPR parameter index	
Z1	Positioning data index	
SM1840	Axis 1 busy signal	
SM1842	Requested	
SM1845	Axis 1 error	
SM1848	Axis 1 start instruction	
SM1850	Axis 1 error reset command	
SM1851	Axis 1 OPR request off	
SM1868	Axis 2 start instruction	

(3) Program example

Positioning programs for Axis 1 are shown below.

(a) Data setting program

- Position control



- Speed/position switching control

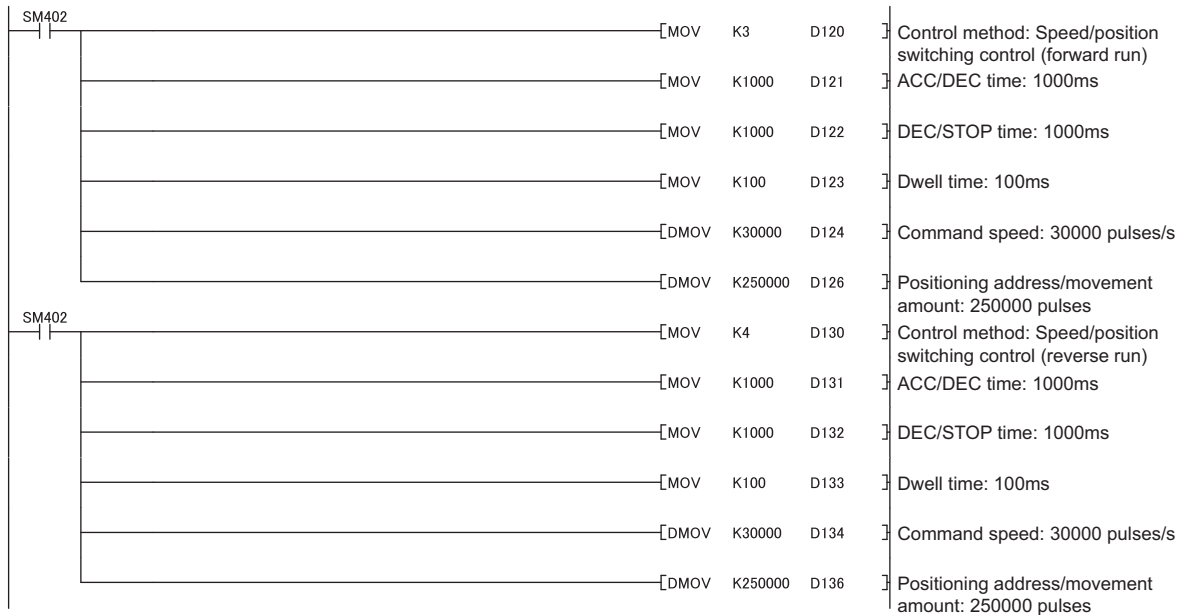

• Current value change

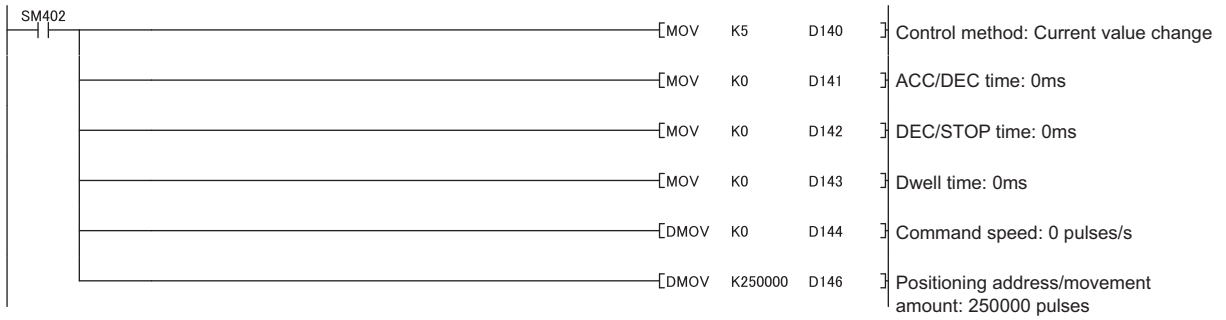

• Speed control

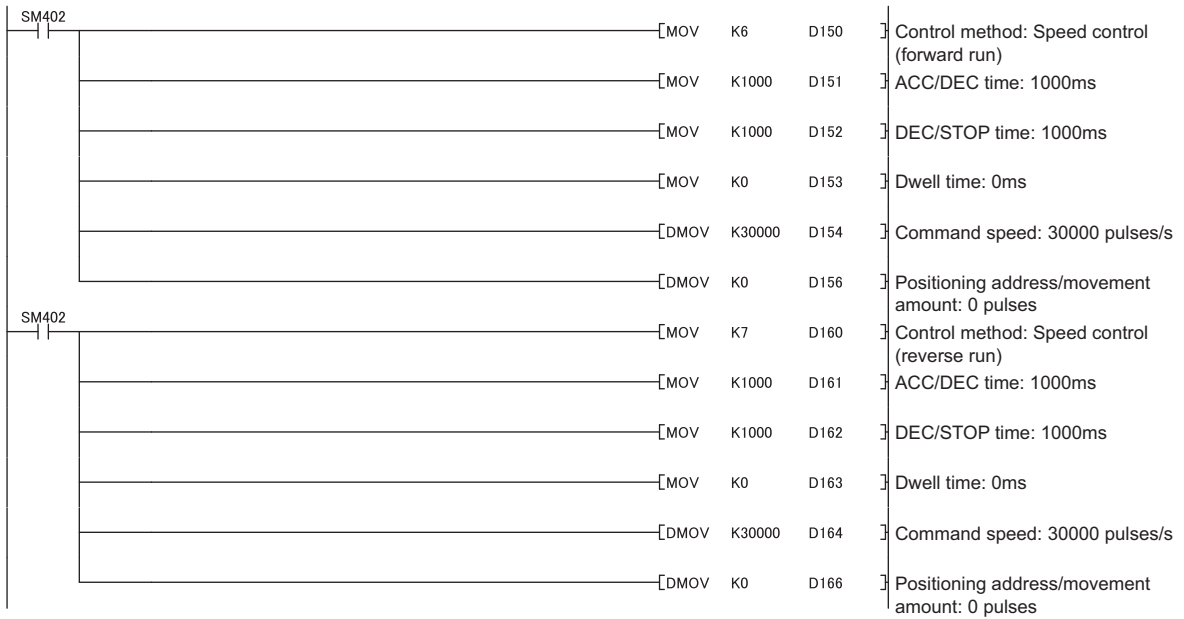

(b) OPR request off program

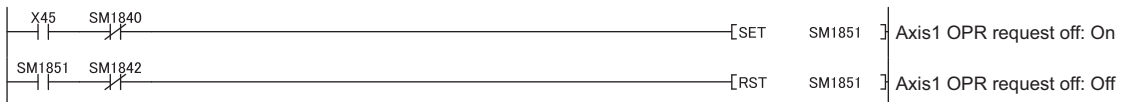

(c) OPR data setting program

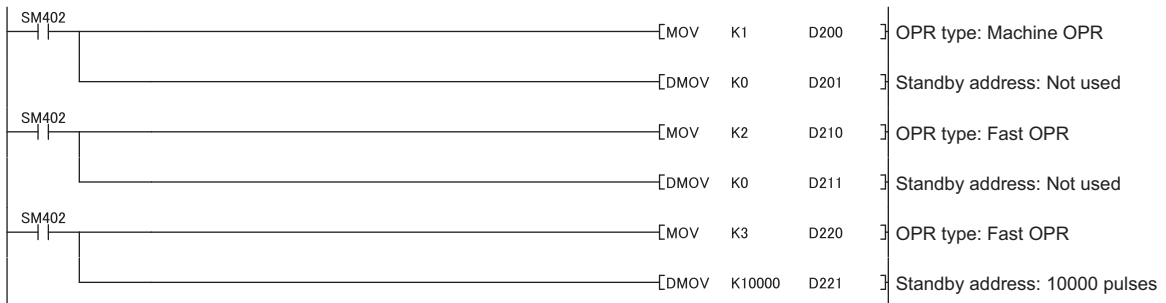

(d) OPR start program

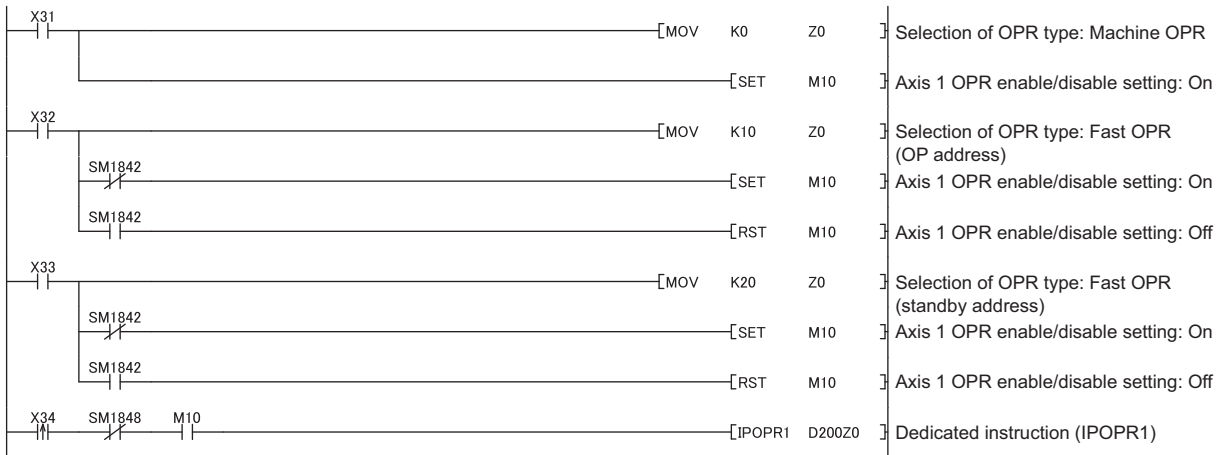

(e) Speed/position switching enable program

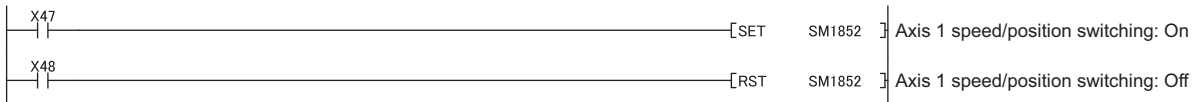

(f) Table start program

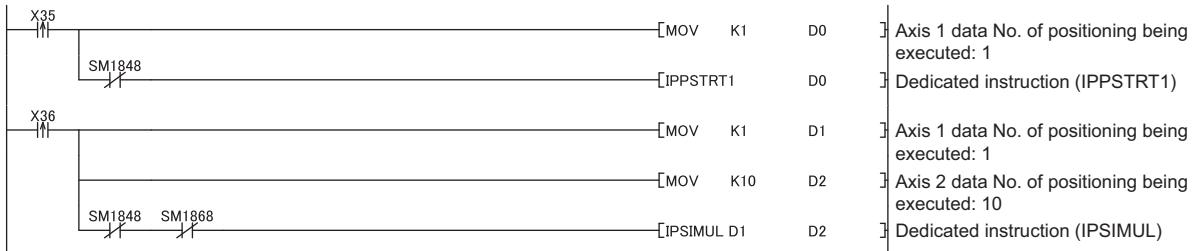

(g) Positioning start program

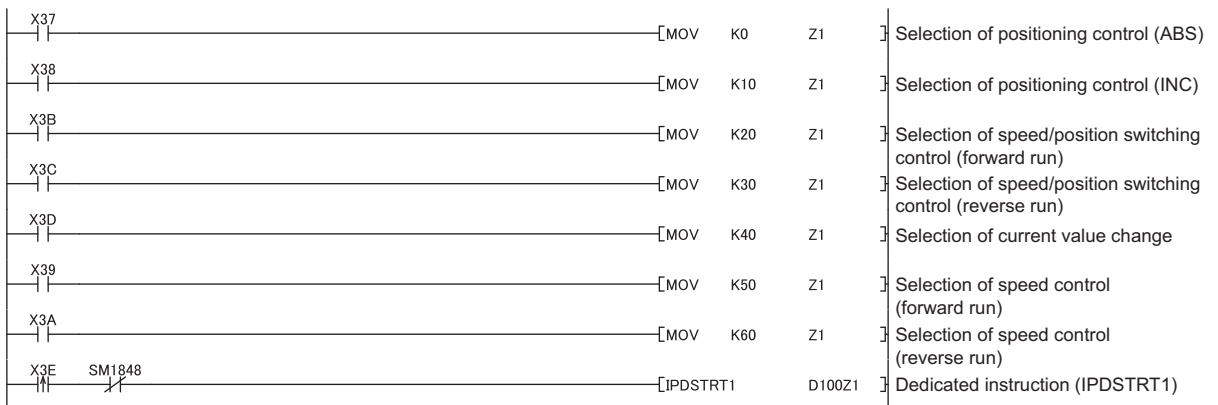

(h) JOG operation program

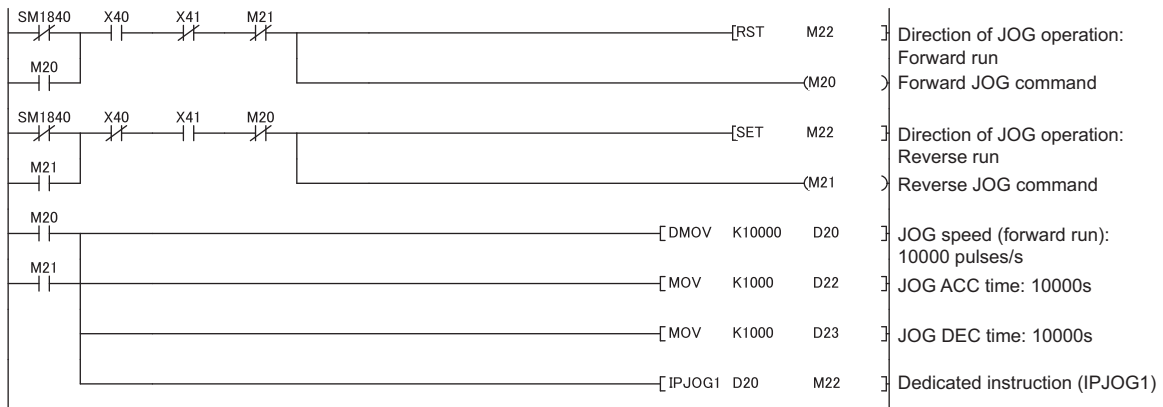

(i) Speed change program

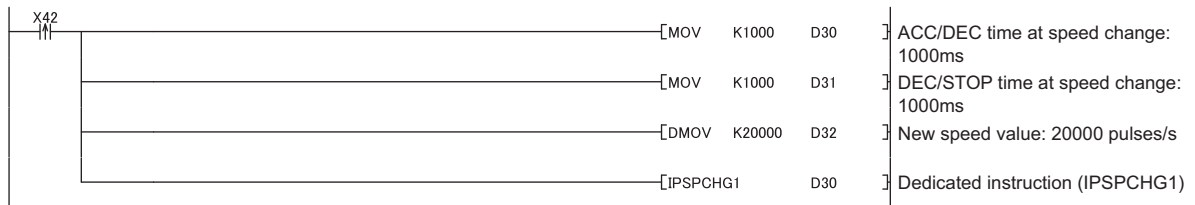

(j) Target position change program



(k) Absolute position restoration program

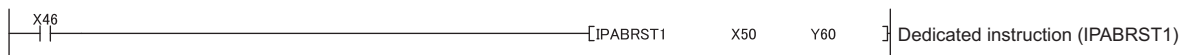

(l) Error, warning reset program

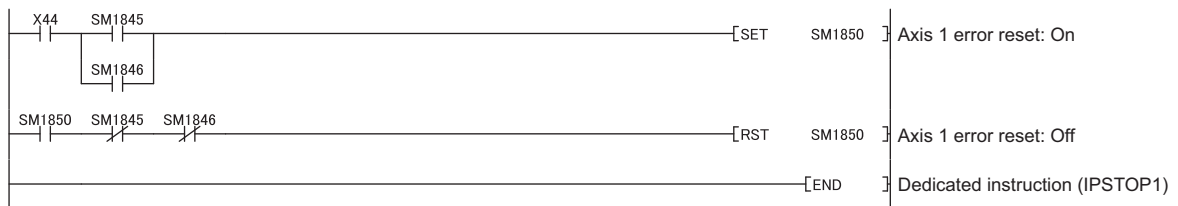

(m) Axis stop program



7.14 Errors and Warnings

This section describes errors and warnings of the positioning function.

(1) Error

When an error occurs, the following operations are performed.

- The I/O ERR. LED turns on.
- The Axis 1 error (SM1845) turns on.
- An error code corresponding to the error is stored to the Axis 1 error code (SD1845) in decimal.
- The Axis 1 axis operation status (SD1844) changes to error occurring (-1).

If an error occurs during operation, the axis decelerates to a stop. (This excludes situations that the range of software stroke limits is exceeded when the target position is changed.) (☞ Page 127, Section 7.10.6 (2) (b))

Interface	Axis	Number	Name	Description
Special relay	Axis 1	SM1845	Axis □ error	The occurrence condition of positioning function errors is indicated. This relay turns off when the axis □ error reset is turned on.
	Axis 2	SM1865		
	Axis 1	SM1850	Axis □ error reset	<ul style="list-style-type: none"> • Reset the axis □ error code. • Turn off the axis □ error.
	Axis 2	SM1870		
Special registers	Axis 1	SD1845	Axis □ error code	When an error occurs, the corresponding error code is stored here. This register is reset when the axis □ error reset is turned on.
	Axis 2	SD1865		
	Axis 1	SD1844	Axis □ axis operation status	When an error occurs, error occurring (-1) is set. When the axis □ error reset is turned on, the value changes to error standing by (0).
	Axis 2	SD1864		

- *1 Until the Axis 1 busy (SM1840) turns off, the Axis error (SM1845) does not turn off even when the Axis 1 error reset (SM1850) is turned on, and accordingly the Axis 1 error code (SD1845) is not reset. Also, the Axis 1 axis operation status (SD1844) does not change to 0: Standing by.

The following table lists the Axis □ error codes.

Axis □ error code (decimal)		Name	Description	Operation at error occurrence	Corrective action
Axis 1	Axis 2				
1100	2100	Hardware stroke limit+	The hardware stroke limit (upper limit signal) turned off.	<ul style="list-style-type: none"> • At start: Operation is not started. • During operation: The axis decelerates to a stop. 	At start: Operation starts from a position where the limit signal is on.
1101	2101	Hardware stroke limit-	The hardware stroke limit (lower limit signal) turned off.		During operation: <ul style="list-style-type: none"> • Revise the OPR speed so that the limit will not be triggered. • Use JOG operation to move to a position where the limit signal turns on.
1102	2102	Stop instruction at start ON	A start request was issued when the Axis stop instruction (IPSTOP1) was being executed.	Operation is not started.	Stop the execution of the Axis stop instruction (IPSTOP1) and then start operation.
1103	2103	Software stroke limit+	<ul style="list-style-type: none"> • Positioning control was performed at a position exceeding the software upper stroke limit. • The Axis 1 current feed value (SD1840, SD1841), "Positioning address/movement amount," new current value or target position change value exceeds the software upper stroke limit. 	<p>At start: Operation is not started.</p> <p>At current value change analysis: The current value is not changed.</p> <p>During operation:</p> <ul style="list-style-type: none"> • During JOG operation, the axis decelerates to a stop when the Axis 1 current feed value (SD1840, SD1841) exceeds the range of software stroke limits. • During position control (including position control of speed/position switching control), the axis decelerates to a stop when the Axis 1 current feed value (SD1840, SD1841) or "Positioning address/movement amount" exceeds the range of software stroke limits. 	<p>At start: Use JOG operation to bring the Axis 1 current feed value (SD1840, SD1841) to within the range of software stroke limits.</p> <p>Current value change: Bring the new current value to within the range of software stroke limits.</p> <p>Target position change value: Bring the target position change value to within the range of software stroke limits.</p>
1104	2104	Software stroke limit-	<ul style="list-style-type: none"> • Positioning control was performed at a position below the software lower stroke limit. • The Axis 1 current feed value (SD1840, SD1841), "Positioning address/movement amount," new current value or target position change value exceeds the software lower stroke limit. 	<ul style="list-style-type: none"> • During position control (including position control of speed/position switching control), the axis decelerates to a stop when the Axis 1 current feed value (SD1840, SD1841) or "Positioning address/movement amount" exceeds the range of software stroke limits. 	<p>During operation:</p> <ul style="list-style-type: none"> • In the case of JOG operation, perform JOG operation in the opposite direction to bring the Axis 1 current feed value (SD1840, SD1841) to within the range of software stroke limits. • During position control, bring "Positioning address/movement amount" to within the range of software stroke limits. • During speed/position switching control, switch between speed control and position control within the range of software stroke limits.
1105	2105	During operation Sequence Execution stopped*1	The CPU unit stopped during operation.	<ul style="list-style-type: none"> • During operation: The axis decelerates to a stop. • During absolute position restoration: Absolute position restoration is not performed. 	Review the program to check for program errors.

*1 This error is not displayed when the LCPU is paused.

(To the next page)

Axis □ error code (decimal)		Name	Description	Operation at error occurrence	Corrective action
Axis 1	Axis 2				
1106	2106	Drive unit ready off	The drive unit ready signal is off at start or turned off during operation.	<ul style="list-style-type: none"> At start: Operation is not started. During operation: The axis decelerates to a stop. 	Check the power condition of the drive unit, wiring with the drive unit, and connection condition of connectors.
1200	2200	Zero signal ON	The OPR method is Stopper 2 or 3 and a zero signal is input at the start of machine OPR control.	Machine OPR control is not performed.	Turn off the zero signal and then perform machine OPR control.
1201	2201	Machine OPR not performed	Fast OPR control was performed when machine OPR control was not performed.	Fast OPR control is not performed.	Perform machine OPR control before fast OPR control.
1202	2202	Retry error	The near-point dog signal is on and limit signal is off.	<ul style="list-style-type: none"> At start of OPR control by near-point dog method: OPR retry operation is not performed During OPR retry operation: The axis decelerates to a stop. 	Correct the limit signal position so that it does not overlap with the area in which the near-point dog signal turns on.
1204	2204	ABS transfer time-out	Communication could not be performed normally with the servo amplifier following the Absolute position restoration instruction (IPABRST1).	Absolute position restoration is not performed.	Review the wirings. Review the setting data of the Absolute position restoration instruction (IPABRST1).
1205	2205	ABS transfer SUM	Communication could not be performed normally with the servo amplifier following the Absolute position restoration instruction (IPABRST1).	Absolute position restoration is not performed.	Review the wirings. Review the setting data of the Absolute position restoration instruction (IPABRST1).
1500	2500	Speed 0 error	The command speed is "0" at the start of position control.	Operation is not started.	Set the command speed to other than "0."
1501	2501	Control method out of range	The set value of control method is outside the setting range.	Operation is not started.	Set the control method to a value within the setting range.
1502	2502	Acceleration/ deceleration time Out of setting range	The set value of JOG ACC time, acceleration/deceleration time or ACC/DEC time at speed change is outside the setting range.	<p>At start: Operation is not started.</p> <p>During operation:</p> <ul style="list-style-type: none"> During speed control (including speed control of speed/position switching control) or JOG operation, the axis decelerates to a stop. During position control (including position control of speed/position switching control), operation continues. 	Set the JOG ACC time, acceleration/deceleration time or ACC/DEC time at speed change to a value within the setting range.

(To the next page)

Axis □ error code (decimal)	Name	Description	Operation at error occurrence	Corrective action	
1503	2503	Deceleration stop time out of range	The set value of JOG DEC time, deceleration stop time or DEC/STOP time at speed change is outside the setting range.	At start: Operation is not started. During operation: • During speed control (including speed control of speed/position switching control) or JOG operation: The axis decelerates to a stop. • During position control (including position control of speed/position switching control): Operation continues.	Set the JOG DEC time, deceleration stop time or DEC/STOP time at speed change to a value within the setting range.
1504	2504	Movement amount setting out of range under speed/position switching control	A negative value is set in "Positioning address/movement amount" when speed/position switching control is selected as the control method.	At start: Operation is not started. During operation: When the target position is changed during position control of speed/position switching control, operation continues.	Correct the value of "Positioning address/movement amount" or target position change value.
1505	2505	Speed/position switching control start not possible	No external command signal is selected when speed/position switching control is selected as the control method.	Operation is not started.	Select an external command signal.
1506	2506	Original position return type setting out of range	The set value of original position return type is outside the setting range.	OPR control is not performed.	Set the original position return type to a value within the setting range.

Point

If a different error occurs while an error is already present, the error code is not rewritten to reflect the latest error.

(2) Warning

When a warning occurs, the following operations are performed.

- The Axis 1 warning (SM1846) turns on.
- A warning code corresponding to the warning is stored to the Axis 1 warning code (SD1846) in decimal.

Different from errors, occurrence of a warning does not stop the operation of CH1. The SD value is always updated with the latest warning code.

Interface	Axis	Number	Name	Description
Special relay	Axis 1	SM1846	Axis □ warning	The occurrence condition of positioning function warnings is indicated. This relay turns off when the axis □ error reset is turned on.
	Axis 2	SM1866		
	Axis 1	SM1850	Axis □ error reset	
	Axis 2	SM1870		
Special registers	Axis 1	SD1846	Axis □ warning code	When a warning occurs, the corresponding warning code is stored here. This register is reset when the axis □ error reset is turned on.
	Axis 2	SD1866		

Remark

When a warning occurs, the Axis 1 axis operation status (SD1844) does not change.

The following table lists the Axis □ warning codes.

Axis □ warning code (decimal)		Name	Description	Operation at warning occurrence	Corrective action
Axis 1	Axis 2				
1020	2020	Out of speed range	The set speed or new speed value is less than the bias speed at start or exceeds the speed limit.	The speed is controlled at the bias speed at start or speed limit.	Change the set speed or new speed value so that it becomes equal to or greater than the bias speed at start or equal to or smaller than the speed limit.
1021	2021	Target position change not possible	<ul style="list-style-type: none"> • The Target position change instruction (IPTPCHG1(P)) was executed other than when position control was active. • The Target position change instruction (IPTPCHG1(P)) was executed when the Axis 1 speed 0 (SM1844) was on. 	Operation continues.	<ul style="list-style-type: none"> • Do not execute the Target position change instruction (IPTPCHG1(P)) other than when position control is active. • Do not execute the Target position change instruction (IPTPCHG1(P)) when the Axis 1 speed 0 (SM1844) is on.
1022	2022	Speed change Not allowed	<ul style="list-style-type: none"> • The Speed change instruction (IPSPCHG1(P)) was executed when OPR control was active. • The Speed change instruction (IPSPCHG1(P)) was executed during acceleration/deceleration when position control (including position control of speed/ position switching control) was active. 	Operation continues.	<ul style="list-style-type: none"> • Do not execute the Speed change instruction (IPSPCHG1(P)) when OPR control is active. • Do not execute the Speed change instruction (IPSPCHG1(P)) during acceleration/deceleration when position control (including position control of speed/position switching control) is active.

7.15 Monitoring with a Programming Tool

When the positioning function is executed, the operating status can be checked on the "Positioning Monitor" window of the programming tool.

 [Tools] ⇨ [Built-in I/O Module Tool]

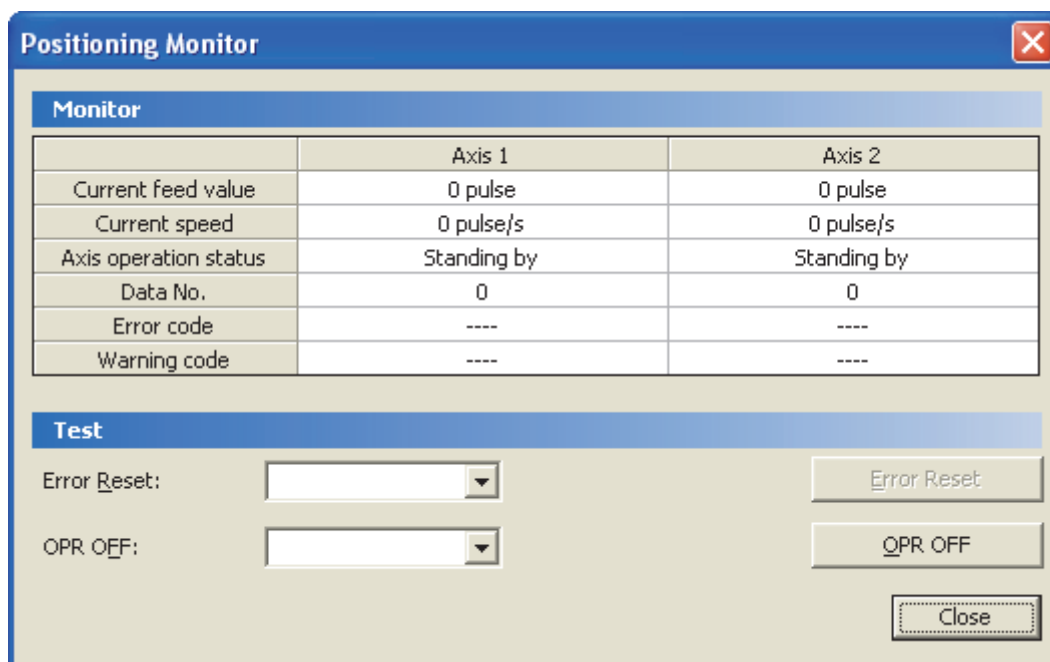

The screenshot shows the "Positioning Monitor" window with a blue title bar and a close button. It is divided into two main sections: "Monitor" and "Test".

Monitor Section:

	Axis 1	Axis 2
Current feed value	0 pulse	0 pulse
Current speed	0 pulse/s	0 pulse/s
Axis operation status	Standing by	Standing by
Data No.	0	0
Error code	----	----
Warning code	----	----

Test Section:

Error Reset:

OPR OFF:

For details, refer to the  GX Works2 Version1 Operating Manual (Common).

CHAPTER 8 HIGH-SPEED COUNTER FUNCTION

8.1 Overview

(1) Definition

This function counts the number of high-speed input pulses that cannot be measured by general counter.

(2) Features

The high-speed counter function is controlled by parameters and dedicated instructions.

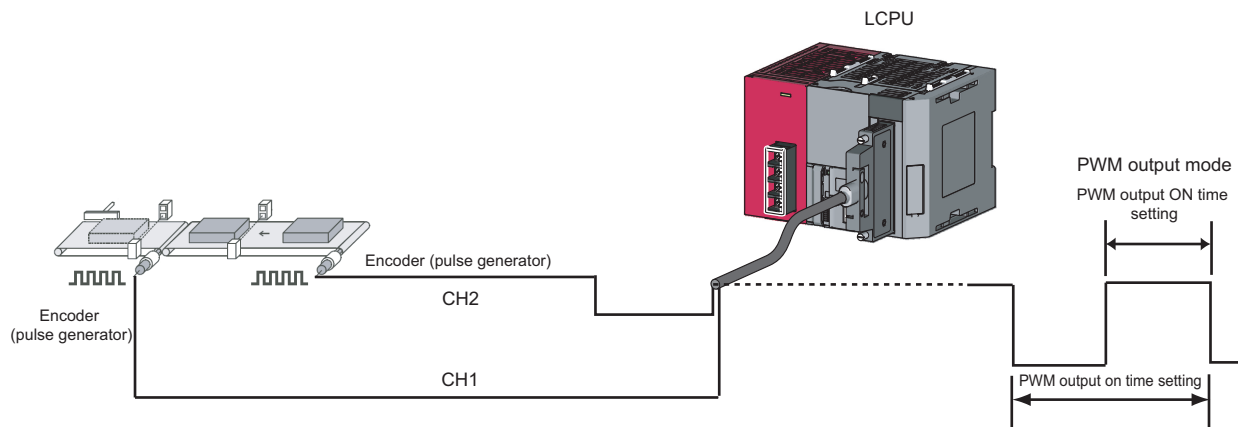

(a) Pulse inputs from two channels

Pulses can be simultaneously input from two pulse generators.

(b) Five operation modes

According to application, an operation mode can be selected from the following five modes.

- Normal mode: Has the CPU module operate as a general high-speed counter.
- Frequency measurement mode: Calculates frequencies from the number of input pulses.
- Rotation speed measurement mode: Calculates a rotation speed from the number of input pulses.
- Pulse measurement mode: Measures the on or off width of input pulses. Select this mode for measuring length.
- PWM (pulse width modulation) output mode: Outputs pulses with the on width and cycle setting. Select this mode when using the CPU module as an oscillator.

(c) Combined use of functions

Functions for preset, count stop, and counter value latch can be used in combination.

(Counter function selection)

(d) Execution of an interrupt program

An interrupt program can be executed when the current counter value and a set value match.

(Coincidence detection interrupt function)

(e) Coincidence output

A coincidence signal can be output when the current counter value and a set value match.

(Coincidence output function)

(3) Function list

The following table lists and describes functions available for the high-speed counter function.

Item	Description	Available operation mode	Reference		
Linear counter function	Counts pulses within the range of -2147483648 to 2147483647 and detects an overflow or an underflow if the count range is exceeded.	Normal mode	Page 203, Section 8.4 (1)		
Ring counter function	Repeatedly counts pulses within the range of the upper limit value to the lower limit value of ring counter.		Page 203, Section 8.4 (1)		
Preset function	Overwrites CH1 current value (SD1880, SD1881) of a counter with a set value.		Page 207, Section 8.4.1 (2)		
Coincidence output function	Compares a set value with CH1 current value (SD1880, SD1881) of a counter and outputs on or off signal.		Page 209, Section 8.4.2		
	Preset at coincidence output function		Overwrites CH1 current value (SD1880, SD1881) of a counter with a set value on the rising edge of Counter value coincidence (No.n) signal.	Page 211, Section 8.4.2 (1)	
	Coincidence detection interrupt function		Starts an interrupt program when CH1 current value (SD1880, SD1881) and a set value match.	Page 213, Section 8.4.3	
Latch counter function	Latches CH1 current value (SD1880, SD1881) of a counter on the rising edge of Latch counter input signal.		Normal mode	Page 218, Section 8.4.4 (2) (a)	
Counter function selection	Latch counter function			Latches CH1 current value (SD1880, SD1881) of a counter on the rising edge of CH1 selected counter function start command (SM1896) or Function input signal.	Page 218, Section 8.4.4 (2) (a)
	Count disable function			Stops counting while CH1 count enable command (SM1895) is on.	Page 220, Section 8.4.4 (2) (c)
	Sampling counter function			Counts pulses input during the specified sampling period.	Page 222, Section 8.4.4 (2) (d)
	Count disable/preset function			Performs the count disable function and the preset function without switching the function.	Page 224, Section 8.4.4 (2) (e)
	Latch counter/preset function		Performs the latch counter function and the preset function without switching the function.	Page 197, Section 8.3.1 (2) (a)	
Internal clock function	Counts clock frequencies generated by the LCPU.		Frequency measurement mode	Page 229, Section 8.5 (5)	
Frequency measurement function	Counts pulses input from the pulse input signals of phases A and B and automatically calculates frequencies.		Rotation speed measurement mode	Page 235, Section 8.6 (5)	
Rotation speed measurement function	Counts pulses input from the pulse input signals of phases A and B and automatically calculates a rotation speed.				

Item	Description	Available operation mode	Reference
Pulse measurement function	Measures the on or off width of pulses input to Function input signal.	Pulse measurement mode	Page 239, Section 8.7 (2)
PWM output function	Outputs PWM waveforms from Coincidence output No.1 signal at the maximum of 200KHZ.	PWM output mode	Page 242, Section 8.8 (2)

8.1.1 Procedure for performing the high-speed counter function

The following shows the procedure.

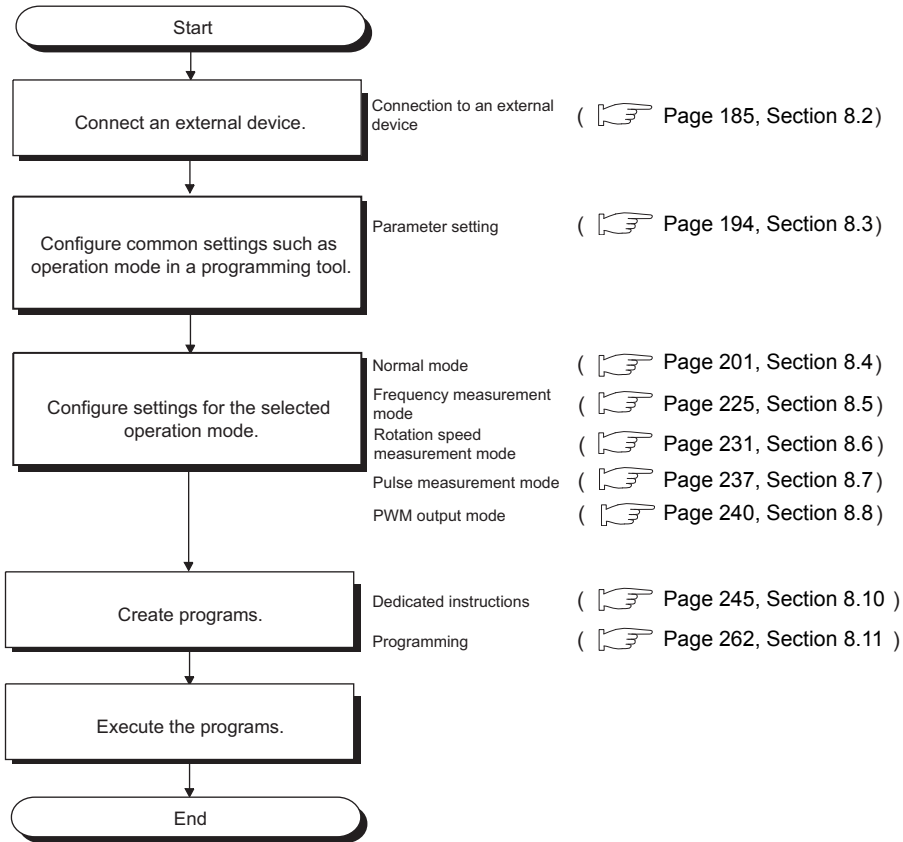





8.2 Connection to External Devices

8.2.1 I/O signals

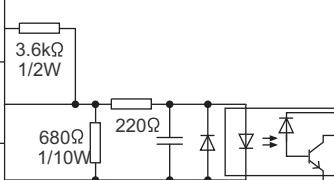
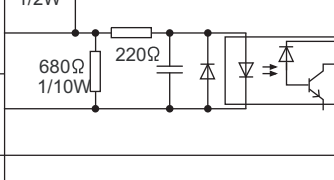
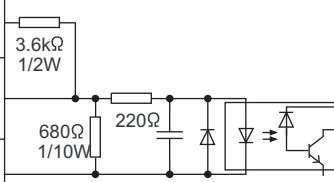
The following shows the simplified diagrams of the internal circuits of LCPU external device connection interface. □ in the signal name indicates either 1 (CH1) or 2 (CH2). For I/O signal settings, refer to  Page 194, Section 8.3.

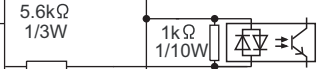
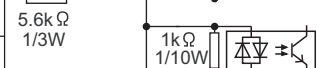
(1) Input

Pin number		Internal circuit	Signal name	
CH1	CH2			
B20	A20			+24V (PULSE A□-24V)
B19	A19		Phase A (PULSE A□)	Differential (PULSE A□-DIFF)
B18	A18		COM (PULSE A□-COM)	
B17	A17			+24V (PULSE B□-24V)
B16	A16		Phase B (PULSE B□)	Differential (PULSE B□-DIFF)
B15	A15		COM (PULSE B□-COM)	
B14	A14			+24V (PULSE Z□-24V)
B13	A13		Phase Z (PULSE Z□)	Differential (PULSE Z□-DIFF)
B12	A12		COM (PULSE Z□-COM)	
B11	A11		Input common	
B10	A10		Function input signal (FUNC□)	
B09	A09		Latch counter input signal (LATCH□)	
B08	A08		-	
B07	A07			
B06	A06			

(2) Output

(a) L02SCPU, L02CPU, L06CPU, L26CPU, L26CPU-BT

Pin number		Internal circuit	Signal name
CH1	CH2		
B05	A05		Coincidence output No.1 signal (EQU□1)
B04	A04		Coincidence output No.2 signal (EQU□2)
B03	A03		- (Not used for the high-speed counter function)
B02	A02		
B01	A01		Output common

(b) L02SCPU-P, L02CPU-P, L06CPU-P, L26CPU-P, L26CPU-PBT

Pin number		Internal circuit	Signal name
CH1	CH2		
B05	A05		Coincidence output No.1 signal (EQU□1)
B04	A04		Coincidence output No.2 signal (EQU□2)
B03	A03		- (Not used for the high-speed counter function)
B02	A02		
B01	A01		Output common

(3) Details of I/O signals

The following table lists and describes the I/O signals of the connector for external devices.

Category	Signal name	Description
Input	Phase A (PULSE A□)	Pulse input signal. Pulses input to these signals are counted according to the operation mode set for the phases A and B.
	Phase B (PULSE B□)	
	Phase Z (PULSE Z□)	External signals to perform the preset function are input.
	Function input signal (In normal mode, set positive or negative logic.)	<p>Normal mode:</p> <ul style="list-style-type: none"> • While the count disable function is selected, external signals to suspend count are input. • While the latch counter function is selected, external signals to perform the latch function are input. • While the count disable/preset function is selected, external signals to stop count or perform the preset function are input. • While the latch counter/preset function is selected, external signals to perform the latch function or the preset function are input. • While the sampling counter function is selected, external signals to start counting during sampling period are input. <p>Pulse measurement mode:</p> <ul style="list-style-type: none"> • The on or off width of pulses input to Function input signal can be measured.
	Latch counter input signal (LATCH□)	This signal is used when the current counter value is latched.
	Input common	Common for Function input signal and Latch counter input signal
Output	Coincidence output No.1 signal (EQU□1)	<p>Normal mode:</p> <ul style="list-style-type: none"> • Signals are output when a count value set by Coincidence output point write instruction (ICCOVWR1(P)) matches CH1 current value (SD1880, SD1881). <p>PWM output mode:</p> <ul style="list-style-type: none"> • PWM waveforms are output. (for Coincidence output No.1 signal only)
	Coincidence output No.2 signal (EQU□2)	
	Output common	Common for Coincidence output No.1 signal and Coincidence output No.2 signal

8.2.2 Wiring

This section describes wiring of a LCPU with an encoder and a controller. For connectors used for external wiring, refer to the following.

 MELSEC-L CPU Module User's Manual (Hardware Design, Maintenance and Inspection).

(1) Wiring precautions

- Inputting a signal with a different voltage may cause malfunction of the module and failure of the connected devices.
- In 1-phase input, connect a pulse input cable to A-phase line.
- When inputting high-speed pulses, take the following noise reduction measures.
 - Always use a shielded twisted pair cable and ground the FG and LG terminals to the protective ground conductor dedicated to the programmable controller.
 - To prevent noise from power cables and I/O cables, do not install shielded twisted pair cables in parallel with them and separate the shielded twisted pair cables at least 100mm away from them. Also, wire the shielded twisted pair cables with the shortest distance.

The following figures show an example of noise reduction measures.

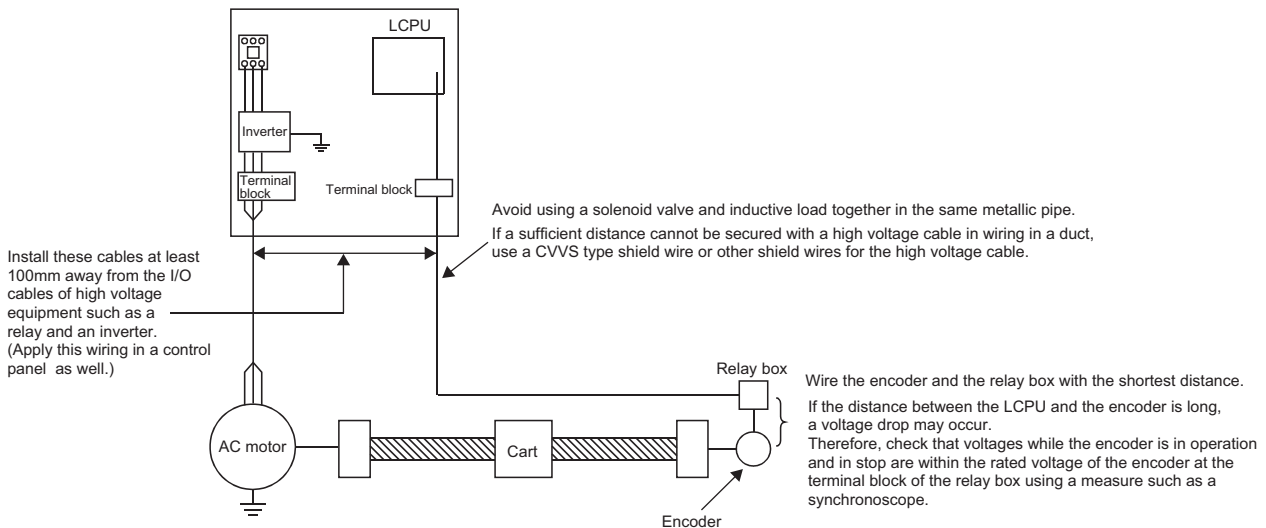

- Ground the shielded twisted pair cable on the encoder side (relay box). (This example shows wiring using 24V sink type.)

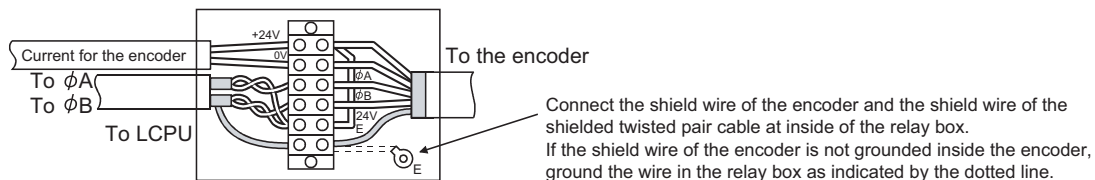

(2) Connectable encoders

Check that the output voltages of the following encoders meet the specifications of the high-speed counter function. ( Page 243, Section 8.9).

- Open collector output type encoder
- Line driver output type encoder

(3) Example of wiring with an encoder

Characters in the parentheses of the terminal part indicate the pin number of CH2.

(a) Example of wiring with an open collector output type encoder (24VDC)

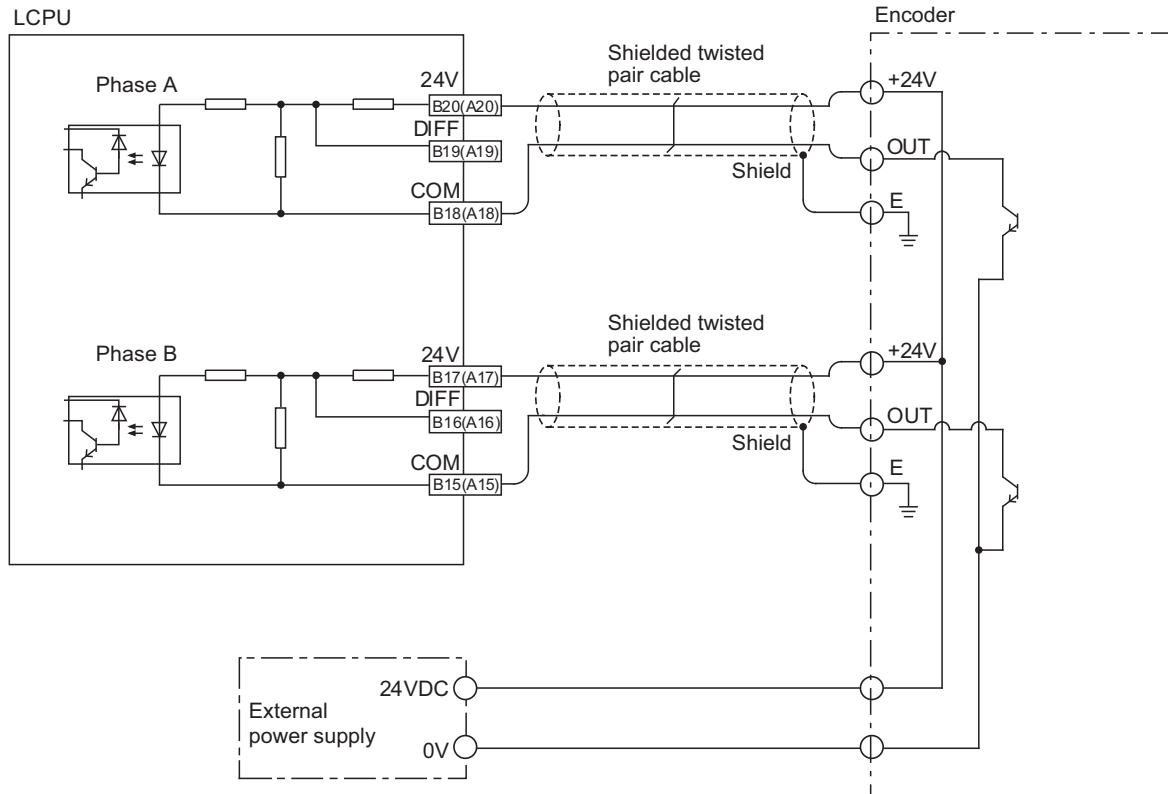

Point

When wiring a LCPU and an encoder, separate power cables and signal cables. The following figures show examples.

- Wiring example

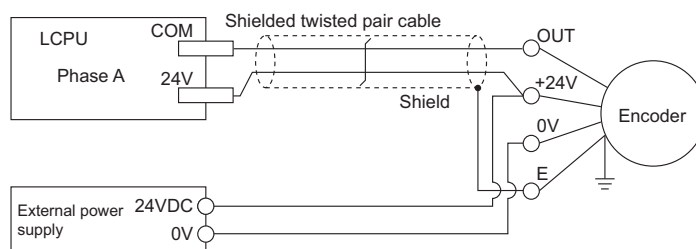

- Improper wiring example

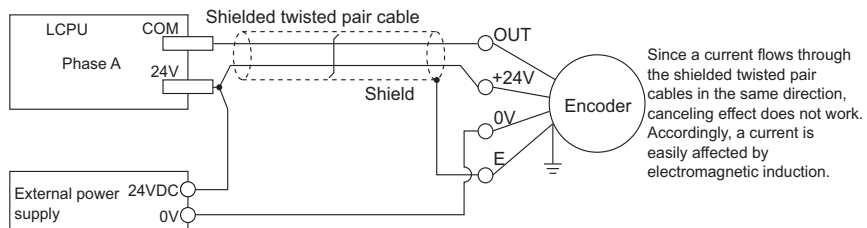

(b) Example of wiring with a line driver (equivalent to AM26LS31) encoder

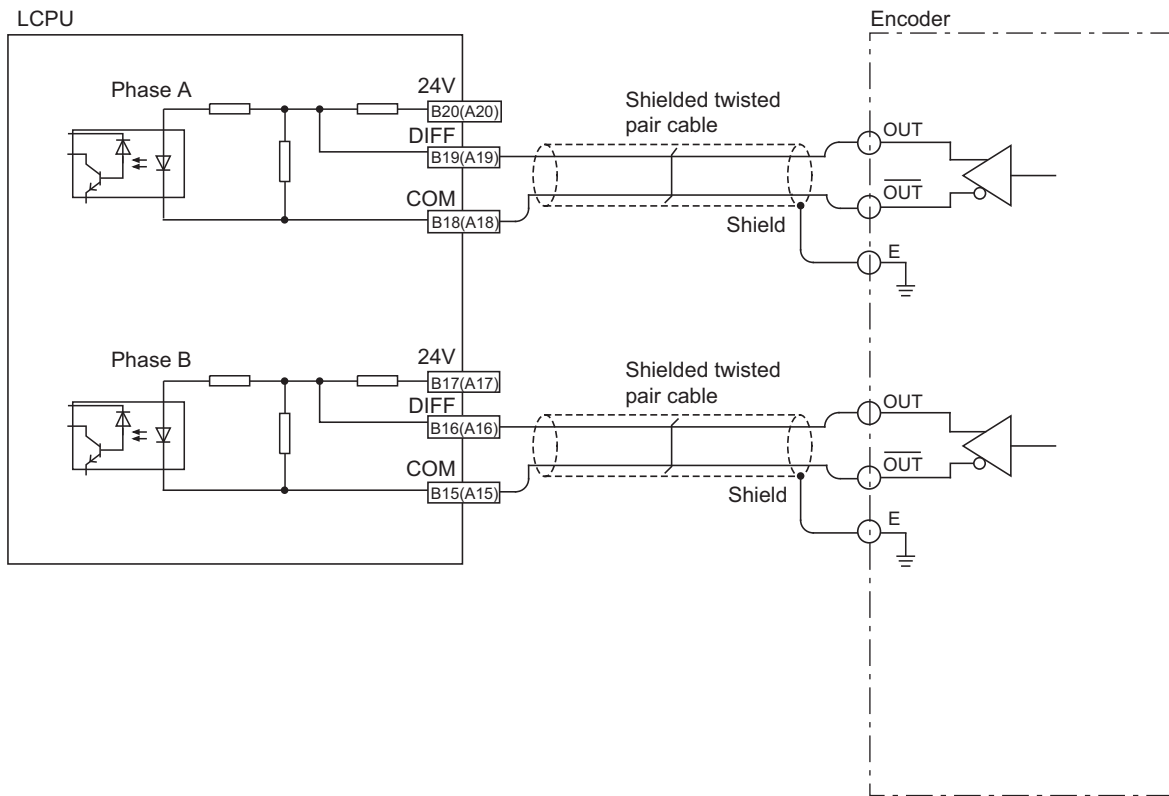

(4) Example of wiring of a controller and external input signals

Characters in the parentheses of the terminal part indicate the pin number of CH2.

(a) Example of wiring with a controller (sink type)

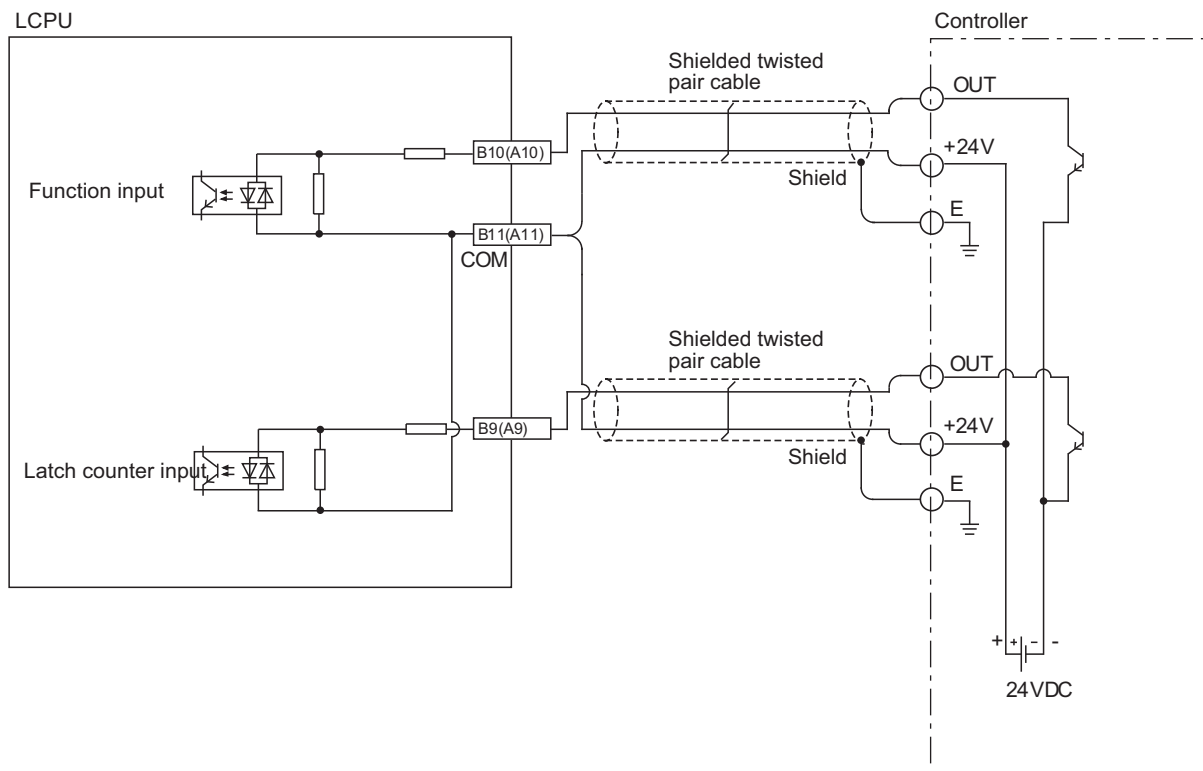

(b) Example of wiring when the controller is a line driver

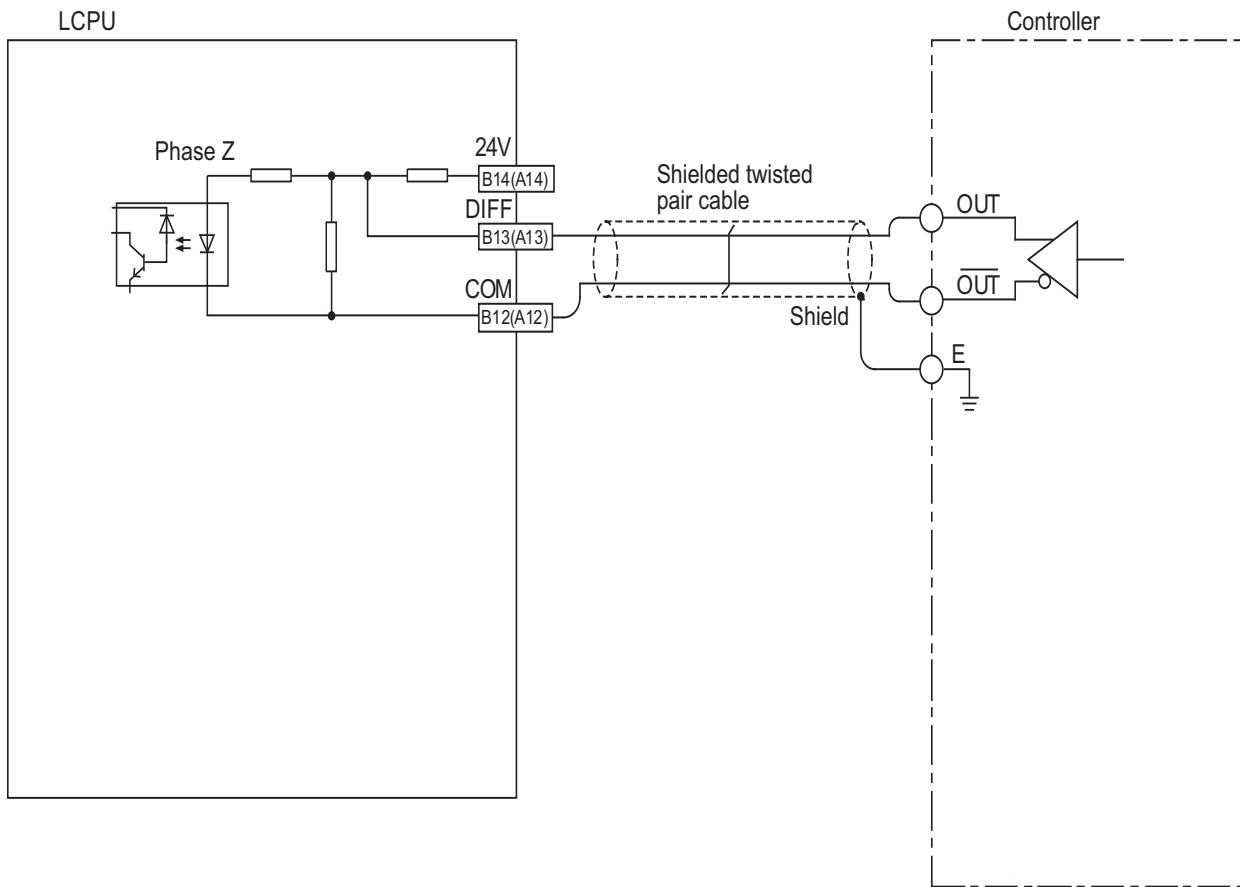

(5) Example of wiring with an external output device

(a) L02SCPU, L02CPU, L06CPU, L26CPU, L26CPU-BT

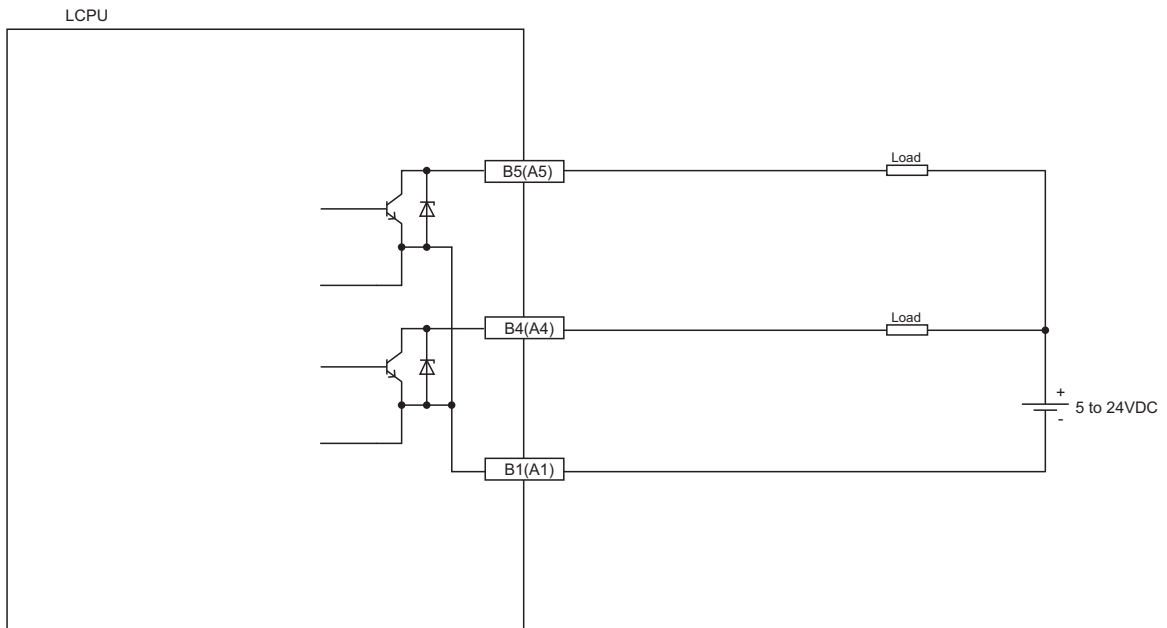

Point

When connecting an inductive load, connect a diode to the load in parallel to prevent the back EMF from being generated for output element protection.

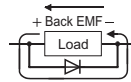

(b) L02SCPU-P, L02CPU-P, L06CPU-P, L26CPU-P, L26CPU-PBT

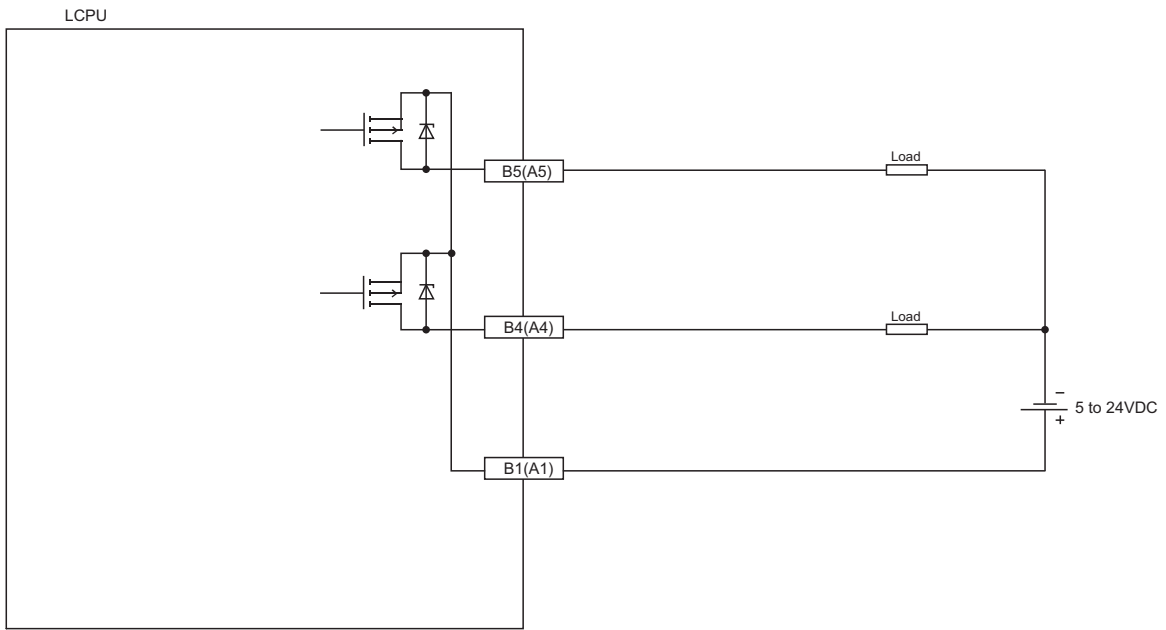

Point

When connecting an inductive load, connect a diode to the load in parallel to prevent the back EMF from being generated for output element protection.

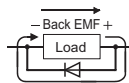

8.3 Parameter Setting

Set parameters for each channel.

1. Click the **High-speed Counter CH1 Setting** button in the "Built-in I/O Function Setting" tab.

2. Select the "Use high-speed counter function (CH1)" checkbox on the top left on the "High-speed Counter CH1 Detailed Setting" screen.
3. Configure required settings.
4. Click the **End** button to exit.

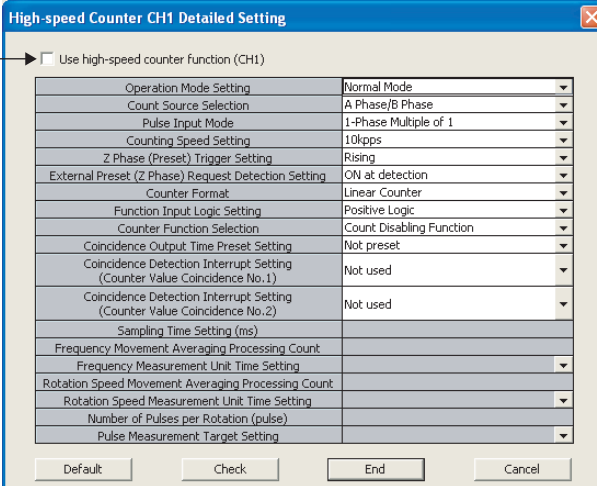
Select the "Use high-speed counter function (CH1)" checkbox.



Item	Description	Default	Available operation mode	Reference
Operation Mode Setting	Select an operation mode.	Normal Mode	— (Common settings)	Page 196, Section 8.3.1
Count Source Selection	Select a count source.	A Phase/B Phase		
Pulse Input Mode	Select a pulse input mode.	1-Phase Multiple of 1		
Counting Speed Setting	Select the counting speed of pulses.	10kpps		
Z Phase (Preset) Trigger Setting	Select a trigger condition to perform the preset function by phase Z input.	Rising	Normal mode	Page 206, Section 8.4.1 (1)
External Preset (Z Phase) Request Detection Setting	Select whether to turn on CH1 external preset (phase Z) request detection (SM1886) when the preset function is performed by phase Z input.	ON at detection		Page 206, Section 8.4.1 (1)
Counter Format	Select a counter type.	Linear Counter		Page 203, Section 8.4 (1)
Function Input Logic Setting	Select logic for Function input signal.	Positive Logic		Page 216, Section 8.4.4 (1) (a)
Counter Function Selection	Select a counter function.	Count Disabling Function		Page 216, Section 8.4.4

(To the next page)

Item	Description	Default	Available operation mode	Reference
Coincidence Output Time Preset Setting	Select whether to perform the preset function on the rising edge of CH1 counter value coincidence (No.1) (SM1881).	Not preset	Normal mode	Page 211, Section 8.4.2 (1)
Coincidence Detection Interrupt Setting (Counter Value Coincidence No.1)	Select whether to perform coincidence detection interrupt using CH1 counter value coincidence (No.1) (SM1881).	Not Used		Page 213, Section 8.4.3 (1)
Coincidence Detection Interrupt Setting (Counter Value Coincidence No.2)	Select whether to perform coincidence detection interrupt using CH1 counter value coincidence (No.2) (SM1884).			
Sampling Time Setting (ms)	Set sampling period for the sampling counter function.	—		Page 216, Section 8.4.4 (1) (b)
Frequency Movement Averaging Processing Count	Set a moving average processing count when frequencies are measured.	—	Frequency measurement mode	Page 225, Section 8.5
Frequency Measurement Unit Time Setting	Select a pulse measurement period to calculate frequencies.	—		
Rotation Speed Movement Averaging Processing Count	Set a moving average processing count when a rotation speed is measured.	—	Rotation speed measurement mode	Page 231, Section 8.6
Rotation Speed Measurement Unit Time Setting	Select a pulse measurement period to calculate a rotation speed.	—		
Number of Pulses per Rotation (pulse)	Set the number of pulses per rotation when a rotation speed is measured.	—		
Pulse Measurement Target Setting	Select a period (on width or off width) during which pulses are measured.	—	Pulse measurement mode	Page 237, Section 8.7

After the settings are configured, used external signals are automatically assigned. Set "Input Response Time" for input signals other than phases A and B, and set "Error Time Output Mode" for output signals for each channel.

According to the settings, external signals are assigned.

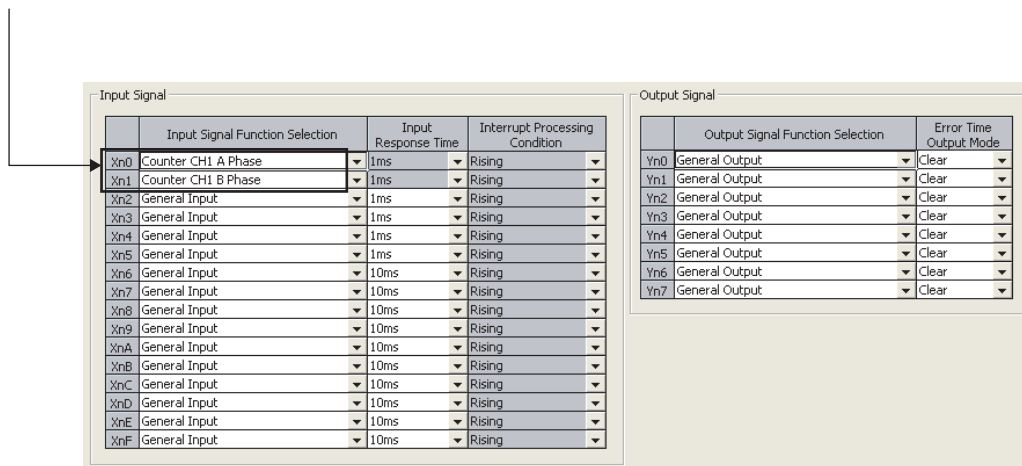

8.3.1 Common settings

This section describes settings common to some operation modes.

(1) Operation mode setting

According to application, select an operation mode from the following five modes. The setting items depend on the selected operation mode. For required settings and available functions for each operation mode, refer to the following table.

Operation mode	Description	Reference
Normal Mode	This mode has the CPU module operate as a general high-speed counter.	Page 201, Section 8.4
Frequency Measurement Mode	The frequencies of pulses input to the pulse input signals of phases A and B are measured.	Page 225, Section 8.5
Rotation Speed Measurement Mode	A rotation speed is calculated from the number of pulses input to the pulse input signals of phases A and B.	Page 231, Section 8.6
Pulse Measurement Mode	The on or off width of pulses input to Function input signal is measured.	Page 237, Section 8.7
PWM Output Mode	PWM waveforms are output from Coincidence output No.1 signal.	Page 240, Section 8.8

(2) Count source selection

Select a count source from the following.

Count source	Description	Available operation mode
A Phase/B Phase	Counts pulses input to the pulse input signals of phases A and B of an external I/O connector. Select a pulse count method in "AgPulse Input Mode".	Normal mode Frequency measurement mode Rotation speed measurement mode
Internal Clock (0.1μs)	Counts pulses generated at the inside of a LCPU in the specified cycle.	Normal mode
Internal Clock (1μs)		
Internal Clock (10μs)		
Internal Clock (100μs)		
Other CH Coincidence Output No.1	Counts pulses at the timing according to the operation mode set to other channels. <ul style="list-style-type: none"> Normal mode: On the rising edge of CH2 counter value coincidence (No.1) (SM1901) (when the own channel is CH1) PWM output mode: On the rising edge of Coincidence output No.1 signal 	Own channel: Normal mode Other channels: Normal mode or PWM output mode

(a) Internal clock

By setting the internal clock, clock frequencies generated at the inside of the LCPU can be counted as input pulses. For example, when the internal clock is used together with the coincidence output function, an on delay timer can be configured.

Ex. Selecting "Internal Clock (100μs)" in Count Source Selection and turning on Coincidence output No.1 signal after the elapse of 180 seconds

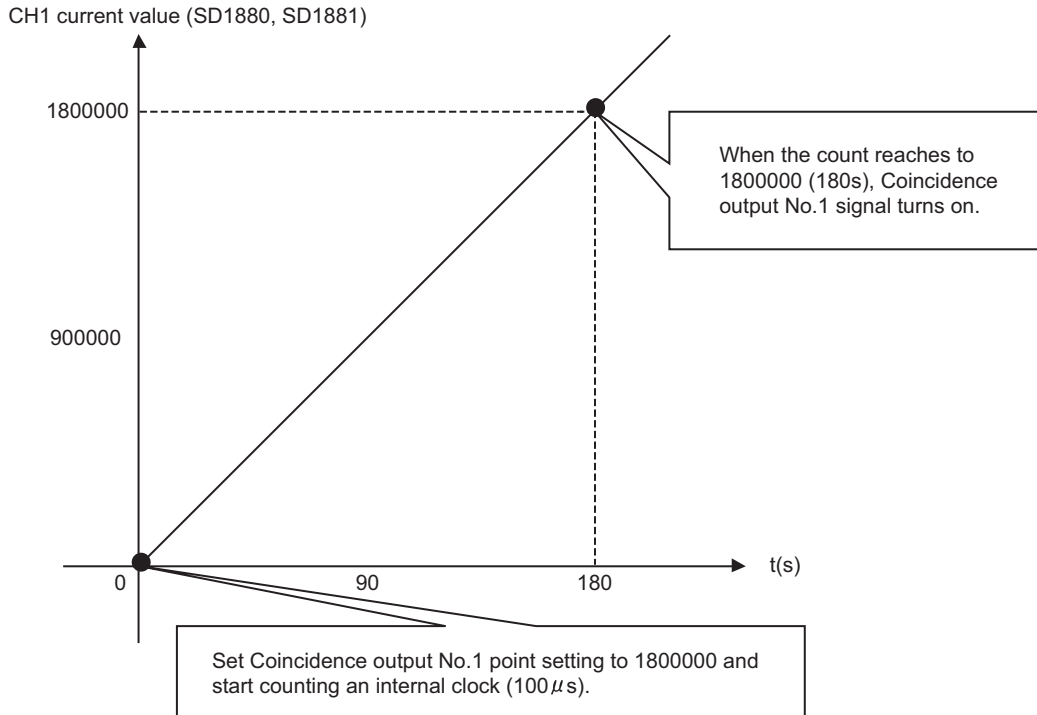

A count value and time have the following relationship.

$$\text{Count value} = \frac{\text{Time (s)}}{\text{Internal clock } (\mu\text{s})}$$

Remark

The accuracy of measured time against a count value is as follows.

Count source	Time accuracy
Internal Clock (0.1μs)	±60ppm and "-6.25ns to + 9.376ns" Ex. When pulses are counted from 0 to 10000, time calculated using a count value is: 1ms (= (10000 - 0) × 0.1μs). However, the measured time will be as follows: (1ms × (1-0.00006) - 6.25ns) to (1ms × (1 + 0.00006) + 9.376ns)
Internal Clock (1μs)	±60ppm
Internal Clock (10μs)	
Internal Clock (100μs)	

(3) Pulse input mode

Select the mode of pulses input to the pulse input signals of phases A and B. The mode can be set when "A Phase/B Phase" has been selected for Count Source Selection. The following eight pulse input modes are available. ϕA and ϕB express phase A and phase B, respectively.

Pulse input mode	Count timing		
1-Phase Multiple of 1	For counting up	<p>ϕA</p> <p>ϕB and CH1 count down command (SM1894)</p>	Counts on the rising edge (\uparrow) of ϕA . Both ϕB and CH1 count down command (SM1894) are off.
	For counting down	<p>ϕA</p> <p>ϕB or CH1 count down command (SM1894)</p>	Counts on the falling edge (\downarrow) of ϕA . Either ϕB or CH1 count down command (SM1894) is on.
1-Phase Multiple of 1 (A Phase Only)	For counting up	<p>ϕA</p> <p>CH1 count down command (SM1894)</p>	Counts on the rising edge (\uparrow) of ϕA . CH1 count down command (SM1894) is off.
	For counting down	<p>ϕA</p> <p>CH1 count down command (SM1894)</p>	Counts on the falling edge (\downarrow) of ϕA . CH1 count down command (SM1894) is on.
1-Phase Multiple of 2	For counting up	<p>ϕA</p> <p>ϕB and CH1 count down command (SM1894)</p>	Counts on the rising edge (\uparrow) and the falling edge (\downarrow) of ϕA . Both ϕB and CH1 count down command (SM1894) are off.
	For counting down	<p>ϕA</p> <p>ϕB and CH1 count down command (SM1894)</p>	Counts on the rising edge (\uparrow) and the falling edge (\downarrow) of ϕA . Either ϕB or CH1 count down command (SM1894) is on.
1-Phase Multiple of 2 (A Phase Only)	For counting up	<p>ϕA</p> <p>CH1 count down command (SM1894)</p>	Counts on the rising edge (\uparrow) and the falling edge (\downarrow) of ϕA . CH1 count down command (SM1894) is off.
	For counting down	<p>ϕA</p> <p>CH1 count down command (SM1894)</p>	Counts on the rising edge (\uparrow) and the falling edge (\downarrow) of ϕA . CH1 count down command (SM1894) is on.

(To the next page)

Pulse input mode	Count timing		
CW/CCW	For counting up		Counts on the rising edge (\uparrow) of ϕA . ϕB is off.
	For counting down		ϕA is off. Counts on the rising edge (\uparrow) of ϕB .
2-Phase Multiple of 1	For counting up		Counts on the rising edge (\uparrow) of ϕA while ϕB is off.
	For counting down		Counts on the falling edge (\downarrow) of ϕA while ϕB is off.
2-Phase Multiple of 2	For counting up		Counts on the rising edge (\uparrow) of ϕA while ϕB is off. Counts on the falling edge (\downarrow) of ϕA while ϕB is on.
	For counting down		Counts on the rising edge (\uparrow) of ϕA while ϕB is on. Counts on the falling edge (\downarrow) of ϕA while ϕB is off.
2-Phase Multiple of 4	For counting up		Counts on the rising edge (\uparrow) of ϕA while ϕB is off. Counts on the falling edge (\downarrow) of ϕA while ϕB is on. Counts on the rising edge (\uparrow) of ϕB while ϕA is on. Counts on the falling edge (\downarrow) of ϕB while ϕA is off.
	For counting down		Counts on the rising edge (\uparrow) of ϕA while ϕB is on. Counts on the falling edge (\downarrow) of ϕA while ϕB is off. Counts on the rising edge (\uparrow) of ϕB while ϕA is off. Counts on the falling edge (\downarrow) of ϕB while ϕA is on.

Point

When a pulse input mode has been set to "1-Phase Multiple of 1 (A Phase Only)" or "1-Phase Multiple of 2 (A Phase Only)", the input signal of phase B can be used for other functions, such as general-purpose input function other than the interrupt input function.

The overview of external connections regarding pulse input is as follows.

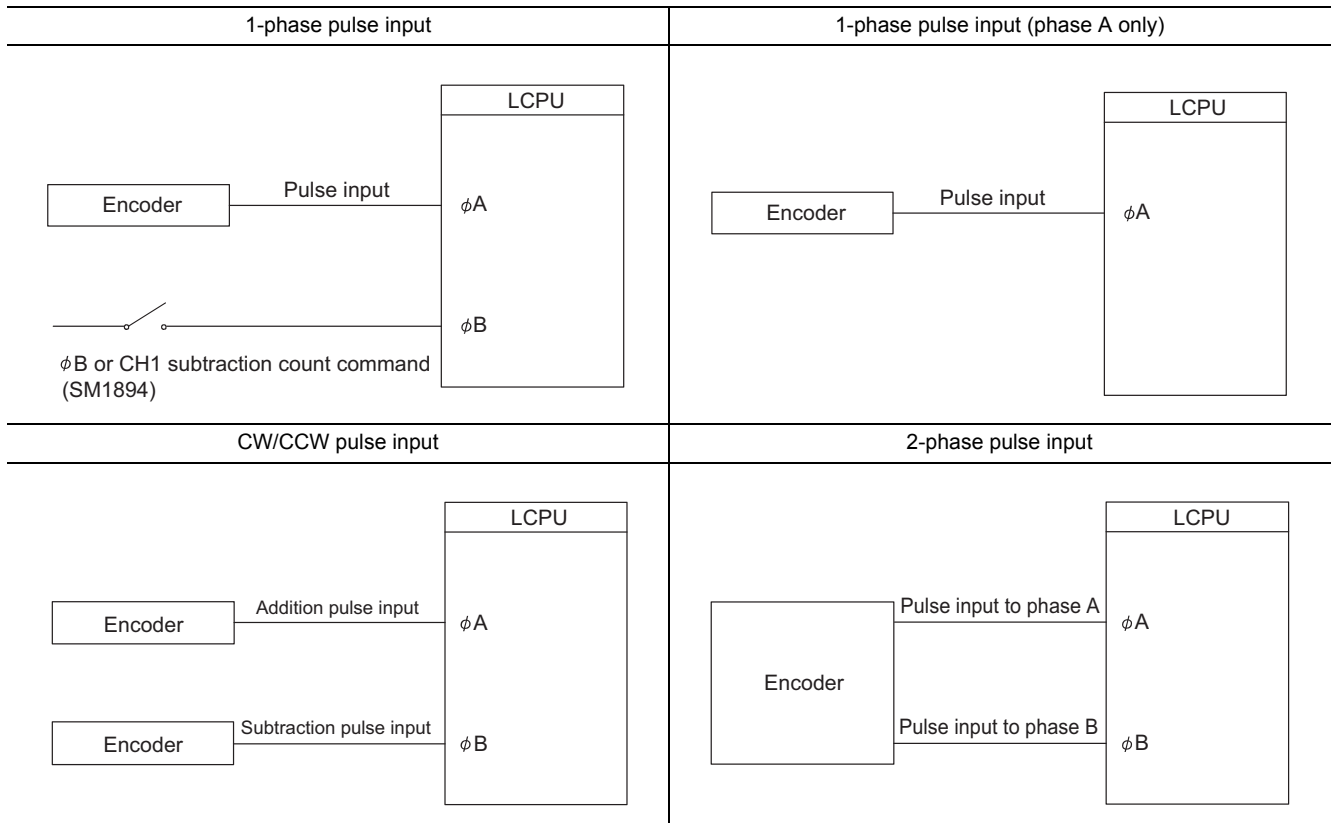

(4) Counting speed setting

Select the counting speed of pulses with considering the following conditions.

Counting speed	Available pulse input mode	Available count source
10kpps	All	A Phase/B Phase
50kpps	All	
100kpps	All other than "2-Phase Multiple of 1"	
200kpps	1-Phase Multiple of 2 1-Phase Multiple of 2 (A Phase Only) 2-Phase Multiple of 4	

8.4 Normal Mode

This section describes settings that become valid and functions that can be used when "Normal Mode" is selected for "Operation Mode Setting". The following table shows I/O signals used in this mode.

○:Wiring required, △:Wiring required when necessary, —:Wiring not required

Count source		Input signal				Output signal							
		Phase A	Phase B	Phase Z	Function input signal	Latch counter input signal	Coincidence output No.1 signal	Coincidence output No.2 signal					
A Phase/ B Phase	1-Phase Multiple of 1 (A Phase Only)	○	—*2	△*3	△*3	△*3	△*3	△*3					
	1-Phase Multiple of 2 (A Phase Only)												
	1-Phase Multiple of 1		○										
	1-Phase Multiple of 2												
	CW/CCW												
	2-Phase Multiple of 1		○						△*3	△*3	△*3	△*3	△*3
	2-Phase Multiple of 2												
	2-Phase Multiple of 4												
Internal Clock	0.1μs	—*2	—*2										
	1μs												
	10μs												
	100μs												
Other CH Coincidence Output No.1*1													

*1 Setting the high-speed counter function of other channel to the normal mode or PWM output mode is required.

*2 The input signal can be used for other functions such as the general-purpose input except the interrupt input.





*3 Wiring the input signal is required depending on the selected counter function. When this signal is not required, it can be used for other functions such as the general-purpose input and general-purpose output.

This section describes required settings and functions for each of the following item.

Item	Reference
Preset	Page 206, Section 8.4.1
Coincidence output	Page 209, Section 8.4.2
Coincidence detection	Page 213, Section 8.4.3
Counter function selection	Page 216, Section 8.4.4

First of all, the setting item, "Counter Format", which is common for all items, is described.

Note that the explanations in this section assume use of CH1. For the special relay, special register, dedicated instructions, error codes, and warning codes for CH2, refer to the following.

- Special relay and special register:  Page 244, Section 8.9 (2)
- Dedicated instructions:  Page 245, Section 8.10
- Error codes:  Page 269, Section 8.12 (1)
- Warning codes:  Page 270, Section 8.12 (2)

(1) Counter format

Select the high-speed counter format.

- Linear Counter: Counts pulses within the range of -2147483648 to 2147483647.
- Ring Counter: Counts pulses within the range between the ring counter upper limit value and the lower limit value.

(a) Operations of the linear counter

This format can be used with any counter functions available in the normal mode.

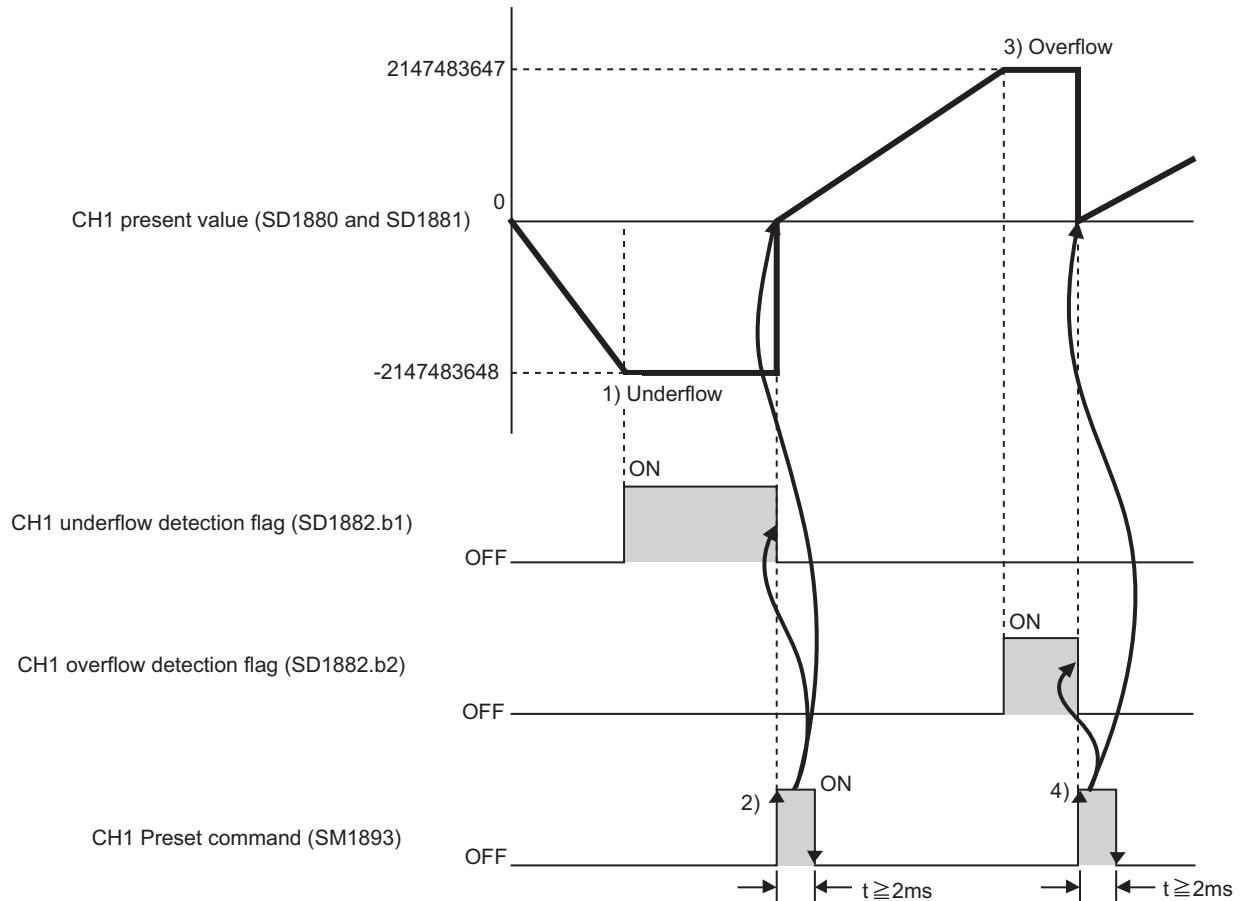

Number	Description
1)	When CH1 current value (SD1880, SD1881) becomes smaller than the lower limit (-2147483648) during counting down, "detection (1)" is stored in the underflow detection flag (SD1882.b1). Even if an additional pulse is inputted, the CH1 current value (SD1880, SD1881) remains at the lower limit (-2147483648).
2)	When performing preset of the current value by turning on the CH1 preset command (SM1893) or other methods, "No detection (0)" is stored in the underflow detection flag (SD1882.b1). The value is preset to "0" in the above chart. And then, counting restarts.
3)	When CH1 current value (SD1880, SD1881) becomes larger than the upper limit (2147483647) during counting up, "detection (1)" is stored in the overflow detection flag (SD1882.b2). Even if an additional pulse is inputted, the CH1 current value (SD1880, SD1881) remains at the upper limit (2147483647).
4)	When presetting the value by turning on the CH1 preset command (SM1893) or other methods, "No detection (0)" is stored in the overflow detection flag (SD1882.b1). The value is preset to "0" in the above chart. And then, counting restarts.

- Errors of the linear counter

When the overflow error or underflow error is detected, "Over/underflow error (CH1 error code: 3100)" occurs.

(b) Operations of the ring counter

This format counts pulses repeatedly within the range within the range between the ring counter upper limit value and the lower limit value. These limit values are set by the ring counter upper/lower limit value write instruction (ICRNGWR1(P)) (Page 247, Section 8.10.1 (2)). This format can be used with any counter functions available in the normal mode. When the ring counter is selected, the overflow error and underflow error does not occur.

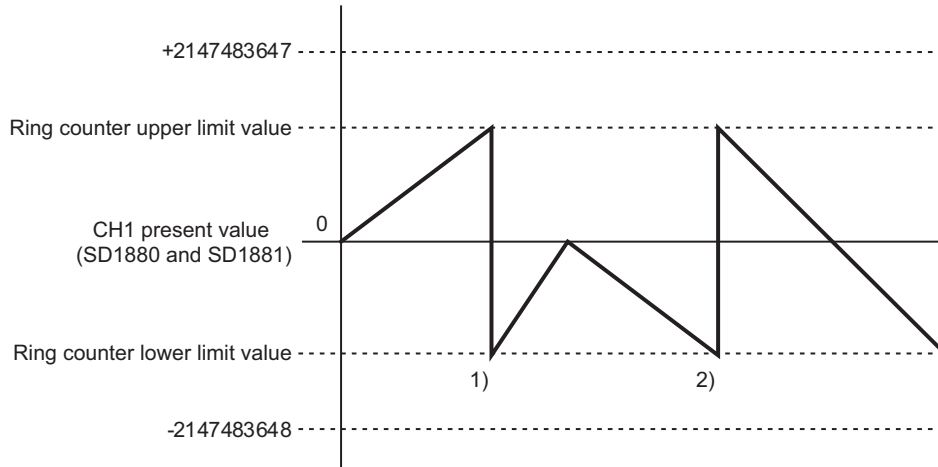

Number	Description
1)	When CH1 current value (SD1880, SD1881) is counted up from "the upper limit value -1", the lower limit value is stored in the current value.
2)	When CH1 current value (SD1880, SD1881) is counted down from the lower limit value, "the upper limit value -1" is stored in the current value.

• Count range of the ring counter

The count range differs depending on the CH1 current value (SD1880, SD1881) when preset is performed or CH1 count enable command (SM1895) is turned on, upper limit value and lower limit value.

Ex. When setting the ring counter lower limit value to -50000 and the ring counter upper limit value to 100000. (Except Range 3)

Count range	Setting condition
<p>Range 1</p> <p>Count range: -50000 to 99999</p>	$\left(\begin{array}{c} \text{Ring counter} \\ \text{lower limit value} \end{array} \right) \leq \left(\begin{array}{c} \text{CH1 present value} \\ \text{(SD1880 and SD1881)} \end{array} \right) \leq \left(\begin{array}{c} \text{Ring counter} \\ \text{upper limit value} \end{array} \right)$ <p>and</p> $\left(\begin{array}{c} \text{Ring counter} \\ \text{lower limit value} \end{array} \right) \neq \left(\begin{array}{c} \text{Ring counter} \\ \text{upper limit value} \end{array} \right)$
<p>Range 2</p> <p>Count range: -2147483648 to 50000, 100001 to 2147483647</p>	$\left(\begin{array}{c} \text{CH1 present value} \\ \text{(SD1880 and SD1881)} \end{array} \right) < \left(\begin{array}{c} \text{Ring counter} \\ \text{lower limit value} \end{array} \right)$ <p>or</p> $\left(\begin{array}{c} \text{CH1 present value} \\ \text{(SD1880 and SD1881)} \end{array} \right) > \left(\begin{array}{c} \text{Ring counter} \\ \text{upper limit value} \end{array} \right)$
<p>Range 3</p> <p>Count range: -2147483648 to 2147483647</p>	$\left(\begin{array}{c} \text{Ring counter} \\ \text{lower limit value} \end{array} \right) = \left(\begin{array}{c} \text{Ring counter} \\ \text{upper limit value} \end{array} \right)$ <p>The CH1 present value (SD1880 and SD1881) is not included in the setting condition.</p>

• Precautions

- The change of upper limit value and lower limit value of ring counter takes effect when rising edge of CH1 count enable command (SM1895) is detected. To enable the changed settings of these values when CH1 count enable command (SM1895) is on, turn off it for 2ms or more and then turn on it.
- When changing the count range by preset, perform it after turning off CH1 count enable command (SM1895) to prevent incorrect counts.

8.4.1 Preset

This function overwrites CH1 current value (SD1880, SD1881) with a value set to Preset value write instruction (ICPREWR1(P)) (preset value) and counts pulses starting from the set value (☞ Page 249, Section 8.10.1 (3)). The following methods are available.





- Preset by phase Z input
- Preset by a program
- Preset by the preset at coincidence output function (☞ Page 211, Section 8.4.2 (1))
- Preset by the count disable/preset function (☞ Page 222, Section 8.4.4 (2) (d))
- Preset by the latch counter/preset function (☞ Page 224, Section 8.4.4 (2) (e))

This section describes preset by phase Z input and preset by a program.

(1) Z phase settings

(a) Z phase (preset) trigger setting

Select a trigger condition to perform the preset function by phase Z input from the following.

Rising	Falling
Phase Z 	Phase Z 
Rising+Falling	During ON
Phase Z 	Phase Z 

(b) External preset (Z phase) request detection setting

When performing the preset function by phase Z input, select whether to turn on CH1 external preset (phase Z) request detection (SM1886). This setting is invalid if "Z Phase (Preset) Trigger Setting" is set to "During ON".

Select either of the following items.

- ON at detection
- Not ON at detection

- Precautions

While CH1 external preset (phase Z) request detection (SM1886) is on, the current value cannot be replaced with the preset value by any method. In this case, turn off this relay by turning on CH1 external preset (phase Z) request detection reset command (SM1897).

(2) Description of the methods

(a) Preset by phase Z input

With phase Z input, the current value is replaced with the preset value when the set trigger condition is met.

Ex. Operation when "Z Phase (Preset) Trigger Setting" is set to "Rising" and "External Preset (Z Phase) Request Detection Setting" is set to "ON at detection"

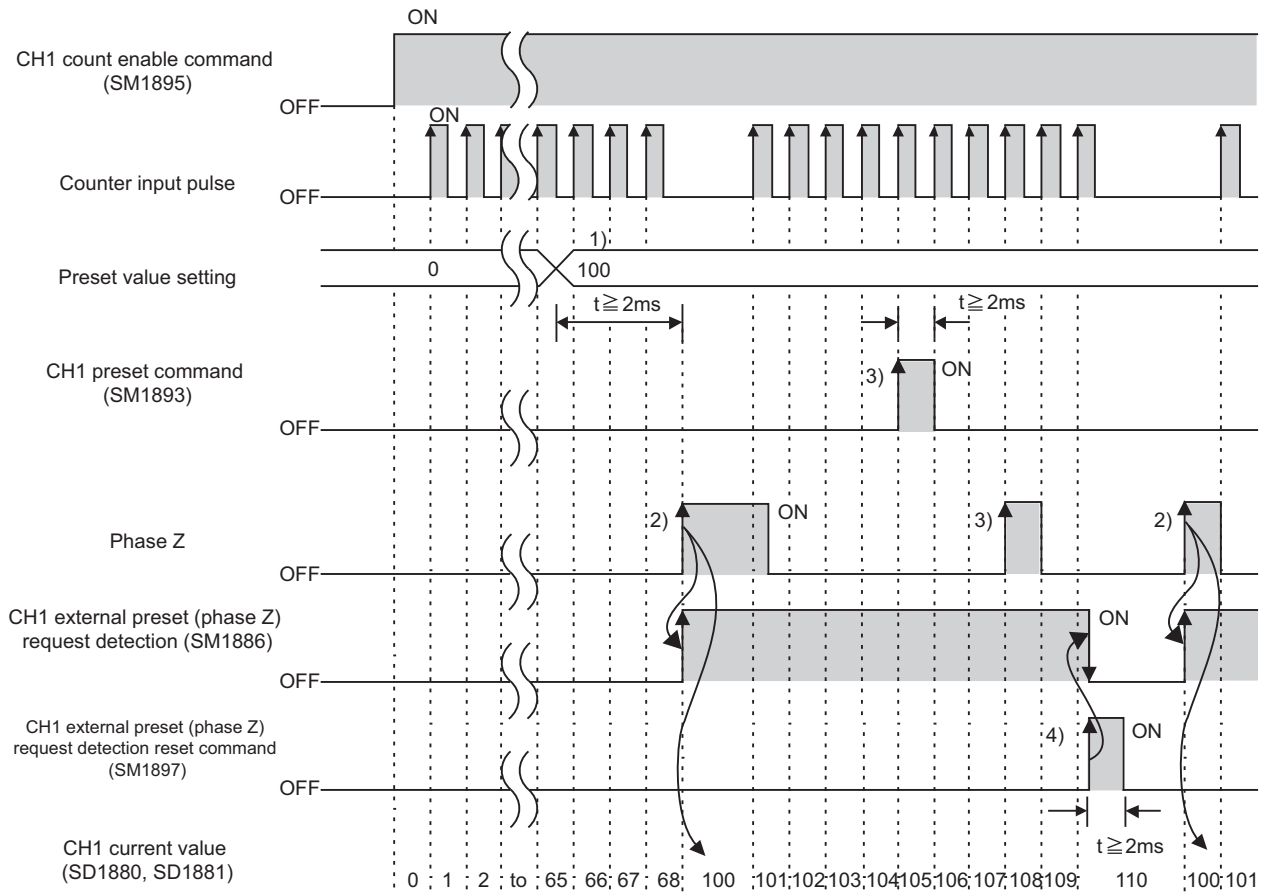

Number	Description
1)	When Preset value write instruction (ICPREWR1(P)) is executed, a set value is overwritten to the preset value setting.
2)	The value written to the preset value setting is stored in CH1 current value (SD1880, SD1881) on the rising edge of phase Z. CH1 external preset (phase Z) request detection (SM1886) turns on. The current value can be replaced with the preset value independent of the on/off status of CH1 count enable command (SM1895).
3)	While CH1 external preset (phase Z) request detection (SM1886) is on, the current value cannot be replaced.
4)	In this case, turn off this relay by turning on CH1 external preset (phase Z) request detection reset command (SM1897).

- Precautions

Provide a 2ms or more interval between the execution command establishment of the Preset value write instruction (ICPREWR1(P)) and replacement with the preset value. If not, the value of the preset value setting before change may be stored in CH1 current value (SD1880, SD1881). When the preset function is performed by CH1 preset command (SM1893), execution of the relay delays. Therefore, providing a period is not required.

(b) Preset by a program

When not using a phase Z and the counter function selection, perform the preset function by turning on CH1 preset command (SM1893) by a program.

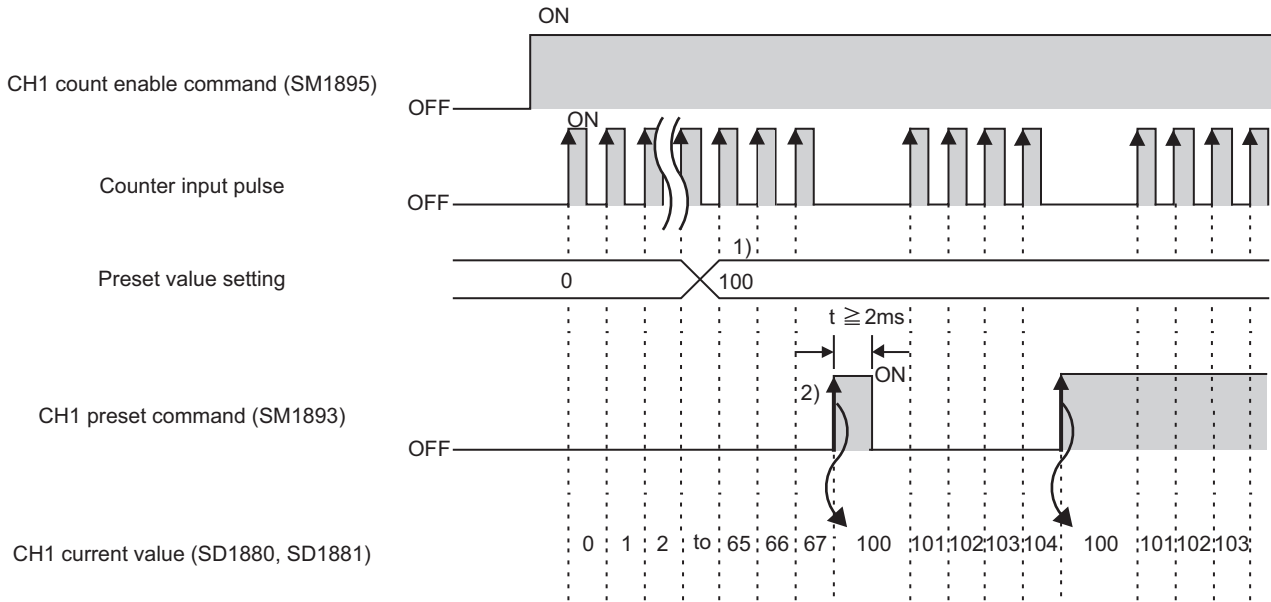

Number	Description
1)	When Preset value write instruction (ICPREWR1(P)) is executed, a set value is overwritten to the preset value setting.
2)	The value written to the preset value setting is stored in CH1 current value (SD1880, SD1881) on the rising edge of CH1 preset command (SM1893). The current value can be replaced with the preset value independent of the on/off status of CH1 count enable command (SM1895).

8.4.2 Coincidence output

Coincidence output is a function by which a signal can be output when a value set by the coincidence output point write instruction (ICCOVWR1(P)) matches the CH1 current value (SD1880 or SD1881). (Page 254, Section 8.10.1 (6)) Two kinds of coincidence outputs (No.1 and No.2) are provided for each channel.

Ex. When the Coincidence output No.1 signal is turned on.

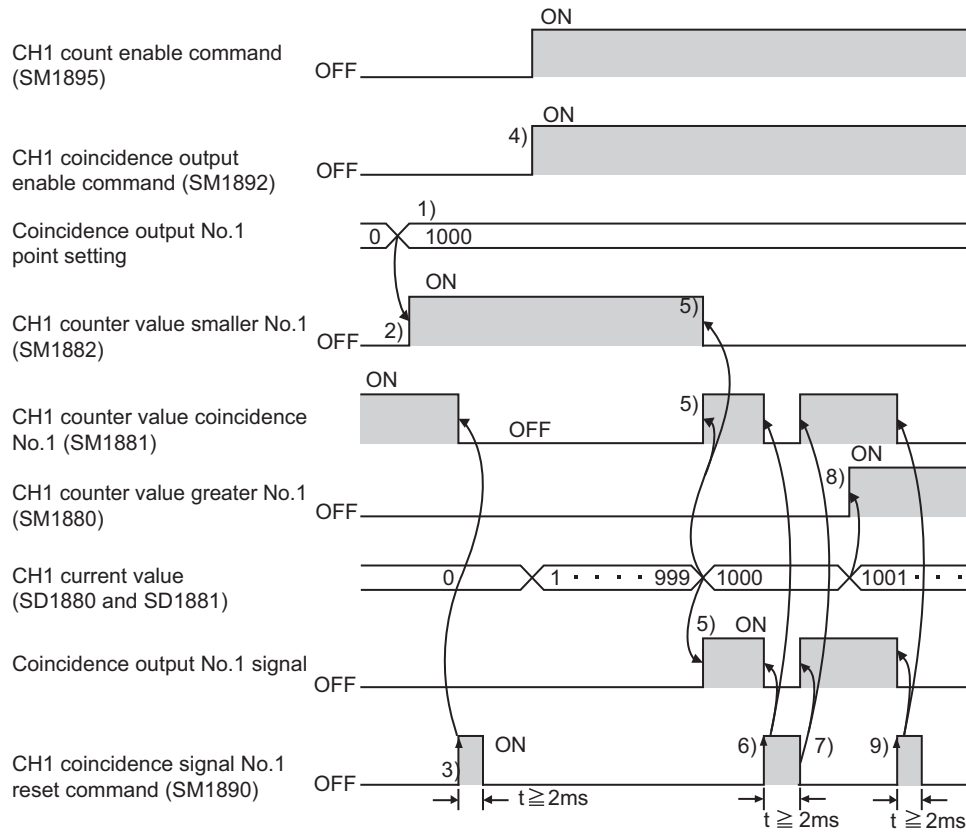

Number	Description
1)	By executing the Coincidence output point write instruction (ICCOVWR1(P)), any value can be written to the coincidence output No.1 point setting area.
2)	When the following condition is met, CH1 counter value smaller (No.1) (SM1882) turns on. • CH1 current value (SD1880 or SD1881) < Coincidence output No.1 point setting
3)	When CH1 coincidence signal No.1 reset command (SM1890) is turned on, CH1 counter value coincidence (No.1) (SM1881) and the Coincidence output No.1 signal turn off.
4)	To enable the output by the Coincidence output No.1 signal, turn on CH1 coincidence output enable command (SM1892). (Output of both the Coincidence output No.1 and No.2 signals is enabled.)
5)	When the following condition is met, CH1 counter value coincidence (No.1) (SM1881) and the Coincidence output No.1 signal turn on. • CH1 current value (SD1880, SD1881) = Coincidence output No.1 point setting Also, when the following condition is met, CH1 counter value smaller (No.1) (SM1882) turns off. • CH1 current value (SD1880 or SD1881) \geq Coincidence output No.1 point setting
6)	If CH1 coincidence signal No.1 reset command (SM1890) is turned on while the values match, CH1 counter value coincidence (No.1) (SM1881) and the Coincidence output No.1 signal turn off.
7)	If CH1 coincidence signal No.1 reset command (SM1890) is turned off while the values match, CH1 counter value coincidence (No.1) (SM1881) and the Coincidence output No.1 signal turn on again.
8)	When the following condition is met, CH1 counter value greater (No.1) (SM1880) turns on. • CH1 current value (SD1880 or SD1881) > Coincidence output No.1 point setting
9)	When CH1 coincidence signal No.1 reset command (SM1890) is turned on, CH1 counter value coincidence (No.1) (SM1881) and the Coincidence output No.1 signal turn off. If CH1 counter value coincidence (No.1) (SM1881) remains on, it cannot turn on the next time.

Point

- CH1 counter value coincidence (No.n) (SM1881 or SM1884) can turn on regardless of the status of CH1 coincidence output enable command (SM1892).
- Due to internal processing of the high counter function, when CH1 counter value coincidence (No.n) is turned on, CH1 counter value greater (No.1) (SM1880) or CH1 counter value smaller (No.1) (SM1882), or CH1 counter value greater (No.2) (SM1883) or CH1 counter value smaller (No.2) (SM1885) may be on.

• Precautions

- When program scan time is less than 2ms, ensure a 2ms or longer on width for Coincidence signal No.n reset command (SM1890 or SM1891) by using a method such as a timer.
- Coincidence output occurs on the rising edge of CH1 counter value coincidence (No.n) (SM1881 or SM1884). Because of this, if it stays on, the next coincidence signal cannot be output. BY turning on CH1 coincidence signal No.n reset command (SM1890 or SM1891), turn off CH1 counter value coincidence (No.n) (SM1881 or SM1884)

(1) Coincidence output time preset setting

Select whether to set a preset value on the rising edge of CH1 counter value coincidence (No.1) (SM1881).

- Not preset
- Preset

This setting is used for an operation such as sizing. Note, however, that this setting is not available for CH1 counter value coincidence (No.2) (SM1884).

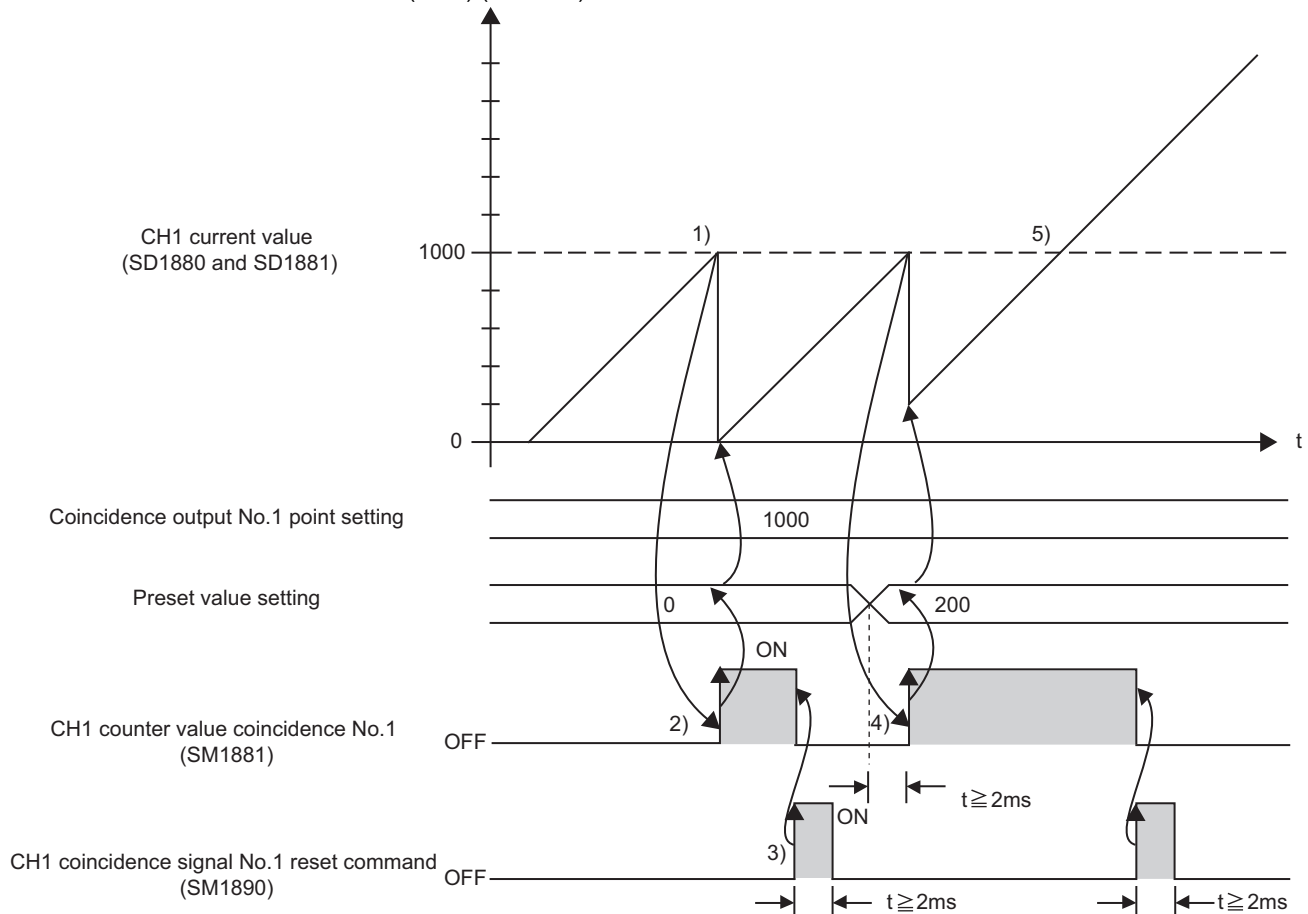

Number	Description
1)	When the following condition is met, CH1 counter value coincidence (No.1) (SM1881) turns on. CH1 current value (SD1880 or SD1881) = Coincidence output No.1 point setting.
2)	The preset value is set on the rising edge of CH1 counter value coincidence (No.1) (SM1881).
3)	Turn on CH1 coincidence signal No.1 reset command (SM1890) so that CH1 counter value coincidence (No.1) (SM1881) will be turned on the next time CH1 current value (SD1880 or SD1881) becomes equal to the coincidence output No.1 point setting.
4)	If the preset value setting has been changed with the Preset value write instruction (ICPREWR1(P)), the new preset value is set.
5)	Even if CH1 current value (SD1880 or SD1881) becomes equal to the coincidence output No.1 point setting with CH1 counter value coincidence (No.1) (SM1881) not turned off, the value will not be replaced with the preset value. This happens because CH1 counter value coincidence (No.1) (SM1881) remains on (does not rise).

(a) Precautions

- While CH1 external preset (phase Z) request detection (SM1886) is on, the current value cannot be replaced with the preset value. In this case, turn off this relay by turning on CH1 external preset (phase Z) request detection reset command (SM1897).
- Provide a 2ms or more interval between the execution command establishment of the Preset value write instruction (ICPREWR1(P)) and replacement with the preset value. If not, a preset value setting before change may be stored in CH1 current value (SD1880 or SD1881).

8.4.3 Coincidence detection

When a match is detected, an interrupt request can be issued to start an interrupt program. There are four points of interrupt factors (interrupt pointers, I0 to I3).

I Number	Interrupt factor
I0	Coincidence detection of CH1 coincidence output No.1 point setting
I1	Coincidence detection of CH1 coincidence output No.2 point setting
I2	Coincidence detection of CH2 coincidence output No.1 point setting
I3	Coincidence detection of CH2 coincidence output No.2 point setting

Interrupt pointer numbers can be changed. (☞ Page 214, Section 8.4.3 (2))

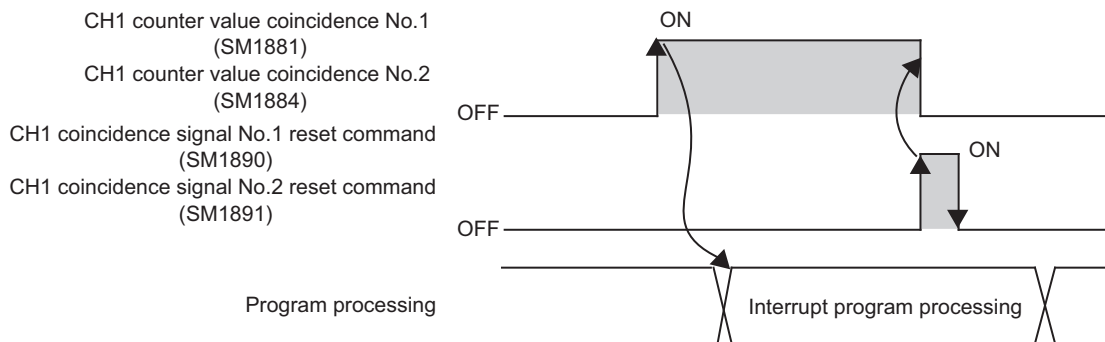

(1) Coincidence detection interrupt setting (counter value coincidence No.n)

Select whether to "use" or "not use" the coincidence detection interrupt function by CH1 counter value output (No.n) (SM1881 or SM1884).

(a) Interrupt program execution setting by the IMASK instruction

Use of the IMASK instruction allows the interrupt program execution to be enabled or disabled (interrupt mask) for each interrupt pointer number. For details on the IMASK instruction, refer to the MELSEC-Q/L Programming Manual (Common Instruction).

(b) Time taken until the interrupt request



Time taken from a coincidence detection to an interrupt request is approximately 150μs.

(c) Precautions

A coincidence detection interrupt occurs on the rising edge of CH1 counter value coincidence (No.n) (SM1881 or SM1884). Because of this, if it stays on, the next coincidence signal cannot be output. BY turning on CH1 coincidence signal No.n reset command (SM1890 or SM1891), turn off CH1 counter value coincidence (No.n) (SM1881 or SM1884).

(2) Changing the interrupt pointer numbers

Configure the settings in the "Intelligent Function Module Interrupt Pointer Setting" dialog box.

1. Click the  button in the "PLC System" tab.
 -  Project window ⇨ [Parameter] ⇨ [PLC Parameter] ⇨ [PLC System] tab
2. Set the interrupt pointer start No., interrupt pointer count, start I/O No., and start SI No.
3. Click the  button to exit.

Ex. When assigning coincidence detection interrupt pointers of high-speed counter CH1 to I50 and higher

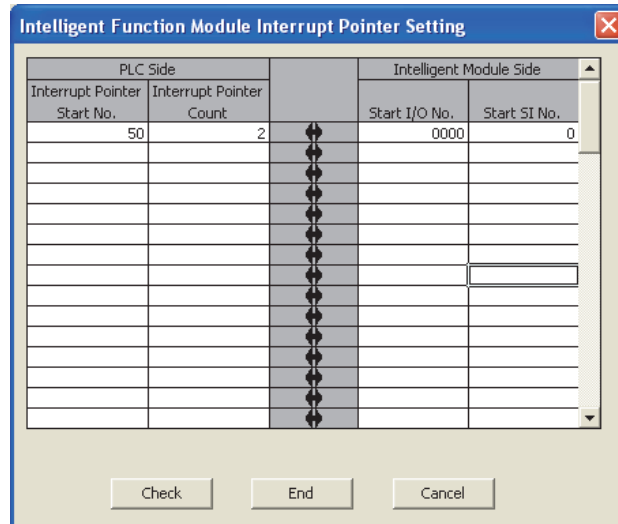

(a) Precautions

When there is no high-speed counter with the coincidence detection output setting and no input interrupt within the range specified in the "Intelligent Function Module Interrupt Pointer Setting" of PLC Parameter, "PARAMETER ERROR" occurs (error code: 3000).

The following are a correct example and an incorrect example of assigning the interrupt pointers of the high-speed counter to I50 and higher as shown above.

- Correct setting example

In this case, there is a high-speed counter (for which coincidence detection interrupt is set) within the range specified in "Intelligent Function Module Interrupt Pointer Setting." Therefore, no error will occur.

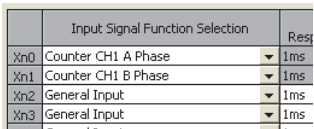
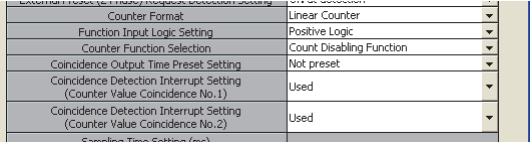
Input signal function selection: setting of high-speed counter X0 and X1	CH1 coincidence detection interrupt setting: set to "Used"
	

- Incorrect setting example

Although CH2 high-speed counter with the coincidence detection interrupt setting is set, both the counter and input interrupt settings do not exist within the range specified in the Intelligent Function Module Interrupt Pointer Setting dialog box. Because of this, an error occurs.

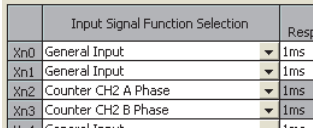
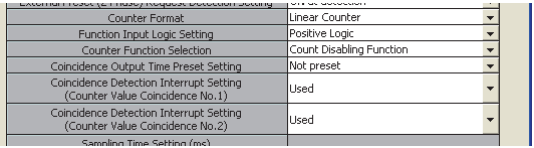
Input signal function selection: setting of high-speed counter X2 and X3	CH2 coincidence detection interrupt setting: set to "Used"																													
 <table border="1" style="margin: auto; border-collapse: collapse;"> <thead> <tr> <th></th> <th>Input Signal Function Selection</th> <th>Res</th> </tr> </thead> <tbody> <tr> <td>Xn0</td> <td>General Input</td> <td>1ms</td> </tr> <tr> <td>Xn1</td> <td>General Input</td> <td>1ms</td> </tr> <tr> <td>Xn2</td> <td>Counter CH2 A Phase</td> <td>1ms</td> </tr> <tr> <td>Xn3</td> <td>Counter CH2 B Phase</td> <td>1ms</td> </tr> </tbody> </table>		Input Signal Function Selection	Res	Xn0	General Input	1ms	Xn1	General Input	1ms	Xn2	Counter CH2 A Phase	1ms	Xn3	Counter CH2 B Phase	1ms	 <table border="1" style="margin: auto; border-collapse: collapse;"> <tbody> <tr> <td>Counter Format</td> <td>Linear Counter</td> </tr> <tr> <td>Function Input Logic Setting</td> <td>Positive Logic</td> </tr> <tr> <td>Counter Function Selection</td> <td>Count Disabling Function</td> </tr> <tr> <td>Coincidence Output Time Preset Setting</td> <td>Not preset</td> </tr> <tr> <td>Coincidence Detection Interrupt Setting (Counter Value Coincidence No.1)</td> <td>Used</td> </tr> <tr> <td>Coincidence Detection Interrupt Setting (Counter Value Coincidence No.2)</td> <td>Used</td> </tr> <tr> <td>Sampling Time Setting (ms)</td> <td></td> </tr> </tbody> </table>	Counter Format	Linear Counter	Function Input Logic Setting	Positive Logic	Counter Function Selection	Count Disabling Function	Coincidence Output Time Preset Setting	Not preset	Coincidence Detection Interrupt Setting (Counter Value Coincidence No.1)	Used	Coincidence Detection Interrupt Setting (Counter Value Coincidence No.2)	Used	Sampling Time Setting (ms)	
	Input Signal Function Selection	Res																												
Xn0	General Input	1ms																												
Xn1	General Input	1ms																												
Xn2	Counter CH2 A Phase	1ms																												
Xn3	Counter CH2 B Phase	1ms																												
Counter Format	Linear Counter																													
Function Input Logic Setting	Positive Logic																													
Counter Function Selection	Count Disabling Function																													
Coincidence Output Time Preset Setting	Not preset																													
Coincidence Detection Interrupt Setting (Counter Value Coincidence No.1)	Used																													
Coincidence Detection Interrupt Setting (Counter Value Coincidence No.2)	Used																													
Sampling Time Setting (ms)																														

8.4.4 Counter function selection

The following counter functions are selectable.

- Latch Counter Function: Latches the current value of the counter.
- Count Disabling Function: Stops the counting while it is enabled.
- Sampling Counter Function: Counts the pulses input during the specified sampling time.
- Count disable/Preset/replace Function: Performs the count disable function and the preset function depending on changes of the Function input signal without switching the function.
- Latch counter/Preset/replace function: Performs the latch counter function and the preset function depending on changes of the Function input signal without switching the function.

These functions can be performed by either of CH1 selected counter function start command (SM1896) or an input from the Function input signal (OR), or the Function input signal only.

○: Applicable, —: N/A

Function	Method	
	CH1 selected counter function start command (SM1896)	Function input signal
Latch Counter Function	○	○
Count Disabling Function	○	○
Sampling Counter Function	○	○
Count disable/Preset/replace Function	—	○
Latch counter/Preset/replace Function	—	○

(1) Required settings

For use of the counter function selection, the following two settings are required.

(a) Function input logic setting

Select a logic for the Function input signal.

- Positive Logic: The Function input signal is on while a voltage is applied.
- Negative Logic: The Function input signal is on while no voltage is applied.

This section explains each function based on the case where "Function Input Logic Setting" is set to "Positive logic" (default).

(b) Sampling time setting

This setting is enabled when "Sampling Counter Function" is selected. Set sampling time for the sampling counter function in units of 10ms.

- Setting range: 10 to 655350 (ms)

Point

A time lag occurs before start of the selected function due to any of the following factors:

- Input response time of the Function input signal
- Program scan time (for CH1 selected counter function start command (SM1896))
- Internal control cycle (1ms) of the high-speed function (for CH1 selected counter function start command (SM1896))

The count error is as follows:

- Count error (maximum) when the Function input signal is used for the function

$$\left(\frac{\text{Input response time setting value (up to 70) (ms)}}{1000} \right) (\text{s}) \times \text{Pulse input speed (pulse/s)}^{*1}$$

- Count error (maximum) in function execution by CH1 selected counter function start command (SM1896)

$$\left(\frac{1 \text{ scan time (ms)} + 2(\text{ms})}{1000} \right) (\text{s}) \times \text{Pulse input speed (pulse/s)}^{*1}$$

In the case of the sampling counter function, a sampling time error due a component error (± 60 ppm) will also occur. Therefore, the count error is: 60ppm)

$$\begin{aligned} & \text{Sampling time (s)}^{*2} \times \frac{60(\text{ppm})}{1000000} \times \text{Pulse input speed (pulse/s)}^{*1} \\ &= \frac{\text{Sampling time (s)}^{*2} \times 6 \times \text{Pulse input speed (pulse/s)}^{*1}}{100000} \end{aligned}$$

*1 Pulse input speed (pulse/s) = pulse input frequency (Hz) \times number of multiples (count)

*2 Sampling time (s) = $\frac{\text{Sampling time setting value (ms)}}{1000}$

(2) Details on each function

(a) Latch counter function

CH1 current value (SD1880 and SD1881) can be latched by setting in "Counter Function Selection" or by using the Latch counter input signal.

- Using "Counter Function Selection": Select "Latch Counter Function" or "Latch Counter/Preset/replace Function". (☞ Page 224, Section 8.4.4 (2) (e))
- Using the Latch counter input signal

The latch count value can be read out into the specified device by the Latch counter value read instruction (ICLTHRD1(P)). (☞ Page 250, Section 8.10.1 (4)) The following explains the operations of both methods.

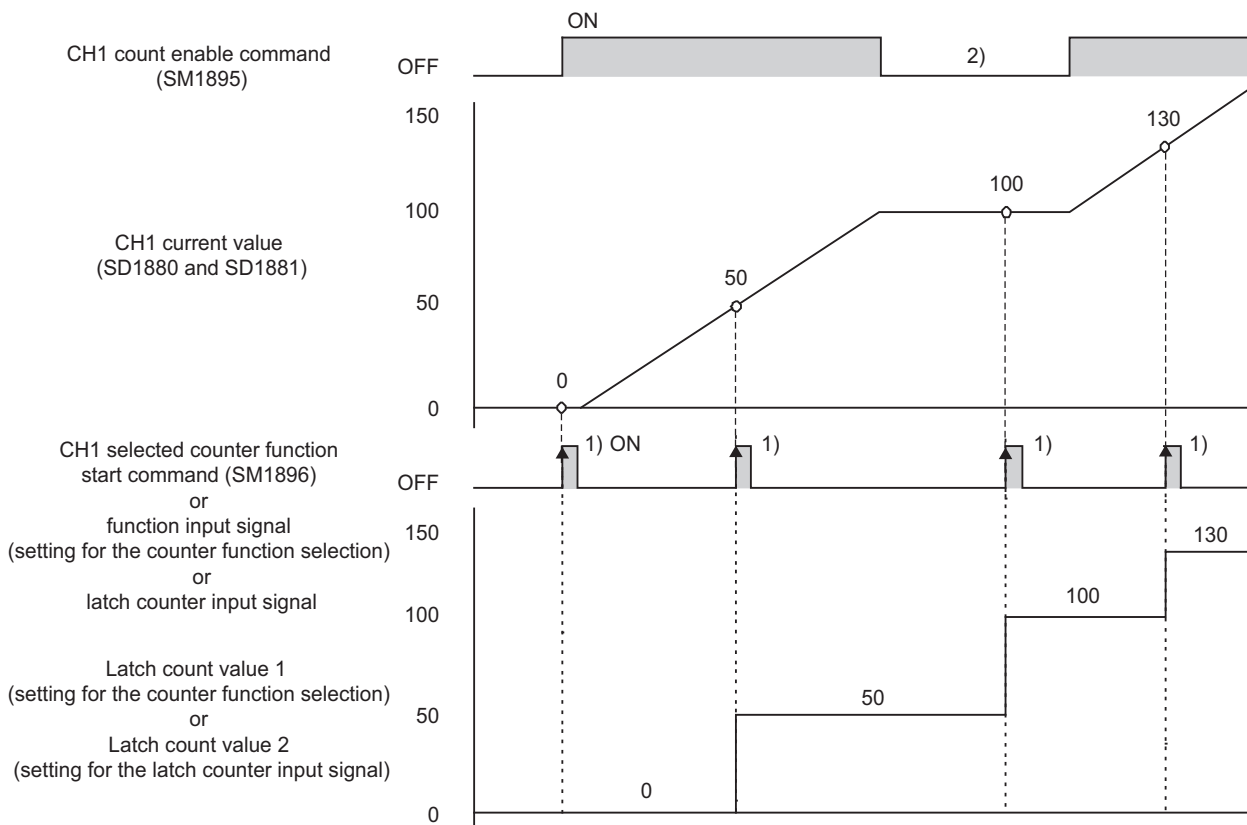

Number	Description
1)	<ul style="list-style-type: none"> • Using "Counter Function Selection": CH1 current value (SD1880 or SD1881) is stored in the latch count value 1 area on the rising edge of CH1 selected counter function start command (SM1896) or the Function input signal. The latch count value 1 can be read out into the specified device by the Latch counter value read instruction (ICLTHRD1(P)). • Using the Latch counter input signal: CH1 current value (SD1880 or SD1881) is stored in the latch count value 2 area on the rising edge of the Latch counter input signal. The latch count value 2 can be also read out into the specified device by the Latch counter value read instruction (ICLTHRD1(P)).
2)	The latch counter function can be performed regardless of the status of CH1 count enable command (SM1895).

• Precautions

- When the latch counter function is performed by the Function input signal or the Latch counter input signal, the actual execution delays by the input response time. Updating latch count value 1 or 2 will cause a further 1ms delay in the updating cycle.
- While either of CH1 selected counter function start command (SM1896) or the Function input signal is on, turning on the other does not latch the counter.

(b) Count disabling function

Counting can be stopped while CH1 count enable command (SM1895) is on. To use this function, select "Count Disabling Function" for "Counter Function Selection."

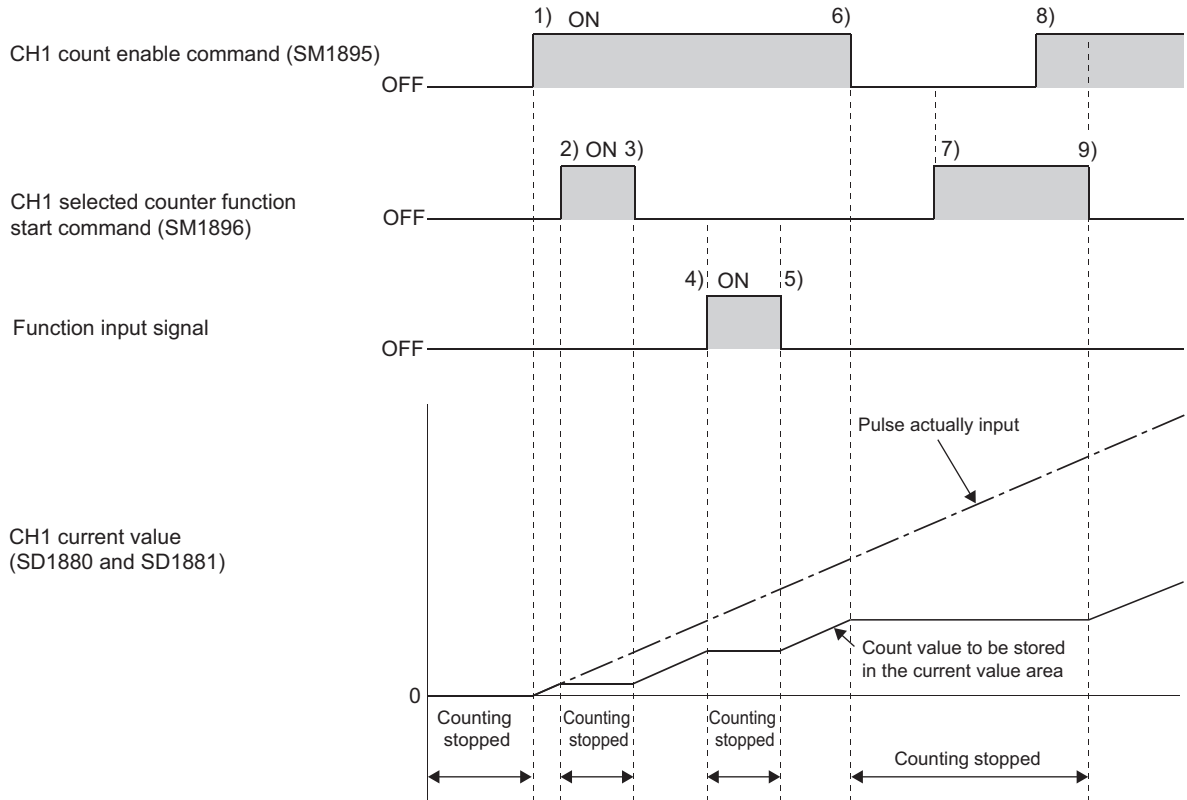

Number	Description
1)	Counting starts when CH1 count enable command (SM1895) turns on.
2)	Counting stops when CH1 selected counter function start command (SM1896) turns on.
3)	Counting restarts when CH1 selected counter function start command (SM1896) turns off.
4)	Counting stops when the Function input signal turns on.
5)	Counting restarts when the Function input signal turns off.
6)	Counting stops when CH1 count enable command (SM1895) is turned off.
7)	Because CH1 count enable command (SM1895) is off, counting stops regardless of CH1 selected counter function start command.
8)	Even though CH1 count enable command (SM1895) is turned on, counting remains stopped because CH1 selected counter function start command (SM1896) is on.
9)	Counting restarts when CH1 selected counter function start command (SM1896) turns off.

(c) Sampling counter function

The pulses input during the specified sampling time (Sampling Time Setting (☞ Page 216, Section 8.4.4 (1) (b))) can be counted. The sampling count value can be read out into the specified device by the Sampling count value read instruction (ICSMPRD1(P)). (☞ Page 252, Section 8.10.1 (5))

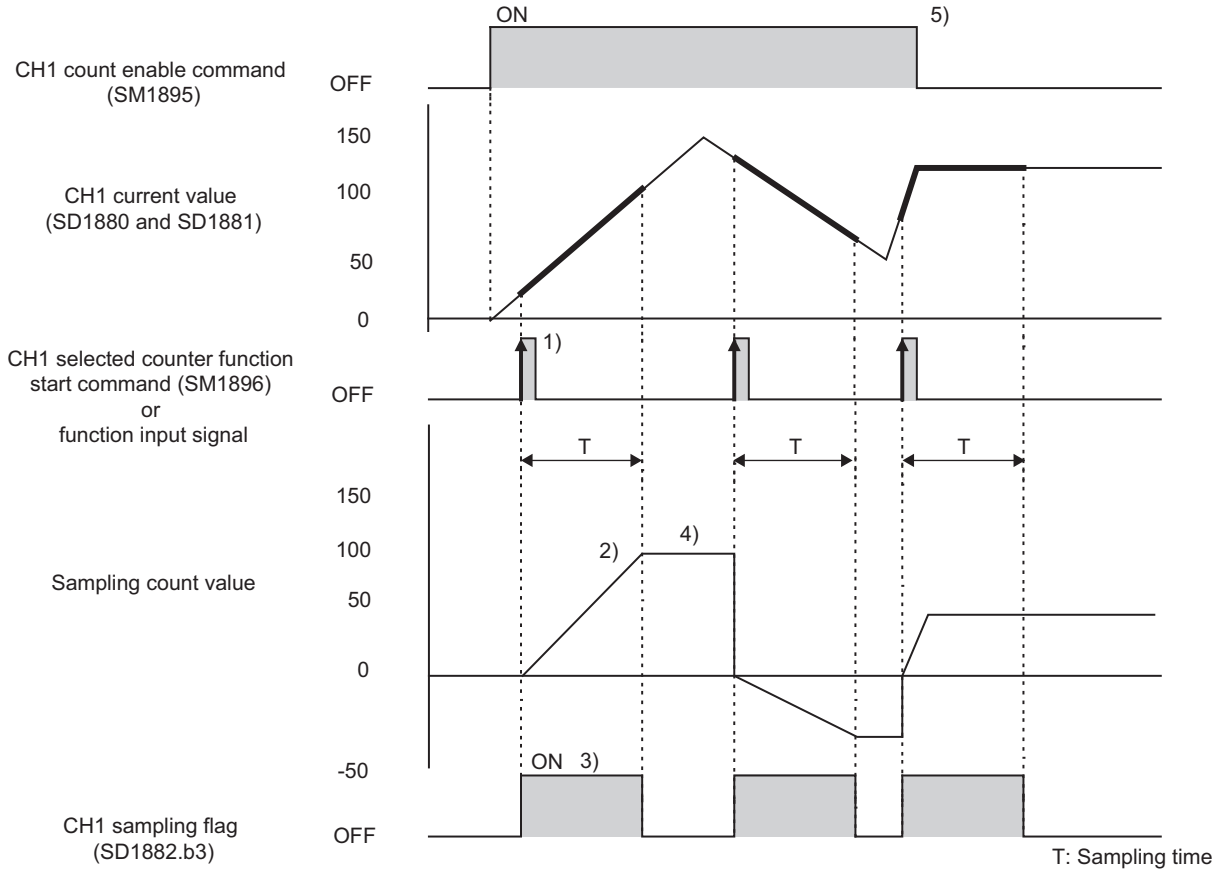

Number	Description
1)	Counting of the input pulses starts from 0 on the rising edge of CH1 selected counter function start command (SM1896) or the Function input signal.
2)	Counting stops when the specified sampling time has elapsed.
3)	During execution of the sampling counter function, Sampling flag (SD1882, b3) is set to 1 (Operating).
4)	Even after termination of the sampling counter function, the sampling count value is retained. The sampling count value can be read out into the specified device by the Sampling count value read instruction (ICSMPRD1(P)).
5)	The sampling counter function can be performed regardless of the status of CH1 count enable command (SM1895).

- Precautions
 - While either of CH1 selected counter function start command (SM1896) or the Function input signal is on, turning on the other does not perform the sampling counter function. If CH1 selected counter function start command (SM1896) or the Function input signal is turned on during execution of the sampling counter function, the sampling time measurement will continue. However, the pulses will be counted from 0.
 - If "Internal Clock (0.1 μ s)" is selected for Count Source Selection and 21475 or more is set for Sampling Time Setting, the sampling count value may exceed the maximum (2147483647). In that case, the sampling count value is fixed to the maximum (2147483647), and "Sampling count value overflow" (CH1 warning code: 3050) is detected. Even after occurrence of this warning, execution of the sampling counter function continues until the sampling time has elapsed.
 - The immediately preceding operation of the sampling counter function continues even after status change from STOP to RUN. Therefore, if the sampling time setting is changed by changing the status from STOP to RUN during execution of the sampling counter function, the change takes effect the next time the sampling counter function is performed.

(d) Count disable/preset/replace function

The count disable function and the preset function can be performed depending on changes of the Function input signal without switching the function.

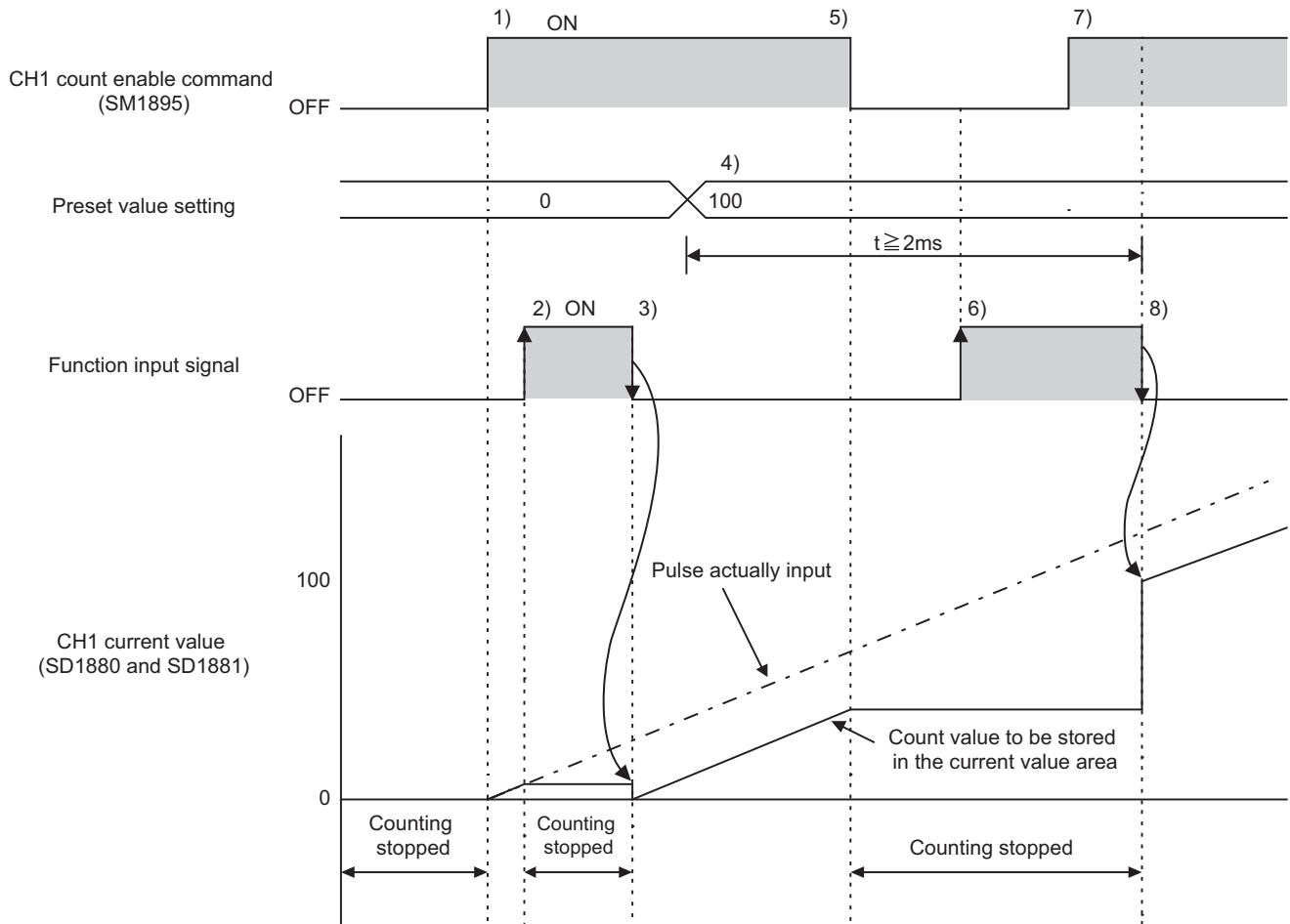

Number	Description
1)	Counting starts when CH1 count enable command (SM1895) is turned on.
2)	Counting stops on the rising edge of the Function input signal.
3)	On the falling edge of the Function input signal, the preset value setting is stored in CH1 current value (SD1880, SD1881), and counting is restarted.
4)	When the Preset value write instruction (ICPREWR1(P)) is executed, a set value is overwritten to the preset value setting.
5)	Counting stops when CH1 count enable command (SM1895) turns off.
6)	Because CH1 count enable command (SM1895) is off, counting stops regardless of the Function input signal.
7)	Even though CH1 count enable command (SM1895) is turned on, counting remains stopped because the Function input signal is on.
8)	On the falling edge of the Function input signal, the preset value setting is stored in CH1 current value (SD1880, SD1881), and counting is restarted.

Point!

The explanation in this section is based on the case where the Function Input Logic Setting is set to Positive Logic (default). The execution timing of the count disable function and the preset function in the case of Negative Logic setting is as shown below.



- Precautions

- The preset function is not available if CH1 external preset (phase Z) request detection (SM1886) is on. (Only the count disable function is executable.) In this case, turn off this relay by turning on CH1 external preset (phase Z) request detection reset command (SM1897).
- Provide a 2ms or more interval between the execution command establishment of the Preset value write instruction (ICPREWR1(P)) and replacement with the preset value. If not, a preset value setting before change may be stored in CH1 current value (SD1880 or SD1881).

(e) Latch counter/preset/replace function

The latch counter function and the preset function can be performed depending on changes of the Function input signal without switching the function.

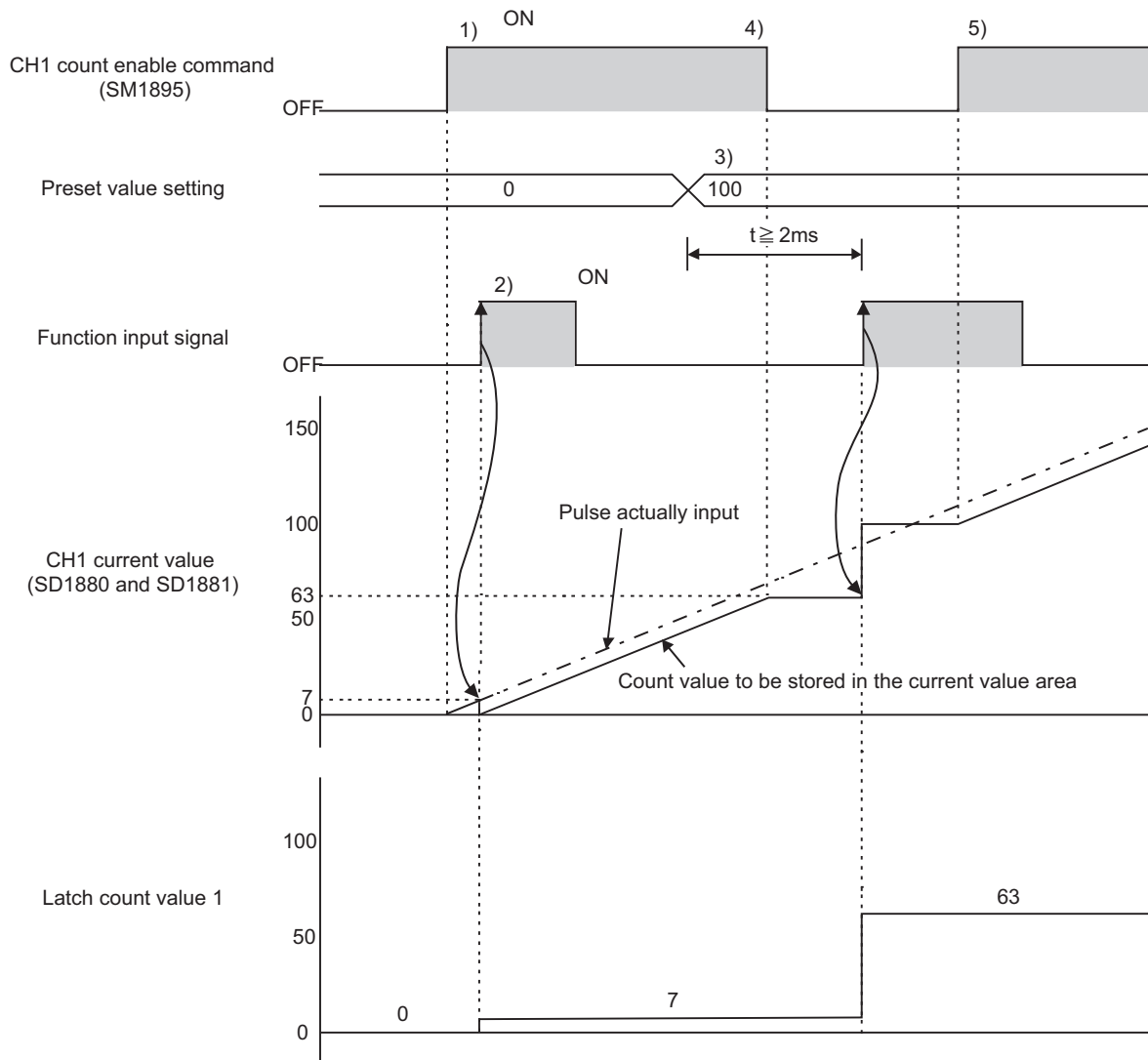

Number	Description
1)	Counting starts when CH1 count enable command (SM1895) is turned on.
2)	On the rising edge of the Function input signal, CH1 current value (SD1880 or SD1881) is stored in the latch count value 1 area. Also, the preset value setting is stored in CH1 current value (SD1880, SD1881). The latch count value 1 can be read out into the specified device by the Latch counter value read instruction (ICLTHRD1(P)).
3)	When the Preset value write instruction (ICPREWR1(P)) is executed, a given value is written as a preset value setting.
4)	Counting stops when CH1 count enable command (SM1895) is turned off.
5)	Counting restarts when CH1 count enable command (SM1895) is turned on.

- Precautions
 - The preset function is not available if CH1 external preset (phase Z) request detection (SM1886) is on. (Only the latch counter function is available.) In this case, turn off this relay by turning on CH1 external preset (phase Z) request detection reset command (SM1897).
 - Provide a 2ms or more interval between the execution command establishment of the Preset value write instruction (ICPREWR1(P)) and replacement with the preset value. If not, the value of the preset value setting before change may be stored in CH1 current value (SD1880, SD1881).

8.5 Frequency Measurement Mode

This section describes settings and functions that become valid when "Frequency Measurement Mode" is selected for "Operation Mode Setting". In this mode, the pulses input from phase A and phase B pulse input signals are counted, and the frequency is automatically calculated from the pulses. The measured frequency value is written to the specified device using the Frequency measurement instruction (ICFCNT1). (☞ Page 246, Section 8.10.1 (1)) The following table shows I/O signals used in this mode.

○: Wiring required, —: Wiring not required

Count source		Input signal				Output signal		
		Phase A	Phase B	Phase Z	Function input signal	Latch counter input signal	Coincidence output No.1 signal	Coincidence output No.2 signal
A Phase/ B Phase	1-Phase Multiple of 1 (A Phase Only)	○	—*1	—*2	—*2	—*2	—*2	—*2
	1-Phase Multiple of 2 (A Phase Only)							
	1-Phase Multiple of 1							
	1-Phase Multiple of 2							
	CW/CCW							
	2-Phase Multiple of 1		○					
	2-Phase Multiple of 2							
	2-Phase Multiple of 4							

*1 The input signal can be used for other functions such as the general-purpose input except the interrupt input.

*2 The signals can be used for other functions such as the general-purpose input and output.

Note that the explanations in this section assume use of CH1. For the special relay, special register, and dedicated instructions for CH2, refer to the following.

- Special relay and special register: ☞ Page 244, Section 8.9 (2)
- Dedicated instructions: ☞ Page 245, Section 8.10

(1) Required settings

(a) Frequency movement averaging processing count

The frequency measurement function performs moving average processing to reduce the unevenness among the measured frequencies. The setting range is 1 to 100 (times). When "1" is set, the processing is not performed. After frequencies are measured for the number of times set to the frequency movement averaging processing count, the average is stored as a measured frequency value.

(b) Frequency measurement unit time setting

Select a pulse measurement time to calculate frequencies from 0.01s, 0.1s, and 1s. The frequencies are calculated using the following formula.

$$\text{Frequency (Hz)} = \frac{\text{Count value per unit time}}{\text{Frequency measurement unit time setting (S)}}$$

When the count per time unit is 0, the frequency becomes 0. When counting down, the frequency becomes a negative value.

(2) Relationship between frequency measurement unit time and frequency

Frequency is calculated from the count value per time unit. (☞ Page 226, Section 8.5 (1) (b)) The following table shows the unit of frequency for each frequency measurement unit time setting when the frequency movement averaging processing count is set to "1". Select an appropriate unit time according to the time and frequency to be measured.

Frequency measurement unit time	Unit of frequency
1s	1Hz
0.1s	10Hz
0.01s	100Hz

(3) Frequency error

Frequency error (maximum) can be calculated using the following formula.

$$\text{Error (maximum) (Hz)} = \text{Actual frequency (Hz)} \times \frac{60(\text{ppm})}{1000000} + \frac{1}{\text{frequency measurement unit time (s)} \times \text{number of frequency moving averages}}$$

Setting larger values for the following items helps reduce error and unevenness among the measured frequencies.

- Frequency measurement unit time
- Frequency movement averaging processing count

(4) Measurement example

In this example, frequency is measured under the following conditions.

- Actual frequency: 1234Hz
- Frequency measurement unit time: 0.01s
- Frequency movement averaging processing count: 1 (The moving average processing is not performed.)

(a) Count value per time unit

Count value per time unit for the actual frequency is calculated as follows using the formula in  Page 226, Section 8.5 (1) (b).

$$1234(\text{Hz}) = \frac{\text{Count value per unit time}}{0.01(\text{s})}$$

$$\text{Count value per unit time} = 12.34$$

The count value should be an integer. For this reason, the count value in this example is 12 or 13 because the numbers after the decimal point is accumulated within the module. When this count value is used in the formula above, the following result can be acquired.

$$\text{Frequency measurement value (Hz)} = \frac{12 \text{ or } 13}{0.01(\text{s})}$$

$$\text{Frequency measurement value (Hz)} = 1200(\text{Hz}) \text{ or } 1300(\text{Hz})$$

(b) Calculating frequency error (maximum)

$$\begin{aligned} \text{Error (maximum) (Hz)} &= 1234(\text{Hz}) \times \frac{60(\text{ppm})}{1000000} + \frac{1}{0.01(\text{s}) \times 1} \\ &= 0.07404(\text{Hz}) + 100(\text{Hz}) \\ &= 100.07404(\text{Hz}) \end{aligned}$$

(c) Reducing unevenness

When the frequency movement averaging processing count setting is changed to "4", frequency error (maximum) will be as follows.

$$\begin{aligned} \text{Error (maximum) (Hz)} &= 1234(\text{Hz}) \times \frac{60(\text{ppm})}{1000000} + \frac{1}{0.01(\text{s}) \times 4} \\ &= 0.07404(\text{Hz}) + 25(\text{Hz}) \\ &= 25.07404(\text{Hz}) \end{aligned}$$

The measured frequency value in this example is 1225Hz or 1250Hz.

Accumulated count value per time unit	Measured frequency value	Measured frequency value obtained by moving average processing (4 times)
12.34	1200Hz	–
24.68	1200Hz	–
37.02	1300Hz	–
49.36	1200Hz	1225Hz
61.70	1200Hz	1225Hz
74.04	1300Hz	1250Hz
86.38	1200Hz	1225Hz
98.72	1200Hz	1225Hz
111.06	1300Hz	1250Hz
...

As shown in the table above, the measured frequency value obtained by moving average processing is closer to the actual frequency value. The following table shows the measurement result for each frequency measurement unit time setting.

Frequency measurement unit time	Measured frequency value	Measured frequency value obtained by moving average processing (4 times)
1s	1234Hz	1234Hz
0.1s	1230 or 1240Hz	1233 or 1235Hz
0.01s	1200 or 1300Hz	1225 or 1250Hz

Point

Even when the pulse input mode is set to "1-Phase Multiple of 2", "1-Phase Multiple of 2 (A Phase Only)", "2-Phase Multiple of 2", or "2-Phase Multiple of 4", frequency (Hz) is calculated based on the count value per time unit.

Ex. When the pulse input mode is set to "1-Phase Multiple of 2", the measured frequency value is 20kHz. This is because even when the input frequency of phase A is 10kHz (10000 pulses per second), the pulse count is 20000 pulses per second (10000 pulse × 2).

(5) Description

The following example describes the frequency measurement operation.

Ex. Operation when the frequency measurement unit time is set to "0.1s" and the frequency movement averaging processing count is set to "4".

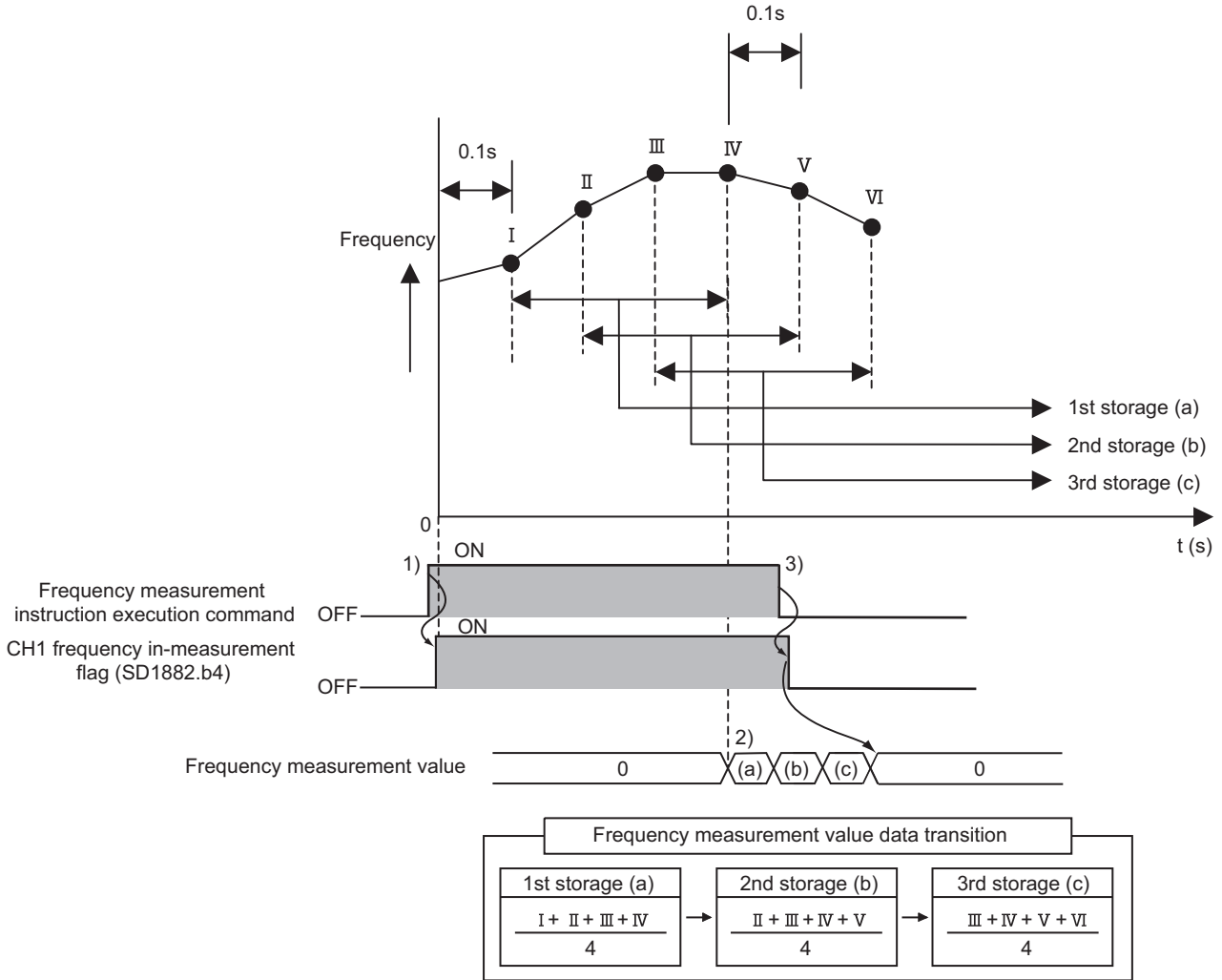

Number	Description
1)	Turning on the execution command for Frequency measurement instruction (ICFCNT1) starts the following operations: <ul style="list-style-type: none"> • Measurement of the frequency • CH1 Frequency measurement flag (SD1882. b4) changes from stopped (0) to operating (1).
2)	While processing the execution command for Frequency measurement instruction(ICFCNT1), a measured frequency value is written to the device specified by the Frequency measurement instruction(ICFCNT1). As the frequency moving average processing count is set as 4 times, an average of the 4 counts is written.
3)	Turning off the execution command for Frequency measurement instruction (ICFCNT1) starts the following operations: <ul style="list-style-type: none"> • Measurement of the frequency stops. • CH1 Frequency measurement flag (SD1882. b4) changes from operating (1) to stopped (0). • The measured frequency value becomes 0. (The frequency is not stored as the setting data of Frequency measurement instruction (ICFCNT1).)

(a) Precautions

To restart frequency measurement after an interruption, execute Frequency measurement instruction (ICFCNT1) after "stopped (0)" is stored in CH1 Frequency measurement flag (SD1882. b4). If another execution command of CH1 Frequency measurement instruction (ICFCNT1) is turned on, failing to check Frequency measurement flag (SD1882. b4), while the measurement is being executed, the command may be ignored because the current measurement does not stop.

8.6 Rotation Speed Measurement Mode

This section describes settings and functions that become valid when "Rotation Speed Measurement Mode" is selected for "Operation Mode Setting". In this mode, the pulses input phase A and phase B pulse input signals are counted, and the rotation speed is automatically calculated from the pulses. The measured rotation speed value is written to the specified device using the Rotation speed measurement instruction (ICRCNT1). (☞ Page 257, Section 8.10.1 (8)) The following table shows I/O signals used in this mode.

○: Wiring required, —: Wiring not required

Count source		Input signal				Output signal		
		Phase A	Phase B	Phase Z	Function input signal	Latch counter input signal	Coincidence output No.1 signal	Coincidence output No.2 signal
A Phase/ B Phase	1-Phase Multiple of 1 (A Phase Only)	○	—*1	—*2	—*2	—*2	—*2	—*2
	1-Phase Multiple of 2 (A Phase Only)							
	1-Phase Multiple of 1	○		—*2	—*2	—*2	—*2	—*2
	1-Phase Multiple of 2							
	CW/CCW							
	2-Phase Multiple of 1		○					
	2-Phase Multiple of 2							
	2-Phase Multiple of 4							

*1 The input signal can be used for other functions such as the general-purpose input except the interrupt input.

*2 The signals can be used for other functions such as the general-purpose input and output.

Note that the explanations in this section assume use of CH1. For the special register, and dedicated instructions for CH2, refer to the following.

- Special register: ☞ Page 244, Section 8.9 (2)
- Dedicated instructions: ☞ Page 245, Section 8.10

(1) Required settings

(a) Rotation speed movement averaging processing count

The rotation speed measurement function performs moving average processing to reduce the unevenness among the measured rotation speed. The setting range is 1 to 100. When "1" is set, the processing is not performed.

(b) Rotation speed measurement unit time setting

Select a pulse measurement unit time to calculate rotation speeds from 0.01s, 0.1s, and 1s. The rotation speeds are calculated using the following formula.

$$\text{Rotation speed (r/min)} = \frac{60 \times \text{count value per unit time}}{\text{Rotation speed measurement unit time setting (S)} \times \text{number of pulses per revolution(pulse)}}$$

When the count per time unit is 0, the rotation speed becomes 0. When counting down, the rotation speed becomes a minus value.

(c) Number of pulses per rotation (pulse)

Set the number of pulses per rotation.

- Setting range 1 to 200000 (pulse)

(2) Relationship between rotation speed measurement unit time and rotation speed

Rotation speed is calculated from the count value per time unit. (☞ Page 232, Section 8.6 (1) (b)) The following table shows the unit of pulse speed for each rotation speed measurement unit time setting when the rotation speed movement averaging processing count is set to "1". Select an appropriate unit time according to the time and rotation speed to be measured.

Rotation speed measurement unit time	Unit of pulse speed
1s	1pulse/s
0.1s	10pulse/s
0.01s	100pulse/s

(3) Rotation speed error

Rotation speed error (maximum) can be calculated using the following formula.

$$\text{Error (maximum) (r/min)} = \text{Actual rotation speed (r/min)} \times \frac{60(\text{ppm})}{1000000} + \frac{60}{\text{rotation speed measurement unit time (s)} \times \text{number of rotation speed moving averages} \times \text{number of pulses per revolution (pulse)}}$$

Setting larger values for the following items helps reduce error and unevenness among the measured rotation speeds.

- Rotation speed measurement unit time
- Rotation speed movement averaging processing count
- Number of pulses per rotation (pulse)

(4) Measurement example

In this example, rotation speed is measured under the following conditions.

- Actual rotation speed: 1234r/min
- Rotation speed measurement unit time: 0.01s
- Rotation speed movement averaging processing count: 1 (The moving average processing is not performed.)
- Number of pulses per rotation (pulse): 60pulses

(a) Count value per time unit

Count value per time unit for the actual rotation speed is calculated as follows using the formula in  Page 232, Section 8.6 (1) (b).

$$1234(\text{r/min}) = \frac{60 \times \text{Count value per unit time}}{0.01(\text{s}) \times 60(\text{pulse})}$$

$$\text{Count value per unit time} = 12.34$$

The count value should be an integer. For this reason, the count value in this example is 12 or 13 because the numbers after the decimal point is accumulated within the module. When this count value is used in the formula above, the following result can be acquired.

$$\text{Rotation speed measurement value (r/min)} = \frac{60 \times (12 \text{ or } 13)}{0.01(\text{s}) \times 60(\text{pulse})}$$

$$\text{Rotation speed measurement value (r/min)} = 1200(\text{r/min}) \text{ or } 1300(\text{r/min})$$

(b) Calculating rotation speed error (maximum)

$$\begin{aligned} \text{Error (maximum) (r/min)} &= 1234(\text{r/min}) \times \frac{60(\text{ppm})}{1000000} + \frac{60}{0.01(\text{s}) \times 1 \times 60(\text{pulse})} \\ &= 0.07404(\text{r/min}) + 100(\text{r/min}) \\ &= 100.07404(\text{r/min}) \end{aligned}$$

(c) Reducing unevenness

When the rotation speed movement averaging processing count setting is changed to "4", rotation speed error (maximum) will be as follows.

$$\begin{aligned} \text{Error (maximum) (r/min)} &= 1234(\text{r/min}) \times \frac{60(\text{ppm})}{1000000} + \frac{60}{0.01(\text{s}) \times 4 \times 60(\text{pulse})} \\ &= 0.07404(\text{r/min}) + 25(\text{r/min}) \\ &= 25.07404(\text{r/min}) \end{aligned}$$

The measured rotation speed value in this example is 1225r/min or 1250r/min.

Accumulated count value per time unit	Measured rotation speed value	Measured rotation speed value obtained by moving average processing (4 times)
12.34	1200r/min	-
24.68	1200r/min	-
37.02	1300r/min	-
49.36	1200r/min	1225r/min
61.70	1200r/min	1225r/min
74.04	1300r/min	1250r/min
86.38	1200r/min	1225r/min
98.72	1200r/min	1225r/min
111.06	1300r/min	1250r/min
...

As shown in the table above, the measured rotation speed value obtained by moving average processing is closer to the actual rotation speed value. The following table shows the measurement result for each rotation speed measurement unit time setting.

Rotation speed measurement unit time	Measured rotation speed value	Measured rotation speed value obtained by moving average processing (4 times)
1s	1234r/min	1234r/min
0.1s	1230 to 1240r/min	1233 to 1235r/min
0.01s	1200 to 1300r/min	1225 to 1250r/min

Point 

Even when the pulse input mode is set to "1-Phase Multiple of 2", "1-Phase Multiple of 2 (A Phase Only)", "2-Phase Multiple of 2", or "2-Phase Multiple of 4", rotation speed (r/min) is calculated based on the count value per time unit.

(5) Description

The operation of rotation speed measurement is shown below.

Ex. Operation when the rotation speed measurement unit time is set to "0.1s" and the rotation speed movement averaging processing count is set to "4".

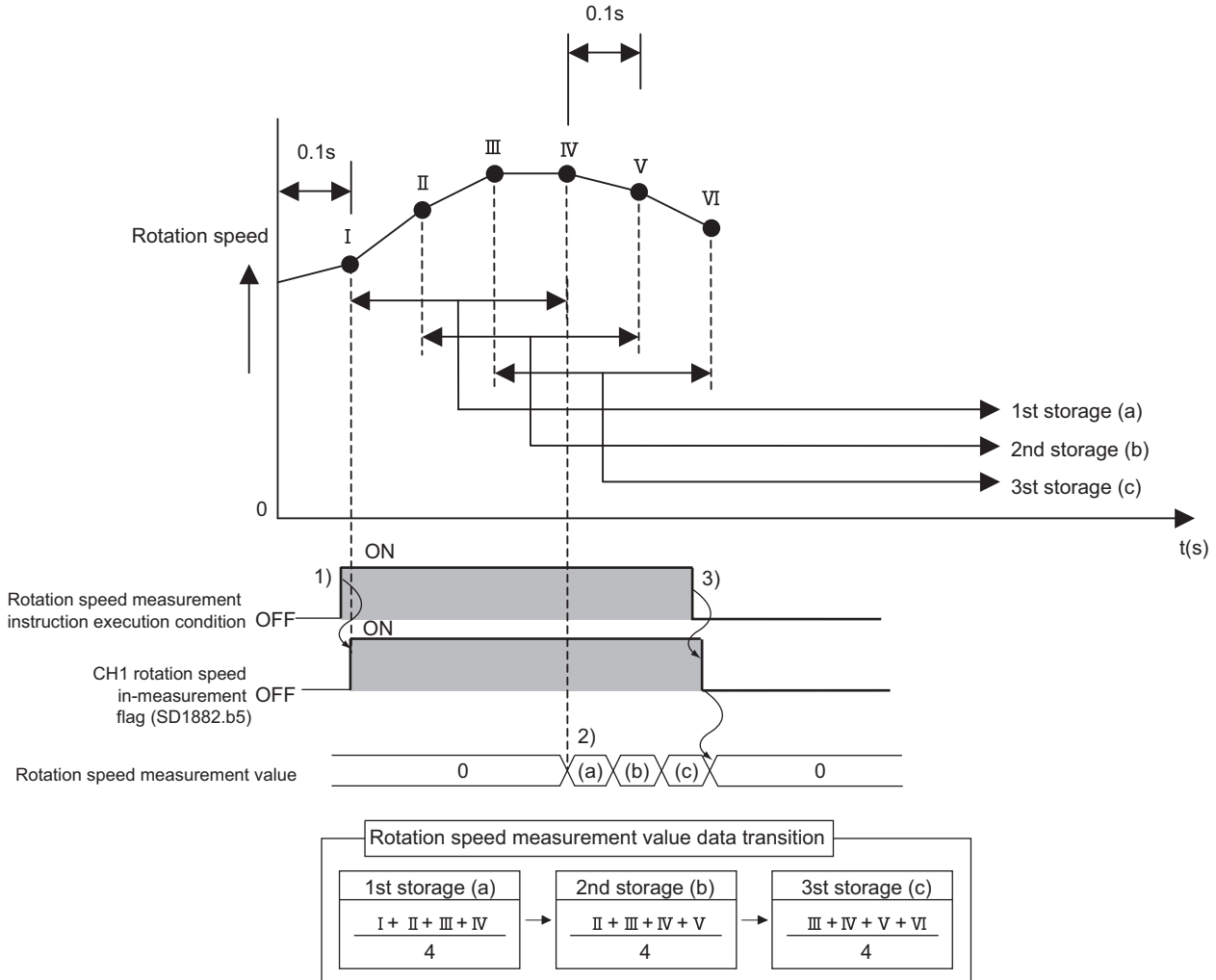

Number	Description
1)	Turning on the execution command for Rotation speed measurement instruction (ICRCNT1) starts the following operations: <ul style="list-style-type: none"> • Measurement of the rotation speed • CH1 Rotation speed in-measurement flag (SD1882.b5) changes from operation stop(0) to operating(1).
2)	While processing the execution command for Rotation speed measurement instruction (ICRCNT1), a measured rotation speed value is written to the device specified by the Rotation speed measurement instruction (ICRCNT1). As the rotation speed moving average processing count is set as 4 times, an average of the 4 counts is saved.
3)	Turning off the execution command for Rotation speed measurement instruction (ICRCNT1) starts the following operations: <ul style="list-style-type: none"> • Measurement of the rotation speed stops • CH1 Rotation speed in-measurement flag (SD1882.b5) changes from operating (1) to operation stop (0). • The measured rotation speed value becomes 0. (The rotation speed is not saved to the setting data of Rotation speed measurement instruction (ICRCNT1).)

(a) Precautions

To restart frequency measurement after an interruption, execute Rotation speed measurement instruction (ICRCNT1) after "stopped (0)" is stored in CH1 Rotation speed in-measurement flag (SD1882.b5). If another execution command of Rotation speed measurement instruction (ICRCNT1) is turned on, failing to check CH2 Rotation speed in-measurement flag (SD1882.b5), while the measurement is being executed, the command may be ignored because the current measurement does not stop.

8.7 Pulse Measurement Mode

This section describes settings and functions that become valid when "Pulse Measurement Mode" is selected for "Operation Mode Setting". In this mode, the on or off width of pulses that are input to Function input signal is measured. The measured pulse value is written to the specified device using the Measured pulse value read instruction (ICPLSRD1(P)). (☞ Page 258, Section 8.10.1 (9)) The following table shows I/O signals used in this mode.

○: Wiring required, —: Wiring not required

Operation mode	Input signal					Output signal	
	Phase A	Phase B	Phase Z	Function input signal	Latch counter input signal	Coincidence output No.1 signal	Coincidence output No.2 signal
Pulse Measurement Mode	_*1	_*1	_*2	○	_*2	_*2	_*2

*1 The input signal can be used for other functions such as the general-purpose input except the interrupt input.

*2 The signals can be used for other functions such as the general-purpose input and output.

Note that the explanations in this section assume use of CH1. For the special relay, special register, dedicated instructions, and error codes for CH2, refer to the following.

- Special relay and special register: ☞ Page 244, Section 8.9 (2)
- Dedicated instructions: ☞ Page 245, Section 8.10
- Error codes: ☞ Page 269, Section 8.12 (1)

(1) Required settings

(a) Pulse measurement target setting

Select a target of pulse measurement from "Pulse ON Width" and "Pulse OFF Width".

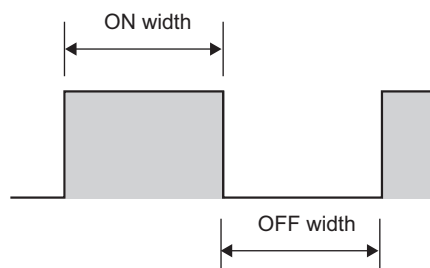

- The range of pulses that can be measured
Pulses can be measured within the range from 2000 to 2147483647 (0.2ms to approx. 214s). If the number of pulses exceeds the range, "Pulse measurement range overflow error" (CH1 error code:3200) occurs. To resume the measurement, perform either of the following operation. Note, however, that these operations do not reset CH1 error code (SD1887), it must be reset by CH1 error reset command (SM1899).
 - Input the pulse measurement target again. (Select on for on width and off for off width).
 - Turn on CH1 pulse measurement start command (SM1898) after turning off the CH1 pulse measurement start command (SM1898) and setting Pulse measurement flag to stopped(0).
- Update intervals of the pulse measurement
Update interval of the pulse measurement is 1ms. If pulses are measured twice or more often within 1ms, only the last measured value is read out to the device by Measured pulse value read instruction (ICPLSRD1(P)).
- Resolution of measured pulse value
The resolution of the measured pulse value varies by the input response time of Function input signal.
(Measured pulse value is the increments of the resolution.)

Input response time	Resolution (0.1 μ s) (time)
0.1ms	50 (5 μ s)
1ms	500 (50 μ s)
5ms	5000 (500 μ s)
10ms	5000 (500 μ s)
20ms	10000 (1000 μ s)
70ms	50000 (5000 μ s)

Point

There is a margin of error for ± 0.1 ms in the measured pulse value, depending on the response time from the standard input circuit.

(2) Description

The following example describes the pulse measurement operation.

Ex. "Pulse ON Width" is selected for "Pulse Measurement Target Setting"

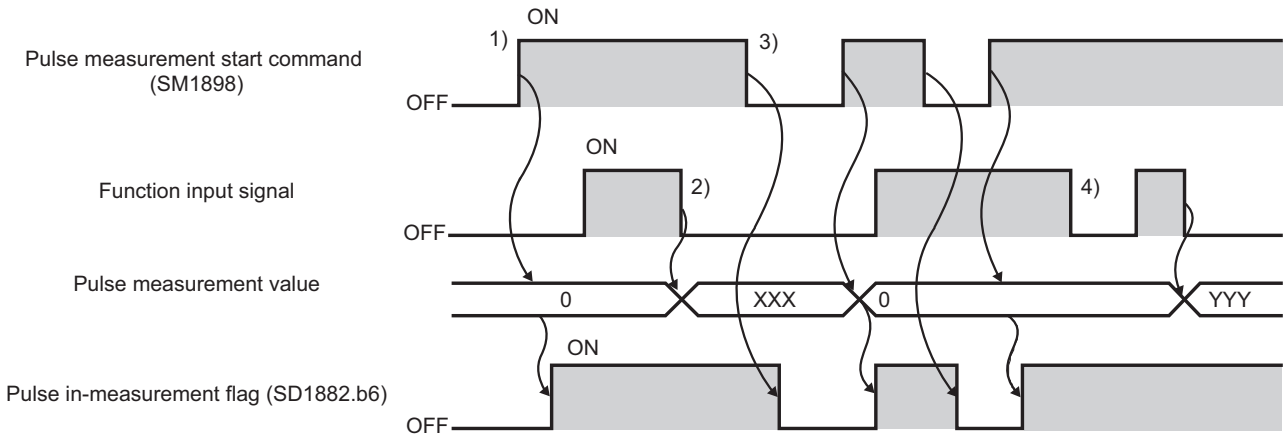

Number	Description
1)	When CH1 Pulse measurement start command turns on, 0 is set as a measured pulse value and then "operating (1)" is stored in CH1 Pulse measurement flag (SD1882.b6).
2)	After completion of the pulse measurement, the measured pulse value can be read to the specified device using Measured pulse value read instruction (ICPLSRD1(P)).
3)	When CH1 Pulse measurement start command is turned off, "stopped (0)" is stored in CH1 Pulse measurement flag (SD1882.b6).
4)	When the pulse measurement target is specified before "operating (1)" is stored in CH1 Pulse measurement flag (SD1882.b6), a measured pulse value will not be updated even if the Function input signal is turned off. Only a value that is specified after "operating (1)" is stored in CH1 Pulse measurement flag (SD1882.b6) can be measured.

Point

Updating of a measured pulse value can be indirectly detected with Function input status (SD1883.b1).

Ex. With "Pulse ON Width" selected for "Pulse Measurement Target Setting", a measured pulse value is stored into D100.

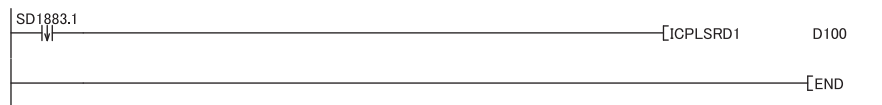

8.8 PWM Output Mode

This section describes settings and functions that become valid when "PWM Output Mode" is selected for "Operation Mode Setting". With this mode, PWM waveforms at a maximum of 200kHz can be output from Coincidence output No.1 signal. (This mode cannot be used for Coincidence output No.2 signal.) Set output waveforms using the PWM output instruction (ICPWM1). (☞ Page 259, Section 8.10.1 (10)) The following table shows I/O signals used in this mode.

○: Wiring required, —: Wiring not required

Operation mode	Input signal					Output signal	
	Phase A	Phase B	Phase Z	Function input signal	Latch counter input signal	Coincidence output No.1 signal	Coincidence output No.2 signal
PWM Output Mode	—*1	—*1	—*2	—*2	—*2	○	—*2

*1 The signals can be used for other functions such as the general-purpose input except the interrupt input.

*2 The signals can be used for other functions such as the general-purpose input and output.

Note that the explanations in this section assume use of CH1. For the special register and dedicated instructions for CH2, refer to the following.

- Special register: ☞ Page 244, Section 8.9 (2)
- Dedicated instructions: ☞ Page 245, Section 8.10

(1) Required settings

(a) Output waveform setting

Store the values of on width and a cycle in the setting data of PWM output instruction (ICPWM1).

Setting item	Setting range	Description
PWM output on width setting value	0 or 10 to 10000000 (0.1μs)	Set the on width of output pulses.
PWM output cycle setting value	50 to 10000000 (0.1μs)	Set a cycle of output pulses.

Set these values so that PWM output on width setting value may be smaller than or equal to PWM output cycle setting value.

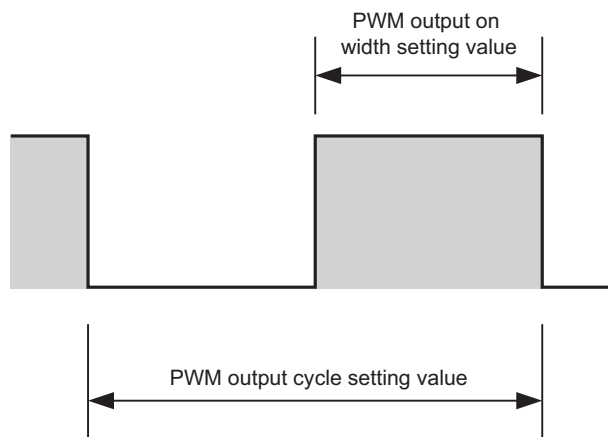

Point

Using a duty ratio^{*1}, PWM output on width can be calculated by the following formula.

$$\text{PWM output on width} = \frac{\text{PWM output cycle} \times \text{Duty ratio (\%)}}{100}$$

*1 A duty ratio refers to the ratio between the on width of signals and cycle.

(2) Description

The operation of PWM output is shown below.

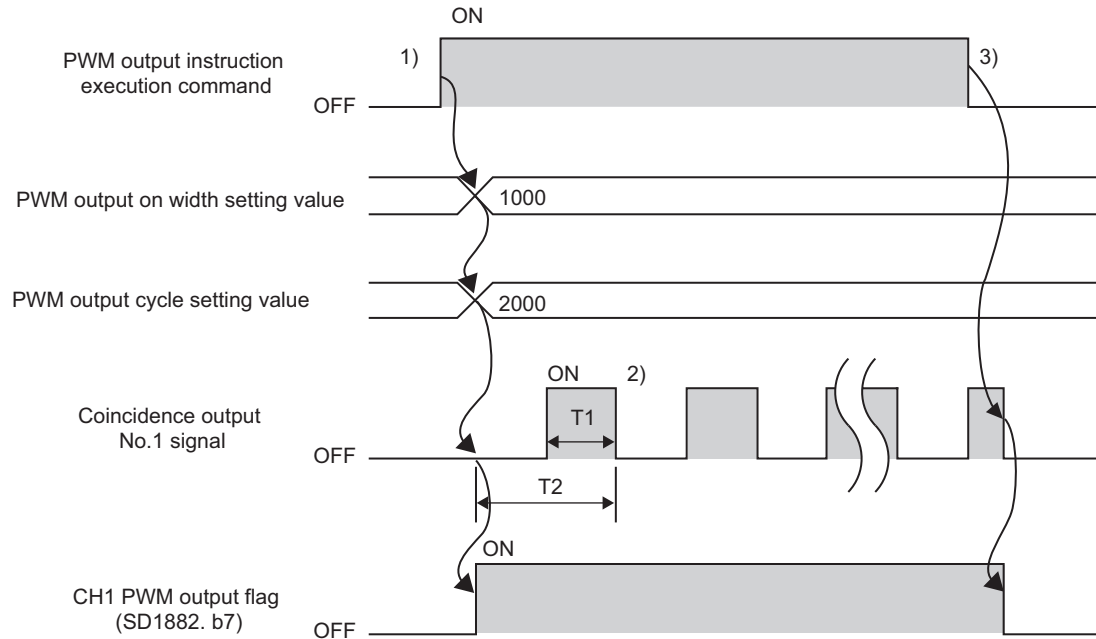

T1: PWM output on width setting value
T2: PWM output cycle setting value

Number	Description
1)	Turning on the PWM output instruction (ICPWM1) execution command starts the following operations. <ul style="list-style-type: none"> The PWM output on width setting value and the PWM output cycle setting value of PWM output instruction (ICPWM1) become valid. (A value changed during PWM output is invalid.) PWM waveforms are output from Coincidence output No.1 signal. (Output is started with the signal off.) CH1 PWM output flag (SD1882. b7) turns from "not operating" (0) to "operating" (1).
2)	While the PWM output instruction (ICPWM1) execution command is established, the output of PWM waveforms is continued.
3)	Turning off the PWM output instruction (ICPWM1) execution command starts the following operations. <ul style="list-style-type: none"> The output of PWM waveforms from Coincidence output No.1 signal is stopped. CH1 PWM output flag (SD1882. b7) turns from "operating" (1) to "not operating" (0).

Point

- Waveforms output from Coincidence output No.1 signal is susceptible to the output circuit of the LCPU and connected devices. When setting output waveforms, observe waveforms with a synchroscope.
- Output of PWM waveforms is started with the signal off.
- Output waveforms can be changed while CH1 PWM output flag (SD1882. b7) is "not operating" (0). When PWM output instruction (ICPWM1) is executed after output waveforms are changed, the waveforms after the change are output.

8.9 Specifications

(1) Performance specifications

The following is the performance specifications of the high-speed counter function.

Item		Description	
		L02SCPU, L02CPU, L06CPU, L26CPU, L26CPU-BT	L02SCPU-P, L02CPU-P, L06CPU-P, L26CPU-P, L26CPU-PBT
Number of channels		2	
Count input signal	Phase		1-phase input (1 multiple/2 multiples) CW/CCW, 2-phase input (1 multiple/2 multiples/4 multiples)
	Signal level	DC input	24VDC, 6.0mA (TYP.)
		Differential input	EIA Standard RS-422-A Differential line driver level (AM26L31(manufactured by Texas Instruments Incorporated) or equivalent)
Counter	Maximum counting speed		200k pulse/s (for 2 multiples of 1 phase and 4 multiples of 2 phases)
	Counting range		-2147483648 to 2147483647
	Model		UP/DOWN preset counter (with ring counter function)
	Minimum count pulse width (Duty ratio 50%)	1 phase	5μs
		2 phases	10μs
Min. phase differential for 2-phase input		5μs	
External input	Phase Z (preset)	DC input	24VDC, 6.0mA (TYP.)
		Differential input	EIA Standard RS-422-A Differential line driver level (AM26L31(manufactured by Texas Instruments Incorporated) or equivalent)
	Function start		24VDC, 4.1mA (TYP.)
	Latch		
Minimum input response time		Phase Z: 10μs Function start, latch: 100μs	
External output	Output type		Sink type Source type
	Output voltage/current	Coincidence output No.1/PWM output	5 to 24VDC, 0.25A ^{*1}
		Coincidence output No.2	5 to 24VDC, 0.1A
	Response time	On	1μs or less (rated load, resistive load)
Off		1μs or less (rated load, resistive load)	
Coincidence output	Comparison range		-2147483648 to 2147483647
	Comparison result		Set value < Counted value Set value = Counted value Set value > Counted value
	Number of output points		2 points/channel
PWM output	Output frequency range		DC to 200kHz
	ON width		1μs
	Duty ratio		On width can be set in increments of 0.1μs.
	Number of output points		1 point/channel
Pulse width measurement	Measurement item		Pulse width (On width: 200μs or more, Off width: 200μs or more)
	Measurement resolution		5μs
	Measurement points		1 point/channel

*1 This applies to the CPU modules whose serial number (first six digits) is "120722" or later. For the CPU modules whose serial number (first six digits) is "120721" or earlier, the specifications will be "5 to 24VDC, 0.1A". For how to check serial numbers, refer to the following.

 MELSEC-L CPU Module User's Manual (Hardware Design, Maintenance and Inspection)

(2) Special relay and special register

The following table lists the special relay (SM) and special register (SD) relevant to the high-speed counter function. □ in the name indicates either of 1 (CH1) or 2 (CH2). For details, refer to the following.

 MELSEC-L CPU Module User's Manual (Hardware Design, Maintenance and Inspection)

Special relay number		Name	Special register number		Name
CH1	CH2		CH1	CH2	
SM1880	SM1900	CH□ counter value greater (No.1)	SD1880	SD1900	CH□ current value
SM1881	SM1901	CH□ counter value coincidence (No.1)	SD1881	SD1901	
SM1882	SM1902	CH□ counter value smaller (No.1)	SD1882	SD1902	CH□ status monitor
SM1883	SM1903	CH□ counter value greater (No.2)	SD1883	SD1903	CH□ external I/O status monitor
SM1884	SM1904	CH□ counter value coincidence (No.2)	SD1884	SD1904	CH□ operation mode monitor
SM1885	SM1905	CH□ counter value smaller (No.2)	SD1885	SD1905	CH□ counter type monitor
SM1886	SM1906	CH□ external preset (phase Z) request detection	SD1886	SD1906	CH□ selected counter function
SM1887	SM1907	CH□ error	SD1887	SD1907	CH□ error code
SM1888	SM1908	CH□ warning	SD1888	SD1908	CH□ warning code
SM1890	SM1910	CH□ coincidence signal No.1 reset command			
SM1891	SM1911	CH□ coincidence signal No.2 reset command			
SM1892	SM1912	CH□ coincidence output enable command			
SM1893	SM1913	CH□ preset command			
SM1894	SM1914	CH□ count down command			
SM1895	SM1915	CH□ count enable command			
SM1896	SM1916	CH□ selected counter function start command			
SM1897	SM1917	CH□ external preset (phase Z) request detection reset command			
SM1898	SM1918	CH□ pulse measurement start command			
SM1899	SM1919	CH□ error reset command			

8.10 Dedicated Instructions

The following table lists and describes dedicated instructions for the high-speed counter function.

Ex. The current value read instruction for CH1 is ICCNTRD1(P) and for CH2 is ICCNTRD2(P).

Instruction		Description	Reference
CH1	CH2		
ICCNTRD1(P)	ICCNTRD2(P)	Stores the current counter value in the special register.	Page 246, Section 8.10.1 (1)
ICRNGWR1(P)	ICRNGWR2(P)	Sets the upper limit value and lower limit value of a ring counter.	Page 247, Section 8.10.1 (2)
ICPREWR1(P)	ICPREWR2(P)	Sets a preset value (a value to replace another).	Page 249, Section 8.10.1 (3)
ICLTHRD1(P)	ICLTHRD2(P)	Stores a latch counter value.	Page 250, Section 8.10.1 (4)
ICSMPRD1(P)	ICSMPRD2(P)	Stores a sampling count value.	Page 252, Section 8.10.1 (5)
ICCOVWR1(P)	ICCOVWR2(P)	Sets a coincidence output No.n point.	Page 254, Section 8.10.1 (6)
ICFCNT1	ICFCNT2	Measures frequency.	Page 246, Section 8.10.1 (1)
ICRCNT1	ICRCNT2	Measures rotation speed.	Page 257, Section 8.10.1 (8)
ICPLSRD1(P)	ICPLSRD2(P)	Stores a measured pulse value.	Page 258, Section 8.10.1 (9)
ICPWM1	ICPWM2	Outputs PWM waveforms.	Page 259, Section 8.10.1 (10)

8.10.1 Details of dedicated instructions

(1) Current value read instructions: ICCNTRD1(P), ICCNTRD2(P)

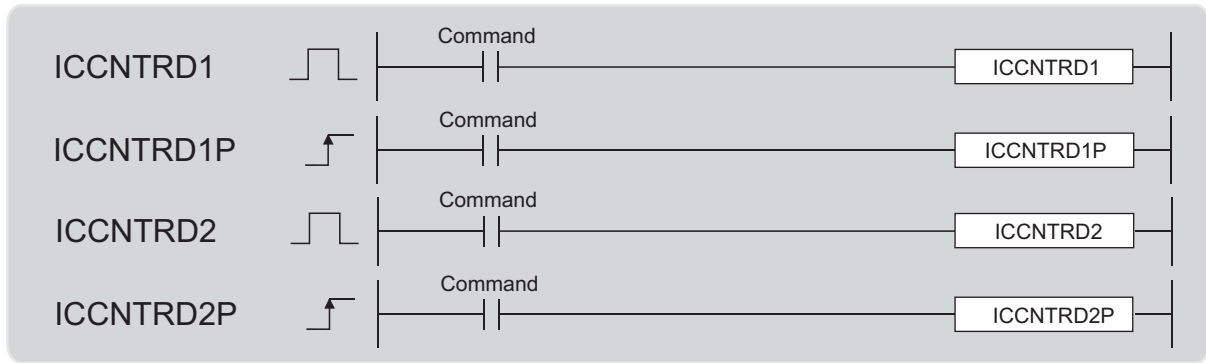

Setting data	Internal device		R, ZR		J□□		U□\G□	Z□	Constant		Others
	Bit	Word	Bit	Word	Bit	Word			K, H	\$	
—	—	—	—	—	—	—	—	—	—	—	—

(a) Setting data

Setting data	Setting item	Setting range	Data type
—	—	—	—

(b) Function

Stores the current counter value in the special register.
The number of steps is basically one.

(c) Error

In the following cases, an operation error occurs. The error flag (SM0) turns on and an error code is stored into SD0.

- Other than "Normal Mode" is selected for "Operation Mode Setting" of the specified channel. (Error code: 4116)
- High-speed counter function of the specified channel is not enabled. (Error code: 4116)

(d) Program example

The latest value is stored into CH1 current value (SD1880, SD1881) when M0 turns on.

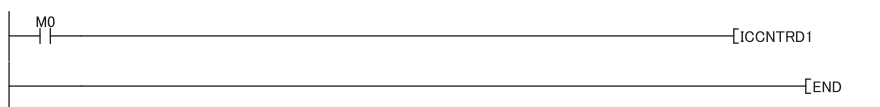

(2) Ring counter upper/lower limit value write instructions: ICRNGWR1(P), ICRNGWR2(P)

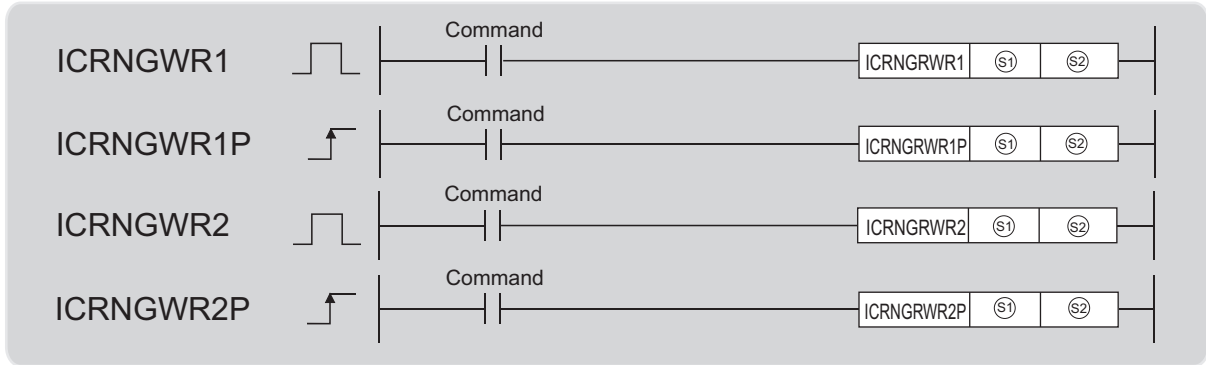

Setting data	Internal device		R, ZR		J□\□		U□\G□	Z□	Constant		Others
	Bit	Word	Bit	Word	Bit	Word			K, H	\$	
S1	—	○	—	○	—	—	—	○	○	—	—
S2	—	○	—	○	—	—	—	○	○	—	—

8

(a) Setting data

Setting data	Setting item	Setting range	Data type
S1	• Start number of the device where a ring counter lower limit value (constant) or a ring counter lower limit value is stored	• Constant: a value within -2147483648 to 2147483647 and is $(S1, S1+1) \leq (S2, S2+1)$ • Device: within the range of the specified device	• Constant: BIN 32-bit • Device: device name
S2	• Ring counter upper limit value (constant) or start number of the device where a ring counter upper limit value is stored		

(b) Function

This instruction sets the upper limit value and lower limit value of a ring counter. The number of steps is basically three.

8.10 Dedicated Instructions
8.10.1 Details of dedicated Instructions

(c) Error

In the following cases, an operation error occurs. The error flag (SM0) turns on and an error code is stored into SD0.

- Ring counter lower limit value is greater than ring counter upper limit value (Error code: 4100)
- The devices specified in (S1) and (S2) are exceeding their range. (Error code: 4101)
- Other than "Normal Mode" is selected for "Operation Mode Setting" of the specified channel. (Error code: 4116)
- Other than "Ring Counter" is selected for "Counter Format" of the specified device. (Error code: 4116)
- High-speed counter function of the specified channel is not enabled. (Error code: 4116)

(d) Program example

100000 is set to a ring counter lower limit value of CH1 and 100000 to a ring counter upper limit value when M0 turns on.

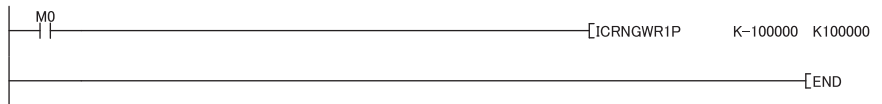

(3) Preset value write instructions: ICPREWR1(P), ICPREWR2(P)

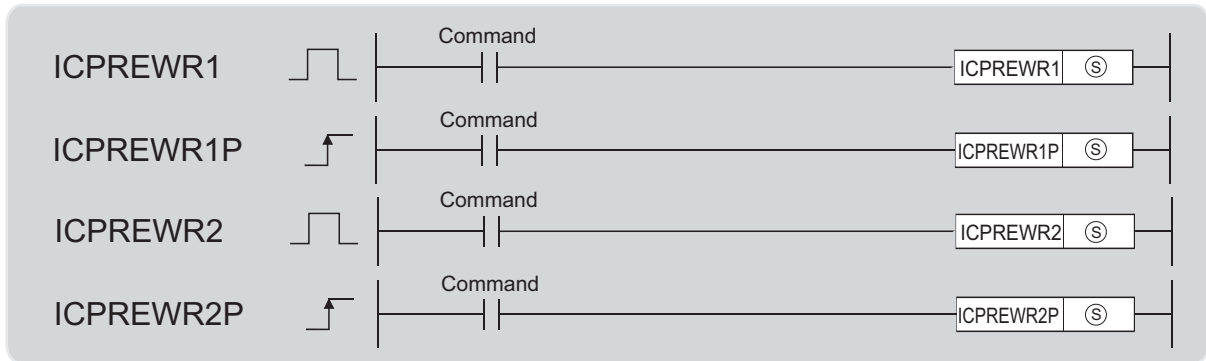

Setting data	Internal device		R, ZR		J□\□		U□\G□	Z□	Constant		Others
	Bit	Word	Bit	Word	Bit	Word			K, H	\$	
Ⓢ	—	○	—	○	—	—	—	○	○	—	—

(a) Setting data

Setting data	Setting item	Setting range	Data type
Ⓢ	<ul style="list-style-type: none"> Preset value setting (constant) Start number of the device where a value to replace is stored 	<ul style="list-style-type: none"> Constant: -2147483648 to 2147483647 Device: within the range of the specified device 	<ul style="list-style-type: none"> Constant: BIN 32-bit Device: device name

(b) Function

This function sets a preset value (a value to replace another).
The number of steps is basically two.

(c) Error

In the following cases, an operation error occurs. The error flag (SM0) turns on and an error code is stored into SD0.

- The device specified in Ⓢ is exceeding its range. (Error code: 4101)
- Other than "Normal Mode" is selected for "Operation Mode Setting" of the specified channel. (Error code: 4116)
- High-speed counter function of the specified channel is not enabled. (Error code: 4116)

(d) Program example

10000 is set as the preset value of CH1 when M0 turns on.

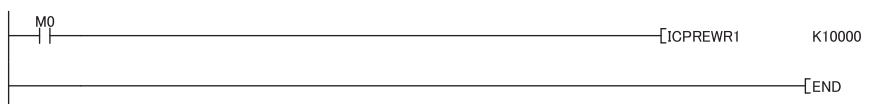

(4) Latch counter value read instructions: ICLTHRD1(P), ICLTHRD2(P)

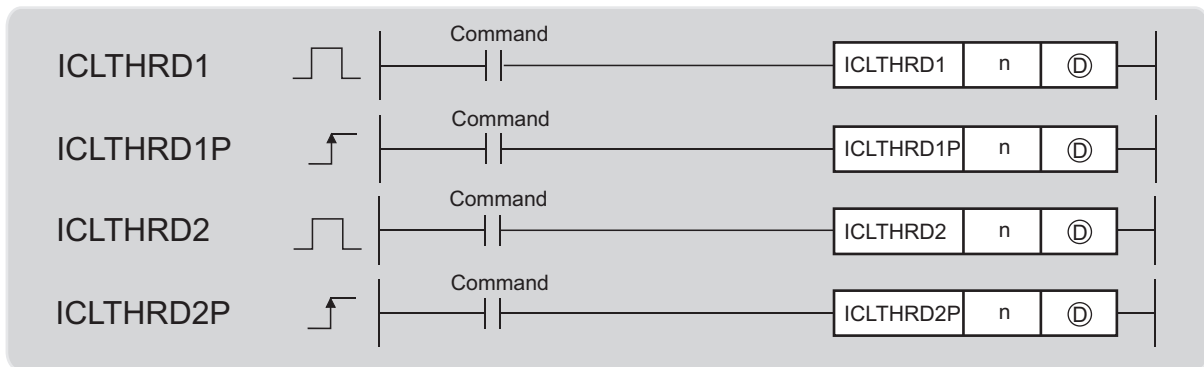

Setting data	Internal device		R, ZR		J□\□		U□\G□	Z□	Constant		Others
	Bit	Word	Bit	Word	Bit	Word			K, H	\$	
n	—	○	—	○	—	—	—	○	○	—	—
Ⓓ	—	○	—	○	—	—	—	○	—	—	—

(a) Setting data

Setting data	Setting item	Setting range	Data type
n	Latch count value number	1, 2	BIN 16-bit
Ⓓ	Start number of the device where a latch count value is stored	Within the range of the specified device	Device name

(b) Function

This instruction stores a latch count value n into Ⓓ and Ⓓ+1.

The number of steps is basically three.

(c) Error

In the following cases, an operation error occurs. The error flag (SM0) turns on and an error code is stored into SD0.

- Other than 1 or 2 is specified to n. (Error code: 4100)
- The device specified in ④ is exceeding its range. (Error code: 4101)
- Inapplicable device is specified in ④. (Error code: 4101)
- While 1 is specified to n, other than "Latch Counter Function" or "Latch Counter/Preset Function" is selected for "Counter Function Selection". (Error code: 4116)
- While 2 is specified to n, other than latch counter input signal is set to external input signals X8 and X9. (Error code: 4116)
- Other than "Normal Mode" is selected for "Operation Mode Setting" of the specified channel. (Error code: 4116)
- High-speed counter function of the specified channel is not enabled. (Error code: 4116)

(d) Program example

The latch count value 1 of CH1 is stored into D100 and D101 when M0 turns on.

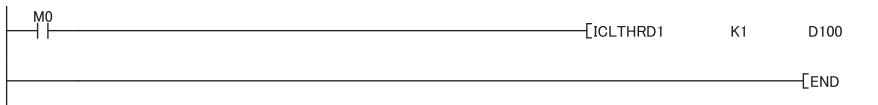

(5) Sampling count value read instructions: ICSMPRD1(P), ICSMPRD2(P)

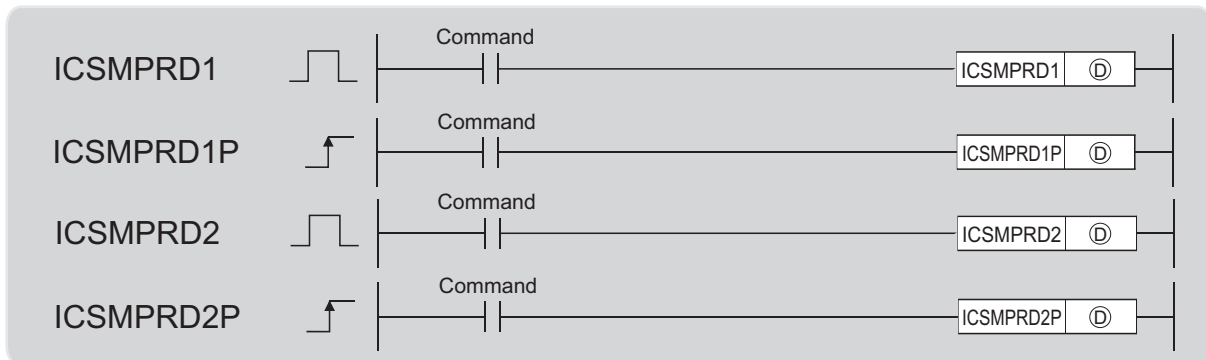

Setting data	Internal device		R, ZR		J□□		U□\G□	Z□	Constant		Others
	Bit	Word	Bit	Word	Bit	Word			K, H	\$	
Ⓓ	—	○	—	○	—	—	—	○	—	—	—

(a) Setting data

Setting data	Setting item	Setting range	Data type
Ⓓ	Start number of the device where a sampling count value setting is stored	Within the range of the specified device	Device name

(b) Function

This instruction stores a sampling count value into Ⓓ and Ⓓ+1.
The number of steps is basically two.

(c) Error

In the following cases, an operation error occurs. The error flag (SM0) turns on and an error code is stored into SD0.

- Inapplicable device is specified in ④. (Error code: 4101)
- The device specified in ④ is exceeding its range. (Error code: 4101)
- Other than "Sampling Counter Function" is selected for "Counter Function Selection" of the specified device. (Error code: 4116)
- Other than "Normal Mode" is selected for "Operation Mode Setting" of the specified channel. (Error code: 4116)
- High-speed counter function of the specified channel is not enabled. (Error code: 4116)

(d) Program example

A sampling count value of CH1 is stored into D100 and D101 when M0 turns on.

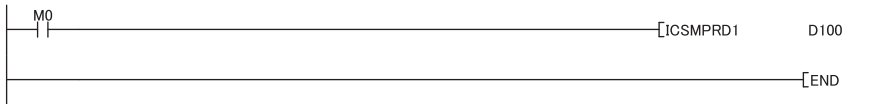

(6) Coincidence output point write instructions: ICCOVWR1(P), ICCOVWR2(P)

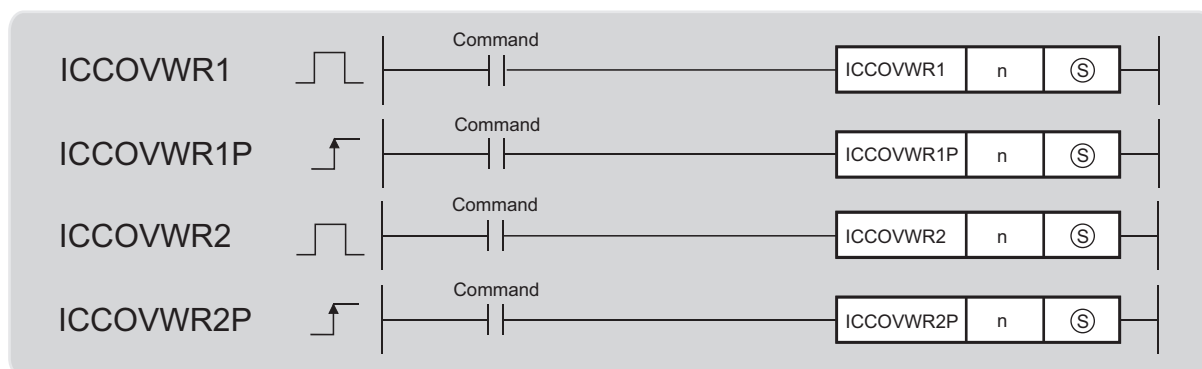

Setting data	Internal device		R, ZR		J□□		U□\G□	Z□	Constant		Others
	Bit	Word	Bit	Word	Bit	Word			K, H	\$	
n	—	○	—	○	—	—	—	○	○	—	—
Ⓢ	—	○	—	○	—	—	—	○	○	—	—

(a) Setting data

Setting data	Setting item	Setting range	Data type
n	Coincidence output No.n point number	1, 2	BIN 16-bit
Ⓢ	<ul style="list-style-type: none"> Coincidence output No.n point setting (constant) Start number of the device where Coincidence output No.n point setting is stored 	<ul style="list-style-type: none"> Constant: -2147483648 to 2147483647 Device: within the range of the specified device 	<ul style="list-style-type: none"> Constant: BIN 32-bit Device: device name

(b) Function

This function sets a coincidence output No.n point.
The number of steps is basically three.

(c) Error

In the following cases, an operation error occurs. The error flag (SM0) turns on and an error code is stored into SD0.

- Other than 1 or 2 is specified to n. (Error code: 4100)
- Inapplicable device is specified in (S). (Error code: 4101)
- The device specified in (S) is exceeding its range. (Error code: 4101)
- Other than "Normal Mode" is selected for "Operation Mode Setting" of the specified channel. (Error code: 4116)
- High-speed counter function of the specified channel is not enabled. (Error code: 4116)

(d) Program example

Values in D100 and D101 are set to coincidence output No.2 point setting of CH1 when M0 turns on.

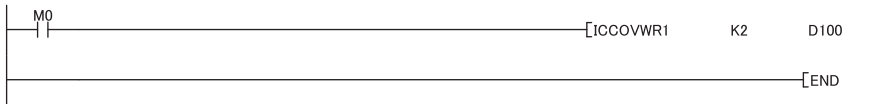

(7) Frequency measurement instructions: ICFCNT1, ICFCNT2

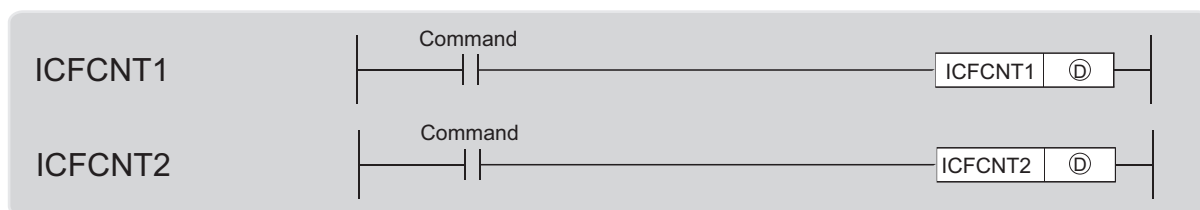

Setting data	Internal device		R, ZR		J□□		U□\G□	Z□	Constant		Others
	Bit	Word	Bit	Word	Bit	Word			K, H	\$	
ⓓ	—	○	—	○	—	—	—	○	—	—	—

(a) Setting data

Setting data	Setting item	Setting range	Data type
ⓓ	Start number of the device where a measured frequency value is stored	Within the range of the specified device	Device name

(b) Function

This instruction measures frequencies according to the value set to "Frequency Measurement Unit Time Setting". When ICFCNT1 is executed, a measured value is stored into ⓓ and ⓓ+1. Frequency measurement starts at rising of the ICFCNT1 execution command and ends at falling. The number of steps is basically two.

(c) Error

In the following cases, an operation error occurs. The error flag (SM0) turns on and an error code is stored into SD0.

- The device specified in ⓓ is exceeding its range. (Error code: 4101)
- Other than "Frequency Measurement Mode" is selected for "Operation Mode Setting" of the specified channel. (Error code: 4116)
- High-speed counter function of the specified channel is not enabled. (Error code: 4116)

(d) Program example

Frequencies are measured at CH1 while M0 is on.

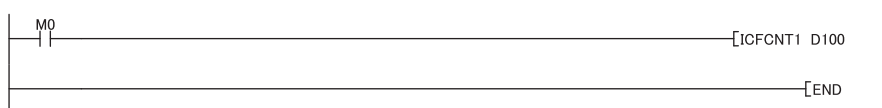

(8) Rotation speed measurement instructions: ICRCNT1, ICRCNT2

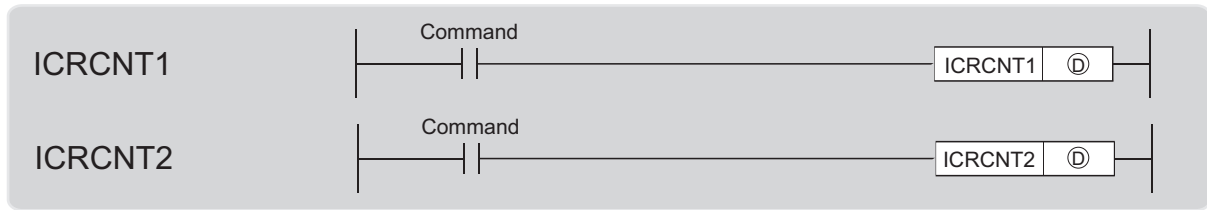

Setting data	Internal device		R, ZR		J□\□		U□\G□	Z□	Constant		Others
	Bit	Word	Bit	Word	Bit	Word			K, H	\$	
Ⓓ	—	○	—	○	—	—	—	○	—	—	—

(a) Setting data

Setting data	Setting item	Setting range	Data type
Ⓓ	Start number of the device where a measured rotation speed value is stored	Within the range of the specified device	Device name

(b) Function

This instruction measures rotation speed according to the value set to "Rotation Speed Measurement Unit Time Setting". When ICRCNT1 is executed, a measured value is stored into Ⓓ and Ⓓ+1. Rotation speed measurement starts at rising of the ICRCNT1 execution command and ends at falling.

The number of steps is basically two.

(c) Error

In the following cases, an operation error occurs. The error flag (SM0) turns on and an error code is stored into SD0.

- The device specified in Ⓓ is exceeding its range. (Error code: 4101)
- Other than "Rotation Speed Measurement Mode" is selected for "Operation Mode Setting" of the specified channel. (Error code: 4116)
- High-speed counter function of the specified channel is not enabled. (Error code: 4116)

(d) Program example

A measured rotation speed value of CH1 is stored into D100 and D101 while M0 is on.

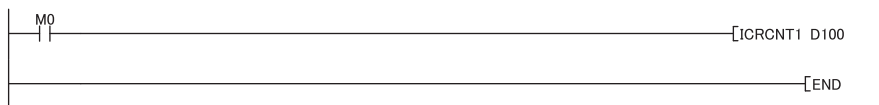

(9) Measured pulse value read instructions: ICPLSRD1(P), ICPLSRD2(P)

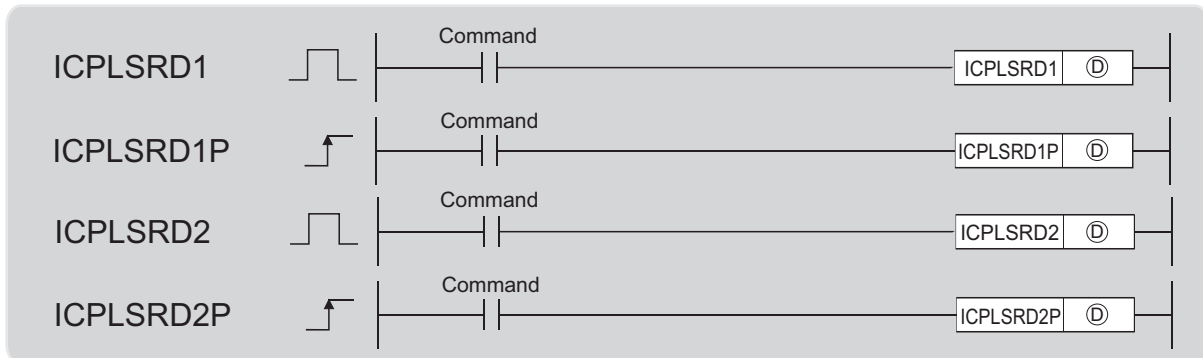

Setting data	Internal device		R, ZR		J□\□		U□\G□	Z□	Constant		Others
	Bit	Word	Bit	Word	Bit	Word			K, H	\$	
Ⓓ	—	○	—	○	—	—	—	○	—	—	—

(a) Setting data

Setting data	Setting item	Setting range	Data type
Ⓓ	Start number of the device where a measured pulse value is stored	Within the range of the specified device	Device name

(b) Function

This instruction stores a measured pulse into Ⓓ and Ⓓ+1.
The number of steps is basically two.

(c) Error

In the following cases, an operation error occurs. The error flag (SM0) turns on and an error code is stored into SD0.

- The device specified in Ⓓ is exceeding its range. (Error code: 4101)
- Other than "Pulse Measurement Mode" is selected for "Operation Mode Setting" of the specified channel. (Error code: 4116)
- High-speed counter function of the specified channel is not enabled. (Error code: 4116)

(d) Program example

A measured pulse value of CH1 is stored into D100 and D101 when M0 turns on.

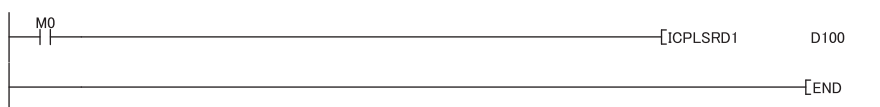

(10)PWM output instructions: ICPWM1, ICPWM2

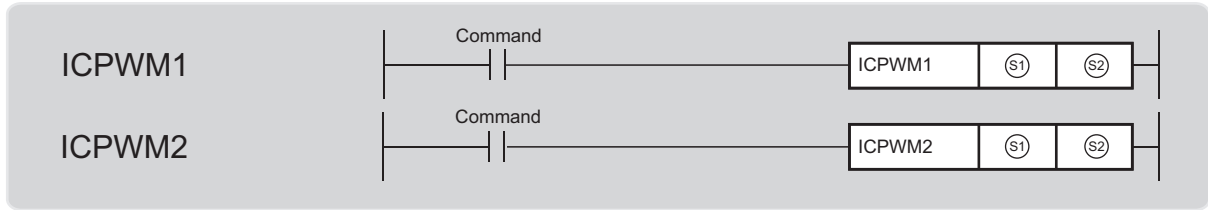

Setting data	Internal device		R, ZR		J□\□		U□\G□	Z□	Constant		Others
	Bit	Word	Bit	Word	Bit	Word			K, H	\$	
Ⓢ1	—	○	—	○	—	—	—	○	○	—	—
Ⓢ2	—	○	—	○	—	—	—	○	○	—	—

(a) Setting data

Setting data	Setting item	Setting range	Data type
Ⓢ1	<ul style="list-style-type: none"> PWM output on width setting value (constant) Start number of the device where a PMW output on width setting value is stored 	<ul style="list-style-type: none"> Constant: 0 or a value within 10 to 10⁷ (0.1μs) and is (Ⓢ1, Ⓢ1+1) ≤ (Ⓢ2, Ⓢ2 +1) Device: within the range of the specified device 	<ul style="list-style-type: none"> Constant: BIN 32-bit Device: device name
Ⓢ2	<ul style="list-style-type: none"> PWM output cycle setting value (constant) Start number of the device where a PWM output cycle setting value is stored 	<ul style="list-style-type: none"> Constant: a value within 50 to 10⁷ (0.1μs) and is (Ⓢ1, Ⓢ1+1) ≤ (Ⓢ2, Ⓢ2 +1) Device: within the range of the specified device 	<ul style="list-style-type: none"> Constant: BIN 32-bit Device: device name

(b) Function

This instruction outputs PWM waveforms. The PWM waveform of the on width (S1 and S1+1) and cycle (S2 and S2+1) is output from the coincidence output No.1 signal while ICPWM1 is being executed. Outputting of the PWM waveform starts from the off status of the instruction.

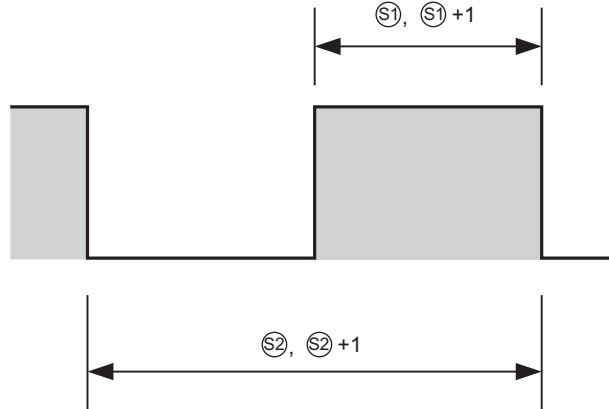

The number of steps is basically three.

(c) Error

In the following cases, an operation error occurs. The error flag (SM0) turns on and an error code is stored into SD0.

- Values outside the range are specified in S1 and S2. (Error code: 4100)
- The data set to S1 and S1+1 is greater than S2 and S2+1. (Error code: 4100)
- The devices specified in S1 and S2 are exceeding their range. (Error code: 4101)
- Other than "PWM Output Mode" is selected for "Operation Mode Setting" of the specified channel. (Error code: 4116)
- High-speed counter function of the specified channel is not enabled. (Error code: 4116)

(d) Program example

The PWM waveform with 1μs of on width and 5μs of cycle is output from CH1 while M0 is on.

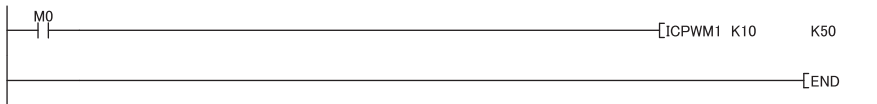

8.10.2 Precautions on dedicated instructions

This section describes the precautions for the following instructions.

- ICFCNT1
- ICRCNT1
- ICPWM1

(1) Multiple instruction executions in one scan

The instruction may not be successfully processed if it is executed to the same channel more than one time in one scan.

(2) Programs with single instruction execution

Programs do not normally processed if any of the instructions is executed in the program that is executed only once, because the off status of the execution command cannot be detected. Use the instruction in a program, such as a scan program, where the off status of an execution command can be detected.

(3) Instructions not requiring an execution command

The following instructions are executed even while the execution command is off, because they can be executed at any time. Therefore, errors can occur even while an execution command is off.

- ICFCNT1
- ICRCNT1
- ICPWM1

8.11 Programming

This section describes the programs for the high-speed counter function. When applying the program examples introduced in this section to an actual system, ensure the applicability and confirm that it will not cause system control problems.

(1) Programming procedure

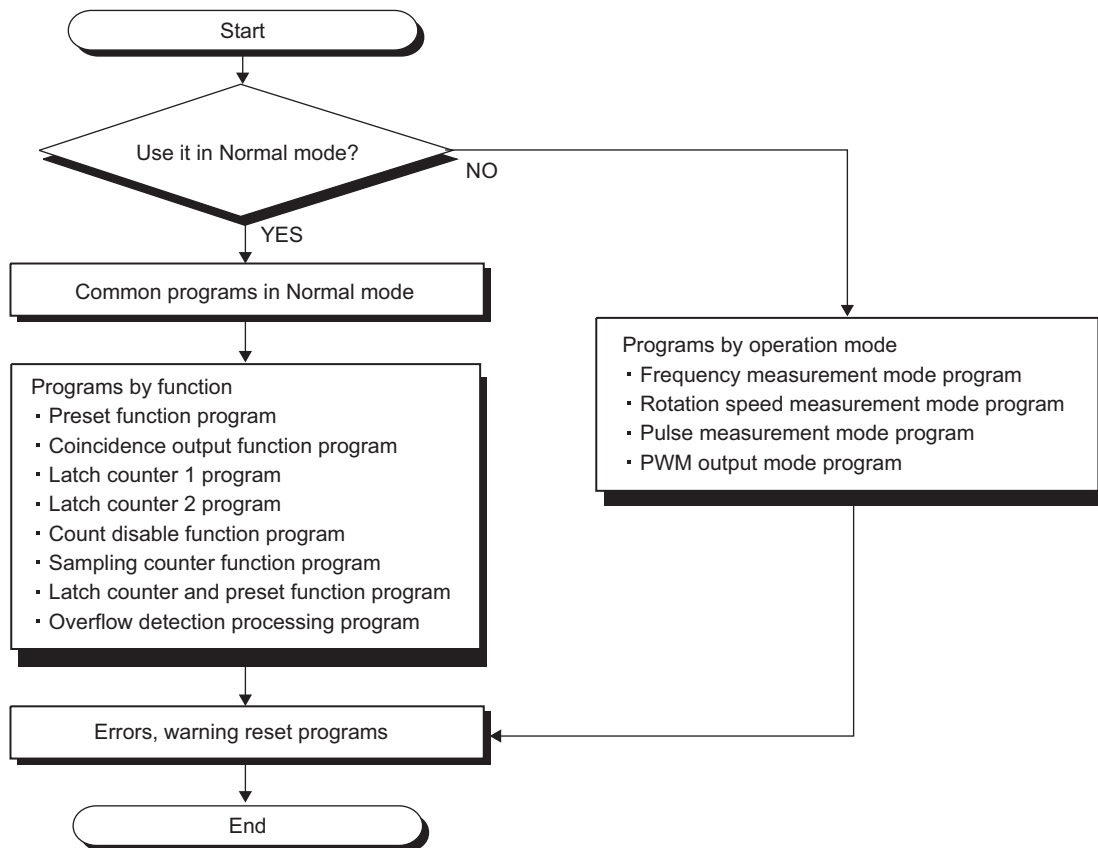

(a) Precautions

Create programs only for the functions to be used.

An error may be caused if a program for the function that is not to be used is executed.

Ex. A frequency mode program is created and executed in the normal mode.

(2) System configuration and programming condition

The following system configuration is used to introduce program examples.

(a) System configuration

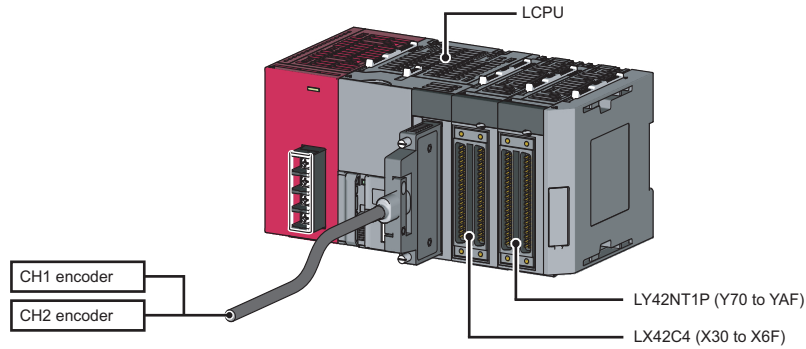

(b) Programming conditions

Device	Function		
X50	CH1 count start signal	LX42C4 (X30 to X6F)	
X51	CH1 count stop signal		
X52	CH1 current value read signal		
X53	CH1 preset command signal		
X54	CH1 counter function execution start signal		
X55	CH1 counter function execution stop signal		
X56	CH1 latch 1 execution command signal		
X57	CH1 latch count data 1 read signal		
X58	CH1 latch count data 2 read signal		
X59	CH1 sampling count start signal		
X5A	CH1 sampling count data read signal		
X5B	CH1 coincidence output enable signal		
X5C	CH1 coincidence LED clear signal		
X5D	CH1 frequency measurement command signal		
X5E	CH1 rotation speed measurement command signal		
X5F	CH1 pulse measurement command signal		
X60	CH1 measured pulse value read signal		
X61	CH1 PWM output command signal		
X62	CH1 error reset command signal		
Y70	CH1 coincidence confirmation LED signal		LY42NT1P (Y70 to YAF)
Y71	CH1 overflow occurrence confirmation LED		
D2000	CH1 current value storage		
D2001			
D2002	CH1 latch count value 1 storage		
D2003			
D2004	CH1 latch count value 2 storage		
D2005			
D2006	CH1 sampling count value storage		
D2007			

(To the next page)

Device	Function
D2008	CH1 measured frequency value storage
D2009	
D2010	CH1 measured rotation value storage
D2011	
D2012	CH1 measured pulse value storage
D2013	
D2014	CH1 error code storage
D2015	CH1 warning code storage
D2020	CH1 error code acquisition
D2021	CH1 warning code acquisition
SM1881	CH1 counter value coincidence (No.1)
SM1887	CH1 error
SM1888	CH1 warning
SM1890	CH1 coincidence signal No.1 reset command
SM1892	CH1 coincidence output enable command
SM1893	CH1 preset command
SM1894	CH1 count down command
SM1895	CH1 count enable command
SM1896	CH1 selected counter function start command
SM1897	CH1 external preset (phase Z) request detection reset command
SM1898	CH1 pulse measurement command signal
SM1899	CH1 error reset command
SD1880	CH1 current value
SD1881	
SD1882	CH1 status monitor
SD1887	CH1 error code
SD1888	CH1 warning code

(3) Program example

The following are program examples of CH1. Note that the coincidence output signal No.2 is on by default (not indicated in the examples below).

Also note that when CH1 coincidence output enable command (SM1892) turns on, Coincidence output No.2 signal also turns on.

(a) Common program in Normal mode

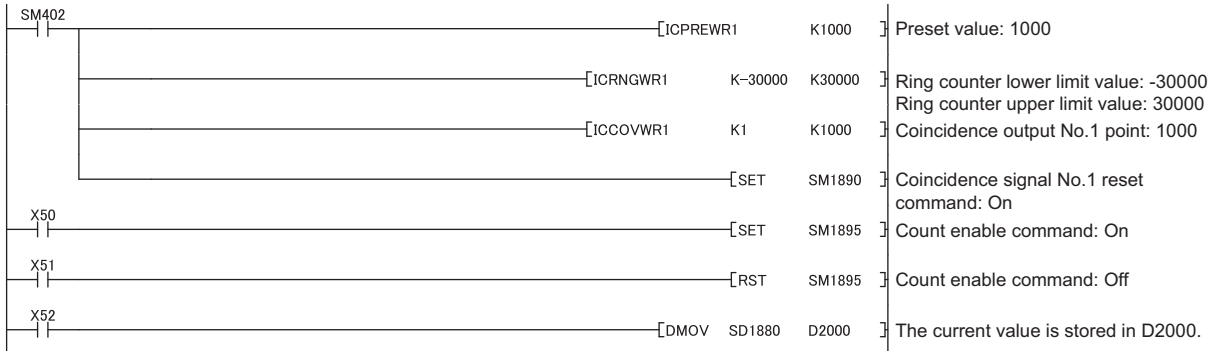

(b) Preset function program



(c) Coincidence output function program

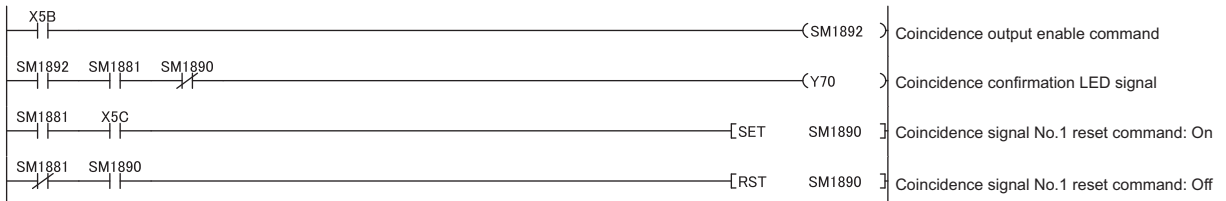

(d) Latch counter 1 program

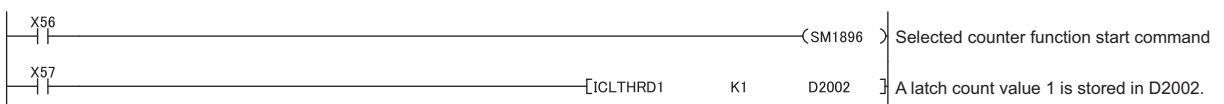

(e) Latch counter 2 program



(f) Count disable function program

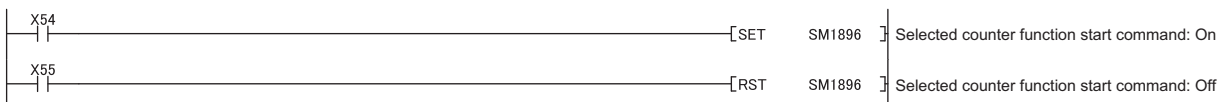

(g) Sampling counter function program

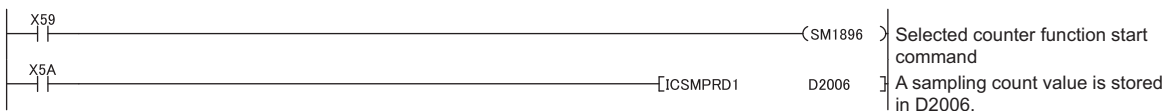

(h) Latch counter and preset function program



} A latch count value is stored in D2002.

(i) Overflow detection processing program



} Overflow occurrence confirmation LED signal

(j) Frequency measurement mode program



} A measured frequency value is stored in D2008.

(k) Rotation speed measurement mode program



} A measured rotation speed value is stored in D2010.

(l) Pulse measurement mode program

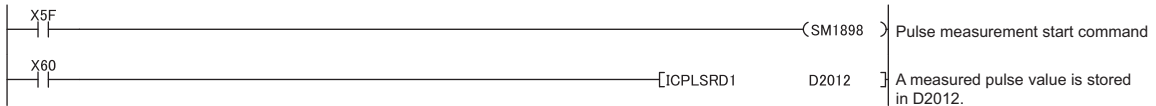

} Pulse measurement start command

} A measured pulse value is stored in D2012.

(m) PWM output mode program

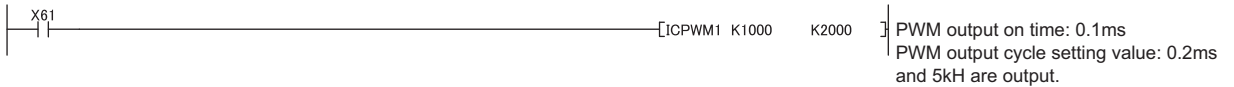

} PWM output on time: 0.1ms
PWM output cycle setting value: 0.2ms and 5kHz are output.

(n) Error, warning reset program

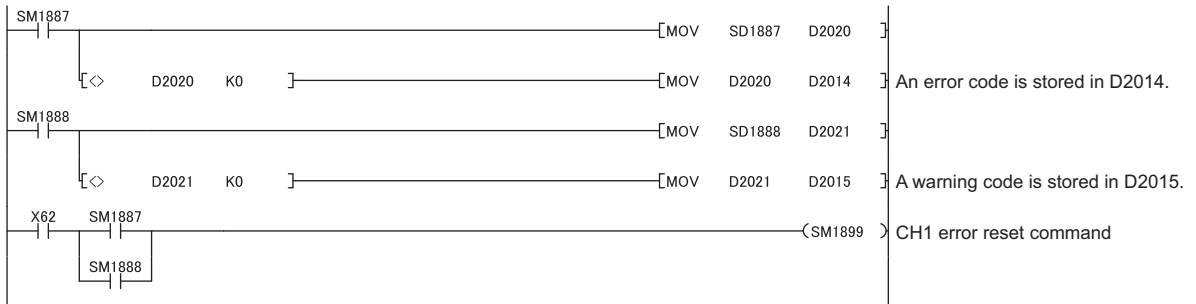

} An error code is stored in D2014.

} A warning code is stored in D2015.

} CH1 error reset command

(4) Program example with the coincidence detection interrupt function

This section introduces an example of interrupt program where CH1 counter value coincidence (No.1) (SM1881) is used. Before using an interrupt pointer, enable an interruption with the IMASK instruction. For details on the IMASK instruction, refer to the following.

 MELSEC-Q/L Programming Manual (Common Instruction)

(a) System configuration

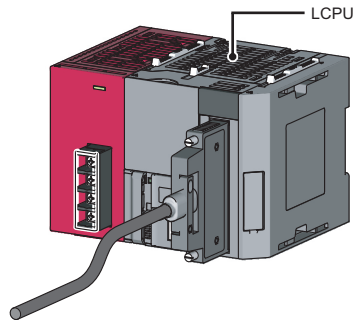

(b) Programming conditions

Provide D20 to enable an interruption of I0.

Device	Function	Setting value
D20	IMASK instruction interruption enable flag storage device	1
D21		0
D22		0
D23		0
D24		0
D25		0
D26		0
D27		0
D28		0
D29		0
D30		0
D31		0
D32		0
D33		0
D34		0
D35		0

(c) Program example

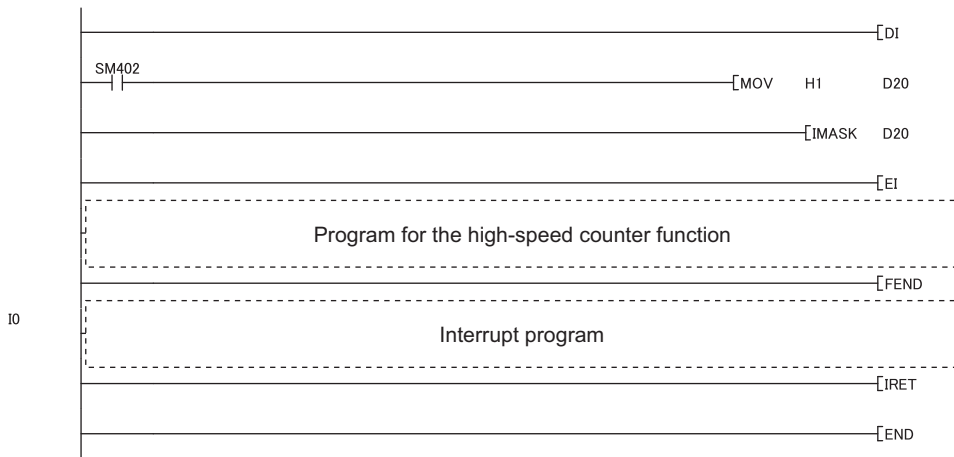

8.12 Errors and Warnings

This section describes errors and warnings of the high-speed counter function.

(1) Error

When an error occurs, the following operations are performed.

- The I/O ERR. LED turns on.
- The CH1 error (SM1887) turns on.
- An error code corresponding to the error is stored to the CH1 error code (SD1887) in decimal.

Interface	Channel	Number	Name	Description
Special relay	CH1	SM1887	CH□error	Indicates whether to an error has occurred in the high-speed counter function. Turns off when CH□ error reset command is turned on.
	CH2	SM1907		
	CH1	SM1899	CH□error reset command	<ul style="list-style-type: none"> • Resets CH□ error code. • Turns off CH□ error.
	CH2	SM1919		
Special register	CH1	SD1887	CH□ error code	An error code is stored upon error. The stored value is reset when CH□ error reset command is turned on.
	CH2	SD1907		

The following table lists the CH□ error codes.

CH□ error code (decimal)		Error name	Description	Operation at error occurrence		Corrective action
CH1	CH2			CH with an error	The other CH	
0		Normal	—	—	—	—
3100	4100	Over/Underflow error	The value in CH1 current value (SD1880, SD1881) has exceeded the following range. -2147483648 to 2147483647 (Linear counter function only)	The linear counter function stops counting.	Note affected.	Replace the value by performing the preset function.
3200	4200	Pulse measurement range overflow error	The measurement target pulse has exceeded the measurable range (approx. 214s)	Stops measurement of pulse.		Enter the measurement target again, or turn on, off, and then on CH1 pulse measurement start command.

Point

- If another error occurs while an error is present, the latest error code will not be stored.
- To reset an error code, remove the error cause first and then reset with CH1 error reset command (SM1899). If the error is reset without removing the error cause, it is detected again and the error code is stored.

(2) Warning

When a warning occurs, the following operations are performed.

- The CH1 warning (SM1888) turns on.
- A warning code corresponding to the warning is stored to the CH1 warning code (SD1888) in decimal.

Different from errors, occurrence of a warning does not stop the operation of CH1. The SD value is always updated with the latest warning code.

Interface	Channel	Number	Name	Description
Special relay	CH1	SM1888	CH□ warning	Indicates whether to a warning of the high-speed counter function has occurred. Turns off when CH□ error reset command is turned on.
	CH2	SM1908		
	CH1	SM1899	CH□ error reset command	
	CH2	SM1919		
Special register	CH1	SD1888	CH□ warning code	A corresponding warning code is stored upon warning. The stored value is reset when CH□ error reset command is turned on.
	CH2	SD1908		

The following table lists the CH□ warning codes.

CH□ warning code (decimal)		Name	Description	Operation at warning occurrence		Corrective action
CH1	CH2			CH with a warning	The other CH	
0		Normal	—	—	—	—
3050	4050	Sampling count value overflow	The sampling count value has exceeded the following range. -2147483648 to 2147483647	Store either value of -2147483648 or 2147483647 and continue counting.	Note affected.	Check that the value obtained from "Input pulse speed (pulse/s) × sampling time" does not exceed the range.

Point

To reset a warning code, remove the cause first and then reset with CH1 error reset command (SM1899). If the warning is reset without removing the cause, it is detected again and the warning code is stored.

8.13 When the LCPU Stops Operation

The following shows the function status when the LCPU stopped its operation.

Function		Operation
Linear counter function		Continues the previous operation before the LCPU stopped.
Ring counter function		
Preset function		
Coincidence output function	Preset at coincidence output function	
	Coincidence detection interrupt function	
Latch counter function		
Counter function selection	Latch counter function	
	Count disable function	
	Sampling counter function	
	Count disable/preset function	
Internal clock function		
Frequency measurement function		Stops the frequency measurement. The frequency that has been used for moving average processing is abandoned. When the CPU module is switched to the RUN status, executing Frequency measurement instruction (ICFCNT1) starts measuring frequencies.
Rotation speed measurement function		Stops the rotation speed measurement. The rotation speed that has been used for moving average processing is abandoned. After the CPU module is switched to the RUN status, turning on Rotation speed measurement instruction (ICRCNT1) starts measuring rotation speed.
Pulse measurement function		Stops the rotation speed measurement. When the CPU module is switched to the RUN status, this function operates according to CH1 pulse measurement start command (SM1898).
PWM output function		Stops outputting PWM waveforms. When the CPU module is switched to the RUN status, executing PWM output instruction (ICPWM1) starts outputting PWM waveforms.

8.14 Monitoring with a Programming Tool

When the high-speed function is executed, the operating status can be checked on the "High-Speed Counter Monitor" window of the programming tool.

 [Tool] ⇒ [Built-in I/O Module Tool]

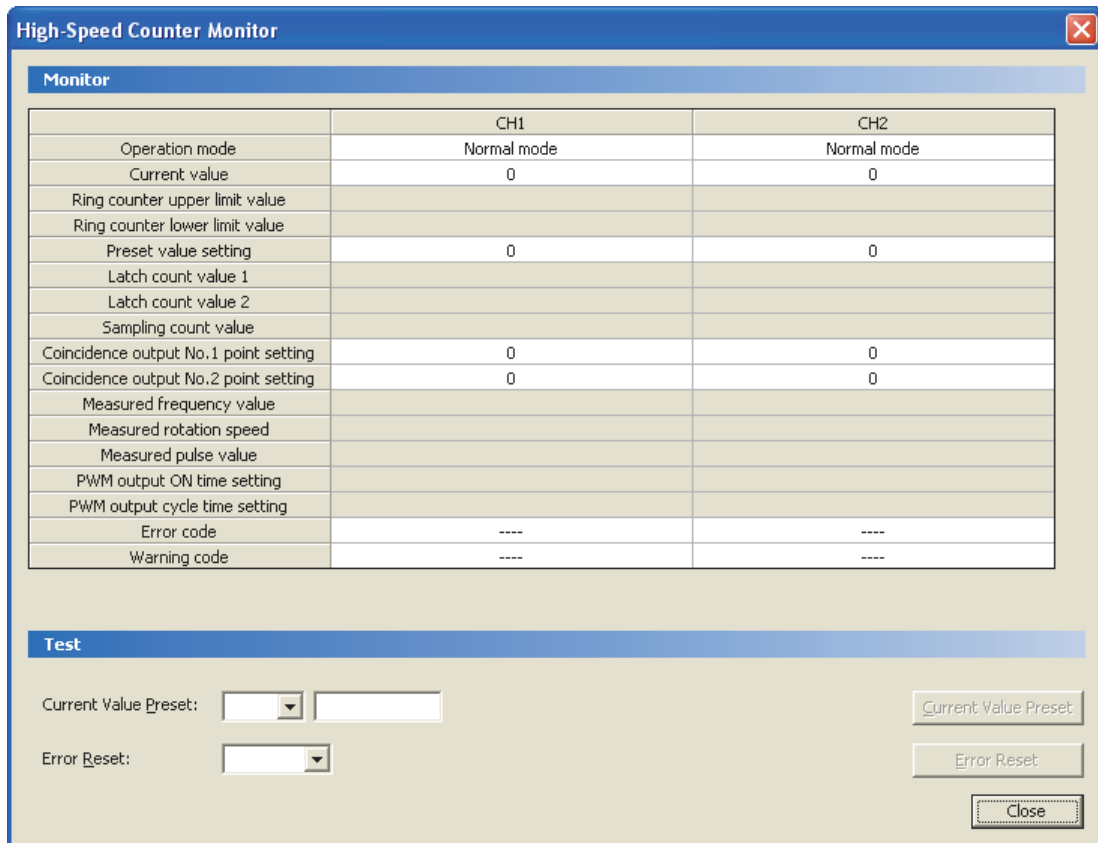

The screenshot shows a software window titled "High-Speed Counter Monitor". It is divided into two main sections: "Monitor" and "Test".

Monitor Section: A table displays the status for two channels, CH1 and CH2.

	CH1	CH2
Operation mode	Normal mode	Normal mode
Current value	0	0
Ring counter upper limit value		
Ring counter lower limit value		
Preset value setting	0	0
Latch count value 1		
Latch count value 2		
Sampling count value		
Coincidence output No.1 point setting	0	0
Coincidence output No.2 point setting	0	0
Measured frequency value		
Measured rotation speed		
Measured pulse value		
PWM output ON time setting		
PWM output cycle time setting		
Error code	----	----
Warning code	----	----

Test Section: Contains controls for resetting values and errors.

- Current Value Preset:
- Error Reset:
-

For details, refer to the following.

 GX Works2 Version1 Operating Manual (Common).

APPENDICES

Appendix 1 Processing Time of Each Instruction

The following tables list operation processing time values of the instructions introduced in this manual.
For the operation processing time of the LCPU, refer to the following.

 MELSEC-Q/L Programming Manual (Common Instruction)

(1) Dedicated instructions for the positioning function

Category	Instruction	Trigger	Processing time (μs)					
			L02SCPU, L02SCPU-P		L02CPU, L02CPU-P		L06CPU, L06CPU-P, L26CPU, L26CPU-P, L26CPU-BT, L26CPU-PBT	
			Min.	Max.	Min.	Max.	Min.	Max.
Dedicated instruction (positioning function)	IPPSTR1	-	18.30	18.30	9.90	9.90	7.30	7.30
	IPPSTR2							
	IPDSTR1	-	30.80	30.80	15.60	15.60	11.90	11.90
	IPDSTR2							
	IPSIMUL	-	25.60	25.60	14.70	14.70	11.80	11.80
	IPOPR1	-	30.70	30.70	15.50	15.50	11.40	11.40
	IPOPR2							
	IPJOG1	-	44.20	44.20	21.30	21.30	16.20	16.20
	IPJOG2							
	IPABRST1	-	62.20	62.20	31.60	31.60	26.00	26.00
	IPABRST2							
	IPSTOP1	-	9.50	9.50	3.80	3.80	3.10	3.10
	IPSTOP2							
	IPSPCHG1	-	33.90	33.90	17.50	17.50	13.40	13.40
	IPSPCHG2							
	IPTPCHG1	-	17.40	17.40	6.90	6.90	5.30	5.30
IIPTPCHG2								

(2) Dedicated instructions for the high-speed counter function

Category	Instruction	Condition	Processing time (μs)					
			L02SCPU, L02SCPU-P		L02CPU, L02CPU-P		L06CPU, L06CPU-P, L26CPU, L26CPU-P, L26CPU-BT, L26CPU-PBT	
			Min.	Max.	Min.	Max.	Min.	Max.
Dedicated instruction (high-speed counter function)	ICNTRD1	–	3.70	8.70	2.10	4.60	1.60	3.80
	ICNTRD2							
	ICRNGWR1	–	6.40	13.10	3.40	6.70	2.70	5.40
	ICRNGWR2							
	ICPREWR1	–	5.40	9.40	2.50	4.90	1.70	3.80
	ICPREWR2							
	ICLTHRD1	–	7.60	16.50	3.60	8.90	3.20	6.30
	ICLTHRD2							
	ICSMPRD1	–	6.10	13.30	2.70	7.00	2.40	5.20
	ICSMPRD2							
	ICCOVWR1	–	6.20	12.60	3.00	6.40	2.50	4.80
	ICCOVWR2							
	ICFCNT1	Contact OFF → ON	19.40	19.40	9.50	9.50	6.90	6.90
	ICFCNT2							
	ICRCNT1	Contact OFF → ON	19.50	19.50	10.00	10.00	7.20	7.20
	ICRCNT2							
	ICPLSRD1	–	6.10	13.30	2.70	7.10	2.30	5.20
	ICPLSRD2	–						
	ICPWM1	Contact OFF → ON	22.80	22.80	10.00	10.00	8.00	8.00
		Contact ON → ON	14.90	14.90	6.90	6.90	4.60	4.60
ICPWM2	Contact OFF → ON	22.80	22.80	10.00	10.00	8.00	8.00	
	Contact ON → ON	14.90	14.90	6.90	6.90	4.60	4.60	

Appendix 2 Connection Examples with Servo Amplifiers

Appendix 2.1 Connection examples with servo amplifiers manufactured by Mitsubishi

(1) Connection example with MR-JN series*5

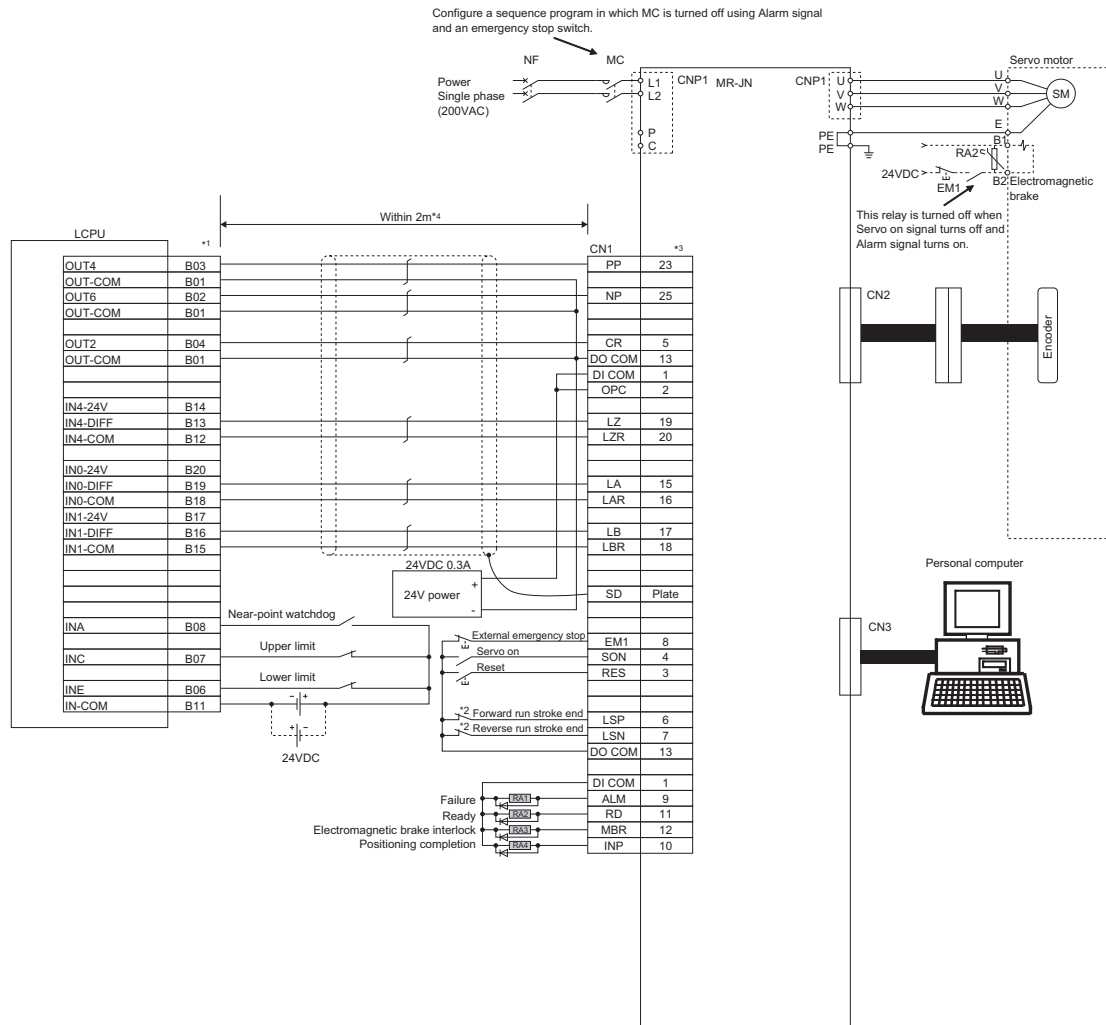

- *1 This is an example for axis 1. For the pin assignment when connecting to axis 2, refer to Page 48, Section 7.2.
- *2 These are limit switches for the servo amplifier (for stop).
- *3 For details on connection, refer to the instruction manual of the servo amplifier MR-JN.
- *4 This is a distance between the LCPU and the servo amplifier.
- *5 The L02SCPU-P, L02CPU-P, L06CPU-P, L26CPU-P, and L26CPU-PBT do not support this series.

(2) Connection example with MR-J3-□ A series*5

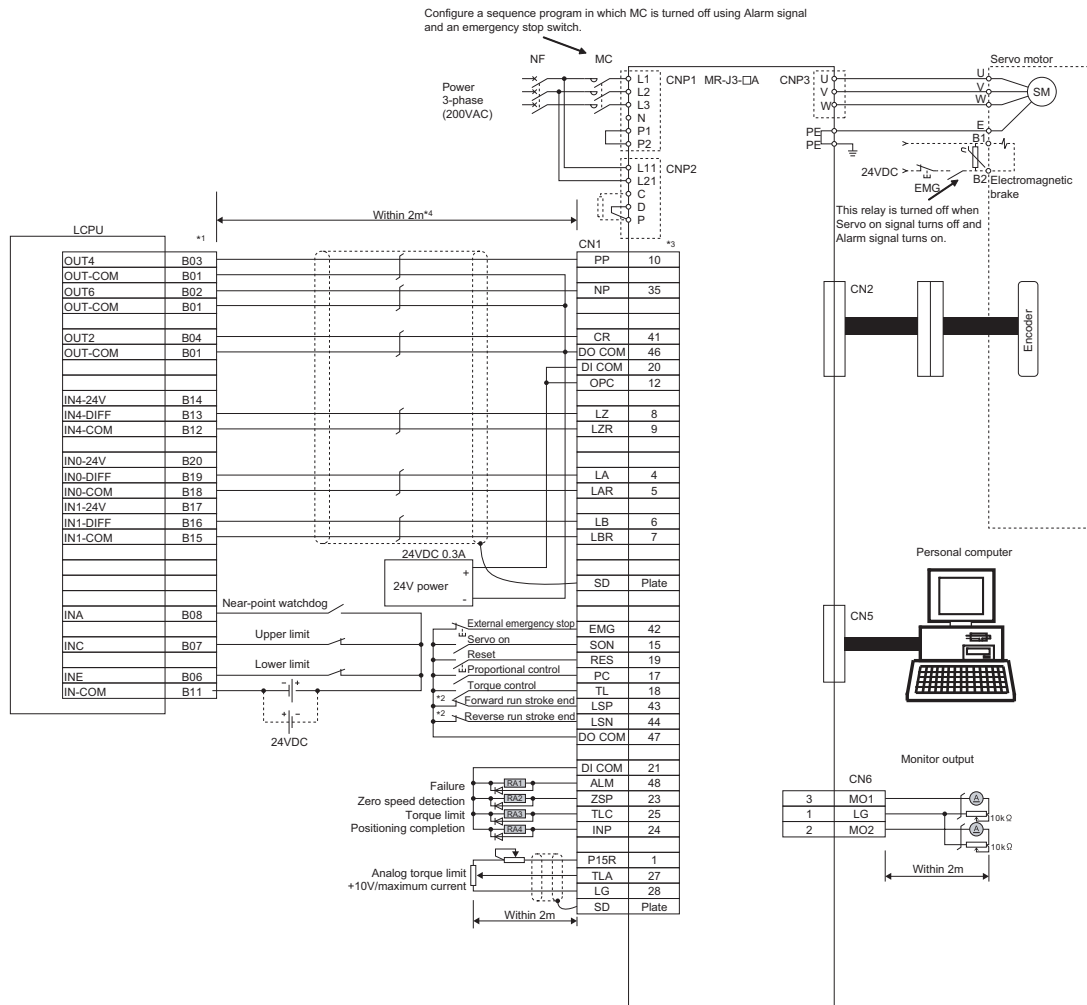

- *1 This is an example for axis 1. For the pin assignment when connecting to axis 2, refer to Page 48, Section 7.2.
- *2 These are limit switches for the servo amplifier (for stop).
- *3 For details on connection, refer to the manual of the servo amplifier MR-J3.
- *4 This is a distance between the L26CPU-P and the servo amplifier.
- *5 The L02SCPU-P, L02CPU-P, L06CPU-P, L26CPU-P, and L26CPU-PBT do not support this series.

Appendix 2.2 Connection examples with stepping motors manufactured by ORIENTAL MOTOR CO.,LTD.



(1) Connection example with RK series

(a) L02SCPU, L02CPU, L06CPU, L26CPU, L26CPU-BT

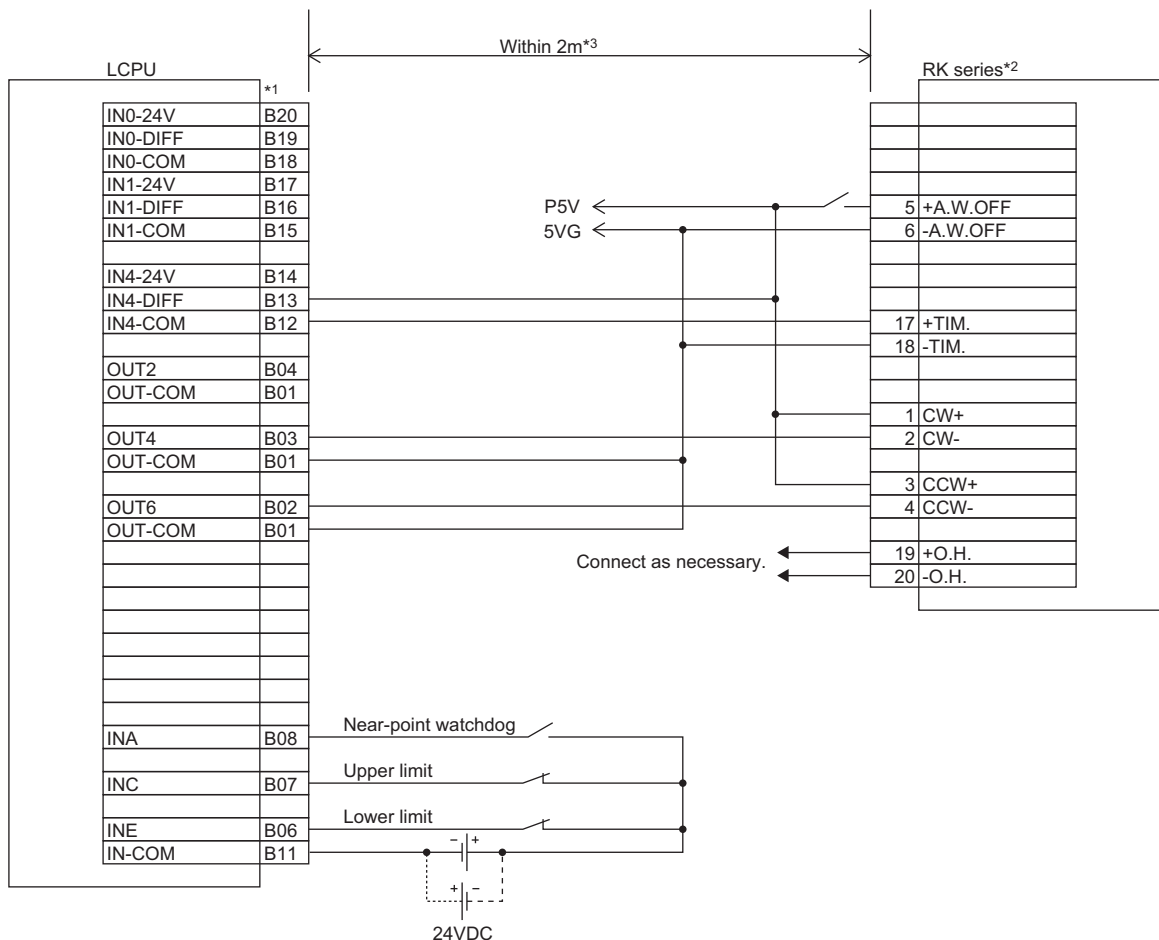

- *1 This is an example for axis 1. For the pin assignment when connecting to axis 2, refer to Page 48, Section 7.2.
- *2 Refer to the manual of the stepping motor drive for information on the stepping motor drive side wiring and various signal wire shields not shown above.
- *3 This is a distance between the LCPU and the stepping motor.

Appendix 2 Connection Examples with Servo Amplifiers
Appendix 2.2 Connection examples with stepping motors manufactured by ORIENTAL MOTOR CO.,LTD.

(b) L02SCPU-P, L02CPU-P, L06CPU-P, L26CPU-P, L26CPU-PBT

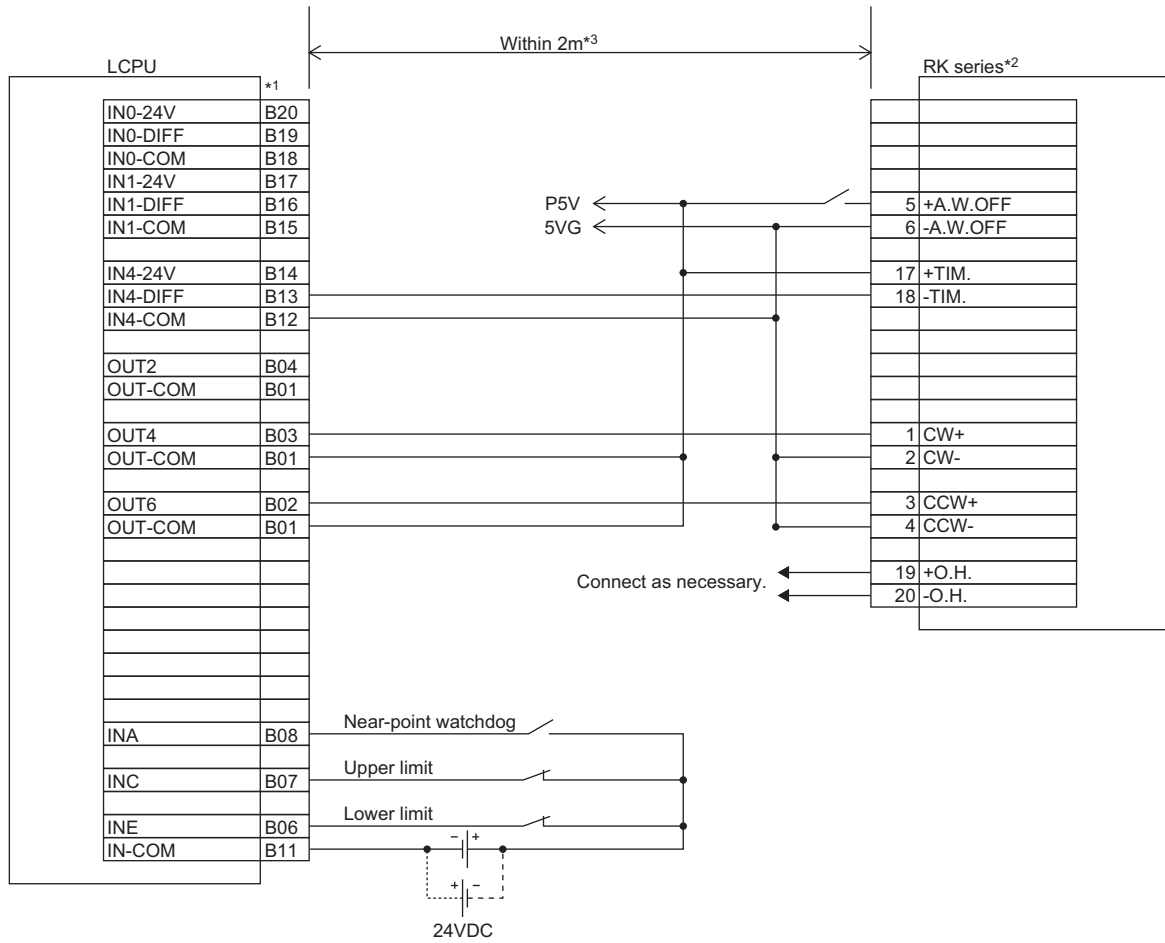

- *1 This is an example for axis 1. For the pin assignment when connecting to axis 2, refer to Page 48, Section 7.2.
- *2 Refer to the manual of the stepping motor drive for information on the stepping motor drive side wiring and various signal wire shields not shown above.
- *3 This is a distance between the LCPU and the stepping motor.

(2) Connection example with AR series

(a) L02SCPU, L02CPU, L06CPU, L26CPU, L26CPU-BT

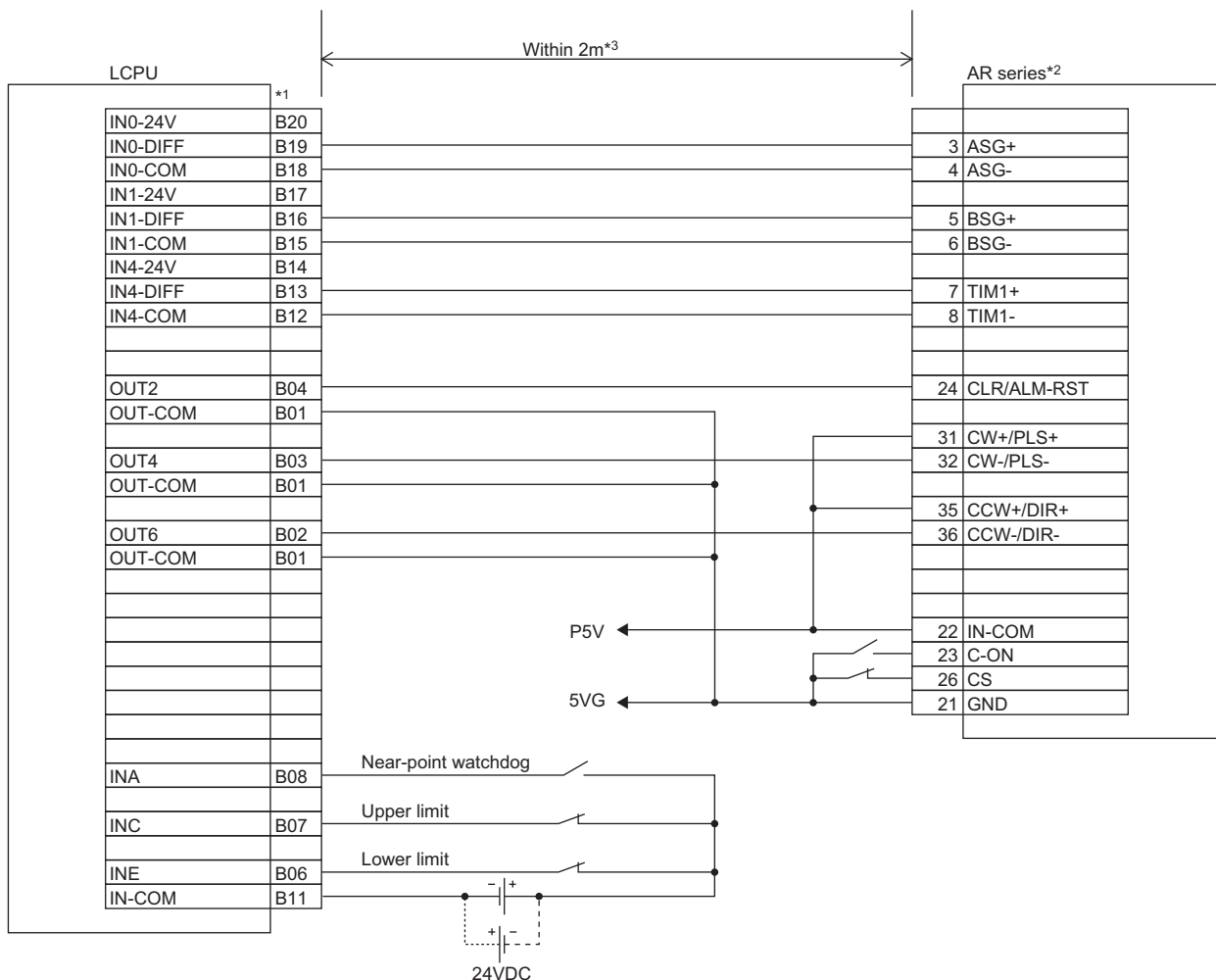

- *1 This is an example for axis 1. For the pin assignment when connecting to axis 2, refer to Page 48, Section 7.2.
- *2 Refer to the manual of the stepping motor drive for information on the stepping motor drive side wiring and various signal wire shields not shown above.
- *3 This is a distance between the LCPU and the stepping motor.

(b) L02SCPU-P, L02CPU-P, L06CPU-P, L26CPU-P, L26CPU-PBT

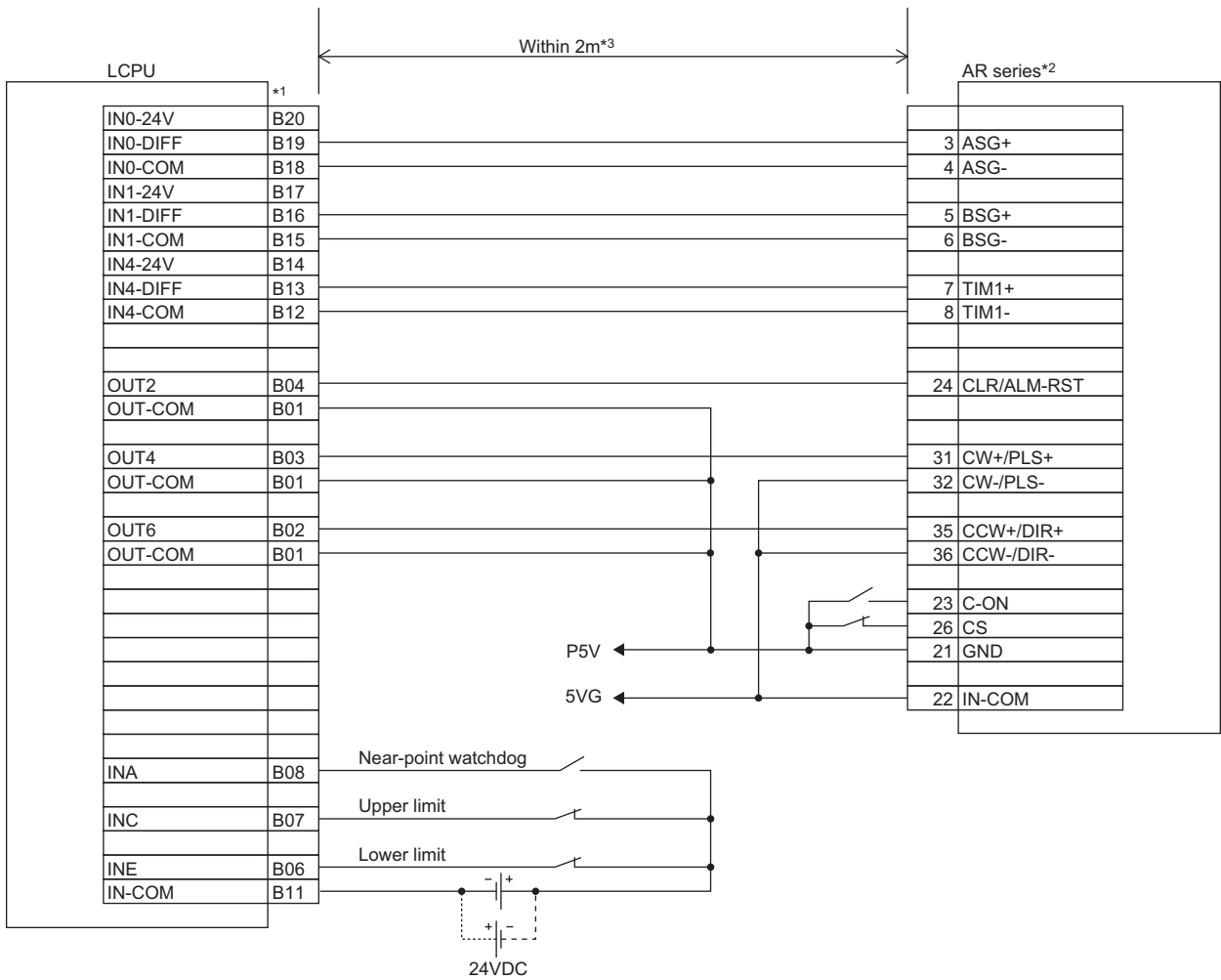

- *1 This is an example for axis 1. For the pin assignment when connecting to axis 2, refer to Page 48, Section 7.2.
- *2 Refer to the manual of the stepping motor drive for information on the stepping motor drive side wiring and various signal wire shields not shown above.
- *3 This is a distance between the L02SCPU-P and the stepping motor.

Appendix 2.3 Connection examples with servo amplifiers manufactured by Panasonic Corporation

(1) Connection example with MINAS-A4 series*4

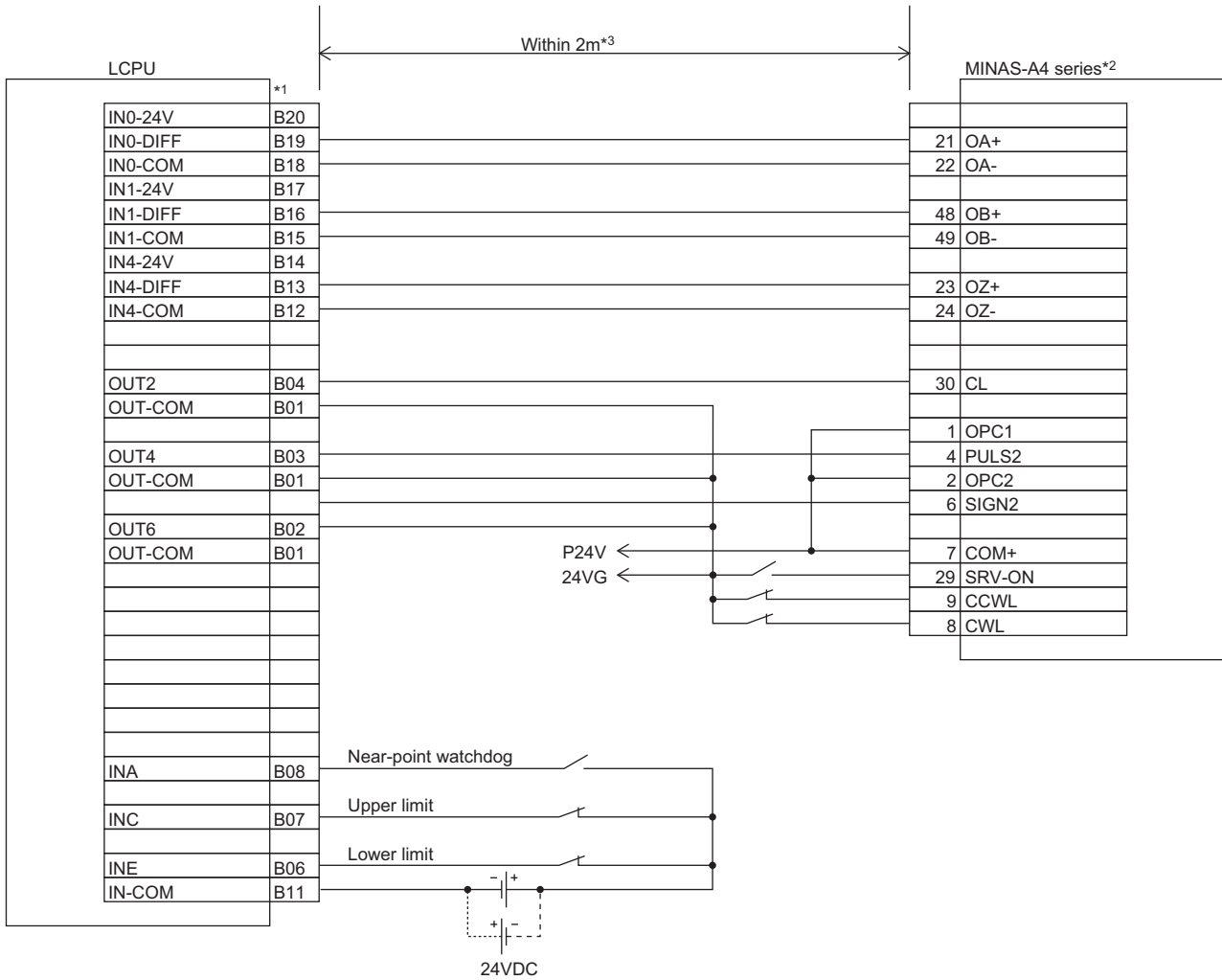

- *1 This is an example for axis 1. For the pin assignment when connecting to axis 2, refer to Page 48, Section 7.2.
- *2 Refer to the manual of the servo amplifier for information on the servo amplifier side wiring and various signal wire shields not shown above.
- *3 This is a distance between the LCPU and the servo amplifier.
- *4 The L02SCPU-P, L02CPU-P, L06CPU-P, L26CPU-P, and L26CPU-PBT do not support this series.

(2) Connection example with MINAS-E series*4

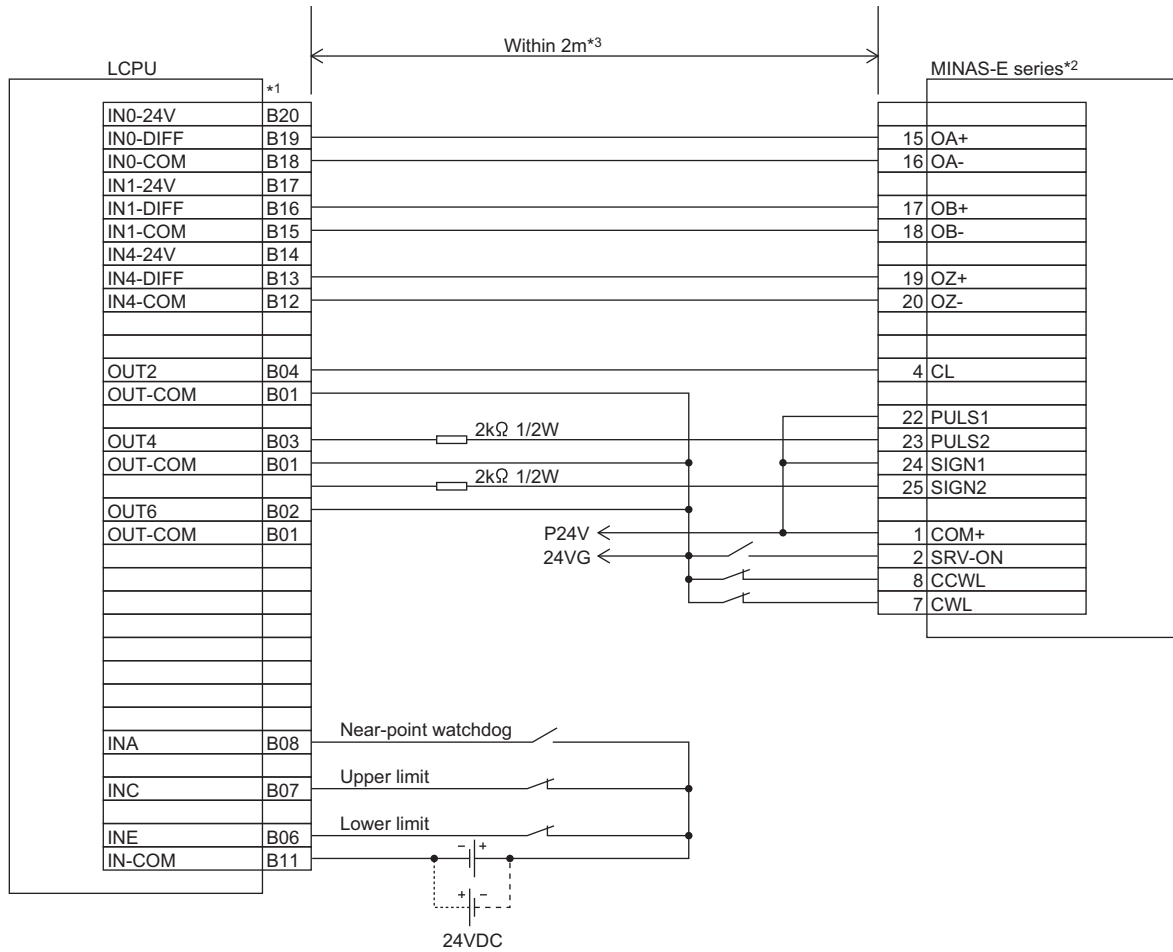

- *1 This is an example for axis 1. For the pin assignment when connecting to axis 2, refer to Page 48, Section 7.2.
- *2 Refer to the manual of the servo amplifier for information on the servo amplifier side wiring and various signal wire shields not shown above.
- *3 This is a distance between the L26CPU and the servo amplifier.
- *4 The L02SCPU-P, L02CPU-P, L06CPU-P, L26CPU-P, and L26CPU-PBT do not support this series.

Appendix 2.4 Connection examples with servo amplifiers manufactured by SANYODENKI CO.,LTD.

A

(1) Connection example with R series*4

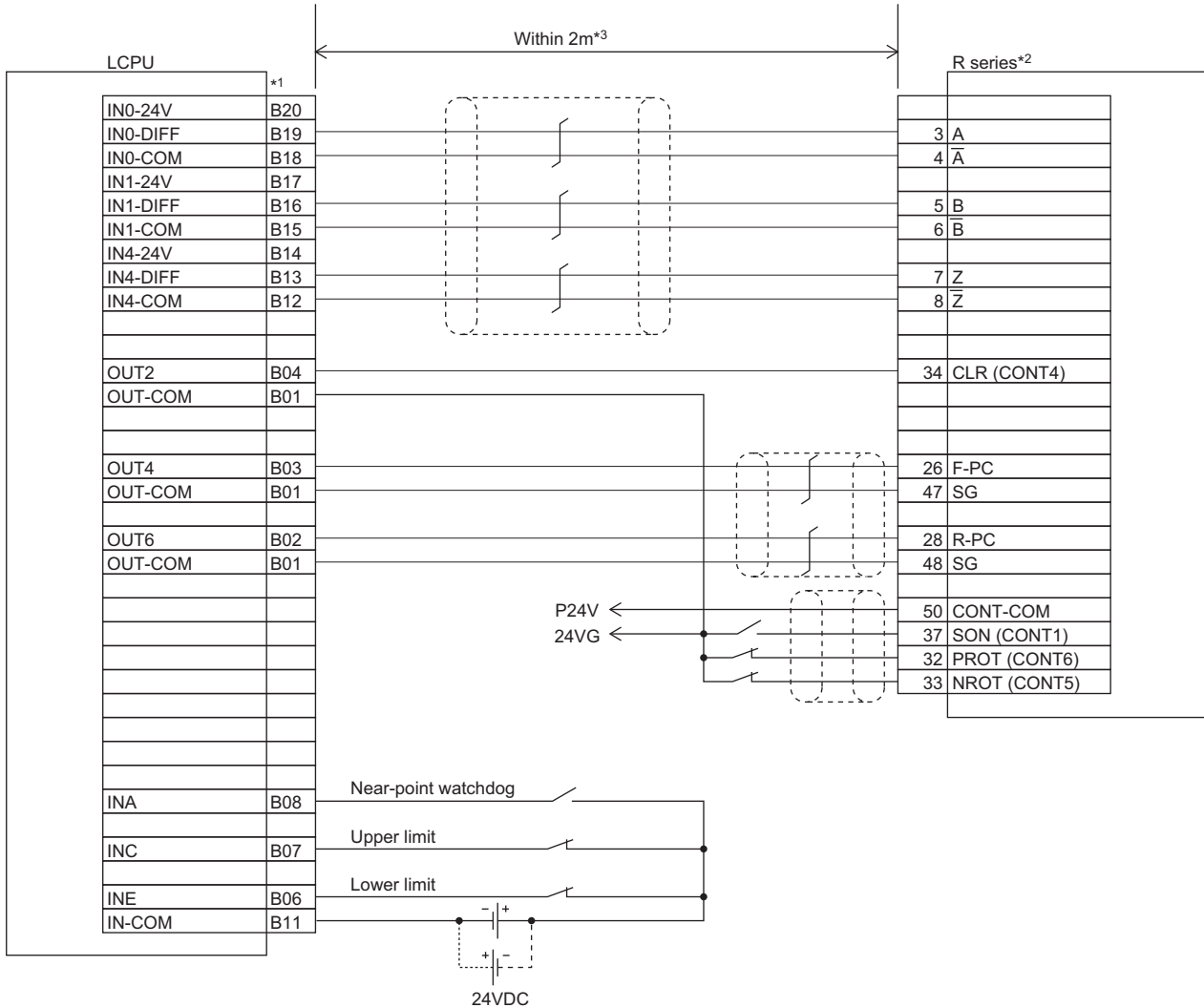

- *1 This is an example for axis 1. For the pin assignment when connecting to axis 2, refer to Page 48, Section 7.2.
- *2 Refer to the manual of the servo amplifier for information on the servo amplifier side wiring and various signal wire shields not shown above.
- *3 This is a distance between the LCPU and the servo amplifier.
- *4 The L02SCPU-P, L02CPU-P, L06CPU-P, L26CPU-P, and L26CPU-PBT do not support this series.

Appendix 2 Connection Examples with Servo Amplifiers
Appendix 2.4 Connection examples with servo amplifiers manufactured by SANYODENKI CO.,LTD.

Appendix 2.5 Connection examples with servo amplifiers manufactured by YASKAWA Electric Corporation

(1) Connection example with Σ -V series*4

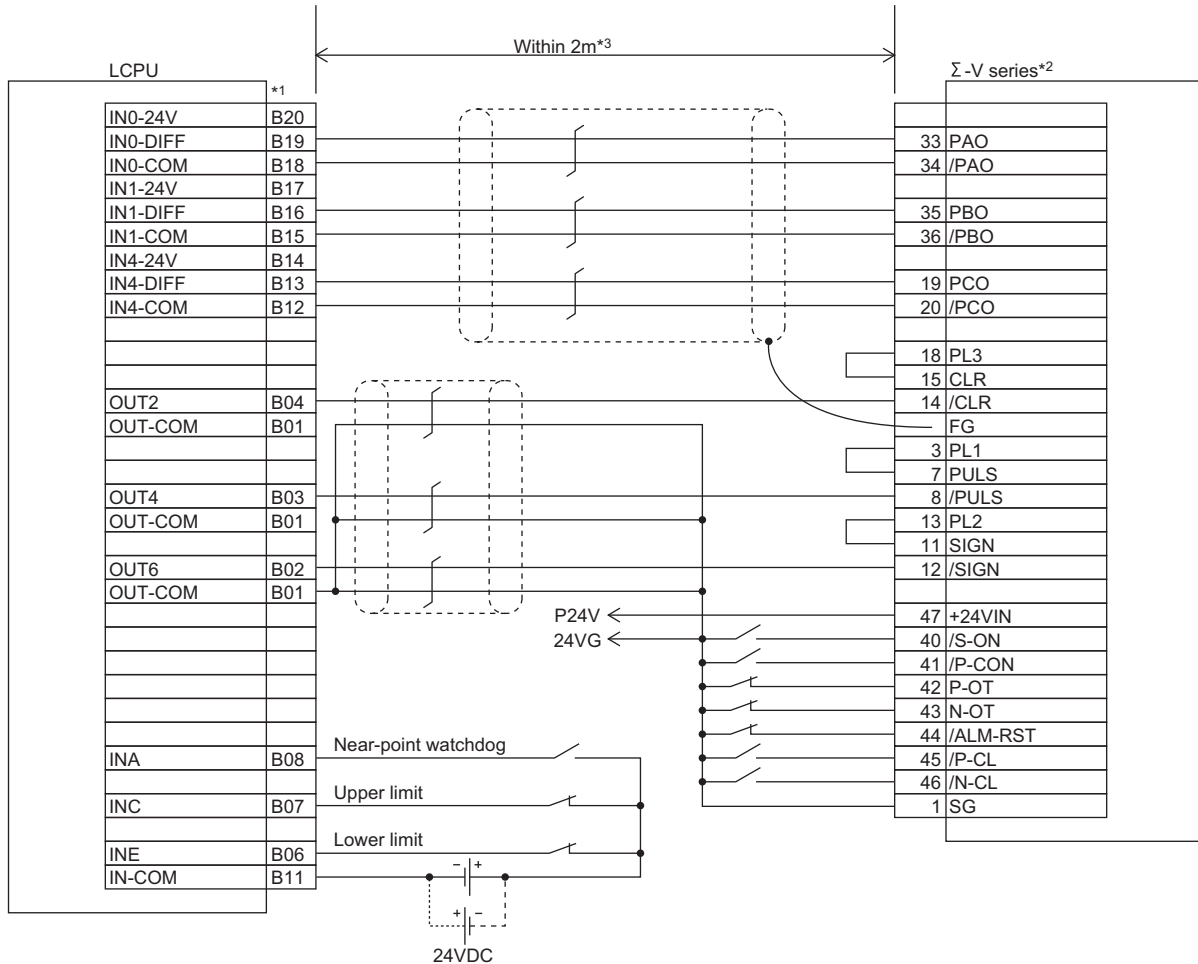

- *1 This is an example for axis 1. For the pin assignment when connecting to axis 2, refer to Page 48, Section 7.2.
- *2 Refer to the manual of the servo amplifier for information on the servo amplifier side wiring and various signal wire shields not shown above.
- *3 This is a distance between the LCPU and the servo amplifier.
- *4 The L02SCPU-P, L02CPU-P, L06CPU-P, L26CPU-P, and L26CPU-PBT do not support this series.

Memo

A

Appendix 2 Connection Examples with Servo Amplifiers
Appendix 2.5 Connection examples with servo amplifiers manufactured by YASKAWA Electric Corporation

INDEX

0 to 9

1-Phase Multiple of 1	198
1-Phase Multiple of 1 (A Phase Only)	198
1-Phase Multiple of 2	198
1-Phase Multiple of 2 (A Phase Only)	198
2-Phase Multiple of 1	199
2-Phase Multiple of 2	199
2-Phase Multiple of 4	199

A

A phase/B phase mode (multiple of 1), A phase/B phase mode (multiple of 4)	56
ABS request flag	137
ABS transfer mode	137
ABS transmission data bit 0	137
ABS transmission data bit 1	137
ABS transmission data ready	137
ACC/DEC time at speed change	158
Acceleration/deceleration system selection	58
Acceleration/deceleration time	95,142
Axis operation status	61

B

Bias speed at start	58
Built-in I/O module tool	27,180,272

C

CCW/SIGN/B phase output	50
Coincidence detection interrupt setting (counter value coincidence No.n)	213
Coincidence output No.1 signal	187
Coincidence output No.2 signal	187
Coincidence output No.n point number	254
Coincidence output No.n point setting	254
Coincidence output time preset setting	211
Command pulse frequency	46
Command speed	95,142
Common terminal arrangement	21
Connectable encoders	188
Control system	93,94,142
Count 1	83
Count 2	86
Count disable function	219
Count disable/preset function	222
Count range of the ring counter	205
Count source selection	196
Counter type	203
Counting speed setting	200
Creep speed	67
Current feed value	61
CW	50
CW/CCW	199
CW/CCW mode	55
CW/PULSE/A phase output	50

D

DEC/STOP time at speed change	158
Deceleration stop time	95,142
Deviation counter clear signal	50
Deviation counter droop pulse amount	46
Direct input	28
Direct output	30
Drive unit	16,43
Drive unit ready signal	50
Droop pulse	43
Duty ratio	241
Dwell time	95,142

E

Encoder	16
Error time output mode	31
Example of wiring when the controller is a line driver	191
Example of wiring with a controller (sink type)	190
Example of wiring with a line driver (equivalent to AM26LS31) encoder	190
Example of wiring with an encoder	189
Example of wiring with an open collector output type encoder (24VDC)	189
Example of wiring with external output equipment	192
External command signal	50
External preset (phase Z) request detection setting	206

F

Feedback pulses	43
Frequency measurement time unit setting	226
Frequency moving average processing count	226
Function input logic setting	216
Function input signal	187
Function input status	239

I

I/O connector pin numbers and corresponding I/O signals	24
Input resistance	20
Input signal assignment	25
Insulation resistance	20,21
Internal circuits	22
Internal clock	197

J

JOG ACC time	151
JOG DEC time	151
JOG speed	151

L	
Latch count value	250
Latch count value number	250
Latch counter function	218
Latch counter input signal	187
Latch counter/preset function	224
LCPU	16
Leakage current at OFF	21
Lower limit signal	50

M	
Maximum voltage drop at ON	21
Measured frequency value	256
Measured pulse value	258
Measured rotation speed value	257
Minimum count pulse width	243
Movement amount per pulse	44,46

N	
Near-point dog method	72
Near-point dog signal	50
Near-point watchdog	16
Negative logic	51
New speed value	158
No method	89
Number of pulses per rotation (pulse)	232

O	
OFF voltage/OFF current	20
ON voltage/ON current	20
OP address	66
Operation mode setting	196
Operations of the linear counter	203
Operations of the ring counter	204
OPR acceleration/deceleration time	67
OPR deceleration stop time	68
OPR direction	65
OPR dwell time	69
OPR method	63
OPR method and I/O signal	70
OPR methods and OPR parameters	65
OPR speed	66
Original position return type	148
Output signal assignment	26
Output waveform setting	241

P	
Phase A	187
Phase B	187
Phase Z	187
Phase Z settings	206
Position loop gain	46
Positioning address/movement amount	93,142
Positioning data No.	140
Preset by a program	208
Preset by phase Z input	207
Preset value setting	249

Program example with the coincidence detection interrupt function	267
Programming tool	16
Pulse frequency	44
Pulse generator	16
Pulse input mode	198
Pulse measurement target setting	238
Pulse output mode	55
PULSE/SIGN mode	56
PWM	16
PWM output cycle setting value	259
PWM output on width setting value	259

R	
Rated input current	20
Rated input voltage	20
Rated load current	21
Rated load voltage	21
Response time	20,21
Ring counter lower limit value	247
Ring counter upper limit value	247
Rotation direction setting	57
Rotation speed measurement time unit setting	232
Rotation speed movement averaging processing count	232

S	
S/W stroke upper limit, S/W stroke lower limit	57
Sampling count value setting	252
Sampling counter function	220
Sampling time setting	216
S-curve acceleration/deceleration	58
Servo amplifier	16
Servo motor	16
Servo on	16,137
Setting of movement amount after near-point dog ON	68
Signal assignment of the connector for external devices	21
Signal loaded from the servo amplifier	154
Signal output to the servo amplifier	154
Specification of JOG operation direction	151
Speed limit value	58
Standby address	148
Stepping motor	16,58
Stopper 1	76
Stopper 2	79
Stopper 3	82

T	
Target position change value	161
Temperature derating curve for the input signal	20
Trapezoid acceleration/deceleration	58

U	
Upper limit signal	50

W

Warning	16
Withstand voltage	20,21
Worm gear	46

Z

Zero signal	16
-------------------	----

INSTRUCTION INDEX

I

ICNTRD1(P),ICNTRD2(P)	246
ICCOVWR1(P), ICCOVWR2(P)	254
ICFCNT1, ICFCNT2	256
ICLTHRD1(P),ICLTHRD2(P)	250
ICPLSRD1(P), ICPLSRD2(P)	258
ICPREWR1(P),ICPREWR2(P)	249
ICPWM1, ICPWM2	259
ICRCNT1, ICRCNT2	257
ICRNGWR1(P),ICRNGWR2(P)	247
ICSMPRD1(P),ICSMPRD2(P)	252
IPABRST1,IPABRST2	154
IPDSTRT1(P),IPDSTRT2(P)	142
IPJOG1,IPJOG2	151
IPOPR1(P),IPOPR2(P)	148
IPPSTRT1(P),IPPSTRT2(P)	140
IPSIMUL(P)	145
IPSPCHG1(P),IPSPCHG2(P)	158
IPSTOP1,IPSTOP2	156
IPTPCHG1(P),IPTPCHG2(P)	161



REVISIONS

*The manual number is given on the bottom left of the back cover.

Print date	Manual number	Revision
January 2010	SH(NA)-080892ENG-A	First edition
October 2010	SH(NA)-080892ENG-B	Revised due to changes in PWM output specifications
July 2011	SH(NA)-080892ENG-C	Descriptions regarding the L02CPU-P and L26CPU-PBT are added.
September 2011	SH(NA)-080892ENG-D	Descriptions regarding the L6EXB, L6EXE, LC06E, LC10E, and LC30E are added.
February 2013	SH(NA)-080892ENG-E	Descriptions regarding the L02SCPU, L06CPU, and L26CPU are added.
May 2013	SH(NA)-080892ENG-F	Descriptions regarding the L02SCPU-P, L06CPU-P, and L26CPU-P are added.

Japanese Manual Version SH-080876-G

This manual confers no industrial property rights or any rights of any other kind, nor does it confer any patent licenses. Mitsubishi Electric Corporation cannot be held responsible for any problems involving industrial property rights which may occur as a result of using the contents noted in this manual.

© 2010 MITSUBISHI ELECTRIC CORPORATION

WARRANTY

Please confirm the following product warranty details before using this product.

1. Gratis Warranty Term and Gratis Warranty Range

If any faults or defects (hereinafter "Failure") found to be the responsibility of Mitsubishi occurs during use of the product within the gratis warranty term, the product shall be repaired at no cost via the sales representative or Mitsubishi Service Company.

However, if repairs are required onsite at domestic or overseas location, expenses to send an engineer will be solely at the customer's discretion. Mitsubishi shall not be held responsible for any re-commissioning, maintenance, or testing on-site that involves replacement of the failed module.

[Gratis Warranty Term]

The gratis warranty term of the product shall be for one year after the date of purchase or delivery to a designated place.

Note that after manufacture and shipment from Mitsubishi, the maximum distribution period shall be six (6) months, and the longest gratis warranty term after manufacturing shall be eighteen (18) months. The gratis warranty term of repair parts shall not exceed the gratis warranty term before repairs.

[Gratis Warranty Range]

- (1) The range shall be limited to normal use within the usage state, usage methods and usage environment, etc., which follow the conditions and precautions, etc., given in the instruction manual, user's manual and caution labels on the product.
- (2) Even within the gratis warranty term, repairs shall be charged for in the following cases.
 1. Failure occurring from inappropriate storage or handling, carelessness or negligence by the user. Failure caused by the user's hardware or software design.
 2. Failure caused by unapproved modifications, etc., to the product by the user.
 3. When the Mitsubishi product is assembled into a user's device, Failure that could have been avoided if functions or structures, judged as necessary in the legal safety measures the user's device is subject to or as necessary by industry standards, had been provided.
 4. Failure that could have been avoided if consumable parts (battery, backlight, fuse, etc.) designated in the instruction manual had been correctly serviced or replaced.
 5. Failure caused by external irresistible forces such as fires or abnormal voltages, and Failure caused by force majeure such as earthquakes, lightning, wind and water damage.
 6. Failure caused by reasons unpredictable by scientific technology standards at time of shipment from Mitsubishi.
 7. Any other failure found not to be the responsibility of Mitsubishi or that admitted not to be so by the user.

2. Onerous repair term after discontinuation of production

- (1) Mitsubishi shall accept onerous product repairs for seven (7) years after production of the product is discontinued.
Discontinuation of production shall be notified with Mitsubishi Technical Bulletins, etc.
- (2) Product supply (including repair parts) is not available after production is discontinued.

3. Overseas service

Overseas, repairs shall be accepted by Mitsubishi's local overseas FA Center. Note that the repair conditions at each FA Center may differ.

4. Exclusion of loss in opportunity and secondary loss from warranty liability

Regardless of the gratis warranty term, Mitsubishi shall not be liable for compensation of damages caused by any cause found not to be the responsibility of Mitsubishi, loss in opportunity, lost profits incurred to the user by Failures of Mitsubishi products, special damages and secondary damages whether foreseeable or not, compensation for accidents, and compensation for damages to products other than Mitsubishi products, replacement by the user, maintenance of on-site equipment, start-up test run and other tasks.

5. Changes in product specifications

The specifications given in the catalogs, manuals or technical documents are subject to change without prior notice.

Microsoft, Windows, Windows Vista, Windows NT, Windows XP, Windows Server, Visio, Excel, PowerPoint, Visual Basic, Visual C++, and Access are either registered trademarks or trademarks of Microsoft Corporation in the United States, Japan, and other countries.

Intel, Pentium, and Celeron are trademarks of Intel Corporation in the United States and other countries.

Ethernet is a registered trademark of Xerox Corp.

The SD and SDHC logos are either registered trademarks or trademarks of SD-3C, LLC.

All other company names and product names used in this manual are either trademarks or registered trademarks of their respective companies.



MELSEC-L CPU Module User's Manual

Built-In I/O Function

MODEL	LCPU-U-IO-E
MODEL CODE	13JZ38
SH(NA)-080892ENG-F(1305)MEE	

 **MITSUBISHI ELECTRIC CORPORATION**

HEAD OFFICE : TOKYO BUILDING, 2-7-3 MARUNOUCHI, CHIYODA-KU, TOKYO 100-8310, JAPAN
NAGOYA WORKS : 1-14, YADA-MINAMI 5-CHOME, HIGASHI-KU, NAGOYA, JAPAN

When exported from Japan, this manual does not require application to the
Ministry of Economy, Trade and Industry for service transaction permission.

Specifications subject to change without notice.