



Mitsubishi Electric AC Servo System

MITSUBISHI ELECTRIC SERVO SYSTEM
MELSERVO-JET

MR-JET-G User's Manual (Parameters)



-MR-JET- _G_
-MR-JET- _G_- _N1

SAFETY INSTRUCTIONS

Please read the instructions carefully before using the equipment.

To use the equipment correctly, do not attempt to install, operate, maintain, or inspect the equipment until you have read through this manual, installation guide, and appended documents carefully. Do not use the equipment until you have a full knowledge of the equipment, safety information and instructions.





In this manual, the safety instruction levels are classified into "WARNING" and "CAUTION".

 WARNING	Indicates that incorrect handling may cause hazardous conditions, resulting in death or severe injury.
 CAUTION	Indicates that incorrect handling may cause hazardous conditions, resulting in medium or slight injury.

Note that the CAUTION level may lead to a serious consequence depending on conditions.

Please follow the instructions of both levels because they are important to personnel safety.

Forbidden actions and required actions are indicated by the following diagrammatic symbols.

	Indicates a forbidden action. For example, "No Fire" is indicated by  .
	Indicates a required action. For example, grounding is indicated by  .

In this manual, precautions for hazards that can lead to property damage, instructions for other functions, and other information are shown separately in the "Point" area.

After reading this manual, keep it accessible to the operator.

[Installation/wiring]

WARNING

- To prevent an electric shock, turn off the power and wait for 15 minutes or more before starting wiring and/or inspection.
 - To prevent an electric shock, ground the servo amplifier.
 - To prevent an electric shock, any person who is involved in wiring should be fully competent to do the work.
 - To prevent an electric shock, mount the servo amplifier before wiring.
 - To prevent an electric shock, connect the protective earth (PE) terminal of the servo amplifier to the protective earth (PE) of the cabinet, then connect the grounding lead wire to the ground.
 - To prevent an electric shock, do not touch the conductive parts.
-

[Setting/adjustment]

WARNING

- To prevent an electric shock, do not operate the switches with wet hands.
-

[Operation]

WARNING

- To prevent an electric shock, do not operate the switches with wet hands.
-

[Maintenance]

WARNING

- To prevent an electric shock, any person who is involved in inspection should be fully competent to do the work.
 - To prevent an electric shock, do not operate the switches with wet hands.
-

ABOUT THE MANUAL

Point

e-Manuals are Mitsubishi Electric FA electronic book manuals that can be browsed with a dedicated tool.

e-Manuals enable the following:

- Searching for desired information in multiple manuals at the same time (manual cross searching)
- Jumping from a link in a manual to another manual for reference
- Browsing for hardware specifications by scrolling over the components shown in product illustrations
- Bookmarking frequently referenced information
- Copying sample programs to engineering software

If using the servo for the first time, prepare and use the following related manuals to ensure that the servo is used safely. For the related manuals, refer to the User's Manual (Introduction).

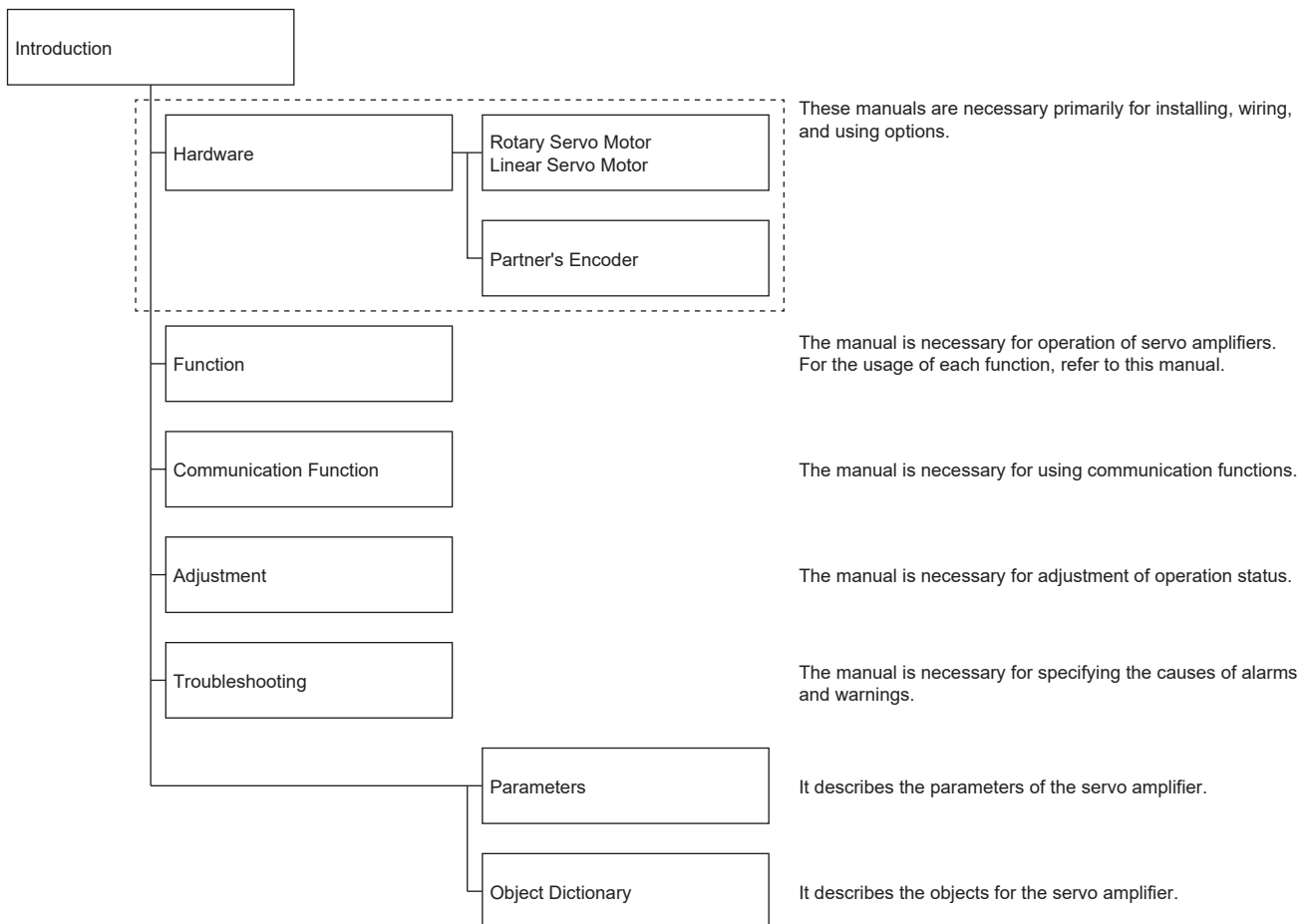

Interpreting servo parameter numbers

For a servo parameter which uses one particular digit to select a function, the position of its digit indicates the detail number of the servo parameter, and the value in hexadecimal which is set to the digit indicates the selected function.

For example, the detail number of the servo parameter in the last digit is expressed as [Pr. PA01.0]. In addition, a servo parameter which uses a combination of several digits to select a function, is expressed using "-" as seen in [Pr. PA01.0-1]. The following is an example of the servo parameter number PA01 with the setting values of "FEDCBA98" in hexadecimal.

- When setting a servo parameter with one particular digit

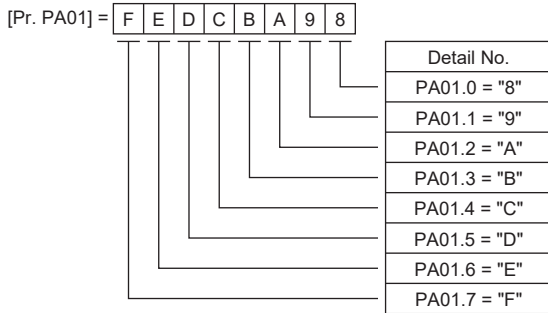

- When setting a servo parameter using a combination of several digits

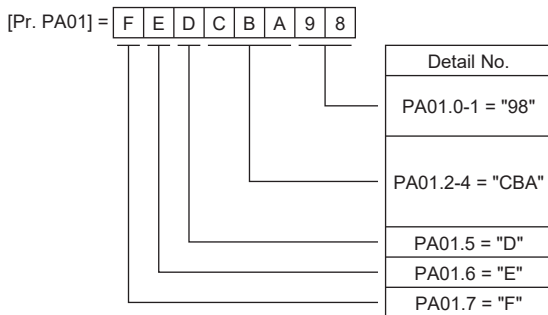

For example, if the servo parameter name is "Function selection A-1", the setting digit name is "Forced stop deceleration function selection", and the setting digit is the fourth last digit in PA04, the servo parameter is expressed as shown below.

[Pr. PA04.3 Forced stop deceleration function selection]

Servo parameter	Symbol	Name	Description
PA04.3	*AOP	Forced stop deceleration function selection	Set "Forced stop deceleration function" to enabled/disabled. Initial value: 1h (enabled)

Global standards and regulations

Compliance with the indicated global standards and regulations is current as of the release date of this manual. Some standards and regulations may have been modified or withdrawn.

U.S. CUSTOMARY UNITS

U.S. customary units are not shown in this manual. Convert the values if necessary according to the following table.

Quantity	SI (metric) unit	U.S. customary unit
Mass	1 [kg]	2.2046 [lb]
Length	1 [mm]	0.03937 [inch]
Torque	1 [N•m]	141.6 [oz•inch]
Moment of inertia	1 [$\times 10^{-4}$ kg•m ²]	5.4675 [oz•inch ²]
Load (thrust load/axial load)	1 [N]	0.2248 [lbf]
Temperature	N [$^{\circ}$ C] \times 9/5 + 32	N [$^{\circ}$ F]

CONTENTS

SAFETY INSTRUCTIONS	1
ABOUT THE MANUAL	3
U.S. CUSTOMARY UNITS	5
CHAPTER 1 SERVO PARAMETER DETAILS	15
1.1 Explanation of servo parameters	15
1.2 Basic setting servo parameters group ([Pr. PA_ _])	16
[Pr. PA01_Operation mode (**STY)]	16
[Pr. PA02_Regenerative option (**REG)]	17
[Pr. PA03_Absolute position detection system (*ABS)]	18
[Pr. PA04_Function selection A-1 (*AOP1)]	19
[Pr. PA06_Electronic gear numerator (*CMX)]	19
[Pr. PA07_Electronic gear denominator (*CDV)]	19
[Pr. PA08_Auto tuning mode (ATU)]	20
[Pr. PA09_Auto tuning response (RSP)]	22
[Pr. PA10_In-position range (INP)]	23
[Pr. PA11_Forward rotation torque limit (TLP)]	24
[Pr. PA12_Reverse rotation torque limit (TLN)]	24
[Pr. PA14_Travel direction selection (*POL)]	25
[Pr. PA17_Servo motor series setting (**MSR)]	26
[Pr. PA18_Servo motor type setting (**MTY)]	26
[Pr. PA19_Servo parameter writing prohibited (*BLK)]	27
[Pr. PA20_Tough drive setting (*TDS)]	28
[Pr. PA21_Function selection A-3 (*AOP3)]	28
[Pr. PA22_Position control configuration selection (**PCS)]	29
[Pr. PA23_Drive recorder desired alarm trigger setting (DRAT)]	29
[Pr. PA24_Function selection A-4 (AOP4)]	30
[Pr. PA25_One-touch tuning - Overshoot permissible level (OTHOV)]	30
[Pr. PA26_Function selection A-5 (*AOP5)]	31
[Pr. PA28_Function selection A-6 (**AOP6)]	31
[Pr. PA34_Quick tuning - Permissible travel distance (QDIS)]	31
1.3 Gain/filter setting servo parameters group ([Pr. PB_ _])	32
[Pr. PB01_Adaptive tuning mode (adaptive filter II) (FILT)]	32
[Pr. PB02_Vibration suppression control tuning mode (advanced vibration suppression control II) (VRFT)]	33
[Pr. PB03_Torque feedback loop gain (TFBGN)]	33
[Pr. PB04_Feed forward gain (FFC)]	33
[Pr. PB06_Load to motor inertia ratio/load to motor mass ratio (GD2)]	34
[Pr. PB07_Model control gain (PG1)]	34
[Pr. PB08_Position control gain (PG2)]	35
[Pr. PB09_Speed control gain (VG2)]	35
[Pr. PB10_Speed integral compensation (VIC)]	35
[Pr. PB11_Speed differential compensation (VDC)]	35
[Pr. PB12_Overshoot amount compensation (OVA)]	36
[Pr. PB13_Machine resonance suppression filter 1 (NH1)]	36
[Pr. PB14_Notch shape selection 1 (NHQ1)]	36
[Pr. PB15_Machine resonance suppression filter 2 (NH2)]	36
[Pr. PB16_Notch shape selection 2 (NHQ2)]	37
[Pr. PB17_Shaft resonance suppression filter (NHF)]	38

[Pr. PB18_Low-pass filter setting (LPF)]	41
[Pr. PB19_Vibration suppression control 1 - Vibration frequency (VRF11)]	42
[Pr. PB20_Vibration suppression control 1 - Resonance frequency (VRF12)]	42
[Pr. PB21_Vibration suppression control 1 - Vibration frequency damping (VRF13)]	42
[Pr. PB22_Vibration suppression control 1 - Resonance frequency damping (VRF14)]	42
[Pr. PB23_Low-pass filter selection (VFBF)]	43
[Pr. PB24_Slight vibration suppression control (*MVS)]	44
[Pr. PB25_Function selection B-1 (*BOP1)]	44
[Pr. PB26_Gain switching function (*CDP)]	45
[Pr. PB27_Gain switching condition (CDL)]	46
[Pr. PB28_Gain switching time constant (CDT)]	46
[Pr. PB29_Gain switching - Load to motor inertia ratio/load to motor mass ratio (GD2B)]	46
[Pr. PB30_Gain switching - Position control gain (PG2B)]	46
[Pr. PB31_Gain switching - Speed control gain (VG2B)]	47
[Pr. PB32_Gain switching - Speed integral compensation (VICB)]	47
[Pr. PB33_Gain switching - Vibration suppression control 1 - Vibration frequency (VRF11B)]	47
[Pr. PB34_Gain switching - Vibration suppression control 1 - Resonance frequency (VRF12B)]	47
[Pr. PB35_Gain switching - Vibration suppression control 1 - Vibration frequency damping (VRF13B)]	48
[Pr. PB36_Gain switching - Vibration suppression control 1 - Resonance frequency damping (VRF14B)]	48
[Pr. PB45_Command notch filter (CNHF)]	48
[Pr. PB46_Machine resonance suppression filter 3 (NH3)]	51
[Pr. PB47_Notch shape selection 3 (NHQ3)]	52
[Pr. PB48_Machine resonance suppression filter 4 (NH4)]	52
[Pr. PB49_Notch shape selection 4 (NHQ4)]	53
[Pr. PB50_Machine resonance suppression filter 5 (NH5)]	53
[Pr. PB51_Notch shape selection 5 (NHQ5)]	54
[Pr. PB52_Vibration suppression control 2 - Vibration frequency (VRF21)]	54
[Pr. PB53_Vibration suppression control 2 - Resonance frequency (VRF22)]	55
[Pr. PB54_Vibration suppression control 2 - Vibration frequency damping (VRF23)]	55
[Pr. PB55_Vibration suppression control 2 - Resonance frequency damping (VRF24)]	55
[Pr. PB56_Gain switching - Vibration suppression control 2 - Vibration frequency (VRF21B)]	55
[Pr. PB57_Gain switching - Vibration suppression control 2 - Resonance frequency (VRF22B)]	56
[Pr. PB58_Gain switching - Vibration suppression control 2 - Vibration frequency damping (VRF23B)]	56
[Pr. PB59_Gain switching - Vibration suppression control 2 - Resonance frequency damping (VRF24B)]	56
[Pr. PB60_Gain switching - Model control gain (PG1B)]	56
[Pr. PB65_Gain switching 2 condition (CDL2)]	57
[Pr. PB66_Gain switching 2 time constant (CDT2)]	57
[Pr. PB67_Gain switching 2 - Load to motor inertia ratio/load to motor mass ratio (GD2C)]	57
[Pr. PB68_Gain switching 2 - Position control gain (PG2C)]	57
[Pr. PB69_Gain switching 2 - Speed control gain (VG2C)]	57
[Pr. PB70_Gain switching 2 - Speed integral compensation (VICC)]	58
[Pr. PB71_Gain switching 2 - Vibration suppression control 1 - Vibration frequency (VRF11C)]	58
[Pr. PB72_Gain switching 2 - Vibration suppression control 1 - Resonance frequency (VRF12C)]	58
[Pr. PB73_Gain switching 2 - Vibration suppression control 1 - Vibration frequency damping (VRF13C)]	59
[Pr. PB74_Gain switching 2 - Vibration suppression control 1 - Resonance frequency damping (VRF14C)]	59
[Pr. PB75_Gain switching 2 - Vibration suppression control 2 - Vibration frequency (VRF21C)]	59
[Pr. PB76_Gain switching 2 - Vibration suppression control 2 - Resonance frequency (VRF22C)]	60
[Pr. PB77_Gain switching 2 - Vibration suppression control 2 - Vibration frequency damping (VRF23C)]	60
[Pr. PB78_Gain switching 2 - Vibration suppression control 2 - Resonance frequency damping (VRF24C)]	60
[Pr. PB79_Gain switching 2 - Model control gain (PG1C)]	61
[Pr. PB81_Command filter (*CFIL)]	61

	[Pr. PB82_Position command smoothing filter time constant (PFT)]	61
1.4	Extension setting servo parameters group ([Pr. PC_ _])	62
	[Pr. PC01_Excessive error alarm trigger level (ERZ)]	62
	[Pr. PC02_Electromagnetic brake sequence output (MBR)]	62
	[Pr. PC04_Function selection C-1 (**COP1)]	62
	[Pr. PC05_Function selection C-2 (**COP2)]	63
	[Pr. PC06_Function selection C-3 (*COP3)]	64
	[Pr. PC07_Zero speed (ZSP)]	64
	[Pr. PC08_Overspeed alarm detection level (OSL)]	64
	[Pr. PC17_Function selection C-4 (**COP4)]	65
	[Pr. PC19_Function selection C-6 (*COP6)]	65
	[Pr. PC20_Function selection C-7 (*COP7)]	66
	[Pr. PC21_Alarm history clear (*BPS)]	66
	[Pr. PC24_Deceleration time constant at forced stop (RSBR)]	67
	[Pr. PC26_Function selection C-8 (**COP8)]	68
	[Pr. PC27_Function selection C-9 (**COP9)]	68
	[Pr. PC29_Function selection C-B (*COPB)]	69
	[Pr. PC31_Vertical axis freefall prevention compensation amount (RSUP1)]	71
	[Pr. PC38_Excessive error warning trigger level (ERW)]	71
	[Pr. PC41_Function selection C-J (*COPJ)]	72
	[Pr. PC42_Function selection C-10 (COP10)]	72
	[Pr. PC43_Forward rotation torque limit 2 (TLP2)]	73
	[Pr. PC44_Reverse rotation torque limit 2 (TLN2)]	73
	[Pr. PC65_Zero speed 2 level (ZSP2L)]	73
	[Pr. PC66_Zero speed 2 filtering time (ZSP2F)]	74
	[Pr. PC67_Following error output level (FEW)]	74
	[Pr. PC69_Following error output filtering time (FEWF)]	74
	[Pr. PC70_In-position 2 - Output range (INP2R)]	75
	[Pr. PC71_In-position 2 - Output filtering time (INP2F)]	75
	[Pr. PC72_Speed reached 2 - Output range (SA2R)]	75
	[Pr. PC73_Speed reached 2 - Output filtering time (SA2F)]	76
	[Pr. PC76_Function selection C-E (*COPE)]	76
	[Pr. PC78_Function selection C-F (*COPF)]	77
	[Pr. PC79_Function selection C-G (*COPG)]	77
	[Pr. PC96_Output open-phase detection time (*OPDT)]	78
1.5	I/O setting servo parameters group ([Pr. PD_ _])	79
	[Pr. PD01_Input signal automatic ON selection 1 (*DIA1)]	79
	[Pr. PD03_Input device selection 1 (*DI1)]	80
	[Pr. PD04_Input device selection 2 (*DI2)]	80
	[Pr. PD05_Input device selection 3 (*DI3)]	81
	[Pr. PD07_Output device selection 1 (*DO1)]	82
	[Pr. PD08_Output device selection 2 (*DO2)]	83
	[Pr. PD09_Output device selection 3 (*DO3)]	83
	[Pr. PD11_Input filter setting (*DIF)]	84
	[Pr. PD12_Function selection D-1 (*DOP1)]	84
	[Pr. PD13_Function selection D-2 (*DOP2)]	85
	[Pr. PD14_Function selection D-3 (*DOP3)]	86
	[Pr. PD38_Input device selection 4 (*DI4)]	86
	[Pr. PD39_Input device selection 5 (*DI5)]	87
	[Pr. PD41_Function selection D-4 (*DOP4)]	87
	[Pr. PD60_DI pin polarity selection (*DIP)]	88

	[Pr. PD61_Function selection D-5 (*DOP5)]	89
1.6	Extension setting 2 servo parameters group ([Pr. PE_ _])	90
	[Pr. PE01_Fully closed loop control function selection 1 (**FCT1)]	90
	[Pr. PE03_Fully closed loop control function selection 2 (*FCT2)]	91
	[Pr. PE04_Fully closed loop control - Feedback pulse electronic gear 1 - Numerator (**FBN)]	92
	[Pr. PE05_Fully closed loop control - Feedback pulse electronic gear 1 - Denominator (**FBD)]	92
	[Pr. PE06_Fully closed loop control - Speed deviation error detection level (BC1)]	92
	[Pr. PE07_Fully closed loop control - Position deviation error detection level (BC2)]	92
	[Pr. PE08_Fully closed loop dual feedback filter (DUF)]	92
	[Pr. PE10_Fully closed loop function selection 3 (FCT3)]	93
	[Pr. PE41_Function selection E-3 (EOP3)]	93
	[Pr. PE44_Lost motion compensation positive-side compensation value selection (LMCP)]	93
	[Pr. PE45_Lost motion compensation negative-side compensation value selection (LMCN)]	94
	[Pr. PE46_Lost motion filter setting (LMFLT)]	94
	[Pr. PE47_Unbalanced torque offset (TOF)]	94
	[Pr. PE48_Lost motion compensation function selection (*LMOP)]	94
	[Pr. PE49_Lost motion compensation timing (LMCD)]	95
	[Pr. PE50_Lost motion compensation dead band (LMCT)]	95
	[Pr. PE51_Load-side encoder resolution setting (**EDV2)]	95
	[Pr. PE53_Maximum torque limit 1 (TLMX1)]	96
1.7	Extension setting 3 servo parameters group ([Pr. PF_ _])	97
	[Pr. PF02_Function selection F-2 (*FOP2)]	97
	[Pr. PF06_Function selection F-5 (*FOP5)]	97
	[Pr. PF12_Electronic dynamic brake operating time (DBT)]	98
	[Pr. PF21_Drive recorder switching time setting (DRT)]	98
	[Pr. PF23_Vibration tough drive - Oscillation detection level (OSCL1)]	98
	[Pr. PF24_Function selection F-9 (*FOP9)]	98
	[Pr. PF25_Instantaneous power failure tough drive detection time (CVAT)]	99
	[Pr. PF29_Function selection F-10 (*FOP10)]	99
	[Pr. PF31_Machine diagnosis function - Friction estimate area judgment speed at low speed (FRIC)]	99
	[Pr. PF32_Oscillation detection alarm time (*VIBT)]	100
	[Pr. PF34_Machine diagnosis function selection (*MFP)]	100
	[Pr. PF63_Function selection F-15 (*FOP15)]	100
	[Pr. PF80_Drive recorder - Operation condition selection (DRMC)]	101
	[Pr. PF81_Drive recorder - Sampling operation selection (DRMS)]	102
	[Pr. PF82_Drive recorder - Trigger operation selection (DRTM)]	102
	[Pr. PF84_Drive recorder - Trigger channel selection (DRTC)]	104
	[Pr. PF85_Drive recorder - Trigger level setting 1 (DRTL1)]	105
	[Pr. PF86_Drive recorder - Trigger level setting 2 (DRTL2)]	105
	[Pr. PF87_Drive recorder - Analog channel setting 1 (DRAC1)]	106
	[Pr. PF88_Drive recorder - Analog channel setting 2 (DRAC2)]	108
	[Pr. PF89_Drive recorder - Analog channel setting 3 (DRAC3)]	109
	[Pr. PF90_Drive recorder - Analog channel setting 4 (DRAC4)]	109
	[Pr. PF91_Drive recorder - Digital channel setting 1 (DRDC1)]	110
	[Pr. PF92_Drive recorder - Digital channel setting 2 (DRDC2)]	112
	[Pr. PF93_Drive recorder - Digital channel setting 3 (DRDC3)]	112
	[Pr. PF94_Drive recorder - Digital channel setting 4 (DRDC4)]	113
	[Pr. PF95_Drive recorder - Clear history (**DRCLR)]	113
1.8	Motor extension setting servo parameters group ([Pr. PL_ _])	114
	[Pr. PL01_Function selection L-1 (**LIT1)]	114
	[Pr. PL02_Linear encoder resolution setting - Numerator (**LIM)]	114

	[Pr. PL03_Linear encoder resolution setting - Denominator (**LID)]	114
	[Pr. PL04_Function selection L-2 (*LIT2)]	115
	[Pr. PL05_Position deviation error detection level (LB1)]	115
	[Pr. PL06_Speed deviation error detection level (LB2)]	115
	[Pr. PL07_Torque deviation error detection level (LB3)]	116
	[Pr. PL08_Function selection L-3 (*LIT3)]	116
	[Pr. PL09_Magnetic pole detection voltage level (LPWM)]	116
	[Pr. PL17_Magnetic pole detection - Minute position detection method - Function selection (LTSTS)]	117
	[Pr. PL18_Magnetic pole detection - Minute position detection method - Identification signal amplitude (IDLV)]	118
1.9	Positioning control setting servo parameters group ([Pr. PT_ _])	119
	[Pr. PT01_Command mode selection (**CTY)]	119
	[Pr. PT02_Function selection T-1 (*TOP1)]	120
	[Pr. PT03_Feed function selection (*FTY)]	121
	[Pr. PT05_Homing speed (ZRF)]	121
	[Pr. PT06_Creep speed (CRF)]	122
	[Pr. PT07_Home position shift distance (ZST)]	122
	[Pr. PT08_Homing position data (ZPS)]	123
	[Pr. PT09_Travel distance after proximity dog (DCT)]	124
	[Pr. PT10_Stopper type homing - Stopping time (ZTM)]	124
	[Pr. PT11_Stopper type homing - Torque limit value (ZTT)]	124
	[Pr. PT12_Rough match output range (CRP)]	124
	[Pr. PT15_Software position limit + (LMP)]	125
	[Pr. PT17_Software position limit - (LMN)]	125
	[Pr. PT19_Position range output 1 address + (*LPP1)]	126
	[Pr. PT21_Position range output 1 address - (*LNP1)]	126
	[Pr. PT26_Function selection T-2 (*TOP2)]	127
	[Pr. PT29_Function selection T-3 (*TOP3)]	128
	[Pr. PT34_Positioning operation data default (**PDEF)]	128
	[Pr. PT38_Function selection T-7 (**TOP7)]	129
	[Pr. PT41_Function selection T-8 (TOP8)]	129
	[Pr. PT45_Homing method (HMM)]	129
	[Pr. PT49_Speed acceleration time constant (STA)]	135
	[Pr. PT50_Speed deceleration time constant (STB)]	135
	[Pr. PT51_S-pattern acceleration/deceleration time constants (STC)]	136
	[Pr. PT53_Torque slope (TQS)]	136
	[Pr. PT55_Function selection T-10 (*TOP10)]	137
	[Pr. PT56_Homing acceleration time constant (HMA)]	137
	[Pr. PT57_Homing deceleration time constant (HMB)]	137
	[Pr. PT65_Profile speed command (PVC)]	138
	[Pr. PT66_Maximum profile speed (MPVC)]	138
	[Pr. PT67_Speed limit (VLMT)]	138
	[Pr. PT68_Function selection T-11 (TOP11)]	139
	[Pr. PT83_Positioning function selection (*MOTOP)]	140
	[Pr. PT85_Function selection T-14 (*TOP14)]	140
1.10	Network setting servo parameters group ([Pr. PN_ _])	141
	[Pr. PN02_Communication error - Detection time (CERT)]	141
	[Pr. PN03_Communication mode setting (**NWMD)]	141
	[Pr. PN05_Communication error - Detection frequency setting (CERF)]	142
	[Pr. PN06_Function selection N-1 (NOP1)]	143
	[Pr. PN07_Communication cycle initial setting (**CCS)]	143

3.9	Network setting servo parameters group ([Pr. PN_ _])	178
3.10	Positioning extension setting servo parameters group ([Pr. PV_ _])	179
CHAPTER 4 SERVO PARAMETER SETTING METHOD		180
4.1	Engineering software	180
4.2	Object dictionary	180
CHAPTER 5 NETWORK PARAMETER DETAILS		182
5.1	Network basic parameters	183
	[Pr. NPA01_IP address setting]	183
	[Pr. NPA02_IP address]	184
	[Pr. NPA04_Subnet mask]	184
	[Pr. NPA08_Host name]	185
	[Pr. NPA09_Node address setting]	185
	[Pr. NPA12_Communication speed]	185
5.2	User authentication parameters	186
	[Pr. NPB01_User authentication and authorization setting]	186
	[Pr. NPB04_User name No.1]	186
	[Pr. NPB05_Authorization level No.1]	187
	[Pr. NPB06_Password No.1]	187
	[Pr. NPB07_User name No.2]	187
	[Pr. NPB08_Authorization level No.2]	188
	[Pr. NPB09_Password No.2]	188
	[Pr. NPB10_User name No.3]	188
	[Pr. NPB11_Authorization level No.3]	188
	[Pr. NPB12_Password No.3]	188
	[Pr. NPB13_User name No.4]	188
	[Pr. NPB14_Authorization level No.4]	189
	[Pr. NPB15_Password No.4]	189
	[Pr. NPB16_User name No.5]	189
	[Pr. NPB17_Authorization level No.5]	189
	[Pr. NPB18_Password No.5]	189
	[Pr. NPB19_User name No.6]	189
	[Pr. NPB20_Authorization level No.6]	190
	[Pr. NPB21_Password No.6]	190
	[Pr. NPB22_User name No.7]	190
	[Pr. NPB23_Authorization level No.7]	190
	[Pr. NPB24_Password No.7]	190
	[Pr. NPB25_User name No.8]	190
	[Pr. NPB26_Authorization level No.8]	191
	[Pr. NPB27_Password No.8]	191
CHAPTER 6 NETWORK PARAMETER SETTING METHOD		192
6.1	Engineering software	192
CHAPTER 7 FUNCTIONAL SAFETY PARAMETER DETAILS		194
7.1	Safety sub-function 1 parameters group ([Pr. PSA_ _])	195
	[Pr. PSA01_Safety sub-function mode selection (**SOA)]	195
	[Pr. PSA02_Functional safety setting (**SMD)]	196
	[Pr. PSA03_SS1 deceleration monitor time (**SST)]	196

	[Pr. PSA04_Safety sub-function - Stop speed (**SSS)]	196
	[Pr. PSA07_SLS deceleration monitor time 1 (**SLSDT1)]	197
	[Pr. PSA08_SLS deceleration monitor time 2 (**SLSDT2)]	197
	[Pr. PSA09_SLS deceleration monitor time 3 (**SLSDT3)]	197
	[Pr. PSA10_SLS deceleration monitor time 4 (**SLSDT4)]	197
	[Pr. PSA11_SLS speed 1 (**SLSS1)]	197
	[Pr. PSA12_SLS speed 2 (**SLSS2)]	197
	[Pr. PSA13_SLS speed 3 (**SLSS3)]	198
	[Pr. PSA14_SLS speed 4 (**SLSS4)]	198
	[Pr. PSA15_Safety sub-function - Speed detection delay time (**SLST)]	198
	[Pr. PSA18_SSM speed (**SSMS)]	198
	[Pr. PSA19_SSM hysteresis width (**SSMHW)]	198
	[Pr. PSA20_Servo motor encoder resolution (**SMER)]	199
	[Pr. PSA22_Position feedback error detection time (**SAADT)]	199
	[Pr. PSA23_Servo motor rated speed (**SMRS)]	199
	[Pr. PSA24_SS1 deceleration monitor time constant (**SSTC)]	199
	[Pr. PSA25_SS1 deceleration monitor speed offset (**SSOF)]	199
	[Pr. PSA26_SS1 deceleration monitor delay time (**SSDT)]	200
	[Pr. PSA27_SDI positive direction monitor delay time (**SDIDTP)]	200
	[Pr. PSA28_SDI negative direction monitor delay time (**SDIDTN)]	200
7.2	Safety sub-function 2 parameters group ([Pr. PSB_ _])	201
	[Pr. PSB10_SLT torque upper limit value 1 (**SLTP1)]	201
	[Pr. PSB11_SLT torque upper limit value 2 (**SLTP2)]	201
	[Pr. PSB12_SLT torque upper limit value 3 (**SLTP3)]	201
	[Pr. PSB13_SLT torque upper limit value 4 (**SLTP4)]	201
	[Pr. PSB14_SLT torque lower limit value 1 (**SLTN1)]	201
	[Pr. PSB15_SLT torque lower limit value 2 (**SLTN2)]	202
	[Pr. PSB16_SLT torque lower limit value 3 (**SLTN3)]	202
	[Pr. PSB17_SLT torque lower limit value 4 (**SLTN4)]	202
	[Pr. PSB18_SLT torque detection delay time (**SLTT)]	202
7.3	Network parameters group ([Pr. PSC_ _])	203
	[Pr. PSC01_Transmission interval monitor time (**SNC)]	203
	[Pr. PSC03_Functional safety - Rotation direction selection/travel direction selection (**SNPOL)]	203
	[Pr. PSC06_Safety verification code (**SAC)]	203
	[Pr. PSC07_FSoE Address setting (**FSADD)]	204
	[Pr. PSC08_Safety communication - Functional safety disabled setting (**SCFN)]	204
	[Pr. PSC09_Safety communication - Output signal polarity setting (**SFPOL)]	206
7.4	Safety I/O device parameters group ([Pr. PSD_ _])	208
	[Pr. PSD01_Input device automatic activation selection (**SDIA)]	208
	[Pr. PSD02_Safety input device selection DI1 (**SDI1)]	209
	[Pr. PSD03_Safety input device selection DI2 (**SDI2)]	210
	[Pr. PSD04_Safety input device selection DI3 (**SDI3)]	210
	[Pr. PSD08_Safety output device selection DO1 (**SDO1)]	211
	[Pr. PSD09_Safety output device selection DO2 (**SDO2)]	212
	[Pr. PSD10_Safety output device selection DO3 (**SDO3)]	212
	[Pr. PSD12_Input device - Noise elimination filter time DI1 (**SDIF1)]	213
	[Pr. PSD13_Input device - Noise elimination filter time DI2 (**SDIF2)]	213
	[Pr. PSD14_Input device - Noise elimination filter time DI3 (**SDIF3)]	214
	[Pr. PSD18_Permissible time for mismatches DI1 (**SDIDT1)]	214
	[Pr. PSD19_Permissible time for mismatches DI2 (**SDIDT2)]	214
	[Pr. PSD20_Permissible time for mismatches DI3 (**SDIDT3)]	214

[Pr. PSD27_Input device - Fixing diagnosis at startup execution selection 1 (**SDID1)]	215
[Pr. PSD29_Output device - Test pulse diagnosis execution selection (**SDOP)]	216
[Pr. PSD30_Output device - Test pulse off time (**SDOPW)]	217
[Pr. PSD31_Output device - Feedback diagnosis execution selection (**SDOD1)]	218
7.5 Extension setting 3 parameters group ([Pr. PSL_ _])	219
[Pr. PSL02_Functional safety - Linear encoder resolution setting - Numerator (**SLIM)]	219
[Pr. PSL03_Functional safety - Linear encoder resolution setting - Denominator (**SLID)]	219
CHAPTER 8 LISTS OF FUNCTIONAL SAFETY PARAMETER INITIAL VALUES	220
8.1 Safety sub-function 1 parameters group ([Pr. PSA_ _])	220
8.2 Safety sub-function 2 parameters group ([Pr. PSB_ _])	222
8.3 Network parameters group ([Pr. PSC_ _])	224
8.4 Safety I/O device parameters group ([Pr. PSD_ _])	225
8.5 Extension setting 3 parameters group ([Pr. PSL_ _])	227
CHAPTER 9 FUNCTIONAL SAFETY PARAMETER SETTING METHOD	228
9.1 Engineering software	228
REVISIONS	230
WARRANTY	231
TRADEMARKS	232

1 SERVO PARAMETER DETAILS

Restrictions

Settable servo parameters and values depend on the controller model, servo amplifier firmware version, and MR Configurator2 software version. For details, refer to the controller user's manual. Refer to the Mitsubishi Electric FA site for the latest software version of MR Configurator2. In addition, the firmware version of the servo amplifier can be checked with MR Configurator2, objects, or by other means.

Precautions

Never make a drastic adjustment or change to the servo parameter values as doing so will make the operation unstable. Do not change the servo parameter settings as described below. Doing so may cause an unexpected condition, such as failing to start up the servo amplifier.

- Changing the values of the servo parameters for manufacturer setting
- Setting a value outside the range
- Changing the fixed value in each servo parameter

When writing servo parameters with the controller, make sure that the control axis No. of the servo amplifier is set correctly. Failure to do so may cause the servo parameter settings of another axis to be written and result in the servo amplifier being in an unexpected condition.

Some servo parameters are adjusted automatically. For example, auto tuning automatically adjusts gain servo parameters. Some servo parameters correspond to the objects that can be updated periodically in cyclic communication. For example, [Pr. PT45 Homing method] corresponds to [Homing method (Obj. 6098h)]. When a relevant object is mapped in cyclic communication, the controller overwrites the servo parameter value written with engineering software. Thus, do not write a value with engineering software.

1.1 Explanation of servo parameters

For how to interpret the servo parameter numbers, refer to "Interpreting servo parameter numbers" in User's Manual (Introduction).

The following explains how to read the details of servo parameters.

Item	Explanation
No.	Indicates the servo parameter No., which can be identified by the servo parameter group and number.
Symbol	Indicates the abbreviation of the servo parameter. *** added to abbreviations means the following. *: After setting, cycle the power, or reset either the controller or the software. **: After setting, cycle the power or reset the software.
Name	Indicates the name of the servo parameter.
Initial value (unit)	Indicates the servo parameter initial value at factory setting. When there is a unit in the servo parameter, the unit is shown with [].
Setting range	Indicates the setting range of the servo parameter.
Ver.	Indicates the supported firmware version of the servo amplifier. The servo parameter is available on servo amplifiers with the firmware version or later.
TSN	Indicates CC-Link IE TSN.
ECT	Indicates EtherCAT.

Servo parameter No., symbols, and names are indicated as follows.

[Pr. PA01 Operation mode (STY)]**

1.2 Basic setting servo parameters group ([Pr. PA_ _])

[Pr. PA01_Operation mode (**STY)]

Initial value	Setting range	Ver.
00003000h	Refer to the relevant detail No.	Refer to the relevant detail No.

[Pr. PA01.0_Control mode selection]

Initial value	Setting range	Ver.
0h	Refer to the text	B8

Select a control mode.

0: Network standard mode

6: Positioning mode (point table method)

The control modes that can be used for each network are as follows.

Command interface	Network	Operation of control mode	
		[Pr. PA01.0] = "0"	[Pr. PA01.0] = "6"
CC-Link IE TSN	0000h (CC-Link IE TSN)	csp/csv/cst/pp/pv/tq/hm/ct	pt/jg/hm
CC-Link IE Field Network Basic	0004h (CC-Link IE Field Network Basic)	pp/pv/tq/hm	pt/jg/hm
EtherCAT	—	csp/csv/cst/pp/pv/tq/hm	pt/jg/hm

*1 Available on servo amplifiers with firmware version C0 or later.

Setting a value other than "0" and "6" triggers [AL. 037 Parameter error].

[Pr. PA01.1_Operation mode selection]

Initial value	Setting range	Ver.
0h	Refer to the text	A4

0: Standard control mode

4: Linear servo motor control mode

The setting value "4" can be used on servo amplifiers with firmware version B2 or later.

[Pr. PA01.4_Fully closed loop operation mode selection]

Initial value	Setting range	Ver.
0h	Refer to the text	C4

Select whether to enable or disable the fully closed loop control mode.

The external encoder communication method of four-wire type cannot be used in the fully closed loop control mode.

When this servo parameter is set to "1" in the linear servo motor control mode, [AL. 037 Parameter error] occurs.

When this servo parameter is set to "1" on a servo amplifier with firmware version earlier than C4, [AL. 037] occurs.

0: Disabled (semi closed loop control mode)

1: Enabled (fully closed loop control mode)

[Pr. PA02_Regenerative option (**REG)]

Initial value	Setting range	Ver.
00000000h	Refer to the relevant detail No.	Refer to the relevant detail No.

[Pr. PA02.0-1_Regenerative option selection]

Initial value	Setting range	Ver.
00h	Refer to the text	A4

Select a regenerative option.

Incorrect setting may cause the regenerative option to burn.

If a selected regenerative option is not for use with the servo amplifier, [AL. 037 Parameter error] occurs.

00: Regenerative option is not used.

- No regenerative resistors are used on servo amplifiers with a capacity of 100 W/200 W.
- Built-in regenerative resistors are used on servo amplifiers with a capacity of 0.4 kW to 7 kW.

02: MR-RB032

03: MR-RB12

05: MR-RB30

06: MR-RB50 (A cooling fan is required.)

0D: MR-RB14

0E: MR-RB34

80: MR-RB1H-4

81: MR-RB3M-4 (A cooling fan is required.)

82: MR-RB3G-4 (A cooling fan is required.)

83: MR-RB5G-4 (A cooling fan is required.)

91: MR-RB3U-4 (A cooling fan is required.)

92: MR-RB5U-4 (A cooling fan is required.)

93: MR-RB3Y-4 (A cooling fan is required.)

94: MR-RB5Y-4 (A cooling fan is required.)

"80", "81", "82", "83", "91", "92", "93", and "94" are available on servo amplifiers with firmware version E8 or later.

[Pr. PA03_Absolute position detection system (*ABS)]

Initial value	Setting range	Ver.
00000000h	Refer to the relevant detail No.	Refer to the relevant detail No.

[Pr. PA03.0_Absolute position detection system selection]

Initial value	Setting range	Ver.
0h	Refer to the text	A4

Set this servo parameter when using the absolute position detection system. If the absolute position detection system is switched to the incremental system, the home position is erased. Execute homing again when the absolute position detection system is enabled.

0: Disabled (incremental system)

1: Enabled (absolute position detection system)

In the following case, enabling the absolute position detection system triggers [AL. 037 Parameter error].

- When an incremental type encoder is being used
- When semi closed/fully closed switching is enabled

By setting [Pr. PF63.0 [AL. 01A.5 Servo motor combination error 3] selection] to "1" (disabled) while the absolute position detection system is enabled, an in-use servo motor with a batteryless absolute position encoder can be replaced without changing the setting value of [Pr. PA03.1 Servo motor replacement preparation].

Connecting a servo motor that had not been connected at the startup of the absolute position detection system will cause [AL. 025 Absolute position erased], erasing absolute position data.

Therefore, check if a correct servo motor is connected.

[Pr. PA03.1_Servo motor replacement preparation]

Initial value	Setting range	Ver.
0h	Refer to the text	C0

To replace an in-use batteryless absolute position encoder equipped servo motor while the absolute position detection system is in enabled status, set this servo parameter to "enabled".

Selecting "1" (enabled) enables servo motor replacement. After completing the servo motor replacement preparation, the value automatically changes to "0" (disabled) and the home position is erased.

After replacing the servo motor, execute homing again.

If [AL. 01A.5 Servo motor combination error 3] occurs after servo motor replacement, set this servo parameter to "1" (enabled), cycle the power, and then deactivate [AL. 01A.5].

0: Disabled

1: Enabled

[Pr. PA04_Function selection A-1 (*AOP1)]

Initial value	Setting range	Ver.
00002000h	Refer to the relevant detail No.	Refer to the relevant detail No.

[Pr. PA04.2_Servo forced stop selection]

Initial value	Setting range	Ver.
0h	Refer to the text	A4

0: Enabled (the forced stop input EM2 or EM1 is used)

1: Disabled (the forced stop input EM2 and EM1 are not used)

[Pr. PA04.3_Forced stop deceleration function selection]

Initial value	Setting range	Ver.
2h	Refer to the text	A4

0: Forced stop deceleration function disabled (EM1 is used)

2: Forced stop deceleration function enabled (EM2 is used)

[Pr. PA06_Electronic gear numerator (*CMX)]

Initial value	Setting range	Ver.
1	1 to 2147483647	A4

Set the electronic gear numerator.

This servo parameter corresponds to [Motor revolutions (Obj. 6091h: 01h)]. When an object is mapped in cyclic communication, the controller overwrites the value written with engineering software. Thus, do not write a value with engineering software.

If the electronic gear is set to a value outside the setting range, noise may be generated during acceleration/deceleration, or operation may not be performed at the preset speed and/or acceleration/deceleration time constants.

The setting range of the electronic gear ([Pr. PA06]/[Pr. PA07 Electronic gear denominator]) is as follows.

Encoder resolution [pulse]	Setting range (CMX/CDV)
16777216	1/64 to 2097152
4194304	1/256 to 524288

When [Pr. PT01.2 Unit for position data] is set to "2" (degree), the following two conditions must be met as well:

- When the electronic gear (CMX/CDV) is reduced to the lowest terms, its numerator and denominator are 16384 (2^{14}) or less.
- When $(CMX \times \text{encoder resolution [pulse]}) / (CDV \times 360000)$ is reduced to the lowest terms, its numerator and denominator are 2147483647 ($2^{31}-1$) or less.

[Pr. PA07_Electronic gear denominator (*CDV)]

Initial value	Setting range	Ver.
1	1 to 2147483647	A4

Set the electronic gear denominator.

Refer to the condition range of [Pr. PA06 Electronic gear numerator] for the electronic gear settings.

☞ Page 19 [Pr. PA06_Electronic gear numerator (*CMX)]

This servo parameter corresponds to [Shaft revolutions (Obj. 6091h: 02h)]. When an object is mapped in cyclic communication, the controller overwrites the value written with engineering software. Thus, do not write a value with engineering software.

[Pr. PA08_Auto tuning mode (ATU)]

Initial value	Setting range	Ver.
00000001h	Refer to the relevant detail No.	Refer to the relevant detail No.

[Pr. PA08.0_Gain adjustment mode selection]

Initial value	Setting range	Ver.
1h	Refer to the text	A4

Select the gain adjustment mode.

0: 2 gain adjustment mode 1 (interpolation mode)

1: Auto tuning mode 1

2: Auto tuning mode 2

3: Manual mode

4: 2 gain adjustment mode 2

5: Quick tuning mode

6: Load to motor inertia ratio monitor mode

Refer to the following table for details.

Setting value of [Pr. PA08.0]	Gain adjustment mode	Servo parameter adjusted automatically
0	2 gain adjustment mode 1 (interpolation mode)	[Pr. PB06 Load to motor inertia ratio/load to motor mass ratio] [Pr. PB08 Position control gain] [Pr. PB09 Speed control gain] [Pr. PB10 Speed integral compensation]
1	Auto tuning mode 1	[Pr. PB06 Load to motor inertia ratio/load to motor mass ratio] [Pr. PB07 Model control gain] [Pr. PB08 Position control gain] [Pr. PB09 Speed control gain] [Pr. PB10 Speed integral compensation]
2	Auto tuning mode 2	[Pr. PB07 Model control gain] [Pr. PB08 Position control gain] [Pr. PB09 Speed control gain] [Pr. PB10 Speed integral compensation]
3	Manual mode	—
4	2 gain adjustment mode 2	[Pr. PB08 Position control gain] [Pr. PB09 Speed control gain] [Pr. PB10 Speed integral compensation]
5	Quick tuning mode	[Pr. PB07 Model control gain] [Pr. PB08 Position control gain] [Pr. PB09 Speed control gain] [Pr. PB10 Speed integral compensation] [Pr. PB13 Machine resonance suppression filter 1] [Pr. PB14 Notch shape selection 1] [Pr. PB15 Machine resonance suppression filter 2] [Pr. PB16 Notch shape selection 2] [Pr. PB18 Low-pass filter setting] [Pr. PB23 Low-pass filter selection] [Pr. PB50 Machine resonance suppression filter 5] [Pr. PB51 Notch shape selection 5] [Pr. PE41 Function selection E-3]
6	Load to motor inertia ratio monitor mode	[Pr. PB06 Load to motor inertia ratio/load to motor mass ratio]

[Pr. PA08.4_Quick tuning - Load to motor inertia ratio setting]

Initial value	Setting range	Ver.
0h	Refer to the text	A4

Set the load to motor inertia ratio at quick tuning. If the load connected to the servo motor is larger than the load to motor inertia ratio set in the servo parameter, an overshoot may occur in positioning operation after quick tuning.

0: Load to motor inertia ratio of 30 times or less

1: Load to motor inertia ratio of 100 times or less

[Pr. PA08.5_Quick tuning - Execution selection]

Initial value	Setting range	Ver.
0h	Refer to the text	A4

Set when to execute quick tuning.

0: At initial servo-on after cycling the power

1: At every servo-on

[Pr. PA08.6_Quick tuning - Restore selection]

Initial value	Setting range	Ver.
0h	Refer to the text	A4

Set whether to return servo parameters to the values from before quick tuning.

0: Disabled

1: Enabled

By setting "1" (enabled), the following servo parameters return to the values from before quick tuning. If quick tuning has never been performed after power on or software reset, setting "1" (enabled) only keeps the current servo parameter values.

No.	Symbol	Name
PB01	FILT	Adaptive tuning mode (adaptive filter II)
PB07	PG1	Model control gain
PB08	PG2	Position control gain
PB09	VG2	Speed control gain
PB10	VIC	Speed integral compensation
PB11	VDC	Speed differential compensation
PB13	NH1	Machine resonance suppression filter 1
PB14	NHQ1	Notch shape selection 1
PB15	NH2	Machine resonance suppression filter 2
PB16	NHQ2	Notch shape selection 2
PB18	LPF	Low-pass filter setting
PB23	VFBF	Low-pass filter selection
PB50	NH5	Machine resonance suppression filter 5
PB51	NHQ5	Notch shape selection 5
PE41	EOP3	Function selection E-3

[Pr. PA09_Auto tuning response (RSP)]

Initial value	Setting range	Ver.
16	Refer to the text	A4

Set the auto tuning response.

Setting value	Machine characteristic	
	Responsiveness	Guideline for machine resonance frequency [Hz]
1	<p>Low response</p> <p>Middle response</p> <p>High response</p>	2.7
2		3.6
3		4.9
4		6.6
5		10.0
6		11.3
7		12.7
8		14.3
9		16.1
10		18.1
11		20.4
12		23.0
13		25.9
14		29.2
15		32.9
16		37.0
17		41.7
18		47.0
19		52.9
20		59.6
21		67.1
22		75.6
23		85.2
24		95.9
25		108.0
26		121.7
27		137.1
28		154.4
29		173.9
30		195.9
31		220.6
32		248.5
33		279.9
34		315.3
35		355.1
36		400.0
37		446.6
38		501.2
39		571.5
40		642.7

[Pr. PA10_In-position range (INP)]

Initial value	Setting range	Ver.
1600 [Refer to the text below for the unit.]	0 to 16777215	A4

Set the in-position range in the command pulse unit.

With the setting of [Pr. PC06.0 In-position range unit selection], the unit can be changed to the servo motor encoder pulse unit.

Review the setting value of this servo parameter according to the resolution of the encoder to be connected.

When the encoder resolution is 24 bits, setting this servo parameter to "6400" is recommended.

- In-position range setting

Control mode	In-position setting range
Profile mode/Cyclic synchronous mode	Range where in-position (INP) is output
Positioning mode (point table method) *1	Range where MEND (traveling completion) and INP (in-position) are output

*1 Available on servo amplifiers with firmware version B8 or later.

- Selecting an encoder for in-position range control

[Pr. PA01.4 Fully closed loop operation mode selection] setting value *1	In-position range unit
0 (semi closed loop control mode)	Command resolution unit (motor-side encoder)
1 (fully closed loop control mode)	Command resolution unit (load-side encoder)

*1 Available on servo amplifiers with firmware version C4 or later.

- In-position range unit

[Pr. PC06.0 In-position range unit selection] setting value	Unit
0 (command unit)	Position command unit *1
1 (servo motor encoder pulse unit)	pulse

*1 The unit can be changed to 0.001 mm, 0.0001 inch, 0.001 degree, or pulse with [Pr. PT01.2 Unit for position data].

 Page 120 [Pr. PT01.2_Unit for position data]

[Pr. PA11_F Forward rotation torque limit (TLP)]

Initial value	Setting range	Ver.
1000.0 [%]	0.0 to 1000.0	A4

The torque or thrust generated by the servo motor can be limited.

Set this servo parameter in relation to the rated torque or continuous thrust (= 100.0 %). Set the servo parameter when limiting the torque of the servo motor for CCW power running or CW regeneration, or when limiting the thrust of the linear servo motor for positive direction power running or negative direction regeneration. If this servo parameter is set to "0.0", the servo motor does not generate torque or thrust.

The polarity of the torque limit can be changed with the setting values of [Pr. PA14 Travel direction selection] and [Pr. PC29.3 Torque POL reflection selection].

This parameter corresponds to [Positive torque limit value (Obj. 60E0h)]. When an object is mapped in cyclic communication, the controller overwrites the value written with engineering software. Thus, do not write a value with engineering software.

Depending on the settings in [Pr. PC29.3] and [Pr. PA14], the corresponding object changes to [Negative torque limit value (Obj. 60E1h)].

If a value larger than the maximum torque or maximum thrust of the servo motor is set, the value will be limited to the maximum torque or maximum thrust of the servo motor.

[Pr. PA12_R Reverse rotation torque limit (TLN)]

Initial value	Setting range	Ver.
1000.0 [%]	0.0 to 1000.0	A4

The torque or thrust generated by the servo motor can be limited.

Set this servo parameter in relation to the rated torque or continuous thrust (= 100.0 %). Set the servo parameter when limiting the torque of the servo motor for CW power running or CCW regeneration, or when limiting the thrust of the linear servo motor for positive direction power running or negative direction regeneration. If this servo parameter is set to "0.0", the servo motor does not generate torque or thrust.

The polarity of the torque limit can be changed with the setting values of [Pr. PA14 Travel direction selection] and [Pr. PC29.3 Torque POL reflection selection].

This servo parameter corresponds to [Negative torque limit value (Obj. 60E1h)]. When an object is mapped in cyclic communication, the controller overwrites the value written with engineering software. Thus, do not write a value with engineering software.

Depending on the settings in [Pr. PC29.3] and [Pr. PA14], the corresponding object changes to [Positive torque limit value (Obj. 60E0h)].

If a value larger than the maximum torque or maximum thrust of the servo motor is set, the value will be limited to the maximum torque or maximum thrust of the servo motor.

[Pr. PA14_Travel direction selection (*POL)]

Initial value	Setting range	Ver.
0	0 to 1	A4

The rotation/travel direction can be changed without changing the polarity of the command from the controller.
 The polarities of the position and speed information are changed by the setting value of [Pr. PA14 Travel direction selection].
 Torque information changes with the combination of [Pr. PA14] and [Pr. PC29.3 Torque POL reflection selection].
 The rotation/travel direction is enabled regardless of the control modes. For example, when the torque polarity is changed with [Pr. PA14] and [Pr. PC29.3], the torque information polarity will also change in the position mode and positioning mode.

• Position information

Setting value of [Pr. PA14]	Servo motor rotation direction/linear servo motor travel direction	
	Positioning address increasing direction	Positioning address decreasing direction
0	CCW or positive direction	CW or negative direction
1	CW or negative direction	CCW or positive direction

• Speed information

Setting value of [Pr. PA14]	Servo motor rotation direction/linear servo motor travel direction	
	Speed handled by the controller: positive	Speed handled by the controller: negative
0	CCW or positive direction	CW or negative direction
1	CW or negative direction	CCW or positive direction

• Torque information

Setting value		Servo motor rotation direction/linear servo motor travel direction	
[Pr. PA14]	[Pr. PC29.3]	Torque handled by the controller: positive	Torque handled by the controller: negative
0	0: Enabled	CCW or positive direction	CW or negative direction
	1: Disabled		
1	0: Enabled	CW or negative direction	CCW or positive direction
	1: Disabled	CCW or positive direction	CW or negative direction

The servo motor rotation direction is as follows.

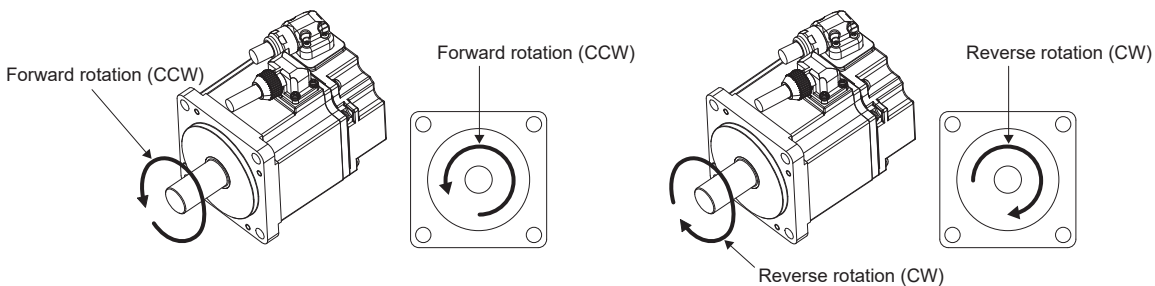

The positive and negative directions of the linear servo motor are as follows.

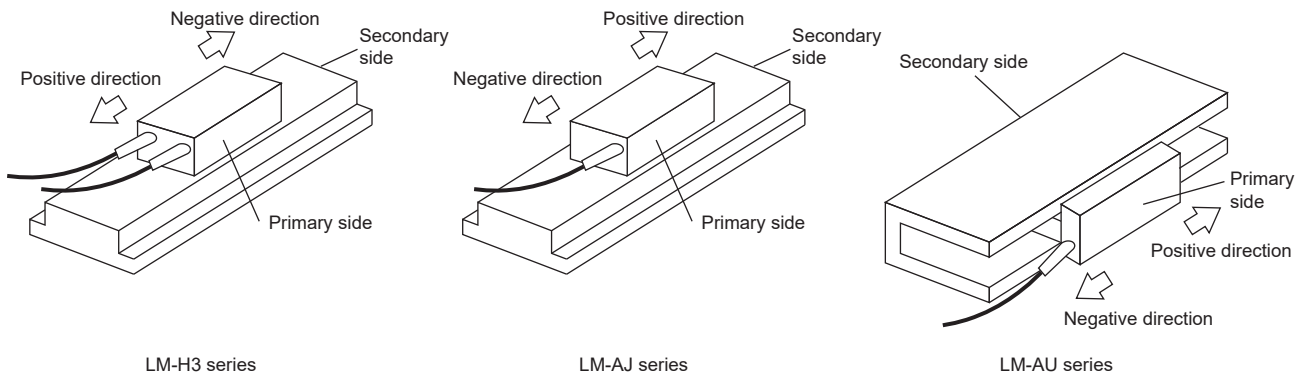

[Pr. PA17_Servo motor series setting (**MSR)]

Initial value	Setting range	Ver.
00000000h	Refer to the text	B2

To select the linear servo motor to be used, set this servo parameter and [Pr. PA18.0-3 Servo motor type setting]. Set this at the same time with [Pr. PA18.0-3]. Refer to the following table for setting values.

Linear servo motor series	Linear servo motor (primary side)	Servo parameter	
		Setting value of [Pr. PA17]	Setting value of [Pr. PA18.0-3]
LM-H3	LM-H3P2A-07P-BSS0	000000BBh	2101h
	LM-H3P3A-12P-CSS0		3101h
	LM-H3P3B-24P-CSS0		3201h
	LM-H3P3C-36P-CSS0		3301h
	LM-H3P3D-48P-CSS0		3401h
	LM-H3P7A-24P-ASS0		7101h
	LM-H3P7B-48P-ASS0		7201h
	LM-H3P7C-72P-ASS0		7301h
	LM-H3P7D-96P-ASS0		7401h
LM-AJ	LM-AJP1B-07K-JSS0	000000DAh	1201h
	LM-AJP1D-14K-JSS0		1401h
	LM-AJP2B-12S-JSS0		2201h
	LM-AJP2D-23T-JSS0		2401h
	LM-AJP3B-17N-JSS0		3201h
	LM-AJP3D-35R-JSS0		3401h
	LM-AJP4B-22M-JSS0		4201h
	LM-AJP4D-45N-JSS0		4401h
	LM-AU		LM-AUP3A-03V-JSS0
LM-AUP3B-06V-JSS0		3202h	
LM-AUP3C-09V-JSS0		3302h	
LM-AUP3D-11R-JSS0		3402h	
LM-AUP4A-04R-JSS0		4102h	
LM-AUP4B-09R-JSS0		4202h	
LM-AUP4C-13P-JSS0		4302h	
LM-AUP4D-18M-JSS0		4402h	
LM-AUP4F-26P-JSS0		4602h	
LM-AUP4H-35M-JSS0		4802h	

[Pr. PA18_Servo motor type setting (**MTY)]

Initial value	Setting range	Ver.
00000000h	Refer to the relevant detail No.	Refer to the relevant detail No.

[Pr. PA18.0-3_Servo motor type setting]

Initial value	Setting range	Ver.
0000h	Refer to the text	B2

When using a linear servo motor, select the linear servo motor to be used with [Pr. PA17 Servo motor series setting] and this servo parameter. Set this at the same time with [Pr. PA17]. Refer to the following for setting values.

☞ Page 26 [Pr. PA17_Servo motor series setting (**MSR)]

[Pr. PA19_Servo parameter writing prohibited (*BLK)]

Initial value	Setting range	Ver.
000000ABh	Refer to the text	A4

Select a reference range and writing range for the servo parameter.

Refer to the following table for setting values.

PA19	Setting value operation	PA	PB	PC	PD	PE	PF	PO	PS	PL, PU	PT, PV	PN
Setting values not listed below	Readable	○	×	×	×	×	×	×	×	×	×	×
	Writable	○	×	×	×	×	×	×	×	×	×	×
0000000A	Readable	19 only	×	×	×	×	×	×	×	×	×	×
	Writable	19 only	×	×	×	×	×	×	×	×	×	×
0000000B	Readable	○	○	○	×	×	×	×	×	×	×	×
	Writable	○	○	○	×	×	×	×	×	×	×	×
0000000C	Readable	○	○	○	○	×	×	×	×	×	×	×
	Writable	○	○	○	○	×	×	×	×	×	×	×
0000000D	Readable	○	○	○	○	×	×	×	○	×	×	×
	Writable	○	○	○	○	×	×	×	○	×	×	×
0000000E	Readable	○	○	○	○	×	×	○	○	×	×	×
	Writable	○	○	○	○	×	×	○	○	×	×	×
0000000F	Readable	○	○	○	○	○	×	○	○	○	×	×
	Writable	○	○	○	○	○	×	○	○	○	×	×
000000AA	Readable	○	○	○	○	○	○	×	×	×	×	×
	Writable	○	○	○	○	○	○	×	×	×	×	×
000000AB (initial value)	Readable	○	○	○	○	○	○	○	○	○	○	○
	Writable	○	○	○	○	○	○	○	○	○	○	○
0000100B	Readable	○	×	×	×	×	×	×	×	×	×	×
	Writable	19 only	×	×	×	×	×	×	×	×	×	×
0000100C	Readable	○	○	○	○	×	×	×	×	×	×	×
	Writable	19 only	×	×	×	×	×	×	×	×	×	×
0000100D	Readable	○	○	○	○	×	×	×	○	×	×	×
	Writable	19 only	×	×	×	×	×	×	×	×	×	×
0000100E	Readable	○	○	○	○	×	×	○	○	×	×	×
	Writable	19 only	×	×	×	×	×	×	×	×	×	×
0000100F	Readable	○	○	○	○	○	×	○	○	○	×	×
	Writable	19 only	×	×	×	×	×	×	×	×	×	×
000010AA	Readable	○	○	○	○	○	○	×	×	×	×	×
	Writable	19 only	×	×	×	×	×	×	×	×	×	×
000010AB	Readable	○	○	○	○	○	○	○	○	○	○	○
	Writable	19 only	×	×	×	×	×	×	×	×	×	×

The settings of this servo parameter are disabled if they are read/written via engineering software (such as MR Configurator2).

The settings of this servo parameter are disabled for parameter objects.

[Pr. PA20_Tough drive setting (*TDS)]

Initial value	Setting range	Ver.
0000000h	Refer to the relevant detail No.	Refer to the relevant detail No.

[Pr. PA20.1_Vibration tough drive selection]

Initial value	Setting range	Ver.
0h	Refer to the text	A4

0: Disabled

1: Machine resonance suppression filter change mode enabled

2: Machine resonance suppression filter automatic setting mode

Selecting other than "0" for this servo parameter suppresses vibrations by automatically changing the setting values of [Pr. PB13 Machine resonance suppression filter 1] and [Pr. PB15 Machine resonance suppression filter 2] if the vibration exceeds the value of the oscillation level set in [Pr. PF23 Vibration tough drive - Oscillation detection level].

For "1", the vibration tough drive functions when [Pr. PB13] and [Pr. PB15] are enabled. For "2", the vibration tough drive functions even when [Pr. PB13] and [Pr. PB15] are disabled.

When using the vibration tough drive, selecting "2" (machine resonance suppression filter automatic setting mode) is recommended.

[Pr. PA20.2_Instantaneous power failure tough drive selection]

Initial value	Setting range	Ver.
0h	Refer to the text	A4

0: Disabled

1: Enabled

Selecting "1" enables to avoid triggering [AL. 010 Undervoltage] by using the electrical energy charged in the capacitor in case that an instantaneous power failure occurs during operation. In [Pr. PF25 Instantaneous power failure tough drive detection time], the time until the occurrence of [AL. 010.1 Voltage drop in the control circuit power] can be set.

[Pr. PA21_Function selection A-3 (*AOP3)]

Initial value	Setting range	Ver.
00000001h	Refer to the relevant detail No.	Refer to the relevant detail No.

[Pr. PA21.0_One-touch tuning function selection]

Initial value	Setting range	Ver.
1h	Refer to the text	A4

0: Disabled

1: Enabled

When the servo parameter is set to "0", the one-touch tuning cannot be performed.

[Pr. PA22_Position control configuration selection (**PCS)]

Initial value	Setting range	Ver.
00000000h	Refer to the relevant detail No.	Refer to the relevant detail No.

[Pr. PA22.1_Super trace function selection]

Initial value	Setting range	Ver.
0h	Refer to the text	A4

0: Disabled
2: Enabled

[Pr. PA22.3_Scale measurement function selection]

Initial value	Setting range	Ver.
0h	Refer to the text	E4

0:Disabled

1:Use with absolute position detection system
2:Use with incremental system

Since the scale measurement encoders support only A/B/Z-phase differential output type encoders, connecting an encoder other than the A/B/Z-phase differential output type and setting a value other than "0" trigger [AL.01A Servo motor combination error].

Since the A/B/Z-phase differential output type encoders are incremental type encoders, the absolute position detection system cannot be used.

Connecting an A/B/Z-phase differential output type encoder and setting "1" (use with absolute position detection system) trigger [AL. 037 Parameter error]. In the fully closed loop control mode, setting a value other than "0" (disabled) triggers [AL. 037].

[Pr. PA23_Drive recorder desired alarm trigger setting (DRAT)]

Initial value	Setting range	Ver.
00000000h	Refer to the relevant detail No.	Refer to the relevant detail No.

This servo parameter is enabled in the following conditions:

- [Pr. PF80.0 Drive recorder - Operation mode selection] = "0" (automatic setting mode)
- [Pr. PF80.0] = "1" (manual setting mode) and [Pr. PF82.0 Drive recorder - Trigger mode selection] = "0" (alarm trigger)

Ex.

To activate the drive recorder when [AL. 050 Overload 1] occurs, set "00005000h".

To activate the drive recorder when [AL. 050.3 Thermal overload error 4 during operation] occurs, set this servo parameter to "00005003h".

[Pr. PA23.0-1_Alarm detail number setting]

Initial value	Setting range	Ver.
00h	00h to FFh	A4

Set this to execute the trigger with a desired alarm detail No. for the drive recorder function.

When "00h" is selected, only the desired alarm No. setting will be enabled.

[Pr. PA23.2-4_Alarm number setting]

Initial value	Setting range	Ver.
000h	000h to FFFh	A4

Set this to execute the trigger with a desired alarm No. for the drive recorder function.

When "000h" is selected, the desired alarm trigger of the drive recorder is disabled.

[Pr. PA24_Function selection A-4 (AOP4)]

Initial value	Setting range	Ver.
0000000h	Refer to the relevant detail No.	Refer to the relevant detail No.

[Pr. PA24.0_Vibration suppression mode selection]

Initial value	Setting range	Ver.
0h	Refer to the text	A4

0: Standard mode

1: 3 inertia mode

2: Low response mode

4: Path tracking mode

When other than "3 inertia mode" is selected, vibration suppression control 2 cannot be used.

Before changing the control mode in "3 inertia mode" or "low response mode", stop the motor.

Before changing the control mode in "path tracking mode", stop the motor.

[Pr. PA24.5_Load to motor inertia ratio/load to motor mass ratio estimation higher precision selection]

Initial value	Setting range	Ver.
0h	Refer to the text	C4

Select whether to enable or disable estimation with higher precision for the load to motor inertia ratio/load to motor mass ratio.

0: Disabled

1: Enabled

When this servo parameter is set to "0" (disabled), [Pr. PB06 Load to motor inertia ratio/load to motor mass ratio] may be estimated at a value smaller than the accurate estimation depending on the operation pattern. Therefore, this servo parameter is recommended to be set to "1" (enabled).

Setting this servo parameter to "1" (enabled) with the equipment on which the gain is adjusted may change the actual movement. Check the movement of the equipment after changing the settings.

[Pr. PA25_One-touch tuning - Overshoot permissible level (OTHOV)]

Initial value	Setting range	Ver.
0 [%]	0 to 100	A4

Set a permissible value of overshoot amount for one-touch tuning as a percentage of the in-position range.

When "0" is set, 50 % is applied.

[Pr. PA26_Function selection A-5 (*AOP5)]

Initial value	Setting range	Ver.
00000000h	Refer to the relevant detail No.	Refer to the relevant detail No.

[Pr. PA26.0_Torque limit function selection at instantaneous power failure]

Initial value	Setting range	Ver.
0h	Refer to the text	A4

0: Disabled

1: Enabled

By setting "1", if an instantaneous power failure occurs during operation, limiting the torque at acceleration saves the electric energy charged in the capacitor in the servo amplifier. And consequently the time until [AL. 010.2 Voltage drop in the main circuit power] occurs can be delayed with instantaneous power failure tough drive function. Thus, the time to be set in [Pr. PF25 Instantaneous power failure tough drive detection time] can be extended.

The torque limit function at instantaneous power failure is enabled when [Pr. PA20.2_ Instantaneous power failure tough drive selection] is "1" (enabled).

This function is disabled in the cyclic synchronous torque mode (cst) and profile torque mode (tq).

[Pr. PA28_Function selection A-6 (**AOP6)]

Initial value	Setting range	Ver.
00000000h	Refer to the relevant detail No.	Refer to the relevant detail No.

[Pr. PA28.4_Speed range limit selection]

Initial value	Setting range	Ver.
0h	Refer to the text	A4

Select the speed to be used for the range restriction of the speed data.

0: Maximum speed

1: Permissible speed

[Pr. PA34_Quick tuning - Permissible travel distance (QDIS)]

Initial value	Setting range	Ver.
0 [0.1 rev], [mm]	0 to 100	A4

Set the permissible travel distance for quick tuning.

If the travel distance for quick tuning exceeds the setting value, the quick tuning error occurs.

When "0" is input, the permissible travel distance for quick tuning is 1.0 rev (when a linear servo motor is used, 10 mm).

1.3 Gain/filter setting servo parameters group ([Pr. PB_ _])

[Pr. PB01_Adaptive tuning mode (adaptive filter II) (FILT)]

Initial value	Setting range	Ver.
00000000h	Refer to the relevant detail No.	Refer to the relevant detail No.

[Pr. PB01.0_Filter tuning mode selection]

Initial value	Setting range	Ver.
0h	Refer to the text	A4

Setting of the adaptive tuning is performed.

Select the adjustment mode of the machine resonance suppression filter 1.

0: Disabled

1: Automatic setting

2: Manual setting

When the servo parameter is set to "automatic setting", [Pr. PB13 Machine resonance suppression filter 1] and [Pr. PB14 Notch shape selection 1] will be set automatically. The automatic setting of machine resonance suppression filter 1 cannot be used if quick tuning is in progress. While quick tuning is in progress, adaptive filter II (adaptive tuning) does not start even if the automatic setting of machine resonance suppression filter 1 is used. The results obtained from the quick tuning are applied to [Pr. PB13] and [Pr. PB14].

Do not use the automatic setting in the torque mode.

[Pr. PB01.3_Tuning accuracy selection]

Initial value	Setting range	Ver.
0h	Refer to the text	A4

0: Standard

1: High accuracy

In the high accuracy mode, the sound during tuning may be larger than in the standard mode, but the frequency is estimated more accurately.

[Pr. PB02_Vibration suppression control tuning mode (advanced vibration suppression control II) (VRFT)]

Initial value	Setting range	Ver.
00000000h	Refer to the relevant detail No.	Refer to the relevant detail No.

[Pr. PB02.0_Vibration suppression control 1 - Tuning mode selection]

Initial value	Setting range	Ver.
0h	Refer to the text	A4

Select the tuning mode of the vibration suppression control 1.

- 0: Disabled
- 1: Automatic setting
- 2: Manual setting

[Pr. PB02.1_Vibration suppression control 2 - Tuning mode selection]

Initial value	Setting range	Ver.
0h	Refer to the text	A4

Select the tuning mode of the vibration suppression control 2. To enable the setting value, set [Pr. PA24.0 Vibration suppression mode selection] to "1" (3 inertia mode).

- 0: Disabled
- 1: Automatic setting
- 2: Manual setting

[Pr. PB03_Torque feedback loop gain (TFBGN)]

When the command interface of the servo amplifier is EtherCAT, this servo parameter is not available.

Initial value	Setting range	Ver.
36000 [rad/s]	0 to 36000	B0

Set the torque feedback gain.

This function is enabled in the continuous operation to torque control mode.

Decreasing the setting value of this servo parameter reduces the collision load during pressing.

6 rad/s is set when the setting value is 6 rad/s or less.

[Pr. PB04_Feed forward gain (FFC)]

Initial value	Setting range	Ver.
0 [%]	0 to 100	A4

Set the feed forward gain.

When "100" is set, the droop pulses are almost 0 in operation at the constant speed. If the super trace control is enabled, the droop pulses are almost 0 in operation at uniform acceleration/deceleration, as well as at the constant speed. However, if sudden acceleration/deceleration is performed, overshoot becomes large. When the feed forward gain is set to 100 %, set a value not smaller than 1 s for the acceleration time constant until the rated speed is reached.

[Pr. PB06_Load to motor inertia ratio/load to motor mass ratio (GD2)]

Initial value	Setting range	Ver.
7.00 [Multiplier]	0.00 to 300.00	A4

Set the load to motor inertia ratio or load to motor mass ratio. Setting a value different from the actual load moment of inertia or load mass may cause an unexpected operation such as an overshoot.

The setting of this servo parameter will be automatic or manual depending on the setting value of [Pr. PA08.0 Gain adjustment mode selection]. Refer to the following table for details. When the servo parameter is set to automatic setting, the value varies within the range of 0.00 to 100.00.

[Pr. PA08.0 Gain adjustment mode selection]	Servo parameter status
"0" (2 gain adjustment mode 1 (interpolation mode))	Automatic setting
"1" (auto tuning mode 1)	
"2" (auto tuning mode 2)	Manual setting
"3" (manual mode)	
"4" (2 gain adjustment mode 2)	
"5" (quick tuning mode)	Automatic setting
"6" (load to motor inertia ratio monitor mode)	

[Pr. PB07_Model control gain (PG1)]

Initial value	Setting range	Ver.
15.0 [rad/s]	1.0 to 8000.0	A4

Set the response gain to the target position.

Increasing the setting value improves responsiveness to the position command, but increasing the value too much raises the likelihood of vibration and noise.

The setting of this servo parameter will be automatic or manual depending on the setting value of [Pr. PA08.0 Gain adjustment mode selection]. Refer to the following table for details.

[Pr. PA08.0]	Servo parameter status
"0" (2 gain adjustment mode 1 (interpolation mode))	Manual setting
"1" (auto tuning mode 1)	Automatic setting
"2" (auto tuning mode 2)	
"3" (manual mode)	Manual setting
"4" (2 gain adjustment mode 2)	Automatic setting
"5" (quick tuning mode)	
"6" (load to motor inertia ratio monitor mode)	Manual setting

When the vibration suppression control is enabled, the settable range of [Pr. PB07 Model control gain] is limited. If [Pr. PB07] exceeds the settable range, the vibration suppression control is disabled.

[Pr. PB08_Position control gain (PG2)]

Initial value	Setting range	Ver.
37.0 [rad/s]	1.0 to 2000.0	A4

Set the gain of the position loop.

Set this servo parameter when increasing the position responsiveness to level load disturbance.

Increasing the setting value improves responsiveness to the load disturbance, but increasing the value too much raises the likelihood of vibration and noise.

The setting of this servo parameter will be automatic or manual depending on the setting value of [Pr. PA08.0 Gain adjustment mode selection]. Refer to the following table for details.

[Pr. PA08.0]	Servo parameter status
"0" (2 gain adjustment mode 1 (interpolation mode))	Automatic setting
"1" (auto tuning mode 1)	
"2" (auto tuning mode 2)	
"3" (manual mode)	Manual setting
"4" (2 gain adjustment mode 2)	Automatic setting
"5" (quick tuning mode)	
"6" (load to motor inertia ratio monitor mode)	Manual setting

[Pr. PB09_Speed control gain (VG2)]

Initial value	Setting range	Ver.
823 [rad/s]	20 to 65535	A4

Set the gain of the speed loop.

Set this servo parameter when vibration occurs on machines with low rigidity or with large backlash. Increasing the setting value improves responsiveness, but increasing the value too much raises the likelihood of vibration and noise.

The setting of this servo parameter will be automatic or manual depending on the setting value of [Pr. PA08.0 Gain adjustment mode selection]. Refer to the following for details.

☞ Page 35 [Pr. PB08_Position control gain (PG2)]

[Pr. PB10_Speed integral compensation (VIC)]

Initial value	Setting range	Ver.
33.7 [ms]	0.1 to 1000.0	A4

Set the integral time constant of the speed loop.

Decreasing the setting value improves responsiveness, but raises the likelihood of vibration and noise.

The setting of this servo parameter will be automatic or manual depending on the setting value of [Pr. PA08.0 Gain adjustment mode selection]. Refer to the following for details.

☞ Page 35 [Pr. PB08_Position control gain (PG2)]

[Pr. PB11_Speed differential compensation (VDC)]

Initial value	Setting range	Ver.
980	0 to 1000	A4

Set the differential compensation.

The enabling conditions vary depending on the setting value in [Pr. PB24.1 PI-PID switching control selection].

[Pr. PB24.1]	The enabling conditions for this servo parameter
"0" (switching is enabled by PID switching signal (C_PC) from controller and the input device (PC))	Enabled by turning on the PID switching signal from controller (C_PC), or by turning on the PC (Proportional control)
"3" (Continuous PID control (proportional control) enabled)	Always enabled

[Pr. PB12_Overshoot amount compensation (OVA)]

Initial value	Setting range	Ver.
0 [%]	0 to 100	A4

Set a dynamic friction torque in percentage to the rated torque at servo motor rated speed. Alternatively, set a percentage of dynamic friction force against the continuous thrust at linear servo motor rated speed.

If the response level is too low or if the torque/thrust is limited, the efficiency of the servo parameter may decrease.

[Pr. PB13_Machine resonance suppression filter 1 (NH1)]

Initial value	Setting range	Ver.
4500 [Hz]	10 to 9000	A4

Set the notch frequency of the machine resonance suppression filter 1.

When [Pr. PA08.0 Gain adjustment mode selection] is set to "5" (quick tuning mode), the setting value of this servo parameter reflects the adjustment result of quick tuning.

When [Pr. PB01.0 Filter tuning mode selection] is set to "1" (automatic setting), the values obtained from adaptive tuning are applied to the setting value of this servo parameter.

When [Pr. PB01.0] is set to "2" (manual setting), set the notch frequency with this servo parameter.

[Pr. PB14_Notch shape selection 1 (NHQ1)]

Initial value	Setting range	Ver.
00000000h	Refer to the relevant detail No.	Refer to the relevant detail No.

[Pr. PB14.1_Notch depth selection 1]

Initial value	Setting range	Ver.
0h	Refer to the text	A4

0: -40 dB

1: -14 dB

2: -8 dB

3: -4 dB

[Pr. PB14.2_Notch width selection 1]

Initial value	Setting range	Ver.
0h	Refer to the text	A4

0: $\alpha = 2$

1: $\alpha = 3$

2: $\alpha = 4$

3: $\alpha = 5$

[Pr. PB15_Machine resonance suppression filter 2 (NH2)]

Initial value	Setting range	Ver.
4500 [Hz]	10 to 9000	A4

Set the notch frequency of the machine resonance suppression filter 2.

When [Pr. PA08.0 Gain adjustment mode selection] is set to "5" (quick tuning mode), the setting value of this servo parameter reflects the adjustment result of quick tuning.

When [Pr. PB16.0 Machine resonance suppression filter 2 selection] is set to "1" (enabled), set the notch frequency with this servo parameter.

[Pr. PB16_Notch shape selection 2 (NHQ2)]

Initial value	Setting range	Ver.
00000000h	Refer to the relevant detail No.	Refer to the relevant detail No.

Set forms of the machine resonance suppression filter 2.

When [Pr. PA08.0 Gain adjustment mode selection] is set to "5" (quick tuning mode), the setting value of this servo parameter reflects the adjustment result of quick tuning.

[Pr. PB16.0_Machine resonance suppression filter 2 selection]

Initial value	Setting range	Ver.
0h	Refer to the text	A4

0: Disabled

1: Enabled

[Pr. PB16.1_Notch depth selection]

Initial value	Setting range	Ver.
0h	Refer to the text	A4

0: -40 dB

1: -14 dB

2: -8 dB

3: -4 dB

[Pr. PB16.2_Notch width selection]

Initial value	Setting range	Ver.
0h	Refer to the text	A4

0: $\alpha = 2$

1: $\alpha = 3$

2: $\alpha = 4$

3: $\alpha = 5$

[Pr. PB17_Shaft resonance suppression filter (NHF)]

Initial value	Setting range	Ver.
00000000h	Refer to the relevant detail No.	Refer to the relevant detail No.

Set the shaft resonance suppression filter.

Use this to suppress a high-frequency machine vibration.

When [Pr. PB23.0 Shaft resonance suppression filter selection] is set to "0" (automatic setting), the value will be calculated automatically from the servo motor used and load to motor inertia ratio. Automatic setting is not carried out when the linear servo motor is used. When "1" (manual setting) is selected, set the shaft resonance suppression filter with this servo parameter.

When [Pr. PB23.0] is set to "2" (disabled), this servo parameter setting is disabled. As a result, the filter performance may be reduced.

When [Pr. PB49.0 Machine resonance suppression filter 4 selection] is set to "1" (enabled), the shaft resonance suppression filter cannot be used.

[Pr. PB17.0-1_Shaft resonance suppression filter setting - Frequency selection]

Initial value	Setting range	Ver.
00h	Refer to the text	A4

Refer to the following table for setting values.

Set the value closest to the required frequency.

Setting value	Frequency [Hz]
00	Disabled
01	Disabled
02	4500
03	3000
04	2250
05	1800
06	1500
07	1285
08	1125
09	1000
0A	900
0B	818
0C	750
0D	692
0E	642
0F	600
10	562
11	529
12	500
13	473
14	450
15	428
16	409
17	391
18	375
19	360
1A	346
1B	333
1C	321
1D	310
1E	300

Setting value	Frequency [Hz]
1F	290
20	Disabled
21	Disabled
22	Disabled
23	Disabled
24	Disabled
25	Disabled
26	Disabled
27	Disabled
28	4500
29	4000
2A	3600
2B	3272
2C	3000
2D	2769
2E	2571
2F	2400
30	2250
31	2117
32	2000
33	1894
34	1800
35	1714
36	1636
37	1565
38	1500
39	1440
3A	1384
3B	1333
3C	1285
3D	1241
3E	1200
3F	1161
40	1125
41	1090
42	1058
43	1028
44	1000
45	972
46	947
47	923
48	900
49	878
4A	857
4B	837
4C	818
4D	800
4E	782
4F	765
50	750
51	734
52	720
53	705

Setting value	Frequency [Hz]
54	692
55	679
56	666
57	654
58	642
59	631
5A	620
5B	610
5C	600
5D	590
5E	580
5F	571
60	562
61	553
62	545
63	537
64	529
65	521
66	514
67	507
68	500
69	493
6A	486
6B	480
6C	473
6D	467
6E	461
6F	455
70	450
71	444
72	439
73	433
74	428
75	423
76	418
77	413
78	409
79	404
7A	400
7B	395
7C	391
7D	387
7E	382
7F	378
80	375
81	371
82	367
83	363
84	360
85	356
86	352
87	349
88	346

Setting value	Frequency [Hz]
89	342
8A	339
8B	336
8C	333
8D	330
8E	327
8F	324
90	321
91	318
92	315
93	313
94	310
95	307
96	305
97	302
98	300
99	297
9A	295
9B	292
9C	290
9D	288
9E	285
9F	283

[Pr. PB17.2_Notch depth selection]

Initial value	Setting range	Ver.
0h	Refer to the text	A4

- 0: -40 dB
- 1: -14 dB
- 2: -8 dB
- 3: -4 dB

[Pr. PB18_Low-pass filter setting (LPF)]

Initial value	Setting range	Ver.
3141 [rad/s]	100 to 36000	A4

Set the low-pass filter.

Refer to the table below for the status of this servo parameter and the setting values of the related servo parameter.

When [Pr. PA08.0 Gain adjustment mode selection] is set to "5" (quick tuning mode), this servo parameter returns to the initial value.

[Pr. PB23.1 Low-pass filter selection]	[Pr. PB18 Low-pass filter setting]
"0" (initial value)	Automatic setting
"1"	Setting value enabled
"2"	Setting value disabled

[Pr. PB19_Vibration suppression control 1 - Vibration frequency (VRF11)]

Initial value	Setting range	Ver.
100.0 [Hz]	0.1 to 300.0	A4

Set the vibration frequency of vibration suppression control 1 to suppress low-frequency machine vibration.

When "1" (automatic setting) is selected in [Pr. PB02.0 Vibration suppression control 1 - Tuning mode selection], this servo parameter will be set automatically. When "2" (manual setting) is selected, set the vibration frequency with this servo parameter.

If [Pr. PB25.0 Model adaptive control selection] is set to "2" (disabled), the vibration suppression control cannot be used.

The available range of [Pr. PB19 Vibration suppression control 1 - Vibration frequency] depends on the value in [Pr. PB07 Model control gain]. If the setting value of [Pr. PB19] exceeds the available range, the vibration suppression control is disabled.

[Pr. PB20_Vibration suppression control 1 - Resonance frequency (VRF12)]

Initial value	Setting range	Ver.
100.0 [Hz]	0.1 to 300.0	A4

Set the resonance frequency of vibration suppression control 1 to suppress low-frequency machine vibration.

When "1" (automatic setting) is selected in [Pr. PB02.0 Vibration suppression control 1 - Tuning mode selection], this servo parameter will be set automatically. When "2" (manual setting) is selected, set the resonance frequency with this servo parameter.

If [Pr. PB25.0 Model adaptive control selection] is set to "2" (disabled), the vibration suppression control cannot be used.

The available range of [Pr. PB20 Vibration suppression control 1 - Resonance frequency] changes depending on the value in [Pr. PB07 Model control gain]. If the setting value of [Pr. PB20] exceeds the available range, the vibration suppression control is disabled.

[Pr. PB21_Vibration suppression control 1 - Vibration frequency damping (VRF13)]

Initial value	Setting range	Ver.
0.00	0.00 to 0.30	A4

Set the damping of the vibration frequency for vibration suppression control 1 to suppress low-frequency machine vibration.

When "1" (automatic setting) is selected in [Pr. PB02.0 Vibration suppression control 1 - Tuning mode selection], this servo parameter will be set automatically. When "2" (manual setting) is selected, set the damping of the vibration frequency with this servo parameter.

[Pr. PB22_Vibration suppression control 1 - Resonance frequency damping (VRF14)]

Initial value	Setting range	Ver.
0.00	0.00 to 0.30	A4

Set the damping of the resonance frequency for vibration suppression control 1 to suppress low-frequency machine vibration.

When "1" (automatic setting) is selected in [Pr. PB02.0 Vibration suppression control 1 - Tuning mode selection], this servo parameter will be set automatically. When "2" (manual setting) is selected, set the damping of the resonance frequency with this servo parameter.

[Pr. PB23_Low-pass filter selection (VFBF)]

Initial value	Setting range	Ver.
00001000h	Refer to the relevant detail No.	Refer to the relevant detail No.

[Pr. PB23.0_Shaft resonance suppression filter selection]

Initial value	Setting range	Ver.
0h	Refer to the text	A4

Select the shaft resonance suppression filter.

0: Automatic setting

1: Manual setting

2: Disabled

When [Pr. PB49.0 Machine resonance suppression filter 4 selection] is set to "1" (enabled), the shaft resonance suppression filter cannot be used.

[Pr. PB23.1_Low-pass filter selection]

Initial value	Setting range	Ver.
0h	Refer to the text	A4

Select the low-pass filter.

0: Automatic setting

1: Manual setting

2: Disabled

When "5" (quick tuning mode) is selected in [Pr. PA08.0 Gain adjustment mode selection], this servo parameter is set to "1" (manual setting).

[Pr. PB23.3_Shaft resonance suppression filter 2 selection]

Initial value	Setting range	Ver.
1h	Refer to the text	A4

0: Disabled

1: Automatic setting

[Pr. PB24_Slight vibration suppression control (*MVS)]

Initial value	Setting range	Ver.
00000000h	Refer to the relevant detail No.	Refer to the relevant detail No.

[Pr. PB24.0_Slight vibration suppression control selection]

Initial value	Setting range	Ver.
0h	Refer to the text	A4

Select the slight vibration suppression control.

0: Disabled

1: Enabled

The slight vibration suppression control is enabled when "3" (manual mode) is selected in [Pr. PA08.0 Gain adjustment mode selection].

The slight vibration suppression control selection can be used in the position mode and positioning mode.

[Pr. PB24.1_PI-PID switching control selection]

Initial value	Setting range	Ver.
0h	Refer to the text	A4

0: PI control enabled (switching is enabled by PID switching signal (C_PC) from controller and the input device (PC))

3: Continuous PID control (proportional control) enabled

If the servo motor at a stop is rotated even for a pulse due to any external factor, it generates torque to compensate for a position mismatch. When the servo motor shaft is to be locked mechanically after positioning completion (stop), enabling the PID control and completing positioning simultaneously will suppress the unnecessary torque generated to compensate for a position mismatch.

[Pr. PB25_Function selection B-1 (*BOP1)]

Initial value	Setting range	Ver.
00000000h	Refer to the relevant detail No.	Refer to the relevant detail No.

[Pr. PB25.0_Model adaptive control selection]

Initial value	Setting range	Ver.
0h	Refer to the text	A4

0: Enabled (model adaptive control)

2: Disabled (PID control)

When "Disabled" is set, vibration suppression control 1 and 2 cannot be used. The overshoot compensation will be disabled.

[Pr. PB26_Gain switching function (*CDP)]

Initial value	Setting range	Ver.
0000000h	Refer to the relevant detail No.	Refer to the relevant detail No.

Select the gain switching condition.

Set the conditions to enable the following values: the gain switching values that have been set from [Pr. PB29 Gain switching - Load to motor inertia ratio/load to motor mass ratio] to [Pr. PB36 Gain switching - Vibration suppression control 1 - Resonance frequency damping] and from [Pr. PB56 Gain switching - Vibration suppression control 2 - Vibration frequency] to [Pr. PB60 Gain switching - Model control gain], and the values of gain switching 2 that have been set from [Pr. PB67 Gain switching 2 - Load to motor inertia ratio/load to motor mass ratio] to [Pr. PB79 Gain switching 2 - Model control gain].

[Pr. PB26.0_Gain switching selection]

Initial value	Setting range	Ver.
0h	Refer to the text	A4

- 0: Disabled
- 1: Signal (CDP/C_CDP)
- 2: Command frequency
- 3: Droop pulses
- 4: Servo motor speed
- 5: Command direction

When "1" is selected, the gain changes to "Gain after gain switching" by using the control command (C_CDP) from the controller or the input device CDP (Gain switching).

When "2" is selected, set [Pr. PT01.2 Unit for position data] to "3" (pulse). Setting [Pr. PT01.2] to a value other than "3" disables gain switching.

[Pr. PB26.1_Gain switching condition selection]

Initial value	Setting range	Ver.
0h	Refer to the text	A4

- 0: Gain after "Gain switching" is enabled with the value of the gain switching condition or more
- 1: Gain after "Gain switching" is enabled with the value of the gain switching condition or less

[Pr. PB26.2_Gain switching time constant - Disabling condition selection]

Initial value	Setting range	Ver.
0h	Refer to the text	A4

- 0: Switching time constant enabled
- 1: Time constant disabled at switching
- 2: Time constant disabled at return

[Pr. PB26.4_Gain switching 2 selection]

Initial value	Setting range	Ver.
0h	Refer to the text	A4

- 0: Disabled
- 1: Signal (CDP2/C_CDP2)
- 2: The same condition as [Pr. PB26.0 Gain switching selection]

When "1" is selected, the gain changes to "Gain after gain switching 2" by using the control command (C_CDP2) from the controller or the input device CDP2 (Gain switching 2).

When "1" is set in [Pr. PB26.0] while "2" has been selected for this servo parameter, the gain changes to "Gain after gain switching 2" by the control command (C_CDP2) from the controller or the input device CDP2 (Gain switching 2).

[Pr. PB26.5_Gain switching selection during a stop]

Initial value	Setting range	Ver.
0h	Refer to the text	A4

0: Gain switching 2 during a stop is disabled

1: Gain switching 2 during a stop is enabled

This servo parameter is enabled in the following condition: [Pr. PB26.4 Gain switching 2 selection] is set to "2" (the same condition as [Pr. PB26.0 Gain switching selection]) and [Pr. PB26.0] is set to "5" (command direction) in the position mode and positioning mode.

[Pr. PB27_Gain switching condition (CDL)]

Initial value	Setting range	Ver.
10 [Refer to the text below for the unit.]	0 to 16777215	A4

Set the value of the gain switching (command frequency, droop pulses, or servo motor speed) selected in [Pr. PB26 Gain switching function].

The set value unit differs depending on the switching condition item. The units are as follows: [kpulse/s] for command frequency, [pulse] for droop pulses, and [r/min] for servo motor speed.

If using a linear servo motor, the unit of the servo motor speed is [mm/s].

[Pr. PB28_Gain switching time constant (CDT)]

Initial value	Setting range	Ver.
1 [ms]	0 to 100	A4

Set the time constant until the gain switches in response to the conditions set in [Pr. PB26 Gain switching function] and [Pr. PB27 Gain switching condition].

[Pr. PB29_Gain switching - Load to motor inertia ratio/load to motor mass ratio (GD2B)]

Initial value	Setting range	Ver.
7.00 [Multiplier]	0.00 to 300.00	A4

Set the load to motor inertia ratio for when the gain switching is enabled.

The setting value of this servo parameter is enabled when [Pr. PA08.0 Gain adjustment mode selection] is set to "3" (manual mode).

[Pr. PB30_Gain switching - Position control gain (PG2B)]

Initial value	Setting range	Ver.
0.0 [rad/s]	0.0 to 2000.0	A4

Set the position control gain for when the gain switching is enabled.

When the setting value of this servo parameter is less than "1.0", the setting value of [Pr. PB08 Position control gain] is applied.

The setting value of this servo parameter is enabled when [Pr. PA08.0 Gain adjustment mode selection] is set to "3" (manual mode).

[Pr. PB31_Gain switching - Speed control gain (VG2B)]

Initial value	Setting range	Ver.
0 [rad/s]	0 to 65535	A4

Set the speed control gain for when the gain switching is enabled.

When the setting value of this servo parameter is less than "20", the setting value of [Pr. PB09 Speed control gain] is applied. The setting value of this servo parameter is enabled when [Pr. PA08.0 Gain adjustment mode selection] is set to "3" (manual mode).

[Pr. PB32_Gain switching - Speed integral compensation (VICB)]

Initial value	Setting range	Ver.
0.0 [ms]	0.0 to 5000.0	A4

Set the speed integral compensation for when the gain switching is enabled.

When the setting value of this servo parameter is less than "0.1", the setting value of [Pr. PB10 Speed integral compensation] is applied.

The setting value of this servo parameter is enabled when [Pr. PA08.0 Gain adjustment mode selection] is set to "3" (manual mode).

[Pr. PB33_Gain switching - Vibration suppression control 1 - Vibration frequency (VRF11B)]

Initial value	Setting range	Ver.
0.0 [Hz]	0.0 to 300.0	A4

Set the vibration frequency of vibration suppression control 1 for when the gain switching is enabled.

When the setting value of this servo parameter is less than "0.1", the setting value of [Pr. PB19 Vibration suppression control 1 - Vibration frequency] is applied.

This servo parameter is enabled in the following conditions:

- [Pr. PA08.0 Gain adjustment mode selection] is set to "3" (manual mode).
- [Pr. PB02.0 Vibration suppression control 1 - Tuning mode selection] is set to "2" (manual setting).
- "1" (signal (CDP/C_CDP)) is selected in [Pr. PB26.0 Gain switching selection].

Switching gains during driving may cause a shock. Switch the gains after the servo motor has stopped.

[Pr. PB34_Gain switching - Vibration suppression control 1 - Resonance frequency (VRF12B)]

Initial value	Setting range	Ver.
0.0 [Hz]	0.0 to 300.0	A4

Set the resonance frequency for vibration suppression control 1 for when the gain switching is enabled.

When the setting value of this servo parameter is less than "0.1", the setting value of [Pr. PB20 Vibration suppression control 1 - Resonance frequency] is applied.

This servo parameter is enabled in the following conditions:

- [Pr. PA08.0 Gain adjustment mode selection] is set to "3" (manual mode).
- [Pr. PB02.0 Vibration suppression control 1 - Tuning mode selection] is set to "2" (manual setting).
- "1" (signal (CDP/C_CDP)) is selected in [Pr. PB26.0 Gain switching selection].

Switching gains during driving may cause a shock. Switch the gains after the servo motor has stopped.

[Pr. PB35_Gain switching - Vibration suppression control 1 - Vibration frequency damping (VRF13B)]

Initial value	Setting range	Ver.
0.00	0.00 to 0.30	A4

Set the damping of the vibration frequency for vibration suppression control 1 for when the gain switching is enabled.

This servo parameter is enabled in the following conditions:

- [Pr. PA08.0 Gain adjustment mode selection] is set to "3" (manual mode).
- [Pr. PB02.0 Vibration suppression control 1 - Tuning mode selection] is set to "2" (manual setting).
- "1" (signal (CDP/C_CDP)) is selected in [Pr. PB26.0 Gain switching selection].

Switching gains during driving may cause a shock. Switch the gains after the servo motor has stopped.

[Pr. PB36_Gain switching - Vibration suppression control 1 - Resonance frequency damping (VRF14B)]

Initial value	Setting range	Ver.
0.00	0.00 to 0.30	A4

Set the damping of the resonance frequency for vibration suppression control 1 for when the gain switching is enabled.

This servo parameter is enabled in the following conditions:

- [Pr. PA08.0 Gain adjustment mode selection] is set to "3" (manual mode).
- [Pr. PB02.0 Vibration suppression control 1 - Tuning mode selection] is set to "2" (manual setting).
- "1" (signal (CDP/C_CDP)) is selected in [Pr. PB26.0 Gain switching selection].

Switching gains during driving may cause a shock. Switch the gains after the servo motor has stopped.

[Pr. PB45_Command notch filter (CNHF)]

Initial value	Setting range	Ver.
00000000h	Refer to the relevant detail No.	Refer to the relevant detail No.

Set the command notch filter.

[Pr. PB45.0-1_Command notch filter setting frequency selection]

Initial value	Setting range	Ver.
00h	Refer to the text	A4

Refer to the following table for the relation of setting values to frequencies.

Setting value	Frequency [Hz]
00	Disabled
01	2000
02	1000
03	666
04	500
06	400
07	333
08	285
09	250
0A	222
0B	200
0C	181
0D	166
0F	153
10	142
11	133
12	125

Setting value	Frequency [Hz]
13	117
14	111
15	105
16	100
17	95
19	90
1A	86
1B	83
1C	80
1D	76
1E	74
1F	71
21	66
22	62
23	58
24	55
25	52
26	50
27	47
29	45
2A	43
2B	41
2C	40
2D	38
2E	37
2F	35
30	34.5
31	33.3
32	31.3
33	29.4
34	27.8
35	26.3
36	25.0
38	23.8
39	22.7
3A	21.7
3B	20.8
3C	20.0
3D	19.2
3E	18.5
3F	17.9
40	17.2
41	16.7
42	15.6
43	14.7
44	13.9
45	13.2
46	12.5
48	11.9
49	11.4
4A	10.9
4B	10.4
4C	10

Setting value	Frequency [Hz]
4D	9.6
4E	9.3
4F	8.9
50	8.6
51	8.3
52	7.8
53	7.4
54	6.9
55	6.6
56	6.3
58	6.0
59	5.7
5A	5.4
5B	5.2
5C	5.0
5D	4.8
5E	4.6
5F	4.5
60	4.31
61	4.17
62	3.91
63	3.68
64	3.47
65	3.29
66	3.13
68	2.98
69	2.84
6A	2.72
6B	2.60
6C	2.50
6D	2.40
6E	2.31
6F	2.23
71	2.08
72	1.95
73	1.84
74	1.74
75	1.64
76	1.56
78	1.49
79	1.42
7A	1.36
7B	1.30
7C	1.25
7D	1.20
7E	1.16
7F	1.12

[Pr. PB45.2_Notch depth selection]

Initial value	Setting range	Ver.
0h	Refer to the text	A4

Refer to the following table for details.

Setting value	Depth [dB]
0	-40.0
1	-24.1
2	-18.1
3	-14.5
4	-12.0
5	-10.1
6	-8.5
7	-7.2
8	-6.0
9	-5.0
A	-4.1
B	-3.3
C	-2.5
D	-1.8
E	-1.2
F	-0.6

[Pr. PB46_Machine resonance suppression filter 3 (NH3)]

Initial value	Setting range	Ver.
4500 [Hz]	10 to 9000	A4

Set the notch frequency of the machine resonance suppression filter 3.

When [Pr. PB47.0 Machine resonance suppression filter 3 selection] is set to "1" (enabled), set the notch frequency with this servo parameter.

[Pr. PB47_Notch shape selection 3 (NHQ3)]

Initial value	Setting range	Ver.
00000000h	Refer to the relevant detail No.	Refer to the relevant detail No.

Set forms of the machine resonance suppression filter 3.

[Pr. PB47.0_Machine resonance suppression filter 3 selection]

Initial value	Setting range	Ver.
0h	Refer to the text	A4

0: Disabled

1: Enabled

[Pr. PB47.1_Notch depth selection]

Initial value	Setting range	Ver.
0h	Refer to the text	A4

0: -40 dB

1: -14 dB

2: -8 dB

3: -4 dB

[Pr. PB47.2_Notch width selection]

Initial value	Setting range	Ver.
0h	Refer to the text	A4

0: $\alpha = 2$

1: $\alpha = 3$

2: $\alpha = 4$

3: $\alpha = 5$

[Pr. PB48_Machine resonance suppression filter 4 (NH4)]

Initial value	Setting range	Ver.
4500 [Hz]	10 to 9000	A4

Set the notch frequency of the machine resonance suppression filter 4.

When [Pr. PB49.0 Machine resonance suppression filter 4 selection] is set to "1" (enabled), set the notch frequency with this servo parameter.

[Pr. PB49_Notch shape selection 4 (NHQ4)]

Initial value	Setting range	Ver.
0000000h	Refer to the relevant detail No.	Refer to the relevant detail No.

Set forms of the machine resonance suppression filter 4.

[Pr. PB49.0_Machine resonance suppression filter 4 selection]

Initial value	Setting range	Ver.
0h	Refer to the text	A4

0: Disabled

1: Enabled

When this setting value is "Enabled", [Pr. PB17 Shaft resonance suppression filter] cannot be used.

[Pr. PB49.1_Notch depth selection]

Initial value	Setting range	Ver.
0h	Refer to the text	A4

0: -40 dB

1: -14 dB

2: -8 dB

3: -4 dB

[Pr. PB49.2_Notch width selection]

Initial value	Setting range	Ver.
0h	Refer to the text	A4

0: $\alpha = 2$

1: $\alpha = 3$

2: $\alpha = 4$

3: $\alpha = 5$

[Pr. PB50_Machine resonance suppression filter 5 (NH5)]

Initial value	Setting range	Ver.
4500 [Hz]	10 to 9000	A4

Set the notch frequency of the machine resonance suppression filter 5.

When [Pr. PB51.0 Machine resonance suppression filter 5 selection] is set to "1" (enabled), set the notch frequency with this servo parameter.

[Pr. PB51_Notch shape selection 5 (NHQ5)]

Initial value	Setting range	Ver.
0000000h	Refer to the relevant detail No.	Refer to the relevant detail No.

Set forms of the machine resonance suppression filter 5.

When [Pr. PA08.0 Gain adjustment mode selection] is set to "5" (quick tuning mode), the setting value of this servo parameter reflects the adjustment result of quick tuning.

When [Pr. PE41.0 Robust filter selection] is set to "1" (enabled), machine resonance suppression filter 5 cannot be used.

[Pr. PB51.0_Machine resonance suppression filter 5 selection]

Initial value	Setting range	Ver.
0h	Refer to the text	A4

0: Disabled

1: Enabled

[Pr. PB51.1_Notch depth selection]

Initial value	Setting range	Ver.
0h	Refer to the text	A4

0: -40 dB

1: -14 dB

2: -8 dB

3: -4 dB

[Pr. PB51.2_Notch width selection]

Initial value	Setting range	Ver.
0h	Refer to the text	A4

0: $\alpha = 2$

1: $\alpha = 3$

2: $\alpha = 4$

3: $\alpha = 5$

[Pr. PB52_Vibration suppression control 2 - Vibration frequency (VRF21)]

Initial value	Setting range	Ver.
100.0 [Hz]	0.1 to 300.0	A4

Set the vibration frequency of vibration suppression control 2 to suppress low-frequency machine vibration.

When "1" (automatic setting) is selected in [Pr. PB02.1 Vibration suppression control 2 - Tuning mode selection], this servo parameter will be set automatically. When "2" (manual setting) is selected, set the vibration frequency with this servo parameter.

The setting value is enabled when [Pr. PA24.0 Vibration suppression mode selection] is set to "1" (3 inertia mode).

The available range of [Pr. PB52 Vibration suppression control 2 - Vibration frequency] depends on the value in [Pr. PB07 Model control gain]. If the setting value of [Pr. PB52] exceeds the available range, the vibration suppression control is disabled.

[Pr. PB53_Vibration suppression control 2 - Resonance frequency (VRF22)]

Initial value	Setting range	Ver.
100.0 [Hz]	0.1 to 300.0	A4

Set the resonance frequency of vibration suppression control 2 to suppress low-frequency machine vibration.

When "1" (automatic setting) is selected in [Pr. PB02.1 Vibration suppression control 2 - Tuning mode selection], this servo parameter will be set automatically. When "2" (manual setting) is selected, set the resonance frequency with this servo parameter.

The setting value is enabled when [Pr. PA24.0 Vibration suppression mode selection] is set to "1" (3 inertia mode).

The available range of [Pr. PB53 Vibration suppression control 2 - Resonance frequency] changes depending on the value in [Pr. PB07 Model control gain]. If the setting value of [Pr. PB53] exceeds the available range, the vibration suppression control is disabled.

[Pr. PB54_Vibration suppression control 2 - Vibration frequency damping (VRF23)]

Initial value	Setting range	Ver.
0.00	0.00 to 0.30	A4

Set the damping of the vibration frequency for vibration suppression control 2 to suppress low-frequency machine vibration.

When "1" (automatic setting) is selected in [Pr. PB02.1 Vibration suppression control 2 - Tuning mode selection], this servo parameter will be set automatically. When "2" (manual setting) is selected, set the damping of the vibration frequency with this servo parameter.

The setting value is enabled when [Pr. PA24.0 Vibration suppression mode selection] is set to "1" (3 inertia mode).

[Pr. PB55_Vibration suppression control 2 - Resonance frequency damping (VRF24)]

Initial value	Setting range	Ver.
0.00	0.00 to 0.30	A4

Set the damping of the resonance frequency for vibration suppression control 2 to suppress low-frequency machine vibration.

When "1" (automatic setting) is selected in [Pr. PB02.1 Vibration suppression control 2 - Tuning mode selection], this servo parameter will be set automatically. When "2" (manual setting) is selected, set the damping of the resonance frequency with this servo parameter.

The setting value is enabled when [Pr. PA24.0 Vibration suppression mode selection] is set to "1" (3 inertia mode).

[Pr. PB56_Gain switching - Vibration suppression control 2 - Vibration frequency (VRF21B)]

Initial value	Setting range	Ver.
0.0 [Hz]	0.0 to 300.0	A4

Set the vibration frequency of vibration suppression control 2 for when the gain switching is enabled.

When the setting value of this servo parameter is less than "0.1", the setting value of [Pr. PB52 Vibration suppression control 2 - Vibration frequency] is applied.

This servo parameter is enabled in the following conditions:

- [Pr. PA08.0 Gain adjustment mode selection] is set to "3" (manual mode).
- [Pr. PA24.0 Vibration suppression mode selection] is set to "1" (3 inertia mode).
- [Pr. PB02.1 Vibration suppression control 2 - Tuning mode selection] is set to "2" (manual setting).
- "1" (signal (CDP/C_CDP)) is selected in [Pr. PB26.0 Gain switching selection].

Switching gains during driving may cause a shock. Switch the gains after the servo motor has stopped.

[Pr. PB57_Gain switching - Vibration suppression control 2 - Resonance frequency (VRF22B)]

Initial value	Setting range	Ver.
0.0 [Hz]	0.0 to 300.0	A4

Set the resonance frequency for vibration suppression control 2 for when the gain switching is enabled.

When the setting value of this servo parameter is less than "0.1", the setting value of [Pr. PB53 Vibration suppression control 2 - Resonance frequency] is applied.

This servo parameter is enabled in the following conditions:

- [Pr. PA08.0 Gain adjustment mode selection] is set to "3" (manual mode).
- [Pr. PA24.0 Vibration suppression mode selection] is set to "1" (3 inertia mode).
- [Pr. PB02.1 Vibration suppression control 2 - Tuning mode selection] is set to "2" (manual setting).
- "1" (signal (CDP/C_CDP)) is selected in [Pr. PB26.0 Gain switching selection].

Switching gains during driving may cause a shock. Switch the gains after the servo motor has stopped.

[Pr. PB58_Gain switching - Vibration suppression control 2 - Vibration frequency damping (VRF23B)]

Initial value	Setting range	Ver.
0.00	0.00 to 0.30	A4

Set the damping of the vibration frequency for vibration suppression control 2 for when the gain switching is enabled.

This servo parameter is enabled in the following conditions:

- [Pr. PA08.0 Gain adjustment mode selection] is set to "3" (manual mode).
- [Pr. PA24.0 Vibration suppression mode selection] is set to "1" (3 inertia mode).
- [Pr. PB02.1 Vibration suppression control 2 - Tuning mode selection] is set to "2" (manual setting).
- "1" (signal (CDP/C_CDP)) is selected in [Pr. PB26.0 Gain switching selection].

Switching gains during driving may cause a shock. Switch the gains after the servo motor has stopped.

[Pr. PB59_Gain switching - Vibration suppression control 2 - Resonance frequency damping (VRF24B)]

Initial value	Setting range	Ver.
0.00	0.00 to 0.30	A4

Set the damping of the resonance frequency for vibration suppression control 2 for when the gain switching is enabled.

This servo parameter is enabled in the following conditions:

- [Pr. PA08.0 Gain adjustment mode selection] is set to "3" (manual mode).
- [Pr. PA24.0 Vibration suppression mode selection] is set to "1" (3 inertia mode).
- [Pr. PB02.1 Vibration suppression control 2 - Tuning mode selection] is set to "2" (manual setting).
- "1" (signal (CDP/C_CDP)) is selected in [Pr. PB26.0 Gain switching selection].

[Pr. PB60_Gain switching - Model control gain (PG1B)]

Initial value	Setting range	Ver.
0.0 [rad/s]	0.0 to 8000.0	A4

Set the model control gain for when the gain switching is enabled.

When the setting value of this servo parameter is less than "1.0", the setting value of [Pr. PB07 Model control gain] is applied.

This servo parameter is enabled in the following conditions:

- [Pr. PA08.0 Gain adjustment mode selection] is set to "3" (manual mode).
- "1" (signal (CDP/C_CDP)) is selected in [Pr. PB26.0 Gain switching selection].

Switching gains during driving may cause a shock. Switch the gains after the servo motor has stopped.

[Pr. PB65_Gain switching 2 condition (CDL2)]

Initial value	Setting range	Ver.
10 [Refer to the text below for the unit.]	0 to 16777215	A4

Set the value of the gain switching (command frequency, droop pulses, or servo motor speed) selected in [Pr. PB26.0 Gain switching selection].

The set value unit differs depending on the switching condition item. The units are as follows: [kpulse/s] for command frequency, [pulse] for droop pulses, and [r/min] for servo motor speed.

If using a linear servo motor, the unit of the servo motor speed is [mm/s].

The setting value is to be larger than in [Pr. PB27 Gain switching condition].

When "0" is set, the gain is not switched to the gain switching 2.

[Pr. PB66_Gain switching 2 time constant (CDT2)]

Initial value	Setting range	Ver.
1 [ms]	0 to 100	A4

Set the time constant until the gain switches from "gain at normal use" or "gain at switching" to "gain at switching 2" in response to the conditions set in [Pr. PB26 Gain switching function] and [Pr. PB65 Gain switching 2 condition].

[Pr. PB67_Gain switching 2 - Load to motor inertia ratio/load to motor mass ratio (GD2C)]

Initial value	Setting range	Ver.
7.00 [Multiplier]	0.00 to 300.00	A4

Set the load to motor inertia ratio/load to motor mass ratio for when the gain switching 2 is enabled.

This servo parameter is enabled when [Pr. PA08.0 Gain adjustment mode selection] is set to "3" (manual mode).

[Pr. PB68_Gain switching 2 - Position control gain (PG2C)]

Initial value	Setting range	Ver.
0.0 [rad/s]	0.0 to 2000.0	A4

Set the position control gain for when the gain switching 2 is enabled.

When the setting value of this servo parameter is less than "1.0", the setting value of [Pr. PB08 Position control gain] is applied.

This servo parameter is enabled when [Pr. PA08.0 Gain adjustment mode selection] is set to "3" (manual mode).

[Pr. PB69_Gain switching 2 - Speed control gain (VG2C)]

Initial value	Setting range	Ver.
0 [rad/s]	0 to 65535	A4

Set the speed control gain for when the gain switching 2 is enabled.

When the setting value of this servo parameter is less than "20", the setting value of [Pr. PB09 Speed control gain] is applied.

This servo parameter is enabled when [Pr. PA08.0 Gain adjustment mode selection] is set to "3" (manual mode).

[Pr. PB70_Gain switching 2 - Speed integral compensation (VICC)]

Initial value	Setting range	Ver.
0.0 [ms]	0.0 to 5000.0	A4

Set the speed integral compensation for when the gain switching 2 is enabled.

When the setting value of this servo parameter is less than "0.1", the setting value of [Pr. PB10 Speed integral compensation] is applied.

This servo parameter is enabled when [Pr. PA08.0 Gain adjustment mode selection] is set to "3" (manual mode).

[Pr. PB71_Gain switching 2 - Vibration suppression control 1 - Vibration frequency (VRF11C)]

Initial value	Setting range	Ver.
0.0 [Hz]	0.0 to 300.0	A4

Set the vibration frequency of vibration suppression control 1 for when the gain switching 2 is enabled.

When the setting value of this servo parameter is less than "0.1", the setting value of [Pr. PB19 Vibration suppression control 1 - Vibration frequency] is applied.

This servo parameter is enabled in the following conditions:

- [Pr. PA08.0 Gain adjustment mode selection] is set to "3" (manual mode).
- [Pr. PB02.0 Vibration suppression control 1 - Tuning mode selection] is set to "2" (manual setting).
- [Pr. PB26.0 Gain switching selection] is set to "1" (signal (CDP/C_CDP)) while [Pr. PB26.4 Gain switching 2 selection] is set to "2" (the same condition as [Pr. PB26.0 Gain switching selection]), or [Pr. PB26.4] is set to "1" (signal (CDP2/C_CDP2)).

Switching gains during driving may cause a shock. Switch the gains after the servo motor has stopped.

[Pr. PB72_Gain switching 2 - Vibration suppression control 1 - Resonance frequency (VRF12C)]

Initial value	Setting range	Ver.
0.0 [Hz]	0.0 to 300.0	A4

Set the resonance frequency for vibration suppression control 1 for when the gain switching 2 is enabled.

When the setting value of this servo parameter is less than "0.1", the setting value of [Pr. PB20 Vibration suppression control 1 - Resonance frequency] is applied.

This servo parameter is enabled in the following conditions:

- [Pr. PA08.0 Gain adjustment mode selection] is set to "3" (manual mode).
- [Pr. PB02.0 Vibration suppression control 1 - Tuning mode selection] is set to "2" (manual setting).
- [Pr. PB26.0 Gain switching selection] is set to "1" (signal (CDP/C_CDP)) while [Pr. PB26.4 Gain switching 2 selection] is set to "2" (the same condition as [Pr. PB26.0 Gain switching selection]), or [Pr. PB26.4] is set to "1" (signal (CDP2/C_CDP2)).

Switching gains during driving may cause a shock. Switch the gains after the servo motor has stopped.

[Pr. PB73_Gain switching 2 - Vibration suppression control 1 - Vibration frequency damping (VRF13C)]

Initial value	Setting range	Ver.
0.00	0.00 to 0.30	A4

Set the damping of the vibration frequency for vibration suppression control 1 for when the gain switching is enabled.

This servo parameter is enabled in the following conditions:

- [Pr. PA08.0 Gain adjustment mode selection] is set to "3" (manual mode).
- [Pr. PB02.0 Vibration suppression control 1 - Tuning mode selection] is set to "2" (manual setting).
- [Pr. PB26.0 Gain switching selection] is set to "1" (signal (CDP/C_CDP)) while [Pr. PB26.4 Gain switching 2 selection] is set to "2" (the same condition as [Pr. PB26.0 Gain switching selection]), or [Pr. PB26.4] is set to "1" (signal (CDP2/C_CDP2)).

Switching gains during driving may cause a shock. Switch the gains after the servo motor has stopped.

[Pr. PB74_Gain switching 2 - Vibration suppression control 1 - Resonance frequency damping (VRF14C)]

Initial value	Setting range	Ver.
0.00	0.00 to 0.30	A4

Set the damping of the resonance frequency for vibration suppression control 1 for when the gain switching is enabled.

This servo parameter is enabled in the following conditions:

- [Pr. PA08.0 Gain adjustment mode selection] is set to "3" (manual mode).
- [Pr. PB02.0 Vibration suppression control 1 - Tuning mode selection] is set to "2" (manual setting).
- [Pr. PB26.0 Gain switching selection] is set to "1" (signal (CDP/C_CDP)) while [Pr. PB26.4 Gain switching 2 selection] is set to "2" (the same condition as [Pr. PB26.0 Gain switching selection]), or [Pr. PB26.4] is set to "1" (signal (CDP2/C_CDP2)).

Switching gains during driving may cause a shock. Switch the gains after the servo motor has stopped.

[Pr. PB75_Gain switching 2 - Vibration suppression control 2 - Vibration frequency (VRF21C)]

Initial value	Setting range	Ver.
0.0 [Hz]	0.0 to 300.0	A4

Set the vibration frequency of vibration suppression control 2 for when the gain switching is enabled.

When the setting value of this servo parameter is less than "0.1", the setting value of [Pr. PB52 Vibration suppression control 2 - Vibration frequency] is applied.

This servo parameter is enabled in the following conditions:

- [Pr. PA08.0 Gain adjustment mode selection] is set to "3" (manual mode).
- [Pr. PA24.0 Vibration suppression mode selection] is set to "1" (3 inertia mode).
- [Pr. PB02.1 Vibration suppression control 2 - Tuning mode selection] is set to "2" (manual setting).
- [Pr. PB26.0 Gain switching selection] is set to "1" (signal (CDP/C_CDP)) while [Pr. PB26.4 Gain switching 2 selection] is set to "2" (the same condition as [Pr. PB26.0 Gain switching selection]), or [Pr. PB26.4] is set to "1" (signal (CDP2/C_CDP2)).

Switching gains during driving may cause a shock. Switch the gains after the servo motor has stopped.

[Pr. PB76_Gain switching 2 - Vibration suppression control 2 - Resonance frequency (VRF22C)]

Initial value	Setting range	Ver.
0.0 [Hz]	0.0 to 300.0	A4

Set the resonance frequency for vibration suppression control 2 for when the gain switching is enabled.

When the setting value of this servo parameter is less than "0.1", the setting value of [Pr. PB53 Vibration suppression control 2 - Resonance frequency] is applied.

This servo parameter is enabled in the following conditions:

- [Pr. PA08.0 Gain adjustment mode selection] is set to "3" (manual mode).
- [Pr. PA24.0 Vibration suppression mode selection] is set to "1" (3 inertia mode).
- [Pr. PB02.1 Vibration suppression control 2 - Tuning mode selection] is set to "2" (manual setting).
- [Pr. PB26.0 Gain switching selection] is set to "1" (signal (CDP/C_CDP)) while [Pr. PB26.4 Gain switching 2 selection] is set to "2" (the same condition as [Pr. PB26.0 Gain switching selection]), or [Pr. PB26.4] is set to "1" (signal (CDP2/C_CDP2)).

Switching gains during driving may cause a shock. Switch the gains after the servo motor has stopped.

[Pr. PB77_Gain switching 2 - Vibration suppression control 2 - Vibration frequency damping (VRF23C)]

Initial value	Setting range	Ver.
0.00	0.00 to 0.30	A4

Set the damping of the vibration frequency for vibration suppression control 2 for when the gain switching is enabled.

This servo parameter is enabled in the following conditions:

- [Pr. PA08.0 Gain adjustment mode selection] is set to "3" (manual mode).
- [Pr. PA24.0 Vibration suppression mode selection] is set to "1" (3 inertia mode).
- [Pr. PB02.1 Vibration suppression control 2 - Tuning mode selection] is set to "2" (manual setting).
- [Pr. PB26.0 Gain switching selection] is set to "1" (signal (CDP/C_CDP)) while [Pr. PB26.4 Gain switching 2 selection] is set to "2" (the same condition as [Pr. PB26.0 Gain switching selection]), or [Pr. PB26.4] is set to "1" (signal (CDP2/C_CDP2)).

Switching gains during driving may cause a shock. Switch the gains after the servo motor has stopped.

[Pr. PB78_Gain switching 2 - Vibration suppression control 2 - Resonance frequency damping (VRF24C)]

Initial value	Setting range	Ver.
0.00	0.00 to 0.30	A4

Set the damping of the resonance frequency for vibration suppression control 2 for when the gain switching is enabled.

This servo parameter is enabled in the following conditions:

- [Pr. PA08.0 Gain adjustment mode selection] is set to "3" (manual mode).
- [Pr. PA24.0 Vibration suppression mode selection] is set to "1" (3 inertia mode).
- [Pr. PB02.1 Vibration suppression control 2 - Tuning mode selection] is set to "2" (manual setting).
- [Pr. PB26.0 Gain switching selection] is set to "1" (signal (CDP/C_CDP)) while [Pr. PB26.4 Gain switching 2 selection] is set to "2" (the same condition as [Pr. PB26.0 Gain switching selection]), or [Pr. PB26.4] is set to "1" (signal (CDP2/C_CDP2)).

Switching gains during driving may cause a shock. Switch the gains after the servo motor has stopped.

[Pr. PB79_Gain switching 2 - Model control gain (PG1C)]

Initial value	Setting range	Ver.
0.0 [rad/s]	0.0 to 8000.0	A4

Set the model control gain for when the gain switching is enabled.

When the setting value of this servo parameter is less than "1.0", the setting value of [Pr. PB07 Model control gain] is applied.

This servo parameter is enabled in the following conditions:

- [Pr. PB26.0 Gain switching selection] is set to "1" (signal (CDP/C_CDP)) while [Pr. PB26.4 Gain switching 2 selection] is set to "2" (the same condition as [Pr. PB26.0 Gain switching selection]), or [Pr. PB26.4] is set to "1" (signal (CDP2/C_CDP2)).

[Pr. PB81_Command filter (*CFIL)]

Initial value	Setting range	Ver.
00000001h	Refer to the relevant detail No.	Refer to the relevant detail No.

[Pr. PB81.4_Position command smoothing filter]

Initial value	Setting range	Ver.
0h	Refer to the text	A4

This function can be used only in the position mode and positioning mode.

This filter and [Pr. PB45 Command notch filter] are mutually exclusive. "1" (enabled) can be set in this function only when [Pr. PB45.0-1 Command notch filter setting frequency selection] is set to "00" (disabled). When a setting value other than "00" (disabled) is set in [Pr. PB45.0-1], the filter is disabled regardless of the setting value.

0: Disabled

1: Enabled

When "1" (enabled) is selected, set the filter time constant with [Pr. PB82 Position command smoothing filter time constant].

[Pr. PB82_Position command smoothing filter time constant (PFT)]

Initial value	Setting range	Ver.
0.0 [ms]	0.0 to 100.0	A4

Set the position command smoothing filter time constant.

This servo parameter can be used when [Pr. PB81.4 Position command smoothing filter] is set to "1" (enabled).

1.4 Extension setting servo parameters group ([Pr. PC_ _])

[Pr. PC01_ Excessive error alarm trigger level (ERZ)]

Initial value	Setting range	Ver.
0 [rev], [mm]	0 to 1000	A4

Set an excessive error alarm trigger level.

If using a rotary servo motor, set the level in units of rev. If 200 rev or higher is set, the value will be clamped to 200 rev.

If using a linear servo motor, the unit of the servo motor speed is [mm/s].

When the value is set to "0", the alarm trigger level for rotary servo motors is 3 rev.

The alarm trigger level for linear servo motors is 100 mm.

The unit can be changed with [Pr. PC06.3 Excessive error alarm trigger level/excessive error warning trigger level - Unit selection].

[Pr. PC02_ Electromagnetic brake sequence output (MBR)]

Initial value	Setting range	Ver.
0 [ms]	0 to 1000	A4

Set the delay time used between the MBR (Electromagnetic brake interlock) shut-off and the base circuit shut-off.

[Pr. PC04_ Function selection C-1 (**COP1)]

Initial value	Setting range	Ver.
00000000h	Refer to the relevant detail No.	Refer to the relevant detail No.

[Pr. PC04.3_ Encoder cable communication method selection]

Initial value	Setting range	Ver.
0h	Refer to the text	A4

0: Two-wire type

1: Four-wire type

When using an A/B/Z-phase differential output type encoder, set "0". Setting "1" triggers [AL. 037 Parameter error].

If the value is set incorrectly, [AL. 016 Encoder initial communication error 1] or [AL. 020 Encoder normal communication error 1] occurs.

[AL. 037] occurs if this servo parameter is set to "1" while [Pr. PA01.4 Fully closed loop operation mode selection] is set to "1" (enabled (fully closed loop control mode)).

[Pr. PC05_Function selection C-2 (**COP2)]

Initial value	Setting range	Ver.
00000000h	Refer to the relevant detail No.	Refer to the relevant detail No.

[Pr. PC05.0_Motor-less operation selection]

Initial value	Setting range	Ver.
0h	Refer to the text	A4

Enable or disable motor-less operation. This operation can be used only in semi closed loop control while a rotary servo motor is used.

0: Disabled

1: Enabled

[Pr. PC05.1_Test operation selection]

Initial value	Setting range	Ver.
0h	Refer to the text	A4

When using servo amplifiers in test operation mode, set this servo parameter to "1".

0: Disabled

1: Enabled

[Pr. PC05.4_Encoder communication circuit diagnosis mode selection]

Initial value	Setting range	Ver.
0h	Refer to the text	A4

Enable or disable the encoder communication circuit diagnosis mode.

[AL. 118.1 Encoder communication circuit diagnosis in progress] occurs during the encoder communication circuit diagnosis mode.

0: Encoder communication circuit diagnosis mode disabled

1: Encoder communication circuit diagnosis mode enabled

[Pr. PC06_Function selection C-3 (*COP3)]

Initial value	Setting range	Ver.
0000000h	Refer to the relevant detail No.	Refer to the relevant detail No.

[Pr. PC06.0_In-position range unit selection]

Initial value	Setting range	Ver.
0h	Refer to the text	A4

Select a unit of the in-position range.

If [Pr. PA01.4 Fully closed loop operation mode selection] is set to "1" (fully closed loop system), the in-position range is in the load-side encoder pulse unit.

This servo parameter is enabled only in the position mode and positioning mode.

0: Command input pulse unit

1: Servo motor encoder pulse unit

[Pr. PC06.3_Excessive error alarm trigger level/excessive error warning trigger level - Unit selection]

Initial value	Setting range	Ver.
0h	Refer to the text	A4

Select the unit used when setting the excessive error alarm trigger level in [Pr. PC01 Excessive error alarm trigger level] and setting the excessive error warning trigger level in [Pr. PC38 Excessive error warning trigger level].

This servo parameter is enabled only in the position mode and positioning mode.

0: [rev] or [mm]

1: [0.1 rev] or [0.1 mm]

2: [0.01 rev] or [0.01 mm]

3: [0.001 rev] or [0.001 mm]

[Pr. PC07_Zero speed (ZSP)]

Initial value	Setting range	Ver.
50 [r/min], [mm/s]	0 to 10000	A4

Set an output range of the zero speed signal (ZSP).

The zero speed signal detection has a hysteresis of 20 [r/min] (20 [mm/s]).

[Pr. PC08_Overspeed alarm detection level (OSL)]

Initial value	Setting range	Ver.
0 [r/min], [mm/s]	0 to 20000	A4

Set an overspeed alarm detection level.

When a value exceeding "servo motor maximum speed × 120 %" is set, the value will be clamped at "servo motor maximum speed × 120 %".

When "0" is set, the value of "servo motor maximum speed × 120 %" will be set.

[Pr. PC17_Function selection C-4 (**COP4)]

Initial value	Setting range	Ver.
00000000h	Refer to the relevant detail No.	Refer to the relevant detail No.

[Pr. PC17.1_Linear encoder multipoint Z-phase input function selection]

Initial value	Setting range	Ver.
0h	Refer to the text	B2

When multiple reference marks exist during the full stroke of the linear encoder, set "1".

0: Disabled

1: Enabled

[Pr. PC19_Function selection C-6 (*COP6)]

Initial value	Setting range	Ver.
00000000h	Refer to the relevant detail No.	Refer to the relevant detail No.

[Pr. PC19.0_[AL. 099 Stroke limit warning] selection]

Initial value	Setting range	Ver.
0h	Refer to the text	A4

Enable or disable [AL. 099 Stroke limit warning].

When "Disabled" is selected, [AL. 099] does not occur while LSP (Forward rotation stroke end) or LSN (Reverse rotation stroke end) is off, but the operation will be stopped with the stroke limit.

0: Enabled

1: Disabled

[Pr. PC19.4_Output open-phase detection selection]

Initial value	Setting range	Ver.
0h	Refer to the text	A4

Enable or disable the detection of output open-phase detection function.

0: Disabled

1: Enabled ([Pr. PC96 Output open-phase detection time] disabled)

2: Enabled ([Pr. PC96 Output open-phase detection time] enabled)

When "2" (Enabled ([Pr. PC96 Output open-phase detection time] enabled)) is set, the setting value of [Pr. PC96 Output open-phase detection time] is the detection time of [AL. 139 Output open-phase error].

[Pr. PC19.6_Output open phase - Judgment speed selection]

Initial value	Setting range	Ver.
0h	Refer to the text	A4

0: Servo motor speed

1: Speed command

When "0" (servo motor speed) is set, the value of the servo motor speed is used for the speed judgment of the output open-phase detection.

When "1" (speed command) is set, the speed command value is used for the speed judgment of the output open-phase detection.

When "2" (disabled (PID control)) is set in [Pr. PB25.0 Model adaptive control selection] in the torque mode, setting "1" (speed command) in this servo parameter does not trigger [AL. 139.2 Output open-phase error]. Set "0" (servo motor speed) in this servo parameter.

[Pr. PC20_Function selection C-7 (*COP7)]

Initial value	Setting range	Ver.
00000000h	Refer to the relevant detail No.	Refer to the relevant detail No.

[Pr. PC20.2_Undervoltage alarm selection]

Initial value	Setting range	Ver.
0h	Refer to the text	A4

Select the alarm or warning that occurs when the bus voltage drops to the undervoltage alarm trigger level.

0: [AL. 010 Undervoltage] occurs regardless of servo motor speed

1: [AL. 0E9 Main circuit off warning] occurs when the servo motor speed is 50 r/min (50 mm/s) or less, and [AL. 010] occurs when over 50 r/min (50 mm/s).

[Pr. PC21_Alarm history clear (*BPS)]

Initial value	Setting range	Ver.
00000000h	Refer to the relevant detail No.	Refer to the relevant detail No.

[Pr. PC21.0_Alarm clear history selection]

Initial value	Setting range	Ver.
0h	Refer to the text	A4

0: Disabled

1: Enabled

When "1" (enabled) is selected, the alarm history will be cleared at either the next power cycle, at software reset, or at controller reset. After the alarm history is cleared, "0" (disabled) will be set to this servo parameter automatically.

[Pr. PC24_Deceleration time constant at forced stop (RSBR)]

Initial value	Setting range	Ver.
100 [ms]	0 to 20000	A4

Set the deceleration time constant for the forced stop deceleration function.

Set the time taken from the rated speed to 0 [r/min] (0 [mm/s]) in units of ms.

When "0" is set, the deceleration time constant is the same as when "100" is set.

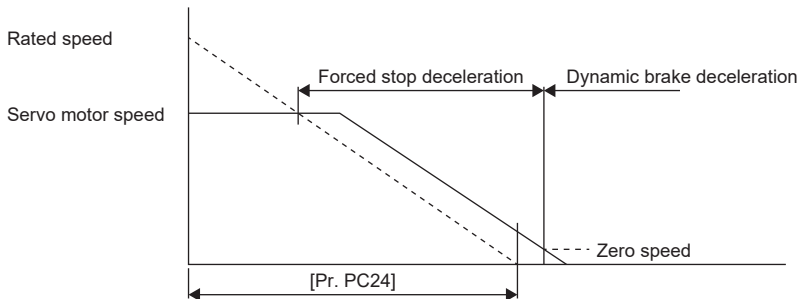

This servo parameter corresponds to [Quick stop deceleration (Obj. 6085h)]. When an object is mapped in cyclic communication, the controller overwrites the value written with engineering software. Thus, do not write a value with engineering software.

This servo parameter is enabled when [Pr. PT01.1 Speed/acceleration/deceleration unit selection] is set to "0". This servo parameter and [Pr. PV09 Deceleration at forced stop] are mutually exclusive.

- If the servo motor torque or thrust is saturated at the maximum value during forced stop deceleration because the set time is too short, the time to stop the servo motor will be longer than the set time constant.
- [AL. 050 Overload 1] or [AL. 051 Overload 2] may occur during forced stop deceleration, depending on the set value.
- After an occurrence of an alarm that executes forced stop deceleration, if another alarm that does not execute forced stop deceleration occurs, or if the power supply (control circuit power supply for MR-JET-_G_-HS(N1)) is shut off, dynamic braking will start regardless of the deceleration time constant setting.
- Set a longer time than deceleration time at quick stop of the controller. If the setting time is too short, [AL. 052 Excessive error] may occur.
- During forced stop deceleration, changes in the setting value are not reflected. If the setting value is changed during forced stop deceleration, the change will be reflected after the deceleration is completed.

[Pr. PC26_Function selection C-8 (**COP8)]

Initial value	Setting range	Ver.
00000050h	Refer to the relevant detail No.	Refer to the relevant detail No.

[Pr. PC26.0_A/B/Z-phase input encoder connection selection]

Initial value	Setting range	Ver.
0h	Refer to the text	B2

0: Disabled (only serial encoders are supported)

2: Enabled (only A/B/Z-phase input encoders are supported)

When the fully closed loop control or scale measurement function is enabled and an A/B/Z-phase differential output type encoder is used on the load side, set "2" (enabled). Setting a value other than "2" will trigger [AL. 01A Servo motor combination error].

[Pr. PC27_Function selection C-9 (**COP9)]

Initial value	Setting range	Ver.
00000000h	Refer to the relevant detail No.	Refer to the relevant detail No.

[Pr. PC27.0_Encoder pulse count polarity selection]

Initial value	Setting range	Ver.
0h	Refer to the text	B2

Select a polarity of the load-side encoder.

In the linear servo motor control mode, the polarity of the servo motor-side encoder changes.

0: Encoder pulse increasing direction in the servo motor CCW or positive direction

1: Encoder pulse decreasing direction in the servo motor CCW or positive direction

[Pr. PC27.2_ABZ phase input interface encoder ABZ phase connection assessment function selection]

Initial value	Setting range	Ver.
0h	Refer to the text	B2

Select the non-signal detection status for the pulse train signal from the A/B/Z-phase input interface encoder being used as a linear encoder.

This function is enabled when an A/B/Z-phase input interface encoder is used.

Setting value	Detection of disconnection	Alarm status		
	Z-phase-side non-signal	Rotary type (scale measurement function enabled)	Fully closed loop control mode	Linear servo motor control mode
0	Enabled	[AL. 071.6 Load-side encoder normal communication - Transmission data error 2] (Z-phase)	[AL. 071.6] (Z-phase)	[AL. 020.6 Encoder normal communication - Transmission data error 2] (Z-phase)
1	Disabled	—	—	—

[Pr. PC27.6_Multipoint Z-phase linear encoder monitor selection]

Initial value	Setting range	Ver.
0h	Refer to the text	D8

When multiple reference marks exist during the full stroke of the linear encoder, set "1".

0:Automatic setting

1:Enabled

If an encoder other than the incremental linear encoder or A/B/Z-phase differential output linear encoder is connected, the setting value of this servo parameter is disabled.

[Pr. PC29_Function selection C-B (*COPB)]

Initial value	Setting range	Ver.
00101000h	Refer to the relevant detail No.	Refer to the relevant detail No.

[Pr. PC29.0_[AL. 0E2.2 Servo motor temperature warning 2] selection]

Initial value	Setting range	Ver.
0h	Refer to the text	C0

Select whether to enable or disable [AL. 0E2.2 Servo motor temperature warning 2] when a servo motor with a batteryless absolute position encoder is used.

0: Enabled

1: Disabled

[Pr. PC29.3_Torque POL reflection selection]

Initial value	Setting range	Ver.
1h	Refer to the text	A4

When this servo parameter setting is enabled, setting of [Pr. PA14 Travel direction selection] changes the polarities in the following items: torque command ([Target torque (Obj. 6071h)] and [Torque demand value (Obj. 6074h)]), torque limit value ([Positive torque limit value (Obj. 60E0h)] and [Negative torque limit value (Obj. 60E1h)]), and torque feedback ([Torque actual value (Obj. 6077h)]).

0: Enabled

1: Disabled

Setting value		Selection of servo motor rotation direction/linear servo motor travel direction	
[Pr. PC29.3]	[Pr. PA14]	Torque handled by the controller: positive	Torque handled by the controller: negative
0: Enabled	0	CCW or positive direction (Forward rotation in power running mode, reverse rotation in regenerative mode)	CW or negative direction (Reverse rotation in power running mode, forward rotation in regenerative mode)
	1	CW or negative direction (Reverse rotation in power running mode, forward rotation in regenerative mode)	CCW or positive direction (Forward rotation in power running mode, reverse rotation in regenerative mode)
1: Disabled	0	CCW or positive direction (Forward rotation in power running mode, reverse rotation in regenerative mode)	CW or negative direction (Reverse rotation in power running mode, forward rotation in regenerative mode)
	1	CCW or positive direction (Forward rotation in power running mode, reverse rotation in regenerative mode)	CW or negative direction (Reverse rotation in power running mode, forward rotation in regenerative mode)

[Pr. PC29.5_[AL. 0E3 Absolute position counter warning] selection]

Initial value	Setting range	Ver.
1h	Refer to the text	A4

Setting digit (BIN)	Function	
	TSN	ECT
___x	<p>[AL. 0E3 Absolute position counter warning] selection 0: Disabled 1: Enabled</p> <p>While this servo parameter is set to "0" (disabled), [AL. 0E3] does not occur even when the rotation amount exceeds the maximum value of the multi-revolution counter or falls below the minimum value.</p> <p>Set this servo parameter to "0" (disabled) when configuring the absolute position detection system in cyclic synchronous mode with a motion module manufactured by Mitsubishi Electric.</p> <p>When the infinite feed function ("2" (degree unit) in [Pr. PT01.2 Unit for position data]) is used, [AL. 0E3.1 Multi-revolution counter travel distance excess warning] does not occur even if this servo parameter is set to "1" (enabled).</p>	<p>[AL. 0E3 Absolute position counter warning] selection 0: Disabled 1: Enabled</p> <p>While this servo parameter is set to "0" (disabled), [AL. 0E3] does not occur even when the rotation amount exceeds the maximum value of the multi-revolution counter or falls below the minimum value.</p> <p>Set this servo parameter to "0" (disabled) when configuring the absolute position detection system in cyclic synchronous mode with a motion module manufactured by Mitsubishi Electric.</p> <p>When the infinite feed function ("2" (degree unit) in [Pr. PT01.2 Unit for position data]) is used or [Pr. PT85.0 Infinite feed function selection] is set to "1" (enabled), [AL. 0E3.1 Multi-revolution counter travel distance excess warning] does not occur even if this servo parameter is set to "1" (enabled).</p>
__x_	For manufacturer setting	
_x__	For manufacturer setting	
x___	For manufacturer setting	

[Pr. PC31_Vertical axis freefall prevention compensation amount (RSUP1)]

Initial value	Setting range	Ver.
0 [0.0001 rev], [0.01 mm]	-25000 to 25000	A4

Set the compensation amount of the vertical axis freefall prevention function.

Set the compensation amount in either the servo motor rotation amount unit or linear servo motor travel distance unit.

When a positive value is set, the compensation is performed to the command address increasing direction. When a negative value is set, compensation is performed to the command address decreasing direction.

The vertical axis freefall prevention function is performed when all of the following conditions are met.

- The control mode is set for the position mode or positioning mode.
- The setting value of this servo parameter is other than "0".
- The forced stop deceleration function is enabled.
- An alarm has occurred or EM2 has turned off when the servo motor rotates at the zero speed or less. Or, the Quick stop command was issued.
- MBR (Electromagnetic brake interlock) was enabled in [Pr. PD07 Output device selection 1] to [Pr. PD09 Output device selection 3] while the base circuit shut-off delay time was set in [Pr. PC02 Electromagnetic brake sequence output].

[Pr. PC38_Excessive error warning trigger level (ERW)]

Initial value	Setting range	Ver.
0 [rev], [mm]	0 to 1000	A4

Set the excessive error warning trigger level.

The unit can be changed with [Pr. PC06.3 Excessive error alarm trigger level/excessive error warning trigger level - Unit selection].

If using a rotary servo motor, set the level in units of rev. If 200 rev or higher is set, the value will be clamped to 200 rev.

If using a linear servo motor, set the level in units of mm.

When "0" is set, [AL. 09B Excessive error warning] does not occur.

If an error reaches the set value, [AL. 09B] occurs. If the error later becomes less than the setting value, the warning will be automatically canceled. The minimum pulse width of the warning signal output is 100 [ms].

Set as follows: [Pr. PC38 Excessive error warning trigger level] < [Pr. PC01 Excessive error alarm trigger level]. When set as [Pr. PC38] ≥ [Pr. PC01], [AL. 052 Excessive error] occurs before the warning.

[Pr. PC41_Function selection C-J (*COPJ)]

Initial value	Setting range	Ver.
0000000h	Refer to the relevant detail No.	Refer to the relevant detail No.

[Pr. PC41.0_[AL. 090.1 Homing incomplete] detection selection]

Initial value	Setting range	Ver.
0h	Refer to the text	A6

Enable or disable [AL. 090.1 Homing incomplete].

This function is enabled in the cyclic synchronous position mode.

When setting this servo parameter to "1" (disabled), set [Pr. PC29.5 [AL. 0E3 Absolute position counter warning] selection] to "0" (disabled).

0: Enabled

1: Disabled

[Pr. PC41.3_Electromagnetic brake sequence output function selection]

Initial value	Setting range	Ver.
0h	Refer to the text	C0

When shifting the PDS state from the Operation enabled state to servo-off, select a state after transition which enables [Pr. PC02 Electromagnetic brake sequence output]. The state changes to the one selected with this servo parameter after the time set in [Pr. PC02] has passed.

0: Switched on

1: Switched on/Ready to switch on/Switch on disabled

[Pr. PC42_Function selection C-10 (COP10)]

Initial value	Setting range	Ver.
0000000h	Refer to the relevant detail No.	Refer to the relevant detail No.

[Pr. PC42.0_Forward/Reverse rotation torque limit 2 selection]

When the command interface of the servo amplifier is CC-Link IE TSN, this servo parameter is not available.

Initial value	Setting range	Ver.
0h	Refer to the text	A4

Enable or disable the torque limit value switching which is performed by CPTL (bit 11 of [Controlword (Obj. 6040h)]) and by CNTL (bit 12 of [Controlword]).

0:Disabled

1:Enabled

For the combinations of servo parameters and objects that are switched by CPTL/CNTL, refer to the following table.

[Pr. PC42.0]/ [Positive/Negative torque limit 2 select (Obj. 2D6Dh:01h)]	Forward rotation torque limit value		Reverse rotation torque limit value	
	CPTL:0	CPTL:1	CNTL:0	CNTL:1
0h/ 0000h	[Pr. PA11]/ [Positive torque limit value (Obj. 60E0h)]	[Pr. PA11]/ [Positive torque limit value (Obj. 60E0h)]	[Pr. PA12]/ [Negative torque limit value (Obj. 60E1h)]	[Pr. PA12]/ [Negative torque limit value (Obj. 60E1h)]
1h/ 0001h	[Pr. PA11]/ [Positive torque limit value (Obj. 60E0h)]	[Pr. PC43]/ [Positive torque limit value2 (Obj. 2D6Dh:02h)]	[Pr. PA12]/ [Negative torque limit value (Obj. 60E1h)]	[Pr. PC44]/ [Negative torque limit value2 (Obj. 2D6Dh:03h)]

This servo parameter corresponds to [Positive/Negative torque limit 2 select (Obj. 2D6Dh: 01h)].

[Pr. PC43_Foward rotation torque limit 2 (TLP2)]

When the command interface of the servo amplifier is CC-Link IE TSN, this servo parameter is not available.

Initial value	Setting range	Ver.
1000.0 [%]	0.0 to 1000.0	A4

The torque or thrust generated by the servo motor can be limited.

Set servo parameters in relation to the rated torque or continuous thrust as 100.0 [%]. Set the servo parameter when limiting the torque of the servo motor for CCW power running or CW regeneration, or when limiting the thrust of the linear servo motor for positive direction power running or negative direction regeneration. If this servo parameter is set to "0.0", the servo motor does not generate torque or thrust.

The polarity of the torque limit can be changed with the setting values of [Pr. PA14 Travel direction selection] and [Pr. PC29.3 Torque POL reflection selection].

This servo parameter corresponds to [Positive torque limit value 2 (Obj. 2D6Dh: 02h)].

Depending on the settings in [Pr. PC29] and [Pr. PA14], the corresponding object changes to [Negative torque limit value 2 (Obj. 2D6Dh: 03h)].

If a value larger than the maximum torque or maximum thrust of the servo motor is set, the value will be limited to the maximum torque or maximum thrust of the servo motor.

[Pr. PC44_Reverse rotation torque limit 2 (TLN2)]

When the command interface of the servo amplifier is CC-Link IE TSN, this servo parameter is not available.

Initial value	Setting range	Ver.
1000.0 [%]	0.0 to 1000.0	A4

The torque or thrust generated by the servo motor can be limited.

Set this servo parameter in relation to the rated torque or continuous thrust (= 100.0 %). Set the servo parameter to limit the torque of the servo motor for CW power running or CCW regeneration, or to limit the thrust of the linear servo motor for positive direction power running or negative direction regeneration. If this servo parameter is set to "0.0", the servo motor does not generate torque or thrust.

The polarity of the torque limit can be changed with the setting values of [Pr. PA14 Travel direction selection] and [Pr. PC29.3 Torque POL reflection selection].

This servo parameter corresponds to [Negative torque limit value 2 (Obj. 2D6Dh: 03h)].

Depending on the settings in [Pr. PC29] and [Pr. PA14], the corresponding object changes to [Positive torque limit value 2 (Obj. 2D6Dh: 02h)].

If a value larger than the maximum torque or maximum thrust of the servo motor is set, the value will be limited to the maximum torque or maximum thrust of the servo motor.

[Pr. PC65_Zero speed 2 level (ZSP2L)]

Initial value	Setting range	Ver.
50.00 [r/min], [mm/s]	0.00 to 655.35	B2

Set the level of speed at which zero speed 2 turns on.

If the state where the absolute value of the servo motor speed exceeds the setting value of this servo parameter continues for the time set in [Pr. PC66 Zero speed 2 filtering time] or longer, bit 12 (Speed) of [Statusword (Obj. 6041h)] turns off.

This function is enabled in the profile velocity mode.

This servo parameter corresponds to [Velocity threshold (Obj. 606Fh)]. When an object is mapped in cyclic communication, the controller overwrites the value written with engineering software. Thus, do not write a value with engineering software.

This servo parameter is enabled when [Pr. PT01.1 Speed/acceleration/deceleration unit selection] is set to "0". This servo parameter and [Pr. PV20 Zero speed 2 level extension setting] are mutually exclusive.

[Pr. PC66_Zero speed 2 filtering time (ZSP2F)]

Initial value	Setting range	Ver.
10 [ms]	0 to 65535	B2

This servo parameter sets the zero speed 2 filtering time.

If the state where the absolute value of the servo motor speed exceeds [Pr. PC65 Zero speed 2 level] continues for the setting value of this servo parameter or longer, bit 12 (Speed) of [Statusword (Obj. 6041h)] turns off.

This function is enabled in the profile velocity mode.

This servo parameter corresponds to [Velocity threshold time (Obj. 6070h)]. When an object is mapped in cyclic communication, the controller overwrites the value written with engineering software. Thus, do not write a value with engineering software.

[Pr. PC67_Following error output level (FEW)]

Initial value	Setting range	Ver.
00C00000h [Command unit]	00000000h to FFFFFFFFh	A4

Set the output level of the following error output.

When the state of "droop pulses \geq the parameter setting value" continues for the time set in [Pr. PC69 Following error output filtering time], bit 13 (Following error) of [Statusword (Obj. 6041h)] turns on.

If "FFFFFFFh" is set, the following error output will be disabled.

Set the value in hexadecimal.

This function is enabled in the cyclic synchronous position mode, profile position mode, point table mode, and JOG operation mode.

This servo parameter corresponds to [Following error window (Obj. 6065h)]. When an object is mapped in cyclic communication, the controller overwrites the value written with engineering software. Thus, do not write a value with engineering software.

The command unit can be changed to 0.001 mm, 0.0001 inch, 0.001 degree, or pulse with [Pr. PT01.2 Unit for position data].

 Page 120 [Pr. PT01.2_Unit for position data]

[Pr. PC69_Following error output filtering time (FEWF)]

Initial value		Setting range	Ver.
TSN	ECT		
10 [ms]	0 [ms]	0 to 65535	A4

Set the time until the following error output turns on.

When the state in which droop pulses \geq [Pr. PC67 Following error output level] continues for the time set in the servo parameter setting value, bit 13 (Following error) of [Statusword (Obj. 6041h)] turns on.

This function is enabled in the cyclic synchronous position mode, profile position mode, point table mode, and JOG operation mode.

This servo parameter corresponds to [Following error time out (Obj. 6066h)]. When an object is mapped in cyclic communication, the controller overwrites the value written with engineering software. Thus, do not write a value with engineering software.

When the setting value of [Pr. PC67] is "FFFFFFFh", the following error output is disabled.

[Pr. PC70_In-position 2 - Output range (INP2R)]

Initial value	Setting range	Ver.
100 [Command unit]	0 to 4294967295	B2

Set the position range where the in-position 2 output turns on.

If the state where the error between the command position and the actual position is within the setting value of this servo parameter continues for the time set in [Pr. PC71 In-position 2 - Output filtering time] or longer, bit 10 (Target reached) of [Statusword (Obj. 6041h)] turns on.

However, if "4294967295" is set, bit 10 (Target reached) of [Statusword (Obj. 6041h)] is always turned on.

Review the setting value of this servo parameter according to the resolution of the encoder to be connected.

When the encoder resolution is 24 bits, setting this servo parameter to "200" is recommended.

This function is enabled in the profile position mode, point table mode, and JOG operation mode.

This servo parameter corresponds to [Position window (Obj. 6067h)]. When an object is mapped in cyclic communication, the controller overwrites the value written with engineering software. Thus, do not write a value with engineering software.

The command unit can be changed to 0.001 mm, 0.0001 inch, 0.001 degree, or pulse with [Pr. PT01.2 Unit for position data].

☞ Page 120 [Pr. PT01.2_Unit for position data]

[Pr. PC71_In-position 2 - Output filtering time (INP2F)]

Initial value		Setting range	Ver.
TSN	ECT		
10 [ms]	0 [ms]	0 to 65535	B2

This servo parameter sets the time until the in-position 2 output turns on.

If the state where the error between the command position and the actual position is within [Pr. PC70 In-position 2 - Output range] continues for the setting value of this servo parameter or longer, bit 10 (Target reached) of [Statusword (Obj. 6041h)] turns on. When [Pr. PC70] is set to "4294967295", bit 10 (Target reached) of [Statusword (Obj. 6041h)] is always turned on.

This function is enabled in the profile position mode, point table mode, and JOG operation mode.

This servo parameter corresponds to [Position window time (Obj. 6068h)]. When an object is mapped in cyclic communication, the controller overwrites the value written with engineering software. Thus, do not write a value with engineering software.

[Pr. PC72_Speed reached 2 - Output range (SA2R)]

Initial value	Setting range	Ver.
20.00 [r/min], [mm/s]	0.00 to 655.35	B2

This servo parameter sets the range of speed at which speed reached 2 output turns on.

If the state where the error between the command speed and the servo motor speed is within the setting value of this servo parameter continues for the time set in [Pr. PC73 Speed reached 2 - Output filtering time] or longer, bit 10 (Target velocity reached) of [Statusword (Obj. 6041h)] turns on.

This function is enabled in the profile velocity mode.

This servo parameter corresponds to [Velocity window (Obj. 606Dh)]. When an object is mapped in cyclic communication, the controller overwrites the value written with engineering software. Thus, do not write a value with engineering software.

This servo parameter is enabled when [Pr. PT01.1 Speed/acceleration/deceleration unit selection] is set to "0". This servo parameter and [Pr. PV19 Speed reached 2 - Output range - Extension setting] are mutually exclusive.

[Pr. PC73_Speed reached 2 - Output filtering time (SA2F)]

Initial value		Setting range	Ver.
TSN	ECT		
10 [ms]	0 [ms]	0 to 65535	B2

This servo parameter sets the time until the speed reached 2 output turns on.

If the state where the error between the speed command and the servo motor speed is within [Pr. PC72 Speed reached 2 - Output filtering time] continues for the setting value of this servo parameter or longer, bit 10 (Target velocity reached) of [Statusword (Obj. 6041h)] turns on.

This function is enabled in the profile velocity mode.

This servo parameter corresponds to [Velocity window time (Obj. 606Eh)]. When an object is mapped in cyclic communication, the controller overwrites the value written with engineering software. Thus, do not write a value with engineering software.

[Pr. PC76_Function selection C-E (*COPE)]

Initial value	Setting range	Ver.
00000001h	Refer to the relevant detail No.	Refer to the relevant detail No.

[Pr. PC76.1_ZSP disabled selection at control switching]

Initial value	Setting range	Ver.
0h	Refer to the text	A4

Select whether to switch the control mode from or to the position mode within the ZSP range.

0: Enabled (control switching is performed within the range of ZSP)

1: Disabled (control switching is performed regardless of the range of ZSP)

If set to "Disabled", control switching may cause a shock.

[Pr. PC76.2_Internal command speed POL reflection selection]

Initial value	Setting range	Ver.
0h	Refer to the text	A4

When this function is enabled, the polarity in [Velocity demand value (Obj. 606Bh)] can be changed with the setting value of [Pr. PA14 Travel direction selection].

0: Automatic setting (1: POL setting enabled)

1: POL setting enabled

2: POL setting disabled

[Pr. PC76.3_Limit switch status read selection]

Initial value	Setting range	Ver.
0h	Refer to the text	B2

The outputs of LSP (Forward rotation stroke end) or LSN (Reverse rotation stroke end) read by [Digital inputs (Obj. 60FDh)] can be reversed.

Refer to the following table for information regarding this servo parameter and outputs.

Setting value	LSP/LSN	[Digital inputs (Obj. 60FDh)]
0	OFF	0
	ON	1
1	OFF	1
	ON	0

[Pr. PC78_Function selection C-F (*COPF)]

Initial value		Setting range	Ver.
TSN	ECT	Refer to the relevant detail No.	Refer to the relevant detail No.
00000000h	00000010h		

[Pr. PC78.1_Maximum torque limit 1 selection]

Initial value	Setting range	Ver.
0h	Refer to the text	A4

Select whether to enable or disable the maximum torque limit 1.

0: Disabled

1: Enabled

[Pr. PC79_Function selection C-G (*COPG)]

Initial value	Setting range	Ver.
00000000h	Refer to the relevant detail No.	Refer to the relevant detail No.

For DI pin numbers corresponding to setting digits, refer to the following table.

If this servo parameter is set incorrectly, [AL. 037 Parameter error] may occur.

Servo parameter number	Setting digit (BIN)	Name	DI pin	
			MR-JET-_G(-N1)	MR-JET-_G_-HS(N1)
[Pr. PC79.0]	___x	For manufacturer setting	—	—
	__x_	DI1 status read selection	CN3-2	CN3-5A
	_x__	DI2 status read selection	CN3-12	CN3-5B
	x___	DI3 status read selection	CN3-19	CN3-6B
[Pr. PC79.1]	___x	DI4 status read selection	CN3-10 *1	CN3-4A
	__x_	DI5 status read selection	CN3-1 *1	CN3-4B
	_x__	EM2/EM1 status read selection	CN3-20	CN3-3B
	x___	For manufacturer setting	—	—

*1 Available on servo amplifiers with firmware version C0 or later and manufactured in July 2022 or later.

[Pr. PC79.0_DI status read selection]

Initial value	Setting range	Ver.
00h	Refer to the text	A4

Select whether to return the on/off state of the input device or the on/off state of the pin when reading [Digital inputs (Obj. 60FDh)].

Setting digit (BIN)	Function
___x	For manufacturer setting
__x_	DI1 status read selection Select the DI1 (bit 17) status read operation. 0: Returns the on/off state of the input device. 1: Returns the on/off state of DI1 pin.
_x__	DI2 status read selection Select the DI2 (bit 18) status read operation. 0: Returns the on/off state of the input device. 1: Returns the on/off state of DI2 pin.
x___	DI3 status read selection Select the DI3 (bit 19) status read operation. 0: Returns the on/off state of the input device. 1: Returns the on/off state of DI3 pin.

[Pr. PC79.1_DI status read selection]

Initial value	Setting range	Ver.
00h	Refer to the text	A4

Select whether to return the on/off state of the input device or the on/off state of the pin when reading [Digital inputs (Obj. 60FDh)].

Setting digit (BIN)	Function
___x	DI4 status read selection Select the DI4 (bit 20) status read operation. 0: Returns the on/off state of the input device. 1: Returns the on/off state of DI4 pin.
__x_	DI5 status read selection Select the DI5 (bit 21) status read operation. 0: Returns the on/off state of the input device. 1: Returns the on/off state of DI5 pin.
_x__	EM2/EM1 status read selection Select the EM2/EM1 (bit 22) status read operation. 0: Returns the on/off state of the input device. 1: Returns the on/off state of EM2/EM1 pin.
x___	For manufacturer setting

[Pr. PC96_Output open-phase detection time (*OPDT)]

Initial value	Setting range	Ver.
0 [0.1 s]	0 to 100	E8

Set the output open-phase detection time.

This servo parameter is enabled when "2" (enabled ([Pr. PC96 Output open-phase detection time] enabled)) is set in [Pr. PC19.4 Output open-phase detection selection]. When a value other than "2" is selected, the setting value of this servo parameter is disabled.

Changing the detection time changes the detection start speed. For the relationship among [Pr. PA01.1 Operation mode selection], [Pr. PC96], and the detection start speed, refer to the following table.

Setting value [0.1 s]	Output open-phase detection time [s]	Detection start speed [r/min] *1	
		[Pr. PA01.1] = "0" (Standard control mode)	[Pr. PA01.1] = "4" (Linear servo motor control mode)
0	Automatic (3.0 s)	50	50
1	0.1	2600	2600
2	0.2	1250	1250
3	0.3	850	850
4	0.4	600	600
5	0.5	500	500
10	1.0	250	250
20	2.0	100	100
25	2.5	100	100
26	2.6	50	50
30	3.0		
40	4.0		
50	5.0		
60	6.0		
70	7.0		
80	8.0		
90	9.0		
100	10.0		

*1 Setting a value that exceeds the maximum speed of the connected servo motor in the detection start speed triggers [AL. 037 Parameter error].

1.5 I/O setting servo parameters group ([Pr. PD_ _])

[Pr. PD01_Input signal automatic ON selection 1 (*DIA1)]

Initial value	Setting range	Ver.
00000000h	Refer to the relevant detail No.	Refer to the relevant detail No.

[Pr. PD01.0_For manufacturer setting]

This servo parameter is for manufacturer setting.

[Pr. PD01.1_For manufacturer setting]

This servo parameter is for manufacturer setting.

[Pr. PD01.2_Input signal automatic ON selection]

Initial value	Setting range	Ver.
0h	Refer to the text	A4

Select input devices that turn on automatically.

Setting digit (BIN)	Function
___x	For manufacturer setting
__x_	For manufacturer setting
_x__	Forward rotation stroke end (LSP) 0: Use for an external input signal 1: Automatic on
x___	Reverse rotation stroke end (LSN) 0: Use for an external input signal 1: Automatic on

[Pr. PD01.3_For manufacturer setting]

This servo parameter is for manufacturer setting.

[Pr. PD01.4_For manufacturer setting]

This servo parameter is for manufacturer setting.

[Pr. PD01.5_For manufacturer setting]

This servo parameter is for manufacturer setting.

[Pr. PD01.6_For manufacturer setting]

This servo parameter is for manufacturer setting.

[Pr. PD01.7_For manufacturer setting]

This servo parameter is for manufacturer setting.

[Pr. PD03_Input device selection 1 (*DI1)]

Initial value	Setting range	Ver.
0000000Ah	Refer to the relevant detail No.	Refer to the relevant detail No.

Select the device to be assigned to the input signal of the CN3 connector. The connector pin numbers to be assigned are as follows.

Model	Connector pin No.	Initially assigned device
MR-JET-_G(-N1)	CN3-2	LSP
MR-JET-_G_-HS(N1)	CN3-5A	LSP

[Pr. PD03.0-1_Device selection]

Initial value	Setting range	Ver.
0Ah	Refer to the text	A4

Refer to the following table for setting values.

Setting value	Input signal device
00	No assigned function
04	PC
0A	LSP
0B	LSN
0D	CDP
0E *1	CLD
22	DOG
2C *1*2	TPR1
2D *1*2	TPR2
40	CDP2
63 *1*2	TPR3

*1 Available on servo amplifiers with firmware version C4 or later.

*2 Assigning TPR1, 2, or 3 to [Pr. PD03 Input device selection 1], [Pr. PD04 Input device selection 2], or [Pr. PD05 Input device selection 3] will cause [AL. 037 Parameter error] to occur.

[Pr. PD04_Input device selection 2 (*DI2)]

Initial value	Setting range	Ver.
0000000Bh	Refer to the relevant detail No.	Refer to the relevant detail No.

Select the device to be assigned to the input signal of the CN3 connector. The connector pin numbers to be assigned are as follows.

Model	Connector pin No.	Initially assigned device
MR-JET-_G(-N1)	CN3-12	LSN
MR-JET-_G_-HS(N1)	CN3-5B	LSN

[Pr. PD04.0-1_Device selection]

Initial value	Setting range	Ver.
0Bh	Refer to the text	A4

Refer to the following for setting values.

☞ Page 80 [Pr. PD03_Input device selection 1 (*DI1)]

[Pr. PD05_Input device selection 3 (*DI3)]

Initial value	Setting range	Ver.
00000022h	Refer to the relevant detail No.	Refer to the relevant detail No.

Select the device to be assigned to the input signal of the CN3 connector. The connector pin numbers to be assigned are as follows.

Model	Connector pin No.	Initially assigned device
MR-JET-_G(-N1)	CN3-19	DOG
MR-JET-_G_-HS(N1)	CN3-6B	DOG

[Pr. PD05.0-1_Device selection]

Initial value	Setting range	Ver.
22h	Refer to the text	A4

Refer to the following for setting values.

 Page 80 [Pr. PD03_Input device selection 1 (*DI1)]

[Pr. PD07_Output device selection 1 (*DO1)]

Initial value	Setting range	Ver.
00000005h	Refer to the relevant detail No.	Refer to the relevant detail No.

Select the device to be assigned to the output signal of CN3 connector. The connector pin numbers to be assigned are as follows.

Model	Connector pin No.	Initially assigned device
MR-JET-_G(-N1)	CN3-13	MBR
MR-JET-_G_-HS(N1)	CN3-1B	MBR

When DB signal is selected in the device selection, the servo-off sequence at power failure changes.

[Pr. PD07.0-1_Device selection]

Initial value	Setting range	Ver.
05h	Refer to the text	A4

Refer to the following table for setting values.

Setting value	Output signal device
00	Always off
02	RD
03	ALM
04	INP
05	MBR
06	DB
07	TLC
08	WNG
09	BWNG
0A	SA
0B	VLC
0C	ZSP
0E	WNGSTOP
0F	CDPS
10 ^{*2}	CLDS
11	ABSV
17	MTTR
18	CDPS2
21 ^{*1}	DOA
22 ^{*1}	DOB
23 ^{*1}	DOC

*1 Available on servo amplifiers with firmware version B6 or later.

*2 Available on servo amplifiers with firmware version C4 or later.

[Pr. PD08_Output device selection 2 (*DO2)]

Initial value	Setting range	Ver.
00000004h	Refer to the relevant detail No.	Refer to the relevant detail No.

Select the device to be assigned to the output signal of CN3 connector. The connector pin numbers to be assigned are as follows.

Model	Connector pin No.	Initially assigned device
MR-JET-_G(-N1)	CN3-9	INP
MR-JET-_G_-HS(N1)	CN3-2A	INP

[Pr. PD08.0-1_Device selection]

Initial value	Setting range	Ver.
04h	Refer to the text	A4

Refer to the following for setting values.

☞ Page 82 [Pr. PD07_Output device selection 1 (*DO1)]

[Pr. PD09_Output device selection 3 (*DO3)]

Initial value	Setting range	Ver.
00000003h	Refer to the relevant detail No.	Refer to the relevant detail No.

Select the device to be assigned to the output signal of CN3 connector. The connector pin numbers to be assigned are as follows.

Model	Connector pin No.	Initially assigned device
MR-JET-_G(-N1)	CN3-15	ALM
MR-JET-_G_-HS(N1)	CN3-2B	ALM

[Pr. PD09.0-1_Device selection]

Initial value	Setting range	Ver.
03h	Refer to the text	A4

Refer to the following for setting values.

☞ Page 82 [Pr. PD07_Output device selection 1 (*DO1)]

[Pr. PD11_Input filter setting (*DIF)]

Initial value	Setting range	Ver.
00000007h	Refer to the relevant detail No.	Refer to the relevant detail No.

[Pr. PD11.0_Input signal filter selection]

Initial value	Setting range	Ver.
7h	Refer to the text	A4

Setting value	Filtering time [ms]
0	No filter
1	0.500
2	1.000
3	1.500
4	2.000
5	2.500
6	3.000
7	3.500
8	4.000
9	4.500
A	5.000
B	5.500

This filter is disabled for pins to which TPR1, TPR2, or TPR3 is assigned.

[Pr. PD12_Function selection D-1 (*DOP1)]

Initial value	Setting range	Ver.
00000101h	Refer to the relevant detail No.	Refer to the relevant detail No.

Set the servo motor thermistor to either enabled or disabled.

[Pr. PD12.3_Servo motor thermistor - Enabled/disabled selection]

Initial value	Setting range	Ver.
0h	Refer to the text	B2

0: Enabled

1: Disabled

This servo parameter is enabled when a servo motor with a built-in thermistor is used. When a servo motor without a thermistor is used, the servo parameter is disabled (temperature monitoring disabled/alarm disabled) regardless of the setting value.

No alarm is detected in motor-less operation.

When the temperature monitoring of the motor thermistor is disabled, "9999 °C" is displayed.

[Pr. PD13_Function selection D-2 (*DOP2)]

Initial value	Setting range	Ver.
00000000h	Refer to the relevant detail No.	Refer to the relevant detail No.

[Pr. PD13.2_INP output signal ON condition selection]

Initial value	Setting range	Ver.
0h	Refer to the text	A4

Select a condition for outputting INP (In-position).

This function is enabled in the cyclic synchronous position mode, profile position mode, and positioning mode (point table method).

INP (In-position) immediately after servo-on or after forced stop is canceled is off.

0: Within the in-position range

1: Within the in-position range and at the completion of command output

2: Within the in-position range, at the completion of command output, and at start signal off

Refer to the following table for details.

Setting value	INP (In-position) ON condition			
	Droop pulses < in-position range	Command output completion ^{*1}	Start signal off	
			Cyclic synchronous position mode	Profile position mode ^{*2} Positioning mode (point table method) ^{*3}
0	○	×	×	×
1	○	○	×	×
2	○	○	×	○

○: Required

×: Not required

^{*1} The condition for completing a command output depends on the operation mode.

<Cyclic synchronous position mode>

When a position command is not input for approximately 1 ms, the command output is considered to have been completed.

<Profile position mode or positioning mode (point table method)>

When the command remaining distance is 0, the command output is considered to have been completed.

^{*2} Available on servo amplifiers with firmware version B2 or later.

^{*3} Available on servo amplifiers with firmware version B8 or later.

[Pr. PD14_Function selection D-3 (*DOP3)]

Initial value	Setting range	Ver.
00000000h	Refer to the relevant detail No.	Refer to the relevant detail No.

[Pr. PD14.1_Output device status at warning occurrence]

Initial value	Setting range	Ver.
0h	Refer to the text	A4

Select ALM (Malfunction) output status at warning occurrence.

Setting value	Device status
0	
1	

[Pr. PD38_Input device selection 4 (*DI4)]

Initial value	Setting range	Ver.
00000000h	Refer to the relevant detail No.	Refer to the relevant detail No.

Assign a device to the input signal of the CN3 connector. The touch probe function can be used by setting this servo parameter to TPR1 to TPR3.

The connector pin numbers to be assigned are as follows.

Model	Connector pin No.	Initially assigned device
MR-JET-_G(-N1)	CN3-10 *1	No assigned function
MR-JET-_G_-HS(N1)	CN3-4A	No assigned function

*1 Available on servo amplifiers with firmware version C0 or later and manufactured in July 2022 or later.

For servo amplifiers manufactured before July 2022, setting [Pr. PD38.0-1 Device selection] to any other value than "00" (no assigned function) triggers [AL. 037 Parameter error].

If duplicated input devices (TPR1 to TPR3) exist in [Pr. PD38 Input device selection 4] and [Pr. PD39 Input device selection 5], [AL. 037 Parameter error] occurs.

Ex.

When TPR1 is duplicated, such as when [Pr. PD38.0-1] = "2Ch" (TPR1) and [Pr. PD39.0-1] = "2Ch" (TPR1)

[Pr. PD38.0-1_Device selection]

Initial value	Setting range	Ver.
2Ch	Refer to the text	C4

Refer to the following for setting values.

☞ Page 80 [Pr. PD03_Input device selection 1 (*DI1)]

[Pr. PD39_Input device selection 5 (*DI5)]

Initial value	Setting range	Ver.
000002Dh	Refer to the relevant detail No.	Refer to the relevant detail No.

Assign a device to the input signal of the CN3 connector. The touch probe function can be used by setting this servo parameter to TPR1 to TPR3.

The connector pin numbers to be assigned are as follows.

Model	Connector pin No.	Initially assigned device
MR-JET-_G(-N1)	CN3-1 *1	No assigned function
MR-JET-_G_-HS(N1)	CN3-4B	No assigned function

*1 Available on servo amplifiers with firmware version C0 or later and manufactured in July 2022 or later.

For servo amplifiers manufactured before July 2022, setting [Pr. PD39.0-1 Device selection] to any other value than "00" (no assigned function) triggers [AL. 037 Parameter error].

If duplicated input devices (TPR1 to TPR3) exist in [Pr. PD38 Input device selection 4] and [Pr. PD39 Input device selection 5], [AL. 037 Parameter error] occurs.

Ex.

When TPR1 is duplicated, such as when [Pr. PD38.0-1] = "2Ch" (TPR1) and [Pr. PD39.0-1] = "2Ch" (TPR1)

[Pr. PD39.0-1_Device selection]

Initial value	Setting range	Ver.
2Dh	Refer to the text	A0

Refer to the following for setting values.

☞ Page 80 [Pr. PD03_Input device selection 1 (*DI1)]

[Pr. PD41_Function selection D-4 (*DOP4)]

Initial value	Setting range	Ver.
00000000h	Refer to the relevant detail No.	Refer to the relevant detail No.

[Pr. PD41.2_Limit switch enabled status selection]

Initial value	Setting range	Ver.
0h	Refer to the text	A4

0: Limit switch always enabled

1: Enabled only for homing mode

If "1" is set, the limit switches during servo motor operation are disabled. To prevent a collision, do not use the limit switch unless the stroke limit is controlled from the controller. The status of the limit switches (S_FLS and S_RLS) is returned.

Even if "1" is set, the limit switches are enabled during the test operation and at magnetic pole detection.

Set "1" if the controller is a Mitsubishi Electric motion module.

[Pr. PD41.3_Sensor input method selection]

Initial value	Setting range	Ver.
0h	Refer to the text	A4

Select the input method for the proximity dog and limit switches.

0: Input from servo amplifier (LSP/LSN/DOG)

1: Input from controller (C_FLS/C_RLS/C_DOG)

When selecting "0", wire the limit switch installed in CCW direction to LSP, and wire the limit switch installed in CW direction to LSN. If the limit switches are wired in the opposite direction, the servo motor will not stop with the limit switches.

When selecting "1", set the limit switch installed in position address increasing direction to C_FLS, and the limit switch installed in decreasing direction to C_RLS. After that, input the limit signals from the controller. If the limit switches are wired in the opposite direction, the servo motor will not stop with the limit switches.

[Pr. PD60_DI pin polarity selection (*DIP)]

Initial value	Setting range	Ver.
00000000h	Refer to the relevant detail No.	Refer to the relevant detail No.

For DI pin numbers corresponding to setting digits, refer to the following table.

If this servo parameter is set incorrectly, [AL. 037 Parameter error] may occur.

If the setting digit (BIN) of the DI pin to which TPR1 to TPR3 are assigned is set to "1", [AL. 037] occurs.

Servo parameter number	Setting digit (BIN)	Name	Connector pin No.	
			MR-JET-_G(-N1)	MR-JET-_G_-HS(N1)
[Pr. PD60.0]	___x	DI pin polarity selection 1	CN3-2	CN3-5A
	__x_	DI pin polarity selection 2	CN3-12	CN3-5B
	_x__	DI pin polarity selection 3	CN3-19	CN3-6B
	x___	DI pin polarity selection 4	CN3-10 *1	CN3-4A
[Pr. PD60.1]	___x	DI pin polarity selection 5	CN3-10 *1	CN3-4B
	__x_	For manufacturer setting	—	—
	_x__	For manufacturer setting	—	—
	x___	For manufacturer setting	—	—

*1 Available on servo amplifiers with firmware version C0 or later and manufactured in July 2022 or later.

[Pr. PD60.0_DI pin polarity selection]

Initial value	Setting range	Ver.
0h	Refer to the text	A4

Select the DI pin polarity.

Setting digit (BIN)	Function
___x	DI pin polarity selection 1 0: ON with 24 V input 1: ON with 0 V input
__x_	DI pin polarity selection 2 0: ON with 24 V input 1: ON with 0 V input
_x__	DI pin polarity selection 3 0: ON with 24 V input 1: ON with 0 V input
x___	DI pin polarity selection 4 0: ON with 24 V input 1: ON with 0 V input

[Pr. PD60.1_For manufacturer setting]

Initial value	Setting range	Ver.
0h	Refer to the text	A4

Select the DI pin polarity.

Setting digit (BIN)	Function
___x	DI pin polarity selection 5 0: ON with 24 V input 1: ON with 0 V input
__x_	For manufacturer setting
_x__	For manufacturer setting
x___	For manufacturer setting

[Pr. PD60.2_For manufacturer setting]

This servo parameter is for manufacturer setting.

[Pr. PD60.3_For manufacturer setting]

This servo parameter is for manufacturer setting.

[Pr. PD60.4_For manufacturer setting]

This servo parameter is for manufacturer setting.

[Pr. PD60.5_For manufacturer setting]

This servo parameter is for manufacturer setting.

[Pr. PD60.6_For manufacturer setting]

This servo parameter is for manufacturer setting.

[Pr. PD60.7_For manufacturer setting]

This servo parameter is for manufacturer setting.

[Pr. PD61_Function selection D-5 (*DOP5)]

Initial value	Setting range	Ver.
00000000h	00000000h to 0000017Fh	Refer to the relevant detail No.

[Pr. PD61.2_[AL. 069 Command error] output selection with absolute position erased]

Initial value	Setting range	Ver.
0h	0h to 1h	E4

Enable or disable the absolute position erased (ABSV) output at occurrence of [AL. 069 Command error].

0:Disabled

1:Enabled

If this servo parameter is set to "1" (enabled), ABSV turns on at occurrence of [AL. 069 Command error].

1.6 Extension setting 2 servo parameters group ([Pr. PE_ _])

[Pr. PE01_Fully closed loop control function selection 1 (**FCT1)]

Initial value	Setting range	Ver.
00000000h	Refer to the relevant detail No.	Refer to the relevant detail No.

[Pr. PE01.0_Fully closed loop function selection]

Initial value	Setting range	Ver.
0h	Refer to the text	C4

Select the fully closed loop function.

This servo parameter is enabled when [Pr. PA01.4 Fully closed loop operation mode selection] is set to "1" (enabled (fully closed loop control mode)).

If this servo parameter is set to "1" while [Pr. PA03.0 Absolute position detection system selection] has been set to "1" (enabled (absolute position detection system)), [AL. 037 Parameter error].

If semi-closed loop control/fully closed loop control switching is performed during operation in the homing mode or the profile position mode while this servo parameter is set to "1", [AL. 0F4.A Fully closed loop control - Switching warning] occurs. In this case, the control method does not switch to the selected control method while the operation is in progress.

When the positioning mode (point table method) is selected, setting this servo parameter to "1" triggers [AL. 037].

0: Always enabled

1: Switching by "fully closed loop selection" from the controller (C_CLD) and by the input device "fully closed loop selection" (CLD)

Fully closed loop selection		Control method
Command from controller (C_CLD)	CLD (fully closed loop selection) *1	
OFF	OFF	Semi closed loop control
ON	OFF	Fully closed loop control
OFF	ON	
ON	ON	

*1 This is always off if CLD (fully closed loop selection) is not assigned to an input device pin.

[Pr. PE01.4_Fully closed loop control - Droop pulse clear selection]

Initial value	Setting range	Ver.
0h	Refer to the text	D4

When switching between semi closed loop control and fully closed loop control is performed, select whether to clear droop pulses.

0: Enabled

1: Disabled

When the setting value of this servo parameter is "0" (enabled), switching the semi closed loop control to the fully closed loop control clears the load-side droop pulses. In addition, switching the fully closed loop control to the semi closed loop control clears the motor-side droop pulses. For these reasons, shock is reduced at switching between semi closed loop control and fully closed loop control.

When the setting value of this servo parameter is "1" (disabled), perform switching between semi closed loop control and fully closed loop control with the motor-side and the load-side connected. If the switching between semi closed loop control and fully closed loop control is performed when the motor-side and the load-side are not connected, the servo motor may cause an unexpected operation such as sudden acceleration.

[Pr. PE03_Fully closed loop control function selection 2 (*FCT2)]

Initial value	Setting range	Ver.
00000003h	Refer to the relevant detail No.	Refer to the relevant detail No.

[Pr. PE03.0_Fully closed loop control error - Detection function selection]

Initial value	Setting range	Ver.
3h	Refer to the text	C4

0: Disabled

1: Speed deviation error detection

2: Position deviation error detection

3: Speed deviation error detection and position deviation error detection

Refer to the following table for the combination with [Pr. PE03.1 Position deviation error - Detection method selection].

○: Error detection enabled —: Error detection disabled

Setting value		Speed deviation error	Position deviation error		
[Pr. PE03.1]	[Pr. PE03.0]		In servo-on state		In servo-off state
			With commands	No commands (= 0)	
0	0	—	—	—	—
0	1	○	—	—	—
0	2	—	○	○	○
0	3	○	○	○	○
1	0	—	—	—	—
1	1	○	—	—	—
1	2	—	—	○	—
1	3	○	—	○	—
2	0	—	—	—	—
2	1	○	—	—	—
2	2	—	—	○	○
2	3	○	—	○	○

[Pr. PE03.1_Position deviation error - Detection method selection]

Initial value	Setting range	Ver.
0h	Refer to the text	C4

0: Continuous detection

1: Detection only at stop (An error is detected if the command is "0".)

2: Detection only at stop 2 (An error is detected during servo-off or if the command is "0" while in servo-on state.)

Refer to the following table for the combination with [Pr. PE03.0 Fully closed loop control error - Detection function selection].

☞ Page 91 [Pr. PE03.0_Fully closed loop control error - Detection function selection]

[Pr. PE03.3_Fully closed loop control error - Reset selection]

Initial value	Setting range	Ver.
0h	Refer to the text	C4

0: Reset disabled (reset by cycling the power or software reset)

1: Reset enabled

[Pr. PE04_Fully closed loop control - Feedback pulse electronic gear 1 - Numerator (**FBN)]

Initial value	Setting range	Ver.
1	1 to 4294967295	C4

If using the fully closed loop control, set the electronic gear numerator to the servo motor encoder pulses.

Set the electronic gear so that the number of the servo motor encoder pulses per servo motor revolution is converted into load-side encoder resolution.

If the reduced electronic gear numerator exceeds 2147483648 (31 bits), [AL. 037 Parameter error] occurs.

[Pr. PE05_Fully closed loop control - Feedback pulse electronic gear 1 - Denominator (**FBD)]

Initial value	Setting range	Ver.
1	1 to 4294967295	C4

If using the fully closed loop control, set the electronic gear denominator to the servo motor encoder pulses.

Set the electronic gear so that the number of the servo motor encoder pulses per servo motor revolution is converted into load-side encoder resolution.

If the reduced electronic gear denominator exceeds 1073741824 (30 bits), [AL. 037 Parameter error] occurs.

[Pr. PE06_Fully closed loop control - Speed deviation error detection level (BC1)]

Initial value	Setting range	Ver.
400 [r/min]	1 to 50000	C4

Set the detection level for triggering [AL. 042.9 Fully closed loop control error based on speed deviation] of the fully closed loop control error detection. If the difference between the speed calculated by the servo motor encoder and the speed calculated by the load-side encoder exceeds the value of this servo parameter, the alarm occurs.

[Pr. PE07_Fully closed loop control - Position deviation error detection level (BC2)]

Initial value	Setting range	Ver.
100 [kpulse]	1 to 20000	C4

Set the detection level for triggering [AL. 042.8 Fully closed loop control error based on position deviation] of the fully closed loop control error detection. If the difference between the position of the servo motor encoder and the position of the load-side encoder exceeds the value of this servo parameter, the alarm occurs.

[Pr. PE08_Fully closed loop dual feedback filter (DUF)]

Initial value	Setting range	Ver.
10 [rad/s]	1 to 4500	C4

Set a dual feedback filter band.

[Pr. PE10_Fully closed loop function selection 3 (FCT3)]

Initial value	Setting range	Ver.
00000000h	Refer to the relevant detail No.	Refer to the relevant detail No.

[Pr. PE10.1_Fully closed loop control - Position deviation error detection level - Unit selection]

Initial value	Setting range	Ver.
0h	Refer to the text	C4

0: 1 kpulse unit

1: 1 pulse unit

[Pr. PE41_Function selection E-3 (EOP3)]

Initial value	Setting range	Ver.
00000000h	Refer to the relevant detail No.	Refer to the relevant detail No.

[Pr. PE41.0_Robust filter selection]

Initial value	Setting range	Ver.
0h	Refer to the text	A4

0: Disabled

1: Enabled

When this setting value is set to "Enabled", the machine resonance suppression filter 5 set in [Pr. PB51 Notch shape selection 5] cannot be used.

[Pr. PE41.6_Unbalanced torque offset setting selection]

Initial value	Setting range	Ver.
0h	Refer to the text	A4

0: Manual setting

1: Automatic setting

If "1" (automatic setting) has been set and friction estimation by the machine diagnosis function has completed for both the forward and reverse rotations, the value of [Pr. PE47 Unbalanced torque offset] will be set automatically according to the estimated friction value. After [Pr. PE47] is set automatically, this servo parameter changes to "0" (Manual setting). The value of [Pr. PE47] will not be set automatically and this servo parameter keeps the value "1" (automatic setting) until friction estimation completes for both the forward and reverse rotations.

[Pr. PE44_Lost motion compensation positive-side compensation value selection (LMCP)]

Initial value	Setting range	Ver.
0 [0.01 %]	0 to 30000	A4

Set the lost motion compensation for when negative speed switches to positive speed in increments of 0.01 % in relation to the rated torque as 100 %.

This function is enabled in the position mode and positioning mode.

[Pr. PE45_Lost motion compensation negative-side compensation value selection (LMCN)]

Initial value	Setting range	Ver.
0 [0.01 %]	0 to 30000	A4

Set the lost motion compensation for when positive speed switches to negative speed in increments of 0.01 % in relation to the rated torque as 100 %.

This function is enabled in the position mode and positioning mode.

[Pr. PE46_Lost motion filter setting (LMFLT)]

Initial value	Setting range	Ver.
0 [0.1 ms]	0 to 30000	A4

When "0" is set, the value is compensated with the compensation amount of the value that was set in [Pr. PE44 Lost motion compensation positive-side compensation value selection] and [Pr. PE45 Lost motion compensation negative-side compensation value selection]. When a value other than "0" is set, the torque is compensated with the high-pass filter output value of the set time constant, and the lost motion compensation will continue.

This function is enabled in the position mode and positioning mode.

[Pr. PE47_Unbalanced torque offset (TOF)]

Initial value	Setting range	Ver.
0 [0.01 %]	-10000 to 10000	A4

Set this to cancel the unbalanced torque of a vertical axis. Set this in relation to the rated torque of the servo motor as 100 %. The torque offset does not need to be set for a machine that does not generate unbalanced torque. This servo parameter can be used in applications where an unbalanced torque is generated constantly, such as when a linear servo motor is operated horizontally with tension applied in one direction.

The torque offset that has been set with this servo parameter is enabled in any control mode. In the torque mode, input commands taking the torque offset into account.

This servo parameter is suitable when the torque offset does not need to be changed dynamically.

[Pr. PE48_Lost motion compensation function selection (*LMOP)]

Initial value	Setting range	Ver.
00000000h	Refer to the relevant detail No.	Refer to the relevant detail No.

This function is enabled in the position mode and positioning mode.

[Pr. PE48.0_Lost motion compensation type selection]

Initial value	Setting range	Ver.
0h	Refer to the text	A4

0: Lost motion compensation disabled

1: Lost motion compensation enabled

[Pr. PE48.1_Lost motion compensation dead band unit setting]

Initial value	Setting range	Ver.
0h	Refer to the text	A4

0: 1 pulse unit

1: 1 kpulse unit

[Pr. PE49_Lost motion compensation timing (LMCD)]

Initial value	Setting range	Ver.
0 [0.1 ms]	0 to 30000	A4

Set the lost motion compensation timing in units of 0.1 ms.

The timing to perform the lost motion compensation function can be delayed by a set time.

This function is enabled in the position mode and positioning mode.

[Pr. PE50_Lost motion compensation dead band (LMCT)]

Initial value	Setting range	Ver.
0 [pulse], [kpulse]	0 to 65535	A4

Set the lost motion compensation dead band. When the fluctuation of droop pulses is equal to or less than the setting value, the speed is recognized as 0. The setting unit can be changed with [Pr. PE48 Lost motion compensation function selection].

Set the servo parameter per encoder unit.

This function is enabled in the position mode and positioning mode.

[Pr. PE51_Load-side encoder resolution setting (**EDV2)]

Initial value	Setting range	Ver.
0 [pulse]	0 to 4294967295	B2

When the fully closed loop control mode or the scale measurement function is enabled, the encoder is recognized as an A/B/Z-phase differential output rotary encoder by setting a load-side encoder resolution in this servo parameter with the A/B/Z-phase differential output rotary encoder connected to the load-side. At this time, the cycle counter is displayed. A load-side encoder resolution is the number of pulses output when the encoder is rotated by one revolution.

When "0" is set in this servo parameter, the encoder is recognized as an A/B/Z-phase differential output linear encoder. At this time, the Z-phase counter (the distance from the linear encoder home position (Z-phase)) is displayed after the Z-phase is passed.

When the resolution set in this servo parameter is either less than 2^{12} or greater than 2^{26} , [AL. 037 Parameter error] occurs.

As shown in the following figures, the display of the load-side encoder information 1 monitor changes depending on the setting value of this servo parameter.

- When "0" is set in [Pr. PE51]

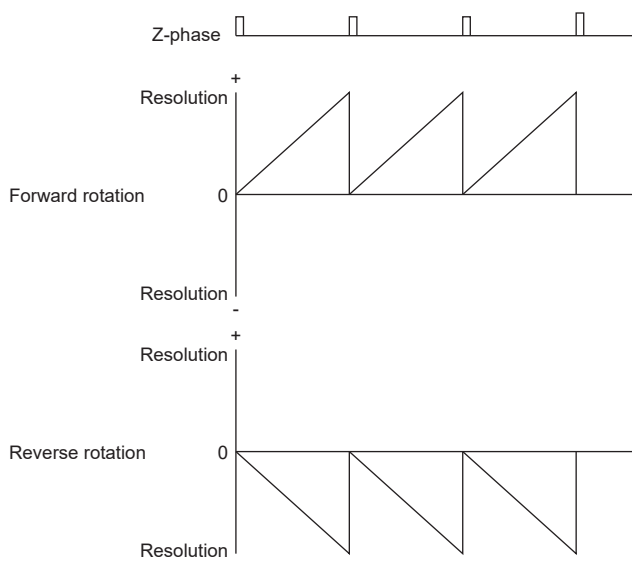

- When a load-side encoder resolution is set in [Pr. PE51]

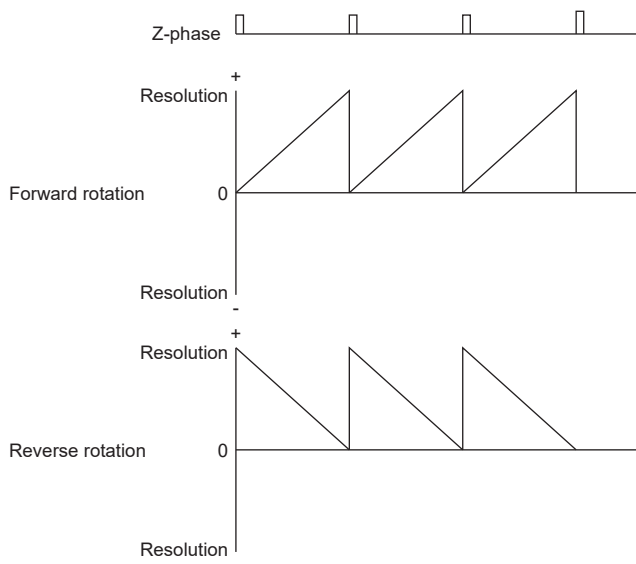

[Pr. PE53_Maximum torque limit 1 (TLMX1)]

Initial value		Setting range	Ver.
TSN	ECT		
0.0 [%]	1000.0 [%]	0.0 to 1000.0	A4

The torque or thrust generated by the servo motor can be limited.

When [Pr. PC78.1 Maximum torque limit 1 selection] is set to "0" (the maximum torque limit 1 is disabled)

The torque limit function using this servo parameter or [Max torque (Obj. 6072h)] is disabled.

The setting value of this servo parameter does not match the setting value of [Max torque (Obj. 6072h)].

[Max torque (Obj. 6072h)] returns the maximum torque of the servo motor.

When [Pr. PC78.1] is set to "1" (the maximum torque limit 1 is enabled)

The torque limit function using this servo parameter or [Max torque (Obj. 6072h)] is enabled.

Set this servo parameter in relation to the rated torque or continuous thrust (= 100.0 %).

If this servo parameter is set to "0.0", the servo motor does not generate torque or thrust.

This servo parameter corresponds to [Max torque (Obj. 6072h)].

When an object is mapped in cyclic communication, the controller overwrites the value written with engineering software.

Thus, do not write a value with engineering software.

1.7 Extension setting 3 servo parameters group ([Pr. PF_ _])

[Pr. PF02_Function selection F-2 (*FOP2)]

Initial value	Setting range	Ver.
00000000h	Refer to the relevant detail No.	Refer to the relevant detail No.

[Pr. PF02.4_Memory writing frequency warning enable/disable selection]

Initial value	Setting range	Ver.
0h	Refer to the text	A4

Enable or disable [AL. 1F8.1 Memory writing frequency warning].

[AL. 1F8.1] indicates that the memory writing frequency has exceeded the guaranteed number of times.

If the servo amplifier continues to be used while the alarm is disabled with this servo parameter, the memory may be corrupted and restoration of the data, such as servo parameters, may fail.

0: Enabled

1: Disabled

[Pr. PF02.5_Memory free space warning enable/disable selection]

Initial value	Setting range	Ver.
0h	Refer to the text	A4

Select whether to enable or disable [AL. 1F8.2 Memory free space warning].

[AL. 1F8.2] indicates that the memory free space is running low.

If the servo amplifier continues to be used while the alarm is disabled with this servo parameter, [AL. 119.7 Memory free space 4-1] may occur and data restoration may fail.

0: Enabled

1: Disabled

[Pr. PF06_Function selection F-5 (*FOP5)]

Initial value	Setting range	Ver.
00000013h	Refer to the relevant detail No.	Refer to the relevant detail No.

[Pr. PF06.0_Electronic dynamic brake selection]

Initial value	Setting range	Ver.
3h	Refer to the text	A4

Enable or disable the electronic dynamic brake.

2: Disabled

3: Enabled only for specific servo motors

For specific servo motors, refer to "Precautions relating to the dynamic brake characteristics" in the User's Manual (Hardware).

[Pr. PF12_Electronic dynamic brake operating time (DBT)]

Initial value	Setting range	Ver.
2000 [ms]	0 to 10000	A4

Set an operating time for the electronic dynamic brake.

[Pr. PF21_Drive recorder switching time setting (DRT)]

Initial value	Setting range	Ver.
0 [s]	-1 to 32767	A4

Set the drive recorder switching time.

When communication is shut off during the use of a graph function, the function will be switched to the drive recorder function after the time set in this servo parameter has passed.

In the following cases during the use of a graph function, the function may be automatically switched to the drive recorder function after the time set in this servo parameter has passed.

- The trigger waiting time is longer than the time set in this servo parameter.
- The waveform data reading time is longer than the time set in this servo parameter.

In the following cases, review the setting value of this servo parameter.

- A communication error occurs after the start of graph measurement.
- The graph measurement is not finished.

When any value of "10" to "32767" is set, the drive recorder function will be switched after the time set in this servo parameter has passed.

When any value of "0" to "9" is set, the drive recorder function will be switched after 10 s.

When "-1" is set, the drive recorder function is disabled.

[Pr. PF23_Vibration tough drive - Oscillation detection level (OSCL1)]

Initial value	Setting range	Ver.
20 [%]	0 to 100	A4

Set the oscillation detection level for readjusting the machine resonance suppression filter while the vibration tough drive is enabled.

When the oscillation level is higher than the setting value of this servo parameter, reset [Pr. PB13 Machine resonance suppression filter 1] or [Pr. PB15 Machine resonance suppression filter 2].

When "0" is set, the oscillation detection level is 20 %.

[Pr. PF24_Function selection F-9 (*FOP9)]

Initial value	Setting range	Ver.
00000000h	Refer to the relevant detail No.	Refer to the relevant detail No.

[Pr. PF24.0_Oscillation detection alarm selection]

Initial value	Setting range	Ver.
0h	Refer to the text	A4

Select the alarm output at oscillation detection.

Select whether to generate an alarm or a warning when an oscillation continues at a level set in [Pr. PF23 Vibration tough drive - Oscillation detection level].

This function is enabled regardless of the setting of [Pr. PA20.1 Vibration tough drive selection].

0: Alarm ([AL. 054 Oscillation detection])

1: Warning ([AL. 0F3.1 Oscillation detection warning])

2: Oscillation detection function disabled (oscillation detection not processed)

[Pr. PF25_ Instantaneous power failure tough drive detection time (CVAT)]

Initial value	Setting range	Ver.
200 [ms]	30 to 2000	A4

Set the time until the occurrence of [AL. 010.1 Voltage drop in the control circuit power].

When the instantaneous power failure time exceeds 200 ms, and the instantaneous power failure voltage is less than 70 % of the rated input voltage, the power may be turned off normally even if a value larger than 200 ms is set in this servo parameter. This function is disabled when [Pr. PA20.2 Instantaneous power failure tough drive selection] is set to "0" (disabled).

[Pr. PF29_ Function selection F-10 (*FOP10)]

Initial value	Setting range	Ver.
00000000h	Refer to the relevant detail No.	Refer to the relevant detail No.

[Pr. PF29.1_ State selection with forced stop in progress]

Initial value	Setting range	Ver.
0h	Refer to the text	B2

Select the PDS state transition for when the forced stop is in progress.

When the servo amplifier detects the forced stop signal off during servo motor rotation, the PDS state transition destination can be selected.

0: Operation enabled

1: Quick stop active

[Pr. PF31_ Machine diagnosis function - Friction estimate area judgment speed at low speed (FRIC)]

Initial value	Setting range	Ver.
0 [r/min], [mm/s]	0 to 65535	A4

Set the servo motor speed to divide the friction estimation area between low-speed and high-speed in the friction estimation process of machine diagnosis.

When the maximum operation speed is under the rated speed, it is recommended to set half the value of the maximum operation speed.

When "0" is set, the judgment speed is half of the rated speed.

The setting value will be clamped at the maximum speed. When changing the speed to the permissible speed, set the speed in [Pr. PA28.4 Speed range limit selection].

By setting [Pr. PF34.6 Friction estimate area judgment speed setting] to "1" (automatic setting), this servo parameter value will be automatically calculated from the operation pattern during servo motor driving and overwrite the value.

Set a value larger than [Pr. PC07 Zero speed] for this servo parameter. If the value is equal to or lower than zero speed, the friction estimation process does not function.

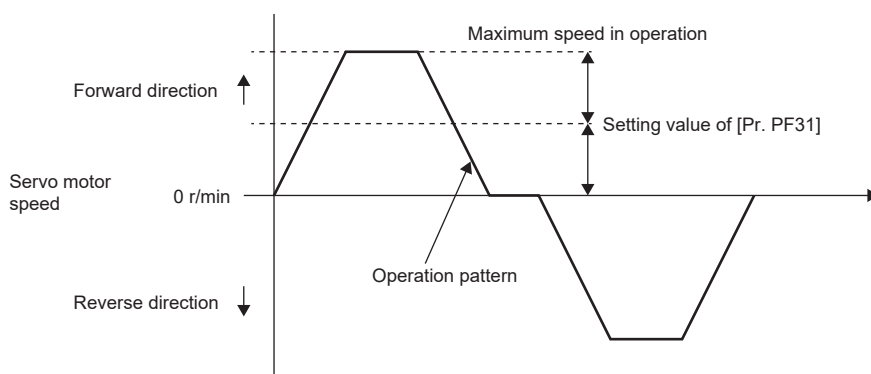

[Pr. PF32_Oscillation detection alarm time (*VIBT)]

Initial value	Setting range	Ver.
50 [100 ms]	0 to 50	A4

Set the time from when oscillation is detected until the occurrence of an alarm or warning.

When "0" is set, the time until the occurrence of the alarm or warning is 5000 ms.

When an oscillation detection alarm or warning is generated during normal operation, set a value larger than "10" (1000 ms).

[Pr. PF34_Machine diagnosis function selection (*MFP)]

Initial value	Setting range	Ver.
00000000h	Refer to the relevant detail No.	Refer to the relevant detail No.

[Pr. PF34.6_Friction estimate area judgment speed setting]

Initial value	Setting range	Ver.
0h	Refer to the text	A4

Select the setting method of "Machine diagnosis function - Friction estimate area judgment speed at low speed".

0: Manual setting

1: Automatic setting

When "1" (automatic setting) is set, [Pr. PF31 Machine diagnosis function - Friction estimate area judgment speed at low speed] will be calculated according to the servo motor operation pattern. After the calculation, [Pr. PF31] is rewritten to the calculation result, and the servo parameter will change to "0" (manual setting).

When "1" (automatic setting) is set, friction estimation stops.

[Pr. PF63_Function selection F-15 (*FOP15)]

Initial value	Setting range	Ver.
00000000h	Refer to the relevant detail No.	Refer to the relevant detail No.

[Pr. PF63.0_[AL. 01A.5 Servo motor combination error 3] selection]

Initial value	Setting range	Ver.
0h	Refer to the text	D0

Select whether to enable or disable [AL. 01A.5 Servo motor combination error 3] for when a servo motor with a batteryless absolute position encoder is replaced.

0: Enabled

1: Disabled

With "1" (disabled) selected, connecting a servo motor that had not been connected at the startup of the absolute position detection system triggers [AL. 025.1 Servo motor encoder absolute position erased] instead of [AL. 01A.5 Servo motor combination error 3].

Connecting a servo motor other than the ones with a batteryless absolute position encoder triggers [AL. 01A.5].

[Pr. PF80_Drive recorder - Operation condition selection (DRMC)]

Initial value	Setting range	Ver.
00000000h	Refer to the relevant detail No.	Refer to the relevant detail No.

[Pr. PF80.0_Drive recorder - Operation mode selection]

Initial value	Setting range	Ver.
0h	Refer to the text	A4

0: Automatic setting mode

1: Manual setting mode

When "0" (automatic setting mode) is set, the setting values of [Pr. PF81 Drive recorder - Sampling operation selection] to [Pr. PF94 Drive recorder - Digital channel setting 4] are disabled. The drive recorder will be activated automatically at the same time as an alarm occurs.

When obtaining desired analog data from the drive recorder, set this servo parameter to "1" (manual setting mode) to set the trigger conditions and sampling cycle, and then start sampling with [Pr. PF81.0 Drive recorder - Sampling start selection]. To disable the drive recorder, set [Pr. PF21 Drive recorder switching time setting] to "-1" (drive recorder function disabled).

[Pr. PF80.2-3_Drive recorder - Sampling cycle selection]

Initial value	Setting range	Ver.
00h	Refer to the text	A4

Set the sampling cycle of the drive recorder.

When [Pr. PF80.0] is set to "0" (automatic setting mode), the setting value of this servo parameter is disabled.

Setting value	8 kHz class
00	Automatic (250 μ s)
05	250 μ s
06	500 μ s
07	1 ms
08	2 ms
09	4 ms
0A	8 ms
0B	16 ms
0C	32 ms
0D	64 ms
0E	128 ms
0F	256 ms
10	512 ms
11	1.024 s

[Pr. PF81_Drive recorder - Sampling operation selection (DRMS)]

Initial value	Setting range	Ver.
00000000h	Refer to the relevant detail No.	Refer to the relevant detail No.

[Pr. PF81.0_Drive recorder - Sampling start selection]

Initial value	Setting range	Ver.
0h	Refer to the text	A4

Set this servo parameter to start drive recorder sampling.

When [Pr. PF80.0 Drive recorder - Operation mode selection] is set to "0" (automatic setting mode), the setting value of the servo parameter is disabled.

When this servo parameter is set to "1" or "2", if the settings of [Pr. PF80.2-3 Drive recorder - Sampling cycle selection] and [Pr. PF82 Drive recorder - Trigger operation selection] to [Pr. PF94 Drive recorder - Digital channel setting 4] are changed, the changed settings are not applied to the drive recorder. To apply the settings, cycle the power, reset the software, or set this servo parameter to "0" (stop sampling), then set "1" or "2" again.

The storage area of the servo amplifier has a limit for the number of writings. If the trigger conditions that have been set in [Pr. PF82] are frequently met, do not continue using this servo parameter when it is set to "2" (continuous sampling).

0: Stop sampling

1: Start a single sampling

2: Start a consecutive sampling

When "1" (start a single sampling) is set, if the trigger conditions are fulfilled after sampling starts, the drive recorder will operate to save data once. After the data has been saved, this servo parameter will be "0" automatically.

When "2" (start a consecutive sampling) is set, if the trigger conditions are fulfilled after sampling starts, the drive recorder will operate to save data. After that, sampling will start again.

[Pr. PF82_Drive recorder - Trigger operation selection (DRTM)]

Initial value	Setting range	Ver.
00000000h	Refer to the relevant detail No.	Refer to the relevant detail No.

[Pr. PF82.0_Drive recorder - Trigger mode selection]

Initial value	Setting range	Ver.
0h	Refer to the text	A4

Select the trigger mode for the drive recorder.

When [Pr. PF80.0 Drive recorder - Operation mode selection] is set to "0" (automatic setting mode), the setting value of the servo parameter is disabled.

0: Alarm trigger

1: Analog trigger/digital trigger

When "0" (alarm trigger) is set, trigger settings other than [Pr. PA23 Drive recorder desired alarm trigger setting] and [Pr. PF84.4-5 Drive recorder - Trigger position setting] are disabled. Refer to the following table for the unavailable servo parameters.

Servo parameter	Name
PF82.1	Drive recorder - Trigger binding condition selection
PF82.2	Drive recorder - Trigger operation selection 1
PF82.3	Drive recorder - Trigger operation selection 2
PF84.0-1	Drive recorder - Trigger channel selection 1
PF84.2-3	Drive recorder - Trigger channel selection 2
PF85	Drive recorder - Trigger level setting 1
PF86	Drive recorder - Trigger level setting 2

[Pr. PF82.1_Drive recorder - Trigger binding condition selection]

Initial value	Setting range	Ver.
0h	Refer to the text	A4

Select the trigger binding condition for the drive recorder.

When this servo parameter is set to "0" (disabled), the settings of [PF84.2-3 Drive recorder - Trigger channel selection 2] and [PF86 Drive recorder - Trigger level setting 2] are disabled.

When [Pr. PF80.0 Drive recorder - Operation mode selection] is set to "0" (automatic setting mode), or [Pr. PF80.0] is set to "1" and [Pr. PF82.0 Drive recorder - Trigger mode selection] is set to "0" (alarm trigger), the setting value of this servo parameter is disabled.

0: Disabled

1: Logical AND of trigger signals

2: Logical OR of trigger signals

[Pr. PF82.2_Drive recorder - Trigger operation selection 1]

Initial value	Setting range	Ver.
0h	Refer to the text	A4

Select whether sampling starts when the signal output for the drive recorder channel set in [Pr. PF84.0-1 Drive recorder - Trigger channel selection 1] exceeds or falls below the set trigger level.

When [Pr. PF80.0 Drive recorder - Operation mode selection] is set to "0" (automatic setting mode), or [Pr. PF80.0] is set to "1" and [Pr. PF82.0] is set to "0", the setting value of this servo parameter is disabled.

0: Rising

1: Falling

[Pr. PF82.3_Drive recorder - Trigger operation selection 2]

Initial value	Setting range	Ver.
0h	Refer to the text	A4

Select whether sampling starts when the signal output for the drive recorder channel set in [Pr. PF84.2-3 Drive recorder - Trigger channel selection 2] exceeds or falls below the set trigger level.

The servo parameter is disabled in the following conditions.

- [Pr. PF80.0 Drive recorder - Operation mode selection] is set to "0" (automatic setting mode)
- [Pr. PF82.0 Drive recorder - Trigger mode selection] is set to "0" (alarm trigger)
- [Pr. PF82.1 Drive recorder - Trigger binding condition selection] is set to "0" (disabled)

0: Rising

1: Falling

[Pr. PF84_Drive recorder - Trigger channel selection (DRTC)]

Initial value	Setting range	Ver.
005A8101h	Refer to the relevant detail No.	Refer to the relevant detail No.

[Pr. PF84.0-1_Drive recorder - Trigger channel selection 1]

Initial value	Setting range	Ver.
01h	Refer to the text	A4

Set the trigger channel No. 1 of the drive recorder.

The servo parameter is disabled in the following conditions.

- [Pr. PF80.0 Drive recorder - Operation mode selection] is set to "0" (automatic setting mode)
- [Pr. PF82.0 Drive recorder - Trigger mode selection] is set to "0" (alarm trigger)

Setting value	Meaning
01	Analog channel 1
02	Analog channel 2
03	Analog channel 3
04	Analog channel 4
05	Analog channel 5
06	Analog channel 6
07	Analog channel 7
81	Digital channel 1
82	Digital channel 2
83	Digital channel 3
84	Digital channel 4
85	Digital channel 5
86	Digital channel 6
87	Digital channel 7
88	Digital channel 8

[Pr. PF84.2-3_Drive recorder - Trigger channel selection 2]

Initial value	Setting range	Ver.
81h	Refer to the text	A4

Set the trigger channel No. 2 of the drive recorder. The setting value is the same as that of [Pr. PF84.0-1].

The servo parameter is disabled in the following conditions.

- [Pr. PF80.0 Drive recorder - Operation mode selection] is set to "0" (automatic setting mode)
- [Pr. PF82.0 Drive recorder - Trigger mode selection] is set to "0" (alarm trigger)
- [Pr. PF82.1 Drive recorder - Trigger binding condition selection] is set to "0" (disabled)

[Pr. PF84.4-5_Drive recorder - Trigger position setting]

Initial value	Setting range	Ver.
5Ah	00h to 6Fh	A4

Convert trigger position 1 (0 % to 100 % of the total sampling time of the drive recorder) to a hexadecimal value, and set the value. When trigger position 1 exceeds 100 %, the value will be clamped to 100 %.

For example, to set the trigger position to 30 %, set "1Eh" in this servo parameter.

[Pr. PF85_Drive recorder - Trigger level setting 1 (DRTL1)]

Initial value	Setting range	Ver.
0	-2147483648 to 2147483647	A4

Set the trigger level of trigger channel No. 1 of the drive recorder in decimal.

Set the value considering the decimal point.

For example, if setting a torque of 100.0 [%] for the trigger level, set this servo parameter to "1000" because the torque unit is [0.1 %].

The servo parameter is disabled in the following conditions.

- [Pr. PF80.0 Drive recorder - Operation mode selection] is set to "0" (automatic setting mode)
- [Pr. PF80.0] is set to "1" (manual setting mode) and [Pr. PF82.0 Drive recorder - Trigger mode selection] is set to "0" (alarm trigger)
- A digital channel is set in the first trigger of [Pr. PF84.0-1 Drive recorder - Trigger channel selection 1]

[Pr. PF86_Drive recorder - Trigger level setting 2 (DRTL2)]

Initial value	Setting range	Ver.
0	-2147483648 to 2147483647	A4

Set the trigger level of trigger channel No. 2 of the drive recorder in decimal.

Set the value considering the decimal point.

For example, if setting a torque of 100.0 [%] for the trigger level, set this servo parameter to "1000" because the torque unit is [0.1 %].

The servo parameter is disabled in the following conditions.

- [Pr. PF80.0 Drive recorder - Operation mode selection] is set to "0" (automatic setting mode)
- [Pr. PF80.0] is set to "1" (manual setting mode) and [Pr. PF82.0 Drive recorder - Trigger mode selection] is set to "0" (alarm trigger)
- [Pr. PF82.1 Drive recorder - Trigger binding condition selection] is set to "0" (disabled)
- A digital channel is set in the second trigger of [Pr. PF84.2-3 Drive recorder - Trigger channel selection 2].

[Pr. PF87_Drive recorder - Analog channel setting 1 (DRAC1)]

Initial value	Setting range	Ver.
00020201h	Refer to the relevant detail No.	Refer to the relevant detail No.

[Pr. PF87.0-2_Drive recorder - Analog channel 1 selection]

Initial value	Setting range	Ver.
201h	Refer to the text	A4

Select the data to be assigned to analog channel 1 of the drive recorder.

The servo parameter is disabled in the following conditions.

- [Pr. PF80.0 Drive recorder - Operation mode selection] = "0" (automatic setting mode)

Refer to the following table for setting values.

Values not listed below are undefined. Only set the values that are listed in the following table.

Setting value	Data type	Unit *1	Category
000	No assigned function	—	—
001	Servo motor speed	r/min	16-bit data
002	Torque/instantaneous torque	0.1 %	
003	Current command	0.1 %	
005	Command pulse frequency (speed unit)	r/min	
007	Droop pulses (1 pulse unit)	pulse	
008	Speed command	r/min	
009	Bus voltage	V	
00C	Effective load ratio	0.1 %	
00D	Regenerative load ratio	0.1 %	
00E	Position within one-revolution	16 pulse	
00F	ABS counter	rev	
010	Load to motor inertia ratio	0.01 multiplier	
011	Torque equivalent to disturbance	0.1 %	
012	Overload alarm margin	0.1 %	
014	Settling time	ms	
015	Overshoot amount	pulse	
01C *4	Load-side encoder droop pulses (1 pulse unit)	pulse	
01E *4	Motor-side/load-side position deviation (1 pulse unit)	pulse	
020 *4	Motor-side/load-side speed deviation	r/min	
021	Servo motor speed (unit of 0.1 r/min)	0.1 r/min	
022	Command pulse frequency (speed unit of 0.1 r/min)	0.1 r/min	
023	Speed command (unit of 0.1 r/min)	0.1 r/min	
024	Torque command	0.1 %	
025	Speed limit value	r/min	
026	Speed limit value (unit of 0.1 r/min)	0.1 r/min	
035	Internal temperature of encoder	°C	
03B *4	Load-side encoder information 1	16 pulse	
03C *4	Load-side encoder information 2	rev	
03D *3	Command number	LSB	
049	Operation mode	LSB	
04C *2	U-phase current feedback (unit of the rated current)	0.1 %	
04D *2	V-phase current feedback (unit of the rated current)	0.1 %	
04E *2	W-phase current feedback (unit of the rated current)	0.1 %	

Setting value	Data type	Unit *1	Category
201	Servo motor speed +	0.1 r/min	32-bit data
202	Command pulse frequency +	kpulse/s	
203	Command pulse frequency (speed unit) +	0.1 r/min	
204	Droop pulses (1 pulse unit) +	pulse	
205	Speed command +	0.1 r/min	
206	Position within one-revolution +	pulse	
207 *4	Load-side encoder information 1 +	pulse	
208 *4	Load-side encoder information 2 +	rev	
209 *4	Load-side droop pulses +	pulse	
20A *5	Controller position command +	pulse	
20B	Feedback position +	pulse	
20C	Excessive error alarm margin +	pulse	
20D *3	Current position (positioning unit) +	pos units	
20E *3	Command position (positioning unit) +	pos units	
20F *3	Command remaining distance (positioning unit) +	pos units	
218	Droop pulses (100 pulse unit) +	100 pulse	
219 *4	Load-side encoder droop pulses (100 pulses unit) +	100 pulse	
21A	Excessive error alarm margin (100 pulses unit) +	100 pulse	
21B	Droop pulses (model position deviation) +	pulse	
21F *5	Motor-side/load-side position deviation (100 pulses unit) +	100 pulse	
220	Speed command 2 +	0.1 r/min	
23C	Droop pulses (command unit) +	pulse	

*1 "mm/s" is used instead of "r/min" for linear servo motors.

*2 Available on servo amplifiers with firmware version B0 or later.

*3 Available on servo amplifiers with firmware version B8 or later.

*4 Available on servo amplifiers with firmware version C4 or later.

*5 Available on servo amplifiers with firmware version D4 or later.

[Pr. PF87.4-6_Drive recorder - Analog channel 2 selection]

Initial value	Setting range	Ver.
002h	Refer to the text	A4

Select the analog channel 2 of the drive recorder.

The servo parameter is disabled in the following conditions.

- [Pr. PF80.0 Drive recorder - Operation mode selection] is set to "0" (automatic setting mode)

Refer to the following for values that can be assigned.

☞ Page 106 [Pr. PF87.0-2_Drive recorder - Analog channel 1 selection]

[Pr. PF88_Drive recorder - Analog channel setting 2 (DRAC2)]

Initial value	Setting range	Ver.
02040003h	Refer to the relevant detail No.	Refer to the relevant detail No.

[Pr. PF88.0-2_Drive recorder - Analog channel 3 selection]

Initial value	Setting range	Ver.
003h	Refer to the text	A4

Select the analog channel 3 of the drive recorder.

The servo parameter is disabled in the following conditions.

- [Pr. PF80.0 Drive recorder - Operation mode selection] is set to "0" (automatic setting mode)

Refer to the following for values that can be assigned.

☞ Page 106 [Pr. PF87.0-2_Drive recorder - Analog channel 1 selection]

[Pr. PF88.4-6_Drive recorder - Analog channel 4 selection]

Initial value	Setting range	Ver.
204h	Refer to the text	A4

Select the analog channel 4 of the drive recorder.

The servo parameter is disabled in the following conditions.

- [Pr. PF80.0 Drive recorder - Operation mode selection] is set to "0" (automatic setting mode)

Refer to the following for values that can be assigned.

☞ Page 106 [Pr. PF87.0-2_Drive recorder - Analog channel 1 selection]

[Pr. PF89_Drive recorder - Analog channel setting 3 (DRAC3)]

Initial value	Setting range	Ver.
00090205h	Refer to the relevant detail No.	Refer to the relevant detail No.

[Pr. PF89.0-2_Drive recorder - Analog channel 5 selection]

Initial value	Setting range	Ver.
205h	Refer to the text	A4

Select the analog channel 5 of the drive recorder.

The servo parameter is disabled in the following conditions.

- [Pr. PF80.0 Drive recorder - Operation mode selection] is set to "0" (automatic setting mode)

Refer to the following for values that can be assigned.

☞ Page 106 [Pr. PF87.0-2_Drive recorder - Analog channel 1 selection]

[Pr. PF89.4-6_Drive recorder - Analog channel 6 selection]

Initial value	Setting range	Ver.
009h	Refer to the text	A4

Select the analog channel 6 of the drive recorder.

The servo parameter is disabled in the following conditions.

- [Pr. PF80.0 Drive recorder - Operation mode selection] is set to "0" (automatic setting mode)

Refer to the following for values that can be assigned.

☞ Page 106 [Pr. PF87.0-2_Drive recorder - Analog channel 1 selection]

[Pr. PF90_Drive recorder - Analog channel setting 4 (DRAC4)]

Initial value	Setting range	Ver.
0000000Ch	Refer to the relevant detail No.	Refer to the relevant detail No.

[Pr. PF90.0-2_Drive recorder - Analog channel 7 selection]

Initial value	Setting range	Ver.
00Ch	Refer to the text	A4

Select the analog channel 7 of the drive recorder.

The servo parameter is disabled in the following conditions.

- [Pr. PF80.0 Drive recorder - Operation mode selection] is set to "0" (automatic setting mode)

Refer to the following for values that can be assigned.

☞ Page 106 [Pr. PF87.0-2_Drive recorder - Analog channel 1 selection]

[Pr. PF91_Drive recorder - Digital channel setting 1 (DRDC1)]

Initial value	Setting range	Ver.
00120000h	Refer to the relevant detail No.	Refer to the relevant detail No.

[Pr. PF91.0-3_Drive recorder - Digital channel 1 selection]

Initial value	Setting range	Ver.
0000h	Refer to the text	A4

Refer to the following table for setting values.

Values not listed below are undefined. Only set the values that are listed in the following table.

Setting value	Symbol	Name	Classification
0000	CSON	Servo-on command	DI
0001	LSP	Forward rotation stroke end	
0002	LSN	Reverse rotation stroke end	
0005	PC	Proportional control	
0006	RES	Reset	
0012	EM2/1	Forced stop	
0013	CRDY	Ready-on command	
0016 *1	STO1	STO1	
0017 *1	STO2	STO2	
001A	CDP2	Gain switching selection 2	
001B	CDP	Gain switching selection	
001C *5	CLD	Fully closed loop selection	
0034 *5	TPR1	Touch probe 1	
0035 *5	TPR2	Touch probe 2	
0036 *5	TPR3	Touch probe 3	
0049	CFLS	Controller upper stroke limit signal being input	
004A	CRLS	Controller lower stroke limit signal being input	
00A0 *6	STOC	STO command	
00A1 *6	SS1C	SS1 command	
00A3 *6	SLS1C	SLS1 command	
00A4 *6	SLS2C	SLS2 command	
00A5 *6	SLS3C	SLS3 command	
00A6 *6	SLS4C	SLS4 command	
00A7 *6	SDIPC	SDIP command	
00A8 *6	SDINC	SDIN command	
00A9 *6	SLT1C	SLT1 command	
00AA *6	SLT2C	SLT2 command	
00AB *6	SLT3C	SLT3 command	
00AC *6	SLT4C	SLT4 command	

Setting value	Symbol	Name	Classification
8000	RD	Ready	DO
8001	SA	Speed reached	
8002	ZSP	Zero speed detection	
8003	TLC	Limiting torque	
8004	VLC	Limiting speed	
8005	INP	In-position completion	
8007	WNG	Warning	
8008	ALM	Malfunction	
8009	OP	Z-phase output	
800A	MBR	Electromagnetic brake interlock	
800B	DB	External dynamic brake	
800F	BWNG	Battery warning	
8010	ALM2	Malfunction 2	
8013	RDY	In ready-on state	
8015 *1	STO	In STO state	
8016	SMPD	Magnetic pole detection completion	
8017	ZPASS	Z-phase already passed	
8018	CDPS2	Variable gain enabled 2	
8019	CDPS	Variable gain enabled	
801A *5	CLDS	Fully closed loop control in progress	
801B	ABSV	Absolute position erased	
801D	IPF	Instantaneous power failure	
801E	SPC	Proportional control in progress	
801F	MTTR	Tough drive in progress	
8032	DOG	DOG signal input in progress	
803C *3	DOA	General-purpose output A	
803D *3	DOB	General-purpose output B	
803E *3	DOC	General-purpose output C	
8043 *2	CPO	Rough match	
8045 *2	POT	Position range	
8047 *4	MEND	Traveling completion	
8049	ZP2	Homing completion 2	
8056 *7	INP2	CiA 402 Target position reached	
80A0 *6	STOS	STO output	
80A1 *6	SS1S	SSS1 output	
80A3 *6	SLS1S	SLS1 output	
80A4 *6	SLS2S	SLS2 output	
80A5 *6	SLS3S	SLS3 output	
80A6 *6	SLS4S	SLS4 output	
80A7 *6	SSMS	SSSM output	
80A9 *6	SBCS	SSBC output	
80AA *6	SDIPS	SDIP output	
80AB *6	SDINS	SDIN output	
80AC *6	SLT1S	SLT1 output	
80AD *6	SLT2S	SLT2 output	
80AE *6	SLT3S	SLT3 output	
80AF *6	SLT4S	SLT4 output	

*1 This signal cannot be used.

*2 Available on servo amplifiers with firmware version B2 or later.

*3 Available on servo amplifiers with firmware version B6 or later.

*4 Available on servo amplifiers with firmware version B8 or later.

*5 Available on servo amplifiers with firmware version C4 or later.

*6 This signal is available only for the MR-JET-_G_-HS (N1).

*7 Available on servo amplifiers with firmware version E4 or later.

[Pr. PF91.4-7_Drive recorder - Digital channel 2 selection]

Initial value	Setting range	Ver.
0012h	Refer to the text	A4

Refer to the following for values that can be assigned.

☞ Page 110 [Pr. PF91.0-3_Drive recorder - Digital channel 1 selection]

[Pr. PF92_Drive recorder - Digital channel setting 2 (DRDC2)]

Initial value	Setting range	Ver.
80058010h	Refer to the relevant detail No.	Refer to the relevant detail No.

[Pr. PF92.0-3_Drive recorder - Digital channel 3 selection]

Initial value	Setting range	Ver.
8010h	Refer to the text	A4

Refer to the following for values that can be assigned.

☞ Page 110 [Pr. PF91.0-3_Drive recorder - Digital channel 1 selection]

[Pr. PF92.4-7_Drive recorder - Digital channel 4 selection]

Initial value	Setting range	Ver.
8005h	Refer to the text	A4

Refer to the following for values that can be assigned.

☞ Page 110 [Pr. PF91.0-3_Drive recorder - Digital channel 1 selection]

[Pr. PF93_Drive recorder - Digital channel setting 3 (DRDC3)]

Initial value	Setting range	Ver.
8000800Ah	Refer to the relevant detail No.	Refer to the relevant detail No.

[Pr. PF93.0-3_Drive recorder - Digital channel 5 selection]

Initial value	Setting range	Ver.
800Ah	Refer to the text	A4

Refer to the following for values that can be assigned.

☞ Page 110 [Pr. PF91.0-3_Drive recorder - Digital channel 1 selection]

[Pr. PF93.4-7_Drive recorder - Digital channel 6 selection]

Initial value	Setting range	Ver.
8000h	Refer to the text	A4

Refer to the following for values that can be assigned.

☞ Page 110 [Pr. PF91.0-3_Drive recorder - Digital channel 1 selection]

[Pr. PF94_Drive recorder - Digital channel setting 4 (DRDC4)]

Initial value	Setting range	Ver.
801D8015h	Refer to the relevant detail No.	Refer to the relevant detail No.

[Pr. PF94.0-3_Drive recorder - Digital channel 7 selection]

Initial value	Setting range	Ver.
8015h	Refer to the text	A4

Refer to the following for values that can be assigned.

☞ Page 110 [Pr. PF91.0-3_Drive recorder - Digital channel 1 selection]

[Pr. PF94.4-7_Drive recorder - Digital channel 8 selection]

Initial value	Setting range	Ver.
801Dh	Refer to the text	A4

Refer to the following for values that can be assigned.

☞ Page 110 [Pr. PF91.0-3_Drive recorder - Digital channel 1 selection]

[Pr. PF95_Drive recorder - Clear history (**DRCLR)]

Initial value	Setting range	Ver.
00000000h	Refer to the relevant detail No.	Refer to the relevant detail No.

[Pr. PF95.0_Drive recorder - Clear history selection]

Initial value	Setting range	Ver.
0h	Refer to the text	A4

0: Disabled

1: Enabled

When "0" (enabled) is set, the drive recorder history will be cleared at the next power-on or software reset. After the drive recorder history is cleared, "0" (disabled) will be set to this servo parameter automatically.

1.8 Motor extension setting servo parameters group ([Pr. PL_ _])

[Pr. PL01_Function selection L-1 (**LIT1)]

Initial value	Setting range	Ver.
00000301h	Refer to the relevant detail No.	Refer to the relevant detail No.

Select a function of the linear servo motor.

[Pr. PL01.0_Servo motor magnetic pole detection selection]

Initial value	Setting range	Ver.
1h	Refer to the text	B2

Select the magnetic pole detection method for the linear servo motor.

0: Magnetic pole detection disabled

1: Magnetic pole detection at initial servo-on after cycling the power or after resetting the communication

5: Magnetic pole detection at every servo-on

The setting value "0" is enabled only with absolute position linear encoders.

Do not set any value other than "0", "1", and "5".

[Pr. PL01.2_Homing stop interval setting]

Initial value	Setting range	Ver.
3h	Refer to the text	B2

Select the stop interval at dog type homing.

This servo parameter is enabled only for linear servo motors.

0: 2^{13} (= 8192) pulses

1: 2^{17} (= 131072) pulses

2: 2^{18} (= 262144) pulses

3: 2^{20} (= 1048576) pulses

4: 2^{22} (= 4194304) pulses

5: 2^{24} (= 16777216) pulses

6: 2^{26} (= 67108864) pulses

[Pr. PL02_Linear encoder resolution setting - Numerator (**LIM)]

Initial value	Setting range	Ver.
1000 [μm]	1 to 65535	B2

Set the linear encoder resolution with [Pr. PL02] and [Pr. PL03].

Set a numerator in [Pr. PL02].

This servo parameter is enabled for linear servo motors.

[Pr. PL03_Linear encoder resolution setting - Denominator (**LID)]

Initial value	Setting range	Ver.
1000 [μm]	1 to 65535	B2

Set the linear encoder resolution with [Pr. PL02] and [Pr. PL03].

Set a denominator in [Pr. PL03].

This servo parameter is enabled for linear servo motors.

[Pr. PL04_Function selection L-2 (*LIT2)]

Initial value	Setting range	Ver.
00000003h	Refer to the relevant detail No.	Refer to the relevant detail No.

Select a function of the linear servo motor.

[Pr. PL04.0_[AL. 042 Servo control error] detection function selection]

Initial value	Setting range	Ver.
3h	Refer to the text	B2

Refer to the following table for setting values.

Setting value	Thrust/torque deviation error	Speed deviation error	Position deviation error
0	Disabled	Disabled	Disabled
1			Enabled
2		Enabled	Disabled
3	Enabled		
4	Enabled	Disabled	Disabled
5			Enabled
6		Enabled	Disabled
7			Enabled

[Pr. PL04.3_[AL. 042 Servo control error] detection controller reset condition selection]

Initial value	Setting range	Ver.
0h	Refer to the text	B2

0: Reset disabled (reset by powering off/on or software reset enabled)

1: Reset enabled

[Pr. PL05_Position deviation error detection level (LB1)]

Initial value	Setting range	Ver.
0 [mm], [0.01 rev]	0 to 1000	B2

Set a position deviation error detection level of the servo control error detection.

When the difference between a model feedback position and actual feedback position is larger than the setting value, [AL. 042.1 Servo control error based on position deviation] will occur.

Note that when "0" is set, the level varies depending on the setting value in [Pr. PA01.1 Operation mode selection].

When a linear servo motor is used: 50 mm

[Pr. PL06_Speed deviation error detection level (LB2)]

Initial value	Setting range	Ver.
0 [mm/s], [r/min]	0 to 20000	B2

Set the speed deviation error detection level of the servo control error detection.

When the difference between a model feedback speed and actual feedback speed is larger than the setting value, [AL. 042.2 Servo control error based on speed deviation] will occur.

Note that when "0" is set, the level varies depending on the setting value in [Pr. PA01.1 Operation mode selection].

When a linear servo motor is used: 1000 mm/s

[Pr. PL07_Torque deviation error detection level (LB3)]

Initial value	Setting range	Ver.
100 [%]	0 to 1000	B2

Set the torque/thrust deviation error detection level of the servo control error detection.

When the difference between a current command and current feedback is larger than the setting value, [AL. 042.3 Servo control error based on torque/thrust deviation] occurs.

[Pr. PL08_Function selection L-3 (*LIT3)]

Initial value	Setting range	Ver.
00001010h	Refer to the relevant detail No.	Refer to the relevant detail No.

Select a function of the linear servo motor.

[Pr. PL08.0_Magnetic pole detection method selection]

Initial value	Setting range	Ver.
0h	Refer to the text	B2

0: Position detection method

4: Minute position detection method

If detecting magnetic poles in a vertical axis, configure a system with equipment such as a counterweight to prevent the linear servo motor from moving with the force of gravity.

[Pr. PL08.2_Magnetic pole detection - Stroke limit enabled/disabled selection]

Initial value	Setting range	Ver.
0h	Refer to the text	B2

0: Enabled

1: Disabled

[Pr. PL09_Magnetic pole detection voltage level (LPWM)]

Initial value	Setting range	Ver.
30 [%]	0 to 100	B2

Set a direct current exciting voltage level in the magnetic pole detection.

If [AL. 032 Overcurrent], [AL. 050 Overload 1], or [AL. 051 Overload 2] occurs during the magnetic pole detection, set a smaller value.

If [AL. 027 Initial magnetic pole detection error] occurs during the magnetic pole detection, set a larger value.

[Pr. PL17_Magnetic pole detection - Minute position detection method - Function selection (LTSTS)]

Initial value	Setting range	Ver.
00000000h	Refer to the relevant detail No.	Refer to the relevant detail No.

This servo parameter is enabled when [Pr. PL08.0 Magnetic pole detection method selection] is set to "4" (minute position detection method).

[Pr. PL17.0_Response selection]

Initial value	Setting range	Ver.
0h	Refer to the text	B2

Select the responsiveness of the minute position detection method.

To make the travel distance at the magnetic pole detection smaller, set a larger value.

Refer to the following table for setting values.

Setting value of [Pr. PL17.0]	Responsiveness
0	
1	
2	
3	
4	
5	
6	
7	
8	
9	
A	
B	
C	
D	
E	
F	

[Pr. PL17.1_Load to motor mass ratio/load to motor inertia ratio selection]

Initial value	Setting range	Ver.
0h	Refer to the text	B2

Select the load to mass of the linear servo motor primary-side ratio used for the minute position detection method. Select a value closest to the actual load.

Refer to the following table for setting values.

Setting value of [Pr. PL17.1]	Load to motor mass ratio
0	10 times or less
1	10 multiplier
2	20 multiplier
3	30 multiplier
4	40 multiplier
5	50 multiplier
6	60 multiplier
7	70 multiplier
8	80 multiplier
9	90 multiplier
A	100 multiplier
B	110 multiplier
C	120 multiplier
D	130 multiplier
E	140 multiplier
F	150 times or more

[Pr. PL18_Magnetic pole detection - Minute position detection method - Identification signal amplitude (IDLV)]

Initial value	Setting range	Ver.
0 [%]	0 to 200	B2

Set an identification signal amplitude to be used in the minute position detection method.

This servo parameter is enabled when [Pr. PL08.0 Magnetic pole detection method selection] is set to "4".

When the setting value of this servo parameter is set to "0", the amplitude will be 100 [%].

1.9 Positioning control setting servo parameters group ([Pr. PT_ _])

[Pr. PT01_Command mode selection (**CTY)]

Initial value		Setting range	Ver.
TSN	ECT		
00000300h	00000310h	Refer to the relevant detail No.	Refer to the relevant detail No.

[Pr. PT01.1_Speed/acceleration/deceleration unit selection]

Initial value		Setting range	Ver.
TSN	ECT		
0h	1h	Refer to the text	A4

Select the unit of speed and the unit of acceleration/deceleration.

This function is enabled in the cyclic synchronous mode, profile mode, and positioning mode (point table method).

Setting value	Speed	Acceleration/deceleration
0	r/min, mm/s ^{*1}	ms
1	Command unit/s ^{*2}	Command unit/s ² ^{*2}

*1 In the linear servo motor control mode, the unit is mm/s.

*2 The command unit can be changed to 0.001 mm, 0.0001 inch, 0.001 degree, or pulse with [Pr. PT01.2 Unit for position data]. The actual servo motor speed (encoder pulse unit) is calculated by multiplying the set speed data by the electronic gear ratio.

The speed of point table and the unit of acceleration/deceleration are changed depending on the setting value of this servo parameter. When the unit is changed, review and reset the point table setting value.

Enabled servo parameters vary depending on whether the setting value of this servo parameter is "0" or "1". Refer to the following table.

Setting value		Object interlocked with servo parameter
0	1	
[Pr. PT65 Profile speed command] ^{*1}	[Pr. PV01 Profile speed command extension setting] ^{*1}	[Profile velocity (Obj. 6081h)]
[Pr. PT66 Maximum profile speed] ^{*1}	[Pr. PV03 Maximum profile speed extension setting] ^{*1}	[Max profile velocity (Obj. 607Fh)]
[Pr. PT49 Speed acceleration time constant] ^{*1}	[Pr. PV05 Profile acceleration] ^{*1}	[Profile acceleration (Obj. 6083h)]
[Pr. PT50 Speed deceleration time constant] ^{*1}	[Pr. PV07 Profile deceleration] ^{*1}	[Profile deceleration (Obj. 6084h)]
[Pr. PC24 Deceleration time constant at forced stop]	[Pr. PV09 Deceleration at forced stop]	[Quick stop deceleration (Obj. 6085h)]
[Pr. PT05 Homing speed]	[Pr. PV11 Homing speed extension setting]	[Speed during search for switch (Obj. 6099h: 01h)]
[Pr. PT06 Creep speed]	[Pr. PV13 Creep speed extension setting]	[Speed during search for zero (Obj. 6099h: 02h)]
[Pr. PT56 Homing acceleration time constant]	[Pr. PV15 Homing acceleration]	[Homing acceleration (Obj. 609Ah)]
[Pr. PT57 Homing deceleration time constant]	[Pr. PV17 Homing deceleration]	—
[Pr. PC72 Speed reached 2 - Output range] ^{*1}	[Pr. PV19 Speed reached 2 - Output range - Extension setting] ^{*1}	[Velocity window (Obj. 606Dh)]
[Pr. PC65 Zero speed 2 level] ^{*1}	[Pr. PV20 Zero speed 2 level extension setting] ^{*1}	[Velocity threshold (Obj. 606Fh)]
[Pr. PT67 Speed limit]	[Pr. PV21 Speed limit extension setting]	[Velocity limit value (Obj. 2D20h)]

*1 Available on servo amplifiers with firmware version B2 or later.

[Pr. PT01.2_Unit for position data]

Initial value	Setting range	Ver.
3h	Refer to the text	B6

0: mm

1: inch

2: degree

3: pulse

If this servo parameter is changed, perform homing.

Refer to the following for the supported control modes and firmware versions.

Control mode	Setting value			
	0 (mm) ^{*4}	1 (inch) ^{*4}	2 (degree) ^{*1*2}	3 (pulse)
Cyclic synchronous mode	—	—	— ^{*3}	A4
Profile mode	—	—	B6	B2
Positioning mode (point table method)	B8	B8	B8	B8

*1 When [Pr. PA01.4 Fully closed loop operation mode selection] is set to "1" (enabled), use a rotary encoder as the load-side encoder. Connecting a linear encoder will trigger [AL. 037 Parameter error].

*2 If [Pr. PA01.1 Operation mode selection] is set to "4" (linear servo motor control mode), [AL. 037] will occur.

*3 When this servo parameter is set to "2", the control mode cannot be switched to the cyclic synchronous mode.

*4 If this value is set in a mode other than the positioning mode (point table method), [AL. 037] will occur.

[Pr. PT02_Function selection T-1 (*TOP1)]

Initial value	Setting range	Ver.
00000001h	Refer to the relevant detail No.	Refer to the relevant detail No.

[Pr. PT02.7_Internal position command - Process speed selection]

Initial value	Setting range	Ver.
0h	Refer to the text	B2

Select the process speed of the position commands generated in the servo amplifier.

0: Standard

1: High speed

[Pr. PT03_Feed function selection (*FTY)]

Initial value	Setting range	Ver.
00000000h	Refer to the relevant detail No.	Refer to the relevant detail No.

[Pr. PT03.2_Degree unit rotation direction selection]

Initial value	Setting range	Ver.
0h	Refer to the text	B6

Select the rotation direction for when [Pr. PT01.2 Unit for position data] is set to "2" (degree).

0: Specified rotation direction

1: Rotation in the direction with the shortest distance

2: Rotation in the address decreasing direction

3: Rotation in the address increasing direction

This function is enabled in the profile position mode and positioning mode (point table method).

When [Pr. PT01.2] is set to a value other than "2", this parameter is disabled.

This servo parameter corresponds to [Positioning option code (Obj. 60F2h)].

Once this servo parameter is changed, the setting will be enabled immediately

When an object is mapped in cyclic communication, the controller overwrites the value written with engineering software.

Thus, do not write a value with engineering software.

When the relative position command is set for the auxiliary function of the point table in the positioning mode (point table method), this servo parameter is disabled.

[Pr. PT05_Homing speed (ZRF)]

Initial value	Setting range	Ver.
100.00 [r/min], [mm/s]	0.00 to 167772.15	A4

Set the servo motor speed for homing.

The servo motor speed is clamped at the maximum speed. When changing the speed to the permissible speed, set the speed in [Pr. PA28.4 Speed range limit selection].

If the set speed exceeds 8000 r/min (mm/s), the speed is clamped at 8000 r/min (mm/s). However, the set speed is clamped when [Pr. PT02.7 Internal position command - Process speed selection] is set to "0".

This function corresponds to [Speed during search for switch (Obj. 6099h: 01h)].

When an object is mapped in cyclic communication, the controller overwrites the value written with engineering software.

Thus, do not write a value with engineering software.

This function is enabled when [Pr. PT01.1 Speed/acceleration/deceleration unit selection] is set to "0". This function and [Pr. PV11 Homing speed extension setting] are mutually exclusive.

[Pr. PT06_Creep speed (CRF)]

Initial value	Setting range	Ver.
10.00 [r/min], [mm/s]	0.00 to 167772.15	A4

When performing a homing, set the servo motor speed after proximity dog.

The servo motor speed is clamped at the maximum speed. When changing the speed to the permissible speed, set the speed in [Pr. PA28.4 Speed range limit selection].

If the set speed exceeds 8000 r/min (mm/s), the speed is clamped at 8000 r/min (mm/s). However, the set speed is clamped when [Pr. PT02.7 Internal position command - Process speed selection] is set to "0".

This function corresponds to [Speed during search for zero (Obj. 6099h: 02h)].

When an object is mapped in cyclic communication, the controller overwrites the value written with engineering software.

Thus, do not write a value with engineering software.

This function is enabled when [Pr. PT01.1] is set to "0". This function and [Pr. PV13 Creep speed extension setting] are mutually exclusive.

[Pr. PT07_Home position shift distance (ZST)]

Initial value	Setting range	Ver.
0 [Command unit]	-2147483648 to 2147483647	A4

Set the home position shift travel distance at homing.

The command unit can be changed to 0.001 mm, 0.0001 inch, 0.001 degree, or pulse with [Pr. PT01.2 Unit for position data].

 Page 120 [Pr. PT01.2_Unit for position data]

The setting range is -359.999 to 359.999 degrees for the degree unit. If a value exceeding 360.000 degrees or less than -360.000 degrees is set, the value will be converted into the remainder obtained by dividing the setting value by 360.000.

-214748364 to -1 can be set on servo amplifiers with firmware version D0 or later.

[Pr. PT08_Homing position data (ZPS)]

Initial value	Setting range	Ver.
0 [Command unit]	-2147483648 to 2147483647	A4

Set the address that is to be the reference point of the machine coordinate system.

Subtracting the setting value of this servo parameter from the machine home position gives the coordinate of the home position. The value in [Position actual value (Obj. 6064h)] changes at the same time as the homing completion.

The setting value of this servo parameter is reflected at completion of homing or when the servo amplifier is connected to a network.

This function is enabled in the cyclic synchronous position mode, profile position mode, and positioning mode (point table method).

The command unit can be changed to 0.001 mm, 0.0001 inch, 0.001 degree, or pulse with [Pr. PT01.2 Unit for position data].

Page 120 [Pr. PT01.2_Unit for position data]

If [Pr. PT01.2] is changed, the homing position data will also be changed. Execute homing again.

This function corresponds to [Home offset (Obj. 607Ch)]. The relation between [Home offset] and this servo parameter is as follows.

$$[\text{Home offset}] = - [\text{Pr. PT08}]$$

The value that is set in this servo parameter is not reflected when the homing is incomplete.

Setting this servo parameter will compensate the software position limit.

After compensation, [Max position range limit (607Dh: 02h)] = [Max position range limit] - [Home offset]

After compensation, [Min position range limit (607Dh: 01h)] = [Min position range limit] - [Home offset]

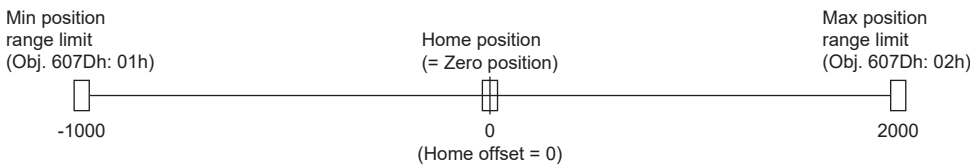

- For Home offset < 0

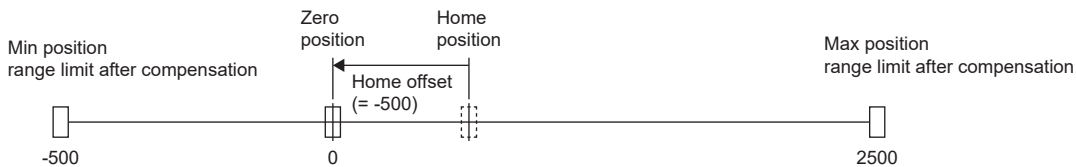

- For Home offset > 0

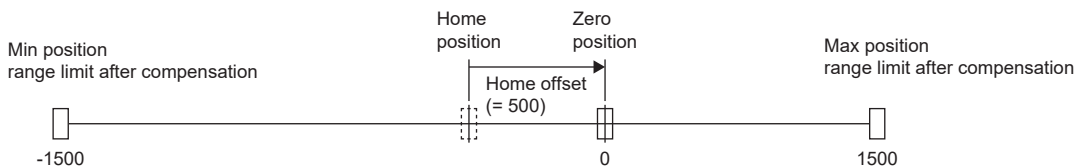

The setting range is 0 to 359.999 degrees for the degree unit. If a value out of the setting range is set, the value will be converted as shown in the table below.

Setting value	After conversion
360.000 to 2147483.647 degrees	The remainder obtained by dividing the setting value by 360.000
-0.001 to -359.999 degrees	The value obtained by adding 360.000 to the setting value
-360.000 to -2147483.648 degrees	The value obtained by adding 360.000 to the remainder after dividing the setting value by 360.000

[Pr. PT09_Travel distance after proximity dog (DCT)]

Initial value	Setting range	Ver.
1000 [Command unit]	0 to 2147483647	A4

Set a travel distance after proximity dog at homing for the count type (Front end detection Z-phase reference) (Homing method -2, -34) and dog reference.

The following shows the homing of the dog reference.

- Dog type rear end reference homing (Homing method -6, -38)
- Count type homing (Front end reference) (Homing method -7, -39)
- Dog type front end reference homing (Homing method -10, -42)
- Homing without index pulse (Homing method 19, 20, 21, 22, 23, 24, 27, 28)

This function is enabled in the cyclic synchronous mode, profile mode, and positioning mode (point table method).

The command unit can be changed to 0.001 mm, 0.0001 inch, 0.001 degree, or pulse with [Pr. PT01.2 Unit for position data].

☞ Page 120 [Pr. PT01.2_Unit for position data]

The setting range is 0 to 359.999 degrees for the degree unit. If a value exceeding 360.000 degrees is set, the value will be converted into the remainder obtained by dividing the setting value by 360.000.

[Pr. PT10_Stopper type homing - Stopping time (ZTM)]

Initial value	Setting range	Ver.
100 [ms]	5 to 1000	A4

Set a time from a moving part touches the stopper and torques reach to the torque limit of [Pr. PT11 Stopper type homing - Torque limit value] to a home position is set for the stopper type homing.

This function is enabled in the cyclic synchronous mode, profile mode, and positioning mode (point table method).

[Pr. PT11_Stopper type homing - Torque limit value (ZTT)]

Initial value	Setting range	Ver.
15.0 [%]	0.1 to 100.0	A4

Set a torque limit value with [%] unit to the rated torque at stopper type homing.

This function is enabled in the cyclic synchronous mode, profile mode, and positioning mode (point table method).

[Pr. PT12_Rough match output range (CRP)]

Initial value	Setting range	Ver.
0 [Command unit]	0 to 2147483647	B2

Set the range of the command remaining distance to output the rough match.

This function is enabled in the profile position mode and positioning mode (point table method).

The command unit can be changed to 0.001 mm, 0.0001 inch, 0.001 degree, or pulse with [Pr. PT01.2 Unit for position data].

☞ Page 120 [Pr. PT01.2_Unit for position data]

[Pr. PT15_Software position limit + (LMP)]

Initial value	Setting range	Ver.
0 [Command unit]	-2147483648 to 2147483647	A4

Set the address increasing side of the software position limit.

This function is enabled in the cyclic synchronous position mode, profile position mode, and positioning mode (point table method). The setting is disabled during homing.

The command unit can be changed to 0.001 mm, 0.0001 inch, 0.001 degree, or pulse with [Pr. PT01.2 Unit for position data].

 Page 120 [Pr. PT01.2_Unit for position data]

Change this function during servo-off, in the homing mode, velocity mode, or torque mode.

When the setting is changed during servo-on in the position mode and positioning mode, [AL. 035 Command frequency error], [AL. 069 Command error], and [AL. 098 Software position limit warning] may occur, depending on the setting order of [Pr. PT15] and [Pr. PT17 Software position limit -].

This function corresponds to [Max position limit (Obj. 607Dh: 02h)].

When an object is mapped in cyclic communication, the controller overwrites the value written with engineering software.

Thus, do not write a value with engineering software.

The enabling/disabling conditions of the software position limit are shown in the table below.

[Pr. PT01.2]	Conditions		
	[Pr. PT15] > [Pr. PT17]	[Pr. PT15] < [Pr. PT17]	[Pr. PT15] = [Pr. PT17]
0 (mm)	Enabled	Disabled	Disabled
1 (inch)			
3 (pulse)			
2 (degree)	Enabled	Enabled	Disabled

[Pr. PT17_Software position limit - (LMN)]

Initial value	Setting range	Ver.
0 [Refer to the text below for the unit.]	-2147483648 to 2147483647	A4

Set the address decreasing side of the software position limit.

The other specifications are the same as [Pr. PT15].

[Pr. PT19_Position range output 1 address + (*LPP1)]

Initial value	Setting range	Ver.
0 [Command unit]	-2147483648 to 2147483647	B2

Set the address increasing side of the position range output 1 address.

Use this servo parameter and [Pr. PT21 Position range output 1 address -] to set the range where position range 1 (POT1) turns on.

This function is enabled in the profile position mode and positioning mode (point table method).

The command unit can be changed to 0.001 mm, 0.0001 inch, 0.001 degree, or pulse with [Pr. PT01.2 Unit for position data].

☞ Page 120 [Pr. PT01.2_Unit for position data]

If [Pr. PT19] is set to a value less than [Pr. PT21] while [Pr. PT01.2] is set to "3" (pulse), [AL. 037 Parameter error] occurs.

When [Pr. PT01.2] is set to "2" (degree), set [Pr. PT21] as the starting point and [Pr. PT19] as the ending point.

An example setting of the degree unit is as follows.

The output range is the section where the servo motor moves from "-" to "+" in the CCW direction.

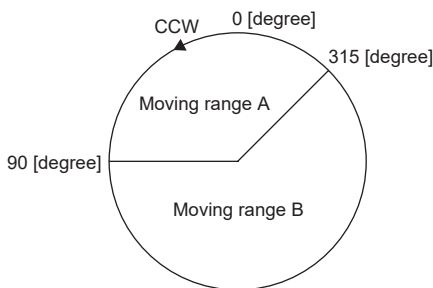

Set the output range of moving range A as follows:

- [Pr. PT21] = 315.000 degrees
- [Pr. PT19] = 90.000 degrees

Set the output range of moving range B as follows:

- [Pr. PT21] = 90.000 degrees
- [Pr. PT19] = 315.000 degrees

The setting range is 0 to 359.999 degrees. If a value out of the setting range is set, the value will be converted as shown in the table below.

The values of the output range shown above will be the values after conversion.

Setting value	After conversion
360.000 to 2147483.647 degrees	The remainder obtained by dividing the setting value by 360.000
-0.001 to -359.999 degrees	The value obtained by adding 360.000 to the setting value
-360.000 to -2147483.648 degrees	The value obtained by adding 360.000 to the remainder after dividing the setting value by 360.000

[Pr. PT21_Position range output 1 address - (*LNP1)]

Initial value	Setting range	Ver.
0 [Command unit]	-2147483648 to 2147483647	B2

Set the address decreasing side of the position range output 1 address.

The other specifications are the same as [Pr. PT19 Position range output 1 address +].

[Pr. PT26_Function selection T-2 (*TOP2)]

Initial value	Setting range	Ver.
00000000h	Refer to the relevant detail No.	Refer to the relevant detail No.

[Pr. PT26.4_Touch probe latch position selection]

Initial value	Setting range	Ver.
0h	0h to 2h	C4

Select the reflecting patterns of [Pr. PA14 Travel direction selection] and [Pr. PT08 Homing position data] to the latch position in the touch probe function.

0: Reflect only some of the patterns of [Pr. PA14]

2: Reflect all the patterns of [Pr. PA14] and [Pr. PT08]

The reflecting patterns are as follows.

[Pr. PT26.4]	Trigger *1 [Touch probe function (Obj. 60B8h)] [Touch probe function 2 (Obj. 2DE8h)]	[Pr. PT01.2 Unit for position data]	[Reflecting the setting value of [Pr. PA14]]	[Reflecting the setting value of [Pr. PT08]]
0	0 (Triggered by inputting touch probe)	0 (mm), 1 (inch), 3 (pulse)	○	—
		2 (degree)	—	○
	1 (Triggered at the zero point of the encoder)	0, 1, 3	○	—
		2	○	—
2	0 (Triggered by inputting touch probe)	0, 1, 3	○	○
		2	○	○
	1 (Triggered at the zero point of the encoder)	0, 1, 3	○	○
		2	○	○

*1 The trigger corresponds to bit 2 or bit 10 of [Touch probe function (Obj. 60B8h)] or bit 2 of [Touch probe function 2 (Obj. 2DE8h)]. The applicable object differs depending on the touch probe device being used.

[Pr. PT29_Function selection T-3 (*TOP3)]

Initial value	Setting range	Ver.
00000000h	Refer to the relevant detail No.	Refer to the relevant detail No.

[Pr. PT29.0_Device input polarity 1]

Initial value	Setting range	Ver.
0h	Refer to the text	A4

Select the proximity dog input polarity.

0: Dog detection with off

1: Dog detection with on

[Pr. PT34_Positioning operation data default (**PDEF)]

Initial value	Setting range	Ver.
00000000h	Refer to the relevant detail No.	Refer to the relevant detail No.

[Pr. PT34.0_Point table default]

Initial value	Setting range	Ver.
0h	Refer to the text	B8

0: Disabled

1: Enabled

When initializing the point table, set "1".

After setting [Pr. PT34.0] = "1" and [Pr. PT34.3 Default availability] = "5" (permitted), cycle the power or reset the software to initialize the point table.

After the initialization is completed, the setting value of [Pr. PT34] is automatically set to "00000000h".

[Pr. PT34.3_Default availability]

Initial value	Setting range	Ver.
0h	Refer to the text	B8

0: Prohibited

5: Permitted

When initializing the point table, set "5".

After the initialization is completed, the setting value of [Pr. PT34] is automatically set to "00000000h".

[Pr. PT38_Function selection T-7 (**TOP7)]

Initial value	Setting range	Ver.
00000000h	Refer to the relevant detail No.	Refer to the relevant detail No.

[Pr. PT38.1_Override selection]

Initial value	Setting range	Ver.
0h	Refer to the text	D4

Select the override function.

0: The override function is disabled.

3: The override function is enabled.

When the setting value of this servo parameter is "3" (the override function is enabled), the override function can be used in the profile position mode (pp), point table mode (pt), JOG operation mode (jg), and homing mode (hm).

[Pr. PT38.4_Limit switch release position assessment function selection]

Initial value	Setting range	Ver.
0h	Refer to the text	B2

Set the limit switch release position assessment function.

This function is enabled in the cyclic synchronous position mode or the cyclic synchronous speed mode.

Refer to the following table for the combinations available for the assessment function.

Setting value	Limit switch release position assessment function
0	Disabled
1	Enabled

[Pr. PT41_Function selection T-8 (TOP8)]

Initial value	Setting range	Ver.
00000010h	Refer to the relevant detail No.	Refer to the relevant detail No.

[Pr. PT41.0_Homing prohibition selection]

Initial value	Setting range	Ver.
0h	Refer to the text	A4

0: Disabled

1: Enabled

When "1" is set, the homing is not performed even if the start signal is turned on in the homing mode.

[Pr. PT45_Homing method (HMM)]

Initial value	Setting range	Ver.
37	Refer to the text	A4

Set a homing method.

An attempt to execute homing with an unsupported method triggers "Homing error". At this time, homing cannot be executed. This function corresponds to [Homing method (Obj. 6098h)].

When an object is mapped in cyclic communication, the controller overwrites the value written with engineering software.

Thus, do not write a value with engineering software.

For servo amplifiers with firmware version D4 or later, the setting of [Pr. PA14 Travel direction selection (*POL)] can be reflected to the homing direction depending on the setting value of [Pr. PT55.1 Homing POL reflection selection]. For details of the homing direction, refer to "Homing mode (hm)" in the MR-JET User's Manual (Function).

- Homing methods

For details of the homing method, refer to "Homing mode (hm)" in the MR-JET User's Manual (Function).

Setting	Homing direction *3		Homing methods	Description
	[Pr. PA14] = 0	[Pr. PA14] = 1		
-1	Forward rotation (CCW) or positive direction	Reverse rotation (CW) or negative direction	Dog type (Rear end detection - Z-phase reference)	Performs homing using the Z-phase pulse after a moving part has moved past the proximity dog. Deceleration starts from the front end of the proximity dog. After the rear end is passed, the position specified by the first Z-phase signal or the position of the first Z-phase signal shifted by the specified home position shift distance is used as the home position.
-2			Count type (Front end detection - Z-phase reference)	Performs homing using the encoder pulse count after a moving part came into contact with the proximity dog. Deceleration starts from the front end of the proximity dog. After the front end is passed, the position specified by the first Z-phase signal after the set distance or the position of the Z-phase signal shifted by the set home position shift distance is set as the home position.
-3	—	—	Data set type	Performs homing without a dog. The current position is set as the home position. Homing can be executed in the Operational enabled state. Homing cannot be executed in the servo-off status.

Setting	Homing direction *3		Homing methods	Description
	[Pr. PA14] = 0	[Pr. PA14] = 1		
-4	Forward rotation (CCW) or positive direction	Reverse rotation (CW) or negative direction	Stopper type (Stopper position reference)	Performs homing with a workpiece pressed against a mechanical stopper. A workpiece is pressed against a mechanical stopper, and the stop position is set as the home position.
-6			Dog type (Rear end detection - rear end reference)	Performs homing with reference to the rear end of the proximity dog. Deceleration starts from the front end of the proximity dog. After the rear end is passed, the position is shifted by the travel distance after proximity dog and the home position shift distance. The position after the shifts is set as the home position.
-7			Count type (Front end detection - front end reference)	Performs homing with reference to the front end of the proximity dog. Deceleration starts from the front end of the proximity dog. The position is shifted by the travel distance after the proximity dog and the home position shift distance. The position after the shifts is set as the home position.
-8			Dog cradle type	Performs homing using the first Z-phase pulse with reference to the front end of the proximity dog. The position specified by either the first Z-phase signal after the front end of the proximity dog is detected or the position of the first Z-phase signal shifted by the home position shift distance can be set as the home position.
-9			Dog type last Z-phase reference	Performs homing using the last Z-phase pulse with reference to the front end of the proximity dog. After the front end of the proximity dog is detected, the position is shifted away from the proximity dog in the reverse direction. Then, the position specified by the first Z-phase signal or the position of the first Z-phase signal shifted by the home position shift distance is used as the home position.
-10			Dog type front end reference	Performs homing with reference to the front end of the proximity dog in the direction of the front end. Starting from the front end of the proximity dog, the position is shifted by the travel distance after the proximity dog and the home position shift distance. The position after the shifts is set as the home position.
-11			Dogless Z-phase reference	Performs homing with reference to the first Z-phase in the direction of the dog front end. The position specified by the first Z-phase signal or the position of the first Z-phase signal shifted by the home position shift distance is used as the home position.

Setting	Homing direction *3		Homing methods	Description		
	[Pr. PA14] = 0	[Pr. PA14] = 1				
-33	Reverse rotation (CW) or negative direction	Forward rotation (CCW) or positive direction	Dog type (Rear end detection - Z-phase reference)	The same as the setting -1.		
-34			Count type (Front end detection - Z-phase reference)	The same as the setting -2.		
-36			Stopper type (Stopper position reference)	The same as the setting -4.		
-38			Dog type (Rear end detection - rear end reference)	The same as the setting -6.		
-39			Count type (Front end detection - front end reference)	The same as the setting -7.		
-40			Dog cradle type	The same as the setting -8.		
-41			Dog type last Z-phase reference	The same as the setting -9.		
-42			Dog type front end reference	The same as the setting-10.		
-43			Dogless Z-phase reference	The same as the setting -11.		
1 *1					Method 1 (Homing on negative limit switch and index pulse)	After the reverse rotation stroke end is detected, the position moves in the opposite direction. Then, the position specified by either the first Z-phase signal after leaving the stroke end or the position of the first Z-phase signal shifted by the home position shift distance can be set as the home position. If the position is shifted in the forward rotation direction, and the forward rotation stroke end is detected before the Z-phase signal is detected, [AL. 090 Homing incomplete warning] will occur. When FLS/RLS is used, this homing method is available on servo amplifiers with firmware version C0 or later.
2 *1			Forward rotation (CCW) or positive direction	Reverse rotation (CW) or negative direction	Method 2 (Homing on positive limit switch and index pulse)	After the forward rotation stroke end is detected, the position moves in the opposite direction. Then, the position specified by either the first Z-phase signal after leaving the stroke end or the position of the first Z-phase signal shifted by the home position shift distance can be set as the home position. If the position is shifted in the reverse rotation direction, and the reverse rotation stroke end is detected before the Z-phase signal is detected, [AL. 090 Homing incomplete warning] will occur. When FLS/RLS is used, this homing method is available on servo amplifiers with firmware version C0 or later.
3	Method 3 (Homing on positive home switch and index pulse)	This is the same as the dog type last Z-phase reference homing. If the stroke end is detected during homing, [AL. 090 Homing incomplete warning] will occur.				
4	Method 4 (Homing on positive home switch and index pulse)	This is the same as the dog cradle type homing. If the stroke end is detected during homing, [AL. 090 Homing incomplete warning] will occur.				
5	Reverse rotation (CW) or negative direction	Forward rotation (CCW) or positive direction	Method 5 (Homing on negative home switch and index pulse)	This is the same as the dog type last Z-phase reference homing. If the stroke end is detected during homing, [AL. 090 Homing incomplete warning] will occur.		
6			Method 6 (Homing on negative home switch and index pulse)	This is the same as the dog cradle type homing. If the stroke end is detected during homing, [AL. 090 Homing incomplete warning] will occur.		

Setting	Homing direction *3		Homing methods	Description
	[Pr. PA14] = 0	[Pr. PA14] = 1		
7	Forward rotation (CCW) or positive direction	Reverse rotation (CW) or negative direction	Method 7 (Homing on home switch and index pulse)	This is the same as the dog type last Z-phase reference homing.
8			Method 8 (Homing on home switch and index pulse)	This is the same as the dog cradle type homing.
9 *2			Method 9 (Homing on home switch and index pulse)	With reference to the rear end of the proximity dog, the home position is the Z-phase pulse immediately before the rear end of the dog. With this homing method, the position shifted by the home position shift distance is used as the home position.
10 *2			Method 10 (Homing on home switch and index pulse)	With reference to the rear end of the proximity dog, the home position is the Z-phase pulse immediately before the rear end of the dog. With this homing method, the position shifted by the home position shift distance is used as the home position.
11	Reverse rotation (CW) or negative direction	Forward rotation (CCW) or positive direction	Method 11 (Homing on home switch and index pulse)	This is the same as the dog type last Z-phase reference homing.
12			Method 12 (Homing on home switch and index pulse)	This is the same as the dog cradle type homing.
13 *2			Method 13 (Homing on home switch and index pulse)	The same as the setting 9.
14 *2			Method 14 (Homing on home switch and index pulse)	The same as the setting 10.
17 *2			Method 17 (Homing without index pulse)	After the reverse rotation stroke end is detected, the position is shifted away from the stroke end in the forward direction, where the home position is set. With this homing method, the position shifted by the home position shift distance is used as the home position. If the position is shifted in the forward rotation direction, and the forward rotation stroke end is detected, [AL. 090 Homing incomplete warning] will occur.
18 *2	Forward rotation (CCW) or positive direction	Reverse rotation (CW) or negative direction	Method 18 (Homing without index pulse)	After the forward rotation stroke end is detected, the position is shifted away from the stroke end in the reverse direction, where the home position is set. With this homing method, the position shifted by the home position shift distance is used as the home position. If the position is shifted in the reverse rotation direction, and the reverse rotation stroke end is detected, [AL. 090 Homing incomplete warning] will occur.
19			Method 19 (Homing without index pulse)	This is the same as the dog type front end reference homing. If the stroke end is detected during homing, [AL. 090 Homing incomplete warning] will occur.
20			Method 20 (Homing without index pulse)	Although this type is the same as the dog cradle type homing, the stop position is not on the Z-phase. Starting from the front end of the dog, the position is shifted by the travel distance after proximity dog and the home position shift distance. The position after the shifts is set as the home position. If the stroke end is detected during homing, [AL. 090 Homing incomplete warning] will occur.

Setting	Homing direction *3		Homing methods	Description
	[Pr. PA14] = 0	[Pr. PA14] = 1		
21	Reverse rotation (CW) or negative direction	Forward rotation (CCW) or positive direction	Method 21 (Homing without index pulse)	This is the same as the dog type front end reference homing. If the stroke end is detected during homing, [AL. 090 Homing incomplete warning] will occur.
22			Method 22 (Homing without index pulse)	Although this type is the same as the dog cradle type homing, the stop position is not on the Z-phase. Starting from the front end of the dog, the position is shifted by the travel distance after proximity dog and the home position shift distance. The position after the shifts is set as the home position. If the stroke end is detected during homing, [AL. 090 Homing incomplete warning] will occur.
23	Forward rotation (CCW) or positive direction	Reverse rotation (CW) or negative direction	Method 23 (Homing without index pulse)	This is the same as the dog type front end reference homing.
24			Method 24 (Homing without index pulse)	Although this type is the same as the dog cradle type homing, the stop position is not on the Z-phase. Starting from the front end of the dog, the position is shifted by the travel distance after proximity dog and the home position shift distance. The position after the shifts is set as the home position.
27	Reverse rotation (CW) or negative direction	Forward rotation (CCW) or positive direction	Method 27 (Homing without index pulse)	This is the same as the dog type front end reference homing.
28			Method 28 (Homing without index pulse)	Although this type is the same as the dog cradle type homing, the stop position is not on the Z-phase. Starting from the front end of the dog, the position is shifted by the travel distance after proximity dog and the home position shift distance. The position after the shifts is set as the home position.
33			Method 33 (Homing on index pulse)	Although this type is the same as the dogless Z-phase reference homing, the creep speed is applied as the movement start speed.
34	Forward rotation (CCW) or positive direction	Reverse rotation (CW) or negative direction	Method 34 (Homing on index pulse)	Although this type is the same as the dogless Z-phase reference homing, the creep speed is applied as the movement start speed.
35	—	—	Method 35 (Homing on current position)	The current position is set as the home position. Homing can be executed even when the servo amplifier is not in the Operational enabled state. Homing can be executed in the servo-off status as well.
37			Method 37 (Homing on current position)	The current position is set as the home position. Homing can be executed even when the servo amplifier is not in the Operational enabled state. Homing can be executed in the servo-off status as well.

*1 Available on servo amplifiers with firmware version B2 or later.

*2 Available on servo amplifiers with firmware version C0 or later.

*3 When "1" is set in [Pr. PT55.1 Homing POL reflection selection] for servo amplifiers with firmware version D4 or later, the setting value of [Pr. PA14 Travel direction selection (*POL)] is reflected at homing.

[Pr. PT49_Speed acceleration time constant (STA)]

Initial value	Setting range	Ver.
0 [ms]	0 to 50000	B2

Set the acceleration time taken by the motor to reach the rated speed from a full stop for the command.

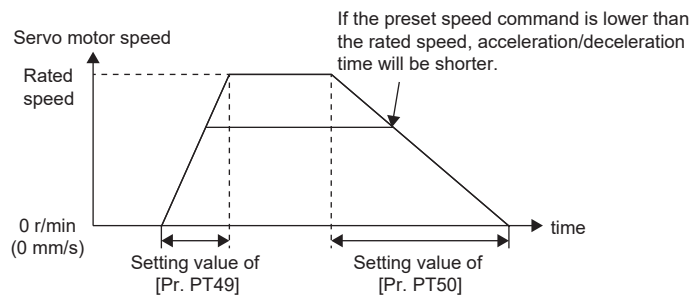

For example, for a servo motor with a rated speed of 3000 [r/min], set 3000 [ms] to accelerate from 0 [r/min] to 1000 [r/min] in 1000 [ms].

This function corresponds to [Profile acceleration (Obj. 6083h)].

When an object is mapped in cyclic communication, the controller overwrites the value written with engineering software.

Thus, do not write a value with engineering software.

This function is enabled when [Pr. PT01.1 Speed/acceleration/deceleration unit selection] is set to "0". This function and [Pr. PV05 Profile acceleration] are mutually exclusive.

When "1" is set in [Pr. PT01.1] in the point table mode (pt), the servo motor accelerates in accordance with the setting value of this servo parameter if "0" is set in the acceleration ([Acceleration (Obj. 2801h to 28FFh: 03h)]).

- Profile mode

This function is enabled in the profile position mode and profile velocity mode.

If a value larger than 20000 [ms] is set in the position mode, [AL. 0F4 Positioning warning] occurs.

- Positioning mode (point table method)

This function is enabled in the JOG operation mode.

If a value larger than 20000 [ms] is set in the JOG operation mode, [AL. 0F4 Positioning warning] occurs.

[Pr. PT50_Speed deceleration time constant (STB)]

Initial value	Setting range	Ver.
0 [ms]	0 to 50000	B2

Set the deceleration time from the rated speed to a motor stop for the command.

This function corresponds to [Profile deceleration (Obj. 6084h)].

When an object is mapped in cyclic communication, the controller overwrites the value written with engineering software.

Thus, do not write a value with engineering software.

This function is enabled when [Pr. PT01.1 Speed/acceleration/deceleration unit selection] is set to "0". This function and [Pr. PV07 Profile deceleration] are mutually exclusive.

When "1" is set in [Pr. PT01.1] in the point table mode (pt), the servo motor decelerates in accordance with the setting value of this servo parameter if "0" is set in the deceleration ([Deceleration (Obj. 2801h to 28FFh: 04h)]).

- Profile mode

This function is enabled in the profile position mode and profile velocity mode.

If a value larger than 20000 [ms] is set in the position mode, [AL. 0F4 Positioning warning] occurs.

- Positioning mode (point table method)

This function is enabled in the JOG operation mode.

If a value larger than 20000 [ms] is set in the JOG operation mode, [AL. 0F4 Positioning warning] occurs.

[Pr. PT51_S-pattern acceleration/deceleration time constants (STC)]

Initial value	Setting range	Ver.
0 [ms]	0 to 5000	B2

Set the time of the arc part for S-pattern acceleration/deceleration time constants.

This setting enables smooth start/stop of the servo motor.

When "0" is set, linear acceleration/deceleration is performed.

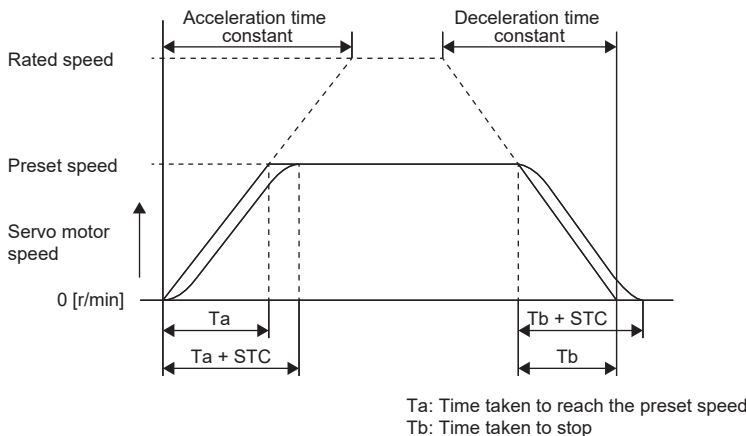

This function is enabled in the profile position mode, profile velocity mode, and positioning mode (point table method).

This function is disabled during homing.

In the profile velocity mode, if a long acceleration or deceleration time is set, a timing error may occur on the arc part against the setting of the S-pattern acceleration deceleration time constants.

The upper limit of the actual time for the arc part is limited to 2000000/acceleration time during acceleration and 2000000/deceleration time during deceleration.

Ex.

At the setting of STA ([Pr. PT49 Speed acceleration time constant]) = 20000, STB ([Pr. PT50 Speed deceleration time constant]) = 5000, and STC = 200, the actual time for the arc part is as follows.

During acceleration: 100 [ms]

$$2000000/20000 = 100 \text{ [ms]} < 200 \text{ [ms]}$$

Therefore, the time is limited to 100 [ms].

During deceleration: 200 [ms]

$$2000000/5000 = 400 \text{ [ms]} > 200 \text{ [ms]}$$

Therefore, it will be 200 [ms] as set.

- Profile position mode and positioning mode (point table method)

If a value of 1000 [ms] or more is set, the value is clamped to 1000 [ms].

The setting is enabled at the next operation start.

[Pr. PT53_Torque slope (TQS)]

Initial value		Setting range	Ver.
TSN	ECT		
0.0 [%/s]	100.0 [%/s]	0.0 to 1000000.0	B2

Set the rate of change in the torque command per second.

When "0.0" is set, the torque slope is disabled.

This function is enabled in the profile torque mode.

This function corresponds to [Torque slope (Obj. 6087h)].

When an object is mapped in cyclic communication, the controller overwrites the value written with engineering software.

Thus, do not write a value with engineering software.

[Pr. PT55_Function selection T-10 (*TOP10)]

Initial value	Setting range	Ver.
00000000h	Refer to the relevant detail No.	Refer to the relevant detail No.

[Pr. PT55.0_Homing deceleration time constant selection]

Initial value	Setting range	Ver.
0h	Refer to the text	A4

Set a value to be used for the acceleration time constant and deceleration time constant at homing.

Setting value	Acceleration time constant	Deceleration time constant
0	[Pr. PT56 Homing acceleration time constant] or [Pr. PV15 Homing acceleration]	
1	[Pr. PT56 Homing acceleration time constant] or [Pr. PV15 Homing acceleration]	[Pr. PT57 Homing deceleration time constant] or [Pr. PV17 Homing deceleration]

[Pr. PT55.1_Homing POL reflection selection]

Initial value	Setting range	Ver.
0h	Refer to the text	D4

When the setting value of this servo parameter is "1" (enabled) and the setting value of [Pr. PA14 Travel direction selection] is "1", the homing direction changes. For details of the homing direction, refer to "Homing mode (hm)" in the MR-JET User's Manual (Function).

0: Disabled

1: Enabled

[Pr. PT56_Homing acceleration time constant (HMA)]

Initial value	Setting range	Ver.
0 [ms]	0 to 20000	A4

Set the acceleration time constant for the homing.

Set the acceleration time taken for the motor to reach the rated speed from a full stop.

When [Pr. PT55.0 Homing deceleration time constant selection] is set to "0", this servo parameter is used as the deceleration time constant at homing.

This function corresponds to [Homing acceleration (Obj. 609Ah)].

When an object is mapped in cyclic communication, the controller overwrites the value written with engineering software.

Thus, do not write a value with engineering software.

This function is enabled when [Pr. PT01.1 Speed/acceleration/deceleration unit selection] is set to "0".

[Pr. PT57_Homing deceleration time constant (HMB)]

Initial value	Setting range	Ver.
0 [ms]	0 to 20000	A4

Set the deceleration time constant at homing.

Set the deceleration time from the rated speed to a motor stop.

This servo parameter is enabled when [Pr. PT55.0 Homing deceleration time constant selection] is set to "1".

This function is enabled when [Pr. PT01.1 Speed/acceleration/deceleration unit selection] is set to "0". This function and [Pr. PV17 Homing deceleration] are mutually exclusive.

[Pr. PT65_Profile speed command (PVC)]

Initial value	Setting range	Ver.
100.00 [r/min], [mm/s]	0.00 to 21474836.47	B2

This function is enabled in the profile position mode and positioning mode (point table method).

This function corresponds to [Profile velocity (Obj. 6081h)].

When an object is mapped in cyclic communication, the controller overwrites the value written with engineering software.

Thus, do not write a value with engineering software.

This function is enabled when [Pr. PT01.1 Speed/acceleration/deceleration unit selection] is set to "0". This function and [Pr. PV01 Profile speed command extension setting] are mutually exclusive.

- Profile mode

Set the profile speed command.

If the set speed exceeds 8000 r/min (mm/s), the speed is clamped at 8000 r/min (mm/s).

However, the set speed is clamped when [Pr. PT02.7 Internal position command - Process speed selection] is set to "0" (standard).

- Positioning mode (point table method)

Set the JOG speed command.

[Pr. PT66_Maximum profile speed (MPVC)]

Initial value	Setting range	Ver.
20000.00 [r/min], [mm/s]	0.00 to 20000.00	B2

Set the maximum profile speed.

This function is enabled in the profile position mode and profile velocity mode.

This function corresponds to [Max profile velocity (Obj. 607Fh)].

When an object is mapped in cyclic communication, the controller overwrites the value written with engineering software.

Thus, do not write a value with engineering software.

This function is enabled when [Pr. PT01.1 Speed/acceleration/deceleration unit selection] is set to "0". This function and [Pr. PV03 Maximum profile speed extension setting] are mutually exclusive.

[Pr. PT67_Speed limit (VLMT)]

Initial value	Setting range	Ver.
3000.00 [r/min], [mm/s]	0.00 to 21474836.47	A4

Set the maximum speed in the torque control.

This function is enabled in the cyclic synchronous torque mode, the profile torque mode, and the continuous operation to torque control mode.

This function corresponds to [Velocity limit value (Obj. 2D20h)].

When an object is mapped in cyclic communication, the controller overwrites the value written with engineering software.

Thus, do not write a value with engineering software.

The speed is 3000 r/min in the initial setting. Change the setting value according to the intended use.

This function is enabled when [Pr. PT01.1 Speed/acceleration/deceleration unit selection] is set to "0". This function and [Pr. PV21 Speed limit extension setting] are mutually exclusive.

[Pr. PT68_Function selection T-11 (TOP11)]

Initial value	Setting range	Ver.
00000002h	Refer to the relevant detail No.	Refer to the relevant detail No.

[Pr. PT68.0_Quick stop method selection]

Initial value	Setting range	Ver.
2h	Refer to the text	A4

Select the quick stop method.

Forced stop deceleration by turning off EM2 (Forced stop 2) is the same as "2" regardless of the setting value of this servo parameter.

When [Pr. PA04.3 Forced stop deceleration function selection] is set to "0" (forced stop deceleration function disabled), the servo motor stops with the dynamic brake regardless of the setting value of this servo parameter.

This function corresponds to [Quick stop option code (Obj. 605Ah)].

When an object is mapped in cyclic communication, the controller overwrites the value written with engineering software.

Thus, do not write a value with engineering software.

Setting value	Description
0 *1	Stop with dynamic brake
1 *1*3	Servo-off after deceleration to a stop at the deceleration time constant of any of the control modes
2	Servo-off after deceleration to a stop with [Quick stop deceleration (Obj. 6085h)]
5 *1*2*3*4*5	Maintain servo-on after deceleration to a stop at the deceleration time constant of any of the control modes
6 *1*2*4*5	Maintain servo-on after deceleration to a stop with [Quick stop deceleration (Obj. 6085h)]

*1 Available on servo amplifiers with firmware version D0 or later.

*2 Not available for CC-Link IE Field Network Basic.

*3 For the deceleration time constants of the control modes, refer to "[Quick stop option code (Obj.605Ah)]" in the User's Manual (Object Dictionary).

*4 When the controller being used cannot perform follow-up in the "Quick stop active" state (during servo-on), do not use this setting value in the cyclic synchronous position mode (csp). For information on whether the controller being used can perform follow-up in the "Quick stop active" state, refer to the manual for the controller.

*5 When canceling Quick stop in the cyclic synchronous position mode (csp), cancel it after servo-off or perform position follow-up with the controller. If Quick stop is canceled without performing position follow-up, the servo motor may suddenly accelerate.

[Pr. PT68.2_Temporary stop method selection]

Initial value	Setting range	Ver.
0h	Refer to the text	A4

Select a temporary stop method.

0: Automatic selection (deceleration to a stop method)

1: Deceleration to a stop method

This function corresponds to [Halt option code (Obj. 605Dh)].

When an object is mapped in cyclic communication, the controller overwrites the value written with engineering software.

Thus, do not write a value with engineering software.

[Pr. PT83_Positioning function selection (*MOTOP)]

Initial value	Setting range	Ver.
00000000h	Refer to the relevant detail No.	Refer to the relevant detail No.

[Pr. PT83.2_Positioning function selection 2]

Initial value	Setting range	Ver.
0h	Refer to the text	D4

Select the positioning function.

Setting digit (BIN)	Functions
___x	M code update setting 0: After the remaining travel distance is cleared, the M code is updated. 1: After the remaining travel distance is cleared, the M code is not updated. Refer to "POSITIONING MODE (POINT TABLE METHOD) (CP)" in the MR-JET User's Manual (Function).
__x_	For manufacturer setting
_x__	For manufacturer setting
x___	For manufacturer setting

[Pr. PT85_Function selection T-14 (*TOP14)]

When the command interface of the servo amplifier is CC-Link IE TSN, this servo parameter is not available.

Initial value	Setting range	Ver.
00000000h	Refer to the relevant detail No.	Refer to the relevant detail No.

[Pr. PT85.0_Infinite feed function selection]

Initial value	Setting range	Ver.
0h	Refer to the text	D0

Enable or disable the infinite feed function.

0:Disabled

1:Enabled

When [Pr. PT85.0] is changed while the absolute position detection system is enabled, perform homing again. If homing is not performed, [AL. 090.5 Homing incomplete warning] occurs at the start of an operation.

1.10 Network setting servo parameters group ([Pr. PN_ _])

[Pr. PN02_Communication error - Detection time (CERT)]

When the command interface of the servo amplifier is EtherCAT, this servo parameter is not available.

Initial value	Setting range	Ver.
0 [ms]	0 to 1000	A4

- For CC-Link IE TSN Class B

Set the threshold until network disconnecting and [AL. 086.2 Network communication error 2] are detected.

The maximum setting range is 1000 ms.

When "0" is set, the detection time is 10 ms.

- For CC-Link IE TSN Class A

Set the threshold until network disconnecting is detected.

When "0" is set, the detection time is 1000 ms.

Ex.

When "1000" is set, the set value becomes 1000 ms.

When [Pr. PD41.2 Limit switch enabled status selection] is set to "1" and [Pr. PD41.3 Sensor input method selection] is set to "1", setting a large value in this parameter prevents the limit switch from working at an occurrence of a communication error, which may result in a collision.

This servo parameter does not guarantee the time until network disconnecting. If an error such as an alive error occurs, network disconnecting may be executed before the time that is set in this servo parameter.

- For CC-Link IE Field Network Basic

Set the threshold until [AL. 086.1 Network communication error 1] is detected.

When "0" is set, the detection time is 1000 ms.

[Pr. PN03_Communication mode setting (**NWMD)]

Initial value	Setting range	Ver.
00000000h	Refer to the relevant detail No.	Refer to the relevant detail No.

[Pr. PN03.1_Network protocol setting]

Initial value	Setting range	Ver.
0h	Refer to the text	D0

Select a CC-Link IE TSN Class.

0: Class B ver. 1.0/2.0

1: Class A ver. 2.0

[Pr. PN03.3_Object attribute selection]

When the command interface of the servo amplifier is CC-Link IE TSN, this servo parameter is not available.

Initial value	Setting range	Ver.
0h	Refer to the text	D4

Select the attribute of the object.

0:Object attribute selection 1

1:Object attribute selection 2

For servo amplifiers with firmware version D4 or later, the PDO Mapping attribute of the following objects has been changed. To use the PDO Mapping attribute before the change, set "1" in this servo parameter.

Index	Sub Index	Object name	Setting value	
			0 (Object attribute selection 1) (after the change)	1 (Object attribute selection 2) (before the change)
6072h	00h	Max Torque	RxPDO	TxPDO/RxPDO
607Ch	00h	Home Offset	RxPDO	TxPDO
6080h	00h	Max motor speed	RxPDO	TxPDO
608Fh	01h	Encoder increments	RxPDO	TxPDO
608Fh	02h	Motor revolutions	RxPDO	TxPDO

When an ESI file is required for setting this parameter to "1" (Object attribute selection 2), contact your local sales office.

[Pr. PN05_Communication error - Detection frequency setting (CERI)]

When the command interface of the servo amplifier is EtherCAT, this servo parameter is not available.

Initial value	Setting range	Ver.
0 [%]	0 to 100	A4

Set the frequency until [AL. 086.5 Network communication error 5] and [AL. 086.6 Network communication error 6] are detected.

The maximum setting range is 100 %.

When "0" is set, the frequency is 8 %.

[Pr. PN06_Function selection N-1 (NOP1)]

Initial value	Setting range	Ver.
00000000h	00000000h to 01111000h	Refer to the relevant detail No.

[Pr. PN06.6_Communication error - Alarm detection setting]

When the command interface of the servo amplifier is EtherCAT, this servo parameter is not available.

Initial value	Setting range	Ver.
0h	0h to 1h	E4

The detection of [AL. 086.1 Network communication error 1] in CC-Link IE TSN can be enabled or disabled.

0:Detection of [AL. 086.1 Network communication error 1] is disabled.

1:Detection of [AL. 086.1 Network communication error 1] is enabled.

When the detection is enabled, disconnecting the communication triggers [AL. 086.1 Network communication error 1]. By setting a state other than OP in "NMT State Download" before the disconnection, the communication can be disconnected without detecting the alarm.

[Pr. PN07_Communication cycle initial setting (**CCS)]

When the command interface of the servo amplifier is CC-Link IE TSN, this servo parameter is not available.

Initial value	Setting range	Ver.
00000000h	Refer to the text	B6

The initial value of the communication cycle in the PDO communication can be set.

Use this servo parameter when [Cycle Time (Obj. 1C32h: 02h)] and [Cycle Time (Obj. 1C33h: 02h)] are not to be set with the master controller (asynchronous mode). This servo parameter setting is not required for master controllers that can change the communication cycle with the objects in the asynchronous mode.

The setting value of this servo parameter will be set in [Cycle Time (Obj. 1C32h: 02h)] and [Cycle Time (Obj. 1C33h: 02h)] as the initial value. Once this servo parameter is set to "0", the objects will be set to "250000 ns (250 μs)". Setting an unsupported communication cycle triggers [AL. 037 Parameter error].

Setting value	Communication cycle
00	Automatic (250 μs)
04	125 μs
05	250 μs
06	500 μs
07	1 ms
08	2 ms
09	4 ms
0A	8 ms

[Pr. PN13_Network protocol setting (**NPS)]

When the command interface of the servo amplifier is EtherCAT, this servo parameter is not available.

Initial value	Setting range	Ver.
00000000h	Refer to the relevant detail No.	Refer to the relevant detail No.

[Pr. PN13.0-3_Network protocol setting]

Initial value	Setting range	Ver.
0000h	Refer to the text	C0

Set the network to be used.

Setting a value other than the following triggers [AL. 037 Parameter error].

Setting value of [Pr. PN13.0-3]	Setting details
0000h	CC-Link IE TSN
0004h	CC-Link IE Field Network Basic

[Pr. PN18_Counter level for communication error detection (CERN)]

When the command interface of the servo amplifier is CC-Link IE TSN, this servo parameter is not available.

Initial value	Setting range	Ver.
9	0 to 32767	A4

Set the threshold until [AL. 086.1 Network receive data error (Network communication error 1)] is detected.

When "0" is set, this parameter is disabled.

If the PDO data is not updated with Sync0, the internal error counter will be added by 3 at a time.

When the PDO data is updated properly, the internal error counter is subtracted by 1.

Refer to the following for the example of the counter.

Receive (SM2) Event	1	0	1	0	1	0	1	0	1	0	1
Internal Error Counter (Setting value = 9)	0	3	2	5	4	7	6	9 (error)	9	9	9

This servo parameter corresponds to [Sync Error Counter Limit (Obj. 10F1h: 02h)].

If detection of [AL. 086.1] is disabled, the servo motor cannot be stopped at occurrence of a communication error. In addition, setting a larger value as the setting value increases the time it takes to stop the servo motor when there is a communication error. Be careful when changing the setting value as there is a danger of collision.

[Pr. PN19_Function selection N-4 (**NOP4)]

When the command interface of the servo amplifier is EtherCAT, this servo parameter is not available.

Initial value	Setting range	Ver.
00000000h	Refer to the relevant detail No.	Refer to the relevant detail No.

[Pr. PN19.1_Parameter automatic setting - Forced transmission mode setting]

Initial value	Setting range	Ver.
0h	Refer to the text	E0

This servo parameter can be used only with CC- Link IE TSN.

If this servo parameter is set to "1" (enabled), servo parameters are transmitted when the servo amplifier is connected to a controller whose parameter automatic setting is enabled.

If this servo parameter is set to "1" (enabled), the time until the communication state of the servo amplifier transitions to Pre-Operational depends on the number of axes whose automatic parameter setting is enabled.

0: Disabled

1: Enabled

[Pr. PN20_Parameter automatic backup update interval (**PABI)]

When the command interface of the servo amplifier is EtherCAT, this servo parameter is not available.

Initial value	Setting range	Ver.
0 [h]	0 to 1000	A4

This servo parameter can be used only with CC-Link IE TSN.

Set the backup interval for a parameter automatic backup to be performed when the specified time passes on an hourly basis.

When the value is set to "0", a parameter automatic backup when the specified time passes is not performed.

When the set backup time is reached while the servo amplifier is not connected to a controller, and the power of the servo amplifier is cycled, even if a connection is established with the controller, backup operation is not immediately performed.

There is a limit to the number of times to write to the data memory of the controller. When the number of connected axes is large and when backup operation is performed at short intervals, the maximum memory writing frequency of the controller may be reached earlier than the operating life.

Therefore, be careful about the frequency of writing when performing a backup.

You can check the frequency of writing so far with the special register in the CPU module.

For details, refer to the CPU module user's manual.

The estimated write interval per number of connected axes is as follows.

1 to 16 axes: Once every hour

17 to 32 axes: Once every two hours

33 to 64 axes: Once every four hours

65 or more axes: Once every six hours

Ex.

When "2" is set for the setting value of this servo parameter

After the power is turned on, whether there is any difference between the previously delivered servo parameter and the current servo parameter is checked every two hours. When there is a difference, backup operation is performed.

[Pr. PN22_Function selection N-5 (**NOP5)]

When the command interface of the servo amplifier is EtherCAT, this servo parameter is not available.

Initial value	Setting range	Ver.
00000000h	Refer to the relevant detail No.	Refer to the relevant detail No.

[Pr. PN22.0_Default mapping mode selection]

Initial value	Setting range	Ver.
0h	Refer to the text	C0

This servo parameter can be used only with CC-Link IE Field Network Basic.

Select a default mapping mode to be used with CC-Link IE Field Network Basic.

0: Mode 1

1: Mode 2

2: Mode 3

The setting value "2" can be set on servo amplifiers with firmware version D4 or later.

[Pr. PN33_Device Warning Mask (DWM)]

When the command interface of the servo amplifier is CC-Link IE TSN, this servo parameter is not available.

Initial value	Setting range	Ver.
FFFFFFFFh	00000000h to FFFFFFFFh	D4

Set the mask values in [Active Device Warning Details (Obj. F381h)] and [Latched Device Warning Details (Obj. F391h)].

This servo parameter corresponds to [Device Warning Mask (Obj. F3A1h)].

For details of the mask values, refer to "[Device Warning Mask (Obj. F3A1h)]" in the following manual.

 MR-JET-G-N1 User's Manual (Object Dictionary)

[Pr. PN34_Device Error Mask (DEM)]

When the command interface of the servo amplifier is CC-Link IE TSN, this servo parameter is not available.

Initial value	Setting range	Ver.
FFFFFFFFh	00000000h to FFFFFFFFh	D4

Set the mask values in [Active Device Error Details (Obj. F383h)] and [Latched Device Error Details (Obj. F393h)].

This servo parameter corresponds to [Device Error Mask (Obj. F3A3h)].

For details of the mask values, refer to "[Device Error Mask (Obj. F3A3h)]" in the following manual.

 MR-JET-G-N1 User's Manual (Object Dictionary)

1.11 Positioning extension setting servo parameters group ([Pr. PV_ _])

[Pr. PV01_Profile speed command extension setting (PVC2)]

Initial value	Setting range	Ver.
0 [Refer to the text below for the unit.]	0 to 4294967295	B2

Set the speed command used in the profile position mode (pp) and JOG operation mode (jg).

The unit can be changed to 0.001 mm/s, 0.0001 inch/s, 0.001 degree/s, or pulse/s with [Pr. PT01.2 Unit for position data].

☞ Page 120 [Pr. PT01.2_Unit for position data]

This function is enabled when [Pr. PT01.1 Speed/acceleration/deceleration unit selection] is set to "1". This function and [Pr. PT65 Profile speed command] are mutually exclusive.

The setting value will be clamped at the maximum speed. When changing the speed to the permissible speed, set the speed in [Pr. PA28.4 Speed range limit selection].

This function corresponds to [Profile velocity (Obj. 6081h)].

When an object is mapped in cyclic communication, the controller overwrites the value written with engineering software.

Thus, do not write a value with engineering software.

[Pr. PV03_Maximum profile speed extension setting (MPVCE)]

Initial value	Setting range	Ver.
2147483647 [Refer to the text below for the unit.]	0 to 4294967295	B2

Set the speed limit value of the profile position mode (pp), profile velocity mode (pv), and JOG operation mode (jg).

The unit can be changed to 0.001 mm/s, 0.0001 inch/s, 0.001 degree/s, or pulse/s with [Pr. PT01.2 Unit for position data].

☞ Page 120 [Pr. PT01.2_Unit for position data]

This function is enabled when [Pr. PT01.1 Speed/acceleration/deceleration unit selection] is set to "1". This function and [Pr. PT66 Maximum profile speed] are mutually exclusive.

This function corresponds to [Max profile velocity (Obj. 607Fh)].

When an object is mapped in cyclic communication, the controller overwrites the value written with engineering software.

Thus, do not write a value with engineering software.

[Pr. PV05_Profile acceleration (PACC)]

Initial value	Setting range	Ver.
0 [Refer to the text below for the unit.]	0 to 4294967295	B2

Set the acceleration used in the profile position mode (pp), profile velocity mode (pv), and JOG operation mode (jg).

The unit can be changed to 0.001 mm/s², 0.0001 inch/s², or 0.001 degree/s² or pulse/s² with [Pr. PT01.2 Unit for position data].

☞ Page 120 [Pr. PT01.2_Unit for position data]

When the setting value of this servo parameter is "0", the servo motor accelerates in accordance with the time constant set in [Pr. PT49 Speed acceleration time constant].

This function is enabled when [Pr. PT01.1 Speed/acceleration/deceleration unit selection] is set to "1". This function and [Pr. PT49] are mutually exclusive.

This function corresponds to [Profile acceleration (Obj. 6083h)].

When an object is mapped in cyclic communication, the controller overwrites the value written with engineering software.

Thus, do not write a value with engineering software.

[Pr. PV07_Profile deceleration (PDEC)]

Initial value	Setting range	Ver.
0 [Refer to the text below for the unit.]	0 to 4294967295	B2

Set the deceleration used in the profile position mode (pp), profile velocity mode (pv), and JOG operation mode (jg). The unit can be changed to 0.001 mm/s², 0.0001 inch/s², or 0.001 degree/s² or pulse/s² with [Pr. PT01.2 Unit for position data].

☞ Page 120 [Pr. PT01.2_Unit for position data]

When the setting value of this servo parameter is "0", the servo motor decelerates in accordance with the time constant set in [Pr. PT50 Speed deceleration time constant].

This function is enabled when [Pr. PT01.1] is set to "1". This function and [Pr. PT50] are mutually exclusive.

This function corresponds to [Profile deceleration (Obj. 6084h)].

When an object is mapped in cyclic communication, the controller overwrites the value written with engineering software.

Thus, do not write a value with engineering software.

[Pr. PV09_Deceleration at forced stop (RSBDEC)]

Initial value	Setting range	Ver.
0 [Refer to the text below for the unit.]	0 to 4294967295	A4

Set the deceleration to be used for the forced stop deceleration function.

The unit can be changed to 0.001 mm/s², 0.0001 inch/s², or 0.001 degree/s² or pulse/s² with [Pr. PT01.2 Unit for position data].

☞ Page 120 [Pr. PT01.2_Unit for position data]

When the setting value of this servo parameter is "0", the servo motor decelerates in accordance with the time constant set in [Pr. PC24 Deceleration time constant at forced stop].

This function is enabled when [Pr. PT01.1 Speed/acceleration/deceleration unit selection] is set to "1". This function and [Pr. PC24] are mutually exclusive.

This function corresponds to [Quick stop deceleration (Obj. 6085h)].

When an object is mapped in cyclic communication, the controller overwrites the value written with engineering software.

Thus, do not write a value with engineering software.

[Pr. PV11_Homing speed extension setting (ZRFE)]

Initial value	Setting range	Ver.
500000 [Refer to the text below for the unit.]	0 to 4294967295	A4

Set the servo motor speed for homing.

The unit can be changed to 0.001 mm/s, 0.0001 inch/s, 0.001 degree/s, or pulse/s with [Pr. PT01.2 Unit for position data].

☞ Page 120 [Pr. PT01.2_Unit for position data]

This function is enabled when [Pr. PT01.1 Speed/acceleration/deceleration unit selection] is set to "1". This function and [Pr. PT05 Homing speed] are mutually exclusive.

The setting value will be clamped at the maximum speed. When changing the speed to the permissible speed, set the speed in [Pr. PA28.4 Speed range limit selection].

This function corresponds to [Speed during search for switch (Obj. 6099h: 01h)].

When an object is mapped in cyclic communication, the controller overwrites the value written with engineering software.

Thus, do not write a value with engineering software.

[Pr. PV13_Creep speed extension setting (CRFE)]

Initial value	Setting range	Ver.
100000 [Refer to the text below for the unit.]	0 to 4294967295	A4

When performing a homing, set the servo motor speed after proximity dog.

The unit can be changed to 0.001 mm/s, 0.0001 inch/s, 0.001 degree/s, or pulse/s with [Pr. PT01.2 Unit for position data].

 Page 120 [Pr. PT01.2_Unit for position data]

This function is enabled when [Pr. PT01.1 Speed/acceleration/deceleration unit selection] is set to "1". This function and [Pr. PT06 Creep speed] are mutually exclusive.

The setting value will be clamped at the maximum speed. When changing the speed to the permissible speed, set the speed in [Pr. PA28.4 Speed range limit selection].

This function corresponds to [Speed during search for zero (Obj. 6099h: 02h)].

When an object is mapped in cyclic communication, the controller overwrites the value written with engineering software.

Thus, do not write a value with engineering software.

[Pr. PV15_Homing acceleration (HMACC)]

Initial value	Setting range	Ver.
0 [Refer to the text below for the unit.]	0 to 4294967295	A4

Set the acceleration for homing.

The unit can be changed to 0.001 mm/s², 0.0001 inch/s², or 0.001 degree/s² or pulse/s² with [Pr. PT01.2 Unit for position data].

 Page 120 [Pr. PT01.2_Unit for position data]

When the setting value of this servo parameter is "0", the servo motor accelerates in accordance with the time constant set in [Pr. PT56 Homing acceleration time constant].

This function is enabled when [Pr. PT01.1 Speed/acceleration/deceleration unit selection] is set to "1". This function and [Pr. PT56] are mutually exclusive.

When [Pr. PT55.0 Homing deceleration time constant selection] is set to "0", this function is used as the deceleration for homing.

This function corresponds to [Homing acceleration (Obj. 609Ah)].

When an object is mapped in cyclic communication, the controller overwrites the value written with engineering software.

Thus, do not write a value with engineering software.

[Pr. PV17_Homing deceleration (HMDEC)]

Initial value	Setting range	Ver.
0 [Refer to the text below for the unit.]	0 to 4294967295	A4

Set the deceleration for homing.

The unit can be changed to 0.001 mm/s², 0.0001 inch/s², or 0.001 degree/s² or pulse/s² with [Pr. PT01.2 Unit for position data].

 Page 120 [Pr. PT01.2_Unit for position data]

When the setting value of this servo parameter is "0", the servo motor decelerates in accordance with the time constant set in [Pr. PT57 Homing deceleration time constant].

This function is enabled when [Pr. PT01.1 Speed/acceleration/deceleration unit selection] is set to "1". This function and [Pr. PT57] are mutually exclusive.

When "1" is selected for [Pr. PT55.0 Homing deceleration time constant selection], set the deceleration for homing. Selecting "0" in [Pr. PT55.0] will disable the setting value.

[Pr. PV19_Speed reached 2 - Output range - Extension setting (SA2RE)]

Initial value	Setting range	Ver.
20000 [Refer to the text below for the unit.]	0 to 65535	B2

Set the speed range in which the speed reached 2 turns on in the profile velocity mode (pv).

If the state where the error between the command speed and the servo motor speed is within the setting value of this servo parameter continues for the time set in [Pr. PC73 Speed reached 2 - Output filtering time] or longer, bit 10 (Target velocity reached) of [Statusword (Obj. 6041h)] turns on.

The unit can be changed to 0.001 degrees/s or pulses/s with [Pr. PT01.2 Unit for position data].

☞ Page 120 [Pr. PT01.2_Unit for position data]

This function is enabled when [Pr. PT01.1 Speed/acceleration/deceleration unit selection] is set to "1". This function and [Pr. PC72 Speed reached 2 - Output range] are mutually exclusive.

This function corresponds to [Velocity window (Obj. 606Dh)].

When an object is mapped in cyclic communication, the controller overwrites the value written with engineering software.

Thus, do not write a value with engineering software.

[Pr. PV20_Zero speed 2 level extension setting (ZSP2LE)]

Initial value	Setting range	Ver.
20 [Refer to the text below for the unit.]	0 to 65535	B2

Set the speed level at which the zero speed 2 turns on in the profile velocity mode (pv).

If the state where the absolute value of the servo motor speed exceeds the setting value of this servo parameter continues for the time set in [Pr. PC66 Zero speed 2 filtering time] or longer, bit 12 (Speed) of [Statusword (Obj. 6041h)] turns off.

The unit can be changed to 0.001 degrees/s or pulses/s with [Pr. PT01.2 Unit for position data].

☞ Page 120 [Pr. PT01.2_Unit for position data]

This function is enabled when [Pr. PT01.1 Speed/acceleration/deceleration unit selection] is set to "1". This function and [Pr. PC65 Zero speed 2 level] are mutually exclusive.

This function corresponds to [Velocity threshold (Obj. 606Fh)].

When an object is mapped in cyclic communication, the controller overwrites the value written with engineering software.

Thus, do not write a value with engineering software.

[Pr. PV21_Speed limit extension setting (VLMTE)]

Initial value	Setting range	Ver.
2147483647 [Refer to the text below for the unit.]	0 to 4294967295	A4

Set the speed limit value of the cyclic synchronous torque mode (cst), the profile torque mode (tq), and the continuous operation to torque control mode (ct).

The unit can be changed to 0.001 degrees/s or pulses/s with [Pr. PT01.2 Unit for position data].

☞ Page 120 [Pr. PT01.2_Unit for position data]

This function is enabled when [Pr. PT01.1 Speed/acceleration/deceleration unit selection] is set to "1". This function and [Pr. PV67 Speed limit] are mutually exclusive.

This function corresponds to [Velocity limit value (Obj. 2D20h)].

When an object is mapped in cyclic communication, the controller overwrites the value written with engineering software.

Thus, do not write a value with engineering software.

[Pr. PV23_Speed unit conversion - Electronic gear numerator (*VCMX)]

Initial value	Setting range	Ver.
1	1 to 1024	A4

Set the electric gear numerator for converting the speed (command unit/s) into a value in speed units.
This function is enabled when [Pr. PT01.1 Speed/acceleration/deceleration unit selection] is set to "1".

[Pr. PV24_Speed unit conversion - Electronic gear denominator (*VCDV)]

Initial value	Setting range	Ver.
1	1 to 256	A4

Set the electric gear denominator for converting the speed command (command unit/s) into a value in speed units.
This function is enabled when [Pr. PT01.1 Speed/acceleration/deceleration unit selection] is set to "1".

[Pr. PV25_Acceleration unit conversion - Electronic gear numerator (*ACMX)]

Initial value	Setting range	Ver.
1	1 to 1024	A4

Set the electric gear numerator for converting the acceleration (command unit/s²) into a value in acceleration/deceleration units.

This function is enabled when [Pr. PT01.1 Speed/acceleration/deceleration unit selection] is set to "1".

[Pr. PV26_Acceleration unit conversion - Electronic gear denominator (*ACDV)]

Initial value	Setting range	Ver.
1	1 to 256	A4

Set the electric gear denominator for converting the acceleration (command unit/s²) into a value in acceleration/deceleration units.

This function is enabled when [Pr. PT01.1 Speed/acceleration/deceleration unit selection] is set to "1".

[Pr. PV29_Acceleration limit (ACCLMT)]

Initial value	Setting range	Ver.
0 [Refer to the text below for the unit.]	0 to 4294967295	C0

Set the acceleration limit value to be used in the profile position mode (pp), profile velocity mode (pv), homing mode (hm), and JOG operation mode (jg).

The unit can be changed to 0.001 mm/s², 0.0001 inch/s², or 0.001 degree/s² or pulse/s² with [Pr. PT01.2 Unit for position data].

 Page 120 [Pr. PT01.2_Unit for position data]

If this servo parameter is set to "0", the acceleration limit is disabled.

This function is enabled when [Pr. PT01.1 Speed/acceleration/deceleration unit selection] is set to "1".

The servo motor accelerates by the setting value of this servo parameter when the following conditions are met:

- The setting value of [Pr. PV05 Profile acceleration] is "0" in pp, pv, or jg mode
- The setting value of [Pr. PV15 Homing acceleration] is "0" in hm mode

This function corresponds to [Max acceleration (Obj. 60C5h)].

When an object is mapped in cyclic communication, the controller overwrites the value written with engineering software.

Thus, do not write a value with engineering software.

[Pr. PV31_Deceleration limit (DECLMT)]

Initial value	Setting range	Ver.
0 [Refer to the text below for the unit.]	0 to 4294967295	C0

Set the deceleration limit value to be used in the profile position mode (pp), profile velocity mode (pv), homing mode (hm), and JOG operation mode (jg).

The unit can be changed to 0.001 mm/s², 0.0001 inch/s², or 0.001 degree/s² or pulse/s² with [Pr. PT01.2 Unit for position data].

 Page 120 [Pr. PT01.2_Unit for position data]

If this servo parameter is set to "0", the deceleration limit is disabled.

This function is enabled when [Pr. PT01.1 Speed/acceleration/deceleration unit selection] is set to "1".

The servo motor decelerates by the setting value of this servo parameter when the following conditions are met:

- The setting value of [Pr. PV07 Profile deceleration] is "0" in pp, pv, or jg mode
- The setting value of [Pr. PV15 Homing acceleration] or [Pr. PV17 Homing deceleration] is "0" in hm mode

This function corresponds to [Max deceleration (Obj. 60C6h)].

When an object is mapped in cyclic communication, the controller overwrites the value written with engineering software.

Thus, do not write a value with engineering software.

2 LISTS OF SERVO PARAMETER SUPPORTED MODES

2.1 Structure

The following shows the meaning of each abbreviation used in the lists. "○" indicates the modes that can be used, and "—" indicates the modes that cannot be used or modes that are not used even if set.

Mode	List abbreviation	Meaning
Operation mode	Standard	Standard control mode
	Linear	Linear servo motor control mode
	Semi closed	Semi closed loop control mode
	Fully closed	Fully closed loop control mode
Control mode	csp	Cyclic synchronous position mode
	csv	Cyclic synchronous velocity mode
	cst	Cyclic synchronous torque mode
	pp	Profile position mode
	pv	Profile velocity mode
	tq	Profile torque mode
	hm	Homing mode
	pt	Point table mode
	jg	JOG operation mode
ct	Continuous operation to torque control mode	

2.2 Lists of supported control modes

Basic setting servo parameters group ([Pr. PA_ _])

No.	Detail No.	Operation mode			Control mode									
		Semi closed		Fully closed	csp	csv	cst	pp	pv	tq	hm	pt	jg	ct
		Standard	Linear	Standard										
PA01	PA01.0	○	○	○	○	○	○	○	○	○	○	○	○	○
	PA01.1	○	○	○	○	○	○	○	○	○	○	○	○	○
	PA01.4	○	—	○	○	○	○	○	○	○	○	○	○	○
PA02	PA02.0-1	○	○	○	○	○	○	○	○	○	○	○	○	○
PA03	PA03.0	○	○	○	○	○	○	○	○	○	○	○	○	○
	PA03.1	○	—	○	○	○	○	○	○	○	○	○	○	○
PA04	PA04.2	○	○	○	○	○	○	○	○	○	○	○	○	○
	PA04.3	○	○	○	○	○	—	○	○	—	○	○	○	—
PA06	—	○	○	○	○	○	○	○	○	○	○	○	○	○
PA07	—	○	○	○	○	○	○	○	○	○	○	○	○	○
PA08	PA08.0	○	○	○	○	○	—	○	○	—	○	○	○	—
	PA08.4	○	○	○	○	○	—	○	○	—	○	○	○	—
	PA08.5	○	○	○	○	○	—	○	○	—	○	○	○	—
	PA08.6	○	○	○	○	○	—	○	○	—	○	○	○	—
PA09	—	○	○	○	○	○	—	○	○	—	○	○	○	○
PA10	—	○	○	○	○	—	—	○	—	—	○	○	○	—
PA11	—	○	○	○	○	○	○	○	○	○	○	○	○	○
PA12	—	○	○	○	○	○	○	○	○	○	○	○	○	○
PA14	—	○	○	○	○	○	○	○	○	○	○	○	○	○
PA17	—	—	○	○	○	○	○	○	○	○	○	○	○	○
PA18	PA18.0-3	—	○	○	○	○	○	○	○	○	○	○	○	○
PA19	—	○	○	○	○	○	○	○	○	○	○	○	○	○
PA20	PA20.1	○	○	○	○	○	—	○	○	—	○	○	○	○
	PA20.2	○	○	○	○	○	○	○	○	○	○	○	○	○
PA21	PA21.0	○	○	○	○	○	—	○	○	—	○	○	○	—
PA22	PA22.1	○	○	○	○	—	—	○	—	—	○	○	○	—
	PA22.3	○	○	—	○	○	○	○	○	○	○	○	○	○
PA23	PA23.0-1	○	○	○	○	○	○	○	○	○	○	○	○	○
	PA23.2-4	○	○	○	○	○	○	○	○	○	○	○	○	○
PA24	PA24.0	○	○	○	○	○	—	○	○	—	○	○	○	—
	PA24.5	○	○	○	○	○	—	○	○	—	○	○	○	—
PA25	—	○	○	○	○	—	—	○	—	—	○	○	○	—
PA26	PA26.0	○	○	○	○	○	○	○	○	○	○	○	○	○
PA28	PA28.4	○	○	○	○	○	○	○	○	○	○	○	○	○
PA34	—	○	○	○	○	○	○	○	○	○	○	○	○	○

Gain/filter setting servo parameters group ([Pr. PB_ _])

No.	Detail No.	Operation mode			Control mode									
		Semi closed		Fully closed	csp	csv	cst	pp	pv	tq	hm	pt	jg	ct
		Standard	Linear	Standard										
PB01	PB01.0	○	○	○	○	○	○	○	○	○	○	○	○	○
	PB01.3	○	○	○	○	○	—	○	○	—	○	○	○	○
PB02	PB02.0	○	○	○	○	—	—	○	—	—	○	○	○	—
	PB02.1	○	○	○	○	—	—	○	—	—	○	○	○	—
PB03	—	○	○	○	—	—	—	—	—	—	—	—	—	○
PB04	—	○	○	○	○	—	—	○	—	—	○	○	○	—
PB06	—	○	○	○	○	○	—	○	○	—	○	○	○	○
PB07	—	○	○	○	○	○	—	○	○	—	○	○	○	—
PB08	—	○	○	○	○	—	—	○	—	—	○	○	○	—
PB09	—	○	○	○	○	○	—	○	○	—	○	○	○	○
PB10	—	○	○	○	○	○	—	○	○	—	○	○	○	○
PB11	—	○	○	○	○	○	—	○	○	—	○	○	○	○
PB12	—	○	○	○	○	—	—	○	—	—	○	○	○	—
PB13	—	○	○	○	○	○	○	○	○	○	○	○	○	○
PB14	PB14.1	○	○	○	○	○	○	○	○	○	○	○	○	○
	PB14.2	○	○	○	○	○	○	○	○	○	○	○	○	○
PB15	—	○	○	○	○	○	○	○	○	○	○	○	○	○
PB16	PB16.0	○	○	○	○	○	○	○	○	○	○	○	○	○
	PB16.1	○	○	○	○	○	○	○	○	○	○	○	○	○
	PB16.2	○	○	○	○	○	○	○	○	○	○	○	○	○
PB17	PB17.0-1	○	○	○	○	○	○	○	○	○	○	○	○	○
	PB17.2	○	○	○	○	○	○	○	○	○	○	○	○	○
PB18	—	○	○	○	○	○	—	○	○	—	○	○	○	○
PB19	—	○	○	○	○	—	—	○	—	—	○	○	○	—
PB20	—	○	○	○	○	—	—	○	—	—	○	○	○	—
PB21	—	○	○	○	○	—	—	○	—	—	○	○	○	—
PB22	—	○	○	○	○	—	—	○	—	—	○	○	○	—
PB23	PB23.0	○	○	○	○	○	○	○	○	○	○	○	○	○
	PB23.1	○	○	○	○	○	—	○	○	—	○	○	○	○
	PB23.3	○	○	○	○	○	○	○	○	○	○	○	○	○
PB24	PB24.0	○	○	○	○	—	—	○	—	—	○	○	○	—
	PB24.1	○	○	○	○	—	—	○	—	—	○	○	○	○
PB25	PB25.0	○	○	○	○	○	—	○	○	—	○	○	○	—
PB26	PB26.0	○	○	○	○	○	—	○	○	—	○	○	○	○
	PB26.1	○	○	○	○	○	—	○	○	—	○	○	○	○
	PB26.2	○	○	○	○	○	—	○	○	—	○	○	○	○
	PB26.4	○	○	○	○	○	—	○	○	—	○	○	○	○
	PB26.5	○	○	○	○	—	—	○	—	—	○	○	○	—
PB27	—	○	○	○	○	○	—	○	○	—	○	○	○	○
PB28	—	○	○	○	○	○	—	○	○	—	○	○	○	○
PB29	—	○	○	○	○	○	—	○	○	—	○	○	○	○
PB30	—	○	○	○	○	—	—	○	—	—	○	○	○	○
PB31	—	○	○	○	○	○	—	○	○	—	○	○	○	○
PB32	—	○	○	○	○	○	—	○	○	—	○	○	○	○
PB33	—	○	○	○	○	—	—	○	—	—	○	○	○	—
PB34	—	○	○	○	○	—	—	○	—	—	○	○	○	—
PB35	—	○	○	○	○	—	—	○	—	—	○	○	○	—
PB36	—	○	○	○	○	—	—	○	—	—	○	○	○	—

No.	Detail No.	Operation mode			Control mode									
		Semi closed		Fully closed	csp	csv	cst	pp	pv	tq	hm	pt	jg	ct
		Standard	Linear	Standard										
PB45	PB45.0-1	○	○	○	○	—	—	○	—	—	○	○	○	—
	PB45.2	○	○	○	○	—	—	○	—	—	○	○	○	—
PB46	—	○	○	○	○	○	○	○	○	○	○	○	○	○
PB47	PB47.0	○	○	○	○	○	○	○	○	○	○	○	○	○
	PB47.1	○	○	○	○	○	○	○	○	○	○	○	○	○
	PB47.2	○	○	○	○	○	○	○	○	○	○	○	○	○
PB48	—	○	○	○	○	○	○	○	○	○	○	○	○	○
PB49	PB49.0	○	○	○	○	○	○	○	○	○	○	○	○	○
	PB49.1	○	○	○	○	○	○	○	○	○	○	○	○	○
	PB49.2	○	○	○	○	○	○	○	○	○	○	○	○	○
PB50	—	○	○	○	○	○	○	○	○	○	○	○	○	○
PB51	PB51.0	○	○	○	○	○	○	○	○	○	○	○	○	○
	PB51.1	○	○	○	○	○	○	○	○	○	○	○	○	○
	PB51.2	○	○	○	○	○	○	○	○	○	○	○	○	○
PB52	—	○	○	○	○	—	—	○	—	—	○	○	○	—
PB53	—	○	○	○	○	—	—	○	—	—	○	○	○	—
PB54	—	○	○	○	○	—	—	○	—	—	○	○	○	—
PB55	—	○	○	○	○	—	—	○	—	—	○	○	○	—
PB56	—	○	○	○	○	—	—	○	—	—	○	○	○	—
PB57	—	○	○	○	○	—	—	○	—	—	○	○	○	—
PB58	—	○	○	○	○	—	—	○	—	—	○	○	○	—
PB59	—	○	○	○	○	—	—	○	—	—	○	○	○	—
PB60	—	○	○	○	○	○	○	—	○	○	—	○	○	—
PB65	—	○	○	○	○	○	○	—	○	○	—	○	○	○
PB66	—	○	○	○	○	○	○	—	○	○	—	○	○	○
PB67	—	○	○	○	○	○	○	—	○	○	—	○	○	○
PB68	—	○	○	○	○	—	—	○	—	—	○	○	○	○
PB69	—	○	○	○	○	○	○	—	○	○	—	○	○	○
PB70	—	○	○	○	○	○	○	—	○	○	—	○	○	○
PB71	—	○	○	○	○	—	—	○	—	—	○	○	○	—
PB72	—	○	○	○	○	—	—	○	—	—	○	○	○	—
PB73	—	○	○	○	○	—	—	○	—	—	○	○	○	—
PB74	—	○	○	○	○	—	—	○	—	—	○	○	○	—
PB75	—	○	○	○	○	—	—	○	—	—	○	○	○	—
PB76	—	○	○	○	○	—	—	○	—	—	○	○	○	—
PB77	—	○	○	○	○	—	—	○	—	—	○	○	○	—
PB78	—	○	○	○	○	—	—	○	—	—	○	○	○	—
PB79	—	○	○	○	○	○	○	—	○	○	—	○	○	—
PB81	PB81.4	○	○	○	○	—	—	○	—	—	○	○	○	—
PB82	—	○	○	○	○	—	—	○	—	—	○	○	○	—

Extension setting servo parameters group ([Pr. PC_ _])

No.	Detail No.	Operation mode			Control mode									
		Semi closed		Fully closed	csp	csv	cst	pp	pv	tq	hm	pt	jg	ct
		Standard	Linear	Standard										
PC01	—	○	○	○	○	—	—	○	—	—	○	○	○	—
PC02	—	○	○	○	○	○	○	○	○	○	○	○	○	○
PC04	PC04.3	○	○	○	○	○	○	○	○	○	○	○	○	○
PC05	PC05.0	○	—	—	○	○	○	○	○	○	○	○	○	○
	PC05.1	○	○	○	○	○	○	○	○	○	○	○	○	○
	PC05.4	○	○	○	○	○	○	○	○	○	○	○	○	○
PC06	PC06.0	○	○	○	○	—	—	○	—	—	○	○	○	—
	PC06.3	○	○	○	○	—	—	○	—	—	○	○	○	—
PC07	—	○	○	○	○	○	○	○	○	○	○	○	○	○
PC08	—	○	○	○	○	○	○	○	○	○	○	○	○	○
PC17	PC17.1	—	○	—	○	○	○	○	○	○	○	○	○	○
PC19	PC19.0	○	○	○	○	○	—	○	○	—	○	○	○	○
	PC19.4	○	○	○	○	○	○	○	○	○	○	○	○	○
	PC19.6	○	○	○	○	○	○	○	○	○	○	○	○	○
PC20	PC20.2	○	○	○	○	○	○	○	○	○	○	○	○	○
PC21	PC21.0	○	○	○	○	○	○	○	○	○	○	○	○	○
PC24	—	○	○	○	○	○	—	○	○	—	○	○	○	—
PC26	PC26.0	○	○	○	○	○	○	○	○	○	○	○	○	○
PC27	PC27.0	○	○	○	○	○	○	○	○	○	○	○	○	○
	PC27.2	○	○	○	○	○	○	○	○	○	○	○	○	○
	PC27.6	—	○	—	○	○	○	○	○	○	○	○	○	—
PC29	PC29.0	○	—	—	○	○	○	○	○	○	○	○	○	○
	PC29.3	○	○	○	○	○	○	○	○	○	○	○	○	○
	PC29.5	○	—	—	○	○	○	○	○	○	○	○	○	○
PC31	—	○	○	○	○	—	—	○	—	—	○	○	○	—
PC38	—	○	○	○	○	—	—	○	—	—	○	○	○	—
PC41	PC41.0	○	○	○	○	—	—	—	—	—	—	—	—	—
	PC41.3	○	○	○	○	○	○	○	○	○	○	○	○	○
PC42	PC42.0	○	○	○	○	○	○	○	○	○	○	○	○	○
PC43	—	○	○	○	○	○	○	○	○	○	○	○	○	○
PC44	—	○	○	○	○	○	○	○	○	○	○	○	○	○
PC65	—	○	○	○	—	—	—	—	○	—	—	—	—	—
PC66	—	○	○	○	—	—	—	—	○	—	—	—	—	—
PC67	—	○	○	○	○	—	—	○	—	—	—	○	○	—
PC69	—	○	○	○	○	—	—	○	—	—	—	○	○	—
PC70	—	○	○	○	—	—	—	○	—	—	—	○	○	—
PC71	—	○	○	○	—	—	—	○	—	—	—	○	○	—
PC72	—	○	○	○	—	—	—	—	○	—	—	—	—	—
PC73	—	○	○	○	—	—	—	—	○	—	—	—	—	—
PC76	PC76.1	○	○	○	○	○	○	○	○	○	○	○	○	—
	PC76.2	○	○	○	○	○	○	○	○	○	○	○	○	○
	PC76.3	○	○	○	○	○	○	○	○	○	○	○	○	○
PC78	PC78.1	○	○	○	○	○	○	○	○	○	○	○	○	○
PC79	PC79.0-1	○	○	○	○	○	○	○	○	○	○	○	○	○
PC96	—	○	—	○	○	○	○	○	○	○	○	○	○	○

I/O setting servo parameters group ([Pr. PD_ _])

No.	Detail No.	Operation mode			Control mode									
		Semi closed		Fully closed	csp	csv	cst	pp	pv	tq	hm	pt	jg	ct
		Standard	Linear	Standard										
PD01	PD01.0-7	○	○	○	○	○	○	○	○	○	○	○	○	○
PD03	PD03.0-1	○	○	○	○	○	○	○	○	○	○	○	○	○
PD04	PD04.0-1	○	○	○	○	○	○	○	○	○	○	○	○	○
PD05	PD05.0-1	○	○	○	○	○	○	○	○	○	○	○	○	○
PD07	PD07.0-1	○	○	○	○	○	○	○	○	○	○	○	○	○
PD08	PD08.0-1	○	○	○	○	○	○	○	○	○	○	○	○	○
PD09	PD09.0-1	○	○	○	○	○	○	○	○	○	○	○	○	○
PD11	PD11.0	○	○	○	○	○	○	○	○	○	○	○	○	○
PD12	PD12.3	○	○	○	○	○	○	○	○	○	○	○	○	○
PD13	PD13.2	○	○	○	○	—	—	○	—	—	○	○	○	—
PD14	PD14.1	○	○	○	○	○	○	○	○	○	○	○	○	○
PD38	PD38.0-1	○	—	○	○	○	○	○	○	○	○	○	○	○
PD39	PD39.0-1	○	—	○	○	○	○	○	○	○	○	○	○	○
PD41	PD41.2	○	○	○	○	○	○	○	○	○	○	○	○	○
	PD41.3	○	○	○	○	○	○	○	○	○	○	○	○	○
PD60	PD60.0-7	○	○	○	○	○	○	○	○	○	○	○	○	○

Extension setting 2 servo parameters group ([Pr. PE_ _])

No.	Detail No.	Operation mode			Control mode									
		Semi closed		Fully closed	csp	csv	cst	pp	pv	tq	hm	pt	jg	ct
		Standard	Linear	Standard										
PE01	PE01.0	—	—	○	○	○	○	—	—	—	—	—	—	—
	PE01.4	—	—	○	○	○	○	—	—	—	—	—	—	—
PE03	PE03.0	—	—	○	○	—	—	○	—	—	○	○	○	—
	PE03.1	—	—	○	○	—	—	○	—	—	○	○	○	—
	PE03.3	—	—	○	○	—	—	○	—	—	○	○	○	—
PE04	—	—	—	○	○	—	—	○	—	—	○	○	○	—
PE05	—	—	—	○	○	—	—	○	—	—	○	○	○	—
PE06	—	—	—	○	○	○	○	○	○	○	○	○	○	○
PE07	—	—	—	○	○	○	○	○	○	○	○	○	○	○
PE08	—	—	—	○	○	—	—	○	—	—	○	○	○	—
PE10	PE10.1	—	—	○	○	○	○	○	○	○	○	○	○	○
PE41	PE41.0	○	○	○	○	○	○	○	○	○	○	○	○	○
	PE41.6	○	○	○	○	○	○	○	○	○	○	○	○	○
PE44	—	○	○	○	○	—	—	○	—	—	○	○	○	—
PE45	—	○	○	○	○	—	—	○	—	—	○	○	○	—
PE46	—	○	○	○	○	—	—	○	—	—	○	○	○	—
PE47	—	○	○	○	○	○	○	○	○	○	○	○	○	○
PE48	PE48.0	○	○	○	○	—	—	○	—	—	○	○	○	—
	PE48.1	○	○	○	○	—	—	○	—	—	○	○	○	—
PE49	—	○	○	○	○	—	—	○	—	—	○	○	○	—
PE50	—	○	○	○	○	—	—	○	—	—	○	○	○	—
PE51	—	○	○	○	○	○	○	○	○	○	○	○	○	○
PE53	—	○	○	○	○	○	○	○	○	○	○	○	○	○

Extension setting 3 servo parameters group ([Pr. PF_ _])

No.	Detail No.	Operation mode			Control mode									
		Semi closed		Fully closed	csp	csv	cst	pp	pv	tq	hm	pt	jg	ct
		Standard	Linear	Standard										
PF02	PF02.4	○	○	○	○	○	○	○	○	○	○	○	○	○
	PF02.5	○	○	○	○	○	○	○	○	○	○	○	○	○
PF06	PF06.0	○	—	○	○	○	○	○	○	○	○	○	○	○
PF12	—	○	—	○	○	○	○	○	○	○	○	○	○	○
PF21	—	○	○	○	○	○	○	○	○	○	○	○	○	○
PF23	—	○	○	○	○	○	○	○	○	—	○	○	○	○
PF24	PF24.0	○	○	○	○	○	○	○	○	○	○	○	○	○
PF25	—	○	○	○	○	○	○	○	○	○	○	○	○	○
PF29	PF29.1	○	○	○	○	○	○	○	○	○	○	○	○	○
PF31	—	○	○	○	○	○	○	○	○	○	○	○	○	○
PF32	—	○	○	○	○	○	—	○	○	—	○	○	○	○
PF34	PF34.6	○	○	○	○	○	○	○	○	○	○	○	○	○
PF63	PF63.0	○	○	○	○	○	○	○	○	○	○	○	○	○
PF80	PF80.0	○	○	○	○	○	○	○	○	○	○	○	○	○
	PF80.2-3	○	○	○	○	○	○	○	○	○	○	○	○	○
PF81	PF81.0	○	○	○	○	○	○	○	○	○	○	○	○	○
PF82	PF82.0	○	○	○	○	○	○	○	○	○	○	○	○	○
	PF82.1	○	○	○	○	○	○	○	○	○	○	○	○	○
	PF82.2	○	○	○	○	○	○	○	○	○	○	○	○	○
	PF82.3	○	○	○	○	○	○	○	○	○	○	○	○	○
PF84	PF84.0-1	○	○	○	○	○	○	○	○	○	○	○	○	○
	PF84.2-3	○	○	○	○	○	○	○	○	○	○	○	○	○
	PF84.4-5	○	○	○	○	○	○	○	○	○	○	○	○	○
PF85	—	○	○	○	○	○	○	○	○	○	○	○	○	○
PF86	—	○	○	○	○	○	○	○	○	○	○	○	○	○
PF87	PF87.0-2	○	○	○	○	○	○	○	○	○	○	○	○	○
	PF87.4-6	○	○	○	○	○	○	○	○	○	○	○	○	○
PF88	PF88.0-2	○	○	○	○	○	○	○	○	○	○	○	○	○
	PF88.4-6	○	○	○	○	○	○	○	○	○	○	○	○	○
PF89	PF89.0-2	○	○	○	○	○	○	○	○	○	○	○	○	○
	PF89.4-6	○	○	○	○	○	○	○	○	○	○	○	○	○
PF90	PF90.0-2	○	○	○	○	○	○	○	○	○	○	○	○	○
PF91	PF91.0-3	○	○	○	○	○	○	○	○	○	○	○	○	○
	PF91.4-7	○	○	○	○	○	○	○	○	○	○	○	○	○
PF92	PF92.0-3	○	○	○	○	○	○	○	○	○	○	○	○	○
	PF92.4-7	○	○	○	○	○	○	○	○	○	○	○	○	○
PF93	PF93.0-3	○	○	○	○	○	○	○	○	○	○	○	○	○
	PF93.4-7	○	○	○	○	○	○	○	○	○	○	○	○	○
PF94	PF94.0-3	○	○	○	○	○	○	○	○	○	○	○	○	○
	PF94.4-7	○	○	○	○	○	○	○	○	○	○	○	○	○
PF95	PF95.0	○	○	○	○	○	○	○	○	○	○	○	○	○

Motor extension setting servo parameters group ([Pr. PL_ _])

No.	Detail No.	Operation mode			Control mode									
		Semi closed		Fully closed	csp	csv	cst	pp	pv	tq	hm	pt	jg	ct
		Standard	Linear	Standard										
PL01	PL01.0	—	○	—	○	○	○	○	○	○	○	○	○	○
	PL01.2	—	○	—	—	—	—	—	—	—	○	—	—	—
PL02	—	—	○	—	○	○	○	○	○	○	○	○	○	○
PL03	—	—	○	—	○	○	○	○	○	○	○	○	○	○
PL04	PL04.0	—	○	—	○	○	○	○	○	○	○	○	○	○
	PL04.3	—	○	—	○	○	○	○	○	○	○	○	○	○
PL05	—	—	○	—	○	—	—	○	—	—	○	○	○	—
PL06	—	—	○	—	○	○	—	○	○	—	○	○	○	—
PL07	—	—	○	—	○	○	○	○	○	○	○	○	○	○
PL08	PL08.0	—	○	—	○	○	○	○	○	○	○	○	○	○
	PL08.2	—	○	—	○	○	○	○	○	○	○	○	○	○
PL09	—	—	○	—	○	○	○	○	○	○	○	○	○	○
PL17	PL17.0	—	○	—	○	○	○	○	○	○	○	○	○	○
	PL17.1	—	○	—	○	○	○	○	○	○	○	○	○	○
PL18	—	—	○	—	○	○	○	○	○	○	○	○	○	○

Positioning control setting servo parameters group ([Pr. PT_ _])

No.	Detail No.	Operation mode			Control mode									
		Semi closed		Fully closed	csp	csv	cst	pp	pv	tq	hm	pt	jg	ct
		Standard	Linear	Standard										
PT01	PT01.1	○	○	○	○	○	○	○	○	○	○	○	○	○
	PT01.2	○	○	○	○	○	○	○	○	○	○	○	○	○
PT02	PT02.7	○	○	○	—	—	—	○	—	—	○	○	○	—
PT03	PT03.2	○	—	○	○	—	—	—	○	—	—	○	—	—
PT05	—	○	○	○	—	—	—	—	—	—	○	—	—	—
PT06	—	○	○	○	—	—	—	—	—	—	○	—	—	—
PT07	—	○	○	○	○	○	○	○	○	○	○	○	○	—
PT08	—	○	○	○	○	—	—	○	○	○	○	○	○	—
PT09	—	○	○	○	○	○	○	○	○	○	○	○	○	—
PT10	—	○	○	○	○	○	○	○	○	○	○	○	○	—
PT11	—	○	○	○	○	○	○	○	○	○	○	○	○	—
PT12	—	○	○	○	—	—	—	○	—	—	○	○	—	—
PT15	—	○	○	○	○	—	—	○	—	—	—	○	○	—
PT17	—	○	○	○	○	—	—	○	—	—	—	○	○	—
PT19	—	○	○	○	○	—	—	○	—	—	—	○	○	—
PT21	—	○	○	○	○	—	—	○	—	—	—	○	○	—
PT26	PT26.4	○	○	○	○	○	○	○	○	○	○	○	○	○
PT29	PT29.0	○	○	○	○	○	○	○	○	○	○	○	○	○
PT34	PT34.0	○	○	○	○	○	○	○	○	○	○	○	○	○
	PT34.3	○	○	○	○	○	○	○	○	○	○	○	○	○
PT38	PT38.1	○	○	○	—	—	—	—	—	—	○	○	○	—
	PT38.4	○	○	○	○	○	—	—	—	—	—	—	—	—
PT41	PT41.0	○	○	○	—	—	—	—	—	—	○	—	—	—
PT45	—	○	○	○	—	—	—	—	—	—	○	—	—	—
PT49	—	○	○	○	—	—	—	○	○	—	—	—	○	—
PT50	—	○	○	○	—	—	—	○	○	—	—	—	○	—
PT51	—	○	○	○	—	—	—	○	○	—	—	○	○	—
PT53	—	○	○	○	—	—	—	—	—	○	—	—	—	—
PT55	PT55.0	○	○	○	—	—	—	—	—	—	○	—	—	—
	PT55.1	○	○	○	—	—	—	—	—	—	○	—	—	—
PT56	—	○	○	○	—	—	—	—	—	—	○	—	—	—
PT57	—	○	○	○	—	—	—	—	—	—	○	—	—	—
PT65	—	○	○	○	—	—	—	○	—	—	—	—	○	—
PT66	—	○	○	○	—	—	—	○	○	—	—	—	○	—
PT67	—	○	○	○	—	—	○	—	—	○	—	—	—	○
PT68	PT68.0	○	○	○	○	○	—	○	○	—	○	○	○	—
	PT68.2	○	○	○	—	—	—	○	○	○	○	○	○	—
PT83	PT83.2	○	○	○	—	—	—	—	—	—	—	○	—	—
PT85	PT85.0	○	—	—	○	—	—	—	—	—	○	—	—	—

Network setting servo parameters group ([Pr. PN_ _])

No.	Detail No.	Operation mode			Control mode									
		Semi closed		Fully closed	csp	csv	cst	pp	pv	tq	hm	pt	jg	ct
		Standard	Linear	Standard										
PN02	—	○	○	○	○	○	○	○	○	○	○	○	○	○
PN03	PN03.1	○	○	○	○	○	○	○	○	○	○	○	○	○
	PN03.3	○	○	○	○	○	○	○	○	○	○	○	○	○
PN05	—	○	○	○	○	○	○	○	○	○	○	○	○	○
PN06	PN06.6	○	○	○	○	○	○	○	○	○	○	○	○	○
PN07	—	○	○	○	○	○	○	○	○	○	○	○	○	○
PN13	PN13.0-3	○	○	○	○	○	○	○	○	○	○	○	○	○
PN18	—	○	○	○	○	○	○	○	○	○	○	○	○	○
PN19	PN19.1	○	○	○	○	○	○	○	○	○	○	○	○	○
PN20	—	○	○	○	○	○	○	○	○	○	○	○	○	○
PN22	PN22.0	○	○	○	○	○	○	○	○	○	○	○	○	○
PN33	—	○	○	○	○	○	○	○	○	○	○	○	○	○
PN34	—	○	○	○	○	○	○	○	○	○	○	○	○	○

Positioning extension setting servo parameters group ([Pr. PV_ _])

No.	Detail No.	Operation mode			Control mode									
		Semi closed		Fully closed	csp	csv	cst	pp	pv	tq	hm	pt	jg	ct
		Standard	Linear	Standard										
PV01	—	○	○	○	—	—	—	○	—	—	—	—	○	—
PV03	—	○	○	○	—	—	—	○	○	—	—	—	○	—
PV05	—	○	○	○	—	—	—	○	○	—	—	—	○	—
PV07	—	○	○	○	—	—	—	○	○	—	—	—	○	—
PV09	—	○	○	○	○	○	—	○	○	—	○	○	○	—
PV11	—	○	○	○	—	—	—	—	—	—	○	—	—	—
PV13	—	○	○	○	—	—	—	—	—	—	○	—	—	—
PV15	—	○	○	○	—	—	—	—	—	—	○	—	—	—
PV17	—	○	○	○	—	—	—	—	—	—	○	—	—	—
PV19	—	○	○	○	—	—	—	—	○	—	—	—	—	—
PV20	—	○	○	○	—	—	—	—	○	—	—	—	—	—
PV21	—	○	○	○	—	—	○	—	—	○	—	—	—	○
PV23	—	○	○	○	○	○	○	○	○	○	○	○	○	—
PV24	—	○	○	○	○	○	○	○	○	○	○	○	○	—
PV25	—	○	○	○	○	○	○	○	○	○	○	○	○	—
PV26	—	○	○	○	○	○	○	○	○	○	○	○	○	—
PV29	—	○	○	○	—	—	—	○	○	—	○	—	○	—
PV31	—	○	○	○	—	—	—	○	○	—	○	—	○	—

3 LISTS OF SERVO PARAMETER INITIAL VALUES

3.1 Basic setting servo parameters group ([Pr. PA_ _])

No.	Initial value
PA01	00003000h
PA02	00000000h
PA03	00000000h
PA04	00002000h
PA05	10000
PA06	1
PA07	1
PA08	00000001h
PA09	16
PA10	1600
PA11	1000.0
PA12	1000.0
PA13	00000000h
PA14	0
PA15	4000
PA16	1
PA17	00000000h
PA18	00000000h
PA19	000000ABh
PA20	00000000h
PA21	00000001h
PA22	00000000h
PA23	00000000h
PA24	00000000h
PA25	0
PA26	00000000h
PA27	00000000h
PA28	00000000h
PA29	0
PA30	0
PA31	0
PA32	00000000h
PA33	0.0
PA34	0
PA35	00000000h
PA36	00000000h
PA37	00000000h
PA38	00000000h
PA39	00000000h
PA40	00000000h
PA41	00000000h
PA42	00000000h
PA43	00000000h
PA44	00000000h

3.2 Gain/filter setting servo parameters group ([Pr. PB_ _])

No.	Initial value
PB01	00000000h
PB02	00000000h
PB03	36000
PB04	0
PB05	500
PB06	7.00
PB07	15.0
PB08	37.0
PB09	823
PB10	33.7
PB11	980
PB12	0
PB13	4500
PB14	00000000h
PB15	4500
PB16	00000000h
PB17	00000000h
PB18	3141
PB19	100.0
PB20	100.0
PB21	0.00
PB22	0.00
PB23	00001000h
PB24	00000000h
PB25	00000000h
PB26	00000000h
PB27	10
PB28	1
PB29	7.00
PB30	0.0
PB31	0
PB32	0.0
PB33	0.0
PB34	0.0
PB35	0.00
PB36	0.00
PB37	1600
PB38	0.000
PB39	0.000
PB40	0.000
PB41	00000000h
PB42	00000000h
PB43	00000000h
PB44	0.00
PB45	00000000h
PB46	4500
PB47	00000000h
PB48	4500

No.	Initial value
PB49	00000000h
PB50	4500
PB51	00000000h
PB52	100.0
PB53	100.0
PB54	0.00
PB55	0.00
PB56	0.0
PB57	0.0
PB58	0.00
PB59	0.00
PB60	0.0
PB61	0.0
PB62	00000000h
PB63	00000000h
PB64	00000000h
PB65	10
PB66	1
PB67	7.00
PB68	0.0
PB69	0
PB70	0.0
PB71	0.0
PB72	0.0
PB73	0.00
PB74	0.00
PB75	0.0
PB76	0.0
PB77	0.00
PB78	0.00
PB79	0.0
PB80	177.0
PB81	00000001h
PB82	0.0
PB83	00000000h
PB84	00000000h
PB85	00000000h
PB86	00000000h
PB87	00000000h
PB88	00000000h
PB89	00000000h
PB90	00000000h
PB91	00000000h
PB92	00000000h

3.3 Extension setting servo parameters group ([Pr. PC_ _])

No.	Initial value	
	TSN	ECT
PC01	0	
PC02	0	
PC03	0000000h	
PC04	0000000h	
PC05	0000000h	
PC06	0000000h	
PC07	50	
PC08	0	
PC09	0000000h	
PC10	0000001h	
PC11	0	
PC12	0	
PC13	0	
PC14	0	
PC15	0	
PC16	0000000h	
PC17	0000000h	
PC18	0000000h	
PC19	0000000h	
PC20	0000000h	
PC21	0000000h	
PC22	0	
PC23	0000000h	
PC24	100	
PC25	0	
PC26	00000050h	
PC27	0000000h	
PC28	0000000h	
PC29	00101000h	
PC30	0	
PC31	0	
PC32	0	
PC33	0	
PC34	100	
PC35	0000000h	
PC36	0000000h	
PC37	0000000h	
PC38	0	
PC39	0.0	
PC40	0.0	
PC41	0000000h	
PC42	0000000h	
PC43	0.0	1000.0
PC44	0.0	1000.0
PC45	0000000h	
PC46	0000000h	
PC47	0000000h	

No.	Initial value	
	TSN	ECT
PC48	00000000h	
PC49	00000000h	
PC50	00000000h	
PC51	00000000h	
PC52	00000000h	
PC53	00000000h	
PC54	00000000h	
PC55	00000000h	
PC56	00000000h	
PC57	00000000h	
PC58	00000000h	
PC59	00000000h	
PC60	00000000h	
PC61	00000000h	
PC62	00000000h	
PC63	00000000h	
PC64	00000000h	
PC65	50.00	
PC66	10	
PC67	00C00000h	
PC68	00000000h	
PC69	10	0
PC70	100	
PC71	10	0
PC72	20.00	
PC73	10	0
PC74	10.0	
PC75	10	
PC76	00000001h	
PC77	1000.0	
PC78	00000000h	00000010h
PC79	00000000h	
PC80	00000000h	
PC81	00000000h	
PC82	00000000h	
PC83	00000000h	
PC84	00000000h	
PC85	00000000h	
PC86	00000000h	
PC87	00000000h	
PC88	00000000h	
PC89	00000000h	
PC90	00000000h	
PC91	00000000h	
PC92	00000000h	
PC93	00000000h	
PC94	00000000h	
PC95	00000000h	
PC96	0	

3.4 I/O setting servo parameters group ([Pr. PD_ _])

No.	Initial value
PD01	00000000h
PD02	00000000h
PD03	0000000Ah
PD04	0000000Bh
PD05	00000022h
PD06	00000000h
PD07	00000005h
PD08	00000004h
PD09	00000003h
PD10	00000000h
PD11	00000007h
PD12	00000101h
PD13	00000000h
PD14	00000000h
PD15	00000000h
PD16	00000000h
PD17	00000000h
PD18	00000000h
PD19	00000000h
PD20	0
PD21	0
PD22	0
PD23	0
PD24	00000000h
PD25	00000000h
PD26	00000000h
PD27	00000000h
PD28	00000000h
PD29	00000000h
PD30	0
PD31	0
PD32	0
PD33	00000000h
PD34	00000000h
PD35	00000000h
PD36	00000000h
PD37	00110001h
PD38	00000000h
PD39	00000000h
PD40	0
PD41	00000000h
PD42	00000000h
PD43	00000000h
PD44	00000000h
PD45	00000000h
PD46	00000000h
PD47	00000000h
PD48	00000000h
PD49	0
PD50	0

No.	Initial value
PD51	0000062h
PD52	0000000h
PD53	0000000h
PD54	0000000h
PD55	0000000h
PD56	0000000h
PD57	0000000h
PD58	0000000h
PD59	0000000h
PD60	0000000h
PD61	0000000h
PD62	0000000h
PD63	0000000h
PD64	0000000h
PD65	0000000h
PD66	0000000h
PD67	0000000h
PD68	0000000h
PD69	0000000h
PD70	0000000h
PD71	0000000h
PD72	0000000h

3.5 Extension setting 2 servo parameters group ([Pr. PE_ _])

No.	Initial value	
	TSN	ECT
PE01	00000000h	
PE02	00000000h	
PE03	00000003h	
PE04	1	
PE05	1	
PE06	400	
PE07	100	
PE08	10	
PE09	00000000h	
PE10	00000000h	
PE11	00000000h	
PE12	00000000h	
PE13	00000000h	
PE14	00000111h	
PE15	20	
PE16	00000000h	
PE17	00000100h	
PE18	00000000h	
PE19	00000000h	
PE20	00000000h	
PE21	00000000h	
PE22	00000000h	
PE23	00000000h	
PE24	00000000h	
PE25	00000000h	
PE26	00000000h	
PE27	00000000h	
PE28	00000000h	
PE29	00000000h	
PE30	00000000h	
PE31	00000000h	
PE32	00000000h	
PE33	00000000h	
PE34	1	
PE35	1	
PE36	0.0	
PE37	0.00	
PE38	0.00	
PE39	20	
PE40	00000000h	
PE41	00000000h	
PE42	0	
PE43	0.0	
PE44	0	
PE45	0	
PE46	0	
PE47	0	

No.	Initial value	
	TSN	ECT
PE48	00000000h	
PE49	0	
PE50	0	
PE51	00000000h	
PE52	00000000h	
PE53	0.0	1000.0
PE54	00000000h	
PE55	00000000h	
PE56	00000000h	
PE57	00000000h	
PE58	00000000h	
PE59	00000000h	
PE60	00000000h	
PE61	0.000	
PE62	0.000	
PE63	0.000	
PE64	0.000	
PE65	0.0	
PE66	0.0	
PE67	0.0	
PE68	00000000h	
PE69	00000000h	
PE70	0.00	
PE71	0	
PE72	1.0000	
PE73	00000000h	
PE74	00000000h	
PE75	00000000h	
PE76	00000000h	
PE77	00000000h	
PE78	0	
PE79	0	
PE80	00000000h	
PE81	00000000h	
PE82	00000000h	
PE83	00000000h	
PE84	00000000h	
PE85	00000000h	
PE86	00000000h	
PE87	00000000h	
PE88	00000000h	

3.6 Extension setting 3 servo parameters group ([Pr. PF_ _])

No.	Initial value
PF01	00000000h
PF02	00000000h
PF03	00000000h
PF04	0
PF05	00000000h
PF06	00000013h
PF07	00000000h
PF08	00000000h
PF09	00000000h
PF10	00000000h
PF11	00000000h
PF12	2000
PF13	00000000h
PF14	10
PF15	00000000h
PF16	00000000h
PF17	00000000h
PF18	10
PF19	0
PF20	0
PF21	0
PF22	200
PF23	20
PF24	00000000h
PF25	200
PF26	0
PF27	0
PF28	0
PF29	00000000h
PF30	0
PF31	0
PF32	50
PF33	00000000h
PF34	00000000h
PF35	00000000h
PF36	00000000h
PF37	00000000h
PF38	00000000h
PF39	00000000h
PF40	00000000h
PF41	0
PF42	0
PF43	0
PF44	0
PF45	0
PF46	0
PF47	0
PF48	00000000h

No.	Initial value
PF49	100
PF50	100
PF51	00000000h
PF52	00000000h
PF53	0
PF54	0
PF55	0
PF56	0
PF57	00000000h
PF58	00000000h
PF59	00000000h
PF60	00000000h
PF61	00000000h
PF62	00000000h
PF63	00000000h
PF64	0
PF65	00000000h
PF66	00000000h
PF67	0
PF68	0
PF69	0
PF70	0
PF71	00000000h
PF72	0
PF73	0
PF74	0
PF75	0
PF76	0
PF77	00000000h
PF78	00000000h
PF79	00110010h
PF80	00000000h
PF81	00000000h
PF82	00000000h
PF83	00000000h
PF84	005A8101h
PF85	0
PF86	0
PF87	00020201h
PF88	02040003h
PF89	00090205h
PF90	0000000Ch
PF91	00120000h
PF92	80058010h
PF93	8000800Ah
PF94	801D8015h
PF95	00000000h
PF96	00000000h
PF97	00000000h
PF98	00000000h
PF99	00000000h

3.7 Motor extension setting servo parameters group ([Pr. PL_ _])

No.	Initial value
PL01	00000301h
PL02	1000
PL03	1000
PL04	00000003h
PL05	0
PL06	0
PL07	100
PL08	00001010h
PL09	30
PL10	5
PL11	100
PL12	500
PL13	00000000h
PL14	00000000h
PL15	20
PL16	0
PL17	00000000h
PL18	0
PL19	0
PL20	0
PL21	0
PL22	0
PL23	00000000h
PL24	0
PL25	0
PL26	00000000h
PL27	00000000h
PL28	00000000h
PL29	0
PL30	00000000h
PL31	00000000h
PL32	00000000h
PL33	00000000h
PL34	00000000h
PL35	00000000h
PL36	00000000h
PL37	00000000h
PL38	00000000h
PL39	00000000h
PL40	00000000h
PL41	00000000h
PL42	00000000h
PL43	00000000h
PL44	00000000h
PL45	00000000h
PL46	00000000h
PL47	00000000h
PL48	00000000h
PL49	00000000h

No.	Initial value
PL50	0
PL51	0
PL52	12
PL53	0
PL54	00000000h
PL55	00000000h
PL56	00000000h
PL57	00000000h
PL58	00000000h
PL59	00000000h
PL60	00000000h
PL61	00000000h
PL62	00000000h
PL63	00000000h
PL64	00000000h
PL65	00000000h
PL66	00000000h
PL67	00000000h
PL68	00000000h
PL69	00000000h
PL70	00000000h
PL71	00000000h
PL72	00000000h

3.8 Positioning control setting servo parameters group ([Pr. PT_ _])

No.	Initial value	
	TSN	ECT
PT01	00000300h	00000310h
PT02	0000001h	
PT03	0000000h	
PT04	0000000h	
PT05	100.00	
PT06	10.00	
PT07	0	
PT08	0	
PT09	1000	
PT10	100	
PT11	15.0	
PT12	0	
PT13	0000000h	
PT14	0	
PT15	0	
PT16	0000000h	
PT17	0	
PT18	0000000h	
PT19	0	
PT20	0000000h	
PT21	0	
PT22	0000000h	
PT23	0000000h	
PT24	0000000h	
PT25	0000000h	
PT26	0000000h	
PT27	0000000h	
PT28	8	
PT29	0000000h	
PT30	0000000h	
PT31	0000000h	
PT32	0000100h	
PT33	0000000h	
PT34	0000000h	
PT35	0000000h	
PT36	0000000h	
PT37	10	
PT38	0000000h	
PT39	100	
PT40	0	
PT41	0000010h	
PT42	0000000h	
PT43	0000000h	
PT44	0000000h	
PT45	37	
PT46	0	
PT47	0000000h	

No.	Initial value	
	TSN	ECT
PT48	00000000h	
PT49	0	
PT50	0	
PT51	0	
PT52	0	
PT53	0.0	100.0
PT54	0	
PT55	00000000h	
PT56	0	
PT57	0	
PT58	100.00	
PT59	500.00	
PT60	1000.00	
PT61	200.00	
PT62	00000000h	
PT63	00000000h	
PT64	00000000h	
PT65	100.00	
PT66	20000.00	
PT67	3000.00	
PT68	00000002h	
PT69	00000000h	
PT70	00000000h	
PT71	00000000h	
PT72	1	
PT73	00000000h	
PT74	1	
PT75	00000000h	
PT76	00000000h	
PT77	00000000h	
PT78	00000000h	
PT79	00000000h	
PT80	00000000h	
PT81	0	
PT82	0	
PT83	00000000h	
PT84	00000000h	
PT85	00000000h	
PT86	00000000h	
PT87	00000000h	
PT88	00000000h	
PT89	00000000h	
PT90	00000000h	

3.9 Network setting servo parameters group ([Pr. PN_ _])

No.	Initial value	
	TSN	ECT
PN01	00000000h	
PN02	0	
PN03	00000000h	
PN04	0	
PN05	0	
PN06	00000000h	
PN07	00000000h	
PN08	00000000h	
PN09	1	
PN10	0	
PN11	3600	
PN12	00000000h	
PN13	00000000h	
PN14	00000000h	
PN15	00000000h	
PN16	00000000h	
PN17	00000000h	
PN18	0	9
PN19	00000000h	
PN20	0	
PN21	00000000h	
PN22	00000000h	
PN23	00000000h	
PN24	00000000h	
PN25	00000000h	
PN26	00000000h	
PN27	00000000h	
PN28	00000000h	
PN29	00000000h	
PN30	00000000h	
PN31	00000000h	
PN32	00000000h	
PN33	FFFFFFFFh	
PN34	FFFFFFFFh	

3.10 Positioning extension setting servo parameters group ([Pr. PV_ _])

No.	Initial value
PV01	0
PV02	0
PV03	2147483647
PV04	0
PV05	0
PV06	0
PV07	0
PV08	0
PV09	0
PV10	0
PV11	500000
PV12	0
PV13	100000
PV14	0
PV15	0
PV16	0
PV17	0
PV18	0
PV19	20000
PV20	20
PV21	2147483647
PV22	0
PV23	1
PV24	1
PV25	1
PV26	1
PV27	1
PV28	1
PV29	0
PV30	00000000h
PV31	0
PV32	0
PV33	00000000h
PV34	00000000h
PV35	00000000h
PV36	00000000h
PV37	00000000h
PV38	00000000h
PV39	00000000h
PV40	00000000h

4 SERVO PARAMETER SETTING METHOD

Servo parameters can be set using the methods shown below. Set the servo parameters using one of these methods.

4.1 Engineering software

Servo parameters can be set using the engineering software manufactured by Mitsubishi Electric such as MR Configurator2. Connect a personal computer and the servo amplifier via a USB cable or a network. For details on how to set servo parameters, refer to Help or the manual for the engineering software.

4.2 Object dictionary

The servo parameters can be changed by writing values on servo parameter objects. The servo parameters can also be changed with objects other than the servo parameter objects that interlock and change with the servo parameters. An example is shown in the table below. Note that if the power is cycled, the changed settings are not retained at the next startup. To retain the changed settings even after cycling the power, save the servo parameter setting value to the non-volatile memory by using [Store Parameters (Obj. 1010h)].

To change the setting of the parameters in which the setting changes are reflected by cycling the power or by resetting the software (parameters whose symbols are preceded by **), change the value of the corresponding object, execute [Store Parameters (Obj. 1010h)], and then cycle the power or reset the software.

Servo parameter	Object	An object other than the servo parameter object that interlocks and changes with the servo parameter
[Pr. PT45 Homing method]	[PT45 (Obj. 24ADh)]	[Homing method (Obj. 6098h)]

5 NETWORK PARAMETER DETAILS

Network parameters are used to set IP addresses and other information necessary to connect the servo amplifier with the controllers and other network equipment. In this chapter, an outline of the network parameters and the contents of each setting are explained.

The network function of the servo amplifier is set with the network parameters. The network parameters are stored in the non-volatile memory of the servo amplifier, and are set to the initial value when using the factory setting. Change the settings as necessary. Refer to the following for the setting methods.

☞ Page 180 SERVO PARAMETER SETTING METHOD

Restrictions

Depending on the model of the motion module, servo amplifier firmware version, and MR Configurator2 software version, some network parameters and ranges cannot be set. Refer to the Mitsubishi Electric FA site for the latest software version of MR Configurator2.

In addition, the firmware version of the servo amplifier can be checked with MR Configurator2, objects, or by other means.

Precautions

Do not change the network parameter settings as described below. Doing so may cause an unexpected condition, such as failing to start up the servo amplifier.

- Changing the values of the network parameters for manufacturer setting.
- Setting a value outside the range
- Changing the fixed value in each digit

If the method for reflecting the setting value of the network parameter is not stated, the value is enabled at the moment that it is changed.

Some of the network parameters support SLMP communication. For example, SLMP commands (IPAddressSet) are written to the IP addresses of the network parameters.

5.1 Network basic parameters

[Pr. NPA01_IP address setting]

When the command interface of the servo amplifier is EtherCAT, this network parameter is not available.

Initial value	Setting range	Size	Ver.
0	Refer to the text	4 bytes	A4

For the setting of IP addresses which are necessary for communication, select whether to use the rotary switches or to use network parameters to obtain the IP addresses.

To enable this network parameter, cycle the power or reset the software after setting.

This network parameter cannot be rewritten via the parameter automatic setting.

Setting value	Rotary switches (SW1/SW2)	IP address	
0: The rotary switch is used.	00h	1st octet	The 1st octet of the setting value in [Pr. NPA02] is used.
		2nd octet	The 2nd octet of the setting value in [Pr. NPA02] is used.
		3rd octet	The 3rd octet of the setting value in [Pr. NPA02] is used.
		4th octet	The 4th octet of the setting value in [Pr. NPA02] is used.
	01h to FEh	1st octet	The 1st octet of the setting value in [Pr. NPA02] is used.
		2nd octet	The 2nd octet of the setting value in [Pr. NPA02] is used.
		3rd octet	The 3rd octet of the setting value in [Pr. NPA02] is used.
		4th octet	The setting value of the rotary switch (SW1/SW2) is used.
	FFh	1st octet	Not used
		2nd octet	
		3rd octet	
		4th octet	
1: Network parameters are used.	—	1st octet	The 1st octet of the setting value in [Pr. NPA02] is used.
		2nd octet	The 2nd octet of the setting value in [Pr. NPA02] is used.
		3rd octet	The 3rd octet of the setting value in [Pr. NPA02] is used.
		4th octet	The 4th octet of the setting value in [Pr. NPA02] is used.

The initial value of the IP address is as follows.

Item	Initial value
IP address	192.168.3.1
Subnet mask	255.255.255.0

[Pr. NPA02_IP address]

When the command interface of the servo amplifier is EtherCAT, this network parameter is not available.

Initial value	Setting range	Size	Ver.
192.168.3.1 (C0A80301h)	Refer to the text	4 bytes	A4

Set the IP address.

Set each octet to a value between 0 to 255.

In the eight digits of hexadecimal, the first to fourth octets are expressed with each pair of digits.

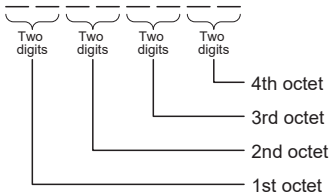

Set the IP address assigned by the network administrator.

Refer to the following for the relation to the rotary switch.

☞ Page 183 [Pr. NPA01_IP address setting]

When SLMP command (IPAddressSet) is received at the time of IP address delivery from the controller, this network parameter is overwritten with the received IP address.

To enable this network parameter, cycle the power or reset the software after setting.

This network parameter cannot be rewritten via the parameter automatic setting.

[Pr. NPA04_Subnet mask]

When the command interface of the servo amplifier is EtherCAT, this network parameter is not available.

Initial value	Setting range	Size	Ver.
255.255.255.0 (FFFFFF00h)	Refer to the text	4 bytes	A4

Set the subnet mask.

Set each octet to a value between 0 to 255.

In the eight digits of hexadecimal, the first to fourth octets are expressed with each pair of digits.

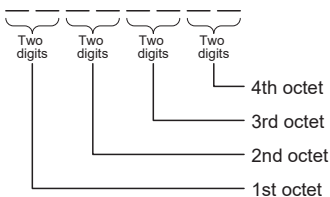

Set the subnet mask assigned by the network administrator.

When SLMP command (IPAddressSet) is received at the time of IP address delivery from the controller, this network parameter is overwritten with the received subnet mask.

To enable this network parameter, cycle the power or reset the software after setting.

This network parameter cannot be rewritten via the parameter automatic setting.

[Pr. NPA08_Host name]

When the command interface of the servo amplifier is EtherCAT, this network parameter is not available.

Initial value	Setting range	Size	Ver.
0 (All NULL)	63 characters (Refer to the text.)	64 bytes	A4

Select a host name.

Set a character string of up to 63 characters for the host name.

The characters that can be input as the host name are 0 to 9, A to Z, a to z, hyphen (-), period (.), colon (:), and underscore (_).

This network parameter can be obtained with SLMP command (NodeSearch). The command is "0E30h" and subcommand is "0000h".

This network parameter can be set with SLMP command (IPAddressSet). The command is "0E31h" and subcommand is "0000h".

[Pr. NPA09_Node address setting]

When the command interface of the servo amplifier is CC-Link IE TSN, this network parameter is not available.

Initial value	Setting range	Size	Ver.
00000000h	00000000h to 0000FFFFh	4 bytes	A5

Set the node address of the network.

When using this network parameter, set the ID setting switch to "00h".

[Pr. NPA12_Communication speed]

When the command interface of the servo amplifier is EtherCAT, this network parameter is not available.

Initial value	Setting range	Size	Ver.
00000002h	Refer to the text	4 bytes	B6

Set the communication speed.

1: 100 Mbps

2: Network automatic setting

To enable this network parameter, cycle the power or reset the software after setting.

Details of the communication speed are as follows:

[Pr. PN13.0-3 Network protocol setting]	[Pr. NPA12]	Communication speed
0000h (CC-Link IE TSN) (initial value)	2 (initial value)	1 Gbps
0000h (CC-Link IE TSN) (initial value)	1	100 Mbps
0004h (CC-Link IE Field Network Basic) *1	2 (initial value)	100 Mbps
0004h (CC-Link IE Field Network Basic) *1	1	100 Mbps

*1 Available on servo amplifiers with firmware version C0 or later.

5.2 User authentication parameters

[Pr. NPB01_User authentication and authorization setting]

When the command interface of the servo amplifier is EtherCAT, this network parameter is not available.

Initial value	Setting range	Size	Ver.
00000000h	Refer to the text	4 bytes	B2

Set the connection method to use for setting the user authentication parameter.

To enable this network parameter, cycle the power or reset the software after setting.

When this network parameter is set to "1" (USB only), the user authentication parameter cannot be rewritten via the parameter automatic setting.

Setting value	Authorization	Description
0	Full access possible	The user authentication parameter can be set via either a USB or Ethernet connection.
1	USB only	The user authentication parameter can only be set via a USB connection.

[Pr. NPB04_User name No.1]

When the command interface of the servo amplifier is EtherCAT, this network parameter is not available.

Initial value	Setting range	Size	Ver.
user	32 characters	36 bytes	B2

Set the user name to use when accessing the FTP server function of the servo amplifier.

Set the user name in accordance with the following restrictions. If a blank (0 character) user name is set, that account will be disabled.

Number of characters	Type of characters
1 to 32	<ul style="list-style-type: none">• Single-byte letters (uppercase)• Single-byte letters (lowercase)• Single-byte numeric characters

If the set user name is identical to an existing account, password and authorization level parameters linked to said user name may be disabled. Ensure that no duplicate user names are set.

[Pr. NPB05_Authorization level No.1]

When the command interface of the servo amplifier is EtherCAT, this network parameter is not available.

Initial value	Setting range	Size	Ver.
00000001h	Refer to the text	4 bytes	B2

Set the authorization level for the user (No.1).

Refer to the following table for details.

Network parameter No.	Setting digit (BIN)	Description
[Pr. NPB05.0]	___x	Firmware update permission selection 0: Prohibited 1: Permitted When "1" (permitted) is set, firmware updates can be performed via the FTP server function.
	__x_	For manufacturer setting
	_x__	Drive recorder data readout permission selection 0: Prohibited 1: Permitted When "1" (permitted) is set, readout of the recorded data in the drive recorder can be performed via the FTP server function.
	x___	For manufacturer setting
[Pr. NPB05.1] [Pr. NPB05.2] [Pr. NPB05.3] [Pr. NPB05.4] [Pr. NPB05.5] [Pr. NPB05.6] [Pr. NPB05.7]	For manufacturer setting	For manufacturer setting

[Pr. NPB06_Password No.1]

When the command interface of the servo amplifier is EtherCAT, this network parameter is not available.

Initial value	Setting range	Size	Ver.
user	—	—	B2

Set the password to use when accessing the FTP server function of the servo amplifier.

Set the password in accordance with the following restrictions.

Number of characters	Type of characters
4 to 32	<ul style="list-style-type: none"> • Single-byte letters (uppercase) • Single-byte letters (lowercase) • Single-byte numeric characters • Special characters <p>"Special characters" refers to the following characters: `~!@#%&*()_+={} ¥: ";'<>?,./[] (additionally, a single-byte space can be used).</p>

[Pr. NPB07_User name No.2]

When the command interface of the servo amplifier is EtherCAT, this network parameter is not available.

Initial value	Setting range	Size	Ver.
0 (All NULL)	32 characters	36 bytes	B2

Set the user name (No.2) to use when accessing the FTP server function of the servo amplifier.

☞ Page 186 [Pr. NPB04_User name No.1]

[Pr. NPB08_Authorization level No.2]

When the command interface of the servo amplifier is EtherCAT, this network parameter is not available.

Initial value	Setting range	Size	Ver.
00000000h	Refer to the text	4 bytes	B2

Set the authorization level for the user (No.2).

☞ Page 187 [Pr. NPB05_Authorization level No.1]

[Pr. NPB09_Password No.2]

When the command interface of the servo amplifier is EtherCAT, this network parameter is not available.

Initial value	Setting range	Size	Ver.
—	—	—	B2

Set the password (No.2) to use when accessing the FTP server function of the servo amplifier.

☞ Page 187 [Pr. NPB06_Password No.1]

[Pr. NPB10_User name No.3]

When the command interface of the servo amplifier is EtherCAT, this network parameter is not available.

Initial value	Setting range	Size	Ver.
0 (All NULL)	32 characters	36 bytes	B2

Set the user name (No.3) to use when accessing the FTP server function of the servo amplifier.

☞ Page 186 [Pr. NPB04_User name No.1]

[Pr. NPB11_Authorization level No.3]

When the command interface of the servo amplifier is EtherCAT, this network parameter is not available.

Initial value	Setting range	Size	Ver.
00000000h	Refer to the text	4 bytes	B2

Set the authorization level for the user (No.3).

☞ Page 187 [Pr. NPB05_Authorization level No.1]

[Pr. NPB12_Password No.3]

When the command interface of the servo amplifier is EtherCAT, this network parameter is not available.

Initial value	Setting range	Size	Ver.
—	—	—	B2

Set the password (No.3) to use when accessing the FTP server function of the servo amplifier.

☞ Page 187 [Pr. NPB06_Password No.1]

[Pr. NPB13_User name No.4]

When the command interface of the servo amplifier is EtherCAT, this network parameter is not available.

Initial value	Setting range	Size	Ver.
0 (All NULL)	32 characters	36 bytes	B2

Set the user name (No.4) to use when accessing the FTP server function of the servo amplifier.

☞ Page 186 [Pr. NPB04_User name No.1]

[Pr. NPB14_ Authorization level No.4]

When the command interface of the servo amplifier is EtherCAT, this network parameter is not available.

Initial value	Setting range	Size	Ver.
00000000h	Refer to the text	4 bytes	B2

Set the authorization level for the user (No.4).

☞ Page 187 [Pr. NPB05_ Authorization level No.1]

[Pr. NPB15_ Password No.4]

When the command interface of the servo amplifier is EtherCAT, this network parameter is not available.

Initial value	Setting range	Size	Ver.
—	—	—	B2

Set the password (No.4) to use when accessing the FTP server function of the servo amplifier.

☞ Page 187 [Pr. NPB06_ Password No.1]

[Pr. NPB16_ User name No.5]

When the command interface of the servo amplifier is EtherCAT, this network parameter is not available.

Initial value	Setting range	Size	Ver.
0 (All NULL)	32 characters	36 bytes	B2

Set the user name (No.5) to use when accessing the FTP server function of the servo amplifier.

☞ Page 186 [Pr. NPB04_ User name No.1]

[Pr. NPB17_ Authorization level No.5]

When the command interface of the servo amplifier is EtherCAT, this network parameter is not available.

Initial value	Setting range	Size	Ver.
00000000h	Refer to the text	4 bytes	B2

Set the authorization level for the user (No.5).

☞ Page 187 [Pr. NPB05_ Authorization level No.1]

[Pr. NPB18_ Password No.5]

When the command interface of the servo amplifier is EtherCAT, this network parameter is not available.

Initial value	Setting range	Size	Ver.
—	—	—	B2

Set the password (No.5) to use when accessing the FTP server function of the servo amplifier.

☞ Page 187 [Pr. NPB06_ Password No.1]

[Pr. NPB19_ User name No.6]

When the command interface of the servo amplifier is EtherCAT, this network parameter is not available.

Initial value	Setting range	Size	Ver.
0 (All NULL)	32 characters	36 bytes	B2

Set the user name (No.6) to use when accessing the FTP server function of the servo amplifier.

☞ Page 186 [Pr. NPB04_ User name No.1]

[Pr. NPB20_Authorization level No.6]

When the command interface of the servo amplifier is EtherCAT, this network parameter is not available.

Initial value	Setting range	Size	Ver.
00000000h	Refer to the text	4 bytes	B2

Set the authorization level for the user (No.6).

☞ Page 187 [Pr. NPB05_Authorization level No.1]

[Pr. NPB21_Password No.6]

When the command interface of the servo amplifier is EtherCAT, this network parameter is not available.

Initial value	Setting range	Size	Ver.
—	—	—	B2

Set the password (No.6) to use when accessing the FTP server function of the servo amplifier.

☞ Page 187 [Pr. NPB06_Password No.1]

[Pr. NPB22_User name No.7]

When the command interface of the servo amplifier is EtherCAT, this network parameter is not available.

Initial value	Setting range	Size	Ver.
0 (All NULL)	32 characters	36 bytes	B2

Set the user name (No.7) to use when accessing the FTP server function of the servo amplifier.

☞ Page 186 [Pr. NPB04_User name No.1]

[Pr. NPB23_Authorization level No.7]

When the command interface of the servo amplifier is EtherCAT, this network parameter is not available.

Initial value	Setting range	Size	Ver.
00000000h	Refer to the text	4 bytes	B2

Set the authorization level for the user (No.7).

☞ Page 187 [Pr. NPB05_Authorization level No.1]

[Pr. NPB24_Password No.7]

When the command interface of the servo amplifier is EtherCAT, this network parameter is not available.

Initial value	Setting range	Size	Ver.
—	—	—	B2

Set the password (No.7) to use when accessing the FTP server function of the servo amplifier.

☞ Page 187 [Pr. NPB06_Password No.1]

[Pr. NPB25_User name No.8]

When the command interface of the servo amplifier is EtherCAT, this network parameter is not available.

Initial value	Setting range	Size	Ver.
0 (All NULL)	32 characters	36 bytes	B2

Set the user name (No.8) to use when accessing the FTP server function of the servo amplifier.

☞ Page 186 [Pr. NPB04_User name No.1]

[Pr. NPB26_Authorization level No.8]

When the command interface of the servo amplifier is EtherCAT, this network parameter is not available.

Initial value	Setting range	Size	Ver.
00000000h	Refer to the text	4 bytes	B2

Set the authorization level for the user (No.8).

☞ Page 187 [Pr. NPB05_Authorization level No.1]

[Pr. NPB27_Password No.8]

When the command interface of the servo amplifier is EtherCAT, this network parameter is not available.

Initial value	Setting range	Size	Ver.
—	—	—	B2

Set the password (No.8) to use when accessing the FTP server function of the servo amplifier.

☞ Page 187 [Pr. NPB06_Password No.1]

6 NETWORK PARAMETER SETTING METHOD

6.1 Engineering software

The network parameters can be set with MR Configurator2. Connect a personal computer and the servo amplifier via a USB cable or a network. For details on how to set network parameters, refer to Help or the manual for the engineering software.

7 FUNCTIONAL SAFETY PARAMETER DETAILS

Restrictions

Settable functional safety parameters and values depend on the servo amplifier firmware version and MR Configurator2 software version. Refer to the Mitsubishi Electric FA site for the latest software version of MR Configurator2. In addition, the firmware version of the servo amplifier can be checked with MR Configurator2, objects, or by other means. When using servo motors with functional safety, executing software reset may trigger [AL. 016 Encoder initial communication error 1]. If [AL. 016] occurs, cycle the power.

Precautions

Do not change the functional safety parameter settings as described below. Doing so may cause an unexpected condition, such as failing to start up the servo amplifier.

- Changing the values of the functional safety parameters for manufacturer setting
- Setting a value outside the range
- Changing the fixed value in each functional safety parameter

"" added to functional safety parameter abbreviations means the following.

**: After setting, cycle the power or reset the software.

7.1 Safety sub-function 1 parameters group ([Pr. PSA_ _])

[Pr. PSA01_Safety sub-function mode selection (**SOA)]

Initial value	Setting range	Ver.
00000000h	Refer to the relevant detail No.	Refer to the relevant detail No.

Set the safety sub-function.

[Pr. PSA01.0_Safety sub-function activation setting]

Initial value	Setting range	Ver.
0h	Refer to the text	E8

0:Disabled

1:Enabled

When setting this functional safety parameter to "1" (enabled), check the setting of each relevant parameter for problems.

[Pr. PSA01.1_Input mode selection]

Initial value	Setting range	Ver.
0h	Refer to the text	E8

0:Safety sub-function control by input device

1:Safety sub-function control by network

2:Test operation

When setting this functional safety parameter to "2" (test operation), the safety sub-function is not available.

For information regarding test operation, refer to "Test operation" in the User's Manual (Introduction).

If this functional safety parameter is set incorrectly, [AL. 537 Parameter setting range error (safety sub-function)] occurs.

Setting "1" on a servo amplifier that cannot use safety sub-function control by network triggers [AL. 537]. For availability of the safety sub-function control by network, refer to "List of safety sub-function compatible units" in the User's Manual (Introduction).

[Pr. PSA02_Functional safety setting (**SMD)]

Initial value	Setting range	Ver.
00000000h	Refer to the relevant detail No.	Refer to the relevant detail No.

[Pr. PSA02.1_Position/Speed monitor setting]

Initial value	Setting range	Ver.
0h	Refer to the text	E8

0:Not monitor the position/speed

2:Monitor the speed without using a servo motor with functional safety.

If this functional safety parameter is set incorrectly, [AL. 537 Parameter setting range error (safety sub-function)] occurs.

[Pr. PSA02.2_Time/Deceleration monitor setting]

Initial value	Setting range	Ver.
0h	Refer to the text	E8

0:Perform time monitoring (SS1)

1:Perform time monitoring (SS1) and deceleration monitoring

If this functional safety parameter is set incorrectly, [AL. 537 Parameter setting range error (safety sub-function)] occurs.

[Pr. PSA02.3_Operation mode selection]

Initial value	Setting range	Ver.
0h	Refer to the text	E8

0:Standard control mode

4:Linear servo motor control mode

If [Pr. PSA02.1 Position/Speed monitor setting] is not set to "0" (Do not monitor the position/speed), set this servo parameter to the same value as [Pr. PA01.1 Operation mode selection]. If this functional safety parameter is set incorrectly, [AL. 537 Parameter setting range error (safety sub-function)] occurs.

[Pr. PSA03_SS1 deceleration monitor time (**SST)]

Initial value	Setting range	Ver.
1000 [ms]	0 to 60000	E8

Set the deceleration time for the SS1 function. This functional safety parameter is used by the following function.

- When using the SS1 function, the STO function activates if the time set in this functional safety parameter elapses during deceleration.

[Pr. PSA04_Safety sub-function - Stop speed (**SSS)]

Initial value	Setting range	Ver.
50 [r/min], [mm/s]	0 to 10000	E8

Set the stop speed. If the absolute value of the servo motor speed is equal to or less than the value set in this functional safety parameter, the servo motor is considered as being stopped.

This functional safety parameter is used by the following two functions.

- When using the SS1 function, the STO function activates if the deceleration speed during deceleration monitoring becomes equal to or less than the servo motor speed set in this functional safety parameter.
- When using the SDI function, the STO function activates if movement counter to the travel direction specified in SDIP or SDIN occurs during direction monitoring due to the servo motor speed set in this functional safety parameter.

[Pr. PSA07_SLS deceleration monitor time 1 (**SLSDT1)]

Initial value	Setting range	Ver.
1000 [ms]	0 to 60000	E8

Set the threshold for the time required for the speed monitoring to start after the SLS1 command is enabled. Specify sufficient time that allows deceleration to the safety speed after the SLS1 command is enabled. Perform deceleration control from the controller or other operation as necessary during this delay time.

[Pr. PSA08_SLS deceleration monitor time 2 (**SLSDT2)]

Initial value	Setting range	Ver.
1000 [ms]	0 to 60000	E8

Set the threshold for the time required for the speed monitoring to start after the SLS2 command is enabled. Specify sufficient time that allows deceleration to the safety speed after the SLS2 command is enabled. Perform deceleration control from the controller or other operation as necessary during this delay time.

[Pr. PSA09_SLS deceleration monitor time 3 (**SLSDT3)]

Initial value	Setting range	Ver.
1000 [ms]	0 to 60000	E8

Set the threshold for the time required for the speed monitoring to start after the SLS3 command is enabled. Specify sufficient time that allows deceleration to the safety speed after the SLS3 command is enabled. Perform deceleration control from the controller or other operation as necessary during this delay time.

[Pr. PSA10_SLS deceleration monitor time 4 (**SLSDT4)]

Initial value	Setting range	Ver.
1000 [ms]	0 to 60000	E8

Set the threshold for the time required for the speed monitoring to start after the SLS4 command is enabled. Specify sufficient time that allows deceleration to the safety speed after the SLS4 command is enabled. Perform deceleration control from the controller or other operation as necessary during this delay time.

[Pr. PSA11_SLS speed 1 (**SLSS1)]

Initial value	Setting range	Ver.
50 [r/min], [mm/s]	0 to 10000	E8

Set the threshold for the safety speed when activating the SLS function with the SLS1 command. When using the SLS function, the STO function activates if the absolute value of the servo motor speed exceeds this value during speed monitoring.

[Pr. PSA12_SLS speed 2 (**SLSS2)]

Initial value	Setting range	Ver.
50 [r/min], [mm/s]	0 to 10000	E8

Set the threshold for the safety speed when activating the SLS function with the SLS2 command. When using the SLS function, the STO function activates if the absolute value of the servo motor speed exceeds this value during speed monitoring.

[Pr. PSA13_SLS speed 3 (**SLSS3)]

Initial value	Setting range	Ver.
50 [r/min], [mm/s]	0 to 10000	E8

Set the threshold for the safety speed when activating the SLS function with the SLS3 command. When using the SLS function, the STO function activates if the absolute value of the servo motor speed exceeds this value during speed monitoring.

[Pr. PSA14_SLS speed 4 (**SLSS4)]

Initial value	Setting range	Ver.
50 [r/min], [mm/s]	0 to 10000	E8

Set the threshold for the safety speed when activating the SLS function with the SLS4 command. When using the SLS function, the STO function activates if the absolute value of the servo motor speed exceeds this value during speed monitoring.

[Pr. PSA15_Safety sub-function - Speed detection delay time (**SLST)]

Initial value	Setting range	Ver.
10 [ms]	5 to 2000	E8

Set the filter time of the delay filter that will judge whether the servo motor speed has exceeded or fallen below the threshold during speed monitoring. The setting of this functional safety parameter delays the response time of the following types of speed monitoring.

- The time required for the STO function to start after the speed is exceeded during speed monitoring via the SLS function
- The time required for the STO function to start after the deceleration speed either exceeds the deceleration monitor speed or falls below the stop speed during deceleration monitoring via the SS1 function

[Pr. PSA18_SSM speed (**SSMS)]

Initial value	Setting range	Ver.
50 [r/min], [mm/s]	0 to 10000	E8

Set the threshold for the safety speed when activating the SSM function. SSMS (SSM output) turns off when the absolute value of the servo motor speed exceeds this speed, and turns on when the absolute value of the servo motor speed falls below this speed. Note that judgment of the absolute value of the servo motor speed uses the hysteresis specified in [Pr. PSA19 SSM hysteresis width].

SSMS (SSM output) is turned off if an alarm that disables the safety sub-function occurs.

If this functional safety parameter is set incorrectly, [AL. 537 Parameter setting range error (safety sub-function)] occurs.

[Pr. PSA19_SSM hysteresis width (**SSMHW)]

Initial value	Setting range	Ver.
20 [r/min], [mm/s]	0 to 10000	E8

Set the threshold for the hysteresis width of SSM speed judgment. Set a value smaller than the value set in [Pr. PSA18 SSM speed].

Setting a value equal to or larger than the value set in [Pr. PSA18] triggers [AL. 537 Parameter setting range error (safety sub-function)].

If this functional safety parameter is set incorrectly, [AL. 537] occurs.

[Pr. PSA20_Servo motor encoder resolution (**SMER)]

Initial value	Setting range	Ver.
67108864 [pulse/rev]	0 to 4294967295	E8

Set the encoder resolution of the servo motor. There is no need to set this functional safety parameter when using a linear servo motor. However, it is necessary to set [Pr. PSL02 Functional safety - Linear encoder resolution setting - Numerator] and [Pr. PSL03 Functional safety - Linear encoder resolution setting - Denominator].

If the value set in this functional safety parameter does not match the resolution of the actually connected encoder, [AL. 537 Parameter setting range error (safety sub-function)] occurs.

If this functional safety parameter is set incorrectly, [AL. 537] occurs.

[Pr. PSA22_Position feedback error detection time (**SAADT)]

Initial value	Setting range	Ver.
60 [min]	0 to 65535	E8

Set the time required for detection of [AL. 52A Position feedback error (safety sub-function)].

The time required to detect a position feedback error when a standard encoder is used will be set.

Diagnosis via [AL. 52A] is not executed if this parameter is set to "0".

[Pr. PSA23_Servo motor rated speed (**SMRS)]

Initial value	Setting range	Ver.
3000 [r/min], [mm/s]	0 to 10000	E8

Set the servo motor rated speed. This functional safety parameter converts the values from [Pr. PSA24 SS1 deceleration monitor time constant] or other parameters into acceleration.

Set the rated speed of the connected servo motor. If the rated speed set in this functional safety parameter does not match the rated speed of the actually connected servo motor, [AL. 537 Parameter setting range error (safety sub-function)] occurs.

[Pr. PSA24_SS1 deceleration monitor time constant (**SSTC)]

Initial value	Setting range	Ver.
100 [ms]	0 to 20000	E8

Set the deceleration time constant for the SS1 function. The STO function activates if the speed does not conform to the deceleration time constant set in this functional safety parameter after deceleration monitoring starts.

[Pr. PSA25_SS1 deceleration monitor speed offset (**SSOF)]

Initial value	Setting range	Ver.
0 [r/min], [mm/s]	0 to 10000	E8

Set the monitor speed offset for [Pr. PSA24 SS1 deceleration monitor time constant].

Use this parameter if overshoot occurs at the start of deceleration.

[Pr. PSA26_SS1 deceleration monitor delay time (**SSDT)]

Initial value	Setting range	Ver.
100 [ms]	0 to 60000	E8

Set the threshold for the time required for the deceleration monitoring to start after the SS1 command is enabled. Specify sufficient time required for the deceleration to start after the SS1 command is enabled.

[Pr. PSA27_SDI positive direction monitor delay time (**SDIDTP)]

Initial value	Setting range	Ver.
1000 [ms]	0 to 60000	E8

Set the time required for the direction monitoring to start after the SDIP command is enabled. Specify sufficient time that allows the travel direction of the servo motor to change to the negative direction after the SDIP command is enabled.

[Pr. PSA28_SDI negative direction monitor delay time (**SDIDTN)]

Initial value	Setting range	Ver.
1000 [ms]	0 to 60000	E8

Set the time required for the direction monitoring to start after the SDIN command is enabled. Specify sufficient time that allows the travel direction of the servo motor to change to the positive direction after the SDIN command is enabled.

7.2 Safety sub-function 2 parameters group ([Pr. PSB_ _])

[Pr. PSB10_SLT torque upper limit value 1 (**SLTP1)]

Initial value	Setting range	Ver.
15.0 [%]	-1000.0 to 1000.0	E8

Set the upper limit threshold for the safety torque when activating the SLT function with the SLT1 command. When using the SLT function, the STO function will activate if the torque exceeds the threshold during torque monitoring. Set a value larger than the value set in [Pr. PSB14 SLT torque lower limit value 1]. If this functional safety parameter is set incorrectly, [AL. 537 Parameter setting range error (safety sub-function)] occurs.

[Pr. PSB11_SLT torque upper limit value 2 (**SLTP2)]

Initial value	Setting range	Ver.
15.0 [%]	-1000.0 to 1000.0	E8

Set the upper limit threshold for the safety torque when activating the SLT function with the SLT2 command. When using the SLT function, the STO function will activate if the torque exceeds the threshold during torque monitoring. Set a value larger than the value set in [Pr. PSB15 SLT torque lower limit value 2]. If this functional safety parameter is set incorrectly, [AL. 537 Parameter setting range error (safety sub-function)] occurs.

[Pr. PSB12_SLT torque upper limit value 3 (**SLTP3)]

Initial value	Setting range	Ver.
15.0 [%]	-1000.0 to 1000.0	E8

Set the upper limit threshold for the safety torque when activating the SLT function with the SLT3 command. When using the SLT function, the STO function will activate if the torque exceeds the threshold during torque monitoring. Set a value larger than the value set in [Pr. PSB16 SLT torque lower limit value 3]. If this functional safety parameter is set incorrectly, [AL. 537 Parameter setting range error (safety sub-function)] occurs.

[Pr. PSB13_SLT torque upper limit value 4 (**SLTP4)]

Initial value	Setting range	Ver.
15.0 [%]	-1000.0 to 1000.0	E8

Set the upper limit threshold for the safety torque when activating the SLT function with the SLT4 command. When using the SLT function, the STO function will activate if the torque exceeds the threshold during torque monitoring. Set a value larger than the value set in [Pr. PSB17 SLT torque lower limit value 4]. If this functional safety parameter is set incorrectly, [AL. 537 Parameter setting range error (safety sub-function)] occurs.

[Pr. PSB14_SLT torque lower limit value 1 (**SLTN1)]

Initial value	Setting range	Ver.
-15.0 [%]	-1000.0 to 1000.0	E8

Set the lower limit threshold for the safety torque when activating the SLT function with the SLT1 command. When using the SLT function, the STO function will activate if the torque falls below the threshold during torque monitoring. Set a value smaller than the value set in [Pr. PSB10 SLT torque upper limit value 1]. If this functional safety parameter is set incorrectly, [AL. 537 Parameter setting range error (safety sub-function)] occurs.

[Pr. PSB15_SLT torque lower limit value 2 (**SLTN2)]

Initial value	Setting range	Ver.
-15.0 [%]	-1000.0 to 1000.0	E8

Set the lower limit threshold for the safety torque when activating the SLT function with the SLT2 command. When using the SLT function, the STO function will activate if the torque falls below the threshold during torque monitoring. Set a value smaller than the value set in [Pr. PSB11 SLT torque upper limit value 2]. If this functional safety parameter is set incorrectly, [AL. 537 Parameter setting range error (safety sub-function)] occurs.

[Pr. PSB16_SLT torque lower limit value 3 (**SLTN3)]

Initial value	Setting range	Ver.
-15.0 [%]	-1000.0 to 1000.0	E8

Set the lower limit threshold for the safety torque when activating the SLT function with the SLT3 command. When using the SLT function, the STO function will activate if the torque falls below the threshold during torque monitoring. Set a value smaller than the value set in [Pr. PSB12 SLT torque upper limit value 3]. If this functional safety parameter is set incorrectly, [AL. 537 Parameter setting range error (safety sub-function)] occurs.

[Pr. PSB17_SLT torque lower limit value 4 (**SLTN4)]

Initial value	Setting range	Ver.
-15.0 [%]	-1000.0 to 1000.0	E8

Set the lower limit threshold for the safety torque when activating the SLT function with the SLT4 command. When using the SLT function, the STO function will activate if the torque falls below the threshold during torque monitoring. Set a value smaller than the value set in [Pr. PSB13 SLT torque upper limit value 4]. If this functional safety parameter is set incorrectly, [AL. 537 Parameter setting range error (safety sub-function)] occurs.

[Pr. PSB18_SLT torque detection delay time (**SLTT)]

Initial value	Setting range	Ver.
10 [ms]	0 to 2000	E8

Set the filter time of the delay filter that will judge whether the torque has exceeded the threshold during torque monitoring. The setting of this functional safety parameter delays the response time of torque monitoring.

7.3 Network parameters group ([Pr. PSC_ _])

[Pr. PSC01_Transmission interval monitor time (**SNC)]

When the command interface of the servo amplifier is EtherCAT, this servo parameter is not available.

Initial value	Setting range	Ver.
32 [ms]	16 to 1000	E8

Select the transmission interval monitor time for safety communication.

Set the transmission interval monitor time so that it matches the safety communication setting of the controller.

This functional safety parameter can be used only with CC-Link IE TSN.

[Pr. PSC03_Functional safety - Rotation direction selection/travel direction selection (**SNPOL)]

Initial value	Setting range	Ver.
00000010h	Refer to the relevant detail No.	Refer to the relevant detail No.

The rotation/travel direction can be changed without changing the polarity of the command from the controller.

[Pr. PSC03.0_Rotation direction selection/travel direction selection]

Initial value	Setting range	Ver.
0h	Refer to the text	E8

Set this functional safety parameter to the same value as [Pr. PA14 Travel direction selection].

Refer to the following table for setting values.

Setting value	Servo motor rotation direction/linear servo motor travel direction	
	At forward rotation pulse input	At reverse rotation pulse input
0	CCW or positive direction	CW or negative direction
1	CW or negative direction	CCW or positive direction

If this functional safety parameter is set incorrectly, [AL. 537 Parameter setting range error (safety sub-function)] occurs.

[Pr. PSC06_Safety verification code (**SAC)]

When the command interface of the servo amplifier is EtherCAT, this servo parameter is not available.

Initial value	Setting range	Ver.
FFFFFFFFh	00000000h to FFFFFFFFh	E8

Set the safety verification code for safety communication.

Set the value used to identify the servo amplifier. Set the MAC address or others so that it is not identical to that of another servo amplifier.

Set the safety verification code to the same value as the value set in the safety communication setting of the master station. If this parameter is set to a non-matching value, [AL. 580 Safety communication setting error (safety sub-function)] occurs.

When setting the MAC address, set the lower 8 digits.

[Pr. PSC07_FSoE Address setting (**FSADD)]

When the command interface of the servo amplifier is CC-Link IE TSN, this functional safety parameter is not available.

Initial value	Setting range	Ver.
0	0 to 65535	E8

Set the FSoE Slave address of the servo amplifier within the range of 1 to 65535.

Set the value used to identify FSoE Slave. Ensure that FSoE Slave has a unique value.

Set FSoE Master to the same value as this functional safety parameter. If it is set to a different value, [AL. 584 FSoE communication setting error (safety sub-function)] occurs.

When [Pr. PSA01.0 Safety sub-function activation setting] is set to "1" (enabled) and [Pr. PSA01.1 Input mode selection] is set to "1" (safety sub-function control by network), setting this functional safety parameter to "0" triggers [AL. 537 Parameter setting range error (Safety sub-function)].

[Pr. PSC08_Safety communication - Functional safety disabled setting (**SCFN)]

Initial value	Setting range	Ver.
0h	Refer to the relevant detail No.	Refer to the relevant detail No.

The setting value of this servo parameter is enabled only when the safety sub-function by network is used.

The disabled safety function will be deactivated even if the clear command is not notified through safety communication.

[Pr. PSC08.0_Functional safety disabled setting 1]

Initial value	Setting range	Ver.
0h	Refer to the text	E8

Setting digit (BIN)	Description
___x	For manufacturer setting
__x_	For manufacturer setting
_x__	SS1C (SS1 command) 0:Enabled 1:Disabled
x___	For manufacturer setting

[Pr. PSC08.1_Functional safety disabled setting 2]

Initial value	Setting range	Ver.
0h	Refer to the text	E8

Setting digit (BIN)	Description
___x	SLS1C (SLS1 command) 0:Enabled 1:Disabled
__x_	SLS2C (SLS2 command) 0:Enabled 1:Disabled
_x__	SLS3C (SLS3 command) 0:Enabled 1:Disabled
x___	SLS4C (SLS4 command) 0:Enabled 1:Disabled

[Pr. PSC08.2_Functional safety disabled setting 3]

Initial value	Setting range	Ver.
0h	Refer to the text	E8
Setting digit (BIN)	Description	
___x	SDIPC (SDIP command) 0:Enabled 1:Disabled	
__x_	SDINC (SDIN command) 0:Enabled 1:Disabled	
_x__	SLT1C (SLT1 command) 0:Enabled 1:Disabled	
x___	SLT2C (SLT2 command) 0:Enabled 1:Disabled	

[Pr. PSC08.3_Functional safety disabled setting 4]

Initial value	Setting range	Ver.
0h	Refer to the text	E8
Setting digit (BIN)	Description	
___x	SLT3C (SLT3 command) 0:Enabled 1:Disabled	
__x_	SLT4C (SLT4 command) 0:Enabled 1:Disabled	
_x__	For manufacturer setting	
x___	For manufacturer setting	

[Pr. PSC09_Safety communication - Output signal polarity setting (**SFPOL)]

Initial value	Setting range	Ver.
0h	Refer to the relevant detail No.	E8

The setting value of this servo parameter is enabled only when the safety sub-function by network is used.

The polarity of the feedback status information for the safety communication can be reversed.

For details of the status information, refer to "Safety sub-function control by network" in the User's Manual (Function).

[Pr. PSC09.0_Output signal polarity setting 1]

Initial value	Setting range	Ver.
0h	Refer to the text	E8

Setting digit (BIN)	Description
___x	For manufacturer setting
__x_	STOS (STO output) 0:Disabled 1:Enabled (Reverse polarity)
_x__	SS1S (SS1 output) 0:Disabled 1:Enabled (Reverse polarity)
x___	For manufacturer setting

[Pr. PSC09.1_Output signal polarity setting 2]

Initial value	Setting range	Ver.
0h	Refer to the text	E8

Setting digit (BIN)	Description
___x	SLS1S (SLS1 output) 0:Disabled 1:Enabled (Reverse polarity)
__x_	SLS2S (SLS2 output) 0:Disabled 1:Enabled (Reverse polarity)
_x__	SLS3S (SLS3 output) 0:Disabled 1:Enabled (Reverse polarity)
x___	SLS4S (SLS4 output) 0:Disabled 1:Enabled (Reverse polarity)

[Pr. PSC09.2_ Output signal polarity setting 3]

Initial value	Setting range	Ver.
0h	Refer to the text	E8
Setting digit (BIN)	Description	
___x	SSM (SSM output) 0:Disabled 1:Enabled (Reverse polarity)	
__x_	For manufacturer setting	
_x__	SBC (SBC output) 0:Disabled 1:Enabled (Reverse polarity)	
x___	SDIPS (SDIP output) 0:Disabled 1:Enabled (Reverse polarity)	

[Pr. PSC09.3_ Output signal polarity setting 4]

Initial value	Setting range	Ver.
0h	Refer to the text	E8
Setting digit (BIN)	Description	
___x	SDINS (SDIN output) 0:Disabled 1:Enabled (Reverse polarity)	
__x_	SLT1S (SLT1 output) 0:Disabled 1:Enabled (Reverse polarity)	
_x__	SLT2S (SLT2 output) 0:Disabled 1:Enabled (Reverse polarity)	
x___	SLT3S (SLT3 output) 0:Disabled 1:Enabled (Reverse polarity)	

[Pr. PSC09.4_ Output signal polarity setting 5]

Initial value	Setting range	Ver.
0h	Refer to the text	E8
Setting digit (BIN)	Description	
___x	SLT4S (SLT4 output) 0:Disabled 1:Enabled (Reverse polarity)	
__x_	For manufacturer setting	
_x__	For manufacturer setting	
x___	For manufacturer setting	

7.4 Safety I/O device parameters group ([Pr. PSD_ _])

[Pr. PSD01_Input device automatic activation selection (**SDIA)]

Initial value	Setting range	Ver.
00000000h	Refer to the relevant detail No.	Refer to the relevant detail No.

This setting is enabled only when the input device is used. This setting allows automatic activation of the SLS function, SLT function, and SDI function. The command set for automatic activation in this setting turns off (function enabled) at system startup, following which the relevant function will start automatically.

Speed monitoring via the SLS function is always enabled by automatically activating SLS1C to SLS4C.

If this functional safety parameter is set incorrectly, [AL. 537 Parameter setting range error (safety sub-function)] occurs.

[Pr. PSD01.0_SLSC function automatic activation selection]

Initial value	Setting range	Ver.
0h	Refer to the text	E8

Setting digit (BIN)	Description
___x	SLS1C (SLS1 command) 0:Not perform automatic activation 1:Perform automatic activation
__x_	SLS2C (SLS2 command) 0:Not perform automatic activation 1:Perform automatic activation
_x__	SLS3C (SLS3 command) 0:Not perform automatic activation 1:Perform automatic activation
x___	SLS4C (SLS4 command) 0:Not perform automatic activation 1:Perform automatic activation

[Pr. PSD01.1_SLTC function automatic activation selection]

Initial value	Setting range	Ver.
0h	Refer to the text	E8

Setting digit (BIN)	Description
___x	SLT1C (SLT1 command) 0:Not perform automatic activation 1:Perform automatic activation
__x_	SLT2C (SLT2 command) 0:Not perform automatic activation 1:Perform automatic activation
_x__	SLT3C (SLT3 command) 0:Not perform automatic activation 1:Perform automatic activation
x___	SLT4C (SLT4 command) 0:Not perform automatic activation 1:Perform automatic activation

[Pr. PSD01.2_SDIC function automatic activation selection]

Initial value	Setting range	Ver.
0h	Refer to the text	E8

Setting digit (BIN)	Description
___x	SDIPC (SDIP command) 0:Not perform automatic activation 1:Perform automatic activation
__x_	SDINC (SDIN command) 0:Not perform automatic activation 1:Perform automatic activation
_x__	For manufacturer setting
x___	For manufacturer setting

[Pr. PSD02_Safety input device selection DI1 (**SDI1)]

Initial value	Setting range	Ver.
00000000h	Refer to the relevant detail No.	Refer to the relevant detail No.

Select the input device to be assigned to SDI1A and SDI1B.

Assign a device to [Pr. PSD02 Safety Input device selection DI1] if "0" (safety sub-function control by input device) is selected in [Pr. PSA01.1 Input mode selection]. If no device is set to [Pr. PSD02], [AL. 537 Parameter setting range error (safety sub-function)] occurs.

If this functional safety parameter is set incorrectly, [AL. 537] occurs.

Refer to the following table for the connector pin corresponding to each SDI.

Hardware symbol	Corresponding connector pin
	MR-JET-_G_-HS(N1)
SDI1A	CN3-8A
SDI1B	CN3-8B

[Pr. PSD02.0-1_Safety input device selection DI1]

Initial value	Setting range	Ver.
00h	Refer to the text	E8

Select the function to be assigned to SDI1A and SDI1B.

Refer to the following table for setting values.

Setting value	Input device
00	None
01	STOC (STO command)
02	SS1C (SS1 command)
04	SLS1C (SLS1 command)
05	SLS2C (SLS2 command)
06	SLS3C (SLS3 command)
07	SLS4C (SLS4 command)
08	SDIPC (SDIP command)
09	SDINC (SDIN command)
0A	SLT1C (SLT1 command)
0B	SLT2C (SLT2 command)
0C	SLT3C (SLT3 command)
0D	SLT4C (SLT4 command)

If an unavailable input device for the safety sub-function is selected, [AL. 537] occurs. For availability of each safety sub-function, refer to "List of safety sub-function compatible units" in the User's Manual (Introduction).

[Pr. PSD03_Safety input device selection DI2 (**SDI2)]

Initial value	Setting range	Ver.
00000000h	Refer to the relevant detail No.	Refer to the relevant detail No.

Select the input device to be assigned to SDI2A and SDI2B.

Refer to the following table for the connector pin corresponding to each SDI.

Hardware symbol	Corresponding connector pin
	MR-JET-_G_-HS(N1)
SDI2A	CN3-12A
SDI2B	CN3-12B

[Pr. PSD03.0-1_Safety input device selection DI2]

Initial value	Setting range	Ver.
00h	00h to 0Eh	E8

Select the function to be assigned to SDI2A and SDI2B.

For details of the setting values, refer to the following.

☞ Page 209 [Pr. PSD02_Safety input device selection DI1 (**SDI1)]

[Pr. PSD04_Safety input device selection DI3 (**SDI3)]

Initial value	Setting range	Ver.
00000000h	Refer to the relevant detail No.	Refer to the relevant detail No.

Select the input device to be assigned to SDI3A and SDI3B.

Refer to the following table for the connector pin corresponding to each SDI.

Hardware symbol	Corresponding connector pin
	MR-JET-_G_-HS(N1)
SDI3A	CN3-13A
SDI3B	CN3-13B

[Pr. PSD04.0-1_Safety input device selection DI3]

Initial value	Setting range	Ver.
00h	00h to 0Eh	E8

Select the function to be assigned to SDI3A and SDI3B.

For details of the setting values, refer to the following.

☞ Page 209 [Pr. PSD02_Safety input device selection DI1 (**SDI1)]

[Pr. PSD08_Safety output device selection DO1 (**SDO1)]

Initial value	Setting range	Ver.
00000000h	Refer to the relevant detail No.	Refer to the relevant detail No.

Select the output device to be assigned to SDO1A and SDO1B.

If this functional safety parameter is set incorrectly, [AL. 537 Parameter setting range error (safety sub-function)] occurs.

Refer to the following table for the connector pin corresponding to each SDO.

Hardware symbol	Corresponding connector pin
	MR-JET-_G_-HS(N1)
SDO1A	CN3-11A
SDO1B	CN3-11B

[Pr. PSD08.0-1_Safety output device selection DO1]

Initial value	Setting range	Ver.
00h	Refer to the text	E8

Select the function to be assigned to SDO1A and SDO1B.

Refer to the following table for setting values.

Setting value	Output device
00	None
01	STOS (STO output)
02	SS1S (SS1 output)
04	SLS1S (SLS1 output)
05	SLS2S (SLS2 output)
06	SLS3S (SLS3 output)
07	SLS4S (SLS4 output)
08	SSMS (SSM output)
0A	SBCS (SBC output)
0B	SDIPS (SDIP output)
0C	SDINS (SDIN output)
0D	SLT1S (SLT1 output)
0E	SLT2S (SLT2 output)
0F	SLT3S (SLT3 output)
10	SLT4S (SLT4 output)

If an unavailable output device for the safety sub-function is selected, [AL. 537] occurs. For availability of each safety sub-function, refer to "List of safety sub-function compatible units" in the User's Manual (Introduction).

[Pr. PSD09_Safety output device selection DO2 (**SDO2)]

Initial value	Setting range	Ver.
00000000h	Refer to the relevant detail No.	Refer to the relevant detail No.

Select the output device to be assigned to SDO2A and SDO2B.

Refer to the following table for the connector pin corresponding to each SDO.

Hardware symbol	Corresponding connector pin
	MR-JET-_G_-HS(N1)
SDO2A	CN3-14A
SDO2B	CN3-14B

[Pr. PSD09.0-1_Safety output device selection DO2]

Initial value	Setting range	Ver.
00h	00h to 1Fh	E8

Select the function to be assigned to SDO2A and SDO2B.

For details of the setting values, refer to the following.

 Page 211 [Pr. PSD08_Safety output device selection DO1 (**SDO1)]

[Pr. PSD10_Safety output device selection DO3 (**SDO3)]

Initial value	Setting range	Ver.
00000000h	Refer to the relevant detail No.	Refer to the relevant detail No.

Select the output device to be assigned to SDO3PA, SDO3NA, SDO3PB, and SDO3NB.

Refer to the following table for the connector pin corresponding to each SDO.

Hardware symbol	Corresponding connector pin
	MR-JET-_G_-HS(N1)
SDO3PA	CN3-15A
SDO3NA	CN3-16A
SDO3PB	CN3-15B
SDO3NB	CN3-16B

[Pr. PSD10.0-1_Safety output device selection DO3]

Initial value	Setting range	Ver.
00h	00h to 1Fh	E8

Select the function to be assigned to SDO3PA, SDO3NA, SDO3PB, and SDO3NB.

For details of the setting values, refer to the following.

 Page 211 [Pr. PSD08_Safety output device selection DO1 (**SDO1)]

[Pr. PSD12_Input device - Noise elimination filter time D11 (**SDIF1)]

Initial value	Setting range	Ver.
00000001h	Refer to the relevant detail No.	Refer to the relevant detail No.

Select the filter time to use for reducing noise from SDI1A and SDI1B.

Refer to the following table for details.

Configuration		Noise elimination filter time
Using a switch		Set 1.00 ms or more.
Using a machine utilizing the diagnosis function	Test pulses are in superposition in the output signal of the device.	Set the time that is at least 1.00 ms longer than the off time for test pulses output by the machine.
	Test pulses are not in superposition in the output signal of the device.	Set 1.00 ms or more.

[Pr. PSD12.0-1_Noise elimination filter time D11]

Initial value	Setting range	Ver.
01h	Refer to the text	E8

Select the filter time for SDI1A and SDI1B.

Refer to the following table for setting values.

Setting value	Filter time [ms]
00	1.000
01	2.000
02	4.000
03	8.000
04	16.000
05	32.000

[Pr. PSD13_Input device - Noise elimination filter time D12 (**SDIF2)]

Initial value	Setting range	Ver.
00000001h	Refer to the relevant detail No.	Refer to the relevant detail No.

Select the filter time to use for reducing noise from SDI2A and SDI2B.

 Page 213 [Pr. PSD12_Input device - Noise elimination filter time D11 (**SDIF1)]

If this functional safety parameter is set incorrectly, [AL. 537 Parameter setting range error (safety sub-function)] occurs.

[Pr. PSD13.0-1_Noise elimination filter time D12]

Initial value	Setting range	Ver.
01h	00h to 05h	E8

Select the noise elimination filter time for SDI2A and SDI2B.

For details of the setting values, refer to the following.

 Page 213 [Pr. PSD12_Input device - Noise elimination filter time D11 (**SDIF1)]

[Pr. PSD14_Input device - Noise elimination filter time DI3 (**SDIF3)]

Initial value	Setting range	Ver.
00000001h	Refer to the relevant detail No.	Refer to the relevant detail No.

Select the filter time to use for reducing noise from SDI3A and SDI3B.

☞ Page 213 [Pr. PSD12_Input device - Noise elimination filter time DI1 (**SDIF1)]

If this functional safety parameter is set incorrectly, [AL. 537 Parameter setting range error (safety sub-function)] occurs.

[Pr. PSD14.0-1_Noise elimination filter time DI3]

Initial value	Setting range	Ver.
01h	00h to 05h	E8

Select the noise elimination filter time for SDI3A and SDI3B.

For details of the setting values, refer to the following.

☞ Page 213 [Pr. PSD12_Input device - Noise elimination filter time DI1 (**SDIF1)]

[Pr. PSD18_Permissible time for mismatches DI1 (**SDIDT1)]

Initial value	Setting range	Ver.
20 [ms]	0 to 60000	E8

Set the permissible mismatched time for SDI1A and SDI1B.

If the mismatched time for SDI1A and SDI1B exceeds the time set in this parameter, [AL. 557 Input device mismatch detection (safety sub-function)] occurs.

If it is set to "0", the alarm will not be detected.

If [Pr. PSA01.0 Safety sub-function activation setting] is set to "0" (disabled), the alarm occurs in 10000 ms (10 s).

Refer to the following table for details.

Model	Setting of [Pr. PSA01.0]	Parameter to be used	Time required for alarm to occur	Alarm to occur
MR-JET-G_HS(N1)	0:Disabled	—	Fixed to 10 s	[AL. 557]
	1:Enabled	[Pr. PSD18]	0 to 60000 ms	[AL. 557]

[Pr. PSD19_Permissible time for mismatches DI2 (**SDIDT2)]

Initial value	Setting range	Ver.
20 [ms]	0 to 60000	E8

Set the permissible mismatched time for SDI2A and SDI2B.

If the mismatched time for SDI2A and SDI2B exceeds the time set in this parameter, [AL. 557 Input device mismatch detection (safety sub-function)] occurs.

If it is set to "0", the alarm will not be detected.

[Pr. PSD20_Permissible time for mismatches DI3 (**SDIDT3)]

Initial value	Setting range	Ver.
20 [ms]	0 to 60000	E8

Set the permissible mismatched time for SDI3A and SDI3B.

If the mismatched time for SDI3A and SDI3B exceeds the time set in this parameter, [AL. 557 Input device mismatch detection (safety sub-function)] occurs.

If it is set to "0", the alarm will not be detected.

[Pr. PSD27_Input device - Fixing diagnosis at startup execution selection 1 (**SDID1)]

Initial value	Setting range	Ver.
00001111h	Refer to the relevant detail No.	Refer to the relevant detail No.

Select whether to perform a fixing diagnosis at startup for SDI1A to SDI1B and SDI3A to SDI3B.

[Pr. PSD27.0_Fixing diagnosis at startup execution selection DI1]

Initial value	Setting range	Ver.
1h	Refer to the text	E8

Select whether to perform a fixing diagnosis at startup for SDI1A and SDI1B.

0:Not diagnose

1:Diagnose

[Pr. PSD27.1_Fixing diagnosis at startup execution selection DI2]

Initial value	Setting range	Ver.
1h	Refer to the text	E8

Select whether to perform a fixing diagnosis at startup for SDI2A and SDI2B.

0:Not diagnose

1:Diagnose

[Pr. PSD27.2_Fixing diagnosis at startup execution selection DI3]

Initial value	Setting range	Ver.
1h	Refer to the text	E8

Select whether to perform a fixing diagnosis at startup for SDI3A and SDI3B.

0:Not diagnose

1:Diagnose

[Pr. PSD29_Output device - Test pulse diagnosis execution selection (**SDOP)]

Initial value	Setting range	Ver.
00001111h	Refer to the relevant detail No.	Refer to the relevant detail No.

Select whether to perform a diagnosis using test pulses for SDO1A to SDO1B and SDO3A to SDO3B.

[Pr. PSD29.0_Test pulse diagnosis execution selection DO1]

Initial value	Setting range	Ver.
1h	Refer to the text	E8

Select whether to perform a diagnosis using test pulses for SDO1A and SDO1B.

When "0" (do not perform diagnosis) is selected, no test pulses are output from SDO1A/SDO1B.

0:Not diagnose

1:Diagnose

[Pr. PSD29.1_Test pulse diagnosis execution selection DO2]

Initial value	Setting range	Ver.
1h	Refer to the text	E8

Select whether to perform a diagnosis using test pulses for SDO2A and SDO2B.

When "0" (do not perform diagnosis) is selected, no test pulses are output from SDO2A/SDO2B.

0:Not diagnose

1:Diagnose

[Pr. PSD29.2_Test pulse diagnosis execution selection DO3]

Initial value	Setting range	Ver.
1h	Refer to the text	E8

Select whether to perform a diagnosis using test pulses for SDO3NA and SDO3NB.

When "0" (do not perform diagnosis) is selected, no test pulses are output from SDO3NA/SDO3NB.

0:Not diagnose

1:Diagnose

[Pr. PSD30_Output device - Test pulse off time (**SDOPW)]

Initial value	Setting range	Ver.
0000000h	Refer to the relevant detail No.	Refer to the relevant detail No.

Select the off pulse time for test pulses output from SDO1A to SDO1B and SDO3A to SDO3B.

[Pr. PSD30.0_Test pulse off time DO1]

Initial value	Setting range	Ver.
0h	Refer to the text	E8

Select the off pulse time for test pulses output from SDO1A and SDO1B.

The setting value of this servo parameter is enabled only when [Pr. PSD29.0 Test pulse diagnosis execution selection DO1] is set to "1".

Refer to the following table for setting values.

Setting value	Off time [ms]
0	0.500
1	1.000
2	2.000

[Pr. PSD30.1_Test pulse off time DO2]

Initial value	Setting range	Ver.
0h	0h to 2h	E8

Select the off pulse time for test pulses output from SDO2A and SDO2B.

The setting value of this servo parameter is enabled only when [Pr. PSD29.1 Test pulse diagnosis execution selection DO2] is set to "1".

For details of the setting values, refer to the following.

☞ Page 217 [Pr. PSD30_Output device - Test pulse off time (**SDOPW)]

[Pr. PSD30.2_Test pulse off time DO3]

Initial value	Setting range	Ver.
0h	0h to 2h	E8

Select the off pulse time for test pulses output from SDO3NA and SDO3NB.

The setting value of this servo parameter is enabled only when [Pr. PSD29.2 Test pulse diagnosis execution selection DO3] is set to "1".

For details of the setting values, refer to the following.

☞ Page 217 [Pr. PSD30_Output device - Test pulse off time (**SDOPW)]

[Pr. PSD31_Output device - Feedback diagnosis execution selection (**SDOD1)]

Initial value	Setting range	Ver.
00001111h	Refer to the relevant detail No.	Refer to the relevant detail No.

Select whether to perform a feedback diagnosis for the output signal of SDO1A to SDO1B and SDO3A to SDO3B.

[Pr. PSD31.0_Feedback diagnosis execution selection DO1]

Initial value	Setting range	Ver.
1h	Refer to the text	E8

Select whether to perform a feedback diagnosis for SDO1A and SDO1B.

Normally, do not change the setting from "1" (perform diagnosis).

0:Not diagnose

1:Diagnose

[Pr. PSD31.1_Feedback diagnosis execution selection DO2]

Initial value	Setting range	Ver.
1h	Refer to the text	E8

Select whether to perform a feedback diagnosis for SDO2A and SDO2B.

Normally, do not change the setting from "1" (perform diagnosis).

0:Not diagnose

1:Diagnose

[Pr. PSD31.2_Feedback diagnosis execution selection DO3]

Initial value	Setting range	Ver.
1h	Refer to the text	E8

Select whether to perform a feedback diagnosis for SDO3NA and SDO3NB.

Normally, do not change the setting from "1" (perform diagnosis).

0:Not diagnose

1:Diagnose

7.5 Extension setting 3 parameters group ([Pr. PSL_ _])

[Pr. PSL02_Functional safety - Linear encoder resolution setting - Numerator (**SLIM)]

Initial value	Setting range	Ver.
1000 [μm]	1 to 65535	E8

Set the linear encoder resolution with [Pr. PSL02] and [Pr. PSL03 Functional safety - Linear encoder resolution setting - Denominator].

Set a numerator in [Pr. PSL02].

This functional safety parameter is enabled only when a linear servo motor is used.

Set this parameter to the same value as the value set in [Pr. PL02 Linear encoder resolution setting - Numerator] to perform position or speed monitoring using a linear servo motor. If this parameter is set to a different value, [AL. 537 Parameter setting range error (safety sub-function)] occurs.

[Pr. PSL03_Functional safety - Linear encoder resolution setting - Denominator (**SLID)]

Initial value	Setting range	Ver.
1000 [μm]	1 to 65535	E8

Set the linear encoder resolution with [Pr. PSL02 Functional safety - Linear encoder resolution setting - Numerator] and [Pr. PSL03].

Set a denominator in [Pr. PSL03].

This functional safety parameter is enabled only when a linear servo motor is used.

Set this parameter to the same value as the value set in [Pr. PL03 Linear encoder resolution setting - Denominator] to perform position or speed monitoring using a linear servo motor. If this parameter is set to a different value, [AL. 537 Parameter setting range error (safety sub-function)] occurs.

8 LISTS OF FUNCTIONAL SAFETY PARAMETER INITIAL VALUES

8.1 Safety sub-function 1 parameters group ([Pr. PSA_ _])

No.	Initial value
PSA01	00000000h
PSA02	00000000h
PSA03	1000
PSA04	50
PSA05	3
PSA06	00000000h
PSA07	1000
PSA08	1000
PSA09	1000
PSA10	1000
PSA11	50
PSA12	50
PSA13	50
PSA14	50
PSA15	10
PSA16	00000000h
PSA17	0
PSA18	50
PSA19	20
PSA20	67108864
PSA21	00000000h
PSA22	60
PSA23	3000
PSA24	100
PSA25	0
PSA26	100
PSA27	1000
PSA28	1000
PSA29	0
PSA30	0
PSA31	0
PSA32	00000000h
PSA33	00000000h
PSA34	00000000h
PSA35	00000000h
PSA36	00000000h
PSA37	00000000h
PSA38	00000000h
PSA39	00000000h
PSA40	00000000h
PSA41	00000000h

No.	Initial value
PSA42	0000000h
PSA43	0000000h
PSA44	0000000h
PSA45	0000000h
PSA46	0000000h
PSA47	0000000h
PSA48	0000000h
PSA49	0000000h
PSA50	0000000h
PSA51	0000000h
PSA52	0000000h
PSA53	0000000h
PSA54	0000000h
PSA55	0000000h
PSA56	0000000h
PSA57	0000000h
PSA58	0000000h
PSA59	0000000h
PSA60	0000000h
PSA61	0000000h
PSA62	0000000h
PSA63	0000000h
PSA64	0000000h

8.2 Safety sub-function 2 parameters group ([Pr. PSB_ _])

No.	Initial value
PSB01	00000000h
PSB02	3
PSB03	00000000h
PSB04	00000000h
PSB05	00000000h
PSB06	3
PSB07	00000000h
PSB08	00000000h
PSB09	00000000h
PSB10	15.0
PSB11	15.0
PSB12	15.0
PSB13	15.0
PSB14	-15.0
PSB15	-15.0
PSB16	-15.0
PSB17	-15.0
PSB18	10
PSB19	100
PSB20	50
PSB21	0
PSB22	15.0
PSB23	-15.0
PSB24	10
PSB25	10
PSB26	00000000h
PSB27	00000000h
PSB28	00000000h
PSB29	00000000h
PSB30	00000000h
PSB31	00000000h
PSB32	00000000h
PSB33	00000000h
PSB34	00000000h
PSB35	00000000h
PSB36	00000000h
PSB37	00000000h
PSB38	00000000h
PSB39	00000000h
PSB40	00000000h
PSB41	00000000h
PSB42	00000000h
PSB43	00000000h
PSB44	00000000h
PSB45	00000000h
PSB46	00000000h

No.	Initial value
PSB47	00000000h
PSB48	00000000h
PSB49	00000000h
PSB50	00000000h
PSB51	00000000h
PSB52	00000000h
PSB53	00000000h
PSB54	00000000h
PSB55	00000000h
PSB56	00000000h
PSB57	00000000h
PSB58	00000000h
PSB59	00000000h
PSB60	00000000h
PSB61	00000000h
PSB62	00000000h
PSB63	00000000h
PSB64	00000000h

8.3 Network parameters group ([Pr. PSC_ _])

No.	Initial value
PSC01	32
PSC02	0000000h
PSC03	0000010h
PSC04	0
PSC05	0000000h
PSC06	FFFFFFFh
PSC07	0000000h
PSC08	0000000h
PSC09	0000000h
PSC10	0000000h
PSC11	0000000h
PSC12	0000000h
PSC13	0000000h
PSC14	0000000h
PSC15	0000000h
PSC16	0000000h
PSC17	0000000h
PSC18	0000000h
PSC19	0000000h
PSC20	0000000h
PSC21	0000000h
PSC22	0000000h
PSC23	0000000h
PSC24	0000000h
PSC25	0000000h
PSC26	0000000h
PSC27	0000000h
PSC28	0000000h
PSC29	0000000h
PSC30	0000000h
PSC31	0000000h
PSC32	0000000h

8.4 Safety I/O device parameters group ([Pr. PSD_ _])

No.	Initial value
PSD01	00000000h
PSD02	00000000h
PSD03	00000000h
PSD04	00000000h
PSD05	00000000h
PSD06	00000000h
PSD07	00000000h
PSD08	00000000h
PSD09	00000000h
PSD10	00000000h
PSD11	00000000h
PSD12	00000001h
PSD13	00000001h
PSD14	00000001h
PSD15	00000001h
PSD16	00000001h
PSD17	00000001h
PSD18	20
PSD19	20
PSD20	20
PSD21	20
PSD22	20
PSD23	20
PSD24	00001111h
PSD25	00000011h
PSD26	00000001h
PSD27	00001111h
PSD28	00000011h
PSD29	00001111h
PSD30	00000000h
PSD31	00001111h
PSD32	00000000h
PSD33	00000000h
PSD34	00000000h
PSD35	00000000h
PSD36	00000000h
PSD37	00000000h
PSD38	00000000h
PSD39	00000000h
PSD40	00000000h
PSD41	00000000h
PSD42	00000000h
PSD43	00000000h
PSD44	00000000h
PSD45	00000000h
PSD46	00000000h
PSD47	00000000h

No.	Initial value
PSD48	00000000h
PSD49	00000000h
PSD50	00000000h
PSD51	00000000h
PSD52	00000000h
PSD53	00000000h
PSD54	00000000h
PSD55	00000000h
PSD56	00000000h
PSD57	00000000h
PSD58	00000000h
PSD59	00000000h
PSD60	00000000h
PSD61	00000000h
PSD62	00000000h
PSD63	00000000h
PSD64	00000000h

8.5 Extension setting 3 parameters group ([Pr. PSL_ _])

No.	Initial value
PSL01	00000000h
PSL02	1000
PSL03	1000
PSL04	00000000h
PSL05	00000000h
PSL06	00000000h
PSL07	00000000h
PSL08	00000000h
PSL09	00000000h
PSL10	00000000h
PSL11	00000000h
PSL12	00000000h
PSL13	00000000h
PSL14	00000000h
PSL15	00000000h
PSL16	00000000h
PSL17	00000000h
PSL18	00000000h
PSL19	00000000h
PSL20	00000000h
PSL21	00000000h
PSL22	00000000h
PSL23	00000000h
PSL24	00000000h
PSL25	00000000h
PSL26	00000000h
PSL27	00000000h
PSL28	00000000h
PSL29	00000000h
PSL30	00000000h
PSL31	00000000h
PSL32	00000000h

9 FUNCTIONAL SAFETY PARAMETER SETTING METHOD

9.1 Engineering software

Functional safety parameters can be set using the engineering software manufactured by Mitsubishi Electric (MR Configurator2).

Connect a personal computer and the servo amplifier via a USB cable or a network.

For details on how to set functional safety parameters, refer to Help or the manual for the engineering software.

REVISIONS

*The manual number is given on the bottom left of the back cover.

Revision date	*Manual number	Description
November 2019	IB(NA)-0300478ENG-A	First edition
July 2020	IB(NA)-0300478ENG-B	■Servo parameters related to the following functions are added: Profile mode, linear servo motor control mode, continuous operation to torque control mode, network function
October 2020	IB(NA)-0300478ENG-C	■Servo parameters related to the following function are added: Degree unit
March 2021	IB(NA)-0300478ENG-D	■Servo parameters related to the following function are added: Positioning mode (point table method)
July 2021	IB(NA)-0300478ENG-E	■Servo parameters related to the following function are added: CC-Link IE Field Network Basic
July 2022	IB(NA)-0300478ENG-F	■Servo parameters and servo motors related to the following functions are added: Fully closed loop system, touch probe, batteryless absolute position encoder equipped servo motor, CC-Link IE TSN Class A
January 2023	IB(NA)-0300478ENG-G	■Servo parameters related to the following function are added: Override function
July 2023	IB(NA)-0300478ENG-H	■Servo parameters related to the following function are added: Drive recorder
January 2024	IB(NA)-0300478ENG-J	■Servo parameters related to the following function are added: Parameter automatic setting
October 2024	IB(NA)-0300478ENG-K	■Servo parameters related to the following functions are added: Functional safety, EtherCAT, scale measurement function

This manual confers no industrial property rights or any rights of any other kind, nor does it confer any patent licenses. Mitsubishi Electric Corporation cannot be held responsible for any problems involving industrial property rights which may occur as a result of using the contents noted in this manual.

© 2019 MITSUBISHI ELECTRIC CORPORATION

WARRANTY

Warranty

1. Warranty period and coverage

We will repair any failure or defect hereinafter referred to as "failure" in our FA equipment hereinafter referred to as the "Product" arisen during warranty period at no charge due to causes for which we are responsible through the distributor from which you purchased the Product or our service provider. However, we will charge the actual cost of dispatching our engineer for an on-site repair work on request by customer in Japan or overseas countries. We are not responsible for any on-site readjustment and/or trial run that may be required after a defective unit are repaired or replaced.

[Term]

For terms of warranty, please contact your original place of purchase.

[Limitations]

(1) You are requested to conduct an initial failure diagnosis by yourself, as a general rule.

It can also be carried out by us or our service company upon your request and the actual cost will be charged. However, it will not be charged if we are responsible for the cause of the failure.

(2) This limited warranty applies only when the condition, method, environment, etc. of use are in compliance with the terms and conditions and instructions that are set forth in the instruction manual and user manual for the Product and the caution label affixed to the Product.

(3) Even during the term of warranty, the repair cost will be charged on you in the following cases;

1. a failure caused by your improper storing or handling, carelessness or negligence, etc., and a failure caused by your hardware or software problem
2. a failure caused by any alteration, etc. to the Product made on your side without our approval
3. a failure which may be regarded as avoidable, if your equipment in which the Product is incorporated is equipped with a safety device required by applicable laws and has any function or structure considered to be indispensable according to a common sense in the industry
4. a failure which may be regarded as avoidable if consumable parts designated in the instruction manual, etc. are duly maintained and replaced
5. any replacement of consumable parts (battery, fan, smoothing capacitor, etc.)
6. a failure caused by external factors such as inevitable accidents, including without limitation fire and abnormal fluctuation of voltage, and acts of God, including without limitation earthquake, lightning and natural disasters
7. a failure generated by an unforeseeable cause with a scientific technology that was not available at the time of the shipment of the Product from our company
8. any other failures which we are not responsible for or which you acknowledge we are not responsible for

2. Term of warranty after the stop of production

(1) We may accept the repair at charge for another seven (7) years after the production of the product is discontinued. The announcement of the stop of production for each model can be seen in our Sales and Service, etc.

(2) Please note that the Product (including its spare parts) cannot be ordered after its stop of production.

3. Service in overseas countries

Our regional FA Center in overseas countries will accept the repair work of the Product. However, the terms and conditions of the repair work may differ depending on each FA Center. Please ask your local FA center for details.

4. Exclusion of loss in opportunity and secondary loss from warranty liability

Regardless of the gratis warranty term, Mitsubishi shall not be liable for compensation to:

- (1) Damages caused by any cause found not to be the responsibility of Mitsubishi.
- (2) Loss in opportunity, lost profits incurred to the user by Failures of Mitsubishi products.
- (3) Special damages and secondary damages whether foreseeable or not, compensation for accidents, and compensation for damages to products other than Mitsubishi products.
- (4) Replacement by the user, maintenance of on-site equipment, start-up test run and other tasks.

5. Change of Product specifications

Specifications listed in our catalogs, manuals or technical documents may be changed without notice.

6. Application and use of the Product

- (1) For the use of our AC Servo, its applications should be those that may not result in a serious damage even if any failure or malfunction occurs in AC Servo, and a backup or fail-safe function should operate on an external system to AC Servo when any failure or malfunction occurs.
- (2) Our AC Servo is designed and manufactured as a general purpose product for use at general industries. Therefore, applications substantially influential on the public interest for such as atomic power plants and other power plants of electric power companies, and also which require a special quality assurance system, including applications for railway companies and government or public offices are not recommended, and we assume no responsibility for any failure caused by these applications when used.
In addition, applications which may be substantially influential to human lives or properties for such as airlines, medical treatments, railway service, incineration and fuel systems, man-operated material handling equipment, entertainment machines, safety machines, etc. are not recommended, and we assume no responsibility for any failure caused by these applications when used. We will review the acceptability of the abovementioned applications, if you agree not to require a specific quality for a specific application. Please contact us for consultation.
- (3) Mitsubishi Electric shall have no responsibility or liability for any problems involving programmable controller trouble and system trouble caused by DoS attacks, unauthorized access, computer viruses, and other cyberattacks.

TRADEMARKS

MELSERVO is a trademark or registered trademark of Mitsubishi Electric Corporation in Japan and/or other countries. All other product names and company names are trademarks or registered trademarks of their respective companies.

IB(NA)-0300478ENG-K(2410)MEE

MODEL:

MODEL CODE:

mitsubishi electric corporation

HEAD OFFICE: TOKYO BLDG., 2-7-3, MARUNOUCHI, CHIYODA-KU, TOKYO 100-8310, JAPAN
NAGOYA WORKS: 1-14, YADA-MINAMI 5-CHOME, HIGASHI-KU, NAGOYA 461-8670, JAPAN

When exported from Japan, this manual does not require application to the
Ministry of Economy, Trade and Industry for service transaction permission.

Specifications subject to change without notice.

Compliance with the indicated global standards and regulations is current as of the release date of this manual.