

650S

SERIES



650S



Software Manual



650S AC Drive

Frames 1, 2, 3

HA500982U001 ISSUE 2

Compatible with Version 2.x Software onwards

© 2010 Parker Hannifin Ltd.

All rights strictly reserved. No part of this document may be stored in a retrieval system, or transmitted in any form or by any means to persons not employed by a Parker SSD Drives company without written permission from Parker SSD Drives, a division of Parker Hannifin Ltd. Although every effort has been taken to ensure the accuracy of this document it may be necessary, without notice, to make amendments or correct omissions. Parker SSD Drives cannot accept responsibility for damage, injury, or expenses resulting therefrom.

WARRANTY

Parker SSD Drives warrants the goods against defects in design, materials and workmanship for the period of 24 months from the date of manufacture, or 12 months from the date of delivery (whichever is the longer period), on the terms detailed in Parker SSD Drives Standard Conditions of Sale IA500504.

Parker SSD Drives reserves the right to change the content and product specification without notice.

Software Manual

Safety Information



FAILURE OR IMPROPER SELECTION OR IMPROPER USE OF THE PRODUCTS DESCRIBED HEREIN OR RELATED ITEMS CAN CAUSE DEATH, PERSONAL INJURY AND PROPERTY DAMAGE.

- This document and other information from Parker-Hannifin Corporation, its subsidiaries and authorized distributors provide product or system options for further investigation by users having technical expertise.
- The user, through its own analysis and testing, is solely responsible for making the final selection of the system and components and assuring that all performance, endurance, maintenance, safety and warning requirements of the application are met. The user must analyze all aspects of the application, follow applicable industry standards, and follow the information concerning the product in the current product catalog and in any other materials provided from Parker or its subsidiaries or authorized distributors.
- To the extent that Parker or its subsidiaries or authorized distributors provide component or system options based upon data or specifications provided by the user, the user is responsible for determining that such data and specifications are suitable and sufficient for all applications and reasonably foreseeable uses of the components or systems.



Safety Information

Requirements

IMPORTANT Please read this information **BEFORE** installing the equipment.

Intended Users

This manual is to be made available to all persons who are required to install, configure or service equipment described herein, or any other associated operation.

The information given is intended to highlight safety issues, and to enable the user to obtain maximum benefit from the equipment.

Complete the following table for future reference detailing how the unit is to be installed and used.

INSTALLATION DETAILS			
Model Number <i>(see product label)</i>		Where installed <i>(for your own information)</i>	
Unit used as a: <i>(refer to "Certification")</i>	<input type="radio"/> Component <input type="radio"/> Relevant Apparatus	Unit fitted:	<input checked="" type="checkbox"/> Enclosure

Application Area

The equipment described is intended for industrial motor speed control utilising AC synchronous permanent magnet machines



Personnel

Installation, operation and maintenance of the equipment should be carried out by qualified personnel. A qualified person is someone who is technically competent and familiar with all safety information and established safety practices; with the installation process, operation and maintenance of this equipment; and with all the hazards involved.



Safety Information

Product Warnings

	Caution Risk of electric shock		Caution Refer to documentation		Earth/Ground Protective Conductor Terminal
---	--	---	--	---	--

Hazards

DANGER! - Ignoring the following may result in injury

1. This equipment can endanger life by exposure to rotating machinery and high voltages.
2. The equipment must be permanently earthed due to the high earth leakage current, and the drive motor must be connected to an appropriate safety earth.
3. Ensure all incoming supplies are isolated before working on the equipment. Be aware that there may be more than one supply connection to the drive.
4. There may still be dangerous voltages present at power terminals (motor output, supply input phases, DC bus and the brake, where fitted) when the motor is at standstill or is stopped.
5. For measurements use only a meter to IEC 61010 (CAT III or higher). Always begin using the highest range. CAT I and CAT II meters must not be used on this product.
6. Allow at least 10 minutes for the drive's capacitors to discharge to safe voltage levels (<50V). Use the specified meter capable of measuring up to 1000V dc & ac rms to confirm that less than 50V is present between all power terminals and between power terminals and earth.
7. Unless otherwise stated, this product must NOT be dismantled. In the event of a fault the drive must be returned. Refer to "Routine Maintenance and Repair".

Safety Information



WARNING! - Ignoring the following may result in injury or damage to equipment

SAFETY

Where there is conflict between EMC and Safety requirements, personnel safety shall always take precedence.

- Never perform high voltage resistance checks on the wiring without first disconnecting the drive from the circuit being tested.
- Whilst ensuring ventilation is sufficient, provide guarding and /or additional safety systems to prevent injury or damage to equipment.
- When replacing a drive in an application and before returning to use, it is essential that all user defined parameters for the product's operation are correctly installed.
- All control and signal terminals are SELV, i.e. protected by double insulation. Ensure all external wiring is rated for the highest system voltage.
- Thermal sensors contained within the motor must have at least basic insulation.
- All exposed metalwork in the Drive is protected by basic insulation and bonded to a safety earth.
- RCDs are not recommended for use with this product but, where their use is mandatory, only Type B RCDs should be used.

EMC

- In a domestic environment this product may cause radio interference in which case supplementary mitigation measures may be required.
- This is a product of the restricted sales distribution class according to IEC 61800-3.
- This equipment contains electrostatic discharge (ESD) sensitive parts. Observe static control precautions when handling, installing and servicing this product.
- It is designated as “professional equipment” as defined in EN61000-3-2. Permission of the supply authority shall be obtained before connection to the low voltage supply.



Safety Information

CAUTION!

APPLICATION RISK

- The specifications, processes and circuitry described herein are for guidance only and may need to be adapted to the user's specific application. We can not guarantee the suitability of the equipment described in this Manual for individual applications.
- It is advised that motors with significantly lower voltage ratings than the supply voltage are **NOT** used with the drive.

RISK ASSESSMENT

Under fault conditions, power loss or unintended operating conditions, the drive may not operate as intended. In particular:

- Stored energy might not discharge to safe levels as quickly as suggested, and can still be present even though the drive appears to be switched off
- The motor's direction of rotation might not be controlled
- The motor speed might not be controlled
- The motor might be energised

A drive is a component within a drive system that may influence its operation or effects under a fault condition. Consideration must be given to:

- Stored energy
 - Supply disconnects
 - Sequencing logic
 - Unintended operation
-

Contents

Chapter 1 Getting Started	1-0
Programming Your Application	1-1
Programming with Block Diagrams	1-1
Modifying a Block Diagram Over Comms	1-1
Function Block Descriptions.....	1-3
Understanding the Function Block Description	1-3
Function Blocks by Category	1-4
Function Blocks in Alphabetical Order.....	1-5
Chapter 2 Parameter Specification	2-0
Parameter Specification	2-1
Specification Table: Tag Number Order.....	2-2
MMI Parameters	2-22
Pref Cross Reference Table.....	2-29
Product-Related Default Values	2-32
* Frequency Dependent Defaults	2-32
** Power Dependent Defaults	2-33
Chapter 3 Serial Communications	3-0
Serial Communications	3-1
Communications Technology Options.....	3-1
DSE Lite.....	3-1
Connection to the P3 Port	3-1
Chapter 4 Sequencing Logic.....	4-0
Sequencing Logic States	4-1
Principle State Machine.....	4-1
Main Sequencing States.....	4-1
State Outputs of the SEQUENCING LOGIC Function Block....	4-2
Transition of States	4-3
State Diagram.....	4-4
External Control of the Drive	4-5
Communications Command	4-5
Communications Status	4-8

Chapter 5 Applications	5-0
Applications	5-1
The Default Application	5-1
How to Load an Application	5-1
Application Description	5-1
Application 1: Basic Speed Control (default).....	5-2
Application 2: Auto/Manual Control.....	5-4
Application 3: Preset Speeds.....	5-6
Application 4: Raise/Lower Trim.....	5-8
Application 5: PID.....	5-10

Cont. 8

Chapter 1 **GETTING STARTED**

Introduction to the 650S Series AC Drive

Programming Your Application	1-1
Programming with Block Diagrams	1-1
Modifying a Block Diagram Over Comms	1-1
Function Block Descriptions	1-3
Understanding the Function Block Description	1-3
Function Blocks by Category	1-4
Function Blocks in Alphabetical Order	1-5

Programming Your Application

You can program the drive to your specific application. This programming simply involves changing parameter values. Access the parameters using the keypad, or DSELite (or other suitable programming tool).

Each Application recalls a pre-programmed set of default parameters and links when it is loaded.

Refer to Chapter 5: “Applications” for further information.

Programming with Block Diagrams

Block diagram programming provides a visual method of planning the software to suit your application. There are block diagrams provided at the end of this chapter, each showing the software connections for an Application. These pages replicate the DSELite programming screens. DSELite is Parker SSD Drive’s own programming tool.

The processes performed by an Application are represented as a block diagram, consisting of *function blocks* and *links*:

- Each function block contains the parameters required for setting-up a particular processing feature. Sometimes more than one instance of a function block is provided for a feature, i.e. for multiple digital inputs.
- Software links are used to connect the function blocks. Each link transfers the value of an output parameter to an input parameter of another (or the same) function block.

Each individual block is a processing feature i.e., it takes the input parameter, processes the information, and makes the result available as one or more output parameters.

Modifying a Block Diagram Over Comms

Configuration and Parameterisation Modes

There are two modes of operation used while modifying a block diagram: *Configuration* and *Parameterisation* modes.

DEFAULT

Parameterisation Mode

In parameterisation mode you can change parameter values. The drive can be running or stopped. Note that some parameters can only be changed when the drive is stopped. It is not possible to modify the internal links when the drive is in parameterisation mode.

Configuration Mode

In the Configuration Mode you can modify the links in the function block diagram. You can also change parameter values, as above. The drive cannot run in this mode.

When you attempt to change a parameter value requiring Configuration Mode to be enabled, the drive automatically enters Configuration Mode.

Once in Configuration Mode, to return to Parameterisation Mode simply press the **E** key repeatedly.

1-2 Programming Your Application

Execution Rules

The complete block diagram is executed every 5ms. Just before a function block is executed, all the links that have that block as their destination are executed, thereby copying new values in to the block's parameter inputs. The input parameters are then processed to produce a new set of output parameters. The execution order of the blocks is automatically arranged for minimal delay.

- The output value transferred by a link on execution is clamped to be between the maximum and minimum value for its destination input parameter.
- Refer to the table below for the result of linking different parameter types.

Source Value (the input)	Source Type	Destination Type	Destination Value (the result)
TRUE	Boolean	Real	0.01
FALSE	Boolean	Real	0.00
≥ 0.005	Real	Boolean	TRUE
≤ 0.005	Real	Boolean	FALSE
LOCAL ONLY (1)	Enumerated	Real	1.00
2.00	Real	Enumerated	REMOTE ONLY (2) (Note that (2) will not always return Remote Only)

Table 1-1 Execution Rules

Saving Your Modifications

Whenever a value/link is changed, the modification is stored automatically and will be saved on power-down.

Function Block Descriptions

Note: To view all parameters available on the MMI, Full menu detail must be selected in the DETAILED MENUS parameter (ST99). Additional blocks/parameters are available over the Comms.

Understanding the Function Block Description

The following function blocks show the parameter information programming the drive.

Input parameters are shown on the left hand side, and output on the right hand side of the block.

The diagrams assume that the UK country code is selected and that 1 power board is fitted. This is reflected in the values of certain “**” in the table below.

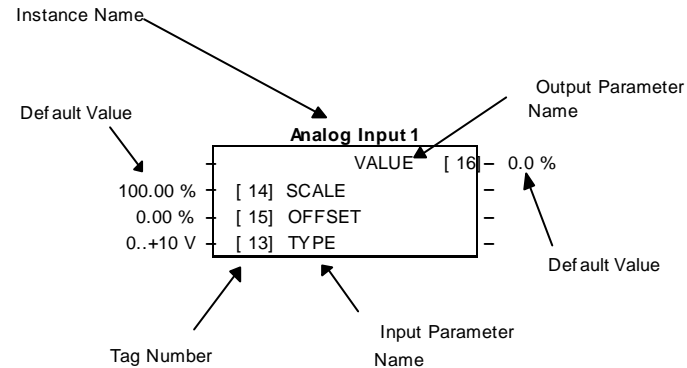

necessary for parameters are shown a 230V 0.25kW Frame parameters, see “*” and

Figure 1-1 Function Block Parameter Information

Instance Name	Names the function block and MMI menu
Default Value	The default value of the unmodified macro, Macro 0
Input/Output Parameter Name	The name shown on DSELite
Tag Number	Unique identification used for communications
*	Parameters marked with “*” are set to a value depending upon the “operating frequency” of the drive. Refer to Chapter 2: “Parameter Specification” - Frequency Dependent Defaults; and the Installation Product Manual, Chapter 5: “The Operator Station” - Changing the Product Code (3-button reset).
**	Parameters marked with “**” are set to a value depending on the overall “power build ” of the drive indicated by the product code. Refer to Chapter 2: “Parameter Specification” - Power Dependent Defaults; and the Installation Product Manual: Chapter 2: “Understanding the Product Code”.

Note: The “Range” for a parameter value is given in the Parameter Description Table on each Function Block page. Ranges for outputs are given as “—..xx %”, for example, indicating an indeterminate integer for the value, to two decimal places.

F	Parameters indicated with F are visible with Full menus only. Refer to the DETAILED MENUS parameter (ST 99) in the MMI ACCESS function block, page 1-46.
M	Parameters indicated with M are Motor Parameters. They are not reset by changing Application using parameter ^P 1; all other parameters are reset to default values.

Function Blocks by Category

The function block descriptions in this chapter are arranged in alphabetical order, however, they are listed below by Category.

Communications

COMMS PORTS 1-20

Configuration

APP CONFIG 1-8

Encoder Functions

ENCODER 1-29

Brake

BRAKE CONTROL 1-16

Inputs/Outputs

ANALOG INPUT 1-5 DIGITAL INPUT 1-23

ANALOG OUTPUT 1-7 DIGITAL OUTPUT 1-24

Menus

APPLICATION MENU 1-11 DISPLAY SCALE 1-26

DISPLAY/KEYPAD 1-25 MMI ACCESS 1-46

Miscellaneous

DEMULTIPLEXER 1-22 MULTIPLEXER 1-49

LOGIC FUNCTION 1-37 VALUE FUNCTION 1-103

Motor Control

DYNAMIC BRAKING 1-28 PMAC DRIVE PROTECT 1-53 SPEED LOOP 1-78

FEEDBACKS 1-31 PMAC MOT PROTECT 1-54 SV MOTOR CTRL 1-82

MOT POLARISATION 1-47 SLEW RATE LIMIT 1-77 SV MOTOR DATA 1-94

TORQUE LIMIT 1-96

Sequencing and Referencing

AUTO RESTART 1-15 REFERENCE 1-64 REFERENCE STOP 1-70

COMMS CONTROL 1-18 REFERENCE JOG 1-67 SEQUENCING LOGIC 1-72

LOCAL CONTROL 1-35 REFERENCE RAMP 1-68

Setpoint Functions

AT LOAD 1-13 PID 1-50 SKIP FREQUENCIES 1-75

AT SPEED 1-14 POSITION 1-55 ZERO SPEED 1-113

MINIMUM SPEED 1-44 RAISE/LOWER 1-62 FLYCATCHING PMAC 1-33

Trips

I/O TRIPS 1-34 TRIPS HISTORY 1-97

STALL TRIP 1-81 TRIPS STATUS 1-99

Function Blocks in Alphabetical Order

ANALOG INPUT

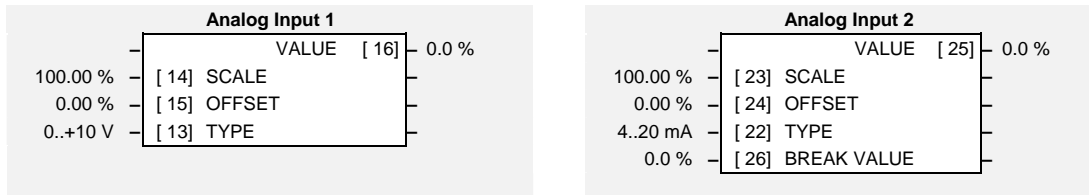

The analog input block converts the input voltage or current into a value expressed as a percentage of a configurable range.

Parameter Descriptions

SCALE *SET/IN IP11 & IP21* *Range: -300.00 to 300.00 %*

A scaling factor applied to the raw input. With a scaling factor of 100.00% and an offset of 0.00%, an input equal to the low input range will appear as a value of 0.00%. Similarly, an input equal to the high input range will appear as a value of 100.00%.

OFFSET *SET/IN IP12 & IP22* *Range: -300.00 to 300.00 %*

An offset added to the input after the scaling factor has been applied.

TYPE *SET/IN IP13 & IP23* *Range: Enumerated - see below*

The input range and type.

ANALOG INPUT 1 supports Types 0 and 1 only. ANALOG INPUT 2 support all types.

Enumerated Value : Type

- 0 : 0..+10 V
- 1 : 0..+5 V
- 2 : 0..20 mA
- 3 : 4..20 mA

BREAK VALUE *Range: -100.0 to 100.0 %*

The value that will appear as the VALUE output when BREAK is TRUE

VALUE  *DIAG/IN IPA1 & IPA2* *Range: —.x %*

The input reading with scaling and offset applied.

1-6 Programming Your Application

Functional Description

The drive has two analog inputs. There is an analog input function block for each:

ANALOG INPUT 1 is associated with the signal on terminal 2

ANALOG INPUT 2 is associated with the signal on terminal 3

The input voltage is pre-processed and converted into a numeric value by the analog input electronics of the drive. The analog input function blocks further process this reading so that a value of 0.00% represents an input equal to the low input range, while a value of 100.00% represents an input equal to the high input range. The SCALE and OFFSET factors are then applied as shown to produce a value suitable for use in the application.

The break detect facility is only used in conjunction with the "4 to 20mA" hardware range. An input break is defined as an input reading less than either 0.1V or 0.45mA. When an input break has been detected, the VALUE output is forced to be the BREAK VALUE.

If the break detect facility is not required, select the "0 to 20mA". You can also apply OFFSET to recreate the "4 to 20mA" hardware range.

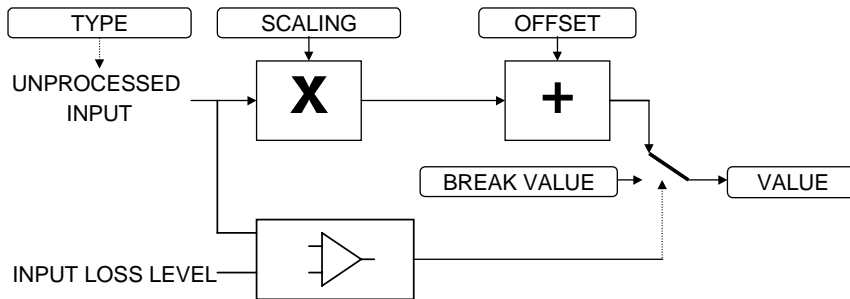

ANALOG OUTPUT

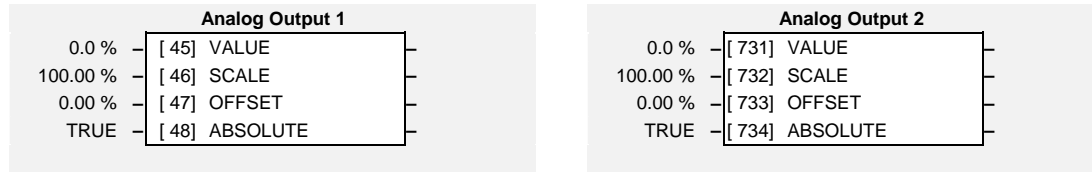

The analog output block converts the demand percentage into a form suitable for driving the analog output electronics of the drive.

Parameter Descriptions

VALUE *DIAG/OUT OPA1 & OPA2* *Range: -300.0 to 300.0 %*

The demanded value to output.

SCALE *SET/OUT OP11 & OP21* *Range: -300.00 to 300.00 %*

A scaling factor to apply to VALUE. A scaling factor of 100.00% has no effect.

OFFSET *SET/OUT OP12 & OP22* *Range: -300.00 to 300.00 %*

An offset added to VALUE after the scaling factor has been applied. An offset factor of 0.00% has no effect.

ABS *SET/OUT OP13 & OP23* *Range: FALSE / TRUE*

When TRUE the output sign is ignored.

Functional Description

The drive has two analog outputs:

ANALOG OUTPUT 1 is associated with terminal 6

ANALOG OUTPUT 2 is associated with terminal 5

The scaling and offset parameters are applied to the demand value as shown.

If ABS is TRUE then the final output is the magnitude of value after being scaled and offset and the output sign is ignored

If ABS is FALSE then as above, except that the output sign is valid.

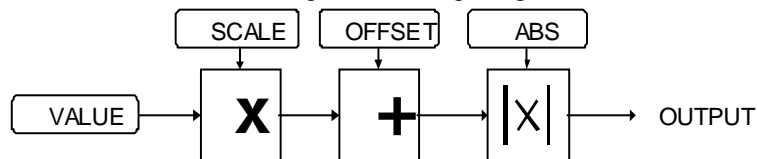

APP CONFIG

This block controls the selection of user application and of the output wiring

App Config		
STANDARD	[1091]	APPLICATION
DEMAND	[1092]	ANOUT 1 SOURCE
NONE	[1109]	ANOUT 2 SOURCE
HEALTH	[1093]	RELAY SOURCE
NONE	[1094]	DIGIO2 SOURCE
NONE	[None]	DIGIO1 SOURCE
FALSE	[1064]	APP LOCK
RUN FWD	[310]	DIGIN 1 DEST
REMOTE REV	[311]	DIGIN 2 DEST
JOG	[312]	DIGIN 3 DEST
NOT STOP	[313]	DIGIN 4 DEST
NOT COAST	[314]	DIGIN 5 DEST
NONE	[311]	DIGIN 6 DEST
NONE	[315]	DIGIN 7 DEST

Parameter Descriptions

APPLICATION *PAR\PI* *Range: Enumerated - see below*

This parameter selects and loads the Application to be used. APP 0 will not control a motor. APP 6, 7 & 8 are for future use. You can edit an Application in DSELite and, then set this parameter to CUSTOM to produce your own custom Application.

Refer to Chapter 5: "Applications" which gives detailed information about each Application.

- 0 : NULL
- 1 : STANDARD
- 2 : LOCAL/REM (AUTO/MANUAL)
- 3 : PRESETS
- 4 : RAISE/LOWER
- 5 : PID
- 6 : APP 6
- 7 : APP 7
- 8 : APP 8
- 9 : CUSTOM

ANOUT 1 SOURCE *SET/CONF OPA1* *Range: Enumerated - see below*

The source of analog output 1, terminal 5. An internal link is made to the selected parameter.

Parameter Descriptions

ANOUT 2 SOURCE *SET/CONF OPA2* *Range: Enumerated - see below*

The source of analog output 1, terminal 5. An internal link is made to the selected parameter.

0 : NONE	<i>No link is made</i>
1 : DEMAND	<i>SPEED DEMAND in the REFERENCE block</i>
2 : CURRENT	<i>MOTOR CURRENT% in the FEEDBACKS block</i>
3 : PID ERROR	<i>ERROR in the PID Block</i>
4 : R/L OUTPUT	<i>OUTPUT in the RAISE/LOWER block</i>

RELAY SOURCE *SET/CONF OPD3* *Range: Enumerated - see below*

The source of the relay output, terminals RL1A and RL1B. An internal link is made to the selected parameter.

DIGIO2 SOURCE *SET/CONF OPD2* *Range: Enumerated - see below*

The source of digital output 2, terminal 10. An internal link is made to the selected parameter.

DIGIO1 SOURCE *SET/CONF OPD1* *Range: Enumerated - see below*

The source of digital output 1, terminal 9. An internal link is made to the selected parameter.

0 : NONE	<i>No link is made</i>
1 : HEALTH	<i>HEALTHY in the SEQ LOGIC block</i>
2 : TRIPPED	<i>TRIPPED in the SEQ LOGIC block</i>
3 : RUNNING	<i>RUNNING in the SEQ LOGIC block</i>
4 : AT ZERO	<i>AT ZERO SPD in the ZERO SPEED block</i>
5 : AT SPEED	<i>AT SPEED in the AT SPEED block</i>
6 : AT LOAD	<i>AT OR ABOVE LOAD in the AT LOAD block</i>

DIGIN1 SOURCE *SET/CONF IPD1* *Range: Enumerated - see below*

The destination of digital input 1, terminal 7. An internal link is made to the selected parameter.

DIGIN2 SOURCE *SET/CONF IPD2* *Range: Enumerated - see below*

The destination of digital input 2, terminal 8. An internal link is made to the selected parameter.

DIGIN3 SOURCE *SET/CONF IPD3* *Range: Enumerated - see below*

The destination of digital input 3, terminal 9. An internal link is made to the selected parameter.

DIGIN4 SOURCE *SET/CONF IPD4* *Range: Enumerated - see below*

The destination of digital input 4, terminal 10. An internal link is made to the selected parameter.

DIGIN5 SOURCE *SET/CONF IPD5* *Range: Enumerated - see below*

The destination of digital input 5, terminal 11. An internal link is made to the selected parameter.

DIGIN6 SOURCE *SET/CONF IPD6* *Range: Enumerated - see below*

The destination of digital input 6, terminal 12. An internal link is made to the selected parameter.

Parameter Descriptions

DIGIN7 SOURCE	<i>SET/CONF IPD7</i>	<i>Range: Enumerated - see below</i>
The destination of digital input 7, terminal 13. An internal link is made to the selected parameter.		
0 : NONE		<i>No link is made</i>
1 : RUN FORWARD		<i>RUN FORWARD input in the SEQUENCING block</i>
2 : RUN REVERSE		<i>RUN REVERSE input in the SEQUENCING block</i>
3 : NOT STOP		<i>NOT STOP input in the SEQUENCING block</i>
4 : JOG		<i>JOG input in the SEQUENCING block</i>
5 : CONTACTOR CLOSED		<i>CONTACTOR CLOSED input in the SEQUENCING block</i>
6 : DRIVE ENABLE		<i>DRIVE ENABLE input in the SEQUENCING block</i>
7 : NOT FAST STOP		<i>NOT FAST STOP input in the SEQUENCING block</i>
8 : NOT COAST STOP		<i>NOT COAST STOP input in the SEQUENCING block</i>
9 : REMOTE REVERSE		<i>REMOTE REVERSE input in the SEQUENCING block</i>
10 : REM TRIP RESET		<i>REM TRIP RESET input in the SEQUENCING block</i>
11 : RAISE INPUT		<i>RAISE INPUT input in the RAISE/LOWER block</i>
12 : LOWER INPUT		<i>LOWER INPUT input in the RAISE/LOWER block</i>
13 : RL RESET		<i>RL RESET input in the RAISE/LOWER block</i>
14 : PID ENABLE		<i>PID ENABLE input in the PID block</i>
15 : VALUE 1 INPUT A		<i>INPUT A input in VALUE 1 block</i>
16 : VALUE 1 INPUT B		<i>INPUT B input in VALUE 1 block</i>
17 : VALUE 1 INPUT C		<i>INPUT C input in VALUE 1 block C</i>
18 : VALUE 2 INPUT A		<i>INPUT A input in VALUE 2 block</i>
19 : VALUE 2 INPUT B		<i>INPUT B input in VALUE 2 block</i>
20 : VALUE 2 INPUT C		<i>INPUT C input in VALUE 2 block</i>
21 : VALUE 3 INPUT C		<i>INPUT C input in VALUE 3 block</i>
22 : VALUE 4 INPUT C		<i>INPUT C input in VALUE 4 block</i>
23 : LOGIC 1 INPUT A		<i>INPUT A input in LOGIC 1 block</i>
24 : LOGIC 1 INPUT B		<i>INPUT B input in LOGIC 1 block</i>
25 : LOGIC 1 INPUT C		<i>INPUT C input in LOGIC 1 block</i>
26 : LOGIC 3 INPUT A		<i>INPUT A input in LOGIC 3 block</i>
27 : LOGIC 3 INPUT B		<i>INPUT B input in LOGIC 3 block</i>
28 : LOGIC 3 INPUT C		<i>INPUT C input in LOGIC 3 block</i>

APP LOCK  *SET\SETP ST98* *Range: FALSE / TRUE*

Set this parameter to TRUE to prevent the APPLICATION parameter from being edited.

APPLICATION MENU

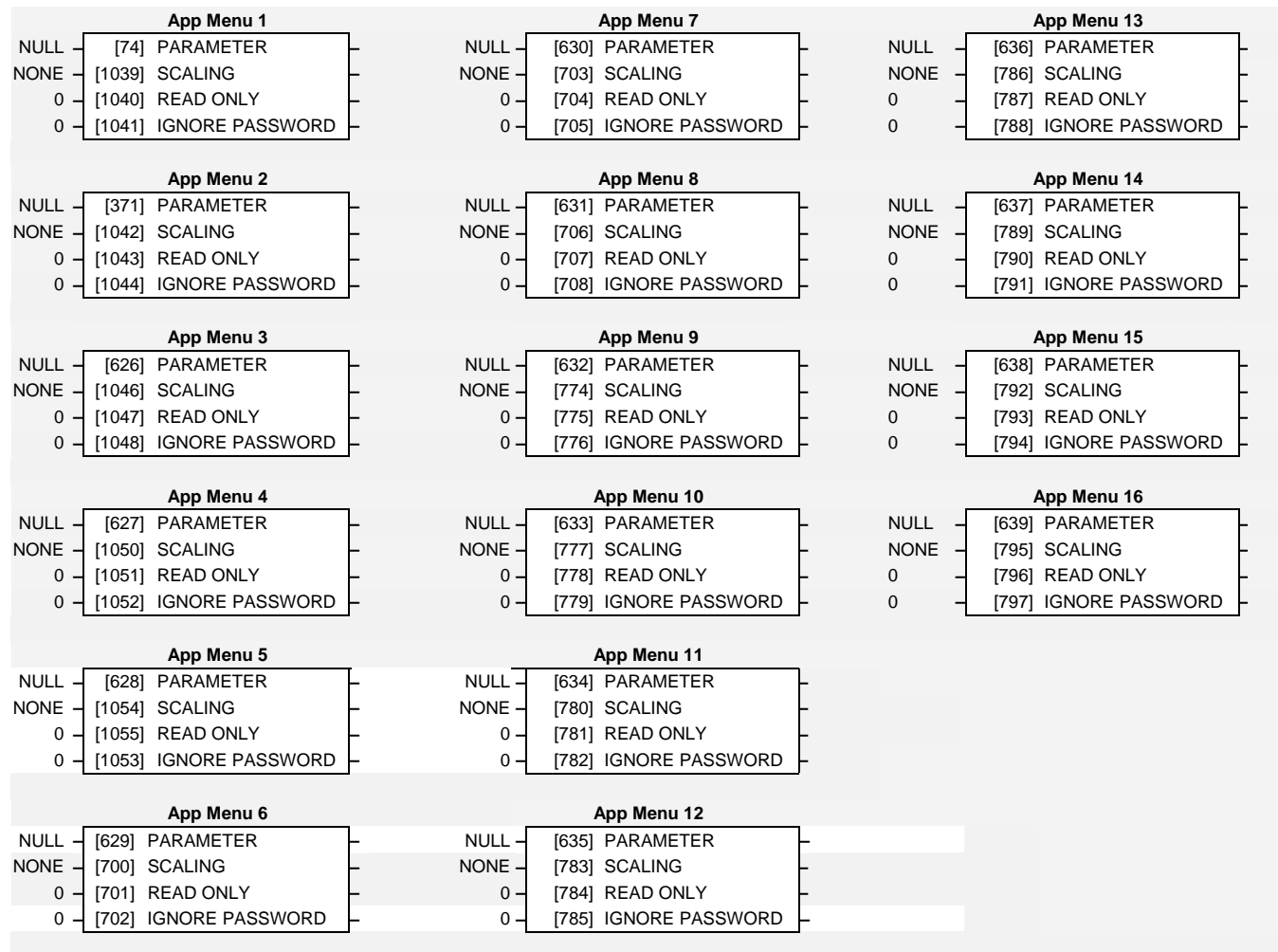

These function blocks are used to define the contents of the APPLICATION menu.

Parameter Descriptions

PARAMETER

Range: 0 to 1763

This selects the parameter to be displayed at the corresponding position in the APPLICATION menu.

SCALING

Range: Enumerated

This selects the scaling function to be used to present the displayed value.

- 0: NONE No scaling is applied to the parameter before display
- 1: DISPLAY SCALE 1 The scaling defined in the function block DISPLAY SCALE 1 is applied to the parameter for display.
- 2: DISPLAY SCALE 2 The scaling defined in the function block DISPLAY SCALE 2 is applied to the parameter for display.

READ ONLY

Range: FALSE/TRUE

Setting this parameter to TRUE disables adjustment of this parameter in the APPLICATION MENU.

IGNORE PASSWORD

Range: FALSE/TRUE

Setting this parameter to TRUE allows the parameter to be adjusted via the APPLICATION MENU without the need to enter the password. This only applies to writable parameters.

AT LOAD

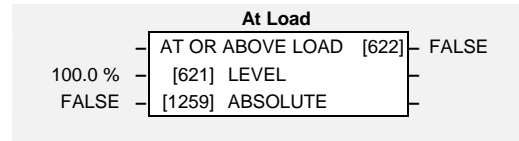

This function block is used to generate the AT OR ABOVE LOAD signal that may be used as a digital output (refer to the APP CONFIG block).

If operating as an open-loop drive (V/F fluxing) it is important to enter the no-load current at rated speed in to the MAG CURRENT parameter (^SCL14 - MOTOR DATA function block), otherwise the LEVEL from this block could be inaccurate.

Parameter Descriptions

LEVEL *SET\SETP ST42* *Range: -300.0 to 300.0 %*

This parameter sets the value of load at which the AT OR ABOVE LOAD parameter becomes TRUE. 100% = rated torque for the motor.

ABSOLUTE *SET\SETP ST43* *Range: FALSE / TRUE*

When TRUE, the direction of rotation is ignored. In this case, the comparison level should always be positive.

When FALSE, the direction of rotation is not ignored. Driving a load in the reverse direction gives a negative value for torque. In this case, the comparison level may be positive or negative.

AT OR ABOVE LOAD *Range: FALSE / TRUE*

This parameter is TRUE if the load is equal to or above the value set by the LEVEL parameter.

AT SPEED

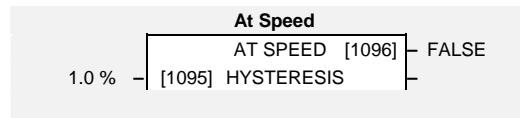

This function block is used to generate the AT SPEED signal that may be used as a digital output (refer to the APP CONFIG block).

Parameter Descriptions

HYSTERESIS

Range: 0.0 to 300.0 %

Provides a hysteresis band about the Speed Setpoint in which the AT SPEED output is stable.

The Speed Setpoint is shown by the Speed Setpoint (%) diagnostic in the Diagnostics menu, which is shown as a percentage of the MAX SPEED parameter (Hz).

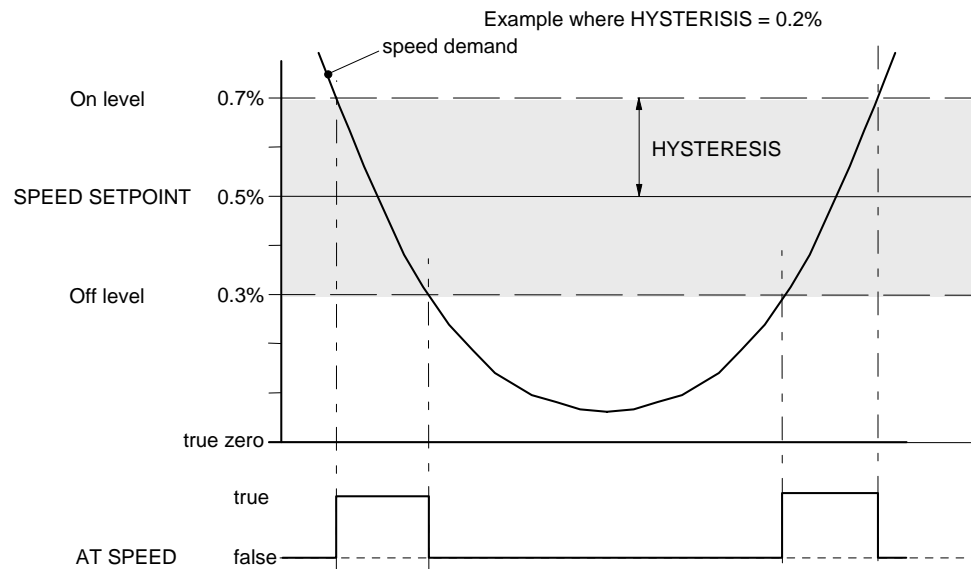

AT SPEED

Range: FALSE / TRUE

This parameter is TRUE when the speed demand is within the hysteresis band, as shown above, otherwise it is FALSE.

BRAKE CONTROL

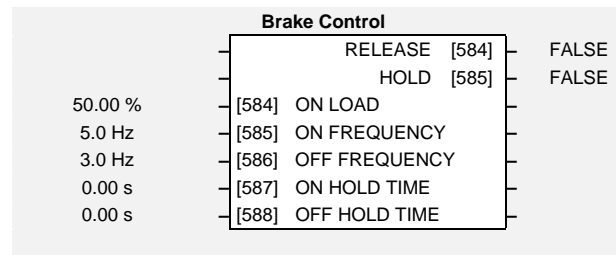

Parameter Descriptions

ON LOAD

Range: 0.00 to 150.00 %

Load level at which the external motor brake is released.

ON FREQUENCY

Range: 0.0 to 500.0 Hz

The output electrical frequency at which the external motor brake is released.

OFF FREQUENCY

Range: 0.0 to 500.0 Hz

The output electrical frequency at which the external motor brake is applied.

ON HOLD TIME

Range: 0.00 to 60.00 s

Sets the duration of the pulse output on HOLD when RELEASE becomes TRUE.

OFF HOLD TIME

Range: 0.00 to 60.00 s

Sets the duration of the pulse output on HOLD when RELEASE becomes FALSE.

RELEASE

Range: FALSE/ TRUE

Boolean output providing a signal to operate the brake delay. Note RELEASE is forced FALSE if the drive is not in Run mode, or if Autotune, Flycatching or Injection Braking are active.

HOLD

Range: FALSE / TRUE

Becomes TRUE when the brake is toggled On or Off by the function block, and remains TRUE for the duration set by OFF HOLD TIME or ON HOLD TIME.

This is used to control electro-mechanical motor brakes in hoist and lift applications.

Functional Description

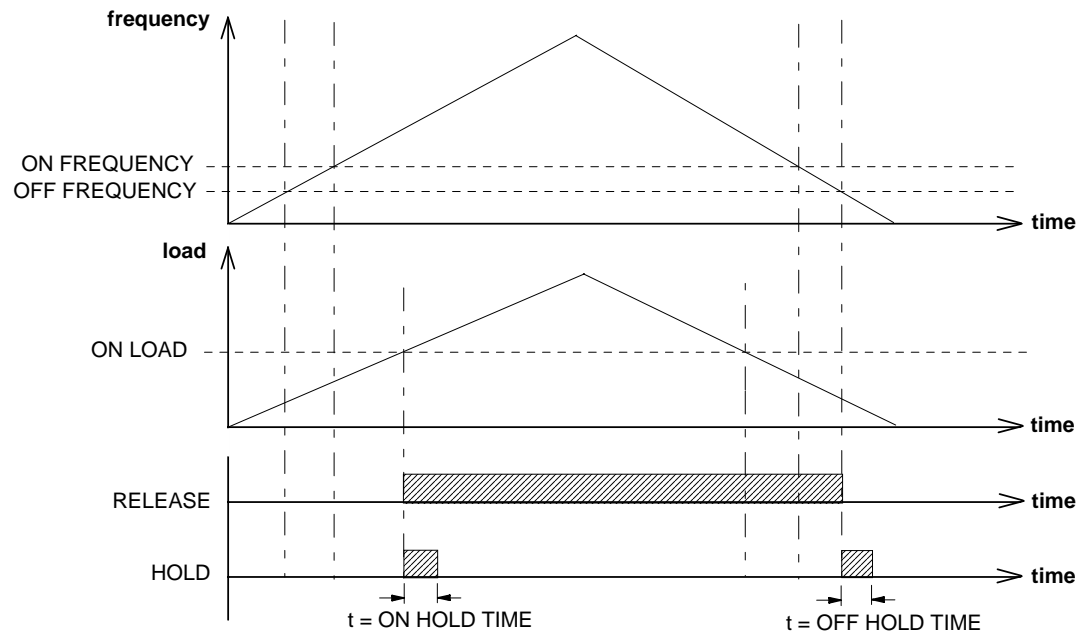

COMMS CONTROL

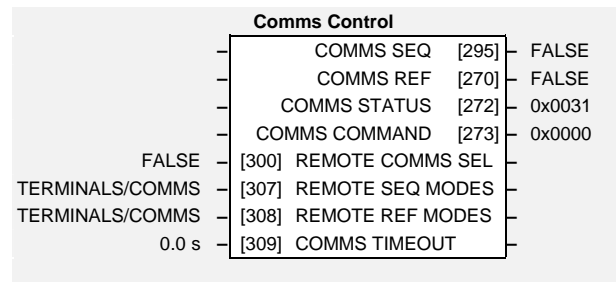

This block switches between Remote Terminal and Remote Comms operating modes.

The drive must be in Remote mode for selection to be made - REMOTE mode is enabled in the LOCAL CONTROL function block (REF MODES) and selected by the keypad. Refer to the outputs of the LOCAL CONTROL function block for the mode in use.

Parameter Descriptions

REMOTE COMMS SEL SET\SERL SE01 *Range: FALSE / TRUE*

Selects the type of remote communications mode:

0 : FALSE, and in REMOTE mode then control is from the terminals.

1 : TRUE, and in REMOTE mode then control is from the communications.

REMOTE SEQ MODES *Range: Enumerated - see below*

Selects the type of remote sequencing mode:

Enumerated Value : Mode

0 : TERMINALS/COMMS

1 : TERMINALS ONLY

2 : COMMS ONLY

REMOTE REF MODES *Range: Enumerated - see below*

Selects the type of remote reference mode:

Enumerated Value : Mode

0 : TERMINALS/COMMS

1 : TERMINALS ONLY

2 : COMMS ONLY

COMMS TIMEOUT SET\SERL SE02 *Range: 0.0 to 600.0 s*

Sets the maximum time allowed between refreshing the COMMS COMMAND parameter. The drive will trip if this time is exceeded. Set the time to 0.00 seconds to disable this feature.

Parameter Descriptions

COMMS SEQ

Range: FALSE / TRUE

Diagnostic indicating if operating in Remote Sequencing Comms Mode.

If FALSE (0), the drive may be in Local Sequencing mode or Remote Sequencing Terminal mode.

COMMS REF

Range: FALSE / TRUE

Diagnostic indicating if operating in Remote Reference Comms Mode.

If FALSE (0), the drive may be in Local Reference mode or Remote Reference Terminal mode.

COMMS STATUS

Range: 0000 to FFFF

Diagnostic showing the 16-bit Status word as seen by the communications.

Refer to Chapter 4: "Sequencing Logic".

COMMS COMMAND

Range: 0000 to FFFF

Diagnostic showing the 16-bit Command as written by the communications.

Refer to Chapter 4: "Sequencing Logic".

COMMS PORTS

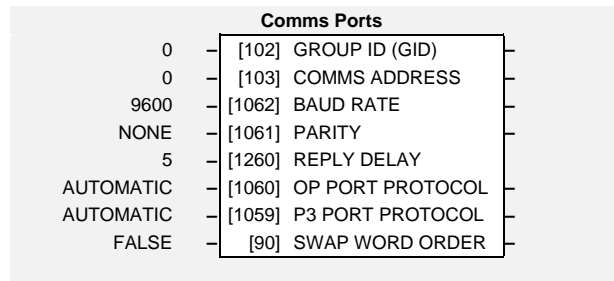

This function block configures the programming ports that allow connection to the keypad, or to a personal computer.

The parameters below are used to identify the drive to the controlling software for drive configuration and storage of parameters.

Parameter Descriptions

GROUP ID (GID)

Range: 0 to 7

The SSD Drives protocol group identity address.

COMMS ADDRESS SET\SERL SE03

Range: 0 to 255

The SSD Drives protocol unit identity address or the Modbus node address.

Note: if set to 0, it will only respond to broadcast messages.

BAUD RATE SET\SERL SE04

Range: Enumerated - see below

Selects the Baud Rate for the MODBUS protocol.

Enumerated Value : Baud Rate

- 0 : 1200
- 1 : 2400
- 2 : 4800
- 3 : 7200
- 4 : 9600
- 5 : 14400
- 6 : 19200
- 7 : 38400
- 8 : 57600

PARITY  *SET\SERL SE05* *Range: Enumerated - see below*
 Selects the Parity for the MODBUS protocol.

Enumerated Value : Parity
 0 : NONE
 1 : ODD
 2 : EVEN

REPLY DELAY  *SET\SERL SE06* *Range: 0 to 200*
 The time in milliseconds between the drive receiving the complete request from the communications master (PLC/PC) and replying to this request.

OP PORT PROTOCOL  *SET\SERL SE07* *Range: Enumerated - see below*
 Selects the protocol to be used by the keypad port on the front of the drive. When EIBISYNC ASCII is selected, BAUD RATE is 19200 and PARITY is EVEN.

Enumerated Value : Protocol
 0 : AUTOMATIC - checks for keypad or EI ASCII
 1 : KEYPAD
 2 : EIBISYNC ASCII
 3 : MODBUS
 4 : FIELDBUS (reserved for future use)

P3 PORT PROTOCOL  *SET\SERL SE08* *Range: Enumerated - see below*
 Selects the protocol to be used by the RS232 programming port on the drive's control board. When EIBISYNC ASCII is selected, BAUD RATE is 19200 and PARITY is EVEN.

Enumerated Value : Protocol
 0 : AUTOMATIC - checks for keypad or EI ASCII
 1 : KEYPAD
 2 : EIBISYNC ASCII
 3 : MODBUS
 4 : FIELDBUS (reserved for future use)

Functional Description

When communicating using the EI BISYNC ASCII protocol, the unit will always respond to GID = 0 and UID = 0, as this is the broadcast address used by the 6901 keypad.

DEMULTIPLEXER

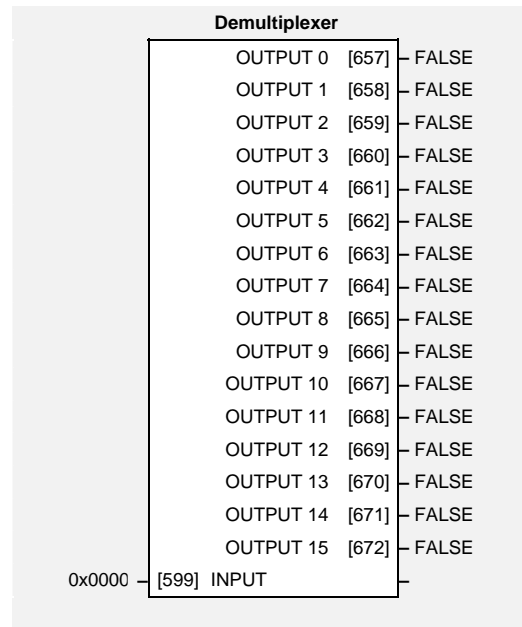

The demultiplexer function block splits the input word into 16 individual bits.

This may be used to extract the individual trip bits from the ACTIVE TRIPS parameter, for example.

Parameter Descriptions

INPUT

The input to be split into its component bits.

Range: 0000 to FFFF

OUTPUT 0 TO OUTPUT 15

Each output returns the corresponding bit of the 16 bit input word.

Range: FALSE / TRUE

DIGITAL INPUT

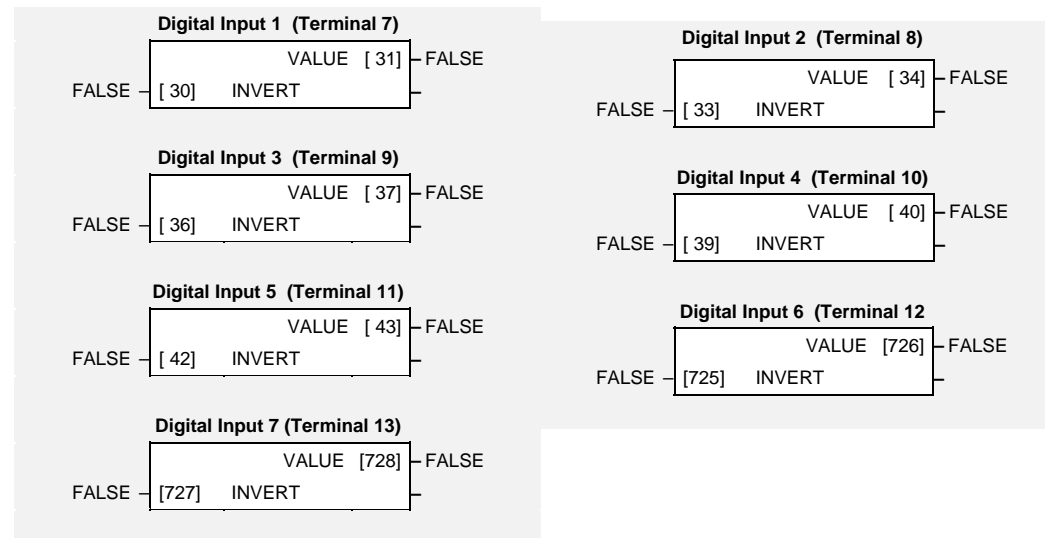

The digital input block converts the physical input voltage to TRUE or FALSE control signals.

Functional Description

There is a DIGITAL INPUT function block associated with each of the following terminals:

The Control Board has seven configurable digital inputs:

- DIGITAL INPUT 1 is associated with terminal 7
- DIGITAL INPUT 2 is associated with terminal 8
- DIGITAL INPUT 3 is associated with terminal 9 (shares terminal with DOUT1)
- DIGITAL INPUT 4 is associated with terminal 10 (shares terminal with DOUT2)
- DIGITAL INPUT 5 is associated with terminal 11
- DIGITAL INPUT 6 is associated with terminal 12
- DIGITAL INPUT 7 is associated with terminal 13

Parameter Descriptions

INVERT *SET/IN IP01 to IP07* *Range: FALSE / TRUE*

Controls the optional inversion of the VALUE output.

VALUE *SET/IN IPD1 to IPD7* *Range: FALSE / TRUE*

The TRUE or FALSE input, (after any inversion).

1-24 Programming Your Application

DIGITAL OUTPUT

The digital output block converts a logic TRUE or FALSE demand to a physical output signal.

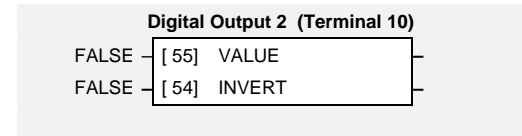
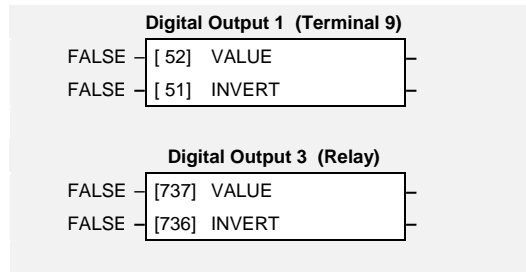

Functional Description

There is a DIGITAL OUTPUT function block associated with each of the following terminals:

The Control Board has three digital outputs (volt-free relay contacts):

- DIGITAL OUTPUT 1 is associated with terminals 9 (shares terminal with DIN3)
- DIGITAL OUTPUT 2 is associated with terminals 10 (shares terminal with DIN4)
- DIGITAL OUTPUT 3 is associated with terminals RL1A and RL1B (user relay)

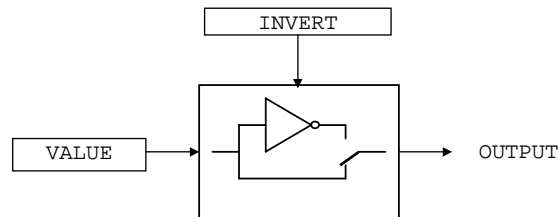

Parameter Descriptions

VALUE SET/OUT OP23 - DOUT2 Range: FALSE / TRUE
 SET/OUT OP33 - DOUT3

The TRUE or FALSE output demand.

INVERT SET/OUT OP22 - DOUT2 Range: FALSE / TRUE
 SET/OUT OP32 - DOUT3

Controls the optional inversion of the VALUE output.

DISPLAY/KEYPAD

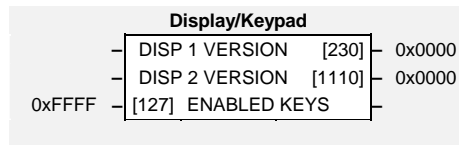

This function block provides information about the keypad connected to the drive and can be used to customise the keypad operation.

Parameter Descriptions

ENABLED KEYS *SET\SETP ST52* *Range: 0000 to FFFF*

The following keys on the 6901 keypad can be enabled or disabled separately. The combination produces the parameter setting as in the table below. The default of 0xFFFF enables all keys.

Parameter Setting	RUN	L/R	JOG	DIR
0000	-	-	-	-
0010	-	-	-	ENABLED
0020	-	-	ENABLED	-
0030	-	-	ENABLED	ENABLED
0040	-	ENABLED	-	-
0050	-	ENABLED	-	ENABLED
0060	-	ENABLED	ENABLED	-
0070	-	ENABLED	ENABLED	ENABLED
0080	ENABLED	-	-	-
0090	ENABLED	-	-	ENABLED
00A0	ENABLED	-	ENABLED	-
00B0	ENABLED	-	ENABLED	ENABLED
00C0	ENABLED	ENABLED	-	-
00D0	ENABLED	ENABLED	-	ENABLED
00E0	ENABLED	ENABLED	ENABLED	-
00F0	ENABLED	ENABLED	ENABLED	ENABLED



6901



6511

When using the standard 6511 and 6521 keypad, disabling the **DIR** key prevents the local setpoint going negative (for reverse). Similarly, disabling the **L/R** key prevents the drive being changed from Local to Remote, or Remote to Local modes.



6521

DISP 1 VERSION *Range: 0000 to FFFF*

This is the software version of the keypad connected to the keypad port on the front of the drive.

DISP 2 VERSION *Range: 0000 to FFFF*

This is the software version of the keypad connected to the RS232 programming port. This port is located on the control board inside the drive.

DISPLAY SCALE

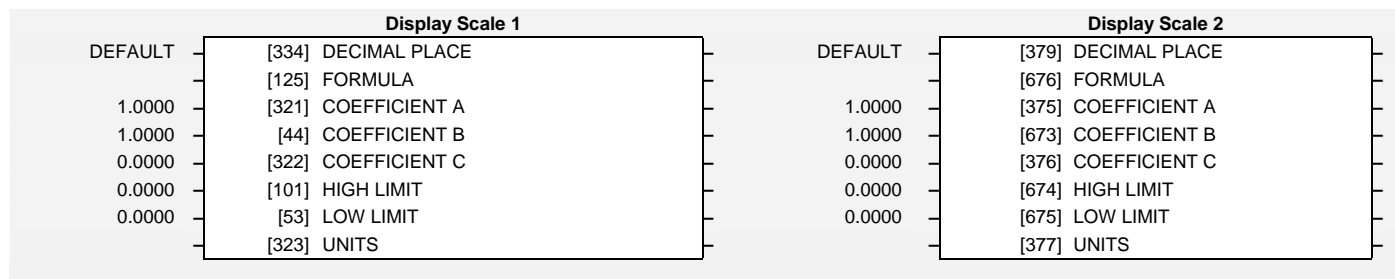

The Display Scale blocks define how parameters are displayed on the Display/Keypad in the Application Menu.

Parameter Descriptions

DECIMAL PLACE

Range: Enumerated - see below

Modifies the resolution used to display a parameter of type REAL.

- 0 : X. Value is displayed with no decimal places*
- 1 : X.X Value is displayed with one decimal places*
- 2 : X.XX Value is displayed with two decimal places*
- 3 : X.XXX Value is displayed with three decimal places*
- 4 : X.XXXX Value is displayed with four decimal places*
- 5 : DEFAULT Value is displayed using default precision for selected parameter*

FORMULA

Range: Enumerated - see below

A formula that is applied to the value of the selected parameter to generate the displayed value. This only applies to parameters of type REAL.

- 0 : The parameter value is not modified*
- 1 : $A/B * X + C$ The parameter value is modified according to the given formula*
- 2 : $A/B * (X+C)$ The parameter value is modified according to the given formula*
- 3 : $A/(B * X) + C$ The parameter value is modified according to the given formula*
- 4 : $A/(B * (X+C))$ The parameter value is modified according to the given formula*

COEFFICIENT A

Range: -332768.0000 to 32768.0000 %

COEFFICIENT B

Range: -332768.0000 to 32768.0000 %

COEFFICIENT C

Range: -332768.0000 to 32768.0000 %

These coefficients are used together with the FORMULA to modify the value of the selected parameter for display.

HIGH LIMIT

Range: -332768.0000 to 32768.0000 %

Defines the maximum value that may be entered for the selected parameter via the Application Menu. When HIGH LIMIT and LOW LIMIT are both zero the

Parameter Descriptions

limits for the selected parameter are used, (modified by FORMULA if necessary)

LOW LIMIT

Range: -332768.0000 to 32768.0000 %

Defines the minimum value that may be entered for the selected parameter via the Application Menu. When HIGH LIMIT and LOW LIMIT are both zero the limits for the selected parameter are used, (modified by FORMULA if necessary)

UNITS

Range: Enumerated - see below

Defines the units to be displayed for the selected parameter in the Application Menu

- 0 :
- 1 : V
- 2 : RPM
- 3 : A
- 4 : kW
- 5 : %
- 6 : %ms
- 7 : Hz
- 8 : s
- 9 : ms
- 10 : Hzs
- 11 : ohms
- 12 : mH
- 13 : Nm
- 14 : deg
- 15 : kgm²
- 16 : Nm/Hz
- 17 : /s²
- 18 : /s³
- 19 : Pa
- 20 : kPa
- 21 : bar
- 22 : degC
- 23 : K
- 24 : m³/h
- 25 : Nm/A
- 26 : VKRPM

Functional Description

The drive has two display scale blocks. Each of these may be associated with an entry in the Application Menu via the SCALE parameter in the APPLICATION MENU block

DYNAMIC BRAKING

Designed for all Motor Control Modes.

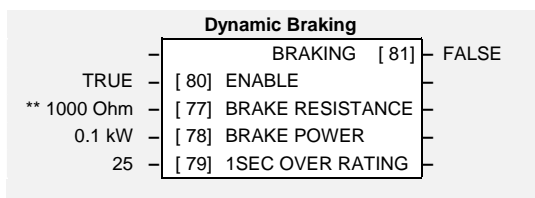

The dynamic braking function block controls the rate at which energy from a regenerating motor is dumped into a resistive load. This dumping prevents the dc link voltage reaching levels which would cause an Overvoltage trip.

Parameter Descriptions

- ENABLE** *SET\SETP ST31* *Range: FALSE / TRUE*
 Enables operation of the dynamic braking block.
- BRAKE RESISTANCE** *SET\SETP ST32* *Range: 1 to 1000 Ohm*
 The value of the load resistance.
- BRAKE POWER** *SET\SETP ST33* *Range: 0.1 to 510.0 kW*
 The power that the load resistance may continually dissipate.
- 1SEC OVER RATING** *SET\SETP ST34* *Range: 1 to 40*
 Multiplier that may be applied to BRAKE POWER for power overloads lasting no more than 1 second.
- BRAKING** *Range: FALSE / TRUE*
 A read-only parameter indicating the state of the brake switch.

Functional Description

When enabled, the DYNAMIC BRAKING block monitors the internal dc link voltage every milli-second and sets the state of the brake switch accordingly.

The dynamic braking block provides a control signal that is used by the SLEW RATE LIMIT block. This causes the setpoint to be temporarily frozen whenever the dynamic brake is operating because the dc link voltage exceeds the internal comparison level. This allows the stop rate to be automatically tuned to the characteristics of the load, motor, drive and brake resistor.

The DYNAMIC BRAKING block operates even when the motor output is not enabled. This allows the block to continually monitor the energy dumped into the braking resistor, and the energy dissipated across the brake switch. With this information the drive is able to deduce the loading on the brake resistor. Optional trips may be enabled should the switch or resistor be loaded beyond its capabilities.

Refer also to the Installation Product Manual, Chapter 12: “Application Notes” - Dynamic Braking.

ENCODER

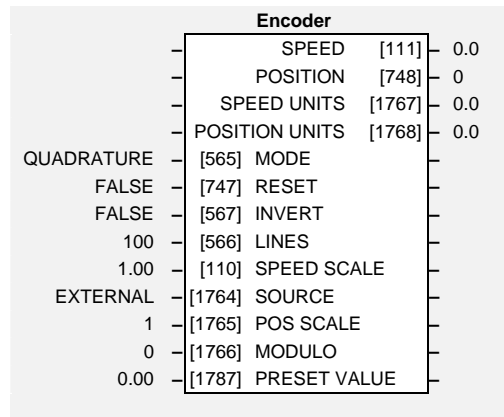

The ENCODER block allows Speed and Position Feedback to be measured.

Parameter Descriptions

MODE *SET\ENC EN01* *Range: Enumerated - see below*

Set this parameter to the requirements for your encoder.

Enumerated Value : Mode

- 0 : QUADRATURE (using digital inputs 6 & 7, ENCA and ENCB respectively)
- 1 : CLOCK/DIR (using digital inputs 6 & 7, ENCA and ENCB respectively)
- 2 : CLOCK (using digital input 6, ENCA)

RESET *SET\ENC EN02* *Range: FALSE / TRUE*

When TRUE the POSITION and SPEED outputs are set (and held) at zero.

INVERT *SET\ENC EN03* *Range: FALSE / TRUE*

When TRUE, changes the sign of the measured speed and the direction of the position count.

LINES *SET\ENC EN04* *Range: 100 to 10000*

The number of lines must be set to match the type of encoder being used. Incorrect setting of this parameter will result in an erroneous speed measurement.

SPEED SCALE *SET\ENC EN05* *Range: 0.00 to 300.00*

This parameter allows the output "speed" to be scaled to any value the user requires. With a default value of 1.00, the output "speed" is measured in revs per second. Changing the SPEED SCALE value to 60.00 will provide an output in revs per minute.

To provide an output in percent of the motor maximum speed, where maximum speed is the maximum speed your motor will run in rpm, the SPEED SCALE

parameter should be set to the result of: $\frac{\text{maximum speed (rpm)}}{6000}$

SPEED *SET\ENC EN06* *Range: xxx.x*

Speed feedback, in units defined by the SPEED SCALE parameter.

Parameter Descriptions

POSITION

Range: xxx

Number of encoder “counts” from when RESET was set to FALSE. The value will increment or decrement depending on the direction the encoder is rotated. The value will “wrap around” between 32767 and -32768.

SOURCE

 SET\ENC EN08

Range: Enumerated - see below

Set this parameter to choose the speed and position feedback source.

Enumerated Value : Source

0 : EXTERNAL (when an external encoder is connected to digital inputs 6 & 7)

1 : INTERNAL (the position and speed is taken from the motor control’s sensorless algorithm, in this case the LINES parameter is not used and set internally to 16384)

POS SCALE

 SET\ENC EN09

Range: 1 to 30000

The parameter allows scaling the position and the speed feedback (in user defined units) from the raw measure. It is expressed in number of lines per unit.

$$\text{POS SCALE [unit]} = \text{LINES [1/rev]} / \text{Number of units/rev [unit/rev]}$$

For example, if LINES = 100 and the unit is defined as 1 rev then the POS SCALE parameter should be equal to 100.

MODULO

 SET\ENC EN10

Range: 0 to 30000

This parameter allows limiting the actual position (POSITION UNITS) range.

- If set to 0 (default value) then the POSITION UNITS diagnostic will “wrap around” automatically between 32767.99 and -32768. The allowed range is [-32768, +32768].
- If set to a value different than 0 then the POSITION UNITS diagnostic will “wrap around” automatically between MODULO value and 0. The allowed range is [0, MODULO].

SPEED UNITS

 SET\ENC EN11

Range: xxx.xx

Speed feedback, in user-defined units.

POSITION UNITS

 SET\ENC EN12

Range: xxx.xx

Position feedback, in user-defined units.

PRESET VALUE

 SET\ENC EN13

Range: -32768.00 to +32768.00

This parameter defines the preset value for the POSITION UNITS diagnostics when PRESET is true.

Functional Description

A quadrature encoder uses 2 input signals (A and B), phase

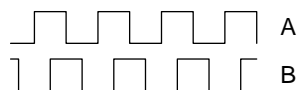

shifted by a quarter of a cycle (90°). Direction is obtained by looking at the combined state of A and B.

Speed is calculated using the following function:

$$\text{SPEED HZ} = \text{filter} \left[\frac{\text{CountsPerSecond}}{\text{Lines} \times 4}, \text{FilterTime} \right]$$

where counts per second are the number of edges received from the encoder. There are 4 counts per line.

FEEDBACKS

Feedbacks		
DC LINK VOLTS	[75]	700 V
MOTOR CURRENT %	[66]	0.0 %
MOTOR CURRENT A	[67]	0.0 A
TERMINAL VOLTS	[1020]	0 V
SPEED FBK RPM	[569]	0.00 RPM
SPEED FBK REV/S	[568]	0.00
SPEED FBK %	[749]	0.00 %
TORQUE FEEDBACK	[70]	0.00 %
FIELD FEEDBACK	[73]	0.00 %
FALSE	[50]	NORMAL DUTY

The FEEDBACKS block allows you to view speed feedback and motor current related diagnostics.

Parameter Descriptions

NORMAL DUTY *PAR\ P12* *Range: FALSE/TRUE*

This parameter is no longer used.

DC LINK VOLTS *DIAG 3* *Range: —. V*

This diagnostic shows the voltage on the dc link capacitors.

MOTOR CURRENT % *Range: —.xx %*

Contains the level of rms line current being drawn from the drive and is seen as a % of the PERM CURRENT parameter setting in the SV MOTOR DATA function block. The value is signed, reflecting the motor state :

- if the sign is the same as the speed setpoint, the motor is providing torque to the load.
- If the sign is opposite to the speed setpoint, the motor is braking the load.

MOTOR CURRENT A *DIAG 4* *Range: —.xx A*

This diagnostic contains the level of rms line current being drawn from the drive.

The value is signed, reflecting the motor state :

- if the sign is the same as the speed setpoint, the motor is providing torque to the load.

If the sign is opposite to the speed setpoint, the motor is braking the load.

SPEED FBK REV/S *Range: —.xx*

This parameter shows the calculated mechanical speed of the motor shaft in revolutions per second.

Parameter Descriptions

SPEED FBK %

Range: —.xx %

- This parameter shows the calculated mechanical speed of the motor shaft as a percentage of the user maximum speed setting (MAX SPEED in the REFERENCE function block).

TORQUE FEEDBACK

SET\SETP ST41

Range: —.xx %

Shows the estimated motor torque, as a percentage of rated motor torque.

FIELD FEEDBACK

Range: —.xx %

This value is always reset to zero, as the flux in the motor is not under software control.

FLYCATCHING PMAC

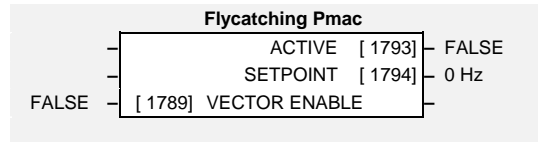

The Flycatching Pmac block allows you used to restart a spinning motor on the fly before controlling the motor to the desired setpoint. This is especially useful for large inertia loads, mainly on applications where the load can be spinned by external means.

When the drive is switched on, the drive will search for a possible rotating speed during 0.2s.

If the real rotating speed is lower than 2% of the MAX SPEED parameter of the REFERENCE Block, the motor is considered as standstill, and the speed generation starts from an equivalent Zero speed.

If the real rotating speed is higher than 2% of the MAX SPEED parameter of the REFERENCE Block, the speed generation starts from the equivalent real speed.

Parameter Descriptions

ACTIVE

Range: FALSE / TRUE

This parameter is used to indicate whether or not the speed search is on the way.

TRUE : The drive is searching for the actual motor speed.

FALSE : The drive is running a standard mode

SETPOINT

Range: — Hz.

This parameter is used to indicate the speed in electrical Hertz that was found during the preceding flycatching search.

VECTOR ENABLE

Range: FALSE / TRUE

This parameter is used to enable/disable the fly-catching feature.

TRUE : Fly-catching is enabled. The motor will search the rotating speed at each torque switch on and start to control the motor from this speed.

FALSE : Fly-catching is disabled. The motor will start to control the motor based on an initial zero speed at each torque switch on.

I/O TRIPS

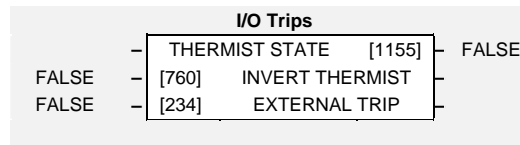

Parameter Descriptions

INVERT THERMIST

Range: FALSE / TRUE

Inverts the sense of the motor thermistor input. The default FALSE is normally-closed/low impedance.

EXTERNAL TRIP

Range: FALSE / TRUE

When this input is set TRUE the drive will trip on EXTERNAL TRIP. This input may be connected to one of the digital inputs to provide an high priority coast to stop that also sets the TRIPPED output high.

THERMIST STATE

Range: FALSE / TRUE

The current state of the motor thermistor trip input, modified by INVERT THERMIST input.

This function block is designed to operate in conjunction with the Digital Input function blocks to trip the drive on a loss of safety control input.

Functional Description

The I/O TRIPS function block allows trips to be generated by signals on the input terminals of the drive. Refer to the Installation Product Manual, Chapter 7 for a description of the trips supported by the drive.

LOCAL CONTROL

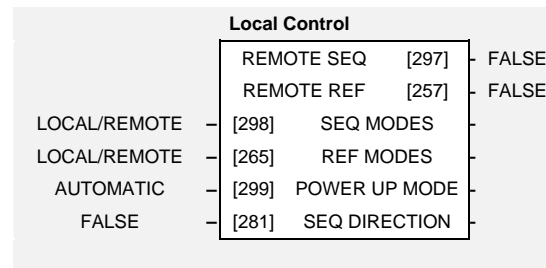

This block allows the available modes of Local and Remote operation to be customised. It also indicates the selected mode.

You can only switch between Local and Remote modes using the keypad. Refer to the Installation Product Manual, Chapter 5: “The Keypad” - Selecting Local or Remote Control.

Parameter Descriptions

SEQ MODES

Range: Enumerated - see below

Allows the source of sequencing (stop/start) commands to be selected. Local/Remote allows selection by the L/R key on the keypad. The remaining two selections disable the L/R key for selecting the sequencing commands source and lock the source to be either Local (keypad) or Remote (an external signal to the drive terminals). The modes supported are:

Enumerated Value : Seq Mode

- 0 : LOCAL/REMOTE
- 1 : LOCAL ONLY
- 2 : REMOTE ONLY

REF MODES

Range: Enumerated - see below

Allows the source of the reference (speed control) signal to be selected. Local/Remote allows selection by the L/R key on the keypad. The remaining two selections disable the L/R key for selecting the reference signal source and lock the source to be either Local (keypad) or Remote (an external signal to the drive terminals). The modes supported are:

Enumerated Value : Ref Mode

- 0 : LOCAL/REMOTE
- 1 : LOCAL ONLY
- 2 : REMOTE ONLY

Parameter Descriptions

POWER UP MODE

Range: Enumerated - see below

Allows the power-up operating mode of the drive to be selected. Local is the keypad, Remote is an external signal to the drive terminals. Automatic is the same mode as at power-down. The modes supported are:

Enumerated Value : Power Up Mode

- 0 : LOCAL
- 1 : REMOTE
- 2 : AUTOMATIC

SEQ DIRECTION

Range: FALSE / TRUE

This parameter is used in conjunction with the 6901 Keypad which has a "direction" key, Forward/Reverse.

When this parameter is set to TRUE, the source of the "direction" command is as defined by the SEQ MODES parameter

When this parameter is set to FALSE, the source of the "direction" command is as defined by the REF MODES parameter

REMOTE SEQ

Range: FALSE / TRUE

This parameter indicates the present source of the sequencing commands. When set to FALSE, stop-start commands are from Local (keypad), when TRUE stop-start commands are from Remote (from the terminals).

REMOTE REF

Range: FALSE / TRUE

This parameter indicates the present source of the reference signal. When set to FALSE, speed control is from Local (keypad), when TRUE speed control is from Remote (from the terminals).

LOGIC FUNCTION

These generic function blocks can be configured to perform one of a number of simple functions upon a fixed number of inputs.

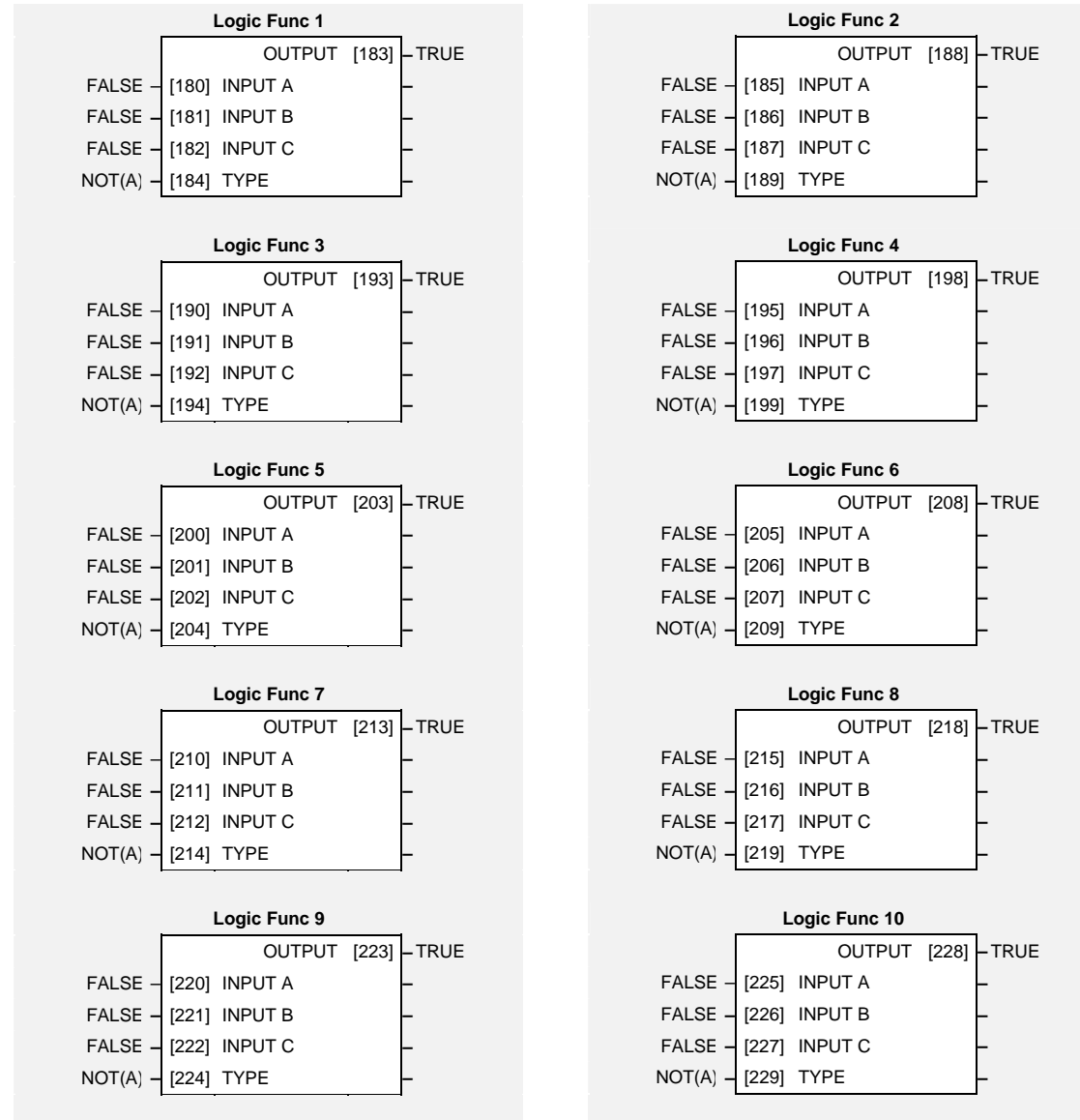

Parameter Descriptions

INPUT A

General purpose logic input.

Range: FALSE / TRUE

INPUT B

General purpose logic input.

Range: FALSE / TRUE

INPUT C

General purpose logic input.

Range: FALSE / TRUE

TYPE

Range: Enumerated - see below

The operation to be performed on the three inputs to produce the output value. The operations that can be selected are:

Enumerated Value : Type

- 0 : NOT(A)
- 1 : AND(A,B,C)
- 2 : NAND(A,B,C)
- 3 : OR(A,B,C)
- 4 : NOR(A,B,C)
- 5 : XOR(A,B)
- 6 : 0-1 EDGE(A)
- 7 : 1-0 EDGE(A)
- 8 : AND(A,B,!C)
- 9 : OR(A,B,!C)
- 10 : S FLIP-FLOP
- 11 : R FLIP-FLOP
- 12 : LATCH
- 13 : SWITCH
- 14 : (A AND B) OR C
- 15 : (A OR B) AND C

OUTPUT

The result of performing the selected operation on the inputs.

Range: FALSE / TRUE

Functional Description

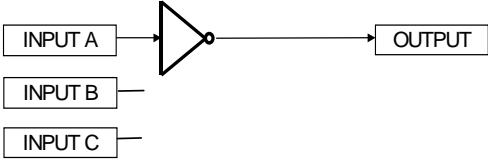
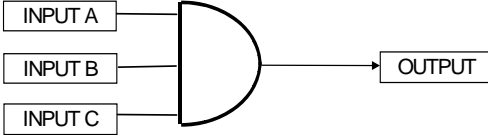
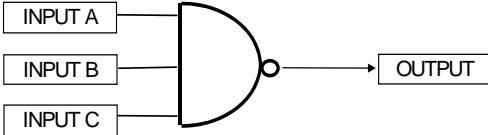
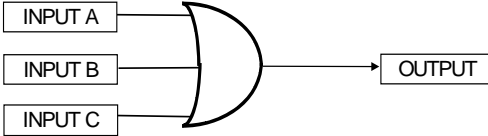
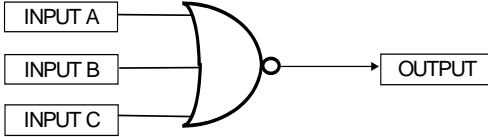
Operation	Description
NOT(A)	<p>NOT(A)</p> <p>If INPUT A is TRUE the OUTPUT is FALSE, otherwise the OUTPUT is TRUE.</p> 
AND(A,B,C)	<p>AND(A,B,C)</p> <p>If A and B and C are all TRUE then the OUTPUT is TRUE, otherwise the OUTPUT is FALSE.</p> 
NAND(A,B,C)	<p>NAND(A,B,C)</p> <p>If A and B and C are all TRUE then the OUTPUT is FALSE, otherwise the OUTPUT is TRUE.</p> 
OR(A,B,C)	<p>OR(A,B,C)</p> <p>If at least one of A or B or C is TRUE then the OUTPUT is TRUE, otherwise the OUTPUT is FALSE.</p> 
NOR(A,B,C)	<p>NOR(A,B,C)</p> <p>If at least one of A or B or C is TRUE then the OUTPUT is FALSE, otherwise the OUTPUT is TRUE.</p> 

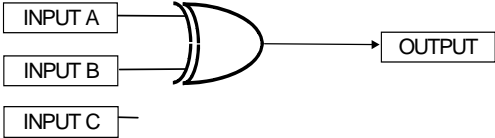
Operation	Description
XOR(A,B)	<p>XOR(A,B)</p> <p>If A and B are the same, (both TRUE or both FALSE), then the output is FALSE, otherwise the output is TRUE.</p> 

0-1 EDGE(A)

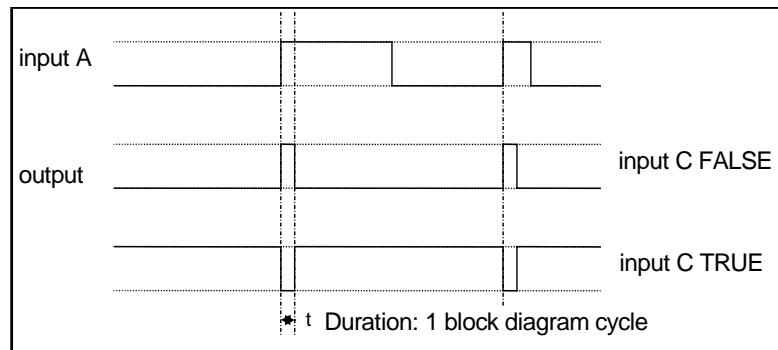

Rising Edge Trigger

Input B is not used.

This function outputs a pulse of 5ms duration when INPUT A to the block becomes TRUE. When INPUT C is TRUE, the output is inverted. The output is held TRUE for one execution of the function block diagram.

Operation	Description
-----------	-------------

1-0 EDGE(A)

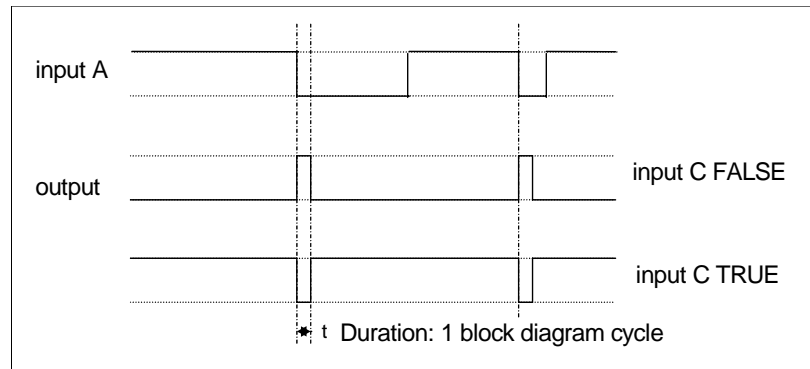

Falling Edge Trigger

Input B is not used.

This function outputs a pulse of 20ms duration when INPUT A to the block becomes FALSE. When INPUT C is TRUE, the output is inverted.

The output is held TRUE for one execution of the function block diagram.

AND(A,B,!C)

AND(A,B,!C)

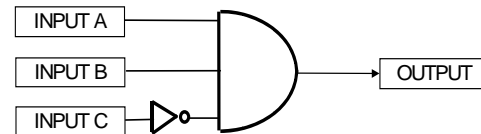

Input State

A	B	C	Output State
0	0	0	0
0	0	1	0
0	1	0	0
0	1	1	0
1	0	0	0
1	0	1	0
1	1	0	1
1	1	1	0

Refer to the Truth Table.

FALSE = 0, TRUE = 1.

1-42 Programming Your Application

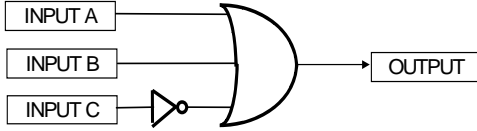
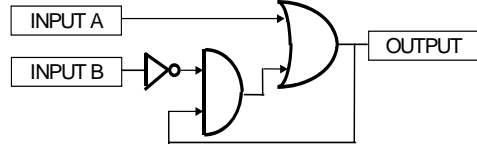
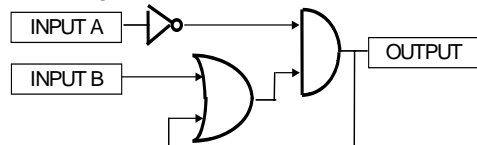
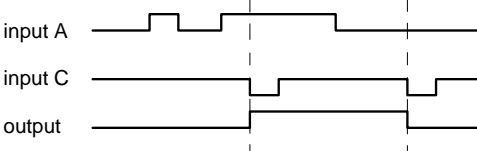
Operation	Description																																					
OR(A,B,!C)	<p>OR(A,B,!C)</p>  <p>Refer to the Truth Table. FALSE = 0, TRUE = 1.</p>	<p>Input State</p> <table border="1"> <thead> <tr> <th>A</th> <th>B</th> <th>C</th> <th>Output State</th> </tr> </thead> <tbody> <tr><td>0</td><td>0</td><td>0</td><td>1</td></tr> <tr><td>0</td><td>0</td><td>1</td><td>0</td></tr> <tr><td>0</td><td>1</td><td>0</td><td>1</td></tr> <tr><td>0</td><td>1</td><td>1</td><td>1</td></tr> <tr><td>1</td><td>0</td><td>0</td><td>1</td></tr> <tr><td>1</td><td>0</td><td>1</td><td>1</td></tr> <tr><td>1</td><td>1</td><td>0</td><td>1</td></tr> <tr><td>1</td><td>1</td><td>1</td><td>1</td></tr> </tbody> </table>	A	B	C	Output State	0	0	0	1	0	0	1	0	0	1	0	1	0	1	1	1	1	0	0	1	1	0	1	1	1	1	0	1	1	1	1	1
A	B	C	Output State																																			
0	0	0	1																																			
0	0	1	0																																			
0	1	0	1																																			
0	1	1	1																																			
1	0	0	1																																			
1	0	1	1																																			
1	1	0	1																																			
1	1	1	1																																			
S FLIP-FLOP	<p>S FLIP-FLOP</p> 	<p>This is a set dominant flip-flop. INPUT A functions as <i>set</i>, and INPUT B as <i>reset</i>.</p>																																				
R FLIP-FLOP	<p>R FLIP-FLOP</p> 	<p>This is a reset dominant flip-flop. INPUT A functions as <i>reset</i>, and INPUT B as <i>set</i>.</p>																																				
LATCH	 <p>When INPUT C is low, the output is the value of INPUT A. This output value is then latched until INPUT C is low again. INPUT B is not used.</p>																																					

Operation	Description
-----------	-------------

SWITCH

When INPUT C is FALSE, the output is equal to INPUT A. When INPUT C is TRUE, the output is equal to INPUT B.

(A AND B) OR C

A	B	C	Output
0	0	0	0
0	0	1	1
0	1	0	0
0	1	1	1
1	0	0	0
1	0	1	1
1	1	0	1
1	1	1	1

(A OR B) AND C

A	B	C	Output
0	0	0	0
0	0	1	0
0	1	0	0
0	1	1	1
1	0	0	0
1	0	1	1
1	1	0	0
1	1	1	1

MINIMUM SPEED

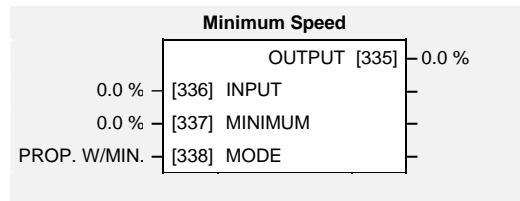

The minimum speed block is used to determine how the drive will follow a reference. There are two modes

1. Proportional : minimum limit
2. Linear: between minimum and maximum.

Parameter Descriptions

INPUT *Range: -300.0 to 300.0 %*

The input for this block.

MINIMUM *Range: -100.0 to 100.0 %*

PAR\ P3

This parameter determines the minimum output value from this block

MODE *Range: Enumerated - see below*

SET\SETP STO6

This parameter represents the operating mode of the block. There are two modes:

Enumerated Value : Operating Mode

0 : PROP. W/MIN.

1 : LINEAR

OUTPUT *Range: —.x %*

The output is determined by the MODE selected, see below.

Functional Description

There are two operating modes for the MINIMUM SPEED block:

Proportional with Minimum

In this mode the MINIMUM SPEED block behaves like a simple clamp. The minimum value has the valid range -100% to 100% and the output is always greater than or equal to the minimum value.

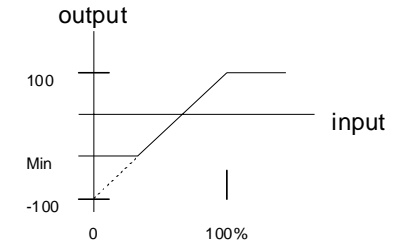

Linear

In this mode the MINIMUM SPEED block first clamps the input to zero then rescales the input such that the output goes linearly between minimum and 100% for an input that goes from 0 to 100%.

Note the constraints:-

- min \geq 0
- input \geq 0
- max = 100%

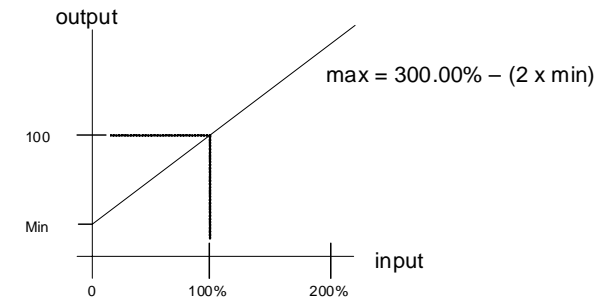

MMI ACCESS

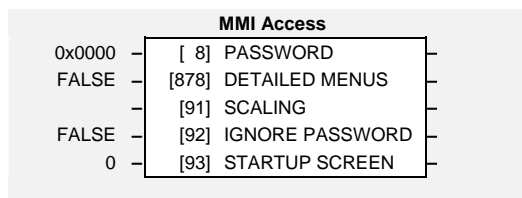

This function block contains options associated with operator station password protection, the local setpoint display and the amount of detail the menu structure will show.

Parameter Descriptions

PASSWORD *PAR\ P99* *Range: 0000 to FFFF*

Setting a non-zero value enables the password feature.

DETAILED MENUS *SET\SETP ST99* *Range: FALSE / TRUE*

Selects Full menu detail for the keypad. The additional parameters shown in the menus are indicated in this manual by **F**.

SCALING *Range: Enumerated*

This selects the scaling function to be used to present the local setpoint.

- 0: NONE No scaling is applied to the local setpoint before display
- 1: DISPLAY SCALE 1 The scaling defined in the function block DISPLAY SCALE 1 is applied to the local setpoint for display.
- 2: DISPLAY SCALE 2 The scaling defined in the function block DISPLAY SCALE 2 is applied to the local setpoint for display.

IGNORE PASSWORD *Range: FALSE/TRUE*

Setting this parameter to TRUE allows the local setpoint to be adjusted without the need to enter the password.

STARTUP SCREEN *Range: 0 to 16*

Selects the position in the Application Menu that will be selected at power on. A value of 0 selects the local setpoint. A value of 1 to 16 selects the corresponding entry in the Application Menu.

MOT POLARISATION

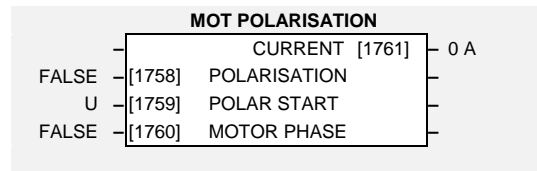

This function block is used to verify the connection between motor and drive, the correct connection of U-V-W motor phases in SV PMAC mode
 To control the motor, the following convention is used:

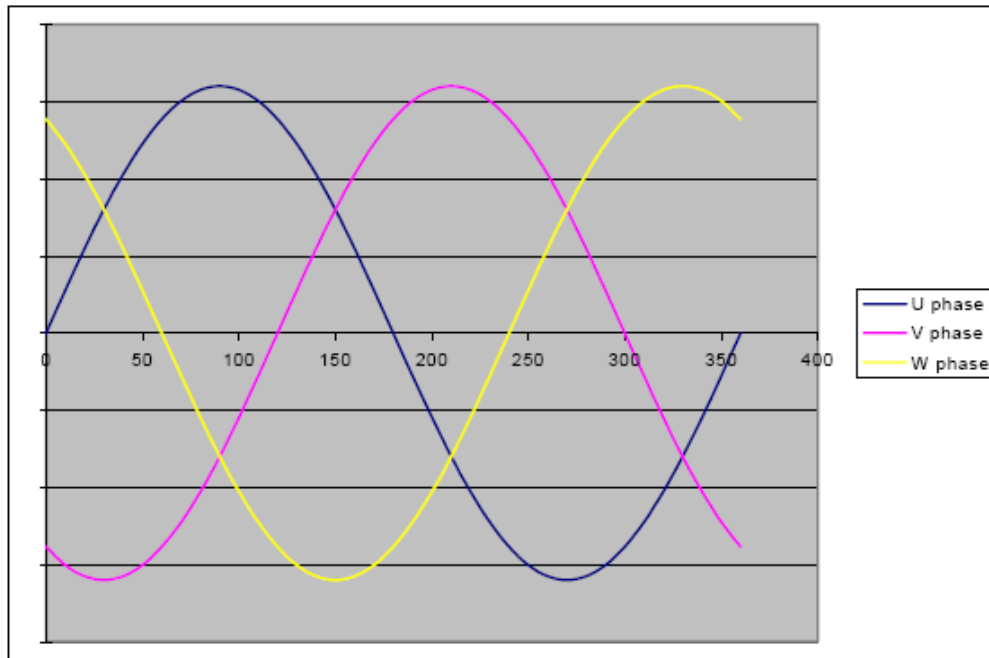

The correct succession of motor phases is U (or M1), V (or M2), W (or M3) if the motor rotates in a clockwise direction looking to the motor shaft on the front side.

For this function, a current setpoint is ramped to the motor. This will cause the rotor to lock to a specific position.

Default values are 1s ramp, and 50% of the motor permanent current (PERM CURRENT)

By changing the current sequence in the 3 motor phases, it is possible to move the motor from one position to another. This is done by changing the MOTOR PHASE parameter.

1-48 Programming Your Application

To start this function:

The motor must be stationary, with no load attached to the motor shaft.

To select this function, POLARISATION and POLAR START must be set.

MOTOR PHASE can be set to U.

1. Activate the torque on the motor.
2. The rotor will lock to a specific position.
3. Change MOTOR PHASE from U to V, V to W, W to U etc.

The motor must rotate in a clockwise direction looking to the motor shaft on the front side.

MULTIPLEXER

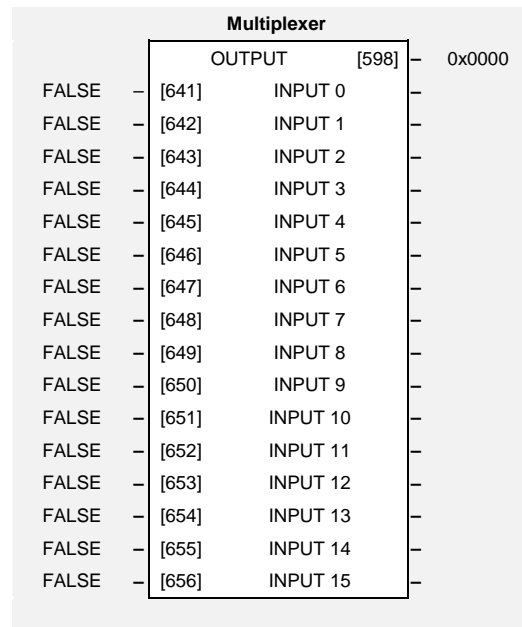

The block collects together 16 Boolean input values into a single word.

For example, it may be used to set and clear individual bits within a word such as the TRIGGERS 1 word for the AUTO RESTART function block.

Parameter Descriptions

INPUT 0 TO INPUT 15

The Boolean inputs to be assembled into a single word.

Range: FALSE / TRUE

OUTPUT

The resulting word.

Range: 0000 to FFFF

PID

PID	
	OUTPUT [1256] 0.00 %
	ERROR [619] 0.00 %
	LIMITING [1257] FALSE
0.00 %	[1247] SETPOINT
0.00 %	[617] FEEDBACK
0.00 %	[1248] FEED FWD
1.00	[618] FEEDBACK GAIN
0.00	[1249] FEED FWD GAIN
0.10	[1250] P GAIN
1.00	[1251] I GAIN
0.00	[1252] D GAIN
300.00 %	[1253] LIMIT
FALSE	[1254] ENABLE PID
FALSE	[1098] INTEGRAL DEFEAT
0.05 s	[1255] D FILTER TC
1.0000	[1258] OUTPUT SCALING

This function block allows the drive to be used in applications requiring a trim to the setpoint, depending on feedback from an external measurement device. Typically this will be used for process control, i.e. pressure or flow.

Parameter Descriptions

SETPOINT

The input setpoint to the PID block.

Range: -300.00 to 300.00 %

FEEDBACK

The feedback input to the PID block.

Range: -300.00 to 300.00 %

FEED FWD

The feed forward input to the PID block.



Range: -300.00 to 300.00 %

FEEDBACK GAIN

 PAR\ P505

The feedback gain of the PID block.

Range: -10.00 to 10.00

FEED FWD GAIN		<i>Range: -10.00 to 10.00</i>
The feed forward gain of the PID block.		
P GAIN	<i>PAR\ P501</i>	<i>Range: 0.00 to 100.00</i>
The Proportional gain of the PID block.		
I GAIN	<i>PAR\ P502</i>	<i>Range: 0.00 to 100.00</i>
The Integral gain of the PID block.		
D GAIN	 <i>PAR\ P503</i>	<i>Range: 0.00 to 100.00</i>
The Derivative gain of the PID block.		
LIMIT	 <i>PAR\ P506</i>	<i>Range: 0.00 to 300.00 %</i>
This parameter determines the maximum positive and negative limits of the PID output.		
ENABLE PID		<i>Range: FALSE / TRUE</i>
When TRUE, the PID output operates normally; when FALSE, the output is zero and the integral term is reset to zero.		
INTEGRAL DEFEAT		<i>Range: FALSE / TRUE</i>
This parameter resets the integral term to zero when TRUE.		
D FILTER TC	 <i>PAR\ P504</i>	<i>Range: 0.05 to 5.00 s</i>
In order to help attenuate high frequency noise on the PID output, a first order output filter has been provided. This parameter determines the output filter time constant.		
OUTPUT		<i>Range: xx.xx %</i>
The output of the PID function.		
ERROR		<i>Range: xx.xx %</i>
The result of SETPOINT - FEEDBACK x FEEDBACK GAIN.		
LIMITING		<i>Range: FALSE / TRUE</i>
This output is TRUE if the output is at the LIMIT value.		
OUTPUT SCALING		<i>Range: -3.0000 to 3.0000</i>
This parameter represents an overall scaling factor which is applied after the PID positive and negative clamps.		

Functional Description

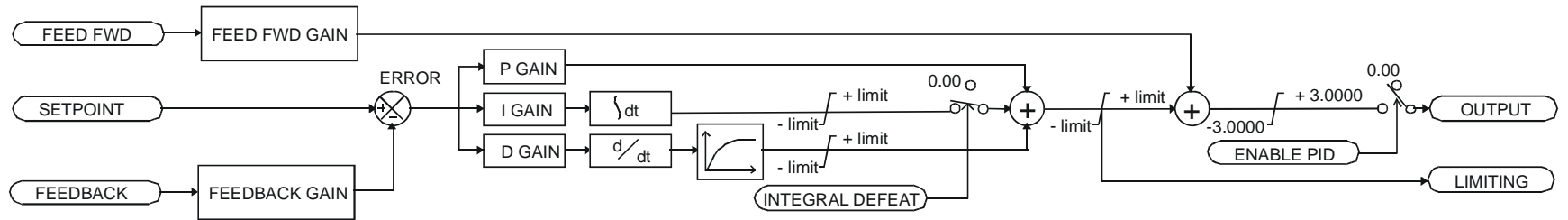

For an application that requires closed loop control, the error term may be derived from the setpoint and feedback using a value function block. This error term is then used by the PID. The output of the PID may be used to trim the demand setpoint via the SPEED TRIM parameter in the REFERENCE function block.

PMAC DRIVE PROTECT

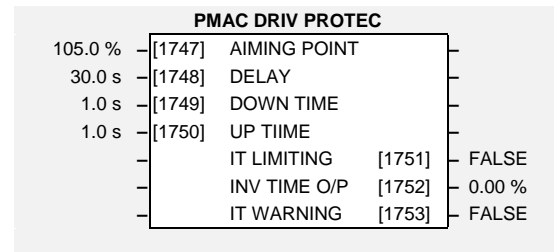

This function block is used to set up parameters associated to the drive protection when used in SV PMAC mode

The purpose of the inverse time is to automatically reduce the drive current limit in response to prolonged overload conditions (drive protection).

Under normal conditions, the drive current limit is set to the minimum value between:

- 150% of the permanent drive current
- MAX CURRENT parameter of the PMAC MOTOR 1 (or PMAC MOTOR 2)

As the drive current exceeds the AIMING POINT level, the excess current is integrated. Motor current is allowed to flow at the minimum value between 150% of permanent drive current and MAX CURRENT, for a period defined by the DELAY parameter. Once this point is reached, the current is ramped down to the AIMING POINT using the DOWN RATE time.

Once the overload condition is removed, the inverse time is ramped back to the maximum current using UP RATE time.

Parameter Descriptions

AIMING POINT *SET/IPPA/IP01* *Range: 50.0 to 150 %*

Determines the final level of the inverse time current limit after a period of prolonged motor overload.

DELAY *SET/IPPA/IP02* *Range: 5.0 to 60.0 s*

Determines the maximum overload duration before inverse time current limit action is taken.

DOWN TIME *SET/IPPA/IP03* *Range: 1.0 to 10.0 s*

Determines the rate at which the inverse time current limit is ramped down to the AIMING POINT after a period of prolonged overload.

UP TIME *SET/IPPA/IP04* *Range: 0.5 to 100.0 s*

Determines the rate at which the inverse time current limit is ramped back to the maximum current.

IT LIMITING *SET/IPPA/IP05* *Range: FALSE / TRUE*

This diagnostic indicates if the drive protection is active.

INV TIME O/P *SET/IPPA/IP06* *Range: —.xx %*

This diagnostic indicates the actual current level limit.

IT WARNING *SET/IPPA/IP07* *Range: FALSE / TRUE*

This diagnostic indicates that the drive will reach its maximum overload level.

PMAC MOT PROTECT

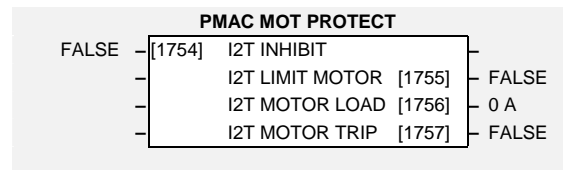

This function block is used to set up parameters associated to the motor protection when used in SV PMAC mode

This is a motor protection based on the rms current flowing in the motor phases. This protection is called I^2T and is based on two parameters of the PMAC MOTOR 1 (or PMAC MOTOR 2):

PERM CURRENT
THERMAL TIME CST.

The rms motor current is filtered with a first order low pass filter based on the THERMAL TIME CST time. The output I2T MOTOR LOAD is a percentage of the motor thermal load (PERM CURRENT is 100%).

The drive trips on MOTOR OVERTEMP when the output exceeds 100%.

If I2T INHIBIT = 1 (TRUE), then the trip is inactive and the motor can run over 100%.

Parameter Descriptions

I2T INHIBIT

Inhibit/enable the action of the motor protection. Inhibit = TRUE

I2T LIMIT MOTOR SET/I2P/2P02

Range:FALSE / TRUE

This is diagnostic information:

- 0 : motor load level is lower than 100%
- 1 : motor load level is higher than 100%

I2T MOTOR LOAD SET/I2P/2P03

Range:--.xx A (rms)

This is a diagnostic information.

iIndicates the percentage of motor load. This value is based on PERM CURRENT (permanent motor current). The time variation is based on THERMAL TIM CST

I2T MOTOR TRIP SET/I2P/2P04

Range:FALSE / TRUE

State of the I2T trip, reported as MOTOR OVERTEMP:

- 0: the motor is running, the motor load level is lower than 100%
- 1: the motor is stopped; the motor load level is higher than 100%

Parameter Descriptions

and then stops after the defined distance.

If TARGET is negative, the motor starts running in the negative direction, waits for the Mark Input rising edge and then stops after the defined distance.

DIRECTION *SET\POS PS05* *Range: Enumerated - see below*

This parameter specifies the move's DIRECTION. It is only used when TYPE = ABSOLUTE, MODULO ≠ 0 and TARGET < MODULO.

Enumerated Value : Direction

- 0 : POSITIVE Motor will always move in the positive direction.
- 1 : NEGATIVE Motor will always move in the negative direction.
- 2 : SHORTEST Motor will choose the direction that gives the shortest travel distance given the actual position and the target position.

Example: if MODULO = 10 and actual position (ENCODER::POSITION UNITS) = 3 how the drive behaves for a TARGET = 1 or 5 or 9 ?

TARGET	DIRECTION		
	POSITIVE	NEGATIVE	SHORTEST
1	Motor will run in the positive direction. Travel distance = $(10-3) + 1 = 8$ units	Motor will run in the negative direction. Travel distance = $3 - 1 = 2$ units	Same as NEGATIVE (minimising the travel distance)
5	Motor will run in the positive direction. Travel distance = $5 - 3 = 2$ units	Motor will run in the negative direction. Travel distance = $3+5 = 8$ units	Same as POSITIVE (minimising the travel distance)
9	Motor will run in the positive direction. Travel distance = $9 - 3 = 6$ units	Motor will run in the negative direction. Travel distance = $3+(10-9) = 4$ units	Same as NEGATIVE (minimising the travel distance)

MAX SPEED *SET\POS PS06* *Range: 0.00 to 32768.00*

This parameter defines the maximum speed (in units/s) allowed during the move. Depending on the move parameters (travel distance, acceleration, deceleration and jerk) this maximum speed may not be reached.

POS WINDOW *SET\POS PS07* *Range: 0.01 to 1000.00*

This parameter is used to set/reset the TARGET REACHED diagnostic.

If the difference between the actual and the target position is smaller than POS WINDOW then TARGET REACHED = TRUE, else TARGET REACHED = FALSE.

REDUCED SPEED *SET\POS PS08* *Range: 0.01 to 1000.00*

This parameter allows reducing the speed set-point at the end of the move command.

REDUCED *SET\POS PS09* *Range: 0.00 to 1000.00*

Parameter Descriptions

WINDOW

This parameter defines the position window length in which, at the end of a move command the speed set-point is reduced to REDUCED SPEED. If it is set to 0.00 then REDUCED SPEED is not used.

GAIN *SET\POS PS10* *Range: 0.10 to 100.00*

This parameter sets the gain of the position loop.

MARK INPUT *SET\POS PS11* *Range: Enumerated - see below*

This parameter specifies the Digital Input that will be used.

Enumerated Value : Mark Input

0 : NONE	When set to none, no rising edge can occur. If a STOP MARK move command is issued it will never finish and could be only interrupted by an ABORT command.
1 : DIN1	Digital Input 1 will be used.
2 : DIN2	Digital Input 2 will be used.
3 : DIN3	Digital Input 3 will be used.
4 : DIN4	Digital Input 4 will be used.
5 : DIN5	Digital Input 5 will be used.
6 : DIN6	Digital Input 6 will be used.
7 : DIN7	Digital Input 7 will be used.

The MARK POSITION diagnostic is updated each time a rising edge occurs on the Mark Input.

If there is an on-going STOP MARK move then the MARK POSITION is added to TARGET giving the absolute target position.

ACTIVE *SET\POS PS12* *Range: FALSE / TRUE*

This diagnostic is TRUE when there is an on-going move command.

It is reset either on the falling edge of START or when the move command has been aborted (ABORT = TRUE) and the drive is at zero speed (ZERO SPEED::AT ZERO SPEED = TRUE).

LOCKED *SET\POS PS13* *Range: FALSE / TRUE*

This diagnostic is TRUE when there is an on-going move command and the position loop is closed (locked).

The position loop is locked when the remaining travel distance (target position – actual position) is smaller than POS WINDOW + REDUCED WINDOW. In this case the speed set-point is equal to the position error (or remaining travel distance) multiplied by GAIN and clamped to REDUCED SPEED.

It is reset either on the falling edge of START or when the move command has been aborted (ABORT = TRUE) and the drive is at zero speed (ZERO SPEED::AT ZERO SPEED = TRUE).

TARGET REACHED *SET\POS PS14* *Range: FALSE / TRUE*

This diagnostic is TRUE when the position error (target position – actual position) is smaller than the position window (POS WINDOW).

It is reset either on the falling edge of START or when the move command has been aborted (ABORT = TRUE) and the drive is at zero speed (ZERO SPEED::AT ZERO SPEED = TRUE).

PRESET

Each block is used to select a value from one of eight inputs, depending on the value of another input. A second output is provided to allow the block to be used as two banks of four inputs.

The Range of preset inputs is -32768.0 to 32767.

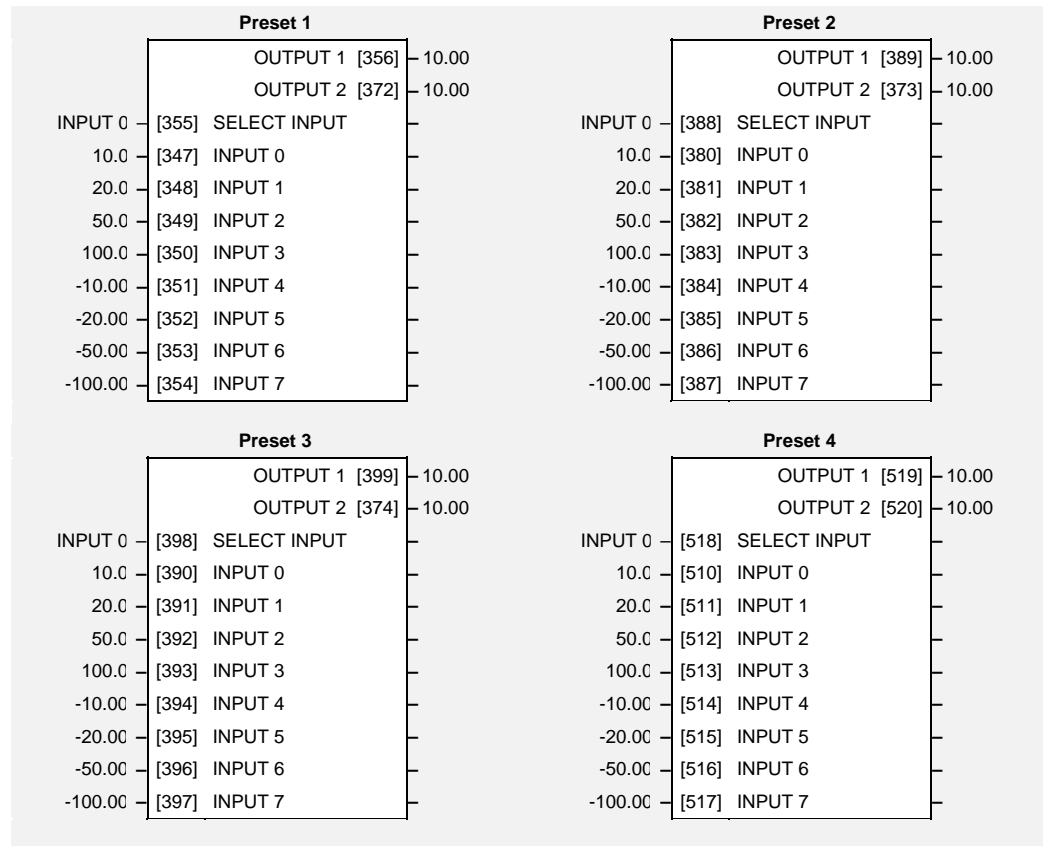

Parameter Descriptions

SELECT INPUT

Range: Enumerated - see below

Determines which of the inputs is routed to OUTPUT 1. In addition, if SELECT INPUT is in the range 0 to 3, INPUT 4 to INPUT 7 respectively is routed to OUTPUT 2.

Enumerated Value : Select Input

0 : INPUT 0
 1 : INPUT 1
 2 : INPUT 2
 3 : INPUT 3
 4 : INPUT 4
 5 : INPUT 5
 6 : INPUT 6
 7 : INPUT 7

INPUT 0 TO INPUT 7

PAR\ P301 to P308

Range: -300.00 to 300.00

Inputs to the Preset block.

OUTPUT 1

Range: —.xx

Selected input.

OUTPUT 2

Range: —.xx

Selected input (if SELECT INPUT is in the correct range).

Functional Description

The Preset function block is a de-multiplexer.

OUTPUT 1 and OUTPUT 2 return the values at selected inputs set by SELECT INPUT.

OUTPUT 2 returns the value of a different input to OUTPUT 1 , i.e:

if SELECT INPUT = 0 then OUTPUT 1 = INPUT 0, OUTPUT 2 = INPUT 4

if SELECT INPUT = 1 then OUTPUT 1 = INPUT 1, OUTPUT 2 = INPUT 5 etc.

When SELECT INPUT is set to 4, 5, 6 or 7, OUTPUT 2 will return a value of zero.

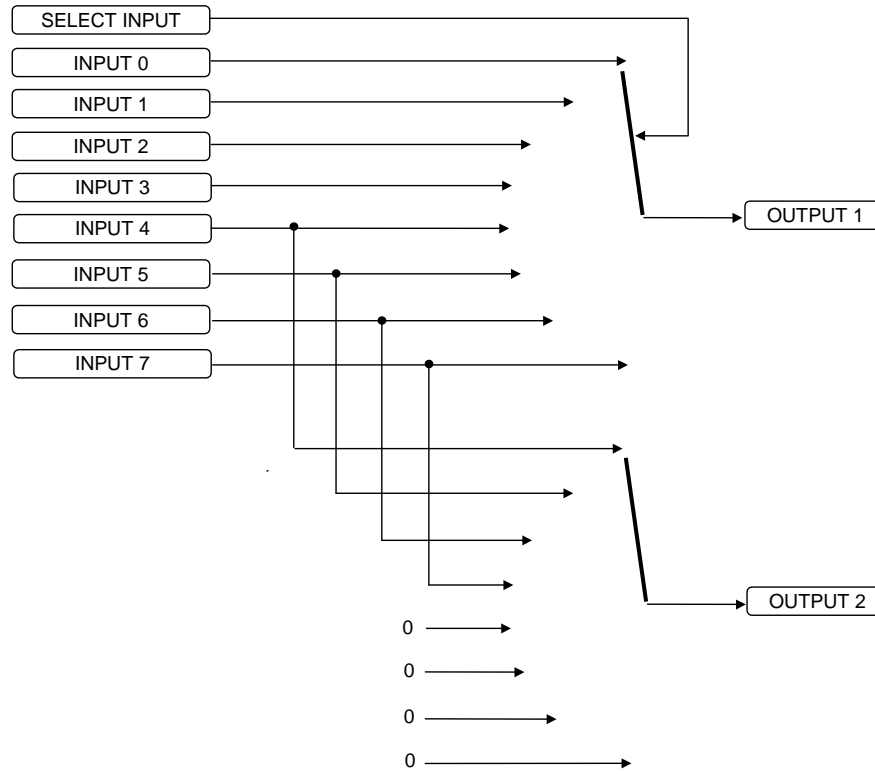

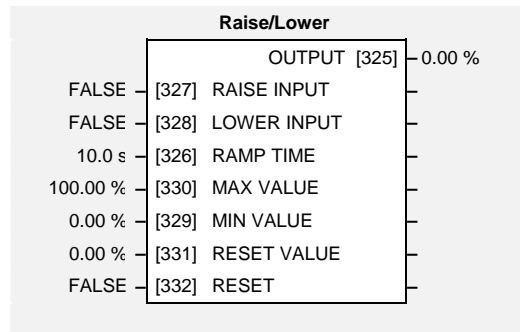
RAISE/LOWER

This function block acts as an internal motorised potentiometer (MOP).

The OUTPUT is preserved during power-down of the drive.

Parameter Descriptions**RAISE INPUT**

Range: FALSE / TRUE

When TRUE causes OUTPUT to ramp up.

LOWER INPUT

Range: FALSE / TRUE

When TRUE causes OUTPUT to ramp down.

RAMP TIME

PAR\ P401

Range: 0.0 to 600.0 s

Rate of change of the OUTPUT. Defined as time to change from 0.00% to 100.00%. Note that the raise and lower rates are always the same.

MAX VALUE

PAR\ P402

Range: -100.00 to 100.00 %

The maximum value to which OUTPUT will ramp up to.

MIN VALUE

PAR\ P403

Range: -100.00 to 100.00 %

The minimum value to which OUTPUT will ramp down to.

RESET VALUE

PAR\ P404

Range: -100.00 to 100.00 %

The value the OUTPUT is set to when RESET is TRUE.

RESET

Range: FALSE / TRUE

When TRUE, forces OUTPUT to track RESET VALUE.

OUTPUT

Range: —.xx %

The ramped output. This parameter is persistent, that is, it is saved throughout a power failure.

Functional Description

The table below describes how OUTPUT is controlled by the RAISE INPUT, LOWER INPUT and RESET inputs.

RESET	RAISE INPUT	LOWER INPUT	Action
TRUE	Any	Any	OUTPUT tracks RESET VALUE
FALSE	TRUE	FALSE	OUTPUT ramps up to MAX VALUE at RAMP TIME
FALSE	FALSE	TRUE	OUTPUT ramps down to MIN VALUE at RAMP TIME
FALSE	FALSE	FALSE	OUTPUT not changed. *
FALSE	TRUE	TRUE	OUTPUT not changed. *

* If OUTPUT is greater than MAX VALUE the OUTPUT will ramp down to MAX VALUE at RAMP TIME. If OUTPUT is less than MIN VALUE the OUTPUT will ramp up to MIN VALUE at RAMP TIME.

IMPORTANT: If MAX VALUE is less than MIN VALUE then OUTPUT will be either the MIN VALUE or the MAX VALUE depending on its initial value.

REFERENCE

Reference	
SPEED DEMAND	[255] 0.0 %
SPEED SETPOINT	[254] 0.0 %
RAMP INPUT	[56] 0.0 %
REVERSE	[256] FALSE
LOCAL SETPOINT	[247] 0.0 %
COMMS SETPOINT	[770] 0.0 %
LOCAL REVERSE	[250] FALSE
0.0 %	[245] REMOTE SETPOINT
0.0 %	[248] SPEED TRIM
* 50.0 Hz	[57] MAX SPEED
110.0 %	[252] MAX SPEED CLAMP
-110.0 %	[253] MIN SPEED CLAMP
FALSE	[243] TRIM IN LOCAL
FALSE	[249] REMOTE REVERSE
0.0 %	[251] LOCAL MIN SPEED

This function block holds all the parameters concerning the generation of the setpoint reference.

Parameter Descriptions**REMOTE SETPOINT**

Range: -110.0 to 110.0 %

This is the target reference that the drive will ramp to in remote reference mode (not including trim), direction is taken from REMOTE REVERSE and the sign of REMOTE SETPOINT.

SPEED TRIM

Range: -110.00 to 110.00 %

The trim is added to the ramp output in remote mode (or if TRIM IN LOCAL is TRUE) to form SPEED DEMAND. The trim is typically connected to the output of a PID in a closed loop system. Note that the output of the REFERENCE RAMP block is set to - SPEED TRIM when the drive is started. This ensures that the SPEED DEMAND ramps from zero.

MAX SPEED

M PAR\ P2

Range: 7.5 to 500.0 Hz

The maximum speed of the drive in electrical Hertz (Hz).

MAX SPEED CLAMP

Range: 0.0 to 1100.0 Hz

Maximum value for SPEED DEMAND

MIN SPEED CLAMP

Range: -110.0 to 0.0 %

Minimum value for SPEED DEMAND.

Parameter Descriptions

TRIM IN LOCAL

Range: FALSE / TRUE

When TRUE, SPEED TRIM is always added to the ramp output. When FALSE, SPEED TRIM is added only in Remote mode.

REMOTE REVERSE

Range: FALSE / TRUE

Demanded direction when in Remote Reference mode. This is usually connected directly to the Sequencing Logic.

LOCAL MIN SPEED

 *SET\SETP ST51*

Range: 0.0 to 100.0 %

The magnitude of the minimum setpoint that will be used when running in Local Mode.

SPEED DEMAND

Range: —.x %

Indicates actual speed demand. This is the input to the frequency controller.

SPEED SETPOINT

DIAG 2

Range: —.x %

This diagnostic indicates target speed. This will be equal to either LOCAL SETPOINT, REMOTE SETPOINT, JOG SETPOINT or COMMS SETPOINT. (Refer to the REFERENCE JOG function block for the JOG SETPOINT parameter).

RAMP INPUT

Range: —.x %

This diagnostic indicates the input to the reference ramp. This is the SPEED SETPOINT, clamped to zero when the drive is stopped.

REVERSE

Range: FALSE / TRUE

Indicates demanded direction. This may not be the actual direction as no account of setpoint sign is taken.

LOCAL SETPOINT

Range: —.x %

Indicates the Operator Station setpoint. It is saved on power down. Direction is taken from LOCAL REVERSE.

COMMS SETPOINT

Range: —.x %

This setpoint is the target reference that the drive will ramp to in Remote Reference Comms mode (not including trim). The direction is always positive, i.e. forward.

LOCAL REVERSE

Range: FALSE / TRUE

Indicates demanded direction in Local Reference mode, saved on power-down.

Functional Description

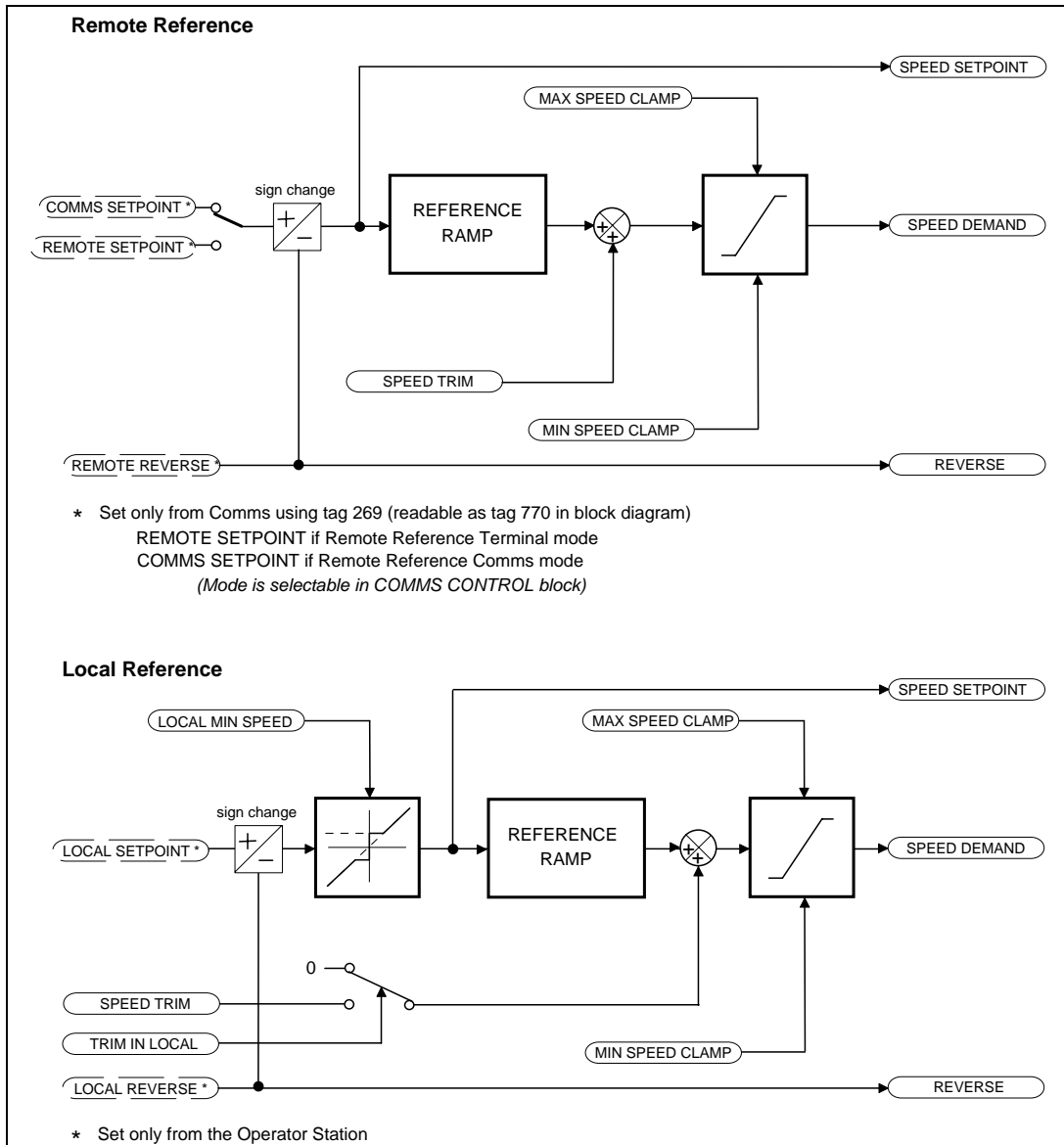

REFERENCE JOG

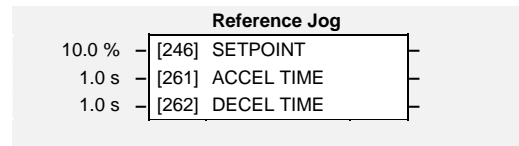

This block holds all the parameters that concern the Jog functionality on the drive.

Parameter Descriptions

SETPOINT *PAR\ P8* *Range: -100.0 to 100.0 %*

The setpoint is the target reference that the drive will ramp to.

ACCEL TIME *SET\SETP ST01* *Range: 0.0 to 3000.0 s*

The time that the drive will take to ramp the jog setpoint from 0.00% to 100.00%.

DECEL TIME *SET\SETP ST02* *Range: 0.0 to 3000.0 s*

The time that the drive will take to ramp the jog setpoint from 100.00% to 0.00%.

Functional Description

The REFERENCE JOG function block is used to configure the action of the drive when used in jog mode.

Start/Stop Controlled Remotely

When the JOG input is TRUE, the SPEED DEMAND (REFERENCE function block) ramps up to the jog SETPOINT at a ramp rate set by jog ACCEL TIME. The drive will continue to run at the jog SETPOINT while the JOG input remains TRUE.

Start/Stop Controlled Locally (6901 keypad)

When the JOG key is pressed and held, the SPEED DEMAND (REFERENCE function block) ramps up to the jog SETPOINT at a ramp rate set by jog ACCEL TIME. Release the jog key to "stop" the drive.

Interaction between RUN and JOG

Only one of these signals can be in effect at any one time; the other signal is ignored. The drive must be "stopped" to change from running to jogging, or vice versa.

REFERENCE RAMP

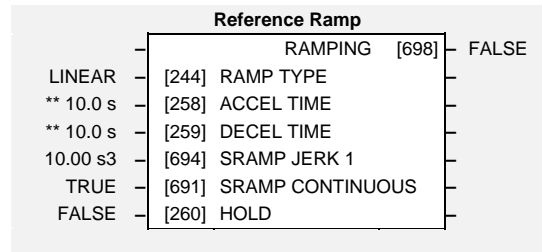

This function block forms part of the reference generation. It provides the facility to control the rate at which the drive will respond to a changing setpoint demand.

Parameter Descriptions

RAMP TYPE *SET\SETP ST03* *Range: Enumerated - see below*

Select the ramp type:

Enumerated Value : Ramp Type

0 : LINEAR

1 : S

ACCEL TIME *PAR\ P4* *Range: 0.0 to 3000.0 s*

The time that the drive will take to ramp the setpoint from 0.00% to 100.00%.

DECEL TIME *PAR\ P5* *Range: 0.0 to 3000.0 s*

The time that the drive will take to ramp the setpoint from 100.00% to 0.00%.

SRAMP JERK 1 *SET\SETP ST04* *Range: 0.00 to 100.00 s³*

Rate of change of acceleration for the first segment of the curve in units per second³, i.e. if the full speed of the machine is 1.25m/s then the acceleration will be: $1.25 \times 50.00\% = 0.625\text{m/s}^3$

SRAMP CONTINUOUS *SET\SETP ST05* *Range: FALSE / TRUE*

When TRUE, and S ramp is selected in RAMP TYPE, forces a smooth transition if the speed setpoint is changed when ramping. The curve is controlled by the SRAMP ACCEL and SRAMP JERK 1 to SRAMP JERK 4 parameters. When FALSE, there is an immediate transition from the old curve to the new curve.

RAMP HOLD *Range: FALSE / TRUE*

When TRUE the output of the ramp is held at its last value.

RAMPING *Range: FALSE / TRUE*

Set TRUE when ramping.

Functional Description

The ramp output takes the form shown below.

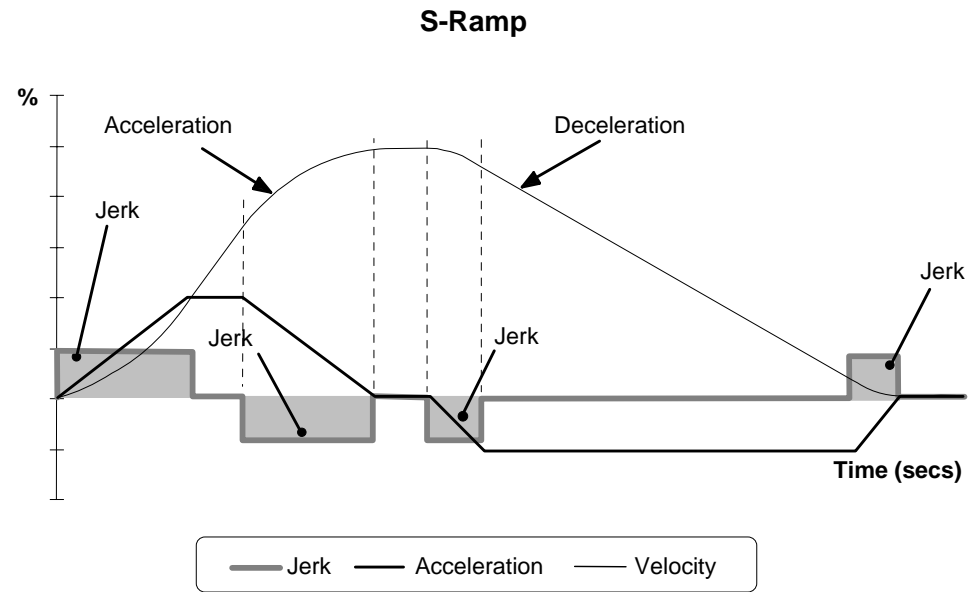

REFERENCE STOP

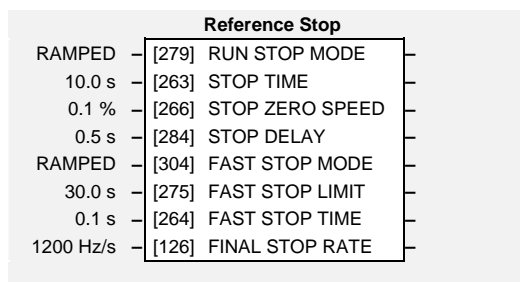

This function block holds all the parameters concerning the stopping method of the drive.

Parameter Descriptions

RUN STOP MODE *PAR\ P9* *Range: Enumerated - see below*

Selects stopping mode that the controller will use once the run command has been removed. The choices are:

Enumerated Value : Stopping Mode

- 0 : RAMPED
- 1 : COAST
- 2 : DC INJECTION

When RAMPED is selected the drive will decelerate using the reference ramp deceleration time, provided it is non zero. When COAST is selected the motor will free-wheel.

DC INJECTION feature can be selected but is equivalent to COAST choice. .

STOP TIME *Range: 0.0 to 600.0 s*

Rate at which the demand is ramped to zero after the ramp has been quenched.

STOP ZERO SPEED *Range: 0.0 to 100.0 %*

Threshold for zero speed detection used by stop sequences.

STOP DELAY *Range: 0.0 to 30.0 s*

Sets the time at which the drive holds zero speed before quenching after a normal stop or a jog stop. This may be particularly useful if a mechanical brake requires time to operate at zero speed, or for jogging a machine to position.

FAST STOP MODE *Range: Enumerated - see below*

Selects stopping mode used during a fast stop, two options ramped or coast.

Enumerated Value : Stopping Mode

- 0 : RAMPED
- 1 : COAST

Parameter Descriptions

FAST STOP LIMIT

Range: 0.0 to 3000.0 s

Maximum time that the drive will try to Fast Stop, before quenching.

FAST STOP TIME

Range: 0.0 to 600.0 s

Rate at which the SPEED DEMAND is ramped to zero (see REFERENCE function block)

FINAL STOP RATE

Range: 12 to 4800 Hz/s

Rate at which any internally generated setpoint trims are removed. For example, the trim due to the slip compensation block.

SEQUENCING LOGIC

Sequencing Logic		
	TRIPPED	[289] FALSE
	RUNNING	[285] FALSE
	JOGGING	[302] FALSE
	STOPPING	[303] FALSE
	OUTPUT CONTACTOR	[286] FALSE
	SWITCH ON ENABLE	[288] TRUE
	SWITCHED ON	[306] FALSE
	READY	[287] FALSE
	SYSTEM RESET	[305] FALSE
	SEQUENCER STATE	[301] START ENABLED
	REMOTE REV OUT	[296] FALSE
	HEALTHY	[274] TRUE
	FAN RUNNING	[620] FALSE
FALSE	[291] RUN FORWARD	
FALSE	[292] RUN REVERSE	
FALSE	[293] NOT STOP	
FALSE	[280] JOG	
TRUE	[1235] CONTACTOR CLOSED	
TRUE	[276] DRIVE ENABLE	
TRUE	[277] NOT FAST STOP	
TRUE	[278] NOT COAST STOP	
FALSE	[294] REMOTE REVERSE	
FALSE	[282] REM TRIP RESET	
TRUE	[290] TRIP RST BY RUN	
TRUE	[283] POWER UP START	
0.000s	[1536] START DELAY	

This function block contains all the parameters relating to the sequencing (start and stop) of the drive.

Before the drive will respond to the RUN FWD, RUN REV or JOG parameters (cause the drive to run or jog), the parameters DRIVE ENABLE, NOT FAST STOP and NOT COAST STOP need to be set to TRUE. In addition, the drive needs to be healthy (HEALTHY is TRUE). The drive will only respond to RUN FWD, RUN REV and JOG if the drive is in the Remote Sequencing mode.

If RUN FWD and RUN REV are TRUE, both are ignored and the drive will stop.

Parameter Descriptions

RUN FWD *Range: FALSE / TRUE*

Setting this parameter to TRUE causes the drive to run in the forward direction.

RUN REV *Range: FALSE / TRUE*

Setting this parameter to TRUE causes the drive to run in the reverse direction.

NOT STOP *Range: FALSE / TRUE*

Parameter Descriptions

Setting this parameter TRUE will latch the RUN FWD or RUN REV commands. Once latched, they can be reset to FALSE and the drive will continue to run. Setting NOT STOP to FALSE causes the run commands to be unlatched.

JOG

Range: FALSE / TRUE

Setting this parameter TRUE causes the drive to run at the speed set by JOG SETPOINT (refer to the REFERENCE JOG function block). Once jogging, setting JOG to FALSE causes the drive to ramp to zero.

CONTACTOR CLOSED

Range: FALSE / TRUE

Feedback used to indicate that the external contactor has been closed. It must be TRUE for the sequencer to proceed from the SWITCHED ON state to the READY STATE, refer to SEQUENCER STATE.

DRIVE ENABLE

Range: FALSE / TRUE

This provides a means of electronically inhibiting drive operation. Whilst running, setting this parameter to FALSE disables the drive operation and causes the motor to coast.

NOT FAST STOP

Range: FALSE / TRUE

Whilst running or jogging, setting this parameter to FALSE causes the drive to ramp to zero. The rate is set by FAST STOP RATE in the STOP function block. The action of setting NOT FAST STOP to TRUE is latched. The drive cannot be restarted until fast stop is completed. This signal is effective even when the drive is in Local mode.

NOT COAST STOP

Range: FALSE / TRUE

Setting this parameter to FALSE disables the drive operation and causes the motor to coast. The action of setting this parameter to TRUE is latched. The drive can not be restarted until the coast stop is completed. This signal is effective even when the drive is in Local mode.

REMOTE REVERSE

Range: FALSE / TRUE

For remote setpoints, setting this to TRUE inverts the demanded direction of motor rotation.

REM TRIP RESET

Range: FALSE / TRUE

On a transition to TRUE, this input clears latched trips.

TRIP RST BY RUN

Range: FALSE / TRUE

This allows the rising edge of run command to clear latched trips.

POWER UP START

Range: FALSE / TRUE

If TRUE, this allows the drive to go directly to run mode if in remote and a run command is present. If FALSE, a low to high transition of the run command is required.

START DELAY

Range: 0.000s to 30.000s

Specifies the time to allow for the motor flux to be established before running.

TRIPPED

Range: FALSE / TRUE

Indicates that there is a latched trip present.

RUNNING

Range: FALSE / TRUE

Parameter Descriptions

Indicates that the drive is in the enabled state.

JOGGING

Range: FALSE / TRUE

Indicates that the drive is in the JOG mode.

STOPPING

Range: FALSE / TRUE

Indicates that the drive is stopping.

OUTPUT CONTACTOR

Range: FALSE / TRUE

Output to be used to drive an external contactor in the motor output. This contactor is normally closed unless a Trip condition has occurred or the drive goes into the re-configuration mode.

SWITCH ON ENABLE

Range: FALSE / TRUE

Sometimes referred to as READY TO SWITCH ON, this parameter indicates that the drive will accept a run command.

SWITCHED ON

Range: FALSE / TRUE

Run accepted. Waiting for CONTACTOR CLOSED and deflux to be completed

READY

Range: FALSE / TRUE

Indicates that the drive's power stack is operable and the drive will run if enabled.

SYSTEM RESET

Range: FALSE / TRUE

TRUE for a single block diagram execution cycle after drive enters either RUN or JOG mode.

SEQUENCER STATE

Range: Enumerated - see below

This parameter indicates the current sequencing state:

Enumerated Value : State

- 0 : START DISABLED
- 1 : START ENABLED
- 2 : SWITCHED ON
- 3 : READY
- 4 : ENABLED
- 5 : F-STOP ACTIVE
- 6 : TRIP ACTIVE
- 7 : TRIPPED

REMOTE REV OUT

Range: FALSE / TRUE

This parameter indicates the current state of remote direction and RUN REV. Note - this is the demanded direction, not the actual direction.

HEALTHY

Range: FALSE / TRUE

Set FALSE when the drive trips, and set TRUE when the run command is removed. This output is False while the pre-charge relay is open on power-up.

FAN RUNNING

Range: FALSE / TRUE

This diagnostic is TRUE is the drive's cooling fans are running.

SKIP FREQUENCIES

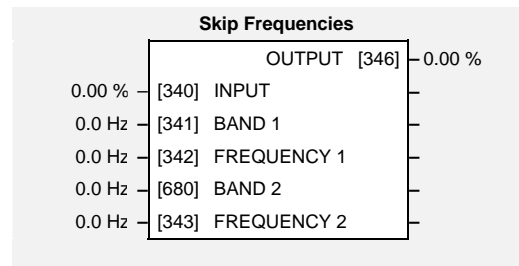

This function block may be used to prevent the drive operating at frequencies that cause mechanical resonance in the load.

Parameter Descriptions

INPUT

The value of the block input in %.

Range: -300.00 to 300.00 %

BAND 1

SET\SETP ST12

The width of each skip band in Hz.

Range: 0.0 to 60.0 Hz

FREQUENCY 1

SET\SETP ST11

This parameter contains the centre frequency of each skip band in Hz.

Range: 0.0 to 240.0 Hz

BAND 2

SET\SETP ST14

The width of each skip band in Hz.

Range: 0.0 to 60.0 Hz

FREQUENCY 2

SET\SETP ST13

This parameter contains the centre frequency of each skip band in Hz.

Range: 0.0 to 240.0 Hz

OUTPUT

Diagnostic on the output of the function block in %

Range: —.xx %

Functional Description

Two programmable skip frequencies are available to avoid resonances within the mechanical system. Enter the value of frequency that causes the resonance using the “FREQUENCY” parameter and then programme the width of the skip band using its “BAND” parameter. The drive will then avoid sustained operation within the forbidden band as shown in the diagram. The skip frequencies are symmetrical and thus work in forward and reverse.

1-76 Programming Your Application

Note: Setting the *FREQUENCY* to 0 disables the corresponding band.
Setting the *BAND* to 0 causes the value of *BAND 1* to be used for this band.

The behaviour of this function block is illustrated below.

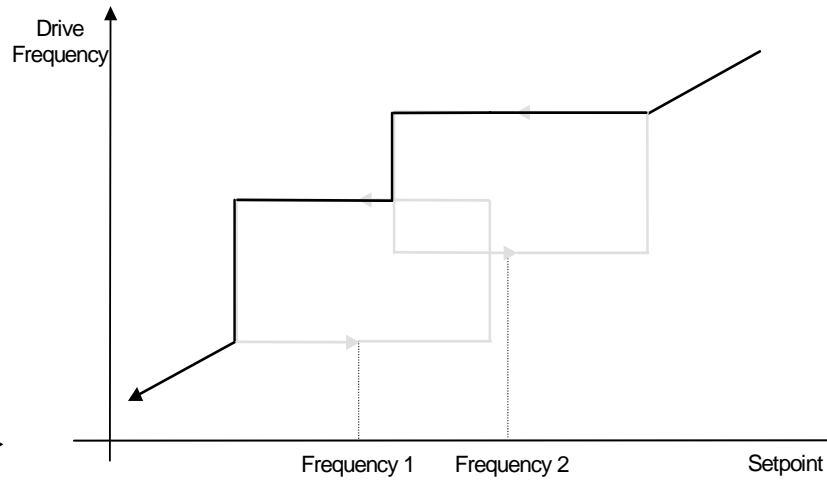
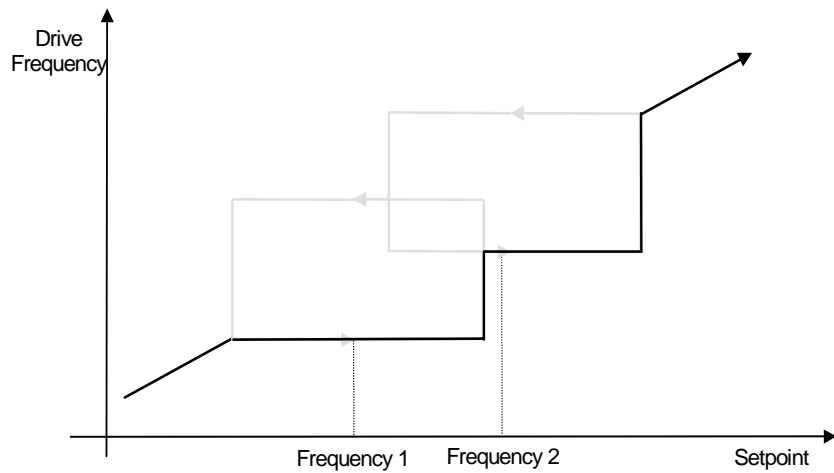
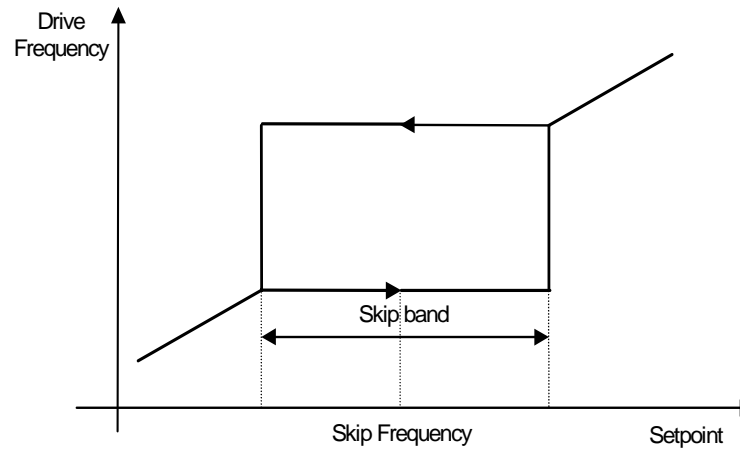

SLEW RATE LIMIT

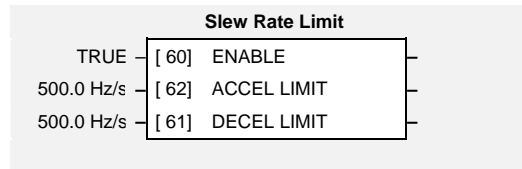

Designed for all Motor Control Modes.

This function block prevents over-current and over-voltage faults occurring due to a rapidly changing setpoint.

Parameter Descriptions

ENABLE

Range: FALSE / TRUE

When this parameter is FALSE, this function block is disabled and the setpoint is unaffected by this function block.

ACCEL LIMIT

Range: 1.0 to 1200.0 Hz/s

The maximum rate at which the setpoint may accelerate away from zero.

DECEL LIMIT

Range: 1.0 to 1200.0 Hz/s

The maximum rate at which the setpoint may decelerate towards zero.

Functional Description

The SLEW RATE LIMIT block obtains the setpoint from the output of the application, correctly scaled by the SETPOINT SCALE block. The rate of change limits are applied and the setpoint is then passed on for further processing.

When the braking block determines that the internal dc link voltage is too high it issues a Hold signal. This causes the SLEW RATE LIMIT block to hold the setpoint at its current value. This typically lasts for only 1ms, time for the excess energy to be dumped into the braking resistor.

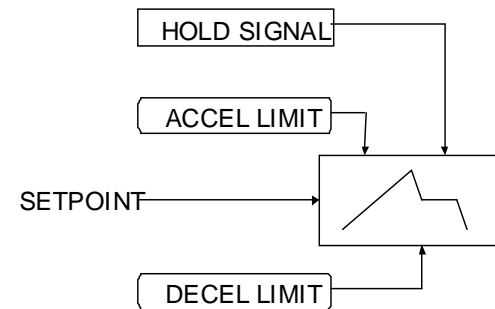
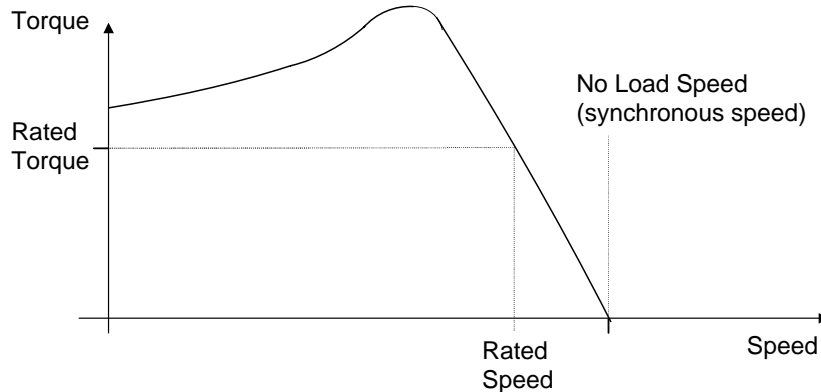

SPEED LOOP

This function block controls the speed of the motor by comparing the actual speed to the demanded speed, and applying more or less torque in response to the error.

Fixed Inputs and Outputs

Speed Demand

This is connected to the output of the SETPOINT SCALE function block.

Speed Feedback

Speed Loop		
-	TOTL SPD DMD RPM	[1203] 0.00 RPM
-	TOTAL SPD DMD %	[1206] 0.00 %
-	SPEED ERROR	[1207] 0.00 %
-	TORQUE DEMAND	[1204] 0.00 %
** 20.00	[1187] SPEED PROP GAIN	
** 500 ms	[1188] SPEED INT TIME	
FALSE	[1189] INT DEFEAT	
0.00 %	[1190] SPEED INT PRESET	
3.0 ms	[1191] SPEED DMD FILTER	
1.5 ms	[1192] SPEED FBK FILTER	
0.00 %	[1193] (AUX) TORQUE DMD	
110.00 %	[1200] SPEED POS LIM	
-110.00 %	[1201] SPEED NEG LIM	
FALSE	[1202] TORQ CTRL MODE	

When configured as SENSORLESS VEC, the speed feedback is calculated from the voltages and currents in the motor.

Torque Demand

Parameter Descriptions

SPEED PROP GAIN



SET\CTRL CL91

Range: 0.00 to 300.00

Sets the proportional gain of the loop.

Speed error (revolutions per second) x proportional gain = torque percent.

SPEED INT TIME



SET\CTRL CL92

Range: 1 to 15000 ms

This is the integral time constant of the speed loop. A speed error which causes the proportional term to produce a torque demand T, will cause the integral term to also ramp up to a torque demand T after a time equal to “speed int time”.

INT DEFEAT

Range: FALSE / TRUE

When TRUE, the integral term does not operate.

SPEED INT PRESET*Range: -500.00 to 500.00 %*

The integral term will be preset to this value when the drive starts.

SPEED DMD FILTER*Range: 0.0 to 14.0 ms*

The speed demand is filtered to reduce ripple. The filter is first order with time constant equal to the value of this parameter.

SPEED FBK FILTER*Range: 0.0 to 15.0 ms*

The speed feedback is filtered to reduce ripple, such as that caused by low line count encoders. The filter is first order with time constant equal to the value of this parameter.

(AUX) TORQUE DMD*Range: -300.00 to 300.00 %*

When the drive is operating in speed control mode, the value of this parameter is added on to the torque demand produced by the speed loop PI. When the drive is operating in torque control mode (i.e. "TORQ CTRL MODE is TRUE) the speed loop PI does not operate and the torque demand becomes the value of this parameter..

The output of the SPEED LOOP function block is a torque demand. This torque demand is passed on to the TORQUE LIMIT function block, which causes the torque to be generated in the motor.

SPEED POS LIM

SET\CTRL CL93

Range: -110.00 to 110.00 %

This sets the upper limit of the speed demand.

SPEED NEG LIM

SET\CTRL CL94

Range: -110.00 to 110.00 %

This sets the lower limit of the speed demand.

TORQ CTRL MODE*Range: FALSE / TRUE*

Selects between Speed Control mode and Torque Control mode. When TRUE, (Torque Control mode) the torque demand output from the speed loop block is the sum of the Direct Input plus the AUX TORQUE DMD parameter.

TOTL SPD DMD RPM*Range: —.xx rpm*

This shows the final values of the speed demand obtained after summing all sources. It is the value presented to the speed loop.

TOTAL SPD DMD %*Range: —.00 %*

This shows the final values of the speed demand obtained after summing all sources. It is the value presented to the speed loop.

SPEED ERROR*Range: —.00 %*

Shows the difference between the demanded speed and the actual speed.

TORQUE DEMAND*Range: —.00 %*

Shows the demanded motor torque as a percentage of rated motor torque.

Functional Description

The speed error (speed demand minus speed feedback) is calculated and processed via a proportional + integral (PI) controller. The output of the PI controller is a torque demand, which is passed directly to the torque control block.

The speed demand is derived from the Setpoint Scale block. When the drive is in SENSORLESS VEC mode, the speed feedback is calculated from the voltages and currents in the motor.

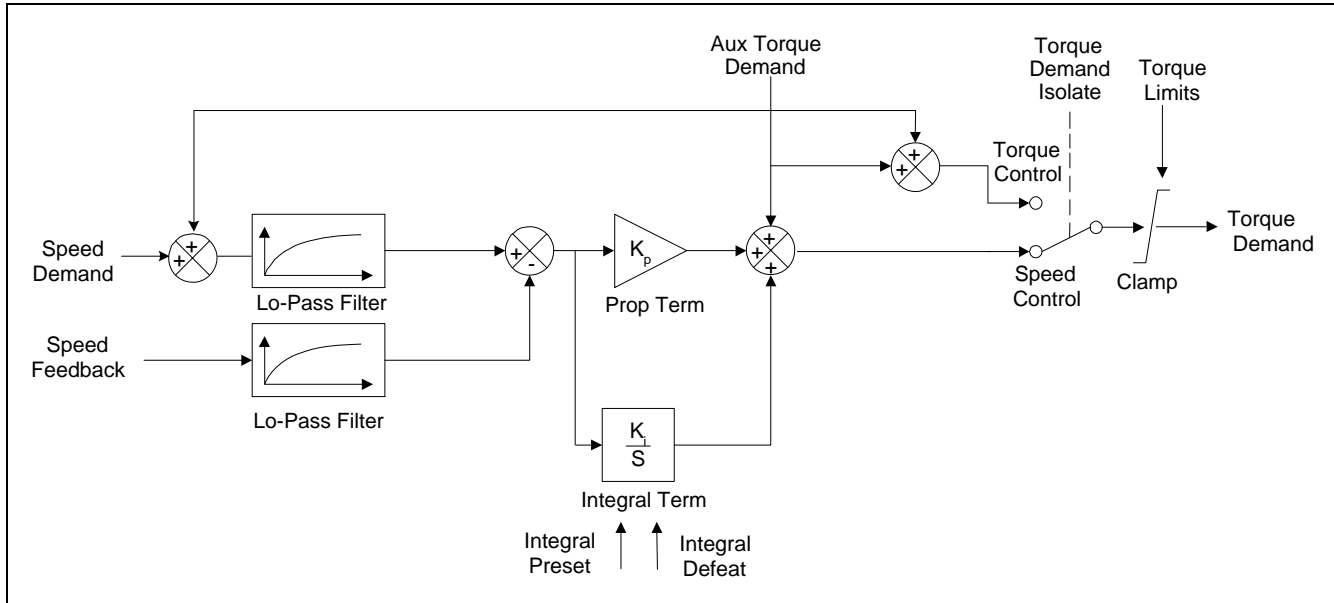

STALL TRIP

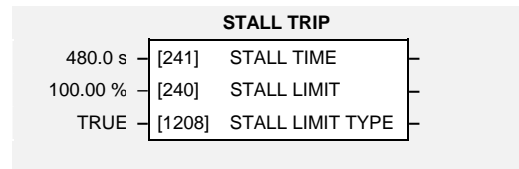

The function block protects the motor from damage that may be caused by continuous operation beyond specification.

Parameter Descriptions

STALL LIMIT

Range: 50.00 to 150.00 %

This parameter determines the level of current in % of the PERM CURRENT parameter setting in the SV MOTOR DATA function block that will cause the stall trip to become active after a STALL TIME time with the drive running in open loop mode or a drive running to a lower speed than expected. The timer is reset whenever the measured current is less than the stall limit

STALL TIME

Range: 0.1 to 3000.0 s

The time after which a stall condition will cause a trip.

STALL LIMIT TYPE

 SET\CTRL CL84

Range: FALSE / TRUE

Enumerated Value : Stall Limit Type

FALSE : TORQUE

TRUE : CURRENT

This parameter is no more used as the PMAC motors have a direct relation between torque and current in their standard uses.

Refer to the Installation Product Manual, Chapter 7 for a description of the trips supported by the drive.

SV MOTOR CTRL

PMAC SV M1		
FALSE	[1717]	TRIP INHIBIT
60.0 Hz	[1718]	LPF SPEED
2.0	[1719]	PI GAIN
20.0 Hz	[1720]	PI INTEGRAL
200 RPM	[1721]	SPD THESHOLD
5.0	[1722]	SPD START GRD
4000 RPM	[1724]	SPD GRD
0.2	[1725]	KE START GRD
1.0	[1726]	KE END GRD
50.0 RPM	[1727]	KE SPD
FALSE	[1728]	ENABLE STARTUP
0.5 s	[1729]	STARTUP TIME
10.0 %	[1730]	STARTUP CURRENT
5.0 %	[1731]	STARTUP SPEED

PMAC SV M2		
FALSE	[1732]	TRIP INHIBIT
60.0 Hz	[1733]	LPF SPEED
2.0	[1734]	PI GAIN
20.0 Hz	[1735]	PI INTEGRAL
200 RPM	[1736]	SPD THESHOLD
5.0	[1737]	SPD START GRD
4000 RPM	[1739]	SPD GRD
0.2	[1740]	KE START GRD
1.0	[1741]	KE END GRD
50.0 RPM	[1742]	KE SPD
FALSE	[1743]	ENABLE STARTUP
0.5 s	[1744]	STARTUP TIME
10.0 %	[1745]	STARTUP CURRENT
5.0 %	[1746]	STARTUP SPEED

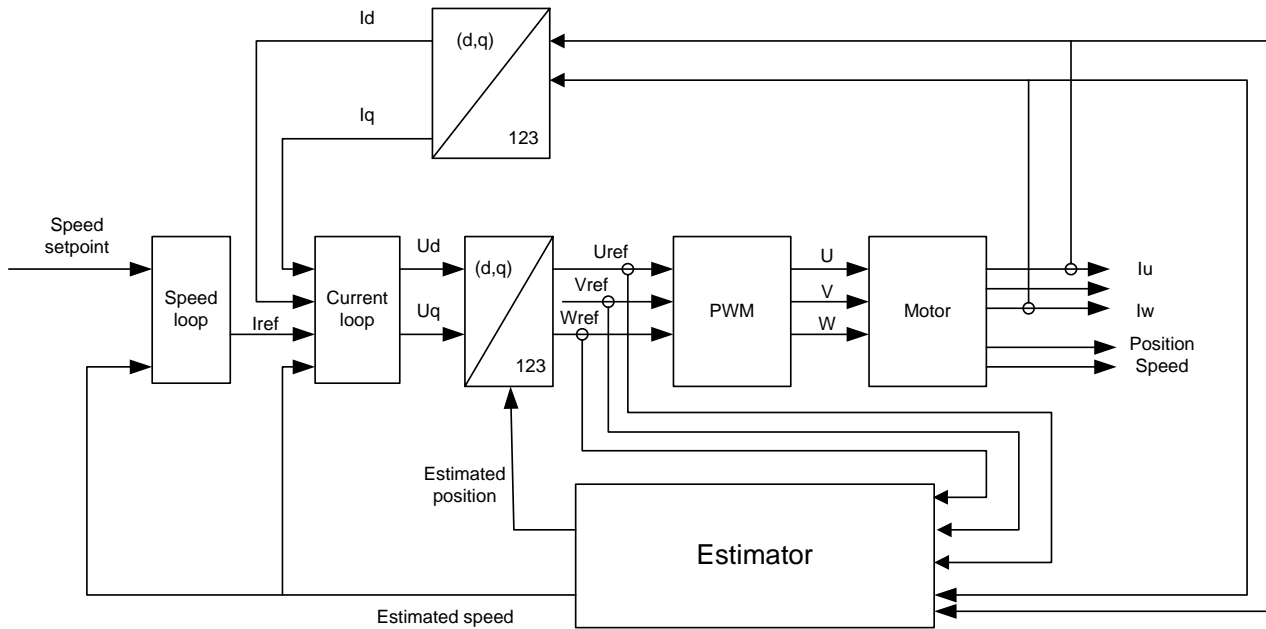

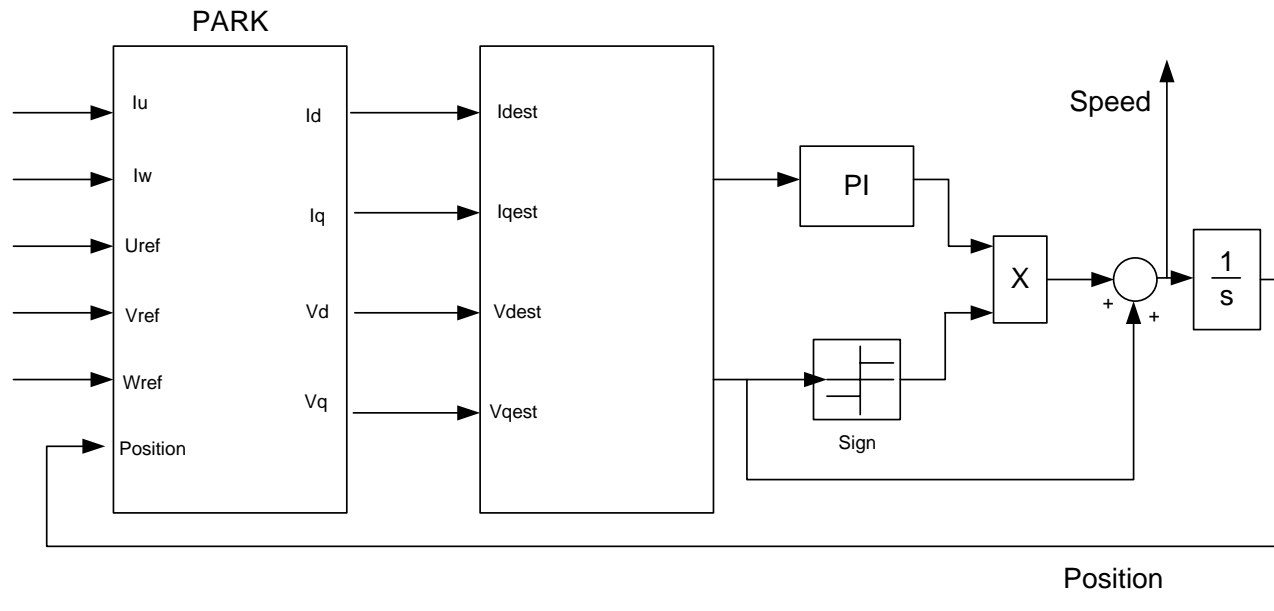

This function is used to set up parameters associated with the algorithm for extracting speed and position information needed to control a PMAC motor in a sensorless way.

Using DSELite (V2.11 at least) and the wizard is required to correctly set up the parameters associated to this function Block.

Parameter Descriptions

TRIP INHIBIT SET/SCP/SC01 & SC51 *Range: FALSE / TRUE*

This parameter is used to inhibit/enable the SV trip.

LPF SPEED SET/SCP/SC02 & SC52 *Range: 1.0 1000.0 Hz*

Set the Low Pass Filter frequency of the estimated speed.

DSELite (V2.11 at least) must be used to correctly set up this parameter.

PI GAIN SET/SCP/SC03 & SC53 *Range: 0.0 to 2000.0*

Set the Proportional gain of the PI corrector used for extracting speed and position.

DSELite (V2.11 at least) must be used to correctly set up this parameter.

1-84 Programming Your Application

PI INTEGRAL  *SET/SCP/SC04 & SC54* Range: 1.0 2000.0 Hz

Set the Integral frequency of the PI corrector used for extracting speed and position.

DSELite (V2.11 at least) must be used to correctly set up this parameter.

SPD THRESHOLD  *SET/SCP/SC05 & SC55* Range: 0 to 30000 RPM

Set the threshold value used to enable/disable the I term of the PI corrector (used for extracting speed and position).

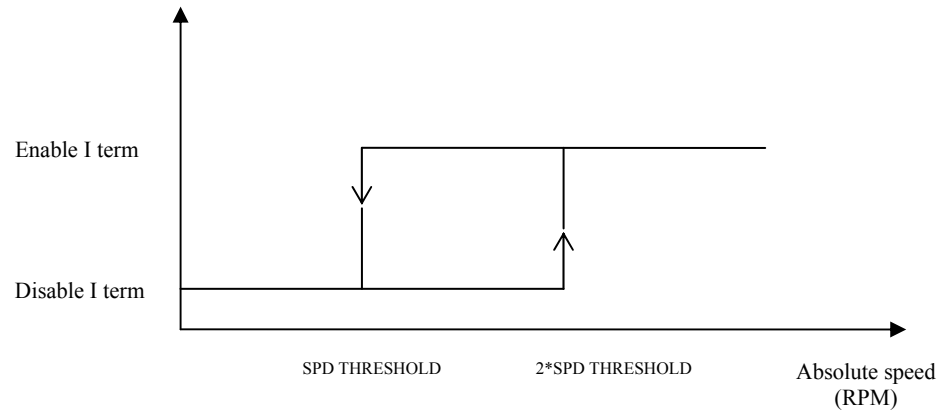

The default value is appropriate for most motors (2000 to 6000RPM). It can be changed to the Nominal motor speed divided by 20 to 30.

SPD START GRD  *SET/SCP/SC06 & SC56* Range: 0.1 to 100.0

The gain of the PI corrector varies as 1 over speed. To maintain the PI gain at a constant value over the whole range of the speed, the gain is internally varied as a function of the speed. This parameter is used to determine where the 1/X variation is starting to work (because of zero and low speed behaviour of the estimation). The default value is 5, and is considered appropriate for most applications.

The total gain applied is: $PI\ GAIN * ADAPTATION\ GAIN$

With:

$ADAPTATION\ GAIN = SPD\ START\ GRD$ from 0 to $SPD\ GRD / SPD\ START\ GRD$

$ADAPTATION\ GAIN = SPD\ GRD / real_speed\ (RPM)$ from $SPD\ GRD / SPD\ START\ GRD$ to $SPD\ GRD$

$ADAPTATION\ GAIN = 1$ above $SPD\ GRD$

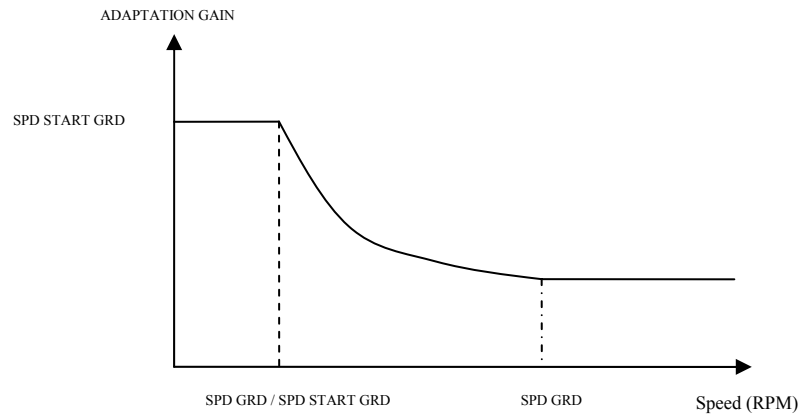

SPD GRD  *SET/SCP/SC08 & SC58* Range: -32000 to 32000 RPM

The gain of the PI corrector varies as 1 over speed. To maintain the PI gain at a constant value over the whole range of the speed, the gain is internally varied as a function of the speed.

This parameter is used to select the speed where the GAIN_ADAPTATION is kept constant and equal to 1 (see graph below). This value must be set to the nominal motor or application speed.

KE START GRD  *SET/SCP/SC09 & SC59* Range: 0.0 to 100.0

This parameter is used to vary the Back EMF versus speed used in the SV algorithm.

The default value of 0.2 is considered appropriate for most applications.

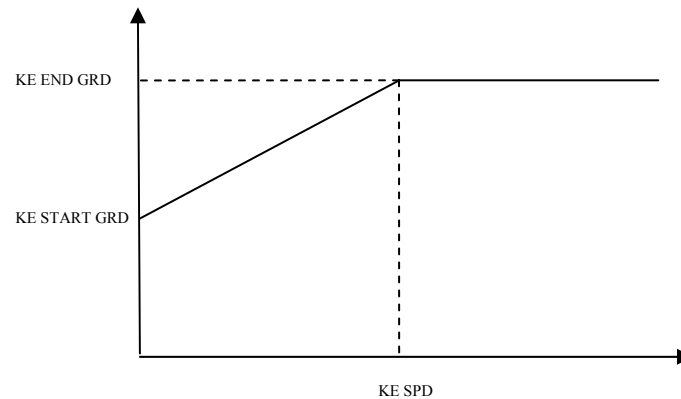

KE END GRD  *SET/SCP/SC10 & SC60* *Range: 0.0 to 100.0*

This parameter is used in conjunction with the ENABLE STARTUP parameter. It selects the This parameter is used to vary the Back EMF versus speed used in the SV algorithm.

The default value of 1.0 is considered appropriate for most applications.

KE SPD  *SET/SCP/SC11 & SC61* *Range: -32000 to 32000 RPM*

This parameter is used to vary the Back EMF versus speed used in the SV algorithm. It defines the speed at which the variation stops. The default value is 50 RPM, and is considered appropriate for most applications.

As it is mostly used to start the motor, a very low value (between 0 to 100RPM) must be selected if changed from the default value.

ENABLE STARTUP  *SET/SCP/SC12 & SC62* *Range: FALSE / TRUE*

This parameter is used to enable/disable a specific startup procedure when the motor/drive is switched ON (starting rotation). This is mainly used where applications need to start the motor with a high inertia and/or friction load and the standard start is ineffective.

This parameter is also used to work in up – down motion, where we need to go down to zero speed or crossing the zero speed point.

Start the motor with a high friction load

The default value is FALSE and a standard start is considered appropriate for most applications, when we only need to run the motor at a constant speed.

When set TRUE, the following procedure is applied each time the motor is switched on and before closing the speed loop, based on the external speed setpoint.

The drive must be used in speed loop mode.

When the drive is switched ON, the system is placed in open loop control.

Step 1:

For a time equal to the 'STARTUP TIME' parameter, the current is ramped to the 'CURRENT STARTUP' value. The sign is dependant upon the speed loop setpoint. A normal value is between 0.5 to 1s.

Step 2:

Once this turn is made, the position is ramped in such a way as to follow the speed setpoint generated, based on the configuration (ramp, etc...), until the STARTUP SPEED value is reached. The speed loop is then closed.

The ramp value must be kept low to insure the motor follows the speed setpoint.

For a positive speed setpoint when the drive is switched ON :

1-88 Programming Your Application

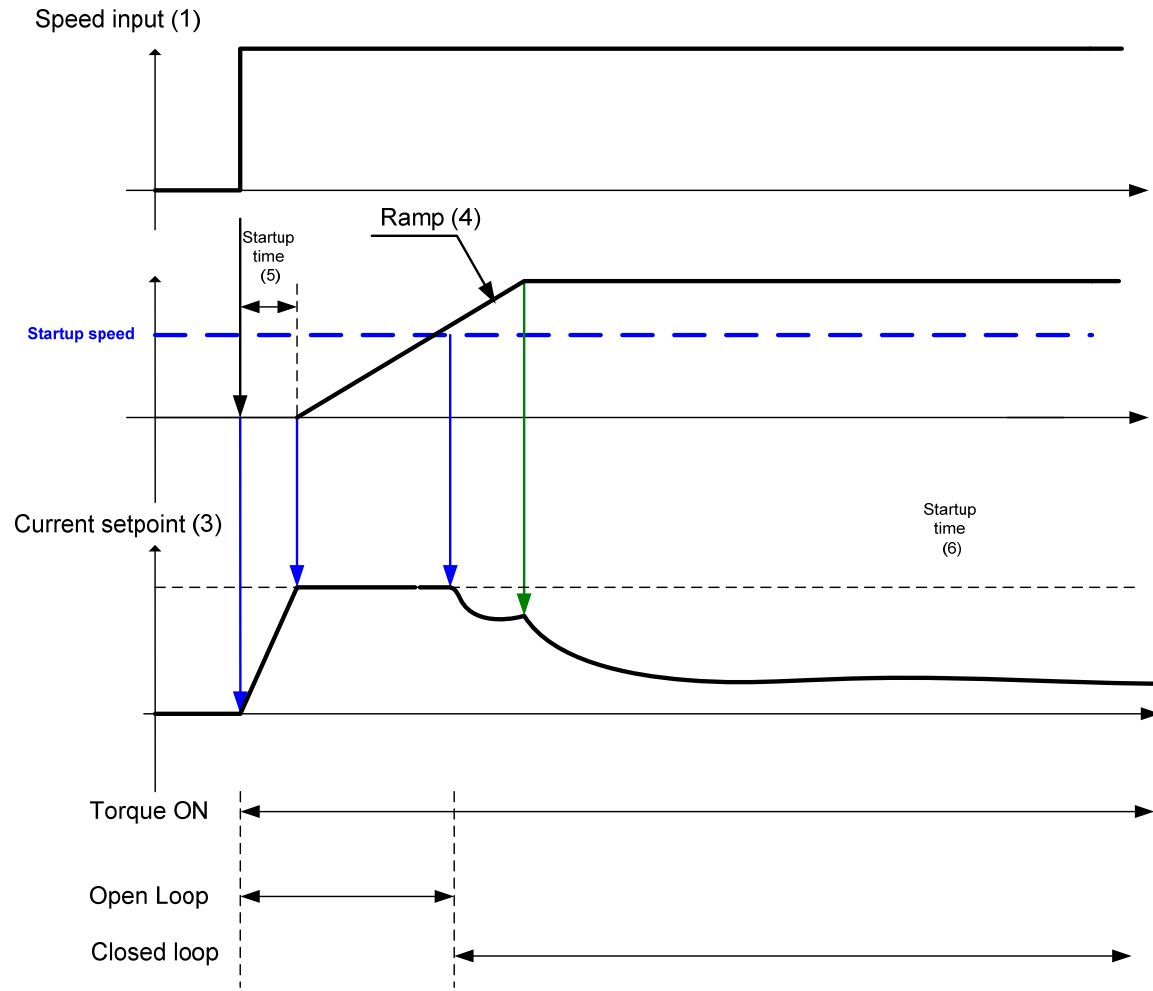

- (1) : User speed setpoint
- (2) : Internal speed setpoint
- (3) ; Internal current setpoint
- (4) ; ramps are generated based on ramp parameters
- (5) : startup procedure : a current is smoothly installed into the motor
- (6) : startup procedure : the motor is rotated for one electrical turn

For a negative speed setpoint when the drive is switched ON :

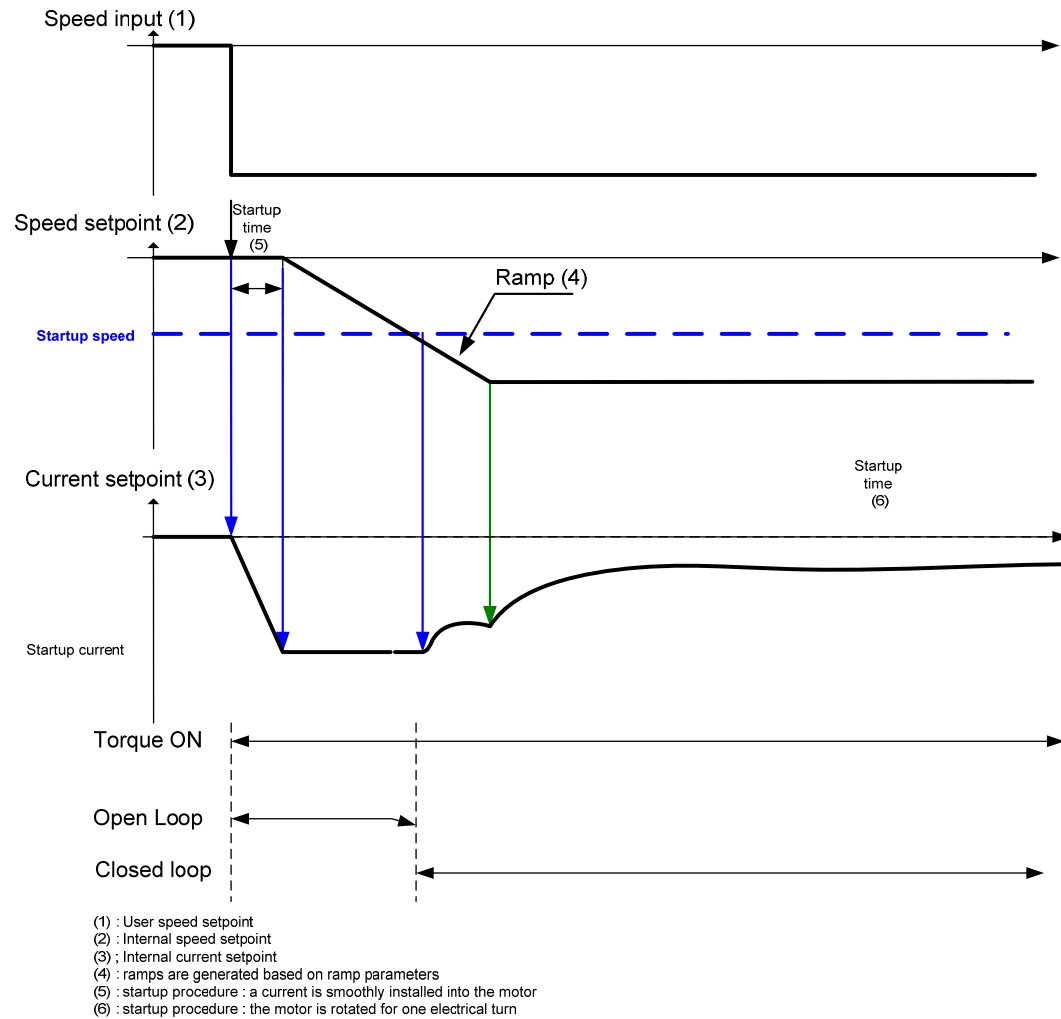

1-90 Programming Your Application

STARTUP TIME *SET/SCP/SC13 & SC63* *Range: 0.0 to 100.0 s*

This parameter is used in conjunction with the ENABLE STARTUP parameter. It selects the duration of Step 1 in the startup procedure used for starting motors with a high inertia and/or friction load:

- the time for the current ramping

The value is dependant upon the motor inertia + load inertia.

STARTUP CURRENT *SET/SCP/SC14 & SC64* *Range: 0.0 to 200.0 %*

This parameter is used in conjunction with the ENABLE STARTUP parameter. It selects the current level during the startup procedure used for starting motors with a high inertia and/or friction load.

The percentage value is a percentage of the nominal motor current (I0 of the PMAC MOTOR function block)

This value cannot be higher than 150% of the drive rating.

The default value of 10% is considered appropriate for most applications with light load, very low friction And low acceleration.

STARTUP SPEED *SET/SCP/SC15 & SC65* *Range: 0.0 to 100.0 %*

This parameter is used in conjunction with the ENABLE STARTUP parameter. It selects the speed setpoint at which the speed control is switched from an open loop mode to a closed loop mode during the startup procedure used for starting motors with a high inertia and/or friction load.

The percentage value is a percentage of the maximum application speed (MAX SPEED of the REFERENCE function block)

In open loop mode, the system is not controlled in speed mode. It must only be used to 'start' the motor under heavy conditions, or to transitorily reach the zero speed or crossing the zero speed setpoint. It is not intended to be used to control accurately a motion.

Up and Down Motion

Positive speed

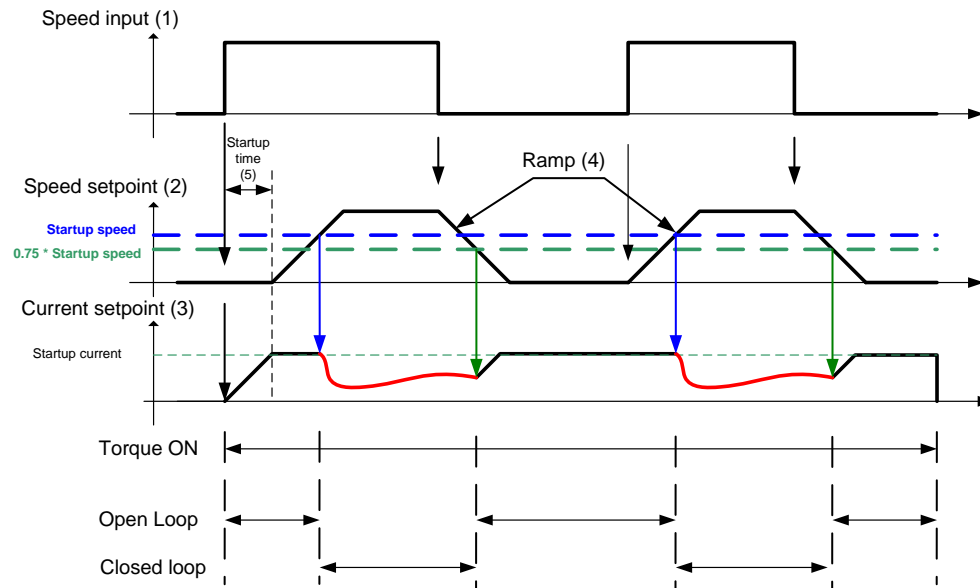

- (1) : User speed setpoint
- (2) : Internal speed setpoint
- (3) : Internal current setpoint
- (4) : ramps are generated based on ramp parameters
- (5) : startup procedure : a current is smoothly installed into the motor

1-92 Programming Your Application

Negative Speed

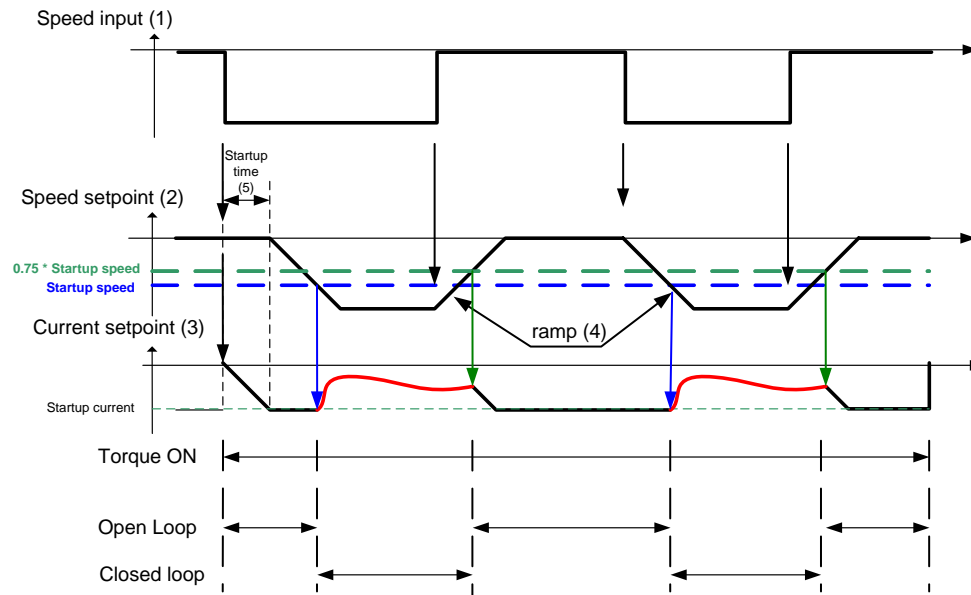

- (1) : User speed setpoint
- (2) : Internal speed setpoint
- (3) : Internal current setpoint
- (4) : ramps are generated based on ramp parameters
- (5) : startup procedure : a current is smoothly installed into the motor

Crossing zero speed

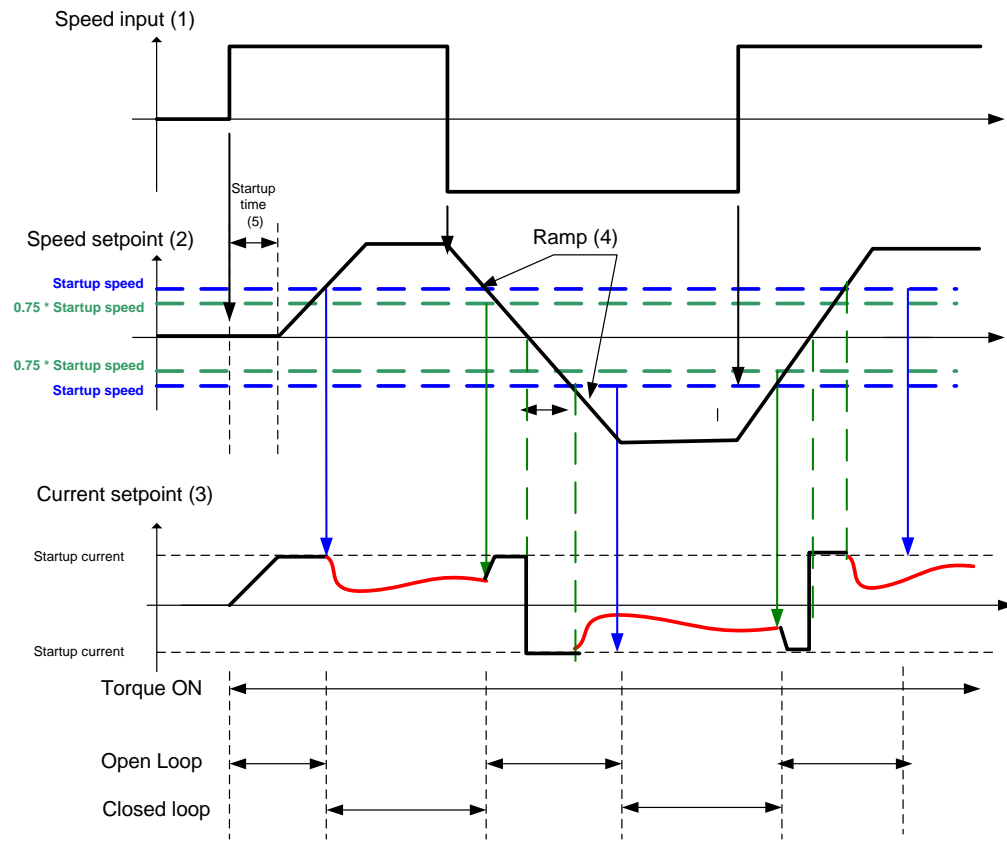







- (1) : User speed setpoint
- (2) : Internal speed setpoint
- (3) : Internal current setpoint
- (4) : ramps are generated based on ramp parameters
- (5) : startup procedure : a current is smoothly installed into the motor
- (6) : zero crossing for the speed input : the current must be inverted into the motor

SV MOTOR DATA

3200	[1687]	MAX SPEED
5.65	[1688]	MAX CURRENT
2.43	[1689]	PERM CURRENT
2.0	[1690]	PERM TORQUE
10	[1691]	POLES
50.9	[1692]	BACK EMF
6.58	[1693]	R
20.3	[1694]	L
0.848	[1695]	KT
0.070	[1696]	INERTIA
0	[1697]	INERTIA SCALE
62.0	[1698]	THERMAL TIME CST
400.0	[1699]	CUR LOOP BWDTH
100.0	[1700]	INTEGRAL FREQ
MOTOR 1	[1701]	SELECT MOTOR 1

3200	[1702]	MAX SPEED
10.6	[1703]	MAX CURRENT
5.24	[1704]	PERM CURRENT
5.5	[1705]	PERM TORQUE
10	[1706]	POLES
65.5	[1707]	BACK EMF
2.19	[1708]	R
10.9	[1709]	L
1.075	[1710]	KT
0.400	[1711]	INERTIA
0	[1712]	INERTIA SCALE
76.4	[1713]	THERMAL TIME CST
400.0	[1714]	CUR LOOP BWDTH
100.0	[1715]	INTEGRAL FREQ
MOTOR 1	[1716]	SELECT MOTOR 1

Parameter Descriptions

- MAX SPEED**  *SET/PAC1/PA01 & PA51* *Range: 0 to 30000*
Set the maximum motor speed.
- MAX CURRENT**  *SET/PAC1/PA02 & PA52* *Range: 1.0 to 512.0*
Set the maximum motor current in Amps rms.
- PERM CURRENT**  *SET/PAC1/PA03 & PA53* *Range: 1.0 to 512.0*
Set the permanent motor current in Amps rms.
- PERM TORQUE**  *SET/PAC1/PA04 & PA54* *Range: 1.0 to 512.0*
Set the permanent motor torque in Nm.
- POLES**  *SET/PAC1/PA05 & PA55* *Range: 0 to 400*
Set the number of motor poles.
- BACK EMF**  *SET/PAC1/PA06 & PA56* *Range: 0.0 to 8192.0*
Set the motor's Back EMF phase to phase, rms value (in Volts/1000RPM)
- R**  *SET/PAC1/PA07 & PA57* *Range: 0.0 to 50.0*
Set the motor's resistance, between phase at 25°C.

L  SET/PAC1/PA08 & PA58 *Range: 0.0 1000.0*

Set the motor's inductance, between phase at permanent current.

KT  SET/PAC1/PA09 & PA59 *Range: 0.0 to 100.0*

Set the motor's torque constant in Nm/Amps rms

This value is given by : PERM TORQUE / PERM CURRENT

INERTIA  SET/PAC1/PA10 & PA60 *Range: 0.0 to 100.0*

Set the motor's inertia. The units for this parameter are set by the INERTIA SCALE parameter.

INERTIA SCALE  SET/PAC1/PA11 & PA61 *Range: See below*

Set the motor's inertia scale.

0 = gm²

1 = kgcm²

2 = kgm²

THERMAL TIME CST  SET/PAC1/PA12 & PA62 *Range: 0.0 to 10000.0 s*

This parameter is used for the motor protection, e.g. I2T motor load. It defines the thermal time constant of the motor that is used to protect the motor against overheating.

Refer to the PMAC MOT PROTECT for a definition.

CUR LOOP BWDTH  SET/PAC1/PA13 & PA63 *Range: 10.0 to 1500.0*

Set the current loop bandwidth in Hz. This value will automatically generate the proportional gain of the PI corrector of the current loop. The proportional gain is calculated based on the 'L' motor parameter.

Modifying this value could induce instability. Please contact Parker SSD Drives if you need to change it.

INTEGRAL FREQ  SET/PAC1/PA14 & PA64 *Range: 1.0 to 600.0*

Set the frequency of the I term of the PI current loop corrector. The ratio CUR LOOP BWDTH / INTEGRAL FREQ must be kept higher than 3.

Modifying this value could induce instability. Please contact Parker SSD Drives if you need to change it.

SELECT MOTOR 1  SET/PAC1/PA15 & PA65 *Range: See below*

Used to select the motor under control:

0 = motor 2 is selected, e.g. SV MOTOR DATA 2 and SV MOTOR CTRL 2 parameters are used by the drive

1 = motor 1 is selected, e.g. SV MOTOR DATA 1 and SV MOTOR CTRL 1 parameters are used by the drive

Change this value only when the drive-motor is not running (motor not under torque).

TORQUE LIMIT

Torque Limit	
150.0 %	ACTUAL POS LIM [1212]
150.0 %	ACTUAL NEG LIM [1213]
200.0 %	[1208] POS TORQUE LIM
-200.0 %	[1209] NEG TORQUE LIM
200.0 %	[1210] MAIN TORQUE LIM
FALSE	[1211] SYMMETRIC LIM
150.00 %	[1554] FAST STOP T-LIM

Designed for all Motor Control Modes.

This function block allows you to set the maximum level of motor rated torque which is allowed before torque limit action occurs.

If the estimated motor torque is greater than the ACTUAL POS LIM value, the motor speed is controlled to maintain the torque at this level. A similar situation occurs if the estimated motor torque is less than the ACTUAL NEG LIM value.

The torque limit function block has separate positive and negative torque limits. In addition, a symmetric main torque limit is also provided.

The lowest positive and negative torque limits (including any current limit or inverse time current limit action) is indicated in the ACTUAL POS LIM and ACTUAL NEG LIM diagnostic. These are the final limits used to limit motor torque.

Parameter Descriptions

POS TORQUE LIM  SET\CTRL CL82 *Range: -500.0 to 500.0 %*

This parameter sets the maximum allowed level of positive motor torque.

NEG TORQUE LIM  SET\CTRL CL83 *Range: -500.0 to 500.0 %*

This parameter sets the maximum allowed level of negative motor torque.

MAIN TORQUE LIM *Range: 0.0 to 300.0 %*

This parameter sets the symmetric limit on the maximum allowed motor torque.

SYMMETRIC LIM *Range: FALSE / TRUE/*

When TRUE, the NEG TORQUE LIM is forced to reflect the POS TORQUE LIM parameter.

FAST STOP T-LIM *Range: 0.00 to 300.00 %*

This parameter sets the torque limit used during a Fast Stop.

ACTUAL POS LIM *Range: —.0 %*

This indicates the final actual positive torque limit including any current limit or inverse time current limit action.

ACTUAL NEG LIM *Range: —.0 %*

This indicates the final actual negative torque limit including any current limit or inverse time current limit action.

TRIPS HISTORY

TRIP 1 (NEWEST [500])	NO TRIP
TRIP 2 [501]	NO TRIP
TRIP 3 [502]	NO TRIP
TRIP 4 [503]	NO TRIP
TRIP 5 [504]	NO TRIP
TRIP 6 [505]	NO TRIP
TRIP 7 [506]	NO TRIP
TRIP 8 [507]	NO TRIP
TRIP 9 [508]	NO TRIP
TRIP 10 (OLDEST [509])	NO TRIP

This function block records the last ten trips that caused the drive to stop.

To do this, it stores the value of the FIRST TRIP parameter, tag number 6, taken from the TRIPS STATUS function block.

Parameter Descriptions

TRIP 1 (NEWEST)

Range: Enumerated

Records the most recent trip that caused the drive to stop. The values that this (and the parameters below) may take are the same as tag number 6, FIRST TRIP, detailed in the TRIPS STATUS function block.

TRIP 2

Range: As above

Records the second most recent trip that caused the drive to stop.

TRIP 3

Range: As above

Records the third most recent trip that caused the drive to stop.

TRIP 4

Range: As above

Records the fourth most recent trip that caused the drive to stop.

TRIP 5

Range: As above

Records the fifth most recent trip that caused the drive to stop.

TRIP 6

Range: As above

Records the sixth most recent trip that caused the drive to stop.

TRIP 7

Range: As above

Records the seventh most recent trip that caused the drive to stop.

Parameter Descriptions

TRIP 8 *Range: As above*
Records the eighth most recent trip that caused the drive to stop.

TRIP 9 *Range: As above*
Records the ninth most recent trip that caused the drive to stop.

TRIP 10 (OLDEST) *Range: As above*
Records the tenth most recent trip that caused the drive to stop.

Functional Description

This function block provides a view of the ten most recent trips that caused the drive to stop. Every time a new trip occurs this is entered as TRIP 1 (NEWEST) and the other recorded trips are moved down. If more than ten trips have occurred since the drive was configured then only the ten most recent trips will be available for inspection.

These parameters are preserved through a power failure.

Refer to TRIPS STATUS, page 1-99 for an explanation of the four-digit codes.

TRIPS STATUS

Trips Status		
	ACTIVE TRIPS	[4] 0x0000
	ACTIVE TRIPS+	[740] 0x0000
	WARNINGS	[5] 0x0000
	WARNINGS+	[741] 0x0000
	FIRST TRIP	[6] NO TRIP
0x0660	[231] DISABLE TRIPS	
0x0000	[742] DISABLED TRIPS+	

The drive supports advanced and flexible trip logic to support monitoring of the drive itself, the motor and the load. This function block provides a view in to the current trip condition(s) and allows some trips to be disabled.

Refer to the "Trips and Fault Finding" chapter in the Installation Product Manual for trip descriptions.

Parameter Descriptions

DISABLE TRIPS and DISABLE TRIPS+

Range: 0000 to FFFF

Indicates which trips have been disabled. Not all trips may be disabled; the DISABLED TRIPS mask is ignored for trips that cannot be disabled. See below for which trips may be disabled and how this parameter is formed.

ACTIVE TRIPS and ACTIVE TRIPS+

Range: 0000 to FFFF

Indicates all active trips, including user-disabled trips that are reporting a trip condition. The parameter returns a coded representation of the trip status. See below for a description of how this parameter is formed.

WARNINGS and WARNINGS+

Range: 0000 to FFFF

Indicates which conditions are likely to cause a trip, including potential conditions that may affect user-disabled trips. These parameters are a coded representation of the warning status. See below for a description of how this parameter is formed.

FIRST TRIP

Range: Enumerated – see table below

From when a trip occurs until that trip is reset, this parameter indicates the trip source. When several trips have occurred, this parameter indicates the first one that was detected.

Functional Description

The tables below show the possible parameter values for the FIRST TRIP, TRIPS HISTORY and the AUTO RESTART function blocks. Each trip has a unique, four-digit hexadecimal number as shown in the tables below.

ACTIVE TRIPS, WARNINGS, DISABLE TRIPS and TRIGGERS 1 (AUTO RESTART function block)					
ID	Trip Name (MMI 6901)	Trip Name (MMI 6511 & 6521)	Mask	Frames 1-3 User Disable	Frames C-F User Disable
0	NO TRIP		0x0000	N/A	N/A
1	OVERVOLTAGE	DCHI	0x0001		
2	UNDERVOLTAGE	DCLO	0x0002		
3	OVERCURRENT	OC	0x0004		
4	HEATSINK	HOT	0x0008		
5	EXTERNAL TRIP	ET	0x0010	✓	✓
6	INVERSE TIME	51 t	0x0020	✓	✓
7	CURRENT LOOP	5L OOP	0x0040	✓	✓
8	MOTOR STALLED	5S t L L	0x0080	✓	✓
9	ANIN FAULT	5 t 3	0x0100	✓	✓
10	BRAKE RESISTOR	5db r	0x0200	✓	✓
11	BRAKE SWITCH	5db S	0x0400	✓	✓
12	DISPLAY/KEYPAD	5dl SP	0x0800	✓	✓
13	LOST COMMS	SCI	0x1000	✓	✓
14	CONTACTOR FBK	CNTC	0x2000	✓	✓
15	SPEED FEEDBACK	5SP d	0x4000	✓	✓
16	■ AMBIENT TEMP	AOT	0x8000		

ACTIVE TRIPS+, WARNINGS+, DISABLE TRIPS+ and TRIGGERS 1+ (AUTO RESTART function block)					
ID	Trip Name (MMI 6901)	Trip Name (MMI 6511 & 6521)	Mask +	Frames 1-3 User Disable	Frames C-F User Disable
17	MOTOR OVERTEMP	50t	0x0001	✓	✓
18	CURRENT LIMIT	I HI	0x0002		
19	<i>Trip 19 (Reserved)</i>	TR19	0x0004		
20	■ 24V FAILURE	T 6	0x0008	✓	✓
21	LOW SPEED OVER I	LSPD	0x0010		
22	10V FAULT	T 4	0x0020	✓	✓
23	<i>Trip 23 (Reserved)</i>	TR23	0x0040		
24	■ DESAT (OVER I)	SHRT	0x0080		
25	DC LINK RIPPLE	DCRP	0x0100		
26	■ BRAKE SHORT CCT	DBSC	0x0200		
27	OVERSPEED	50SPd	0x0400	✓	✓
28	ANOUT FAULT	T 5	0x0800	✓	✓
29	DIGIO 1 (T9) FAULT	T 9	0x1000	✓	✓
30	DIGIO 2 (T10) FAULT	T 10	0x2000	✓	✓
31	UNKNOWN	TRIP	0x4000		
32	OTHER	TR32	0x8000		
33	<i>Trip 33 (Reserved)</i>	ICAL	0x8000	N/A	N/A
34	MAX SPEED LOW	ATN1	0x8000	N/A	N/A
35	MAIN VOLTS LOW	ATN2	0x8000	N/A	N/A
36	NOT AT SPEED	ATN3	0x8000	N/A	N/A
37	MAG CURRENT FAIL	ATN4	0x8000	N/A	N/A
38	NEGATIVE SLIP F	ATN5	0x8000	N/A	N/A
39	TR TOO LARGE	ATN6	0x8000	N/A	N/A
40	TR TOO SMALL	ATN7	0x8000	N/A	N/A
41	MAX RPM DATA ERR	ATN8	0x8000	N/A	N/A
42	MOTOR TURNING ERR	ATNA	0x8000	N/A	N/A
43	MOTOR STALL ERR	ATNB	0x8000	N/A	N/A
44	LEAKGE L TIMEOUT	ATN9	0x8000	N/A	N/A

■ Not available on 650S Frames 1-3

1-102 Programming Your Application

Enter FFFF to select/accept all, for example, entering FFFF for TRIGGERS 1 would make the drive auto-restart for trips with IDs from 1 to 16 inclusive.

Keypads (MMIs):

Trips shown as displays, i.e. , can be disabled using the keypads in the TRIPS menu. Other trips, as indicated, can be disabled over the Comms.



6901



6511



6521

Hexadecimal Representation of Trips

Decimal number	Display
10	A
11	B
12	C
13	D
14	E
15	F

When more than one trip is to be represented at the same time then the trip codes are simply added together to form the value displayed. Within each digit, values between 10 and 15 are displayed as letters A to F

For example referring to the tables above, if the ACTIVE TRIPS parameter is **02C8**, then this represents:

a “2” in digit 3

an “8” and a “4” in digit 2

(8+4 = 12, displayed as C)

an “8” in digit 1

This in turn represents the active trips BRAKE RESISTOR, MOTOR STALLED, CURRENT LOOP and HEATSINK, (an unlikely situation).

In the same way, the ACTIVE TRIPS + parameter displaying **02C8** would represent BRAKE SHORT CCT, DESAT (OVER I), Trip 23 (Reserved) and 24V FAILURE, (another unlikely situation).

Note: The hexadecimal value is used over comms, however, pressing the **M** key whilst displaying the hexadecimal trip value will show the list of all trips and their current values.

VALUE FUNCTION

The value function blocks can be configured to perform one of a number of functions upon a fixed number of inputs.

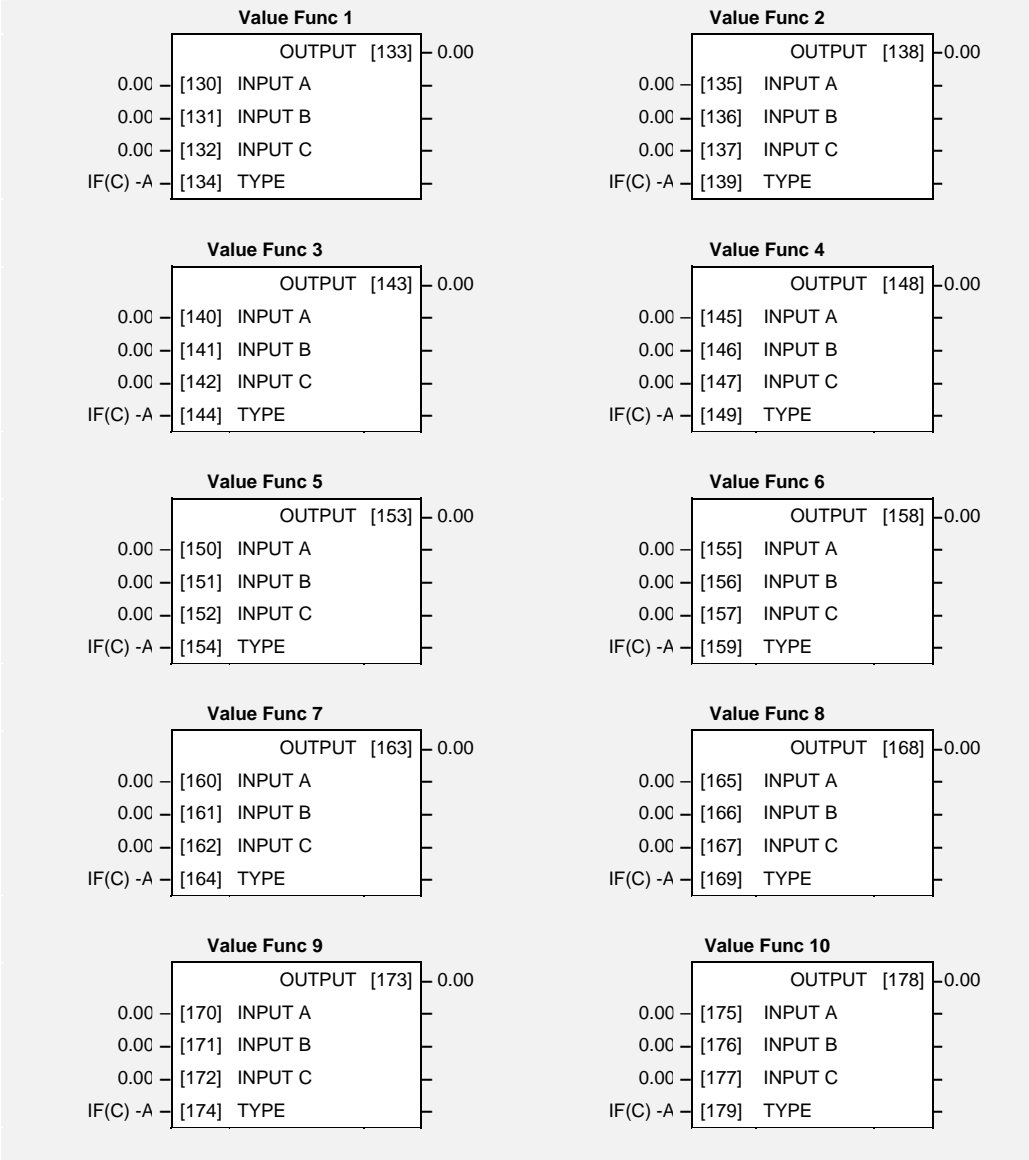

Boolean inputs and outputs are
Outputs: FALSE = 0.00, TRUE = 0.01
Inputs: -0.005 < x < 0.005 = FALSE, Else TRUE

Parameter Descriptions

INPUT A

General purpose input.

Range: -32768.00 to 32767.00

INPUT B

General purpose input.

Range: -32768.00 to 32767.00

INPUT C

General purpose input.

Range: -32768.00 to 32767.00

TYPE

Range: Enumerated - see below

The operation to be performed on the three inputs to produce the output value.

Enumerated Value : Type

0 : *IF(C) -A*

1 : *ABS(A+B+C)*

2 : *SWITCH(A,B)*

3 : *(A*B)/C*

4 : *A+B+C*

5 : *A-B-C*

6 : *B<=A<=C*

7 : *A>B+/-C*

8 : *A>=B*

9 : *ABS(A)>B+/-C*

10 : *ABS(A)>=B*

11 : *A(I+B)*

12 : *IF(C) HOLD(A)*

13 : *BINARY DECODE*

14 : *ON DELAY*

15 : *OFF DELAY*

16 : *TIMER*

17 : *MINIMUM PULSE*

18 : *PULSE TRAIN*

19 : *WINDOW*

20 : *UP/DWN COUNTER*

21 : *(A*B)/C ROUND*

22 : *WINDOW NO HYST*

23 : *WIND A>=B,A<=C*

24 : *A<=B*

25 : *((A*B)/100)+C*

26 : *MIN(A,B,C)*

27 : *MAX(A,B,C)*

28 : *PROFILE SQRT*

29 : *PROFILE LINEAR*

30 : *PROFILE x^2*

31 : *PROFILE x^3*

32 : *PROFILE x^4*

33 : *ON A>B, OFF A<C*

34 : *(A+B) CLAMPED C*

35 : *(A-B) CLAMPED C*

36 : *(A*B) CLAMPED C*

37 : *(A/B) CLAMPED C*

38 : *A>=B:A, A<=C:0*

39 : *(A * B) + C*

40 : *A * (B + C)*

41 : *A * (B - C)*

42 : *A * (I+B/C)*

43 : *A * (I+(B * C))*

44 : *MONOSTABLE HIGH*

45 : *MONOSTABLE LOW*

46 : *FILTER*

Range: —.xx

OUTPUT

The result of performing the selected operation on the inputs.

Functional Description

OUTPUT is generated from the inputs according to the operation type selected. The output is always limited to be within the range -32768.00 to +32767.00.

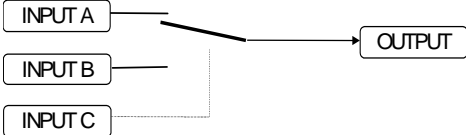
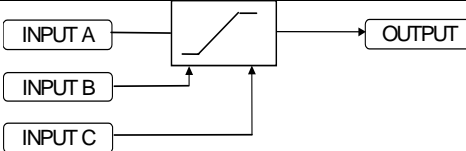
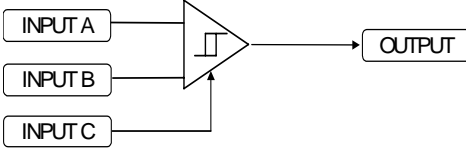
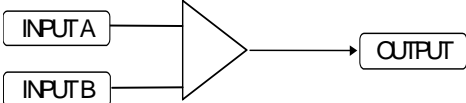
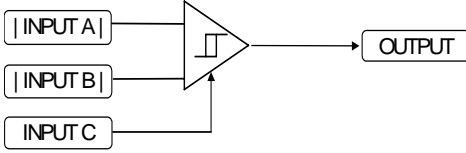
Operation	Description
IF(C) -A	If INPUT C is not zero the OUTPUT is minus INPUT A, otherwise the OUTPUT is the same as INPUT A.
ABS(A+B+C)	The OUTPUT is set to the absolute value of INPUT A + INPUT B + INPUT C.
SWITCH(A,B)	 <p>If INPUT C is zero the OUTPUT is set to INPUT A, otherwise the output is set to INPUT B</p>
(A*B)/C	The OUTPUT is set to (INPUT A * INPUT B) / (INPUT C).
A+B+C	The OUTPUT is set to (INPUT A + INPUT B + INPUT C).
A-B-C	The OUTPUT is set to (INPUT A - INPUT B - INPUT C).
$B \leq A \leq C$	 <p>The OUTPUT is set to the value of INPUT A, limited to between a maximum value of INPUT C and a minimum value of INPUT B. If INPUT B is greater than INPUT C the output is undefined.</p>
$A > B +/- C$	 <p>The OUTPUT is TRUE if INPUT A is greater than INPUT B + INPUT C. The OUTPUT is FALSE if INPUT A is less than INPUT B - INPUT C.</p> <p>Otherwise the OUTPUT is unchanged. In this way the block acts as a simple comparator with a comparison level of INPUT B and a hysteresis band equal to +/- INPUT C.</p>
$A \geq B$	 <p>The OUTPUT is TRUE if INPUT A is greater than or equal to INPUT B, otherwise the OUTPUT is FALSE.</p>
$ABS(A) > ABS(B) +/- C$	 <p>The OUTPUT is TRUE if the magnitude of INPUT A is greater than or equal to the magnitude of INPUT B - INPUT C.</p>

1-106 Programming Your Application

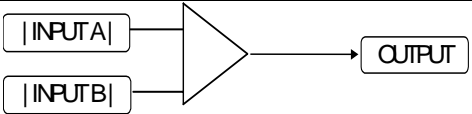
Operation	Description																																				
	The OUTPUT is FALSE if the magnitude of INPUT A is less than the magnitude of INPUT B - INPUT C. Otherwise the OUTPUT is unchanged. In this way the block acts as a magnitude comparator with a comparison level of INPUT B and a hysteresis band equal to +/- INPUT C.																																				
$ABS(A) > ABS(B)$	 <p>The OUTPUT is TRUE if the magnitude of INPUT A is greater than or equal to the magnitude of INPUT B, otherwise the OUTPUT is FALSE.</p>																																				
$A(1+B)$	The OUTPUT is set to $INPUT A + (INPUT A * INPUT B / 100.00)$.																																				
IF(C) HOLD A	<p>If INPUT C is zero, the OUTPUT is set to INPUT A, otherwise the OUTPUT is unchanged.</p> <p>On powering up the drive, the output will be pre-loaded with the last saved value of input B.</p>																																				
BINARY DECODE	<p>The OUTPUT is set according to which of the INPUTs are non-zero.</p> <table border="1"> <thead> <tr> <th>INPUT C</th> <th>INPUT B</th> <th>INPUT A</th> <th>OUTPUT</th> </tr> </thead> <tbody> <tr> <td>0</td> <td>0</td> <td>0</td> <td>0.00</td> </tr> <tr> <td>0</td> <td>0</td> <td>≠0</td> <td>1.00</td> </tr> <tr> <td>0</td> <td>≠0</td> <td>0</td> <td>2.00</td> </tr> <tr> <td>0</td> <td>≠0</td> <td>≠0</td> <td>3.00</td> </tr> <tr> <td>≠0</td> <td>0</td> <td>0</td> <td>4.00</td> </tr> <tr> <td>≠0</td> <td>0</td> <td>≠0</td> <td>5.00</td> </tr> <tr> <td>≠0</td> <td>≠0</td> <td>0</td> <td>6.00</td> </tr> <tr> <td>≠0</td> <td>≠0</td> <td>≠0</td> <td>7.00</td> </tr> </tbody> </table> <p>In the above table, ≠0 indicates that the corresponding input is not zero.</p>	INPUT C	INPUT B	INPUT A	OUTPUT	0	0	0	0.00	0	0	≠0	1.00	0	≠0	0	2.00	0	≠0	≠0	3.00	≠0	0	0	4.00	≠0	0	≠0	5.00	≠0	≠0	0	6.00	≠0	≠0	≠0	7.00
INPUT C	INPUT B	INPUT A	OUTPUT																																		
0	0	0	0.00																																		
0	0	≠0	1.00																																		
0	≠0	0	2.00																																		
0	≠0	≠0	3.00																																		
≠0	0	0	4.00																																		
≠0	0	≠0	5.00																																		
≠0	≠0	0	6.00																																		
≠0	≠0	≠0	7.00																																		

Operation	Description
-----------	-------------

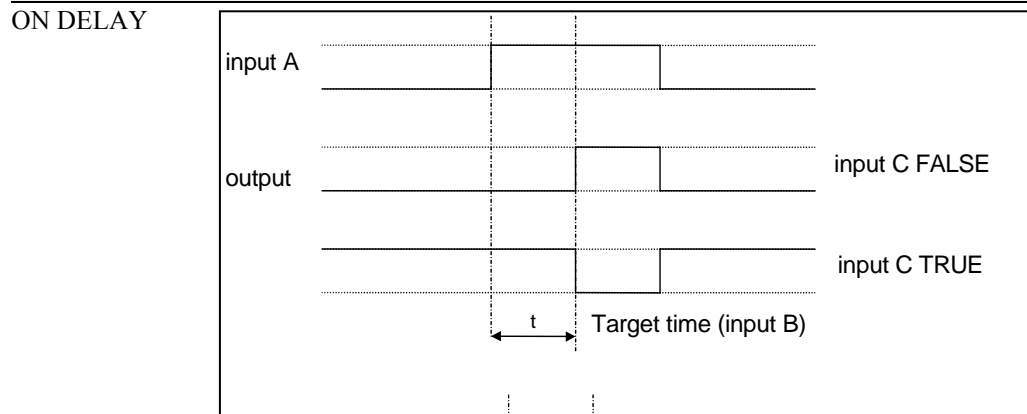

A programmable delay between receiving and outputting a Boolean TRUE signal.

INPUT A becoming TRUE starts the delay timer. INPUT B sets the duration of the delay in seconds (1 = 1 second). At the end of the duration, OUTPUT becomes TRUE unless INPUT A has reverted to FALSE. Setting INPUT C to TRUE ($\neq 0$) inverts the output.

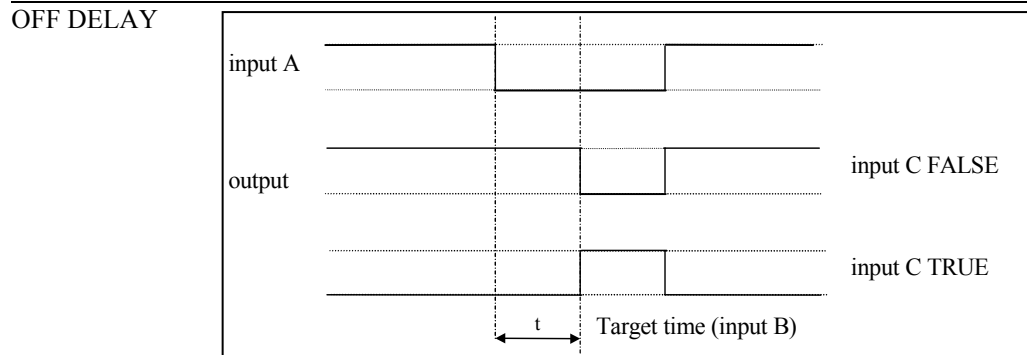

A programmable delay between receiving and outputting a Boolean FALSE signal.

INPUT A becoming FALSE starts the delay timer. INPUT B sets the duration of the delay in seconds (1 = 1 second). Setting INPUT C to TRUE ($\neq 0$) inverts the output. At the end of the duration, OUTPUT becomes FALSE unless INPUT A has reverted to TRUE.

Operation	Description
-----------	-------------

TIMER

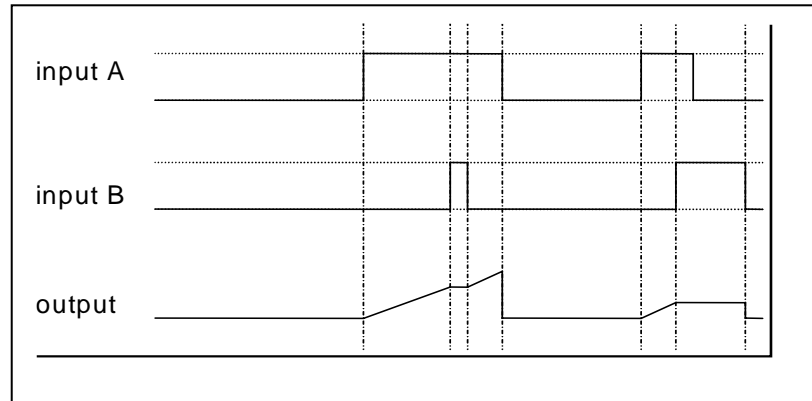

Times the period elapsed from when INPUT A is set TRUE and held TRUE, to when INPUT B becomes TRUE.

OUTPUT is the duration of the timer in seconds (1 = 1 second), starting from zero. If INPUT B is TRUE, the value for OUTPUT is held until INPUT B is released. If on release INPUT A is still TRUE, the timer will continue from the held value. Setting INPUT A and INPUT B to FALSE resets the timer.

INPUT C is not used.

MINIMUM PULSE

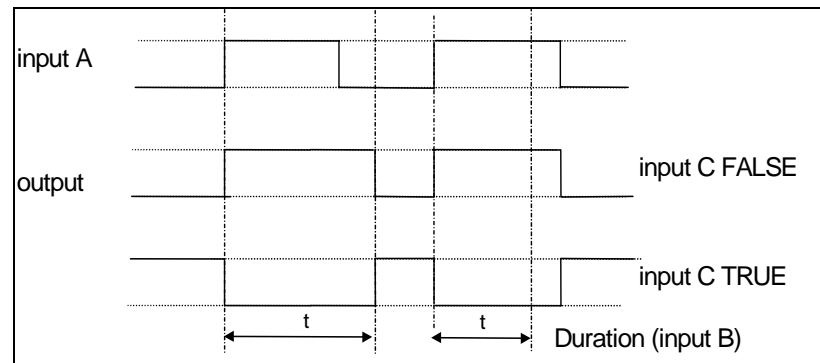

Creates an output of adjustable minimum time when INPUT A is TRUE. (INPUT A is assumed to be a sequence of TRUE pulses and FALSE off periods.)

INPUT B sets the length of the minimum pulse required in seconds (1 = 1 second). INPUT C inverts the output when TRUE. The duration of the pulse is *at least* the period set by INPUT B.

Operation	Description
-----------	-------------

PULSE TRAIN

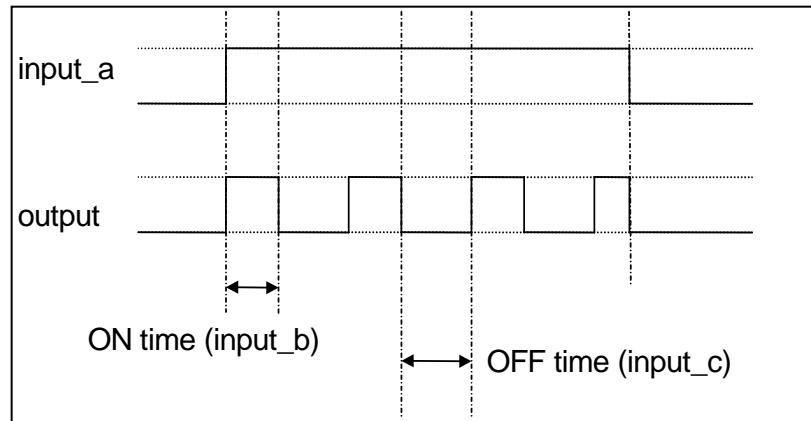

Creates a pulsed FALSE / TRUE output of programmable frequency.

INPUT A enables the pulse train when TRUE, disables when FALSE. INPUT B sets the length of the *on* part of the pulse in seconds (1 = 1 second). INPUT C sets the length of the *off* part of the pulse in seconds (1 = 1 second).

Operation	Description
-----------	-------------

WINDOW

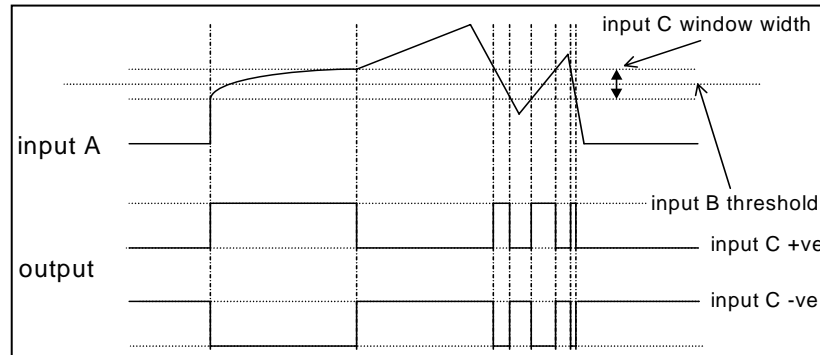

This function outputs TRUE when INPUT A is within a programmable range, and FALSE otherwise.

INPUT B sets the threshold of the window to be monitored. INPUT C defines the range of the window around the threshold. When the value of INPUT A is inside the window, the window expands by 0.01 to avoid flutter on output if noisy, i.e. if INPUT B = 5 and INPUT C = 4 then the range is 3 to 7, expanded to 2.5 to 7.5 when the value if INPUT A is inside the window.

If INPUT C is set to zero, the output will only be TRUE if INPUT A is exactly equal to INPUT B (this is fulfilled in the default condition when inputs A, B & C are all zero)

If INPUT C is set to a negative value, its absolute value defines the window range, and the output is inverted.

UP/DOWN COUNTER

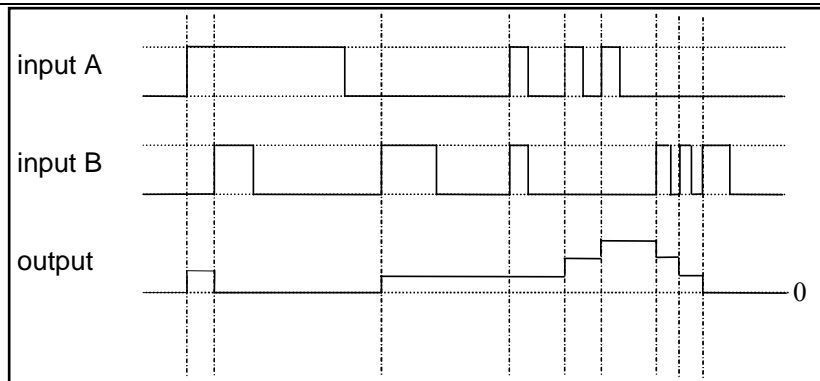

INPUT A provides a rising edge trigger to increment the output count by one. INPUT B provides a rising edge trigger to decrement the output count by one. INPUT C holds the output at zero.

The output starts at zero. The output is limited at ± 300.00 .

Operation	Description
(A*B)/C ROUND	The OUTPUT is set to (INPUT A * INPUT B) / (INPUT C). This is the same as (A*B)/C (enumerated value 3) except that the result is rounded.
WINDOW NO HYST	This is the same as WINDOW (enumerated value 19) except that there is no hysteresis when inside the `window`. Thus, from the diagram given in WINDOW, if INPUT B = 5 and INPUT C = 4 then the range is 3 to 7.
WIND A>=B,A<=C	This is the same as WINDOW (enumerated value 19) except that instead of setting hysteresis, the upper and lower limits are set independently. The lower limit is INPUT B, the upper limit is INPUT C. OUTPUT is True if $B \leq A \leq C$.
A<=B	The OUTPUT is True if INPUT A is less than or equal to INPUT B, otherwise OUTPUT is False.
((A*B)/100)+C	OUTPUT is set to (INPUT A x INPUT B)/100 + + INPUT C.
MIN(A,B,C)	The OUTPUT is set to the minimum value of INPUT A, B and C.
MAX(A,B,C)	The OUTPUT is set to the maximum value of INPUT A, B and C.
PROFILE SQRT	OUTPUT = INPUT B + (INPUT C - INPUT B) x square root A.
PROFILE LINEAR	OUTPUT = INPUT B + (INPUT C - INPUT B) x INPUT A
PROFILE x^2	OUTPUT = INPUT B + (INPUT C - INPUT B) x (INPUT A) ²
PROFILE x^3	OUTPUT = INPUT B + (INPUT C - INPUT B) x (INPUT A) ³
PROFILE x^4	OUTPUT = INPUT B + (INPUT C - INPUT B) x (INPUT A) ⁴
ON A>B, OFF A<C	If INPUT A is greater than INPUT B the OUTPUT is set to TRUE. If INPUT A is less than INPUT B the OUTPUT is set to FALSE. If INPUT A is the same as INPUT B the OUTPUT is unchanged.
(A+B) CLAMPED C	
(A-B) CLAMPED C	For each of these functions OUTPUT is the result of performing the indicated operation on INPUT A and INPUT B. This result is clamped by INPUT C according to the following rules:
(A*B) CLAMPED C	If INPUT C is greater than 0.0 then OUTPUT is clamped to be always less than INPUT C. If INPUT C is negative then OUTPUT is clamped to be always greater than INPUT C. If INPUT C is zero then OUTPUT is not clamped.
(A/B) CLAMPED C	
A>=B:A, A<=C:0	If INPUT A is greater than or equal to INPUT B then OUTPUT is the same as INPUT A. Otherwise, if INPUT A is less than or equal to INPUT C then OUTPUT set to zero.If neither of the above conditions met then OUTPUT is unchanged.
(A * B) + C	The OUTPUT is set to (INPUT A * INPUT B) + (INPUT C).
A * (B + C)	The OUTPUT is set to (INPUT A) * (INPUT B + INPUT C).

1-112 Programming Your Application

Operation	Description
$A * (B - C)$	The OUTPUT is set to $(INPUT A) * (INPUT B - INPUT C)$.
$A * (1+B/C)$	The OUTPUT is set to $(INPUT A) * (1.0 + (INPUT B / INPUT C))$.
$A * (1+(B * C))$	The OUTPUT is set to $(INPUT A) * (1.0 + (INPUT B * INPUT C))$.
MONOSTABLE HIGH	Outputs a pulse on the rising edge of INPUT A. The pulse width is determined by INPUT B, (in seconds). If input C is TRUE then the output is inverted. If a second rising edge is detected before the pulse has completed, the pulse is prolonged so that it will complete INPUT B seconds following the last rising edge.
MONOSTABLE LOW	Outputs a pulse on the falling edge of INPUT A. The pulse width is determined by INPUT B, (in seconds). If input C is TRUE then the output is inverted. If a second falling edge is detected before the pulse has completed, the pulse is prolonged so that it will complete INPUT B seconds following the last falling edge.
FILTER	The output is the result of passing INPUT A through a first order filter. The filter time constant is set by INPUT B, in seconds. When INPUT C is TRUE the OUTPUT is reset to the value of INPUT A.

ZERO SPEED

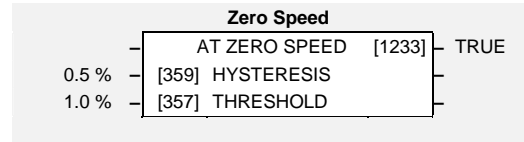

This function block detects when the speed is at or close to zero. HYSTERESIS and THRESHOLD are user-definable.

Parameter Descriptions

HYSTERESIS

Range: 0.0 to 300.0 %

Provides a hysteresis band about which the outputs are stable.

IF the hysteresis value is \geq to the Threshold

THEN the level is set to 2 x the hysteresis value and the Off level is set to zero,

ELSE the On level = Threshold + Hysteresis and the Off level = Threshold - Hysteresis.

THRESHOLD

Range: 0.0 to 300.0 %

The nominal level below which the outputs are set.

AT ZERO SPEED

Range: FALSE / TRUE

TRUE when at zero speed feedback, as defined by THRESHOLD and HYSTERESIS.

IF (abs(speed feedback)) > On Level at zero speed = FALSE

ELSE if (abs(speed feedback)) \leq Off Level at zero speed = TRUE

ELSE at zero speed is unchanged

1-114 Programming Your Application

Functional Description

Note: The speed feedback used is the speed demand added to all trims, (such as those due to stabilisation or slip compensation).

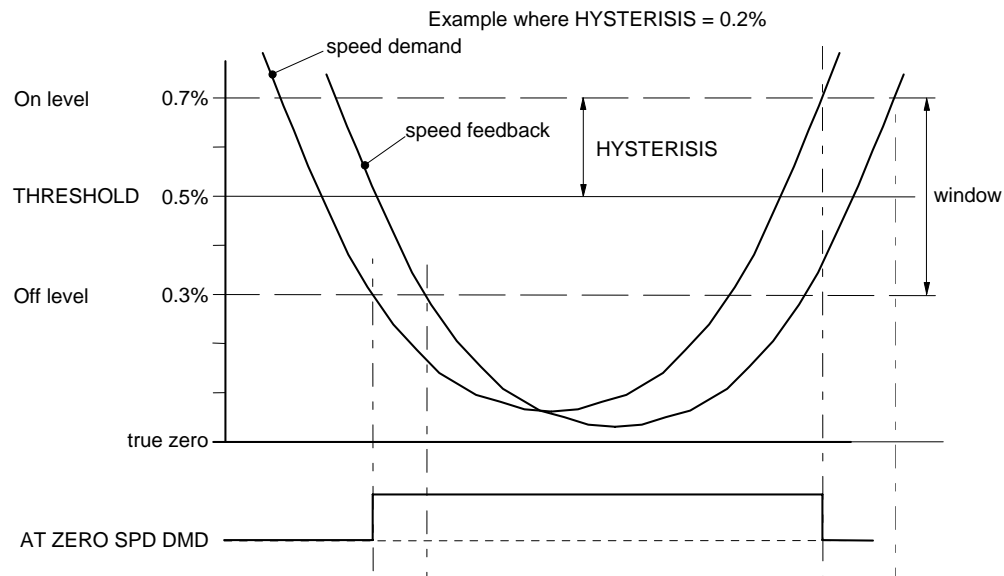

Chapter 2 **PARAMETER SPECIFICATION**

Parameter Specification	2-1
Specification Table: Tag Number Order	2-2
MMI Parameters	2-22
Pref Cross Reference Table	2-28
Product-Related Default Values	2-30
* Frequency Dependent Defaults	2-30
** Power Dependent Defaults	2-31

Parameter Specification

The headings for the Tag No. table are described below.

Tag	A numeric identification of the parameter.
Pref	A numeric identification of the parameter
MMI Name	The parameter name as it appears on the MMI (keypad).
DSELITE Name	The parameter name as it appears in SSD Drives' own programming tool, DSE Lite.
Function Block	The function block under which the parameter is stored in CELITE.
Type	REAL Floating point value INT Integer value BOOL A Boolean (bit) representing FALSE or TRUE ENUM An enumerated value representing a selection WORD 16 Bit hexadecimal number TAG Requires the Tag Number of a parameter
Range	This varies with parameter type: REAL, INT The upper and lower limits of the parameter BOOL 0 = FALSE, 1 = TRUE ENUM A list of possible selections for that parameter WORD 0000 to FFFF (hexadecimal) TAG The upper and lower limits of the parameter
ID	Serial Communications Mnemonic: Refer to Chapter 3: "Serial Communications"

In the MMI Parameters table the following Notes apply:

- F** Parameter only visible on MMI in detailed menus mode.
- M** Parameter is a Motor parameter, not reset on changing Application.
- (0) Modbus decimal point is xxx.
- (1) Modbus decimal point is xxx.x
- (2) Modbus decimal point is xx.xx
- (3) Modbus decimal point is x.xxx

2-2 Parameter Specification

Specification Table: Tag Number Order

TAG	Pref	DSElite Name	MMI Name	Function Block Name	Range	Type	ID
4	50.03	ACTIVE TRIPS		TRIPS STATUS	Output	WORD	04
5	50.05	WARNINGS		TRIPS STATUS	Output	WORD	05
6	50.07	FIRST TRIP		TRIPS STATUS	0 : NO TRIP 1 : OVERVOLTAGE 2 : UNDERVOLTAGE 3 : OVERCURRENT 4 : HEATSINK 5 : EXTERNAL TRIP 6 : INVERSE TIME 7 : CURRENT LOOP 8 : MOTOR STALLED 9 : ANIN FAULT 10 : BRAKE RESISTOR 11 : BRAKE SWITCH 12 : DISPLAY / KEYPAD 13 : LOST COMMS 14 : CONTACTOR FBK 15 : SPEED FEEDBACK 16 : AMBIENT TEMP 17 : MOTOR OVERTEMP 18 : CURRENT LIMIT 19 : SHORT CIRCUIT 20 : 24V FAILURE 21 : LOW SPEED OVER I 22 : 10V FAULT 23 : ENCODER 1 FAULT 24 : DESAT (OVER I) 25 : VDC RIPPLE 26 : BRAKE SHORT CCT 27 : OVERSPEED 28 : AOUT1 FAULT 29 : DIG IO 1 FAULT 30 : DIG IO 2 FAULT 31 : UNKNOWN 32 : OTHER 33 : ZERO I CAL 34 : MAX SPEED LOW 35 : MAINS VOLTS LOW 36 : NOT AT SPEED 37 : MAG CURRENT FAIL 38 : NEGATIVE SLIP F 39 : TR TOO LARGE 40 : TR TOO SMALL 41 : MAX RPM DATA ERR 42 : MOTOR TURNING ERR 43 : MOTOR STALL ERR 44 : LEAKGE L TIMEOUT	ENUM	06
8	21.01	PASSWORD	PAR 99	MMI ACCESS	0x0000 to 0xFFFF	WORD	08
13	10.03	TYPE	SET\IN IP13	ANALOG INPUT 1	0 : 0..10 V 1 : 0...5 V	ENUM	0d

TAG	Pref	DSElite Name	MMI Name	Function Block Name	Range	Type	ID
14	10.01	SCALE	SET\IN IP11	ANALOG INPUT 1	-300.00 to 300.00	REAL	0e
15	10.02	OFFSET	SET\IN IP12	ANALOG INPUT 1	-300.00 to 300.00	REAL	0f
16	10.05	VALUE	DIAG IPA1	ANALOG INPUT 1	Output (2)	REAL	0g
22	11.03	TYPE	SET\IN IP23	ANALOG INPUT 2	0 : 0..10 V 1 : 0...5 V 2 : 0..20 mA 3 : 4..20 mA	ENUM	0m
23	11.01	SCALE	SET\IN IP21	ANALOG INPUT 2	-300.00 to 300.00	REAL	0n
24	11.02	OFFSET	SET\IN IP22	ANALOG INPUT 2	-300.00 to 300.00	REAL	0o
25	11.06	VALUE	DIAG IPA2	ANALOG INPUT 2	Output (2)	REAL	0p
26	11.04	BREAK VALUE		ANALOG INPUT 2	-100.0 to 100.0 (2)	REAL	0q
30	13.01	INVERT 1	SET\IN IPD1	DIGITAL INPUTS	0 to 1	BOOL	0u
31	13.09	INPUT 1		DIGITAL INPUTS	Output	BOOL	0v
33	13.02	INVERT 2	SET\IN IPD2	DIGITAL INPUTS	0 to 1	BOOL	0x
34	13.10	INPUT 2		DIGITAL INPUTS	Output	BOOL	0y
36	13.03	INVERT 3	SET\IN IPD3	DIGITAL INPUTS	0 to 1	BOOL	10
37	13.11	INPUT 3		DIGITAL INPUTS	Output	BOOL	11
39	13.04	INVERT 4	SET\IN IPD4	DIGITAL INPUTS	0 to 1	BOOL	13
40	13.12	INPUT 4		DIGITAL INPUTS	Output	BOOL	14
42	13.05	INVERT 5	SET\IN IPD5	DIGITAL INPUTS	0 to 1	BOOL	16
43	13.13	INPUT 5		DIGITAL INPUTS	Output	BOOL	17
44	71.1.4	COEFFICIENT B		DISPLAY SCALE 1	-32768.0000 to 32767.0000 (2)	REAL	18
45	12.1.1	VALUE	DIAG OPA1	ANALOG OUTPUT 1	-300.0 to 300.0 (2)	REAL	19
46	12.1.2	SCALE	SET\OUT OP11	ANALOG OUTPUT 1	-300.00 to 300.00	REAL	1a
47	12.1.3	OFFSET	SET\OUT OP12	ANALOG OUTPUT 1	-300.00 to 300.00	REAL	1b
48	12.1.4	ABSOLUTE	SET\OUT OP13	ANALOG OUTPUT 1	0 to 1	BOOL	1c
50	27.01	NORMAL DUTY		FEEDBACKS	0 to 1	BOOL	1e
51	14.02	INVERT 1	SET\OUT OPD1	DIGITAL OUTPUTS	0 to 1	BOOL	1f
52	14.01	DIGOUT 1		DIGITAL OUTPUTS	0 to 1	BOOL	1g
53	71.1.7	LOW LIMIT		DISPLAY SCALE 1	-32768.0000 to 32767.0000 (2)	REAL	1h
54	14.04	INVERT 2	SET\OUT OPD2	DIGITAL OUTPUTS	0 to 1	BOOL	1i
55	14.03	DIGOUT 2		DIGITAL OUTPUTS	0 to 1	BOOL	1j
56	23.11	RAMP INPUT		REFERENCE	Output (2)	REAL	1k
57	23.03	MAX SPEED	PAR 2	REFERENCE	7.5 to 500.0	REAL	1l
60	34.01	ENABLE		SLEW RATE LIMIT	0 to 1	BOOL	1o
61	34.03	DECEL LIMIT		SLEW RATE LIMIT	1.0 to 1200.0	REAL	1p
62	34.02	ACCEL LIMIT		SLEW RATE LIMIT	1.0 to 1200.0	REAL	1q
66	27.03	MOTOR CURRENT %		FEEDBACKS	Output	REAL	1u
67	27.04	MOTOR CURRENT A	DIAG 4	FEEDBACKS	Output	REAL	1v
70	27.11	TORQUE FEEDBACK		FEEDBACKS	Output	REAL	1y
73	27.12	FIELD FEEDBACK		FEEDBACKS	Output	REAL	21
74	70.1.1	PARAMETER		APP MENU 1	0 to 1763	PREF	22

2-4 Parameter Specification

TAG	Pref	DSElite Name	MMI Name	Function Block Name	Range	Type	ID
75	27.02	DC LINK VOLTS	DIAG 3	FEEDBACKS	Output	REAL	23
77	36.04	BRAKE RESISTANCE	SET\SETP ST32	DYNAMIC BRAKING	1 to 1000	INT	25
78	36.05	BRAKE POWER	SET\SETP ST33	DYNAMIC BRAKING	0.1 to 510.0	REAL	26
79	36.06	1SEC OVER RATING	SET\SETP ST34	DYNAMIC BRAKING	1 to 40	INT	27
80	36.01	ENABLE	SET\SETP ST31	DYNAMIC BRAKING	0 to 1	BOOL	28
81	36.03	BRAKING		DYNAMIC BRAKING	Output	BOOL	29
90	18.10	SWAP WORD ORDER		COMMS PORTS	0 to 1	BOOL	2i
91	21.04	SCALING		MMI ACCESS	0 : NONE 1 : DISPLAY SCALE 1 2 : DISPLAY SCALE 2	ENUM	2j
92	21.05	IGNORE PASSWORD		MMI ACCESS	0 to 1	BOOL	2k
93	21.06	STARTUP SCREEN		MMI ACCESS	0 to 16	INT	2l
98	25.01	RANDOM PATTERN		PATTERN GEN	0 to 1	BOOL	2q
100	25.02	DEFLUX DELAY		PATTERN GEN	0.1 to 10.0	REAL	2s
101	71.1.6	HIGH LIMIT		DISPLAY SCALE 1	-32768.0000 to 32767.0000 (2)	REAL	2t
102	18.01	GROUP ID (GID)		COMMS PORTS	0 to 7	INT	2u
103	18.02	COMMS ADDRESS	SET\SERL SE03	COMMS PORTS	0 to 255	INT	2v
110	66.05	SPEED SCALE	SET\ENC EN05	ENCODER	0.00 to 300.00	REAL	32
111	66.06	SPEED	SET\ENC EN06	ENCODER	Output (0)	REAL	33
117	18.08	RS485 PROTOCOL		COMMS PORTS	Same as 18.06	ENUM	39
125	71.1.2	FORMULA		DISPLAY SCALE 1	0 : 1 : A/B * X + C 2 : A/B * (X+C) 3 : A/(B * X) + C 4 : A/(B * (X+C))	ENUM	3h
126	43.08	FINAL STOP RATE		REFERENCE STOP	12. to 4800.	REAL	3i
127	22.01	ENABLED KEYS	SET\SETP ST52	DISPLAY/KEYPAD	0x0000 to 0xFFFF	WORD	3j
129	18.09	SWITCH OP PORT		COMMS PORTS	0 to 1	BOOL	3l
130	15.1.1	INPUT A		VALUE FUNC 1	-32768.00 to 32767.00	REAL	3m
131	15.1.2	INPUT B		VALUE FUNC 1	-32768.00 to 32767.00	REAL	3n
132	15.1.3	INPUT C		VALUE FUNC 1	-32768.00 to 32767.00	REAL	3o
133	15.1.5	OUTPUT		VALUE FUNC 1	Output	REAL	3p
134	15.1.4	TYPE		VALUE FUNC 1	0 : IF(C) -A 1 : ABS(A+B+C) 2 : SWITCH(A,B) 3 : (A*B)/C 4 : A+B+C 5 : A-B-C 6 : B<=A<=C 7 : A>B+/-C 8 : A>=B 9 : ABS(A)>B+/-C 10 : ABS(A)>=B 11 : A(1+B) 12 : IF(C) HOLD(A) 13 : BINARY DECODE 14 : ON DELAY	ENUM	3q

TAG	Pref	DSElite Name	MMI Name	Function Block Name	Range	Type	ID
					15 : OFF DELAY 16 : TIMER 17 : MINIMUM PULSE 18 : PULSE TRAIN 19 : WINDOW 20 : UP/DWN COUNTER 21 : (A*B)/C ROUND 22 : WINDOW NO HYST 23 : WIND A>=B,A<=C 24 : A<=B 25 : ((A*B)/100)+C 26 : MIN(A,B,C) 27 : MAX(A,B,C) 28 : PROFILE SQRT 29 : PROFILE LINEAR 30 : PROFILE x^2 31 : PROFILE x^3 32 : PROFILE x^4 33 : ON A>B, OFF A<C 34 : (A+B) CLAMPED C 35 : (A-B) CLAMPED C 36 : (A*B) CLAMPED C 37 : (A/B) CLAMPED C 38 : A>=B:A, A<=C:0 39 : (A * B) + C 40 : A * (B + C) 41 : A * (B - C) 42 : A * (1+B/C) 43 : A * (1+(B * C)) 44 : MONOSTABLE HIGH 45 : MONOSTABLE LOW 46 : FILTER		
135	15.2.1	INPUT A		VALUE FUNC 2	-32768.00 to 32767.00	REAL	3r
136	15.2.2	INPUT B		VALUE FUNC 2	-32768.00 to 32767.00	REAL	3s
137	15.2.3	INPUT C		VALUE FUNC 2	-32768.00 to 32767.00	REAL	3t
138	15.2.5	OUTPUT		VALUE FUNC 2	Output	REAL	3u
139	15.2.4	TYPE		VALUE FUNC 2	Same as 15.1.4	ENUM	3v
140	15.3.1	INPUT A		VALUE FUNC 3	-32768.00 to 32767.00	REAL	3w
141	15.3.2	INPUT B		VALUE FUNC 3	-32768.00 to 32767.00	REAL	3x
142	15.3.3	INPUT C		VALUE FUNC 3	-32768.00 to 32767.00	REAL	3y
143	15.3.5	OUTPUT		VALUE FUNC 3	Output	REAL	3z
144	15.3.4	TYPE		VALUE FUNC 3	Same as 15.1.4	ENUM	40
145	15.4.1	INPUT A		VALUE FUNC 4	-32768.00 to 32767.00	REAL	41
146	15.4.2	INPUT B		VALUE FUNC 4	-32768.00 to 32767.00	REAL	42
147	15.4.3	INPUT C		VALUE FUNC 4	-32768.00 to 32767.00	REAL	43
148	15.4.5	OUTPUT		VALUE FUNC 4	Output	REAL	44
149	15.4.4	TYPE		VALUE FUNC 4	Same as 15.1.4	ENUM	45
150	15.5.1	INPUT A		VALUE FUNC 5	-32768.00 to 32767.00	REAL	46
151	15.5.2	INPUT B		VALUE FUNC 5	-32768.00 to 32767.00	REAL	47
152	15.5.3	INPUT C		VALUE FUNC 5	-32768.00 to 32767.00	REAL	48

2-6 Parameter Specification

TAG	Pref	DSElite Name	MMI Name	Function Block Name	Range	Type	ID
153	15.5.5	OUTPUT		VALUE FUNC 5	Output	REAL	49
154	15.5.4	TYPE		VALUE FUNC 5	Same as 15.1.4	ENUM	4a
155	15.6.1	INPUT A		VALUE FUNC 6	-32768.00 to 32767.00	REAL	4b
156	15.6.2	INPUT B		VALUE FUNC 6	-32768.00 to 32767.00	REAL	4c
157	15.6.3	INPUT C		VALUE FUNC 6	-32768.00 to 32767.00	REAL	4d
158	15.6.5	OUTPUT		VALUE FUNC 6	Output	REAL	4e
159	15.6.4	TYPE		VALUE FUNC 6	Same as 15.1.4	ENUM	4f
160	15.7.1	INPUT A		VALUE FUNC 7	-32768.00 to 32767.00	REAL	4g
161	15.7.2	INPUT B		VALUE FUNC 7	-32768.00 to 32767.00	REAL	4h
162	15.7.3	INPUT C		VALUE FUNC 7	-32768.00 to 32767.00	REAL	4i
163	15.7.5	OUTPUT		VALUE FUNC 7	Output	REAL	4j
164	15.7.4	TYPE		VALUE FUNC 7	Same as 15.1.4	ENUM	4k
165	15.8.1	INPUT A		VALUE FUNC 8	-32768.00 to 32767.00	REAL	4l
166	15.8.2	INPUT B		VALUE FUNC 8	-32768.00 to 32767.00	REAL	4m
167	15.8.3	INPUT C		VALUE FUNC 8	-32768.00 to 32767.00	REAL	4n
168	15.8.5	OUTPUT		VALUE FUNC 8	Output	REAL	4o
169	15.8.4	TYPE		VALUE FUNC 8	Same as 15.1.4	ENUM	4p
170	15.9.1	INPUT A		VALUE FUNC 9	-32768.00 to 32767.00	REAL	4q
171	15.9.2	INPUT B		VALUE FUNC 9	-32768.00 to 32767.00	REAL	4r
172	15.9.3	INPUT C		VALUE FUNC 9	-32768.00 to 32767.00	REAL	4s
173	15.9.5	OUTPUT		VALUE FUNC 9	Output	REAL	4t
174	15.9.4	TYPE		VALUE FUNC 9	Same as 15.1.4	ENUM	4u
175	15.10.1	INPUT A		VALUE FUNC 10	-32768.00 to 32767.00	REAL	4v
176	15.10.2	INPUT B		VALUE FUNC 10	-32768.00 to 32767.00	REAL	4w
177	15.10.3	INPUT C		VALUE FUNC 10	-32768.00 to 32767.00	REAL	4x
178	15.10.5	OUTPUT		VALUE FUNC 10	Output	REAL	4y
179	15.10.4	TYPE		VALUE FUNC 10	Same as 15.1.4	ENUM	4z
180	16.1.1	INPUT A		LOGIC FUNC 1	0 to 1	BOOL	50
181	16.1.2	INPUT B		LOGIC FUNC 1	0 to 1	BOOL	51
182	16.1.3	INPUT C		LOGIC FUNC 1	0 to 1	BOOL	52
183	16.1.5	OUTPUT		LOGIC FUNC 1	Output	BOOL	53
184	16.1.4	TYPE		LOGIC FUNC 1	0 : NOT(A) 1 : AND(A,B,C) 2 : NAND(A,B,C) 3 : OR(A,B,C) 4 : NOR(A,B,C) 5 : XOR(A,B) 6 : 0-1 EDGE(A) 7 : 1-0 EDGE(A) 8 : AND(A,B,IC) 9 : OR(A,B,IC) 10 : S FLIP-FLOP 11 : R FLIP-FLOP 12 : LATCH 13 : SWITCH	ENUM	54

TAG	Pref	DSElite Name	MMI Name	Function Block Name	Range	Type	ID
					14 : (A AND B) OR C 15 : (A OR B) AND C		
185	16.2.1	INPUT A		LOGIC FUNC 2	0 to 1	BOOL	55
186	16.2.2	INPUT B		LOGIC FUNC 2	0 to 1	BOOL	56
187	16.2.3	INPUT C		LOGIC FUNC 2	0 to 1	BOOL	57
188	16.2.5	OUTPUT		LOGIC FUNC 2	Output	BOOL	58
189	16.2.4	TYPE		LOGIC FUNC 2	Same as 16.1.4	ENUM	59
190	16.3.1	INPUT A		LOGIC FUNC 3	0 to 1	BOOL	5a
191	16.3.2	INPUT B		LOGIC FUNC 3	0 to 1	BOOL	5b
192	16.3.3	INPUT C		LOGIC FUNC 3	0 to 1	BOOL	5c
193	16.3.5	OUTPUT		LOGIC FUNC 3	Output	BOOL	5d
194	16.3.4	TYPE		LOGIC FUNC 3	Same as 16.1.4	ENUM	5e
195	16.4.1	INPUT A		LOGIC FUNC 4	0 to 1	BOOL	5f
196	16.4.2	INPUT B		LOGIC FUNC 4	0 to 1	BOOL	5g
197	16.4.3	INPUT C		LOGIC FUNC 4	0 to 1	BOOL	5h
198	16.4.5	OUTPUT		LOGIC FUNC 4	Output	BOOL	5i
199	16.4.4	TYPE		LOGIC FUNC 4	Same as 16.1.4	ENUM	5j
200	16.5.1	INPUT A		LOGIC FUNC 5	0 to 1	BOOL	5k
201	16.5.2	INPUT B		LOGIC FUNC 5	0 to 1	BOOL	5l
202	16.5.3	INPUT C		LOGIC FUNC 5	0 to 1	BOOL	5m
203	16.5.5	OUTPUT		LOGIC FUNC 5	Output	BOOL	5n
204	16.5.4	TYPE		LOGIC FUNC 5	Same as 16.1.4	ENUM	5o
205	16.6.1	INPUT A		LOGIC FUNC 6	0 to 1	BOOL	5p
206	16.6.2	INPUT B		LOGIC FUNC 6	0 to 1	BOOL	5q
207	16.6.3	INPUT C		LOGIC FUNC 6	0 to 1	BOOL	5r
208	16.6.5	OUTPUT		LOGIC FUNC 6	Output	BOOL	5s
209	16.6.4	TYPE		LOGIC FUNC 6	Same as 16.1.4	ENUM	5t
210	16.7.1	INPUT A		LOGIC FUNC 7	0 to 1	BOOL	5u
211	16.7.2	INPUT B		LOGIC FUNC 7	0 to 1	BOOL	5v
212	16.7.3	INPUT C		LOGIC FUNC 7	0 to 1	BOOL	5w
213	16.7.5	OUTPUT		LOGIC FUNC 7	Output	BOOL	5x
214	16.7.4	TYPE		LOGIC FUNC 7	Same as 16.1.4	ENUM	5y
215	16.8.1	INPUT A		LOGIC FUNC 8	0 to 1	BOOL	5z
216	16.8.2	INPUT B		LOGIC FUNC 8	0 to 1	BOOL	60
217	16.8.3	INPUT C		LOGIC FUNC 8	0 to 1	BOOL	61
218	16.8.5	OUTPUT		LOGIC FUNC 8	Output	BOOL	62
219	16.8.4	TYPE		LOGIC FUNC 8	Same as 16.1.4	ENUM	63
220	16.9.1	INPUT A		LOGIC FUNC 9	0 to 1	BOOL	64
221	16.9.2	INPUT B		LOGIC FUNC 9	0 to 1	BOOL	65
222	16.9.3	INPUT C		LOGIC FUNC 9	0 to 1	BOOL	66
223	16.9.5	OUTPUT		LOGIC FUNC 9	Output	BOOL	67

2-8 Parameter Specification

TAG	Pref	DSElite Name	MMI Name	Function Block Name	Range	Type	ID
224	16.9.4	TYPE		LOGIC FUNC 9	Same as 16.1.4	ENUM	68
225	16.10.1	INPUT A		LOGIC FUNC 10	0 to 1	BOOL	69
226	16.10.2	INPUT B		LOGIC FUNC 10	0 to 1	BOOL	6a
227	16.10.3	INPUT C		LOGIC FUNC 10	0 to 1	BOOL	6b
228	16.10.5	OUTPUT		LOGIC FUNC 10	Output	BOOL	6c
229	16.10.4	TYPE		LOGIC FUNC 10	Same as 16.1.4	ENUM	6d
230	22.02	DISP 1 VERSION		DISPLAY/KEYPAD	Output	WORD	6e
231	50.01	DISABLE TRIPS	SET\TRIP LOOP	TRIPS STATUS	0x0000 to 0xFFFF	WORD	6f
234	54.02	EXTERNAL TRIP		IO TRIPS	0 to 1	BOOL	6i
240	56.02	STALL LIMIT		STALL TRIP	50.00 to 150.00	REAL	6o
241	56.01	STALL TIME		STALL TRIP	0.1 to 3000.0	REAL	6p
243	23.06	TRIM IN LOCAL		REFERENCE	0 to 1	BOOL	6r
244	42.01	RAMP TYPE	SET\SETP ST03	REFERENCE RAMP	0 : LINEAR 1 : S	ENUM	6s
245	23.01	REMOTE SETPOINT		REFERENCE	-110.0 to 110.0 (2)	REAL	6t
246	20.01	SETPOINT	PAR 8	REFERENCE JOG	-100.0 to 100.0 (2)	REAL	6u
247	23.13	LOCAL SETPOINT		REFERENCE	-100.0 to 100.0 (2)	REAL	6v
248	23.02	SPEED TRIM		REFERENCE	-110.0 to 110.0 (2)	REAL	6w
249	23.07	REMOTE REVERSE		REFERENCE	0 to 1	BOOL	6x
250	23.15	LOCAL REVERSE		REFERENCE	Output	BOOL	6y
251	23.16	LOCAL MIN SPEED	SET\SETP ST51	REFERENCE	0.0 to 100.0	REAL	6z
252	23.04	MAX SPEED CLAMP		REFERENCE	0.0 to 110.0 (2)	REAL	70
253	23.05	MIN SPEED CLAMP		REFERENCE	-110.0 to 0.0 (2)	REAL	71
254	23.10	SPEED SETPOINT	DIAG 2	REFERENCE	Output (2)	REAL	72
255	23.09	SPEED DEMAND		REFERENCE	Output (2)	REAL	73
256	23.12	REVERSE		REFERENCE	Output	BOOL	74
257	41.06	REMOTE REF		LOCAL CONTROL	Output	BOOL	75
258	42.02	ACCEL TIME	PAR 4	REFERENCE RAMP	0.0 to 3000.0	REAL	76
259	42.03	DECEL TIME	PAR 5	REFERENCE RAMP	0.0 to 3000.0	REAL	77
260	42.06	HOLD		REFERENCE RAMP	0 to 1	BOOL	78
261	20.02	ACCEL TIME	SET\SETP ST01	REFERENCE JOG	0.0 to 3000.0	REAL	79
262	20.03	DECEL TIME	SET\SETP ST02	REFERENCE JOG	0.0 to 3000.0	REAL	7a
263	43.02	STOP TIME		REFERENCE STOP	0.0 to 600.0	REAL	7b
264	43.07	FAST STOP TIME		REFERENCE STOP	0.0 to 600.0	REAL	7c
265	41.02	REF MODES		LOCAL CONTROL	Same as 41.01	ENUM	7d
266	43.03	STOP ZERO SPEED		REFERENCE STOP	0.0 to 100.0 (2)	REAL	7e
270	19.07	COMMS REF		COMMS CONTROL	Output	BOOL	7i
272	19.08	COMMS STATUS		COMMS CONTROL	Output	WORD	7k
273	19.09	COMMS COMMAND		COMMS CONTROL	Output	WORD	7l
274	24.24	HEALTHY		SEQUENCING LOGIC	Output	BOOL	7m
275	43.06	FAST STOP LIMIT		REFERENCE STOP	0.0 to 3000.0	REAL	7n

TAG	Pref	DSElite Name	MMI Name	Function Block Name	Range	Type	ID
276	24.06	DRIVE ENABLE		SEQUENCING LOGIC	0 to 1	BOOL	7o
277	24.07	NOT FAST STOP		SEQUENCING LOGIC	0 to 1	BOOL	7p
278	24.08	NOT COAST STOP		SEQUENCING LOGIC	0 to 1	BOOL	7q
279	43.01	RUN STOP MODE	PAR 9	REFERENCE STOP	0 : RAMPED 1 : COAST 2 : DC INJECTION	ENUM	7r
280	24.04	JOG		SEQUENCING LOGIC	0 to 1	BOOL	7s
281	41.04	SEQ DIRECTION		LOCAL CONTROL	0 to 1	BOOL	7t
282	24.10	REM TRIP RESET		SEQUENCING LOGIC	0 to 1	BOOL	7u
283	24.12	POWER UP START		SEQUENCING LOGIC	0 to 1	BOOL	7v
284	43.04	STOP DELAY		REFERENCE STOP	0.0 to 30.0 (3)	REAL	7w
285	24.14	RUNNING		SEQUENCING LOGIC	Output	BOOL	7x
286	24.17	OUTPUT CONTACTOR		SEQUENCING LOGIC	Output	BOOL	7y
287	24.20	READY		SEQUENCING LOGIC	Output	BOOL	7z
288	24.18	SWITCH ON ENABLE		SEQUENCING LOGIC	Output	BOOL	80
289	24.13	TRIPPED		SEQUENCING LOGIC	Output	BOOL	81
290	24.11	TRIP RST BY RUN		SEQUENCING LOGIC	0 to 1	BOOL	82
291	24.01	RUN FORWARD		SEQUENCING LOGIC	0 to 1	BOOL	83
292	24.02	RUN REVERSE		SEQUENCING LOGIC	0 to 1	BOOL	84
293	24.03	NOT STOP		SEQUENCING LOGIC	0 to 1	BOOL	85
294	24.09	REMOTE REVERSE		SEQUENCING LOGIC	0 to 1	BOOL	86
295	19.06	COMMS SEQ		COMMS CONTROL	Output	BOOL	87
296	24.23	REMOTE REV OUT		SEQUENCING LOGIC	Output	BOOL	88
297	41.05	REMOTE SEQ		LOCAL CONTROL	Output	BOOL	89
298	41.01	SEQ MODES		LOCAL CONTROL	0 : LOCAL/REMOTE 1 : LOCAL ONLY 2 : REMOTE ONLY	ENUM	8a
299	41.03	POWER UP MODE		LOCAL CONTROL	0 : LOCAL 1 : REMOTE 2 : AUTOMATIC	ENUM	8b
300	19.01	REMOTE COMMS SEL	SET\SERL SE01	COMMS CONTROL	0 to 1	BOOL	8c
301	24.22	SEQUENCER STATE		SEQUENCING LOGIC	0 : START DISABLED 1 : START ENABLED 2 : SWITCHED ON 3 : READY 4 : ENABLED 5 : F-STOP ACTIVE 6 : TRIP ACTIVE 7 : TRIPPED 8 : RESTART PENDING	ENUM	8d
302	24.15	JOGGING		SEQUENCING LOGIC	Output	BOOL	8e
303	24.16	STOPPING		SEQUENCING LOGIC	Output	BOOL	8f
304	43.05	FAST STOP MODE		REFERENCE STOP	0 : RAMPED 1 : COAST	ENUM	8g
305	24.21	SYSTEM RESET		SEQUENCING LOGIC	Output	BOOL	8h

2-10 Parameter Specification

TAG	Pref	DSElite Name	MMI Name	Function Block Name	Range	Type	ID
306	24.19	SWITCHED ON		SEQUENCING LOGIC	Output	BOOL	8i
307	19.02	REMOTE SEQ MODES		COMMS CONTROL	0 : TERMINALS/COMMS 1 : TERMINALS ONLY 2 : COMMS ONLY	ENUM	8j
308	19.03	REMOTE REF MODES		COMMS CONTROL	Same as 19.02	ENUM	8k
309	19.04	COMMS TIMEOUT	SET\SERL SE02	COMMS CONTROL	0.0 to 600.0	REAL	8l
310	7.08	DIGIN 1 DEST	SET\CONF IPD1	APP CONFIG	0 : NONE 1 : RUN FORWARD 2 : RUN REVERSE 3 : NOT STOP 4 : JOG 5 : CONTACTOR CLOSED 6 : DRIVE ENABLE 7 : NOT FAST STOP 8 : NOT COAST STOP 9 : REMOTE REVERSE 10 : REM TRIP RESET 11 : RAISE INPUT 12 : LOWER INPUT 13 : RL RESET 14 : PID ENABLE 15 : VALUE 1 INPUT A 16 : VALUE 1 INPUT B 17 : VALUE 1 INPUT C 18 : VALUE 2 INPUT A 19 : VALUE 2 INPUT B 20 : VALUE 2 INPUT C 21 : VALUE 3 INPUT C 22 : VALUE 4 INPUT C 23 : LOGIC 1 INPUT A 24 : LOGIC 1 INPUT B 25 : LOGIC 1 INPUT C 26 : LOGIC 3 INPUT A 27 : LOGIC 3 INPUT B 28 : LOGIC 3 INPUT C	ENUM	8m
311	7.09	DIGIN 2 DEST	SET\CONF IPD2	APP CONFIG	Same as 7.08	ENUM	8n
312	7.10	DIGIN 3 DEST	SET\CONF IPD3	APP CONFIG	Same as 7.08	ENUM	8o
313	7.11	DIGIN 4 DEST	SET\CONF IPD4	APP CONFIG	Same as 7.08	ENUM	8p
314	7.12	DIGIN 5 DEST	SET\CONF IPD5	APP CONFIG	Same as 7.08	ENUM	8q
315	7.13	DIGIN 6 DEST	SET\CONF IPD6	APP CONFIG	Same as 7.08	ENUM	8r
316	7.14	DIGIN 7 DEST	SET\CONF IPD7	APP CONFIG	Same as 7.08	ENUM	8s
321	71.1.3	COEFFICIENT A		DISPLAY SCALE 1	-32768.0000 to 32767.0000 (2)	REAL	8x
322	71.1.5	COEFFICIENT C		DISPLAY SCALE 1	-32768.0000 to 32767.0000 (2)	REAL	8y
323	71.1.8	UNITS		DISPLAY SCALE 1	0 : 1 : V 2 : RPM 3 : A 4 : kW 5 : % 6 : %ms 7 : Hz 8 : s	ENUM	8z

TAG	Pref	DSElite Name	MMI Name	Function Block Name	Range	Type	ID
					9 : ms 10 : Hzs 11 : ohms 12 : mH 13 : Nm 14 : deg 15 : kgm ² 16 : Nm/Hz 17 : /s ² 18 : /s ³ 19 : Pa 20 : kPa 21 : bar 22 : degC 23 : K 24 : m ³ /h 25 : Nm/A 26 : VKRPM		
325	44.08	OUTPUT		RAISE/LOWER	Output	REAL	91
326	44.03	RAMP TIME		RAISE/LOWER	0.0 to 600.0	REAL	92
327	44.01	RAISE INPUT		RAISE/LOWER	0 to 1	BOOL	93
328	44.02	LOWER INPUT		RAISE/LOWER	0 to 1	BOOL	94
329	44.05	MIN VALUE		RAISE/LOWER	-100.00 to 100.00	REAL	95
330	44.04	MAX VALUE		RAISE/LOWER	-100.00 to 100.00	REAL	96
331	44.06	RESET VALUE		RAISE/LOWER	-100.00 to 100.00	REAL	97
332	44.07	RESET		RAISE/LOWER	0 to 1	BOOL	98
334	71.1.1	DECIMAL PLACE		DISPLAY SCALE 1	0 : X. 1 : X.X 2 : X.XX 3 : X.XXX 4 : X.XXXX 5 : DEFAULT	ENUM	9a
335	45.04	OUTPUT		MINIMUM SPEED	Output (2)	REAL	9b
336	45.01	INPUT		MINIMUM SPEED	-300.0 to 300.0 (2)	REAL	9c
337	45.02	MINIMUM	PAR 3	MINIMUM SPEED	-100.0 to 100.0 (2)	REAL	9d
338	45.03	MODE	SET\SETP ST06	MINIMUM SPEED	0 : PROP. W/MIN 1 : LINEAR	ENUM	9e
340	55.01	INPUT		SKIP FREQUENCIES	-300.00 to 300.00	REAL	9g
341	55.02	BAND 1	SET\SETP ST12	SKIP FREQUENCIES	0.0 to 60.0	REAL	9h
342	55.03	FREQUENCY 1	SET\SETP ST11	SKIP FREQUENCIES	0.0 to 300.0	REAL	9i
343	55.05	FREQUENCY 2	SET\SETP ST13	SKIP FREQUENCIES	0.0 to 300.0	REAL	9j
346	55.06	OUTPUT		SKIP FREQUENCIES	Output	REAL	9m
347	17.1.2	INPUT 0		PRESET 1	-32768.00 to 32767.00	REAL	9n
348	17.1.3	INPUT 1		PRESET 1	-32768.00 to 32767.00	REAL	9o
349	17.1.4	INPUT 2		PRESET 1	-32768.00 to 32767.00	REAL	9p
350	17.1.5	INPUT 3		PRESET 1	-32768.00 to 32767.00	REAL	9q
351	17.1.6	INPUT 4		PRESET 1	-32768.00 to 32767.00	REAL	9r

2-12 Parameter Specification

TAG	Pref	DSElite Name	MMI Name	Function Block Name	Range	Type	ID
352	17.1.7	INPUT 5		PRESET 1	-32768.00 to 32767.00	REAL	9s
353	17.1.8	INPUT 6		PRESET 1	-32768.00 to 32767.00	REAL	9t
354	17.1.9	INPUT 7		PRESET 1	-32768.00 to 32767.00	REAL	9u
355	17.1.1	SELECT INPUT		PRESET 1	0 : INPUT 0 1 : INPUT 1 2 : INPUT 2 3 : INPUT 3 4 : INPUT 4 5 : INPUT 5 6 : INPUT 6 7 : INPUT 7	ENUM	9v
356	17.1.10	OUTPUT 1		PRESET 1	Output	REAL	9w
357	49.02	THRESHOLD		ZERO SPEED	0.0 to 300.0 (2)	REAL	9x
359	49.01	HYSTERISIS		ZERO SPEED	0.0 to 300.0 (2)	REAL	9z
371	70.2.1	PARAMETER		APP MENU 2	0 to 1763	PREF	ab
372	17.1.11	OUTPUT 2		PRESET 1	Output	REAL	ac
373	17.2.11	OUTPUT 2		PRESET 2	Output	REAL	ad
374	17.3.11	OUTPUT 2		PRESET 3	Output	REAL	ae
375	72.2.3	COEFFICIENT A		DISPLAY SCALE 2	-32768.0000 to 32767.0000 (2)	REAL	af
376	72.2.5	COEFFICIENT C		DISPLAY SCALE 2	-32768.0000 to 32767.0000 (2)	REAL	ag
377	72.2.8	UNITS		DISPLAY SCALE 2	Same as 71.1.8	ENUM	ah
379	72.2.1	DECIMAL PLACE		DISPLAY SCALE 2	Same as 71.1.1	ENUM	aj
380	17.2.2	INPUT 0		PRESET 2	-32768.00 to 32767.00	REAL	ak
381	17.2.3	INPUT 1		PRESET 2	-32768.00 to 32767.00	REAL	al
382	17.2.4	INPUT 2		PRESET 2	-32768.00 to 32767.00	REAL	am
383	17.2.5	INPUT 3		PRESET 2	-32768.00 to 32767.00	REAL	an
384	17.2.6	INPUT 4		PRESET 2	-32768.00 to 32767.00	REAL	ao
385	17.2.7	INPUT 5		PRESET 2	-32768.00 to 32767.00	REAL	ap
386	17.2.8	INPUT 6		PRESET 2	-32768.00 to 32767.00	REAL	aq
387	17.2.9	INPUT 7		PRESET 2	-32768.00 to 32767.00	REAL	ar
388	17.2.1	SELECT INPUT		PRESET 2	Same as 17.1.1	ENUM	as
389	17.2.10	OUTPUT 1		PRESET 2	Output	REAL	at
390	17.3.2	INPUT 0		PRESET 3	-32768.00 to 32767.00	REAL	au
391	17.3.3	INPUT 1		PRESET 3	-32768.00 to 32767.00	REAL	av
392	17.3.4	INPUT 2		PRESET 3	-32768.00 to 32767.00	REAL	aw
393	17.3.5	INPUT 3		PRESET 3	-32768.00 to 32767.00	REAL	ax
394	17.3.6	INPUT 4		PRESET 3	-32768.00 to 32767.00	REAL	ay
395	17.3.7	INPUT 5		PRESET 3	-32768.00 to 32767.00	REAL	az
396	17.3.8	INPUT 6		PRESET 3	-32768.00 to 32767.00	REAL	b0
397	17.3.9	INPUT 7		PRESET 3	-32768.00 to 32767.00	REAL	b1
398	17.3.1	SELECT INPUT		PRESET 3	Same as 17.1.1	ENUM	b2
399	17.3.10	OUTPUT 1		PRESET 3	Output	REAL	b3
500	51.01	TRIP 1 (NEWEST)	DIAG TH1	TRIPS HISTORY	Same as 50.07	ENUM	dw

TAG	Pref	DSElite Name	MMI Name	Function Block Name	Range	Type	ID
501	51.02	TRIP 2	DIAG TH2	TRIPS HISTORY	Same as 50.07	ENUM	dx
502	51.03	TRIP 3	DIAG TH3	TRIPS HISTORY	Same as 50.07	ENUM	dy
503	51.04	TRIP 4	DIAG TH4	TRIPS HISTORY	Same as 50.07	ENUM	dz
504	51.05	TRIP 5	DIAG TH5	TRIPS HISTORY	Same as 50.07	ENUM	e0
505	51.06	TRIP 6	DIAG TH6	TRIPS HISTORY	Same as 50.07	ENUM	e1
506	51.07	TRIP 7	DIAG TH7	TRIPS HISTORY	Same as 50.07	ENUM	e2
507	51.08	TRIP 8	DIAG TH8	TRIPS HISTORY	Same as 50.07	ENUM	e3
508	51.09	TRIP 9	DIAG TH9	TRIPS HISTORY	Same as 50.07	ENUM	e4
509	51.10	TRIP 10 (OLDEST)	DIAG TH10	TRIPS HISTORY	Same as 50.07	ENUM	e5
510	17.4.2	INPUT 0		PRESET 4	-32768.00 to 32767.00	REAL	e6
511	17.4.3	INPUT 1		PRESET 4	-32768.00 to 32767.00	REAL	e7
512	17.4.4	INPUT 2		PRESET 4	-32768.00 to 32767.00	REAL	e8
513	17.4.5	INPUT 3		PRESET 4	-32768.00 to 32767.00	REAL	e9
514	17.4.6	INPUT 4		PRESET 4	-32768.00 to 32767.00	REAL	ea
515	17.4.7	INPUT 5		PRESET 4	-32768.00 to 32767.00	REAL	eb
516	17.4.8	INPUT 6		PRESET 4	-32768.00 to 32767.00	REAL	ec
517	17.4.9	INPUT 7		PRESET 4	-32768.00 to 32767.00	REAL	ed
518	17.4.1	SELECT INPUT		PRESET 4	Same as 17.1.1	ENUM	ee
519	17.4.10	OUTPUT 1		PRESET 4	Output	REAL	ef
520	17.4.11	OUTPUT 2		PRESET 4	Output	REAL	eg
565	66.01	MODE	SET\ENC EN01	ENCODER	0 : QUADRATURE 1 : CLOCK/DIR 2 : CLOCK	ENUM	fp
566	66.04	LINES	SET\ENC EN04	ENCODER	100 to 10000	INT	fq
567	66.03	INVERT	SET\ENC EN03	ENCODER	0 to 1	BOOL	fr
568	27.07	SPEED FBK REV/S		FEEDBACKS	Output	REAL	fs
569	27.06	SPEED FBK RPM		FEEDBACKS	Output (1)	REAL	ft
584	69.01	ON LOAD		BRAKE CONTROL	0.00 to 150.00	REAL	g8
585	69.02	ON FREQUENCY		BRAKE CONTROL	0.0 to 500.0	REAL	g9
586	69.03	OFF FREQUENCY		BRAKE CONTROL	0.0 to 500.0	REAL	ga
587	69.04	ON HOLD TIME		BRAKE CONTROL	0.00 to 300.00	REAL	gb
588	69.05	OFF HOLD TIME		BRAKE CONTROL	0.00 to 300.00	REAL	gc
589	69.06	RELEASE		BRAKE CONTROL	Output	BOOL	gd
590	69.07	HOLD		BRAKE CONTROL	Output	BOOL	ge
591	25.03	DRIVE FREQUENCY	DIAG 1	PATTERN GEN	Output (2)	REAL	gf
598	47.17	OUTPUT		MULTIPLEXER	Output	WORD	gm
599	48.01	INPUT		DEMULTIPLEXER	0x0000 to 0xFFFF	WORD	gn
608	40.05	PENDING		AUTO RESTART	Output	BOOL	gw
609	40.03	TRIGGERS 1	SET\SETP ST23	AUTO RESTART	0x0000 to 0xFFFF	WORD	gx
612	40.01	ATTEMPTS	SET\SETP ST21	AUTO RESTART	0 to 10	INT	h0
613	40.02	ATTEMPT DELAY 1	SET\SETP ST22	AUTO RESTART	0.0 to 600.0	REAL	h1
614	40.07	ATTEMPTS LEFT		AUTO RESTART	Output	INT	h2

2-14 Parameter Specification

TAG	Pref	DSElite Name	MMI Name	Function Block Name	Range	Type	ID
615	40.08	TIME LEFT		AUTO RESTART	Output	REAL	h3
616	40.06	RESTARTING		AUTO RESTART	Output	BOOL	h4
617	46.02	FEEDBACK		PID	-300.00 to 300.00	REAL	h5
618	46.04	FEEDBACK GAIN		PID	-10.00 to 10.00	REAL	h6
619	46.14	ERROR		PID	Output	REAL	h7
620	24.26	FAN RUNNING		SEQUENCING LOGIC	Output	BOOL	h8
621	65.01	LEVEL		AT LOAD	-300.0 to 300.0 (2)	REAL	h9
622	65.02	AT OR ABOVE LOAD		AT LOAD	Output	BOOL	ha
626	70.3.1	PARAMETER		APP MENU 3	0 to 1763	PREF	he
627	70.4.1	PARAMETER		APP MENU 4	0 to 1763	PREF	hf
628	70.5.1	PARAMETER		APP MENU 5	0 to 1763	PREF	hg
629	70.6.1	PARAMETER		APP MENU 6	0 to 1763	PREF	hh
630	70.7.1	PARAMETER		APP MENU 7	0 to 1763	PREF	hi
631	70.8.1	PARAMETER		APP MENU 8	0 to 1763	PREF	hj
632	70.9.1	PARAMETER		APP MENU 9	0 to 1763	PREF	hk
633	70.10.1	PARAMETER		APP MENU 10	0 to 1763	PREF	hl
634	70.11.1	PARAMETER		APP MENU 11	0 to 1763	PREF	hm
635	70.12.1	PARAMETER		APP MENU 12	0 to 1763	PREF	hn
636	70.13.1	PARAMETER		APP MENU 13	0 to 1763	PREF	ho
637	70.14.1	PARAMETER		APP MENU 14	0 to 1763	PREF	hp
638	70.15.1	PARAMETER		APP MENU 15	0 to 1763	PREF	hq
639	70.16.1	PARAMETER		APP MENU 16	0 to 1763	PREF	hr
641	47.01	INPUT 0		MULTIPLEXER	0 to 1	BOOL	ht
642	47.02	INPUT 1		MULTIPLEXER	0 to 1	BOOL	hu
643	47.03	INPUT 2		MULTIPLEXER	0 to 1	BOOL	hv
644	47.04	INPUT 3		MULTIPLEXER	0 to 1	BOOL	hw
645	47.05	INPUT 4		MULTIPLEXER	0 to 1	BOOL	hx
646	47.06	INPUT 5		MULTIPLEXER	0 to 1	BOOL	hy
647	47.07	INPUT 6		MULTIPLEXER	0 to 1	BOOL	hz
648	47.08	INPUT 7		MULTIPLEXER	0 to 1	BOOL	i0
649	47.09	INPUT 8		MULTIPLEXER	0 to 1	BOOL	i1
650	47.10	INPUT 9		MULTIPLEXER	0 to 1	BOOL	i2
651	47.11	INPUT 10		MULTIPLEXER	0 to 1	BOOL	i3
652	47.12	INPUT 11		MULTIPLEXER	0 to 1	BOOL	i4
653	47.13	INPUT 12		MULTIPLEXER	0 to 1	BOOL	i5
654	47.14	INPUT 13		MULTIPLEXER	0 to 1	BOOL	i6
655	47.15	INPUT 14		MULTIPLEXER	0 to 1	BOOL	i7
656	47.16	INPUT 15		MULTIPLEXER	0 to 1	BOOL	i8
657	48.02	OUTPUT 0		DEMULTIPLEXER	Output	BOOL	i9
658	48.03	OUTPUT 1		DEMULTIPLEXER	Output	BOOL	ia
659	48.04	OUTPUT 2		DEMULTIPLEXER	Output	BOOL	ib

TAG	Pref	DSElite Name	MMI Name	Function Block Name	Range	Type	ID
660	48.05	OUTPUT 3		DEMULTIPLEXER	Output	BOOL	ic
661	48.06	OUTPUT 4		DEMULTIPLEXER	Output	BOOL	id
662	48.07	OUTPUT 5		DEMULTIPLEXER	Output	BOOL	ie
663	48.08	OUTPUT 6		DEMULTIPLEXER	Output	BOOL	if
664	48.09	OUTPUT 7		DEMULTIPLEXER	Output	BOOL	ig
665	48.10	OUTPUT 8		DEMULTIPLEXER	Output	BOOL	ih
666	48.11	OUTPUT 9		DEMULTIPLEXER	Output	BOOL	ii
667	48.12	OUTPUT 10		DEMULTIPLEXER	Output	BOOL	ij
668	48.13	OUTPUT 11		DEMULTIPLEXER	Output	BOOL	ik
669	48.14	OUTPUT 12		DEMULTIPLEXER	Output	BOOL	il
670	48.15	OUTPUT 13		DEMULTIPLEXER	Output	BOOL	im
671	48.16	OUTPUT 14		DEMULTIPLEXER	Output	BOOL	in
672	48.17	OUTPUT 15		DEMULTIPLEXER	Output	BOOL	io
673	72.2.4	COEFFICIENT B		DISPLAY SCALE 2	-32768.0000 to 32767.0000 (2)	REAL	ip
674	72.2.6	HIGH LIMIT		DISPLAY SCALE 2	-32768.0000 to 32767.0000 (2)	REAL	iq
675	72.2.7	LOW LIMIT		DISPLAY SCALE 2	-32768.0000 to 32767.0000 (2)	REAL	ir
676	72.2.2	FORMULA		DISPLAY SCALE 2	Same as 71.1.2	ENUM	is
680	55.04	BAND 2	SET\SETP ST14	SKIP FREQUENCIES	0.0 to 60.0	REAL	iw
691	42.05	SRAMP CONTINUOUS	SET\SETP ST05	REFERENCE RAMP	0 to 1	BOOL	j7
694	42.04	SRAMP JERK 1	SET\SETP ST04	REFERENCE RAMP	0.01 to 100.00	REAL	ja
698	42.07	RAMPING		REFERENCE RAMP	Output	BOOL	je
700	70.6.2	SCALING		APP MENU 6	Same as 21.04	ENUM	ig
701	70.6.3	READ ONLY		APP MENU 6	0 to 1	BOOL	jh
702	70.6.4	IGNORE PASSWORD		APP MENU 6	0 to 1	BOOL	ji
703	70.7.2	SCALING		APP MENU 7	Same as 21.04	ENUM	jj
704	70.7.3	READ ONLY		APP MENU 7	0 to 1	BOOL	jk
705	70.7.4	IGNORE PASSWORD		APP MENU 7	0 to 1	BOOL	jl
706	70.8.2	SCALING		APP MENU 8	Same as 21.04	ENUM	jm
707	70.8.3	READ ONLY		APP MENU 8	0 to 1	BOOL	jn
708	70.8.4	IGNORE PASSWORD		APP MENU 8	0 to 1	BOOL	jo
725	13.06	INVERT 6	SET\IN IPD6	DIGITAL INPUTS	0 to 1	BOOL	k5
726	13.14	INPUT 6		DIGITAL INPUTS	Output	BOOL	k6
727	13.07	INVERT 7	SET\IN IPD7	DIGITAL INPUTS	0 to 1	BOOL	k7
728	13.15	INPUT 7		DIGITAL INPUTS	Output	BOOL	k8
731	12.2.1	VALUE	DIAG OPA2	ANALOG OUTPUT 2	-300.0 to 300.0 (2)	REAL	kb
732	12.2.2	SCALE	SET\OUT OP21	ANALOG OUTPUT 2	-300.00 to 300.00	REAL	kc
733	12.2.3	OFFSET	SET\OUT OP22	ANALOG OUTPUT 2	-300.00 to 300.00	REAL	kd
734	12.2.4	ABSOLUTE	SET\OUT OP23	ANALOG OUTPUT 2	0 to 1	BOOL	ke
736	14.06	INVERT 3	SET\OUT OPD3	DIGITAL OUTPUTS	0 to 1	BOOL	kg
737	14.05	DIGOUT 3		DIGITAL OUTPUTS	0 to 1	BOOL	kh
740	50.04	ACTIVE TRIPS+		TRIPS STATUS	Output	WORD	kk

2-16 Parameter Specification

TAG	Pref	DSElite Name	MMI Name	Function Block Name	Range	Type	ID
741	50.06	WARNINGS+		TRIPS STATUS	Output	WORD	kl
742	50.02	DISABLE TRIPS+	SET\TRIP_OT	TRIPS STATUS	0x0000 to 0xFFFF	WORD	km
744	40.04	TRIGGERS 1+	SET\SETP ST24	AUTO RESTART	0x0000 to 0xFFFF	WORD	ko
747	66.02	RESET	SET\ENC EN02	ENCODER	0 to 1	BOOL	kr
748	66.07	POSITION		ENCODER	Output	REAL	ks
749	27.08	SPEED FBK %		FEEDBACKS	Output	REAL	kt
760	54.01	INVERT THERMIST		IO TRIPS	0 to 1	BOOL	l4
770	23.14	COMMS SETPOINT		REFERENCE	Output (2)	REAL	le
774	70.9.2	SCALING		APP MENU 9	Same as 21.04	ENUM	li
775	70.9.3	READ ONLY		APP MENU 9	0 to 1	BOOL	lj
776	70.9.4	IGNORE PASSWORD		APP MENU 9	0 to 1	BOOL	lk
777	70.10.2	SCALING		APP MENU 10	Same as 21.04	ENUM	ll
778	70.10.3	READ ONLY		APP MENU 10	0 to 1	BOOL	lm
779	70.10.4	IGNORE PASSWORD		APP MENU 10	0 to 1	BOOL	ln
780	70.11.2	SCALING		APP MENU 11	Same as 21.04	ENUM	lo
781	70.11.3	READ ONLY		APP MENU 11	0 to 1	BOOL	lp
782	70.11.4	IGNORE PASSWORD		APP MENU 11	0 to 1	BOOL	lq
783	70.12.2	SCALING		APP MENU 12	Same as 21.04	ENUM	lr
784	70.12.3	READ ONLY		APP MENU 12	0 to 1	BOOL	ls
785	70.12.4	IGNORE PASSWORD		APP MENU 12	0 to 1	BOOL	lt
786	70.13.2	SCALING		APP MENU 13	Same as 21.04	ENUM	lu
787	70.13.3	READ ONLY		APP MENU 13	0 to 1	BOOL	lv
788	70.13.4	IGNORE PASSWORD		APP MENU 13	0 to 1	BOOL	lw
789	70.14.2	SCALING		APP MENU 14	Same as 21.04	ENUM	lx
790	70.14.3	READ ONLY		APP MENU 14	0 to 1	BOOL	ly
791	70.14.4	IGNORE PASSWORD		APP MENU 14	0 to 1	BOOL	lz
792	70.15.2	SCALING		APP MENU 15	Same as 21.04	ENUM	m0
793	70.15.3	READ ONLY		APP MENU 15	0 to 1	BOOL	m1
794	70.15.4	IGNORE PASSWORD		APP MENU 15	0 to 1	BOOL	m2
795	70.16.2	SCALING		APP MENU 16	Same as 21.04	ENUM	m3
796	70.16.3	READ ONLY		APP MENU 16	0 to 1	BOOL	m4
797	70.16.4	IGNORE PASSWORD		APP MENU 16	0 to 1	BOOL	m5
878	21.02	DETAILED MENUS	SET\SETP ST99	MMI ACCESS	0 to 1	BOOL	oe
1020	27.05	TERMINAL VOLTS		FEEDBACKS	Output	REAL	sc
1039	70.1.2	SCALING		APP MENU 1	Same as 21.04	ENUM	sv
1040	70.1.3	READ ONLY		APP MENU 1	0 to 1	BOOL	sw
1041	70.1.4	IGNORE PASSWORD		APP MENU 1	0 to 1	BOOL	sx
1042	70.2.2	SCALING		APP MENU 2	Same as 21.04	ENUM	sy
1043	70.2.3	READ ONLY		APP MENU 2	0 to 1	BOOL	sz
1044	70.2.4	IGNORE PASSWORD		APP MENU 2	0 to 1	BOOL	t0
1046	70.3.2	SCALING		APP MENU 3	Same as 21.04	ENUM	t2

TAG	Pref	DSElite Name	MMI Name	Function Block Name	Range	Type	ID
1047	70.3.3	READ ONLY		APP MENU 3	0 to 1	BOOL	f3
1048	70.3.4	IGNORE PASSWORD		APP MENU 3	0 to 1	BOOL	f4
1050	70.4.2	SCALING		APP MENU 4	Same as 21.04	ENUM	t6
1051	70.4.3	READ ONLY		APP MENU 4	0 to 1	BOOL	f7
1052	70.4.4	IGNORE PASSWORD		APP MENU 4	0 to 1	BOOL	f8
1053	70.5.4	IGNORE PASSWORD		APP MENU 5	0 to 1	BOOL	f9
1054	70.5.2	SCALING		APP MENU 5	Same as 21.04	ENUM	ta
1055	70.5.3	READ ONLY		APP MENU 5	0 to 1	BOOL	tb
1059	18.07	P3 PORT PROTOCOL	SET\SERL SE08	COMMS PORTS	Same as 18.06	ENUM	tf
1060	18.06	OP PORT PROTOCOL	SET\SERL SE07	COMMS PORTS	0 : AUTOMATIC 1 : KEYPAD 2 : EIBISYNC ASCII 3 : MODBUS 4 : FIELDBUS	ENUM	tg
1061	18.04	PARITY	SET\SERL SE05	COMMS PORTS	0 : NONE 1 : ODD 2 : EVEN	ENUM	th
1062	18.03	BAUD RATE	SET\SERL SE04	COMMS PORTS	0 : 1200 1 : 2400 2 : 4800 3 : 7200 4 : 9600 5 : 14400 6 : 19200 7 : 38400 8 : 57600	ENUM	fi
1064	7.07	APP LOCK	SET\SETP ST98	APP CONFIG	0 to 1	BOOL	fk
1091	7.01	APPLICATION	PAR 1	APP CONFIG	0 : NULL 1 : STANDARD 2 : LOCAL/REM 3 : PRESETS 4 : RAISE/LOWER 5 : PID 6 : APP 6 7 : APP 7 8 : APP 8 9 : CUSTOM	ENUM	ub
1092	7.02	ANOUT 1 SOURCE	SET\CONF OPA1	APP CONFIG	0 : NONE 1 : DEMAND 2 : CURRENT 3 : PID ERROR 4 : R/L OUTPUT	ENUM	uc
1093	7.04	RELAY SOURCE	SET\CONF OPD3	APP CONFIG	0 : NONE 1 : HEALTH 2 : TRIPPED 3 : RUNNING 4 : AT ZERO 5 : AT SPEED 6 : AT LOAD	ENUM	ud
1094	7.05	DIGIO 2 SOURCE	SET\CONF OPD2	APP CONFIG	Same as 7.04	ENUM	ue

2-18 Parameter Specification

TAG	Pref	DSElite Name	MMI Name	Function Block Name	Range	Type	ID
1095	52.01	HYSTERISIS		AT SPEED	0.0 to 300.0 (2)	REAL	uf
1096	52.02	AT SPEED		AT SPEED	Output	BOOL	ug
1098	46.11	INTEGRAL DEFEAT		PID	0 to 1	BOOL	ui
1109	7.03	ANOUT 2 SOURCE	SET\CONF OPA2	APP CONFIG	Same as 7.02	ENUM	ut
1110	22.03	DISP 2 VERSION		DISPLAY/KEYPAD	Output	WORD	uu
1155	54.03	THERMIST STATE		IO TRIPS	Output	BOOL	w3
1187	59.01	SPEED PROP GAIN	SET\CTRL CL91	SPEED LOOP	0.00 to 300.00	REAL	wz
1188	59.02	SPEED INT TIME	SET\CTRL CL92	SPEED LOOP	1. to 15000.	REAL	x0
1189	59.03	INT DEFEAT		SPEED LOOP	0 to 1	BOOL	x1
1190	59.04	SPEED INT PRESET		SPEED LOOP	-500.00 to 500.00 (1)	REAL	x2
1191	59.05	SPEED DMD FILTER		SPEED LOOP	0.0 to 14.0	REAL	x3
1192	59.06	SPEED FBK FILTER		SPEED LOOP	0.0 to 15.0	REAL	x4
1193	59.07	(AUX) TORQUE DMD		SPEED LOOP	-300.00 to 300.00	REAL	x5
1194	59.11	ADAPTIVE THRESH		SPEED LOOP	0.00 to 10.00	REAL	x6
1195	59.12	ADAPTIVE P-GAIN		SPEED LOOP	0.00 to 300.00	REAL	x7
1200	59.08	SPEED POS LIM	SET\CTRL CL93	SPEED LOOP	-110.00 to 110.00	REAL	xc
1201	59.09	SPEED NEG LIM	SET\CTRL CL94	SPEED LOOP	-110.00 to 110.00	REAL	xd
1202	59.10	TORQ CTRL MODE		SPEED LOOP	0 to 1	BOOL	xe
1203	59.13	TOTL SPD DMD RPM		SPEED LOOP	Output (0)	REAL	xf
1204	59.16	TORQUE DEMAND		SPEED LOOP	Output	REAL	xg
1206	59.14	TOTAL SPD DMD %		SPEED LOOP	Output	REAL	xi
1207	59.15	SPEED ERROR		SPEED LOOP	Output	REAL	xj
1208	38.01	POS TORQUE LIM	SET\CTRL CL82	TORQUE LIMIT	-500.0 to 500.0	REAL	xk
1209	38.02	NEG TORQUE LIM	SET\CTRL CL83	TORQUE LIMIT	-500.0 to 500.0	REAL	xl
1210	38.03	MAIN TORQUE LIM		TORQUE LIMIT	0.0 to 500.0	REAL	xm
1211	38.04	SYMMETRIC LIM		TORQUE LIMIT	0 to 1	BOOL	xn
1212	38.05	ACTUAL POS LIM		TORQUE LIMIT	Output (2)	REAL	xo
1213	38.06	ACTUAL NEG LIM		TORQUE LIMIT	Output (2)	REAL	xp
1233	49.03	AT ZERO SPEED		ZERO SPEED	Output	BOOL	y9
1235	24.05	CONTACTOR CLOSED		SEQUENCING LOGIC	0 to 1	BOOL	yb
1247	46.01	SETPOINT		PID	-300.00 to 300.00	REAL	yn
1248	46.03	FEED FWD		PID	-300.00 to 300.00	REAL	yo
1249	46.05	FEED FWD GAIN		PID	-10.00 to 10.00	REAL	yp
1250	46.06	P GAIN		PID	0.00 to 100.00	REAL	yq
1251	46.07	I GAIN		PID	0.00 to 100.00	REAL	yr
1252	46.08	D GAIN		PID	0.00 to 100.00	REAL	ys
1253	46.09	LIMIT		PID	0.00 to 300.00	REAL	yt
1254	46.10	ENABLE PID		PID	0 to 1	BOOL	yu
1255	46.12	D FILTER TC		PID	0.05 to 5.00	REAL	yv
1256	46.13	OUTPUT		PID	Output	REAL	yw
1257	46.15	LIMITING		PID	Output	BOOL	yx

TAG	Pref	DSElite Name	MMI Name	Function Block Name	Range	Type	ID
1258	46.16	OUTPUT SCALING		PID	-3.0000 to 3.0000	REAL	yy
1259	65.03	ABSOLUTE		AT LOAD	0 to 1	BOOL	yz
1260	18.05	REPLY DELAY ms	SET\SERL SE06	COMMS PORTS	0 to 200	INT	z0
1536	24.25	START DELAY		SEQUENCING LOGIC	0.000 to 30.000	REAL	jG
1554	38.07	FAST STOP T-LIM		TORQUE LIMIT	-300.00 to 300.00	REAL	jY
1632	56.03	STALL LIMIT TYPE	SET\CTRL CL84	STALL TRIP	0 to 1	BOOL	mY
1687	73.1.1	MAX SPEED	SET\PAC1 PA01	SV MOTOR DATA 1	0. to 30000.	REAL	pB
1688	73.1.2	MAX CURRENT	SET\PAC1 PA02	SV MOTOR DATA 1	0.0 to 512.0 (0)	REAL	pC
1689	73.1.3	PERM CURRENT	SET\PAC1 PA03	SV MOTOR DATA 1	0.0 to 512.0 (0)	REAL	pD
1690	73.1.4	PERM TORQUE	SET\PAC1 PA04	SV MOTOR DATA 1	0.0 to 512.0 (0)	REAL	pE
1691	73.1.5	POLES	SET\PAC1 PA05	SV MOTOR DATA 1	0 to 400	INT	pF
1692	73.1.6	BACK EMF	SET\PAC1 PA06	SV MOTOR DATA 1	0.0 to 8192.0 (0)	REAL	pG
1693	73.1.7	R	SET\PAC1 PA07	SV MOTOR DATA 1	0.00 to 50.00 (0)	REAL	pH
1694	73.1.8	L	SET\PAC1 PA08	SV MOTOR DATA 1	0.00 to 1000.00 (0)	REAL	pl
1695	73.1.9	KT	SET\PAC1 PA09	SV MOTOR DATA 1	0.00 to 100.00 (0)	REAL	pJ
1696	73.1.10	INERTIA	SET\PAC1 PA10	SV MOTOR DATA 1	0.00 to 100.00 (0)	REAL	pK
1697	73.1.11	INERTIA SCALE	SET\PAC1 PA11	SV MOTOR DATA 1	0 : gm2 1 : kgcm2 2 : kgm2	ENUM	pL
1698	73.1.12	THERMAL TIME CST	SET\PAC1 PA12	SV MOTOR DATA 1	0. to 10000.	REAL	pM
1699	73.1.13	CUR LOOP BWDTH	SET\PAC1 PA13	SV MOTOR DATA 1	10. to 1500.	REAL	pN
1700	73.1.14	INTEGRAL FREQ	SET\PAC1 PA14	SV MOTOR DATA 1	1. to 600.	REAL	pO
1701	73.1.15	SELECT MOTOR 1	SET\PAC1 PA15	SV MOTOR DATA 1	0 to 1	BOOL	pP
1702	73.2.1	MAX SPEED	SET\PAC2 PA51	SV MOTOR DATA 2	0. to 30000.	REAL	pQ
1703	73.2.2	MAX CURRENT	SET\PAC2 PA52	SV MOTOR DATA 2	0.0 to 512.0 (0)	REAL	pR
1704	73.2.3	PERM CURRENT	SET\PAC2 PA53	SV MOTOR DATA 2	0.0 to 512.0 (0)	REAL	pS
1705	73.2.4	PERM TORQUE	SET\PAC2 PA54	SV MOTOR DATA 2	0.0 to 512.0 (0)	REAL	pT
1706	73.2.5	POLES	SET\PAC2 PA55	SV MOTOR DATA 2	0 to 400	INT	pU
1707	73.2.6	BACK EMF	SET\PAC2 PA56	SV MOTOR DATA 2	0.0 to 8192.0 (0)	REAL	pV
1708	73.2.7	R	SET\PAC2 PA57	SV MOTOR DATA 2	0.00 to 50.00 (0)	REAL	pW
1709	73.2.8	L	SET\PAC2 PA58	SV MOTOR DATA 2	0.00 to 1000.00 (0)	REAL	pX
1710	73.2.9	KT	SET\PAC2 PA59	SV MOTOR DATA 2	0.00 to 100.00 (0)	REAL	pY
1711	73.2.10	INERTIA	SET\PAC2 PA60	SV MOTOR DATA 2	0.00 to 100.00 (0)	REAL	pZ
1712	73.2.11	INERTIA SCALE	SET\PAC2 PA61	SV MOTOR DATA 2	Same as 73.1.11	ENUM	qA
1713	73.2.12	THERMAL TIME CST	SET\PAC2 PA62	SV MOTOR DATA 2	0. to 10000.	REAL	qB
1714	73.2.13	CUR LOOP BWDTH	SET\PAC2 PA63	SV MOTOR DATA 2	10. to 1500.	REAL	qC
1715	73.2.14	INTEGRAL FREQ	SET\PAC2 PA64	SV MOTOR DATA 2	1. to 600.	REAL	qD
1716	73.2.15	SELECT MOTOR 1		SV MOTOR DATA 2	0 to 1	BOOL	qE
1717	74.1.1	TRIP INHIBIT	SET\SCP1 SC01	SV MOTOR CTRL 1	0 to 1	BOOL	qF
1718	74.1.2	LPF SPEED	SET\SCP1 SC02	SV MOTOR CTRL 1	1. to 2000.	REAL	qG
1719	74.1.3	PI GAIN	SET\SCP1 SC03	SV MOTOR CTRL 1	0.0 to 2000.0 (0)	REAL	qH
1720	74.1.4	PI INTEGRAL	SET\SCP1 SC04	SV MOTOR CTRL 1	1. to 2000.	REAL	qI

2-20 Parameter Specification

TAG	Pref	DSElite Name	MMI Name	Function Block Name	Range	Type	ID
1721	74.1.5	SPD THRESHOLD	SET\SCP1 SC05	SV MOTOR CTRL 1	0. to 10000.	REAL	qJ
1722	74.1.6	SPD START GRD	SET\SCP1 SC06	SV MOTOR CTRL 1	0.0 to 100.0 (0)	REAL	qK
1724	74.1.8	SPD GRD	SET\SCP1 SC08	SV MOTOR CTRL 1	0. to 32000.	REAL	qM
1725	74.1.9	KE START GRD	SET\SCP1 SC09	SV MOTOR CTRL 1	0.0 to 100.0 (0)	REAL	qN
1726	74.1.10	KE END GRD	SET\SCP1 SC10	SV MOTOR CTRL 1	0.0 to 100.0 (0)	REAL	qO
1727	74.1.11	KE SPD	SET\SCP1 SC11	SV MOTOR CTRL 1	0. to 30000.	REAL	qP
1728	74.1.12	ENABLE STARTUP	SET\SCP1 SC12	SV MOTOR CTRL 1	0 to 1	BOOL	qQ
1729	74.1.13	STARTUP TIME	SET\SCP1 SC13	SV MOTOR CTRL 1	0.0 to 100.0 (0)	REAL	qR
1730	74.1.14	STARTUP CURRENT	SET\SCP1 SC14	SV MOTOR CTRL 1	0.0 to 200.0 (0)	REAL	qS
1731	74.1.15	STARTUP SPEED	SET\SCP1 SC15	SV MOTOR CTRL 1	0.0 to 100.0 (0)	REAL	qT
1732	74.2.1	TRIP INHIBIT	SET\SCP2 SC51	SV MOTOR CTRL 2	0 to 1	BOOL	qU
1733	74.2.2	LPF SPEED	SET\SCP2 SC52	SV MOTOR CTRL 2	1. to 2000.	REAL	qV
1734	74.2.3	PI GAIN	SET\SCP2 SC53	SV MOTOR CTRL 2	0.0 to 2000.0 (0)	REAL	qW
1735	74.2.4	PI INTEGRAL	SET\SCP2 SC54	SV MOTOR CTRL 2	1. to 2000.	REAL	qX
1736	74.2.5	SPD THRESHOLD	SET\SCP2 SC55	SV MOTOR CTRL 2	0. to 10000.	REAL	qY
1737	74.2.6	SPD START GRD	SET\SCP2 SC56	SV MOTOR CTRL 2	0.0 to 100.0 (0)	REAL	qZ
1739	74.2.8	SPD GRD	SET\SCP2 SC58	SV MOTOR CTRL 2	0. to 32000.	REAL	rB
1740	74.2.9	KE START GRD	SET\SCP2 SC59	SV MOTOR CTRL 2	0.0 to 100.0 (0)	REAL	rC
1741	74.2.10	KE END GRD	SET\SCP2 SC60	SV MOTOR CTRL 2	0.0 to 100.0 (0)	REAL	rD
1742	74.2.11	KE SPD	SET\SCP2 SC61	SV MOTOR CTRL 2	0. to 30000.	REAL	rE
1743	74.2.12	ENABLE STARTUP	SET\SCP2 SC62	SV MOTOR CTRL 2	0 to 1	BOOL	rF
1744	74.2.13	STARTUP TIME	SET\SCP2 SC63	SV MOTOR CTRL 2	0.0 to 100.0 (0)	REAL	rG
1745	74.2.14	STARTUP CURRENT	SET\SCP2 SC64	SV MOTOR CTRL 2	0.0 to 200.0 (0)	REAL	rH
1746	74.2.15	STARTUP SPEED	SET\SCP2 SC65	SV MOTOR CTRL 2	0.0 to 100.0 (0)	REAL	rI
1747	75.1.1	AIMING POINT	SET\IPPA IP01	INVERS TIME PMAC	50. to 150. (2)	REAL	rJ
1748	75.1.2	DELAY	SET\IPPA IP02	INVERS TIME PMAC	5.0 to 60.0	REAL	rK
1749	75.1.3	DOWN TIME	SET\IPPA IP03	INVERS TIME PMAC	1.0 to 10.0	REAL	rL
1750	75.1.4	UP TIME	SET\IPPA IP04	INVERS TIME PMAC	1.0 to 100.0	REAL	rM
1751	75.1.5	IT LIMITING	SET\IPPA IP05	INVERS TIME PMAC	Output	BOOL	rN
1752	75.1.6	INVERSE TIME OP	SET\IPPA IP06	INVERS TIME PMAC	Output	REAL	rO
1753	75.1.7	IT WARNING	SET\IPPA IP07	INVERS TIME PMAC	Output	BOOL	rP
1754	76.1.1	I2T INHIBIT	SET\I2PM 2P01	MOT PMAC PROTECT	0 to 1	BOOL	rQ
1755	76.1.2	I2T LIMIT MOTOR	SET\I2PM 2P02	MOT PMAC PROTECT	Output	BOOL	rR
1756	76.1.3	I2T MOTOR LOAD	SET\I2PM 2P03	MOT PMAC PROTECT	Output	REAL	rS
1757	76.1.4	I2T MOTOR TRIP	SET\I2PM 2P04	MOT PMAC PROTECT	Output	BOOL	rT
1758	77.1.1	POLARISATION	SET\POLM PO01	SV MOTOR POL	0 to 1	BOOL	rU
1759	77.1.2	POLAR START	SET\POLM PO02	SV MOTOR POL	0 to 1	BOOL	rV
1760	77.1.3	MOTOR PHASE	SET\POLM PO03	SV MOTOR POL	0 : U PHASE 1 : V PHASE 2 : W PHASE	ENUM	rW
1761	77.1.4	CURRENT	SET\POLM PO04	SV MOTOR POL	Output	REAL	rX
1764	66.8	SOURCE	SET\ENC EN08	ENCODER	0 : EXTERNAL	ENUM	sA

TAG	Pref	DSElite Name	MMI Name	Function Block Name	Range	Type	ID
					1 : INTERNAL		
1765	66.9	POS SCALE	SET\ENC EN09	ENCODER	1 to 30000	REAL	sB
1766	66.10	MODULO	SET\ENC EN10	ENCODER	0 to 30000	REAL	sC
1767	66.11	SPEED UNITS	SET\ENC EN11	ENCODER	Output	REAL	sD
1768	66.12	POSITION UNITS	SET\ENC EN12	ENCODER	Output	REAL	sE
1769	78.1	START	SET\POS PS01	POSITION	0 to 1	BOOL	sF
1770	78.2	ABORT	SET\POS PS02	POSITION	0 to 1	BOOL	sG
1771	78.3	TARGET	SET\POS PS03	POSITION	-32768.00 to +32768.00	REAL	sH
1772	78.4	TYPE	SET\POS PS04	POSITION	0 : ABSOLUTE 1 : RELATIVE 2 : STOP MARK	ENUM	sl
1773	78.5	DIRECTION	SET\POS PS05	POSITION	0 : POSITIVE 1 : NEGATIVE 2 : SHORTEST	ENUM	sJ
1774	78.6	MAX SPEED	SET\POS PS06	POSITION	0.00 to 32768.00	REAL	sK
1775	78.7	POS WINDOW	SET\POS PS07	POSITION	0.01 to 1000.00	REAL	sL
1776	78.8	REDUCED SPEED	SET\POS PS08	POSITION	0.01 to 1000.00	REAL	sM
1777	78.9	REDUCED WINDOW	SET\POS PS09	POSITION	0.00 to 1000.00	REAL	sN
1778	78.10	GAIN	SET\POS PS10	POSITION	0.10 to 100.00	REAL	sO
1779	78.11	MARK INPUT	SET\POS PS11	POSITION	0 : NONE 1 : DIN1 2 : DIN2 3 : DIN3 4 : DIN4 5 : DIN5 6 : DIN6 7 : DIN7	ENUM	sP
1780	78.12	ACTIVE	SET\POS PS12	POSITION	0 to 1	BOOL	sQ
1781	78.13	LOCKED	SET\POS PS13	POSITION	0 to 1	BOOL	sR
1782	78.14	TARGET REACHED	SET\POS PS14	POSITION	0 to 1	BOOL	sS
1783	78.15	MARK POSITION	SET\POS PS15	POSITION	-32768.00 to +32768.00	REAL	sT
1787	78.18	PRESET VALUE	SET\ENC EN13	ENCODER	-32768.00 to +32768.00	REAL	sX
1788	78.19	PRESET ON MARK	SET\POS PS19	POSITION	0 to 1	BOOL	sY
1789	79.01	VECTOR ENABLE	SET\FLY FLO1	FLYCATCHING PMAC	0 to 1	BOOL	sZ
1793	79.02	ACTIVE	SET\FLY FLO5	FLYCATCHING PMAC	0 to 1	BOOL	tD
1793	79.03	SETPOINT	SET\FLY FLO6	FLYCATCHING PMAC	0 to 1	REAL	tE

MMI Parameters

MMI Name	ASCII MMI Name	Function Block name	DSElite Name	Notes	TAG	ID
DIAG Menu, (Diagnostics)						
	DRIVE FREQUENCY	PATTERN GEN	DRIVE FREQUENCY		591	gf
	SPEED SETPOINT	REFERENCE	SPEED SETPOINT		254	72
	DC LINK VOLTS	FEEDBACKS	DC LINK VOLTS		75	23
	MOTOR CURRENT	FEEDBACKS	MOTOR CURRENT A		67	1v
IN\DIN	DIGIN WORD	DIGITAL INPUTS	INPUT WORD			00
IN\IPA1	ANIN 1 VALUE	ANALOG INPUT 1	VALUE		16	0g
IN\IPA2	ANIN 2 VALUE	ANALOG INPUT 2	VALUE		25	0p
OUT\DOUT	DIGOUT WORD	DIGITAL OUTPUTS	DIGOUT WORD			00
OUT\OPA1	ANOUT 1 VALUE	ANALOG OUTPUT 1	VALUE		45	19
OUT\OPA2	ANOUT 2 VALUE	ANALOG OUTPUT 2	VALUE		731	kb
TRIP\TH1	TRIP 1 (NEWEST)	TRIPS HISTORY	TRIP 1 (NEWEST)		500	dw
TRIP\TH2	TRIP 2	TRIPS HISTORY	TRIP 2		501	dx
TRIP\TH3	TRIP 3	TRIPS HISTORY	TRIP 3		502	dy
TRIP\TH4	TRIP 4	TRIPS HISTORY	TRIP 4		503	dz
TRIP\TH5	TRIP 5	TRIPS HISTORY	TRIP 5		504	e0
TRIP\TH6	TRIP 6	TRIPS HISTORY	TRIP 6		505	e1
TRIP\TH7	TRIP 7	TRIPS HISTORY	TRIP 7		506	e2
TRIP\TH8	TRIP 8	TRIPS HISTORY	TRIP 8		507	e3
TRIP\TH9	TRIP 9	TRIPS HISTORY	TRIP 9		508	e4
TRIP\TH10	TRIP 10 (OLDEST)	TRIPS HISTORY	TRIP 10 (OLDEST)		509	e5
PAR Menu (Parameter)						
PAR 1	APPLICATION	APP CONFIG	APPLICATION		1091	ub
PAR 2	MAX SPEED	REFERENCE	MAX SPEED		57	11
PAR 3	MIN SPEED	MINIMUM SPEED	MINIMUM		337	9d
PAR 4	ACCEL TIME	REFERENCE RAMP	ACCEL TIME		258	76
PAR 5	DECEL TIME	REFERENCE RAMP	DECEL TIME		259	77
PAR 8	JOG SETPOINT	REFERENCE JOG	SETPOINT		246	6u
PAR 9	RUN STOP MODE	REFERENCE STOP	RUN STOP MODE		279	7r
PAR 99	PASSWORD	MMI ACCESS	PASSWORD		8	08

MMI Name	ASCII MMI Name	Function Block name	DSElite Name	Notes	TAG	ID
SET Menu (Setup)						
CTRL Menu (Control)						
SET\CTRL CL82	POS TORQUE LIMIT	TORQUE LIMIT	POS TORQUE LIM		1208	xk
SET\CTRL CL83	NEG TORQUE LIMIT	TORQUE LIMIT	NEG TORQUE LIM		1209	xl
SET\CTRL CL84	STALL TRIP TYPE	STALL TRIP	STALL LIMIT TYPE	F	1632	mY
SET\CTRL CL91	SPEED PROP GAIN	SPEED LOOP	SPEED PROP GAIN	F M	1187	wz
SET\CTRL CL92	SPEED INT TIME	SPEED LOOP	SPEED INT TIME	F M	1188	x0
SET\CTRL CL93	SPEED POS LIMIT	SPEED LOOP	SPEED POS LIM	F	1200	xc
SET\CTRL CL94	SPEED NEG LIMIT	SPEED LOOP	SPEED NEG LIM	F	1201	xd
IN Menu (Input)						
SET\IN IPD1	DIGIN 1 INVERT	DIGITAL INPUTS	INVERT 1		30	0u
SET\IN IPD2	DIGIN 2 INVERT	DIGITAL INPUTS	INVERT 2		33	0x
SET\IN IPD3	DIGIN 3 INVERT	DIGITAL INPUTS	INVERT 3		36	10
SET\IN IPD4	DIGIN 4 INVERT	DIGITAL INPUTS	INVERT 4		39	13
SET\IN IPD5	DIGIN 5 INVERT	DIGITAL INPUTS	INVERT 5		42	16
SET\IN IPD6	DIGIN 6 INVERT	DIGITAL INPUTS	INVERT 6		725	k5
SET\IN IPD7	DIGIN 7 INVERT	DIGITAL INPUTS	INVERT 7		727	k7
SET\IN IP11	ANIN 1 SCALE	ANALOG INPUT 1	SCALE		14	0e
SET\IN IP12	ANIN 1 OFFSET	ANALOG INPUT 1	OFFSET		15	0f
SET\IN IP13	ANIN 1 TYPE	ANALOG INPUT 1	TYPE		13	0d
SET\IN IP21	ANIN 2 SCALE	ANALOG INPUT 2	SCALE		23	0n
SET\IN IP22	ANIN 2 OFFSET	ANALOG INPUT 2	OFFSET		24	0o
SET\IN IP23	ANIN 2 TYPE	ANALOG INPUT 2	TYPE		22	0m
OUT Menu (Output)						
SET\OUT OPD1	DIGOUT 1 INVERT	DIGITAL OUTPUTS	INVERT 1		51	1f
SET\OUT OPD2	DIGOUT 2 INVERT	DIGITAL OUTPUTS	INVERT 2		54	1i
SET\OUT OPD3	RELAY INVERT	DIGITAL OUTPUTS	INVERT 3		736	kg
SET\OUT OP11	ANOUT 1 SCALE	ANALOG OUTPUT 1	SCALE		46	1a
SET\OUT OP12	ANOUT 1 OFFSET	ANALOG OUTPUT 1	OFFSET		47	1b
SET\OUT OP13	ANOUT 1 ABS	ANALOG OUTPUT 1	ABSOLUTE		48	1c
SET\OUT OP21	ANOUT 2 SCALE	ANALOG OUTPUT 2	SCALE		732	kc
SET\OUT OP22	ANOUT 2 OFFSET	ANALOG OUTPUT 2	OFFSET		733	kd
SET\OUT OP23	ANOUT 2 ABS	ANALOG OUTPUT 2	ABSOLUTE		734	ke
CONF Menu (Configuration)						
SET\CONF IPD1	DIGIN 1 DEST	APP CONFIG	DIGIN 1 DEST	F	310	8m
SET\CONF IPD2	DIGIN 2 DEST	APP CONFIG	DIGIN 2 DEST	F	311	8n
SET\CONF IPD3	DIGIN 3 DEST	APP CONFIG	DIGIN 3 DEST	F	312	8o
SET\CONF IPD4	DIGIN 4 DEST	APP CONFIG	DIGIN 4 DEST	F	313	8p
SET\CONF IPD5	DIGIN 5 DEST	APP CONFIG	DIGIN 5 DEST	F	314	8q
SET\CONF IPD6	DIGIN 6 DEST	APP CONFIG	DIGIN 6 DEST	F	315	8r
SET\CONF IPD7	DIGIN 7 DEST	APP CONFIG	DIGIN 7 DEST	F	316	8s

2-24 Parameter Specification

MMI Name	ASCII MMI Name	Function Block name	DSElite Name	Notes	TAG	ID
SET\CONF OPD1	DIGOUT 1 SOURCE	APP CONFIG	DIGIO 1 SOURCE	F		00
SET\CONF OPD2	DIGOUT 2 SOURCE	APP CONFIG	DIGIO 2 SOURCE	F	1094	ue
SET\CONF OPD3	RELAY SOURCE	APP CONFIG	RELAY SOURCE	F	1093	ud
SET\CONF OPA1	ANOUT 1 SOURCE	APP CONFIG	ANOUT 1 SOURCE	F	1092	uc
SET\CONF OPA2	ANOUT 2 SOURCE	APP CONFIG	ANOUT 2 SOURCE	F	1109	ut
TRIP Menu (Trips)						
SET\TRIP LOOP	4 TO 20 _{ma} LOOP	TRIPS STATUS	DISABLE TRIPS		231	6f
SET\TRIP T 3	ANIN 2 OVERLOAD	TRIPS STATUS	DISABLE TRIPS		231	6f
SET\TRIP STILL	MOTOR STALLED	TRIPS STATUS	DISABLE TRIPS		231	6f
SET\TRIP OT	MOTOR OVERTEMP	TRIPS STATUS	DISABLE TRIPS+		742	km
SET\TRIP IT	INVERSE TIME	TRIPS STATUS	DISABLE TRIPS		231	6f
SET\TRIP DB R	BRAKE RESISTOR	TRIPS STATUS	DISABLE TRIPS		231	6f
SET\TRIP DB S	BRAKE SWITCH	TRIPS STATUS	DISABLE TRIPS		231	6f
SET\TRIP SPD	SPEED FEEDBACK	TRIPS STATUS	DISABLE TRIPS		231	6f
SET\TRIP OSPD	OVERSPEED	TRIPS STATUS	DISABLE TRIPS+		742	km
SET\TRIP DISP	DISPLAY / KEYPAD	TRIPS STATUS	DISABLE TRIPS		231	6f
SET\TRIP DCRP	VDC RIPPLE	TRIPS STATUS	DISABLE TRIPS+	F	742	km
SERL Menu (Serial Communications)						
SET\SERL SE01	REMOTE COMMS SEL	COMMS CONTROL	REMOTE COMMS SEL	F	300	8c
SET\SERL SE02	COMMS TIMEOUT	COMMS CONTROL	COMMS TIMEOUT	F	309	8l
SET\SERL SE03	COMMS ADDRESS	COMMS PORTS	COMMS ADDRESS	F	103	2v
SET\SERL SE04	COMMS BAUD RATE	COMMS PORTS	BAUD RATE	F	1062	ti
SET\SERL SE05	COMMS PARITY	COMMS PORTS	PARITY	F	1061	th
SET\SERL SE06	REPLY DELAY _{ms}	COMMS PORTS	REPLY DELAY _{ms}	F	1260	z0
SET\SERL SE07	PROTOCOL, (OP)	COMMS PORTS	OP PORT PROTOCOL	F	1060	tg
SET\SERL SE08	PROTOCOL, (P3)	COMMS PORTS	P3 PORT PROTOCOL	F	1059	tf
SETP Menu (Setup)						
SET\SETP ST01	JOG ACCEL TIME	REFERENCE JOG	ACCEL TIME		261	79
SET\SETP ST02	JOG DECEL TIME	REFERENCE JOG	DECEL TIME		262	7a
SET\SETP ST03	RAMP TYPE	REFERENCE RAMP	RAMP TYPE		244	6s
SET\SETP ST04	S RAMP JERK	REFERENCE RAMP	SRAMP JERK 1		694	ja
SET\SETP ST05	S RAMP CONT	REFERENCE RAMP	SRAMP CONTINUOUS		691	j7
SET\SETP ST06	MIN SPEED MODE	MINIMUM SPEED	MODE		338	9e
SET\SETP ST11	SKIP FREQ 1	SKIP FREQUENCIES	FREQUENCY 1		342	9i
SET\SETP ST12	SKIP FREQ 1 BAND	SKIP FREQUENCIES	BAND 1		341	9h
SET\SETP ST13	SKIP FREQ 2	SKIP FREQUENCIES	FREQUENCY 2		343	9j
SET\SETP ST14	SKIP FREQ 2 BAND	SKIP FREQUENCIES	BAND 2		680	iw
SET\SETP ST21	AR ATTEMPTS	AUTO RESTART	ATTEMPTS		612	h0
SET\SETP ST22	AR DELAY	AUTO RESTART	ATTEMPT DELAY 1		613	h1
SET\SETP ST23	AR TRIGGERS	AUTO RESTART	TRIGGERS 1		609	gx
SET\SETP ST24	AR TRIGGERS+	AUTO RESTART	TRIGGERS 1+		744	ko
SET\SETP ST31	DB ENABLE	DYNAMIC BRAKING	ENABLE		80	28

MMI Name	ASCII MMI Name	Function Block name	DSElite Name	Notes	TAG	ID
SET\SETP ST32	DB RESISTANCE	DYNAMIC BRAKING	BRAKE RESISTANCE		77	25
SET\SETP ST33	DB POWER	DYNAMIC BRAKING	BRAKE POWER		78	26
SET\SETP ST34	DB OVER-RATING	DYNAMIC BRAKING	1 SEC OVER RATING		79	27
SET\SETP ST51	LOCAL MIN SPEED	REFERENCE	LOCAL MIN SPEED	F	251	6z
SET\SETP ST52	ENABLE D KEYS	DISPLAY/KEYPAD	ENABLED KEYS	F	127	3j
SET\SETP ST98	APPLICATION LOCK	APP CONFIG	APP LOCK	F	1064	tk
SET\SETP ST99	DETAILED MENUS	MMI ACCESS	DETAILED MENUS		878	oe
ENC Menu (Encoder)						
SET\ENC EN01	ENC MODE	ENCODER	MODE	F	565	fp
SET\ENC EN02	ENC RESET	ENCODER	RESET	F	747	kr
SET\ENC EN03	ENC INVERT	ENCODER	INVERT	F	567	fr
SET\ENC EN04	ENC LINES	ENCODER	LINES	F	566	fq
SET\ENC EN05	ENC SPEED SCALE	ENCODER	SPEED SCALE	F	110	32
SET\ENC EN06	ENC SPEED	ENCODER	SPEED	F	111	33
SET\ENC EN08	ENC SOURCE	ENCODER	SOURCE	F	1764	sA
SET\ENC EN09	ENC POS SCALE	ENCODER	POSITION SCALE	F	1765	sB
SET\ENC EN10	ENC MODULO	ENCODER	MODULO	F	1766	sC
SET\ENC EN11	ENC SPEED UNITS	ENCODER	SPEED UNITS	F	1767	sD
SET\ENC EN12	ENC POS UNITS	ENCODER	POSITION UNITS	F	1768	sE
SET\ENC EN13	ENC PRESET VALUE	ENCODER	PRESET VALUE	F	1787	sX
PAC1 Menu (PMAC Motor 1)						
SET\PAC1 PA01	NMAX M1	SV MOTOR DATA 1	MAX SPEED	M	1687	pB
SET\PAC1 PA02	IIMP M1	SV MOTOR DATA 1	MAX CURRENT	M	1688	pC
SET\PAC1 PA03	I0 M1	SV MOTOR DATA 1	PERM CURRENT	M	1689	pD
SET\PAC1 PA04	M0 M1	SV MOTOR DATA 1	PERM TORQUE	M	1690	pE
SET\PAC1 PA05	POLES M1	SV MOTOR DATA 1	POLES	M	1691	pF
SET\PAC1 PA06	KE M1	SV MOTOR DATA 1	BACK EMF	M	1692	pG
SET\PAC1 PA07	R M1	SV MOTOR DATA 1	R	M	1693	pH
SET\PAC1 PA08	L M1	SV MOTOR DATA 1	L	M	1694	pl
SET\PAC1 PA09	KT M1	SV MOTOR DATA 1	KT	M	1695	pJ
SET\PAC1 PA10	INERTIA M1	SV MOTOR DATA 1	INERTIA	M	1696	pK
SET\PAC1 PA11	INERTIA SCALE M1	SV MOTOR DATA 1	INERTIA SCALE	M	1697	pL
SET\PAC1 PA12	THERM TIME CST M1	SV MOTOR DATA 1	THERMAL TIME CST	M	1698	pM
SET\PAC1 PA13	I BANDWIDTH M1	SV MOTOR DATA 1	CUR LOOP BWDTH	M	1699	pN
SET\PAC1 PA14	I INT FREQ M1	SV MOTOR DATA 1	INTEGRAL FREQ	M	1700	pO
SET\PAC1 PA15	SELECT MOTOR 1	SV MOTOR DATA 1	SELECT MOTOR 1	M	1701	pP
PAC2 Menu (PMAC Motor 2)						
SET\PAC2 PA51	NMAX M2	SV MOTOR DATA 2	MAX SPEED	M	1702	pQ
SET\PAC2 PA52	IIMP M2	SV MOTOR DATA 2	MAX CURRENT	M	1703	pR
SET\PAC2 PA53	I0 M2	SV MOTOR DATA 2	PERM CURRENT	M	1704	pS
SET\PAC2 PA54	M0 M2	SV MOTOR DATA 2	PERM TORQUE	M	1705	pT
SET\PAC2 PA55	POLES M2	SV MOTOR DATA 2	POLES	M	1706	pU

2-26 Parameter Specification

MMI Name	ASCII MMI Name	Function Block name	DSElite Name	Notes	TAG	ID
SET\PAC2 PA56	KE M2	SV MOTOR DATA 2	BACK EMF	M	1707	pV
SET\PAC2 PA57	R M2	SV MOTOR DATA 2	R	M	1708	pW
SET\PAC2 PA58	L M2	SV MOTOR DATA 2	L	M	1709	pX
SET\PAC2 PA59	KT M2	SV MOTOR DATA 2	KT	M	1710	pY
SET\PAC2 PA60	INERTIA M2	SV MOTOR DATA 2	INERTIA	M	1711	pZ
SET\PAC2 PA61	INERTIA SCALE M2	SV MOTOR DATA 2	INERTIA SCALE	M	1712	qA
SET\PAC2 PA62	THERM TIME CST M2	SV MOTOR DATA 2	THERMAL TIME CST	M	1713	qB
SET\PAC2 PA63	I BANDWIDTH M2	SV MOTOR DATA 2	CUR LOOP BWDTH	M	1714	qC
SET\PAC2 PA64	I INT FREQ M2	SV MOTOR DATA 2	INTEGRAL FREQ	M	1715	qD
SCP1 Menu (PMAC SV M1)						
SET\SCP1 SC01	TRIP INHIBIT	SV MOTOR CTRL 1	TRIP INHIBIT		1717	qF
SET\SCP1 SC02	LPF SPEED M1	SV MOTOR CTRL 1	LPF SPEED		1718	qG
SET\SCP1 SC03	PI GAIN M1	SV MOTOR CTRL 1	PI GAIN		1719	qH
SET\SCP1 SC04	PI INTEGRAL M1	SV MOTOR CTRL 1	PI INTEGRAL		1720	qI
SET\SCP1 SC05	SPD THRESHOLD M1	SV MOTOR CTRL 1	SPD THRESHOLD		1721	qJ
SET\SCP1 SC06	SPD START GRD M1	SV MOTOR CTRL 1	SPD START GRD		1722	qK
SET\SCP1 SC07	SPD END GRD M1	SV MOTOR CTRL 1	SPD END GRD	F	1723	qL
SET\SCP1 SC08	SPD GRD M1	SV MOTOR CTRL 1	SPD GRD		1724	qM
SET\SCP1 SC09	KE START GRD M1	SV MOTOR CTRL 1	KE START GRD		1725	qN
SET\SCP1 SC10	KE END GRD M1	SV MOTOR CTRL 1	KE END GRD		1726	qO
SET\SCP1 SC11	KE SPD M1	SV MOTOR CTRL 1	KE SPD		1727	qP
SET\SCP1 SC12	ENABLE STARTUP	SV MOTOR CTRL 1	ENABLE STARTUP		1728	qQ
SET\SCP1 SC13	STARTUP TIME	SV MOTOR CTRL 1	STARTUP TIME		1729	qR
SET\SCP1 SC14	STARTUP CURRENT	SV MOTOR CTRL 1	STARTUP CURRENT		1730	qS
SET\SCP1 SC15	STARTUP SPEED	SV MOTOR CTRL 1	STARTUP SPEED		1731	qT
SCP2 Menu (PMAC SV M2)						
SET\SCP2 SC51	TRIP INHIBIT	SV MOTOR CTRL 2	TRIP INHIBIT		1732	qU
SET\SCP2 SC52	LPF SPEED M2	SV MOTOR CTRL 2	LPF SPEED		1733	qV
SET\SCP2 SC53	PI GAIN M2	SV MOTOR CTRL 2	PI GAIN		1734	qW
SET\SCP2 SC54	PI INTEGRAL M2	SV MOTOR CTRL 2	PI INTEGRAL		1735	qX
SET\SCP2 SC55	SPD THRESHOLD M2	SV MOTOR CTRL 2	SPD THRESHOLD		1736	qY
SET\SCP2 SC56	SPD START GRD M2	SV MOTOR CTRL 2	SPD START GRD		1737	qZ
SET\SCP2 SC57	SPD END GRD M2	SV MOTOR CTRL 2	SPD END GRD	F	1738	rA
SET\SCP2 SC58	SPD GRD M2	SV MOTOR CTRL 2	SPD GRD		1739	rB
SET\SCP2 SC59	KE START GRD M2	SV MOTOR CTRL 2	KE START GRD		1740	rC
SET\SCP2 SC60	KE END GRD M2	SV MOTOR CTRL 2	KE END GRD		1741	rD
SET\SCP2 SC61	KE SPD M2	SV MOTOR CTRL 2	KE SPD		1742	rE
SET\SCP2 SC62	ENABLE STARTUP	SV MOTOR CTRL 2	ENABLE STARTUP		1743	rF
SET\SCP2 SC63	STARTUP TIME	SV MOTOR CTRL 2	STARTUP TIME		1744	rG
SET\SCP2 SC64	STARTUP CURRENT	SV MOTOR CTRL 2	STARTUP CURRENT		1745	rH
SET\SCP2 SC65	STARTUP SPEED	SV MOTOR CTRL 2	STARTUP SPEED		1746	rI
IPPA Menu (PMAC Drive Protect)						

MMI Name	ASCII MMI Name	Function Block name	DSElite Name	Notes	TAG	ID
SET\IPPA IP01	AIMING POINT	INVERS TIME PMAC	AIMING POINT		1747	rJ
SET\IPPA IP02	DELAY	INVERS TIME PMAC	DELAY		1748	rK
SET\IPPA IP03	DOWN RATE	INVERS TIME PMAC	DOWN TIME		1749	rL
SET\IPPA IP04	UP RATE	INVERS TIME PMAC	UP TIME		1750	rM
SET\IPPA IP05	LIMITING	INVERS TIME PMAC	IT LIMITING		1751	rN
SET\IPPA IP06	OUTPUT	INVERS TIME PMAC	INVERSE TIME OP		1752	rO
SET\IPPA IP07	WARNING	INVERS TIME PMAC	IT WARNING		1753	rP
I2PM Menu (PMAC MOT Protect)						
SET\I2PM 2P01	I2T INHIBIT	MOT PMAC PROTECT	I2T INHIBIT		1754	rQ
SET\I2PM 2P02	I2T LIMIT MOTOR	MOT PMAC PROTECT	I2T LIMIT MOTOR		1755	rR
SET\I2PM 2P03	I2T MOTOR LOAD	MOT PMAC PROTECT	I2T MOTOR LOAD		1756	rS
SET\I2PM 2P04	I2T MOTOR TRIP	MOT PMAC PROTECT	I2T MOTOR TRIP		1757	rT
POLM Menu (MOT Polarisation)						
SET\POLM PO01	POLARISATION	SV MOTOR POL	POLARISATION		1758	rU
SET\POLM PO02	POLAR START	SV MOTOR POL	POLAR START		1759	rV
SET\POLM PO03	MOTOR PHASE	SV MOTOR POL	MOTOR PHASE		1760	rW
SET\POLM PO04	CURRENT	SV MOTOR POL	CURRENT		1761	rX
POS Menu (POSITION)						
SET\POS PS01	START	POSITION	START		1769	sF
SET\POS PS02	ABORT	POSITION	ABORT		1770	sG
SET\POS PS03	TARGET	POSITION	TARGET		1771	sH
SET\POS PS04	TYPE	POSITION	TYPE		1772	sI
SET\POS PS05	DIRECTION	POSITION	DIRECTION		1773	sJ
SET\POS PS06	MAX SPEED	POSITION	MAX SPEED		1774	sK
SET\POS PS07	WINDOW	POSITION	POS WINDOW		1775	sL
SET\POS PS08	REDUCED SPEED	POSITION	REDUCED SPEED		1776	sM
SET\POS PS09	REDUCED WINDOW	POSITION	REDUCED WINDOW		1777	sN
SET\POS PS10	GAIN	POSITION	GAIN		1778	sO
SET\POS PS11	MARK INPUT	POSITION	MARK INPUT		1779	sP
SET\POS PS12	ACTIVE	POSITION	ACTIVE		1780	sQ
SET\POS PS13	LOCKED	POSITION	LOCKED		1781	sR
SET\POS PS14	TARGET REACHED	POSITION	TARGET REACHED		1782	sS
SET\POS PS15	MARK POSITION	POSITION	MARK POSITION		1783	sT
SET\POS PS19	PRESET ON MARK	POSITION	PRESET ON MARK		1788	sY
FLY Menu (FLYCATCHING PMAC)						
SET\FLY FL01	VECTOR ENABLE	FLYCATCHING PMAC	VECTOR ENABLE		1789	sZ
SET\FLY FL05	ACTIVE	FLYCATCHING PMAC	ACTIVE		1793	tD
SET\FLY FL07	SETPOINT	FLYCATCHING PMAC	SETPOINT		1794	tE

Product-Related Default Values

All examples given in this book are based on a UK, 400V, 50Hz, 11kW drive.

* Frequency Dependent Defaults

These parameter values (marked with “*” in function block descriptions and Application diagrams) are dependent upon the drive’s “default frequency”.

Changing the “default frequency” parameter from 50Hz to 60Hz, and vice versa, causes the values of the parameters in the table below to be changed.

To change the “default frequency”, power-down the drive. Power-up the drive holding down the STOP and DOWN keys on the keypad. Release the keys to display the ° 0.01 parameter.

Caution

You are now in a menu containing some sensitive and important parameters.

Press the UP key to display the ° 0.02 parameter. Press the M key. The values for this parameter are: 0 = 50Hz default, 1 = 60Hz default. Select the setting using the UP/DOWN keys and then press the E key. Power-down the drive and power-up again holding down the UP and DOWN keys. This resets **ALL** parameters to their correct default values, including Motor Parameters.

Frequency Dependent Defaults					
Display	Parameter	Function Block	Tag	50Hz Operation	60Hz Operation
P 2	MAX SPEED	REFERENCE	57	50Hz	60Hz
# The correct value is selected for the size of drive - refer to the Power Dependent Parameters table below					
* The correct value is selected for the drive, however, when 60Hz is selected the 400V unit = 460V					

**** Power Dependent Defaults**

These parameters (marked with “***” in function block descriptions and Application diagrams) are set to a value depending on the drive's overall “power-build” indicated by the Product Code. We recommend that you do not change the Product Code.

230V Build Power Dependent Defaults			Frame 1	Frame 2
Parameter	Function Block	Tag	0.75kW	1.5kW
ACCEL TIME	REFERENCE RAMP	258	10.0 s	10.0 s
DECEL TIME	REFERENCE RAMP	259	10.0 s	10.0 s
SPEED INT TIME	SPEED LOOP	1188	500. ms	500. ms
BRAKE RESISTANCE	DYNAMIC BRAKING	77	1000	1000

400V Build Power Dependent Defaults			Frame 2	
Parameter	Function Block	Tag	0.75kW	2.2kW
ACCEL TIME	REFERENCE RAMP	258	10.0 s	10.0 s
DECEL TIME	REFERENCE RAMP	259	10.0 s	10.0 s
SPEED INT TIME	SPEED LOOP	1188	500. ms	500. ms
BRAKE RESISTANCE	DYNAMIC BRAKING	77	1000	1000

400V Build Power Dependent Defaults			Frame 3	
Parameter	Function Block	Tag	4.0 kW	7.5 kW
ACCEL TIME	REFERENCE RAMP	258	10.0 s	10.0 s
DECEL TIME	REFERENCE RAMP	259	10.0 s	10.0 s
SPEED INT TIME	SPEED LOOP	1188	500. ms	500. ms
BRAKE RESISTANCE	DYNAMIC BRAKING	77	1000	1000

Chapter 3 **SERIAL COMMUNICATIONS**

Serial Communications	3-1
Communications Technology Options	3-1
DSE Lite	3-1
Connection to the P3 Port	3-1

Serial Communications

Communications Technology Options

These options provide a serial data port allowing drives to be linked to form a network. Using a PLC/SCADA or other intelligent device, this network can be continuously controlled to provide supervision and monitoring for each drive in the system. The Communication Modules fit to the front of the drive, replacing the keypad.

The options available are:

- RS232/RS485 Communication Module
- Profibus, (DPV0) Communication Module

Refer to the Communications Interface Technical Manual for further details.

DSE Lite

This is Parker SSD Drives' Windows-based block programming software. It has a graphical user-interface and drawing tools to allow you to create block programming diagrams quickly and easily. Contact your local Parker SSD Drives sales office.

Connection to the P3 Port

The port is an un-isolated RS232, 19200 Baud, supporting the standard EI bisynch ASCII communications protocol. Contact SSD Drives for further information.

Using the P3 port on the drive, parameters can be monitored and updated by a suitable PC programming tool, i.e. DSE Lite.

P3 Port

A standard P3 lead is used to connect to the drive.

P3 Port Pin	Lead	Signal
1	Black	0V
2	Red	5V
3	Green	TX
4	Yellow	RX

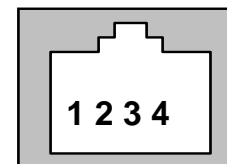

3-2 Serial Communications

6-Way Lead to DB9/DB25 Connector

Note: *There is 5V present on pin 2 of the P3 port - do not connect this to your PC.*

P3 Port Pin	Lead	Female DB9 Pin	Female DB25 Pin
1	Black	5	7
2	Red	not connected	not connected
3	Green	2	3
4	Yellow	3	2

Chapter 4 **SEQUENCING LOGIC**

Sequencing Logic States	4-1
Principle State Machine.....	4-1
Main Sequencing States.....	4-1
State Outputs of the SEQUENCING LOGIC Function Block.....	4-2
Transition of States	4-3
State Diagram.....	4-4
External Control of the Drive	4-5
Communications Command	4-5
Communications Status	4-8

Sequencing Logic States

Principle State Machine

The drive's reaction to commands is defined by a state machine. This determines which commands provide the demanded action, and in which sequence.

Main Sequencing States

The main sequencing state of the unit is indicated by an enumerated value given by the parameter SEQUENCER STATE under SEQUENCING LOGIC menu at level 3.

Enumerated Value	Main Seq State	Standard Name	Description
0	START DISABLED	Switch On Disabled	The Inverter will not accept a switch on command
1	START ENABLED	Ready To Switch On	The Inverter will accept a switch on command
2	SWITCHED ON	Switched On	The Inverter's stack is enabled
3	READY	Ready	Waiting for Contactor to be closed
4	ENABLED	Enabled	The Inverter is enabled and operational
5	F-STOP ACTIVE	Fast-Stop Active	Fast stop is active
6	TRIP ACTIVE	Trip Active	The Inverter is processing a trip event
7	TRIPPED	Tripped	The Inverter is tripped awaiting trip reset

Table 4-1 Enumerated Values for the SEQUENCING LOGIC Function Block

4-2 Sequencing Logic

State Outputs of the SEQUENCING LOGIC Function Block

The following table shows the states of individual parameters for the SEQUENCING LOGIC function block required to produce the condition of the MAIN SEQ STATE parameter.

	START DISABLED	START ENABLED	SWITCHED ON	READY	ENABLED	F-STOP ACTIVE	TRIP ACTIVE	TRIPPED
Tripped	FALSE	FALSE	FALSE	FALSE	FALSE	FALSE	TRUE	TRUE
Running	FALSE	FALSE	FALSE	FALSE	TRUE	FALSE	FALSE	FALSE
Jogging	FALSE	FALSE	FALSE	FALSE	Note 1	FALSE	FALSE	FALSE
Stopping	FALSE	FALSE	FALSE	FALSE	Note 2	TRUE	FALSE	FALSE
Output Contactor	Depends on previous state	Depends on previous state	TRUE	TRUE	TRUE	TRUE	TRUE	FALSE
Switch On Enable	FALSE	TRUE	TRUE	TRUE	TRUE	TRUE	TRUE	FALSE
Switched On	FALSE	FALSE	TRUE	TRUE	TRUE	TRUE	TRUE	FALSE
Ready	FALSE	FALSE	FALSE	TRUE	TRUE	TRUE	TRUE	FALSE
Healthy	TRUE	TRUE	TRUE	TRUE	TRUE	TRUE	FALSE	FALSE Note 3

Table 4-2 Parameter States for the MAIN SEQ STATE Parameter

- Note:**
- JOGGING* is set **TRUE** once the jog cycle has started, and remains **TRUE** until the jog cycle has finished which is when either the stop delay has finished or another mode is demanded.
 - STOPPING* is set **TRUE** during the stopping cycles commanded by either *RUNNING* going low, *JOGGING* going low or if Fast Stop is active, i.e. *SEQUENCING LOGIC* is **F-STOP ACTIVE**.
 - Once Run and Jog are both **FALSE**, *HEALTHY O/P* will be set **TRUE**.

Transition of States

The transition matrix describes what causes the transition from one state to another, for example see no. 4 below: the transition from “Ready To Switch On” to “Trip Active” is triggered by “TRIP” going TRUE. Note – where a state has more than one exit transition, the transition with the lowest number has priority.

Refer to the following table and state diagram.

	Current State	Next State	Cause (FALSE to TRUE)
1	Power Up	Switch On Disabled	Power-Up, Restore Configuration or exit from Configuration mode.
2	Switch On Disabled	Trip Active	Trip
3	Switch On Disabled	Ready To Switch On	RUN = FALSE, JOG = FALSE, NOT FAST STOP = TRUE and NOT COAST STOP = TRUE
4	Ready To Switch On	Trip Active	Trip
5	Ready To Switch On	Switch On Disabled	NOT COAST STOP = FALSE or NOT FAST STOP = FALSE
6	Ready To Switch On	Switched On	RUN = TRUE or JOG = TRUE
7	Switched On	Trip Active	Trip (includes CONTACTOR CLOSED = FALSE after 10 seconds)
8	Switched On	Switch On Disabled	NOT COAST STOP = FALSE or NOT FAST STOP = FALSE
9	Switched On	Ready To Switch On	RUN = FALSE and JOG = FALSE
10	Switched On	Ready	CONTACTOR CLOSED = TRUE and defluxed
11	Ready	Trip Active	Trip (includes CONTACTOR CLOSED = FALSE)
12	Ready	Switch On Disabled	NOT COAST STOP = FALSE or NOT FAST STOP = FALSE
13	Ready	Ready To Switch On	RUN = FALSE and JOG = FALSE
14	Ready	Enabled	ENABLE = TRUE
15	Enabled	Trip Active	Trip (includes CONTACTOR CLOSED = FALSE)
16	Enabled	Switch On Disabled	NOT COAST STOP = FALSE
17	Enabled	Fast Stop Active	NOT FAST STOP = FALSE
18	Enabled	Ready To Switch On	RUN = FALSE, JOG = FALSE and stopping complete
19	Enabled	Ready	ENABLE = FALSE
20	Fast Stop Active	Trip Active	Trip (includes CONTACTOR CLOSED = FALSE)
21	Fast Stop Active	Switch On Disabled	Fast Stop timer expired or FAST STOP MODE = Coast Stop OR Inverter at zero setpoint
22	Trip Active	Tripped	Stack quenched
23	Tripped	Switch On Disabled	Trip = FALSE and TRIP RESET 0->1 transition

Table 4-3 Transition Matrix

4-4 Sequencing Logic

State Diagram

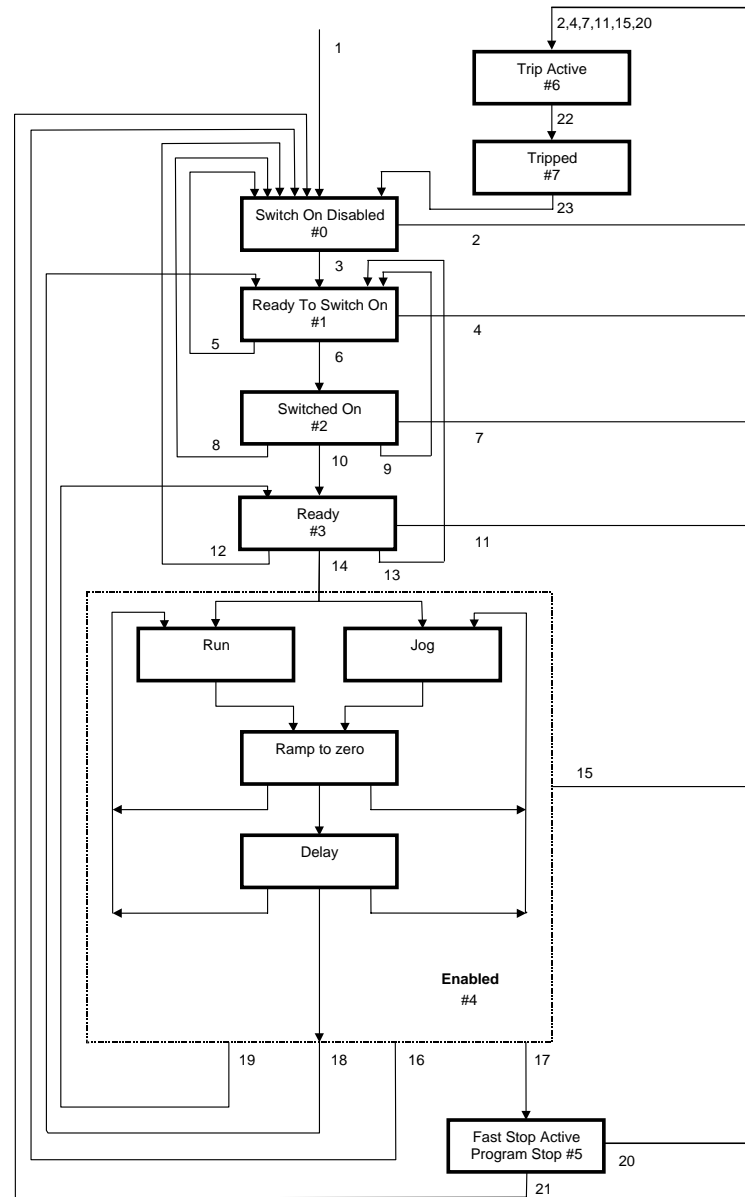

External Control of the Drive

Communications Command

When sequencing is in the Remote Comms mode, the sequencing of the Inverter is controlled by writing to the hidden parameter COMMS COMMAND (Tag 271). This parameter can only be written to using a communications interface. The output parameter (Tag 273) COMMS COMMAND of the COMMS CONTROL function block is provided as a diagnostic.

The COMMS COMMAND parameter is a 16-bit word based on standard fieldbus drive profiles. Some bits are not implemented in this release (see “Supported” column of the table below).

Bit	Name	Description	Supported	Required Value
0	Switch On	OFF1 Operational	✓	
1	(Not) Disable Voltage	OFF2 Coast Stop	✓	
2	(Not) Quick Stop	OFF3 Fast Stop	✓	
3	Enable Operation		✓	
4	Enable Ramp Output	=0 to set ramp output to zero		1
5	Enable Ramp	=0 to hold ramp		1
6	Enable Ramp Input	=0 to set ramp input to zero		1
7	Reset Fault	Reset on 0 to 1 transition	✓	
8				0
9				0
10	Remote	=1 to control remotely		1
11				0
12				0
13				0
14				0
15				0

4-6 Sequencing Logic

Switch On

Replaces the RUN FWD, RUN REV and NOT STOP parameters of the SEQUENCING LOGIC function block. When Set (=1) is the same as:

RUN FWD	=	TRUE
RUN REV	=	FALSE
NOT STOP	=	FALSE

When Cleared (= 0) is the same as:

RUN FWD	=	FALSE
RUN REV	=	FALSE
NOT STOP	=	FALSE

(Not) Disable Voltage

ANDed with the NOT COAST STOP parameter of the SEQUENCING LOGIC function block.

When both Set (=1) is the same as:

NOT COAST STOP	=	TRUE
----------------	---	------

When either or both Cleared (= 0) is the same as :

NOT COAST STOP	=	FALSE
----------------	---	-------

(Not) Quick Stop

ANDed with the NOT FAST STOP parameter on the SEQUENCING LOGIC function block.

When both Set (=1) is the same as:

NOT FAST STOP	=	TRUE
---------------	---	------

When either or both Cleared (= 0) is the same as :

NOT FAST STOP	=	FALSE
---------------	---	-------

Enable Operation

ANDed with the DRIVE ENABLE parameter on the SEQUENCING LOGIC function block.

When both Set (=1) is the same as:

DRIVE ENABLE	=	TRUE
--------------	---	------

When either or both Cleared (= 0) is the same as:

DRIVE ENABLE	=	FALSE
--------------	---	-------

Enable Ramp Output, Enable Ramp, Enable Ramp Input

Not implemented. The state of these bits must be set (=1) to allow this feature to be added in the future.

Reset Fault

Replaces the REM TRIP RESET parameter on the SEQUENCING LOCIC function block. When Set (=1) is the same as:

REM TRIP RESET = TRUE

When Cleared (= 0) is the same as :

REM TRIP RESET = FALSE

Remote

Not implemented. It is intended to allow the PLC to toggle between local and remote. The state of this must be set (=1) to allow this feature to be added in the future.

Example Commands

047F hexadecimal to RUN

047E hexadecimal to STOP

4-8 Sequencing Logic

Communications Status

The COMMS STATUS parameter (Tag 272) in the COMMS CONTROL function block monitors the sequencing of the Inverter. It is a 16-bit word based on standard fieldbus drive profiles. Some bits are not implemented in the initial release and are set to 0 (see “Supported” column of the table below).

Bit	Name	Description	Supported
0	Ready To Switch On		✓
1	Switched On	Ready for operation (refer control bit 0)	✓
2	Operation Enabled	(refer control bit 3)	✓
3	Fault	Tripped	✓
4	(Not) Voltage Disabled	OFF 2 Command pending	✓
5	(Not) Quick Stop	OFF 3 Command pending	✓
6	Switch On Disable	Switch On Inhibited	✓
7	Warning		
8	SP / PV in Range		
9	Remote	= 1 if Drive will accept Command Word	✓
10	Setpoint Reached	The input is True if the system ramp output matches the demanded setpoint.	✓
11	Internal Limit Active	This input is True if the internal current limit is active.	✓
12			
13			
14			
15			

Ready To Switch On

Same as the SWITCH ON ENABLE output parameter of the SEQUENCING LOGIC function block.

Switched On

Same as the SWITCHED ON output parameter of the SEQUENCING LOGIC function block.

Operation Enabled

Same as the RUNNING output parameter of the SEQUENCING LOGIC function block.

Fault

Same as the TRIPPED output parameter of the SEQUENCING LOGIC function block.

(Not) Voltage Disabled

If in Remote Comms mode, this is the same as Bit 1 of the COMMS COMMAND parameter. Otherwise it is the same as the NOT COAST STOP input parameter of the SEQUENCING LOGIC function block.

(Not) Quick Stop

If in Remote Comms mode, this is the same as Bit 2 of the COMMS COMMAND parameter. Otherwise it is the same as the NOT FAST STOP input parameter of the SEQUENCING LOGIC function block.

Switch On Disable

Set (=1) only when in START DISABLED state, refer to Table 4-1.

Remote

This bit is set (= 1) if the Inverter is in Remote mode **AND** the parameter REMOTE COMMS SEL of the COMMS CONTROL function block is Set (= 1).

4-10 Sequencing Logic

Chapter 5 **APPLICATIONS**

|

Applications	5-1
The Default Application	5-1
How to Load an Application.....	5-1
Application Description.....	5-1
Application 1: Basic Speed Control (default)	5-2
Application 2: Auto/Manual Control.....	5-4
Application 3: Preset Speeds	5-6
Application 4: Raise/Lower Trim.....	5-8
Application 5: PID	5-10

Applications

The Default Application

The drive is supplied with 6 Applications, Application 0 to Application 5. Each Application recalls a pre-programmed set of parameters and internal links when it is loaded.

DEFAULT

- Application 0 will not control a motor. Loading Application 0 removes all internal links.
- Application 1 is the factory default application, providing for basic speed control
- Application 2 supplies speed control using a manual or auto setpoint
- Application 3 supplies speed control using preset speeds
- Application 4 is a set-up providing speed control with Raise/Lower Trim digital inputs
- Application 5 supplies speed control with PID control

How to Load an Application

The Applications are stored in the **PAR** menu.

From the **PAR** menu, go to parameter **P I** by pressing the **M** key twice.

Use the **▲** **▼** keys to select the appropriate Application by number.

Press the **E** key to load the Application.

Application Description

Note: Parameters whose default values are product-related are indicated in the block diagrams with * or **. Refer to Chapter 2: "Parameter Specification" - Product-Related Default Values.

5-2 Applications

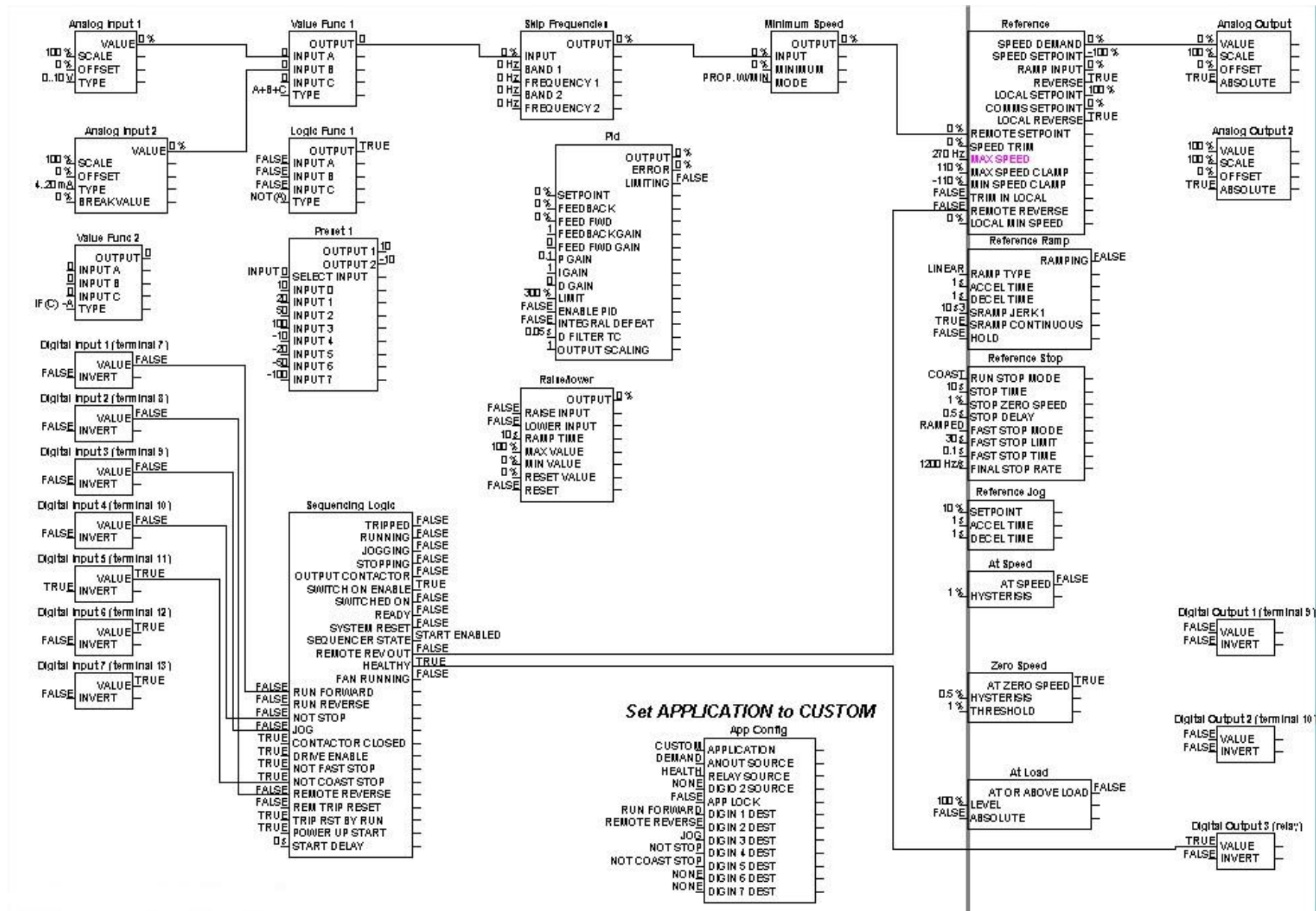

Application 1: Basic Speed Control (default)

Application 1: Basic Speed Control (default)

This Application is ideal for general purpose applications. It provides push-button or switched start/stop control. The setpoint is the sum of the two analogue inputs AIN1 and AIN2, providing Speed Setpoint + Speed Trim capability.

Control Wiring I/O			
Terminal	Name	Purpose	Comment
13	DIGITAL INPUT 7	<i>Not configured</i>	<i>Not Used</i>
11	DIGITAL INPUT 5	Not Coast Stop (inverted)	24V = coast to stop 0V = drive may run
10	DIGITAL INPUT 4	Not Stop	24V = RUN FWD and RUN REV signals latched 0V = RUN FWD and RUN REV signals not latched
9	DIGITAL INPUT 3	Jog	24V = jog
8	DIGITAL INPUT 2	Direction	0V = remote forward 24V = remote reverse
7	DIGITAL INPUT 1	Run Forward	24V = run forward
5	ANALOG OUTPUT 1	Ramp Output	absolute speed demand 0V = 0%, 10V = 100%
3	ANALOG INPUT 2	Speed Trim	4mA = 0%, 20mA = 100%
2	ANALOG INPUT 1	Speed Setpoint	0V = 0%, 10V = 100%
RL1A RL1B	DIGITAL OUTPUT 3 (relay)	HEALTH	Open = tripped, i.e. not healthy

5-4 Applications

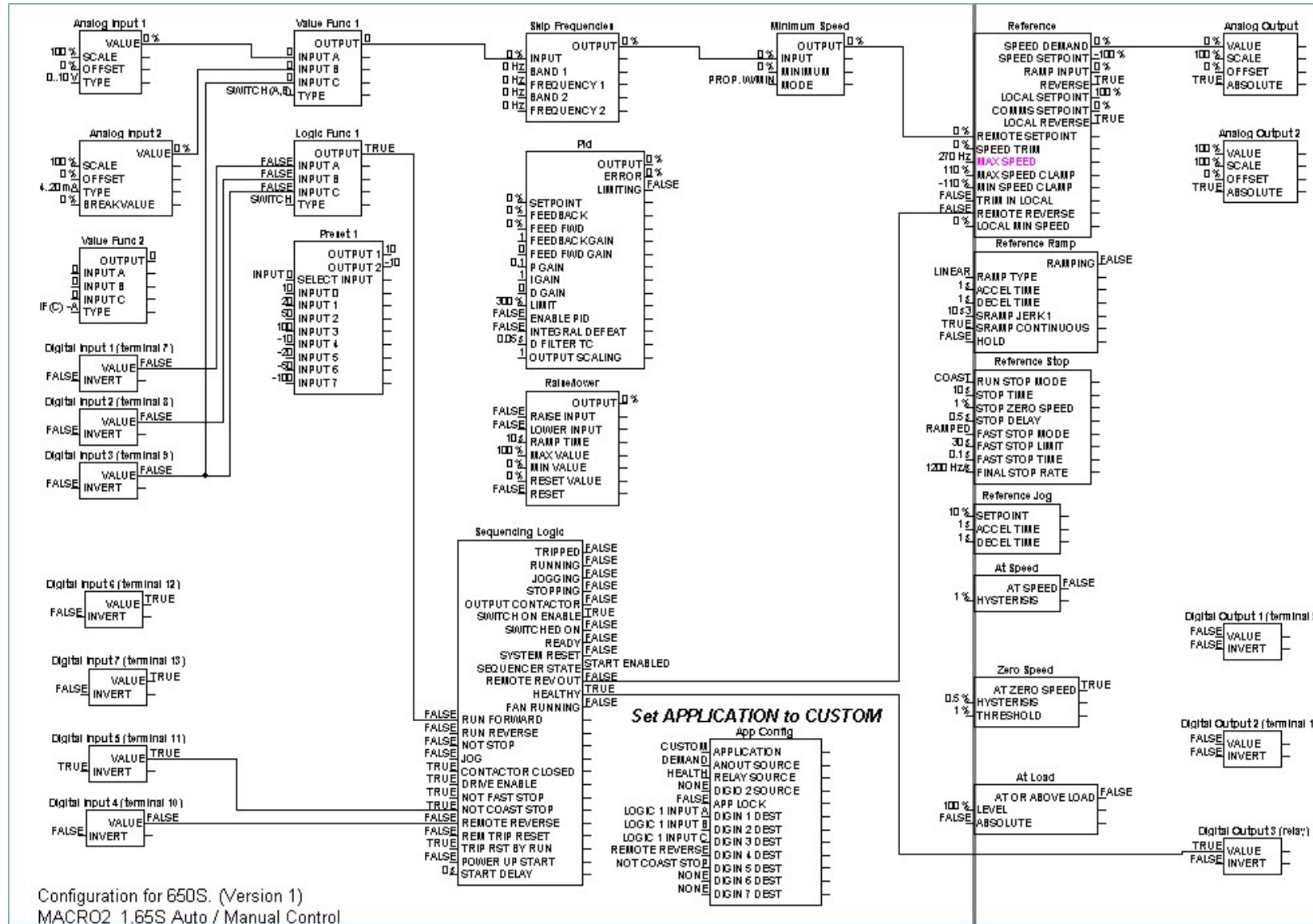

Application 2: Auto/Manual Control

Application 2: Auto/Manual Control

Two Run inputs and two Setpoint inputs are provided. The Auto/Manual switch selects which pair of inputs is active.

The Application is sometimes referred to as Local/Remote.

Control Wiring I/O			
Terminal	Name	Purpose	Comment
12	DIGITAL INPUT 6	<i>Not configured</i>	<i>Not Used</i>
11	DIGITAL INPUT 5	Not Coast Stop (inverted)	24V = coast to stop 0V = drive may run
10	DIGITAL INPUT 4	Remote Reverse	0V = remote forward 24V = remote reverse
9 8 7	DIGITAL INPUT 3 DIGITAL INPUT 2 DIGITAL INPUT 1	Select Auto Run Manual Run	24V = run forward
5	ANALOG OUTPUT 1	Ramp Output	absolute speed demand 0V = 0%, 10V = 100%
3	ANALOG INPUT 2	Auto Setpoint	4mA = 0%, 20mA = 100%
2	ANALOG INPUT 1	Manual Setpoint	0V = 0%, 10V = 100%
RL1A RL1B	DIGITAL OUTPUT 3 (relay)	HEALTH	Open = tripped, i.e. not healthy

5-6 Applications

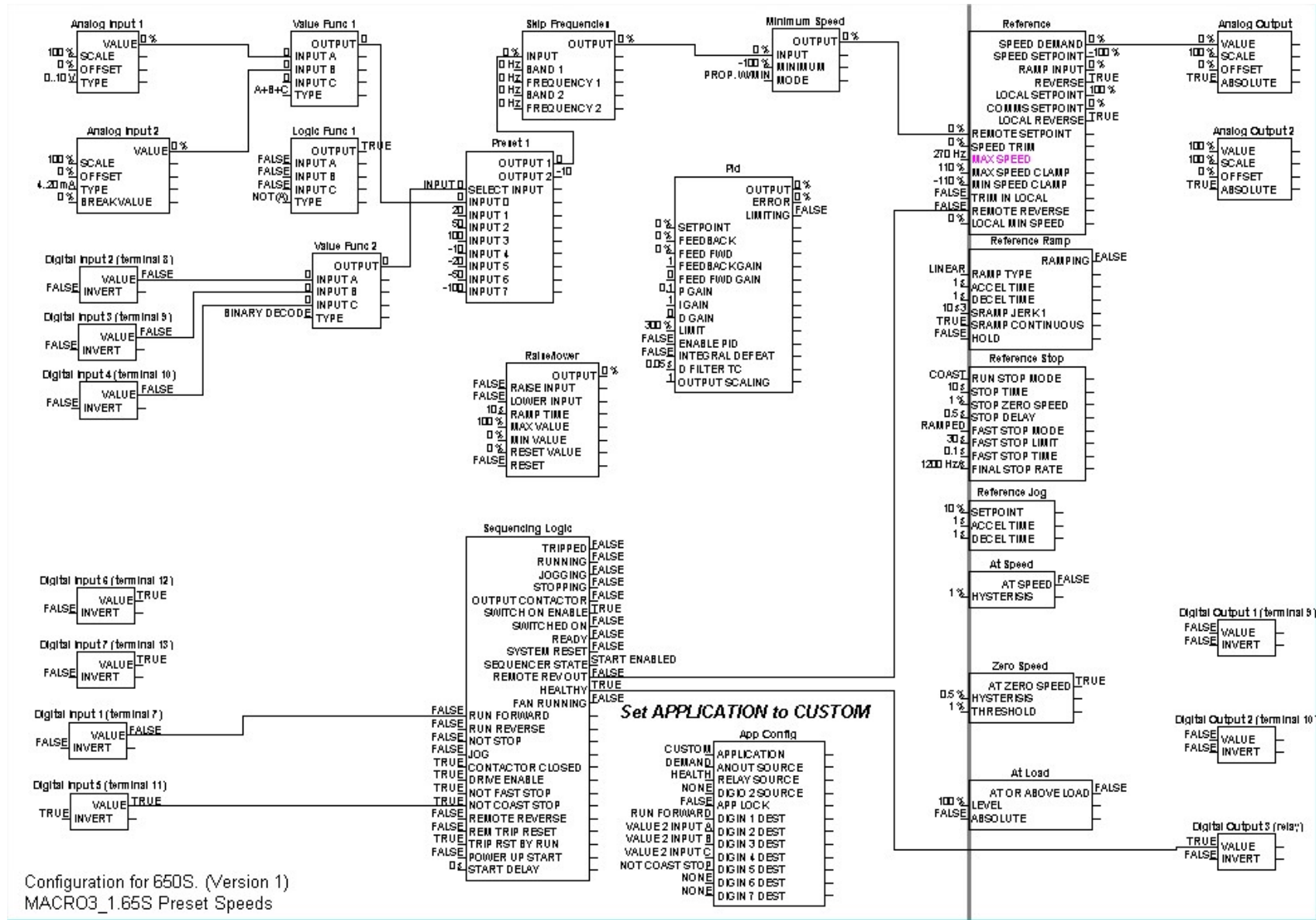

Application 3: Preset Speeds

Application 3: Preset Speeds

This is ideal for applications requiring multiple discrete speed levels.

The setpoint is selected from either the sum of the analogue inputs, (as in Application 1 and known here as PRESET 0), or as one of up to seven other pre-defined speed levels. These are selected using DIN2, DIN3 and DIN4, refer to the Truth Table below.

Edit parameters P₃₀₂ to P₃₀₈ on the keypad to re-define the speed levels of PRESET 1 to PRESET 7. Reverse direction is achieved by entering a negative speed setpoint.

Control Wiring I/O			
Terminal	Name	Purpose	Comment
13	DIGITAL INPUT 7	<i>Not configured</i>	<i>Not Used</i>
12	DIGITAL INPUT 6	<i>Not configured</i>	<i>Not Used</i>
11	DIGITAL INPUT 5	Not Coast Stop (inverted)	24V = coast to stop 0V = drive may run
10 9 8	DIGITAL INPUT 4 DIGITAL INPUT 3 DIGITAL INPUT 2	Preset Select 3 Preset Select 2 Preset Select 1	Preset Speed Select Preset Speed Select Preset Speed Select
7	DIGITAL INPUT 1	Run Forward	24V = run forward
5	ANALOG OUTPUT 1	Ramp Output	absolute speed demand 0V = 0%, 10V = 100%
3	ANALOG INPUT 2	Speed Trim	4mA = 0%, 20mA = 100%
2	ANALOG INPUT 1	Speed Setpoint	0V = 0%, 10V = 100%
RL1A RL1B	DIGITAL OUTPUT 3 (relay)	HEALTH	Open = tripped, i.e. not healthy

Preset Speed Truth Table

DIN4/DOU2	DIN3	DIN2	Preset
0V	0V	0V	0
0V	0V	24V	1
0V	24V	0V	2
0V	24V	24V	3
24V	0V	0V	4
24V	0V	24V	5
24V	24V	0V	6
24V	24V	24V	7

5-8 Applications

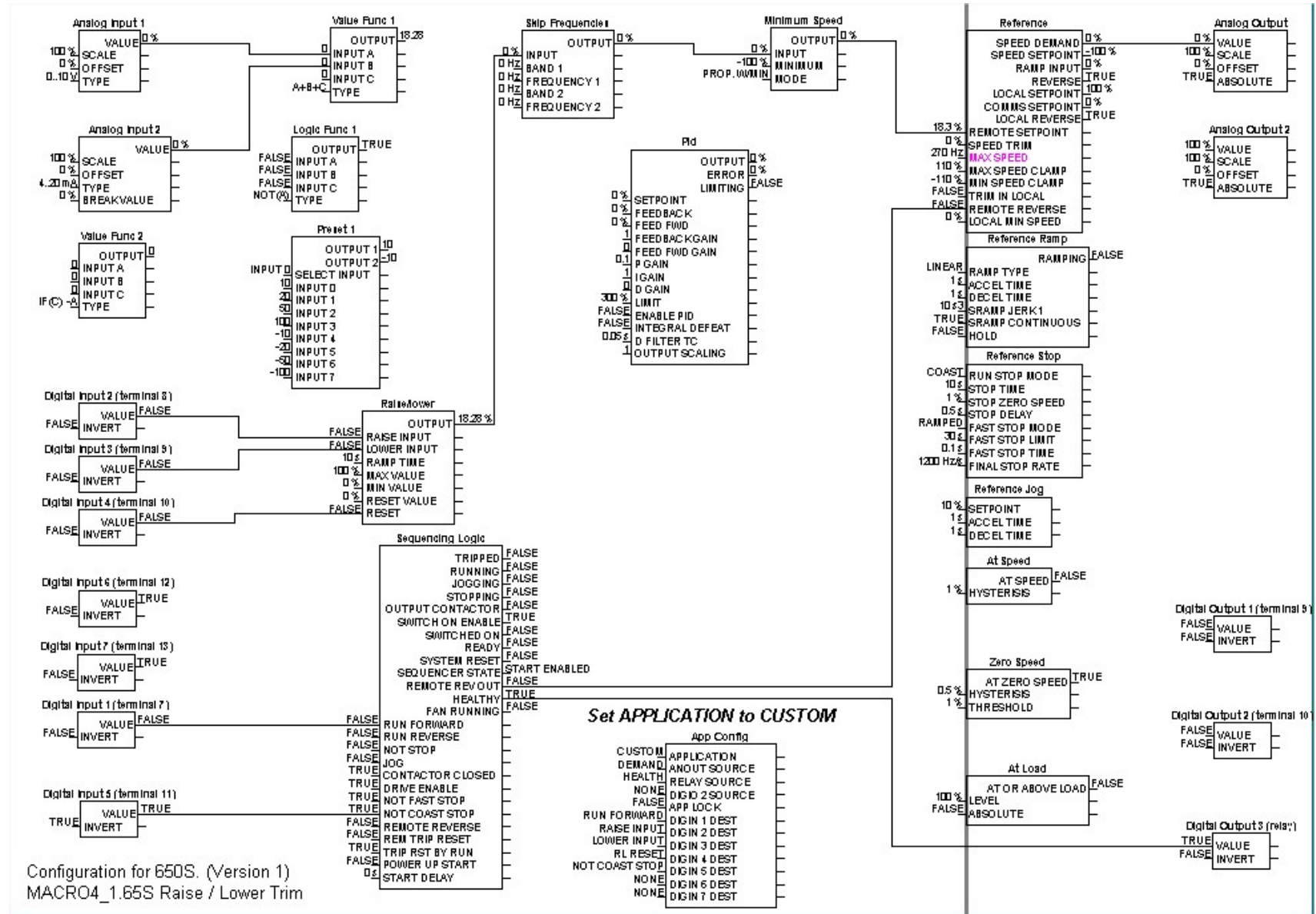

Application 4: Raise/Lower Trim

Application 4: Raise/Lower Trim

This Application mimics the operation of a motorised potentiometer. Digital inputs allow the setpoint to be increased and decreased between limits. The limits and ramp rate can be set using the keypad.

The Application is sometimes referred to as Motorised Potentiometer.

Control Wiring I/O			
Terminal	Name	Purpose	Comment
13	DIGITAL INPUT 7	<i>Not configured</i>	<i>Not Used</i>
12	DIGITAL INPUT 6	<i>Not configured</i>	<i>Not Used</i>
11	DIGITAL INPUT 5	Not Coast Stop (inverted)	24V = coast to stop 0V = drive may run
10	DIGITAL INPUT 4	Reset	24V = reset Raise/Lower
9	DIGITAL INPUT 3	Lower Input	24V = Lower inputl
8	DIGITAL INPUT 2	Raise Input	24V = raise input
7	DIGITAL INPUT 1	Run Forward	24V = run forward
5	ANALOG OUTPUT 1	Ramp Output	absolute speed demand 0V = 0%, 10V = 100%
RL1A RL1B	DIGITAL OUTPUT 3 (relay)	HEALTH	Open = tripped, i.e. not healthy

5-10 Applications

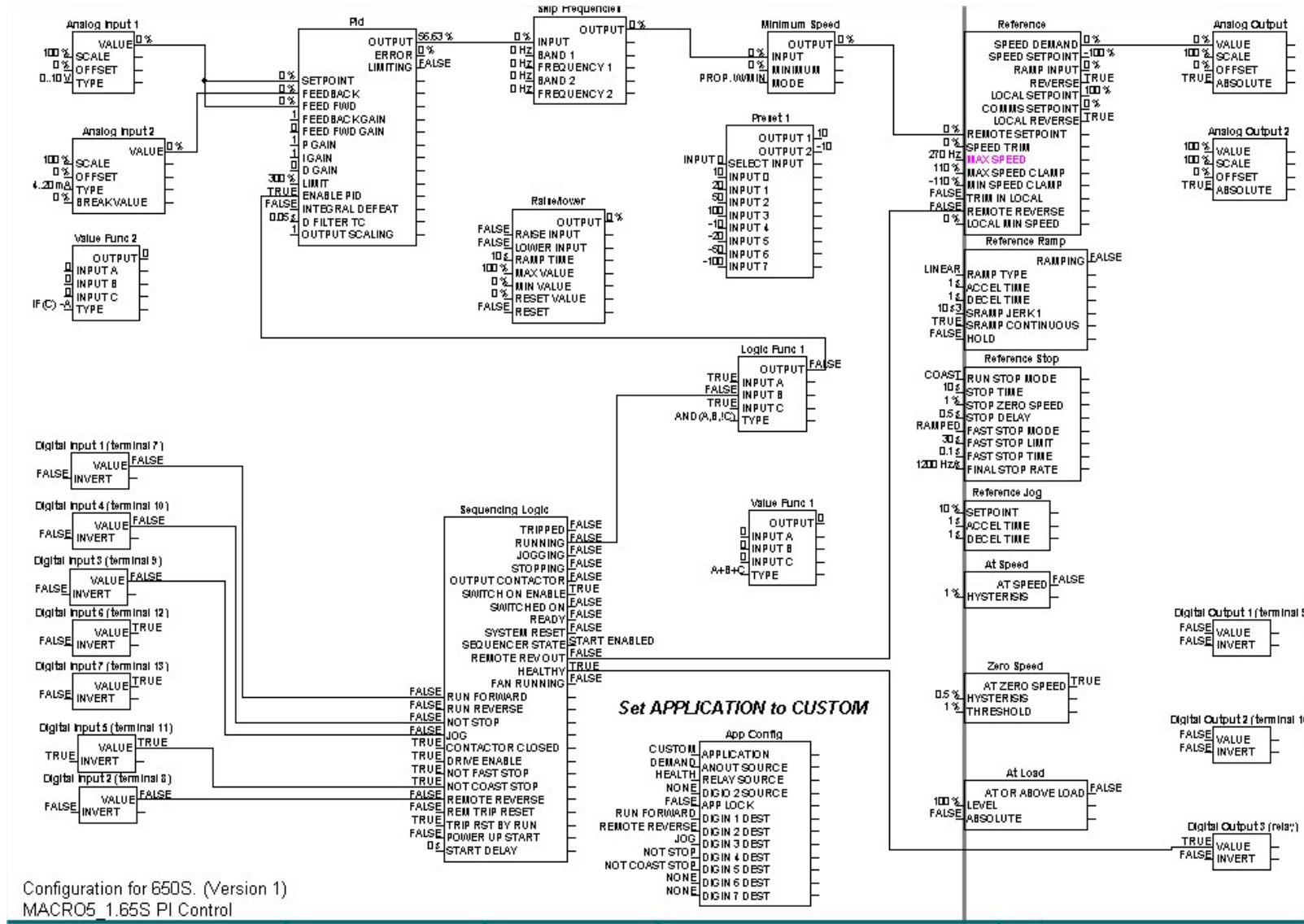

Application 5: PID

Application 5: PID

A simple application using a Proportional-Integral-Derivative 3-term controller. The setpoint is taken from AIN1, with feedback signal from the process on AIN2. The scale and offset features of the analogue input blocks may be used to correctly scale these signals. The difference between these two signals is taken as the PID error. The output of the PID block is then used as the drive setpoint.

Control Wiring I/O			
Terminal	Name	Purpose	Comment
13	DIGITAL INPUT 7	<i>Not configured</i>	<i>Not Used</i>
12	DIGITAL INPUT 6	<i>Not configured</i>	<i>Not Used</i>
11	DIGITAL INPUT 5	Not Coast Stop (inverted)	24V = coast to stop 0V = drive may run
10	DIGITAL INPUT 4	Not Stop	24V = RUN FWD and RUN REV signals latched 0V = RUN FWD and RUN REV signals not latched
9	DIGITAL INPUT 3	Jog	24V = jog
8	DIGITAL INPUT 2	Remote Reverse	0V = remote forward 24V = remote reverse
7	DIGITAL INPUT 1	Run Forward	24V = run forward
5	ANALOG OUTPUT 1	Ramp Output	absolute speed demand 0V = 0%, 10V = 100%
3	ANALOG INPUT 2	Process Feedback	0V = 0%, 10V = 100%
2	ANALOG INPUT 1	Process Setpoint	0V = 0%, 10V = 100%
RL1A RL1B	DIGITAL OUTPUT 3 (relay)	HEALTH	Open = tripped, i.e. not healthy

Motor Control

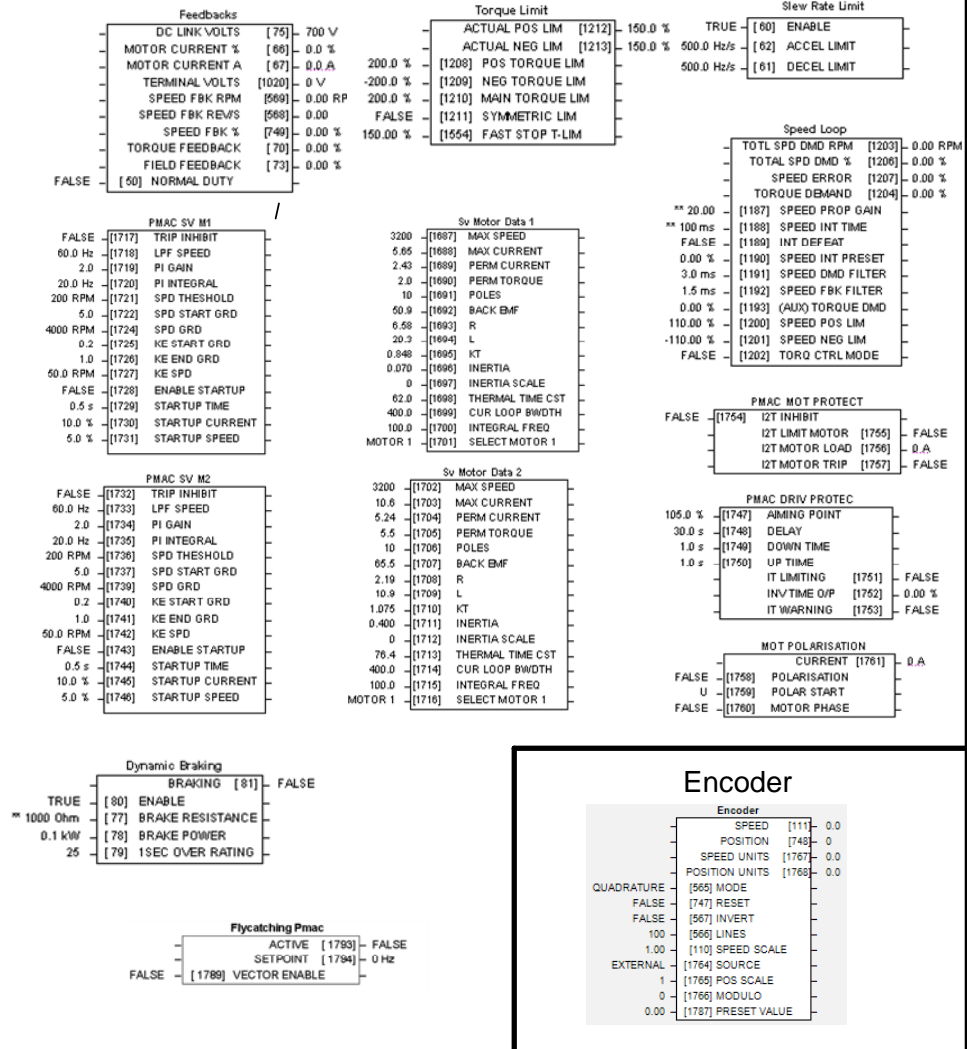

Sequencing and Reference

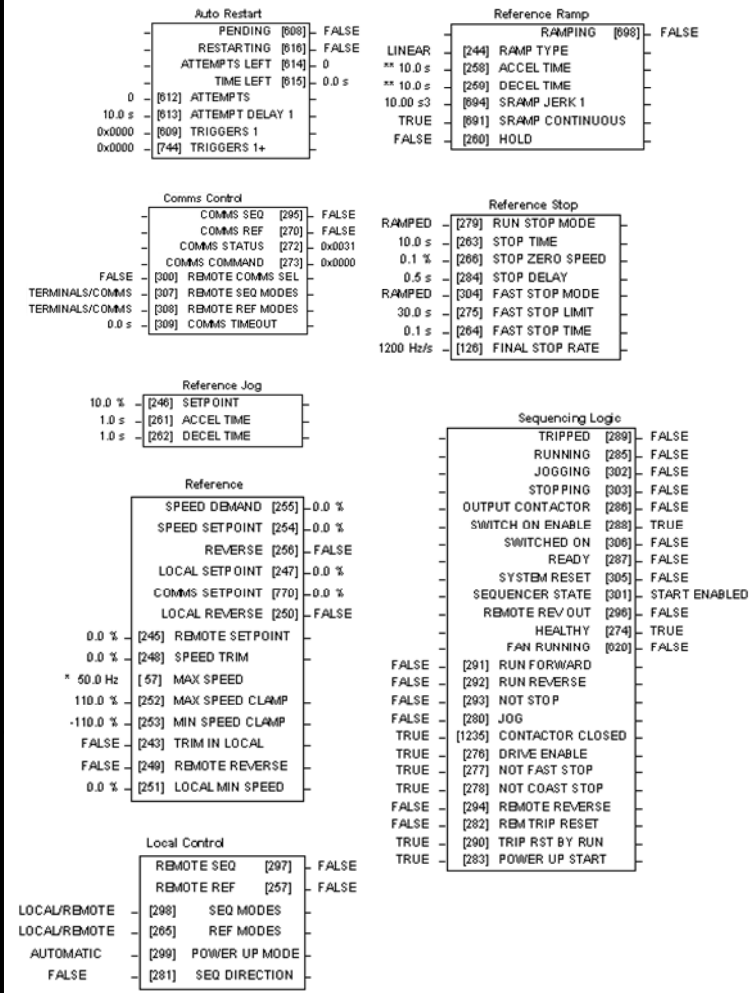

Application Control Blocks

Some of these blocks may already be in use by the Applications

Setpoint Functions

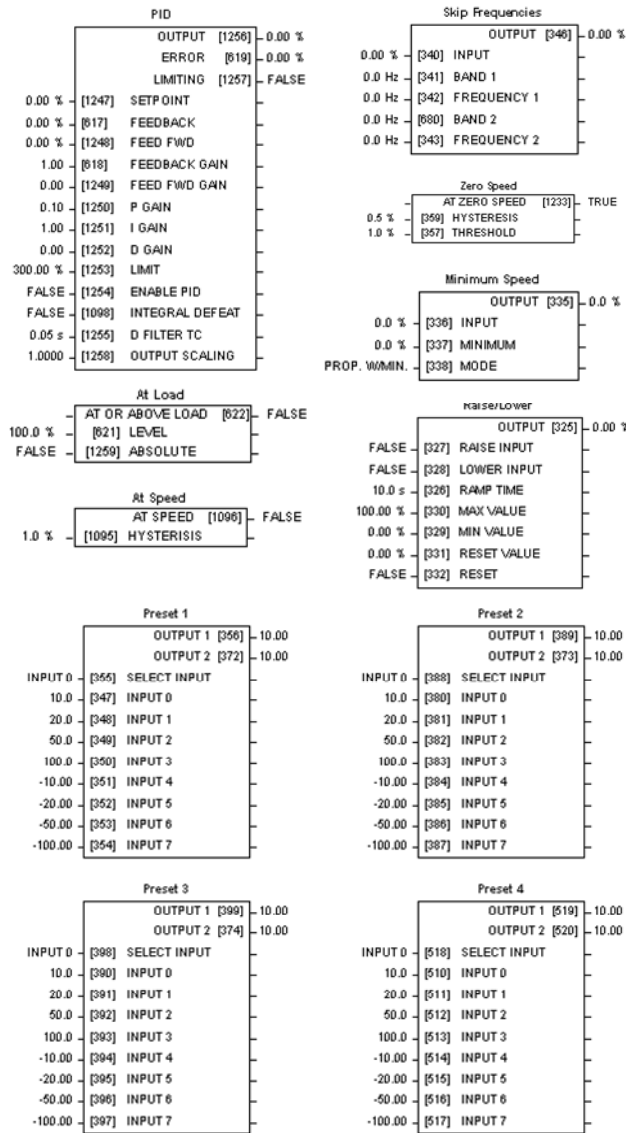

Trips

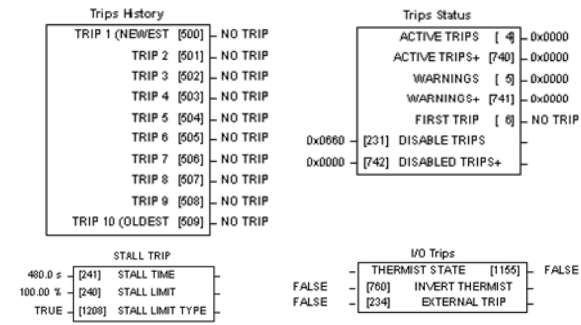

Communications

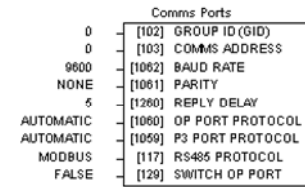

Brake

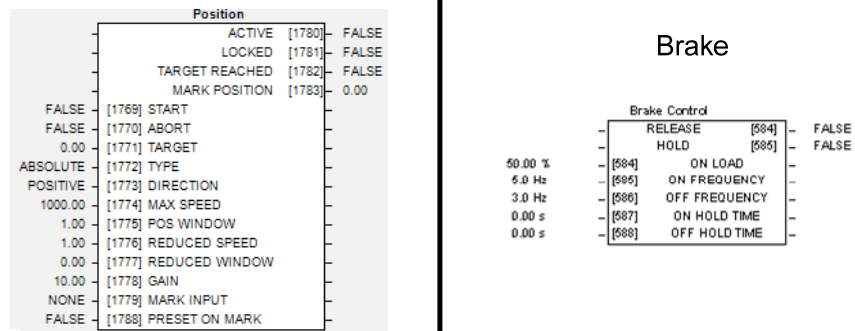

Application Control Blocks

Some of these blocks may already be in use by the Applications

Miscellaneous

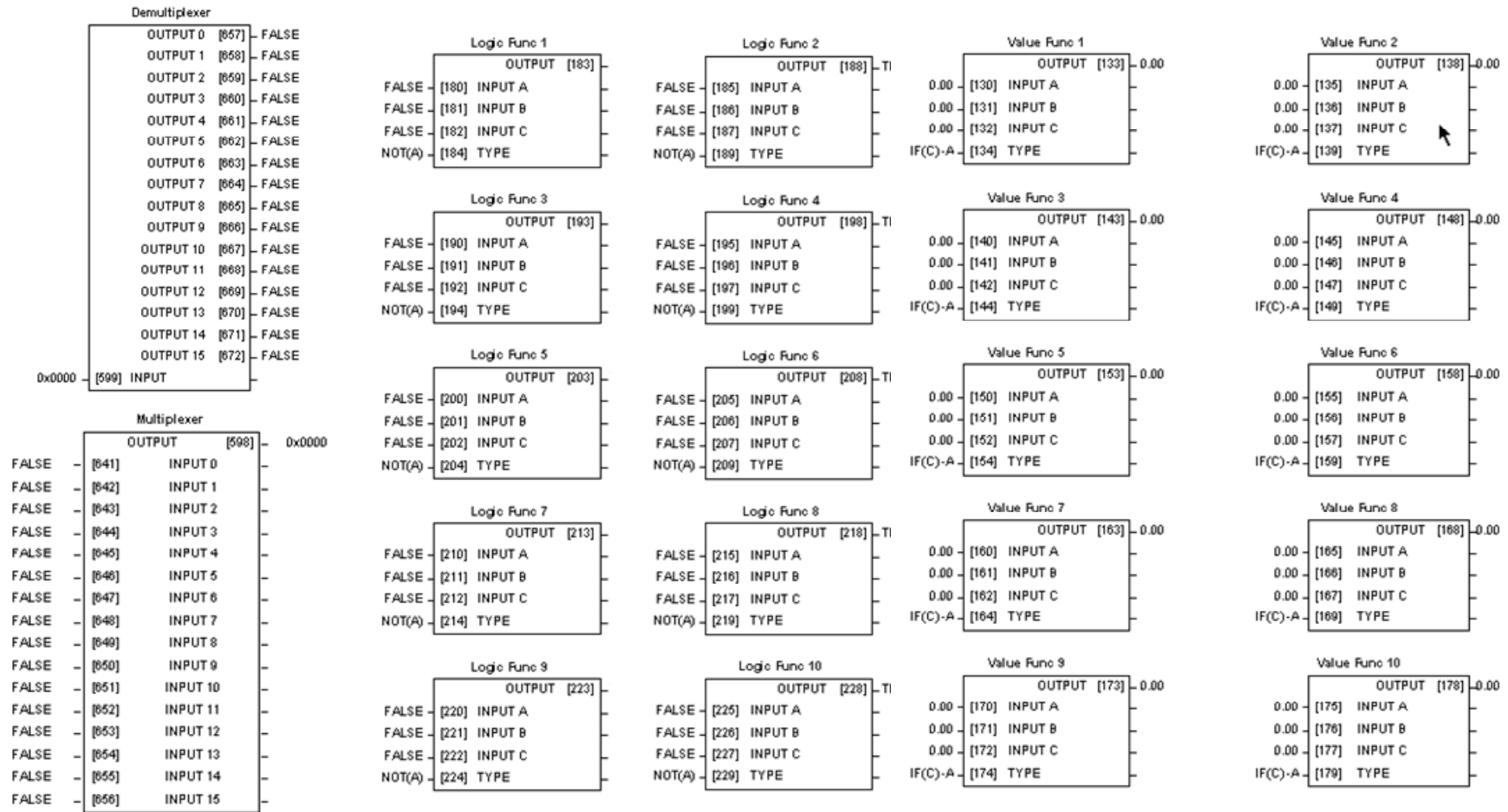

Application Control Blocks

Some of these blocks may already be in use by the Applications

Menus

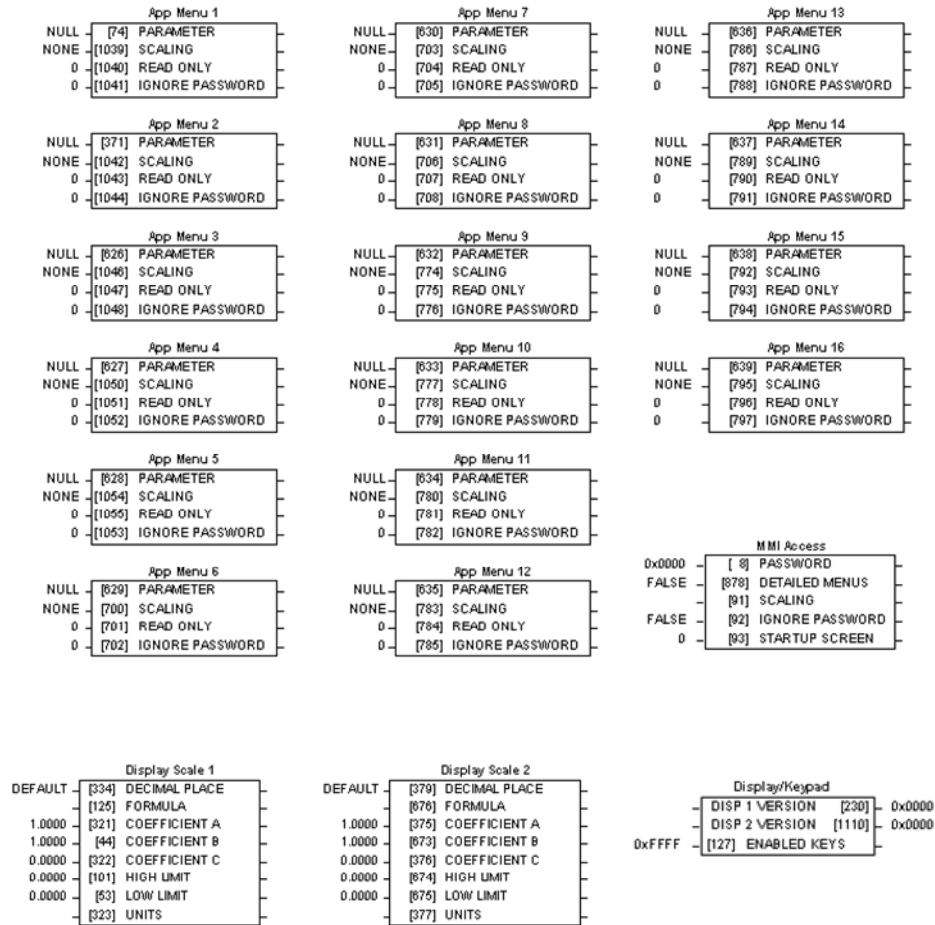

Configuration

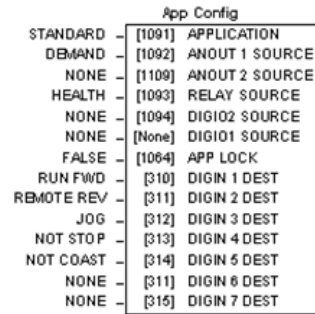

Inputs and Outputs

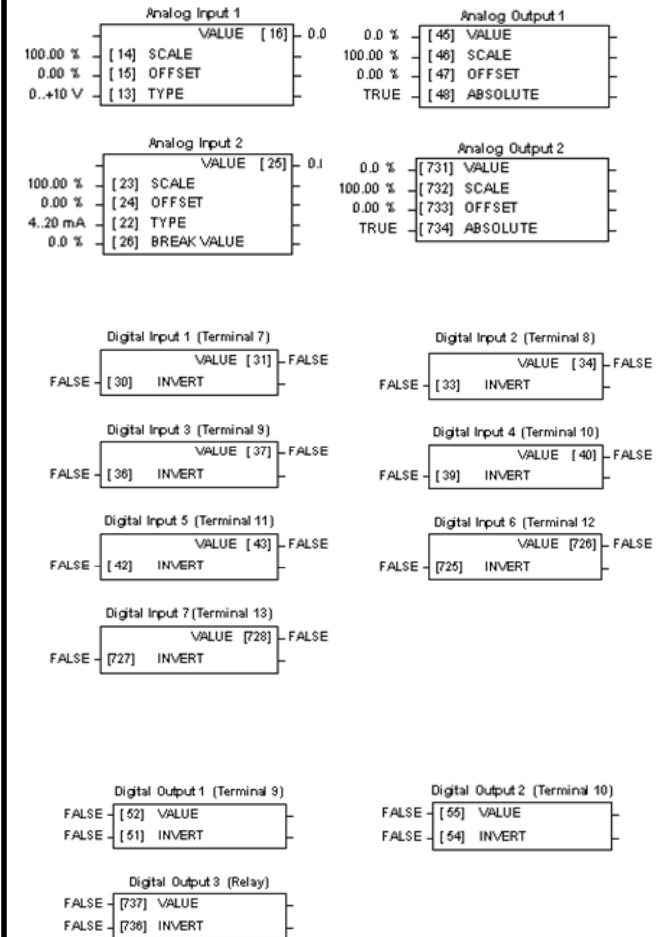

Application Control Blocks

Some of these blocks may already be in use by the Applications

UK Head Office: Parker SSD Drives
New Courtwick Lane, Littlehampton, West Sussex BN17 7RZ
Tel: +44 (0)1903 737000 Fax: +44 (0)1903 737100

CANADA
Parker Hannifin Canada
Motion and Control Division
160 Chisholm Drive
Milton, Ontario L9T 3G9
Tel: +1 (905) 693-3000
Fax: +1 (905) 876-1958

CHINA
Parker Hannifin Motion & Control
(Shanghai) Co. Ltd.
280 Yunqiao Road,
Jinqiao Export Processing Zone,
Pudong District, Shanghai 201206
Tel: +86(21)5031 2525
Fax: +86(21)5854 7599

FRANCE
Parker SSD Parvex
8 Avenue du Lac
B.P. 249
21007 Dijon Cedex
Tel: +33 (0)3 80 42 41 40
Fax: +33 (0)3 80 42 41 23

GERMANY
Parker Hannifin GmbH
Von-Humboldt-Strasse 10
64646 Heppenheim
Tel: +49 (6252) 798200
Fax: +49 (6252) 798205

ITALY
Parker Hannifin SPA
Via C. Gounod, Cinisello Balsamo
1-200092,
Milano
Tel: +39 (0236) 1081
Fax: +39 (0236) 108400

USA
Parker Hannifin Corporation
SSD Drives
9225 Forsyth Park Drive
Charlotte
North Carolina 28273
Tel: +1 (704) 588 3246
Fax: +1 (704) 588 3249

05/03/09

Local availability and service support also in:

SERVICE &
REPAIR
CENTRES

Argentina • Australia • Austria • Bangladesh • Belgium • Brazil • Chile • Colombia • Costa Rica • Cyprus
Czech Republic • Denmark • Ecuador • Egypt • Finland • Greece • Hong Kong • Hungary • India • Indonesia
Iran • Ireland • Israel • Japan • Jordan • Kenya • Korea • Kuwait • Lithuania • Malaysia • Netherlands
New Zealand • Nigeria • Norway • Peru • Philippines • Poland • Portugal • Qatar • Romania • Russia
Saudi Arabia • Singapore • Slovenia • Slovakia • South Africa • Spain • Sri Lanka • Sweden • Switzerland
Taiwan • Thailand • Turkey • United Arab Emirates • Vietnam • Zimbabwe

www.ssddrives.com

