



690+ series

Frame G, H & J

HA465084U002 Issue 6
Product Manual

aerospace
climate control
electromechanical
filtration
fluid & gas handling
hydraulics
pneumatics
process control
sealing & shielding



ENGINEERING **YOUR** SUCCESS.

FAILURE OR IMPROPER SELECTION OR IMPROPER USE OF THE PRODUCTS DESCRIBED HEREIN OR RELATED ITEMS CAN CAUSE DEATH, PERSONAL INJURY AND PROPERTY DAMAGE.

This document and other information from Parker-Hannifin Corporation, its subsidiaries and authorized distributors provide product or system options for further investigation by users having technical expertise.

The user, through its own analysis and testing, is solely responsible for making the final selection of the system and components and assuring that all performance, endurance, maintenance, safety and warning requirements of the application are met. The user must analyze all aspects of the application, follow applicable industry standards, and follow the information concerning the product in the current product catalog and in any other materials provided from Parker or its subsidiaries or authorized distributors.

To the extent that Parker or its subsidiaries or authorized distributors provide component or system options based upon data or specifications provided by the user, the user is responsible for determining that such data and specifications are suitable and sufficient for all applications and reasonably foreseeable uses of the components or systems.



690+ Series

AC Drive

Frame G, H & J

Product Manual

HA465084U002 Issue 6

Compatible with Version 5.x Software

2016 Parker Hannifin Manufacturing Ltd.

All rights strictly reserved. No part of this document may be stored in a retrieval system, or transmitted in any form or by any means to persons not employed by a Parker Hannifin Manufacturing Limited company without written permission from Parker Hannifin Manufacturing Ltd. Although every effort has been taken to ensure the accuracy of this document it may be necessary, without notice, to make amendments or correct omissions. Parker Hannifin Manufacturing Limited cannot accept responsibility for damage, injury, or expenses resulting therefrom.

WARRANTY

The general terms and conditions of sale of goods and/or services of Parker Hannifin Europe Sarl, Luxembourg, Switzerland Branch, Etoy, apply to this product unless otherwise agreed. The terms and conditions are available on our website www.parker.com/termsandconditions/switzerland

Parker Hannifin Manufacturing Limited reserves the right to change the content and product specification without notice.

Safety Information



Requirements

IMPORTANT: Please read this information BEFORE installing the equipment.

Intended Users

This manual is to be made available to all persons who are required to install, configure or service equipment described herein, or any other associated operation.

The information given is intended to highlight safety issues, EMC considerations, and to enable the user to obtain maximum benefit from the equipment.

Complete the following table for future reference detailing how the unit is to be installed and used.

INSTALLATION DETAILS	
Model Number <i>(see product label)</i>	
Where installed <i>(for your own information)</i>	
Unit used as a: <i>(refer to Certification for the Inverter)</i>	<input type="checkbox"/> Component <input type="checkbox"/> Relevant Apparatus
Unit fitted:	<input type="checkbox"/> Wall-mounted <input type="checkbox"/> Enclosure

Application Area

The equipment described is intended for industrial motor speed control utilising DC motors, AC induction or AC synchronous machines

Personnel

Installation, operation and maintenance of the equipment should be carried out by qualified personnel. A qualified person is someone who is technically competent and familiar with all safety information and established safety practices; with the installation process, operation and maintenance of this equipment; and with all the hazards involved.

Product Warnings

 DANGER Risk of electric shock	 WARNING Hot surfaces	 Caution Refer to documentation	 Earth/Ground Protective Conductor Terminal
---	--	--	--

Safety Information



Hazards

DANGER! - Ignoring the following may result in injury

1. This equipment can endanger life by exposure to rotating machinery and high voltages.
2. The equipment must be permanently earthed due to the high earth leakage current, and the drive motor must be connected to an appropriate safety earth.
3. Ensure all incoming supplies are isolated before working on the equipment. Be aware that there may be more than one supply connection to the drive.
4. There may still be dangerous voltages present at power terminals (motor output, supply input phases, DC bus and the brake, where fitted) when the motor is at standstill or is stopped.
5. For measurements use only a meter to IEC 61010 (CAT III or higher). Always begin using the highest range. CAT I and CAT II meters must not be used on this product.
6. Allow at least 5 minutes for the drive's capacitors to discharge to safe voltage levels (<50V). Use the specified meter capable of measuring up to 1000V dc & ac rms to confirm that less than 50V is present between all power terminals and earth.
7. Unless otherwise stated, this product must NOT be dismantled. In the event of a fault the drive must be returned. Refer to "Routine Maintenance and Repair".

WARNING! - Ignoring the following may result in injury or damage to equipment

SAFETY

Where there is conflict between EMC and Safety requirements, personnel safety shall always take precedence.

- Never perform high voltage resistance checks on the wiring without first disconnecting the drive from the circuit being tested.
- Whilst ensuring ventilation is sufficient, provide guarding and /or additional safety systems to prevent injury or damage to equipment.
- When replacing a drive in an application and before returning to use, it is essential that all user defined parameters for the product's operation are correctly installed.
- All control and signal terminals are SELV, i.e. protected by double insulation. Ensure all external wiring is rated for the highest system voltage.
- Thermal sensors contained within the motor must have at least basic insulation.
- All exposed metalwork in the Inverter is protected by basic insulation and bonded to a safety earth.
- RCDs are not recommended for use with this product but, where their use is mandatory, only Type B RCDs should be used.

EMC

- In a domestic environment this product may cause radio interference in which case supplementary mitigation measures may be required.
- This equipment contains electrostatic discharge (ESD) sensitive parts. Observe static control precautions when handling, installing and servicing this product.
- This is a product of the restricted sales distribution class according to IEC 61800-3. It is designated as "professional equipment" as defined in EN61000-3-2. Permission of the supply authority shall be obtained before connection to the low voltage supply.

CAUTION!

APPLICATION RISK

- The specifications, processes and circuitry described herein are for guidance only and may need to be adapted to the user's specific application. We can not guarantee the suitability of the equipment described in this Manual for individual applications.

RISK ASSESSMENT

Under fault conditions, power loss or unintended operating conditions, the drive may not operate as intended.

In particular:

- Stored energy might not discharge to safe levels as quickly as suggested, and can still be present even though the drive appears to be switched off
- The motor's direction of rotation might not be controlled
- The motor speed might not be controlled
- The motor might be energised

A drive is a component within a drive system that may influence its operation or effects under a fault condition. Consideration must be given to:

- Stored energy
- Supply disconnects
- Sequencing logic
- Unintended operation

Contents

	<i>Contents</i>	<i>Page</i>
CHAPTER 1	GETTING STARTED	1-1
	Introduction	1-1
	Equipment Inspection.....	1-1
	Packaging and Lifting Details.....	1-1
	About this Manual.....	1-1
	Initial Steps.....	1-2
	How the Manual is Organised	1-2
CHAPTER 2	AN OVERVIEW OF THE DRIVE	2-1
	Component Identification	2-1
	Control Features.....	2-2
	Functional Overview	2-3
CHAPTER 3	INSTALLING THE DRIVE	3-1
	Mechanical Installation	3-1
	Handling the Drive	3-1
	Air Flow.....	3-1
	Ventilation	3-1
	Fitting the Top Vent and Gasket (690+ H & J).....	3-2
	Installing the External Vent Kit (Frame G).....	3-3
	Mounting the Drive.....	3-4
	AC Line Choke	3-5
	Main Cooling Fan and Supply Requirements	3-9
	Electrical Installation	3-9
	Power Wiring and Protective Earth (PE)  Connections	3-10
	Motor Thermistor Connections	3-10
	Control Wiring Connections.....	3-11
	Optional Equipment.....	3-12
	Installation Drawings	3-26
CHAPTER 4	OPERATING THE DRIVE	4-1
	Pre-Operation Checks.....	4-1
	Control Philosophy.....	4-2
	Start/Stop and Speed Control.....	4-2
	Initial Start-up Routines.....	4-4
	Routine 1: Remote Control using Control Terminals.....	4-4
	Routine 2: Local Control using the Keypad	4-5
	The Autotune Feature.....	4-7
	The Start/Stop Mode Explained.....	4-10
	Starting and Stopping Methods	4-11
	Normal Stopping Methods.....	4-11
	Advanced Stopping Methods.....	4-13
	Starting Methods	4-14
CHAPTER 5	THE KEYPAD	5-1
	Connecting the Keypad.....	5-1
	Controlling the Drive using the Keypad	5-2
	Control Key Definitions	5-2
	LED Indications.....	5-3
	The Menu System	5-4
	Navigating the Menu System.....	5-4
	Menu Viewing Levels	5-4
	Changing a Parameter Value.....	5-5
	What do the Symbols mean next to some Parameters?	5-5
	Alert Message Displays	5-5

Contents

<i>Contents</i>	<i>Page</i>
The Menu System Map.....	5-6
The PROG Key	5-7
The PROG Key	5-8
The L/R Key	5-8
The OPERATOR Menu.....	5-9
Parameter Selection	5-9
String Entry.....	5-10
The DIAGNOSTICS Menu.....	5-11
The QUICK SETUP Menu	5-15
The SYSTEM Menu	5-16
Saving/Restoring/Deleting Your Application	5-16
Selecting the Language.....	5-18
Special Menu Features	5-18
Quick Save Feature	5-18
Quick Tag Information	5-19
Quick Link Information	5-19
Password Protection.....	5-20
Power-up Key Combinations	5-21
Resetting to Factory Defaults (2-button reset)	5-21
Changing the Product Code (3-button reset)	5-21
Quick Enter Configuration Mode	5-22
CHAPTER 6 TRIPS AND FAULT FINDING 6-1	
Trips.....	6-1
What Happens when a Trip Occurs.....	6-1
Resetting a Trip Condition.....	6-1
Using the Keypad to Manage Trips	6-2
Checksum Fail.....	6-5
Fault Finding	6-5
CHAPTER 7 ROUTINE MAINTENANCE AND REPAIR 7-1	
Routine Maintenance	7-1
Repair.....	7-1
Saving Your Application Data	7-1
Returning the Unit to Parker Hannifin Manufacturing Limited	7-1
Disposal	7-1
Spares List	7-2
Component Replacement	7-3
CHAPTER 8 TECHNICAL SPECIFICATIONS 8-1	
Understanding the Product Code	8-1
690+ Model Recognition (Frame G)	8-3
690+ Model Recognition (Frame H)	8-3
690+ Model Recognition (Frame J).....	8-3
Environmental Details.....	8-4
Earthing/Safety Details	8-4
Cabling Requirements for EMC Compliance	8-5
Terminal Block Wire Sizes	8-5
Electrical Ratings (Frame G)	8-6
Electrical Ratings (Frame H)	8-7
Electrical Ratings (Frame J)	8-8
External AC Supply (RFI) Filter (Part Number CO467843U340)	8-9
AC Line Choke	8-9
Internal Dynamic Brake Switch (Frame G)	8-10
Internal Dynamic Brake Switch (Frame H).....	8-10
Internal Dynamic Brake Switch (Frame J).....	8-10

Contents

<i>Contents</i>	<i>Page</i>	
Control Terminals.....	8-11	
System Board Terminals (option)	8-12	
Analog Inputs/Outputs	8-13	
Digital Inputs	8-13	
Digital Outputs	8-13	
System Board Digital Inputs/Outputs (DIGIO11-15)	8-13	
Supply Harmonic Analysis (Frame G Quadratic).....	8-14	
Supply Harmonic Analysis (Frame H Quadratic)	8-15	
Supply Harmonic Analysis (Frame J Quadratic)	8-16	
CHAPTER 9	CERTIFICATION FOR THE DRIVE	9-1
Requirements for EMC Compliance	9-1	9-1
Minimising Radiated Emissions	9-1	9-1
Earthing Requirements	9-1	9-1
Cabling Requirements	9-2	9-2
EMC Installation Options	9-3	9-3
Requirements for UL Compliance	9-5	9-5
European Directives and the CE Mark.....	9-8	9-8
CE Marking for Low Voltage Directive	9-8	9-8
CE Marking for EMC - Who is Responsible?	9-8	9-8
Which Standards Apply?	9-9	9-9
Certificates	9-10	9-10
CHAPTER 10	APPLICATION NOTES	10-1
Synchronous Motor Control	10-1	10-1
Brake Motors	10-1	10-1
Using Line Chokes	10-2	10-2
Using Output Contactors.....	10-2	10-2
Using Motor Chokes	10-2	10-2
Using Multiple Motors on a Single Drive	10-3	10-3
Dynamic Braking.....	10-3	10-3
High Starting Torque.....	10-4	10-4
Winder Applications	10-4	10-4
Roll Diameter Calculation Accuracy.....	10-4	10-4
Basic Set-up Instruction	10-6	10-6
Equations	10-7	10-7
4-Q Regen Control/Common DC Bus Applications.....	10-10	10-10
Introduction.....	10-10	10-10
4-Q Active Front End	10-11	10-11
Drive Set-up	10-13	10-13
Macro 8 : 4Q Regen.....	10-14	10-14
Connection Diagram for Macro 8A Single Motor System	10-14	10-14
A Single Motor System	10-15	10-15
A Multi-Motor System.....	10-16	10-16
A Smart Brake System.....	10-17	10-17
DC Link Fuses	10-18	10-18
Pre-Charge Sizing	10-19	10-19
3-Phase Choke Sizing.....	10-20	10-20
CHAPTER 11	APPLICATION MACROS	11-1
The Default Application	11-1	11-1
Macro Descriptions	11-1	11-1
Macro 0	11-1	11-1
Macro 1: Basic Speed Control (default)	11-2	11-2
Macro 1: Basic Speed Control (default)	11-3	11-3

Introduction

The 690+ Series AC Drive is designed for speed control of standard 3-phase induction motors. These larger models are available in a range of ratings for constant torque and quadratic torque applications. This dual mode feature provides a cost effective solution to general industrial applications, as well as the control of pumps and fans.

- The unit can be controlled remotely using configurable analogue and digital inputs and outputs, requiring no optional equipment.
- Controlling the unit locally using the 6901 Keypad, or remotely using DSELite (or other suitable PC programming tool) gives access to parameters, diagnostic messages, trip settings and full application programming. Other features also become available, such as the advanced sensorless vector control scheme which gives high torque, low speed operation; selectable switching frequencies; and a unique Quiet Pattern control system that minimises audible noise from the motor.
- Technology Options can be fitted to the drive to give serial communications, closed loop speed control, and the factory-fitted dynamic braking functions.
- A factory-fitted System Board enables the drive for high end web processing or mini PLC replacement applications.

IMPORTANT: Motors used must be suitable for drive duty.

Note: *Do not attempt to control motors whose rated current is less than 25% of the drive rated current. Poor motor control or Autotune problems may occur if you do.*

Equipment Inspection

- Check for signs of transit damage
- Check the product code on the rating label conforms to your requirement.

If the unit is not being installed immediately, store the unit in a well-ventilated place away from high temperatures, humidity, dust, or metal particles.

Refer to Chapter 2: “An Overview of the Drive” to check the rating label/product code.

Refer to Chapter 7: “Routine Maintenance and Repair” for information on returning damaged goods.

Packaging and Lifting Details

Caution

The packaging is combustible and, if disposed of in this manner incorrectly, may lead to the generation of lethal toxic fumes.

Save the packaging in case of return. Improper packaging can result in transit damage.

Use a safe and suitable lifting procedure when moving the drive. Never lift the drive by its terminal connections.

Refer to Chapter 2: “An Overview of the Drive” – Component Identification for the lifting ring locations. Refer to Chapter 3: “Installing the Drive” - Mounting the Drive for unit weights.

Refer to Chapter 3: “Installing the Drive” – Handling the Drive for further information.

About this Manual

This manual is intended for use by the installer, user and programmer of the 690+ drive. It assumes a reasonable level of understanding in these three disciplines.

1-2 Getting Started

Note: Please read all Safety Information before proceeding with the installation and operation of this unit.

Enter the “Model Number” from the rating label into the table at the front of this manual. There is also a column for you to record your application’s parameter settings in the Parameter Specification Table in the Software Product Manual. It is important that you pass these manuals on to any new user of this unit. They can be downloaded from www.parker.com/ssd.

Initial Steps

Use the manuals to help you plan the following:

Installation

Know your requirements:

- certification requirements, CE/UL/CUL conformance
- wall-mount or enclosure?
- conformance with local installation requirements
- supply and cabling requirements

Operation

Know your operator:

- how is it to be operated, local and/or remote?
- what level of user is going to operate the unit?
- decide on the best menu level for the keypad (where supplied)

Programming (Keypad or suitable PC programming tool only)

Know your application:

- install the most appropriate macro
- plan your “block diagram programming”
- enter a password to guard against illicit or accidental changes
- customise the keypad to the application

How the Manual is Organised

The information is arranged in to separate “Installation” and “Software” Product Manuals. The Installation Product Manual is considered to be Volume 1, the Software Product Manual is Volume 2. Each manual is divided into chapters and paragraphs. Page numbering restarts with every chapter, i.e. 5-3 is Chapter 5, page 3.

Application Block Diagrams

You will find the appropriate diagrams at the rear of each manual. The pages unfold to show a complete block diagram, these will become your programming tool as you become more familiar with the 690+ unit’s software.

Quick-Start Guide

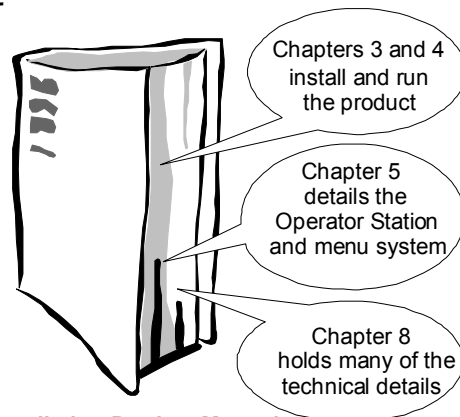

Installation Product Manual

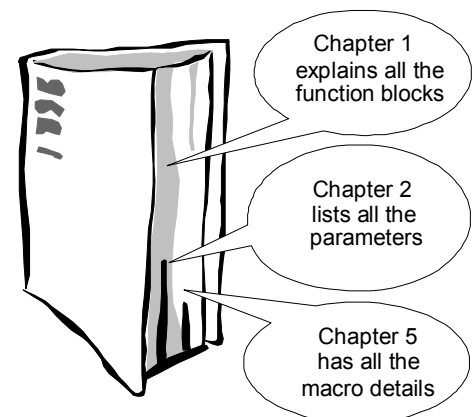

Software Product Manual

Information for Users without a Keypad

This symbol identifies important text for users operating the drive using the default (factory) set-up. If the text is italic, *such as this*, then the information is especially for users without the keypad or suitable PC programming tool.

DEFAULT

AN OVERVIEW OF THE DRIVE

Component Identification

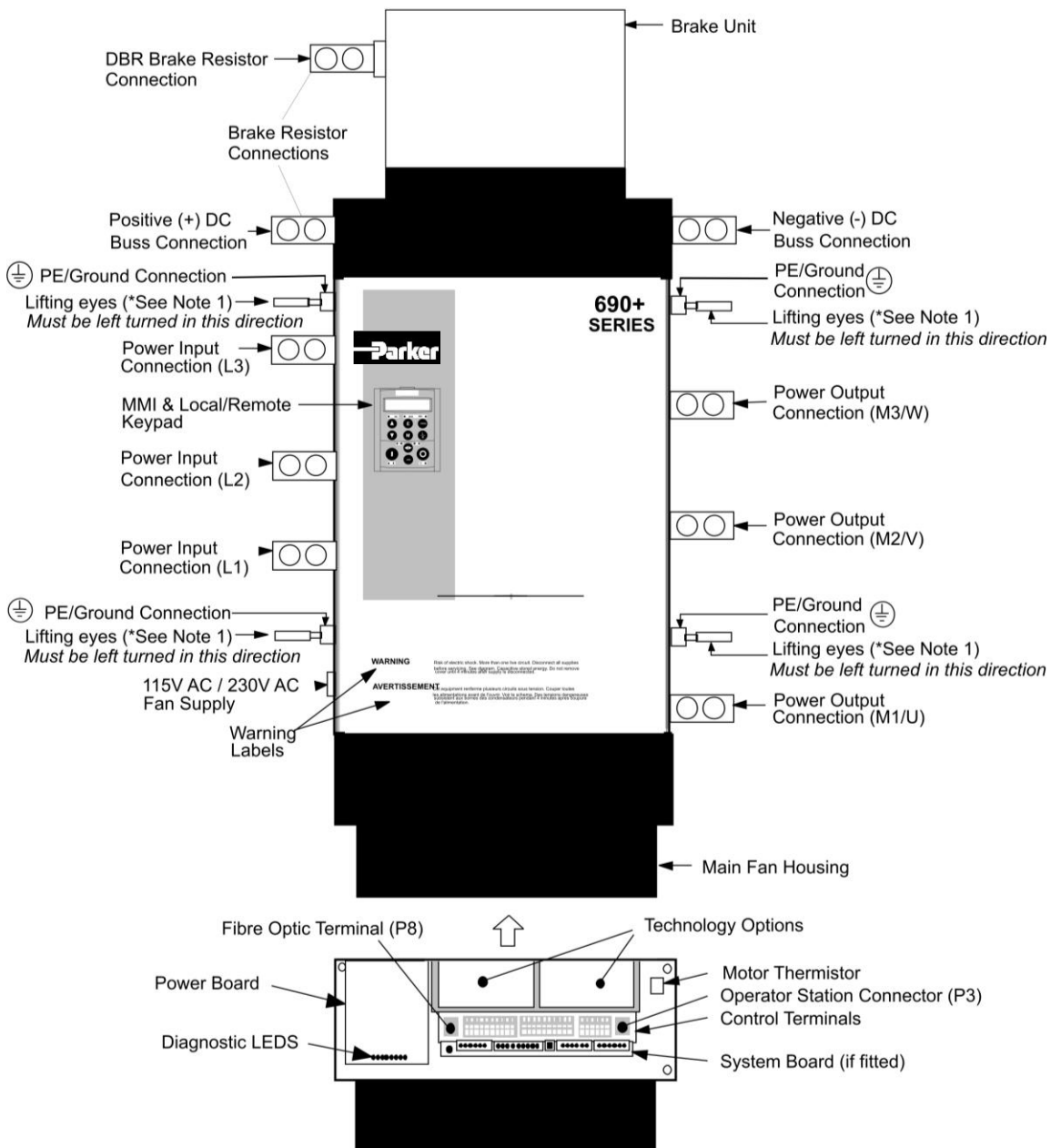

* Note 1:

PE / Grounding Connections

Lifting eyes must be replaced with supply and motor earth (ground) connections using M10 bolts and washers supplied. Under no circumstances should lifting eyes be used to make the PE / grounding connection.



Figure Chapter 2 -1 690+ Frequency Drive – Frame G illustrated

2-2 An Overview of the Drive

Equipment Supplied

The following equipment is supplied as standard with each product:

- 1) Frequency drive
- 2) Quickstart & Safety Information
- 3) Lifting eyes (4 off)
- 4) Exhaust duct and top vent assembly
- 5) Main cooling fan (Frame J only)

Product Range

Chassis Size	Nominal Power Constant Torque 460V ac	Nominal Power Quadratic Torque 460V ac
Frame G	110-180kW, 150-300hp	132-220kW, 200-350hp
Frame H	200-280kW, 300-450hp	250-315kW, 400-500hp
Frame J	315kW, 500hp	355kW, 550hp

Control Features

The drive is fully-featured when controlled using the optional keypad (or a suitable PC programming tool).

DEFAULT

The 'General' control features below are not user-selectable when the unit is controlled using the analog and digital inputs and outputs.

General	Output Frequency	Selectable 0-500Hz, or 0-590Hz (<i>Contact Parker Hannifin for higher output frequency</i>) $\geq 6\text{kHz}$ (V/Hz mode) Selectable 0-120Hz (sensorless vector mode) Selectable 0-350Hz (closed loop vector mode)
	Switching Frequency	<i>Constant Torque</i> : 2.5kHz for G & H units, 2kHz for J units <i>Quadratic Torque</i> : 2.5kHz for G & H units, 2kHz for J units
	Voltage Boost	0-25% (Fixed or Auto Boost)
	Flux Control	1. V/F control with linear or fan law profile 2. Sensorless vector 3. Closed loop vector (with speed feedback Technology Box)
	Skip Frequencies	4 skip frequencies with adjustable skip band width
	Preset Speeds	8 presets with programmable ramp rates
	Stopping Modes	Ramp, ramp with hold, coast, dc injection, fast stop
	Ramps	Symmetric or asymmetric ramp up and down rates
	Raise/Lower	Programmable MOP function
	Jog	Programmable jog speed
	Logic Functions	10 programmable 3 input logic function blocks performing NOT, AND, NAND, OR, NOR and XOR functions
	Value Functions	10 programmable 3 input value function blocks performing IF, ABS, SWITCH, RATIO, ADD, SUB, RATIO, TRACK/HOLD, and BINARY DECODE functions
	Diagnostics	Full diagnostic and monitoring facilities
Protection	Trip Conditions	Output short line to line, and line to earth Overcurrent > 220% I* overload 50-105% (adjustable) Heatsink overtemperature Motor Thermistor overtemperature Overvoltage and undervoltage
	Current Limit	Adjustable 50%-150% 180% shock load limit
	Voltage/ Frequency Profile	Linear law, Fan Law, User Defined (v5.1 onwards)
Inputs/ Outputs	Analog Inputs	4 configurable inputs - voltage or current
	Analog Outputs	3 configurable outputs - voltage or current
	Digital Inputs	7 configurable 24V dc inputs, 1 fixed 24V dc input
	Relay/Digital Outputs	3 relay contacts (voltage-free)

Table Chapter 2 -1 Control Features

Functional Overview

690+ AC Drives are microprocessor based 3-phase drives used to control the speed of standard 3-phase induction motors. An extensive range of configuration options are available to the user. A menu structure controlled using the man-machine interface (MMI) allows access to various options and adjustable parameters.

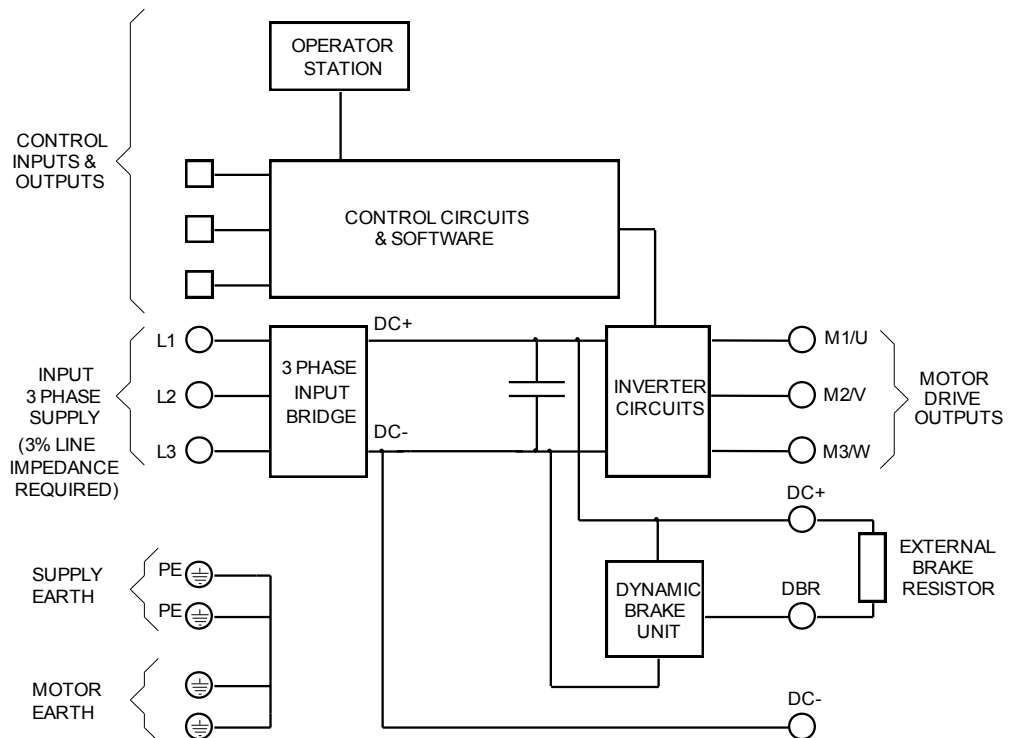

The diagram above shows the basic internal arrangement of the drive with the circuitry split between the control circuits, and the power circuits.

Power Circuits

IMPORTANT: An external AC Line Choke is required between the supply and L1, L2, L3. Refer to Chapter 8: "Technical Specifications" - AC Line Choke.

The 3-phase supply is input on terminals L1, L2 and L3 and is rectified to give a DC output to the drive circuits. The connection between the rectifier and drive is called the DC link and comprises a positive and negative DC connection with an in-line choke.

Dynamic Braking

The in-line choke and DC link capacitors, smooth the DC voltage prior to input to the drive power stage. During motor deceleration or at other times when the motor acts as a generator, energy flows from the motor into the DC link capacitors and causes the DC link voltage to rise. The drive trips if the DC link voltage rises above the over voltage trip level. If the dynamic braking option is used, an external brake resistor is switched to be in parallel with the capacitors and absorbs the energy when the DC link voltage rises to the braking level. Voltage detection is performed by the control circuits and the switching is performed by the optional dynamic brake circuit. Refer to Chapter 3: Drive Brake Unit for details of the dynamic braking option.

Motor Drive Output

The drive circuits convert the DC input to the 3 phase output used to drive the motor. The GATE DRIVE signals generated by the control circuits control the drive circuits to reproduce the 3-phase MOTOR DRIVE OUTPUTS. The frequency and amplitude are determined by the control inputs and by the parameters set up via the MMI.

2-4 An Overview of the Drive

Control Circuits and Software

Inputs to the control circuit are provided by physical connections to the control board terminals (identified on the left and right hand edges of the Block Diagram) and by parameters set via the MMI display.

Processor

The processor provides for a range of analog and digital inputs and outputs, together with their reference supplies. For further details refer to Chapter 8: "Technical Specifications" - Control Terminals.

Technology Options

Comms Technology Box

This is a multi-way connector and processor bus interface with control signals allowing various Technology Box protocol options to be fitted to the drive.

Speed Feedback Technology Box

Provides speed feedback for HTTL encoders.

Keypad Interface

This is a non-isolated RS232 serial link for communication with the keypad. Alternatively, a PC running Parker Hannifin Manufacturing "DSE Lite" Windows-based configuration software (or some other suitable PC programming tool) can be used to graphically program and configure the drive.

Parameters

Parameters are values or options that are programmed via the Setup Parameters and System menus within the MMI structure. These are usually set up during installation and commissioning and are not changed during normal operation.

Number parameters assign a value to a variable, eg. PRESET 1 which determines the motor speed if PRESET 1 is selected.

Logic parameters are used to control switching functions, eg. ADVANCE which controls a software switch that adds counts to the position error calculator.

Refer to Chapter 5 for further information about the keypad (MMI). The separate Software Product Manual gives details about parameters.

Diagnostics

Number and logic diagnostics are values and settings that can be displayed via the Diagnostic menu within the MMI. These values are read-only and are provided for the user to determine operating or fault conditions. Refer to Chapter 5: "The Keypad" for further information and descriptions of the diagnostics.

System Board Interface

The System Board interface hosts the optional System Board which enhances the 690+ product in to a fully featured systems drive.

INSTALLING THE DRIVE

IMPORTANT: Read Chapter 9: “Certification for the Drive” before installing this unit.

Mechanical Installation

Handling the Drive

Prepare a clear, flat surface to receive the drive before attempting to move it. Do not damage any terminal connections when putting the drive down.

IMPORTANT: Under no circumstances must the drive be lifted using the power terminals.

The drives are supplied with 4 lifting eye bolts fitted to the 4 PE/grounding locations on the sides of the drive for handling using a hoist.

Frames G and H may be set on end for installation by forklift. Frame J may be placed on forklift blades with care to avoid the fan mounting studs and fan power terminals on the bottom (with the fan removed - the fan is shipped separately from the drive).

Air Flow

The drives use very large airflows and have been designed with specific airflow patterns within a cabinet. It is generally intended that the bulk of the air comes into the cabinet at the top, flows down (some going through the drive to maintain internal temperatures), into the main cooling fan, through the drive, the brake/exhaust duct (supplied), and finally out the top of the cabinet through vent assembly (supplied).

This flow pattern insures that the top of the cabinet is effectively evacuated and the inside of the drive is cooled by fresh air.

The brake/exhaust duct allows for field installation of a braking module and it gives clearance for inlet air to come from the front of the cabinet into the top of the drive and down; we strongly recommend that this is fitted with the drive whether a brake is fitted or not. It is also important that the top vent is properly fitted to assure that the exhaust air is not recirculated. Refer to drawings HG465731U001, 2 and 3 at the end of this chapter for typical cubicle layout information.

We recommend that these drives are separated from other equipment in a large multifunction cabinet so that the airflow is better controlled. i.e. air heated by other items should not affect the inlet temperature to the drive’s main fan.

Care should be taken in placing the cabinet so that there is sufficient space in front of the cabinet to keep the exhaust air and inlet air separated. If there is not sufficient

space, redirection of the exhaust air is required. These drives dissipate substantial heat (refer to Chapter 8: “Technical Specifications” – Electrical Ratings, for Total Power Loss) and therefore sufficient volume for exhaust venting is required to keep the drive from raising the operating temperature beyond that specified in the Environmental Specification.

For the volumetric airflow rate of each drive, refer to Main Cooling Fan and Supply Requirements, page 3-9.

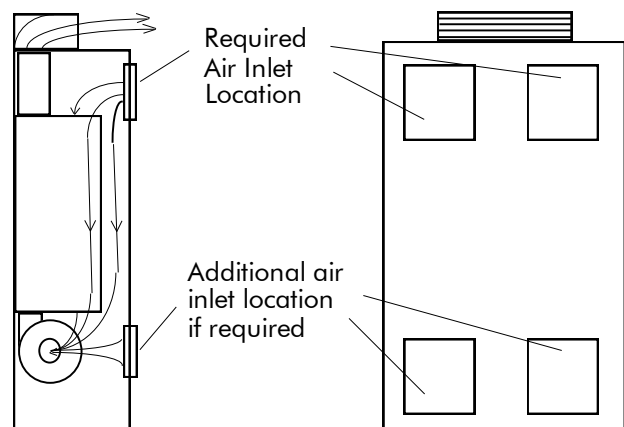

Ventilation

The drive gives off heat in normal operation and must therefore be mounted to allow the free flow of air through the ventilation slots and heatsink. Maintain minimum clearances for ventilation, and ensure that heat generated by other adjacent equipment is not transmitted to the

3-2 Installing the Drive

drive. Refer to drawings HG465731U001, 2 and 3 at the end of this chapter for information to ensure adequate cooling of the drive. Be aware that other equipment may have its own clearance requirements. When mounting two or more 690+ units together, these clearances are additive. Ensure that the mounting surface is normally cool.

Fitting the Top Vent and Gasket (690+ H & J)

WARNING!

This unit must be operated with either a brake unit or blanking plate fitted to the supplied outlet duct. The top vent is then mounted on to the outlet duct. It is very important that the gasket for the vent is correctly fitted to the brake/exhaust outlet duct. Otherwise, hot exhaust air will flow back into the cabinet and overheat the drive. The brake/exhaust outlet duct should protrude from the top of the cabinet by 5-10mm to ensure engagement with the gasket. Refer to drawings HG465731U001 & HG465731U002 at the end of this chapter.

This assembly provides IP-22 protection for the drive when fitted properly. The main function is to seal the path of return air to the enclosure as well as protect against falling contaminants. The same assembly is used for frame sizes H & J. The different sizes are accommodated by removal of the gasket inserts.

Supplied parts:

Qty.	Description
1	Vent top
1	Top Vent Baffle
1	Mounting Flange
1	Gasket
4	M6 support studs
2	M6 x 195 hex studs
1	Grille
8	M6x25 panhead slotted screws
8	M6 flat washers
20	M6 hex captive nuts

Tools Required:

M10 wrench, quantity 2
#3 Phillips or posidrive screwdriver
10mm (3/8") flat blade screwdriver

Assembly Procedure

On cabinets with removable panels the following procedure should be performed off the cabinet. For non-removable cabinets this procedure should be performed prior to mounting the drive.

Note: If the drive is not removed, then it must be protected from any cutting chips.

1. Cut top of cabinet as per drawing HG465731U001 & HG465731U002 at the end of this chapter.
2. Install (4) M/M support studs in rearmost row of holes in pattern
3. Install (2) F/F M6 x 195 support studs in forward most holes with (2) M6 x 10 posidrive screws

Complete the following with the drive and exhaust duct fitted to ensure a good fit of the gasket to the duct.

4. Fit the gasket over the 4 support studs and exhaust duct.
5. Fit the mounting flange over the gasket and attach via (8) M6 x 25 screws, (16) M6 washers, and (8) M6 nuts.
6. Fit the top vent baffle over the support studs.
7. Fit grommet strip to bottom edge of grill and position.
8. Fit vent top over the 4 support studs and grill.
9. Fix vent top via (2) M6 x 10 screws (using a 10 mm wrench on the support studs through the grill is helpful in aligning the stud to the hole in the top) and (4) M6 nuts and washers.

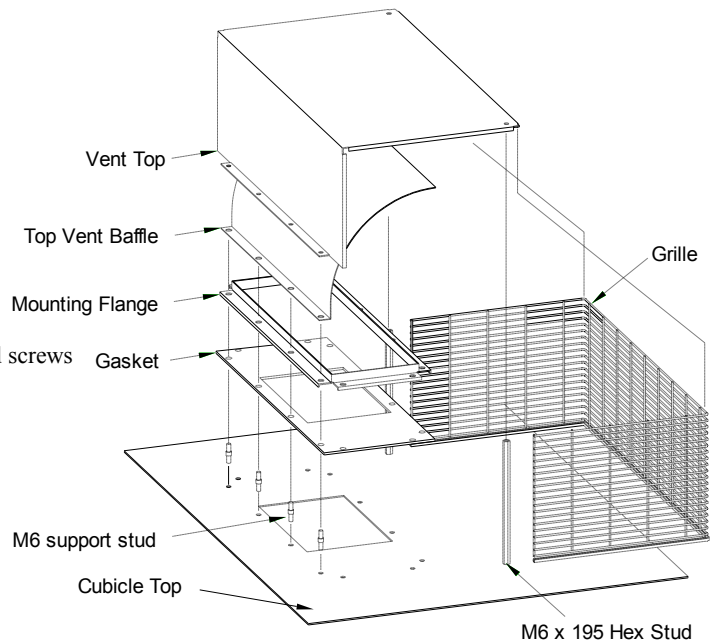

Installing the External Vent Kit (Frame G)

Parker Hannifin Manufacturing Part Numbers: Frame G : LA465720U001

Refer to Drawing HG465731U003 Sheet 2 at the end of this Chapter for top panel and mounting plate hole positions.

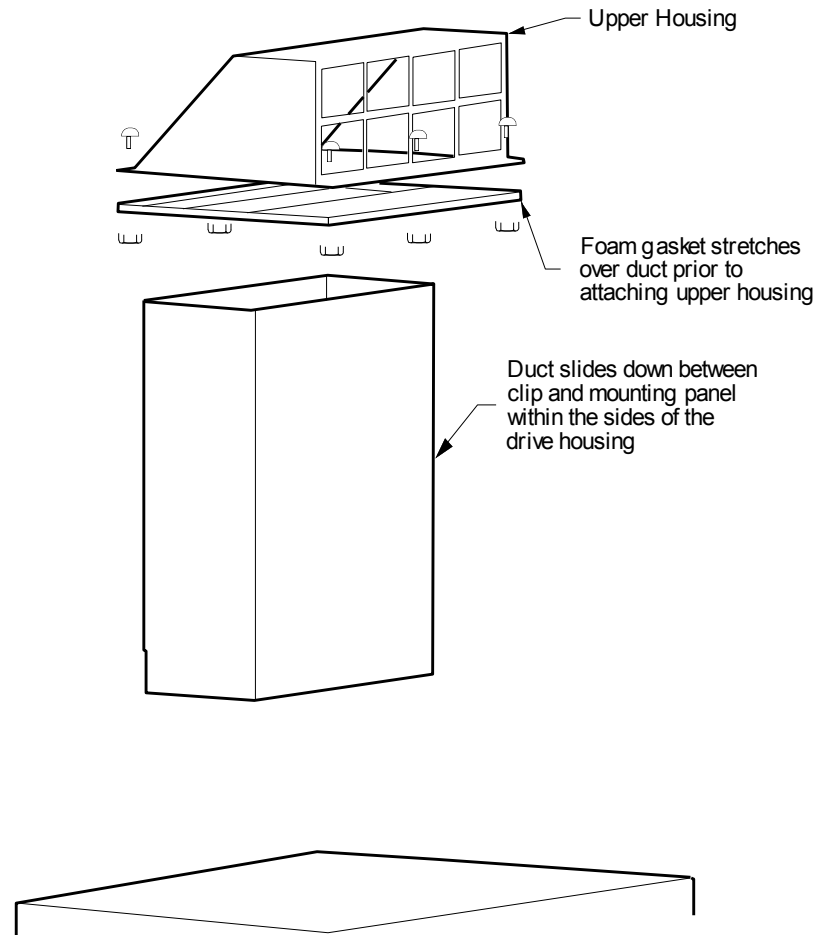

3-4 Installing the Drive

Mounting the Drive

IMPORTANT: The 690+ drive must be securely mounted using all 10 off M8 mounting hole positions as detailed on HG465731U00. Refer to the drawings at the end of this chapter.

It must be mounted inside a suitable cubicle, depending upon the required level of EMC compliance – refer to Chapter 8: “Technical Specifications”.

Mechanical Details

Frame G, H & J

Mounting Orientation	Vertical, on a solid, flat, vertical surface
Power Terminations	<p><i>3-phase supply and output terminals</i> Bus-bars with 2 off M12 holes, 25mm separation. 2 off M12 bolt, nut and washer supplied. Tightening torque 97Nm (71.5lb-ft)</p> <p><i>Protective earth terminals</i> 4 off M10 bolts with conical washers - supplied loose Tightening torque 55Nm (40.5lb-ft)</p> <p><i>DC link terminals</i> Bus-bars with 2 off M12 holes, 35mm separation. Designed to accept semiconductor fuses directly mounted on terminals (eg. Gould Sawmut A100P) 2 off M12 bolt, nut and washer supplied. Tightening torque 97Nm (71.5lb-ft)</p> <p><i>Dynamic brake terminal</i> Bus-bars with 2 off M12 holes, 44mm separation. 2 off M12 bolt, nut and washer supplied. Tightening torque 97Nm (71.5lb-ft)</p>
Control Terminations	<p>Removable screw connectors for 0.75mm² wire (18 AWG)</p> <p>Terminals will accept up to 1.5mm² wire (16 AWG)</p> <p>Tightening torque 0.6Nm (0.4lb-ft)</p>

Frame G

Weight	100kg (108kg including Dynamic Brake unit)
Dimensions	Refer to drawing HG465731U003

Frame H

Weight	125kg (138kg including Dynamic Brake unit)
Dimensions	Refer to drawing HG465731U002

Frame J

Weight	160kg (176kg including Dynamic Brake unit)
Dimensions	Refer to drawing HG465731U001

AC Line Choke

IMPORTANT: The drive must be used with an AC Line Choke, however, where an drive is individually supplied from a dedicated transformer with the required impedance, the AC Line Choke is not required.

Note: Refer to Chapter 8: "Technical Specifications" for further information.

Caution

Failure to provide the correct line impedance will severely reduce the drives lifetime and could result in catastrophic failure of the drive.

Rating Guidelines for AC Line Chokes

Parker Hannifin Manufacturing can supply the line chokes listed in Chapter 8: "Technical Specifications" - Line Chokes.

If you wish to source your own line choke refer to the individual Electrical Rating tables in Chapter 8 for the relevant rms line currents. For constant torque applications refer to the AC Line Choke table for the peak instantaneous line current under overload conditions.

Note that the choke thermal design must accommodate the harmonic currents present in the supply waveform. These will vary according to supply impedance, but as a general guideline, the values used in the diagram below can be used.

1. Number of supply phases: 3
2. Frequency of operation: 50 - 60 Hz
3. Choke inductance during overload should be a minimum of 90% of nominal inductance.

Typical AC Line Current Waveform

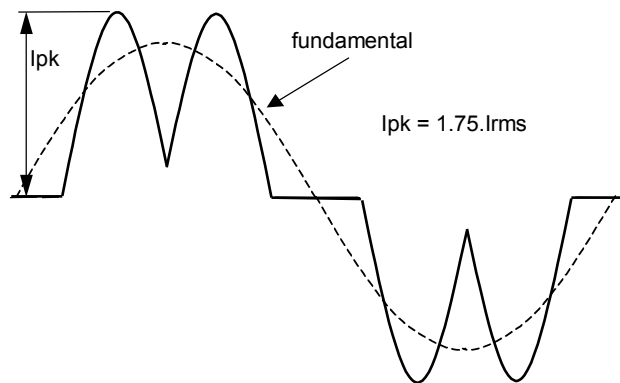

Typical AC Line Harmonic Current Content

(Refer to Parker Hannifin Manufacturing for exact information)

fundamental	90%
5th harmonic	40%
7th harmonic	15%
11th harmonic	7%
13th harmonic	3%

3-6 Installing the Drive

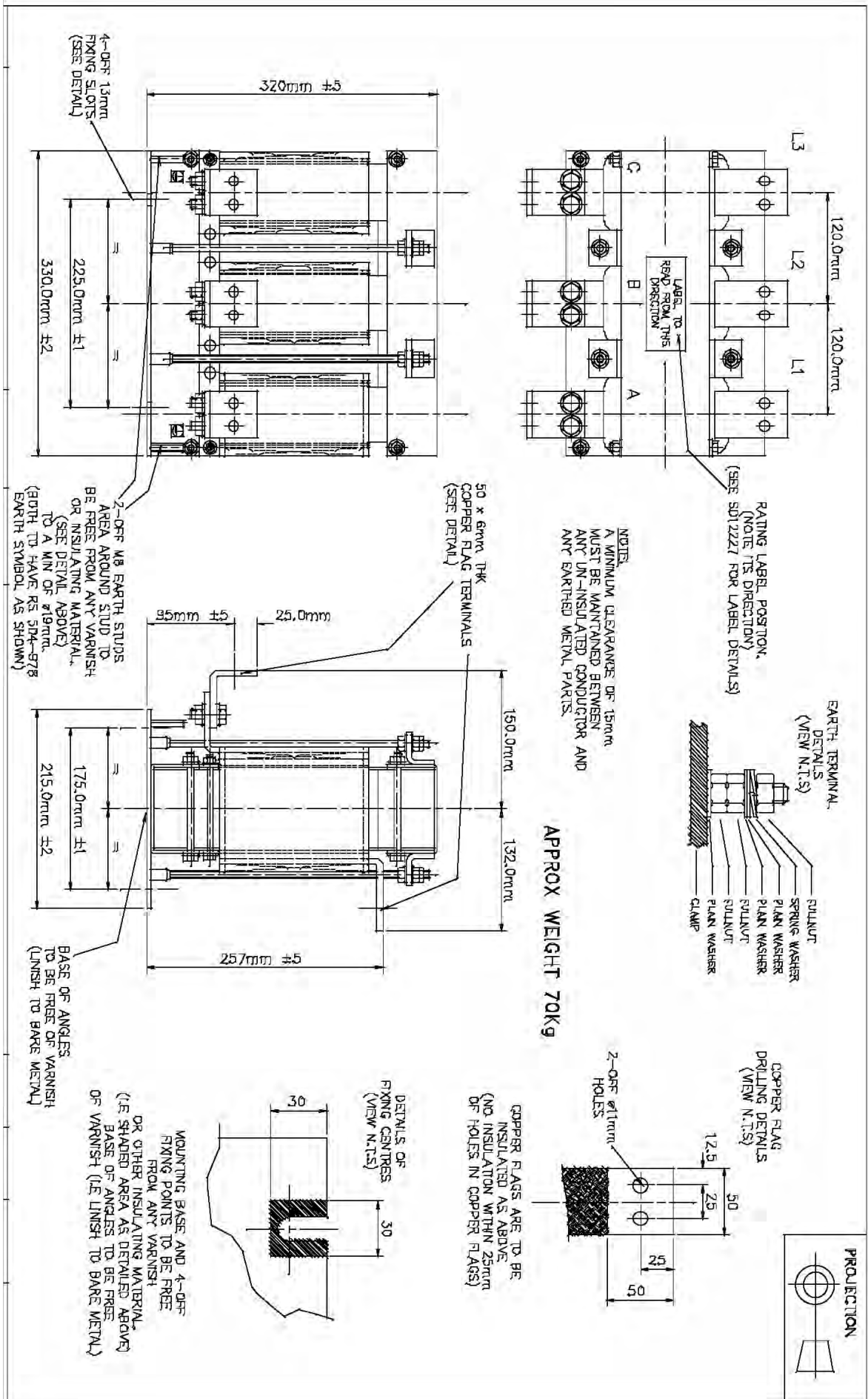

315A, 75µH Choke Outline Drawing for Frames G, H & J - Drawing No. SD12224

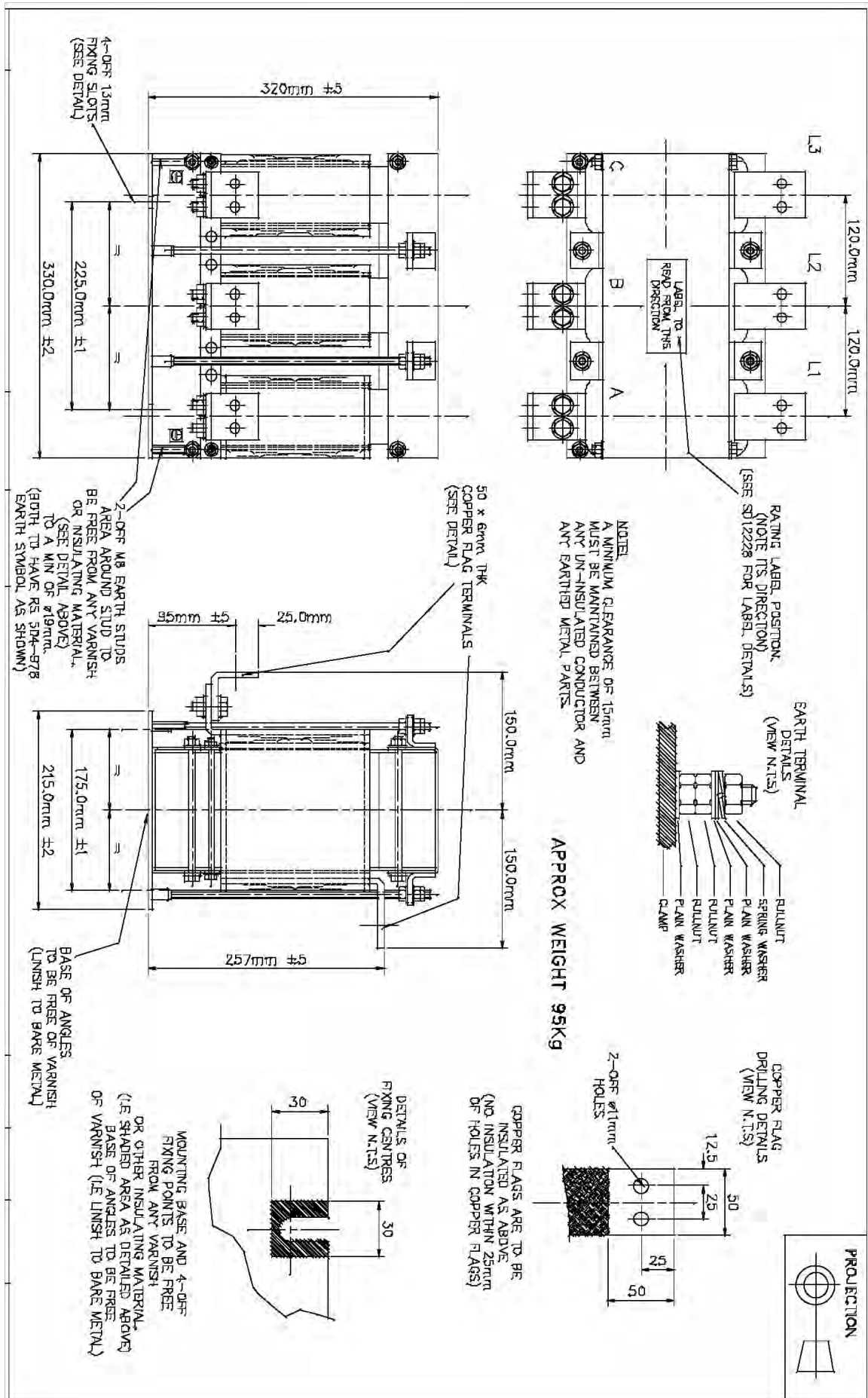

3-8 Installing the Drive

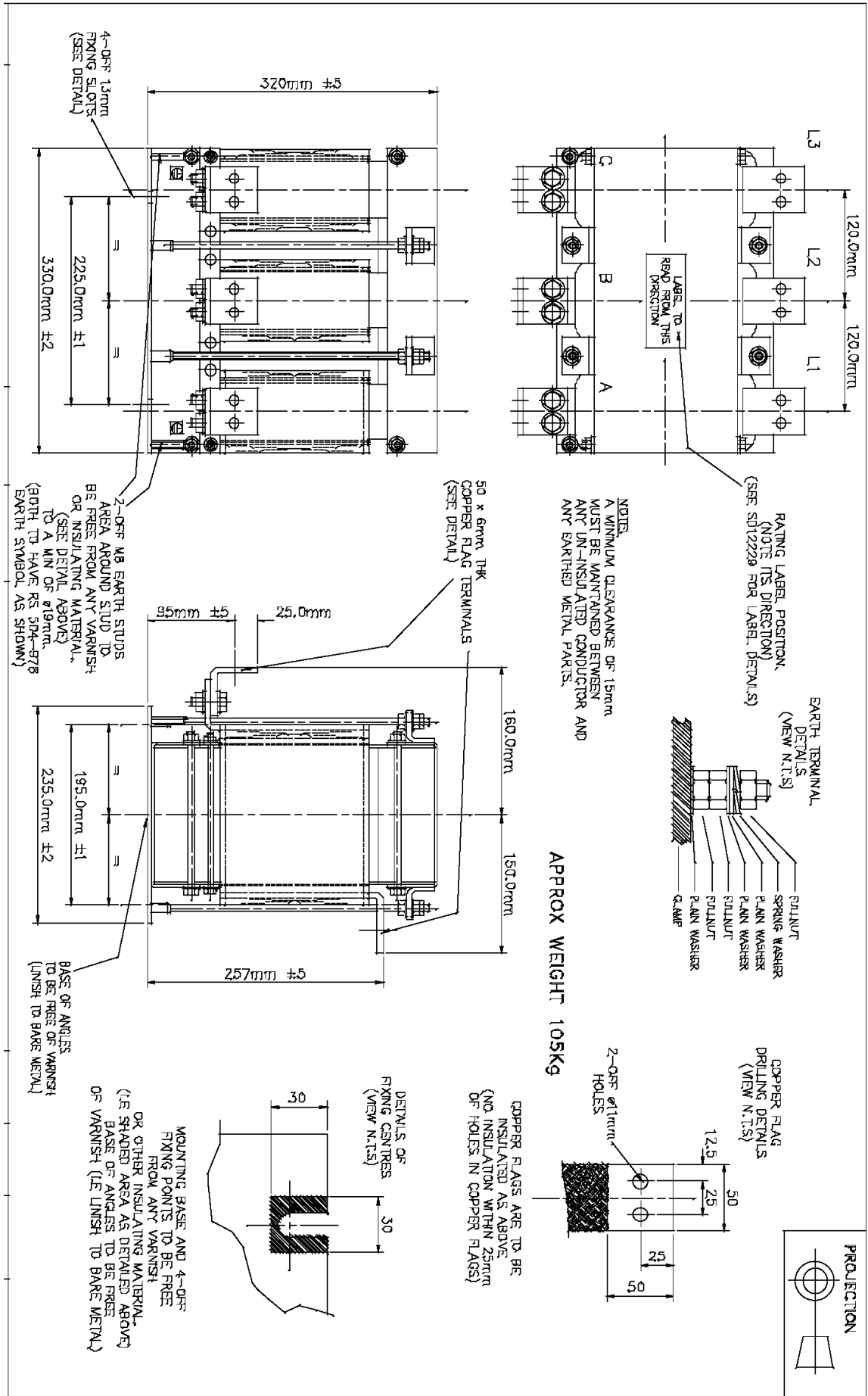

680A, 35µH Choke Outline Drawing for Frames G, H & J - Drawing No. SD12226

Main Cooling Fan and Supply Requirements

The Frame G and H drives have an integral main cooling fan. However, the Frame J drive has a separate main cooling fan which must be fitted to the bottom panel of the enclosure as shown in drawing HG465731U001 at the end of this chapter, with the 4 off M6 nuts provided. Refer to drawing HG463151D002 for fan wiring details (Frame J only) in Chapter 7: “Routine Maintenance and Repair” – Fan Replacement.

The drives require an external single phase supply and fuse protection (motor start type) for the main cooling fan.

Drive	Part Number	Airflow (cfm / m ³ /hr)	Supply Volts	Watts	Fuse
690G ≤132kW	DL389775	350/595	115	205	3A
	DL464085	350/595	230	195	2A
690G >132kW	DL465651U115	475/807	115	315	4A
	DL465651U230	475/807	230	330	2A
690G >132kW	DL471062U115	475/807	115	405	5A
	DL471062U1230	475/807	230	355	3A
690H	DL389776U001	883/1500	115	560	8A
	DL464086U001	883/1500	230	520	4A
690J	DL389776U001	1032/1753	115	600	10A
	DL464086U001	1032/1753	230	560	5A

Electrical Installation

IMPORTANT: Please read the Safety Information on page Cont. 3 & 4 before proceeding.

WARNING!
Ensure that all wiring is electrically isolated and cannot be made “live” unintentionally by other personnel.

Note: Refer to Chapter 8: “Technical Specifications” for additional Cabling Requirements and Terminal Block Wire Sizes.

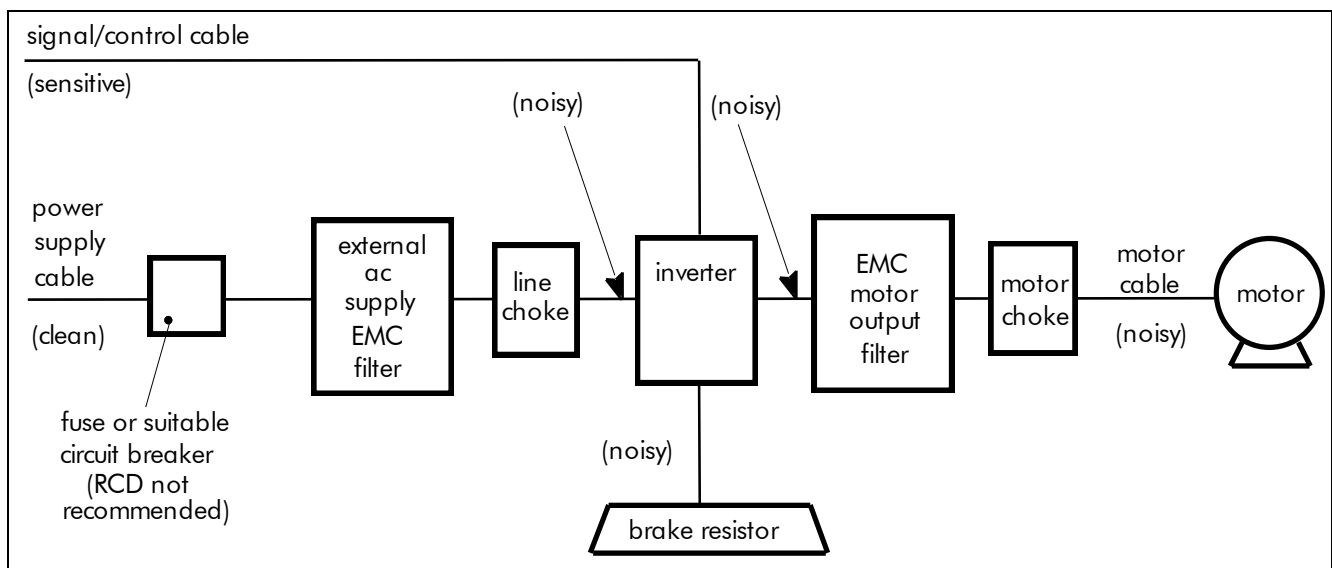
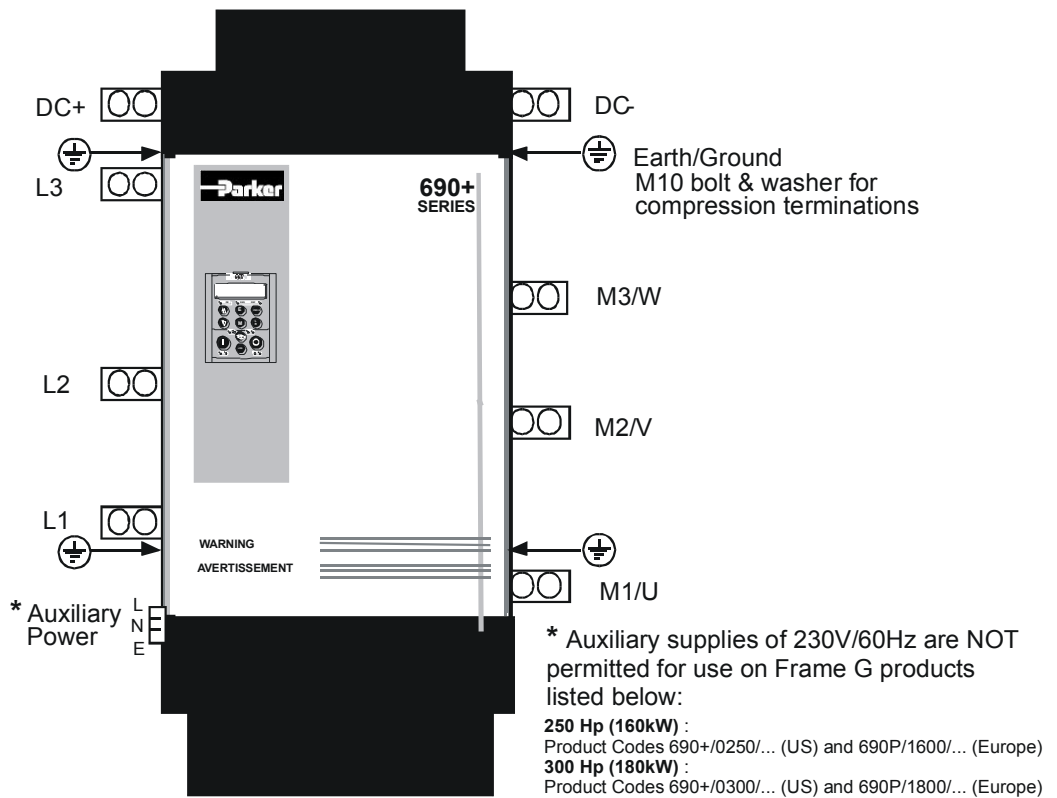

Figure 3-1 Cabling Requirements

Cables are considered to be electrically *sensitive*, *clean* or *noisy*. You should already have planned your cable routes with respect to segregating these cables for EMC compliance. If not, refer to Chapter 9: “Certification for the Drive”.

3-10 Installing the Drive

Power Wiring and Protective Earth (PE) Connections



The unit must be **permanently earthed**. Protect the incoming mains supply using a suitable fuse or circuit breaker (circuit breaker types RCD, ELCB, GFCI are not recommended). Refer to “Earth Fault Monitoring Systems”, page 3-25.

IMPORTANT: The drive is only suitable for earth referenced supplies (TN) when fitted with an external ac supply EMC filter.

The unit must be **permanently earthed** according to EN 50178:

- ◆ A cross-section conductor of at least 10mm² is required. This can be achieved either by using a single conductor (PE) or by laying a second conductor though separate terminals (PE2 where provided) and electrically in parallel.

Refer to Chapter 9: “Certification for the Drive” - EMC Installation Options.

Motor Thermistor Connections

This input is provided to detect over-temperature in motors fitted with an internal thermistor. There is no polarity to the thermistor connections.

IMPORTANT: This input provides “Basic” insulation only to the SELV control circuits and assumes the motor has “Basic” insulation to the windings/mains circuits.

The thermistor type supported is PTC ‘Type A’ as defined in IEC 34-11 Part 2. The drive uses the following resistance thresholds:

Rising temperature trip resistance: 1650 to 4000Ω
 Falling temperature trip reset resistance: 750 to 1650Ω

If the motor is not fitted with an internal thermistor, you should disable the thermistor trip function either by setting INVERT THERMIST to be TRUE, or by linking the thermistor terminals.

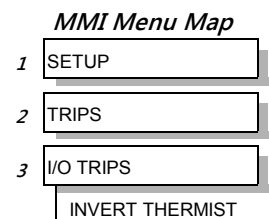

Control Wiring Connections

All 690+ Series AC Drives have the same control wiring connections.

Note: Use screened control cables to comply with EMC requirements. All screens terminated using a gland at the gland plate.

1. Feed the control cables into the drive through the metal gland plate and connect to the control terminals. The diagram below shows the typical control connections required for operation as a simple speed controller.
 - Each bank of cables (1-10, 11-20 and 21-26) **must** be secured together with a cable tie as close to the terminals as possible.
2. Refit and secure the terminal cover using the retaining screws.

IMPORTANT: The control board 0V must be connected to protective earth outside of the product to meet EMC and safety requirements.

Note: Refer to Chapter 8: "Technical Specifications" for Control Terminal information

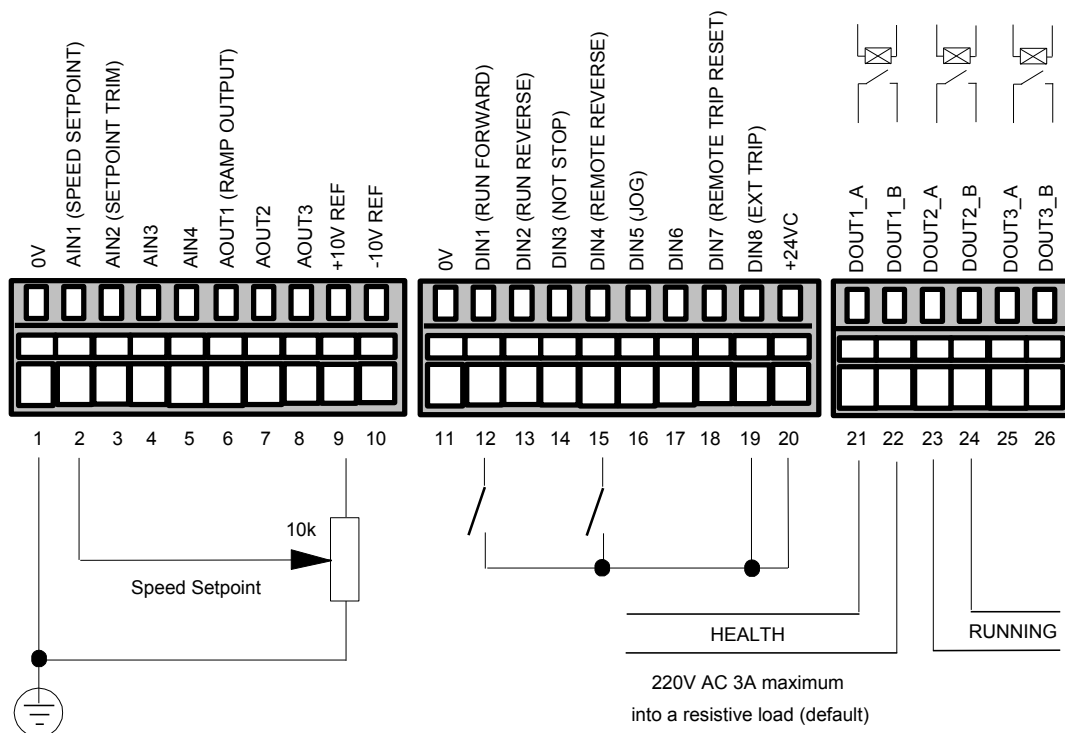

Figure 3-2 Typical Connection to the Control Terminals

3-12 Installing the Drive

Optional Equipment

System Board

With this expansion board, the 690+ drive is suitable for high-end web processing and mini PLC replacement applications.

The following features are provided:

- Converts AIN1-4 in to high resolution (12-bit plus sign) non-isolated analog inputs
- 5 configurable fully-isolated digital inputs/outputs (for PLC applications), individually selectable to input or output
- Supplies variable voltage, isolated encoder power supply
- Decoding logic to interface the encoder to the microprocessor
- Master Encoder Input (isolated HTTL), A, B and Z
- Slave Encoder Input (isolated HTTL), A, B and Z
- Encoder Re-Transmit (isolated HTTL), A, B and Z

Front View (with items removed)

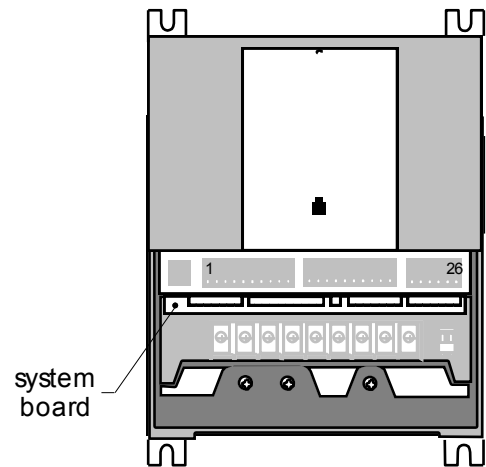

Frame B illustrated

External Power Supply

An external 0V and 24V dc ($\pm 10\%$) 1A power supply is required for the board to operate and supply the digital I/O and encoder power supply at maximum loading.

System Board Kit

LA503493 System Board kit is made up with the following:

Item	Part No.	Qty
System Board	AH463889U001	1
Spacer - Nylon	BG467482U001	1
Spacer - Brass	BG467483U001	1
Spacer - Nylon	BG467484U001	2
Spacer - Nylon	BG465155U002	2
Screw	FB084K25	2
Terminal Blocks	GE388048U001	3
	CE388047U001	1
Instruction	HA503519	1
Leaflet		

Fitting the System Board (Frames C – K only)



Caution Remove all power from the drive before commencing.

1. First remove the cover from the 690+ to expose the housing for removal.

2. Unscrew the 3 screws holding the control housing.

(Frame E, F, G, H and J have 2 extra screws).

3. Lift up the housing so you can detach the two ribbon cables from the rear, and then remove the housing.

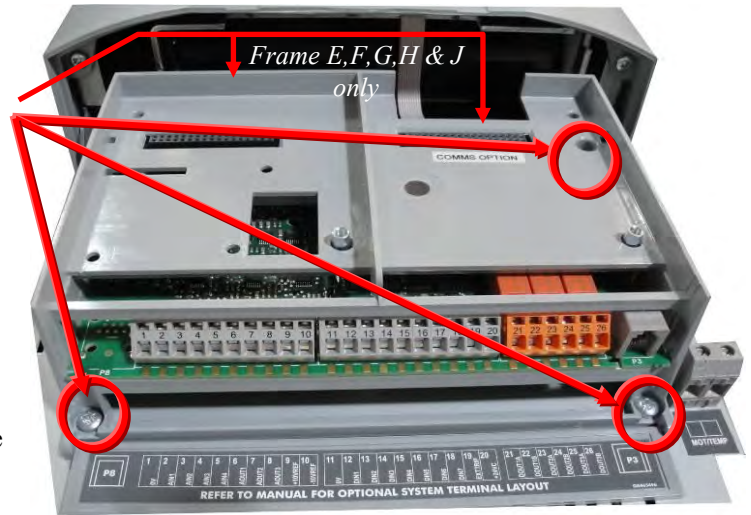

Frame D illustrated

4. Now prepare the system board:



- 4.1 Fit the 2 x nylon spacers into the PCB, (BG467484U001).

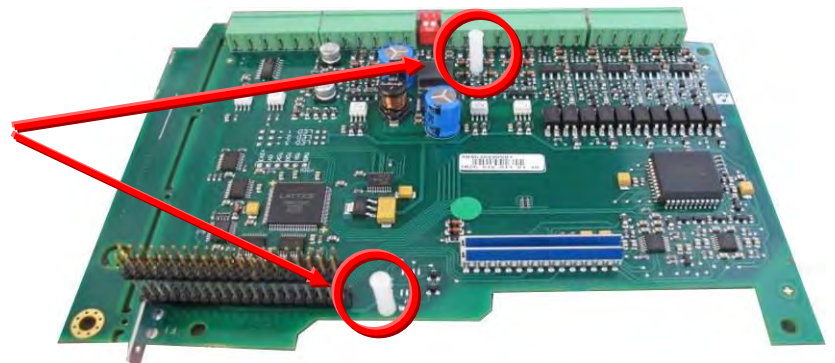

3-14 Installing the Drive

5. Install the system board into the housing by:
 - 5.1 Invert the control housing and system board.
 - 5.2 Remove the two screws holding the control board and discard, leaving the control board in place.

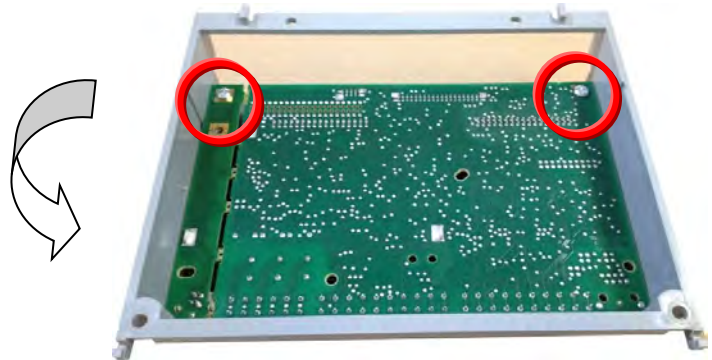

6. Insert the system board under the lip of the housing, align the multi pin connector and push down to locate the nylon spacers to the control board surface.

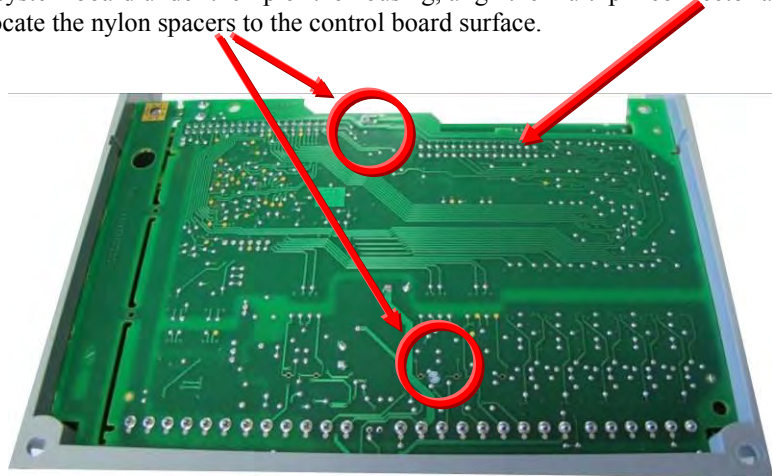

7. Ensure the pin header is seated in position correctly

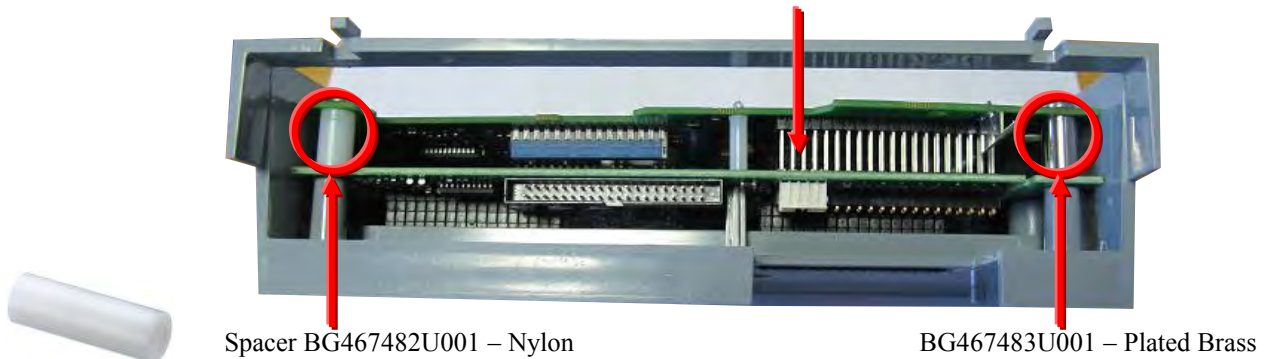

8. You can now slide the spacers in-between the control and system boards, as shown above, making sure they are in their correct locations as shown.
9. Fit and hand tighten the screws FB084K25 in two positions through the spacers.

10. Rotate the control housing back to its original position.
11. Replace the two nylon spacers already on the product by the shorter versions supplied, BG465155U002

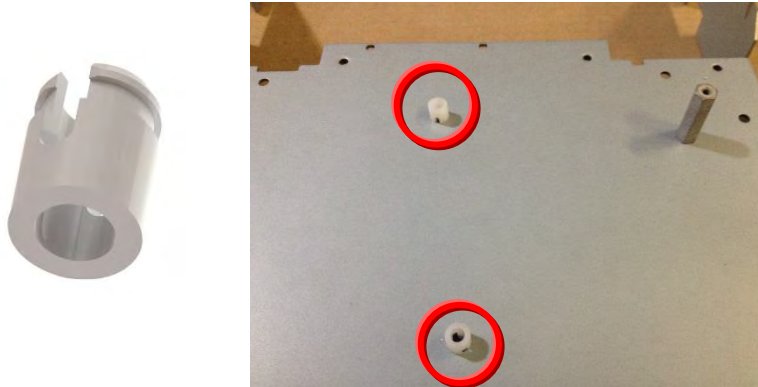

12. Reconnect rear ribbon cables then;
 - (a) Frames C to D hook the housing into the main product assembly.
 - (b) Frames E to J place into the main product aligning the fixing holes.
13. Replace the three, or five, screws to hold down the control housing, as appropriate.

Encoder Input Specification

Maximum Pulse Rate	250kHz
Receiver Current	≤10mA per channel
Input Format	Two differential channels in quadrature
Differential Input Threshold	3V ±1
Encoder Supply	Maximum load = 200mA. Voltage adjustable 12-24V by switches SW1 & SW2

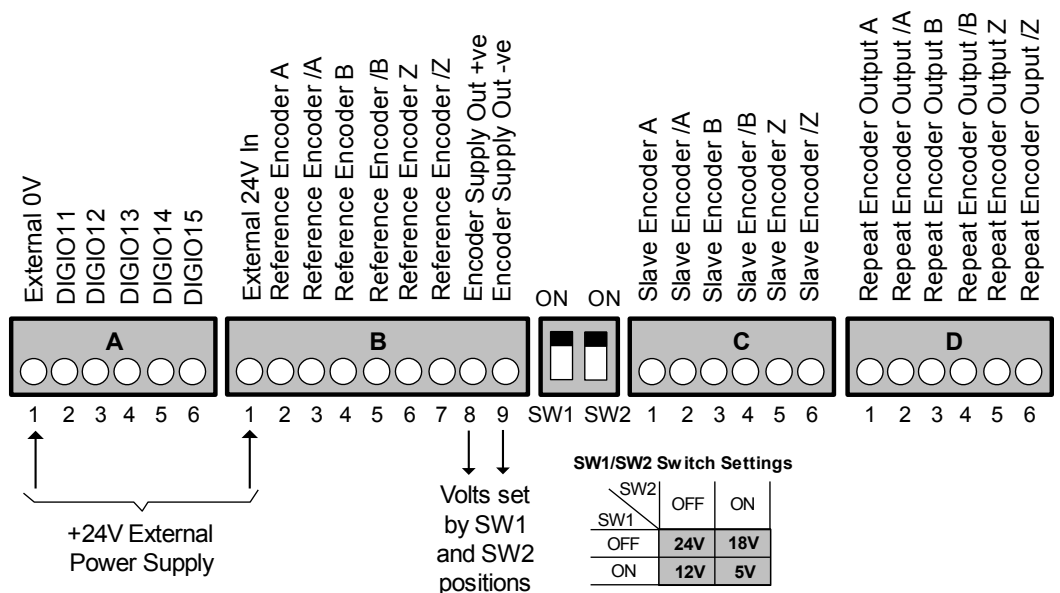

Figure Chapter 3 -3 System Board Terminals

3-16 Installing the Drive

Encoder Connections

Take special care wiring the encoders to the system board due to the low level of the signals.

All wiring to the system board should be made in screened cable. Use cable with an overall screen and a screen over each individual pair. To ensure compliance with the EMC Directive the overall cable screen should be connected to the encoder body and to the drive chassis.

Recommended cable (pairs individually screened):

Belden equivalent 8777

Parker Hannifin Manufacturing Part Number CM052666

Differential Encoders

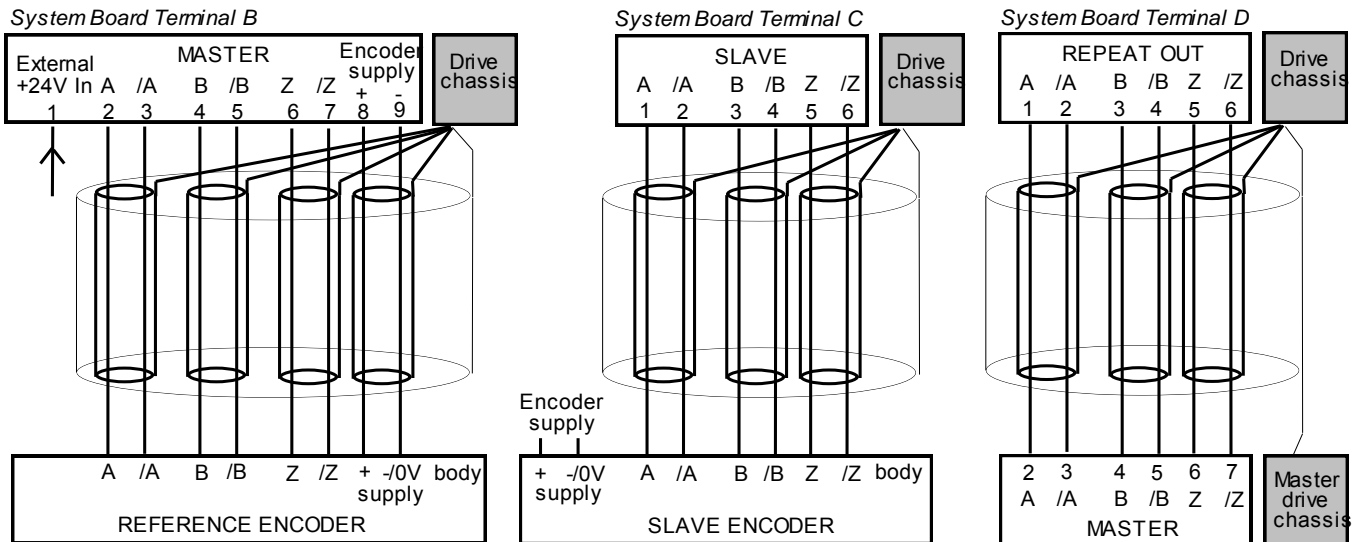

Single-Ended Encoders

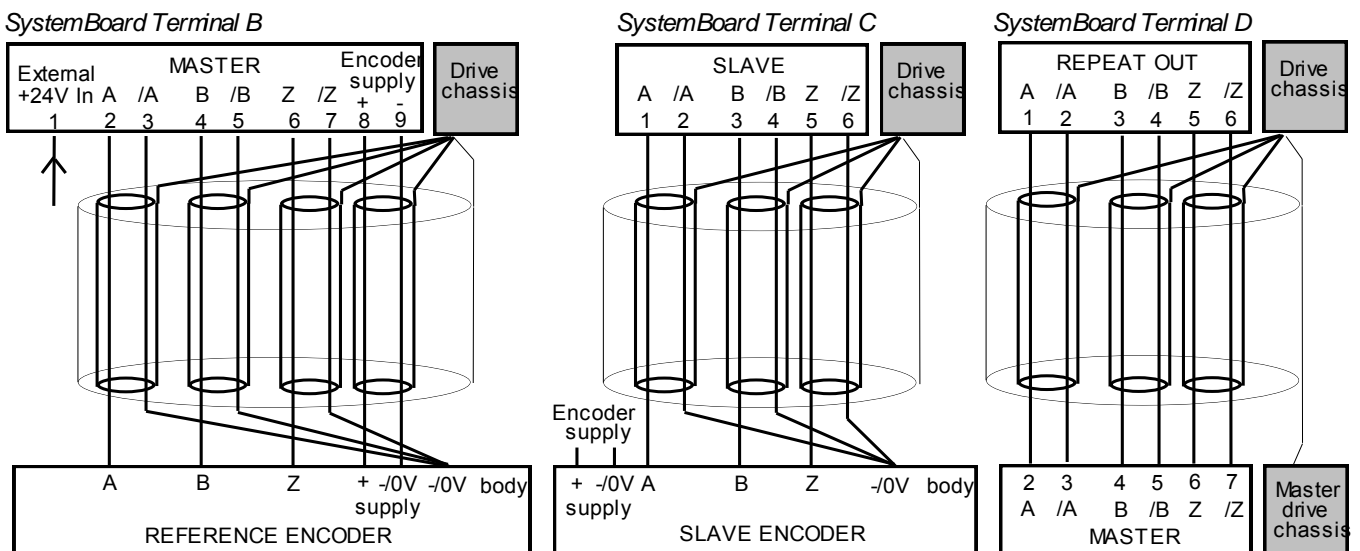

Parker Hannifin Manufacturing Approved Encoders

Operation with 5V encoders is not recommended. We recommend using 10-24V differential encoders, as shown below.

Recommended Encoder (12mm bore)	Hengstler: Parker Hannifin Manufacturing Part Number:	RI 58TD//2048ED.37IF DD464475U012
Alternative Encoders (20mm bore)	Hengstler: Parker Hannifin Manufacturing Part Number:	RI 76TD/2048ED-4N20IF DD464475U020

Encoders are available from Hengstler in other accuracies such as 500 lines/rev or 2000 lines/rev to suit the application.

Technology Options

(Master drive only).

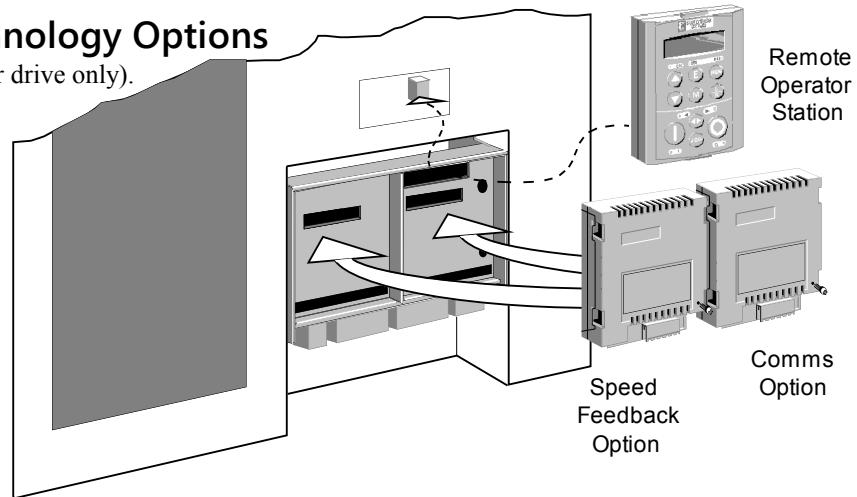

WARNING!

Isolate the drive before fitting or removing the option.

There are two Technology Options:

1. Speed Feedback
2. Communications

These are plugged into the two positions, as illustrated above.

All Technology Options are designed as plug-in technology boxes. You can operate the drive with the Speed Feedback and/or Communications Technology Options, but you **cannot** use two options of the same kind.

Note: Refer to the appropriate Technology Option Technical Manual for further information.

Technology Box

Remove a technology box option by carefully pushing a long screwdriver (for instance) under the option and gently prising it out. The pins are protected by the option moulding.



Item	Part No: Frames G, H, J
TB1 Comms Technology Option	
<i>Plug-in field bus communications interface options.</i>	
Profibus	6055/PROF
Profibus Technology Option manual	HA463561U001
RS485/RS422/Modbus/EI Bisynch	6055/EI00
RS485 Technology Option manual	HA463560U001
Link	6055/LINK
Link Technology Option manual	HA470237
Device Net	6055/DNET
Device Net Technology Option Manual	HA463575U001
CANopen	6055/CAN
CANopen Technology Option Manual	HA467800U001
Modbus Plus	6055/MBP
Modbus Plus Technology Option Manual	HA468032U001
ControlNet	6055/CNET
ControlNet Technology Option Manual	HA468029U001
LonWorks	6055/LON
LonWorks Technology Option Manual	HA468031U001
TB2 Speed Feedback Technology Option	
<i>Plug-in speed feedback HTTL Encoder option.</i>	
Technology Box (Frames C, D, E, F, G, H, J)	6054/HTTL

Drive Brake Unit

Note: Refer to Chapter 8: "Technical Specifications" - Internal Dynamic Brake Switch for further details.

The brake unit is optional. However, it is possible to retro-fit a brake unit should the need arise. There are three brake units, one for each drive frame size.

The brake units have the following specification -

Operating voltage:	750 - 820V dc
Maximum duty cycle:	30%
Maximum on time:	20 seconds
Continuous duty:	30% of Constant Torque drive rating

Note: For more detail refer to Chapter 8: "Technical Specifications".

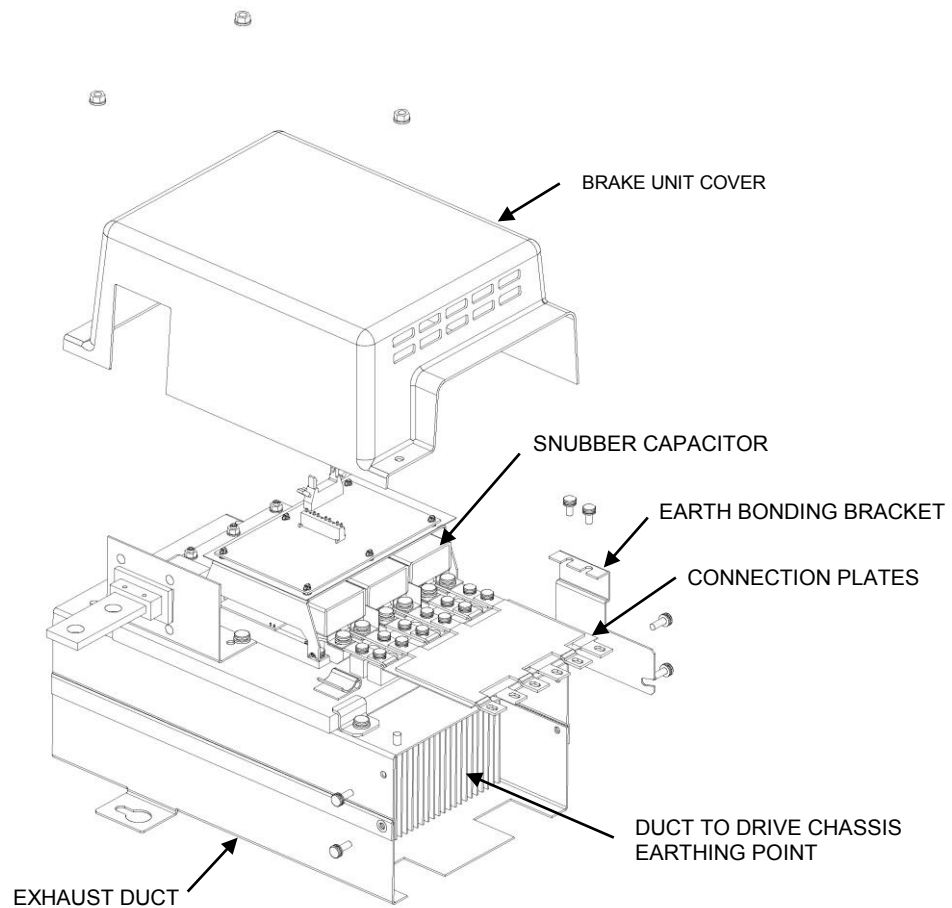

The original exhaust duct supplied with the drive or the exhaust duct supplied with the brake unit may be used in the final installation.

The brake unit consists of the following parts:

- Exhaust Duct.
- Heatsink & IGBT assembly.
- Control cable.
- Brake connection plates - 1 set for type 8/9 and 2 sets for type 10.
- Heatsink fixings.
- Brake unit cover and retaining nuts.
- Earth bonding bracket.

The brake unit is shipped in a pre-assembled state (except for the connection plate(s)). It is recommended that this assembly is carefully studied prior to installation within the cubicle. We also recommend that the brake unit heatsink/IGBT assembly is removed from the exhaust duct before installing the unit within the cubicle.

3-20 Installing the Drive

Required tools

- M10 spanner
- #3 posidrive or phillips torque screwdriver
- #2 posidrive or phillips torque screwdriver

Installation Procedure

WARNING!

Follow the procedure carefully.

Disconnect all electrical supplies before working on the drive - allow 15 minutes for the drive dc link capacitors to fully discharge.

Do not drop any screws, nuts or extraneous parts into the drive.

Refer to Figure 3-5, page 3-21, for typical brake unit installation.

1. Remove the brake unit cover.
2. Remove the earth bonding bracket from the heatsink.
3. Loosen heatsink clamps.
4. Remove the heatsink/IGBT assembly and carefully place it on a clear flat surface - take care not to damage the heatsink fins.
5. If retro-fitting the brake unit to an existing exhaust duct then: Remove the exhaust duct aperture cover and screws. Transfer heatsink clamps and screws from shipping brake duct to existing drive duct.
6. Remove the drive's top front cover (plastic) via 2 off ¼ turn fasteners at top of drive.
7. Remove drive top cover which is attached via 4 off M5 screws on the side and 2 off M5 screws on the top. Care should be taken to prevent the cover from falling into the drive and damaging the internal components. If fitting a new exhaust duct assembly, fit the duct assembly in to the top panel and secure to drive with 4 off M5 screws. Secure to the mounting panel with M8 fixings.
8. Install brake unit IGBT/heatsink assembly within exhaust duct and tighten clamps. Take care not to damage components on the open PCB with handtools.
9. Connect brake unit control cable to the 14 way bulkhead connector at the top of the drive.
10. Secure the brake connecting plate(s) to the phase joining tabs of the drive top phase (M3/U) and the phase joining tabs on the brake unit with M5 screws provided. Tighten to 4Nm (3ft/lbs).
11. Fit earth bonding bracket to heatsink and duct connection/earthing screws (M5) to exhaust duct. Tighten to 4 Nm (3 ft-lb). **NOTE - This connection must not be omitted as it is required for safety reasons.**
12. Replace drive top cover, **exercise care to not damage brake connection plates with the top cover as this will compromise the electrical insulation.** Tighten 4 off M5 screws on side of drive and 2 off M5 screws on top of cover to 2.5 Nm (1.84 ft-lb).
13. Replace drive front top cover with 2 off ¼ turn fasteners.
14. Fit brake unit cover with M6 captive washer nuts.

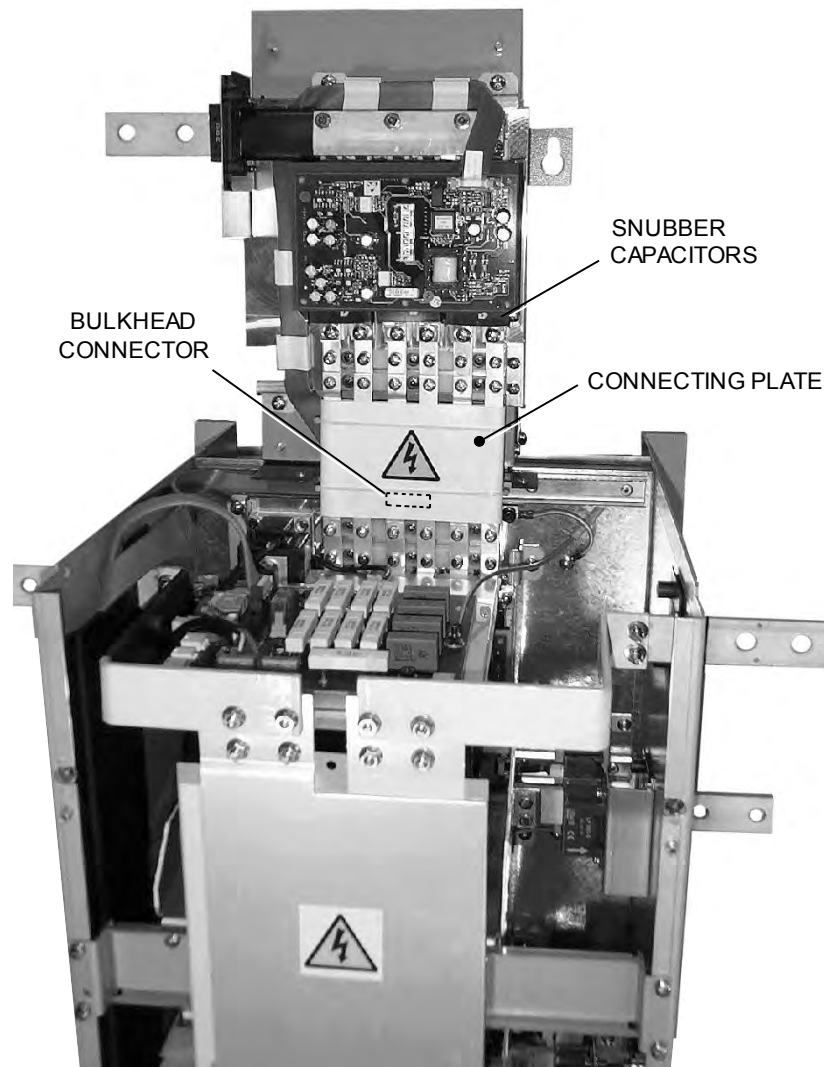

Figure 3-5 Front View of Exhaust Duct/Brake Unit/Drive Assembly showing the Brake Connecting Plate and Snubber Capacitors fitted

External AC Supply EMC Filter

WARNING!

The specified external filters are only suitable for use with TN supplies. Please check for suitability in Chapter 8: "Technical Specifications" - External AC Supply (RFI) Filters.

Do not touch filter terminals or cabling for at least 3 minutes after removing the ac supply. Only use the ac supply filter with a permanent earth connection.

Mount the EMC filter and line choke as close as possible to the drive module. Take care not to obstruct the filter or drive ventilation ducts. Allow 40mm spacing between filters.

Connections between the drive, choke and filter must always be as short as possible, and be segregated from all other cables. If this cable/busbar exceeds 1.0m in length then it must be replaced with a screened/armoured cable, with the screen/armour earthed at both the filter, choke and drive ends with large-area contact surfaces, preferably with metal cable glands.

The routing of the connections between the filter, choke and drive module should be chosen to ensure their close proximity. **Ensure that the filter output leads are separated from the filter input leads. Failure to achieve this will result in increased conducted emissions.**

3-22 Installing the Drive

Caution

The filter flying leads may reach 100°C under normal operating conditions. These should be separated by at least one cable diameter and adequately ventilated.

The connection between the drive module and the motor must be installed away from all other cables or wires. Ideally the filter(s) and choke will be mounted onto the same metallic back panel as the drive. The RF connection between the drive, filter, choke and panel should be enhanced as follows:-

- Remove any paint/insulation between the mounting points of the EMC filter(s), choke, drive module and panel.
- Liberally apply petroleum jelly over the mounting points and securing threads to prevent corrosion. Alternately conducting paint could be used on mounting panels.
- If the proceeding is not possible, then the RF earth bond between the filter and drive module is usefully improved by making an additional RF earth connection using wire braid of at least 10mm² cross sectional area (due to skin effect).

Note: *Metal surfaces such as eloxized or yellow chromed (e.g., cable mounting or 35mm DIN rails, screws and bolts) have a high RF impedance which can be very detrimental to EMC performance.*

A low RF impedance path must be provided between the motor frame and back panel on which the drive, choke and EMC filters are mounted. This low impedance RF path should follow the path of the motor cables in order to minimise the loop area. **Failure to do so will result in increased conducted emissions.**

This will normally be achieved by:-

1. Bonding the armour of the motor supply cables at one end to the motor frame and at the other to the cubicle back panel. Ideally 360° bonding is required, which can be achieved with cable glands.
2. Ensuring that conduit containing the motor supply cables is bonded together using braid. The conduit shall also be bonded to the motor frame and the cubicle back panel.

AC Supply Filter CO467843U340

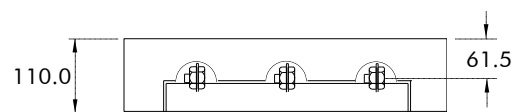
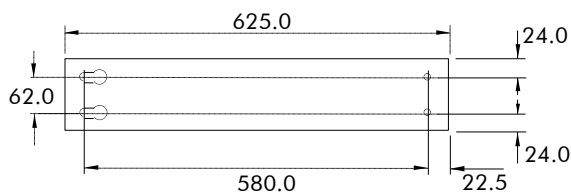
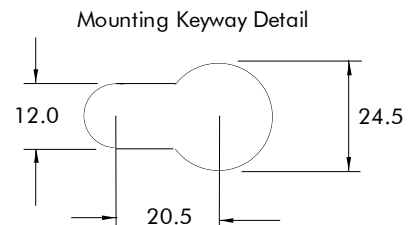
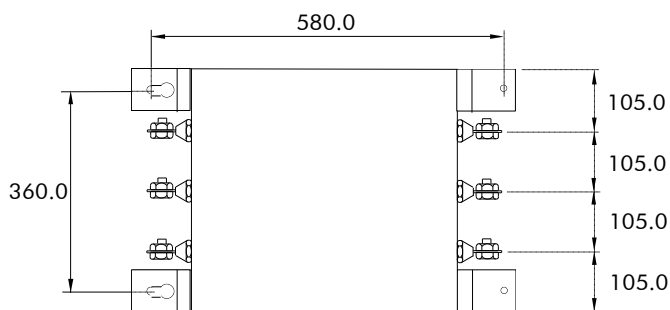

Dimensions are in millimetres

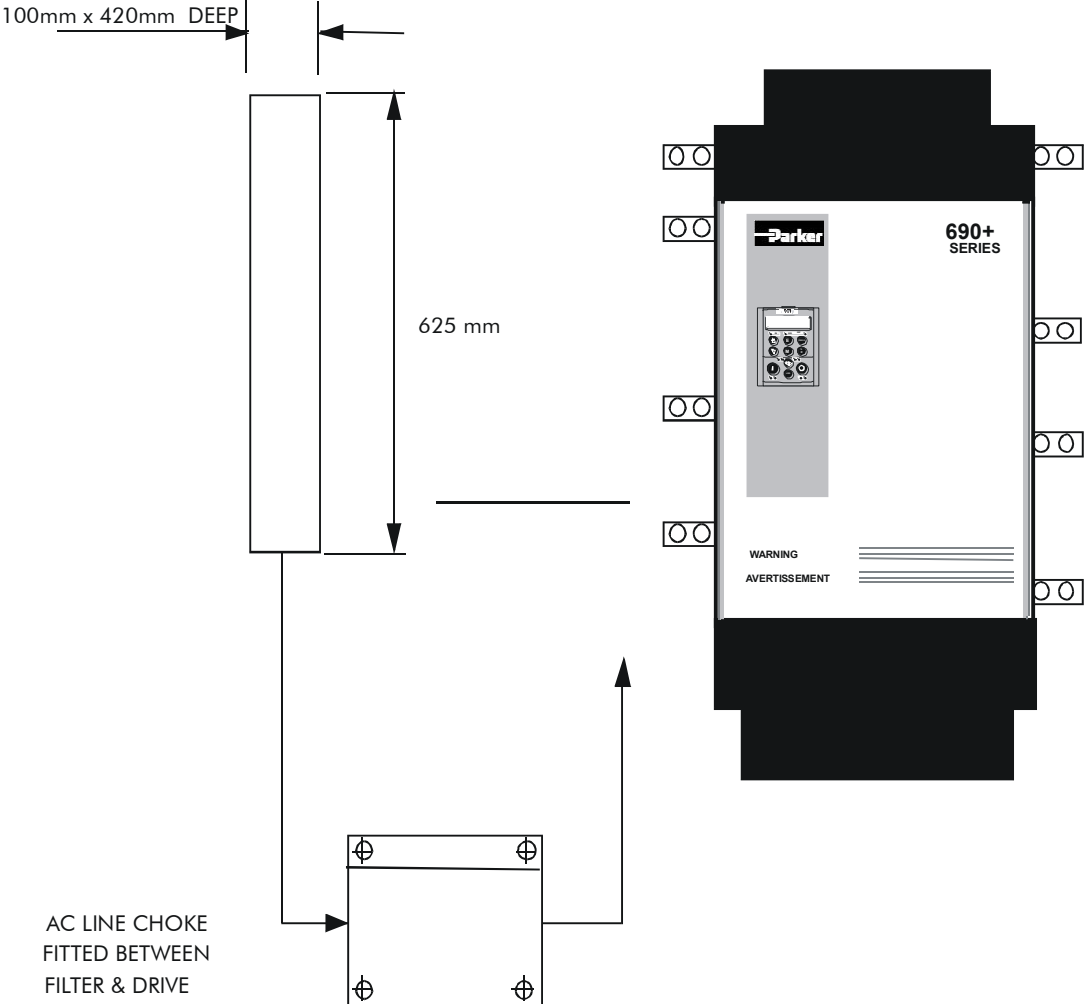

Filter Mounting Details Using 1 off Part No. CO467843U340 for Type G

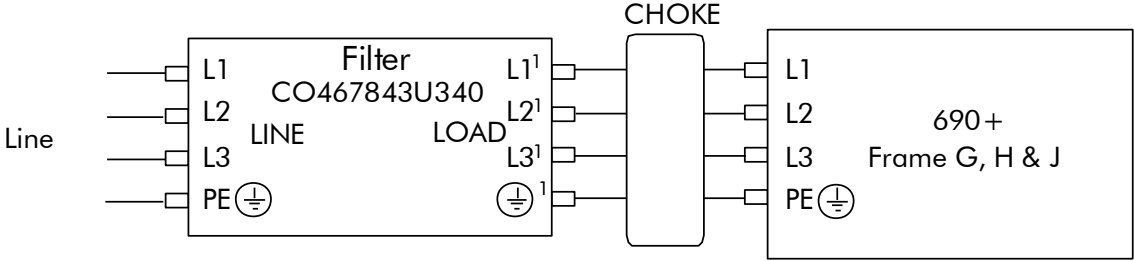

Typical Wiring Details Using 1 off Part No. CO467843U340 for Frame G

3-24 Installing the Drive

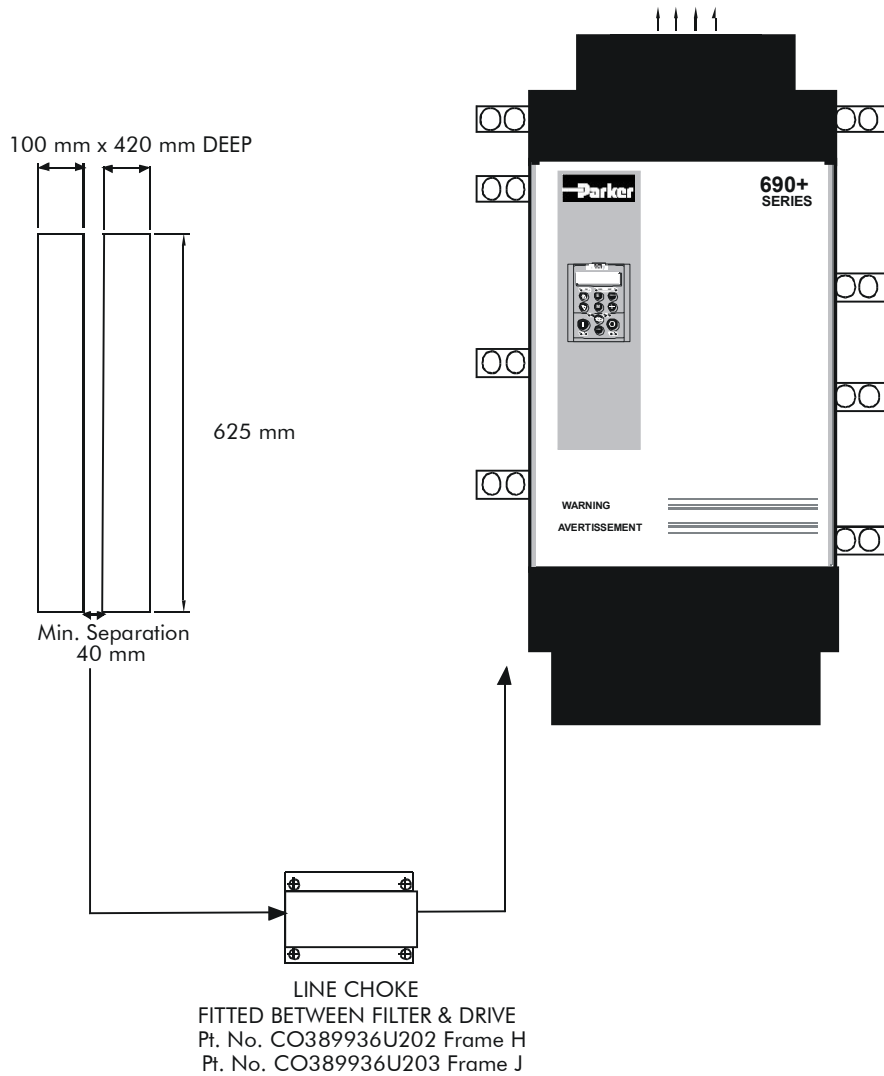

Figure B-4 Filter Mounting Details using 2 off Part No. CO467843U340 Frames H & J

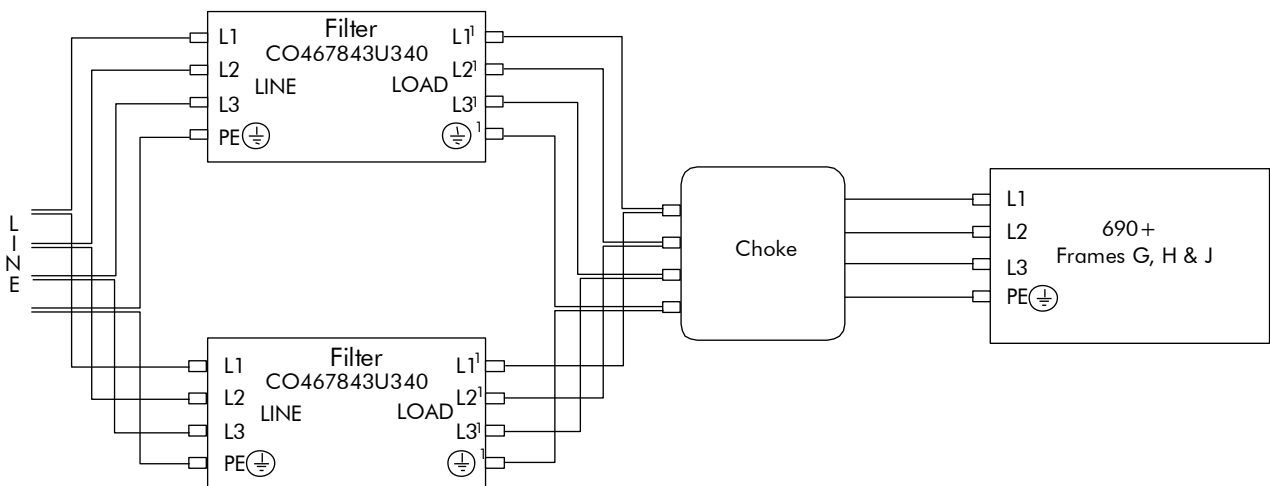

Figure B-5 Using 2 off Part No. CO467843U340 Frame H (2200) and Frame J

Note: For 690+ Frames G, H & J, the specified line choke in table B-1 must still be fitted between the 690+ and its filter. This is to ensure reliability of both the filter and drive.

EMC Motor Output Filter

This can help the drive achieve EMC and filter thermal conformance. It also ensures longer motor life by reducing the high voltage slew rate and overvoltage stresses. Mount the filter as close to the VSD as possible. Please refer to Parker Hannifin Manufacturing for the selection of a suitable filter.

Output Contactors

Output contactors can be used, although we recommend that this type of operation is limited to emergency use only, or in a system where the drive can be inhibited before closing or opening this contactor.

Earth Fault Monitoring Systems

We do not recommend the use of circuit breakers (e.g. RCD, ELCB, GFCI), but where their use is mandatory, they should:

- Operate correctly with dc and ac protective earth currents (i.e. type B RCDs as in Amendment 2 of IEC755).
- Have adjustable trip amplitude and time characteristics to prevent nuisance tripping on switch-on.

When the ac supply is switched on, a pulse of current flows to earth to charge the internal/external ac supply EMC filter's internal capacitors which are connected between phase and earth. This has been minimised in Parker Hannifin Manufacturing filters, but may still trip out any circuit breaker in the earth system. In addition, high frequency and dc components of earth leakage currents will flow under normal operating conditions. Under certain fault conditions larger dc protective earth currents may flow. The protective function of some circuit breakers cannot be guaranteed under such operating conditions.

WARNING!

Circuit breakers used with VSDs and other similar equipment are not suitable for personnel protection. Use another means to provide personal safety. Refer to EN50178 / EN60204-1

AC Motor Choke (output)

Installations with long cable runs may suffer from nuisance overcurrent trips, refer to Chapter 8: "Technical Specifications" - Cabling Requirements for maximum cable lengths. A choke may be fitted in the drive output to limit capacitive current. Screened cable has a higher capacitance and may cause problems in shorter runs.

Frame	Parker Hannifin Part Number
G	CO466709U073
H	CO466709U083
J	CO466250U012

Contact Parker Hannifin Manufacturing for recommended choke values.

5703/1 Speed Repeater Support

The 5703/1 unit provides the facility to run a line of drives in speed-lock. For accurate speed holding, encoder feedback is required. Ratioed speed-locking is supported.

A 16-bit signal is passed between the drives using a fibre optic link connected to the P3 port on each drive. The P3 port operates RS232 compatible signal levels. The 5703/1 unit converts these signals into a fibre optic signal for transmission, and from the converted optical signal to RS232 for reception.

Refer to the manual supplied with the 5703/1 Speed Repeater.

Note: *The P3 port is configured for 5703/1 support using the MMI. Refer to the Software Product Manual, Chapter 1: "Programming Your Application"*

3-26 Installing the Drive

Installation Drawings

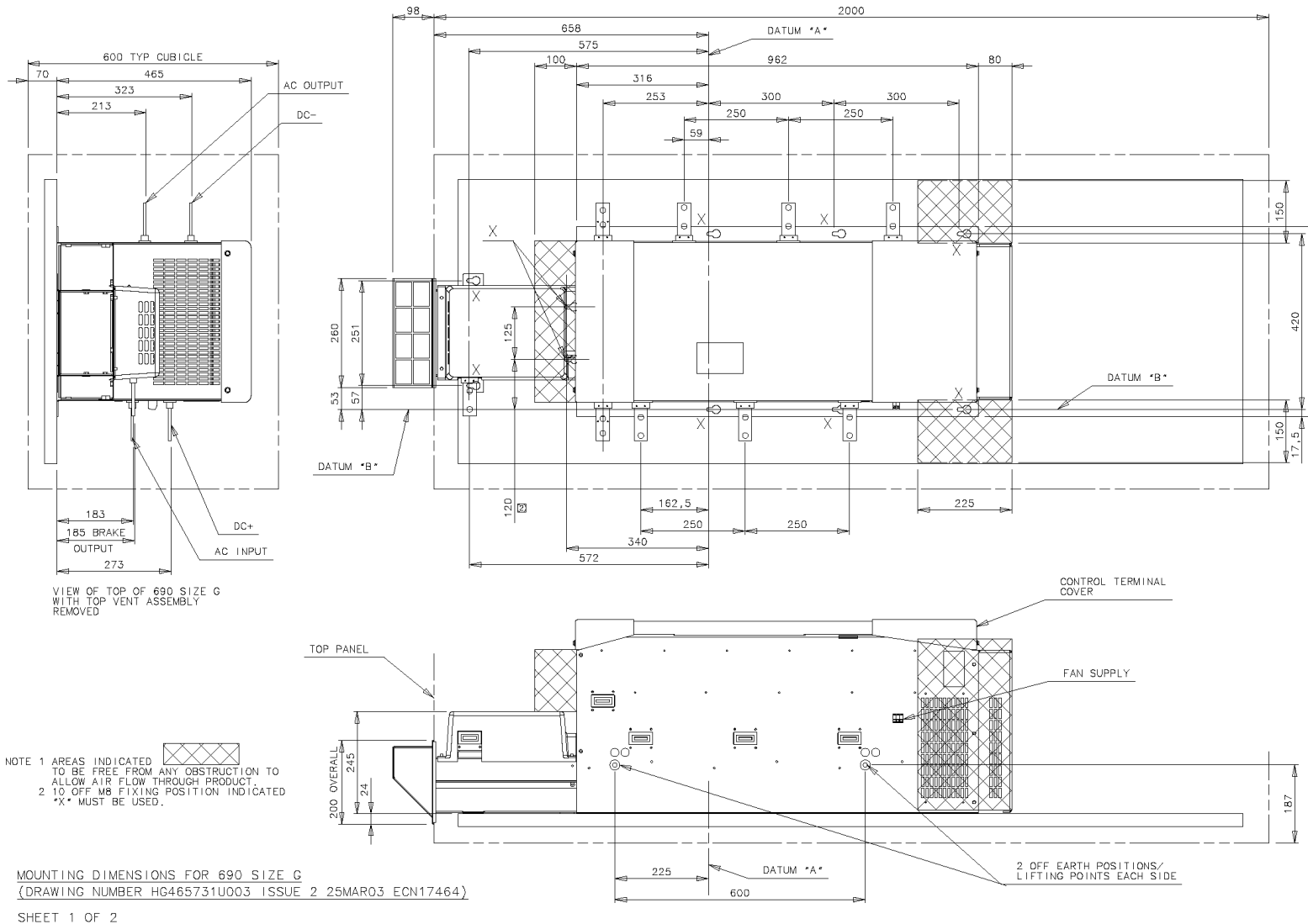

The 690+ drive must be securely mounted using all 10 off M8 mounting hole positions as shown.

Frame G Typical Cubicle Installation Outline Drawing (HG465731U003 Sheet 1)

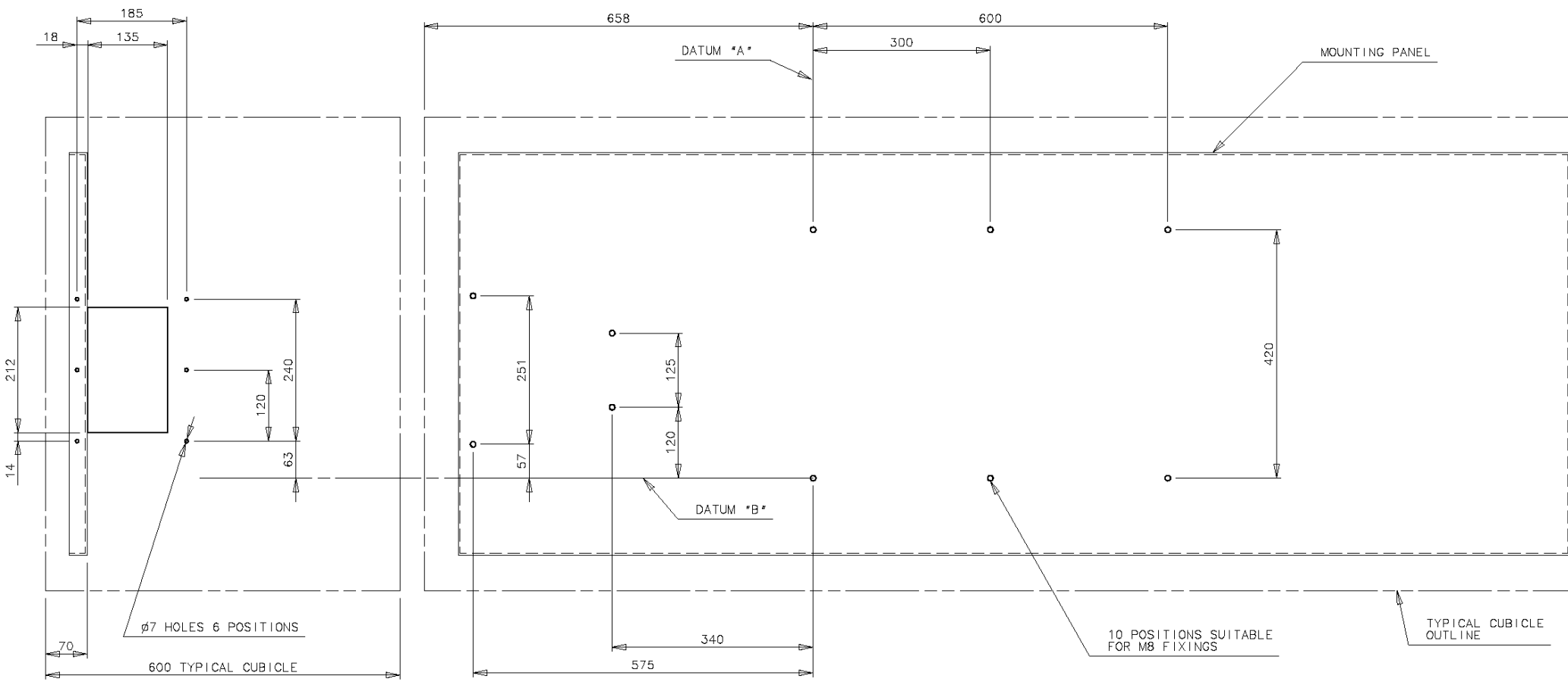

TYPICAL CUBICLE DETAIL SHOWING TOP PANEL AND MOUNTING PLATE HOLE POSITIONS FOR 690 SIZE G

MOUNTING DIMENSIONS FOR 690 SIZE G
 {DRAWING NUMBER HG465731U003 ISSUE 2 25MAR03 ECN17464}

SHEET 2 OF 2

Frame G Typical Cubicle Machining (HG465731U003 Sheet 2)

3-28 Installing the Drive

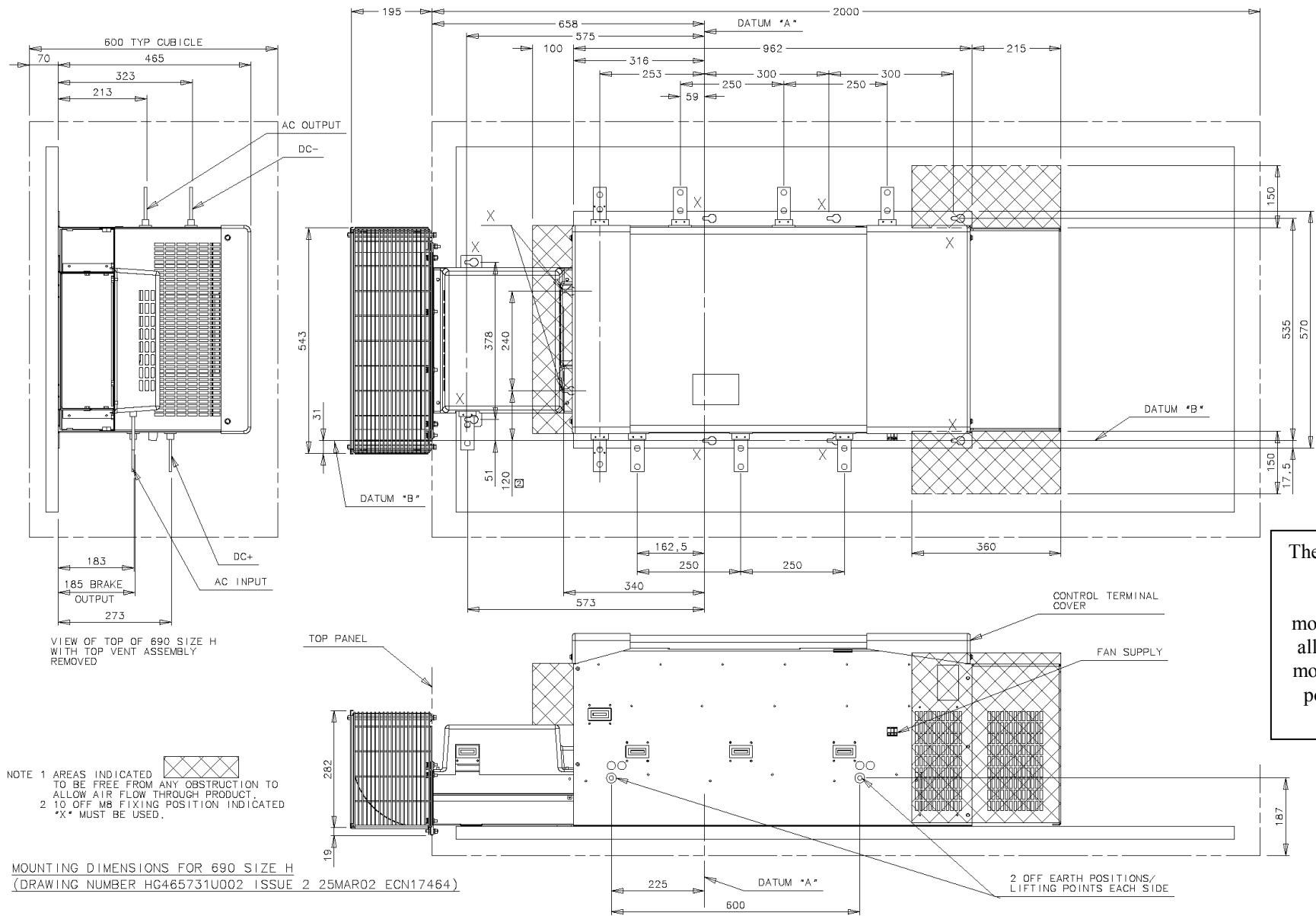

Frame H Typical Cubicle Installation Outline Drawing (HG465731U002 Sheet 1)

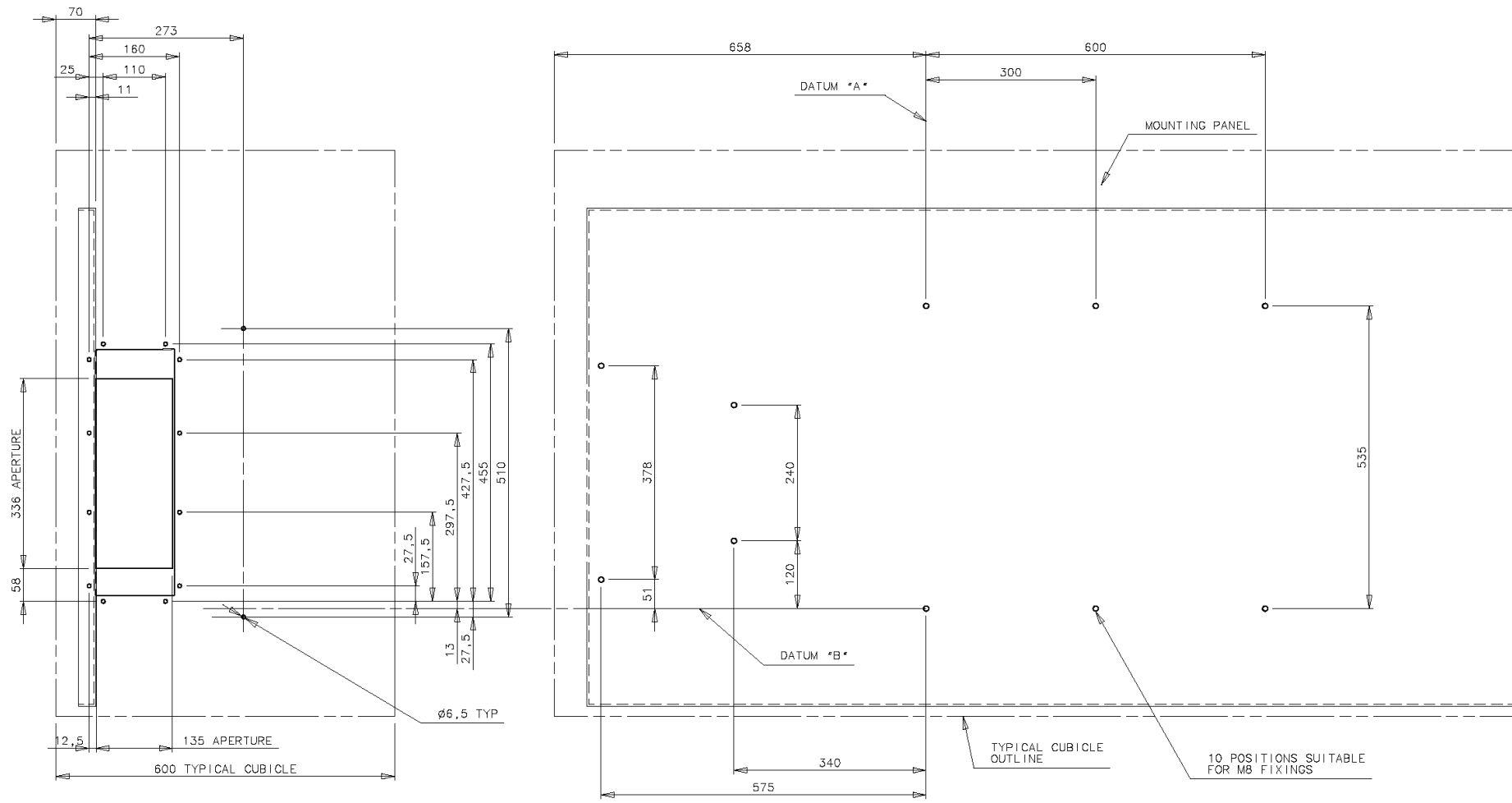

TYPICAL CUBICLE DETAIL SHOWING TOP PANEL AND MOUNTING PLATE HOLE POSITIONS FOR 690 SIZE H

MOUNTING DIMENSIONS FOR 690 SIZE H
 (DRAWING NUMBER HG465731U002 ISSUE 2 25MAR02 ECN17464)

SHEET 2 OF 2

Frame H Typical Cubicle Machining (HG465731U002 Sheet 2)

3-30 Installing the Drive

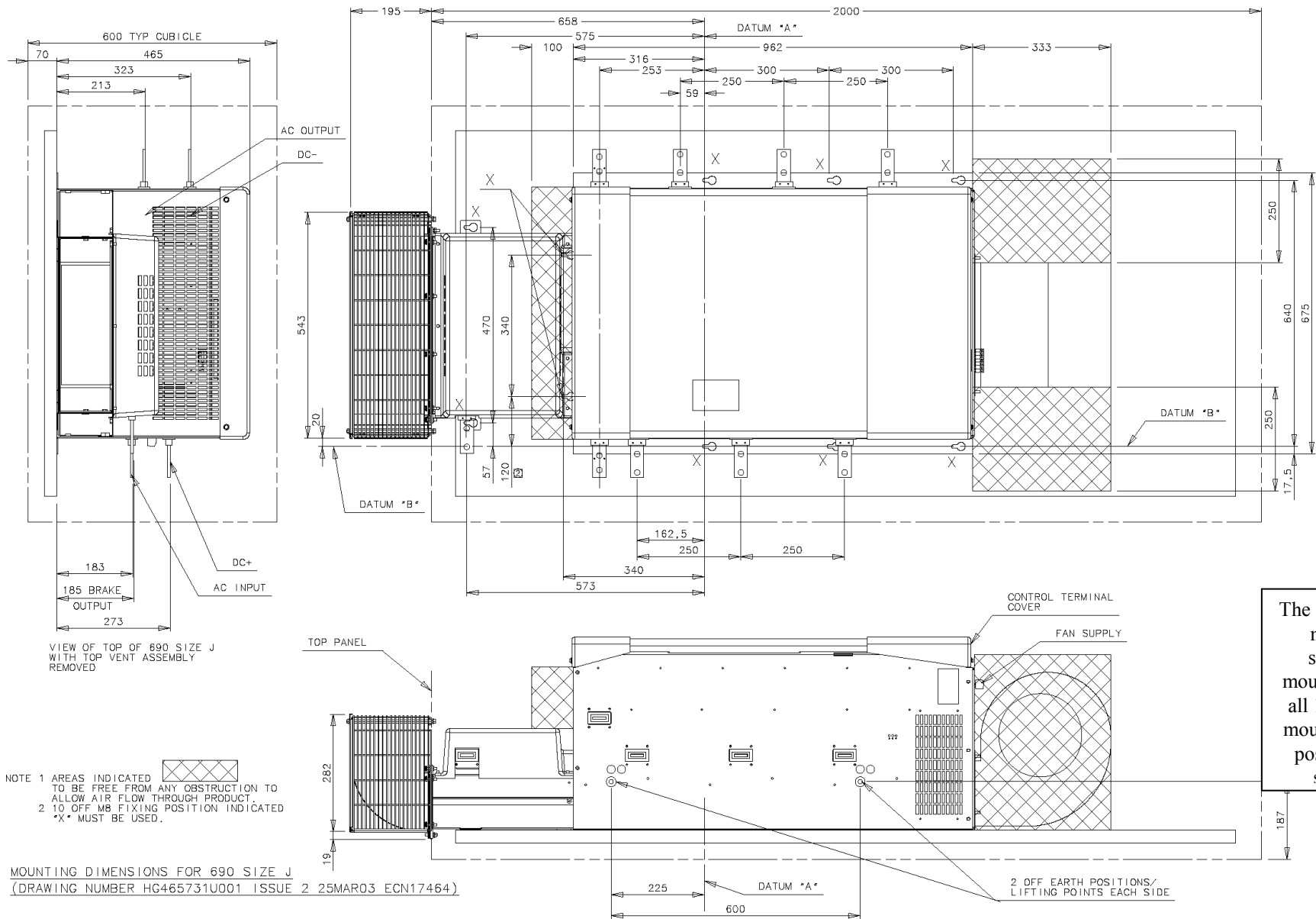

The 690+ drive must be securely mounted using all 10 off M8 mounting hole positions as shown.

Frame J Typical Cubicle Installation Outline Drawing (HG465731U001 Sheet 1)

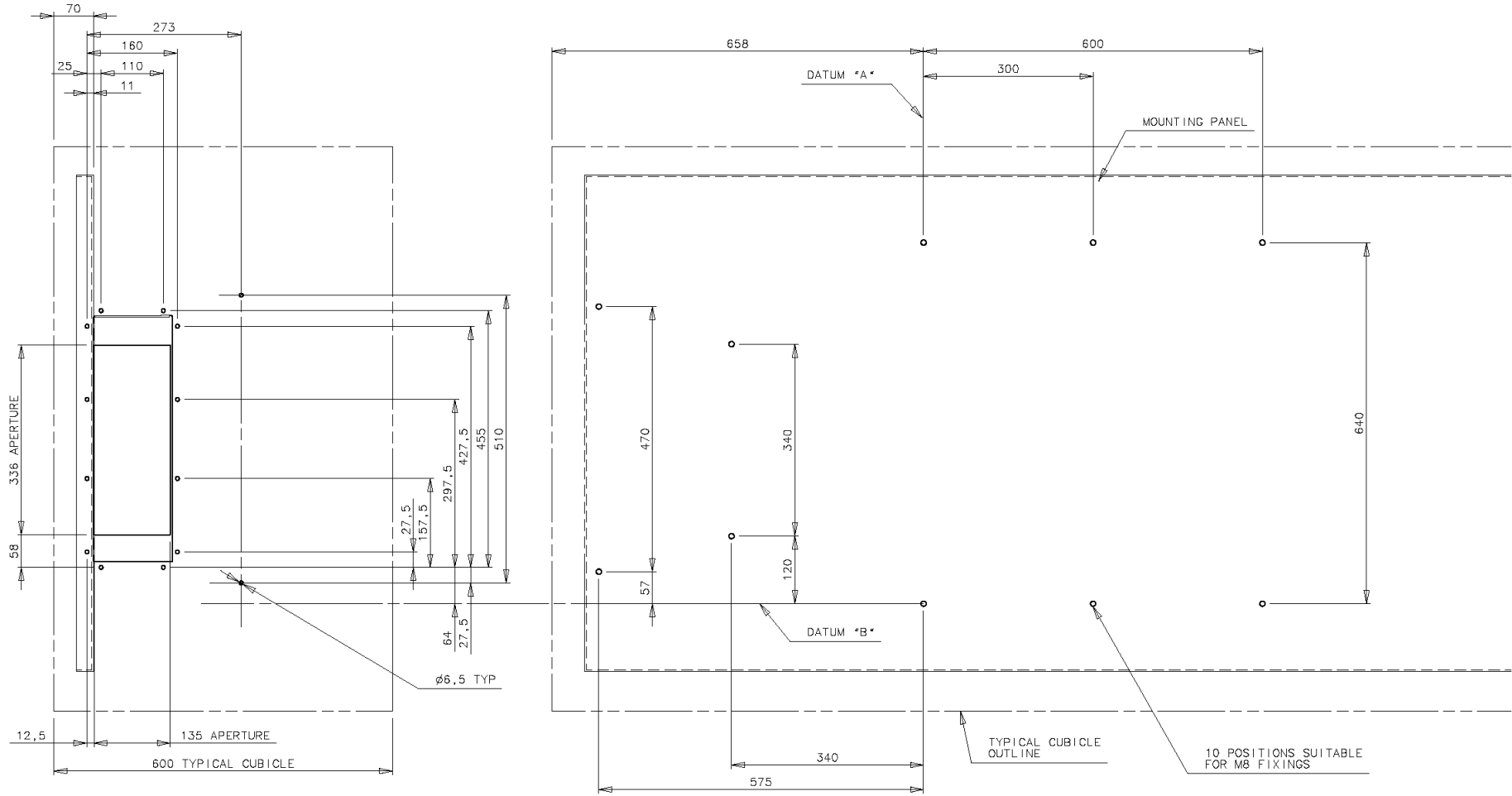

TYPICAL CUBICLE DETAIL SHOWING TOP PANEL AND MOUNTING PLATE HOLE POSITIONS FOR 690 SIZE J

MOUNTING DIMENSIONS FOR 690 SIZE J
 (DRAWING NUMBER HG465731U001 ISSUE 2 25MAR03 ECN17464)

SHEET 2 OF 2

Frame J Typical Cubicle Machining (HG465731U001 Sheet 2)

OPERATING THE DRIVE

DEFAULT

By default, the drive will operate in Remote Start/Stop and Remote Speed Control. Analog and digital inputs and outputs are selected to control the unit.

The drive will operate as an open-loop drive. No set-up or tuning is required. It is programmed to control an induction motor of equivalent power, current and voltage rating to the drive.

In this chapter, refer to Control Philosophy, Initial Start-up Routine, (Routine 1: Remote Control using Control Terminals) and The Start/Stop Mode Explained.

Pre-Operation Checks

WARNING!

Wait for 5 minutes after disconnecting power before working on any part of the system or removing the terminal cover from the drive.

Initial checks before applying power:

- Mains power supply voltage is correct.
- Motor is of correct voltage rating and is connected in either star or delta, as appropriate.
- Check all external wiring circuits - power, control, motor and earth connections.

Note: *Completely disconnect the drive before point to point checking with a buzzer, or when checking insulation with a Meggar.*

- Check for damage to equipment.
- Check for loose ends, clippings, drilling swarf etc. lodged in the drive and system.
- If possible check that the motor can be turned freely, and that any cooling fans are intact and free from obstruction.

Ensure the safety of the complete system before the drive is energised:

- Ensure that rotation of the motor in either direction will not cause damage.
- Ensure that nobody else is working on another part of the system which will be affected by powering up.
- Ensure that other equipment will not be adversely affected by powering up.

Prepare to energise the drive and system as follows:

- Remove the supply fuses, or isolate using the supply circuit breaker.
- Disconnect the load from the motor shaft, if possible.
- If any of the drive's control terminals are not being used, check whether these unused terminals need to be tied high or low. Refer to Chapter 8: "Technical Specifications" - Control Terminals.
- Check external run contacts are open.
- Check external speed setpoints are all zero.

Re-apply power to the drive and system

The drive has Macro 1 installed as the factory default. If you are controlling the drive in Remote control, refer to the Software Product Manual : "Application Macros" for details of other macros.

4-2 Operating the Drive

Control Philosophy

There are four ways to control the drive using Remote and Local control:

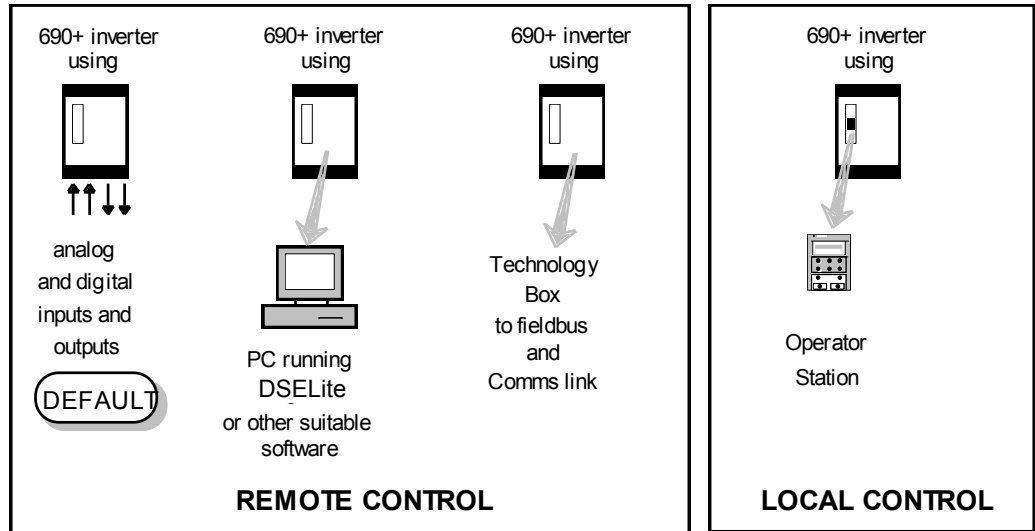

Figure Chapter 4 -1 Remote and Local Control Modes

Start/Stop and Speed Control

There are two forms of control in operation at any time: *Start/Stop* and *Speed Control*. Each can be individually selected to be under either Local or Remote Control.

- **Local or Remote Start/Stop** decides how you will start and stop the drive.
- **Local or Remote Speed Control** determines how you will control the motor speed.

In each case, Local and Remote control are offered by using the following:

Local: The Keypad

Remote: Analog and digital inputs and outputs, RS232 Port or the 6053 Technology Box

Thus the drive can operate in one of four combinations of local and remote modes:

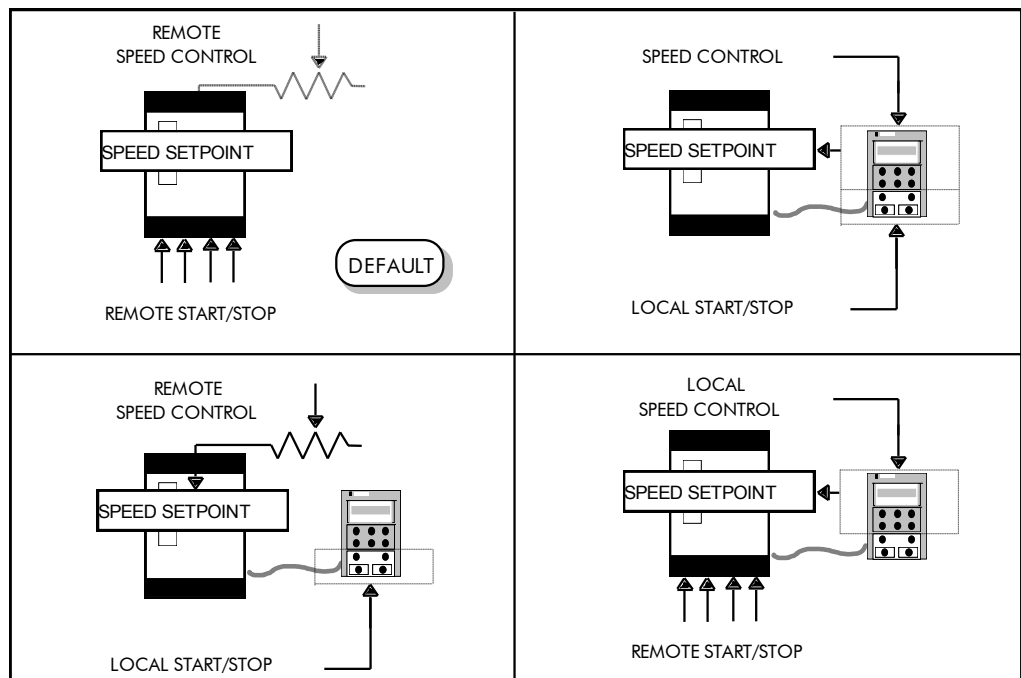

Figure Chapter 4 -2 The Four Combinations of Local and Remote Control

Note: *Start/Stop is also known as "Sequencing".
Speed Control is also known as "Reference Generation".*

Selecting Local or Remote Control

If the default combination of remote Start/Stop and Speed Control is not suitable for your application, follow the instructions below using the keypad or a suitable PC programming tool to select suitable combinations of local or remote control.

Note: *You can only change between Local and Remote control when the drive is "stopped".*

To change a combination the keypad must have FULL VIEW selected; allowing you to view enough of the menu structure to make the change. Refer to Chapter 5: "The Keypad" - Menu Viewing Levels.

The **L/R** key on the keypad toggles between **Local** and **Remote** control, changing both Start/Stop and Speed Control modes at the same time.

However, you can "fix" either or both modes in software to be either Local or Remote control. This makes the **L/R** key inoperative for that mode. In this way, you can select a combination where both Local and Remote modes are present.

To do this, go to the LOCAL CONTROL menu at level 4 and select either:

LOCAL ONLY	Sets Local control
REMOTE ONLY	Sets Remote control
LOCAL/REMOTE	Gives selection powers back to the L/R key.

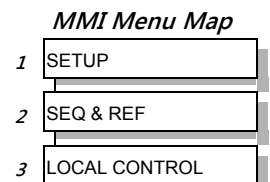

Fixing only one of the modes will mean that the **L/R** key will still toggle the other mode between Local and Remote control.

LED Indications

The mode of control is indicated by the "LOCAL" LEDs on the keypad:

SEQ = Start/Stop
REF = Speed Control

If the LED is illuminated (●), then LOCAL mode is in force.

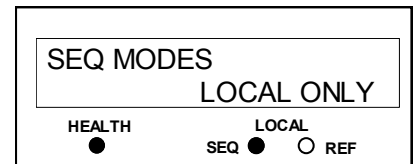

Figure Chapter 4 -3 Control Mode LED Indications

Note: *The default is for the **L/R** key to be operative for both Sequencing and Reference Generation, and to be set for Remote control, i.e. both LEDs will be off.*

4-4 Operating the Drive

Initial Start-up Routines

WARNING!

Unpredictable motion, especially if motor parameters are incorrect.
Ensure no personnel are in the vicinity of the motor or any connected machinery.
Ensure that no machinery connected to the motor will be damaged by unpredictable motion.
Ensure that the emergency stop circuits function correctly before running the motor for the first time.

Replace the supply fuses or circuit breaker and apply power to the drive.

The routine below will run the drive in the default V/F fluxing control mode (VOLTS / HZ) to begin with using either the Control Terminals, or the keypad (if supplied).

Routine 1: Remote Control using Control Terminals

DEFAULT

This is the simplest method of operating the drive. No Set-up or tuning is required. The drive can only operate in V/F Fluxing control mode (VOLTS / HZ).

This routine assumes that the drive's control terminals are wired as shown in Figure 3-15 "Typical Connection to the Control Terminals".

IMPORTANT: Ensure that the speed potentiometer is set to zero.

1. Power-up the unit. The HEALTH LED will light (the RUN LED remains off).
If the HEALTH LED flashes, the drive has tripped. Refer to Chapter 6: "Trips and Fault Finding" to investigate and remove the cause of the trip. Reset the unit by momentarily closing either the RESET switch or the RUN switch. The HEALTH LED will now light.
2. Close the RUN switch. The RUN LED will flash if the setpoint is at zero. Turn the speed potentiometer up a little to apply a small speed setpoint. The RUN LED will light and the motor will rotate slowly.

Reverse the motor's direction of rotation either by pressing the DIR key, or by swapping two of the motor phases (**WARNING: Disconnect the mains supply first**).

Reading the Status LEDs

The HEALTH and RUN LEDs indicate status. The LEDs are considered to operate in five different ways:

- OFF
- SHORT FLASH
- EQUAL FLASH
- LONG FLASH
- ON

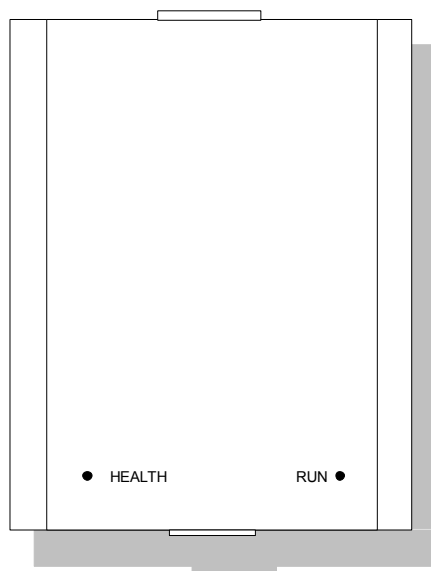

Figure Chapter 4 -4 Blank Cover showing LED Operation























HEALTH	RUN	Drive State
		Re-configuration, or corrupted non-volatile memory at power-up
		Tripped
		Auto Restarting, waiting for trip cause to clear
		Auto Restarting, timing
		Stopped
		Running with zero reference, enable false or contactor feedback false
		Running
		Stopping
		Braking and running with zero speed demand
		Braking and running
		Braking and stopping

Table Chapter 4 -1 Status indications given by the Blank Cover Health and Run LEDs

Routine 2: Local Control using the Keypad

Note: Refer to Chapter 5: “The Keypad” to familiarise yourself with the keypad’s LED indications, and how to use the keys and menu structure.

This routine assumes that the drive’s control terminals are wired as shown in Figure 3-15 “Typical Connection to the Control Terminals” and the keypad is fitted.

1. Power-up the unit. The display will show the power-up screen, “AC MOTOR DRIVE”. After a few seconds, SETPOINT (REMOTE) will appear on the display. The HEALTH, STOP, and FWD LEDs will light.

*If the HEALTH LED flashes, the drive has tripped. The display will indicate the reason for the trip. Refer to Chapter 6: “Trips and Fault Finding” to investigate and remove the cause of the trip. Reset the trip condition by pressing the **Stop/Reset** key on the keypad. The HEALTH LED will now light.*

2. Press the **L/R** (Local/Remote) key to enable Local control. Both the LOCAL SEQ and LOCAL REF LEDs will light when Local control is enabled.
3. Press the **RUN** key. The RUN LED will light and the motor will rotate slowly. (The RUN LED would flash if the setpoint was at zero.)
4. Reverse the motor’s direction of rotation by pressing either the **DIR** key, or by swapping two of the motor phases (**WARNING: Disconnect the mains supply first**).

Using the keypad (or other suitable programming tool) the drive must now be set-up:

- as a simple Open-loop Drive (V/F fluxing)
- in Sensorless Vector Fluxing mode
- in Closed-Loop Vector mode

4-6 Operating the Drive

Set-up as an Open-loop Drive (V/F Fluxing)

The parameters from the QUICK SETUP menu most likely to require attention in this control mode (VOLTS / HZ) are shown below.

MMI Menu Map

1 QUICK SETUP

Tag	QUICK SET-UP Parameters	Default	Brief Description
1105	CONTROL MODE	VOLTS / HZ	Selects the control mode for the drive
106	BASE FREQUENCY	* 50.0 Hz	Frequency at which maximum output volts is generated
931	MAX SPEED	* 1500 RPM	Max speed clamp and scale factor for other speed parameters
337	MIN SPEED	-100.00 %	Min speed clamp
258	RAMP ACCEL TIME	10.0 s	Acceleration time from 0Hz to max speed
259	RAMP DECEL TIME	10.0 s	Deceleration time from max speed to 0Hz
104	V/F SHAPE	LINEAR LAW	Constant torque V to F characteristic
50	QUADRATIC TORQUE	FALSE	Selects between Constant or Quadratic mode of operation
64	MOTOR CURRENT	** 11.3 A	Calibrates drive to motor full load current
365	CURRENT LIMIT	100.00%	Level of motor current as % of FULL LOAD CALIB
107	FIXED BOOST	** 0.00 %	Boosts starting torque by adding volts at low speed
279	RUN STOP MODE	RAMPED	Ramp to standstill when RUN signal removed
246	JOG SETPOINT	10.0 %	Drive speed setpoint whilst jogging
13	ANALOG INPUT 1	0..+10 V	Input range and type
22	ANALOG INPUT 2	0..+10 V	Input range and type
712	ANALOG INPUT 3	0..+10 V	Input range and type
719	ANALOG INPUT 4	0..+10 V	Input range and type
231	DISABLED TRIPS	0000 >>	Sub-menu to set disabled trips
742	DISABLED TRIPS +	0040 >>	Sub-menu to set disabled trips
1083	MOTOR BASE FREQ	** 50.0 Hz	Frequency at which drive gives maximum output volts
1084	MOTOR VOLTAGE	** 400.0 V	Maximum motor output voltage
65	MAG CURRENT	** 3.39 A	Calibrates drive to motor no load current
83	NAMEPLATE RPM	** 1445 RPM	Motor nameplate speed
84	MOTOR POLES	** 4	Number of motor poles

Set-up using the Sensorless Vector Fluxing Mode

The drive must be tuned to the motor in use by matching the motor parameters in the drive to those of the motor being controlled.

MMI Menu Map

1 QUICK SETUP

IMPORTANT: You **MUST** use the Autotune feature.

Enter values for the following parameters in the QUICK SETUP menu.

Tag	QUICK SET-UP Parameters	Default	Brief Description
1105	CONTROL MODE	SENSORLESS VEC	Selects the control mode for the drive
931	MAX SPEED	* 1500 RPM	Max speed clamp and scale factor for other speed parameters
64	MOTOR CURRENT	** 11.3 A	Calibrates drive to motor full load current
365	CURRENT LIMIT	100.00%	Level of motor current as % of FULL LOAD CALIB
1083	MOTOR BASE FREQ	** 50.0 Hz	Frequency at which drive gives maximum output volts
1084	MOTOR VOLTAGE	** 400.0 V	Maximum motor output voltage
83	NAMEPLATE RPM	** 1445 RPM	Motor nameplate speed (motor synchronous speed (rpm) minus full load slip)
84	MOTOR POLES	** 4	Number of motor poles
603	AUTOTUNE ENABLE	FALSE	Enables the Autotune feature

For more information refer to Chapter 5: "The Keypad" - The QUICK SETUP Menu.

Set-up using the Closed-loop Vector Mode

WARNING!

When the drive is run for the first time the direction of rotation will be unknown, the drive may run inconsistently, and the speed control may not operate.

In this mode, speed feedback signals from the motor shaft encoder are processed to determine the rotational speed of the shaft. A PI algorithm within the software uses this information to produce varying gate drive signals to the drive circuits. These signals cause the drive to output the required voltage and frequency for a particular motor speed.

If the encoder is to be fitted to the System Board option rather than the Speed Feedback option, set SPD LOOP SPD FBK to SLAVE ENCODER.

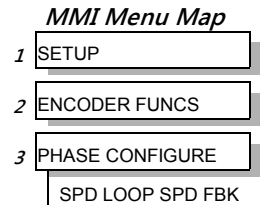

IMPORTANT: You **MUST** use the Autotune feature.

Enter values for the following parameters in the QUICK SETUP menu.

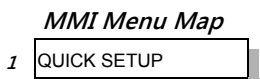

Tag	QUICK SET-UP Parameters	Default	Brief Description
1105	CONTROL MODE	CLOSED-LOOP VEC	Selects the control mode for the drive
931	MAX SPEED	* 1500 RPM	Max speed clamp and scale factor for other speed parameters
64	MOTOR CURRENT	** 11.3 A	Calibrates drive to motor full load current
365	CURRENT LIMIT	100.00%	Level of motor current as % of FULL LOAD CALIB
566	ENCODER LINES	** 2048	Set to the number of lines used by the encoder
1083	MOTOR BASE FREQ	** 50.0 Hz	Frequency at which drive gives maximum output volts
1084	MOTOR VOLTAGE	** 400.0 V	Maximum motor output voltage
83	NAMEPLATE RPM	** 1445 RPM	Motor nameplate speed (motor synchronous speed (rpm) minus full load slip)
84	MOTOR POLES	** 4	Number of motor poles
124	MOTOR CONNECTION	** STAR	Type of motor connection
567	ENCODER INVERT	FALSE	Encoder direction
603	AUTOTUNE ENABLE	FALSE	Enables the Autotune feature

For more information refer to Chapter 5: "The Keypad" - The QUICK SETUP Menu.

The Autotune Feature

IMPORTANT: You **MUST** carry out an Autotune if you intend to use the drive in either of the two vector control modes. If you are using it in Volts/Hz control an Autotune is not necessary.

The Autotune feature identifies motor characteristics to allow the drive to control the motor. It loads the values into the parameters below, which are in the QUICK SETUP menu.

Parameter	Description	Note
ENCODER INVERT	Encoder direction	Parameter is only set up if drive is configured to run as Closed-loop Vector Not measured by Stationary Autotune
MAG CURRENT	Magnetising current	Not measured by Stationary Autotune
STATOR RES	Per phase stator resistance	

4-8 Operating the Drive

Parameter	Description	Note
LEAKAGE INDUC	Per phase stator leakage inductance	
MUTUAL INDUC	Per phase mutual inductance	
ROTOR TIME CONST	Rotor time constant	This is identified from magnetising current and motor nameplate rpm

For further information on the functions of all parameters, refer to the Software Product Manual, Chapter 1: “Programming your Application”.

Stationary or Rotating Autotune?

Will the motor spin freely, i.e. not connected to a load, during the Autotune?

- If it can spin freely, use a Rotating Autotune (preferred)
- If it cannot spin freely, use a Stationary Autotune

	Action	Requirements
Rotating Autotune <i>Preferred method</i>	Spins the motor up to the maximum speed set by the user to identify all necessary motor characteristics	Motor must spin freely during Autotune
Stationary Autotune <i>Only used when the motor cannot spin freely during the Autotune feature</i>	Motor does not spin during Autotune. A limited set of motor characteristics are identified	You must enter the correct value of magnetising current Do not subsequently operate the drive above base speed In Closed-loop Vector Mode set up the encoder direction parameter

Necessary Data

You **MUST** enter values for the following parameters, found in the QUICK SETUP menu, before an Autotune can be carried out:

MMI Menu Map
1 

MOTOR CURRENT
MOTOR BASE FREQ
MOTOR VOLTAGE (maximum motor output voltage)
NAMEPLATE RPM (motor nameplate speed)
MOTOR POLES (the number of motor poles)
ENCODER LINES (if an encoder is fitted, enter the number of lines used by the encoder)

Performing a Rotating Autotune

Check that the motor can rotate freely in the forward direction. Ensure also that the motor is unloaded. Ideally, the motor shaft should be disconnected. If the motor is connected to a gearbox this is ok, provided that there is nothing on the output of the gearbox which could load the motor.

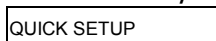
1. In the QUICK SETUP menu, set MAX SPEED to the maximum speed at which you will operate the drive in normal operation. The Autotune will characterise the motor up to 30% above this speed. If you later wish to run faster than this, you will need to carry out another Autotune. **MMI Menu Map**
1 
2. Set AUTOTUNE ENABLE to TRUE, and start the drive. The drive will carry out a Rotating Autotune, indicated by the Run and Stop led's flashing. This may take several minutes, during which the motor will be accelerated to maximum speed and then brought to a stop. When complete, the drive is returned to the stopped condition and the AUTOTUNE ENABLE parameter is reset to FALSE. In Closed-loop Vector mode (with an encoder) the encoder sign has been adjusted by the Autotune feature.

IMPORTANT: Now perform a SAVE CONFIG to save your new settings. Refer to Chapter 5: “The Keypad” - Quick Save Feature.

Performing a Stationary Autotune

Before starting the stationary Autotune, you **MUST** enter the value of magnetising current for the motor. This may be available on the motor nameplate. If not, you may need to contact the motor supplier.

1. In the AUTOTUNE menu, set the MODE parameter to STATIONARY.
2. Set ENABLE to TRUE, and start the drive. The drive will carry out a stationary Autotune, injecting current into the motor but not turning the shaft. The Run and Stop led's will flash. When complete, the drive is returned to the stopped condition and the AUTOTUNE ENABLE parameter is reset to FALSE.

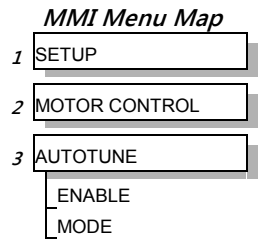

IMPORTANT: Now perform a SAVE CONFIG to save your new settings. Refer to Chapter 5: "The Keypad" - Quick Save Feature.

- If the drive is configured to run in Sensorless Vector mode, set-up is complete.
- If the drive is configured to run in Closed-loop Vector mode, i.e. using an encoder, then the encoder direction must be set up. Refer to "Setting the Encoder Sign" below.

Setting the Encoder Sign

If you have performed a Stationary Autotune in Closed-loop Vector mode, you should check the encoder direction as follows:

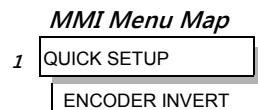

Look and listen to the motion of the motor when the drive is running at a speed demand of between 5 - 10%.

As a test, use the **Up** (♦) control key to increase the speed to about double the original figure. Change the direction of rotation using the **FWD/REV** control key.

If ENCODER INVERT is correct, the motor will rotate smoothly and will respond to the changes in speed demand and direction.

If ENCODER INVERT is incorrect, the motor will rotate in a jerky and/or noisy manner. Alternatively, it may rotate smoothly at a very low speed but not respond to changes in speed demand or direction.

- Change the setting of ENCODER INVERT to change the encoder sign.
- Change the direction of rotation back to the original direction. Re-set the speed demand.

The encoder sign is now correct for the original motor direction.

If however the direction of the motor is incorrect at this point, then power down the entire drive, wait for 3 minutes (for the dc link capacitors to discharge) and then swap the motor drive cables M1/U and M2/V. Change the setting of ENCODER INVERT.

The encoder sign is now correct for the new motor direction.

4-10 Operating the Drive

The Start/Stop Mode Explained

The default configuration below shows the drive in Remote control, (using the analog and digital inputs and outputs). This example will be referred to in the following explanations.

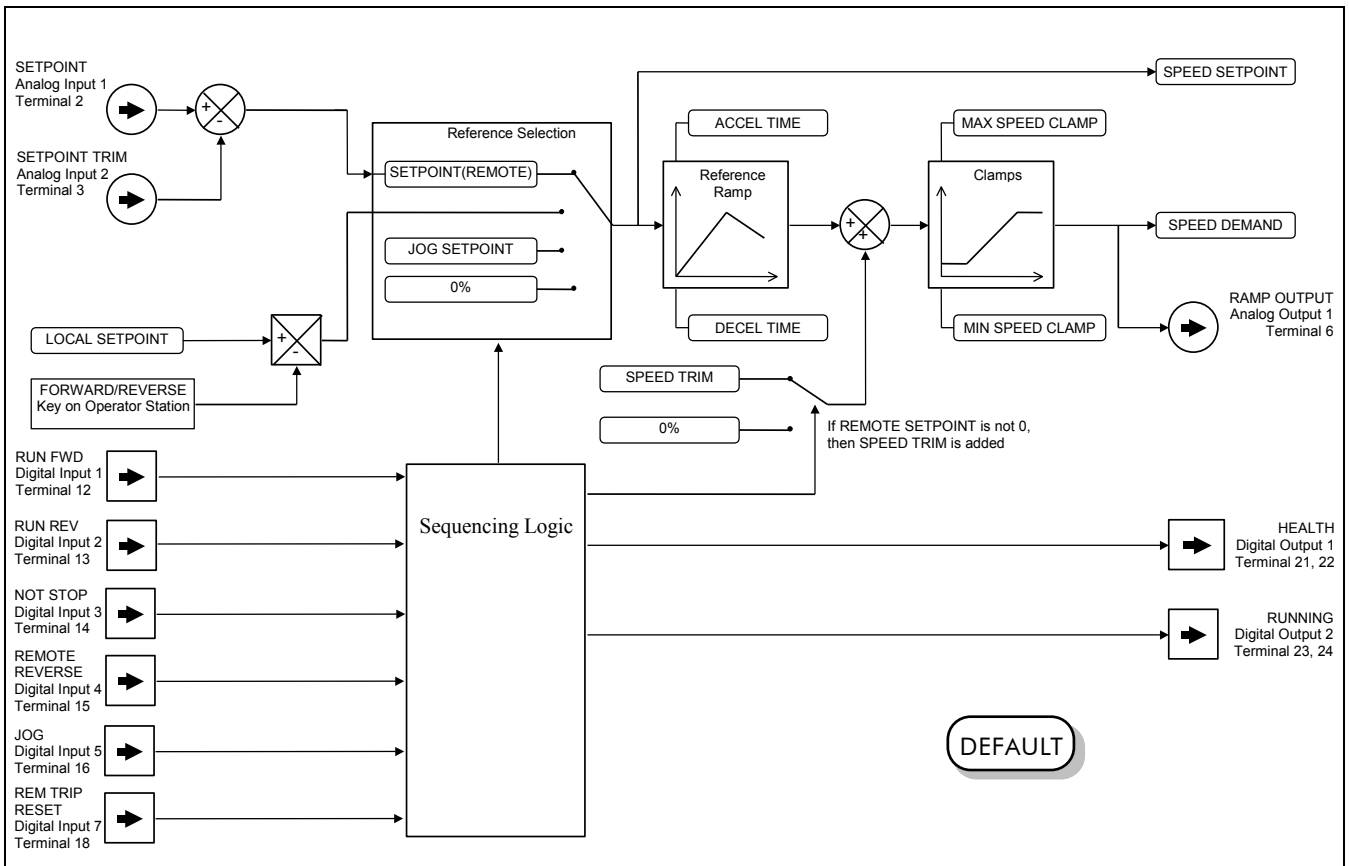

Figure Chapter 4 -5 Portion of the Default Configuration

Start/Stop Controlled Remotely

DEFAULT

In the configuration shown, the reference value is obtained by summing ANALOG INPUT 1 and ANALOG INPUT 2. The direction of rotation is controlled by DIGITAL INPUT 4. When the RUN input (DIGITAL INPUT 1) is TRUE, the SPEED DEMAND ramps up to the reference value at a rate controlled by ACCEL TIME. The drive will continue to run at the reference value while the RUN input remains TRUE.

Similarly when the JOG input (DIGITAL INPUT 5) is TRUE, the SPEED DEMAND ramps up to the JOG SETPOINT at a ramp rate set by JOG ACCEL TIME (not shown in the diagram). The drive will continue to run at the JOG SETPOINT while the JOG input remains TRUE.

Start/Stop Controlled Locally

The reference value is set by the SETPOINT (LOCAL) parameter. The direction of rotation is controlled by the DIR key (forward/reverse) on the keypad. When the RUN key is pressed the SPEED DEMAND ramps up to the reference value at a rate controlled by ACCEL TIME. The drive will continue to run at the reference value even when the RUN key is released. Press the STOP key to “stop” the drive.

When the JOG key is pressed and held, the SPEED DEMAND ramps up to the JOG SETPOINT at a ramp rate set by JOG ACCEL TIME (not shown in the diagram). Release the JOG key to “stop” the drive.

Interaction between RUN and JOG

Only one of these signals can be in effect at any one time; the other signal is ignored. The drive must be “stopped” to change from running to jogging, or vice versa.

Start/Stop Mode Diagnostics

In the configuration shown, Start/Stop mode provides two DIGITAL OUTPUT signals (RUNNING and HEALTH).

The RUNNING signal is TRUE from the time a start command is processed until a stop sequence is completed. This normally means the time between the drive starting until the power stack is quenched. Refer to the Software Product Manual, Chapter 4: “Sequencing Logic States” for a more detailed description.

The HEALTH output is TRUE when the drive is not tripped.

Additional diagnostic parameters are available when using the keypad. These are described in the Software Product Manual, Chapter 4: “Programming Your Application” and “Sequencing Logic States”.

Starting and Stopping Methods

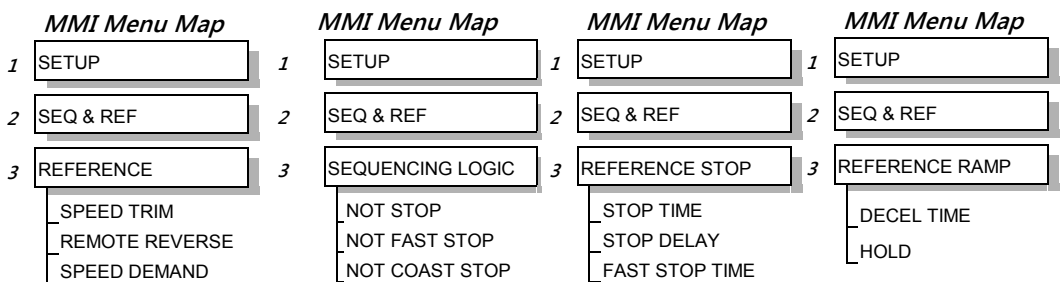

Note: Refer to the Software Product Manual, Chapter 1: “Programming Your Application” - REFERENCE, SEQUENCING LOGIC, REFERENCE STOP and REFERENCE RAMP, for explanations of parameters.

Normal Stopping Methods

DEFAULT

Macro 1 is set to “Ramp to Stop” (at STOP TIME, set to 10.0s).

- To “stop” the locally controlled drive press the STOP key on the keypad
- To “stop” the remotely controlled drive remove the 24V from the RUN FWD input, terminal 12

With the keypad, or suitable programming tool, the drive can be selected to “Ramp to Stop”, or to “Coast to Stop” at one of two rates (STOP TIME or FAST STOP TIME).

4-12 Operating the Drive

Ramp to Stop

When a stop command is received, the drive decelerates from its actual speed towards zero for the programmed DECEL TIME time. When this time has elapsed, SPEED TRIM is ramped to 0% in the programmed STOP TIME time.

Note: If SPEED TRIM does not operate, SPEED DEMAND is reduced to 0% in DECEL TIME.

The power stack remains energised until the STOP DELAY period has elapsed.

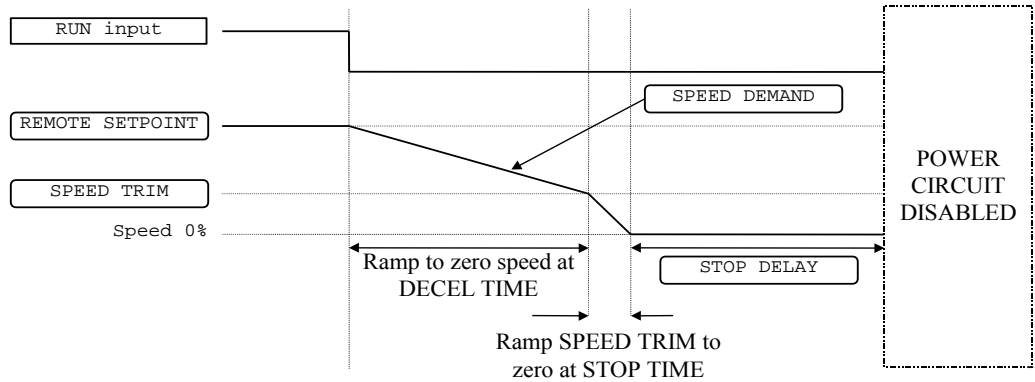

Figure Chapter 4 -6 Ramp to Stop with a Remote Reference

A special case exists when the DECEL TIME is set to 0.0 seconds, or when the HOLD parameter is TRUE. In both these situations the SPEED DEMAND will ramp down to zero at the STOP TIME.

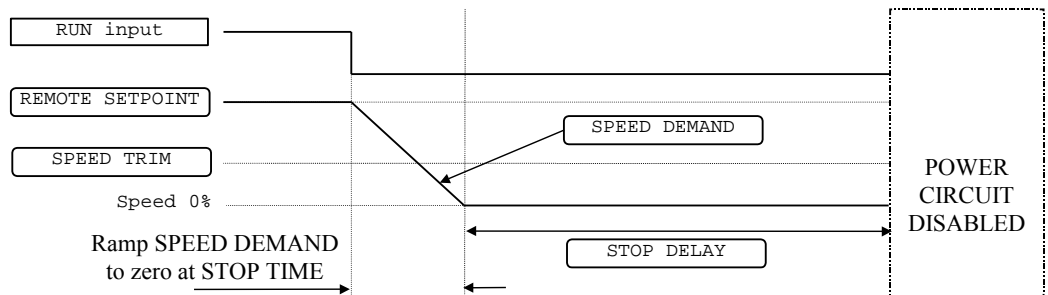

Figure Chapter 4 -7 Remote to Stop with a Remote Reference: no DECEL TIME

Coast to Stop

In this mode the DECEL TIME ramp and the STOP TIME ramp are both ignored. Thus the SPEED DEMAND changes immediately to 0% as soon as the Stop command is given. The power stack is also immediately disabled at this time, causing the load to coast.

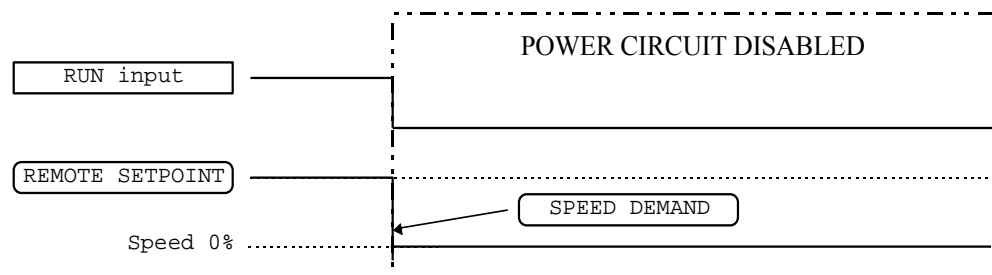

Figure Chapter 4 -8 Coast to Stop with a Remote Reference

Advanced Stopping Methods

The drive can be selected to NOT FAST STOP or to NOT COAST STOP. The stopping procedure is unaffected by Local or Remote Sequencing options.

Forced Fast Stop

The Not Fast Stop mode overrides the RUN FWD, RUN REV and JOG inputs in Remote mode, and the RUN and JOG keypad keys in Local mode. It is selected by setting NOT FAST STOP to TRUE.

The Fast Stop mode can be set to either RAMP or COAST. The stopping sequence starts when the NOT FAST STOP input goes FALSE, regardless of the state of the RUN input.

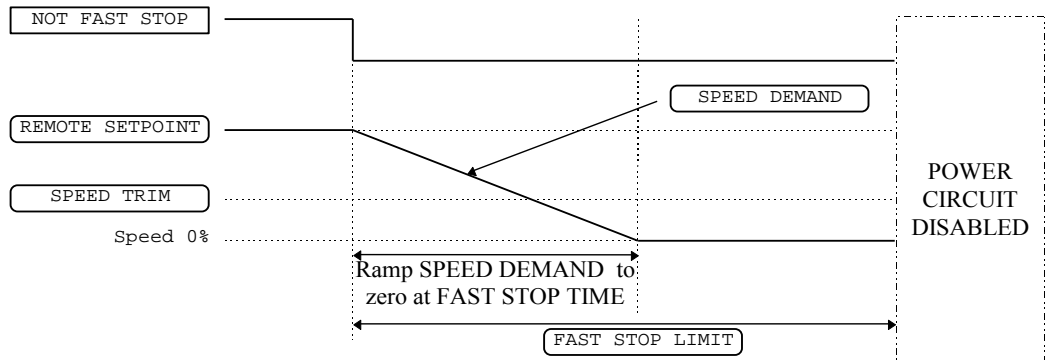

Figure Chapter 4 -9 Forced Fast Stop RAMP Mode example

Forced Coast Stop

Using the Not Coast Stop mode immediately disables the power stack, causing the load to coast to a stop. The drive gives priority to the NOT COAST STOP signal. The NOT FAST STOP signal is therefore ignored while NOT COAST STOP is active.

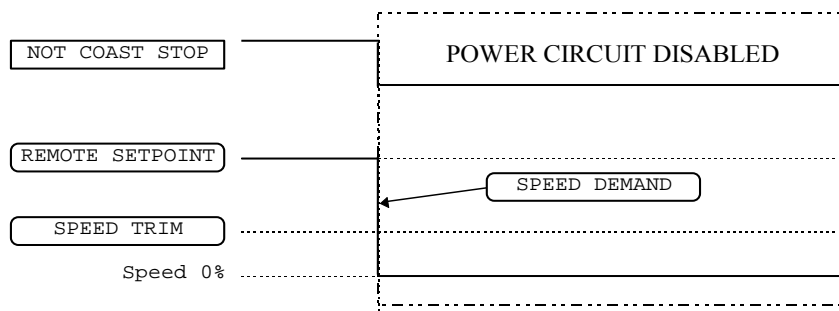

Figure Chapter 4 -10 Forced Coast Stop example

The Trip Condition

When a trip condition is detected, a similar stopping method to NOT COAST STOP is used. The power stack cannot be re-enabled until the trip condition has been cleared and successfully reset. Refer to Chapter 6: "Trips and Fault Finding" for further details.

4-14 Operating the Drive

Logic Stopping

The drive can be stopped by setting the NOT STOP to FALSE for a short time, (>100 ms). The stop sequence continues even if the NOT STOP signal goes inactive before the drive is stopped. Various combinations of stop logic are shown below.

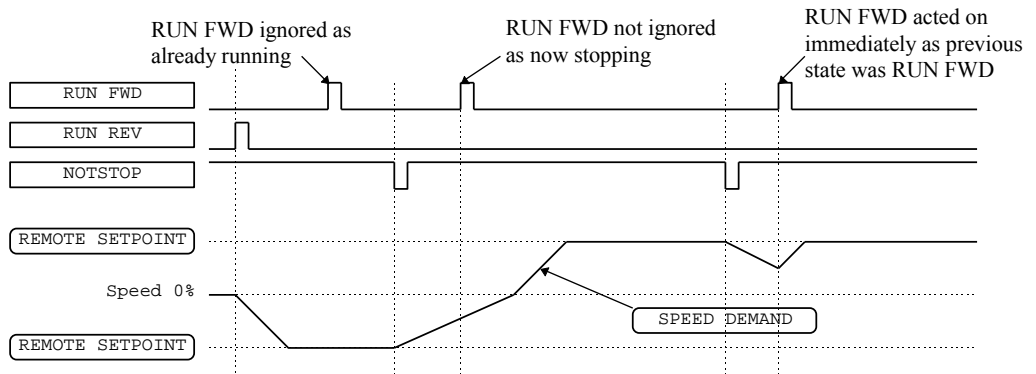

Figure Chapter 4 -11 Interaction between RUN FWD, RUN REV and NOT STOP Parameters

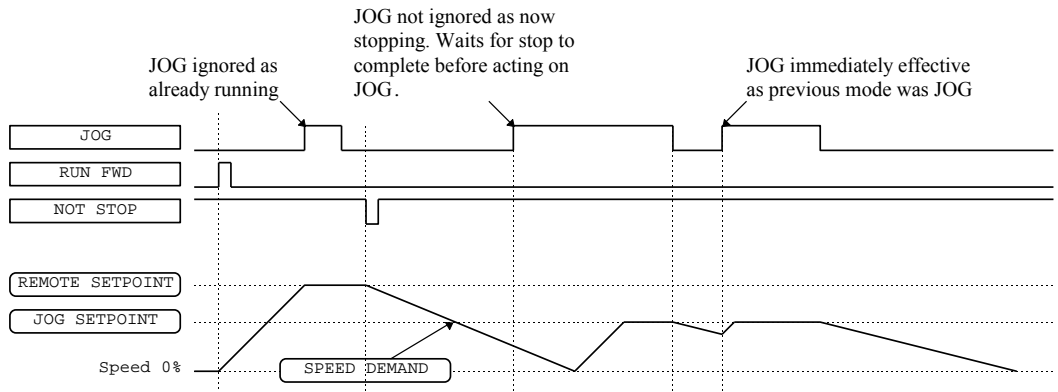

Figure Chapter 4 -12 Example of the Interaction between RUN and JOG Parameters

Starting Methods

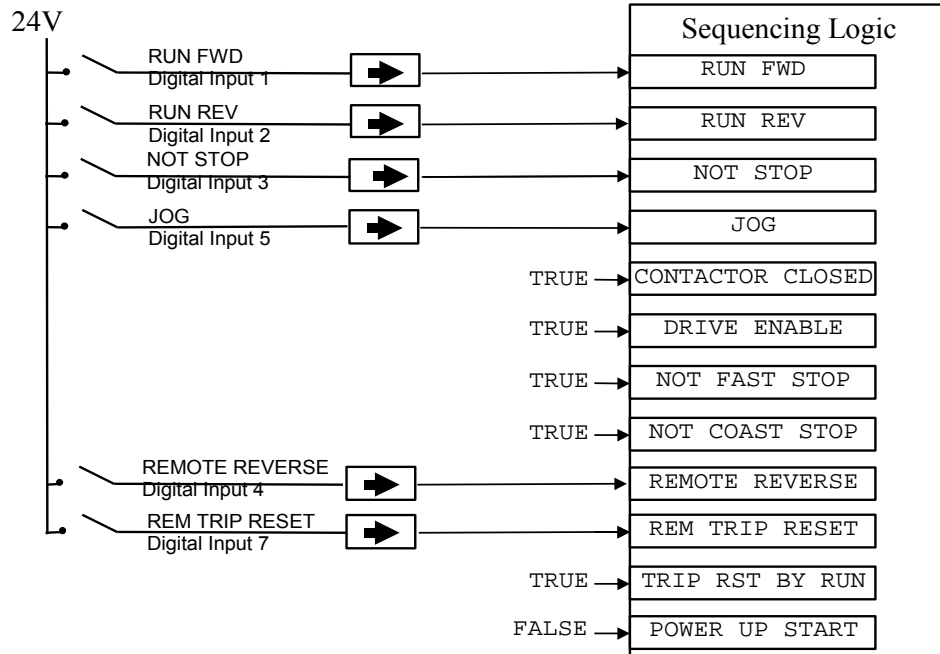

Figure Chapter 4 -13 Default Sequencing Wiring (Macro 1)

The methods below can be used when the drive has Macro 1, 2, 3 or 4 installed.

DEFAULT

The default configuration view above caters for Single, Two, and Three Wire Logic Starting without rewiring. Note that the NOT STOP parameter is active (FALSE - not wired to), meaning that the drive will only run while the relevant RUN parameters are held TRUE.

Starting Several Drives Simultaneously

IMPORTANT: We do not recommend that the DRIVE ENABLE signal is used to start a drive in “normal” use.

Use the DRIVE ENABLE parameter to control the output power stack. When this parameter is FALSE, the power stack is disabled regardless of the state of any other parameters. In conjunction with the HEALTH output parameter, DRIVE ENABLE can synchronise several drives on power-up.

Single Wire Logic Starting

Use just DIGITAL INPUT 1 when the motor direction will always be the same. All other digital inputs are FALSE (0V). The motor will run while the RUN FWD switch is closed, and will stop when it is open.

Two Wire Logic Starting

This uses two inputs; RUN FWD and RUN REV. The drive can operate in forward and reverse depending upon which switch is closed. If both RUN FWD and RUN REV are TRUE (24V) at the same time, both are ignored and the drive will stop.

Three Wire Logic Starting

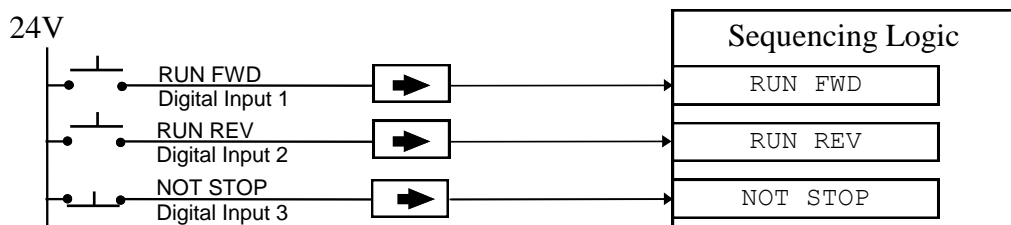

Figure Chapter 4 -14 Wiring for Three Wire Logic Starting

This example uses three inputs; RUN FWD, RUN REV and NOT STOP.

- Fit normally-open push button switches to RUN FWD and RUN REV.
- Fit a normally-closed push button switch to NOT STOP, thus NOT STOP is held TRUE (24V). When TRUE, the action of NOT STOP is to latch the RUN FWD and RUN REV signals. When FALSE, these signals are not latched.

For example, operating the RUN FWD switch starts the drive running forward. Operating the RUN REV switch causes the drive to run in reverse. Operating the NOT STOP switch (making “NOT STOP” FALSE) at any time causes the drive to stop running.

Note: The JOG parameter is never latched in this way. The drive only jogs while the JOG parameter is TRUE.

Connecting the Keypad

The Keypad is a plug-in MMI (Man-Machine Interface) option that allows full use of the drive's features.

It provides for local control of the drive, monitoring, and complete access for application programming.

Insert the Keypad into the front of the drive (replacing the blank cover and plugging into the RS232 programming port); or mount it up to 3 metres away using the optional panel mounting kit with connecting lead: refer to Chapter 3: "Installing the Drive" - Fitting the Remote 6901 Keypad.

Two Keypads (or one and a PC running suitable programming software) can be used simultaneously. In this case each Keypad runs independently.

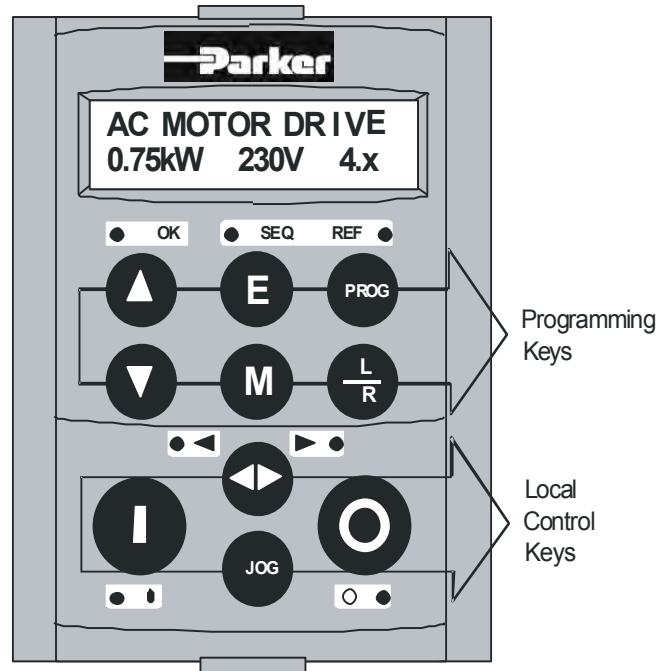

Figure 5-1 Keypad displaying Welcome screen

The drive can operate in one of two modes:

Remote Control Mode: Allowing access for application programming using digital and analog inputs and outputs

Local Control Mode: Providing local control and monitoring of the drive using the Keypad, or PC running suitable programming software

Local control keys are inactive when Remote control mode is selected and vice versa, with one exception; the L/R key toggles Local or Remote control modes and so is always operative.

HINT: Customise the action of the Keypad to create an effective working tool.

The Power-Up Condition

On power-up, a default Welcome screen is displayed for several seconds showing the product description; power rating, voltage and software version of the drive. After a few seconds the display changes to the SETPOINT (REMOTE) parameter.

Note: By default the drive always initialises in Remote control mode, with the Local control keys inactive, making it unlikely that the motor could be started accidentally.

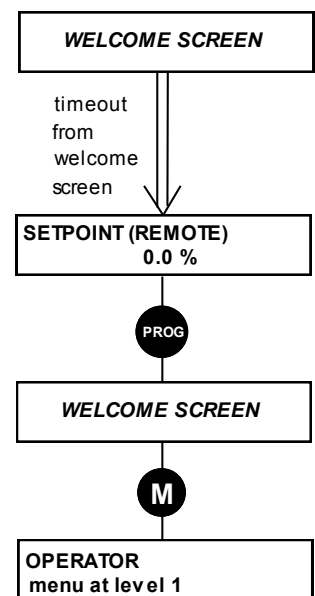

Remote Mode (default)







Controlling the Drive using the Keypad

Control Key Definitions





Note: Refer to Chapter 4: "Operating the Drive" for more detail about Remote and Local modes.

Keys for Programming the Drive

Note: See "Navigating the Menu System", page 5-4 for a quick-start to using the menu.

<p>UP</p> 	<p><i>Navigation</i> - Moves upwards through the list of parameters.</p> <p><i>Parameter</i> - Increments the value of the displayed parameter.</p> <p><i>Command Acknowledge</i> - Confirms action when in a command menu.</p>
<p>DOWN</p> 	<p><i>Navigation</i> - Moves downwards through the list of parameters.</p> <p><i>Parameter</i> - Decrements the value of the displayed parameter.</p>
<p>ESCAPE</p> 	<p><i>Navigation</i> - Displays the previous level's Menu.</p> <p><i>Parameter</i> - Returns to the parameter list.</p> <p><i>Trip Acknowledge</i> - Acknowledges displayed Trip or Error message.</p>
<p>MENU</p> 	<p><i>Navigation</i> - Displays the next Menu level, or the first parameter of the current Menu.</p> <p><i>Parameter</i> - Allows a writable parameter to be modified (this is indicated by → appearing on the left of the bottom line).</p>
<p>PROG</p> 	<p><i>Navigation</i> - Toggles between current locations within the Operator menu and any other menu.</p>
<p>LOCAL/ REMOTE</p> 	<p><i>Control</i> - Toggles between Remote and Local Control for both Start/Stop (Seq) and Speed Control (Ref). When toggling, the display automatically goes to the relevant SETPOINT screen, and the SETPOINT (LOCAL) screen will have the ♦ and ◆ keys enabled to alter the setpoint.</p>



Keys for Operating the Drive Locally

<p>FORWARD/ REVERSE</p> 	<p><i>Control</i> - Changes the direction of motor rotation. Only operates when the drive is in Local Speed Control mode.</p>
<p>JOG</p> 	<p><i>Control</i> - Runs the motor at a speed determined by the JOG SETPOINT parameter. When the key is released, the drive returns to "stopped". Only operates when the drive is "stopped" and in Local Start/Stop mode.</p>
<p>RUN</p> 	<p><i>Control</i> - Runs the motor at a speed determined by the LOCAL SETPOINT or REMOTE SETPOINT parameter.</p> <p><i>Trip Reset</i> - Resets any trips and then runs the motor as above. Only operates when the drive is in Local Start/Stop (Seq) mode.</p>
<p>STOP/RESET</p> 	<p><i>Control</i> - Stops the motor. Only operates when the drive is in Local Sequence mode.</p> <p><i>Trip Reset</i> - Resets any trips and clears displayed message if trip is no longer active.</p>

5-3 The Keypad







































LED Indications











There are seven LEDs that indicate the status of the drive. Each LED is considered to operate in three different ways:









-  OFF
-  FLASH
-  ON

The LEDs are labelled HEALTH, LOCAL (as SEQ and REF), FWD, REV, RUN, and STOP.

Combinations of these LEDs have the following meanings:

HEALTH	RUN	STOP	Drive State
 	 	 	Re-Configuration
 			Tripped
			Stopped
		 	Stopping
	 		Running with zero speed demand or enable false or contactor feedback false
			Running
	 	 	Autotuning
 	 		Auto Restarting, waiting for trip cause to clear
 	 		Auto Restarting, timing

FWD	REV	Forward / Reverse State
		Requested direction and actual direction are forward
		Requested direction and actual direction are reverse
 		Requested direction is forward but actual direction is reverse
	 	Requested direction is reverse but actual direction is forward

LOCAL SEQ	LOCAL REF	Local / Remote Mode
		Start/Stop (Seq) and Speed Control (Ref) are controlled from the terminals
		Start/Stop (Seq) is controlled using the RUN, STOP, JOG and FWD/REV keys. Speed Control (Ref) is controlled from the terminals
		Start/Stop (Seq) is controlled from the terminals Speed Control (Ref) is controlled using the up (▲) and down (▼) keys
		Start/Stop (Seq) and Speed Control (Ref) are controlled using the Keypad keys

The Menu System

The menu system is divided into a 'tree' structure with 5 menu levels. Menu Level 1 is at the top of the tree.

The Keypad has selectable "viewing levels" which can restrict the view of the menu system.

Below is a simple description of the menus at Menu Level 1:

- OPERATOR: a customised view of selected parameters contained in the SETUP menu. You can create a working list of parameters for operating your drive.
- DIAGNOSTICS: a view of important diagnostic parameters contained in the SETUP menu.
- QUICK SETUP: contains all the parameters necessary for the drive to turn the motor.
- SETUP: contains all the function block parameters for programming your application.
- SYSTEM: Macro selection.

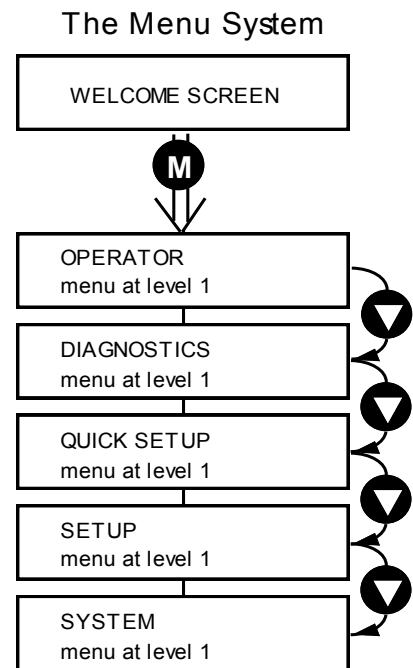

Figure 5-2 The Menu System showing Menus at Level 1

Navigating the Menu System

On power-up, the Keypad defaults into the OPERATOR menu, timing out from the Welcome screen. You can skip the timeout by pressing the **M** key immediately after power-up which will take you directly to the OPERATOR menu.

The menu system can be thought of as map which is navigated using the four keys shown opposite.

Keys **E** and **M** navigate through the menu levels. The up (▲) and down (▼) keys scroll through the Menu and Parameter lists.

Refer to "The Menu System Map" to see how the full menu is mapped.

HINT: Remember that because the Menu and Parameter lists are looped, the ▲ key can quickly move you to the last Menu or Parameter in the loop.

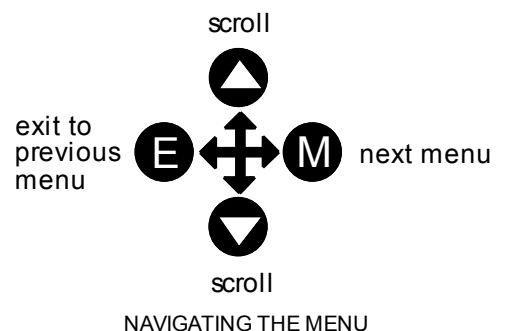

Menu Viewing Levels

For ease of operation there are three 'viewing levels' for the Keypad. The setting for the VIEW LEVEL parameter decides how much of the menu system will be displayed. The choice of menu for each has been designed around a type of user, hence we have the Operator, Basic and Advanced viewing levels.

In the QUICK SETUP menu, press the ▲ key to quickly move to VIEW LEVEL, the last parameter in the menu.

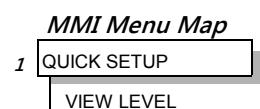

Note: The contents of the OPERATOR menu remains unchanged for all view levels.

Refer to " ", page 5-6 to see how VIEW LEVEL changes the menu.

5-5 The Keypad

Changing a Parameter Value

Refer to “The Menu System Map to see how the full menu is mapped.

Each menu contains parameters.

With the Parameter you want on view, press M to begin editing.

The up (↑) and down (↓) keys will now change the parameter/function value.

Press E to finish editing.

The four keys will once again navigate around the Menus. Refer back to “Navigating the Menu System”, page 5-4.

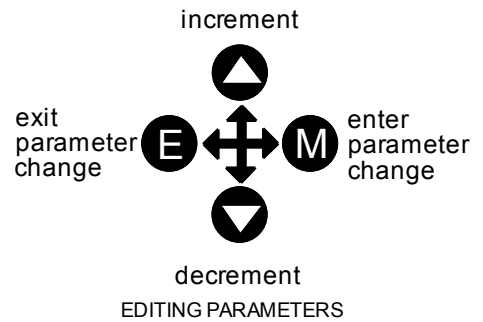

Note: *When viewing a “number” value, i.e. 100.00%, pressing the M key moves the cursor along the number for editing of that character by the up (↑) and down (↓) keys. “Alphanumeric” values, i.e. PUMP 2, are produced and edited in a similar way.*

What do the Symbols mean next to some Parameters?

Parameter Status Information → ← =

→	Pressing M in a parameter displays → on the left of the bottom line to indicate that the up and down keys will now change parameter values. Pressing E removes the symbol and reverts the up and down keys to scrolling through the parameters.
←	A writable parameter may be non-writable if it is the destination of a link. In this case it will be indicated by ← appearing on the left of the bottom line.
←	A Feedback Link is indicated by ← appearing on the right of the bottom line. Refer to the Software Product Manual, Chapter 1: “Programming Your Application”.
=	Non-writable parameters are identified by = appearing on the left of the bottom line. <i>Note that some parameters become non-writable when the drive is running.</i>

Expanded Menu Information >>

The parameters listed below are followed by >> to the right of the bottom display line indicating that there is more information. Press the M key to display a further list of parameters.

AUTO RESTART menu at level 4: AR TRIGGERS 1, AR TRIGGERS+ 1, AR TRIGGERS 2
AR TRIGGERS+ 2

TRIPS STATUS menu at level 4: DISABLED TRIPS, DISABLED TRIPS+,
ACTIVE TRIPS, ACTIVE TRIPS+,
TRIP WARNINGS, TRIP WARNINGS+

OP STATION menu at level 4: ENABLED KEYS

Alert Message Displays

A message will be displayed on the Keypad when either:

- A requested operation is not allowed:
The top line details the illegal operation, while the bottom line gives the reason or cause. See example opposite.
- The drive has tripped:
The top line indicates a trip has occurred while the bottom line gives the reason for the trip. See example opposite.

* KEY INACTIVE * REMOTE SEQ

*** TRIPPED *** HEATSINK TEMP

Most messages are displayed for only a short period, or for as long as an illegal operation is tried, however, trip messages must be acknowledged by pressing the E key.

Experience will show how to avoid most messages. They are displayed in clear, concise language for easy interpretation. Refer to Chapter 6: “Trips and Fault Finding” for trip messages and reasons.

The Menu System Map

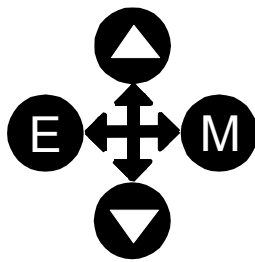
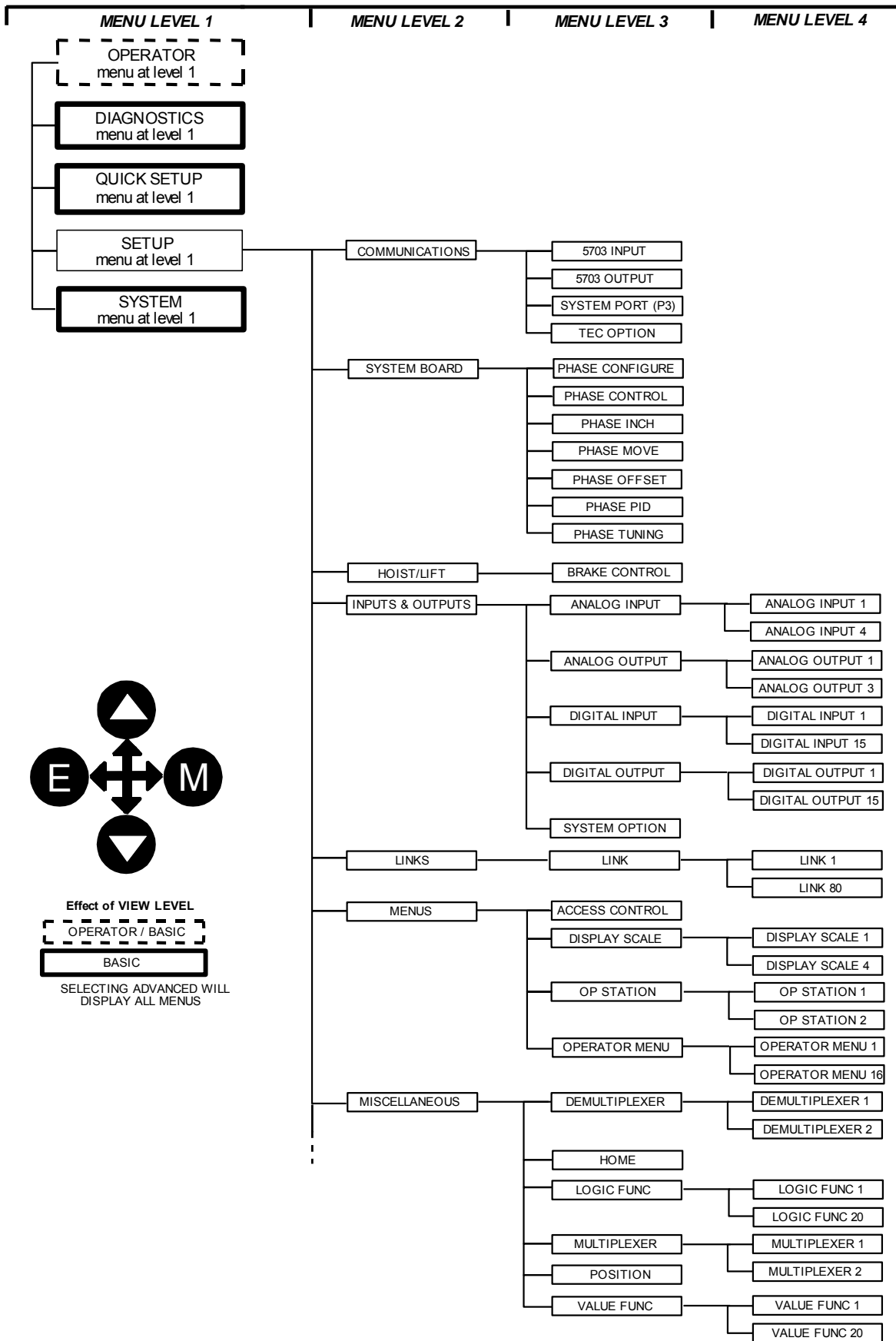

Effect of VIEW LEVEL
 OPERATOR / BASIC
 BASIC
 SELECTING ADVANCED WILL
 DISPLAY ALL MENUS

Note: When VIEW LEVEL is set to OPERATOR, the PROG key also toggles to the VIEW LEVEL parameter in the QUICK SETUP menu. This can be password protected.

5-7 The Keypad

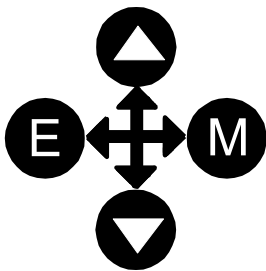
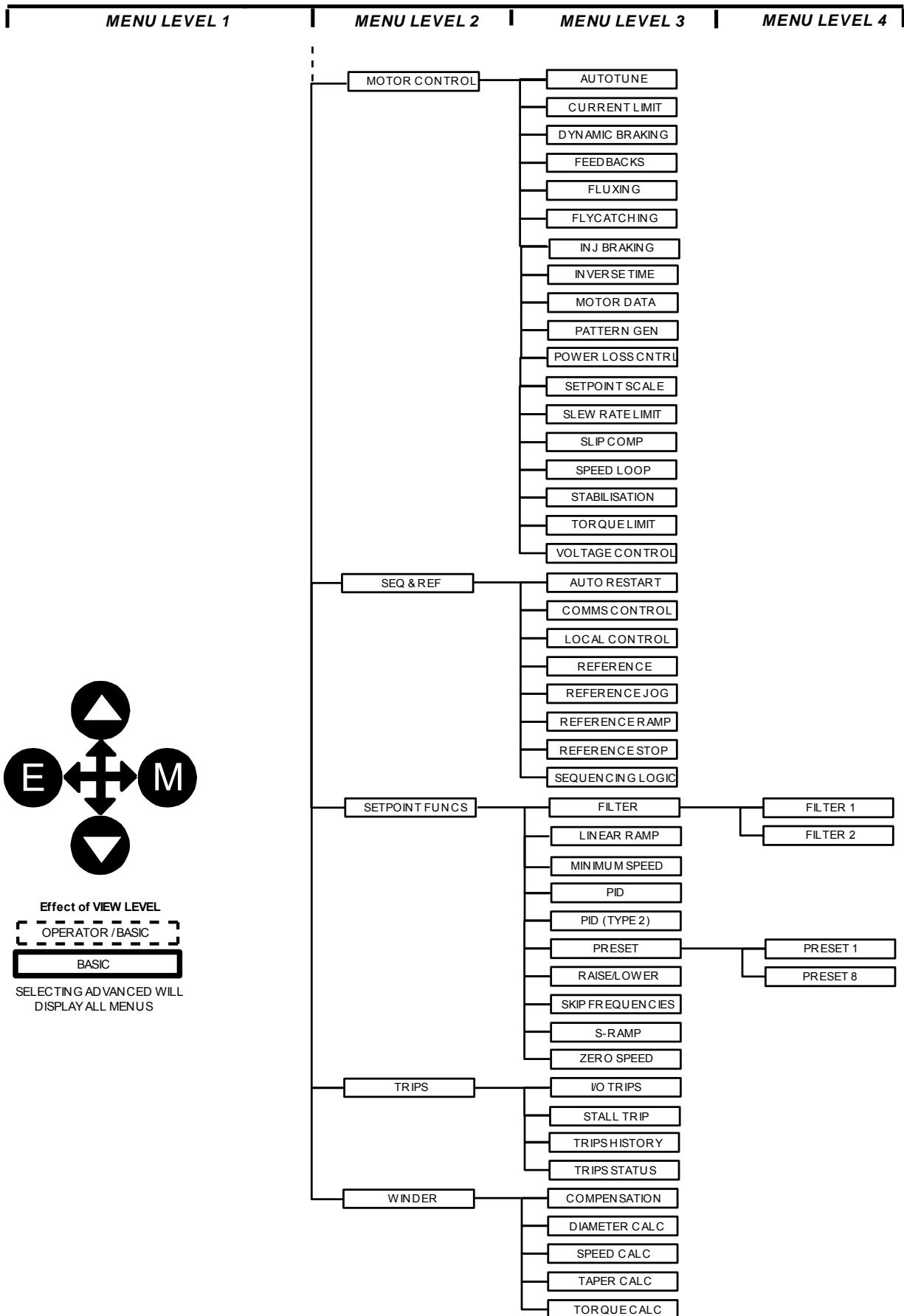

Effect of VIEW LEVEL
 OPERATOR/BASIC (dashed box)
 BASIC (solid box)
 SELECTING ADVANCED WILL DISPLAY ALL MENUS

The PROG Key

The **PROG** key toggles between the OPERATOR menu and any other menu, remembering and returning to previous positions in each menu. As you press the **PROG** key, the title of the menu you are about to enter is displayed, i.e. OPERATOR or for example DIAGNOSTICS. Releasing the key clears the display and releases you into that menu.

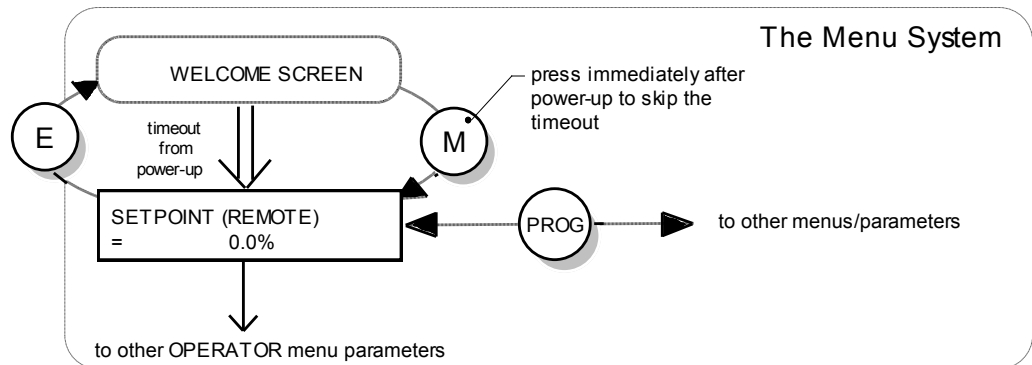

Figure 5-3 The Menu System showing Operation of the E, M and PROG Keys

Holding the PROG key for approximately three seconds takes you to the SAVE CONFIG menu. Refer to "Quick Save Feature", page 5-18.

The L/R Key

The **L/R** key (LOCAL/REMOTE) toggles between Remote and Local Control. In doing so, the view of the SETPOINT parameter in the OPERATOR menu toggles between SETPOINT (LOCAL) and SETPOINT (REMOTE). The default is for the SETPOINT (REMOTE) parameter to be displayed.

Note: A different naming convention is applied in the OPERATOR menu for these parameters when displayed as the first parameter entry:

- REMOTE SETPOINT is displayed as SETPOINT (REMOTE)
- LOCAL SETPOINT is displayed as SETPOINT (LOCAL)
- COMMS SETPOINT is displayed as SETPOINT (COMMS)
- JOG SETPOINT is displayed as SETPOINT (JOG)

Pressing the L/R key when in Remote mode takes you directly to the SETPOINT (LOCAL) parameter with the Edit mode enabled. Press the PROG key to return to the previous display.

5-9 The Keypad

The OPERATOR Menu

You can create 16 “custom screens” for display in the OPERATOR menu at level 1.

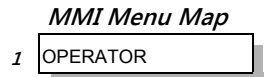

Each screen contains:

- a top line of sixteen characters
- user-definable units
- user-selectable scaling factor
- user selectable limits
- user selectable coefficients

This feature may be used to re-display the setpoint, for example, in more convenient units.

To add an item to the Operator Menu select a parameter (as shown below) in an OPERATOR MENU function block. You can also give the parameter a new name, and set the scaling and units to be displayed.

Note: If *PARAMETER* is set to *NULL*, the Operator Menu item is not included in the Operator Menu.

Parameter Selection

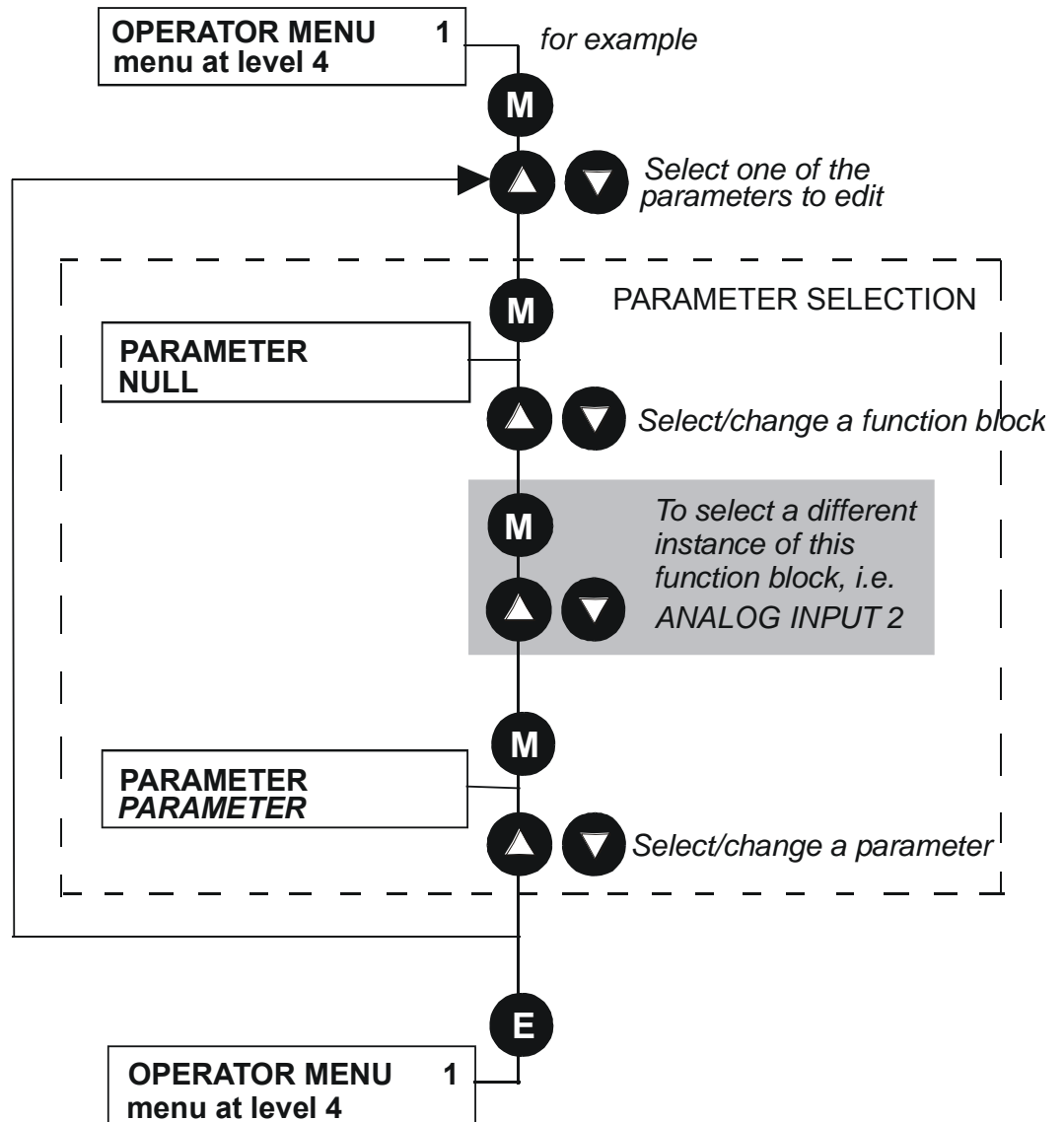

Figure 5-4 Parameter Selection

String Entry

Customising the Parameter Name

To enter a string:

- Press the **M** key to begin entering a character.
- Use the (◀) and down (⬇) keys to scroll through the character set for each of the character spaces. If a key is not pressed within 2 seconds, the cursor will progressively move to the left of the screen.
- Press the **M** key to move to the next character within 2 seconds.
- Press the **E** key to exit parameter editing.

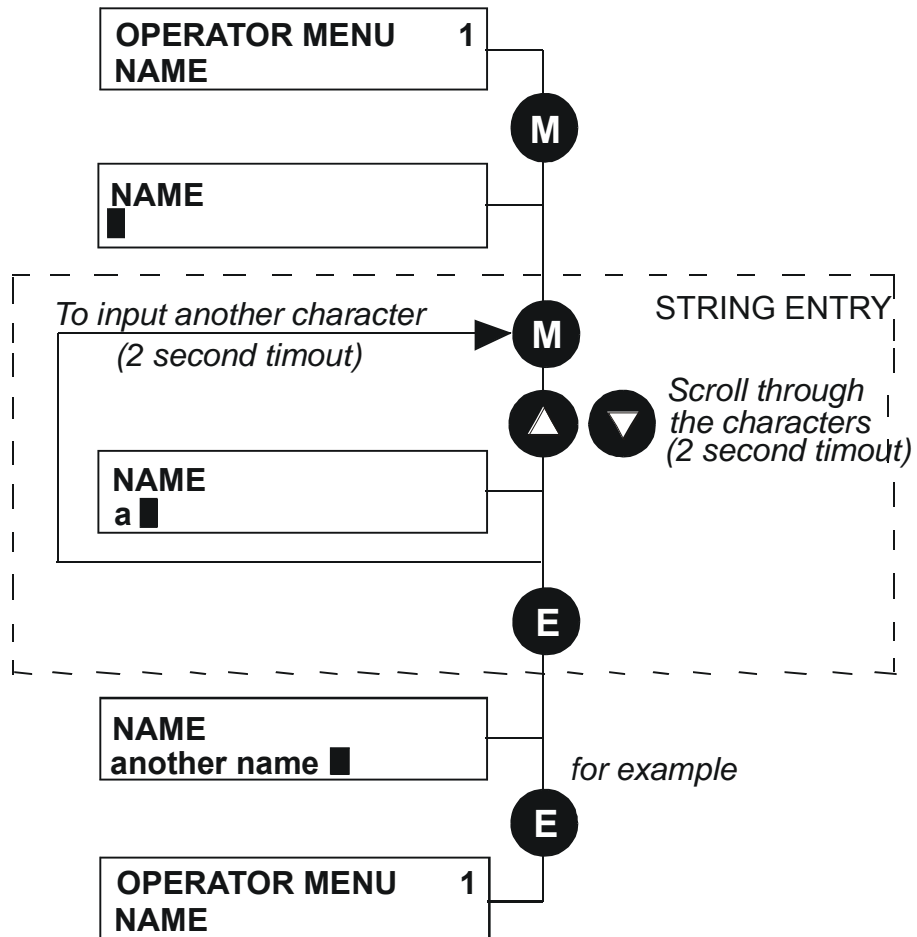

Figure 5-5 String Entry

Note: For details about user-definable units, scaling factors, limits and coefficients refer to the Software Product Manual, Chapter 1: Programming Your Application - OPERATOR MENU and DISPLAY SCALE function blocks.

The DIAGNOSTICS Menu

Diagnostics are used to monitor the status of the drive, internal variables, and its inputs and outputs.

MMI Menu Map	
1	DIAGNOSTICS

The table below describes the parameters contained in the DIAGNOSTICS menu at level 1.

Ranges are given as “—.xx %”, for example, indicating an indeterminate integer for the value.

(Note the reference in brackets to the function block where each parameter is stored. Refer to the Software Product Manual).

The DIAGNOSTICS Menu

SPEED DEMAND	Tag No. 255	Range: —.xx %
Indicates actual speed demand. This is the input to the frequency controller. <i>(Refer to the REFERENCE function block)</i>		
REMOTE SETPOINT	Tag No. 245	Range: —.xx %
This is the target reference that the drive will ramp to in remote reference mode (not including trim), direction is taken from REMOTE REVERSE and the sign of REMOTE SETPOINT. <i>(Refer to the REFERENCE function block)</i>		
COMMS SETPOINT	Tag No. 770	Range: —.xx %
This setpoint is the target reference that the drive will ramp to in Remote Reference Comms mode (not including trim). The direction is always positive, i.e. forward. <i>(Refer to the REFERENCE function block)</i>		
LOCAL SETPOINT	Tag No. 247	Range: —.xx %
Indicates the Keypad setpoint. It is always a positive quantity; saved on power down. Direction is taken from LOCAL REVERSE. <i>(Refer to the REFERENCE function block)</i>		
JOG SETPOINT	Tag No. 246	Range: —.xx %
The setpoint is the target reference that the drive will ramp to. <i>(Refer to the REFERENCE function block)</i>		
TOTAL SPD DMD RPM	Tag No. 1203	Range: —.xx rpm
The final value of speed demand obtained after summing all sources. <i>(Refer to the SPEED LOOP function block)</i>		
TOTAL SPD DMD %	Tag No. 1206	Range: —.xx %
The final value of speed demand obtained after summing all sources. <i>(Refer to the SPEED LOOP function block)</i>		
SPEED FBK RPM	Tag No. 569	Range: —.xx rpm
The mechanical speed of the motor shaft in revolutions per minute. <i>(Refer to the FEEDBACKS function block)</i>		
SPEED FBK %	Tag No. 749	Range: —.xx %
Shows the mechanical speed of the motor shaft as a percentage of the maximum speed setting. <i>(Refer to the FEEDBACKS function block)</i>		
SPEED ERROR	Tag No. 1207	Range: —.xx %
The difference between the demanded speed and the actual speed. <i>(Refer to the SPEED LOOP function block)</i>		
DRIVE FREQUENCY	Tag No. 591	Range: —.xx Hz
Shows the drive output frequency in Hz. <i>(Refer to the PATTERN GEN function block)</i>		

The DIAGNOSTICS Menu

DIRECT INPUT	Tag No. 1205	Range: —.xx %
The value of the direct input, after scaling and clamping. (Refer to the <i>SPEED LOOP</i> function block)		
TORQ DMD ISOLATE	Tag No. 1202	Range: FALSE / TRUE
Speed Control mode and Torque Control mode selection. Torque Control mode = TRUE. (Refer to the <i>SPEED LOOP</i> function block)		
ACTUAL POS LIM	Tag No. 1212	Range: —.xx %
The final actual positive torque limit. (Refer to the <i>TORQUE LIMIT</i> function block)		
ACTUAL NEG LIM	Tag No. 1213	Range: —.xx %
The final actual negative torque limit. (Refer to the <i>TORQUE LIMIT</i> function block)		
AUX TORQUE DMD	Tag No. 1193	Range: —.xx %
The auxiliary motor torque as a percentage of rated motor torque. (Refer to the <i>SPEED LOOP</i> function block)		
TORQUE DEMAND	Tag No. 1204	Range: —.xx %
The demanded motor torque as a percentage of rated motor torque. (Refer to the <i>SPEED LOOP</i> function block)		
TORQUE FEEDBACK	Tag No. 70	Range: —.xx %
The estimated motor torque, as a percentage of rated motor torque. (Refer to the <i>FEEDBACKS</i> function block)		
FIELD FEEDBACK	Tag No. 73	Range: —.xx %
A value of 100% indicates the motor is operating at rated magnetic flux (field). (Refer to the <i>FEEDBACKS</i> function block)		
MOTOR CURRENT %	Tag No. 66	Range: —.xx %
This diagnostic contains the level of rms line current being drawn from the drive and is seen as a % of the MOTOR CURRENT parameter setting in the MOTOR DATA function block. (Refer to the <i>FEEDBACKS</i> function block)		
MOTOR CURRENT A	Tag No. 67	Range: —.x A
This diagnostic contains the level of rms line current being drawn from the drive. (Refer to the <i>FEEDBACKS</i> function block)		
DC LINK VOLTS	Tag No. 75	Range: —. V
The internal dc voltage tested by the FEEDBACKS block. (Refer to the <i>FEEDBACKS</i> function block)		
TERMINAL VOLTS	Tag No. 1020	Range: —. V
This shows the rms voltage, between phases, applied by the drive to the motor terminals. (Refer to the <i>FEEDBACKS</i> function block)		
BRAKING	Tag No. 81	Range: FALSE / TRUE
A read-only parameter indicating the state of the brake switch. (Refer to the <i>DYNAMIC BRAKING</i> function block)		
DRIVE FREQUENCY	Tag No. 591	Range: —.x Hz
The drive output frequency. (Refer to the <i>PATTERN GEN</i> function block)		

5-13 The Keypad

The DIAGNOSTICS Menu

ACTIVE TRIPS	Tag No. 4	Range: 0000 to FFFF
Indicates which trips are currently active. These parameters are a coded representation of the trip status. <i>(Refer to the TRIPS STATUS function block)</i>		
ACTIVE TRIPS +	Tag No. 740	Range: 0000 to FFFF
Indicates which trips are currently active. These parameters are a coded representation of the trip status. <i>(Refer to the TRIPS STATUS function block)</i>		
FIRST TRIP	Tag No. 6	Range: Enumerated - refer to block
From when a trip occurs until that trip is reset, this parameter indicates the trip source. When several trips have occurred, this parameter indicates the first one that was detected. <i>(Refer to the TRIPS STATUS function block)</i>		
ANALOG INPUT 1	Tag No. 16	Range: —.xx %
(VALUE) The input reading with scaling and offset applied. <i>(Refer to the ANALOG INPUT function block)</i>		
ANALOG INPUT 2	Tag No. 25	Range: —.xx %
(VALUE) The input reading with scaling and offset applied. <i>(Refer to the ANALOG INPUT function block)</i>		
ANALOG INPUT 3	Tag No. 715	Range: —.xx %
(VALUE) The input reading with scaling and offset applied. <i>(Refer to the ANALOG INPUT function block)</i>		
ANALOG INPUT 4	Tag No. 722	Range: —.xx %
(VALUE) The input reading with scaling and offset applied. <i>(Refer to the ANALOG INPUT function block)</i>		
DIGITAL INPUT 1	Tag No. 31	Range: FALSE / TRUE
(VALUE) The TRUE or FALSE input, (after any inversion). <i>(Refer to the DIGITAL INPUT function block)</i>		
DIGITAL INPUT 2	Tag No. 34	Range: FALSE / TRUE
(VALUE) The TRUE or FALSE input, (after any inversion). <i>(Refer to the DIGITAL INPUT function block)</i>		
DIGITAL INPUT 3	Tag No. 37	Range: FALSE / TRUE
(VALUE) The TRUE or FALSE input, (after any inversion). <i>(Refer to the DIGITAL INPUT function block)</i>		
DIGITAL INPUT 4	Tag No. 40	Range: FALSE / TRUE
(VALUE) The TRUE or FALSE input, (after any inversion). <i>(Refer to the DIGITAL INPUT function block)</i>		
DIGITAL INPUT 5	Tag No. 43	Range: FALSE / TRUE
(VALUE) The TRUE or FALSE input, (after any inversion). <i>(Refer to the DIGITAL INPUT function block)</i>		
DIGITAL INPUT 6	Tag No. 726	Range: FALSE / TRUE
(VALUE) The TRUE or FALSE input, (after any inversion). <i>(Refer to the DIGITAL INPUT function block)</i>		

The DIAGNOSTICS Menu

DIGITAL INPUT 7	Tag No. 728	Range: FALSE / TRUE
(VALUE) The TRUE or FALSE input, (after any inversion).		
<i>(Refer to the DIGITAL INPUT function block)</i>		
EXTERNAL TRIP	Tag No. 234	Range: FALSE / TRUE
(EXTERNAL) A general purpose signal designed to be internally wired to a digital input block. When this signal goes TRUE this causes an EXTERNAL TRIP to occur, (unless this trip is disabled within the TRIPS area). This parameter is not saved in the drive's non-volatile memory and thus is reset to the default setting at power-up.		
<i>(Refer to the I/O TRIPS function block)</i>		
ANALOG OUTPUT 1	Tag No. 45	Range: —.xx %
(VALUE) The demanded value to output.		
<i>(Refer to the ANALOG OUTPUT function block)</i>		
ANALOG OUTPUT 2	Tag No. 731	Range: —.xx %
(VALUE) The demanded value to output.		
<i>(Refer to the ANALOG OUTPUT function block)</i>		
ANALOG OUTPUT 3	Tag No. 800	Range: —.xx %
(VALUE) The demanded value to output.		
<i>(Refer to the ANALOG OUTPUT function block)</i>		
DIGITAL OUTPUT 1	Tag No. 52	Range: FALSE / TRUE
(VALUE) The TRUE or FALSE output demand.		
<i>(Refer to the DIGITAL OUTPUT function block)</i>		
DIGITAL OUTPUT 2	Tag No. 55	Range: FALSE / TRUE
(VALUE) The TRUE or FALSE output demand.		
<i>(Refer to the DIGITAL OUTPUT function block)</i>		
DIGITAL OUTPUT 3	Tag No. 737	Range: FALSE / TRUE
(VALUE) The TRUE or FALSE output demand.		
<i>(Refer to the DIGITAL OUTPUT function block)</i>		

The QUICK SETUP Menu

By loading a different macro, you are installing the default settings for that macro's application. Once a macro has been loaded (or the default Macro 1 is used), the parameters most likely to require attention are contained in the QUICK SETUP menu at level 1.

MMI Menu Map

1 QUICK SETUP

The Default values in the table below are correct for when the UK country code is selected and a 400V 5.5kW Frame C power board is fitted. Some parameters in the table are marked:

* Value dependent upon the Language field of the Product Code, e.g. UK

** Value dependent upon the overall "power-build", e.g. 400V, 5.5kW

The values may be different for your drive/application.

Tag	QUICK SET-UP Parameters	Default	Brief Description
1105	CONTROL MODE	VOLTS / HZ	Selects the control mode for the drive
1032	MAX SPEED	* 1500 RPM	Max speed clamp and scale factor for other speed parameters
337	MIN SPEED	-100.00 %	Min speed clamp
258	RAMP ACCEL TIME	10.0 s	Acceleration time from 0Hz to max speed
259	RAMP DECEL TIME	10.0 s	Deceleration time from max speed to 0Hz
279	RUN STOP MODE	RAMPED	Ramp to standstill when RUN signal removed
246	JOG SETPOINT	10.0 %	Drive speed setpoint whilst jogging
106	VHZ BASE FREQ	** 50.0 Hz	Determines the frequency at which maximum output volts is generated
104	V/F SHAPE	LINEAR LAW	Constant torque V to F characteristic
50	QUADRATIC TORQUE	FALSE	Selects between Constant or Quadratic mode of operation
64	MOTOR CURRENT	** 11.3 A	Calibrates drive to motor full load current
107	FIXED BOOST	** 6.00 %	Boosts starting torque by adding volts at low speed
365	CURRENT LIMIT	100.00%	Level of motor current as % of FULL LOAD CALIB
1159	MOTOR BASE FREQ	** 50.0 Hz	Frequency at which drive gives maximum output volts
1160	MOTOR VOLTAGE	** 400.0 V	Maximum motor output voltage
83	NAMEPLATE RPM	** 1445 RPM	Motor nameplate speed
84	MOTOR POLES	** 4	Number of motor poles
124	MOTOR CONNECTION	** STAR	Type of motor connection
761	ENCODER SUPPLY	10.0V	Set to supply voltage required by the encoder
566	ENCODER LINES	** 2048	Set to the number of lines used by the encoder
567	ENCODER INVERT	FALSE	Encoder direction
603	AUTOTUNE ENABLE	FALSE	Enables the Autotune feature
65	MAG CURRENT	** 3.39 A	Calibrates drive to motor no load current
119	STATOR RES	** 1.3625 Ω	Motor per-phase stator resistance
120	LEAKAGE INDUC	** 43.37 mH	Motor per-phase stator leakage inductance
121	MUTUAL INDUC	** 173.48 mH	Motor per-phase stator mutual (magnetising) inductance
1163	ROTOR TIME CONST	** 276.04 ms	The motor model rotor time constant as determined by Autotune
1187	SPEED PROP GAIN	20.00	Sets the proportional gain of the loop
1188	SPEED INT TIME	100 ms	The integral time constant of the speed loop
13	AIN 1 TYPE	0..+10 V	Input range and type
22	AIN 2 TYPE	0..+10 V	Input range and type
712	AIN 3 TYPE	0..+10 V	Input range and type
719	AIN 4 TYPE	0..+10 V	Input range and type
231	DISABLE TRIPS	0000 >>	Sub-menu to set disabled trips
742	DISABLE TRIPS +	0040 >>	Sub-menu to set disabled trips
876	VIEW LEVEL	TRUE	Selects full menu for MMI display

Table 5-1 Parameters for setting-up the drive

The SYSTEM Menu

Saving/Restoring/Deleting Your Application

Caution

On power-up, the drive will always run APPLICATION.

HINT: The default APPLICATION supplied with the drive is a copy of Macro 1. Saving your current configuration to APPLICATION will ensure that it is always ready to run on power-up.

SAVE CONFIG

The SAVE CONFIG menu saves your current settings to the displayed config name.

You can save to any config name listed. Saving to an existing config name, rather than a newly created config name, will overwrite the previous information.

By default, the only name in this list will be APPLICATION. As you create new config names, they will be added to this list. If you also save the new config into APPLICATION, it will always be restored on power-up.

MMI Menu Map

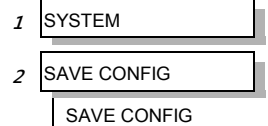

Note: Because factory macros are read-only, they do not appear in the SAVE CONFIG menu.

To save an application see below.

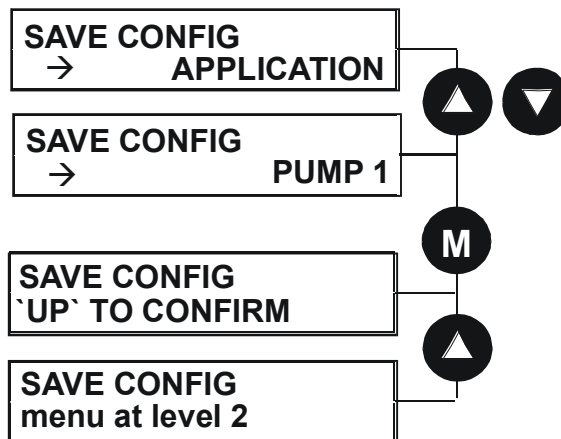

RESTORE CONFIG

This menu restores the displayed application/macro to the drive.

To restore an application/macro see below.

MMI Menu Map

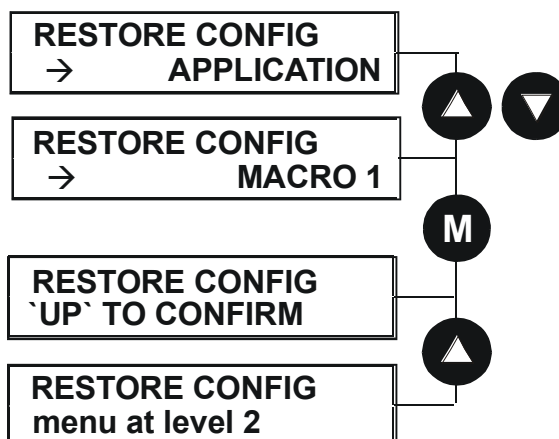
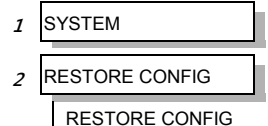

5-17 The Keypad

NEW CONFIG NAME

Use the NEW CONFIG NAME parameter to create a new config name.

The Keypad provides a default name, APPLICATION, for you to save your application in. You can save more than one application using different names, e.g. PUMP 1, PUMP 2.

To enter a config name see below. Refer to “Figure 5-5 String Entry”, page 5-10 for details of how to enter a string.

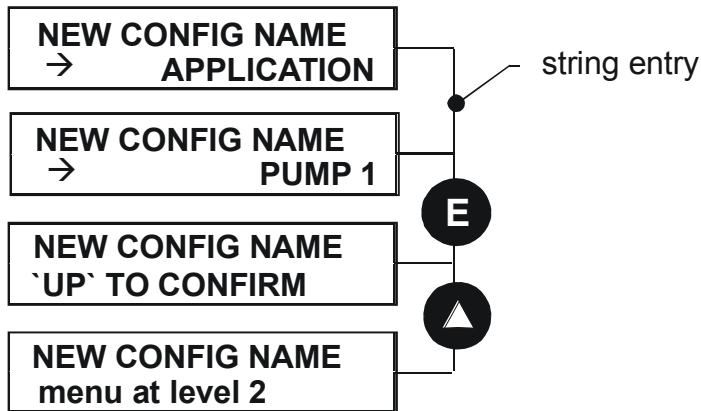
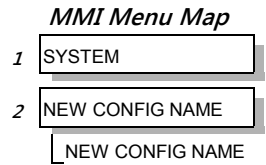

DELETE CONFIG

You can delete your own applications in this menu.

Note: If you delete APPLICATION, don't worry. Software always provides a new APPLICATION on power-up which will be the same as MACRO 1.

You cannot delete the factory macros.

To delete an application see below.

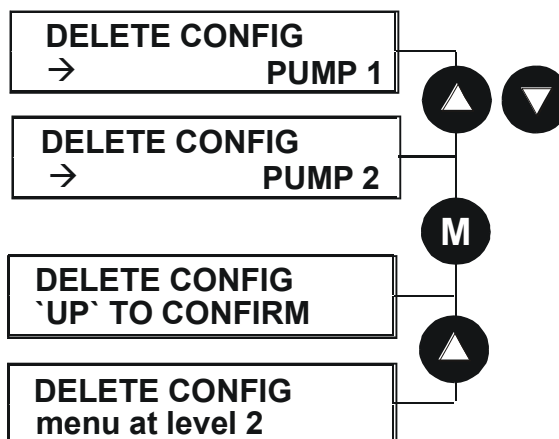
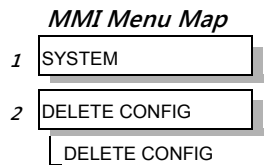

Selecting the Language

This option selects a different display language.

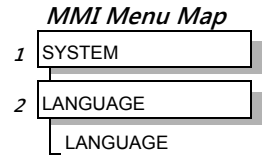
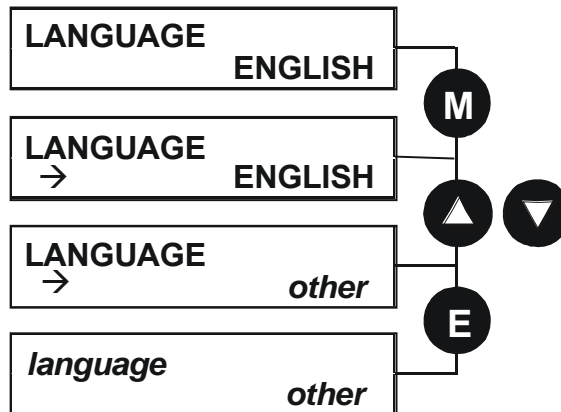

The available languages are: ENGLISH, GERMAN, FRENCH, SPANISH, ITALIAN, SWEDISH, POLISH, PORTUGUESE.

Special Menu Features

Quick Save Feature

From anywhere in the menu system, hold down the **PROG** key for approximately 3 seconds to move quickly to the SAVE CONFIG menu. You can save your application and return conveniently to your original display.

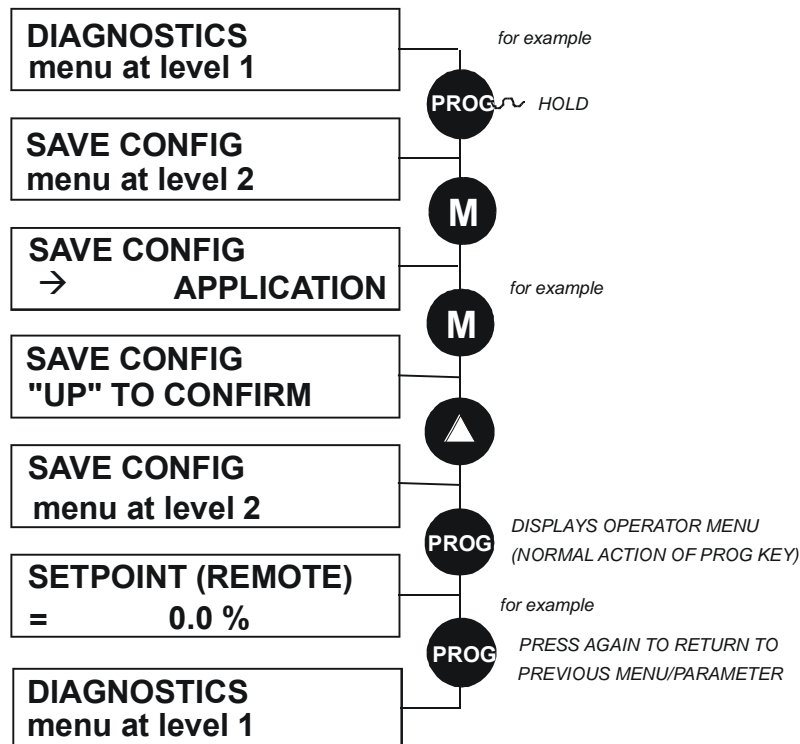

5-19 The Keypad

Quick Tag Information

With a parameter displayed, hold down the **M** key for approximately 3 seconds to display the parameter's tag number (a message may be displayed during this time).

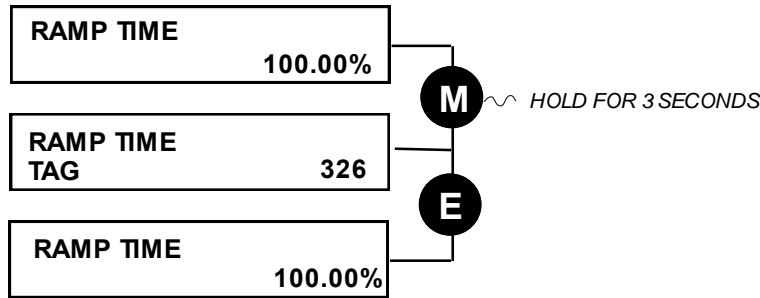

Quick Link Information

When in Advanced view level and with the Quick Tag Information on display, press the **M** key in any *configurable* parameter to display link information about that parameter.

The drive is in Parameterisation Mode and links cannot be edited.

Note: Quick Link Information is not available for parameters that are non-configurable.

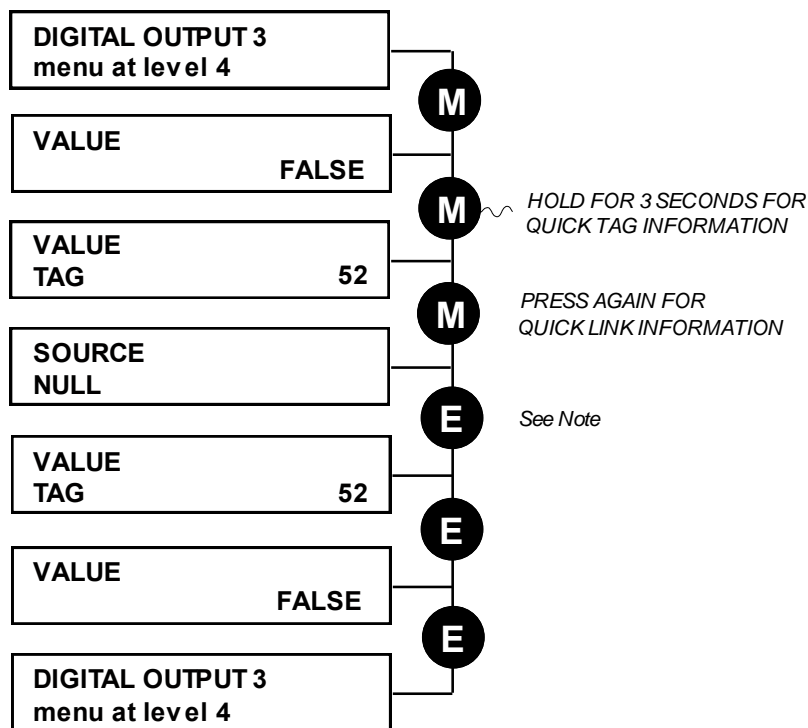

Note: The drive must be in Configuration mode before links can be edited. Pressing the **M** key at this point will display the ENABLE CONFIG page. Refer to the Software Product Manual, Chapter 1: "Programming Your Application" - Making and Breaking Links in Configuration Mode.

Password Protection

When activated, the password prevents unauthorised parameter modification by making all parameters “read-only”. If you attempt to modify a password protected parameter, you will be prompted for the password.

The password protection is activated/deactivated using the PASSWORD parameter.

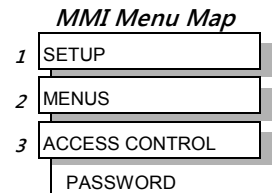

To Activate Password Protection

By default the password feature is deactivated, i.e. 0000.

1. Enter a new password in the PASSWORD parameter (anything other than the default value of 0000), for example 0002.
2. Press the **E** key repeatedly until the Welcome screen is displayed. Pressing the **E** key again activates password protection.

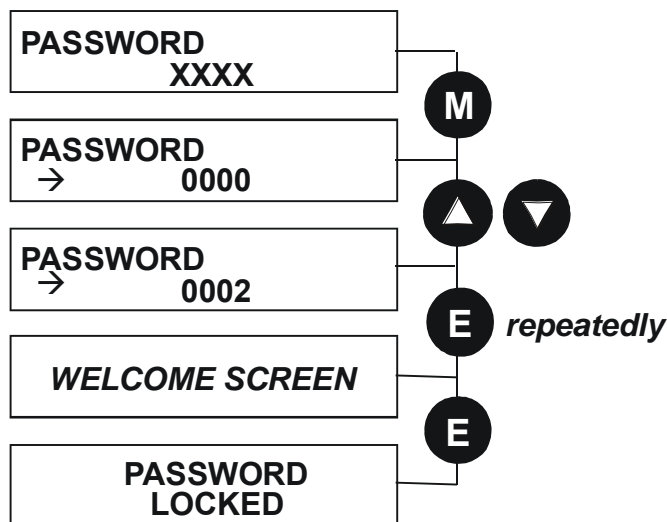

Note: Perform a *SAVE CONFIG* if you need the password to be saved on power-down.

To De-activate Password Protection

If you try to change the value of a parameter with password protection activated, the PASSWORD screen is displayed for you to enter the current password. If you enter the password correctly password protection is temporarily de-activated.

To Re-activate Password Protection

Re-activate an existing password by pressing the **E** key repeatedly until the PASSWORD LOCKED screen is displayed.

Note: You can choose to have the password protect individual parameters in the OPERATOR menu. Under default conditions these are not protected. Refer to the Software Product Manual, Chapter 1: “Programming Your Application” - OPERATOR MENU::IGNORE PASSWORD and ACCESS CONTROL::NO SETPOINT PWRD.

To Remove Password Protection (default status)

Navigate to the PASSWORD parameter and enter the current password. Press the **E** key. Reset the password to 0000. Password protection is now removed.

You can check that password protection has been removed by repeatedly pressing the **E** key until the Welcome screen is displayed. Pressing the **E** key again will NOT display the PASSWORD LOCKED screen.

Note: Perform a *SAVE CONFIG* if you need “no password” to be saved on power-down.

Power-up Key Combinations

Resetting to Factory Defaults (2-button reset)

A special key combination restores to the drive the current product code default values and Macro 1 parameter values. This feature is only available at power-up as a security measure.

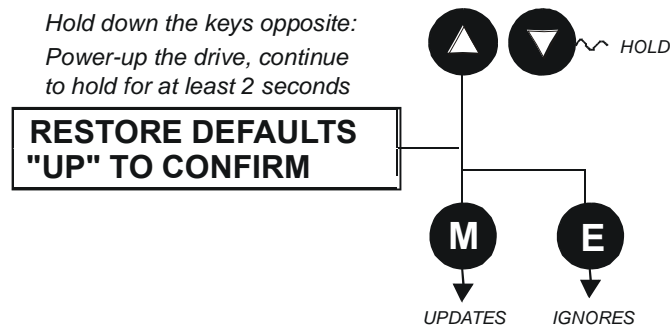

Changing the Product Code (3-button reset)

On rare occasions it may be necessary to change the default settings by changing the Product Code. The Product Code is referred to in Chapter 2.

A special key combination is required to change the product code. This feature is only available at power-up as a security measure.

The 3-button reset will take you to the POWER BOARD menu in the expanded SYSTEM menu (highlighted in the diagram below).

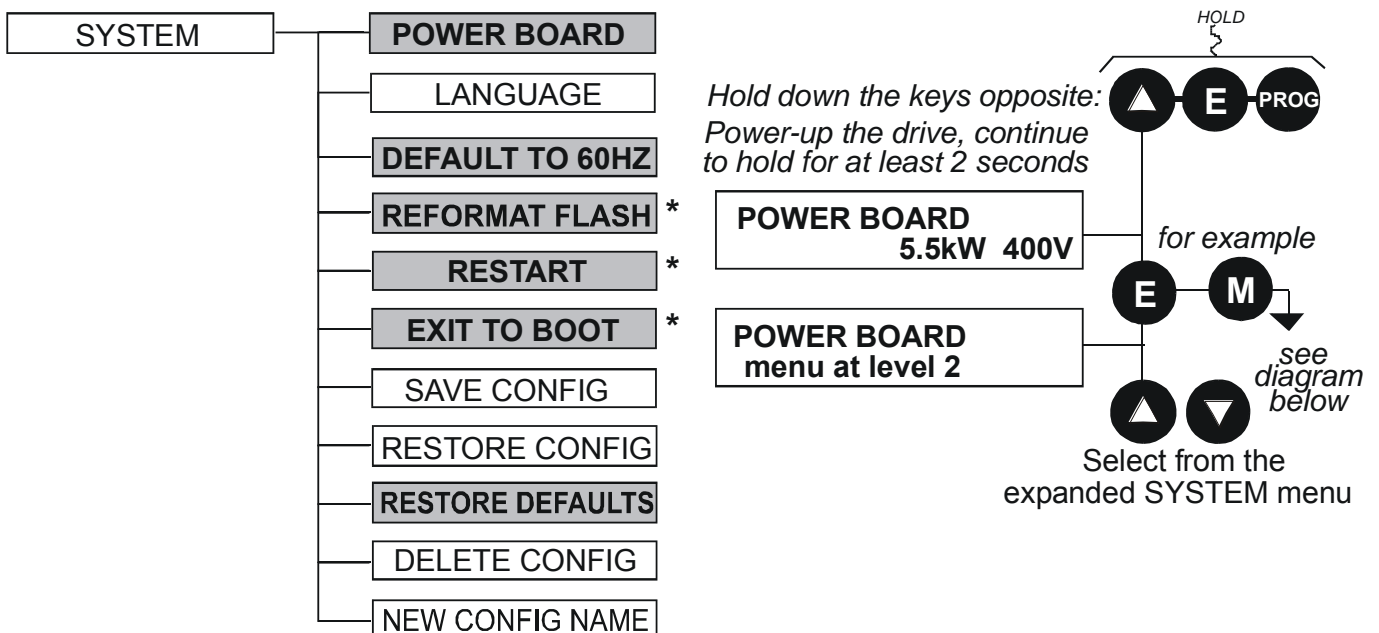

IMPORTANT: We recommend the menus marked *above are only used by Parker Hannifin Manufacturing or suitably qualified personnel.

Refer to The SYSTEM Menu, page 5-16 for all non-highlighted menus.

POWER BOARD

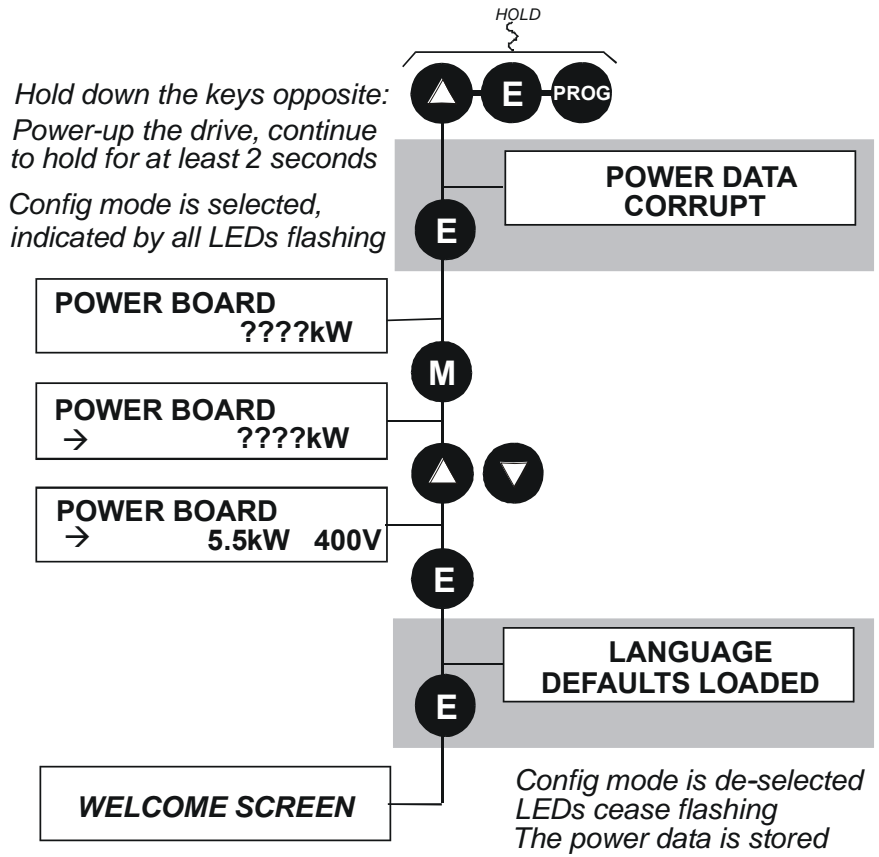

The diagram above shows a 3-button reset when there is no power data stored in the drive. If the drive has power data stored, then the “Power Data Corrupt” and “Language Defaults Loaded” alert messages will not be displayed, also the display will show the current power board selection, instead of “????kW ???V”.

DEFAULT TO 60HZ

The setting of this parameter selects the drive operating frequency. It affects those parameters whose values are dependent upon the default base frequency of the drive. Settings will only be updated following a “restore macro” operation.

Refer to the Software Product Manual, Chapter 2: “Parameter Specification” - Frequency Dependent Defaults.

RESTORE DEFAULTS

Refer to “Resetting to Factory Defaults (2-button reset)”, page 5-21.

Quick Enter Configuration Mode

You can initialise the drive in Configuration Mode by holding the **STOP** key during power-up.

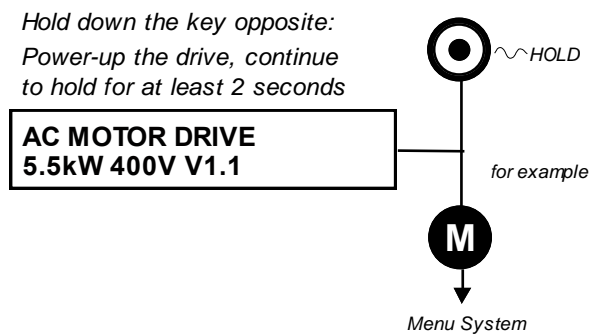

Trips

What Happens when a Trip Occurs

When a trip occurs, the drive's power stage is immediately disabled causing the motor and load to coast to a stop. The trip is latched until action is taken to reset it. This ensures that trips due to transient conditions are captured and the drive is disabled, even when the original cause of the trip is no longer present

Drive Indications

If a trip condition is detected the unit displays and performs the following actions.

1. The HEALTH LED flashes indicating a Trip condition has occurred. (Investigate, find and remove the cause of the trip.)
2. The programming block SEQ & REF::SEQUENCING LOGIC::TRIPPED signal is set to TRUE.

DEFAULT

The DIGITAL OUTPUT 1 (HEALTH) digital output changes between TRUE/FALSE, depending on the output logic.

Keypad Indications (when connected)

If a trip condition is detected the MMI displays and performs the following actions.

1. The HEALTH LED on the keypad flashes indicating a Trip condition has occurred and a trip message is displayed stating the cause of the trip.
2. The programming block SEQ & REF::SEQUENCING LOGIC::TRIPPED signal is set to TRUE.
The DIGITAL OUTPUT 1 (HEALTH) digital output changes between TRUE/FALSE, depending on the output logic.
3. The trip message(s) must be acknowledged by pressing the **STOP** key. The trip message may be cleared by pressing the **E** key. Refer to Chapter 5: "The Keypad" - Alert Message Displays.

Resetting a Trip Condition

All trips must be reset before the drive can be re-enabled. A trip can only be reset once the trip condition is no longer active, i.e. a trip due to a heatsink over-temperature will not reset until the temperature is below the trip level.

Note: More than one trip can be active at any time. For example, it is possible for both the HEATSINK and the OVERVOLTAGE trips to be active. Alternatively it is possible for the drive to trip due to an OVERCURRENT error and then for the HEATSINK trip to become active after the drive has stopped (this may occur due to the thermal time constant of the heatsink).

DEFAULT

Reset the trip(s) using the remote trip reset input, or by pressing the **STOP** key on the keypad.

Success is indicated by the HEALTH LED (on the unit or MMI) ceasing to flash and returning to a healthy "ON" state. The programming block SEQ & REF::SEQUENCING LOGIC::TRIPPED output is reset to FALSE.

Using the Keypad to Manage Trips

Trip Messages

If the drive trips, then the display immediately shows a message indicating the reason for the trip. The possible trip messages are given in the table below.

Trip Message and Meaning	Possible Reason for Trip
OVERVOLTAGE The drive internal dc link voltage is too high	The supply voltage is too high Trying to decelerate a large inertia load too quickly The brake resistor is open circuit
UNDERVOLTAGE The drive internal dc link voltage is too low	The supply voltage is too low The supply has been lost A supply phase is missing
OVERCURRENT The motor current being drawn from the drive is too high	Trying to accelerate a large inertia load too quickly Trying to decelerate a large inertia load too quickly Application of shock load to motor Short circuit between motor phases Short circuit between motor phase and earth Motor output cables too long or too many parallel motors connected to the drive Fixed or auto boost levels are set too high
HEATSINK The drive heatsink temperature is too high	The ambient air temperature is too high Poor ventilation or spacing between drives
EXTERNAL TRIP User trip caused via control terminals	+24V not present on external trip (e.g. terminal 19, Macro 1).
INPUT 1 BREAK A signal break has been detected on analog input 1 (terminal 1)	Analog input is incorrectly configured for 4-20mA operation Break in external control wiring
INPUT 2 BREAK A signal break has been detected on analog input 2 (terminal 2)	Analog input is incorrectly configured for 4-20mA operation Break in external control wiring
MOTOR STALLED The motor has stalled (not rotating)	Motor loading too great Current limit level is set too low Stall trip duration is set too low Fixed or auto boost levels are set too high
BRAKE RESISTOR External dynamic braking resistor has been overloaded	Trying to decelerate a large inertia load too quickly or too often
BRAKE SWITCH Internal dynamic braking switch has been overloaded	Trying to decelerate a large inertia load too quickly or too often
OP STATION Keypad has been disconnected from drive whilst drive is running in local control	Keypad accidentally disconnected from drive

6-3 Trips and Fault Finding

Trip Message and Meaning	Possible Reason for Trip
LOST COMMS	COMMS TIMEOUT parameter set too short (refer to COMMS CONTROL menu at level 3)
CONTACTOR FBK	The CONTACTOR CLOSED input in the SEQUENCING LOGIC function block remained FALSE after a run command was issued
SPEED FEEDBACK	SPEED ERROR > 50.00% for 10 seconds
AMBIENT TEMP	The ambient temperature in the drive is too high
MOTOR OVERTEMP The motor temperature is too high	Excessive load Motor voltage rating incorrect FIXED BOOST and/or AUTO BOOST set too high Prolonged operation of the motor at low speed without forced cooling Check setting of INVERT THERMIST parameter in I/O TRIPS menu at level 3. Break in motor thermistor connection
CURRENT LIMIT If the current exceeds 180% of stack rated current for a period of 1 second, the drive will trip. This is caused by shock loads	Remove the cause of the shock load
SHORT CIRCUIT	The output is short circuited
24V FAILURE The 24V customer output has fallen below 17V	24V customer output is short circuited Excessive loading
LOW SPEED OVER I The motor is drawing too much current (>100%) at zero output frequency	FIXED BOOST and/or AUTO BOOST set too high (refer to FLUXING menu at level 4)
<i>TRIP 22</i>	<i>Reserved</i>
ENCODER 1 FAULT DESAT (OVER I)	The Error input on the Encoder TB is in the Error state Instantaneous overcurrent. Refer to OVERCURRENT in this table
VDC RIPPLE	The dc link ripple voltage is too high. Check for a missing input phase.
BRAKE SHORT CCT Brake resistor overcurrent	Check resistance brake resistor value is greater than minimum allowed
OVERSPEED	Speed feedback > 150% for 0.1 seconds
UNKNOWN	An unknown trip - refer to Parker Hannifin Manufacturing Ltd
MAX SPEED LOW	During Autotune the motor is required to run at the nameplate speed of the motor. If MAX SPEED RPM limits the speed to less than this value, an error will be reported. Increase the value of MAX SPEED RPM up to the nameplate rpm of the motor (as a minimum). It may be reduced, if required, after the Autotune is complete.
MAINS VOLTS LOW	The mains input voltage is not sufficient to carry out the Autotune. Re-try when the mains has recovered.
NOT AT SPEED	The motor was unable to reach the required speed to carry out the Autotune. Possible reasons include: <ul style="list-style-type: none"> motor shaft not free to turn the motor data is incorrect

Trip Message and Meaning	Possible Reason for Trip
MAG CURRENT FAIL	It was not possible to find a suitable value of magnetising current to achieve the required operating condition for the motor. Check the motor data is correct, especially nameplate rpm and motor volts. Also check that the motor is correctly rated for the drive.
NEGATIVE SLIP F	Autotune has calculated a negative slip frequency, which is not valid. Nameplate rpm may have been set to a value higher than the base speed of the motor. Check nameplate rpm, base frequency, and pole pairs are correct.
TR TOO LARGE	The calculated value of rotor time constant is too large. Check the value of nameplate rpm.
TR TOO SMALL	The calculated value of rotor time constant is too small. Check the value of nameplate rpm.
MAX RPM DATA ERR	This error is reported when the MAX SPEED RPM is set to a value outside the range for which Autotune has gathered data. Autotune gathers data on the motor characteristics up to 30% beyond "max speed rpm". If MAX SPEED RPM is later increased beyond this range, the drive had no data for this new operating area, and so will report an error. To run the motor beyond this point it is necessary to re-autotune with MAX SPEED RPM set to a higher value.
STACK TRIP	The drive was unable to distinguish between an overcurrent/Dsat or overvoltage trip
LEAKGE L TIMEOUT	The leakage inductance measurement requires a test current to be inserted into the motor. It has not been possible to achieve the required level of current. Check that the motor is wired correctly.
POWER LOSS STOP	Power Loss Stop sequence has ramped Speed Setpoint to zero or timed out
MOTR TURNING ERR	The motor must be stationary when starting the Autotune
MOTR STALLED ERR	The motor must be able to rotate during Autotune
INVERSE TIME	The inverse time current limit is active: <ul style="list-style-type: none"> motor loading is too great: motor current >150% for 60s in Constant duty motor current >110% for 60s in Quadratic duty fixed or autoboot levels are too high

Table 6-1 Trip Messages

Automatic Trip Reset

Using the keypad, the drive can be configured to automatically attempt to reset a trip when an attempt is made to start driving the motor, or after a preset time once the trip condition has occurred. The following function blocks (MMI menus) are used to enable automatic trip resets.

Seq & Ref::Auto Restart (Auto-Reset)
Seq & Ref::Sequencing Logic

Setting Trip Conditions

The following function blocks (MMI menus) are used to set trip conditions:

Trips::I/O Trips
Trips::Trips Status

6-5 Trips and Fault Finding

Viewing Trip Conditions

The following function blocks (MMI menus) can be viewed to investigate trip conditions:

- Seq & Ref::Sequencing Logic
- Trips::Trips History
- Trips::Trips Status

Checksum Fail

When the drive powers-up, non-volatile memory is checked to ensure that it has not been corrupted. In the rare event of corruption being detected, the drive will not function. This may occur when replacing the control board with an unprogrammed control board.

DEFAULT

Drive Indications

The failure is indicated by the HEALTH and RUN LEDs showing SHORT FLASH, .

Referring to Chapter 4: “Operating the Drive” - Reading the Status LEDs, you will note that this also indicates Re-configuration mode, but this mode (and hence the indication) is not available to the drive unless controlled by an MMI or Comms link.

Because you are controlling the drive locally (no MMI or Comms link etc.), the unit must be returned to Parker Hannifin Manufacturing Limited for reprogramming, refer to Chapter 7: “Routine Maintenance and Repair”. However, if you have access to a keypad or suitable PC programming tool, the unit can be reset.

Keypad Indications (when connected)

The MMI displays the message opposite.

Acknowledge the message by pressing the **E** key. This action automatically loads and saves Macro 1 default parameters and the ENGLISH 50Hz Product Code.

If your unit was using a different Product Code or macro, you must reload the Product Code of your choice, reload the macro of your choice, and perform a Parameter Save (SAVE/COMMAND menu) in that order.

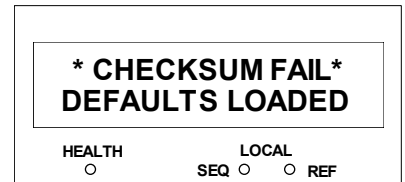

If data will not save correctly, the keypad will display a failure message. In this case, the drive has developed a fault and must be returned to Parker Hannifin Manufacturing. Refer to Chapter 7: “Routine Maintenance and Repair”.

Fault Finding

Problem	Possible Cause	Remedy
Drive will not power-up	Fuse blown	Check supply details, replace with correct fuse. Check Product Code against Model No.
	Faulty cabling	Check all connections are correct and secure. Check cable continuity
Drive fuse keeps blowing	Faulty cabling or connections wrong Faulty drive	Check for problem and rectify before replacing with correct fuse Contact Parker
Cannot obtain HEALTH state	Incorrect or no supply available	Check supply details
Motor will not run at switch-on	Motor jammed	Stop the drive and clear the jam
Motor runs and stops	Motor becomes jammed	Stop the drive and clear the jam
Motor won't rotate or runs in reverse	Encoder fault	Check encoder connections
	Open circuit speed reference potentiometer	Check terminal

Table 6-2 Fault Finding

Troubleshooting LEDs

In addition to the diagnostics provided by the keypad, eight fault LEDs situated on the power control board provide an indication of the cause of a fault trip. The fault LEDs are visible when the bottom terminal cover is removed - refer to Figure 1.1. The table below indicates the function of the LEDs.

Fault	Illuminated LEDs								Action
Output overcurrent					5				Output current greater than trip level - check output wiring and motor for insulation breakdown or short circuits either between phases or between phase and earth
M1 phase IGBT fault alarm	1				5				Excessive output current
M2 phase IGBT fault alarm		2			5				
M3 phase IGBT fault alarm			3		5				
DB unit IGBT fault alarm				4	5				Check wiring and verify value of brake resistor
M1 phase IGBT over-temperature	1					6			Maximum IGBT junction temperature exceeded
M2 phase IGBT over-temperature		2				6			
M3 phase IGBT over-temperature			3			6			
DB unit IGBT over-temperature				4		6			
Output current imbalance					5	6			Check wiring to motor and motor itself for earth faults
CAL board not fitted					5	6	7	8	Internal fault - consult supplier
Internal supply fail							7	8	Internal fault - consult supplier
FPGA not programmed	1	2	3	4	5	6	7	8	Internal fault - consult supplier

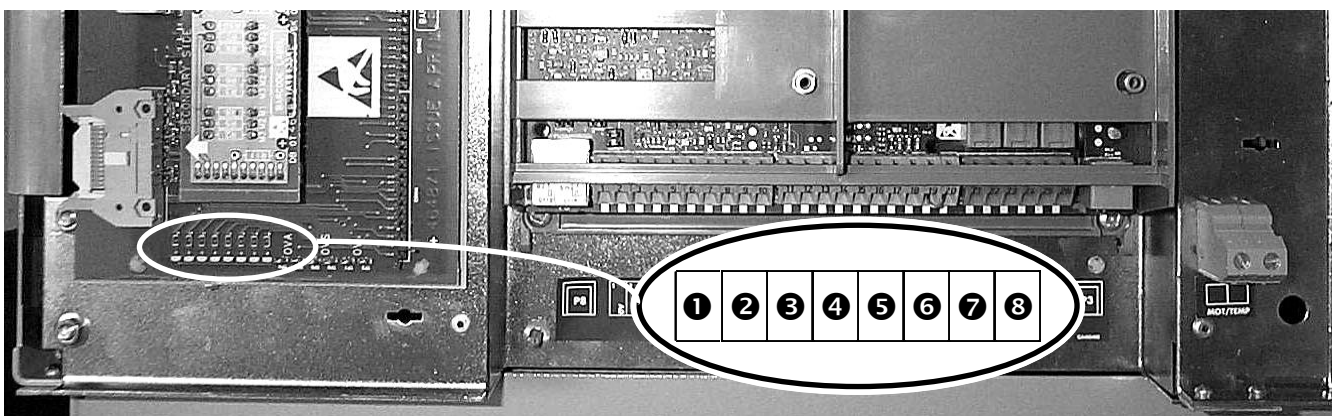

Routine Maintenance

Periodically inspect the drive for build-up of dust or obstructions that may affect ventilation of the unit. Remove this using dry air.

Repair

The 690+ range of drives have been designed to be serviceable units. In the unlikely event of component failure, it is possible to replace the faulty item without having to replace the complete drive unit.

Replacement of components should only be carried out by electrically competent personnel with the knowledge/expertise required to perform the relevant operation.

i.e. in order to replace component parts; drive disassembly, rebuild and re-testing is required.

Saving Your Application Data

In the event of a factory repair, application data will be saved whenever possible. However, we advise you to copy your application settings before returning the unit.

Returning the Unit to Parker Hannifin Manufacturing Limited

Please have the following information available:

- The model and serial number - see the unit's rating label
- Details of the fault

Contact your nearest Parker Hannifin Manufacturing Service Centre to arrange return of the item.

You will be given a *Returned Material Authorisation*. Use this as a reference on all paperwork you return with the faulty item. Pack and despatch the item in the original packing materials; or at least an anti-static enclosure. Do not allow packaging chips to enter the unit.

Disposal

This product contains materials which are consignable waste under the Special Waste Regulations 1996 which complies with the EC Hazardous Waste Directive - Directive 91/689/EEC.

We recommend you dispose of the appropriate materials in accordance with the valid environmental control laws. The following table shows which materials can be recycled and which have to be disposed of in a special way.

Material	Recycle	Disposal
metal	yes	no
plastics material	yes	no
printed circuit board	no	yes

The printed circuit board should be disposed of in one of two ways:

1. High temperature incineration (minimum temperature 1200°C) by an incinerator authorised under parts A or B of the Environmental Protection Act
2. Disposal in an engineered land fill site that is licensed to take aluminium electrolytic capacitors. Do not dispose of in a land fill site set aside for domestic waste.

Packaging

During transport our products are protected by suitable packaging. This is entirely environmentally compatible and should be taken for central disposal as secondary raw material.

Spares List

Parker Hannifin Manufacturing are able to provide guidance regarding the necessary component part to be replaced. The serviceable component parts are listed below.

Electro-Mechanical Parts

The selection of the following items are product/kW rating dependant.

Drive	Main Cooling Fan		Motor Start Capacitor for Main Cooling fan		Internal Extractor Fan	
	Fan Voltage		Fan Voltage		Fan Voltage	
	115V	230V	115V	230V	115V	230V
Frame G 110-132kW	DL389775	DL464085	CY471723	CY464087U001	-	-
Frame G 160-180kW	DL471062U115	DL471062U230	-	-	-	-
Frame H	DL389776U001	DL464086U001	CY389842	CY464088	-	-
Frame J	DL389776U001	DL464086U001	CY389842	CY464088	DL049612*	DL049612*

** 2 fans wired in series for 230V rating*

Drive	Phase Assembly	Brake Unit Assembly
Frame G 110KW	LA465082U101	LA465083U101
Frame G 132KW	LA465082U102	
Frame G 160KW	LA465082U103	
Frame G 180KW	LA465082U104	
Frame H 200-220KW	LA465082U105	LA465083U102
Frame H 250-280KW	LA465082U106	
Frame J 315KW	LA465082U107	LA465083U103

Printed Circuit Boards

The printed circuit boards listed below are common within the 690+ range of drives.

Description	Part Number
Switch Mode Power Supply PCB	AH464883U101
Power Control PCB	AH464871U002
Line Suppression PCB	AH389192U001

7-3 Routine Maintenance and Repair

Component Replacement

Having identified the faulty component part and taken delivery of replacement part(s) the following replacement procedure should be carefully adhered to.

WARNING!

FAILURE TO FOLLOW PROCEDURE MAY RESULT IN DAMAGE TO THE DRIVE AND POSSIBLE ELECTRICAL SHOCK HAZARD! PERSONNEL PERFORMING COMPONENT REPLACEMENT PROCEDURES MUST BE ELECTRICALLY COMPETENT AND POSSESS THE KNOWLEDGE /EXPERTISE REQUIRED TO PERFORM THE RELEVANT OPERATION

BEFORE PERFORMING MAINTENANCE ON THIS UNIT, ENSURE ISOLATION OF THE MAIN SUPPLY TO TERMINALS L1, L2 AND L3.

WAIT FOR AT LEAST 5 MINUTES FOR THE DC LINK TERMINALS (DC+ AND DC-) TO DISCHARGE TO SAFE VOLTAGE LEVELS (<50V), FAILURE TO DO SO CONSTITUTES AN ELECTRICAL SHOCK HAZARD.

Caution

This equipment contains electrostatic discharge (ESD) sensitive parts. Observe static control precautions when handling, installing and servicing this product.

Printed Circuit Board (PCB) Replacement

Observe all electrical warnings and static handling precautions at the front of this section - 'Component Replacement'

Power Control PCB, CALIBRATION Card and Control PCB Replacement

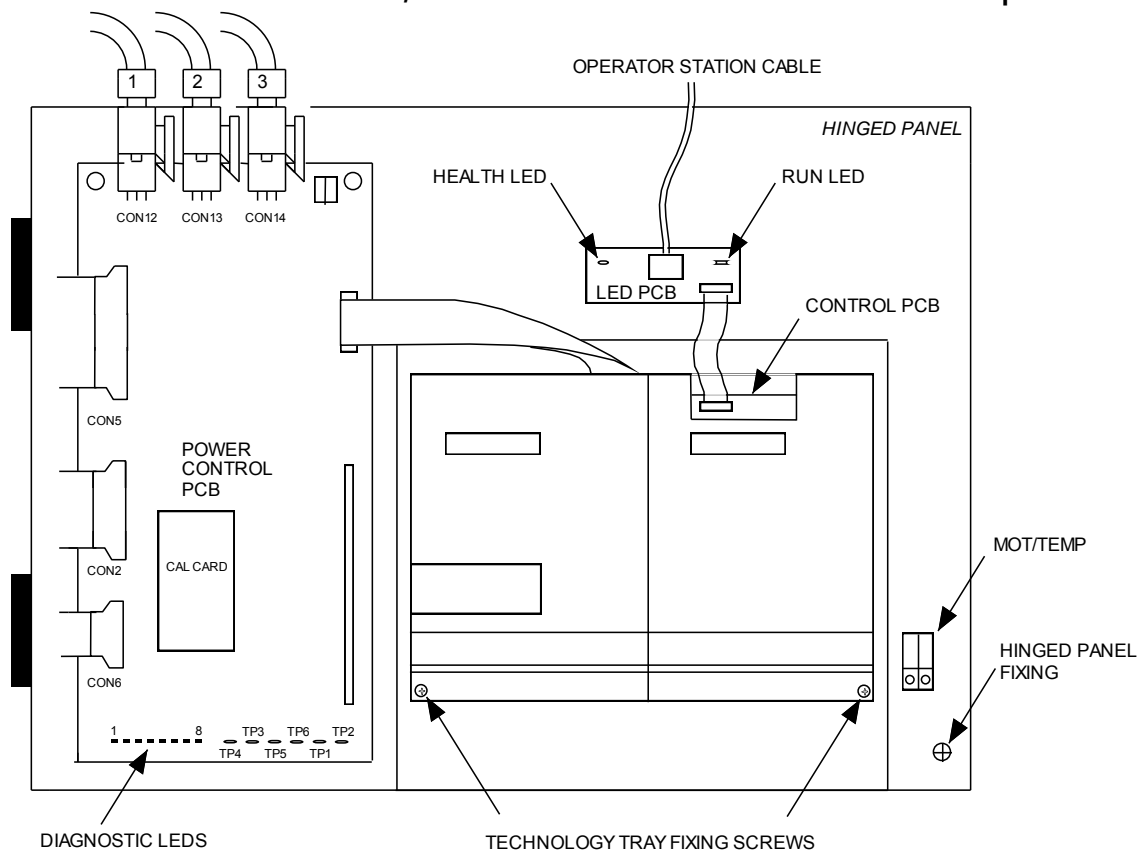
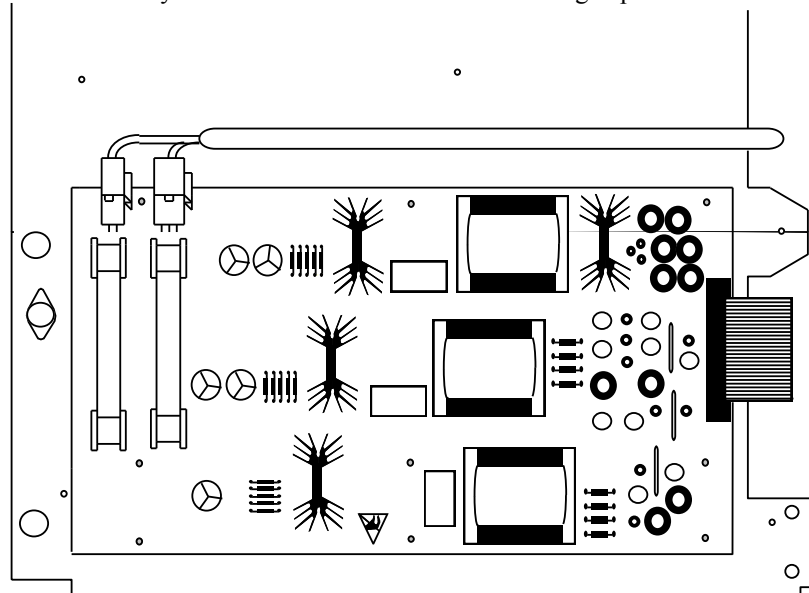

Figure 7.1

1. Remove drive top and bottom terminal cover (plastic) via 2 off ¼ turn fasteners at top and bottom of drive.
2. Disconnect 4-way op-station cable from LED PCB.
3. Remove drive front cover (metal) which is attached via 4 off ¼ turn fasteners (take care not to damage PCBs beneath cover).
4. It is now possible to view the power control PCB and Cal Card as shown in figure 7.1.
To access the Control PCB: disconnect the cable from the LED PCB, remove the 2 screws securing the Technology Tray, lower the tray and unhook from the hinged door.
5. Take note of PCB connectivity and carefully remove and replace PCB, ensuring that PCB is re-connected correctly.
6. Replace drive front cover (metal) which is attached via 4 off ¼ turn fasteners (take care not to damage PCBs beneath cover).
7. Re-connect 4-way op-station cable to LED PCB.
8. Re-fit drive top and bottom terminal cover (plastic) via 2 off ¼ turn fasteners at top and bottom of drive.

SMPS PCB Replacement

1. Follow steps 1 to 3 of procedure 'Power Control PCB, CAL card and control PCB Replacement'. Release hinged panel fixing - 1 off ¼ turn fastener as shown in Figure 7.1.
2. The SMPS PCB may now be viewed on reverse side of hinged panel as shown below.



AH464883U101

Figure 7.2 SMPS PCBs

3. Take note of PCB connectivity and carefully remove and replace PCB, ensuring that PCB is re-connected correctly. Correctly refit any insulating parts that may be present.
4. Re-fit hinged panel and ¼ turn fastener as shown in figure 7.1.
5. Replace drive front cover (metal) which is attached via 4 off ¼ turn fasteners (take care not to damage PCBs beneath cover).
6. Re-connect 4-way op-station cable to LED PCB (see figure 7.1).
7. Re-fit drive top and bottom terminal cover (plastic) via 2 off ¼ turn fasteners at top and bottom of drive.

7-5 Routine Maintenance and Repair

Line Suppression AH389192 PCB Replacement

1. Remove drive top and bottom terminal cover (plastic) via 2 off ¼ turn fasteners at top and bottom of drive.
2. Disconnect 4-way op-station cable from LED PCB (see figure 7.1).
3. Remove drive front cover (metal) which is attached via 4 off ¼ turn fasteners (take care not to damage PCBs beneath cover).
4. Release hinged panel fixing - 1 off ¼ turn fastener as shown in figure 7.1.
5. The line suppression PCB is located inside drive enclosure beneath the hinged panel and can be visually identified as shown below.

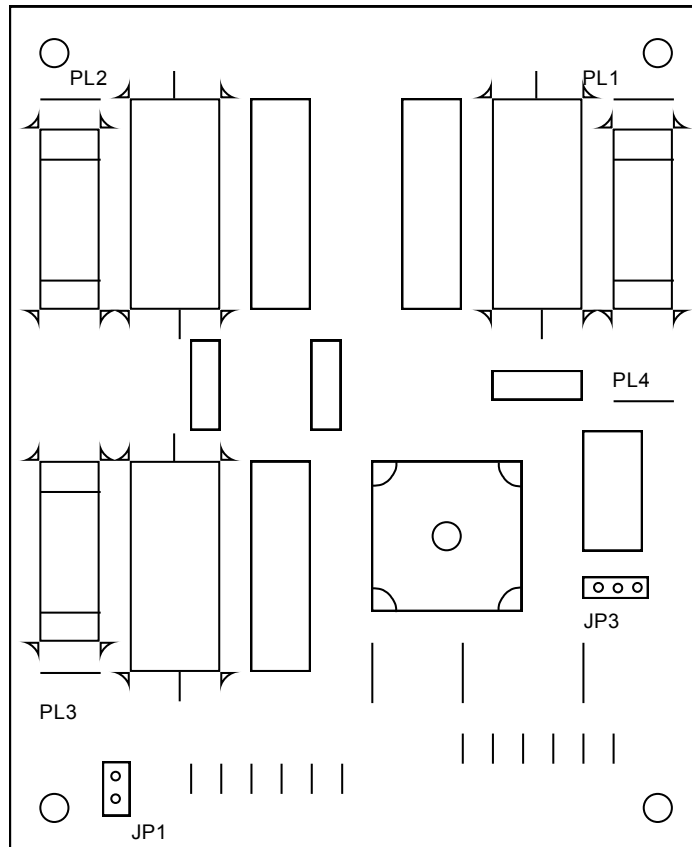

Figure 7.3 - Line Suppression PCB

6. Take note of PCB connectivity and carefully remove and replace PCB, ensuring that PCB is re-connected correctly.
7. Re-fit hinged panel and ¼ turn fastener as shown in figure 7.1.
8. Replace drive front cover (metal) which is attached via 4 off ¼ turn fasteners (take care not to damage PCBs beneath cover).
9. Re-connect 4-way op-station cable to LED PCB (see figure 7.1).
10. Re-fit drive top and bottom terminal cover (plastic) via 2 off ¼ turn fasteners at top and bottom of drive.

Fan Replacement

Observe all electrical warnings and static handling precautions at the front of this section - 'Component Replacement'.

It is possible to replace the drive main cooling fan should the need arise. Having replaced the main cooling fan, ensure that the wiring loom routing/fixing is preserved. This is an electrical safety requirement.

Frames G & H Drive Main Cooling Fan and Fan Start Capacitor Replacement

1. Remove drive top and bottom terminal cover (plastic) via 2 off ¼ turn fasteners at top and bottom of drive.
2. Disconnect 4-way op-station cable from LED PCB (see figure 7.1).
3. Remove drive front cover (metal) which is attached via 4 off ¼ turn fasteners (take care not to damage PCBs beneath cover).
4. Remove Main Fan housing (see figure 1.1).
5. Release hinged panel fixing - 1 off ¼ turn fastener as shown in figure 7.1.
6. Take note of fan and fan start capacitor wiring. Disconnect fan and fan start capacitor wiring.
7. Remove fan mounting nuts. Remove fan start capacitor mounting nuts(s). Remove fan and fan start capacitor taking care not to damage other components within drive.
8. Replace fan and fan start capacitor taking care not to damage other components within drive.
9. Re-connect fan wiring loom and ensure that electrical safety isolation is preserved. (Refer to wiring diagram HJ463151D001 at the end of this section.)
10. Re-fit fan housing (see figure 1.1).
11. Re-fit drive front cover (metal) via 4 off ¼ turn fasteners (take care not to damage PCBs beneath cover).
12. Re-connect 4-way op-station cable to LED PCB (see figure 7.1).
13. Re-fit drive top and bottom terminal cover (plastic) via 2 off ¼ turn fasteners at top and bottom of drive.

Frame J Drive Main Cooling Fan, Internal Extractor Fan and Main Fan Start Capacitor Replacement

In addition to the main cooling fan, the Frame J drive also has two internal 120 mm square fans. The main cooling fan, internal cooling fans and main cooling fan start capacitor are mounted on the bottom panel of the drive (See drawing HG 463009G001 - section 5-2 of this manual). Having replaced the fan, ensure that the fan wiring loom routing/fixing is preserved. Refer to wiring diagram HJ463151D002 at the end of this section. ***This is an electrical safety requirement.***

Replacement of Fan Start Capacitor

1. Disconnect fan start capacitor wiring (two faston connectors at top of capacitor).
2. Remove fan start capacitor mounting nuts(s).
3. Replace and reconnect start capacitor, taking care not to damage other components within drive.

Replacement of Main Cooling Fan Only

1. Disconnect fan supply wire loom at terminal block on bottom panel of drive. Note the colour coding of the connections to the terminal block
2. Remove fan mounting nuts. Remove fan and fan start capacitor taking care not to damage other components within drive.
3. Re-connect fan wiring loom and ensure that electrical safety isolation is preserved.
4. Refit the lower panel assembly to the drive.

Replacement of Internal 120mm Square Cooling Fans

1. While supporting the fan, remove the 6 M6 screws on the very bottom of the drive.
2. Lower the fan and panel assembly out of the drive.
3. Remove the lower panel assembly.
4. Disconnect supply cable at faulty fan.
5. Replace fan.
6. Reconnect supply cable.
7. Re-fit lower panel assembly.

7-7 Routine Maintenance and Repair

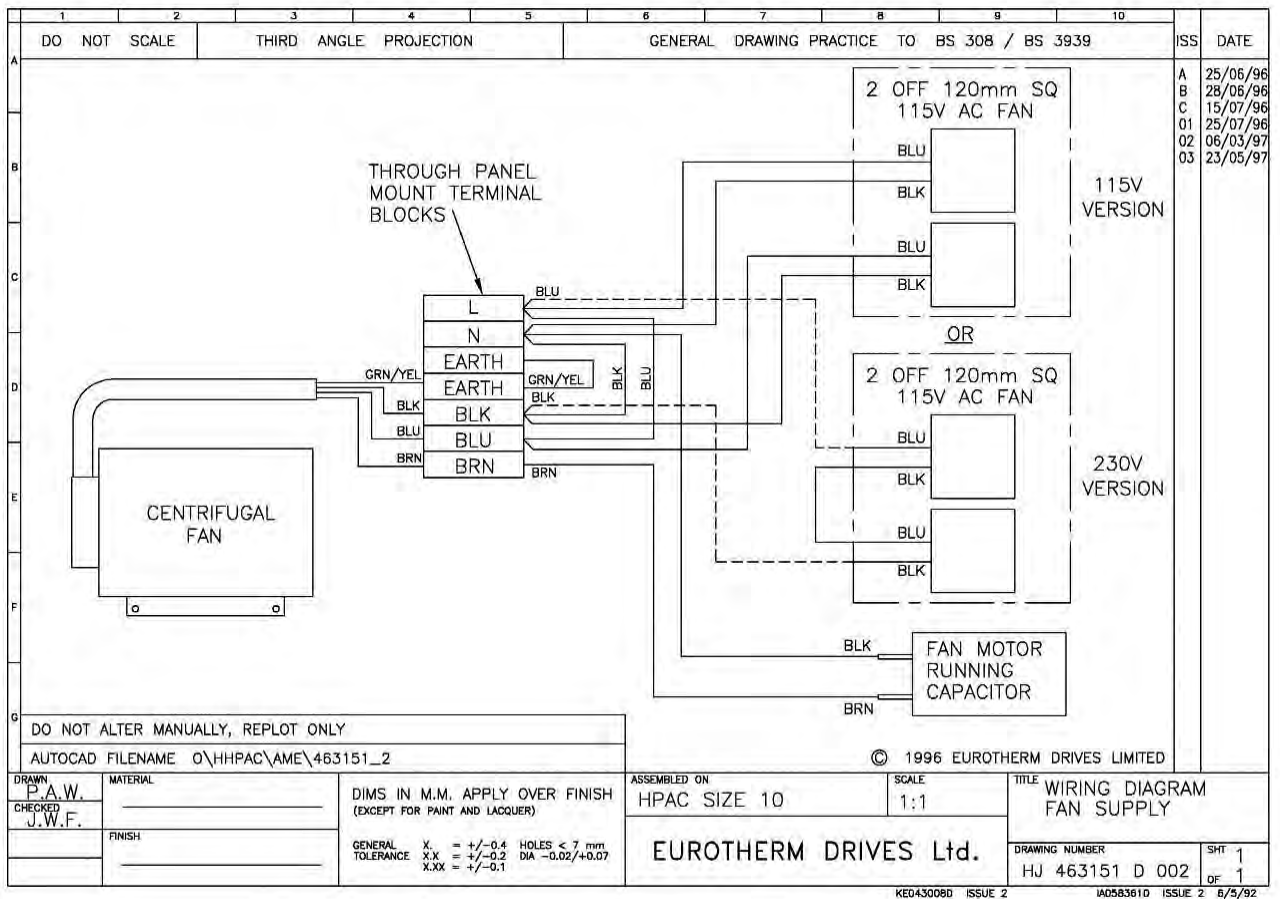
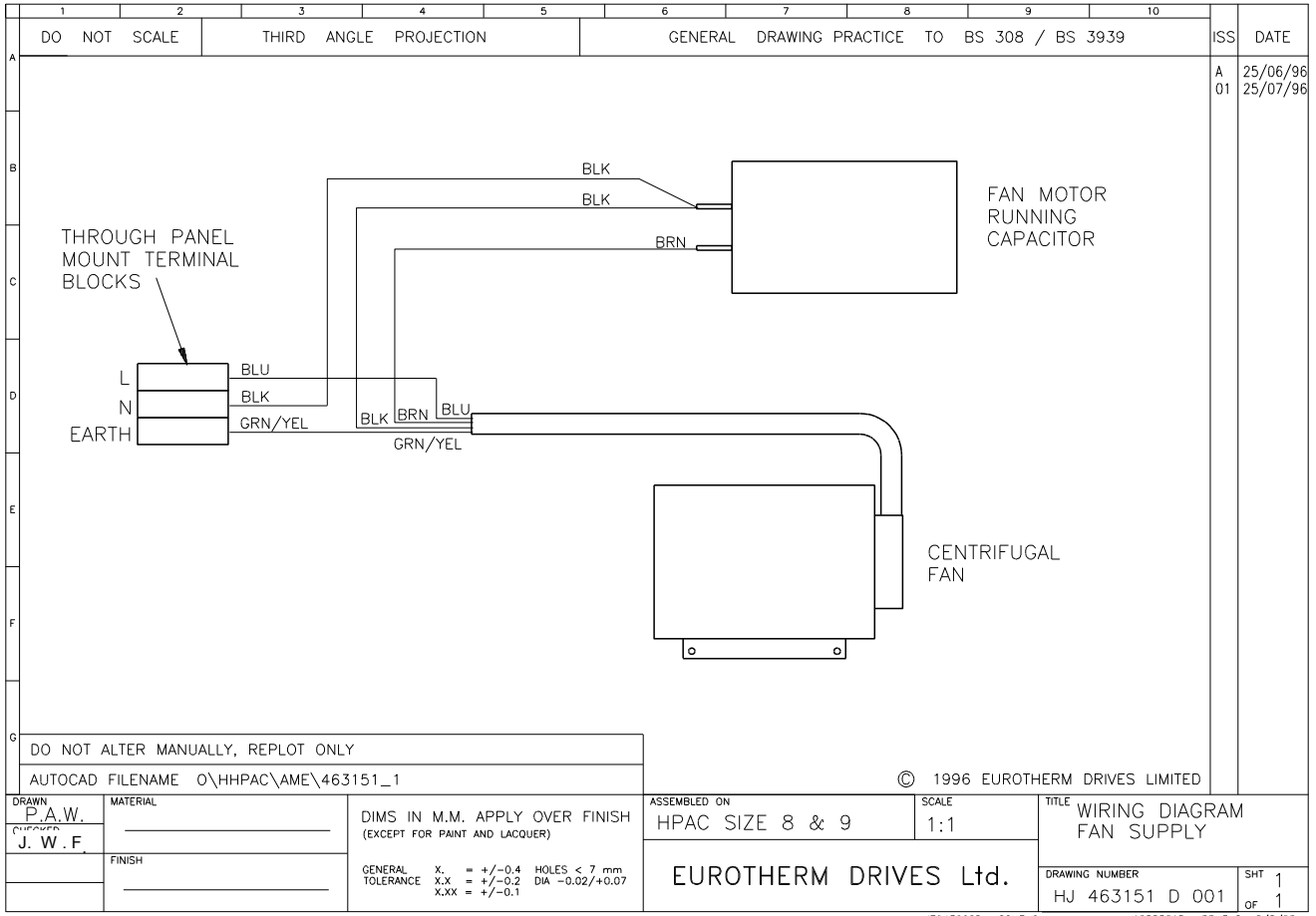

Phase Assembly Replacement

The drive power stage consists of 3 identical phase assemblies. Each phase assembly consists of heatsink, IGBT module plus gate drive pcb, 1/3 of the input bridge, DC link capacitors and PCB 'AH389193'. It is intended that the whole phase assembly be carried as a spare part and replaced as a unit. Spare phase assemblies are available for each of the three drive frame sizes. The spare phase assembly comes with a 'service tray' which is designed to assist in phase assembly replacement. It also protects the other delicate components within the drive during the replacement procedure.

Observe all electrical warnings and static handling precautions at the front of this section - 'Component Replacement'.

Supplied Parts

- Service plate.
- M5 screws (2 off)
- Heatsink clamps (2 off 690+G, 4 off 690+H & J) - used to retain phase assembly in packaging. They are to be reused in the replacement assembly if the original clamps are excessively distorted.
- Insulating caps - 3 off

Required Tools

- Drive ratchet wrench, 300mm extension, 8mm & 10mm socket.
- Drive No. 2 & 3 Posidrive bits.

Phase Assembly Removal Procedure

Refer to Figure 9.4 - 'Power Component Identification' at the end of this section.

1. Remove drive top and bottom terminal cover (plastic) via 2 off ¼ turn fasteners at top and bottom of drive.
2. Disconnect 4-way op-station cable from LED PCB (see figure 7.1).
3. Remove drive front cover (metal) which is attached via 4 off ¼ turn fasteners (take care not to damage PCBs beneath cover).
4. Remove DC+ and DC- bus bars at the top of the drive. - remove 2 M6 captive nuts at the capacitor joining plate assembly and 2 M6 captive nuts at the external connection busbars. (300 mm long extension recommend for this step).
5. Remove capacitor joining plate assembly via M6 captive washer nuts. Note that the nuts on the left hand side of the M2 phase are covered with plastic insulating caps. **These caps are a safety requirement and must be fitted.**
6. If removing the M3 phase limb from a drive which has a Brake unit fitted, it will be necessary to remove the brake connecting plate. (Refer to Chapter 3).
7. Remove 2 M6 captive nuts from input busbar on phase limb to be replaced. (300 mm long extension recommended for this step).
8. Remove 2 M6 hex bolts and washers from output busbar on phase limb to be replaced (300mm long extension recommended for this step).
9. Disconnect cable(s) from printed circuit board on phase limb to be replaced. Take note of PCB connectivity.
10. Disconnect earth wire on phase limb to be replaced by removing 1 off M5 captive nut at chassis.
11. Insert service plate underneath phase limb to be removed. Secure to side panels of drive using the two M5 screws supplied.
12. 690G: Remove heatsink clamp screws (3 per phase assembly) and remove clamp plates. 690H & J: Loosen heatsink clamps (4 per phase assembly) and rotate through 90°.
13. Carefully remove phase limb assembly.

7-9 Routine Maintenance and Repair

Phase Assembly Replacement Procedure

1. Replace any badly distorted heatsink clamps with spare clamps provided. (Clamps used in packaging).
2. Carefully slide replacement phase limb assembly into position making sure that the studs on the input busbars (left-hand side) located in the holes provided on the phase limb busbar. Re-fit nuts and washers, but do not tighten.
3. Re-fit output busbar bolts and washers and tighten to 6.8 NM torque.
4. Secure phase limb assembly to chassis using heatsink clamps.
5. Remove service plate.
6. Tighten input busbar nuts to 6.8 NM torque.
7. Secure earth wire to chassis - 4NM torque.
8. Reconnect cable(s) to phase limb assembly printed circuit board.
9. Refit capacitor joining plate with M6 captive nuts to 6.8 NM torque.
10. Refit insulating caps to M2 (middle) left-hand side capacitor joining plate nuts.
11. Refit DC busbars 2 off M6 captive nuts on capacitor joining plate tightened to 6.8 NM torque and 2 off M6 captive nuts at the external connection busbars tightened to 6.8 NM torque.
12. Refit brake connection plate and top cover if required (refer to Chapter 3)
13. Refit drive front cover (metal) via 4 off ¼ turn fasteners (take care not to damage PCBs beneath cover).
14. Reconnect 4-way op-station cable to LED PCB (see figure 7.1).
15. Refit drive top and bottom terminal cover (plastic) via 2 off ¼ turn fasteners at top and bottom of drive.

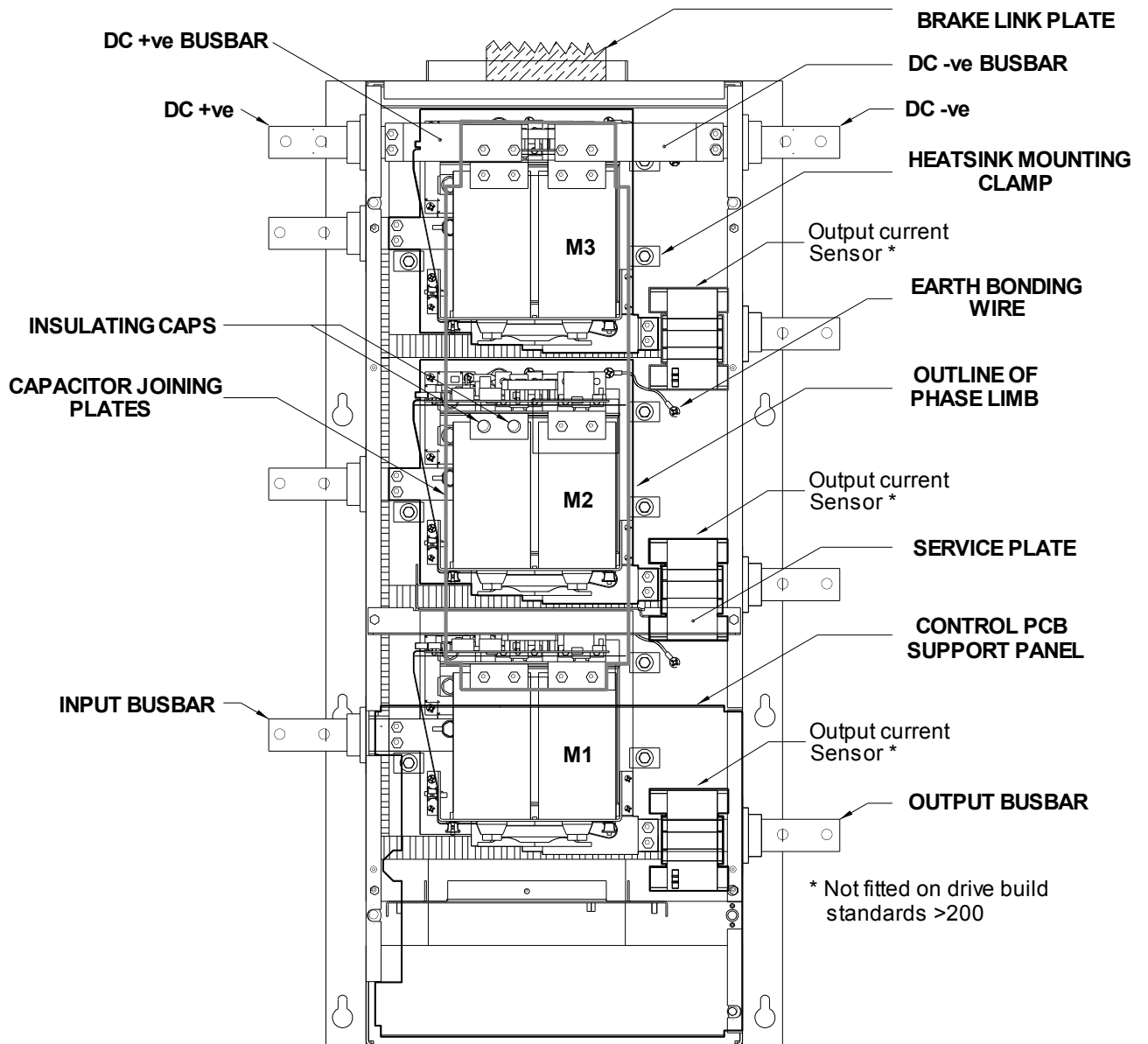

Figure 7.4 Power Component Identification (Frame G)

Understanding the Product Code

Manufacturing Product Codes

The unit is fully identified using an alphanumeric code which records how the drive was calibrated, and its various settings when dispatched from the factory.

The Product Code appears as the “Model No.”. Each block of the Product Code is identified as below:

AC690+ (400/460V) Integrator Series Frame G, H & J

	Block 1	Block 2	Block 3	Block 4
	690	-	43 3216 G 1	- B 0 0 P 00 - A 4 0 C
Family	690 inverter range			
	Constant Torque 400v rating	Constant Torque 460v ratings		
	Supply Voltage	Output Current	Output Current	Frame Size
Current/Power Rating	400/460v 3ph	kW	HP	
				43
	110	216	175	216 G
	132	250	200	250 G
	160	316	250	316 G
	180	361	300	361 G
	200	375		375 H
	220	420	350	420 H
	250	480	400	480 H
	280	520	450	520 H
	315	590	500	590 J
Auxiliary supply	Not required (frames B-E)			0
	115v 1ph (Frame F-J only)			1
	230v 1ph (Frame F-J only)			2
Brake Switch	Not Fitted (optional on Frame D-J)			0
	Brake switch fitted (mandatory on frames B & C, optional on frames D-J)			B
Filter	Not fitted (Optional on frame B, mandatory on frames C-F)			0
	Filter fitted (Optional on frames B only)			F
System Board	Not fitted			0
	System Board fitted			S
Mechanical Style	Panel Mount (Option on Frames B-E, mandatory on Frames F-J)			P
Special Option	None			00
	Documented special options (01-99)			
Destination	English (50Hz)			A
	English (60Hz)			B
	German			D
	Spanish			E
	French			F
	Portuguese			G
	Italian			I
	Polish			L
	Swedish			S
Keypad	6901 Keypad fitted (option on Frames B-F, mandatory on frames G-J)			4
Speed Feedback	None			0
	HTTL Encoder			3
Comms	None			0
	ControlNet			C
	DeviceNet			D
	Ethernet			E
	Johnson Metasys			J
	Link			L
	ModBus +			M
	CanOpen			N
	Profibus			P
	RS485 (EI Bisynch)			R
	Siemens Apogee			S
	LonWorks			W

US Model Number & Legacy Product Codes

Catalog Number (North America)

The unit is identified using a 6 block alphanumeric code which records how the drive was calibrated, and its various settings when dispatched from the factory.

The Product Code appears as the “Cat No.”. Each block of the Product Code is identified as below:

Typical example:

690+/0200/460/1BN

This is a 200Hp 690+, rated at 380 to 460V supply, NEMA 1, braking option fitted, no system board.

Frame G, H, J – Catalog Number (North America)																	
Block No.	Variable	Description															
1	690+	Generic product															
2	XXXX	Four numbers specifying the power output in Hp (Constant Torque): <table style="width: 100%; border: none;"> <tr> <td style="width: 33%;">Frame G</td> <td style="width: 33%;">Frame H</td> <td style="width: 33%;">Frame J</td> </tr> <tr> <td>0175 = 175Hp</td> <td>0350 = 350Hp</td> <td>0500 = 500Hp</td> </tr> <tr> <td>0200 = 200Hp</td> <td>0400 = 400Hp</td> <td></td> </tr> <tr> <td>0250 = 250Hp</td> <td>0450 = 450Hp</td> <td></td> </tr> <tr> <td>0300 = 300Hp</td> <td></td> <td></td> </tr> </table>	Frame G	Frame H	Frame J	0175 = 175Hp	0350 = 350Hp	0500 = 500Hp	0200 = 200Hp	0400 = 400Hp		0250 = 250Hp	0450 = 450Hp		0300 = 300Hp		
Frame G	Frame H	Frame J															
0175 = 175Hp	0350 = 350Hp	0500 = 500Hp															
0200 = 200Hp	0400 = 400Hp																
0250 = 250Hp	0450 = 450Hp																
0300 = 300Hp																	
3	XXX	Three numbers specifying the nominal input voltage rating: 460 380 to 460V (±10%) 50/60Hz															
4	XXX	Characters specifying the enclosure option: C - Chassis (IP20 only)															
5	XX	Characters specifying the braking option: N Brake power switch not fitted (Frames D & E only) B Brake power switch fitted - no braking resistors supplied Note: External braking resistors should be specified and ordered separately.															
6	XX	Characters specifying the systems board: N Not fitted S System board fitted															

8-3 Technical Specifications

690+ Model Recognition (Frame G)

The 690+G drive is produced in four power ratings, identified by the Product Code.

380-460V Supply

Model Recognition		CONSTANT TORQUE	QUADRATIC TORQUE
Model Number (Europe)	Catalog Number (North America)	Motor Power (kW/hp)	Motor Power (kW/hp)
690-433216...	690+0175/460...	110/175	132/200
690-433250...	690+0200/460...	132/200	160/250
690-433316...	690+0250/460...	160/250	180/300
690-433361...	690+0300/460...	180/300	220/350

690+ Model Recognition (Frame H)

The 690+H drive is produced in four power ratings, identified by the Product Code.

380-460V Supply

Model Recognition		CONSTANT TORQUE	QUADRATIC TORQUE
Model Number (Europe)	Catalog Number (North America)	Motor Power (kW/hp)	Motor Power (kW/hp)
690-433375...	-	200/ -	250/ -
690-433420...	690+0350/460...	220/350	250/400
690-433480...	690+0400/460...	250/400	300/450
690-433520...	690+0450/460...	280/450	315/500

690+ Model Recognition (Frame J)

The 690+J drive is produced in one power rating, identified by the Product Code.

380-460V Supply

Model Recognition		CONSTANT TORQUE	QUADRATIC TORQUE
Model Number (Europe)	Catalog Number (North America)	Motor Power (kW/hp)	Motor Power (kW/hp)
690-433590...	690+0500/460...	315/500	355/550

Environmental Details		
Operating Temperature Constant Torque Quadratic Torque	Operating temperature is defined as the ambient temperature to the immediate surround of the drive, when the drive and other equipment adjacent to it is operating at worst case conditions. 0°C to 40°C, derate up to a maximum of 50°C 0°C to 40°, derate up to a maximum of 50°C Derate linearly at 1% per degree centigrade for temperature exceeding the maximum rating ambient for the drive.	
Storage Temperature	-25°C to +55°C	
Shipping Temperature	-25°C to +70 °C	
Product Enclosure Rating	Cubicle Mounted	IP20, IP00 power terminals UL (c-UL) Open Type (North America/Canada)
	Cubicle Mounted, fitted with Top Vent	IP20, IP00 power terminals UL (c-UL) Open Type (North America/Canada)
Altitude	If greater than 1000m above sea level, derate by 1% per 100m to a maximum of 2000m	
Humidity	Maximum 85% relative humidity at 40°C non-condensing	
Atmosphere	Non flammable, non corrosive and dust free	
Climatic Conditions	Class 3k3, as defined by EN50178	
Vibration	Test Fc of EN60068-2-6 10Hz <= f <= 57Hz sinusoidal 0.075mm amplitude 57Hz <= f <= 150Hz sinusoidal 1g 10 sweep cycles per axis on each of three mutually perpendicular axis	
Safety Overvoltage Category Pollution Degree Europe North America/Canada	Overvoltage Category III	
	Pollution Degree 2	
	When fitted inside a cubicle, this product conforms with the Low Voltage Directive 2006/95/EC using EN50178 to show compliance.	
	Complies with the requirements of UL508C as an open-type drive.	

Earthing/Safety Details			
Earthing	Permanent earthing is mandatory on all units. <ul style="list-style-type: none"> Use a copper protective earth conductor 10mm² minimum cross-section. Local wiring regulations always take precedence. 		
Input Supply Details (TN) and (IT)	Drives without filters are suitable for earth referenced (TN) or non-earth referenced (IT) supplies. External filters are available for use on earth referenced (TN) supplies only.		
Prospective Short Circuit Current (PSCC)	Frame G 100kA maximum	Frame H 100kA maximum	Frame J 100kA maximum
Earth Leakage Current	>> 100mA (all models)		

8-5 Technical Specifications

Cabling Requirements for EMC Compliance					
	Power Supply Cable	Motor Cable	External AC Supply EMC Filter to Drive Cable	Brake Resistor Cable	Signal/Control Cable
Cable Type (for EMC Compliance)	Unscreened	Screened/armoured	Screened/armoured	Screened/armoured	Screened
Segregation	From all other wiring (clean)	From all other wiring (noisy)			From all other wiring (sensitive)
Length Limitations With External AC Supply EMC Filter	Unlimited	50 metres	0.3 metres	25 metres	25 metres
Screen to Earth Connection		Both ends	Both ends	Both ends	Drive end only
Output Choke		300 metres maximum			
* Maximum motor cable length under any circumstances					

Terminal Block Wire Sizes						
Wire sizes should be chosen with respect to the operating conditions and your local National Electrical Safety Installation Requirements. Local wiring regulations always take precedence.						
For UL sizes refer to Chapter 9: "Certification for the Drive" - Requirements for UL Compliance.						
Fan Terminals (mm ² /AWG)	Motor Thermistor (mm ² /AWG)	DC Output Busbar (mm)	AC Input/Output Busbar (mm)	Brake Busbar (mm)	Control Terminals (mm ² /AWG)	System Board Terminals (option) (mm ² /AWG)
0.2 - 6/24 -10	0.5 - 16/20 - 6	2 x Ø13 holes, 35mm apart	2 x Ø13 holes, 44mm apart	2 x Ø13 holes, 44mm apart	2.5/14	2.5/14

Electrical Ratings (Frame G)

Motor power, output current and input current must not be exceeded under steady state operating conditions.

NOTES:

1. **IMPORTANT : 3% line impedance MUST be provided for each unit**, and is assumed in the quoted input current values. Failure to do so will severely shorten DC link capacitor lifetime and could result in damage to the bridge. Refer to AC Line Choke table.
2. Input currents for kW ratings are at 400V 50Hz ac input, and for Hp ratings at 460V 60Hz ac input.
3. Short circuit protection Semiconductor Fuses should be installed in the 3-phase supply to the drive module to protect the input bridge. Circuit breakers or HRC fuses will not protect the input bridge.
4. Fundamental Input Power Factor : 0.95
5. Output Voltage (maximum) = Input Voltage
6. Output Frequency : 0 to 120Hz
7. Fan Inlet Temperature Range : 0 to 40°C
8. Earth Leakage Current : >>100mA. Product must be permanently earthed.
9. True value given, note that the MMI will display 3kHz

380-460V ±10%, 45-65Hz

Suitable for earth referenced (TN) and non earth referenced (IT) supplies.



CONSTANT TORQUE (Output Overload Motoring 150% for 60s)

Model Number (Europe)	Catalog Number (North America)	Motor Power	Output Current (A)	Input Current (A)	Input Fuse Rating (A)	Heatsink Power Loss (W)	Total Power Loss (W)	Maximum Switching Frequency (kHz)	Input Bridge I ² t (A ² s)
				Notes 1 & 2	Note 3			Note 9	
690-433216...	690+0175/460...	110kW 175hp	216 216	216 186	250	2097	2426	2.5 2.5	304000 304000
690-433250...	690+0200/460...	132kW 200hp	250 250	246 236	300	2598	2912	2.5 2.5	304000 304000
690-433316...	690+0250/460...	160kW 250hp	316 316	305 307	350	3169	3500	2.5 2.5	813000 813000
690-433361...	690+0300/460...	180kW 300hp	361 361	336 358	400	3347	3723	2.5 2.5	813000 813000

QUADRATIC TORQUE (Output Overload Motoring 110% for 60s)

Model Number (Europe)	Catalog Number (North America)	Motor Power	Output Current (A)	Input Current (A)	Input Fuse Rating (A)	Heatsink Power Loss (W)	Total Power Loss (W)	Maximum Switching Frequency (kHz)	Input Bridge I ² t (A ² s)
				Notes 1 & 2	Note 3			Note 9	
690-433216...	690+0175/460...	132kW 200hp	260 260	247 239	300	2590	2920	2.5 2.5	304000 304000
690-433250...	690+0200/460...	150kW 250hp	302 302	297 288	350	3169	3482	2.5 2.5	304000 304000
690-433316...	690+0250/460...	180kW 300hp	361 361	341 358	450	3635	3967	2.5 2.5	813000 813000
690-433361...	690+0300/460...	220kW 350hp	420 420	402 411	450	4032	4409	2.5 2.5	813000 813000

8-7 Technical Specifications

Electrical Ratings (Frame H)

Motor power, output current and input current must not be exceeded under steady state operating conditions.

NOTES:

1. **IMPORTANT : 3% line impedance MUST be provided for each unit**, and is assumed in the quoted input current values. Failure to do so will severely shorten DC link capacitor lifetime and could result in damage to the bridge. Refer to AC Line Choke table.
2. Input currents for kW ratings are at 400V 50Hz ac input, and for Hp ratings at 460V 60Hz ac input.
3. Short circuit protection Semiconductor Fuses should be installed in the 3-phase supply to the drive module to protect the input bridge. Circuit breakers or HRC fuses will not protect the input bridge.
4. Fundamental Input Power Factor : 0.95
5. Output Voltage (maximum) = Input Voltage
6. Output Frequency : 0 to 120Hz
7. Fan Inlet Temperature Range : 0 to 40°C
8. Earth Leakage Current : >>100mA. Product must be permanently earthed.
9. True value given, note that the MMI will display 3kHz

380-460V ±10%, 45-65Hz

Suitable for earth referenced (TN) and non earth referenced (IT) supplies.



CONSTANT TORQUE (Output Overload Motoring 150% for 60s)

Model Number (Europe)	Catalog Number (North America)	Motor Power	Output Current (A)	Input Current (A) <small>Notes 1 & 2</small>	Input Fuse Rating (A) <small>Note 3</small>	Heatsink Power Loss (W)	Total Power Loss (W)	Maximum Switching Frequency (kHz) <small>Note 9</small>	Input Bridge I ² t (A ² s)
690-433375...		200kW	375	367	450	3566	3954	2.5	813000
690-433420...	690+0350/460...	220kW	420	400	450	4030	4418	2.5	813000
		350hp	420	409				2.5	813000
690-433480...	690+0400/460...	250kW	480	466	550	4559	4984	2.5	813000
		400hp	480	477				2.5	813000
690-433520...	690+0450/460...	280kW	520	516	600	5031	5469	2.5	813000
		450hp	520	529				2.5	813000

QUADRATIC TORQUE (Output Overload Motoring 110% for 60s)

Model Number (Europe)	Catalog Number (North America)	Motor Power	Output Current (A)	Input Current (A) <small>Notes 1 & 2</small>	Input Fuse Rating (A) <small>Note 3</small>	Heatsink Power Loss (W)	Total Power Loss (W)	Maximum Switching Frequency (kHz) <small>Note 9</small>	Input Bridge I ² t (A ² s)
690-433375...		250kW	480	450	550	4704	5092	2.5	813000
690-433420...	690+0350/460...	250kW	480	450	550	4704	5092	2.5	813000
		400hp	480	461				2.5	813000
690-433480...	690+0400/460...	300kW	545	545	650	5317	5743	2.5	813000
		450hp	545	529				2.5	813000
690-433520...	690+0450/460...	315kW	590	571	650	5761	6200	2.5	813000
		500hp	590	581				2.5	813000

Electrical Ratings (Frame J)

Motor power, output current and input current must not be exceeded under steady state operating conditions.

NOTES:

1. **IMPORTANT : 3% line impedance MUST be provided for each unit**, and is assumed in the quoted input current values. Failure to do so will severely shorten DC link capacitor lifetime and could result in damage to the input bridge. Refer to AC Line Choke table.
2. Input currents for kW ratings are at 400V 50Hz ac input, and for Hp ratings at 460V 60Hz ac input.
3. Short circuit protection Semiconductor Fuses should be installed in the 3-phase supply to the drive module to protect the input bridge. Circuit breakers or HRC fuses will not protect the input bridge.
4. Fundamental Input Power Factor : 0.95
5. Output Voltage (maximum) = Input Voltage
6. Output Frequency : 0 to 120Hz
7. Fan Inlet Temperature Range : 0 to 40°C
8. Earth Leakage Current : >>100mA. Product must be permanently earthed.
9. True value given, note that the MMI will display 3kHz

380-460V ±10%, 45-65Hz

Suitable for earth referenced (TN) and non earth referenced (IT) supplies.



CONSTANT TORQUE (Output Overload Motoring 150% for 60s)

Model Number (Europe)	Catalog Number (North America)	Motor Power	Output Current (A)	Input Current (A) <small>Notes 1 & 2</small>	Input Fuse Rating (A) <small>Note 3</small>	Heatsink Power Loss (W)	Total Power Loss (W)	Maximum Switching Frequency (kHz) <small>Note 9</small>	Input Bridge I ² t (A ² s)
690-433590...	690+0500/460...	315kW 500hp	590 590	576 584	600	5788	6260	2.5 2.5	813000 813000

QUADRATIC TORQUE (Output Overload Motoring 110% for 60s)

Model Number (Europe)	Catalog Number (North America)	Motor Power	Output Current (A)	Input Current (A) <small>Notes 1 & 2</small>	Input Fuse Rating (A) <small>Note 3</small>	Heatsink Power Loss (W)	Total Power Loss (W)	Maximum Switching Frequency (kHz) <small>Note 9</small>	Input Bridge I ² t (A ² s)
690-433590...	690+0500/460...	355kW 550hp	650 650	642 636	650	6479	6951	2.5 2.5	813000 813000

8-9 Technical Specifications

External AC Supply (RFI) Filter (Part Number CO467843U340)

The drive can be supplied with filters to meet the 'industrial' Class A conducted emission limits of EN55011 when used with 50m of screened motor cable and the specified 3% minimum AC line choke as listed below.

Frame Size	Motor Power (kW)	Number of Filters Required in Parallel	Phase	Watt Loss (W)	Leakage Current (mA)	Current (A)	Maximum Supply Voltage (V)	EMC Performance Class (Industrial)	Maximum Motor Cable Length (m)	AC Line Choke
G	110	1	3	50	>100mA	340	460	Class A	50	CO389936U401
G	132	1	3	50	>100mA	340	460	Class A	50	CO389936U401
G	160	2	3	100	>100mA	340	460	Class A	50	CO389936U402
G	180	2	3	100	>100mA	340	460	Class A	50	CO389936U402
H	200	2	3	100	>100mA	340	460	Class A	50	CO389936U402
H	220	2	3	100	>100mA	340	460	Class A	50	CO389936U402
H	250	2	3	100	>100mA	340	460	Class A	50	CO389936U403
H	280	2	3	100	>100mA	340	460	Class A	50	CO389936U403
J	315	2	3	100	>100mA	340	460	Class A	50	CO389936U403

Filters suitable for earth referenced (TN) supplies only. The filter is suitable for use at 3kHz switching frequency only.

AC Line Choke

Frame G, H, J drives MUST use an AC Line Choke. However, where a drive is individually supplied from a dedicated transformer with the required impedance, the AC Line Choke is not required.

Where a system comprises a number of Frame G, H and J drives connected to a common supply, a separate AC Line Choke is required in the supply to each drive.

When an EMC external ac supply filter is used, the AC Line Choke must be fitted between the filter and the drive.

Caution

Failure to provide the correct line impedance will severely reduce the drives lifetime and could result in catastrophic failure of the drive.

The required AC Line Choke line impedance is nominally 3% of the drive rating.

Parker Hannifin Manufacturing can supply the following ac line chokes:

Frame Size	Constant/Quadratic Torque Rating		Inductance/Phase (μH)	Maximum Continuous AC Line Current -Quadratic Torque (A rms)	Peak Current @ 150% Constant Torque Rating (A peak)	Parker Part No.
	kW @ 380V	Hp @ 460V				
G	110/132	175/200	75	260	560	CO389936U401
	132/160			239	560	
	160/180			313	620	
	180/220	200/250	50	288	620	
		250/300		359	790	
H	200/250	350/400	35	358	790	CO389936U402
	220/250			423	860	
	250/300			411	860	
	280/315			474	915	
				474	995	
J	315/355	450/500	35	461	995	CO389936U403
				574	1180	
				529	1180	
				601	1295	
				581	1295	
J	315/355	500/550	35	676	1430	CO389936U403
				636	1430	





Internal Dynamic Brake Switch (Frame G)					
Motor Power (kW)	Brake Switch Peak Current (A)	Peak Brake Dissipation (kW/hp)	Brake Switch Continuous Current (A)	Continuous Brake Dissipation (kW/hp)	Minimum Brake Resistor Value (Ω)
380-460V $\pm 10\%$, 45-65Hz DC link brake voltage: 750 - 820V					
20s maximum, 30% duty					
180	360	270/360	72	54/72	2.08

Internal Dynamic Brake Switch (Frame H)					
Motor Power (kW)	Brake Switch Peak Current (A)	Peak Brake Dissipation (kW/hp)	Brake Switch Continuous Current (A)	Continuous Brake Dissipation (kW/hp)	Minimum Brake Resistor Value (Ω)
380-460V $\pm 10\%$, 45-65Hz DC link brake voltage: 750 - 820V					
20s maximum, 30% duty					
280	560	420/560	112	84/112	1.34

Internal Dynamic Brake Switch (Frame J)					
Motor Power (kW)	Brake Switch Peak Current (A)	Peak Brake Dissipation (kW/hp)	Brake Switch Continuous Current (A)	Continuous Brake Dissipation (kW/hp)	Minimum Brake Resistor Value (Ω)
380-460V $\pm 10\%$, 45-65Hz DC link brake voltage: 750 - 820V					
20s maximum, 30% duty					
315	630	473/630	126	95/126	1.19

8-11 Technical Specifications

Control Terminals			
Terminal No.	Name	Range	Description (Default functions are for Macro 1)
ANALOG I/O TERMINAL BLOCK			
This is a 10-way connector carrying all customer analog I/O.			
1	0V		0V reference for analog i/o
2	AIN1 (SPEED)	0-10V, $\pm 10V$, 0-20V 0-20mA, 4-20mA	Configurable analog input Default function = Speed Setpoint
3	AIN2 (TRIM)	0-10V, $\pm 10V$, 0-20V 0-20mA, 4-20mA	Configurable analog input Default function = Speed Trim
4	AIN3	0-10V, $\pm 10V$, 0-20V	Configurable analog input
5	AIN4	0-10V, $\pm 10V$, 0-20V	Configurable analog input
6	AOUT1 (RAMP)	0-10V, 0-20mA, 4-20mA	Configurable analog output Default function = Ramp Output
7	AOUT2	$\pm 10V$	Configurable analog output No default function
8	AOUT3	$\pm 10V$	Configurable analog output No default function
9	+10V REF	10V	10V reference for analog i/o Load 10mA maximum
10	-10V REF	-10V	-10V reference for analog i/o Load 10mA maximum
DIGITAL INPUT TERMINAL BLOCK			
This is a 10-way connector carrying all digital inputs.			
11	0V		All inputs below 24V=high , 0V=low
12	DIN1 (RUN FWD)	0-24V	Configurable digital input Default function = RUN FWD 0V = Stop, 24V = Run
13	DIN2 (RUN REV)	0-24V	Configurable digital input Default function = RUN REV 0V = Stop, 24V = Run
14	DIN3 (NOT STOP)	0-24V	Configurable digital input Default function = NOT STOP 0V = Stop, 24V = Run
15	DIN4 (REMOTE REVERSE)	0-24V	Configurable digital input Default function = DIRECTION 0V = Forward, 24V = Reverse
16	DIN 5 (JOG)	0-24V	Configurable digital input Default function = JOG 24V = Jog, 0V = Stop
17	DIN6	0-24V	Configurable digital input No default function
18	DIN7 (REMOTE TRIP RESET)	0-24V	Configurable digital input Default function = TRIP RESET 24V = Reset
19	DIN8 (EXT TRIP)	0-24V	Non-configurable digital input Default function = EXTERNAL TRIP (active low) 24V = No Trip, 0V = Trip
20	+24VC		Customer +24V (max load 150mA)
RELAY OUTPUT TERMINAL BLOCK			
These relay outputs are volt-free, normally-open contacts rated to 230V, 3A with resistive load. Connection is by a 6-way spring clamp connector.			
21	DOUT1_A	normally-open relay contacts	Default function DOUT1 closed = healthy
22	DOUT1_B	normally-open relay contacts	
23	DOUT2_A	normally-open relay contacts	Default function DOUT2 closed = running
24	DOUT2_B	normally-open relay contacts	
25	DOUT3_A	normally-open relay contacts	No default function
26	DOUT3_B	normally-open relay contacts	

System Board Terminals (option)			
Terminal No.	Name	Range	Description (Default functions are for Macro 1)
			
Terminal A 1 2 3 4 5 6			
1	External 0V		User-supplied 0V reference
2	DIGIO11		Configurable digital input/output
3	DIGIO12		Configurable digital input/output
4	DIGIO13		Configurable digital input/output
5	DIGIO14		Configurable digital input/output
6	DIGIO15		Configurable digital input/output
			
Terminal B 1 2 3 4 5 6 7 8 9			
1	External 24V In	24V dc ($\pm 10\%$) 1A	User-supplied power supply
2	Reference Encoder A		Input
3	Reference Encoder /A		Input
4	Reference Encoder B		Input
5	Reference Encoder /B		Input
6	Reference Encoder Z		Input
7	Reference Encoder /Z		Input
8	Encoder Supply Out	5V, 12V, 18V, 24V	User selectable (max load 500mA)
9	External 0V		User-supplied 0V reference
			
Terminal C 1 2 3 4 5 6			
1	Slave Encoder A		Input
2	Slave Encoder /A		Input
3	Slave Encoder B		Input
4	Slave Encoder /B		Input
5	Slave Encoder Z		Input
6	Slave Encoder /Z		Input
			
Terminal D 1 2 3 4 5 6			
1	Repeat Encoder Output A		Output
2	Repeat Encoder Output /A		Output
3	Repeat Encoder Output B		Output
4	Repeat Encoder Output /B		Output
5	Repeat Encoder Output Z		Output
6	Repeat Encoder Output /Z		Output

8-13 Technical Specifications

Analog Inputs/Outputs		
	Inputs	Output
Range	0-10V, $\pm 10V$, 0-20mA or 4-20mA (range set in software)	0-10V, 0-20mA or 4-20mA (range set in software)
Impedance	Voltage range = 47k Ω Current range = 220 Ω	Voltage range = 100 Ω Recommended Load - 220 Ω
Resolution	10 bits (1 in 1024)	10 bits (1 in 1024)
Sample Rate	5ms (one selected input can be 1ms)	5ms
System Board		
With System Board option fitted, the $\pm 10V$ range is enhanced as follows:		
Range	$\pm 10V$ (range set in software)	
Impedance	Voltage range = 14k Ω	
Resolution	12 bit + sign (1 in 8192)	
Sample Rate	5ms (one selected input can be 1ms)	
Digital Inputs		
Operating Range	0-5V dc = OFF, 15-24V dc = ON (-30V dc absolute minimum, +30V dc absolute maximum)	
Input Impedance	6.8k Ω	
Sample Rate	5ms	
Digital Outputs		
These are volt-free relay contacts. 50V dc max, 0.3A max (for inductive loads up to L/R=40ms, a suitable freewheel diode must be used).		
Maximum Voltage	230V ac	
Maximum Current	3A resistive load	
System Board Digital Inputs/Outputs (DIGIO11-15)		
These are individually, user-configurable as an Input or Output. Refer to the Software Product Manual, Chapter 1: "Programming Your Application" – DIGITAL INPUTS and DIGITAL OUTPUTS.		
	Input	Output
Maximum Voltage	EXT 24Vin + 0.6V	24V dc
Maximum Current		100mA
Operating Range	0-5V dc = OFF, 15-24V dc = ON (-30V dc absolute minimum, +30V dc absolute maximum)	24V dc = ON * 0V dc = OFF * range: 19.1V (full load) to 25.1V (no load)
Input Impedance	6.8k Ω	
Sample Rate	5ms	5ms

Supply Harmonic Analysis (Frame G Quadratic)

The results conform to stage 2 and stage 3 of the Engineering Recommendation G.5/3 September 1976, Classification 'C': Limits for Harmonics in the UK Electricity Industry.

$$THD(V) \times 100 = \frac{\sqrt{\sum_{h=2}^{h=40} Q_{h^2}}}{Q^{1n}} \%$$

Fundamental Voltage (V)	400			
Drive Type	Three Phase			
Short Circuit Supply = Supply impedance	10000A \equiv 73 μ H	18000A \equiv 41 μ H		
Motor Power (kW)	132	160	180	220
Typical Motor Efficiency %	90	90	90	90
Harmonic No.	RMS Current (A)			
1	215.9	262.5	295.6	361.0
3	0.1	0.1	0.2	0.3
5	74.9	92.5	108.7	122.1
7	23.6	29.8	36.9	36.8
9	0.1	0.0	0.0	0.0
11	13.9	17.4	20.3	23.2
13	6.9	8.5	9.7	11.5
15	0.1	0.0	0.0	0.0
17	5.4	6.9	8.4	9.0
19	3.9	4.9	5.4	6.6
21	0.1	0.0	0.0	0.1
23	2.5	3.2	4.0	4.1
25	2.3	3.0	3.4	3.9
27	0.1	0.0	0.0	0.1
29	1.4	1.8	2.2	2.4
31	1.3	1.8	2.1	2.2
33	0.1	0.0	0.0	0.0
35	1.0	1.2	1.4	1.7
37	0.8	1.1	1.3	1.4
39	0.1	0.0	0.0	0.1
40	0.0	0.0	0.0	0.0
41	0.7	0.9	1.1	1.3
42	0.0	0.0	0.0	0.0
43	0.6	0.8	0.9	1.1
44	0.0	0.0	0.0	0.0
45	0.1	0.1	0.0	0.1
46	0.0	0.0	0.0	0.0
47	0.5	0.7	0.8	0.9
48	0.0	0.0	0.0	0.0
49	0.5	0.6	0.7	0.8
50	0.0	0.0	0.0	0.0
Total RMS Current (A)	230.4	280.8	318.2	384.0
THD (V) %	2.7553	1.9076	2.2541	2.5016

8-15 Technical Specifications

Supply Harmonic Analysis (Frame H Quadratic)

The results conform to stage 2 and stage 3 of the Engineering Recommendation G.5/3 September 1976, Classification 'C': Limits for Harmonics in the UK Electricity Industry.

$$THD(V) \times 100 = \frac{\sqrt{\sum_{h=2}^{h=40} Q_{h^2}}}{Q^{1n}} \%$$

Fundamental Voltage (V)	400		
Drive Type	Three Phase		
Short Circuit Supply = Supply impedance	18000A \equiv 41 μ H		30000A \equiv 24 μ H
Motor Power (kW)	250	300	315
Typical Motor Efficiency %	90	90	90
Harmonic No.	RMS Current (A)		
1	410.5	493.6	517.3
3	0.2	0.1	0.1
5	131.0	174.8	179.5
7	37.1	55.2	55.3
9	0.0	0.0	0.1
11	24.9	32.8	33.7
13	13.1	15.6	16.3
15	0.0	0.0	0.1
17	9.1	13.2	13.3
19	7.3	9.0	9.4
21	0.0	0.0	0.2
23	4.0	6.2	6.1
25	4.0	5.5	5.6
27	0.0	0.0	0.1
29	2.5	3.4	3.4
31	2.2	3.3	3.3
33	0.0	0.0	0.2
35	1.9	2.3	2.5
37	1.5	2.0	2.1
39	0.0	0.1	0.1
40	0.0	0.0	0.0
41	1.3	1.8	1.9
42	0.0	0.0	0.0
43	1.2	1.4	1.5
44	0.0	0.0	0.0
45	0.0	0.1	0.2
46	0.0	0.0	0.0
47	0.9	1.4	1.4
48	0.0	0.0	0.0
49	0.9	1.1	1.2
50	0.0	0.0	0.1
Total RMS Current (A)	433.6	528.1	552.0
THD (V) %	2.6645	2.1305	2.1827

Supply Harmonic Analysis (Frame J Quadratic)

The results conform to stage 2 and stage 3 of the Engineering Recommendation G.5/3 September 1976, Classification 'C': Limits for Harmonics in the UK Electricity Industry.

$$THD(V) \times 100 = \frac{\sqrt{\sum_{h=2}^{h=40} Q_{h^2}}}{Q^{1n}} \%$$

Fundamental Voltage (V)	400
Drive Type	Three Phase
Short Circuit Supply = Supply impedance	30000A \approx 24 μ H
Motor Power (kW)	355
Typical Motor Efficiency %	90
Harmonic No.	RMS Current (A)
1	583.0
3	0.1
5	193.4
7	55.8
9	0.0
11	36.3
13	18.2
15	0.0
17	13.7
19	10.4
21	0.0
23	6.1
25	5.9
27	0.0
29	3.6
31	3.3
33	0.0
35	2.7
37	2.1
39	0.0
40	0.0
41	1.9
42	0.1
43	1.6
44	0.1
45	0.0
46	0.1
47	1.4
48	0.1
49	1.3
50	0.1
Total RMS Current (A)	618.5
THD (V) %	2.3288

Requirements for EMC Compliance

All Variable Speed Drives (VSDs) potentially produce electrical emissions which are radiated into the environment and conducted back into the ac supply. VSDs are inherently immune to any additional external electrical noise. The following information is provided to maximise the Electro Magnetic Compatibility (EMC) of VSDs and systems in their intended operating environment, by minimising their emissions and maximising their immunity.

Minimising Radiated Emissions

EN50081-1/EN50081-2 /EN55011/EN55022/EN61800-3 radiated emission measurements are made between 30MHz and 1GHz in the far field at a distance of 10 to 30 metres. Limits lower than 30MHz or in close proximity are not specified. Emissions from individual components tend to be additive.

- Use a screened/armoured cable between VSD/cubicle and motor containing the motor protective earth (PE) connection. It should have a 360° screen termination. Earth screen at both ends connecting to the motor frame and cubicle. Maintain the screen integrity using 360° terminations.

Note: *Some hazardous area installations may preclude direct earthing at both ends of the screen, in this case earth one end via a 1 μ F 50Vac capacitor, and the other as normal.*

- Keep unshielded cable as short as possible inside the cubicle.
- Always maintain the integrity of the shield.
- If the cable is interrupted to insert contactors etc., re-connect the screen using the shortest possible route.
- Keep the length of screen stripped-back as short as possible when making screen connections.
- Ideally use 360° screen terminations using cable glands or 'U' clips on power screen rails.

If a shielded cable is not available, lay unshielded motor cables in a metal conduit which will act as a shield. The conduit must be continuous with a direct electrical contact to the VSD and motor housing. If links are necessary, use braid with a minimum cross sectional area of 10mm².

Note: *Some motor gland boxes and conduit glands are made of plastic, if this is the case, then braid must be connected between the screen and the chassis. In addition at the motor end, ensure that the screen is electrically connected to the motor frame since some terminal boxes are insulated from the frame by gasket/paint.*

Earthing Requirements

IMPORTANT: Protective earthing always takes precedence over EMC earthing.

Protective Earth (PE) Connections

Note: *In accordance with installations to EN60204, only one protective earth conductor is permitted at each protective earth terminal contacting point.*

Local wiring regulations may require the protective earth connection of the motor to be connected locally, i.e. not as specified in these instructions. This will not cause shielding problems because of the relatively high RF impedance of the local earth connection.

EMC Earth Connections

For compliance with EMC requirements, we recommend that the "0V/signal ground" is separately earthed. When a number of units are used in a system, these terminals should be connected together at a single, local earthing point.

Control and signal cables for the encoder, all analog inputs, and communications require screening with the screen connected only at the VSD end. However, if high frequency noise is still a problem, earth screen at the non VSD end via a 0.1 μ F capacitor.

Note: *Connect the screen (at the VSD end) to the VSD protective earth point, and not to the control board terminals.*

Cabling Requirements

Note: *Refer to Chapter 8: "Technical Specifications" for additional Cabling Requirements.*

Planning Cable Runs

- Use the shortest possible motor cable lengths.
- Use a single length of cable to a star junction point to feed multiple motors.
- Keep electrically noisy and sensitive cables apart.
- Keep electrically noisy and sensitive parallel cable runs to a minimum. Separate parallel cable runs by at least 0.25 metres. For runs longer than 10 metres, separation should be increased proportionally. For example if the parallel runs were 50m, then the separation would be $(50/10) \times 0.25\text{m} = 1.25\text{m}$.
- Sensitive cables should cross noisy cables at 90°.
- Never run sensitive cables close or parallel to the motor, dc link and braking chopper circuit for any distance.
- Never run supply, dc link or motor cables in the same bundle as the signal/control and feedback cables, even if they are screened.
- Ensure EMC filter input and output cables are separately routed and do not couple across the filter.

Increasing Motor Cable Length

Because cable capacitance and hence conducted emissions increase with motor cable length, conformance to EMC limits is only guaranteed with the specified ac supply filter option using a maximum cable length as specified in Chapter 11: "Technical Specifications".

This maximum cable length can be improved using the specified external input or output filters. Refer to Chapter 8: "Technical Specifications" - External AC Supply (RFI) Filters.

Screened/armoured cable has significant capacitance between the conductors and screen which increases linearly with cable length (typically 200pF/m but varies with cable type and current rating).

Long cable lengths may have the following undesirable effects:

- Tripping on 'overcurrent' as the cable capacitance is charged and discharged at the switching frequency.
- Producing increased conducted emissions which degrade the performance of the EMC filter due to saturation.
- Causing RCDs (Residual Current Devices) to trip due to increased high frequency earth current.
- Producing increased heating inside the EMC ac supply filter from the increased conducted emissions.

These effects can be overcome by adding chokes or output filters at the output of the VSD.

9-3 Certification for the Drive

EMC Installation Options

The unit, when installed for Class A or Class B operation, will be compliant with EN55011/EN55022 for radiated emissions, as described below.

Screening & Earthing (cubicle mounted, Class B)

Note: *The installation requirements of local safety standards must be achieved regarding the safety of electrical equipment for machines.. Refer to Chapter 3: "Installing the Drive" - Power Wiring and Protective Earth (PE) Connections* .

The unit is installed for Class B operation when mounted inside a cubicle having 10dB attenuation between 30 and 100MHz (typically the attenuation provided by a metal cabinet with no aperture of dimension greater than 0.15m), using the recommended ac supply filter and having met all cabling requirements.

Note: *Radiated magnetic and electric fields inside the cubicle will be high and any components fitted inside must be sufficiently immune.*

The VSD, external filter and associated equipment are mounted onto a conducting, metal mounting panel. Do not use cubicle constructions that use insulating mounting panels or undefined mounting structures. Cables between the VSD and motor must be screened or armoured and terminated at the VSD or locally on the back panel.

Single VSD - Single Motor

Apply a single point series earthing strategy for a single VSD mounted in a cubicle as shown.

The protective earth connection (PE) to the motor must be run inside the screened cable between the motor and VSD and be connected to the motor protective earth terminal on the VSD.

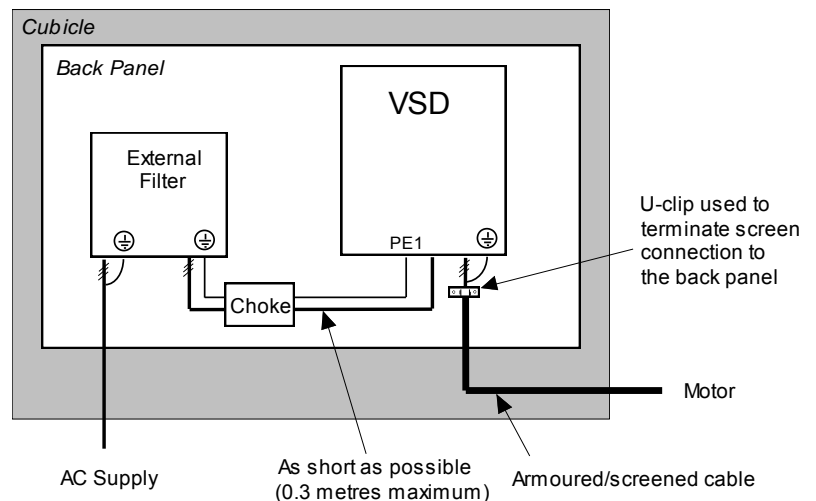

Figure Chapter 9 -1 EMC and Safety Earthing Cabling

Single VSD - Multiple Motors

Note: *Refer to Chapter 10: "Application Notes" - Using Multiple Motors on a Single Drive.*

If connecting multiple motors to a single VSD, use a star junction point for motor cable connections. Use a metal box with entry and exit cable glands to maintain shield integrity. Refer to Chapter 10: Application Notes" - Using Multiple Motors on a Single Drive.

Star Point Earthing

A star-point earthing policy separates 'noisy' and 'clean' earths. Four separate earth busbars (three are insulated from the mounting panel) connect to a single earth point (star point) near the incoming safety earth from the main supply. Flexible, large cross-section cable is used to ensure a low HF impedance. Busbars are arranged so that connection to the single earth point is as short as possible.

1 Clean Earth Busbar (insulated from the mounting panel)

Used as a reference point for all signal and control cabling. This may be further subdivided into an analog and a digital reference busbar, each separately connected to the star earthing point. The digital reference is also used for any 24V control.

Note: The 690+ uses a single clean earth busbar for analog and digital.

2 Dirty Earth Busbar (insulated from the mounting panel)

Used for all power earths, i.e. protective earth connection. It is also used as a reference for any 110 or 220V control used, and for the control transformer screen.

3 Metal Work Earth Busbar

The back panel is used as this earth busbar, and should provide earthing points for all parts of the cubicle including panels and doors. This busbar is also used for power screened cables which terminate near to (10cm) or directly into a VSD - such as motor cables, braking choppers and their resistors, or between VSDs - refer to the appropriate product manual to identify these. Use U-clips to clamp the screened cables to the back panel to ensure optimum HF connection.

4 Signal/Control Screen Earth Busbar (insulated from the mounting panel)

Used for signal/control screened cables which **do not** go directly to the VSD. Place this busbar as close as possible to the point of cable entry. 'U' clamp the screened cables to the busbars to ensure an optimum HF connection.

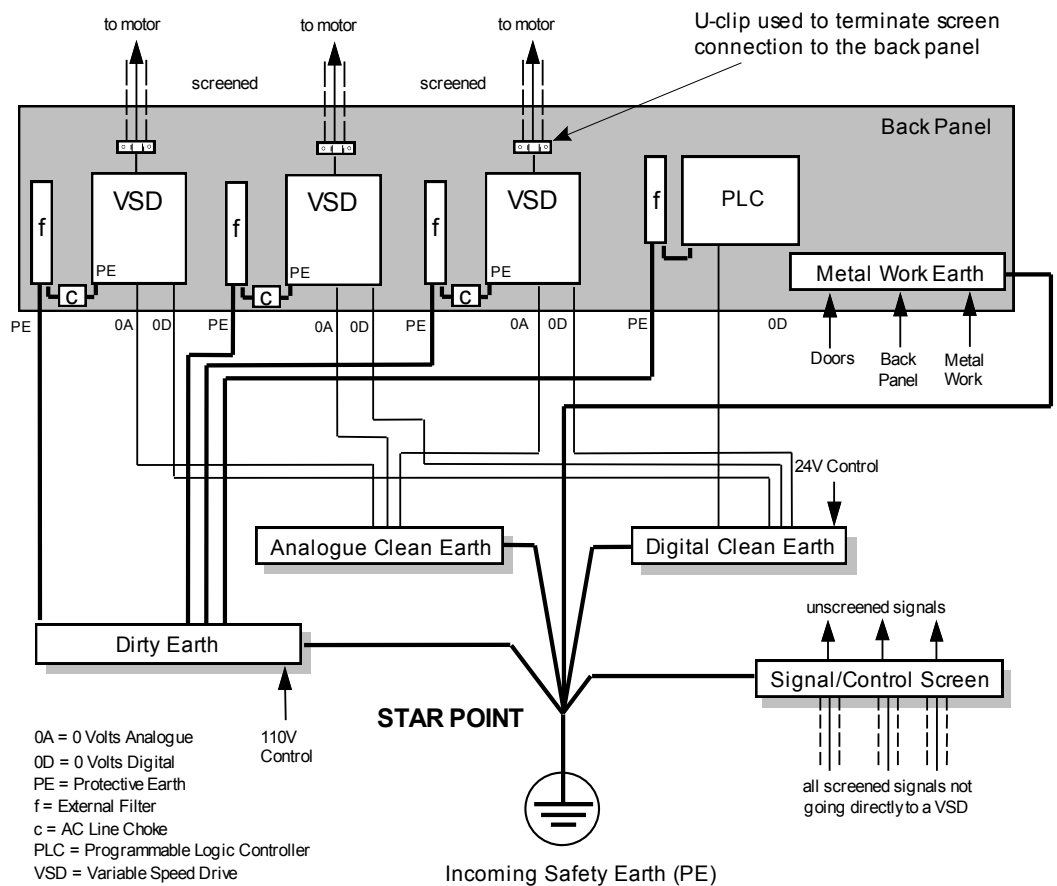

Sensitive Equipment

The proximity of the source and victim circuit has a large effect on radiated coupling. The electromagnetic fields produced by VSDs falls off rapidly with distance from the cabling/cubicle. Remember that the radiated fields from EMC compliant drive systems are measured at least 10m from the equipment, over the band 30-1000MHz. Any equipment placed closer than this will see larger magnitude fields, especially when very close to the drive.

Do not place magnetic/electric field sensitive equipment within 0.25 metres of the following parts of the VSD system:

- Variable Speed Drive (VSD)
- EMC output filters
- Input or output chokes/transformers
- The cable between VSD and motor (even when screened/armoured)

9-5 Certification for the Drive

- Connections to external braking chopper and resistor (even when screened/armoured)
- AC/DC brushed motors (due to commutation)
- DC link connections (even when screened/armoured)
- Relays and contactors (even when suppressed)

From experience, the following equipment is particularly sensitive and requires careful installation.

- Any transducers which produce low level analog outputs (<1V) , e.g. load cells, strain gauges, thermocouples, piezoelectric transducers, anemometers, LVDTs
- Wide band width control inputs (>100Hz)
- AM radios (long and medium wave only)
- Video cameras and closed circuit TV
- Office personal computers
- Capacitive devices such as proximity sensors and level transducers
- Mains borne communication systems
- Equipment not suitable for operation in the intended EMC environment, i.e. with insufficient immunity to new EMC standards

Requirements for UL Compliance

Solid-State Motor Overload Protection

These devices provide Class 10 motor overload protection. The maximum internal overload protection level (current limit) is 150% for 60 seconds in Constant, and 110% for 60s in Quadratic. Refer to the Software Product Manual, Chapter 1: Programming Your Application - CURRENT LIMIT for user current limit adjustment information.

An external motor overload protective device must be provided by the installer where the motor has a full-load ampere rating of less than 50% of the drive output rating; or when the MOTOR STALLED trip is TRUE (TRIPS STATUS::DISABLE TRIPS>> MOTOR STALLED); or when the STALL TIME parameter is increased above 480 seconds (refer to the 690+ Software Manual, Chapter 1 : STALL TRIP).

Motor over temperature sensing is required. Motors used in conjunction with the drive controller shall be protected with PTC sensor(s) or relays suitable for use with the variable speed drive. Technical details can be found in Chapter 3 Installing the Drive.

Short Circuit Rating

The drives are suitable for use on a circuit capable of delivering not more than 100,000 RMS Symmetrical Amperes, 460V maximum.

Solid-State Short-Circuit Protection

These devices are provided with Solid-State Short-Circuit (output) Protection. Integral solid state short circuit protection does not provide branch circuit protection. Branch circuit protection requirements must be in accordance with the latest edition of the National Electrical Code NEC/NFPA-70 and any additional local codes.

Recommended Branch Circuit Protection

It is recommended that UL Listed (JDDZ) non-renewable cartridge fuses, Class K5 or H; or UL Listed (JDRX) renewable cartridge fuses, Class H, are installed upstream of the drive. Refer to Chapter 8: "Technical Specifications" - Electrical Ratings for Input Fuse Ratings.

Motor Base Frequency

The motor base frequency rating is 480Hz maximum.

Field Wiring Temperature Rating

Use 75°C Copper conductors only.

Field Wiring Terminal Markings

For correct field wiring connections that are to be made to each terminal refer to Chapter 3: "Installing the Drive" - Power Wiring Connections, and Control Wiring Connections.

Terminal Tightening Torque

Refer to Chapter 3: "Installing the Drive" - Mechanical Details.

Recommended Wire Sizes

North American wire sizes are based on NEC/NFPA-70 for ampacities of thermoplastic-insulated (75°C) copper conductors assuming not more than three current-carrying conductors in raceway or cable, based on ambient temperature of 30°C.

The wire sizes allow for an ampacity of 125% of the rated input and output amperes for motor branch-circuit conductors as specified in NEC/NFPA-70.

FRAME G				
460V ±10%				
CONSTANT TORQUE				
Product Code for Europe	Model Catalog Code for North America	Power Input Kcmil	Power Output Kcmil	Brake Output AWG
690-433216G...	690+/0150/460...	250	300	6
690-433250G...	690+/0200/460...	350	400	4
690-433316G...	690+/0250/460...	600	600	4
690-433361G...	690+/0300/460...	700	700	3
QUADRATIC TORQUE				
Product Code for Europe	Model Catalog Code for North America	Power Input Kcmil	Power Output Kcmil	Brake Output AWG
690-433216G..	690+/0150/460...	350	400	
690-433250G...	690+/0200/460...	500	500	
FRAME H				
460V ±10%				
CONSTANT TORQUE				
Product Code for Europe	Model Catalog Code for North America	Power Input Kcmil	Power Output Kcmil	Brake Output AWG
690-433375H...	690+/0300/460...	700	750	3
690-433420H...	690+/0350/460...	900	1000	2
690-433480H...	690+/0400/460...	1500	1500	1
690-433520H...	690+/0450/460...	2000	1750	1/0
QUADRATIC TORQUE				
Product Code for Europe	Model Catalog Code for North America	Power Input	Power Output	Brake Output AWG
690-433375H...	690+/0300/460...	1250Kcmil	1500 Kcmil	
690-433420H...	690+/0350/460...	1250 Kcmil	1500 Kcmil	
690-433480H...	690+/0400/460...	2000 Kcmil	1@3"	
690-433520H...	690+/0450/460...	1@3"	1@3"	
690-433316G...	690+/0250/460...	700	700	
690-433361G...	690+/0300/460...	900	900	
FRAME J				
460V ±10%				
CONSTANT TORQUE				
Product Code for Europe	Model Catalog Code for North America	Power Input	Power Output	Brake Output AWG
690-433590J...	690+/0500/460...	1@3"	1@3"	2/0
QUADRATIC TORQUE				
Product Code for Europe	Model Catalog Code for North America	Power Input	Power Output	Brake Output
690-433590J...	690+/0500/460...	1@3"	1@3"	

9-7 Certification for the Drive

Field Grounding Terminals

The field grounding terminals are identified with the International Grounding Symbol (IEC Publication 417, Symbol 5019).



Operating Ambient Temperature

All units are considered acceptable for use in a maximum ambient temperature of 40°C.

UL Terminations

UL compression Terminal Lug Kits are available for the drives which provide sets of lugs suitable for the following ratings. These lugs must be applied with the correct tooling as described in the Installation Instructions provided with each Lug Kit.

The following Terminal Kits are available for the connection of Power Wiring.

Catalog Number	Constant Torque	Quadratic Torque	Terminal Kit No.
Frame G			
690+/0150/460...	150HP	200HP	LA465682U001
690+/1320/460...	200HP	250HP	LA465682U002
690+/1600/460...	250HP	300HP	LA465682U003
690+/1800/460...	300HP	350HP	LA465682U004
Frame H			
690+/0300/460...	300HP	400HP	LA465682U005
690+/0350/460...	350HP	400HP	LA465682U006
690+/0400/460...	400HP	450HP	LA465682U007
690+/0450/460...	450HP	500HP	LA465682U008
Frame J			
690+/0500/460...	500HP	550HP	LA465682U009

European Directives and the CE Mark

The following information is supplied to provide a basic understanding of the EMC and low voltage directives CE marking requirements. The following literature is recommended for further information:

- *Recommendations for Application of Power Drive Systems (PDS), European Council Directives - CE Marking and Technical Standardisation - (CEMEP)*

Available from your local trade association or Parker Hannifin Manufacturing Limited office

The European machines and drives manufacturers via their national trade associations have formed the European Committee of Manufacturers of Electrical Machines and Power Electronics (CEMEP). Parker Hannifin Manufacturing Limited and other major European drives manufacturers are working to the CEMEP recommendations on CE marking. The CE mark shows that a product complies with the relevant EU directives, in our case the Low Voltage Directive and, in some instances, the EMC Directive.

CE Marking for Low Voltage Directive

When installed in accordance with this manual, the drive is CE marked by Parker Hannifin Manufacturing Limited in accordance with the low voltage directive (S.I. No. 3260 implements this LVD directive into UK law). An EU Declaration of Conformity (low voltage directive) is included at the end of this chapter.

CE Marking for EMC - Who is Responsible?

Note: *The specified EMC emission and immunity performance of this unit can only be achieved when the unit is installed to the EMC Installation Instructions given in this manual.*

According to S.I. No. 2373 which implements the EMC directive into UK law, the requirement for CE marking this unit falls into two categories:

1. Where the supplied unit has an intrinsic/direct function to the end user, then the unit is classed as **relevant apparatus**.
2. Where the supplied unit is incorporated into a higher system/apparatus or machine which includes (at least) the motor, cable and a driven load but is unable to function without this unit, then the unit is classed as a **component**.

■ **Relevant Apparatus - Parker Hannifin Manufacturing Responsibility**

Occasionally, say in a case where an existing fixed speed motor - such as a fan or pump - is converted to variable speed with an add-on drive module (*relevant apparatus*), it becomes the responsibility of Parker Hannifin Manufacturing to apply the CE mark and issue an EU Declaration of Conformity for the EMC Directive. This declaration and the CE mark is included at the end of this chapter.

■ **Component - Customer Responsibility**

The majority of Parker Hannifin Manufacturing products are classed as *components* and therefore we cannot apply the CE mark or produce an EU Declaration of Conformity in respect of EMC. It is therefore the manufacturer/supplier/installer of the higher system/apparatus or machine who must conform to the EMC directive and CE mark.

Legal Requirements for CE Marking

IMPORTANT: Before installation, clearly understand who is responsible for conformance with the EMC directive. Misappropriation of the CE mark is a criminal offence.

It is important that you have now defined who is responsible for conforming to the EMC directive, either:

■ Parker Hannifin Manufacturing Responsibility

You intend to use the unit as *relevant apparatus*.

When the specified EMC filter is correctly fitted to the unit following EMC installation instructions, it complies with the relevant standards indicated in the following tables. The fitting of the filter is mandatory for the CE marking of this unit to apply.

The relevant declarations are to be found at the end of this chapter. The CE mark is displayed on the EU Declaration of Conformity (EMC Directive) provided at the end of this chapter.

■ Customer Responsibility

You intend to use the unit as a *component*, therefore you have a choice:

1. To fit the specified filter following EMC installation instructions, which may help you gain EMC compliance for the final machine/system.
2. Not to fit the specified filter, but use a combination of global or local filtering and screening methods, natural migration through distance, or the use of distributed parasitic elements of the existing installation.

Note: *When two or more EMC compliant components are combined to form the final machine/system, the resulting machine/system may no longer be compliant, (emissions tend to be additive, immunity is determined by the least immune component). Understand the EMC environment and applicable standards to keep additional compliance costs to a minimum.*

Applying for CE Marking for EMC

We have supplied a Manufacturer's EMC Declaration at the end of this chapter that you can use as a basis for your own justification of overall compliance with the EMC directive. There are three methods of demonstrating conformity:

1. Self-certification to a relevant standard
2. Third party testing to a relevant standard
3. Writing a technical construction file stating the technical rationale as to why your final machine/system is compliant. An EMC "competent body" must then assess this and issue a technical report or certificate to demonstrate compliance.
Refer to EMC Directive 2014/30/EU.

With EMC compliance, an EU Declaration of Conformity and the CE mark will be issued for your final machine/system.

IMPORTANT: Professional end users with EMC expertise who are using drive modules and cubicle systems defined as components who supply, place on the market or install the relevant apparatus must take responsibility for demonstrating EMC conformance and applying the CE mark and issuing an EU Declaration of Conformity.

Which Standards Apply?

Power Drive Product Specific

The standards that may apply to this unit come under two broad categories:

1. Emission - these standards limit the interference caused by operating (this) drive module.
2. Immunity - these standards limit the effect of interference (on this unit) from other electrical and electronic apparatus.

Conformance can be demonstrated using the Product Specific Standard.

Certificates

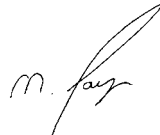
690P	
<div style="display: flex; justify-content: space-between; align-items: center;"> <div style="font-size: 2em; font-weight: bold;">CE</div> <div style="text-align: center;"> <h3>EU DECLARATIONS OF CONFORMITY</h3> <p>Date CE marked first applied: 01.04.2000</p> </div> </div>	
<div style="text-align: center; background-color: black; color: white; padding: 2px; margin-bottom: 5px;">EMC Directive</div> <p style="text-align: center;">In accordance with the EU Directive 2014/30/EU</p> <p>We Parker Hannifin Manufacturing Limited, address as below, declare under our sole responsibility that the above Electronic Products when installed and operated with reference to the instructions in the Product Manual (provided with each piece of equipment) is in accordance with the relevant clauses from the following standard:-</p> <p style="text-align: center;">* BSEN61800-3</p>	<div style="text-align: center; background-color: black; color: white; padding: 2px; margin-bottom: 5px;">Low Voltage Directive</div> <p style="text-align: center;">In accordance with the EU Directive 2014/35/EU</p> <p>We Parker Hannifin Manufacturing Limited, address as below, declare under our sole responsibility that the above Electronic Products when installed and operated with reference to the instructions in the Product Manual (provided with each piece of equipment), is in accordance with the relevant clauses from the following standard :-</p> <p style="text-align: center;">EN50178</p>
<h3>MANUFACTURERS DECLARATIONS</h3>	
<div style="text-align: center; background-color: black; color: white; padding: 2px; margin-bottom: 5px;">EMC Declaration</div> <p>We Parker Hannifin Manufacturing Limited, address as below, declare under our sole responsibility that the above Electronic Products when installed and operated with reference to the instructions in the Product Manual (provided with each piece of equipment) is in accordance with the relevant clauses from the following standard:-</p> <p style="text-align: center;">* BSEN61800-3</p>	<div style="text-align: center; background-color: black; color: white; padding: 2px; margin-bottom: 5px;">Machinery Directive</div> <p>The above Electronic Products are components to be incorporated into machinery and may not be operated alone. The complete machinery or installation using this equipment may only be put into service when the safety considerations of the Directive 2006/42EC are fully adhered to. Particular reference should be made to EN60204-1 (Safety of Machinery - Electrical Equipment of Machines). All instructions, warnings and safety information of the Product Manual must be adhered to.</p>
 <p style="text-align: center;">_____ 1st May 2016 Dr Martin Payn (EME Division Engineering Manager)</p>	
<p><i>* Compliant with the immunity requirements of the Standard without specified EMC filters.</i></p>	
<p>PARKER HANNIFIN MANUFACTURING LTD, ELECTROMECHANICAL & DRIVES BUSINESS UNIT, NEW COURTWICK LANE, LITTLEHAMPTON, WEST SUSSEX BN17 7RZ TELEPHONE: +44(0)1903 737000 FAX: +44(0)1903 737100</p> <p><small>Registered Number: 4806503 England. Registered Office: 55 Maylands Avenue, Hemel Hempstead, Herts HP2 4SJ</small></p>	

Issued for compliance with the EMC Directive when the unit is used as *relevant apparatus*.

This is provided to aid your justification for EMC compliance when the unit is used as a *component*.

The drive is CE marked in accordance with the low voltage directive for electrical equipment and appliances in the voltage range when installed correctly.

Since the potential hazards are mainly electrical rather than mechanical, the drive does not fall under the machinery directive. However, we do supply a manufacturer's declaration for when the drive is used (as a *component*) in machinery.

Application advice is available through our Technical Support Department, who can also arrange for on-site assistance if required. Refer to the back cover of this manual for the address of your local Parker Hannifin Manufacturing Limited Company.

- Always use gold flash relays, or others designed for low current operation (5mA), on all control wiring.
- Remove all power factor correction equipment from the motor side of the drive before use.
- Avoid using motors with low efficiency and small $\cos \phi$ (power factor) as they require a larger kVA rated drive to produce the correct shaft kW.

Synchronous Motor Control

Although intended primarily for use with induction (asynchronous) motors, drives can also be used for speed control of synchronous motors. Synchronous motors can offer economic solutions in applications where tight control of speed is required together with the low maintenance characteristics of an ac motor.

The two most common types of synchronous ac motor are *permanent magnet* and *wound rotor*.

In contrast to induction motors, synchronous motors run at synchronous speed whether on full load or no load. Synchronous speed is set by the frequency of the supply applied to the stator. The stator flux can be kept constant by keeping the stator volts/frequency ratio constant, as with an induction motor.

Torque is produced in the motor by an increase in load angle between the stator and rotor fluxes. Maximum torque occurs when the load angle approaches 90° . If the load angle exceeds this value then torque drops and the motor will stall. Systems involving synchronous motors need careful design to ensure that the motor can accelerate the load and handle transient load changes without stalling.

Brake Motors

Brake motors are used in applications requiring a mechanical brake for safety or other operational reasons. The motor can be a standard induction motor fitted with an electro-mechanical brake, or it could be a special conical rotor machine. In the case of a conical rotor machine the spring-loaded brake is controlled by the motor terminal voltage as follows:

- At rest the motor is braked.
- When the motor is energised an axial component of the magnetic field due to the conical air-gap overcomes the force of the brake spring and draws the rotor into the stator. This axial displacement releases the brake and allows the motor to accelerate like a normal induction motor.
- When the motor is de-energised the magnetic field collapses and the brake spring displaces the rotor, pushing the brake disc against the braking surface.

Drives can be used to control the speed of conical rotor brake motors since the linear V/F characteristic maintains the motor magnetic field constant over the speed range. It will be necessary to set the FIXED BOOST parameter to overcome motor losses at low speed (see FLUXING menu at level 3).

Using Line Chokes

Line chokes **are required** to limit input current to these Parker Hannifin Manufacturing Limited.

Using Output Contactors

The use of output contactors is permitted. It is recommended that this type of operation be limited to emergency use only or in a system where the drive can be inhibited before closing or opening this contactor.

Using Motor Chokes

Installations with motor cable runs in excess of 50m may suffer from nuisance overcurrent trips. This is due to the capacitance of the cable causing current spikes to be drawn from the drive output. A choke may be fitted in the drive output which limits the capacitive current. Screened cable has a higher capacitance and may cause problems in shorter runs.

Contact Parker Hannifin Manufacturing Limited for recommended choke values.

Using Multiple Motors on a Single Drive

A single large drive can be used to supply several smaller motors provided that each individual motor has overload protection.

Note: Conventional V/F control strategy must be enabled for use with parallel motors. (Sensorless vector control strategy cannot be used). See the VECTOR ENABLE parameter under VECTOR SETUP menu at level 2.

The drive must be rated to supply the **total motor current**. It is not sufficient to simply sum the power ratings of the motors, since the drive has also to supply the magnetising current for each motor.

Note that the overload device will not prevent the motor overheating due to inadequate cooling at low speed. Force vented motors may be required; consult your motor supplier.

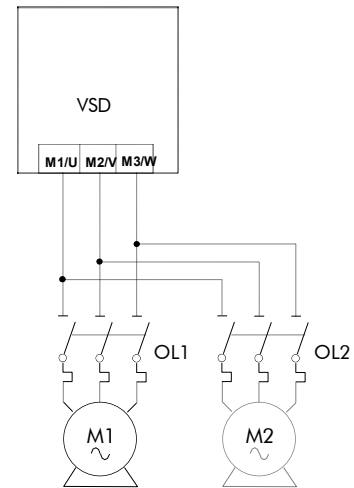

Figure 10-1 Single drive supplying multiple Motors

WARNING!

All motors should be connected to the drive output before the START command is given.

Caution

Restrict the total cable length on multiple motor installations as follows:

50 metres with no output choke fitted,
300 metres with choke.

Dynamic Braking

During deceleration, or with an overhauling load, the motor acts as a generator. Energy flows back from the motor into the dc link capacitors within the drive. This causes the dc link voltage to rise. If the dc link voltage exceeds 810V for the 400V build (or 890V for the 500V build) then the drive will trip to protect the capacitors and the drive power devices. The amount of energy that can be absorbed in the capacitors is relatively small; typically more than 20% braking

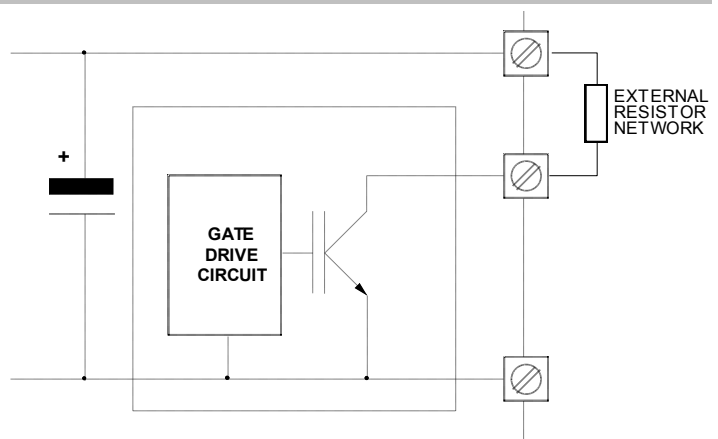

Figure 10-2 Dynamic Braking Circuit

torque will cause the drive to trip on overvoltage. Dynamic braking increases the braking capability of the drive by dissipating the excess energy in a high power resistor connected across the dc link, see above. Refer to the Power Wiring Connection Diagrams in Chapter 3.

The Dynamic Braking Option is a PCB with an extra IGBT power device fitted. It is fitted inside the drive package and is connected to the negative side of the dc link.

When the dc link voltage rises above that specified for each Frame size (Chapter 8: “Technical Specifications” - Internal Dynamic Brake Switch) the brake unit switches the external resistor network across the dc link. The brake unit switches off again when the dc link voltage falls below the threshold level. The amount of energy produced by the motor during regeneration depends upon the DECEL TIME parameter (refer to the REFERENCE RAMP and DYNAMIC BRAKING function blocks) and the inertia of the load.

Refer to Chapter 3: “Installing the Drive” - External Brake Resistor for brake resistor selection information.

High Starting Torque

Applications requiring high motor starting torque (greater than 100% of rated torque) need careful setup of the drive voltage boost feature. For most motors, a FIXED BOOST parameter (FLUXING function block) setting of 6.0% is usually adequate. Setting the FIXED BOOST parameter level too high can cause the drive current limit feature to operate. If this occurs, the drive will be unable to ramp up in frequency. The IT LIMITING diagnostic (INVERSE TIME function block) will indicate TRUE when the inverse time current limit feature is operating. Simply reducing the level of the FIXED BOOST parameter will remove this problem. It is important to use the minimum level of FIXED BOOST necessary to accelerate the load. Using a level of FIXED BOOST higher than necessary will lead to increased motor heating and increased risk of drive overload.

Note: *Motor torques greater than 100% require high currents to be drawn from the drive. Thus, the CURRENT LIMIT parameter (CURRENT LIMIT function block) will have to be set accordingly such that the drive current limit feature will not activate when accelerating the load.*

The best motor starting performance can be achieved by setting up the SLIP COMP function block, refer to the Software Product Manual: “Programming Your Application” - SLIP COMP. Also setting the BASE VOLTS parameter (VOLTAGE CONTROL function block) to 115.4% and the FREQ SELECT parameter (PATTERN GEN function block) to 3kHz, can help to start difficult loads in the most extreme cases.

Winder Applications

The drive contains function blocks for winder applications; refer to the Software Product Manual, Chapter 5: “Application Macros”.

Roll Diameter Calculation Accuracy

With any centre winding system it is most important, under all conditions, that the roll diameter is set within the winder block to accurately match the winding roll.

At Zero Speed

The diameter calculation division will not calculate accurately below a certain minimum line speed, and will not calculate at all at zero speed.

If the diameter is not accurately set at zero speed the winder may not start without large changes in web tension. It is therefore most important for good winder performance that the diameter is reset to the correct value before the machine is started. The following diagrams show typical ways to preset the roll diameter.

10-5 Application Notes

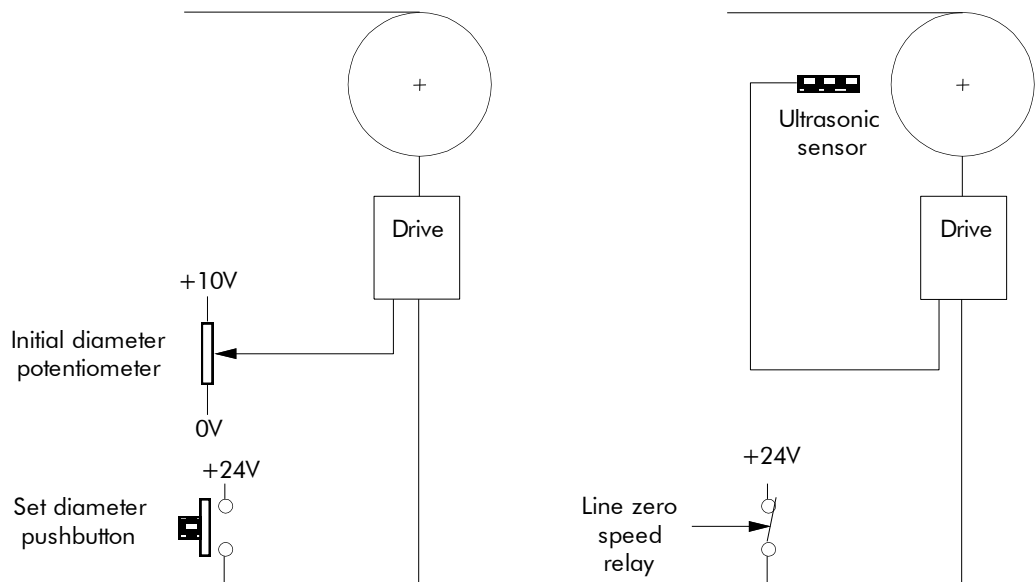

Figure 10-3 Roll Diameter

The left hand diagram above shows a simple, low accuracy way of pre-setting the roll diameter. Here, a potentiometer is used by the machine operator to set the roll diameter. The potentiometer is scaled such that 10V is 100% diameter. When the push button is pressed, the diameter calculator is preset to the potentiometer value. The push button should be suitably interlocked with the line drive so that the diameter cannot be preset when the machine is running.

The right hand diagram shows a more accurate method where the diameter is measured using an ultrasonic sensor. This measurement technique is especially useful for unwind applications where the diameter of the incoming roll is not known.

Other methods such as mechanical diameter followers, or lay on arms can be useful to provide the diameter signal. The requirements here are correct scaling and linearity over the diameter range.

It is also important to preset the diameter accurately in the case of twin turret winders. Here, the diameter should be accurately preset using either diameter measurement in the case of unwinds, or fixed potentiometers corresponding to the core diameters in the case of rewinds. The setting of the diameter will determine the speed match of the new roll in relation to the line speed.

The winder block diameter calculator is frozen below a Line Reference threshold, set by the MINIMUM SPEED parameter (DIAMETER CALC function block). The default value for this parameter in the Winder macro is set at 5%. This is satisfactory for most line speeds and diameter build-up ratios. The MINIMUM SPEED parameter must not be reduced significantly as diameter errors may result at low line speeds.

When Running

Since the winder block calculates the roll diameter using a division of the Line Reference and Winder Speed feedback signals, it is important that these signals are accurate.

Ideally, in order to improve accuracy, the diameter calculation signals need to be the actual speeds of the line and winder. The reel speed reference however, needs to be driven from the Line Reference in order to give good acceleration performance for the winder.

The following diagram shows the Line Reference and Line Speed signals used to give an improved accuracy winder.

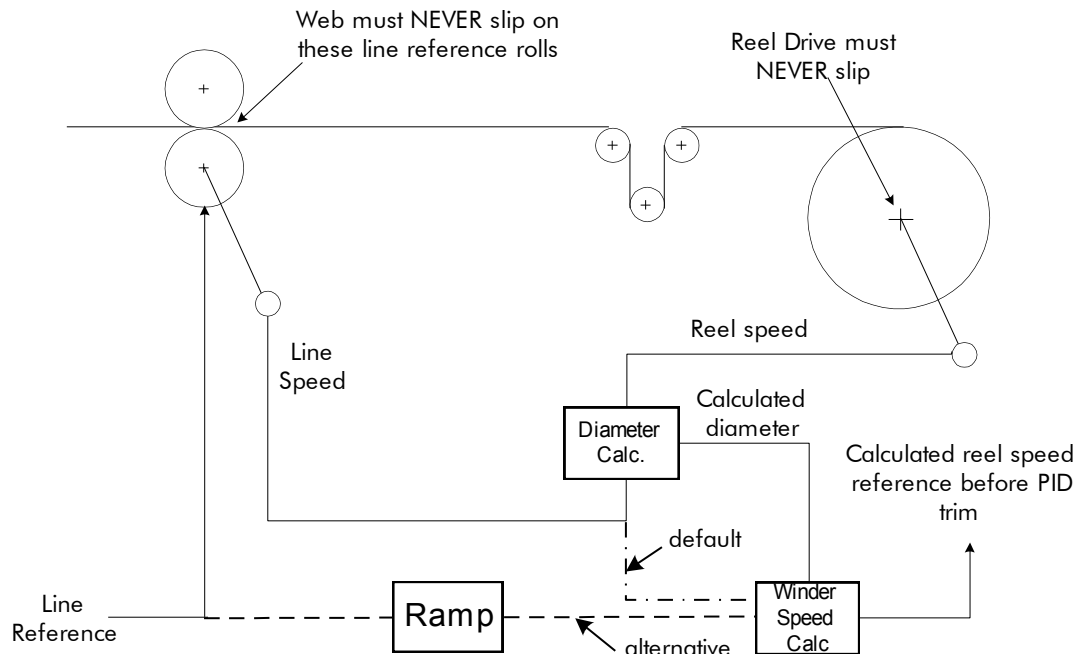

Figure 10-4 Line Reference and Line Speed

By default, Line Speed is connected to ANIN 1 and is used both as Line Reference and Line Speed.

Alternatively, a separate analog input for Line Reference may be used for the winder speed calculation.

If an analog tach is used for Line Speed, it must be scaled $\pm 10V$ full scale.

Note: *It is most important for centre wind systems that the web does not slip on the line reference rolls. Also the reel drive must never slip.*

If slipping does occur, the diameter calculator will not be accurate, and very poor winder performance will result.

Basic Set-up Instruction

This section describes the operations required to set up drives containing the closed loop winder blocks.

Two different types of closed loop winders are described above, but the basic steps required to set up the drive are very similar in both cases.

If the drive is configured using the display and keys, it is important to ensure that the parameters of the drive are saved to the application on a regular basis. If this is not done, parameters adjusted during the following set-up may be lost if the auxiliary supply to the drive fails.

Information Required

The following information is required from the winding machine manufacturer in order to set up the winder blocks:-

- Absolute minimum roll diameter.
- Absolute maximum roll diameter.
- Absolute maximum line speed.
- Motor maximum speed, at smallest roll diameter and maximum line speed.

Set-up with no Web connected to the Winder

The majority of the drive set-up should be performed without web connected to the centre winder. This allows the winding spindle to rotate freely, without being restrained by the web.

Before configuring the Closed Loop centre winder load the Winder macro, refer to the Software Product Manual, Chapter 5: "Application Macros".

DIAMETER CALC Function Block

Set the MINIMUM DIAMETER parameter with the drive stopped.

This value can be calculated, knowing the absolute maximum and minimum roll diameters and applying the equation:-

$$\text{Min Diameter} = \frac{\text{Smallest core diameter}}{\text{Maximum roll diameter}} \times 100\%$$

It is important that the absolute maximum range of diameter is used when calculating the minimum diameter parameter.

Commission the Drive Control Loops

Since the winder blocks are equally applicable for Unwind and Rewind applications the following convention for the sign of the various set points and the direction of rotation, is useful:

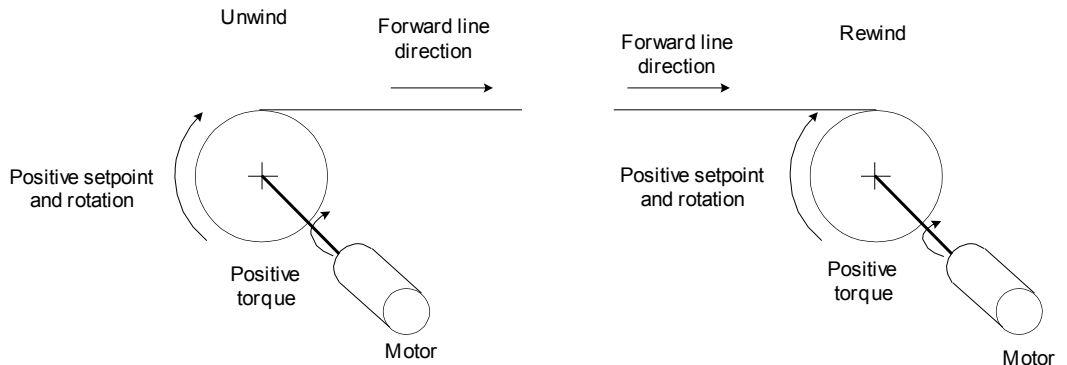

All directions are shown overwinding, with OVERWIND set TRUE

Figure 10-5 Conventions

Equations

The following equations are used to determine motor torque and power requirements.

Simple Centre Winder Equations

It is assumed that the winders operate in constant tension mode.

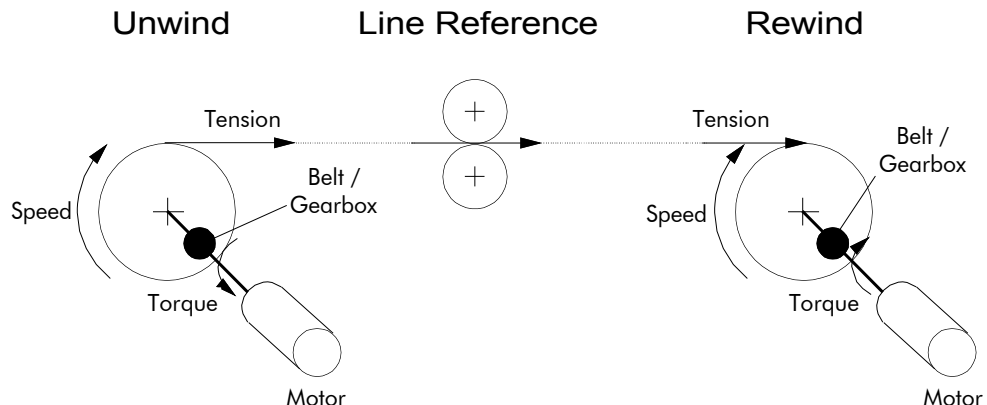

Figure 10-6 Constant Tension Winder

Metric Units

The following SI units are used to produce the equations shown below.

- Tension - Kilograms force (kgf)
- Torque - Newton Metres (Nm)
- Line Speed - Metres/Sec (MS-1)
- Line accel - Metres/Sec2 (MS-2)
- Rotation speed - RPM (RPM)
- Roll Diameter - Metres (M)
- Power - KWatt (kW)
- Mass - kg (kg)

Motor Power

The following diagram shows the motor and roll powers at maximum line speed compared to roll speed.

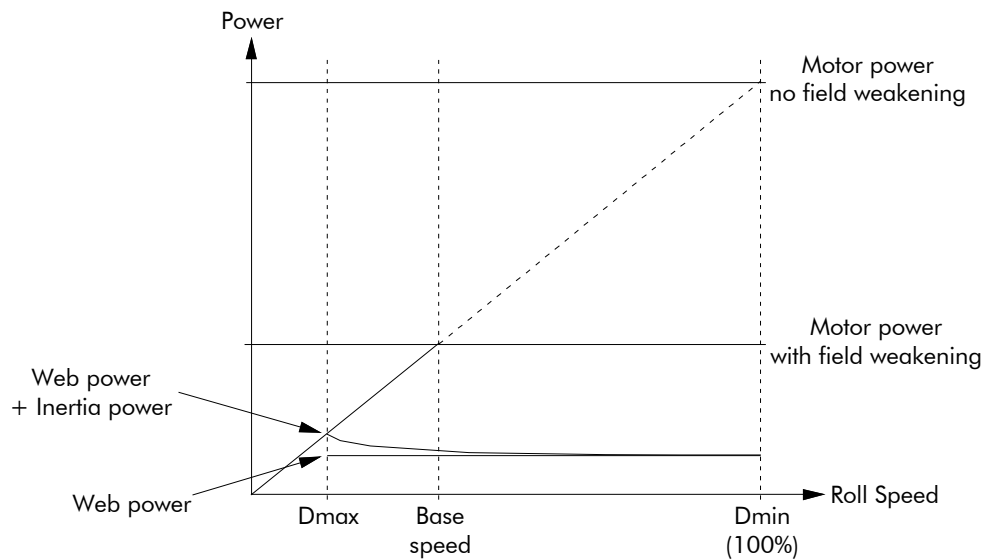

Figure 10-7 Motor Power

The above graph is for the case of constant tension. Friction is ignored.

$$Power_{Web} = \frac{Tension \times Max\ Line\ Speed}{101.94} \text{ kW}$$

$$Power_{Inertia} = \frac{Roll\ Mass \times Max\ Line\ Accel \times Max\ Line\ Speed}{2000} \text{ kW}$$

$$Power_{Friction} = \frac{Motor\ Max\ Speed}{9549} \times Motor\ Torque_{Friction} \text{ kW}$$

Using the above individual roll powers

$$Power_{Roll} = Power_{Web} + Power_{Inertia} + Power_{Friction} \text{ kW}$$

Referring to a motor with field weakening

$$\therefore Power_{Motor} = \left\{ (Power_{Web} + Power_{Inertia}) \times \frac{Diameter\ Build\ Up}{Constant\ Power\ Range} \right\} + Power_{Friction} \text{ kW}$$

Here, the Constant Power Range is the motor field weakening range.

This parameter is 1 if no field weakening.

10-9 Application Notes

Motor Torque

The worst case motor torque will exist for the following conditions:-

Maximum roll diameter

Maximum acceleration rate

Maximum roll width

Maximum material tension

Maximum roll mass

$$\text{Torque}_{\text{Tension}} = \text{Tension} \times \text{Roll Diameter} \times 4,905$$

Assuming the roll is a solid cylinder

$$\text{Torque}_{\text{Inertia}} = \frac{\text{Roll Mass} \times \text{Line Accel} \times \text{Roll Diameter}}{4}$$

$$\text{Torque}_{\text{Roll}} = \text{Torque}_{\text{Tension}} + \text{Torque}_{\text{Inertia}}$$

$$\therefore \text{Torque}_{\text{Motor}} = \frac{\text{Torque}_{\text{Roll}}}{\text{Ratio}_{\text{Gearbox}}} + \text{Torque}_{\text{Friction}}$$

Motor Speed

The maximum motor speed will exist under the following conditions:-

Maximum line speed

Smallest core diameter

Maximum gearbox ratio

$$\text{Speed}_{\text{Roll}} = \frac{\text{Speed}_{\text{Line}}}{\text{Diameter}} \times 19.1 \text{ RPM}$$

$$\therefore \text{Speed}_{\text{Motor}} = \text{Speed}_{\text{Roll}} \times \text{Ratio}_{\text{Gearbox}} \text{ RPM}$$

4-Q Regen Control/Common DC Bus Applications

Introduction

A **4-Q REGEN** (4 Quadrant Regenerative) control mode is available on all 690+ Series AC Drives that :

- ◆ use Software Version 5.1 or greater

AND

- ◆ display “/007” in Block 12 of the (Europe) Product Code, indicating that Special Option 7 is applied (“Y” cap disconnection)

IMPORTANT: All drives in a common DC link scheme using a 4-Q Regen front-end **must** have their internal “Y” caps to earth (PE) removed.

The **4-Q REGEN** control mode allows a single 690+ to act as a 4-Q power supply unit that is capable of drawing (motoring) and supplying (regenerating) sinusoidal, near-unity power factor current from the supply.

The output from the 4-Q Regen drive acts as a DC supply which is used to power other drives on a common DC Bus system.

A maximum of 90% of the constant torque current rating is available from the drive while in 4-Q Regen control mode. The variable torque current rating is unavailable in this control mode.

Advantages

Using the 690+ as a 4-Q power supply in common DC Bus schemes provides the following advantages:

- Simplified approach to Common DC Link systems
- Allows standard 690+ drive to act as 4-Q DC Link power supply unit
- Near-sinusoidal supply currents (Motoring and Regenerating)
- Near-unity power factor operation (0.99 or better)
- Low supply harmonics currents (helps to meet G5/4 and IEEE519)

WARNING!

690+ AC Drives operating in **4-Q REGEN** control mode are **NOT** suitable for use on systems where the mains supply (L1, L2, L3) is provided by a generator (where the supply cannot absorb the regenerated current).

4-Q Active Front End

The 4-Q Regen drive requires the following 4-Q Active Front End:

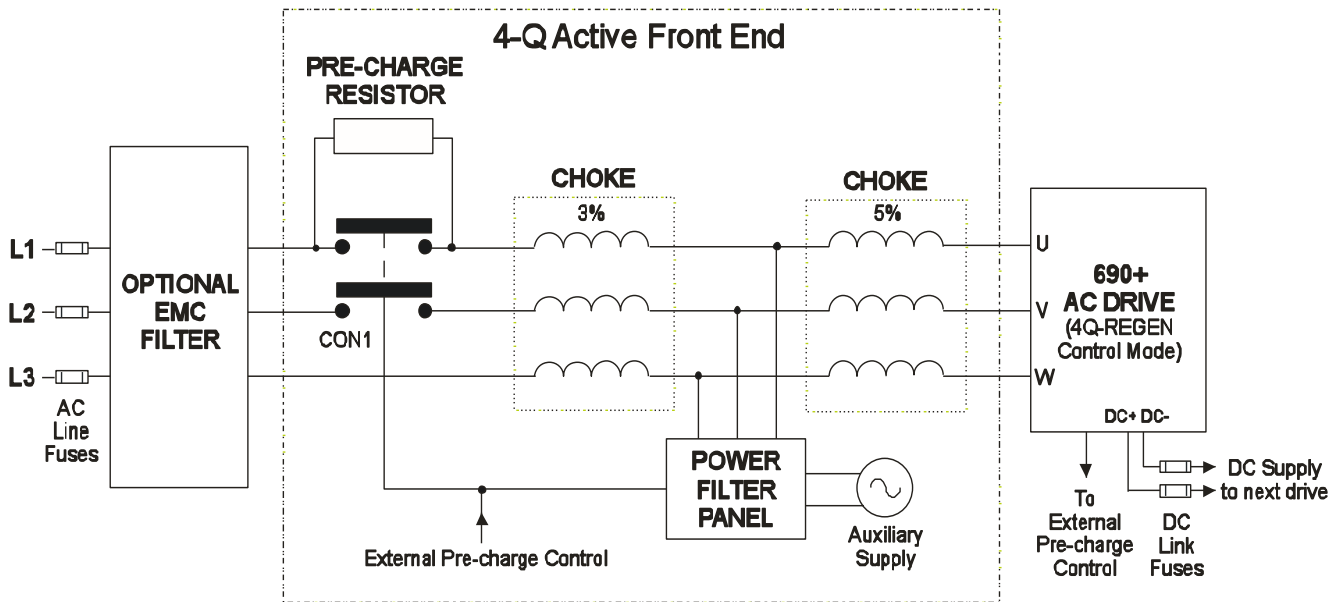

Notes:

Contactor CON1 is rated to match the 4-Q power supply drive current (AC1 rating)
 The 3% and 5% line chokes are custom designed for this application. Refer to page 10-20
 The 4-Q Active Front End connects to the U, V, W terminals on the 4Q-Regen Drive.

Power Filter Panel				
Frame	kW	Volts	Part Number 110V fans + control	Part Number 230V fans + control
B	4	230	LA482467U004	LA482470U004
C	7.5	230	LA482467U011	LA482470U011
D	18.5	230	LA482467U018	LA482470U018
E	22	230	LA482467U030	LA482470U030
F	45	230	LA482467U055	LA482470U055
B	6	400	LA482468U006	LA482471U006
C	15	400	LA482468U018	LA482471U018
D	30	400	LA482468U037	LA482471U037
E	45	400	LA482468U055	LA482471U055
F	90	400	LA482468U110	LA482471U110
G	180	400	LA482468U220	LA482471U220
H	280	400	LA482468U315	LA482471U315
J	315	400	LA482468U355	LA482471U355
B	6	500	LA482469U006	LA482472U006
C	15	500	LA482469U018	LA482472U018
D	30	500	LA482469U037	LA482472U037
E	45	500	LA482469U055	LA482472U055
F	90	500	LA482469U110	LA482472U110
G	180	500	LA482469U220	LA482472U220
H	280	500	LA482469U315	LA482472U315
J	315	500	LA482469U355	LA482472U355

EMC Filtering

We recommend all 690+ Regen systems meet the EMC product specific standard EN61800-3:1997. To achieve this, an EMC filter is required. Refer to Chapter 8 for details of suitable filters.

Contactor and Fusing

- ◆ Use AC Line Fuses to protect the 4-Q Regen drive. These fast, semiconductor protection fuses must be capable of withstanding the system AC supply voltage. Refer to "Input Fuse Ratings" in Chapter 8.
- ◆ The AC contactor, CON1, used in the external pre-charge circuit must have an AC1 or thermal rating of the constant torque current rating of the 4-Q Regen drive. Refer to page 10-10-19.
- ◆ Use DC Link fuses in both the DC+ and DC- lines to protect each drive connected to the common DC bus. The fuses must be of suitable current rating and capable of withstanding 1000Vdc . Although HRC fuses would be adequate, the high DC voltage requirement (1000Vdc) may limit the choice to semiconductor fuses. Refer to page 10-18.
- ◆ The DC contactor used in the Brake Mode system (described on page 110-17) must have an adequate thermal rating for the regen current required. Typically the regen rating of the system, and hence the rating of the DC contactor and fuses, will be less than motoring requirement as the contactor should not open under load.

Drive Set-up

The 690+ drive must be set-up correctly to work in a 4-Q Regen Control/Common DC Bus Application.

Typically a 690+ system will contain a 4-Q Regen drive providing the 4-Q power supply, and one or more 690+ drives on the common DC bus.

Regen Control			
-	SYNCHRONIZING	[1641]	FALSE
-	SYNCHRONIZED	[1642]	FALSE
-	PHASE LOSS	[1643]	FALSE
-	CLOSE PRECHARGE	[1644]	FALSE
-	ENABLE DRIVE	[1645]	FALSE
-	STATUS	[1646]	SUPPLY FREQ LOW
TRUE	[1633] PRECHARGE CLOSED		
720V	[1634] DC VOLTS DEMAND		
FALSE	[1678] BRAKE MODE		

Settings

All 690+ Drives	
<p>ALL 690+ drives in the system MUST have their "Y" caps disconnected (see "Introduction" on page 10-10).</p>	
<p>Set the demanded boosted DC link voltage (DC VOLTS DEMAND) appropriately for the drive voltage rating. This is given in the separate table below.</p> <p>Refer to the Software Product Manual, Chapter 1 for a full description of the REGEN CONTROL function block parameters.</p>	<p>MMI Menu Map</p> <ol style="list-style-type: none"> 1 SETUP 2 MOTOR CONTROL 3 REGEN CNTRL <p>DC VOLTS DEMAND</p>
690+ 4-Q Regen Drive:	
<p>Load "Macro 8" via the RESTORE CONFIG menu.</p> <p>Refer to page 10-14 for wiring details.</p>	<p>MMI Menu Map</p> <ol style="list-style-type: none"> 1 SYSTEM 2 RESTORE CONFIG <p>RESTORE CONFIG</p>
<p>Set the CONTROL MODE parameter to "4-Q REGEN".</p>	<p>MMI Menu Map</p> <ol style="list-style-type: none"> 1 SETUP 2 MOTOR CONTROL 3 MOTOR DATA <p>CONTROL MODE LEAKAGE INDUC</p>
<p>Set the LEAKAGE INDUC parameter to the value of the total line choke inductance. Refer to page 10-21.</p>	
Other 690+ Drives on the Bus	
<p>Set the ENABLE parameter in the SLEW RATE LIMIT function block to FALSE. This disables ramp-hold during deceleration on high link volts feature.</p>	<p>MMI Menu Map</p> <ol style="list-style-type: none"> 1 SETUP 2 MOTOR CONTROL 3 SLEW RATE LIMIT <p>ENABLE</p>
<p>If in Volts/Hz motor control mode, the VOLTAGE MODE parameter in the VOLTAGE CONTROL function block MUST be set to FIXED. This will ensure the motor is not overfluxed by the boosted 720V DC Bus. Failure to do this may lead to motor overheating and possible burn out.</p>	<p>MMI Menu Map</p> <ol style="list-style-type: none"> 1 SETUP 2 MOTOR CONTROL 3 VOLTAGE CONTROL <p>VOLTAGE MODE</p>

Setting for DC VOLTS DEMAND Parameter

Drive Voltage Rating (V)	Under Volts Trip Level (V)	Over Volts Trip Level (V)	Recommended DC VOLTS DEMAND
380V – 460V	410V	820V	720V
220V – 240V	205V	410V	370V

Macro 8 : 4Q Regen

Macro 8 is provided to simplify the set-up of 4-Q Regen systems. A full description of Macro 8 can be found in the Software Product Manual, Chapter 5.

Note: To use Macro 8, set the CONTROL MODE parameter to "4-Q REGEN", and set the LEAKAGE INDUC parameter to the value of the total line choke inductance (refer to page 10-21), as discussed in "Drive Set-up" page 10-13.

Macro 8 provides the following connections:

- ◆ **Digital Input 1** (terminal 12, PRECHARGE CLOSED, Tag 1633) is used to confirm the status of the pre-charge circuit (open or closed). The 4-Q Regen drive is not allowed to synchronise to the mains unless the pre-charge relay is closed and the NOT COAST STOP parameter is True.
- ◆ **Digital Input 2** (terminal 13, NOT COAST STOP, Tag 278) is used to run the 4-Q Regen drive.
- ◆ **Digital Output 3** (terminals 25 & 26, CLOSE PRECHARGE, Tag 1644) controls the external pre-charge circuit and goes True to close the contactor when DC link volts are established.

In Macro 8, the Run command is default True. Thus the drive automatically synchronises to the mains when the pre-charge relay closes. Digital Input 2 is used to cause a coast stop in case of emergencies.

		Regen Control	
	-	SYNCHRONIZING	[1641]- FALSE
	-	SYNCHRONIZED	[1642]- FALSE
	-	PHASE LOSS	[1643]- FALSE
	-	CLOSE PRECHARGE	[1644]- <u>software link</u> <input type="checkbox"/>
	-	ENABLE DRIVE	[1645]- FALSE
	-	STATUS	[1646]- SUPPLY FREQ LOW
Digital Input 1	<input type="checkbox"/> <u>software link</u>	[1633] PRECHARGE CLOSED	-
	720V	[1634] DC VOLTS DEMAND	-
	FALSE	[1678] BRAKE MODE	-

Connection Diagram for Macro 8

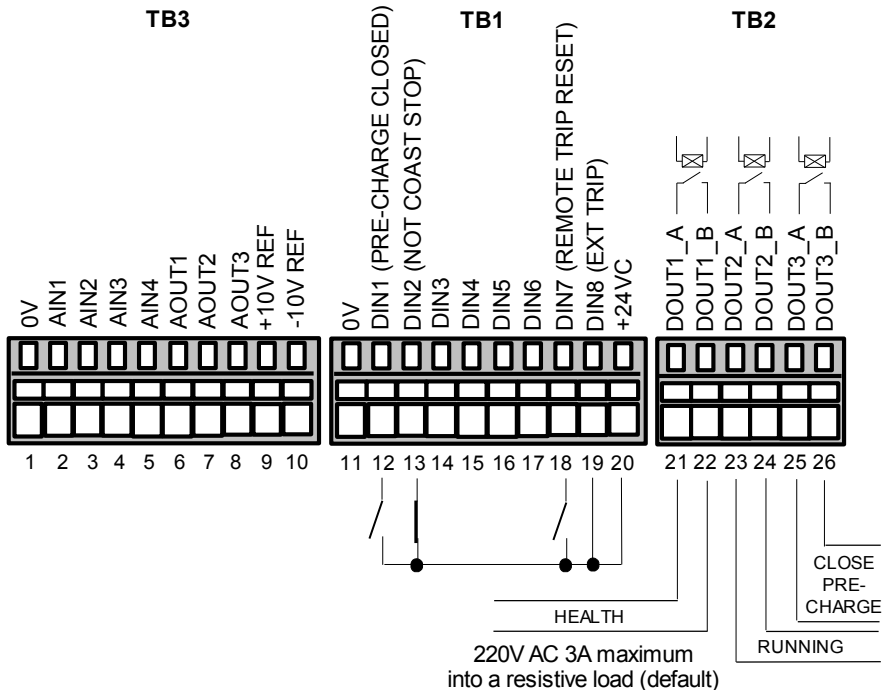

A Single Motor System

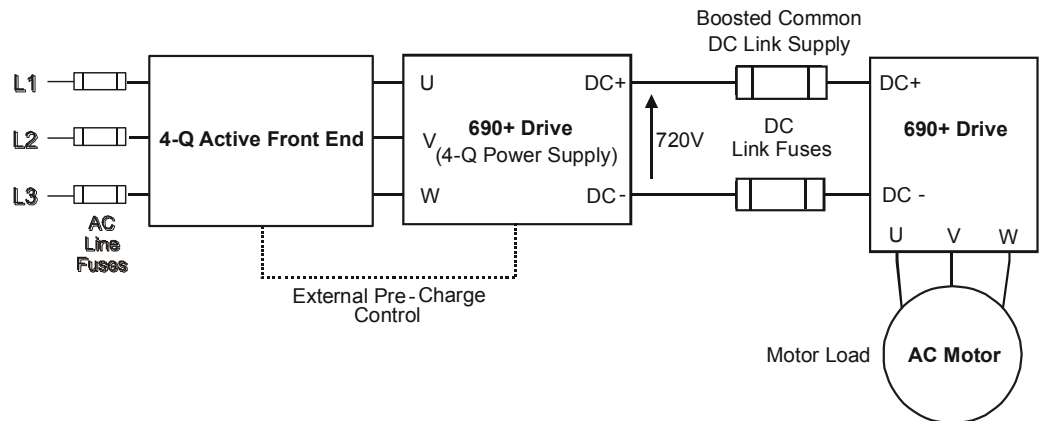

The simplest configuration for 4-Q Regen control is a single 690+ Regen drive acting as the unity power factor supply, connected via the DC link to another 690+ driving the application.

Applications of single motor 4-Q Regen systems include :

- Hoist and Elevators
- Dynamometer test rigs
- Unwind Stands
- Installations that would otherwise require a Harmonic Power Filter

In this system, the two 690+ drives are matched in power. The 4-Q Regen drive supplies the full motoring and regenerating requirement of the load.

Additional external equipment required by the 4-Q Regen drive includes :

- EMC Filter
- AC Line Fuses
- DC Link Fuses

No extra hardware is required to detect the rotation, frequency and phase of the mains supply. Also, no dynamic braking resistor is required.

When mains power is applied to the 4-Q Regen drive, the DC link slowly charges through the external pre-charge circuit and the drive's internal power supply will start in the normal way. If the 4-Q Regen drive is healthy and the Run signal is applied, it will synchronise to the mains supply (phase, rotation and frequency). This process takes approximately 100ms. After synchronisation, the DC link on the common bus is boosted to approximately 720V (on a 400V product). This high value of DC link volts is required for successful regen operation.

A Multi-Motor System

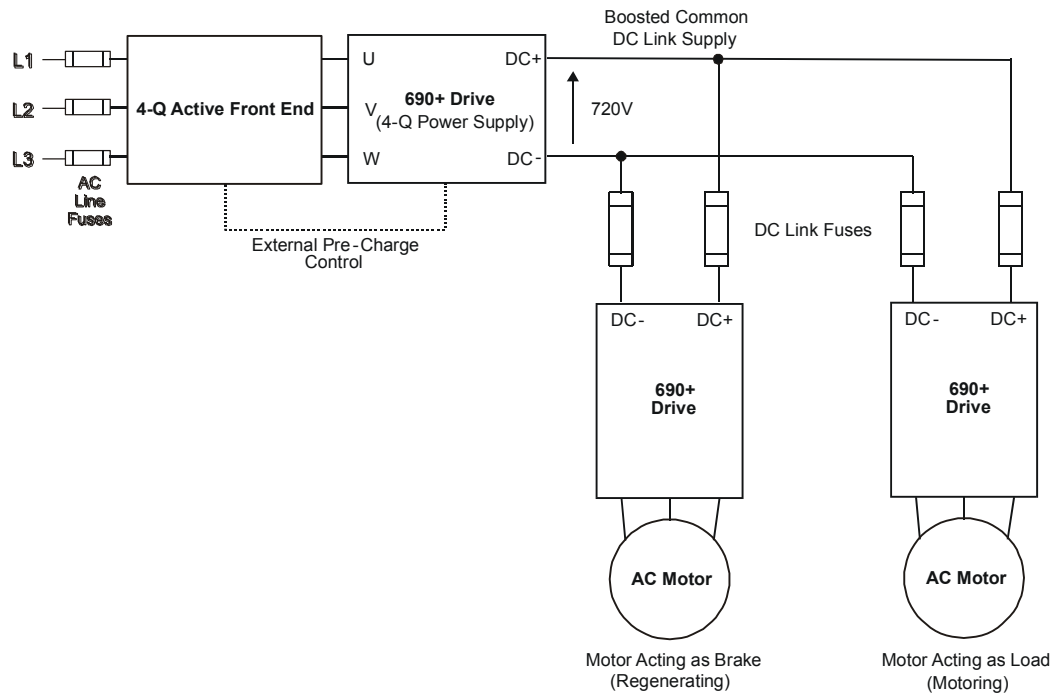

In many applications, the total power consumed by the system is less than the installed power of the drives. This is because some drives are motoring (eg. winders) and some are regenerating (eg. unwinders). In these situations it is convenient to connect the drives on a common DC link.

In this system, the 4-Q Regen drive supplies the motoring and regenerating requirement of the load.

Additional external equipment required by the 4-Q Regen drive includes :

- EMC Filter
- AC Line Fuses
- DC Link Fuses

No extra hardware is required to detect the rotation, frequency and phase of the mains supply. Also, no dynamic braking resistor is required.

The 4-Q Regen drive draws sinusoidal, unity power factor current from the supply and only has to be rated for either the power consumed or supplied by the system, or by the system braking requirements, whichever is the larger.

Dynamic Braking (eg. for Emergency Stopping purposes) can still be used in this control mode if required.

A Smart Brake System

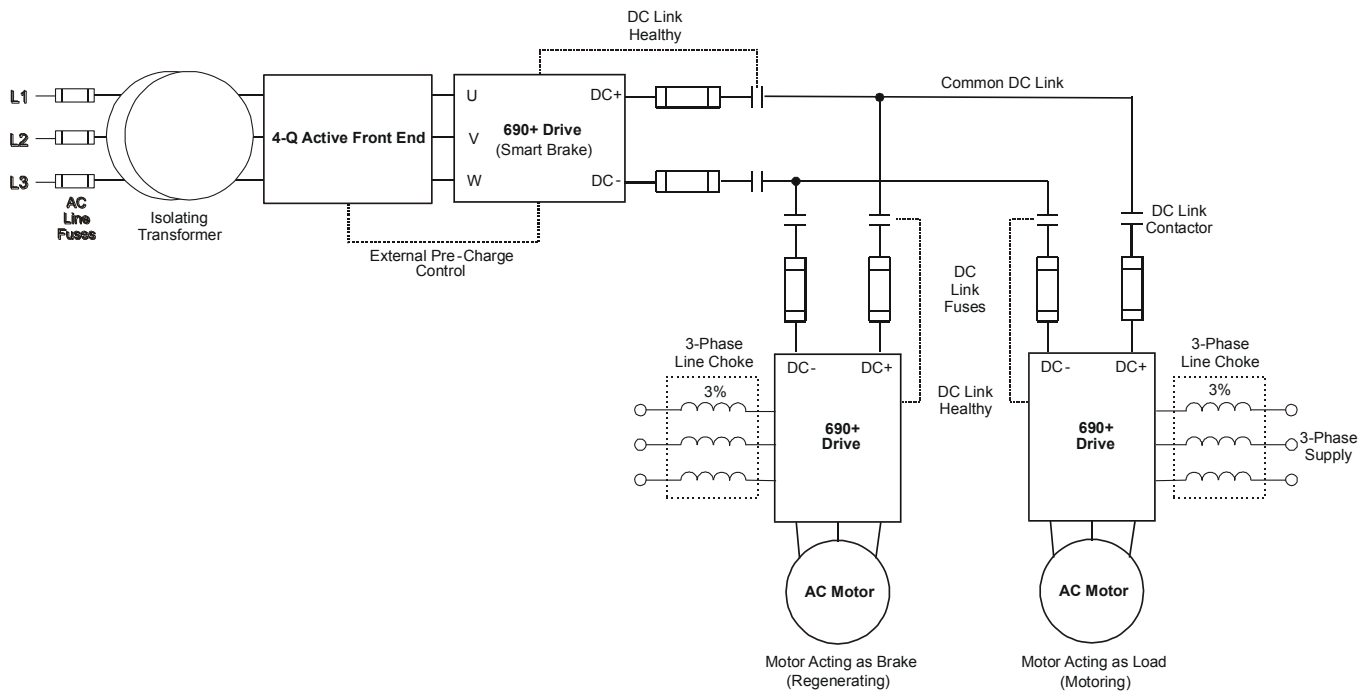

IMPORTANT: It is essential to use an isolation transformer on the supply to the Smart Brake drive, as shown above.

The 4-Q Regen drive can act as a Smart Brake:

MMI Menu Map

- 1 SETUP
 - 2 MOTOR CONTROL
 - 3 REGEN CNTRL
- BRAKE MODE

4-Q Regen Drive:

- ◆ In addition to the settings given in "Drive Set-up", page 10-13, set the BRAKE MODE parameter in the REGEN CONTROL function block to TRUE.

In this system, the 4-Q Regen drive supplies the regenerating requirement of the load.

Additional external equipment required by the 4-Q Regen drive includes :

- EMC Filter
- AC Line Fuses
- DC Link Fuses

During motoring operation, the drives on the common link are supplied via their own internal 3-phase diode bridge. The 4-Q Regen drive tracks the mains supply but does not supply motoring power to the common DC Link.

During regeneration, the DC link voltage will rise and trigger the 4-Q Regen drive to return the excess power to the mains (sinusoidal current, unity power factor).

Thus, the 4-Q Regen drive acts as a smart, no loss, Dynamic Brake.

The BRAKE MODE allows the level of regeneration (braking) capacity in the system to be rated differently from the required motoring capacity.

When using the Brake Mode, each drive is responsible for pre-charging its own DC Link. When an individual drive is pre-charged and healthy, it connects itself on to the common DC Bus via a DC contactor.

The drives disconnect from the common bus if a trip occurs.

DC Link Fuses

Below is a list of parts for the DC Link Fuses. Refer to the Electrical Ratings tables for Quadratic Duty motor powers. Select the correct part for the drive's Motor Power.

Motor Power (Constant Duty @ 400V) (kW/Hp)	Frame Size	DC Fuse Rating (A)	DC Fuse Type	Fuse	Fuse Switch	Fuse Holder
0.75/1	B	15	CO89495J	CS481079	CS481099	CS481039
1.5/2	B	15	CO89495J	CS481079	CS481099	CS481039
2.2/3	B	15	CO89495J	CS481079	CS481099	CS481039
4/5	B	15	CO89495J	CS481079	CS481099	CS481039
5.5/7.5	C	40	SO86795J	CS481080	CS481099	CS481039
7.5/10	C	40	SO86795J	CS481080	CS481099	CS481039
11/15	C	40	SO86795J	CS481080	CS481099	CS481039
15/20	D	80	FWP 80BI	CS481081	CS481088	
18.5/25	D	80	FWP 80BI	CS481081	CS481088	
22/30	D	80	FWP 80BI	CS481081	CS481088	
30/40	E	150	IXL70F150	CS481082	CS481088	
37/50	E	150	IXL70F150	CS481082	CS481088	
45/60	E	150	IXL70F150	CS481082	CS481088	
55/75	F	300	IXL70F300	CS481083	CS481088	
75/100	F	300	IXL70F300	CS481083	CS481088	
90/125	F	300	IXL70F300	CS481083	CS481088	
90/150	F	300	IXL70F300	CS481083	CS481088	
110/150	G	350	IXL70F350	CS481084	CS481088	
132/200	G	600	IXL70F600	CS481085	CS481088	
160/250	G	600	IXL70F600	CS481085	CS481088	
200/300	H	600	IXL70F600	CS481085	CS481088	
220/350	H	800	FWP 800AI	CS481086	CS481088	
250/400	H	800	FWP 800AI	CS481086	CS481088	
280/450	H	800	FWP 800AI	CS481086	CS481088	
315/500	J	900	FWP 900AI	CS481087	CS481088	

Pre-Charge Sizing

The external pre-charge contactor is required to carry the full load current rating (including overload) of the 4-Q Regen drive. Thus, it must have an AC1 rating of the Constant Duty current rating of the drive. Refer to the Electrical Ratings tables for Constant Duty motor powers.

We recommend that standard Parker Hannifin Manufacturing Dynamic Braking resistors are used for the external pre-charge circuit. The continuous and peak power capabilities of these resistors are given below:

Parker Part N°	Resistance (Ω)	Continuous Power Rating (W)	Peak Power Rating (kW)
CZ389853	100	100	2.5
CZ463068	56	200	5
CZ388396	36	500	12.5

The recommended pre-charge resistor networks are shown in the table below. The table indicates the amount of total DC Link capacitance the network can charge for a given supply voltage.

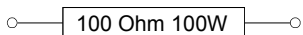
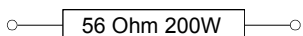
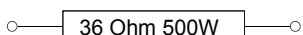
External Pre-Charge Network	Continuous Power Rating (W)	Impulse Joule Rating (J)	Pre-Charge Capability (μF) @ 240V _{rms} +10%	Pre-Charge Capability (μF) @ 460V _{rms} +10%
	100	2,500	35,000	9,700
	200	5,000	71,000	19,500
	500	12,500	179,000	48,800

The internal DC Link Capacitance for each drive in the 690+ range is given in the table below:

Drive Power (kW/HP)	400V Units		230V Units	
	Frame	μF	Frame	μF
0.75/1	B	190	B	380
1.5/2	B	190	B	760
2.2/3	B	380	B	1140
4/5	B	380	B	1520
5.5/7.5	C	500	C	2000
7.5/10	C	1000	C	3000
11/15	C	1000	D	3000
15/20	D	1500	D	4000
18.5/25	D	2000	D	4000
22/30	D	2000	E	6000
30/40	E	2500	F	11200
37/50	E	3000	F	11200
45/60	E	3500	F	11200

Drive Power (kW/Hp)	400V Units		230V Units	
	Frame	μF	Frame	μF
55/75	F	5600		
75/100	F	5600		
90/125	F	5600		
90/150	F	5600		
110/150	G	6600		
132/200	G	9900		
160/250	G	13500		
180/300	G	13500		
200/300	H	14850		
220/350	H	14850		
250/400	H	20250		
280/450	H	20250		
315/500	J	19800		

Simply sum the DC Link capacitance for all the drives on the common DC Link and select the appropriate pre-charge network.

For example a system comprising 5, 30kW, 400V Frame E drives would have a total DC Link capacitance of:

$$C_{Total} = 5 \times 2500 \mu F = 12,500 \mu F$$

This is less than 19,500μF and thus a 56Ω, 200W (CZ463068) resistor will be adequate.

3-Phase Choke Sizing

One of the benefits of the 690+ 4-Q Regen drive is the reduction in the levels of harmonic currents drawn from the supply. The total harmonic distortion (THD) of the mains current is related to the PWM switching frequency, the supply voltage, the supply frequency and the inductance of the 3-phase line choke. The maximum allowed PWM carrier frequency in non-overload conditions, for each frame size is given below:

690+ Frame Size	PWM Carrier Frequency
B to F	3kHz
G and H	2.5kHz
J	2kHz

The IEEE 519 standard (IEEE Standard Practices and Requirements for Harmonic Control in Electrical Power Systems) requires a THD of current of 5%. The tables below show the recommended 3-phase line chokes (5% and 3% in series) and expected THD of current for 400V and 230V drives.

The PWM switching produces high levels of harmonic current in the 3% chokes. It is essential to have these properly rated to avoid significant overheating. Suitable chokes have been developed for Parker Hannifin Manufacturing Limited and their Part Numbers are provided below.

10-21 Application Notes

3% Choke

Drive Frame Size	Motor Power (kW/HP)	Input Voltage (V)	Active Front End	Choke	Inductance (μH)	Currents			
						50Hz	1kHz	2.5kHz	Sum
B	4/5	230	LA468346U004	CO468341U004	854	14.95	0.39	0.00	15
C	7.5/10	230	LA468346U008	CO468341U011	503	25.38	0.66	0.00	26
D	18.5/25	230	LA468346U018	CO468341U018	208	61.63	1.59	0.00	62
E	22/30	230	LA468346U022	CO468341U030	177	72.50	1.87	0.00	73
F	45/60	230	LA468346U045	CO468341U055	92	139.57	3.60	0.00	140
B	6/10	400	LA468345U006	CO468325U006	1750	12.69	0.33	0.00	13
C	15/20	400	LA468345U015	CO468325U018	817	27.19	0.70	0.00	28
D	30/40	400	LA468345U030	CO468325U037	416	53.47	1.38	0.00	54
E	45/60	400	LA468345U045	CO468325U055	282	78.85	2.04	0.00	79
F	90/150	400	LA468345U090	CO468325U110	137	163.13	4.21	0.00	164
G	180/300	400	LA468345U180	CO468325U220	68	327.17	8.45	0.00	328
H	280/450	400	LA468345U280	CO468325U315	48	471.28	12.17	0.00	472
J	315/500	400	LA468345U315	CO468325U355	42	534.72	13.81	0.00	535

5% Choke

Drive Frame Size	Motor Power (kW/HP)	Input Voltage (V)	Active Front End	Choke	Inductance (μH)	Currents			
						50Hz	1kHz	2.5kHz	Sum
B	4/5	230	LA468346U004	CO468342U004	1424	14.85	0.30	2.72	16
C	7.5/10	230	LA468346U008	CO468342U011	839	25.20	0.50	4.61	26
D	18.5/25	230	LA468346U018	CO468342U018	346	61.20	1.22	11.20	63
E	22/30	230	LA468346U022	CO468342U030	294	72.00	1.44	13.18	74
F	45/60	230	LA468346U045	CO468342U055	153	138.60	2.77	25.36	141
B	6/10	400	LA468345U006	CO468326U006	2918	12.60	0.25	2.31	13
C	15/20	400	LA468345U015	CO468326U018	1362	27.00	0.54	4.94	28
D	30/40	400	LA468345U030	CO468326U037	693	53.10	1.06	9.72	54
E	45/60	400	LA468345U045	CO468326U055	470	78.30	1.57	14.33	80
F	90/150	400	LA468345U090	CO468326U110	227	162.00	3.24	29.65	165
G	180/300	400	LA468345U180	CO468326U220	114	324.90	6.50	59.46	331
H	280/450	400	LA468345U280	CO468326U315	79	468.00	9.36	85.64	476
J	315/500	400	LA468345U315	CO468326U355	70	531.00	10.62	97.17	540

Note: Lower values for THD of current can be achieved by adding extra line impedance.

The Default Application

The drive is supplied with various macros. Each macro recalls a pre-programmed set of parameters when it is loaded.

- Macro 1 is the factory default macro, providing for basic speed control

Note: Refer to the Software Product Manual for details of other macros.

Macro Descriptions

Note: Parameters whose default values are product-related are indicated in the block diagrams with * or **. Refer to the Software Manual, Chapter 2: "An Overview of the Drive" - Product-Related Default Values.

Macro 0

This macro will not control a motor.

It is included to document the differences between all the configurations, using this as the baseline.

Loading Macro 0 removes all internal links, and sets all parameter values to the values defined for each function block in the Software Product Manual - Chapter 1: Programming Your Application.

The OPERATOR Menu for Macro 0

The default OPERATOR menu is shown below.

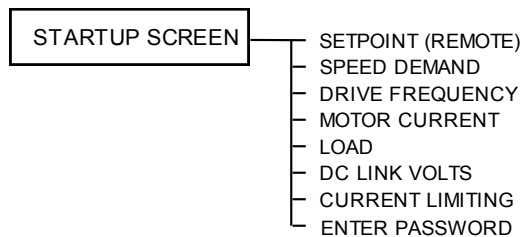

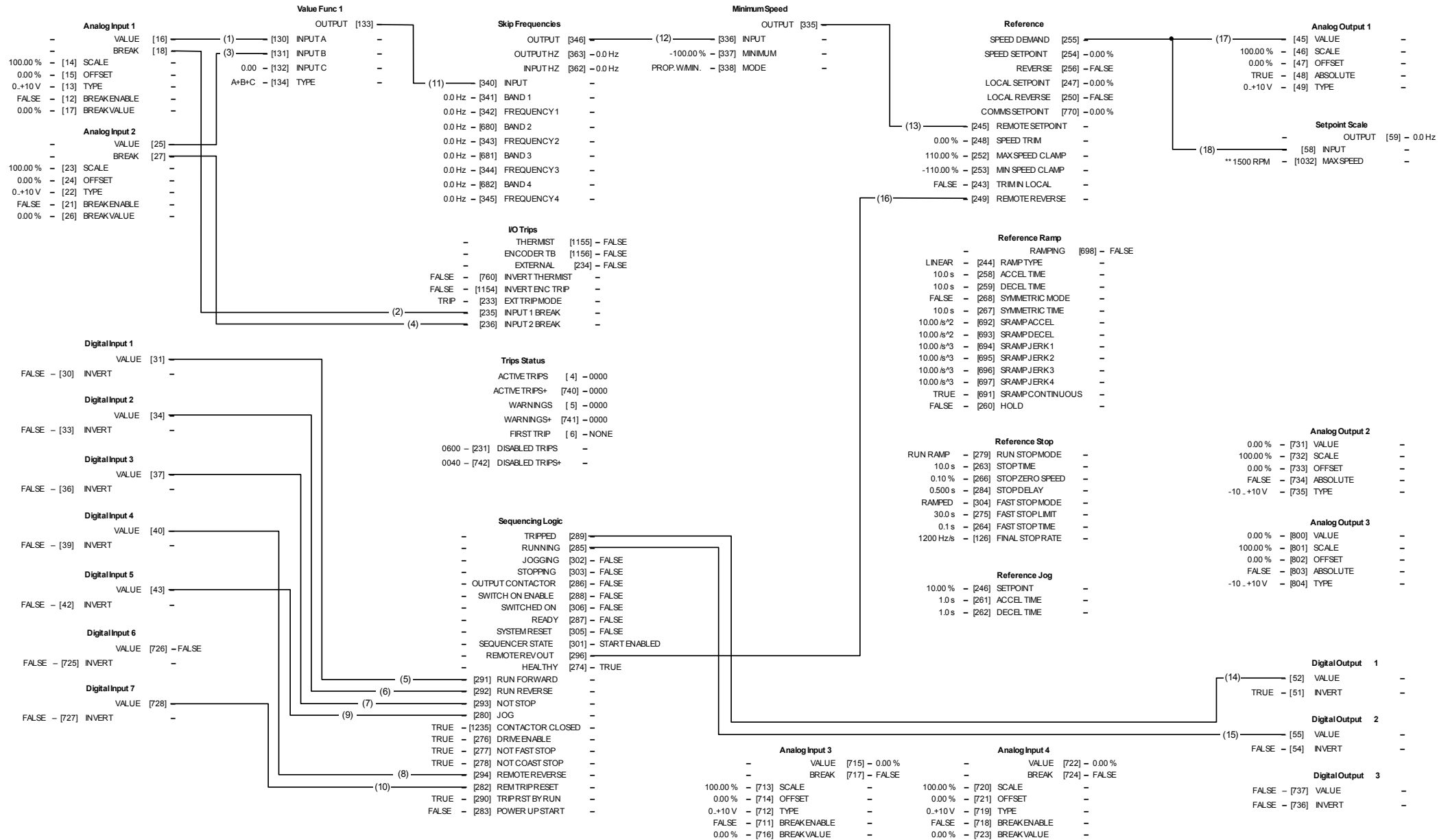

Macro 1: Basic Speed Control (default)

Macro 1: Basic Speed Control (default)

This macro provides standard control of the drive.

Control Wiring I/O			
Terminal	Name	Purpose	Comment
2	ANALOG INPUT 1	Speed Setpoint	0V = 0%, 10V = 100%
3	ANALOG INPUT 2	Speed Trim	0V = 0%, 10V = 100%
6	ANALOG OUTPUT 1	Ramp Output	absolute speed demand 0V = 0%, 10V = 100%
12	DIGITAL INPUT 1	Run Forward	24V = run forward
13	DIGITAL INPUT 2	Run Reverse	24V = run reverse
14	DIGITAL INPUT 3	Not Stop	24V = RUN FWD and RUN REV signals latched 0V = RUN FWD and RUN REV signals not latched
15	DIGITAL INPUT 4	Remote Reverse	0V = remote forward 24V = remote reverse
16	DIGITAL INPUT 5	Jog	24V = jog
18	DIGITAL INPUT 7	Remote Trip Reset	24V = reset trips
19	DIGITAL INPUT 8	External Trip	<i>Non-configurable</i> 0V = Trip (connect to terminal 20)
21, 22	DIGITAL OUTPUT 1	Health	0V = tripped, i.e. not healthy
23, 24	DIGITAL OUTPUT 2	Running	0V = stopped, 24V = running

The Operator Menu for Macro 1

The default Operator Menu is shown below.

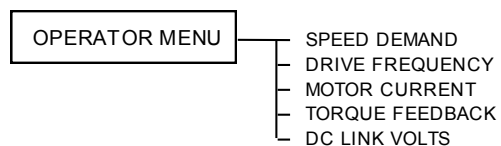

Parker Worldwide

AE – UAE, Dubai
Tel: +971 4 8127100
parker.me@parker.com

AR – Argentina, Buenos Aires
Tel: +54 3327 44 4129

AT – Austria, Wiener Neustadt
Tel: +43 (0)2622 23501-0
parker.austria@parker.com

AT – Eastern Europe, Wiener Neustadt
Tel: +43 (0)2622 23501 900
parker.easteurope@parker.com

AU – Australia, Castle Hill
Tel: +61 (0)2-9634 7777

AZ – Azerbaijan, Baku
Tel: +994 50 2233 458
parker.azerbaijan@parker.com

BE/LU – Belgium, Nivelles
Tel: +32 (0)67 280 900
parker.belgium@parker.com

BR – Brazil, Cachoeirinha RS
Tel: +55 51 3470 9144

BY – Belarus, Minsk
Tel: +375 17 209 9399
parker.belarus@parker.com

CA – Canada, Milton, Ontario
Tel: +1 905 693 3000

CH – Switzerland, Etoy
Tel: +41 (0)21 821 87 00
parker.switzerland@parker.com

CL – Chile, Santiago
Tel: +56 2 623 1216

CN – China, Shanghai
Tel: +86 21 2899 5000

CZ – Czech Republic, Klecany
Tel: +420 284 083 111
parker.czechrepublic@parker.com

DE – Germany, Kaarst
Tel: +49 (0)2131 4016 0
parker.germany@parker.com

DK – Denmark, Ballerup
Tel: +45 43 56 04 00
parker.denmark@parker.com

ES – Spain, Madrid
Tel: +34 902 330 001
parker.spain@parker.com

FI – Finland, Vantaa

Tel: +358 (0)20 753 2500
parker.finland@parker.com

FR – France, Contamine s/Arve
Tel: +33 (0)4 50 25 80 25
parker.france@parker.com

GR – Greece, Athens
Tel: +30 210 933 6450
parker.greece@parker.com

HK – Hong Kong
Tel: +852 2428 8008

HU – Hungary, Budapest
Tel: +36 1 220 4155
parker.hungary@parker.com

IE – Ireland, Dublin
Tel: +353 (0)1 466 6370
parker.ireland@parker.com

IN – India, Mumbai
Tel: +91 22 6513 7081-85

IT – Italy, Corsico (MI)
Tel: +39 02 45 19 21
parker.italy@parker.com

JP – Japan, Tokyo
Tel: +81 (0)3 6408 3901

KR – South Korea, Seoul
Tel: +82 2 559 0400

KZ – Kazakhstan, Almaty
Tel: +7 7272 505 800
parker.easteurope@parker.com

MX – Mexico, Apodaca
Tel: +52 81 8156 6000

MY – Malaysia, Shah Alam
Tel: +60 3 7849 0800

NL – The Netherlands, Oldenzaal
Tel: +31 (0)541 585 000
parker.nl@parker.com

NO – Norway, Asker
Tel: +47 66 75 34 00
parker.norway@parker.com

**NZ – New Zealand, Mt
++Wellington**
Tel: +64 9 574 1744

PL – Poland, Warsaw
Tel: +48 (0)22 573 24 00
parker.poland@parker.com

PT – Portugal, Leca da Palmeira
Tel: +351 22 999 7360
parker.portugal@parker.com

RO – Romania, Bucharest
Tel: +40 21 252 1382
parker.romania@parker.com

RU – Russia, Moscow
Tel: +7 495 645-2156
parker.russia@parker.com

SE – Sweden, Spånga
Tel: +46 (0)8 59 79 50 00
parker.sweden@parker.com

SG – Singapore
Tel: +65 6887 6300

SK – Slovakia, Banská Bystrica
Tel: +421 484 162 252
parker.slovakia@parker.com

SL – Slovenia, Novo Mesto
Tel: +386 7 337 6650
parker.slovenia@parker.com

TH – Thailand, Bangkok
Tel: +662 717 8140

TR – Turkey, Istanbul
Tel: +90 216 4997081
parker.turkey@parker.com

TW – Taiwan, Taipei
Tel: +886 2 2298 8987

UA – Ukraine, Kiev
Tel: +380 44 494 2731
parker.ukraine@parker.com

UK – United Kingdom, Warwick
Tel: +44 (0)1926 317 878
parker.uk@parker.com

US – USA, Cleveland
Tel: +1 216 896 3000

VE – Venezuela, Caracas
Tel: +58 212 238 5422

ZA – South Africa, Kempton Park
Tel: +27 (0)11 961 0700
parker.southafrica@parker.com

**European Product Information
Centre**

**Free phone: 00 800 27 27 5374
(from AT, BE, CH, CZ, DE, EE, ES,
FI, FR, IE, IL, IS, IT, LU, MT, NL, NO,**

© 2013 Parker Hannifin Corporation. All rights reserved.

Parker Hannifin Manufacturing Limited
Automation Group, Electromechanical Drives Business Unit,
New Courtwick Lane,
Littlehampton
West Sussex BN17 7RZ
United Kingdom

Tel.: +44 (0) 1903 737000
Fax: +44 (0) 1903 737100
www.parker.com/ssd



* H A 4 6 5 0 8 4 U 0 0 2 0 6 *