



aerospace  
 climate control  
**electromechanical**  
 filtration  
 fluid & gas handling  
 hydraulics  
 pneumatics  
 process control  
 sealing & shielding



# DC Drives

## 506/7/8, 512C, 514C Series

### Product Catalog



ENGINEERING YOUR SUCCESS.

# Table of Contents

Series		Power Range	Page
	Introduction to Parker Hannifin		3
	DC drives range overview		4
<b>DC506/7/8</b>	DC506/7/8 1 phase analog DC Drive	0.25 to 2 HP	6
<b>DC512</b>	DC512C 1 phase analog DC Drive	1.5 to 10 HP	7
<b>DC514</b>	DC514C 1 phase analog regenerative DC Drive	1.5 to 10 HP	8
<b>Accessories</b>	EMC filters	All	9

## **WARNING - USER RESPONSIBILITY**

FAILURE OR IMPROPER SELECTION OR IMPROPER USE OF THE PRODUCTS DESCRIBED HEREIN OR RELATED ITEMS CAN CAUSE DEATH, PERSONAL INJURY AND PROPERTY DAMAGE.

This document and other information from Parker Hannifin Corporation, its subsidiaries and authorized distributors provide product or system options for further investigation by users having technical expertise.

The user, through its own analysis and testing, is solely responsible for making the final selection of the system and components and assuring that all performance, endurance, maintenance, safety and warning requirements of the application are met. The user must analyze all aspects of the application, follow applicable industry standards, and follow the information concerning the product in the current product catalog and in any other materials provided from Parker or its subsidiaries or authorized distributors.

To the extent that Parker or its subsidiaries or authorized distributors provide component or system options based upon data or specifications provided by the user, the user is responsible for determining that such data and specifications are suitable and sufficient for all applications and reasonably foreseeable uses of the components or systems.

## **OFFER OF SALE**

The items described in this document are hereby offered for sale by Parker Hannifin Corporation, its subsidiaries or its authorized distributors. This offer and its acceptance by the provisions stated in the detailed 'Offer of Sale' which is available upon request.

# Parker Hannifin

The global leader in motion and control technologies and systems

## Global Partnerships Global Support

Parker is committed to helping make our customers more productive and more profitable through our global offering of motion and control products and systems. In an increasingly competitive global economy, we seek to develop customer relationships as technology partnerships. Working closely with our customers, we can ensure the best selection of technologies to suit the needs of our customers' applications.



## Electromechanical Technologies for High Dynamic Performance and Precision Motion

Parker electromechanical technologies form an important part of Parker's global motion and control offering. Electromechanical systems combine high performance speed and position control with the flexibility to adapt the systems to the rapidly changing needs of the industries we serve.



aerospace  
climate control  
**electromechanical**  
filtration  
fluid & gas handling  
hydraulics  
pneumatics  
process control  
sealing & shielding



## About Parker Hannifin Corporation

With annual sales exceeding \$12 billion in fiscal year 2011, Parker Hannifin is the world's leading diversified manufacturer of motion and control technologies and systems, providing precision-engineered solutions for a wide variety of mobile, industrial and aerospace markets. The company employs approximately 58,000 people in 47 countries around

the world. Parker has increased its annual dividends paid to shareholders for 55 consecutive years, among the top five longest-running dividend-increase records in the S&P 500 index. For more information, visit the company's web site at <http://www.parker.com>, or its investor information site at <http://www.phstock.com>

# Variable Speed DC Drives

## Range Overview 1 HP - 2000 HP

Global DC Drive Solutions to Maximize Flexibility and Increase performance

With more than 30 years of worldwide application experience, Parker assists its customers in improving productivity and reducing energy consumption with a comprehensive, robust range of DC drives and drive systems. Parker DC drive products are sold, supported and serviced worldwide, with solutions from simple speed control to complex multi-motor coordinated process control. Parker DC drive products are easy to configure and commission, with simple but flexible function block-based configuration tools and connectivity with all major industrial fieldbus networks.

### Digital DC Drives Maximize Flexibility and Functionality

Using the same 32-bit control architecture as our current range of AC drive products, Parker's range of digital DC drives provides the same high level of functionality - and with it flexibility and performance - as comparable AC drive systems, while simultaneously allowing the user to integrate both AC and DC drive systems in a single machine with the same interface and software.

### Retrofit Existing Applications with the Latest Technology

By retrofitting existing DC motor applications with Parker digital DC drives, the user can avoid the cost of replacing an existing functioning, DC motor with a similar AC drive system, while still enjoying the benefits of a flexible control platform and high performance drive.

## DC Drives Product Range Overview

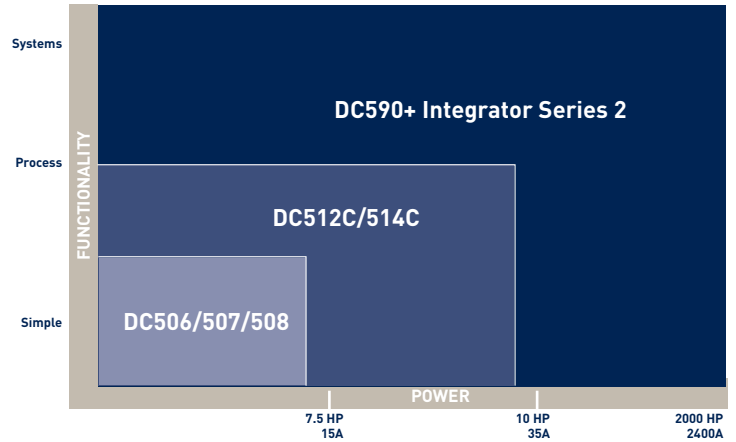

### DRV Package - "Ready to Install" DC Drives

Save design time, panel space and the time and cost of component sourcing and installation with Parker's unique DRV drive format. DRV drives include all peripheral power components typically required in a DC drive system, integrated in a self-contained package. This package contains the additional components within the footprint of the standard drive module and saves significant panel space while reducing complexity and improving the appearance.

### DC590+ Integrator Series 2 Digital DC Drive

The DC590+ uses an advanced control platform to provide high levels of flexibility and performance for a wide range of applications. Designed for machine integrators, the DC590+ features function block programming, multiple communications and feedback options and support worldwide. Available as non-regenerative or full four quadrant regenerative. Available from 1-2400A maximum. Fieldbus options include Profibus-DP, CANopen, Modbus RTU, Ethernet and DeviceNet.

Typical applications include

- Converting machinery
- Hoists and cranes
- Plastics processing machinery
- Wire and cable manufacturing
- Automotive test stands



# Variable Speed DC Drives

## Range Overview 1 HP - 2000 HP

### DC590+ DRV - "Ready to Install" Series 2

The DC590+ DRV Series version is a complete packaged drive solution, including AC line contactor, AC line fuses, DC fuse, control / field fuse and provisions for a motor blower starter. The DRV series reduces panel complexity while saving on panel space. Available to 1750 HP (2400A) maximum.

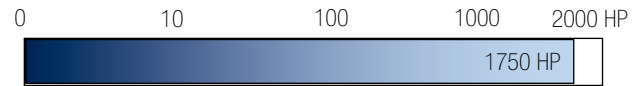

### Analog DC Drives Range

#### Single Phase Analog Non-Isolated Converter: 506/507/508

Economical, compact torque and speed control of permanent magnet or shunt wound DC motors. Selectable between 110VAC or 230VAC single phase supply. Tachometer or armature voltage feedback, 3, 6, or 12A armature options.

Typical applications include:

- Conveyors, basic speed control
- Packaging machinery

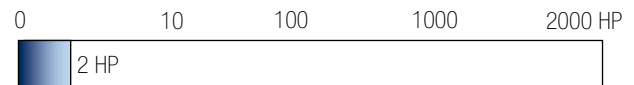

#### Single Phase Two Quadrant Analog Isolated Converter: 512C

The 512C provides effective torque and speed control of permanent magnet or wound field DC motors. Extremely linear speed and current loops in an isolated package, ideal for single or multiple motor applications up to 32A (10 HP at highest input voltage).

Typical applications include:

- Centrifugal fans and pumps
- Extruders and mixers
- Small paper converting machines

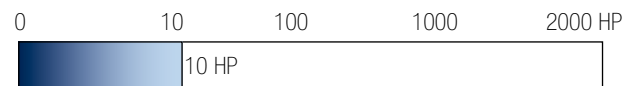

#### Single Phase Four Quadrant Analog Isolated Converter: 514C

The 514C offers full four quadrant regenerative control of permanent magnet or wound field DC motors. Ideal for applications requiring accurate or rapid deceleration of high inertia loads. Effective for single or multiple motor applications to 32A (10 HP at highest input voltage).

Typical applications include:

- Machine tool spindles
- Wire drawing machines
- Winders/Reelers

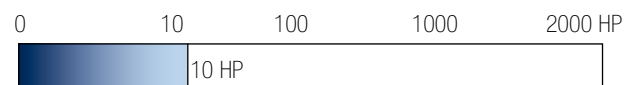

# Analog DC Drives

506/507/508 Series

Up to 2 HP/12A



## Description

The 506, 507 and 508 series drives break new ground in cost-effective DC motor control. Available in 3, 6 or 12A armature ratings, the feature packed minimum footprint design is ideal for speed or torque control of permanent magnet or shunt wound DC motors fed from single phase supplies.

Typical applications include:

- Fans and pumps
- Conveyors
- Packaging machinery

**Low cost high featured design**

**IP20 protected covers**

**Compact footprint and DIN rail mounting**

**Selectable 110V or 230V supply**

**Selectable tach or armature voltage feedback**

## Standards

CE Marked

EN61800-3 (EMC) with external filter

EN50178 (safety, low voltage directive)

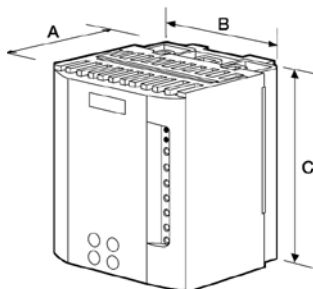
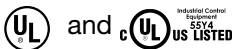

## Technical Specification

Supply voltage	110-120V, or 220-240V $\pm 10\%$ single phase 50-60Hz $\pm 5\%$
Ambient conditions	0-45°C, Altitude 1000m
<b>Installation/diagnostics</b>	
Environment	IP20 Protection
Mounting	DIN rail
Control	Speed or torque
Output	2A DC field control
Detection	15 second stall detect
Protection	Electronic overcurrent protection
Signal	Drive healthy and zero speed
Inputs	Main and trim setpoint inputs
Ramps	Independent acceleration and deceleration ramps
Diagnostics	Via LED
<b>Potentiometer Adjustments</b>	
Speed	maximum / minimum
Current limit	
Speed stability	
Time	Acceleration (1-15 seconds) Deceleration (1-15 seconds)
IR compensation	
<b>Switch selectable</b>	
Supply voltage	110/120V or 220/240V
Speed Feedback	Tach generator/armature voltage feedback
Calibration	Speed and Current

## Characteristics

Part Number	Armature Current ADC	HP	Supply Voltage VAC	Armature Voltage VDC	Field Voltage VDC
506/03/240	3A	0.2	110-120	90	100
	3A	0.5	220-240	180	210
507/06/240	6A	0.5	110-120	90	100
	6A	1.0	220-240	180	210
508/12/240	12A	1.3	110-120	90	100
	12A	2.0	220-240	180	210

## Dimensions (in/mm)

Type	A	B	C	Weight (lb/kg)
506	3.1/80	4.1/105	5.5/140	1.3/0.59
507	3.1/80	4.1/105	5.5/140	1.3/0.59
508	3.5/90	4.1/105	5.5/140	1.6/0.70

Note: Color of enclosure may vary from illustration

# Analog DC Drives

512C Series

Up to 32A



## Technical Specifications

AC Supply Voltage Single Phase	110-115V, 220-240V or 380-415V $\pm 10\%$ ; 50-60Hz $\pm 5\%$
Ambient	0-40°C, Altitude max 1000m
Overload	150% for 60 seconds
Speed range	20:1 (arm v f/b), 100:1 (tach fb)
Voltage selection	Jumper selection of supply voltage
Control	Speed or torque
Diagnostic LED's	Power on, Stall, Overcurrent trip
Protection	Electronic overcurrent protection
Analog Inputs	Setpoint ramp 0-10V Auxiliary speed setpoint 0-10V Current limit 0-7.5V Tach gen input 0-350VDC
Analog Outputs (Buffered)	Speed 0-10V, 5mA Current 0-5V, 5mA Ramped setpoint 0-10V, 5mA
Reference supply	10VDC (5mA)
Digital Inputs (2)	Run, Stall override
Digital Outputs (2)	Drive Healthy, Zero Spd/Zero Setpt
<b>Potentiometer Adjustments</b>	
Speed (2)	Maximum/Minimum
Current limit	0-110%
Speed stability	
Ramp time (2)	Accel, Decel (1-40 seconds)
IR Compensation	
Zero speed offset	

## Description

Isolated control circuitry, a host of features, and extremely linear control loop make the 512C ideal for single motor or multi-drive applications. The 512C is suitable for controlling permanent magnet or field wound DC motors in speed or torque control, and can be used "open loop" with armature voltage feedback, or with DC tach feedback for enhanced regulation and speed range. Chassis mount, IP00 rating.

Typical applications include:

- Centrifugal fans and pumps
- Extruders and mixers
- Conveyors

Part Number	Armature Current
512C/040/000	4A
512C/080/000	8A
512C/160/000	16A
512C/320/000	32A

## Common Specifications: 512C and 514C

### Voltage Ratings:

Supply Voltage	Armature Voltage	Field Voltage
110 VAC	90 VDC	3A @ 100 VDC
240 VAC	180 VDC	3A @ 210 VDC
415-480 VAC	320 VDC	3A @ 360 VDC

### Standards:

CE Marked

EN61800-3 (EMC) with external filter  
EN50178 (safety, low voltage directive)



# Analog DC Drives

514C Series  
Up to 32A



## Description

The regenerative 514C DC drive offers full four quadrant control of DC motors from single phase supplies. As such it is ideal for applications involving overhauling loads or where rapid and accurate deceleration is required. 514C can be used “open loop” with armature voltage feedback, or with DC tach feedback for enhanced regulation and speed range. Chassis mount, IP00 rating.

Typical applications include:

- Machine tool spindles
- Wire drawing machines
- Winders/Reelers

Part Number	Armature Current
514C/040/000	4A
514C/080/000	8A
514C/160/000	16A
514C/320/000	32A

## Technical Specification

AC Supply Voltage Single Phase	110-480V ±10%; 50-60Hz ±5%
Ambient	0-40°C, Altitude max 1000m
Overload	150% for 60 seconds
Voltage selection	Jumper selection of supply voltage
Speed Control	20:1 (arm v f/b), 100:1 (tach fb)
Torque Control	2% accuracy, closed loop w/PI
Diagnostic LED's	Power on, Stall, Overcurrent, PLL lock, Current limit
Protection	Electronic overcurrent protection
Analog Inputs	Setpoint ramp 0-10V Pos/neg trim setpoint 0-10V Current limit 0-7.5V Current demand 0-10V Thermistor <200Ω OK, >1800Ω overtemp Tach gen input +/-350VDC
Analog Outputs (Buffered)	Setpoint ramp +/-10V, 5mA Total setpoint +/-10V, 5mA Speed +/- 10V, 5mA Current demand +/-10V, 5mA Current meter +/-5V, 5mA
Reference supply (2)	+10VDC, -10VDC (5mA)
Digital Inputs (3)	Run, Enable, Stall override
Digital Outputs (2)	Drive Healthy, Zero Spd/Zero Setpt
<b>Potentiometer Adjustments</b>	
Speed (3)	Maximum, Zero, Zero threshold
Current limit	0-110%
Speed loop (2)	Proportional, Integral
Ramp time (2)	Accel, Decel (1-40 seconds)
IR Compensation	
Current loop (2)	Proportional, Integral

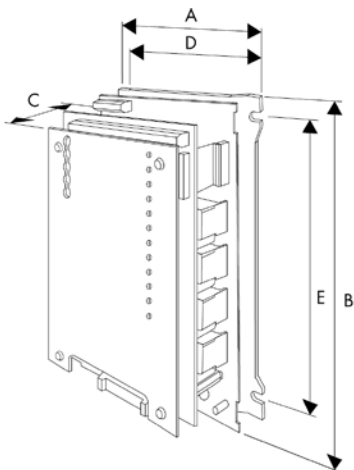

## Dimensions (in/mm):

Type	A	B	C	D	E	Wt (lb/kg)
512C/040, /080, /160, 514C/040, /080	6.3/160	9.4/240	3.5/90	5.8/148	8.3/210	3.5/1.6
512C/320, 514C/160, /320	6.3/160	9.4/240	5.1/130	5.8/148	8.3/210	6.6/3.0

Note: Color of front panel may vary from illustration



# EMC Filters

for AC and DC Drives

## Description

A range of pre-selected EMC (Electromagnetic Compatibility)/RFI (Radio Frequency Interference) Filters are available, suitable for all drives. These filters are a cost effective and easily implemented solution for the abatement of EMC in order to meet certain directives. Installation of the drive must be in accordance with the installation guidelines in the product manual.

Filters described as “footprint” type are designed to save panel space by mounting behind the drive.



Drive mounted on a “footprint” filter

## Ordering

Part Number	Rating	Type	Description
CO389115	Up to 3 HP	Footprint	EMC Filter for DC drives 506, 507, and 508, 1 phase, up to 460V
CO389113	5 HP	Footprint	EMC Filter for DC drives 512C, 514C, 1 phase, up to 460V
CO389114	7.5 HP	Footprint	EMC Filter for DC drives 512C, 514C, 1 phase, up to 460V

# Parker Worldwide

**AE – UAE, Dubai**

Tel: +971 4 8127100  
parker.me@parker.com

**AR – Argentina, Buenos Aires**

Tel: +54 3327 44 4129

**AT – Austria, Wiener Neustadt**

Tel: +43 (0)2622 23501-0  
parker.austria@parker.com

**AT – Eastern Europe, Wiener Neustadt**

Tel: +43 (0)2622 23501 900  
parker.easteurope@parker.com

**AU – Australia, Castle Hill**

Tel: +61 (0)2-9634 7777

**AZ – Azerbaijan, Baku**

Tel: +994 50 2233 458  
parker.azerbaijan@parker.com

**BE/LU – Belgium, Nivelles**

Tel: +32 (0)67 280 900  
parker.belgium@parker.com

**BR – Brazil, Cachoeirinha RS**

Tel: +55 51 3470 9144

**BY – Belarus, Minsk**

Tel: +375 17 209 9399  
parker.belarus@parker.com

**CA – Canada, Milton, Ontario**

Tel: +1 905 693 3000

**CH – Switzerland, Etoy**

Tel: +41 (0)21 821 87 00  
parker.switzerland@parker.com

**CL – Chile, Santiago**

Tel: +56 2 623 1216

**CN – China, Shanghai**

Tel: +86 21 2899 5000

**CZ – Czech Republic, Klecany**

Tel: +420 284 083 111  
parker.czechrepublic@parker.com

**DE – Germany, Kaarst**

Tel: +49 (0)2131 4016 0  
parker.germany@parker.com

**DK – Denmark, Ballerup**

Tel: +45 43 56 04 00  
parker.denmark@parker.com

**ES – Spain, Madrid**

Tel: +34 902 330 001  
parker.spain@parker.com

**FI – Finland, Vantaa**

Tel: +358 (0)20 753 2500  
parker.finland@parker.com

**FR – France, Contamine s/Arve**

Tel: +33 (0)4 50 25 80 25  
parker.france@parker.com

**GR – Greece, Athens**

Tel: +30 210 933 6450  
parker.greece@parker.com

**HK – Hong Kong**

Tel: +852 2428 8008

**HU – Hungary, Budapest**

Tel: +36 1 220 4155  
parker.hungary@parker.com

**IE – Ireland, Dublin**

Tel: +353 (0)1 466 6370  
parker.ireland@parker.com

**IN – India, Mumbai**

Tel: +91 22 6513 7081-85

**IT – Italy, Corsico (MI)**

Tel: +39 02 45 19 21  
parker.italy@parker.com

**JP – Japan, Tokyo**

Tel: +81 (0)3 6408 3901

**KR – South Korea, Seoul**

Tel: +82 2 559 0400

**KZ – Kazakhstan, Almaty**

Tel: +7 7272 505 800  
parker.easteurope@parker.com

**LV – Latvia, Riga**

Tel: +371 6 745 2601  
parker.latvia@parker.com

**MX – Mexico, Apodaca**

Tel: +52 81 8156 6000

**MY – Malaysia, Shah Alam**

Tel: +60 3 7849 0800

**NL – The Netherlands, Oldenzaal**

Tel: +31 (0)541 585 000  
parker.nl@parker.com

**NO – Norway, Ski**

Tel: +47 64 91 10 00  
parker.norway@parker.com

**NZ – New Zealand, Mt Wellington**

Tel: +64 9 574 1744

**PL – Poland, Warsaw**

Tel: +48 (0)22 573 24 00  
parker.poland@parker.com

**PT – Portugal, Leca da Palmeira**

Tel: +351 22 999 7360  
parker.portugal@parker.com

**RO – Romania, Bucharest**

Tel: +40 21 252 1382  
parker.romania@parker.com

**RU – Russia, Moscow**

Tel: +7 495 645-2156  
parker.russia@parker.com

**SE – Sweden, Spånga**

Tel: +46 (0)8 59 79 50 00  
parker.sweden@parker.com

**SG – Singapore**

Tel: +65 6887 6300

**SK – Slovakia, Banská Bystrica**

Tel: +421 484 162 252  
parker.slovakia@parker.com

**SL – Slovenia, Novo Mesto**

Tel: +386 7 337 6650  
parker.slovenia@parker.com

**TH – Thailand, Bangkok**

Tel: +662 717 8140

**TR – Turkey, Istanbul**

Tel: +90 216 4997081  
parker.turkey@parker.com

**TW – Taiwan, Taipei**

Tel: +886 2 2298 8987

**UA – Ukraine, Kiev**

Tel: +380 44 494 2731  
parker.ukraine@parker.com

**UK – United Kingdom, Warwick**

Tel: +44 (0)1926 317 878  
parker.uk@parker.com

**US – USA, Cleveland**

Tel: +1 216 896 3000

**VE – Venezuela, Caracas**

Tel: +58 212 238 5422

**ZA – South Africa, Kempton Park**

Tel: +27 (0)11 961 0700  
parker.southafrica@parker.com



## Parker Hannifin Corporation

### SSD Drives Division

9225 Forsyth Park Dr.

Charlotte, NC 28273 USA

Tel: (704) 588-3246 Fax: (704) 588-3249

info.us.ssd@parker.com

www.ssddrives.com/usa www.parker.com/ssdusa