

Gemini GV



The Gemini GV Digital Servo Drive

The Gemini GV is a compact, low-cost, digital servo drive available in six power levels for producing up to 40 Amps continuous and 100 Amps peak current, or up to 29.4 kW of peak power. The Gemini GV is easily configurable via RS232/485 using Compumotor's Motion Planner™ on a PC or Pocket Motion Planner™ on a Window's CE™-based palm PC. With the available power levels, small package size, low cost, and numerous drive features, the Gemini GV will be the obvious choice for all of your low-to-mid power servo drive applications.

Simplified Tuning/Configuration

Tuning and configuration are easy. They are accomplished via RS232/485 with a PC or palm PC. Only the motor and some basic load information must be known by the drive to determine baseline-tuning gains. These are simple parameter entries the user can complete with the help of the front-end software tools. Users also have the ability to override these parameters for special application requirements.

Features

Performance

- Provides six power ranges for up to 11.8 kW of continuous power
- Torque, velocity, step & direction and CW/CCW modes
- Encoder tracking mode
- Digital notch filters provide the tools to eliminate mechanical resonance
- Sinusoidal commutation with encoder or resolver feedback
- Simplified tuning and configuration
- Variable resolution for encoder signal output as well as the command input
- Wide range of PWM frequencies for linear motor support

Protection

- Short-circuit protection – phase-to-phase and phase-to-ground
- Inrush current protection
- Drive over-voltage protection
- Drive under-voltage (brownout) protection
- Drive and motor over-temperature protection
- Current-foldback protection
- Regeneration protection

Physical

- A wide selection of brushless servo motors are available from Compumotor including the SM, BE, NeoMetric, J and M Series motors; a family of Linear Motors is also available
- Three input power ranges available: low – 120V, universal – 120/240V, and high – 240V
- Diagnostic LEDs for drive status, firmware download, and optional keep alive mode

Gemini Family Features

- 24V Keep Alive (not required) – keeps logic alive if AC power is removed
- Error Log – records 10 most recent errors with time stamp
- Approvals: UL Recognition, cUL, CE (LVD), and CE (EMC)
- Configurable via RS232/485 using Compumotor's Motion Planner™ on a PC or Pocket Motion Planner™ on a Windows CE™-based Palm PC

See Stepper Drive section for the full line of Gemini stepper drives and drive/controllers.

Gemini GV6



The Gemini GV6 Digital Servo Drive with Basic Controller

Compumotor's Gemini GV6 is a compact, low-cost, digital servo drive/controller. In addition to all of the drive features of the Gemini GV, the GV6 incorporates basic motion control and programming capabilities, allowing solutions for many distributed control applications. The Gemini GV6 is easily configured/programmed via RS232/485 using Compumotor's Motion Planner™ on a PC or Pocket Motion Planner™ on a Windows CE™-based Palm PC. The Gemini GV6 also offers connectivity to several field buses including Profibus and DeviceNet.

Features

Performance

- Incorporates all of the powerful features of the Gemini GV digital servo drive
- Provides six power ranges for up to 11.8 kW of continuous power
- Stand-alone servo controller and drive in one small package
- Full ASCII communications capability
- Control features such as registration, motion profiles, S-curve velocity profiling and conditional statements
- Program storage: Up to 32 programs or 190 lines of program code
- Daisy chain up to 99 units
- Simplified configuration and tuning
- 8 programmable inputs and 6 programmable outputs
- Wide range of PWM frequencies for linear motor support

Protection

- Short-circuit protection – phase-to-phase and phase-to-ground
- Inrush current protection
- Drive over-voltage protection

Protection, continued

- Drive under-voltage (brownout) protection
- Drive and motor over-temperature protection
- Current-foldback protection
- Regeneration protection

Physical

- A wide selection of brushless servo motors are available from Compumotor including the SM Series, NeoMetric, J Series and M Series motors; a family of Linear Motors is also available
- Three input power ranges available: low – 120V, universal – 120/240V, and high – 240V
- Diagnostic LEDs for drive status, firmware download, and keep alive mode

Connectivity

- RS232/485 serial communications (ASCII)
- Profibus DP (optional)
- DeviceNet (optional)

Gemini Family Features

- 24V Keep Alive (not required) – keeps logic alive if AC power is removed
- Error Log—records 10 most recent errors with time stamp
- Approvals: UL Recognition, cUL, CE (LVD), and CE (EMC)
- Configurable/Programmable via RS232/485 using Compumotor's Motion Planner™ on a PC or Pocket Motion Planner™ on a Windows CE™-based Palm PC

When can I take advantage of a low-cost stepper motor? Applications with . . .

- | | |
|--|--------------------------|
| ✓ Predictable loads | ✓ Continuous power needs |
| ✓ High stiffness at rest required | ✓ Speed less than 50 rps |
| ✓ High accuracy, resolution and reliability required | |

Gemini GV6K



The Gemini GV6K Digital Servo Drive with Full-Feature Controller

Compumotor's Gemini GV6K is the most powerful addition to the Gemini servo family lineup. This full-feature, standalone drive/controller offers a complete motion control solution in one economical, compact package. The GV6K comes complete with the same features, connectivity and front-end software tools as the Gemini GV and Gemini GV6. In addition to offering many of the drive features of the Gemini GV and control features of the Gemini GV6, the GV6K incorporates the flexibility and control functionality of Compumotor's 6K Controller to allow highly advanced motion control and sequencing capabilities for unrivaled flexibility in many distributed-control applications. The GV6K is easily configured/programmed via RS232/485 using Compumotor's Windows-based Motion Planner™ software package. The GV6K also offers connectivity to any ASCII-based serial device, including HMI panels and PLC ASCII modules. Products such as OPTO 22™ Snap I/O, DVT™ Vision Systems and AB™ SLC 5/05 PLC platforms can also be used for data chaining using the GV6K's Ethernet Client feature.

Features

Performance

- Combines the powerful features of the 6K Controller with the Gemini GV digital servo drive for a complete standalone servo solution in one small package
- Six power ranges for up to 11.8 kW of continuous power
- Full ASCII communication capability
- Control features such as following, registration, multitasking, PLC scan, electronic cam profiling, S-curve profiling, scaling, high-level math functionality and more
- Program storage: 300KB standard (battery backed)
- Daisy chaining of up to 99 units
- Simplified configuration and tuning

Protection

- Short-circuit protection – phase-to-phase and phase-to-ground
- Inrush current protection
- Drive over-voltage protection
- Drive under-voltage (brownout) protection
- Drive and motor over-temperature protection
- Current-foldback protection
- Regeneration protection

Physical

- Compatible with a wide selection of brushless servo motors, such as the Compumotor SM, BE, NeoMetric, J and M Series motors
- Supports linear servo motors, such as the Compumotor LXR and SL motor series
- Three input power ranges available: low – 120VAC, universal – 120/240VAC, and high – 240VAC

Gemini Family Features

- 24VDC Keep Alive Circuit (24VDC supply required) – powers the controller section independent of AC power and maintains vital position and controller information
- Error Log – records 10 most recent errors with time stamp
- Wide range of PWM frequencies for linear motor support
- Approvals: UL Recognition, cUL, CE (LVD), and CE (EMC)
- Diagnostic LEDs for drive status, firmware, download and 24VDC control power active
- Configurable/Programmable via RS232/485 or Ethernet using Compumotor's Motion Planner™

Gemini Offers Greater Flexibility and More Reliability Than Ever Before. Call 1-800-358-9070 Today.

Connectivity

- Two serial communication ports: one RS232 port (3 wire) and one RS232/RS485 port (4 wire)
- Ethernet communication port (10 Base-T, 10 Mbps twisted pair)
- Imbedded Ethernet Client – provides up to six client connections to the following devices: AB™ SLC 5/05 PLC, OPTO 22 SNAP™ I/O or DVT™ vision camera system
- Peer-to-peer data chain – allows direct Ethernet connectivity with up to 8 Gem6K or 6K devices for distributed control
- Master encoder port – allows for following from an external feedback signal
- Expandable I/O (up to 256 additional discrete I/O points, and/or 192 Ethernet I/O points)

Software and Standard Control Features

- Complete position-based following and electronic cam profiling
- Compiled motion functionality
- Multitasking (up to 10 individual programs simultaneously)
- PLC scan mode
- Floating point, integer and binary variables with high-level math functionality
- Full scaling functionality
- Comprehensive program monitoring, status and diagnostic features
- Full-feature 6K language command set
- Compatibility with platforms such as VisualBasic™, Visual C++™ and NI LabVIEW™

I/O Capabilities

- Onboard I/O: 8 digital inputs (3 programmable limits, 5 programmable), 6 digital outputs, 1 analog input, 2 D/A monitor outputs, 1 relay output
- Software selectable onboard input/output functionality
- Expandable serial I/O of up to 256 additional discrete digital I/O points, 64 analog I/O points or a combination of both digital and analog points
- Expandable Ethernet I/O of up to 192 additional digital or analog I/O points using Ethernet Client with OPTO 22 SNAP™ I/O modules
- Registration input capability
- Software selectable I/O high/low active level
- 5-24VDC selectable input reference voltage
- Inputs: selectable as sinking or sourcing; outputs: open collector (sinking)

Gemini Family Summary

	Servo			Stepper		
	GV	GV6	GV6K	GT	GT6	GT6K
CE, UL Recognition	●	●	●	●	●	●
RS232/485	●	●	●	●	●	●
Encoderless Stall Detect				●	●	●
Ethernet			●			●
Profibus		●			●	
DeviceNet		●			●	
± 10V Command Input	●			●		
Step/Direction, CW/CCW Command Input	●			●		
Encoder Signal Input	●		●	●		●
Onboard I/O	○	●	●	○	●	●
Expandable I/O			●			●
Registration		●	●		●	●
System Status & Diagnostics	●	●	●	●	●	●
Scaling			●			●
Variables		○	●		○	●
Following	○		●	○		●
Multitasking			●			●
Compiled Motion		○	●		○	●

- Full Functionality
- Limited Functionality

GEMINI FAMILY FEATURES

GV/GV6 Common Specifications

Specifications	GV (GV6)-L3	GV (GV6)-U3	GV (GV6)-U6	GV (GV6)-U12	GV (GV6)-H20	GV (GV6)-H40
Drive Input Power						
Voltage	95-132VAC	95-265VAC	95-265 VAC	95-265 VAC	208-265 VAC	208-265 VAC
Phase	1Ø	1Ø	1Ø	1Ø	1 or 3Ø	3Ø
Frequency	50/60 Hz	50/60 Hz	50/60 Hz	50/60 Hz	50/60 Hz	50/60 Hz
24V Keep Alive (Optional)	24 VDC +/- 20% @ x Amps max	24 VDC +/- 20%	24 VDC +/- 20%	24 VDC +/- 20%	24 VDC +/- 20%	24 VDC +/- 20%
Drive Output Power						
Bus Voltage	170 VDC	170/340 VDC	70/340 VDC	170/340 VDC	295/340 VDC	295/340 VDC
PWM**	40 kHz	8 kHz	8, 16, 20 KhZ User selectable (current deration applies)			
Continuous Current *	3 Amps	3 Amps	6 Amps	12 Amps	20 Amps	40 Amps
Continuous Power	0.44 kW	0.88 kW	1.75 kW	3.5 kW	5.9 kW	11.8 kW
Peak Current*	7.5 Amps	7.5 Amps	15 Amps	30 Amps	50 Amps	100 Amps
Peak Power	1.1 kW	2.2 kW	4.4 kW	8.75 kW	14.7 kW	29.4 kW
Commutation	Sinusoidal	Sinusoidal	Sinusoidal	Sinusoidal	Sinusoidal	Sinusoidal

Performance	
Servo Update Accuracy	50 micro seconds Solid lines represent 240VAC operation, continuous and peak. Dashed lines represent performance using 120VACinput. Speed/torque curves may vary +/- 10%. +/- 0.5 arc min (0.0833°), encoder dependent.
Command Inputs – GV	
Velocity and Torque Mode	12 bit, +/- 10 V
Position Mode	Step & Direction/CW & CCW/Encoder Tracking
Inputs – GV	
Enable, Reset	5-24VDC Selectable, 1/3 1/3 1/3 voltage switching threshold
Neg/Pos Limits	5-24VDC Selectable, 1/3 1/3 1/3 voltage switching threshold
User Fault	5-24VDC Selectable, 1/3 1/3 1/3 voltage switching threshold
Encoder	8 MHz Post Quadrature
Inputs – GV6	
8 Programmable	5-24VDC Selectable, 1/3 1/3 1/3 voltage switching threshold
Enable, Reset	5-24VDC Selectable, 1/3 1/3 1/3 voltage switching threshold
Encoder	8 MHz Post Quadrature
Analog Input	12 bit, +/- 10 VDC input voltage (1 ms update)
Outputs – GV	
Fault, At Limit	Open collector, 300mA sink capability
Position Error	Open collector, 300mA sink capability
Analog Monitors	+/- 10 V scalable, 8 bit (not to be used as control functions)
Encoder	Programmable up to 1,024,000 counts/rev post quadrature
Relay	Normally open, dry contact
Outputs – GV6	
6 Programmable	Open collector, 300mA sink capabilities
Analog Monitors	+/- 10 V scalable, 8 bit (not to be used as control functions)
Encoder	Programmable up to 1,024,000 counts/rev post quadrature
Relay	Normally open, dry contact
Communications	
Type	RS232/ RS485 (4-wire), ASCII or 8 bit binary protocol
Baud Rate	Fixed at 9600
Daisy Chain – GV6	Up to 99
Fieldbus (GV6)	Profibus (optional), DeviceNet (optional)
Environmental	
Temperature	Still air: 113°F (45°C), moving air: 122°F (50°C)
Humidity	0-95%, non-condensing
Shock/Vibration	Shock:15G half-sine @ 11 msec/vibration: 2G, 10-2000 Hz
Protection	
Short Circuit	Phase-to-phase, phase-to-ground
Brownout	AC drops below 85 VAC
Over Temperature	Shutdown fault at 131°F (55°C)
Standards	
Physical	UL, cUL, CE (LVD), CE (EMC)
Compumotor Motors	SM Series, BE Series, NeoMetric Series, J Series, M Series, and Linear Motors
Non-Compumotor Motors	Please refer to the GV and GV6 Hardware Installation Guide
Connectors	
Serial	9-pin D-shell (male)
Motor and Power	Barrier screw terminal
Command and I/O	50-pin High density Amp Champ - .050 Series II (with screw attachment)
Feedback	26-pin High density Amp Champ - .050 Series II (with screw attachment)
+24VDC/Relay	4-pin removable terminal block

* Peak of sine wave
** Motor ripple frequency is rated at twice the PWM value for a given drive

GV6K Common Specifications

Specifications	GV6K-L3	GV6K-U3	GV6K-U6	GV6K-U12	GV6K-H20	GV6K-H40
Drive Input Power						
Voltage	95-132VAC	95-265VAC	95-265 VAC	95-265 VAC	208-265 VAC	208-265 VAC
Phase	1Ø	1Ø	1Ø	1Ø	1Ø or 3Ø	3Ø
Frequency	50/60 Hz	50/60 Hz	50/60 Hz	50/60 Hz	50/60 Hz	50/60 Hz
24V Keep Alive (Required)	24 VDC +/- 20%	24 VDC +/- 20%	24 VDC +/- 20%	24 VDC +/- 20%	24 VDC +/- 20%	24 VDC +/- 20%
Drive Output Power						
Bus Voltage	170 VDC	170/340 VDC	70/340 VDC	170/340 VDC	295/340 VDC	295/340 VDC
PWM**	40 kHz	8 kHz	8, 16, 20 KhZ User selectable (current deration applies)			
Continuous Current *	3 Amps	3 Amps	6 Amps	12 Amps	20 Amps	40 Amps
Continuous Power	0.44 kW	0.88 kW	1.75 kW	3.5 kW	5.9 kW	11.8 kW
Peak Current*	7.5 Amps	7.5 Amps	15 Amps	30 Amps	50 Amps	100 Amps
Peak Power	1.1 kW	2.2 kW	4.4 kW	8.75 kW	14.7 kW	29.4 kW
Commutation	Sinusoidal	Sinusoidal	Sinusoidal	Sinusoidal	Sinusoidal	Sinusoidal

Performance

Servo Update Accuracy

50 micro seconds
Solid lines represent 240VAC operation, continuous and peak. Dashed lines represent performance using 120VACinput. Speed/torque curves may vary +/- 10%. +/- 0.5 arc min (0.0833°), encoder dependent.

Inputs – Onboard

8 Programmable
1 Analog
Enable, Reset
Encoder

5-24VDC Selectable, 1/3 1/3 1/3 voltage switching threshold
12-bit, +/- 10 VDC input voltage (2 ms update)
5-24VDC Selectable, 1/3 1/3 1/3 voltage switching threshold
8 MHz Post Quadrature

Inputs – Expansion (Optional)

Up to 256 additional digital inputs (2ms update)
Up to 64 additional 12-bit analog inputs (+/- 10 VDC)
Up to 192 analog or digital Ethernet inputs via Ethernet Client and OPTO22™ SNAP I/O Module

Outputs – Onboard

6 Programmable
2 Analog Monitors
Encoder / Resolver
Relay

Open collector, 300mA sink capability
+/- 10 V scalable, 8 bit (not to be used as control functions)
Programmable up to 1,024,000 counts/rev post quadrature
Normally open, dry contact

Outputs – Expansion (Optional)

Up to 256 additional digital outputs (2ms update)
Up to 64 additional 12-bit analog outputs (+/- 10 VDC)
Up to 192 analog or digital Ethernet outputs via Ethernet Client and OPTO22™ SNAP I/O Module

Communications

Type
Baud Rate
Daisy Chain
Ethernet
Protocols supported

Serial: RS232/ RS485 (4-wire), ASCII
Selectable up to 115200
Up to 99
10 Base-T (10 Mbps twisted pair)
TCP/IP and UDP, ModBus/TCP, AB Ethernet and ASCII over Ethernet

Environmental

Temperature
Humidity
Shock/Vibration

Still air: 113°F (45°C), moving air: 122°F (50°C)
0-95%, non-condensing
Shock:15G half-sine @ 11 msec/ vibration: 2G, 10-2000 Hz

Protection

Short Circuit
Brownout
Over Temperature

Phase-to-phase, phase-to-ground
AC drops below 85 VAC
Shutdown fault at 131°F (55°C)

Standards

Physical

Compumotor Motors
Non-Compumotor Motors
Connectors
 Serial (Com1 & Com2)
 Ethernet
 Motor and Power
 Command, Onboard I/O
 Feedback
 Master Encoder
 Expandable I/O
 +24VDC/Relay

SM Series, BE Series, NeoMetric Series, J Series, M Series, and Linear Motors
Please refer to the GV and GV6 Hardware Installation Guide

9-pin D-shell (male)
RJ45 connector for 10 Base-T
Barrier screw terminal
50-pin High density Amp Champ - .050 Series II (with screw attachment)
26-pin High density Amp Champ - .050 Series II (with screw attachment)
9-pin D shell (female)
15-pin D shell (female)
4-pin removable terminal block

* Peak of sine wave

** Motor ripple frequency is rated at twice the PWM value for a given drive

Gemini GV/GV6 Connections and LEDs

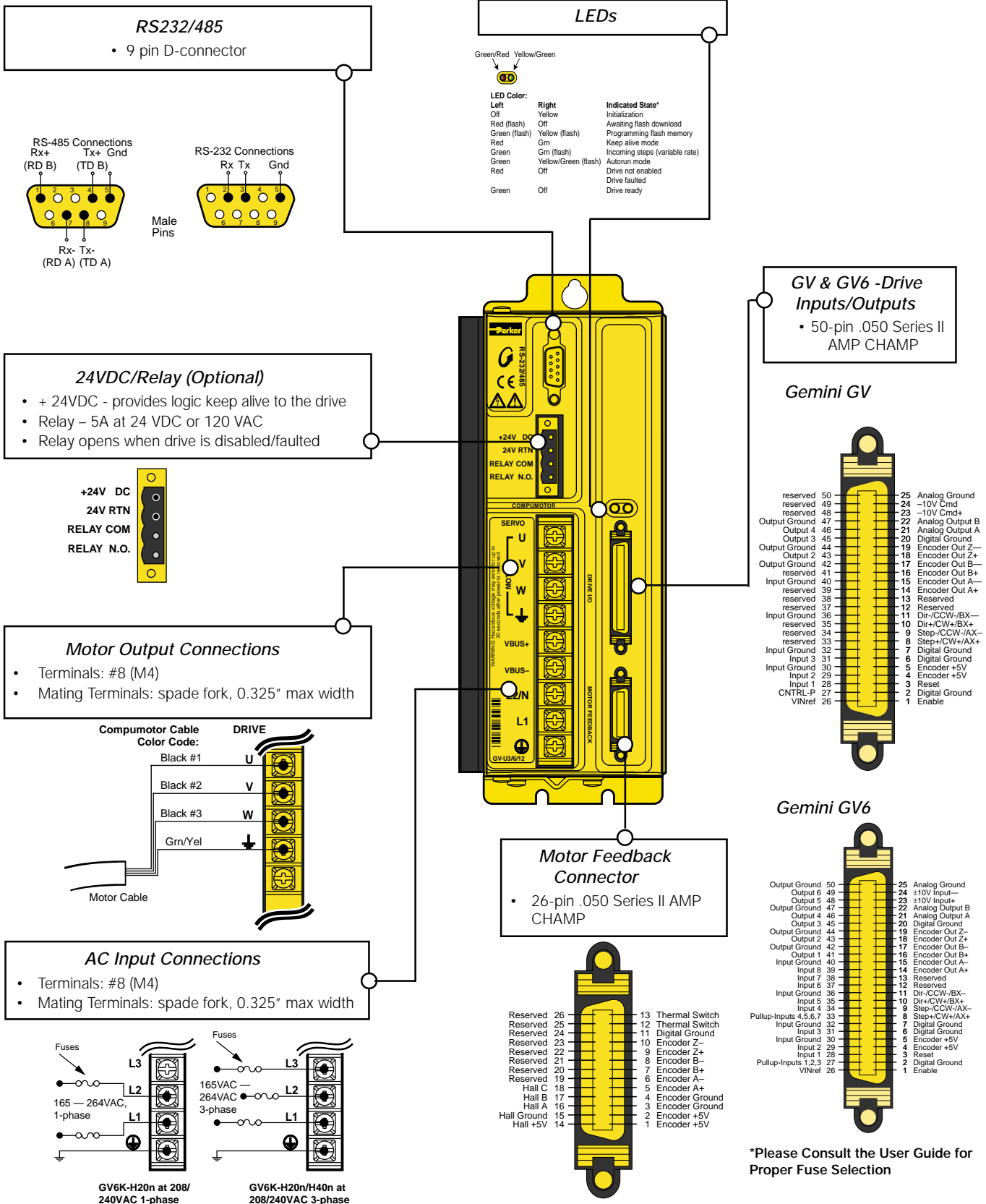

*Please Consult the User Guide for Proper Fuse Selection

See Stepper Drive section for the full line of Gemini stepper drives and drive/controllers.

Gemini GV6 with Profibus Option

Profibus LED Indicators

LED	SteadyFlash	Function	Status
FB1	--	Not used	--
FB2	Off	Module is not online	FBS bit #4= 0
	Green	Module is online	FBS bit #4= 1
FB3	Off	Module is not offline	FBS bit #4= 1
	Red	Module is offline	FBS bit #4= 0
FB4	Off	No diagnostics present	--
	Red	1 flash/second - FBSIZE setting does not match network configuration	--
	Red	4 flashes/second - hardware failure	--

Profibus Connector Pin Out

Pin	Name	Function
Housing	Shield	Protective earth
1	Not connected	--
2	Not connected	--
3	B-Line	Positive Rx/TxD
4	RTS	Request to send*
5	GND BUS	Isolated GND*
6	+5V BUS	Isolated +5V*
7	Not connected	--
8	A-Line	Negative Rx/TxD
9	Not connected	--

Profibus Baud Rate

The GV6 will automatically detect the baud rate of the Profibus network. For a complete list of supported baud rates, see the CMTR090E.GSD file, which accompanies the Gemini product.

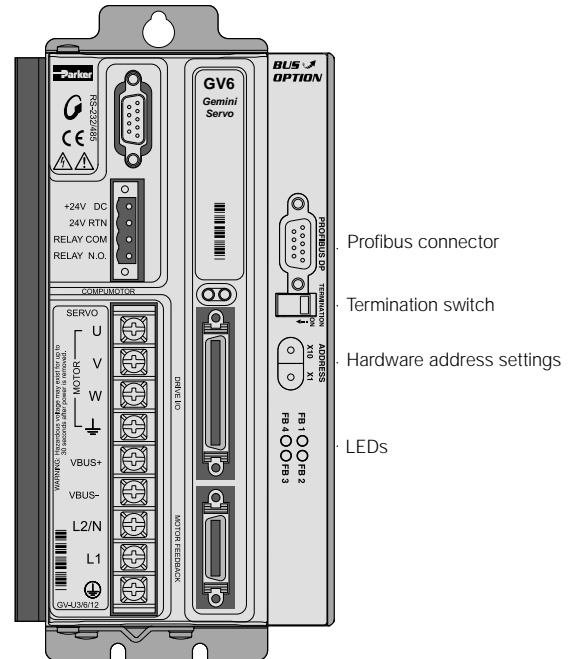

Gemini GV6 with DeviceNet Option

DeviceNet LED Indicators

LED	Steady	Flash	Function	Status
FB1	--	--	Not used	--
FB2	Off	--	Not powered/not online	--
	Green		Network link is OK	FBS bit #4= 1
	Red		Network critical link failure	FBS bit #5= 1
	Green	1 flash/second	network link not connected	FBS bit #6= 1
	Red	1 flash/second	network connection timeout	FBS bit #7= 1
FB3	Off		No power	--
	Green		Module device operational	FBS bit #8= 1
	Red		Unrecoverable fault	FBS bit #9= 1
	Green	1 flash/second	module in standby	FBS bit #10= 1
	Red	1 flash/second	module minor fault	FBS bit #11= 1
FB4	--	--	Not used	--

DeviceNet Connector Pin Out

Pin	Name	Function
1	V-	DC Return
2	CAN_L	CANBUS LOW
3	SHIELD	Protective earth
4	CAN_H	CANBUS HIGH
5	V+	+24 VDC Power*

* 30mA in standby and 100mA in rush

DeviceNet Baud Rate

To configure baud rate via hardware, dip switches are provided to set a baud rate of 125, 250 or 500kb. Setting the dip switches to 0xFF (all ON) enables software configuration of baud rate.

Baud rate (Bit/sec)	BD1	BD2
125k	OFF	OFF
250k	OFF	ON
500k	ON	OFF
Reserved	ON	ON

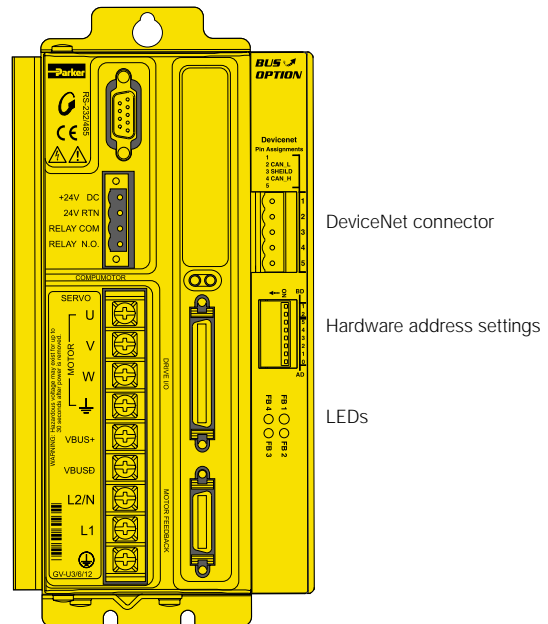

See Also:
The Profibus or DeviceNet
User Guide
for complete specifications

RS-232/485 Connector – COM1 – Port 1

To configure drive parameters, connect a PC to this port. Use Motion Planner for drive configuration. Enabling Ethernet will disable the COM1 port.

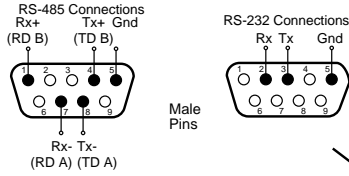

RS-232 Connector – COM2 – Port 2

Connect an RP240, or use this port for RS-232. Download OS through this port only. Ethernet and COM2 can both be active at the same time.

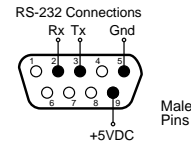

GV6K Digital Controller/Drive

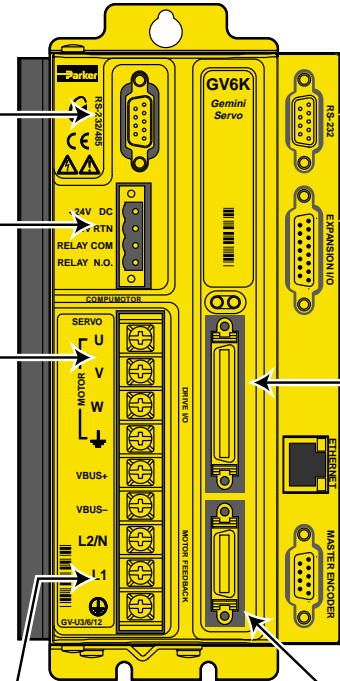

+24VDC/Relay Connector

Required +24VDC input. 19.2 – 28.8 VDC, 500 mA maximum.

When drive is enabled, it holds relay closed.

Relay rating: 5A at 24VDC or RELAY COM 120VAC.

If drive is faulted or disabled, relay will open. (Typical use: control of motor brake.)



Expansion I/O Connector

Connect as many as eight EVM32-II I/O modules in series, for up to 256 additional I/O points.

50 Pin DRIVE I/O Connector

Output Ground	50	25	Analog Ground
Output 6	49	24	Analog Input—
Output 5	48	23	Analog Input+
Output Ground	47	22	Analog Output B
Output 4	46	21	Analog Output A
Output 3	45	20	Digital Ground
Output Ground	44	19	Enc Out Z—
Output 2	43	18	Enc Out Z+
Output Ground	42	17	Enc Out B—/Dir— Out
Output 1	41	16	Enc Out B+/Dir+ Out
Input/Limit Ground	40	15	Enc Out A—/Step— Out
Input 3	39	14	Enc Out A+/Step+ Out
(Trig B) Input 2	38	13	Reserved
(Trig A) Input 1	37	12	Reserved
Input/Limit Ground	36	11	Reserved
(Master Trig) Input 5	35	10	Reserved
Input 4	34	9	Reserved
CNTRL-P: Inputs 1 — 5	33	8	Reserved
Input/Limit Ground	32	7	Digital Ground
(Home) Limit 3	31	6	Digital Ground
Input/Limit Ground	30	5	Reserved
(Neg) Limit 2	29	4	Reserved
(Pos) Limit 1	28	3	Reset
CNTRL-P: Lim 1 —	327	2	Digital Ground
VINref	26	1	Enable

Motor Output Connections

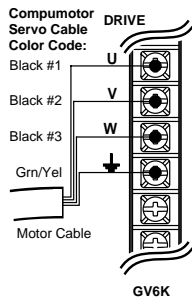

AC Input Connections

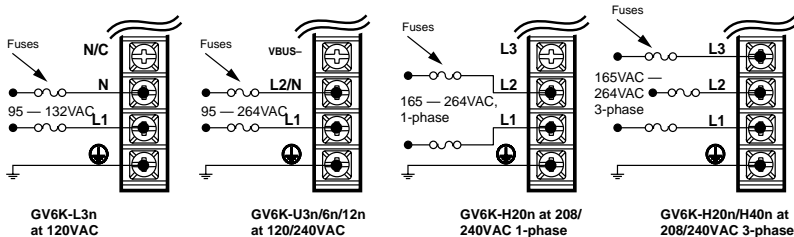

26 Pin MOTOR FEEDBACK Connector

Cos—	26	13	Thermal Switch
Cos+	25	12	Thermal Switch
Sin—	24	11	Digital Ground
Sin+	23	10	Encoder Z—
Reserved	22	9	Encoder Z+
Reserved	21	8	Encoder B—
Ref 1—	20	7	Encoder B+
Ref 1+	19	6	Encoder A—
Hall C	18	5	Encoder A+
Hall B	17	4	Encoder Ground
Hall A	16	3	Encoder Ground
Hall Ground	15	2	Encoder +5V
Hall +5V	14	1	Encoder +5V

Protective Circuits

- Short Circuit Protection
- Inrush Current Protection
- Drive Overtemperature Protection
- Motor Overtemperature Protection
- Undervoltage Protection
- Overvoltage Protection
- Current Foldback
- Regeneration Protection

LEDs

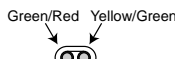

LED Color:	Right	Indicated State
Left	Right	+24VDC only
Red	Grn	AC only
Red	Yel	Motion in progress
Grn	Grn (flash)	Autonun mode
Grn	Yel/Grn (flash)	Drive not enabled; or Drive faulted
Red	Off	Initializing
Off	Yel	Drive ready
Grn	Off	

Environmental Specifications

Operating Temperature	Still Air: 45°C (113°F)
	Moving Air: 50°C (122°F)
Storage Temperature:	-40°C — 85°C (-40°F — 185°F)
Humidity:	0 — 95%, non-condensing

Ethernet Connector

RJ-45 connector for 10Base-T (10Mbps twisted pair) TCP/IP protocol. Default address is 192.168.10.30. Green LED on = Connection OK; Amber LED on = Transmitting

Master Encoder Connector

Connect an encoder for Following. Not for servo feedback or stepper stall detect.

See Stepper Drive section for the full line of Gemini stepper drives and drive/controllers.

Gemini Dimensional Drawings

GV/GV6 Dimensions in inches (mm)

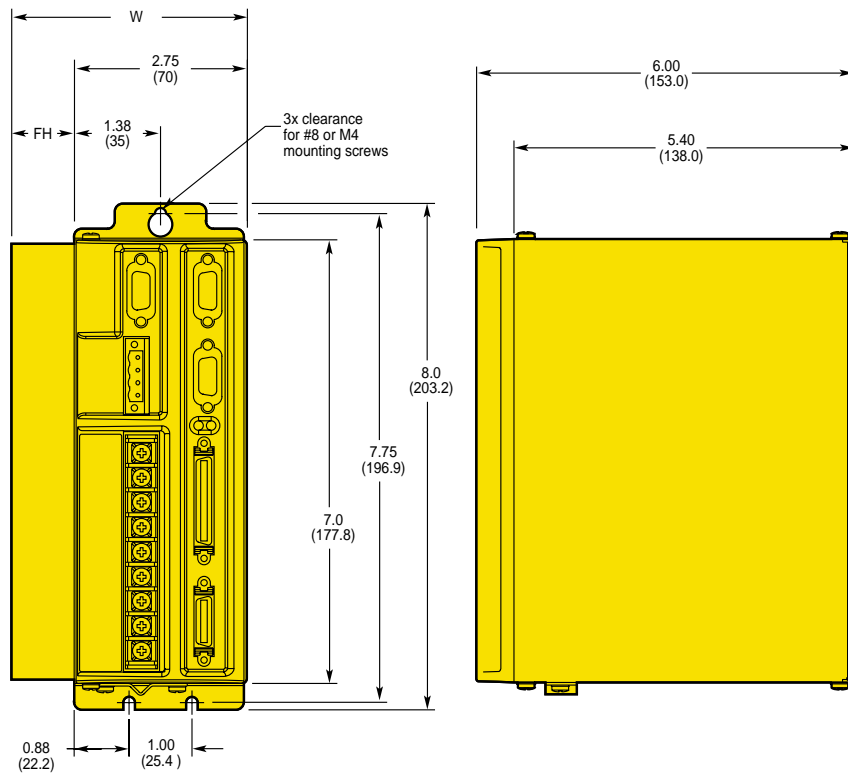

Power Level	W Width IN (mm)	FH FIN Height IN (mm)
L3	3.13 (79.4)	0.38 (9.5)
U3	3.13 (79.4)	0.38 (9.5)
U6	3.75 (95.3)	1.00 (25.4)
U12	3.75 (95.3)	1.00 (25.4)
H20	5.00 (127)	2.25 (57.2)
H40	5.00 (127)	2.25 (57.2)
GPDM	2.75 (70.0)	0.00 (0.0)

GV6K/GV6-PB/GV6-DN Dimensions in inches (mm)

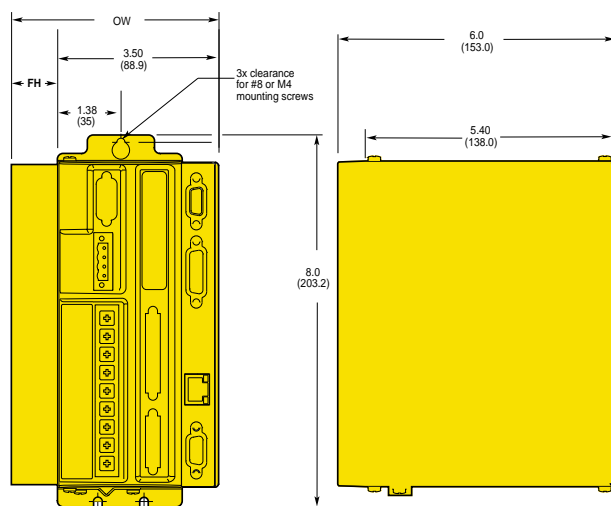

Power Level	OW Overall Width IN (mm)	FH Fin Height IN (mm)	OL Overall Length IN (mm)	OH Overall Height IN (mm)
L3	3.88 (98.6)	0.38 (9.5)	8.0 (203.2)	6.0 (153.0)
U3	3.88 (98.6)	0.38 (9.5)	8.0 (203.2)	6.0 (153.0)
U6	4.50 (114.3)	1.00 (25.4)	8.0 (203.2)	6.0 (153.0)
U12	4.50 (114.3)	1.00 (25.4)	8.0 (203.2)	6.0 (153.0)
H20	5.75 (146.1)	2.25 (57.2)	9.9 (251.5)	6.0 (153.0)
H40	5.69 (144.6)	N/A	12.5 (317.5)	8.49 (215.7)

Gemini Ordering Nomenclature

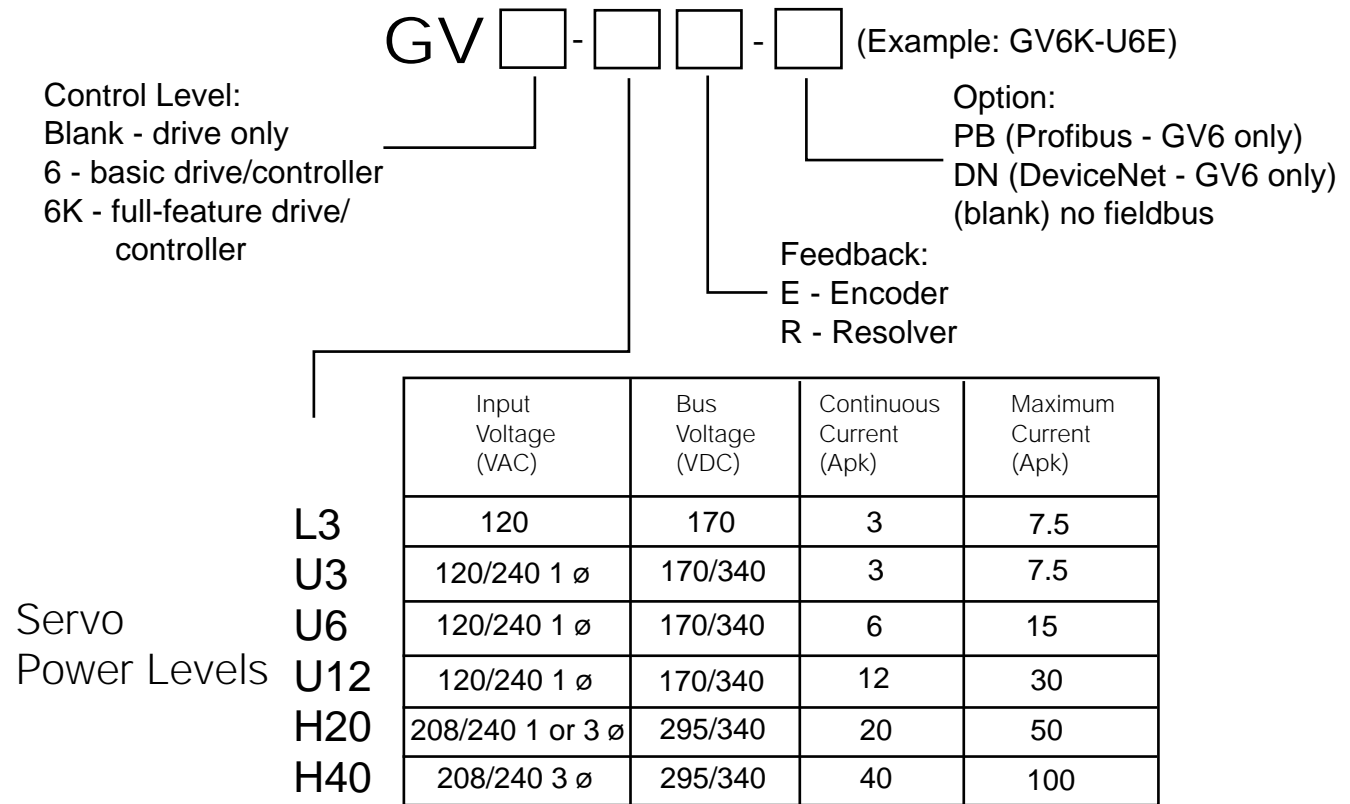

Compatible Servo Motors

- SM Series (in 16 and 23 frame sizes)
- BE Series (in 16, 23 and 34 frame sizes)
- NeoMetric Series (in 34, 70mm and 92 frame sizes)
- J Series (in 34, 70mm and 92 frame sizes)
- M Series (in 105mm - 205mm frame sizes)

Motor Cabling Options

- CE(LVD & EMC) compliant MS connector option
- Flying lead option (with GFB-Kit)
- 10' cable option (with GFB-Kit)
- C1 quick connection option (Coming Soon)

See Also:

The Gemini Family of Digital Stepper Drive Products in the Stepper Section

See Stepper Drive section for the full line of Gemini stepper drives and drive/controllers.

Cables and Accessories

Gemini to 6K Controller (GV only)

Part Number	Product Description
71-016966-10	Gemini to 6K Step & Direction command cable, 10', CE(LVD&EMC) (position mode)
71-016987-10	Gemini to 6K Analog command cable, 10', CE(LVD&EMC) (torque or velocity mode)
71-018183-10	Gemini to 6K Step & Dir or Analog command cable, 10', CE(LVD&EMC) (all modes)
71-019862-04	Gemini to 6K Step & Direction command cable, 4', (non CE) (position mode)
71-019863-04	Gemini to 6K Step & Dir or Analog command cable, 4', (non-CE) (all modes)

50-Pin High Density (Entire Family)

Part Number	Product Description
GEM-VM50	Gemini 50-pin screw terminal breakout board with 3' cable
71-016943-10	10' cable, 50-pin high density to flying leads, CE(LVD&EMC)
71-019861-04	4' cable, Gemini 50-pin high density to flying leads (non-CE)
71-019861-10	10' cable, Gemini 50-pin high density to flying leads (non-CE)
GC-50	50-pin Gemini connector with terminal strips
GC-SDA	Gemini connector with 11-pin terminal strips (drive commands only)

26-Pin High Density (Entire Family)

Part Number	Product Description
GC-26	Gemini connector with 26-pin terminal strips
GFB-KIT	26-pin Gemini connector kit

Additional Accessories (Entire Family)

Part Number	Product Description
71-016939-10	10' cable, RS232/485 null modem, CE(LVD&EMC)
GPDM	Gemini Power Dissipation Module



Selecting a Servo Motor and Cables

The following cable sets are recommended when combining the shown Gemini GV, GV6 and GV6K power levels with the following Compumotor servo motors.

Power Level	Motor	Cable Sets	Power Level	Motor	Cable Sets
L3E	BE161CJ-NMSN BE162CJ-NMSN BE163CJ-NMSN BE162CJ-NMSN SM161AE-NGSN SM162AE-NGSN SM231AE-NGSN SM232AE-NGSN	BE-GS CABLE-nn 23GS CABLE-nn	U12R	BE341JR-NMSN BE342HR-NMSN BE343JR-NMSN BE344JR-NMSN N/J0701FR-NMSN N/J0702FR-NMSN N/J0703GR-NMSN N0704GR-NMSN N/J0921GR-NMSN N/J0922GR-NMSN N/J0923HR-NMSN N0924JR-NMSN M1053KR-KMSN M1054KR-KMSN	BE-GR CABLE-nn 70GR CABLE-nn 92GR CABLE-nn 105GR CABLE-nn
L3R	SM231AR-NMSN SM232AR-NMSN SM233AR-NMSN	23GR CABLE-nn	H20E	BE342KJ-NMSN BE343LJ-NMSN N/J0923KE-NMSN N0924KE-NMSN M1053KJ-KMSN M1054KJ-KMSN M1453LJ-KMSN M1454NJ-KMSN M1455PJ-KMSN M2052PJ-KMSN	BE-GS CABLE-nn 92GS CABLE-nn 105GS CABLE-nn 145GS CABLE-nn 205GS CABLE-nn
U3E	BE161CJ-NMSN BE162CJ-NMSN BE163CJ-NMSN BE164CJ-NMSN BE230CJ-NMSN BE231DJ-NMSN BE232DJ-NMSN BE233DJ-NMSN	BE-GS CABLE-nn BE-GS CABLE-nn	U3R	BE230DR-NMSN BE231DR-NMSN BE232DR-NMSN	BE-GR CABLE-nn
U6E	BE232FJ-NMSN BE233FJ-NMSN BE341FJ-NMSN BE342FJ-NMSN N/J0701DE-NMSN N/J0702EE-NMSN N/J0703FE-NMSN N0704FE-NMSN	BE-GS CABLE-nn 70GS CABLE-nn	H20R	BE342KR-NMSN BE343LR-NMSN N/J0923KR-NMSN N0924KR-NMSN M1053KR-KMSN M1054KR-KMSN M1453LR-KMSN M1454NR-KMSN M1455PR-KMSN M2052PR-KMSN	BE-GR CABLE-nn 92GR CABLE-nn 105GR CABLE-nn 145GR CABLE-nn 205GR CABLE-nn
U6R	BE232FR-NMSN BE233FR-NMSN BE341FR-NMSN BE342FR-NMSN N/J0701DR-NMSN N/J0702ER-NMSN N/J0703FR-NMSN N0704FR-NMSN N/J0921FE-NMSN	BE-GR CABLE-nn 70GR CABLE-nn 92GR CABLE-nn	H40E	M1053KJ-KMSN M1054KJ-KMSN M1453LJ-KMSN M1454NJ-KMSN M1455PJ-KMSN M2052PJ-KMSN	105GS CABLE-nn 145GS CABLE-nn 205GS CABLE-nn
U12E	BE341JJ-NMSN BE342JJ-NMSN BE232JJ-NMSN N/J0701FE-NMSN N/J0702FE-NMSN N/0703GE-NMSN N/J0704GE-NMSN N/J0921GE-NMSN N/J0922GE-NMSN N/J0922JE-NMSN N/J0923HE-NMSN N0924JE-NMSN M1053KJ-NMSN M1054KJ-NMSN	BE-GS CABLE-nn 70GS CABLE-nn 92GS CABLE-nn 105GS CABLE-nn	H40R	M1053KR-KMSN M1054KR-KMSN M1453LR-KMSN M1454NR-KMSN M1455PR-KMSN M2053RR-KPTN M2054SR-KPTN	105GR CABLE-nn 145GR CABLE-nn 205GR CABLE-nn

For complete motor and cable information, please refer to the Motor Cable Table at the end of the Servo Motors section.

- ### ADDITIONAL CABLE INFORMATION
- Each cable set comes with 1 motor cable and 1 feedback cable.
 - All cables have MS connectors and are CE(LVD&EMC) compliant.
 - Motors may also be purchased with either flying leads or non-removable cables if GC-26 or GFB KIT are purchased.
 - Motor and/or feedback cables may also be purchased individually.
 - Cable sets: nn denotes cable lengths. Cables available in selected lengths. Call for details.
 - For motors with brake option, refer to the motor/cable table for appropriate cable part numbers.

Motor Speed-Torque Performance Curves

Gemini with SM motors, 16 and 23 frame, encoder feedback, 120 VAC*

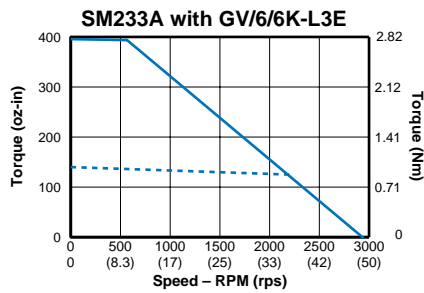
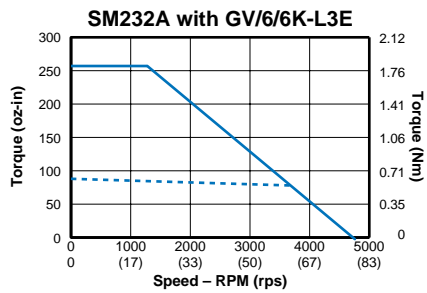
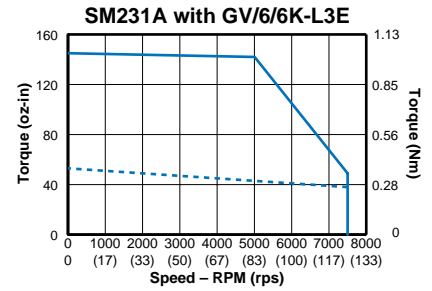
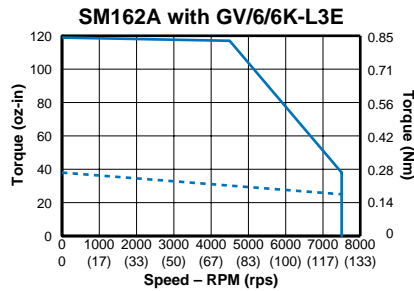
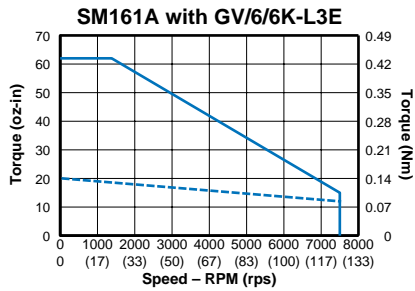

--- CONTINUOUS — PEAK

NOTES:

- Speed-torque curves limited to 7,500 rpm (motor mechanical limit).
- Curves represent 120VAC (nominal) operation.
- Actual speed-torque curves may vary $\pm 10\%$.
- Speed-torque curves are based on motor current values listed in *Motor Parameter Table*, available on the Motion Planner CD and on the Compumotor Web site, www.compumotor.com.
- For speed-torque curves of motors that may have been released after this catalog was published, see the *Gemini Motor Reference* section of the Compumotor Web site.

*Encoder feedback performance shown. Resolver-based systems provide up to an 8% increase of continuous and peak torque at all speeds over encoder-based systems. Refer to the Servo Motors section for more information on resolver motors.

Motor Speed-Torque Performance Curves

Gemini with BE motors, 16 and 23 frame, encoder feedback, 120/240 VAC*

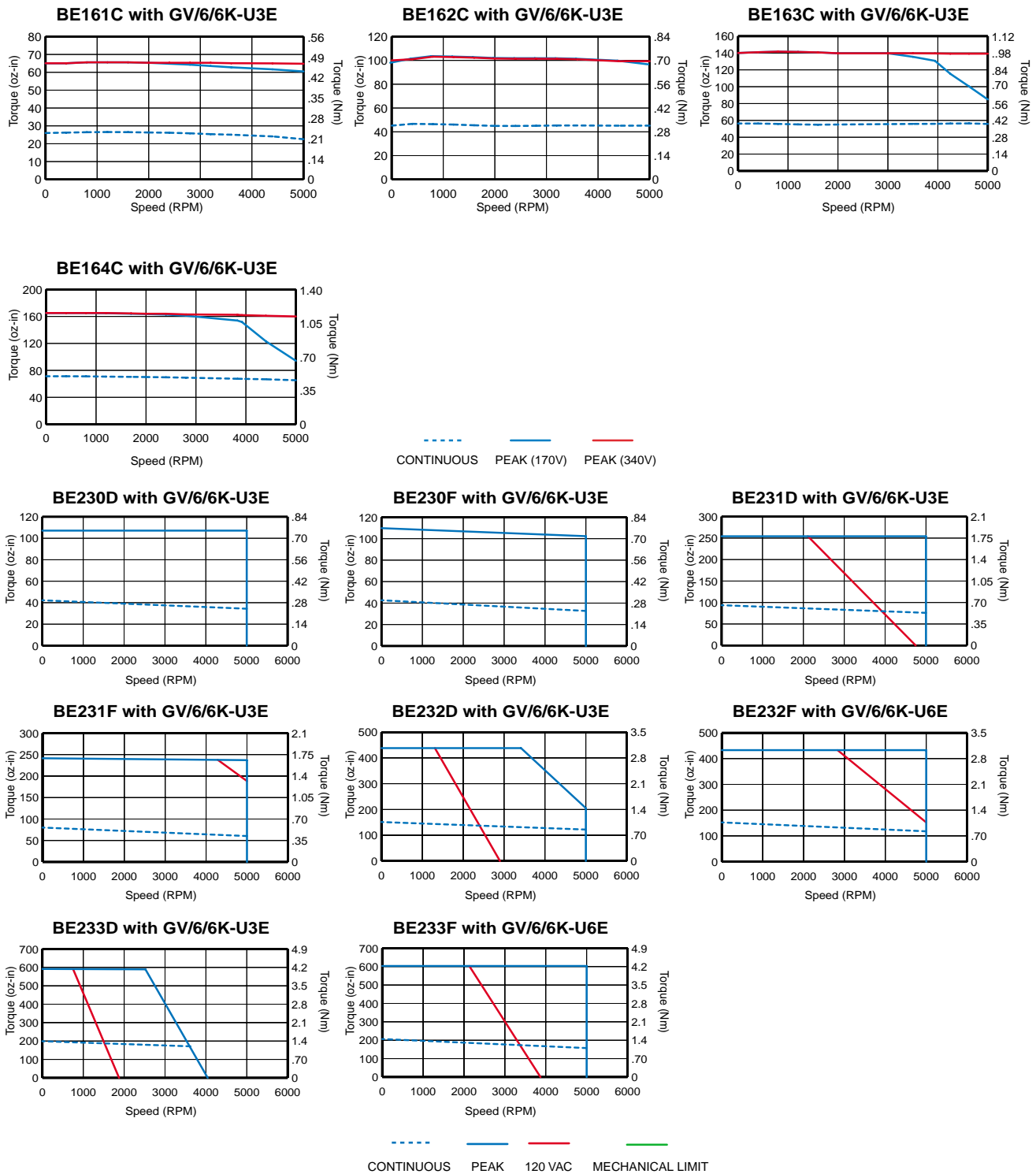

*Encoder feedback performance shown. Resolver-based systems provide up to an 8% increase of continuous and peak torque at all speeds over encoder-based systems. Refer to the Servo Motors section for more information on resolver motors.

See Stepper Drive section for the full line of Gemini stepper drives and drive/controllers.

Motor Speed-Torque Performance Curves

Gemini with BE motors, 34 frame, encoder feedback, 120/240 VAC*

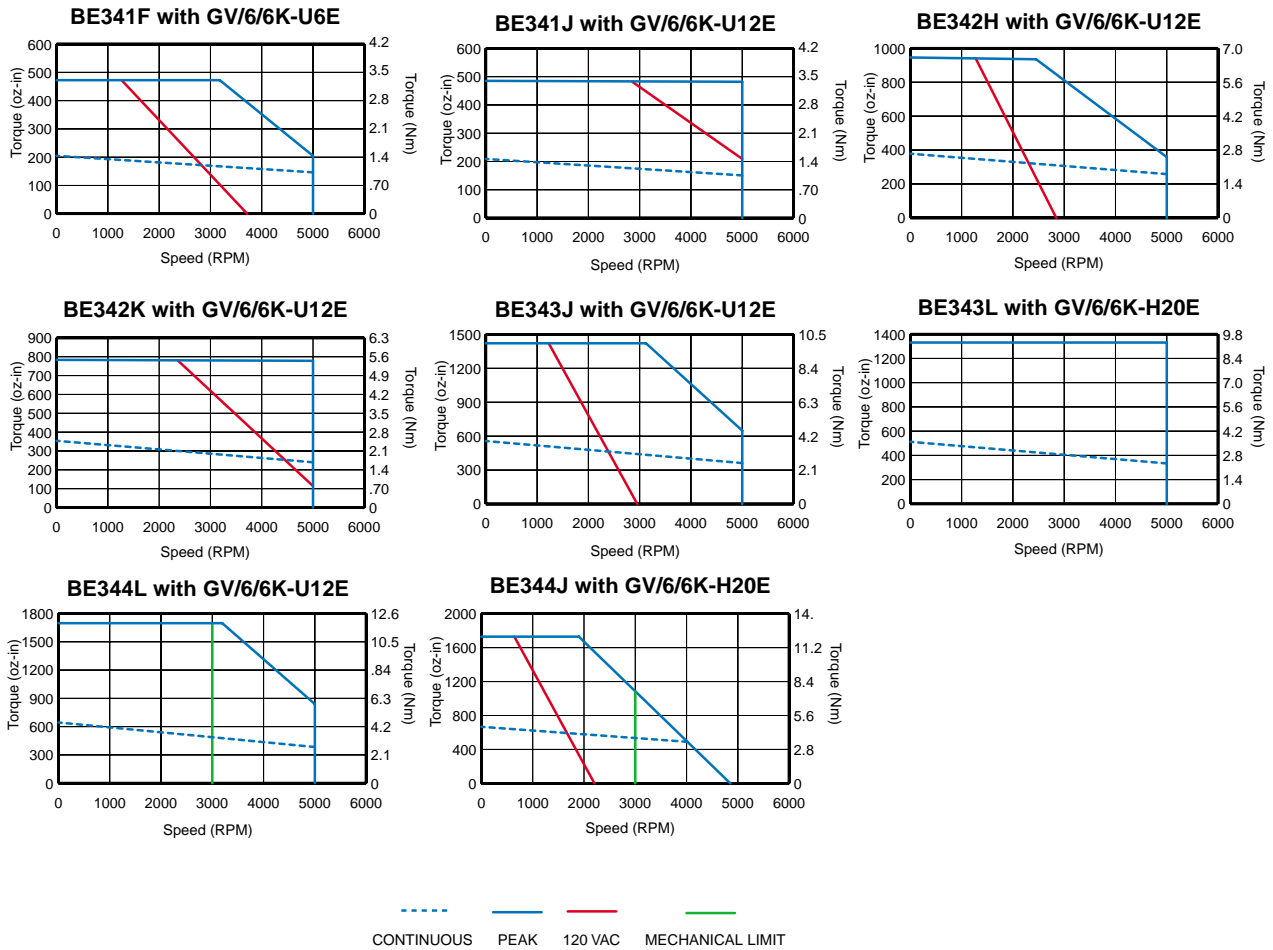

*Encoder feedback performance shown. Resolver-based systems provide up to an 8% increase of continuous and peak torque at all speeds over encoder-based systems. Refer to the Servo Motors section for more information on resolver motors.

Motor Speed-Torque Performance Curves

Gemini with NeoMetric and J series motors, 70mm and 34 frame, encoder feedback, 120/240 VAC*

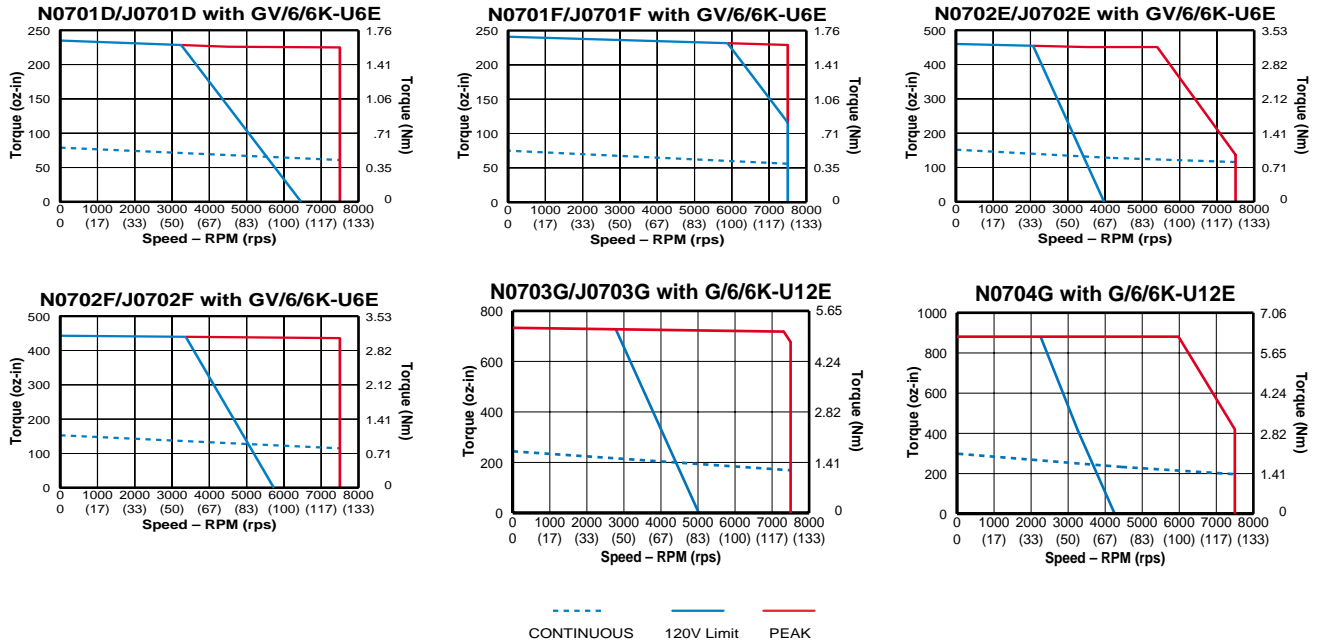

NOTES:

- Speed-torque curves limited to 7,500 rpm (motor mechanical limit).
- Curves represent 120VAC (nominal) and 240VAC (nominal) operation.
- Actual speed-torque curves may vary $\pm 10\%$.
- Speed-torque curves are based on motor current values listed in *Motor Parameter Table*, available on the Motion Planner CD and on the Compumotor Web site, www.compumotor.com.
- For speed-torque curves of motors that may have been released after this catalog was published, see the *Gemini Motor Reference* section of the Compumotor Web site.

*Encoder feedback performance shown. Resolver-based systems provide up to an 8% increase of continuous and peak torque at all speeds over encoder-based systems. Refer to the Servo Motors section for more information on resolver motors.

See Stepper Drive section for the full line of Gemini stepper drives and drive/controllers.

Motor Speed-Torque Performance Curves

Gemini with NeoMetric and J series motors, 92mm frame, encoder feedback, 120/240 VAC*

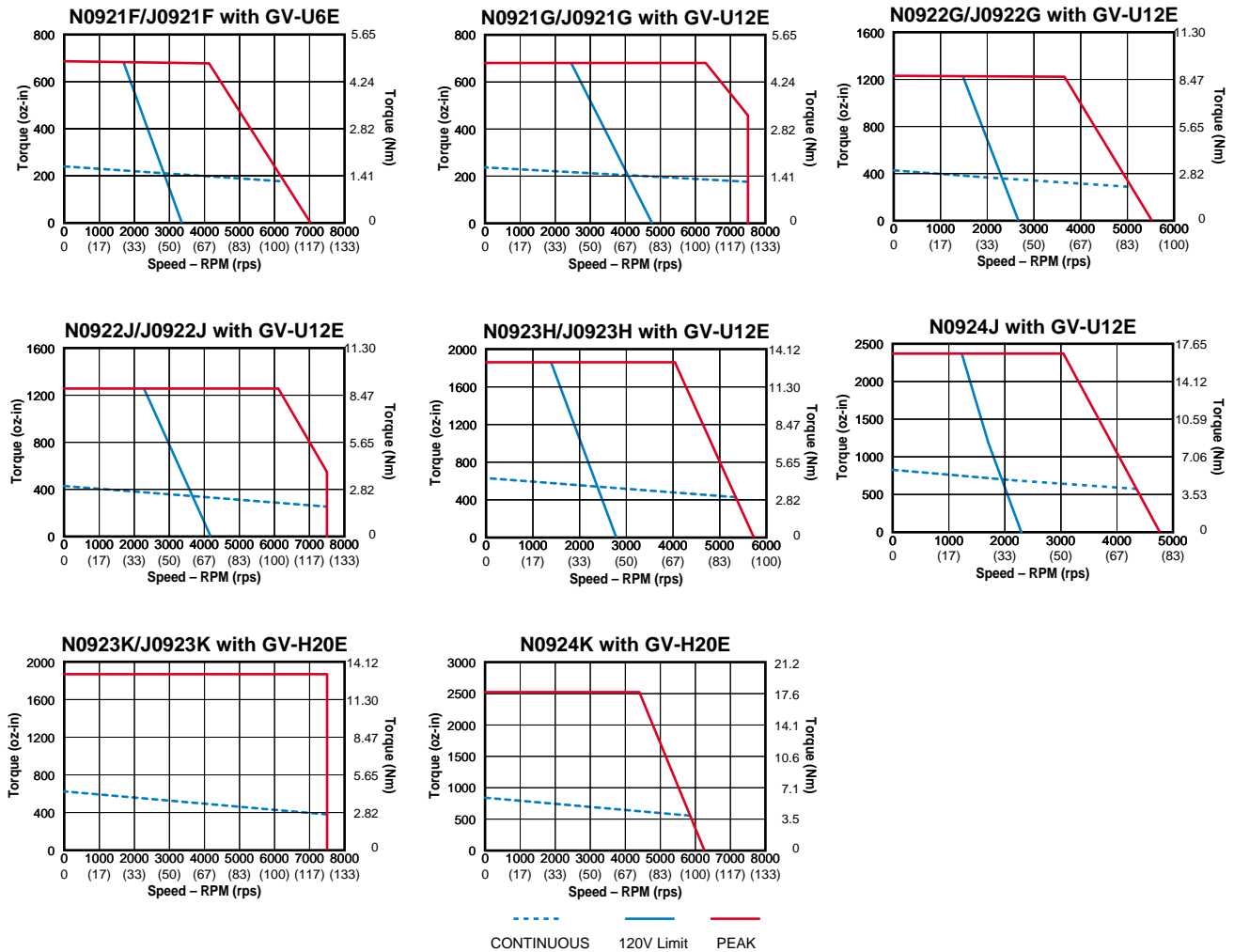

NOTES:

- Speed-torque curves limited to 7,500 rpm (motor mechanical limit).
- Curves represent 120VAC (nominal) and 240VAC (nominal) operation.
- Actual speed-torque curves may vary $\pm 10\%$.
- Speed-torque curves are based on motor current values listed in *Motor Parameter Table*, available on the Motion Planner CD and on the Compumotor Web site, www.compumotor.com.
- For speed-torque curves of motors that may have been released after this catalog was published, see the *Gemini Motor Reference* section of the Compumotor Web site.

*Encoder feedback performance shown. Resolver-based systems provide up to an 8% increase of continuous and peak torque at all speeds over encoder-based systems. Refer to the Servo Motors section for more information on resolver motors.

Motor Speed-Torque Performance Curves

Gemini with M series motors, 105, 145 and 205mm frame, encoder feedback, 240 VAC*

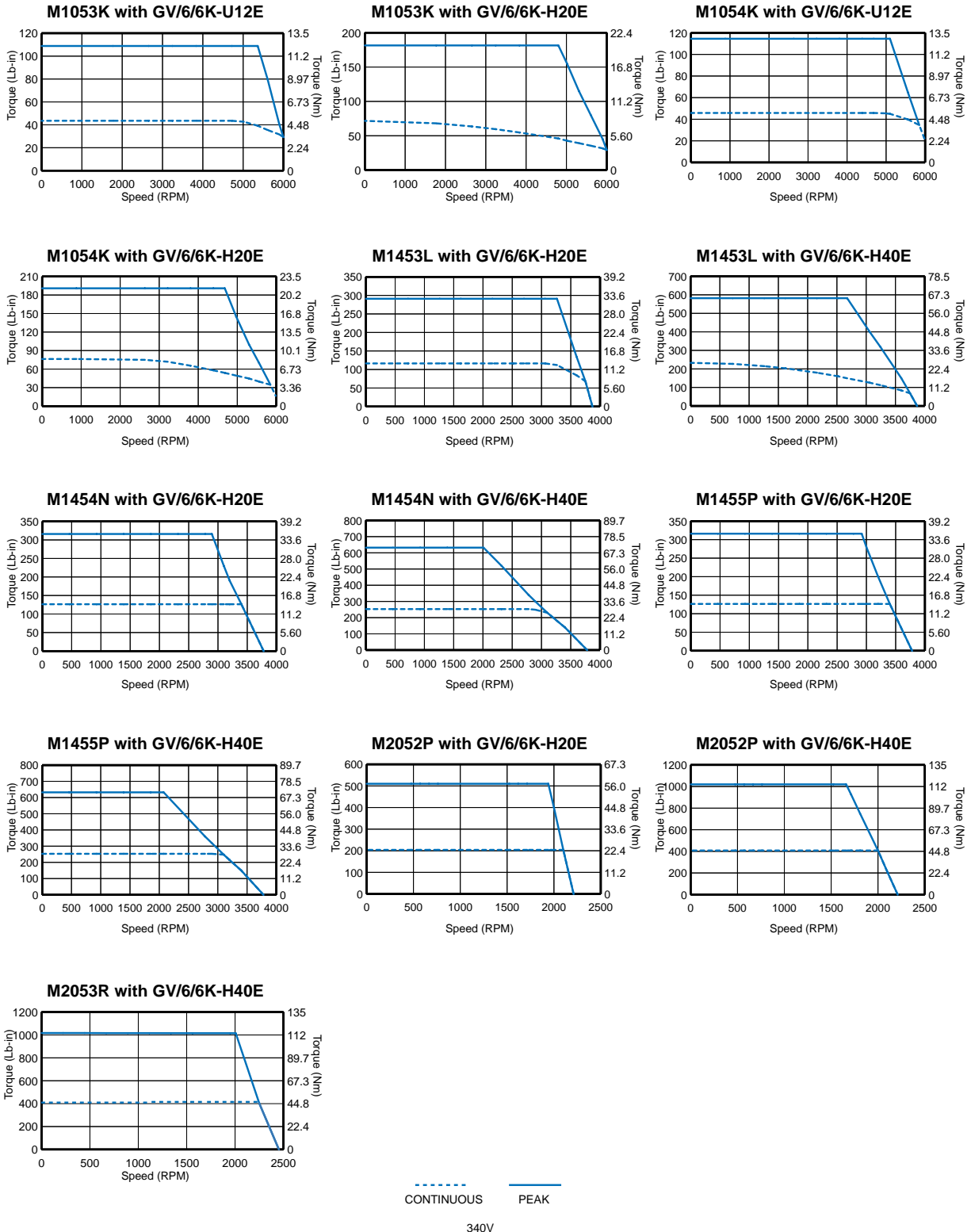

*Encoder feedback performance shown. Resolver-based systems provide up to an 8% increase of continuous and peak torque at all speeds over encoder-based systems. Refer to the Servo Motors section for more information on resolver motors.

See Stepper Drive section for the full line of Gemini stepper drives and drive/controllers.