

aerospace  
climate control  
**electromechanical**  
filtration  
fluid & gas handling  
hydraulics  
pneumatics  
process control  
sealing & shielding

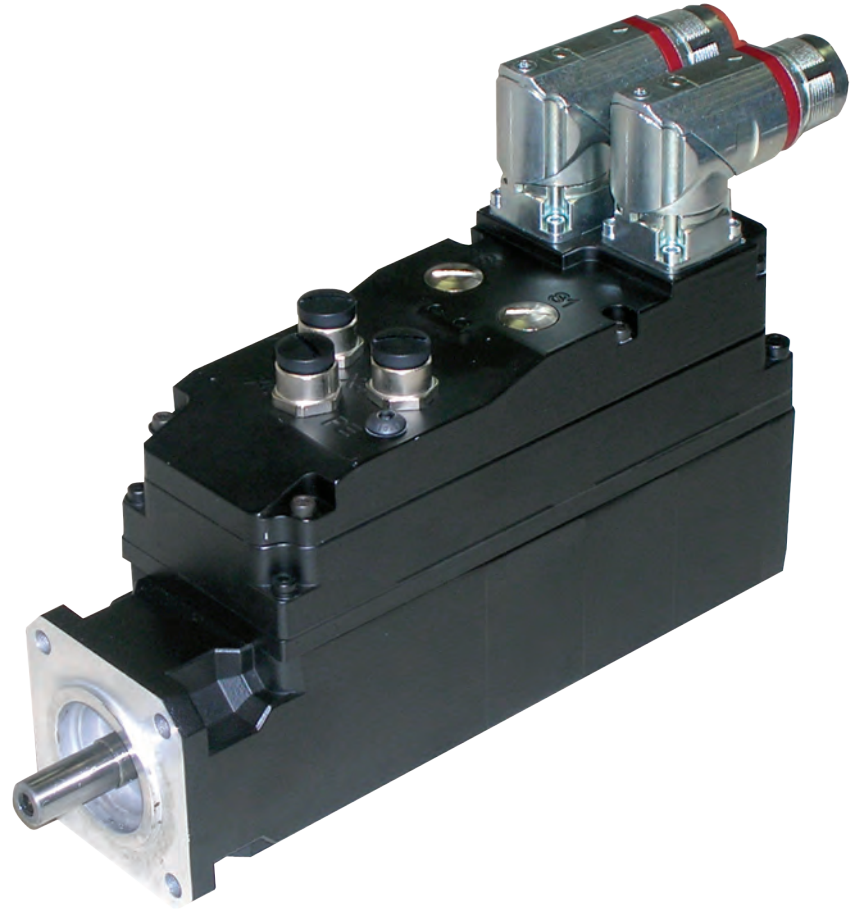

## Motornet DC

Brushless Servomotor with Integrated  
Servo Drive 0.9 - 7.5 Nm

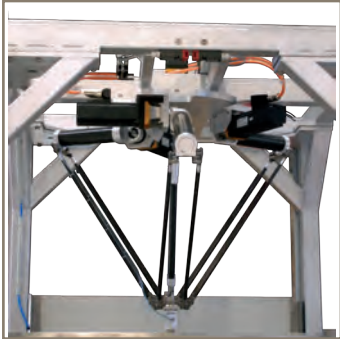

ENGINEERING YOUR SUCCESS.



**WARNING – USER RESPONSIBILITY**

**FAILURE OR IMPROPER SELECTION OR IMPROPER USE OF THE PRODUCTS DESCRIBED HEREIN OR RELATED ITEMS CAN CAUSE DEATH, PERSONAL INJURY AND PROPERTY DAMAGE.**

- This document and other information from Parker-Hannifin Corporation, its subsidiaries and authorized distributors provide product or system options for further investigation by users having technical expertise.
- The user, through its own analysis and testing, is solely responsible for making the final selection of the system and components and assuring that all performance, endurance, maintenance, safety and warning requirements of the application are met. The user must analyze all aspects of the application, follow applicable industry standards, and follow the information concerning the product in the current product catalog and in any other materials provided from Parker or its subsidiaries or authorized distributors.
- To the extent that Parker or its subsidiaries or authorized distributors provide component or system options based upon data or specifications provided by the user, the user is responsible for determining that such data and specifications are suitable and sufficient for all applications and reasonably foreseeable uses of the components or systems.

<b>Overview .....</b>	<b>5</b>
<b>Technical Characteristics.....</b>	<b>8</b>
General Characteristics.....	8
Motornet DC - Torque vs Speed Characteristic Curves.....	8
Electrical Characteristics .....	10
Environmental Characteristics.....	11
Standards & Conformance .....	11
Dimensions .....	12
Connector Layout.....	13
Typical Connection Diagram .....	13
<b>Accessories.....</b>	<b>14</b>
<b>Hybrid Integrated Motion Solutions .....</b>	<b>15</b>
TPDM: Triple Power Drive.....	16
SMB/H-MB/H: Brushless servo motors .....	16
Interact Xpress: HMI .....	16
PIO: I/O System .....	16
PS/RS Series: Planetary Gearheads .....	16
<b>Order Code.....</b>	<b>17</b>
MDC - Motornet DC.....	17
Motornet DC Hybrid Cables .....	18
Mains module: PSUP .....	18
Capacitor module.....	18
Mains filter for PSUP .....	18
Braking resistors .....	18
PSI - Power Supply Interface for Motornet DC.....	18

# Parker Hannifin

## The global leader in motion and control technologies

### A world class player on a local stage

#### Global Product Design

Parker Hannifin has more than 40 years experience in the design and manufacturing of drives, controls, motors and mechanical products. With dedicated global product development teams, Parker draws on industry-leading technological leadership and experience from engineering teams in Europe, North America and Asia.

#### Local Application Expertise

Parker has local engineering resources committed to adapting and applying our current products and technologies to best fit our customers' needs.

#### Manufacturing to Meet Our Customers' Needs

Parker is committed to meeting the increasing service demands that our customers require to succeed in the global industrial market. Parker's manufacturing teams seek continuous improvement through the implementation of lean manufacturing methods throughout the process. We measure ourselves on meeting our customers' expectations of quality and delivery, not just our own. In order to meet these expectations, Parker operates and continues to invest in our manufacturing facilities in Europe, North America and Asia.

#### Electromechanical Worldwide Manufacturing Locations

##### Europe

Littlehampton, United Kingdom  
Dijon, France  
Offenburg, Germany  
Filderstadt, Germany  
Milan, Italy

##### Asia

Wuxi, China  
Chennai, India

##### North America

Rohnert Park, California  
Irwin, Pennsylvania  
Charlotte, North Carolina  
New Ulm, Minnesota



Offenburg, Germany

#### Local Manufacturing and Support in Europe

Parker provides sales assistance and local technical support through a network of dedicated sales teams and authorized technical distributors throughout Europe.

For contact information, please refer to the Sales Offices on the back cover of this document or visit [www.parker.com](http://www.parker.com)



Milan, Italy



Littlehampton, UK

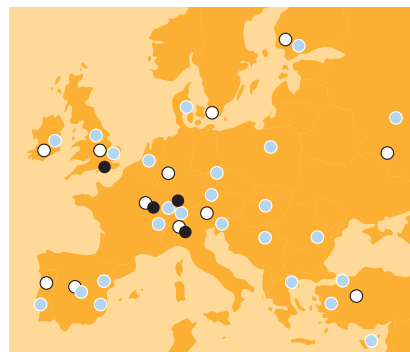

- Electromechanical Manufacturing
- Parker Sales Offices
- Distributors



Dijon, France

# Brushless Servomotor with Integrated Servo Drive - Motornet DC

## Overview

### Description

Motornet DC is a brushless servomotor system with integrated servo drive, supplied from a DC-bus voltage. Hybrid power, control and communications cables, a Power supply and Interface module complete the system and local I/O's can be connected directly to the motor.

Ideally suited to multi-axis applications where a number of motors are mounted in close proximity on the machine, Motornet DC allows a decentralized approach to motion control to be taken.

- **Packaging Machines**
- **Rotary Tables**
- **Filling, bottling and capping machines**

Motion control functionality is executed by means of EtherCAT communication or optionally CANopen DS402 communication.

### Features

- **Feedback: Resolver / EnDat (optional)**
- **Fieldbus: EtherCAT**
- **2 digital Inputs / 2 digital Outputs**
- **Protection level: IP64 standard, IP65 / IP67 (optional)**
- **STO (optional)**
- **CAN Service Bus**



### Technical Characteristics - Overview

230 VAC supply

		Size		
		MDC60	MDC70	MDC100
Speed 3000 min <sup>-1</sup>	Stall torque [Nm]	1	2.5	6.5
	Peak torque [Nm]	4	11	15
Speed 6000 min <sup>-1</sup>	Stall torque [Nm]	0.9	1.9	-
	Peak torque [Nm]	4	7	-
Inertia without brake [kgmm <sup>2</sup> ]		30.2	100	504

400 VAC supply

		Size		
		MDC60	MDC70	MDC100
Speed 3000 min <sup>-1</sup>	Stall torque [Nm]	1	2.6	7.5
	Peak torque [Nm]	4	11	26.7
Speed 5200 min <sup>-1</sup>	Stall torque [Nm]	-	-	5.7
	Peak torque [Nm]	-	-	15
Speed 6000 min <sup>-1</sup>	Stall torque [Nm]	0.9	2.2	-
	Peak torque [Nm]	4	7	-
Inertia without brake [kgmm <sup>2</sup> ]		30.2	100	504

### Typical System Architecture

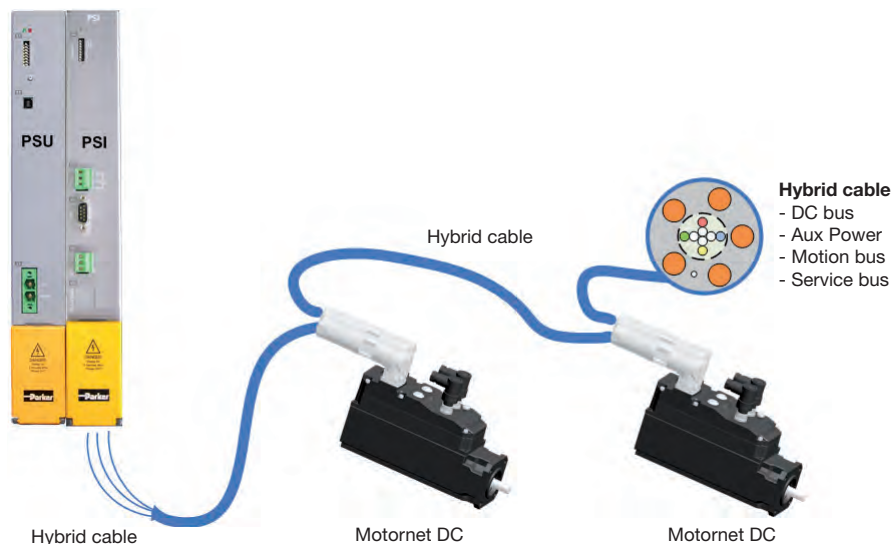

## Motornet DC System

### Description

The next logical evolution in machine motion control, Motornet DC integrates servo control electronics into a brushless servomotor creating a self-contained motor and servo controller. This offers considerable benefits in terms of machine design by allowing a decentralised motion control architecture to be used. This in turn allows substantial savings in time and materials to be realised, while reducing machine footprints.

Typical applications for Motornet DC include packaging machines and rotary tables where numerous motors are mounted on the machine.



Motornet DC

### Features and Benefits

#### Quick and simple machine configuration and reduced wiring

The hybrid cabling solution, which contains all power supply, control and communications signalling offers machine builders a number of benefits including:

- Simplified plug and socket connections at the motor
- Reduced number of connections and potential points of failure
- Reduced wiring time and cost of associated cabling

#### Reduced machine footprint

With a power supply and PSI Interface module being the only additional components required in the cabinet, the electronics footprint is up to 70 % smaller than traditional centralised solutions. Additionally, all wiring changes are made on the machine via plug and socket connections rather than in the electrical cabinet.

#### Modular machine design

Because of the modular nature of Motornet DC, machine design becomes very easy. Additional axes can be added with very little effort, simply by duplicating schematic drawings from other axes. This not only reduces engineering time and costs, but simplifies build and significantly improves time to market.

#### Efficient power control

Motornet DC works on a common DC bus power supply that allows the system to share much of the braking energy to other Motornet DC units rather than dissipating it in the form of heat via external resistors. In some instances, the resistor can be removed completely and in others a smaller resistor is required.



PSUP - Power Supply Unit and  
PSI - Power Supply Interface for  
Motornet DC

## Application

Motornet DC is ideally suited to applications where a number of motors are mounted in close proximity on a machine, such as a filling machine. In this case, the reduced cabling and electronics allow a much smaller physical footprint for the machine to be developed. Motornet DC is suited to packaging lines in general as the plug and play nature of its cable architecture allows new machine modules to be easily added or removed without considerable rewiring cost being incurred.

- **Packaging lines**
- **Rotary tables**
- **Filling, bottling and capping machinery**



---

## Functionality

Motornet DC offers full motion control and is designed to complement the existing Parker servo drive and motor product range. Being flexible in its configuration, Motornet DC can be used to provide repeatable and accurate motion control for a wide range of applications and can be integrated into a larger hybrid motion solution.



---

## Standard Version

Available in flange sizes of 60 mm, 70 mm and 100 mm with continuous torque ratings of 0.9 to 7.5 Nm and motor speeds up to 6000 min<sup>-1</sup>. Motornet DC can be configured to suit the needs of any number of applications with a range of options. As standard Motornet DC is supplied with:

- **EtherCAT**
- **Localised I/O - 2 digital inputs and 2 digital outputs**
- **Resolver feedback**
- **CAN Service Bus**

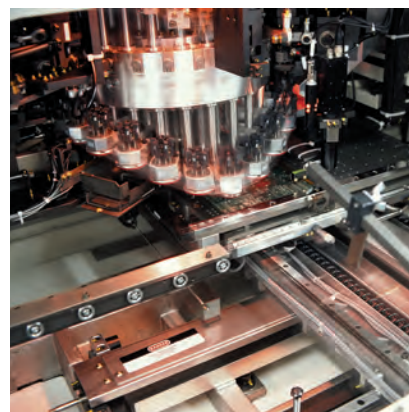

---

## Options

The capabilities of Motornet DC can be further enhanced with numerous options which are available upon request, including:

- **IP65 protection for harsh environments**
- **Safe Torque Off (STO) functionality**
- **CANopen DS402 communication in place of EtherCAT**
- **Encoder feedback**
- **Holding brake**

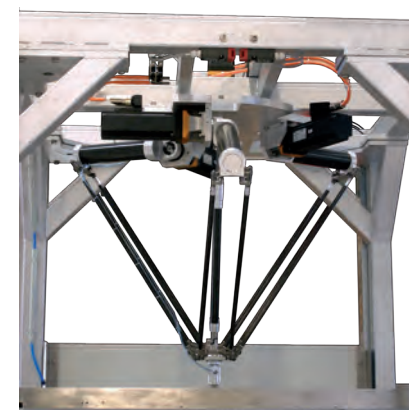

# Technical Characteristics

## General Characteristics

Type	AC Voltage Power Supply [VAC]	Speed [min <sup>-1</sup> ]	Rated torque [Nm]	Rated power [W]	Cont. stall torque [Nm]	Peak torque [Nm]	Peak power [W]	Inertia (without brake) [kgmm <sup>2</sup> ]
MDC60	230	3000	0.90	314	1.0	4.0	1257	30.2
		6000	0.55	384	0.9	4.0	2513	
	400	3000	0.90	314	1.0	4.0	1257	
		6000	0.55	384	0.9	4.0	2513	
MDC70	230	3000	2.00	698	2.5	11.0	3456	100
		6000	0.50	620	1.9	7.0	4398	
	400	3000	2.00	698	2.6	11.0	3456	
		6000	0.50	698	2.2	11.0	6911	
MDC100	230	3000	4.40	1535	6.5	15.0	4712	504
	400	3000	4.40	1535	7.5	26.7	8388	
		5200	1.00	1536	5.7	15.0	8168	

Data refer to MDC mounted in horizontal position to allow for free convection , at 40 °C ambient temperature.

## Motornet DC - Torque vs Speed Characteristic Curves

MDC60 - 3000 min<sup>-1</sup> 230 VAC

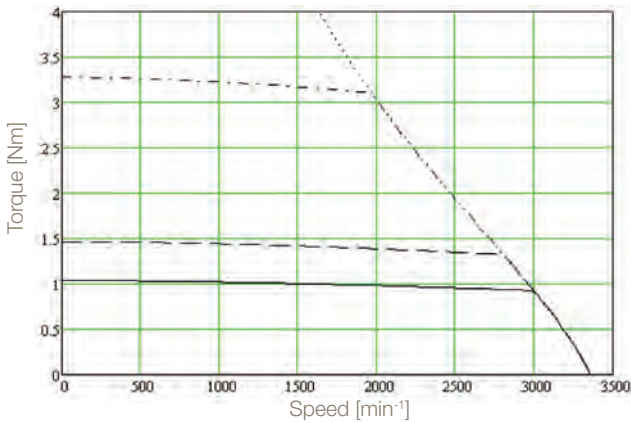

MDC60 - 3000 min<sup>-1</sup> 400 VAC

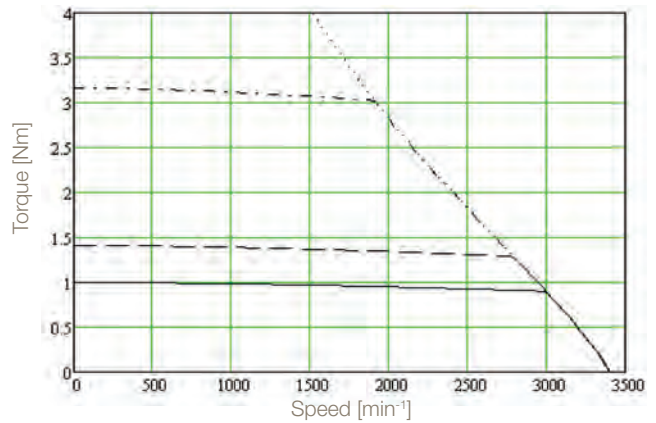

MDC60 - 6000 min<sup>-1</sup> 230 VAC

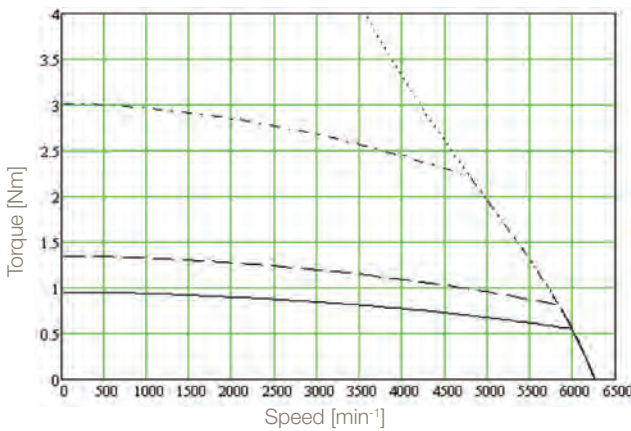

MDC60 - 6000 min<sup>-1</sup> 400 VAC

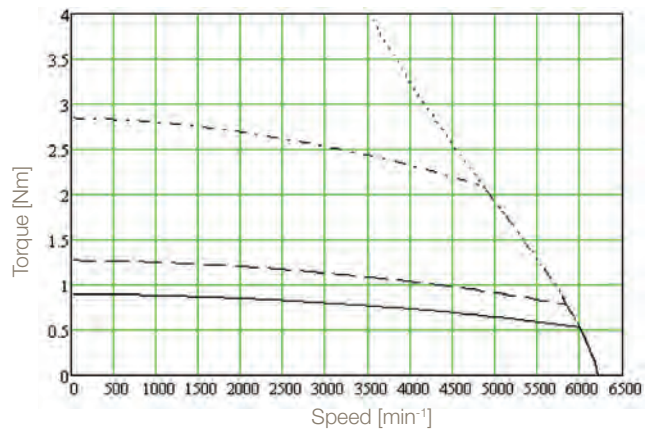

**Key**

- ..... Voltage Limit
- S1 60 K ΔT
- - S3 50 %
- · S3 10 %



**MDC70 - 3000 min<sup>-1</sup> 230 VAC**

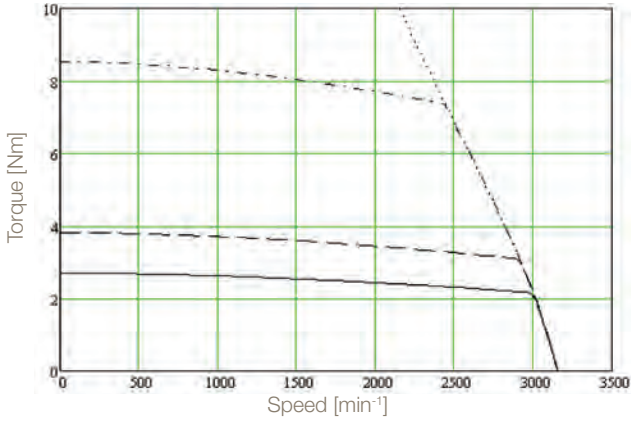

**MDC70 - 3000 min<sup>-1</sup> 400 VAC**

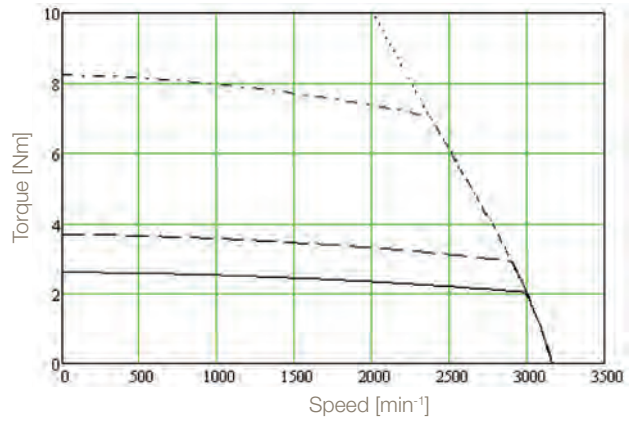

**MDC70 - 6000 min<sup>-1</sup> 230 VAC**

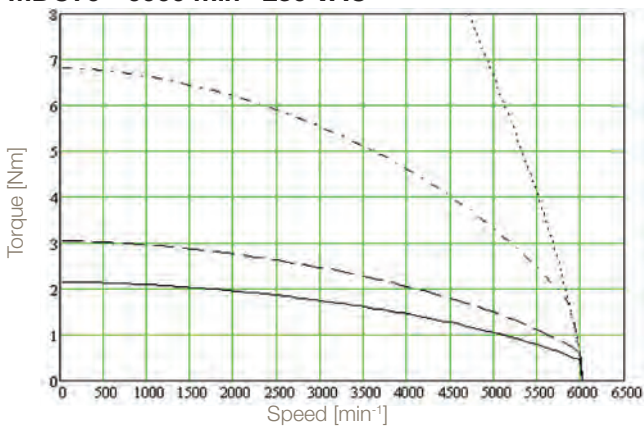

**MDC70 - 6000 min<sup>-1</sup> 400 VAC**

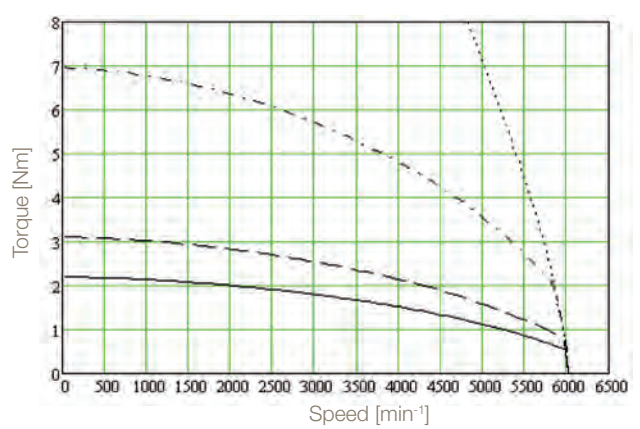

**MDC100 - 3000 min<sup>-1</sup> 400 VAC**

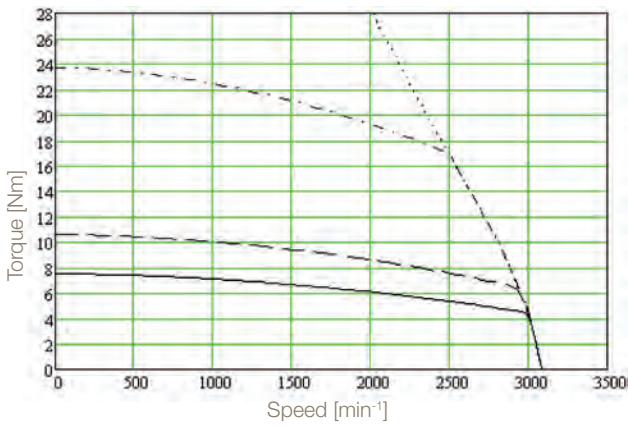

**MDC100 - 3000 min<sup>-1</sup> 230 VAC**

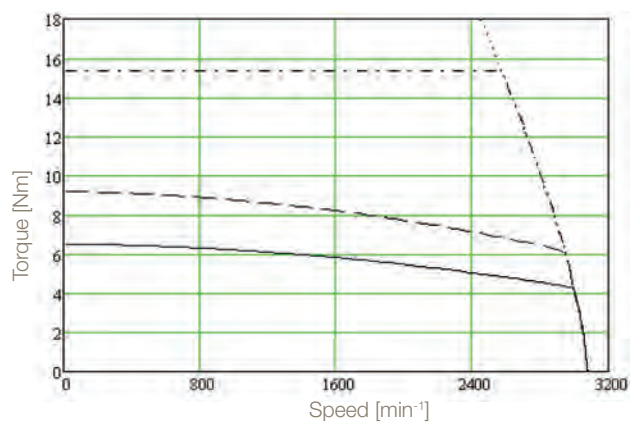

**MDC100 - 5200 min<sup>-1</sup> 400 VAC**

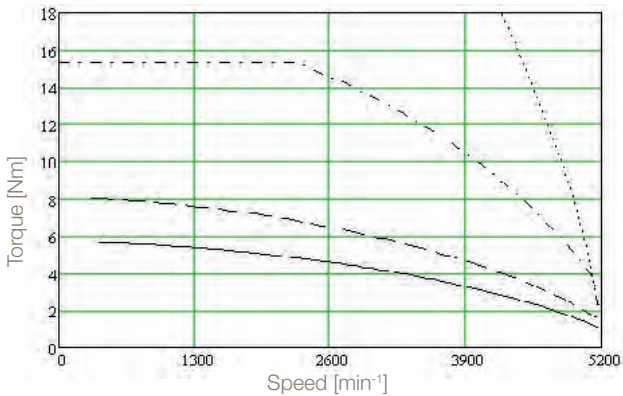

- Key**
- ..... Voltage Limit
  - S1 60 K ΔT
  - - S3 50 %
  - · S3 10 %

## Electrical Characteristics

### MDC - Motornet DC

Motornet DC Model		MDC60	MDC70	MDC100
	Unit			
<b>Auxiliary Voltage Supply</b>				
Rated Input Voltage	[V]	24...48 VDC (0...+10 %)		
Maximum Input Current <sup>1)</sup>	[A]	20		
Control Stage Input Power	[W]	12		
<b>Power Stage Voltage</b>				
Maximum DC Voltage Supply	[V]	750 VDC		

<sup>1)</sup> This is the maximum rated input current that may be supplied to the overall MDC branch. To calculate the maximum number of MDC units that can be connected in a single branch without exceeding this value, the user must also consider the input braking current.

### PSUP - Power Supply Unit

#### Mains Supply

Power Supply Type	Unit	PSUP10			PSUP20			PSUP30 <sup>(2)</sup>		
Input Voltage		3*230...480 VAC ±10 % 50...60 Hz (Rated voltage 3*400 VAC)								
Output Voltage		325...680 VDC ±10 %								
Supplied Voltage	[VAC]	230	400	480	230	400	480	230	400	480
Output Power	[kVA]	6	10	10	12	20	20	18	30	30
Output Peak Power (<5 s)	[kVA]	12	20	20	24	40	40	34	60	60

#### Control Supply

Rated Input Voltage		24 VDC ±10 %								
Maximum Ripple		1 V <sub>pkpk</sub>								
Supply Current	[A]	PSUP10D6: 0,2 A			PSUP20D6: 0,3 A			PSUP30D6: 0,3 A		

<sup>(2)</sup> Operation of the PSUP30 only with line choke.

### PSI - Power Supply Fieldbus Interface for Motornet DC

Power Supply Interface	Unit	PSI5	PSI10	PSI20
<b>Supply Voltage</b>				
DC Voltage Range	[V]	300...750 VDC		
<b>Regenerative braking</b>				
Capacity	[µF]	470	940	940
Storable energy	[WS]	75@400 VAC 42@480 VAC	150@400 VAC 84@480 VAC	150@400 VAC 84@480 VAC

## Environmental Characteristics

### Motornet DC, PSUP - Power Supply Unit and PSI - Power Supply Interface

Temperature			
	<ul style="list-style-type: none"> <li>Operating Temperature: 0...+40 °C</li> <li>Storage Temperature: -25...+55 °C</li> <li>Shipping Temperature: -25...+70 °C</li> </ul>		
Product Enclosure Rating			
	Motornet DC	PSUP	PSI
	IP64, IP65 / IP67 as option	IP20 (only in closed electrical cabinet) UL open type equipment	
Altitude			
	1000 m ASL. Derate output current by 1.5 % per 100 m to a maximum of 2000 m		
Humidity			
	<ul style="list-style-type: none"> <li>Operating Humidity: Class 3K3 - Maximum 85 % non-condensing</li> <li>Storage Humidity: Class 1K3 - Maximum 95 % non-condensing</li> <li>Shipping Humidity: Class 2K3 - Maximum 95 % at 40 °C</li> </ul>		
Operating Vibration			
	Motornet DC	PSUP	PSI
	3M1 Class 2...9 Hz width 0.3 mm 9...200 Hz accel. 1 m/s <sup>2</sup>	IEC60068-2-6 10...57 Hz width 0.075 mm 57...150 Hz accel. 9.81 m/s <sup>2</sup>	

## Standards & Conformance

### Motornet DC

2006/95/EC	Low Voltage Directive
2004/108/CE	EMC Directive
EN 61800-3	Adjustable speed electrical power drive systems - Part 3: EMC product standard including specific test method
EN 61800-5-1	Adjustable speed electrical power drive systems - Part 5-1: Safety requirements - Electrical, thermal and energy
EN 60034-1	Rotating electrical machines - Part 1: Rating and performances
EN 60034-5	Rotating electrical machines. Part 5: Degrees of protection provided by the integral design of rotating electrical machines (IP code) - Classification

### PSUP - Power Supply Unit and PSI - Power Supply Interface for Motornet DC

2006/95/EC	Low voltage directive
2004/108/CE	EMC Directive
EN 61800-3	Adjustable speed electrical power drive systems - Part 3: EMC product standard including specific test method
EN 61800-5-1	Adjustable speed electrical power drive systems - Part 5-1: Safety requirements - Electrical, thermal and energy

## Dimensions

### Motornet DC

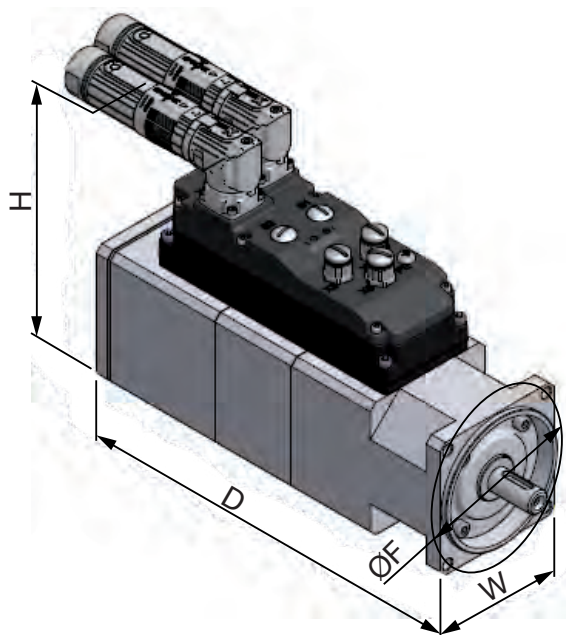

Type	Flange	H [mm]	W [mm]	D [mm]	ød x length [mm]	øPilot [mm]	F [mm]	Weight [kg]
MDC60	5	154	70	192	9x20 / 11x 23	60	75	2.7
	8		60			40	63	
MDC70	5	164	70	287	11x23 / 14x30 / 19x40	60	75	5.2
MDC100	5	194	100	262	19x40 / 24x50	95	115	8.6
	8					80	100	

### PSU - Power Supply Unit and PSI - Power Supply Interface for Motornet DC

Type	W [mm]	D [mm]	Weight [kg]
PSUP10, PSI5/PSI10/PSI20	50	270	3.6
PSUP20/PSUP30	100	270	5.4

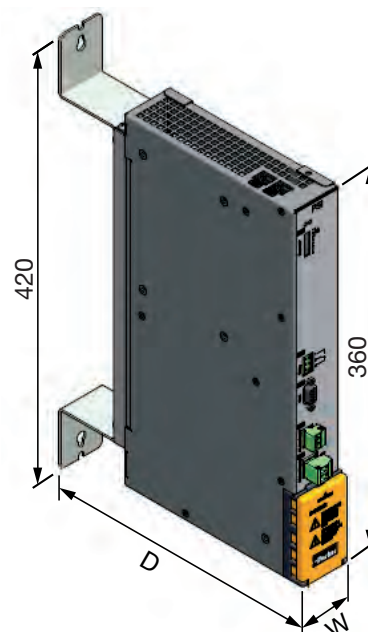

## Connector Layout

### Motornet DC

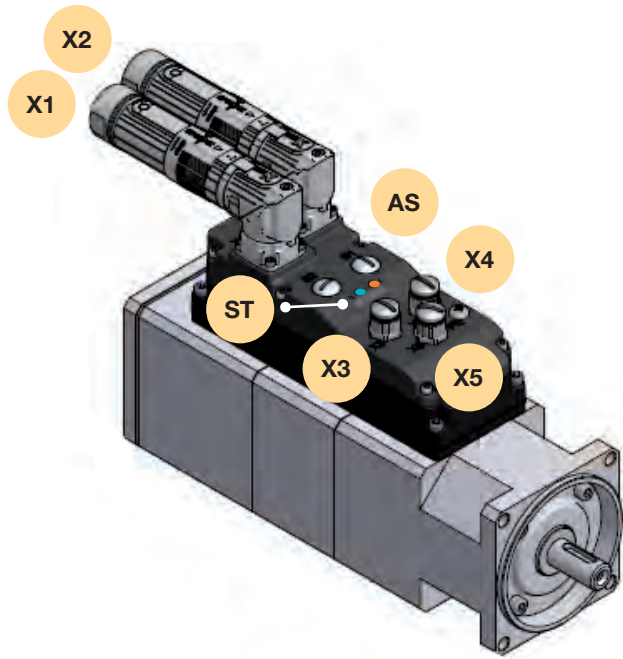

Key	Description
X1	IN: DC Bus, 24 VDC Supply, Motion Bus, Service Bus
X2	OUT: DC Bus, 24 VDC Supply, Motion Bus, Service Bus
X3	Digital Inputs
X4	Digital Outputs
X5	I/O STO, RS232
AS	Address setting selector switches
ST	Status LEDs: Green - Power On, Red - Status

## Typical Connection Diagram

### Motornet DC

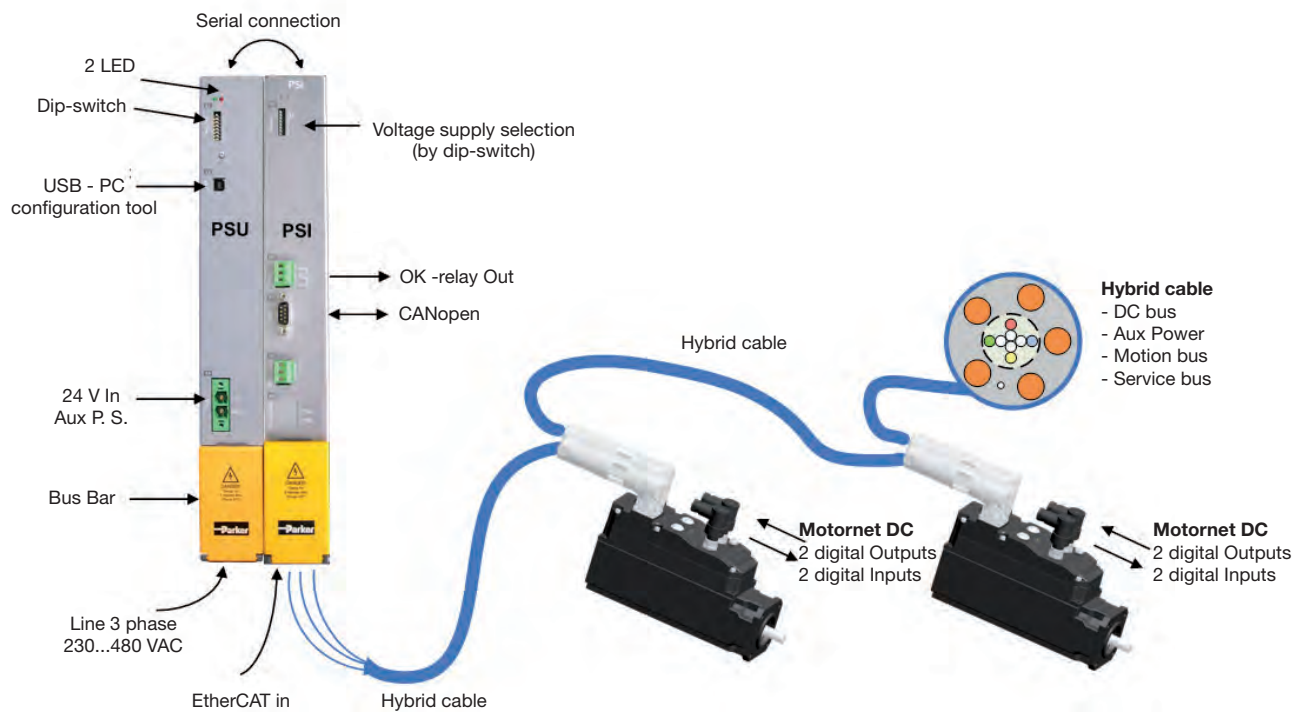

# Accessories

## Configuration Software - MotionWiz

MotionWiz is free of charge downloadable configuration software that allows users to configure and optimise the Motornet DC series with a few easy clicks of the mouse.

MotionWiz features an intuitive, easy and simple to use Windows® style environment to aid installation, optimisation and diagnostic use.

MotionWiz permits operation in both "on line" mode, directly in the controller, and in "offline" mode, remotely on the PC before downloading to the controller.

To simplify the configuration of systems with a large number of similar axes but with different motion profiles, MotionWiz allows users to copy the configuration from one application to another.

Inside the MotionWiz configurator is a database containing the technical characteristics of the full range of Parker motors and drives.

MotionWiz can be downloaded at [www.parker.com/eme/motornet](http://www.parker.com/eme/motornet)

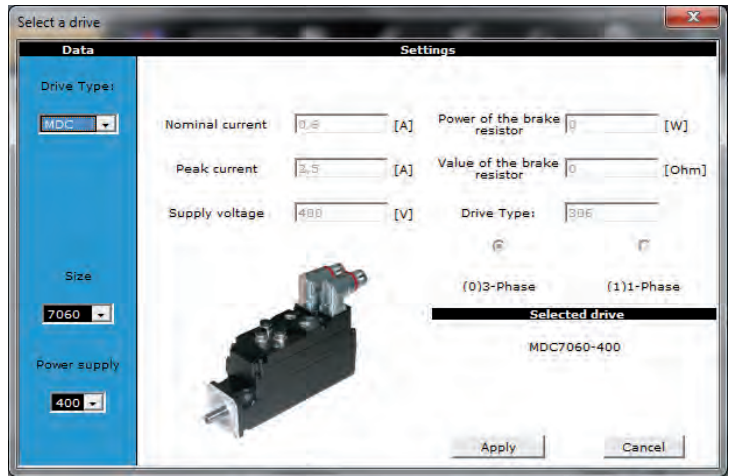

MotionWiz: Motor's size selection

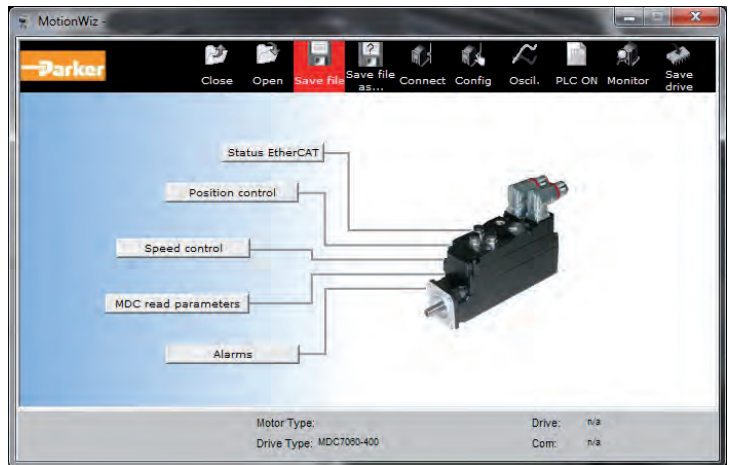

MotionWiz: MDC page - Main electronic control parameters and fieldbus status

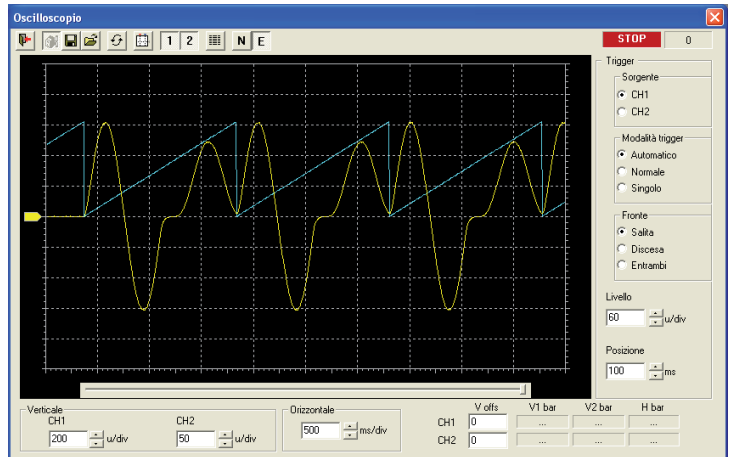

MotionWiz Oscilloscope: Real speed & torque trends

# Hybrid Integrated Motion Solutions

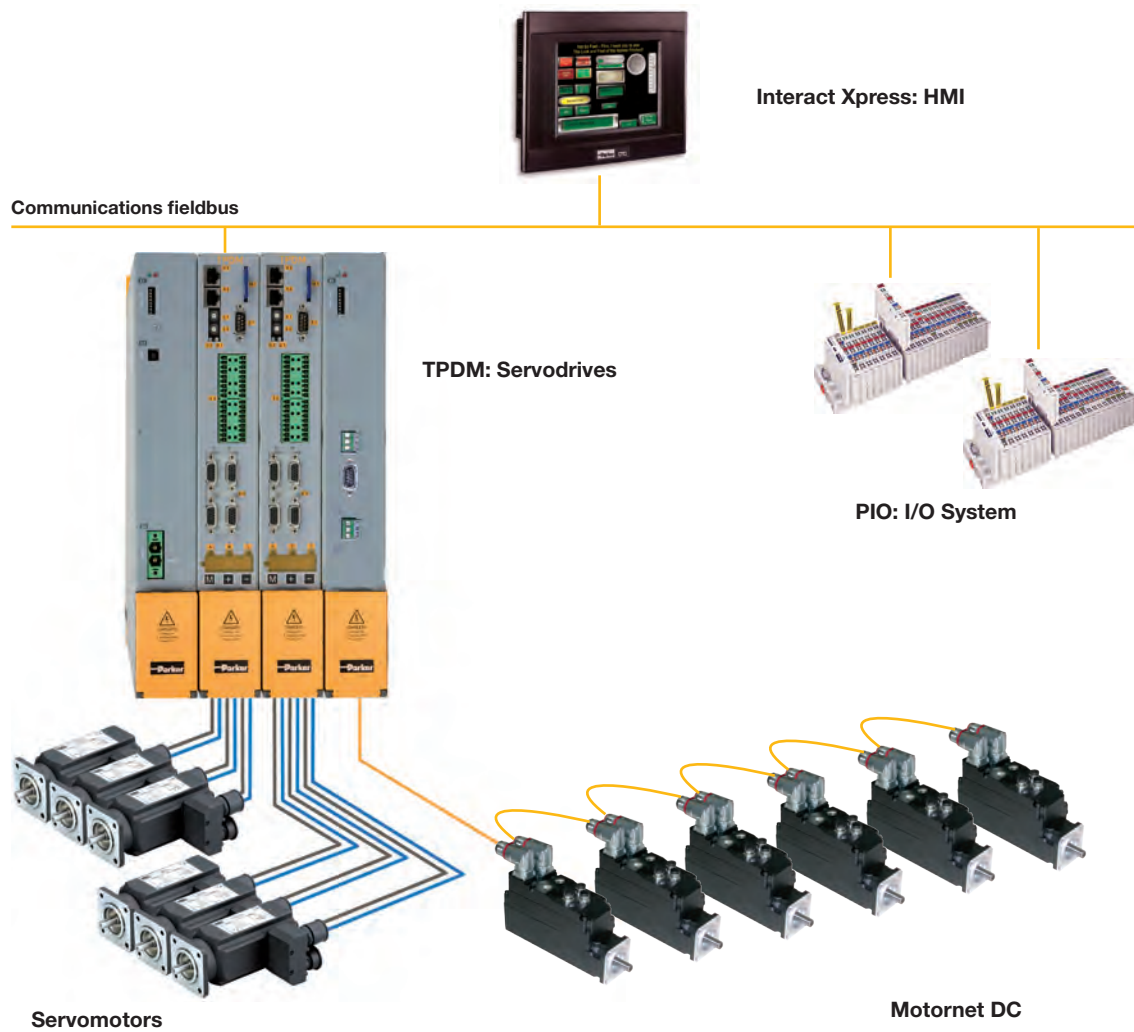

In this example Motornet DC is shown in a system which also uses the TPD-M series servoamplifier, SMB/H series servomotors, InteractXpress series HMI and PIO series I/O to form a complete integrated hybrid motion solution. This type of architecture can be used for the complete control of packaging or process lines.

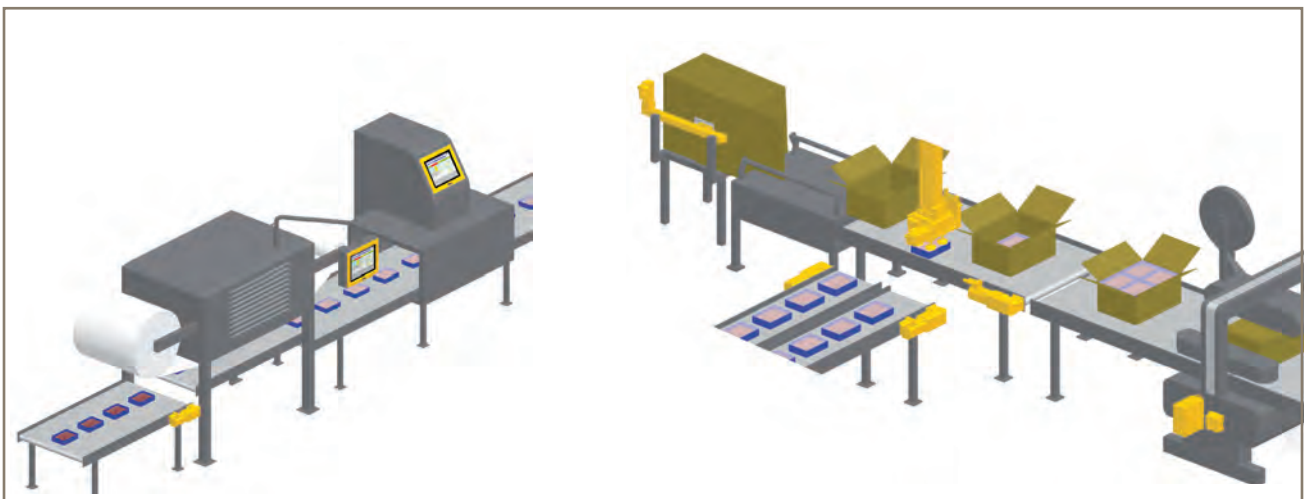

### TPDM: Triple Power Drive

TPD-M is a flexible servo drive that integrates three power stages in a single housing. The flexibility of the TPD-M servo drive is based on the power stage adapting to supply the corresponding servo motor with the necessary power within the range of 2 to 30 Amperes. The base configuration consists of a common DC bus supply (PSU) and TPD-M multiple modules connected through DC bus bars. The modular concept allows a system to be configured using 50 mm wide modules comprising either 3 axes, 2 axes or a single axis. A single common DC bus supply can support up to 15 modules.



### SMB/H-MB/H: Brushless servo motors

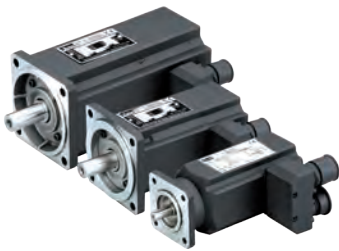

The MB/H and SMB/H Series of highly-dynamic brushless servo motors utilise "salient pole" technology to produce an extremely compact design. Motor dimensions are drastically reduced and significant gains in terms of torque and dynamic performance are achieved. The high quality Neodymium-Iron-Boron magnets and the encapsulation method used to fasten them to the shaft, allows the two Series' to achieve very high acceleration and withstand high overloads without risk of demagnetisation or detachment of the magnets. The MB/H and SMB/H Series is available in sizes from 0.2 to 285 Nm.

### Interact Xpress: HMI

Interact Xpress is Parker's HMI hardware and software solution, for the process's control in distributed applications where multiple HMIs are deployed on a single machine or across several remote stations. Interact Xpress software, features an advanced development environment for easy creation of rich graphics and multimedia applications. Interact Xpress allows you to run, view and edit on line - from any PC - applications in Internet Explorer™ browser. Available with 6, 8, 10 and 15 inch, these units are specifically designed to optimize the performance, storage and connectivity features of the software.



### PIO: I/O System



Parker's PIO modular bus terminal system offers a range of popular industrial fieldbus networks to interface to a wide variety of control signals from field-based devices. Connection to field level devices can be implemented quickly and reliably with PIO.

### PS/RS Series: Planetary Gearheads

Stealth advanced gearheads are available in either in-line or right-angled versions with 8 frame sizes and 12 gear ratios. With input speeds up to 6000 min<sup>-1</sup> and exceptionally quiet, strong and reliable operation, you can be confident that there is a Stealth advanced gearhead to fit any of your high performance servo application needs.





# Order Code

## MDC - Motornet DC

	1	2	3	4	5	6	7	8	9	10	11	12	13	14	15
Order example	<b>MDC</b>	<b>E</b>	<b>A</b>	<b>60</b>	<b>30</b>	<b>5</b>	<b>9</b>	<b>S</b>	<b>Hxx</b>	<b>F4</b>	<b>M</b>	<b>R</b>	<b>E</b>	<b>64</b>	<b>4</b>

<b>1 Motor family</b>	<b>MDC</b>	Motornet DC - integrated resolver
<b>2 Encoder*</b>	<b>Empty field</b>	Resolver
	<b>E</b>	Encoder (option)
<b>3 Brake*</b>	<b>Empty field</b>	Without holding brake
	<b>A</b>	With holding brake (option)
<b>4 Motor frame size (Refer to compatibility table)</b>	<b>60</b>	60 mm motor frame
	<b>70</b>	70 mm motor frame
	<b>100</b>	100 mm motor frame
<b>5 Nominal speed (Refer to compatibility table)</b>	<b>30</b>	3000 min <sup>-1</sup> (230/400 VAC - all frames)
	<b>52</b>	5200 min <sup>-1</sup> (400 VAC - frame 100 only)
	<b>60</b>	6000 min <sup>-1</sup> (230/400 VAC - not frame 100)
<b>6 Flange</b>	<b>5</b>	Flange 5 (available for all sizes)
	<b>8</b>	Flange 8 (contact your local sales office)
<b>7 Shaft diameter</b>	<b>9</b>	9 mm shaft (frame 60 only)
	<b>11</b>	11 mm shaft (frame 60 and 70)
	<b>14</b>	14 mm shaft (frame 70 only)
	<b>19</b>	19 mm shaft (frames 70 and 100)
	<b>24</b>	24 mm shaft (frame 100 only)
<b>8 Smooth shaft - keyway</b>	<b>Empty field</b>	With keyway
	<b>S</b>	Without keyway

<b>9 Motor shaft*</b>	<b>Empty field</b>	Standard shaft
	<b>Hxx</b>	Hollow shaft, xx = internal dia. (max 12 mm) Available only for MDC70 and MDC100 with resolver
<b>10 Feedback</b>	<b>Empty field</b>	Standard resolver
	<b>F4</b>	Encoder EQI1130 (EnDat) (with E selected in block 2)
<b>11 Increased inertia*</b>	<b>Empty field</b>	Standard inertia
	<b>M</b>	Increased inertia (option)
<b>12 Safe torque off (STO)*</b>	<b>Empty field</b>	Without safe torque off
	<b>R</b>	With safe torque off (option)
<b>13 Fieldbus</b>	<b>E</b>	EtherCAT
	<b>D*</b>	CANopen (option)
<b>14 Protection level</b>	<b>64</b>	IP64 protection
	<b>65</b>	IP65 protection (option)
	<b>67</b>	IP67 protection (option)
<b>15 AC supply voltage (PSU supply voltage)</b>	<b>2</b>	230 VAC
	<b>4</b>	400 VAC

\* Option currently under development

## Motornet DC Hybrid Cables

	1	2	3	4
Order example	<b>HYBCA</b>	<b>0030</b>	<b>PSI</b>	<b>4</b>

<b>1 Cable type</b>	<b>HYBCA</b>	Hybrid cable for Motornet DC
<b>2 Length (x10 mm)</b>	<b>0030</b>	300 mm
	<b>0100</b>	1000 mm (1 m)
	<b>1000</b>	10 m
Note: maximum cable length is 15 m		
<b>3 Connector Type</b>	<b>PSI</b>	Wired cable for PSI to MDC with PSI connector and female mating MDC connector
	<b>MDC</b>	Wired cable for MDC to MDC with male and female mating MDC connectors
<b>4 Cable Size</b>	<b>Empty field</b>	2.5 mm <sup>2</sup> cable size
	<b>4</b>	4.0 mm <sup>2</sup> cable size

### Cables options

HYBCA1	MDC hybrid cable only (no connectors) - 1 m length / 2.5 mm <sup>2</sup>
HYBCA14	MDC hybrid cable only (no connectors) - 1 m length / 4 mm <sup>2</sup>
CONMDCMV	MDC hybrid connector (male)
CONMDCFV	MDC hybrid connector (female)
TAPMDCETH	Terminal cup for MDC EtherCAT
TAPMDCETHS	Terminal cup for MDC EtherCAT with Service Bus

## Mains module: PSUP

	1	2	3	4	5	
Order example	<b>PSU</b>	<b>P</b>	<b>10</b>	<b>D6</b>	<b>USB</b>	<b>M00</b>

<b>1 Device family</b>	<b>PSU</b>	Power module
<b>2 Device typ</b>	<b>P</b>	Power module
<b>3 Nominal power; supply voltage</b>	<b>10 D6</b>	10 kW; 400 VAC (3-phase)
	<b>20 D6</b>	20 kW; 400 VAC (3-phase)
	<b>30 D6</b>	30 kW; 400 VAC (3-phase) <sup>1)</sup>
<b>4 Interface</b>	<b>USB</b>	USB connection
<b>5 Options</b>	<b>M00</b>	no additional supplement

<sup>1)</sup> Operation of the PSUP30 only with line choke.  
Required line choke for the PSUP30: 0.45 mH / 55 A  
**We offer the following line chokes:**  
LCG-0055-0.45 mH (WxDxH: 180 mmx140 mmx157 mm; 10 kg)  
LCG-0055-0.45 mH-UL (with UL certification)  
(WxDxH: 180 mmx170 mmx157 mm; 15 kg)

## Capacitor module

	1	2
Order example	<b>PSC</b>	<b>023 M00</b>

<b>1 Accessories</b>	<b>PSC</b>	Capacitor module
<b>2 Type</b>	<b>023 M00</b>	2300 µF no additional supplement
	<b>047 M00</b>	4700 µF no additional supplement
	<b>068 M00</b>	6800 µF no additional supplement

## Mains filter for PSUP

	1	2
Order example	<b>NFI</b>	<b>03/01</b>

<b>1 Accessories</b>	<b>NFI</b>	Mains filter
<b>2 Type</b>	<b>03/01</b>	for PSUP10 Reference axis combination 3 x 480 V 25 A 6 x 10 m motor cable length
	<b>03/02</b>	for PSUP10 Reference axis combination 3 x 480 V 25 A 6 x 50 m motor cable length
	<b>03/03</b>	for PSUP20, PSUP30 Reference axis combination 3 x 480 V 50 A 6 x 50 m motor cable length

## Braking resistors

	1	2
Order example	<b>BRM</b>	<b>05/01</b>

<b>1 Accessories</b>	<b>BRM</b>	Braking resistor
<b>2 Type</b>	<b>13/01</b>	30 Ω / 0.5 kW <sub>cont.</sub> for PSUP10D6, for PSUP20D6 (2x30Ω parallel)
	<b>14/01</b>	15 Ω / 0.5 kW <sub>cont.</sub> for PSUP10D6 (2 x 15 Ω in series) for PSUP20, PSUP30
	<b>12/01</b>	18 Ω / 4.5 kW <sub>cont.</sub> for PSUP30

## PSI - Power Supply Interface for Motornet DC

	1	2	3
Order example	<b>PSI</b>	<b>10</b>	<b>P</b>

<b>1 Device type</b>	<b>PSI</b>	Power supply interface for Motornet DC
<b>2</b>	<b>5</b>	5 kW rating
	<b>10</b>	10 kW rating
	<b>20</b>	20 kW rating

# Parker's Motion & Control Technologies

At Parker, we're guided by a relentless drive to help our customers become more productive and achieve higher levels of profitability by engineering the best systems for their requirements. It means looking at customer applications from many angles to find new ways to create value. Whatever the motion and control technology need, Parker has the experience, breadth of product and global reach to consistently deliver. No company knows more about motion and control technology than Parker. For further info call 00800 27 27 5374.



## AEROSPACE

### Key Markets

- Aircraft engines
- Business & general aviation
- Commercial transports
- Land-based weapons systems
- Military aircraft
- Missiles & launch vehicles
- Regional transports
- Unmanned aerial vehicles

### Key Products

- Flight control systems & components
- Fluid conveyance systems
- Fluid metering delivery & atomization devices
- Fuel systems & components
- Hydraulic systems & components
- Inert nitrogen generating systems
- Pneumatic systems & components
- Wheels & brakes



## CLIMATE CONTROL

### Key Markets

- Agriculture
- Air conditioning
- Food, beverage & dairy
- Life sciences & medical
- Precision cooling
- Processing
- Transportation

### Key Products

- CO<sup>2</sup> controls
- Electronic controllers
- Filter driers
- Hand shut-off valves
- Hose & fittings
- Pressure regulating valves
- Refrigerant distributors
- Safety relief valves
- Solenoid valves
- Thermostatic expansion valves



## ELECTROMECHANICAL

### Key Markets

- Aerospace
- Factory automation
- Food & beverage
- Life science & medical
- Machine tools
- Packaging machinery
- Paper machinery
- Plastics machinery & converting
- Primary metals
- Semiconductor & electronics
- Textile
- Wire & cable

### Key Products

- AC/DC drives & systems
- Electric actuators
- Controllers
- Gantry robots
- Gearheads
- Human machine interfaces
- Industrial PCs
- Inverters
- Linear motors, slides and stages
- Precision stages
- Stepper motors
- Servo motors, drives & controls
- Structural extrusions



## FILTRATION

### Key Markets

- Food & beverage
- Industrial machinery
- Life sciences
- Marine
- Mobile equipment
- Oil & gas
- Power generation
- Process
- Transportation

### Key Products

- Analytical gas generators
- Compressed air & gas filters
- Condition monitoring
- Engine air, fuel & oil filtration & systems
- Hydraulic, lubrication & coolant filters
- Process, chemical, water & microfiltration filters
- Nitrogen, hydrogen & zero air generators



## FLUID & GAS HANDLING

### Key Markets

- Aerospace
- Agriculture
- Bulk chemical handling
- Construction machinery
- Food & beverage
- Fuel & gas delivery
- Industrial machinery
- Mobile
- Oil & gas
- Transportation
- Welding

### Key Products

- Brass fittings & valves
- Diagnostic equipment
- Fluid conveyance systems
- Industrial hose
- PTFE & PFA hose, tubing & plastic fittings
- Rubber & thermoplastic hose & couplings
- Tube fittings & adapters
- Quick disconnects



## HYDRAULICS

### Key Markets

- Aerospace
- Aerial lift
- Agriculture
- Construction machinery
- Forestry
- Industrial machinery
- Mining
- Oil & gas
- Power generation & energy
- Truck hydraulics

### Key Products

- Diagnostic equipment
- Hydraulic cylinders & accumulators
- Hydraulic motors & pumps
- Hydraulic systems
- Hydraulic valves & controls
- Power take-offs
- Rubber & thermoplastic hose & couplings
- Tube fittings & adapters
- Quick disconnects



## PNEUMATICS

### Key Markets

- Aerospace
- Conveyor & material handling
- Factory automation
- Food & beverage
- Life science & medical
- Machine tools
- Packaging machinery
- Transportation & automotive

### Key Products

- Air preparation
- Compact cylinders
- Field bus valve systems
- Grippers
- Guided cylinders
- Manifolds
- Miniature fluidics
- Pneumatic accessories
- Pneumatic actuators & grippers
- Pneumatic valves and controls
- Rodless cylinders
- Rotary actuators
- Tie rod cylinders
- Vacuum generators, cups & sensors



## PROCESS CONTROL

### Key Markets

- Chemical & refining
- Food, beverage & dairy
- Medical & dental
- Microelectronics
- Oil & gas
- Power generation

### Key Products

- Analytical sample conditioning products & systems
- Fluoropolymer chemical delivery fittings, valves & pumps
- High purity gas delivery fittings, valves & regulators
- Instrumentation fittings, valves & regulators
- Medium pressure fittings & valves
- Process control manifolds



## SEALING & SHIELDING

### Key Markets

- Aerospace
- Chemical processing
- Consumer
- Energy, oil & gas
- Fluid power
- General industrial
- Information technology
- Life sciences
- Military
- Semiconductor
- Telecommunications
- Transportation

### Key Products

- Dynamic seals
- Elastomeric o-rings
- EMI shielding
- Extruded & precision-cut, fabricated elastomeric seals
- Homogeneous & inserted elastomeric shapes
- High temperature metal seals
- Metal & plastic retained composite seals
- Thermal management

# Parker Worldwide

## Europe, Middle East, Africa

**AE – United Arab Emirates, Dubai**  
Tel: +971 4 8127100  
parker.me@parker.com

**AT – Austria, Wiener Neustadt**  
Tel: +43 (0)2622 23501-0  
parker.austria@parker.com

**AT – Eastern Europe, Wiener Neustadt**  
Tel: +43 (0)2622 23501 900  
parker.easteurope@parker.com

**AZ – Azerbaijan, Baku**  
Tel: +994 50 2233 458  
parker.azerbaijan@parker.com

**BE/LU – Belgium, Nivelles**  
Tel: +32 (0)67 280 900  
parker.belgium@parker.com

**BY – Belarus, Minsk**  
Tel: +375 17 209 9399  
parker.belarus@parker.com

**CH – Switzerland, Etoy**  
Tel: +41 (0)21 821 87 00  
parker.switzerland@parker.com

**CZ – Czech Republic, Klecany**  
Tel: +420 284 083 111  
parker.czechrepublic@parker.com

**DE – Germany, Kaarst**  
Tel: +49 (0)2131 4016 0  
parker.germany@parker.com

**DK – Denmark, Ballerup**  
Tel: +45 43 56 04 00  
parker.denmark@parker.com

**ES – Spain, Madrid**  
Tel: +34 902 330 001  
parker.spain@parker.com

**FI – Finland, Vantaa**  
Tel: +358 (0)20 753 2500  
parker.finland@parker.com

**FR – France, Contamine s/Arve**  
Tel: +33 (0)4 50 25 80 25  
parker.france@parker.com

**GR – Greece, Athens**  
Tel: +30 210 933 6450  
parker.greece@parker.com

**HU – Hungary, Budaörs**  
Tel: +36 23 885 470  
parker.hungary@parker.com

**IE – Ireland, Dublin**  
Tel: +353 (0)1 466 6370  
parker.ireland@parker.com

**IT – Italy, Corsico (MI)**  
Tel: +39 02 45 19 21  
parker.italy@parker.com

**KZ – Kazakhstan, Almaty**  
Tel: +7 7273 561 000  
parker.easteurope@parker.com

**NL – The Netherlands, Oldenzaal**  
Tel: +31 (0)541 585 000  
parker.nl@parker.com

**NO – Norway, Asker**  
Tel: +47 66 75 34 00  
parker.norway@parker.com

**PL – Poland, Warsaw**  
Tel: +48 (0)22 573 24 00  
parker.poland@parker.com

**PT – Portugal, Leca da Palmeira**  
Tel: +351 22 999 7360  
parker.portugal@parker.com

**RO – Romania, Bucharest**  
Tel: +40 21 252 1382  
parker.romania@parker.com

**RU – Russia, Moscow**  
Tel: +7 495 645-2156  
parker.russia@parker.com

**SE – Sweden, Spånga**  
Tel: +46 (0)8 59 79 50 00  
parker.sweden@parker.com

**SK – Slovakia, Banská Bystrica**  
Tel: +421 484 162 252  
parker.slovakia@parker.com

**SL – Slovenia, Novo Mesto**  
Tel: +386 7 337 6650  
parker.slovenia@parker.com

**TR – Turkey, Istanbul**  
Tel: +90 216 4997081  
parker.turkey@parker.com

**UA – Ukraine, Kiev**  
Tel: +380 44 494 2731  
parker.ukraine@parker.com

**UK – United Kingdom, Warwick**  
Tel: +44 (0)1926 317 878  
parker.uk@parker.com

**ZA – South Africa, Kempton Park**  
Tel: +27 (0)11 961 0700  
parker.southafrica@parker.com

## North America

**CA – Canada, Milton, Ontario**  
Tel: +1 905 693 3000

**US – USA, Cleveland**  
Tel: +1 216 896 3000

## Asia Pacific

**AU – Australia, Castle Hill**  
Tel: +61 (0)2-9634 7777

**CN – China, Shanghai**  
Tel: +86 21 2899 5000

**HK – Hong Kong**  
Tel: +852 2428 8008

**IN – India, Mumbai**  
Tel: +91 22 6513 7081-85

**JP – Japan, Tokyo**  
Tel: +81 (0)3 6408 3901

**KR – South Korea, Seoul**  
Tel: +82 2 559 0400

**MY – Malaysia, Shah Alam**  
Tel: +60 3 7849 0800

**NZ – New Zealand, Mt Wellington**  
Tel: +64 9 574 1744

**SG – Singapore**  
Tel: +65 6887 6300

**TH – Thailand, Bangkok**  
Tel: +662 186 7000-99

**TW – Taiwan, Taipei**  
Tel: +886 2 2298 8987

## South America

**AR – Argentina, Buenos Aires**  
Tel: +54 3327 44 4129

**BR – Brazil, Sao Jose dos Campos**  
Tel: +55 800 727 5374

**CL – Chile, Santiago**  
Tel: +56 2 623 1216

**MX – Mexico, Apodaca**  
Tel: +52 81 8156 6000



### EMEA Product Information Centre

Free phone: 00 800 27 27 5374

(from AT, BE, CH, CZ, DE, DK, EE, ES, FI, FR, IE, IL, IS, IT, LU, MT, NL, NO, PL, PT, RU, SE, SK, UK, ZA)

### US Product Information Centre

Toll-free number: 1-800-27 27 537

www.parker.com