

SLVD-N

Compact Servo Drive



ENGINEERING YOUR SUCCESS.



WARNING – USER RESPONSIBILITY

FAILURE OR IMPROPER SELECTION OR IMPROPER USE OF THE PRODUCTS DESCRIBED HEREIN OR RELATED ITEMS CAN CAUSE DEATH, PERSONAL INJURY AND PROPERTY DAMAGE.

- This document and other information from Parker-Hannifin Corporation, its subsidiaries and authorized distributors provide product or system options for further investigation by users having technical expertise.
- The user, through its own analysis and testing, is solely responsible for making the final selection of the system and components and assuring that all performance, endurance, maintenance, safety and warning requirements of the application are met. The user must analyze all aspects of the application, follow applicable industry standards, and follow the information concerning the product in the current product catalog and in any other materials provided from Parker or its subsidiaries or authorized distributors.
- To the extent that Parker or its subsidiaries or authorized distributors provide component or system options based upon data or specifications provided by the user, the user is responsible for determining that such data and specifications are suitable and sufficient for all applications and reasonably foreseeable uses of the components or systems.

Overview	5
Technical Characteristics	7
Technical Data	7
SLVD-N Features.....	7
Electrical Characteristics.....	8
Environmental Characteristics	8
Standards and Conformance.....	8
Dimensions	9
Connector Layout.....	9
Accessories and Options	10
Keypad.....	10
I/O Expansion Module.....	10
Cables.....	10
Network Bridge	10
Safety Option	10
EtherCAT Fieldbus	10
Software.....	11
Order Code	12
Compact Servo Drive - SLVD-N	12
Accessories.....	12

Compact Servo Drive - SLVD-N

Overview

Description

SLVD-N is the family of compact digital servo drives for brushless motors which, in addition to positioning applications with trapezoidal profile, electrical shaft, electronic cam, spindle orientation, simulator of stepper motor and torque control, holds a PLC inside able to talk to the most common industrial programming systems, giving a great freedom of use of the inputs and outputs. It also allows the development of additional configurations to the basis features of the drive, such as gains adjustment of the loop in relation to speed or space, torque monitoring used for tools etc.

The SLVD-N range is equipped with a serial interface RS422/RS485 allowing the operator to configure, monitoring, give commands to up to 32 units simultaneously. A CANbus interface is available both in communication mode and in real time mode with SBCCAN, CANopen, DS402 protocols.

Typical applications:

- Packaging machines
- Pick & place systems
- General purpose machines

Features

- Torque/current/speed control
- Advanced manager of torque limits
- Management of speed windows
- Positioner
- Electric shaft
- Electronic cam
- Controls the motor torque with the addition of speed control
- Virtual master
- Internal PLC - programming according to IEC61131 (option)
- Configurable feedback
- Standard interface: RS422/485, CANopen
- Optional interface: EtherCAT / PROFINET
- Internal braking resistor
- Internal EMC filter for three phase power supply
- Safety: STO function optional (certification expired, recertification pending)



Technical Characteristics - Overview

Power supply	200...230 VAC single/three phase ($\pm 10\%$) 50-60 Hz ($\pm 5\%$) - only TT/TN networks
Control supply	24 VDC (-0/+10 %)
Overload	200 % for 2 s
Operating temperature	0...45 °C
Operating humidity	<85 % non condensing
Altitude	1000 m asl with 1.5 % derating every 100 m, up to 2000 m
Protections	IP20
International standards	CE, cUL

Model	Continuous current [A]	Peak current [A]	Size
SLVD1N	1.25	2.5	1
SLVD2N	2.5	5	
SLVD5N	5	10	
SLVD7N	7	14	
SLVD10N	10	20	2
SLVD15N	15	30	
SLVD17N	17	34	

Industry: Robotics

Application: Painting robot

6/7 axes painting robot controlled by the SLVD-N servo drive. Full control of the machine is done with a dedicated motion controller and the remote I/O is managed over CANopen.

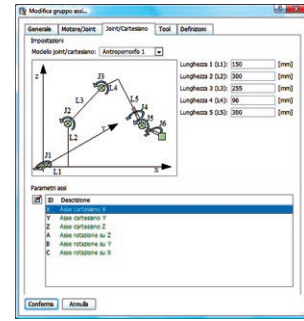

Industry: Glass Industry

Application: Machining Centre

A 4 axis machine (x, y, z, mandrel) executing the following operations: drilling, threading and linear milling on materials of different types. The system comprises of 4 SLVD-N and 4 SMB motors. The control of the machine is via a dedicated motion controller. The remote I/O is controlled with CANopen protocol.

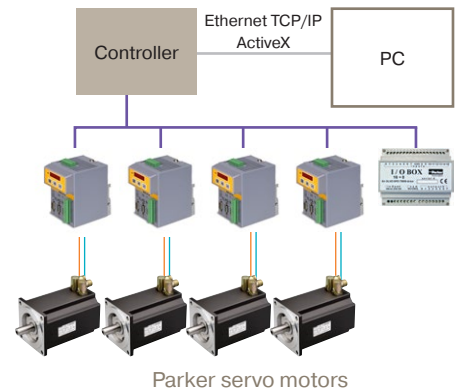

Industry: Beverage Industry

Application: Multi-head bottle capper

A multi-head machine able to cap bottles of different format. Each head, in order to reduce setup time, installs 2 SLVD-Ns, one dedicated to the vertical movement of the head depending on the carousel position and the other dedicated to the capping with preset torque. The machine is made of up to 16 heads with 2 SLVD-Ns each. The control of the machine based to a motion controller. The remoted I/O is controlled with CANopen protocol.



Multi-head bottle capper

A multi-head machine to cap bottles of different formats. Each head has 1 SLVD-N dedicated to cap fastening with torque control. The machine is made of up to 32 heads with 1 SLVD-N per head. The control of the machine based on a motion controller. The remote I/O is controlled with CANopen protocol.

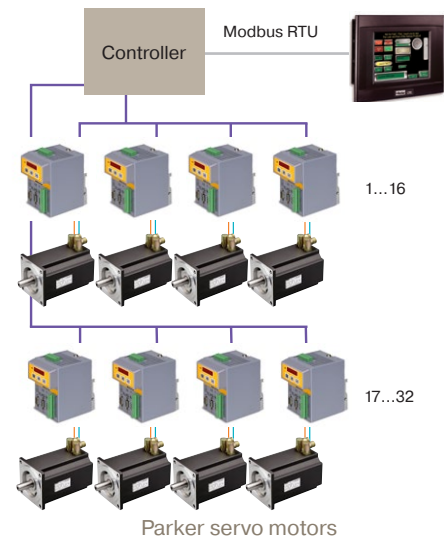

Technical Characteristics

Technical Data

Model		SLVD1N	SLVD2N	SLVD5N	SLVD7N	SLVD10N	SLVD15N	SLVD17N	
	Unit								
Input and output characteristic									
Rated input current (FLA)	[A _{eff}]	1.5	2.99	5.99	8.38	11.97	17.96	20.36	
Rated output current	[A _{eff}]	1.25	2.5	5	7	10	15	17	
Peak output current (2 s)	[A]	2.5	5	10	14	20	30	34 (30@8 kHz)	
Shaft power	[kW]	0.345	0.7	1.5	2.2	3.0	4.5	5	
Continuous service installed load (power derating)	1ph [kVA]	0.85	1.5	1.5	1.8	3.0	3.3	3.3	
	3ph	0.95	1.6	2.3	3	5.25	6.5	6.5	
Continuous service input current (power derating)	1ph [A _{eff}]	3.8	6.5	6.5	7.8	14.3	14.3	14.3	
	3ph	2.4	4.2	5.9	7.6	13.3	17.2	17.2	
Power stage dissipation	[W]	9.3	19.2	52.0	75.1	100.3	158.3	180	
Switching frequency	[kHz]	4...8							4...8
Output frequency	[Hz]	0...450							
Dynamic braking and intermediate DC circuit									
Internal DC capacitors (±20 %)	[µF]	680			820	1800			
Braking resistor internal	[Ω]	40				16			
Peak internal braking power to 415 VDC	[kW]	4.3				10.7			
Max continuous external braking power	[kW]	1				2			
Max duty cycle (internal resistance)	[%]	1.20				1.10			

SLVD-N Features

Feedback	<ul style="list-style-type: none"> • Resolver (SLVD-N) • Encoder (SLVD-NE) • Encoder+Hall (SLVD-NH)
Auxiliary encoder input	in quadrature
Max frequency encoder input	400 kHz
RS422 encoder simulation output	4...65 000 steps/rev
Max frequency	160 kHz
Serial link	RS422 / RS485
Fieldbus	CAN ISO/DIS11898
Inputs / outputs	<ul style="list-style-type: none"> • 4 digital inputs 0...24 V • 2 digital outputs • 1 differential analog reference ±10 V • 1 differential auxiliary analog input ±10 V • 1 analogue output single ended ±4 V
Safety technology	STO function optional - (certification expired, recertification pending)

Electrical Characteristics

Power supply

Model		SLVD-N
	Unit	Control stage
Supply voltage	[VDC]	24 V (-0...+10 %)
Max. ripple	[V _{pkpk}]	Do not go over the range
Current rating of the external power supply	[A]	1
Control electronics dissipation	[W]	15
EMC filter	-	internal
		Power stage
Mains frequency	[Hz]	50...60 ±5 %
Supply voltage (3-phase or 1-phase)	[VAC]	200...230 ±10 % (only for TT, TN mains)
DC voltage range	[VDC]	282...325 ±10 %
EMC filter	-	internal

Environmental Characteristics

Ambient conditions

Temperature range	<ul style="list-style-type: none"> Operating temperature: 3K3 class, 0...+45 °C (+32...+113 °F) Storage temperature: 1K4 class, -25 ...+55 °C (-4...+131 °F) Transportation temperature: 2K3 class, -25 ... +70 °C (-13...+158 °F)
Humidity	<ul style="list-style-type: none"> Operating humidity: 3K3 class, 5...85 % without ice and condensation Storage humidity: 1K3 class, 5...95 % without ice and condensation Transportation humidity: 2K3 class, 95 % a 40 °C
Altitude (*)	≤1000 m asl (≤3281 feet asl)
Protection degree	IP20 (only in close electric cabinet), UL open type equipment
Pollution degree	2 or lower (no conductive dust allowed)

* For higher installation altitude, derate the output current by 1.5 % each 100 m up to 2000 m maximum

Shock and vibration

IEC60068-2-6	Frequency [Hz]	Width [mm]	Acceleration [m/s ²]
	10 ≤ f ≤ 57	0.075	-
	57 < f ≤ 150	-	9.81

Standards and Conformance

Safety standards	<ul style="list-style-type: none"> 2006/95/EC: Low voltage directive EN 61800-5-1: Adjustable speed electrical power drive systems - part 5-1: safety requirements, electrical, thermal and energy
Certification	<ul style="list-style-type: none"> UL: UL508C (USA) Power Conversion Equipment CSA: CSA22.2 Nr. 14-5 (Canada) Power Conversion Equipment
Electromagnetic compatibility	<ul style="list-style-type: none"> 2004/108/EC: EMC directive EN 61800-3: Adjustable speed electrical power drive systems - part 3: EMC requirement and specific test methods

Dimensions

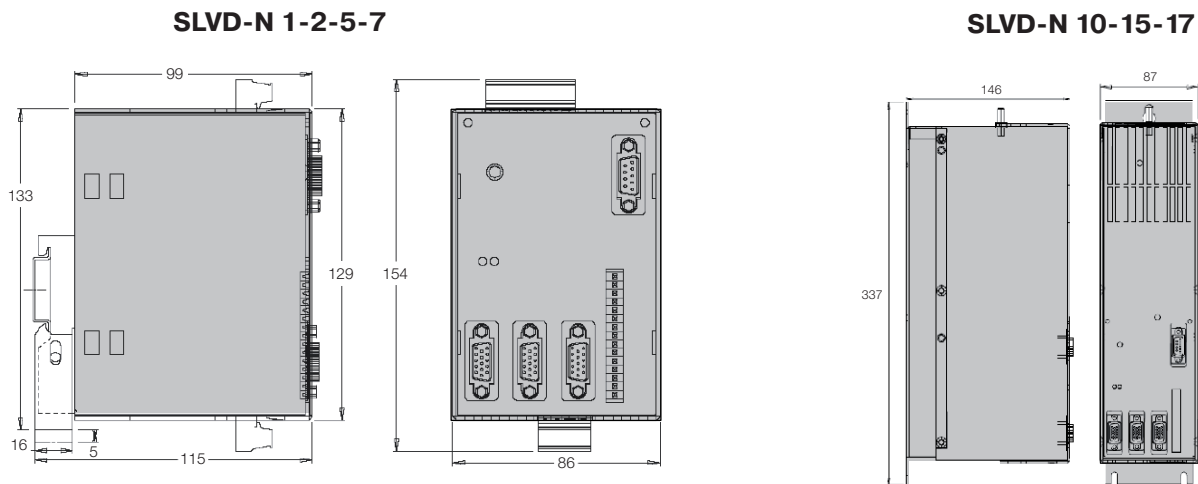

Model	Height [mm]	Width [mm]	Depth [mm]	Weight [kg]
SLVD-N 1-2-5-7	154	86	115	1.1
SLVD-N 10-15-17	337	87	146	3.1

Connector Layout

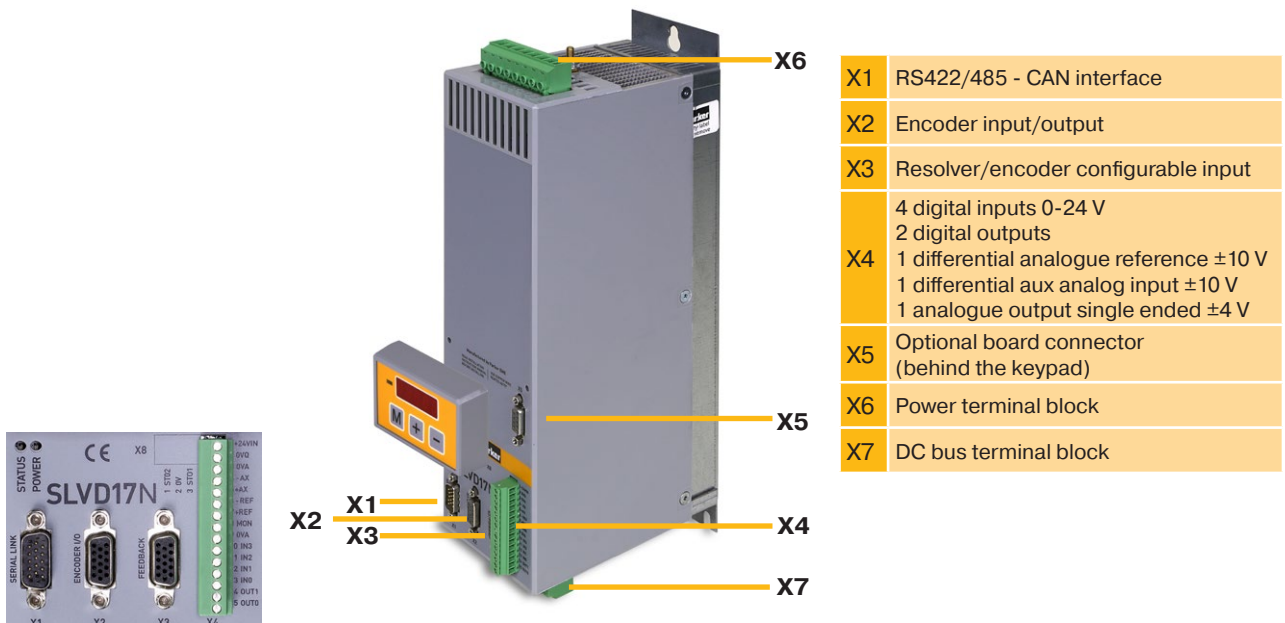

Accessories and Options

Keypad

SK158/L ¹⁾

Easy to use to program the functional data, control the status of the converter and send commands.



Cables

- Power and signal cables for resolver, incremental and absolute encoder and SinCos feedback
- Cable to connect a Bridge with several SLVD-N drives



Safety Option

Option "Safe Torque off" (STO) for all SLVD-N drives available (certification expired, recertification pending)

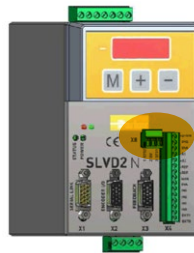

Fieldbus

Applying industrial standard fieldbus systems enables the SLVD-N to be very versatile.

Option EtherCAT (E5, E6):

Feature: 1 EtherCAT option for up to 3 SLVD-N (requirement SLVD-N with EtherCAT protocol)

Option PROFINET (P1, P2)



Fieldbus box (option E5,E8)

¹⁾ Not in combination with option E5,E8

Software

MotionWiz and LogicLab

The free MotionWiz configuration software is available to configure the SLVD-N system with just a few clicks of the mouse. MotionWiz features an easy and "friendly" interface to speed up installation, optimisation and diagnostics procedures. To simplify configuration, MotionWiz shows a typical Windows® environment on the monitor with dialogue windows and toolbars.

MotionWiz permits performing operations in both "on line" mode, directly in the mechanism, and in "off line" mode in remote on the PC. In this case, personalised configuration can be sent to the mechanism subsequently.

To simplify the configuration of systems with a large number of axis but with different cuts and the same operating mode, MotionWiz permits maintaining the same mechanism configuration and only changing the type of selected motor. Inside the MotionWiz configurator is a database containing the data of standard Parker motors.

MotionWiz incorporates "picoPLC", a built-in PLC environment programmable with standard language. PicoPLC allows the external word to communicate with the drive and to execute function sequences. Should the custom application require additional computational resources, an option software environment can be used, programmable with PLC commands according to IEC61131-3.

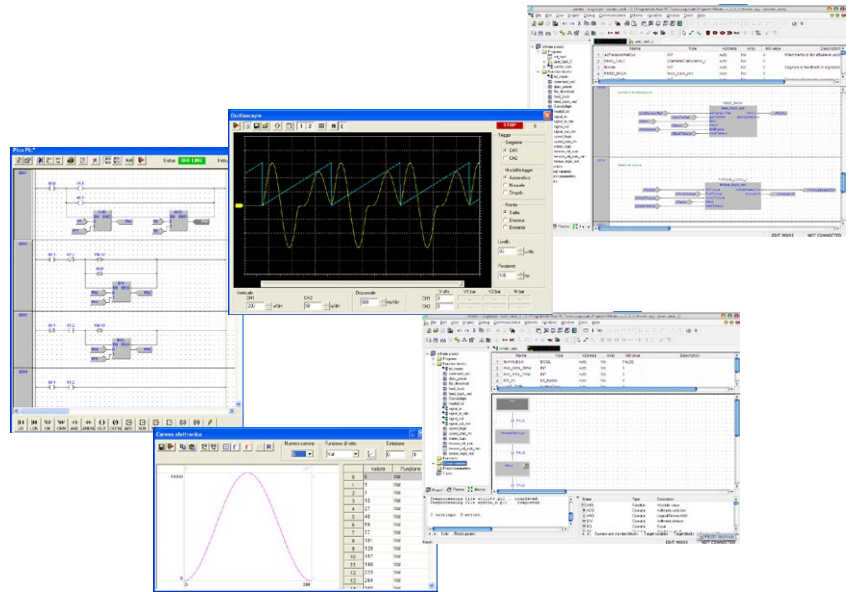

Order Code

Compact Servo Drive - SLVD-N

	1	2	3	4	5	6	7	8
Order example	SLVD	1	N	S	E			UL

1 Servo family	SLVD	Compact Digital Servodrive
2 Drive size (nominal current)	1	1 A
	2	2 A
	5	5 A
	7	7 A
	10	10 A
	15	15 A
	17	17 A
3 Version	N	New version
4 Protocol	S	SBCCAN protocol (standard)
	C	CANopen protocol (DS301)
	D	CANopen protocol (DS402)
	E5	EtherCAT protocol (only with optional board E5 or E6 in the bus system)
	P1	PROFINET (only with optional board P1 or P2)
5 Encoder input	Empty field	Resolver
	E	EnDat/incremental/SinCos encoder input (from motor feedback)
	H	Incremental encoder input with Hall sensor (from motor feedback)
	F	SinCos encoder input
6 Optional boards	Empty field	without optional board
	E5	OP-ETCAT - EtherCAT option (for up to 3 SLVD-N, keypad SK158/L not possible)
	E6	E5 + DB9 for keypad SK158/L (for up to 3 SLVD-N)
	P1	PROFINET
	P2	P1 + DB9 for keypad SK158/L
7 Safety	Empty field	without STO
	R	STO - Safe Torque Off (certification expired, recertification pending)
8 Firmware review	Empty field	without UL certification
	UL	UL certification (not for all drive sizes available, please contact your Parker partner)



Parker's Motion & Control Technologies

At Parker, we're guided by a relentless drive to help our customers become more productive and achieve higher levels of profitability by engineering the best systems for their requirements. It means looking at customer applications from many angles to find new ways to create value. Whatever the motion and control technology need, Parker has the experience, breadth of product and global reach to consistently deliver. No company knows more about motion and control technology than Parker. For further info call 00800 27 27 5374



Aerospace

Key Markets

Aftermarket services
Commercial transports
Engines
General & business aviation
Helicopters
Launch vehicles
Military aircraft
Missiles
Power generation
Regional transports
Unmanned aerial vehicles

Key Products

Control systems & actuation products
Engine systems & components
Fluid conveyance systems & components
Fluid metering, delivery & atomization devices
Fuel systems & components
Fuel tank inerting systems
Hydraulic systems & components
Thermal management
Wheels & brakes



Climate Control

Key Markets

Agriculture
Air conditioning
Construction Machinery
Food & beverage
Industrial machinery
Life sciences
Oil & gas
Precision cooling
Process
Refrigeration
Transportation

Key Products

Accumulators
Advanced actuators
CO₂ controls
Electronic controllers
Filter driers
Hand shut-off valves
Heat exchangers
Hose & fittings
Pressure regulating valves
Refrigerant distributors
Safety relief valves
Smart pumps
Solenoid valves
Thermostatic expansion valves



Electromechanical

Key Markets

Aerospace
Factory automation
Life science & medical
Machine tools
Packaging machinery
Paper machinery
Plastics machinery & converting
Primary metals
Semiconductor & electronics
Textile
Wire & cable

Key Products

AC/DC drives & systems
Electric actuators, gantry robots & slides
Electrohydraulic actuation systems
Electromechanical actuation systems
Human machine interface
Linear motors
Stepper motors, servo motors, drives & controls
Structural extrusions



Filtration

Key Markets

Aerospace
Food & beverage
Industrial plant & equipment
Life sciences
Marine
Mobile equipment
Oil & gas
Power generation & renewable energy
Process
Transportation
Water Purification

Key Products

Analytical gas generators
Compressed air filters & dryers
Engine air, coolant, fuel & oil filtration systems
Fluid condition monitoring systems
Hydraulic & lubrication filters
Hydrogen, nitrogen & zero air generators
Instrumentation filters
Membrane & fiber filters
Microfiltration
Sterile air filtration
Water desalination & purification filters & systems



Fluid & Gas Handling

Key Markets

Aerial lift
Agriculture
Bulk chemical handling
Construction machinery
Food & beverage
Fuel & gas delivery
Industrial machinery
Life sciences
Marine
Mining
Mobile
Oil & gas
Renewable energy
Transportation

Key Products

Check valves
Connectors for low pressure fluid conveyance
Deep sea umbilicals
Diagnostic equipment
Hose couplings
Industrial hose
Mooring systems & power cables
PTFE hose & tubing
Quick couplings
Rubber & thermoplastic hose
Tube fittings & adapters
Tubing & plastic fittings



Hydraulics

Key Markets

Aerial lift
Agriculture
Alternative energy
Construction machinery
Forestry
Industrial machinery
Machine tools
Marine
Material handling
Mining
Oil & gas
Power generation
Refuse vehicles
Renewable energy
Truck hydraulics
Turf equipment

Key Products

Accumulators
Cartridge valves
Electrohydraulic actuators
Human machine interfaces
Hybrid drives
Hydraulic cylinders
Hydraulic motors & pumps
Hydraulic systems
Hydraulic valves & controls
Hydrostatic steering
Integrated hydraulic circuits
Power take-offs
Power units
Rotary actuators
Sensors



Pneumatics

Key Markets

Aerospace
Conveyor & material handling
Factory automation
Life science & medical
Machine tools
Packaging machinery
Transportation & automotive

Key Products

Air preparation
Brass fittings & valves
Manifolds
Pneumatic accessories
Pneumatic actuators & grippers
Pneumatic valves & controls
Quick disconnects
Rotary actuators
Rubber & thermoplastic hose & couplings
Structural extrusions
Thermoplastic tubing & fittings
Vacuum generators, cups & sensors



Process Control

Key Markets

Alternative fuels
Biopharmaceuticals
Chemical & refining
Food & beverage
Marine & shipbuilding
Medical & dental
Microelectronics
Nuclear Power
Offshore oil exploration
Oil & gas
Pharmaceuticals
Power generation
Pulp & paper
Steel
Water/wastewater

Key Products

Analytical Instruments
Analytical sample conditioning products & systems
Chemical injection fittings & valves
Fluoropolymer chemical delivery fittings, valves & pumps
High purity gas delivery fittings, valves, regulators & digital flow controllers
Industrial mass flow meters/controllers
Permanent no-weld tube fittings
Precision industrial regulators & flow controllers
Process control double block & bleeds
Process control fittings, valves, regulators & manifold valves



Sealing & Shielding

Key Markets

Aerospace
Chemical processing
Consumer
Fluid power
General industrial
Information technology
Life sciences
Microelectronics
Military
Oil & gas
Power generation
Renewable energy
Telecommunications
Transportation

Key Products

Dynamic seals
Elastomeric o-rings
Electro-medical instrument design & assembly
EMI shielding
Extruded & precision-cut, fabricated elastomeric seals
High temperature metal seals
Homogeneous & inserted elastomeric shapes
Medical device fabrication & assembly
Metal & plastic retained composite seals
Shielded optical windows
Silicone tubing & extrusions
Thermal management
Vibration dampening

www.parker.com



European Headquarters
La Tuilière 6, 1163 Etoy,
Switzerland
Tel: +41 21 821 85 00

Your authorized Distributor