

Variable speed drives Altivar 31C

For 3-phase asynchronous motors from 0.18 to 15 kW

Catalogue

January **2010**



Variable speed drives Altivar 31C

- **Selection guide** page 2
- **Presentation** page 4
- **Altivar 31C variable speed drives**
 - **Characteristics** page 8
 - **References** page 14
- **Options**
 - **Additional EMC input filters** page 20
 - **Output filters, motor chokes and ferrite suppressors** page 22
 - **Communication buses and networks** page 24
- **SoMove setup software** page 28
- **Dimensions** page 30
- **Schemes** page 34
- **Installation recommendations** page 36
- **Motors starters** page 37
- **Functions** page 38

IP 54 or IP 55 variable speed drives for asynchronous and synchronous motors

Type of machine	Simple machines	Pumps and fans (building (HVAC)) (1)
Power range for 50...60 Hz (kW) line supply	0.18...15	0.75...75
Single-phase 200...240 V (kW)	0.18...2.2	–
Three-phase 380...480 V (kW)	–	0.75...75
Three-phase 380...500 V (kW)	0.37...15	–
Degree of protection	IP 55	IP 54
Variants	Enclosure customizable up to 4 kW: Vario switch disconnecter, LEDs, selector switch, potentiometer	Enclosure customizable up to 5.5 kW: Vario switch disconnecter
Drive	0.5...500 Hz	0.5...200 Hz
Output frequency	0.5...500 Hz	0.5...200 Hz
Type of control	Sensorless flux vector control Voltage/frequency ratio	Sensorless flux vector control Voltage/frequency ratio (2 points) Energy saving ratio
	–	–
Transient overtorque	170...200% of the nominal motor torque	120% of the nominal motor torque for 60 seconds
Functions		
Number of functions	50	50
Number of preset speeds	16	7
Number of I/O		
Analog inputs	3	2
Logic inputs	6	3
Analog outputs	1	1
Logic outputs	–	–
Relay outputs	2	2
Communication	Modbus and CANopen	Modbus
Integrated	Modbus TCP, Fipio, PROFIBUS DP, DeviceNet	LONWORKS, METASYS N2, APOGEE FLN, BACnet
Available as an option		
Cards (available as an option)	–	–
Dialogue tools	IP 65 remote display terminal	IP 50 remote display terminal
Configuration tools	SoMove setup software Simple Loader configuration tool	PCSoft setup software for Altivar 21 drive
Standards and certifications	IEC 61800-5-1, IEC 61800-3 (environments 1 and 2, categories C1 to C3) CE, UL, CSA, C-Tick, GOST	CE, UL, CSA, C-Tick, NOM
References	ATV 31C	ATV 21W
Pages	14	Please refer to the "Altivar 21 variable speed drives" catalogue

(1) Heating, Ventilation and Air Conditioning

**Pumps and fans
(industrial)**

Complex machines



0.75...90

0.75...75

0.75...90

0.75...75

UL Type 12/IP 54

Equipped with a Vario switch disconnecter

Equipped with a Vario switch disconnecter

0.5...1000 Hz from 0.75 to 45 kW
0.5...500 Hz from 55...90 kW

Sensorless flux vector control
Voltage/frequency ratio (2 or 5 points)
Energy saving ratio

Vector control without speed feedback

120...130% of the nominal motor torque for 60 seconds

0...1600 Hz from 0.75 to 37 kW
0...500 Hz from 45 to 75 kW

Sensorless flux vector control
Voltage/frequency ratio (2 or 5 points)
ENA System

Vector control with or without speed feedback

220% of the nominal motor torque for 2 seconds
170% for 60 seconds

>100

8

2...4

6...20

1...3

0...8

2...4

>150

16

2...4

6...20

1...3

0...8

2...4

Modbus and CANopen

Modbus TCP, Fipio, Modbus/Uni-Telway, Modbus Plus, EtherNet/IP, DeviceNet, PROFIBUS DP, PROFIBUS DP V1, INTERBUS S, CC-Link, LonWORKS, METASYS N2, APOGEE FLN, BACnet

Modbus TCP, Fipio, Modbus/Uni-Telway, Modbus Plus, EtherNet/IP, DeviceNet, PROFIBUS DP, PROFIBUS DP V1, INTERBUS S, CC-Link

I/O extension cards, Controller Inside programmable card, multi-pump cards

Interface cards for incremental, resolver, SinCos, SinCos Hiperface®, EnDat® or SSI encoders, I/O extension cards, Controller Inside programmable card, overhead crane card

IP 54 or IP 65 remote graphic display terminal

SoMove setup software

Simple Loader configuration tool

IEC 61800-5-1, IEC 61800-3 (environments 1 and 2, categories C1 to C3), IEC 61000-4-2/4-3/4-4/4-5/4-6/4-11

CE, UL, CSA, DNV, C-Tick, NOM, GOST

ATV 61W

ATV 61 E5

ATV 71W

ATV 71E5

Please refer to the "Altivar 61 variable speed drives" catalogue

Please refer to the "Altivar 71 variable speed drives" catalogue



Application: conveying

Presentation

The Altivar 31C drive is a frequency inverter for three-phase 200...500 V asynchronous motors rated from 0.18 kW to 15 kW.

The enclosed Altivar 31C offer with its rugged design, compact size and integrated functions is specifically adapted to respond to numerous applications requiring an IP 55 degree of protection in a hostile environment.

These characteristics also offer the possibility of installing the Altivar 31C drive as close to the motor as possible.

Examples of solutions provided:

- IP 55 drive offering a remote solution which can be customized depending on the model
- Drive integrating the Modbus and CANopen communication protocols
- Numerous options for loading, printing and saving drive configurations using the remote display terminal, SoMove setup software and the Simple Loader configuration tool

Applications

The Altivar 31C drive incorporates functions that are suitable for numerous applications, including:

- Material handling (conveyors, hoists, etc.)
- Packing and packaging machines (labelling machines, sack filling machines, etc.)
- Pumping applications (suction pumps, centrifugal pumps, circulating pumps, mono-pump and multi-pump stations, etc.)
- Machines equipped with fans (air or smoke extraction, plastic film making machines, ovens, boilers, washing machines, etc.)
- Specialist machines (mixers, kneaders, textile machines, etc.)



Application: ventilation

Functions

The Altivar 31C drive has six logic inputs, three analog inputs, one logic/analog output and two relay outputs.

Main integrated functions:

- Motor and drive protection
- Linear, S, U or customized acceleration and deceleration ramps
- +/- speed
- 16 preset speeds
- PI regulator and references
- 2-wire/3-wire control
- Brake sequence
- Automatic catching a spinning load with speed detection and automatic restart
- Fault configuration and stop type configuration
- Saving the configuration in the drive

Several functions can be assigned to one logic input.

A optimized offer

The Altivar 31C range of variable speed drives covers motor power ratings from 0.18 kW to 15 kW with two types of power supply:

- 200 V to 240 V single-phase 0.18 kW to 2.2 kW: **ATV 31C●●●M2**
- 380 V to 500 V three-phase 0.37 kW to 15 kW: **ATV 31C●●●N4**

Available in 200...240 V single-phase supply and up to 4 kW in three-phase 380...500 V supply, the drive is supplied in a customizable enclosure suitable for ready-to-use motor starter applications. From 5.5 kW in three-phase 380...500 V supply, the drive is supplied in a standard enclosure.

The Altivar 31C drive includes an integrated terminal with display, menu scroll keys and local run and stop control keys.

It also incorporates the Modbus and CANopen industrial communication protocols as standard. It communicates on these communication buses and networks by means of a single RJ45 connector. This can be located remotely under the enclosure via an IP 55 internal cable, to be ordered separately.

The entire range complies with international standards IEC 61800-5-1, IEC 61800-2 and IEC 61800-3, UL, CSA and GOST certifications and has been developed to meet the requirements of European Directives to obtain the CE mark.



Application: textiles

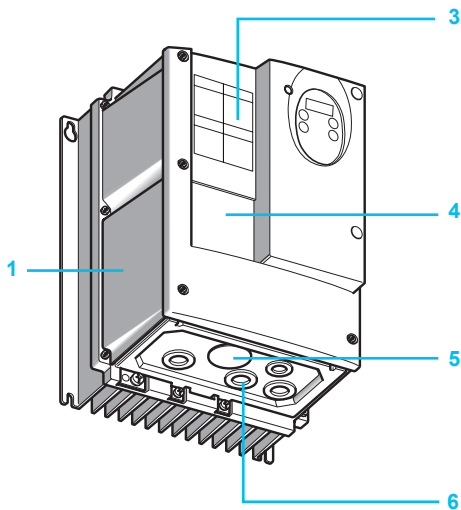

Customizable enclosure:
ATV 31C●●M2, ATV 31C037N4...CU40N4

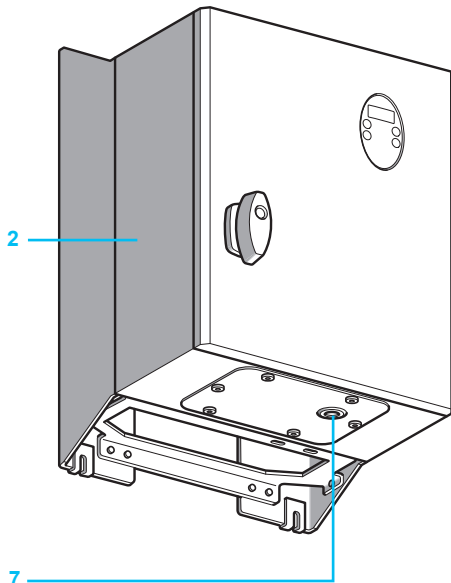

Standard enclosure:
ATV 31CU55N4...CD15N4

An optimized offer (continued)

Customizable enclosed drive (0.18 kW to 4 kW)

This range allows full customization of the human-machine interface part of the enclosure.

The IP 55 enclosure includes:

- A drive **1** with external heatsink
- Removable covers **3** to **6** for adding the following components:
 - **3**: 3 buttons and/or LEDs with plastic flange (Ø 22) and 1 speed reference potentiometer
 - **4**: A Vario switch disconnecter or GV2 circuit-breaker
 - **5**: A blanking plug for the RJ45 connector on the IP 55 internal cable
 - **6**: A cable gland for cable routing

The combinations (circuit-breaker/contactor/drive) required for the motor starter function can be found on page 37.

Example references:

- 3-pole Vario switch disconnecter (V●● + KC●1●Z)
- Selector switch with 3 fixed positions XB5 D33
- LED XB5 AV●●
- 2.2 kΩ potentiometer, SZ1 RV1202

These references are to be ordered separately and can be found in the "Motor starter solutions. Control and protection components" and "Control and signalling components" catalogues.

These products are supplied as standard for customer assembly and wiring.

However, it is also possible to order ready-wired and connected components; please consult our Customer Care Centre.

Standard enclosed drive (5.5 kW to 15 kW)

The IP 55 enclosure includes:

- A drive **2** with external heatsink and fans
- A blanking plug **7** for the RJ45 connector on the IP 55 internal cable

The combinations (circuit-breaker/contactor/drive) required for the motor starter function can be found on page 37.

Electromagnetic compatibility, EMC

The incorporation of EMC filters in Altivar 31C drives as standard simplifies installation and provides a very economical means of ensuring devices meet the criteria to receive the CE mark. If necessary, optional additional EMC filters are available.

External accessories and options

Various external accessories and options can be used with the Altivar 31C (**1** or **2**):

- Braking resistors
- Line chokes
- Additional EMC input filters
- Output filters, motor chokes and ferrite suppressors
- IP 55 cordsets with RJ45 connectors for control via Modbus serial link or CANopen machine bus

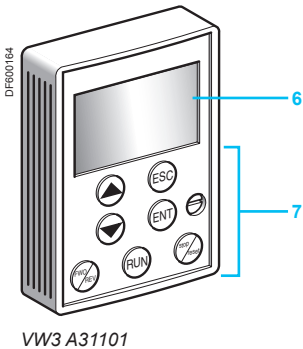
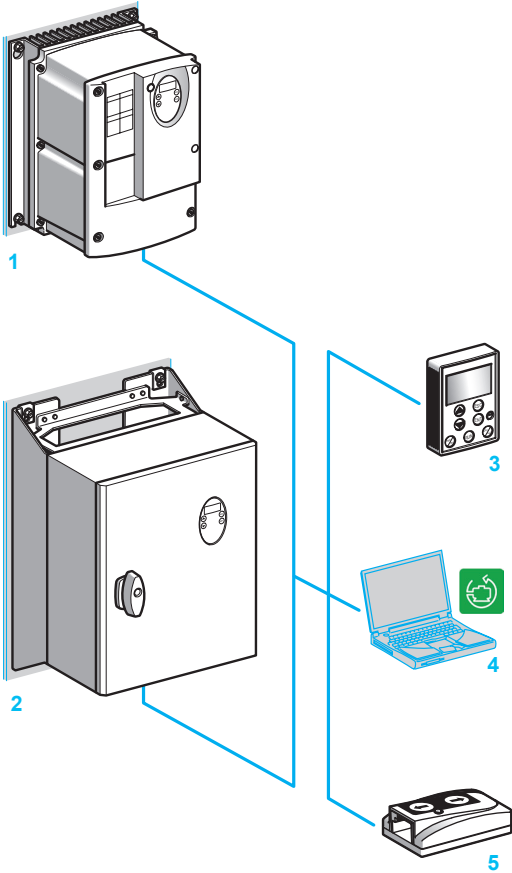

An optimized offer (continued)

Dialogue options and configuration tools

Various dialogue options provide access to the Altivar 31C drive's (1 or 2) configuration, adjustment, control and signalling functions.

Options available:

- Remote display terminal 3
- SoMove setup software 4
- Simple Loader configuration tool 5

Remote display terminal

The remote terminal connects directly to the Altivar 31C drive.

It can be mounted on the door of an enclosure (wall-mounted or floor-standing) with IP 65 protection on the front panel.

The remote display terminal is used:

- To control, adjust and configure the drive remotely
- For visible remote signalling
- To save and download configurations; 4 configuration files can be saved.

Description

6 Display

- 4-digit display visible at 5 m
- Display of numeric values and codes
- The display flashes when a value is stored
- The display flashes to indicate a fault on the drive

7 Use of keys:

- Navigation arrows, ENT and ESC keys for settings and configurations
- FWD/REV key: Reverses the direction of rotation of the motor
- RUN key: Local control of motor operation
- STOP/RESET key: Local control of motor stopping/drive fault clearing

SoMove setup software

The SoMove setup software can be used to access the configuration, adjustment, debugging (using the Oscilloscope function) and maintenance functions for Schneider Electric variable speed drives and starters.

The SoMove software can also be used to customize the integrated display terminal menus.

Simple Loader configuration tool

The Simple Loader configuration tool enables one powered-up drive's configuration to be duplicated on another powered-up drive.

It is connected to the drive's RJ45 communication port.

An optimized offer (continued)

Communication buses and networks

In addition to the Modbus serial link and CANopen machine bus which can be accessed directly, various modules can be used to connect the Altivar 31C to the following communication buses and networks:

- Modbus TCP network
- Fipio bus
- PROFIBUS DP bus
- DeviceNet network

The communication buses and networks provide access to the Altivar 31C drive's configuration, adjustment, control and monitoring functions.
See page 24.

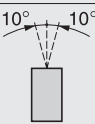
Environmental characteristics			
Conformity to standards			Altivar 31C drives have been developed to conform to the strictest international standards and the recommendations relating to electrical industrial control equipment (IEC, EN), in particular: IEC 61800-5-1 (low voltage), IEC 61800-3 (EMC immunity and conducted and radiated EMC emissions)
EMC immunity			IEC 61800-3, Environments 1 and 2 (EMC requirement and specific test methods) IEC 61000-4-2 level 3 (electrostatic discharge immunity test) IEC 61000-4-3 level 3 (radio-frequency radiated electromagnetic field immunity test) IEC 61000-4-4 level 4 (electrical fast transient/burst immunity test) IEC 61000-4-5 level 3 (surge immunity test)
Conducted and radiated EMC emissions for drives	ATV 31C●●●●●		IEC 61800-3, Environments: 2 (industrial power supply) and 1 (public power supply), restricted distribution
	ATV 31C018M2...CU15M2 ATV 31C037N4...CU40N4		IEC 61800-3 category C2 With additional EMC filter (1): ■ IEC 61800-3 category C1
	ATV 31CU22M2 ATV 31CU55N4...CD15N4		IEC 61800-3 category C3 With additional EMC filter (1): ■ IEC 61800-3 category C2 ■ IEC 61800-3 category C1
CE marking			The drives are marked CE according to the European low voltage (2006/95/EC) and EMC (2004/108/EC) directives
Product certification	ATV 31C●●●●●		C-Tick
	ATV 31C●●●●M2 ATV 31C037N4...CU40N4		UL, CSA and GOST
Degree of protection			IP 55
Vibration resistance	Drive not mounted on rail 		Conforming to IEC 60068-2-6: 1.5 mm peak to peak from 3 to 13 Hz, 1 gn from 13 to 200 Hz
Shock resistance			15 gn for 11 ms conforming to IEC 60068-2-27
Maximum ambient pollution Definition of insulation			Degree 2 conforming to IEC 61800-5-1
Environmental conditions Use			IEC 60721-3-3 classes 3C2 and 3S2
Relative humidity		%	5...95 non condensing, no dripping water, according to IEC 60068-2-3
Ambient air temperature around the device	Operation	°C	- 10...+ 40 without derating
	Storage	°C	- 25...+ 70
Maximum operating altitude		m	1000 without derating (above this, derate the current by 1% per additional 100 m)
Operating position Maximum permanent angle in relation to the normal vertical mounting position			

(1) See table on page 21 to check the permitted cable lengths.

Drive characteristics			
Output frequency range		Hz	0...500
Switching frequency		kHz	Nominal switching frequency: 4 kHz without derating in continuous operation. 2...16 adjustable during operation. Above 4 kHz in steady state, derate the nominal drive current. The nominal motor current should not exceed this value. See derating curves on page 36
Speed range			1...50
Transient overtorque			170...200% of nominal motor torque (typical value)
Braking torque	With braking resistor	ATV 31C●●●●●	100% of nominal motor torque continuously and up to 150% for 60 s
	Without braking resistor	ATV 31C018M2	150% of nominal motor torque (typical value)
		ATV 31C037M2...C075M2 ATV 31C037N4...C075N4	100% of nominal motor torque (typical value)
		ATV 31CU11M2, CU15M2 ATV 31CU11N4, CU15N4	50% of nominal motor torque (typical value)
		ATV 31CU22M2 ATV 31CU22N4...CD15N4	30% of nominal motor torque (typical value)
Maximum transient current			150% of the nominal drive current for 60 seconds (typical value)
Motor control profile			Sensorless flux vector control with PWM (<i>Pulse width modulation</i>) motor control signal Factory-set for most constant torque applications Possible options: specific ratios for pumps and fans, energy saving or constant torque U/f for special motors
Frequency loop gains			Factory-set with speed loop stability and gain Possible options for machines with high resistive torque or high inertia, or for machines with fast cycles
Slip compensation			Automatic whatever the load. Can be suppressed or adjusted
Electrical power characteristics			
Power supply	Voltage	V	200 - 15% ... 240 + 10% single-phase for ATV 31C●●●M2 380 - 15% ... 500 + 10% three-phase for ATV 31C●●●N4
	Frequency	Hz	50...60 + 5%
Prospective short-circuit current I _{sc}	ATV 31C●●●M2	A	≤ 1000 (I _{sc} at the connection point) for single-phase power supply
	ATV 312C037N4...CU40N4	A	≤ 5000 (I _{sc} at the connection point) for three-phase power supply
	ATV 312CU55N4...CD15N4	A	≤ 22000 (I _{sc} at the connection point) for three-phase power supply
Drive supply voltage and output voltage			Drive supply voltage
	ATV 31C●●●M2	V	200...240 single-phase
	ATV 31C●●●N4	V	380...500 three-phase
			Drive output voltage for motor
			200...240 three-phase
			380...500 three-phase
Connection characteristics (drive terminals for line supply, motor output, DC bus and braking resistor)			
Drive terminals			L1, L2, L3, U, V, W, PC/–, PA/+, PB
Maximum wire size and tightening torque	ATV 31C018M2...C075M2		2.5 mm ² (AWG 14) 0.8 Nm
	ATV 31CU11M2...CU22M2 ATV 31C037N4...CU40N4		5 mm ² (AWG 10) 1.2 Nm
	ATV 31CU55N4, CU75N4		16 mm ² (AWG 6) 2.5 Nm
	ATV 31CD11N4, CD15N4		25 mm ² (AWG 3) 4.5 Nm
Electrical isolation			Electrical isolation between power and control (inputs, outputs, power supplies)

Electrical control characteristics		
Available internal supplies		Short-circuit and overload protection: <ul style="list-style-type: none"> ■ One 10 V \pm (0/+ 8%) supply for the reference potentiometer (2.2 to 10 kΩ), maximum current 10 mA ■ One 24 V \pm supply (min. 19 V, max. 30 V) for the logic inputs, maximum current 100 mA
Configurable analog inputs		Sampling time < 8 ms Resolution: 10 bits Accuracy: \pm 4.3% Linearity: \pm 0.2% of the maximum scale value Use: <ul style="list-style-type: none"> ■ 100 m maximum with shielded cable ■ 25 m maximum with unshielded cable
	A1	One 0...10 V \pm analog voltage input, impedance 30 k Ω , max. safe voltage 30 V
	A2	One \pm 10 V bipolar voltage analog input, impedance 30 k Ω , maximum safe voltage 30 V
	A13	Current analog input X-Y mA by programming X and Y from 0 to 20 mA, with impedance 250 Ω
Analog voltage outputs or analog current outputs configurable as logic outputs		2 analog outputs: <ul style="list-style-type: none"> ■ 1 analog voltage output (AOV) ■ 1 analog current output (AOC) configurable as a logic output These 2 analog outputs cannot be used at the same time
	AOV	0...10 V \pm analog voltage output, min. load impedance 470 Ω 8-bit resolution, accuracy \pm 1%, linearity \pm 0.2% of the maximum scale value
	AOC	0...20 mA analog current output, max. load impedance 800 Ω 8-bit resolution, accuracy \pm 1%, linearity \pm 0.2% The AOC analog output can be configured as a 24 V logic output, max. 20 mA, min. load impedance 1.2 k Ω Refresh time < 8 ms
Configurable relay outputs	R1A, R1B, R1C	1 relay logic output, one N/C contact and one N/O contact with common point Minimum switching capacity: 10 mA for 5 V \pm Maximum switching capacity: <ul style="list-style-type: none"> ■ On resistive load ($\cos \varphi = 1$ and L/R = 0 ms): 5 A for 250 V \sim or 30 V \pm ■ On inductive load ($\cos \varphi = 0.4$ and L/R = 7 ms): 2 A for 250 V \sim or 30 V \pm Sampling time < 8 ms Switching: 100,000 operations
	R2A, R2B	1 relay logic output, one N/C contact, contact open on fault Minimum switching capacity: 10 mA for 5 V \pm Maximum switching capacity: <ul style="list-style-type: none"> ■ On resistive load ($\cos \varphi = 1$ and L/R = 0 ms): 5 A for 250 V \sim or 30 V \pm ■ On inductive load ($\cos \varphi = 0.4$ and L/R = 7 ms): 2 A for 250 V \sim or 30 V \pm Sampling time < 8 ms Switching: 100,000 operations
Logic inputs LI	LI1...LI6	6 programmable logic inputs, compatible with PLC level 1, standard IEC 61131-2 Impedance 3.5 k Ω 24 V \pm internal or 24 V \pm external power supply (min. 19 V, max. 30 V) Max. current: 100 mA Sampling time < 4 ms Multiple assignment makes it possible to configure several functions on one input (for example: LI1 assigned to forward and preset speed 2, LI3 assigned to reverse and preset speed 3)
	Positive logic (Source)	State 0 if < 5 V or logic input not wired State 1 if > 11 V
	Negative logic (Sink)	State 0 if > 19 V or logic input not wired State 1 if < 13 V
	CLI position	Connection to PLC output (see diagram on page 35)
Maximum I/O wire size and tightening torque		2.5 mm ² (AWG 14) 0.6 Nm

Electrical control characteristics (continued)			
Acceleration and deceleration ramps			Ramp profiles: <ul style="list-style-type: none"> ■ Linear, can be adjusted separately from 0.1 to 999.9 s ■ S, U or customized Automatic adaptation of deceleration ramp time if braking capacities exceeded, possible inhibition of this adaptation (use of braking resistor)
Braking to a standstill			By DC injection: <ul style="list-style-type: none"> ■ By a command on a programmable logic input ■ Automatically as soon as the estimated output frequency drops to < 0.5 Hz, period adjustable from 0.1 to 30 s or continuous, current adjustable from 0 to 1.2 In
Main drive protection and safety features			Thermal protection against overheating Protection against short-circuits between motor phases Protection against input phase loss Protection against output phase loss Overcurrent protection between output phases and earth Line supply overvoltage and undervoltage safety features Input phase loss safety feature, for three-phase supply
Motor protection (see page 51)			Thermal protection integrated in the drive by continuous calculation of the I ² t
Dielectric strength	Between earth and power terminals	ATV 31C●●●M2	2040 V ∴
		ATV 31C●●●N4	2410 V ∴
	Between control and power terminals	ATV 31C●●●M2	2880 V ∼
		ATV 31C●●●N4	3400 V ∼
Earth insulation resistance			> 500 MΩ (electrical isolation), 500 V ∴ for 1 minute
Signalling			1 red LED on front: LED lit indicates presence of drive voltage Display coded by 4-digit display unit displaying the CANopen bus status (RUN and ERR)
Frequency resolution	Display units	Hz	0.1
	Analog inputs	Hz	Resolution = ((high speed - low speed)/1024) Min. value 0.1
Time constant on a change of setpoint		ms	5

Communication port characteristics		
Available protocols		Modbus and CANopen protocols integrated in the drive. Both these protocols can be accessed via a single RJ45 connector which can be located remotely under the enclosure with the IP 55 internal cable (to be ordered separately; see page 24)
Modbus protocol		
Structure	Connector	RJ45
	Physical interface	RS 485
	Transmission mode	RTU
	Transmission speed	4800, 9600 or 19200 bps, configurable via the integrated display terminal, remote display terminal or SoMove setup software
	Number of subscribers	31
	Address	1 to 247, configurable via the integrated display terminal, remote display terminal or SoMove setup software
Services	Functional profiles	CiA 402
	Messaging	Read Holding Registers (03) Write Single Register (06) Write Multiple Registers (16) Read Device Identification (43)
	Communication monitoring	Configurable
CANopen protocol		
Structure	Connector	RJ45
	Network management	Slave
	Transmission speed	10, 20, 50, 125, 250, 500 kbps or 1 Mbps, configurable via the integrated display terminal, remote display terminal or SoMove setup software
	Number of subscribers	127
	Address (Node ID)	1 to 127, configurable via the integrated display terminal, remote display terminal or SoMove setup software
Services	Number of PDOs (Process Data Objects)	2 PDOs: ■ PDO 1: non-configurable ■ PDO 6: configurable
	PDO modes	PDO 1: asynchronous PDO 6: asynchronous, synchronous, cyclic asynchronous
	Number of SDOs (Service Data Objects)	1 receive SDO and 1 transmit SDO
	Functional profiles	CiA 402
	Communication monitoring	Node guarding and Heartbeat, Boot-up messages, Emergency messages, Sync and NMT
	Diagnostics	Using LEDs
Description file		An eds file is available on our website (www.schneider-electric.com) or on the "Description of the Motion & Drives offer" DVD-ROM

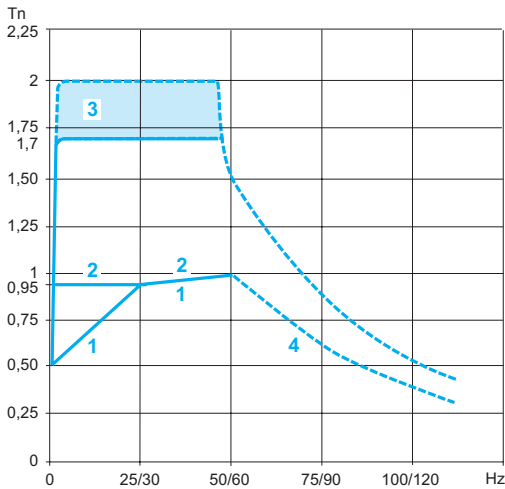

Torque characteristics (typical curves)

The curves opposite define the available continuous torque and transient overtorque for both self-cooled and force-cooled motors. The only difference is in the ability of the motor to provide a high continuous torque at less than half the nominal speed.

- 1 Self-cooled motor: continuous useful torque (1)
- 2 Force-cooled motor: continuous useful torque
- 3 Transient overtorque 1.7 to 2 Tn
- 4 Torque in overspeed at constant power (2)

Special uses

Use with a motor with different power to the drive rating

The device can power any motor which has a lower rating than that for which the drive was designed.

For motor ratings slightly higher than that of the drive, check that the current taken does not exceed the continuous output current of the drive.

Test on a low power motor or without a motor

In a testing or maintenance environment the drive can be checked without having to resort to using a motor with the same rating as the drive (particularly useful in the case of high power drives). This use requires deactivation of motor phase loss detection.

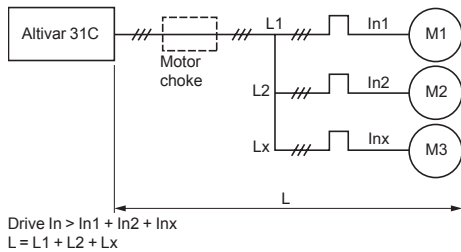

Connecting motors in parallel

Connecting motors in parallel

The drive rating must be greater than or equal to the sum of the currents and powers of the motors to be controlled.

In this case, it is necessary to provide external thermal protection for each motor using probes or thermal overload relays.

If three or more motors are connected in parallel, it is advisable to install a motor choke between the drive and the motors.

See page 22.

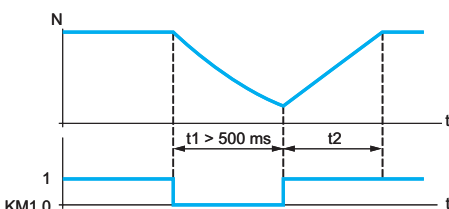
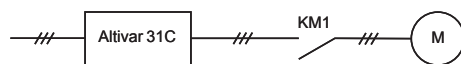

KM1: contactor
 t1: KM1 opening time (motor freewheeling)
 t2: acceleration with ramp
 N: speed

Example of loss of output contactor

Switching the motor at the drive output

Switching can be carried out with the drive locked or unlocked. If the drive is switched on-the-fly (drive unlocked), the motor is controlled and accelerates until it reaches the reference speed smoothly following the acceleration ramp.

This use requires configuration of automatic catching a spinning load ("catch on the fly") and activation of the function which manages the presence of an output contactor.

Note: Depending on the drive rating, downstream ferrite suppressors may be required between the drive and the output contactor (see page 22).

Typical applications: Loss of safety circuit at drive output, bypass function, switching of motors connected in parallel.

Recommendations for use: Synchronize control of the output contactor with that of a freewheel stop request from the drive on a logic input.

- (1) For power ratings ≤ 250 W, less derating is required (20% instead of 50% at very low frequencies).
- (2) The nominal motor frequency and the maximum output frequency can be adjusted from 40 to 500 Hz. The mechanical overspeed characteristics of the selected motor must be checked with the manufacturer.



ATV 31C022M2

IP 55 enclosed drives (frequency range from 0.5 to 500 Hz)											
Motor		Line supply				Altivar 31C					
Power indicated on rating plate (1)	kW	HP	Line current(2)		Apparent power kVA	Max. prospective line Isc (3) kA	Nominal current A	Maximum transient current for 60 s A	Power dissipated at nominal load W	Reference (4)	Weight kg
			at U1	at U2							
Single-phase supply voltage: 200...240 V (5) 50/60 Hz, with integrated EMC filters											
0.18	0.25		3	2.5	0.6	1	1.5	2.3	24	ATV 31C018M2 (6)	6.300
0.37	0.5		5.3	4.4	1	1	3.3	5	41	ATV 31C037M2 (6)	6.300
0.55	0.75		6.8	5.8	1.4	1	3.7	5.6	46	ATV 31C055M2 (6)	6.300
0.75	1		8.9	7.5	1.8	1	4.8	7.2	60	ATV 31C075M2 (6)	8.800
1.1	1.5		12.1	10.2	2.4	1	6.9	10.4	74	ATV 31CU11M2 (6)	8.800
1.5	2		15.8	13.3	3.2	1	8	12	90	ATV 31CU15M2 (6)	8.800
2.2	3		21.9	18.4	4.4	1	11	16.5	123	ATV 31CU22M2 (6)	10.700
Three-phase supply voltage: 380...500 V (5) 50/60 Hz, with integrated EMC filters											
0.37	0.5		2.2	1.7	1.5	5	1.5	2.3	32	ATV 31C037N4 (6)	8.800
0.55	0.75		2.8	2.2	1.8	5	1.9	2.9	37	ATV 31C055N4 (6)	8.800
0.75	1		3.6	2.7	2.4	5	2.3	3.5	41	ATV 31C075N4 (6)	8.800
1.1	1.5		4.9	3.7	3.2	5	3	4.5	48	ATV 31CU11N4 (6)	8.800
1.5	2		6.4	4.8	4.2	5	4.1	6.2	61	ATV 31CU15N4 (6)	8.800
2.2	3		8.9	6.7	5.9	5	5.5	8.3	79	ATV 31CU22N4 (6)	10.700
3	–		10.9	8.3	7.1	5	7.1	10.7	125	ATV 31CU30N4 (6)	10.700
4	5		13.9	10.6	9.2	5	9.5	14.3	150	ATV 31CU40N4 (6)	10.700
5.5	7.5		21.9	16.5	15	22	14.3	21.5	232	ATV 31CU55N4	23.600
7.5	10		27.7	21	18	22	17	25.5	269	ATV 31CU75N4	23.600
11	15		37.2	28.4	25	22	27.7	41.6	397	ATV 31CD11N4	32.500
15	20		48.2	36.8	32	22	33	49.5	492	ATV 31CD15N4	32.500



ATV 31CU75N4

(1) These values are given for a nominal switching frequency of 4 kHz, for use in continuous operation. The switching frequency is adjustable from 2 to 16 kHz. Above 4 kHz, derate the nominal drive current. The nominal motor current should not exceed this value. See derating curves on page 36.

(2) Typical value for a 4-pole motor and a maximum switching frequency of 4 kHz, with no additional line choke, for the max. prospective line current.

(3) If line Isc is greater than the values in the table, add line chokes (see page 19).

(4) To order a drive to be used in traverse control applications, add a T to the end of the reference. Example: **ATV 31C018M2T**

(5) Nominal supply voltage, min. U1, max. U2: 200 (U1)...240 V (U2), 380 (U1)...500 V (U2).

(6) ATV 31C●●●M2 and ATV 31C037N4...CU40N4 drives are supplied in a customizable enclosure. The human-machine interface can thus be completed with a switch disconnecter, LEDs and Ø 22 buttons for ready-to-use motor starter applications. See page 5.

These components must be ordered separately, and are not supplied pre-installed; if you wish Schneider Electric to undertake wiring and assembly, please contact our Customer Care Centre.



VW3 A31101

Remote display terminal

This terminal is used to locate the integrated display terminal of the Altivar 31C drive remotely on the door of an enclosure with IP 65 protection.

It is used to:

- Control, adjust and configure the drive remotely
 - Display the drive status and faults remotely
 - Save and download configurations; 4 configuration files can be saved
- Its maximum operating temperature is 50°C.

References

Description	Degree of protection	Reference	Weight kg
Remote display terminal supplied with:	IP 65	VW3 A31101	–
<ul style="list-style-type: none"> ■ Seal and screws for IP 65 mounting ■ A 3 m cable with a RJ45 connector on the drive end and a SUB-D connector on the remote display terminal end 			

SoMove setup software

SoMove setup software for PC is used to prepare drive configuration files.

The PC can be connected to the drive:

- Directly, using the USB/RJ45 cable (TCSM CNAM 3M002P)
- Using a Bluetooth® wireless connection, via the Modbus Bluetooth® adaptor (VW3 A8 114)

See page 28.

Simple Loader configuration tool

The Simple Loader configuration tool enables one powered-up drive's configuration to be duplicated on another powered-up drive. It is connected to the drive's RJ45 communication port.

References

Description	Reference	Weight kg
Simple Loader configuration tool Supplied with a connection cable equipped with 2 RJ45 connectors.	VW3 A8 120	–

Documentation

Description	Reference	Weight kg
"Description of the Motion & Drives offer" DVD-ROM Comprises (1):	VW3 A8 200	0.100
<ul style="list-style-type: none"> ■ Technical documentation (programming manuals, installation manuals, quick reference guides) ■ Catalogues ■ Brochures 		

(1) The contents of this DVD-ROM are also available on our website "www.schneider-electric.com"



VW3 A8 120

Presentation

The resistor enables the Altivar 31C drive to operate while braking to a standstill or during slowdown braking, by dissipating the braking energy.

Two types of resistor are available:

- Enclosed model (IP 20 casing) designed to comply with the EMC standard and protected by a temperature-controlled switch or thermal overload relay.

This model enables maximum transient braking torque.

The resistors are designed to be mounted on the outside of the enclosure, but should not inhibit natural cooling. Air inlets and outlets must not be obstructed in any way.

The air must be free of dust, corrosive gas and condensation.

- Non-protected model (IP 00) for lower power ratings only.

Applications

Machines with high inertia, driving loads and machines with fast cycles.

General characteristics

Type of braking resistor			VW3 A7 723...725	VW3 A7 701...VW3 A7 703
Ambient temperature around the device	Operation	°C	40	0...+ 50
	Storage	°C	- 25...+ 70	
Degree of protection of the casing			IP 00	IP 20
Thermal protection			None	Via temperature-controlled switch or via the drive
Temperature-controlled switch (1)	Activation temperature	°C	–	120
	Max. voltage - max. current		–	250 V ~ - 1 A
	Min. voltage - min. current		–	24 V ~ - 0.1 A
	Maximum switch resistance	mΩ	–	60
Operating factor for the dynamic brake transistors			The average power that can be dissipated at 40°C from the resistor into the casing is determined for a load factor during braking that corresponds to most common applications. The dynamic brake transistor is sized so that it can tolerate: - The nominal motor power continuously - 150% of the nominal motor power for 60 s	

(1) The switch must be connected in the sequence (use for signalling or in line contactor control).

Load factor and determining the nominal power

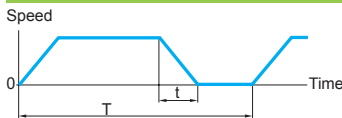

Load factor: $\frac{t}{T}$
 t: braking time in s
 T: cycle time in s

The average power that can be dissipated at 40°C from the resistor into the casing is determined for a load factor during braking that corresponds to most common applications. This load factor is defined in the table above.

For a specific application (example: handling), the nominal power of the resistor must be redefined incorporating the new load factor.

Chart 1

Graph of the average power as a function of the braking torque for a load factor

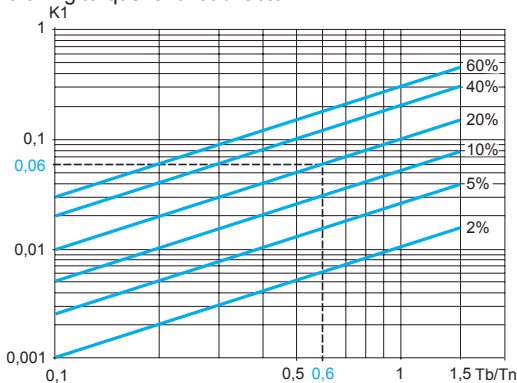

Example:

Motor power $P_m = 4 \text{ kW}$
 Motor efficiency $\eta = 0.85$
 Braking torque $T_b = 0.6 T_n$
 Braking time $t = 10 \text{ s}$
 Cycle time $T = 50 \text{ s}$
 Load factor $f_m = \frac{t}{T} = 20\%$

Use chart 1 to determine coefficient K_1 corresponding to a braking torque of $0.6 T_n$ and a load factor of 20%.
 $K_1 = 0.06$

Chart 2

Permissible resistor overload as a function of time (characteristic curve)

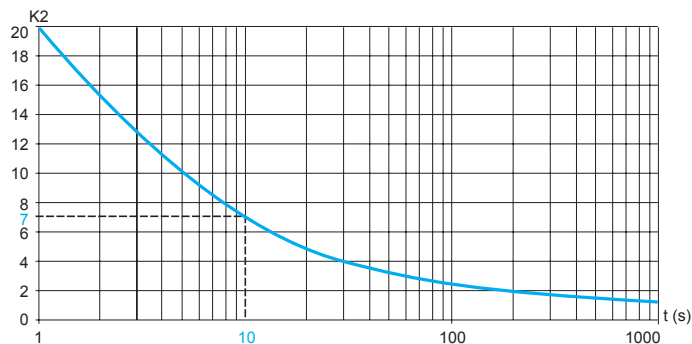

Use chart 2 to determine coefficient K_2 corresponding to a braking time of 10 seconds.
 $K_2 = 7$

The nominal power of the resistor (Pn) must be greater than:

$$P_n = P_m \times K_1 \times \eta \left(1 + \frac{1}{K_2 \times f_m}\right) = 4 \cdot 10^3 \times 0.06 \times 0.8 \left(1 + \frac{1}{7 \times 0.2}\right) = 350 \text{ W}$$



VW3 A7 723

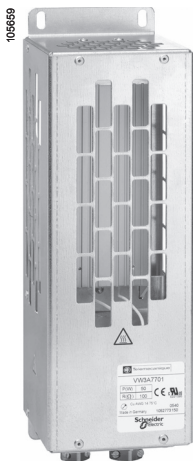

VW3 A7 701

For drives	Minimum resistor value (1)	Ohmic value	Average power available at		Reference	Weight
			40°C (2)	50°C		
	Ω	Ω	W	W		kg
Non-protected braking resistors						
ATV 31C018M2...C075M2	40	100	32	28	VW3 A7 723	0.600
ATV 31CU11M2, CU15M2	27					
ATV 31C037N4...C075N4	80					
ATV 31CU11N4...CU22N4	54					
ATV 31CU30N4	55	100	40	35	VW3 A7 725	0.850
ATV 31CU40N4	36					
ATV 31CU22M2	25	68	32	28	VW3 A7 724	0.600
Protected braking resistors						
ATV 31C018M2...C075M2	40	100	58	50	VW3 A7 701	2.000
ATV 31CU11M2, CU15M2	27					
ATV 31C037N4...C075N4	80					
ATV 31CU11N...CU22N4	54					
ATV 31CU22M2	25	60	115	100	VW3 A7 702	2.400
ATV 31CU30N4	55	100	58	50	VW3 A7 701	2.000
ATV 31CU40N4	36					
ATV 31CU55N4	29	60	115	100	VW3 A7 702	2.400
ATV 31CU75N4	19					
ATV 31CD11N4, CD15N4	20	28	231	200	VW3 A7 703	3.500

(1) Depends on the drive rating.

(2) Power that can be dissipated by the resistor at the maximum temperature of 115°C, corresponding to a maximum temperature rise of 75°C in a 40°C environment.

Presentation

Line chokes provide improved protection against overvoltages on the line supply and reduce harmonic distortion of the current produced by the drive.

The recommended chokes limit the line current.

They have been developed in line with standard IEC 61800-5-1 (VDE 0160 level 1 high-energy overvoltages on the line supply).

The inductance values are defined for a voltage drop between 3% and 5% of the nominal line voltage. Values higher than this will cause loss of torque.

The use of line chokes is recommended in particular under the following circumstances:

- Line supply with significant disturbance from other equipment (interference, overvoltages)
- Line supply with voltage imbalance between phases > 1.8% of nominal voltage
- Drive supplied by a line with very low impedance (in the vicinity of a power transformer 10 times more powerful than the drive rating)
- Installation of a large number of frequency inverters on the same line
- Reduction of overloads on the $\cos \phi$ correction capacitors, if the installation includes a power factor correction unit

The prospective short-circuit current at the drive connection point must not exceed the maximum value indicated in the reference tables. The use of chokes allows connection to the following line supplies:

- Max. I_{sc} 22 kA for 200/240 V
- Max. I_{sc} 65 kA for 380/500 V

Characteristics

Type of line choke		VZ1 L004 M010	VZ1 L007 UM50	VZ1 L018 UM20	VW3 A4 551	VW3 A4 552	VW3 A4 553	VW3 A4 554
Conforming to standards		IEC 61800-5-1 (VDE 0160 level 1 high-energy overvoltages on the line supply)						
Voltage drop		Between 3% and 5% of the nominal supply voltage. Values higher than this will cause loss of torque.						
Degree of protection	Choke	IP 00						
	Terminals	IP 20						IP 10
Inductance value	mH	10	5	2	10	4	2	1
Nominal current	A	4	7	18	4	10	16	30
Losses	W	17	20	30	45	65	75	90

Variable speed drives

Altivar 31C

Option: line chokes

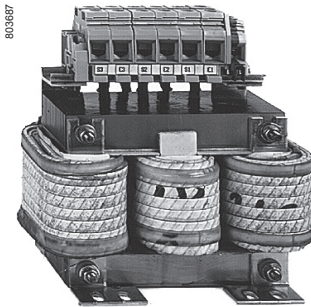

VW3A4 55●

Line chokes

Altivar 31C	Line current without choke				Line current with choke		Choke Reference	Weight
	U min. (1)		U max. (1)		U min. (1)			
	A	A	A	A	A	A	kg	
Single-phase supply voltage: 200...240 V 50/60 Hz								
ATV 31C018M2	3.0	2.5	2.1	1.8	VZ1 L004M010	0.630		
ATV 31C037M2	5.3	4.4	3.9	3.3				
ATV 31C055M2	6.8	5.8	5.2	4.3	VZ1 L007UM50	0.880		
ATV 31C075M2	8.9	7.5	7.0	5.9				
ATV 31CU11M2	12.1	10.2	10.2	8.6	VZ1 L018UM20	1.990		
ATV 31CU15M2	15.8	13.3	13.4	11.4				
ATV 31CU22M2	21.9	18.4	19.2	16.1				
Three-phase supply voltage: 380...500 V 50/60 Hz								
ATV 31C037N4	2.2	1.7	1.1	0.9	VW3 A4 551	1.500		
ATV 31C055N4	2.8	2.2	1.4	1.2				
ATV 31C075N4	3.6	2.7	1.8	1.5				
ATV 31CU11N4	4.9	3.7	2.6	2				
ATV 31CU15N4	6.4	4.8	3.4	2.6				
ATV 31CU22N4	8.9	6.7	5	4.1	VW3 A4 552	3.000		
ATV 31CU30N4	10.9	8.3	6.5	5.2				
ATV 31CU40N4	13.9	10.6	8.5	6.6				
ATV 31CU55N4	21.9	16.5	11.7	9.3	VW3 A4 553	3.500		
ATV 31CU75N4	27.7	21	15.4	12.1				
ATV 31CD11N4	37.2	28.4	22.5	18.1	VW3 A4 554	6.000		
ATV 31CD15N4	48.2	36.8	29.6	23.3				
(1) Nominal supply voltage:								
For drives					Nominal voltage			
					U min.		U max.	
ATV 31C●●●M2					200		240	
ATV 31C●●●N4					380		500	

Presentation

Integrated filters

The Altivar 31C drive has integrated radio interference input filters to comply with the EMC (Electromagnetic Compatibility) standard for variable speed electrical power drive products IEC 61800-3 categories C2 or C3 and the European EMC Directive. See page 8.

Additional EMC input filters

The additional filters enable the drives to meet more stringent requirements; they are designed to reduce conducted emissions on the line supply below the limits of standard IEC 61800-3 category C1 or C2 (see page 21).

These additional filters are mounted outside the enclosure.

Use according to the type of line supply

Additional EMC filters can only be used on TN (neutral connection) and TT (neutral to earth) type systems.

Standard IEC 61800-3, appendix D2.1, states that on IT systems (isolated or impedance earthed neutral), filters can cause permanent insulation monitors to operate in a random manner.

The effectiveness of additional filters on this type of system depends on the type of impedance between neutral and earth, and therefore cannot be predicted.

If a machine is to be installed on an IT network, one solution is to insert an isolation transformer and connect the machine locally on a TN or TT network.

Characteristics

Conforming to standards			EN 133200
Degree of protection			IP 21 and IP 41 on upper part
Maximum relative humidity			93% non-condensing, no dripping water conforming to IEC 60068-2-3
Ambient temperature around the device	Operation	°C	- 10...+ 60
	Storage	°C	- 25...+ 70
Maximum operating altitude	Without derating	m	1000 (above this, derate the current by 1% for every additional 100 m)
Vibration resistance	Conforming to IEC 60068-2-6		1.5 mm peak to peak from 3 to 13 Hz 1 gn peak from 13 to 150 Hz
Shock resistance	Conforming to IEC 60068-2-27		15 gn for 11 ms
Maximum nominal voltage	50/60 Hz single-phase	V	240 + 10%
	50/60 Hz three-phase	V	240 + 10% 500 + 10%

Variable speed drives

Altivar 31C

Option: additional EMC input filters



VW3 A31405

Additional EMC input filters

For drives	Filter						
Reference	Maximum length of shielded cable (1)	In (2)	II (3)	Losses (4)	Reference	Weight	
	IEC/EN 61800-3 (5)						
	Category C2	Category C1	A	mA	W		
	m	m				kg	
Single-phase supply voltage: 200...240 V 50/60 Hz							
ATV 31C018M2 ATV 31C037M2 ATV 31C055M2 ATV 31C075M2	50	20	9	100	3.7	VW3 A31401 0.600	
ATV 31CU11M2 ATV 31CU15M2	50	20	16	150	6.9	VW3 A31403 0.775	
ATV 31CU22M2	50	20	22	80	7.5	VW3 A31405 1.130	
Three-phase supply voltage: 380...500 V 50/60 Hz							
ATV 31C037N4 ATV 31C055N4 ATV 31C075N4 ATV 31CU11N4 ATV 31CU15N4	50	20	15	15	9.9	VW3 A31404 1.000	
ATV 31CU22N4 ATV 31CU30N4 ATV 31CU40N4	50	20	25	35	15.8	VW3 A31406 1.650	
ATV 31CU55N4 ATV 31CU75N4	50	20	47	45	19.3	VW3 A31407 3.150	
ATV 31CD11N4 ATV 31CD15N4	50	20	49	45	27.4	VW3 A31409 4.750	

(1) The filter selection tables give the maximum lengths for shielded cables connecting motors to drives for a switching frequency of 2 to 16 kHz. These maximum lengths are given as examples only, as they vary depending on the stray capacitance of the motors and the cables used. If motors are connected in parallel, it is the sum of the cable lengths that should be taken into account.

(2) In: nominal filter current.

(3) II: maximum earth leakage current at 50 Hz.

(4) Via heat dissipation, at the nominal filter current (In).

(5) Standard IEC 61800-3: EMC immunity and conducted and radiated EMC emissions:

- Category C1: public power supply (residential)

- Category C2: industrial power supply

Variable speed drives

Altivar 31C

Options: output filters, motor chokes and ferrite suppressors

Presentation

Output filters and motor chokes can be inserted between the Altivar 31C drive and the motor to:

- Limit the dv/dt at the motor terminals (500 to 1500 V/μs), for cables longer than 50 m
- Filter interference caused by opening a contactor placed between the filter and the motor
- Reduce the motor earth leakage current

The output filter range comprises LR filter cells.

Ferrite suppressors are necessary on ATV 31C●●●M2 drives when a contactor is used for downstream opening.

LR filter cell

This cell comprises 3 high-frequency chokes and 3 resistors.

The LR filter cell is particularly suitable for:

- Reducing the dv/dt at the motor terminals
- Using long motor cables (see characteristics table on page 23)

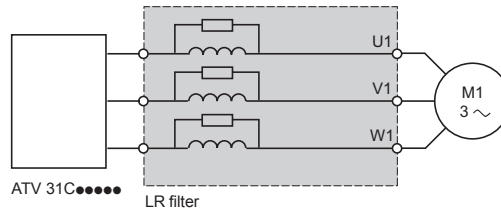

Motor choke

The motor choke is particularly suitable for:

- Reducing overvoltages at the motor terminals (see length of motor cable in characteristics table on page 23)
- Minimizing the current wave, thus reducing motor noise

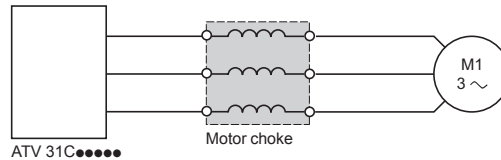

Ferrite suppressors for downstream contactor opening

Ferrite suppressors for downstream contactor opening are inserted on the motor cable between ATV 31C●●●M2 drives and the output contactor.

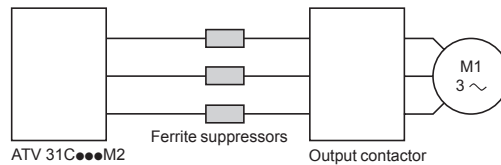

Characteristics (1)					
		LR filter cells (2)	Motor chokes		
		VW3 A58451...A58453	VW3 A4 552...555		
Drive switching frequency		kHz	0.5...4	4	
Length of motor cable	Shielded cables	m	≤ 100		
	Unshielded cables	m	≤ 200		
Degree of protection			IP 20		

References					
LR filter cells					
Description	For drives	Losses	Nominal current	Reference	Weight
		W	A		
LR filter cells	ATV 31C018M2...CU15M2	150	10	VW3 A58451	7.400
	ATV 31C037N4...CU40N4				
	ATV 31CU22M2	180	16	VW3 A58452	7.400
	ATV 31CU55N4				
	ATV 31CU75N4...CD15N4	220	33	VW3 A58453	12.500

Motor chokes					
Description	For drives	Losses	Nominal current	Reference	Weight
		W	A		
Motor chokes	ATV 31CU22N4...CU40N4	65	10	VW3 A4 552	3.000
	ATV 31CU22M2	75	16	VW3 A4 553	3.500
	ATV 31CU55N4				
	ATV 31CU75N4, CD11N4	90	30	VW3 A4 554	6.000
	ATV 31CD15N4	80	60	VW3 A4 555	11.000

Ferrite suppressors for downstream contactor opening					
Description	For drives	Order in multiples of	Unit reference	Weight	
				kg	
Ferrite suppressors for downstream contactor opening	ATV 31C018M2	3	VW3 A31451	0.300	
	ATV 31C037M2	3	VW3 A31452	0.200	
	ATV 31C055M2...CU22M2	3	VW3 A31453	0.100	

(1) Filter performance is ensured if the cable lengths between the motor and the drive given in the table above are not exceeded. For an application with several motors connected in parallel, the cable length must include all cabling. If a cable longer than that recommended is used, the filters may overheat.

(2) For other LR filter configurations, please consult our Customer Care Centre.

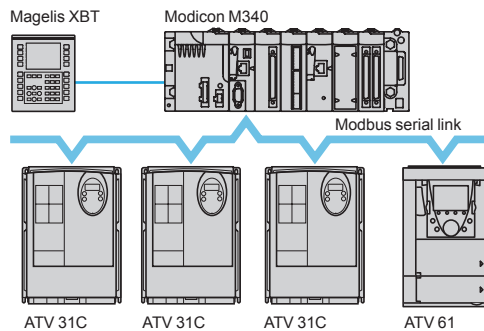

Example of configuration on the Modbus serial link

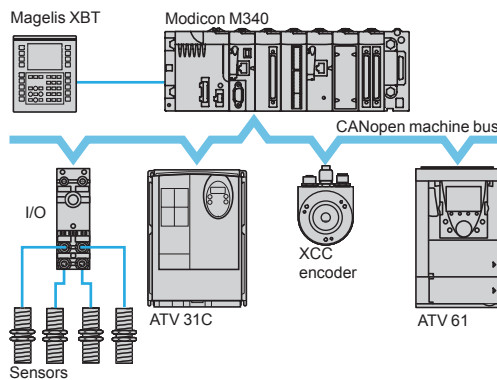

Example of configuration on CANopen machine bus

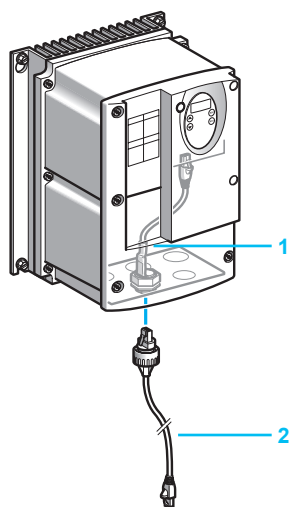

RJ45 connection accessories with IP 55 degree of protection

Presentation

The Altivar 31C drive integrates the Modbus and CANopen communication protocols. Both these protocols can be accessed via the RJ45 communication port which can be located remotely under the enclosure with the IP 55 internal cable (see below).

The Altivar 31C drive can also be connected, via modules that are available as options, to the following industrial communication buses and networks:

- Modbus TCP network
- Fipio bus
- PROFIBUS DP bus
- DeviceNet network

The communication function provides access to the drive's configuration, adjustment, control and monitoring functions.

Functions

All the functions of the Altivar 31C drive can be accessed via the communication buses and networks:

- Control
- Monitoring
- Adjustment
- Configuration

The speed command and reference may come from the following control sources:

- I/O terminals
- Communication buses and networks
- Remote display terminal

The Altivar 31C drive's advanced functions can be used to manage switching of these drive control sources according to the application requirements.

The communication periodic I/O data assignment can be selected using the network configuration software.

The Altivar 31C drive is controlled using the CiA 402 profile.

Communication is monitored according to criteria specific to each protocol. However, regardless of the protocol, it is possible to configure how the drive responds to a communication fault:

- Freewheel stop, stop on ramp, fast stop or braked stop
- Maintain the last command received
- Fallback position at a predefined speed
- Ignore the fault

RJ45 connection accessories with IP 55 degree of protection

Description	Item no.	Length m	Reference	Weight kg
Internal IP55 cable for Modbus and CANopen bus equipped with an RJ45 connector and an IP 55 RJ45 base. It can be used to locate the ATV 31C drive's RJ45 port remotely on the underside while maintaining the IP 55 degree of protection. Requires IP 55 external cable VW A0 1501 to ensure the IP 55 protection index is maintained.	1	0.3	VW3 A0 1500	0.050
External IP55 cable for Modbus and CANopen bus equipped with an RJ45 connector and an IP 55 RJ45 connector. It can be used to connect an ATV 31C drive equipped with a VW3 A0 1500 cable to ensure the IP 55 protection index is maintained.	2	3	VW3 A0 1501	0.130

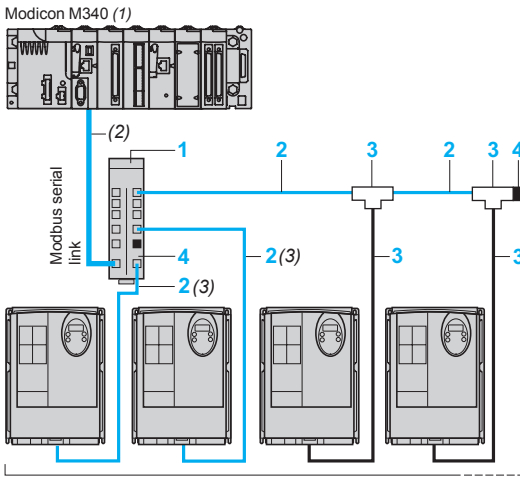

ATV 31C
Example of Modbus serial link architecture, connections via splitter boxes and RJ45 connectors

Modbus serial link

Accessories for connection via splitter boxes and RJ45 connectors

Description	Item no.	Length	Unit reference	Weight
		m		kg
Modbus splitter box 10 RJ45 connectors and 1 screw terminal block	1	–	LU9 GC3	0.500
Cables for Modbus serial link equipped with 2 RJ45 connectors	2	0.3	VW3 A8 306 R03	0.025
	1	1	VW3 A8 306 R10	0.060
	3	3	VW3 A8 306 R30	0.130
Modbus T-junction boxes (with integrated cable)	3	0.3	VW3 A8 306 TF03	–
	1	1	VW3 A8 306 TF10	–
Modbus line terminator for RJ45 connector (4)	4	–	VW3 A8 306 RC	0.200
	4	–	VW3 A8 306 R	0.200

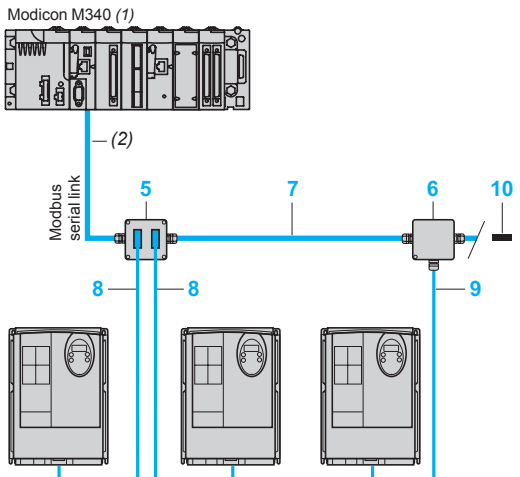

ATV 31C
Example of Modbus serial link architecture, connections via tap junctions

Accessories for connection via tap junctions

Description	Item no.	Length	Unit reference	Weight
		m		kg
Modbus subscriber socket 2 x 15-way female SUB-D connectors and 2 screw terminal blocks, RC line terminator To be connected using cable VW3 A8 306	5	–	TSX SCA 62	0.570
Modbus tap 3 screw terminal blocks, RC line terminator To be connected using cable VW3 A8 306 D30	6	–	TSX SCA 50	0.520
RS 485 double shielded twisted pair Modbus cables Supplied without connector	7	100	TSX CSA 100	–
		200	TSX CSA 200	–
		500	TSX CSA 500	–
Modbus drop cable 1 RJ45 connector and 1 x 15-way male SUB-D connector for TSX SCA 62	8	3	VW3 A8 306	0.150
Modbus drop cable 1 RJ45 connector and one stripped end for TSX SCA 50	9	3	VW3 A8 306 D30	0.150
Modbus line terminator for screw terminal block (4) (5)	10	–	VW3 A8 306 DRC	0.200
	10	–	VW3 A8 306 DR	0.200



TSX SCA 62



TSX SCA 50

- (1) Please refer to the "M340 Automation platform" catalogue.
 (2) Cable dependent on the type of controller or PLC. Please consult our website "www.schneider-electric.com".
 (3) Possibility of using the IP 55 external cable for Modbus and CANopen buses VW3 A0 1501 (see page 24)
 (4) Depends on the bus architecture.
 (5) Order in multiples of 2.

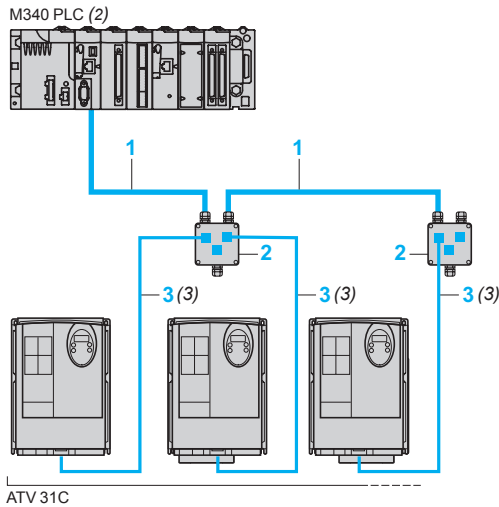

Example of architecture with CANopen machine bus



TSX CAN C●●●●

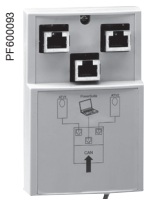

VW3 CAN TAP2

CANopen machine bus

Connection cables and accessories (1)

Description	Item no.	Length	Unit	Weight
			reference	
		m		kg
CANopen cable Standard cable, C€ marking. Low smoke emission, halogen-free. Flame retardant (IEC 60332-1)	1	50	TSX CAN CA50	4.930
		100	TSX CAN CA100	8.800
		300	TSX CAN CA300	24.560
CANopen cable Standard cable, UL certification, C€ marking Flame retardant (IEC 60332-2)	1	50	TSX CAN CB50	3.580
		100	TSX CAN CB100	7.840
		300	TSX CAN CB300	21.870
CANopen cable Cable for harsh environments (4) or mobile installations, C€ marking Low smoke emission, halogen-free. Flame retardant (IEC 60332-1)	1	50	TSX CAN CD50	3.510
		100	TSX CAN CD100	7.770
		300	TSX CAN CD300	21.700
IP20 CANopen junction boxes equipped with: ■ 2 screw terminal blocks for trunk cable tap link ■ 2 RJ45 connectors for connecting drives ■ 1 RJ45 connector for connecting a PC	2	–	VW3 CAN TAP2	0.480
Daisy chain tap equipped with: ■ 2 spring terminals for daisy chain connection of the CANopen bus ■ 1 cable equipped with an RJ45 connector for connecting the drive	–	0.6	TCS CTN026M16M	–
Daisy chain tap equipped with: ■ 2 RJ45 connectors for daisy chain connection of the CANopen bus ■ 1 cable equipped with an RJ45 connector for connecting the drive	–	0.3	TCS CTN023F13M03	–
CANopen line terminator for screw terminal connector (5)	–	–	TCS CAR01NM120	–
CANopen cordsets equipped with 2 RJ45 connectors	3 (3)	0.3	VW3 CAN CARR03	0.050
		1	VW3 CAN CARR1	0.500

(1) For other connection accessories, please refer to the "Industrial communication networks in machines and installations" catalogue.

(2) Please refer to the "M340 Automation platform" catalogue.

(3) Possibility of using the IP 55 external cable for Modbus and CANopen buses VW3 A0 1501 (see page 24)

(4) Standard environment:

- No particular environmental constraints
- Operating temperature between + 5°C and + 60°C
- Fixed installation

Harsh environment:

- Resistance to hydrocarbons, industrial oils, detergents, solder splashes
- Relative humidity up to 100%
- Saline atmosphere
- Operating temperature between - 10°C and + 70°C
- Significant temperature variations

(5) Order in multiples of 2.

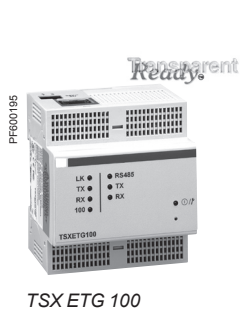

TSX ETG 100



LUF P1

Other communication buses and networks

Description	Cables to be connected	Reference	Weight kg
Ethernet Modbus gateway/router (1) Class B10 For connection to the Modbus TCP network	VW3 A8 306 D30 (2)	TSX ETG 100	–
Fipio/Modbus gateway (3) For connection to the Fipio bus	VW3 A8 306 R●● (2)	LUF P1	0.245
PROFIBUS DP/Modbus gateway (3) For connection to the PROFIBUS DP bus Parameters set using ABC Configurator software (3)	VW3 A8 306 R●● (2)	LUF P7	0.245
DeviceNet/Modbus gateway (3) For connection to the DeviceNet network	VW3 A8 306 R●● (2)	LUF P9	0.245

(1) Please refer to the "Industrial communication networks in machines and installations" catalogue.

(2) See page 25.

(3) Please refer to the "TeSys U starter-controllers" catalogue.



SoMove start page

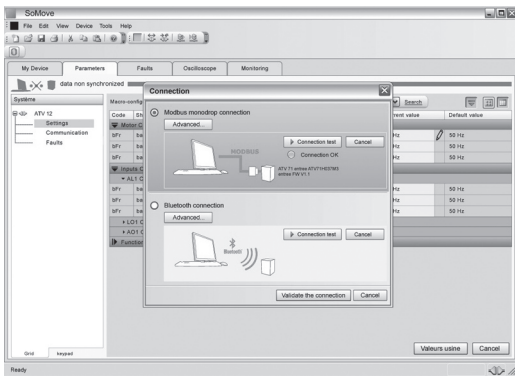

Connecting the SoMove software to the device

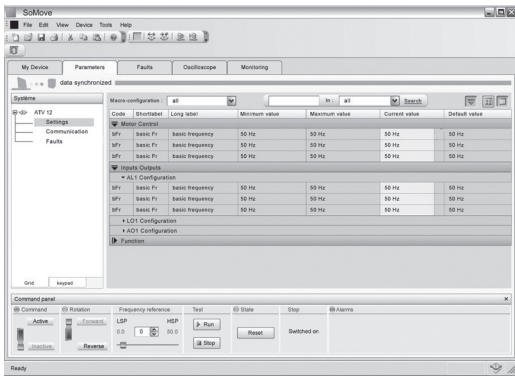

SoMove software control panel

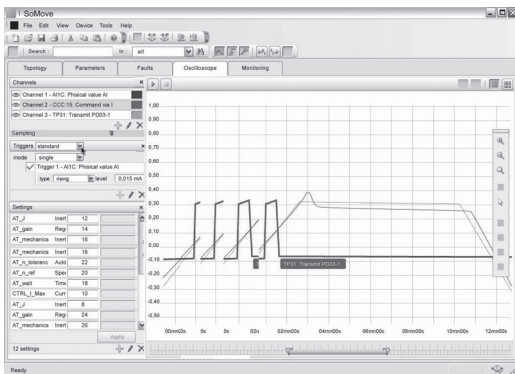

SoMove software oscilloscope function

Presentation

SoMove is user-friendly setup software for PCs, for setting up the following Schneider Electric motor control devices:

- ATV 12, ATV 312, ATV 31, ATV 61 and ATV 71 variable speed drives
- ATS 22 starters
- TeSys U starter-controllers
- TeSys T motor management system
- Lexium 32 servo drives

SoMove software incorporates various functions for the device setup phases, such as:

- Configuration preparation
- Setup
- Maintenance

To facilitate setup and maintenance, SoMove software can use a direct USB/RJ45 cable link or a Bluetooth® wireless link. SoMove software is also compatible with the Multi-Loader configuration tool and SoMove Mobile software for mobile phones. These tools can save a significant amount of time when loading, duplicating or editing configurations on a device.

SoMove software and all the DTM's (Device Type Managers) associated with the devices can be downloaded from our website www.schneider-electric.com.

Functions

Configuration preparation in disconnected mode

SoMove software has a genuine disconnected mode which provides access to all the device parameters. This mode can be used to generate the device configuration. The configuration can be saved, printed and exported to office automation software. SoMove software checks the consistency of the parameters, validating the configurations created in disconnected mode.

A large number of functions are available in disconnected mode, in particular:

- The device configuration software wizard
- The configuration comparison function
- Saving, copying, printing and creating configuration files for export to Multi-Loader, SoMove Mobile or Microsoft Excel® tools, and sending configurations by e-mail.

Setup

When the PC is connected to the device, SoMove software can be used for:

- Transferring the configuration that has been generated onto the device
- Adjustment and monitoring. This includes such functions as:
 - The oscilloscope
 - Displaying communication parameters
- Easy control using the control panel user interface
- Saving the final configuration

Maintenance

In order to simplify maintenance operations, SoMove software can be used to:

- Compare the configuration of a device currently being used with a configuration saved on the PC
- Transfer a configuration to a device
- Compare oscilloscope curves
- Save oscilloscope curves and faults

User interface

SoMove software provides fast, direct access to all information on the device via 5 tabs:

- My Device: displays all the information on the device (type, reference, software versions, option cards, etc.)
- Parameters: displays all the device adjustment parameters, shown in a table or in the form of diagrams
- Faults: displays a list of the faults that may be encountered with the device, the fault log and current faults or alarms
- Monitoring: provides a dynamic display of the device status, its I/O and all the monitoring parameters. It is possible to create your own control panel by selecting your parameters and how they are to be represented
- Oscilloscope: provides a high-speed oscilloscope (recording traces in the device) or low-speed oscilloscope (recording traces in the software for devices that do not have an integrated oscilloscope).



SoMove setup software



VW3 A8 114

Functions (continued)

Connections

Modbus serial link

The PC running SoMove software can be connected directly via the RJ45 connector on the device and the USB port on the PC with the USB/RJ45 cable. See references table below.

Bluetooth® wireless link

SoMove software can communicate via Bluetooth® wireless link with a device equipped with the Modbus-Bluetooth® adaptor. This adaptor is connected to the terminal port or the Modbus network port on the device. It has a 10 m range (class 2). If the PC does not have Bluetooth® technology, use the USB-Bluetooth® adaptor. See references table below.

References

Designation	Description	Reference	Weight kg
SoMove setup software	Includes: <ul style="list-style-type: none"> ■ SoMove setup software for PC in Chinese, English, French, German, Italian and Spanish ■ DTMs (Device Type Managers) and technical documentation for variable speed drives, starters and servo motors 	(1)	–
USB/RJ45 cable	Used to connect a PC to the device. This cable is 2.5 m long, and has a USB connector (PC end) and an RJ45 connector (device end).	TCSM CNAM 3M002P	–
Modbus-Bluetooth® adaptor	Enables the device to communicate via Bluetooth® serial link. Includes: <ul style="list-style-type: none"> ■ 1 Bluetooth® adaptor (range 10 m, class 2) with an RJ45 connector ■ For SoMove: 1 x 0.1 m cable with 2 x RJ45 connectors ■ For TwidoSuite: 1 x 0.1 m cable with 1 RJ45 connector and 1 mini DIN connector 	VW3 A8 114	0.155
USB-Bluetooth® adaptor for PC	This adaptor is required for a PC that does not have Bluetooth® technology. It is connected to a USB port on the PC. Range 10 m (class 2)	VW3 A8 115	0.290

Environments

SoMove operates in the following PC environments and configurations:

- Microsoft Windows® SP3
- Microsoft Windows® Vista
- Pentium IV (or equivalent), 1 GHz, hard disk with 1 GB available space, 512 MB of RAM (minimum configuration)

(1) Available on our website www.schneider-electric.com.

Drives

ATV 31C●●●M2, ATV 31C037N4...CU40N4

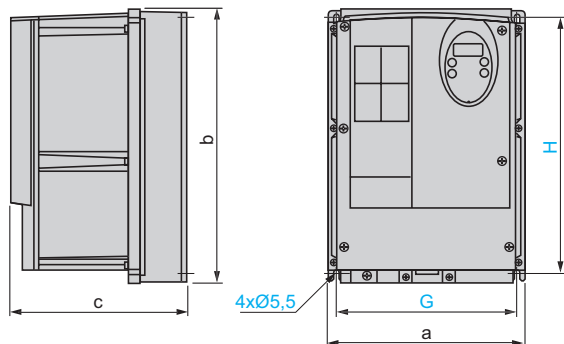

ATV 31C	a	b	c	G	H
018M2...075M2	210	240	163	192	218
U11M2, U15M2 037N4...U15N4	215	297	192	197	277
U22M2 U22N4...U40N4	230	340	208	212	318

ATV 31CU55N4...CD15N4

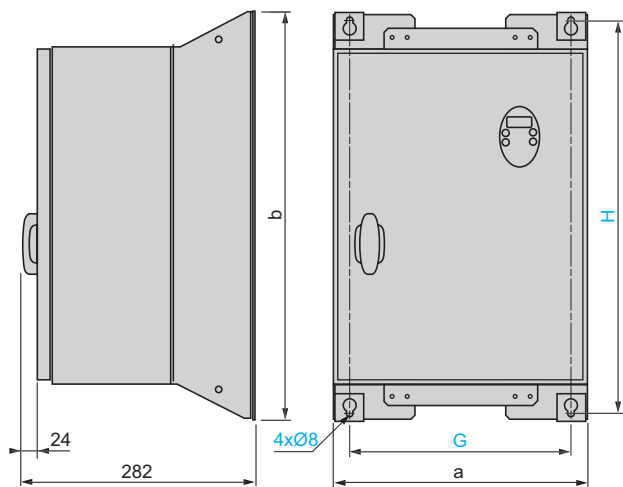

ATV 31C	a	b	G	H
U55N4, U75N4	320	512	279	480
D11N4, D15N4	440	625	399	594

Options

Remote display terminal

VW3 A31101

Cut-outs and drill holes

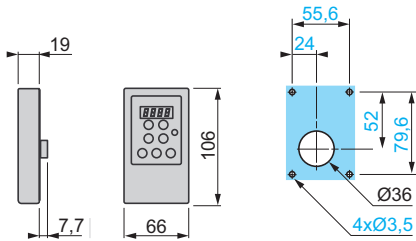

Non-protected braking resistors

VW3 A7 723, 724

2-wire output, length 0.5 m

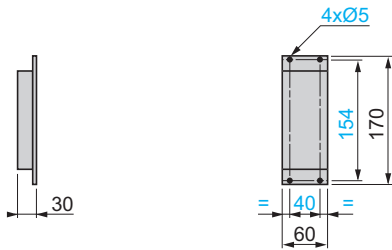

VW3 A7 725

2-wire output, length 0.5 m

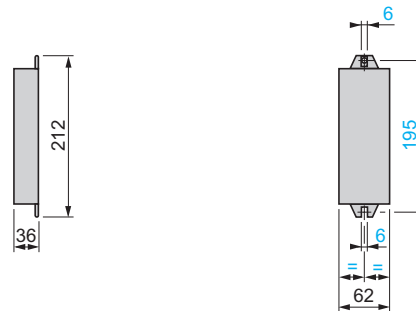

Protected braking resistors

VW3 A7 701...703

Installation recommendations

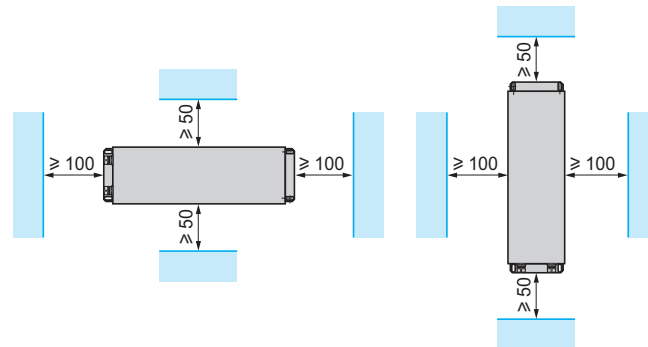
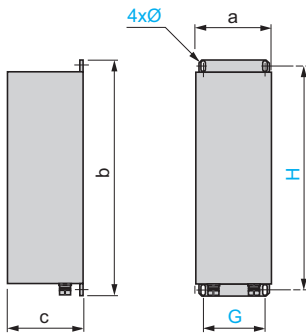

VW3	a	b	c	G	H	Ø
A7 701	95	295	95	70	275	6 x 12
A7 702	95	395	95	70	375	6 x 12
A7 703	140	395	120	120	375	6 x 12

Options (continued)

Line chokes

VZ1 L004M010, L007UM50, L018UM20

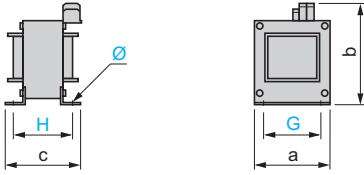

VZ1	a	b	c	G	H	Ø
L004M010	60	100	80	50	44	4 x 9
L007UM50	60	100	95	50	60	4 x 9
L018UM20	85	120	105	70	70	5 x 11

Line chokes and motor chokes

VW3 A4 551...555

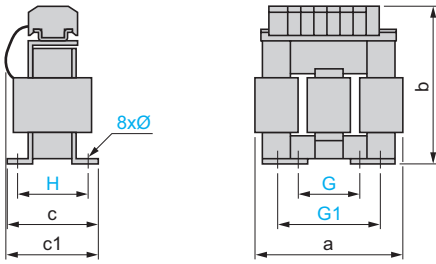

VW3	a	b	c	c1	G	G1	H	Ø
A4 551	100	135	55	60	40	60	42	6 x 9
A4 552, 553	130	155	85	90	60	80.5	62	6 x 12
A4 554	155	170	115	135	75	107	90	6 x 12
A4 555	180	210	125	165	85	122	105	6 x 12

Additional EMC input filters

VW3 A31401, A31403...A31406, A31407, A31409

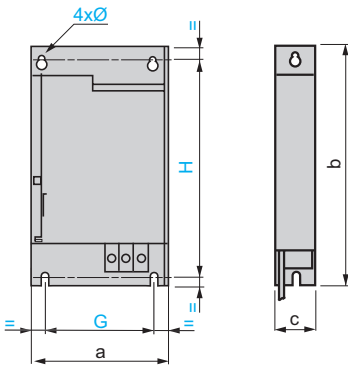

VW3	a	b	c	G	H	Ø
A31401	72	195	37	52	180	4.5
A31403	107	195	35	85	180	4.5
A31404	107	195	42	85	180	4.5
A31405	140	235	35	120	215	4.5
A31406	140	235	50	120	215	4.5
A31407	180	305	60	140	285	5.5
A31409	245	395	60	205	375	5.5

Options (continued)

LR filter cells

VW3 A58451...A58453

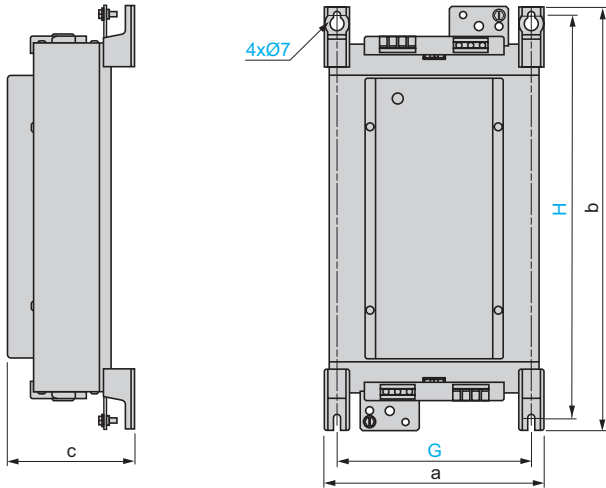

VW3	a	b	c	G	H
A58451, A58452	169.5	340	123	150	315
A58453	239	467.5	139.5	212	444

Ferrite suppressors for downstream contactor opening

VW3 A31451...A31453

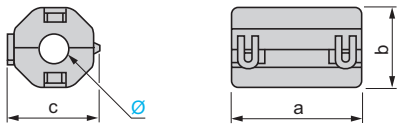

VW3	a	b	c	Ø
A31451	33.5	33	33	13
A31452	33	21.5	22.5	9
A31453	30	19	19	6

ATV 31C●●●M2
Single-phase power supply

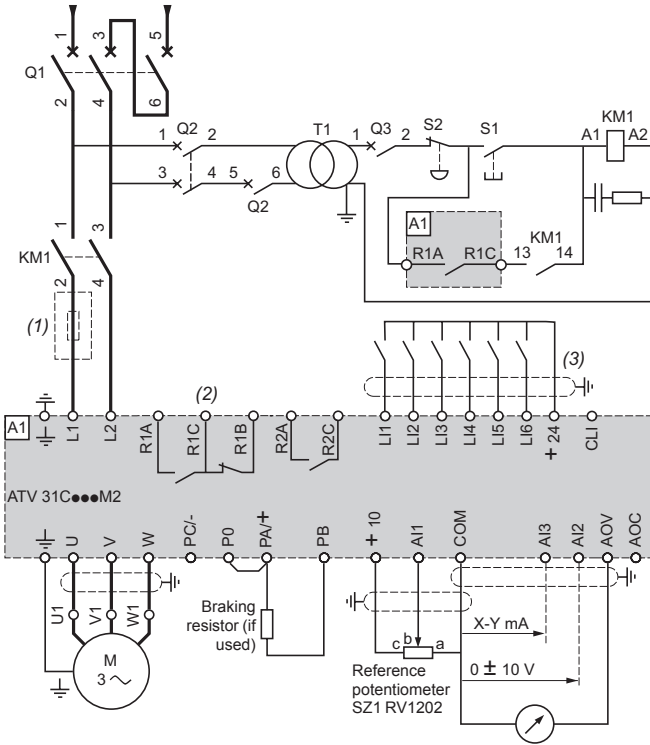

ATV 31C●●●N4
Three-phase power supply

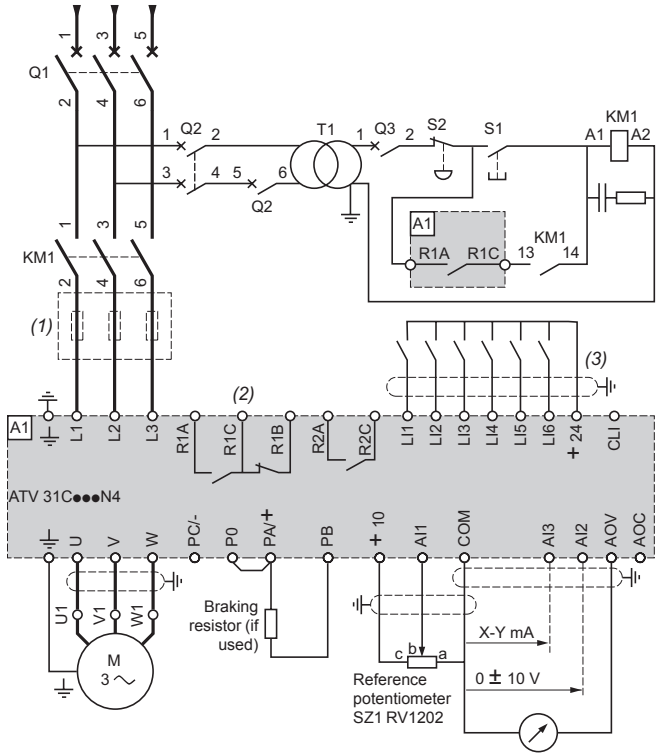

- (1) Line choke (single-phase or three-phase).
- (2) Fault relay contacts. Used for remote signalling of the drive status.
- (3) Connection of the common for the logic inputs depends on the position of the switch (see schemes below).

Note: Install interference suppressors on all inductive circuits near the drive or connected on the same circuit, such as relays, contactors, solenoid valves, fluorescent lighting, etc.

Compatible components (for a complete list of references, please refer to the "Motor starter solutions - Control and protection components" catalogue).

Item	Description
KM1	Line contactor LC1 ●●● + suppressor module LA4 DA2U (see page 37)
Q1	GV2 L magnetic circuit-breaker (see page 37)
Q2	GV2-L magnetic circuit-breaker rated at twice the nominal primary current of T1
Q3	GB2 CB05 thermal magnetic circuit-breaker
S1, S2	XB4 B or XB5 A pushbuttons
T1	100 VA transformer 220 V secondary

Examples of recommended schemes

Logic input switches

Source position

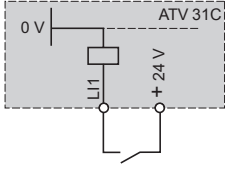

Sink position

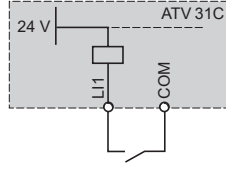

CLI position with PLC transistor outputs

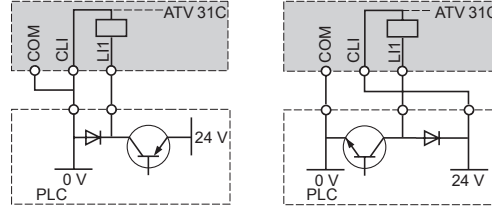

AOC output

Wired as logic output

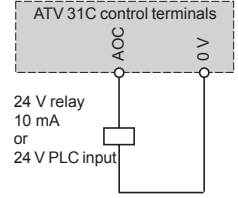

2-wire control

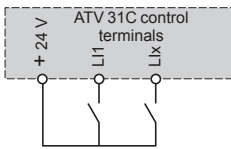

L11: Forward
L1x: Reverse

3-wire control

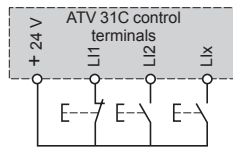

L11: Stop
L12: Forward
L1x: Reverse

Voltage analog inputs

External + 10 V

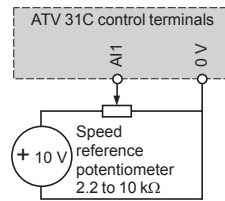

External ± 10 V

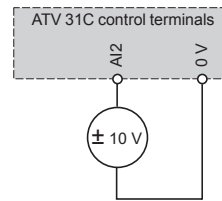

Current analog input

0-20 mA, 4-20 mA, X-Y mA

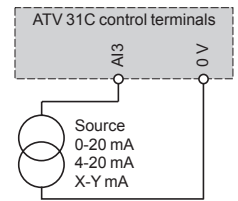

Additional EMC input filters VW3 A3140●

Single-phase power supply

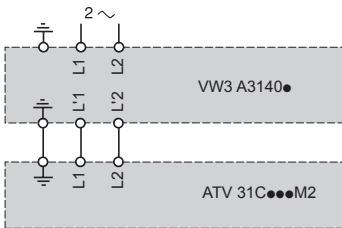

Three-phase power supply

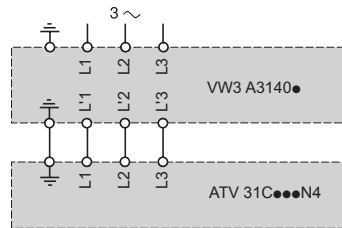

Connections for ensuring conformity to EMC standards

Principle

- Earths between the drive, motor and cable shielding must have “high-frequency” equipotentiality.
- Use shielded cables with the shielding connected to earth throughout 360° at both ends for the motor cable, the braking resistor cable and the control-signal cables. Metal conduit or ducting can be used for part of the shielding length provided that there is no break in the continuity of the earth connection.
- Ensure maximum separation between the power supply cable and the motor cable.

Operation on an IT system (isolated or impedance earthed neutral)

Use a permanent insulation monitor compatible with non-linear loads, such as the Schneider Electric XM200 (please consult our website “www.schneider-electric.com” or contact our Customer Care Centre).

ATV 31C●●●●● drives have integrated EMC filters.

For use on an IT system, these filters can be disconnected by removing their earth connection:

- By removing a jumper for ATV 31C●●●M2 and ATV 31C037N4...CU40N4
- By moving a wire with cable tag for ATV 31CU55N4...CD15N4

Installation recommendations

Installation

- Install the unit vertically, at $\pm 10^\circ$.
- Avoid moving it close to heating elements.
- Leave sufficient free space to ensure that the air required for cooling purposes can circulate from the bottom to the top of the unit.

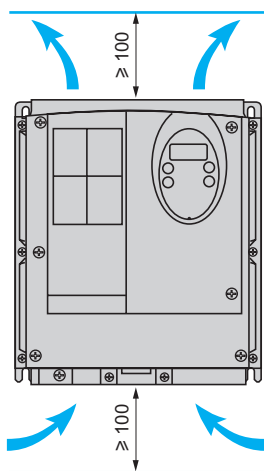

Drive current derating curves

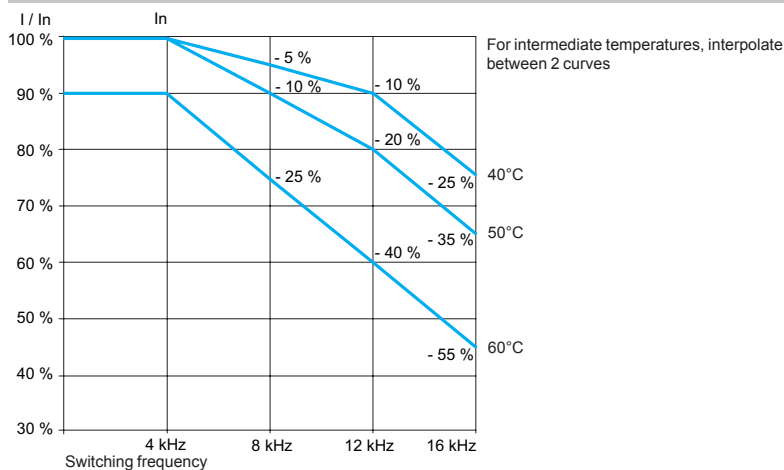

Applications

The combinations listed below can be used to assemble a complete motor starter comprising a circuit-breaker, a contactor and an Altivar 31C variable speed drive.

The circuit-breaker provides protection against accidental short-circuits, disconnection and, if necessary, isolation.

The contactor controls and manages any safety features and isolates the motor on stopping.

The Altivar 31C drive is protected electronically against short-circuits between phases and between phase and earth; it therefore ensures continuity of service and thermal protection of the motor.



GV2 L14
+
LC1 D09
+
ATV 31C075M2

Motor starter for ATV 31C drive

Standard power rating of 50/60 Hz 4-pole motors (1)		Drive	Circuit-breaker	Max. prosp. line Isc	Contactor (2)	
kW	HP	Reference	Reference	Rating	Add voltage reference to basic reference to obtain full reference (3)	
				A	kA	
Single-phase supply voltage: 200...240 V						
0.18	0.25	ATV 31C018M2	GV2 L08	4	1	LC1 D09●●
0.37	0.5	ATV 31C037M2	GV2 L10	6.3	1	LC1 D09●●
0.55	0.75	ATV 31C055M2	GV2 L14	10	1	LC1 D09●●
0.75	1	ATV 31C075M2	GV2 L14	10	1	LC1 D09●●
1.1	1.5	ATV 31CU11M2	GV2 L16	14	1	LC1 D09●●
1.5	2	ATV 31CU15M2	GV2 L20	18	1	LC1 D09●●
2.2	3	ATV 31CU22M2	GV2 L22	25	1	LC1 D09●●
Three-phase supply voltage: 380...500 V						
0.37	0.5	ATV 31C037N4	GV2 L07	2.5	5	LC1 D09●●
0.55	0.75	ATV 31C055N4	GV2 L08	4	5	LC1 D09●●
0.75	1	ATV 31C075N4	GV2 L08	4	5	LC1 D09●●
1.1	1.5	ATV 31CU11N4	GV2 L10	6.3	5	LC1 D09●●
1.5	2	ATV 31CU15N4	GV2 L14	10	5	LC1 D09●●
2.2	3	ATV 31CU22N4	GV2 L14	10	5	LC1 D09●●
3	–	ATV 31CU30N4	GV2 L16	14	5	LC1 D09●●
4	5	ATV 31CU40N4	GV2 L16	14	5	LC1 D09●●
5.5	7.5	ATV 31CU55N4	GV2 L22	25	22	LC1 D09●●
7.5	10	ATV 31CU75N4	GV2 L32	32	22	LC1 D18●●
11	15	ATV 31CD11N4	GV3 L40	40	22	LC1 D25●●
15	20	ATV 31CD15N4	GV3 L50	50	22	LC1 D32●●

(1) The values expressed in HP conform to the NEC (National Electrical Code).

(2) Composition of LC1-D09/D18/D25/D32 contactors: 3 poles + 1 N/O auxiliary contact + 1 N/C auxiliary contact

(3) Replace ●● with the control circuit voltage reference indicated in the table below:

AC control circuit

	Volts ~	24	48	110	220/230	230	230/240
LC1-D	50/60 Hz	B7	E7	F7	M7	P7	U7

For other voltages between 24 V and 660 V, or a DC control circuit, please refer to the "Motor starter solutions - Control and protection components" catalogue.

Summary of functions

Drive factory setting

Presentation	page 39
--------------	---------

Functions of the display and keys

Presentation	page 39
Remote display terminal option	page 40
Menu access levels	page 40
Menu access code	page 40

Application functions

Operating speed range	page 40
Acceleration and deceleration ramp times	page 40
Acceleration and deceleration ramp profiles	page 41
Ramp switching	page 41
Automatic adaptation of deceleration ramp	page 42
Voltage/frequency ratio	page 42
Auto-tuning	page 42
Switching frequency, noise reduction	page 42
Skip frequencies	page 43
Speed setpoint	page 43
Analog inputs	page 43
Preset speeds	page 43
+/- speed	page 44
Save reference	page 44
Jog operation	page 45
Command and reference channels	page 45
Reference switching	page 45
Summing inputs	page 45
PI regulator	page 46
Current limit switching	page 46
Limiting low speed operating time	page 46
Motor switching	page 46
Command switching	page 47
2-wire control	page 47
3-wire control	page 47
Forced local mode	page 47
Freewheel stop	page 47
Fast stop	page 47
DC injection stop	page 47
Brake control	page 48
Limit switch management	page 48
Monitoring	page 48
Fault management	page 49
Fault reset	page 49
General reset (disables all faults)	page 49
Controlled stop on loss of line supply	page 49
Stop mode in the event of a fault	page 49
Automatic catching of a spinning load with speed detection ("catch on the fly")	page 50
Automatic restart	page 50
Derated operation in the event of an undervoltage	page 50
Fault relay, unlocking	page 50
Resetting operating time to zero	page 50
Motor thermal protection	page 51
Drive thermal protection	page 51
R1, R2 relay configuration	page 51
AOC/AOV analog outputs	page 52
Saving and retrieving the configuration	page 52

Spooling functions

Traverse Control	page 53
Counter Wobble	page 54

Function compatibility

Function compatibility table	page 55
------------------------------	---------

Drive factory setting

The drive is supplied ready for use in most applications, with the following functions and settings:

- Nominal motor frequency: 50 Hz
- Motor voltage: 230 V (ATV 31C●●●M2) or 400 V (ATV 31C●●●N4)
- Linear ramp times: 3 seconds
- Low speed (LSP): 0 Hz, high speed (HSP): 50 Hz
- Normal stop mode on deceleration ramp
- Stop mode in the event of a fault: freewheel
- Motor thermal current = nominal drive current
- Standstill injection braking current = 0.7 x nominal drive current, for 0.5 seconds
- Constant torque operation with sensorless flux vector control
- Logic inputs:
 - 2 directions of operation (LI1, LI2), 2-wire control
 - 4 preset speeds (LI3, LI4): LSP (low speed), 10 Hz, 15 Hz, 20 Hz
- Analog inputs:
 - AI1 speed reference (0 +10 V)
 - AI2 (0 ± 10 V) summing of AI1
 - AI3 (4-20 mA) not configured
- Relay R1: fault relay
- Relay R2: not assigned
- Analog output AOC: 0-20 mA, image of the motor frequency
- Automatic adaptation of the deceleration ramp in the event of overbraking
- Switching frequency 4 kHz, random frequency

Functions of the display and keys

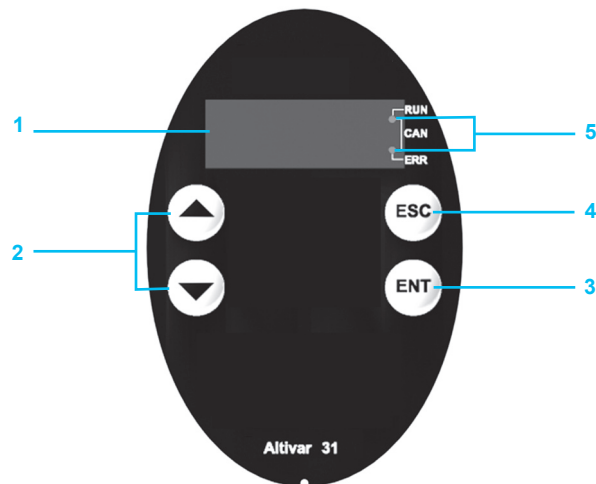

- 1 Information is displayed in the form of codes or values on a 4-digit display
- 2 Buttons for scrolling through the menus or modifying values
- 3 “ENT”: Validation button for entering a menu or confirming the new value selected
- 4 “ESC”: Button for exiting the menus (no confirmation)
- 5 Two diagnostic LEDs for the CANopen bus

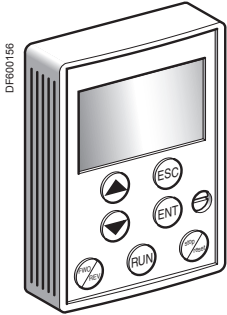

Remote display terminal

■ Remote display terminal option

The remote display terminal can be mounted on the door of an enclosure. It can be used to save 4 drive configuration files.

It comprises an LCD display with programming and control keys and a switch for locking access to the menus.

Drive control keys:

- FWD/RV: Reversal of the direction of rotation
- RUN: Motor run command
- STOP/RESET: Motor stop command or fault reset

The speed reference is given by the remote display terminal. Only the freewheel stop, fast stop and DC injection stop commands remain active on the terminals.

If the drive/operator terminal link is broken, the drive locks in fault mode. Its subsequent action depends on the command and reference channel programming.

Note: Protection via customer confidential code has priority over the switch.

■ Menu access levels

There are three access levels:

- Level 1: Access to standard functions. Significantly, this level permits interchangeability with the Altivar 28.
- Level 2: Access to advanced application functions.
- Level 3: Access to advanced application functions and management of mixed control modes.

■ Menu access code

Enables the drive configuration to be protected using an access code.

When access is locked using a code, only the adjustment and monitoring parameters can be accessed.

Application functions

■ Operating speed range

This function is used to determine the two frequency limits which define the speed range permitted by the machine under actual operating conditions for all applications with or without overspeed.

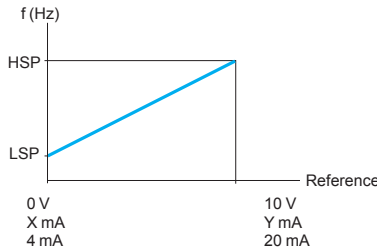

LSP: low speed, from 0 to HSP, factory setting 0
 HSP: high speed, from LSP to f max., factory setting 50 Hz
 X: configurable between 0 and 20 mA, factory setting 4 mA
 Y: configurable between 4 and 20 mA, factory setting 20 mA

■ Acceleration and deceleration ramp times

This function is used to define acceleration and deceleration ramp times according to the application and the machine dynamics.

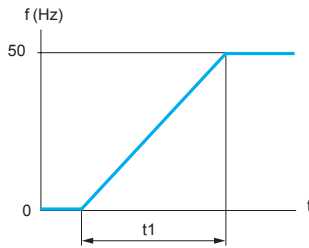

Linear acceleration ramp

t1: acceleration time

t2: deceleration time

t1 and t2 can be set independently between 0.1 and 999.9 s, factory setting: 3 s

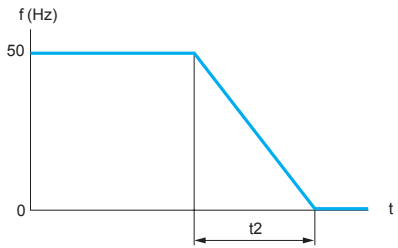

Linear deceleration ramp

Acceleration and deceleration ramp profiles

These enable a gradual increase of the output frequency starting from a speed reference, following a linear profile or a preset profile.

- For applications such as material handling, packaging, transportation of people: the use of S ramps takes up mechanical backlash and eliminates jolts, and limits “non-following” of speed during rapid transient operation of high-inertia machines.
- For pumping applications (installation with centrifugal pump and non-return valve): valve closing can be controlled more accurately if U ramps are used.
- Selecting linear, S, U or customized profiles assigns both the acceleration and deceleration ramps.

S ramps

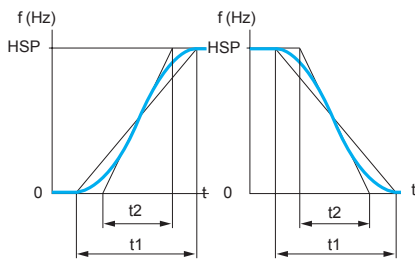

HSP: high speed
 t1: ramp time set
 $t2 = 0.6 \times t1$
 The rounding coefficient is fixed.

U ramps

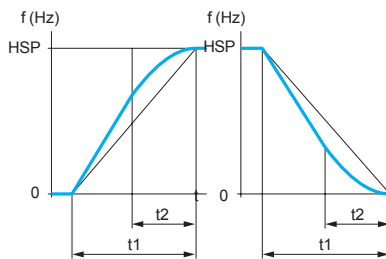

HSP: high speed
 t1: ramp time set
 $t2 = 0.5 \times t1$
 The rounding coefficient is fixed.

Customized ramps

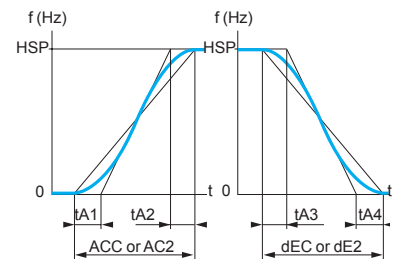

HSP: high speed
 tA1: can be set between 0 and 100% (of ACC or AC2)
 tA2: can be set between 0 and (100% - tA1) (of ACC or AC2)
 tA3: can be set between 0 and 100% (of dEC or dE2)
 tA4: can be set between 0 and (100% - tA3) (of dEC or dE2)
 ACC: acceleration ramp 1 time
 AC2: acceleration ramp 2 time
 dEC: deceleration ramp 1 time
 dE2: deceleration ramp 2 time

Ramp switching

This function is used to switch two acceleration and deceleration ramp times, which can be set separately.

Ramp switching can be enabled by:

- A logic input
- A frequency threshold
- A combination of logic input and frequency threshold

This function is suitable for:

- Material handling with smooth starting and approach
- Machines with fast steady state speed correction

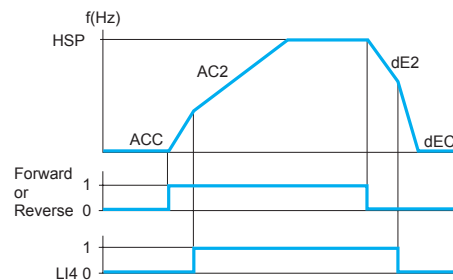

Acceleration 1 (ACC) and deceleration 1 (dEC):
 - adjustment 0.1 to 999.9 s
 - factory setting 3 s
 Acceleration 2 (AC2) and deceleration 2 (dE2):
 - adjustment 0.1 to 999.9 s
 - factory setting 5 s
 HSP: high speed

Example of switching using logic input LI4

■ Automatic adaptation of deceleration ramp

Used to automatically adapt the deceleration ramp if the initial setting is too low when the load inertia is taken into account. It avoids the drive locking in the event of an **overbraking** fault.

This function is suitable for all applications not requiring precise stopping and not using braking resistors.

Automatic adaptation must be cancelled if the machine has position control with stopping on a ramp and a braking resistor installed. This function is automatically disabled if the brake sequence is configured.

■ Voltage/frequency ratio

□ Motor and power supply characteristics

This function is used to determine the limit values for the voltage/frequency ratio according to the characteristics of the line supply, motor and application.

The following values should be set for constant or variable torque applications with or without overspeed:

- The base frequency corresponding to the line supply
- The nominal motor frequency (in Hz) given on the motor rating plate
- The nominal motor voltage (in V) given on the motor rating plate
- The maximum output frequency of the drive (in Hz)

□ Type of voltage/frequency ratio

This is used to adapt the voltage/frequency ratio to the application in order to optimize performance for the following applications:

- Constant torque applications (machines with average loads operating at low speed) with motors connected in parallel or special motors (e.g. resistive cage motor): ratio **L**
- Variable torque applications (pumps, fans): ratio **P**
- Machines with heavy loads operating at low speed, machines with fast cycles, with (sensorless) flux vector control: ratio **n**
- Energy saving, for machines with slow torque and speed variations: ratio **nLd**. The voltage is automatically reduced to minimum depending on the torque required.

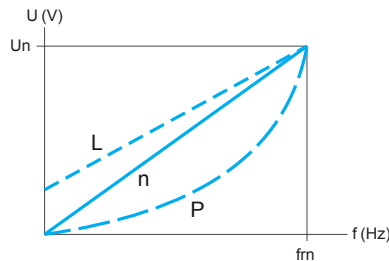

Un: nominal motor voltage
fn: nominal motor frequency

■ Auto-tuning

Auto-tuning can be performed:

- Voluntarily by the operator using dialogue tools via local control or the serial link
- Each time the drive is switched on
- On each run command
- By enabling a logic input

Auto-tuning is used to optimize application performance.

■ Switching frequency, noise reduction

Adjusting the switching frequency setting reduces the noise generated by the motor. The switching frequency is modulated randomly in order to avoid resonance. This function can be disabled if it causes instability.

High frequency switching of the intermediate DC voltage can be used to supply the motor with a current wave that has little harmonic distortion. The switching frequency can be adjusted during operation to reduce the noise generated by the motor.

Value: 2 to 16 kHz. Factory setting 4 kHz.

For all applications which require low motor noise.

■ Skip frequencies

This function suppresses one or two critical speeds that may cause mechanical resonance.

It is possible to prohibit prolonged operation of the motor on one or two frequency bands (± 1 Hz), around an adjustable frequency on the speed range.

This function is suitable for lightweight machines, bulk product conveyors with an unbalanced motor, fans and centrifugal pumps.

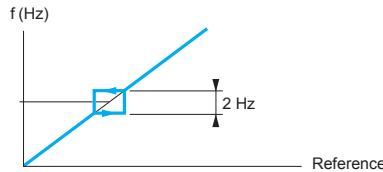

Motor speed change depending on the skip frequency reference

■ Speed reference

The speed reference can come from different sources, depending on the drive configuration:

- References provided by 3 analog inputs
- The potentiometer reference
- The +/- speed function via logic input, using the keypad or remote display terminal keys
- The remote display terminal reference
- Speed references provided by the communication bus or networks

These sources are managed by programming the reference functions and channels.

■ Analog inputs

There are 3 analog inputs:

- 2 voltage inputs:
 - 0-10 V (AI1)
 - ± 10 V (AI2)
- 1 current input:
 - X-Y mA (AI3), where X is configurable between 0 and 20 mA, and Y is configurable between 4 and 20 mA

■ Preset speeds

This function is used to switch preset speed references.

Choose between 2, 4, 8 or 16 preset speeds.

Enabled by means of 1, 2, 3 or 4 logic inputs.

The preset speeds are adjustable in increments of 0.1 Hz from 0 Hz to 500 Hz.

This function is suitable for material handling and machines with several operating speeds.

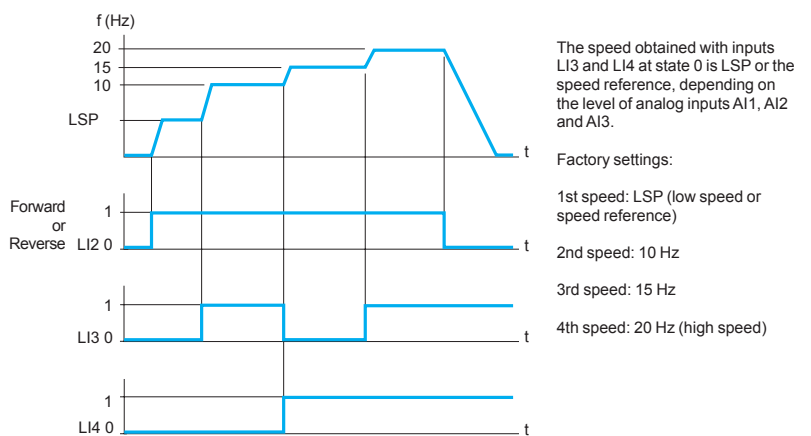

Example of operation with 4 preset speeds and 2 logic inputs

■ +/- speed

This function is used to increase or decrease a speed reference by means of one or two logic inputs, with or without the last reference being saved (motorized potentiometer function).

This function is suitable for centralized control of a machine with several sections operating in one direction or for control by a pendant control station of a material handling crane with two operating directions.

Two types of operation are available:

- Use of single-action buttons: two logic inputs are required in addition to the operating direction(s).

The input assigned to the + speed command increases the speed, the input assigned to the - speed command decreases the speed.

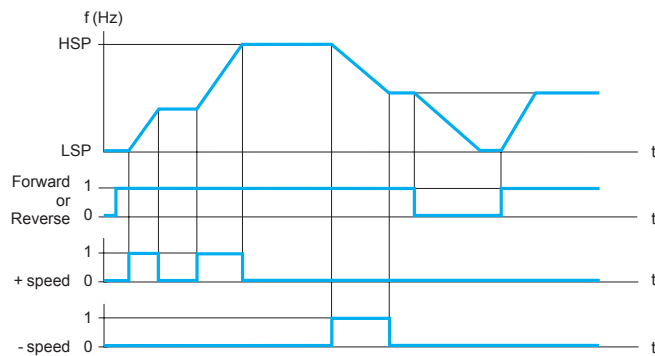

Example of "+/- speed" with two logic inputs, single-action buttons and reference saving.

- Use of double-action buttons (only one logic input assigned to + speed is necessary)

Logic inputs:

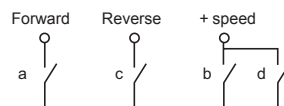

a and c: 1st press
b and d: 2nd press

	Released (- speed)	1st press (speed maintained)	2nd press (+ speed)
Forward button	-	a	a and b
Reverse button	-	c	c and d

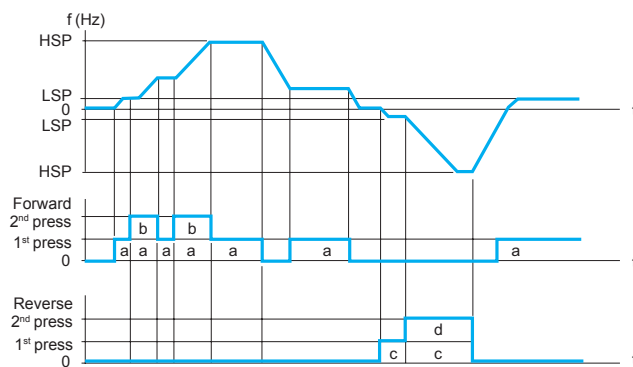

LSP: low speed; HSP: high speed

Example with double-action buttons and one logic input.

Note: This type of +/- speed control is incompatible with 3-wire control.

■ Save reference

This function is associated with +/- speed control.

It enables the last speed reference prior to the loss of the run command or line supply to be read and saved. The saved reference is applied the next time a run command is received.

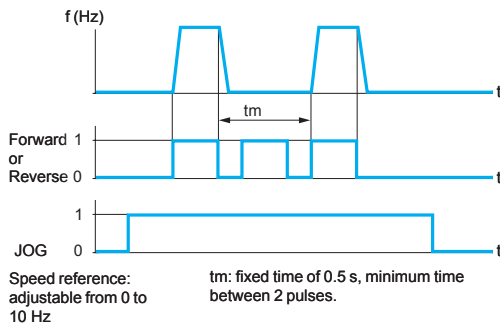

Example of jog operation

Jog operation

This function is used for pulse operation with minimum ramp times (0.1 s), a limited speed reference and minimum time between 2 pulses. It is enabled by one logic input and pulses issued by the operating direction command.

This function is suitable for machines with product insertion in manual mode (e.g. gradual movement of the mechanism during maintenance operations).

Command and reference channels

There are several command and reference channels, which can be independent. Commands and speed references can be sent using the following methods:

- Terminals (logic and analog inputs)
- Via the serial link
 - remote display terminal
 - Modbus control word
 - CANopen control word

The command channels and speed reference channels can be separate. Example: speed reference issued by CANopen and command issued by the remote display terminal.

Note: The STOP keys on the keypad and the remote display terminal may retain priority. The Summing inputs and PI regulator functions only apply to one reference channel.

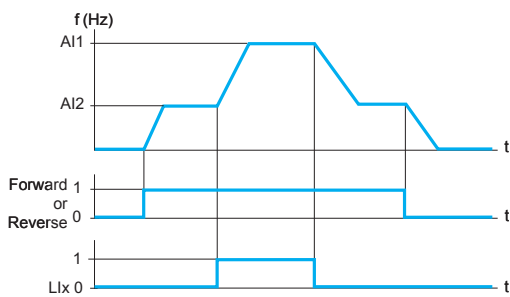

Example of reference switching

Reference switching

Switching between two speed references can be enabled via:

- A logic input
- A bit in a Modbus or CANopen control word

Reference 1 is active if the logic input (or control word bit) is at 0. Reference 2 is active if the logic input (or control word bit) is at 1.

The reference can be switched with the motor running.

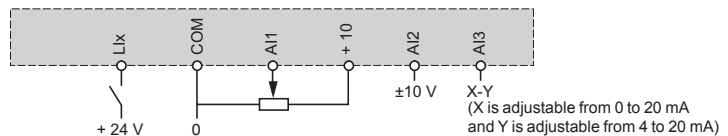

Connection diagram for reference switching

Summing inputs

This function is used to add together two to three speed references from different sources.

The references to be added together are selected from all the possible types of speed reference.

Example:

Reference 1 from AI1

Reference 2 from AI2

Reference 3 from AIP

Drive speed reference: reference 1 + reference 2 + reference 3.

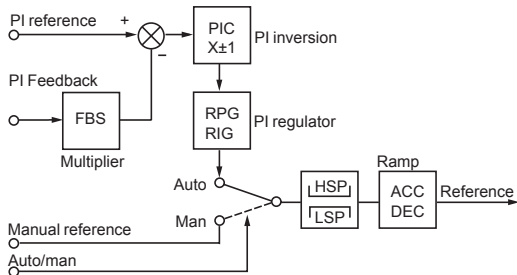

ACC: Acceleration
 DEC: Deceleration
 FBS: PI feedback multiplication coefficient
 HSP: High speed
 PIC: Reversal of the direction of correction of the PI regulator
 LSP: Low speed
 RIG: PI regulator integral gain
 RPG: PI regulator proportional gain

PI regulator

■ **PI regulator**

This function is used for simple control of a flow rate or a pressure with a sensor supplying a feedback signal adapted to the drive. This function is suitable for pump and fan applications.

□ **PI reference:**

- Internal regulator reference, adjustable from 0 to 100
- Regulation reference selected from all the possible types of regulation reference
- Preset PI references
- **2 or 4 preset PI references** adjustable from 0 to 100, require the use of one or two logic inputs respectively

□ **Manual reference**

- Speed reference selected from all the possible types of speed reference

□ **PI feedback:**

- Analog input AI1, AI2 or AI3

□ **Auto/Man:**

- Logic input LI for switching operation to speed reference (Man) or PI regulation (Auto).

During operation in automatic mode, the process feedback can be adapted to correct inverse PI, adjust the proportional and integral gain, or apply a ramp (time = ACC - DEC) for establishing the PI action on starting and stopping. The motor speed is limited to between LSP and HSP.

Note: The PI function is incompatible with the Preset speeds and JOG functions. The PI reference can also be transmitted on line via the Modbus RS485 serial link or via the CANopen bus.

■ **Current limit switching**

A second current limit can be configured between 0.25 and 1.5 times the nominal drive current.

Used to limit the torque and the temperature rise of the motor.

Switching between the two current limits can be enabled via:

- A logic input
- A bit in a Modbus or CANopen control word

■ **Limiting low speed operating time**

The motor is stopped automatically after a period of operation at low speed (LSP) with a zero reference and a run command present.

This time can be set between 0.1 and 999.9 seconds (0 corresponds to an unlimited time). Factory setting: 0 s. The motor restarts automatically on the ramp when the reference reappears or if the run command is interrupted and then re-established.

This function is suitable for automatic stopping/starting of pressure-regulated pumps.

■ **Motor switching**

This function allows two motors with different power ratings to be supplied alternately by the same drive. Switching must take place with the drive stopped and locked, using an appropriate sequence at the drive output.

The function can be used to adapt the motor parameters. The following parameters are switched automatically:

- Nominal motor voltage
- Nominal motor frequency
- Nominal motor current
- Nominal motor speed
- Motor cosine Phi (power factor)
- Selection of the type of voltage/frequency ratio for motor 2
- IR compensation, motor 2
- Motor frequency loop gain
- Motor stability
- Motor slip compensation

Motor thermal protection is disabled by this function.

Motor switching can be enabled by:

- A logic input
- A bit in a Modbus or CANopen control word

With hoisting applications, this function enables a single drive to be used for vertical and horizontal movements.

■ Command switching

Switching the command channel provides a choice of 2 control modes. Switching is enabled by:

- A logic input
- A bit in a Modbus or CANopen control word

■ 2-wire control

This function is used to control the direction of operation by means of a stay-put contact.

It is enabled by means of one or two logic inputs (one or two directions of operation). This function is suitable for all non-reversing and reversing applications.

Three operating modes are possible:

- Detection of the state of the logic inputs
- Detection of a change of state of the logic inputs
- Detection of the state of the logic inputs with forward operation having priority over reverse

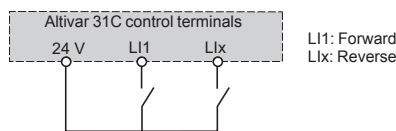

Wiring diagram for 2-wire control

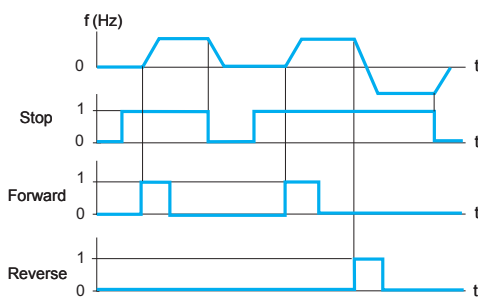

Example of operation with 3-wire control

■ 3-wire control

This function is used to control the operating direction and stopping by means of pulsed contacts.

It is enabled by means of two or three logic inputs (one or two directions of operation).

This function is suitable for all non-reversing and reversing applications.

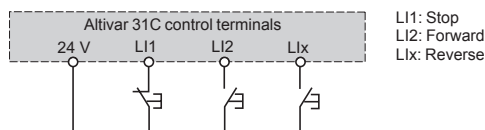

Wiring diagram for 3-wire control

■ Forced local mode

Forced local mode imposes control via the terminals or display terminal and disables all other control modes.

The following references and commands are available for forced local mode:

- References AI1, or AI2, or AI3 and command via logic inputs
- Reference and command via the remote display terminal

The changeover to forced local mode is enabled by a logic input.

■ Freewheel stop

This stops the motor by resistive torque if the motor power supply is cut.

A freewheel stop is achieved by:

- Configuring a normal stop command as a freewheel stop (on disappearance of a run command or appearance of a stop command)
- Enabling a logic input

■ Fast stop

This is used to achieve a braked stop with a deceleration ramp time (divided by 2 to 10) that is acceptable for the drive/motor unit without locking on an overbraking fault. This is used for conveyors with electrical emergency stop braking.

A fast stop is achieved by:

- Configuring a normal stop as a fast stop (on disappearance of a run command or appearance of a stop command)
- Enabling a logic input

■ DC injection stop

This function is used for low speed braking of high-inertia fans, or to maintaining torque on stopping in the case of fans located in an airflow.

A DC injection stop is achieved by:

- Configuring a normal stop as a DC injection stop (on disappearance of a run command or appearance of a stop command)
- Enabling a logic input

The DC value and the braking time on stopping are adjustable.

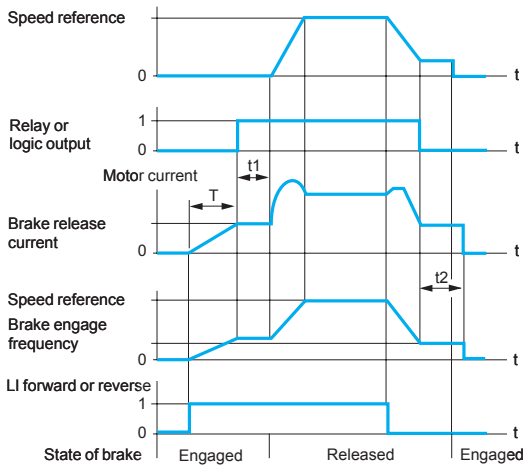

Accessible settings:
 t_1 : brake release time delay
 t_2 : brake engage time delay

Brake control

■ **Brake control**

This function is used to manage control of an electromagnetic brake in synchronization with starting and stopping the motor to avoid jolts and speed errors. The brake control sequence is managed by the drive.

Adjustable values for releasing the brake: current threshold and time delay

Adjustable values for engaging the brake: frequency threshold and time delay

Enabled by: relay logic output R2 or logic output AOC assigned to brake control.

This function is suitable for material handling applications with movements equipped with electromagnetic brakes (hoisting) and machines requiring holding brake control (unbalanced machines).

□ **Principle:**

- Vertical hoisting movement:

Maintains motor torque in an upward direction when the brake is being released and engaged, in order to hold the load and start smoothly as soon as the brake is released.

- Horizontal hoisting movement:

Synchronizes brake release with the build-up of torque during starting and brake engage at zero speed on stopping, to prevent jolting.

The recommended brake control settings for vertical hoisting applications are as follows (for horizontal hoisting applications, set the current threshold to zero):

- Brake release current: Set the brake release current to the nominal current

indicated on the motor. If, during testing, the torque is insufficient, increase the brake release current (the maximum value is imposed by the drive).

- Acceleration time: For hoisting applications it is advisable to set the acceleration ramps to more than 0.5 seconds. Ensure that the drive does not change to current limiting.

The same recommendation applies for deceleration.

Note: For a hoisting movement, a braking resistor should be used. Ensure that the selected settings and configurations will not result in dropping or loss of control of the load being lifted.

- Brake release time delay t_1 : Adjust according to the type of brake. It is the time required for the mechanical brake to release.

- Brake engage frequency: Set to twice the nominal slip, then adjust according to the result.

- Brake engage time delay t_2 : Adjust according to the type of brake. It is the time required for the mechanical brake to engage.

■ **Limit switch management**

Used to manage the operation of one or two limit switches (with one or two operating directions).

Each limit (forward, reverse) is associated with a logic input. The type of stop that occurs on detection of a limit can be configured as normal, freewheel or fast.

Following a stop, the motor can restart in the opposite direction only.

■ **Monitoring**

The following data can be displayed:

- Frequency reference
- Internal PI reference
- Frequency reference (absolute value)
- Output frequency applied to the motor (value signed in two's complement)
- Output frequency in customer units
- Current in the motor
- Motor power: 100% = nominal power
- Line voltage
- Motor thermal state:
100%: nominal thermal state, 118%: motor overload threshold
- Drive thermal state:
100%: nominal thermal state, 118%: drive overload threshold
- Motor torque: 100% = nominal torque
- Last detected fault
- Operating time
- Auto-tuning status
- Configuration and state of logic inputs
- Configuration of analog inputs

■ Fault management

There are various operating modes in the event of resettable faults:

- Freewheel stop
- Drive switches to the fallback speed
- The drive maintains the speed at which it was operating when the fault occurred, until the fault disappears
- Stop on ramp
- Fast stop

The following resettable faults are detected:

- Drive overheating
- Motor overheating
- CANopen bus fault
- Modbus serial link failure
- External faults
- Loss of 4-20 mA signal

■ Fault reset

This function is used to clear the last fault by means of a logic input.

The restart conditions after a reset are the same as those of a normal power-up. Resets the following faults: overvoltage, overspeed, external fault, drive overheating, output phase loss, DC bus overvoltage, loss of 4-20 mA reference, load slipping, motor overload if the thermal state is less than 100%, serial link fault.

Line supply undervoltage and input phase loss faults are reset automatically when the line supply is restored.

This function is suitable for applications where the drives are difficult to access, for example on moving parts or in material handling systems.

■ General reset (disables all faults)

This function disables all faults, including thermal protection (forced operation), and can result in irreparable damage to the drive.

This invalidates the warranty.

This function is suitable for applications where restarting may be crucial (conveyor in an oven, smoke extraction system, machines with solidifying products that need to be removed).

The function is enabled by a logic input.

Fault monitoring is active if the logic input is at state 1.

All faults are reset on a change of state \uparrow of the logic input.

■ Controlled stop on loss of line supply

This function is used to control motor stopping on a loss of line supply.

It is suitable for material handling, machines with high inertia, continuous product processing machines.

Type of stop possible:

- Locking of the drive and freewheel stop
- Stop which uses the mechanical inertia to maintain the drive power supply as long as possible
- Stop on ramp
- Fast stop (depends on the inertia and the braking ability of the drive)

■ Stop mode in the event of a fault

The type of stop that occurs on detection of a fault can be configured as normal, freewheel or fast for the following faults:

- External fault (detection enabled by a logic input or a bit in a Modbus or CANopen control word)
- Motor phase loss fault

If an output contactor is being used between the drive and the motor, the motor phase loss fault should be disabled.

■ **Automatic catching of a spinning load with speed detection** (“catch on the fly”)

This function is used to restart the motor smoothly after one of the following events, provided the run command is still present:

- Loss of line supply or power off
- Fault reset or automatic restart
- Freewheel stop

On disappearance of the event, the rms speed of the motor is detected in order to restart on a ramp from this speed and return to the reference speed. Speed detection can take up to 1 s depending on the initial deviation.

This function is automatically disabled if the brake sequence is configured.

It is suitable for machines for which the motor speed loss is negligible during the loss of line supply (such as machines with high inertia, fans and pumps driven by a residual flow, etc.).

■ **Automatic restart**

This function enables the drive to be restarted automatically after it has locked in fault mode, provided the relevant fault has disappeared and the other operating conditions permit a restart.

This restart is performed by a series of automatic attempts separated by increasingly longer waiting periods of 1 s, 5 s, 10 s, then 1 minute for subsequent periods.

The restart procedure can last between 5 minutes and an unlimited time.

If the drive has not restarted after the configured time, it will lock and the procedure is abandoned until it has been powered off and on again.

The faults which permit this type of restart are:

- Line overvoltage
- Motor thermal overload
- Drive thermal overload
- DC bus overvoltage
- Loss of one input phase
- External fault
- Loss of 4-20 mA reference
- CANopen bus fault
- Modbus serial link fault
- Line voltage too low. For this fault, the function is always active, even if it is not configured.

For these faults, the relay configured as a fault relay remains activated if the function is configured. The speed reference and direction of operation must be maintained for this function.

This function is suitable for machines or installations which are in continuous operation or are not monitored, and where a restart will not endanger equipment or personnel in any way.

■ **Derated operation in the event of an undervoltage**

The line voltage monitoring threshold is lowered to 50% of the motor voltage.

In this case, a line choke must be used and the performance of the drive cannot be guaranteed.

■ **Fault relay, unlocking**

The fault relay is energized when the drive is powered up and is not faulty.

It has one common point C/O contact.

The drive is unlocked after a fault in one of the following ways:

- By powering down until the ON LED goes out, then switching the drive back on
- By assigning a logic input to the External faults function
- By the Automatic restart function if it has been configured

■ **Resetting operating time to zero**

The drive operating time can be reset to zero.

■ Motor thermal protection

The theoretical temperature rise of the motor is continuously calculated to provide indirect thermal protection. Thermal protection can be set between 0.2 and 1.5 times the nominal drive current. This function is suitable for all applications with self-cooled motors.

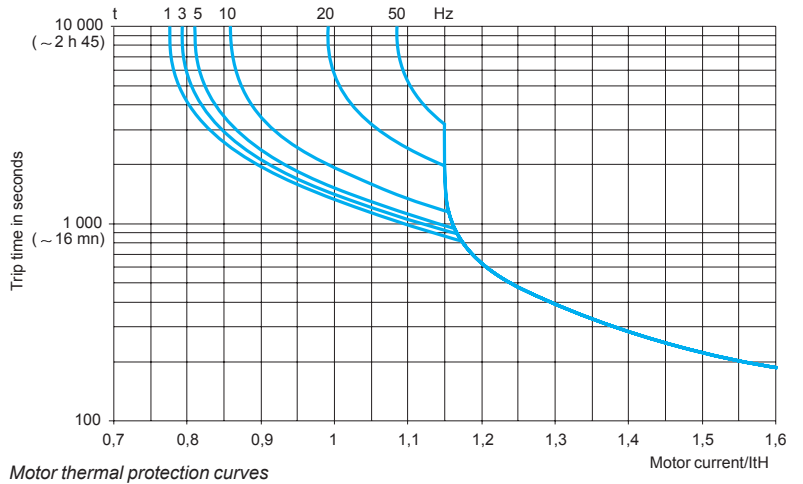

■ Drive thermal protection

Thermal protection, by a PTC probe mounted on the heatsink or integrated in the power module, ensures that the drive is protected in the event of poor ventilation or excessive ambient temperatures. Locks the drive in the event of a fault.

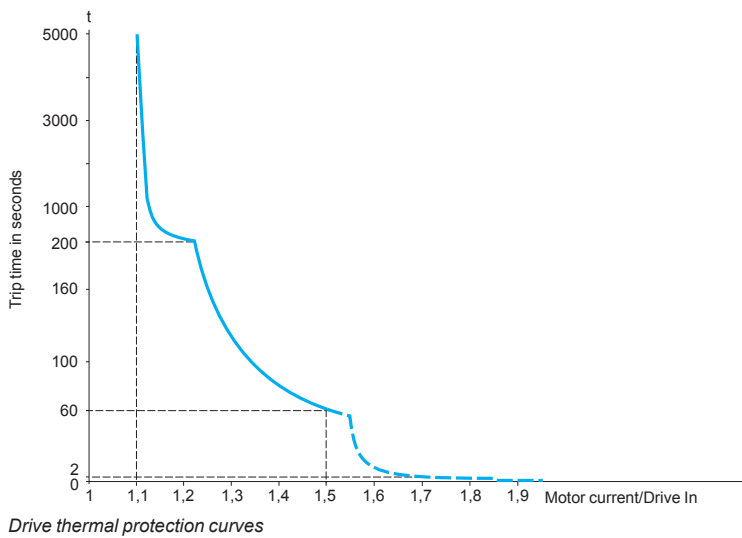

■ R1/R2 relay configuration

The following states are signalled when the relay is powered on:

- Drive fault
- Drive running
- Frequency threshold reached
- High speed reached
- Current threshold reached
- Frequency reference reached
- Motor thermal threshold reached
- Brake sequence (R2 only)

■ AOC/AOV analog outputs

The same data is available on analog outputs AOC and AOV.

The following assignments are possible:

- Motor current
- Motor frequency
- Motor torque
- Power supplied by the drive
- Drive fault
- Frequency threshold reached
- High speed reached
- Current threshold reached
- Frequency reference reached
- Motor thermal threshold reached
- Brake sequence

The setting of analog outputs AOC/AOV modifies the characteristics of the current analog output AOC or the voltage analog output AOV.

AOC: can be set as 0-20 mA or 4-20 mA

AOV: can be set as 0-10 V

■ Saving and retrieving the configuration

A configuration can be saved to the EEPROM. This function is used to store a drive configuration in addition to the current configuration.

Retrieving this configuration clears the current configuration.

Spooling functions (in textile applications). Functions only available with ATV 31C●●●T drives

■ Traverse Control

Function for winding reels of yarn

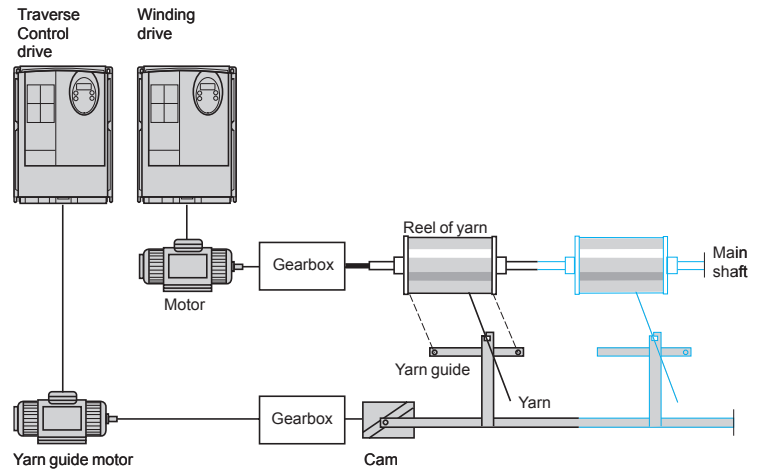

The cam rotation speed must follow a precise profile to ensure a regular, compact, linear reel is obtained.

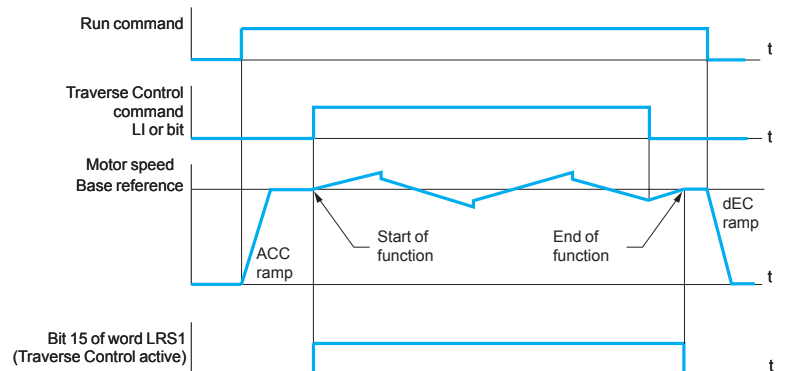

The function starts when the drive has reached its base reference and the Traverse Control command has been enabled. When the Traverse Control command is no longer enabled, the drive returns to its base reference following the drive ACC or dEC ramp. As soon as this reference is reached, the function stops.

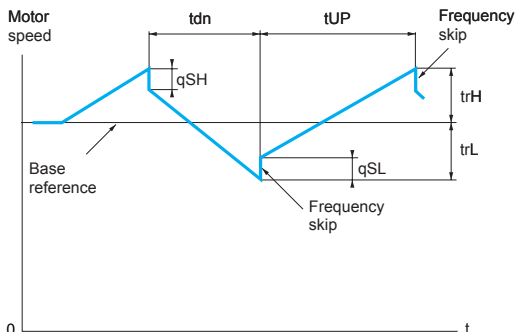

- tdn: Traverse Control deceleration time, in seconds
- tUP: Traverse Control acceleration time, in seconds
- trH: Traverse frequency high, in Hertz
- trL: Traverse frequency low, in Hertz
- qSH: Quick step high, in Hertz
- qSL: Quick step low, in Hertz

Definition of the cycle of frequency variations around the base reference

Function parameters

Using certain parameters, it is possible to define the cycle of frequency variations around the base reference (see opposite).

The Traverse Control (yarn control) command can be assigned by a logic input or a bit in a Modbus or CANopen control word.

Reel management

Various parameters are used to manage the reel, such as the reel spooling time, the decrease in the base reference, reel changes, etc.

Main parameters necessary for reel management:

- tbO: Time taken to spool a reel, in minutes. This parameter is intended to signal the end of winding. When the Traverse Control operating time since the command reaches the value of tbO, the logic output or one of the drive relays changes to state 1, to signal the end of the reel.
- dtF: Decrease in the base reference. In certain cases, the base reference has to be reduced as the reel increases in size.
- rtr: Reinitialize Traverse Control. As long as this parameter remains at 1, the Traverse Control function is disabled and the speed is the same as the base reference. This command is used primarily when changing reels.

■ Counter Wobble

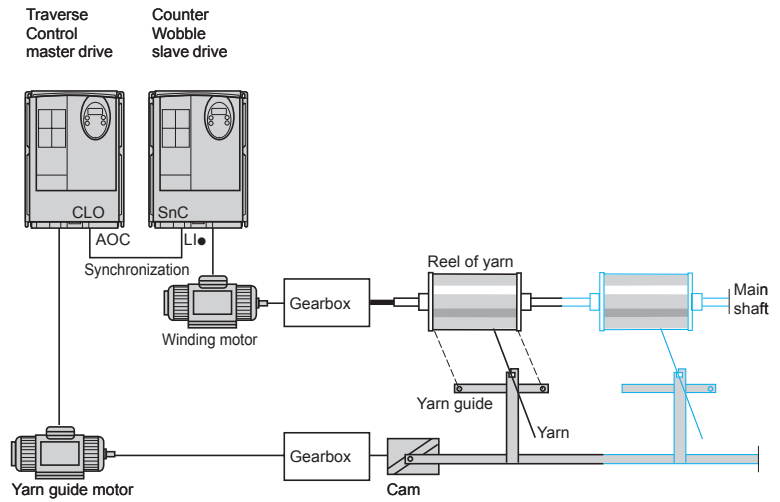

The Counter Wobble function is used in certain applications to obtain a constant yarn tension when the Traverse Control function is producing considerable variations in speed on the yarn guide motor.

Two special drives, a master (Traverse Control) and a slave (Counter Wobble), are necessary for this function.

The master drive controls the speed of the yarn guide, while the slave drive controls the winding speed. The function assigns the slave a speed profile, which is in antiphase to that of the master. This means that synchronization is required, using one of the master's logic outputs (AOC) and one of the slave's logic inputs (LI).

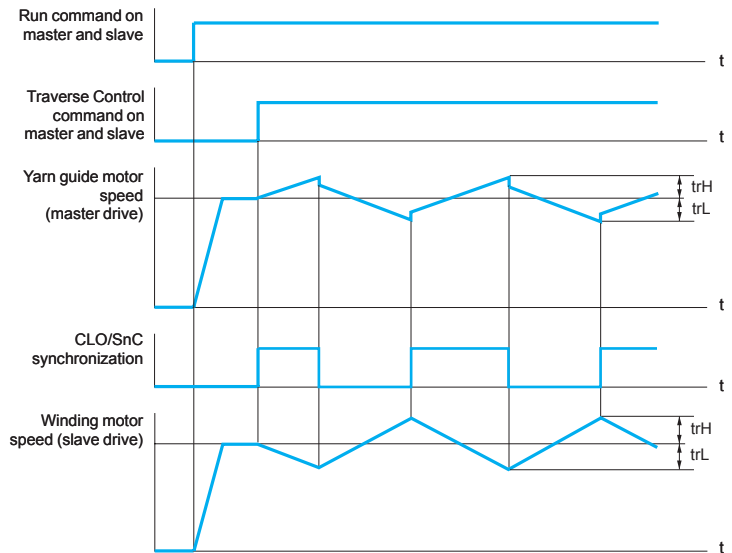

For the function to start, the following conditions must be met:

- motor speed base references attained on the master and slave drives
- "yarn control" (trC) input activated
- synchronization signal present

Function compatibility table

■ **Configurable I/O**

Functions which are not listed in this table are fully compatible. Stop functions have priority over run commands.

The selection of functions is limited by:

- The number of drive I/O
- The incompatibility of certain functions with one another

Functions	Summing inputs	+/- speed	Limit switch management	Preset speeds	PI regulator	Jog operation	Brake sequence	DC injection stop	Fast stop	Freewheel stop
Summing inputs		⊖		↑	⊖	↑				
+/- speed	⊖			⊖	⊖	⊖				
Limit switch management					⊖					
Preset speeds	←	⊖			⊖	↑				
PI regulator	⊖	⊖	⊖	⊖		⊖	⊖			
Jog operation	←	⊖		←	⊖		⊖			
Brake sequence					⊖	⊖		⊖		
DC injection stop							⊖			↑
Fast stop										↑
Freewheel stop							←	←		

⊖	Incompatible functions
⊖	Compatible functions
	Not applicable

Priority functions (functions which cannot be active at the same time)

←	The arrow indicates which function has priority
↑	Example: The Freewheel stop function has priority over the Fast stop function.

Schneider Electric Industries SAS

www.schneider-electric.com

Head Office
35, rue Joseph Monier
F-92500 Rueil-Malmaison
France

The information provided in this documentation contains general descriptions and/or technical characteristics of the performance of the products contained herein. This documentation is not intended as a substitute for and is not to be used for determining suitability or reliability of these products for specific user applications. It is the duty of any such user or integrator to perform the appropriate and complete risk analysis, evaluation and testing of the products with respect to the relevant specific application or use thereof. Neither Schneider Electric nor any of its affiliates or subsidiaries shall be responsible or liable for misuse of the information contained herein.

Design: Schneider Electric
Photos: Schneider Electric
Printed by: